

# ONKYO®

## DVD Receiver

# *DR-S501*

## Instruction Manual

Thank you for purchasing the Onkyo DVD receiver. Read this manual carefully before using your new DVD receiver. A good understanding of its features and operation will allow you to achieve optimum performance and enjoyment.

Keep this manual for future reference.

## Contents

Overview ..... 2

Connections..... 17

Getting Started and Setting up ... 29

Basic Operations ..... 31

Playback Techniques ..... 44

Advanced Operations ..... 52

Detailed Settings ..... 55

Miscellaneous information ..... 68

Remote Control Codes List  
–The end of this manual–



## WARNING:

TO REDUCE THE RISK OF FIRE OR ELECTRIC SHOCK, DO NOT EXPOSE THIS APPARATUS TO RAIN OR MOISTURE.

## CAUTION:

TO REDUCE THE RISK OF ELECTRIC SHOCK, DO NOT REMOVE COVER (OR BACK). NO USER-SERVICEABLE PARTS INSIDE. REFER SERVICING TO QUALIFIED SERVICE PERSONNEL.



**WARNING**  
RISK OF ELECTRIC SHOCK  
DO NOT OPEN

**AVIS**  
RISQUE DE CHOC ELECTRIQUE  
NE PAS OUVRI



The lightning flash with arrowhead symbol, within an equilateral triangle, is intended to alert the user to the presence of uninsulated "dangerous voltage" within the product's enclosure that may be of sufficient magnitude to constitute a risk of electric shock to persons.



The exclamation point within an equilateral triangle is intended to alert the user to the presence of important operating and maintenance (servicing) instructions in the literature accompanying the appliance.

## Important Safety Instructions

1. Read these instructions.
2. Keep these instructions.
3. Heed all warnings.
4. Follow all instructions.
5. Do not use this apparatus near water.
6. Clean only with dry cloth.
7. Do not block any ventilation openings. Install in accordance with the manufacturer's instructions.
8. Do not install near any heat sources such as radiators, heat registers, stoves, or other apparatus (including amplifiers) that produce heat.
9. Do not defeat the safety purpose of the polarized or grounding-type plug. A polarized plug has two blades with one wider than the other. A grounding type plug has two blades and a third grounding prong. The wide blade or the third prong are provided for your safety. If the provided plug does not fit into your outlet, consult an electrician for replacement of the obsolete outlet.
10. Protect the power cord from being walked on or pinched particularly at plugs, convenience receptacles, and the point where they exit from the apparatus.
11. Only use attachments/accessories specified by the manufacturer.
12. Use only with the cart, stand, PORTABLE CART WARNING tripod, bracket, or table specified by the manufacturer, or sold with the apparatus. When a cart is used, use caution when moving the cart/apparatus combination to avoid injury from tip-over.   
S3125A
13. Unplug this apparatus during lightning storms or when unused for long periods of time.
14. Refer all servicing to qualified service personnel. Servicing is required when the apparatus has been damaged in any way, such as power-supply cord or plug is damaged, liquid has been spilled or objects have fallen into the apparatus, the apparatus has been exposed to rain or moisture, does not operate normally, or has been dropped.
15. Damage Requiring Service
  - Unplug the apparatus from the wall outlet and refer servicing to qualified service personnel under the following conditions:
    - A. When the power-supply cord or plug is damaged,
    - B. If liquid has been spilled, or objects have fallen into the apparatus,
    - C. If the apparatus has been exposed to rain or water,
    - D. If the apparatus does not operate normally by following the operating instructions. Adjust only those controls that are covered by the operating instructions as an improper adjustment of other controls may result in damage and will often require extensive work by a qualified technician to restore the apparatus to its normal operation,
    - E. If the apparatus has been dropped or damaged in any way, and
    - F. When the apparatus exhibits a distinct change in performance this indicates a need for service.
16. Object and Liquid Entry
  - Never push objects of any kind into the apparatus through openings as they may touch dangerous voltage points or short-out parts that could result in a fire or electric shock. The apparatus shall not be exposed to dripping or splashing and no objects filled with liquids, such as vases shall be placed on the apparatus.
  - Don't put candles or other burning objects on top of this unit.
17. Batteries
  - Always consider the environmental issues and follow local regulations when disposing of batteries.
18. If you install the apparatus in a built-in installation, such as a bookcase or rack, ensure that there is adequate ventilation.
  - Leave 20 cm (8") of free space at the top and sides and 10 cm (4") at the rear. The rear edge of the shelf or board above the apparatus shall be set 10 cm (4") away from the rear panel or wall, creating a flue-like gap for warm air to escape.

# Precautions



---

1. **Recording Copyright**—Unless it's for personal use only, recording copyrighted material is illegal without the permission of the copyright holder.
2. **AC Fuse**—The AC fuse inside the unit is not user-serviceable. If you cannot turn on the unit, contact your Onkyo dealer.
3. **Care**—Occasionally you should dust the unit all over with a soft cloth. For stubborn stains, use a soft cloth dampened with a weak solution of mild detergent and water. Dry the unit immediately afterwards with a clean cloth. Don't use abrasive cloths, thinners, alcohol, or other chemical solvents, because they may damage the finish or remove the panel lettering.
4. **Power**  
**WARNING**  
BEFORE PLUGGING IN THE UNIT FOR THE FIRST TIME, READ THE FOLLOWING SECTION CAREFULLY.  
AC outlet voltages vary from country to country. Make sure that the voltage in your area meets the voltage requirements printed on the unit's rear panel (e.g., AC 230 V, 50 Hz or AC 120 V, 60 Hz).  
The power cord plug is used to disconnect this unit from the AC power source. Make sure that the plug is readily operable (easily accessible) at all times.  
Pressing the [STANDBY/ON] button to select Standby mode does not fully shutdown the unit. If you do not intend to use the unit for an extended period, remove the power cord from the AC outlet.
5. **Never Touch this Unit with Wet Hands**—Never handle this unit or its power cord while your hands are wet or damp. If water or any other liquid gets inside this unit, have it checked by your Onkyo dealer.
6. **Handling Notes**
  - If you need to transport this unit, use the original packaging to pack it how it was when you originally bought it.
  - Do not leave rubber or plastic items on this unit for a long time, because they may leave marks on the case.
  - This unit's top and rear panels may get warm after prolonged use. This is normal.
  - If you do not use this unit for a long time, it may not work properly the next time you turn it on, so be sure to use it occasionally.
  - When you've finished using this unit, remove all discs and turn off the power.
7. **Installing this Unit**
  - Install this unit in a well-ventilated location.
  - Ensure that there's adequate ventilation all around this unit, especially if it's installed in an audio rack. If the ventilation is inadequate, the unit may overheat, leading to malfunction.

- Do not expose this unit to direct sunlight or heat sources, because its internal temperature may rise, shortening the life of the optical pickup.
  - Avoid damp and dusty places, and places subject to vibrations from loudspeakers. Never put the unit on top of, or directly above a loudspeaker.
  - Install this unit horizontally. Never use it on its side or on a sloping surface, because it may cause a malfunction.
  - If you install this unit near a TV, radio, or VCR, the picture and sound quality may be affected. If this occurs, move this unit away from the TV, radio, or VCR.
8. **To Obtain a Clear Picture**—This unit is a high-tech, precision device. If the lens on the optical pickup, or the disc drive mechanism becomes dirty or worn, the picture quality may be affected. To maintain the best picture quality, we recommend regular inspection and maintenance (cleaning or worn part replacement) every 1,000 hours of use depending on the operating environment. Contact your Onkyo dealer for details.
  9. **Moisture Condensation**  
**Moisture condensation may damage this unit.**  
Read the following carefully:  
Moisture may condense on the lens of the optical pickup, one of the most important parts inside this unit.
    - Moisture condensation can occur in the following situations:
      - The unit is moved from a cold place to a warm place.
      - A heater is turned on, or cold air from an air conditioner is hitting the unit.
      - In the summer, when this unit is moved from an air conditioned room to a hot and humid place.
      - The unit is used in a humid place.
    - Do not use this unit when there's the possibility of moisture condensation occurring. Doing so may damage your discs and certain parts inside this unit.

If condensation does occur, remove all discs and leave this unit turned on for two to three hours. By this time, the unit will have warmed up and any condensation will have evaporated.

## Precautions—Continued

**10. Region Numbers**—The DVD standard uses region numbers to control how discs can be played around the world, the world being divided into six regions. This unit will only play DVD discs that match its region number, which can be found on its rear panel (e.g., , ).

**11. About this Manual**—This manual explains how to use all of this unit's functions. Although the DVD standard offers many special features, not all discs use them all, so depending on the disc being played, this unit may not respond to certain functions. See the disc's sleeve notes for supported features.

This unit contains a semiconductor laser system and is classified as a "CLASS 1 LASER PRODUCT". So, to use this model properly, read this Instruction Manual carefully. In case of any trouble, please contact the store where you purchased the unit.

To prevent being exposed to the laser beam, do not try to open the enclosure.

### CAUTION:

CLASS 1M VISIBLE AND INVISIBLE LASER RADIATION WHEN OPEN. DO NOT VIEW DIRECTLY WITH OPTICAL INSTRUMENTS.

THIS PRODUCT UTILIZES A LASER. USE OF CONTROLS OR ADJUSTMENTS OR PERFORMANCE OF PROCEDURES OTHER THAN THOSE SPECIFIED HEREIN MAY RESULT IN HAZARDOUS RADIATION EXPOSURE.

The label on the right is applied on the rear panel.



1. This unit is a CLASS 1 LASER PRODUCT and employs a laser inside the cabinet.
2. To prevent the laser from being exposed, do not remove the cover. Refer servicing to qualified personnel.

## For European Models

Declaration of Conformity	
We, ONKYO EUROPE ELECTRONICS GmbH LIEGNITZERSTRASSE 6, 82194 GROEBENZELL, GERMANY	
declare in own responsibility, that the ONKYO product described in this instruction manual is in compliance with the corresponding technical standards such as EN60065, EN55013, EN55020 and EN61000-3-2, -3-3.	
GROEBENZELL, GERMANY	 K. MIYAGI
ONKYO EUROPE ELECTRONICS GmbH	

# Supplied Accessories

---

Make sure you have the following accessories:

---

RC-704S

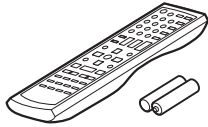

**Remote controller & 2 batteries (AA/R6)**

---



**Video cable (RCA) (1.5 m)**

---

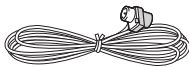

**Indoor FM antenna**

---



**AM loop antenna**

---

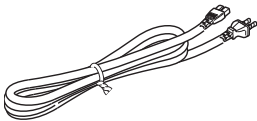

**Power cord**

---

\* In catalogs and on packaging, the letter at the end of the product name indicates the color. Specifications and operations are the same regardless of color.

# Introduction

## Features

### Highlights

- Dolby<sup>\*1</sup> Digital, DTS<sup>\*2</sup>
- DVD-Video, Video CD, audio CD
- MP3, WMA,<sup>\*3</sup> JPEG, DivX<sup>®\*4</sup>
- DVD-Audio and Super Audio CD
- CD-R/RW, DVD-R/RW, and DVD+R/RW compatible
- HDMI<sup>\*5</sup> digital interface

### Video

- HDMI Pass-Thru (1080p Compatible; 1 Input/1 Output)
- HDTV-Capable (50 MHz)
- JPEG in High Definition
- Advanced 108 MHz/14-bit video D/A converter
- 2 Composite Video Inputs
- Component and composite video outputs
- 1 SCART Connector (European model only)
- Repeat/A-B Repeat/Random/Memory playback
- Supports 4:3 and 16:9 aspect ratio TVs
- Three view modes providing a best-fit picture regardless of TV aspects
- Picture Zoom Function
- Parental Lock function
- Screen Saver function

### Audio

- 192 kHz/24-bit D/A converter
- 2 Digital Inputs (1 Optical/1 Coaxial)
- Theater-Dimensional<sup>\*6</sup> Virtual Surround
- Direct Mode and Pure Audio Mode
- Dynamic Range Control setting

### Others

- Compatible with RI Dock for iPod
- A/V Sync Control Function (up to 100 ms)
- 40 AM/FM Presets
- 1/4-inch phone jack
- Aluminum Front Panel, Volume and Input Selector Knob
- Adjustable display brightness



Manufactured under license from Dolby Laboratories.

Dolby, Pro Logic, and the double-D symbol are trademarks of Dolby Laboratories.



Digital Surround | 96/24

“DTS” is a registered trademark of DTS, Inc. and “96/24” is a trademark of DTS, Inc.

\*3



Windows Media, and the Windows logo are trademarks, or registered trademarks of Microsoft Corporation in the United States and/or other countries.

\*4



DivX, DivX Certified, and associated logos are trademarks of DivX, Inc. and are used under license.

\*5



HDMI, the HDMI logo and High-Definition Multimedia Interface are trademarks or registered trademarks of HDMI licensing LLC.

\*6 “Theater-Dimensional” is a trademark of Onkyo Corporation.

\* Apple and iPod are trademarks of Apple, Inc., registered in the U.S. and other countries.

This product incorporates copyright protection technology that is protected by U.S. patents and other intellectual property rights. Use of this copyright protection technology must be authorized by Macrovision Corporation, and is intended for home and other limited consumer uses only unless otherwise authorized by Macrovision. Reverse engineering or disassembly is prohibited.

# Contents

<b>Overview</b>	
Important Safety Instructions .....	2
Precautions .....	3
Supplied Accessories .....	5
Introduction .....	6
Features .....	6
Disc Notes .....	8
Before Using the DVD receiver .....	11
Installing the Batteries .....	11
Using the Remote Controller .....	11
Front & Rear Panels .....	12
Front Panel .....	12
Display .....	13
Rear Panel .....	14
Remote Controller .....	15

<b>Connections</b>	
Connecting the DVD receiver .....	17
Placing the Speakers .....	17
Connecting Your Speakers .....	17
Connecting Antenna .....	19
AV Cables & Connectors .....	21
Video Output/Video Setting Matrix .....	22
Video Signal Flow Chart .....	22
Before Making Any Connections .....	23
Basic Setup .....	23
Connecting Your TV (video connection) .....	24
Connecting Other AV Component .....	25
Connecting an RI Dock .....	26
Digital Audio Connection .....	26
Connecting your HDTV or AV component with an HDMI connection .....	27
Connecting the Power/Turning on the DVD receiver .....	28

<b>Getting Started and Setting up</b>	
Initial Setup .....	29
First Time Setup .....	29
HDMI and Progressive Settings .....	30
Setting the HDMI .....	30
Selecting Progressive or Interlaced .....	30

<b>Basic Operations</b>	
Understanding Common Operations .....	31
Adjusting the Volume .....	31
Selecting the Input Source .....	31
Using Headphones .....	31
Muting the DVD receiver .....	32
Using the Sleep Timer .....	32
Adjusting Subwoofer Level .....	32
Playing Discs .....	33
Starting, Pausing & Stopping Playback .....	33
Select Next & Previous track/chapter .....	34
Fast Forward & Reverse .....	35
Forward Frame-by-Frame Playback .....	35
Navigating DVD & VCD Disc Menus .....	36
Navigating CDs & Super Audio CDs .....	36
Navigating MP3, WMA & DivX Discs .....	37
Viewing a Slideshow of JPEG Images .....	38
Listening to the Radio .....	39
Using the Tuner .....	39
Presetting AM/FM Stations .....	40
Using RDS (European models only) .....	41
Using the Listening Modes .....	42
Selecting Listening Modes .....	42
About the Listening Modes .....	42

<b>Playback Techniques</b>	
Advanced Playback .....	44
Selecting Chapters/Titles/Tracks/Folders by Number .....	44
Searching by Time .....	45
Repeat Playback .....	46
A-B Repeat Playback .....	46
Random Playback .....	47
Memory Playback .....	48
Last Memory .....	49
Zooming .....	50
Selecting Camera Angles .....	50
Selecting Soundtracks .....	51
Selecting Subtitles .....	51

<b>Advanced Operations</b>	
Disc and Input Information .....	52
Displaying Information .....	52
Controlling Other Components .....	53
Controlling a TV connected to the DVD receiver .....	53
Controlling an Apple iPod in RI Dock connected to the DVD receiver .....	54

<b>Detailed Settings</b>	
Configuring the DVD receiver .....	55
Setup Menu .....	55
DVD Onscreen Setup Menus .....	58
Using the Onscreen Setup Menus .....	59
Picture Menu .....	60
Audio Menu .....	62
Language Menu .....	63
Display Menu .....	65
Operation Setting Menu .....	66

<b>Miscellaneous information</b>	
Additional information .....	68
Resetting the receiver .....	68
DVD-Video regions .....	68
Disc Content Organization .....	68
Glossary .....	69
Troubleshooting .....	71
Power .....	71
Audio .....	71
Video .....	72
Tuner .....	73
Remote Controller .....	73
Disc Playback .....	73
Connection with External Devices .....	74
Others .....	74
HDMI Status Mode .....	75
Specifications .....	76

<b>Remote Control Codes List</b>	
The end of this manual	

**Disc Notes**

**Supported Discs**

The DVD receiver supports the following discs.

Disc	Logo	Format or file type
DVD-Video		*1
DVD-Audio		DVD-Audio
Super Audio CD		Super Audio CD (single layer, dual layer, hybrid)
DVD-R*2		DVD-Video, MP3, WMA, JPEG
DVD-RW*2		DVD-Video, MP3, WMA, JPEG
Video CD		Including PBC
Audio CD*3		PCM
CD-R*2		Audio CD, MP3, WMA, JPEG, DivX
CD-RW*2		Audio CD, MP3, WMA, JPEG
JPEG CD		JPEG

– DVD+R/RW –

The DVD receiver supports DVD+R/RW discs recorded in the following formats:

- Discs recorded in DVD-Video mode.
- Discs recorded in ISO 9660 Level 2 or Joliet format containing MP3, WMA, or JPEG files.

\*1 The DVD receiver’s region number is printed on the rear panel. If you attempt to play a disc intended for another region, the message appears onscreen.

\*2 MP3, WMA, and JPEG files are supported on discs recorded in ISO 9660 Level 2 or Joliet format. (See “MP3/WMA/JPEG Compatibility” on page 9 for more details.) However, some CD-R, CD-RW, DVD-R, and DVD-RW discs may not work properly for any of the following reasons: incomplete disc finalization, disc burner characteristics, disc characteristics, the disc is damaged or dirty, the disc contains only a small amount of data. Discs that contain different types of files, JPEG, MP3, WMA, DivX, and so on, are not supported. See the manual supplied with your disc burner for more information. Condensation or dirt on the optical pickup lens can also affect playback.

\*3 Some audio CDs feature copy protection that doesn’t conform to the official CD standard. Since these are nonstandard discs, they may not play properly in the DVD receiver.

- The DVD receiver does not support disc types not listed.
- The DVD receiver supports 8 cm and 12 cm discs.
- Don’t use discs with an unusual shape, such as those shown below, because you may damage the DVD receiver.











- Don’t use discs that have residue from adhesive tape, rental discs with peeling labels, or discs with custom-made labels or stickers. Doing so may damage the DVD receiver and you may not be able to remove the disc properly.

**About playing copy-controlled CDs**

Some copy-controlled CDs may not conform to official CD standards. They are special discs and may not play on the DVD receiver.

**Function Support**

The following icons are used throughout this manual to indicate which functions can be used with the various disc formats and file types.

Icon	Disc format or file type
	DVD-Video
	DVD-Audio
	Super Audio CD
	Video CD
	Audio CD
	MP3 file
	WMA file
	JPEG file
	DivX®

**About this Manual**

This manual explains how to use all of the DVD receiver’s functions. Although the DVD standard offers many special features, not all discs use them all, so depending on the disc being played, the DVD receiver may not respond to certain functions. See your disc’s sleeve notes for supported features.

When you attempt to use a DVD feature that is not available, this logo may appear onscreen, indicating that the feature is not supported by the current disc or by the DVD receiver.





### **MP3/WMA/JPEG Compatibility**

---

- The DVD receiver can play/display MP3, WMA, and JPEG files recorded on CD-R, CD-RW, DVD-R, DVD-RW, DVD+R and DVD+RW discs.
- Discs must be in ISO 9660 Level 2 or Joliet format (folders can be up to eight levels deep). Music files recorded on discs that use the HFS (hierarchical file system) cannot be played.
- Discs must be finalized.
- The DVD receiver can only recognize the first session on multisession discs.
- You can determine the order in which the DVD receiver plays/displays your MP3/WMA songs and JPEG pictures by prefixing file and folder names with a three-digit number. For example 001.Root, 002.Folder, and so on, and 001.Track.mp3, 002.Track.mp3, and so on.
- Only the first eight characters of folder and track names (excluding the filename extension) are displayed.
- The folder numbered “001” appears as “ROOT” in the Disc Navigator.
- The DVD receiver supports up to 255 folders and up to 255 files per folder.
- If you try to play an incompatible file, the message “This format cannot be played.” appears on the display.

#### ■ **MP3**

- MP3 files must be MPEG1 Audio Layer 3 format, 44.1 or 48 kHz, fixed bit-rate.
- MP3 files must have a “.mp3” or “.MP3” filename extension.
- Variable bit-rates (VBR) from 32 kbps to 320 kbps are supported. (Playing times may display incorrectly with VBR.)

#### ■ **WMA**

- WMA files must have the copyright option turned off.
- Sampling rates 44.1/48 kHz are supported.
- Variable bit-rates (VBR) from 48 kbps to 192 kbps (44.1 kHz) and 128 kbps to 192 kbps (48 kHz) are supported. (Playing times may display incorrectly with VBR.)
- WMA files must have a “.wma” or “.WMA” filename extension.

#### ■ **JPEG**

- JPEG files must have a “.jpg” or “.JPG” filename extension.
- JPEG files must be less than 5 megabytes in size.
- JPEG files up to 5,700 x 3,800 pixels are supported.

### **About WMA**

---

WMA is an acronym for Windows Media Audio and refers to an audio compression technology developed by

Microsoft Corporation. WMA content can be encoded by using Windows Media® Player version 7/7.1 or 8.

### **About DivX**

---

DivX is a compressed digital video format created by the DivX® video codec from DivXNetworks, Inc. This receiver can play DivX video files burned on CD-R discs. When naming files on a disc prior to burning, keep in mind that by default they will be played in alphabetical order.

### **DivX video compatibility**

---



- Official DivX® Certified product.
- Plays all versions of DivX® video (including DivX® 6) with standard playback of DivX® media files).

DivX® disc compatibility with this receiver is limited as follows:

<b>Playable discs</b>	CD-R CD-RW not recommended
<b>File system</b>	ISO9660 Level 1, 2, or Joliet
<b>File name</b>	A file name should be in alphabet and numerals only, and must incorporate “AVI” extension. e.g. “*****.AVI”
<b>Total number of folders</b>	Less than 255
<b>Total number of files</b>	Less than 255

### Handling Discs

---

- Never touch the underside of a disc. Always hold discs by the edge, as shown.

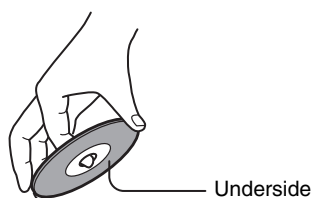

- Never attach adhesive tape or sticky labels to discs.



### Cleaning Discs

---

- For best results, keep your discs clean. Fingerprints and dust can affect the sound and picture quality and should be removed as follows. Using a clean soft cloth, wipe from the center outwards, as shown. Never wipe in a circular direction.

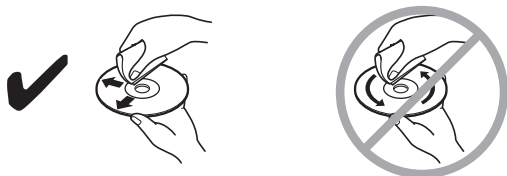

- To remove stubborn dust or dirt, wipe the disc with a damp soft cloth, and then dry it with a dry cloth.
- Never use solvent-based cleaning fluids, such as thinner or benzine, commercially available cleaners, or antistatic sprays intended for vinyl records, because they may damage the disc.

### Storing Discs

---

- Don't store discs in places subject to direct sunlight, or near heat sources.
- Don't store discs in places subject to moisture or dust, such as in a bathroom or near a humidifier.
- Always store discs in their cases and vertically. Stacking, or putting objects on unprotected discs may cause warping, scratches, or other damage.

### Copyright

---

It is forbidden by law to copy, broadcast, show, broadcast on cable, play in public, or rent copyrighted material without permission.

DVD-Video discs are copy-protected, and any recordings made from these discs will be distorted.

This product incorporates copyright protection technology that is protected by method claims of certain U.S. patents and other intellectual property rights owned by Macrovision Corporation and other rights owners. Use of this copyright-protection technology must be authorized by Macrovision Corporation, and is intended for home and other limited viewing uses only, unless otherwise authorized by Macrovision Corporation. Reverse engineering or disassembly is prohibited.

# Before Using the DVD receiver

## Installing the Batteries

- 1 To open the battery compartment, press the small hollow and slide off the cover.**

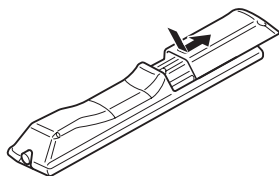

- 2 Insert the two supplied batteries (AA/R6) in accordance with the polarity diagram inside the battery compartment.**

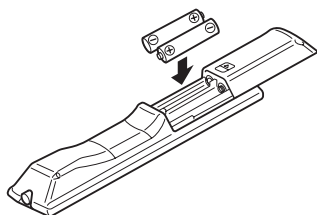

- 3 Put the cover onto the remote controller and slide it shut.**

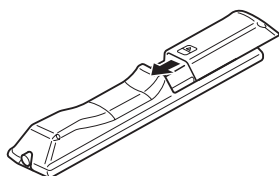

### Notes:

- If the remote controller doesn't work reliably, try replacing both batteries.
- Don't mix new and old batteries, or different types of batteries.
- If you intend not to use the remote controller for a long time, remove the batteries to prevent possible leakage and corrosion.
- Flat batteries should be removed as soon as possible to prevent possible leakage and corrosion.

## Using the Remote Controller

To use the remote controller, point it at the DVD receiver's remote control sensor, as shown below.

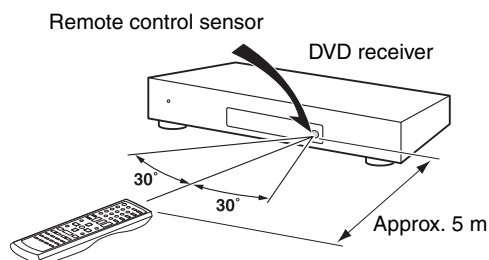

### Notes:

- The remote controller may not work reliably if the DVD receiver is subjected to bright light, such as direct sunlight or inverter-type fluorescent lights. Keep this in mind when installing the DVD receiver.
- If another remote controller of the same type is used in the same room, or the DVD receiver is installed close to equipment that uses infrared rays, the remote controller may not work reliably.
- Don't put anything, such as a book, on the remote controller, because the buttons may be pressed inadvertently, thereby draining the batteries.
- The remote controller may not work reliably if the DVD receiver is installed in a rack behind colored glass doors. Keep this in mind when installing the DVD receiver.
- The remote controller will not work if there's an obstacle between it and the DVD receiver's remote control sensor.

# Front & Rear Panels

For detailed information, refer to the pages in brackets.

## Front Panel

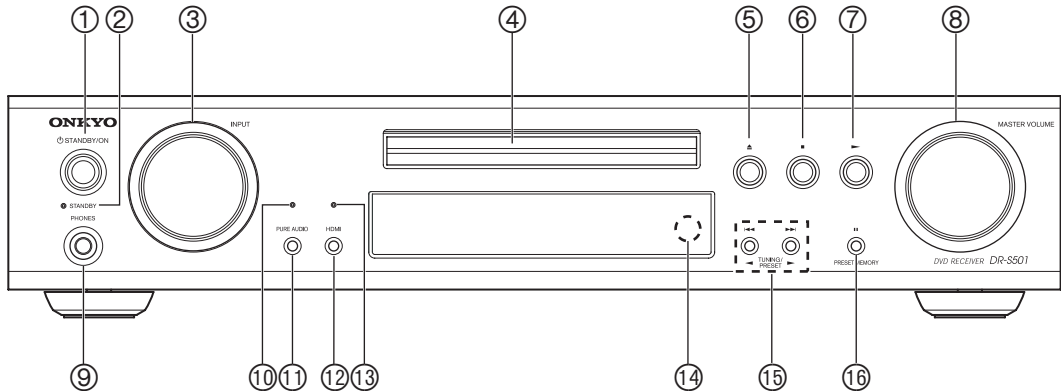

- ① **STANDBY/ON button [28]**  
This button is used to set the DVD receiver to On or Standby.
- ② **STANDBY indicator [28]**  
This indicator lights up when the DVD receiver is in Standby.
- ③ **INPUT selector [31] and indicator**  
This selector is used to select from the following input sources: DVD, VIDEO 1, VIDEO 2/DOCK, FM, AM.
- ④ **Disc tray [33]**  
Discs are loaded here.
- ⑤ **▲ (open/close) button [33]**  
This button is used to open and close the disc tray. The input source is automatically set to DVD.
- ⑥ **■ (stop) button [34]**  
This button is used to stop playback.
- ⑦ **▶ (play) button [33]**  
This button is used to start playback. The input source is automatically set to DVD.
- ⑧ **MASTER VOLUME control [31] and indicator**  
This control is used to adjust the volume of the DVD receiver to Min, 1 through 79, Max.
- ⑨ **PHONES jack [31]**  
This 1/4-inch phone jack is for connecting a standard pair of stereo headphones for private listening.
- ⑩ **PURE AUDIO indicator [42]**  
This indicator lights up when the Pure Audio listening mode is selected.
- ⑪ **PURE AUDIO button [42]**  
Selects the Pure Audio listening mode.
- ⑫ **HDMI button [30]**  
This button is used to turn HDMI on or off.
- ⑬ **HDMI indicator [30]**  
This indicator lights up when a HDMI signal is being output.
- ⑭ **Remote control sensor [11]**  
This sensor receives control signals from the remote controller.
- ⑮ **Previous/Next ◀◀/▶▶ buttons or TUNING/PRESET ◀/▶ buttons [34, 39]**  
The Previous [◀◀] button is used to select the previous chapter or track. During playback it selects the beginning of the current track.  
The Next [▶▶] button is used to select the next chapter or track.  
When the AM or FM input source is selected, these buttons are used to tune the tuner, or select radio presets.
- ⑯ **|| (pause) button or PRESET/MEMORY button [33, 35, 40]**  
This button is used to pause playback. While playback is paused, pressing this button moves the video forward one frame at a time.  
When the AM or FM input source is selected, this button is used to store the radio presets.

Display

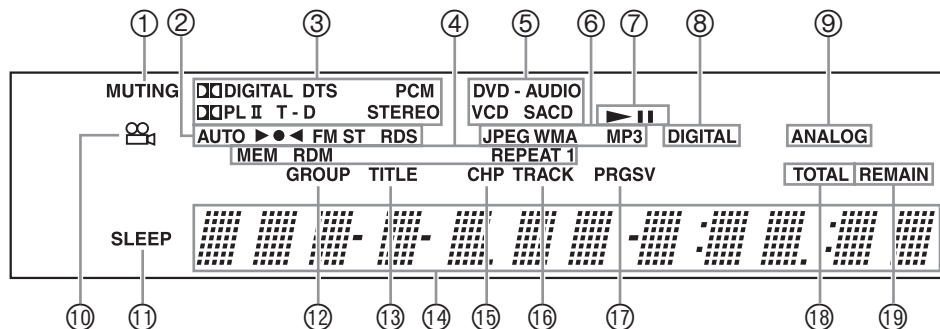

- ① **MUTING indicator**  
This indicator flashes while the DVD receiver is muted.
- ② **Tuning indicators**  
**AUTO:** This indicator lights up when the Auto Tuning mode is selected, and disappears when the Manual Tuning mode is selected.  
**▶●◀:** This indicator lights up when the DVD receiver is tuned into a radio station.  
**FM ST:** This indicator lights up when the DVD receiver is tuned to a stereo FM station.  
**RDS (European model only):** This indicator lights up when the DVD receiver is tuned to a radio station that supports RDS (Radio Data System).
- ③ **Listening mode & format indicators**  
These indicators show the currently selected listening mode and the format of the playing disc.
- ④ **Playback mode indicators**  
**MEM:** Lights up when memory playback is selected.  
**RDM:** Lights up when random playback is selected.  
**REPEAT:** Lights up when repeat playback is selected for all the tracks.  
**REPEAT 1:** Lights up when repeat playback is selected for a track.
- ⑤ **Disc type indicators**  
These indicators show the type of disc loaded.
- ⑥ **Data type indicators**  
These indicators show the type of data loaded.
- ⑦ **Disc operation indicators**  
These indicators show the status of disc playback.
- ⑧ **DIGITAL indicator**  
This indicator lights up when the digital audio signal input is used.
- ⑨ **ANALOG indicator**  
This indicator lights up when the analog audio signal input is used.
- ⑩ **Camera angle  indicator**  
This indicator appears if the DVD-Video disc being played features multiple camera angles.
- ⑪ **SLEEP indicator**  
This indicator lights up when the Sleep function has been set.
- ⑫ **GROUP indicator**  
While stopped, the total number of groups on the current DVD-Audio disc is displayed here. During playback, the number of the current group is displayed.
- ⑬ **TITLE indicator**  
During playback, the number of the current title is displayed.
- ⑭ **Message & time area**  
Time information, such as total time, remaining time, and so on, is displayed here in hours, minutes, and seconds. Other messages are also displayed.
- ⑮ **CHP indicator**  
This indicator appears while the number of the current chapter is being displayed.
- ⑯ **TRACK indicator**  
This indicator appears while track numbers are being displayed. While stopped, the total number of tracks on the current SACD or audio CD are displayed. During playback, the number of the current track is displayed.
- ⑰ **PRGSV indicator**  
This indicator appears when progressive video is being output by the component video output.
- ⑱ **TOTAL indicator**  
This indicator appears while the total number or total time is being displayed.
- ⑲ **REMAIN indicator**  
This indicator appears while the remaining time is being displayed.

## Rear Panel

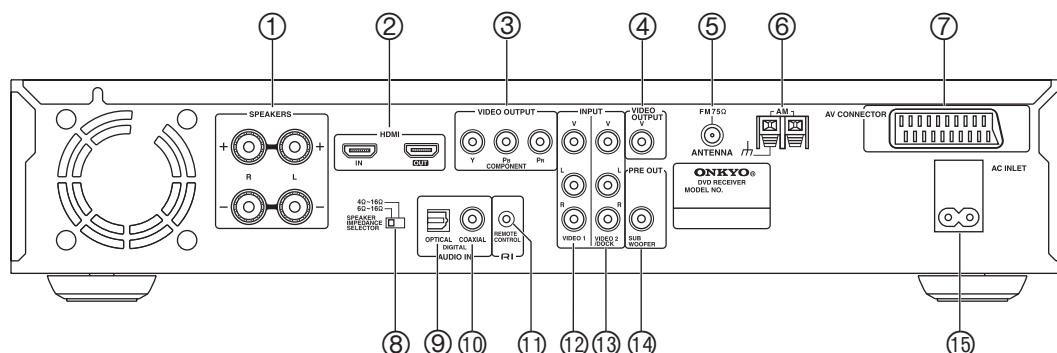

### ① SPEAKERS [18]

These terminal posts are for connecting your front speakers.

### ② HDMI IN/OUT [27]

HDMI (High Definition Multimedia Interface) connections carry digital audio and digital video. The HDMI input is for connecting components with HDMI outputs. The HDMI output is for connecting a TV or projector with an HDMI input.

### ③ COMPONENT VIDEO OUTPUT [24]

These jacks output component video and can be connected to an component video input on a TV or projector.

### ④ VIDEO OUTPUT [23]

This RCA connector can be used to connect a TV or projector with a composite video input.

### ⑤ FM ANTENNA [19]

This jack is for connecting an FM antenna.

### ⑥ AM ANTENNA [19]

These push terminals are for connecting an AM antenna.

### ⑦ AV CONNECTOR (European model only) [24]

This SCART output can be connected to a TV or projector with a SCART input. This SCART connector outputs 2-channel stereo audio, composite video, and RGB video.

### ⑧ SPEAKER IMPEDANCE SELECTOR [18]

This selector is used to select impedances of your speakers. If the impedance of any of front speakers is 4 ohms or more but less than 6, set the speaker impedance to “4Ω~16Ω”.

### ⑨ OPTICAL DIGITAL AUDIO IN [26]

This optical digital audio input can be connected to an optical digital audio output on a DVD recorder, or game console.

This input is assigned for VIDEO 1 INPUT in default.

If you output audio from this input during

VIDEO 2/DOCK INPUT is selected, you must change the “Video2 Input” setting to “OPT” from “Coax” (page 55).

### ⑩ COAXIAL DIGITAL AUDIO IN [26]

This coaxial digital audio input can be connected to a coaxial digital audio output on a DVD recorder or game console.

This input is assigned for VIDEO 2/DOCK INPUT in default.

If you output audio from this input during VIDEO 1 INPUT is selected, you must change the “Video1 Input” setting to “Coax” from “OPT” (page 55).

### ⑪ RI REMOTE CONTROL [26]

This RI (Remote Interactive) jack can be connected to an RI jack on Onkyo RI Dock. The DVD receiver remote controller can then be used to control the RI Dock. To use RI, you must make an analog audio connection (RCA) between the DVD receiver and the RI Dock, even if they are connected digitally.

### ⑫ VIDEO 1 INPUT [25]

Here you can connect other video equipment. Input jacks include composite video and analog audio input.

### ⑬ VIDEO 2/DOCK INPUT [26]

Here you can connect Onkyo RI DOCK or other video equipment. Input jacks include composite video and analog audio input.

### ⑭ SUBWOOFER PRE OUT [18]

A powered subwoofer can be connected here.

### ⑮ AC INLET [28]

The supplied power cord is connected here. The other of the power cord should be connected to a suitable wall outlet.

Remote Controller

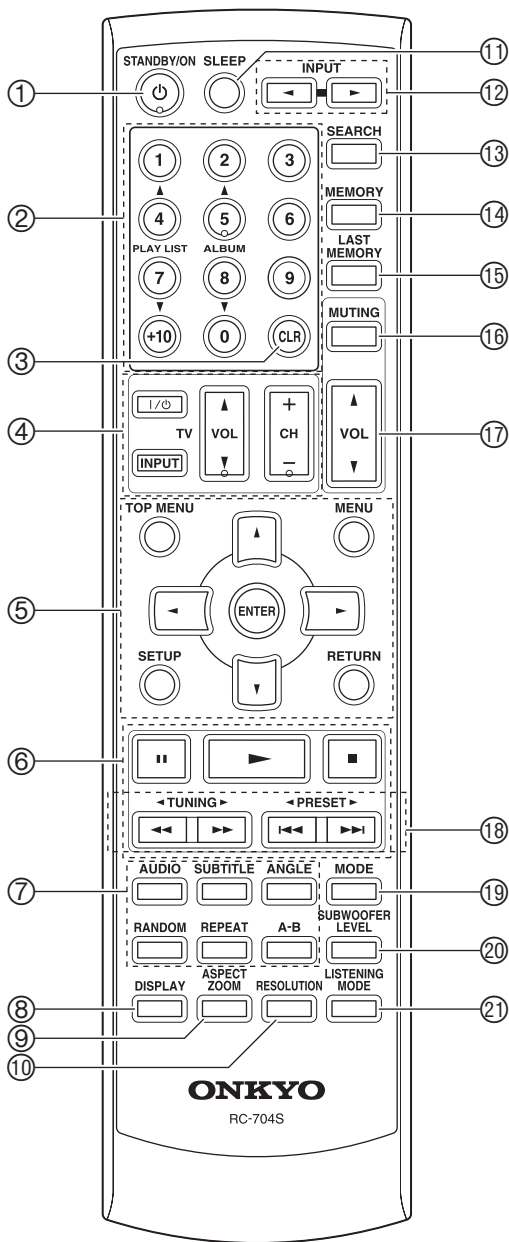

① **STANDBY/ON button\*** [28]

This button is used to set the DVD receiver to Standby or turn on. Don't turn on the DVD receiver until you've completed, and double checked all connections (pages 23–27).

② **Number buttons\*** [44, 45, 66]

These buttons are used to enter title, chapter, and track numbers and to enter times for locating specific points in time.

③ **CLR button** [40, 44, 45, 49]

This button is used to cancel various functions.

④ **TV Control buttons** [53]

These buttons are used to control a TV. You must enter the appropriate remote control code first.

⑤ **Disc and DVD receiver menu buttons**

**TOP MENU button\*** [36, 38]

With DVD discs, this button displays the main menu. With a JPEG disc, it displays thumbnails of the images. With a Video CD, it turns PBC on or off.

**MENU button\*** [36, 38]

This button is used to display a menu on a DVD or to open the Disc Navigator when using a JPEG disc.

**Cursor** ◀▶/▲/▼ **buttons\*** [36, 55, 59]

These buttons are used to navigate menus.

**ENTER button\*** [36, 55, 59]

This button is used to start playback of the selected title, chapter, or track, and to confirm settings.

**SETUP button** [55, 59]

This button is used to open and close the setup menus.

**RETURN button** [55]

This button is used to return to the previous display when changing settings.

### ⑥ Basic Playback buttons\*

#### **Pause button [33, 35]**

This button is used to pause playback. While playback is paused, pressing this button moves the video forward one frame at a time.

#### **Play button [33]**

This button is used to start playback.



#### **Stop button [34]**



This button is used to stop playback.

#### **Fast Reverse/Fast Forward / buttons [35]**

These buttons are used for fast reverse and fast forward.

#### **Previous/Next / buttons [34]**

The Previous [] button is used to select the previous chapter or track. During playback it selects the beginning of the current track.

The Next [] button is used to select the next chapter or track.

### ⑦ Advanced Playback buttons

#### **AUDIO button [51]**

This button is used to select foreign language soundtracks and audio formats (e.g., Dolby Digital or DTS) on DVD-Video discs.

#### **SUBTITLE button [51]**

This button is used to select subtitles on DVD-Video discs.

#### **ANGLE button [50]**

This button is used to select camera angles on DVD-Video discs.

#### **RANDOM button\* [47]**

This button is used with the Random function.

#### **REPEAT button\* [46]**

This button is used to set the Repeat function.

#### **A-B button [46]**

This button is used to set the A-B Repeat function.

### ⑧ DISPLAY button [52]

This button is used to display information about the disc or the current input source. Press it repeatedly to display more information.

### ⑨ ASPECT/ZOOM button [50, 60]

This button is used to change the view mode. Pressing and holding it for a few seconds selects Zoom mode.

### ⑩ RESOLUTION button [30]

This button is used to select a video resolution for the HDMI OUT.

### ⑪ SLEEP button [32]

This button is used with the Sleep function.

### ⑫ INPUT button [31]

This button is used to select the input sources.

### ⑬ SEARCH button [40, 44, 45]

This button is used to search for titles, chapters, groups, folders, tracks, and specific points in time. When the AM or FM input source is selected, you can tune into AM and FM stations directly by entering the appropriate frequency.

### ⑭ MEMORY button [48]

This button is used with the Memory function. When the AM or FM input source is selected, this button is used to store the radio presets.

### ⑮ LAST MEMORY button [49]

This button is used with the Last Memory function for DVD playback.

### ⑯ MUTING button [32]



This button is used to mute or unmute the DVD receiver.

### ⑰ VOL button [31]



This button is used to adjust the volume of the DVD receiver.

### ⑱ Tuner buttons

#### **TUNING button [39]**

When the AM or FM input source is selected, the TUNING [] buttons are used to tune the tuner.



#### **PRESET buttons [40]**

When the AM or FM input source is selected, the PRESET [] buttons are used to select radio presets.

### ⑲ MODE button\* [39]

This button is used to select the Auto or Manual tuning mode.

### ⑳ SUBWOOFER LEVEL button [32]

This button is used to access the Subwoofer Level menu. Use the Left and Right [] buttons to adjust the volume.

### ㉑ LISTENING MODE button [42]

This button is used to select the listening modes.

\* For buttons to control an Apple iPod in RI Dock with an RI connection, see page 54.



# Connecting the DVD receiver

## Placing the Speakers

### Front Left and Right Speakers

- Place the front left and right speakers symmetrically and so that the distance from the listening position is the same.
- When placing speakers, direct the speakers toward the position of the listener's ears where the listener sits to enjoy music or movies.
- Place the two speakers so that the heights of the two speakers are aligned. The ideal height for the speakers is the height of the listener's ears.

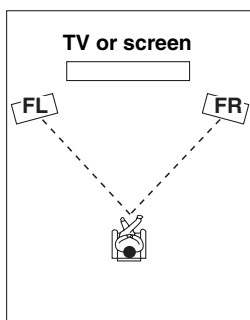

**FL:** Front left speaker

**FR:** Front right speaker

### Subwoofer

Using a subwoofer greatly improves the volume level and sound quality of bass sounds. The subwoofer effect depends not only on the listening position but also on the shape of the listening room.

- In general, place the subwoofer in a corner of the room or at a point  $\frac{1}{3}$  the width of the room.
- Play a movie or music that contains high quality bass sounds to determine the subwoofer placement. Change the subwoofer's position and check the effect, then select the position where the bass sounds are best heard.

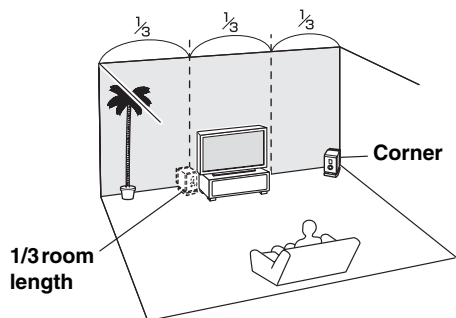

## Connecting Your Speakers

### Speaker Connection Precautions



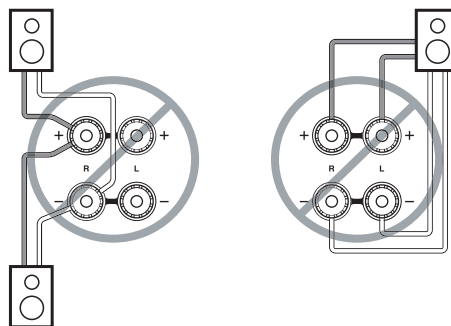
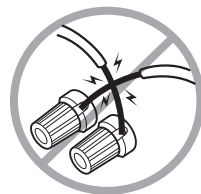

Read the following before connecting your speakers:

- You can connect speakers with an impedance of between 4 and 16 ohms. If the impedance of any of the connected speakers is 4 ohms or more, but less than 6 ohms, be sure to set the speaker impedance to "4Ω~16Ω" (see page 18). If you use speakers with a lower impedance, and use the DVD receiver at high volume levels for a long period of time, the built-in protection circuit may be activated.
- Disconnect the power cord from the wall outlet before making any connections.
- Read the instructions supplied with your speakers.
- Pay close attention to speaker wiring polarity. In other words, connect positive (+) terminals only to positive (+) terminals, and negative (-) terminals only to negative (-) terminals. If you get them the wrong way around, the sound will be out of phase and will sound unnatural.
- Unnecessarily long, or very thin speaker cables may affect the sound quality and should be avoided.
- Be careful not to short the positive and negative wires. Doing so may damage the DVD receiver.
- Make sure the metal core of the wire does not have contact with the DVD receiver's rear panel. Doing so may damage the DVD receiver.
- Don't connect more than one cable to each speaker terminal. Doing so may damage the DVD receiver.
- Don't connect one speaker to several terminals.

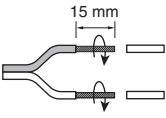

## Connecting the DVD receiver—Continued

### Connecting the Speaker Cables

- 1 Strip about 15 mm of insulation from the ends of the speaker cables, and twist the bare wires tightly, as shown.**  

- 2 Unscrew the terminal.**  

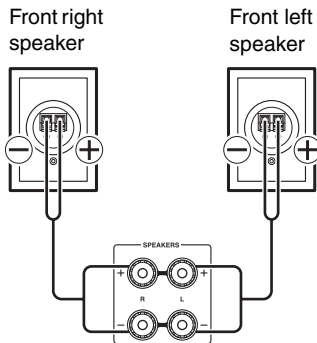
- 3 Fully insert the bare wires.**  

- 4 Screw the terminal tight.**  

The following illustration shows which speaker should be connected to each pair of terminals.

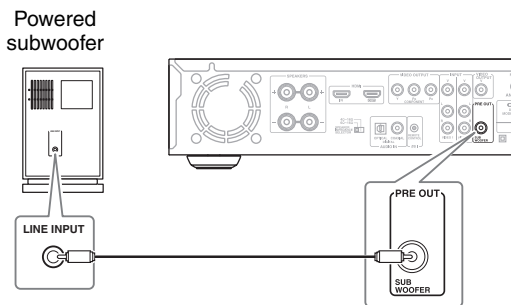

### Connecting a Powered Subwoofer

Using a suitable cable, connect the DVD receiver's SUBWOOFER PRE OUT to an input on your powered subwoofer, as shown.



### Speaker Impedance

If the impedance of any of front speakers is 4 ohms or more but less than 6, set the speaker impedance to “4Ω~16Ω”.

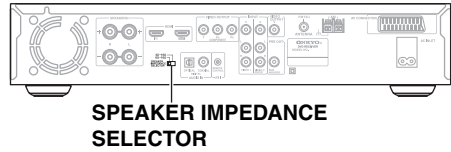

**Use the SPEAKER IMPEDANCE SELECTOR to select speaker impedance.**

**4Ω~16Ω:**

Select if the impedance of any of speakers is 4 ohms or more but less than 6.

**6Ω~16Ω:**

Select if the impedances of all speakers are between 6 and 16 ohms.

#### Note:

Change of the settings may be required for some speakers (see page 55).

## Connecting the DVD receiver—Continued

### Connecting Antenna

This section explains how to connect the supplied indoor FM antenna and AM loop antenna, and how to connect commercially available outdoor FM and AM antennas. The DVD receiver won't pick up any radio signals without any antenna connected, so you must connect the antenna to use the tuner.

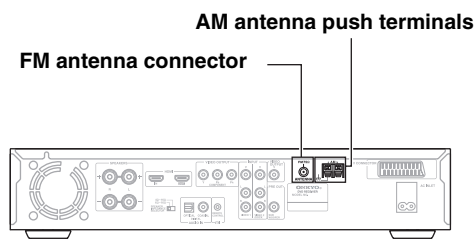

### Connecting the Indoor FM Antenna

The supplied indoor FM antenna is for indoor use only.

#### 1 Attach the FM antenna, as shown.

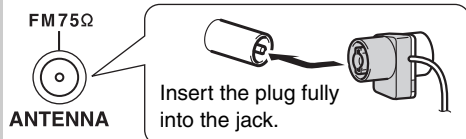

Once your DVD receiver is ready for use, you'll need to tune into an FM radio station and adjust the position of the FM antenna to achieve the best possible reception.

#### 2 Use thumbtacks or something similar to fix the FM antenna into position.

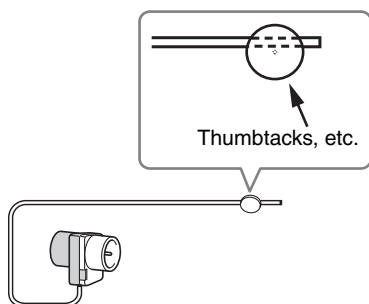

**Caution:** Be careful that you don't injure yourself when using thumbtacks.

If you cannot achieve good reception with the supplied indoor FM antenna, try a commercially available outdoor FM antenna instead (see page 20).

### Connecting the AM Loop Antenna

The supplied indoor AM loop antenna is for indoor use only.

#### 1 Assemble the AM loop antenna, inserting the tabs into the base, as shown.

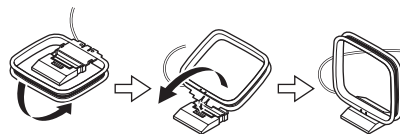

#### 2 Connect both wires of the AM loop antenna to the AM antenna push terminals, as shown.

The antenna connection is polarity sensitive. Connect the black wire to the ground terminal ( $\text{⏏}$ ). Connect the other wire to the other terminal. Make sure that the wires are attached securely and that the push terminals are gripping the bare wires, not the insulation.

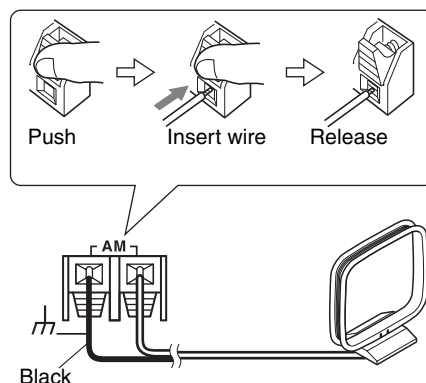

Once your DVD receiver is ready for use, you'll need to tune into an AM radio station and adjust the position of the AM antenna to achieve the best possible reception.

Keep the antenna as far away as possible from your DVD receiver, TV, speaker cables, and power cords.

If you cannot achieve good reception with the supplied indoor AM loop antenna, try using it with a commercially available outdoor AM antenna (see page 20).

## Connecting the DVD receiver—Continued

### Connecting an Outdoor FM Antenna

If you cannot achieve good reception with the supplied indoor FM antenna, try a commercially available outdoor FM antenna instead.

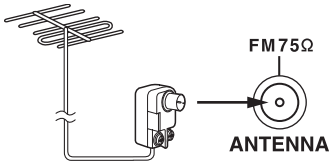

#### Notes:

- Outdoor FM antennas work best outside, but usable results can sometimes be obtained when installed in an attic or loft.
- For best results, install the outdoor FM antenna well away from tall buildings, preferably with a clear line of sight to your local FM transmitter.
- Outdoor antenna should be located away from possible noise sources, such as neon signs, busy roads, etc.
- For safety reasons, outdoor antenna should be situated well away from power lines and other high-voltage equipment.
- Outdoor antenna must be grounded in accordance with local regulations to prevent electrical shock hazards.

#### ■ Using a TV/FM Antenna Splitter

It's best not to use the same antenna for both FM and TV reception, as this can cause interference problems. If circumstances demand it, use a TV/FM antenna splitter, as shown.

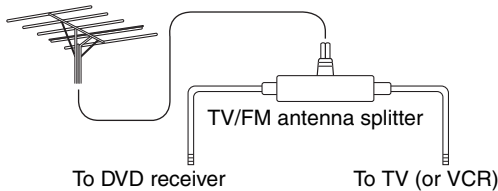

### Connecting an Outdoor AM Antenna

If good reception cannot be achieved using the supplied AM loop antenna, an outdoor AM antenna can be used in addition to the loop antenna, as shown.

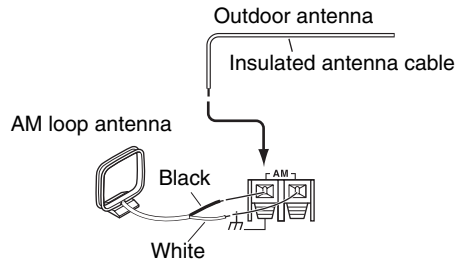





Outdoor AM antennas work best when installed outside horizontally, but good results can sometimes be obtained indoors by mounting horizontally above a window. Note that the AM loop antenna should be left connected. Outdoor antenna must be grounded in accordance with local regulations to prevent electrical shock hazards.





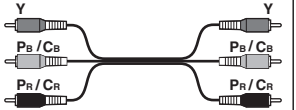
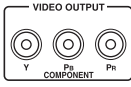

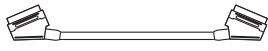
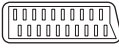
## Connecting the DVD receiver—Continued

### AV Cables & Connectors

#### Video

	Cable	Jack	Description
<b>HDMI</b>			HDMI connections can carry uncompressed, standard or high definition digital video and digital audio, for the best picture and sound quality.
<b>Component video</b>			Component video separates the luminance (Y) and color difference signals (Pr, Pb), providing the best picture quality. Some TV manufacturers label their component video inputs differently.
<b>Composite video (supplied)</b>			Composite video can be found on virtually all TVs, VCRs, and video equipment.
<b>Scart (European model only)</b>			SCART connections carry analog audio and video (composite, RGB) all in one cable.

#### Audio

	Cable	Jack	Description
<b>Optical digital</b>			Optical digital audio connections provide better audio quality than analog connections.
<b>Coaxial digital</b>			Coaxial digital audio connections provide better audio quality than analog connections.
<b>Analog</b>			RCA analog audio connectors can be found on virtually all AV components.

## Connecting the DVD receiver—Continued

### Video Output/Video Setting Matrix

The following matrix shows how the video outputs work in relation to the various video settings.

✓: Output

Setting	HDMI Output Setting (page 29, 30)				
	On (default)			Off	
	HD Resolution (page 30)			Progressive Setting (page 30)	
	Auto	480p / 576p (default)	720p, 1080i	Progressive	Interlace
Video output					
HDMI	✓	✓	✓ <sup>*3</sup>	No output	No output
Component	✓ <sup>*1</sup>	✓ <sup>*2</sup>	No output	✓ <sup>*2</sup>	✓
Composite	✓ <sup>*1</sup>	✓	No output	✓	✓
SCART <sup>*4</sup> (European model only)	✓ <sup>*1</sup>	✓	No output	✓	✓

\*1 No picture will be output from other than HDMI when you connect the TV that the native resolution is “720p” or “1080i”.

\*2 If your TV doesn’t support progressive scanning, you’ll get no picture.

\*3 If your TV doesn’t support the “HD Resolution” settings of “720p” and “1080i”, you’ll get no picture.

\*4 With the “SCART Output Setting”, you can choose “RGB” or composite video for the SCART output. However, when HDMI is on, you cannot select “RGB”. Also, when “RGB” is selected, nothing will be output by the component video output (see page 62).

### Video Signal Flow Chart

Video input signals flow through the DVD receiver as shown.

HDMI input pass through HDMI output signals as it is.

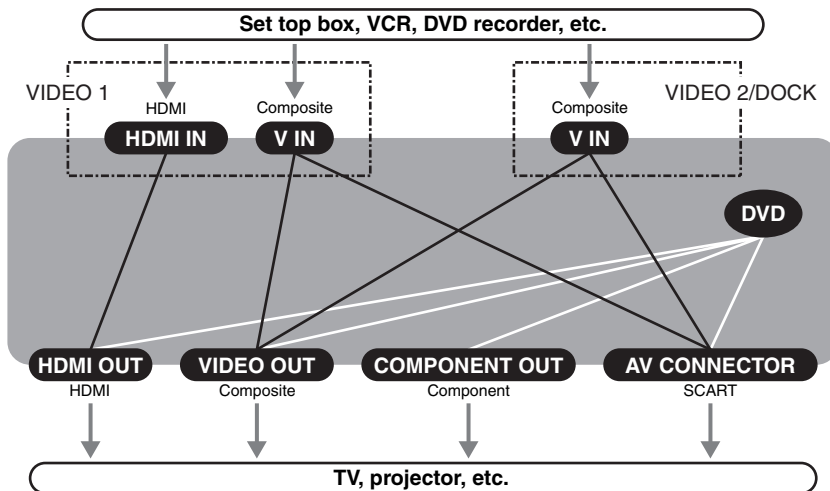

## Connecting the DVD receiver—Continued

### Before Making Any Connections

- Read the manuals supplied with your AV components.
- Don't connect the power cord until you've completed all audio and video connections.

### RCA AV Connection Color Coding

RCA AV connections are usually color coded: red, white, and yellow. Use red plugs to connect right-channel audio inputs and outputs (typically labeled "R"). Use white plugs to connect left-channel audio inputs and outputs (typically labeled "L"). And use yellow plugs to connect composite video inputs and outputs.

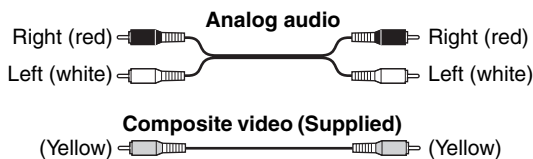

- Push each plug in all the way to make a good connection (loose connections can cause noise or malfunctions).
- To prevent interference, keep audio and video cables away from power cords and speaker cables.

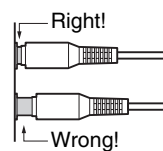

### Optical Digital Jacks

The DVD receiver's optical digital connectors have a shutter-type cover that opens when an optical plug is inserted, and closes when it's removed. Push the plug in all the way.

**Caution:** To prevent shutter damage, hold the optical plug straight when inserting and removing.

### Basic Setup

The setup described here is a basic setup that allows you to play discs using just the cables supplied with the receiver.

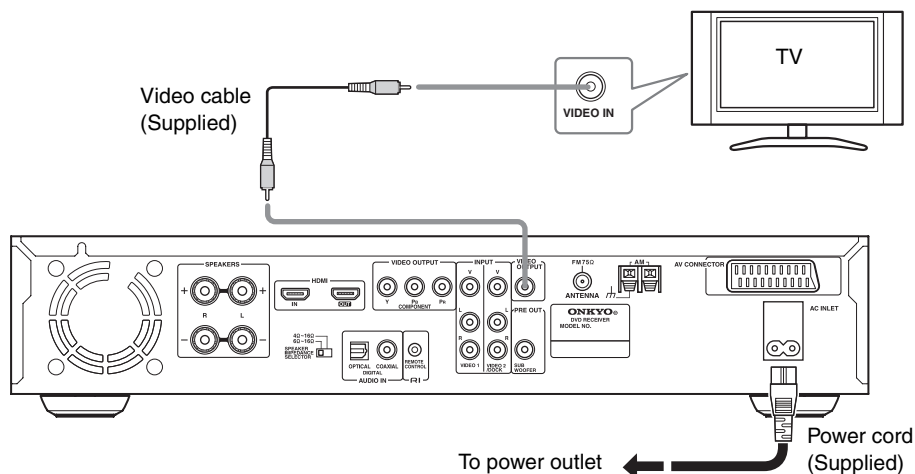

This receiver is equipped with copy protection technology. Do not connect this receiver to your TV via a VCR using Video cable, as the picture from this receiver will not appear properly on your TV. (This receiver may also not be compatible with some combination TV/VCRs for the same reason; refer to the manufacturer for more information.)

1. **Connect the VIDEO OUTPUT jack to the composite video input on your TV.** Use the supplied Video cable (RCA), connecting the yellow plug to the video output. See the following page if you want to use other cable for the video connection.
2. **Connect the supplied AC power cord to the AC INLET, then plug into a power outlet.**

## Connecting Your TV (video connection)

- Connect the DVD receiver directly to your TV. If you connect the DVD receiver through a VCR, TV/VCR combination, or video selector, the picture may be distorted because DVD-Video discs are usually copy protected.

## Using Component Video

You can use the component video output instead of the standard video out jack to connect this receiver to your TV (or other equipment).

This will provide better quality picture than composite video.

**This jack cannot output the signal from composite video input.**

- Use a component video cable (not supplied) to connect the COMPONENT VIDEO OUTPUT jacks to a component video input on your TV (or monitor).

If you connect the component video output to a TV or another component that doesn't support progressive scanning, be sure to turn off HDMI (see page 30).

You can set the component video output to Progressive or Interlaced (see page 30).

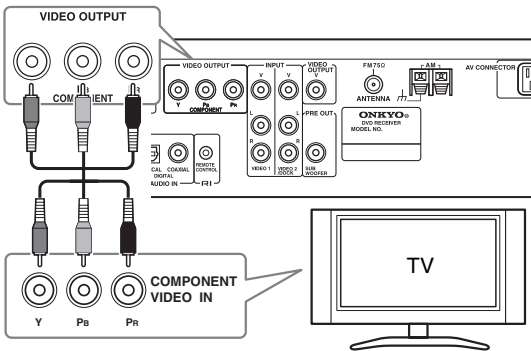

### Compatibility of this unit with progressive-scan TVs.

This receiver is compatible with progressive video Macro Vision System Copy Guard.

CONSUMERS SHOULD NOTE THAT NOT ALL HIGH DEFINITION TELEVISION SETS ARE FULLY COMPATIBLE WITH THIS PRODUCT AND MAY CAUSE ARTIFACTS TO BE DISPLAYED IN THE PICTURE. IN CASE OF 525 OR 625 PROGRESSIVE SCAN PICTURE PROBLEMS, IT IS RECOMMENDED THAT THE USER SWITCH THE CONNECTION TO THE "STANDARD DEFINITION" OUTPUT. IF THERE ARE QUESTIONS REGARDING OUR TV SET COMPATIBILITY WITH THIS MODEL 525p AND 625p DVD RECEIVER, PLEASE CONTACT OUR CUSTOMER SERVICE CENTER.

## Using SCART (European model only)

If your TV has a SCART-type AV input, you can use a SCART cable to connect this receiver to your TV. This type of connection carries both the sound and the picture.

- Use a SCART cable (not supplied) to connect the AV CONNECTOR to an AV input on your TV.

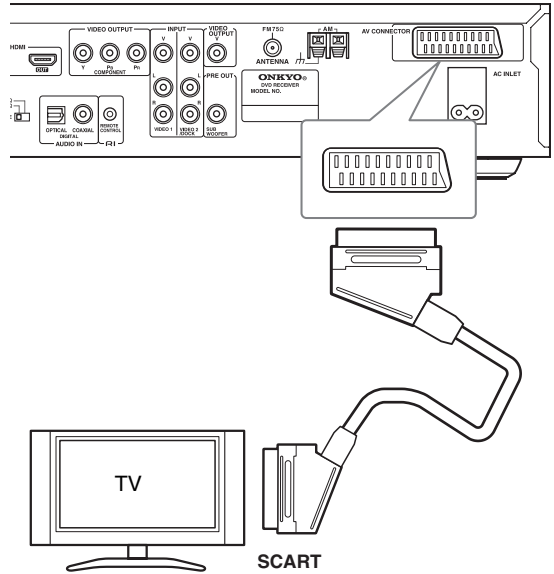

This connector can output composite video, or RGB video. The default setting is composite, which should work with all TVs. Consult the manual that came with your TV to see if you can use one of the higher quality settings. See page 62 for how to change the video output.



## Connecting the DVD receiver—Continued

### Connecting Other AV Component

You can use an AV cable to connect VIDEO 1 INPUT L/R or V jack to your AV component such as a set top box, VCR, and DVD recorder.

Connect your AV component's analog audio and Video output jack to the DVD receiver's VIDEO 1 INPUT L/R or V jack.

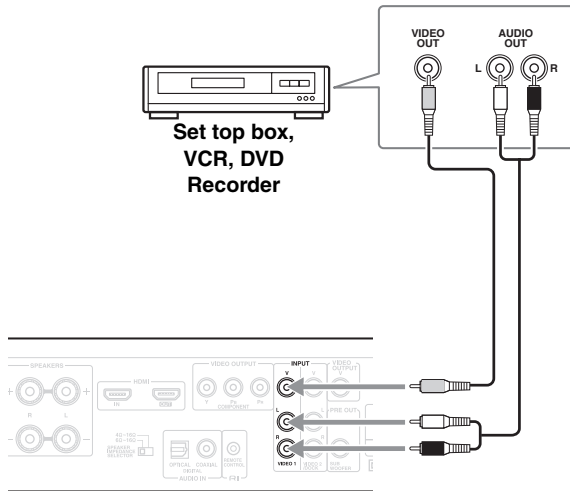

**Note:**

You can also use optical/coaxial digital cable instead of the audio cable (see page 26).

## Connecting an RI Dock

### ■ iPod with video or RI Dock with the OSD mode

Connect your RI Dock's analog audio output jacks and Video output jack to the DVD receiver's VIDEO 2/DOCK INPUT L/R jacks and V jack. Connect the RI Dock with an **RI** cable. (Onkyo DS-A1X/A2/A2X hookup shown below.)

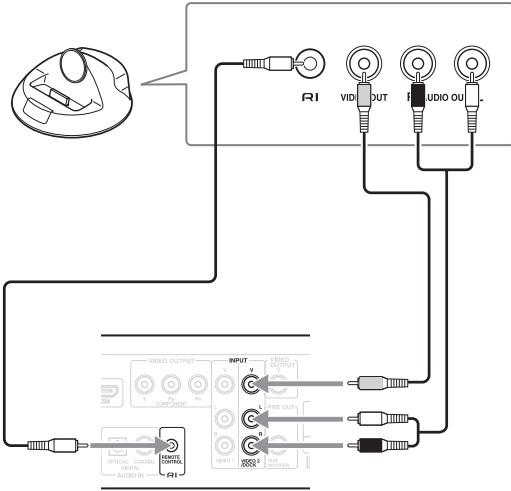

### ■ iPod without video

Connect your RI Dock's analog audio output jacks to the DVD receiver's VIDEO 2/DOCK INPUT jacks. Connect the RI Dock with an **RI** cable. (Onkyo DS-A1 hookup shown below.)

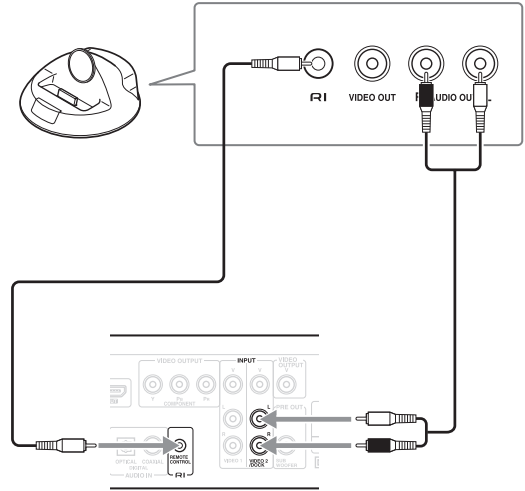

#### Notes:

- Set the RI Dock's RI MODE switch to HDD or HDD/DOCK.
- Press the INPUT [◀]/[▶] buttons to select "VIDEO2/DOCK".
- Refer to the RI Dock's instruction manual.

## Digital Audio Connection

You can use optical/coaxial digital cable instead of the audio cable when connecting with other AV components. Connect your AV component's digital audio output jack to corresponding COAXIAL or OPTICAL DIGITAL AUDIO IN jack of the DVD receiver.

You must assign that jack to an input (see page 57).

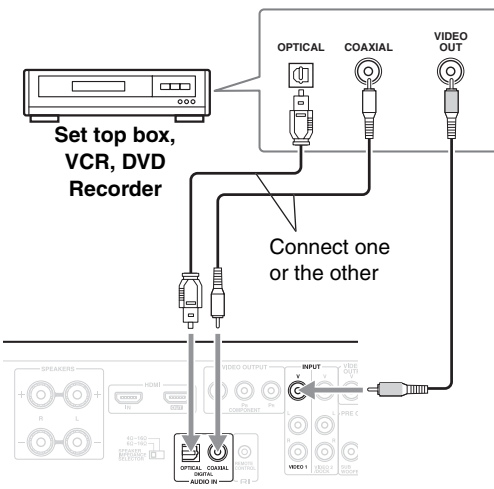

#### Notes:

- Optical digital audio input is assigned for VIDEO 1 INPUT in default. If you output audio from this input during VIDEO 2/DOCK INPUT is selected, you must change the "Video2 Input" setting to "OPT" from "Coax".
- Coaxial digital audio input is assigned for VIDEO 2/DOCK INPUT in default. If you output audio from this input during VIDEO 1 INPUT is selected, you must change the "Video1 Input" setting to "Coax" from "OPT".

### Connecting your HDTV or AV component with an HDMI connection

This section shows how to connect the DVD receiver to an HDTV, projector, or game console that has an HDMI input/output socket.

#### What is HDMI?

HDMI (High Definition Multimedia Interface) is a new connection format that can carry uncompressed, standard or high definition digital video and digital audio. Until now, several separate video and audio cables have been required to connect AV components together. With HDMI, a single cable is all that's necessary to achieve the best picture quality.

HDMI video is compatible with DVI (Digital Visual Interface). To send HDMI video to a DVI input requires an HDMI-to-DVI cable. The DVD receiver supports HDCP (High-bandwidth Digital Content Protection), and for an HDMI-to-DVI connection to work, the other component must also support it. Note that this may not work with some DVI components.

#### Using HDMI

Use the HDMI cable (not supplied) to connect the DVD receiver's HDMI OUT to an HDMI input on your TV. In the same manner, connect the DVD receiver's HDMI IN to an HDMI OUT on the game console, etc.

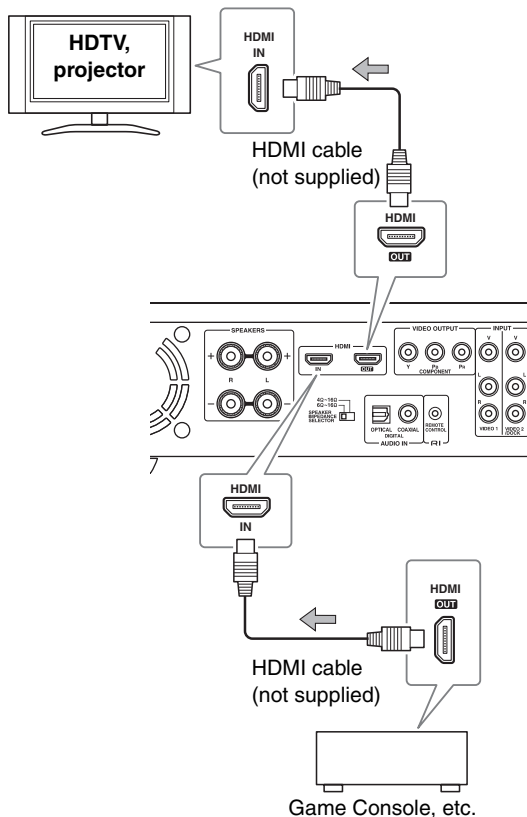

#### Notes:

- The DVD receiver supports HDCP (High-bandwidth Digital Content Protection), a protection system for digital video. HDMI components that you connect to the DVD receiver must also support HDCP.
- The DVD receiver supports High-Definition Multimedia Interface Specification Information Version 1.0.

#### HDMI & the DVD receiver

##### ■ Video

The DVD receiver's HDMI OUT supports the following video resolutions:

- 720 x 480p (progressive), 60 Hz
- 720 x 576p (progressive), 50 Hz
- 1280 x 720p (progressive), 50/60 Hz
- 1920 x 1080i (interlaced), 50/60 Hz

If the connected HDTV or projector doesn't support a resolution, you may get no picture.

On the DVD receiver, you can select a resolution suitable for use with the connected HDTV or projector (see page 30).

##### ■ Audio Formats

The DVD receiver's HDMI OUT supports the following audio formats:

- PCM (96 kHz, 48 kHz, 44.1 kHz)
- Dolby Digital
- DTS

#### Notes:

- If your HDMI-compatible TV or projector doesn't support Dolby Digital and DTS, the HDMI OUT will not output digital audio in that format. In this case, set the "Digital/HDMI Audio Out" setting to "PCM" (see page 62).
- If your TV doesn't support digital audio at high sampling rates, set the "Linear PCM Out" setting to "Down Sample On", so that it's down sampled to below 48 kHz (see page 62).
- Note that audio from SACD discs or audio from the multi channel area of a DVD-Audio discs is not output by the HDMI OUT.
- The audio signal input from HDMI IN is not output from the speakers connected to the DVD receiver but only from the TV.  
With some TVs and input signals, no sound may be output. In these cases, set the connected device's output to PCM.
- Audio and video inputs from VIDEO 1 INPUT or VIDEO 2/DOCK INPUT are not be output from HDMI OUT.

# Connecting the Power/Turning on the DVD receiver

## Before connecting

- Make sure that all the connections on pages 17–27 are complete (the connection to a TV is required).

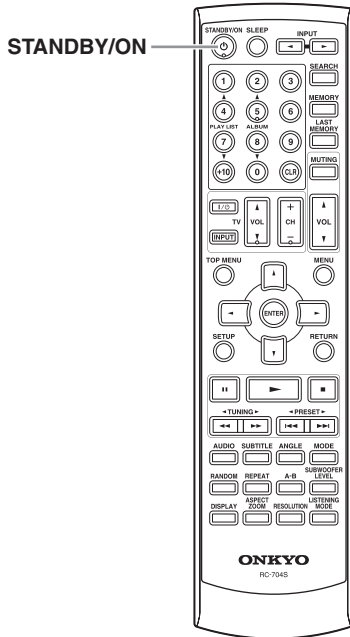
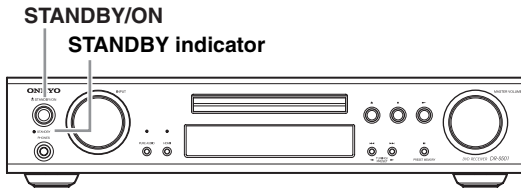

- Before unplugging the receiver from the power outlet, make sure you first switch it into standby.
- For the above reasons, do not plug this receiver into a switched power supply found on some amplifiers and AV receivers.

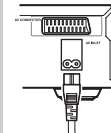

➔ To a wall outlet

## 2

### DVD receiver

STANDBY/ON



Remote controller



Press [STANDBY/ON] button on the DVD receiver or the remote controller.

Turn on your TV and select the input through which the DVD receiver is connected.

The DVD receiver turns on and the STANDBY indicator turns off.

- To put the DVD receiver in the standby mode, press [STANDBY/ON] on the DVD receiver, or [STANDBY/ON] on the remote controller.
- While the STANDBY indicator lights up, the DVD receiver can receive signals from the remote controller.
- Setting the [STANDBY/ON] button to standby does not shut off the power completely.

## 1

Plug the supplied power cord into the AC INLET and then into the power outlet on the wall.

- Do not use a power cord other than the one supplied with the DVD receiver. The power cord supplied is designed for use with the DVD receiver and should not be used with any other device.
- Never have the power cord disconnected from the DVD receiver while the other end is plugged into the wall outlet. Doing so may cause an electric shock. Always connect by plugging into the wall outlet last and disconnect by unplugging from the wall outlet first.

### Note:

DVD receiver features a screen saver and an auto power off function. If the receiver is stopped and no button is pressed for 15 minutes, the screen saver starts (see page 65).

# Initial Setup

This chapter explains the settings you need to make the very first time the DVD receiver is turned on. Basically this manual contains procedures using the remote controller.

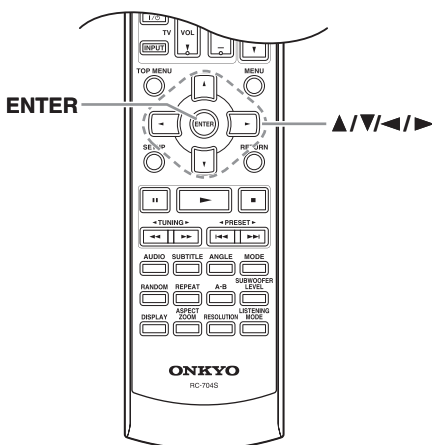

## First Time Setup

The very first time you turn on the DVD receiver, the “Initial Setup” menu appears onscreen.

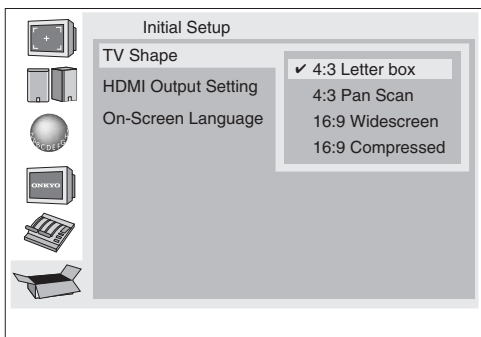

Here you need to make a few settings to get the DVD receiver up and running. You can change these settings later (see page 59).

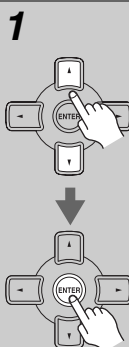

**1** Use the Up and Down [▲]/[▼] buttons to select “TV Shape”, and then press [ENTER].

Select “4:3 Letter box” or “4:3 Pan Scan” if you have a 4:3 TV. Select “16:9 Widescreen” or “16:9 Compressed” if you have a widescreen TV. See page 60 for more information.

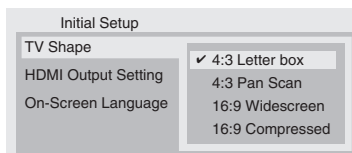

The “HDMI Output Setting” menu appears next.

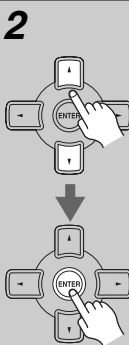

**2** Use the Up and Down [▲]/[▼] buttons to select “On” or “Off” for “HDMI Output Setting”, and then press [ENTER].

Select “On” to use the HDMI output.

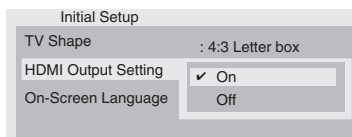

The “On-Screen Language” menu appears next.

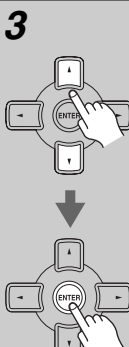

**3** Use the Up and Down [▲]/[▼] buttons to select a language, and then press [ENTER].

See page 63 for more information on the language options.

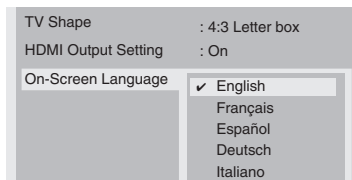

The “Initial Setup” menu closes and the setup is complete.

The DVD receiver is now ready to use.

### Note:

You can cancel the “Initial Setup” by pressing the [SETUP] button and complete the settings later by using the onscreen setup menus (see page 59).

# HDMI and Progressive Settings

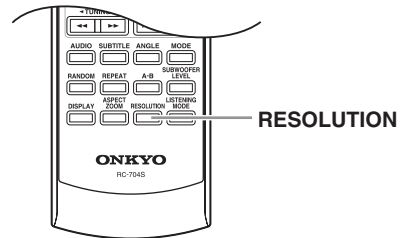
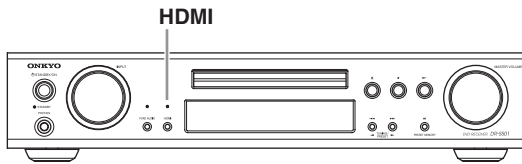



**Note:**

Stop playback before perform these settings.

## Setting the HDMI

This section explains how to turn on the HDMI OUT and change the video resolution when your TV or projector is connected to the HDMI OUT.

<p><b>1</b></p> <p>DVD receiver</p> <p>HDMI</p> 	<p><b>Press the DVD receiver's [HDMI] button to turn on HDMI.</b></p>
<p><b>2</b></p> <p>Remote controller</p> <p>RESOLUTION</p> 	<p><b>Press the [RESOLUTION] button repeatedly to change the HDMI resolution.</b></p> <p>The first button press displays the current resolution onscreen. Press the button again while the resolution is displayed to change the setting.</p>

The DVD receiver supports the following resolutions:

**AUTO:**

The resolution is automatically set to the native resolution of the TV connected to the HDMI OUT.

If the DVD receiver does not support the TV's native resolution setting, the resolution 480p/576p will be used.

**480p (480p / 576p) (default):**

The setting displayed depends on the country in which you purchased the DVD receiver.

720 × 480p 60Hz or 720 × 576p 50Hz

Also output by the DVD receiver's analog video outputs. With this setting, component video output will be progressive.

**720p:**

1280 × 720p 50/60Hz

Not output by the DVD receiver's analog video outputs.

**1080i:**

1920 × 1080i 50/60Hz

Not output by the DVD receiver's analog video outputs.

**Tip:**

These settings can also be changed by using the onscreen setup menus (see pages 60, 61).



**Note:**

Be sure to choose a resolution that's supported by your TV. If you select a resolution that your TV doesn't support, there will be no picture.

## Selecting Progressive or Interlaced

If your TV supports progressive video, you can set the DVD receiver to progressive and enjoy progressive video on your TV. If your TV doesn't support progressive video, set the DVD receiver to interlaced.

When HDMI output is at 480p/576p, the component video output is fixed at progressive and depending on the selected resolution there may be no output, so turn off the HDMI OUT before changing this setting.

<p><b>1</b></p> <p>DVD receiver</p> <p>HDMI</p> 	<p><b>Press the DVD receiver's [HDMI] button to turn off HDMI.</b></p>
<p><b>2</b></p> <p>Remote controller</p> <p>RESOLUTION</p> 	<p><b>Use the [RESOLUTION] button to select "Progressive" or "Interlace".</b></p> <p>The first button press displays the current setting onscreen. Press the button again while the setting is displayed to change the setting.</p> <p>The PRGSV indicator appears on the display when progressive is selected.</p>

# Understanding Common Operations

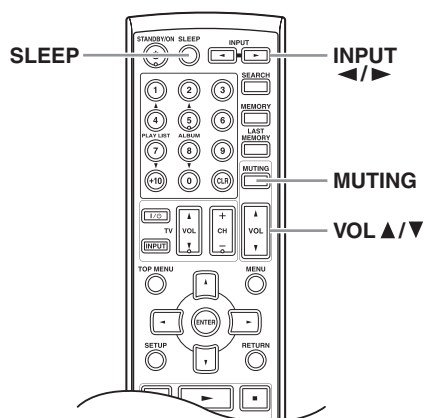
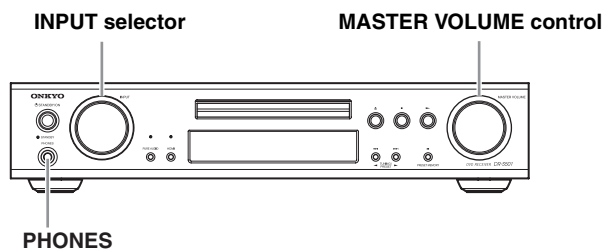

## Adjusting the Volume

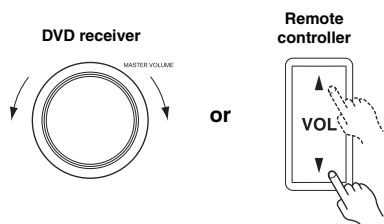

Use the MASTER VOLUME control, or the remote controller's VOL [▲]/[▼] button.

The volume can be set to "Min", "1" through "79", "Max".

Depending on subwoofer level or listening mode, the maximum volume varies.

## Selecting the Input Source

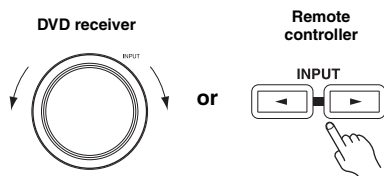

You can select DVD, FM, AM, or connected other AV component (set top box, Onkyo RI Dock) as the input source.

Use the DVD receiver's INPUT selector to select the input source.

To select the input source with the remote controller, press the INPUT [◀] or [▶] button repeatedly.



When reproducing the audio and video signals from HDMI IN, select "VIDEO 1".

## Using Headphones

You can connect a pair of stereo headphones (1/4-inch phone plug) to the DVD receiver's PHONES jack for private listening, as shown.

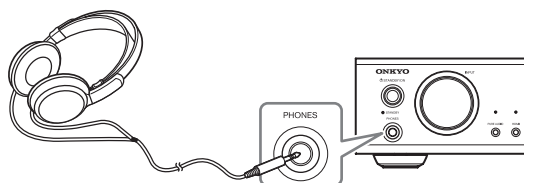

### Notes:

- Always turn down the volume before connecting your headphones.
- The speakers are turned off while the headphones plug is inserted in the PHONES jack.
- When you connect a pair of headphones, the listening mode is set to "Stereo", unless it's already set to "Stereo", "Direct", or "Pure Audio".
- Only the Stereo, Direct and Pure Audio listening modes can be used with headphones (the listening modes available also depend on the currently selected input source).

### Muting the DVD receiver

You can temporarily mute the output of the DVD receiver.

Remote controller

MUTING



**Press the [MUTING] button.**

The output is muted and the MUTING indicator flashes on the display, as shown.



To unmute the DVD receiver, press the [MUTING] button again, or adjust the volume.

The Mute function is cancelled when the DVD receiver is set to Standby.

### Adjusting Subwoofer Level

You can adjust the level of Subwoofer during playback.

Remote controller

SUBWOOFER LEVEL



**Press the [SUBWOOFER LEVEL] button, and then use the Left and Right [◀]/[▶] buttons to adjust the volume.**

You can adjust the volume of Subwoofer from -15 dB to +12 dB in 1 dB steps.

When you've finished, press the [SUBWOOFER LEVEL] button again.



### Using the Sleep Timer

With the sleep timer, you can set the DVD receiver to turn off automatically after a specified period.

Remote controller

SLEEP



**Press the [SLEEP] button repeatedly to select the required sleep time.**

The sleep time can be set from 90 to 10 minutes in 10 minute steps.

The SLEEP indicator appears on the display when the sleep timer has been set. The specified sleep time appears on the display for about five seconds, then the previous display reappears.

If you need to cancel the sleep timer, press the [SLEEP] button repeatedly until the SLEEP indicator disappears.

To check the time remaining until the DVD receiver sleeps, press the [SLEEP] button. Note that if you press the [SLEEP] button while the sleep time is being displayed, you'll shorten the sleep time by 10 minutes.



# Playing Discs

This chapter covers basic playback. Advanced playback functions are covered in the “Advanced Playback” on page 44.

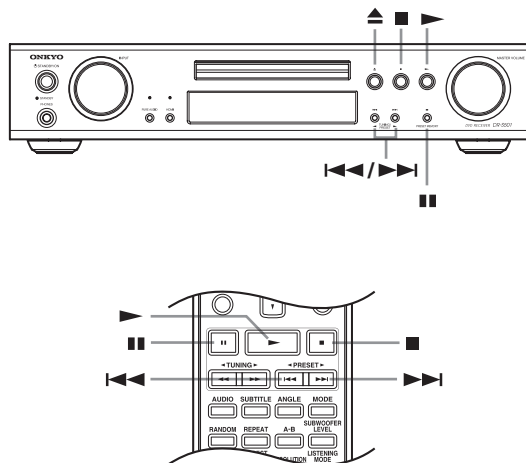

**1**

DVD receiver



**Press Open/Close [▲] to open the disc tray.**

The input source is automatically set to DVD.

**2**

**Load a disc.**

Load a disc with the label side facing up, using the disc tray guide to align the disc (if you're loading a double-sided DVD disc, load it with the side you want to play face down).

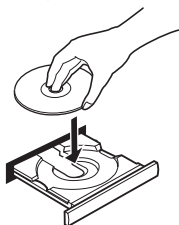

**3**

**Press Open/Close [▲].**

The disc tray closes and the relevant disc type indicator appears on the display.



**Tip:**

If you press the Play [▶] button, the disc tray will close and, depending on the type of disc, playback will start automatically.

**Note:**

Only load discs that are supported by the DVD receiver. See pages 8 to 10.

## Starting, Pausing & Stopping Playback

This section explains how to start, pause, and stop playback.

**Start**

DVD receiver



Remote controller



**To start playback, press the Play [▶] button.**

Playback starts and the Play ▶ indicator appears on the display.

If you're playing a DVD-Video disc, or a VCD with PBC (Playback Control), you may need to start playback from a menu (see page 36).

- For details on playing MP3, WMA, DivX, or JPEG picture discs, see pages 37 and 38.

**Pause**

DVD receiver



Remote controller



**To pause playback, press the Pause [⏸] button.**

Playback pauses and the Pause ⏸ indicator appears on the display.

To restart playback, press the Play [▶] button. Playback restarts and the Pause ⏸ indicator disappears.

For DVD-Audio discs, pause cannot be used while a menu is displayed.

**■ Stop**  
DVD receiver



**Remote controller**

**To stop playback, press the Stop [■] button.**  
Playback stops and the Play ► indicator disappears.

- When you stop playback of a DVD-Video disc, the DVD receiver remembers the point at which playback was stopped and “Resume” appears onscreen. To resume playback from that point, press the Play [►] button. To cancel the “Resume” function, press the Stop [■] button again. The Resume function is reset when the disc is removed from the DVD receiver.
- With the Last Memory function you can resume playback from any point even if the disc has been removed (see page 49).

**Notes:**

- Prolonged display of the same picture or menu may cause irreparable damage to your TV screen known as *screen burn-in*. To prevent this, don't keep playback paused for too long and always press the Stop [■] button when you've finished playing a DVD disc or VCD. The DVD receiver features a screen saver to protect your TV from the effects of burn-in (see page 65).
- With some DVD-Video discs, you may experience picture noise that is not normally visible with standard TV broadcasts. This is usually because DVD-Video uses a lot of high-resolution video data. The amount of noise, if any, will depend on your particular TV and the problem can sometimes be alleviated by turning down the TV's sharpness control.

## Select Next & Previous track/chapter

DVD-V DVD-A SACD VCD CD MP3 WMA DivX JPEG

This section explains how to skip to the next and previous track and chapter.

**■ Select Next track/chapter**  
DVD receiver

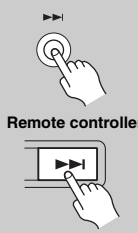

**Remote controller**

**During Playback, press the Next [▶▶] button to select next track/chapter.**  
The Next track/chapter starts playback.

---

**■ Select Previous track/chapter**  
DVD receiver

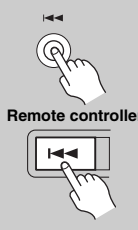

**Remote controller**

**During Playback, press the Previous [◀◀] button to select previous track/chapter.**  
The first press selects the beginning of the current track.

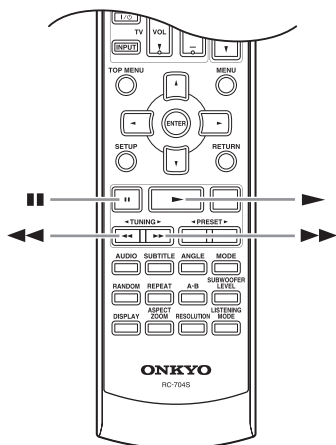

## Forward Frame-by-Frame Playback

DVD-V VCD

With frame-by-frame playback you can view individual picture frames one at a time forward.

### ■ Forward frame-by-frame

**Press the Pause [||] button. Press it repeatedly to view subsequent frames.**



To resume normal playback, press the Play [▶] button.

## Fast Forward & Reverse

DVD-V DVD-A SACD VCD CD MP3 DivX

This section explains how to fast forward and reverse.

### ■ Fast forward



**During playback, press the [▶▶] button to start fast forward.**

Playback fast forwards and “▶▶x2” appears onscreen.

To change the fast-forward speed, press the [▶▶] button repeatedly to select: x2, x4, x8, x16.

To resume normal playback, press the Play [▶] button.

### ■ Fast reverse



**During playback, press the [◀◀] button to start fast reverse.**

Playback reverses and “◀◀x2” appears onscreen.

To change the fast-reverse speed, press the [◀◀] button repeatedly to select: x2, x4, x8, x16.

To resume normal playback, press the Play [▶] button.

### Notes:

- Fast forward and fast reverse may not always work at the speed shown onscreen.
- For discs other than audio CDs, no sound is output during fast forward or fast reverse.
- For DVD-Audio discs, fast forward and fast reverse cannot be used while a menu is displayed.

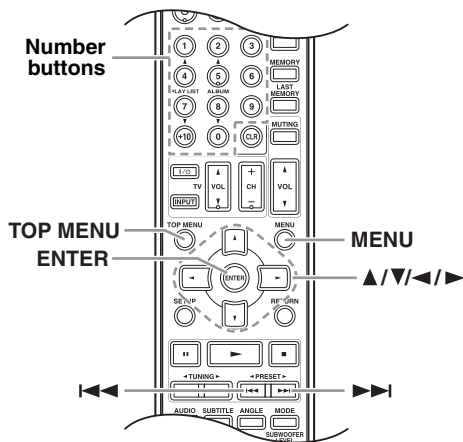

**Navigating DVD & VCD Disc Menus**

DVD-V DVD-A VCD

DVD-Video discs usually have a menu from which you can select titles, chapters, and other options, including soundtracks, subtitles, and audio formats (e.g., Dolby Digital or DTS). VCDs that support PBC (Playback Control) may also have an onscreen menu.

**1 Load a DVD or VCD.**  
 With DVDs, a menu usually appears when the Play [▶] button is pressed. If it doesn't, try pressing the [TOP MENU] button.  
 With VCDs that support PBC, you may have to press the Play [▶] button to display the menu.

**2 On a DVD menu, use the arrow [▲], [▼], [◀], [▶] buttons to select an item, and then press [ENTER].**

**On a VCD menu, use the number buttons to select the tracks.**  
 If the VCD's menu consists of several pages, use the Next [▶▶] and Previous [◀◀] buttons to view them. During playback, you can return to the menu by pressing the [RETURN] button.

- Notes:**
- Not all DVDs and VCDs have menus.
  - Menu operation varies from disc-to-disc. See the disc's sleeve notes for details.

- On some DVDs, to display the disc menu, press the [MENU] button.
- Since the multichannel input source of DVD-Audio is down mixed, the output will be a processed audio. To output an original audio, select the 2-channel source. Some DVD-Audio discs may not be down mixed; in this case select the 2-channel source.

**To set VCD's PBC on and off**  
 PBC menus can be turned on or off by pressing the [TOP MENU] button.

**Navigating CDs & Super Audio CDs**

SACD CD

This section explains how to play audio CDs and Super Audio CDs with the "Disc Navigator".

**1 Load an audio CD or Super Audio CD.**  
 The "Disc Navigator" appears.

The tracks are displayed.

**2 Use the Up and Down [▲]/[▼] buttons to select a track, and press [ENTER] to start playback.**  
 With SACDs, you can select the multi-channel area, 2-channel area, or CD layer by pressing the [AUDIO] button. Since the multichannel area is down mixed, the output will be a processed audio.  
 To output an original audio, select the 2-channel area.

**Note:**  
 During random playback or memory playback, the arrow buttons cannot be used.

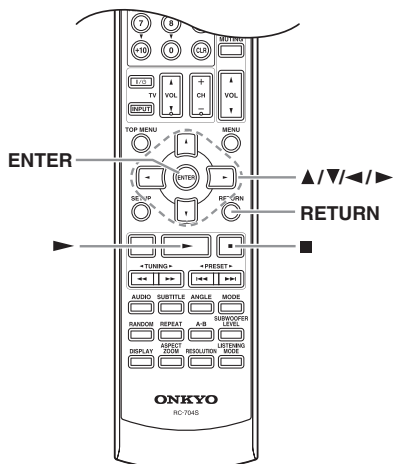

## Navigating MP3, WMA & DivX Discs

MP3 WMA DivX

This section explains how to play MP3, WMA, and DivX files with the “Disc Navigator”.

**1**

**Load an MP3, WMA, or DivX disc.**  
The “Disc Navigator” appears.

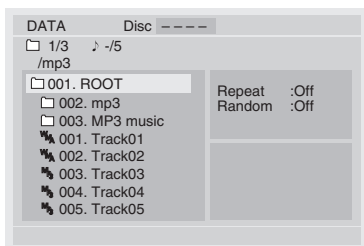

Initially, the folders in the root directory are displayed.

The DVD receiver numbers folders and tracks in hierarchical order. You can use these numbers to select folders and tracks directly with the Search function (see page 44).

**2**

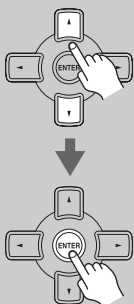

**To open a folder, use the Up and Down [▲]/[▼] buttons to select it, and then press [ENTER].**

The contents of the folder are displayed.

**3**

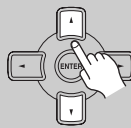

**Use the Up and Down [▲]/[▼] buttons to select tracks and sub-folders in the open folder.**

To open a folder in the list, press the [ENTER] button. To close a folder (i.e., move back up the directory tree), press the [RETURN] button. Alternatively, select the item at the top of the list and press the [ENTER] button.

Use the Left and Right [◀]/[▶] buttons to display the other folders that contain playable tracks.

**4**



**To play the selected track, press the Play [▶] or [ENTER] button.**

If available, the ID3 tag information, (Title name, Artist name, Album name, and so on) will scroll across the bottom of the screen.

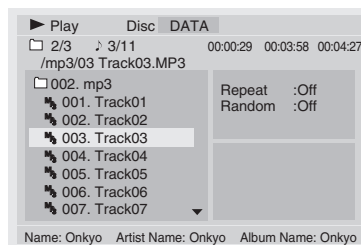

For MP3 playback

Subsequent tracks in the same folder are played in order.

**5**



**Press the Stop [■] button to stop playback.**

**Note:**

During random playback or memory playback, the arrow buttons cannot be used.

**Viewing a Slideshow of JPEG Images**



This section explains how to display a slideshow of JPEG images on your TV.

**1** **Load a JPEG disc.**  
The “Disc Navigator” appears.

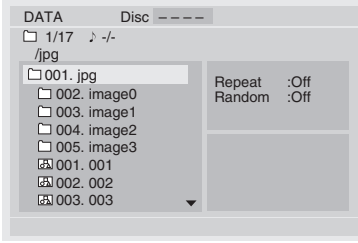

Initially, the folders in the root directory are displayed. The DVD receiver numbers folders and files in hierarchical order. You can use these numbers to select folders and files directly with the Search function (see page 44).

**2** **To open a folder, use the Up and Down [▲]/[▼] buttons to select it, and then press [ENTER].**  
The contents of the folder are displayed.

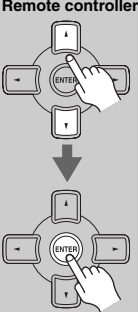

**3** **Use the Up and Down [▲]/[▼] buttons to select images and subfolders in the open folder.**  
A thumbnail-size preview for the currently selected image is displayed.

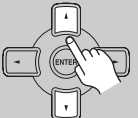
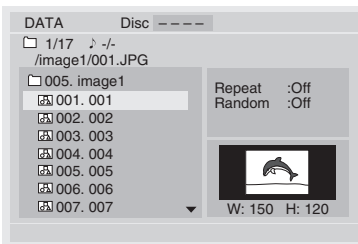

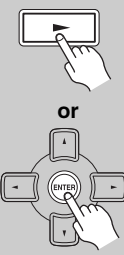

To open a folder in the list, press the [ENTER] button. To close a folder (i.e., move back up the directory tree), press the [RETURN] button. Alternatively, select the item at the top of the list and press the [ENTER] button. Use the Left and Right [◀]/[▶] buttons to display other folders that contain JPEG images.

**4** **To play a slideshow, press the Play [▶] or [ENTER] button.**  
Subsequent images are displayed in order, with each image being displayed for five seconds.  
To display an image for longer, press the Pause [⏸] button. Press the Play [▶] button to resume.  
Use the Previous and Next [◀◀]/[▶▶] buttons to view the previous or next image.  
To flip a picture 180 degrees, use the Up and Down [▲]/[▼] buttons (not while zoomed in).  
To rotate a picture counterclockwise or clockwise, use the Left and Right [◀]/[▶] buttons (not while zoomed in).  
To zoom in or out, use the [▶▶] and [◀◀] buttons. While zoomed in, use the [◀]/[▶]/[▲]/[▼] buttons to move around the picture.



**5** **To stop the slideshow, press the Stop [■] or [MENU] button.**  
The slideshow stops automatically when all pictures have been displayed.



■ **To display thumbnails**  
To display thumbnails, in step 3, after opening the folder you want to display, press the [TOP MENU] button. Use the arrow [◀], [▶], [▲], [▼] buttons to select the thumbnails, and press [ENTER] to start a slideshow. Press the [MENU] button to return to the “Disc Navigator”.  
Use the Previous and Next [◀◀]/[▶▶] buttons to display other pages.

■ **About HD JPEG**  
If your TV is connected via HDMI and the HDMI resolution is set to 720p or 1080i, you can view your JPEG images in high definition (see page 61).

# Listening to the Radio

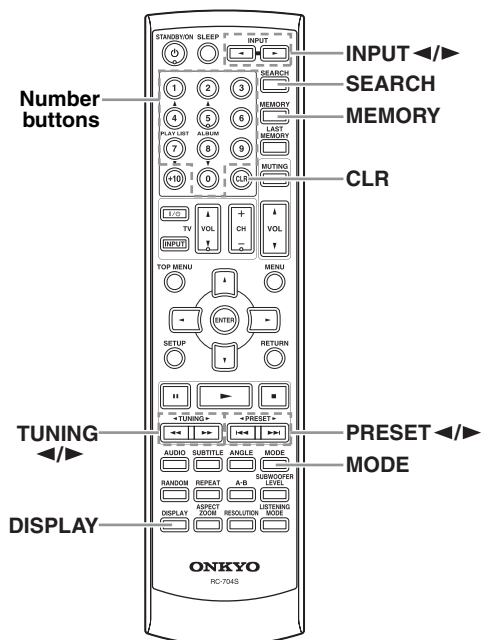

## Using the Tuner

With the built-in tuner you can enjoy AM and FM radio stations. You can store your favorite stations as presets for quick selection.

## Listening to the Radio

**Use the INPUT [◀/▶] button to select either AM or FM.**  
 In this example, FM has been selected.

Band Frequency  
 (Actual display depends on country)

## Tuning into Radio Stations

### ■ Auto Tuning Mode

- 1** Press the [MODE] button so that the **AUTO** indicator appears on the display.
- 2** Press the **TUNING** [◀/▶] button. Searching stops when a station is found. To stop searching, press Stop [■] button.

When tuned into a station, the ▶◀ indicator appears. When tuned into a stereo FM station, the FM ST indicator appears on the display, as shown.

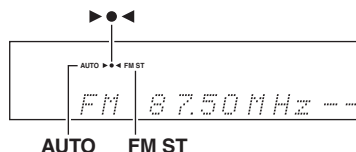

### Note:

This procedure can also be performed on the DVD receiver by using its TUNING/PRESET [◀/▶] button. Press the TUNING/PRESET [◀/▶] button to start searching for a few seconds. Pressing the TUNING/PRESET [◀/▶] button again stops the searching. After this, press the button repeatedly to change the frequency one step at a time.

### ■ Manual Tuning Mode

- 1** Press the [MODE] button so that the **AUTO** indicator disappears from the display.
- 2** Press and hold the **TUNING** [◀/▶] button. The frequency stops changing when you release the button. Press the buttons repeatedly to change the frequency one step at a time.

Radio Frequency can be changed in 0.05 MHz steps for FM and 9 kHz steps for AM. You can change the interval of the steps for AM frequency (not European models) (see page 55).

In Manual Tuning mode, FM stations will be in mono.

### Tuning into weak FM stereo stations

If the signal from a stereo FM station is weak, it may be impossible to get good reception. In this case, switch to Manual Tuning mode and listen to the station in mono.

## Listening to the Radio—Continued





### ■ Tuning into Stations by Frequency

You can tune into AM and FM stations directly by entering the appropriate frequency.

<b>1</b> 	<b>Press the [SEARCH] button.</b>
<b>2</b>	<b>Within 8 seconds, use the number buttons to enter the frequency of the radio station.</b> For example, to tune to 87.50 (FM), press 8, 7, 5, 0.

### Presetting AM/FM Stations

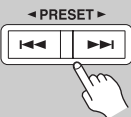
You can store a combination of up to 40 of your favorite AM/FM radio stations as presets.

<b>1</b>	<b>Tune into the AM/FM station that you want to store as a preset.</b>
<b>2</b> 	<b>Press the [MEMORY] button.</b> The preset number flashes. 
<b>3</b> 	<b>While the preset number is flashing (about 8 seconds), use the PRESET [◀]/[▶] buttons to select a preset from 1 through 40.</b>
<b>4</b> 	<b>Press the [MEMORY] button again to store the station or channel.</b> The station or channel is stored and the preset number stops flashing. Repeat this procedure for all of your favorite AM/FM radio stations.

#### Note:

This procedure can also be performed on the DVD receiver by using its [PRESET/MEMORY] button and TUNING/PRESET [◀]/[▶] button. First press the [PRESET/MEMORY] button, use TUNING/PRESET [◀]/[▶] button to select a preset and then press the [PRESET/MEMORY] button again.

### Selecting Presets

	<b>To select a preset, use the PRESET [◀]/[▶] buttons.</b>
---	--

#### Notes:

- This procedure can also be performed by using the number buttons.  
To enter, for example, “12”, press the [1] button followed by the [2] button.
- This procedure can also be performed on the DVD receiver by using its TUNING/PRESET [◀]/[▶] button.

### Deleting Presets

<b>1</b>	<b>Select the preset that you want to delete.</b> See the previous section.
<b>2</b> 	<b>Press the [CLR] button twice.</b> The preset is deleted and its number disappears from the display.



### Using RDS (European models only)

RDS only works with European models and only in areas where RDS broadcasts are available.

When tuned into an RDS station, the RDS indicator appears.

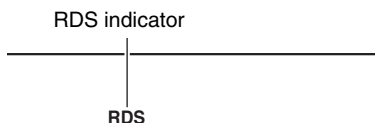

#### ■ What is RDS?

RDS stands for *Radio Data System* and is a method of transmitting data in FM radio signals. It was developed by the European Broadcasting Union (EBU) and is available in most European countries. Many FM stations use it these days. In addition to displaying text information, RDS can also help you find radio stations by type (e.g., news, sport, rock, etc.).

The DVD receiver supports two types of RDS information:

#### **PS (Program Service)**

When tuned to an RDS station that's broadcasting PS information, the station's name will be displayed.

#### **RT (Radio Text)**

When tuned to an RDS station that's broadcasting text information, the text will be shown on the display.

**DISPLAY**

Press the [DISPLAY] button repeatedly to show the following information.

Frequency → PS  
(Program Service name)

↑ RT (Radio Text)

↓

The diagram shows a hand pressing a button labeled "DISPLAY". Below this, text explains that pressing the button repeatedly shows information. A flow diagram shows "Frequency" pointing to "PS (Program Service name)", which then points down to "RT (Radio Text)". An arrow also points from "RT (Radio Text)" back up to "Frequency".

#### **Notes:**

- In some cases, the text characters displayed on the DVD receiver may not be identical to those broadcast by the radio station. Also, unexpected characters may be displayed when unsupported characters are received. This is not a malfunction.
- If the signal from an RDS station is weak, RDS data may be displayed intermittently or not at all.

# Using the Listening Modes

## Selecting Listening Modes

See “About the Listening Modes” in the right column for detailed information about the listening modes.

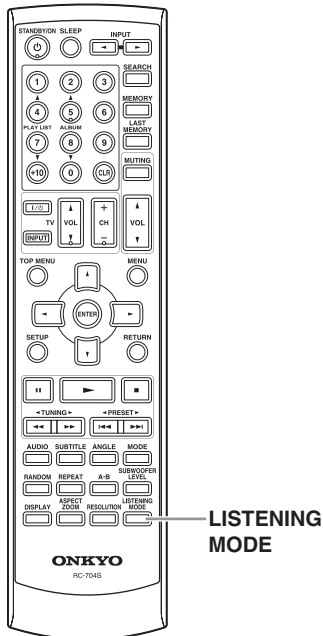

## About the Listening Modes

### Pure Audio

In this mode, the display and video circuitry are turned off, minimizing possible noise sources for the ultimate in high-fidelity reproduction.

### Direct

In this mode, audio from the input source is output directly with minimal processing, providing high-fidelity reproduction.

### Stereo

The selected input source is processed as a stereo signal and output by the front left and right speakers and the subwoofer if connected.

### T-D (Theater-Dimensional)

With this mode you can enjoy a virtual 5.1 surround sound even with only two speakers. This works by controlling how sounds reach the listener's left and right ears. Good results may not be possible if there's too much reverb, so we recommend that you use this mode in an environment with little or no natural reverb.

### Notes:

- T-D listening mode cannot be selected while headphones are connected to the DVD receiver.
- During playback a DVD-Audio or SACD, T-D listening mode cannot be selected.
- In the case of SCART connection, the output volume from the TV will be lower than other listening modes.

### LISTENING MODE



**Press the [LISTENING MODE] button to select a listening mode.**

Pressing this button repeatedly cycles through all of the listening modes that can be used with the current input source.

## Selecting Pure Audio Listening Mode on the DVD receiver

Pure Audio listening mode can also be selected on the DVD receiver's [PURE AUDIO] button.

### DVD receiver

### PURE AUDIO



**Press the [PURE AUDIO] button.**

Video output and display are turned off and PURE AUDIO indicator lights up.

Pressing this button again will select the previous listening mode.

## Using the Listening Modes—Continued

### T-D (Theater-Dimensional) Listening Angle Setting

With this setting, you can specify the angle of the front left and right speakers relative to the listening position. Processing for the Theater-Dimensional listening mode is based on this setting. Ideally, the front left and right speakers should be equidistant from the listening position and at an angle close to one of the three available settings.

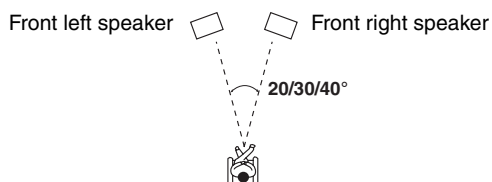

**1**

Remote controller

SETUP



HOLD

Press and hold the [SETUP] button for 3 seconds.

When selecting the input other than DVD, just press the [SETUP] button. “Balance” appears on the display.

**2**

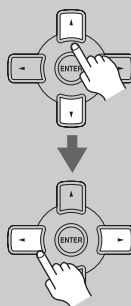

Use the Up and Down [▲]/[▼] buttons to select “Angle”, and use the Left and Right [◀]/[▶] buttons to select: “Narrow”, “Middle”, or “Wide”.

**Narrow:** Select if the listening angle is 20 degrees.

**Middle:** Select if the listening angle is 30 degrees (default).

**Wide:** Select if the listening angle is 40 degrees.

**3**

SETUP



When you’ve finished, press the [SETUP] button again.

The setup menu closes.

**Note:**

Only when the T-D listening mode is selected, this setting is available.

### Listening Mode and Receiver Settings

Depending on the listening mode, the setup menu settings may be enabled/disabled as shown below.

✓: available

Settings	Page #	Listening Mode			
		Pure Audio	Direct	Stereo	T-D
Speaker Output Balance	56	—	—	✓	✓
Subwoofer Level	32	—	—	✓	✓
Correcting Sound and Picture Sync	56	—	—	✓	✓
Crossover Frequency	57	—	—	✓*1	✓
Enabling/Disabling the Subwoofer	56	—	—	✓	✓
Front Speakers Size	56	—	—	✓*2	✓

\*1 During playback a DVD-Audio or SACD, this setting is fixed at 100 Hz.

\*2 During playback a DVD-Audio or SACD, this setting is fixed at Small.

# Advanced Playback

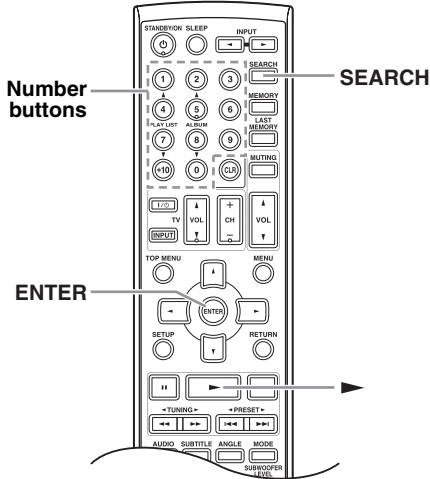

## Selecting Chapters/Titles/Tracks/Folders by Number

DVD-A DVD-V SACD VCD CD MP3 WMA DivX

With the “Search” function you can select chapters, titles, and tracks by number. To use the function with DVD, DVD playback is required.

**1**



**Press the [SEARCH] button.**

The “Search” window appears onscreen.

This is what appears for DVDs.

Search		
Disc	Title	Chapter
DVD-VIDEO	Current/Total 1/ 19	Current/Total -- / 78

This is what appears for CDs.

Search	
Disc	Track
CDDA	Current/Total 1/ 10

**2**



**Use the number buttons to specify a title, chapter, or track number.**

To enter, for example, “12”, press the [1] button followed by the [2] button.

Search		
Disc	Title	Chapter
DVD-VIDEO	Current/Total 12/ 19	Current/Total 5 / 7

Entered title number appears here

Entered chapter number appears here

If you’re playing a DVD, MP3, WMA, or DivX disc, use the Left and Right [◀/▶] buttons to select the Title/Group/Folder and Chapter/Track fields. To clear a number, press the [CLR] button.

**3**



or



**Press the Play [▶] or [ENTER] button to start playback of the specified title, chapter, or track.**

### Notes:

- During playback, you can select other chapters or tracks directly by using the number buttons (i.e., without pressing the [SEARCH] button). For example, to select chapter #2, simply press [2]. To select chapter #10, press [+10] and [0].
- DVD-Video discs usually have menus for selecting titles and chapters.
- When Video CD PBC is on, you can’t search for tracks. Turn PBC off first.
- The [SEARCH] button cannot be used during random playback or memory playback.
- Search may not work with some discs.

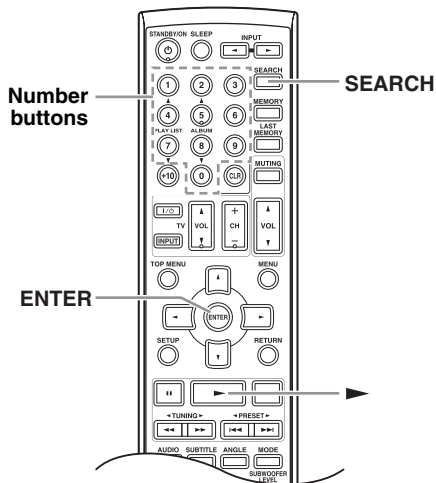

### Notes:

- In some cases, playback may start from a slightly different point to the one that you specify.
- Time search may not work with some discs.
- Time search cannot be used while a DVD-Video or Video CD menu is displayed onscreen.
- The [SEARCH] button cannot be used during random playback or memory playback.

## Searching by Time

DVD-A DVD-V SACD VCD CD

With the “Search” function you can search by time.

<p><b>1</b></p>	<p><b>During playback, press the [SEARCH] button twice.</b></p> <p>The “Search” window appears onscreen.</p>
<p><b>2</b></p>	<p><b>Use the number buttons to enter a time.</b></p> <p>Time search only works within the current title or track.</p> <p>To enter, for example, 5 minutes, 30 seconds, press [5] [3] [0] buttons.</p> <p>To clear a number, press the [CLR] button.</p>
<p><b>3</b></p> <p>or</p>	<p><b>Press the Play [▶] or [ENTER] button to start playback of the specified time.</b></p>

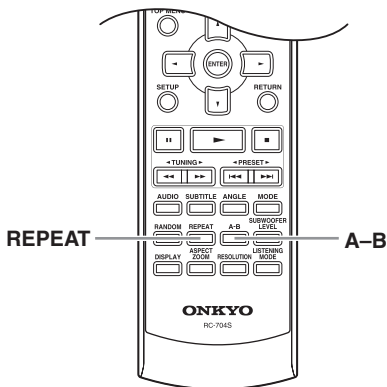

## Repeat Playback

DVD-A DVD-V SACD VCD CD MP3 WMA JPEG

With the “Repeat” function you can play a disc, title, chapter, group, track, or folder over-and-over again.

**1**



**During playback, press the [REPEAT] button repeatedly to select a repeat option.**

The selected repeat option appears onscreen.

The available options depend on the type of disc, as follows:

**DVD-Video:** Chapter Repeat, Title Repeat, Disc Repeat, Repeat Off.

**DVD-Audio:** Track Repeat, Group Repeat, Repeat Off.

**SACD, VCD, CD:** Track Repeat, Disc Repeat, Repeat Off.

**MP3, JPEG, WMA:** Track Repeat, Folder Repeat, Disc Repeat, Repeat Off.

**2**



**To cancel repeat playback, use the [REPEAT] button to select “Repeat Off”.**

### Notes:

- Repeat playback may not work with some discs.
- If the “Memory Playback” function is on (see page 48), the selectable options are “Memory Repeat”, which plays the playlist repeatedly, and “Repeat Off”.
- To use the Repeat function with a VCD that supports PBC, you must first turn off PBC (see page 36).

## A-B Repeat Playback

DVD-V SACD VCD CD MP3

With the “Repeat A-B” function you can play a specified section over-and-over again.

**1**



**During playback, press the [A-B] button to set the A point (i.e., the start of the section you want to repeat).**

“Repeat A-” appears onscreen and “-R\_A” appears on the display.

**2**



**Press the [A-B] button again to set the B point (i.e., the end of the section you want to repeat).**

Playback repeats between the A and B points, and “Repeat A-B” appears onscreen and “-R\_AB” appears on the display.

**3**



**To cancel A-B repeat playback, press the [A-B] button.**

### Notes:

- The “Repeat A-B” function may not work with some DVD-Video discs and VCDs that support PBC.
- In some cases, the A and B points may be at slightly different points to the ones that you specify.

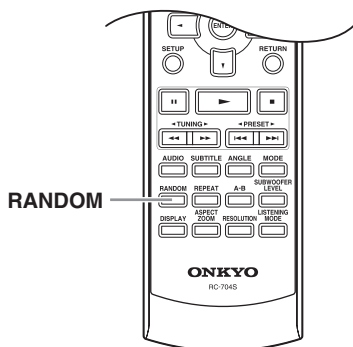

- To use the “Random” function with a VCD that supports PBC, you must first turn off PBC (see page 36).
- If the “Memory Playback” function is on (page 48), random playback is unavailable.
- You can’t use the [SEARCH] button during random playback.
- During random playback, the remote controller’s arrow [▲], [▼], [◀], [▶] buttons and number buttons don’t work with the “Disc Navigator”.
- The “Random” function cannot be used with JPEG files.

### Random Playback

DVD-V DVD-A SACD VCD CD MP3 WMA

With the “Random” function you can enjoy a random selection of titles, chapters, groups, tracks, or folders.

1

RANDOM



**During playback, press the [RANDOM] button repeatedly to select a random option.**

The selected random option appears onscreen.

The options available depend on the type of disc, as follows:

**DVD-Video:** Title Random, Disc Random, Random Off.

**DVD-Audio:** Group Random, Random Off.

**SACD, VCD, CD:** Disc Random, Random Off.

**MP3, WMA:** Folder Random, Disc Random, Random Off.

With the “Title Random” option, chapters within the current title are played at random. With the “Disc Random” option, titles, chapters, groups, tracks, or folders on the disc are played at random.

Random playback begins after the current chapter or track has finished.

Random playback stops automatically when all of the items have been played once.

2

RANDOM



**To cancel random playback, use the [RANDOM] button to select “Random Off”.**

#### Notes:

- Random playback may not work with some discs.

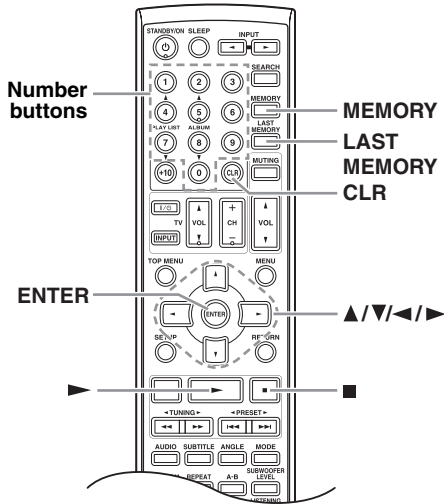

## Memory Playback

DVD-V DVD-A SACD VCD CD MP3 WMA

With the “Memory Playback” function you can create your own memory list of titles, chapters, and tracks.

**1** Press the [MEMORY] button. The “Memory List” window appears onscreen, as shown.



Memory List		
No.	Title/Folder	Chapter/Track
▶ Current/Total 001 / 019 Current/Total --- / 078		
01	--- / 019	--- / 078
02	--- / 019	--- / 078
03	--- / 019	--- / 078
04	--- / 019	--- / 078
05	--- / 019	--- / 078
06	--- / 019	--- / 078
07	--- / 019	--- / 078
08	--- / 019	--- / 078

The top row (▶) is used to enter title/folder and chapter/track numbers. The steps in the memory list are numbered.

**2** Enter the title/folder (group), and chapter/track numbers of the item you want to add to the memory list, and then press [ENTER]. Use the remote controller’s Left/Right [◀]/[▶] buttons to select the parameters, and use the number buttons to enter the number. The new item is added to the memory list as step 01.

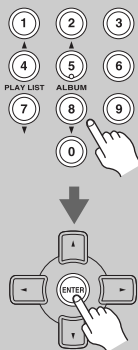

**3** Repeat step 2 to add more items to the memory list. You can add up to 32 items to the memory list.

**4** To play the memory list, press the Play [▶] button. The “Memory List” window must be open when you press the Play [▶] button.



**5** To stop playback, press the Stop [■] button. While playback is stopped, you can delete the memory list by pressing the [CLR] button. While playback is stopped, you can cancel the Memory Playback function by pressing the Stop [■] button again.



## Adding New Items to the List

**1** Use the Up/Down [▲]/[▼] buttons to select the step which you want to insert the new item, and then press the [ENTER] button.

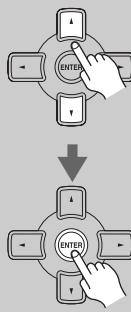

Memory List		
No.	Title/Folder	Chapter/Track
▶ Current/Total 001 / 019 Current/Total --- / 078		
01	005 / 019	001 / 078
02	002 / 019	012 / 078
03	--- / 019	--- / 078
04	003 / 019	004 / 078
05	010 / 019	003 / 078
06	--- / 019	--- / 078
07	--- / 019	--- / 078
08	--- / 019	--- / 078

**2** Enter the title/folder (group), and chapter/track numbers of the item to be inserted. Use the remote controller’s Left/Right [◀]/[▶] buttons to select the parameters, and use the number buttons to enter the number.



**3** Press the [ENTER] button. The new item is inserted into the memory list and subsequent items move down the list.





## Deleting Items from the List

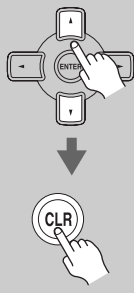

**Use the Up/Down [▲]/[▼] buttons to select it, and then press the [CLR] button.**  
The item is deleted and subsequent items move up the list.

## Editing Steps

**1** Use the Up/Down [▲]/[▼] buttons to select the step.

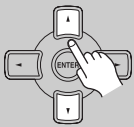

**2** Use the Left/Right [◀]/[▶] buttons and number buttons to edit the title/folder (group) or chapter/track numbers, and then press [ENTER].



### Notes:

- To close the “Memory List” window, press the [RETURN] button.
- The memory list will be deleted when the DVD receiver is set to Standby or the disc tray is opened.
- To use this function with a VCD that supports PBC, you must first turn off PBC.
- The Memory Playback function cannot be used with some discs.
- JPEG images can be added to the memory list, however, they will not be displayed.

## Last Memory



With the “Last Memory” function you can resume playback from where you left off even if the disc has been removed and the DVD receiver has been set to Standby. “Last Memory” also remembers the soundtrack and subtitle settings you were using.

**1** During DVD playback, press the [LAST MEMORY] button.



The last memory point for the disc is stored, “Last Mem” appears on the display. If the [LAST MEMORY] button is pressed again, the last memory point is updated.

**2** To stop playback, press the Stop [■] button. Now you may remove the disc and turn off the DVD receiver.



**3** To resume playback, load the disc, and then press the Play [▶] button.



The “Last Memory” dialog box appears.

Last Memory is set.  
Start playback from memory location?

Yes    No    Memory Clear

**4** To resume playback from the last memory point, select “Yes”, and then press [ENTER].



To start playback from the present point, select “No”, and then press [ENTER]. To delete the last memory point, select “Memory Clear”, and then press [ENTER].

### Notes:

- The “Last Memory” function can store the last point for up to six DVDs. When you set the “Last Memory” function for a seventh disc, the first disc’s settings are deleted.
- The “Last Memory” function will not work while a menu is being displayed onscreen.
- The “Last Memory” function may not work with some DVDs.

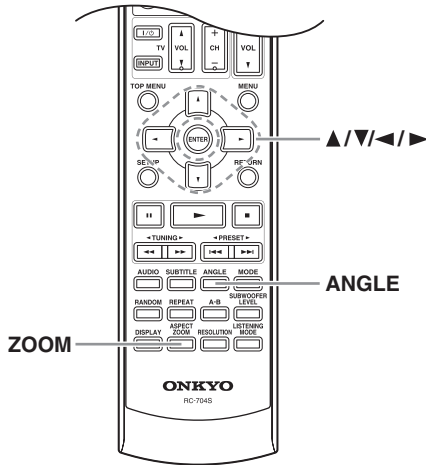

## Selecting Camera Angles



Some DVDs feature multiple camera angles that allow you to view scenes from different angles. When a DVD features multiple camera angles, the camera  $\alpha_1$  indicator appears on the display. Such discs usually have the camera angle logo ( $\alpha_1$ ) printed on the sleeve.



**Press the [ANGLE] button repeatedly to cycle through the available camera angles.**

The number of the currently selected camera angle appears onscreen. For example, on a disc with three camera angles, you'd see 1/3, 2/3, and 3/3.

## Zooming



With the Zoom function you can enlarge any part of the picture.

<p><b>1</b></p> <p>ASPECT ZOOM</p> <p>HOLD</p>	<p><b>During playback or while playback is paused, press and hold the [ZOOM] button for 3 seconds.</b> “Zoom x1.0” appears onscreen.</p>
<p><b>2</b></p> <p>ASPECT ZOOM</p>	<p><b>Press the [ZOOM] again repeatedly to Zoom in.</b></p> <p>The number of zoom steps available depends on the resolution of the disc or file.</p> <p>After the maximum zoom, the picture returns to its normal size.</p>
<p><b>3</b></p> <p>ENTER</p>	<p><b>To see other areas of the picture while zoomed, use the remote controller's arrow [▲], [▼], [◀], [▶] buttons.</b></p>

### Notes:

- The Zoom function may not work with some discs.
- The Zoom function cannot be used with HD JPEG.
- The Zoom function cannot be used with disc menus.

### Notes:

- With some DVDs you may not be able to select different camera angles even though the camera  $\alpha_1$  indicator is displayed.
- With some DVDs you can select camera angles from a menu.

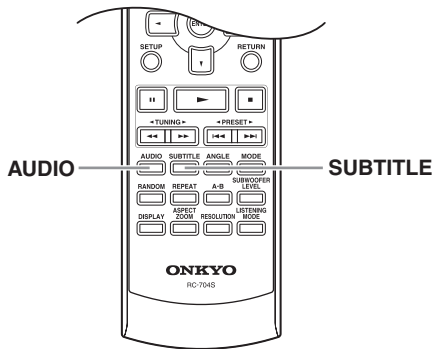

### Selecting Soundtracks

DVD-V DVD-A SACD

Some DVD-Video discs feature soundtracks in several languages or audio formats (e.g., Dolby Digital or DTS). Music DVD-Video discs and DVD-Audio discs sometimes feature audio in several formats, such as PCM, Dolby Digital, or DTS. See the disc's sleeve notes for details.

AUDIO



**During playback, press the [AUDIO] button repeatedly to cycle through the available soundtracks.**

The name of the selected soundtrack appears onscreen for several seconds. For SACDs, you can select the multichannel area, 2-channel area, or CD layer. If you make a selection during playback, playback will stop.

#### Notes:

- With DVD-Video discs, when you stop playback and cancel the “Resume” function (see page 34), the soundtrack language will revert to your default language (see page 63), or the disc's default language.
- With some discs, selecting another soundtrack may cause the picture to skip momentarily.
- With some DVDs you need to select soundtracks from a menu, and you may not be able to select other soundtracks during playback.
- Since the multichannel input source of SACD and DVD-Audio is down mixed, the output will be a processed audio. To output an original audio, select the 2-channel source. Some DVD-Audio discs may not be down mixed; in this case select the 2-channel source.

### Selecting Subtitles

DVD-V

Some DVD-Video discs feature subtitles in several languages. See the disc's sleeve notes for details.

SUBTITLE



**During playback, press the [SUBTITLE] button repeatedly to cycle through the available subtitles.**

The name of the selected subtitle appears onscreen for several seconds. To turn off subtitles, use the [SUBTITLE] button to select “Off”.

#### Notes:

- When you stop playback and cancel the “Resume” function (see page 34), the subtitle language will revert to your default subtitle language (see page 63), or the disc's default subtitle language.
- With some DVDs you can select subtitles from a menu, and you may not be able to select subtitles during playback.

# Disc and Input Information

---

## Displaying Information

You can display various information about the current disc, or input source as follows.

Remote controller



**Press the [DISPLAY] button repeatedly to cycle through the available information.**

During playback of a disc, various information appears onscreen.

The operating status (e.g., Stop, Play, Resume) and disc type information is displayed along the top of the screen.

## Disc Information

---

The information displayed depends on the type of disc, as follows:

### ■ DVD-Video

#### Onscreen:

- Current/total title number, elapsed title time, remaining title time, total title time, selected soundtrack, selected subtitle, and the number of available camera angles.
- Current/total chapter number, elapsed chapter time, remaining chapter time, and total chapter time.

#### Display:

- Elapsed chapter time
- Remaining title time

### ■ DVD-Audio

#### Onscreen:

- Current/total track number, elapsed track time, remaining track time, total track time, and selected soundtrack.
- Current/total group number, elapsed group time, remaining group time, and total group time.

#### Display:

- Elapsed track time
- Remaining track time
- Elapsed disc time

### ■ Video CD

#### Onscreen:

- Current/total track number, elapsed track time, remaining track time, and total track time.
- Current/total track number, elapsed track time, remaining disc time, and total disc time.

#### Display:

- Elapsed track time
- Remaining track time
- Elapsed disc time
- Remaining disc time

#### Note:

If PBC is on, no information is displayed when the [DISPLAY] button is pressed.

### ■ Audio CD, Super Audio CD

#### Onscreen:

- Current/total track number, elapsed track time, remaining track time, and total track time.
- Current/total track number, elapsed disc time, remaining disc time, and total disc time.

#### Display:

- Elapsed track time
- Remaining track time
- Elapsed disc time
- Remaining disc time

### ■ MP3, WMA

#### Onscreen:

- Current/total folder number, current/total track number in the folder, elapsed track time, remaining track time (MP3 only), and total track time (MP3 only).

#### Display:

- Elapsed track time
- File name
- Folder name
- Total number of folders

### ■ JPEG

#### Display:

- Folder number, track number
- File name
- Folder name
- Total number of folders

### ■ DivX

#### Onscreen:

- Current/total track number, elapsed track time, remaining track time, total track time, selected soundtrack, and selected subtitle.

#### Display:

- Elapsed track time
- File name
- Folder name
- Total number of folders

## Input Information

---

The information displayed depends on the type of input source, as follows:

#### Display:

- Input source
- Signal format\*
- Listening mode

\* If the input signal is analog, no format information is displayed.

# Controlling Other Components

## Controlling a TV connected to the DVD receiver

You can control a TV. You must enter the appropriate remote control code first.

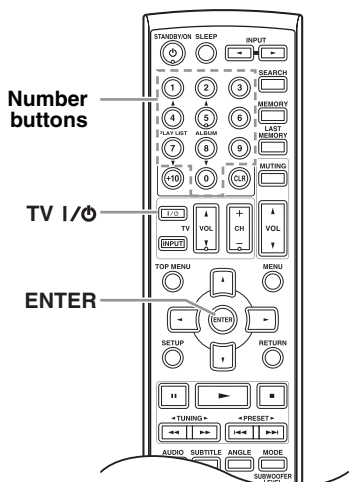

## 4

**Point the remote controller at the TV, and check the operation.**

If the remote controller doesn't work as expected, and several remote codes are listed, try each one in turn and use the one that works best.

### Note:

The remote control codes provided are correct at the time of printing, but are subject to change.

## Controlling a TV

To control a TV, point the remote controller at it and use the buttons explained below. With some TVs, certain buttons may not work as expected, and some may not work at all.

## Entering Remote Control Codes

**1** Look up the appropriate remote control code in the "Remote Control Codes list" at the end of this manual.

**2** Hold down the TV [I/O] and [ENTER] buttons for about 3 seconds.



**3** Within 30 seconds, use the number buttons to enter the 4-digit remote control code.

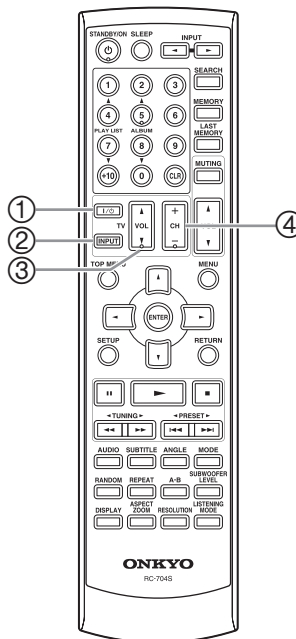

- ① **TV [I/O]**  
Sets the TV to Standby or On.
- ② **TV [INPUT]**  
Selects the TV's AV input.
- ③ **TV VOL [▲]/[▼]**  
Adjusts the TV's volume.
- ④ **TV [CH +/-]**  
Selects channels on the TV.

## Controlling an Apple iPod in RI Dock connected to the DVD receiver

When operating an Apple iPod in RI Dock with an **RI** connection, you can control it by DVD receiver's remote controller.

### When Using an RI Dock:

- Connect the RI Dock to the VIDEO 2/DOCK INPUT jacks (see page 26).
- Set the RI Dock's RI MODE switch to HDD or HDD/DOCK.
- See to the RI Dock's instruction manual for more information.

Press the INPUT [◀]/[▶] buttons to select "VIDEO 2/DOCK".

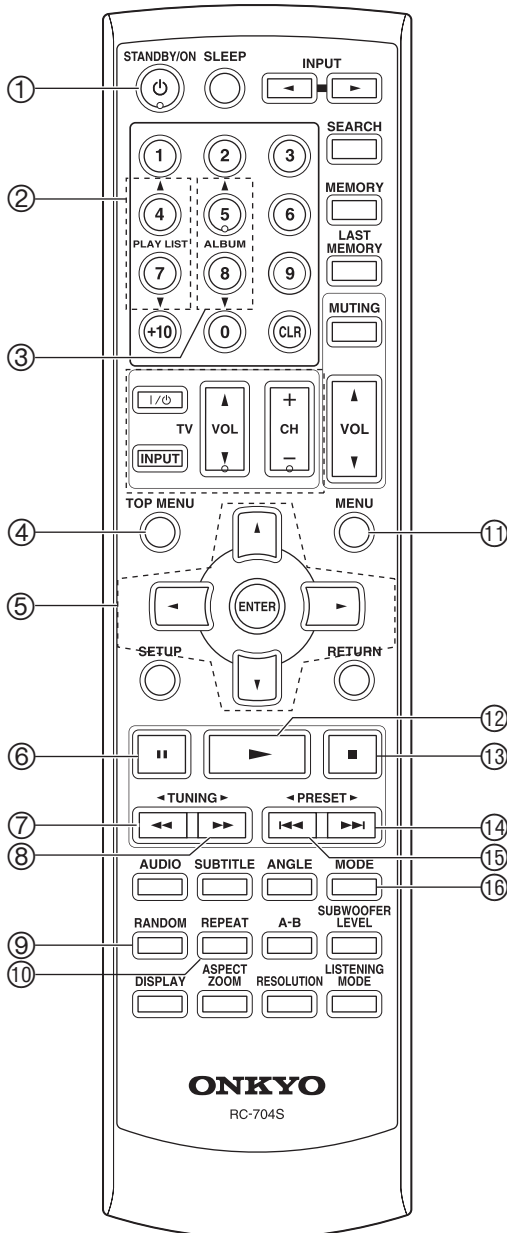

- STANDBY/ON button**  
Sets the iPod to Standby or On.
- PLAYLIST [▲]/[▼] buttons\***  
Used to select the previous or next playlist on the iPod.
- ALBUM [▲]/[▼] button\***  
Selects the next or previous album.
- TOP MENU button\***  
Used to access menus.
- Arrow [▲]/[▼] and ENTER buttons\***  
Used to navigate menus and select items.
- Pause [||] button**  
Pauses playback. (With 3rd generation iPods, it works as a Play/Pause button.)
- Rewind [◀◀] button**  
Press and hold to rewind.
- Fast Forward [▶▶] button**  
Press and hold to fast forward.
- RANDOM button\***  
Used with the shuffle function.
- REPEAT button\***  
Used with the repeat function.
- MENU button**  
Works as a Mode button when used with a DS-A2/A2X RI Dock.
- PLAY [▶] button**  
Starts playback. If the component is off, it will turn on automatically. (With 3rd generation iPods, this button works as a Play/Pause button.)
- Stop [■] button**  
Stops playback and displays a menu.
- Next [▶▶] button**  
Selects the next song.
- Previous [◀◀] button**  
Restarts the current song. Press it twice to select the previous song.
- MODE button\***  
Turns on the backlight for 30 seconds.

\* Buttons marked with an asterisk (\*) are not supported by 3rd generation iPods.

### Notes:

- **Auto Power On Function**  
If you start iPod playback while the DVD receiver is on Standby, the DVD receiver will automatically turn on and select VIDEO2/DOCK input. Then, your iPod will start playback.
- **Direct Change Function**  
If you start iPod playback while listening to another input source, the DVD receiver will automatically select VIDEO2/DOCK input.
- When you don't listen to the iPod, stop playback. The direct change function activates at the change of tracks to automatically change the input to VIDEO2/DOCK.

# Configuring the DVD receiver

## Setup Menu

Here you can configure the DVD receiver in this menu on display.

The configurations are common for the all input settings excluding “AVSync”, “Video1 Input”, “Video2 Input”, and “AMFreq”.

**1**  
Remote controller  
SETUP  
  
HOLD

**Press and hold the [SETUP] button for 3 seconds.**  
When selecting the input other than DVD, just press the [SETUP] button. “Balance” appears on the display.

**2**

**Use the Up and Down [▲]/[▼] buttons to select the menus and use the Left and Right [◀]/[▶] buttons to select settings.**



**3**

**When you've finished, press the [SETUP] button again.**  
The setup menu closes.  
Press the [RETURN] button to return previous display.



For detailed information, refer to the pages in brackets.

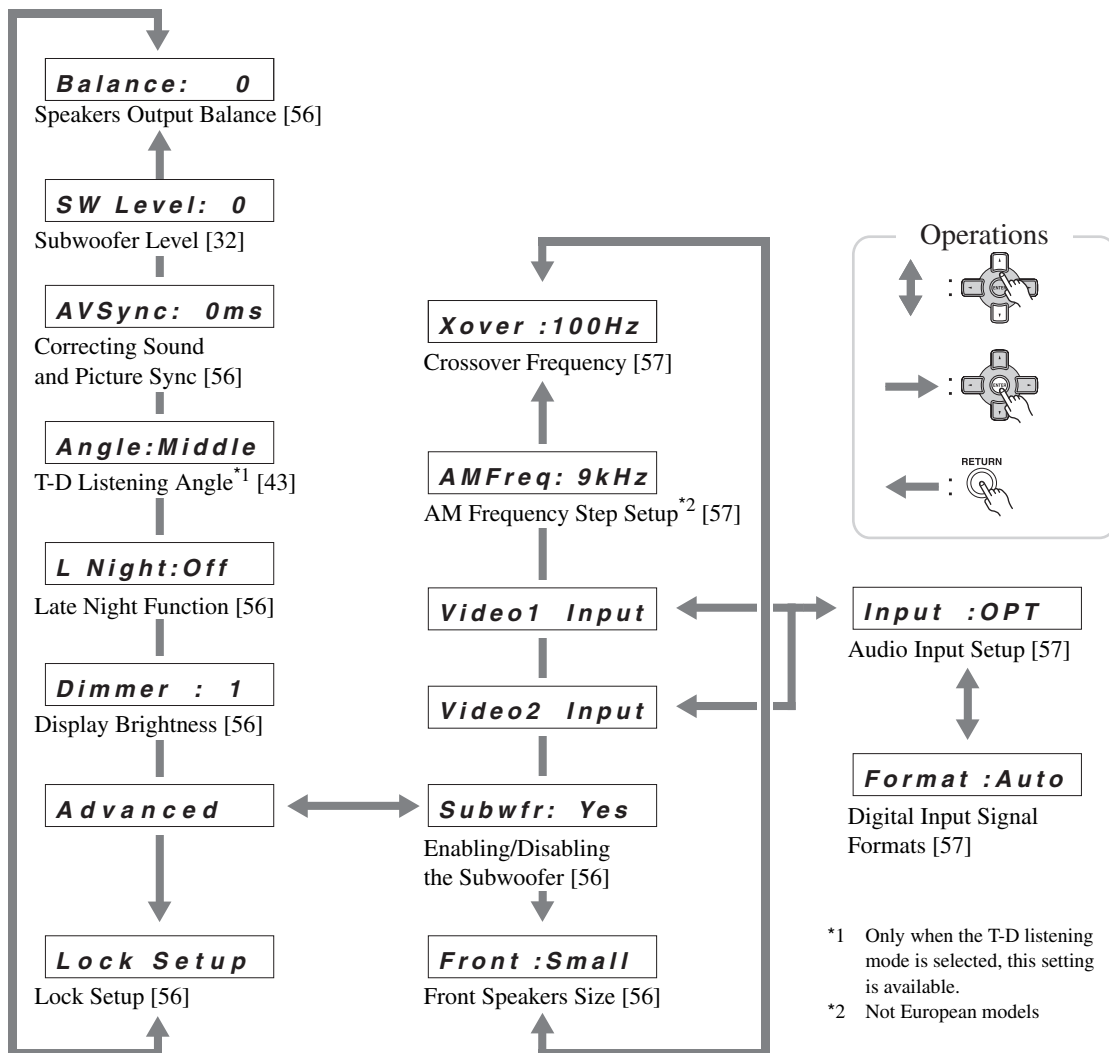

### Speakers Output Balance

---

Here you can adjust the output balance of speakers. The balance can be adjusted from “L + 12” to “R + 12” in 1 steps.

#### Note:

When the listening mode is set to “Direct” or “Pure Audio”, no effect will be produced.

### Correcting Sound and Picture Sync

---

When using progressive scanning on your DVD receiver, you may find that the picture and sound are out of sync. With this setting, you can correct this by delaying the audio signals.

- You can set it from 0 to 100 milliseconds (msec) in 20 millisecond steps.
- The setting is available for each input source other than FM and AM.

#### Note:

When the listening mode is set to “Direct” or “Pure Audio”, no effect will be produced.

### Late Night Function (Dolby Digital only)

---

With the Late Night function, you can reduce the dynamic range of Dolby Digital material so that you can still hear quiet parts even when listening at low volume levels—ideal for watching movies late at night when you don’t want to disturb anyone.

**Off:** Late Night function off (default).

**Low:** Small reduction in dynamic range.

**High:** Big reduction in dynamic range.

#### Notes:

- Depending on the design of the contents, there are some materials that will show no effect even when the Late Night mode is operating.
- The Late Night function resets to the default when the DVD receiver is set to Standby.

### Display Brightness

---

You can adjust the brightness of the display.

- 1: Normal + INPUT selector and MASTER VOLUME light on.
- 2: Normal + INPUT selector and MASTER VOLUME light off.
- 3: Dim + INPUT selector and MASTER VOLUME light off.
- 4: Dimmer + INPUT selector and MASTER VOLUME light off.

### Lock Setup

---

With this preference, you can protect your settings by locking the setup menus.

When the setup menus are locked, you cannot change any setting.

**Locked:** Setup menus locked.

**Unlocked:** Setup menus not locked.

### Enabling/Disabling the Subwoofer

---

This section explains how to specify enabling/disabling the subwoofer.

**Yes:** Select if a subwoofer is connected.

**No:** Select if no subwoofer is connected.

### Front Speakers Size

---

This section explains how to specify front speakers sizes.

For speakers with a cone diameter larger than 16 cm, specify “**Large**”.

For those with a smaller diameter, specify “**Small**”. The crossover frequency can be changed on page 57.

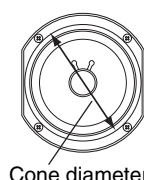

**Small:** Select if the front speakers are small.

**Large:** Select if the front speakers are large.

#### Notes:

- If the “Enabling/Disabling the Subwoofer” the above is set to “No”, this setting is fixed at “Large”.
- When the listening mode is set to “Direct” or “Pure Audio”, no effect will be produced.



### Crossover Frequency

This setting only applies to the speakers that you specified as “*Small*” in the “Front Speakers Size” on page 56. To get the best bass performance from your speaker system, you need to set the crossover frequency according to the size and frequency response of your speakers. Use the diameter of the smallest speaker in your system when choosing the crossover frequency.

Speaker cone diameter	Crossover frequency
Over 20 cm	40/50/60 Hz*
16–20 cm	80 Hz
13–16 cm	100 Hz(default)
9–13 cm	120 Hz
9 cm	150/200 Hz*

\*Choose the setting suitable for the speaker.

#### Notes:

- For a more accurate setting, look up the frequency response in the manuals supplied with your speakers and set accordingly.
- Choose a higher crossover frequency if you want more sound from your subwoofer.
- When a DVD-Audio or an SACD is played in the Stereo listening mode, no effect will be produced.
- When the listening mode is set to Direct, or Pure Audio, no effect will be produced.

### AM Frequency Step Setup (not European models)

You must specify the AM frequency step used in your area. Note that when this setting is changed, all radio presets are deleted.

**10 kHz:** Select if 10 kHz steps are used in your area.

**9 kHz:** Select if 9 kHz steps are used in your area.

### Audio Input Setup

If you connect a component to a digital input jack, you must assign that jack to an input. For example, if you connect your DVD recorder to the COAXIAL DIGITAL AUDIO IN jack, you should assign that jack to the “Video 1 input”. By default, the COAXIAL DIGITAL AUDIO IN jack is assigned to the “Video 2 input”, although this can be changed.

Here are the default assignments.

Input	Default assignment
VIDEO 1 INPUT	OPT
VIDEO 2/DOCK INPUT	Coax

**OPT:** optical digital audio input

**Coax:** coaxial digital audio input

**ANA:** analog audio input

#### Note:

The same audio input cannot be simultaneously assigned to both VIDEO 1 INPUT and VIDEO 2/DOCK INPUT.

### Digital Input Signal Formats

The digital input signal formats are available only for the input sources that you have assigned a digital input jack (see above).

Normally, the DVD receiver detects the signal format automatically. However, if you experience either of the following issues when playing PCM or DTS material, you can manually set the signal format to PCM or DTS:

- If the beginnings of tracks from a PCM source are cut off, try setting the format to PCM.
- If noise is produced when fast forwarding or reversing a DTS CD, try setting the format to DTS.

**DTS or PCM:** The DTS or PCM indicator, depending on which format you have set, flashes, and only signals in that format are output. Digital signals in other formats are ignored.



**Auto (default):** The format is detected automatically. If no digital input signal is present, the corresponding analog input is used instead.

# DVD Onscreen Setup Menus

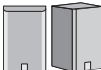

This chapter explains the various functions and settings of the onscreen setup menus.

Functions and settings are arranged into six menus: *Picture*, *Audio*, *Language*, *Display*, *Operation Setting*, and *Initial Setup*.

The following table lists all the functions and settings, with a brief description and page number where you can find full details.

Menu	Setting	Description	Page #
<b>Picture</b> 	TV Shape	Select the aspect ratio that matches your TV.	60
	View Mode	Stretch the picture to fit your TV screen.	60
	HDMI Output Setting	Turn HDMI video output on or off.	60
	Progressive Setting	Set the component video output to progressive or interlaced.	61
	HD Resolution	Select the video resolution for the HDMI OUT.	61
	HD JPEG Mode	For displaying JPEG images at a high resolution on a HDTV.	61
	Video Black Level	Choose a video black level.	61
	Brightness	Adjust the picture brightness.	61
	Sharpness	Adjust the picture sharpness.	61
	PAL Output Setting	Convert the disc's video format to NTSC or PAL.	62
	SCART Output Setting (European model only)	Selects the video format for the SCART output: RGB or composite.	62
<b>Audio</b> 	Digital/HDMI Audio Out	Settings for the digital signal output by the HDMI digital audio outputs.	62
	Linear PCM Out	Select whether or not the DVD receiver down samples digital audio.	62
<b>Language</b> 	On-Screen Language	Select a language for the onscreen setup menus and messages.	63
	Disc Menu Language	Select your preferred language for disc menus.	63
	Audio Language	Select your preferred language for soundtracks.	63
	Subtitle Language	Select your preferred language for subtitles.	63
	DivX Subtitle	Select your preferred language for DivX subtitle.	65
<b>Display</b> 	On-Screen Display	Turn on or off onscreen messages and indicators.	65
	On-Screen Display Color	Select a color for onscreen setup menus and messages.	65
	Background	Select a background color for when playback is stopped.	65
	Screen Saver	Set the Screen Saver function.	65

## DVD Onscreen Setup Menus—Continued

Menu	Setting	Description	Page #
<b>Operation Setting</b> 	Parental Lock	Set the Parental Lock function.	66
	Security Code	Change the security code for use with parental lock.	66
	DVD Priority Contents	Determines what's played on DVD-Audio discs with DVD-Video contents.	67
	SACD Priority Contents	Determines how the SACD multichannel and 2-channel area and the CD area are played.	67
	DivX Registration	Displays your DivX VOD registration code	67
<b>Initial Setup</b> 	TV Shape	This menu appears automatically the very first time you turn on your DVD receiver. (These settings are available in other menus.)	29
	HDMI Output Setting		
	On-Screen Language		

### Using the Onscreen Setup Menus

This section explains how to navigate the onscreen setup menus.

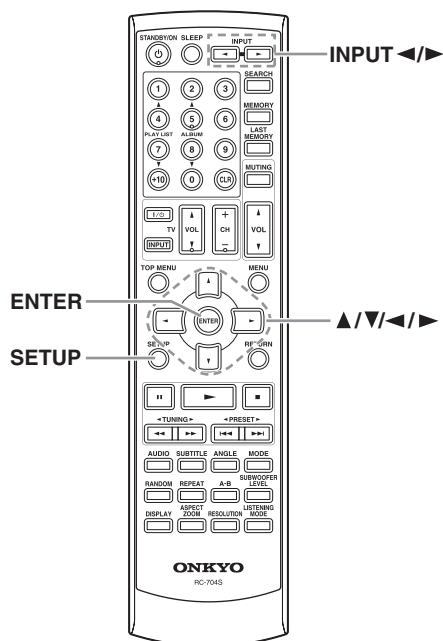

**2**



Use the arrow [**▲**]/[**▼**]/[**◀**]/[**▶**] buttons to navigate the menus, and press the [**ENTER**] button to see the available options.

**3**



Use the Up/Down [**▲**]/[**▼**] buttons to select the options, and press the [**ENTER**] button to confirm your selection.

**4**



When you've finished, press the [**SETUP**] button again. The onscreen setup menu closes.

**1**

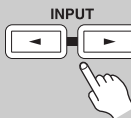

Press the **INPUT** [**◀**]/[**▶**] buttons to select "DVD", and then press the [**SETUP**] button.

The onscreen setup menu appears, as shown.

Picture

- TV Shape : 4:3 Letter box
- View Mode : Normal
- HDMI Output Setting : On
- Progressive Setting : Progressive
- HD Resolution : 480p / 576p
- HD JPEG mode : Off
- Video Black Level : Light
- Brightness : 4
- Sharpness : 4

### Picture Menu

#### TV Shape

With this setting you can select a picture format to match the aspect ratio of your TV.

##### 4:3 Letter box (default):

Choose this option if you have a standard TV (4:3 aspect ratio). When you watch widescreen DVD-Video movies, the entire picture will be visible and there will be black bars at the top and bottom of the screen, as shown.



##### 4:3 Pan Scan:

Choose this option if you have a standard TV (4:3 aspect ratio) and want to use the full height of the screen when watching widescreen DVD-Video movies. In order to use the full height of the screen, the picture will be cropped on both sides, as shown. This option won't work with discs that don't support pan and scan.



##### 16:9 Widescreen:

Choose this option if you have a widescreen TV (16:9 aspect ratio). Depends on TV, the picture appears stretched when watching programs in 4:3 format.

##### 16:9 Compressed:

Choose this option if you have a widescreen TV (16:9 aspect ratio) and the picture appears stretched when watching programs in 4:3 format. This option will correct the issue.



#### Notes:

- This setting does not apply to DVD menus.
- When the HDMI OUT signal is at a resolution of 720p or 1080i, programs in 4:3 format will appear stretched, so we recommend that you select the “16:9 Compressed” option.
- With some DVD-Video discs this setting may have no effect. See the disc's sleeve notes to see which picture format is used.

#### View Mode

With this setting you can adjust the aspect of the picture so that it fits your TV screen. Due to your TV's aspect ratio setting and the DVD's aspect ratio, black bars may appear above and below the picture or at the sides and the aspect of the picture may be unsuitable. In this case, use this setting to adjust the aspect of the picture as you like.

##### Normal (default):

The picture is displayed in its original aspect ratio.

##### View Mode1:

The picture is stretched horizontally to make it fit the height of the screen.

##### View Mode2:

The picture is stretched vertically to make it fit the width of the screen.

##### View Mode3:

The picture is stretched horizontally and vertically.

#### Tip:

The view mode can also be changed by using the remote controller's [ASPECT] button.



#### Note:

This setting does not apply to DVD menus.

#### HDMI Output Setting

With this setting you can turn the HDMI video output on or off. See page 30 for more information.

##### On (default):

Video is output by the HDMI OUT.

##### Off:

Video is not output by the HDMI OUT.

#### Tip:

This setting can also be changed by using the [HDMI] button on the front panel (see page 30).

#### Note:

When this setting is set to “On”, video is output by the analog video outputs only when the “HD Resolution” is set to “480p (480p / 576p)”.

### **Progressive Setting**

---

With this setting you can set the component video output to progressive or interlaced. While the “HDMI Output Setting” is set to “On”, this setting is fixed at “Progressive” and cannot be changed. See page 30 for more information.

**Interlace:**

Component video output is interlaced.

**Progressive (default):**

Component video output is progressive.

**Tip:**

When the “HDMI Output Setting” is set to “Off”, you can also change this setting by using the remote controller’s [RESOLUTION] button (see page 30).

### **HD Resolution**

---

With this setting you can set the video resolution for the HDMI OUT. See page 30 for more information.

**Auto:**

The resolution is automatically set to the native resolution of the TV connected to the HDMI OUT.

**480p (480p / 576p) (default):**

The setting displayed depends on the country in which you purchased the DVD receiver.

720 x 480p 60 Hz or 720 x 576p 50 Hz

**720p:**

1280 x 720p 50/60 Hz

**1080i:**

1920 x 1080i 50/60 Hz

**Tip:**

When the “HDMI Output Setting” is set to “On”, you can also change this setting by using the remote controller’s [RESOLUTION] button (see page 30).

**Note:**

Initially, the DVD receiver is configured to output both HDMI and analog video. However, if after changing the resolution settings there’s no picture, with the analog video connection or HDMI connection in place, press the [RESOLUTION] button repeatedly to restore the picture.

### **HD JPEG Mode**

---

If your TV is connected to the HDMI OUT and the HDMI resolution is set to 720p or 1080i, this setting allows you to display your JPEG pictures in high definition.

**On:**

JPEG pictures displayed in high definition.

**Off (default):**

JPEG pictures displayed as normal.

**Notes:**

- If your TV is connected to a video output other than the HDMI OUT, or the HDMI output resolution is set to something other than 720p or 1080i, even if this setting is set to “On”, your JPEG pictures will not be displayed in high definition.
- When using HD JPEG, it may take a while to display each picture. And the Zoom function cannot be used. Also, onscreen status messages such as “Play” and “Stop” are not displayed.

### **Video Black Level**

---

With this setting you can adjust the picture blackness for the analog video outputs. It does not affect the component video output when its set to progressive.

**Light:**

Blacks are lighter, and the entire picture becomes lighter.

**Dark:**

Blacks are darker, and the entire picture becomes darker.

### **Brightness**

---

With this setting you can adjust the picture brightness.

**Level 1-7:**

“1” is the darkest. “7” is the brightest. The default brightness is “4 (standard)”.

### **Sharpness**

---

With this setting you can adjust the picture sharpness.

**Level 1-7:**

“1” is the softest. “7” is the sharpest. The default sharpness is “4 (standard)”.

### **PAL Output Setting**

---

With this setting you can specify how the DVD receiver outputs video signals when playing NTSC format DVD-Video discs or Video CDs.

**Auto (default):**

Use this option if your TV supports both PAL and NTSC. The DVD receiver does not convert the video format. When you play a PAL disc, the video output will be PAL format. And when you play an NTSC disc, it'll be NTSC format.

**NTSC:**

Use this option if your TV doesn't support PAL playback, or the picture is distorted when watching PAL discs. The DVD receiver will convert PAL format video signals to NTSC-compatible format.

**PAL:**

Use this option if your TV doesn't support NTSC playback, or the picture is distorted when watching NTSC discs. The DVD receiver will convert NTSC format video signals to PAL-compatible format.

**Note:**

If you select the wrong setting by mistake and lose the picture, while pressing and holding the Next [▶▶] button on the front panel, press the [STANDBY/ON] button on the front panel repeatedly to get picture.

### **SCART Output Setting (European model only)**

---

With this setting you can select the video format to be used for the SCART AV CONNECTOR: RGB or composite video. Before changing this setting, refer to your TV's manual to see if its SCART input can accept video signals in these formats.

**Composite (default):**

Composite video offers standard quality.

**RGB:**

This format offers the best picture quality.

**Notes:**

- If you select a format that is not supported by your TV, the setup menu may disappear from the screen. If this happens, switch off your equipment, connect the DVD receiver to your TV with a composite video cable, and then change this setting.
- When "RGB" is selected, nothing is output by the component video output and HDMI output.

### **Audio Menu**

#### **Digital/HDMI Audio Out**

---

With this setting you can configure the HDMI digital output.

**All (default):**

Dolby Digital and DTS signals are output as they are.

If your TV or amp doesn't support higher sampling rates, set the "Linear PCM Out" setting to "Down Sample On" (below).

**PCM:**

Dolby Digital and DTS signals are down mixed to 2 channels and output as PCM. If your TV doesn't support Dolby Digital and DTS, choose this option. Audio from speakers connected to DVD receiver is also changed to PCM.

**Note:**

MPEG is output as PCM regardless of this setting.

#### **Linear PCM Out**

---

With this setting you can configure the DVD receiver to output digital audio with higher sampling rates (e.g., 88.2 kHz, 96 kHz) as it is or to down sample it to 48 kHz or below.

If the TV you connect to the DVD receiver's HDMI output supports 96 kHz digital audio, select "Down Sample Off". Otherwise, select "Down Sample On".

**Down Sample On:**

Source of 48 kHz or more is down sampled to 48 or 44.1 kHz.

**Down Sample Off (default):**

Sources are output as they are.

**Notes:**

- Some copy-protected DVD-Video discs may use 96 kHz digital audio only for D/A conversion to the analog audio outputs.
- With some discs, even if you select "Down Sample Off", the digital audio will be down sampled, and in some cases may not be output by the DVD receiver's HDMI output.

### Language Menu

#### ***On-Screen Language***

---

With this setting you can select a language for the onscreen setup menus and messages.

Select one of the displayed languages.

#### ***Disc Menu Language***

---

With this setting you can select your preferred language for disc menus. When you play a DVD-Video disc with multiple language disc menus, your preferred language will be selected automatically.

Select “Others” if the language you want is not displayed. See “Selecting Other Languages” on page 64.

##### **Notes:**

- Not all DVD-Video discs have menus in multiple languages.
- Even if a DVD-Video disc has menus in multiple languages, this setting may not always work.
- If a DVD has only one menu language, that will be used.
- With some DVD-Video discs you can select languages from a menu.

#### ***Audio Language***

---

With this setting you can select your preferred language for soundtracks. When you play a DVD-Video disc with multiple language soundtracks, your preferred language will be selected automatically.

Select “Others” if the language you want is not displayed. See “Selecting Other Languages” on page 64.

##### **Notes:**

- Not all DVD-Video discs have soundtracks in multiple languages.
- Even if a DVD-Video disc has soundtracks in multiple languages, this setting may not always work.
- If a DVD has only one soundtrack, that will be used.
- With some DVD-Video discs you can select languages from a menu.

### Subtitle Language

---

With this setting you can select your preferred language for subtitles. When you play a DVD-Video disc with multiple language subtitles, your preferred language will be selected automatically.

Select “No Subtitle” if you don’t want subtitles displayed. Select “Others” if the language you want is not displayed. See “Selecting Other Languages” on page 64.



##### **Notes:**

- Not all DVD-Video discs have subtitles.
- Even if a DVD-Video disc has subtitles in multiple languages, this setting may not always work.
- If a DVD has only one subtitle language, that will be used.
- With some DVD-Video discs you can select subtitles from a menu.

## DVD Onscreen Setup Menus—Continued

### ■ Selecting Other Languages

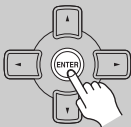
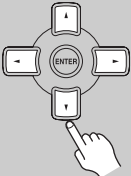
This section explains how to select other languages for disc menus, audio, and subtitles.

<b>1</b> Remote controller 	<b>Select “Others” from the “Disc Menu Language”, “Audio Language”, or “Subtitle Language” menu, and then press [ENTER].</b>
<b>2</b> 	<b>Use the Left/Right [◀]/[▶] buttons to select the code.</b> Use the Up/Down [▲]/[▼] buttons to enter a language code. See adjacent table for language codes.
<b>3</b> 	<b>When you’ve finished, press the [ENTER] button.</b>

Use this list when specifying other languages.

Language	Code
Japanese	JA
English	EN
French	FR
German	DE
Italian	IT
Spanish	ES
Chinese	ZH
Dutch	NL
Portuguese	PT
Swedish	SV
Russian	RU
Korean	KO
Greek	EL
Afar	AA
Abkhazian	AB
Afrikaans	AF
Amharic	AM
Arabic	AR
Assamese	AS
Aymara	AY
Azerbaijani	AZ
Bashkir	BA
Byelorussian	BE
Bulgarian	BG
Bihari	BH
Bislama	BI
Bengali	BN

Language	Code
Kirghiz	KY
Latin	LA
Lingala	LN
Laothian	LO
Lithuanian	LT
Latvian	LV
Malagasy	MG
Maori	MI
Macedonian	MK
Malayalam	ML
Mongolian	MN
Moldavian	MO
Marathi	MR
Malay	MS
Maltese	MT
Burmese	MY
Nauru	NA
Nepali	NE
Norwegian	NO
Occitan	OC
Oromo	OM
Oriya	OR
Panjabi	PA
Polish	PL
Pashto, Pushto	PS
Quechua	QU
Rhaeto-Romance	RM

Language	Code
Tibetan	BO
Breton	BR
Catalan	CA
Corsican	CO
Czech	CS
Welsh	CY
Danish	DA
Bhutani	DZ
Esperanto	EO
Estonian	ET
Basque	EU
Persian	FA
Finnish	FI
Fiji	FJ
Faroese	FO
Frisian	FY
Irish	GA
Scots-Gaelic	GD
Galician	GL
Guarani	GN
Gujarati	GU
Hausa	HA
Hindi	HI
Croatian	HR
Hungarian	HU
Armenian	HY
Interlingua	IA
Interlingue	IE
Inupiak	IK
Indonesian	IN
Icelandic	IS
Hebrew	IW
Yiddish	JI
Javanese	JW
Georgian	KA
Kazakh	KK
Greenlandic	KL
Cambodian	KM
Kannada	KN
Kashmiri	KS
Kurdish	KU

Language	Code
Kirundi	RN
Romanian	RO
Kinyarwanda	RW
Sanskrit	SA
Sindhi	SD
Sangho	SG
Serbo-Croatian	SH
Sinhalese	SI
Slovak	SK
Slovenian	SL
Samoa	SM
Shona	SN
Somali	SO
Albanian	SQ
Serbian	SR
Siswati	SS
Sesotho	ST
Sundanese	SU
Swahili	SW
Tamil	TA
Telugu	TE
Tajik	TG
Thai	TH
Tigrinya	TI
Turkmen	TK
Tagalog	TL
Setswana	TN
Tonga	TO
Turkish	TR
Tsonga	TS
Tatar	TT
Twi	TW
Ukrainian	UK
Urdu	UR
Uzbek	UZ
Vietnamese	VI
Volapük	VO
Wolof	WO
Xhosa	XH
Yoruba	YO
Zulu	ZU



### ***DivX Subtitle***

---

Some DivX video discs include subtitles in one or more languages. The disc packaging will usually inform you about which subtitle languages are available.

With this setting you can select your preferred language for DivX subtitles. When you play a DivX disc with multiple language subtitles, your preferred language will be selected automatically.

You can select DivX subtitle languages by region:

**Unicode (UTF-8):**

Unicode encoding scheme. Two bytes are used to encode each character.

**Western European**

**Turkish**

**Central European**

**Cyrillic**

**Greek**

**Hebrew**

**Arabic**

**Baltic**

**Vietnam**

**Note:**

Some external subtitle files may display incorrectly or not at all.

### **Display Menu**

#### ***On-Screen Display***

---

With this setting you can turn on or off onscreen messages, such as “Play”, “Stop”, and “Resume”.

**Off:**

Onscreen messages are not displayed.

**On (default):**

Onscreen messages are displayed.

#### ***On-Screen Display Color***

---

With this setting you can set the color and theme of the Disc navigation window.

**Sapphire**

**Pearl**

**Amethyst**

**Garnet**

#### ***Background***

---

With this setting you can select the color of the background that’s displayed when the DVD receiver is stopped.

**Blue**

**Gray**

**Graphic:**

The theme picture specified for the “On-Screen Display Color” setting is used.

#### ***Screen Saver***

---

With the Screen Saver function you can protect your TV against screen burn-in, which can occur when the same image or menu is displayed for a long time.

**Off:**

Screen saver off.

**On (default):**

Screen saver on.





When the “Screen Saver” function is set to “On”, and playback is stopped for 15 minutes, the Screen Saver function automatically displays a moving image.

Once the screen saver has been activated, you can cancel it by pressing either the Play [▶] button.

**Operation Setting Menu**

**Setting the Parental Lock**

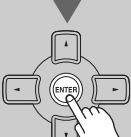
With the Parental Lock function you can block access to certain scenes that the authors have flagged as being unsuitable for children.

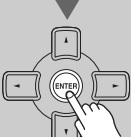
<b>1</b>	<b>Select “Operation Setting” menu in the setup.</b>
<b>2</b> Remote controller  	<b>Use the Up/Down [▲]/[▼] buttons to select “Parental Lock”, and then press the [ENTER] button.</b> The password (security code) input screen appears.
<b>3</b>  	<b>Enter the security code using the remote controller’s number buttons, and then press the [ENTER] button.</b> The default security code is “8888”. You can change the security code in the next section.
<b>4</b>  	<b>Use the Up/Down [▲]/[▼] buttons to change the level of parental lock, and then press the [ENTER] button.</b> At level 8 parental lock is off, with level 1 being the strictest level.







**Notes:**

- When entering a security code, you can use the [CLR] button to delete the numbers entered so far, if necessary.
- Not all discs use parental lock. See the disc’s sleeve notes for details.

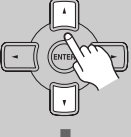
- Discs with parental lock may cut certain scenes, replace certain scenes with children-friendly scenes, or prevent playback of the entire disc.

**Change the Security Code**

To change the Security Code, confirm your existing code then enter a new one.

<b>1</b>	<b>Select “Operation Setting” menu in the setup.</b>
<b>2</b> Remote controller  	<b>Use the Up/Down [▲]/[▼] buttons to select “Security Code”, and then press the [ENTER] button.</b> The password (security code) input screen appears.
<b>3</b>  	<b>Enter the existing security code using the remote controller’s number buttons, and then press the [ENTER] button.</b> The default security code is “8888”. Even if a new security code has been entered, the code “8888” can still be used. Once the security code has been entered, the new security code input screen appears.
<b>4</b>  	<b>Enter the new security code using the remote controller’s number buttons, and then press the [ENTER] button.</b> The new security code has been set.

**Note:**

If you forget your security code, enter “8888” instead. “8888” is a security code that can always be used.

### **DVD Priority Contents**

---

This setting determines what is played when a DVD-Audio disc also contains DVD-Video material.

**DVD-AUDIO (default):**

The DVD-Audio material is played.

**DVD-VIDEO:**

The DVD-Video material is played.

### **SACD Priority Contents**

---

SACDs have two separate areas for storing audio tracks—one for multichannel audio, the other for 2-channel stereo audio. In addition, hybrid SACDs have an extra layer for playback in standard CD players. With this setting you can determine how SACDs are played by the DVD receiver.

**2 ch Area (default):**

The 2-channel stereo audio tracks are played.

**Multi ch Area:**

The multichannel audio tracks are played.

**CD Area:**

The CD layer of hybrid SACDs is played.

**Note:**

This setting determines which area of the disc is played initially. If “Multi ch Area” is selected, and an SACD that contains no multichannel area is loaded, the 2-channel area will be played.

### **DivX® Registration**

---

To play DivX VOD (video on demand) content on this DVD receiver, you first need to register it with your DivX VOD content provider. You do this by generating a DivX VOD registration code, which you then submit to your provider.

Your 8-digit registration code is displayed.

Burn DivX VOD content that you download to a blank CD-R.

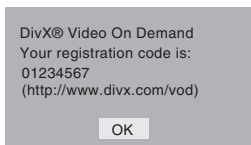

Make a note of the code as you will need it when you register with a DivX VOD provider.

**Important:**

DivX VOD content is protected by DRM (digital rights management). This restricts playback of content to specific, registered devices.

# Additional information

## Resetting the receiver

Use this procedure to reset all the receiver's settings to the factory default.

Note that resetting the DVD receiver will delete your radio presets and custom settings.

<b>1</b>	<b>Turn on the DVD receiver.</b>
<b>2</b>	<b>Using the front panel buttons, hold down the Stop [■] button and press [STANDBY/ON] button.</b>

DVD receiver

**HOLD**

**+**

STANDBY/ON

## DVD-Video regions

All DVD-Video discs carry a region mark on the case somewhere that indicates which region(s) of the world the disc is compatible with. Your DVD receiver also has a region mark, which you can find on the rear panel. Discs from incompatible regions will not play in this receiver. Discs marked "ALL" will play in any player. The diagram below shows the various DVD regions of the world.

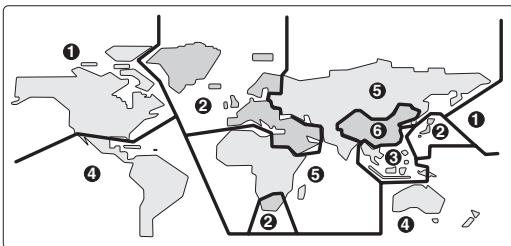

## Disc Content Organization

### ■ DVD-Video Format

DVD-Video discs contain titles, which are usually subdivided into chapters.

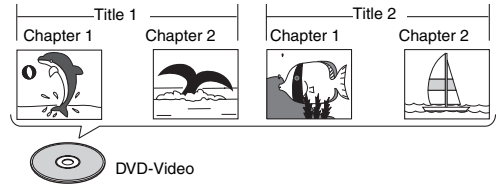

### ■ DVD-Audio

DVD-Audio discs contain groups and tracks.

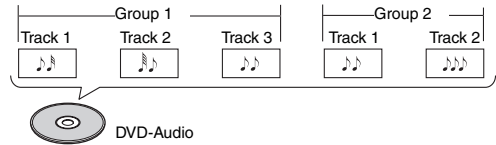

### ■ SACD

SACDs have two separate areas for storing audio tracks—one for multichannel audio, the other for 2-channel stereo audio. In addition, hybrid SACDs have an extra layer for playback in standard CD players.

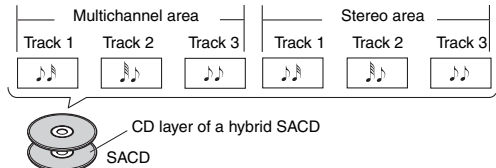

### ■ VCD

VCDs contain video tracks.

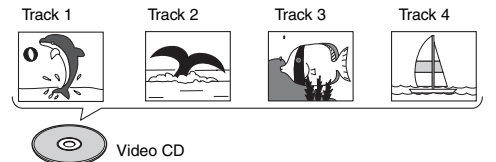

### ■ Audio CD Format

Audio CDs contain tracks.



### ■ MP3, WMA, JPEG & DivX Files

MP3, WMA, JPEG, and DivX files are typically organized into folders. The DVD receiver handles MP3, WMA, JPEG, and DivX files as tracks.

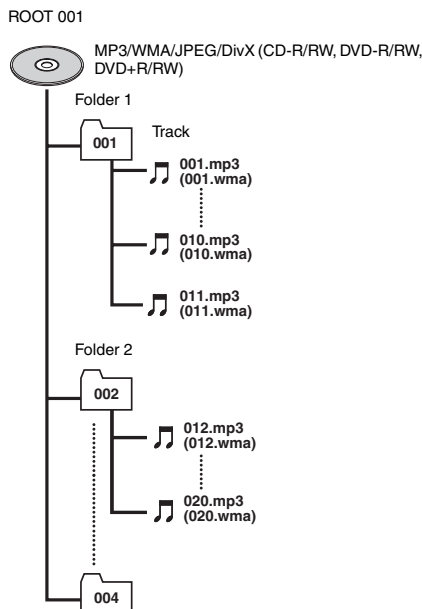

## Glossary

---

### Analog audio

An electrical signal that directly represents sound. Compare this to digital audio which can be an electrical signal, but is an indirect representation of sound. See also “Digital audio.”

### Aspect ratio

The width of a TV screen relative to its height. Conventional TVs are 4:3 (in other words, the screen is almost square); widescreen models are 16:9 (the screen is almost twice as wide as it is high).

### Digital audio

An indirect representation of sound by numbers. During recording, the sound is measured at discrete intervals (44,100 times a second for CD audio) by an analog-to-digital converter, generating a stream of numbers.

On playback, a digital-to-analog converter generates an analog signal based on these numbers. See also “Sampling frequency” and “Analog audio.”

### DivX

DivX is a media technology created by DivX, Inc. DivX media files contain compressed video. DivX files can also include advanced media features like menus, subtitles, and alternate audio tracks.

### Dolby Digital

Using a maximum of 5.1 channels of audio, this high quality surround system is used in many of the finer movie theaters around the world.

The display shows which channels are active, for example showing 3/2.1. The 3 being the two front channels and the center channel; the 2 being the surround channels, and the .1 being the LFE channel.

### Down Mix

Down mixing reduces the number of surround-sound channels and mixes the multi-channel audio that is used in Dolby Digital and DTS so that the audio matches the number of speakers and other elements of the output environment.

### DRM

DRM (digital rights management) is a type of server software developed to enable secure distribution of paid content over the web, recently incorporated by WMA (Windows Media Audio).

### DTS

DTS stands for Digital Theater Systems. DTS is a surround system different from Dolby Digital that has become a popular surround sound format for movies.

**Dynamic range**

The difference between the quietest and loudest sounds possible in an audio signal (without distorting or getting lost in noise).

Dolby Digital and DTS soundtracks are capable of a very wide dynamic range, delivering dramatic cinema-like effects.

**File extension**

A tag added to the end of a filename to indicate the type of file. For example, “.mp3” indicates an MP3 file.

**HD**

Abbreviation for high definition, as in HDTV (high-definition TV).

**HDCP (High-bandwidth Digital Content Protection)**

The video encryption technology developed by Intel for HDMI/DVI. It's designed to protect video content and requires a HDCP-compatible device to display the encrypted video.

**HDMI**

HDMI (High-Definition Multimedia Interface) is a high-speed digital interface which has the capability to support standard, enhanced, or high-definition video plus standard to multichannel surround-sound audio on a single digital connection. HDMI features include uncompressed digital video, a bandwidth of up to 5 gigabytes per second and communication between the AV source and AV devices such as DTVs.

**ISO 9660 format**

International standard for the volume and file structure of CD-ROM discs.

**JPEG**

A file format used for still images, such as photographs and illustrations. JPEG files are identified by the file extension “.jpg” or “.JPG”. Most digital cameras use this format.

**LFE**

LFE refers to the low-frequency effect sounds that are used in Dolby Digital and DTS. Generally, the subwoofers function more effectively when these sounds are contained in the signal from the disc or other media.

**MP3**

MP3 (MPEG1 audio layer 3) is a compressed audio file format. Files are recognized by their file extension “.mp3” or “.MP3”.

**MPEG video**

The video format used for Video CDs and DVDs. Video CD uses the older MPEG-1 standard, while DVD uses the newer and much better quality MPEG-2 standard.

**NTSC (National Television Standards Committee)**

This is one broadcasting system for color televisions, and is used in the U.S., Korea, Central and South America, Japan, and other countries. The system consists of 525 horizontal scan lines, and is divided into 30 frames per second. It uses an interlacing method which skips every other scan line to produce an image (field) with one-half of the full resolution, and displays 60 such fields per second.

**PAL (Phase alternation by line)**

This is one broadcasting system for color televisions, and is used primarily in Europe. This system consists of 625 horizontal scan lines. It uses an interlacing method with 25 frames (50 fields) per second. The vertical resolution is higher than NTSC, however the frame rate is lower.

**PBC (PlayBack Control) (Video CD only)**

A system of navigating a Video CD through on-screen menus recorded onto the disc. Especially good for discs that you would normally not watch from beginning to end all at once—karaoke discs, for example.

**PCM (Pulse Code Modulation)**

The most common system of encoding digital audio, found on CDs and DAT. Excellent quality, but requires a lot of data compared to formats such as Dolby Digital.

**Progressive scan video**

All the lines that make up a video picture are updated in one pass (compared to interlace which takes two passes to update the whole picture).

**Regions (DVD-Video only)**

These associate discs and players with particular areas of the world. This unit will only play discs that have compatible region codes. You can find the region code of your unit by looking on the rear panel. Some discs are compatible with more than one region (or all regions).

**Sampling frequency**

The rate at which sound is measured to be turned into digital audio data. The higher the rate, the better the sound quality, but the more digital information is generated. Standard CD audio has a sampling frequency of 44.1kHz, which means 44,100 samples (measurements) per second. See also “Digital audio.”

**T-D (Theater-Dimensional)**

This is a virtual surround-sound technology that was developed by Onkyo Corporation. For details, see page 42.

**WMA**

WMA is short for Windows Media Audio and refers to an audio compression technology developed by Microsoft Corporation. WMA data can be encoded by using Windows Media Player version 8.

# Troubleshooting

If you have any trouble using the DVD receiver, look for a solution in this section. If you can't resolve the issue yourself, contact your Onkyo dealer.

The DVD receiver does not work or shows no reaction.

DVD receiver



HOLD

Press and hold Stop [■] button for 10 seconds to forcibly shut down the DVD receiver.

## Power

### The power to the system is not turned on

- Make sure that the power cord is plugged into the AC outlet. Make sure that the other end of the power cord is properly connected to the DVD receiver's AC INLET (page 23).
- Unplug the power cord from the AC outlet, wait for 10 seconds or more, then plug the cable in again.

### The power is turned off during the operation

- If the SLEEP indicator is lit on the display, the Sleep timer is functioning. Cancel the Sleep timer (page 32).
- If the STANDBY indicator is blinking on and off, the built-in protection circuit is activated. Be careful not to short the positive and negative wires.

### The DVD receiver turns off as soon as it's turned on

- The amp protection circuit has been activated.  
Remove the power cord from the wall outlet immediately. Disconnect all speaker cables and input sources, and leave the DVD receiver with its power cord disconnected for 1 hour. After that, reconnect the power cord and set the volume to maximum. If the DVD receiver stays on, set the volume to minimum, disconnect the power cord, and reconnect your speakers and input sources. If the DVD receiver turns off when you set the volume to maximum, disconnect the power cord, and contact your Onkyo dealer.

## Audio

### The sound is not heard or very quiet

- Make sure the power cord is plugged into an AC outlet.
- Make sure that all audio connecting plugs are pushed in all the way (page 23).
- Make sure that none of the connecting cables are bent, twisted, or damaged.
- Make sure that the speakers are connected correctly and the speaker cables' core wires touch only the speaker connectors (page 17).
- Check to make sure that the volume level is not set to minimum (page 31).
- Make sure that the input source is properly selected (page 31).
- Check to make sure the muting function is not engaged. If the MUTING indicator is flashing, the sound is muted. Cancel the muting function (page 32).
- When the headphones are connected, the speakers do not output any sound. Disconnect the headphones (page 31).
- Make sure that the digital input source is assigned properly (page 57).
- Check the digital audio output setting on the connected device. On some game consoles, such as those that support DVD, the default setting is off.
- The audio signal input from HDMI IN is not output from the speakers connected to the DVD receiver. Make the analog or digital connection (pages 25, 26).

### There's no sound with a certain signal format

- Check the digital audio output setting on the connected device. On some game consoles, such as those that support DVD, the default setting is off.

### Sound is not good

- Make sure that the speaker cords are connected correctly. Check their polarity (+/-) (page 17).
- Connect the analog audio cables (RCA) firmly (page 23).
- Sound quality could be affected by a strong magnetic field, such as a TV set. Locate such a device far from the DVD receiver.
- If you have any devices that emit high intensity radio waves near the DVD receiver, such as a cellular phone in operation (calling), noise may be generated.
- The DVD receiver uses a rotating unit whose precision instrument generates faint hissing sound while reading a disc during playing back or searching a track; you may hear it in a silent environment.
- Using cable ties to bundle audio cables with power cord, speaker cables, and so on may degrade the audio performance, so don't do it.

### The subwoofer produces no sound

- When you play source material that contains no information in the LFE channel, the subwoofer produces no sound.
- Make sure the subwoofer is configured correctly (page 55).

### Headphones makes noise or no sound

- There may be a bad contact. Clean up the headphones terminal. For information on how to clean up, see the instruction manual attached to the headphones. Otherwise, verify the cord of the headphones which may be broken.

### Sound Quality

- The sound quality becomes stable when 10 to 30 minutes have passed after the power was turned on.
- Using cable ties to bundle audio cables with speaker cables may degrade the audio performance, so don't do it.

### The Late Night function doesn't work

- Make sure the source material is Dolby Digital.

### The beginning of audio received by an HDMI IN can't be heard

- Since it takes longer to identify the format of an HDMI signal than it does for other digital audio signals, audio output may not start immediately.

### There's no sound to your TV connected to an HDMI OUT

- You won't hear any sound from the HDMI OUT if your TV only supports DVI.
- Change the HDMI setting on your TV to HDMI.
- Your TV doesn't support Dolby or DTS. Change the "Digital/HDMI Audio Out" setting to "PCM" (page 62).
- Your TV doesn't support 88.2 kHz, 96 kHz, 176.4 kHz or 196 kHz PCM. Change the "Linear PCM Out" setting to "Down Sample On" (page 62).

### The TV audio with SCART connection is strange. The volume is too low. There's no bass sound.

- When listening to the TV audio with SCART connection, set the listening mode to "Stereo" or "Direct".
- When outputting the subwoofer's audio from the TV, set the "Subwfr" setting to "No" (page 55).

## Video

### There's no picture

- Make sure that all video connecting plugs are pushed in all the way (page 23).
- Make sure that each video component is properly connected. (pages 23-27)
- If the video source is connected to an HDMI input, your TV must be connected to the HDMI OUT (page 27). Your TV input must be changed to HDMI.
- While the Pure Audio listening mode is selected, the video circuitry is turned off.
- On your TV, make sure that the video input to which the DVD receiver is connected is selected.
- The "PAL Output Setting" is set wrong for your TV. Change the "PAL Output Setting" to suit your TV (page 62).
- The "SCART Output Setting" is set wrong for your TV. Make sure your TV supports the selected video output format (page 62).

### There's no picture from a source connected to an HDMI IN

- The TV or display does not support the current video resolution and you need to select another resolution on your AV component.

### There's no picture to your TV connected to an HDMI OUT

- The HDMI Output Setting is set to Off or your TV doesn't support HDMI Resolution settings of 720p and 1080i (page 30).
- Try pressing the [HDMI] button on the front panel repeatedly to switch the HDMI Output Setting to on, and then pressing the [RESOLUTION] button on the remote controller repeatedly to get picture (page 30).
- If the DVD receiver is connected to your AV component, try connecting it directly to your TV. It will not work if you connect to a component that doesn't support HDCP (page 27).

### There's no picture to your TV connected to an Component Video Output

- Your TV does not support progressive scanning, and the HDMI Output Setting is on. While the HDMI Output Setting is on, the component video output outputs progressive video. Try pressing the [HDMI] button on the front panel repeatedly to switch the HDMI Output Setting to off, and then pressing the [RESOLUTION] button repeatedly to switch to Interlaced (page 30).
- Press the [RESOLUTION] button repeatedly to select 480p (480p/576p) (page 30).

### There's no picture to your TV connected to an Composite Video Output

- Try pressing the [RESOLUTION] button on the remote controller repeatedly to get picture (page 22).



### Tuner

#### Reception is noisy, FM stereo reception is noisy, or the FM ST indicator doesn't appear

- Relocate your antenna.
- Move the DVD receiver away from your TV or computer.
- When listening to an AM station, operating the remote controller may cause noise.
- Passing cars and airplanes can cause interference.
- Concrete walls weaken radio signals.
- If nothing improves the reception, install an outdoor antenna.

### Remote Controller

#### The remote controller doesn't work

- Make sure that the batteries are installed with the correct polarity (page 11).
- Install new batteries. Don't mix different types of batteries, or old and new batteries (page 11).
- Make sure that the remote controller is not too far away from the DVD receiver, and that there's no obstruction between the remote controller and the DVD receiver's remote control sensor (page 11).
- Make sure that the DVD receiver is not subjected to direct sunshine or inverter-type fluorescent lights. Relocate if necessary.
- If the DVD receiver is installed in a rack or cabinet with colored-glass doors, the remote controller may not work reliably when the doors are closed.
- When using the remote controller to control other manufacturers' AV components, some buttons may not work as expected.

#### Can't control a TV

- Make sure you've entered the correct remote control code.
- To control another manufacturer's TV, point the remote controller at the component. Be sure to enter the appropriate remote control code first (page 53).

#### Can't control an RI Dock

- Make sure that the **RI** cable and analog audio cable are connected properly. Connecting only an **RI** cable won't work (page 26).
- To control an RI Dock that's connected via **RI**, point the remote controller at the DVD receiver.

#### The **RI** functions don't work

- To use **RI**, you must make an **RI** connection and an analog audio connection (RCA) between the component and DVD receiver, even if they are connected digitally (page 26).

### Disc Playback

#### The disc won't play or is automatically ejected after loading

- Make sure the disc is free from dirt and dust and is not damaged (page 10).
- Make sure the disc is loaded with the label side face up and aligned properly in the disc tray guide.
- If the region number on a DVD-Video disc does not match the number on the receiver, the disc cannot be used (page 68).
- Condensation inside the receiver: Allow time for condensation to evaporate. Avoid using the player near an air-conditioning unit.
- Reload the disc with the label side face up.
- If the Parental Lock function is active, defeat it or change the level (page 66).

#### The disc doesn't play in the correct order

- Defeat special playback modes such as Repeat Play, Memory Playback, and Random Playback (pages 46–48.)

#### Track numbers cannot be stored when setting MEMORY playback

- Make sure that the disc has been loaded, and the track(s) you try to program are included on the disc.

#### It takes a long time until playback starts

- It may take time for the DVD receiver to load and read a CD or DVD that contains many tracks.

#### New settings made in the onscreen setup menus while a disc is playing are ineffective

- Some settings can be changed while a disc is playing, but are not effective until the disc is stopped then restarted: Press the Stop [■] button, then start playback again.

#### Screen is stretched or aspect does not change

- The "TV Shape" setting in the onscreen setup menu is incorrect. See page 60 for how to set it correctly for your TV/monitor.

#### Picture disturbance during playback or the picture is dark

- This receiver is compatible with Macro-Vision System copy guard. Some discs include a copy prevention signal, and when this type of disc is played back, stripes etc., may appear on some sections of the picture depending on the TV. This is not a malfunction.
- Due to the receiver's copy protection circuits, connection of this device through a VCR or an AV selector may prevent recording or cause picture problems. This is not a malfunction.

### No sound, or sound is distorted

- No sound is output when scanning discs other than audio CDs and SACDs.
- Check that the disc is free from dust and dirt, and that it is not damaged (page 10).
- Check that the plugs and terminals are free of dirt, oxide, etc. and clean if necessary. Also check the cable for damage.

### Noticeable difference in DVD and CD volume

- This is due to differences in the audio format and is not a malfunction.

### DVD-Audio playback stops

- The disc may have been illegally copied.

### Can't watch the DVD-Video

- With some DVD-Video Discs, you need to select an audio output format from a menu.

### Can't watch the DVD-Video material on a DVD-Audio disc

- Set the "DVD Priority Contents" setting to "DVD-VIDEO" (page 67).

### Can't play the multichannel area of a hybrid SACD

- Set the "SACD Priority Contents" setting to "Multi ch Area" (page 67).

### Can't play MP3 and JPEG discs

- Use only ISO 9660 Level 2 format discs (page 9).
- The disc has not been finalized. Finalize the disc (page 9).

### Can't select MP3 files

- MP3 files without a ".mp3" or ".MP3" filename extension are not recognized.
- The MP3 disc is a multisession disc. Only files in the first session of a multisession disc can be played (page 9).

### Can't play WMA files

- WMA files without a ".wma" or ".WMA" filename extension are not recognized.
- The WMA file's copyright option is on. Don't use the copyright option (page 9).

### Can't view JPEG files

- JPEG files without a ".jpg" or ".JPG" or ".JPEG" filename extension are not recognized.
- The JPEG file is too big. Use JPEG files that are less than 5 megabytes (page 9).

### Can't play a DivX file

- Make sure the DivX file was encoded with the predetermined format (page 9).

### DivX plays but there's no sound

- Try re-encoding the file with a supported audio format.

## Connection with External Devices

### No sound is heard from the connected device

- Make sure that the optical digital cable is not bent over or damaged.
- Set the "Digital/HDMI Audio Out" to "PCM", because the TV supports only PCM signals.

### The turntable sounds still

- Make sure if the turntable has built in phono equalizer.
- If the turntable has no phono equalizer built in, you must provide one separately.

### The turntable makes no sound

- If your turntable uses an MC cartridge, you must connect an MC transformer or an MC head amp.

### The Colors of the TV Picture Bleed

- Locate the speakers far from the TV.

## Others

### The display doesn't work

- The display is turned off when the Pure Audio listening mode is selected (page 42).

The DVD receiver contains a microcomputer for signal processing and control functions. In very rare situations, severe interference, noise from an external source, or static electricity may cause it to lockup. In the unlikely event that this happens, unplug the power cord from the wall outlet, wait at least five seconds, and then plug it back in again.

Before disconnecting the power cord from the wall outlet, set the DVD receiver to Standby.

### HDMI Status Mode

If you're using an HDMI connection and there's no picture or sound, you can check the status of the HDMI connection by pressing and holding down the DVD receiver's [DISPLAY] button for 10 seconds until a message ID appears on the display. Look up the message ID in the following tables and check the HDMI connections and settings on both the DVD receiver and the connected component.

#### HDMI connection and HDMI-related settings status

Displayed ID	Message
MSG ID 001 MSG ID 015	Turn the DVD receiver and the connected component off, then turn them on again. Make sure that the connected component is working properly and that the DVD receiver's HDMI settings are configured suitably for that component.
MSG ID 021	Input is selected other than DVD or VIDEO1. No output from HDMI OUT.
MSG ID 022	When the DVD or VIDEO1 input is selected, the HDMI Output Setting is set to Off. Change it to On (page 30).
MSG ID 023	Check the settings and connections of the TV and component connected to DVD receiver.
MSG ID 024	Pure Audio listening mode is selected. Set other listening modes.

#### No picture from the HDMI connection

Displayed ID	Message
MSG ID 002	The "HDMI Output Setting" is set to "Off". Change it to "On" (page 30).
MSG ID 003 MSG ID 004	The HDMI cable may not be connected properly. Check the connection. Also, make sure the HDMI input on the TV is correctly configured to received HDMI.
MSG ID 005 MSG ID 006 MSG ID 007	Make sure the HDMI input on the TV is correctly configured to received HDMI. The connected component may not support HDCP. Make sure the connected component supports HDCP. Turn the DVD receiver and the connected component off, then turn them on again. The DVD receiver may be connected to the other component's DVI jack. Some TVs may not properly receive the video output by the DVD receiver. Also, with a DVI connection, there will be no sound.
MSG ID 008	The DVD receiver's "HD Resolution" setting is set to "720p" or "1080i". If your TV doesn't support these resolutions, select another resolution (page 30).
MSG ID 009	The connected component may not be receiving the HDMI signal properly. Try selecting another resolution on the DVD receiver (page 30).

#### No sound from the HDMI connection

Displayed ID	Message
MSG ID 011 MSG ID 014	The connected component may not support 96 kHz PCM. Set the DVD receiver's "Linear PCM Out" setting to "Down Sample On" (page 62).
MSG ID 012 MSG ID 013	The connected component may not support Dolby Digital. Set the DVD receiver's "Digital/HDMI Audio Out" setting to "PCM" (page 62).
MSG ID 016 MSG ID 017	The connected component may not support DTS. Set the DVD receiver's "Digital/HDMI Audio Out" setting to "PCM" (page 62).
MSG ID 020	Audio from SACDs is not output by the HDMI OUT.

# Specifications

---

## Amplifier Section

---

Rated Output Power (IEC)	2 ch × 50 W at 6 ohms, 1 kHz, 2 ch driven
THD (Total Harmonic Distortion)	0.9% (Power Rated) 0.08% (1 kHz, 1 W)
Input Sensitivity and Impedance	200 mV/47 kΩ (LINE)
Frequency Response	5 Hz - 100 kHz/+1 dB - 3 dB (Direct mode)
Signal to Noise Ratio	106 dB (LINE, IHF-A)
Speaker Impedance	4 Ω - or 6 Ω - 16 Ω

## Video Section

---

Signal System	PAL/NTSC
Composite Video Output/Impedance	1.0 V (p-p)/75 Ω negative sync, RCA
Component Video Output/Impedance	Y: 1.0 V (p-p)/75 Ω PB/PR: 0.7 V (p-p)/75 Ω RCA/ phono
AV Connector (European model only)	1.0 V (p-p)/75 Ω, Scart
Component Video Frequency Response	5 Hz - 50 MHz - 3 dB

## Tuner Section

---

FM Tuning Frequency Range	87.5 MHz - 108.0 MHz
AM Tuning Frequency Range	European: 522 kHz - 1611 kHz Others: 522/530 kHz - 1611/1710 kHz
Preset Channel	40

## General

---

Power Supply	European: AC 230 V, 50 Hz Others: AC 220 V, 50/60 Hz
Power Consumption	115 W
Stand-by Power Consumption	0.4 W
Dimensions (W × H × D)	435 × 90 × 415 mm
Weight	8.6 kg
Operation Condition Temperature and Humidity	5°C–35°C (41°F–95°F), 5%–85%
Disc Compatibility	SACD, DVD-Audio, DVD-Video, DVD-R/RW (VIDEO), DVD+R/RW, CD, CD-R/RW, Video CD, MP3, WMA, JPEG, DivX Disc that have not been property finalized may only be partially playable or not playable at all

## Video Inputs

HDMI	IN
Composite	VIDEO1, VIDEO2/DOCK

## Video Outputs

HDMI	OUT
Component	OUT
Composite	VIDEO OUTPUT

## Audio Inputs

Digital Inputs	Optical: 1 Coaxial: 1
Analog Inputs	VIDEO1, VIDEO2/DOCK

## Audio Outputs

Subwoofer Pre Output	1
Speaker Outputs	FL, FR
Phones	1

Specifications and features are subject to change without notice.

# Remote Control Codes List

TV	
888	0264
Acura	0009
Addison	0092, 0108, 0653, 1150
Admiral	0093, 0463
Advent	0761, 0783, 0815, 0817, 0842
Aiko	0092
Aiwa	1916
Akai	0009, 0030, 0208, 0264, 0361, 0602, 0672, 0702, 0753, 0812, 1935
Akura	0264
Alba	0009, 0037, 0371
Albatron	0700, 0843
Alfide	0672
America Action	0180
Amstrad	0009, 0037, 0171, 0371, 0433
Anam	0009, 0161, 0180, 0250, 0700
Anam National	0161, 0250, 0650
Anhua	0051
Anitech	0009
AOC	0009, 0030, 0060, 0092, 0093, 0108, 0178, 0180, 0451, 0474, 1150
Aolinpike	0264
Apex Digital	0748, 0765, 0767, 0879, 1217
Audinac	0180
Audiosonic	0037, 0109
Audiovox	0092, 0180, 0451, 0623, 0802, 0875
Aventura	0171
Awa	0009
Baihe	0009, 0264
Baile	0001, 0009, 0661
Baird	0343
Baohuashi	0264
Baosheng	0009, 0817
Barco	0556
Basic Line	0009
Baur	0037, 0361, 0512
Baysonic	0180
Beaumark	0178
Beijing	0001, 0009, 0208, 0226, 0264, 0661, 0812, 0817

TV	
Beko	0714
Bell & Howell	0154
BenQ	1032
Beon	0037
Blaupunkt	0195
Blue Sky	0556, 1037, 1254, 1314
BPL	0208, 0896
Bradford	0180
Brandt	0109, 0335
Broksonic	0236, 0463, 1935
Bush	0009, 0037, 0371, 0698, 1037
C-Tech	0896
Caihong	0009, 0817
Cailing	0748
Candle	0030, 0056, 0186
Carnivale	0030
Carver	0054, 0170
Cascade	0009
Cathay	0037
CCE	0037
Celebrity	0000
Celera	0765
Celestial	0767
Centrex	0780
Centurion	0037
CGE	0074
Changcheng	0001, 0009, 0051, 0264, 0661, 0817
Changfei	0009, 0817
Changfeng	0264, 0753, 0817
Changhai	0009, 0817
Changhong	0009, 0156, 0264, 0508, 0765, 0767, 0783, 0817, 1156
Chengdu	0009, 0817
Ching Tai	0009, 0092, 0474
Chun Yun	0000, 0009, 0092, 0161, 0180, 0474, 0700, 0843, 1150
Chunfeng	0009, 0264
Chung Hsin	0053, 0108, 0180, 0474, 1150
Chunsun	0009, 0817
Cimline	0009
Cinema	0672
Cineral	0092, 0451
Citizen	0030, 0056, 0060, 0092, 0186, 1935

TV	
Clarion	0180
Clarivox	0037
Commercial Solutions	0047, 1447
Concerto	0056
Conrac	0808
Conrowa	0009, 0145, 0156, 0264, 0698, 0753, 1156
Contec	0009, 0180
Craig	0161, 0180
Crosley	0054, 0074
Crown	0009, 0037, 0180, 0418, 0672
Crown Mustang	0672
Curtis Mathes	0030, 0047, 0054, 0056, 0060, 0093, 0145, 0154, 0166, 0451, 0702, 1147, 1347
CXC	0180
Daewoo	0009, 0030, 0037, 0056, 0092, 0108, 0154, 0170, 0178, 0180, 0451, 0474, 0623, 0634, 0661, 0672, 0700, 0880, 1150, 1661
Dansai	0037
Dayton	0009
Dayu	0661
De Graaf	0208
Decca	0037
Dell	1080, 1178
Denon	0145, 0511
Denver	0587
Dick Smith Electronics	0698
Digatron	0037
Digital Life	0780
Digitor	0037, 0698
Digix	0880
Dixi	0009, 0037
Dongda	0009
Donghai	0009
DSE	0698
Dumont	0017
Durabrand	0171, 0178, 0180, 0463, 1034

## Remote Control Codes List—Continued

TV	
ECE	0037
Electroband	0000
Electrograph	1755
Electrohome	0463
Elektra	0017, 1661
Elin	0037
Elta	0009
Emerson	0154, 0171, 0178, 0180, 0236, 0361, 0463, 0623
Envision	0030, 0813
Erres	0037
ESA	0171, 0812
Ether	0009, 0030, 0161
Etron	0009
Feilang	0009
Feilu	0009, 0817
Feiyan	0264
Feiyue	0009, 0817
Ferguson	0037, 0109, 0335, 0343, 0560
Fidelity	0361
Finlandia	0208, 0346
Finlux	0037, 0346
Firstar	0009, 0236
Firstline	0009
Fisher	0154, 0208
Flint	0455
Formenti	0037
Fortress	0093
Frontech	0264
Fujitsu	0186, 0683, 0809, 0853, 1181
Fujitsu General	0186
Fujitsu Siemens	1163
Funai	0171, 0180, 0264, 0342
Furi	0145, 0264, 0817
Futuretech	0180
Ganxin	0817
Gateway	1755, 1756
GE	0030, 0047, 0051, 0092, 0178, 0180, 0451, 0560, 1347, 1447, 1454
GEC	0037
Geloso	0009
General	0186
Gibraltar	0017, 0030

TV	
Gintai	0474, 1150
Go Video	0886
GoldStar	0001, 0030, 0037, 0056, 0109, 0154, 0178, 1150, 1378
Goodmans	0037, 0343, 0360, 0371, 0634
Gradiente	0053, 0056, 0170
Graetz	0361, 0714
Granada	0037, 0208
Grandin	0610, 0865, 0880
Grundig	0037, 0195, 0556, 0587, 0672, 0706, 1935
Grunpy	0180
Haier	0037, 0508, 0587, 0698, 0896, 1034
Haihong	0009
Haiyan	0264, 0817
Hallmark	0178
Hankook	0030, 0056, 0178, 0180
Hanseatic	0037, 0361, 0556, 0661, 0808
Harman/Kardon	0054
Harvard	0180
Harwa	0773
Havermy	0093
HCM	0009
Helios	0865
Hello Kitty	0451
Himitsu	0180
Hinari	0009, 0037
Hisawa	0455
Hisense	0009, 0145, 0156, 0508, 0556, 0748, 0753, 0780, 1156
Hitachi	0009, 0030, 0056, 0092, 0109, 0145, 0156, 0178, 0186, 0225, 0474, 0508, 1037, 1145, 1150, 1156, 1245, 1256, 1378
Hitec	0698
Hoehner	0865
Hongmei	0009, 0093, 0264, 0817
Hongyan	0264, 0817
Hua Tun	0009, 1150
Huafa	0009, 0145

TV	
Huanghaimei	0009
Huanghe	0009, 0817
Huanglong	0009
Huangshan	0009, 0264, 0817
Huanyu	0264, 0817
Huaqiang	0264
Huari	0145, 0264
Huodateji	0051
Hypson	0037, 0264
Hyundai	0849, 0865
ICE	0264, 0371
Imperial	0074, 0418
Imperial Crown	0001, 0009, 0264, 0661
Indiana	0037
Infinity	0054
Innova	0037
Insignia	0171
Inteq	0017
Interfunk	0037, 0361, 0512
Intervision	0037, 0264
IRT	0451, 0698, 1661
ITS	0371
ITT	0361
JBL	0054
JCB	0000
Jean	0009, 0051, 0092, 0156, 0236, 0474
Jensen	0761, 0815, 0817
Jiahua	0051
JiaLiCai	0009, 0264
Jinfeng	0051, 0208, 0226, 0817
Jinque	0009, 0264, 0817
Jinta	0009, 0264
Jinxing	0009, 0037, 0054, 0145, 0156, 0264, 0556, 0698, 0817
Juhua	0264, 0817
JVC	0053, 0160, 0371, 0463, 0508, 0606, 0653, 0683, 0731, 1172, 1253

## Remote Control Codes List—Continued

TV	
Kaige	0009, 0264, 0817
Kaisui	0009
Kanghua	0896
Kangli	0001, 0009, 0264, 0661, 0817
Kangyi	0009, 0264
Karcher	0610
Kathrein	0556
KEC	0180
Kendo	0037
Kenwood	0030
Khind	0706, 0896
Kioto	0054, 0556, 0706
KLH	0765, 0767
KLL	0037
Kolin	0053, 0108, 0150, 0180, 0474, 1150, 1331
Kongque	0009, 0264, 0817
Konka	0037, 0587, 0817
Korpel	0037
Kost	1262, 1483
Koyoda	0009
KTV	0030, 0180
Kuaile	0009, 0264
Kulun	0009
Kunlun	0051, 0208, 0226, 0264, 0661, 0817
L&S Electronic	0808
Leyco	0037, 0264
LG	0001, 0030, 0037, 0056, 0060, 0108, 0178, 0442, 0474, 0644, 0700, 0714, 0856, 1178, 1265, 1378
Liesenk & Tter	0037
Lihua	0817
Local India TV	0009, 0208, 0264, 0371, 0602
Local Malaysia TV	0698
Loewe	0136, 0512, 0633, 0790
Logik	0001, 1217
Longjiang	0264, 0817
Luxman	0056
Luxor	0361
LXI	0047, 0054, 0154, 0156, 0178

TV	
M & S	0054
M Electronic	0009, 0037, 0109, 0346, 0480
Magnavox	0030, 0054, 0186, 0706, 0780, 0802, 1254, 1454
Manesth	0264
Marantz	0030, 0037, 0054, 0556, 0704, 0855
Mark	0037
Mastro	0053, 0698, 0706, 0780
Matsui	0009, 0035, 0037, 0208, 0371, 0443
Matsushita	0161, 0250, 0650
Maxent	1755
Meck	0698
Mediator	0037
Medion	0808, 0880, 1037, 1248
Megapower	0700
Megatron	0145, 0178
Meile	0264, 0817
Memorex	0009, 0150, 0154, 0178, 0463, 1037
Mercury	0001
Mermaid	0037
Metronic	0625
Metz	0388, 0447, 0746
MGA	0030, 0150, 0178
Micromaxx	0808
Microstar	0808
Midland	0017, 0047, 0051
Mitsubishi	0030, 0056, 0093, 0108, 0150, 0154, 0178, 0180, 0236, 0250, 0474, 0512, 0817, 0836, 1150, 1171, 1182, 1250
Monivision	0700, 0843
Motorola	0093
MTC	0030, 0056, 0060, 0512
Mudan	0009, 0051, 0208, 0226, 0264, 0817
Multitech	0009, 0180
Murphy	0474
Myryad	0556
NAD	0156, 0178, 0361, 0866
Nanbao	0009, 0264

TV	
Nansheng	0264, 0817
National	0051, 0208, 0226, 0508
NEC	0009, 0030, 0051, 0053, 0056, 0154, 0156, 0170, 0178, 0186, 0264, 0455, 0474, 0508, 0704, 0817, 1150, 1378, 1456, 1704
Neckermann	0037, 0556
NEI	0037
Neovia	0865
Netsat	0037
NetTV	1755
Newave	0009, 0092, 0093, 0161, 0178, 1150
Nikkai	0035, 0037, 0264
Nikko	0030, 0092, 0178
Noblex	0154
Nokia	0361, 0480, 0606
Norcent	0748, 0824
Nordmende	0109, 0343, 0560
NTC	0092
Oceanic	0361
Olevia	1144, 1240, 1331
Onida	0053, 1253
Onwa	0180, 0433
Optimus	0154, 0166, 0250, 0650
Optonica	0093
Orion	0037, 0236, 0443, 0463, 0474, 0880, 1463
Osaki	0264, 0474
Otto Versand	0037, 0343, 0512, 0556

## Remote Control Codes List—Continued

TV	
Palladium	0418
Palsonic	0773
Panama	0264
Panasonic	0037, 0051, 0054, 0161, 0208, 0226, 0250, 0508, 0650, 0896, 1168, 1175, 1177
Panda	0009, 0051, 0208, 0226, 0264, 0508, 0698, 0706, 0780, 0817
Pausa	0009
Penney	0030, 0047, 0051, 0060, 0156, 0178, 1347, 1378
Philco	0030, 0037, 0054, 0056, 0074, 0145, 0178, 0180, 0186, 0463, 0474, 1661
Philips	0000, 0030, 0037, 0051, 0054, 0056, 0092, 0108, 0178, 0186, 0474, 0556, 0690, 1454, 1483
Phonola	0037
Pilot	0030, 0706
Pioneer	0109, 0166, 0679, 0760, 0866
Polaroid	0765, 0865, 1262, 1276, 1314, 1341, 1498
Portland	0092
Prima	0761, 0783, 0815, 0817
Princeton	0700
Prism	0051
Profex	0009, 0361
Proscan	0047, 1347, 1447
Protech	0009, 0037, 0264, 0418
Proton	0001, 0009, 0030, 0056, 0178, 0474, 0644
Proview	1498
Pulsar	0017
Pye	0037
Qingdao	0051, 0208, 0226, 0264, 0817
Quasar	0051, 0250, 0650
Quelle	0037, 0074, 0361, 0512
R-Line	0037

TV	
Radiola	0037
RadioShack	0030, 0047, 0056, 0154, 0178, 0180
RCA	0000, 0030, 0047, 0060, 0090, 0092, 0178, 0618, 0679, 1047, 1147, 1247, 1347, 1447, 1454, 1547
Realistic	0030, 0056, 0154, 0178, 0180
Rediffusion	0361
Relisys	0865
Reoc	0714
Revox	0037
Rex	0264
Roadstar	0009, 0264, 0418
Rowa	0009, 0037, 0698, 0712, 0748, 0817
Runco	0017, 0030
Ruyi	0817
Saba	0109, 0335, 0343
Sagem	0610
Saige	0009, 0817
Saisho	0009, 0264
Salora	0361
Sampo	0009, 0030, 0092, 0093, 0154, 0171, 0178, 0474, 0650, 0700, 1755
Samsung	0009, 0030, 0037, 0056, 0060, 0090, 0092, 0154, 0156, 0178, 0208, 0226, 0264, 0474, 0556, 0587, 0618, 0644, 0702, 0766, 0812, 0814, 0817, 1060, 1150
Sanjian	0264
Sansei	0451
Sansui	0463, 0706, 1935
Sanyo	0088, 0145, 0154, 0156, 0180, 0208, 0264, 0376, 0424, 0474, 0508, 1150, 1179
Sanyuan	0009, 0093, 0817
SBR	0037
Sceptre	1217
Schaub Lorenz	0361
Schneider	0037, 0371, 0394
Scotch	0178

TV	
Scott	0178, 0180, 0236
Sears	0047, 0054, 0056, 0154, 0156, 0171, 0178
SEG	0264, 1037, 1163
Semivox	0180
Semp	0156, 1356
Sentra	0035
Shancha	0264, 0817
Shanghai	0009, 0208, 0226, 0264, 0817
Shaofeng	0145, 0817
Sharp	0009, 0030, 0093, 0256, 0474, 0650, 0787, 0818, 1165, 1193
Shen Ying	0009, 0092, 0474
Shencai	0009, 0145, 0264
Sheng Chia	0009, 0093, 0236, 0474, 1150
Shenyang	0009, 0264, 0753, 0817
Sherwood	0009
Siemens	0037, 0195
Signet	1262
Simpson	0186
SKY	0037
Sky Brazil	0880
Skygiant	0180
Skyworth	0009, 0037, 0264, 0698, 0748, 0753, 0817
Sliding	0865, 0880
Songba	0009
Sonitron	0208
Sonoko	0009, 0037
Sonolor	0208
Sontec	0037
Sony	0000, 0650, 1100, 1167, 1300, 1505, 1651
Soundesign	0178, 0180, 0186
Soundwave	0037, 0418
Sowa	0051, 0060, 0092, 0156, 0178, 0226, 0474, 1150



## Remote Control Codes List—Continued

TV	
Squareview	0171
SSS	0180
Standard	0009
Starlite	0180
Studio Experience	0843
Sunkai	0865
Superscan	0093, 0864
Supra	0056
Supreme	0000
Susumu	0474
SVA	0587, 0748, 0865, 0870, 0871
Swisstec	0880
Sylvania	0030, 0054, 0171, 1314
Symphonic	0171, 0180
Synco	0000, 0060, 0092, 0093, 0178, 0451, 0474
Syntax	1144, 1240, 1331
Sysline	0037
T+A	0447
Tacico	0009, 0092, 0178, 0474, 1150
Tai Yi	0009, 1150
Taishan	0009, 0817
Tandy	0093
Tashiko	0092, 0650, 1150
Tatung	0009, 0037, 0051, 0054, 0060, 0154, 0156, 0474, 1150, 1156, 1254, 1756
TCL	0698, 0706
TCM	0808
Teac	0009, 0037, 0264, 0418, 0455, 0698, 0706, 0712, 1037, 1755
Technics	0051, 0250, 0650
Technisson	0714
Techview	0847
Techwood	0051, 0056, 1163
Teco	0009, 0051, 0092, 0093, 0178, 0264, 0474, 0653
Teknika	0054, 0056, 0060, 0092, 0150, 0180, 0186
Teleavia	0343

TV	
Telefunken	0056, 0074, 0109, 0335, 0343, 0625, 0702, 0896
Teletech	0009
Teleton	0186
Tera	0030, 0092, 0474
Tevion	0767
Texla	0780
Thomson	0109, 0343, 0560, 0625, 1447
Thorn	0035, 0037, 0074, 0343, 0361, 0512
Thorn-Ferguson	0343
Tiane	0093, 0817
TMK	0056, 0178
TNCi	0017
Tobo	0009, 0264, 0748
Tongguang	0264
Tongtel	0780
Tophouse	0180
Toshiba	0009, 0035, 0060, 0093, 0145, 0154, 0156, 0161, 0264, 0508, 0509, 0618, 0644, 0650, 0845, 1150, 1156, 1169, 1173, 1256, 1265, 1356, 1456, 1508, 1656, 1704, 1935
TRANS-continents	0865
Transonic	0587, 0698, 0712
Tuntex	0009, 0030, 0092, 0474
TVS	0463
Universum	0037, 0074, 0264, 0346, 0474
V7 Videoseven	1755
Vector Research	0030
Vestel	0037
Victor	0053, 0160, 0250, 0376, 0650, 0653
Videocon	0037, 0508
Vidikron	0054
Vidtech	0178
Viewsonic	0857, 0864, 0885, 1755
Vizio	0864, 0885, 1756
Voxson	0178

TV	
Wards	0030, 0054, 0056, 0178, 0866, 1156
Warumaia	0661
Watson	0037
Waycon	0156
Weipai	0009
Westinghouse	0885, 0889, 1282
White Westinghouse	0037, 0186, 0463, 0623
Xenius	0661
Xiahua	0009, 0264, 0698, 0773, 0817
Xianghai	0009
Xiangyang	0264
Xiangyu	0009
Xihu	0264, 0817
Xingfu	0009
Xinghai	0264
Xoro	1217
Yamaha	0030
Yapshe	0250
Yingge	0009
Yoko	0037, 0264
Yonggu	0009
Youlanasi	0817
Yousida	0009
Yuhang	0009
Zenith	0017, 0092, 0178, 0463, 1265
ZhuHai	0009
Zonda	0698

### TV/DVD Combination

Akai	1935
Broksonic	1935
Bush	0698, 1037
Citizen	1935
Denver	0587
Grundig	1935
Sansui	1935
Toshiba	1935
Transonic	0587

# Memo

---

---

# Memo

---

---

## **ONKYO CORPORATION**

Sales & Product Planning Div. : 2-1, Nisshin-cho, Neyagawa-shi, OSAKA 572-8540, JAPAN  
Tel: 072-831-8023 Fax: 072-831-8124

### **ONKYO U.S.A. CORPORATION**

18 Park Way, Upper Saddle River, N.J. 07458, U.S.A.  
Tel: 201-785-2600 Fax: 201-785-2650 <http://www.us.onkyo.com/>

### **ONKYO EUROPE ELECTRONICS GmbH**

Liegnitzerstrasse 6, 82194 Groebenzell, GERMANY  
Tel: +49-8142-4401-0 Fax: +49-8142-4401-555 <http://www.eu.onkyo.com/>

### **ONKYO EUROPE UK Office**

Suite 1, Gregories Court, Gregories Road, Beaconsfield, Buckinghamshire, HP9 1HQ  
UNITED KINGDOM Tel: +44-(0)1494-681515 Fax: +44(0)-1494-680452

### **ONKYO CHINA LIMITED**

Unit 1&12, 9/F, Ever Gain Plaza Tower 1, 88, Container Port Road, Kwai Chung,  
N.T., HONG KONG Tel: 852-2429-3118 Fax: 852-2428-9039  
<http://www.ch.onkyo.com/>



Y0708-1

SN 29344555

(C) Copyright 2007 ONKYO CORPORATION Japan. All rights reserved.



\* 2 9 3 4 4 5 5 5 \*