



*The NB-Series of pellet heaters have been designed and built for the European domestic pellet heating market and is imported, distributed and supported in Australia by PFTAS Pty Ltd.*





## Table of Contents

INTRODUCTION .....	3
1. Welcome .....	3
2. Benefits .....	3
3. Safety.....	3
4. Fuel Requirement.....	3
5. Specifications .....	5
6. Pellet fuel consumption .....	5
7. Mechanical.....	7
8. Warranty .....	8
USERS GUIDE .....	9
1. Operations Instructions - Quick reference guide.....	9
2. Operating Instructions - Detailed.....	10
a) Startup.....	10
b) Shutdown .....	10
c) Power Level - Pellet Feed rate .....	11
d) ECO Stage .....	11
e) Set the Thermostat Temperature .....	11
f) Automatic or Manual .....	11
g) Check Temperatures .....	12
3. Setup - Quick reference guide.....	13
4. Setup Instructions - Explained .....	18
a) Cleaning.....	18
b) ECO Mode .....	18
c) Language .....	18
d) Setting the program schedule.....	18
e) Setting the clock.....	18
f) Saving the settings .....	18
g) Exit setup.....	18
5. Error codes .....	19
6. Maintenance .....	20
a. Minor Maintenance .....	20
b. Major Maintenance.....	21
7. Troubleshooting .....	23
INSTALLERS GUIDE .....	25
1. Installation.....	25
2. Electronic Plan.....	31

## INTRODUCTION

### 1. Welcome

Thank you for choosing the NB-Series pellet burning heater. Your pellet heater is designed to provide the utmost safety, reliability and efficiency. This guide will help you get the best from your heater and should be retained for future reference.

### 2. Benefits

Your pellet fire gives you and your family all the benefits of the latest clean-burning technology. Overseas, pellet heating has become very popular due to environmental and energy issues.

- **Energy-efficient.** Pellets are burnt at optimum fuel to air ratios. This means that they burn efficiently (>85%) producing real heat for minimum cost.
- **Environmental.** Pellet fuel delivers a much cleaner burn than coal or wood and meets the toughest emission standards in the world when burnt in a specifically designed pellet heaters. Emission rates of around 0.1 gram are common for pellet heaters which is 40 times cleaner than the current Australian standard for wood heaters (4 grams as at February 2012). Pellet heaters should only emit a small amount of visible smoke during the ignition phase which only lasts for a few seconds each time the heater is started.
- **Healthy.** Because pellets burn so cleanly, there is little to no smoke, soot or ash to contaminate the environment. Silica (sand) and other trace minerals found in the wood that cannot burn accumulate in the ash pan and can be deposited onto your garden as fertilizer.
- **Easy to use.** The NB-Series pellet heater makes heating so easy. The fire starts with a push of the switch or automatically with program and temperature control. No matches or kindling or lugging heavy and dirty fire wood.

### 3. Safety

**Installation:** This appliance and flue system must be installed in accordance with the appropriate requirements of the Australian Building Code.

- Always make sure that the firepot is ash-free before starting your fire.
- Keep the hopper lid closed unless adding fuel.
- Only use approved wood pellets – DO NOT use any other fuel or accelerants.
- Do not burn waste wood chips, paper or rubbish.
- Never open the front door after starting the fire.
- The front of heater will get hot, do not touch hot surfaces. Keep children clear and or use a child safety guard.
- Only clean the heater when it is cold.
- Empty the ash pan before it over fills. Ash and embers must be cool before disposal.
- Never hang cloths too close to any heater.

### 4. Fuel Requirement

Your pellet heater has been designed to burn wood pellets only. Do not use any other type of fuel as this will void any warranties stated in this manual.

Quality pellet fuel is a natural product manufactured without any binders or additives. The pellets are formed under pressure from waste sawdust. There are many variables that will affect the



## Pellet Heater Owner's Manual - NB-Series

composition of the pellet fuel and the specifications. The performance of your pellet heater is greatly affected by the type and quality of wood pellets being burned. As the heat output of various quality wood pellets differs, so will the performance and heat output of the pellet heater.

We recommend the use of pellets that meet or exceed these standards. Please use a recommended pellet type.

<b>Moisture content (as fired basis) CEN/TS 14774-1 and ISO 687</b>	<b>≤12%</b>
<b>Ash content (as fired basis) ISO1171</b>	<b>≤0.7% without bark ≤2.0% with bark</b>
<b>Volatile matter (dry, ash-free basis) ISO562</b>	<b>80% to 88%</b>
<b>Hydrogen content (as fired basis) ISO609</b>	<b>5.0%to 6.5%</b>
<b>Carbon content (as fired basis) ISO609</b>	<b>40% to 50%</b>
<b>Sulfur content (as fired basis) ISO 351 and ISO 334</b>	<b>≤0.1%</b>
<b>Net (lower) calorific value (as fired basis) ISO1928</b>	<b>16900KJ/KG to 19500KJ/KG Average 5.3 kWh/Kg</b>
<b>Diameter</b>	<b>5mm to 6.5mm</b>
<b>Length</b>	<b>≤30mm</b>

### **CAUTION:**

It is important to select and use only pellets that are dry and free of dirt or any impurities such as high salt content. Dirty fuel will adversely affect the operation and performance of the unit and will void the warranty.

**ASH:** The ash content of the fuel and operation of your heater will directly determine the frequency of cleaning. The use of high ash fuels may result in the heater needing to be cleaned daily. A low ash fuel may allow longer intervals between cleaning.

**CLINKERING:** clinkers are silica (sand) or other impurities in the fuel that will form a hard mass during the burning process. This hard mass will block the air flow through the Burn Pot and affect the performance of the heater. Any fuel, even approved types, may tend to clinker. Check the Burn-Pot daily to ensure that the holes are not blocked with clinkers.

If they become blocked, remove the burn pot (when the unit is cold) and clean/scrape the clinkers out. Clean the holes with a small pointed object if required. Refer to the section Routine Cleaning and Maintenance.

Pellets made from Harwood present less clinkering than those made from softwood species.



# Pellet Heater Owner's Manual - NB-Series

**PELLET FEED RATES:** Due to different fuel densities and sizes, pellet feed rates may vary. This may require an adjustment to combustion fan's speed or to the auger feed trim setting on low (contact PFTAS).

## 5. Specifications

The Pellet heater is an advanced design and has individual fresh air input and exhaust venting systems. Negative pressure burning technology causes high efficiency and little ash output during burning. High output, quick heating and low fuel costs are its advantages.

Model		MacLeod	MacLeod	MacLeod	Grace	Grace
Description	Unit	Mini	Midi	Maxi	Insert	Console
Heat Output (High)	Watts	6,000	9,000	12,000	13,000	13,000
Heat Area	M2	80	120	160	170	170
Efficiency	%	85	90	90	90	90
Hopper Capacity	Kg	5	12	30	30	30
Burn rate (Min - Max)	Kg/Hr	0.6-1.2	0.6-1.8	0.6-2.0	1.0-2.3	1.0-2.3
Electricity (running)	Watts	100	100	100	100	100
Electricity (start-up)	Watts	300	300	300	300	300
Dimensions (W*H*D)	mm	463*740 *570	463*918 *570	540*1020* 620	648*747 *618	665*772 *623
Weight	Kg	70	80	100	120	120

## 6. Pellet fuel consumption

### a. Introduction

Modern pellet heaters have automatic feed control with fixed feed rate settings. This makes the heater easy to use but does take away our ability to fine tune the pellet feed rate to account for pellet fuel length differences that may occur.

### b. Wood Pellet Length

From season to season, batch to batch or brand to brand, it's very likely that the pellets you buy could be shorter or longer in length on average. This is very normal. There are several variables that determine the length of a pellet during manufacturing and any one of them could be different from brand to brand or season to season. **How does this effect burn?** Longer pellets will feed less fuel into the fire with the rotations of the auger than shorter pellets. If everything else in the pellet heater stays the same, and the only difference in the fuel is pellet length, shorter pellets will provide more fuel to the fire than longer pellets resulting in more heat output. Longer pellets will provide less fuel and therefore produce less heat for the same setting.



## **c. Consumption Specifications**

The fuel consumption rate for Pellet Heaters is usually stated as a minimum and a maximum. These limits are based on an average. A heater may claim a minimum of 600 grams per hour on low and 1.8 kgs on high. In reality these feed rates may be more or less depending on the pellet length. Pellet heaters are designed to be reliable and not go out on the lowest setting. If the minimum feed rate was set too low the heater could go out un-expectedly if the pellet length was longer than the average.

## **d. Heat Output**

The heat produced is directly related to the amount of fuel consumed. The faster fuel is consumed the hotter the fire and the warmer your house will be. Conversely, less fuel, less heat and lower cost to operate. Due to the ease of starting and stopping a modern pellet heater, it is more economical to turn the heater off when in bed or when the house is unoccupied.

## **e. Feed settings**

The power setting P1 has been programed to provide as close as possible to the rated specifications of the heater while using typical (normal) sized pellets. If you find that the average pellet size is smaller than normal, select P2 or P3 as these setting has been programed to feed less fuel.

## **f. Conclusion**

Using the correct heat setting and or thermostat setting will maintain your desired comfort level by replacing the heat being lost by your home. If you are unable to reach the desired comfort level on the highest heat setting then you will require additional heating or reduce the heat being lost (better insulation, reduce draughts etc). If your home is too hot on the lowest setting (ECO) then turn the heater off manually or contact Pellet Fires Tasmania Customer Service for more information and assistance.

## 7. Mechanical

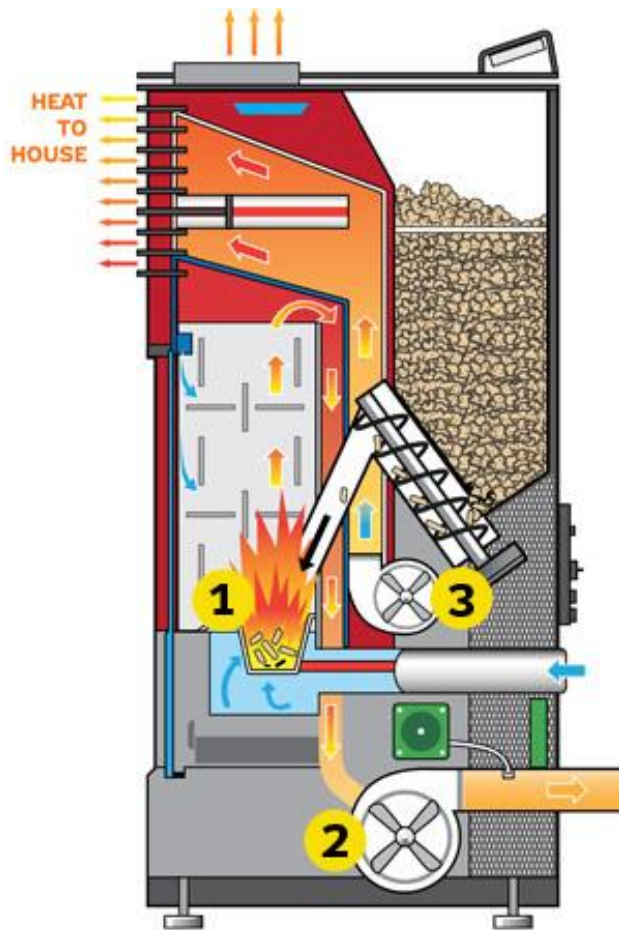

The heater is mainly made up of following items  
 - 1. Combustion burn pot 2. Exhaust fan 3. Room circulation fan and auger motor.

The following is a list of main components and their functions:

### IGNITER

The HEATER comes equipped with an automatic electric igniter for lighting the fuel when the heater is in lighting mode only. The igniter remains energized for the first eight minutes of the lighting sequence.

### VACCUM SWITCH

The HEATER has a safety vacuum switch located behind the left door, fastened to the base. If a low pressure is created in the firebox by a leak, opening the front door, a blocked flue, or unsealed ash drawer, the vacuum switch will sense it and cause the heater to go into a shutdown mode.

### AUGER AND AUGER MOTOR

The 2 RPM auger motor turns the auger lifting pellets up the auger tube. The pellets are then dropped down a tube and into the firepot. The auger is controlled by the control board.

### OVER TEMPERATURE THERMOSTAT

This safety switch is installed on the bottom of hopper and will shut off the heater if it senses excessive temperatures (70 degrees).

### CONVECTION BLOWER THERMOSTAT

This switch is installed on the vent pipe and turns the convection blower on when the heater is above 40 degrees.



## Pellet Heater Owner's Manual - NB-Series

### 8. Warranty

PFTAS Pty Ltd (ACN 119 678 090) hereby warrants to the original purchaser of the NB-Series Pellet Heater, that it will be free from defect in material and workmanship under normal use in accordance with the Owner's Manual.

PFTAS shall at no cost to the consumer, upon such defects occurring, at its option repair or replace such faulty materials or workmanship.

Our goods come with guarantees that cannot be excluded under the Australian Consumer Law. You are entitled to a replacement or refund for a major failure and for compensation for any other reasonably foreseeable loss or damage. You are also entitled to have the goods repaired or replaced if the goods fail to be of acceptable quality and the failure does not amount to a major failure.

- Warranty coverage begins from the date of original installation or within three months of purchase, whichever occurs first.
- This warranty is only valid while the appliance remains at the site of the original installation.
- This warranty only covers appliances that are purchased from an authorized PFTAS dealer or distributor. Refer to [www.pftas.com.au](http://www.pftas.com.au).
- Service fees may apply if you seek warranty service from a dealer other than from whom you originally purchased the product.
- Travel and shipping costs are not covered by this warranty.
- This warranty does not cover any defects, failures, operating difficulties or damage caused due to accident, abuse, alteration, misapplication, improper installation, improper maintenance or service or failure to perform normal and routine maintenance.

Warranty Period		Components Covered
Parts	Labour	
3 year	1 year	All components not listed below
2 year	0 years	Firepots and burn pots
5 years	1 years	Firebox and heat exchanger
5 years	1 year	Flue parts
90 days	90 days	Glass window, door rope seals, external painted finishes.
90 days	90 days	All replacement parts and labour beyond the warranty period.
0	0	Normal wear and tear and internal paint finishes

The benefits of this warranty are in addition to all other rights and remedies to a consumer under the Commonwealth of Australia Competition and Consumer Act 2010 or other Commonwealth or State legislation and this warranty does not purport to limit or exclude such rights and remedies.



## USERS GUIDE

### 1. Operations Instructions - Quick reference guide

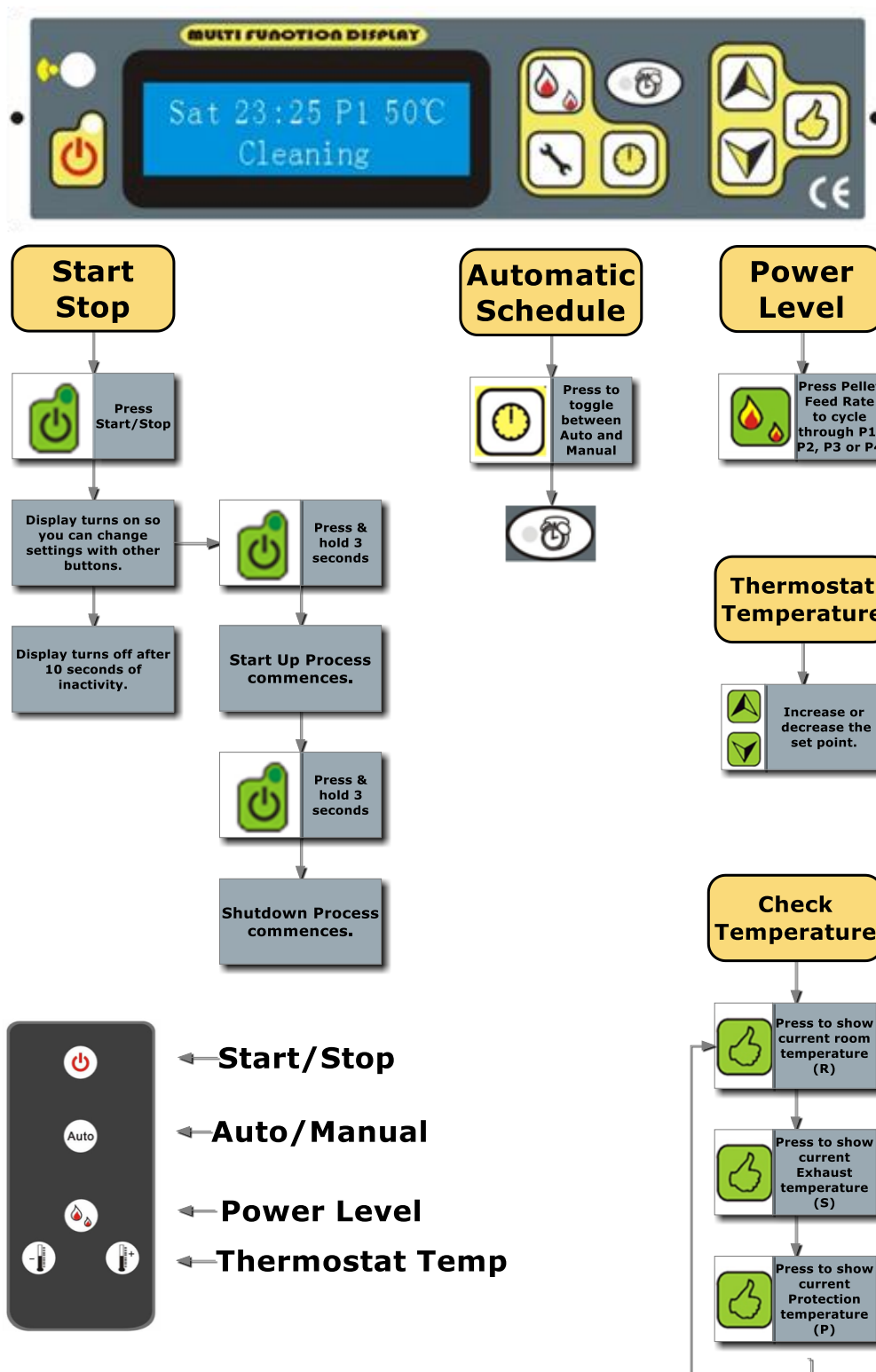

## 2. Operating Instructions - Detailed

### a) Startup

- Check the hopper has pellets and the burn pot is clear of ash or clinker build up.
- Clean the burn pot, glass and ash pan if necessary.
- Press the On/Off button  once and then again but hold for 3 seconds with the second push. If using the remote control, then press the Start/Stop button twice.

Message, CLEANING will be shown first, (The exhaust system is flushed with air)



Message, FEEDING will be shown next, (Pellets are feed into the burn pot)



Message, LIGHTING will be shown next, (Electric igniter heats up and lights the pellets)



Message, STABILIZATION will be shown next (Normal operation, pellets are fed as per the power setting and the room fan turns on once the heater is >35 degrees)

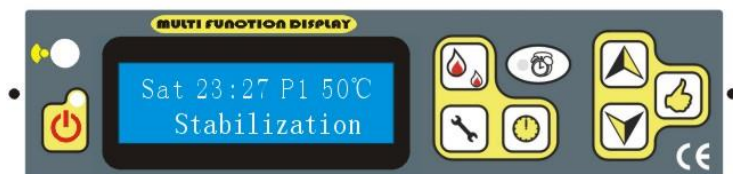

### b) Shutdown

Press the On/Off button on remote control or push and hold panel button for 3 seconds.

Message, Switching Off will be shown first, (Fuel feed stops, pellets burn away)



After the temperature in the heater is below 30degree, 'GOODBYE' is displayed. (STOPPED)

## c) Power Level - Pellet Feed rate

There are four pellet feed rate settings which determines the heat output.

Pressing the key  to select P1 to P4 which is displayed.



- MINIMUM POWER P4 (about 27% )
- LOW POWER P3
- MEDIUM POWER P2
- MAXIMUM POWER P1 (100% )



## d) ECO Stage

If the room temperature exceeds the set room temperature the stove is stopped automatically if ECO1 is selected or turns to minimum power in order to save energy if ECO2 is selected:



After the room temperature drops down, and below the set room temperature (3degrees), it automatically switches on again or goes back to the previous Power level.



## e) Set the Thermostat Temperature

Press the keys   adjust the room temperature set point.

The pellet heater will either operate at the set pellet feed rate (P1,P2,P3 or P4) until the actual room temperature exceeds the set point at which time the heater will automatically switch to the selected ECO Mode. (Turn off or run at minimum power).

## f) Automatic or Manual

Automatic mode turns the heater on and or off as determined by the programmed timer schedule.

Press the Auto button  to switch between Auto or Manual. If the light is on,  the automatic program is selected. Otherwise it is manual.

## g) Check Temperatures



Press the keys

The number with “R” is the temperature for room.

The number with “S” is the temperature for the Smoke

The number with “P” is the temperature for the Protection.

For example:

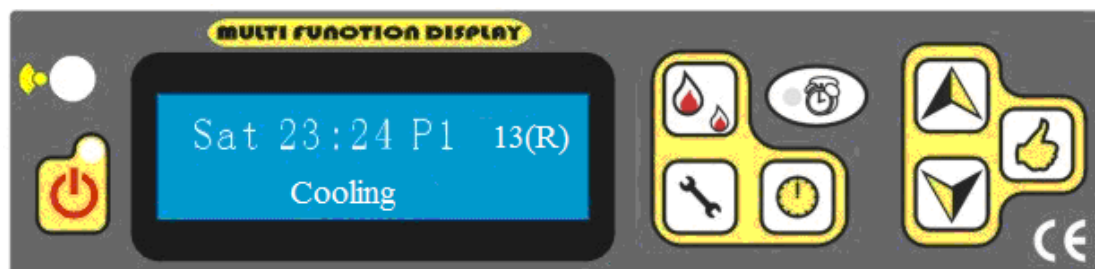

It means that the room temperature is 13 degree.

### 3. Setup - Quick reference guide

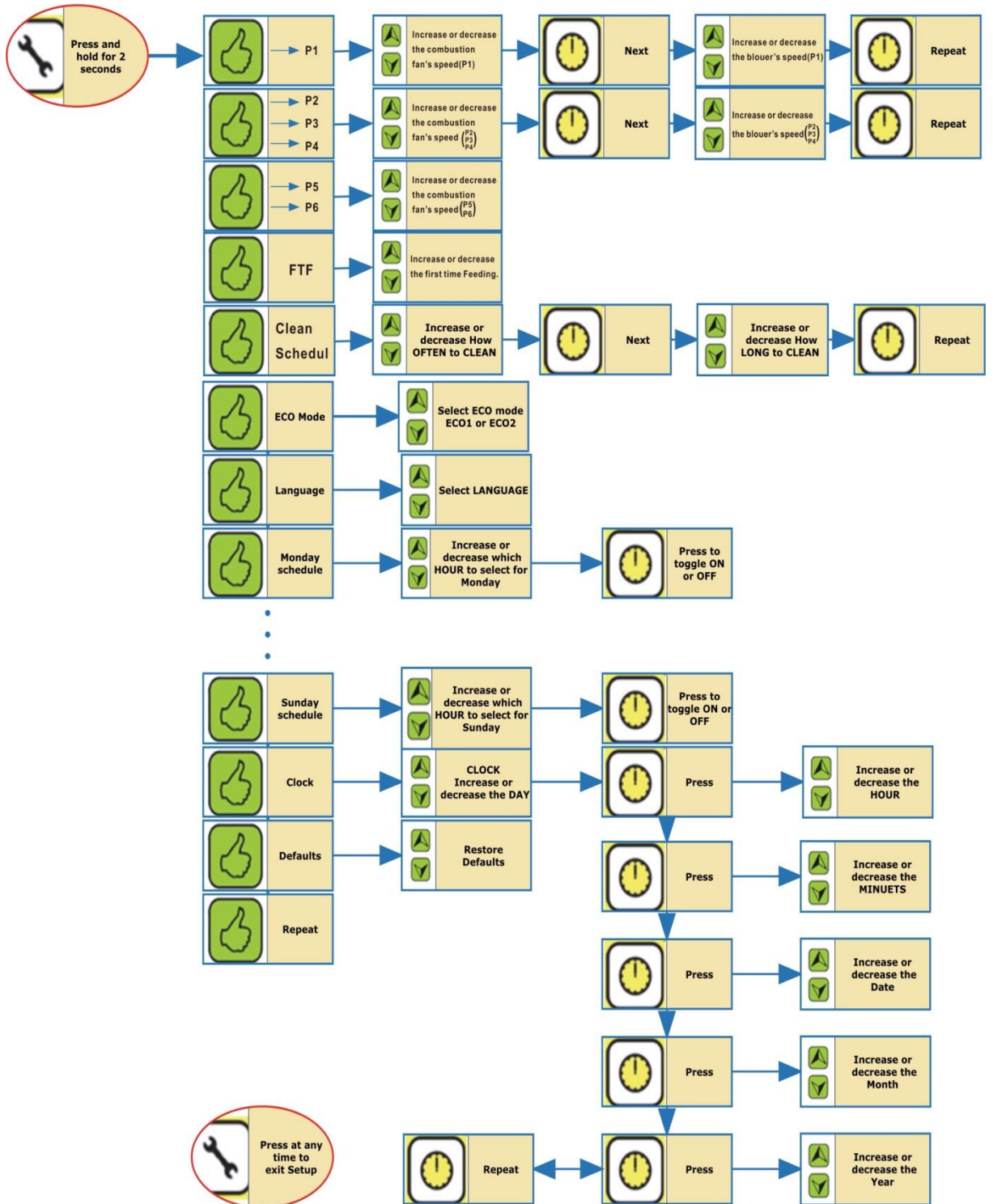



Combustion fan and blower (room fan) speed settings

Pressing the keys  up to 2 seconds, on the display shows:



S= SMOKE(EXHUAST FAN) F=FAN(BLOWER)

By press  to move from "S 0" TO "F 0", By press  to adjust the speed of them.

Both of them can be adjust from 20 to -20. Normally, Factory setting is 0. 20 is max. and -20 is min.

Press  to save the setting and go to P2, and P3, and P4, as following:

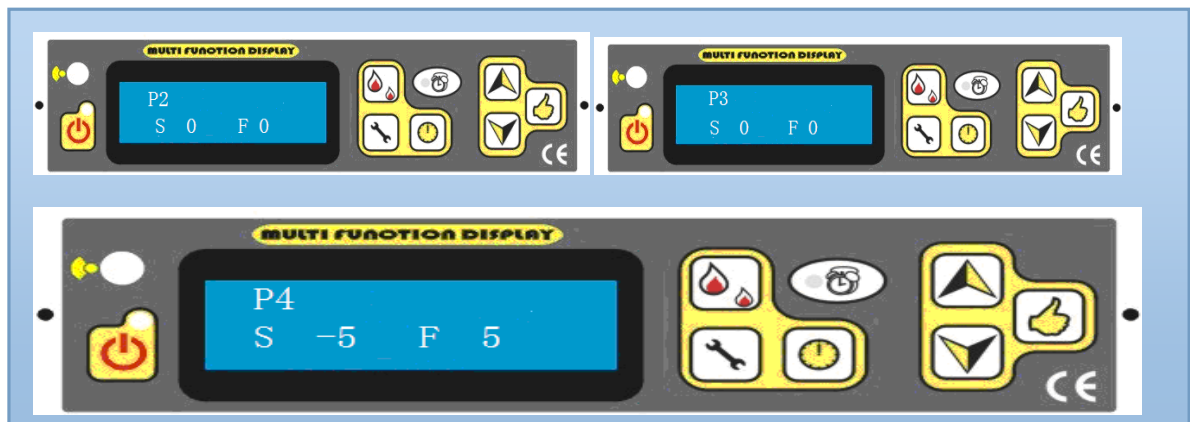

After P4, it is P5, this data is related to the exhaust fan's speed of the "Cleaning" stage. The adjustable range is also from 20 to -20

The following is P6; this data is related to the exhaust fan's speed of the "Feeding", "Lighting" and some minutes of "Stabilization" stage. The adjustable range is also from 20 to -20

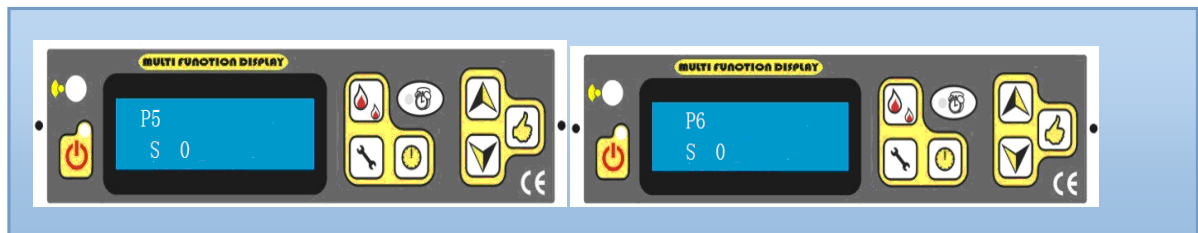



First time Feeding quantity setting

Keep Pressing , it shows:

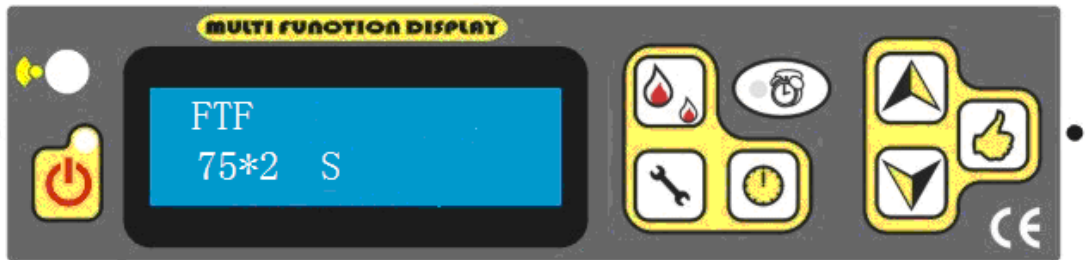

FTF= FRIST TIME FEEDING

75\*2 S MEANS 150 SECONDS' FEEDING TIME. You can adjust the time by pressing





CLOCK SETTING

Press the key , the time can be amended:



You can select week or time by keys ,

also using   to change the day or time , to save the correct data by press 

and move to next stage.

## CLEANING SETTING

you can adjust the time of cleaning during the operation----- “every X mins, last Y”  
Seconds to cleaning the burning pot  key



For example every 30mins Last 15 seconds:



## TIMER SETTING





Press the key  into next stage: On the display the following wording will appear



With this function you program the heater for a weekly programming, associating the switching on and the switching off at the pre fixed timetables. You can program daily switching on and switching off for the whole week.

By keeping pressing the key , you will found the attached instruction above,

Then you can press  to choose week days

By pressing  , to select hours, then press  to decide the hour on or Off.

On the above line it is showed the day which is programming, the hour with the functioning state.

On the below line the programmed hour are displayed.

- Lower one means off, taller on means on, which also shows on superior line



## LANGUAGE SETTING

By keeping pressing the key  it will appear the following words:



With this function you can select language. By pressing the ke

## ECO mode SETTING

By keeping pressing the key  it will appear the following words:

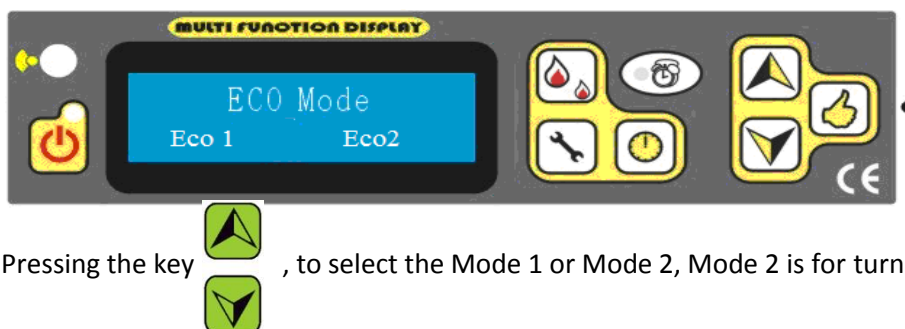

Pressing the key , to select the Mode 1 or Mode 2, Mode 2 is for turning to minimum Power, while mode 1 is for stopping the stove.

## Restore Defaults select

Keeping pressing the key  it will appear the following words

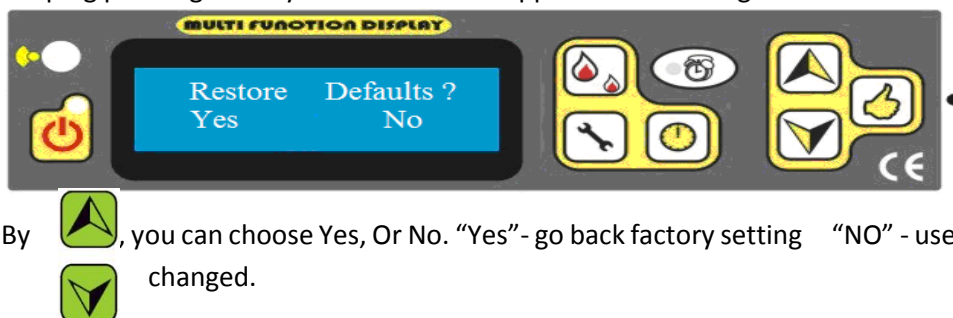

By , you can choose Yes, Or No. "Yes" - go back factory setting "NO" - use the data you have changed.

Pressing the key  the programming will finish.



## 4. Setup Instructions - Explained

To enter the setup mode, press and hold the Spanner button DOWN for 2 seconds.

Please refer to the Quick reference guide for the correct button sequence; the following is an explanation of each feature.

### a) Cleaning

The heater automatically cleans ash from the burn pot on a regular basis by reducing the fire to a very low burn and then introducing a brief blast of air. You are able to choose how often you want the cleaning process to occur and for how long it should take. The default settings should be adequate for the type of pellet fuel available and need not be changed.

### b) ECO Mode

When selected, the ECO1 option turns the heater OFF when the room temperature is above the thermostat setting. ECO1 is NOT recommended for Tasmanian conditions and homes. The ECO2 option reduces the power (heat output) level to the lowest power setting (P4). This is like an overnight burn setting and is the recommended option for medium and larger areas because it does not cause the heater to go through the startup and shutdown sequences.

### c) Language

Select the language of choice. Default is English.

### d) Setting the program schedule

Each hour of each day of the week can be set to be ON or OFF allowing simple or complex schedules to be programmed which operate when the Auto setting is activated. *EG - Automatically turn ON and stay on between 6am and 8am then again from 4pm to 10pm Monday to Friday and OFF Saturday and Sunday so that MANUAL operation is used as required on those days.*

### e) Setting the clock

The hour, minutes, day, month and year can be set to local time. Please adjust as required for day light savings time.

### f) Saving the settings

If changes are made, you need to save the settings as the new default; else the original settings will remain after the power is turned off and back on again (power failure).

### g) Exit setup

Press the spanner button at any time to exit the setup programming mode.

### 5. Error codes

- Fire Error = protection was activated due to over temperature or a component failure. Contact customer support.
- E1 = Failure to light. Check ash in the burn pot, clean and attempt to start again. If the heater fails to light after several attempts contact customer support.
- E2 = Fire went out. Refill the hopper and attempt to start again.
- E3 = Earthquake if a detector is fitted (only applicable in earthquake areas like Japan).
- E4 = Temperature sensor error.
- E5 = Vacuum problem. Check that the door is closed or a service may be required due to a buildup of ash or a blockage in the exhaust system.
- E6 = Hopper protection sensor over temperature. Check room fan speed.
- E7 = Power failure. Clear error code and resume operation.
- E8 = Blocked exhaust passages. Heater needs to be serviced.
  
- ESC1 = Temperature sensor 1 is short circuited. Contact customer support.
- ESO1 = Temperature sensor 1 is open circuited. Contact customer support.
- ESC2 = Temperature sensor 2 is short circuited. Contact customer support.
- ESO2 = Temperature sensor 2 is open circuited. Contact customer support.
- ESC3 = Temperature sensor 3 is short circuited. Contact customer support.
- ESO3 = Temperature sensor 3 is open circuited. Contact customer support.



To clear an error code, Press and hold the  key for 2 seconds (a beep will confirm). In the event of multiple error messages (eg E1 and E5), it may be necessary to power off the heater at the power point and then clear the error code.

## 6. Maintenance

Unplug and let the HEATER cool before performing any maintenance or cleaning. The frequency of performing the following cleaning procedures depends on the quality and amount of the pellets burned. **Not cleaning this unit will cause it to burn poorly and may void your heater's warranty.**

### a. Minor Maintenance

#### BURN POT CLEANING



The combustion fan comes on at high speed once an hour to blow the byproducts of combustion out of the burn pot. However, the burn pot should be cleaned more thoroughly after burning about 10 bags of pellets. The burn pot has a number of gaps in the bottom and sides that provide combustion air to the burning pellets. The extreme temperatures in the burn pot can cause impurities in the pellets to form ash and clinkers that the automatic cleaning cannot deal with.

When the heater is cool, open the front door and lift out the burn pot. Scrape the inner bottom and sides of the pot with a screwdriver to remove all ash and clinkers from these surfaces. Replace the burn pot making sure the high side of the pot is rotated toward the front of the heater. Vacuum clean underneath where the burn pot sits, around the door and anywhere ash can be seen.

#### CLEANING GLASS

**Caution:** Do not open the front door when the heater is hot. Clean the glass using a soft cloth or paper towel and a glass cleaner (Windex). A damp cloth with small amount of ash from the firebox can also be used to clean the glass.

#### ASH DRAWER REMOVAL AND CLEANING

**Caution:** Do not remove the ash drawer when the heater is hot. Open the door and pull the ash drawer forward and away from the heater. Empty the ash drawer in a metal container just in case there are still some hot embers amongst the ash. The ash may be spread on the lawn or in a garden. Reinstall the ash drawer.

#### HOPPER

Fine sawdust will build up in the bottom of the hopper over time which can impede pellet feed. Before refilling the hopper, check for sawdust and vacuum out if necessary.

## b. Major Maintenance

The Major maintenance procedures would be carried out as part of an annual service provided by PFTAS customer support or can be carried out by an experienced operator.

**\*\* Disconnect the unit from the main power supply before attempting any service work inside the heater \*\*\***

### CLEANING THE COMBUSTION BLOWER

To clean the combustion blower, remove the retaining nuts, the motor with fan attached can be pulled from the fan housing. The fan blades and the fan housing can be vacuumed once the motor is removed. When reinstalling the motor, a new gasket may need to be installed between the motor and the fan housing. To complete the reinstallation, place the motor back on the fan housing and reinstall the nuts. Make sure the motor's green ground wire is secured under one of the nuts.

### CLEANING THE FLUE GAS PASSAGEWAYS

Cleaning the flue passageways should be done at least once a year. Burning high ash pellets may require this cleaning to be done more often. Clean these passageways only when the heater and ash is cold. On the both sides of the heater is an access cover that can be removed by unscrewing the screws. Insert a cleaning brush in the openings to loosen any ash buildup and use a vacuum cleaner to remove the loosed ash. Reinstall the cover when cleaning is complete.

There are also two more access holes located behind the ash drawer. Remove the ash drawer and loosen the two 5/32" allen head screws shown as D in the drawing below. Rotate the covers over the access holes and use a brush and vacuum to clean the ash. Rotate the covers back over the holes and tighten the screws.

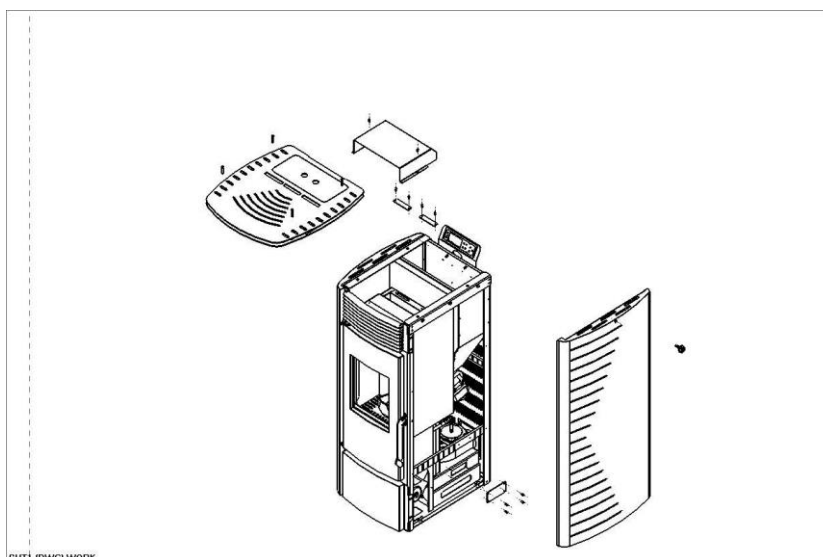

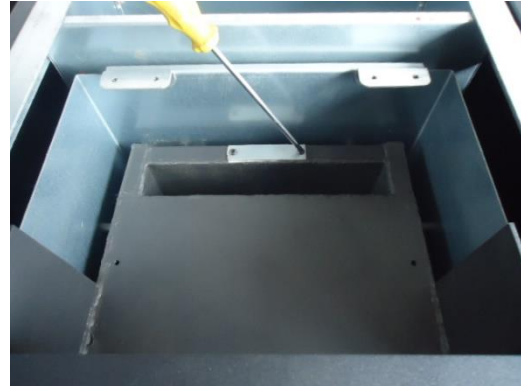

## CLEANING THE CONVECTION BLOWER

To clean the convection blower remove the right side door. A vacuum can be used to remove any dust accumulation on the blower's blades or inside the blower duct. Caution should be used not to damage the blower's blades during cleaning.

## CLEANING THE VENT PIPE

Incomplete combustion, such as occurs during start up, shutdown, or incorrect operation of the heater will lead to some soot formation which will collect in the exhaust venting system. The exhaust venting system should be inspected at least once every year to determine if cleaning is necessary. Sweep the pipe as needed. A cleanout tee in the vent system will facilitate this cleaning.

## **Required Cleaning Schedule after Number of Bags Burned**

Burn Pot=10 bags

Ash Drawer=20 bags

Flue Fan=100 bags

Blower=100 bags

NOTE: Cleaning schedule will vary depending on quality of pellets used. High ash pellets will require the heater to be cleaned more frequently.

## 7. Troubleshooting

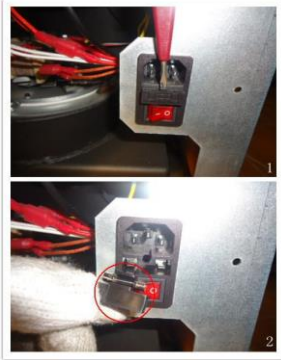
Problems	Reason	Solution
1. No panel display	No power.	Check the power outlet and heater plug at the back of the heater. Check the fuse – 
2. The blower doesn't work after pressing the start button.	It is normal. It will start automatically when the temperature is below 30 degrees on the venting pipe.	Please wait
If after 15 minutes, it still does not work, there must be a failure.	Electronic component failure	Contact customer service.
1. No pellet feed. There are three feeding process stages.		
A. During start up, FEEDING is displayed.	Feed unit is blocked.	Clear the blockage.
	No auger drive.	Contact customer support.
	No fuel in the hopper.	Fill the hopper.
B. Second stage ignites the pellets. LIGHTING is displayed.	It is normal	Please be patient
	Igniter failure	Contact customer support.
C. Normal operating stage STABILIZATION is displayed.	Feed unit is blocked.	Clear the blockage.
	No auger drive.	Contact customer support.
	No fuel in the hopper.	Fill the fuel into the hopper.
4. Burn pot overflows. Orange or lazy fire.	Lack of air for burning.	Clean the exhaust air way path.



5. The fire goes out.	The level of feeding speed is too low or too much air flow.	Contact customer support.
5 Heater switches off after 15 minutes.	Heater has not reached operating temperature.	Clean out the burn pot and start again. If fails a second time contact customer support.





## INSTALLERS GUIDE

### 1. Installation

**ALL NATIONAL AND LOCAL REGULATIONS AND BUILDING CODES SHALL BE COMPLIED WITH WHEN INSTALLING THE APPLIANCE.**

#### Clearances:

When installing this unit on a combustible floor (for example linoleum, hardwood flooring) a noncombustible hearth pad (15mm thickness) must be under the unit. The pad must extend at least the width of the appliance and at least the depth of the appliance plus 150 mm) in front of the appliance.

The clearance between the walls or to the top is no less than 50mm however sufficient clearance needs to be allowed for service access.

#### Electrical:

The unit must be grounded. The grounded electrical cord should be connected to a standard 230V, 50Hz (4.5 Amps), electrical outlet. Be careful that the electrical cord is not trapped under the appliance and that it is clear of any hot surfaces or sharp edges and also must be accessible. If this power cord should become damaged, a replacement power cord must be purchased from the manufacturer or a qualified dealer.

The average electric power consumption is between 45 and 100 watts. During the automatic ignition process (duration 10 minutes) approx. 350 watts.

## Exhaust venting pipe Installation:

Horizontal and Up (Snorkel),

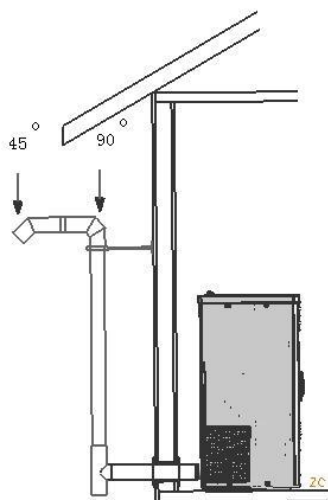

Horizontal (But it is not recommended, when the electronic power is off, the smoke might come out if the heater is on )

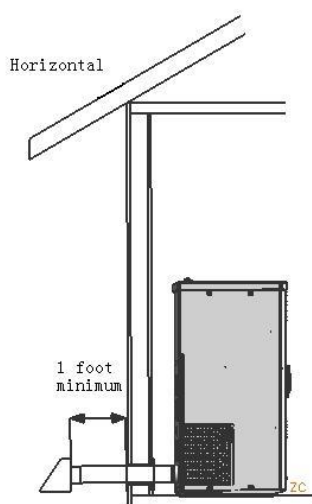

Horizontal and Up through the eave

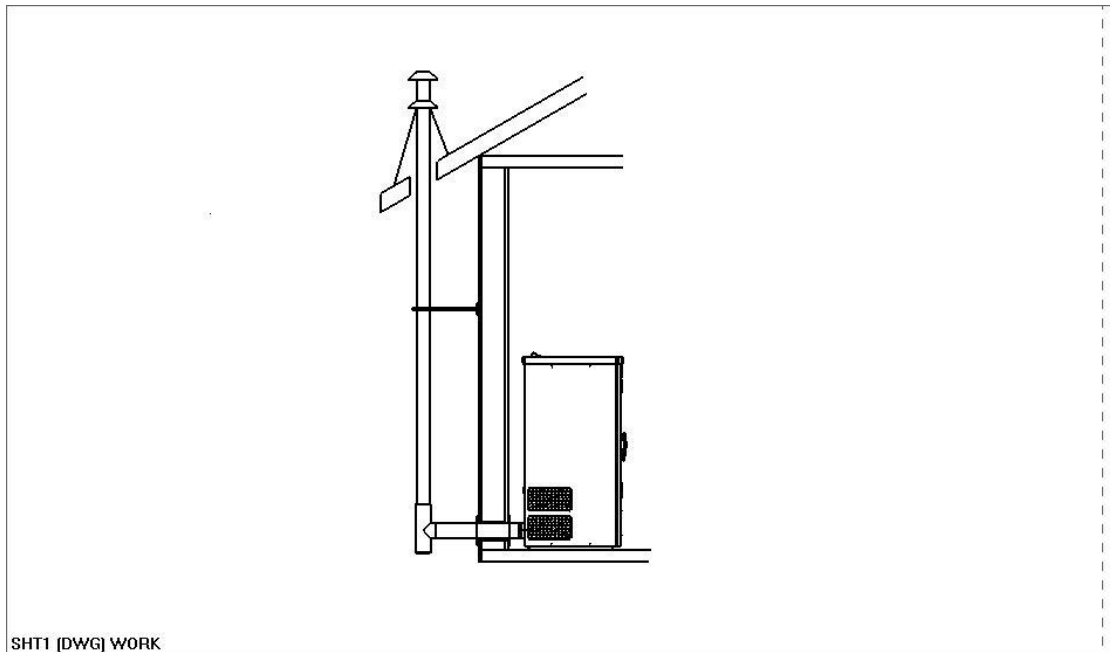

The Distance between wall and heater when it is installed in the house (MM)

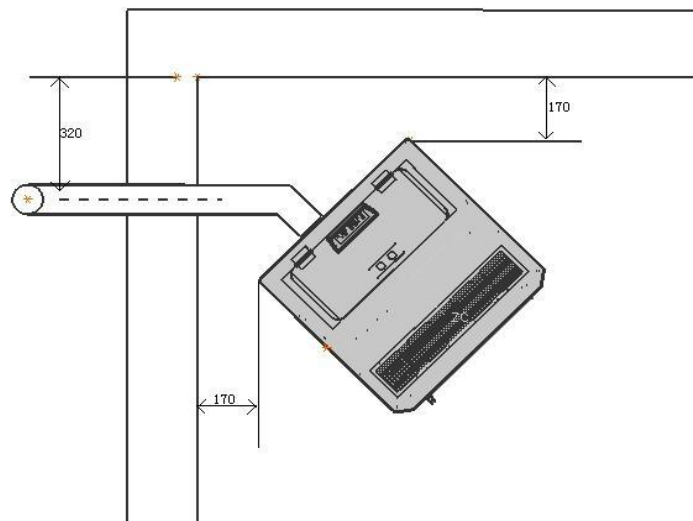

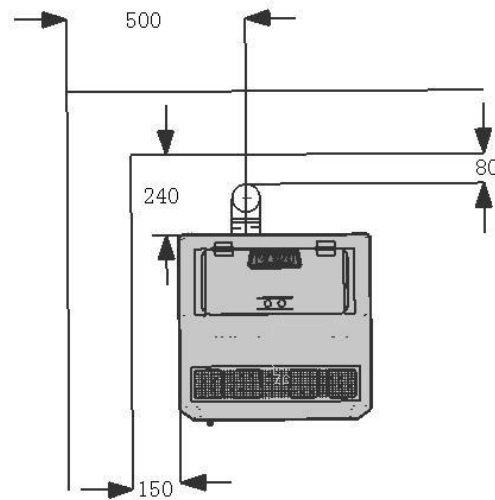

Air input pipe diameter is 50 mm, exhaust venting pipe diameter is 80 mm. The total length of vent pipe should be less than 3m without elbows. Indoor venting pipe joint should be sealed by silicone sealant to prevent exhaust leaking into the room. Venting pipe and termination should be waterproof.

If the vent pipe is longer than 3m and needs elbows, the pipe diameter must be increased properly for smooth convection. If not, it will influence the burning and the heater may not work properly.

## Vent Termination Requirements

Do not terminate the vent in any enclosed or semi enclosed areas such as a carport, garage, attic, crawlspace, narrow walkway, closely fenced area, under a sundeck or porch, or any location that can build up a concentration of fumes such as stairwells, covered breezeway etc.

Vent surfaces can become hot enough to cause burns if touched. Noncombustible shielding or guards may be required.

Termination must exhaust above the inlet elevation. It is recommended that at least 1 M of vertical pipe be installed outside when the heater is vented directly through a wall. This will create a natural draft to prevent the possibility of smoke or odor during appliance shut down or power failure and avoids exposing people or shrubs to high temperatures.

The vent should terminate no less than 1m below or 1m horizontally from, and no less than 300mm above doors and windows, or gravity /ventilation air inlets into the building.

Locate the vent termination at least 1m away from combustible material such as shrubs, plants, grass, fences and adjacent buildings.

The heater's flue collar is 3" in diameter. An approved wall thimble or approved ceiling firestop must



## Pellet Heater Owner's Manual - NB-Series

---

be used when the pellet pipe passes through a combustible wall or ceiling.

The heater's combustion blower pressurizes and pushes flue gases out the pellet pipe. As a result, all pipe joints should be locked together or screwed with three screws if the pipe does not have a locking system and sealed with high temperature silicone.

**DO NOT INSTALL A FLUE DAMPER IN THE EXHAUST VENTING SYSTEM OF THIS UNIT. DO NOT CONNECT THIS UNIT TO A CHIMNEY FLUE SERVING ANOTHER APPLIANCE.**

### **Mobile Home Installations**

The following are required for installation of the HEATER in mobile homes.

Connecting the HEATER to outside combustion air is optional, except in mobile home installations and when required by local building codes. The heater's air intake will accept 50mm pipe to accommodate outside air installations. The air intake on the exterior of the home should always be located substantially below the flue termination and terminate with a cover to keep out weather and pests.

The heater must be fastened to the floor using lag screws (mobile home only). The screws can be inserted through the holes in the pedestal located behind the side doors.

The heater must be grounded with a #8 or larger copper wire.

### **WARNING:**

**DO NOT INSTALL THIS HEATER IN A SLEEPING ROOM IN A MANUFACTURED HOME.**

### **SURGE PROTECTORS**

A surge protector is recommended to ensure the heater's electrical components are not damaged due to a surge in the electrical supply. Only high quality protector should be used—cheap ones do not provide the protection needed.

### **THERMOSTAT INSTALLATION**

The heater comes from the factory wired to operate manually see control board operation on the following page. A low voltage thermostat has been installed on the heater and is mounted at the front behind the room air fan inlet or on the back of the unit.

**CAUTION INSTALLATION AND REPAIR SHOULD ONLY BE PERFORMAED BY A QUALIFIED SERVICE TECHNICIAN. DO NOT ATTEMPT TO SERVICE THE APPLIANCE YOURSELF.**

Avoid over firing the stove do not hand feed pellets to the appliance. Never use gasoline, gasoline type lantern fuel, kerosene, charcoal lighter fluid, or similar liquids to start or flesh up a fire in this heater. Keep all such liquids well away from the heater while it is in use. For your safety, do not install or operate your heater without first reading and understanding this manual.

Due to high temperature, the heater should be located out of traffic areas and away from furniture and draperies. Children and adults should be alert to the hazards of high surface temperature and should stay away to avoid burns or clothing ignition. Young children should be carefully supervised



## Pellet Heater Owner's Manual - NB-Series

---

when they are in the same room as the HEATER. Clothing or any other flammable material should not be placed on or near the heater. Any grille, panel, or glass removed for service **MUST** be replaced prior to operating the heater.

Do not operate appliance with the glass front removed, cracked, or broken. Replacement of the glass should be done by a qualified service technician.

## 2. Electronic Plan

