

Rockwell Automation Library of Process Objects: HART Modules for PlantPax DCS

Version 4.1



Important User Information

Read this document and the documents listed in the additional resources section about installation, configuration, and operation of this equipment before you install, configure, operate, or maintain this product. Users are required to familiarize themselves with installation and wiring instructions in addition to requirements of all applicable codes, laws, and standards.

Activities including installation, adjustments, putting into service, use, assembly, disassembly, and maintenance are required to be carried out by suitably trained personnel in accordance with applicable code of practice.

If this equipment is used in a manner not specified by the manufacturer, the protection provided by the equipment may be impaired.

In no event will Rockwell Automation, Inc. be responsible or liable for indirect or consequential damages resulting from the use or application of this equipment.

The examples and diagrams in this manual are included solely for illustrative purposes. Because of the many variables and requirements associated with any particular installation, Rockwell Automation, Inc. cannot assume responsibility or liability for actual use based on the examples and diagrams.

No patent liability is assumed by Rockwell Automation, Inc. with respect to use of information, circuits, equipment, or software described in this manual.

Reproduction of the contents of this manual, in whole or in part, without written permission of Rockwell Automation, Inc., is prohibited

Throughout this manual, when necessary, we use notes to make you aware of safety considerations.



WARNING: Identifies information about practices or circumstances that can cause an explosion in a hazardous environment, which may lead to personal injury or death, property damage, or economic loss.



ATTENTION: Identifies information about practices or circumstances that can lead to personal injury or death, property damage, or economic loss. Attentions help you identify a hazard, avoid a hazard, and recognize the consequence.

IMPORTANT Identifies information that is critical for successful application and understanding of the product.

Labels may also be on or inside the equipment to provide specific precautions.



SHOCK HAZARD: Labels may be on or inside the equipment, for example, a drive or motor, to alert people that dangerous voltage may be present.



BURN HAZARD: Labels may be on or inside the equipment, for example, a drive or motor, to alert people that surfaces may reach dangerous temperatures.



ARC FLASH HAZARD: Labels may be on or inside the equipment, for example, a motor control center, to alert people to potential Arc Flash. Arc Flash will cause severe injury or death. Wear proper Personal Protective Equipment (PPE). Follow ALL Regulatory requirements for safe work practices and for Personal Protective Equipment (PPE).

Preface	Summary of Changes	7
	Additional Resources	7
	Chapter 1	
Supported Modules and Guidelines	Supported Modules	9
	Guidelines	10
	Required Files	14
	Controller Files	14
	Visualization Files	15
	Chapter 2	
Build Your Application	Input Module Integration	21
	Add Input Module	21
	Import Rungs	26
	Add P_AIn_HART Add-On Instruction	36
	Link Analog Signal	44
	Output Module Integration	46
	Add Output Module	46
	Import Rungs	48
	Add P_AOutHART Add-On Instruction	53
	Link Analog Signal	58
	Chapter 3	
HART Analog Input (P_AInHART)	Controller Code	62
	Input Structure for HART Analog Input	64
	Output Structure for HART Analog Input	68
	Local Configuration Tags for HART Analog Input	72
	Operations	74
	Alarms	74
	Simulation	74
	Execution	75
	Display Elements	76
	Status/Quality Indicators	79
	Threshold Indicators	80
	Alarm Indicators	80
	Maintenance Bypass Indicator	81
	Using a Display Element	81
	Quick Display Interaction	83
	Basic Faceplate Attributes	84
	Advanced Properties Display	87
	HMI Configuration Tab Page 2	90
	Diagnostics Tab	91
	Alarms Tab	91
	Trend Display	92

HART Analog Output (P_AOutHART)	<p>Chapter 4</p> <ul style="list-style-type: none"> Controller Code 94 <ul style="list-style-type: none"> InOut Structure for HART Analog Input 94 Input Structure for HART Analog Output 95 Output Structure for HART Analog Output 100 Local Configuration Tags for HART Analog Output 105 Operations 106 <ul style="list-style-type: none"> Command Sources 106 Alarms 107 Simulation 107 Execution 108 Display Elements 109 <ul style="list-style-type: none"> Status/Quality Indicators 110 Alarm Indicators 111 Maintenance Bypass Indicator 112 Using a Display Element 113 Quick Display 115 Basic Faceplate Attributes 115 <ul style="list-style-type: none"> Maintenance Tab 118 Advanced Properties Display 118 Engineering Tab 120 Diagnostics Tab 126 Alarms Tab 127 Alarm Indicators 127
Module Messaging Reference	<p>Appendix A</p> <ul style="list-style-type: none"> Configuration for ControlLogix I/O (1756), Spectrum Controls POINT I/O (1734sc), and Ex I/O (1719) 129 <ul style="list-style-type: none"> MSG Instruction to Get Device Information 130 MSG Instruction to Get Module Diagnostic Data 132 MSG configuration for FLEX I/O (1794) HART Analog Module 133 <ul style="list-style-type: none"> MSG Instructions to Get Device Information 133 MSG to Reset the Device Information Available Flag 136 MSG Instruction to Get Module Diagnostic Data 138 Spectrum Controls Compact I/O (1769sc) 139 Configuration for Redundant I/O (1715) Modules 139 <ul style="list-style-type: none"> MSG Instruction to Get Device Information 140 MSG Instruction to Initiate Retrieval of Module Diagnostic Data 142 MSG Instruction to Complete Retrieval of Module Diagnostic Data 143

Determine the 1794-IF8IHNFXT Module	Appendix B
	Data Type Selection 145
I_PAX_HART_DEVICE Configuration Example	Appendix C
	Download and install the 5094 HART Analog Add-On Profile .. 147
	Add the 5094 Adapter Module to the Project I/O Configuration 149
	Add the 5094-IF8IH Module to the Project I/O Configuration.. 151
	Add the HART Device to the Project I/O Configuration 152
	Configure the Analog Input Channel 154
	Import the I_PAX_HART_DEVICE and P_AInHART Add-On Instructions. 155
	Create the P_AInHART instance 158

Notes:

The purpose of this manual is to facilitate the integration of HART devices into a PlantPAx® system or Integrated Architecture®. The P_AInHART and P_AOutHART objects are included with the Rockwell Automation Library of Process Objects.

Summary of Changes

Topic	Page
Added Appendix C	147

For the latest compatible software information and to download the Rockwell Automation® Library of Process Objects, see the Product Compatibility and Download Center at <http://www.rockwellautomation.com/rockwellautomation/support/pcdc.page>.

Additional Resources

The documents in the following table contain additional information concerning related products from Rockwell Automation.

Resource	Description
PlantPAx Distributed Control System Selection Guide, publication PROCES-SG001	Provides information to assist with equipment procurement for your PlantPAx system.
PlantPAx Distributed Control System Reference Manual, publication PROCES-RM001	Provides characterized recommendations for implementing your PlantPAx system.
Logix5000™ Controllers Add-On Instructions Programming Manual, publication 1756-PM010	Provides information for the design, configuration, and programming of Add-On Instructions.
1756 ControlLogix I/O Specifications Technical Data, publication 1756-TD002	Provides technical data for the ControlLogix® HART analog I/O Modules.
ControlLogix HART Analog I/O Modules User Manual, publication 1756-UM533	Provides installation and configuration information, and information on how to troubleshoot for the ControlLogix HART analog I/O Modules.
Rockwell Automation Library of Process Objects, publication PROCES-RM002	Provides an overview of the code objects, display elements, and faceplates that comprise the Rockwell Automation Library of Process Objects.
Rockwell Automation Library of Process Objects: Logic Instructions Reference Manual, publication PROCES-RM013	Provides information on how to select the logic that is contained in Add-On Instructions to control and monitor a device. Also, informs when to use and not use the instruction for a project.
Rockwell Automation Library of Process Objects: Display Elements Reference Manual, publication PROCES-RM014	Compiles the HMI visualization files that comprise the Rockwell Automation Library of Process Objects from individual manuals into one reference manual.

You can view or download publications at <http://www.rockwellautomation.com/literature/>. To order paper copies of technical documentation, contact your local Allen-Bradley distributor or Rockwell Automation sales representative.

Notes:

Supported Modules and Guidelines

The P_AInHART and P_AOutHART objects that are the subject of this manual provide a common interface point for process control strategies. This organization provides modularity and streamlined integration by separating device-specific connectivity from input and output processing.

This chapter identifies the module families that are supported for use with the P_AInHART and P_AOutHART Instructions, identifies which I/O Module Add-On Instruction to use, and lists required files.

The following table lists the topics in this chapter.

Topic	Page
Supported Modules	9
Guidelines	10
Required Files	14

Supported Modules

[Table 1](#) lists the I/O modules that work with P_AInHART and P_AOutHART.

Table 1 - Supported Modules

Module Family	HART Module	Process Library Add-On Instruction	Description
1715 Redundant I/O Modules	1715-IF16 ⁽²⁾	I_1715IF16_FW3	Allen-Bradley® Redundant I/O 16-channel Analog Input module with HART
	1715-OF8I ⁽²⁾	I_1715OF8I_FW3	Allen-Bradley Redundant I/O 8-channel isolated Analog Output module with HART
1718 EX I/O Modules ⁽¹⁾	1718-CF4H	I_1718_1719AI4H	Allen-Bradley Intrinsically Safe 4-channel HART Analog (configured as input) module
	1718-CF4H	I_1718_1719A04H	Allen-Bradley Intrinsically Safe 4-channel HART Analog (configured as output) module
	1718-IF4HB	I_1718_1719AI4H	Allen-Bradley Intrinsically Safe 4-channel HART Analog Input Wide module
1719 EX I/O Modules	1719-CF4H	I_1718_1719AI4H	Allen-Bradley Intrinsically Safe 4-channel HART Analog (configured as input) module
	1719-CF4H	I_1718_1719A04H	Allen-Bradley Intrinsically Safe 4-channel HART Analog (configured as output) module
	1719-IF4HB	I_1718_1719AI4H	Allen-Bradley Intrinsically Safe 4-channel HART Analog Input Wide module

Table 1 - Supported Modules

Module Family	HART Module	Process Library Add-On Instruction	Description
1734 POINT I/O™ Modules	1734sc-IE2CH	I_1734scIE2CH	Spectrum Controls POINT I/O 2-channel HART Analog Input module
	1734sc-IE4CH	I_1734scIE4CH	Spectrum Controls POINT I/O 4-channel HART Analog Input module
	1734sc-OE2CIH	I_1734scOE2CIH	Spectrum Controls POINT I/O 2-channel Isolated HART Analog Output module
1756 ControlLogix® I/O Modules	1756-IF8H	I_1756IF8H	Allen-Bradley ControlLogix 8-channel HART Analog Input module
	1756-IF8IH	I_1756IF8IH	Allen-Bradley ControlLogix 8-channel Isolated HART Analog Input module
	1756-IF16H	I_1756IF16H	Allen-Bradley ControlLogix 16-channel HART Analog Input module
	1756-IF16IH		Allen-Bradley ControlLogix 16-channel Isolated HART Analog Input module
	1756-OF8H	I_1756OF8H	Allen-Bradley ControlLogix 8-channel HART Analog Output module
	1756-OF8IH	I_1756-OF8IH	Allen-Bradley ControlLogix 8-channel Isolated HART Analog Output module
1769 Compact I/O™ Modules	1769sc-IF4IH	I_1769scIF4IH	Spectrum Controls Compact I/O 4-channel Isolated HART Analog Input module
	1769sc-OF4IH	I_1794scOF4IH	Spectrum Controls Compact I/O 4-channel Isolated HART Analog Output module
1794 FLEX™ I/O Modules	1794-IF8IH	I_1794IF8IH	Allen-Bradley FLEX I/O 8-channel Isolated HART Analog Input module
	1794-IF8IHNFXT ⁽³⁾	I_1794IF8IHNFXT	Allen-Bradley FLEX I/O-XT™ Extended Temperature 8-channel Isolated HART Analog Input module
	1794-OF8IH	I_1794OF8IH	Allen-Bradley FLEX I/O 8-channel Isolated HART Analog Output module

(1) Even though they have their own AOPs the 1718 I/O modules use the same data types as the 1719 I/O. The 1718 I/O modules can be placed in hazardous areas whereas the 1719 I/O modules get wired to devices that are in a hazardous area.

(2) Supported in Library Release 3.5-04 and later. Requires controller firmware revision 20 or later.

(3) Supported in Library Release 3.5-02 and later. Requires controller firmware revision 24 or later.

Guidelines

This section contains a brief description of HART communication, P_AInHART, P_AOutHART, and additional capabilities.

About HART Communication

HART I/O modules communicate with field devices in two simultaneous ways: with an analog signal and a digital signal. The analog signal uses a range of 4.0...20.0 mA DC, and the digital communication signal is superimposed on the analog signal.

For analog inputs, the field device provides the analog signal, and the signal usually represents the main measurement that is provided by the device. For example, a temperature transmitter with a range of 0...200 °C (32...392 °F) provides a signal of:

- 4.0 mA DC when it measures 0 °C (32 °F).

- 20.0 mA DC when it measures 200 °C (392 °F).
- A proportional value in between for temperatures within the range, such as 12 mA DC for 100 °C (212 °F).

For analog outputs, the analog signal is provided by the analog output module and sent to the field device, such as a valve positioner. A signal of 4.0 mA DC can request that the valve is fully closed, and 20.0 mA DC request that the valve is fully open. Signal levels in between 4.0...20.0 mA DC represent a percentage open.

For both analog input modules and analog output modules, the HART digital signal gathers data and diagnostics from the field device. The HART protocol provides for sending four floating point values from the device to the I/O module, along with the units of measure and status for each:

- Primary Variable (PV)
- Secondary Variable (SV)
- Third Variable (TV)
- Fourth Variable (FV)

Generally, what data values are sent in these variables depend on the device and can be configured in the field device. For the temperature transmitter, the PV can be a digital copy of the main measured process temperature. The SV can be the same value in other units (Fahrenheit). The TV can be the temperature of the transmitter electronics, and the FV can be unused.

For the valve positioner example, the variables can be used to report requested valve position, actual position, air supply pressure, and so on.

P_AInHART

Use an instance of the P_AInHART instruction for each defined HART analog input channel with a connected field device (transmitter).

This instruction provides standard analog input functionality, plus digital HART values, status, enumerations, and diagnostics. The instruction receives the following values from the field device (if so configured):

- Analog Value ('AV' in parameter names)
 - The analog value is scaled to engineering units and filtered by using a simple first-order filter with configurable time constant.
- Digital Values:
 - Primary Variable (PV)
 - Secondary Variable (SV)
 - Third Variable (TV)
 - Fourth Variable (FV)

For each value, the instruction provides status, diagnostics, and units of measure. Lookup tables provide diagnostic text and units of measure text that is based on enumeration values that are received from the HART device.

We included generic lookup tables plus lookup tables for specific Endress+Hauser instruments in the Library Template. We have also made sample applications available as part of the Rockwell Automation Library of Process Objects download set. See Rockwell Automation Library of Process Objects, publication [PROCES-RM002](#) for more information on process objects.

The instruction also retrieves text and analog scaling information from the device and can use this data to populate configuration fields of the instruction that correspond. Retrieval of HART device information can be automatically or manually initiated.

For the Analog Value only, the instruction also provides the following threshold status and alarms, configurable delay times, and deadbands:

- High-High
- High
- Low
- Low-Low
- Out of Range (Fail)

To provide threshold alarms for any of the digital values, use an instance of the P_AIn (analog input) instruction that is tied to the variable for which alarms are required.

The P_AInHART instruction can be used for each channel on a supported HART Analog Input module. The instruction can be used even if a non-HART device is wired to the channel. In this case, this instruction includes a configuration option to turn off display of the HART data on the faceplate.

P_AInHART, the HART Analog Input instruction, provides these additional capabilities:

- Maintenance selection of the substitute value function to allow manual override of the analog input signal (AV).
- Monitors input quality and communication status. Value and indication of source and quality for the input signal and the final AV value.

P_AOutHART

Use an instance of this instruction for each defined HART analog output channel with a connected field device (actuator).

This instruction outputs an analog controlled variable (CV) to the field device. The instruction receives the following values from the module and the field device (if so configured):

- Analog (loopback) Value ('AV' in parameter names)
- Digital Values:
 - Primary Variable (PV)
 - Secondary Variable (SV)
 - Third Variable (TV)

- Fourth Variable (FV)

For each value, the instruction provides status, diagnostics, and units of measure. Diagnostic text and units of measure text are provided by lookup that is based on enumeration values that are received from the HART device.

Generic lookup tables, plus a lookup table for specific Metso Neles® valve actuators, are included in the Library Template and Sample applications. The library is part of the Rockwell Automation Library of Process Objects download set.

The instruction also retrieves text and analog scaling information from the device and can use this data to populate configuration fields of the instruction that correspond. Retrieval of HART device information can be automatically or manually initiated.

Other than the HART-specific functions, the P_AOutHART instruction functions much like the basic P_AOut Analog Output instruction, and provides these same capabilities:

- Monitors I/O fault input and raises an alarm on an I/O fault.
- Ownership of the analog output through the standard P_CmdSrc Add-On Instruction (refer to the Operations section).
- Ability for an operator, program logic, or an external control to set an analog-controlled variable (CV, or output) to a specific value. The entered CV is scaled from engineering units to raw (output card) units.
- Interlocks (bypassable and non-bypassable) that are conditions that force the analog output to a specific configured (safe) value or cause it to hold its current value (configurable). Provides an alarm when an interlock causes the Analog Output CV to be changed. Provides maintenance personnel the capability to bypass the bypassable interlocks.
- Override CV input, which determines the CV in Override command source. See [Command Sources on page 106](#) for more information.
- Simulation capability: the output of the analog output is held at zero and I/O faults are ignored. However, the instruction can be manipulated as if a working analog output were present. This capability is often used for activities such as instruction testing and operator training.
- Increase and decrease rate of change limits (ramping) for the output that the operator or program set. Provides a configurable limit for the maximum allowed rate of increase and for the maximum allowed rate of decrease.
- Tieback input (REAL) and a Hand request input (BOOL); when Hand is asserted, the CV is forced to follow the Tieback value.

Required Files

Add-On Instructions are reusable code objects that contain encapsulated logic that can streamline implementing your system. This code helps you create your own instruction set for programming logic as a supplement to the instruction set provided natively in the ControlLogix firmware. An Add-On Instruction is defined once in each controller project, and can be instantiated multiple times in your application code as needed.

Controller Files

Module Add-On Instruction and RUNG files follow.

Module	Add-On Instruction Import File	Rung Import File
1715		
1715-IF16	1715-IF16_4.10.00_AOIL5X	1715-IF16_4.10.00_RUNG.L5X
1715-OF8I	1715-OF8I_4.10.00_AOIL5X	1715-OF8I_4.10.00_RUNG.L5X
1718		
1718-CF4H (as Input) 1718-IF4HB	1718_1719-AI4H_4.10.00_AOIL5X	I_1718_1719-AI4H_4.10.00_RUNG.L5X
1718-CF4H (as Output)	1718_1719-AO4H_4.10.00_AOIL5X	I_1718_1719-AO4H_4.10.00_RUNG.L5X
1719		
1719-CF4H (as Input) 1719-IF4HB	1718_1719-AI4H_4.10.00_AOIL5X	I_1718_1719-AI4H_4.10.00_RUNG.L5X
1719-CF4H (as Output)	1718_1719-AO4H_4.10.00_AOIL5X	I_1718_1719-AO4H_4.10.00_RUNG.L5X
1734sc		
1734sc-IE2CH	I_1734scIE2CH_4.10.00_AOIL5X	I_1734scIE2CH_4.10.00_RUNG.L5X
1734sc-IE4CH	I_1734scIE4CH_4.10.00_AOIL5X	I_1734scIE4CH_4.10.00_RUNG.L5X
1734sc-OE2CIH	I_1734scOE2CIH_4.10.00_AOIL5X	I_1734scOE2CIH_4.10.00_RUNG.L5X
1756		
1756-IF8H	I_1756IF8H_4.10.00_AOIL5X	I_1756IF8H_4.10.00_RUNG.L5X
1756-IF16H 1756-IF16IH	I_1756IF16H_1756IF16IH_4.10.00_AOIL5X	I_1756IF16H_1756IF16IH_4.10.00_RUNG.L5X
1756-OF8H	I_1756OF8H_4.10.00_AOIL5X	I_1756OF8H_4.10.00_RUNG.L5X
1756-OF8IH	I_1756OF8IH_4.10.00_AOIL5X	I_1756OF8IH_4.10.00_RUNG.L5X
1756-IF8IH	I_1756IF8IH_4.10.00_AOIL5X	I_1756IF8IH_4.10.00_RUNG.L5X
1769sc		
1769sc-IF4IH	I_1769scIF4IH_4.10.00_AOIL5X	I_1769scIF4IH_4.10.00_RUNG.L5X

Module	Add-On Instruction Import File	Rung Import File
1769sc-OF4IH	I_1769scOF4IH_4.10.00_AOIL5X	I_1769scOF4IH_4.10.00_RUNG.L5X
1794		
1794-IF8IH	I_1794IF8IH_4.10.00_AOIL5X	I_1756IF8IH_4.10.00_RUNG.L5X
1794-OF8IH	I_1794OF8IH_4.10.00_AOIL5X	I_1794OF8IH_4.10.00_RUNG.L5X
1794-IF8IHNFXT	See Appendix B	See Appendix B

The P_AInHART_4.10.00_AOIL5X and P_AOutHART_4.10.00_AOIL5X Add-On Instructions must be imported into the controller project to be used in the controller configuration. The service release number (boldfaced) can change as service revisions are created.

Visualization Files

This Add-On Instruction has associated visualization files that provide a common user interface. These files can be downloaded from the Product Compatibility and Download Center at <http://www.rockwellautomation.com/rockwellautomation/support/pcdc.page>.

IMPORT- The visualization file dependencies require Process Library content imports to occur in a specific order as reflected in the following tables:

- Images
- Global Objects
- Standard Displays
- HMI Tags

Images are external graphic files that can be used in displays. Images must be imported to use in FactoryTalk® View software.

P_AInHART Files

When imported, PNG files are renamed by FactoryTalk View with a .bmp file extension, but retain a .png format.

Table 2 - P_AInHART Visualization Files: Images (.png)

FactoryTalk View SE Software	FactoryTalk View ME Software	Description
All .png files in the images folder	All .png files in the images folder	The common icons that are used in the global objects and standard displays for all Process Objects.

The Global Object files (.ggfx file type) in [Table 3](#) are Process Library display elements that are created once and referenced multiple times on multiple displays

in an application. When changes are made to a Global Object, all instances in the application are automatically updated.

Table 3 - P_AInHART Visualization Files: Global Objects (.ggfx)

FactoryTalk View SE Software	FactoryTalk View ME Software	Description
(RA-BAS) Common Faceplate Objects	(RA-BAS-ME) Common Faceplate Objects	Global objects used on process object faceplates.
(RA_BAS) Process Faceplate Common Objects	(RA_BAS-ME) Process Faceplate Common Objects	Faceplate Configuration, Navigation, Command, and Display Objects.
(RA-BAS) P_AIn Graphics Library	(RA-BAS-ME) P_AIn Graphics Library	Analog Input global-object device symbols that are used to build process graphics.
(RA-BAS) Process Alarm Objects	(RA-BAS-ME) Process Alarm Objects	Global objects that are used to manage alarms on process object faceplates.
(RA-BAS) Process Faceplate Analog Objects	(RA-BAS-ME) Process Faceplate Analog Objects	Analog global objects used on process object faceplates.

The Standard Display files (.gfx file type) in [Table 4](#) are the Process Library displays that you see at runtime.

Table 4 - P_AInHART Visualization Files: Standard Displays (.gfx)

FactoryTalk View SE Software	FactoryTalk View ME Software	Description
(RA-BAS) P_AInHART-Faceplate	(RA-BAS-ME) P_AInHART-Faceplate	The faceplate that is used for the object.
(RA-BAS) P_AInHART-Quick	(RA-BAS-ME) P_AInHART-Quick	The Quick display that is used for the object.
(RA-BAS) P_AInHART-Advanced	(RA-BAS-ME) P_AInHART-Advanced	The faceplate that is used to manage the advanced properties of the object.
(RA-BAS) P_Alarm-Faceplate	(RA-BAS-ME) P_Alarm-Faceplate	The faceplate that is used to manage alarms for the object.
(RA-BAS) P_Gate-Faceplate	(RA-BAS-ME) P_Gate-Faceplate	The gate faceplate display used for the object.
(RA-BAS) Process PVcapture-Trend	(RA-BAS-ME) Process PVcapture-Trend	The faceplate that is used to display and capture trends for the object.

HMI Tags are created in a FactoryTalk View ME application to support tab switching on Process Library faceplates. The HMI tags can be imported via the comma-separated values file (.csv file type) in [Table 5](#).

Table 5 - P_AInHART Visualization Files: HMI Tags (.csv)

FactoryTalk View SE Software	FactoryTalk View ME Software	Description
FTViewSE_ProcessLibrary_Tags_4_0_xx.CSV	FTVME_PlantPaxLib_Tags_4_0_xx.csv where xx = the service release number.	These tags must be imported into the FactoryTalk View ME project to support switching tabs on any Process Object faceplate.

P_AOutHART Files

PNG files are renamed by FactoryTalk View with a .bmp file extension when they are imported, but they retain a .png format.

Table 6 - P_AOutHART Visualization Files: Images (.png)

FactoryTalk View SE Software	FactoryTalk View ME Software	Description
All .png files in the images folder	All .png files in the images folder	These images are the common icons that are used in the global objects and standard displays for all Process Objects.

The Global Object files (.ggfx file type) in [Table 7](#) are Process Library display elements that are created once and referenced multiple times on multiple displays in an application. When changes are made to a Global Object, all instances in the application are automatically updated.

Table 7 - P_AOutHART Visualization Files: Global Objects (.ggfx)

FactoryTalk View SE Software	FactoryTalk View ME Software	Description
(RA-BAS) Common Faceplate Objects	(RA-BAS-ME) Common Faceplate Objects	Global objects used on process object faceplates.
(RA_BAS) Process Command Source Objects	(RA_BAS-ME) Process Command Source Objects	Faceplate command-source objects; global objects that are used for managing command sources on process object faceplates.
(RA_BAS) Process Faceplate Common Objects	(RA_BAS-ME) Process Faceplate Common Objects	Faceplate Configuration, Navigation, Command, and Display Objects.
(RA-BAS) Process Alarm Objects	(RA-BAS-ME) Process Alarm Objects	Global objects that are used to manage alarms on process object faceplates.
(RA-BAS) Process Diagnostic Objects	(RA-BAS-ME) Process Diagnostic Objects	Diagnostic global objects used on process object faceplates.
(RA-BAS) Process Faceplate Analog Objects	(RA-BAS-ME) Process Faceplate Analog Objects	Analog global objects used on process object faceplates.
(RA-BAS) Process Graphics Library	(RA-BAS-ME) Process Graphics Library	Process global-object device symbols used to build process graphics.
(RA-BAS) Process Interlock Objects	(RA-BAS-ME) Process Interlock Objects	Global objects that are used to manage interlocks and permissives on process object faceplates.

The Standard Display files (.gfx file type) in [Table 8](#) are the Process Library displays that you see at runtime.

Table 8 - P_AOutHART Visualization Files: Standard Displays (.gfx)

FactoryTalk View SE Software	FactoryTalk View ME Software	Description
(RA-BAS) P_Alarm-Faceplate	(RA-BAS-ME) P_Alarm-Faceplate	The faceplate that is used to manage alarms for the object.
(RA-BAS) P_AOutHART-Faceplate	(RA-BAS-ME) P_AOutHART-Faceplate	The faceplate that is used for the object.
(RA-BAS) P_AOutHART-Quick	(RA-BAS-ME) P_AOutHART-Quick	The quick display that is used for the object.
(RA-BAS) P_AOutHART-Advanced	(RA-BAS-ME) P_AOutHART-Advanced	The faceplate that is used to manage the advanced properties of the object.
(RA-BAS) P_Gate-Faceplate	(RA-BAS-ME) P_Gate-Faceplate	The gate faceplate display used for the object.
(RA-BAS) P_AOut-Faceplate	(RA-BAS-ME) P_AOut-Faceplate	The faceplate that is used for the object.
(RA-BAS) P_AOut-Quick	(RA-BAS-ME) P_AOut-Quick	The Quick display that is used for the object.
(RA-BAS) P_CmdSrc-Faceplate	(RA-BAS-ME) P_CmdSrc-Faceplate	The faceplate that is used to configure the P_CmdSrc object.
(RA-BAS) P_CmdSrc-Advanced	(RA-BAS-ME) P_CmdSrc-Advanced	The faceplate that is used to configure the advanced properties of the P_CmdSrc object.
(RA-BAS) Process Analog Family-Help	(RA-BAS-ME) Process Analog Family-Help	The Help display for Analog objects

Table 8 - P_AOutHART Visualization Files: Standard Displays (.gfx)

FactoryTalk View SE Software	FactoryTalk View ME Software	Description
(RA-BAS) P_Intlk-Faceplate	(RA-BAS-ME) P_Intlk-Faceplate	Optional The interlock faceplate used for the object. Use this file if your Discrete Output has an associated P_Intlk object and you enable navigation to its faceplate from the Discrete Output faceplate.
(RA-BAS) Process Interlock Family-Help	(RA-BAS-ME) Process Interlock Family-Help	Optional Interlock/permisives help display that is used for the object. Use this file if you use the P_Intlk or P_Perm faceplate.

HMI tags are created in a FactoryTalk View ME application to support tab switching on Process Library faceplates. The HMI tags can be imported via the comma-separated values file (.csv file type) in [Table 9](#).

Table 9 - P_AOutHART Visualization Files: HMI Tags (.csv)

FactoryTalk View SE Software	FactoryTalk View ME Software	Description
FTViewSE_ProcessLibrary_Tags_4_0_XX.CSV	FTVME_PlantPAxLib_Tags_4_0_XX.csv where XX = the service release number.	These tags must be imported into the FactoryTalk View ME project to support switching tabs on any Process Object faceplate.

Notes:

Build Your Application

The 1756-IF8H and 1756-OF8IH modules are used as examples in the integration of the various HART input and output modules with the Rockwell Automation® Library of Process Objects. The procedures for all modules are the same, but the set of tags that are created can vary by I/O family.

The following table lists the topics.

Topic	Page
Input Module Integration	21
Output Module Integration	46

Input Module Integration

You must have a project with a controller already configured. Make sure that the project path is set to the correct controller. For the purposes of this document, we refer to this project path as the target application.

Add Input Module

The desired HART I/O module must be added into the project I/O configuration.

TIP We recommend that you copy the module from the sample projects that are included in the library. By copying the module, several module options are configured for you.

Follow these steps to add an input module to your project:

1. Open Project in the Files>Premier Integration Samples>Project folder.

2. Select a sample .ACD file, right-click, and choose copy.

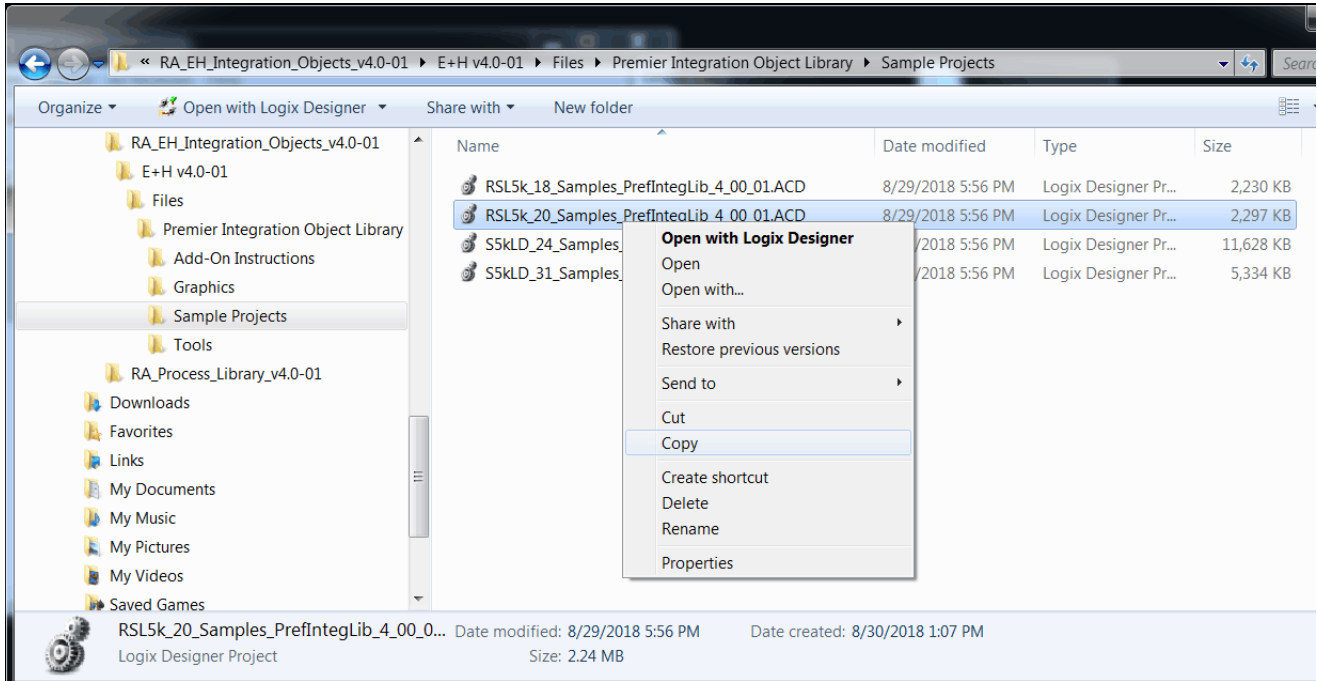

3. On your desktop, right-click and select Paste to place the ACD file on your desktop.

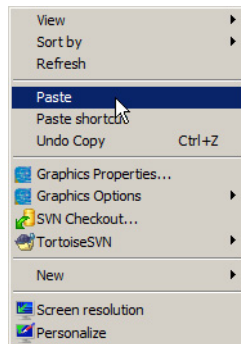

4. Double-click the sample ACD icon or right-click the icon and select Open with RSLogix 5000®.

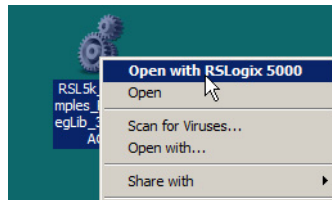

5. In RSLogix 5000 software (version 20 or earlier) or Studio 5000 Logix Designer® application (version 21 or later), open your target application (App_With_HART_IO.ACD in our example).

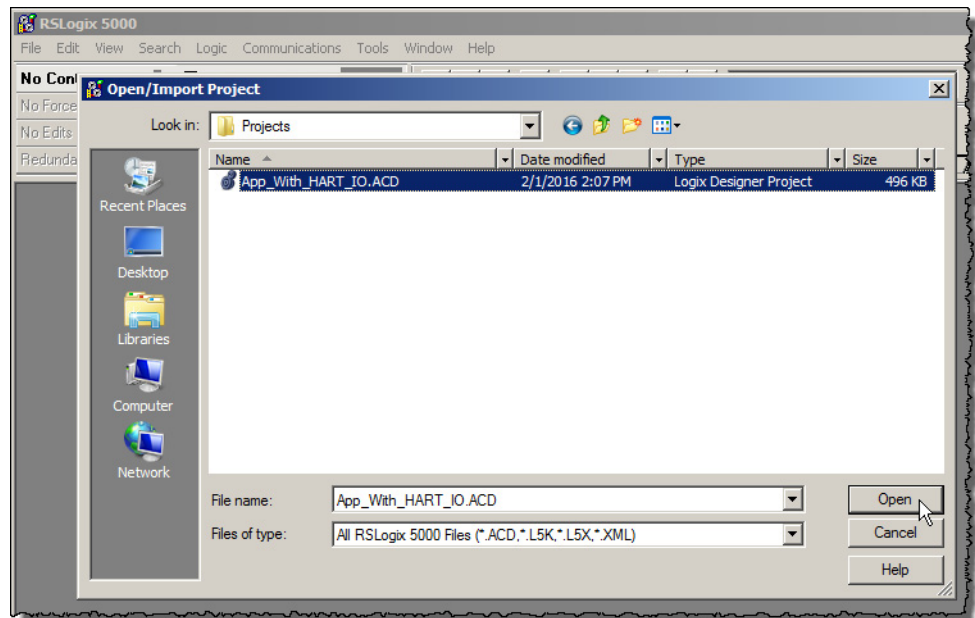

- In the Controller Organizer of the Samples application, right-click the module type that you want to copy and choose Copy.

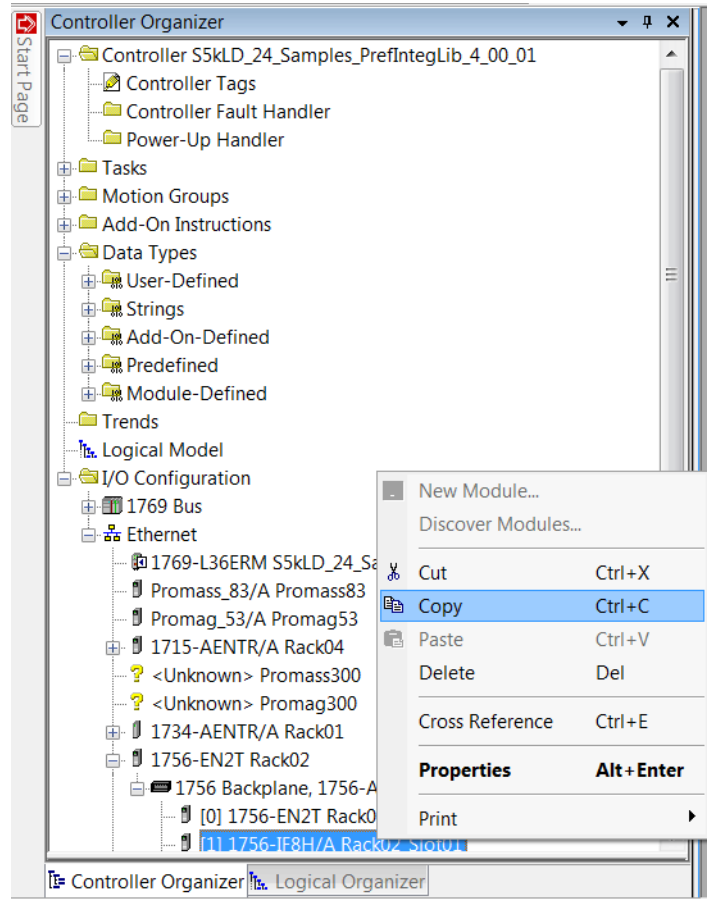

- In your target application, right-click the 1756 backplane in the Controller Organizer and choose paste.

For other I/O families, paste the module you copied into the appropriate backplane.

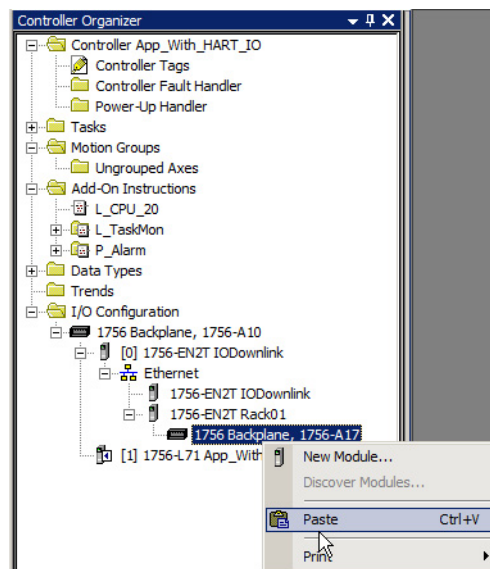

The selected module now appears in the project at the slot location from the sample project.

8. Double-click the module.

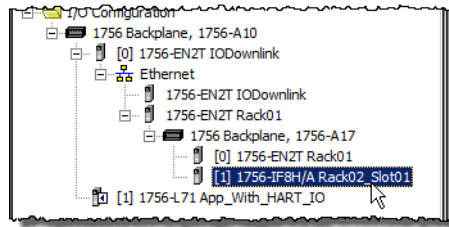

The Module Properties window appears.

9. Change the module name in accordance with the naming convention of your project (see [Table 10 on page 29](#) for the convention used in this example.).

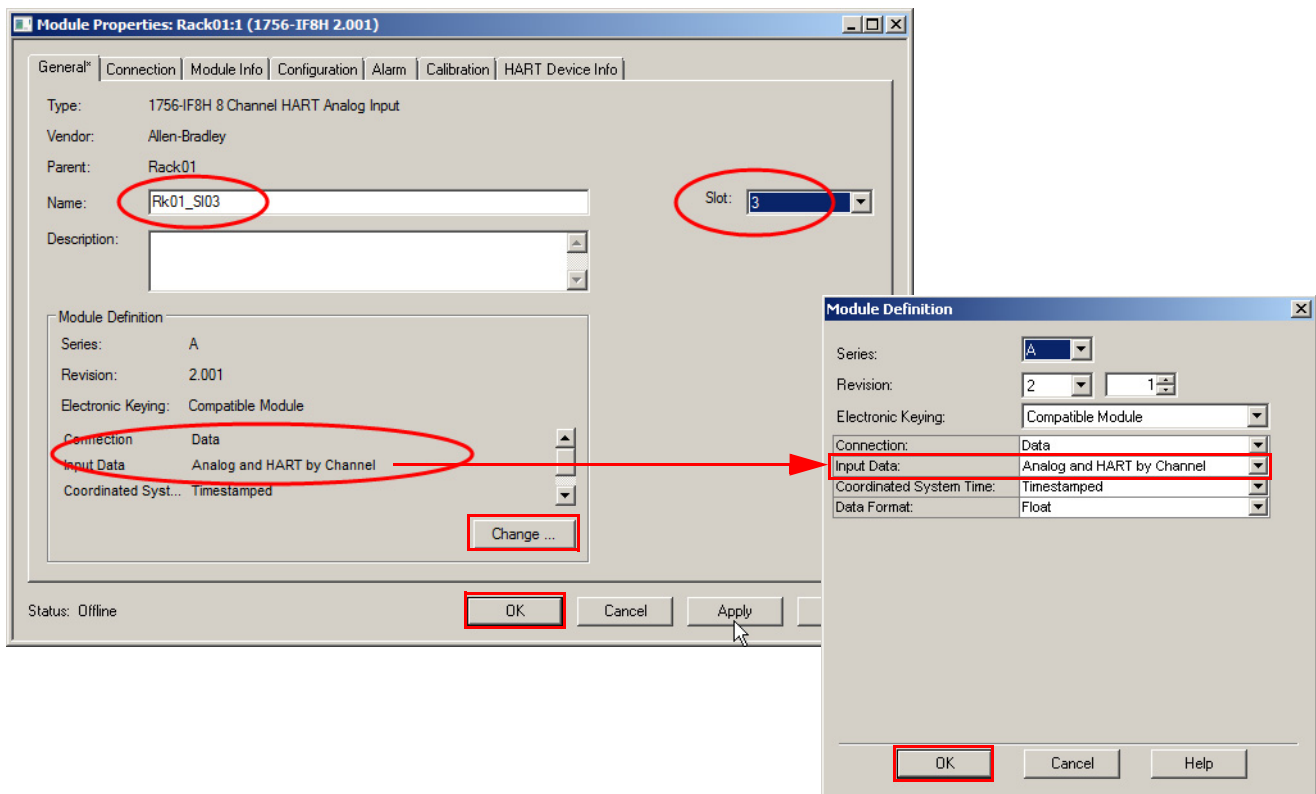

10. Set the Slot to match the actual location of the module.

IMPORT- For Bulletin 1794 FLEX™ I/O HART modules only, the module Add-On Instruction has a Cfg_Slot configuration parameter. This parameter must be set to the HART module 'slot' number on the FLEX Bus for Device Information messages to execute correctly.

- Click Change, set the Input Data to 'Analog and HART by Channel', and click OK.
- In the Controller Organizer, note the names of the Communication and I/O modules for future use.

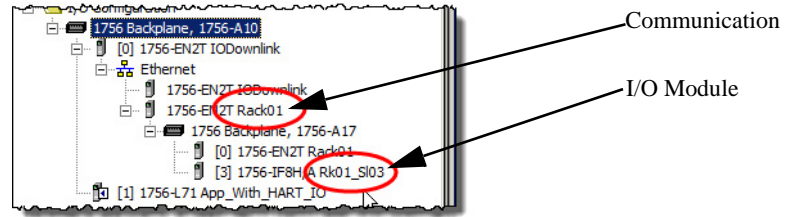

- Open the controller tags and note the input and configuration tags for this module.

Controller Tags - App_With_HART_IO(controller)

Scope: App_With_HART1 Show: All Tags

Name	Value	Force Mask	Style	Data Type
R01_S03_DevelopMSG	{...}	{...}		MESSAGE
R01_S03_EntryStatus	2#0100_001...		Binary	INT
R01_S03_ModDiagBuf	{...}	{...}	Decimal	SINT[224]
R01_S03_ModDiagMSG	{...}	{...}		MESSAGE
Rack01:2:C	{...}	{...}		AB:1756_OF8H:C:0
Rack01:2:I	{...}	{...}		AB:1756_OF8H:O:0
Rack01:2:O	{...}	{...}		AB:1756_OF8H:C:0
Rack01:3:C	{...}	{...}		AB:1756_IF8H:O:0
Rack01:3:I	{...}	{...}		AB:1756_IF8H_AnalogHARTbyChannel:I:0
Rack01:3:O	{...}	{...}		AB:1756_ENET_17SLOT:I:0
Rack01:0	{...}	{...}		AB:1756_ENET_17SLOT:O:0

Monitor Tags / Edit Tags

Import Rungs

The easiest way to add the logic to support your HART I/O module is to use the provided rung import to add the logic to a ladder diagram routine. Use the rung import procedure to create the required tags, Add-On Instructions, Data Types, and MSG (message instruction) configurations.

- In the target Controller Organizer, double-click a ladder diagram routine (HART_Modules in our example).

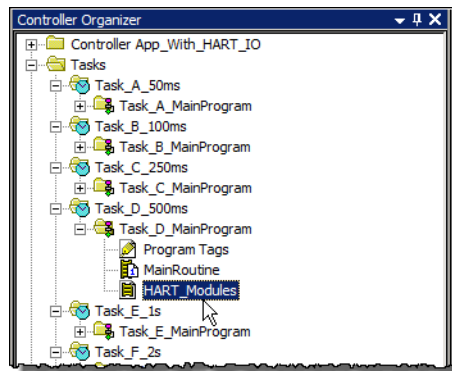

The ladder diagram appears.

2. Scroll to the end of the ladder diagram, right-click in the left margin, and choose Import Rungs.

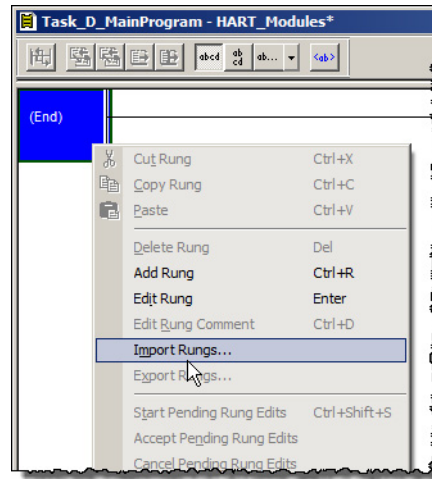

The Import Rung dialog box appears.

3. In the Import Rung dialog box, navigate to the Rung import file that matches the given module, select it, and click Open.

IMPORT- See [Appendix B on page 145](#) if you are using 1794-IF8IHNFXT to determine the correct file to import.

- Make sure that you select the RUNG import file, not the Add-On Instruction import file.
- The HART module import files are in the library download:

Name	Date modified	Type	Size
I_1756IF8H_4.10.00_RUNG.L5X	3/4/2019 1:16 PM	Logix Designer X...	
I_1756IF8IH_4.10.00_AOIL5X	3/4/2019 10:46 AM	Logix Designer X...	
I_1756IF8IH_4.10.00_RUNG.L5X	3/4/2019 1:19 PM	Logix Designer X...	
I_1756IF16H_1756IF16IH_4.10.00_AOIL5X	3/4/2019 10:44 AM	Logix Designer X...	
I_1756IF16H_1756IF16IH_4.10.00_RUNG.L5X	3/4/2019 1:17 PM	Logix Designer X...	
I_1756IF16H_1756IF16IH_ListenOnly_4.10.00_...	3/4/2019 10:52 AM	Logix Designer X...	
I_1756OF8H_4.10.00_AOIL5X	3/4/2019 10:47 AM	Logix Designer X...	
I_1756OF8H_4.10.00_RUNG.L5X	3/4/2019 1:18 PM	Logix Designer X...	
I_1756OF8IH_4.10.00_AOIL5X			
I_1756OF8IH_4.10.00_RUNG.L5X			
I_1769scIF4IH_4.10.00_TEST_A_AOIL5X			
I_1769scIF4IH_4.10.00_TEST_A_RUNG.L5X			

Logix Designer Rungs
Allen-Bradley 1756-OF8H 8-channel HART analog import
Number of Rungs: 2
Export Date: Mon Mar 04 14:18:34 2019
Software Version: V18.02

File name:

The Import Configuration dialog box appears.

You must address any red flagged items in the Import Content.

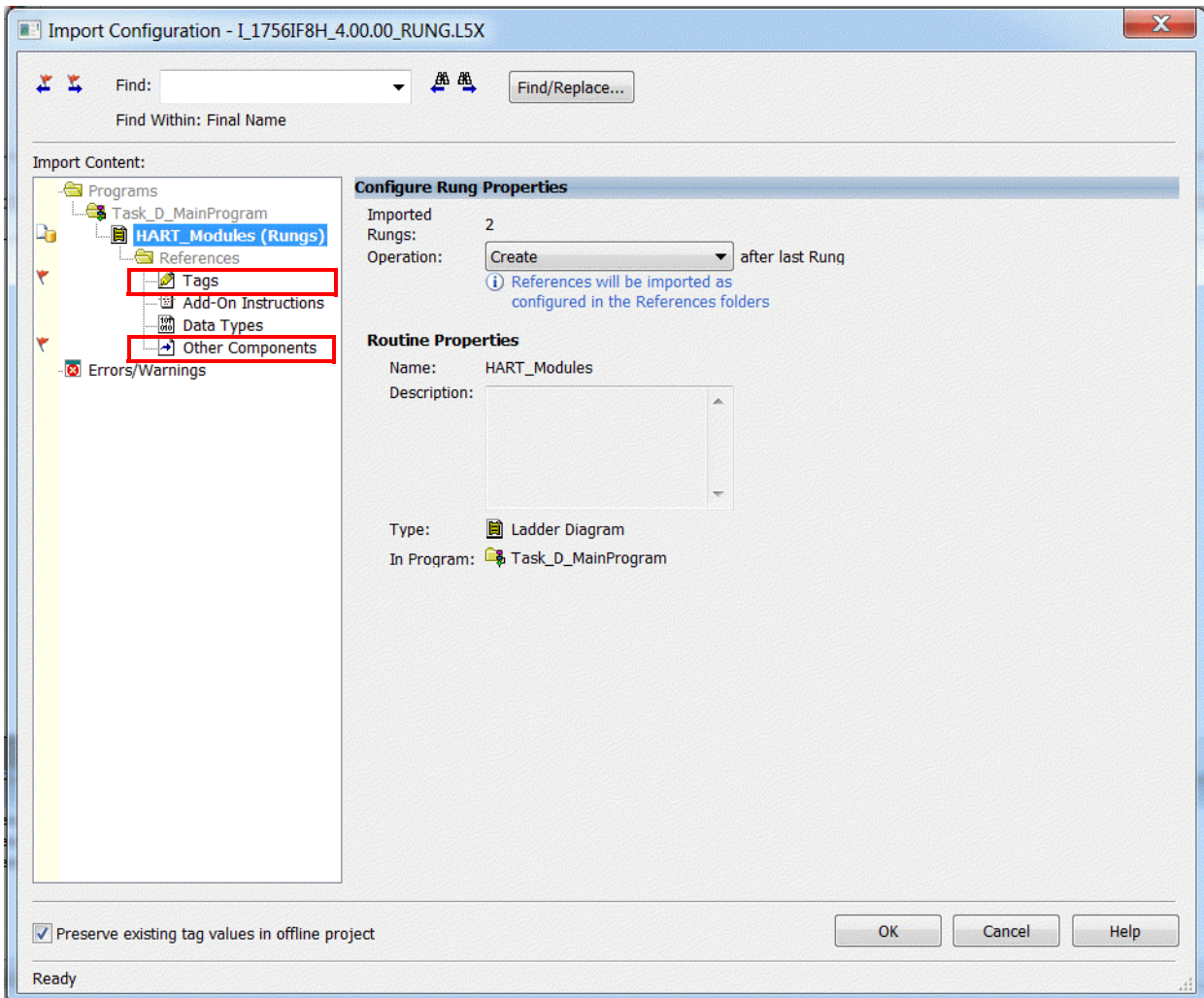

Configure Tag References

The tags that are used on this rung must be renamed with new names for this instance.

The following table describes how to name the HART modules and components.

Table 10 - Tag Naming Conventions Used in This Example

Name of	How to Name	Default in RUNG Import Used in Example	Final Name in Example
HART module	Enter in Module Properties Dialog when you create the module.	Rk02_S101	Rk01_S103
Chassis	Enter in Module Properties Dialog when you create the communication module.	Rack02	Rack01
Configuration tag for module	Automatically named by using chassis and slot number	Rack02:1:C	Rack01:3:C
Input tag for module	Automatically named by using chassis and slot number	Rack02:1:I	Rack01:3:I
Output tag for module (output modules only)	Automatically named by using chassis and slot number	(Rack02:1:O)	(Rack01:3:O)
Module Add-On Instruction backing tag	Enter this name in the Configure Tag References panel in the Rung Import Configuration. You can use any valid tag name. We recommend the remaining tag names use this name as a base. Use the Find/Replace dialog box to apply this name base to all remaining tags.	R02_S01	R01_S03
Channel Data Array tag	Use Add-On Instruction backing tag plus '_ChanData'.	R02_S01_ChanData	R01_S03_ChanData
Device Information MSG tag	Use Add-On Instruction backing tag plus '_DevInfoMSG'.	R02_S01_DevInfoMSG	R01_S03_DevInfoMSG
Data buffer tag used with Device Information MSG	Use Add-On Instruction backing tag plus '_DevInfoBuf'.	R02_S01_DevInfoBuf	R01_S03_DevInfoBuf
INT tag used with GSV for module connection status	Use Add-On Instruction backing tag plus '_EntryStatus'.	R02_S01_EntryStatus	R01_S03_EntryStatus
Module Diagnostic MSG tag	Use Add-On Instruction backing tag plus '_ModDiagMSG'.	R02_S01_ModDiagMSG	R01_S03_ModDiagMSG
Data buffer tag used with Module Diagnostic MSG	Use Add-On Instruction backing tag plus '_ModDiagBuf'.	R02_S01_ModDiagBuf	R01_S03_ModDiagBuf

1. In the Import Content panel, click Tags and the Configure Tag References panel appears.
2. Click Find/Replace.

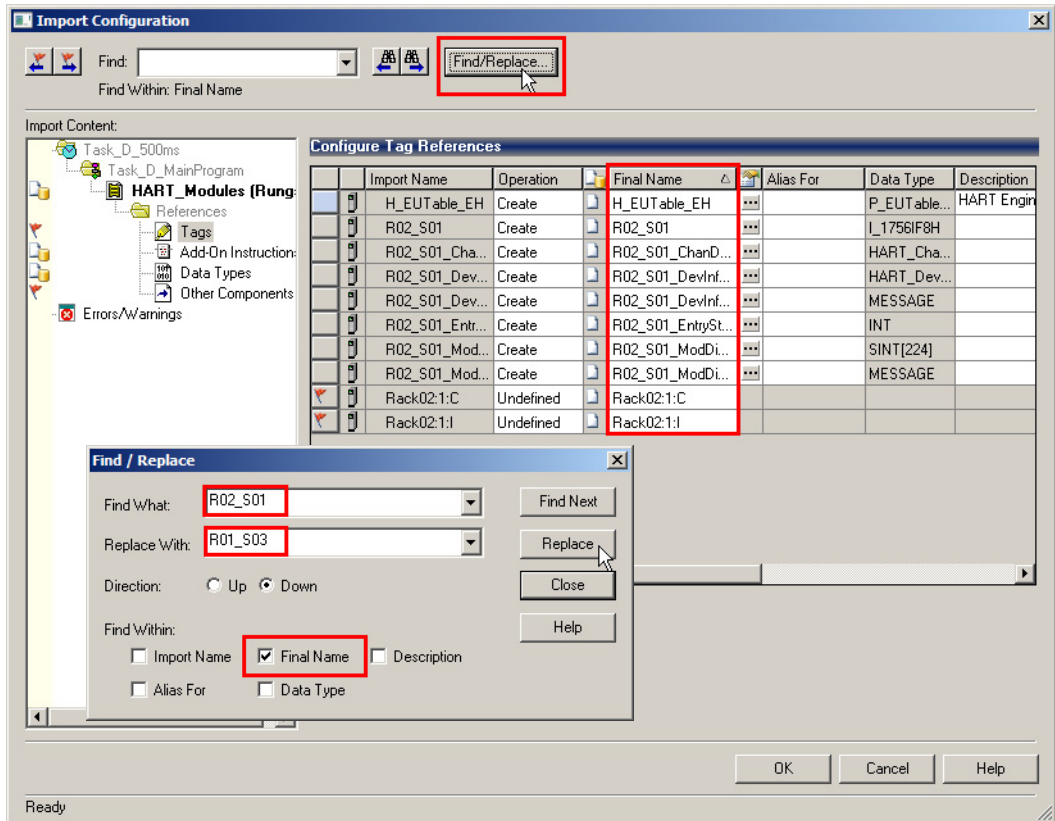

The Find/Replace dialog box appears.

3. In Find What, type the name of the tag you want to replace (R02_S01 in our example).
4. In Replace With, type the replacement name for the tag (R01_S03 in our example). The replacement name is the tag name base for this module.
5. Click Final Name as the search area.
6. Click Replace.

All tag names that contain your 'Find What name' are replaced.

7. Click Find/Replace.

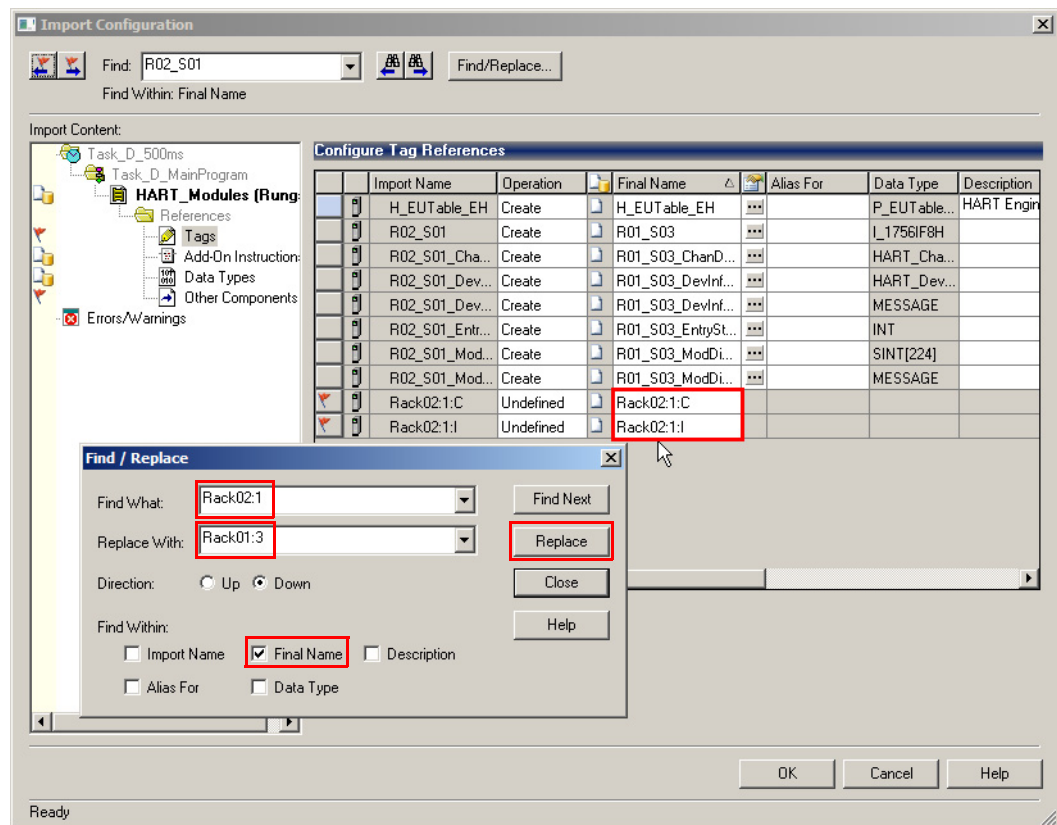

The Find/Replace dialog box appears.

TIP In the next steps, use Find/Replace, not the Find pull-down menu.

Use Find/Replace to automatically configure the message communication paths. The Find pull-down menu does not.

8. In Find What, type the name of the tag you want to replace (Rack02:1 in our example).
9. In Replace With, type the replacement name for the tag (Rack01:3 in our example). The replacement name is the tag name base for the module you pasted previously.
10. Click Final Name as the search area.
11. Click Replace.

All tag names that contain your 'Find What name' are replaced.

Additional Reference Configurations

The rest of the references (Add-On Instructions, Data Types, and Other Components) must be created or configured for the input module being used.

The Data Types (UDTs) used on the rungs must be created if they do not exist. If the correct Data Types are already in place in the application (correct name and definition for each), there is no need to reimport. The same Data Type is used for ALL instances.

The Add-On Instructions that are used on the rungs must be created if they do not exist. If the correct Add-On Instructions are already in place in the application (correct name and definition for each), there is no need to reimport. The same Add-On Instruction definition (with the same name) works for ALL instances.

1. In the Import Content panel, click Add-On Instructions.

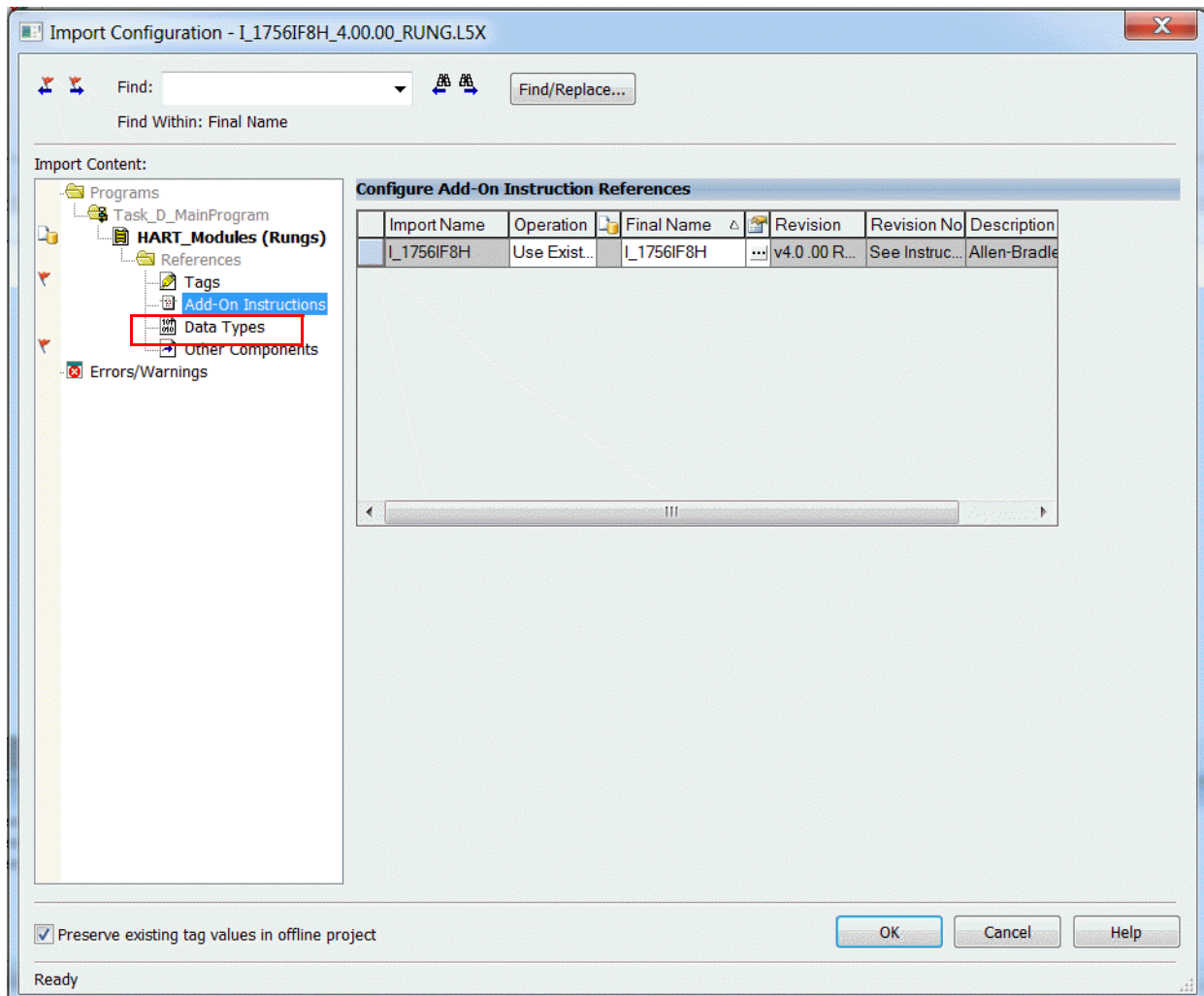

The Configure Add-On Instruction References panel appears.

- In the Operation column, select the appropriate option.

IMPORT- The following conditions apply when Operation is selected:

- If the instruction or data type that is being imported does not exist (not previously imported), the Operation is 'Create'. That instruction or data type is imported and added to the user application.
 - If the imported instruction or data type is named the same as one that exists in the application and is the same (already imported), the Operation is 'Use Existing'. That instruction or data type is not to be reimported -- it is already there and correct.
 - If the instruction or data type that is being imported is named the same as one that exists in the application and is different, the Operation is 'Overwrite'. If you have any doubt, check uses of that instruction or data type and verify that you actually want to overwrite the old definition. The version being imported is required for correct operation of these HART Add-On Instructions.
-

- Make any other necessary changes.
- Click Data Types.

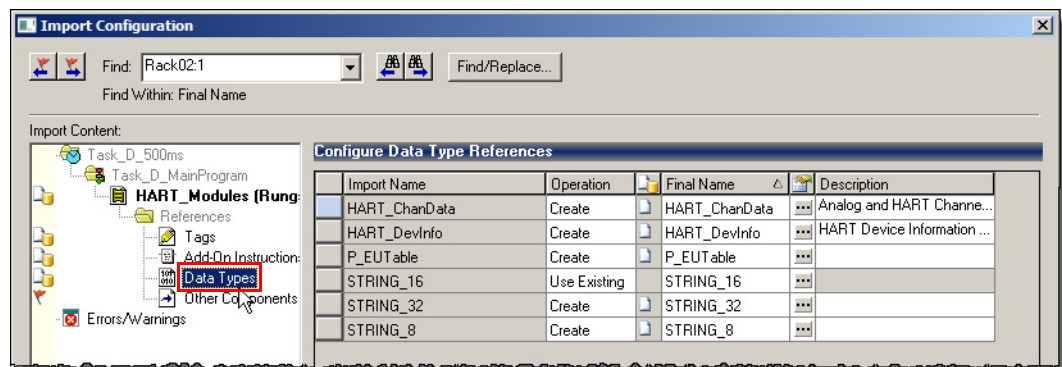

The Configure Data Type References panel appears.

- Make any necessary changes.

6. Click Other Components.

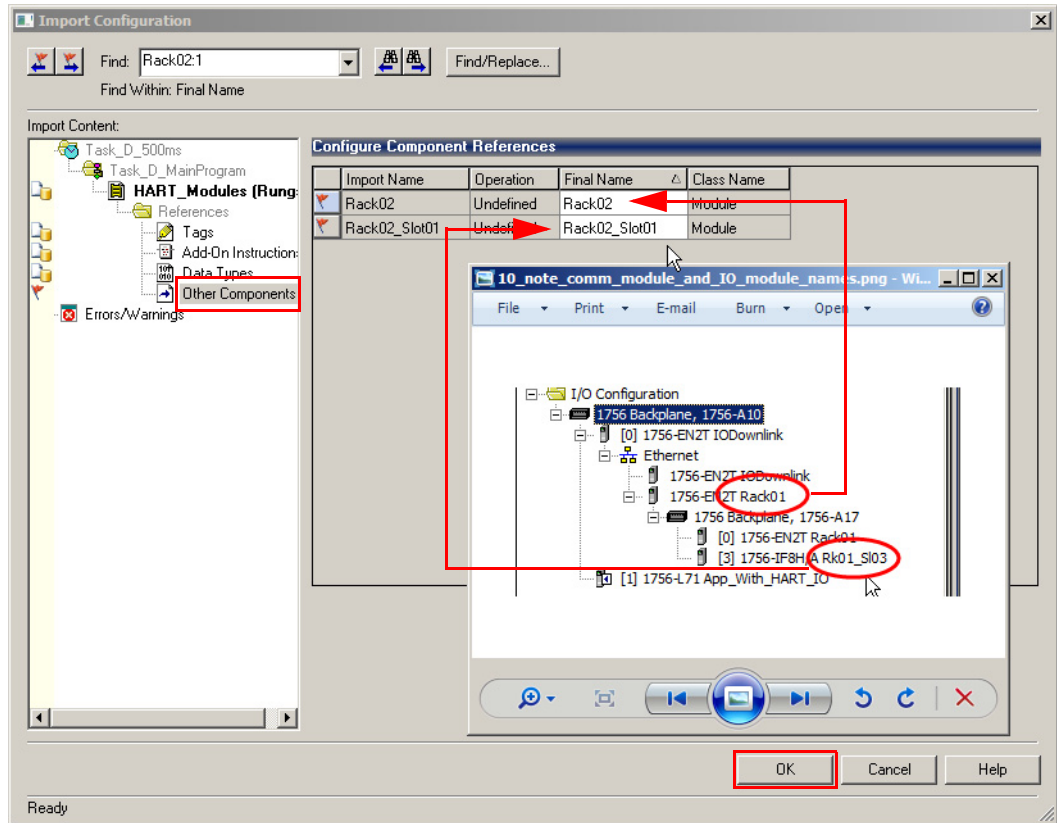

The Configure Component References panel appears.

TIP For local I/O, use the name of the HART I/O module (Rk01_SL03 in our example) in both of the following steps.

7. Click the Final Name for the Communication Module and type the name that you noted earlier in [step 12 on page 26](#).
8. Click the Final Name for the I/O Module and type the name.
Use the name that you noted earlier in [step 12 on page 26](#), or use the pull-down list to select the name.
9. Make any other necessary changes.
10. On the Import Configuration dialog box, click OK.
Two rungs of logic are added to your logic.
11. Return to the ladder diagram window.
12. Double-click the rung comment and make any necessary changes.

13. Press Enter when you are finished.

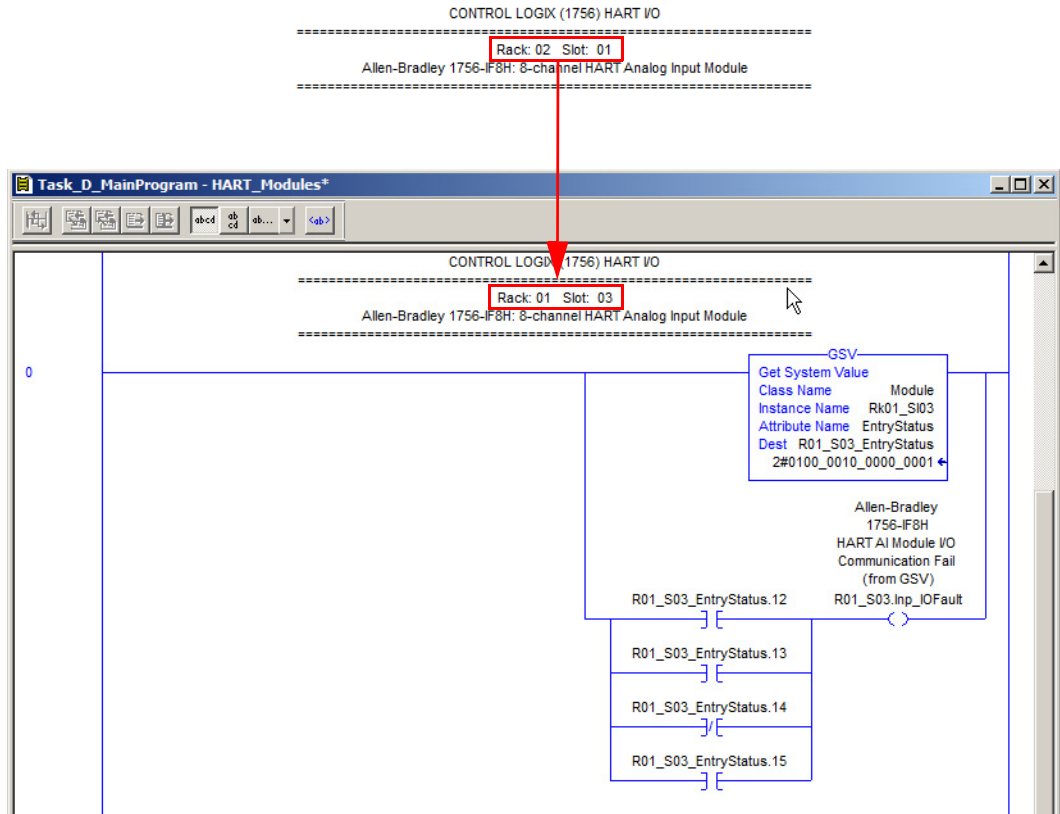

See [Module Messaging Reference on page 129](#) for information on MSG configurations on the modules.

Add P_AIn_HART Add-On Instruction

TIP You must import the P_AInHART Add-On Instruction only once for the project.

The P_AInHART Add-On Instruction receives an analog measurement value from an input module and receives digital signals from the device for a given channel.

IMPORT- An instance of the P_AInHART instruction is used for each channel (device) on the input module.

Perform the following steps:

1. In the target Controller Organizer, right-click Add-On Instructions and choose 'Import Add-On Instruction.'

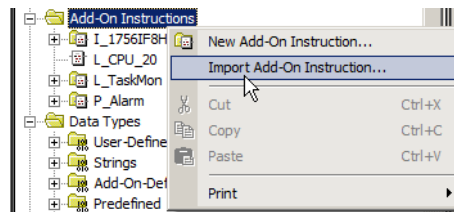

The Import Add-On Instruction dialog box appears.

2. Select the P_AInHART Add-On Instruction and click Open.

Name	Date modified	Type	Size
P_AInFFR_4.10.00_AOI.L5X	3/4/2019 12:49 PM	Logix Designer X...	211 KB
P_AInHART_4.10.00_AOI.L5X	3/4/2019 12:50 PM	Logix Designer X...	277 KB
P_AInMulti_4.10.00_TEST_B_AOI.L5X	3/5/2019 4:01 PM	Logix Designer X...	384 KB
P_AInPAR_4.10.00_AOI.L5X	3/4/2019 12:50 PM	Logix Designer X...	204 KB
P_AInPAR_A_4.10.00_AOI.L5X	3/4/2019 12:50 PM	Logix Designer X...	204 KB
P_Alarm_4.10.00_AOI.L5X	3/4/2019 12:30 PM	Logix Designer X...	62 KB
P_AOut_4.10.00_TEST_C_AOI.L5X	3/5/2019 4:04 PM	Logix Designer X...	227 KB
P_AOutHART_4.10.00_TEST_D_AOI.L5X	3/4/2019 12:50 PM	Logix Designer X...	296 KB
P_CmdSrc_4.10.00_TEST_B_AOI.L5X	3/4/2019 12:32 PM	Logix Designer X...	66 KB
P_D4SD_4.10.00_TEST_D_AOI.L5X	3/5/2019 4:07 PM	Logix Designer X...	281 KB
P_DBC_4.10.00_TEST_D_AOI.L5X	3/5/2019 4:10 PM	Logix Designer X...	287 KB
P_DIn_4.10.00_AOI.L5X	3/5/2019 4:12 PM	Logix Designer X...	155 KB

File name:

Files of type: RSLogix 5000 XML Files (*.L5X)

Files containing: Add-On Instruction

Into: Add-On Instructions

The Import Configuration dialog box appears.

3. If there are any red flags in the Import Content area, they must be addressed.

See [Configure Tag References on page 29](#) for an example of clearing red flags.

4. When there are no red flags, click OK.

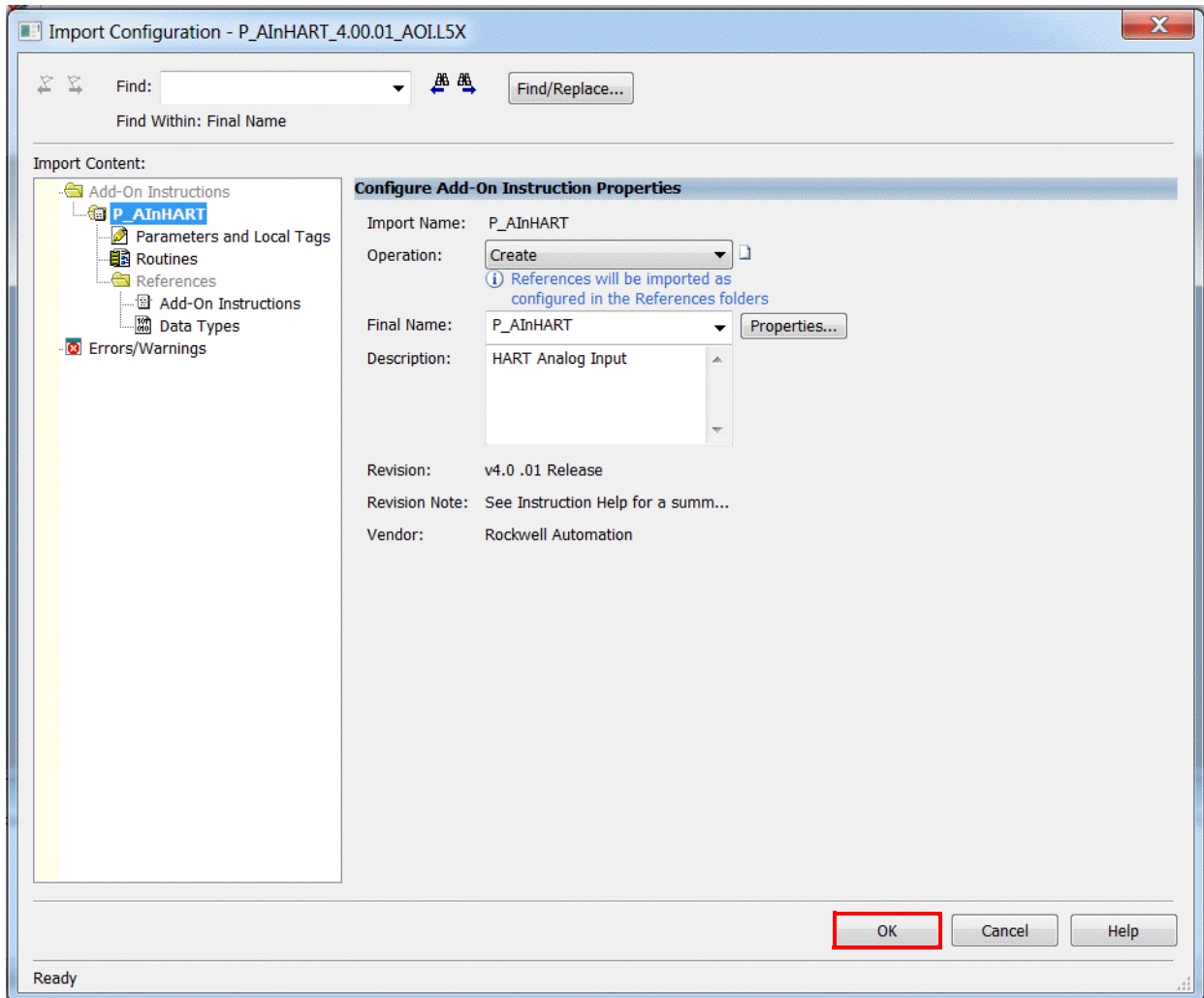

TIP Besides P_AInHART, P_Alarm and P_Gate also are imported.

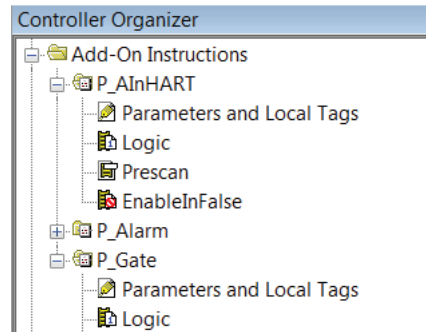

TIP You must import the P_AInHART Add-On Instruction (steps [1](#) through [4](#)) only once for the project. The remaining steps apply to each channel (instance).

- In the Controller Organizer, double-click the routine in your process application (Monitor_Pressures in our example) where you want the P_AInHART instance for this channel.

For this example, we are using a function block diagram routine. The P_AInHART instruction can be used in ladder diagram or structured text routines, also.

The routine workspace opens.

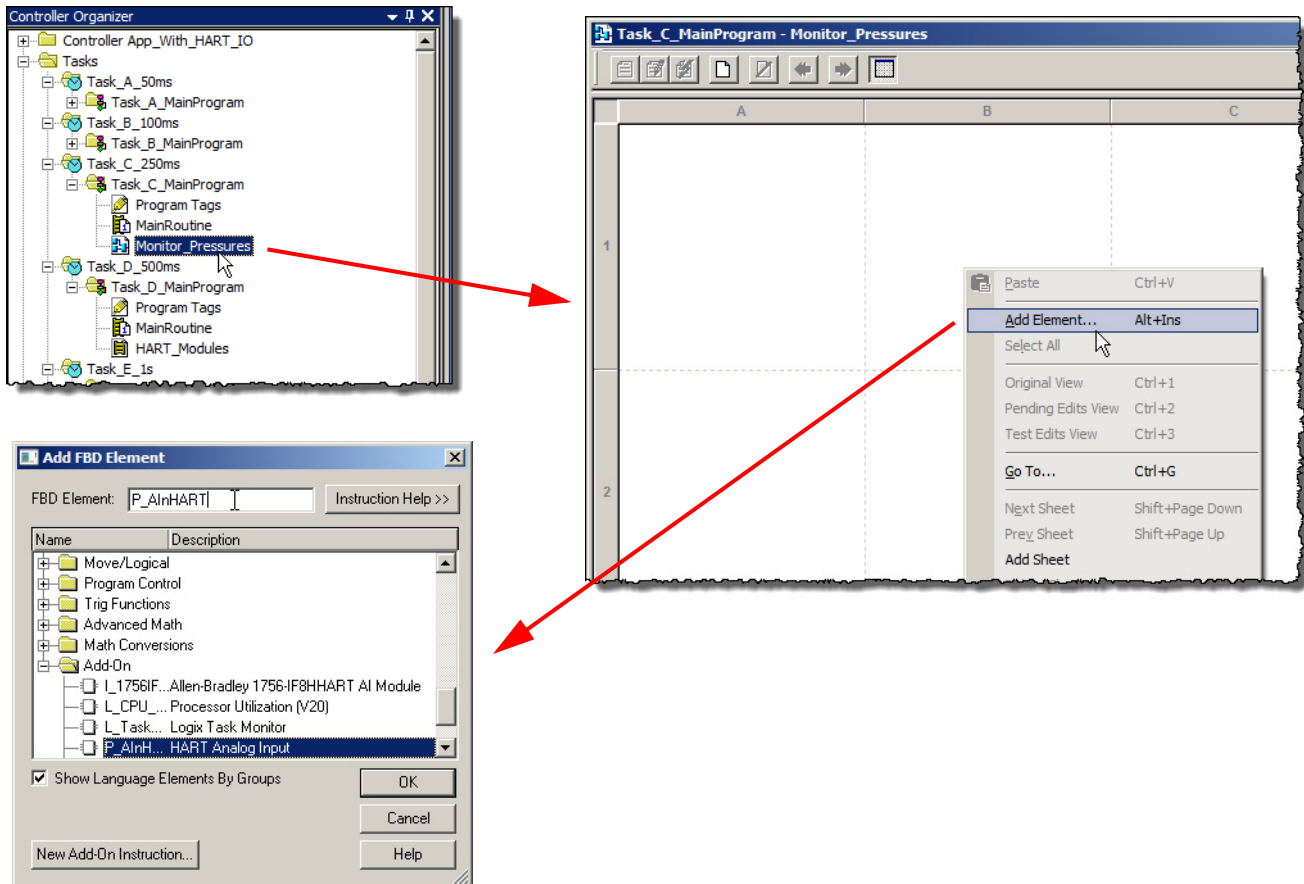

- In the workspace, right-click and choose Add Element.

The Add FBD Element dialog box appears.

- Under the Add-On folder, select the HART Analog Input Add-On Instruction and click OK.

The HART Analog Input element is added.

8. Double-click the tag name, type a new tag name (PI_1403 in our example), and press Enter.

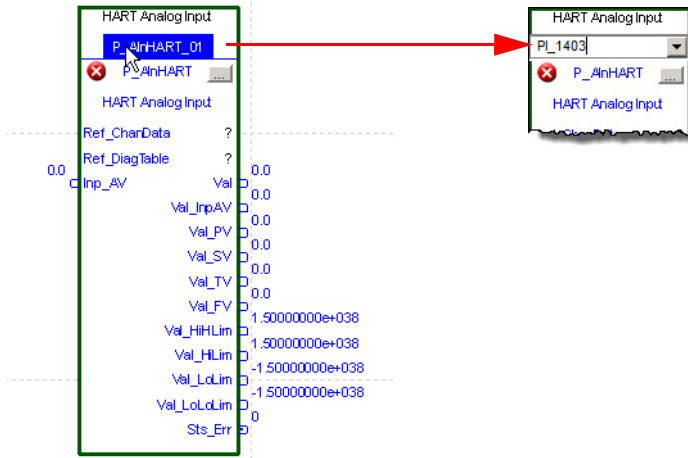

9. Right-click the new tag name and choose New <new tag name> (New PI_1403 in our example).

The New Tag dialog box appears.

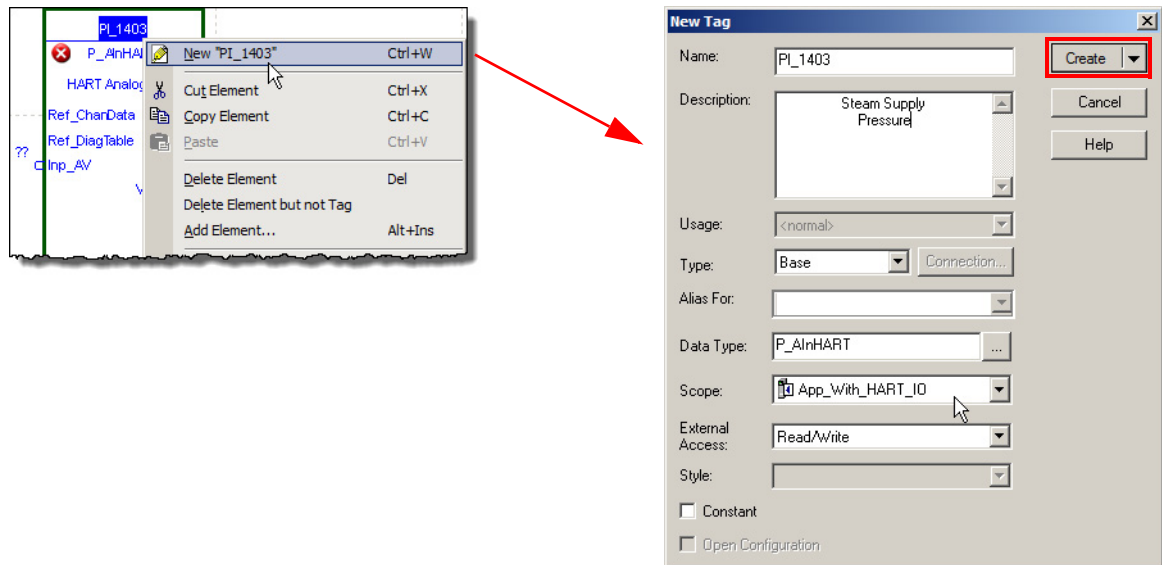

10. In the New Tag dialog box, the following fields are completed by default:
 - Name
 - Data Type
 - External Access (must be Read/Write)
11. Type an optional Description.
12. Select a Scope from the pull-down menu (controller scope in this example) and click Create.

13. On the HART Analog Input element, double-click the question mark that corresponds to Ref_ChانData.
- A pull-down menu appears.
14. Either type or select the channel data array for the module.
 15. Add an array index that indicates the correct channel and press Enter.

IMPORT- See Ref_ChانData in the HART module instruction for the base array name.

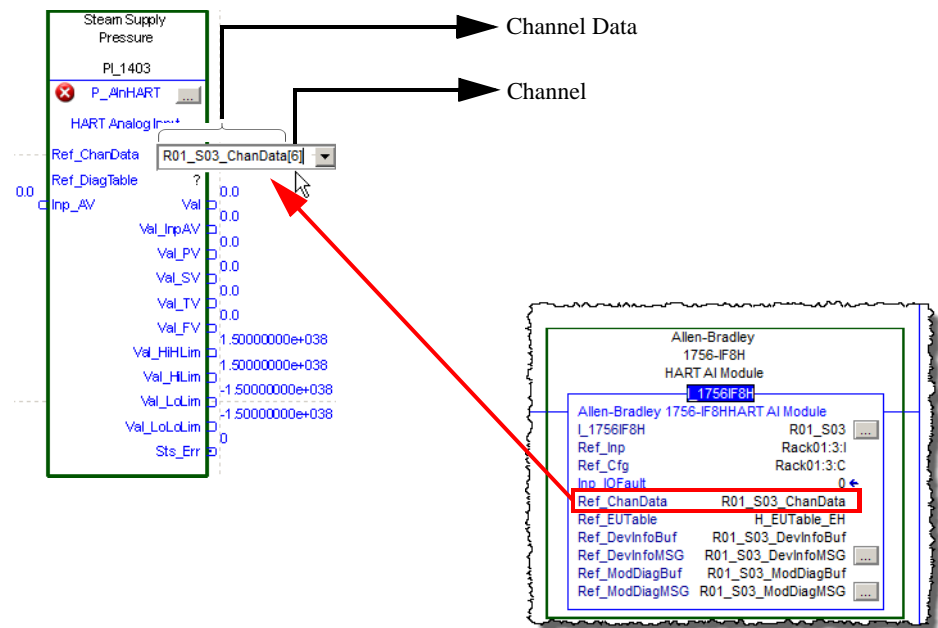

IMPORT- For 1719 I/O, the I/O channels are numbered 1...4 but the channel data array indices are numbered [0]...[3]. For all other I/O families, I/O channels are numbered starting at zero.

In this example, our device is wired to channel 6.

16. **In the samples application**, in the Controller Organizer, double-click Controller tags.

The Controller Tags window appears.

17. Select the Edit Tags tab at the bottom of the window.
18. Right-click the tag for the diagnostic table that matches the field device you are using (E+H Cerebar and Deltabar in our example) and choose copy.

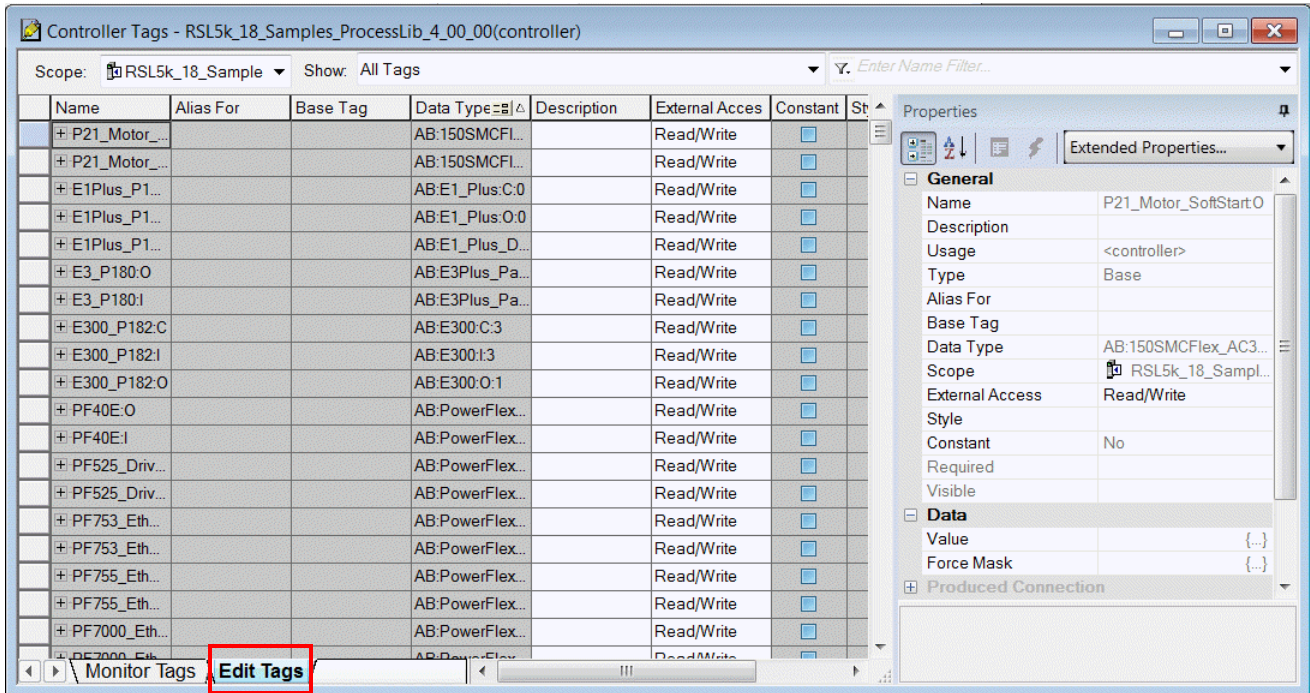

19. In your application (App_With_HART_IO in our example), in the Controller Organizer, open the controller tags, select the Edit Tags tab, and scroll to the bottom of the controller tags.

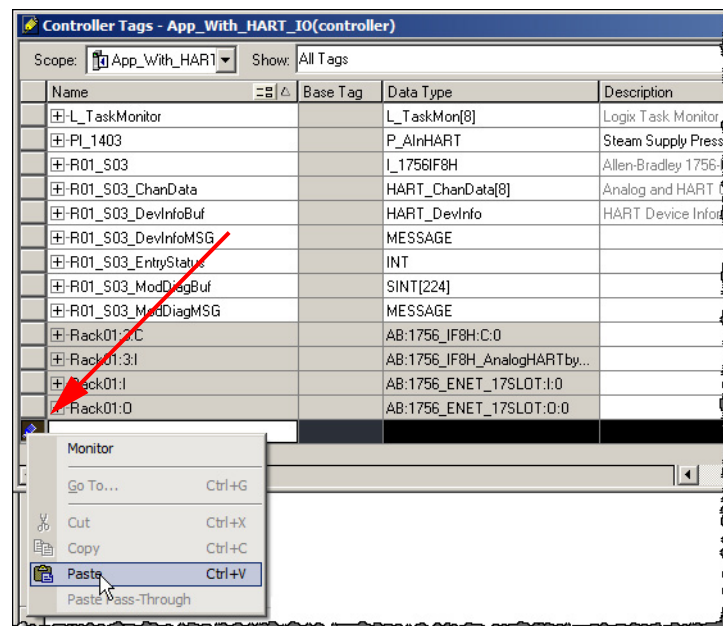

20. In the empty row, right-click the box that is left of the columns, and choose Paste.

TIP Only one instance of a Diagnostic table tag is needed for all similar devices.

Name	Alias For
H_DiagTable_Pressure_S	

21. On the HART Analog Input element, double-click the question mark that corresponds to Ref_DiagTable.

A pull-down list appears.

22. Either type or select the Diagnostic table tag that was copied, and press Enter.

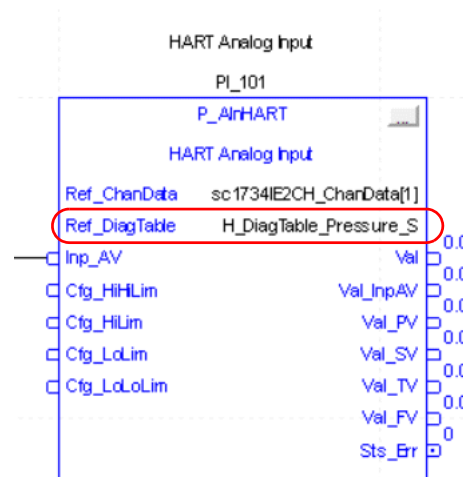

TIP If a Diagnostic table tag is not included for your device, you can use the HART5_DiagTable_Generic or HART7_DiagTable_Generic table tag, or create your own. The Online Premier Integration Configuration Tool can be useful when you build your table tag.

Link Analog Signal

In this section, the analog channel data from the card you added to the project must be connected to the input of P_AInHART instruction.

Complete the following steps:

1. If the Language Element toolbar is not visible:
 - a. Click View and choose Toolbars.
 - b. Select Language Element and click OK.

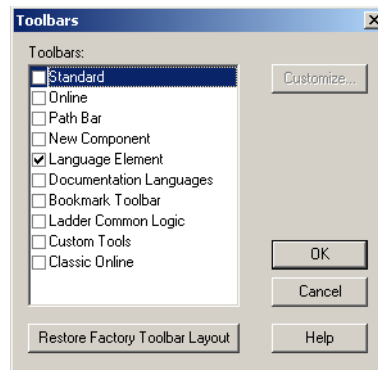

2. In the Language Element toolbar, drag-and-drop an 'Input Reference' to Inp_AV on the workspace.

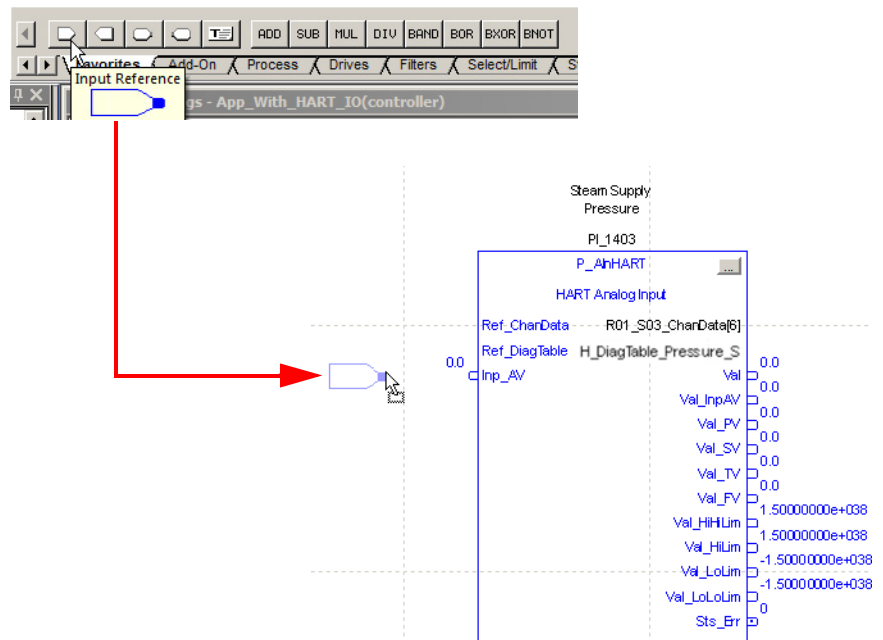

- Double-click inside the Input Reference symbol and choose the analog input from the module.

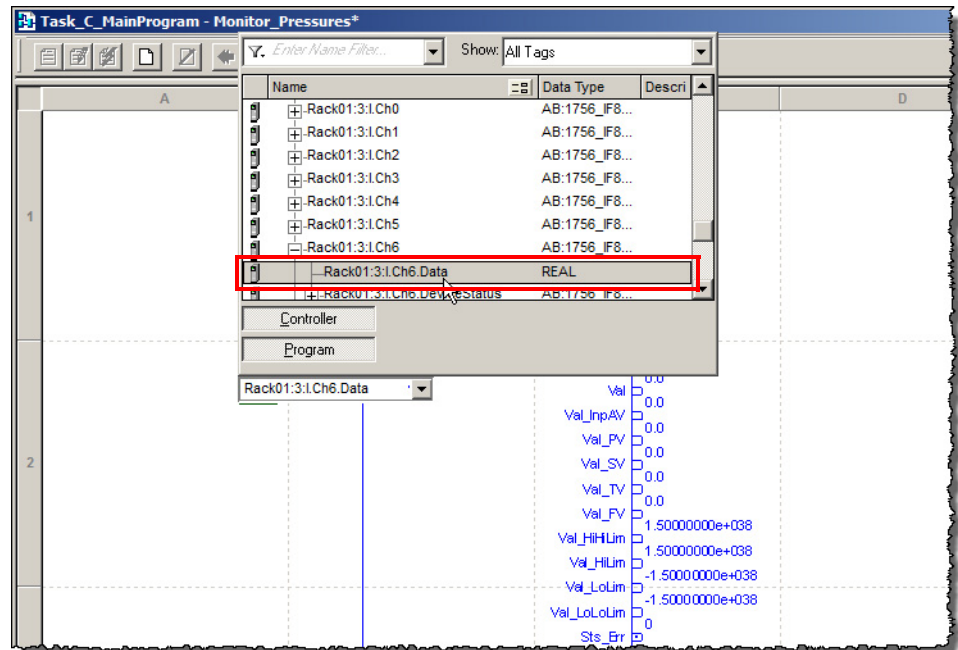

IMPORT- The input data structure varies based on the I/O family. See the user manual for your module for the location of the analog signal input.

- Add a wire from the Input Reference symbol to Inp_AV.

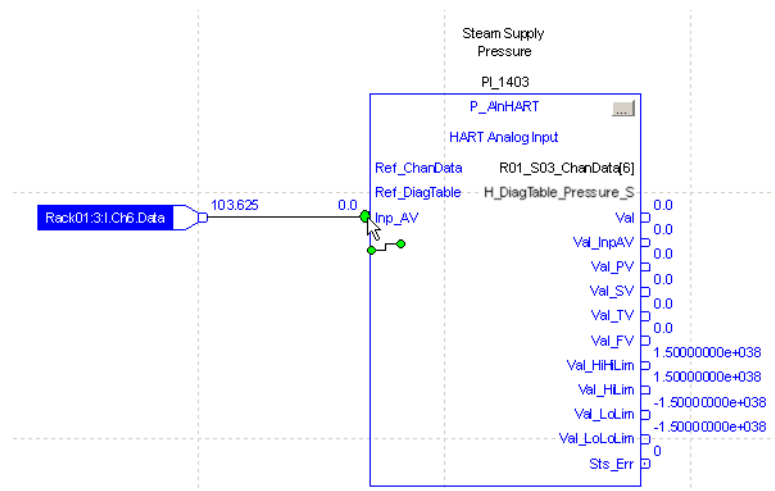

Your completed function block for a HART channel instance is similar to the following image.

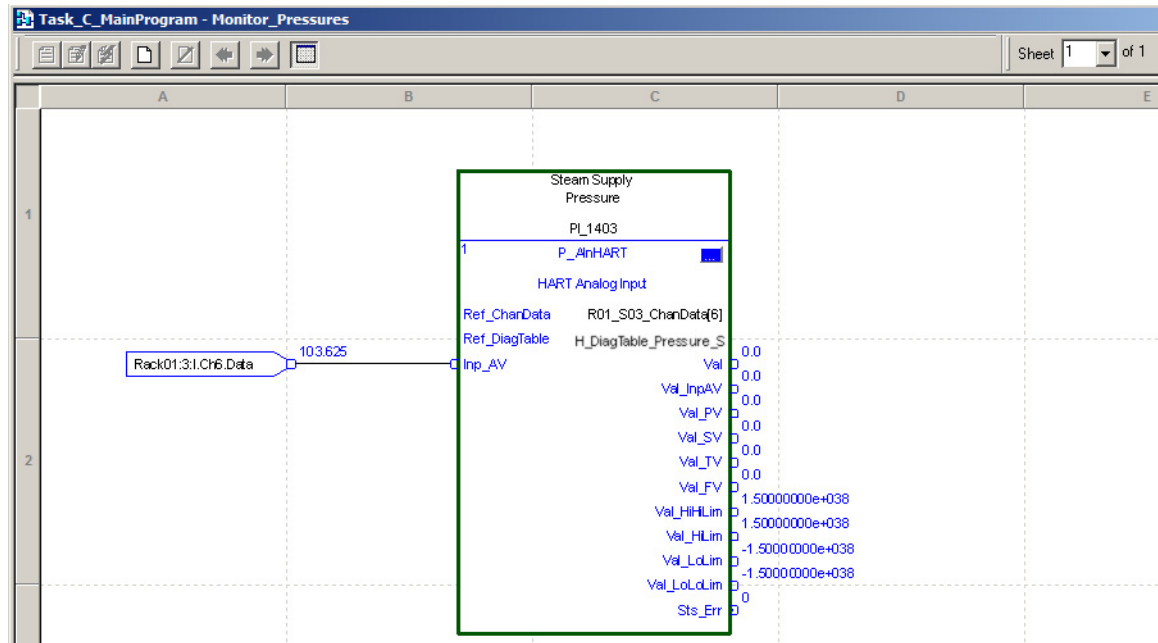

Output Module Integration

You must have a project open with a controller already configured. Make sure that the project path is set to the correct controller.

Add Output Module

The desired HART I/O module must be added into the project I/O configuration.

TIP We recommend that you copy the module from the sample projects that are included in the library. By copying the module, several module options are configured for you. The following procedures use this method.

1. Open Project in the Files>Premier Integration Samples>Project folder.
2. Copy a sample .ACD file and paste it on your desktop.
3. Open the application, copy the sample module and paste it into your project.

The selected module now appears in the project.

- Change the module name in accordance with the naming convention of your project.

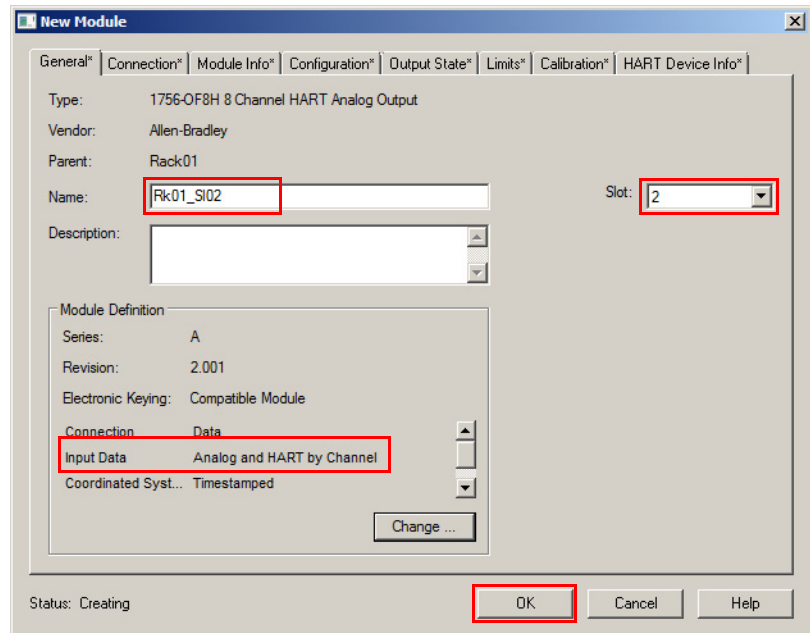

- If necessary, change the Slot to match the desired location for the module.
- In the Module Definition area, make sure that Input Data is 'Analog and HART by Channel'. If it is necessary to change Input Data, click Change.

The Module Definition dialog box appears.

- Make sure that the Input Data row is set to 'Analog and HART by Channel'.
 - Click OK to close the Module Definition dialog box.
- In the Controller Organizer, note the names of the Communication and I/O modules for future use.

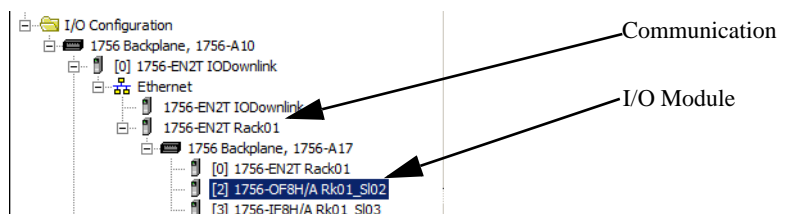

Import Rungs

The easiest way to add the logic to support your HART I/O module is to use the provided rung import to add the logic to a ladder diagram routine. Use the rung import procedure to create, not only the logic, but to create the required tags and MSG (message instruction) configurations.

1. At the end of the ladder diagram, right-click in the left margin, and choose Import Rungs.

The Import Rung dialog box appears.

2. In the Import Rung dialog box, navigate to the Rung import file that matches the given module, select it, and click Import.

Name	Date modified	Type	Size
I_1756IF8H_4.10.00_RUNG.L5X	3/4/2019 1:16 PM	Logix Designer X...	
I_1756IF8IH_4.10.00_AOI.L5X	3/4/2019 10:46 AM	Logix Designer X...	
I_1756IF8IH_4.10.00_RUNG.L5X	3/4/2019 1:19 PM	Logix Designer X...	
I_1756IF16H_1756IF16IH_4.10.00_AOI.L5X	3/4/2019 10:44 AM	Logix Designer X...	
I_1756IF16H_1756IF16IH_4.10.00_RUNG.L5X	3/4/2019 1:17 PM	Logix Designer X...	
I_1756IF16H_1756IF16IH_ListenOnly_4.10.00_...	3/4/2019 10:52 AM	Logix Designer X...	
I_1756OF8H_4.10.00_AOI.L5X	3/4/2019 10:47 AM	Logix Designer X...	
I_1756OF8H_4.10.00_RUNG.L5X	3/4/2019 1:18 PM	Logix Designer X...	
I_1756OF8IH_4.10.00_AOI.L5X			
I_1756OF8IH_4.10.00_RUNG.L5X			
I_1769scIF4IH_4.10.00_TEST_A_AOI.L5X			
I_1769scIF4IH_4.10.00_TEST_A_RUNG.L5X			

Logix Designer Rungs
 Allen-Bradley 1756-OF8H 8-channel HART analog import
 Number of Rungs: 2
 Export Date: Mon Mar 04 14:18:34 2019
 Software Version: V18.02

File name:

The Import Configuration dialog box appears.

3. If there are red flagged items in the Import Content, make any fixes that are necessary.

Configure Tag References

The default Final Names for the imported rungs must be changed.

1. In the Import Content panel, click Tags and the Configure Tag References panel appears.
2. Click Find/Replace.

The Find/Replace dialog box appears.

3. In Find What, type the name of the tag you want to replace (R02_S03 in our example).
4. In Replace With, type the replacement name for the tag (R01_S02 in our example). The replacement name is the tag name base for this module.
5. Click Final Name as the search area.
6. Click Replace.

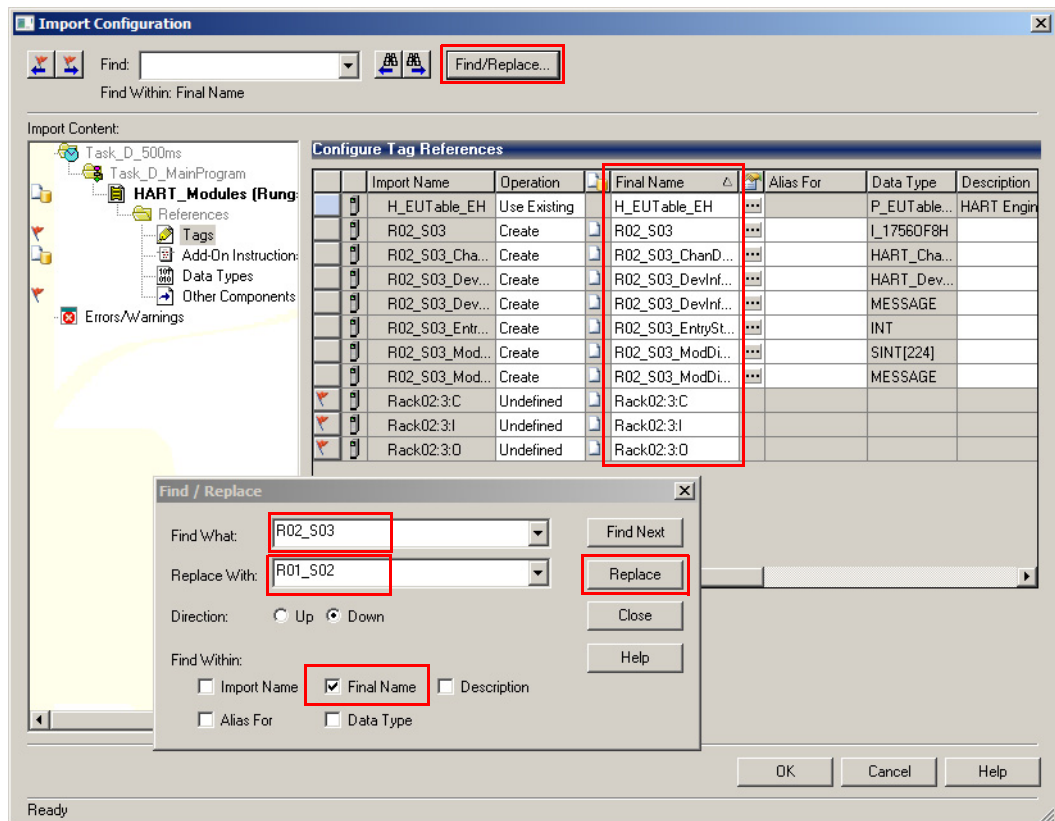

All tag names that contain your 'Find What name' are replaced.

7. Click Find/Replace.

The Find/Replace dialog box appears.

8. In Find What, type the name of the tag you want to replace (R02_S03 in our example).
9. In Replace With, type the replacement name for the tag (R01_S02 in our example). The replacement name is the tag name base for the module you pasted previously.
10. Click Final Name as the search area.

11. Click Replace.

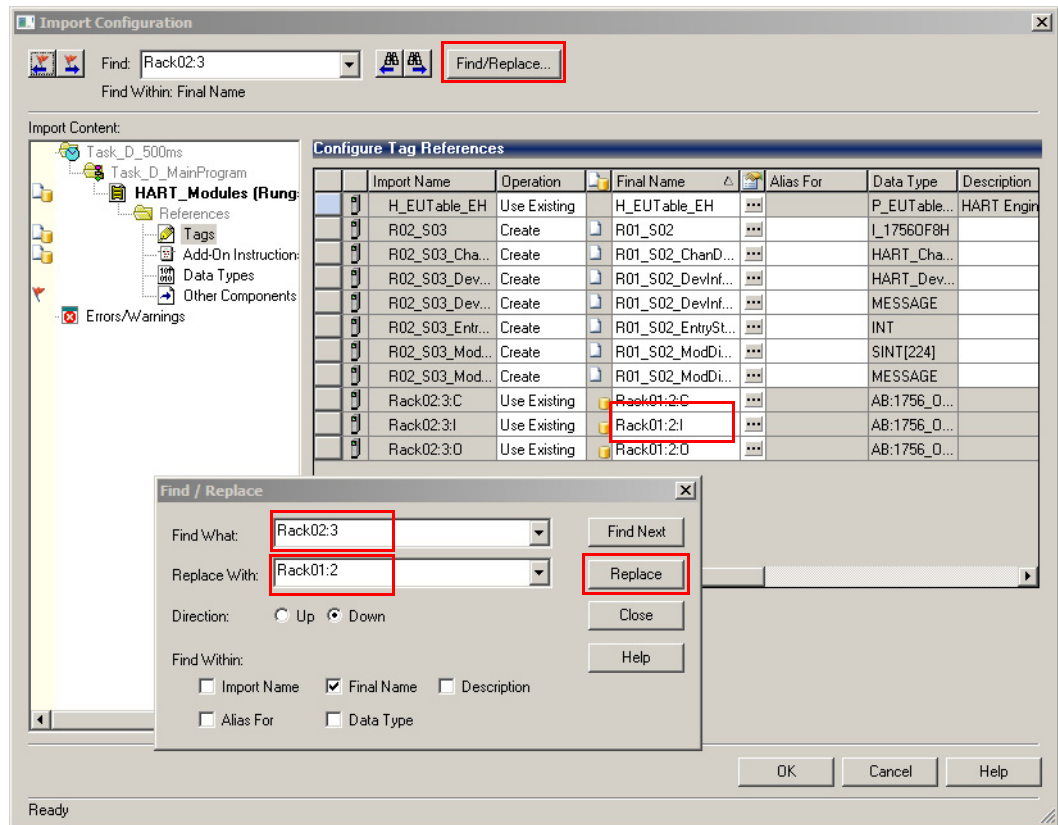

All tag names that contain your 'Find What name' are replaced.

Additional Reference Configurations

The rest of the references (Add-On Instructions, Data Types, and Other Components) must be created or configured for the output module.

The Data Types (UDTs) used on the rungs must be created if they do not exist. If the correct Data Types are already in place in the application (correct name and definition for each), there is no need to reimport. The same Data Type is used for ALL instances.

The Add-On Instructions that are used on the rungs must be created if they do not exist. If the correct Add-On Instructions are already in place in the application (correct name and definition for each), there is no need to reimport. The same Add-On Instruction definition (with the same name) works for ALL instances.

1. In the Import Content panel, click Add-On Instructions.

The Configure Add-On Instruction References panel appears.

2. In the Operation column, select the appropriate option.

IMPORT- The following conditions apply when Operation is selected:

- If the imported instruction or data type does not exist (not previously imported), the Operation is 'Create'. That instruction or data type is imported and added to the user application.
- If the imported instruction or data type is named the same as one that exists in the application and is the same (already imported), the Operation is 'Use Existing'. That instruction or data type is not to be reimported -- it is already there and correct.
- If the instruction or data type that is imported is named the same as one that exists in the application, but is different, the Operation is 'Overwrite'. In most cases, 'Overwrite' is correct; for example, when you are upgrading the application from an older version of the library. If you have any doubt, check uses of that instruction or data type and verify that you actually want to overwrite the old definition. The version that is imported is required for correct operation of these HART Add-On Instructions.

3. Make any other necessary changes.

4. Click Data Types.

The Configure Data Type References panel appears.

5. Make any necessary changes.

6. Click Other Components.

The Configure Component References panel appears.

7. Click the Final Name for the Communication Module and type the name that you noted earlier in [step 12 on page 26](#).
8. Click the Final Name for the I/O Module and type the name that you noted earlier in [step 12 on page 26](#).

9. Make any other necessary changes.

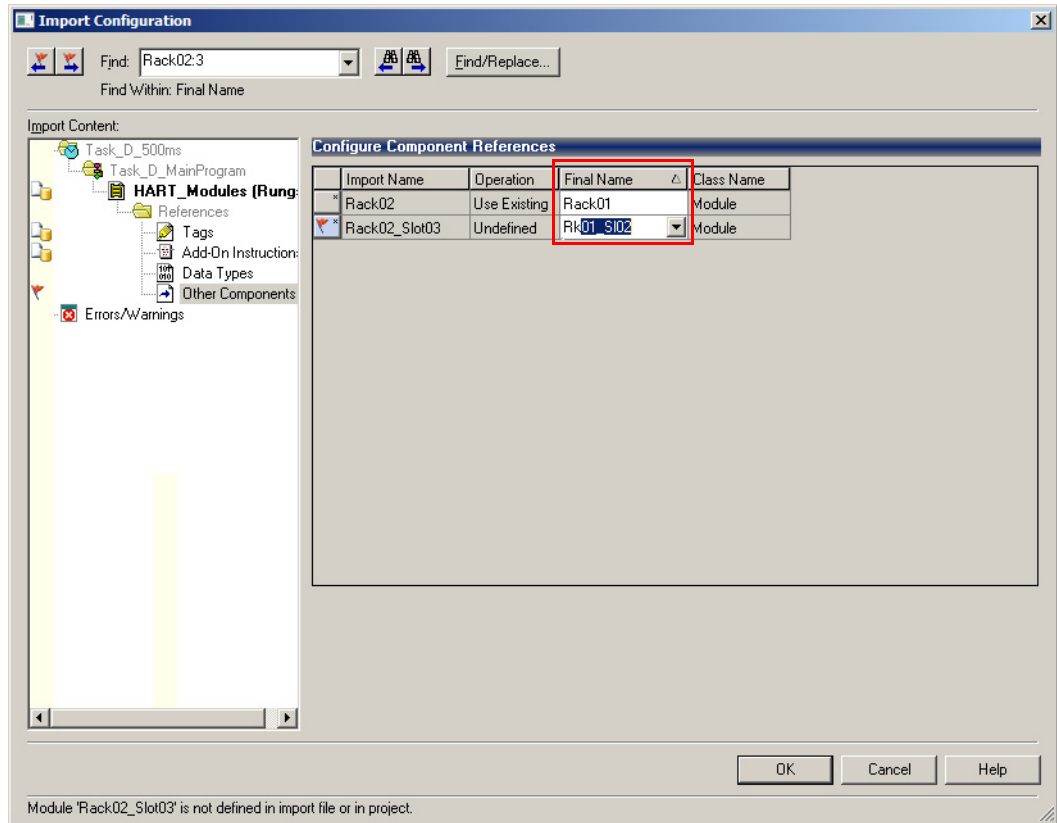

10. On the Import Configuration dialog box, click OK.
Two rungs of logic are added to your logic.
11. Return to the ladder diagram window.
12. Double-click the rung comment and make any necessary changes.

See [Module Messaging Reference on page 129](#) for information on MSG configurations on the modules.

By using Find/Replace in the previous steps, the MSG configurations already have the correct path applied.

Add P_AOutHART Add-On Instruction

The P_AOutHART Add-On Instruction receives digital signals from the device and provides an analog signal to the output module for a given channel.

IMPORT- An instance of the P_AOutHART instruction is used for each channel (device) on the output module.

Perform the following steps:

1. In the Controller Organizer, right-click Add-On Instructions and choose 'Import Add-On Instruction'.

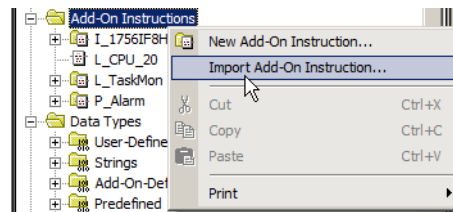

The 'Import Add-On Instruction dialog box appears.

2. In the 'Import Add-On Instruction dialog box, select the P_AOutHART Add-On Instruction and click Open.

Name	Date modified	Type
P_AInDual_4.10.00_AOI.L5X	3/5/2019 3:39 PM	Logix Designer
P_AInFFR_4.10.00_AOI.L5X	3/4/2019 12:49 PM	Logix Designer
P_AInHART_4.10.00_TEST_D_AOI.L5X	3/4/2019 12:50 PM	Logix Designer
P_AInMulti_4.10.00_TEST_B_AOI.L5X	3/5/2019 4:01 PM	Logix Designer
P_AInPAR_4.10.00_AOI.L5X	3/4/2019 12:50 PM	Logix Designer
P_AInPAR_A_4.10.00_AOI.L5X	3/4/2019 12:50 PM	Logix Designer
P_Alarm_4.10.00_AOI.L5X	3/4/2019 12:30 PM	Logix Designer
P_AOut_4.10.00_TEST_C_AOI.L5X	3/5/2019 4:04 PM	Logix Designer
P_AOutHART_4.10.00_AOI.L5X	3/4/2019 12:50 PM	Logix Designer
P_CmdSrc_4.10.00_TEST_B_AOI.L5X	3/4/2019 12:32 PM	Logix Designer
P_D4SD_4.10.00_TEST_D_AOI.L5X	3/5/2019 4:07 PM	Logix Designer

File name:

The Import Configuration dialog box appears.

3. If there are any red flags, they must be addressed; otherwise, click OK.

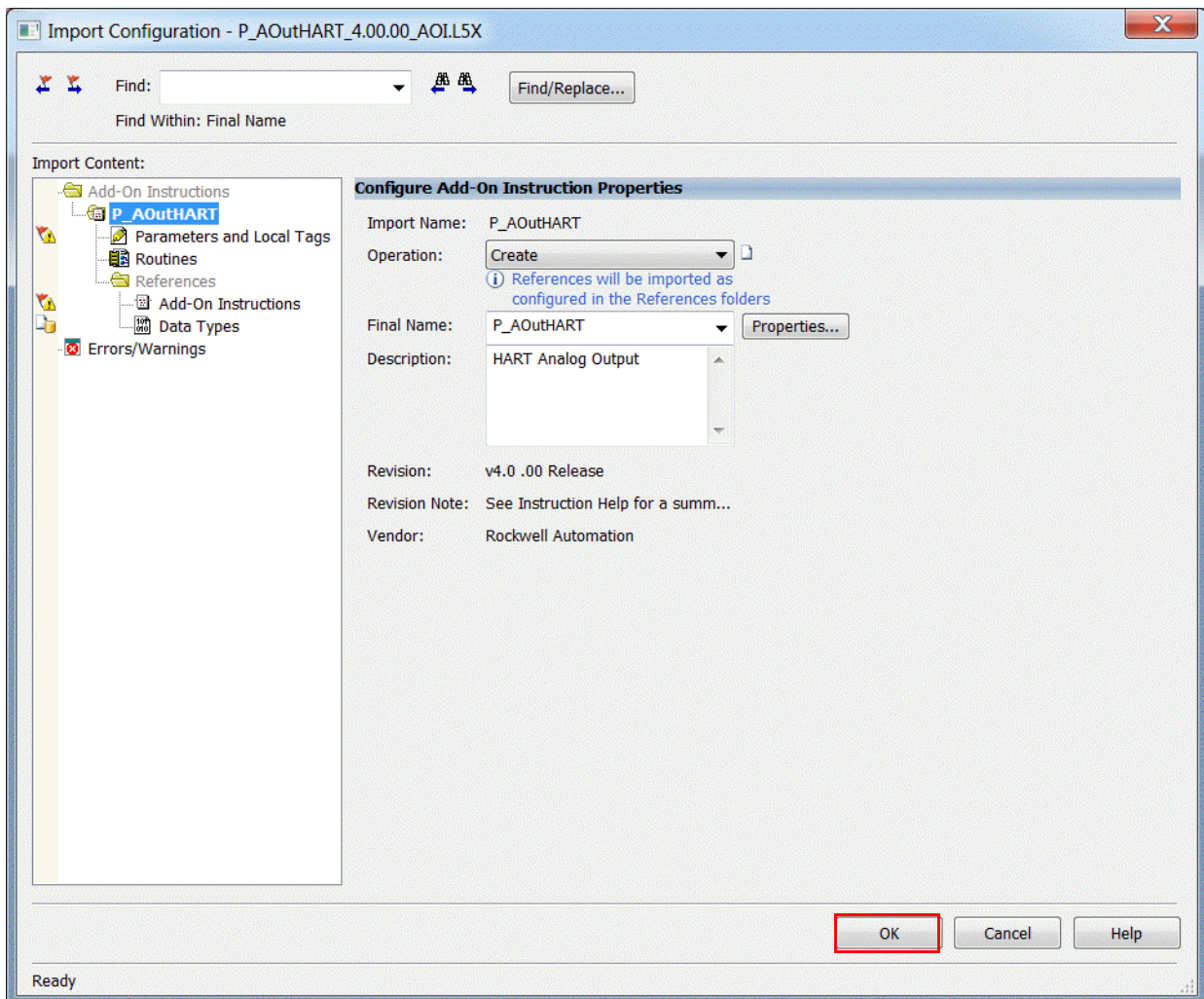

The P_Alarm, P_CmdSrc, and P_AOutHART definitions are imported.

TIP You must import the P_AOutHART Add-On Instruction (steps [1](#) through [3](#)) only once for the project. The remaining steps apply to each channel (instance).

4. In the Controller Organizer, double-click the routine in your process application where you want the P_AOutHART instance for this channel.

A workspace opens.

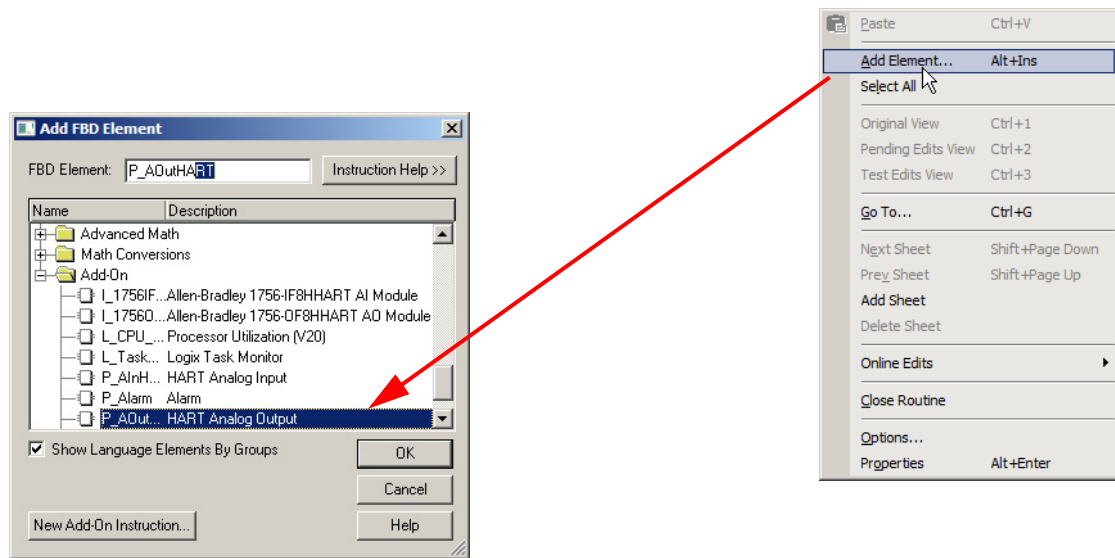

5. In the workspace, right-click and choose Add Element.

The Add FBD Element dialog box appears.

6. Under the Add-On folder, select the HART Analog Output Add-On Instruction and click OK.

The HART Analog Output element is added.

7. Double-click the tag name, type a new tag name (PV_1403 in our example), and press Enter.

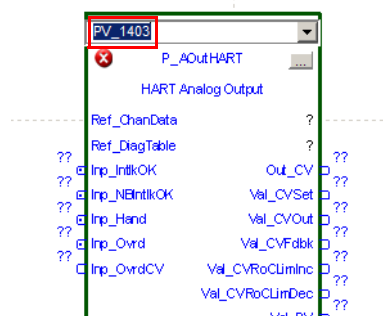

8. Right-click the new tag name and choose New <new tag name> (New PV_1403 in our example).

The New Tag dialog box appears.

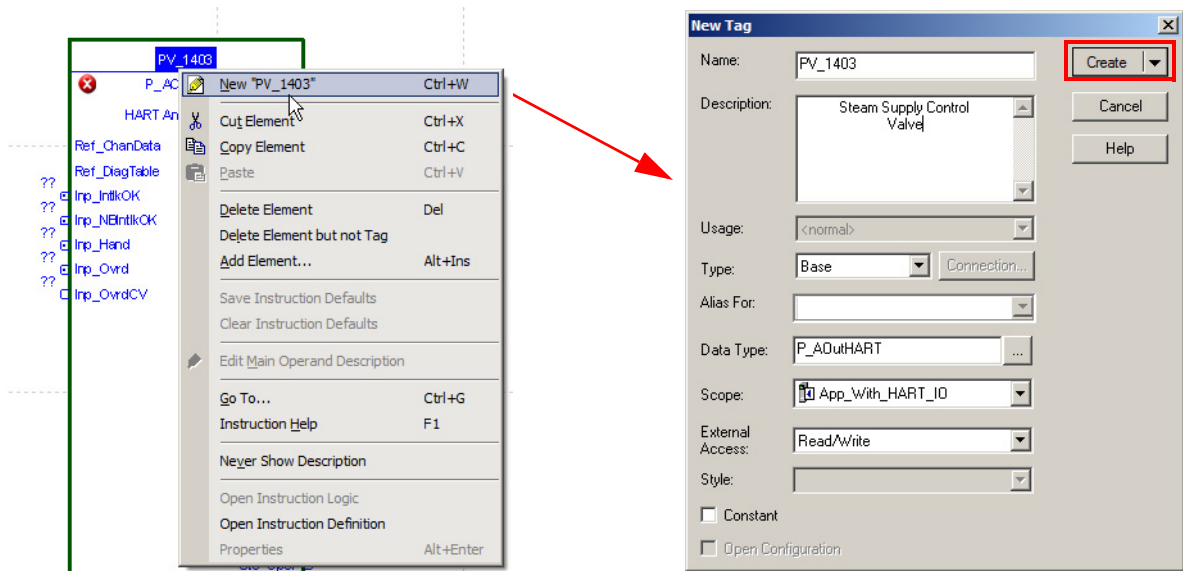

9. In the New Tag dialog box, the following fields are completed by default:
 - Name
 - Data Type
 - External Access (must be Read/Write)
10. (Optional) Type in a Description.
11. Select a Scope from the pull-down list (controller scope in our example) and click Create.

12. On the HART Analog Output element, double-click the question mark that corresponds to Ref_ChanData.

A pull-down list appears.
13. Either type or select the channel data array for the module, then add an array index that indicates the correct channel and press Enter.

IMPORT- See Ref_ChanData in the HART module instruction for the base array name.

TIP In this example, our field device is connected to channel 4 of the module.

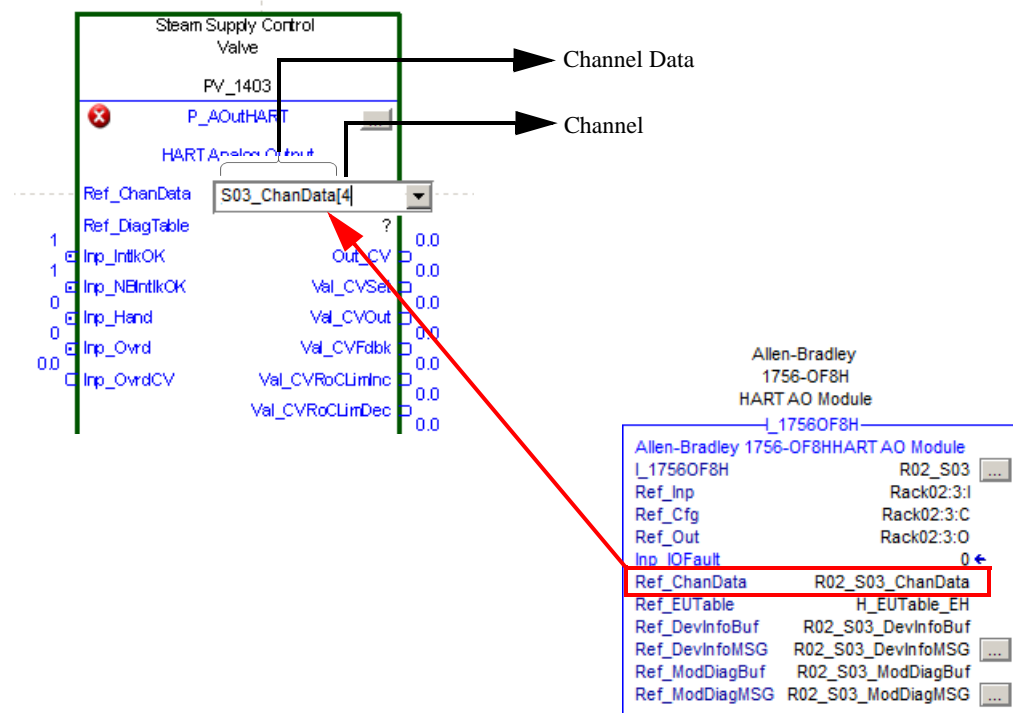

14. **In the samples application**, in the Controller Organizer, double-click Controller tags.

The Controller Tags window appears.
15. Select the Edit Tags tab.
16. Right-click the tag for the diagnostic table that matches the field device you are using and choose copy.
17. **In your application** (App_With_HART_IO in our example), in the Controller Organizer, open the controller tags, select the Edit Tags tab, and scroll to the bottom of the controller tags.

18. In the empty row, right-click the box that is left of the columns, and choose Paste.

TIP Only one instance of a Diagnostic table tag is needed for all similar devices.

19. On the HART Analog Input element, double-click the question mark that corresponds to Ref_DiagTable.

A pull-down list appears.

20. Either type or select the Diagnostic table tag that was copied, and press Enter.

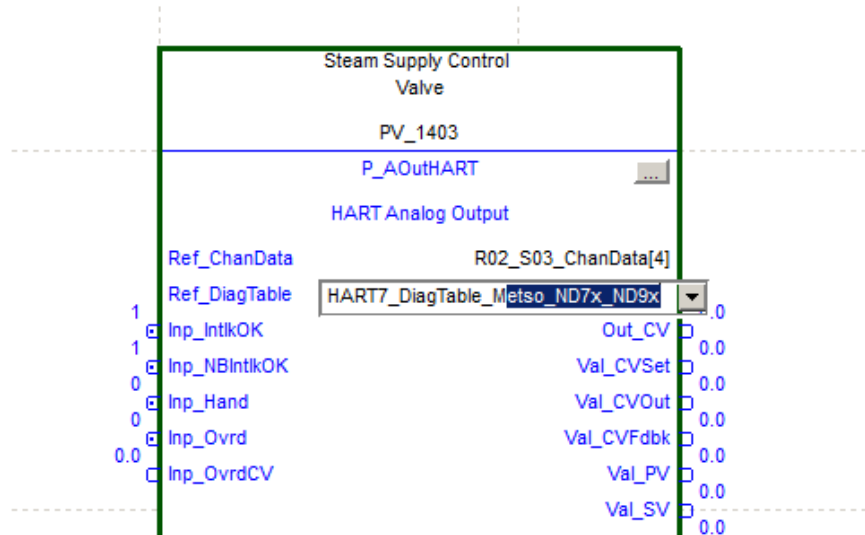

TIP If a Diagnostic table tag is not included for your device, you can use the H_DiagTable_Generic table tag, or create your own. The Online Premier Integration Configuration Tool can be useful when you build your table tag.

Link Analog Signal

In this section, the analog channel data from the card you added to the project must be connected to the output of P_AOutHART instruction.

Complete the following steps:

1. If the Language Element toolbar is not visible, do the following:
 - a. Click View and choose Toolbars.

- b. Select Language Element and click OK.

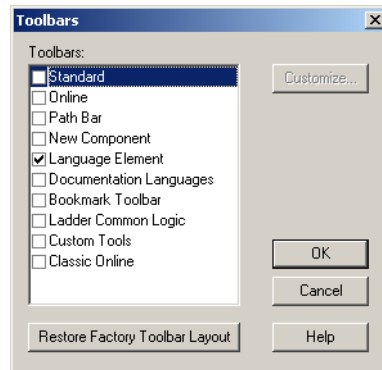

2. In the Language Element toolbar, drag-and-drop an 'output Reference' to Out_CV on the workspace.
3. Double-click inside the Output Reference symbol and choose the analog output from the module.

IMPORT- The output data structure varies based on I/O family. See the user manual for your module for the location of the analog output signal.

4. Add a wire from the Output Reference symbol to Out_CV.

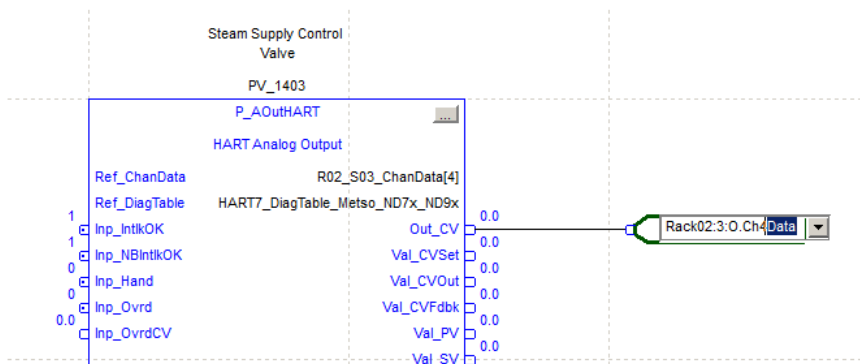

Your completed function block for a HART channel instance can look similar to the following image.

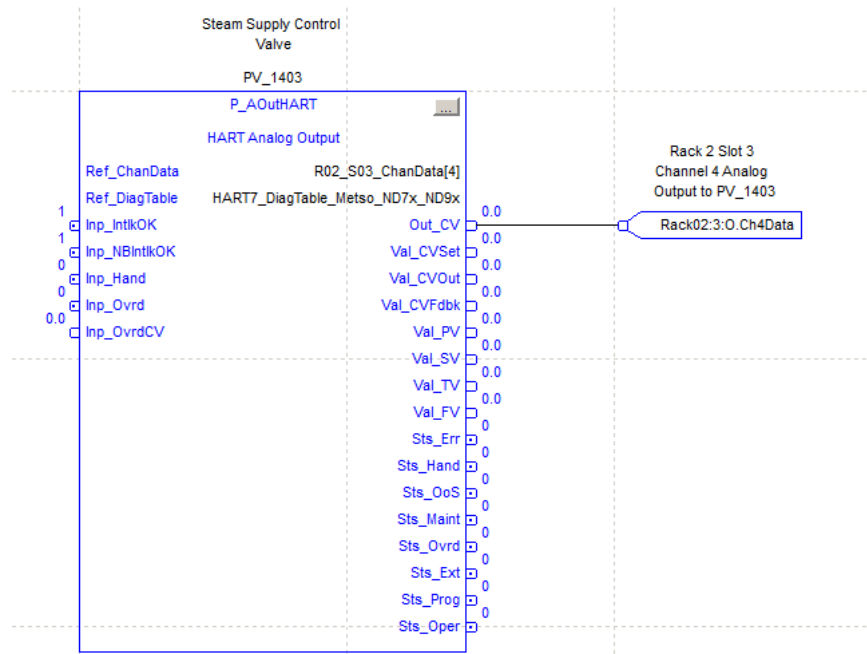

HART Analog Input (P_AInHART)

The following table describes the topics in this chapter.

Topic	Page
Controller Code	62
Operations	74
Display Elements	76
Quick Display Interaction	83
Basic Faceplate Attributes	84

This instruction monitors one analog input from a flow, level, pressure, temperature, or other HART-connected analog sensor. Alarms are provided when the analog value exceeds user-specified thresholds (high and low). The instruction also provides capabilities for linear scaling of an analog input value from raw (input) units to engineering (output) units. Entry of a substitute Process Variable (PV), which handles an out-of-range or faulted input, is included. The global object and faceplate that is shown in the following images are examples of the graphical interface tools for this Add-On Instruction.

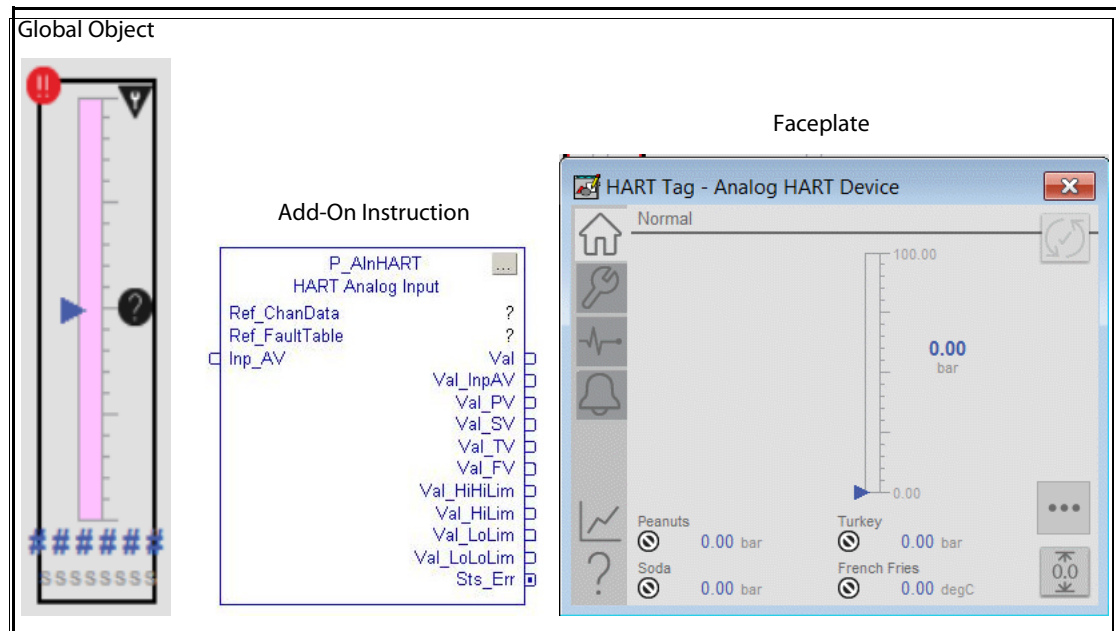

Controller Code

This section describes the parameter references for this Add-On Instruction.

InOut parameters are used to link the Add-On Instruction to external tags that contain necessary data for the instruction to operate. These external tags must be of the data type shown.

Table 11 - P_AInHART InOut Parameters

InOut Parameters	Data Type	Description
Ref_ChanData	HART_ChanData	Channel Data from HART AI Channel
Ref_DiagTable	P_DiagTable[1]	Lookup table for Diagnostic Code to text

The diagnostic lookup table (Ref_DiagTable) is a tag that contains a list (array) of entries with diagnostic codes, the corresponding description, and a 'NAMUR status'.

The following image shows diagnostic codes 21 and 22 from the E+H Prosonic lookup table.

Name	Value
HART7_DiagTable_ProsonicS[21]	{...}
HART7_DiagTable_ProsonicS[22]	{...}
HART7_DiagTable_ProsonicS[23]	{...}
HART7_DiagTable_ProsonicS[23].Code	21
HART7_DiagTable_ProsonicS[23].Desc	'A232 Sensor 1 Defect, Chk ...
HART7_DiagTable_ProsonicS[23].NAMURSts	16
HART7_DiagTable_ProsonicS[23].InfoOnly	0
HART7_DiagTable_ProsonicS[23].MaintReqd	0
HART7_DiagTable_ProsonicS[23].OffSpec	0
HART7_DiagTable_ProsonicS[23].FuncCheck	0
HART7_DiagTable_ProsonicS[23].Failure	1
HART7_DiagTable_ProsonicS[24]	{...}
HART7_DiagTable_ProsonicS[24].Code	22
HART7_DiagTable_ProsonicS[24].Desc	'A232 Sensor 2 Defect, Chk ...
HART7_DiagTable_ProsonicS[24].NAMURSts	16
HART7_DiagTable_ProsonicS[24].InfoOnly	0
HART7_DiagTable_ProsonicS[24].MaintReqd	0
HART7_DiagTable_ProsonicS[24].OffSpec	0
HART7_DiagTable_ProsonicS[24].FuncCheck	0
HART7_DiagTable_ProsonicS[24].Failure	1

The code corresponds to a bit offset in the HART Code48 response from the device. Byte 0 bit 0 of the Code48 response is code '0'. Byte 0 bit 1 is code '1'. Byte 10 bit 0 is code '80' (8 bits per byte). The highest code number is 199, which is byte 24 bit 7.

There are several Diagnostic Lookup tables that are provided in the Preferred Integration Samples ACD file. There are 'generic' HART5 and HART7 diagnostic tables and several tables for Endress+Hauser HART instruments.

The screenshot shows a software window titled "Controller Tags - RSL5k_20_Template_ProcLib_4_10_00_all(controller)". The window contains a table of diagnostic lookup tables. The table has columns for Name, Alias For, Base Tag, Data Type, and Description. The entries are organized by device type, with HART5 and HART7 diagnostic tables listed. The table is scrollable, and the bottom of the window shows "Monitor Tags" and "Edit Tags" buttons.

Name	Alias For	Base Tag	Data Type	Description
HART5_DiagTable_Generic			P_DiagTable[203]	HART Cmd48 Diagnostic Lookup Table: Generic HART5 device
HART5_DiagTable_Prowil73			P_DiagTable[58]	HART Cmd48 Diagnostic Lookup Table: E+H Prowil 73
HART5_DiagTable_TMass65l			P_DiagTable[68]	HART Cmd48 Diagnostic Lookup Table: E+H TMass 65l
HART5_DiagTable_TMT162			P_DiagTable[53]	HART Cmd48 Diagnostic Lookup Table: E+H TMT 162
HART5_DiagTable_TMT182			P_DiagTable[111]	HART Cmd48 Diagnostic Lookup Table: E+H TMT182 Temperature
HART7_DiagTable_FMG_60			P_DiagTable[111]	HART Cmd48 Diagnostic Lookup Table: E+H Gammapiot FMG 60
HART7_DiagTable_Generic			P_DiagTable[203]	HART Cmd48 Diagnostic Lookup Table: Generic HART7 device
HART7_DiagTable_LevelflexFMP5x			P_DiagTable[109]	HART Cmd48 Diagnostic Lookup Table: E+H Levelflex FMP5x
HART7_DiagTable_LevelflexM			P_DiagTable[98]	HART Cmd48 Diagnostic Lookup Table: E+H Levelflex M
HART7_DiagTable_LiquilineCM44x			P_DiagTable[177]	HART Cmd48 Diagnostic Lookup Table: E+H Liquiline CM442 / 444 / 448
HART7_DiagTable_LiquilineCM82_rev1			P_DiagTable[178]	HART Cmd48 Diagnostic Lookup Table: E+H Liquiline CM82 Fw Rev. 1
HART7_DiagTable_LiquilineM_Cond			P_DiagTable[155]	HART Cmd48 Diagnostic Lookup Table: E+H Liquiline M Conductivity
HART7_DiagTable_LiquilineM_Cond_rev4			P_DiagTable[156]	HART Cmd48 Diagnostic Lookup Table: E+H Liquiline M Conductivity rev 4.x
HART7_DiagTable_LiquilineM_Oxy_rev4			P_DiagTable[160]	HART Cmd48 Diagnostic Lookup Table: E+H Liquiline M Oxygen rev 4.x
HART7_DiagTable_LiquilineM_Oxygen			P_DiagTable[139]	HART Cmd48 Diagnostic Lookup Table: E+H Liquiline M Oxygen
HART7_DiagTable_LiquilineM_pH_rev4			P_DiagTable[155]	HART Cmd48 Diagnostic Lookup Table: E+H Liquiline M pH/ORP rev 4.x
HART7_DiagTable_LiquilineM_pHORP			P_DiagTable[154]	HART Cmd48 Diagnostic Lookup Table: E+H Liquiline M pH / ORP
HART7_DiagTable_LiquistationCSFxx			P_DiagTable[129]	HART Cmd48 Diagnostic Lookup Table: E+H Liquistation CSFxx
HART7_DiagTable_Metso_ND7x_ND9x			P_DiagTable[122]	HART Cmd48 Diagnostic Lookup Table: Metso ND7xxx and ND9xxx Positioners
HART7_DiagTable_MicropilotFMR5x			P_DiagTable[116]	HART Cmd48 Diagnostic Lookup Table: E+H Micropilot FMR5x
HART7_DiagTable_MicropilotFMR6x			P_DiagTable[106]	HART Cmd48 Diagnostic Lookup Table: E+H Micropilot FMR6x
HART7_DiagTable_MicropilotFMR20			P_DiagTable[86]	HART Cmd48 Diagnostic Lookup Table: E+H Micropilot FMR 20
HART7_DiagTable_MicropilotM			P_DiagTable[100]	HART Cmd48 Diagnostic Lookup Table: E+H Micropilot M
HART7_DiagTable_Pressure_M			P_DiagTable[114]	HART Cmd48 Diagnostic Lookup Table: E+H Cerabar, Deltabar, Deltapilot M
HART7_DiagTable_Pressure_S			P_DiagTable[138]	HART Cmd48 Diagnostic Lookup Table: E+H Cerabar, Deltabar, Deltapilot S
HART7_DiagTable_Promag53			P_DiagTable[158]	HART Cmd48 Diagnostic Lookup Table: E+H Promag 53
HART7_DiagTable_Promag100			P_DiagTable[124]	HART Cmd48 Diagnostic Lookup Table: E+H Promag 100
HART7_DiagTable_Promag200			P_DiagTable[111]	HART Cmd48 Diagnostic Lookup Table: E+H Promag 200
HART7_DiagTable_Promag300_500			P_DiagTable[154]	HART Cmd48 Diagnostic Lookup Table: E+H Promag 300 and Promag 500
HART7_DiagTable_Promag400			P_DiagTable[141]	HART Cmd48 Diagnostic Lookup Table: E+H Promag 400
HART7_DiagTable_Promag400_rev9			P_DiagTable[146]	HART Cmd48 Diagnostic Lookup Table: E+H Promag 400 rev 9
HART7_DiagTable_Promass83			P_DiagTable[174]	HART Cmd48 Diagnostic Lookup Table: E+H Promass 83
HART7_DiagTable_Promass100			P_DiagTable[124]	HART Cmd48 Diagnostic Lookup Table: E+H Promass 100
HART7_DiagTable_Promass200			P_DiagTable[128]	HART Cmd48 Diagnostic Lookup Table: E+H Promass 200
HART7_DiagTable_Promass300_500			P_DiagTable[148]	HART Cmd48 Diagnostic Lookup Table: E+H Promass 300 and Promass 500
HART7_DiagTable_ProsonicFlow_100_rev1			P_DiagTable[125]	HART Cmd48 Diagnostic Lookup Table: E+H Prosonic Flow 100 rev 1.x
HART7_DiagTable_ProsonicFlowB200			P_DiagTable[126]	HART Cmd48 Diagnostic Lookup Table: E+H Prosonic Flow B200
HART7_DiagTable_ProsonicM			P_DiagTable[101]	HART Cmd48 Diagnostic Lookup Table: E+H Prosonic M
HART7_DiagTable_ProsonicS			P_DiagTable[203]	HART Cmd48 Diagnostic Lookup Table: E+H Prosonic S
HART7_DiagTable_Prowil200			P_DiagTable[144]	HART Cmd48 Diagnostic Lookup Table: E+H Prowil
HART7_DiagTable_TMT7? rev1			P_DiagTable[103]	HART Cmd48 Diagnostic Lookup Table: E+H TMT7? rev 1

Input Structure for HART Analog Input

Input parameters include the following:

- Input data elements (Inp_) are typically used to connect field inputs from I/O modules or signals from other objects.
- Configuration data elements (Cfg_) are used to set configurable capabilities and features of the instruction.
- Commands (PCmd_, OCmd_, MCmd_) are used by program logic, operators, and maintenance personnel to request instruction actions.
- Settings (PSet_, OSet_, MSet_) are used by program logic, operators, and maintenance personnel to establish runtime setpoints, thresholds, and so forth. A Setting (without a leading P, O, or M) establishes runtime settings regardless of role.

Table 12 - P_AInHART Input Parameters

Input Parameter	Data Type	Alias For	Default	Description
EnableIn	BOOL		1	Enable Input—System-Defined Parameter
Inp_AV	REAL		0.0	Direct analog PV from Input Assembly
Inp_IOFault	BOOL		0	1 = I/O connection faulted 0 = OK (option, use with produced/consumed tags, and so forth)
Inp_Sim	BOOL		0	1 = Use simulated analog PV (Set_SimPV) 0 = Use analog Input (Inp_PV)
Inp_HiHiGate	BOOL	HiHiGate.Inp_Gate	1	These parameters are the gate inputs that are used for status detection. When set to 1, the corresponding analog input threshold monitoring is enabled. When enabled, the threshold detection on-delay and off-delay timers are applied after the gate delay timer. When set to 0, detection is disabled and the corresponding status output is forced off. If the status is used as an alarm, this input provides a method for suppression-by-design alarm management.
Inp_HiGate		HiGate.Inp_Gate		
Inp_LoGate		LoGate.Inp_Gate		
Inp_LoLoGate		LoLoGate.Inp_Gate		
Inp_FailGate		FailGate.Inp_Gate		
Inp_Reset	BOOL		0	Input parameter that is used to reset alarms. When set to 1, all alarms that require a reset are reset.
Cfg_NoSubstPV	BOOL		0	This parameter disables the maintenance substitution feature. <ul style="list-style-type: none"> • When this parameter is 0, the Substitute analog PV function is allowed. • When this parameter is 1, the Substitute analog PV Maintenance function is disallowed.
Cfg_HasHART	BOOL		1	1 = HART instrument 0 = non-HART (4...20 mA only) instrument
Cfg_HasMoreObj	BOOL		0	1=Tells HMI an object with more info is available
Cfg_HasPV	BOOL		1	1 = Digital variable is configured and displayed: <ul style="list-style-type: none"> • PV (primary variable) • SV (secondary variable) • TV (third variable) • FV (fourth variable)
Cfg_HasSV				
Cfg_HasTV				
Cfg_HasFV				
Cfg_UseHART Text	BOOL		0	1 = Use HART text for Description, Label, Tag, engineering units 0 = Manually entered
Cfg_UseHART Scaling	BOOL		0	1 = Use HART scaling for raw, engineering units ranges 0 = Manually entered ranges

Table 12 - P_AInHART Input Parameters

Input Parameter	Data Type	Alias For	Default	Description
Cfg_AutoUpd DevInfo	BOOL		1	1 = automatically update device information 0 = no auto update
Cfg_ManUpd DevInfo	BOOL		0	1 = allow manual device information update request 0 = disallow
Cfg_HasHiHiAlm	BOOL	HiHi.Cfg_Exists		These parameters determine whether the corresponding alarm exists and is checked or if the alarm does not exist and is not used. When these parameters are 1, the corresponding alarm exists.
Cfg_HasHiAlm		Hi.Cfg_Exists		
Cfg_HasLoAlm		Lo.Cfg_Exists		
Cfg_HasLoLoAlm		LoLo.Cfg_Exists		
Cfg_HasFailAlm		Fail.Cfg_Exists		
Cfg_HiHiResetReqd	BOOL	HiHi.Cfg_ResetReqd	0	These parameters determine whether a reset is required to clear the alarm status. When these parameters are 1, the alarm is latched ON when the alarm occurs. After the alarm condition returns to normal, a reset is required to clear the alarm status. For example, OCmd_Reset, Inp_Reset, or Hi.OCmd_Reset is required to clear Alm_Hi alarm after the alarm is set and the value returns to normal. When these parameters are 0, no reset is required and the alarm status is cleared when the alarm condition returns to normal. IMPORTANT: If the reset clears the alarm, it also acknowledges the alarm.
Cfg_HiResetReqd		Hi.Cfg_ResetReqd		
Cfg_LoResetReqd		Lo.Cfg_ResetReqd		
Cfg_LoLoResetReqd		LoLo.Cfg_ResetReqd		
Cfg_FailResetReqd		Fail.Cfg_ResetReqd		
Cfg_HiHiAckReqd	BOOL	HiHi.Cfg_AckReqd		These parameters determine whether an acknowledgment is required for an alarm. When these parameters are 1, the acknowledge (ack) bit is cleared when the alarm occurs. An acknowledge command (for example, PCmd_FailAck or Fail.OCmd_Ack) is required to acknowledge the alarm. When set to 0, the Acknowledge bit is set when an alarm occurs, indicating an acknowledged alarm, and no acknowledge command is required.
Cfg_HiAckReqd		Hi.Cfg_AckReqd		
Cfg_LoAckReqd		Lo.Cfg_AckReqd		
Cfg_LoLoAckReqd		LoLo.Cfg_AckReqd		
Cfg_FailAckReqd		Fail.Cfg_AckReqd		
Cfg_HiHiSeverity	INT	HiHi.Cfg_Severity	750	These parameters determine the severity of each alarm. The severity drives the color and symbol that are used to indicate alarm status on the faceplate and global object. The following are valid values: 1...250 = Low 251...500 = Medium 501...750 = High 751...1000 = Urgent IMPORTANT: For FactoryTalk® View Site Edition (SE) software, version 7.0, these severity parameters drive only the indication on the global object and faceplate. The Alarms and Events definition of severity drives the color and symbol that is used on the alarm banner and summary. Also, the definition also drives the value that FactoryTalk Alarms and Events display commands returned.
Cfg_HiSeverity		Hi.Cfg_Severity	500	
Cfg_LoSeverity		Lo.Cfg_Severity	500	
Cfg_LoLoSeverity		LoLo.Cfg_Severity	750	
Cfg_FailSeverity		Fail.Cfg_Severity	1000	
Cfg_InpRawMin	REAL		0.0	Input (unscaled) minimum for Scaling
Cfg_InpRawMax	REAL		100.0	Input (unscaled) maximum for Scaling
Cfg_PVEUMin	REAL		0.0	Analog PV (Output) minimum for Scaling to engineering units
Cfg_PVEUMax	REAL		100.0	Analog PV (Output) maximum for Scaling to engineering units
Cfg_FiltTC	REAL		0.0	Analog PV Filter Time Constant (s), 0.0 = unfiltered
Cfg_HiHiLim	REAL			
Cfg_HiLim	REAL			

Table 12 - P_AInHART Input Parameters

Input Parameter	Data Type	Alias For	Default	Description
Cfg_LoLim	REAL			
Cfg_LoLoLim	REAL			
Cfg_FailHiLim	REAL		103.958336	Out-of-Range (fail) High Limit (engineering units)
Cfg_FailLoLim	REAL		-2.0833333	Out-of-Range (fail) Low Limit (engineering units)
Cfg_HiHiDB	REAL		1.0	These parameters set the deadband (hysteresis) that is applied to each alarm limit, which is used to help prevent a noisy signal from generating spurious alarms. EXAMPLE: If the High Alarm is enabled (Cfg_HasHiAlm = 1), the High Alarm Limit (Val_HiLim) is 90, and the High Alarm deadband (Cfg_HiDB) is 5, then the high alarm is generated when the output (Val) rises above 90. The high alarm is cleared once the output (Val) falls below 85 (90 minus 5).
Cfg_HiDB			1.0	
Cfg_LoDB			1.0	
Cfg_LoLoDB			1.0	
Cfg_FailDB			0.41666666	
Cfg_HiHiOnDly	DINT	HiHiGate.Cfg_OnDly	0	These parameters determine the minimum time (in seconds) the PV must remain beyond the status threshold for the status to be set. On-delay times are used to avoid unnecessary alarms when an output (Val) briefly overshoots its threshold (for example, Val_HiHiLim).
Cfg_HiOnDly		HiGate.Cfg_OnDly		
Cfg_LoOnDly		LoGate.Cfg_OnDly		
Cfg_LoLoOnDly		LoLoGate.Cfg_OnDly		
Cfg_FailOnDly		FailGate.Cfg_OnDly		
Cfg_HiHiOffDly	DINT	HiHiGate.Cfg_OffDly	0	These parameters determine the amount of time (in seconds) the output must stay within each status threshold to clear the status. Off-delay times are used to reduce alarm chatter. EXAMPLE: If Cfg_HiOffDly is 5 seconds, the output (Val) must be below the status limit (Val_HiHiLim) minus deadband (Cfg_HiHiDB) for 5 seconds before the status is returned to normal.
Cfg_HiOffDly		HiGate.Cfg_OffDly		
Cfg_LoOffDly		LoGate.Cfg_OffDly		
Cfg_LoLoOffDly		LoLoGate.Cfg_OffDly		
Cfg_FailOffDly		FailGate.Cfg_OffDly		
Cfg_HiHiGateDly	DINT	HiHiGate.Cfg_GateDly	0	These parameters determine the amount of time (in seconds) the gate input must be turned on for threshold detection to be enabled. On-delays and off-delays are applied after the gate delay is complete.
Cfg_HiGateDly		HiGate.Cfg_GateDly		
Cfg_LoGateDly		LoGate.Cfg_GateDly		
Cfg_LoLoGateDly		LoLoGate.Cfg_GateDly		
Cfg_FailGateDly		FailGate.Cfg_GateDly		
MSet_SubstPV	REAL		0.0	Maintenance-entered Substitute Analog PV (engineering units)
Set_SimPV	REAL		0.0	Analog PV used in Simulation (Inp_Sim = 1) (engineering units)
Set_SimHARTPV	REAL		0.0	PV, SV, TV, or FV used in Simulation (Inp_Sim = 1) (primary, secondary, third, or fourth value in engineering units)
Set_SimHARTSV				
Set_SimHARTTV				
Set_SimHARTFV				

Table 12 - P_AInHART Input Parameters

Input Parameter	Data Type	Alias For	Default	Description
PCmd_ClearCapt	BOOL		0	<ul style="list-style-type: none"> Set PCmd_ClearCapt to 1 to clear the captured minimum/maximum PV excursion values The parameter is reset automatically
PCmd_Reset	BOOL		0	<ul style="list-style-type: none"> Set PCmd_Reset to 1 to reset all alarms that require it This parameter is always reset automatically
PCmd_HiHiAck	BOOL	HiHi.PCmd_Ack	0	<ul style="list-style-type: none"> Set PCmd_<Alarm>Ack to 1 to Acknowledge alarm The parameter is reset automatically
PCmd_HiAck		Hi.PCmd_Ack		
PCmd_LoAck		Lo.PCmd_Ack		
PCmd_LoLoAck		LoLo.PCmd_Ack		
PCmd_FailAck		Fail.PCmd_Ack		
PCmd_HiHiSuppress	BOOL	HiHi.PCmd_Suppress	0	<ul style="list-style-type: none"> Set PCmd_<Alarm>Suppress to 1 to suppress the alarm The parameter is reset automatically
PCmd_HiSuppress		Hi.PCmd_Suppress		
PCmd_LoSuppress		Lo.PCmd_Suppress		
PCmd_LoLoSuppress		LoLo.PCmd_Suppress		
PCmd_FailSuppress		Fail.PCmd_Suppress		
PCmd_HiHiUnsuppress	BOOL	HiHi.PCmd_Unsuppress	0	<ul style="list-style-type: none"> Set PCmd_<Alarm>Unsuppress to unsuppress the alarm The Parameter is reset automatically
PCmd_HiUnsuppress		Hi.PCmd_Unsuppress		
PCmd_LoUnsuppress		Lo.PCmd_Unsuppress		
PCmd_LoLoUnsuppress		LoLo.PCmd_Unsuppress		
PCmd_FailUnsuppress		Fail.PCmd_Unsuppress		
PCmd_HiHiUnshelve	BOOL	HiHi.PCmd_Unshelve	0	<ul style="list-style-type: none"> Set PCmd_<Alarm>Unshelve to 1 to Unshelve alarm The parameter is reset automatically
PCmd_HiUnshelve		Hi.PCmd_Unshelve		
PCmd_LoUnshelve		Lo.PCmd_Unshelve		
PCmd_LoLoUnshelve		LoLo.PCmd_Unshelve		
PCmd_FailUnshelve		Fail.PCmd_Unshelve		
MCmd_Rel	BOOL	CmdSrc.MCmd_Rel	0	Maintenance command to Release Ownership (Maintenance to Operator/Program/Overload)
OCmd_Unlock	BOOL	CmdSrc.OCmd_UnlockRel	0	Operator command to Unlock/Release (Operator to Program) Ownership

The following Operator and Maintenance Commands/Settings are sent from the HMI and required to be contained in Local Tags. Their external access attribute is set to ReadWrite.

Table 13 - P_AInHART Commands and Settings in Local Tags

Local Tags	Data Type	Alias For	Default	Description
MCmd_InpPV	BOOL	MRdy_InpPV	0	Maintenance command to use Input Analog PV (normal)
MCmd_SubstPV	BOOL	MRdy_SubstPV	0	Maintenance command to use Substitute Analog PV (override input)
MCmd_UpdDevInfo	BOOL	MRdy_UpdDevInfo	0	Maintenance command to request update of device info
MSet_SubstPV	REAL		0.0	Maintenance-Entered Substitute Analog PV (engineering units)
OCmd_ClearCapt	BOOL		0	Operator command to clear the captured minimum/maximum analog PV excursion values
OCmd_Reset	BOOL	ORdy_Reset	0	Operator command to Reset all alarms requiring Reset
OCmd_ResetAckAll	BOOL	ORdy_ResetAckAll	0	Operator command to Reset and Acknowledge all alarms

Output Structure for HART Analog Input

Output parameters include the following:

- Value data elements (Val_) are numeric outputs of the instruction for use by the HMI. Also, other application logic or software packages can use values.
- Source and Quality data elements (SrcQ_) are outputs of the instruction that is used by the HMI to indicate PV source and quality.
- Status data elements (Sts_) are bit outputs of the instruction for use by the HMI. Also, other application logic can use status bits.
- Error data elements (Err_) are outputs of the instruction that indicate a particular configuration error. If any Err_ bit is set, then the Sts_Err configuration error summary status is set and the Invalid Configuration indicator is displayed on the HMI.
- Alarm data elements (Alm_) are outputs of the instruction that indicate a particular alarm has occurred.
- Acknowledge data elements (Ack_) are outputs of the instruction that indicate the corresponding alarm has been acknowledged.
- Ready data elements (Rdy_) are bit outputs of the instruction that are used by the HMI to enable or disable Command buttons and Setting entry fields.

Table 14 - P_AInHART Output Parameters

Parameter	Data Type	Alias For	Description
EnableOut	BOOL		Enable Output—System-Defined Parameter
Val	REAL		Analog Value (after Substitute PV, if used)
Val_InpAV	REAL		Analog Input Value (actual, before Substitute PV selection)
Val_PVMinCapt	REAL		Captured Analog PV Minimum excursion or Maximum excursion since last cleared
Val_PVMaxCapt			
Val_PVEUMin	REAL		Minimum and maximum of analog scaled range = Min (Cfg_PVEUMin, Cfg_PVEUMax) or MAX (Cfg_PVEUMin, Cfg_PVEUMax)
Val_PVEUMax			

Table 14 - P_AInHART Output Parameters

Parameter	Data Type	Alias For	Description
Val_PV	REAL		Digital (HART) variable value:
Val_SV			<ul style="list-style-type: none"> • Primary Variable (PV) • Secondary Variable (SV) • Third Variable (TV) • Fourth Variable (FV)
Val_TV			
Val_FV			
Val_DiagCode1	DINT		HART Diagnostic Code 1, 2, or 3: 0...199
Val_DiagCode2			-1 = No diagnostic
Val_DiagCode3			
Val_NAMURSts1	DINT		NAMUR NE107 Status for HART Diagnostic Code:
Val_NAMURSts2			0 = OK
Val_NAMURSts3			1 = Information 2 = Maintenance required 4 = Off specification (uncertain) 8 = Function check (substitution) 16 = Failure
SrcQ_IO	SINT		I/O signal source and quality.
SrcQ			Final analog PV source and quality. GOOD 0 = I/O live and confirmed good quality 1 = I/O live and assumed good quality 2 = No feedback configured, assumed good quality TEST 8 = Device simulated 9 = Device loopback simulation 10 = Manually entered value UNCERTAIN 16 = Live input, off-specification 17 = Value substituted at device/bus 18 = Value substituted by maintenance (Has and not Use) 19 = Shed, uses last good value 20 = Shed, uses replacement value BAD 32 = Signal failure (out-of-range, NaN, invalid combination) 33 = I/O channel fault 34 = I/O module fault 35 = Bad I/O configuration (for example, scaling parameters)
SrcQ_PV	SINT		Source and Quality of the following:
SrcQ_SV			<ul style="list-style-type: none"> • HART PV value • HART SV value • HART TV value • HART FV value
SrcQ_TV			
SrcQ_FV			
Val_Fdbk	SINT		Device Feedback: 0 = PV Good 1 = PV Uncertain 2 = PV Bad 3 = PV Subst. or Sim.
Val_Fault	SINT		Device Fault Status: 0 = none 20 = Lo 21 = Hi 24 = LoLo 25 = HiHi 32 = Fail 34 = CfgErr

Table 14 - P_AInHART Output Parameters

Parameter	Data Type	Alias For	Description
Val_Notify	SINT		Current alarm level and acknowledgment (enumeration): 0 = No alarm 1 = Alarm cleared: a reset or acknowledge is required 2 = Low (acknowledged) 3 = Low (unacknowledged) 4 = Medium (acknowledged) 5 = Medium (unacknowledged) 6 = High (acknowledged) 7 = High (unacknowledged) 8 = Urgent (acknowledged) 9 = Urgent (unacknowledged)
Sts_SubstPV	BOOL		1 = Uses Substitute analog PV (input being overridden)
Sts_InpPV	BOOL		1 = Uses input analog PV (normal)
Sts_PVBad	BOOL		1 = Analog PV bad quality or out of range
Sts_PVUncertain	BOOL		1 = Analog PV Value is uncertain (quality)
Sts_MaintByp	BOOL		1 = A Maintenance Bypass is active, display icon
Sts_AlmInh	BOOL		1 = An Alarm is inhibited, disabled, or suppressed, display icon
Sts_Err	BOOL		1 = Error in configuration (see detail Err_bits for reason), display icon
Err_Raw	BOOL		1 = Error in configuration: <ul style="list-style-type: none"> Raw Input Scaling minimum = maximum Scaled engineering units minimum = maximum On Delay, Off Delay, Gate Delay Time Invalid (use 0...2,147,483 seconds) PV filter parameters (RateTime, TC) Status Deadband is < 0.0 Alarm Minimum On Time, Shelf Time, Severity
Err_EU			
Err_Timer			
Err_Filt			
Err_DB			
Err_Alarm			
Sts_HiHiCmp	BOOL	HiHiGate.Inp	PV High-High, High, Low, Low-Low, or Fail comparison result 1 = High-High, High, Low, Low-Low, or Fail
Sts_HiCmp		HiGate.Inp	
Sts_LoCmp		LoGate.Inp	
Sts_LoLoCmp		LoLoGate.Inp	
Sts_FailCmp		FailGate.Inp	
Sts_HiHiGate	BOOL	HiHiGate.Sts_Gate	PV High-High, High, Low, Low-Low, or Fail gate delay status 1 = Done.
Sts_HiGate		HiGate.Sts_Gate	
Sts_LoGate		LoGate.Sts_Gate	
Sts_LoLoGate		LoLoGate.Sts_Gate	
Sts_FailGate		FailGate.Sts_Gate	
Sts_HiHi	BOOL	HiHi.Inp	1 = Analog Input is above High-High or High limit
Sts_Hi		Hi.Inp	
Sts_Lo		Lo.Inp	1 = Analog Input is below Low or Low-Low limit
Sts_LoLo		LoLo.Inp	
Sts_Fail		Fail.Inp	1 = Analog Input is Out of Range or analog PV Bad

Table 14 - P_AInHART Output Parameters

Parameter	Data Type	Alias For	Description
Alm_HiHi	BOOL	HiHi.Alm	1 = Analog Input is in High-High, High, Low, Low-Low, or Fail (analog PV bad or out of range) alarm.
Alm_Hi		Hi.Alm	
Alm_Lo		Lo.Alm	
Alm_LoLo		LoLo.Alm	
Alm_Fail		Fail.Alm	
Ack_HiHi	BOOL	HiHi.Ack	1 = High-High, High, Low, Low-Low, or Analog Input failure alarm has been acknowledged.
Ack_Hi		Hi.Ack	
Ack_Lo		Lo.Ack	
Ack_LoLo		LoLo.Ack	
Ack_Fail		Fail.Ack	
Sts_HiHiDisabled	BOOL	HiHi.Disabled	1 = High-High, High, Low, Low-Low, or Fail alarm is disabled (by Maintenance).
Sts_HiDisabled		Hi.Disabled	
Sts_LoDisabled		Lo.Disabled	
Sts_LoLoDisabled		LoLo.Disabled	
Sts_FailDisabled		Fail.Disabled	
Sts_HiHiShelved	BOOL	HiHi.Shelved	1 = High-High, High, Low, Low-Low, or Fail alarm is shelved (by Operator).
Sts_HiShelved		Hi.Shelved	
Sts_LoShelved		Lo.Shelved	
Sts_LoLoShelved		LoLo.Shelved	
Sts_FailShelved		Fail.Shelved	
Sts_HiHiSuppressed	BOOL	HiHi.Suppressed	1 = High-High, High, Low, Low-Low, or Fail alarm is suppressed (by Program).
Sts_HiSuppressed		Hi.Suppressed	
Sts_LoSuppressed		Lo.Suppressed	
Sts_LoLoSuppressed		LoLo.Suppressed	
Sts_FailSuppressed		Fail.Suppressed	
P_AInHART	BOOL		Unique Parameter Name for auto-discovery

The following Operator and Maintenance Readies are sent to the HMI and required to be contained in Local Tags. Their external access attribute is set to ReadOnly.

Table 15 - P_AInHART Readies in Local Tags

Local Tags	Data Type	Alias For	Description
MRdy_UpdDevInfo	BOOL	MCmd_UpDevInfo	1 = Ready for: <ul style="list-style-type: none"> • MCmd_UpdDevInfo • MCmd_SubstPV • MCmd_InpPV.
MRdy_SubstPV		MCmd_SubstPV	
MRdy_InpPV		MCmd_InpPV	
ORdy_Reset	BOOL	OCmd_Reset	1 = At least one Alarm requires Reset
ORdy_ResetAckAll	BOOL	OCmd_ResetAckAll	1 = At least one Alarm requires Reset or Acknowledgment

Local Configuration Tags for HART Analog Input

Configuration parameters that are array, string, or structure data types cannot be configured as parameters for Add-on Instructions. Configuration parameters of these types appear as local tags to the Add-On Instruction. Configure local tags through the HMI faceplates or in the Studio 5000 Logix Designer® application. Open the instruction logic of the Add-On Instruction instance, and then open the Data Monitor on a local tag. These parameters cannot be modified with controller logic or the Logix Designer application export/import functionality.

Table 16 - P_AInHART Local Configuration Tags

Tag Name	Data Type	Default	Description
Cfg_Desc	STRING_40	'Analog Input (HART)'	Description for display on HMI. This string is shown in the title bar of the faceplate.
Cfg_EU	STRING_8	'%'	Analog PV Engineering units for display on HMI (from lookup table).
Cfg_FVEU	STRING_8	"	Engineering units for HART fourth variable display on HMI.
Cfg_FVLabel	STRING_16	"	Label for HART fourth variable for display on HMI.
Cfg_Label	STRING_20	'Analog Input (HART)'	Label for graphic symbol displayed on HMI. This string appears on the graphic symbol.
Cfg_PVEU	STRING_8	"	Engineering units for HART primary variable display on HMI.
Cfg_PVLabel	STRING_16	"	Label for HART primary variable for display on HMI.
Cfg_SVEU	STRING_8	"	Engineering units for HART secondary variable display on HMI.
Cfg_SVLabel	STRING_16	"	Label for HART secondary variable for display on HMI.

Table 16 - P_AInHART Local Configuration Tags

Tag Name	Data Type	Default	Description
Cfg_Tag	STRING _20	'P_AInHART'	Tag name for display on HMI. This string is shown in the title bar of the faceplate.
Cfg_TVEU	STRING _8	"	Engineering units for HART third variable display on HMI
Cfg_TVLabel	STRING _16	"	Label for HART third variable for display on HMI.

Operations

This section describes the primary operations for Add-on Instructions.

Alarms

This instruction uses the following alarms, which are implemented by using embedded P_Alarm and P_Gate Add-On Instructions.

Table 17 - Alarms

Alarm Name	P_Alarm Name	P_Gate Name	Description
Fail	Fail	FailGate	Raised when any of the following is true: <ul style="list-style-type: none"> • The analog PV quality is bad • The Inp_PVBad input is true • The analog PV is outside the configured failure limits • The analog PV is infinite or not a number (floating point exception) • The raw or engineering unit range configuration is invalid
High PV	Hi	HiGate	Raised when the analog PV is above the High threshold. The operator or program logic sets the threshold. Deadband, gating, and timing are set in configuration.
High-High PV	HiHi	HiHiGate	Raised when the analog PV is above the High-High threshold. The operator or program logic sets the threshold. Deadband, gating, and timing are set in configuration.
Low PV	Lo	LoGate	Raised when the analog PV is below the Low threshold. The operator or program logic sets the threshold. Deadband, gating, and timing are set in configuration.
Low-Low PV	LoLo	LoLoGate	Raised when the analog PV is below the Low-Low threshold. The operator or program logic sets the threshold. Deadband, gating, and timing are set in configuration.

The following convention can be used to access parameters of the P_Alarm object: [P_Alarm Name].[P_Alarm Parameter].

For more information, see the following Rockwell Automation Library of Process Objects publications:

- Common Alarm Block (P_Alarm) Reference Manual, publication [PROCES-RM013](#)
- Condition Gate Delay (P_Gate) Reference Manual, publication [PROCES-RM014](#)

Simulation



Simulation in P_AInHART disables the normal analog input (Inp_AV) and provides an input on the Operator faceplate for you to enter your own input value (Set_SimPV).

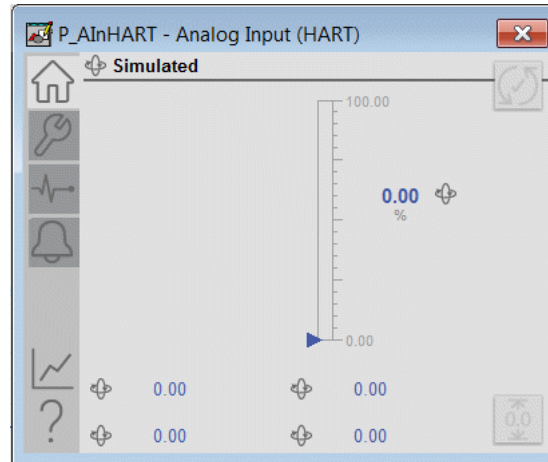

The following parameters can simulate digital variable inputs:

- Set_SimHARTPV
- Set_SimHARTSV
- Set_SimHARTTV
- Set_SimHARTFV

You must set the Inp_Sim parameter in the controller to '1' to enable simulation. The Simulation icon is displayed near the top of the Operator faceplate, which indicates the device is in simulation.

When you have finished in simulation, set the Inp_Sim parameter in the controller to '0' to return to normal operation. Simulation values are entered on the Diagnostics tab.

Execution

The following table explains the handling of instruction execution conditions.

Table 18 - Execution Conditions

Condition	Description
EnableIn False (false rung)	The P_AIn Instruction shows a status of bad quality (Sts_PVBad) and an indication on the HMI. All alarms are cleared. Calculation of the scaled Val_InpPV is executed to indicate to the operator the actual input value, even though the primary PV (Val) is not updated (holds last value).
Powerup (prescan, first scan)	Any commands received before first scan are discarded. Embedded P_Alarm instructions are handled in accordance with their standard power-up procedures. See the Reference Manual for the P_Alarm Instruction for more information.
Postscan (SFC transition)	No SFC postscan logic is provided.

See the Logix5000™ Controllers Add-On Instructions Programming Manual, publication [1756-PM010](#), for more information.

Display Elements

A display element (global object) is created once and can be referenced multiple times on multiple displays in an application. When changes are made to the original (base) object, the instantiated copies (reference objects) are automatically updated. Use of global objects, with tag structures in the ControlLogix® system, aid consistency and save the time to engineer.

IMPORT- The P_AInHART instruction uses the same Display Elements as the basic Analog Input (P_AIn) instruction.

Table 19 - P_AIn Display Elements Description



Display Element Name	Display Element	Description
GO_P_AIn		Standard analog input global object.
GO_P_AIn_Trend		Analog input with a trend of the Primary Value and limits (high-high, high, low, and low-low).
GO_P_AIn_TrendWCapture		The object is the same as GO_P_AIn_Trend except it displays a capture of the Primary Value.
GO_P_AIn_Indicator		Primary Value indicated by a moving triangle. The graphic display includes limits that are displayed with filled bars.

Table 19 - P_AIn Display Elements Description

Display Element Name	Display Element	Description
GO_P_AIn_IndicatorWCapture		<p>This object is the same as the GO_P_AIn_Indicator plus a light gray minimum/maximum capture area.</p>
GO_P_AInX		<p>Primary Value that is displayed as a bar graph. The graphic display includes limits that are displayed as lines on the graph.</p>

Common attributes of the P_AIn global objects include the following:

- Current value of the PV with engineering units
- Status/quality/threshold indicator
- Maintenance bypass indicator
- Engineering units
- Label
- Color alarm border that changes and blinks on unacknowledged alarm
- Alarm indicator that changes color with the severity of an alarm

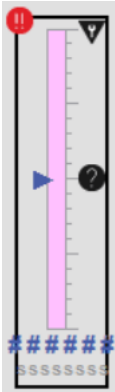
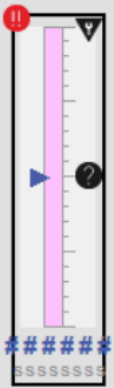
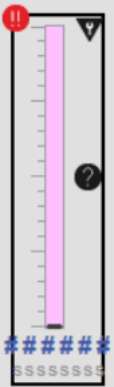
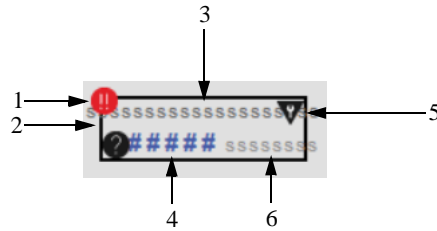





Table 20 - Global Object Description

Item	Description
1	Alarm indicator
2	Alarm border
3	Label
4	Process variable
5	Maintenance bypass indicator
6	Engineering units

Status/Quality Indicators

One of these symbols appears on the graphic symbol when the described condition is true.

Table 21 - Status/Quality Indicators

Graphic Symbol	Description
	Invalid configuration.
	Data quality bad/failure.
	Data Quality degraded: uncertain, test, simulations, substitution, or out of specification.
No symbol displayed	I/O communication and quality good, configuration valid.

TIP When the Invalid Configuration indicator appears, you can find what configuration setting is invalid by following the indicators. Click the graphic symbol to open the faceplate. The Invalid Configuration indicator appears next to the appropriate tab at the top of the faceplate to help you find the configuration error. Once you navigate to the tab, the misconfiguration is flagged with this indicator.







For the HART Analog Input Instruction, the Invalid Configuration indicator appears under the following conditions:

- The Input Raw Scaling Minimum and Raw Maximum Scaling parameters are set to the same value.
- The Scaled Engineering Units Minimum and Scaled Engineering Units Maximum are set to the same value.
- PV Filter parameters (RateTime and TC) are invalid.
- A Status Deadband is set to a negative value.
- An Alarm On-delay, Off-delay, or Gate Delay time is set to a value less than zero or greater than 2,147,483 seconds.
- Alarm Severity is set to a value less than 1 or greater than 1000.
- Alarm minimum on time or shelf time is invalid.

Threshold Indicators

These indicators show that the analog PV has exceeded a threshold.





Table 22 - Threshold Indicators

Graphic Symbol	Description
	High-High threshold exceeded
	High threshold exceeded
	Low threshold exceeded
	Low-Low threshold exceeded

Alarm Indicators

One of these symbols appears on the left of the label to indicate the described alarm condition. The alarm border blinks if acknowledgment of an alarm condition is required. Once the alarm is acknowledged, the alarm border remains the color that corresponds to the severity of the alarm and the alarm symbol is still present.

Table 23 - Alarm Indicator Descriptions

Symbol	Border Color	Description
	Red	Urgent-severity alarm
	Orange	High-severity alarm
	Yellow	Medium-severity alarm
	Magenta	Low-severity alarm
	White	Return to normal (no alarm condition), but a previous alarm has not been acknowledged

See Rockwell Automation® Library of Process Objects: Logic Instructions Reference Manual, publication [PROCES-RM013](#), for more information.

Maintenance Bypass Indicator

The maintenance bypass indicator appears at the top right of the display element to indicate that a maintenance bypass has been activated. For the HART Analog Input instruction, the maintenance bypass indicator appears when the Substitute PV function is enabled. A Maintenance-entered value supersedes the 'live' process variable.

Table 24 - Maintenance Bypass Indicator

Graphic Symbol	Description
	A maintenance bypass is active
No symbol displayed	No maintenance bypass is active

TIP When the Maintenance Bypass Indicator appears, you can find what condition was bypassed by following the indicators. Click the graphic symbol to open the faceplate. The Maintenance bypass indicator appears next to the appropriate tab at the top of the faceplate to help you find the bypass. Once you navigate to the tab, the bypassed item is flagged with this indicator.

For the HART Analog Input instruction, the Maintenance Bypass indicator appears when the Substitute PV function is enabled. A Maintenance-entered value supersedes the 'live' PV.

Using a Display Element

The global objects for P_AInHART can be found in the global object file (RA-BAS) P_AIn Graphics Library.ggfx.

IMPORT- The P_AInHART instruction uses the same display elements as the P_PAIn basic analog input.

Follow these steps to use a global object.

1. Copy the global object from the global object file and paste it in the display file.

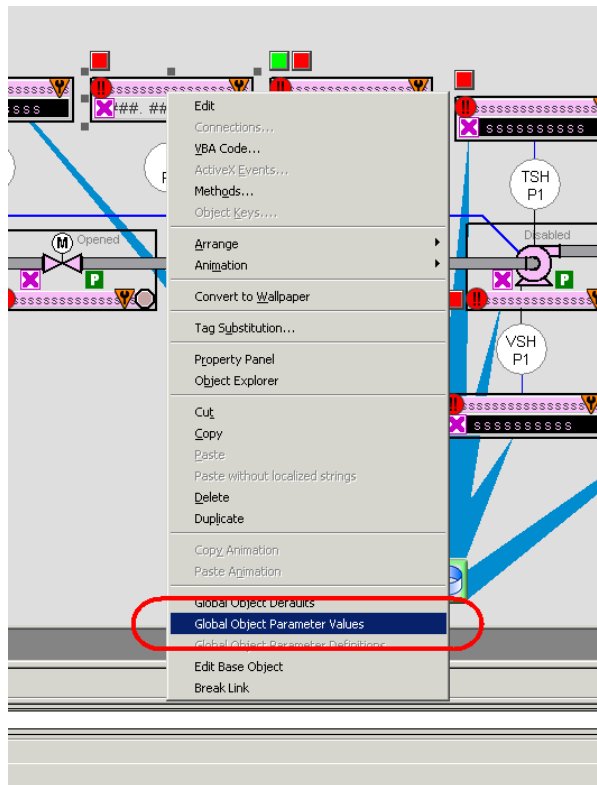

2. In the display, right-click the global object and choose Global Object Parameter Values.

The Global Object Parameter Values dialog box appears.

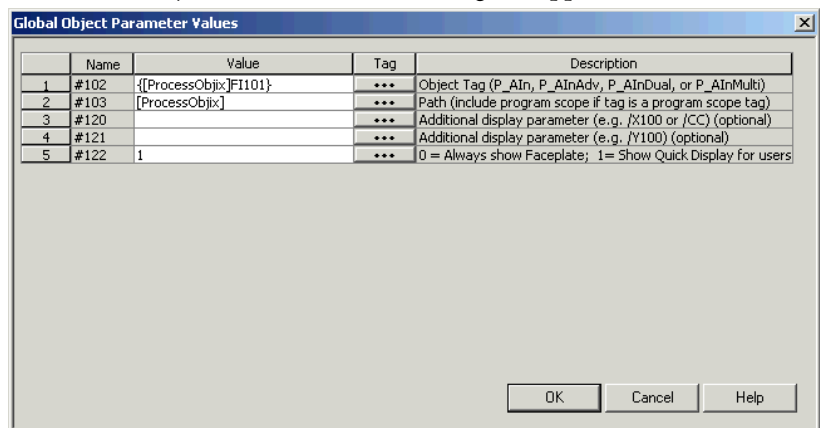

The global object parameters are as follows.

Table 25 - Global Object Parameters

Parameter	Required	Description
#102	Y	Object tag to point to the name of the associated object Add-On Instruction in the controller.
#103	Y	Path that is used for display navigation features to other objects. Include program scope if tag is a program scope tag.
#120	N	Additional parameter to pass to the display command to open the faceplate. Typically, used to define position for the faceplate.
#121	N	Additional parameter to pass to the display command to open the faceplate. When you define X and Y coordinates, separate parameters so that #120 defines X and #121 defines Y. This additional parameter permits these same parameters to be used in subsequent display commands that originate from the faceplate.
#122	Y	The following are the options for the global object display: 0 = Always show faceplate 1 = Show Quick Display for users without Maintenance access (Code C) 2 = Always show Quick Display

- In the Value column, type the tag or value as specified in the Description column.

In our example:

```
#102  {[ProcessObjix]FI101}
#103  [ProcessObjix]
```

TIP Click the ellipsis (...) to browse and select a tag. Values for items marked '(optional)' can be left blank.

- Click OK.

Quick Display Interaction

A Quick Display screen provides the means for operators to perform simple interactions with the P_AInHART instruction instance. From the Quick Display, click the Home button to navigate to the faceplate for full access for operation, maintenance, and configuration. The following figure shows an example of a quick display.

Figure 1 - P_AInHART

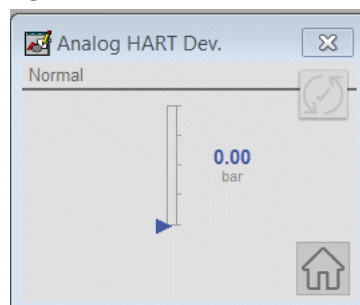

Basic Faceplate Attributes

The P_AInHART faceplate consists of tabs, and each tab consists of one or more pages. The Operator (Home) tab is displayed when the faceplate is initially opened. The faceplate provides the means for operators, maintenance personnel, engineers, and others to interact with the P_AInHART instruction instance, which includes a view of its status and values. Faceplates also manipulate an instruction through its commands and settings. Click the appropriate icon on the left of the faceplate to access a specific tab.

This section provides an overview of the faceplate attributes that are common across the objects. More details are supplied in the individual section for each object.

Operator (Home) Tab

The Faceplate initially opens to the Operator (Home) tab. From here, an operator can monitor the device status.

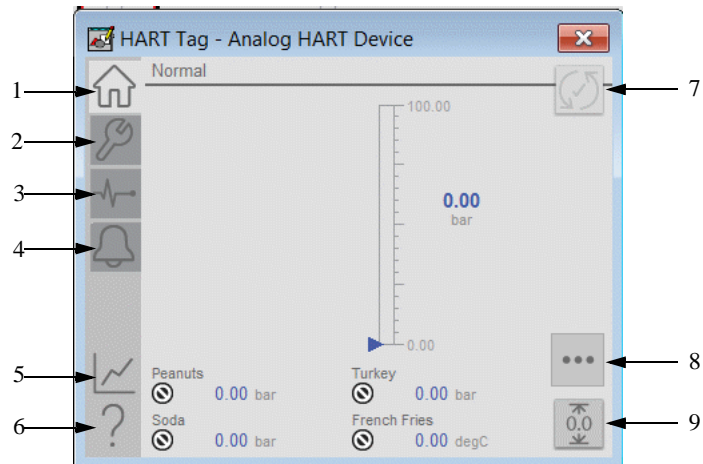
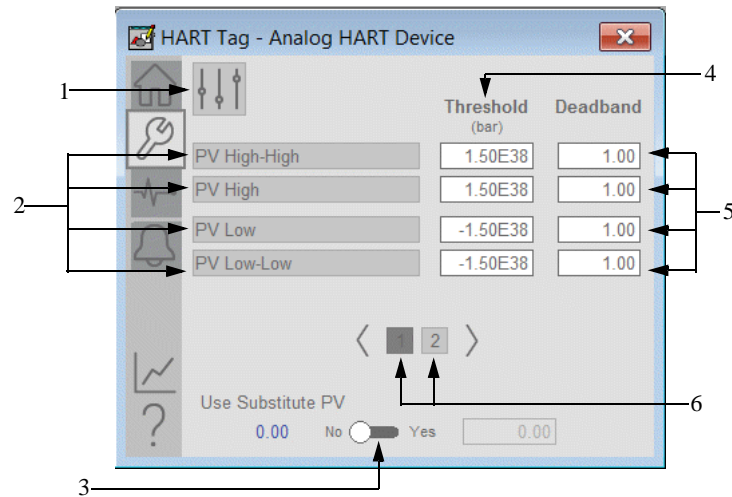

Table 26 - Operator Tab Description

Item	Action
1	Click to open the Operator tab.
2	Click to open the Maintenance tab.
3	Click to open the Diagnostics tab.
4	Click to open the Alarm tab.
5	Click to open the Trends display.
6	Click to open the Help file.
7	Click to reset and acknowledge all alarms.
8	Click to navigate to an object with more information.
9	Clear capture of minimum/maximum extents.

Maintenance Tab

In the maintenance tab, there is a button for Advanced properties. Also, there are page identifiers at the bottom if there are multiple configuration pages. Maintenance personnel use the information and controls on the Maintenance tab to adjust to device parameters. Also, the tab is used to troubleshoot and temporarily work around device problems, and disable the device for routine maintenance. See the following diagram for common attributes of the maintenance tab.



IMPORT- Click a threshold name to open the P_Gate faceplate. From the P_Gate faceplate, you can configure and perform additional operations for each alarm, including Gate Delay, Status On-delay, Status Off-delay, and Threshold Name.

Table 27 - Maintenance Tab Page 1 Descriptions

Item	Description
1	Click to open the advanced properties. The engineering and HMI configuration settings become available.
2	Threshold Name: Click a threshold name to open the associated P_Gate faceplate.
3	Use Substitute PV: Click to input a substitute process variable.
4	Type the threshold (trip point) for analog input alarms.
5	Type the deadband (hysteresis) that applies to each alarm limit. Deadband helps prevent a noisy signal from generating numerous spurious alarms. Example: If the High alarm limit is 90.0 and the High alarm deadband is 5, once the signal rises above 90.0, it generates a High alarm. The signal must fall below 85.0 (90.0 minus 5.0) for the alarm to clear.
6	Page identifiers. Click to navigate to another page.

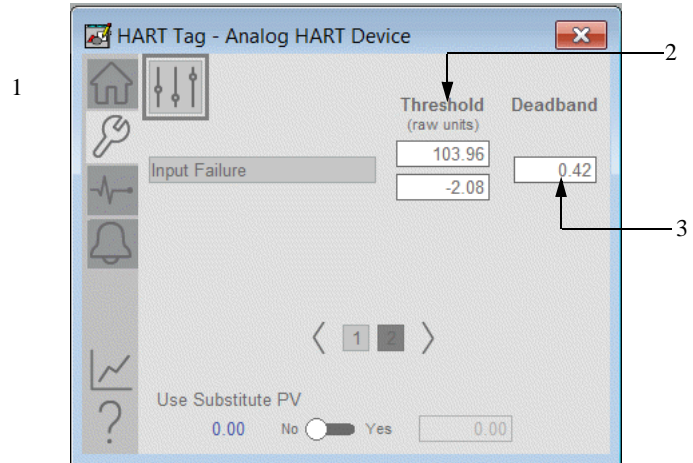

Table 28 - Maintenance Tab Page 2 Descriptions

Item	Description
1	Threshold name: Click a threshold name to open the associated P_Gate faceplate.
2	Type the threshold (trip point) minimum/maximum
3	Process variable fail deadband. Type the deadband (hysteresis) that is applied to each alarm limit. Deadband helps prevent a noisy signal from generating numerous spurious alarms. Example: If the High alarm limit is 90.0 and the High alarm deadband is 5.0, once the signal rises above 90.0, it generates a High alarm. The signal must fall below 85.0 (90.0 minus 5.0) for the alarm to clear.

Rockwell Automation Library of Process Objects: Display Elements Reference Manual, publication [PROCES-RM014](#), for more information.

Advanced Properties Display

The Advanced Properties Display opens to the engineering settings. The Advanced Properties Display provides access to device configuration parameters and ranges, and options for device and I/O setup. This tab is used for initial system commissioning or later system changes.

Engineering Tab Page 1

You can configure whether an object has HART PV, SV, TV, or FV inputs, input and scaled ranges, and units for the device.

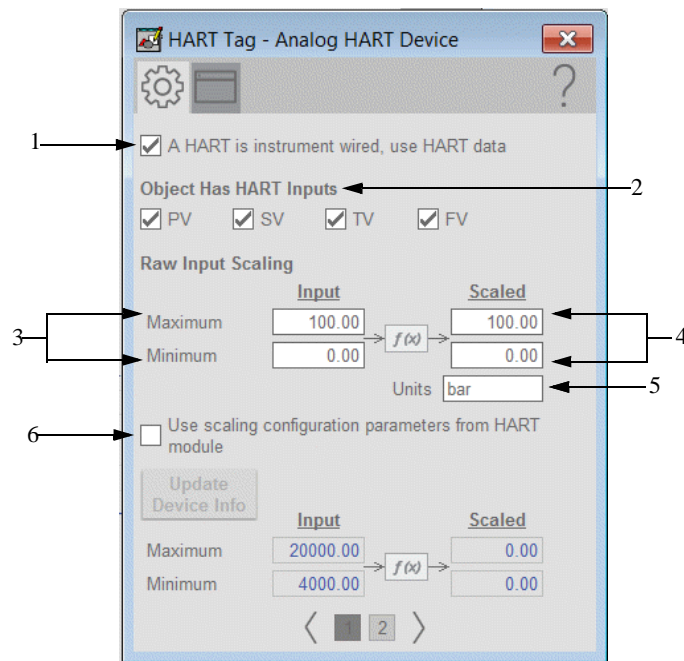

Table 29 - Engineering Tab Page 1 Description

Item	Description
1	Check to use HART data from the connected instrument. Clear this checkbox to use local data.
2	Check when HART is configured with PV, SV, TV, or FV.
3	Input (unscaled) minimum and maximum These parameters must be set to the range of the signal that is connected to the Inp_Process Variable Input. The raw minimum default is 0.0, and the raw maximum default is 100.0. Example: If your input card provides a signal from 4.0...20.0mA, set Cfg_InpRawMin to 4.0 and Cfg_InpRawMax to 20.0. The raw minimum/maximum and engineering units minimum/maximum are used for scaling to engineering units.

Item	Description
4	<p>EU minimum and maximum for scaling These parameters must be set to match the Process Variable range of the input signal that is connected to Inp_PV. The Process Variable engineering units minimum default is 0.0, and the Process Variable engineering units maximum is 100.0. Example: If your input card provides a signal from 4...20mA that represents -50...250°C, set the PV EU minimum to -50.0 and the PV EU maximum to 250.0. The raw minimum/maximum and Process Variable engineering units minimum/maximum are used for scaling to engineering units.</p>
5	Type engineering units for display on the HMI.
6	<p>Check to use scaling for raw and engineering units ranges received from the device via HART. Clear this checkbox to use manually entered ranges.</p>

Engineering Tab Page 2

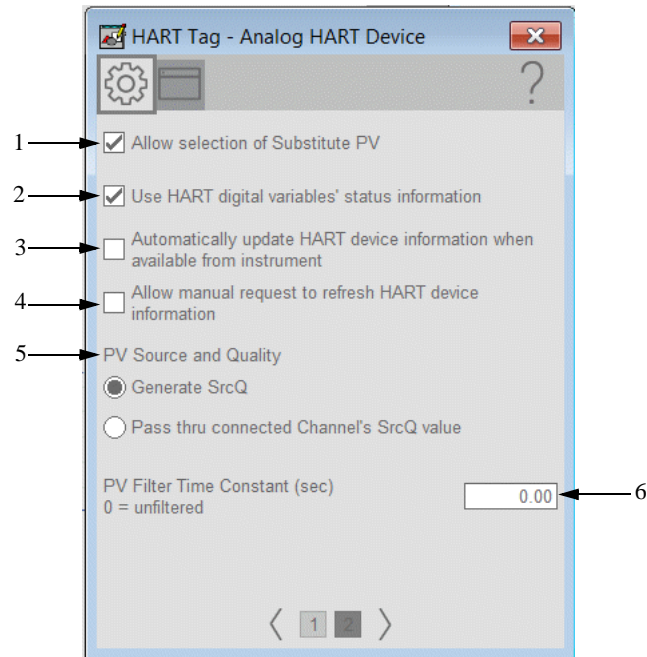

Table 30 - Engineering Tab Page 2 Description

Item	Description
1	Check to allow the Substitute Process Variable Maintenance function. Clear this checkbox to disallow the Substitute Process Variable Maintenance function (default).
2	Check to display the digital variables' (PV, SV, TV, FV) status as received via HART. Clear this checkbox to disable automatic updating of HART device information.
3	Check to update automatically the HART device information when available. Clear this checkbox to disable automatic updating of HART device information.

Item	Description
4	Check to allow operator to update HART device information. Clear to help prevent operator from being able to manually update HART device information.
5	PV Source and Quality Generate SrcQ: This instruction determines the analog Process Variable quality using Inp_PVBad, Inp_PVUncertain, and the PV value (out of range, infinite, or not a number). Pass thru connected Channel's SrcQ value: This instruction uses the Source and Quality (SrcQ) value that is provided by an upstream object (such as P_AIChan) via Inp_PVSrcQ to determine the analog PV source and quality.
6	Type the time, in seconds, for the process variable filter time constant.

HMI Configuration Tab Page 1

See [Basic Faceplate Attributes on page 84](#) for the description of the common attributes.

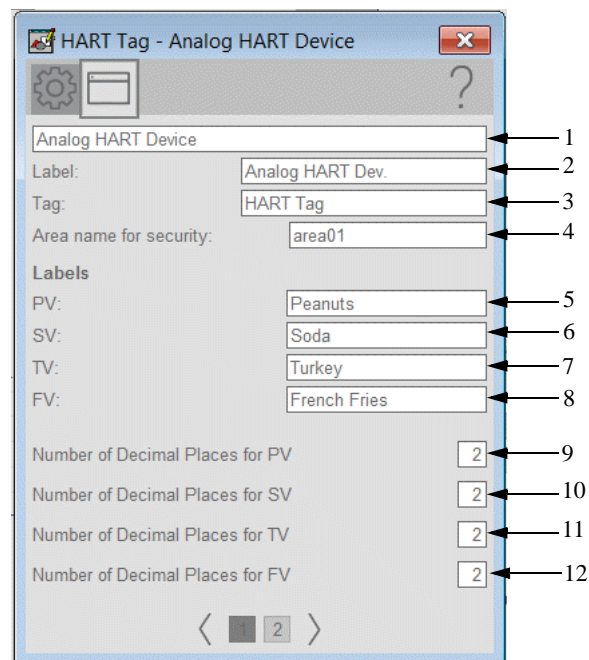

Table 31 - HMI Configuration Tab Page 1 Description

Item	Description
1	Type the name of the HMI device.
2	Type the label for the device.
3	Type the tag for the device.
4	Type the area name of the device.
5	Type the label for the HART PV.
6	Type the label for the HART SV.
7	Type the label for the HART TV.
8	Type the label for the HART FV.

Item	Description
9	Type in the number of decimal places that are displayed for the HART PV.
10	Type in the number of decimal places that are displayed for the HART SV.
11	Type in the number of decimal places that are displayed for the HART TV.
12	Type in the number of decimal places that are displayed for the HART FV.

HMI Configuration Tab Page 2

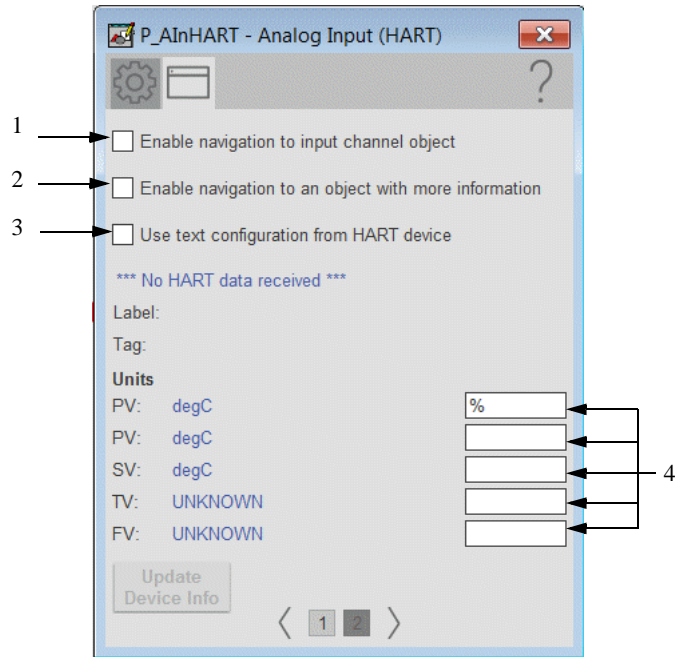
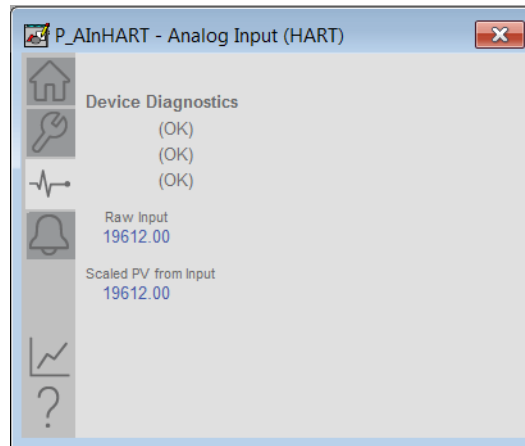

Table 32 - HMI Configuration Tab Page 2 Description

Item	Description
1	Check to enable navigation to the associate input channel object.
2	Check to enable navigation to an object with more information (Cfg_HasMoreObj is set to true.) This can be configured to navigate to an AOI backing tag or a UDT tag that has HMI_Type and HMI_Lib defined. For example, there is a motor with the tag name P101 and there is a need to have the more information button navigate to the parent P_LLS object. A tag is created for the P_LLS object that is given the alias P101_More. When the more information button is pressed on the motor, it links to P101_More. This will open the faceplate for the LLS object.
3	Check to use text configuration from HART device.
4	Type the text to display the units of measure for each variable.

Diagnostics Tab

The Diagnostics tab provides indications that are helpful to diagnose or help prevent device problems. The device problems can include specific reasons a device is 'Not Ready', device warnings and faults, warning and fault history, and predictive/preventive maintenance data.



Alarms Tab

The Alarms tab displays each configured alarm for the P_AInHART instruction. The icon on the tab for the alarms page changes color to show the current active alarm status. A blinking alarm icon indicates that one or more alarms must be acknowledged or the device must be reset.

When the Reset and Acknowledge All Alarms button is enabled, the border around the alarm blinks. This blinking indicates that the alarm requires acknowledgment or reset. The Alarm Acknowledge button is enabled if the alarm requires acknowledgment. Click the button to acknowledge the alarm.

IMPORT- Alarms are provided for the analog value only. There are no alarms for the digital PV, SV, TV, or FV.

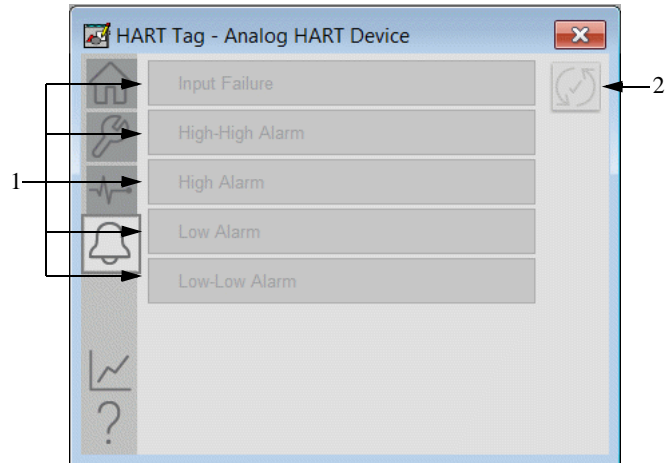
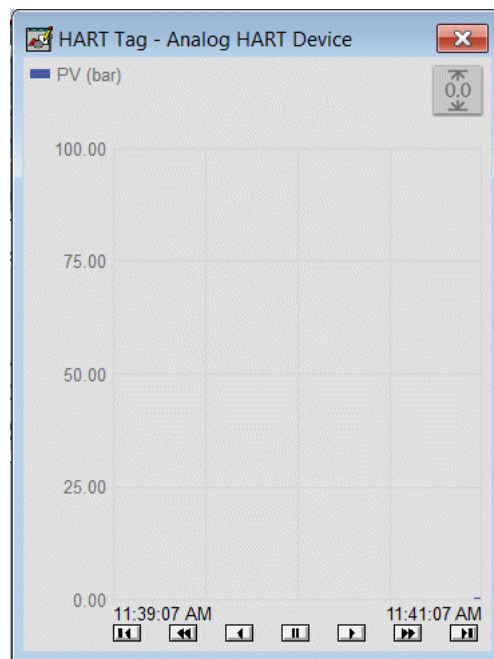

Table 33 - Alarm Tab Description

Item	Description
1	Alarm descriptions
2	Click to reset and acknowledge all alarms.

Trend Display

The Trend display shows trend charts of key device data over time. These faceplate trends provide a quick view of current device performance to supplement, but not replace, dedicated historical or live trend displays. The trends displays are common across all I/O Processing Add-On Instructions.



HART Analog Output (P_AOutHART)

The P_AOutHART (HART Analog Output) Add-On Instruction is used to manipulate an analog output to control a field device, such as a control valve or a motorized gate positioner. The output responds to an Operator (manual) or Program setting of the Controlled Variable (CV) signal.

The following table lists the topics.

Topic	Page
Controller Code	94
Operations	106
Display Elements	109
Quick Display	115
Basic Faceplate Attributes	115

The P_AOutHART instruction controls the analog output in various modes (Operator, Program, Override, Maintenance, Hand), monitoring for fault conditions. The global object and faceplate that are shown in the following image are examples of the graphical interface tools for this Add-On Instruction.

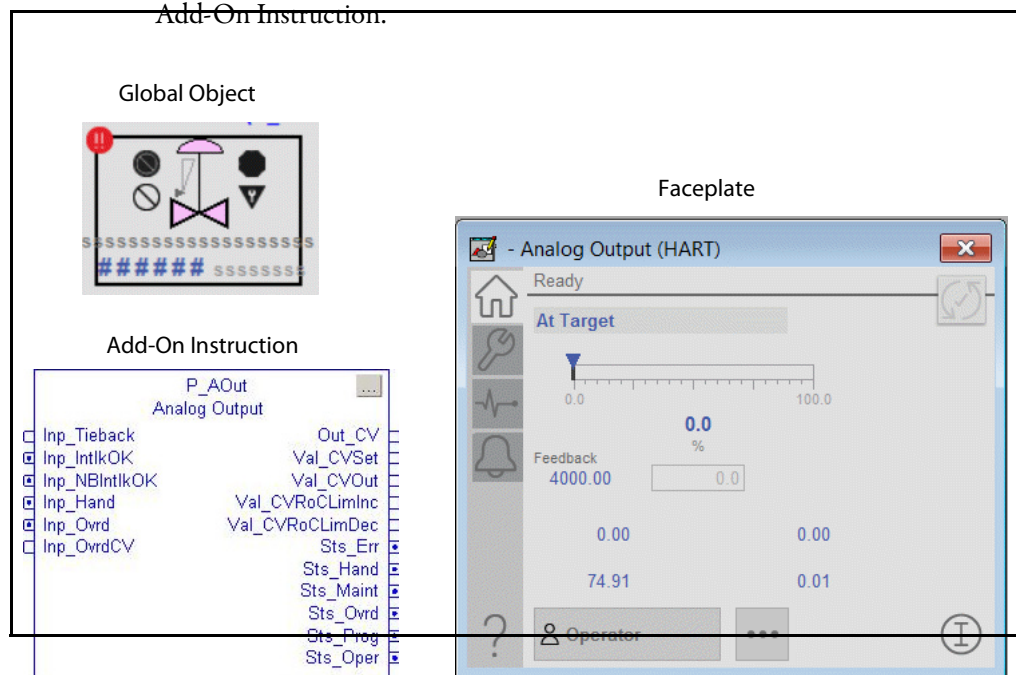

Controller Code

This section describes the parameter references for this Add-On Instruction.

InOut Structure for HART Analog Input

InOut parameters are used to link the Add-On Instruction to external tags that contain necessary data for the instruction to operate. These external tags must be of the data type shown.

InOut Parameters	Data Type	Description
Ref_ChanData	HART_ChanData	Channel Data from HART AO Channel
Ref_DiagTable	P_DiagTable[1]	Lookup table for Diagnostic Code to text

The diagnostic lookup table (Ref_DiagTable) is a tag that contains a list (array) of entries with diagnostic codes, the corresponding description, and a 'NAMUR status'.

The following image shows diagnostic codes 21 and 22 from the E+H Prosonic lookup table.

Name	Value
HART7_DiagTable_ProsonicS[21]	{...}
HART7_DiagTable_ProsonicS[22]	{...}
HART7_DiagTable_ProsonicS[23]	{...}
HART7_DiagTable_ProsonicS[23].Code	21
HART7_DiagTable_ProsonicS[23].Desc	'A232 Sensor 1 Defect, Chk ...
HART7_DiagTable_ProsonicS[23].NAMURSts	16
HART7_DiagTable_ProsonicS[23].InfoOnly	0
HART7_DiagTable_ProsonicS[23].MaintReqd	0
HART7_DiagTable_ProsonicS[23].OffSpec	0
HART7_DiagTable_ProsonicS[23].FuncCheck	0
HART7_DiagTable_ProsonicS[23].Failure	1
HART7_DiagTable_ProsonicS[24]	{...}
HART7_DiagTable_ProsonicS[24].Code	22
HART7_DiagTable_ProsonicS[24].Desc	'A232 Sensor 2 Defect, Chk ...
HART7_DiagTable_ProsonicS[24].NAMURSts	16
HART7_DiagTable_ProsonicS[24].InfoOnly	0
HART7_DiagTable_ProsonicS[24].MaintReqd	0
HART7_DiagTable_ProsonicS[24].OffSpec	0
HART7_DiagTable_ProsonicS[24].FuncCheck	0
HART7_DiagTable_ProsonicS[24].Failure	1

The code corresponds to a bit offset in the HART Code48 response from the device. Byte 0 bit 0 of the Code48 response is code '0'. Byte 0 bit 1 is code '1'. Byte 10 bit 0 is code '80' (8 bits per byte). The highest code number is 199, which is bit 24 bit 7.

There are several Diagnostic Lookup tables that are provided in the Preferred Integration Samples ACD file. There are 'generic' HART5 and HART7 diagnostic tables and several tables for Endress+Hauser HART instruments.

Name	Alias For	Base Tag	Data Type	Description
HART5_DiagTable_Generic			P_DiagTable[203]	HART Cmd48 Diagnostic Lookup Table: Generic HART5 device
HART5_DiagTable_Prowirl73			P_DiagTable[58]	HART Cmd48 Diagnostic Lookup Table: E+H Prowirl 73
HART5_DiagTable_TMass65I			P_DiagTable[68]	HART Cmd48 Diagnostic Lookup Table: E+H TMass 65I
HART5_DiagTable_TMT162			P_DiagTable[53]	HART Cmd48 Diagnostic Lookup Table: E+H TMT 162
HART5_DiagTable_TMT182			P_DiagTable[11]	HART Cmd48 Diagnostic Lookup Table: E+H TMT182 Temperature
HART7_DiagTable_FMG_60			P_DiagTable[111]	HART Cmd48 Diagnostic Lookup Table: E+H GammapiLOT FMG 60
HART7_DiagTable_Generic			P_DiagTable[203]	HART Cmd48 Diagnostic Lookup Table: Generic HART7 device
HART7_DiagTable_LevellflexFMP5x			P_DiagTable[109]	HART Cmd48 Diagnostic Lookup Table: E+H Levellflex FMP5x
HART7_DiagTable_LevellflexM			P_DiagTable[98]	HART Cmd48 Diagnostic Lookup Table: E+H Levellflex M
HART7_DiagTable_LiquilineCM44x			P_DiagTable[177]	HART Cmd48 Diagnostic Lookup Table: E+H Liquiline CM442 / 444 / 448
HART7_DiagTable_LiquilineCM82_rev1			P_DiagTable[178]	HART Cmd48 Diagnostic Lookup Table: E+H Liquiline CM82 Fw Rev. 1
HART7_DiagTable_LiquilineM_Cond			P_DiagTable[155]	HART Cmd48 Diagnostic Lookup Table: E+H Liquiline M Conductivity
HART7_DiagTable_LiquilineM_Cond_rev4			P_DiagTable[156]	HART Cmd48 Diagnostic Lookup Table: E+H LiquilineM Conductivity rev 4.x
HART7_DiagTable_LiquilineM_Oxy_rev4			P_DiagTable[160]	HART Cmd48 Diagnostic Lookup Table: E+H LiquilineM Oxygen rev 4.x
HART7_DiagTable_LiquilineM_Oxygen			P_DiagTable[139]	HART Cmd48 Diagnostic Lookup Table: E+H Liquiline M Oxygen
HART7_DiagTable_LiquilineM_pH_rev4			P_DiagTable[155]	HART Cmd48 Diagnostic Lookup Table: E+H LiquilineM pH/ORP rev 4.x
HART7_DiagTable_LiquilineM_pHORP			P_DiagTable[154]	HART Cmd48 Diagnostic Lookup Table: E+H Liquiline M pH / ORP
HART7_DiagTable_LiquistationCSFxx			P_DiagTable[129]	HART Cmd48 Diagnostic Lookup Table: E+H Liquistation CSFxx
HART7_DiagTable_Metso_ND7x_ND9x			P_DiagTable[122]	HART Cmd48 Diagnostic Lookup Table: Metso ND7xxx and ND9xxx Positioners
HART7_DiagTable_MicropilotFMR5x			P_DiagTable[116]	HART Cmd48 Diagnostic Lookup Table: E+H Micropilot FMR5x
HART7_DiagTable_MicropilotFMR6x			P_DiagTable[106]	HART Cmd48 Diagnostic Lookup Table: E+H Micropilot FMR6x
HART7_DiagTable_MicropilotFMR20			P_DiagTable[96]	HART Cmd48 Diagnostic Lookup Table: E+H Micropilot FMR 20
HART7_DiagTable_MicropilotM			P_DiagTable[100]	HART Cmd48 Diagnostic Lookup Table: E+H Micropilot M
HART7_DiagTable_Pressure_M			P_DiagTable[114]	HART Cmd48 Diagnostic Lookup Table: E+H Cerabar, Deltabar, Deltapilot M
HART7_DiagTable_Pressure_S			P_DiagTable[138]	HART Cmd48 Diagnostic Lookup Table: E+H Cerabar, Deltabar, Deltapilot S
HART7_DiagTable_Promag53			P_DiagTable[158]	HART Cmd48 Diagnostic Lookup Table: E+H Promag 53
HART7_DiagTable_Promag100			P_DiagTable[124]	HART Cmd48 Diagnostic Lookup Table: E+H Promag 100
HART7_DiagTable_Promag200			P_DiagTable[111]	HART Cmd48 Diagnostic Lookup Table: E+H Promag 200
HART7_DiagTable_Promag300_500			P_DiagTable[154]	HART Cmd48 Diagnostic Lookup Table: E+H Promag 300 and Promag 500
HART7_DiagTable_Promag400			P_DiagTable[141]	HART Cmd48 Diagnostic Lookup Table: E+H Promag 400
HART7_DiagTable_Promag400_rev9			P_DiagTable[146]	HART Cmd48 Diagnostic Lookup Table: E+H Promag 400 rev 9
HART7_DiagTable_Promass83			P_DiagTable[174]	HART Cmd48 Diagnostic Lookup Table: E+H Promass 83
HART7_DiagTable_Promass100			P_DiagTable[124]	HART Cmd48 Diagnostic Lookup Table: E+H Promass 100
HART7_DiagTable_Promass200			P_DiagTable[128]	HART Cmd48 Diagnostic Lookup Table: E+H Promass 200
HART7_DiagTable_Promass300_500			P_DiagTable[148]	HART Cmd48 Diagnostic Lookup Table: E+H Promass 300 and Promass 500
HART7_DiagTable_ProsonicFlow_100_rev1			P_DiagTable[125]	HART Cmd48 Diagnostic Lookup Table: E+H Prosonic Flow 100 rev 1.x
HART7_DiagTable_ProsonicFlowB200			P_DiagTable[126]	HART Cmd48 Diagnostic Lookup Table: E+H Prosonic Flow B200
HART7_DiagTable_ProsonicM			P_DiagTable[101]	HART Cmd48 Diagnostic Lookup Table: E+H Prosonic M
HART7_DiagTable_ProsonicS			P_DiagTable[203]	HART Cmd48 Diagnostic Lookup Table: E+H Prosonic S
HART7_DiagTable_Prowirl200			P_DiagTable[144]	HART Cmd48 Diagnostic Lookup Table: E+H Prowirl
HART7_DiagTable_TMT72_rev1			P_DiagTable[103]	HART Cmd48 Diagnostic Lookup Table: E+H TMT72 rev 1

Input Structure for HART Analog Output

Input parameters include the following:

- Input data elements (Inp_) are typically used to connect field inputs from I/O modules or signals from other objects.
- Configuration data elements (Cfg_) are used to set configurable capabilities and features of the instruction.
- Commands (PCmd_, OCmd_, XCmd_, MCmd_) are used by program logic, operators, and maintenance personnel to request instruction actions.

Settings (PSet_, OSet_, XSet_, MSet_) are used by program logic, operators, and maintenance personnel to establish runtime setpoints, thresholds, and so forth. A setting (without a leading P, O, X, or M) establishes runtime settings regardless of role or command source.

Input Parameter	Data Type	Alias For	Default	Description
EnableIn	BOOL		1	Enable Input—System-Defined Parameter
Inp_IntlkOK	BOOL		1	1 = Interlocks OK, Analog Output can be set
Inp_NBIntlkOK	BOOL		1	1 = Non-bypassable interlocks OK, analog output can be set if bypassable interlocks are bypassed.
Inp_IOFault	BOOL		0	Input Communication Status: 0 = OK 1 = Fail
Inp_Sim	BOOL		0	Simulation input. When set to 0, the instruction operates normally. When set to 1, the instruction acts as normal but the output is held at zero.
Inp_Hand	BOOL	CmdSrc.Inp_Hand	0	1 = Acquire Hand (typically hardwired local) Mode 0 = Release Hand Mode
Inp_Ovrd	BOOL	CmdSrc.Inp_Ovrd	0	1 = Acquire Override (higher priority program logic) Mode 0 = Release Override Mode
Inp_OvrdCV	REAL		0.0	CV target in Override Mode
Inp_Reset	BOOL		0	1 = Reset latched Alarms
Cfg_ShedHold	BOOL		0	1 = Hold Output on Interlock 0 = Go to Cfg_IntlkCV
Cfg_SkipRoCLim	BOOL		0	1 = Skip rate-of-change limits in Interlock, Maintenance, and Override modes
Cfg_SetTrack	BOOL		1	This parameter is used to configure bumpless behavior of setting parameters when switching modes. When this parameter is 1 and the instruction is in Program mode, the operator settings track the program settings. When this parameter is 1 and instruction is in Operator mode, the program settings track the operator settings; and the simulation inputs match the output values (transitions are bumpless). When this parameter is 0, this instruction does not modify the operator settings and program settings. In this case, when the mode is changed, the effective value of the setting can change depending on the program-set and operator-set values.
Cfg_SetTrackOvrdHand	BOOL		0	1 = Program/Operator settings track Override/Hand CV
Cfg_HasHART	BOOL		1	1 = HART instrument 0 = non-HART (4...20 mA only) instrument
Cfg_HasMoreObj	BOOL		0	1=Tells HMI an object with more info is available
Cfg_HasPV	BOOL		1	1 = Digital variable is configured and displayed: PV (primary variable) SV (secondary variable) TV (third variable) FV (fourth variable)
Cfg_HasSV				
Cfg_HasTV				
Cfg_HasFV				
Cfg_UseHARTText	BOOL		0	1 = Use HART text for Description, Label, Tag, Engineering Units 0 = Manually entered

Input Parameter	Data Type	Alias For	Default	Description
Cfg_UseHARTScaling	BOOL		0	1 = Use HART scaling for raw, engineering units ranges 0 = Manually entered ranges
Cfg_AutoUpdDevInfo	BOOL		1	1 = Automatically update device information 0 = No auto update
Cfg_ManUpdDevInfo	BOOL		0	1 = Allow manual device-information update request 0 = disallow
Cfg_HasIntlkObj	BOOL		0	1 = Tells the HMI that an interlock object is connected to Inp_Intlk. IMPORTANT: The name of the Interlock object in the controller must be this object name with the suffix '_Intlk'. For example, if your P_AOutHART object has the name 'AOut123', then its Interlock object must be named 'AOut123_Intlk'.
Cfg_HasCVNav	BOOL		0	1 = Tells HMI to enable navigation to a connected CV object by using the tag name in Cfg_CVNavTag
Cfg_OvrIntlk	BOOL		0	1 = Override ignores Bypassable Interlock 0 = always use Interlock
Cfg_ShedOnIOFault	BOOL		1	1 = Hold output or set output to interlock CV and Alarm on I/O Fault (see Cfg_ShedHold on page 96) 0 = Alarm only on I/O Fault
Cfg_HasIntlkTripAlarm	BOOL	IntlkTrip.Cfg_Exists	0	1 = Interlock Trip alarm or I/O fault alarm exists and is checked
Cfg_HasIOFaultAlarm		IOFault.Cfg_Exists		
Cfg_IntlkTripResetReqd	BOOL	IntlkTrip.Cfg_ResetReqd	0	1 = A reset is required to clear Interlock Trip alarm or I/O Fault Alarm
Cfg_IOFaultResetReqd		IOFault.Cfg_ResetReqd		
Cfg_IntlkTripAckReqd	BOOL	IntlkTrip.Cfg_AckReqd	1	1 = An acknowledge is required for Interlock Trip Alarm or I/O Fault Alarm
Cfg_IOFaultAckReqd		IOFault.Cfg_AckReqd		
Cfg_IntlkTripSeverity	INT	IntlkTrip.Cfg_Severity	500	These parameters determine the severity of each alarm. This severity drives the color and symbol that are used to indicate alarm status on the faceplate and global object. The following are valid values: 1...250 = Low 251...500 = Medium 501...750 = High 751...1000 = Urgent IMPORTANT: For FactoryTalk® View software version 7, these severity parameters drive only the indication on the global object and faceplate. The Alarms and Events severity definition drives the color and symbol that are used on the alarm banner and summary. Also, the Alarms and Events severity definition drives the value that is returned by FactoryTalk Alarms and Events display commands.
Cfg_IOFaultSeverity		IOFault.Cfg_Severity	1000	
Cfg_MinCV	REAL		0.0	Minimum CV (in engineering units, to set limit)
Cfg_MaxCV	REAL		100.0	Maximum CV (in engineering units, to set limit)
Cfg_MaxCVRoCInc	REAL		10.0	Maximum allowed CV Rate of Change (Increasing) or maximum allowed CV Rate of Change (Decreasing) setting (engineering units/sec)
Cfg_MaxCVRoCDec				

Input Parameter	Data Type	Alias For	Default	Description
Cfg_IntlkCV	REAL		0.0	CV Target when interlocked (if not Cfg_ShedHold)
Cfg_CVEUMin	REAL		0.0	CV Minimum in Engineering Units (for scaling)
Cfg_CVEUMax	REAL		100.0	CV Maximum in Engineering Units (for scaling)
Cfg_CVRawMin	REAL		0.0	CV Minimum in I/O (raw) Units (for scaling)
Cfg_CVRawMax	REAL		100.0	CV Maximum in I/O (raw) Units (for scaling)
Cfg_MaxInactiveCV	REAL		0.0	When Val_CVOut is greater than this value (in CV engineering units), set Sts_Active (for HMI)
PSet_CV	REAL		0.0	Program Setting of Controlled Variable (output) (in engineering units)
PSet_CVRoCLimInc	REAL		0.0	Program setting of CV Rate of Change limit, Increasing or Decreasing (in engineering units/second)
PSet_CVRoCLimDec				
PSet_Owner	DINT		0	Program Owner Request ID (nonzero) or Release (zero)
OSet_CV	REAL		0.0	Operator Setting of Controlled Variable (output) (in engineering units)
OSet_CVRoCLimInc	REAL		0.0	Operator Setting of CV Rate of Change limit, Increasing or Decreasing (in engineering units/second)
OSet_CVRoCLimDec				
Set_SimHARTPV	REAL		0.0	Setting value of Variable in Simulation (Inp_Sim = 1) PV (PVEU) SV (SVEU) TV (TVEU) FV (FVEU)
Set_SimHARTSV				
Set_SimHARTTV				
Set_SimHARTFV				
PCmd_Prog	BOOL	CmdSrc.PCmd_Prog	0	<ul style="list-style-type: none"> Set PCmd_Acq to 1 to Acquire Set PCmd_Rel to 1 to Release These parameters reset automatically
PCmd_Oper		CmdSrc.PCmd_Oper		
PCmd_Lock	BOOL	CmdSrc.PCmd_Lock	0	<ul style="list-style-type: none"> Set PCmd_Lock to 1 to Lock Set PCmd_Unlock to 1 to Unlock These parameters reset automatically
PCmd_Unlock		CmdSrc.PCmd_Unlock		
PCmd_Reset	BOOL		0	<ul style="list-style-type: none"> Set PCmd_Reset to 1 to reset all alarms that require a reset This parameter is always reset automatically
PCmd_IntlkTripAck	BOOL	IntlkTrip.PCmd_Ack	0	<ul style="list-style-type: none"> Set PCmd_<Alarm>Ack to 1 to Acknowledge alarm The parameter is reset automatically
PCmd_IOFaultAck		IOFault.PCmd_Ack		
PCmd_IntlkTripSuppress	BOOL	IntlkTrip.PCmd_Suppress	0	<ul style="list-style-type: none"> Set PCmd_<Alarm>Suppress to 1 to suppress alarm Set PCmd_<Alarm>Unsuppress to 1 to unsuppress alarm These parameters reset automatically
PCmd_IOFaultSuppress		IOFault.PCmd_Suppress		
PCmd_IntlkTripUnsuppress		IntlkTrip.PCmd_Unsuppress		
PCmd_IOFaultUnsuppress		IOFault.PCmd_Unsuppress		

Input Parameter	Data Type	Alias For	Default	Description
PCmd_IntlkTripUnshelve	BOOL	IntlkTrip.PCmd_Unshelve	0	<ul style="list-style-type: none"> Set PCmd_<Alarm>Unshelve to 1 to Unshelve alarm The parameter is reset automatically
PCmd_IOFaultUnshelve		IOFault.PCmd_Unshelve		
MCmd_Rel	BOOL	CmdSrc.MCmd_Rel	0	Maintenance Command to Release Ownership (Maintenance to Operator/Program/Override)
OCmd_Unlock	BOOL	CmdSrc.OCmd_Unlock	0	Operator Command to Unlock/Release (Operator to Program) Ownership

The following Operator and Maintenance Commands/Settings are sent from the HMI and required to be contained in Local Tags. Their external access attribute is set to ReadWrite.

Table 34 - P_AOutHART Commands and Settings in Local Tags

Local Tags	Data Type	Alias For	Description
MCmd_Bypass	BOOL	MRdy_Bypass	I=Ready to receive: IMPORTANT All of the preceding enable the HMI button.
MCmd_Check		MRdy_Check	
MCmd_UpdDevInfo		MRdy_UpDevInfo	
OCmd_Reset	BOOL	ORdy_Reset	Operator Command to Reset all alarms requiring Reset
OCmd_ResetAckAll	BOOL	ORdy_ResetAckAll	Operator Command to Reset and Acknowledge all alarms
OSet_CV	BOOL	ORdy_CV	Operator Command

Output Structure for HART Analog Output

Output parameters include the following:

- Output data elements (Out_) are the primary outputs of the instruction, typically used by hardware output modules; however, they are used by other application logic.
- Value data elements (Val_) are numeric outputs of the instruction for use by the HMI. Values are also used by other application logic or software packages.
- Source and Quality data elements (SrcQ_) are outputs of the instruction that are used by the HMI to indicate PV source and quality.
- Status data elements (Sts_) are bit outputs of the instruction for use by the HMI. Also, status bits are used by other application logic.
- Error data elements (Err_) are outputs of the instruction that indicate a particular configuration error. If any Err_ bit is set, then the Sts_Err configuration error summary status is set, and the Invalid Configuration indicator is displayed on the HMI.
- Not Ready data elements (Nrdy_) are bit outputs of the instruction for use by the HMI for displaying the Device Not Ready indicator. Also, these bits are used by other application logic.
- Alarm data elements (Alm_) are outputs of the instruction that indicate a particular alarm has occurred.
- Acknowledge data elements (Ack_) are outputs of the instruction that indicate the corresponding alarm has been acknowledged.
- Ready data elements (Rdy_) are bit outputs of the instruction used by the HMI to enable or disable Command buttons and Setting entry fields.

Table 35 - P_AOutHART Output Parameters

Output Parameter	Data Type	Alias For	Description
EnableOut	BOOL		Enable Output - System-Defined Parameter
Out_CV	REAL		CV Output in Raw (I/O Card) Units
Val_CVSet	REAL		Value of selected CV Setting (before rate limit, in engineering units)
Val_CVOut	REAL		Value of CV Output (after rate limit) (in engineering units)
Val_CVFdbk	REAL		Value of CV readback from analog output channel IMPORTANT: This variable is an echo of the CV provided by the I/O card and does NOT represent an actual position of any actuator device. The actual position can be configured as one of the HART variables: PV, SV, TV or FV, and depends on what data the device is configured to send in those variables.
Val_CVRoCLimInc	REAL		Value of CV Rate of Change Limit, Increasing (in engineering units/second)
Val_CVRoCLimDec	REAL		Value of CV Rate of Change Limit, Decreasing (in engineering units/second)
Val_CVEUMin	REAL		Minimum of scaled range = minimum (Cfg_CVEUMin, Cfg_CVEUMax)
Val_CVEUMax	REAL		Maximum of scaled range = maximum (Cfg_CVEUMin, Cfg_CVEUMax)

Output Parameter	Data Type	Alias For	Description
Val_PV Val_SV Val_TV Val_FV	REAL		Value of HART variable: <ul style="list-style-type: none"> • Primary Variable (PV) • Secondary Variable (SV) • Third Variable (TV) • Fourth Variable (FV)
Val_DiagCode1 Val_DiagCode2 Val_DiagCode3	DINT		HART Diagnostic Code (0...199, -1 = no diagnostics): #1 #2 #3
Val_NAMURSts1 Val_NAMURSts2 Val_NAMURSts3	DINT		NAMUR NE107 Status for HART Diagnostic Code: 0 = OK 1 = Information 2 = Maintenance required 4 = Off specification (uncertain) 8 = Function check (substitution) 16 = Failure
SrcQ_IO SrcQ	SINT		Source and Quality of primary I/O (enumeration) Final analog source and quality: GOOD 0 = I/O live and confirmed good quality 1 = I/O live and assumed good quality 2 = No feedback configured, assumed good quality TEST 8 = Device simulated 9 = Device loopback simulation 10 = Manually entered value UNCERTAIN 16 = Live input, off-specification 17 = Value substituted at device/bus 18 = Value substituted by maintenance (Has and not Use) 19 = Shed, uses last good value 20 = Shed, uses replacement value BAD 32 = Signal failure (out-of-range, NaN, invalid combination) 33 = I/O channel fault 34 = I/O module fault 35 = Bad I/O configuration (for example, scaling parameters)
SrcQ_PV SrcQ_SV SrcQ_TV SrcQ_FV	SINT		Source and Quality of HART value: PV SV TV FV
Val_Sts	SINT		0 = At target 1 = Ramp down 2 = Ramp up 3 = Clamp minimum 4 = Clamp maximum 33 = Disabled
Val_Fault	SINT		Device fault status: 0 = None 32 = I/O fault 34 = Configuration error

Output Parameter	Data Type	Alias For	Description
Val_Mode	SINT	Mode.Val	The current mode is shown with status bits and as an enumeration 'Val-Mode' as follows: 0 = No mode 1 = Hand 2 = Maintenance 3 = Override 4 = Program (locked) 5 = Operator (locked) 6 = Program (unlocked, Operator is default) 7 = Operator (unlocked, Program is default) 8 = Program (unlocked, Program is default) 9 = Operator (unlocked, Operator is default)
Val_Owner	DINT		Current Object Owner ID (0 = not owned)
Val_Notify	SINT		Current alarm level and acknowledgment (enumeration): 0 = No alarm 1 = Alarm cleared: a reset or acknowledge is required 2 = Low (acknowledged) 3 = Low (unacknowledged) 4 = Medium (acknowledged) 5 = Medium (unacknowledged) 6 = High (acknowledged) 7 = High (unacknowledged) 8 = Urgent (acknowledged) 9 = Urgent (unacknowledged)
Sts_Ramping	BOOL		1 = CV is ramping to target
Sts_Clamped	BOOL		1 = CV Set is clamped at CVMin or CVMax
Sts_SkipRoCLim	BOOL		1 = Rate of Change Limiting was skipped in this scan (Maintenance, Override, Interlock, or Hand)
Sts_Active	BOOL		1 = CV is greater than Cfg_MaxInactiveCV, show graphic symbol as 'active'
Sts_Available	BOOL		1 = Analog Output available for control by automation (Program)
Sts_Bypass	BOOL		1 = Bypassable Interlocks are Bypassed
Sts_BypActive	BOOL		1 = Bypassing Active (Bypassed or Maintenance)
Sts_Disabled	BOOL		1 = Output is Disabled
Sts_NotRdy	BOOL		1 = Device Not Ready, see detail bits for reason
Nrdy_CfgErr	BOOL		1 = Device Not Ready: <ul style="list-style-type: none"> • Configuration Error • Interlock Not OK • I/O Fault (Shed Requires Reset) • Device Out of Service
Nrdy_Intlk			
Nrdy_IOFault			
Nrdy_OoS			
Sts_MaintByp	BOOL		1 = Device has a Maintenance Bypass function active
Sts_AlmInh	BOOL		1 = One or more Alarms Shelved, Disabled, or Suppressed
Sts_Err	BOOL		1 = Error in configuration: see detail bits for reason
Err_Limit	BOOL		1 = Error in configuration: <ul style="list-style-type: none"> • CV limits swapped. • Scaled CV engineering units minimum = maximum • Raw-output scaling minimum = maximum • Alarm minimum on time or severity
Err_EU			
Err_Raw			
Err_Alarm			
Sts_Hand	BOOL	Mode.Sts_Hand	1 = Mode is Hand (supersedes Maintenance, Override, Program, and Operator)
Sts_Maint	BOOL	Mode.Sts_Maint	1 = Mode is Maintenance (supersedes Override, Program, and Operator)

Output Parameter	Data Type	Alias For	Description
Sts_Ovrd	BOOL	Mode.Sts_Ovrd	1 = Mode is Override (supersedes Program and Operator)
Sts_Ext	BOOL	Mode.Sts_Ext	1 = Mode is Ext
Sts_Prog	BOOL	Mode.Sts_Prog	1 = Mode is Program
Sts_Oper	BOOL	Mode.Sts_Oper	1 = Mode is Operator
Sts_ProgOperLock	BOOL	Mode.Sts_ProgOperLock	1 = Program or Operator has requested Mode Lock
Sts_MAcqRcvd	BOOL	Mode.Sts_MAcqRcvd	1 = Maintenance Acquire command received this scan
Sts_IntkTrip	BOOL	IntkTrip.Inp	1 = Status: CV held or forced by interlock NOT OK (1-shot)
Sts_IOFault		IOFault.Inp	1 = I/O Fault Status (0=OK, 1=Bad)
Alm_IntkTrip	BOOL	IntkTrip.Alm	1 = Alarm: CV held or forced by interlock Not OK or I/O Fault alarm
Alm_IOFault		IOFault.Alm	
Ack_IntkTrip	BOOL	IntkTrip.Ack	1 = Interlock Trip or I/O Fault alarm has been acknowledged
Ack_IOFault		IOFault.Ack	
Sts_IntkTripDisabled	BOOL	IntkTrip.Disabled	1 = Maintenance disabled Interlock Trip or I/O Fault alarm
Sts_IOFaultDisabled		IOFault.Disabled	
Sts_IntkTripShelved	BOOL	IntkTrip.Shelved	1 = Operator shelved Interlock Trip or I/O Fault alarm
Sts_IOFaultShelved		IOFault.Shelved	
Sts_IntkTripSuppressed	BOOL	IntkTrip.Suppressed	1 = Program suppressed Interlock Trip or I/O Fault alarm
Sts_IOFaultSuppressed		IOFault.Suppressed	
MRdy_Rel	BOOL	CmdSrc.MRdy_Rel	
ORdy_Unlock	BOOL	CmdSrc.OCmd_Unlock	
P_AOutHART	BOOL		Unique Parameter Name for auto-discovery

The following Operator and Maintenance Readies are sent to the HMI and are required to be contained in Local Tags. Their external access attribute is set to ReadOnly.

Table 36 - P_AInHART Readies in Local Tags

Local Tag	Data Type	Alias For	Description
MRdy_Bypass	BOOL		1 = Ready to receive: • MCmd_UpdDevInfo • MCmd_Bypass • MCmd_Check IMPORTANT All of the preceding enable the HMI button.
MRdy_Check			
MRdy_UpdDevInfo			
ORdy_CV			1 = Ready to receive: • OSet_CV IMPORTANT The preceding enables the corresponding data entry field.
ORdy_Reset			1 = At least one Alarm requires Reset
ORdy_ResetAckAll			1 = At least one Alarm or latched Shed condition requires Reset or Acknowledge

Local Configuration Tags for HART Analog Output

Configuration parameters that are array, string, or structure data types cannot be configured as parameters for Add-On Instructions. Configuration parameters of these types appear as local tags to the Add-On Instruction. Local tags can be configured through the HMI faceplates or in the Studio 5000 Logix Designer® application.

Open the instruction logic of the Add-On Instruction instance, and then open the data monitor on a local tag, to perform this configuration. These parameters cannot be modified by using controller logic or the Logix Designer application export/import functionality.

Tag Name	Data Type	Default	Description
Cfg_CVN avTag	STRING_N avTag	"	Tag name for destination of CV Navigation button. IMPORTANT: This function does not apply to FactoryTalk View ME software.
Cfg_Desc	STRING_40	'Analog Output'	Description for display on HMI
Cfg_EU	STRING_8	'%'	Engineering units for CV display on HMI
Cfg_FVE U	STRING_8	"	Engineering units for HART FV display on HMI
Cfg_FVLa bel	STRING_16	"	Label for Fourth Variable for display on HMI
Cfg_Label	STRING_20	'Analog Output'	Label for graphic symbol displayed on HMI
Cfg_PVE U	STRING_8	"	Engineering units for HART PV display on HMI
Cfg_PVLa bel	STRING_16	"	Label for Primary Variable for display on HMI
Cfg_SVE U	STRING_8	"	Engineering units for HART SV display on HMI
Cfg_SVLa bel	STRING_16	"	Label for Secondary Variable for display on HMI
Cfg_Tag	STRING_20	'P_AOutH ART'	Tag name for display on HMI
Cfg_TVE U	STRING_8	"	Engineering units for HART TV display on HMI
Cfg_TVLa bel	STRING_16	"	Label for Third Variable for display on HMI

Operations

This section describes the primary operations for Add-On Instructions.

Command Sources

This instruction uses the following standard command sources, which are implemented by using an embedded P_CmdSrc Add-On Instruction.

Table 37 - Command Sources

Command Source	Description
Operator	The Operator owns control of the device. Operator commands (OCmd_) and Operator settings (OSet_) from the HMI are accepted.
Program	Program logic owns control of the loop. Program Commands (PCmd_) and Program Settings (PSet_) are accepted.
External	An external system or other external devices control the object via logic. External Commands from the HMI are accepted.
Override	Priority logic owns control of the device and supersedes Operator and Program control. Override Inputs (Inp_OvrCmd and other Inp_OvrDxxx values) are accepted. If so configured, bypassable interlocks and permissives are bypassed.
Maintenance	Maintenance owns control of the device and supersedes Operator, Program, and Override control. Operator commands and settings from the HMI are accepted. Bypassable interlocks and permissives are bypassed, and device timeout checks are not processed.
Out of Service	The object may be placed Out of Service by Maintenance from the HMI (Maintenance Out of Service). The object also may be placed Out of Service by scanning the instruction false (in a Ladder Diagram implementation). Furthermore, the object may be placed Out of Service by exposing and wiring the EnableIn input pin and setting it false (in a Function Block Diagram implementation). When the object is Out of Service, outputs are held de-energized/at zero, and alarms are inhibited.
Hand	Hardwired logic or other logic outside the instruction owns control of the device. The instruction tracks the state of the device for bumpless transfer back to one of the other modes.

See Rockwell Automation® Library of Process Objects: Logic Instructions Reference Manual, publication [PROCES-RM013](#), for more information.

Alarms

This instruction uses the following alarms, which are implemented by using the embedded P_Alarm Add-On Instruction.

Table 38 - Alarms

Alarm Name	P_Alarm Name	P_Gate Name	Description
Interlock Trip	IntlkTrip	None	Raised when an interlock 'not OK' condition causes the output CV to be changed to the configured Interlock CV value or held at its last value. If interlocks are not bypassed, a bypassable interlock or a non-bypassable interlock 'not OK' condition initiates an interlock trip. If interlocks are bypassed, only a non-bypassable interlock 'not OK' condition initiates an interlock trip.
I/O Fault	IOFault	None	Raised when the Inp_IOFault input is true. This input is used to indicate to the instruction that a communication failure has occurred for its I/O. If the I/O Fault is configured as a shed fault, the output CV is set to the configured Interlock CV or held at its last value until reset.

Parameters of the P_Alarm object can be accessed by using the following convention: [P_Alarm Name].[P_Alarm Parameter].

See Rockwell Automation Library of Process Objects: Logic Instructions Reference Manual, publication [PROCES-RM013](#), for more information.

Simulation

Simulation in P_AOutHART simulates the requested CV, sets the Out_CV output to 0, and ignores any I/O Faults.

You can simulate digital inputs by using the following parameters:

- Set_SimHARTPV
- Set_SimHARTSV
- Set_SimHARTTV
- Set_SimHARTFV



You must set the Inp_Sim parameter in the controller to '1' to enable simulation. The Simulation/Loopback Test icon is displayed near the top of the Operator faceplate, which indicates the device is in simulation.

When you have finished in simulation, set the Inp_Sim parameter in the controller to '0' to return to normal operation.

Execution

The following table explains the handling of instruction execution conditions.





Condition	Description
EnableIn False (false rung)	Processing for EnableIn False (False Rung) is handled the same as if command disabled the Analog Output. The CV output is de-energized (zeroed), and the Analog Output instruction is shown as disabled on the HMI. The mode is shown as No mode.
Powerup (prescan, first scan)	The embedded P_CmdSrc and P_Alarm instructions handle processing of command sources and alarms on prescan and powerup. See PROCES-RM013 for details. On powerup, the analog output ownership is set to default; otherwise, all data remains in the state it was in at power down.
Postscan (SFC transition)	No SFC postscan logic is provided.

See the Logix 5000™ Controllers Add-On Instructions Programming Manual, publication [1756-PM010](#), for more information.

Display Elements

A display element (global object) is created once and can be referenced multiple times on multiple displays in an application. When changes are made to the original (base) object, the instantiated copies (reference objects) are automatically updated. Use of global objects, with tag structures in the ControlLogix® system, aid consistency and save the time it takes to engineer.

IMPORTANT The P_AOutHART instruction uses the same display elements as the Analog Output (P_AOut) instruction.

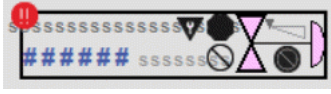
Display Element Name	Display Element	Description
GO_P_AOut		Standard analog output global object.
GO_ProcessControlValve		Normal controlled valve symbol for horizontal pipe.
GO_ProcessControlValve1		Inverted controlled valve symbol for horizontal pipe.
GO_ProcessControlValve2		Controlled valve symbol for vertical pipe (pipe to the left).
GO_ProcessControlValve3		Controlled valve symbol for vertical pipe (pipe to the right).

Common attributes of the P_AOut global objects include the following:

- Graphical representation of the device with output bar
- Label
- Maintenance Bypass indicator
- Current value of the CV with its engineering units
- Command Source indicator
- Alarm indicator that changes color with the severity of an alarm
- Border that changes color and blinks for an unacknowledged alarm
- Status/Quality indicator







Table 39 - Display Element Description

Item	Description
1	Alarm Border

Status/Quality Indicators

One of these symbols appears on the graphic symbol when the described condition is true.

Table 40 - Status/Quality Indicators

Graphic Symbol	Description
	Invalid configuration.
	Out of Service
	Data Quality degraded: uncertain, test, simulation, substitution, or out of specification.
	The device is not ready to operate.
No symbol displayed	I/O communication and quality good, configuration valid.



For the Analog Output instruction, the Invalid Configuration indicator appears under the following conditions:

- Configured maximum CV clamp value (Cfg_CVMax) is less than the minimum CV clamp value (Cfg_CVMin).
- Scaled CV engineering units minimum and engineering units maximum scaling parameters are set to the same value.
- Output raw minimum and raw maximum scaling parameters are set to the same value.
- Alarm Minimum On Time or Shelf Time invalid.

- Alarm Severity is set to a value less than 1 or greater than 1000.

TIP When the Not Ready indicator appears, you can find what condition helps prevent operation by following the indicators. Click the graphic symbol to open the faceplate. The Not Ready indicator appears next to the appropriate tab at the top of the faceplate to guide you to find the condition. When you navigate to the tab, the condition that helps prevent operation is flagged.







For the Analog Output Instruction, the Device Not Ready indicator appears under the following conditions:

- The device is out of service.
- There is a configuration error.
- Interlock is not OK.
- I/O Fault and shed requires reset.
- Device logic is disabled or there is no mode.

Alarm Indicators

One of these symbols appears on the left side of the label to indicate the described alarm condition and the alarm border and label background change color. The alarm border and label background blink if acknowledgment of an alarm condition is required. Once the alarm is acknowledged, the alarm border and label background remain the color that corresponds to the severity of the alarm.

Symbol	Border and Label Background	Description
	Red	Urgent-severity alarm
	Orange	High-severity alarm
	Yellow	Medium-severity alarm
	Magenta	Low-severity alarm
	White	Return to normal (no alarm condition), but a previous alarm has not been acknowledged.

See the Rockwell Automation Library of Process Objects Reference Manual, publication [PROCES-RM002](#), for more information.

Maintenance Bypass Indicator

The maintenance bypass indicator appears to the right of the label to indicate that a maintenance bypass has been activated. For the HART Analog Output instructions, the maintenance Bypass indicator appears when the Interlocks are bypassed.

Table 41 - Maintenance Bypass Indicator

Graphic Symbol	Description
	A maintenance bypass is active.
No symbol displayed	No maintenance bypass is active.

TIP When the Maintenance bypass indicator appears, you can find what condition was bypassed by following the indicators. Click the graphic symbol to open the faceplate. The Maintenance bypass indicator appears next to the appropriate tab at the top of the faceplate to help you find the bypass. Once you navigate to the tab, the bypassed item is flagged with this indicator.

Using a Display Element

The global objects for P_AOutHART can be found in the global object file (RA-BAS) Process Graphics Library.ggfx. Follow these steps to use a global object.

1. Copy the global object from the global object file and paste it in the display file.

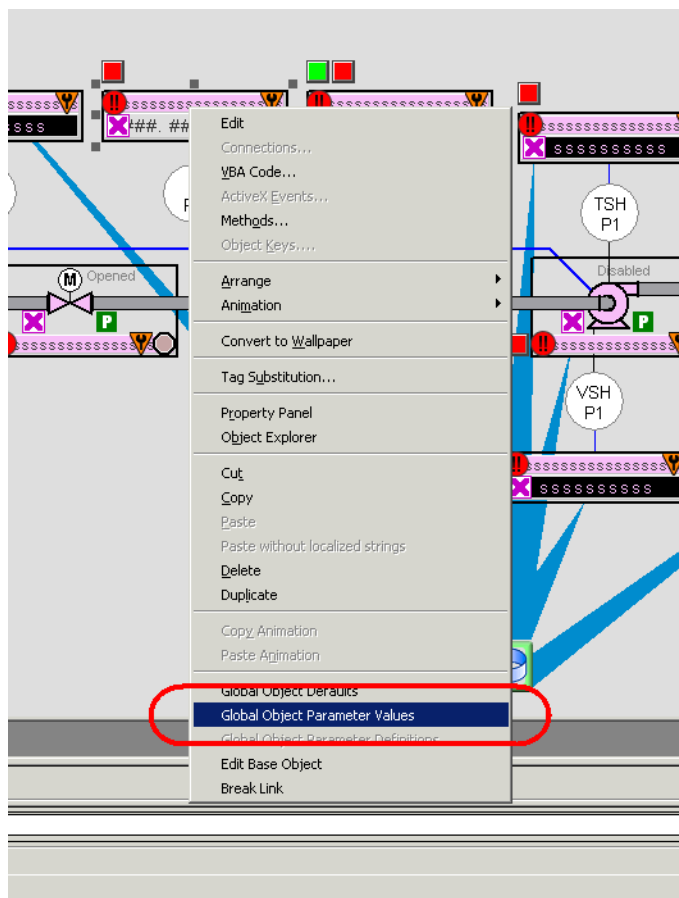

2. In the display, right-click the global object and choose Global Object Parameter Values.

The Global Object Parameter Values dialog box appears.

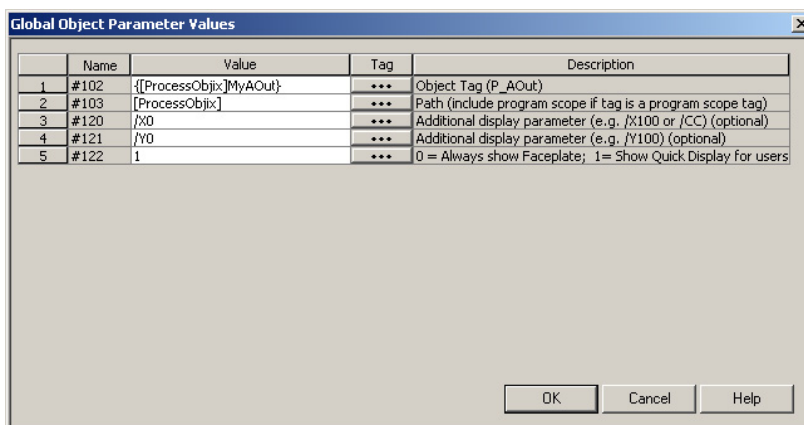

The global object parameters are as follows.

Parameter	Required	Description
#102	Y	Object tag to point to the name of the associated object Add-On Instruction in the controller.
#103	Y	Path that is used for display navigation features to other objects. Include program scope if tag is a program scope tag.
#120	N	Additional parameter to pass to the display command to open the faceplate. Typically used to define position for the faceplate.
#121	N	Additional parameter to pass to the display command to open the faceplate. If you define X and Y coordinates, separate the parameters so that #120 defines X and #121 defines Y. This separation permits these same parameters to be used in subsequent display commands that originate from the faceplate.
#122	Y	The following are the options for the global object display: 0 = Always show faceplate 1 = Show Quick Display for users without Maintenance access (Code C) 2 = Always show Quick Display

- In the Value column, type the tag or value as specified in the Description column.

TIP Click the ellipsis (...) to browse and select a tag.
Values for items marked '(optional)' can be left blank.

- Click OK.

Quick Display

The Quick Display screen provides means for operators to perform simple interactions with the P_AOutHART instruction instance. From the Quick Display, you can navigate to the faceplate for full access.

Figure 2 - P_AOutHART

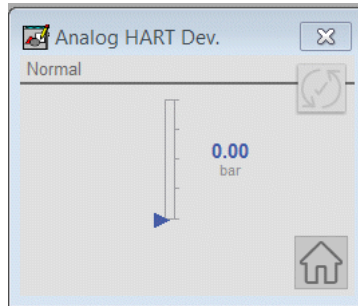

Basic Faceplate Attributes

The P_AOutHART faceplate consists of tabs, and each tab consists of one or more pages. The Operator (Home) tab is displayed when the faceplate is initially opened. The faceplate provides the means for operators, maintenance personnel, engineers, and others to interact with the P_AOutHART Add-On Instruction instance, which includes a view of its status and values. Faceplates also manipulate an instruction through its commands and settings. Click the appropriate icon on the left of the faceplate to access a specific tab.

This section provides an overview of the faceplate attributes that are common across the objects. More details are supplied in the individual section for each object. The title bar of the faceplate contains the value of local configuration tags Cfg_Tag and Cfg_Desc.

Operator (Home) Tab

The faceplate initially opens to the Operator (Home) tab. From here, an operator can monitor the device status and manually operate the device when it is in Operator mode.

The Operator tab shows the following information:

- Current mode (Operator, Program, Override, Maintenance, or Hand)
- Analog Output State (At Target, Ramping Down, Ramping Up, Clamped at min, Clamped at max, or disabled)
- Bar graph that displays the current output Control Variable (CV) as a pointer and the target CV as a line
- Rates of change increases and decreases for the output CV
- Interlock state

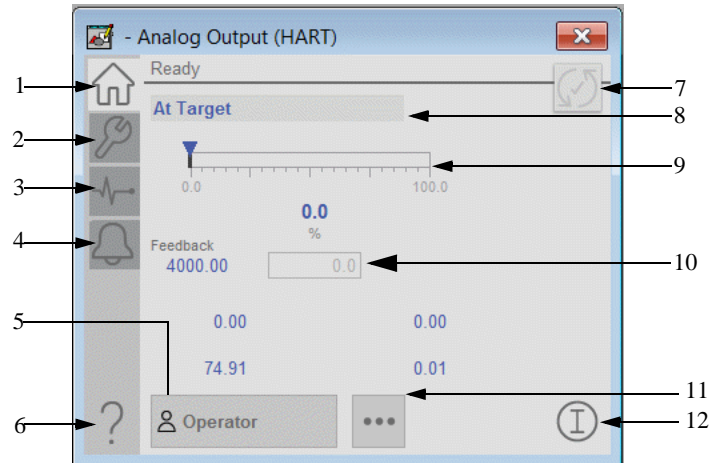

Table 42 - Operator Tab Description





Item	Action
1	Click to open the Operator tab.
2	Click to open the Maintenance tab.
3	Click to open the Diagnostics tab.
4	Click to open the Alarm tab.
5	Command Source Indicator. Click to change Command Source.
6	Click to open the Help file.
7	Click to reset and acknowledge all alarms.
8	Analog Output State
9	Ramp Up/Down Control Slider
10	Click to enter Operator CV setting.
11	Click to navigate to an object with more information.
12	Interlock indicator

If the object is configured to have an interlock object (`Cfg_HasIntlkObj` is true), the interlock indication becomes a button that opens the faceplate of the source object that is used as an interlock. (This source object is often a `P_Intlk` interlock object). If the object is not configured as above, the interlock is an indicator only.

See Rockwell Automation Library of Process Objects: Logic Instructions Reference Manual, publication [PROCES-RM013](#), for more information.

One of these symbols appears to indicate the described interlock condition.

Table 43 - Interlock Status Indicators

Graphic Symbol	Description
	One or more conditions not OK
	Non-bypassed conditions OK
	All conditions OK, bypass active
	All conditions OK

Maintenance Tab

Maintenance personnel use the information and controls on the Maintenance tab in order to adjust device parameters. Also, the tab is used to troubleshoot and temporarily work around device problems, and disable the device for routine maintenance.

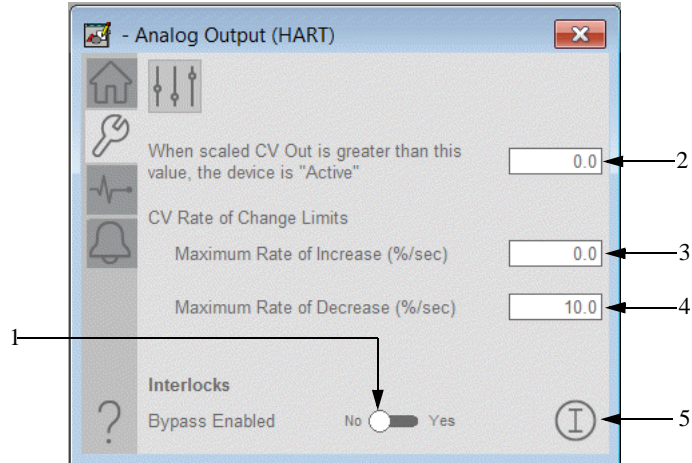

Table 44 - Maintenance Tab Description

Item	Description
1	Click YES to bypass checking of bypassable interlocks and permissives.
2	Type the CV value above which the device shows as “Active”. When Val_CVOut is greater than this value, Sts_Active is set to 1, and the HMI shows the graphic symbol in the active state (for example, control valve shown as Open). When Val_CVOut is less than or equal to this value, Sts_Active is set to 0, and the HMI shows the graphic symbol in the inactive state (for example, control valve shown as Closed).
3	Type the Rate of Change Limit for increasing the Control Variable.
4	Type the Rate of Change Limit for decreasing the Control Variable.
5	Interlock status indicator.

Advanced Properties Display

The Advanced Properties Display provides access to device configuration parameters and ranges, and options for device and I/O setup. The advanced maintenance, engineering tab, and the HMI configuration tab can be reached from the Advanced Properties Display. This tab is used for initial system commissioning or later system changes.

Advanced Maintenance Tab

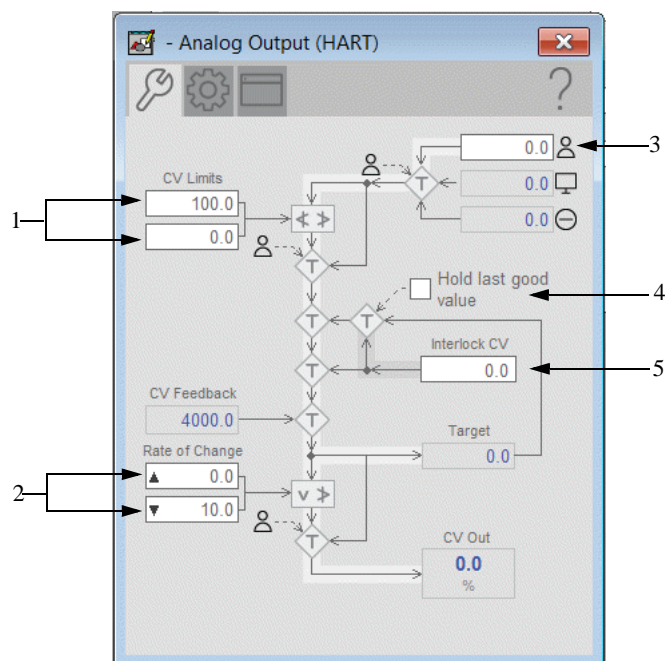

Table 45 - Advanced Properties Display Description

Item	Description
1	Controlled Variable clamp limits. Type the clamping limits for the Controlled Variable in engineering units. Clamp limits are enforced in Operator and Program command sources only.
2	Type the maximum allowed value for the Rate of Change Limit in engineering units per second. A value of zero allows any rate of change to be input by the Program or Operator.
3	Type the Operator command source Controlled Variable Target in engineering units. This entry is available in Operator command source and Maintenance command source.
4	Check, and the Controlled Variable holds at the last good value when an Interlock trips or an I/O Fault occurs. Clear this, and the Controlled Variable goes to the Interlock Controlled Variable value when an Interlock trips or an I/O Fault occurs.
5	Type the interlock target Controlled Variable in engineering units. This value is used for the Controlled Variable when interlocked or on an I/O Fault, but only if Hold Last Good Value is not selected.

Engineering Tab

The Engineering tab provides access to device configuration parameters and ranges, options for device and I/O setup, and displayed text. Also, the Engineering tab provides faceplate-to-faceplate navigation settings for initial system commissioning or later system changes.

The Engineering tab is divided into three pages.

Engineering Tab Page 1

On Page 1 of the Engineering tab, you can configure the mode, description, label, tag, and CV units for the device.

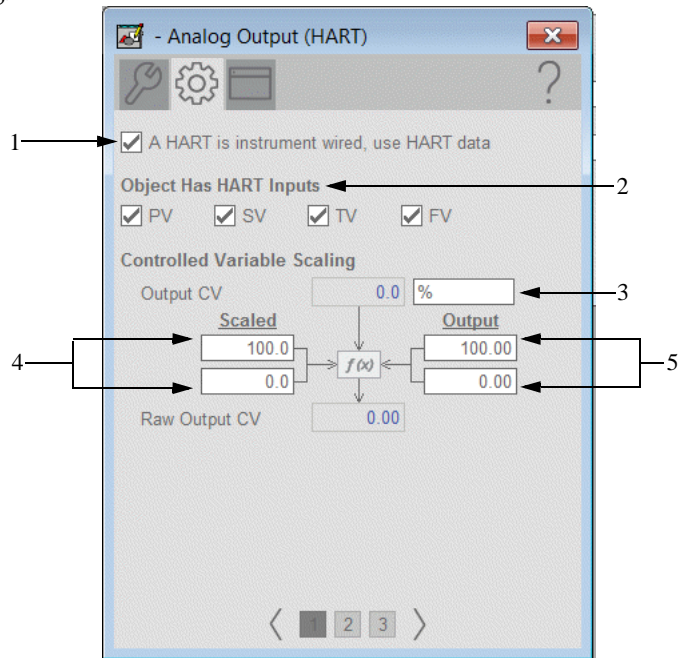

Table 46 - Engineering Tab Page 1 Description

Item	Description
1	Check to use HART data from the connected instrument. Clear this checkbox to use local data.
2	Check when HART is configured with PV, SV, TV, or FV.
3	Engineering Units label.
4	Type values for the maximum and minimum scaled (engineering units). IMPORTANT: The 'Use scaling configuration parameters from HART module' checkbox on Engineering Tab Page 2 must be clear for this field to be available.
5	Type values for the maximum and minimum output (Raw) scaling ranges. IMPORTANT: The 'Use scaling configuration parameters from HART module' checkbox on Engineering Tab Page 2 must be clear for this field to be available.

Engineering Tab Page 2

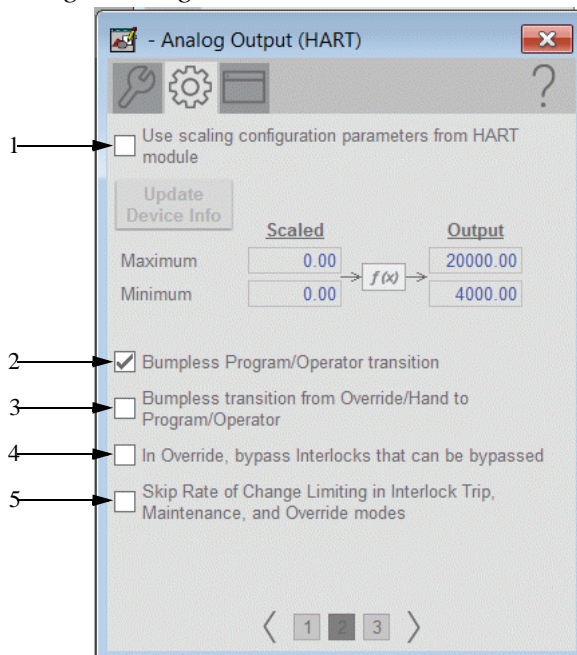

Table 47 - Engineering Tab Page 2 Description

Item	Description
1	Check to use HART scaling for raw and engineering units ranges. Clear this checkbox to use manually entered ranges.
2	Check so that when this parameter is: <ul style="list-style-type: none"> On, the operator settings track the program settings when command source is Program, and program settings track the operator settings when the command source is Operator. Transition between command sources is bumpless. Off, the operator settings and program settings retain their values regardless of command source. When the command source is changed, the value of a limit can change, such as from the Program-Set value to the Operator-Set value.
3	Check so that Program and Operator settings track when the command source is Hand or Override.
4	Check to bypass Interlocks that can be bypassed while in Override command source.
5	Check to have the CV immediately go to its target value or configured Interlock CV value when an Interlock trips or the instruction is placed in Maintenance or Override Mode. Clear to have the CV always use rate of change limit (ramping) of the CV output.

Engineering Tab Page 3

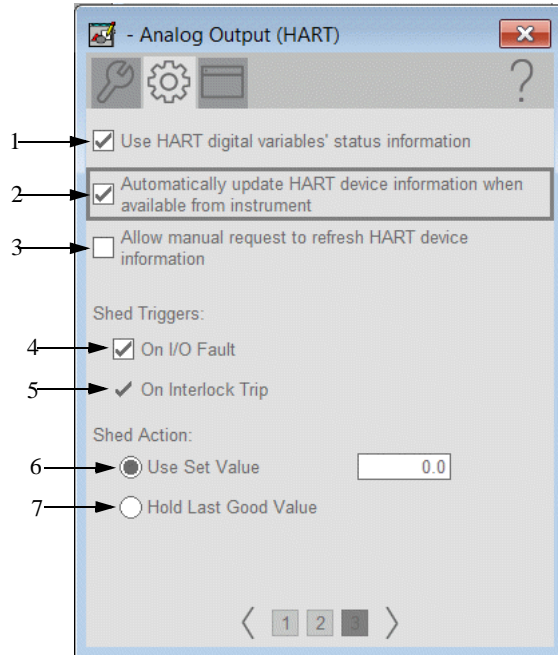

Table 48 - Engineering Tab Page 3 Descriptions

Item	Description
1	Check to use HART data from the connected instrument. Clear this checkbox to use local data.
2	Check to update automatically the HART device information when available. Clear to disable automatic updates of HART device information.
3	Check to allow operator to update HART device information. Clear to help prevent manual updates of HART device information by the operator.
4	Check so that an I/O Fault triggers a shed of the output to the configured shed set value or to hold last good output. The shed condition is latched internally to the Add-On Instruction. When the I/O Fault condition clears, a Reset command is required to return to normal operation. Clear this checkbox so that the I/O Fault condition does not affect operation (but can still generate an alarm).
5	This selection cannot be changed. The configured shed action always takes place on an interlock trip.
6	Choose this option to set the analog output to the configured shed set value when a condition configured as a shed trigger occurs.
7	Choose this option to hold the analog output at its last good value when a condition configured as a shed trigger occurs.

HMI Configuration Tab Page 1

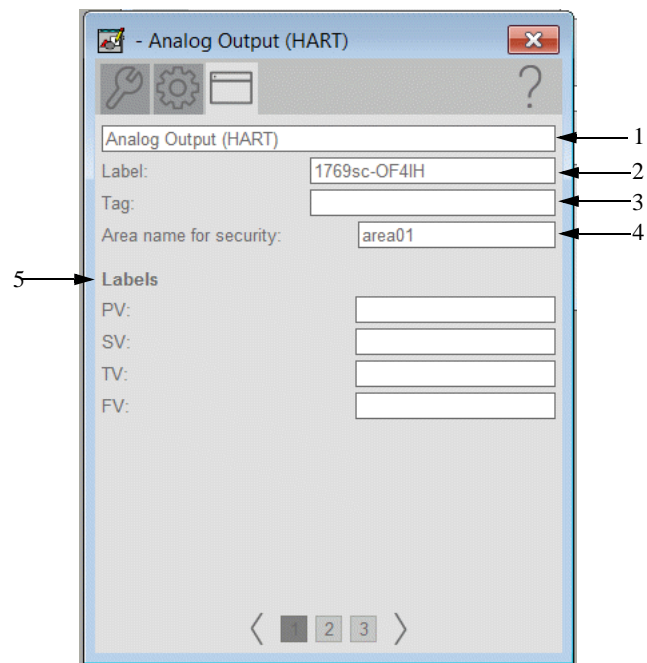

Table 49 - HMI Configuration Tab Page 1 Description

Item	Description
1	Type the name of the HMI screen.
2	Type the label of the analog output.
3	Type the tag of the analog output.
4	Type the area name of the analog output.
5	Type the labels to show on the Operator tab for PV, SV, TV, and FV.

HMI Configuration Tab Page 2

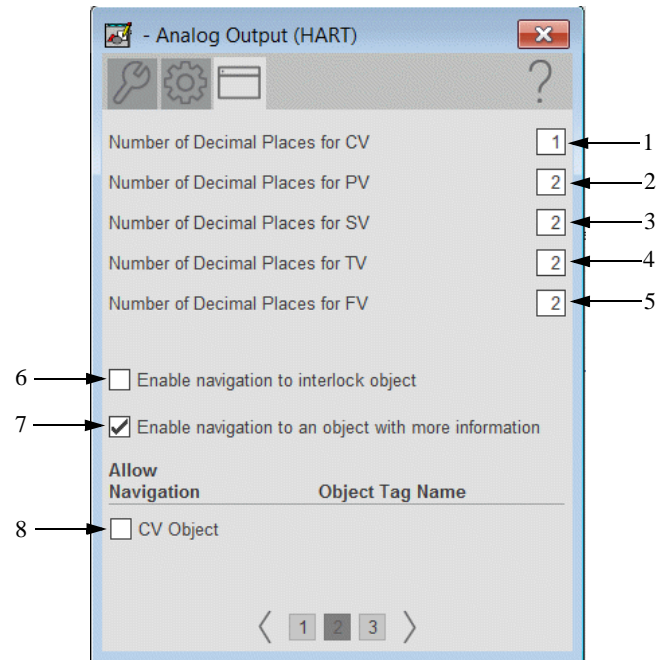

Table 50 - HMI Configuration Tab Page 2 Description

Item	Description
1	Type the number of decimal places to be shown for the Control Variable.
2	Type the number of decimal places to be shown for the Primary Variable.
3	Type the number of decimal places to be shown for the Secondary Variable.
4	Type the number of decimal places to be shown for the Third Variable.
5	Type the number of decimal places to be shown for the Fourth Variable.
6	Check if an interlock instruction is used with this output.
7	Check to enable navigation to an object with more information (Cfg_HasMoreObj is set to true.) This can be configured to navigate to an AOI backing tag or a UDT tag that has HMI_Type and HMI_Lib defined. For example, there is a motor with the tag name P101 and there is a need to have the more information button navigate to the parent P_LLS object. A tag is created for the P_LLS object that is given the alias P101_More. When the more information button is pressed on the motor, it links to P101_More. This will open the faceplate for the LLS object.
8	Check to permit navigation to the faceplate of the object that is the source of the CV for this object.

HMI Configuration Tab Page 3

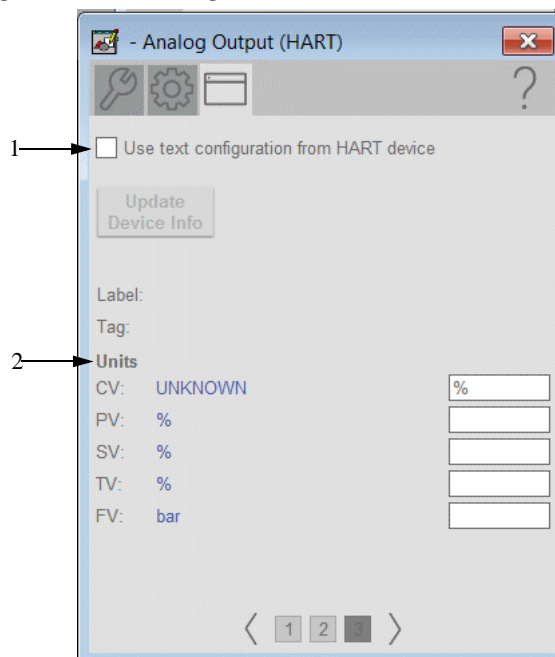
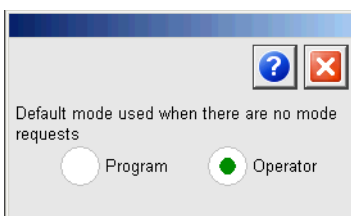

Table 51 - HMI Configuration Tab Page 3 Description

Item	Description
1	Check to use HART text for Description, Label, and Tag. Clear the checkbox to use manual input (see Engineering Tab Page 1 on page 120).
2	Type the CV, PV, SV, TV, and FV engineering units for display on the HMI.

Command Source Configuration Display



This display lets you select the default command source for the object by selecting the appropriate command source.

IMPORTANT If no command source is requested, a change to the default command source causes a change to the command source of the instruction.

You must have FactoryTalk View security code E to select the default command source on this display.

Diagnostics Tab

The Diagnostics tab provides indications that are helpful to diagnose or help prevent device problems. These device problems can include specific reasons that a device is 'Not Ready', device warnings and faults, warning and fault history, and predictive/preventive maintenance data.

The Diagnostics tab displays possible reasons for the device not being ready.

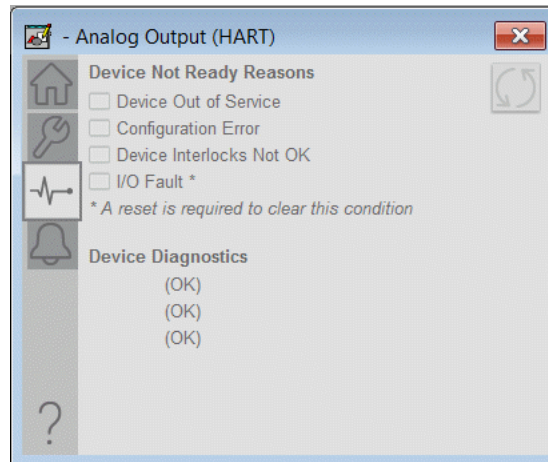

Alarms Tab

The Alarms tab displays each configured alarm for the P_AOutHART instruction. The icon on the tab for the alarms page changes color to show the current active alarm status. A blinking alarm icon indicates that one or more alarms must be acknowledged or the device must be reset.

When the Reset and Acknowledge All Alarms button is enabled, the border around the alarm blinks. This blinking indicates that the alarm requires acknowledgment or reset. The Alarm Acknowledge button is enabled if the alarm requires acknowledgment. Click the button with the check mark to acknowledge the alarm.

IMPORTANT Alarms are provided for the analog value only. There are no alarms for the digital PV, SV, TV, or FV.

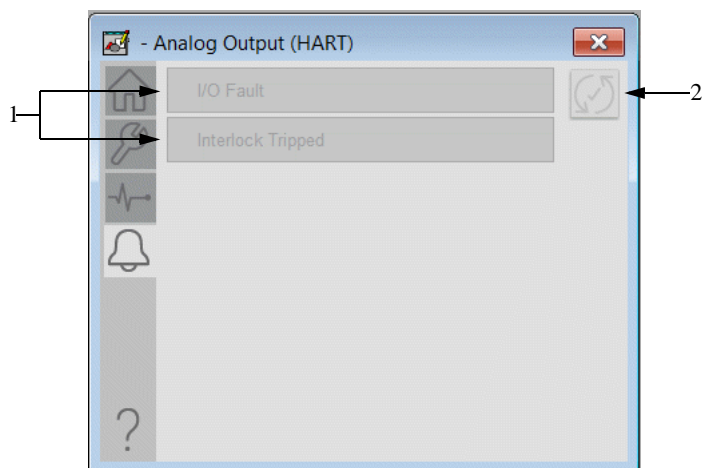





Table 52 - Alarms Tab Description

Item	Description
1	Alarm descriptions
2	Click to reset and acknowledge all alarms.

Alarm Indicators

One of these symbols appears on the left of the label to indicate the described alarm condition. The alarm border blinks if acknowledgment of an alarm condition is required. Once the alarm is acknowledged, the alarm border remains the color that corresponds to the severity of the alarm and the alarm symbol is still present.

Table 53 - Alarm Indicator Descriptions

Symbol	Border Color	Description
	Red	Urgent-severity alarm
	Orange	High-severity alarm
	Yellow	Medium-severity alarm
	Magenta	Low-severity alarm
	White	Return to normal (no alarm condition), but a previous alarm has not been acknowledged

See Rockwell Automation Library of Process Objects Reference Manual, publication [PROCES-RM002](#), for more information.

Module Messaging Reference

This section shows message (MSG) instruction configuration for all HART Analog I/O modules.

If you use the RUNG import procedure that is outlined on [page 26](#) to create the module Add-On Instruction instances, these MSG configurations are set for you on import. However, you can refer to this section if you are having trouble getting HART device information or diagnostics from your module.

Configuration for ControlLogix I/O (1756), Spectrum Controls POINT I/O (1734sc), and Ex I/O (1719)

MSG configuration for the Allen-Bradley® ControlLogix® I/O (1756) HART analog modules, Spectrum Controls POINT I/O™ (1734sc) HART analog modules, and Allen-Bradley Ex I/O (1718 and 1719) HART analog modules is applicable to the following modules:

- 1756-IF8H
- 1756-IF8IH
- 1756-IF16H
- 1756-IF16IH
- 1756-OF8H
- 1756-OF8IH
- 1734sc-IE2CH
- 1734sc-IE4CH
- 1734sc-OE2CIH
- 1718-CF4H (configured as input)
- 1718-CF4H (configured as output)
- 1718-IF4HB
- 1719-CF4H (configured as input)
- 1719-CF4H (configured as output)
- 1719-IF4HB

MSG Instruction to Get Device Information

This section covers the MSG instruction that is used to get device information from tag <base>_DevInfoMSG.

Configuration Tab

The Configuration tab can be used to set the Message Type, Destination Element, and other MSG settings.

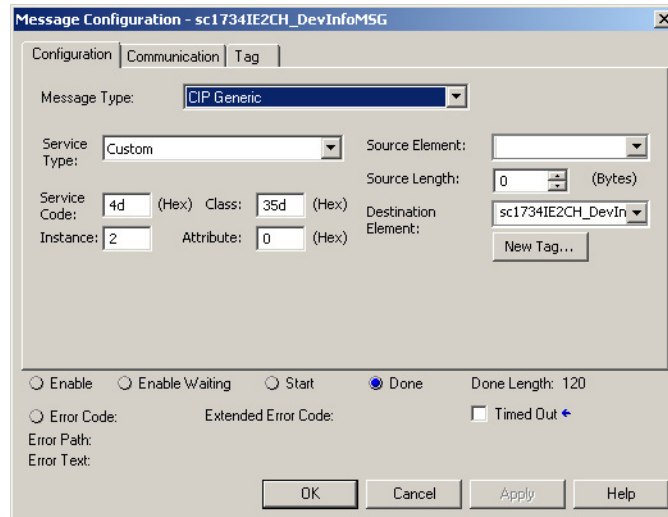

The following table shows example message configuration settings for a 1734sc-IE2CH module.

Field	Value
Type	Click the pull-down arrow and choose CIP Generic.
Service Type	Click the pull-down arrow and choose Custom.
Service Code	Type 4d.
Class	Type 35d.
Instance	This field is set by Add-On Instruction logic as required.
Attribute	Type zero.
Source Element	None, leave blank.
Source Length	Type zero.
Destination Element	Click the pull-down arrow and choose the following: Tag: <base>_DevInfoBuf (device information buffer) Type: HART_DevInfo (not an array)

Communication Tab

The Communication tab is used to set the Path. Use Browse to navigate to and select the Path.

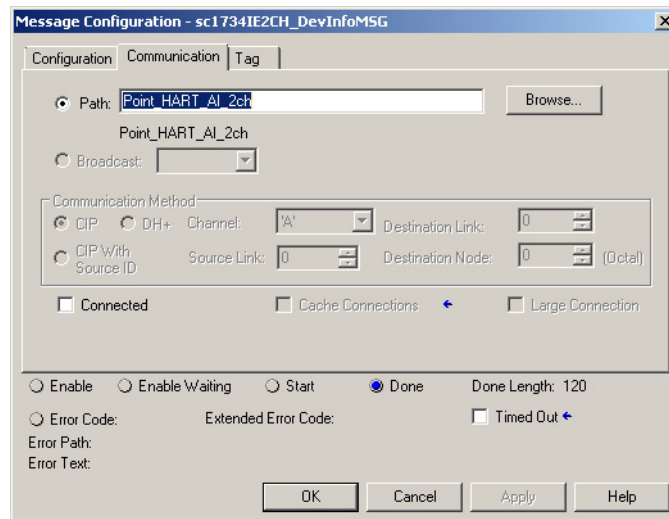

The following table shows the message communication settings for the example 1734sc-IE2CH module

Field	Value
Path	Click Browse and choose the path to the HART module name in the I/O configuration tree.
Connected	Leave the box blank (unchecked).

MSG Instruction to Get Module Diagnostic Data

This section covers the MSG instruction that is used to get diagnostic data from tag <base>_ModDiagMSG.

Configuration Tab

The Configuration tab can be used to set the Message Type, Destination Element, and other MSG settings.

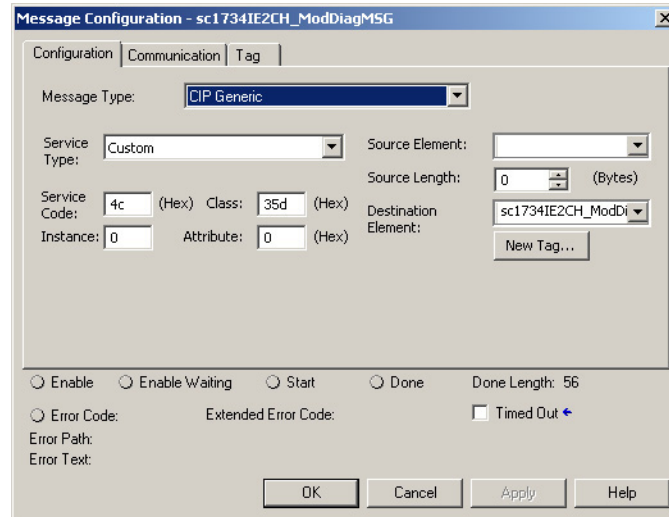

The following table shows example message configuration settings for a 1734sc-IE2CH module.

Field	Value
Type	Click the pull-down arrow and choose CIP Generic.
Service Type	Click the pull-down arrow and choose Custom.
Service Code	Type 4c.
Class	Type 35d.
Instance	This field is set by Add-On Instruction logic, as required.
Attribute	Type zero.
Source Element	None, leave blank.
Source Length	Type zero.
Destination Element	Click the pull-down arrow and choose the following: Tag: <base>_ModDiagBuf[0] (Module Diagnostic Buffer) Type: SINT array. The size of the array is [28]*number of I/O channels on the module: <ul style="list-style-type: none"> • 2-channels: SINT[56] • 4-channels: SINT[112] • 8-channels: SINT[224] • 16-channels: SINT[448] The MSG instruction must point to element [0] of the array.

Communication Tab

This information is identical to Device Information Message

Field	Value
Path	Click Browse and choose the path to the Point I/O HART module name in the I/O configuration tree.
Connected	Leave the box blank (unchecked).

MSG configuration for FLEX I/O (1794) HART Analog Module

This section covers the following modules:

- 1794-IF8IH
- 1794-OF8IH
- 1794-IF8IHNFXT

MSG Instructions to Get Device Information

There are three MSG instructions that are used to get device information:

- MSG 1 of 3 to get Device Information (Tag: <base>_DevInfoMSG1)
- MSG 2 of 3 to get Device Information (Tag: <base>_DevInfoMSG2)
- MSG 3 of 3 to get Device Information (Tag: <base>_DevInfoMSG3)

All three MSG instructions are configured the same. The module Add-On Instruction manages the differences in Instance and Attribute values for the three MSG instruction instances.

IMPORTANT The Flex™ I/O communication adapter acts as a proxy for the HART I/O module. The module Add-On Instruction for the Flex I/O HART modules must have the correct slot number configured in Cfg_Slot.

Configuration Tab

The Configuration tab can be used to set the Message Type, Destination Element, and other MSG settings.

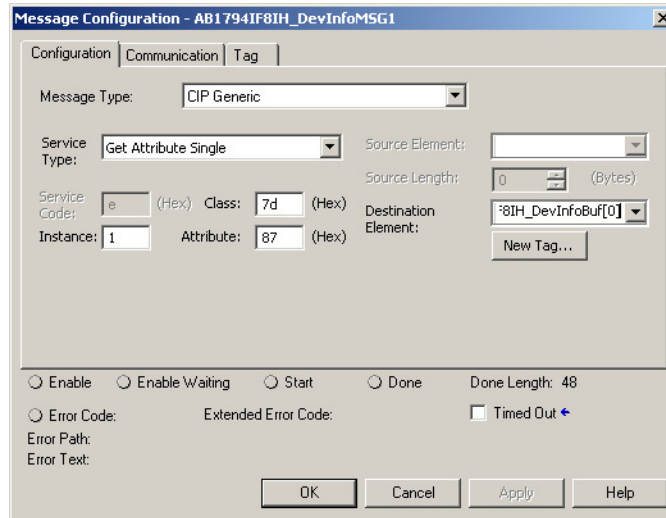

The following table shows example message configuration settings for a 1794-IF8IH module.

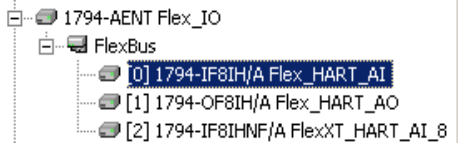
Field	Value
Type	Click the pull-down arrow and choose CIP Generic.
Service Type	Click the pull-down arrow and choose Get Attribute Single.
Service Code	0e (hex) (field cannot be entered for Get Attribute Single service)
Class	Type 7d.
Instance	This field is set by the module Add-On Instruction. However, you must properly configure the slot number in Cfg_Slot. For the example below, the slot number is 0.  (The instance value is simply the slot number plus 1.)
Attribute	This field is set by the module Add-On Instruction as required.
Source Element	None (field cannot be entered for Get Attribute Single service).
Source Length	0 (field cannot be entered for Get Attribute Single service).
Destination Element	Tag: <base>_DevInfoBuf[0] IMPORTANT: The TAG type for the DevInfoBuf for 1794 modules only is SINT[60], an array of 60 bytes. Each MSG instruction must point to element [0] of the array.

Communication Tab

The Communication tab can be used to set the Path.

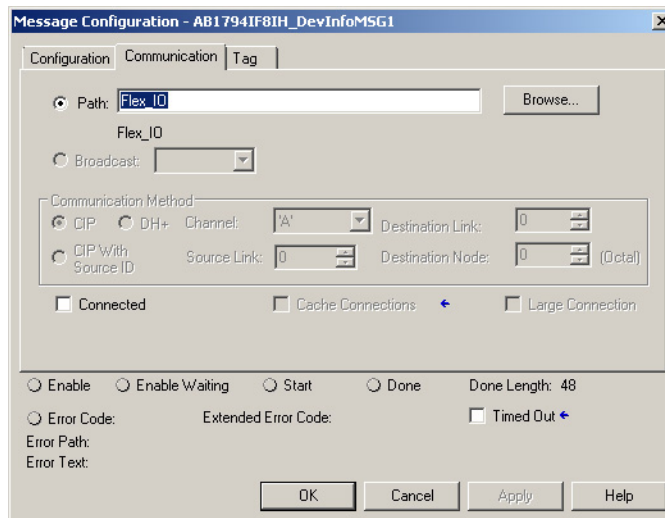

The following table shows the message communication settings for the example 1794-IF8IH module.

Field	Value
Path	Click Browse and choose the path to the FLEX I/O adapter name in the I/O configuration tree. IMPORTANT: For 1794 modules only, the FLEX I/O adapter, and not the FLEX I/O HART module, must be the target of the MSG instruction. The FLEXBus does not support CIP messaging, and the I/O adapter serves as a proxy for the HART I/O Module. In the example above, the FLEX I/O adapter, named 'Flex_IO', is used in the MSG Path.
Connected	Leave the box blank (unchecked).

MSG to Reset the Device Information Available Flag

This section covers the MSG instruction that is used to reset the Device Information Available Flag data from tag <base>_ResetDevInfoMSG.

Configuration Tab

The Configuration tab can be used to set the Message Type, Source Element, and other MSG settings

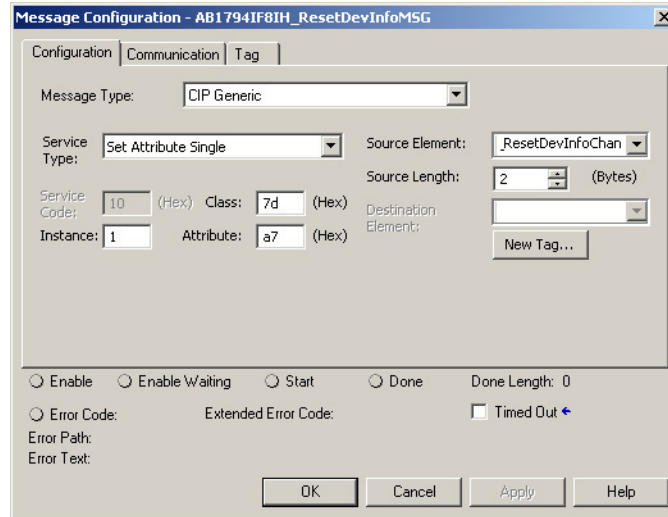

The following table shows the message configuration settings for the example 1794-IF8IH input module.

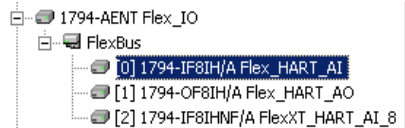
Field	Value
Message Type	Click the pull-down arrow and choose CIP Generic.
Service Type	Click the pull-down arrow and choose Set Attribute Single.
Service Code	10 (field cannot be entered for Set Attribute Single service).
Class	Type 7d.
Instance	This field is set by the module Add-On Instruction, as required. However, you must properly configure the slot number in Cfg_Slot. For the example, the slot number shown is 0.  (The instance value is simply the slot number plus 1.)
Attribute	This field is set by the module Add-On Instruction, as required.

Field	Value
Source Element	Click the pull-down arrow and choose the following: Tag: <base>_ResetDevInfoChan (type INT) The value of this tag is set by the module Add-On Instruction, as required.
Source Length	Type 2.
Destination Element	None (field cannot be entered for Set Attribute Single service).

Communication Tab

This information is the same as the Get Device Information MSG instructions.

Field	Value
Path	Click Browse and choose the path to the FLEX I/O adapter name in the I/O configuration tree. IMPORTANT: For 1794 modules only, the FLEX I/O adapter, and not the FLEX I/O HART module, must be the target of the MSG instruction. The FlexBus does not support CIP messaging, and the I/O adapter serves as a proxy for the HART I/O Module.
Connected	Leave the box blank (unchecked).

MSG Instruction to Get Module Diagnostic Data

This section covers the MSG instruction that is used to get diagnostic data from tag <base>_ModDiagMSG.

Configuration Tab

The Configuration tab can be used to set the Message Type, Destination Element, and other MSG settings.

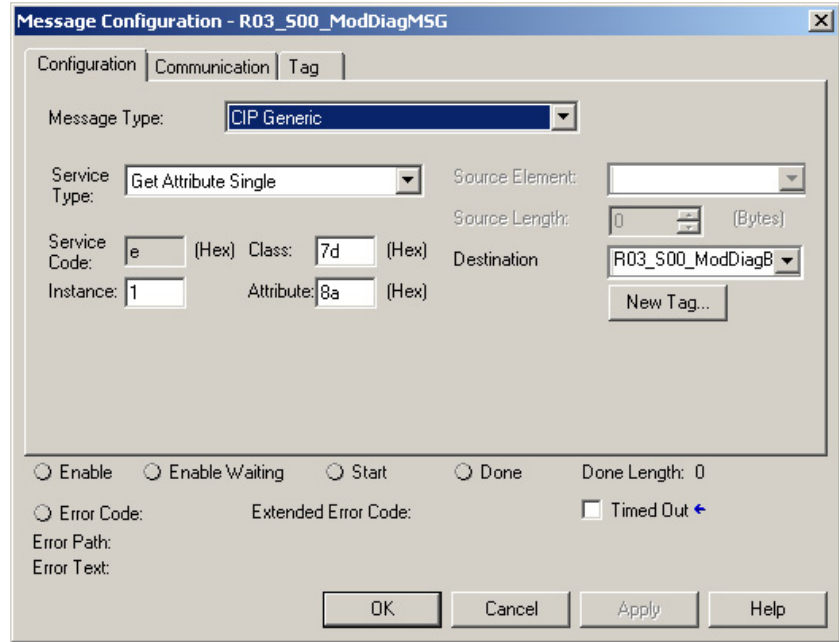

The following table shows example message configuration settings for a 1794IF8IH module.

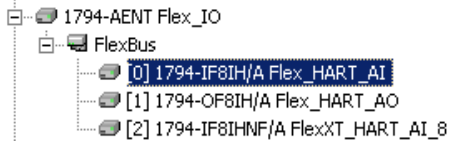
Field	Value
Type	Click the pull-down arrow and choose CIP Generic.
Service Type	Click the pull-down arrow and choose 'Get Attribute Single.'
Service Code	Always e
Class	Type 7d.
Instance	This field is set by the module Add-On Instruction. However, you must properly configure the slot number in Cfg_Slot. For the example below, the slot number is 0.  (The instance value is simply the slot number plus 1.)
Attribute	Type 8a
Source Element	None, leave blank.
Source Length	Always 0 for type 'Get Attribute Single.'

Field	Value
Destination Element	Click the pull-down arrow and choose the following: Tag: <base>_ModDiagBuf[0] (Module Diagnostic Buffer) Type: SINT array. The size of the array is: • 8-channels: SINT[224] The MSG instruction must point to element [0] of the array.

Communication Tab

This information is identical to Device Information Message

Field	Value
Path	Click Browse and choose the path to the FLEX I/O adapter name in the I/O configuration tree. IMPORTANT: For 1794 modules only, the FLEX I/O adapter, and not the FLEX I/O HART module, must be the target of the MSG instruction. The FLEXBus does not support CIP messaging, and the I/O adapter serves as a proxy for the HART I/O Module. In the example above, the FLEX I/O adapter, named 'Flex_IO', is used in the MSG Path.
Connected	Leave the box blank (unchecked).

Spectrum Controls Compact I/O (1769sc)

There is no message configuration for the following Spectrum Controls Compact I/O™ (1769sc) HART analog modules:

- 1769sc-IF4IH
- 1769sc-OF4IH

These modules do not use message instructions to get HART device information.

Configuration for Redundant I/O (1715) Modules

This section covers the following modules:

- 1715-IF16
- 1715-OF8I

Firmware in these modules must be at least major revision 3 (FW3.x or later) for these modules to support HART communication. In addition, the module must have HART pass-through messaging enabled.

The rung imports provided include an OTL instruction to enable pass-through messaging.

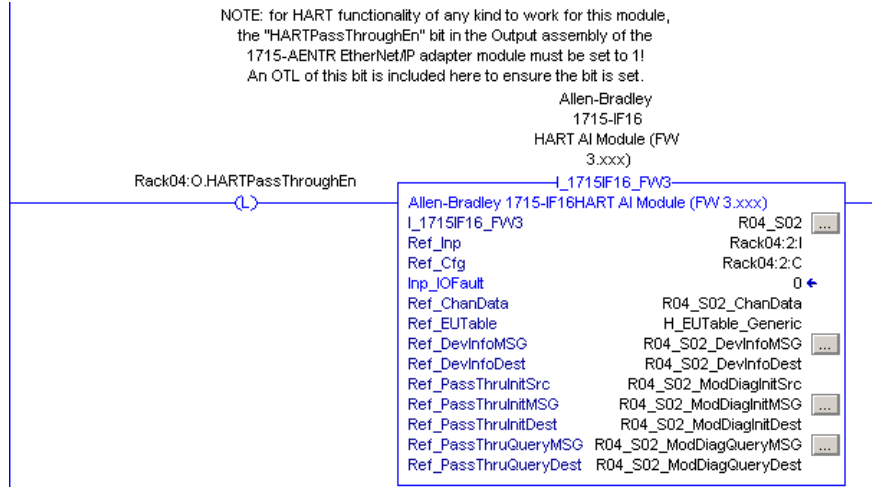

MSG Instruction to Get Device Information

This section covers the MSG Instruction that is used to get device information. The MSG tag name is <base>_DevInfoMSG.

Configuration Tab

Use the Configuration tab to set the Message Type, Destination Element, and other MSG settings.

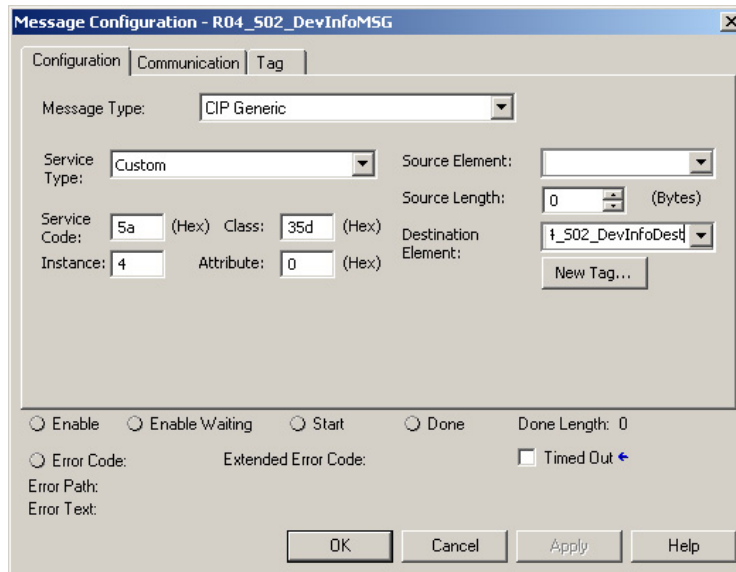

The following table shows example message configuration settings for a 1715-IF16 module.

Field	Value
Message Type	Click the pull-down arrow and choose CIP Generic.
Service Type	Click the pull-down arrow and choose Custom.
Service Code	Type 5a.
Class	Type 35d.
Instance	This field is set by Add-On Instruction logic as required.
Attribute	Type zero.
Source Element	None, leave blank.
Source Length	Type zero.
Destination Element	Click the pull-down arrow and choose the following: Tag: <base>_DevInfoBuf Type: HART_DevInfo (not an array)

Communication Tab

Use the Communication tab to set the path to the module. Click Browse and navigate to the module in the I/O configuration tree to select the path.

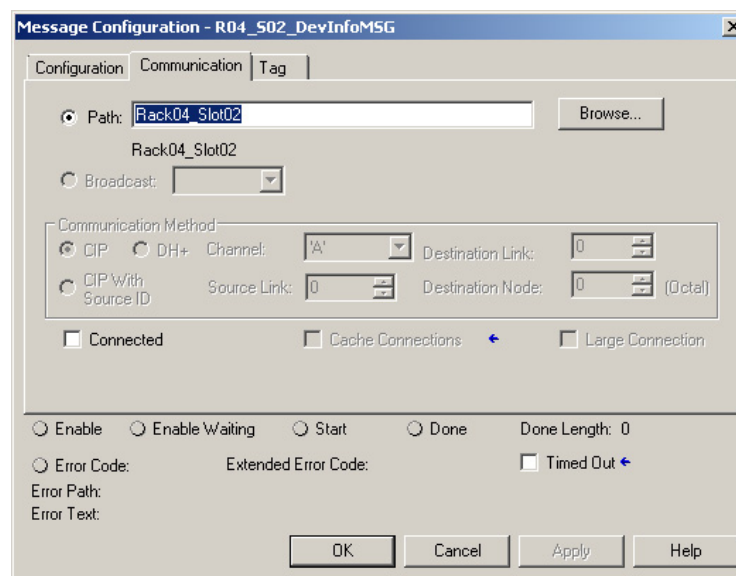

The following table shows the message communication settings for the example 1715-IF16 module.

Field	Value
Path	Click Browse and choose the path to the module name in the I/O configuration tree.
Connected	Leave the box blank (unchecked).

MSG Instruction to Initiate Retrieval of Module Diagnostic Data

This section covers the MSG instruction that is used to initiate retrieval of diagnostic data from the device. The MSG tag name is <base>_MSG.ModDiagInitMSG.

Configuration Tab

Use the Configuration tab to set the Message Type, Destination Element, and other MSG settings.

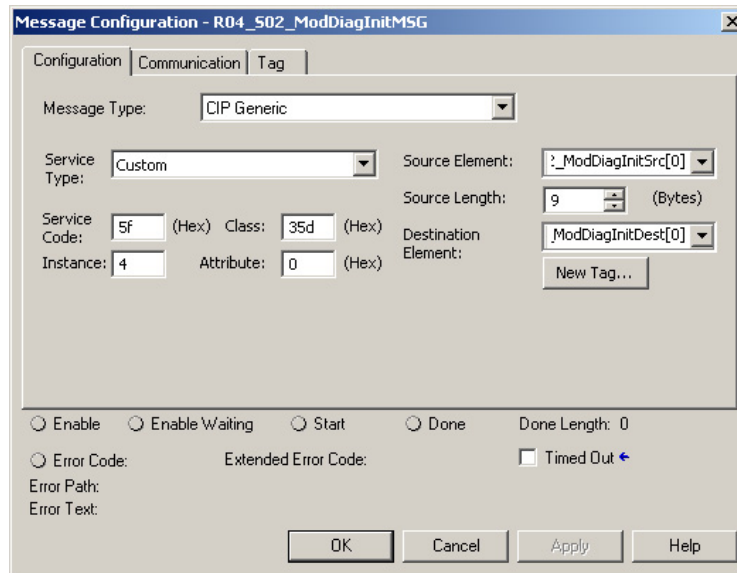

The following table shows the message configuration settings for the example 1715-IF16 module.

Field	Value
Message Type	Click the pull-down arrow and choose CIP Generic.
Service Type	Click the pull-down arrow and choose Custom.
Service Code	Type 5f.
Class	Type 35d.
Instance	This field is set by Add-On Instruction logic as required.
Attribute	Type zero.

Field	Value
Source Element	Click the pull-down arrow and choose the following: Tag: <base>_ModDiagInitSrc[0] Type: SINT[10]
Source Length	Type 9.
Destination Element	Click the pull-down arrow and choose the following: Tag: <base>_ModDiagInitDest[0] Type: SIINT[10]

Communication Tab

Use the Communication tab to set the path to the module. The path is the same as for the Device Information message.

See [page 141](#).

MSG Instruction to Complete Retrieval of Module Diagnostic Data

This section covers the MSG instruction that is used to complete the retrieval of diagnostic data from the device. The MSG tag name is <base>_MSG.ModDiagInitMSG.

Configuration Tab

Use the Configuration tab to set the Message Type, Destination Element, and other MSG settings.

The screenshot shows the 'Message Configuration - R04_S02_ModDiagQueryMSG' dialog box. It has three tabs: 'Configuration', 'Communication', and 'Tag'. The 'Configuration' tab is selected. The settings are as follows:

- Message Type: CIP Generic (dropdown)
- Service Type: Custom (dropdown)
- Source Element: ModDiagInitDest[2] (dropdown)
- Source Length: 1 (spin box) (Bytes)
- Service Code: 60 (Hex) (text box)
- Class: 35d (Hex) (text box)
- Destination Element: ModDiagQueryDest (dropdown)
- Instance: 4 (text box)
- Attribute: 0 (Hex) (text box)
- New Tag... (button)
- Enable: (radio button)
- Enable Waiting: (radio button)
- Start: (radio button)
- Done: (radio button)
- Done Length: 0 (text box)
- Timed Out: (checkbox)
- Error Code: (text box)
- Extended Error Code: (text box)
- Error Path: (text box)
- Error Text: (text box)
- Buttons: OK, Cancel, Apply, Help

The following table shows the message configuration settings for the example 1715-IF16 module.

Field	Value
Message Type	Click the pull-down arrow and choose CIP Generic.
Service Type	Click the pull-down arrow and choose Custom.
Service Code	Type 60.
Class	Type 35d.
Instance	This field is set by Add-On Instruction logic as required.
Attribute	Type zero.
Source Element	Click the pull-down arrow and choose the following: Tag: <base>_ModDiagInitDest[2] Type: SINT (This is member [2] of the data received by the 'Init' message.)
Source Length	Type 1.
Destination Element	Click the pull-down arrow and choose the following: Tag: <base>_ModDiagQueryDest Type: SIINT[50]

Communication Tab

Use the Communication tab to set the path to the module. The path is the same as for the device information message.

See [page 141](#).

Determine the 1794-IF8IHNFXT Module

Data Type Selection

This section describes how to select the data type to choose the AOI/Rung Import file for the 1794-IF8IHNFXT module.

1. From the controller organizer, double-click controller tags to open the tag monitor.



2. Locate the tag with the HART Extended Status. This tag appears after the basic input tag and adds a digit at the end, such as :I2 or :I3.

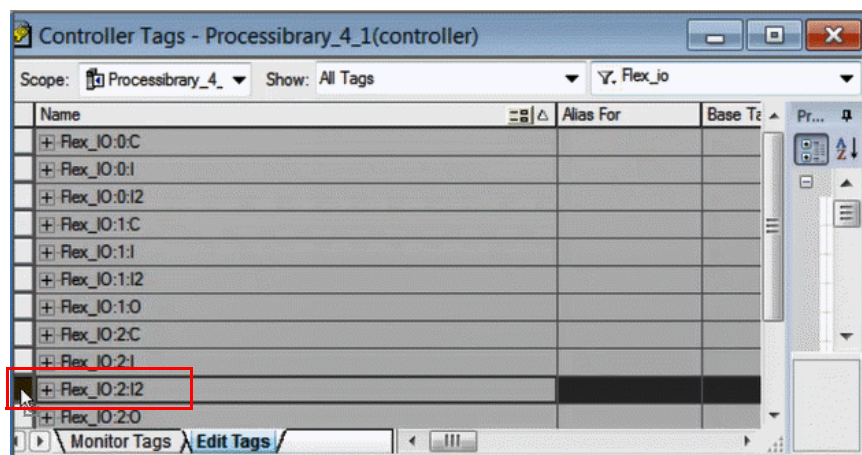

3. Determine the Data Type.

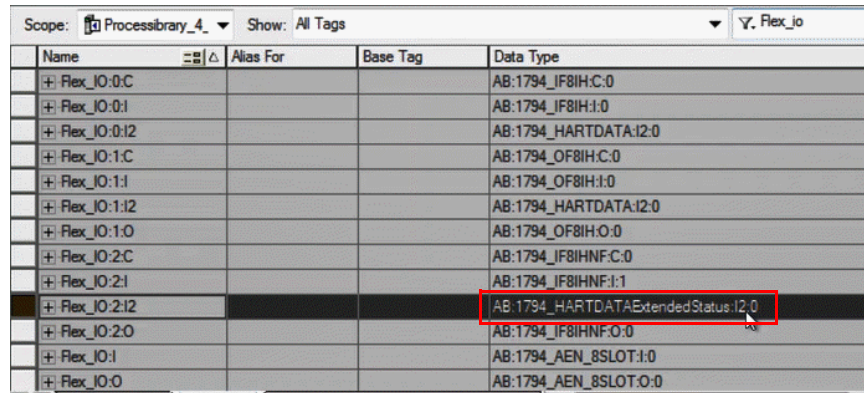

Name	Alias For	Base Tag	Data Type
Flex_JO-0:C			AB:1794_IF8IH:C:0
Flex_JO-0:I			AB:1794_IF8IH:I:0
Flex_JO-0:I2			AB:1794_HARTDATA:I2:0
Flex_JO-1:C			AB:1794_OF8IH:C:0
Flex_JO-1:I			AB:1794_OF8IH:I:0
Flex_JO-1:I2			AB:1794_HARTDATA:I2:0
Flex_JO-1:O			AB:1794_OF8IH:O:0
Flex_JO-2:C			AB:1794_IF8IHNF:C:0
Flex_JO-2:I			AB:1794_IF8IHNF:I:1
Flex_JO-2:I2			AB:1794_HARTDATAExtendedStatus I2:0
Flex_JO-2:O			AB:1794_IF8IHNF:O:0
Flex_JO:I			AB:1794_AEN_8SLOT:I:0
Flex_JO:O			AB:1794_AEN_8SLOT:O:0

4. Import the matching AOI/RUNG file based on the data type.

- If the data type ends in I2:0, as seen in example, the correct AOI/Rung files are:
 - I_1794IF8IHNFXT2_4.10.00_AOIL5X
 - I_1794IF8IHNFXT2_4.10.00_RUNG.L5X
- If the data type ends in I:0, the correct AOI/Rung files are:
 - I_1794IF8IHNFXT_4.10.00_AOIL5X
 - I_1794IF8IHNFXT_4.10.00_RUNG.L5X

I_PAX_HART_DEVICE Configuration Example

This appendix describes how to configure the I_PAX_HART_DEVICE instruction to bring data from a HART device using a 5094-IF8IH module to a P_AInHART instruction. This example requires a a Logix 5380 or Logix 5580 controller using Version 33 or later.

Download and install the 5094 HART Analog Add-On Profile

The Add-on Profile can be accessed from the [Product Compatibility and Download Center](#).

1. Search for “5094-HART”

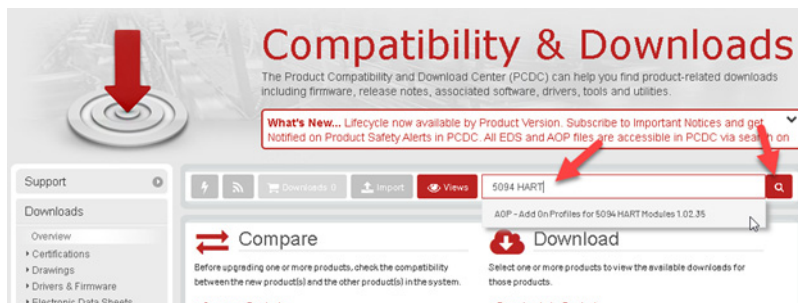

2. Select Download.

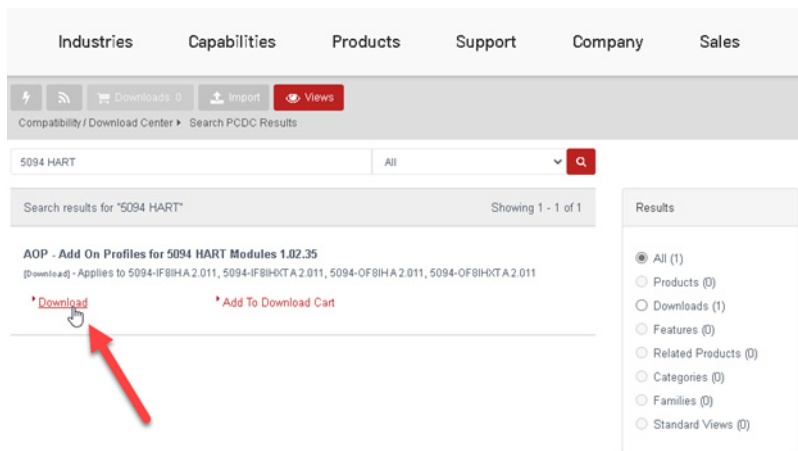

3. Select Files, then select the Add-on Profiles, EDS Files, and Firmware.

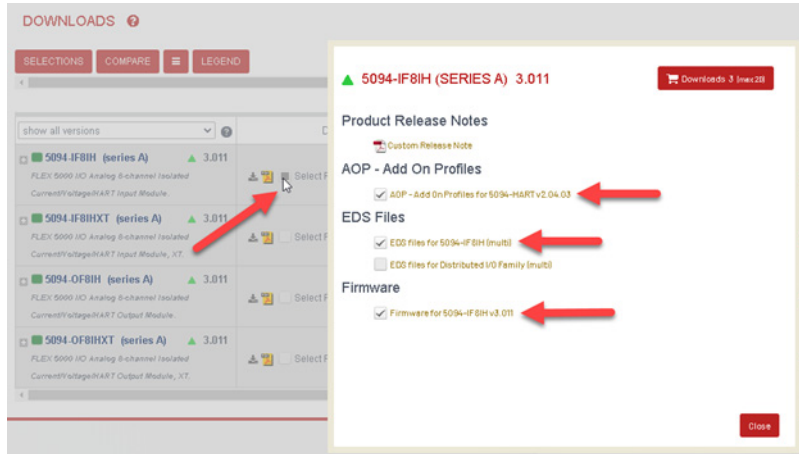

4. Select Download Now.

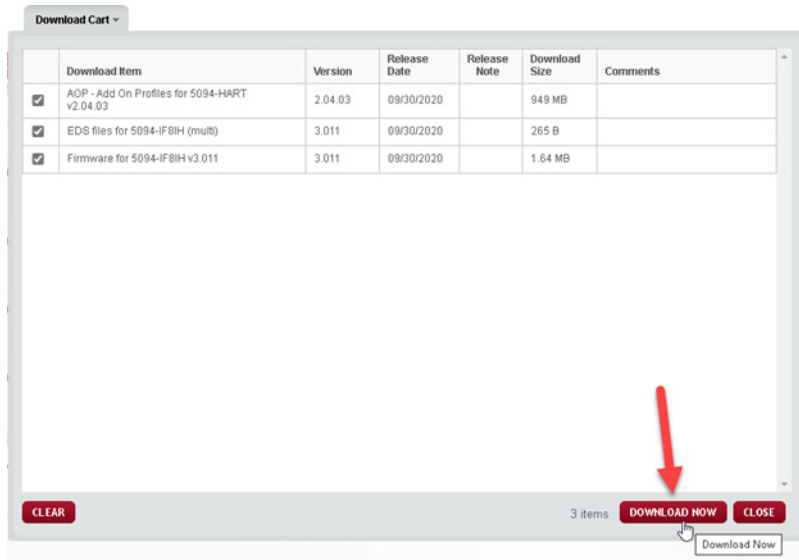

The files are downloaded into a zip file using the download manager.

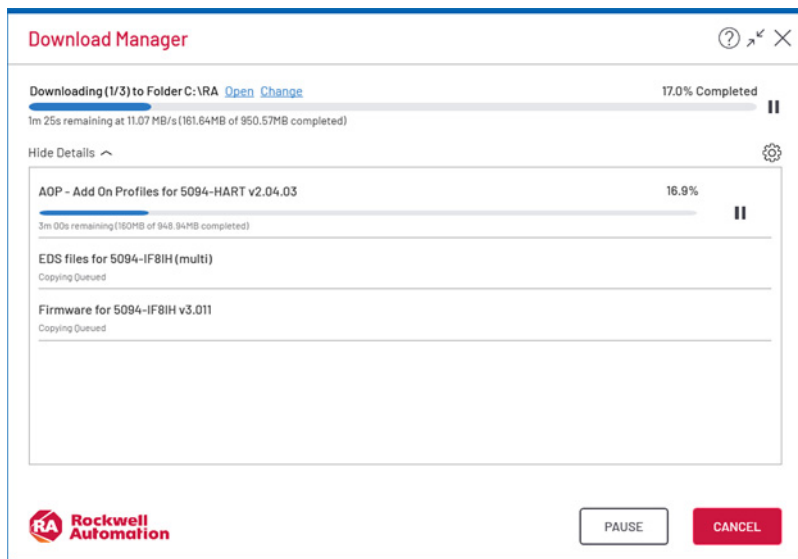

5. Extract the files from the ZIP folder.
6. Run mpsetup.exe as Administrator.

Add the 5094 Adapter Module to the Project I/O Configuration

1. In the controller Organizer for your project, select the Ethernet network to be used to communicate with the 5094 I/O. Right-click and select “New Module...”

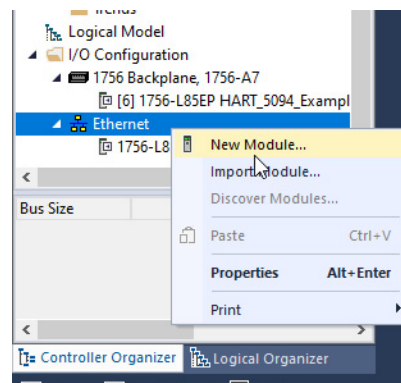

2. Select the catalog number of the 5094 adapter you are using and Create.

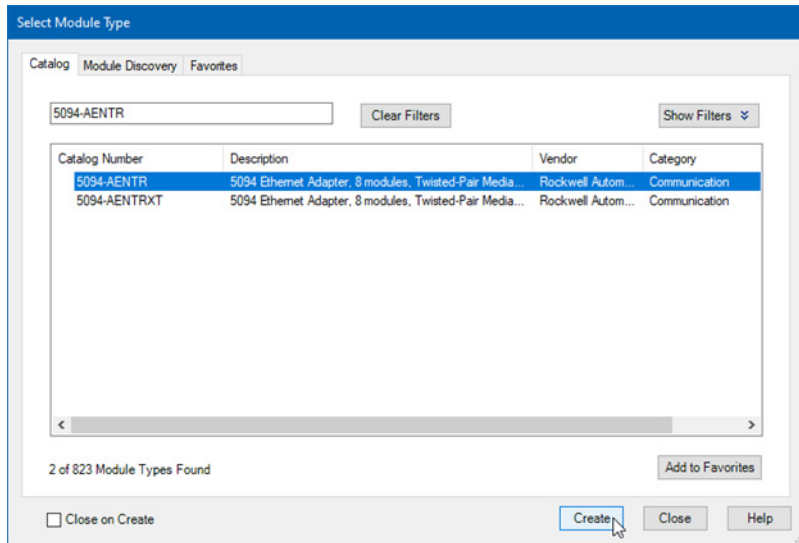

3. Enter the name and IP address for the adapter.

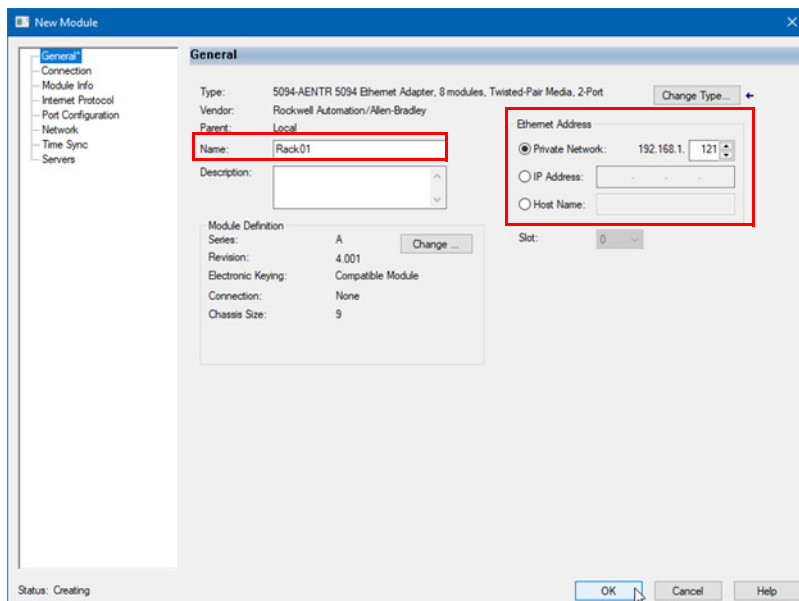

Add the 5094-IF8IH Module to the Project I/O Configuration

1. In the controller Organizer for your project, select the 5094 Backplane. Right-click and select “New Module...”

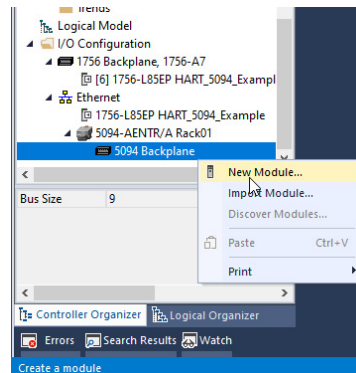

2. Select the 5094-IF8IH module and “Create”.

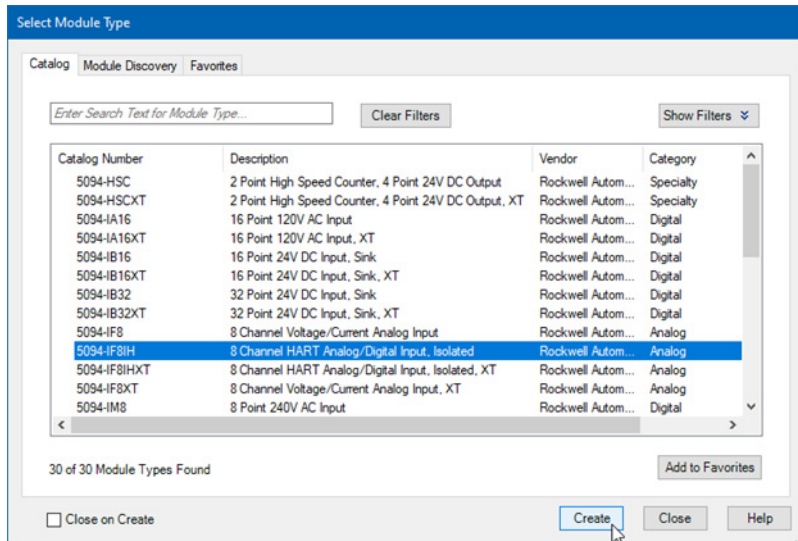

3. Select OK to accept the module defaults.

Add the HART Device to the Project I/O Configuration

1. In the controller Organizer for your project, select the HART network. Right-click and select “New Module...”

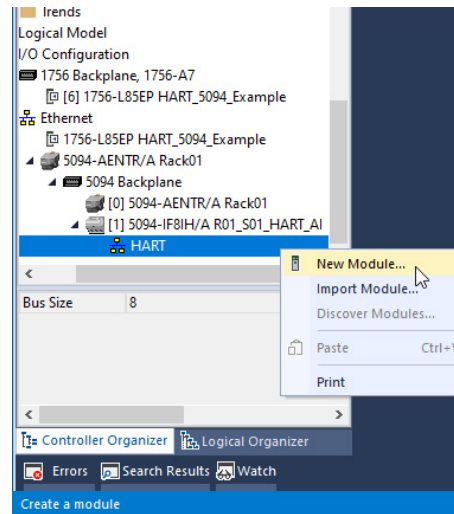

2. Select the type of HART transmitter and “Create”.

In this example, we are using an Endress+Hauser Deltabar-S device.

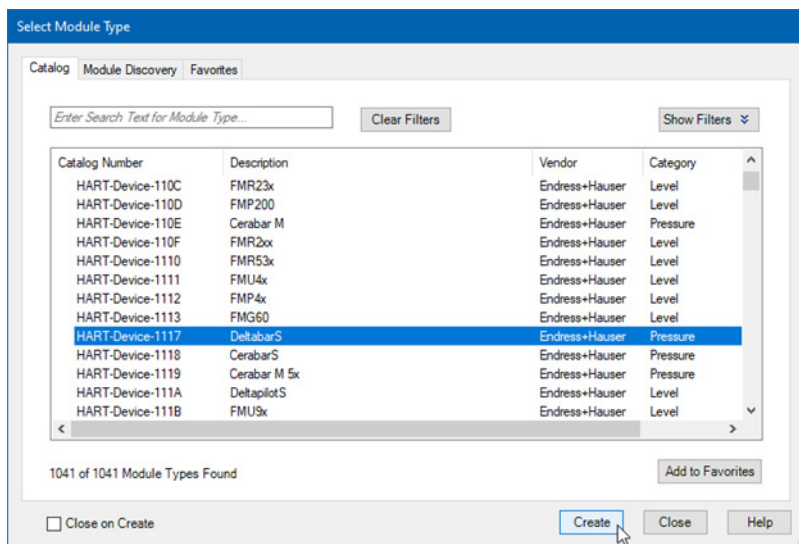

- In the New Module dialog box, enter a name for the transmitter then select Change in the Module Definition section.

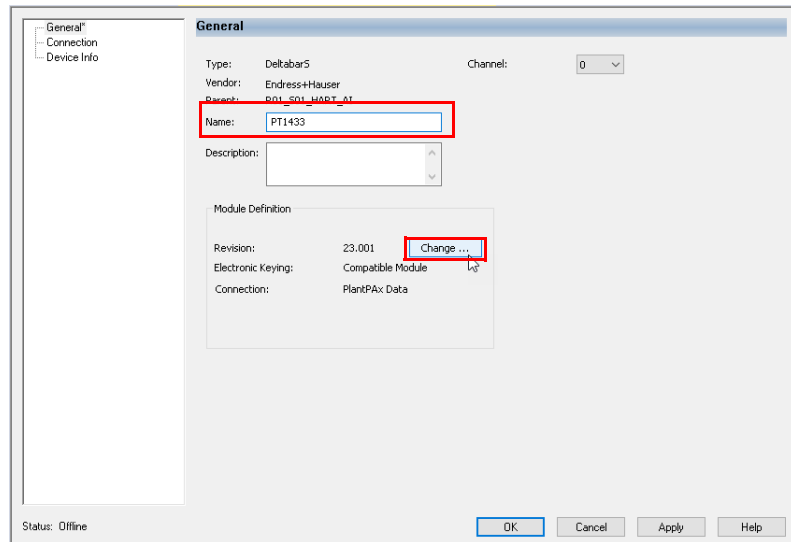

- Change the Connection type to PlantPAx Data.

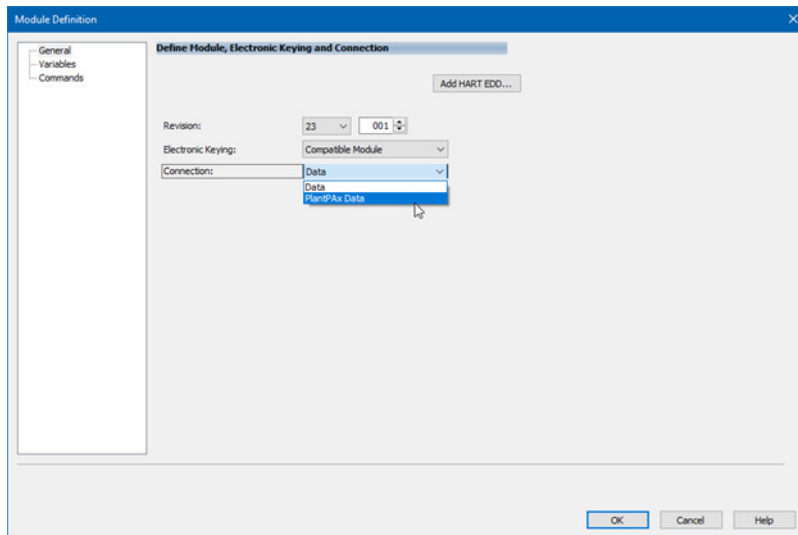

- Changing the connection type causes a change in data types for the input and output data.

Select Yes to change the module definition.

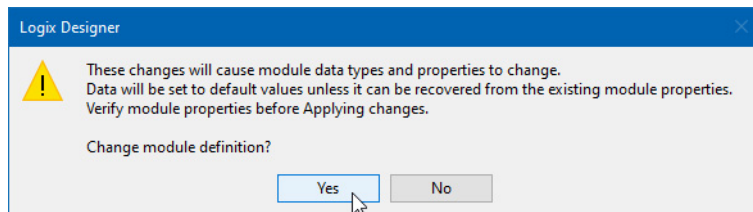

6. Verify the information and Select OK.

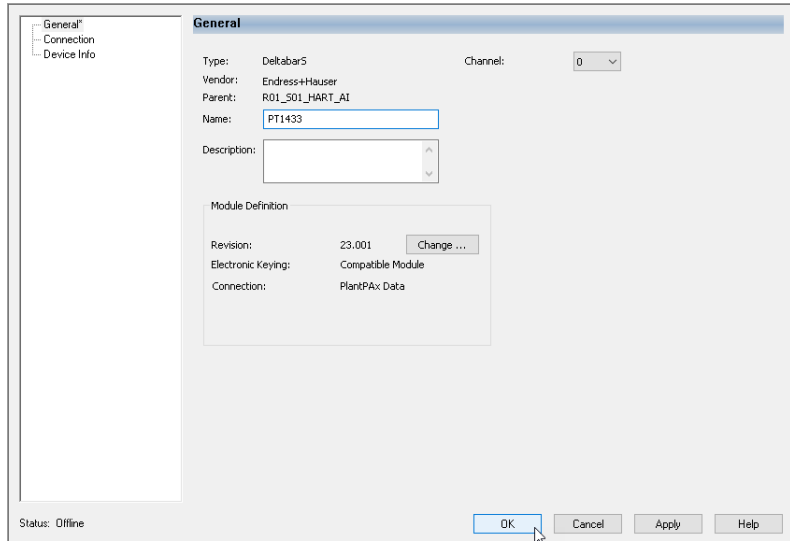

Configure the Analog Input Channel

1. In the controller Organizer for your project, select the 5094-IF8IH module created. Double-click to open the Properties dialog.

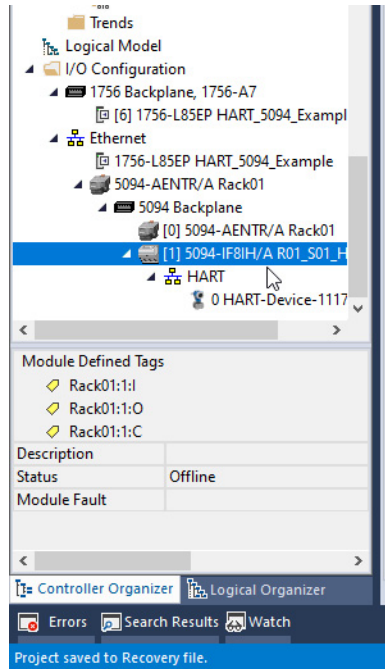

2. Select the channel where the transmitter is connected. In this example, it is Channel 00. Select the box to Enable HART communication on this channel.

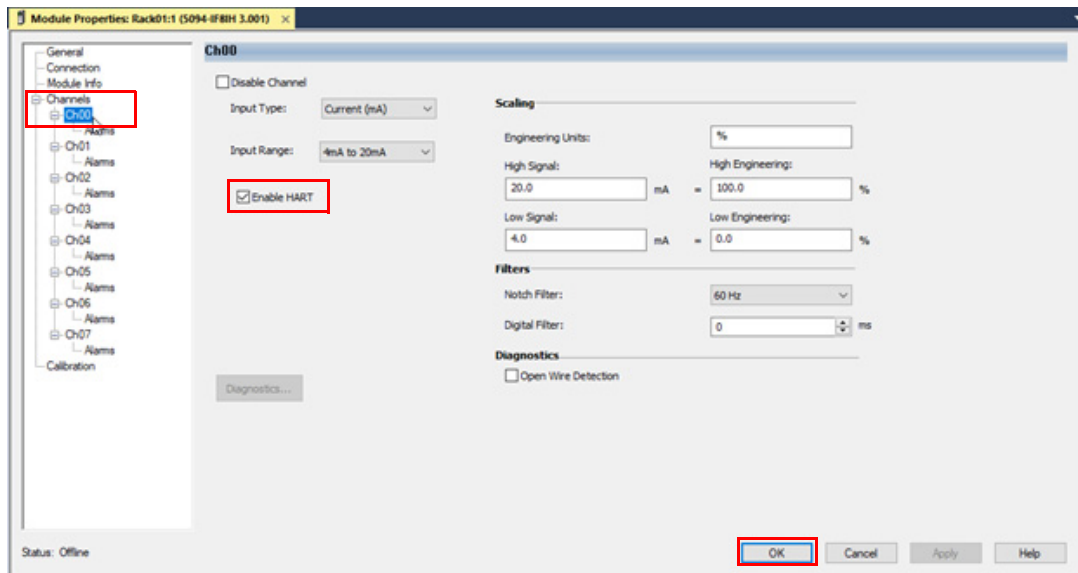

Import the I_PAX_HART_DEVICE and P_AInHART Add-On Instructions

1. Open the Ladder Diagram routine where you wish to place the I_PAX_HART_DEVICE rung.
2. “Right-click on the left margin of the logic and select “Import Rungs...”

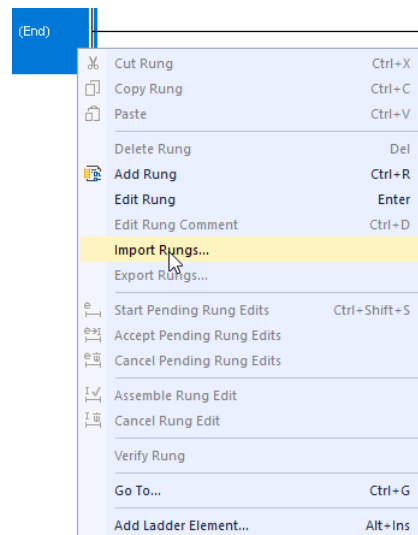

3. “Navigate to where you downloaded the Endress+Hauser Library, to the Premier Integration Object Library folder. Select the I_PAX_HART_DEVICE_4.10.04_RUNG.L5X file and click Open.

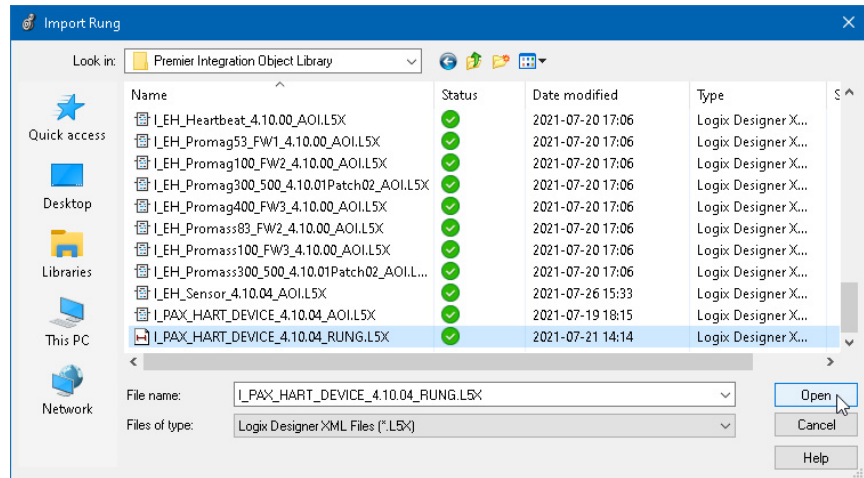

- Select the Tags folder under “References” in the Import Configuration display. The default names use “PT101” and “PT_101”. You can replace these names with the names you want to use in your application. For this example, we are using the “PT1433” device we created above for the input data, and “PT_1433” for the other names. Use the Find/Replace function to change the final names for import.

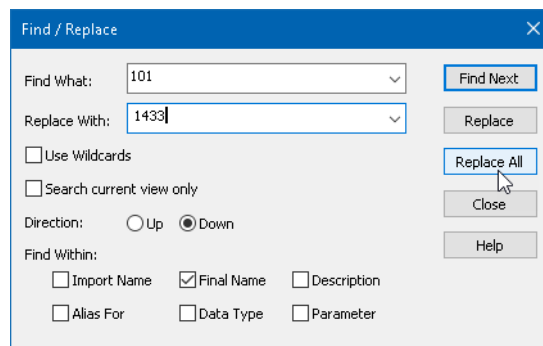
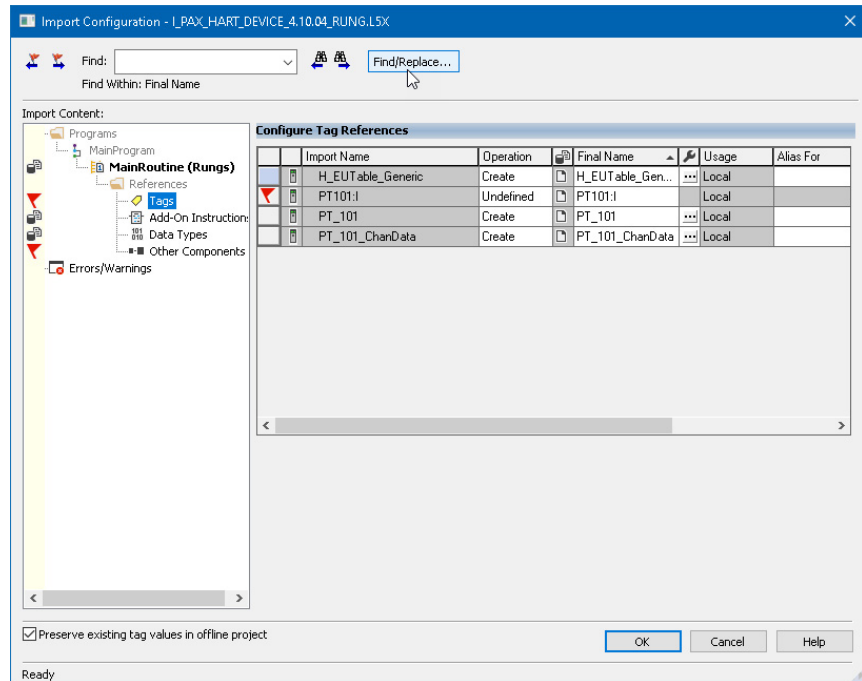

- Close the Find / Replace dialog. The required tags and rung logic will be created on import. Click OK.

The I_PAX_HART_DEVICE Add-On Instruction is imported, and the rung of logic is created which places the HART data from the transmitter, including engineering units text, into the PT_1433_ChanData tag for use by the P_AInHART instruction.

- In the Controller Organizer, expand the “Assets” folder, and right-click on the “Add-On Instructions” folder. Select “Import Add-On Instruction...”

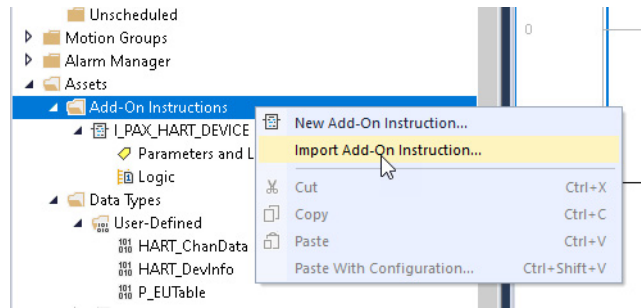

- Navigate to where you downloaded the Library of Process Objects 4.10.04 and select the Process Object Library folder. Select the P_AInHART_4.10.04_AOI.L5X file and click Open.

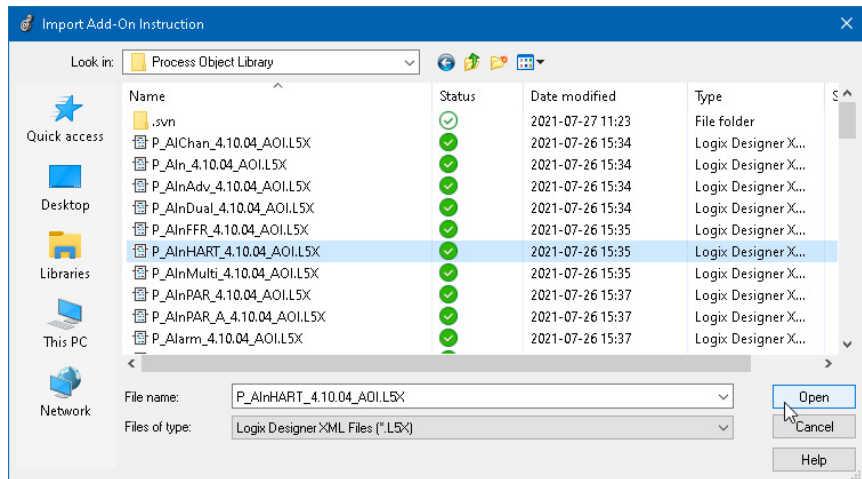

- Select OK in the Import Configuration dialog.

Create the P_AInHART instance

- Open the Function Block Diagram routine where you want to place the P_AInHART instance.

2. Right-click on the workspace and select Add element...

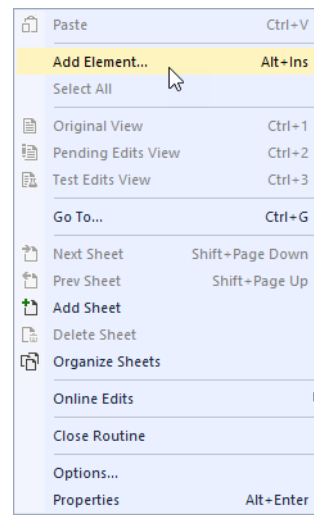

3. In the FBD Element field, type P_AInHART. Select OK.

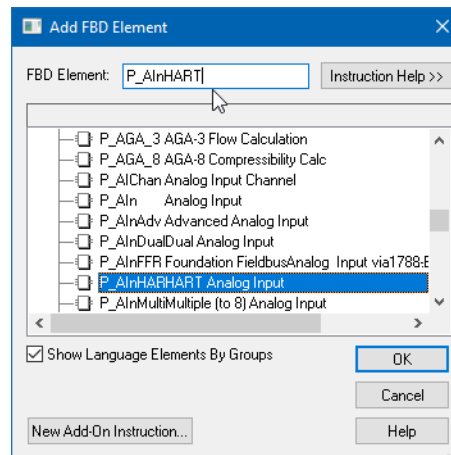

The new instance appears on the workspace, with the default tagname "P_AInHART_01".

- Right-click on the name and select Edit “P_AInHART_01” Properties to change this to “PI_1433”, the desired tagname.

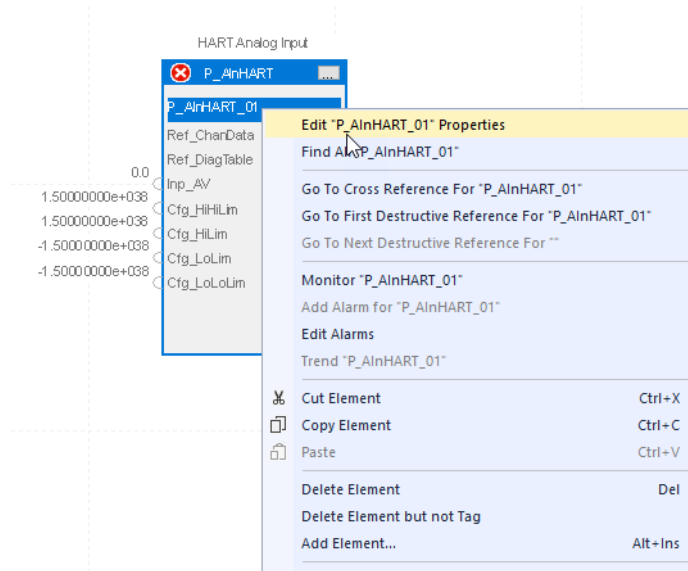

- Enter the correct tagname and select OK.

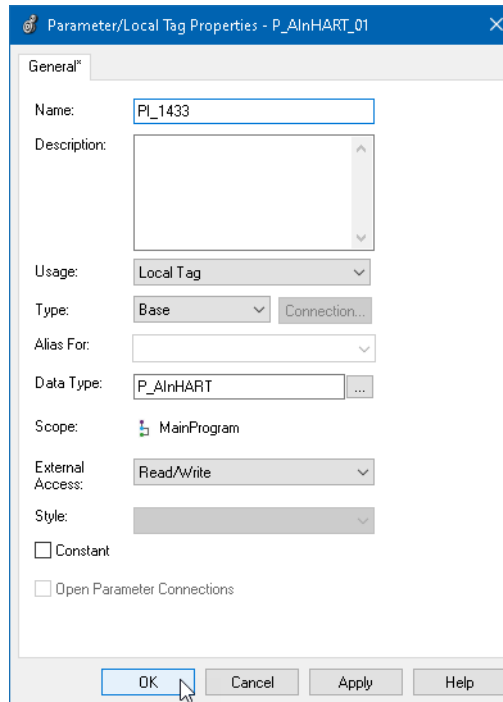

- Enter or select the name of the HART Channel Data tag you created in the rung import for the Ref_ChanData parameter.

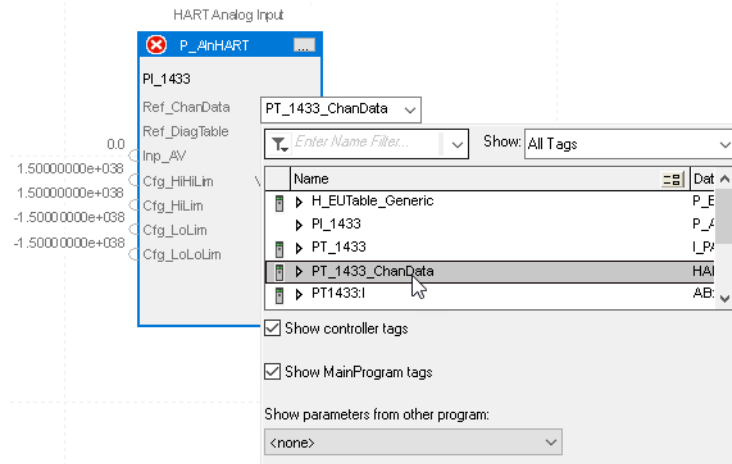

- Enter the name of the appropriate HART diagnostic table tag from the Controller Tags for the Ref_DiagTable parameter. If you use a Process Library Template ACD file to start your project, these tags are already in place. If you started from an empty project ACD file, you can copy the tags from a Template ACD.

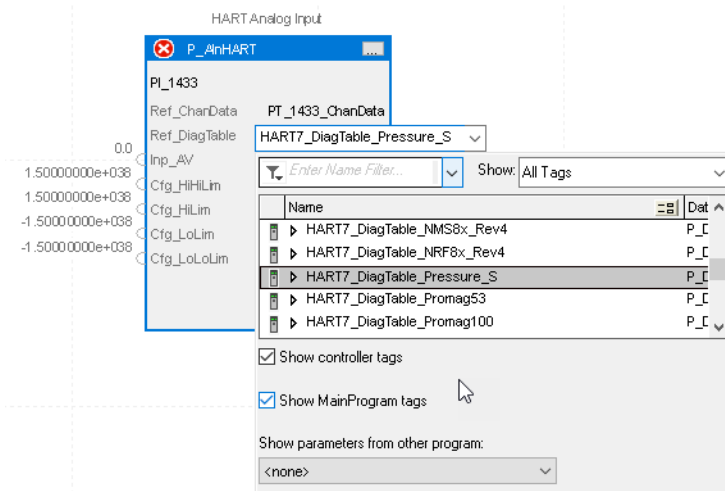

8. Add an IREF element and connect it to the Inp_AV pin on the function block. This IREF is used to bring in the analog signal, which is in the 5094-IF8IH MODULE input data tag.

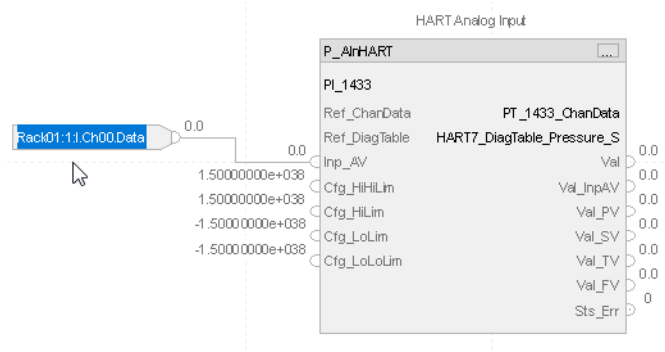

Rockwell Automation Support

Use the following resources to access support information.

Technical Support Center	Knowledgebase Articles, How-to Videos, FAQs, Chat, User Forums, and Product Notification Updates.	https://rockwellautomation.custhelp.com/
Local Technical Support Phone Numbers	Locate the phone number for your country.	http://www.rockwellautomation.com/global/support/get-support-now.page
Direct Dial Codes	Find the Direct Dial Code for your product. Use the code to route your call directly to a technical support engineer.	http://www.rockwellautomation.com/global/support/direct-dial.page
Literature Library	Installation Instructions, Manuals, Brochures, and Technical Data.	http://www.rockwellautomation.com/global/literature-library/overview.page
Product Compatibility and Download Center (PCDC)	Get help determining how products interact, check features and capabilities, and find associated firmware.	http://www.rockwellautomation.com/global/support/pcdc.page

Documentation Feedback

Rockwell Automation maintains current product environmental information on its website at <http://www.rockwellautomation.com/rockwellautomation/about-us/sustainability->

Allen-Bradley, Compact I/O, ControlLogix, FactoryTalk, FLEX, Logix5000, PlantPax, POINT I/O, Rockwell Automation, Rockwell Software, RSLogix 5000, and Studio 5000 Logix Designer are trademarks of Rockwell Automation, Inc.

Rockwell Otomasyon Ticaret A.Ş., Kar Plaza İş Merkezi E Blok Kat:6 34752 İçerenköy, İstanbul, Tel: +90 (216) 5698400

www.rockwellautomation.com

Power, Control and Information Solutions Headquarters

Americas: Rockwell Automation, 1201 South Second Street, Milwaukee, WI 53204-2496 USA, Tel: (1) 414.382.2000, Fax: (1) 414.382.4444

Europe/Middle East/Africa: Rockwell Automation NV, Pegasus Park, De Kleetlaan 12a, 1831 Diegem, Belgium, Tel: (32) 2 663 0600, Fax: (32) 2 663 0640

Asia Pacific: Rockwell Automation, Level 14, Core F, Cyberport 3, 100 Cyberport Road, Hong Kong, Tel: (852) 2887 4788, Fax: (852) 2508 1846

Publication PROCES-RM010F-EN-P - August 2021

Supersedes Publication Supersedes Publication PROCES-RM010E-EN-P - August 2020

Copyright © 2021 Rockwell Automation, Inc. All rights reserved. Printed in the U.S.A.