



**TRANE®**

*Cooling and Heating  
Systems and Services*

# Installation Operation Maintenance

---

## Series R™ Air-Cooled Helical Rotary Liquid Chiller

**RTAD 085 - 180 (50Hz)  
Standard, Free Cooling and Heat  
Recovery models**



---

**RTAD-SVX01F-E4**

# General information

---

## Foreword

These instructions are given as a guide to good practice in the installation, start-up, operation, and maintenance by the user, of Trane RTAD chillers. They do not contain full service procedures necessary for the continued successful operation of this equipment. The services of a qualified technician should be employed through the medium of a maintenance contract with a reputable service company. Read this manual thoroughly before unit start-up.

Units are assembled, pressure tested, dehydrated, charged and run tested before shipment.

## Warnings and cautions

Warnings and Cautions appear at appropriate sections throughout this manual. Your personal safety and the proper operation of this machine require that you follow them carefully. The constructor assumes no liability for installations or servicing performed by unqualified personnel.

**WARNING!** Indicates a potentially hazardous situation which, if not avoided, could result in death or serious injury.

**CAUTION!** Indicates a potentially hazardous situation which, if not avoided, may result in minor or moderate injury. It may also be used to alert against unsafe practices or for equipment or property-damage-only accidents.

## Safety recommendations

To avoid death, injury, equipment or property damage, the following recommendations should be observed during maintenance and service visits:

1. The maximum allowable pressures for system leak testing on low and high pressure side are given in the chapter "Installation". Always provide a pressure regulator.
2. Disconnect the main power supply before any servicing on the unit.
3. Service work on the refrigeration system and the electrical system should be carried out only by qualified and experienced personnel.

## Reception

On arrival, inspect the unit before signing the delivery note.

### Reception in France only:

In case of visible damage: The consignee (or the site representative) must specify any damage on the delivery note, legibly sign and date the delivery note, and the truck driver must countersign it. The consignee (or the site representative) must notify Trane Epinal Operations - Claims team and send a copy of the delivery note. The customer (or the site representative) should send a registered letter to the last carrier within 3 days of delivery.

*Note: for deliveries in France, even concealed damage must be looked for at delivery and immediately treated as visible damage.*

# General information

---

## **Reception in all countries except France:**

In case of concealed damage: The consignee (or the site representative) must send a registered letter to the last carrier within 7 days of delivery, claiming for the described damage. A copy of this letter must be sent to Trane Epinal Operations - Claims team.

## **Warranty**

Warranty is based on the general terms and conditions of the manufacturer. The warranty is void if the equipment is repaired or modified without the written approval of the manufacturer, if the operating limits are exceeded or if the control system or the electrical wiring is modified. Damage due to misuse, lack of maintenance or failure to comply with the manufacturer's instructions or recommendations is not covered by the warranty obligation. If the user does not conform to the rules of this manual, it may entail cancellation of warranty and liabilities by the manufacturer.

## **Refrigerant**

The refrigerant provided by the manufacturer meets all the requirements of our units. When using recycled or reprocessed refrigerant, it is advisable to ensure its quality is equivalent to that of a new refrigerant. For this, it is necessary to have a precise analysis made by a specialized laboratory. If this condition is not respected, the manufacturer warranty could be cancelled.

## **Maintenance contract**

It is strongly recommended that you sign a maintenance contract with your local Service Agency. This contract provides regular maintenance of your installation by a specialist in our equipment. Regular maintenance ensures that any malfunction is detected and corrected in good time and minimizes the possibility that serious damage will occur. Finally, regular maintenance ensures the maximum operating life of your equipment. We would remind you that failure to respect these installation and maintenance instructions may result in immediate cancellation of the warranty.

## **Training**

To assist you in obtaining the best use of it and maintaining it in perfect operating condition over a long period of time, the manufacturer has at your disposal a refrigeration and air conditioning service school. The principal aim of this is to give operators and technicians a better knowledge of the equipment they are using, or that is under their charge. Emphasis is particularly given to the importance of periodic checks on the unit operating parameters as well as on preventive maintenance, which reduces the cost of owning the unit by avoiding serious and costly breakdown.

# Contents

---

<b>General Information</b>	<b>2</b>
Unit Inspection	7
Loose Parts Inventory	7
General Data - Standard cooling unit	8
General Data - Free-cooling unit	16
General Data - Heat Recovery unit	18
Unit Dimensions	23
<b>Installation - Mechanical</b>	<b>24</b>
Installation Responsibilities	24
Nameplates	24
Storage	26
Location Requirements	26
Isolation and Sound Emission	26
Neoprene Isolator Installation	26
Noise Considerations	26
Foundation	27
Clearances	27
Drainage	28
Unit Water Piping	28
Unit Piping	28
Entering Chilled Water Piping	29
Leaving Chilled Water Piping	29
Heat Recovery Water Piping	29
Evaporator Drain	29
Evaporator Flow Switch	29
Water Treatment	30
Water Pressure Gauges	41
Water Pressure Relief Valves	41
Freeze Protection	41

# Contents

---

<b>Installation - Electrical</b>	<b>42</b>
General Recommendations	43
Installer-Supplied Components	48
Power Supply Wiring	48
Control Power Supply	48
Heater Power Supply	48
Water Pump Power Supply	48
Interconnecting Wiring	49
Chilled Water Flow (Pump) Interlock	49
Chilled Water Pump Control	49
Alarm and Status Relay Outputs (Programmable Relays)	52
Low Voltage Wiring	54
External Emergency Stop	54
External Auto/Stop	54
External Circuit Lockout - Circuit 1 and Circuit 2	54
Ice Making Option	55
External Chilled Water Setpoint (CWS)	55
External Current Limit Setpoint (CLS)	56
Outdoor Air Temperature Sensor	56
Communication Card CSR	57
Communication link connection procedure	57
LonTalk communication interface	58
<b>Operating Principles</b>	<b>64</b>
System schematics	64
<b>Pre-Start Checkout</b>	<b>67</b>
Installation Checklist	67
Receiving	67
Unit Location and Mounting	67
Unit Piping	67
Electrical Wiring	67
General	68
Unit Voltage Power Supply	69
Unit Voltage Imbalance	69
Unit Voltage Phasing	69
Water System Flow Rates	70
Water System Pressure Drop	70



# Contents

---

<b>Unit Start-up Procedures</b>	<b>71</b>
Daily Unit Start-Up	71
General	72
Seasonal Unit Start-Up Procedure	73
System Restart After Extended Shutdown	73
<b>Unit Shutdown Procedures</b>	<b>74</b>
Temporary Shutdown And Restart	74
Extended Shutdown Procedure	74
<b>Maintenance</b>	<b>75</b>
General	75
Weekly Maintenance	75
Monthly Maintenance	75
Annual Maintenance	75
<b>Maintenance Procedures</b>	<b>76</b>
Refrigerant Emission Control	76
Refrigerant and Oil Charge Management	77
R134a Field Charging Procedure	77
Refrigerant Charging	77
Isolating the Refrigerant in the High Pressure Side	78
Isolating the Refrigerant in the Low Pressure Side	78
Adding Refrigerant	79
Refrigerant Filter Changing Procedure	79
Lubrication System	80
Oil Charging Procedure	80
Factory (initial) Oil Charging Procedure	81
Field Oil Charging Procedure	82
Evaporator HeatTape Checkout Procedure	83
Safety recommendations	83

# General Information

Figure 1 - Typical Unit Nameplate

TYPE	[ ]			
1	CRC	N° SERIE	CCYY	N° ORGANISME NOTIFIE
	[ ]	[ ]	[ ]	[ ]
	QTE-QTY	V / Hz / Ph	A max / FLA	kW max
C1	[ ]	[ ]	[ ]	[ ]
C2	[ ]	[ ]	[ ]	[ ]
	[ ]	[ ]	[ ]	[ ]
	[ ]	[ ]	[ ]	[ ]
CONTROLE - CONTROL		[ ]		VA
INTENSITE DEMARRAGE - STARTING AMPS			[ ]	
FLUIDE	[ ]		C1/C2	[ ] kg
	[ ]		C1/C2	[ ] l
PS	BP-LP	[ ] bar	HP-HP	[ ] bar
EN/DE/IT/ES/DA/FI/NL/NO/PT/SV/CZ/PO/HU/EL				
1	Type / Typ / Tipo / Tipo / Type / Τυπι / Type / Type / Tipo / Typ / Typ / Typ / Tipus / Τύπος			
2	Serial nb / Serienummer / Numero di serie / Numero de serie / Serienummer / Sarjanumero / Serienummer / Serienummer / Numero di serie / Tillverkningsnummer / Sérovié číslo / Number fabryczny / Sorozat szám / Αριθμός σειράς			
3	Notified body / Benannte Stelle / Organismo notificato / Organismo notificado / Bemyndiget organ / Ilmottettujen laitosten / Aangemelde Instantie / Ramme nr. / Organismo notificado / Anmäkt organ / Autorizovaná osoba / Organizacja notyfikowana / Regisztráció száma / Σώμα γνωστοποίησης			
4	Fluid / Fluide / Fluido / Fluido / Fluidum / Fluidi / Stof / Kuldemedium / Fluido / Fluid / Kapalina / Czynnik / Közeg / ρευστό			
	 <b>88130 CHARMES - FRANCE</b> AN AMERICAN STANDARD COMPANY			

## Unit Inspection

When the unit is delivered, verify that it is the correct unit and that it is properly equipped. Compare the information which appears on the unit nameplate with the ordering and submittal information. A typical unit nameplate is shown in Figure 1.

## Loose Parts Inventory

Check all the accessories and loose parts which are shipped with the unit against the shipping list. Included in these items will be water vessel drain plugs, rigging and electrical diagrams, and service literature, which are placed inside the control panel and/or starter panel for shipment.

# General Information

## General Data - SI Units

**Table 1 - General Data RTAD Standard**

Size		085	100	115	125	145	150	165	180
Compressor Quantity		2	2	2	2	2	2	2	2
Nominal Size (1)	(Tons)	40/40	50/50	60/60	70/70	85/70	85/85	100/85	100/100
<b>Evaporator</b>									
Evaporator Model		EG120	EG140	EG170	EG200	EG200	EG200	EG250	EG250
Water Storage	(l)	106	270	222	204	204	204	415	415
Minimum Flow	(l/s)	4.1	6.0	7.3	8.8	8.8	8.8	11.6	11.6
Maximum Flow	(l/s)	17.3	20.8	24.8	30.7	30.7	30.7	38.0	38.0
<b>Condenser</b>									
Qty of Coils		2	2	2	2	2	2	2	2
Coil Length	(mm)	2743	3658	3658	3658	4572	4572	5486	5486
Coil Height	(mm)	1626	1626	1626	1626	1626	1626	1626	1626
Fin series	(Fins/ft)	192	192	192	192	192	192	192	192
Number of Rows		3/3	2/2	3/3	3/3	3/3	3/3	3/3	3/3
<b>Condenser Fans</b>									
Quantity (1)		3/3	3/3	3/3	3/3	5/4	5/5	6/5	6/6
Diameter	(mm)	762	762	762	762	762	762	762	762
Total Air Flow	(m <sup>3</sup> /s)	23.4	28.5	27.0	27.0	37.0	39.0	44.9	46.8
Nominal RPM		915	915	915	915	915	915	915	915
Tip Speed	(m/s)	36.5	36.5	36.5	36.5	36.5	36.5	36.5	36.5
Motor kW	(kW)	2.05	2.05	2.05	2.05	2.05	2.05	2.05	2.05
<b>Min Starting/Oper Ambient (2)</b>									
Standard Unit	(°C)	0	0	0	0	0	0	0	0
Low Ambient Unit	(°C)	-18	-18	-18	-18	-18	-18	-18	-18
<b>General Unit</b>									
Refrigerant		HFC 134a	HFC 134a	HFC 134a	HFC 134a	HFC 134a	HFC 134a	HFC 134a	HFC 134a
No. Of independent Refrigerant Circuits		2	2	2	2	2	2	2	2
% Min. Load (3)		17	17	17	17	17	17	17	17
Refrigerant Charge (1)	(kg)	24/24	30/32	35/36	36/37	44/48	44/48	61/59	61/61
Oil Charge (1)	(l)	6/6	7/7	9/9	10/10	10/10	10/10	15/11	15/15
Operating Weight (4)	(kg)	2660	3105	3555	3570	4260	4520	5440	5525
Shipping Weight (4)	(kg)	2554	2838	3333	3368	4057	4317	5023	5108

**Table 2 - General Data RTAD High Efficiency**

Size		085	100	115	125	145	150
Compressor Quantity		2	2	2	2	2	2
Nominal Size (1)	(Tons)	40/40	50/50	60/60	70/70	85/70	85/85
<b>Evaporator</b>							
Evaporator Model		EG140	EG170	EG200	EG200	EG250	EG250
Water Storage	(l)	270	222	204	204	415	415
Minimum Flow	(l/s)	6.0	7.3	8.8	8.8	11.6	11.6
Maximum Flow	(l/s)	20.8	24.8	30.7	30.7	38.0	38.0
<b>Condenser</b>							
Qty of Coils		2	2	2	2	2	2
Coil Length	(mm)	3658	3658	4572	4572	5486	5486
Coil Height	(mm)	1626	1626	1626	1626	1626	1626
Fin series	(Fins/ft)	192	192	192	192	192	192
Number of Rows		3/3	3/3	3/3	3/3	3/3	3/3
<b>Condenser Fans</b>							
Quantity (1)		3/3	4/4	4/4	5/5	6/5	6/6
Diameter	(mm)	762	762	762	762	762	762
Total Air Flow	(m <sup>3</sup> /s)	27.0	31.2	35.0	39.0	44.8	46.8
Nominal RPM		915	915	915	915	915	915
Tip Speed	(m/s)	36.5	36.5	36.5	36.5	36.5	36.5
Motor kW	(kW)	2.05	2.05	2.05	2.05	2.05	2.05
<b>Min Starting/Oper Ambient (2)</b>							
Standard Unit	(°C)	0	0	0	0	0	0
Low Ambient Unit	(°C)	-18	-18	-18	-18	-18	-18
<b>General Unit</b>							
Refrigerant		HFC 134a	HFC 134a	HFC 134a	HFC 134a	HFC 134a	HFC 134a
No. Of independent Refrigerant Circuits		2	2	2	2	2	2
% Min. Load (3)		17	17	17	17	17	17
Refrigerant Charge (1)	(kg)	32/34	35/36	42/45	42/45	59/61	59/61
Oil Charge (1)	(l)	6/6	7/7	10/10	10/10	11/11	11/11
Operating Weight (4)	(kg)	3240	3370	3905	4000	5390	5445
Shipping Weight (4)	(kg)	2973	3148	3702	3797	4973	5028

**Notes:**

- (1) Data containing information on two circuits shown as follows: ckt1/ckt2
- (2) Minimum start-up/operation ambient based on a 2.22 m/s (5mph) wind across the condenser.
- (3) Percent minimum load is for total machine at 10°C (50F) ambient and 7°C (44F) leaving chilled water temp. Not each individual circuit
- (4) Weights with aluminium fins, power disconnect switch, isolators and pressure gauges



# General Information

**Table 3 - General Data RTAD Standard Low Noise**

Size	085	100	115	125	145	150	165	180
Compressor Quantity	2	2	2	2	2	2	2	2
Nominal Size (1)	(Tons) 40/40	50/50	60/60	70/70	85/70	85/85	100/85	100/100
<b>Evaporator</b>								
Evaporator Model	EG120	EG140	EG170	EG200	EG200	EG200	EG250	EG250
Water Storage (l)	106	270	222	204	204	204	415	415
Minimum Flow (l/s)	4.1	6.0	7.3	8.8	8.8	8.8	11.6	11.6
Maximum Flow (l/s)	17.3	20.8	24.8	30.7	30.7	30.7	38.0	38.0
<b>Condenser</b>								
Qty of Coils	2	2	2	2	2	2	2	2
Coil Length (mm)	2743	3658	3658	3658	4572	4572	5486	5486
Coil Height (mm)	1626	1626	1626	1626	1626	1626	1626	1626
Fin series (Fins/ft)	192	192	192	192	192	192	192	192
Number of Rows	3/3	2/2	3/3	3/3	3/3	3/3	3/3	3/3
<b>Condenser Fans</b>								
Quantity (1)	3/3	3/3	3/3	3/3	5/4	5/5	6/5	6/6
Diameter (mm)	762	762	762	762	762	762	762	762
Total Air Flow (m <sup>3</sup> /s)	18.1	22.4	21.0	21.0	28.7	30.1	34.7	36.2
Nominal RPM	730	730	730	730	730	730	730	730
Tip Speed (m/s)	29.1	29.1	29.1	29.1	29.1	29.1	29.1	29.1
Motor kW	1.30	1.30	1.30	1.30	1.30	1.30	1.30	1.30
<b>Min Starting/Oper Ambient (2)</b>								
Standard Unit (°C)	0	0	0	0	0	0	0	0
Low Ambient Unit (°C)	-18	-18	-18	-18	-18	-18	-18	-18
<b>General Unit</b>								
Refrigerant	HFC 134a	HFC 134a	HFC 134a	HFC 134a	HFC 134a	HFC 134a	HFC 134a	HFC 134a
No. Of independent Refrigerant Circuits	2	2	2	2	2	2	2	2
% Min. Load (3)	17	17	17	17	17	17	17	17
Refrigerant Charge (1) (kg)	24/24	30/32	35/36	36/37	44/48	44/48	61/59	61/61
Oil Charge (1) (l)	6/6	7/7	9/9	10/10	10/10	10/10	15/11	15/15
Operating Weight (4) (kg)	2760	3205	3655	3670	4360	4620	5540	5625
Shipping Weight (4) (kg)	2654	2938	3433	3468	4157	4417	5123	5208

**Table 4 - General Data RTAD High Efficiency Low Noise**

Size	085	100	115	125	145	150
Compressor Quantity	2	2	2	2	2	2
Nominal Size (1)	(Tons) 40/40	50/50	60/60	70/70	85/70	85/85
<b>Evaporator</b>						
Evaporator Model	EG140	EG170	EG200	EG200	EG250	EG250
Water Storage (l)	270	222	204	204	415	415
Minimum Flow (l/s)	6.0	7.3	8.8	8.8	11.6	11.6
Maximum Flow (l/s)	20.8	24.8	30.7	30.7	38.0	38.0
<b>Condenser</b>						
Qty of Coils	2	2	2	2	2	2
Coil Length (mm)	3658	3658	4572	4572	5486	5486
Coil Height (mm)	1626	1626	1626	1626	1626	1626
Fin series (Fins/ft)	192	192	192	192	192	192
Number of Rows	3/3	3/3	3/3	3/3	3/3	3/3
<b>Condenser Fans</b>						
Quantity (1)	3/3	4/4	4/4	5/5	6/5	6/6
Diameter (mm)	762	762	762	762	762	762
Total Air Flow (m <sup>3</sup> /s)	21.0	24.1	27.2	30.1	34.7	36.1
Nominal RPM	690	690	690	690	690	690
Tip Speed (m/s)	27.5	27.5	27.5	27.5	27.5	27.5
Motor kW	1.30	1.30	1.30	1.30	1.30	1.30
<b>Min Starting/Oper Ambient (2)</b>						
Standard Unit (°C)	0	0	0	0	0	0
Low Ambient Unit (°C)	-18	-18	-18	-18	-18	-18
<b>General Unit</b>						
Refrigerant	HFC 134a	HFC 134a	HFC 134a	HFC 134a	HFC 134a	HFC 134a
No. Of independent Refrigerant Circuits	2	2	2	2	2	2
% Min. Load (3)	17	17	17	17	17	17
Refrigerant Charge (1) (kg)	32/34	35/36	42/45	42/45	59/61	59/61
Oil Charge (1) (l)	6/6	7/7	10/10	10/10	11/11	11/11
Operating Weight (4) (kg)	3340	3470	4005	4100	5490	5545
Shipping Weight (4) (kg)	3073	3248	3802	3897	5073	5128

**Notes:**

- (1) Data containing information on two circuits shown as follows: ckt1/ckt2
- (2) Minimum start-up/operation ambient based on a 2.22 m/s (5mph) wind across the condenser.
- (3) Percent minimum load is for total machine at 10°C (50F) ambient and 7°C (44F) leaving chilled water temp. Not each individual circuit
- (4) Weights with aluminium fins, power disconnect switch, isolators and pressure gauges

# General Information

**Table 5 - General Data RTAD Standard Low Noise with Night Noise Set Back option**

Size	085	100	115	125	145	150	165	180
Compressor Quantity	2	2	2	2	2	2	2	2
Nominal Size (1) (Tons)	40/40	50/50	60/60	70/70	85/70	85/85	100/85	100/100
<b>Evaporator</b>								
Evaporator Model	EG120	EG140	EG170	EG200	EG200	EG200	EG250	EG250
Water Storage (l)	106	270	222	204	204	204	415	415
Minimum Flow (l/s)	4.1	6.0	7.3	8.8	8.8	8.8	11.6	11.6
Maximum Flow (l/s)	17.3	20.8	24.8	30.7	30.7	30.7	38.0	38.0
<b>Condenser</b>								
Qty of Coils	2	2	2	2	2	2	2	2
Coil Length (mm)	2743	3658	3658	3658	4572	4572	5486	5486
Coil Height (mm)	1626	1626	1626	1626	1626	1626	1626	1626
Fin series (Fins/ft)	192	192	192	192	192	192	192	192
Number of Rows	3/3	2/2	3/3	3/3	3/3	3/3	3/3	3/3
<b>Condenser Fans</b>								
Quantity (1)	2/2	3/3	3/3	3/3	4/4	4/4	5/5	5/5
Diameter (mm)	762	762	762	762	762	762	762	762
Total Air Flow (m <sup>3</sup> /s)	13.4	20.5	19.3	19.3	25.0	25.0	30.7	30.7
Nominal RPM	550	550	550	550	550	550	550	550
Tip Speed (m/s)	21.9	21.9	21.9	21.9	21.9	21.9	21.9	21.9
Motor kW	1.05	1.05	1.05	1.05	1.05	1.05	1.05	1.05
<b>Min Starting/Oper Ambient (2)</b>								
Standard Unit (°C)	0	0	0	0	0	0	0	0
Low Ambient Unit (°C)	-18	-18	-18	-18	-18	-18	-18	-18
<b>General Unit</b>								
Refrigerant	HFC 134a	HFC 134a	HFC 134a	HFC 134a	HFC 134a	HFC 134a	HFC 134a	HFC 134a
No. Of independent Refrigerant Circuits	2	2	2	2	2	2	2	2
% Min. Load (3)	17	17	17	17	17	17	17	17
Refrigerant Charge (1) (kg)	24/24	30/32	35/36	36/37	44/48	44/48	61/59	61/61
Oil Charge (1) (l)	6/6	7/7	9/9	10/10	10/10	10/10	15/11	15/15
Operating Weight (4) (kg)	2660	3205	3655	3670	4310	4520	5490	5525
Shipping Weight (4) (kg)	2554	2938	3433	3468	4107	4317	5073	5108

**Table 6 - General Data RTAD High Efficiency Low Noise with Night Noise Set Back option**

Size	085	100	115	125	145	150
Compressor Quantity	2	2	2	2	2	2
Nominal Size (1) (Tons)	40/40	50/50	60/60	70/70	85/70	85/85
<b>Evaporator</b>						
Evaporator Model	EG140	EG170	EG200	EG200	EG250	EG250
Water Storage (l)	270	222	204	204	415	415
Minimum Flow (l/s)	6.0	7.3	8.8	8.8	11.6	11.6
Maximum Flow (l/s)	20.8	24.8	30.7	30.7	38.0	38.0
<b>Condenser</b>						
Qty of Coils	2	2	2	2	2	2
Coil Length (mm)	3658	3658	4572	4572	5486	5486
Coil Height (mm)	1626	1626	1626	1626	1626	1626
Fin series (Fins/ft)	192	192	192	192	192	192
Number of Rows	3/3	3/3	3/3	3/3	3/3	3/3
<b>Condenser Fans</b>						
Quantity (1)	3/3	3/3	4/4	4/4	5/5	5/5
Diameter (mm)	762	762	762	762	762	762
Total Air Flow (m <sup>3</sup> /s)	19.2	19.2	24.9	25.0	30.6	30.6
Nominal RPM	550	550	550	550	550	550
Tip Speed (m/s)	21.9	21.9	21.9	21.9	21.9	21.9
Motor kW	1.05	1.05	1.05	1.05	1.05	1.05
<b>Min Starting/Oper Ambient (2)</b>						
Standard Unit (°C)	0	0	0	0	0	0
Low Ambient Unit (°C)	-18	-18	-18	-18	-18	-18
<b>General Unit</b>						
Refrigerant	HFC 134a	HFC 134a	HFC 134a	HFC 134a	HFC 134a	HFC 134a
No. Of independent Refrigerant Circuits	2	2	2	2	2	2
% Min. Load (3)	17	17	17	17	17	17
Refrigerant Charge (1) (kg)	32/34	35/36	42/45	42/45	59/61	59/61
Oil Charge (1) (l)	6/6	7/7	10/10	10/10	11/11	11/11
Operating Weight (4) (kg)	3340	3370	4005	4000	5440	5445
Shipping Weight (4) (kg)	3073	3148	3802	3797	5023	5028

**Notes:**

- (1) Data containing information on two circuits shown as follows: ckt1/ckt2
- (2) Minimum start-up/operation ambient based on a 2.22 m/s (5mph) wind across the condenser.
- (3) Percent minimum load is for total machine at 10°C (50F) ambient and 7°C (44F) leaving chilled water temp. Not each individual circuit
- (4) Weights with aluminium fins, power disconnect switch, isolators and pressure gauges

# General Information

**Table 7 - General Data RTAD Standard High External Static Pressure**

Size	085	100	115	125	145	150	165	180
Compressor Quantity	2	2	2	2	2	2	2	2
Nominal Size (1)	(Tons) 40/40	50/50	60/60	70/70	85/70	85/85	100/85	100/100
<b>Evaporator</b>								
Evaporator Model	EG120	EG140	EG170	EG200	EG200	EG200	EG250	EG250
Water Storage (l)	106	270	222	204	204	204	415	415
Minimum Flow (l/s)	4.1	6.0	7.3	8.8	8.8	8.8	11.6	11.6
Maximum Flow (l/s)	17.3	20.8	24.8	30.7	30.7	30.7	38.0	38.0
<b>Condenser</b>								
Qty of Coils	2	2	2	2	2	2	2	2
Coil Length (mm)	2743	3658	3658	3658	4572	4572	5486	5486
Coil Height (mm)	1626	1626	1626	1626	1626	1626	1626	1626
Fin series (Fins/ft)	192	192	192	192	192	192	192	192
Number of Rows	3/3	2/2	3/3	3/3	3/3	3/3	3/3	3/3
<b>Condenser Fans</b>								
Quantity (1)	3/3	3/3	3/3	3/3	5/4	5/5	6/5	6/6
Diameter (mm)	762	762	762	762	762	762	762	762
Total Air Flow (m <sup>3</sup> /s)	23.7	29.5	27.6	27.6	37.6	39.5	45.5	47.4
Nominal RPM	935	935	935	935	935	935	935	935
Tip Speed (m/s)	37.3	37.3	37.3	37.3	37.3	37.3	37.3	37.3
Motor kW	2.21	2.21	2.21	2.21	2.21	2.21	2.21	2.21
<b>Min Starting/Oper Ambient (2)</b>								
Standard Unit (°C)	0	0	0	0	0	0	0	0
Low Ambient Unit (°C)	-18	-18	-18	-18	-18	-18	-18	-18
<b>General Unit</b>								
Refrigerant	R134a	R134a	R134a	R134a	R134a	R134a	R134a	R134a
No. Of independent Refrigerant Circuits	2	2	2	2	2	2	2	2
% Min. Load (3)	17	17	17	17	17	17	17	17
Refrigerant Charge (1) (kg)	24/24	30/32	35/36	36/37	44/48	44/48	61/59	61/61
Oil Charge (1) (l)	6/6	7/7	9/9	10/10	10/10	10/10	15/11	15/15
Operating Weight (4) (kg)	2660	3105	3555	3570	4260	4520	5440	5525
Shipping Weight (4) (kg)	2554	2838	3333	3368	4057	4317	5023	5108

**Table 8 - General Data RTAD High Efficiency High External Static Pressure**

Size	085	100	115	125	145	150
Compressor Quantity	2	2	2	2	2	2
Nominal Size (1)	(Tons) 40/40	50/50	60/60	70/70	85/70	85/85
<b>Evaporator</b>						
Evaporator Model	EG140	EG170	EG200	EG200	EG250	EG250
Water Storage (l)	270	222	204	204	415	415
Minimum Flow (l/s)	6.0	7.3	8.8	8.8	11.6	11.6
Maximum Flow (l/s)	20.8	24.8	30.7	30.7	38.0	38.0
<b>Condenser</b>						
Qty of Coils	2	2	2	2	2	2
Coil Length (mm)	3658	3658	4572	4572	5486	5486
Coil Height (mm)	1626	1626	1626	1626	1626	1626
Fin series (Fins/ft)	192	192	192	192	192	192
Number of Rows	3/3	3/3	3/3	3/3	3/3	3/3
<b>Condenser Fans</b>						
Quantity (1)	3/3	4/4	4/4	5/5	6/5	6/6
Diameter (mm)	762	762	762	762	762	762
Total Air Flow (m <sup>3</sup> /s)	27.6	31.5	35.6	39.4	45.4	47.3
Nominal RPM	935	935	935	935	935	935
Tip Speed (m/s)	37.3	37.3	37.3	37.3	37.3	37.3
Motor kW	2.21	2.21	2.21	2.21	2.21	2.21
<b>Min Starting/Oper Ambient (2)</b>						
Standard Unit (°C)	0	0	0	0	0	0
Low Ambient Unit (°C)	-18	-18	-18	-18	-18	-18
<b>General Unit</b>						
Refrigerant	R134a	R134a	R134a	R134a	R134a	R134a
No. Of independent Refrigerant Circuits	2	2	2	2	2	2
% Min. Load (3)	17	17	17	17	17	17
Refrigerant Charge (1) (kg)	32/34	35/36	42/45	42/45	59/61	59/61
Oil Charge (1) (l)	6/6	7/7	10/10	10/10	11/11	11/11
Operating Weight (4) (kg)	3240	3370	3905	4000	5390	5445
Shipping Weight (4) (kg)	2973	3148	3702	3797	4973	5028

**Notes:**

- (1) Data containing information on two circuits shown as follows: ckt1/ckt2
- (2) Minimum start-up/operation ambient based on a 2.22 m/s (5mph) wind across the condenser.
- (3) Percent minimum load is for total machine at 10°C (50F) ambient and 7°C (44F) leaving chilled water temp. Not each individual circuit
- (4) Weights with aluminium fins, power disconnect switch, isolators and pressure gauges

# General Information

## English Units

**Table 9 - General Data RTAD Standard**

Size		085	100	115	125	145	150	165	180
Compressor Quantity		2	2	2	2	2	2	2	2
Nominal Size (1)	(Tons)	40/40	50/50	60/60	70/70	85/70	85/85	100/85	100/100
<b>Evaporator</b>									
Evaporator Model		EG120	EG140	EG170	EG200	EG200	EG200	EG250	EG250
Water Storage	(Gallon)	28.0	71.3	58.7	53.9	53.9	53.9	109.6	109.6
Minimum Flow	(GPM)	65.2	95.1	115.0	139.2	139.2	139.2	184.0	184.0
Maximum Flow	(GPM)	274.6	329.9	393.1	486.4	486.4	486.4	603.0	603.0
<b>Condenser</b>									
Qty of Coils		2	2	2	2	2	2	2	2
Coil Length	(inch)	108	144	144	144	180	180	216	216
Coil Height	(inch)	64	64	64	64	64	64	64	64
Fin series	(Fins/ft)	192	192	192	192	192	192	192	192
Number of Rows		3/3	2/2	3/3	3/3	3/3	3/3	3/3	3/3
<b>Condenser Fans</b>									
Quantity (1)		3/3	3/3	3/3	3/3	5/4	5/5	6/5	6/6
Diameter	(inch)	30	30	30	30	30	30	30	30
Total Air Flow	(CFM)	49556	60460	57194	57248	78439	82716	95103	99250
Nominal RPM		915	915	915	915	915	915	915	915
Tip Speed	(Ft/s)	119.8	119.8	119.8	119.8	119.8	119.8	119.8	119.8
Motor kW	(kW)	2.05	2.05	2.05	2.05	2.05	2.05	2.05	2.05
<b>Min Starting/Oper Ambient (2)</b>									
Standard Unit	(°F)	32	32	32	32	32	32	32	32
Low Ambient Unit	(°F)	0	0	0	0	0	0	0	0
<b>General Unit</b>									
Refrigerant		HFC 134a	HFC 134a	HFC 134a	HFC 134a	HFC 134a	HFC 134a	HFC 134a	HFC 134a
No. Of independent Refrigerant Circuits		2	2	2	2	2	2	2	2
% Min. Load (3)		17	17	17	17	17	17	17	17
Refrigerant Charge (1)	(lbs.)	52.9/52.9	66.1/70.5	77.2/79.4	79.4/81.6	97/105.8	97/105.8	134.5/130.1	134.5/134.5
Oil Charge (1)	(Gallon)	1.59/1.59	1.85/1.85	2.38/2.38	2.64/2.64	2.64/2.64	2.64/2.64	3.96/2.91	3.96/3.96
Operating Weight (4)	(lbs.)	5864	6845	7837	7871	9392	9965	11993	12181
Shipping Weight (4)	(lbs.)	5631	6257	7348	7425	8944	9517	11074	11261

**Table 10 - General Data RTAD High Efficiency**

Size		085	100	115	125	145	150
Compressor Quantity		2	2	2	2	2	2
Nominal Size (1)	(Tons)	40/40	50/50	60/60	70/70	85/70	85/85
<b>Evaporator</b>							
Evaporator Model		EG140	EG170	EG200	EG200	EG250	EG250
Water Storage	(Gallon)	71.3	58.7	53.9	53.9	109.6	109.6
Minimum Flow	(GPM)	95.1	115.0	139.2	139.2	184.0	184.0
Maximum Flow	(GPM)	329.9	393.1	486.4	486.4	603.0	603.0
<b>Condenser</b>							
Qty of Coils		2	2	2	2	2	2
Coil Length	(inch)	144	144	180	180	216	216
Coil Height	(inch)	64	64	64	64	64	64
Fin series	(Fins/ft)	192	192	192	192	192	192
Number of Rows		3/3	3/3	3/3	3/3	3/3	3/3
<b>Condenser Fans</b>							
Quantity (1)		3/3	4/4	4/4	5/5	6/5	6/6
Diameter	(inch)	30	30	30	30	30	30
Total Air Flow	(CFM)	57108	66046	74100	82628	95008	99132
Nominal RPM		915	915	915	915	915	915
Tip Speed	(Ft/s)	119.8	119.8	119.8	119.8	119.8	119.8
Motor kW	(kW)	2.05	2.05	2.05	2.05	2.05	2.05
<b>Min Starting/Oper Ambient (2)</b>							
Standard Unit	(°F)	32	32	32	32	32	32
Low Ambient Unit	(°F)	0	0	0	0	0	0
<b>General Unit</b>							
Refrigerant		HFC 134a	HFC 134a	HFC 134a	HFC 134a	HFC 134a	HFC 134a
No. Of independent Refrigerant Circuits		2	2	2	2	2	2
% Min. Load (3)		17	17	17	17	17	17
Refrigerant Charge (1)	(lbs.)	70.5/75.0	77.2/79.4	92.6/99.2	92.6/99.2	130.1/134.5	130.1/134.5
Oil Charge (1)	(Gallon)	1.59/1.59	1.85/1.85	2.64/2.64	2.64/2.64	2.91/2.91	2.91/2.91
Operating Weight (4)	(lbs.)	7143	7430	8609	8818	11883	12004
Shipping Weight (4)	(lbs.)	6554	6940	8162	8371	10964	11085

**Notes:**

- (1) Data containing information on two circuits shown as follows: ckt1/ckt2
- (2) Minimum start-up/operation ambient based on a 2.22 m/s (5mph) wind across the condenser.
- (3) Percent minimum load is for total machine at 10°C (50F) ambient and 7°C (44F) leaving chilled water temp. Not each individual circuit
- (4) Weights with aluminium fins, power disconnect switch, isolators and pressure gauges

# General Information

**Table 11 - General Data RTAD Standard Low Noise**

Size	085	100	115	125	145	150	165	180
Compressor Quantity	2	2	2	2	2	2	2	2
Nominal Size (1)	(Tons) 40/40	50/50	60/60	70/70	85/70	85/85	100/85	100/100
<b>Evaporator</b>								
Evaporator Model	EG120	EG140	EG170	EG200	EG200	EG200	EG250	EG250
Water Storage	(Gallon) 28.0	71.3	58.7	53.9	53.9	53.9	109.6	109.6
Minimum Flow	(GPM) 65.2	95.1	115.0	139.2	139.2	139.2	184.0	184.0
Maximum Flow	(GPM) 274.6	329.9	393.1	486.4	486.4	486.4	603.0	603.0
<b>Condenser</b>								
Qty of Coils	2	2	2	2	2	2	2	2
Coil Length	(inch) 108	144	144	144	180	180	216	216
Coil Height	(inch) 64	64	64	64	64	64	64	64
Fin series	(Fins/ft) 192	192	192	192	192	192	192	192
Number of Rows	3/3	2/2	3/3	3/3	3/3	3/3	3/3	3/3
<b>Condenser Fans</b>								
Quantity (1)	3/3	3/3	3/3	3/3	5/4	5/5	6/5	6/6
Diameter	(inch) 30	30	30	30	30	30	30	30
Total Air Flow	(CFM) 38246	47434	44514	44568	60751	63878	73628	76644
Nominal RPM	730	730	730	730	730	730	730	730
Tip Speed	(Ft/s) 95.6	95.6	95.6	95.6	95.6	95.6	95.6	95.6
Motor kW	(kW) 1.3	1.3	1.3	1.3	1.3	1.3	1.3	1.3
<b>Min Starting/Oper Ambient (2)</b>								
Standard Unit	(°F) 32	32	32	32	32	32	32	32
Low Ambient Unit	(°F) 0	0	0	0	0	0	0	0
<b>General Unit</b>								
Refrigerant	HFC 134a	HFC 134a	HFC 134a	HFC 134a	HFC 134a	HFC 134a	HFC 134a	HFC 134a
No. Of independent Refrigerant Circuits	2	2	2	2	2	2	2	2
% Min. Load (3)	17	17	17	17	17	17	17	17
Refrigerant Charge (1)	(Lbs.) 52.9/52.9	66.1/70.5	77.2/79.4	79.4/81.6	97/105.8	97/105.8	134.5/130.1	134.5/134.5
Oil Charge (1)	(Gallon) 1.59/1.59	1.85/1.85	2.38/2.38	2.64/2.64	2.64/2.64	2.64/2.64	3.96/2.91	3.96/3.96
Operating Weight (4)	(Lbs.) 6085	7066	8058	8091	9612	10185	12214	12401
Shipping Weight (4)	(Lbs.) 5851	6477	7568	7646	9165	9738	11294	11482

**Table 12 - General Data RTAD High Efficiency Low Noise**

Size	085	100	115	125	145	150
Compressor Quantity	2	2	2	2	2	2
Nominal Size (1)	(Tons) 40/40	50/50	60/60	70/70	85/70	85/85
<b>Evaporator</b>						
Evaporator Model	EG140	EG170	EG200	EG200	EG250	EG250
Water Storage	(Gallon) 71.3	58.7	53.9	53.9	109.6	109.6
Minimum Flow	(GPM) 95.1	115.0	139.2	139.2	184.0	184.0
Maximum Flow	(GPM) 329.9	393.1	486.4	486.4	603.0	603.0
<b>Condenser</b>						
Qty of Coils	2	2	2	2	2	2
Coil Length	(inch) 144	144	180	180	216	216
Coil Height	(inch) 64	64	64	64	64	64
Fin series	(Fins/ft) 192	192	192	192	192	192
Number of Rows	3/3	3/3	3/3	3/3	3/3	3/3
<b>Condenser Fans</b>						
Quantity (1)	3/3	4/4	4/4	5/5	6/5	6/6
Diameter	(inch) 30	30	30	30	30	30
Total Air Flow	(CFM) 44426	50964	57562	63784	73521	76510
Nominal RPM	690	690	690	690	690	690
Tip Speed	(Ft/s) 90.3	90.3	90.3	90.3	90.3	90.3
Motor kW	(kW) 1.3	1.3	1.3	1.3	1.3	1.3
<b>Min Starting/Oper Ambient (2)</b>						
Standard Unit	(°F) 32	32	32	32	32	32
Low Ambient Unit	(°F) 0	0	0	0	0	0
<b>General Unit</b>						
Refrigerant	HFC 134a	HFC 134a	HFC 134a	HFC 134a	HFC 134a	HFC 134a
No. Of independent Refrigerant Circuits	2	2	2	2	2	2
% Min. Load (3)	17	17	17	17	17	17
Refrigerant Charge (1)	(Lbs.) 70.5/75.0	77.2/79.4	92.6/99.2	92.6/99.2	130.1/134.5	130.1/134.5
Oil Charge (1)	(Gallon) 1.59/1.59	1.85/1.85	2.64/2.64	2.64/2.64	2.91/2.91	2.91/2.91
Operating Weight (4)	(Lbs.) 7363	7650	8830	9039	12103	12225
Shipping Weight (4)	(Lbs.) 6775	7161	8382	8591	11184	11305

**Notes:**

- (1) Data containing information on two circuits shown as follows: ckt1/ckt2
- (2) Minimum start-up/operation ambient based on a 2.22 m/s (5mph) wind across the condenser.
- (3) Percent minimum load is for total machine at 10°C (50F) ambient and 7°C (44F) leaving chilled water temp. Not each individual circuit
- (4) Weights with aluminium fins, power disconnect switch, isolators and pressure gauges

# General Information

**Table 13 - General Data RTAD Standard Low Noise with Night Noise Set Back option**

Size	085	100	115	125	145	150	165	180
Compressor Quantity	2	2	2	2	2	2	2	2
Nominal Size (1) (Tons)	40/40	50/50	60/60	70/70	85/70	85/85	100/85	100/100
<b>Evaporator</b>								
Evaporator Model	EG120	EG140	EG170	EG200	EG200	EG200	EG250	EG250
Water Storage (Gallon)	28.0	71.3	58.7	53.9	53.9	53.9	109.6	109.6
Minimum Flow (GPM)	65.2	95.1	115.0	139.2	139.2	139.2	184.0	184.0
Maximum Flow (GPM)	274.6	329.9	393.1	486.4	486.4	486.4	603.0	603.0
<b>Condenser</b>								
Qty of Coils	2	2	2	2	2	2	2	2
Coil Length (inch)	108	144	144	144	180	180	216	216
Coil Height (inch)	64	64	64	64	64	64	64	64
Fin series (Fins/ft)	192	192	192	192	192	192	192	192
Number of Rows	37318	37289	37318	37318	37318	37318	37318	37318
<b>Condenser Fans</b>								
Quantity (1)	2/2	3/3	3/3	3/3	4/4	4/4	5/5	5/5
Diameter (inch)	30	30	30	30	30	30	30	30
Total Air Flow (CFM)	28479	43376	40791	40842	52929	52962	64956	65000
Nominal RPM	550	550	550	550	550	550	550	550
Tip Speed (Ft/s)	72.0	72.0	72.0	72.0	72.0	72.0	72.0	72.0
Motor kW (kW)	1.05	1.05	1.05	1.05	1.05	1.05	1.05	1.05
<b>Min Starting/Oper Ambient (2)</b>								
Standard Unit (°F)	32	32	32	32	32	32	32	32
Low Ambient Unit (°F)	0	0	0	0	0	0	0	0
<b>General Unit</b>								
Refrigerant	HFC 134a	HFC 134a	HFC 134a	HFC 134a	HFC 134a	HFC 134a	HFC 134a	HFC 134a
No. Of independent Refrigerant Circuits	2	2	2	2	2	2	2	2
% Min. Load (3)	17	17	17	17	17	17	17	17
Refrigerant Charge (1) (lbs.)	52.9/52.9	66.1/70.5	77.2/79.4	79.4/81.6	97/105.8	97/105.8	134.5/130.1	134.5/134.5
Oil Charge (1) (Gallon)	1.59/1.59	1.85/1.85	2.38/2.38	2.64/2.64	2.64/2.64	2.64/2.64	3.96/2.91	3.96/3.96
Operating Weight (4) (lbs.)	5864	7066	8058	8091	9502	9965	12103	12181
Shipping Weight (4) (lbs.)	5631	6477	7568	7646	9054	9517	11184	11261

**Table 14 - General Data RTAD High Efficiency Low Noise with with Night Noise Set Back option**

Size	085	100	115	125	145	150
Compressor Quantity	2	2	2	2	2	2
Nominal Size (1) (Tons)	40/40	50/50	60/60	70/70	85/70	85/85
<b>Evaporator</b>						
Evaporator Model	EG140	EG170	EG200	EG200	EG250	EG250
Water Storage (Gallon)	71.3	58.7	53.9	53.9	109.6	109.6
Minimum Flow (GPM)	95.1	115.0	139.2	139.2	184.0	184.0
Maximum Flow (GPM)	329.9	393.1	486.4	486.4	603.0	603.0
<b>Condenser</b>						
Qty of Coils	2	2	2	2	2	2
Coil Length (inch)	144	144	180	180	216	216
Coil Height (inch)	64	64	64	64	64	64
Fin series (Fins/ft)	192	192	192	192	192	192
Number of Rows	37318	37318	37318	37318	37318	37318
<b>Condenser Fans</b>						
Quantity (1)	3/3	3/3	4/4	4/4	5/5	5/5
Diameter (inch)	30	30	30	30	30	30
Total Air Flow (CFM)	40710	40746	52846	52904	64872	64906
Nominal RPM	550	550	550	550	550	550
Tip Speed (Ft/s)	72.0	72.0	72.0	72.0	72.0	72.0
Motor kW (kW)	1.05	1.05	1.05	1.05	1.05	1.05
<b>Min Starting/Oper Ambient (2)</b>						
Standard Unit (°F)	32	32	32	32	32	32
Low Ambient Unit (°F)	0	0	0	0	0	0
<b>General Unit</b>						
Refrigerant	HFC 134a	HFC 134a	HFC 134a	HFC 134a	HFC 134a	HFC 134a
No. Of independent Refrigerant Circuits	2	2	2	2	2	2
% Min. Load (3)	17	17	17	17	17	17
Refrigerant Charge (1) (lbs.)	70.5/75.0	77.2/79.4	92.6/99.2	92.6/99.2	130.1/134.5	130.1/134.5
Oil Charge (1) (Gallon)	1.59/1.59	1.85/1.85	2.64/2.64	2.64/2.64	2.91/2.91	2.91/2.91
Operating Weight (4) (lbs.)	7363	7430	8830	8818	11993	12004
Shipping Weight (4) (lbs.)	6775	6940	8382	8371	11074	11085

**Notes:**

- (1) Data containing information on two circuits shown as follows: ckt1/ckt2
- (2) Minimum start-up/operation ambient based on a 2.22 m/s (5mph) wind across the condenser.
- (3) Percent minimum load is for total machine at 10°C (50F) ambient and 7°C (44F) leaving chilled water temp. Not each individual circuit
- (4) Weights with aluminium fins, power disconnect switch, isolators and pressure gauges

# General Information

**Table 15 - General Data RTAD Standard High External Static Pressure**

Size		085	100	115	125	145	150	165	180
Compressor Quantity		2	2	2	2	2	2	2	2
Nominal Size (1)	(Tons)	40/40	50/50	60/60	70/70	85/70	85/85	100/85	100/100
<b>Evaporator</b>									
Evaporator Model		EG120	EG140	EG170	EG200	EG200	EG200	EG250	EG250
Water Storage	(Gallon)	28.0	71.3	58.7	53.9	53.9	53.9	109.6	109.6
Minimum Flow	(GPM)	65.2	95.1	115.0	139.2	139.2	139.2	184.0	184.0
Maximum Flow	(GPM)	274.6	329.9	393.1	486.4	486.4	486.4	603.0	603.0
<b>Condenser</b>									
Qty of Coils		2	2	2	2	2	2	2	2
Coil Length	(inch)	108	144	144	144	180	180	216	216
Coil Height	(inch)	64	64	64	64	64	64	64	64
Fin series	(Fins/ft)	192	192	192	192	192	192	192	192
Number of Rows		37683	37654	37683	37683	37683	37683	37683	37683
<b>Condenser Fans</b>									
Quantity (1)		3/3	3/3	3/3	3/3	5/4	5/5	6/5	6/6
Diameter	(inch)	30	30	30	30	30	30	30	30
Total Air Flow	(CFM)	50118	62540	58514	58578	79569	83640	96363	100368
Nominal RPM		935	935	935	935	935	935	935	935
Tip Speed	(Ft/s)	122.4	122.4	122.4	122.4	122.4	122.4	122.4	122.4
Motor kW	(kW)	2.21	2.21	2.21	2.21	2.21	2.21	2.21	2.21
<b>Min Starting/Oper Ambient (2)</b>									
Standard Unit	(°F)	32	32	32	32	32	32	32	32
Low Ambient Unit	(°F)	0	0	0	0	0	0	0	0
<b>General Unit</b>									
Refrigerant		R134a	R134a	R134a	R134a	R134a	R134a	R134a	R134a
No. Of independent Refrigerant Circuits		2	2	2	2	2	2	2	2
% Min. Load (3)		17	17	17	17	17	17	17	17
Refrigerant Charge (1)	(lbs.)	52.9/52.9	66.1/70.5	77.2/79.4	79.4/81.6	97/105.8	97/105.8	134.5/130.1	134.5/134.5
Oil Charge (1)	(Gallon)	1.59/1.59	1.85/1.85	2.38/2.38	2.64/2.64	2.64/2.64	2.64/2.64	3.96/2.91	3.96/3.96
Operating Weight (4)	(lbs.)	5864	6845	7837	7871	9392	9965	11993	12181
Shipping Weight (4)	(lbs.)	5631	6257	7348	7425	8944	9517	11074	11261

**Table 16 - General Data RTAD High Efficiency High External Static Pressure**

Size		085	100	115	125	145	150
Compressor Quantity		2	2	2	2	2	2
Nominal Size (1)	(Tons)	40/40	50/50	60/60	70/70	85/70	85/85
<b>Evaporator</b>							
Evaporator Model		EG140	EG170	EG200	EG200	EG250	EG250
Water Storage	(Gallon)	71.3	58.7	53.9	53.9	109.6	109.6
Minimum Flow	(GPM)	95.1	115.0	139.2	139.2	184.0	184.0
Maximum Flow	(GPM)	329.9	393.1	486.4	486.4	603.0	603.0
<b>Condenser</b>							
Qty of Coils		2	2	2	2	2	2
Coil Length	(inch)	144	144	180	180	216	216
Coil Height	(inch)	64	64	64	64	64	64
Fin series	(Fins/ft)	192	192	192	192	192	192
Number of Rows		37683	37683	37683	37683	37683	37683
<b>Condenser Fans</b>							
Quantity (1)		3/3	4/4	4/4	5/5	6/5	6/6
Diameter	(inch)	30	30	30	30	30	30
Total Air Flow	(CFM)	58412	66796	75432	83562	96257	100248
Nominal RPM		935	935	935	935	935	935
Tip Speed	(Ft/s)	122.4	122.4	122.4	122.4	122.4	122.4
Motor kW	(kW)	2.21	2.21	2.21	2.21	2.21	2.21
<b>Min Starting/Oper Ambient (2)</b>							
Standard Unit	(°F)	32	32	32	32	32	32
Low Ambient Unit	(°F)	0	0	0	0	0	0
<b>General Unit</b>							
Refrigerant		R134a	R134a	R134a	R134a	R134a	R134a
No. Of independent Refrigerant Circuits		2	2	2	2	2	2
% Min. Load (3)		17	17	17	17	17	17
Refrigerant Charge (1)	(lbs.)	70.5/75.0	77.2/79.4	92.6/99.2	92.6/99.2	130.1/134.5	130.1/134.5
Oil Charge (1)	(Gallon)	1.59/1.59	1.85/1.85	2.64/2.64	2.64/2.64	2.91/2.91	2.91/2.91
Operating Weight (4)	(lbs.)	7143	7430	8609	8818	11883	12004
Shipping Weight (4)	(lbs.)	6554	6940	8162	8371	10964	11085

**Notes:**

- (1) Data containing information on two circuits shown as follows: ckt1/ckt2
- (2) Minimum start-up/operation ambient based on a 2.22 m/s (5mph) wind across the condenser.
- (3) Percent minimum load is for total machine at 10°C (50F) ambient and 7°C (44F) leaving chilled water temp. Not each individual circuit.
- (4) Weights with aluminium fins, power disconnect switch, isolators and pressure gauges

# General Information

**Note:**

All Free Cooling units must be freeze protected with 30% Ethylene Glycol in the cooling loop circuit which is the most convenient percentage in order to protect the unit against freezing.

Protection coverage with 30% Ethylene Glycol:

- freezing point without burst effect = -13°C;
- freezing point with burst effect = -50°C.

**Table 17 - General Data RTAD FC Standard**

Unit Size		085	100	115	125	145	150	165	180
Number of Compressors		2	2	2	2	2	2	2	2
Nominal Size (1)	(Tons)	40/40	50/50	60/60	70/70	85/70	85/85	100/85	100/100
<b>Evaporator</b>									
Evaporator Model		EG120	EG140	EG170	EG200	EG200	EG200	EG250	EG250
Water Storage	(l)	106	270	222	204	204	204	415	415
Minimum Flow	(l/s)	4.1	6	7.3	8.8	8.8	8.8	11.6	11.6
Maximum Flow	(l/s)	17.3	20.8	24.8	30.7	30.7	30.7	38	38
<b>Free-Cooler</b>									
Number of Coils		1	1	1	1	1	1	1	1
Fin series	(Fins/ft)	152	152	122	122	152	152	152	152
Number of Rows		4	4	6	6	5	5	5	5
Water Storage (Evap+Free-Cooler)	(l)	265	481	538	520	531	531	806	806
<b>Condenser</b>									
Number of Coils		2	2	2	2	2	2	2	2
Fin series	(Fins/ft)	192	192	192	192	192	192	192	192
Number of Rows		3/3	2/2	3/3	3/3	3/3	3/3	3/3	3/3
<b>Condenser Fans</b>									
Quantity (1)		3/3	3/3	3/3	4/4	5/4	5/5	6/5	6/6
Diameter	(mm)	762	762	762	762	762	762	762	762
Total Air Flow	(m <sup>3</sup> /s)	17.9/13.0	21.6/15.7	20.4/14.7	23.5/17.2	28.4/20.6	29/21.2	34.2/24.8	34.7/25.4
Nominal Speed	(rpm)	935/740	935/740	935/740	935/740	935/740	935/740	935/740	935/740
Motor kW	(kW)	1.7/0.85	1.7/0.85	1.7/0.85	1.7/0.85	1.7/0.85	1.7/0.85	1.7/0.85	1.7/0.85
Min Starting/ Oper Ambient(2)	(°C)	-18	-18	-18	-18	-18	-18	-18	-18
<b>General Unit</b>									
Refrigerant		HFC 134a	HFC 134a	HFC 134a	HFC 134a	HFC 134a	HFC 134a	HFC 134a	HFC 134a
No. Of independent Refrigerant Circuits		2	2	2	2	2	2	2	2
% Min. Load (3)		17	17	17	17	17	17	17	17
<b>Weight, Capacities &amp; Dimensions</b>									
Refrigerant Charge (1)	(kg)	24/24	30/32	35/36	36/37	44/48	44/48	61/59	61/61
Oil Charge (1)	(l)	6/6	7/7	9/9	10/10	10/10	10/10	15/11	15/15
Operating Weight (4)	(kg)	3685	4492	5291	5446	6296	6241	7884	7969
Shipping Weight (4)	(kg)	3300	3740	4530	4720	5560	5505	6665	6750
Length	(mm)	3900	4850	4850	4850	5770	5770	6810	6810
Width	(mm)	2420	2420	2420	2420	2420	2420	2460	2460
Height	(mm)	2605	2605	2605	2605	2645	2645	2745	2745
Water Connection Diameter	(mm)	139.7	139.7	139.7	139.7	139.7	139.7	168.3	168.3
Water Connection Type		Victaulic	Victaulic	Victaulic	Victaulic	Victaulic	Victaulic	Victaulic	Victaulic

(1) Data containing information on two circuits shown as follows: ckt1/ckt2

(2) Minimum start-up/operation ambient based on a 2.22 m/s wind across the condenser

(3) Percent minimum load is for total machine at 10°C ambient and 7°C leaving chilled water temp. Not each individual circuit.

(4) Weights with aluminium fins, power disconnect switch, isolators and pressure gauges



# General Information

**Table 18 - General Data RTAD FC High Efficiency**

Unit Size		085	100	115	125	145	150
Number of Compressors		2	2	2	2	2	2
Nominal Size (1)	(Tons)	40/40	50/50	60/60	70/70	85/70	85/85
<b>Evaporator</b>							
Evaporator Model		EG 140	EG 170	EG 200	EG 200	EG 250	EG 250
Water Storage	(l)	270	222	204	204	415	415
Minimum Flow	(l/s)	6	7.3	8.8	8.8	11.6	11.6
Maximum Flow	(l/s)	20.8	24.8	30.7	30.7	38	38
<b>Free-Cooler</b>							
Number of Coils		1	1	1	1	1	1
Fin series	(Fins/ft)	152	122	152	152	152	152
Number of Rows		4	6	5	5	5	5
Water Storage (Evap+Free-Cooler)	(l)	481	538	531	531	806	806
<b>Condenser</b>							
Number of Coils		2	2	2	2	2	2
Fin series	(Fins/ft)	192	192	192	192	192	192
Number of Rows		3/3	3/3	3/3	3/3	3/3	3/3
<b>Condenser Fans</b>							
Quantity (1)		3/3	4/4	4/4	5/5	6/5	6/6
Diameter	(mm)	762	762	762	762	762	762
Total Air Flow	(m <sup>3</sup> /s)	20.8/15.1	23.5/17.2	26/18.9	28.9/21.2	34.1/24.8	34.7/25.4
Nominal Speed	(rpm)	935/740	935/740	935/740	935/740	935/740	935/740
Motor kW	(kW)	1.7/0.85	1.7/0.85	1.7/0.85	1.7/0.85	1.7/0.85	1.7/0.85
<b>Min Starting/ Oper Ambient(2)</b>	(°C)	-18	-18	-18	-18	-18	-18
<b>General Unit</b>							
Refrigerant		HFC 134a	HFC 134a	HFC 134a	HFC 134a	HFC 134a	HFC 134a
No. Of independent Refrigerant Circuits		2	2	2	2	2	2
% Min. Load (3)		17	17	17	17	17	17
<b>Weight, Capacities &amp; Dimensions</b>							
Refrigerant Charge (1)	(kg)	32/34	35/36	42/45	42/45	59/61	59/61
Oil Charge (1)	(l)	6/6	7/7	10/10	10/10	11/11	11/11
Operating Weight (4)	(kg)	4627	5106	5905	6000	7834	7889
Shipping Weight (4)	(kg)	3875	4345	5170	5265	6615	6670
Length	(mm)	4850	4850	5770	5770	6810	6810
Width	(mm)	2420	2420	2420	2420	2460	2460
Height	(mm)	2605	2605	2645	2645	2745	2745
Water Connection Diameter	(mm)	139.7	139.7	139.7	139.7	168.3	168.3
Water Connection Type		Victaulic	Victaulic	Victaulic	Victaulic	Victaulic	Victaulic

(1) Data containing information on two circuits shown as follows: ckt1/ckt2

(2) Minimum start-up/operation ambient based on a 2.22 m/s wind across the condenser

(3) Percent minimum load is for total machine at 10°C ambient and 7°C leaving chilled water temp. Not each individual circuit.

(4) Weights with aluminium fins, power disconnect switch, isolators and pressure gauges

# General Information

**Table 19 - General Data RTAD Heat Recovery Standard**

Unit Size		085	100	115	125	145	150	165	180
Number of Compressors		2	2	2	2	2	2	2	2
Nominal Size (1)	(Tons)	40/40	50/50	60/60	70/70	85/70	85/85	100/85	100/100
<b>Evaporator</b>									
Evaporator Model		EG120	EG140	EG170	EG200	EG200	EG200	EG250	EG250
Water Storage	(l)	106	269	223	204	204	204	415	415
Minimum Flow	(l/s)	4.1	6	7.3	8.8	8.8	8.8	11.6	11.6
Maximum Flow	(l/s)	17.3	20.8	24.8	30.7	30.7	30.7	38.0	38.0
Water Connection Type		Victaulic							
Water Connection Diameter	(inch-mm)	5" 1/2 O.D.- 139.7	6" - 168.3	6" - 168.3	6" - 168.3	6" - 168.3	6" - 168.3	6" - 168.3	6" - 168.3
<b>Heat Recovery Heat-Exchanger</b>									
Type		Brazen Plates							
Water connection type		Victaulic							
<b>PHR</b>									
Connection diameter	(inch-mm)	2" - 60.3	2" - 60.3	2" - 60.3	2" - 60.3	2" - 60.3	2" - 60.3	2" - 60.3	2" - 60.3
Water Storage capacity	(l)	8	8	9	9	11	11	12	12
<b>THR</b>									
Connection diameter	(inch-mm)	-	2" - 60.3	2" - 60.3	2" - 60.3	3" O.D. - 76.1	3" O.D. - 76.1	3" O.D. - 76.1	3" O.D. - 76.1
Water Storage capacity	(l)	-	10	14	14	16	16	19	19
<b>Condenser</b>									
Number of Coils		2	2	2	2	2	2	2	2
Fin series	(Fins/ft)	192	192	192	192	192	192	192	192
Number of Rows		3/3	2/2	3/3	3/3	3/3	3/3	3/3	3/3
<b>Condenser Fans</b>									
Quantity (1)		3/3	3/3	3/3	3/3	5/4	5/5	6/5	6/6
Diameter	(mm)	762	762	762	762	762	762	762	762
Total Air Flow	(m <sup>3</sup> /s)	23.4	28.5	27.0	27.0	37.0	39.0	44.9	46.8
Nominal Speed	(rpm)	930	930	930	930	930	930	930	930
Motor kW	(kW)	1.72	1.72	1.72	1.72	1.72	1.72	1.72	1.72
<b>Min Starting/Oper Ambient (2)</b>									
PHR	(°C)	0	0	0	0	0	0	0	0
THR	(°C)	-18	-18	-18	-18	-18	-18	-18	-18
<b>General Unit</b>									
Refrigerant		HFC 134a	HFC 134a	HFC 134a	HFC 134a	HFC 134a	HFC 134a	HFC 134a	HFC 134a
No. Of independent Refrigerant Circuits		2	2	2	2	2	2	2	2
% Min. Load (3)		17	17	17	17	17	17	17	17
<b>Weight, Capacities &amp; Dimensions</b>									
<b>PHR</b>									
Refrigerant Charge (1)	(kg)	26/26	33/35	38/39	39/40	47/51	47/51	65/63	65/65
Oil Charge (1)	(l)	6/6	7/7	9/9	10/10	10/10	10/10	15/11	15/15
Operating Weight (4)	(kg)	2736	3176	3635	3650	4345	4605	5535	5622
Shipping Weight (4)	(kg)	2622	2899	3403	3437	4130	4390	5108	5195
<b>THR</b>									
Refrigerant Charge (1)	(kg)	-	55 / 52	67 / 64	68 / 64	86 / 84	86 / 84	100 / 95	100 / 98
Oil Charge (1)	(l)	-	5 / 4	8 / 7	8 / 7	8 / 7	8 / 7	13 / 7	13 / 12
Operating Weight (4)	(kg)	-	3347	3833	3848	4615	4875	5806	5891
Shipping Weight (4)	(kg)	-	3061	3589	3623	4382	4642	5359	5444
<b>Dimensions</b>									
Length	(mm)	3507	4426	4426	4426	5351	5351	6370	6370
Width	(mm)	2260	2260	2260	2260	2260	2260	2260	2260
Height	(mm)	2095	2095	2095	2095	2115	2115	2215	2215

(1) Data containing information on two circuits shown as follows: ckt1/ckt2

(2) Minimum start-up/operation ambient based on a 2.22 m/s wind across the condenser.

(3) Percent minimum load is for total machine at 10°C ambient and 7°C leaving chilled water temp. Not each individual circuit.

(4) With aluminum fins

# General Information

**Table 20 - General Data RTAD Heat Recovery High Efficiency**

Unit Size		085	100	115	125	145	150
Number of Compressors		2	2	2	2	2	2
Nominal Size (1)	(Tons)	40/40	50/50	60/60	70/70	85/70	85/85
<b>Evaporator</b>							
Evaporator Model		EG140	EG170	EG200	EG200	EG250	EG250
Water Storage	(l)	269	223	204	204	415	415
Minimum Flow	(l/s)	6	7.3	8.8	8.8	11.6	11.6
Maximum Flow	l/s)	20.8	24.8	30.7	30.7	38.0	38.0
Water Connection Type		Victaulic					
Water Connection Diameter	(inch-mm)	6" - 168.3	6" - 168.3	6" - 168.3	6" - 168.3	6" - 168.3	6" - 168.3
<b>Heat Recovery Heat-Exchanger</b>							
Type		Brazen Plates					
Water connection type		Victaulic					
<b>PHR</b>							
Connection diameter	(inch-mm)	2" - 60.3	2" - 60.3	2" - 60.3	2" - 60.3	2" - 60.3	2" - 60.3
Water Storage capacity	(l)	8	8	9	9	11	11
<b>THR</b>							
Connection diameter	(inch-mm)	2" - 60.3	2" - 60.3	2" - 60.3	2" - 60.3	3" O.D. - 76.1	3" O.D. - 76.1
Water Storage capacity	(l)	10	10	14	14	16	16
<b>Condenser</b>							
Number of Coils		2	2	2	2	2	2
Fin series	(Fins/ft)	192	192	192	192	192	192
Number of Rows		3/3	3/3	3/3	3/3	3/3	3/3
<b>Condenser Fans</b>							
Quantity (1)		3/3	4/4	4/4	5/5	6/5	6/6
Diameter	(mm)	762	762	762	762	762	762
Total Air Flow	(m <sup>3</sup> /s)	27.0	31.2	35.0	39.0	44.9	46.8
Nominal Speed	(rpm)	930	930	930	930	930	930
Motor kW	(kW)	1.72	1.72	1.72	1.72	1.72	1.72
<b>Min Starting/Oper Ambient (2)</b>							
PHR	(°C)	0	0	0	0	0	0
THR	(°C)	-18	-18	-18	-18	-18	-18
<b>General Unit</b>							
Refrigerant		HFC 134a	HFC 134a	HFC 134a	HFC 134a	HFC 134a	HFC 134a
No. Of independent Refrigerant Circuits		2	2	2	2	2	2
% Min. Load (3)		17	17	17	17	17	17
<b>Weight, Capacities &amp; Dimensions</b>							
<b>PHR</b>							
Refrigerant Charge (1)	(kg)	35/37	38/39	45/48	45/48	63/65	63/65
Oil Charge (1)	(l)	6/6	7/7	10/10	10/10	11/11	11/11
Operating Weight (4)	(kg)	3311	3441	3984	4079	5474	5529
Shipping Weight (4)	(kg)	2375	2504	3045	3140	4532	4587
<b>THR</b>							
Refrigerant Charge (1)	(kg)	63 / 60	65 / 62	86 / 84	86 / 84	97 / 95	97 / 95
Oil Charge (1)	(l)	5 / 4	5 / 4	8 / 7	8 / 7	8 / 7	8 / 7
Operating Weight (4)	(kg)	3494	3624	4238	4333	5731	5786
Shipping Weight (4)	(kg)	3208	3384	4013	4108	5287	5342
<b>Dimensions</b>							
Length	(mm)	4426	4426	5351	5351	6370	6370
Width	(mm)	2260	2260	2260	2260	2260	2260
Height	(mm)	2095	2095	2115	2115	2215	2215

(1) Data containing information on two circuits shown as follows: ckt1/ckt2

(2) Minimum start-up/operation ambient based on a 2.22 m/s wind across the condenser.

(3) Percent minimum load is for total machine at 10°C ambient and 7°C leaving chilled water temp. Not each individual circuit.

(4) With aluminum fins

# General Information

**Table 21 - General Data RTAD Heat Recovery Standard Low Noise**

Unit Size		085	100	115	125	145	150	165	180
Number of Compressors		2	2	2	2	2	2	2	2
Nominal Size (1)	(Tons)	40/40	50/50	60/60	70/70	85/70	85/85	100/85	100/100
<b>Evaporator</b>									
Evaporator Model		EG120	EG140	EG170	EG200	EG200	EG200	EG250	EG250
Water Storage	(l)	106	269	223	204	204	204	415	415
Minimum Flow	(l/s)	4.1	6	7.3	8.8	8.8	8.8	11.6	11.6
Maximum Flow	(l/s)	17.3	20.8	24.8	30.7	30.7	30.7	38.0	38.0
Water Connection Type		Victaulic							
Water Connection Diameter	(inch-mm)	5"1/2 O.D.-139.7	6" - 168.3	6" - 168.3	6" - 168.3	6" - 168.3	6" - 168.3	6" - 168.3	6" - 168.3
<b>Heat Recovery Heat-Exchanger</b>									
Type		Brazen Plates							
Water connection type		Victaulic							
<b>PHR</b>									
Connection diameter	(inch-mm)	2" - 60.3	2" - 60.3	2" - 60.3	2" - 60.3	2" - 60.3	2" - 60.3	2" - 60.3	2" - 60.3
Water Storage capacity	(l)	8	8	9	9	11	11	12	12
<b>THR</b>									
Connection diameter	(inch-mm)	-	2" - 60.3	2" - 60.3	2" - 60.3	3" O.D. - 76.1	3" O.D. - 76.1	3" O.D. - 76.1	3" O.D. - 76.1
Water Storage capacity	(l)	-	10	14	14	16	16	19	19
<b>Condenser</b>									
Number of Coils		2	2	2	2	2	2	2	2
Fin series	(Fins/ft)	192	192	192	192	192	192	192	192
Number of Rows		3/3	2/2	3/3	3/3	3/3	3/3	3/3	3/3
<b>Condenser Fans</b>									
Quantity (1)		3/3	3/3	3/3	3/3	5/4	5/5	6/5	6/6
Diameter	(mm)	762	762	762	762	762	762	762	762
Total Air Flow	(m <sup>3</sup> /s)	18.1	22.4	21.0	21.0	28.7	30.1	34.7	36.2
Nominal Speed	(rpm)	750	750	750	750	750	750	750	750
Motor kW	(kW)	1.23	1.23	1.23	1.23	1.23	1.23	1.23	1.23
<b>Min Starting/Oper Ambient (2)</b>									
PHR	(°C)	0	0	0	0	0	0	0	0
THR	(°C)	-18	-18	-18	-18	-18	-18	-18	-18
<b>General Unit</b>									
Refrigerant		HFC 134a	HFC 134a	HFC 134a	HFC 134a	HFC 134a	HFC 134a	HFC 134a	HFC 134a
No. Of independent Refrigerant Circuits		2	2	2	2	2	2	2	2
% Min. Load (3)		17	17	17	17	17	17	17	17
<b>Weight, Capacities &amp; Dimensions</b>									
<b>PHR</b>									
Refrigerant Charge (1)	(kg)	26/26	33/35	38/39	39/40	47/51	47/51	65/63	65/65
Oil Charge (1)	(l)	6/6	7/7	9/9	10/10	10/10	10/10	15/11	15/15
Operating Weight (4)	(kg)	2836	3276	3735	3750	4445	4705	5635	5722
Shipping Weight (4)	(kg)	2082	2520	2978	2991	3686	3946	4873	4960
<b>THR</b>									
Refrigerant Charge (1)	(kg)	-	55 / 52	67 / 64	68 / 64	86 / 84	86 / 84	100 / 95	100 / 98
Oil Charge (1)	(l)	-	5 / 4	8 / 7	8 / 7	8 / 7	8 / 7	13 / 7	13 / 12
Operating Weight (4)	(kg)	-	3447	3933	3948	4715	4975	5906	5991
Shipping Weight (4)	(kg)	-	3161	3689	3723	4482	4742	5459	5544
<b>Dimensions</b>									
Length	(mm)	3507	4426	4426	4426	5351	5351	6370	6370
Width	(mm)	2260	2260	2260	2260	2260	2260	2260	2260
Height	(mm)	2095	2095	2095	2095	2115	2115	2215	2215

(1) Data containing information on two circuits shown as follows: ckt1/ckt2

(2) Minimum start-up/operation ambient based on a 2.22 m/s wind across the condenser.

(3) Percent minimum load is for total machine at 10°C ambient and 7°C leaving chilled water temp. Not each individual circuit.

(4) With aluminum fins

# General Information

**Table 22 - General Data RTAD Heat Recovery High Efficiency Low Noise**

Unit Size		085	100	115	125	145	150
Number of Compressors		2	2	2	2	2	2
Nominal Size (1)	(Tons)	40/40	50/50	60/60	70/70	85/70	85/85
<b>Evaporator</b>							
Evaporator Model		EG140	EG170	EG200	EG200	EG250	EG250
Water Storage	(l)	269	223	204	204	415	415
Minimum Flow	(l/s)	6	7.3	8.8	8.8	11.6	11.6
Maximum Flow	l/s)	20.8	24.8	30.7	30.7	38	38
Water Connection Type		Victaulic					
Water Connection Diameter	(inch-mm)	6" - 168.3	6" - 168.3	6" - 168.3	6" - 168.3	6" - 168.3	6" - 168.3
<b>Heat Recovery Heat-Exchanger</b>							
Type		Brazen Plates					
Water connection type		Victaulic					
<b>PHR</b>							
Connection diameter		2" - 60.3	2" - 60.3	2" - 60.3	2" - 60.3	2" - 60.3	2" - 60.3
Water Storage capacity	(l)	8	8	9	9	11	11
<b>THR</b>							
Connection diameter	(inch-mm)	2" - 60.3	2" - 60.3	2" - 60.3	2" - 60.3	3" O.D. - 76.1	3" O.D. - 76.1
Water Storage capacity	(l)	10	10	14	14	16	16
<b>Condenser</b>							
Number of Coils		2	2	2	2	2	2
Fin series	(Fins/ft)	192	192	192	192	192	192
Number of Rows		3/3	3/3	3/3	3/3	3/3	3/3
<b>Condenser Fans</b>							
Quantity (1)		3/3	4/4	4/4	5/5	6/5	6/6
Diameter	(mm)	762	762	762	762	762	762
Total Air Flow	(m <sup>3</sup> /s)	21.0	24.1	27.2	30.1	34.7	36.2
Nominal Speed	(rpm)	750	750	750	750	750	750
Motor kW	(kW)	1.23	1.23	1.23	1.23	1.23	1.23
<b>Min Starting/Oper Ambient (2)</b>							
PHR	(°C)	0	0	0	0	0	0
THR	(°C)	-18	-18	-18	-18	-18	-18
<b>General Unit</b>							
Refrigerant		HFC 134a	HFC 134a	HFC 134a	HFC 134a	HFC 134a	HFC 134a
No. Of independent Refrigerant Circuits		2	2	2	2	2	2
% Min. Load (3)		17	17	17	17	17	17
<b>Weight, Capacities &amp; Dimensions</b>							
<b>PHR</b>							
Refrigerant Charge (1)	(kg)	35/37	38/39	45/48	45/48	63/65	63/65
Oil Charge (1)	(l)	6/6	7/7	10/10	10/10	11/11	11/11
Operating Weight (4)	(kg)	3411	3541	4084	4179	5574	5629
Shipping Weight (4)	(kg)	2655	2784	3325	3420	4812	4867
<b>THR</b>							
Refrigerant Charge (1)	(kg)	63 / 60	65 / 62	86 / 84	86 / 84	97 / 95	97 / 95
Oil Charge (1)	(l)	5 / 4	5 / 4	8 / 7	8 / 7	8 / 7	8 / 7
Operating Weight (4)	(kg)	3594	3724	4338	4433	5831	5886
Shipping Weight (4)	(kg)	3308	3484	4113	4208	5387	5442
<b>Dimensions</b>							
Length	(mm)	4426	4426	5351	5351	6370	6370
Width	(mm)	2260	2260	2260	2260	2260	2260
Height	(mm)	2095	2095	2115	2115	2215	2215

(1) Data containing information on two circuits shown as follows: ckt1/ckt2

(2) Minimum start-up/operation ambient based on a 2.22 m/s wind across the condenser.

(3) Percent minimum load is for total machine at 10°C ambient and 7°C leaving chilled water temp. Not each individual circuit.

(4) With aluminum fins

# General Information

The below hydraulic module operating weight must be added to the RTAD operating weight.

**Table 23 - Hydraulic module additional operating weight - SI units (kg)**

RTAD 115 HE - RTAD 125 HE - RTAD 145 SE - RTAD 150 SE		Expansion vessel		
Pump type	Pump model	Without	50 litres	80 litres
Single	LRN 208-13/5.5 - LRN 208-14/7.5	400	460	500
	SIL 208-16/11 - SIL 208-17/15	455	515	555
Dual	JRN 208-13/5.5 - JRN 208-14/7.5	490	550	590
	SIL 208-16/11 - SIL 208-17/15	600	660	700
RTAD 145 HE - RTAD 150 HE - RTAD 165 SE - RTAD 180 HE		Expansion vessel		
Single	LRN 208-13/5.5 - LRN 208-14/7.5	510	570	610
	SIL 208-16/11 - SIL 208-17/15	565	625	665
Dual	JRN 208-13/5.5 - JRN 208-14/7.5	600	660	700
	SIL 208-16/11 - SIL 208-17/15	710	770	810

**Hydraulic module additional operating weight - English units (lbs)**

RTAD 115 HE - RTAD 125 HE - RTAD 145 SE - RTAD 150 SE		Expansion vessel		
Pump type	Pump model	Without	50 litres	80 litres
Single	LRN 208-13/5.5 - LRN 208-14/7.5	882	1014	1102
	SIL 208-16/11 - SIL 208-17/15	1003	1135	1224
Dual	JRN 208-13/5.5 - JRN 208-14/7.5	1080	1213	1301
	SIL 208-16/11 - SIL 208-17/15	1323	1455	1543
RTAD 145 HE - RTAD 150 HE - RTAD 165 SE - RTAD 180 HE		Expansion vessel		
Single	LRN 208-13/5.5 - LRN 208-14/7.5	1124	1257	1345
	SIL 208-16/11 - SIL 208-17/15	1246	1378	1466
Dual	JRN 208-13/5.5 - JRN 208-14/7.5	1323	1455	1543
	SIL 208-16/11 - SIL 208-17/15	1565	1698	1786

# General Information

## Unit Dimensions

Figure 2 - Unit Dimensions and Minimum Recommended Clearances

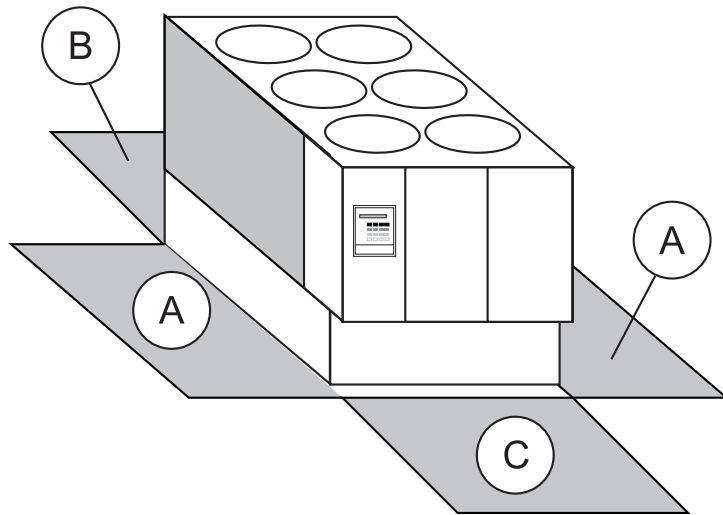

Table 24

Unit Size	Unit Dimensions (mm)			Minimum clearances (mm)		
	Length	Width	Height	A	B	C
<b>Standard, Partial Heat Recovery, and Total Heat Recovery</b>						
RTAD 085	3507	2260	2095	1200	1000	1000
RTAD 100-115-125	4426	2260	2095	1200	1000	1000
RTAD 145-150	5351	2260	2115	1200	1000	1000
RTAD 165-180	6370	2260	2215	1200	1000	1000
RTAD 085-100 HE	4426	2260	2095	1200	1000	1000
RTAD 115-125 HE	5351	2260	2115	1200	1000	1000
RTAD 145-150 HE	6370	2260	2215	1200	1000	1000
<b>Free Cooling</b>						
RTAD 085	3900	2420	2605	1200	1000	1000
RTAD 100-115-125	4850	2420	2605	1200	1000	1000
RTAD 145-150	5770	2420	2645	1200	1000	1000
RTAD 165-180	6810	2460	2745	1200	1000	1000
RTAD 085-100 HE	4850	2420	2605	1200	1000	1000
RTAD 115-125 HE	5770	2420	2645	1200	1000	1000
RTAD 145-150 HE	6810	2460	2745	1200	1000	1000

Note: Size 085 does not exist for Total Heat Recovery option but HE version is available

# Installation - Mechanical

## Installation Responsibilities

Generally, the contractor must do the following when installing an RTAD unit:

- Install unit on a flat foundation, level (within 1/4" [6 mm] across the length of the unit), and strong enough to support unit loading.
- Install unit per the instructions contained in this manual.
- Install any optional sensors and make electrical connections at the UCM-CLD.
- Where specified, provide and install valves in water piping upstream and downstream of evaporator water connections to isolate the evaporator for maintenance, and to balance/trim system.
- Furnish and install flow switch and/or auxiliary contacts to prove chilled water flow.
- Furnish and install pressure gauges in inlet and outlet piping of the evaporator.

- Furnish and install a drain valve to the bottom of the evaporator shell.
- Supply and install a vent cock to the top of the evaporator shell.
- Furnish and install strainers ahead of all pumps and automatic modulating valves.
- Provide and install field wiring.
- Install heat tape and insulate the chilled water lines and any other portions of the system, as required, to prevent sweating under normal operating conditions or freezing during low ambient temperature conditions.
- Start unit under supervision of a qualified service technician.

## Nameplates

The RTAD outdoor unit nameplates (Figure 1) are applied to the exterior of the control panel. A compressor nameplate is located on each compressor.

### Outdoor Unit Nameplate

The outdoor unit nameplate provides the following information:

- Unit model and size description
- Unit serial number
- Identifies unit electrical requirements
- Lists correct operating charges of R-134a and refrigerant oil (Trane OIL00048)
- Lists unit test pressures

### Compressor Nameplate

The compressor nameplate provides following information:

- Compressor model number.
- Compressor serial number.
- Compressor electrical characteristics.
- Utilization range
- Recommended refrigerant



# Installation - Mechanical

Figure 3 - Rigging the Unit

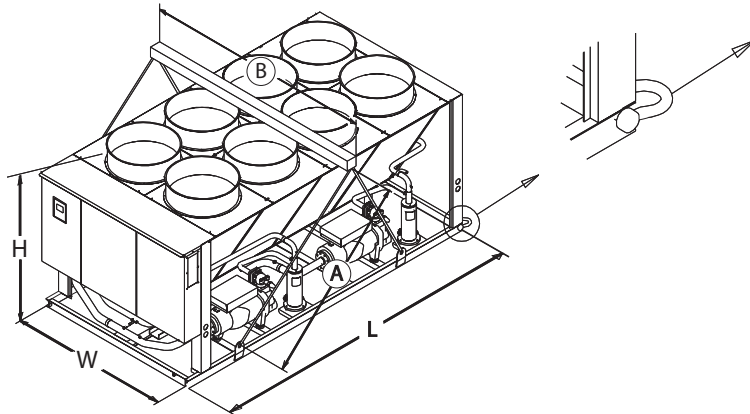

Table 25

Unit Size	Lengths (mm)				Maximum weight (kg)(1)		
	A	B	L	H max	W	Aluminium	Copper
<b>Standard</b>							
RTAD 085	4000	2400	3507	2215	2260	2740	3070
RTAD 100-115-125	4000	2400	4426	2215	2260	3565	4005
RTAD 145-150	4000	2400	5351	2215	2260	4530	4940
RTAD 165-180	4000	2400	6370	2215	2260	5345	5855
RTAD 085-100 HE	4000	2400	4426	2215	2260	3345	3785
RTAD 115-125 HE	4000	2400	5351	2215	2260	4010	4560
RTAD 145-150 HE	4000	2400	6370	2215	2260	5265	5775
<b>Partial Heat Recovery</b>							
RTAD 085	4000	2400	3507	2215	2260	2810	3140
RTAD 100-115-125	4000	2400	4426	2215	2260	3635	4075
RTAD 145-150	4000	2400	5351	2215	2260	4605	5015
RTAD 165-180	4000	2400	6370	2215	2260	5430	5940
RTAD 085-100 HE	4000	2400	4426	2215	2260	3405	3845
RTAD 115-125 HE	4000	2400	5351	2215	2260	4080	4630
RTAD 145-150 HE	4000	2400	6370	2215	2260	5340	5850
<b>Total Heat Recovery</b>							
RTAD 100	4000	2400	4426	2215	2260	3260	3540
RTAD 115-125	4000	2400	4426	2215	2260	3820	4260
RTAD 145-150	4000	2400	5351	2215	2260	4855	5265
RTAD 165-180	4000	2400	6370	2215	2260	5680	6190
RTAD 085-100 HE	4000	2400	4426	2215	2260	3580	3845
RTAD 115-125 HE	4000	2400	5351	2215	2260	4320	4870
RTAD 145-150 HE	4000	2400	6370	2215	2260	5580	6090
<b>Free Cooling</b>							
RTAD 085	4600	2600	3900	2605	2420	3485	-
RTAD 100-115-125	4600	2600	4850	2605	2420	4920	-
RTAD 145-150	4600	2600	5770	2645	2420	5720	-
RTAD 165-180	4600	2600	6810	2745	2460	6985	-
RTAD 085-100 HE	4600	2600	4850	2605	2420	4540	-
RTAD 115-125 HE	4600	2600	5770	2645	2420	5480	-
RTAD 145-150 HE	4600	2600	6810	2745	2460	6905	-
RTAD 145-150 SE	4000	2400	5351	2215	2260	5265	5675
RTAD 165-180 SE	4000	2400	6370	2215	2260	6145	6655
RTAD 115-125 HE	4000	2400	5351	2215	2260	4740	5150
RTAD 145-150 HE	4000	2400	6370	2215	2260	6145	6655

Note: Size 085 does not exist for Total Heat Recovery option but HE version is available  
 (1) Maximum weight with all options

# Installation - Mechanical

## Storage

Extended storage of the outdoor unit prior to installation requires the following precautionary measures:

- Store the outdoor unit in a secure area.
- At least every three months (quarterly), check the pressure in the refrigerant circuits to verify that the refrigerant charge is intact. If it is not, contact a qualified service organization and the appropriate Trane sales office.
- Close the discharge and liquid line isolation valves.

**CAUTION! Refer to nameplate for unit weight and additional installation instructions contained inside the control panel. Other lifting arrangements may cause equipment damage or serious personal injury.**

## Location Requirements Isolation and Sound Emission

The most effective form of isolation is to locate the unit away from any sound sensitive area. Structurally transmitted sound can be reduced by elastomeric vibration eliminators. Spring isolators are not recommended. Consult an acoustical engineer in critical sound applications. For maximum isolation effect, isolate water lines and electrical conduit. Wall sleeves and rubber isolated piping hangers can be used to reduce the sound transmitted through water piping. To reduce the sound transmitted through electrical conduit, use flexible electrical conduit. State and local codes on sound emissions should always be considered. Since the environment in which a sound source is located affects sound pressure, unit placement must be carefully evaluated. Sound power levels for Trane air-cooled RTAD chillers are available on request.

For additional reduction of sound and vibration, install the optional neoprene isolators. Construct an isolated concrete pad for the unit or provide concrete footings at the unit mounting points. Mount the unit directly to the concrete pads or footings. Level the unit using the base rail as a reference. Use shims as necessary to level the unit.

## Neoprene Isolator (optional) Installation

Refer to submittals for diagrams.

- 1 Secure the isolators to the mounting surface using the mounting slots in the isolator base plate. **DO NOT** fully tighten the isolator mounting bolts at this time.
- 2 Align the mounting holes in the base of the unit with the threaded positioning pins on the top of the isolators.
- 3 Lower the unit onto the isolators and secure the isolator to the unit with a nut. Maximum isolator deflection should be 1/4 inch (6 mm).
- 4 Level the unit carefully. Fully tighten the isolator mounting bolts.

## Noise Considerations

Locate the outdoor unit away from sound sensitive areas. If required, install rubber vibration isolators in all water piping and use flexible electrical conduit. Consult an acoustical engineer for critical applications. Also refer to Trane Engineering Bulletins for application information on RTAD chillers.

## Important note for Free-cooling units:

To reduce sound levels, a sound enclosure can be mounted around the compressors. For further sound level reduction, the fan speed should be forced onto low speed (e.g. 740 rpm). This can be done using the control panel. Make sure that option 20, shown on the wiring diagram, is correctly wired.

# Installation - Mechanical

---

## Foundation

Provide rigid, non-warping mounting pads or a concrete foundation of sufficient strength and mass to support the outdoor unit operating weight (i.e., including completed piping, and full operating charges of refrigerant, oil and water). Refer to Tables 1-23 for unit operating weights. Once in place, the outdoor unit must be level within 1/4" (6 mm) over its length and width. A base or foundation is not required if the selected unit location is level and strong enough to support the unit's operating weight. Trane is not responsible for equipment problems resulting from an improperly designed or constructed foundation.

*Note: To allow for cleaning under the condensing coil, it is recommended that an opening be left between the unit base and the concrete pad.*

## Clearances

Refer to Figure 2 for minimum clearances. Provide enough space around the outdoor unit to allow the installation and maintenance personnel unrestricted access to all service points. Refer to submittal drawings for the unit dimensions. A minimum of four feet is recommended for compressor service. Provide sufficient clearance for the opening of control panel doors. In all cases, local codes which require additional clearances will take precedence over these recommendations.

Unobstructed flow of condenser air is essential to maintain chiller capacity and operating efficiency. When determining unit placement, give careful consideration to assuring a sufficient flow of air across the condenser heat transfer surface. Two detrimental conditions are possible and must be avoided if optimum performance is to be achieved: warm air recirculation and coil starvation. Warm air recirculation occurs when discharge air from the condenser fans is recycled back to the condenser coil inlet. Coil starvation occurs when free airflow to (or from) the condenser is restricted. Both warm air recirculation and coil starvation cause reduction in unit efficiency and capacity due to the increased head pressures. Debris, trash, supplies etc. should not be allowed to accumulate in the vicinity of the unit. Supply air movement may draw debris into the condenser coil, blocking spaces between coil fins and causing coil starvation. Special consideration should be given to low ambient units. Condenser coils and fan discharge must be kept free of snow or other obstructions to permit adequate airflow for satisfactory unit operation.

# Installation - Mechanical

---

In situations where equipment must be installed with less clearance than recommended, such as frequently occurs in retrofit and rooftop applications, restricted airflow is common. The Main Processor will direct the unit to make as much chilled water as possible given the actual installed conditions. Consult your Trane sales engineer for more details.

*Note: If the outdoor unit configuration requires a variance to the clearance dimensions, contact your Trane Sales Office Representative. Also refer to Trane Engineering Bulletins for application information on RTAD chillers.*

## Drainage

Provide a large capacity drain for water vessel drain-down during shutdown or repair. The evaporator is provided with a drain connection. All local and national codes apply. The vent on the top of the evaporator shell is provided to prevent a vacuum by allowing air into the evaporator for complete drainage.

## Unit Water Piping

Thoroughly flush all water piping to the unit before making the final piping connections to the unit.

**CAUTION! If using an acidic commercial flushing solution, construct a temporary bypass around the unit to prevent damage to internal components of the evaporator. To avoid possible equipment damage, do not use untreated or improperly treated system water.**

**CAUTION! As the unit contains pressure approved vessels and sensitive electronic equipment, do not use arc welding directly on the unit or even close to the unit. Do not weld near the Victaulic connections.**

## Unit Piping

Components and layout will vary slightly, depending on the location of connections and the water source.

*Note: The chilled water piping to the evaporator is to be Victaulic type connections. For Free Cooling units, Free Cooling coil connections are also to be Victaulic™ type connections.*

To prevent damage to chilled water components, do not allow evaporator pressure (maximum working pressure) to exceed 16 bar.

Provide shutoff valves in lines to the gauges to isolate them from the system when they are not in use. Use rubber vibration eliminators to prevent vibration transmission through the water lines. If desired, install thermometers in the lines to monitor entering and leaving water temperatures. Install a balancing valve in the leaving water line to control water flow balance. Install shutoff valves on both the entering and leaving water lines so that the evaporator can be isolated for service.

**CAUTION! A pipe strainer must be installed in the entering water line. Failure to do so can allow waterborne debris to enter the evaporator.**

"Piping components" include all devices and controls used to provide proper water system operation and unit operating safety. These components and their general locations are given below.

# Installation - Mechanical

## Entering Chilled Water Piping

- Air vents (to bleed air from system).
- Water pressure gauges with shutoff valves.
- Vibration eliminators.
- Shutoff (isolation) valves. Thermometers (if desired).
- Clean-out tees.
- Pipe strainer.

**CAUTION! Install strainer in evaporator water inlet piping. Failure to do so can result in evaporator tube damage.**

## Leaving Chilled Water Piping

- Air vents (to bleed air from system).
- Water pressure gauges with shutoff valves.
- Vibration eliminators.
- Shutoff (isolation) valves.
- Thermometers.
- Clean-out tees.
- Balancing valve.
- Flow Switch

**CAUTION! To prevent evaporator damage, do not exceed 16 bar evaporator water pressure.**

## Heat Recovery Water Piping

### Entering:

- Air vents
- Water pressure gauges
- Vibration eliminator / expansion compensator
- Shutoff valve
- Thermometers
- Pipe strainer
- Clean-out tees

### Leaving:

- Air vents
- Water pressure gauges
- Vibration eliminator / expansion compensator
- Shutoff valve
- Thermometers
- Balancing valve
- Clean-out tees

## Evaporator Drain

A 3/4" drain connection is located under the evaporator shell. This may be connected to a suitable drain to permit evaporator drainage during unit servicing. A shutoff valve must be installed on the drain line.

## Evaporator Flow Switch

Specific connection and schematic wiring diagrams are shipped with the unit. Some piping and control schemes, particularly those using a single water pump for both chilled and hot water must be analyzed to determine how and or if a flow-sensing device will provide desired operation.

Follow the manufacturer's recommendations for selection and installation procedures. General guidelines for flow switch installation are outlined below

1. Mount the switch upright, with a minimum of 5 pipe diameters of straight horizontal run on each side. Do not install close to elbows, orifices or valves.

*Note: The arrow on the switch must point in the direction of flow.*

2. To prevent switch fluttering, remove all air from the water system.

*Note: The UCM-CLD provides a 6-second time delay after a "loss-of-flow" diagnostic before shutting the unit down. Contact a qualified service representative if nuisance machine shutdowns persist.*

3. Adjust the switch to open when water flow falls below nominal.

Evaporator data is given in Tables 1-22. Flow switch contacts are closed on proof of water flow.

4. Install a pipe strainer in the entering evaporator water line to protect components from waterborne debris.

# Installation - Mechanical

## Water Treatment

**CAUTION! If calcium chloride is used for water treatment, an applicable corrosion inhibitor must also be used. Failure to do so may result in damage to system components.**

Dirt, scale, products of corrosion and other foreign material will adversely affect heat transfer between the water and system components. Foreign matter in the chilled water system can also increase pressure drop and, consequently, reduce water flow.

Proper water treatment must be determined locally, depending on the type of system and local water characteristics. Neither salt nor brackish water is recommended for use in Trane air-cooled Series R™ chillers. Use of either will lead to a shortened life to an indeterminable degree. Trane encourages the employment of a reputable water treatment specialist, familiar with local water conditions, to assist in this determination and in the establishment of a proper water treatment program.

Using untreated or improperly treated water in these units may result in inefficient operation and possible tube damage. Consult a qualified water treatment specialist to determine whether treatment is needed. The following disclamatory label is provided on each RTAD unit:  
*Note: The use of improperly treated or untreated water in this equipment may result in scaling, erosion, corrosion, algae or slime. The services of a qualified water treatment specialist should be engaged to determine what treatment, if any, is advisable. Trane warranty specifically excludes liability for corrosion, erosion or deterioration of Trane equipment.*

**CAUTION! Do not use untreated or improperly treated water. Equipment damage may occur.**

Figure 4 - Evaporator Water Pressure Drop RTAD

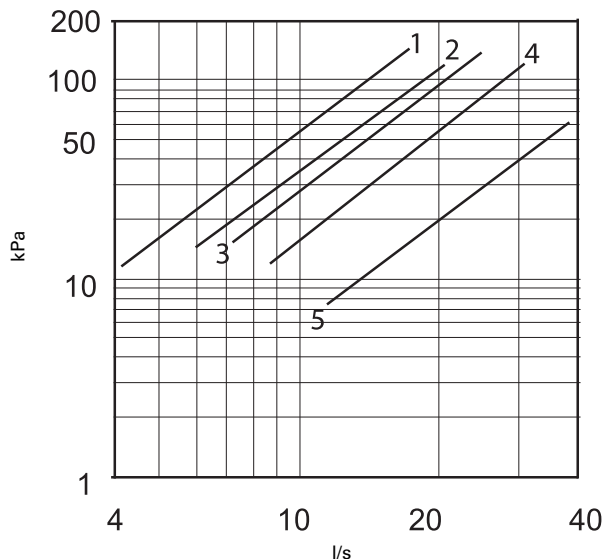

- 1 = 085 STD
- 2 = 115 STD, 100 HE
- 3 = 100 STD, 085 HE
- 4 = 125 STD, 145 STD, 150 STD, 115 HE, 125 HE
- 5 = 165 STD, 180 STD, 145 HE, 150 HE

Note: Valid for standard, Free-cooling and Heat Recovery versions

# Installation - Mechanical

**Figure 5 - RTAD 115HE - 125HE - 145SE - 150SE**  
**Single pump available static pressure**

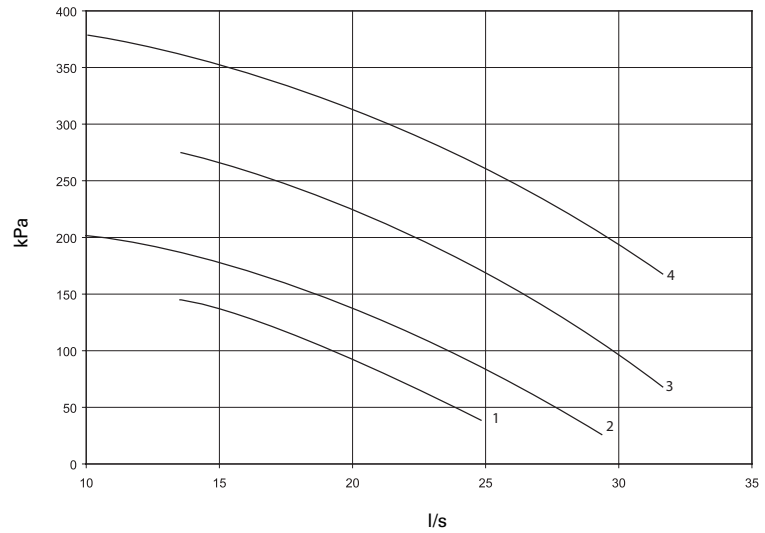

- 1 = LRN 208-13/5.5
- 2 = LRN 208-14/7.5
- 3 = SIL 208-16/11
- 4 = SIL 208-17/15

**Figure 6 - RTAD 115HE - 125HE - 145SE - 150SE**  
**Dual pump available static pressure**

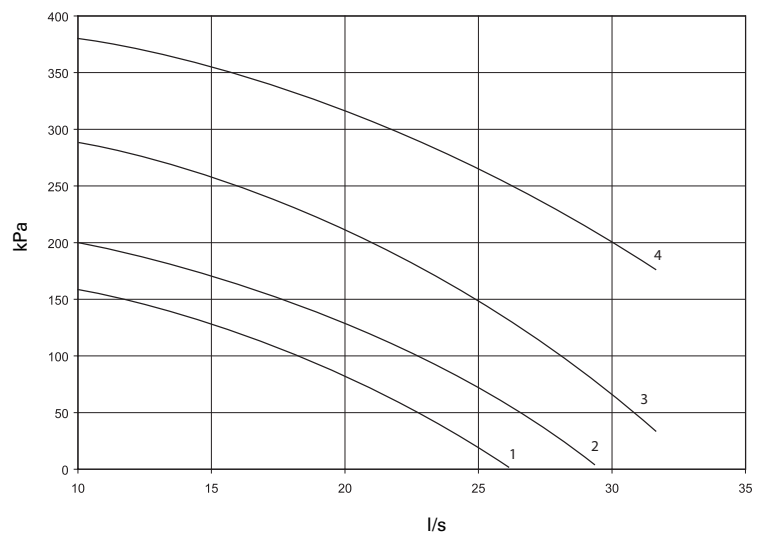

- 1 = JRN 208-13/5.5
- 2 = JRN 208-14/7.5
- 3 = DIL 208-16/11
- 4 = DIL 208-17/15

# Installation - Mechanical

**Figure 7 - RTAD 145HE - 150HE - 165SE - 180SE  
Single Pump Available Static Pressure**

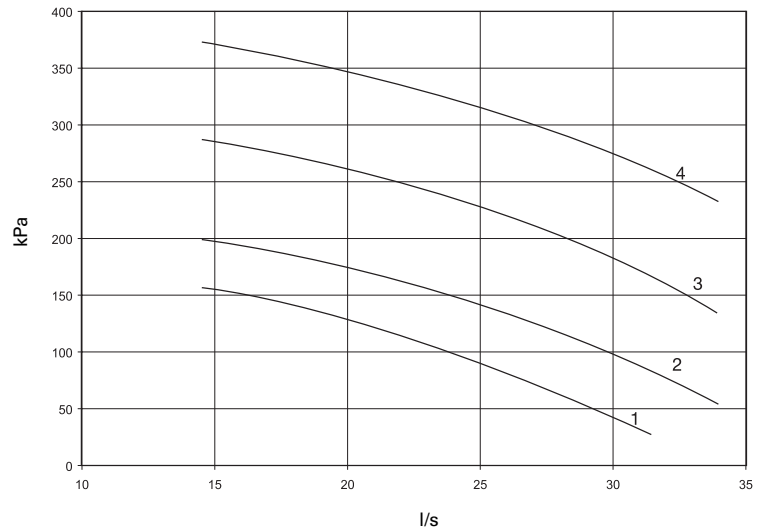

- 1 = LRN 208-13/5.5
- 2 = LRN 208-14/7.5
- 3 = SIL 208-16/11
- 4 = SIL 208-17/15

**Figure 8 - RTAD 145HE - 150HE - 165SE - 180SE  
Dual pump Available static pressure**

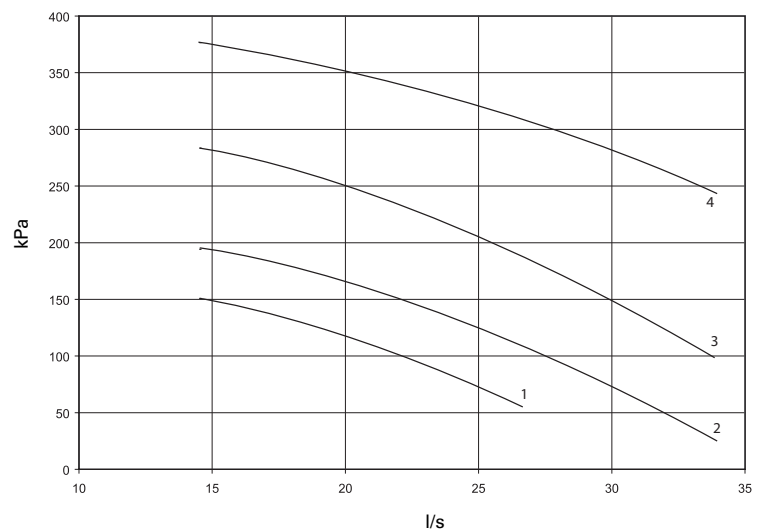

- 1 = JRN 208-13/5.5
- 2 = JRN 208-14/7.5
- 3 = DIL 208-16/11
- 4 = DIL 208-17/15



# Installation - Mechanical

**Figure 9 - RTAD 115HE - 125HE - 145SE - 150SE  
Pump Capacity Curve Single Pump**

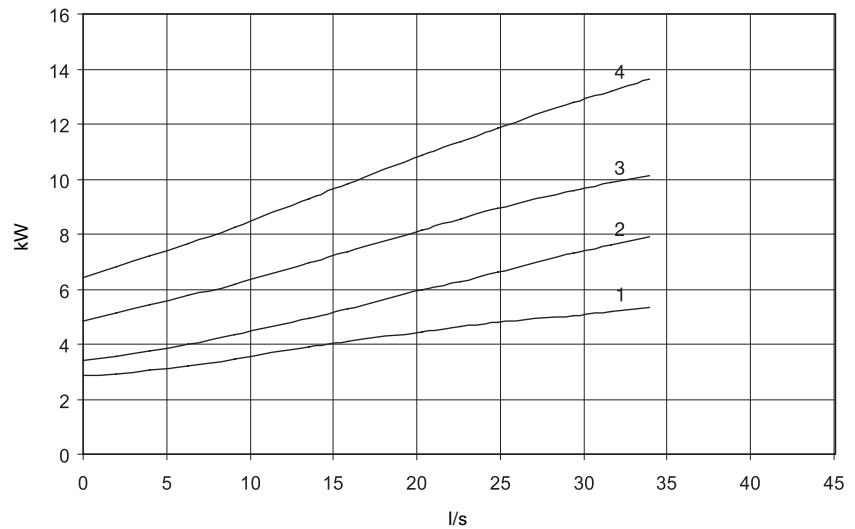

- 1 = LRN 208-13/5.5
- 2 = LRN 208-14/7.5
- 3 = SIL 208-16/11
- 4 = SIL 208-17/15

**Figure 10 - RTAD 115HE - 125HE - 145SE - 150SE  
Pump Capacity Curve Dual Pump**

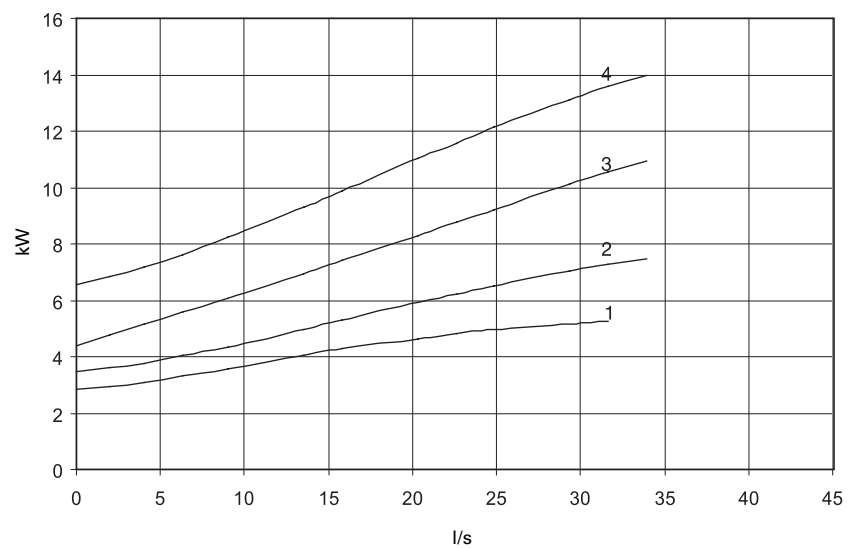

- 1 = LRN 208-13/5.5
- 2 = LRN 208-14/7.5
- 3 = SIL 208-16/11
- 4 = SIL 208-17/15

# Installation - Mechanical

**Figure 11 - RTAD 145HE - 150HE - 165SE - 180SE  
Pump Current Curve Single Pump**

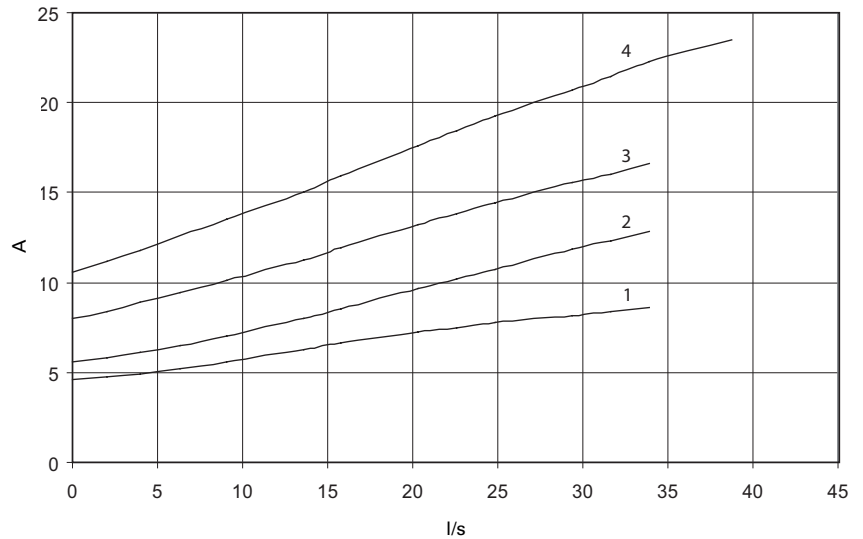

- 1 = JRN 208-13/5.5
- 2 = JRN 208-14/7.5
- 3 = DIL 208-16/11
- 4 = DIL 208-17/15

**Figure 12 - RTAD 145HE - 150HE - 165SE - 180SE  
Pump Current Curve Dual Pump**

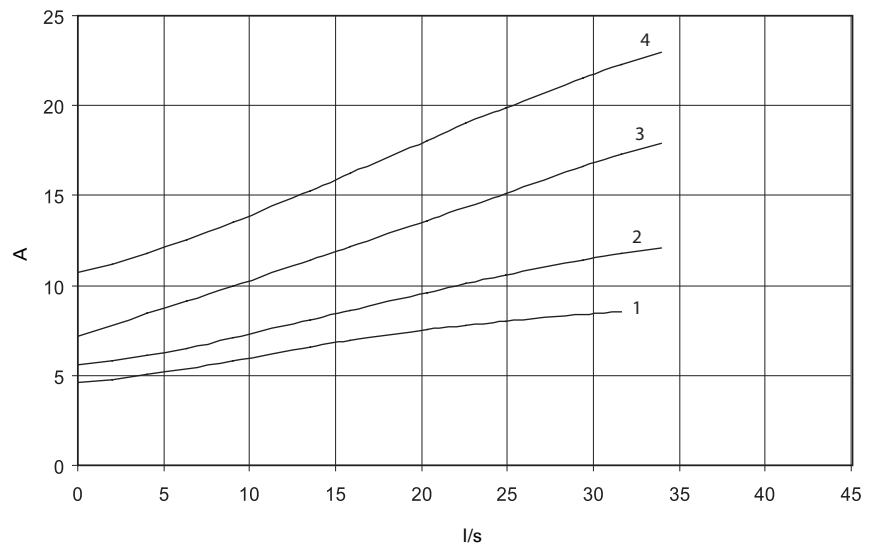

- 1 = JRN 208-13/5.5
- 2 = JRN 208-14/7.5
- 3 = DIL 208-16/11
- 4 = DIL 208-17/15

# Installation - Mechanical

**Figure 13 - Water Pressure Drop RTAD Free Cooling - Compressor Mode**

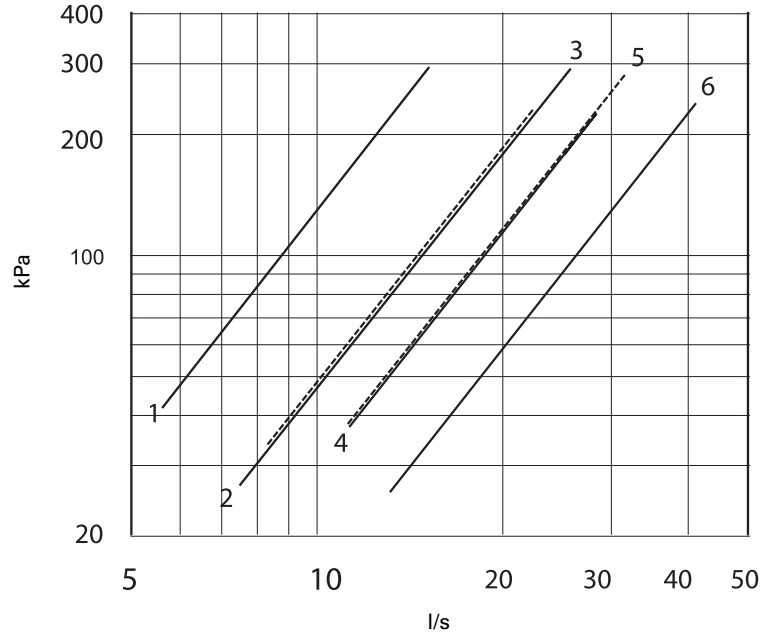

**Figure 14 - Water Pressure Drop RTAD Free Cooling - Free Cooling Mode**

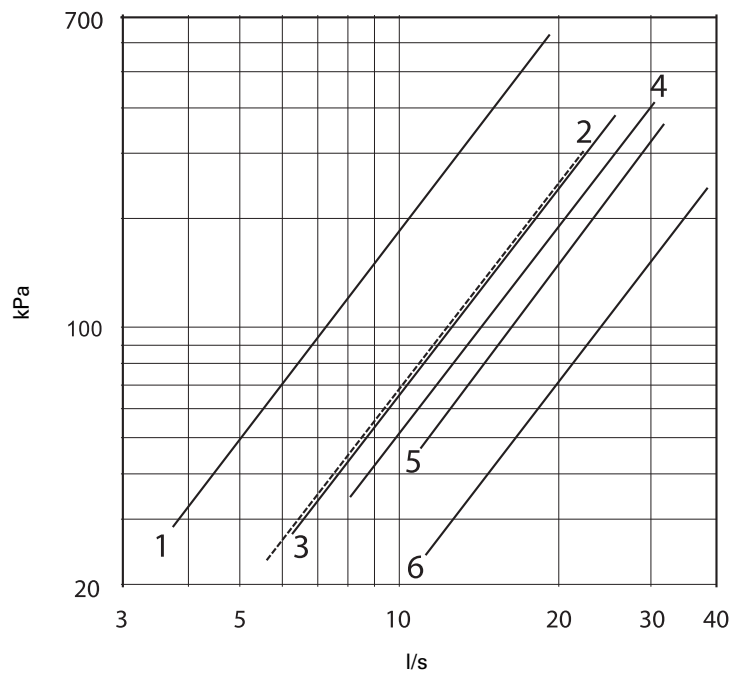

- 1 = 085 STD
- 2 = 085 HE, 100 STD
- 3 = 100 HE, 115 STD
- 4 = 115 HE, 125 HE, 145 STD, 150 STD
- 5 = 125 STD
- 6 = 145 HE, 150 HE, 165 STD, 180 STD

# Installation - Mechanical

**Figure 15 - Condenser Water Pressure Drop RTAD Partial Heat Recovery - Heating Mode**

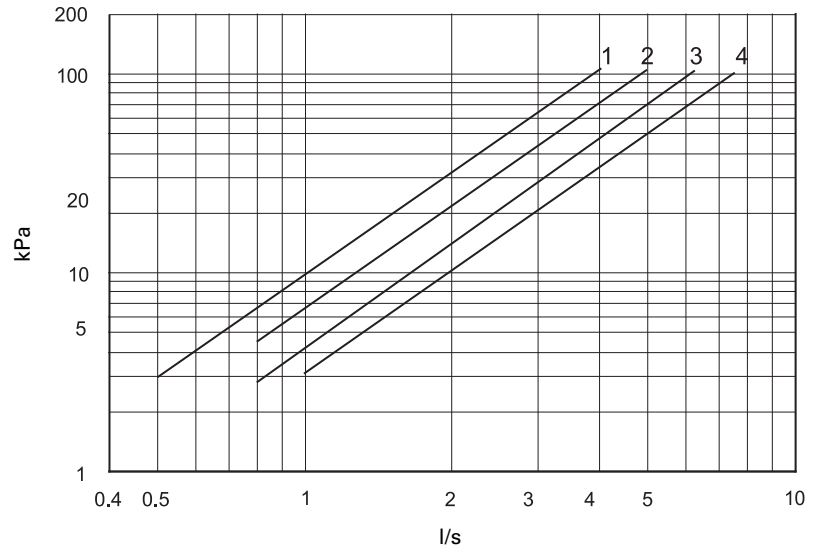

- 1 = 085-100
- 2 = 115-125
- 3 = 145-150
- 4 = 165-180

**Figure 16 - Condenser Water Pressure Drop RTAD Total Heat Recovery - Heating Mode**

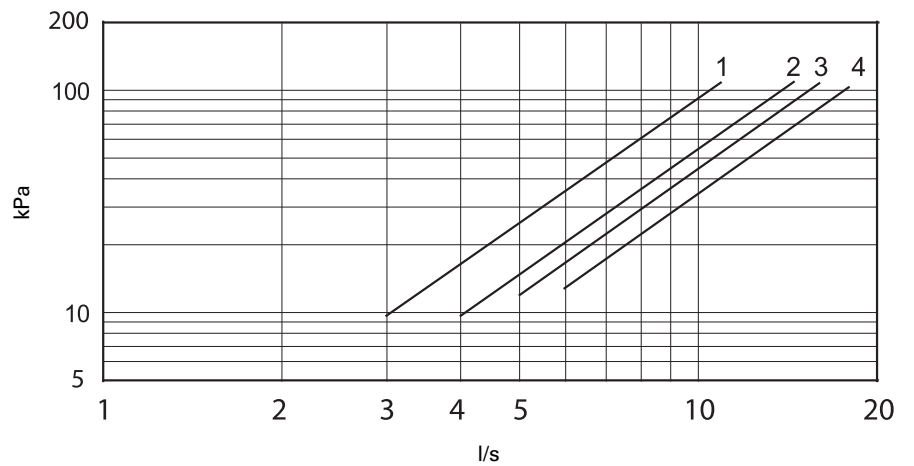

- 1 = 085-100
- 2 = 115-125
- 3 = 145-150
- 4 = 165-180

# Installation - Mechanical

**Figure 17 - 3-way Valve Pressure Drop RTAD Total Heat Recovery - Heating mode**

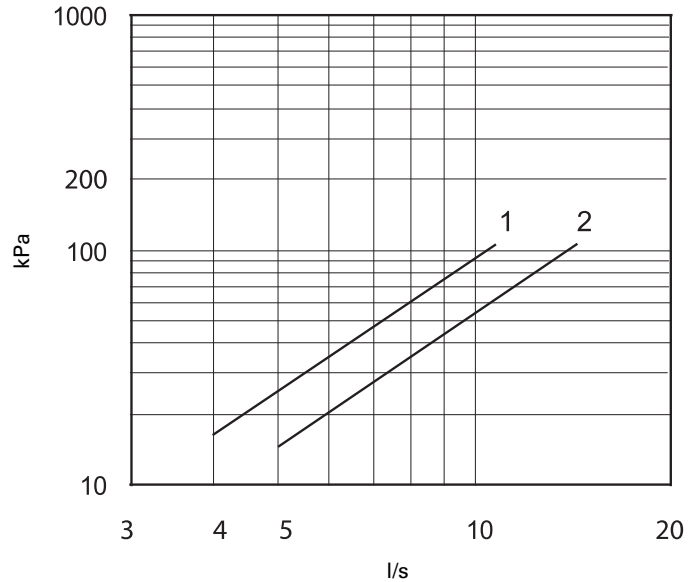

1 = 085-100-115-125  
2 = 145-150-165-180

**Figure 18 - Suggested piping for typical RTAD Standard and Heat Recovery evaporator without hydraulic module**

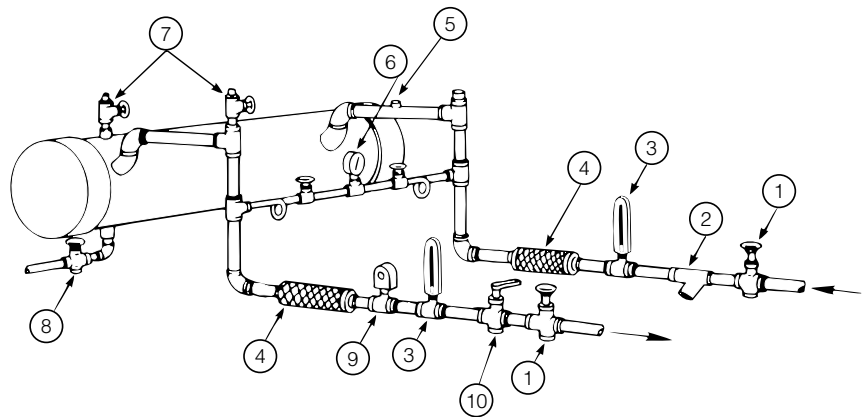

- |                              |                                     |
|------------------------------|-------------------------------------|
| 1. Gate valve                | 6. Valved pressure gauge            |
| 2. Water strainer            | 7. Vent                             |
| 3. Thermometer (user option) | 8. Drain                            |
| 4. Vibration eliminator      | 9. Flow switch (chilled water flow) |
| 5. Relief valve              | 10. Balancing valve                 |

# Installation - Mechanical

**Figure 19 - Suggested piping for typical RTAD with hydraulic module**

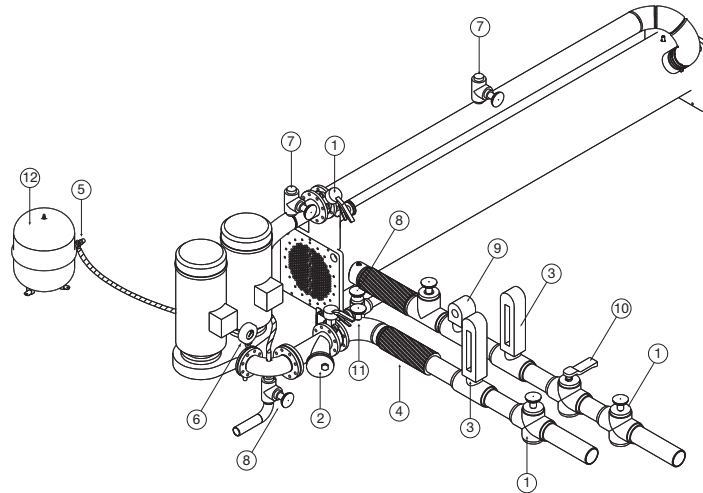

- |                              |  |
|------------------------------|--|
| 1. Gate valve                | 8. Drain   |
| 2. Water strainer            | 9. Flow switch (chilled water flow) Trane-supplied |
| 3. Thermometer (user option) | 10. Balancing valve                                |
| 4. Vibration eliminator      | 11. Pressure port                                  |
| 5. Relief valve              | 12. Expansion vessel (option)                      |
| 6. Pressure gauge            |  |
| 7. Vent                      |  |

**Figure 20 - Suggested piping for typical RTAD Free Cooling evaporator**

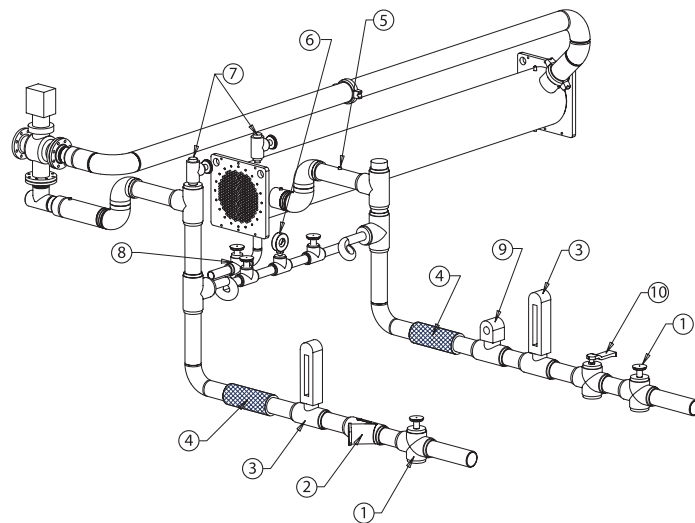

- |                              |                                     |
|------------------------------|-------------------------------------|
| 1. Gate valve                | 7. Vent                             |
| 2. Water strainer            | 8. Drain                            |
| 3. Thermometer (user option) | 9. Flow switch (chilled water flow) |
| 4. Vibration eliminator      | 10. Balancing valve                 |
| 5. Relief valve              |                                     |
| 6. Valved pressure gauge     |                                     |

# Installation - Mechanical

**Figure 21 - Suggested condenser piping for typical RTAD PHR**

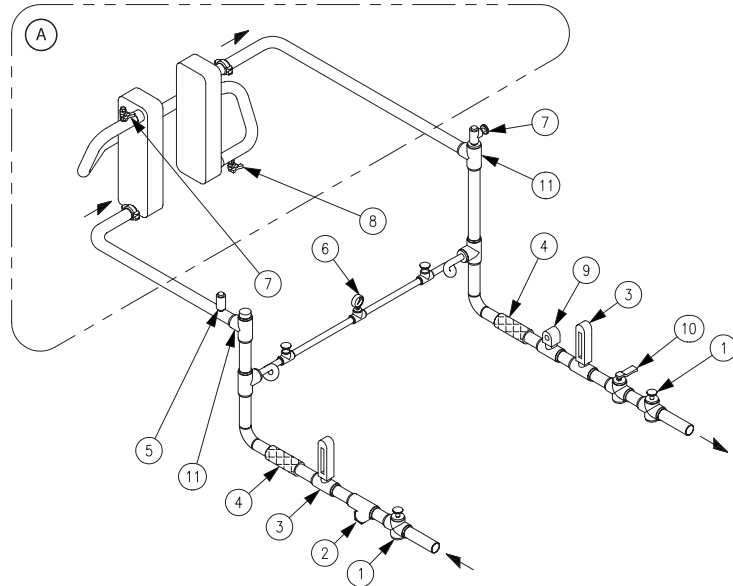

- |                              |                                  |
|------------------------------|----------------------------------|
| A. Trane-supplied            | 6. Valved pressure gauge         |
| 1. Gate valve                | 7. Vent                          |
| 2. Water strainer            | 8. Drain                         |
| 3. Thermometer (user option) | 9. Flow switch (warm water flow) |
| 4. Vibration eliminator      | 10. Balancing valve              |
| 5. Relief valve              | 11. Clean out tee                |

**Figure 22 - Suggested condenser piping for typical RTAD THR with 3-way valve**

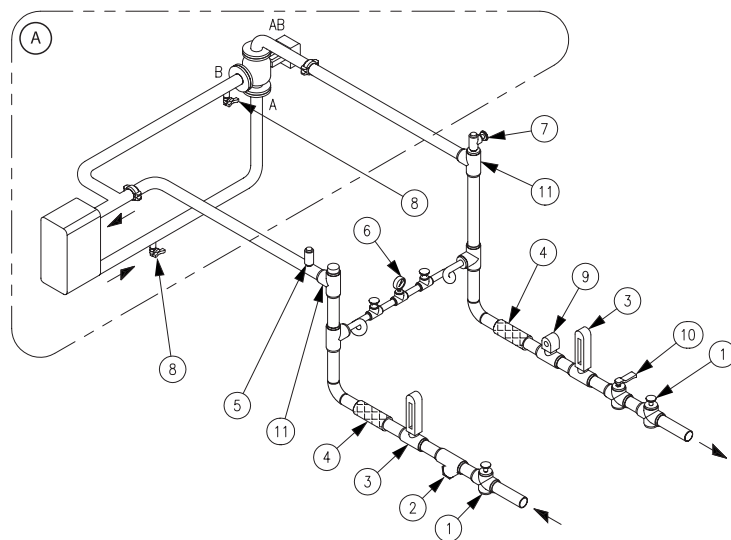

- |   |                                  |
|---|----------------------------------|
| A. Trane-supplied with 3-way valve option | 6. Valved pressure gauge         |
| 1. Gate valve                             | 7. Vent                          |
| 2. Water strainer                         | 8. Drain                         |
| 3. Thermometer (user option)              | 9. Flow switch (warm water flow) |
| 4. Vibration eliminator                   | 10. Balancing valve              |
| 5. Relief valve                           | 11. Clean out tee                |

# Installation - Mechanical

**Figure 23 - Suggested condenser piping for typical RTAD THR without 3-way valve**

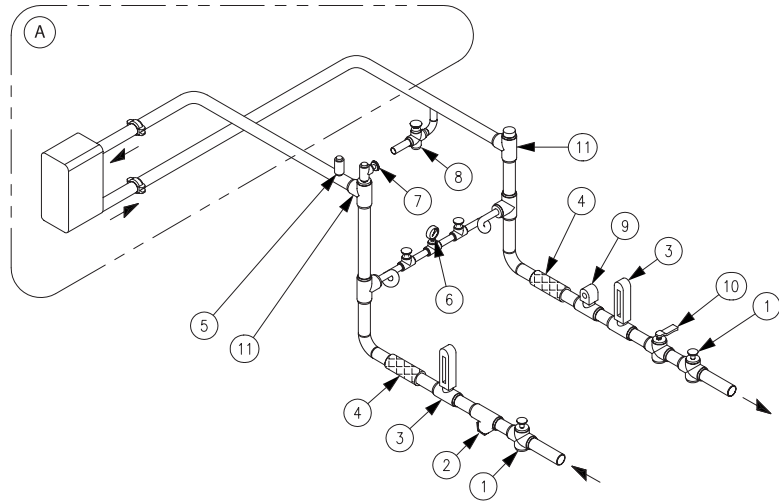

- |  |   |
|--|---|
| <p>A. Trane-supplied without 3-way valve option</p> <ol style="list-style-type: none"> <li>1. Gate valve</li> <li>2. Water strainer</li> <li>3. Thermometer (user option)</li> <li>4. Vibration eliminator</li> <li>5. Relief valve</li> </ol> | <ol style="list-style-type: none"> <li>6. Valved pressure gauge</li> <li>7. Vent</li> <li>8. Drain</li> <li>9. Flow switch (warm water flow)</li> <li>10. Balancing valve</li> <li>11. Clean out tee</li> </ol> |
|--|---|



# Installation - Mechanical

## Water Pressure Gauges

Install field-supplied pressure components as shown in Figure 18-23. Locate pressure gauges or taps in a straight run of pipe; avoid placement near elbows, etc. Be sure to install the gauges at the same elevation on each shell if the shells have opposite-end water connections.

To read manifolded pressure gauges, open one valve and close the other (depending upon the reading desired). This eliminates errors resulting from differently calibrated gauges installed at unmatched elevations.

## Water Pressure Relief Valves

**CAUTION! To prevent shell damage, install pressure relief valves in the evaporator water system.**

Install a water pressure relief valve in the evaporator inlet piping between the evaporator and the inlet shutoff valve, as shown in Figures 18-23. Water vessels with close-coupled shutoff valves have a high potential for hydrostatic pressure buildup on a water temperature increase. Refer to applicable codes for relief valve installation guidelines.

## Freeze Protection

If the unit will remain operational at subfreezing ambient temperatures, the chilled water system must be protected from freezing, following the steps listed below

- 1 Heaters are factory-installed on the packaged unit evaporator and will protect it from freezing in ambient temperatures down to -18°C (0°F).
- 2 Install heat tape on all water piping, pumps, and other components that may be damaged if exposed to freezing temperatures. Heat tape must be designed for low ambient temperature applications. Heat tape selection should be based on the lowest expected ambient temperature.
- 3 Add a non-freezing, low temperature, corrosion inhibiting, heat transfer fluid to the chilled water system. The solution must be strong enough to provide protection against ice formation at the lowest anticipated ambient temperature. Refer to Tables 1-22 for evaporator water storage capacities.

*Note: Use of glycol type antifreeze reduces the cooling capacity of the unit and must be considered in the design of the system specifications.*

*Note: All Free Cooling units must be freeze protected with 30% Ethylene Glycol in the cooling loop circuit which is the most convenient percentage in order to protect the unit against freezing.*

*Protection coverage with 30% Ethylene Glycol:*

- freezing point without burst effect = - 13°C;
- freezing point with burst effect = - 50°C.

In ambient temperatures below -18°C, the water circuit must be protected against freezing by the one of the following methods:

- *purge the water circuit or add an anti-freeze fluid.*
- *Activate the heat tapes on the unit and do not shut the unit down.*

## Freeze protection with hydraulic module and dual pump

To protect the chiller against freezing, there are 5 means of protection:

- Using the proper glycol percentage in the water (no risk of damage due to power failure)
- Draining the unit during the cold season. However, be aware of the corrosion process when drained.
- Using the heat tape protection (protect the unit down to -18°C)
- Using freeze protection by pump activation.
- Using pump activation and heat protection one being a safety for the other.

### CAUTION!

When using the freeze protection by pump activation during the cold season, water must be able to circulate freely. Check that no closure valve or other device might block waterflow.

Note:

For dual pump hydraulic model, activation of the heat tape is not done through the thermostat but by the pump controller.

Single pump hydraulic module does not provide protection by pump activation and require the thermostat.

# Installation - Electrical

## Using glycol with hydraulic module

If the glycol brine percentage is not at the recommended percentage (greyed area), corrosion inhibitor present in the glycol may not be efficient enough.

For instance, not only a glycol protection of 15% will only provide protection to the unit against freezing down to -5°C but also it might generate additional corrosion that could damage the pumps mechanical seals.

### CAUTION!

Some corrosion inhibitors may be harmful to the mechanical seal or to the cast iron of the pump.

In case of application with negative temperature at the evaporator or usage of another type of fluid, please contact your local Trane sales engineer. A relief valve is located at pump suction limiting water circuit pressure at 4 bar. Nitrogen pressure inside of the expansion tank must be equal to the geometric height of the installation + 0.5 bar. In order to avoid air entering in the water circuit, expansion tank must be inflated with nitrogen. Pressure must be checked yearly. For a good pump operation, pump suction pressure must be between 0.5 and 3.5 bar when pump runs.

## Heat Recovery Units

The heat recovery condenser(s) is (are) insulated and a heater is factory-installed (only available on Total Heat Recovery units) and will protect from freezing in ambient temperatures down to -18°C.

*Note: The inlet and outlet tubes and the optional 3-way valve (Total Heat Recovery units) should be protected against freezing by one of the following methods:*

- install heat tape on all water piping and around the 3-way valve
- add ethylene glycol or equivalent anti-freeze fluid.

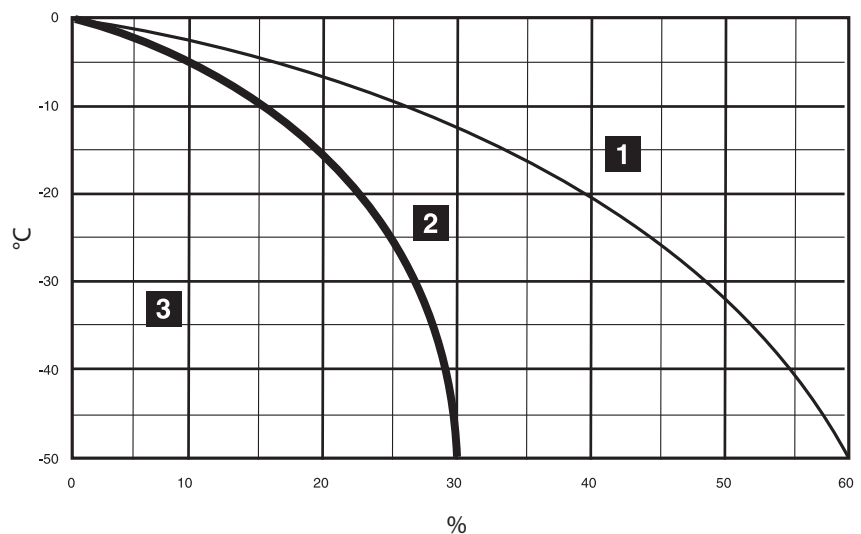
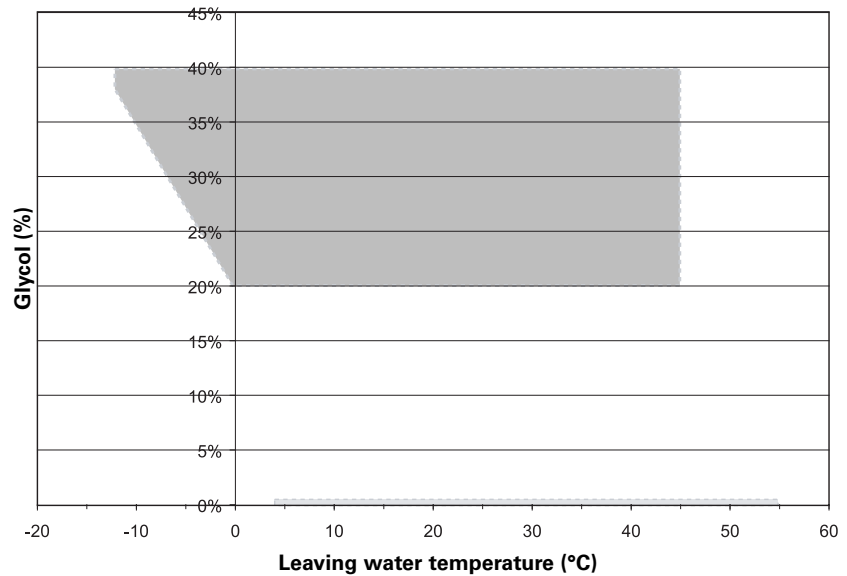

- % = % ethylene glycol
- °C = Brine temperature
- 1 = Liquid
- 2 = Freezing without burst effect
- 3 = Freezing with burst effect

# Installation - Electrical

## General Recommendations

**WARNING!** The warning label shown in Figure 24 is displayed on the equipment. Strict adherence to these warnings must be observed. Failure to do so may result in personal injury or death.

All wiring must comply with CE codes. Typical field wiring diagrams are included in the unit control panel. Minimum circuit ampacities and other unit electrical data are on the unit nameplate and in the general data tables. See the unit order specifications for actual electrical data. Specific electrical schematics and connection diagrams are shipped with the unit.

**CAUTION!** To avoid corrosion and overheating at terminal connections, use copper conductors only. Failure to do so may result in damage to the equipment.

Do not allow conduit to interfere with other components, structural members or equipment. Control voltage (115V) wiring in conduit must be separate from conduit carrying low voltage (<30V) wiring. **CAUTION!** To prevent control malfunctions, do not run low voltage wiring (<30V) in conduit with conductors carrying more than 30 volts.

Figure 24 - Warning Label

 
Ouvrir le sectionneur principal avant toute intervention. Certains circuits restent sous tension après coupure du sectionneur principal.
Bevor mit arbeiten an elektrischen teilen begonnen werden kann, muss der haupschalter geoeffnet werden. Dennoch ist zu beachten, dass bestimmte stromkreise weiterhin spannungsfuehrend sind.
Open main disconnect switch before servicing any electrical component. Some circuits remain live after opening main disconnect switch.
Prima di effettuare qualsiasi intervento, aprire il sezionatore principale. Alcuni circuiti rimangono sotto tensione dopo aver aperto il sezionatore principale.
Voor service aan de koelinstallatie schakel de spanning uit door het uitschakelen van de hoofdschakelaar. Enkele elektrische componenten blijven onder spanning staan na het uitschakelen van de hoofdschakelaar.
Abrir el sectionador antes de toda intervencion en el panel electrico. Algunos circuitos quedan con tension mantenida despues de la apuertura del sectionador.
Πριν οποιαδηποτε παρεμβαση, ανοιξτε τον κεντρικο αποζευκτηρα. Μετα τη διακοπη του κεντρικου αποζευκτηρα, ορισμενα κυκλωματα παραμενουν υπο ταση.
Desligar o interruptor principal antes de qualquer intervençao. Alguns circuitos permanecem ligados à corrente depois de o interruptor principal ser desligado.
Afbryd hovedleningsadskilleren før indgreb. Visse kredse er stadig under spænding, selv efter at hovedledningsadskilleren er afbrudt.
Öppna huvudfrånskiljaren innan du utför någon annan åtgärd. Vissa kretsängar kan vara strömförande även efter att frånskiljaren har frånskopplats.
Frakobble hovedbryteren før du gjør noe annet. Enkelte ledninger kann være strömførende selv etter at hovedbryteren er frakoblet.
Avaa pääkatkaisija aina ennen toiminnan käynnistämistä. Pääkatkaisijan sulkemisen jälkeen joihinkin virtapiireihin saattaa jäädä jännitettä.

# Installation - Electrical

**Table 26 - Unit Wiring 400/3/50 - Standard cooling unit / Partial Heat Recovery and Total Heat Recovery units**

Unit Size	Nbr of Power Connections	Maximum Amps (1)	Starting Amps (2)	Power Factor (5)	Disconnect Switch Size (A)	Compressor Fuse Size (A)	Evaporator heater (kW)
<b>Standard</b>							
085	1	242	255	0.90	250	6 x 125	0.217
100	1	282	306	0.88	400	6 x 160	0.217
115	1	323	359	0.89	400	6 x 200	0.217
125	1	387	425	0.90	500	6 x 250	0.217
145	1	437	471	0.90	500	6 x 250	0.217
150	1	477	502	0.89	630	6 x 250	0.217
165	1	527	570	0.89	630	315 + 250	0.217
180	1	576	608	0.89	630	6 x 315	0.217
<b>High Efficiency</b>							
085	1	242	255	0.90	250	6 x 125	0.217
100	1	291	315	0.88	400	6 x 160	0.217
115	1	332	368	0.89	400	6 x 200	0.217
125	1	405	443	0.90	500	6 x 250	0.217
145	1	446	480	0.90	500	6 x 250	0.217
150	1	486	511	0.89	630	6 x 250	0.217
<b>High Ambient</b>							
085	1	242	255	0.90	400	6 x 160	0.217
100	1	291	315	0.88	400	6 x 200	0.217
115	1	332	368	0.89	400	6 x 250	0.217
125	1	405	443	0.90	500	6 x 250	0.217
145	1	446	480	0.90	630	6 x 250	0.217
150	1	486	511	0.89	630	6 x 315	0.217
165	1	527	570	0.89	630	400 + 315	0.217
180	1	576	608	0.89	800	6 x 400	0.217
<b>Standard Low Noise</b>							
085	1	230	243	0.90	250	6 x 125	0.217
100	1	270	294	0.88	400	6 x 160	0.217
115	1	311	347	0.89	400	6 x 200	0.217
125	1	375	413	0.90	500	6 x 250	0.217
145	1	419	453	0.90	500	6 x 250	0.217
150	1	457	482	0.89	630	6 x 250	0.217
165	1	505	548	0.89	630	315 + 250	0.217
180	1	552	584	0.89	630	6 x 315	0.217
<b>High Efficiency Low Noise</b>							
085	1	230	243	0.90	250	6 x 125	0.217
100	1	275	299	0.88	400	6 x 160	0.217
115	1	316	352	0.89	400	6 x 200	0.217
125	1	385	423	0.90	500	6 x 250	0.217
145	1	424	458	0.90	500	6 x 250	0.217
150	1	462	487	0.89	630	6 x 250	0.217
<b>Standard Low Noise with Night Noise Set Back option</b>							
085	1	226	238	0.90	250	6 x 125	0.217
100	1	270	295	0.88	400	6 x 160	0.217
115	1	312	348	0.89	400	6 x 200	0.217
125	1	376	414	0.90	500	6 x 250	0.217
145	1	417	451	0.90	500	6 x 250	0.217
150	1	453	478	0.89	630	6 x 250	0.217
165	1	503	546	0.89	630	315 + 250	0.217
180	1	548	580	0.89	630	6 x 315	0.217
<b>High Efficiency Low Noise with Night Noise Set Back option</b>							
085	1	231	244	0.90	250	6 x 125	0.217
100	1	270	295	0.88	400	6 x 160	0.217
115	1	317	353	0.89	400	6 x 200	0.217
125	1	381	419	0.90	500	6 x 250	0.217
145	1	381	456	0.90	500	6 x 250	0.217
150	1	381	483	0.89	630	6 x 250	0.217

# Installation - Electrical

**Table 27 - Unit Wiring 400/3/50/ cont - Standard cooling unit / Partial Heat Recovery and Total Heat Recovery units**

Unit Size	Nbr of Power Connections	Maximum Amps (1)	Starting Amps (2)	Power Factor (5)	Disconnect Switch Size (A)	Compressor Fuse Size (A)	Evaporator heater (kW)
<b>Standard with High External Static Pressure</b>							
085	1	231	244	0.90	250	6 x 125	0.217
100	1	278	302	0.88	400	6 x 160	0.217
115	1	319	355	0.89	400	6 x 200	0.217
125	1	383	421	0.90	500	6 x 250	0.217
145	1	427	461	0.90	500	6 x 250	0.217
150	1	463	488	0.89	630	6 x 250	0.217
165	1	516	559	0.89	630	315 + 250	0.217
180	1	561	593	0.89	630	6 x 315	0.217
<b>High Efficiency with High External Static Pressure</b>							
085	1	239	251	0.90	250	6 x 125	0.217
100	1	278	302	0.88	400	6 x 160	0.217
115	1	327	363	0.89	400	6 x 200	0.217
125	1	391	429	0.90	500	6 x 250	0.217
145	1	435	469	0.90	500	6 x 250	0.217
150	1	471	496	0.89	630	6 x 250	0.217

**Table 28 - Motor Data 400/3/50 - Standard cooling unit / Partial Heat Recovery and Total Heat Recovery units**

Unit Size	Qty	Compressor (Each)						Fans (Each)			Control (400V)		
		RLA Amps		Max Amps (3)		Starting Amps (4)		Qty	kW	FLA	Fans fuse size (A)	VA	A
Ckt 1	Ckt 2	Ckt 1	Ckt 2	Ckt 1	Ckt 2	Ckt 1	Ckt 2						
<b>Standard</b>													
085	2	80	80	106	106	144	144	6	2.05	4.5	3 x 50	1600	4
100	2	95	95	125	125	180	180	6	2.05	4.5	3 x 50	1600	4
115	2	111	111	146	146	217	217	6	2.05	4.5	3 x 50	1600	4
125	2	135	135	178	178	259	259	6	2.05	4.5	3 x 50	1600	4
145	2	162	135	214	178	291	259	9	2.05	4.5	3 x 63	1600	4
150	2	162	162	214	214	291	291	10	2.05	4.5	3 x 63	1600	4
165	2	196	162	259	214	354	291	11	2.05	4.5	3 x 63	1600	4
180	2	196	196	259	259	354	354	12	2.05	4.5	3 x 63	1600	4
<b>High Efficiency</b>													
085	2	80	80	106	106	144	144	6	2.05	4.5	3 x 50	1600	4
100	2	95	95	125	125	180	180	8	2.05	4.5	3 x 50	1600	4
115	2	111	111	146	146	217	217	8	2.05	4.5	3 x 50	1600	4
125	2	135	135	178	178	259	259	10	2.05	4.5	3 x 50	1600	4
145	2	162	135	214	178	291	259	11	2.05	4.5	3 x 63	1600	4
150	2	162	162	214	214	291	291	12	2.05	4.5	3 x 63	1600	4
<b>Standard Low Noise</b>													
085	2	80	80	106	106	144	144	6	1.30	2.5	3 x 50	1600	4
100	2	95	95	125	125	180	180	6	1.30	2.5	3 x 50	1600	4
115	2	111	111	146	146	217	217	6	1.30	2.5	3 x 50	1600	4
125	2	135	135	178	178	259	259	6	1.30	2.5	3 x 50	1600	4
145	2	162	135	214	178	291	259	9	1.30	2.5	3 x 63	1600	4
150	2	162	162	214	214	291	291	10	1.30	2.5	3 x 63	1600	4
165	2	196	162	259	214	354	291	11	1.30	2.5	3 x 63	1600	4
180	2	196	196	259	259	354	354	12	1.30	2.5	3 x 63	1600	4
<b>High Efficiency Low Noise option</b>													
085	2	80	80	106	106	144	144	6	1.30	2.5	3 x 50	1600	4
100	2	95	95	125	125	180	180	8	1.30	2.5	3 x 50	1600	4
115	2	111	111	146	146	217	217	8	1.30	2.5	3 x 50	1600	4
125	2	135	135	178	178	259	259	10	1.30	2.5	3 x 50	1600	4
145	2	162	135	214	178	291	259	11	1.30	2.5	3 x 63	1600	4
150	2	162	162	214	214	291	291	12	1.30	2.5	3 x 63	1600	4
<b>Standard Low Noise with Night Noise Set Back option</b>													
085	2	80	80	106	106	144	144	4	1.05	2.6	3 x 50	1600	4
100	2	95	95	125	125	180	180	6	1.05	2.6	3 x 50	1600	4
115	2	111	111	146	146	217	217	6	1.05	2.6	3 x 50	1600	4
125	2	135	135	178	178	259	259	6	1.05	2.6	3 x 50	1600	4
145	2	162	135	214	178	291	259	8	1.05	2.6	3 x 63	1600	4
150	2	162	162	214	214	291	291	8	1.05	2.6	3 x 63	1600	4
165	2	196	162	259	214	354	291	10	1.05	2.6	3 x 63	1600	4
180	2	196	196	259	259	354	354	10	1.05	2.6	3 x 63	1600	4

# Installation - Electrical

**Table 29 - Motor Data 400/3/50/ cont - Standard cooling unit / Partial Heat Recovery and Total Heat Recovery units**

Unit Size	Qty	Compressor (Each)						Fans (Each)			Control		
		RLA Amps		Max Amps (3)		Starting Amps (4)		kW	FLA	Fans fuse size (A)	VA	(400V)	
		Ckt 1	Ckt 2	Ckt 1	Ckt 2	Ckt 1	Ckt 2	Qty					
<b>High Efficiency Low Noise with Night Noise Set Back option</b>													
085	2	80	80	106	106	144	144	6	1.05	2.6	3 x 50	1600	4
100	2	95	95	125	125	180	180	6	1.05	2.6	3 x 50	1600	4
115	2	111	111	146	146	217	217	8	1.05	2.6	3 x 50	1600	4
125	2	135	135	178	178	259	259	8	1.05	2.6	3 x 50	1600	4
145	2	162	135	214	178	291	259	10	1.05	2.6	3 x 63	1600	4
150	2	162	162	214	214	291	291	10	1.05	2.6	3 x 63	1600	4
<b>Standard with High External Static Pressure</b>													
085	2	80	80	106	106	144	144	4	2.21	3.9	3 x 50	1600	4
100	2	95	95	125	125	180	180	6	2.21	3.9	3 x 50	1600	4
115	2	111	111	146	146	217	217	6	2.21	3.9	3 x 50	1600	4
125	2	135	135	178	178	259	259	6	2.21	3.9	3 x 50	1600	4
145	2	162	135	214	178	291	259	8	2.21	3.9	3 x 63	1600	4
150	2	162	162	214	214	291	291	8	2.21	3.9	3 x 63	1600	4
165	2	196	162	259	214	354	291	10	2.21	3.9	3 x 63	1600	4
180	2	196	196	259	259	354	354	10	2.21	3.9	3 x 63	1600	4
<b>High Efficiency with High External Static Pressure</b>													
085	2	80	80	106	106	144	144	6	2.21	3.9	3 x 50	1600	4
100	2	95	95	125	125	180	180	6	2.21	3.9	3 x 50	1600	4
115	2	111	111	146	146	217	217	8	2.21	3.9	3 x 50	1600	4
125	2	135	135	178	178	259	259	8	2.21	3.9	3 x 50	1600	4
145	2	162	135	214	178	291	259	10	2.21	3.9	3 x 63	1600	4
150	2	162	162	214	214	291	291	10	2.21	3.9	3 x 63	1600	4

**Notes:**

1. Maximum Compressors FLA + all fans FLA + control Amps
2. Starting Amps of the circuit with the largest compressor circuit including fans plus RLA of the second circuit including fans + control Amps
3. Maximum FLA per compressor.
4. Compressors starting Amps, Star delta start.
5. Compressor Power Factor

**Table 30 - Compressor motor electrical data - 50 Hz - Free Cooling unit**

Unit Size	Nominal voltage (V/Ph/Hz)	Maximum unit kW (kW)	Maximum RLA (1) (A)	Starting amps (A)	Power factor
RTAD 085 FC STD	400/3/50	149	239	251	0.90
RTAD 085 FC STD	400/3/50	149	239	251	0.90
RTAD 100 FC STD	400/3/50	169	278	302	0.88
RTAD 115 FC STD	400/3/50	199	319	355	0.89
RTAD 125 FC STD	400/3/50	244	391	429	0.90
RTAD 145 FC STD	400/3/50	268	431	465	0.90
RTAD 150 FC STD	400/3/50	291	471	496	0.89
RTAD 165 FC STD	400/3/50	294	520	563	0.89
RTAD 180 FC STD	400/3/50	352	569	601	0.89
RTAD 085 FC HE	400/3/50	149	239	251	0.90
RTAD 100 FC HE	400/3/50	174	286	310	0.88
RTAD 115 FC HE	400/3/50	204	327	363	0.89
RTAD 125 FC HE	400/3/50	249	399	437	0.90
RTAD 145 FC HE	400/3/50	273	439	473	0.90
RTAD 150 FC HE	400/3/50	296	479	504	0.89

(1) To take in account for the sizing of power cables

# Installation - Electrical

**Table 31 - General electrical data**

Unit Size	Nominal voltage (V/Ph/Hz)	Crankcase heater Compressor (W)	Control circuit (VA)	Short circuit intensity (kA)
RTAD 085 FC STD	400/3/50	150	1600	35
RTAD 100 FC STD	400/3/50	150	1600	35
RTAD 115 FC STD	400/3/50	150	1600	35
RTAD 125 FC STD	400/3/50	150	1600	35
RTAD 145 FC STD	400/3/50	150	1600	35
RTAD 150 FC STD	400/3/50	150	1600	35
RTAD 165 FC STD	400/3/50	150	1600	35
RTAD 180 FC STD	400/3/50	150	1600	35
RTAD 085 FC HE	400/3/50	150	1600	35
RTAD 100 FC HE	400/3/50	150	1600	35
RTAD 115 FC HE	400/3/50	150	1600	35
RTAD 125 FC HE	400/3/50	150	1600	35
RTAD 145 FC HE	400/3/50	150	1600	35
RTAD 150 FC HE	400/3/50	150	1600	35

**Table 32 - Electrical connections**

Unit Size	Compressor fuse size (1) (A)	Disconnect switch size (1) (A)	Minimum connecting wire (1) (mm <sup>2</sup> )	Maximum connecting wire (1) (mm <sup>2</sup> )
RTAD 085 FC STD	6 x 125	250	95	150
RTAD 100 FC STD	6 x 160	400	185	240
RTAD 115 FC STD	6 x 200	400	185	240
RTAD 125 FC STD	6 x 250	500	240	240
RTAD 145 FC STD	6 x 250	500	240	240
RTAD 150 FC STD	6 x 250	630	2 x 150	2 x 300
RTAD 165 FC STD	315 + 250	630	2 x 150	2 x 300
RTAD 180 FC STD	6 x 315	630	2 x 150	2 x 300
RTAD 085 FC HE	6 x 125	250	95	150
RTAD 100 FC HE	6 x 160	400	185	240
RTAD 115 FC HE	6 x 200	400	185	240
RTAD 125 FC HE	6 x 250	500	240	240
RTAD 145 FC HE	6 x 250	500	240	240
RTAD 150 FC HE	6 x 250	630	2 x 150	2 x 300

(1) To take in account for the sizing of power cables

**Table 33 - Hydraulic module electrical data**

		Single or dual pump			
		Pump 1	Pump 2	Pump 3	Pump 4
<b>Standard Efficiency unit</b>					
145	kW (1)	5.0	6.5	9.2	12.1
150	kW (1)	5.1	6.8	9.7	12.7
165	kW (1)	5.1	7.1	10.1	13.2
180	kW (1)	5.2	7.3	10.5	13.6
<b>High Efficiency unit</b>					
115	kW (1)	4.7	5.9	8.3	11.0
125	kW (1)	4.9	6.4	9.1	12.0
145	kW (1)	5.0	6.6	9.3	12.2
150	kW (1)	5.1	6.8	9.7	12.6
<b>All sizes</b>					
Maximum amps	(A)	10.3	13.8	20	26.5
Power factor		0.89	0.89	0.88	0.88

(1) Power input at Eurovent conditions: Ambient temperature 35°C, water temperature 12/7°C

# Installation - Electrical

1. As standard, all units have single point power connection.
2. LRA (Locked Rotor Amps) - based on full winding (x-line) start units. LRA for wye-delta starters is 1/3 of LRA of x-line units.
3. VOLTAGE UTILIZATION RANGE:

Rated Voltage	Utilization Range
400/50/3	340-460

For the RTAD 100 only, the Utilization Range is 360 - 460 Volts

## Installer-Supplied Components

**CAUTION! Customer wiring interface connections are shown in the electrical schematics and connection diagrams that are shipped with the unit. The installer must provide the following components if not ordered with the unit:**

- Power supply wiring (in conduit) for all field-wired connections.
- All control (interconnecting) wiring (in conduit) for field supplied devices.
- Fused-disconnect switches or circuit breakers.
- Power factor correction capacitors.

## Power Supply Wiring

All power supply wiring must be sized and selected accordingly by the project engineer in accordance with EN 60204.

**WARNING! To prevent injury or death, disconnect all electrical power sources before completing wiring connections to the unit.**

All wiring must comply with CE electrical codes. The installing (or electrical) contractor must provide and install the system interconnecting wiring and the power supply wiring. It must be properly sized and equipped with the appropriate fused disconnect switches. The type and installation location(s) of the fused disconnects must comply with all applicable codes.

**CAUTION! Use only copper conductors for terminal connections to avoid corrosion or overheating.**

Cut holes into the sides of the control panel for the appropriately sized power wiring conduits.

The wiring is passed through these conduits and connected to the terminal blocks, optional unit-mounted disconnects, or circuit breakers.

To provide proper phasing of 3-phase input, make connections as shown in field wiring diagrams and as stated on the Warning label in the starter panel. For additional information on proper phasing, refer to "Unit Voltage Phasing." Proper equipment ground must be provided to each ground connection in the panel (one for each customer-supplied conductor per phase).

## Control Power Supply

The unit is equipped with a control power transformer; it is not necessary to provide additional control power voltage to the unit. The RTAD units are factory-connected for 400V/3/50 with a factory-installed control power transformer.

## Heater Power Supply

The evaporator shell is insulated from ambient air and protected from freezing temperatures by electric heaters. A heater also protects the heat recovery condenser(s) (only available on Total Heat Recovery units). The heaters will provide protection from ambient temperatures down to -18°C (0°F). The heaters are factory-wired back to the unit control panel.

As an option, the heater will be energized by a thermostat when the temperature drops to 43°F (6.1°C).

**CAUTION! Control panel main processor does not check for loss of power to the heat tape nor does it verify thermostat operation. A qualified technician must verify power to the heat tape and confirm operation of the heat tape thermostat to avoid catastrophic damage to the evaporator.**

## Water Pump Power Supply

Provide power supply wiring with fused disconnect for the chilled water pump(s).



# Installation - Electrical

## Interconnecting Wiring

### Chilled Water Flow (Pump) Interlock

The model RTAD chiller requires a field-supplied control voltage contact input through a flow proving switch 6S56 and an auxiliary contact 6K51 of the chilled water pump contactor.

**IMPORTANT: Do not turn the chiller on or off using the chilled-water interlocks.**

When making field connections, refer to the appropriate field layout, wiring schematics, and control diagrams that ship with the unit.

### Chilled-water pump control

**CAUTION! The chilled-water pump must operate for a minimum of one minute after the UCM-CLD receives a command, through the external Auto/Stop input, to shut down the chilled-water system.**

On the RTAD units, the controller will initiate the "Run:Unload" mode to terminate a cycle from any of the following:

- Stop key pressed
- Loss of load
- External Auto/Stop input opened

The "Run:Unload" operating mode commands the compressor to completely unload, which takes about ½ minute. This will allow the compressors to be totally unloaded for the next start-up. If only the proof-of-chilled-water-flow interlock is used, the chiller will shut down with an immediate (non-friendly) shutdown and initiate an automatic reset diagnostic.

1. External Auto/Stop (terminals A1 TB3-3 and -4). This input is supplied by the field. A contact closure will start the chiller water pump and chiller, via the UCM-CLD pump control contacts. Opening the contact will put the operating compressors into "Run:Unload" mode and initiate a timing period (1 to 30 minutes, adjustable through the Clear Language Display). This will delay termination of the chilled-water pump operation via the UCM pump control contacts. Examples of the input terminals 1UTB3-3 and -4 would be a time clock, ambient thermostat, building automation system, etc.

2. UCM-CLD Pump Control Contacts (Terminals A1 TB4-8 and -9)

This output is a set of contacts that will close, starting the chilled-water pump when the external Auto/Stop contacts are closed. When the contacts are opened, 1 to 30 minutes later (adjustable through the Clear Language Display), the UCM-CLD pump control contacts open.

3. Proof-of-Chilled-Water-Flow Interlock (Terminals A1 TB3-1 and -2)

This terminal must be field-installed. Contact closure between the terminals indicates proof of chilled-water flow. Examples of this are a pump starter auxiliary contact, flow switch, differential pressure switch, or a contact from a building automation system. Opening of this contact will immediately shut down the chiller and initiate an automatic reset diagnostic, indicating loss of chilled-water flow.

# Installation - Electrical

---

## Specification for Free Cooling units:

1. External Auto/Stop (terminals A70 J8-IDH14 and 6X2-1).  
This input is supplied by the field. A contact closure will start the chiller water pump and chiller, via the UCM-CLD and A70 (regulation for Free Cooling mode) pump control contacts. Opening the contact will put the operating compressors into "Run:Unload" mode and initiate a timing period (1 to 30 minutes, adjustable through the Clear Language Display). This will delay termination of the chilled-water pump operation via the UCM pump control contacts. Examples of the input terminals 1UTB3-3 and -4 would be a time clock, ambient thermostat, building automation system, etc.
2. UCM-CLD and A 70 Pump Control Contacts (Terminals A70 J14-C7 and -NO7)  
This output is a set of contacts that will close, starting the chilled-water pump when the external Auto/Stop contacts are closed. When the contacts are opened, 1 to 30 minutes later (adjustable through the Clear Language Display), the UCM-CLD and A70 pump control contacts open.
3. Proof-of-Chilled-Water-Flow Interlock (Terminals A70 J18-IDC13 and -ID13H)  
This terminal must be field-installed. Contact closure between the terminals indicates proof of chilledwater flow. Examples of this are a pump starter auxiliary contact, flow switch, differential pressure switch, or a contact from a building automation system. Opening of this contact will immediately shut down the chiller and initiate an automatic reset diagnostic, indicating loss of chilled-water flow.
4. Free Cooling enable input (terminals A70 J5-IDI and 6X2-4).  
This input is supplied by the field. This is a digital input that indicates if the Free Cooling mode is validated, or if only the Compressor mode must run. If this input is open, then only the Compressor mode will be available. If this input is close, then the control will select the best mode (Free Cooling mode or Compressor mode).

# Installation - Electrical

## Specification for Total Heat Recovery units

The heat recovery mode should be validated by a dry contact supplied by the field. The chiller will run in heat recovery mode if the dry contact is closed and if there is a need for cooling. A 3-way valve will protect the operation of the chiller when the return hot water temperature is too low. This 3-way valve will not be used if a variable speed pump is used. In this case, the control module for Heat Recovery (A70) will provide a 2-10V output proportional to the water flow.

*Note: the hot water pump should run at least 3 minutes after heat recovery mode is off. During these 3 minutes, the water flow through the heat recovery condenser will gradually be reduced to switch smoothly to the conventional cooling mode. See Figure 25 for details.*

Figure 25 - Control wiring for pump

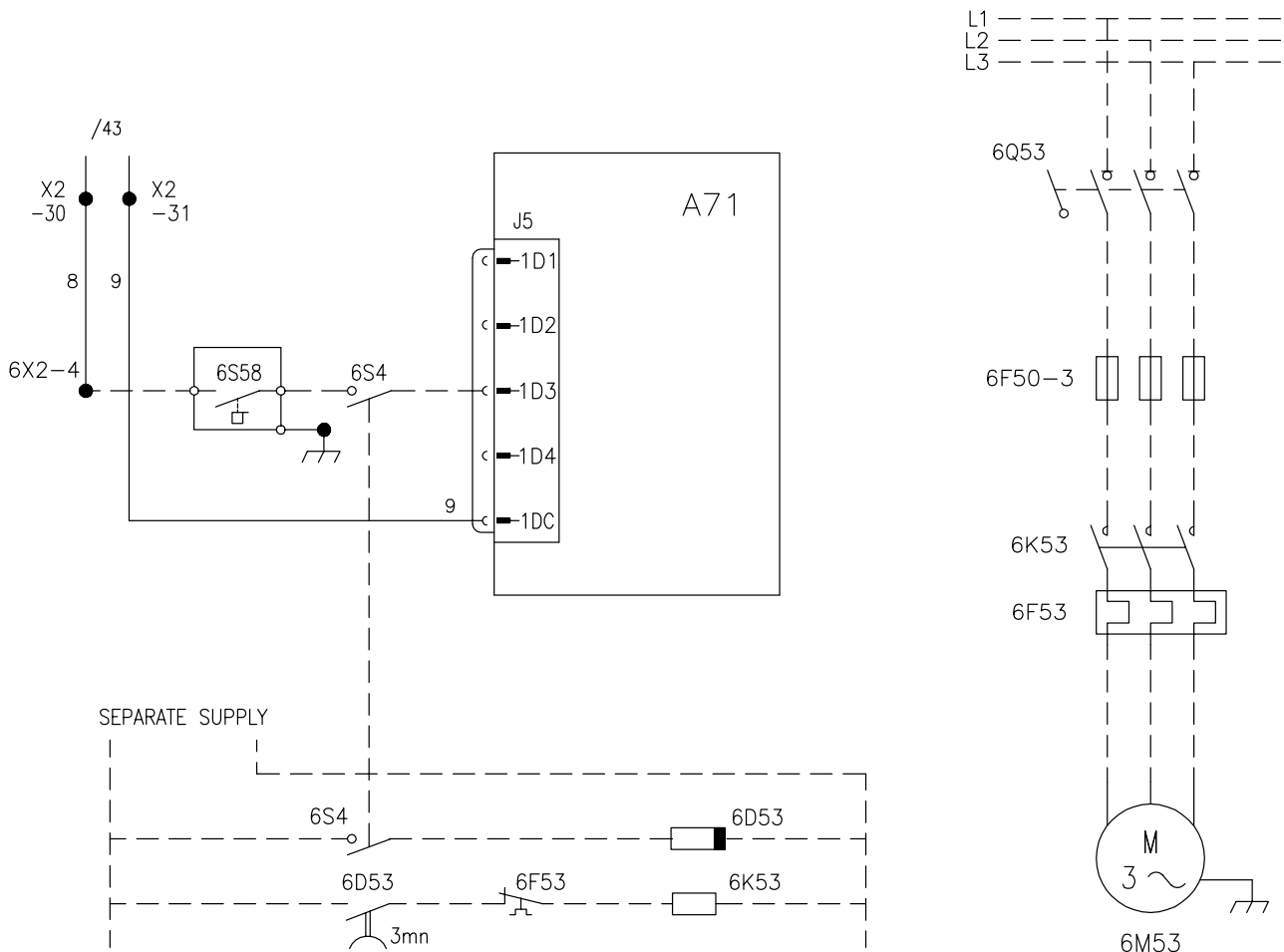

# Installation - Electrical

## Alarm and Status Relay Output (Programmable Relays)

Alarm/Running/Maximum Capacity Outputs Terminals 1 to 7 on terminal strip TB4 of the A1 board provide a variety of contact outputs on the RTAD. These are dependent on the setting of Programmable Relay Setup (Service Setting Menu) and its relationship to diagnostics, compressors operating, and the system operating at full capacity. As shown in Figure 26, there are three relays.

*Notes: For Free Cooling units a programmable relay output (terminals A70 J17-C12-NO12 and -NC12) is available. It provides a normally close contact. Following functions are available:*

- ❑ A70 ready to work, or working: the normally open contact will close as soon as the controller is powered and run, without any sensor(s) or sequence(s) failure.
- ❑ A70 failure: the normally open contact will close as long as there is a failure detect on sensor(s) or in sequence(s).
- ❑ Free cooling on: the normally open contact will close as long as the unit is making cold water with free cooling.

**Figure 26 - Alarm / Running / Maximum capacity relay output for the RTAD unit.**

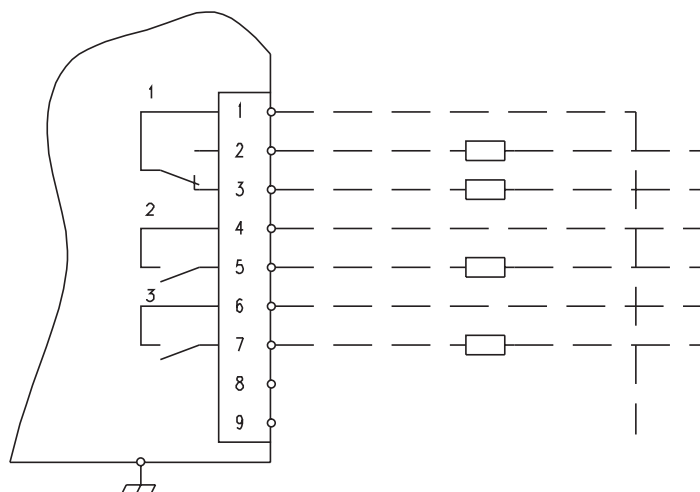

# Installation - Electrical

**Table 34 - Alarm / Running / Maximum capacity relay output configuration**

Relay output configuration		
1	Relay 1	Alarm
	Relay 2	Compressor running
	Relay 3	Maximum capacity
2	Relay 1	Circuit 1 alarm
	Relay 2	Circuit 2 alarm
	Relay 3	Maximum capacity
3	Relay 1	Alarm
	Relay 2	Circuit 1 running
	Relay 3	Circuit 2 running

**Table 35 - Alarm / Running / Maximum capacity menu setting**

Programmable Relay Setup Setting (service setting menu)	Relay Output Configuration (Table 26)	Diagnostic that the Alarm relay(s) is active		
		MMR / CMR diag.	MAR / CAR diag.	IFW diag.
1	1	YES	NO	NO
2	1	YES	YES	NO
3	1	YES	YES	YES
4	1	YES	NO	YES
5	2	YES	NO	NO
6	2	YES	YES	NO
7	2	YES	YES	YES
8	2	YES	NO	YES
9	3	YES	NO	NO
10	3	YES	YES	NO
11	3	YES	YES	YES
12	3	YES	NO	YES

Notes:  
 MMR: Machine Manual Reset  
 CMR: Circuit Manual Reset  
 MAR: Machine Auto Reset  
 CAR: Circuit Auto Reset  
 IFW: Informational Warnings

# Installation - Electrical

---

## Low-voltage wiring

The remote devices described below require low-voltage wiring. All wiring to and from these remote analog devices to the UCM-CLD (and A70 for Free cooling/Heat Recovery units), as described in this paragraph, must be made with shielded, twisted-pair conductors. Be sure to ground the shielding only at the Clear Language Display.

**CAUTION! To prevent control malfunction, do not run low-voltage wiring (<30V) in conduits with conductors carrying more than 30 V.**

## External Emergency stop (normal trip)

The Clear Language Display provides auxiliary control for a customer-specified or -installed latching tripout. When this remote contact 6S2 (furnished by the customer) is provided, the chiller will run normally when the contact is closed. When the contact opens, the unit will trip off on a manually resettable diagnostic. This condition requires manual reset at the chiller switch on the front of the Clear Language Display. To connect, first remove the jumper located between terminal 3 and 4 of A1 TB1. Refer to the field diagrams that are shipped with the unit.

## External Auto/Stop

If the unit requires the external Auto/Stop function, the installer must provide leads from the remote contacts 6S1 to the proper terminals of the module A1 (to A70 for Free-cooling units) terminals TB3-3 and TB3-4 (J8-IDH14 and 6X2-1 for Free cooling/Heat Recovery units), in the control panel.

The chiller will run normally when the contact is closed. When the contact opens, the compressor(s), if operating, will go to the RUN:UNLOAD operating mode and cycle off. Unit operation will be inhibited. Re-closure of the contacts will permit the unit to automatically return to normal operation. Field-supplied contacts for all low voltage connections must be compatible with dry circuit 24VDC for a 12 mA resistive load. Refer to the field diagrams that are shipped with the unit.

## External circuit lockout - Circuit 1

The UCM provides auxiliary control of a customer-specified or -installed contact closure, for individual operation of circuit number 1. If the contact is closed, the refrigerant circuit will not operate. The refrigerant circuit will run normally when the contact is opened. External circuit lockout will only function if External Circuit Lockout (service setting Menu) is enabled. Connections are shown in the field diagrams that are shipped with the unit.

## External circuit lockout - Circuit 2

The UCM provides auxiliary control of a customer-specified or -installed contact closure, for individual operation of circuit number 2. If the contact is closed, the refrigerant circuit will not operate. The refrigerant circuit will run normally when the contact is opened. External circuit lockout will only function if External Circuit Lockout (service setting Menu) is enabled. Connections are shown in the field diagrams that are shipped with the unit.

# Installation - Electrical

## Ice-making option

Ice-machine control (Operator Setting Menu) must be enabled. The UCM provides auxiliary control for a customer-specified or installed contact closure for ice making. When the remote contact connected to the module A9, terminals TB1 1 and 2, is provided, the chiller will run normally when the contact is open. Upon contact closure, the UCM will initiate an ice-building mode, in which the unit runs fully loaded at all times. In ice-building, the current setpoint will be set at 120%. For example, if the front panel or external current limit setpoint is set to 80%, in ice-building the active current limit is 120%.

If, while in ice-building mode, the unit gets down to the freestat setting (water or refrigerant), the unit will shut down on a manually resettable diagnostic, just as in normal operation.

## External chilled-water setpoint: voltage source 2-10 V (dc), or current source 4-20 mA

This option allows the external setting of the chilled-water setpoint (CWS), independent of the front panel chilled-water setpoint, by one of two means:

- 1 - An isolated voltage input 2-10 V (dc)
- 2 - An isolated current loop input 4-20 mA

*Note: For Free-Cooling units, this option will be available only in Compressor mode.*

## Isolated 2-10 V (dc) voltage source input

Set dipswitch SW1-1 of the option module A9 to "OFF." Connect the voltage source to terminals 4 (+) and 5 (-) on option module A9 TB1. CWS is now based on the following equation:

$$\text{CWS } ^\circ\text{C} = (\text{V (dc)} * 4.51) - 26.83$$

Sample values for CWS vs. V (dc) signals are shown in Table 36

**Table 36 - Input values vs. External chilled-water setpoint**

Voltage (V (dc))	Current (mA)	Resulting chilled-water setpoint (°C)
3.7	7.2	-10
4.8	9.2	-5
5.9	11.3	0
7.1	13.3	5
8.2	15.4	10

## Isolated 4-20 mA current source input

Set dipswitch SW1-1 of the option module A9 to "ON."

Connect the current source terminals 4 (+) and 5 (-).

CWS is now based on the following equation:

$$\text{Setpoint } (^\circ\text{C}) = (\text{mA} * 2.44) - 27.56$$

# Installation - Electrical

## External current limit setpoint: voltage source 2-10 V (dc) or current source 4-20 mA.

This option allows the external setting of the current limit setpoint (CLS), independent of the front panel current-limit setpoint, by one of the two means:

- 1 - an isolated voltage input 2-10 V (dc)
- 2 - an isolated voltage input 4-20 mA

To enable external current-limit setpoint operation, external current-limit setpoint (operator setting menu) should be set to "E" using the clear language display.

### 1- 2-10 V (dc) voltage source input

Set dipswitch SW1-2 of the option module A9 to "OFF."

Connect the voltage source to terminals 7 (+) and 8 (-) of the option module A9. CLS is now based on the following equation:

$$\text{CLS \%} = (\text{V (dc)} * 10) + 20$$

Sample values for CLS vs. V(dc) signals are shown in Table 33.

Minimum setpoint: 40% (2.0 V (dc)input)

Maximum setpoint: 120% (10.0 V (dc)input)

### 4-20 mA Current source input

Set dipswitch SW1-2 of the option module A9 to "ON." Connect the current source to terminal 7 (+) and 8 (-) of option module A9. CLS is now based on the following equation:

$$\text{CLS \%} = (\text{mA} * 5) + 20$$

Sample values for CLS versus mA signals are shown in Table 29.

Minimum setpoint = 40% (4.0 mA)

Maximum setpoint = 120% (20.0 mA)

**Table 37 - Input values vs. external current-limit setpoint**

Voltage (V (dc))	Current (mA)	Resulting chilled-water setpoint (°C)
2.0	4.0	40
3.0	6.0	50
4.0	8.0	60
5.0	10.0	70
6.0	12.0	80
7.0	14.0	90
8.0	16.0	100
9.0	18.0	110
10.0	20.0	120

## Outdoor air-temperature sensor

This sensor is used for low ambient lockout and chilled-water reset by outdoor air temperature. This sensor is optional on the RTAD units. Remove the sensor from its shipping location in the control panel and install it in the fresh-air intake on the north wall of the building. Protect the sensor from direct sunlight and shelter it from the elements. Connect leads to terminals 1 and 2 from module A9TB1. All wiring to and from the remote sensor must be made with shielded, twisted-pair conductors.

Be sure to ground the shielding only at the UCM-CLD. Apply tape to the sensor end of the shielding to prevent it from contacting the surface.

**WARNING! To prevent injury or death, disconnect the electrical power source before completing wiring connections to the unit.**

*Note: Not available for Free-Cooling units.*



# Installation - Electrical

---

**CAUTION!** To prevent overheating at the terminal connections, use copper conductors only.

## Communication card CSR

This option allows the Clear Language Display in the control panel on RTAD units to exchange information (operating setpoints and Auto/Standby commands) with a higher-level control device, such as Tracer. A shielded, twisted-pair connection establishes the bidirectional communications link between the unit control panel and the Tracer.

*Note: The shielded, twisted-pair conductors must run in a separate conduit.*

**CAUTION!** To prevent control malfunction, do not run low-voltage wiring (<30V) in conduits with conductors carrying more than 30 volts.

Field wiring for the communication link must meet the following requirements:

1. All wiring must be in accordance with local codes.
2. Communication link wiring must be shielded, twisted-pair wiring.
3. The maximum total length for each communication link is 1,500 meters.
4. The communication link cannot pass between buildings.
5. All UCM-CLD on the communication link can be connected in a "daisy chain" configuration.

## Communication-link connection procedure

1. Refer to the Tracer installation literature to determine proper communication-link termination connections at the Tracer module.
2. Connect the shield of the communication-link wiring to the designated shield terminal at the Tracer module.
3. Connect leads to terminals 1 to 4 of TB2 of the module A9 of the UCM-CLD to the Tracer. There is no polarity requirement for the connection.
4. At the UCM-CLD, the shield should be cut and taped to prevent any contact between the shield and ground.

*Note: On multiple-unit installations, splice the shielding of the twisted pairs that come into each UCM-CLD in the "daisy chain" system. Tape the spliced connections to prevent any contact between the shield and ground. At the last Clear Language Display in the chain, the shield should be cut and taped off.*

5. To get the chiller to communicate with a Tracer on a multiple-unit controller, the ICS address under the "service settings" menu must be set and the optional A9 module must be installed. Contact your local Trane representative for this matter.

# Installation - Electrical

## LonTalk® Communications Interface for Chillers (LCI-C)

The unit controller provides an optional LonTalk Communication Interface (LCI-C) between the chiller and a Building Automation System (BAS). An LCI-C LLID shall be used to provide "gateway" functionality between a LonTalk compatible device and the chiller. The inputs/outputs include both mandatory and optional network variables as established by the LonMark Functional Chiller Profile 8040.

This section introduces the LCI-C device for RTAD. For further information please refer to the manual ACC-SVN32A-EN.

If you are connecting the LCI-C to a Tracer Summit™ system, you will not need the network variable information given in this part.

If you are connecting the LCI-C to a non-Trane building automation system using LonTalk™, Appendixes A through B will provide you with the system integration information you will need regarding network variables.

### LonMark certification

The LonMark organization promotes LonTalk as an industry standard for control communication. The LCI-C is certified to the LonMark Chiller Functional Profile 8040 Version 1.0, and follows LonTalk FTT-10A communications system technology. Compliance with this technology means that the LCI-C can provide an interface for non-Trane LonTalk networks.

### Network variables

LonTalk uses network variables to communicate points on a communication link. LonMark has defined a list of standard network variables.

### Chiller Functional Profile

LonMark calls their standard list of variables for chiller control the Chiller Functional Profile. This profile is meant to allow interoperability between control systems and chillers, regardless of chiller type or manufacturer.

### The LCI-C Extension

The LCI-C Extension is a list of additional network variables Trane created that are over and above the ones defined by the Chiller Functional Profile. The LCI-C Extension is considered "open" because the network variables are not proprietary. The network variables in the LCI-C Extension are defined in the "User defined types" section.

### LCI-C shipment and inspection

The LCI-C is either factory-installed with the chiller controller or shipped as an individual part for field installation.

### Storage

If the LCI-C is stored for a period of time prior to being installed, it must be protected from the elements. The temperature of the storage location should be between -40 °C and 70 °C and the relative humidity should be 0-95%, non-condensing.

### Communications

The Tracer LCI-C controller communicates via Trane's LonTalk protocol. Typically, a communication link is applied between unit controllers and a building automation system. Communication also is possible via Rover service tool. Peer-to-peer communication across controllers is possible even when a building automation system is not present.

You do not need to observe polarity for LonTalk communication links.

The LonTalk communications protocol allows peer to peer communications between controllers, which allows controllers to share information or data. A communicated variable input such as setpoint, space temperature, or outdoor air temperature has priority over a locally wired input to the controller.

Example: if the LCI-C controller has a wired outdoor air temperature sensor and Tracer Summit or another LonTalk controller sends it a communicated outdoor air temperature, the communicated value is used by the LCI-C controller. If a communicated input value is lost, the LCI-C controller reverts to using the locally wired sensor input.

### Device Addressing

LonTalk devices are given a unique address by the manufacturer. This address is called a Neuron ID. Each LCI-C controller can be identified by its unique Neuron ID, which is printed on a label on the controller.

The Neuron ID is also displayed when communication is established using Tracer Summit or Rover service tool. The Neuron ID format is 00-01-64-1C- 2B-00.

# Installation - Electrical

## LonTalk Communication Link Wiring Requirements

The LonTalk communications link is for connection to a Building LonTalk Network. The Communications link wiring is dependent on the network architecture. It is recommended that a System Integrator refer to "LonWorks FTT-10A Free Topology Transceiver User's Guide" by the Echelon Corporation for proper wire selection.

The physical limits are defined in Chapter 4, Network Cabling and Connection. This User's Guide is available on the Echelon Web page. A typical wire recommendation is Belden 85102, single twisted pair, stranded 19/29, unshielded, 150 C.

For additional wiring information, refer to Trane's "LonTalk Wiring Installation guide" (BAS-SVN01A-EN.)

**Table 38 - Glossary**

<b>Comm5</b>	Tranes implementation of the LonTalk protocol.
<b>IPC</b>	Acronym for interprocessor communications.
<b>LonMark International</b>	LonMark International is a global membership organization created to promote and advance the business of efficient and effective integration of open, multi-vendor control systems utilizing ANSI/EIA/CEA 709.1 (LonTalk) and related standards.
<b>LonMark Chiller Functional profile</b>	A standard list of network variables, mandatory and optional, that LonMark defines for chiller controller communications on a LonTalk network.
<b>LonMark communications interface (LCI)</b>	An interface developed by Trane to allow unit controllers to communicate using LonTalk protocol.
<b>LCI-C Extension software</b>	Trane LCI-C software that implements network variables from both the LonMark Chiller Functional Profile and Trane Chiller Extension.
<b>LonTalk Protocol</b>	An interoperable protocol developed by the Echelon Corporation and named as a standard by the Electronics Industries Alliance (EIA-709.1). It is packaged on a Neuron processor that is on the LCI-C LLID.
<b>LonTalk network</b>	A collection of LonTalk devices that communicate and interact with one another.
network variable input (nvi)	A controller's input data item that enables it to exchange data values with other devices on the LonTalk network. This type of data item can be changed and controlled.
network variable output (nvo)	A controller's output data item that enables it to exchange data values with other devices on the LonTalk network. This type of data item is for status only.
network variable type	A pre-defined structure for a network variable. A network variable type can be either a standard network variable type (SNVT) or a user-defined network variable type (UNVT).
<b>Neuron ID</b>	A unique 48-bit digital identifying number assigned by Echelon to every Neuron processor produced. This number is printed on a label that is attached to the LCI-C. Neuron IDs eliminate the need to set addresses with DIP switches.
<b>Neuron software</b>	Software within the LCI-C Neuron processor that defines its program ID and network variables.
<b>Program ID</b>	An identifier stored in the LCI-C Neuron processor that identifies the application program that is running. All controllers with the same Program ID have the same network variable list.
<b>Rover service tool</b>	A Trane software program used as a service tool to configure Trane LonTalk controllers, flash download Neuron software, make LonTalk bindings between network variables, and otherwise install devices on a LonTalk network. Rover can also be described as a LonTalk network management tool.
<b>SCPT</b>	Acronym for standard configuration parameter type. A pre-defined structure for communicating configuration information.
<b>SNVT</b>	Acronym for standard network variable type. See network variable type.
System integration	Generally, the ability for products designed independently to communicate with each other by using the same communications protocol. Specifically in relation to Trane products, the ability for them to monitor and/or control another vendors equipment by using an open, standard protocol.
Trane Chiller Extension	The network variables that Trane provides in addition to the network variables provided by the LonMark Chiller Functional Profile, 8040 Version 1. (Not all network variables in the Trane Chiller Extension are available for every chiller type.)
<b>UCPT</b>	Acronym for user-defined configuration parameter type. A pre-defined structure for communicating configuration information.
<b>UNVT</b>	Acronym for user-defined network variable type. See network variable type.

# Installation - Electrical

**Table 39 - Network Variable List**

Index	Network Variable	SNVT Type
0	nciLocation	SNVT_str_asc(36)
1	nciChillerEnable	SNVT_switch(95)
2	nciMinOutTm	SNVT_time_sec(107)
3	nciSndHrtBt	SNVT_time_sec(107)
4	nciCapacityLim	SNVT_lev_percent(81)
5	nciCoolSetpt	SNVT_temp_p(105)
6	nciMode	SNVT_hvac_mode(108)
7	nciHeatSetpt	SNVT_temp_p(105)
8	nciDefaults	SNVT_switch(95)
9	nciRcvHrtBt	SCPTmaxRcvTime(48)
10	nciRefrigerant	UCPT_refrig_type
11	nciMfgLocation	UCPT_manufacturing_location
12	nciChillerType	SCPT_chiller_type
13	nciDevMajVer	SCPTdevMajVer(165)
14	nciDevMinVer	SCPTdevMinVer(166)
17	nviChillerEnable	SNVT_switch(95)
18	nviCoolSetpt	SNVT_temp_p(105)
19	nvoOnOff	SNVT_switch(95)
20	nvoActiveSetpt	SNVT_temp_p(105)
21	nviCapacityLim	SNVT_lev_percent(81)
22	nviMode	SNVT_hvac_mode(108)
23	nviHeatSetpt	SNVT_temp_p(105)
24	nvoActualCap	SNVT_lev_percent(81)
25	nvoCapacityLim	SNVT_lev_percent(81)
26	nvoLvgChWTemp	SNVT_temp_p(105)
27	nvoEntChWTemp	SNVT_temp_p(105)
28	nvoEntCndWTemp	SNVT_temp_p(105)
29	nvoLvgCndWTemp	SNVT_temp_p(105)
30	nvoAlarmDescr	SNVT_str_asc(36)
31	nvoChillerStat	SNVT_chlr_status(127)
32	nviRequest	SNVT_obj_request(92)
33	nvoStatus	SNVT_obj_status(93)

Index	Network Variable	SNVT Type
34	nviTraneVar2	UNVT
35	nvoTraneVar9	UNVT
36	nvoStatusOutputs	SNVT_state(83)
37	nvoCprsrRunning	SNVT_state(83)
38	nvoCondFans	SNVT_state(83)
39	nvoEvapWtrPump	SNVT_switch(95)
40	nvoEvapWtrFlow	SNVT_switch(95)
41	nvoCondWtrPump	SNVT_switch(95)
42	nvoCondWtrFlow	SNVT_switch(95)
43	nvoOutdoorTemp	SNVT_temp_p(105)
44	nvoUnitVoltage	UNVT_3phase_volt
45	nvoEvapRfgrPrsC1	SNVT_press_f(59)
46	nvoEvapRfgrPrsC2	SNVT_press_f(59)
47	nvoEvapRfgrTmpC1	SNVT_temp_p(105)
48	nvoEvapRfgrTmpC2	SNVT_temp_p(105)
49	nvoCondRfgrPrsC1	SNVT_press_f(59)
50	nvoCondRfgrPrsC2	SNVT_press_f(59)
51	nvoCondRfgrTmpC1	SNVT_temp_p(105)
52	nvoCondRfgrTmpC2	SNVT_temp_p(105)
53	nvoAirFlowPctC1	SNVT_lev_percent(81)
54	nvoAirFlowPctC2	SNVT_lev_percent(81)
55	nvoOilTempA	SNVT_temp_p(105)
56	nvoOilTempB	SNVT_temp_p(105)
57	nvoOilTempC	SNVT_temp_p(105)
58	nvoOilTempD	SNVT_temp_p(105)
59	nvoCurrentA	UNVT_3phase_current
60	nvoCurrentB	UNVT_3phase_current
61	nvoCurrentC	UNVT_3phase_current
62	nvoCurrentD	UNVT_3phase_current
63	nvoStartsRunTmA	UNVT_starts_runtime
64	nvoStartsRunTmB	UNVT_starts_runtime
65	nvoStartsRunTmC	UNVT_starts_runtime
66	nvoStartsRunTmD	UNVT_starts_runtime

# Installation - Electrical

## User defined types

This appendix includes

- User-defined network variable types
- User-defined configuration property types

These user-defined types have been created by Trane for use by Trane controllers.

In many cases, the Trane user-defined types contain standard network

variable types (SNVTs) to make them easy to understand.

## User-defined network variable types (UNVTs)

UNVT\_purge\_information

### Structure definition

Field in structure	Byte	Bit definition	Description
SNVT_state	Byte 0 (MSB)	Bits 0-7 (MSB) Bit 8 Bit 9 Bit 10 Bits 11-15(LSB)	Validity of bits 8-15 (1=Valid) Refrigeration Circuit On (1) Pumping Out (1) Regenerating (1) Not Used
SNVT_time_f	Byte 1-2 (LSB)		Purge 24 Hour Pumpout Average

UNVT\_starts\_runtime

### Structure definition

Field in structure	Definition
SNVT_count_f	Compressor Starts
SNVT_time_f	Compressor Run Time

SUNVT\_3phase\_current

### Structure definition

Field in structure	Definition
SNVT_amp_ac	L1 Current (Amps)
SNVT_amp_ac	L2 Current (Amps)
SNVT_amp_ac	L3 Current (Amps)
SNVT_lev_percent	L1 Current (%RLA)
SNVT_lev_percent	L2 Current (%RLA)
SNVT_lev_percent	L3 Current (%RLA)

UNVT\_3phase\_volt

### Structure definition

Field in structure	Definition
SNVT_volt_ac	AB Voltage
SNVT_volt_ac	BC Voltage
SNVT_volt_ac	CA Voltage

# Installation - Electrical

UNVT\_refrig

Range of enumeration values

Enumeration	Definition	Description (reference: ARI guideline K)
0	RT_R11	R-11 (Trichlorofluoromethane)
1	RT_R12	R-12 (Dichlorodifluoromethane)
2	RT_R13	R-13 (Chlorotrifluoromethane)
3	RT_R13B1	R-13B1 (Bromotrifluoromethane)
4	RT_R14	R-14
5	RT_R21	R-21
6	RT_R22	R-22 (Chlorodifluoromethane)
7	RT_R23	R-23 (Trifluoromethane)
8	RT_R32	R-32
9	RT_R40	R-40
10	RT_R112	R-112
11	RT_R113	R-113 (Trichlorotrifluoroethane)
12	RT_R114	R-114 (Dichlorotetrafluoroethane)
13	RT_R115	R-115
14	RT_R116	R-116
15	RT_R123	R-123 (Dichlorotrifluoroethane)
16	RT_R124	R-124 (Chlorotetrafluoroethane)
17	RT_R125	R-125
18	RT_R134a	R-134a (Tetrafluoroethane)
19	RT_R141B	R-141B
20	RT_R142B	R-142B
21	RT_R143A	R-143A
22	RT_R152A	R-152A
23	RT_R401A	R-401A (Chlorodifluoromethane, Difluoroethane, Chlorotetrafluoroethane)
24	RT_R401B	R-401B (Chlorodifluoromethane, Difluoroethane, Chlorotetrafluoroethane)
25	RT_R402A	R-402A (Chlorodifluoromethane, Pentafluoro-ethane, Propane)
26	RT_R402B	R-402B (Chlorodifluoromethane, Pentafluoro-ethane, Propane)
27	RT_R403B	R-403B (Chlorodifluoromethane, Octafluoro-propane, Propane)
28	RT_R404A	R-404A (Pentafluoroethane, Trifluoroethane, Tetrafluoroethane)
29	RT_R406A	R-406A (Chlorodifluoroethane, Isobutane, Chlorodifluoroethane)
30	RT_R407A	R-407A (Difluoromethane, Pentafluoroethane, Tetrafluoroethane)
31	RT_R407B	R-407B (Difluoromethane, Pentafluoroethane, Tetrafluoroethane)
32	RT_R407C	R-407C (Difluoromethane, Pentafluoroethane, Tetrafluoroethane)
33	RT_R408A	R-408A (Chlorodifluoromethane, Trifluoroethane, Pentafluoroethane)
34	RT_R409A	R-409A (Chlorodifluoromethane, Chlorotetrafluoro-ethane, Chlorodifluoroethane)
35	RT_R410A	R-410A (Difluoromethane, Pentafluoroethane)
36	RT_R414B	R-414B (Chlorodifluoromethane, Chlorotetrafluoro-ethane, Chlorodifluoroethane, Isobutane)
37	RT_R416A	R-416A (Tetrafluoroethane, Chlorotetrafluoro-ethane, Butane)
38	RT_R500	R-500 (Dichlorodifluoromethane, Difluoroethane)
39	RT_R502	R-502 (Chlorodifluoromethane, Chloropentafluoro-ethane)
40	RT_R503	R-503 (Chlorotrifluoromethane, Trifluoromethane)
41	RT_R507	R-507 (Pentafluoroethane, Trifluoroethane)
42	RT_R508B	R-508B (Trifluoromethane, Hexafluoroethane)
43	RT_R717	R-717
44-254	RT_RESERVED	Reserved for future use
0xFF	RT_INVALID	Invalid (default)

# Installation - Electrical

## User-defined configuration property types

UCPT\_chiller\_type

### Structure definition

Item	Type	Bytes	Range and meaning
Model information (See enumeration definitions table below.)	Unsigned 8-bit (enum)	1	Range of enum values in UCPT_chiller_type
Unit capacity	SNVT_power_f	4	Capacity of unit (in watts)
Cooling type	Unsigned 8-bit (enum)	1	0 = water-cooled 1 = air-cooled 2-254 = unused
Number of circuits	Unsigned 8-bit	1	0-2; number of circuits on unit
Number of compressors on circuit 1	Unsigned 8-bit	1	0-3; number of compressors on circuit 1
Number of compressors on circuit 2	Unsigned 8-bit	1	0-3; number of compressors on circuit 2
Total length		9	

## Enumeration definitions for UCPT\_chiller\_type

Enumeration	um n (Trane chiller model designators)
0	RTA
1	CVH
2	CVG
3	CVR
4	CDH
5	RTH
6	CGW
7	CGA
8	CCA
9	RTW
10	RTX
11	RTU
12-254	Unused
255	Invalid (unknown)

UCPT\_manufacturing\_location

### Range of enumeration values

Enumeration	Enumeration definition
0	Field applied (unknown location)
1	La Crosse, Wisconsin
2	Pueblo, Colorado
3	Charmes, France
4	Rushville, Indiana
5	Macon, Georgia
6	Waco, Texas
7	Lexington, Kentucky
8	Forsyth, Georgia
9	Clarksville, Tennessee
10	Ft. Smith, Arkansas
11	Penang, China
12	Colchester, UK
13	Curitiba, Brazil
14	Taicang, China
15 to 254	Unused
255	Invalid (unknown location)

# Operating Principles

Figure 27 - System/Oil system schematic for Standard cooling /Partial Heat Recovery units

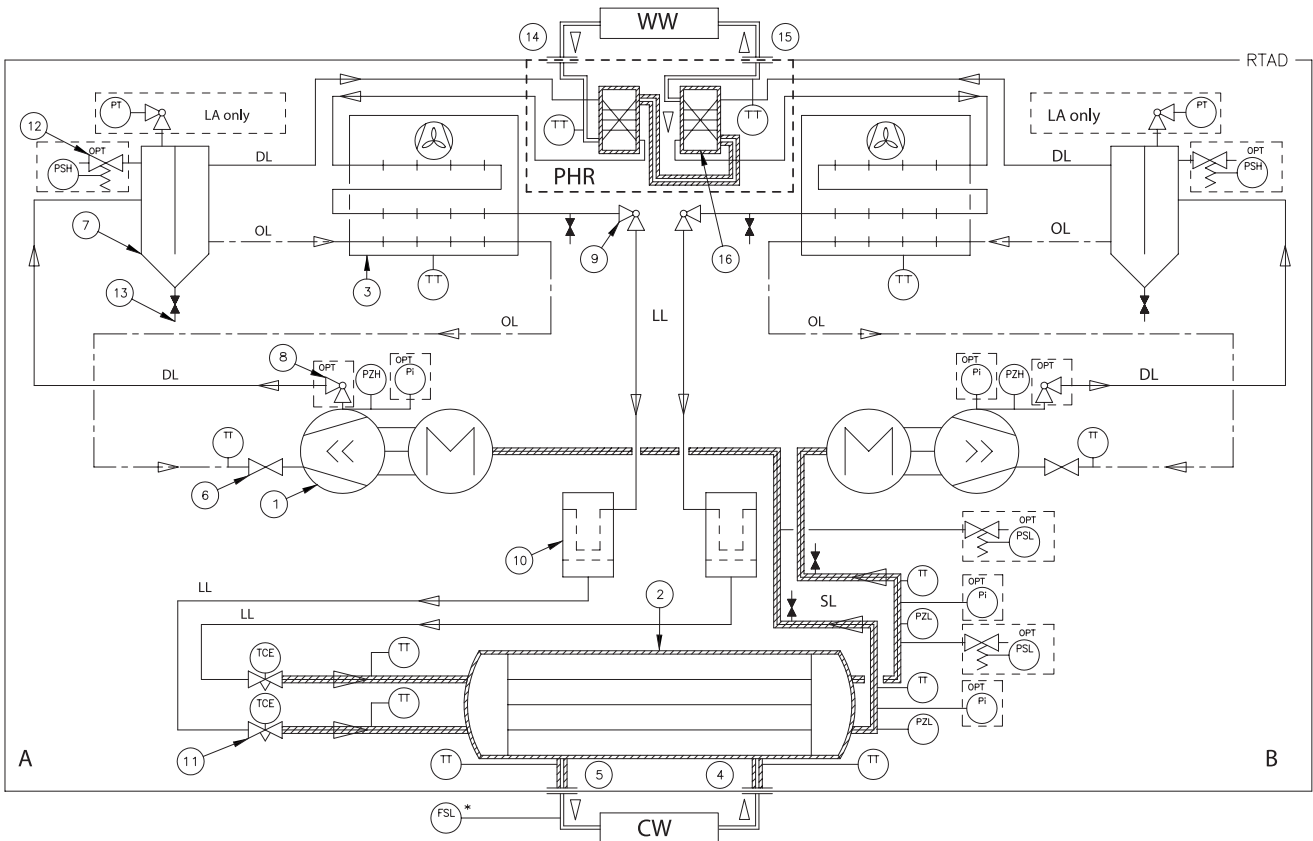

- 1 = Screw compressor
- 2 = Evaporator
- 3 = Air-cooled condenser
- 4 = Evaporator water inlet connection
- 5 = Evaporator water outlet connection
- 6 = Oil service valve
- 7 = Oil separator
- 8 = Discharge service valve
- 9 = Liquid shutoff valve
- 10 = Filter drier
- 11 = Electric expansion valve
- 12 = Relief valve
- 13 = Service valve
- PI = Gauge
- PT = Pressure transducer
- PSH = High pressure relief valve
- PSL = Low pressure relief valve

- PZH = High pressure switch
- PZL = Low pressure switch
- TT = Temperature sensor
- TCE = Electric expansion valve
- OPT = Option
- DL = Discharge line
- SL = Suction line
- LL = Liquid line
- A = Circuit A
- B = Circuit B
- LA only = Low or wide ambient temperature only
- FSL = Flow switch (supplied by Trane - option)
- PHR = Partial Heat Recovery option
- CW = Chilled water
- WW = Warm water



# Operating Principles

Figure 28 - System schematic for Free-Cooling units

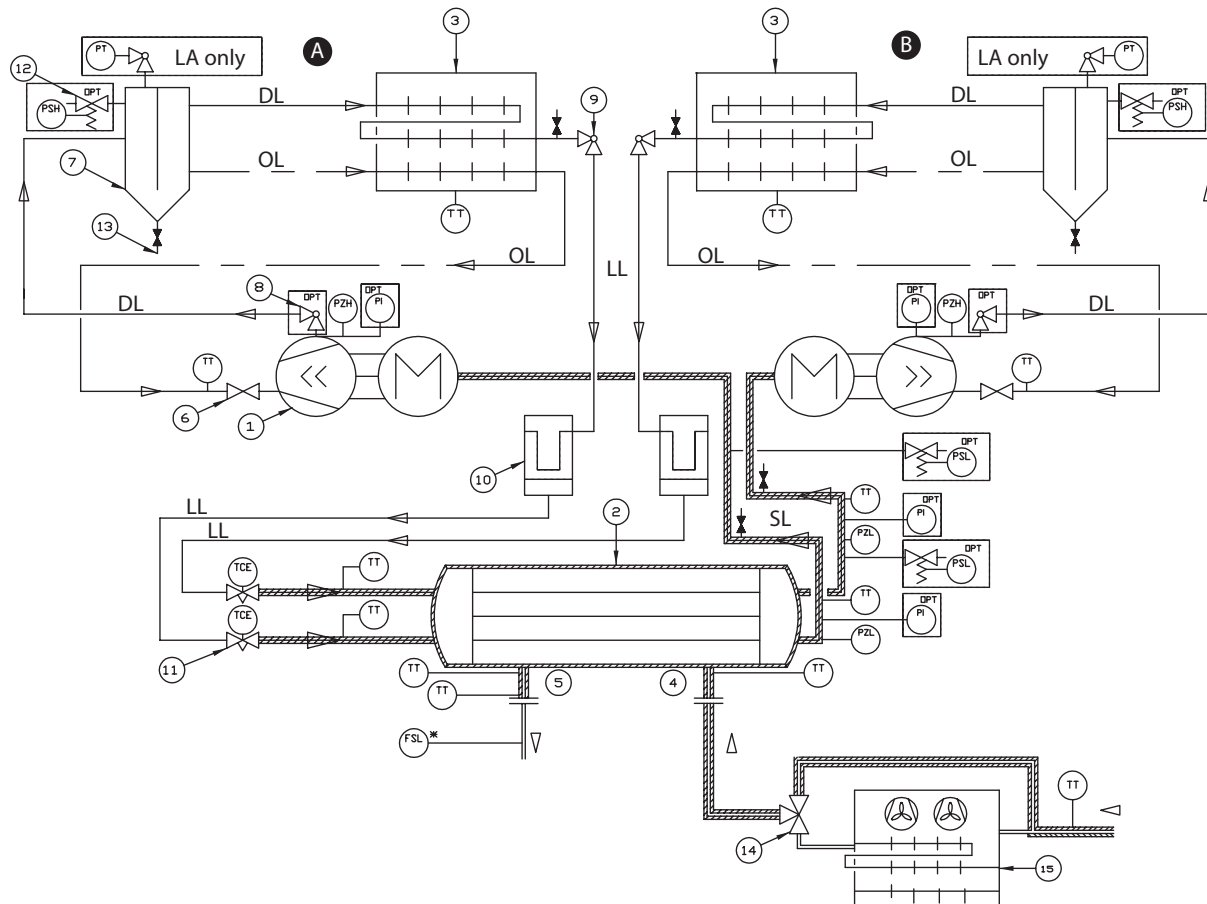

- |  |   |
|--|---|
| 1 = Screw compressor                   | PZH = High pressure switch                        |
| 2 = Evaporator                         | PZL = Low pressure switch                         |
| 3 = Air-cooled condenser               | TT = Temperature sensor                           |
| 4 = Evaporator water inlet connection  | TCE = Electric expansion valve                    |
| 5 = Evaporator water outlet connection | OPT = Option                                      |
| 6 = Oil service valve                  | DL = Discharge line                               |
| 7 = Oil separator                      | SL = Suction line                                 |
| 8 = Discharge service valve            | LL = Liquid line                                  |
| 9 = Liquid shutoff valve               | A = Circuit A                                     |
| 10 = Filter drier                      | B = Circuit B                                     |
| 11 = Electric expansion valve          | LA only = Low or wide ambient<br>temperature only |
| 12 = Relief valve                      | FSL = Flow switch                                 |
| 13 = Service valve                     |   |
| 14 = 3-way valve                       |   |
| PI = Gauge                             |   |
| PT = Pressure transducer               |   |
| PSH = High pressure relief valve       |   |
| PSL = Low pressure relief valve        |   |

# Operating Principles

Figure 29 - System schematic for Total Heat Recovery units

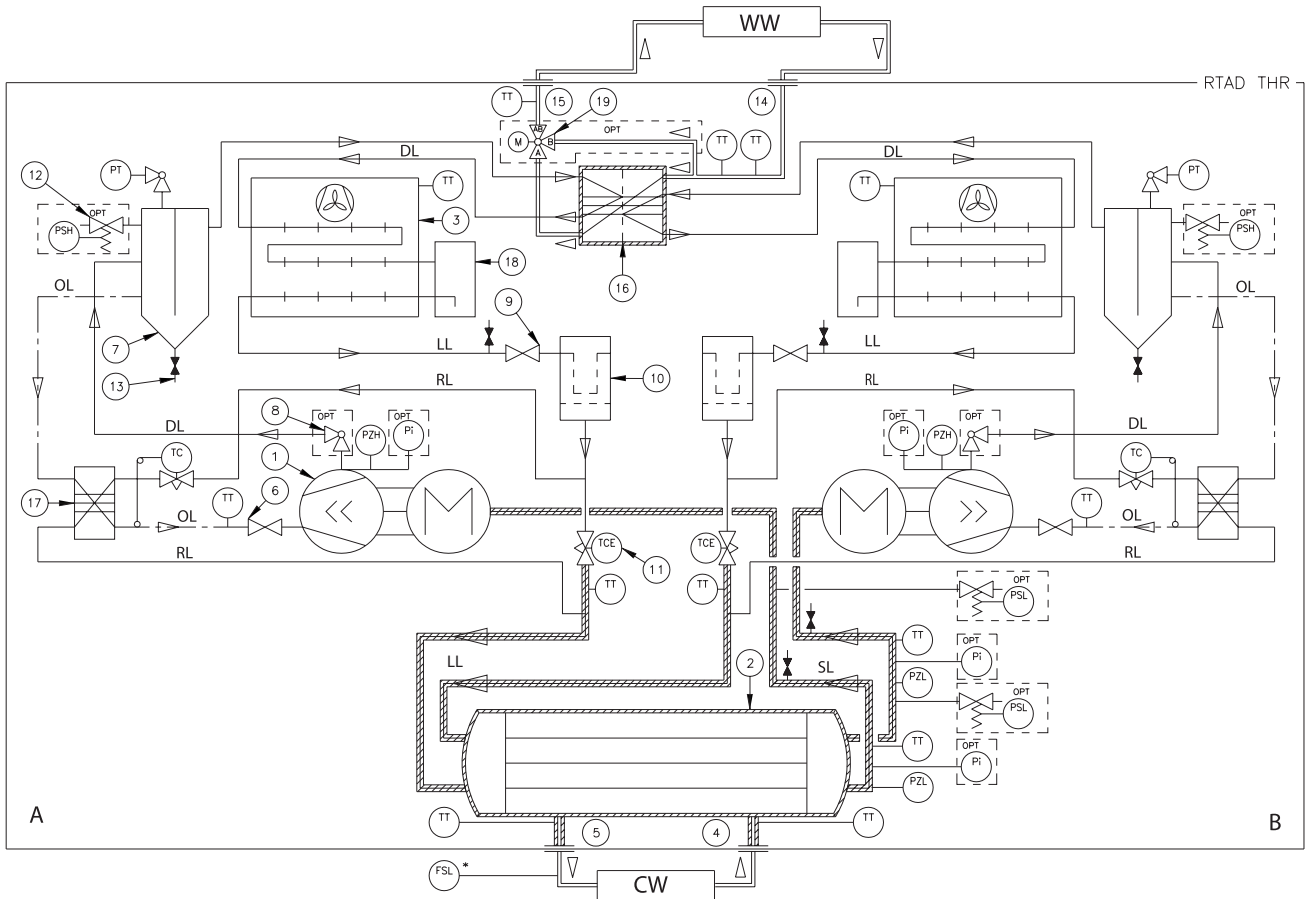

- 1 = Screw compressor
- 2 = Evaporator
- 3 = Air-cooled condenser
- 4 = Evaporator water inlet connection
- 5 = Evaporator water outlet connection
- 6 = Oil service valve
- 7 = Oil separator
- 8 = Discharge service valve
- 9 = Liquid shutoff valve
- 10 = Filter drier
- 11 = Electric expansion valve
- 12 = Relief valve
- 13 = Service valve
- 14 = 3-way valve
- PI = Gauge
- PT = Pressure transducer
- PSH = High pressure relief valve

- PSL = Low pressure relief valve
- PZH = High pressure switch
- PZL = Low pressure switch
- TT = Temperature sensor
- TCE = Electric expansion valve
- OPT = Option
- DL = Discharge line
- SL = Suction line
- LL = Liquid line
- RL = Auxiliary oil cooler refrigerant line
- A = Circuit A
- B = Circuit B
- LA only = Low or wide ambient temperature only
- FSL = Flow switch

# Pre-Start Checkout

## Installation Checklist

Complete this checklist as the unit is installed and verify that all recommended procedures are accomplished before the unit is started. This checklist does not replace the detailed Instructions given in the "Installation -Mechanical" and "Installation -Electrical" sections of this manual. Read both sections completely, to become familiar with the installation procedures, prior to beginning the work.

## Receiving

- Verify that the unit nameplate data corresponds to the ordering information.
- Inspect the unit for shipping damage and any shortages of materials. Report any damage or shortage to the carrier.

## Unit Location and Mounting

- Inspect the location desired for installation and verify adequate service access clearances.
- Provide drainage for evaporator water.
- Remove and discard all shipping materials (cartons, etc.)
- Install optional rubber isolators, if required.
- Level the unit and secure it to the mounting surface.

## Units with hydraulic module

### CAUTION!

- The pump must not be used to fill the water loop.
- The pump must not be activated until the system is fully filled with water.
- Using the pump with absent or insufficient water will end up in damaging the mechanical seal.

## Unit Piping

- Flush all unit water piping before making final connections to the unit.

**CAUTION! If using an acidic commercial flushing solution, construct a temporary bypass around the unit to prevent damage to internal components of the evaporator. To avoid possible equipment damage, do not use untreated or improperly treated system water.**

- Connect the chilled water piping to the evaporator.

*Note: On Free-Cooling units, the chilled water piping will be connected to the evaporator on one side and to the 3-way valve on the other side (see Figure 28)*

- Install pressure gauges and shutoff valves on the chilled water inlet and outlet to the evaporator.
- Install a water strainer in the entering chilled water line.
- Install a balancing valve and flow switch (recommended) in the leaving chilled water line.
- Install a drain with shutoff valve or a drain plug on the evaporator waterbox.
- Vent the chilled water system at high points in the system piping.
- Apply heat tape and insulation, as necessary, to protect all exposed piping from freeze-up.

## PHR/THR units

- Ensure that the heat recovery water piping is ready to operate, filled with water and air purged.
- Ensure that a water strainer is installed.
- Check the position of thermometers and manometers.

## Electrical Wiring

**WARNING! To prevent injury or death, disconnect electrical power source before completing wiring connections to the unit.**

**CAUTION! To avoid corrosion and overheating at terminal connections, use copper conductors only.**

- Connect the unit power supply wiring with fused-disconnect to the terminal block or lugs (or unit-mounted disconnect) in the power section of the control panel.
- Connect power supply wiring to the evaporator heater.
- Connect power supply wiring to the chilled water pump.
- Connect power supply wiring to any auxiliary heat tapes.
- Connect the auxiliary contact of the chilled water pump (6K51) in series with the flow switch, if installed, and then connect to the proper terminals.
- For the External Auto/Stop function, install wiring from remote contact (6S1) to the proper terminals on the circuit board.
- Check chilled water pumps interconnection to control panel.

*Note: On Free-Cooling units, for free cooling enable output, install wiring from remote contact (6S3) to the proper terminals on the circuit board.*

**CAUTION! Information in Interconnecting Wiring: Chilled Water Pump Interlock and External Auto/Stop must be adhered to or equipment damage may occur.**

## Heat Recovery units

- Ensure that the Heat Recovery mode input is correctly wired (dry contact)
- Check that the hot water pump has a 3 minute time delay after the Heat Recovery mode is switched off.

# Pre-Start Checkout

- ❑ If alarm and status relay outputs are used, install leads from the panel to the proper terminals on circuit board.
- ❑ If the emergency stop function is used, install low voltage leads to terminals on circuit board.
- ❑ Connect separate power for the External Emergency Stop option, if applicable.
- ❑ If the ice making-option is used, install leads on terminals TB1-1 and 2 on module A9.

## General

When installation is complete, but prior to putting the unit into service, the following pre-start procedures must be reviewed and verified correct:

**WARNING! Disconnect all electric power including remote disconnects before servicing. Failure to disconnect power before servicing can cause severe personal injury or death.**

- 1 Inspect all wiring connections in the compressor power circuits (disconnects, terminal block, contactors, compressor junction box terminals, etc.). to be sure they are clean and tight.

**CAUTION! Verify all connections are made. Loose connections can cause overheating and undervoltage conditions at the compressor motor.**

- 2 Open all refrigerant valves in the discharge, liquid, oil and oil return lines.

**CAUTION! Do not operate the unit with the compressor, oil discharge, liquid line service valves and the manual shutoff on the refrigerant supply to the coolers "CLOSED". Failure to have these "OPEN" may cause serious compressor damage.**

- 3 Check the power supply voltage to the unit at the main power fused-disconnect switch. Voltage must be within the voltage utilization range and also stamped on the unit nameplate. Voltage imbalance must not exceed 3%.

- 4 Check the unit power phasing L1-L2-L3 in the starter to be sure that it has been installed in an "ABC" phase sequence.

**CAUTION! Improper power phasing can result in equipment damage due to reverse rotation.**

**CAUTION! Do not use untreated or improperly treated water. Equipment damage may occur.**

- 5 Fill the evaporator chilled water circuit. Vent the system while it is being filled. Open the vents on the top of the evaporator shell while filling and close when filling is completed.

**Important: The use of improperly treated or untreated water in this equipment may result in scaling, erosion, corrosion, algae or slime. The services of a qualified water treatment specialist should be engaged to determine what treatment, if any, is advisable. Trane warranty specifically excludes liability of corrosion, erosion or deterioration of Trane equipment. Trane assumes no responsibilities for the results of the use of untreated or improperly treated water or saline or brackish water.**

- 6 Close the fused-disconnect switch(es) that supplies power to the chilled water pump starter.
- 7 Start the chilled water pump to begin circulation of the water. Inspect all piping for leakage and make any necessary repairs.
- 8 With water circulating through the system, adjust water flow and check water pressure drop through the evaporator.
- 9 Adjust the chilled water flow switch for proper operation.

**WARNING! Use extreme caution when performing the following procedure with power applied. Failure to do so can result in personal injury or death.**

- 10 Reapply power to complete procedures.
- 11 Prove all Interlock and Interconnecting Wiring Interlock and External as described in the Electrical Installation section.
- 12 Check and set, as required, all UCM-CLD menu items.
- Note: On Total Heat Recovery and Free-Cooling units, also check and set the A70 module.*
- 13 Stop the chilled water pump.
- 14 Energize compressor and oil separators 24 hours prior to unit start-up.

# Pre-Start Checkout

## Unit Voltage Power Supply

Voltage to the unit must meet the criteria given in the Installation-Electrical Section. Measure each leg of the supply voltage at the unit's main power fused- disconnect. If the measured voltage on any leg is not within specified range, notify the supplier of the power and correct the situation before operating the unit.

**CAUTION!** Provide adequate voltage to the unit. Failure to do so can cause control components to malfunction and shorten the life of relay contact, compressor motors and contactors.

**CAUTION!** Power supply with TT or TN earthing arrangement is not compatible with IT (Insulated Neutral) earthing arrangement.

## Unit Voltage Imbalance

Excessive voltage imbalance between the phases of three-phase system can cause motors to overheat and eventually fail. The maximum allowable imbalance is 3 percent. Voltage imbalance is determined using the following calculations:

$$\% \text{ Imbalance} = [(V_x - V_{ave}) \times 100] / V_{ave}$$

$$V_{ave} = (V_1 + V_2 + V_3) / 3$$

**V<sub>x</sub>** = phase with the greatest difference from V<sub>ave</sub> (without regard to the sign)

For example, if the three measured voltages are 221, 230, and 227 volts, the average would be:

$$(221+230+227)/3 = 226$$

The percentage of the imbalance is then:

$$[100 * (221-226)] / 226 = 2.2\%$$

This exceeds the maximum allowable (2%) by 0.2 percent.

## Unit Voltage Phasing

**WARNING!** It is imperative that L1, L2, L3 in the starter be connected in the A-B-C phase sequence to prevent equipment damage due to reverse rotation.

It is important that proper rotation of the compressors be established before the unit is started.

Proper motor rotation requires confirmation of the electrical phase sequence of the power supply. The motor is internally connected for clockwise rotation with the incoming power supply phased A, B, C.

Basically, voltages generated in each phase of a polyphase alternator or circuit are called phase voltages. In a three-phase circuit, three sine wave voltages are generated, differing in phase by 120 electrical degrees. The order in which the three voltages of a three-phase system succeed one another is called phase sequence or phase rotation. This is determined by the direction of rotation of the alternator. When rotation is clockwise, phase sequence is usually called "ABC," when counterclockwise, "CBA."

This direction may be reversed outside the alternator by interchanging any two of the line wires. It is this possible interchange of wiring that makes a phase sequence indicator necessary if the operator is to quickly determine the phase rotation of the motor.

# Pre-Start Checkout

Proper compressor motor electrical phasing can be quickly determined and corrected before starting the unit. Use a quality instrument, such as the Associated Research Model 45 Phase Sequence Indicator, and follow this procedure.

- 1 Press the STOP key on the UCM-CLD.
- 2 Open the electrical disconnect or circuit protection switch that provides line power to the line power terminal block(s) in the starter panel (or to the unit-mounted disconnect).
- 3 Connect the phase sequence indicator leads to the line Power terminal block, as follows:

Phase Sequence Lead	Terminal
Black (Phase A)	L1
Red (Phase B)	L2
Yellow (Phase C)	L3

- 4 Turn power on by closing the unit supply power fused-disconnect switch.
- 5 Read the phase sequence on the indicator. The "ABC" LED on the face of the phase indicator will glow if phase is "ABC."

**WARNING! To prevent injury or death due to electrocution, take extreme care when performing service procedures with electrical power energized.**

- 6 If the "CBA" indicator glows instead, open the unit main power disconnect and switch two line leads on the line power terminal block(s) (or the unit mounted disconnect). Reclose the main power disconnect and recheck the phasing.

**CAUTION! Do not interchange any load leads that are from the unit contactors or the motor terminals. Doing so may damage the equipment.**

- 7 Reopen the unit disconnect and disconnect the phase indicator.

## Water System Flow Rates

Establish a balanced chilled water flow through the evaporator. The flow rates should fall between the minimum and maximum values given on the pressure drop curves. Chilled water flow rates below the minimum values will result in laminar flow, which reduces heat transfer and causes either loss of EXV control or repeated nuisance, low temperature, cutouts. Flow rates that are too high can cause tube damage in the evaporator.

## Water System Pressure Drop

Measure water pressure drop through the evaporator at the field-installed pressure taps on the system water piping. Use the same gauge for each measurement. Do not include valves, strainers fittings in the pressure drop readings.

Pressure drop readings should be approximately those shown in the pressure drop charts in the Installation - Mechanical section.

# Unit Start-up Procedures

---

## Daily Unit Start-Up

The time line for sequence of operation is shown at the end of this section and depicts the nominal delays and sequences that a chiller would experience during a typical operational cycle. The time line begins with a power up of the main power to the chiller. The sequence assumes a RTAD chiller with no diagnostics or malfunctioning components. External events such as the operator placing the chiller in Auto or Stop, chilled water flow through the evaporator, and application of load to the chilled water loop causing loop water temperature increases are depicted and the chillers responses to those events are shown, with appropriate delays noted. The effects of diagnostics, and other external interlocks other than evaporator water flow proving, are not considered. The response of the CLD Display is also depicted on the time line.

### For Free Cooling units only:

At power up, the unit will choose either if it should start in Free-Cooling mode or in Compressor mode through the Carel™ module:

- If only Free-Cooling is available, then Free-Cooling mode will be entered immediately at this time.
- If only Compressor mode is available, then Compressor mode will be entered immediately at this time.
- If both modes are available, then the mode to enter will depend on a few conditions. If ( (Leaving Water Temperature) - (Active Chilled Water Setpoint) ) > 2 \* (Dead band), or if Free-Cooling coil cannot generate more than 5% of its delta T at current conditions, then the Compressor mode will be entered immediately. If these conditions are false for at least 15 minutes, then the Free-Cooling mode will be entered immediately.

To allow the system to operate even in case of failure on chiller or on free cooling side, a menu allows the service technician to choose between the following modes:

- ❑ **Auto mode:** This is the default mode. If enable by external Free-Cooling Enable input (FCE), the software will choose between Free-Cooling mode or Compressor mode. If disable by FCE, the Compressor mode will always be enabled. In auto mode the RTAD Free-Cooling unit will always start-up in Compressor mode and then if conditions to pass in Free-Cooling mode are verified for at least 15 minutes, the Free-Cooling mode will be enabled.
- ❑ **Compressor mode only:** Compressor mode will always be enabled.
- ❑ **Free-cooling mode only:** Free-Cooling will always be enabled. This will allow service on compressor side of the unit.

**WARNING! This menu will enable function made by the software, but service technician must remove all power supply before servicing parts, especially on moving dangerous devices.**

# Unit Start-up Procedures

## General

If the pre-start checkout, as discussed above, has been completed, the unit is ready to start.

- 1 Press the STOP key on the CLD module.
- 2 As necessary, adjust the setpoint values in the UCM-CLD « Operator Settings » menu.
- 3 Close the fused-disconnect switch for the chilled water pump. Energize the pump(s) to start water circulation.
- 4 Check the service valves on the discharge line, oil line and liquid line for each circuit. These valves must be open (backseated) before starting the compressors.

**CAUTION! To prevent compressor damage, do not operate the unit until all refrigerant and oil line service valves are opened.**

- 5 Verify that the chilled water pump runs for at least one minute after the chiller is commanded to stop (for normal chilled water systems).
- 6 Press the AUTO key. If the chiller control calls for cooling and all safety interlocks are closed, the unit will start. The compressor(s) will load and unload in response to the leaving chilled water temperature.

Once the system has been operating for approximately 30 minutes and has become stabilized, complete the remaining start-up procedures, as follows:

- 1 Check the evaporator refrigerant pressure and the condenser refrigerant pressure under Refrigerant Report on the CLD Module. The pressures are referenced to sea level (1013 mbar -14.7 psia).
- 2 Measure the system discharge superheat.
- 3 Measure the system subcooling.

- 4 A shortage of refrigerant is indicated if operating pressures are low and subcooling is also low. If the operating pressures, sight glass, superheat and subcooling readings indicate a refrigerant shortage, gas-charge refrigerant into each circuit, as required. With the unit running, add refrigerant vapor by connecting the charging line to the suction charging service valve port until operating conditions become normal.

**CAUTION! If both suction and discharge pressures are low but subcooling is normal, a problem other than refrigerant shortage exists. Do not add refrigerant, as this may result in overcharging the circuit. Use only refrigerants specified on the unit nameplate (HFC 134a) and Trane Oil 00048. Failure to do so may cause compressor damage and improper unit operation.**

*Note: On Free-Cooling units, in Compressor mode, the procedure will remain the same. In Free Cooling mode, only point 1 needs to be checked, as the compressors are not running. To release more cooling capacity and reduce pressure drop, Trane recommends using 50% nominal water flow while in Free Cooling mode.*



# Unit Start-up Procedures

---

## Seasonal Unit Start-Up Procedure

- 1 Close all valves and re-install the drain plugs in the evaporator.
  - 2 Service the auxiliary equipment according to the start-up/maintenance instructions provided by the respective equipment manufacturers.
  - 3 Close the vents in the evaporator chilled water circuits.
  - 4 Open all the valves in the evaporator chilled water circuits.
  - 5 Open all refrigerant valves to verify they are in the open condition.
  - 6 If the evaporator was previously drained, vent and fill the evaporator and chilled water circuit. When all air is removed from the system, re-install the vent plugs on top of the evaporator shell.
- CAUTION! Ensure that the compressor and oil separator heaters have been operating for a minimum of 24 hours before starting. Failure to do so may result in equipment damage.**
- 7 Check the adjustment and operation of each safety and operating control.
  - 8 Close all disconnect switches.
  - 9 Refer to the sequence for daily unit startup for the remainder of the seasonal startup.

## System Restart After Extended Shutdown

Follow the procedures below to restart the unit after extended shutdown:

- 1 Verify that the liquid line service valves, oil line, compressor discharge service valves (when supplied) are open (backseated).

**CAUTION! To prevent damage to the compressor, be sure that all refrigerant valves are open before starting the unit.**

- 2 Check the oil separator oil level (see Maintenance Procedures section).
- 3 Fill the evaporator water circuit. Vent the system while it is being filled. Open the vent on the top of the evaporator while filling and close when filling is completed.

**CAUTION! Do not use untreated or improperly treated water. Equipment damage may occur.**

- 4 Close the fused-disconnect switches that provides power to the chilled water pump.
- 5 Start the evaporator water pump and, while water is circulating, inspect all piping for leakage. Make any necessary repairs before starting the unit.
- 6 While the water is circulating, adjust the water flows and check the water pressure drops through the evaporator. Refer to "Water System Flow Rates" and "Water System Pressure Drop".
- 7 Adjust the flow switch on the evaporator piping for proper operation.
- 8 Stop the water pump. The unit is now ready for start-up as described in "Start-Up Procedures".

# Unit Shutdown Procedures

---

## Temporary Shutdown And Restart

To shut the unit down for a short time, use the following procedure:

- 1 Press the STOP key on the UCM-CLD. The compressors will continue to operate and, after unloading for 20 seconds, will stop when the compressor contactors de-energize.

*Note: On Free-Cooling units in Free Cooling mode, only the fans will stop. In Compressor mode, there is no change.*

- 2 Stop the water circulation by turning off the chilled water pump. To restart the unit after a temporary shutdown, enable the chilled water pump and press the AUTO key. The unit will start normally, provided the following conditions exist:

- The control module receives a call for cooling and the differential-to-start is above the setpoint.
- All system operating interlocks and safety circuits are satisfied.

## Extended Shutdown Procedure

The following procedure is to be followed if the system is to be taken out of service for an

extended period of time, e.g. seasonal shutdown:

- 1 Test the unit for refrigerant leaks and repair as necessary.
- 2 Open the electrical disconnect switches for the chilled water pump. Lock the switches in the "OPEN" position.

**CAUTION! Lock the chilled water pump disconnect Switch in the "OPEN" position, to prevent pump damage.**

- 3 Close all chilled water supply valves. Drain the water from the evaporator.
- 4 Open the unit main electrical disconnect and unit-mounted disconnect (if installed) and lock on the "OPEN" position.

**CAUTION! Lock the disconnects in the "OPEN" position to prevent accidental start-up and damage to the system when it has been setup for extended shutdown.**

- 5 At least every three months (quarterly), check the refrigerant pressure in the unit to verify that the refrigerant charge is intact.

*Note: For Free-Cooling units, check the percentage of ethylene glycol in the water circuit in order to protect against freeze-up.*

# Maintenance

---

## General

Perform all maintenance procedures and inspections at the recommended intervals. This will prolong the life of the chiller and minimize the possibility of costly failures. Record an operating history for the unit, which will serve as a valuable diagnostic tool for service personnel. By observing trends in operating conditions, an operator can anticipate and prevent problem situations before they occur. After the unit has been operating for approximately 30 minutes and the system has stabilized, check the operating conditions and complete the procedures below:

## Weekly Maintenance

While unit is running in stable conditions.

1 Check UCM-CLD pressure for Evaporator, Condenser and Oil.

2 The subcooling should never be less than 3°C (5.4°F) under any circumstances.

**CAUTION! A clear sightglass alone does not mean that the system is properly charged. Also check rest of system operating conditions.**

3 Inspect the entire system for unusual conditions and inspect the condenser coils for dirt and debris. If the coils are dirty, refer to coil cleaning.

*Note: On Free-Cooling units, the Free Cooling coil has to be checked too.*

## Monthly Maintenance

1 Perform all weekly maintenance procedures.

2 Record the system subcooling.

3 Record the system superheat.

4 Make any repairs necessary.

5 Clean the strainer after 2 hours of operation.

## Annual Maintenance

1 Perform all weekly and monthly procedures.

2 Check oil sump oil level while unit is off.

*Note: Routine changing of the oil is not required. Use an oil analysis to determine the condition of the oil.*

3 Have a qualified laboratory perform a compressor oil analysis to determine system moisture content and acid level. This analysis is a valuable diagnostic tool.

4 Contact a qualified service organization to leak test the chiller, to check operating and safety controls, and to inspect electrical components for deficiencies.

5 Inspect all piping components for leakage and damage. Clean out any inline strainers.

6 Clean and repaint any areas that show signs of corrosion.

7 Clean the condenser coils.

**WARNING! Position all electrical disconnects in the "Open" position and lock them to prevent injury or death due to electrical shock.**

*Note: On Free-Cooling units, the Free Cooling coil has to be checked too.*

8 Check and tighten all electrical connections as necessary.

## Pump maintenance

Pumps motor bearings and mechanical seals have a designed life expectancy of 20000-25000 hours of operation. For critical applications it might be necessary to change the components as a preventive measure.

# Maintenance Procedures

---

All the air-cooled RTAD chillers are given a complete functional test at the factory covering sensors, wiring, electrical components, microprocessor function, communication capability, expansion valve performance and fans. Where applicable, each unit is factory preset to the customer's design conditions, including leaving water temperature setpoint, current limit, and reset temperature setpoint.

*Note: Free-Cooling units are freeze-protected with 30% ethylene glycol in the cooling loop circuit which is the most convenient percentage to protect the unit against freeze-up.*

*Protection coverage with 30% ethylene glycol:*

- freezing point without burst effect = -13°C

- freezing point with burst effect = -50°C

*It is necessary to regularly check the percentage of ethylene glycol in the water circuit (at least every three months).*

## Refrigerant Emission Control

Conservation and emission reduction can be accomplished by following recommended Trane operation, maintenance and service procedures, with specific attention to the following:

- 1 Refrigerant used in any type of air conditioning or refrigerating equipment should be recovered for reuse, recovered and/or recycled for reuse, or reprocessed (reclaimed). Never release refrigerant into the atmosphere.
- 2 Always determine possible recycle or reclaim requirements of the recovered refrigerant before beginning recovery by any method.
- 3 Use approved containment vessels and safety standards. Comply with all applicable transportation standards when shipping refrigerant containers.
- 4 To minimize emissions while recovering refrigerant, use recycling equipment. Always attempt to use methods which will pull the lowest possible vacuum while recovering and condensing refrigerant into containment.
- 5 Refrigeration-system cleanup methods that use filters and dryers are preferred. Do not use solvents that have ozone depletion factors. Properly dispose of used materials.

- 6 Take extra care to properly maintain all service equipment that directly supports refrigeration service work, such as gauges, hoses, vacuum pumps and recycling equipment.
- 7 Stay aware of unit enhancements, conversion refrigerants, compatible parts and manufacturer's recommendations which will reduce refrigerant emissions and increase equipment operating efficiencies. Follow manufacturer's specific guidelines for conversion of existing systems.
- 8 In order to assist in reducing power-generation emissions, always attempt to improve equipment performance with improved maintenance and operations that will help conserve energy resources.

# Maintenance Procedures

## Refrigerant and Oil Charge Management

Proper oil and refrigerant charge is essential for proper unit operation, unit performance, and environmental protection. Only trained and licensed service personal should service the chiller.

### Some symptoms of a refrigerant under charged unit:

- Low Subcooling
- Larger than normal evaporator approach temperatures (Leaving Water Temperature - Saturated Evaporator Temperature)
- Low Evaporator Refrigerant Temperature Limit
- Low Refrigerant Temperature Cutout diagnostic
- Fully open expansion valve
- Possible whistling sound coming from liquid line (due to high vapor velocity)
- Possible low discharge superheat at high loads
- High Condenser + Subcooler Pressure drop

### Some symptoms of a refrigerant over charged unit:

- High Subcooling
- Larger than normal condenser approach temperatures (Entering Condenser Saturated Temperature - Entering Air Temperature)
- Condenser Pressure Limit
- High Pressure Cutout diagnostic
- More than normal number of fans running
- Erratic Fan Control
- Higher than normal compressor power
- Very low discharge superheat at startup
- Compressor rattle or grinding sound at startup

### Some symptoms of an oil over charged unit:

- Larger than normal evaporator approach temperatures (Leaving Water Temperature - Saturated Evaporator Temperature)
- Low Evaporator Refrigerant Temperature Limit
- Low Refrigerant Temperature Cutout diagnostic
- Very erratic liquid level control
- Low unit capacity
- Low discharge superheat (especially at high loads)
- Compressor rattle or grinding sound
- High oil sump level after normal shut down

### Some symptoms of an oil under charged unit:

- Compressor rattle or grinding sound
- Lower than normal pressure drop through oil system
- Seized or Welded Compressors
- Low oil sump level after normal shut down
- Lower than normal oil concentrations in evaporator

## R134a Field Charging Procedure

Be certain that the electrical power to the unit is disconnected before performing this procedure.

**WARNING! Position all electrical disconnects in the "OPEN" position and lock them to prevent injury or death due to electrocution.**

## Refrigerant Charging

If the refrigerant charge needs to be adjusted, be certain to monitor the subcooling and superheat measurements. The subcooling needs to be between 6°C (10°F) and 12°C (20°F) when the unit is running fully loaded. The ambient temperature is between 24°C (75°F) and 38°C (100°F) and the leaving water temperature is between 5°C (41°F) and 13°C (55°F).

# Maintenance Procedures

---

## Isolating the refrigerant charge in the high pressure side for Low Side Repairs.

To perform this operation the unit must be equipped with the optional discharge service valve

If the refrigerant charge needs to be isolated in the high side of the unit, perform the following procedures:

- 1 Press the STOP key and send the unit to a stopping mode.
- 2 Place a manifold gauge set on the backseat port of the liquid line service valve before actually closing the valve.
- 3 Close the liquid line service valve.
- 4 While the unit is in the STOP mode, enable Service Pumpdown for the specific compressor. Service Pumpdown is found under the Service Tests menu of the UCM-CLD.

*Note: Service Pumpdown can only be enabled for one compressor at a time. Only one pumpdown per compressor can be performed, until the unit has been reset.*

With Service Pumpdown enabled, the Restart inhibit will be ignored, the EXV will be prepositioned and the selected compressor will start and run for one minute.

5 Once the compressor stops, close the discharge service valve on the compressor (this valve is optional on RTAD).

6 The remaining refrigerant needs to be recovered from the suction line service valve. Attach the inlet of a recovery system to the port of the charging valve. Attach the outlet of the recovery system to the manifold gauge set that is already attached to the access port on the liquid line service valve. The condenser will be used as a storage vessel.

7 Complete all necessary repairs.

8 Evacuate out of the suction line service charging valve.

9 Break the vacuum by adding refrigerant in the suction line through the service valve.

10 Open all valves, start the unit and verify the refrigerant charge by measuring the subcooling.

## Isolating the refrigerant charge in the low pressure side for High Side Repairs

If the refrigerant charge needs to be isolated in the low side of the unit, perform the following procedures:

- 1 Press the STOP key and send the unit to a stopping mode.
- 2 Close the discharge service valve (optional on RTAD).
- 3 Before closing the liquid line service valve, attach a manifold gauge set to the liquid line backseat port.
- 4 Close the liquid line service valve.
- 5 Attach the inlet of a liquid transfer pump to the manifold gauge set and the outlet of the service valve mounted on the suction line.

This will transfer the liquid refrigerant. As the low pressure side cannot contain all the charge, the remaining refrigerant will be transferred to a separate vessel.

6 Remove all of the vapor from the high side of the system.

7 Complete all necessary repairs.

8 Evacuate the high side through the access port on the liquid line service valve.

9 Open all the valves and run the unit. Verify the refrigerant charge by measuring the subcooling.

# Maintenance Procedures

## Adding Refrigerant

If the entire charge has been removed, perform the following procedures to recharge the unit.

- 1 Open all service valves
- 2 Establish water flow through the evaporator. Connect a hose from the refrigerant bottle to the backseat port on the liquid line shutoff valve. Midseat the valve.

**CAUTION! The evaporator water flow needs to be established and maintained while adjusting the charge to avoid freezing and rupturing the tubes.**

- 3 It may not be possible to put the entire amount of refrigerant charge required using step 2. If so, start the unit and add liquid refrigerant through the liquid line service valve.
- 4 Once the unit has been charged with refrigerant, start the unit. Measure the subcooling and verify that the refrigerant charge is correct.

**Table 40 - Refrigerant Charge per Circuit (kg).**

Unit Size	Circuit A	Circuit B
<b>Standard</b>		
<b>Free Cooling</b>		
RTAD 085	24	24
RTAD 100	30	32
RTAD 115	35	36
RTAD 125	36	37
RTAD 145	44	48
RTAD 150	44	48
RTAD 165	61	59
RTAD 180	61	61
RTAD 085 HE	32	34
RTAD 100 HE	35	36
RTAD 115 HE	42	45
RTAD 125 HE	42	45
RTAD 145 HE	59	61
RTAD 150 HE	59	61
<b>Partial Heat Recovery</b>		
RTAD 085	26	26
RTAD 100	33	35
RTAD 115	38	39
RTAD 125	39	40
RTAD 145	47	51
RTAD 150	47	51
RTAD 165	65	63
RTAD 180	65	65
RTAD 085 HE	35	37
RTAD 100 HE	38	39
RTAD 115 HE	45	48
RTAD 125 HE	45	48
RTAD 145 HE	63	65
RTAD 150 HE	63	65
<b>Total Heat Recovery</b>		
RTAD 100	55	52
RTAD 115	67	64
RTAD 125	68	64
RTAD 145	86	84
RTAD 150	86	84
RTAD 165	100	95
RTAD 180	100	98
RTAD 085 HE	63	60
RTAD 100 HE	65	62
RTAD 115 HE	86	84
RTAD 125 HE	86	84
RTAD 145 HE	97	95
RTAD 150 HE	97	95

Note: Size 085 does not exist for Total Heat Recovery option but HE version is available

## Refrigerant Filter Changing Procedure

A dirty filter is indicated by a temperature gradient across the filter, corresponding to a pressure drop. If the temperature downstream of the filter is 4.4°C (8°F) lower than the upstream temperature, the filter should be replaced. A temperature drop can also indicate that the unit is undercharged. Ensure proper subcooling before taking temperature readings.

- 1 With the unit off, verify that the EXV is closed. Close liquid line isolation valve. On units with remote evaporators or oil cooling circuits, close ball valve on oil cooler liquid line.
  - 2 Attach vacuum hose to service port on liquid line filter flange.
  - 3 Evacuate refrigerant from liquid line and store.
  - 4 Remove vacuum hose.
  - 5 Depress schrader valve to equalize pressure in liquid line with atmospheric pressure.
  - 6 Remove bolts that retain filter flange.
  - 7 Remove old filter element.
  - 8 Inspect replacement filter element and lubricate o-ring with Trane OIL00048.
- Note: do not use mineral oil. It will contaminate the system.*
- 9 Install new filter element in filter housing.
  - 10 Inspect flange gasket and replace if damaged.
  - 11 Install flange and torque bolts to 19-22 mN (14-16 lb-ft).
  - 12 Attach vacuum hose and evacuate liquid line.
  - 13 Remove vacuum hose from liquid line and attach charging hose.
  - 14 Replace stored charge in liquid line.
  - 15 Remove charging hose.
  - 16 Open liquid line isolation valve. On units with remote evaporators or oil cooler circuits, open oil cooler liquid line ball valve.

# Maintenance Procedures

## Lubrication System

The lubrication system has been designed to keep most of the oil lines filled with oil as long as there is a proper oil level in the oil sump.

The total oil charge can be removed by draining the oil system, oil return line from the evaporator, the evaporator, and the compressor. Very small quantities of oil may be found in other components.

## Oil Charging Procedure

Proper charging of the oil system is critical to the reliability of the compressor and chiller.

Too little oil can cause the compressor to run hot and inefficiently. When taken to an extreme, low oil level may result in infant failure of the compressor. Too much oil will result in high oil- circulation rates, which will foul the condenser and evaporator performance. This will result in inefficient operation of the chiller. Taken to an extreme, high oil levels may result in erratic expansion valve control or shut down of the chiller due to low evaporator-refrigerant temperature. Too much oil may contribute to long-term bearing wear. Additionally, excessive compressor wear is probable when the compressor is started with the oil lines dry.

*Note: The oil system schematics are represented in Figures 27-29.*

The oil system consists of the following components:

- Compressor
- Oil separator
- Discharge line with optional service valve
- Oil line from separator to compressor
- Oil line drain (lowest point in system)
- Oil cooler
- Oil temperature sensor
- Oil line shut off valve with flare service connection
- Oil filter (internal to compressor) with flare fitting service connection and schrader valve
- Oil flow control valve (internal to the compressor after the filter)

The standard oil charge for each circuit size is in Table 41.

**Table 41 - Standard oil charge (l) (1)**

Unit size	Circuit A	Circuit B
<b>Standard</b>		
<b>Partial Heat Recovery</b>		
<b>Free Cooling</b>		
RTAD 085	6	6
RTAD 100	7	7
RTAD 115	9	9
RTAD 125-145-150	10	10
RTAD 165	15	11
RTAD 180	15	15
RTAD 085 HE	6	6
RTAD 100 HE	7	7
RTAD 115-125 HE	10	10
RTAD 145-150 HE	11	11
<b>Total Heat Recovery</b>		
RTAD 100	5	4
RTAD 115-125-145-150	8	7
RTAD 165	13	7
RTAD 180	13	12
RTAD 085-100 HE	5	4
RTAD 115-125-145-150 HE	8	7

Note: Size 085 does not exist for Total Heat Recovery option but HE version is available  
(1) Including oil charge within compressors.

*Recommendation: check the oil level in the sump using a sight glass attached to charging hoses.*



# Maintenance Procedures

1 To measure the oil level, use the oil drain valve on the oil line and a service valve on the discharge line. This measurement can only be made when the circuit is not running.

*Note: the bottom plate of the oil separator is approximately 25mm (1") thick.*

2 After the unit has run for a while, the oil level in the sump can vary greatly. However, if the unit has run "normal" conditions for a long time the level should be between 25 to -100mm (+1" to - 4" )

The field charging procedure depends on the circumstances that resulted in the need for oil charge.

1 Some service procedures may result in loss of small quantities of oil that must be replaced (oil analysis, compressor filter replacement, re-tubing the evaporator, and so forth.).

2 Additionally, some maintenance procedures may result in virtually all of the oil being removed (compressor motor burn or total removal of the charge to trouble shoot a unit).

3 Finally, leaks may result in a loss of oil that must be replaced.

## Factory (initial) Oil-Charging Procedure

The initial charging procedure should be followed any time the unit is new or has had all of the oil removed.

1 Add 1 liter oil to the motor cavity or suction line prior to installing the compressor into the chiller.

2 The oil-line shutoff valve must be open to allow the oil to pass into the oil lines and the oil separator.

3 The oil charging port is a ¼" (6mm) flare fitting with a schrader valve that is on the side of the oil-filter housing. This is the port that must be used to add oil into the compressor so that the filter and lines are full at the first start of the compressor.

4 Oil may be put into the unit using either of two methods:

**CAUTION! Use only Trane Oil 00048 in the RTAD units to avoid any catastrophic damage to the compressor or unit.**

- Have the unit in vacuum. Hook up the oil charging hose to oil charging fitting and submerge the other end into the oil container. Let the vacuum draw the required amount of oil into the unit.

- Have the unit at the same pressure as the oil. Hook up the oil charging hose to the oil charging fitting and the other end to an oil pump. Use the pump to draw oil out of the oil container and push the required amount of oil into the unit.

*Note: the compressor filter has an internal shut off valve that will prevent oil from entering the compressor while the compressor is not running. Therefore, there is no concern about flooding the compressor with oil.*

# Maintenance Procedures

## Field Oil-Charging Procedure

Use the initial charging procedure when virtually all of the oil has been removed.

*Note: this procedure can be followed even with the refrigerant charge isolated in the evaporating section of the unit.*

**If small quantities of oil were removed to service refrigeration components,** such as the

evaporator, simply replace the oil that was removed into the serviced component prior to vacuum and recharge of the refrigerant.

**If oil was removed to service a compressor or change the filter** follow this procedure:

- 1 If the compressor is a new compressor or has been removed from the system and reworked, add 1 liter oil to the motor cavity prior to installing the compressor into the chiller.
- 2 Install the compressor in the system. Make sure that the filter shut off valve is closed.

Other compressor isolation valves may also be closed depending upon the service that was completed. For example, changing the oil filter would require the compressor to be isolated and pulled into vacuum.

*Note: Ensure that the compressor is not pressurized.*

- 3 Open the flare fitting on the oil-line shut off valve.
- 4 Open the flare fitting on the filter housing. This is the port that must be used to put oil into the compressor.
- 5 Install charging hose on oil charging port (with the Schrader valve) and the other on the oil canister.
- 6 Lift the oil canister, or use a pump, to pour oil into the filter housing.
- 7 When oil comes out of the flare fitting on the oil line shut off valve the filter is full. Stop adding oil.
- 8 Put the cap on the flare on the oil line shut off valve, remove the charging hose and put the cap back on the flare on the filter housing.
- 9 Vacuum the compressor (low side) and prepare it for inclusion in the system. There is a service valve on the suction line. Use these valves to vacuum the compressor.
- 10 Open the oil line shut off valve. Severe damage to the compressor can result if the oil line shut off valve is closed when the compressor is started.

**WARNING! Catastrophic damage to the compressor will occur if the oil line shut off valve or the isolation valves are left closed on unit start-up.**

- 11 Open the other compressor isolation valves.

*Note: this procedure assumes that the oil that is put into the filter housing does not have contaminants such as non-condensable gases. The oil forces these gases out of the filter and oil line shut off valve without the need to pull a vacuum on this small volume. If the oil has been in an open container or is otherwise contaminated, then this small volume must be subject to vacuum as well. However, the filter cavity is full of oil. Therefore, be sure to use a flash tank in line with the vacuum pump to make sure that oil, that is pulled out of the filter cavity, does not slug the vacuum pump.*

# Maintenance Procedures

---

## Evaporator Heat Tape Checkout Procedure

**CAUTION! If the heat tapes wrapped around the evaporator barrel fail, the evaporator will freeze causing catastrophic damage to the entire unit.**

To check the heat tapes wrapped around the barrel follow the procedures below.

- 1 Locate the connection under the evaporator insulation near the bottom of the barrel.

**CAUTION! Do not cut past the evaporator insulation. Electrical damage to the heat tape wires will occur if cutting of the insulation is done improperly.**

The resistance can be checked with an ohmmeter to determine if there is an open or a short. If a heater has failed, replace as follows:

- 1 Remove the insulation around the heater.
- 2 Remove the old heater.
- 3 The factory installed heaters have the wire run under the insulation of the evaporator. This can be copied by cutting a small strip of insulation out and replacing it with tape.
- 4 Replace any insulation that was removed.
- 5 Wire the heaters into the system as per the wiring diagram.
- 6 Recheck the resistance to verify that they are wired correctly.

## Safety recommendations

To avoid accidents and damage, the following recommendations should be observed during maintenance and service visits:

1. The maximum allowable pressures for system leak testing on low and high pressure side are given in the chapter "Installation". Always provide a pressure regulator.
2. Disconnect the main supply before any servicing on the unit.
3. Service work on the refrigeration system and the electrical system should be carried out only by qualified and experienced personnel.



**TRANE®**

Cooling and Heating  
Systems and Services



Quality Management  
System Approval



---

Literature Order Number	RTAD-SVX01F-E4
-------------------------	----------------

---

Date	1007
------	------

---

New / Supersedes	RTAD-SVX01E-E4_1206
------------------	---------------------

---

Stocking Location	Europe
-------------------	--------

---

*Trane has a policy of continuous product and product data improvement and reserves the right to change design and specifications without notice. Only qualified technicians should perform the installation and servicing of equipment referred to in this publication.*

**www.trane.com**

For more information, contact your local  
sales office or e-mail us at [comfort@trane.com](mailto:comfort@trane.com)

Trane BVBA  
Chaussée de Wavre 1789 - 1160 Brussels, Belgium  
ON 0888.048.262 - RPR BRUSSELS