



# The Stock Guide

Lithonia Lighting® | Acuity Controls





AcuityControls

AEL American Electric Lighting

ANTIQUE STREET LAMPS

eldoLED

DISTECH CONTROLS

gotham

HEALTHCARE LIGHTING

HOLOPHANE LEADER IN LIGHTING SOLUTIONS

HYDREL

JUNO LIGHTING GROUP

LITHONIA LIGHTING

MARK ARCHITECTURAL LIGHTING

Peerless

RELOC WIRING SOLUTIONS

SUNOPTICS

WINONA solutions | forms | light





# A Trusted Partner for Over 100 Years

With more than 100 years of experience, Acuity Brands is the North American market leader and one of the world's leading providers of innovative lighting systems. Our comprehensive portfolio and proven in-depth knowledge of indoor and outdoor luminaires, controls and daylighting, provide customers with integrated, intelligent solutions from one company.

## About The Stock Guide

Highlighting the most popular and competitively priced products from brands such as Lithonia Lighting®, Sensor Switch® and nLight®, the Stock Guide is a catalog that simplifies product selection—allowing you to improve productivity and drive sales growth. Products in this guide are:

- **Stocked and available for same-day shipment** from one of our Regional Manufacturing and Distribution Centers.\*
- **Guaranteed for sale** – If the product does not sell within 12 months of the distributor date of purchase, the product can be easily returned when accompanied by a replacement order of approximate equal value.\*
- **Backed by Acuity Brands** – Each product has a warranty subject to the limitations and exclusions set forth in the Acuity Brands Term and Conditions of Sale. For more information, visit [www.acuitybrands.com/CustomerResources/Terms\\_and\\_conditions](http://www.acuitybrands.com/CustomerResources/Terms_and_conditions).
- **Eligible for free freight** – If your order is made of products within this guide and is on a qualifying stock order, it will qualify for free freight. Visit [www.acuitybrands.com/CustomerResources/Terms\\_and\\_conditions](http://www.acuitybrands.com/CustomerResources/Terms_and_conditions) for requirements.

\*Inventory and availability subject to change. Visit Acuity Distributor Center for the most up-to-date inventory availability information or contact your local Acuity Brands Agency Representative. Only product stocked in one of our Regional Manufacturing and Distribution Centers are eligible for a return of equal value.

# QUALITY SERVICE DELIVERED

# SHIPPED IN 48 HOURS OR LESS.

## When you need products fast, we are LightQuick®

Because your customers demand a high level of service even when project timelines are tight, count on Acuity Brands to deliver the product you need – when, where and how you need it. All products in this guide are part of the LightQuick program and ship from one of our six Regional Manufacturing and Distribution Centers (RMDCs) strategically located around North America.

### Broad Portfolio of Products - Ready to Ship

Product availability and quick delivery of a broad portfolio of products is key to meeting tight construction schedules and ultimately, to your success. We can deliver the right product when you need it.

- Over 7,000 products in-stock and available for same-day shipment or for will-call pickup\*
- Over 100,000 products can be made-to-order for shipment in 2 days or less\*^

### Rapid Response From Local Customer Care

High levels of service distinguish top distributors, and you need a partner that can help you consistently deliver. Our customer care teams are located on-site in our RMDCs allowing us to provide you with quick answers and resolutions to even your most complicated manufacturing and logistic situations.

### Customized Solutions to Meet Unique Project Requirements

No two projects are alike and neither are the products and solutions needed to service them. We can tailor our manufacturing and logistic capabilities to meet even your most complex customer requirements.

### Logistic Capabilities

[Special Carton Markings](#) to assist with job site logistics and coordination

[Job Packs](#) to avoid excessive jobsite waste and to save time

[Custom Pallet Sizes](#) to meet your unique job site requirements

[Local Delivery Trucks](#) to bring you products when you need them 24/7\*\*

[Custom Fabrication](#) to meet your specific opportunity needs

[Infinite Powder Paint Options](#) to transform a product's finish

[Custom Length Poles](#) and drill patterns that reduce normal lead time from 6 – 8 weeks to 2 days

\*\*Available in specific markets | \*Order must be received by 3pm local time of RMDC. | ^Quantities limited to 100 per SKU.



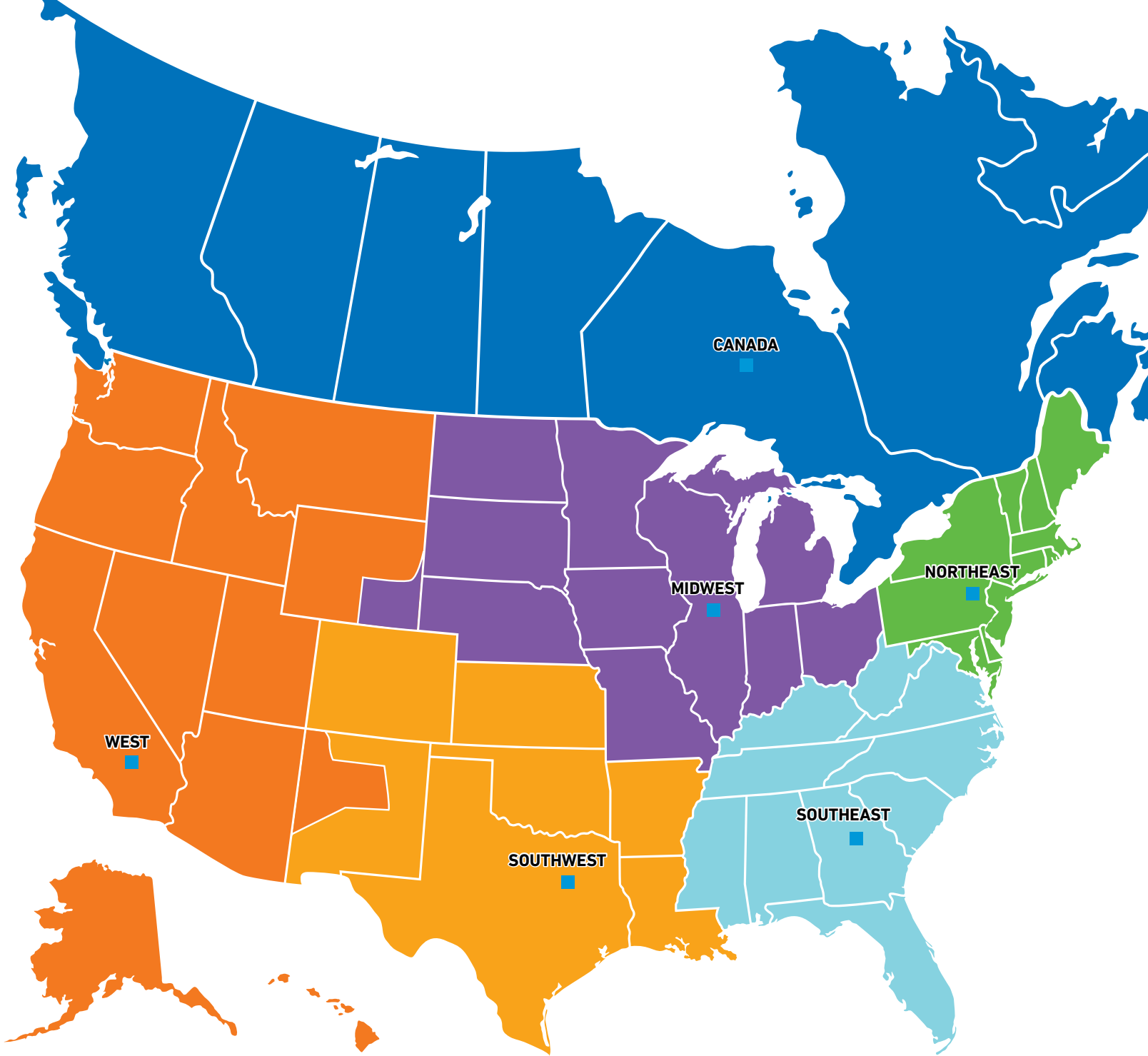

■ Regional Manufacturing and Distribution Center

### Beyond LightQuick

Can't find what you are looking for in this Stock Guide? We have more than one million products which can ship in 10 days or less from eleven manufacturing and distribution centers around North America. Refer to page 164 in this Stock Guide to learn more about our specialty Quick Ship products from our leading specialty lighting and controls brands!

## Simplify the Way You do Business

We are committed to supporting you every step of the way – before, during and after the sale. This guide, in addition to our sales network and vast portfolio of resources, services and tools, is our commitment to simplify the way you do business so you can reduce costs, improve productivity and drive sales growth. Check out some of the tools to the right.





## Tools that Simplify

### Acuity Distributor Center



Acuity Distributor Center (ADC) is a self-service, online portal that delivers valuable

information to our authorized distributors in just a few clicks! ADC helps to effectively manage your business by streamlining information, reducing transactional costs and improving productivity.

#### With ADC you can:

- View Order Status
- View Product Availability
- View Credit Memos and Invoices
- Submit Freight Claims
- Dynamically Build Custom Product Catalog
- Stay Up-to-Date on the Latest Promotions

Visit [www.acuitydistributorcenter.com](http://www.acuitydistributorcenter.com) to get started today!

### Electronic Data Interchange (EDI)

Acuity Brands is committed to delivering a full range of EDI capabilities to help distributors simplify their operations and reduce the transactional costs associated with processing daily stock business.

- EDI Capabilities:
- 850 Purchase Orders
- 855 P.O. Acknowledgments
- 856 Advance Ship Notice
- 810 Invoicing
- 820 Remittance & EFT
- 845 Into Stock Pricing
- 846 Stock Inventory

#### Benefits of EDI:

- Streamline orders for frequent stock products with EDI automation
- Accurate product data provided through the IDW and Trade Service
- Dedicated E-Commerce group to lead EDI implementation projects. Contact them at [ecommerce@AcuityBrands.com](mailto:ecommerce@AcuityBrands.com)

Learn more at [www.acuitybrands.com/EDI](http://www.acuitybrands.com/EDI)

### Freight Claim Assistance Program

Acuity Brands resolves freight claims for damage or shortages on your behalf rather than having you file them with the carrier. Follow these simple steps and simply submit electronically from ADC:

1. When you receive a shipment, inspect for damage and count the packages for overage or shortage in the presence of the driver. Be sure to verify the number of pieces and not just the number of pallets. Any discrepancies must be clearly noted on the carrier's delivery receipt prior to signing for items.
2. Log onto ADC to reference the shipment and order lines that need a claim filed against them.
3. Retain any damaged or over-shipments for a reasonable period of time to allow the carrier or Acuity Brands to inspect and salvage the product. Acuity Brands will notify you when and how product should be disposed.

Visit [www.acuitydistributorcenter.com](http://www.acuitydistributorcenter.com) for more details.

### IDEA's Industry Data Warehouse (IDW)

Acuity Brands is committed to providing IDW with timely and accurate product data so you increase efficiency by having access to the most up-to-date product data to populate your ERP, web store and catalogs.

- 98% compliance score for IDEA's Data Certification Program
- Approximately 4,000 products maintained and refreshed on a regular basis
- UNSPSC Classification for all items

# Key Information and Symbols

## Lighting Facts®

Lighting Facts is sponsored by the U.S Department of Energy (DOE) to assure and improve the quality of LED lighting products. Participation and product submissions to Lighting Facts is open to those who manufacture, sell and recommend the best in LED lighting.

Much like the nutrition facts label on food products, the Lighting Facts label makes sure consumers and retailers have all the information they need to know to make an informed decision when shopping for LED lighting products.

Learn more at [www.LightingFacts.com](http://www.LightingFacts.com)

### Anatomy of the Lighting Facts® Label

**Light Output/Lumens**  
Measures light output. The higher the number, the more light is emitted.

**Watts**  
Measures energy required to light the product. The lower the wattage, the less energy used.

**Lumens per Watt/Efficacy**  
Measures efficiency. The higher the number, the more efficient the product.

**Color Accuracy**  
Color Rendering Index (CRI) 70

**Color Rendering Index (CRI)**  
Measures color accuracy. Color rendition is the effect of the lamp's light spectrum on the color appearance of objects.

**Light Color**  
Correlated Color Temperature (CCT) 4000 (Bright White)

**Correlated Color Temperature (CCT)**  
Measures light color. "Cool" colors have higher Kelvin temperatures (3600-5500 K). "Warm" colors have lower color temperatures (2700-3500 K).

**IESNA LM-79-2008**  
Industry standardized test procedure that measures performance qualities of LED luminaires and integral lamps. It allows for a true comparison of luminaires regardless of the light source.

**Registration Number**  
**Model Number**  
**Type**



## DesignLights Consortium®

The DLC is a collaboration of utility companies and regional energy efficiency organizations with the goal to ensure that high-quality, energy-efficient lighting design becomes commonplace in all lighting installations.

To find out more about DLC and which Acuity Brands products are listed, visit [www.designlights.org](http://www.designlights.org).

Be sure to check back often as we are continually adding products!



## ENERGY STAR®

ENERGY STAR® is a joint program of the U.S. Environmental Protection Agency and the U.S. Department of Energy helping us all save money and protect the environment through energy efficient products and practices.

Visit [www.energystar.gov](http://www.energystar.gov) for more information.





### LED

The LED symbol designates Acuity Brands® products utilizing innovative solid-state technology. Products that dim will have the dimmable LED symbol.



### Wet Location

A location in which water may drip, splash, or flow on or against electrical equipment. A wet location fixture is constructed so that water cannot enter or accumulate in the wireway, lampholders or other electrical parts.



### Damp Location

An exterior or interior location that is normally or periodically subject to condensation of moisture in, on, or adjacent to electrical equipment, and includes partially protected locations.

## eldoLED

### eldoLED

A family of high performance, intelligent LED drivers for LED-based lighting systems. The drivers provide full-range dimming and advanced capabilities such as flicker-free dimming to off, optimum power efficiency, configurability and robust thermal management in a small footprint. Drivers work with a wide range of current and voltage outputs and communicate with a variety of sensors as well as integrate with external controls systems across industry-standard protocols.



### California Title 24

The California Title 24 code is intended to reduce energy consumption in California and was recently updated with the latest standards effective as of July 1, 2014. The energy code applies to residential and commercial building for new construction and renovations, and the use of advanced lighting controls to synchronize light levels with daylight, occupancy, and multi-level control demand response capability are required in order to be compliant.

**For more information on Title 24, visit <http://www.energy.ca.gov/title24/2013standards/rulemaking/documents/>. Contact your local Acuity brands sales representative for more information.**



### Nighttime Friendly

Designates products with superior optical control that are consistent with goals of USGBC LEED® and meet Green Globes™ product criteria for light pollution reduction. These products are full cutoff and no more than 10% of the lumens from the luminaire are emitted above 80° from nadir.

**Be sure to look for products with these logos throughout the stock guide.**





# The Stock Guide

Lithonia Lighting® | Acuity Controls







## **Table of Contents**

---

<b>Commercial</b>	<b>10</b>
<b>Downlighting</b>	<b>26</b>
<b>Residential</b>	<b>60</b>
<b>Industrial</b>	<b>76</b>
<b>Emergency</b>	<b>94</b>
<b>Outdoor</b>	<b>106</b>
<b>Controls</b>	<b>142</b>
<b>Network Controls</b>	<b>154</b>

# COMMERCIAL







<b>12</b>	Recessed - LED Lensed Troffer
<b>13</b>	Troffer LED Relight Kit
<b>14</b>	Recessed - Fluorescent Lensed Troffer
<b>16</b>	Recessed - LED Center Basket
<b>18</b>	Recessed - Fluorescent Parabolic
<b>20</b>	Recessed - Fluorescent Center Basket
<b>21</b>	Recessed - Fluorescent Volumetric
<b>22</b>	Surface - Fluorescent Wall Brackets
<b>23</b>	Surface - LED Wraps
<b>24</b>	Surface - Fluorescent Wraps

# GTL



## Features

- Ideal for one-for-one replacement of existing fluorescent lensed troffers providing energy savings without disrupting the look of the overall space
- Pattern #12 acrylic lens
- Affordable LED lay-in delivers general ambient lighting for many applications such as schools, offices and hospitals
- Smooth hemmed sides and smooth inward-formed end flanges for easy handling
- Long-life LEDs, coupled with high-efficiency drivers, provide a superior level of illumination
- 0-10V dimming standard. Damp location listed
- DesignLight Consortium® (DLC) qualified product

## Ordering Information

Catalog Number	UPC	Description	Replaces Up To	Lumens	Input Watts	CCT	CRI	Voltage	DLC	Pallet Quantity
2GTL2 3300LM LP835	889804702637	2x2 LED Lay-In Troffer	2 U-Bent 32WT8	3300	32	3500 K	82	120-277	Yes	56
2GTL2 3300LM LP840	889804702460	2x2 LED Lay-In Troffer	2 U-Bent 32WT8	3300	32	4000 K	82	120-277	Yes	56
2GTL2 3700LM LP835	889804704143	2x2 LED Lay-In Troffer	2 U-Bent 32WT8	3700	35	3500 K	82	120-277	Yes	56
2GTL2 3700LM LP840	889804704242	2x2 LED Lay-In Troffer	2 U-Bent 32WT8	3700	35	4000 K	82	120-277	Yes	56
2GTL4 4400LM LP835	889804706598	2x4 LED Lay-In Troffer	2 Lamp 32WT8	4400	34	3500 K	82	120-277	Yes	28
2GTL4 4400LM LP840	889804706956	2x4 LED Lay-In Troffer	2 Lamp 32WT8	4400	34	4000 K	82	120-277	Yes	28
2GTL4 5000LM LP835	889804710366	2x4 LED Lay-In Troffer	3 Lamp 32WT8	5000	41	3500 K	82	120-277	Yes	28
2GTL4 5000LM LP840	889804710458	2x4 LED Lay-In Troffer	3 Lamp 32WT8	5000	41	4000 K	82	120-277	Yes	28
GTL4 3700LM LP835	889804707076	1x4 LED Lay-In Troffer	2 Lamp 32WT8	3700	35	3500 K	82	120-277	Yes	40
GTL4 3700LM LP840	889804707090	1x4 LED Lay-In Troffer	2 Lamp 32WT8	3700	35	4000 K	82	120-277	Yes	40

## Dimensions

GTL 2x4 and 2x2

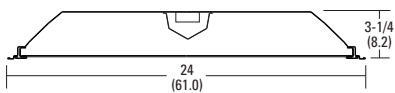

GTL 1x4

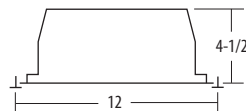

Certain airborne contaminants can diminish integrity of acrylic. See pg. 168 for Acrylic Compatibility table for suitable uses.



Features

- Ideal solution for renovating existing fluorescent lensed troffers, delivering improved quality of light and refreshing the space
- Relight kits are designed for quick installation without the need to access the plenum
- Designed to fit most recessed fixtures mounted in T-grid installations
- Energy consumption is lowered with advanced LEDs for more efficient lighting – delivering up to 119 LPW



Ordering Information

Catalog Number	UPC	Description	Replaces Up To	Lumens	Input Watts	CCT	CRI	Voltage	DLC	Pallet Quantity
2GTL2R 30L LP835	888791777321	2x2 LED Troffer Retrofit Kit	2 Lamp 17W T8	2500	28	3500 K	82	120-277	Yes	24
2GTL2R 30L LP840	888791777345	2x2 LED Troffer Retrofit Kit	2 Lamp 17W T8	2600	28	4000 K	82	120-277	Yes	24
2GTL4R 40L LP835	888791760705	2x4 LED Troffer Retrofit Kit	2 Lamp 32W T8	4200	39	3500 K	82	120-277	Yes	38
2GTL4R 40L LP840	888791760750	2x4 LED Troffer Retrofit Kit	2 Lamp 32W T8	4400	39	4000 K	82	120-277	Yes	38

Dimensions

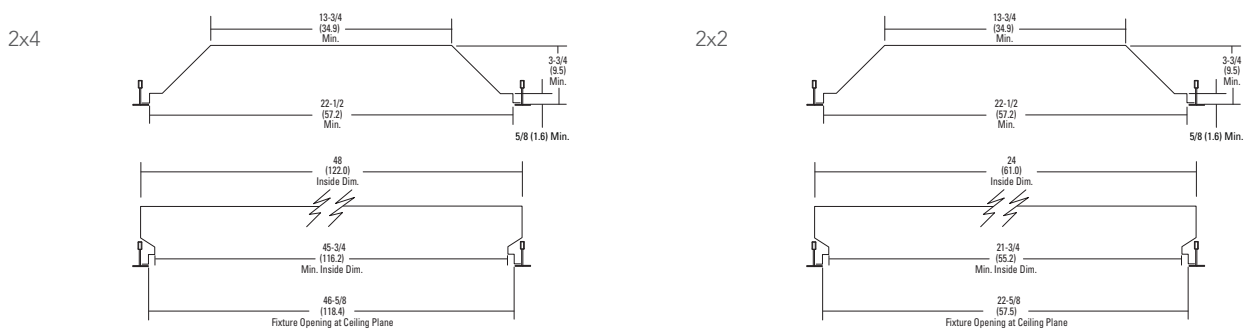

# GT



## Features

- Recessed fluorescent lensed fixture with standard instant start ballast for grid T-bar ceilings
- Low-profile design ideal for restricted plenum applications
- Smooth hemmed sides and smooth ends promote easy handling during installation
- Standard steel door frame has superior structural integrity with premium extruded appearance and mitered corners
- Pattern #12 acrylic lens

## Ordering Information

Catalog Number	UPC	Description	Input Watts	Voltage	Ballast Type	Lamp Included	# of Lamps	Pallet Quantity
GT2 MV	745975081714	2x4 Troffer	56	120-277	Instant Start	No	2	28
GT2U MV	745975081967	2x2 Troffer, U-shaped Lamps	56	120-277	Instant Start	No	2	56
GT3 2MV	745975083510	2x4 Troffer, 2-Ballasts	85	120-277	Instant Start	No	3	28
GT3 MV	745975081721	2x4 Troffer	84	120-277	Instant Start	No	3	28
GT3L MV	745975081684	2x4 Troffer, 3500 K Lamps Installed	84	120-277	Instant Start	Yes	3	28
GT3L41 MV	745975083541	2x4 Troffer, 4100 K Lamps Installed	84	120-277	Instant Start	Yes	3	28
GT3LW MV	745975081882	2x4 Troffer, 3500 K Lamps Installed, 6' whip	84	120-277	Instant Start	Yes	3	28
GT3L41W MV	745975799206	2x4 Troffer, 4100 K Lamps Installed, 6' whip	84	120-277	Instant Start	Yes	3	28
GT4 2MV	745975081998	2x4 Troffer, 2-Ballasts	112	120-277	Instant Start	No	4	28
GT4 MV	745975081776	2x4 Troffer	111	120-277	Instant Start	No	4	28
GT4L MV	745975081912	2x4 Troffer, 3500 K Lamps Installed	111	120-277	Instant Start	Yes	4	28
GT4L41 MV	745975083565	2x4 Troffer, 4100 K Lamps Installed	111	120-277	Instant Start	Yes	4	28
GT4LW MV	745975081707	2x4 Troffer, 3500 K Lamps Installed, 6' whip	111	120-277	Instant Start	Yes	4	28
GT4L41W MV	745975083534	2x4 Troffer, 4100 K Lamps Installed, 6' whip	111	120-277	Instant Start	Yes	4	28

## Dimensions

GT 2x4

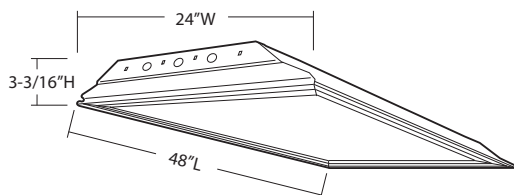

GT2U 2x2

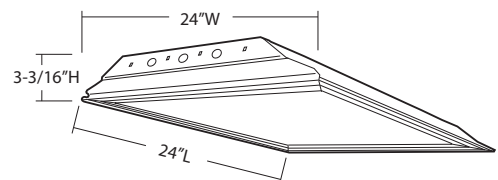

Certain airborne contaminants can diminish integrity of acrylic. See pg. 168 for Acrylic Compatibility table for suitable uses.

## Features

- Recessed fluorescent lensed fixture with premium instant start ballast for grid T-bar ceilings
- Low-profile design ideal for restricted plenum applications
- Smooth hemmed sides and smooth ends promote easy handling during installation
- Standard steel door frame has superior structural integrity with premium extruded appearance and mitered corners
- Pattern #12 acrylic lens



## Ordering Information

Catalog Number	UPC	Description	Input Watts	Voltage	Ballast Type	Lamp Included	# of Lamps	Pallet Quantity
2GT8 2 32 A12 MVOLT GEB10IS	784231155004	2x4 Troffer	56	120-277	Instant Start	No	2	28
2GT8 2 U316 A12 MVOLT GEB10IS	784231145067	2x2 Troffer, U-shaped Lamps	56	120-277	Instant Start	No	2	56
2GT8 3 32 A12 MVOLT 1/3 GEB10IS	784231139479	2x4 Troffer	84	120-277	Instant Start	No	3	28
2GT8 3 32 A12 MVOLT 1/3 GEB10IS LP835	745980173305	2x4 Troffer, 3500 K Lamps Installed	84	120-277	Instant Start	Yes	3	28
2GT8 3 32 A12 MVOLT 1/3 GEB10IS PWS1836 LP835	745980642788	2x4 Troffer, 6' Whip, 3500 K Lamps Installed, 6' Whip	84	120-277	Instant Start	Yes	3	28
2GT8 3 32 A12 MVOLT GEB10IS	784231159330	2x4 Troffer	85	120-277	Instant Start	No	3	28
2GT8 4 32 A12 MVOLT 1/4 GEB10IS	784231139462	2x4 Troffer	111	120-277	Instant Start	No	4	28
2GT8 4 32 A12 MVOLT 1/4 GEB10IS LP835	745980137000	2x4 Troffer, 3500 K Lamps Installed	111	120-277	Instant Start	Yes	4	28
2GT8 4 32 A12 MVOLT 1/4 GEB10IS LP841	745979045095	2x4 Troffer, 4100 K Lamps Installed	111	120-277	Instant Start	Yes	4	28
2GT8 4 32 A12 MVOLT 1/4 GEB10IS PWS1836 LP835	745981545743	2x4 Troffer, 6' Whip, 3500 K Lamps Installed, 6' Whip	111	120-277	Instant Start	Yes	4	28
2GT8 4 32 A12 MVOLT 1/4 GEB10IS PWS1836 LP841	745980078358	2x4 Troffer, 6' Whip, 4100 K Lamps Installed, 6' Whip	111	120-277	Instant Start	Yes	4	28
2GT8 4 32 A12 MVOLT GEB10IS	784231150023	2x4 Troffer	112	120-277	Instant Start	No	4	28
GT8 2 32 A12 MVOLT GEB10IS	784231179116	1x4 Troffer	56	120-277	Instant Start	No	2	40
GT8 F 2 32 A12 MVOLT GEB10IS	784231179154	1x4 Troffer, Flanged	56	120-277	Instant Start	No	2	14

## Dimensions

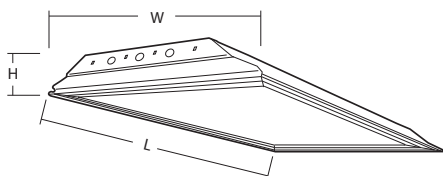

Width: 12" (1x4) or 24" (2x2; 2x4)  
 Length: 24" (2x2) or 48" (1x4; 2x4)  
 Height: 4-1/2" (1x4) or 3-3/16" (2x2; 2x4)

## Accessories

Catalog Number	UPC	Description
DGA14	784231089293	Dry-Wall Grid Adaptor, 1x4
DGA22	784231093818	Dry-Wall Grid Adaptor, 2x2
DGA24	784231089217	Dry-Wall Grid Adaptor, 2x4
L2GT8 A12	784231132562	2GT8 2x4 Lens only, #12 Pattern Acrylic

Certain airborne contaminants can diminish integrity of acrylic. See pg. 168 for Acrylic Compatibility table for suitable uses.



# FSL



## Features

- Ideal LED solution for offices, schools, healthcare and retail applications
- Delivers energy savings up to 50% compared to linear fluorescent lighting
- High-efficacy light engine delivers long life and excellent color to ensure a quality lighting installation
- Designed to provide 90% lumen maintenance for at least 60,000 hours
- Standard 0-10V dimming driver
- Most popular stock configurations listed below
- See specification sheet for integrated controls, multiple lumen packages and driver options to provide solutions for all your lighting needs



eldoLED®



## Ordering Information

Catalog Number	UPC	Description	Replaces Up To	Lumens	Input Watts	CCT	CRI	Voltage	DLC	Pallet Quantity
2FSL2 33L EZ1 LP835	820476827631	2x2 LED Troffer	2 lamp 17W T8	3500	35	3500 K	82	120-277	Yes	32
2FSL2 33L EZ1 LP840	820476874406	2x2 LED Troffer	2 lamp 17W T8	3600	35	4000 K	82	120-277	Yes	32
2FSL4 40L EZ1 LP835	820476827877	2x4 LED Troffer	2 lamp 32W T8	4200	39	3500 K	82	120-277	Yes	16
2FSL4 40L EZ1 LP840	820476874369	2x4 LED Troffer	2 lamp 32W T8	4300	39	4000 K	82	120-277	Yes	16

## Dimensions

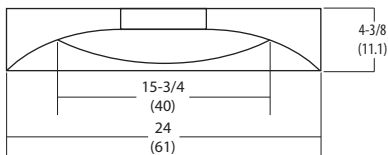

## Accessories

Catalog Number	UPC	Description
2FS4 F916	820476896422	Mounting Trim for 2x4 FSL Troffer

Certain airborne contaminants can diminish integrity of acrylic. See pg. 168 for Acrylic Compatibility table for suitable uses.

Features

- Ideal use for lighting applications including schools, offices and other commercial spaces, retail, hospitals and healthcare facilities
- Popular center basket design
- Low-profile design (2-3/8" deep)
- High-efficacy LED light engines deliver energy savings and low maintenance compared to traditional sources
- High-performance extruded acrylic diffusers conceal LEDs and efficiently deliver light in a volumetric distribution
- Designed to provide 90% lumen maintenance for at least 60,000 hours
- Standard 0-10V dimming driver



Ordering Information

Catalog Number	UPC	Description	Replaces Up To	Lumens	Input Watts	CCT	CRI	Voltage	DLC	Pallet Quantity
2BLT2 33LADP LP835	889804471908	2x2 Center Basket LED Lensed Troffer	2 Lamp 17WT8	3200	30	3500 K	82	120-277	Yes	52
2BLT2 33LADP LP840	889804471939	2x2 Center Basket LED Lensed Troffer	2 Lamp 17WT8	3300	30	4000 K	82	120-277	Yes	52
2BLT4 40LADP LP835	889804471953	2x4 Center Basket LED Lensed Troffer	2 Lamp 32WT8	3900	34	3500 K	82	120-277	Yes	26
2BLT4 40LADP LP840	889804488265	2x4 Center Basket LED Lensed Troffer	2 Lamp 32WT8	4000	34	4000 K	82	120-277	Yes	26
2BLT4 46LADP LP835	889804541403	2x4 Center Basket LED Lensed Troffer	3 Lamp 32WT8	4500	38	3500 K	82	120-277	Yes	26
2BLT4 46LADP LP840	889804541533	2x4 Center Basket LED Lensed Troffer	3 Lamp 32WT8	4600	38	4000 K	82	120-277	Yes	26
BLT4 40LADP LP835	889804541557	1x4 Center Basket LED Lensed Troffer	2 Lamp 32WT8	3900	34	3500 K	82	120-277	Yes	39
BLT4 40LADP LP840	889804541571	1x4 Center Basket LED Lensed Troffer	2 Lamp 32WT8	4000	34	4000 K	82	120-277	Yes	39

Dimensions

**BLT 2x2**  
 Length: 23-3/4 (60.3)  
 Width: 23-3/4 (60.3)  
 Depth: 2-3/8 (6.0)

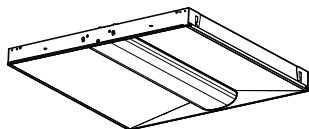

**BLT 1x4**  
 Length: 47-3/4 (121.2)  
 Width: 11-3/4 (29.8)  
 Depth: 2-3/4 (6.9)

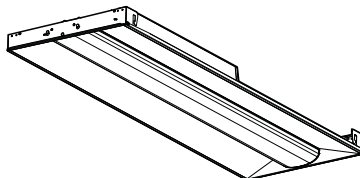

**BLT 2x4**  
 Length: 47-3/4 (121.2)  
 Width: 23-3/4 (60.3)  
 Depth: 2-3/8 (6.0)

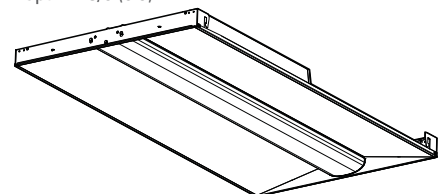

Certain airborne contaminants can diminish integrity of acrylic. See pg. 168 for Acrylic Compatibility table for suitable uses.



# PT



## Features

- Ideal for use in open area applications where optical control, visual comfort and light cut-off are important
- Hemmed sides and ends provide smooth edges for easy handling during installation
- Mitered corners and interlocking construction assure precise parabolic shaped louver
- Integral T-bar safety clips hold fixture to T-bar securely; no fasteners required
- Hinges die-formed for maximum strength
- Spring action latches concealed in black reveal
- 2'x4' features 18-cell louver with semi-specular (diffuse) finish; 2'x2' features 9-cell louver in same finish
- Standard Instant Start ballast

## Ordering Information

Catalog Number	UPC	Description	Input Watts	Voltage	Ballast Type	Lamp Included	# of Lamps	Pallet Quantity
PT2U MV	745975079247	2x2 Troffer, Static	56	120-277	Instant Start	No	2	40
PT2UA MV	745975490417	2x2 Troffer, Air	56	120-277	Instant Start	No	2	40
PT3 2MV	745975118373	2x4 Troffer, Static, 2-Ballasts	85	120-277	Instant Start	No	3	20
PT3 MV	745975079155	2x4 Troffer, Static	84	120-277	Instant Start	No	3	20
PT3A MV	745975079513	2x4 Troffer, Air	84	120-277	Instant Start	No	3	20
PT3ALW MV	745975466528	2x4 Troffer, Air, 3500 K Lamps Installed, 6' Whip	84	120-277	Instant Start	Yes	3	20
PT3L MV	745975079421	2x4 Troffer	84	120-277	Instant Start	Yes	3	20
PT3LW MV	745975079360	2x4 Troffer, Static, 3500 K Lamps Installed, 6' Whip	84	120-277	Instant Start	Yes	3	20

## Dimensions

PT3 2x4 – 18 Cell

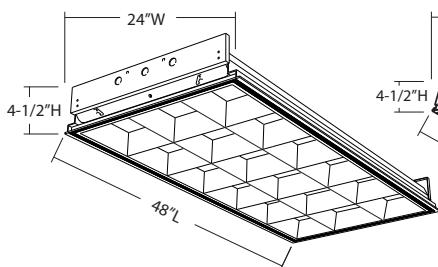

PT2U 2x2 – 9 Cell

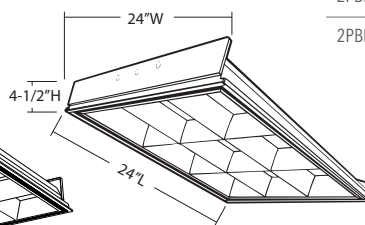

## Accessories

Catalog Number	UPC	Description
2PBL3N 18LD	784231106815	2PM3N 2x4 Parabolic Louver
2PBL3N2 9LD	745974538738	2PM3N 2x2 Parabolic Louver

Features

- Ideal for use in open area applications where optical control, visual comfort and light cut-off are important
- Hemmed sides and ends provide smooth edges for easy handling during installation
- Mitered corners and interlocking construction assure precise parabolic shaped louver
- Integral T-bar safety clips hold fixture to T-bar securely; no fasteners required
- Hinges die-formed for maximum strength
- Spring action latches concealed in black reveal
- Premium Instant Start Ballast



Ordering Information

Catalog Number	UPC	Description	Input Watts	Voltage	Ballast Type	Lamp Included	# of Lamps	Pallet Quantity
2PM3N G B 2 32 12LD MVOLT GEB10IS	745971728507	2x4 Troffer, Static, 12-Cell Louver	56	120-277	Instant Start	No	2	20
2PM3N G B 2 32 18LD MVOLT GEB10IS	784231180631	2x4 Troffer, Static, 18-Cell Louver	56	120-277	Instant Start	No	2	20
2PM3N G B 2 U316 9LD MVOLT GEB10IS	784231162446	2x2 Troffer, Static, 9-Cell Louver	56	120-277	Instant Start	No	2	40
2PM3N G B 3 17 9LD MVOLT 1/3 GEB10IS	745972194097	2x2 Troffer, Static, 9-Cell Louver	84	120-277	Instant Start	No	3	40
2PM3N G B 3 32 18LD MVOLT 1/3 GEB10IS	784231139509	2x4 Troffer, Static, 18-Cell Louver	84	120-277	Instant Start	No	3	20
2PM3N G B 3 32 18LD MVOLT 1/3 GEB10IS LP835	745979705777	2x4 Troffer, Static, 18-Cell Louver, 3500 K Lamps Installed	84	120-277	Instant Start	Yes	3	20
2PM3N G B 3 32 18LD MVOLT 1/3 GEB10IS PWS1836 LP835	745980452783	2x4 Troffer, Static, 18-Cell Louver, 3500 K Lamps Installed, 6' Whip	84	120-277	Instant Start	Yes	3	20
2PM3N G B 3 32 18LD MVOLT GEB10IS	784231164570	2x4 Troffer, Static, 18-Cell Louver, 2-Ballasts	85	120-277	Instant Start	No	3	20
2PM3N G B 4 32 32LD MVOLT 1/4 GEB10IS	784231173756	2x4 Troffer, Static, 32-Cell Louver	111	120-277	Instant Start	No	4	20
2PM3N G D 3 32 18LD MVOLT 1/3 GEB10IS ACS	784231145074	2x4 Troffer, Air, 18-Cell Louver	84	120-277	Instant Start	No	3	20

Dimensions

2PM3N 2x4

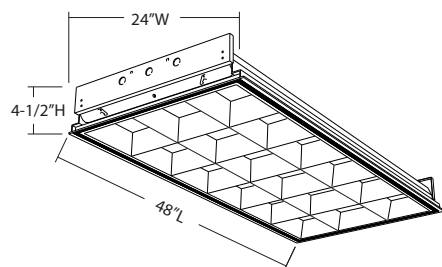

2PM3N 2x2

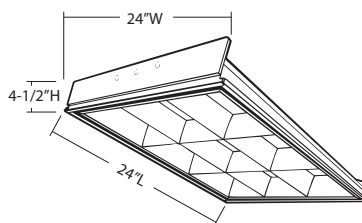

## 2AV



### Features

- Avante is ideal for open office areas, public indoor spaces, libraries and airport waiting areas
- Available in 2'x2' and 2'x4' configurations with symmetric distributions for general area lighting applications
- Injection-molded plastic light traps prevent light leaks between shielding and end plates
- Basket diffuser formed from round hole perforated steel and finished in matte white powder paint
- Matte-white polyester powder paint finished reflectors provide uniform light distribution
- Features optimum mix of directional and diffuse reflected light for balanced illumination

### Ordering Information

Catalog Number	UPC	Description	Input Watts	Voltage	Ballast Type	Lamp Included	# of Lamps	Pallet Quantity
2AV G 2 17 MDR MVOLT GEB10IS	745972199269	2x2 Recessed Direct/Indirect Troffer	56	120-277	Instant Start	No	2	28
2AV G 2 32 MDR MVOLT GEB10IS	784231145494	2x4 Recessed Direct/Indirect Troffer	56	120-277	Instant Start	No	2	14
2AV G 2 CF40 MDR MVOLT GEB10RS	784231145524	2x2 Recessed Direct/Indirect Troffer	67	120-277	Instant Start	No	2	28
2AV G 3 17 MDR MVOLT 1/3 GEB10IS	745972177526	2x2 Recessed Direct/Indirect Troffer	84	120-277	Instant Start	No	3	28
2AV G 3 32 MDR MVOLT 1/3 GEB10IS	784231145517	2x4 Recessed Direct/Indirect Troffer	84	120-277	Instant Start	No	3	14
2AV G 3 32 MDR MVOLT GEB10IS	784231145500	2x4 Recessed Direct/Indirect Troffer, 2-Ballasts	85	120-277	Instant Start	No	3	14

### Dimensions

2AV 2x4

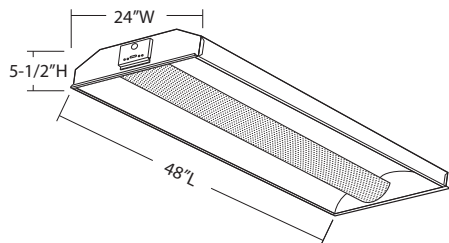

2AV 2x2

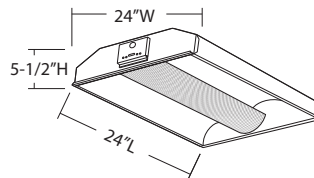

Certain airborne contaminants can diminish integrity of acrylic. See pg. 168 for Acrylic Compatibility table for suitable uses.



**Features**

- Ideal for volumetric lighting applications such as offices, schools, hospitals and retail applications
- Low profile 3-1/8" depth makes RT5™ fixture perfect for applications where plenum height is a factor
- Two-piece refractor system includes micro-facets that echo the frequency of the prisms in the refractor, providing a quiet appearance in the ceiling
- Step-dimming options (available with GEB95S ballast) allows the system to be switched to 50% power for compliance with common energy codes
- Features a side access ballast entry
- Each model includes 3500 K lamp



**Ordering Information**

Catalog Number	UPC	Description	Input Watts	Voltage	Ballast Type	Lamp Included	# of Lamps	Pallet Quantity
2RT5 14T5 MVOLT GEB115 LP835	784231001264	2x2 T5, Recessed Volumetric Lighting	39	120-277	Programmed Start	Yes	2	56
2RT5 28T5 MVOLT GEB95 LPM835P	784231013816	2x4 T5, Recessed Volumetric Lighting	60	120-277	Programmed Start	Yes	2	28
2RT5 28T5 MVOLT GEB95S LPM835P	784231002377	2x4 T5, Recessed Volumetric Lighting	60	120-277	Step-Dimming	Yes	2	28

**Dimensions**

2RT5 2x4

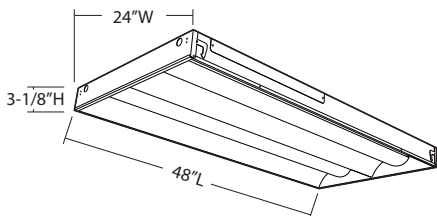

2RT5 2x2

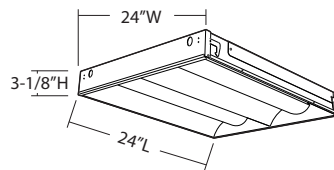

Certain airborne contaminants can diminish integrity of acrylic. See pg. 168 for Acrylic Compatibility table for suitable uses.

## WC/WP



## Features

- Ideal for stairwells, corridors, lavatories or any utility application
- Surface - Wall Brackets (WC/WP)
- For wall or ceiling mounting - vertical or horizontal
- Provides up/down distribution
- Available in 2' and 4' configurations with two lamps in cross section
- WP is damp location listed
- WC is dry location listed

## Ordering Information

Catalog Number	UPC	Description	Input Watts	Voltage	Ballast Type	Lamp Included	# of Lamps	Pallet Quantity
WC 2 17 MVOLT GEB10IS	745972185842	2' Commercial Wall Bracket	56	120-277	Instant Start	No	2	40
WC 2 32 MVOLT GEB10IS	784231159231	4' Commercial Wall Bracket	56	120-277	Instant Start	No	2	20
WP 2 32 MVOLT GEB10IS	784231176207	4' Premium Wall Bracket	56	120-277	Instant Start	No	2	40

## Dimensions

WC

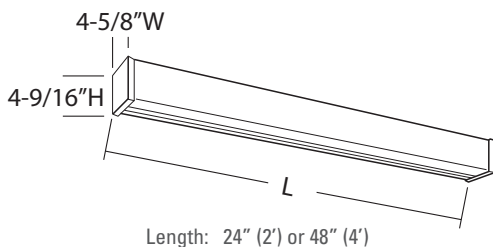

WP

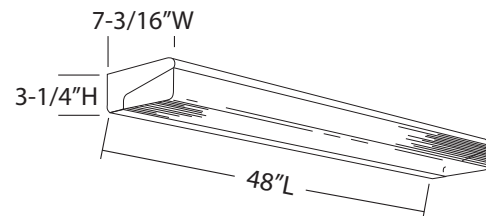

Certain airborne contaminants can diminish integrity of acrylic. See pg. 168 for Acrylic Compatibility table for suitable uses.



Features

- Ideal for closets, storage rooms, hallways and office spaces
- Designed to replace existing 2-lamp T8 and T12 fluorescent wraparounds
- Available in two CCTs: 3500 K and 4000 K
- The LED system delivers long life and excellent color to ensure a quality, low-maintenance lighting installation
- LB offers a decorative appearance with a curved diffuser; SB features a flat bottom diffuser
- Designed to provide 90% lumen maintenance for at least 60,000 hours
- Damp location listed

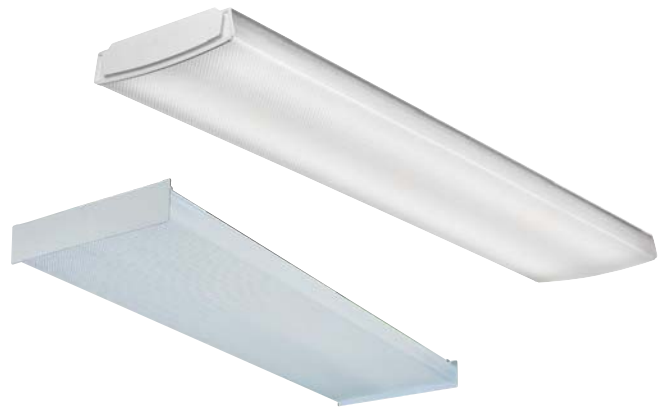

Ordering Information

Catalog Number	UPC	Description	Replaces Up To	Lumens	Input Watts	CCT	CRI	Voltage	DLC	Pallet Quantity
LBL2 LP835	753573917564	2' LED Wraparound, Curved Profile	2 Lamp 17WT8	2200	23	3500 K	82	120-277	Yes	112
LBL2 LP840	753573917595	2' LED Wraparound, Curved Profile	2 Lamp 17WT8	2200	23	4000 K	82	120-277	Yes	112
LBL4 LP835	753573917601	4' LED Wraparound, Curved Profile	2 Lamp 32WT8	4500	41	3500 K	82	120-277	Yes	56
LBL4 LP840	753573917632	4' LED Wraparound, Curved Profile	2 Lamp 32WT8	4600	41	4000 K	82	120-277	Yes	56
SBL2 LP835	888791995633	2' LED Wraparound, Square Profile	2 Lamp 17WT8	2400	23	3500 K	82	120-277	Yes	140
SBL2 LP840	888791835397	2' LED Wraparound, Square Profile	2 Lamp 17WT8	2400	23	4000 K	82	120-277	Yes	140
SBL4 LP835	888791995640	4' LED Wraparound, Square Profile	2 Lamp 32WT8	4500	39	3500 K	82	120-277	Yes	75
SBL4 LP840	888791832365	4' LED Wraparound, Square Profile	2 Lamp 32WT8	4500	39	4000 K	82	120-277	Yes	75

Dimensions

LBL

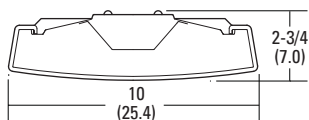

Length: 24" (2') or 48" (4')

SBL

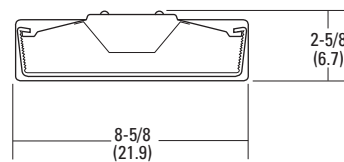

Length: 24" (2') or 48" (4')

Certain airborne contaminants can diminish integrity of acrylic. See pg. 168 for Acrylic Compatibility table for suitable uses.

## LB/RB/SB



## Features

- LB intended for surface or stem mounting, unit or row installation, SB is intended for surface or stem mounting, unit or row installation; RB is intended for surface mounting, unit installation
- Ideal for light commercial and residential applications
- Features acrylic prismatic diffuser and standard Instant Start ballast
- LB offers a decorative appearance with a curved diffuser, SB features a flat bottom diffuser and RB offers a small profile design
- Damp location listed

## Ordering Information

Catalog Number	UPC	Description	Input Watts	Voltage	Ballast Type	Lamp Included	# of Lamps	Pallet Quantity
LB232 MV	745975088508	Contractor Select Wraparound, Curved Profile	56	120-277	Instant Start	No	2	56
LB432 MV	745975088492	Contractor Select Wraparound, Curved Profile	111	120-277	Instant Start	No	4	34
RB232 MV	745975747092	Contractor Select Wraparound, Narrow Profile	56	120-277	Instant Start	No	2	144
SB217 MV	745975145188	Contractor Select Wraparound, Square Profile	28	120-277	Instant Start	No	2	140
SB232 MV	745975083633	Contractor Select Wraparound, Square Profile	56	120-277	Instant Start	No	2	75
SB432 MV	745975083619	Contractor Select Wraparound, Square Profile	111	120-277	Instant Start	No	4	42

## Accessories

Catalog Number	UPC	Description
D2LB48	784231135952	LB Acrylic Diffuser
D2SB48	784231015032	SB Acrylic Diffuser
DLB48	784231135969	LB Acrylic Diffuser
DSB48	784231014929	SB Acrylic Diffuser

## Dimensions

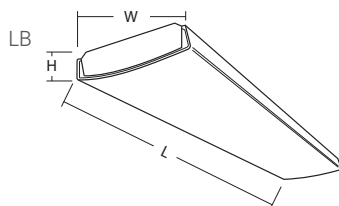

Height: 2-3/4" (2-Lamp) or 3" (3- and 4-Lamp)  
 Width: 10" (2-Lamp) or 15-3/8" (3- and 4-Lamp)  
 Length: 48" or 96" (tandem)

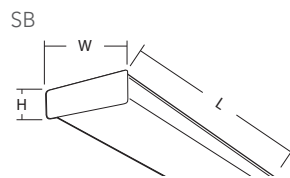

Height: 2-5/8" (2-Lamp) or 2-7/8" (4-Lamp)  
 Width: 8-5/8" (2-Lamp) or 13-3/4" (4-Lamp)  
 Length: 48" (2-Lamp or 4-Lamp) or 96" (tandem 4-Lamp)

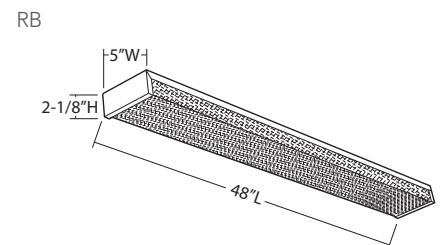

Certain airborne contaminants can diminish integrity of acrylic. See pg. 168 for Acrylic Compatibility table for suitable uses.

Features

- Intended for surface or stem mounting, unit or row installation
- Ideal for light commercial and residential applications
- Features acrylic prismatic diffuser and premium Instant Start ballast
- LB offers a decorative appearance with a curved diffuser; SB features a flat bottom diffuser



Ordering Information

Catalog Number	UPC	Description	Input Watts	Voltage	Ballast Type	Lamp Included	# of Lamps	Pallet Quantity
LB 2 17 MVOLT GEB10IS	745972176260	Wraparound, Curved Profile	28	120-277	Instant Start	No	2	112
LB 2 32 MVOLT GEB10IS	784231151105	Wraparound, Curved Profile	56	120-277	Instant Start	No	2	56
LB 3 32 MVOLT 1/3 GEB10IS	784231151112	Wraparound, Curved Profile	84	120-277	Instant Start	No	3	34
LB 4 32 MVOLT 1/4 GEB10IS	784231151129	Wraparound, Curved Profile	111	120-277	Instant Start	No	4	34
LB 4 32 MVOLT GEB10IS	784231163979	Wraparound, Curved Profile	112	120-277	Instant Start	No	4	34
SB 2 32 120 RE	784231170809	Wraparound, Square Profile	56	120	Instant Start	No	2	75
SB 2 32 MVOLT GEB10IS	784231149973	Wraparound, Square Profile	56	120-277	Instant Start	No	2	75
SB 4 32 MVOLT 1/4 GEB10IS	784231149980	Wraparound, Square Profile	111	120-277	Instant Start	No	4	42
TLB 2 32 MVOLT 1/4 GEB10IS	784231159385	Tandem Wraparound, Curved Profile	111	120-277	Instant Start	No	4	56
TSB 2 32 MVOLT 1/4 GEB10IS	784231012291	Tandem Wraparound, Square Profile	111	120-277	Instant Start	No	4	75

Dimensions

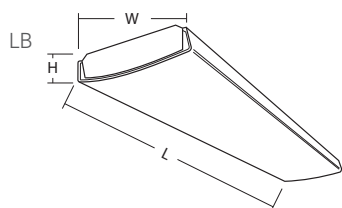

Height: 2-3/4" (2-Lamp) or 3" (3- and 4-Lamp)  
 Width: 10" (2-Lamp) or 15-3/8" (3- and 4-Lamp)  
 Length: 48" or 96" (tandem)

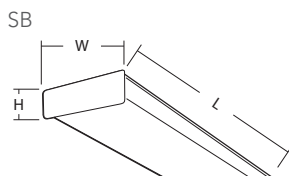

Height: 2-5/8" (2-Lamp) or 2-7/8" (4-Lamp)  
 Width: 8-5/8" (2-Lamp) or 13-3/4" (4-Lamp)  
 Length: 48" (2-Lamp or 4-Lamp) or 96" (tandem 4-Lamp)

Certain airborne contaminants can diminish integrity of acrylic. See pg. 168 for Acrylic Compatibility table for suitable uses.



# DOWNLIGHTING





<b>28</b>	Commercial LED Downlighting
<b>30</b>	6" & 8" Commercial Horizontal Frame-Ins
<b>31</b>	6" & 8" Commercial Vertical Frame-Ins
<b>32</b>	6" Residential LED Housings and LED Modules
<b>36</b>	6" Residential LED Gimbals
<b>38</b>	5" Residential LED Housings and LED Modules
<b>40</b>	5" Residential LED Gimbals
<b>43</b>	4" Residential LED Housings and LED Modules
<b>46</b>	4" Residential LED Gimbals
<b>48</b>	6" Residential Housings and Trims
<b>52</b>	5" Residential Housings and Trims
<b>54</b>	4" Residential Housings and Trims
<b>56</b>	6" Residential Premium Housings and Trims

## LDN6



## Features

- Typical applications include corridors, lobbies, conference rooms and private offices
- 16-gauge galvanized steel mounting/plaster frame with trim clips to mount open conical shape reflector
- Vertically adjustable mounting brackets that use 16-gauge flat bar hangers (included), 1/2" conduit or C channel T-bar fasteners. Provides 3-3/4" total adjustment
- Galvanized steel junction box with bottom-hinged access covers and spring latches
- Maximum 1-1/2" ceiling thickness
- High-efficiency, eldoLED 0-10V dimming driver mounted to the junction box, dims luminaire to 10% of its light output
- Maintains 70% lumen output for more than 50,000 hours
- Aluminum full reflectors are optically designed to maximize lumen output and provide superior glare control

## Ordering Information

Catalog Number	UPC	Description	Replaces Up To	Lumens	Input Watts	CCT	Voltage	ENERGY STAR®	Pallet Quantity
LDN6 35/10 120 HSG	820476829901	6" LED New Construction Downlight	1/26W CFL	1000	18	3500 K	120	Yes	84
LDN6 35/10 277 HSG	820476830006	6" LED New Construction Downlight	1/26W CFL	1000	18	3500 K	277	Yes	96
LDN6 35/15 120 HSG	820476823725	6" LED New Construction Downlight	1/32W CFL	1500	26	3500 K	120	Yes	96
LDN6 35/15 277 HSG	820476829994	6" LED New Construction Downlight	1/32W CFL	1500	26	3500 K	277	Yes	96
LDN6 35/20 120 HSG	820476813269	6" LED New Construction Downlight	1/42W CFL, 2/26W CFL	2000	35	3500 K	120	Yes	96
LDN6 35/20 277 HSG	820476829970	6" LED New Construction Downlight	1/42W CFL, 2/26W CFL	2000	35	3500 K	277	Yes	96

## Trim Kits

Catalog Number	UPC	Description
LO6AR	820476892851	LDN6 Open Semi-Specular, Clear
LW6AR	820476892974	LDN6 Open Wallwash Semi-Specular, Clear

## Dimensions

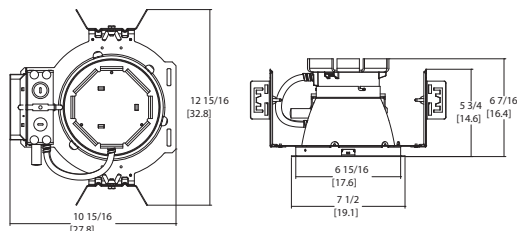



Features

- LED downlight for retrofit of installed 6" or 8" nominal commercial "pan-style" housings with incandescent, compact fluorescent (CFL), or high intensity discharge (HID) sources
- Multiple lumen packages available to replace the installed base of CFL or HID sources with energy savings up to 50%
- LED light source with diffuse lens recessed in a reflector with a 55-degree cutoff
- Aluminum full reflectors are optically designed to maximize lumen output and provide superior glare control
- Minimum CRI of 80
- Proprietary electrical design allows for excellent line voltage dimming down to 10% light output on 120V product
- Maintains 70% lumen output for more than 50,000 hours for 6" housing and more than 60,000 hours for 8" housings



Ordering Information

Catalog Number	UPC	Description	Replaces Up To	Lumens	Input Watts	CCT	Voltage	ENERGY STAR®	Pallet Quantity
RV6 35/10 120 HSG	820476808586	6" LED Retrofit	75W PAL HAL, 120W BR40, 1/26W CFL	889	14	3500 K	120	Yes	125
RV6 35/10 277 HSG	820476818363	6" LED Retrofit	75W PAL HAL, 120W BR40, 1/26W CFL	1212	16	3500 K	277	Yes	125
RV6 35/15 120 HSG	820476809491	6" LED Retrofit	90W PAR HAL, 150W A21, 1/32W CFL	1433	22	3500 K	120	Yes	125
RV6 35/15 277 HSG	820476818486	6" LED Retrofit	90W PAR HAL, 150W A21, 1/32W CFL	1565	23	3500 K	277	Yes	125
RV8 35/30 120 HSG	820476677656	8" LED Retrofit	300W BR40 INCAN, 2/32 CFL, 70W ED17 HID	2803	42	3500 K	120	Yes	100
RV8 35/30 277 HSG	820476677250	8" LED Retrofit	300W BR40 INCAN, 2/32 CFL, 70W ED17 HID	2980	44	3500 K	277	Yes	100

Trim Kits

Catalog Number	UPC	Description
RO6AR	820476884474	6" Clear Reflector, Semi-Specular Finish
RO6WR	820476885099	6" White Reflector
RO8AR	820476226267	8" Clear Reflector, Semi-Specular Finish
RO8WR	820476226441	8" White Reflector

Dimensions

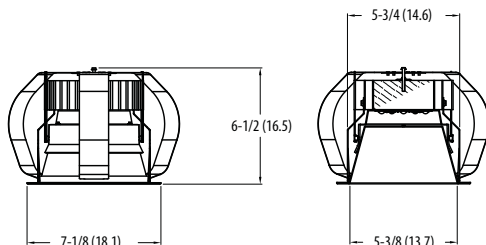

# 6HF/LF6N/LF8N



## Features

- Ideal for a wide variety of low- to medium-height ceiling applications including commercial, retail and hospitality spaces where an open or damp location lensed fixture is required
- Fixtures are UL Listed for through-branch wiring, NON-IC recessed mounting and damp location
- Galvanized steel mounting frame-in with mechanical trim retention (yoke) ensures secure and flush reflector mounting to ceiling
- Maximum ceiling thickness of 1½"

## Ordering Information

Catalog Number	UPC	Description	Input Watts	Voltage	Lamp Included	Pallet Quantity
6HF 1/26-42TRT MVOLT	745976714239	Light Commercial 6" CFL Horizontal, One Triple-Tube Lamp	26,32,42	120-277	No	72
6HF 2/26DTT MVOLT	745976714376	Light Commercial 6" CFL Horizontal, Two 26 W DTT Lamps	42	120-277	No	72
LF6N 1/26-42TRT MVOLT	745975581900	Premium Commercial 6" CFL Horizontal, One Triple-Tube Lamp	26,32,42	120-277	No	63
LF6N 2/26DTT MVOLT	745975581917	Premium Commercial 6" CFL Horizontal, Two 26 W DTT Lamps	42	120-277	No	63
LF8N 1/26-42TRT MVOLT	745975580026	Premium Commercial 8" CFL Horizontal, 1 Triple-Tube Lamp	26,32,42	120-277	No	63
LF8N 2/26-42TRT MVOLT	745975579983	Premium Commercial 8" CFL Horizontal, 2 Triple-Tube Lamps	42,64,84	120-277	No	63

## Trim Kits

Catalog Number	UPC	Description
F601	745972113654	6" Open White Reflector, 1 DTT/TRT Horizontal Lamp
F601A	745980396346	6" Open Clear Diffuse Reflector, 1 DTT/TRT Horizontal Lamp
F601AZ	784231177594	6" Clear Semi-Specular Open Reflector, 1 DTT/TRT Horizontal Lamp
F602A	784231083802	6" Clear Diffuse Open Reflector, 2:DTT Horizontal Lamps
F602AZ	784231142424	6" Clear Semi-Specular Open Reflector, 2:DTT Horizontal Lamps
F801AZ	784231177587	8" Clear Semi-Specular Open Reflector, 1 DTT/TRT Horizontal Lamp
F802AZ U	784231152591	8" Clear Semi-Specular Open Reflector, 2:DTT/TRT Horizontal Lamps

## Dimensions

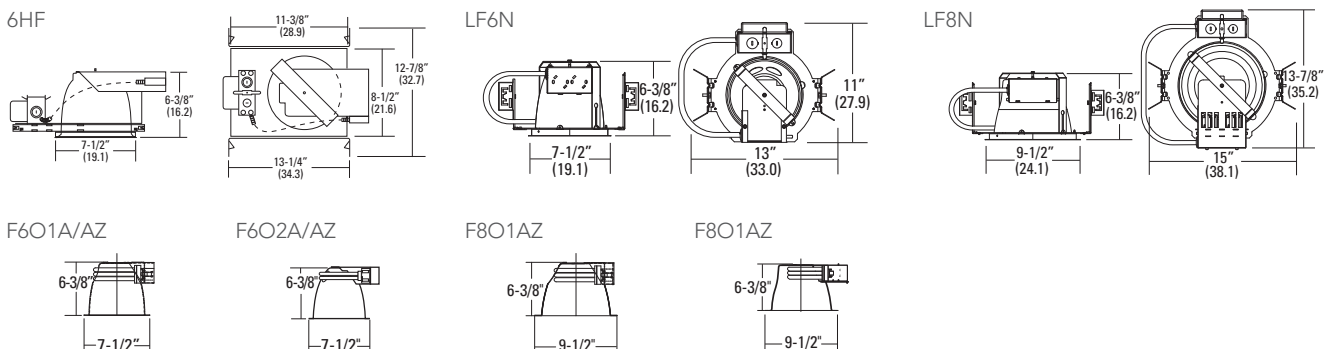

Features

- Ideal for a wide variety of low- to medium-height ceiling applications including commercial, retail and hospitality spaces where a baffled fixture is required
- Fixtures are UL Listed for through-branch wiring, NON-IC recessed mounting and damp location
- Galvanized steel mounting frame-in with high-friction retention clips secure optical system
- Utilizes an extruded socket housing that attaches to the reflector via key hole mount, which provides superior heat dissipation and extended lamp life
- Maximum ceiling thickness of 1½"
- Class P thermally protected ballast protects against improper contact with insulation. Minimum starting temperature is 0°F/-18°C.



Ordering Information

Catalog Number	UPC	Description	Input Watts	Voltage	Lamp Included	Pallet Quantity
6VF 26-42TRT MVOLT	745976714895	Light Commercial 6" CFL Vertical, One Triple-Tube Lamp	42	120-277	No	72
LP6FN 26-42TRT MVOLT	745975571246	Premium Commercial 6" CFL Vertical, One Triple-Tube Lamp	42	120-277	No	63
LP8FN 26-42TRT MVOLT	745975579792	Premium Commercial 6" CFL Vertical, One Triple-Tube Lamp	42	120-277	No	63

Trim Kits

Catalog Number	UPC	Description
609A	745975550036	6" Open Clear Diffuse Reflector, 1 Vertical Lamp
609AZ	745975550104	6" Open Clear Semi-Specular Reflector, 1 Vertical Lamp

Dimensions

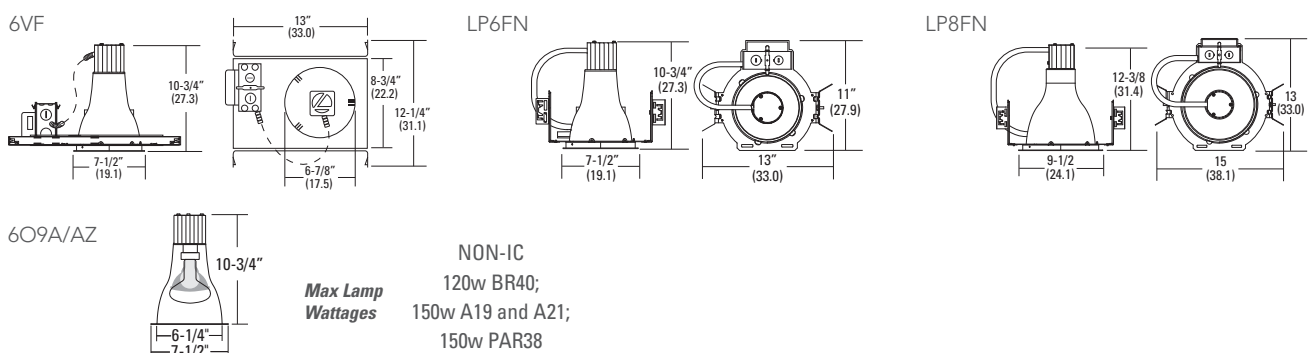





Features

- Recessed housings rated IC/NON-IC for new construction or remodel applications
- New construction housings come with factory-installed captive bar hangers which span 24" and feature built-in nailers and T-Bar clips
- Remodel housing with heavy-gauge galvanized steel raceway arm utilizes remodel clips for installation in plaster, sheetrock, or mechanical ceilings
- Quick disconnect provided for power connection to the LED modules
- Suitable for ceilings up to 1½" thick
- Damp location listed; Title 24 compliant



Ordering Information

Catalog Number	UPC	Description	Lamp Source	Voltage	Finish	Lamp Included	Pallet Quantity
L7XLED T24	820476280566	6" Air-Tight, IC/Non-IC New Construction Housing, LED Base	LED	120	Gray	No	120
L7XRLED T24	820476467738	6" Air-Tight, IC/Non-IC Remodel Housing, LED Base	LED	120	Gray	No	144

Dimensions

L7XLED

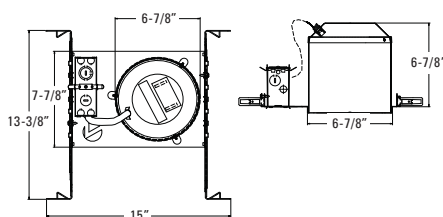

L7XRLED

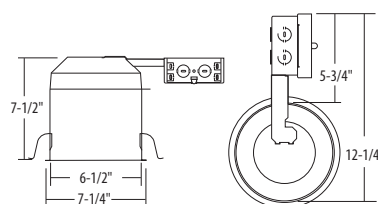

## 6BPMW LED



### Features

- P Series LED modules are ideal for retrofit into existing downlight cans for new construction and remodel applications
- 86% more efficient than incandescent luminaires
- Maintains 70% light output for at least 50,000 hours
- Maintains the same look, feel and warmth reminiscent of incandescent lamps through seamless Center2Edge™ dimming and instant-on capabilities
- Deep recessed lens and baffle provide low glare
- Includes E26 adapter for easy install, as well as splice kit for energy rebates
- Wet location listed; Title 24 compliant
- See specification sheet for additional finishes

### Ordering Information

Catalog Number	UPC	Description	Replaces Up To	Lumens	Input Watts	CCT	CRI	Voltage	Finish	ENERGY STAR®	Pallet Quantity
6BPMW LED 27K 90CRI M6	820476902048	6" LED Module	65W Incandescent	600	11	2700 K	90	120	White	Yes	270
6BPMW LED 30K 90CRI M6	820476902109	6" LED Module	65W Incandescent	600	11	3000 K	90	120	White	Yes	270
6BPMW LED 40K 90CRI M6	888791291094	6" LED Module	65W Incandescent	650	10	4000 K	90	120	White	Yes	270
6BPMW HL LED 27K 90CRI M6	820476902147	6" LED Module, High Lumen	100W Incandescent	860	16	2700 K	90	120	White	Yes	270
6BPMW HL LED 30K 90CRI M6	820476902185	6" LED Module, High Lumen	100W Incandescent	860	16	3000 K	90	120	White	Yes	270
6BPMW HL LED 40K 90CRI M6	888791291179	6" LED Module, High Lumen	100W Incandescent	950	16	4000 K	90	120	White	Yes	270

### Dimensions

6BP

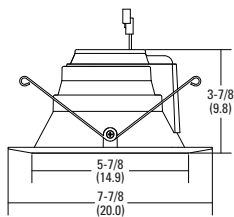

## Features

- E Series LED modules are ideal for retrofit into existing downlight cans for new construction and remodel applications
- Maintains 70% light output for at least 35,000 hours
- Line voltage dimmable to 10%
- More flexibility with 5" and 6" housing compatibility in one module
- Offers Instant on and Center2Edge™ dimming like traditional sources
- Wet location listed; 90 CRI versions are Title 24 compliant



## Ordering Information

Catalog Number	UPC	Description	Replaces Up To	Lumens	Input Watts	CCT	CRI	Voltage	Finish	ENERGY STAR®	Pallet Quantity
65BEMW LED 27K M6	888791169355	5"/6" LED Module	65W Incandescent	640	12	2700 K	82	120	White	Yes	360
65BEMW LED 30K M6	888791169409	5"/6" LED Module	65W Incandescent	687	12	3000 K	82	120	White	Yes	360
65BEMW LED 40K M6	888791169430	5"/6" LED Module	65W Incandescent	711	12	4000 K	82	120	White	Yes	360
65BEMW LED 27K 90CRI M6	889804129267	5"/6" LED Module	65W Incandescent	650	10	2700 K	90	120	White	Yes	360
65BEMW LED 30K 90CRI M6	889804129243	5"/6" LED Module	65W Incandescent	690	10	3000 K	90	120	White	Yes	360

## Dimensions

65B

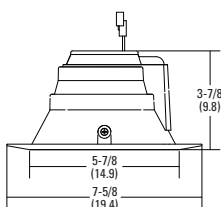



# 6iGMW



## Features

- iGimbals are ideal for retrofit into existing downlight cans for new construction and remodel applications
- Maintains at least 70% light output for 35,000 hours
- Line voltage dimmable to 15%
- Combines functionality of an "eyeball" with ease of using a gimbal
- Provides 50° of up/down adjustable tilt with 360° rotation
- 24/7 "Commerical Grade"
- Damp location listed; Title 24 compliant

## Ordering Information

Catalog Number	UPC	Description	Replaces Up To	Lumens	Input Watts	CCT	CRI	Voltage	Finish	ENERGY STAR®	Pallet Quantity
6iGMW LED 27K 90CRI M6	889804426700	6" LED iGimbal, Adjustable	65W Incandescent	720	12	2700 K	90	120	White	Yes	192
6iGMW LED 30K 90CRI M6	889804426762	6" LED iGimbal, Adjustable	65W Incandescent	750	12	3000 K	90	120	White	Yes	192

## Dimensions

6iGMW

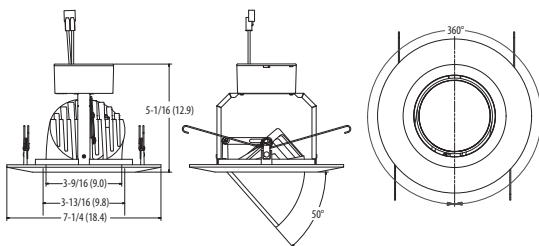

Features

- Gimbals are ideal for retrofit into existing downlight cans for new construction and remodel applications
- Maintains 70% light output for at least 35,000 hours
- Line voltage dimmable to 10%
- Provides 35° tilt in both directions with 180° rotation
- Provides directional lighting for accent and sloped ceiling applications
- Damp location listed; Title 24 compliant



Ordering Information

Catalog Number	UPC	Description	Replaces Up To	Lumens	Input Watts	CCT	CRI	Voltage	Finish	ENERGY STAR®	Pallet Quantity
6G1MW LED 30K 90CRI M6	889804156614	6" LED Gimbal, Adjustable	65W Incandescent	790	10	3000 K	90	120	White	Yes	192
6G1MB LED 30K 90CRI M6	889804156645	6" LED Gimbal, Adjustable	65W Incandescent	790	10	3000 K	90	120	Black	Yes	192
6G1BN LED 30K 90CRI M6	889804156638	6" LED Gimbal, Adjustable	65W Incandescent	790	10	3000 K	90	120	Nickel	Yes	192
6G1ORB LED 30K 90CRI M6	889804156621	6" LED Gimbal, Adjustable	65W Incandescent	790	10	3000 K	90	120	Bronze	Yes	192

Dimensions

6G1

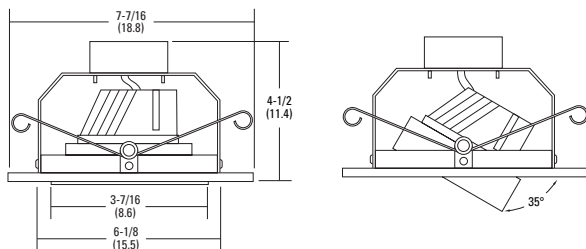

# L5 LED



## Features

- Recessed housings rated IC/NON-IC for new construction for remodel applications
- New construction housings come with factory-installed captive bar hangers which span 24" and feature built-in nailers and T-Bar clips
- Remodel housing with heavy-gauge galvanized steel raceway arm utilizes remodel clips for installation in plaster, sheetrock, or mechanical ceilings
- Quick disconnect provided for power connection to the LED modules
- Suitable for ceilings up to 1½" thick
- Damp location listed; Title 24 compliant

## Ordering Information

Catalog Number	UPC	Description	Lamp Source	Voltage	Finish	Lamp Included	Pallet Quantity
L5LED T24	820476364273	5" Air-Tight, IC/Non-IC New Construction Housing, LED Base	LED	120	Gray	No	144
L5RLED T24	820476467899	5" Air-Tight, IC/Non-IC Remodel Housing, LED Base	LED	120	Gray	No	144

## Dimensions

L5LED

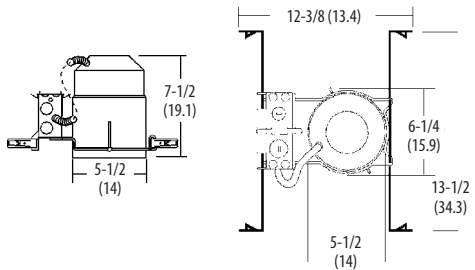

L5RLED

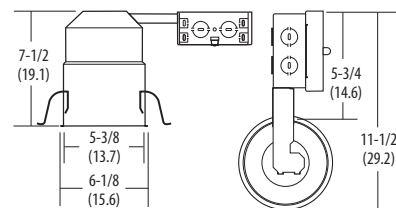

Features

- P Series LED modules are ideal for retrofit into existing downlight cans for new construction and remodel applications
- 86% more efficient than incandescent luminaires
- The LED module maintains 70% light output for at least 50,000 hours
- Maintains the same look, feel and warmth reminiscent of incandescent lamps through seamless Center2Edge™ dimming and instant-on capabilities
- Deep recessed lens and baffle provide low glare
- Includes E26 adapter for easy install, as well as splice kit for energy rebates
- Wet location listed; Title 24 compliant
- See specification sheet for additional finishes



Ordering Information

Catalog Number	UPC	Description	Replaces Up To	Lumens	Input Watts	CCT	CRI	Voltage	Finish	ENERGY STAR®	Pallet Quantity
5BPMW LED 27K 90CRI M6	820476902192	5" LED Module	65W Incandescent	600	11	2700 K	90	120	White	Yes	324
5BPMW LED 30K 90CRI M6	820476902246	5" LED Module	65W Incandescent	600	11	3000 K	90	120	White	Yes	324
5BPMW LED 40K 90CRI M6	888791290912	5" LED Module	65W Incandescent	650	11	4000 K	90	120	White	Yes	324

Dimensions

5BP

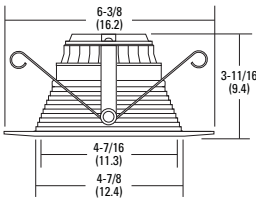



## 5iGMW



## Features

- iGimbals are ideal for retrofit into existing downlight cans for new construction and remodel applications
- Maintains at least 70% light output for 35,000 hours
- Line voltage dimmable to 15%
- Combines functionality of an "eyeball" with ease of using a gimbal
- Provides 50° of up/down adjustable tilt with 360° rotation
- 24/7 "Commerical Grade"
- Damp location listed; Title 24 compliant

## Ordering Information

Catalog Number	UPC	Description	Replaces Up To	Lumens	Input Watts	CCT	CRI	Voltage	Finish	ENERGY STAR®	Pallet Quantity
5iGMW LED 27K 90CRI M6	889804426687	5" LED iGimbal, Adjustable	65W Incandescent	720	12	2700 K	90	120	White	Yes	144
5iGMW LED 30K 90CRI M6	889804426762	5" LED iGimbal, Adjustable	65W Incandescent	750	12	3000 K	90	120	White	Yes	144

## Dimensions

5iGMW

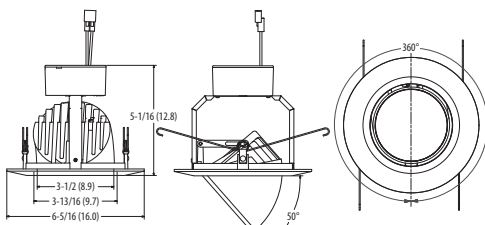

Features

- Gimbals are ideal for retrofit into existing downlight cans for new construction and remodel applications
- Maintains 70% light output for at least 35,000 hours
- Line voltage dimmable to 10%
- Provides directional lighting for accent and sloped ceiling with 35° tilt in both directions and 180° rotation
- Damp location listed; Title 24 compliant



Ordering Information

Catalog Number	UPC	Description	Replaces Up To	Lumens	Input Watts	CCT	CRI	Voltage	Finish	ENERGY STAR®	Pallet Quantity
5G1MW LED 30K 90CRI M6	889804156577	5" LED Gimbal, Adjustable	65W Incandescent	500	8	3000 K	90	120	White	Yes	144
5G1MB LED 30K 90CRI M6	889804156607	5" LED Gimbal, Adjustable	65W Incandescent	500	8	3000 K	90	120	Black	Yes	144
5G1BN LED 30K 90CRI M6	889804156591	5" LED Gimbal, Adjustable	65W Incandescent	500	8	3000 K	90	120	Nickel	Yes	144
5G1ORB LED 30K 90CRI M6	889804156584	5" LED Gimbal, Adjustable	65W Incandescent	500	8	3000 K	90	120	Bronze	Yes	144

Dimensions

5G1

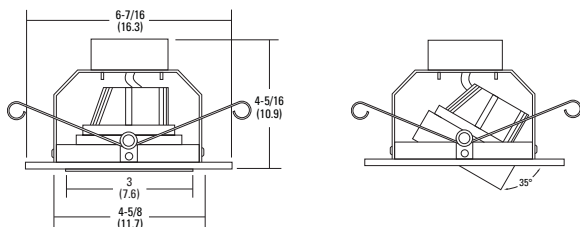



Features

- Recessed housings rated IC/NON-IC for new construction for remodel applications
- Factory-installed captive bar hangers which span 24" and feature built-in nailers and T-Bar clips
- Remodel housing with heavy-gauge galvanized steel raceway arm utilizes remodel clips for installation in plaster, sheetrock, or mechanical ceilings
- Quick disconnect provided for power connection to the LED modules
- Suitable for ceilings up to 1½" thick
- Damp location listed; Title 24 compliant



Ordering Information

Catalog Number	UPC	Description	Lamp Source	Voltage	Finish	Lamp Included	Pallet Quantity
L3LED T24	820476364419	4" Air-Tight, IC/Non-IC New Construction Housing, LED Base	LED	120	Gray	No	144
L3RLED T24	820476467967	4" Air-Tight, IC/Non-IC / Remodel Housing, LED Base	LED	120	Gray	No	312

Dimensions

L3LED

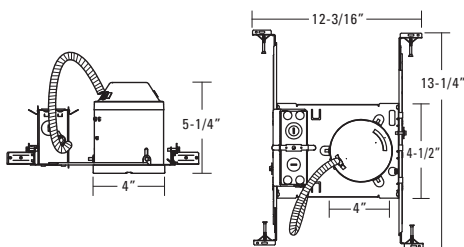

L3RLED

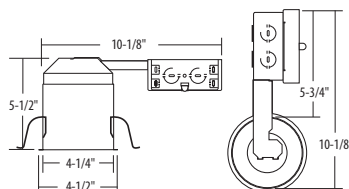



## 4BPMW LED



### Features

- P Series LED modules are ideal for retrofit into existing downlight cans for new construction and remodel applications
- 86% more efficient than incandescent luminaires
- Maintains 70% light output for at least 50,000 hours
- Maintains the same look, feel and warmth reminiscent of incandescent lamps through seamless Center2Edge™ dimming and instant-on capabilities
- Deep recessed lens and baffle provide low glare
- Includes E26 adapter for easy install, as well as splice kit for energy rebates
- Wet location; Title 24 compliant
- See specification sheet for additional finishes

### Ordering Information

Catalog Number	UPC	Description	Replaces Up To	Lumens	Input Watts	CCT	CRI	Voltage	Finish	ENERGY STAR®	Pallet Quantity
4BPMW LED 27K 90CRI M6	820476902260	4" LED Module	65W Incandescent	600	11	2700 K	90	120	White	Yes	432
4BPMW LED 30K 90CRI M6	820476902291	4" LED Module	65W Incandescent	600	11	3000 K	90	120	White	Yes	432
4BPMW LED 40K 90CRI M6	888791290417	4" LED Module	65W Incandescent	650	11	4000 K	90	120	White	Yes	432

### Dimensions

4BP

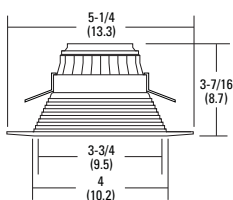

Features

- E Series LED modules are ideal for retrofit into existing downlight cans for new construction and remodel applications
- Maintains 70% light output for at least 35,000 hours
- Line voltage dimmable to 10%
- Offers Instant on and Center2Edge™ dimming like traditional sources
- Wet location listed; 90 CRI versions are Title 24 compliant



Ordering Information

Catalog Number	UPC	Description	Replaces Up To	Lumens	Input Watts	CCT	CRI	Voltage	Finish	ENERGY STAR®	Pallet Quantity
4BEMW LED 27K M6	888791169393	4" LED Module	65W Incandescent	530	10	2700 K	80	120	White	Yes	432
4BEMW LED 30K M6	888791169423	4" LED Module	65W Incandescent	570	10	3000 K	80	120	White	Yes	432
4BEMW LED 40K M6	888791169454	4" LED Module	65W Incandescent	600	10	4000 K	80	120	White	Yes	432
4BEMW LED 27K 90CRI M6	889804129328	4" LED Module	65W Incandescent	600	10	2700 K	90	120	White	Yes	432
4BEMW LED 30K 90CRI M6	889804129298	4" LED Module	65W Incandescent	630	10	3000 K	90	120	White	Yes	432

Dimensions

4BE

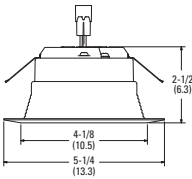

## 4iGMW



## Features

- iGimbals are ideal for retrofit into existing downlight cans for new construction and remodel applications
- Maintains at least 70% light output for 35,000 hours
- Line voltage dimmable to 15%
- Combines functionality of an "eyeball" with ease of using a gimbal
- Provides 50° of up/down adjustable tilt with 360° rotation
- 24/7 "Commerical Grade"
- Damp location listed; Title 24 compliant

## Ordering Information

Catalog Number	UPC	Description	Replaces Up To	Lumens	Input Watts	CCT	CRI	Voltage	Finish	ENERGY STAR®	Pallet Quantity
4iGMW LED 27K 90CRI M6	889804426663	4" LED iGimbal, Adjustable	50W Incandescent	610	10	3000 K	90	120	White	Yes	144
4iGMW LED 30K 90CRI M6	889804426731	4" LED iGimbal, Adjustable	50W Incandescent	640	10	3000 K	90	120	White	Yes	144

## Dimensions

4iGMW

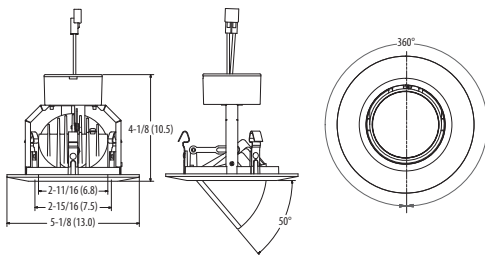

Features

- Gimbals are ideal for retrofit into existing downlight cans for new construction and remodel applications
- Maintains 70% light output for at least 35,000 hours
- Line voltage dimmable to 10%
- Provides 35° tilt in both directions with 180° rotation
- Provides directional lighting for accent and sloped ceiling applications
- Damp location listed; Title 24 compliant



Ordering Information

Catalog Number	UPC	Description	Replaces Up To	Lumens	Input Watts	CCT	CRI	Voltage	Finish	ENERGY STAR®	Pallet Quantity
4G1MW LED 30K 90CRI M6	889804156379	4" LED Gimbal, Adjustable	50W Incandescent	500	7	3000 K	90	120	White	Yes	144
4G1MB LED 30K 90CRI M6	889804156492	4" LED Gimbal, Adjustable	50W Incandescent	500	7	3000 K	90	120	Black	Yes	144
4G1BN LED 30K 90CRI M6	889804156409	4" LED Gimbal, Adjustable	50W Incandescent	500	7	3000 K	90	120	Nickel	Yes	144
4G1ORB LED 30K 90CRI M6	889804156393	4" LED Gimbal, Adjustable	50W Incandescent	500	7	3000 K	90	120	Bronze	Yes	144

Dimensions

4G1

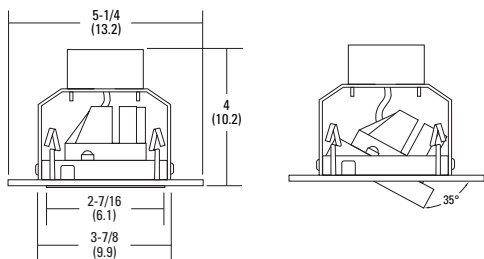



# L7X/L7XR



## Features

- Recessed housings rated IC/Non-IC for new construction or remodel applications
- New construction housings come with factory-installed captive bar hangers which spans 24" and feature built-in nailers and T-Bar clips
- Remodel housing with heavy-gauge galvanized steel raceway arm utilizes remodel clips for installation in plaster, sheetrock, or mechanical ceilings
- Suitable for ceilings up to 1½" thick
- Damp location listed (see trim selection for wet location listings); Title 24 compliant

## Ordering Information

Catalog Number	UPC	Description	Lamp Source	Voltage	Finish	Lamp Included	Pallet Quantity
L7X	784231091906	6" New Construction Housing, Contractor Select	Incandescent	120	Gray	No	120
L7XR	745973789704	6" Remodel Housing, Contractor Select	Incandescent	120	Gray	No	144

## Dimensions

L7X

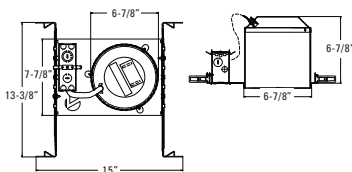

L7XR

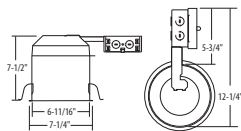

Features

- IC/NON-IC rated trims
- Baffle, eyeball and open trims are damp location listed
- Lensed trims are wet location listed
- Trim retention (clips): Retaining clips riveted to top of reflector hold trim inside housing
- Trim retention (TOR): Two-side mounted torsion springs on the trim and 2 receiving brackets in the can ensure a consistently tight fit with the ceiling



Ordering Information

Catalog Number	UPC	Description	Flange Range	Fits Shallow	Finish	Lamp Included	Pallet Quantity
702 TOR	745975280780	6" Open Trim	Narrow	No	White	No	576
7B2W TOR	745975231416	6" Baffle Trim	Narrow	No	White	No	576
7B2 TOR	745975231911	6" Baffle Trim	Narrow	No	Black	No	1440
7E1 TOR	784231085455	6" Eyeball Trim	Narrow	No	White	No	300
6H2O TOR	745975375448	6" PAR30 WETlite Trim	Stepped	No	White	Yes	180
7LD1	784231085448	6" Drop Opal Lens Trim	Wide	Yes	White	No	360

Dimensions

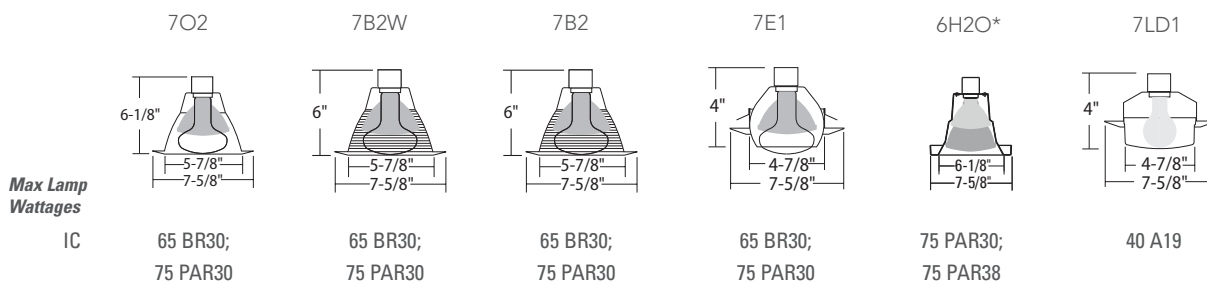

\*Only available for 2x8 new construction (LC6)

# L7XP/L7XPR



## Features

- Recessed housings rated IC/Non-IC for new construction or remodel applications
- New construction housings come with factory-installed captive bar hangers which spans 24" and feature built-in nailers and T-Bar clips
- Remodel housing with heavy-gauge galvanized steel raceway arm utilizes remodel clips for installation in plaster, sheetrock, or mechanical ceilings
- Suitable for ceilings up to 1½" thick
- Damp location listed (see trim selection for wet location listings); Title 24 compliant

## Ordering Information

Catalog Number	UPC	Description	Lamp Source	Voltage	Finish	Lamp Included	Pallet Quantity
L7XP	784231104170	6" Airtight IC/Non-IC New Construction Shallow Housing, Contractor Select	Incandescent	120	Gray	No	102
L7XPR	745973344965	6" Airtight IC/Non-IC Remodel Shallow Housing, Contractor Select	Incandescent	120	Gray	No	96

## Dimensions

L7XP

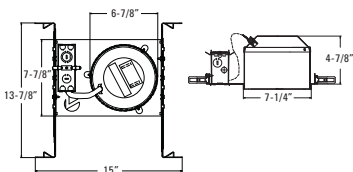

L7XPR

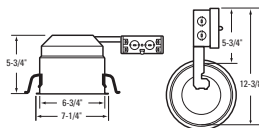

## Features

- IC/NON-IC rated trims
- Baffle, eyeball and open trims are damp location listed
- Lensed trims are wet location listed
- Trim retention (clips): Retaining clips riveted to top of reflector hold trim inside housing
- Trim retention (TOR): Two-side mounted torsion springs on the trim and 2 receiving brackets in the can ensure a consistently tight fit with the ceiling



## Ordering Information

Catalog Number	UPC	Description	Flange Range	Fits Shallow	Finish	Lamp Included	Pallet Quantity
701TOR	745975232161	6" Open Trim	Wide	Yes	White	No	480
7B1WTOR	784231109984	6" Baffle Trim	Wide	Yes	White	No	1440
CO1	745973753095	6" Open Trim	Wide	Yes	White	No	456
CB1W	745973753309	6" Baffle Trim	Wide	Yes	White	No	450
CE1	745973753347	6" Eyeball Trim	Narrow	Yes	White	No	144
CB1	745973753293	6" Baffle Trim	Wide	Yes	Black	No	450
7LD1	784231085448	6" Drop Opal Lens Trim	Wide	Yes	White	No	360
CLF1	745973753354	6" Flush Opal Lens Trim	Wide	Yes	White	No	216

## Dimensions

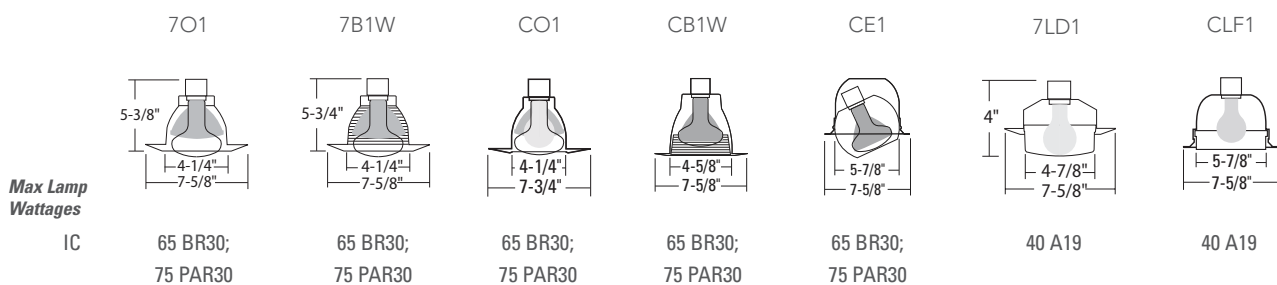



# L5/L5R



## Features

- Recessed housings rated IC/Non-IC for new construction or remodel applications
- New construction housings come with factory-installed captive bar hangers which spans 24" and feature built-in nailers and T-Bar clips
- Remodel housing with heavy-gauge galvanized steel raceway arm utilizes remodel clips for installation in plaster, sheetrock, or mechanical ceilings
- Suitable for ceilings up to 1½" thick
- Damp location listed (see trim selection for wet location listings); Title 24 compliant

## Ordering Information

Catalog Number	UPC	Description	Lamp Source	Voltage	Finish	Lamp Included	Pallet Quantity
L5	745973345160	5" Airtight IC/Non-IC New Construction Housing, Contractor Select	Incandescent	120	Gray	No	144
L5R	745973345276	5" Airtight IC/Non-IC Remodel Housing, Contractor Select	Incandescent	120	Gray	No	144

## Dimensions

L5

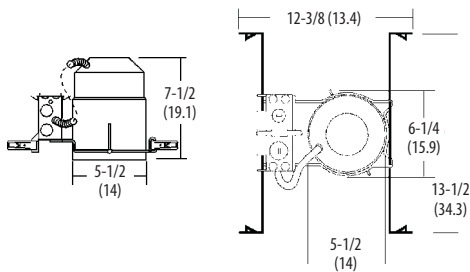

L5R

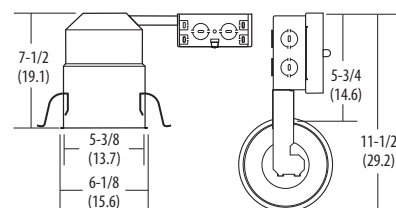

## Features

- IC/NON-IC rated trims
- Baffle, eyeball and open trims are damp location listed
- Lensed trims are wet location listed
- Trim retention (clips): Retaining clips riveted to top of reflector hold trim inside housing
- Trim retention (TOR): Two-side mounted torsion springs on the trim and 2 receiving brackets in the can ensure a consistently tight fit with the ceiling



## Ordering Information

Catalog Number	UPC	Description	Flange Range	Fits Shallow	Finish	Lamp Included	Pallet Quantity
502 TOR	745975375592	5" Open Trim	Narrow	N/A	White	No	1008
5B2W TOR	745975234097	5" Baffle Trim	Narrow	N/A	White	No	720
5B2 TOR	745975234110	5" Baffle Trim	Narrow	N/A	Black	No	720
5E1	745973752883	5" Eyeball Trim	Narrow	N/A	White	No	504
5G2MW PAR30	745976399689	5" Adjustable Gimbal Trim	Narrow	N/A	White	No	144
5H2O TOR	745975375851	5" PAR30 WETlite Trim	Stepped	N/A	White	Yes	180

## Dimensions

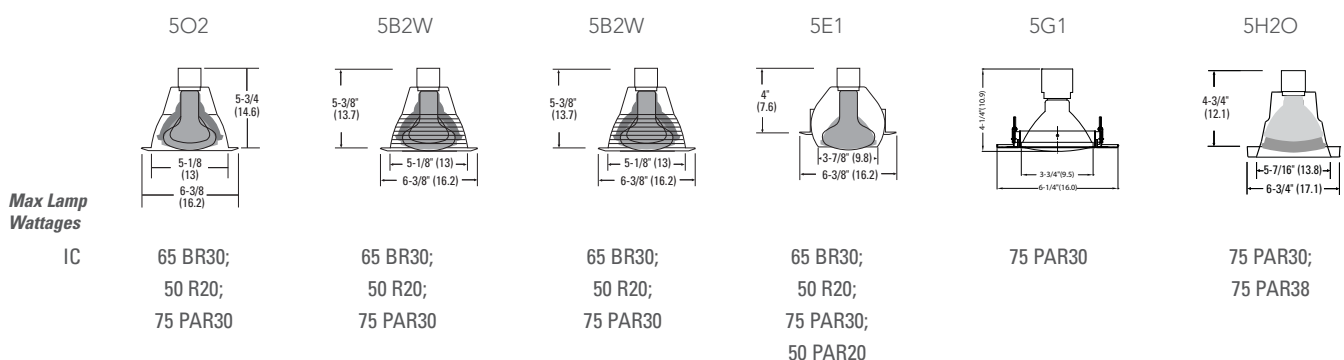

# L3/L3R



## Features

- Recessed housing rated IC/NON-IC for new construction or remodel applications
- Factory-installed captive bar hangers which spans 24" and feature built-in nailers and T-Bar clips
- Remodel housing with heavy-gauge galvanized steel raceway arm utilizes remodel clips for installation in plaster, sheetrock, or mechanical ceilings
- Suitable for ceilings up to 1½" thick
- Damp location listed; Title 24 compliant

## Ordering Information

Catalog Number	UPC	Description	Lamp Source	Voltage	Finish	Lamp Included	Pallet Quantity
L3	745973345313	4" Airtight IC/Non-IC New Construction Housing, Contractor Select	Incandescent	120	Gray	No	144
L3R	745973345566	4" Airtight IC/Non-IC Remodel Housing, Contractor Select	Incandescent	120	Gray	No	312

## Dimensions

L3

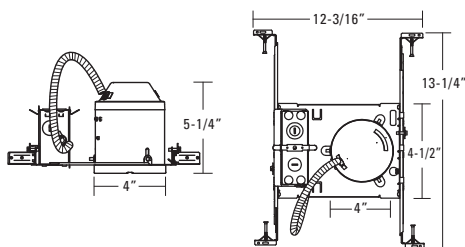

L3R

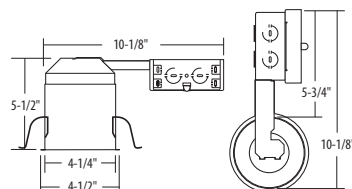

## Features

- IC/NON-IC rated trims
- Baffle, eyeball and open trims are damp location listed
- WETlite™ trims are wet location listed
- Trim retention (clips): Retaining clips riveted to top of reflector hold trim inside housing



White Open

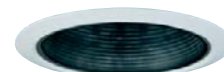

Black Baffle



White Eyeball



White WETlite



## Ordering Information

Catalog Number	UPC	Description	Flange Range	Finish	Lamp Included	Pallet Quantity
301	745975234158	4" Open Trim	Wide	White	No	1344
3B1W R24	745975234264	4" Baffle Trim	Wide	White	No	1536
3B1	745975234295	4" Baffle Trim	Wide	Black	No	1296
3B2W	745975281015	4" Baffle Trim	Narrow	White	No	1536
3E1	745973752937	4" Eyeball Trim	Narrow	White	No	1080
3H20	745975281060	4" PAR30 WETlite Trim	Stepped	White	Yes	630

## Dimensions

	301	3B1W	3B1	3B2W	3E1	3H20
<b>Max Lamp Wattages</b>	IC 30 R20; 35 PAR20 NON-IC 50 PAR20	35 PAR20; 50 PAR20; 50 R20	35 PAR20 50 PAR20	30 R20; 35 PAR20 50 R20	50 PAR20 50 R20	75 PAR30 (short neck) —

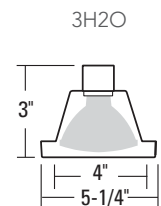
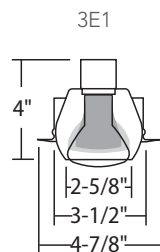
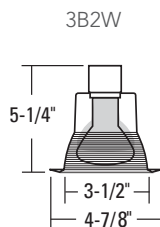
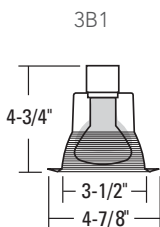
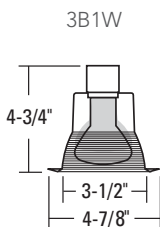
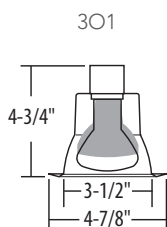



# LC6/LI6

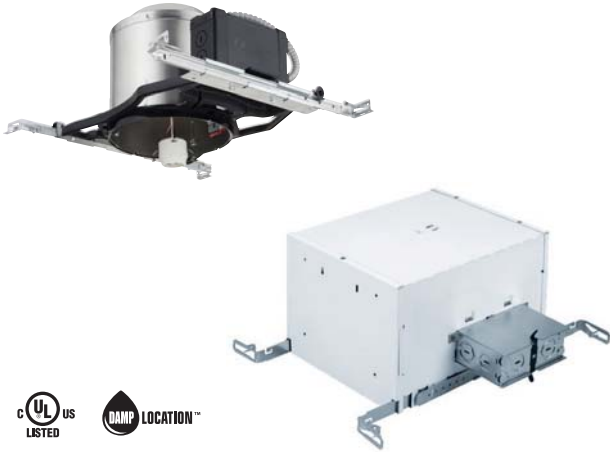

## Features

- Recessed housing rated IC/Non-IC for new construction
- Injection-molded frame with aluminum can provides superior thermal performance for a wider range of trims
- Factory-installed captive bar hangers which spans 24" and feature built-in nailers and T-Bar clips
- Engineering-grade thermoplastic junction box with four built-in romex clamps
- Pre-assembled poke-home connectors for ease of wiring
- Damp location listed (see trim selection for wet location listing)

## Ordering Information

Catalog Number	UPC	Description	Lamp Source	Voltage	Finish	Lamp Included	Pallet Quantity
LC6	784231051146	6" Airtight IC/Non-IC New Construction Housing	Incandescent	120	Black	No	120
LI6	784231067567	6" Airtight IC New Construction, Sloped Ceiling Housing	Incandescent	120	White	No	45

## Dimensions

LC6

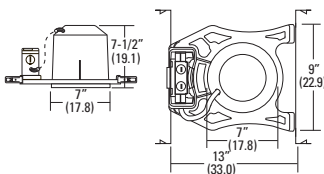

LI6

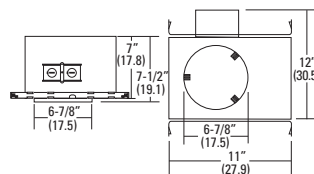

## Features

- IC/NON-IC rated trims
- Baffle, eyeball and open trims are damp location listed
- Lensed trims are wet location listed
- Trim retention (clips): Retaining clips riveted to top of reflector hold trim inside housing
- Trim retention (TOR): Two-side mounted torsion springs on the trim and 2 receiving brackets in the can ensure a consistently tight fit with the ceiling



## Ordering Information

Catalog Number	UPC	Description	Flange Range	Fits Shallow	Finish	Lamp Included	Pallet Quantity
702 TOR	745975280780	6" Open Trim	Narrow	No	White	No	576
7B2W TOR	745975231416	6" Baffle Trim	Narrow	No	White	No	576
7B2 TOR	745975231911	6" Baffle Trim	Narrow	No	Black	No	1440
7E1 TOR	784231085455	6" Eyeball Trim	Narrow	No	White	No	300
6H2O TOR	745975375448	6" PAR30 WETlite Trim	Stepped	No	White	Yes	180
7LD1	784231085448	6" Drop Opal Lens Trim	Wide	No	White	No	360
6SB1W	784231051900	6" Sloped Trim	Narrow	No	White	No	150
6S01	784231051931	6" Sloped Trim	Narrow	No	White	No	150

## Dimensions

	702	7B2W/7B2	7E1	6H2O*	7LD1	6SB1W	6S01
<b>Max Lamp Wattages</b>							
IC	65 BR30; 75 PAR30	65 BR30; 75 PAR30	65 BR30; 75 PAR30	75 PAR30; 75 PAR38	40 A19	65 BR30; 75 PAR30; 90 BR40; 100 PAR38	65 BR30; 75 PAR30; 90 BR40; 100 PAR38

\*Only available for 2x8 new construction (LC6)

# LCP



## Features

- Recessed incandescent housings rated IC and Non-IC for new construction
- Injection-molded frame with aluminum can provides superior thermal performance for a wider range of trims
- Factory-installed captive bar hangers which spans 24" and feature stepped shank nail and positioning guide with intergral T-bar locks built-in nailers and T-Bar clips
- Engineering-grade thermoplastic junction box with four built-in romex clamps
- Pre-assembled poke-home connectors for ease of wiring
- Damp location listed (see trim selection for wet location listing)

## Ordering Information

Catalog Number	UPC	Description	Lamp Source	Voltage	Finish	Lamp Included	Pallet Quantity
LCP	784231051108	6" Airtight IC/Non-IC New Construction, Shallow Housing	Incandescent	120	Black	No	144

## Dimensions

LCP

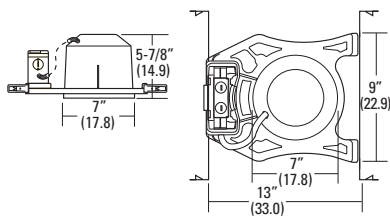

## Features

- IC/NON-IC rated trims
- Baffle, eyeball and open trims are damp location listed
- Lensed trims are wet location listed
- Trim retention (clips): Retaining clips riveted to top of reflector hold trim inside housing
- Trim retention (TOR): Two-side mounted torsion springs on the trim and 2 receiving brackets in the can ensure a consistently tight fit with the ceiling



## Ordering Information

Catalog Number	UPC	Description	Flange Range	Fits Shallow	Finish	Lamp Included	Pallet Quantity
701 TOR	745975232161	6" Open Trim	Wide	Yes	White	No	480
7B1W TOR	784231109984	6" Baffle Trim	Wide	Yes	White	No	1440
CO1	745973753095	6" Open Trim	Wide	Yes	White	No	456
CB1W	745973753309	6" Baffle Trim	Wide	Yes	White	No	450
CE1	745973753347	6" Eyeball Trim	Narrow	Yes	White	No	144
CB1	745973753293	6" Baffle Trim	Wide	Yes	Black	No	450
7LD1	784231085448	6" Drop Opal Lens Trim	Wide	Yes	White	No	360
CLF1	745973753354	6" Flush Opal Lens Trim	Wide	Yes	White	No	216

## Dimensions

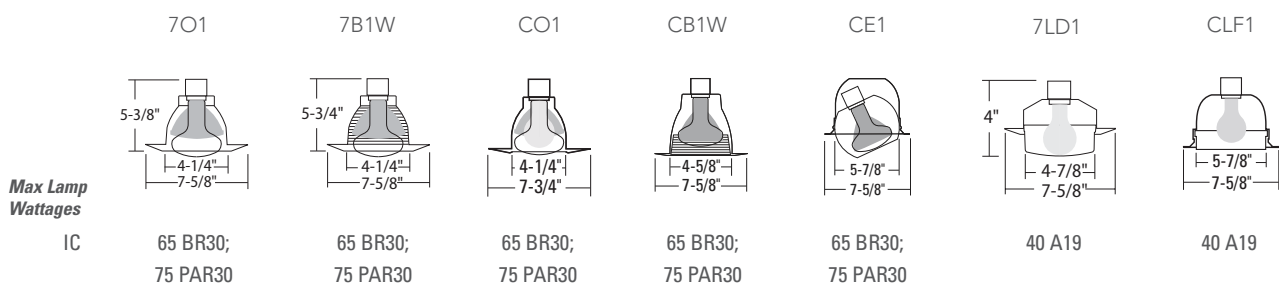

# RESIDENTIAL







<b>62</b>	LED Flush Mount
<b>67</b>	Fluorescent Linear Flush Mount
<b>69</b>	LED Closet Light
<b>70</b>	LED Flush/Semi-Flush Mount
<b>71</b>	Fluorescent Flush/Semi-Flush Mount
<b>72</b>	LED Undercabinet
<b>74</b>	Fluorescent Undercabinet
<b>75</b>	LED Shoplight

## FMML 7



## Features

- 7" LED Versi Lite™ is an energy-efficient lighting solution for an array of residential and light commercial spaces, such as closets, foyers, hallways, utility work areas, stairways and much more
- Wet location option available
- High-efficiency LED light engine reduces power consumption up to 84% compared to a 60W incandescent
- Dimmable to 10% on a standard TRIAC dimmer; zero in-rush current
- Designed to provide 70% lumen maintenance for at least 50,000 hours

## Ordering Information

Catalog Number	UPC	Description	Replaces Up To	Lumens	Input Watts	CCT	CRI	Voltage	Finish	ENERGY STAR®	Pallet Quantity
FMML 7 827 DDBT M6	820476961410	7" Versi Lite	60W Incandescent	600	10	2700 K	85	120	Bronze	Yes	540
FMML 7 827 M6	820476290114	7" Versi Lite	60W Incandescent	600	10	2700 K	85	120	White	Yes	540
FMML 7 827 WL M6	888791001037	7" Versi Lite, Wet Location	60W Incandescent	600	10	2700 K	85	120	White	Yes	540
FMML 7 830 DDBT M6	820476935350	7" Versi Lite	60W Incandescent	600	10	3000 K	85	120	Bronze	Yes	540
FMML 7 830 M6	820476182860	7" Versi Lite	60W Incandescent	600	10	3000 K	85	120	White	Yes	540
FMML 7 830 WL DDBT M6	820476795909	7" Versi Lite, Wet Location	60W Incandescent	600	10	3000 K	85	120	Bronze	Yes	540
FMML 7 830 WL M6	820476780080	7" Versi Lite, Wet Location	60W Incandescent	600	10	3000 K	85	120	White	Yes	540
FMML 7 840 DDBT M6	820476935336	7" Versi Lite	60W Incandescent	600	10	4000 K	85	120	Bronze	Yes	540
FMML 7 840 M6	753573647355	7" Versi Lite	60W Incandescent	600	10	4000 K	85	120	White	Yes	540
FMML 7 840 WL DDBT M6	820476655173	7" Versi Lite, Wet Location	60W Incandescent	600	10	4000 K	85	120	Bronze	Yes	540
FMML 7 840 WL M6	820476881145	7" Versi Lite, Wet Location	60W Incandescent	600	10	4000 K	85	120	White	Yes	540

## Dimensions

Width: 7-1/4" (18.4)  
Height: 1-3/4" (4.4)

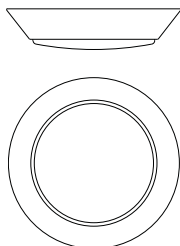

## Accessories

Catalog Number	UPC	Description
DFMML	820476661907	Replacement Diffuser

Certain airborne contaminants can diminish integrity of acrylic. See pg. 168 for Acrylic Compatibility table for suitable uses.

Features

- 13" LED Versi Lite™ is an energy-efficient lighting solution for an array of residential and light commercial spaces, such as closets, foyers, hallways, utility work areas, stairways and much more
- Wet location option available
- High-efficiency LED light engine reduces power consumption up to 84% compared to a 2-75W Incandescent
- Dimmable to 10% on a standard TRIAC dimmer; zero in-rush current
- Designed to provide 70% lumen maintenance for at least 50,000 hours



Ordering Information

Catalog Number	UPC	Description	Replaces Up To	Lumens	Input Watts	CCT	CRI	Voltage	Finish	ENERGY STAR®	Pallet Quantity
FMML 13 827	888791432985	13" Versi Lite	2-75W Incandescent	1800	28	2700 K	83	120	White	Yes	120
FMML 13 827 DDBT	888791433050	13" Versi Lite	2-75W Incandescent	1800	28	2700 K	83	120	Bronze	Yes	120
FMML 13 827 WL	888791432817	13" Versi Lite, Wet Location	2-75W Incandescent	1800	28	2700 K	83	120	White	Yes	120
FMML 13 827 WL DDBT	888791432886	13" Versi Lite, Wet Location	2-75W Incandescent	1800	28	2700 K	83	120	Bronze	Yes	120
FMML 13 830	888791432961	13" Versi Lite	2-75W Incandescent	1900	28	3000 K	83	120	White	Yes	120
FMML 13 830 DDBT	888791433043	13" Versi Lite	2-75W Incandescent	1900	28	3000 K	83	120	Bronze	Yes	120
FMML 13 830 WL	888791432725	13" Versi Lite, Wet Location	2-75W Incandescent	1900	28	3000 K	83	120	White	Yes	120
FMML 13 830 WL DDBT	888791432862	13" Versi Lite, Wet Location	2-75W Incandescent	1900	28	3000 K	83	120	Bronze	Yes	120
FMML 13 840	888791432954	13" Versi Lite	2-75W Incandescent	2000	28	4000 K	83	120	White	Yes	120
FMML 13 840 DDBT	888791433005	13" Versi Lite	2-75W Incandescent	2000	28	4000 K	83	120	Bronze	Yes	120
FMML 13 840 WL	888791432619	13" Versi Lite, Wet Location	2-75W Incandescent	2000	28	4000 K	83	120	White	Yes	120
FMML 13 840 WL DDBT	888791432831	13" Versi Lite, Wet Location	2-75W Incandescent	2000	28	4000 K	83	120	Bronze	Yes	120

Dimensions

Width: 13" (33.0)  
Height: 2-1/2" (6.4)

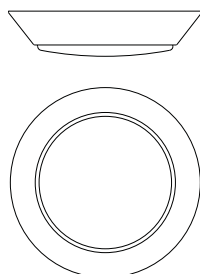

Accessories

Catalog Number	UPC	Description
DFMML 13	889804541625	Replacement Diffuser

Certain airborne contaminants can diminish integrity of acrylic. See pg. 168 for Acrylic Compatibility table for suitable uses.

## FMLRL/FMLS



### Features

- LED Low Profile Rounds and Squares are ideal for use in closets, foyers, hallways, corridors, bedrooms, offices, utility work areas, stairways and more
- Easy-to-install white acrylic diffuser is available in 11" and 14" sizes
- High-efficiency LED light engine reduces power consumption up to 80% compared to an incandescent
- Dimmable to 10% on a standard TRIAC dimmer; zero in-rush current
- Designed to provide 70% lumen maintenance for at least 50,000 hours
- Damp location listed

### Ordering Information

Catalog Number	UPC	Description	Replaces Up To	Lumens	Input Watts	CCT	CRI	Voltage	ENERGY STAR®	Pallet Quantity
FMLRL 11 14830 M4	820476883071	11" Round LED Flush Mount	75W Incandescent	1100	16	3000 K	85	120	Yes	72
FMLRL 11 14840 M4	753573687405	11" Round LED Flush Mount	75W Incandescent	1100	16	4000 K	85	120	Yes	72
FMLRL 14 20830 M4	820476883118	14" Round LED Flush Mount	2 - 60W Incandescent	1600	24	3000 K	85	120	Yes	32
FMLRL 14 20840 M4	753573687412	14" Round LED Flush Mount	2 - 60W Incandescent	1600	24	4000 K	85	120	Yes	32
FMLS 11 14830 M4	820476883125	11" Square LED Flush Mount	75W Incandescent	1100	16	3000 K	85	120	Yes	72
FMLS 11 14840 M4	753573687436	11" Square LED Flush Mount	75W Incandescent	1100	16	4000 K	85	120	Yes	72
FMLS 14 20830 M4	820476883149	14" Square LED Flush Mount	2 - 60W Incandescent	1600	24	3000 K	85	120	Yes	32
FMLS 14 20840 M4	753573687467	14" Square LED Flush Mount	2 - 60W Incandescent	1600	24	4000 K	85	120	Yes	32

### Dimensions

Height: FMLRL 11 – 2-7/8" (7.3)  
 FMLRL 14 – 3-1/8" (7.9)  
 Width: FMLRL 11 – 11" (27.9)  
 FMLRL 14 – 13-11/16" (34.7)

Height: FMLS 11 – 2-7/8" (7.3)  
 FMLS 14 – 3-1/8" (7.9)  
 Width: FMLS 11 – 11" (27.9)  
 FMLS 14 – 13-11/16" (34.7)

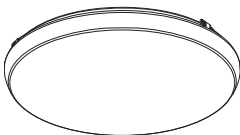

### Accessories

Catalog Number	UPC	Description
DFMLRL11 M4	820476158476	Acrylic Lens Only for the 11" LED Round
DFMLRL14 M4	820476158506	Acrylic Lens Only for the 14" LED Round

Certain airborne contaminants can diminish integrity of acrylic. See pg. 168 for Acrylic Compatibility table for suitable uses.

### Features

- LED Linear LitePuff is ideal for use in kitchens, offices, utility work areas, stairways and other applications where affordable and reliable illumination is desired
- Low-profile, linear fixture with durable white, acrylic diffuser provides widespread, uniform illumination
- High-efficiency LED light engine reduces power consumption up to 40% compared to an incandescent
- Lift-and-shift diffuser offers easy removal for cleaning with no clips to lose or break
- Designed to provide 70% lumen maintenance for at least 50,000 hours
- Damp location listed



### Ordering Information

Catalog Number	UPC	Description	Replaces Up To	Lumens	Input Watts	CCT	CRI	Voltage	ENERGY STAR®	Pallet Quantity
FMLL 9 30840	753573658511	LED Linear Low-Profile Flush Mount	2-T8 Fluorescent	3200	35	4000 K	85	120	Yes	36

### Dimensions

Width: 9-1/4" (23.5)  
 Length: 47-7/8" (121.7)

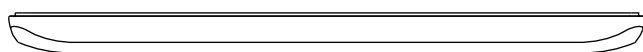

### Accessories

Catalog Number	UPC	Description
DFMML 9	753573658474	Replacement Diffuser for LED LitePuff

Certain airborne contaminants can diminish integrity of acrylic. See pg. 168 for Acrylic Compatibility table for suitable uses.



## FMLWL



## Features

- LED narrow wrap is a low-profile, linear fixture with decorative end caps and white, acrylic diffuser for widespread, uniform illumination
- Ideal for use in kitchens, offices, utility work areas, stairways and many other applications
- Provides general illumination for surface-mount residential and light commercial applications
- Designed to provide 70% lumen maintenance for at least 50,000 hours
- Damp location listed

## Ordering Information

Catalog Number	UPC	Description	Replaces Up To	Lumens	Input Watts	CCT	CRI	Voltage	ENERGY STAR®	Pallet Quantity
FMLWL 24 840	888791197921	2' LED Wrap/Flush Mount	17W T8 Fluorescent	1200	20	4000 K	85	120	Yes	182
FMLWL 48 827	889804105995	4' LED Wrap/Flush Mount	32W T8 Fluorescent	2400	40	2700 K	85	120	Yes	91
FMLWL 48 830	88791940893	4' LED Wrap/Flush Mount	32W T8 Fluorescent	2400	40	3000 K	85	120	Yes	91
FMLWL 48 835	888791982343	4' LED Wrap/Flush Mount	32W T8 Fluorescent	2400	40	3500 K	85	120	Yes	91
FMLWL 48 840	888791197969	4' LED Wrap/Flush Mount	32W T8 Fluorescent	2400	40	4000 K	85	120	Yes	91

## Dimensions

	2'	4'
Width:	5-1/2" (14.0)	5-1/2" (14.0)
Length:	24-1/2" (62.2)	47-2/5" (120.4)
Depth:	2-3/5" (6.6)	2-3/5" (6.6)

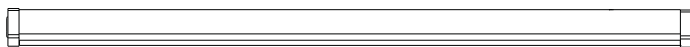

## Accessories

Catalog Number	UPC	Description
DFMLWL 24	888791448627	2' White Acrylic Diffuser
DFMLWL 48	888791448634	4' White Acrylic Diffuser

Certain airborne contaminants can diminish integrity of acrylic. See pg. 168 for Acrylic Compatibility table for suitable uses.

Features

- Fluorescent Litepuff is ideal for general illumination in residential and light commercial applications
- Durable, white acrylic diffuser provides widespread, uniform illumination and allows easy access for cleaning and maintenance



Ordering Information

Catalog Number	UPC	Description	Input Watts	Voltage	Ballast Type	Lamp Included	# of Lamps	ENERGY STAR®	Pallet Quantity
10640RE	784231166994	Fluorescent Litepuff, 4', 2-Light T8	32	120	Electronic	No	2	Yes	30
10642RE	784231167007	Fluorescent Litepuff, 4', 4-Light T8	32	120	Electronic	No	4	Yes	22

Dimensions

Width: 11-1/4" (1x4) or 16-5/8" (1-1/2x4)

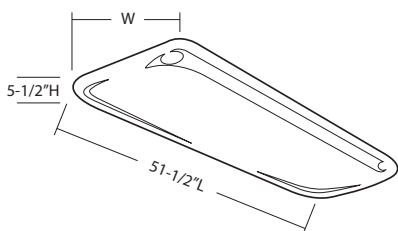

Accessories

Catalog Number	UPC	Description
D15PUFF	784231142622	Replacement Diffuser for 4-40W Litepuff
D15PUFF2	784231142639	Diffuser Lightpuff
D2PUFF2	78423116975	Diffuser Lightpuff
DPUFF	784231142615	Diffuser Litepuff 2 ft.

Certain airborne contaminants can diminish integrity of acrylic. See pg. 168 for Acrylic Compatibility table for suitable uses.

## FMMCL



## Features

- FMMCL closet lights are ideal for pantries, utility closets, laundry rooms or any location needing energy-efficient lighting
- Can be mounted to either the wall or ceiling. Mounting hardware included for mounting to standard round, octagon or horizontal rectangle junction box
- 4 1/4" x 4 1/2" mounting plate supplied with 18" and 24" models can be rotated to accommodate vertical junction box
- Features a white acrylic diffuser with either a pull chain (S1) or passive infrared (PIR) sensor for easy On/Off operation
- Designed to provide 70% lumen maintenance for at least 50,000 hours
- High-efficiency LED light engine reduces power consumption by up to 80% compared to an incandescent
- Damp location listed

## Ordering Information

Catalog Number	UPC	Description	Replaces Up To	Lumens	Input Watts	CCT	CRI	Voltage	ENERGY STAR®	Pallet Quantity
FMMCL 840 PIR M4	745971128925	7" Closet Light, PIR Sensor	60W Incandescent	575	10	4000 K	85	120	Yes	840
FMMCL 840 S1 M4	820476778513	7" Closet Light, Pull Chain	60W Incandescent	575	10	4000 K	85	120	Yes	840
FMMCL 18 840 PIR M4	888791964974	18" Closet Light, PIR Sensor	75W Incandescent	925	14	4000 K	85	120	Yes	384
FMMCL 18 840 S1 M4	888791964912	18" Closet Light, Pull Chain	75W Incandescent	925	14	4000 K	85	120	Yes	384
FMMCL 24 840 PIR M4	888791965001	24" Closet Light, PIR Sensor	90W Incandescent	1225	17	4000 K	85	120	Yes	192
FMMCL 24 840 S1 M4	888791964943	24" Closet Light, Pull Chain	90W Incandescent	1225	17	4000 K	85	120	Yes	192

## Dimensions

7"

Height: 4-1/4" (10.8)  
Width: 6-5/8" (16.8)  
Depth: 1-5/8" (4.1)

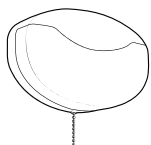

18"

Height: 3-1/4" (8.2)\*  
Width: 17-6/8" (45)  
Depth: 1-3/8" (3.6)

\*Mounting plate extends height to 4 1/4"

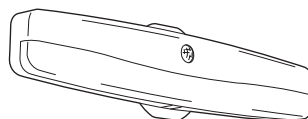

24"

Height: 3-1/4" (8.2)\*  
Width: 23-5/8" (60)  
Depth: 1-3/8" (3.6)

\*Mounting plate extends height to 4 1/4"

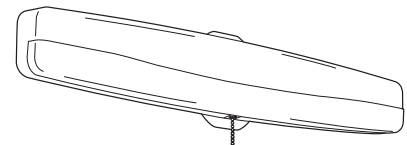

Certain airborne contaminants can diminish integrity of acrylic. See pg. 168 for Acrylic Compatibility table for suitable uses.



## FMSATL



## Features

- LED Saturn Round or Square fixture is ideal for use in foyers, corridors, hallways, bedrooms, offices, utility work areas, stairways and many other light commercial or residential settings
- Brushed nickel finish; also available in bronze
- Designed to provide 70% lumen maintenance for at least 50,000 hours
- High-efficiency LED light engine reduces power consumption by up to 84% compared to an incandescent
- Damp location listed

## Ordering Information

Catalog Number	UPC	Description	Replaces Up To	Lumens	Input Watts	CCT	CRI	Voltage	ENERGY STAR®	Pallet Quantity
FMSATL 13 14830 BN M4	820476253249	Saturn 13" LED Flush Mount, Round	2 - 60W Incandescent	1000	16	3000 K	83	120	Yes	72
FMSATL 13 14840 BN M4	820476054594	Saturn 13" LED Flush Mount, Round	2 - 60W Incandescent	1000	16	4000 K	86	120	Yes	72
FMSSATL 13 14830 BN M4	888791772234	Saturn 13" LED Flush Mount, Square	2 - 60W Incandescent	1000	16	3000 K	84	120	Yes	72
FMSSATL 13 14840 BN M4	888791772258	Saturn 13" LED Flush Mount, Square	2 - 60W Incandescent	1000	16	4000 K	86	120	Yes	72
FMSATL 16 20830 BN M4	820476253263	Saturn 16" LED Flush Mount, Round	2 - 75W Incandescent	1600	24	3000 K	83	120	Yes	32
FMSATL 16 20840 BN M4	820476154324	Saturn 16" LED Flush Mount, Round	2 - 75W Incandescent	1600	24	4000 K	80	120	Yes	32

## Accessories

Catalog Number	UPC	Description
3SHL6 BN M6	820476846670	6" Stem Hanger in Brushed Nickel
CAHL6 BN M10	888791396119	6" Canopy Hanger in Brushed Nickel
DSATL 13 M4	820476846663	Replacement Lens/Diffuser for Saturn 13"

## Dimensions

Nominal size	Model number	Mounting configuration	(A) Width inches (cm)	(B) Depth inches (cm)
13" dia	FMSATL 13	Flush	12-9/16 (31.9)	3-1/8 (7.9)
	FMSSATL 13	Semi-flush*		8-3/8 (21.3)
16" dia	FMSATL 16	Flush	16 (40.6)	3-5/8 (9.2)
		Semi-flush*		9-5/8 (24.5)

\*Requires 3-stem hanger kit. See Accessories/Replacement parts below.

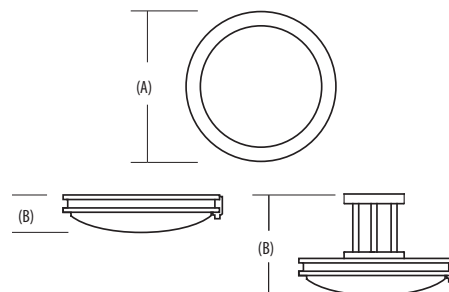

Certain airborne contaminants can diminish integrity of acrylic. See pg. 168 for Acrylic Compatibility table for suitable uses.

Features

- The Fluorescent Saturn Round is ideal for use in foyers, corridors, hallways, bedrooms, offices, utility work areas, stairways and many other light commercial or residential settings
- Brushed nickel finish
- One 26W compact fluorescent 3500 K lamp included
- Semi-flush mounting hardware included
- Damp location listed



Ordering Information

Catalog Number	UPC	Description	Input Watts	Voltage	Ballast Type	Lamp Included	# of Lamps	ENERGY STAR®	Pallet Quantity
11750 BN M4	784231173190	Saturn 13" Fluorescent Flush Mount, Round	26	120	Electronic	Yes	1	No	48

Accessories

Catalog Number	UPC	Description
DSATN16	784231180990	Diffuser for Saturn 16"

Dimensions

Height: 3-1/8" (small), or 3-1/4" (large)      Height: 8-3/8" (small), or 8-5/8" (large)  
 Width: 13" (small), or 16" (large)              Width: 13" (small), or 16" (large)

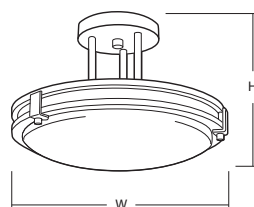
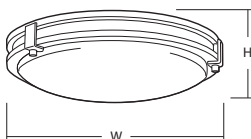

Certain airborne contaminants can diminish integrity of acrylic. See pg. 168 for Acrylic Compatibility table for suitable uses.



# RAZ



## Features

- The Rayzer™ is ideal for task or accent lighting under and over cabinets, display cases, office lighting, coves and utility/work areas
- Durable aluminum construction in a low-profile design. Can be plugged in or direct-wired (splice box and 24" connector cord required for direct-wiring)
- Designed to provide 70% lumen maintenance for at least 50,000 hours
- High-efficiency LED light engine reduces power consumption by up to 64%
- Link up to 10' of modular system to one transformer (required, sold separately, see below)
- All fixtures include an 18" connector and mounting hardware

## Ordering Information

Catalog Number	UPC	Description	Replaces Up To	Lumens	Input Watts	CCT	CRI	Voltage	ENERGY STAR®	Pallet Quantity
RAZ9 M6	745976882754	9" LED Undercabinet	8-14W CF	175	5	3000 K	85	120	No	1512
RAZ12 M6	745976882778	12" LED Undercabinet	8-14W CF	240	7	3000 K	85	120	No	1134
RAZ18 M6	745976885137	18" LED Undercabinet	8-14W CF	350	10	3000 K	85	120	No	216
RAZ24 M6	745977165573	24" LED Undercabinet	8-14W CF	440	13	3000 K	85	120	No	756

## Dimensions

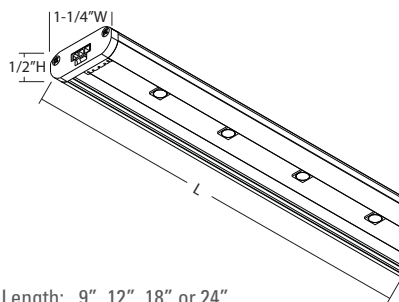

Length: 9", 12", 18" or 24"

## Accessories

Catalog Number	UPC	Description
RAZTRANS24 120 M6	745976882952	Rayzer Transformer, 120V
RAZTRANS24 MVOLT M6	745976882983	Rayzer Transformer, 120-277V
RAZDIM M12	745976882976	Rayzer Dimmer
RAZ CC3 M12	745976883041	Rayzer Connector Cord 3"
RAZ CC24 M12	745976883034	Rayzer Connector Cord 24"
RAZ CC121 M12	745977165580	Rayzer Connector Cord 121"
RAZ LVCC M12	745976883058	Rayzer Low Voltage Connector Cord
RAZ ERC M12	745976883140	Rayzer End Row Connector
RAZ PHD M12	745976883157	Rayzer Power Hub Distributor
RAZ INLS26 M12	745976883393	Rayzer In-Line Switch

Features

- Provides task or accent lighting in commercial, retail, hospitality and residential applications
- Features low-profile design with integral driver and on/off rocker switch
- Available for use with most standard dimmable switches
- Swivel head allows light to be directed to desired area
- Designed to provide 70% lumen maintenance for at least 50,000 hours
- High-efficiency LED light engine reduces power consumption by up to 64%
- Damp location listed



Ordering Information

Catalog Number	UPC	Description	Replaces Up To	Lumens	Input Watts	CCT	CRI	Voltage	ENERGY STAR®	Pallet Quantity
UCLD 12 WH M4	753573031680	12" LED Undercabinet	8-14W CF	220	5	3000 K	83	120	Yes	576
UCLD 18 WH M4	753573031758	18" LED Undercabinet	8-14W CF	375	8	3000 K	83	120	Yes	384
UCLD 24 WH M4	753573031789	24" LED Undercabinet	8-14W CF	500	12	3000 K	83	120	Yes	432

Dimensions

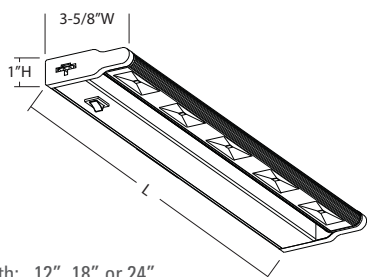

Length: 12", 18" or 24"

Accessories

Catalog Number	UPC	Description
UCD JB M12	745974384847	Undercabinet Junction Box
UC ERC R12	784231177372	1-1/8" Row Connector for End-to-End Connections
UC ERC24 R12	784231177365	24" Connector Cord



### Features

- Ideal for use in school, display or residential applications
- Trim, low-profile design with rocker switch
- Snap-fit, shatter-resistant, milk-white acrylic diffuser

### Ordering Information

Catalog Number	UPC	Description	Input Watts	Voltage	Ballast Type	Lamp Included	# of Lamps	ENERGY STAR®	Pallet Quantity
UC 12E 120 SWR M6	784231123317	12" Undercabinet, T5 Fluorescent	8	120	Instant-Start	No	1	No	504
UC 21E 120 SWR M6	784231123324	21" Undercabinet, T5 Fluorescent	13	120	Instant-Start	No	1	No	336
UC 24E 120 SWR M6	784231123331	24" Undercabinet, T5 Fluorescent	16	120	Instant-Start	No	2	No	336
UC 33E 120 SWR M6	784231123348	33" Undercabinet, T5 Fluorescent	21	120	Instant-Start	No	2	No	168
UC 42E 120 SWR M6	784231123355	42" Undercabinet, T5 Fluorescent	26	120	Instant-Start	No	2	No	168
UC8 15 120 SWR M6	784231183656	15" Undercabinet, T8 Fluorescent	15	120	Instant-Start	No	1	No	336
UC8 17 120 SWR M6	784231183663	17" Undercabinet, T8 Fluorescent	17	120	Instant-Start	No	1	No	324
UC8 25 120 SWR M6	784231183670	25" Undercabinet, T8 Fluorescent	25	120	Instant-Start	No	1	No	168
UC8 32 120 SWR M6	784231183687	32" Undercabinet, T8 Fluorescent	32	120	Instant-Start	No	1	No	168

### Dimensions

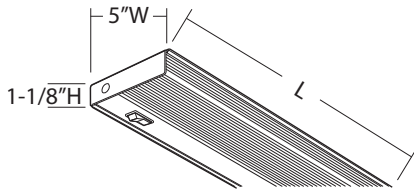

Length: 12", 21", 24", 33" or 42"

### Accessories

Catalog Number	UPC	Description
DUC12	745974136965	12" White Acrylic Diffuser for T5 Undercabinet
DUC21	784231151136	21" White Acrylic Diffuser for T5 Undercabinet
DUC24	784231128640	24" White Acrylic Diffuser for T5 Undercabinet
DUC33	784231128602	33" White Acrylic Diffuser for T5 Undercabinet
DUC42	745979237049	42" White Acrylic Diffuser for T5 Undercabinet
DUC818	784231185650	18" White Acrylic Diffuser for T8 Undercabinet
DUC824	784231185667	24" White Acrylic Diffuser for T8 Undercabinet
DUC836	784231185674	36" White Acrylic Diffuser for T8 Undercabinet
DUC848	784231185681	48" White Acrylic Diffuser for T8 Undercabinet

Certain airborne contaminants can diminish integrity of acrylic. See pg. 168 for Acrylic Compatibility table for suitable uses.

## Features

- Ideal for use in workshops, utility rooms, garages, and more
- Constructed of a metal housing with decorative plastic end caps and a pull chain for easy on/off operation
- Designed to provide 70% lumen maintenance for at least 50,000 hours
- XWLED is IP65 rated and is fully gasketed to protect against wet, cold and dusty environments. Starts down to 0°F (-18°C)

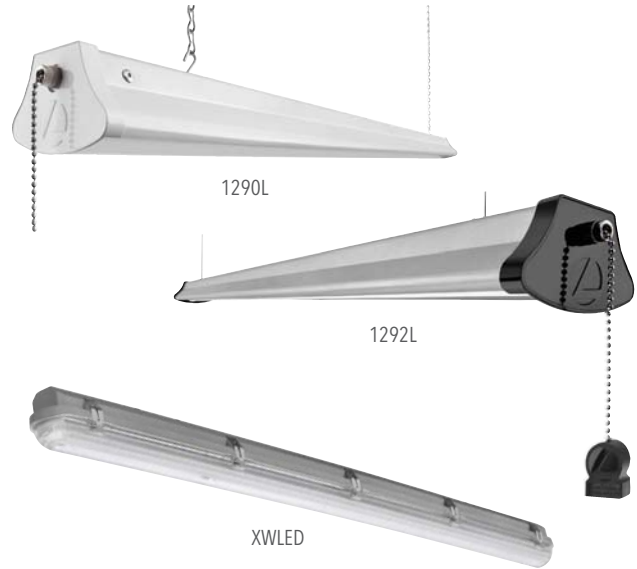

## Ordering Information

Catalog Number	UPC	Description	Replaces Up To	Lumens	Input Watts	CCT	CRI	Voltage	ENERGY STAR®	Pallet Quantity
1290L	820476312458	LED Shoplight, White Housing, White Ends, 5' White Cord/Plug	1 - T8 Fluorescent	1700	25	4000 K	87	120	No	165
1292L	820476312472	LED Shoplight, Silver Housing, Black Ends, 5' Black Cord/Plug	2 - T8 Fluorescent	2900	40	4000 K	87	120	No	165
XWLED4 120	753573431121	4" Slim LED Wet Light	1 - T8 Fluorescent	1800	24	4000 K	88	120	Yes	156

## Dimensions

1290L/1292L

Length: 46-5/8" (118.3)  
 Width: 3-3/4" (9.6)  
 Height: 2-3/8" (6.0)

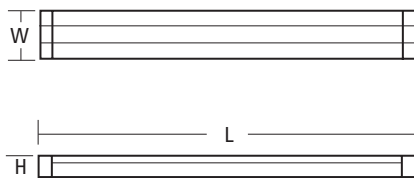

XWLED

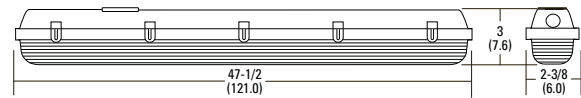



# INDUSTRIAL







78	LED High Bay
80	Fluorescent High Bay
82	HID High and Low Bay
84	Enclosed and Gasketed
86	Strip Lighting - Wet Location
88	Strip Lighting - Damp Location
90	Strip Lighting - Dry Location
92	Strip Lighting - Low Profile
93	Strip Lighting - Industrial



# JCBL



## Features

- The JCBL LED Round Highbay is designed for Industrial spaces, delivering performance and energy savings vs conventional HID and FL Lighting.
- Designed for mounting heights up to 30'
- Aluminum heat sink to maximize heat dissipation and extend the life of the luminaire
- UL listed for Damp Location, IP65 rated optics
- Ambient temperature operation from 32°F (0°C) to 50°C, 122°F (50°C)
- Multiple reflector options including aluminum, prismatic acrylic and polycarbonate

## Ordering Information

Catalog Number	UPC	Description	Replaces Up To	Lumens	Input Watts	CCT	Voltage	Distribution	DLC	Contractor Select	Pallet Quantity
JCBL 18000LM MVOLT GZ10 40K 70CRI HC6	889804925357	JCBL 18000LM housing with hook and 6' cord	250-400w HID	18000	162	4000K	120-277	Medium	Yes	Yes	30
JCBL 18000LM MVOLT GZ10 40K 70CRI PM	889804925357	JCBL 18000LM housing with pendant mounting	250-400w HID	18000	162	4000K	120-277	Medium	Yes	Yes	30
JCBL 24000LM MVOLT GZ10 40K 70CRI PM	889804925319	JCBL 24000LM housing with pendant mounting	250-400w HID	24000	200	4000K	120-277	Medium	Yes	Yes	30
JCBL 24000LM MVOLT GZ10 40K 70CRI HC6	889804925296	JCBL 24000LM housing with hook and 6' cord	250-400w HID	24000	200	4000K	120-277	Medium	Yes	Yes	30

## Accessories

Catalog Number	UPC	Description
SALR U	889804924220	16" Specular Aluminum Reflector
ACFR U	889804924244	16" Frosted Acrylic Reflector
ACDRP U	889804925005	16" Frosted Acrylic Drop Lens

## Dimensions

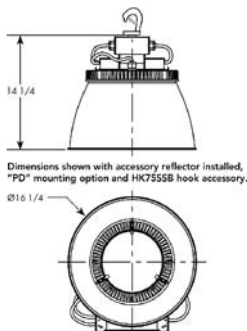

Certain airborne contaminants can diminish integrity of acrylic. See pg. 168 for Acrylic Compatibility table for suitable uses.

Features

- I-BEAM® LED High Bay is an ideal one-for-one replacement of conventional lighting systems such as HID and fluorescent
- Applications include warehousing, manufacturing, gymnasiums, and other large indoor spaces with mounting heights up to 40'
- Suitable for suspension by chain, cable, surface-mounting bracket, hook monopoint or single (pendant) monopoint
- IBL - Listed for ambient environments up to 131°F (55°C)
- IBH - Listed for ambient environments up to 104°F (40°C)



Ordering Information

Catalog Number	UPC	Description	Replaces Up To	Lumens	Input Watts	CCT	Voltage	Distribution	DLC	Contractor Select	Pallet Quantity
IBH 12L MVOLT	820476772351	LED Bay Light	4-Lamp T8	12000	108	4000 K	120-277	Medium	Yes	Yes	48
IBH 18L MVOLT	820476682117	LED Bay Light	4-Lamp T5HO, 6-Lamp T8	18000	140	4000 K	120-277	Medium	Yes	Yes	24
IBH 24L MVOLT	820476617775	LED Bay Light	6-Lamp T5HO, 8-Lamp T8	24000	216	4000 K	120-277	Medium	Yes	Yes	24
IBL 18LWD LP740 DLC	753573372264	LED Bay Light	4-Lamp T5HO, 6-Lamp T8	25000	197	4000 K	120-277	Wide	Yes	No	36
IBL 24LWD LP740 DLC	753573361398	LED Bay Light	6-Lamp T5HO, 8-Lamp T8	32000	245	4000 K	120-277	Wide	Yes	No	36

Accessories

Catalog Number	UPC	Description
IBAC120 M20	745975244904	Aircraft Cable 10' with Hook (One Pair)
IBAC240 M20	745975244911	Aircraft Cable 20' with Hook (One Pair)
WGIBH	820476173134	Wireguard for Use with 12L IBH
WGIBH4	820476834028	Wireguard for Use with 18L or 24L IBH
WGIBL	753573558019	Wireguard

Dimensions

IBH 12L

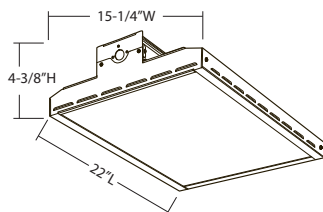

IBH 18L and IBH 24L

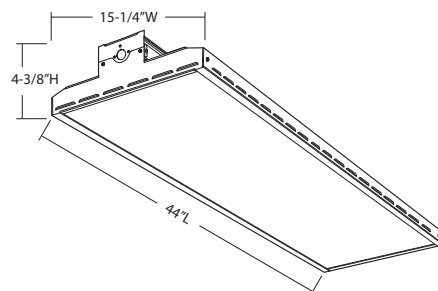

IBL

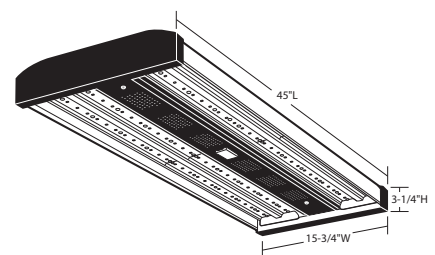

# IBZ



## Features

- IBZ is an ideal one-for-one replacement of common metal halide high bay systems
- Available with either narrow distribution optics for aisles or wide distribution optics for general lighting
- Lamped 32W T8 fixtures come standard with 32W/841 lamps
- Lamped T5HO fixtures come standard with 54W/841 lamps
- Ballast disconnect standard

## Ordering Information

Catalog Number	UPC	Description	Distribution	Voltage	Input Watts	Ballast Type	Lamp Included	# of Lamps	Contractor Select	Pallet Quantity
IBZT8 4	745977147661	T8 Fluorescent High Bay	Narrow	120-277	112	Instant Start	No	4	Yes	51
IBZT8 6	745977147791	T8 Fluorescent High Bay	Narrow	120-277	170	Instant Start	No	6	Yes	36
IBZT8 6 WD	745977147845	T8 Fluorescent High Bay	Wide	120-277	170	Instant Start	No	6	Yes	36
IBZT5 4	745977144141	T5 Fluorescent High Bay	Narrow	120-277	240	Program Rapid Start	No	4	Yes	51
IBZT5 4L	745977147197	T5 Fluorescent High Bay	Narrow	120-277	240	Program Rapid Start	Yes	4	Yes	51
IBZT5 6	745977147432	T5 Fluorescent High Bay	Narrow	120-277	360	Program Rapid Start	No	6	Yes	36
IBZT5 6L	745977147470	T5 Fluorescent High Bay	Narrow	120-277	360	Program Rapid Start	Yes	6	Yes	36
IBZT5 6L WD	745977147579	T5 Fluorescent High Bay	Wide	120-277	360	Program Rapid Start	Yes	6	Yes	36
IBZ 632	745975977390	T8 Fluorescent High Bay	Narrow	120-277	148	Instant Start	No	6	No	36
IBZ 632 WD	745977279874	T8 Fluorescent High Bay	Wide	120-277	148	Instant Start	No	6	No	36
IBZ 632L	745976255480	T8 Fluorescent High Bay	Narrow	120-277	148	Instant Start	Yes	6	No	36
IBZ 454 GEB10PS90	753573123019	T5 Fluorescent High Bay	Narrow	120-277	240	Program Rapid Start	No	4	No	51
IBZ 454L GEB10PS90	753573153498	T5 Fluorescent High Bay	Narrow	120-277	240	Program Rapid Start	Yes	4	No	51
IBZ 454L WD GEB10PS90	753573235583	T5 Fluorescent High Bay	Wide	120-277	240	Program Rapid Start	Yes	4	No	51
IBZ 654L GEB10PS90	753573163268	T5 Fluorescent High Bay	Narrow	120-277	360	Program Rapid Start	Yes	6	No	36
IBZ 654L WD GEB10PS90	753573205784	T5 Fluorescent High Bay	Wide	120-277	360	Program Rapid Start	Yes	6	No	36

## Dimensions

IBZ 4 Lamp

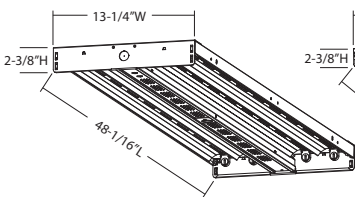

IBZ 6 Lamp

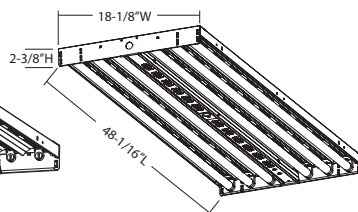

## Accessories

Catalog Number	UPC	Description
WGIBZ14	745977349157	Wireguard for 4-Lamp Fixture
WGIBZ19	745977102844	Wireguard for 6-Lamp Fixture
IBAC120 M20	745975244904	Adjustable 10' Aircraft Cable with Cabinet Hooks
IBAC240 M20	745975244911	Adjustable 20' Aircraft Cable with Cabinet Hooks
IBZACVH M100	745972937373	10' Adjustable Aircraft Cable with V-Hook





## CHD/CXD/CTL



### Features

- CHD open high bay fixture with anodized aluminum reflector is ideal for use in high mounting height (over 20') that require high efficiencies and horizontal illumination
- CXD enclosed low bay fixture with white painted aluminum reflector and prismatic acrylic lens. Designed to produce balanced vertical and horizontal illumination for mounting heights of up to 20'
- CTL HID worklight with steel safety cage for use as a temporary light source
- Each packed in convenient distributor stocking packaging including complete assembly (housing and reflector or housing and safety cage)
- Die-cast aluminum housing
- Includes steel hook with spring steel latch
- Worklight (CTL) comes standard with 6' power cord (16/3 black with twist-lock plug); pre-wired for 120V

### Ordering Information

Catalog Number	UPC	Description	Input Watts	Voltage	Ballast Type	Lamp Included	Contractor Select	Pallet Quantity
CHD400PPSL	745975116041	High Bay Fixture	452	120/208/240/277	Constant-Wattage Autotransformer	Yes	Yes	18
CXD400PPSL	745975116027	Low Bay Fixture	452	120/208/240/277	Constant-Wattage Autotransformer	Yes	Yes	12
CTL400PPSL	745975136582	Low Bay Worklight	452	120/208/240/277	Constant-Wattage Autotransformer	Yes	Yes	18

### Accessories

Catalog Number	UPC	Description
A15 U	784231015759	CHD Reflector
CXA20	745975415540	CXD Reflector
WKLTCAGE U	745977119316	Replacement Worklight Cage

### Dimensions

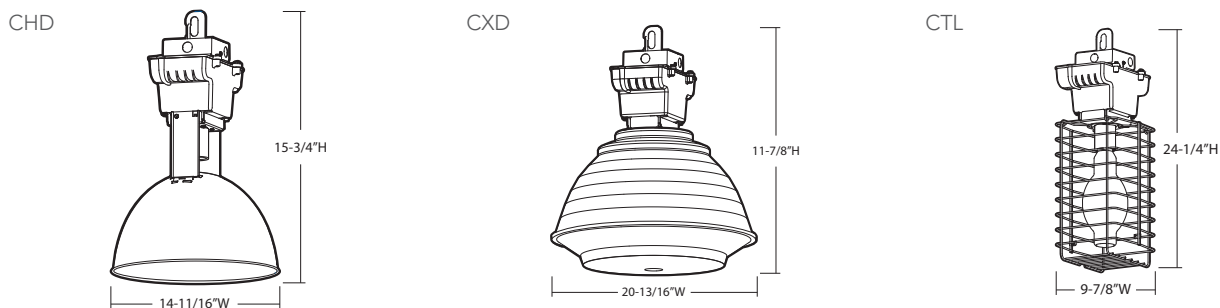

Certain airborne contaminants can diminish integrity of acrylic. See pg. 168 for Acrylic Compatibility table for suitable uses.



Features

- TH open high bay housing suitable for mounting heights over 20'
- TX enclosed low bay housing suitable for mounting heights up to 20'
- THD/TXD distributor packs include housing, reflector and lamp for a simple stocking solution
- Standard with protected "PINK" socket and O-rated lamp



Ordering Information

Catalog Number	UPC	Description	Input Watts	Voltage	Ballast Type	Lamp Included	Pallet Quantity
TH 400MP 480 SCWA HSG	745975184569	High Bay Ballast Housing	454	480	Constant-Wattage Autotransformer	No	80
TH 400MP TB SCWA HSG	745975184613	High Bay Ballast Housing	452	120/208/240/277	Constant-Wattage Autotransformer	No	80
TX 400MP TB SCWA HSG	745975200979	Ballast Housing	452	120/208/240/277	Constant-Wattage Autotransformer	No	80
THD 400MP A15 TB SCWA LPI	745975184682	Open High Bay Fixture - Distributor Pack	452	120/208/240/277	Constant-Wattage Autotransformer	Yes	8
TXD 400MP A23 TB SCWA LPI	745975184903	Enclosed High Bay Fixture - Distributor Pack	452	120/208/240/277	Constant-Wattage Autotransformer	Yes	8

Accessories

Catalog Number	UPC	Description
A16 U	784231031506	16" Aluminum Optical
PA22 U	784231032299	22" Acrylic Refractor
A23 U	784231081761	23" Aluminum Reflector with Acrylic Drop Lens
A23LD J4	784231081778	23" Aluminum Reflector (Job Pack 4)
AR23 J4	784231036785	23" Acrylic Lens Only (Job Pack 4)
AR23 U	784231062241	23" Acrylic Lens Only

Dimensions

TH A16

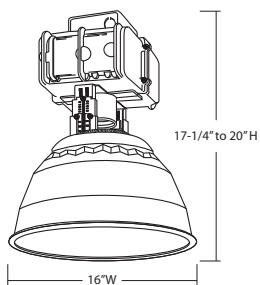

TH A22

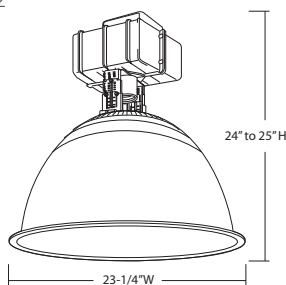

TX A23/TXD A23

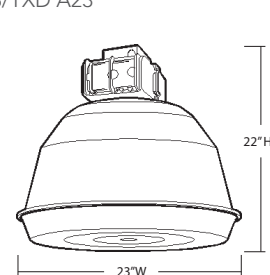

Certain airborne contaminants can diminish integrity of acrylic. See pg. 168 for Acrylic Compatibility table for suitable uses.

## DMW2



## Features

- DMW2 is ideal for applications including transit, parking garages, awnings, cold storage, food processing and environments where moisture or dust is present
- 4' performance in an easy-to-handle, 2' design
- Two-piece snap together design, stay-in-place captive latches, and simplified wire connections make installation simple
- Delivers up to 60% energy savings vs comparable fluorescent
- Designed to provide 85% lumen maintenance for at least 60,000 hours
- Flicker-free dimming to 1%
- IP65 and IP66 rated; 1500 PSI hose-down; NSF listed for splash zone II

## Ordering Information

Catalog Number	UPC	Description	Replaces Up To	Lumens	Input Watts	CCT	Voltage	Distribution	DLC	Pallet Quantity
DMW2 L24 2000LM AFL MD MVOLT GZ1 40K 80CRI	889804321548	LED Enclosed and Gasketed Luminaire	1-32T8 Lamp	2000	18	4000 K	120-277	Medium	Yes	96
DMW2 L24 2000LM AFL MD MVOLT GZ1 50K 80CRI	889804321609	LED Enclosed and Gasketed Luminaire	1-32T8 Lamp	2000	18	5000 K	120-277	Medium	Yes	96
DMW2 L24 3000LM AFL MD MVOLT GZ1 40K 80CRI	889804321562	LED Enclosed and Gasketed Luminaire	2-32T8 Lamps	3000	27	4000 K	120-277	Medium	Yes	96
DMW2 L24 3000LM AFL MD MVOLT GZ1 50K 80CRI	889804321616	LED Enclosed and Gasketed Luminaire	2-32T8 Lamps	3000	27	5000 K	120-277	Medium	Yes	96
DMW2 L24 4000LM AFL MD MVOLT GZ1 40K 80CRI	889804321586	LED Enclosed and Gasketed Luminaire	3-32T8 Lamps, 2-54T5HO Lamps	4000	40	4000 K	120-277	Medium	Yes	96
DMW2 L24 4000LM AFL MD MVOLT GZ1 50K 80CRI	889804321692	LED Enclosed and Gasketed Luminaire	3-32T8 Lamps, 2-54T5HO Lamps	4000	40	5000 K	120-277	Medium	Yes	96

## Accessories

Catalog Number	UPC	Description
DMW2WLF	784231147444	Wet Location Fitting
DMW2QMD	889804583175	Quick-mount Ceiling Bracket

## Dimensions

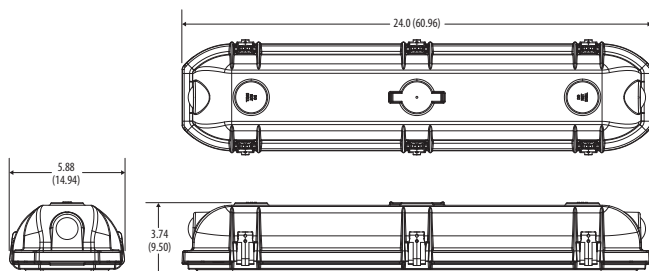

Certain airborne contaminants can diminish integrity of acrylic. See pg. 168 for Acrylic Compatibility table for suitable uses.

### Features

- DMW is ideal for harsh environments where dust, dirt, humidity or moisture is present
- Suitable for surface or suspended mounting, unit or row installation; horizontal wall mount only
- Impact-resistant, reinforced polyester fiberglass housing
- Features shatter-resistant 50% DR acrylic diffuser as standard
- Poured-in gasketing provides a continuous seal between housing and diffuser
- Captive, corrosion-resistant, cam-action latches secure the diffuser; 2 stainless steel mounting brackets included
- UL Listed for wet location, NSF Listed and IP65 rated



### Ordering Information

Catalog Number	UPC	Description	Input Watts	Voltage	Ballast Type	Lamp Included	Pallet Quantity
DMW 2 32 MVOLT GEB10IS	784231151099	Enclosed Industrial, T8	32	120-277	Instant Start	No	41
DMW 2 54T5HO MVOLT GEB10PS90	745975221059	Enclosed Industrial, T5HO	54	120-277	Rapid Start	No	41
DMW 2 96T8 MVOLT GEB10IS	784231003930	Enclosed Industrial, T8	59	120-277	Instant Start	No	28
TDMW 2 32 MVOLT 1/4 GEB10IS	784231003916	Tandem Enclosed Industrial, T8	32	120-277	Instant Start	No	28

### Accessories

Catalog Number	UPC	Description
BCD	784231088241	Bracket for Hanger Chain Mounting
DDM48 U	784231013595	4' Enclosed Fixture Replacement Lens (Unit Packed)
DDM96 U	784231016794	8' Enclosed Fixture Replacement Lens (Unit Packed)
DMW/EGW LATCH J10	745975750788	8' Enclosed Fixture Replacement Latch (Job Packed with Qty 10)
DMW/EGW LATCH J6	745975750764	4' Enclosed Fixture Replacement Latch (Job Packed with Qty 6)
DMW/VRISMB	745976558864	Surface Mount Bracket for Use with DMW

### Dimensions

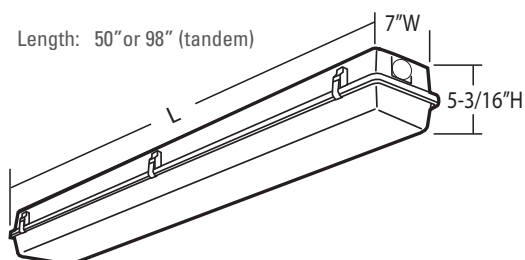

Certain airborne contaminants can diminish integrity of acrylic. See pg. 168 for Acrylic Compatibility table for suitable uses.

## XWMLED



### Features

- XWMLED is ideal for damp/wet locations such as outdoor venues, canopies and locker rooms
- Features a light gray, fully gasketed polycarbonate housing and stainless steel captive latches provide a tight seal
- Includes a UV-stabilized, high impact, clear polycarbonate lens for maximum light output and vandal resistance
- Stainless steel mounting brackets included (2) for flush mounting to a ceiling or wall (horizontally or vertically)
- UL Listed for wet locations and IP65 rated
- Ambient operation from -22°F (-30°C) to 104°F (40°C)
- Designed to provide 70% lumen maintenance for at least 50,000 hours

### Ordering Information

Catalog Number	UPC	Description	Replaces Up To	Lumens	Input Watts	CCT	Voltage	Distribution	DLC	Pallet Quantity
XWMLED	753573956365	LED Wet Location Industrial	1 - 32WT847	1800	24	4000 K	120-277	Medium	No	180

### Dimensions

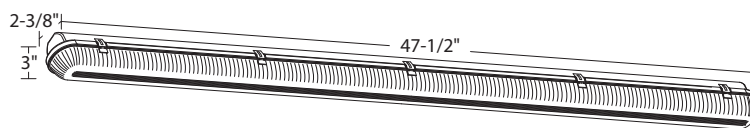

Certain airborne contaminants can diminish integrity of acrylic. See pg. 168 for Acrylic Compatibility table for suitable uses.

### Features

- XWL is ideal for applications where dirt, dust, humidity, moisture and cold temperatures are present
- Features a light gray, fully gasketed polycarbonate housing and snap-fit polycarbonate latches provide a tight seal
- Includes a UV-stabilized, impact-resistant, clear prismatic polycarbonate lens
- Designed for low to medium mounting heights
- Stainless steel mounting brackets included (2)
- UL Listed for wet locations and IP65 rated
- Ambient operation from 0°F (-18°C) to 77°F (25°C)



### Ordering Information

Catalog Number	UPC	Description	Input Watts	Voltage	Ballast Type	Lamp Included	Pallet Quantity
XWL232 MV	745975639755	Wet Location Industrial	54	120-277	Instant Start	No	63
XWL254 MV	745976008697	Wet Location Industrial	117	120-277	Program Rapid Start	No	63

### Accessories

Catalog Number	UPC	Description
DXWL48	745976866143	Wet Location Replacement Lens

### Dimensions

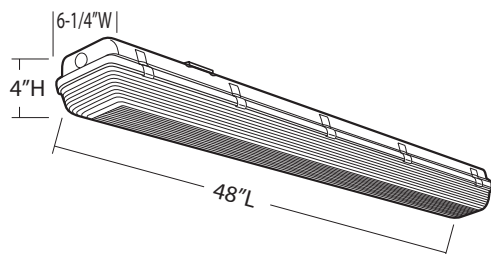



## ZL1D/ZL1N



### Features

- ZL Strips are ideal for new construction and T8 retrofit applications in commercial, retail, manufacturing warehouse and display applications
- Built on the compact, low-profile Z strip channel, this medium distribution LED strip offers long nearly maintenance-free life, several color temperatures, lumen outputs and lengths
- Fixture may be surface mounted (with or without ZSPRG hanger), pendant or stem mounted with appropriate mounting options
- Six-point aligner locks in place for easy continuous row mounting
- ZL1D drop lens provides 11% uplight to eliminate cave effect

### Ordering Information

Catalog Number	UPC	Description	Replaces Up To	Lumens	Input Watts	CCT	Voltage	DLC	Pallet Quantity
ZL1D L48 3000LM FST MVOLT 40K 80CRI WH	889804317404	4' Z Series LED Strip with Drop Lens	1-Lamp 32WT8, 1-Lamp 54WT5HO	3000	30	4000 K	120-277	No	176
ZL1D L48 5000LM FST MVOLT 40K 80CRI WH	889804065909	4' Z Series LED Strip with Drop Lens	2-Lamp 32WT8, 1-Lamp 54WT5HO	5000	38	4000 K	120-277	No	176
ZL1D L48 7000LM FST MVOLT 40K 80CRI WH	889804065893	4' Z Series LED Strip with Drop Lens	3-Lamp 32WT8, 2-Lamp 54WT5HO	7000	70	4000 K	120-277	No	176
ZL1N L48 3000LM FST MVOLT 40K 80CRI WH	820476797576	4' Z Series LED Strip with Frosted Lens	1-Lamp 32WT8, 1-Lamp 54WT5HO	3000	30	4000 K	120-277	Yes	176
ZL1N L48 5000LM FST MVOLT 40K 80CRI WH	820476800931	4' Z Series LED Strip with Frosted Lens	2-Lamp 32WT8, 1-Lamp 54WT5HO	5000	38	4000 K	120-277	Yes	176
ZL1N L48 7000LM FST MVOLT 40K 80CRI WH	820476805196	4' Z Series LED Strip with Frosted Lens	3-Lamp 32WT8, 2-Lamp 54WT5HO	7000	70	4000 K	120-277	Yes	176
TZL1D L96 6000LM FST MVOLT 40K 80CRI WH	889804317442	8' Z Series LED Strip with Drop Lens	3-Lamp 32WT8, 2-Lamp 54WT5HO	6000	59	4000 K	120-277	No	176
TZL1D L96 10000LM FST MVOLT 40K 80CRI WH	889804065916	8' Z Series LED Strip with Drop Lens	4-Lamp 32WT8, 2-Lamp 54WT5HO	10000	75	4000 K	120-277	No	176
TZL1D L96 14000LM FST MVOLT 40K 80CRI WH	889804065923	8' Z Series LED Strip with Drop Lens	4-Lamp 32WT8, 3-Lamp 54WT5HO	14000	139	4000 K	120-277	No	176
TZL1N L96 6000LM FST MVOLT 40K 80CRI WH	820476834424	8' Z Series LED Strip with Frosted Lens	3-Lamp 32WT8, 2-Lamp 54WT5HO	6000	59	4000 K	120-277	Yes	176
TZL1N L96 10000LM FST MVOLT 40K 80CRI WH	820476833953	8' Z Series LED Strip with Frosted Lens	4-Lamp 32WT8, 2-Lamp 54WT5HO	10000	75	4000 K	120-277	Yes	176
TZL1N L96 14000LM FST MVOLT 40K 80CRI WH	820476814693	8' Z Series LED Strip with Frosted Lens	4-Lamp 32WT8, 3-Lamp 54WT5HO	14000	139	4000 K	120-277	Yes	176

### Dimensions

#### ZL1D L48

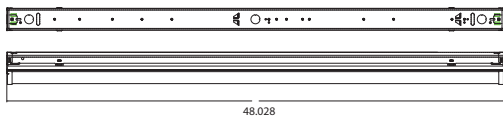

### Accessories

Catalog Number	UPC	Description
ZLANGBKT	889804292640	Angle Bracket for Use with ZL Series







## MNSL



### Features

- MNSL is ideal for task lighting, restrooms, under/over cabinet and storage closets; suitable for tight spaces
- Features low glare diffuse lens and snap-lock tool-less channel for quick and easy installation
- Surface mounting on ceiling or wall (horizontal or vertical); not designed for continuous row mounting
- Suitable for dry locations

### Ordering Information

Catalog Number	UPC	Description	Replaces Up To	Lumens	Input Watts	CCT	Voltage	Distribution	DLC	Pallet Quantity
MNSL MV M6	753573945437	Mini LED Strip Light	1 - 32WT8	2100	24	4000 K	120-277	Medium	No	504

### Accessories

Catalog Number	UPC	Description
HC36 M12	784231021828	Chain Hangers (1 Pair, 36" Long)

### Dimensions

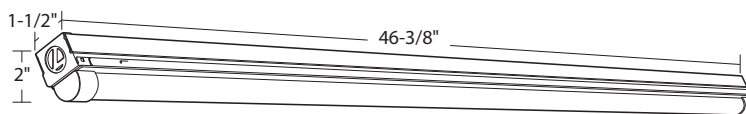

### Features

- Z strips are ideal for commercial, retail, manufacturing, warehouse, and cove and display applications
- Secure-fit design of the patent-pending channel cover allows for easy access and quick attachment
- Patent-pending “three point” row aligner locks channel together for straighter, faster row assembly without fasteners
- Pre-loaded sockets improves speed of installation and reduces potential socket breakage
- Compact “gripper back” channel offers structural strength and reduces shipping damage
- Easy “snap n’ lock” end plates allow for quick attachment and exact fit
- Improved “locking track” lamp holder enhances channel strength and lamp stability
- Damp location listed



### Ordering Information

Catalog Number	UPC	Description	Input Watts	Voltage	Ballast Type	Lamp Included	# of Lamps	Contractor Select	Pallet Quantity
Z232 MV	745976682941	T8 Low-Profile Strip	58	120-277	Instant Start	No	2	Yes	224
TZ232 MV	745976682989	Tandem, T8 Low-Profile Strip	112	120-277	Instant Start	No	2	Yes	224
Z 1 32 MVOLT GEB10IS	745975499182	T8 Low-Profile Strip	29	120-277	Instant Start	No	2	No	224
Z 2 32 MVOLT GEB10IS	745975500680	T8 Low-Profile Strip	28	120-277	Instant Start	No	2	No	224
Z 2 54T5HO MVOLT GEB10PS	745975499304	T5 Low-Profile Strip	120	120-277	Program Start	No	2	No	224
TZ 2 32 MVOLT 1/4 GEB10IS	745975500772	Tandem, T8 Low-Profile Strip	112	120-277	Instant Start	No	2	No	224
TZ 2 54T5HO MVOLT 1/4 GEB10PS	745975809233	Tandem, T5 Low-Profile Strip	240	120-277	Program Start	No	2	No	224

### Dimensions

1 lamp

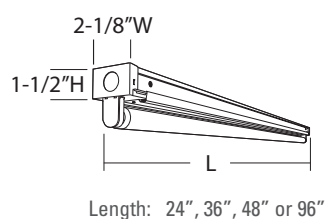

2 lamp

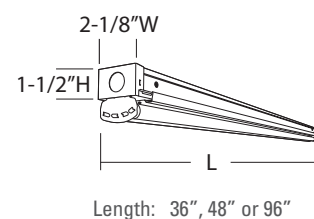

### Accessories

Catalog Number	UPC	Description
WGZ48	745975629633	48" Base Wireguard, White
ZAC72	784231967355	72" Aircraft Cable with Canopy
ZAC120	784231967317	120" Aircraft Cable with Canopy
ZAC144	784231939659	144" Aircraft Cable with Canopy
ZACF72	784231967379	72" Aircraft Cable with Feed and Canopy
ZACF120	784231967331	120" Aircraft Cable with Feed and Canopy
ZACF144	784231939666	144" Aircraft Cable with Feed and Canopy

## C



## Features

- C Strips are ideal for applications such as retail, commercial and light industrial
- Wide-body construction, die-formed from code-gauge steel with white enamel finish
- Sturdy channel cover secured by captive quarter-turn latch for easy access to wireway
- End plate used for continuous row installation applications
- Ideal for surface or suspended mounting
- Damp location listed

## Ordering Information

Catalog Number	UPC	Description	Input Watts	Voltage	Ballast Type	Lamp Included	Contractor Select	Pallet Quantity
C232 MV	745975079711	T8 General Purpose Strip	50/50	120-277	Instant Start	No	Yes	99
C296T8 MV	745977076145	T8 General Purpose Strip	112	120-277	Instant Start	No	Yes	99
TC232 MV	745975080809	Tandem, T8 General Purpose Strip	97/97	120-277	Instant Start	No	Yes	99
C 1 32 MVOLT GEB10IS	745977592621	T8 General Purpose Strip	29	120-277	Instant Start	No	No	99
C 2 32 120 RE	784231170830	T8 General Purpose Strip	56	120	Residential Instant Start	No	No	99
C 2 32 MVOLT GEB10IS	784231151082	T8 General Purpose Strip	58	120-277	Instant Start	No	No	99
C 2 96T8 MVOLT GEB10IS	784231163993	T8 General Purpose Strip	112	120-277	Instant Start	No	No	99
TC 2 32 MVOLT 1/4 GEB10IS	784231159248	Tandem, T8 General Purpose Strip	112	120-277	Instant Start	No	No	99

## Accessories

Catalog Number	UPC	Description
HRC	745978395986	Hanger for Use with C Strip
WGCUN NST	745974439240	48" Base Wireguard, White

## Dimensions

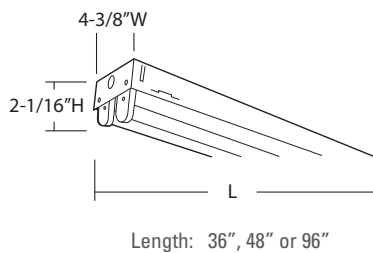



## Features

- L Strips are ideal for applications such as retail, light industrial and warehouses
- Die-formed from code-gauge steel with white enamel finish and 12" wide solid top reflector
- End plate used for continuous row installation applications
- For surface or suspended mounting at heights up to 16'
- Damp location listed



## Ordering Information

Catalog Number	UPC	Description	Input Watts	Voltage	Ballast Type	Lamp Included	Contractor Select	Pallet Quantity
L232 MV	745975276394	T8 General Purpose Industrial	50/50	120-277	Instant Start	No	Yes	51
TL232 MV	745975276387	Tandem, T8 General Purpose Industrial	97/97	120-277	Instant Start	No	Yes	51
L 2 32 MVOLT GEB10IS	784231159255	T8 Industrial, Solid Top	58	120-277	Instant Start	No	No	51
TL 2 32 MVOLT 1/4 GEB10IS	784231159378	Tandem, T8 Industrial, Solid Top	112	120-277	Instant Start	No	No	51
LA 2 32 MVOLT GEB10IS	784231176153	T8 Industrial, Apertured Reflector	58	120-277	Instant Start	No	No	51
TLA 2 32 MVOLT 1/4 GEB10IS	784231176221	Tandem, T8 Industrial, Apertured Reflector	112	120-277	Instant Start	No	No	51

## Accessories

Catalog Number	UPC	Description
WGL	784231023778	48" Base Wireguard, White (Order 2 For 8')

## Dimensions

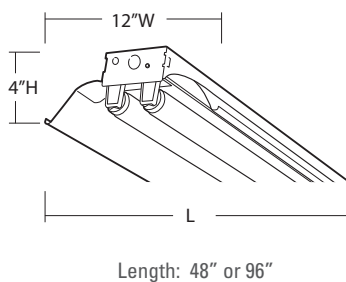

# EMERGENCY







<b>96</b>	Quantum® Emergency Exits
<b>97</b>	Quantum® LED Emergency Combos
<b>98</b>	Quantum® LED Emergency Lighting Units
<b>100</b>	Exits and LED Emergency Lighting Units
<b>101</b>	LED Emergency Combos
<b>102</b>	Architectural Exits and Emergency Lighting Units
<b>103</b>	Emergency Batteries
<b>104</b>	Emergency Remotes

## LQM



## Features

- Quantum® LQM sets a new standard for applications requiring attractive, quick-installation exit signs with low energy consumption and goes well beyond simply “meeting code”
- Precision-molded, white thermoplastic housing is impact- and scratch-resistant, corrosion-proof and UV-stabilized to resist discoloration
- Innovative, snap-together design allows installation in less than three minutes
- Typical LED life of up to 10 years
- Conveniently located test switch and status indicator provide visual and manual means of monitoring system operation for emergency models only
- Automatic recharge after battery discharge
- Emergency models include maintenance-free, sealed nickel cadmium battery that provides 90 minutes of emergency power

## Ordering Information

Catalog Number	UPC	Description	Input Watts	Voltage	Battery Included	Pallet Quantity
LQM S W 3 R 120/277 M6	784231011508	LED Exit, Red, AC Only	1	120/277	No	270
LQM S W 3 G 120/277 M6	784231011584	LED Exit, Green, AC Only	1	120/277	No	270
LQM S W 3 R 120/277 EL N M6	784231011553	LED Exit, Red, Battery Backup	1	120/277	Yes	270
LQM S W 3 G 120/277 EL N M6	784231011614	LED Exit, Green, Battery Backup	1	120/277	Yes	270
LQM S W 3 R 120/277 EL N SD M6	745974522164	LED Exit, Red, Battery Backup and Self-Diagnostics	1	120/277	Yes	270

## Accessories

Catalog Number	UPC	Description
ELA WGEXT	745975918218	Wireguard (Top Mount), 11"H x 14"W x 6-3/4"D
ELA WG1	745976304652	Wireguard (Back Mount), 13-1/2"H x 15"W x 6"D
ELA WGEXE	745976154530	Wireguard (End Mount), 11"H x 15"W x 4-3/4"D

## Dimensions



Features

- Quantum® Combos set new standards for applications requiring both exit sign and emergency lighting unit equipment and goes well beyond simply “meeting code”
- Precision-molded, white thermoplastic housing is impact and scratch-resistant, corrosion-proof and UV-stabilized to resist discoloration
- Features two LED lamp heads with 12 parallel white LEDs in each; typical LED life of up to 10 years
- Fully assembled single-face exit with optional extra faceplate for easy field conversion to double face
- Sealed, maintenance-free nickel cadmium battery delivers 90 minute capacity to emergency lamps
- Quick-Mount® snap-together construction permits installation in less than three minutes
- HO models are compatible with 9.6V LED remotes



Ordering Information

Catalog Number	UPC	Description	Lamp Source	Input Watts	Voltage	Pallet Quantity
LHQM LED R M6	745976254438	LED Combo, Red, Battery Back-up	LED	3	120/277	96
LHQM LED G M6	745976253950	LED Combo, Green, Battery Back-up	LED	3	120/277	96
LHQM LED R HO M6	745976254322	LED Combo, Red, High Output Battery Back-up	LED	3	120/277	96
LHQM LED G HO M6	745976254469	LED Combo, Green, High Output Battery Back-up	LED	3	120/277	96

Accessories

Catalog Number	UPC	Description
ELA LQMUS12	745975847785	12" Brushed Aluminum Stem Kit
ELA WG2M	784231095409	Wireguard, 15"H x 21-1/4"W x 12"D
ELA WG3	745976304669	Wireguard (Back Mount), 13-1/2"H x 30"W x 6"D

Dimensions

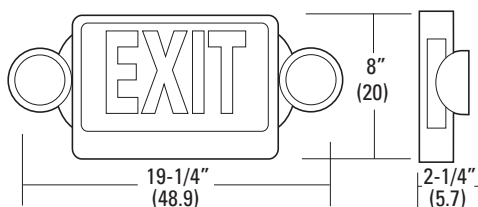



# ELMLT



## Features

- Quantum® ELMLT sets a new standard in emergency illumination for applications where building-occupant safety is a top priority and goes well beyond simply “meeting code”
- Ceiling- or wall-mount
- Suitable for mounting heights from 7.5’ to 20’ and fixture spacing up to 66’
- Delivers constant light output throughout discharge period
- With a life of 10 years or 2,000 cycles, the high-performance lithium iron phosphate battery reduces maintenance compared to traditional battery types
- Simple test switch and LED status indicator lights
- Improved lamp head adjustments for ease of setup

## Ordering Information

Catalog Number	UPC	Description	Lamp Source	Input Watts	Voltage	Pallet Quantity
ELMLTWLP06VS LTP	820476831782	LED Emergency Lighting Unit	LED	16.2	120-277	216

## Accessories

Catalog Number	UPC	Description
ELA WG1	745976304652	Wireguard (Back Mount), 13-1/2"H x 15"W x 6"D
ELA LRT	745980861295	Remote Test Laser
ELAVS	784231176085	Thermoplastic Vandal Shield

## Dimensions

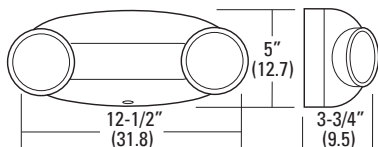

Features

- Quantum® premium LED emergency lighting unit sets a new standard in emergency illumination for applications where building-occupant safety is a top priority and goes well beyond simply “meeting code”
- Ceiling- or wall-mount
- The ELM2 LED is suitable for mounting heights of 7.5’ and up to 25’ fixture spacing
- The ELM6 LED features a linear light distribution which maximizes uniformity and fixture-to-fixture spacings allowing for mounting heights from 7.5’ to 12’ and up to 50’ fixture spacing
- Precision-molded, white thermoplastic housing is impact- and scratch-resistant, corrosion-proof and UV-stabilized to resist discoloration
- Remote capability with certain options



Ordering Information

Catalog Number	UPC	Description	Lamp Source	Input Watts	Voltage	Pallet Quantity
ELM2 LED M12	745975223992	LED Emergency Lighting Unit, Ni-cad Battery	LED	1	120/277	288
ELM2 LED HO M12	745975850259	LED Emergency Lighting Unit, High Output Ni-cad Battery	LED	1	120/277	288
ELM6 LED W LP03VS	889804002416	LED Emergency Lighting Unit, Lead Calcium Battery	LED	1	120/277	330

Accessories

Catalog Number	UPC	Description
ELA WG1	745976304652	Wireguard (Back Mount), 13-1/2”H x 15”W x 6”D

Dimensions

ELM2 LED

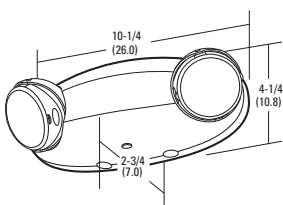

ELM6 LED

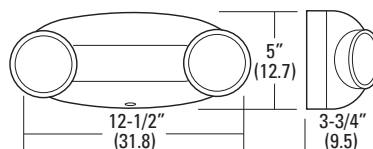

## EXR LED/EXG LED



### Features

- Ideal for applications requiring general-purpose emergency exit signage
- Sealed, maintenance-free Nickel cadmium (Ni-cad) battery provides 90 minutes of emergency power
- The typical life of the LED lamp is 10 years
- High-impact, white thermoplastic housing for general purpose applications
- Single-face with extra faceplate for field conversion to double-face

### Ordering Information

Catalog Number	UPC	Description	Lamp Source	Input Watts	Voltage	Battery Included	Contractor Select	Pallet Quantity
EXR LED M6	784231874684	LED Exit, Red, AC Only	LED	0.8	120/277	No	Yes	360
EXG LED M6	784231874806	LED Exit, Green, AC Only	LED	0.8	120/277	No	Yes	360
EXR LED EL M6	784231874738	LED Exit, Red, Battery Back-up	LED	0.8	120/277	Yes	Yes	360
EXG LED EL M6	784231874851	LED Exit, Green, Battery Back-up	LED	0.8	120/277	Yes	Yes	360

### Dimensions

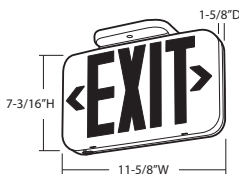

### Accessories

Catalog Number	UPC	Description
ELA WGEXE	745976154530	Wireguard (End Mount), 11\"/>
ELA WG1	745976304652	Wireguard (Back Mount), 13-1/2\"/>

## EU2 LED



### Features

- Ideal for applications requiring general-purpose emergency lighting
- High-impact, white thermoplastic housing with long-lasting, efficient, ultra-bright, white LED lamp heads
- Lamp head track and swivel arrangement allows for full range of lamp adjustment
- Long-life Nickel cadmium (Ni-cad) battery provides 90 minutes of emergency power

### Ordering Information

Catalog Number	UPC	Description	Lamp Source	Input Watts	Voltage	Contractor Select	Pallet Quantity
EU2 LED M12	784231874493	LED Emergency Lighting Unit	LED	1.8	120/277	Yes	324

### Dimensions

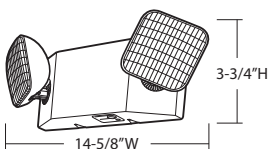

### Accessories

Catalog Number	UPC	Description
ELA WG1	745976304652	Wireguard (Back Mount), 13-1/2\"/>

Features

- Ideal for applications requiring both exit sign and unit equipment
- High-impact, white thermoplastic exit/unit combo with long-lasting, efficient, ultra-bright, white LED lamp heads
- Single-face with extra faceplate for field conversion to double-face
- Long-life Nickel cadmium (Ni-cad) battery provides 90 minutes of emergency lighting
- HO high output option available to power 9.6V LED remote heads



Ordering Information

Catalog Number	UPC	Description	Lamp Source	Input Watts	Voltage	Contractor Select	Pallet Quantity
ECR LED M6	784231874516	LED Combo, Red, Battery Back-up	LED	3.2	120/277	Yes	108
ECG LED M6	784231874592	LED Combo, Green, Battery Back-up	LED	3.2	120/277	Yes	108
ECR LED HO M6	784231874561	LED Combo, Red, High Output Battery Back-up	LED	3.8	120/277	Yes	108
ECG LED HO M6	784231874615	LED Combo, Green, High Output Battery Back-up	LED	3.8	120/277	Yes	108

Dimensions



Accessories

Catalog Number	UPC	Description
ELA WG3	745976304669	Wireguard (Back Mount), 13-1/2\"/>

ECBR/ECBG

Features

- Ideal replacement for traditional exit/unit combo's for applications where a modern, sleeker look is desired
- Single-face with extra faceplate for field conversion to double-face
- Long-life Nickel cadmium (Ni-cad) battery provides 90 minutes of emergency lighting
- LED integrated emergency light bar swivels to allow full range of light adjustment



Ordering Information

Catalog Number	UPC	Description	Lamp Source	Input Watts	Voltage	Contractor Select	Pallet Quantity
ECBR LED M6	784231874912	Integrated LED Light Bar, Red, Battery Back-up	LED	2.32	120/277	Yes	360
ECBG LED M6	784231874943	Integrated LED Light Bar, Green, Battery Back-up	LED	2.32	120/277	Yes	360

Dimensions

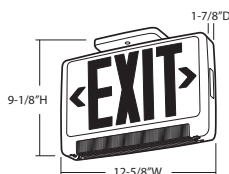

Accessories

Catalog Number	UPC	Description
ELA WG1	745976304652	Wireguard (back mount), 13-1/2\"/>

## EDG/EDGR

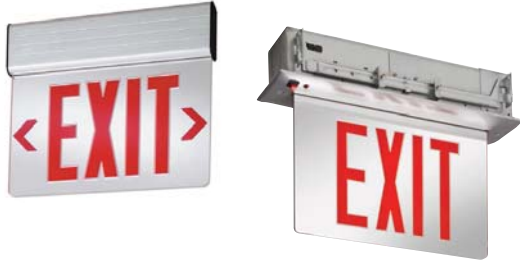

### Features

- Suitable for applications requiring attractive edge-lit exit signage, universal installation and low energy consumption
- Universal directional indicators. Field selected and attached
- Brushed aluminum finish housing
- Sealed, maintenance-free Nickel cadmium (Ni-cad) battery delivers 90-minutes capacity to emergency lamps
- Typical life of the exit LED lamp is 10 years

### Ordering Information

Catalog Number	UPC	Description	Input Watts	Voltage	Battery Included	Pallet Quantity
EDG 1 R EL M6	745974508250	LED Exit, Surface-Mount, Single Face, Red with Battery Backup	3	120/277	Yes	144
EDG 1 G EL M6	745974508281	LED Exit, Surface-Mount, Single Face, Green with Battery Backup	2.6	120/277	Yes	144
EDGR 1 R EL M4	745975264971	LED Exit, Recessed-Mount, Single Face, Red with Battery Backup	3	120/277	Yes	64
EDGR 1 G EL M4	745975265046	LED Exit, Recessed-Mount, Single Face, Green with Battery Backup	2.6	120/277	Yes	64

### Dimensions

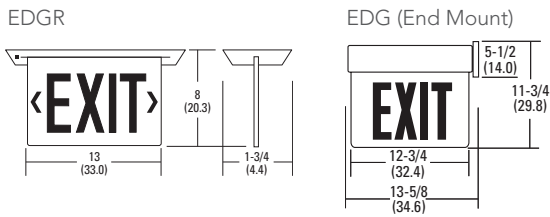

### Accessories

Catalog Number	UPC	Description
ELA US12	784231000519	12" Brushed Aluminum Stem Kit
ELA W US12	784231000526	12" White Stem Kit

## AFN



### Features

- Affinity® premium emergency lighting unit is ideal for applications requiring attractive emergency lighting unit equipment
- Wet location listed for outdoor use
- Compact, low-profile architectural design
- Provide a minimum of 90 minutes illumination for the rated wattage upon loss of AC power
- Maintenance-free lead acid (SLA) or Nickel cadmium (Ni-cad) battery (EXT)

### Ordering Information

Catalog Number	UPC	Description	Light Source	Input Watts	Voltage	Battery Type	Pallet Quantity
AFN DB EXT	745974403708	Architectural Emergency Lighting Unit, Dark Bronze	Xenon	21 (120V)	120/277	High-temperature Ni-cad with battery heater	108
AFN W	745975255696	Architectural Emergency Lighting Unit, White	Xenon	1.1 (120V)	120/277	Lead Acid (SLA)	216

### Dimensions

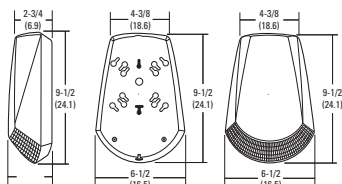

### Accessories

Catalog Number	UPC	Description
ELAFNR DB	745975497768	Affinity Remote Fixture, Dark Bronze



Features

- Emergency ballast for operation of fluorescent fixture upon AC power loss.
- Sealed maintenance-free Nickel cadmium (Ni-cad) battery
- Provides 90 minutes of emergency back-up



Ordering Information

Catalog Number	UPC	Description	Supply Voltage	Input Watts Based on 120V	Lumen Output	Pallet Quantity
PS1400QD MVOLT M8	820476729898	Linear Fluorescent, 1400 Lumen Output	120-277	3.3	1400	416
PSQ500QD MVOLT M12	820476730016	Linear Fluorescent, 500 Lumen Output	120-277	2.5	500	576
PS600QD MVOLT M12	820476729973	Linear Fluorescent, 600 Lumen Output	120-277	2.2	600	576
PS1030 M12	888791760033	LED, 10W @ 30VDC Output	120-277	10	1350	480
PS1050 M12	888791760071	LED, 10W @ 50VDC Output	120-277	10	1350	480
PSDL3 M6	784231103210	Four-pin, Compact Fluorescent, 9-24W	120/277	3	580-3200	180

Accessories

Catalog Number	UPC	Description
ELATSPLP	784231154694	Test Switch/Pilot Light

# ELA



ELA LT24 (single)



ELA LT24 (twin)



ELA Q (single)



ELA T Q (twin)



## Features

- To be powered by Quantum® LED series unit or combo with high-output option as part of an emergency lighting system providing light for the path of egress
- Fully adjustable lamp heads meet all aiming requirements
- Constructed of strong, UV-stabilized thermoplastic that resists discoloration
- Lamp housing snaps off for easy lamp replacement
- Single, twin and weather-proof remote lamps available
- Includes 12 white LEDs per lamp head (ELA Q LED remotes only - L0304 & L0309)
- ELA Q is damp location listed from 50°F to 104°F
- ELA QWP is wet location listed from 14°F to 122°F

## Ordering Information

Catalog Number	UPC	Description	Lamp Source	Lamp Wattage	Voltage	Pallet Quantity
ELA W SGL LT24 LP03VS	889804360448	LED Remote Single Head, White, 3W	LED	2.3	6, 9.6, 12	264
ELA W SGL LT24 LP06VS	820476780684	LED Remote Single Head, White, 6W	LED	5.4	6, 9.6, 12	264
ELA W T LT24 LP06VS	888791041460	LED Remote Twin Head, White, 12W	LED	5.4	6, 9.6, 12	264
ELA Q L0304 M12	745975850280	LED Remote Single Head, White, 1.5W 3.6V	LED	1.5	3.6	432
ELAT Q L0304 M12	745975851393	LED Remote Twin Head, White, 3W 3.6V	LED	1.5	3.6	384
ELAT QWP L0304 M12	745976253844	LED Remote Twin Head, Gray, Weather-Proof, 3W 3.6V	LED	1.5	3.6	384
ELA Q L0309 M12	745972706931	LED Remote Single Head, White, 1.5W 9.6V	LED	1.5	9.6	432
ELAT QWP L0309 M12	745972707297	LED Remote Twin Head, Gray, Weather-Proof, 3W 9.6V	LED	1.5	9.6	192

## Dimensions

ELA SGL LT24

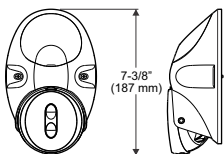

ELA T LT24

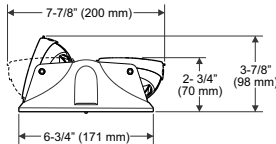

ELA T Q

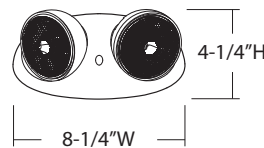

ELA Q

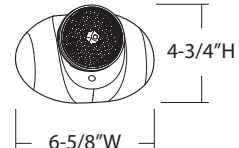

Features

- To be powered by 9.6V battery equipment as part of an emergency lighting system providing light for the path of egress
- Fully adjustable lamp heads meet all aiming requirements
- Lamp housing snaps off for easy lamp replacement



Ordering Information

Catalog Number	UPC	Description	Lamp Source	Lamp Wattage	Voltage	Pallet Quantity
ELA LED M12	784231918326	LED Remote Single Head, 1W 9.6V	LED	1	9.6	432
ELA LED T M12	784231918357	LED Remote Twin Head, 2W 9.6V	LED	1	9.6	288
ELA LED TWP M12	784231918449	LED Remote Twin Head, Weather-Proof, 2W 9.6V	LED	1	9.6	192
ELA LED WP M12	784231918418	LED Remote Single Head, Weather-Proof, 1W 9.6V	LED	1	9.6	432

Dimensions

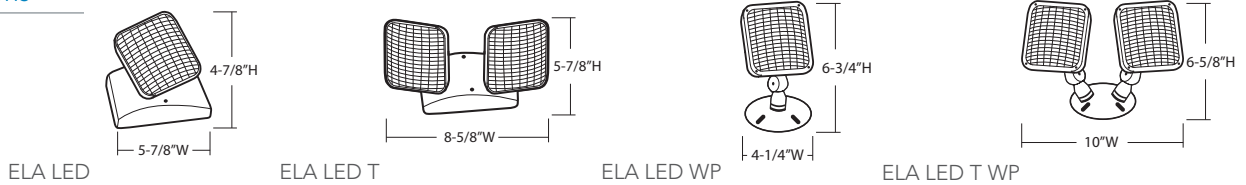

ELA NX

Features

- To be powered by 6V battery equipment as part of an emergency lighting system providing light for the path of egress
- Fully adjustable lamp heads meet all aiming requirements
- Lamp housing snaps off for easy lamp replacement
- ELA NX designed for damp and wet location applications



Ordering Information

Catalog Number	UPC	Description	Lamp Source	Input Watts	Voltage	Pallet Quantity
ELA NX H0606	784231006788	Sealed and Gasketed Single Remote Head, 6W 6V Halogen	Halogen	6	6	180
ELA NX H0806	784231006719	Sealed and Gasketed Single Remote Head, 8W 6V Halogen	Halogen	6	6	96
ELA NX N0806	784231006542	Sealed and Gasketed Single Remote Head, 8W 6V Incandescent	Incandescent	6	6	180

Dimensions

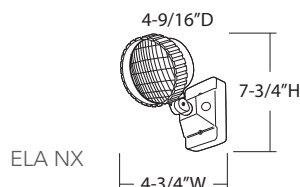

**OUTDOOR**





- 108** | Wall Mounted
- 122** | FloodLights
- 130** | Area Luminaires
- 132** | Canopy / Garage Luminaires
- 134** | Security Lighting Luminaires
- 141** | Motion Sensors



## TWH/TWP LED



### Features

- Ideal for outdoor storage areas, warehouse and factory perimeters and loading docks
- Typical energy savings of 77% over metal halide
- High performance optics deliver exceptional light uniformity
- Expected service life of 20+ years
- Features individual LED optics to deliver more lumens to the target area
- Choice of cast/glass (TWH) or vandal-resistant polycarbonate (TWP) front cover
- Maintains 87% of light output for at least 100,000 hours of service

### Ordering Information

Catalog Number	UPC	Description	Replaces Up To	Lumens	Input Watts	CCT	Voltage	Finish	Photocell Included	DLC	Pallet Quantity
TWH LED 10C 40K	889804427707	LED Wall Pack, Glass Lens	175W-250W MH	3300	39	4000 K	120-277	Dark Bronze	No	Yes	30
TWH LED 10C 50K	753573896999	LED Wall Pack, Glass Lens	175W-250W MH	3400	39	5000 K	120-277	Dark Bronze	No	Yes	30
TWH LED 20C 40K	889804427776	LED Wall Pack, Glass Lens	400W MH	6900	72	4000 K	120-277	Dark Bronze	No	Yes	30
TWH LED 20C 50K	753573897026	LED Wall Pack, Glass Lens	400W MH	7000	72	5000 K	120-277	Dark Bronze	No	Yes	30
TWH LED 30C 40K	889804427813	LED Wall Pack, Glass Lens	400W MH equivalent	8300	104	4000 K	120-277	Dark Bronze	No	Yes	30
TWH LED 30C 50K	753573897033	LED Wall Pack, Glass Lens	400W MH equivalent	8400	104	5000 K	120-277	Dark Bronze	No	Yes	30
TWP LED 10C 40K	889804427837	LED Wall Pack, Polycarbonate Lens	100W MH	2100	26	4000 K	120-277	Dark Bronze	No	Yes	30
TWP LED 10C 50K	753573897040	LED Wall Pack, Polycarbonate Lens	100W MH	2100	26	5000 K	120-277	Dark Bronze	No	Yes	30
TWP LED 20C 40K	889804427875	LED Wall Pack, Polycarbonate Lens	175W MH	4200	45	4000 K	120-277	Dark Bronze	No	Yes	30
TWP LED 20C 50K	753573897071	LED Wall Pack, Polycarbonate Lens	175W MH	4200	45	5000 K	120-277	Dark Bronze	No	Yes	30
TWP LED 30C 40K	889804427882	LED Wall Pack, Polycarbonate Lens	250W MH	5100	67	4000 K	120-277	Dark Bronze	No	Yes	30
TWP LED 30C 50K	753573897118	LED Wall Pack, Polycarbonate Lens	250W MH	5200	67	5000 K	120-277	Dark Bronze	No	Yes	30

### Accessories

Catalog Number	UPC	Description
TWHVG U	784231037324	Vandal Guard
TWHWG U	784231174135	Wire Guard

### Dimensions

TWH LED

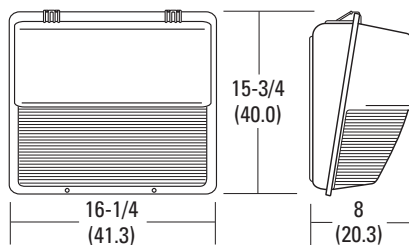

TWP LED

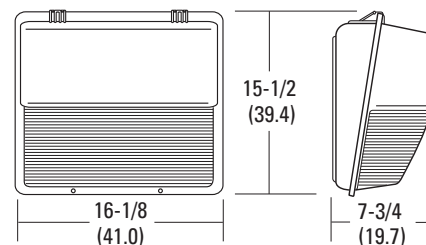

Features

- Ideal for outdoor storage areas, warehouse and factory perimeters and loading docks
- Rugged, die-cast aluminum housing
- Choice of cast/glass (TWH) or vandal-resistant polycarbonate (TWP) front cover
- Corrosion-resistant captive external hardware includes slotted hex-head fasteners
- EISA compliant



Ordering Information

Catalog Number	UPC	Description	Lamp Source	Input Watts	Voltage	Finish	Lamp Included	Pallet Quantity
TWH 250M TB SCWA LPI	745975201792	HID Wall Pack, Glass Lens	Metal Halide	291	120/208/240/277	Dark Bronze	Yes	30
TWH 400M TB SCWA LPI	745975201815	HID Wall Pack, Glass Lens	Metal Halide	452	120/208/240/277	Dark Bronze	Yes	30
TWP 150M TB LPI	745975125180	HID Wall Pack, Polycarbonate Lens	Metal Halide	185	120/208/240/277	Dark Bronze	Yes	30
TWP 150S TB LPI	784231034903	HID Wall Pack, Polycarbonate Lens	High Pressure Sodium	190	120/208/240/277	Dark Bronze	Yes	30

Accessories

Catalog Number	UPC	Description
TWHVG U	784231037324	Vandal Guard
TWHWG U	784231174135	Wire Guard

Dimensions

TWH

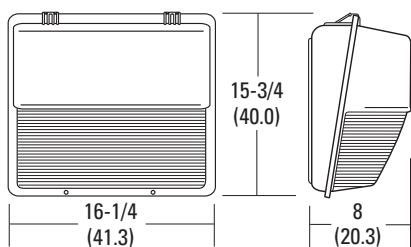

TWP

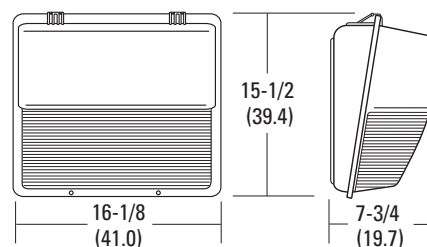

## TWR1 LED/TWR2 LED



### Features

- Ideal for outdoor security and perimeter lighting in commercial applications
- Featuring a classic dayform, the TWR LED offers a traditional appearance and is powered by advanced LEDs
- Typical energy savings of 77% over metal halide
- Mounts to recessed junction box or surface wiring via conduit entry points
- Maintains 87% of light output for at least 100,000 hours of service

### Ordering Information

Catalog Number	UPC	Description	Replaces Up To	Lumens	Input Watts	CCT	Voltage	Finish	Photocell Included	DLC	Pallet Quantity
TWR1 LED 1 40K MVOLT M2	820476256783	LED Wall Pack, Glass Lens	175W MH	2100	33	4000 K	120-277	Dark Bronze	No	Yes	36
TWR1 LED 1 50K MVOLT M2	753573833512	LED Wall Pack, Glass Lens	175W MH	2100	35	5000 K	120-277	Dark Bronze	No	Yes	60
TWR1 LED 1 50K MVOLT PE M2	820476256820	LED Wall Pack, Glass Lens	175W MH	2100	35	5000 K	120-277	Dark Bronze	Yes	Yes	36
TWR1 LED 2 40K MVOLT M2	820476256790	LED Wall Pack, Glass Lens	250W MH	3500	39	4000 K	120-277	Dark Bronze	No	Yes	36
TWR1 LED 2 50K MVOLT M2	753573833529	LED Wall Pack, Glass Lens	250W MH	3500	41	5000 K	120-277	Dark Bronze	No	Yes	60
TWR1 LED 2 50K MVOLT PE M2	820476368738	LED Wall Pack, Glass Lens	250W MH	3500	41	5000 K	120-277	Dark Bronze	Yes	Yes	36
TWR1 LED 3 40K MVOLT M2	820476256806	LED Wall Pack, Glass Lens	320W MH	4900	55	4000 K	120-277	Dark Bronze	No	Yes	36
TWR1 LED 3 50K MVOLT M2	753573833550	LED Wall Pack, Glass Lens	320W MH	4900	59	5000 K	120-277	Dark Bronze	No	Yes	60
TWR1 LED 3 50K MVOLT PE M2	820476368745	LED Wall Pack, Glass Lens	320W MH	4900	59	5000 K	120-277	Dark Bronze	Yes	Yes	36
TWR2 LED 1 50K MVOLT DDB	753573833574	LED Wall Pack, Glass Lens	400W MH	6900	79	5000 K	120-277	Dark Bronze	No	No	32

### Accessories

Catalog Number	UPC	Description
TWR1WG U	784231161906	TWR1 Wire Guard
TWR2WG U	784231161913	TWR2 Wire Guard

### Dimensions

TWR1 LED

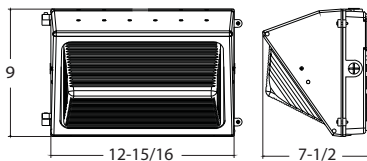

TWR2 LED

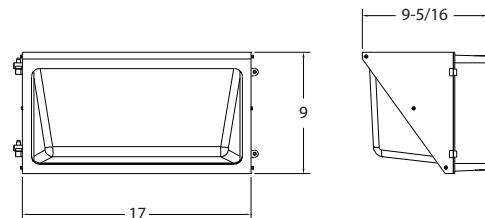

Features

- Ideal for outdoor security and perimeter lighting in commercial applications
- Rugged, corrosion-resistant, die-cast aluminum back housing and hinged door frame
- Castings are sealed with a one-piece gasket to prevent contamination
- Mounts to recessed junction box or surface wiring via conduit entry points
- EISA compliant



Ordering Information

Catalog Number	UPC	Description	Lamp Source	Input Watts	Voltage	Finish	Lamp Included	Pallet Quantity
TWR1 150M TB LPI	745975146000	HID Wall Pack, Glass Lens	Metal Halide	185	120/208/240/277	Dark Bronze	Yes	36
TWR2 250M TB SCWA LPI	745975145324	HID Wall Pack, Glass Lens	Metal Halide	291	120/208/240/277	Dark Bronze	Yes	24
TWR2 400M TB SCWA LPI	745975145348	HID Wall Pack, Glass Lens	Metal Halide	452	120/208/240/277	Dark Bronze	Yes	24

Accessories

Catalog Number	UPC	Description
TWR1WG U	784231161906	TWR1 Wire Guard
TWR2WG U	784231161913	TWR2 Wire Guard

Dimensions

TWR1

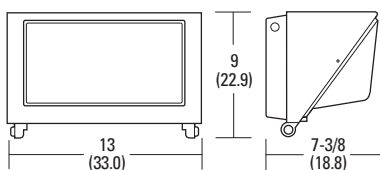

TWR2

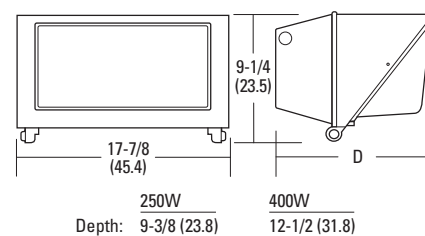

## OLWX1



## Features

- Ideal for outdoor applications such as building perimeters, loading areas, driveways and sign- and building-floodlighting
- High-performance LEDs behind clear glass for maximum light output
- Typical energy savings of up to 83% over metal halide
- Suitable for wet locations; may be inverted
- Floodlighting accessories convert wall pack into floodlight
- Maintains 73% of light output for at least 100,000 hours of service

## Ordering Information

Catalog Number	UPC	Description	Replaces Up To	Lumens	Input Watts	CCT	Voltage	Finish	Photocell Included	DLC	Pallet Quantity
OLWX1 LED 13W 40K M4	888791000115	LED Low Profile Wall Pack	70W MH	1200	14	4000 K	120-277	Dark Bronze	No	Yes	180
OLWX1 LED 13W 50K M4	888791000122	LED Low Profile Wall Pack	70W MH	1200	14	5000 K	120-277	Dark Bronze	No	Yes	180
OLWX1 LED 13W 50K 347 M4	888791000177	LED Low Profile Wall Pack	70W MH	1200	14	5000 K	347	Dark Bronze	No	Yes	180
OLWX1 LED 13W 40K 120 PE M4	888791000146	LED Low Profile Wall Pack with Photocell	70W MH	1200	14	4000 K	120	Dark Bronze	Yes	Yes	180
OLWX1 LED 13W 50K 120 PE M4	888791000153	LED Low Profile Wall Pack with Photocell	70W MH	1200	14	5000 K	120	Dark Bronze	Yes	Yes	180
OLWX1 LED 20W 40K M4	888791000184	LED Low Profile Wall Pack	150W MH	1800	22	4000 K	120-277	Dark Bronze	No	Yes	180
OLWX1 LED 20W 50K M4	888791000191	LED Low Profile Wall Pack	150W MH	1800	22	5000 K	120-277	Dark Bronze	No	Yes	160
OLWX1 LED 20W 50K 347 M4	888791000689	LED Low Profile Wall Pack	150W MH	1800	22	5000 K	347	Dark Bronze	No	Yes	160
OLWX1 LED 20W 40K 120 PE M4	888791000207	LED Low Profile Wall Pack with Photocell	150W MH	1800	22	4000 K	120	Dark Bronze	Yes	Yes	180
OLWX1 LED 20W 50K 120 PE M4	888791000214	LED Low Profile Wall Pack with Photocell	150W MH	1800	22	5000 K	120	Dark Bronze	Yes	Yes	180
OLWX1 LED 40W 40K M4	888791000696	LED Low Profile Wall Pack	250W MH	4000	39	4000 K	120-277	Dark Bronze	No	Yes	180
OLWX1 LED 40W 50K M4	888791000726	LED Low Profile Wall Pack	250W MH	4000	37	5000 K	120-277	Dark Bronze	No	Yes	180
OLWX1 LED 40W 50K 347 M4	888791000757	LED Low Profile Wall Pack	250W MH	4000	37	5000 K	347	Dark Bronze	No	Yes	180
OLWX1 LED 40W 40K 120 PE M4	888791000733	LED Low Profile Wall Pack with Photocell	250W MH	4000	39	4000 K	120	Dark Bronze	Yes	Yes	180
OLWX1 LED 40W 50K 120 PE M4	888791000740	LED Low Profile Wall Pack with Photocell	250W MH	4000	37	5000 K	120	Dark Bronze	Yes	Yes	180

## Dimensions

## OLWX1

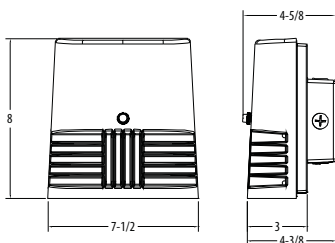

## Accessories

Catalog Number	UPC	Description
OLWX1THK M12	888791000801	OLWX1 Floodlight Mount, Knuckle
OLWX1TS M12	888791000771	OLWX1 Floodlight Mount, Slipfitter
OLWX1YK M12	888791000795	OLWX1 Floodlight Mount, Yoke



Features

- Ideal for outdoor applications such as building perimeters, loading areas, driveways and sign and building floodlighting
- High-performance LEDs behind clear glass for maximum light output.
- Typical energy savings of up to 83% over metal halide
- Suitable for wet locations; may be inverted
- Floodlighting accessories convert wall pack into floodlight
- Maintains 76% of light output for at least 100,000 hours of service



Ordering Information

Catalog Number	UPC	Description	Replaces Up To	Lumens	Input Watts	CCT	Voltage	Finish	Photocell Included	DLC	Pallet Quantity
OLWX2 LED 90W 40K DDB M2	888791000818	LED Low Profile Wall Pack	400W MH, < 20ft Mounting Height	7000	88	4000 K	120-277	Dark Bronze	No	Yes	24
OLWX2 LED 90W 50K DDB M2	888791000832	LED Low Profile Wall Pack	400W MH, < 20ft Mounting Height	7000	88	5000 K	120-277	Dark Bronze	No	Yes	24
OLWX2 LED 90W 50K 347 DDB M2	888791000870	LED Low Profile Wall Pack	400W MH, < 20ft Mounting Height	7000	88	5000 K	347	Dark Bronze	No	Yes	24
OLWX2 LED 90W 40K 120 PE DDB M2	888791000849	LED Low Profile Wall Pack with Photocell	400W MH, < 20ft Mounting Height	7000	88	4000 K	120	Dark Bronze	Yes	Yes	24
OLWX2 LED 90W 50K 120 PE DDB M2	888791000863	LED Low Profile Wall Pack with Photocell	400W MH, < 20ft Mounting Height	7000	88	5000 K	120	Dark Bronze	Yes	Yes	24
OLWX2 LED 150W 40K DDB M2	888791000887	LED Low Profile Wall Pack	400W MH, > 20ft Mounting Height	13000	146	4000 K	120-277	Dark Bronze	No	Yes	24
OLWX2 LED 150W 50K DDB M2	888791000900	LED Low Profile Wall Pack	400W MH, > 20ft Mounting Height	13000	148	5000 K	120-277	Dark Bronze	No	Yes	24
OLWX2 LED 150W 50K 347 DDB M2	888791000931	LED Low Profile Wall Pack	400W MH, > 20ft Mounting Height	13000	148	5000 K	347	Dark Bronze	No	Yes	24
OLWX2 LED 150W 40K 120 PE DDB M2	888791000917	LED Low Profile Wall Pack with Photocell	400W MH, > 20ft Mounting Height	13000	146	4000 K	120	Dark Bronze	Yes	Yes	24
OLWX2 LED 150W 50K 120 PE DDB M2	888791000924	LED Low Profile Wall Pack with Photocell	400W MH, > 20ft Mounting Height	13000	148	5000 K	120	Dark Bronze	Yes	Yes	24

Dimensions

OLWX2

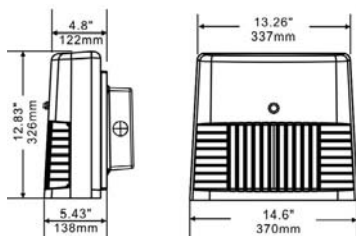

Accessories

Catalog Number	UPC	Description
OLWX2TS M4	888791000948	OLWX2 Floodlight Mount, Slipfitter
OLWX2YK M4	888791000962	OLWX2 Floodlight Mount, Yoke

## OLW



## Features

- Ideal for lighting building facades, parking areas, walkways, garages and loading areas
- Features a sturdy weather-resistant aluminum housing and a clear polycarbonate lens that protects the optics from moisture, dirt and other contaminants
- Precision optics provide Type 5 distribution (OLW14) or Type 3 distribution (OLW 23 and OLW 31)
- Adjustable dusk-to-dawn, multi-volt photocell is standard
- OLW 23 and OLW 31 meet Nighttime Friendly standard; order full cutoff shield for OLW14 to meet Nighttime Friendly
- Maintains 70% of light output for at least 100,000 hours of service



## Ordering Information

Catalog Number	UPC	Description	Replaces Up To	Lumens	Input Watts	CCT	Voltage	Finish	Photocell Included	DLC	Pallet Quantity
OLW14 M2	745977919336	LED Wall Pack	50W MH	1490	18	5000 K	120-277	Bronze	Yes	Yes	128
OLW14 WH M2	784231432594	LED Wall Pack	50W MH	1490	18	5000 K	120-277	White	Yes	Yes	128
OLW 23 M2	784231814574	LED Wall Pack	100W MH	2700	32	5000 K	120-277	Dark Bronze	Yes	Yes	96
OLW 31 M2	784231815458	LED Wall Pack	250W MH	3900	45	5000 K	120-277	Dark Bronze	Yes	Yes	96
OLW 31 WH M2	753573385509	LED Wall Pack	250W MH	3900	45	5000 K	120-277	White	Yes	Yes	96

## Accessories

Catalog Number	UPC	Description
FCOS M24	784231337462	OLW14 Full Cutoff Shield

## Dimensions

OLW14

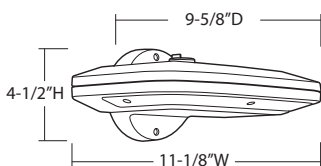

OLW 23/OLW 31

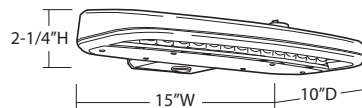



## TWS LED



### Features

- Ideal for providing outdoor security and perimeter lighting in commercial applications
- Same durable construction as our traditional wall packs but with long-life, energy-efficient LEDs
- Dusk-to-dawn photocell provides automatic on/off
- Maintains 95% of light output for at least 100,000 hours of service

### Ordering Information

Catalog Number	UPC	Description	Replaces Up To	Lumens	Input Watts	CCT	Voltage	Finish	Photocell Included	DLC	Pallet Quantity
TWS LED 1 50K 120 PE M4	753573833468	LED Wall Pack	42W CFL/70W HPS	1000	19	5000 K	120	Dark Bronze	Yes	No	144

### Dimensions

TWS LED

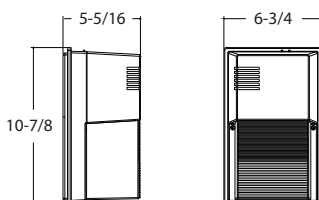

### Accessories

Catalog Number	UPC	Description
TWSWG U	784231177204	TWS Wire Guard

### Features

- Ideal for providing outdoor security and perimeter lighting in commercial applications
- Rugged, corrosion-resistant housing
- Housings are sealed with a one-piece gasket to prevent contamination
- Dusk-to-dawn photocell provides automatic on/off



### Ordering Information

Catalog Number	UPC	Description	Lamp Source	Input Watts	Voltage	Finish	Photocell Included	Lamp Included	Pallet Quantity
TWS 26/42TRT 120 PE L/LP M6	784231177211	Small Wall Pack	Compact Fluorescent	26-46	120	Dark Bronze	Yes	No	144
TWS 26/42TRT MVOLT L/LP M6	784231177334	Small Wall Pack	Compact Fluorescent	26-46	120-277	Dark Bronze	No	No	144
TWS 50M 120 PE LPI M6	784231183588	Small Wall Pack	Metal Halide	67	120	Dark Bronze	Yes	Yes	144
TWS 70S 120 PE LPI M6	784231177129	Small Wall Pack	High Pressure Sodium	96	120	Dark Bronze	Yes	Yes	144

### Dimensions

TWS

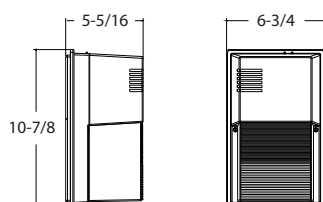

### Accessories

Catalog Number	UPC	Description
TWSWG U	784231177204	TWS Wire Guard



## OLWP



## Features

- Ideal for commercial or residential applications such as driveways, patios, loading areas and warehouses
- Outdoor LED wall pack offers a traditional look with over 50% less power consumption
- Photocell turns light on at dusk and off at dawn for additional energy savings
- Rugged, corrosion-resistant housing
- Maintains 70% of light output for at least 100,000 hours of service

## Ordering Information

Catalog Number	UPC	Description	Replaces Up To	Lumens	Input Watts	CCT	Voltage	Finish	Photocell Included	DLC	Pallet Quantity
OLWP 11 PE BZ M4	753573853428	LED Small Wall Pack	42W CFL/70W HPS	1100	20	4000 K	120	Bronze	Yes	No	320

## Dimensions

OLWP

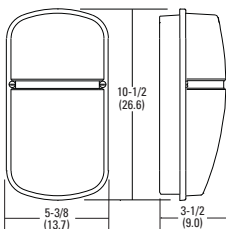

Features

- Ideal for providing outdoor security and perimeter lighting in commercial applications
- Photocell turns light on at dusk and off at dawn for additional energy savings
- Rugged, corrosion-resistant housing



Ordering Information

Catalog Number	UPC	Description	Lamp Source	Input Watts	Voltage	Finish	Photocell Included	Lamp Included	Pallet Quantity
OWP3 42F 120 P LP BZ M4	745974444367	Small Wall Pack	Compact Fluorescent	46	120	Bronze	Yes	Yes	256
OWP3 42F 120 P LP WH M4	745975460199	Small Wall Pack	Compact Fluorescent	46	120	White	Yes	Yes	256

Dimensions

OWP3

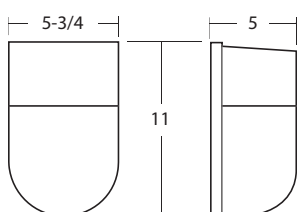

Accessories

Catalog Number	UPC	Description
CF42TRT41 4PIN M6	745975453498	42W Replacement Lamp

## OLCS/OLLW



## Features

- Ideal for residential and commercial outdoor applications such as walkways and stairways requiring nearly maintenance-free, general security-illumination
- Mounts easily to recessed junction box (by others)
- Rugged cast aluminum housing provides superior resistance to corrosion and weathering
- Maintains 70% of light output for at least 100,000 hours of service

## Ordering Information

Catalog Number	UPC	Description	Replaces Up To	Lumens	Input Watts	CCT	Voltage	Finish	Photocell Included	DLC	Pallet Quantity
OLCS 8 DDB M4	753573525059	LED Sconce	60W Incandescent	460	9	4000 K	120	Dark Bronze	No	No	96
OLCS 8 WH M4	753573827788	LED Sconce	60W Incandescent	510	9	4000 K	120	White	No	No	96
OLLWD DDB M6	753573330097	LED 1-Light Sconce	75W Incandescent	270	9	4000 K	120-277	Dark Bronze	No	No	540
OLLWD WH M6	753573330103	LED 1-Light Sconce	75W Incandescent	270	9	4000 K	120-277	White	No	No	540
OLLWU DDB M6	753573330073	LED 2-Light Sconce	75W Incandescent	500	14	4000 K	120-277	Dark Bronze	No	No	432
OLLWU WH M6	753573330080	LED 2-Light Sconce	75W Incandescent	500	14	4000 K	120-277	White	No	No	432

## Dimensions

OLCS

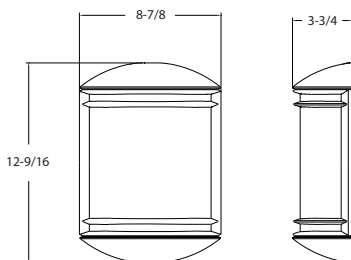

OLLWD

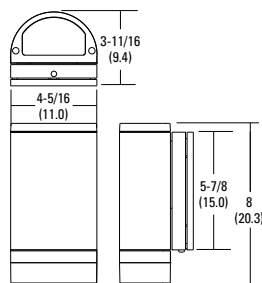

OLLWU

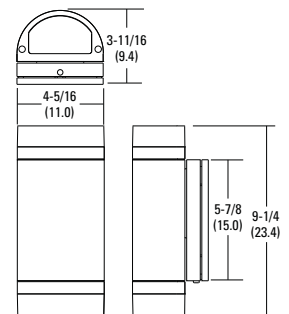

### Features

- Ideal for applications such as lighting entrances, walkways and stairways
- Polycarbonate lens protects the LED from moisture, dirt and other contaminants
- Mounts easily to recessed junction box (by others)
- Maintains 70% of light output for at least 100,000 hours of service



### Ordering Information

Catalog Number	UPC	Description	Replaces Up To	Lumens	Input Watts	CCT	Voltage	Finish	Photocell Included	DLC	Pallet Quantity
OLSR DDB M6	753573325932	LED Step Light, Round	50W Halogen	370	9	4000 K	120-277	Dark Bronze	No	No	432
OLSR WH M6	753573325413	LED Step Light, Round	50W Halogen	370	9	4000 K	120-277	White	No	No	432
OLSS DDB M6	753573325253	LED Step Light, Square	50W Halogen	330	9	4000 K	120-277	Dark Bronze	No	No	576
OLSS WH M6	753573325376	LED Step Light, Square	50W Halogen	330	9	4000 K	120-277	White	No	No	576

### Dimensions

OLSR

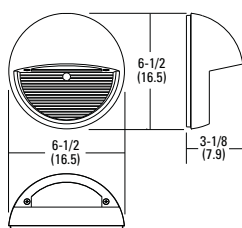

OLSS

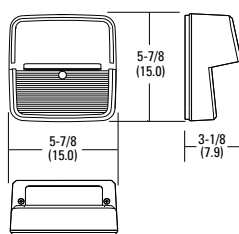

## DSXF1/DSXF2



## Features

- Ideal for wallwash, security and general area lighting in many commercial and institutional applications
- Precision-molded wide flood reflectors are engineered for superior field-to-beam ratios, uniformity and spacing
- IP65 rated
- NEMA Type 6 distribution
- Knuckle mount with 1/2" NPS threaded pipe standard
- Maintains 80% of light output for at least 100,000 hours of service

## Ordering Information

Catalog Number	UPC	Description	Replaces Up To	Lumens	Input Watts	CCT	Voltage	Finish	Photocell Included	DLC	Pallet Quantity
DSXF1 LED 1 40K M4	753573384885	LED Floodlight	70W MH	2000	19	4000 K	120-277	Dark Bronze	No	Yes	144
DSXF1 LED 1 50K M4	753573384854	LED Floodlight	70W MH	2100	19	5000 K	120-277	Dark Bronze	No	Yes	144
DSXF1 LED 2 40K M4	753573385073	LED Floodlight	150W MH	4000	37	4000 K	120-277	Dark Bronze	No	Yes	144
DSXF1 LED 2 50K M4	753573384960	LED Floodlight	150W MH	4000	37	5000 K	120-277	Dark Bronze	No	Yes	144
DSXF2 LED 3 40K M2	753573385486	LED Floodlight	175W MH	6100	54	4000 K	120-277	Dark Bronze	No	Yes	108
DSXF2 LED 3 50K M2	753573385097	LED Floodlight	175W MH	5700	54	5000 K	120-277	Dark Bronze	No	Yes	108
DSXF2 LED 4 40K M2	753573385554	LED Floodlight	250W MH	7600	74	4000 K	120-277	Dark Bronze	No	Yes	108
DSXF2 LED 4 50K M2	753573385516	LED Floodlight	250W MH	7600	74	5000 K	120-277	Dark Bronze	No	Yes	108

## Accessories

Catalog Number	UPC	Description
DSXF1/2TS DDBXD U	753573706731	DSXF1/2 Tenon Slipfitter
DSXF1FV DDBXD U	753573694809	DSXF1 Full Visor
DSXF1UBV DDBXD U	753573701231	DSXF1 Upper/Bottom Visor
DSXF1VG U	753573748939	DSXF1 Vandal Guard
DSXF2FV DDBXD U	753573712763	DSXF2 Full Visor
DSXF2UBV DDBXD U	753573689874	DSXF2 Upper/Bottom Visor
DSXF2VG U	753573900658	DSXF2 Vandal Guard

## Dimensions

DSXF1

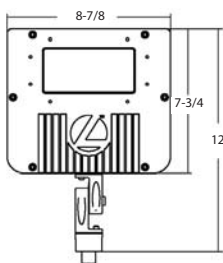

DSXF2

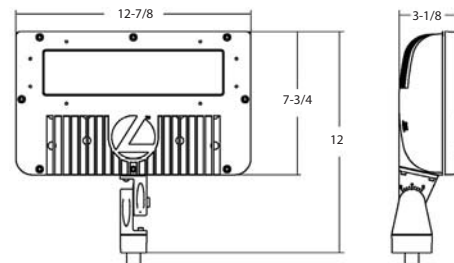



Features

- Ideal for wallwash, security and general area lighting in many commercial and institutional applications
- Precision-molded wide flood reflectors are engineered for superior field-to-beam ratios, uniformity and spacing
- IP66 rated
- NEMA Type 6 distribution
- Maintains 96% of light output for at least 100,000 hours of service



Ordering Information

Catalog Number	UPC	Description	Replaces Up To	Lumens	Input Watts	CCT	Voltage	Finish	Photocell Included	DLC	Pallet Quantity
DSXF3 LED 6 P1 40K IS	745971443905	LED Floodlight, Slipfitter	400W MH	15200	129	4000 K	120-277	Dark Bronze	Slipfitter	Yes	30
DSXF3 LED 6 P1 50K IS	745971443912	LED Floodlight, Slipfitter	400W MH	15200	129	5000 K	120-277	Dark Bronze	Slipfitter	Yes	30
DSXF3 LED 6 P1 40K YKC62	745971443851	LED Floodlight, Yoke	400W MH	15200	129	4000 K	120-277	Dark Bronze	Yoke	Yes	30
DSXF3 LED 6 P1 50K YKC62	745971443929	LED Floodlight, Yoke	400W MH	15200	129	5000 K	120-277	Dark Bronze	Yoke	Yes	30

Accessories

Catalog Number	UPC	Description
DSXF3UBV DDBXD U	753573728009	Upper/Bottom Visor Accessory
DSXF3FV DDBXD U	753573786955	Full Visor Accessory
DSXF3VG U	753573748946	DSXF3 Vandal Guard
DSXF3WG DBLXD U	753573730293	DSXF3 Wire Guard

Dimensions

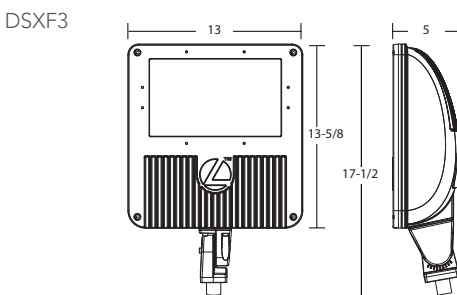

## OFL1 LED



## Features

- High-performance general purpose floodlight ideal for security and general area lighting in commercial and industrial applications
- Replaces 70W – 150W MH with typical energy savings of over 67%
- Available with knuckle, yoke or integral slipfitter mounting configurations
- Wireguard and vandal guard accessories available
- IP65 rated
- Maintains 78% of light output for at least 50,000 hours of service

## Ordering Information

Catalog Number	UPC	Description	Replaces Up To	Lumens	Input Watts	CCT	Voltage	Finish	Photocell Included	DLC	Pallet Quantity
OFL1 LED P1 40K MVOLTHK DDBXD M4	889804467093	LED Floodlight	70W MH	2000 K	23	4000 K	120-277	Dark Bronze	No	Yes	60
OFL1 LED P1 50K MVOLTHK DDBXD M4	889804467147	LED Floodlight	70W MH	2100 K	23	5000 K	120-277	Dark Bronze	No	Yes	60
OFL1 LED P1 40K MVOLTYK DDBXD M4	889804467185	LED Floodlight	70W MH	2000 K	23	4000 K	120-277	Dark Bronze	No	Yes	60
OFL1 LED P1 50K MVOLTYK DDBXD M4	889804467215	LED Floodlight	70W MH	2100 K	23	5000 K	120-277	Dark Bronze	No	Yes	60
OFL1 LED P2 40K MVOLTHK DDBXD M4	889804467222	LED Floodlight	150W MH	3900 K	48	4000 K	120-277	Dark Bronze	No	Yes	60
OFL1 LED P2 50K MVOLTHK DDBXD M4	889804467246	LED Floodlight	150W MH	3900 K	49	5000 K	120-277	Dark Bronze	No	Yes	60
OFL1 LED P2 40K MVOLTYK DDBXD M4	889804467314	LED Floodlight	150W MH	3900 K	48	4000 K	120-277	Dark Bronze	No	Yes	60
OFL1 LED P2 50K MVOLTYK DDBXD M4	889804467321	LED Floodlight	150W MH	3900 K	49	5000 K	120-277	Dark Bronze	No	Yes	60

## Dimensions

## OFL1 LED

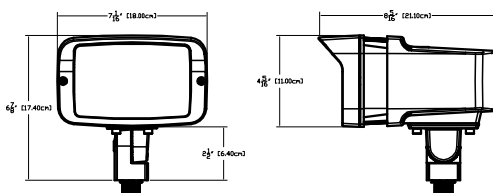

## Accessories

Catalog Number	UPC	Description
OFL1WG M6	889804468885	OFL1 Wireguard
OFL1VG M6	889804468892	OFL1 Vandalguard

Features

- High-performance general purpose floodlight ideal for security and general area lighting in commercial and industrial applications
- Replaces 250W – 400W MH with typical energy savings of up to 54%
- Available with yoke or integral slipfitter mounting configurations
- Wireguard and vandal guard accessories available
- IP65 rated
- Maintains 77% of light output for at least 50,000 hours of service



Ordering Information

Catalog Number	UPC	Description	Replaces Up To	Lumens	Input Watts	CCT	Voltage	Finish	Photocell Included	DLC	Pallet Quantity
OFL2 LED P2 40K MVOLT IS DDBXD M2	889804468571	LED Floodlight	250W MH	10,000	121	4000 K	120-277	Dark Bronze	No	Yes	36
OFL2 LED P2 50K MVOLT IS DDBXD M2	889804468601	LED Floodlight	250W MH	10,200	121	5000 K	120-277	Dark Bronze	No	Yes	36
OFL2 LED P2 40K MVOLT YK DDBXD M2	889804468625	LED Floodlight	250W MH	10,000	121	4000 K	120-277	Dark Bronze	No	Yes	36
OFL2 LED P2 50K MVOLT YK DDBXD M2	889804468649	LED Floodlight	250W MH	10,200	121	5000 K	120-277	Dark Bronze	No	Yes	36
OFL2 LED P2 40K 347 IS DDBXD M2	889804468656	LED Floodlight	250W MH	10,000	121	4000 K	347	Dark Bronze	No	No	36
OFL2 LED P2 50K 347 IS DDBXD M2	889804468663	LED Floodlight	250W MH	10,200	121	5000 K	347	Dark Bronze	No	No	36
OFL2 LED P2 40K 347 YK DDBXD M2	889804468694	LED Floodlight	250W MH	10,000	121	4000 K	347	Dark Bronze	No	No	36
OFL2 LED P2 50K 347 YK DDBXD M2	889804468700	LED Floodlight	250W MH	10,200	121	5000 K	347	Dark Bronze	No	No	36
OFL2 LED P3 40K MVOLT IS DDBXD M2	889804468717	LED Floodlight	400W MH	14,900	183	4000 K	120-277	Dark Bronze	No	Yes	36
OFL2 LED P3 50K MVOLT IS DDBXD M2	889804468731	LED Floodlight	400W MH	15,000	183	5000 K	120-277	Dark Bronze	No	Yes	36
OFL2 LED P3 40K MVOLT YK DDBXD M2	889804468748	LED Floodlight	400W MH	14,900	183	4000 K	120-277	Dark Bronze	No	Yes	36
OFL2 LED P3 50K MVOLT YK DDBXD M2	889804468793	LED Floodlight	400W MH	15,000	183	5000 K	120-277	Dark Bronze	No	Yes	36
OFL2 LED P3 40K 347 IS DDBXD M2	889804468809	LED Floodlight	400W MH	14,900	183	4000 K	347	Dark Bronze	No	No	36
OFL2 LED P3 50K 347 IS DDBXD M2	889804468816	LED Floodlight	400W MH	15,000	183	5000 K	347	Dark Bronze	No	No	36
OFL2 LED P3 40K 347 YK DDBXD M2	889804468823	LED Floodlight	400W MH	14,900	183	4000 K	347	Dark Bronze	No	No	36
OFL2 LED P3 50K 347 YK DDBXD M2	889804468830	LED Floodlight	400W MH	15,000	183	5000 K	347	Dark Bronze	No	No	36

Dimensions

OFL2 LED

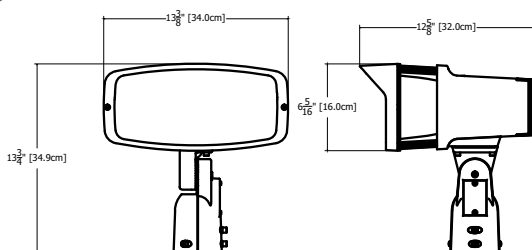

Accessories

Catalog Number	UPC	Description
OFL2WG M6	889804468915	OFL2 Wireguard
OFL2VG M6	889804468939	OFL2 Vandalguard

## OLB



## Features

- Designed for signs, landscape lighting and commercial or residential building facades
- Available in two distributions, 5x5 general flood (OLBF) and 2x2 spot (OLBS)
- 5000K CCT LEDs for maximum illumination and 3000K CCT LEDs for best match to existing incandescent lighting
- Housing is IP65 rated
- Maintains 82% of light output for at least 100,000 hours of service

## Ordering Information

Catalog Number	UPC	Description	Replaces Up To	Lumens	Input Watts	CCT	Voltage	Finish	Photocell Included	DLC	Pallet Quantity
OLBF 8 30K DDB M6	820476007569	LED Bullet Flood	100W Halogen	600	11	3000 K	120-277	Dark Bronze	No	No	288
OLBF 8 50K DDB M6	753573899495	LED Bullet Flood	100W Halogen	800	11	5000 K	120-277	Dark Bronze	No	No	288
OLBS 8 30K DDB M6	820476007576	LED Bullet Spot	100W Halogen	600	11	3000 K	120-277	Dark Bronze	No	No	288
OLBS 8 50K DDB M6	753573899310	LED Bullet Spot	100W Halogen	800	11	5000 K	120-277	Dark Bronze	No	No	288

## Dimensions

OLBF

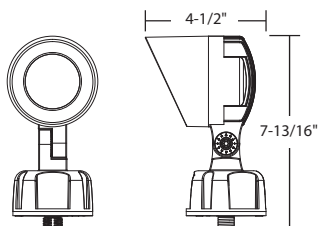

OLBS

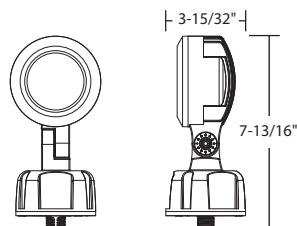







## TFL/TFA



### Features

- Ideal for recreation areas, parking lots, building facades and car lots or any general purpose outdoor application
- Heavy-duty, die-cast aluminum construction
- Front bezel is fully sealed with one-piece, bonded silicone gasket
- Lens is made of clear, tempered glass which is thermal- and shock-resistant
- EISA compliant



### Ordering Information

Catalog Number	UPC	Description	Lamp Source	Input Watts	Voltage	Finish	Lamp Included	Pallet Quantity
TFL250M RA2 TB SCWA LPI	745975201334	Medium Floodlight, Horizontal Lamp	Metal Halide	291	120/208/240/277	Dark Bronze	Yes	34
TFL250M TA2 TB SCWA LPI	745975212798	Medium Floodlight, Vertical Lamp	Metal Halide	291	120/208/240/277	Dark Bronze	Yes	34
TFL400M RA2 TB SCWA IS LPI	745975201464	Medium Floodlight, Horizontal Lamp, Integral Slipfitter	Metal Halide	452	120/208/240/277	Dark Bronze	Yes	34
TFL400M RA2 TB SCWA LPI	745975201402	Medium Floodlight, Horizontal Lamp	Metal Halide	452	120/208/240/277	Dark Bronze	Yes	34
TFA1000M TA TB IS LPI	784231151525	Large Floodlight, Vertical Lamp, Integral Slipfitter	Metal Halide	1080	120/208/240/277	Dark Bronze	Yes	8
TFA1000M TA TB LPI	784231151532	Large Floodlight, Vertical Lamp	Metal Halide	1080	120/208/240/277	Dark Bronze	Yes	8

### Dimensions

TFL

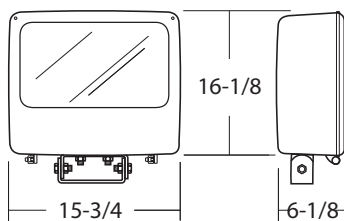

TFA

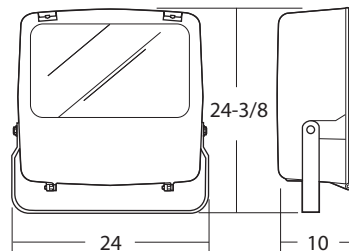

Features

- Ideal for signs, flags, recreation areas, parking lots, building facades and landscape lighting
- Die-cast aluminum housing and removable front bezel
- Front bezel removes via position-oriented hinge-cam design and is fully sealed with one-piece, bonded silicone gasket
- Lens is made of clear, tempered glass which is thermal- and shock-resistant
- EISA compliant



Ordering Information

Catalog Number	UPC	Description	Lamp Source	Input Watts	Voltage	Finish	Lamp Included	Pallet Quantity
TFM 100M RB TB LPI	784231102640	Small Flood Light	Metal Halide	129	120/208/240/277	Dark Bronze	Yes	64
TFM 100M TATB LPI	784231142301	Small Flood Light	Metal Halide	129	120/208/240/277	Dark Bronze	Yes	64
TFM 150M RB TB LPI	745975310708	Small Flood Light	Metal Halide	185	120/208/240/277	Dark Bronze	Yes	64
TFR 250M TATB SCWA LPI	745975201631	Medium Flood Light	Metal Halide	291	120/208/240/277	Dark Bronze	Yes	24
TFR 400M TATB SCWA IS LPI	745975201655	Medium Flood Light	Metal Halide	452	120/208/240/277	Dark Bronze	Yes	24
TFR 400M TATB SCWA LPI	745975201679	Medium Flood Light	Metal Halide	452	120/208/240/277	Dark Bronze	Yes	24

Dimensions

TFM

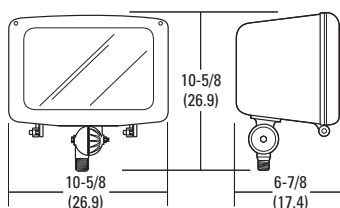

TFR

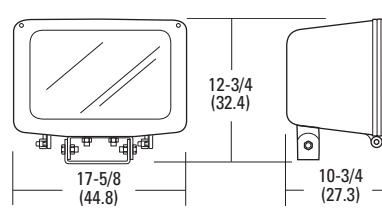

## KADL/KARD LED



### Features

- Ideal for illuminating streets, walkways, parking lots, and surrounding areas
- KADL features a universal mounting bracket for mounting to any hole pattern without redrilling
- KADL features a 9" mounting arm
- KARD LED retrofits any existing 250 – 400W metal halide or high pressure sodium KAD into a high performance LED luminaire in less than three minutes
- Maintains 79% of light output for at least 100,000 hours of service

### Ordering Information

Catalog Number	UPC	Description	Replaces Up To	Lumens	Input Watts	CCT	Voltage	Finish	Photocell Included	DLC	Pallet Quantity
KADL 30C 40K R3	888791864243	LED Area Light, Type 3 Distribution	250W MH	9400	108	4000 K	120-277	Dark Bronze	No	Yes	16
KADL 30C 40K R5	888791864274	LED Area Light, Type 5 Distribution	250W MH	10000	108	4000 K	120-277	Dark Bronze	No	Yes	16
KADL 40C 40K R3	888791864304	LED Area Light, Type 3 Distribution	400W MH	12200	141	4000 K	120-277	Dark Bronze	No	Yes	16
KADL 40C 40K R5	888791862584	LED Area Light, Type 5 Distribution	400W MH	13000	141	4000 K	120-277	Dark Bronze	No	Yes	16
KADL 30C 40K R3 PIRH	888791864519	LED Area Light, Type 3 Distribution, Motion Sensor	250W MH	9400	108	4000 K	120-277	Dark Bronze	No	Yes	16
KADL 30C 40K R5 PIRH	888791864526	LED Area Light, Type 5 Distribution, Motion Sensor	250W MH	10000	108	4000 K	120-277	Dark Bronze	No	Yes	16
KADL 40C 40K R3 PIRH	888791864533	LED Area Light, Type 3 Distribution, Motion Sensor	400W MH	12200	141	4000 K	120-277	Dark Bronze	No	Yes	16
KADL 40C 40K R5 PIRH	888791864540	LED Area Light, Type 5 Distribution, Motion Sensor	400W MH	13000	141	4000 K	120-277	Dark Bronze	No	Yes	16
KARD LED 30C 1000 40K R3 MVOLT DDBXD	888791824018	LED Retrofit Door, Type 3 Distribution	250W MH	9000	108	4000 K	120-277	Dark Bronze	No	Yes	16
KARD LED 30C 1000 40K R5 MVOLT DDBXD	888791999334	LED Retrofit Door, Type 5 Distribution	250W MH	9600	108	4000 K	120-277	Dark Bronze	No	Yes	16
KARD LED 40C 1000 40K R3 MVOLT DDBXD	888791750843	LED Retrofit Door, Type 3 Distribution	400W MH	12000	141	4000 K	120-277	Dark Bronze	No	Yes	16
KARD LED 40C 1000 40K R5 MVOLT DDBXD	888791940909	LED Retrofit Door, Type 5 Distribution	400W MH	12900	141	4000 K	120-277	Dark Bronze	No	Yes	16

### Dimensions

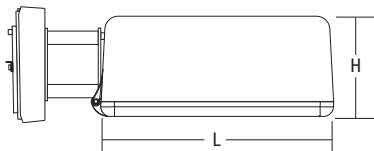

Length: 17-1/2 (44.5)  
Width: 17-1/2 (44.5)  
Height: 7-1/8 (18.1)

### Accessories

Catalog Number	UPC	Description
DLL127F 1.5 JU	820476015830	Photocell - SSL Twist-lock (120-277V)
KADLEDHS 30C U	888791791099	Houseside Shield for 30 LED Unit
KADLEDHS 40C U	888791791068	Houseside Shield for 40 LED Unit
KADWG U	745973273999	Wire Guard Accessory

### Features

- D-Series Size 0 is the perfect solution for replacing up to 250W or 400W MH
- Extraordinary energy savings with over 105 LPW
- Sleek, low-profile design for striking yet understated appearance
- Integrated upswept mounting arm
- DSX0 features our universal mounting bracket to retrofit onto any hole pattern without redrilling
- Maintains up to 96% of light output for at least 100,000 hours of service



### Ordering Information

Catalog Number	UPC	Description	Replaces Up To	Lumens	Input Watts	CCT	Voltage	Finish	Photocell Included	DLC	Pallet Quantity
DSX0 LED 20C 1000 50K T3M MVOLT PUMBA DDBXD	820476822087	LED Area Light, Type 3 Distribution	250W MH	7800	72	5000 K	120-277	Dark Bronze	No	Yes	20
DSX0 LED 40C 1000 50K T3M MVOLT PUMBA DDBXD	820476822131	LED Area Light, Type 3 Distribution	400W MH	15100	138	5000 K	120-277	Dark Bronze	No	Yes	20

### Dimensions

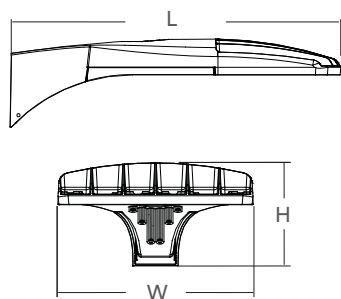

Length: 26 (66.0)  
 Width: 13 (33.0)  
 Height: 7 (17.8)

### Accessories

Catalog Number	UPC	Description
DSX0HS 20C U	820476797422	Houseside Shield for 20 LED (20C) Unit
DSX0HS 40C U	820476554612	Houseside Shield for 40 LED (40C) Unit
DSX0DDL U	820476584008	Diffused Drop Lens (polycarbonate)
KMA8 DDBXD U	745972959269	Mast Arm Mounting Bracket Adaptor

## OLCFM/VRC



## Features

- Ideal nearly maintenance-free general illumination for residential and commercial outdoor applications such as porches, covered walkways, parking areas, and store entrances
- OLCFM mounts to recessed junction box (by others)
- VRC mounts to a recessed junction box (by others) or can be surface mounted with three conduit entry points
- Polycarbonate lens is designed for even light distribution
- Maintains 84% of light output for at least 100,000 hours of service (VRC LED)

## Ordering Information

Catalog Number	UPC	Description	Replaces Up To	Lumens	Input Watts	CCT	Voltage	Finish	Photocell Included	DLC	Pallet Quantity
OLCFM 15 DDB M4	753573616917	LED Decorative Canopy	100W Incandescent	1000	16	4000 K	120	Dark Bronze	No	No	108
OLCFM 15 WH M4	753573826118	LED Decorative Canopy	100W Incandescent	1100	16	4000 K	120	White	No	No	108
VRC LED 1 50K MVOLT M2	753573853367	LED Canopy	250W MH	3400	41	5000 K	120-277	Dark Bronze	No	No	48

## Dimensions

OLCFM

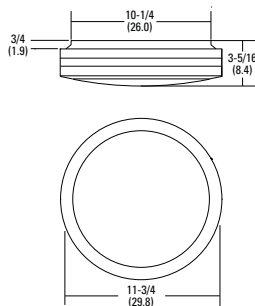

VRC

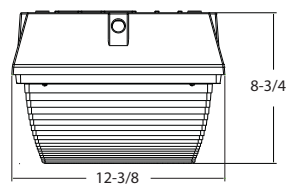





## TDD LED/OLAW23



### Features

- Provides years of nearly maintenance-free illumination for outdoor applications such as building facades, building perimeters, parking areas, walkways, garages and service roads
- Sturdy weather-resistant aluminum housing; clear polycarbonate lens that protects the optics from moisture, dirt and other contaminants
- Wall or arm mount; all mounting hardware included (mounting arm sold separately)
- Maintains up to 87% of light output for at least 100,000 hours of service (TDD LED 2)

### Ordering Information

Catalog Number	UPC	Description	Replaces Up To	Lumens	Input Watts	CCT	Voltage	Finish	Photocell Included	DLC	Pallet Quantity
OLAW23 53K 120 PE BZ M2	784231606162	Led Security Light, Adjustable Photocell	65W CFL	2300	35	5000 K	120	Bronze	Yes	No	120
TDD LED 1 40K 120 PE M4	753573853374	Led Security Light, Button Photocell	100W MH	1400	21	4000 K	120	Grey	Yes	No	180
TDD LED 2 50K 120 PER M4	820476920684	Led Security Light, Twist-Lock Photocell	175W Mercury Vapor	3300	37	5000 K	120	Grey	Yes	Yes	64

### Accessories

Catalog Number	UPC	Description
OMA DDB M6	753573174714	18" Steel Mounting Arm, Bronze
OMA M6	745973700907	18" Steel Mounting Arm, Grey

### Dimensions

OLAW23

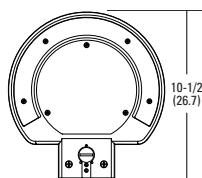
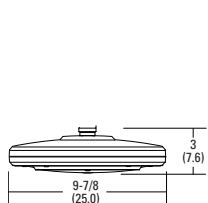

TDD LED 1

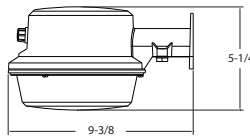
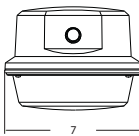

TDD LED 2

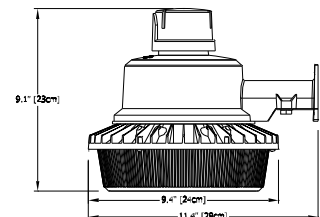

Certain airborne contaminants can diminish integrity of acrylic. See pg. 168 for Acrylic Compatibility table for suitable uses.

### Features

- Arm-mounted security light for yards, service roads and building perimeters
- Rugged, die-cast aluminum head with photocell included
- Formed aluminum reflector and open-bottom refractor for ease of maintenance and lamp replacement
- Prismatic refractor provides uniform symmetrical Type V distribution
- Mounting arm and all mounting hardware included in carton



### Ordering Information

Catalog Number	UPC	Description	Lamp Source	Input Watts	Voltage	Finish	Photocell Included	Lamp Included	Pallet Quantity
TDD100ML 120 M2	745974100140	Security Light	Metal Halide	129	120	Grey	Yes	Yes	24
TDD150SL 120 M2	745973506172	Security Light	High Pressure Sodium	190	120	Grey	Yes	Yes	24
TDD65L 120 M2	745974487494	Security Light	Compact Fluorescent	37	120	Grey	Yes	Yes	32

### Accessories

Catalog Number	UPC	Description
CF65QT41 M6	745974156413	65W Compact Fluorescent Replacement Lamp
RK1 TDDLENS M6	784231146026	Replacement Lens for 100W MH and 150 HPS Only
OMA M6	745973700907	18" Steel Mounting Arm, Grey

### Dimensions

TDD (Fluorescent)

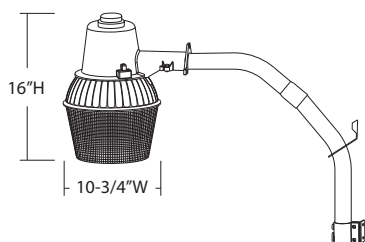

TDD (HID)

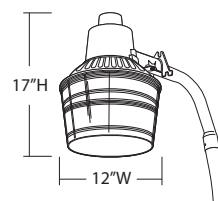

Certain airborne contaminants can diminish integrity of acrylic. See pg. 168 for Acrylic Compatibility table for suitable uses.

## OLVT



## Features

- Frosted glass globe protects LEDs and ensures even light distribution for many general purpose outdoor applications
- Wall or ceiling mount with integrated wet location junction box
- Cast-aluminum housing with corrosion-resistant paint in an industrial grey finish
- Sealed gasket protects against moisture and dust
- Maintains 70% of light output for at least 50,000 hours of service

## Ordering Information

Catalog Number	UPC	Description	Replaces Up To	Lumens	Input Watts	CCT	Voltage	Finish	Photocell Included	DLC	Pallet Quantity
OLVTCM M6	753573237433	LED Vapor Tight, Ceiling Mount	100-150W Incandescent	600	15	4000 K	120-277	Grey	No	No	216
OLVTWM M6	753573237457	LED Vapor Tight, Wall Mount	100-150W Incandescent	600	15	4000 K	120-277	Grey	No	No	162

## Dimensions

Ceiling

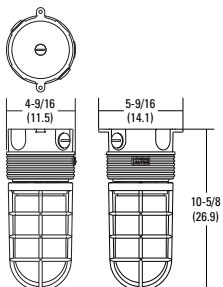

Wall

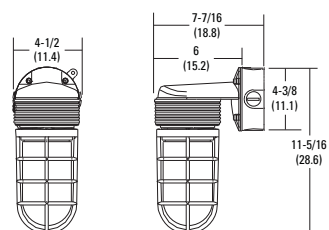

### Features

- Utility wall- or ceiling-mounted fixtures for general purpose applications
- Designed for easy installation and maintenance
- Rugged die-cast aluminum housing with heavy-duty glass globe
- 3/4" threaded knockouts allow for side or top conduit entry
- Junction box included



### Ordering Information

Catalog Number	UPC	Description	Lamp Source	Input Watts	Voltage	Finish	Lamp Included	Pallet Quantity
VC150I M12	745973817704	Utility Vapor Tight, Ceiling Mount	Incandescent	150W	120	Grey	No	288
VW150I M12	745973817681	Utility Vapor Tight, Wall Mount	Incandescent	150W	120	Grey	No	192

### Dimensions

Ceiling



- VC150I**  
Height: 9"  
Width: 4-1/2"
- VC300I**  
Height: 11-3/8"  
Width: 5-3/4"
- VC42L**  
Height: 14-7/8"  
Width: 7"

Wall



- VW150I**  
Height: 10"  
Width: 7-1/4"
- VW300I**  
Height: 11-7/8"  
Width: 8-3/4"
- VW42L**  
Height: 15-1/2"  
Width: 8-3/4"



## OLF/OLFL



## Features

- Designed for residential and commercial outdoor applications such as yards, driveways, patios, loading areas and warehouses
- Rugged cast-aluminum, corrosion-resistant rear housing and lamp heads thermally isolate the LEDs and driver promoting long life
- OLF features OMS1000 motion detection head with 180-degree detection and up to 70' of forward motion detection
- Maintains 70% of light output for at least 50,000 hours of service
- Wet location listed for mounting higher than 4' above ground

## Ordering Information

Catalog Number	UPC	Description	Replaces Up To	Lumens	Input Watts	CCT	Voltage	Finish	Photocell Included	DLC	Pallet Quantity
OLF 2RH 40K 120 MO BZ M6	820476314605	LED Security Floodlight with Motion Sensor	2-Head PAR38 60W Halogen	1560	19	4000 K	120	Bronze	Yes	No	216
OLF 2RH 40K 120 MO WH M6	820476314636	LED Security Floodlight with Motion Sensor	2-Head PAR38 60W Halogen	1560	19	4000 K	120	White	Yes	No	216
OLFL 14 PE BZ M4	753573853497	LED Security Light	300W Quartz Halogen	1350	18	4000 K	120	Bronze	Yes	No	360

## Dimensions

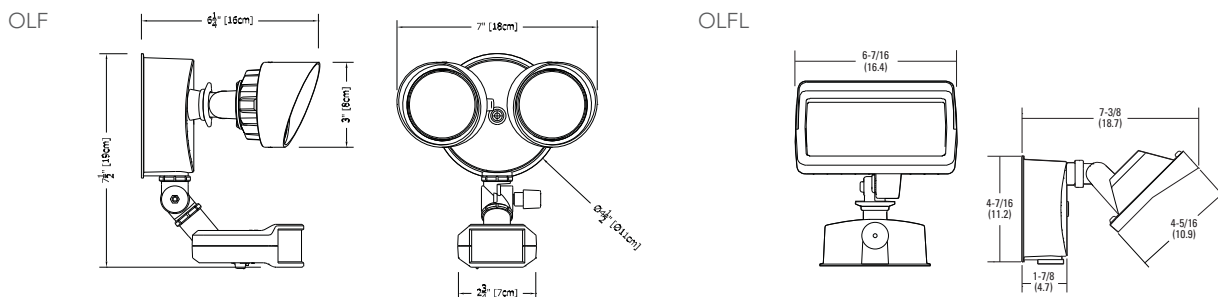

### Features

- Designed for residential and commercial outdoor applications such as yards, driveways, patios, loading areas and warehouses
- Rugged cast aluminum, corrosion-resistant housing in bronze (BZ) or white (WH)
- Available with 2 adjustable heads (6LC) or 3 adjustable heads (9LN) allowing precise illumination
- Photocell (P) option turns light on at dusk and off at dawn for energy savings and convenience
- Motion sensor (MO) option provides 180° detection with up to 70' forward range and additional downward perimeter protection for added security; included photocell prevents activation during daylight
- Maintains 70% of light output for at least 50,000 hours of service



### Ordering Information

Catalog Number	UPC	Description	Replaces Up To	Lumens	Input Watts	CCT	Voltage	Finish	Photocell Included	DLC	Pallet Quantity
OFLR 6LC 120 MO BZ M2	745973299388	2-Head LED Security Floodlight with Motion Sensor	2-Head PAR38 60W Halogen	1100	22	5000 K	120	Bronze	Yes	No	180
OFLR 6LC 120 MO WH M2	745973299302	2-Head LED Security Floodlight with Motion Sensor	2-Head PAR38 60W Halogen	1100	22	5000 K	120	White	Yes	No	180
OFLR 6LC 120 P BZ M2	745973299401	2-Head LED Security Floodlight	2-Head PAR38 60W Halogen	1100	20	5000 K	120	Bronze	Yes	No	250
OFLR 6LC 120 P WH M2	745973299340	2-Head LED Security Floodlight	2-Head PAR38 60W Halogen	1100	20	5000 K	120	White	Yes	No	300
OFLR 9LN 120 MO BZ M2	753573674245	3-Head LED Security Floodlight with Motion Sensor	2-Head PAR38 90W Halogen	2100	33	5000 K	120	Bronze	Yes	No	144
OFLR 9LN 120 MO WH M2	753573674191	3-Head LED Security Floodlight with Motion Sensor	2-Head PAR38 90W Halogen	2100	33	5000 K	120	White	Yes	No	144
OFLR 9LN 120 P BZ M2	753573674344	3-Head LED Security Floodlight	2-Head PAR38 90W Halogen	2100	33	5000 K	120	Bronze	Yes	No	192
OFLR 9LN 120 P WH M2	753573674320	3-Head LED Security Floodlight	2-Head PAR38 90W Halogen	2100	33	5000 K	120	White	Yes	No	144

### Dimensions

OFLR (Twin Head)

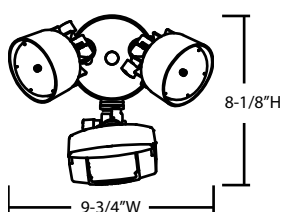

OFLR (Triple Head)

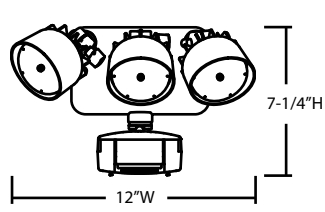

OFLR (Twin Head)

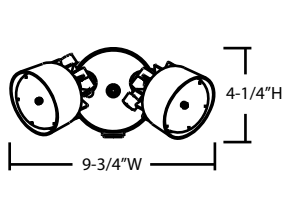

OFLR (Triple Head)

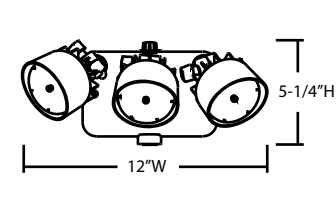

# OMS



## Features

- Ideal for general illumination for residential and commercial outdoor applications such as yards, driveways, patios, loading areas and warehouses
- Metal PAR holders, cast aluminum back plate and precision molded polycarbonate motion sensor housing
- Detection range up to 70'

## Ordering Information

Catalog Number	UPC	Description	Lamp Source	Input Watts	Voltage	Finish	Photocell Included	Lamp Included	Pallet Quantity
OMS 1000 PR2 120 DDB M4	820476549571	2-Head PAR Holder, 1000-Series Motion Sensor	Incandescent	Up To 150W per Head	120	Dark Bronze	Yes	No	336
OMS 1000 PR2 120 WH M4	820476549595	2-Head PAR Holder, 1000-Series Motion Sensor	Incandescent	Up To 150W per Head	120	White	Yes	No	336
OMS 2000 PR2 120 DDB M4	820476549601	2-Head PAR Holder, 2000-Series Motion Sensor	Incandescent	Up To 150W per Head	120	Dark Bronze	Yes	No	160
OMS 2000 PR2 120 WH M4	820476549625	2-Head PAR Holder, 2000-Series Motion Sensor	Incandescent	Up To 150W per Head	120	White	Yes	No	160
OMS 3000 PR2 120 DDB M4	888791132670	2-Head PAR Holder, 3000-Series Motion Sensor	Incandescent	Up To 150W per Head	120	Dark Bronze	Yes	No	160
OMS 3000 PR2 120 WH M4	888791132663	2-Head PAR Holder, 3000-Series Motion Sensor	Incandescent	Up To 150W per Head	120	White	Yes	No	160

## Dimensions

OMS 1000

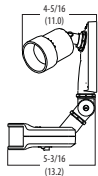
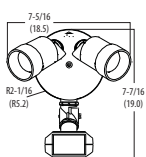

OMS 2000

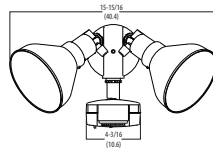
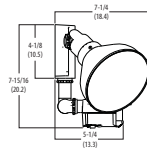

OMS 3000

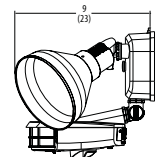
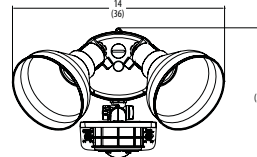

Features

- Designed to be used with traditional and LED outdoor lights providing ON/OFF control when motion is detected
- Adjustable forward and downward sensors for maximum setup flexibility to avoid false detections
- Detection range up to 75' (OMS 3000)
- Mounts to standard 1/2" conduit entry points



Ordering Information

Catalog Number	UPC	Description	Incandescent Switching Capacity	Voltage	Finish	Photocell Included	Pallet Quantity
OMS 1000 120 DDB M6	820476549496	1000 Series Motion Sensor	8 Amps, 500 Watts	120	Dark Bronze	Yes	1344
OMS 1000 120 WH M6	820476549519	1000 Series Motion Sensor	8 Amps, 500 Watts	120	White	Yes	1344
OMS 2000 120 DDB M6	820476549526	2000 Series Motion Sensor	10 Amps, 1000 Watts	120	Dark Bronze	Yes	756
OMS 2000 120 WH M6	820476549540	2000 Series Motion Sensor	10 Amps, 1000 Watts	120	White	Yes	756
OMS 3000 120 DDB M4	820476549717	3000 Series Motion Sensor	10 Amps, 1000 Watts	120	Dark Bronze	Yes	480
OMS 3000 120 WH M4	820476549748	3000 Series Motion Sensor	10 Amps, 1000 Watts	120	White	Yes	480

Dimensions

OMS 1000

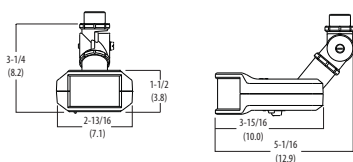

OMS 2000

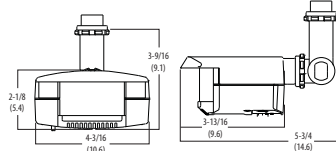

OMS 3000

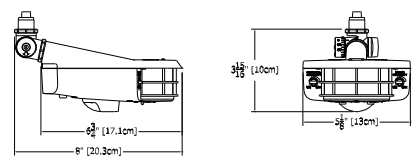



# CONTROLS







**AcuityControls**

Sensor Switch™

- 144** | Wall Switch Controls
- 146** | Ceiling Mount Sensors
- 148** | Fixture Mount Sensors
- 149** | Fixture Mount Interchangeable  
Lens Sensors
- 150** | Snap-Fit Sensor
- 151** | Wide View & Hallway Sensors
- 152** | Preset Timer Switches
- 153** | Power Packs

# WSX/WSD



WSX

WSD



## Features

- Ideal for private offices, restrooms and small spaces
- Digital PIR detection - excellent radio frequency immunity
- Optional Passive Dual Technology (PDT) utilizes PIR/Microphonics™ detection
- Miswire protection, reversible line & load connections
- Convertible neutral to ground wiring
- Small motion detection up to 20'
- Push-button programmable without removing cover plate
- Compatible w/ LEDs, electronic & magnetic ballasts, CFLs, & incandescents
- WSX also features a photocell, vandal resistant lens and soft-click buttons

## Ordering Information

Catalog Number	UPC	Description	Detection Type	Pole	Voltage Type	Color	Voltage	Pallet Quantity
WSX WH	753573767527	Wall Switch Sensor	Passive Infrared (PIR)	1-Pole	Line	White	120-277	1728
WSX IV	820476070174	Wall Switch Sensor	Passive Infrared (PIR)	1-Pole	Line	Ivory	120-277	1728
WSX PDT WH	753573767510	Wall Switch Sensor	Passive Dual Technology (PDT)	1-Pole	Line	White	120-277	1728
WSX PDT IV	820476070181	Wall Switch Sensor	Passive Dual Technology (PDT)	1-Pole	Line	Ivory	120-277	1728
WSX 2P WH	820476070211	Wall Switch Sensor	Passive Infrared (PIR)	2-Pole	Line	White	120-277	1728
WSX 2P IV	820476169885	Wall Switch Sensor	Passive Infrared (PIR)	2-Pole	Line	Ivory	120-277	1728
WSX PDT 2P WH	753573767473	Wall Switch Sensor	Passive Dual Technology (PDT)	2-Pole	Line	White	120-277	1728
WSX PDT 2P IV	820476169939	Wall Switch Sensor	Passive Dual Technology (PDT)	2-Pole	Line	Ivory	120-277	1728
WSD WH	745975809714	Wall Switch Sensor	Passive Infrared (PIR)	1-Pole	Line	White	120-277	1728
WSD PDT WH	745975810048	Wall Switch Sensor	Passive Dual Technology (PDT)	1-Pole	Line	White	120-277	1728
WSD 2P WH	745975809981	Wall Switch Sensor	Passive Infrared (PIR)	2-Pole	Line	White	120-277	1728
WSD PDT 2P WH	745975810086	Wall Switch Sensor	Passive Dual Technology (PDT)	2-Pole	Line	White	120-277	1728

## Dimensions

WSX

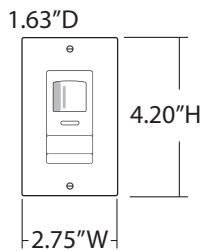

WSD

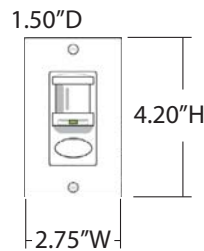

Features (All)

- Ideal for private offices, private restrooms, closets, copy rooms, or any other small enclosed spaces
- 0-10V Dimming Wall Switches
- Miswire protection, reversible line & load connections
- Convertible neutral to ground wiring
- Optional eldoLED® compatibility for advanced dimming control
- Push-button programmable without removing cover plate



WSX D

SPODMRD



WSX D

- Digital PIR detection and optional Passive Dual Technology (PDT) utilizes PIR/ Microphonics™ detection
- Small motion detection up to 20'

SPODMRD

- Optional preset timer function
- Great alternative when occupancy sensing is not required

Ordering Information

Catalog Number	UPC	Description	Detection Type	Dimming	Voltage Type	Color	Voltage	Pallet Quantity
WSX D WH	889804540062	Wall Switch Sensor	Passive Infrared (PIR)	0-10V	Line	White	120-277	1728
WSX D IV	889804540123	Wall Switch Sensor	Passive Infrared (PIR)	0-10V	Line	Ivory	120-277	1728
WSX PDT D WH	889804540079	Wall Switch Sensor	Passive Dual Technology (PDT)	0-10V	Line	White	120-277	1728
WSX PDT D IV	889804540291	Wall Switch Sensor	Passive Dual Technology (PDT)	0-10V	Line	Ivory	120-277	1728
WSX EZ D WH	889804653090	Wall Switch Sensor	Passive Infrared (PIR)	0-10V	Line	White	120-277	1728
WSX EZ D IV	889804702576	Wall Switch Sensor	Passive Infrared (PIR)	0-10V	Line	Ivory	120-277	1728
WSX PDT EZ D WH	889804685022	Wall Switch Sensor	Passive Dual Technology (PDT)	0-10V	Line	White	120-277	1728
WSX PDT EZ D IV	889804702620	Wall Switch Sensor	Passive Dual Technology (PDT)	0-10V	Line	Ivory	120-277	1728
SPODMRD WH	889804540314	Wall Switch	N/A	0-10V	Line	White	120-277	1728
SPODMRD IV	889804540260	Wall Switch	N/A	0-10V	Line	Ivory	120-277	1728
SPODMRD EZ WH	889804675009	Wall Switch	N/A	0-10V	Line	White	120-277	1728
SPODMRD EZ IV	889804691726	Wall Switch	N/A	0-10V	Line	Ivory	120-277	1728

Dimensions

WSX D

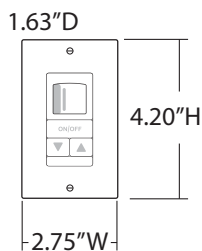

SPODMRD

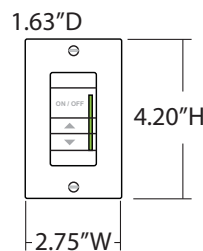

## CM/CMR



### Features

- Ideal for offices, conference rooms, restrooms, warehouses, cafeterias, classrooms and corridors
- Digital PIR detection - excellent radio frequency immunity
- Optional Passive Dual Technology (PDT) utilizes PIR/ Microphonics™ detection
- 360° coverage pattern
- 30 seconds to 30 minutes time delay
- Push-button programmable
- Minimum On-Timer (LampMaximizer®)
- Convenient test mode
- Line voltage sensors feature self-contained relay, no minimum load and mis-wire protection
- Photocontrol sensors are perfect for spaces with windows and feature automatic set-point calibration

### Ordering Information

Catalog Number	UPC	Description	Detection Type	Coverage	Voltage Type	Color	Voltage	Pallet Quantity
CM 6	745975808311	Ceiling Mount Sensor	Passive Infrared (PIR)	High Bay 360°	Low	White	12-24	1200
CM 9	745975808304	Ceiling Mount Sensor	Passive Infrared (PIR)	Small Motion 360°	Low	White	12-24	1200
CM 10	745975808335	Ceiling Mount Sensor	Passive Infrared (PIR)	Large Motion 360°	Low	White	12-24	1200
CM PDT 9	745975808229	Ceiling Mount Sensor	Passive Dual Technology (PDT)	Small Motion 360°	Low	White	12-24	1200
CM PDT 10	745975808243	Ceiling Mount Sensor	Passive Dual Technology (PDT)	Large Motion 360°	Low	White	12-24	1200
CM PDT 9 R	745975860463	Ceiling Mount Sensor	Passive Dual Technology (PDT)	Small Motion 360°	Low	White	12-24	1200
CM PDT 10 R	745975860609	Ceiling Mount Sensor	Passive Dual Technology (PDT)	Large Motion 360°	Low	White	12-24	1200
CMR 6	745975808267	Ceiling Mount Sensor	Passive Infrared (PIR)	High Bay 360°	Line	White	120-277	1200
CMR 9	745975808281	Ceiling Mount Sensor	Passive Infrared (PIR)	Small Motion 360°	Line	White	120-277	1200
CMR 10	745975808250	Ceiling Mount Sensor	Passive Infrared (PIR)	Large Motion 360°	Line	White	120-277	1200
CMR PDT 9	745975809448	Ceiling Mount Sensor	Passive Dual Technology (PDT)	Small Motion 360°	Line	White	120-277	1200
CMR PDT 10	745975809530	Ceiling Mount Sensor	Passive Dual Technology (PDT)	Large Motion 360°	Line	White	120-277	1200
CM PC	745975860241	Ceiling Mount Sensor	N/A	Photocontrol	Low	White	12-24	1200
CM ADC	745975859337	Ceiling Mount Sensor	N/A	Photocontrol	Low	White	12-24	1200
CM PC ADC	745975860364	Ceiling Mount Sensor	N/A	Photocontrol	Low	White	12-24	1200
CMR PC	745975864430	Ceiling Mount Sensor	N/A	Photocontrol	Line	White	120-277	1200
CMR ADC	745975862689	Ceiling Mount Sensor	N/A	Photocontrol	Line	White	120-277	1200
CMR PC ADC	745975864508	Ceiling Mount Sensor	N/A	Photocontrol	Line	White	120-277	1200

### Dimensions

CM/CMR

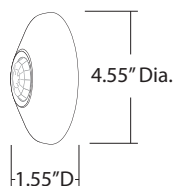







## CMRB/HMRB



### Features

- Ideal for high mount (CMRB 6) and high mount end of aisle (HMRB 10) applications
- Digital PIR detection - excellent radio frequency immunity
- Miswire protection, reversible line & load connections
- Self-contained relay(s)
- No minimum load
- 30 seconds to 30 minutes time delay
- Push-button programmable
- Minimum On-Timer (LampMaximizer®)
- Convenient test mode

### Ordering Information

Catalog Number	UPC	Description	Detection Type	Coverage	Voltage Type	Color	Voltage	Pallet Quantity
CMRB 6	745975808359	Fixture Mount Sensor	Passive Infrared (PIR)	High Bay 360°	Line	White	120/277	1200
HMRB 10	745975866625	Fixture Mount Sensor	Passive Infrared (PIR)	High Bay End-of-Aisle	Line	White	120/277	1200

### Dimensions

CMRB

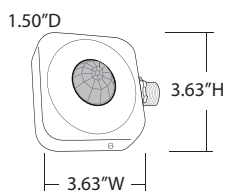

HMRB

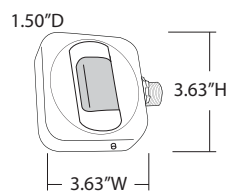

Features

- Ideal for a range of applications including auditoriums, cafeterias, classrooms, conference rooms, corridors, gymnasiums, private offices, restrooms, stairwells and warehouses
- Four interchangeable lenses - high mount 360°, high mount aisleway, large motion 360°, small motion 360°
- Integrated mounting bracket drops lens down 3" from chase nipple - no bracket accessory required
- Digital PIR detection – excellent radio frequency immunity
- Miswire protection, reversible line & load connections
- Push-button programmable
- Minimum On-Timer (LampMaximizer®)
- Convenient test mode



**6** High Bay 360°



**50** High Bay Bi-Directional Aisleway



**10** Large Motion / Extended Range 360°



**9** Small Motion / Standard Range 360°

Ordering Information

Catalog Number	UPC	Description	Detection Type	Coverage	Voltage Type	Color	Voltage	Pallet Quantity
LSXR 9	820476096426	Fixture Mount Sensor	Passive Infrared (PIR)	Small Motion 360°	Line	White	120-277	1200
LSXR 50	820476096440	Fixture Mount Sensor	Passive Infrared (PIR)	High Mount Aisleway	Line	White	120-277	1200
LSXR 610	820476095115	Fixture Mount Sensor	Passive Infrared (PIR)	High Bay 360° & Large Motion 360°	Line	White	120-277	1200
LSXR 610 2P	820476667756	Fixture Mount Sensor	Passive Infrared (PIR)	High Bay 360° & Large Motion 360°	Line	White	120-277	1200
LSXR 610 HL	820476527449	Fixture Mount Sensor	Passive Infrared (PIR)	High Bay 360° & Large Motion 360°	Line	White	120-277	1200
LSXR 610 HL HVOLT	888791402001	Fixture Mount Sensor	Passive Infrared (PIR)	High Bay 360° & Large Motion 360°	Line	White	347-480	1200
LSXR PC	888791141450	Fixture Mount Sensor	Passive Infrared (PIR)	Photocontrol	Line	White	120-277	1200
LSXR PC ADC	889804472813	Fixture Mount Sensor	Passive Infrared (PIR)	Photocontrol	Line	White	120-277	1200

Dimensions

LSXR

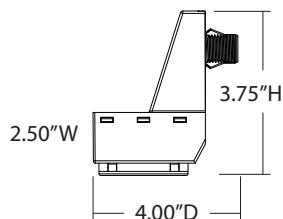

## SFR



## Features

- Ideal for open offices, warehouses and gymnasiums
- Compact line voltage sensor snaps directly into fixture
- Convenient snap-in mounting
- 360° Coverage Pattern
- Miswire protection, reversible line & load connections
- Self-contained relay
- No minimum load
- Push-button programmable
- User adjustable time delay

## Ordering Information

Catalog Number	UPC	Description	Detection Type	Coverage	Voltage Type	Color	Voltage	Pallet Quantity
SFR 30	820476233159	Snap-Fit Sensor	Passive Infrared (PIR)	Universal 360°	Line	White	120/277	1500

## Dimensions

SFR

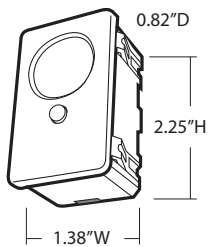

### Features

- Ideal for corridors and wide areas, such as classrooms
- Digital PIR detection - excellent radio frequency immunity
- Optional Passive Dual Technology (PDT) utilizes PIR/ Microphonics™ detection (WV only)
- Miswire protection, reversible line & load connections
- 30 seconds to 30 minutes time delay
- Push-button programmable
- Minimum On-Timer (LampMaximizer®)
- Convenient test mode



### Ordering Information

Catalog Number	UPC	Description	Detection Type	Coverage	Voltage Type	Color	Voltage	Pallet Quantity
WV 16	745975810093	Corner Mount Sensor	Passive Infrared (PIR)	Wide View	Low	White	12-24	1500
WV PDT 16	745975810116	Corner Mount Sensor	Passive Dual Technology (PDT)	Wide View	Low	White	12-24	1500
HW13	745975809561	Wall Mount Sensor	Passive Infrared (PIR)	End-of-Hallway	Low	White	12-24	1500

### Accessories

Catalog Number	UPC	Description
WV BR	745975810109	Wide View Ceiling Mount Bracket

### Dimensions

WV/HW

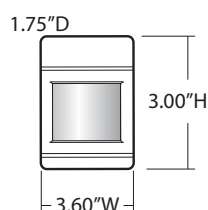

# PTS



## Features

- Ideal for stockrooms and mechanical rooms
- Six preset timer selections
- Miswire protection, reversible line & load connections
- No neutral connection required
- No minimum load requirement
- Self-contained relay
- Optional audible timeout warning at 45, 30, and 15 seconds

## Ordering Information

Catalog Number	UPC	Description	Maximum Setting	Voltage Type	Color	Voltage	Pallet Quantity
PTS 60 WH	784231457870	Preset Timer Wall Switch	60 Minutes	Line	White	120/277	1728
PTS 60 IV	784231531563	Preset Timer Wall Switch	60 Minutes	Line	Ivory	120/277	1728
PTS 720 WH	784231457962	Preset Timer Wall Switch	720 Minutes	Line	White	120/277	1728
PTS 720 IV	784231531594	Preset Timer Wall Switch	720 Minutes	Line	Ivory	120/277	1728

## Dimensions

PTS

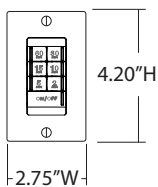



Features

- Ideal for powering low voltage sensors
- Patented Relay Contact Protection (PP20 only)
- Plenum rated
- Powers up to 14 sensors
- Self-contained relay



Ordering Information

Catalog Number	UPC	Description	Voltage Type	Color	Voltage	Pallet Quantity
MP20	745975809585	Mini Power Pack	Line	Black	120/277	1400
PP20	745975809592	Power Pack	Line	Black	120/277	1400

Dimensions

MP20/PP20

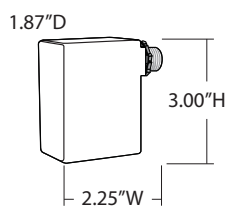

# NETWORK CONTROLS







**AcuityControls**

nLight®

- 156** | Wall Switch Sensor Controls
- 157** | WallPod Controls
- 158** | Graphic WallPod Controls
- 160** | Ceiling Mount Occupancy Sensors
- 161** | Ceiling Mount Daylighting Controls
- 162** | Power Packs

## nWSX LV



nWSX LV



nWSX LV DX

### Features

- Ideal for private office, copy room, and private restroom applications
- Digital PIR detection - excellent radio frequency immunity
- Optional Passive Dual Technology (PDT) utilizes PIR/ Microphonics™ detection
- Controls nLight enabled fixtures without a powerpack
- Provides On/Off and/or Raise/Lower control
- Multiple nWSX sensors or WallPods can be used in 3 way (or greater) configurations without traveler wires
- Remotely configurable/upgradeable

### Ordering Information

Catalog Number	UPC	Description	Detection Type	Dimming	Voltage Type	Color	Power Consumption	Pallet Quantity
nWSX LV WH	753573920427	Wall Switch Sensor	Passive Infrared (PIR)	N/A	Low	White	< 3mA	1728
nWSX LV IV	753573974185	Wall Switch Sensor	Passive Infrared (PIR)	N/A	Low	Ivory	< 3mA	1728
nWSX LV DX WH	753573769026	Wall Switch Sensor	Passive Infrared (PIR)	Controls Dimmable NEF or PP*	Low	White	< 3mA	1728
nWSX LV DX IV	753573974222	Wall Switch Sensor	Passive Infrared (PIR)	Controls Dimmable NEF or PP*	Low	Ivory	< 3mA	1728
nWSX PDT LV DX WH	753573973911	Wall Switch Sensor	Passive Dual Technology (PDT)	Controls Dimmable NEF or PP*	Low	White	< 3mA	1728
nWSX PDT LV DX IV	753573974253	Wall Switch Sensor	Passive Dual Technology (PDT)	Controls Dimmable NEF or PP*	Low	Ivory	< 3mA	1728

\*NEF is an nLight enabled fixture; PP is an nLight powerpack

### Dimensions

nWSX

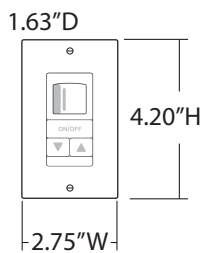

### Accessories

Catalog Number	UPC	Description
CAT5 15FT J1	753573308782	(1) 15FT CAT-5e Cable

Features

- Ideal for any nLight controlled room
- Controls nLight enabled fixtures without a powerpack
- Provides On/Off and/or Raise/Lower control
- Single or dual channel
- Remotely configurable/upgradeable



nPODM

nPODM DX

nPODM 2P

nPODM 2P DX

Ordering Information

Catalog Number	UPC	Description	Channels	Dimming	Voltage Type	Color	Power Consumption	Pallet Quantity
nPODM WH	745977901355	WallPod	Single Channel	N/A	Low	White	< 5mA	1728
nPODM IV	745977901140	WallPod	Single Channel	N/A	Low	Ivory	< 5mA	1728
nPODM DX WH	745977903502	WallPod	Single Channel	Controls Dimmable NEF or PP*	Low	White	< 5mA	1728
nPODM DX IV	745977901539	WallPod	Single Channel	Controls Dimmable NEF or PP*	Low	Ivory	< 5mA	1728
nPODM 2P WH	745977903618	WallPod	Dual Channel	N/A	Low	White	< 5mA	1728
nPODM 2P IV	745977903601	WallPod	Dual Channel	N/A	Low	Ivory	< 5mA	1728
nPODM 2P DX WH	745977911958	WallPod	Dual Channel	Controls Dimmable NEF or PP*	Low	White	< 5mA	1728
nPODM 2P DX IV	745977911941	WallPod	Dual Channel	Controls Dimmable NEF or PP*	Low	Ivory	< 5mA	1728

\*NEF is an nLight enabled fixture; PP is an nLight powerpack

Dimensions

nPODM

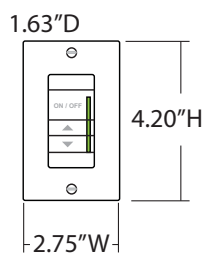

Accessories

Catalog Number	UPC	Description
CAT5 15FT J1	753573308782	(1) 15FT CAT-5e Cable



## nPOD GFX



### Features

- Ideal for any nLight controlled room
- Full color touch screen
- Provides up to 16 On/Off/Dim control
- Provides up to 16 preset scenes
- User customization of all presets and On/Off/Dim controls
- Low voltage device mounts to a single gang switch box
- Optional password protection for controls and setup screens
- Remotely configurable/upgradeable

### Ordering Information

Catalog Number	UPC	Description	Maximum Channels	Maximum Scenes	Operation	Color	Voltage	Pallet Quantity
nPOD GFX WH	745977225239	Graphic WallPod	16	16	On/Off/Dim	White	120/277	144
nPOD GFX IV	753573099420	Graphic WallPod	16	16	On/Off/Dim	Ivory	120/277	144

### Dimensions

nPOD GFX

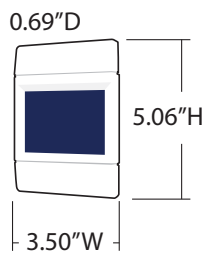

### Accessories

Catalog Number	UPC	Description
CAT5 15FT J1	753573308782	(1) 15FT CAT-5e Cable



## nCM



## Features

- nCM 9 ideal for open offices, larger offices, conference rooms and restrooms.
- nCM 10 is ideal for corridors, locker rooms, low bay warehouses and stairwells
- Digital PIR detection - excellent radio frequency immunity
- Optional Passive Dual Technology (PDT) utilizes PIR/ Microphonics™ detection
- 360° coverage at 8 - 15' mounting heights (~500ft<sup>2</sup> - nCM 9, ~2000ft<sup>2</sup> - nCM 10)
- Integrated On/Off photocell standard (disabled by default)
- Adjustable settings (e.g. occupancy time delays, photocell set-points) via push-button or SensorView software application
- Remotely configurable/upgradeable
- RJB indicates rear RJ45 port location (CAT5e patch cable & RJ45 splitter included)

## Ordering Information

Catalog Number	UPC	Description	Detection Type	Coverage	Voltage Type	Color	Power Consumption	Pallet Quantity
nCM 9 RJB	888791703108	Ceiling Mount Sensor	Passive Infrared (PIR)	Small Motion 360°	Low	White	< 3mA	1200
nCM PDT 9 RJB	888791720761	Ceiling Mount Sensor	Passive Dual Technology (PDT)	Small Motion 360°	Low	White	< 3mA	1200
nCM 10 RJB	888791703092	Ceiling Mount Sensor	Passive Infrared (PIR)	Large Motion 360°	Low	White	< 3mA	1200
nCM PDT 10 RJB	888791720754	Ceiling Mount Sensor	Passive Dual Technology (PDT)	Large Motion 360°	Low	White	< 3mA	1200

## Dimensions

nCM

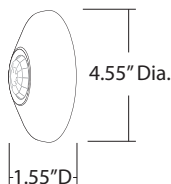

## Accessories

Catalog Number	UPC	Description
CAT5 15FT J1	753573308782	(1) 15FT CAT-5e Cable

Features

- Ideal for spaces with daylight exposure (windows)
- Daylight Harvesting Photocell
- Auto dimming of lights based on daylight in space
- Controls nLight enabled fixtures or nLight dimming relay pack
- Adjustable settings (e.g. set-point) via push-button or SensorView™ software application
- Remotely configurable/upgradeable
- RJB indicates rear RJ45 port location (CAT5e patch cable & RJ45 splitter included)



Ordering Information

Catalog Number	UPC	Description	Detection Type	Voltage Type	Color	Power Consumption	Pallet Quantity
nCM ADCX RJB	888791720822	Ceiling Mount Sensor	Dimming Photocontrol	Low	White	< 3mA	1200

Dimensions

nCM

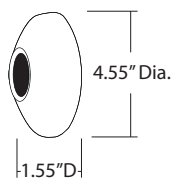

Accessories

Catalog Number	UPC	Description
CAT5 15FT J1	753573308782	(1) 15FT CAT-5e Cable

## nPP



## Features

- Ideal for any nLight controlled room
- Relay pack for controlling non-nLight enabled fixtures
- Self-contained relay switches line voltage load
- Optional 0-10V dimming
- PL option for plug load control (tracks occupancy)
- Plenum rated
- Remotely configurable/upgradeable

## Ordering Information

Catalog Number	UPC	Description	Dimming	Power	Specialty	Voltage Type	Color	Voltage	Pallet Quantity
nPP16	745975903672	Power Pack	N/A	16A	N/A	Line	White	120/277	1400
nPP16 D	888791190915	Power Pack	0-10V	16A	N/A	Line	White	120/277	1400
nPP16 D ER	888791190939	Power Pack	0-10V	16A	Emergency	Line	Red	120/277	1400
nPP16 ER	753573217732	Power Pack	N/A	16A	Emergency	Line	Red	120/277	1400
nPP20 PL	889804095630	Power Pack	N/A	20A	Plug Load Control	Line	Blue	120	1400

## Dimensions

nPP

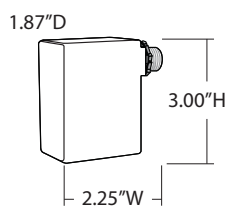

## Accessories

Catalog Number	UPC	Description
CAT5 15FT J1	753573308782	(1) 15FT CAT-5e Cable





Igneous Ⓞ  
• come from volcanoes  
• big crystals  
  
Granite  
Obsidian  
Basaltic Lava  
Pumice

Sedimentary Ⓞ  
• crushed up rocks  
• have very straight lines and streaks  
  
Conglomerate  
Sandstone  
Shale  
Limestone

# Acuity Brands® QuickShip Programs

When you need lighting and controls products fast, Acuity Brands delivers! With more than one million products in our QuickShip programs from eleven manufacturing and distribution centers around the country, we can quickly ship and meet the needs of the market in virtually every category of lighting and controls.



## LightQuick®

2-day shipment on select stock and made-to-order products from Lithonia Lighting®, Gotham®, Sensor Switch®, nLight®, Reloc® Wiring and Mark Architectural Lighting®



## Antique Street Lamps® Rapid-Ship

10-day shipment on select Antique Street Lamps products



## Hydrel®

5-day shipment on select Hydrel products



## Lighting Control & Design®

2-day shipment on select LC&D products



## Mark Architectural Lighting™

10-day shipment on select Mark Architectural Lighting products



## Peerless® QuickShip

10-day shipment with no surcharge or 5-day shipment with small surcharge on select products



## Sunoptics®

Stock products at warehouse locations nationwide including: Sacramento, Dallas, Chicago and Atlanta.

For more information, visit [www.acuitybrands.com/quickship](http://www.acuitybrands.com/quickship)

# Acuity Tools

## Acuity Distributor Center



Acuity Distributor Center (ADC) is a self-service, online portal that delivers valuable

information to our authorized distributors in just a few clicks! ADC helps to effectively manage your business by streamlining information, reducing transactional costs and improving productivity.

### With ADC you can:

- View Order Status
- View Product Availability
- View Credit Memos and Invoices
- Submit Freight Claims
- Dynamically Build Custom Product Catalog
- Stay Up-to-Date on the Latest Promotions

Visit [www.acuitydistributorcenter.com](http://www.acuitydistributorcenter.com) to get started!

## Trial Installation Program (T.I.P.)

Seeing is believing! The Trial Installation Program allows customers to install fixtures on-site to ensure they meet the customer's needs. Whether they would like to test energy savings or performance, or even view the luminaire in the space for aesthetic reasons, take advantage of the program today!

- Order up to **10 products\*** per product family or project
- **90-day trial period.** If you are not satisfied, return the merchandise (freight prepaid) in saleable condition and in its original packaging within 90 days for a credit
- Distributor will be invoiced at shipment with 90-day terms

Schedule a call with your Acuity Brands sales representative to learn more!

## Data Logger Monitoring System

Sensor Switch, the industry leader in lighting control innovation, presents the Data Logger Monitoring System for modeling facility lighting and occupancy patterns. Primarily used to quantify potential energy savings from occupancy sensor projects, this powerful tool is essential for performance contractors, lighting retrofitters, and facility managers when calculating Return on Investment (ROI) and payback estimates.

**AcuityControls.**

*Sensor Switch...*

### Data logger functionality includes:

- Recording activity of building's lighting as well as its occupants
- Analyzing information and generates customized reports that can quantify potential energy savings from occupancy sensor project.
- Providing data in "Lights On vs. Occupancy" timeline

Use of system is provided to qualified customers at no charge. Check out [www.sensorswitch.com/datalogger](http://www.sensorswitch.com/datalogger) to learn more.

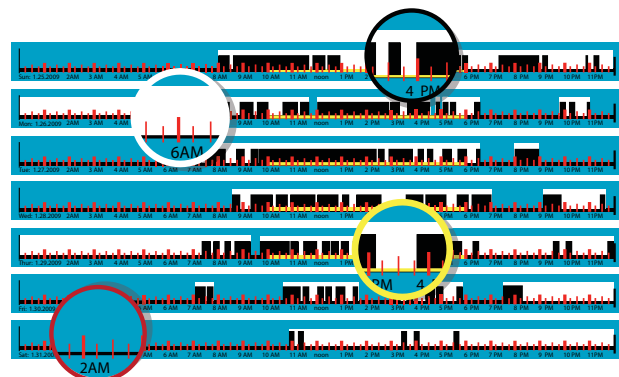

- Red lines represent time intervals
- White bars represent when the lights are on
- Yellow lines represent peak billing hours
- Black bars represent occupancy in the room

# Acuity Tools



## Why use the tool?

The **Visual Economic Tool** allows users to develop realistic costs over the lifetime of a lighting system, offering a more meaningful business evaluation than simple payback calculators.

## Benefits

Don't stop at Simple Payback – start comparing total Life Cycle Cost for your designs! [www.visual-3d.com/software/designtools.aspx](http://www.visual-3d.com/software/designtools.aspx)

### Calculate

- Perform simple energy-only simple payback estimates or create estimates that include maintenance, controls or HVA

### Collaborate

- Save time and promote consistency by loading data from the Visual Economic Tool into Visual's other design tool

### Choose

- Choose products from the entire Acuity Brands indoor and outdoor lighting products portfolio
- The tool will also accept non-Acuity Brands lighting product data

### Compare

- Compare using various lighting controls methods and common light sources

## Other Valuable Resources



Area Tool



Floodlight Tool



Interior Tool



Photometric Tool



Roadway Tool



Template Tool



Wallwash Tool

# Acuity Resources



## Acuity Brands Centers for Light & Space

Acuity Brands continues to lead in lighting, controls and daylighting educational seminars. The Centers for Light & Space (CL&S) are designed to provide comprehensive education and training programs to arm our customers with the knowledge of applying the best lighting solution for every environment.

Our breadth of training capabilities will expose our customers with the latest innovations that improve lighting quality, save energy, and integrate digital controls, daylighting & building systems while accentuating the architectural space.

Our locations include:

- Conyers, GA
- Granville, OH
- Berkeley, CA
- New York, NY

Visit [www.acuitybrands.com/resources/training-education](http://www.acuitybrands.com/resources/training-education) to access the CL&S program calendar at your nearest location.

Can't make the trip? Check out our virtual learning modules, which allow you to learn at your own pace and include AIA continuing education units and NCQLP learning units.



## Acuity Brands Library and Mobile App

For the most up-to-date marketing collateral and product literature, check out our AB Library at [www.acuitybrands.com/library](http://www.acuitybrands.com/library). There you will find catalogs like our Product Selection Guide and Stock Guide. You can even go mobile with the AB Library App for Apple® and Android devices!



## Acuity Store

The Acuity Store is your one-stop-shop for Acuity Brands branded merchandise. Browse our store for everything from apparel, drinkware, office supplies, electronics, gifts, giveaways and more! Plus, you can even add your logo to co-brand merchandise upon order entry. Visit [www.acuitystore.com](http://www.acuitystore.com) to check it out today!



# Acrylic Compatibility Table

Certain chemicals that may exist in end-user locations release airborne contaminants that can impact the integrity and safety of key fixture components that contain acrylic material. Immediate damage may occur such as crazing, cracking, permeation losses and mechanical failure. Products with visually noticeable deterioration have diminished integrity and must be replaced immediately with a more suitable product for the application.

This table identifies the most common chemicals and is not intended to be all-inclusive. Exposure to compounds identified as "Not Acceptable" will void all warranties associated with the product. Acrylic components should not be used in areas where these chemicals are used and where these chemicals become mists or airborne vapors. Ensure that chemical interactions are considered when selecting fixtures. For additional information please consult an authorized factory representative.

## Not Acceptable

Acetaldehyde, 100%  
Acetates  
Acetic Acid, Glacial, 100%  
Acetic Anhydride  
Acetone  
Acetonitrile  
Acetophenone  
Acrylic Paints  
Alcohol, Allyl  
Alcohol, Amyl  
Alcohol, Benzyl  
Alcohol, Ethyl, 100%  
Alcohol, Ethyl, 50%  
Alcohol, Isopropyl, 100%  
Alcohol, Methyl, 10%  
Alcohol, Methyl, 100%  
Alcohol, Methyl, 50%  
Alcohol, N-Butyl  
Amyl Acetate  
Aniline  
Aviation Fuel (100 Octane)  
Benzaldehyde  
Benzene  
Benzoic Aldehyde  
Brake Fluid  
Bromine Gas  
Butanol  
Butraldehyde  
Butyl Acetyl Ricinoleate  
Butyl Stearate  
Carbolic Acid  
Carbon Disulfide  
Carbon Disulfide  
Cellulose Paints  
Chlorinated Hydrocarbons  
Chlorinated Solvents  
Chlorine Gas  
Chlorophenol  
Chromic Acid, 40%  
Cloves  
Cosmoline Removers  
Cresol  
Cyclohexane  
Cyclohexanone  
Cyclohexene  
Detergent Solution  
Diacetone Alcohol  
Diamyl Phthalate

Dibutyl Sebacate  
Diethyl Ether  
Dimethyl Formamide  
Diethyl Sebacate  
Dioxane  
Ether  
Ethyl Acetate  
Ethyl Alcohol, Concentrated  
Ethyl Bromide  
Ethyl Butyrate  
Ethylene Bromide  
Ethylene Dibromide  
Ethylene Oxide (Moist)  
Glass Cleaners Glycol  
Hydrogen Peroxide, 28%  
Hydrogen Peroxide, 3%  
Iron Perchloride  
Isoctane  
Isopropyl Alcohol  
Lacquer Thinner  
Lactic Acid Butyl Ester  
Mercury Chloride  
Meta-Cresol  
Methanol, 15%  
Methanol, Concentrated  
Methyl Benzoate  
Methyl Chloride  
Methyl Cyclohexanol  
Methyl Ethyl Ketone  
Methyl Naphthalene  
Methyl Salicylate Methylamine  
Methylene Dichloride  
Mineral Oil  
Motor Fuel Mixture, with Benzene  
Nail Polish  
Naphtha  
N-Butyric Acid, 100%  
Nitric Acid, 40%  
Nitric Acid, 70%  
Nitrobenzene  
N-Octane  
Organic Solvents  
Paint Removers  
Paint Thinner  
Perchloroethylene

Petroleum Ether (100-120C)  
Phenois  
Phenol, Aqueous, 5%  
Phosphoric Acid, 95% @ 20C  
Phthalates  
Pyridine  
Sodium Carbonate, 2% S  
odium Carbonate, 20%  
Sodium Phosphate  
Sulfur Dioxide, Liquid  
Sulfuric Acid, 98%  
Sulfurous Acid, Concentrated  
Tincture of Iodine, 5% Toluene  
Transformer Oil  
Trichloroethane  
Trichloroacetic Acid  
Trichloroethylene  
Turpentine  
Unleaded Gasoline  
Vegetable Oil  
Xylene

## Acceptable

2-Ethylhexyl Sebacate  
Acetic Acid 5%  
Ammonia-based Cleaners  
Ammonia Gas  
Ammonium Hydroxide, 28%  
Ammonium Nitrate  
Ammonium Phosphate  
Aniseed, Bay Leaves, Nutmeg  
Anti-freeze  
Beer  
Bleaching Power Paste  
Bleaching Powder Solution, 2%  
Calcium Hypochlorite  
Car Wash Detergent  
Carbon Dioxide Gas  
Carbon Monoxide Gas  
Caustic Potash  
Chlorine Based Cleaners  
Chlorine, Aqueous, 2%  
Citric Acid, 10%  
Coffee Cooking Oil  
Cottonseed Oil  
Diethylene Glycol  
Epoxy Adhesives  
Ethyl Alcohol, 15%  
Ethylene Glycol E  
Ethylene Oxide (Dry)  
Ferric Chloride, Aqueous, 10%  
Formaldehyde, Aqueous, 40%  
Fruit Juice  
Glycerol  
Heptane  
Hexane  
Hydrochloric Acid, 38%  
Kerosene  
Lactic Acid  
Metal Carbonates  
Metal Chlorides  
Metal Sulfates  
Methane Gas  
Milk  
Milk, Chocolate  
Motor Fuel Mixture, without  
Benzene  
Motor Oil  
Natural Gas  
Nitric Acid, 10%  
Nitrogen Dioxide Gas

Nitrogen Monoxide Gas  
Olefric Carbolic Acids  
Oleic Acid  
Olive Oil  
Oxalic Acid, 100%  
Oxygen Gas  
Ozone Gas  
Paraffin, Medicinal  
Pepper, Cinnamon, Onions  
Phosphoric Acid, 10% @ 20C  
Photographic Baths  
Polishing Compounds  
Potassium Chlorate  
Potassium Cyanide  
Potassium Dichromate, 10%  
Potassium Hydroxide @ 20C  
Potassium Permanganate  
Potassium Sulfite  
Power Steering Fluid  
PropyleneP  
ure-oil Paints  
Silicone Oil  
Silver Nitrate  
Soap Suds  
Soda  
Sodium Chloride, 10%  
Sodium Cyanide  
Sodium Fluoride  
Sodium Hydroxide, 60%  
Sodium Nitrate  
Sodium Thiosulphate, 40%  
Stearic Acid  
Sulfur Dioxide, Dry Gas  
Sulfuric Acid, 30%  
Sulfurous Acid, 5%  
Tararic Acid, 50%  
Transmission Fluid  
Tricresyl Phosphate  
Triethyl Amine  
Vinegar  
Water, Mineral Water  
Wax Polish  
White Spirit  
Whitewash  
Wine

The statements, technical information and recommendations obtained herein are believed to be accurate as of June 1, 2009. Since the conditions and methods of use of the product and of the information referred to herein are beyond our control, Acuity Brands Lighting expressly disclaims any and all liability. NO WARRANTY OF FITNESS FOR ANY PARTICULAR PURPOSE, WARRANTY OF MERCHANTABILITY OR ANY OTHER WARRANTY, EXPRESS OR IMPLIED, IS MADE CONCERNING THE GOODS DESCRIBED OR THE INFORMATION PROVIDED HEREIN. The user should thoroughly test any application before commercialization.

# Index

Model Number	Page	Model Number	Page	Model Number	Page
11750	71	FSL	16	OLW 23	114
10640RE	67	FSMSATL	70	OLW 31	114
10642RE	67	GT	14	OLWP	118
1290L	75	GT8	15	OLWX1	112
1292L	75	GTL	12	OLWX2	113
2AV	20	GTLR	13	OMS 1000	141
2PM3N	19	HMRB 10	148	OMS 1000 PR2	140
4BEMW	45	HW 13	151	OMS 2000	141
4BPMW	44	IBH	79	OMS 2000 PR2	140
4G1	47	IBL	79	OMS 3000	141
4IGMW	46	IBZ	80	OMS 3000 PR2	140
5BPMW	39	JCBL	78	OWP3	119
5G1	41	KADL	130	PP20	153
5IGMW	40	KADRD	130	PS1030	103
65BEMW	35	L	93	PS1050	103
6BPMW	34	L3X	54	PS1400QD	103
6G1	37	L3X LED	43	PS600QD	103
6HF	30	L3XR	54	PSDL3	103
6IGMW	36	L3XR LED	43	PSQ500QD	103
6VF	31	L5	52	PT	18
AFN	102	L5 LED	38	PTS	152
BLT	17	L5R	52	RAZ	72
C	92	L5R LED	38	RB (CS)	24
CHD	82	L7X	48	RT5	21
CM 10	146	L7X LED	33	RV6	29
CM 9	146	L7XP	50	RV8	29
CM ADC	146	L7XR	18	SB	25
CM PC	146	L7XR LED	33	SB (CS)	24
CM PC ADC	146	LB	25	SBL	23
CM PDT 10R	146	LB (CS)	24	SFR 30	150
CM PDT 9 R	146	LBL	23	SPODMRD	145
CM6	146	LC6	56	TDD	135
CMR 10	146	LCP	58	TDD LED1	134
CMR 6	146	LDN6	28	TDD LED2	134
CMR 9	146	LF6N	30	TFA	128
CMR ADC	146	LF8N	30	TFL	128
CMR PC	146	LHQM LED	97	TFM	129
CMR PC ADC	146	LI6	56	TH	83
CMR PDT 10	146	LP6FN	31	TRF	129
CMR PDT 9	146	LP8FN	31	TWH	109
CMRB 6	148	LQM	96	TWH LED	108
CTL	82	LSXR	149	TWP	109
CXD	82	MNSL	90	TWP LED	108
DMW	85	MP20	153	TWR1 LED/TWR2 LED	110
DMW2	84	NCM	160	TWR1/TWR2	111
DSX0	131	NCM ADX	161	TWS	117
DSXF1	122	NPOD GFX	158	TWS LED	116
DSXF2	122	NPODM	157	TX	83
DSXF3	123	NPP16	162	UC	74
ECBR/ECBG	101	NPP16 D ER	162	UCLD	73
ECR LED/ECG LED	101	NPP16D	162	VC	137
EDG/EDGR	102	NPP20 PL	162	VRC	132
ELA (QUANTUM)	104	NWSX LV	156	VW	137
ELA LED	105	OFL1 LED	124	WC 2 17 MVOLT GEB101S	22
ELM2 LED	99	OFL2 LED	125	WC 2 32 MVOLT GEB101S	22
ELM6 LED	99	OLAW23	134	WP 2 32 MVOLT GEB101S	22
ELMLT	98	OLB	126	WSD	144
EU2 LED	100	OLCFM	132	WSX	144
EXG LED	100	OLCS	120	WSX D	145
EXR LED	100	OLF	138	WV 16	151
FMLL	65	OLFL	138	WV PDT 16	151
FMLRL	64	OLFR 6	139	XWL	87
FMLSL	64	OLFR 9	139	XWLED4	75
FMLWL	66	OLLWD/OLLWU	120	XWMLED	86
FMMCL	68	OLS	121	Z/Z232	91
FMML 13	63	OLVT	136	ZL1D	88
FMML 7	62	OLW 14	114	ZL1N	88

**AcuityBrands.**

Expanding the boundaries of lighting™

One Lithonia Way, Conyers, Georgia 30012 | Phone: 800.922.9641  
©2016 Acuity Brands Lighting, Inc. All rights reserved. | 5/16 | AB\_2107

**AcuityControls.**

**AEL** American  
Electric  
Lighting

**ANTIQUE**  
STREET LAMPS

eldoLED®

**DISTECH**  
CONTROLS™

**gotham**®

**HEALTHCARE**  
LIGHTING®

**HOLOPHANE**  
LEADER IN LIGHTING SOLUTIONS

**HYDREL**

**JUNO LIGHTING GROUP**

**LITHONIA**  
LIGHTING

**MARK**  
ARCHITECTURAL  
LIGHTING

Peerless®

**RELOC**  
WIRING SOLUTIONS

**SUNOPTICS**

**WINONA**  
solutions | forms | light