

OIL-FREE CENTRIFUGAL COMPRESSORS



ZH⁺ & ZH 355-900 (355-900 kW/500-1200 hp)
ZH⁺ & ZH 630-1600 (630-1600 kW/900-2250 hp)

Atlas Copco





ZH⁺ & ZH RANGE: HIGH EFFICIENCY & RELIABILITY

Engineered using innovative in-house technology, the ZH⁺ and ZH range captures years of experience in advanced compressed air solutions to save energy and guarantee reliability of oil-free air supply in multiple environments.



Driving down energy costs

Superior oil-free turbo air ends provide the optimum combination of a high flow with low energy consumption. Ample sized cooling, low pressure drops and an efficient drive train result in high compressor package efficiency. Further energy savings are possible with Atlas Copco's heat-of-compression MD, ND and XD dryers.

Assuring your peace of mind

From the factory to the field, Atlas Copco has the expertise and products, service and support to meet customer demands. Through interaction and dedicated service during all stages of the process, Atlas Copco has accomplished a broad customer base around the world. Hundreds of thousands of unflinching running hours give proof of our long-term local and global service and support commitment to engineering companies and contractors as well as end customers.

Keeping your production up and running

ZH⁺ & ZH compressors are built using strict codes of quality control, and are designed and manufactured according to ISO 9001, ISO 14001, ISO 22000 and OHSAS 18001. Atlas Copco's proven, superior turbo technology and over-sized cooling provide you with the highest efficiency and reliability, together with AGMA class A4/ISO 1328 class 4 gears for low noise and vibrations, high-grade stainless steel coolers for very long lifetime, and an integrated lubrication system. The result is the highest reliability you need.



PROVEN TURBO POWER

Your application deserves a reliable supply of oil-free compressed air at the lowest energy cost. Atlas Copco has been building oil-free centrifugal compressors for process and plant air applications for decades.

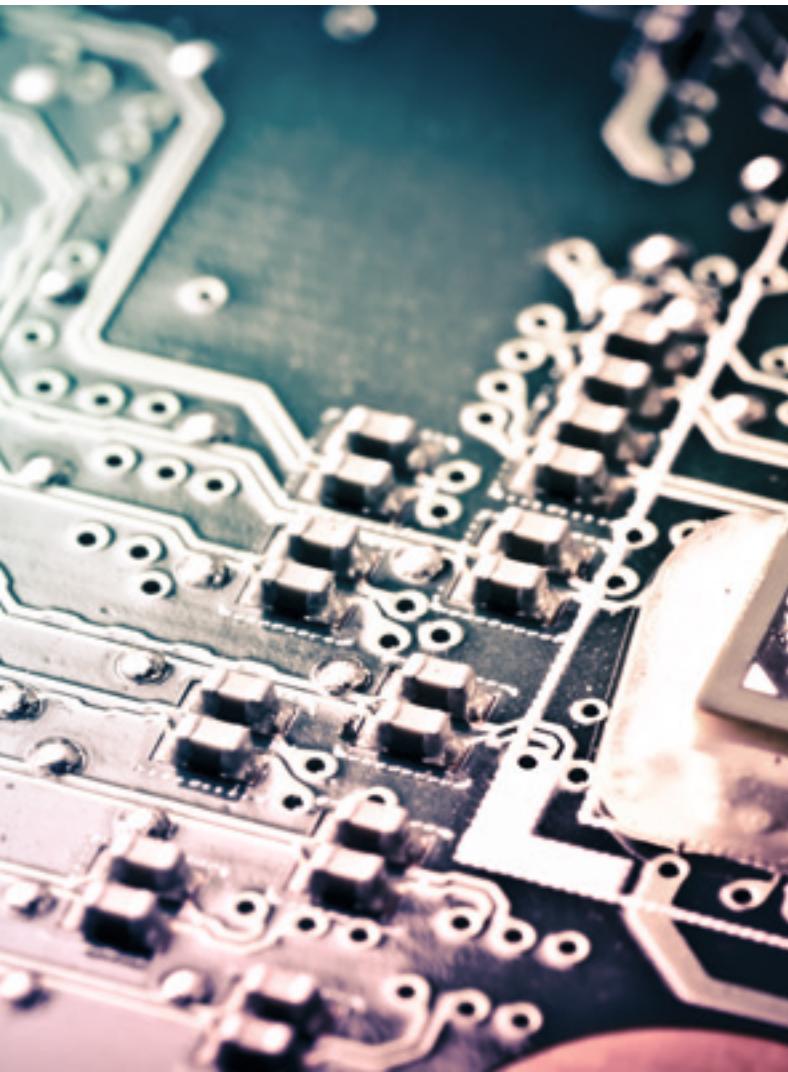

Electronics

- Clean, dry, high-quality air (Class 0) is essential, produced with optimal energy efficiency.
- Applications include the removal of microscopic debris from the surfaces of computer chips and computer boards.

Textiles

- Class 0 certified air quality for the highly sensitive production processes in the textile industry.
- Applications include spinning, weaving, dyeing, texturizing, winding and coning.

Metal manufacturing

- Reliable compressors are essential for your demanding metal manufacturing applications.
- Atlas Copco provides a complete, ready-to-use solution including all components and options with low service cost.

Food & beverage

- Your reputation is at stake so you can't afford to compromise on product quality.
- Applications: Instrument air, cleaning air, food storage, cooling and spraying, filling and capping.

CLASS 0: THE INDUSTRY STANDARD

Oil-free air is used in all kinds of industries where air quality is paramount for the end product and production process. These applications include food and beverage processing, pharmaceutical manufacturing and packaging, chemical and petrochemical processing, semiconductor and electronics manufacturing, the medical sector, automotive paint spraying, textile manufacturing and many more. In these critical environments, contamination by even the smallest quantities of oil can result in costly production downtime and product spoilage.

First in oil-free air technology

Over the past sixty years Atlas Copco has pioneered the development of oil-free air technology, resulting in a range of air compressors and blowers that provide 100% pure, clean air. Through continuous research and development, Atlas Copco achieved a new milestone, setting the standard for air purity as the first manufacturer to be awarded ISO 8573-1 CLASS 0 certification.

Eliminating any risk

As the industry leader committed to meeting the needs of the most demanding customers, Atlas Copco requested the renowned TÜV institute to type-test its range of oil-free compressors and blowers. Using the most rigorous testing methodologies available, all possible oil forms were measured across a range of temperatures and pressures. The TÜV found no traces of oil at all in the output air stream. Thus Atlas Copco is not only the first compressor and blower manufacturer to receive CLASS 0 certification, but also exceeds ISO 8573-1 CLASS 0 specifications.

CLASS	Concentration total oil (aerosol, liquid, vapor) mg/m ³
0	As specified by the equipment user or supplier and more stringent than class 1
1	< 0.01
2	< 0.1
3	< 1
4	< 5

Current ISO 8573-1 (2010) classes (the five main classes and the associated maximum concentration in total oil content).



ZH+ & ZH 355-900: THE OIL-FREE CENTRIFUGAL COMPRESSOR OF YOUR CHOICE

1

Completely packaged solution

- All-in-one standard package incorporating the latest technology in a built-to-last design.
- Includes internal piping, coolers, motor, lubrication, inlet guide vanes and control system.
- Installation is fault-free, and commissioning is quick.
- Optional features for customization to a specific production environment.

2

Efficient inlet silencer and filter

- Inlet filter is combined with a silencer to reduce noise level and protect the compression stage.
- Handy pressure drop indication on the control panel.

3

Integrated blow-off valve and silencer

- No external air, no additional piping and no additional mounting required.
- Auto-dual and Constant Pressure Control modes for cost-efficient response to variable air demands.

4

Mounted cooling water manifold

- Cooling water distribution to intercoolers, aftercooler and oil cooler.
- Individual adjustment of flow through intercoolers and aftercooler.

5

Small footprint

- Lowest footprint on the market in their range.
- Saves valuable and often expensive floor space in a facility.

ZH+



6

Sound attenuating enclosure

Ensures optimal working conditions for everyone in the immediate environment.

7

Energy saving inlet guide vanes

- Smart and efficient capacity control.
- Adjustable inlet guide vanes save up to 9% energy at reduced air demand.
- Reliable servo-motor based actuator for accurate alignment with the variable air demand.

ZH

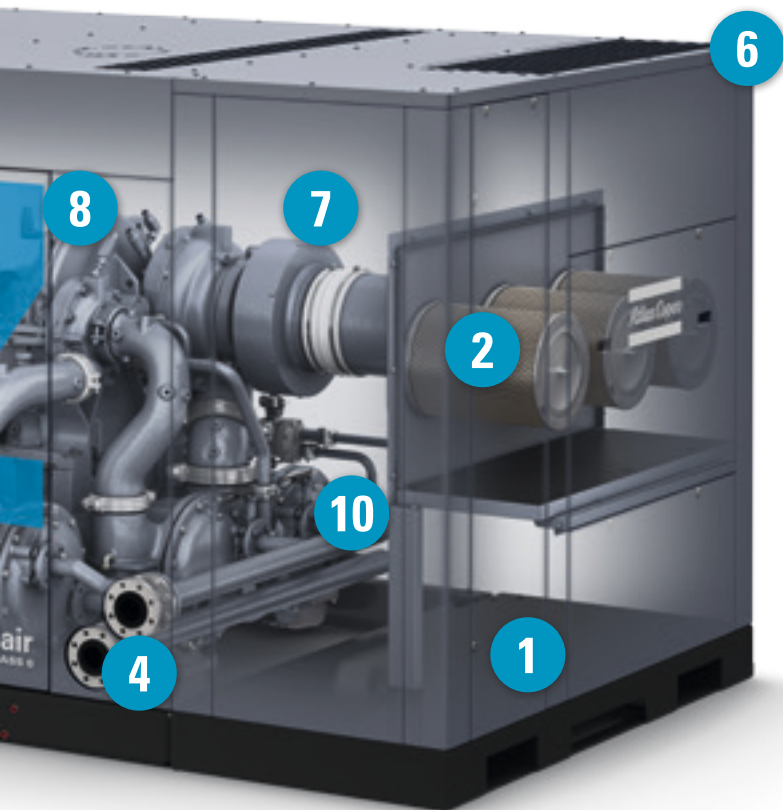
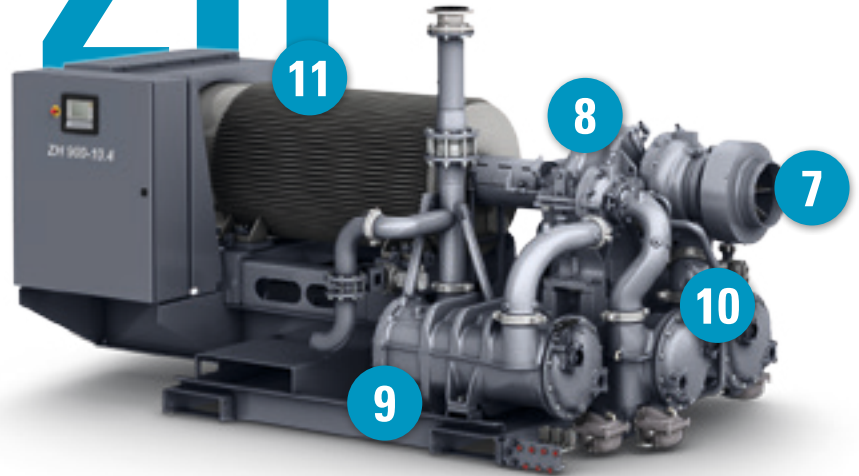

8

Easily accessible gearbox

- Horizontally-split, easing access to gears and high/low speed bearings.
- Short inspection and maintenance times.

9

High efficiency intercoolers and aftercoolers

- Low air approach temperature and pressure drop.
- For higher reliability and easier maintenance, the coolers are separated from the compressor core unit.
- Stainless steel tubes and full epoxy coating inside cooler shells increase corrosion resistance.

10

Complete oil system with oil reservoir, breathing system and auxiliary oil pump

- Fully equipped oil reservoir with temperature sensor and level sight glass.
- Main shaft driven oil pump, supported by auxiliary oil pump during start-up and coast-down.
- Flexible connections to maximize leak tightness.

11

Motor

- High-efficiency main motor.
- Available in IP23 & IP55 versions.

ZH+ & ZH 630-1600: HIGH END TURBO POWER



1

Plug-and-play packaged solution

- All-in-one solution: fault-free installation, easy commissioning and quick start-up.
- Includes core compressor and integrated air inlet system, coolers, blow-off valve and silencer, drive motor, complete lub oil system and control system.

2

Efficient inlet filter and silencer

- Protects the compression stages and reduces the noise level.
- Pressure drop indication on the control panel to monitor best performance.

3

On skid blow-off valve and silencer

- No additional piping or mounting, no external air required.
- Auto-dual and Constant Pressure Control modes for cost-efficient variable compressed air demands.

4

Easy to connect cooling water manifold

- One connection serves intercoolers, aftercooler, oil cooler and main motor.
- Individual flow adjustment for intercoolers and aftercooler.

5

Small footprint

- Highest ratio flow/footprint on the market.
- Saves valuable space in a facility.
- Easy upgrade of existing installations.

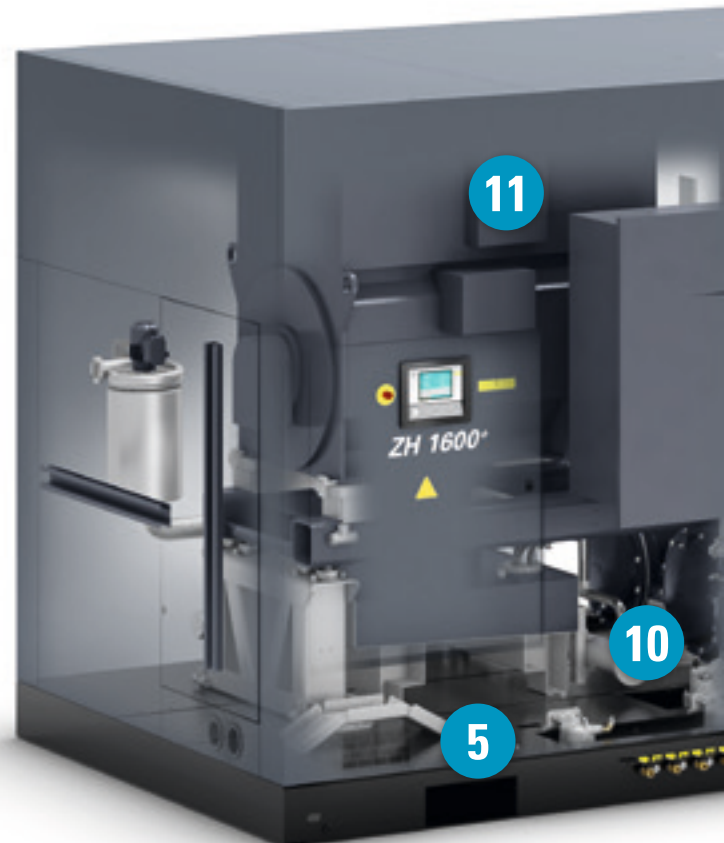

6

Sound attenuating enclosure

Reduces noise related stress on anyone working in the immediate environment.

7

Intelligent Inlet Guide Vanes controls

- Accurate servo-motor-driven positioning ensures stable behavior even under agile compressed air demands and large turndowns.
- Reliable, smart and efficient capacity control saving up to 9% energy at reduced compressed air demand.

8

Easy preventive maintenance access

- Horizontally-split gearbox, with quick access to major rotating components.
- Short inspection and maintenance times.

9

Compact state-of-the-art coolers

- Separately mounted for increased reliability and easier maintenance.
- Epoxy coated air path for increased corrosion resistance.
- Stainless steel tubing for straightforward cleaning.
- Compact and efficient design with low approach temperature and pressure drop.

10

On board full oil lubrication system

- Includes oil reservoir with heater, temperature monitoring and level sight glass.
- Main shaft driven oil pump, supported by auxiliary oil pump during start-up and coast-down.
- Breather system preventing oil fumes.
- Flexible leak free connections.

11

Silent care-free high efficiency main motor

- Water-cooled (IP55) variant.
- Simplifies on-site installation (no need for cooling air ducts).
- Low noise emission.



PROVEN TURBO TECHNOLOGY

Easily accessible gearbox

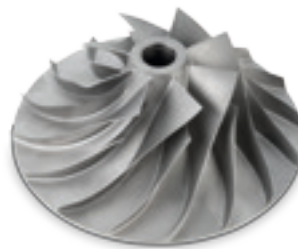

A

B

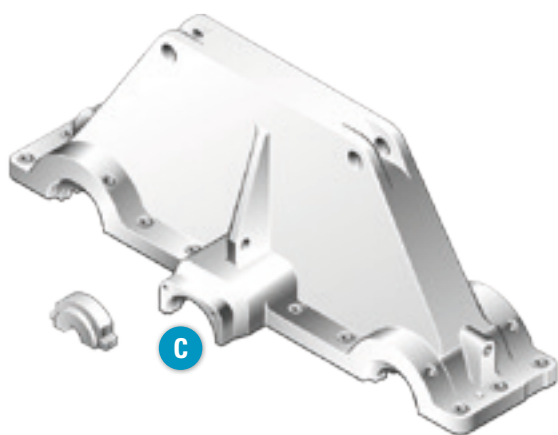
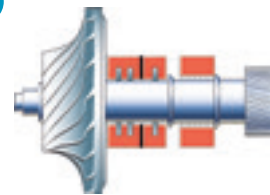

C

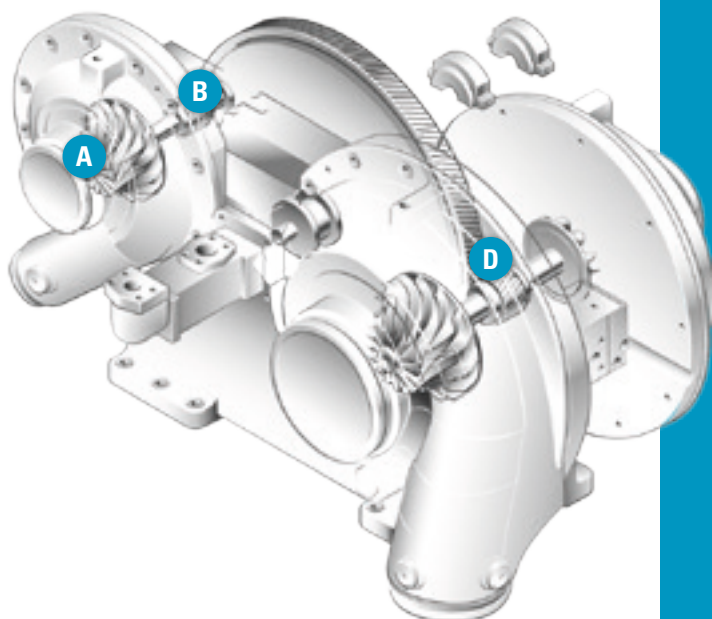

A

B

D

A Individually designed impellers

- Dedicated impeller design for each power and pressure variant.
- Backward leaning impeller design for greater operating flexibility and maximized turndown ratio.

B Oil and air seals

- Reliable long service life.
- Minimized compressed air leakage to atmosphere.
- No external instrument air required for "Class 0" certification.

C Reliable horizontally split bearings

- Flexible pad bearings and combined radial bearing/thrust bearing for extended lifetime, high reliability and stability, easy inspection.

D Bull gear & high speed pinions

- AGMA O-13/ISO 1328-2 grade 4 quality gears for longer lifetime, minimized mechanical losses and lower noise levels.
- Full interchangeability of individual components.



C

D



THE MAGIC FORMULA: TURBO+ SCREW

Obtain the most efficient compressor solution for your high capacity application in the market by combining the advanced turbo technology of the ZH+ with the regulating capabilities of the ZR screw compressor with Variable Speed Drive (VSD). Eliminating costly blow-off in all operating conditions, this combination is ideal to achieve the highest return on investment while enjoying the benefits of the ZH+ turbo and ZR screw technology.

Reduced blow-off

While turbo compressors are very efficient in turndown, a lot of energy is wasted during blow-off by expanding part of the compressed air into the blow-off valve and silencer. By combining two turbo compressors in an erratically varying air demand, the expensive blow-off is reduced but not completely eliminated.

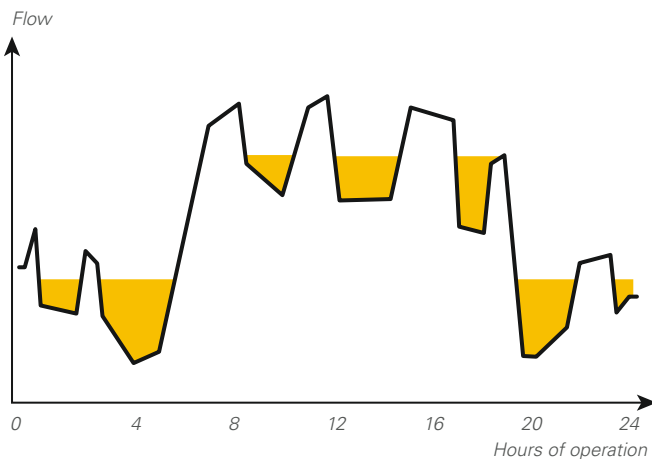

● Operation with blow-off ● Operation without blow-off

Eliminated blow-off

Atlas Copco's unique Variable Speed Drive (VSD) technology closely follows the air demand by automatically adjusting the motor speed. When combining the ZH+ turbo compressor and the ZR screw compressor with VSD, the highest efficiency is achieved by completely eliminating blow-off.

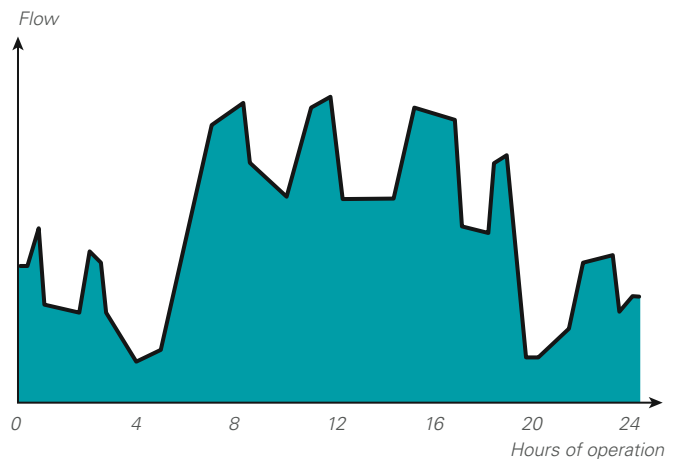

Find out how much you can save

Atlas Copco can help you map the load/air demand profile of your current compressor and blower installation and indicate potential energy savings with VSD compressors and blowers. **For more information, please contact your local Atlas Copco representative.**

MONITORING AND CONTROL: HOW TO GET THE MOST FROM THE LEAST

The Elektronikon® unit controller is specially designed to maximize the performance of your compressors and air treatment equipment under a variety of conditions. Our solutions provide you with key benefits such as increased energy efficiency, lower energy consumption, reduced maintenance times and less stress... less stress for both you and your entire air system.



Intelligence is part of the package

- High resolution color display gives you an easy to understand readout of the equipment's running conditions.
- Clear icons and intuitive navigation provides you fast access to all of the important settings and data.
- Monitoring of the equipment running conditions and maintenance status; bringing this information to your attention when needed.
- Operation of the equipment to deliver specifically and reliably to your compressed air needs.
- Built in remote control and notifications functions provided as standard, including simple to use Ethernet based communication.
- Support for 31 different languages, including character based languages.



Online & mobile monitoring

Monitor your compressors over the Ethernet with the Elektronikon® unit controller. Monitoring features include warning indications, compressor shut-down and maintenance scheduling. An Atlas Copco App is available for iPhone/Android phones as well as iPad and Android tablets. It allows fingertip monitoring of your compressed air system through your own secured network.



Full optimization - ES system controller

Improve product quality every minute that your facility is in operation. Atlas Copco's ES system controllers offer a convenient way to achieve optimized performance from your low pressure equipment through a single centralized point of monitoring and control. With the ES system controller watching over your compressors and compressed air network, you will have a highly dependable and energy efficient solution working with your facility to manage operating costs.

Dual pressure set-point and Delayed Second Stop

Most production processes create fluctuating levels of demand which, in turn, can create energy waste in low use periods. Using the graphic Elektronikon® unit controller, you can manually or automatically create two different system pressure bands to optimize energy use and reduce costs at low use times. In addition, the sophisticated Delayed Second Stop (DSS) runs the drive motor only when needed. As the desired system pressure is maintained while the drive motor's run time is minimized, energy consumption is kept to a minimum.

Without DSS

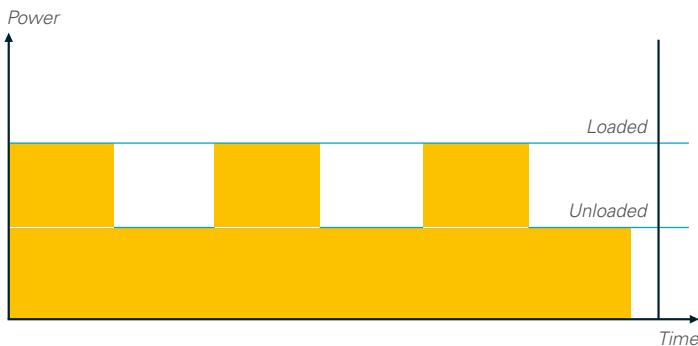

With DSS

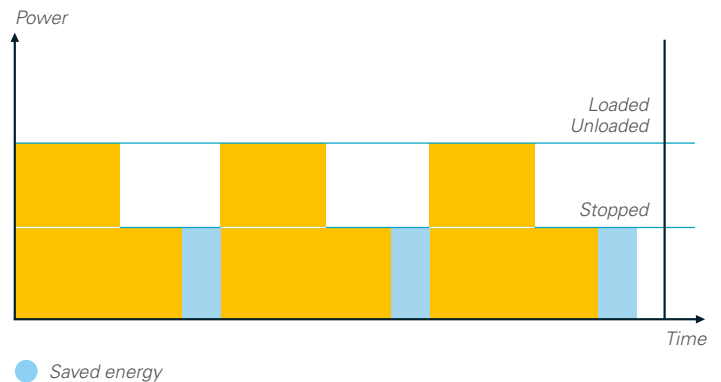

SMARTLINK*: Data Monitoring Program

- A remote monitoring system that helps you optimize your compressed air system and save you energy and cost.
- It offers you a complete insight in your compressed air network and anticipates on potential problems by warning you up-front.

**Please contact your local sales representative for more information.*

A DRYER SOLUTION FOR EVERY NEED

Untreated compressed air contains moisture and possibly dirt particles that can damage your air system and contaminate your end product. The resulting maintenance costs far exceed air treatment costs. Atlas Copco believes in effective prevention and provides a complete range of air treatment solutions to protect investments, equipment, production processes and end products.

Heat of compression reactivated adsorption dryers

XD-G

-70°C/-40°C/-20°C
-94°F/-40°F/-4°F

- Use of freely available heat of compression.
- Limited pressure drop.
- Variants for dew point suppression and guaranteed dew point.
- Variants without loss of compressed air.

XD-S

-20°C/+3°C
-4°F/+37°F

Rotary drum heat of compression dryers

ND

-40°C/-20°C
-40°F/-4°F

MD

-20°C/+3°C
-4°F/+37°F

- Use of freely available heat of compression.
- Negligible power consumption.
- Variants with extra heat augmentation for lower dew points.



Heat reactivated adsorption dryer

BD

-70°C / -40°C / -20°C
-94°F / -40°F / -4°F

- Use of electrical heaters for regenerating the desiccant.
- Limited pressure drop.
- Variants without loss of compressed air.

Refrigerant dryer

FD

+3°C / +20°C
+37°F / +68°F

- Use of cooling circuit for cooling down compressed air.
- Guaranteed pressure dew points.
- Lowest energy consumption in all operating conditions.
- Air and water cooled variants.

ENGINEERED SOLUTIONS

Atlas Copco recognizes the need to combine our serially produced compressors and dryers with the specifications and standards applied by major companies for equipment purchases. Strategically located departments within the Atlas Copco Group take care of the design and manufacturing of customized equipment to operate at extreme temperatures, often in remote locations.

Innovative technology

As original manufacturer of the equipment, Atlas Copco understands all performance capabilities and ensures that the equipment operates within them. All equipment is covered by our manufacturer warranty. The reliability, longevity and performance of our equipment will not be compromised. A global aftermarket operation employing 360 field service engineers in 160 countries ensures reliable maintenance by Atlas Copco as part of a local service operation.

Innovative systems

We are fully aware that project management can be complex. We have developed an Internet based application called IC³ which is shared by all Atlas Copco sites worldwide, to give a transparent view of data and drawings and to easily contribute to the project if required.

Innovative engineering

Each project is unique and by entering into partnership with our customers, we can appreciate the challenge at hand, ask the relevant questions and design the best engineered solution for all your needs.



OPTIMIZE YOUR SYSTEM

With the ZH⁺ & ZH, Atlas Copco provides an all-in-one solution incorporating the latest technology in a built-to-last design. To further optimize your ZH⁺ or ZH's performance or to simply tailor it to your specific production environment, optional features are available.

Standard scope of supply

		ZH ⁺	ZH
Air circuit	Air inlet filter and silencer	✓	•
	Inlet Guide Vanes	✓	✓
	Fully coated air path	✓	✓
	Check valve	✓	✓
	Air outlet compensator	✓	✓
	Integrated blow-off valve	✓	✓
	Integrated blow-off silencer	✓	•
Cooling circuit	Drain traps on all coolers	✓	✓
	Cooling water manifold	✓	•
	Water in- and outlet compensator	✓	•
Oil circuit	Fully integrated lubrication system	✓	✓
General	Motor	IP55	IP23
	Elektronikon® control module	✓	✓
	Canopy	✓	-

Additional features & options

	ZH ⁺	ZH
EZ-install (inlet filter & silencer, blow-off silencer)	-	•
Cooling water manifold	-	•
Hot air variant (no aftercooler)	•	•
Electronic drains	•	-
Dual oil filter	•	•
Dual oil cooler	•	-
Stainless steel oil cooler	•	-
Extended motor protection kit (anti-condensation heater + PT100's in windings and bearings)	•	•
Oversized motor	•	-
Full data package (extra temperature and pressure sensors on stage inlet)	•	-
Full core monitoring (XYZ vibration sensors + PT1000's on high speed bearings)	•	-
Material & core test certificates	•	•

✓: Standard •: Optional -: Not available

WEIGHT & DIMENSIONS

TYPE	Weight (kg)		Dimensions (mm)		
	2-stage	3-stage	L	W	H
ZH 355*	8050	-	5268	2230	2230
ZH 400*	8350	8950			
ZH 450*	8450	9050			
ZH 500*	8600	9200			
ZH 560*	9200	9800			
ZH 630*	-	9950			
ZH 710*	-	10200			
ZH 800*	-	11150			
ZH 900*	-	11150			

TYPE	Weight (kg)		Dimensions (mm)		
	2-stage	3-stage	L	W	H
ZH 355	6325	-	3970	2230	2230
ZH 400	6625	7225			
ZH 450	6725	7325			
ZH 500	6875	7475			
ZH 560	7475	8075			
ZH 630	-	8225			
ZH 710	-	9475			
ZH 800	-	9425			
ZH 900	-	9425			

TYPE	Weight (kg)		Dimensions (mm)		
	2-stage	3-stage	L	W	H
ZH 630*	9940	-	5220	2350	2770
ZH 710*	9940	-			
ZH 800*	9940	-			
ZH 900*	9940	10580			
ZH 1000*	9940	10580			
ZH 1120*	-	10580			
ZH 1250*	-	10580			
ZH 1400*	-	11470			
ZH 1600*	-	11470			

TYPE	Weight (kg)		Dimensions (mm)		
	2-stage	3-stage	L	W	H
ZH 630	9220	-	4320	2350	2680
ZH 710	9220	-			
ZH 800	9220	-			
ZH 900	9220	9860			
ZH 1000	9220	9860			
ZH 1120	-	9860			
ZH 1250	-	9860			
ZH 1400	-	10750			
ZH 1600	-	10750			



TECHNICAL SPECIFICATIONS 50 HZ

2 stage variant

TYPE	2.5 barg			3.5 barg			3.9 barg			4.2 barg			4.6 barg			5 barg			5.5 barg			Installed motor power
	l/s	m³/hr	cfm	l/s	m³/hr	cfm	l/s	m³/hr	cfm	l/s	m³/hr	cfm	l/s	m³/hr	cfm	l/s	m³/hr	cfm	l/s	m³/hr	cfm	Kw
ZH 355(+)	-	-	-	1578	5681	3344	1452	5227	3077	1390	5004	2946	1321	4756	2799	-	-	-	-	-	-	355
ZH 400(+)	-	-	-	1814	6530	3844	1679	6044	3558	1593	5735	3376	1520	5472	3221	-	-	-	1376	4954	2916	400
ZH 450(+)	-	-	-	2052	7387	4348	1906	6862	4039	1813	6527	3842	1722	6199	3649	-	-	-	1570	5652	3327	450
ZH 500(+)	-	-	-	2280	8208	4832	2135	7686	4524	2036	7330	4315	1935	6966	4101	-	-	-	1761	6340	3732	500
ZH 560(+)	-	-	-	2548	9173	5400	2400	8640	5086	2297	8269	4868	2189	7880	4639	-	-	-	1986	7150	4209	560
ZH 630(+)	3241	11668	6868	2884	10382	6112	2720	9792	5764	2585	9306	5478	2440	8784	5171	-	-	-	-	-	-	630
ZH 710(+)	3671	13216	7779	3272	11779	6934	3087	11113	6542	2937	10573	6224	2775	9990	5881	2631	9472	5575	2484	8942	5264	710
ZH 800(+)	4140	14904	8773	3701	13324	7843	3503	12611	7423	3333	11999	7063	3148	11333	6671	2986	10750	6328	2828	10181	5993	800
ZH 900(+)	4655	16758	9865	4160	14976	8816	3951	14224	8373	3775	13590	8000	3571	12856	7567	3383	12179	7169	3204	11534	6790	900
ZH 1000(+)	-	-	-	4609	16592	9767	4381	15772	9284	4196	15106	8892	3983	14339	8441	3781	13612	8012	3582	12895	7591	1000
ZH 1120(+)	-	-	-	-	-	-	4753	17111	10072	4690	16884	9939	4468	16085	9468	4252	15307	9011	4033	14519	8546	1120

3 stage variant

TYPE	6 barg			7 barg			8 barg			9 barg			10.4 barg			13 barg			Installed motor power		
	l/s	m³/hr	cfm	l/s	m³/hr	cfm	l/s	m³/hr	cfm	l/s	m³/hr	cfm	l/s	m³/hr	cfm	l/s	m³/hr	cfm	Kw		
ZH 400(+)	-	-	-	1272	4579	2696	1234	4442	2615	-	-	-	-	-	-	-	-	-	-	-	400
ZH 450(+)	-	-	-	1444	5198	3060	1404	5054	2975	1284	4622	2721	-	-	-	-	-	-	-	-	450
ZH 500(+)	-	-	-	1615	5814	3422	1572	5659	3331	1447	5209	3066	1341	4828	2842	-	-	-	-	-	500
ZH 560(+)	-	-	-	1824	6566	3865	1777	6397	3766	1641	5908	3478	1521	5476	3223	1351	4864	2863	-	-	560
ZH 630(+)	-	-	-	2063	7427	4372	2013	7247	4266	1919	6908	4067	1763	6347	3736	1541	5548	3266	-	-	630
ZH 710(+)	-	-	-	2331	8392	4940	2274	8186	4819	2176	7834	4611	2005	7218	4249	1757	6325	3723	-	-	710
ZH 800(+)	-	-	-	2620	9432	5552	2556	9202	5417	2451	8824	5194	2283	8219	4838	1995	7182	4228	-	-	800
ZH 900(+)	-	-	-	-	-	-	-	-	-	2590	9324	5489	2578	9281	5463	-	-	-	-	-	900
ZH 800(+)	2824	10166	5984	-	-	-	-	-	-	-	-	-	-	-	-	-	-	-	-	-	800
ZH 900(+)	3197	11509	6775	3009	10832	6376	2868	10325	6078	2734	9842	5794	2523	9083	5347	-	-	-	-	-	900
ZH 1000(+)	3568	12845	7561	3360	12096	7120	3198	11513	6777	3056	11002	6476	2822	10159	5980	2518	9065	5336	-	-	1000
ZH 1120(+)	4003	14411	8483	3774	13586	7998	3603	12971	7635	3443	12395	7296	3189	11480	6758	2845	10242	6029	-	-	1120
ZH 1250(+)	4464	16070	9460	4214	15170	8930	4026	14494	8532	3855	13878	8169	3578	12881	7582	3197	11509	6775	-	-	1250
ZH 1400(+)	-	-	-	4717	16981	9996	4503	16211	9542	4318	15545	9150	4016	14458	8510	3596	12946	7620	-	-	1400
ZH 1600(+)	-	-	-	-	-	-	4812	17323	10197	4704	16934	9968	4582	16495	9710	4128	14861	8748	-	-	1600

Free Air Delivery according to ASME PTC10 and ISO 5389.

Reference conditions:

- Inlet pressure 1 bar(a)
- Inlet temperature 35°C (95°F)
- Humidity 60%
- Cooling water temperature 26.7°C (80°F)

TECHNICAL SPECIFICATIONS 60 HZ

2 stage variant

TYPE	35 psig			50 psig			55 psig			60 psig			65 psig			70 psig			80 psig			Installed motor power	
	l/s	m³/hr	cfm	l/s	m³/hr	cfm	l/s	m³/hr	cfm	l/s	m³/hr	cfm	l/s	m³/hr	cfm	l/s	m³/hr	cfm	l/s	m³/hr	cfm	Hp	
ZH 355(+)	-	-	-	1545	5562	3274	1436	5170	3043	1364	4910	2891	1288	4637	2729	-	-	-	-	-	-	-	500
ZH 400(+)	-	-	-	1778	6401	3768	1656	5962	3509	1576	5674	3340	1493	5375	3164	-	-	-	1358	4889	2878	-	600
ZH 450(+)	-	-	-	2013	7247	4266	1876	6754	3976	1787	6433	3787	1698	6113	3598	-	-	-	1546	5566	3276	-	600
ZH 500(+)	-	-	-	2237	8053	4741	2097	7549	4444	2001	7204	4240	1901	6844	4028	-	-	-	1731	6232	3668	-	700
ZH 560(+)	-	-	-	2501	9004	5300	2353	8471	4986	2252	8107	4772	2143	7715	4541	-	-	-	1953	7031	4139	-	800
ZH 630(+)	3235	11646	6855	2871	10336	6084	2721	9796	5766	2571	9256	5448	2436	8770	5162	-	-	-	-	-	-	-	900
ZH 710(+)	3664	13190	7765	3259	11732	6906	3088	11117	6544	2923	10523	6194	2770	9972	5870	2637	9493	5588	2452	8827	5196	-	1000
ZH 800(+)	4133	14879	8758	3686	13270	7811	3504	12614	7425	3317	11941	7029	3143	11315	6660	2991	10768	6338	2793	10055	5919	-	1000
ZH 900(+)	4650	16740	9854	4144	14918	8782	3952	14227	8375	3758	13529	7964	3564	12830	7553	3387	12193	7178	3165	11394	6707	-	1250
ZH 1000(+)	-	-	-	4593	16535	9733	4383	15779	9288	4177	15037	8852	3976	14314	8426	3784	13622	8019	3541	12748	7504	-	1500
ZH 1120(+)	-	-	-	-	-	-	4757	17125	10081	4671	16816	9898	4461	16060	9453	4253	15311	9013	3988	14357	8451	-	1500

3 stage variant

TYPE	85 psig			100 psig			115 psig			130 psig			150 psig			190 psig			Installed motor power	
	l/s	m³/hr	cfm	l/s	m³/hr	cfm	l/s	m³/hr	cfm	l/s	m³/hr	cfm	l/s	m³/hr	cfm	l/s	m³/hr	cfm	Hp	
ZH 400(+)	-	-	-	1252	4507	2653	1213	4367	2571	-	-	-	-	-	-	-	-	-	-	600
ZH 450(+)	-	-	-	1423	5123	3016	1381	4972	2927	1275	4590	2702	-	-	-	-	-	-	-	600
ZH 500(+)	-	-	-	1592	5731	3374	1547	5569	3278	1431	5152	3032	1325	4770	2808	-	-	-	-	700
ZH 560(+)	-	-	-	1798	6473	3810	1749	6296	3706	1619	5828	3431	1504	5414	3187	1344	4838	2848	-	800
ZH 630(+)	-	-	-	2035	7326	4312	1982	7135	4200	1889	6800	4003	1738	6257	3683	1529	5504	3240	-	900
ZH 710(+)	-	-	-	2299	8276	4872	2240	8064	4747	2142	7711	4539	1978	7121	4192	1740	6264	3687	-	1000
ZH 800(+)	-	-	-	2586	9310	5480	2519	9068	5338	2412	8683	5111	2244	8078	4755	1979	7124	4194	-	1250
ZH 900(+)	-	-	-	-	-	-	-	-	-	2549	9176	5402	2531	9112	5364	-	-	-	-	1250
ZH 800(+)	2810	10116	5955	-	-	-	-	-	-	-	-	-	-	-	-	-	-	-	-	1250
ZH 900(+)	3182	11455	6743	2990	10764	6336	2843	10235	6025	2707	9745	5737	2498	8993	5294	-	-	-	-	1250
ZH 1000(+)	3552	12787	7527	3339	12020	7076	3172	11419	6722	3026	10894	6413	2795	10062	5923	2483	8939	5262	-	1500
ZH 1120(+)	3985	14346	8445	3751	13504	7949	3574	12866	7574	3410	12276	7226	3159	11372	6694	2807	10105	5948	-	1500
ZH 1250(+)	4444	15998	9417	4189	15080	8877	3995	14382	8466	3819	13748	8093	3546	12766	7514	3156	11362	6688	-	1750
ZH 1400(+)	-	-	-	4690	16884	9939	4469	16088	9470	4279	15404	9068	3982	14335	8438	3553	12791	7529	-	2000
ZH 1600(+)	-	-	-	-	-	-	4777	17197	10123	4662	16783	9879	4544	16358	9629	4081	14692	8648	-	2250

Free Air Delivery according to ASME PTC10 and ISO 5389.

Reference conditions:

- Inlet pressure 1 bar(a)
- Inlet temperature 35°C (95°F)
- Humidity 60%
- Cooling water temperature 26.7°C (80°F)

COMMITTED TO SUSTAINABLE PRODUCTIVITY

We stand by our responsibilities towards our customers, towards the environment and the people around us. We make performance stand the test of time. This is what we call – Sustainable Productivity.



www.atlascopco.com

The Atlas Copco logo, consisting of the brand name 'Atlas Copco' in a stylized font, flanked by two horizontal bars above and below it.