



## PRECAUTIONS

- **READ AND FOLLOW ALL SAFETY INSTRUCTIONS.**
- **CAUTION - RISK OF ELECTRICAL SHOCK.** To prevent electrical shock, turn off power at the circuit breaker before installing or servicing unit. Never wire energized electrical components.
- **NOTICE:** For installation by a licensed electrician in accordance with National and/or local Electrical Codes and the following instructions.
- **CAUTION: USE COPPER CONDUCTOR ONLY.**
- Be sure to read and understand all instructions before installing or servicing unit
- For Indoor use only. Do not use outdoors.
- Do not mount near gas or electric heaters.
- Disconnect switch or a circuit breaker must be provided and marked as the disconnecting device.
- The use of accessory equipment not recommended by the manufacturer may cause an unsafe condition.
- Confirm that device ratings are suitable for application prior to installation.
- No user serviceable parts contained inside unit. Refer all service related questions to the factory. All servicing shall be performed by qualified service personnel.
- Equipment should be mounted in locations and at heights where it will not readily be subjected to tampering by unauthorized personnel.
- Use only approved materials and components (i.e. twist on connectors, electrical box, etc.) as appropriate for installation.
- **NOTICE:** Do not install if product appears to be damaged.
- If the equipment is used in a manner not specified by the manufacturer, the protection provided by the equipment may be impaired.
- Do not use this equipment for other than intended use.

# Line Voltage Power Connections

- 1 Always use and follow Installation Instructions.
- 2 **Mount the panel enclosure** – Mount the CX panel securely to building structure in accordance with local code requirements. Remove panel door prior to mounting enclosure. All mounting holes are located such that no additional disassembly is required to complete mounting. Mounting keyhole location and dimensions are included in the CX Panel Installation Instructions.
- 3 **Install Individual Relay Cards as required** – When panels include combinations of different types of relays, these must be field installed. Control power must be disconnected to the panel motherboard prior to installing relay cards. Once installation of all cards is complete, restore control power to mother board. Read and follow installation instructions provided with the individual relay cards when installing.
- 4 **Connect CX Panel input power** – Select the appropriate input voltage leads to match the available line voltage input. Make connection to incoming circuit with appropriately sized twist-on wire connectors.
- 5 **Connect controlled lighting loads** – Each relay card is provided with terminal blocks for connection to lighting circuits to be controlled. Each terminal will accommodate two (2)-#10-#14 copper solid or stranded wire of the same size and type. Relays connected to the same supply circuit may be jumpered on the line side. All line voltage connections should be made with the circuit breaker feeding the load in the locked off position.
- 6 **Test controlled lighting loads** – Once circuits are connected to line and load sides of terminals, test each for shorts and proper grounding prior to energizing the circuit breaker feeding the load.
- 7 **Record controlled lighting loads in Panel Schedule** – After completion of all testing include in the panel schedule the name and/or location of the load controlled and the panel and circuit designation of the source line power.

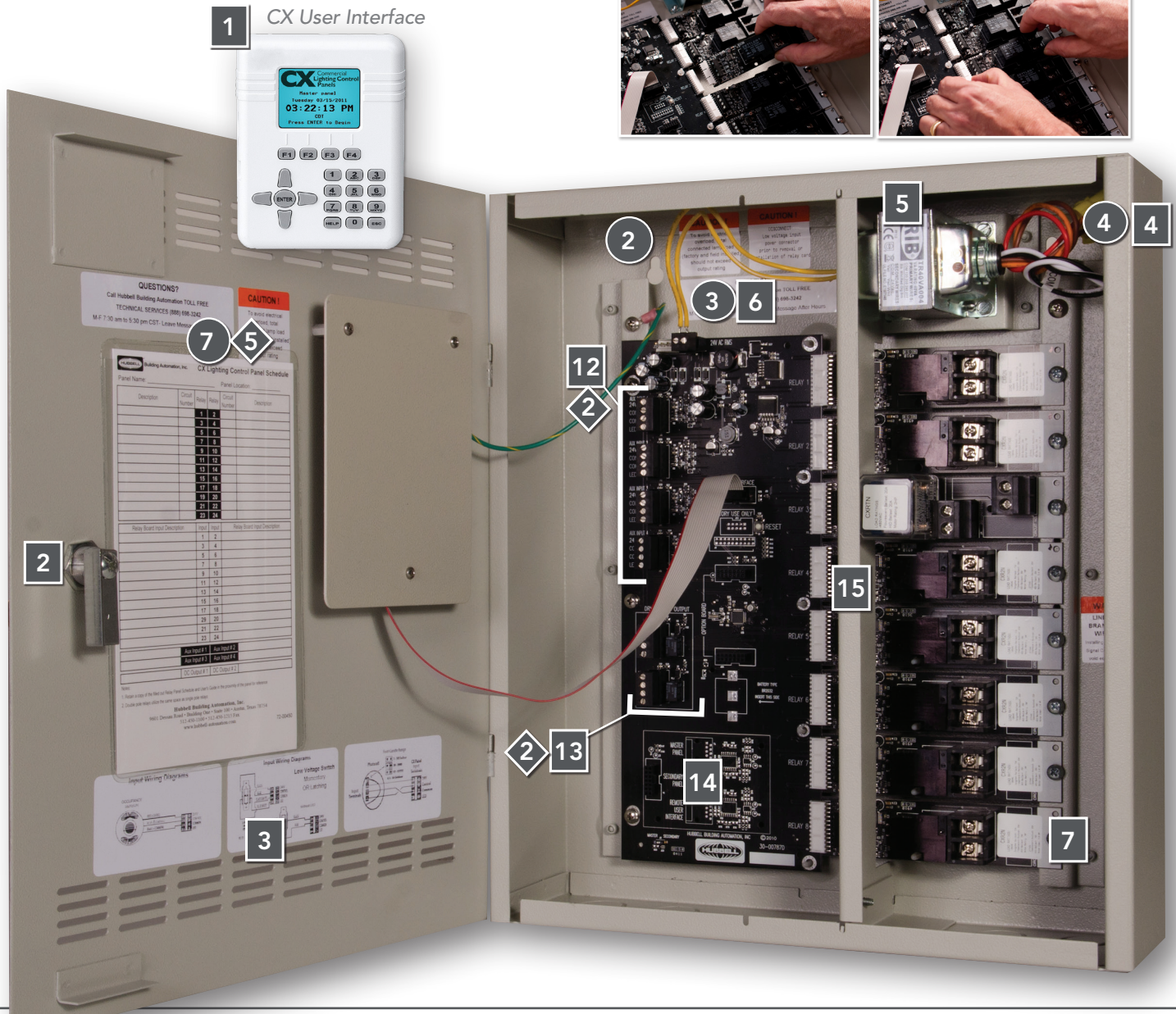

1 CX User Interface

Installing Relay Card

## CX Panel Components

- 1 CX Panel User Interface** – The easy to use and understand color LCD Display with keypad has been designed based on input styles of commonly used devices such as cell phones.
- 2 Panel Door Lock** – The CX Panel is designed to be locked once the qualified electrician has completed all connections. All programming, system status, and manual controls are available via the User Interface once the door is secured.
- 3 Low Voltage Input Device Wiring Diagrams**– Indicates point-to-point connection requirements for each type of device.
- 4 Line Voltage Input Leads** – These leads are marked for various input supply voltages.
- 5 Control Power Transformer** – This transformer has multi-tap leads to be connected to common input line voltage supply.
- 6 Control Power Disconnect** – A disconnect plug is provided for low voltage input control power to allow for safe removal and replacement of relay cards.
- 7 Individual Relay Card** – Relays are individually mounted for easy replacement, improved reliability and to allow for panels to include any mix of relay types.
- 8 Relay Manual Override Button**– Allows for relays to be manually operated. Manual control of relays is also available through the User Interface.
- 9 Relay Status Light** – Indicates relay operation status.
- 10 Relay Board Input Terminal Block** – Any type of low voltage input including Switches, Motion Sensors or Photocells may be connected to any relay input terminal block. These inputs are software assignable as to type and control. Any input can control any relay or group.
- 11 Line Voltage Control Circuit Terminals** – Lighting circuits are connected to these heavy duty screw terminals. Each terminal will accommodate two #14 - #10 stranded or solid copper wire of the same type and size.
- 12 Auxiliary Inputs** – The CX Panel is supplied with additional low voltage inputs to accommodate a wide variety of control scenarios that require more than one input for a relay or group. Any type of low voltage input including Switches, Motion Sensors or Photocells may be connected to any input terminal block. These inputs are software assignable as to type and control. Any input can control any relay or group.

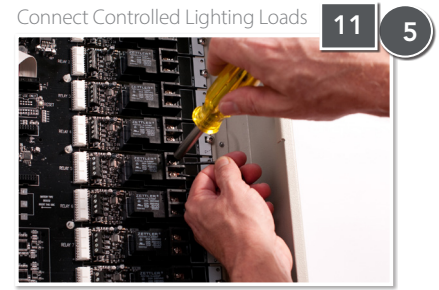

- 13 Dry Contact Output Terminals** – Each Output Terminal allows for the CX Panel to signal other systems with N.O./N.C. momentary or maintained contacts.
- 14 Master/Secondary Panel Interface Card Connector** – Cards provided with the secondary panel provide easy connection with Cat5e/6 cable.
- 15 Wireway Divider** - Separates Line and Low Voltage wiring.

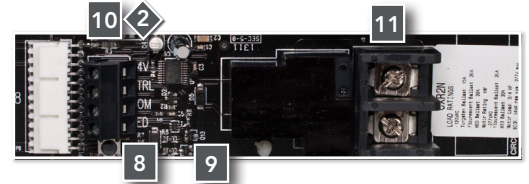

Individual Mounted Relay Card

## Low Voltage Input/Output Connections

- 1** Always use and follow Installation Instructions.
- 2 Connect Low Voltage Inputs** – There are low voltage inputs, one each on each relay card and auxiliary inputs on the motherboard. Any device can be connected to any input. All inputs are software assignable to any type of device, including low voltage switches, motion sensors, or photocells. Any input can control any relay, group or output. Wiring diagrams for each type of device are indicated inside the panel door and in this document. Each panel provides enough device power for one device per relay, including devices that may be wired in parallel to a single input.
- 3 Inputs should be connected based on zone control** – Where relays are controlled by single devices, inputs should be connected to the input terminal on that specific relay. Even though any input can be mapped to any relay or group, it is easier for programming and future modifications if inputs and relays are aligned.
- 4 Switches or Sensors that control the same zone should be connected in parallel to a single input** – Low voltage switches and motion sensors can be connected in parallel for like devices when more than one device controls the same zone.
- 5 Record Inputs in Panel Schedule** - After completion of all connections, include in the panel schedule the name, type and/or location of the input device and the relay or group controlled.

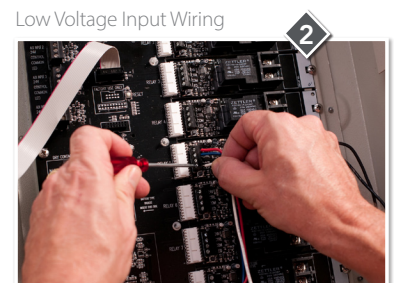

Low Voltage Input Wiring

## CX Dimming Card Features

- Full range dimming with preset dimming levels.
- Ramp Up, Fade Down, Minimum Dim Level.
- Max Dim Level (Demand Response System Settings)
- Operates with 0-10VDC dimmable drivers.
- Provides manual and automatic control of dimming levels.
- 8 Dimming channels per card.
- Works with CXSW wall stations.

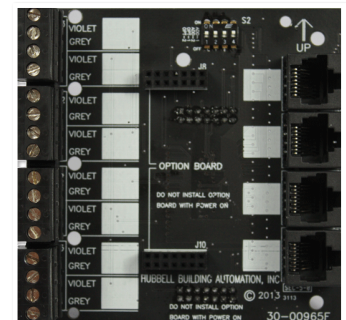

CX Dimming Card

## Low Voltage Device Input Wiring Diagrams

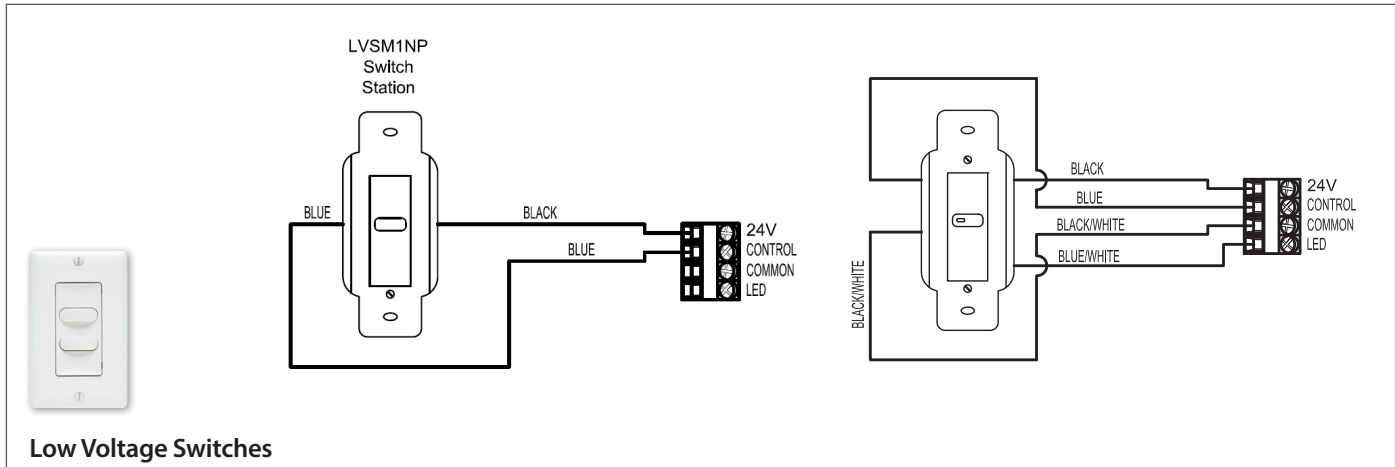
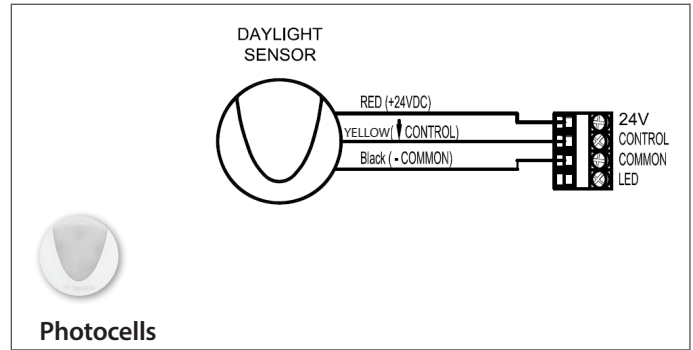
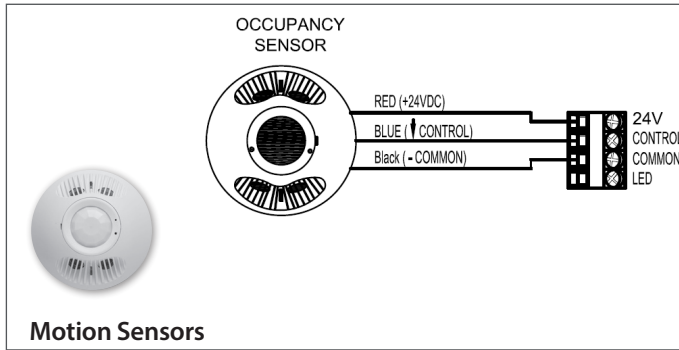

## CX User Interface Functions

**Color LCD Display** – Allows for most programming to be completed in a single screen. Right side scroll bars appear when more choices are available than are currently visible.

**Function Keys** – These keys provide programming choices in various screens. Key labels appear on-screen when keys are available.

**Alpha-Numeric Keypad** – This keypad is used to populate names and numeric values while programming. Tap/Scroll operation is similar to that used for cell phones.

**Escape Key** – This key takes the user to the previous screen. Warning prompts when changes have been made but not saved.

**Help Key** – This key will bring up help screens in specific locations driven by the field that is highlighted.

**Navigation Keys** – Allows user to navigate Up/Down/Right/Left/Toggle through editable fields to select program choices.

**Enter Key** – Use this key to make selections.



# CX Panels- Programming Guide

## SYSTEM SETTINGS

From the Main Menu SELECT System Settings, and then press ENTER

### DATE/TIME PREFERENCES

1. **SELECT** Set Date/Time Preferences, and then press **ENTER**.
2. Use the **RIGHT** and **LEFT** arrow keys to enable or disable Daylight Savings Time
3. Scroll down and use the **RIGHT** and **LEFT** arrow keys to choose a date format
4. Scroll down and use the **RIGHT** and **LEFT** arrow keys to choose the time format
5. Scroll down and use the **RIGHT** and **LEFT** arrow keys to choose a Time Zone
6. Scroll down to **[SAVE]** and press **ENTER** to finish

### SET DATE/TIME

1. Use the alphanumeric keypad to enter the date
2. Use the alphanumeric keypad to enter the time
3. Use the push-button to Choose **AM** or **PM**
4. Scroll down to **[SAVE]** and press **ENTER** to finish

### ASTRO CLOCK SETTINGS

1. **SELECT** Astro Clock Settings, and then press **ENTER**.
2. Press the **ENTER** key and use the alpha-numeric keypad to enter the first letter of a major City near your location. A list will appear that can be scrolled to find the city of your choice.
3. Press **ENTER** to auto-populate the longitude and latitude values.
4. Alternately, if you know these values Scroll to each field and enter the data for your area.
5. Scroll down to **[SAVE]** and press **ENTER** to finish

### OPEN/CLOSE TIMES

This feature is useful if several schedules will be required and need to be keyed to a facility operating schedule that will change frequently. When schedules are keyed to the Open/Close Time rather than discrete times, it is only necessary to change the Open/Closed Time to affect the schedule change on the multiple schedules. Most basic programs will not need to make use of this function.

1. Use the **RIGHT** and **LEFT** arrow keys to select the days of the week for this Open/Close Time
2. Scroll down and select "Not blocked by holidays" to ignore Holidays. Or select "Blocked by holidays" if the Open/Close Time will be superseded by Holiday dates.
3. Scroll down and use the **RIGHT** and **LEFT** arrow keys to **SELECT OPEN** time: format, fill in the appropriate fields
4. Scroll down and use the **RIGHT** and **LEFT** arrow keys to **SELECT CLOSE** time: format, fill in the appropriate fields
5. Scroll down and use the **RIGHT** and **LEFT** arrow keys to **SELECT Date Range**: format, fill in the appropriate fields
6. Scroll down to **[SAVE]** and press **ENTER** to finish

### PANEL NAME

Use the alphanumeric keypad to enter a name for the panel. This is optional.

### AFTER-HOURS SWEEP

After hours sweeps are useful for turning off lights that may have been left on by occupants after the OFF schedule has occurred.

1. Use the **RIGHT** and **LEFT** arrow keys to **SELECT** a source for the Sweep start time
2. Use the alphanumeric keypad to set the Time or the Offset as required for the chosen source
3. Scroll down and use the alphanumeric keypad to enter the time interval to wait between sweeps
4. Scroll down and **SELECT [CHANGE]** to choose the Relays or Group to Sweep
5. Scroll down to **[SAVE]** and press **ENTER** to finish

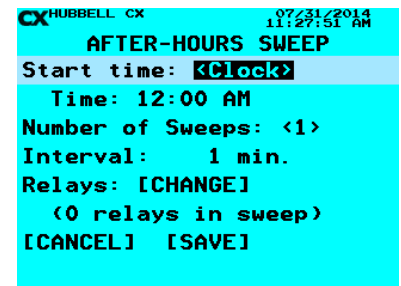
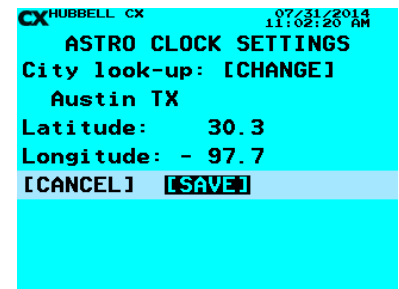
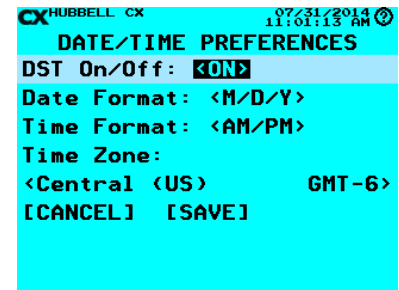
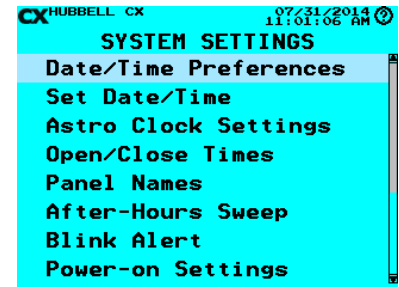

## BLINK ALERT

Use this feature to warn occupants of an impending OFF by blinking the lights.

1. Use the alphanumeric keypad to set the Warning period; to number of minutes before the OFF that the Blink Alert will occur
2. Scroll down and use the alphanumeric keypad to enter the Override time: to the number of minutes the OFF event will be delayed when the override switch is pressed
3. Scroll down to [SAVE] and press ENTER to finish

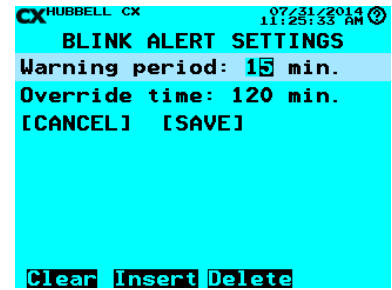

## POWER-ON SETTINGS

This feature is used to determine what state the relays and outputs will be set to after a power outage.

1. Use the buttons to select a state for All Relays+Outputs
2. Scroll down and use the buttons to select the state of individual Relays and Outputs
1. Press the [SAVE] button to finish

## RELAY FUNCTION

Use this function to name and set other specific attributes for relays

1. Use the UP and DOWN arrow keys to SELECT a Relay and press ENTER
2. Use the alphanumeric keypad to name the Relay. This is optional.
3. Scroll down and use the RIGHT and LEFT arrow keys to choose a Function:
  - <No Blink> - the relay ignores the Blink Alert
  - <Blink> - the relay follows Blink Alert
  - <HID> - the Relay does not blink but does follow the Override time
  - <LineV> - the Relay responds to OFF by blinking OFF and back ON to accommodate the function requirement of the LineV series Automatic Switch
4. Scroll down to [SAVE] and press ENTER to finish

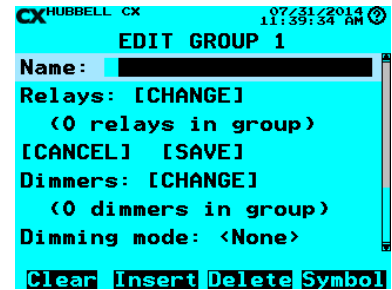

## IDLE TIME-OUT SETTINGS

Use the alphanumeric keypad to set the number of minutes the user interface screen will wait before returning to the Home screen. A value of "0" disables this function.

## BACKLIGHT SETTINGS

Use this function to change the user interface backlight functions.

## CLOCK ADJUSTMENT

This feature can be used to improve the accuracy of the internal clock if necessary. Enter a value to slow the clock the amount indicated.

## FACTORY DEFAULTS

Use this feature to set the panel back to factory fresh program values. Use the RIGHT and LEFT arrow keys to SELECT <YES> and press ENTER

## GROUPS

Groups are useful when a control function such as a Switch, Schedule, or Photocell must control multiple loads. Groups may contain Relays and/or Dimmers (requires the optional dimming card). Creating a Group loads allows the loads to be controlled together and eliminates the need for separate programming.

1. From the Main Menu SELECT Groups, and then press ENTER
2. SELECT a Group, and then press ENTER. The solid box next to the Group number indicates that it has been programmed.
3. Edit the name field using the alpha-numeric keypad. Press ENTER to select from name list

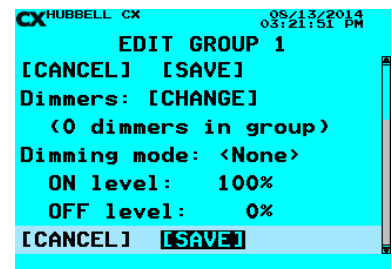

## RELAYS

4. SELECT [CHANGE] in the Relays field
5. Select the relays to be included in the Group and then Press ENTER
6. Scroll down to [SAVE] and press ENTER to finish selecting relays

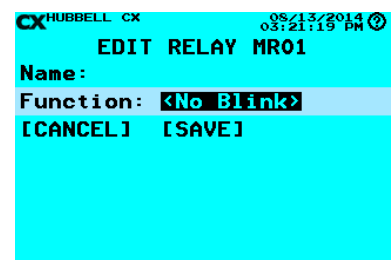

## DIMMERS

7. **SELECT [CHANGE]** in the Dimmers field
8. Select the dimmers to be included in the group and Press **ENTER**
9. Scroll down to Dimming mode: and **SELECT** <ON-only>, < OFF - only>, or <ON + OFF> to set when dimming actions will be performed
10. Scroll down to ON level: - this is the level to which the dimmer will be set when the Group receives an ON action
11. Scroll down to OFF level: - this is the level to which the dimmer will be set when the Group receives an OFF action. Note that the ON level and OFF level must never be set to the same value.
12. Scroll down to **[SAVE]** and press **ENTER** to finish selecting dimmers

## SCHEDULES

Each Schedule can affect a Relay or a Group. If you need to schedule a Dimmer, the Dimmer must be included in a Group.

1. From the Main Menu **SELECT** Schedules, and then press **ENTER**.
2. **SELECT** a Schedule, and then press **ENTER**. The solid box next to the group number indicates that it has been programmed.
3. Edit the name field using the alpha-numeric keypad.
4. **SELECT [CHANGE]** in the Control field
5. Select the Relay or Group to be controlled and then Press **ENTER**
6. **SELECT [CHANGE]** in the [Times] field
7. Choose which days of the week that this schedule will affect
8. Scroll down and select "Not blocked by holidays" if this schedule should ignore Holidays. Or select "Blocked by holidays" if the Schedule will be superseded by Holiday dates.
9. Input the schedule times in the appropriate fields, and then Press **ENTER**
10. Scroll down to **[SAVE]** and press **ENTER** to finish
11. Scroll down to ON priority: and select the Priority level at which the ON event will be executed
12. Scroll down to OFF priority: and select the Priority level at which the OFF event will be executed. Note that both Priority level selections should be left at <Normal> for most basic programs. See "Working with Priorities"
13. Scroll down to **[SAVE]** and press **ENTER** to finish creating the Schedule

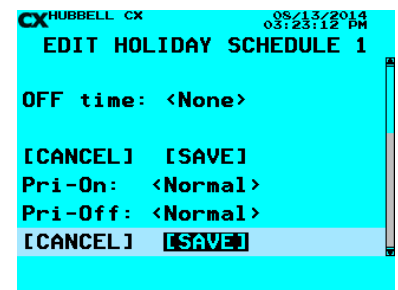
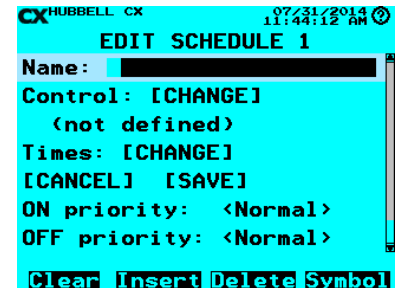

## HOLIDAYS

The Holiday feature allows for alternate schedules to be automatically run on standard or selected holiday dates.

From the **Main Menu** select Holidays and press **ENTER**



### STANDARD U.S. HOLIDAYS

Use this selection to choose from a list of standard Holidays

1. **SELECT** Standard U.S. Holidays and press **ENTER**
2. Use the **UP** and **DOWN** arrow keys to select a Holiday and press **ENTER** to include
3. Press **SAVE** to finish the selection and return to the **HOLIDAYS** menu

### HOLIDAY DATES

Use this selection to create customized Holiday dates and date ranges.

1. **SELECT** Holiday Dates and press **ENTER**
2. Use the **UP** and **DOWN** arrow keys to select a Holiday and press **ENTER**
3. Edit the name field using the alpha-numeric keypad
4. Use the **RIGHT** and **LEFT** arrow keys to toggle through the available Holiday Schedules
5. Scroll down to Year: and enter the year for the new Holiday
6. **SELECT** Date range: and **SELECT [CHANGE]**
7. Use the **RIGHT** and **LEFT** arrow keys to choose the range
8. Enter the Date or Date range for the Holiday
9. Scroll down to **[SAVE]** and press **ENTER** to save the Date(s) and return to the EDIT HOLIDAY screen
10. Scroll down to **[SAVE]** and press **ENTER** to save the new Holiday

## HOLIDAY SCHEDULES

Use this selection to create a Holiday Schedule

1. Use the **UP** and **DOWN** arrow keys to select one of the available Holiday Schedules and press **ENTER**
2. Edit the name field using the alpha-numeric keypad
3. **SELECT** Control: [**CHANGE**] and press **ENTER** to select a Relay or Group to control
4. Use the **UP** and **DOWN** arrow keys to select a Relay or a Group and press **ENTER**
5. Enter an ON time and an OFF time for the Schedule. If you choose Sunrise or Sunset you can also enter an offset time to have the control action happen before Sunrise or after Sunset.
6. Scroll down and **SELECT** [**SAVE**] to finish creating the Holiday Schedule and return to the **SELECT HOLIDAY SCHEDULE** screen

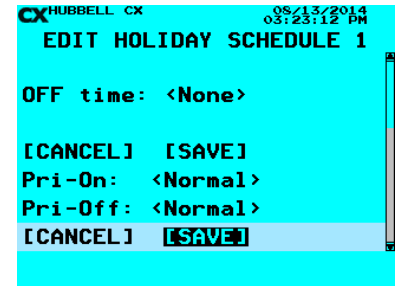

## CLEAR EXPIRED HOLIDAYS

Use this feature to clean out Holidays that have already occurred, remove blanks, etc.

**SELECT** Clear Expired Holidays and press **ENTER**

Use the **RIGHT** and **LEFT** arrow keys to toggle selection to <Yes> and press **ENTER**

## INPUTS

Inputs are uniquely configured based on the type of device that is connected to the input. These can include Switches, Photocells, or Occupancy Sensors.

1. From the Main Menu **SELECT** Inputs, and then press **ENTER**
2. **SELECT** an Input, and then press **ENTER**. The solid box next to the Input number indicates that it has been programmed. MI01 would be the master panel relay card 1 input. MAX1 would be the master panel auxiliary input 1.
3. Edit the name field using the alpha-numeric keypad.
4. **SELECT** <Switch> in the Type field
5. Use the **RIGHT** and **LEFT** arrow key to toggle to the desired input type.

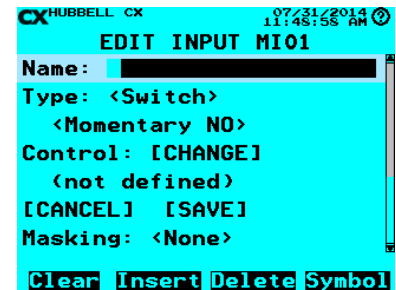

### INPUT TYPE = <SWITCH>

1. Scroll down and select <Momentary NO>. Leave this setting for most basic normally open switch applications.
2. Use the **RIGHT** and **LEFT** arrow keys to toggle the switch types. Momentary Switches may be set to Temporary Priority. See "Working with Priorities"

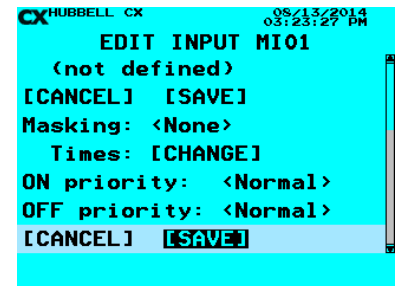

### INPUT TYPE = <MOTION>

Use this Input setting if an Occupancy Sensor is connected to the Input

### INPUT TYPE = <PHOTOCELL>

Use this Input setting if a photocell is connected to the Input.

1. **SELECT** [**CHANGE**] in the Settings: field
2. Select <0 - 100%> in the Input range: field and use the **RIGHT** and **LEFT** arrow key to toggle to the desired range. The 0 - 100% range selection allows generic set up without using specific foot candle levels. Other choices use a specific foot candle range based on the Photocell selection. Consult the documentation included with the photocell.
3. Enter values in the On and Off threshold fields indicating at what ambient light level the load is to switch ON and OFF
4. Set the OFF delay time to determine how long the panel will wait before turning off the load after the OFF threshold is reached. The OFF delay should not be left at 0 as this could cause undesirable cycling of the lighting.
5. The Sensor Level setting is used only for indoor dimming applications. This is the amount of natural light the photocell is currently seeing and must be set with the electric light turned off. Scroll down and **SELECT** [**SET LEVEL**] to automatically capture the current level. The Sensor Level may also be manually input or adjusted.
6. The Design Level setting is used only for indoor dimming applications. This is the desired room light level with contribution from both the natural and electric light.
7. Scroll down to [**SAVE**] and press **ENTER** to save the photocell setup and return to the Input screen **Input Type = <Timed-ON/OFF>**

This input type allows an ON/OFF switch to have an automatic OFF timer

1. Scroll down to the On time: field
2. Enter the desired number of minutes



## Input Type = <Timed-ON-only>

This input type allows an ON only switch to have an automatic OFF timer

1. Scroll down to the On time: field
2. Enter the desired number of minutes

After setting up one of the above Input Types continue:

### SELECT [CHANGE] in the Control field

1. Choose the Relay or Group to be controlled and then Press ENTER
2. Scroll down to [SAVE] and press ENTER to save the selection

## INPUT MASKING

Masking allows ON and/or OFF actions to be disabled during selected periods of time.

This feature is commonly used to prevent timed override switches from operating during normal business hours.

1. Scroll down and SELECT Masking <None>
2. Use the RIGHT and LEFT arrow key to toggle to the desired setting  
NOTE: Selecting <ON> will allow OFF only and selecting <OFF> will allow ON only. Selecting <ON + OFF> will disable the switch.
3. Scroll down and SELECT Times: [CHANGE]
4. Populate the fields to enter the time period the Masking will be in affect
5. Scroll down to [SAVE] and press ENTER to return to the Edit Inputs screen

ON and OFF Priorities should be left at <Normal> for most applications. See "Working with Priorities"

## OUTPUTS

Use this selection to program the CX panel's auxiliary low voltage outputs

1. Use the UP and DOWN arrow keys to select one of the Aux outputs and press ENTER
2. Edit the name field using the alpha-numeric keypad
3. SELECT Type: <Toggle> and use the RIGHT and LEFT arrow keys to toggle between the Type choices
4. SELECT Control: <Input> and choose Input or Schedule
5. Scroll down and SELECT [CHANGE] to choose an Input or a Schedule to control the Output
6. Scroll down and use the RIGHT and LEFT arrow keys to select if this Output is to follow "OFF" sweeps during after hours. See "After-Hour Sweep" under System Settings
7. Scroll down and SELECT [SAVE] to finish setting up the Aux Output

## PRESETS

Presets allow a series of control actions to be associated with a single Input action such as pressing a button.

1. From the Main Menu SELECT Presets and press ENTER
2. SELECT desired Preset and press ENTER.
3. Using the keypad enter a Preset Name.
4. SELECT Action #1 [Add Action] and press ENTER. Use the RIGHT and LEFT arrow keys to toggle through options which include:
  - ON - turns a Relay or Group ON when an ON event is received
  - OFF - turns a Relay or Group OFF when an ON event is received
  - DIM - sets a Dimmer level when an ON event is received; a Group can also be specified
  - PRESET - performs another preset's actions (this only works one level deep, and passes along the ON/OFF event status, and allows up to 64 actions from a single preset)
  - TOGGLE - changes the state of a Relay or Group; if this is the first action, it sets a pushbutton's ON or OFF event state
  - OFF->ON - turns a Relay or Group ON when an OFF event is received
  - OFF->OFF - turns a Relay or Group OFF when an OFF event is received
  - OFF->DIM - sets a Dimmer level when an OFF event is received; a Group can also be specified
  - DELETE - deletes the action when the preset is saved
5. SELECT Device [CHANGE] and press ENTER.
6. Select the Relay(s) or Group to be controlled and then Press ENTER

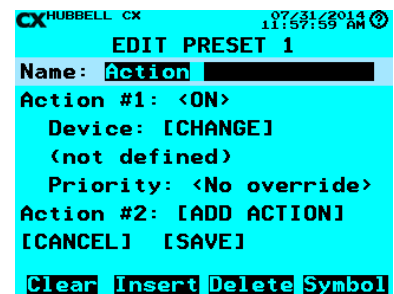
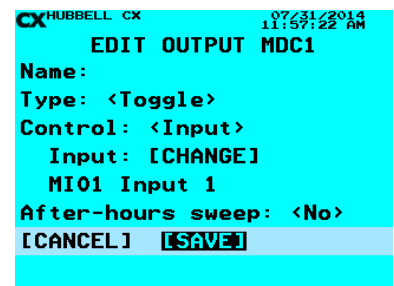
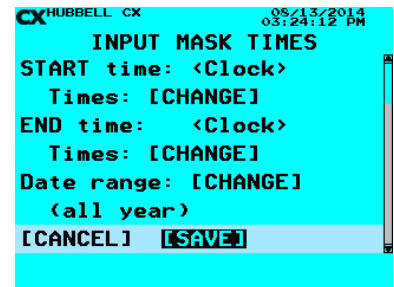
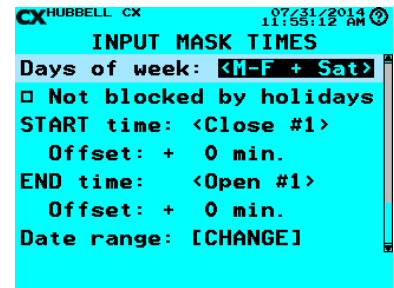

7. SELECT Action #2 [Add Action] and press ENTER. Repeat the above steps to add additional actions to the Preset
8. Scroll down and select [SAVE] and press ENTER to finish

## WORKING WITH PRIORITIES

The CX panel supports an array of four priority levels for Inputs and Schedules with Master being the highest priority. The most commonly used are Low and High with Normal being the panel wide default. Think of these as a vertical array with 4 priority “slots”. Each Relay has its own “priority array” where each slot can be populated with an ON or OFF state. The current state of the Relay will always be the state in highest slot. Priorities are persistent and are continuously evaluated to determine the relay state. For example, a relay that is scheduled ON by a Schedule at Low priority will not turn ON after a Photocell input with an OFF Priority set at Normal has previously turned it off. This can be very useful, especially when combining Photocell and Schedule control where the Schedule is turning outdoor lights ON near dawn in the morning.

Slot 1	Master	N/A
Slot 2	High	OFF
Slot 3	Normal	ON
Slot 4	Low	N/A

Some inputs can be set to enable Temporary Priority. This creates a priority “one shot” ON or OFF event where the priority is not persistent. A Temporary Priority controls the relay at one of the slot levels but then is immediately is cleared out.

## DIMMING

The CX panel must have the optional 0 - 10V dimming board installed to use any dimming functions.

1. From the Main Menu SELECT Dimming, and press ENTER
2. SELECT Dimmers and press ENTER to access the EDIT DIMMER screen
4. SELECT the desired Dimmer
5. Create a Name using the Keypad.

## DIM TO OFF

1. SELECT Dim-to-off: <Disabled>
2. Use the RIGHT and LEFT arrow keys to toggle between Enabled and Disabled. Enabling Dim-to-off will allow the dimmer to turn off the Relay based upon dimming level. If the level is set to 20% and the input drives the dimming channel below this value the associated Relay or Group will turn off. This may be useful where ballasts or drivers may flicker at lower levels.
3. Set the Level: – This sets the point where the Relay or Group will turn off based on dimmer level.
4. Set the Time: – This sets the time the system will wait once the Dimmer crosses the Dim-to-off level before it turns off the Relay or Group
5. Scroll down to Relay: SELECT [CHOOSE] and press, ENTER.
6. Select a Relay or Group for association with this dimmer.

## DIMMER INPUTS

There are four RJ45 Dimmer Input ports located on each dimmer board. Each port can be configured to control up to two Dimmers/Groups and two Relays for a maximum of 8 Raise/Lower switches and 8 ON/OFF switches.

1. From the Main Menu SELECT Dimming, and press ENTER
2. SELECT Dimmer Inputs and press ENTER to access the SELECT DIMMER INPUT screen
3. SELECT one of the four Dimmer Inputs
4. Edit the name field using the alpha-numeric keypad
5. SELECT Switch A - F [CHANGE] to set up the switch functions
6. SELECT Type: <Switch>. Use the RIGHT and LEFT arrow keys to toggle the switch types
7. Temp priority (temporary priority) should be <No> for most applications. See “Working With Priorities”
8. SELECT [CHANGE] in the Control field and choose a Relay or Group for the switch to control
9. Scroll down and select [SAVE] and press ENTER to save the control assignment
10. Set the ON and OFF priority for the input. Use the RIGHT and LEFT arrow keys to toggle the choices. See “Working With Priorities”

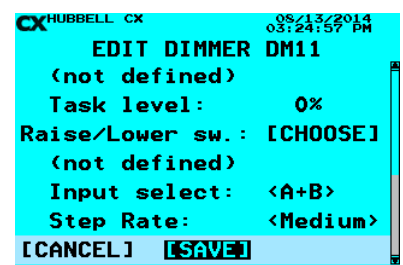
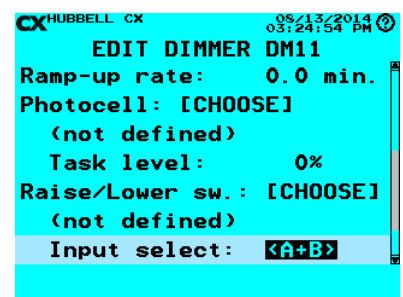
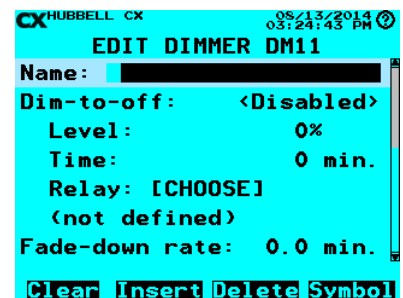
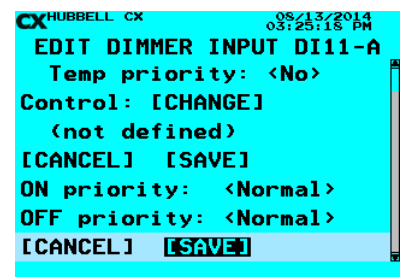
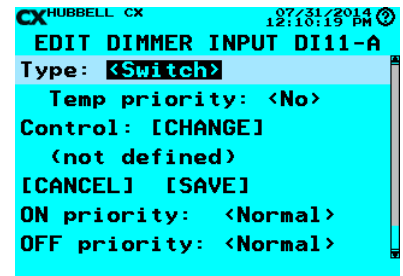
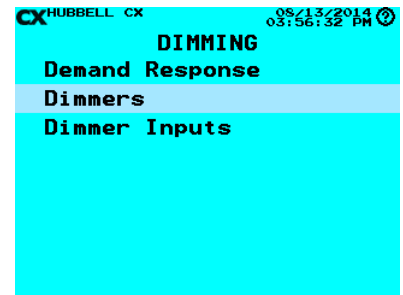

## DAYLIGHT HARVESTING

1. SELECT Fade-down/Ramp-up rate to configure how quickly the Dimmer adjusts its level when used with a Photocell for daylight harvesting.
2. SELECT Photocell: [CHOOSE] and press ENTER to configure daylight harvesting for this Dimmer
3. SELECT an Input that has been configured with a Photocell
4. SELECT Task level: and enter the desired light level to be maintained by the Photocell. Due to field conditions, it is often necessary to adjust this setting up or down to achieve the desired foot candle reading as measured with a meter.

IMPORTANT NOTE: When using Dimming for Daylight Harvesting, the Dimmer or Group being controlled by the Photocell must be set back to 100% after an override in order for Daylight Harvesting to take over and function. This can be done using the Group ON level: <100%> function or a Preset with the dimmer set to 100%.

## MANUAL RAISE/LOWER DIMMING

1. SELECT Raise/Lower sw. [CHOOSE], and Press ENTER to configure a Raise/Lower switch for manual control of the Dimmer. The switch must be connected to one of the RJ45 Dimming Input ports on the dimming board and must be configured.
2. SELECT the Dimming Input to which the Raise/Lower switch is connected and press ENTER.
3. SELECT Input select: <A+B>. By default this will make the CXSW wall station first to buttons to operate as a Raise/lower function of the associated dimmer channel. Also selectable are <C+D> and <E+F>. By default these assignments are based on button 1 as A, button 2 as B, button 3 as C, button 4 as C, button 5 as E and button 6 as F; if a CXSW6 button is selected. See CXSW wall station Install guide for re-programming.
4. SELECT Step Rate: <Medium>. Use the RIGHT and LEFT arrow keys to toggle the rate choices. Medium works well for most manual Raise/Lower applications
5. Scroll down and select [SAVE] and press ENTER to finish and return to the SELECT DIMMER screen

## DEMAND RESPONSE

The CX panel with optional dimming board(s) installed can respond to an input calling for the curtailment of lighting power (Demand Response). A simple maintained contact closure from another system, smart-meter, or BAS is all that is required to activate this feature.

1. From the Main Menu SELECT Dimming, and press ENTER
2. SELECT Demand Response and press ENTER.
3. SELECT D.R. input: [CHANGE] and press ENTER.
4. SELECT the input that has been defined and is connected to the Demand Response contact closure. The input must be set as Type: <Maintained NO>. The Control for the Input should remain (not defined).
5. SELECT Dimming level: and enter the percentage dimming level that will be the maximum allowed while Demand Response is active. When active, the CX panel will automatically cap the dimming level of all dimming outputs at the set level. Dimmers currently below the cap level will not change. Dimmers currently above the cap level will dim down to the cap level. This setting may not be overridden by the user. If using manual Raise/Lower dimmers, the user may lower the dim level to 0% but cannot raise the Dimmer above the cap level. When Demand Response becomes inactive, the dimming levels will not change. However, normal control will be resumed.
6. Scroll to [SAVE] and press, ENTER. The Demand Response dimming level is saved.

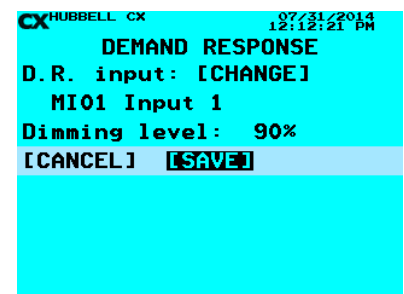

## SYSTEM TOOLS

Scroll down to System Tools and press ENTER to access the SYSTEM TOOLS menu

## MANUAL CONTROL

1. Use the UP and DOWN arrow keys to make a selection and press ENTER
2. Use the UP and DOWN arrow keys to choose an item to control
3. Use the UP and DOWN arrow keys to turn the item ON and OFF
4. Press the ESC key to back out of this function

## SYSTEM STATUS

This feature is useful in determining if various control features are working as expected. Choose an item from the menu and press ENTER to see the status

## SAVE/RESTORE PROGRAM

This feature is used to save the program or back-up the user programming. The system allows the saving of up to three versions of panel programming in internal memory. Most useful is the ability to save the program to an SD card for safe storage away from the panel.

## BACKING UP THE PROGRAM

1. Insert an SD card into the slot in the controller
2. Choose Export Program
3. Use the alphanumeric keypad to name the file
4. Scroll to [SAVE] and press ENTER to save the file to the SD card

## RESTORING THE PROGRAM

1. Insert the SD card with the back-up panel program into the slot in the controller
2. Choose Import Program
3. Select the file and press enter to restore the program

## PRIORITIES/MASKING

Use this feature to check or edit the priority and masking settings made during the programming of Inputs and Schedules

## ACCESS CONTROL

Use this feature to create and manage passwords for users. User #1 is always set to Master level. Additional users can be set to Limited or View Only access.

## DIAGNOSTICS

Use to check the status of the battery backup for the memory and communication status

## UPDATE FIRMWARE

Can be used to install a newer firmware version in the panel. Contact factory for additional information.

## CONTROLLER VERSION

Provides technical information about the panel. Contact factory for additional information.

