

**Inverter Air Conditioner
User Manual**

KSV25CRH, KSV35CRH, KSV71CRH

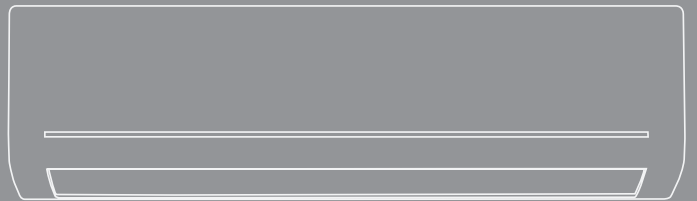

Congratulations

Congratulations and thank you for choosing our Inverter split system room air conditioner. We are sure you will find your new air conditioner a pleasure to use. Before you use the air conditioner, we recommend that you read through the entire user manual, which provides the description of the air conditioner and its functions.

To avoid the risks that are always present when you use an electrical appliance, it is important that the air conditioner is installed correctly and that you read the safety instructions carefully to avoid misuse and hazards.

We recommend that you keep this instruction booklet for future reference and pass it on to any future owners.

Conditions of use

This appliance is intended to be used in household and similar applications such as :

- staff kitchen areas in shops, offices and other working environments.
- farm houses.
- by clients in hotels, motels and other residential type environments.
- bed and breakfast type environments.

This air conditioner is designed for and intended to be used in normal domestic applications only.

Record model and serial number here:

Model number:

Serial number:



environment

Information on disposal for users

- Most of the packing materials are recyclable. Please dispose of those materials through your local recycling depot or by placing them in appropriate collection containers.
- If you wish to discard this air conditioner, please contact your local authorities and ask for the correct method of disposal.



R32 refrigerant warning

This product uses R32 difluoromethane refrigerant, which is a mildly flammable gas class 2.2 according to AS 1677 and must be handled by a refrigeration mechanic with appropriate Australian refrigerant handling licence.

Contents

Safety Instructions

Warnings 3

Product description

Installation drawing..... 5

Remote control specifications 6

Operating instructions

Indoor unit display 7

Remote control operation..... 8

Indicators on LCD 10

How to use the buttons 11

Timer operation 12

Special functions 14

Airflow directional control 15

Care and maintenance

Before maintenance..... 17

Cleaning the unit..... 17

Cleaning the air filter and air freshening filter 17

Preparation for extended non-operation..... 18

Pre season inspection..... 18

Troubleshooting tips

Troubleshooting tips..... 19

Warranty 23

Safety instructions

Meanings of symbols used in this manual are shown below:



warning

This symbol indicates information concerning your personal safety or information on how to avoid damaging the air conditioner



important

This symbol indicates tips and information about use of the appliance



environment

This symbol indicates tips and information about economical and ecological use of the appliance



important

- Contact an authorised installer for installation of this unit.
- Installation work must be performed in accordance with the national wiring standards by authorised personnel only.
- This air conditioner may need to be installed on its own separate circuit. Please refer to AS/NZS3000 and local wiring regulations for requirements.
- Contact an authorised service technician for repair or maintenance of this unit.
- This appliance is not intended for use by persons (including children) with reduced physical, sensory or mental capabilities, or lack of experience and knowledge, unless they have been given supervision or instruction concerning use of the appliance by a person responsible for their safety.
- Children should be supervised to ensure that they do not play with the air conditioner.
- If the system is to be moved to another location or disposed of, only a suitably qualified person is permitted to undertake such work.
- Take care not to catch fingers on the fan blade when adjusting vertical louvres.
- This air conditioner uses R32 refrigerant.
- Do not use this air conditioner for non-specified special purposes (e.g. preserving precision devices, food, pets, plants, and art objects). Usage in such a manner could damage your property.
- Always insert the filters securely. Clean the filters every 3 months, or as required.



warning

- Do not use means to accelerate the defrosting process or to clean, other than those recommended by the manufacturer.
- Do not store the appliance in a room with continuously operating ignition sources (for example open flames, an operating electric heater or an operating gas appliance with a continuously lit pilot flame).
- Do not pierce or burn any part of the air conditioner.
- Be aware that the refrigerant is odourless and any gas leak is not detectable by smell.
- Ensure the unit is properly connected to the power. Excess heat generation caused by incorrect connection may result in an electric shock or fire.
- Do not operate or stop the unit by switching on or off at the power source. This may cause an electric shock or fire due to excess heat generation.
- Do not operate with wet hands or in damp environment. This may cause an electric shock.
- Always ensure that the unit is correctly earthed. No earthing may cause electric shock.
- Do not allow water to run into electric parts. It may cause failure of the unit or electric shock.
- Use a correctly rated circuit breaker or fuse. There is risk of fire or electric shock.
- Disconnect the power if strange sounds, smells, or smoke come from the unit. It may cause fire and electric shock.
- Do not drink water drained from the air conditioner. It may contain contaminants that could make you sick.
- Do not open the unit during operation. It may cause electric shock.
- Ventilate room before operating the air conditioner if there has been or may have been a flammable gas leak from another appliance. It may cause an explosion, fire and burns.
- Do not disassemble or modify unit. It may cause failure and electric shock.
- When the air filter is to be removed, do not touch the metal parts of the unit. It may cause an injury.
- Do not clean the air conditioner with water. Water may enter the unit and degrade the insulation. It may cause an electric shock.
- Ventilate the room well when used together with a stove or other combustion heating device. An oxygen shortage may occur.
- Exposure of direct airflow to occupants, pets or plants for an extended period of time could be a health hazard.

Safety instructions



warning

- Do not place obstacles around air inlets or inside of air outlet. It may cause failure of appliance or accident.
- Turn off at the main power switch if the unit will not be used for a long period of time. It may cause failure of the unit or fire.
- Do not use strong chemical cleaners such as detergents, abrasive cleaners or thinners, as they may damage the appliance causing scratches, discolouration or deteriorate the surface finish. Use a soft cloth for cleaning.
- Where the airconditioned is installed on an external wall bracket ensure that the installation bracket of the outdoor appliance is not damaged due to prolonged exposure. If bracket is damaged, the unit may fall and damage may occur.
- Use caution when unpacking and installing. Sharp edges could cause injury.
- If water enters the unit, turn the unit off and disconnect the power, contact a qualified service technician.

Troubleshooting

You'll find many answers to common problems in the chart of troubleshooting tips on page 19. If you review the chart of Troubleshooting Tips first, you may not need to call for service.

Service

For repair and maintenance, contact your authorised service dealer.

Refer to the contact numbers in the warranty section on the back page of this manual.

Installation drawing

Fig. 1

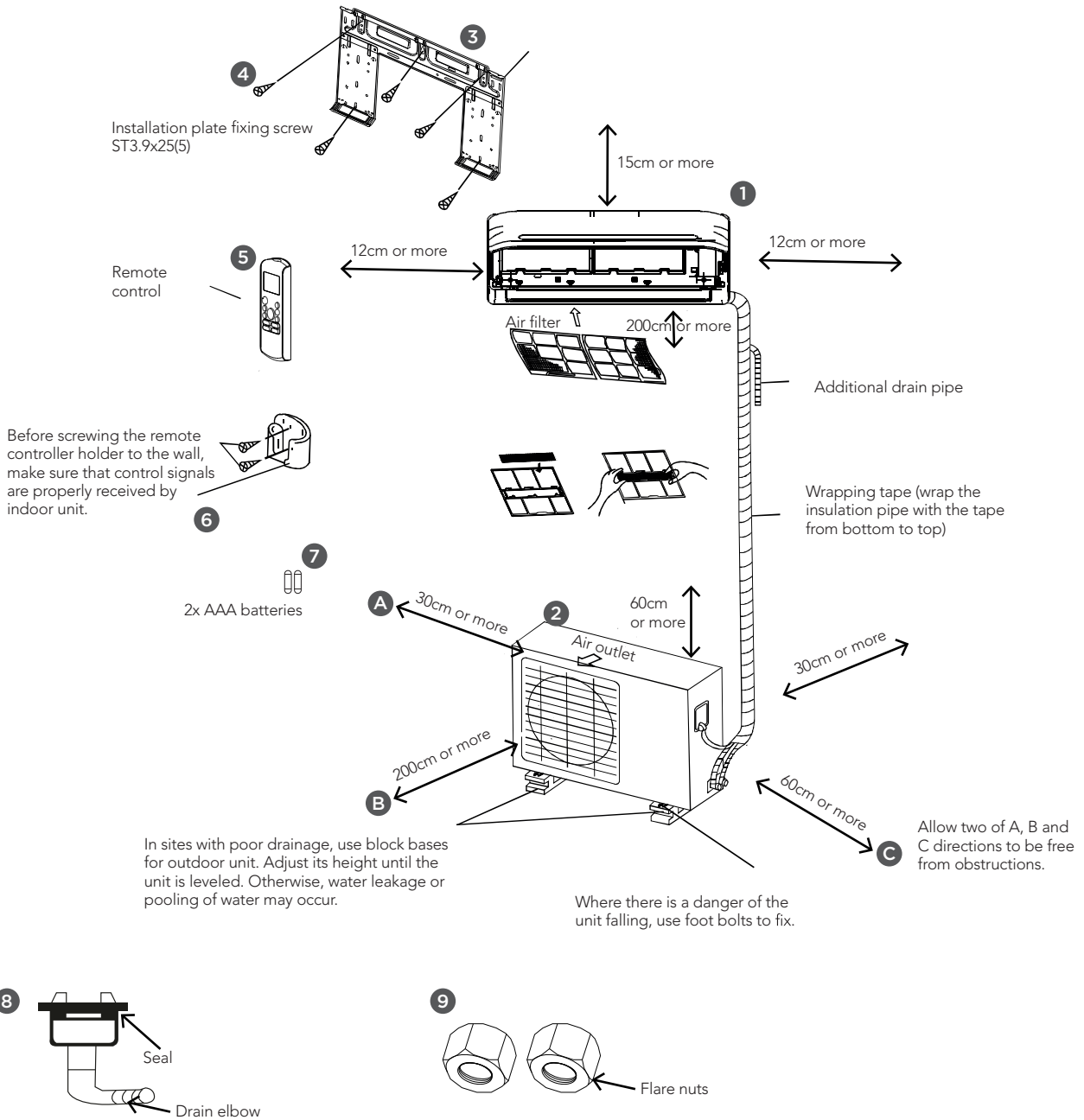

Air Conditioner	Qty.		Qty.
1 Indoor unit	1	7 Battery (AAA 1.5V)	2
2 Outdoor unit	1	8 Drain elbow & seal	1
3 Indoor unit mounting plate	1	9 Flare nuts	2
4 Mounting plate fixing screws, ST3.9x25	5	10 Installation Manual	1
5 Remote controller	1	11 User manual	1
6 Remote controller holder	1		

NOTE: Appearance of outdoor unit and indoor unit may differ from some models. The actual shape shall prevail.

Remote control specifications

Rated voltage	3.0V (2x 1.5V AAA)
Signal receiving range	8m

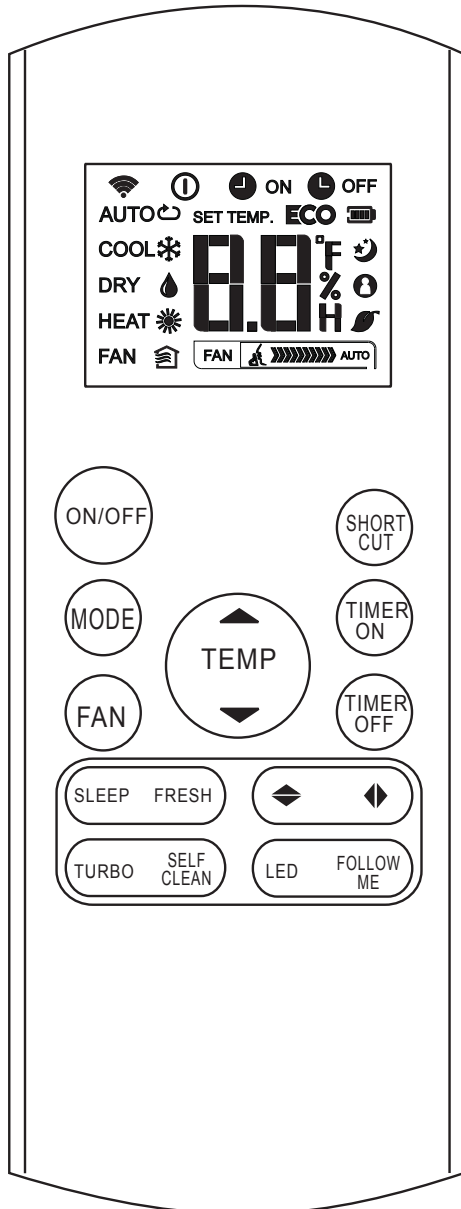

Using the remote control

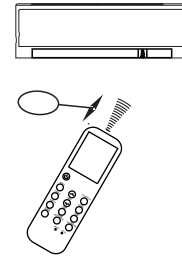

Location of the remote controller

- Use the remote controller within a distance of 8 meters from the appliance, pointing it towards the receiver. Reception is confirmed by a beep.

caution

- The air conditioner will not operate if curtains, doors or other materials block the signals from the remote controller to the indoor unit.
- Prevent any liquid from falling into the remote controller. Do not expose the remote controller to direct sunlight or heat.
- If the infrared signal receiver on the indoor unit is exposed to direct sunlight, the air conditioner may not function properly.
- Use curtains to prevent the sunlight from falling on the receiver.
- If other electrical appliances react to the remote controller, either move these appliances or consult your local dealer.
- Do not drop the remote controller. Handle with care.
- Do not place heavy objects on the remote controller, or step on it.

Location of the remote controller

- The remote controller can be attached to a wall or pillar by using a remote controller holder.
- Before installing the remote controller, check that the air conditioner receives the signals properly.
- Install the remote controller holder with two screws.
- For installing or removing the remote controller, move it up or down in the holder.

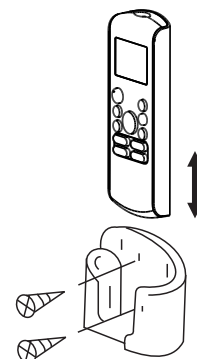

Indoor unit display

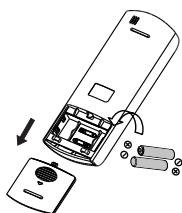

Digital display

- Displays the temperature settings when the air conditioner is operational.
- Displays the room temperature in FAN mode.
- Displays the self-diagnostic codes.
- Displays **ON** for three seconds when Timer ON, Swing or Turbo feature is activated.
- Displays **OF** for three seconds when Timer OFF is set.
- Displays **OF** for three seconds when Swing or Turbo feature is cancelled.
- Displays **df** under defrosting operation.
- Displays **SC** during self clean operation (if applicable).
- Displays **FC** when forced cooling mode is activated by pressing the manual start button 2 times within 5 seconds (refer page 16).
- If you want to turn off the indoor unit display (for example to make the room dark for sleeping), press the LED button on the remote control.

Replacing batteries

The following cases signify exhausted batteries. Replace old batteries with new ones.

- Receiving beep is not emitted when a signal is transmitted.
- Indicator fades away.

The remote controller is powered by two dry batteries (2x AAA 1.5V) housed in the back rear part and protected by a cover.

1. Remove the cover in the rear part of the remote controller.
2. Remove the old batteries and insert the new batteries, placing the (+) and (-) ends correctly.
3. Put the cover back on.

NOTE: When the batteries are removed, the remote controller erases all programming. After inserting new batteries, the remote controller must be reprogrammed.

warning

- Do not mix old and new batteries or batteries of different types.
- Do not leave the batteries in the remote controller if they are not going to be used for 2 or 3 months.
- Do not dispose batteries as unsorted general waste. Collection of such waste separately for special treatment is necessary.

Operation of buttons

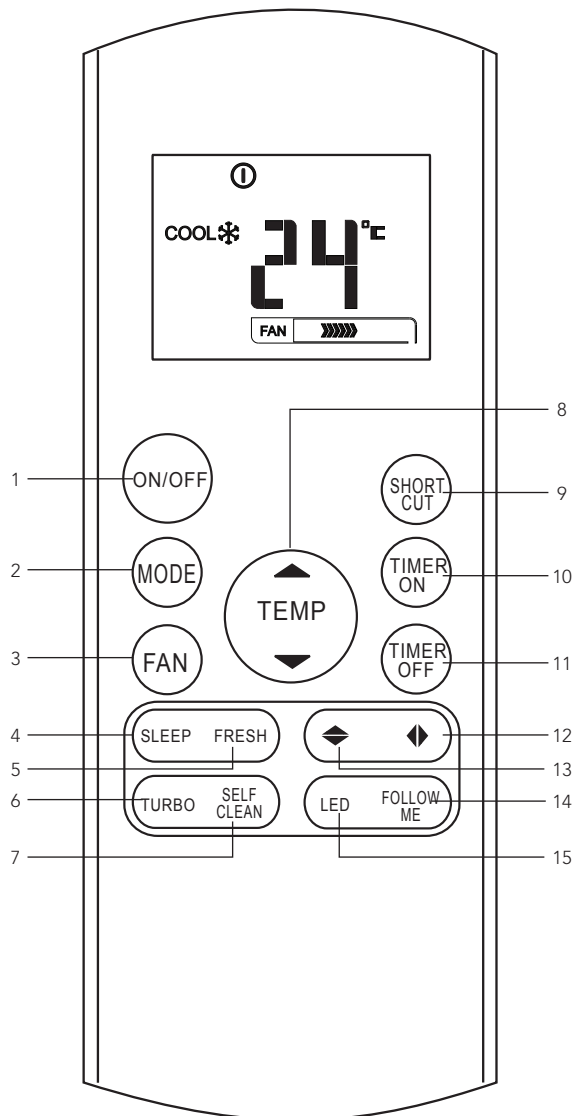

1. ON/OFF Button
This button turns the air conditioner ON and OFF.
2. MODE Button
Press this button to modify the air conditioner mode in a sequence of following:
➤ AUTO > COOL > DRY > FAN
3. FAN Button
Used to select the fan speed in four steps:
➤ AUTO > LOW > MED > HIGH

NOTE: You can not switch the fan speed in AUTO or DRY mode.
4. SLEEP Button
 - Active/Disable sleep function. It can maintain the most comfortable temperature and save energy. This function is available on COOL or AUTO mode only.
 - For the detail , see sleep operation on page.
NOTE: While the unit is running under SLEEP mode, it will be cancelled if MODE, FAN SPEED or ON/OFF button is pressed.
5. FRESH Button (Not available for this unit)
Active/Disable FRESH function. When the FRESH function is initiated, the Ionizer/Plasma Dust Collector (depending on models) is energized and will help to remove pollen and impurities from the air.
6. TURBO Button
Active/Disable Turbo function. Turbo function enables the unit to reach the preset temperature in the shortest time.
7. SELF CLEAN Button
Active/Disable Self Clean function
8. UP Button (▲)
Push this button to increase the indoor temperature setting in 1°C increments to 30°C.
DOWN Button (▼)
Push this button to decrease the indoor temperature setting in 1°C increments to 17°C.
9. SHORT CUT Button
 - Used to restore the current settings or resume previous settings.
 - On the first time connecting to the power, if push the SHORTCUT button, the unit will operate on AUTO mode, 26°C, and fan speed is Auto.
 - Push this button when remote controller is on, the system will automatically revert back to the previous settings including operating mode, setting temperature, fan speed level and sleep feature (if activated).
 - If pushing more than 2 seconds, the system will automatically restore the current operation settings including operating mode, setting temperature, fan speed level and sleep feature (if activated).

Operation of buttons

10. **TIMER ON Button**
Press this button to initiate the auto-on time sequence.
Each press will increase the auto-timed setting in 30 minute increments. When the setting time displays 10.0, each press will increase the auto timed setting by 60 minute increments.
To cancel the auto-timed program, simply adjust the auto-on time to 0.0.
11. **TIMER OFF Button**
Press this button to initiate the auto-off time sequence.
Each press will increase the auto-timed setting in 30 minute increments. When the setting time displays 10.0, each press will increase the auto-timed setting 60 minute increments.
To cancel the auto timed program, simply adjust the auto-off time to 0.0
12. **Swing Button ◀▶ (Not available for this unit)**
Used to stop or start vertical over auto swing feature.
13. **Swing Button ◀▶**
Used to stop or start horizontal louver auto swing feature.
The louver changes 6 degree in angle for each press. If keep pushing more than 2 seconds, the louver will swing up and down automatically.
14. **FOLLOW ME Button**
Push this button to initiate the Follow Me feature, which allows the indoor ambient temperature reading to be taken from the remote control. The remote control will send the temperature reading to the air conditioner every 3 minutes.
To cancel the follow me feature, press the follow me button a second time. The air-conditioner will cancel the Follow Me Feature automatically if the indoor unit does not receive the signal from the remote control within a 7 minutes period.
15. **LED Button**
Disable/Active indoor screen Display. When pushing the button, the indoor screen display is cleared, press it again to light the display.
NOTE: pressing LED button also disables the beep sound.

Indicators on LCD

Information are displayed when the remote controller is powered up.

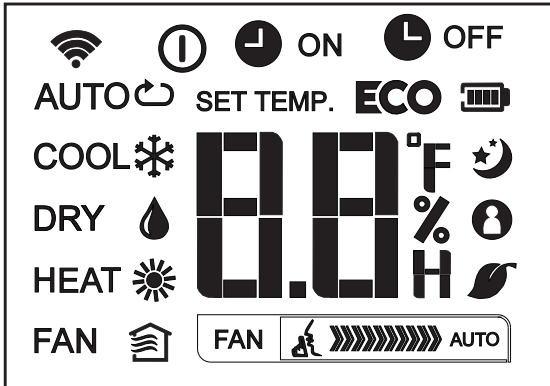

Mode display



Icon	Function
	Displayed when data transmitted
	Displayed when remote controller is ON
	Battery display (low battery detection)
	Displayed when TIMER ON time is set
	Displayed when TIMER OFF time is set
	Show set temperature or room temperature, or time under TIMER setting
	Displayed in Sleep Mode operation
	Indicated that the air conditioner is operating in follow me mode

Fan speed indication

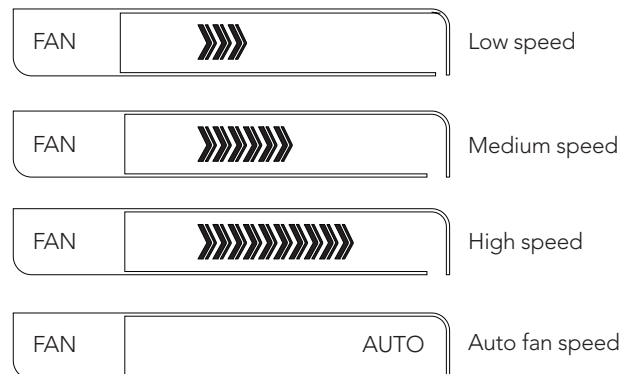

NOTE: All indicators shown in the figure are for the purpose of clear presentation. But during the actual operation only the relative functional signs are shown on the display window.

How to use the buttons

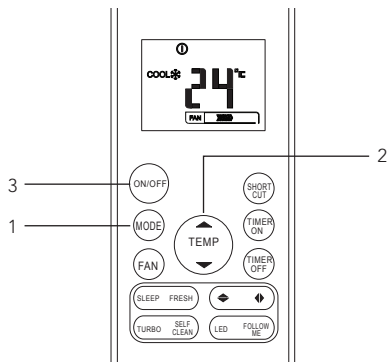

Auto operation

Ensure the unit is plugged in and power is available. The OPERATION indicator on the display panel of the indoor unit starts flashing.

1. Press the MODE button to select Auto.
2. Press the UP/DOWN button to set the desired temperature. The temperature can be set within a range of 17°C–30°C in 1°C increments.
3. Press the ON/OFF button to start the air conditioner.

NOTE:

1. In the Auto mode, the air conditioner can logically choose the mode of Cooling and Fan by sensing the difference between the actual ambient room temperature and the setting temperature on the remote controller.
2. In the Auto mode, you can not adjust the fan speed. It has already been automatically controlled.
3. If the Auto mode is not comfortable for you, the desired mode can be selected manually.

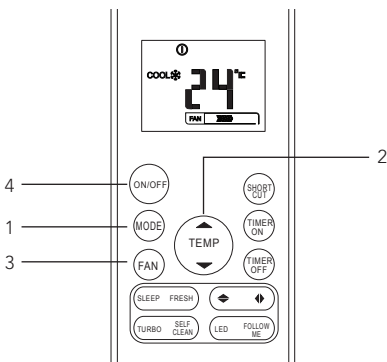

Cooling/Fan operation

Ensure the unit is plugged in and power is available.

1. Press the MODE button to select COOL or FAN mode.
2. Press the UP/DOWN buttons to set the desired temperature. The temperature can be set within a range of 17°C–30°C in 1°C increments.
3. Press the FAN button to select the fan speed in four steps- Auto, Low, Med, or High.
4. Press the ON/OFF button to start the air conditioner.

NOTE: In the FAN mode, the setting temperature is not displayed in the remote controller and you are not able to control the room temperature either. In this case, only step 1, 3 and 4 may be performed.

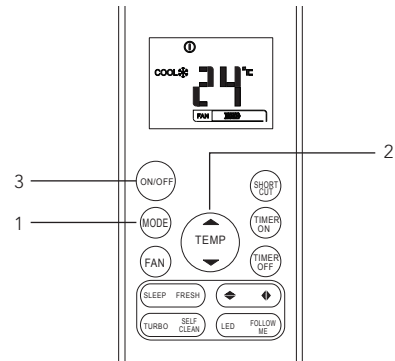

Dehumidifying operation

Ensure the unit is plugged in and power is available. The OPERATION indicator on the display panel of the indoor unit starts flashing.

1. Press the MODE button to select DRY mode.
2. Press the UP/DOWN buttons to set the desired temperature. The temperature can be set within a range of 17°C–30°C in 1°C increments.
3. Press the ON/OFF button to start the air conditioner.

NOTE: In the Dehumidifying mode, you can not adjust the fan speed. It has already been automatically controlled.

Timer operation

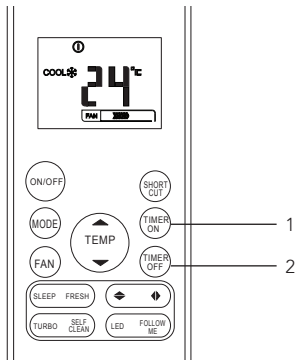

Press the TIMER ON button can set the auto-on time of the unit.
Press the TIMER OFF button can set the auto-off time of the unit.

To set the Auto-ON time

1. Press the TIMER ON button. The remote controller shows TIMER ON, the last Auto-on setting time and the signal "H" will be shown on the LCD display area. Now it is ready to reset the Auto-on time to START the operation.
2. Push the TIMER ON button again to set desired Auto-on time. Each time you press the button, the time increases by half an hour between 0 and 10 hours and by one hour between 10 and 24 hours.
3. After setting the TIMER ON, there will be a one second delay before the remote controller transmits the signal to the air conditioner. Then, after approximately another 2 seconds, the signal "H" will disappear and the set temperature will re-appear on the LCD display window.

To set the Auto-OFF time

1. Press the TIMER OFF button. The remote controller shows TIMER OFF, the last Auto-off setting time and the signal "H" will be shown on the LCD display area. Now it is ready to reset the Auto-off time to stop the operation.
2. Push the TIMER OFF button again to set desired Auto-off time. Each time you press the button, the time increases by half an hour between 0 and 10 hours and by one hour between 10 and 24 hours.
3. After setting the TIMER OFF, there will be a one second delay before the remote controller transmits the signal to the air conditioner. Then, after approximately another 2 seconds, the signal "H" will disappear and the set temperature will reappear on the LCD display window.

caution

- When you select the timer operation, the remote controller automatically transmits the timer signal to the indoor unit for the specified time. Therefore, keep the remote controller in a location where it can transmit the signal to the indoor unit properly.
- Timer setting is in half hourly intervals up to 10 hours then hourly intervals to 24 hours

Examples of timer operation

Timer on (Auto-on Operation)

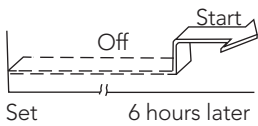

The TIMER ON feature is useful when you want the unit to turn on automatically before you return home. The air conditioner will automatically start operating at the set time.

Example

To start the air conditioner in 6 hours.

1. Press the TIMER ON button, the last setting of starting operation time and the signal "H" will show on the display area.
2. Press the TIMER ON button to display "6.0H" on the TIMER ON display of the remote controller.
3. Wait for 3 seconds and the digital display area will show the temperature again. The "TIMER ON" indicator remains on and this function is activated.

Timer off (Auto-off Operation)

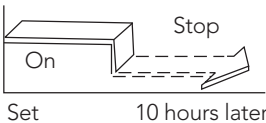
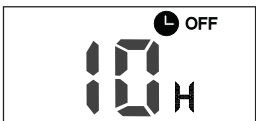

The TIMER OFF feature is useful when you want the unit to turn off automatically after you go to bed. The air conditioner will stop automatically at the set time.

Example

To stop the air conditioner in 10 hours.

1. Press the TIMER OFF button, the last setting of stopping operation time and the signal "H" will show on the display area.
2. Press the TIMER OFF button to display "10H" on the TIMER OFF display of the remote controller.
3. Wait for 3 seconds and the digital display area will show the temperature again. The "TIMER OFF" indicator remains on and this function is activated.

Combined timer (Setting both ON and OFF timers simultaneously)

Timer off/Timer on (On/Stop/Start operation)

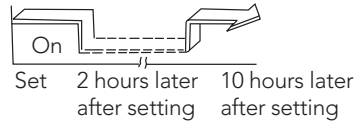

This feature is useful when you want to stop the air conditioner after you go to bed, and start it again in the morning when you wake up or when you return home.

Example

To stop the air conditioner 2 hours after setting and start it again 10 hours after setting.

1. Press the TIMER OFF button.
2. Press the TIMER OFF button again to display 2.0H on the TIMER OFF display.
3. Press the TIMER ON button.
4. Press the TIMER ON button again to display 10H on the TIMER ON display.
5. Wait for 3 seconds and the digital display area will show the temperature again. The "TIMER ON OFF" indicator remains on and this function is activated.

Timer off/Timer on (On/Stop/Start operation)

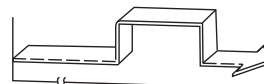

This feature is useful when you want to start the air conditioner before you wake up and stop it after you leave the house.

Example

To start the air conditioner 2 hours after setting, and stop it 5 hours after setting.

1. Press the TIMER ON button.
2. Press the TIMER ON button again to display 2.0H on the TIMER ON display.
3. Press the TIMER OFF button.
4. Press the TIMER OFF button again to display 5.0H on the TIMER OFF display.
5. Wait for 3 seconds and the digital display area will show the temperature again. The "TIMER ON & TIMER OFF" indicator remains on and this function is activated.

Special functions

SLEEP operation

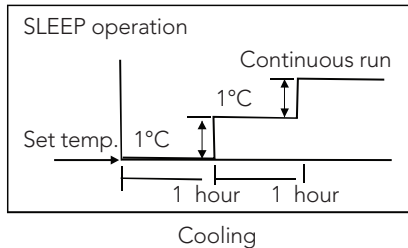

When selected, the set temperature will increase by 1°C per hour for the first 2 hours. Until new settings are entered or the air conditioner is shut down.

Sleep function saves energy and improves night time by optimising sleeping temperature.

Refrigerant leakage detection

When refrigerant leakage is detected, the indoor unit will display EC code.

Louvre angle memory function

Within the scope of safety angle, the horizontal louvre angle is memorised and will return to the position last selected by user. If it exceeds, it will memorize the boundary of safety angle. This will not happen when Turbo or manual control buttons are pressed or after a power interruption. So we strongly suggest that the open angle of the horizontal louvre should not be set too small, in case the condensed water forms and drips from the horizontal louvre.

SELF CLEAN function

- Airborne bacteria use the moisture on the indoor heat exchanger to grow. Regular drying of the exchanger prevents this growth. By simply pressing the SELF CLEAN button, the system will automatically manage the process. This cleaning action may be done as frequently as desired.
- Only the indoor fan is active in low speed for 30 minutes and the unit turns off automatically.

NOTE:

- *Activating self clean function does not replace the need to clean the filters. The filters must be cleaned at least every 3 months, or as required to maintain good cleanliness and performance of this air conditioner.*
- *This function is only activated in COOLING or DRY mode.*
- *Before activation the air conditioner, it is recommended to run the air conditioner under cooling operation for about 30 minutes.*
- *Pressing the SELF CLEAN or ON/OFF button again during the cleaning cycle will cancel the operation and turn the unit off.*

Auto-restart function

In event of power interruption such as a blackout, the air conditioner stops once. But it restarts automatically and performs previous operation when the power supply is resumed.

Mute operation

Press the LED button on the remote controller can turn off the indoor screen display, and also turn off the Air conditioner buzzer, which create a comfortable and quiet environment.

Airflow directional control

The direction of airflow can be adjusted for maximum comfort.

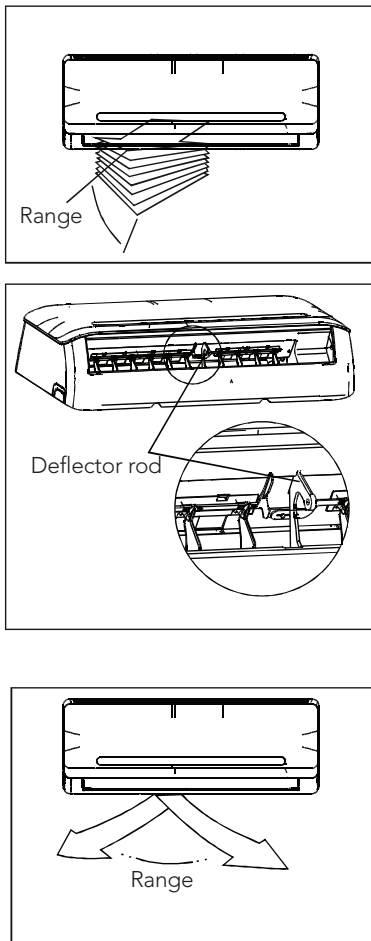

caution

- Do not operate the air conditioner for long periods with the air flow direction set downward in cooling or dehumidifying mode. Otherwise, condensation may occur on the surface of the horizontal louver causing moisture to drop on to the floor or on furnishings.
- After a quick restart, the horizontal louver may remain static for approximately 10 seconds.
- Open angle of the horizontal louver should not be set too small, as COOLING performance may be reduced due to too restricted air flow area.
- Do not move the vertical (up/down) louver manually, otherwise the vertical louver will be out of sync. But if this happens, please cease operating, switch off power for a few seconds, then restart the air conditioner.

Optimal operation

To achieve optimal performance, please note the following:

- Adjust the air flow direction correctly so that it is not towards people.
- Adjust the temperature to achieve moderate comfort levels. Excessively low temperature waste energy.
- Improve performance by keeping windows and doors closed.
- Limit energy usage (run time) by using the TIMER function.
- Do not put any object near air inlet or air outlet, as the efficiency of the air conditioner may be reduced and may cause the air conditioner to stop running.
- Inspect and clean the filters every 3 months or as required. Ensure that the filters are correctly inserted after cleaning.

Adjusting vertical air flow (Up/Down)

The vertical airflow direction is controlled by using the remote control. This can be set to a fixed direction or to automatically swing up and down for even air distribution. Refer to Remote Control section page 9 for operation details .

Adjusting horizontal air flow (Left/Right)

- The airflow can be directed horizontally (left to right) by manually adjusting the deflector rod.

important

Do not put your fingers into the panel of the blower and suction side. The high-speed fan inside may cause injury.

Operating temperature

Location	Temperature range
Room	17°C – 32°C
Outside	0°C – 50°C

The Air conditioner temperature can be set between the range of 17°C to 30°C.

NOTE:

1. Optimum performance will be achieved within these operating temperatures. If the air conditioner is used outside of the above conditions, certain safety protection features might come into operation and cause the unit to function abnormally.
2. If the air conditioner runs for a long time in cooling mode and the humidity is high (over 80%), condensed water may drip out of the unit. Please set the vertical air flow louvre to its maximum angle (vertically to the floor), and set HIGH fan mode.

Manual operation



caution

- This switch is used for testing purposes only. Please do not use it unless necessary.
- To restore the remote controller operation, use the remote controller directly.

This air conditioner is equipped with a manual switch to allow operation should the remote control fail to work. It can be accessed by opening the front panel.

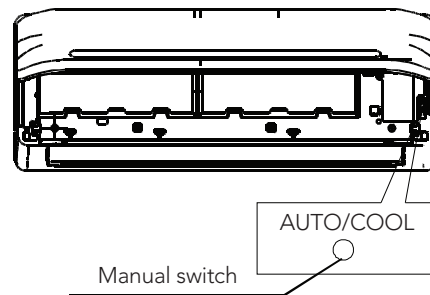

NOTE: The unit must be turned off before operating the manual control button. If the unit is operational, continue pressing the manual control button until the unit is off.

- Open the front panel until it locks. There is a "click" when the mechanism engages.
- One press of the manual control switch will lead to the forced AUTO operation. Press the switch twice within 5 seconds to operate in forced COOL mode, "FC" will be shown on the display. After about 30 minutes operation in forced COOL mode, the air conditioner will switch to AUTO mode and "FC" will be replaced with AUTO mode set temperature of "24" on the display.
- Close the panel after manual operation has been started.
- Press the button again while the air conditioner is running to turn off.

Care and maintenance

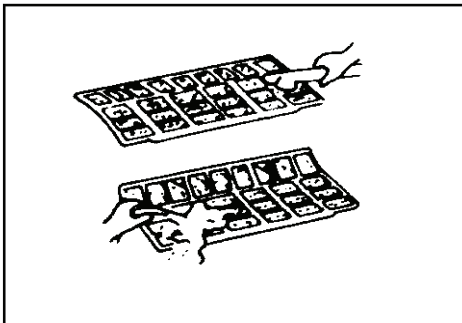
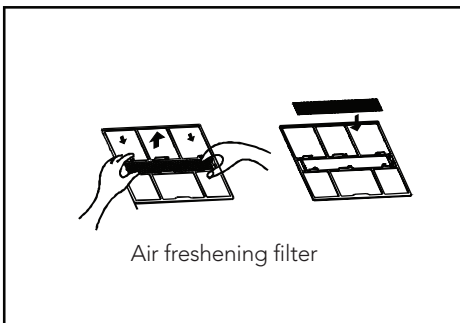
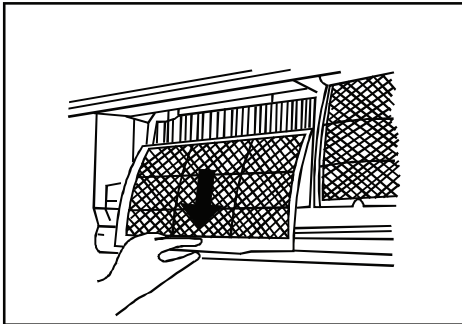
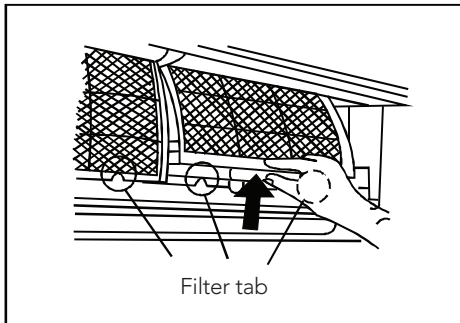
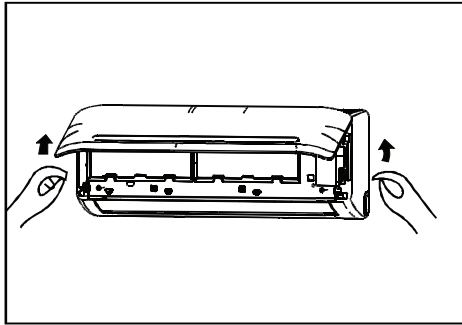

Before maintenance

- Turn the system off before cleaning. To clean, wipe with a soft, dry cloth. Do not use bleach or abrasives.

NOTE: Power supply must be disconnected before attempting to clean or service.

warning

Servicing shall only be performed as recommended by the equipment manufacturer. Maintenance and repair requiring the assistance of other skilled personnel shall be carried out under the supervision of the person competent in the use of flammable refrigerants. For more details, please refer to the Information on servicing on installation manual.

- Do not use a chemically treated cloth or duster to clean the unit.
- Do not use benzene, thinner, polishing powder, or similar solvents for cleaning. These may cause the plastic surface to crack or deform.
- Never use water hotter than 40°C to clean the front panel, it could cause deformation or discoloration.

Cleaning the unit

Wipe the unit with a soft dry cloth only. If the unit is very dirty, wipe it with a cloth soaked in warm water.

Cleaning the air filter and air freshening filter

A clogged air filter reduces the efficiency of this unit. Please clean the filter every 3 months, or as required..

1. Open the front panel by carefully lifting both ends at the same time. At a certain angle, a clicking sound is heard and it becomes self-supporting. For some models, please use the suspension bars to prop up the panel.
2. Use the tab provided to move the filter first up a little, then slightly towards you. Now extract the filter by gently drawing downwards.
3. Unclip the small air freshening filter from the large air filter. Clean it with vacuum, and replace it occasionally.
4. Clean the large air filter with soapy water. Rinse with fresh water. Shake off excess water and dry it up in cool place, replace it occasionally.

Care and maintenance

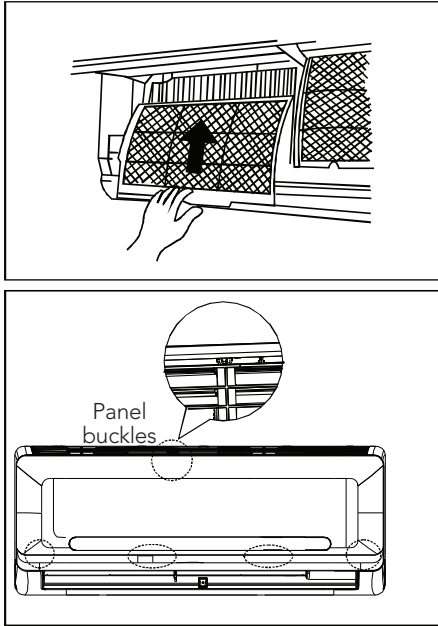

5. After the filters are dry, refit the small filters onto the large air filter.
6. Re-insert the filters back into the unit following the reverse order as described in steps 1 & 2.
7. Close the front panel. Make sure the buckles are fully fit and the panel is completely closed.

Preparation for extended non-operation

If you plan not to use unit for a long time, perform the following:

1. Clean the indoor unit and filters.
2. Operate the fan for about half a day to dry the inside of the unit.
3. Stop the air conditioner and disconnect power.
4. Remove the batteries from the remote controller. The outdoor unit requires periodic maintenance and cleaning. Do not attempt to do this yourself. Contact your dealer or service provider.

Pre-season inspection

- Damaged or disconnected wires.
- Clean the indoor unit and filters.
- Check water or oil leaks.
- Check that the outdoor unit is clear of leaves, rubbish and other objects that may block the air inlet or outlet.
- Check if the remote control batteries are flat, replace as required.

warning

- Do not touch the metal parts of the unit when removing the filter. Injuries can occur when handling sharp metal edges.
- Do not use water to clean inside the air conditioner. Exposure to water can destroy the insulation, leading to possible electric shock.
- When cleaning the unit, first make sure that the power and circuit breaker are turned off.
- Do not wash air filter with hot water at more than 40°C . Shake off moisture completely and dry it in the shade. Do not expose it directly to the sun, it may shrink.

Troubleshooting

Troubleshooting tips

The following events may occur during normal operation, and may not indicate malfunction

Symptom	Cause
Operation is delayed after restart	To prevent blowout of the fuse, the compressor will not operate while the protection circuit is working for about 3 minutes after sudden OFF/ON operation of the power supply, this is normal operation and designed to protect the compressor.
Fan speed changes from off, to very slow and then normal	Automatically happens in heating mode : <ul style="list-style-type: none"> perform automatic defrosting operation, perform low temperature heating operation
Mist coming out of the indoor unit	In COOL mode, a mist generated by condensation formed with sudden cooling process may be emitted.
Low volume sounds are emitted by the air conditioner	Hissing sound-- during operation or immediately after stopping the air conditioner, refrigerant flowing sound may be heard. Squeaking sound-- normal expansion and contraction of plastic and metal parts caused by temperature change during the operation. Rushing air-- when louvre resets its position.
Dust discharges from the unit	May occur when air conditioner is used for the first time or has not been used for a long time.
Emits a peculiar odour	Various smells generated from interior textile, furniture, or cigarette smoke absorbed into the air conditioner may be emitted. If not the case call an authorised service contractor.
Changes to fan only while cooling mode	Room temperature reaches the temperature setting of the remote control. If not the case call your suitable contractor.
Operation is erratic, unpredictable or unresponsive	Interference from cell phone towers and remote boosters may cause the unit to malfunction Disconnect the power and then re-connect. Press the ON/OFF button on the remote controller to restart operation.

NOTE: If the problem is not resolved, please contact a local dealer or the nearest customer service centre. Be sure to inform them of the detailed malfunctions and unit model number.

Troubleshooting

Before you call for or request servicing, troubleshoot a problem by performing following checks:

Symptom	Diagnostic
Unit will not operate	<p>Is there a power failure?</p> <p>Has a switch been turned off, a circuit breaker tripped or a fuse blown?</p> <p>Is the timer operating?</p> <p>Are the batteries used in the remote controller exhausted?</p> <p>Are the batteries used in the remote controller loaded properly?</p>
Poor cooling performance	<p>Are the air filters dirty?</p> <p>Is air flow unrestricted in & out of indoor & outdoor units?</p> <p>Are the temperature and mode settings correct?</p> <p>Are the windows or doors left opened?</p> <p>Is fan speed on high and louvres allowing maximum flow?</p> <p>Is direct or strong sunlight shinning into the room while in operation?</p> <p>Are there other heating apparatus or computers operating, or too many people in the room while in operation?</p>
Indicator lamps continue flashing	<p>The unit may stop operation or continue to run in a safety condition. Wait for about 10 minutes, the fault may be removed automatically, if not, switch the power supply to the air conditioner off and on. If the problem still exists, then switch off the power and contact the nearest customer service center.</p>
Error code appears in the indoor unit, such as: E0,E1,E2.... P1,P2,P3.....or F1, F2,F3.....	

If the problem persists even if you perform these checks or diagnostics, immediately stop operation and contact the authorized service center. Be sure to inform them of the detailed malfunctions and unit model number.



caution

In the case of ANY of the following, turn off the unit immediately

- Power cord is damaged or abnormally warm.
- Burning odours are smelled.
- Loud or abnormal sounds are heard.
- A power fuse blows or a circuit breaker trips frequently.
- Water or other objects fall into or out of the unit.

Do not attempt to correct these items yourself. Contact a authorized service provider.

This document sets out the terms and conditions of the product warranties for Kelvinator Appliances. It is an important document. Please keep it with your proof of purchase documents in a safe place for future reference should there be a manufacturing defect in your Appliance. This warranty is in addition to other rights you may have under the Australian Consumer Law.

1. In this warranty:

- (a) 'ACL' or 'Australian Consumer Law' means Schedule 2 to the Competition and Consumer Act 2010;
- (b) 'Appliance' means any Electrolux product purchased by you and accompanied by this document;
- (c) 'ASC' means Electrolux's authorised serviced centres;
- (d) 'Kelvinator' is the brand controlled by Electrolux Home Products Pty Ltd of 163 O'Riordan Street, Mascot NSW 2020, ABN 51 004 762 341 in respect of Appliances purchased in Australia and Electrolux (NZ) Limited (collectively "Electrolux") of 3-5 Niall Burgess Road, Mount Wellington, in respect of Appliances purchased in New Zealand;
- (e) 'Warranty Condition' means:
 - (i) evidence by the customer that the Appliance was installed by a licensed air conditioner installer and in accordance with Electrolux installation guidelines as set out in the installation manual;
 - (ii) the Appliance rating is correct for the size and thermal characteristics of the room;
 - (iii) the Appliance has been regularly maintained in accordance with Electrolux guidelines as set out in the user manual;
 - (iv) the Appliance is designed for providing human comfort and should be used under ambient conditions as set out in the product specifications and general air quality conditions.
- (f) 'Warranty Period' means the period specified in clause 3 of this warranty;
- (g) 'you' means the purchaser of the Appliance not having purchased the Appliance for re-sale, and 'your' has a corresponding meaning.

2. Application: This warranty only applies to new Appliances, purchased and used in Australia or New Zealand and is in addition to (and does not exclude, restrict, or modify in any way) other rights and remedies under a law to which the Appliances or services relate, including any non-excludable statutory guarantees in Australia and New Zealand.

3. Warranty Period: Subject to these terms and conditions, this warranty continues for in Australia for a period of 60 months and in New Zealand for a period of 60 months, following the date of original purchase of the Appliance.

4. Repair or replace warranty: During the Warranty Period, Electrolux or its ASC will, at no extra charge if your Appliance is readily accessible for service, without special equipment and subject to these terms and conditions, repair or replace any parts which it considers to be defective. Electrolux may, in its absolute discretion, choose whether the remedy offered for a valid warranty claim is repair or replacement. Electrolux or its ASC may use refurbished parts to repair your Appliance. You agree that any replaced Appliances or parts become the property of Electrolux.

5. Travel and transportation costs: Subject to clause 7, Electrolux will bear the reasonable cost of transportation, travel and delivery of the Appliance to and from Electrolux or its ASC. Travel and transportation will be arranged by Electrolux as part of any valid warranty claim.

6. Proof of purchase is required before you can make a claim under this warranty.

7. Exclusions: You may not make a claim under this warranty unless the defect claimed is due to faulty or defective parts or workmanship. This warranty does not cover:

- (a) light globes, batteries, filters or similar perishable parts;
- (b) parts and Appliances not supplied by Electrolux;
- (c) cosmetic damage which does not affect the operation of the Appliance;
- (d) damage to the Appliance caused by:
 - (i) negligence or accident;
 - (ii) misuse or abuse, including failure to properly maintain or service;
 - (iii) improper, negligent or faulty servicing or repair works done by anyone other than an Electrolux authorised repairer or ASC;
 - (iv) normal wear and tear;
 - (v) power surges, electrical storm damage or incorrect power supply;
 - (vi) incomplete or improper installation;
 - (vii) incorrect, improper or inappropriate operation;
 - (viii) insect or vermin infestation;
 - (ix) failure to comply with any additional instructions supplied with the Appliance; and
 - (x) a breach of the Warranty Conditions.

In addition, Electrolux is not liable under this warranty if:

- (a) the Appliance has been, or Electrolux reasonably believes that the Appliance has been, used for purposes other than those for which the Appliance was intended, including where the Appliance has been used for any non-domestic purpose;
- (b) the Appliance is modified without authority from Electrolux in writing;
- (c) the Appliance's serial number or warranty seal has been removed or defaced.

8. How to claim under this warranty: To enquire about claiming under this warranty, please follow these steps:

- (a) carefully check the operating instructions, user manual and the terms of this warranty;
- (b) have the model and serial number of the Appliance available;
- (c) have the proof of purchase (e.g. an invoice) available;
- (d) telephone the numbers shown below.

9. Australia: For Appliances and services provided by Electrolux in Australia: Electrolux goods come with guarantees that cannot be excluded under the Australian Consumer Law. You are entitled to a replacement or refund for a major failure and for compensation for any other reasonably foreseeable loss or damage. You are also entitled to have the Appliance repaired or replaced if the Appliance fails to be of acceptable quality and the failure does not amount to a major failure. 'Acceptable quality' and 'major failure' have the same meaning as referred to in the ACL.

10. New Zealand: For Appliances and services provided by Electrolux in New Zealand, the Appliances come with a guarantee by Electrolux pursuant to the provisions of the Consumer Guarantees Act, the Sale of Goods Act and the Fair Trading Act. Where the Appliance was purchased in New Zealand for commercial purposes the Consumer Guarantee Act does not apply.

11. Confidentiality: You accept that if you make a warranty claim, Electrolux and its agents including ASC may exchange information in relation to you to enable Electrolux to meet its obligations under this warranty.

Important Notice

Before calling for service, please ensure that the steps listed in clause 8 above have been followed.

<p>FOR SERVICE or to find the address of your nearest authorised service centre in Australia PLEASE CALL 13 13 49 For the cost of a local call (Australia only)</p>	<p>AUSTRALIA ELECTROLUX HOME PRODUCTS 163 O'Riordan Street, Mascot NSW 2020 electrolux.com.au</p>	<p>FOR SPARE PARTS or to find the address of your nearest spare parts centre in Australia PLEASE CALL 13 13 50 For the cost of a local call (Australia only)</p>
<p>FOR SERVICE or to find the address of your nearest authorised service centre in New Zealand PLEASE CALL 0800 10 66 10 (New Zealand only)</p>	<p>NEW ZEALAND ELECTROLUX (NZ) Limited 3-5 Niall Burgess Road, Mount Wellington electrolux.co.nz</p>	<p>FOR SPARE PARTS or to find the address of your nearest spare parts centre in New Zealand PLEASE CALL 0800 10 66 20 (New Zealand only)</p>

For more information on all Kelvinator appliances, or for dimension and installation information, call into your retailer, phone or email our customer care team or visit our website:

AUSTRALIA

phone: 13 13 49

email: customercare@electrolux.com.au

web: kelvinator.com.au

NEW ZEALAND

phone: 0800 436 245

email: customercare@electrolux.co.nz

web: kelvinator.co.nz

Kelvinator. We are part of the Electrolux Family.
To add a touch of professional inspiration to
your home, visit electrolux.com.au