

 BY JOHNSON CONTROLS	YORK SOLUTION AIR HANDLING UNITS	
INSTALLATION AND STARTUP INSTRUCTIONS	Supersedes 102.20-N1 (1108)	Form 102.20-N1 (1109)

YORK SOLUTION INDOOR AND OUTDOOR MODELS

Renewal Parts
 Form 102.20-RP1
 With P/N contact Balt. Parts
 (800) 932-1701
 Manufactured or specialty parts
 contact Airside (800) 545-7814

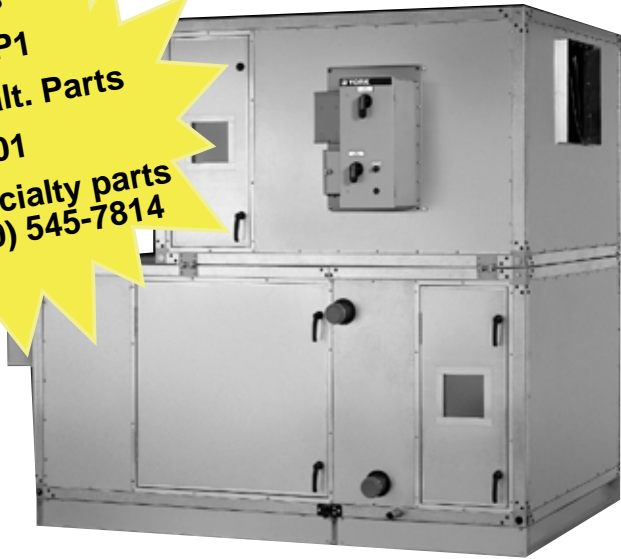

LD09624

INDOOR UNIT

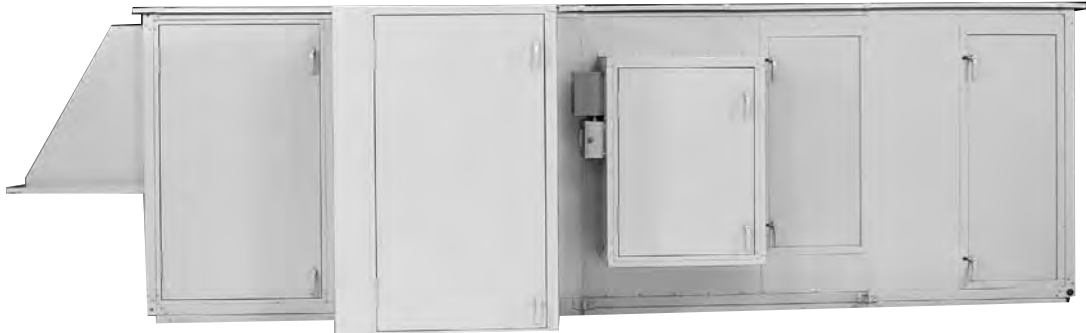

LD09688

OUTDOOR UNIT

IMPORTANT!

READ BEFORE PROCEEDING!

GENERAL SAFETY GUIDELINES

This equipment is a relatively complicated apparatus. During installation, operation, maintenance or service, individuals may be exposed to certain components or conditions including, but not limited to: refrigerants, oils, and materials under pressure, rotating components, and both high and low voltage. Each of these items has the potential, if misused or handled improperly, to cause bodily injury or death. It is the obligation and responsibility of operating/service personnel to identify and recognize these inherent hazards, protect themselves, and proceed safely in completing their tasks. Failure to comply with any of these requirements could result in serious damage to the equipment and the property in which it is situated, as well as severe personal injury or death to themselves and people at the site.

This document is intended for use by owner-authorized operating/service personnel. It is expected that this individual possesses independent training that will enable them to perform their assigned tasks properly and safely. It is essential that, prior to performing any task on this equipment, this individual shall have read and understood this document and any referenced materials. This individual shall also be familiar with and comply with all applicable governmental standards and regulations pertaining to the task in question.

SAFETY SYMBOLS

The following symbols are used in this document to alert the reader to areas of concern:



DANGER indicates an imminently hazardous situation, which if not avoided, will result in death or serious injury.

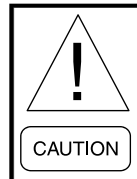

CAUTION identifies a hazard which could lead to damage to the machine, damage to other equipment and/or environmental pollution. Usually an instruction will be given, together with a brief explanation.



WARNING indicates a potentially hazardous situation, which if not avoided, could result in death or serious injury.

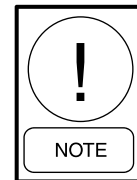

NOTE is used to highlight additional information that may be helpful to you.



Consider for IAQ compliance per ASHRAE STANDARD 62-2001



External wiring, unless specified as an optional connection in the manufacturer's product line, is NOT to be connected inside the control panel cabinet. Devices such as relays, switches, transducers and controls may NOT be installed inside the control panel. NO external wiring is allowed to run through the control panel. All wiring must be in accordance with Johnson Controls published specifications and must be performed ONLY by qualified Johnson Controls personnel. Johnson Controls will not be responsible for damages/problems resulting from improper connections to the controls or application of improper control signals. Failure to follow this will void the manufacturer's warranty and cause serious damage to property or injury to persons.

***NOTICE TO CUSTOMER/CONTRACTOR
PROTECT YOUR WARRANTY PRIOR TO
STARTUP.***

- Read and follow the Installation and Start-up Instructions provided with this equipment.
- Storage of this equipment **MUST** be on a flat surface and protected from the weather.
- Protect this equipment from damage, construction dirt, debris and water.

DO NOT OPERATE DOORS WHEN UNIT IS NOT ON A FLAT SURFACE.

- Isolate this equipment from pressure testing of water, steam, gas and air piping.
- Do not test, clean and flush piping through coils in this equipment.
- Isolate this equipment from temporary building power.
- Contact local Johnson Controls Service for purchase of Startup Service with two weeks advance notice. Provide current job site contact.
- To perform a careful and thorough startup, verify the following:
 - Reliable power will be available for startup.
 - Ductwork is complete.
 - Controls are complete.

- Shipping splits completely re-assembled, sealed and wired.
- Filters are installed and secured.
- All shipping materials have been removed.

***METAL TAB USED TO SECURE
DOOR IS A SAFETY DEVICE. DO
NOT DISCARD IT.***

- Start-up will be performed according to that outlined in Section 3 of the Installation and Start-up Instructions provided.
- Temporary use of air handler requires startup performed according to that outlined in Section 3 of the Installation and Start-up Instructions provided.
- A qualified startup technician must complete the “**AIR HANDLING UNITS START-UP CHECK LIST**” Form 100.00-CL1 and file a copy at the local YORK Service Office. This form is provided in the information package with each air handler.
- Rotate fans every four (4) weeks beginning upon arrival.

CHANGEABILITY OF THIS DOCUMENT

In complying with Johnson Controls policy for continuous product improvement, the information contained in this document is subject to change without notice. While Johnson Controls makes no commitment to update or provide current information automatically to the manual owner, that information, if applicable, can be obtained by contacting the nearest Johnson Controls Service office.

It is the responsibility of operating/service personnel to verify the applicability of these documents to the equipment in question. If there is any question in the mind of operating/service personnel as to the applicability of these documents, then prior to working on the equipment, they should verify with the owner whether the equipment has been modified and if current literature is available.

THIS PAGE INTENTIONALLY LEFT BLANK

TABLE OF CONTENTS

GENERAL SAFETY GUIDELINES	2
CHANGEABILITY OF THIS DOCUMENT	3
TABLE OF CONTENTS	5
LIST OF FIGURES.....	11
LIST OF TABLES.....	15
INTRODUCTION	17
GENERAL.....	17
TYPICAL YORK SOLUTION OPERATION IN “HVAC” SYSTEM.....	17
Ventilation System	17
Economizer System - Typical.....	18
Heating Operation	18
Cooling Operation.....	18
HAND IDENTIFICATION	18
SEGMENT IDENTIFICATION.....	19
Unit Identification.....	21
Unit ID Label	21
Skid ID Label	21
Segment Identification Box.....	21
Loose Component ID Label	22
Filter ID Label	22
Direction of Airflow	22
1.0 PRE-INSTALLATION	1-1
RECEIVING	1-1
RIGGING OF INDOOR AND OUTDOOR UNITS	1-1
Off-Loading.....	1-2
Crane And Spreader Bars	1-2
Fork Lift.....	1-2
Come-A-Longs or Power Pull	1-2
Shackles.....	1-3
INSPECTION	1-4
Check For Damage.....	1-4
Receiver Responsibility	1-4
Indoor Units.....	1-4
Outdoor Units.....	1-4
Checking for Non Mounted Parts	1-4
STORAGE	1-4
Short-Term Storage.....	1-4
Long-Term Storage	1-5
Preventive Maintenance Prior to Long Term Storage	1-5
Periodic Fan Check.....	1-5

TABLE OF CONTENTS (CONT'D)

2.0 INSTALLATION.....	2-1
SITE PREPARATION	2-1
Outdoor Units (Site Prep).....	2-1
Mounting.....	2-2
Curb	2-2
Steel Frame	2-3
Indoor Units (Site Prep).....	2-3
Clearance.....	2-5
Mounting.....	2-5
Floor.....	2-5
Housekeeping Pad.....	2-5
Ceiling Suspended Units	2-6
UNIT INSTALLATION.....	2-7
Tools Needed.....	2-7
Ship Loose Parts.....	2-8
Assembly of Outdoor Unit.....	2-13
Installing Single Piece Outdoor Unit.....	2-13
Installing Multiple Piece Outdoor Unit	2-13
Assembly of Indoor Unit.....	2-17
Installing Multiple Piece Indoor Unit	2-17
Installation of Tiered Unit.....	2-21
Assembly of End Channel Shipping Split	2-23
HOOD INSTALLATION WITH OPTIONAL MIST ELIMINATORS.....	2-24
OUTDOOR AIR TEMPERATURE AND/OR HUMIDITY SENSORS	2-24
ACTUATOR INSTALLATION	2-25
INSTALLATION OF MULTIZONE (MZ) DAMPERS.....	2-26
Damper Installation.....	2-26
Actuator Installation Multizone (MZ) - Field Supplied	2-27
INERTIA FAN BASE FILL INSTRUCTION	2-27
HUMIDIFIERS.....	2-27
UVC EMITTER LIGHTS	2-28
AIR MEASURING DEVICE CONNECTIONS (WHEN PROVIDED).....	2-29
Air Measuring at The Fan Inlets.....	2-29
Air Measuring at Unit Inlets.....	2-29
PIPE CHASE INSTALLATION	2-30
Tools Required	2-30
Materials Required	2-30
Procedure	2-30
Condensate Drain Arrangement.....	2-35
ELECTRICAL - GENERAL.....	2-36

TABLE OF CONTENTS (CONT'D)

POWER CONNECTIONS	2-37
Single Point Power.....	2-37
Motors for Supply Fan, Return Fan, Exhaust Fan.....	2-37
Energy Recovery Wheel Option.....	2-37
Gas Heat Option.....	2-38
Electric Heat Option.....	2-39
Available Power Options.....	2-39
Electric Heat Disconnect Switch Options.....	2-39
Available Control Options.....	2-40
Installation.....	2-40
APPLICATION INFORMATION	2-40
MECHANICAL INSTALLATION	2-40
ELECTRICAL INSTALLATION	2-42
Humidifier Option (Electric).....	2-43
Humidifier Option.....	2-43
PIPING CONNECTIONS	2-44
Coil Piping.....	2-45
Staggered Coils.....	2-45
Water.....	2-46
Water Coils - Hot Water and Chilled Water.....	2-46
Hot and Chilled Water Coil Performance.....	2-46
Water Treatment.....	2-48
Steam.....	2-48
Steam Coils.....	2-48
Steam Distributing Coils.....	2-48
Steam Control.....	2-48
Steam Traps.....	2-49
VIFB and IFB.....	2-50
Refrigeration.....	2-54
Direct Expansion Coils (DX).....	2-54
DX Coil Types.....	2-55
Combined Coil Types.....	2-55
DX Coil Circuiting.....	2-55
DX Coil Circuiting And Staging.....	2-57
Thermostatic Expansion Valves (TXV).....	2-59
Hot Gas Bypass.....	2-59
Maintaining Adequate Airflow.....	2-59
VAV Systems.....	2-59

TABLE OF CONTENTS (CONT'D)

Drains And Traps.....	2-61
Condensate Drain Piping	2-61
Condensate Drain Trap.....	2-61
Elevating Unit for Gravity Floor Drain Connections.....	2-62
Duct Connections	2-62
Duct Connection Guidelines.....	2-62
Duct Connections	2-63
Flanged Ducts or Sleeves	2-63
Raw or Straight Edge Ducts or Sleeves	2-63
Sound and Vibration Transmission.....	2-64
Front and Rear Discharge Outdoor Unit Duct Installation.....	2-64
Air Filters	2-65
Filter Types	2-65
Maintenance and Replacement	2-65
Filter Latches.....	2-66
Installation of 2" Perfectpleat, Premium or Premium HM	2-68
Installation of Spring Latches	2-68
Installation of 4" Amair 300x Pleated Filter	2-69
Installation of SH Single Headered Filters.....	2-70
Installation of Latches	2-70
Installation of a 2" Prefilter In Combination with a Single Header Final Filter.....	2-70
Installation of Latches	2-70
Installation of a Varicel DH Double Headered Filter	2-71
Installation of Spring Latches	2-71
Installation of a 2" and 4" Prefilter in Combination With a Double Header Final Filter.....	2-72
Installation of Spring Latches	2-72
Installation of Prefilter Latches	2-72
HEPA Filters.....	2-74
Welded Bevel Seal Frame	2-74
Visual Control Filter Clamps.....	2-74

TABLE OF CONTENTS (CONT'D)

3.0 STARTUP	3-1
PRE START-UP	3-2
PRE START UP FAN ASSEMBLY INSPECTION	3-3
Motors - ODP vs. TEFC	3-3
Isolators	3-4
Preparing Fan Isolators for Operation	3-4
START-UP	3-5
CHECK OPERATION OF FANS	3-5
Check Operation of Dampers	3-5
Airflow Control Dampers	3-5
Typical Actuators Locations	3-6
Basic Actuators Installation	3-6
Damper Blade Orientation	3-6
Energize Fan Motor(s)	3-7
Variable Speed Drive (VSD)	3-7
Set Up of a Non-Factory Mounted VFD	3-7
Check Doors and Latches for Proper Adjustment	3-8
Sheaves	3-8
General Guidelines for Replacing an Adjustable Sheave with a Fixed Sheave:	3-8
Energy Recovery Wheel	3-9
Unit Configuration	3-9
Indoor Units	3-9
Outdoor Units	3-9
Start-Up Procedure for Energy Recovery Wheel	3-9
Indirect Fired Gas Heat Start Up	3-11
Introduction	3-11
Identify the Unit Type	3-11
Preliminary Coordination	3-12
Tools Recommended	3-12
Air Handler Pre Start Checks	3-12
Burner Pre Start Checks	3-12
Burner Start-Up Procedure	3-14
Condensate Drain Arrangement	3-15
Electric Heat Startup	3-25
Airflow Requirements	3-25

THIS PAGE INTENTIONALLY LEFT BLANK

LIST OF FIGURES

FIG. 1 – CUTAWAY OF YORK SOLUTION SHOWING VARIOUS SEGMENTS.....	17
FIG. 2 – UNIT AND COIL HAND IDENTIFICATION.....	18
FIG. 3 – UNIT ID LABEL.....	21
FIG. 4 – SKID ID LABEL.....	21
FIG. 5 – SEGMENT ID BOX EXAMPLE.....	21
FIG. 6 – LOOSE COMPONENT ID LABELS.....	22
FIG. 7 – FILTER LABELS.....	22
FIG. 1-1 – RECOMMENDED LIFTING WITH FOUR LIFTING POINTS.....	1-1
FIG. 1-2 – RECOMMENDED LIFTING WITH MULTIPLE POINTS.....	1-1
FIG. 1-3 – TYPICAL COME-A-LONG TYPES.....	1-2
FIG. 1-4 – PROPER LIFTING WITH SHACKLE AT CORNER.....	1-3
FIG. 1-5 – PROPER LIFTING WITH SHACKLE AT LIFTING LUG.....	1-3
FIG. 1-6 – RECOMMENDED LIFTING WITH BASERAIL.....	1-3
FIG. 1-7 – LONG-TERM STORAGE REQUIREMENT - FIELD PREPARATION.....	1-6
FIG. 1-8 – LONG-TERM STORAGE PERIODIC CHECKLIST AND LOGS.....	1-7
FIG. 2-1 – MINIMUM SERVICE CLEARANCES.....	2-1
FIG. 2-2 – TYPICAL CURB ASSEMBLY.....	2-4
FIG. 2-3 – NO BASERAIL – HOUSEKEEPING PAD REQUIRED TO ACCOMMODATE TRAP HEIGHT.....	2-5
FIG. 2-4 – NO HOUSEKEEPING PAD – BASERAIL REQUIRED TO ACCOMMODATE TRAP HEIGHT.....	2-5
FIG. 2-5 – WITH BASERAIL AND HOUSEKEEPING PAD.....	2-5
FIG. 2-6 – CEILING SUSPENDED UNIT.....	2-6
FIG. 2-7 – TOOLS TYPICALLY USED FOR ASSEMBLY OF SHIPPING SPLITS.....	2-7
FIG. 2-8 – SECOND TIER TIE-DOWN FASTENER PACK P/N 386-03419-000.....	2-8
FIG. 2-9 – BOTTOM RACEWAY SHIPPING SPLIT FASTENER PACK P/N 386-03418-000.....	2-8
FIG. 2-10 – BASERAIL SHIPPING SPLIT FASTENER PACK P/N 386-03417-000.....	2-8
FIG. 2-11 – TOP RACEWAY SPLIT FASTENER PACK.....	2-8
FIG. 2-12 – PIPE CHASE, HOODS & SEAM CAPS.....	2-9
FIG. 2-13 – MISCELLANEOUS PARTS FOR OPTIONS.....	2-10
FIG. 2-14 – HARDWARE, GASKETING, CAULK, PAINT AND TAPE.....	2-11
FIG. 2-15 – SHIPPING SPLIT EXAMPLES.....	2-12
FIG. 2-16 – SHIPPING SPLIT EXAMPLES FOR EXPANDED CABINET.....	2-12
FIG. 2-17 – APPLYING GASKET.....	2-14
FIG. 2-18 – ELECTRICAL CONNECTIONS.....	2-14
FIG. 2-19 – REMOVE AND REPOSITION SHIPPING SPLIT ANGLE.....	2-15
FIG. 2-20 – BRINGING SECTIONS TOGETHER.....	2-16
FIG. 2-21 – APPLYING GASKET TO SHIPPING SPLIT.....	2-17
FIG. 2-22 – APPLYING GASKET TO DOOR FRAME WHEN AT SHIPPING SPLIT.....	2-17
FIG. 2-23 – ASSEMBLY OF END CHANNEL SHIPPING SPLIT (EXPANDED CABINET).....	2-18
FIG. 2-24 – REMOVE AND REPOSITION SHIPPING SPLIT ANGLE.....	2-18
FIG. 2-25 – PLACING AND ANCHORING FIRST SECTION AND ATTACHING COME-A-LONGS.....	2-19
FIG. 2-26 – REMOVE LIFTING LUGS AND SAVE HARDWARE.....	2-19
FIG. 2-27 – ELECTRICAL CONNECTIONS.....	2-19

LIST OF FIGURES (CONT'D)

FIG. 2-28 – INSTALLING BOLTS AFTER PULLING UNITS TIGHT TOGETHER	2-20
FIG. 2-29 – TIERED UNIT	2-21
FIG. 2-30 – TIERED UNIT SECURED WITH BRACKETS	2-21
FIG. 2-31 – APPLY GASKETS TO TOP PANEL BOTTOM TIER	2-21
FIG. 2-32 – GUIDING BRACKETS TOGETHER.....	2-22
FIG. 2-33 – ASSEMBLY OF END CHANNEL SHIPPING SPLIT	2-23
FIG. 2-34 – HOOD INSTALLATION WITH OPTIONAL MIST ELIMINATORS	2-24
FIG. 2-35 – DIRECT COUPLED ON JACKSHAFT.....	2-25
FIG. 2-36 – MZ DAMPER/ACTUATOR ASSEMBLY.....	2-26
FIG. 2-37 – DAMPER SHAFT EXTENSION KIT.....	2-27
FIG. 2-38 – V-MOD INSTALLATION	2-28
FIG. 2-39 – V-RAY INSTALLATION	2-28
FIG. 2-40 – V-FLEX INSTALLATION	2-28
FIG. 2-41 – INSTALL GASKET UNDER ROOF OVERHANG	2-30
FIG. 2-42 – APPLY GASKET TO PIPE CHASE.....	2-31
FIG. 2-43 – PIPE CHASE BASERAIL TO UNIT BASERAIL INSTALLATION	2-31
FIG. 2-44 – SCREW PIPE CHASE TOP AND BOTTOM INTERNAL FLANGES TO AIR HANDLER	2-31
FIG. 2-45 – BASERAIL CAULK APPLICATION.....	2-32
FIG. 2-46 – PIPE CHASE TO ROOF INSTALLATION.....	2-32
FIG. 2-47 – PIPE CHASE TO AIR HANDLER CAULK APPLICATION.....	2-32
FIG. 2-48 – INSTALL COVER ANGLE.....	2-32
FIG. 2-49 – PROPER POSITIONING OF COVER ANGLE WITH NOTCH ON AIR HANDLER SIDE.....	2-33
FIG. 2-50 – PROPER PATTERN FOR INSTALLING SELF-DRILLING SCREWS TO COVER ANGLE.....	2-33
FIG. 2-51 – BASERAIL COVER APPLICATION.....	2-33
FIG. 2-52 – GAS FURNACE FUEL VENTING SYSTEM	2-34
FIG. 2-53 – GAS FURNACE CONDENSATE DRAIN TRAP	2-35
FIG. 2-54 – TYPICAL MOTOR DATA / NAMEPLATE.....	2-37
FIG. 2-55 – TYPICAL POWER WIRING OF ENERGY RECOVERY WHEEL	2-37
FIG. 2-56 – GAS BURNER COMPONENT LOCATIONS	2-38
FIG. 2-57 – MAIN POWER AND CONTROL PANEL W/ COVER OPEN	2-38
FIG. 2-58 – TYPICAL ELECTRIC HEAT CONTROL PANEL INTERIOR WIRING AND COMPONENTS	2-39
FIG. 2-59 – TYPICAL FIELD CONTROL AND POWER CONNECTIONS.....	2-39
FIG. 2-60 – PRESSURE PROBE DIRECTION	2-41
FIG. 2-61 – AIRFLOW SWITCH CONNECTIONS	2-41
FIG. 2-62 – TYPICAL HUMIDIFIER PANEL LAYOUT	2-43
FIG. 2-63 – SUPPLY POWER KNOCKOUTS.....	2-43
FIG. 2-64 – HUMIDIFIER POINTS	2-43
FIG. 2-65 – PIPE CHASE ENCLOSURE	2-44
FIG. 2-66 – FACTORY COIL CONNECTIONS.....	2-44
FIG. 2-67 – STAGGERED COIL CONFIGURATIONS	2-45
FIG. 2-68 – CHILLED WATER COIL CONNECTIONS	2-46
FIG. 2-69 – HOT WATER PIPING - 2 WAY VALVE.....	2-47

LIST OF FIGURES (CONT'D)

FIG. 2-70 – HOT WATER PIPING WITH DIVERTING VALVE	2-47
FIG. 2-71 – STEAM COIL PIPING ARRANGEMENTS.....	2-49
FIG. 2-72 – INTEGRAL FACE AND BYPASS COIL (HORIZONTAL; TUBES, STEAM SHOWN).....	2-50
FIG. 2-73 – VERTICAL INTEGRAL FACE AND BYPASS COIL	2-50
FIG. 2-74 – HOT WATER PIPING FOR 2 ROW COIL VIFB	2-52
FIG. 2-75 – HOT WATER PIPING FOR IFB	2-52
FIG. 2-76 – STEAM PIPING FOR VIFB COIL.....	2-53
FIG. 2-77 – TYPICAL PIPING AND SUNDRIES AT THE DX COIL.....	2-54
FIG. 2-78 – DX COIL CIRCUITING TYPES	2-55
FIG. 2-79 – NON-STACKED COIL DESIGN - SQ SPECIAL	2-56
FIG. 2-80 – NON-STACKED COIL DESIGN - STANDARD	2-56
FIG. 2-81 – STACKED COIL DESIGN - STANDARD	2-57
FIG. 2-82 – STACKED COIL DESIGNS - SQ SPECIAL	2-57
FIG. 2-83 – STACKED COIL CIRCUITING	2-57
FIG. 2-84 – ONE COIL CIRCUIT PERREFRIGERANT CIRCUIT	2-58
FIG. 2-85 – TWO COIL CIRCUITS PERREFRIGERANT CIRCUIT	2-58
FIG. 2-86 – DO NOT USE THE ABOVE CONFIGURATION.	2-58
FIG. 2-87 – THREE COMPRESSOR YCUL	2-58
FIG. 2-88 – DO NOT USE THE ABOVE CONFIGURATION.	2-58
FIG. 2-89 – SIX COMPRESSOR YCUL	2-59
FIG. 2-90 – DRAIN TRAP SHOWING WATER LOCATION DURING DRAW THROUGH OPERATION STAGES	2-61
FIG. 2-91 – TRAP DETAIL FOR DRAW THROUGH APPLICATION.....	2-61
FIG. 2-92 – TRAP DETAIL FOR BLOW THROUGH APPLICATION.....	2-61
FIG. 2-93 – COMBINING DRAIN LINES.....	2-62
FIG. 2-94 – RECOMMENDED DISCHARGE DUCT ARRANGEMENT WHEN TURNS ARE REQUIRED.....	2-62
FIG. 2-95 – RECOMMENDED DISCHARGE DUCT ARRANGEMENT WHEN TURNS ARE REQUIRED.....	2-63
FIG. 2-96 – DUCT PENETRATION OF ROOF	2-64
FIG. 2-97 – ROOF TO DUCT INSTALLATION - HORIZONTAL DISCHARGE.....	2-64
FIG. 2-97A – TYPICAL FILTERS	2-65
FIG. 2-98 – FILTER LATCHES.....	2-66
FIG. 2-99 – CORRECTLY INSTALLED LATCH P/N 026-35778-000.....	2-68
FIG. 2-100 – FULLY INSTALLED FILTER	2-68
FIG. 2-101 – CORRECTLY INSTALLED LATCH P/N 026-35778-007.....	2-69
FIG. 2-102 – PLACE THE END OF THE LATCH OVER THE FILTER FRAME, SECURING THE FILTER TO THE FRAME.....	2-69
FIG. 2-103 – INSTALLED CARTRIDGE FILTER	2-70
FIG. 2-104 – INSTALL LATCH P//N 026-35778-007.....	2-70
FIG. 2-105 – INSTALLED CARTRIGE W/PLEATS.....	2-70
FIG. 2-106 – CORRECT USE OF KNOCKOUTS	2-71
FIG. 2-107 – CORRECT LATCH/KNOCKOUT CONFIGURATION.	2-71

LIST OF FIGURES (CONT'D)

FIG. 2-108 – FRAME WITH 4 LATCHES INSTALLED.	2-71
FIG. 2-109 – SPRING LATCH SHOULD BE PULLED AND FASTENED IN HOLE IN THE HEADER OF THE FILTER.	2-71
FIG. 2-110 – CORRECT LATCH/KNOCKOUT CONFIGURATION. P/N 026-35778-006.....	2-72
FIG. 2-111 – FRAME WITH 4 LATCHES INSTALLED	2-72
FIG. 2-112 – PREFILTER LATCH AFTER INSTALLATION ONTO FILTER HEADER.....	2-72
FIG. 2-113 – POSITION PREFILTER IN FRONT OF THE FINAL FILTER. (2" W/026-36339-000 LATCH SHOWN)	2-73
FIG. 2-114 – SPRING THE END OF THE LATCH SO THAT IT FITS OVER THE EDGE OF THE PREFILTER. (4" W/026-36339-000 LATCH SHOWN)	2-73
FIG. 2-115 – COMPLETED ASSEMBLY	2-73
FIG. 2-116 – HEPA FILTER FRAME CROSS SECTION VIEW	2-74
FIG. 2-117 – VISUAL CONTROL FILTER CLAMPS.....	2-74
FIG. 2-118 – HEPA FILTER INSTALLATION	2-75
FIG. 2-119 – WELDED BEVEL SEAL FILTER INSTALLATION.....	2-75
FIG. 3-1 – TERMINATION CHART INSIDE ENCLOSURE DOOR	3-2
FIG. 3-2 – FAN AND MOTOR ISOLATOR SUPPORT FRAME.	3-3
FIG. 3-3 – ODP (OPEN DRIP PROOF)	3-3
FIG. 3-4 – TEFC (TOTALLY ENCLOSED FAN COOLED).....	3-4
FIG. 3-5 – SPRING ISOLATOR.....	3-4
FIG. 3-6 – SEISMIC SNUBBER	3-4
FIG. 3-7 – EXAMPLE OF SWEEP BALANCE RESULTS	3-7
FIG. 3-8 – TYPICAL DRIVE KIT DATA TAG	3-8
FIG. 3-9 – INDOOR UNIT - VERTICAL WHEEL.....	3-9
FIG. 3-10 – OUTDOOR UNIT - HORIZONTAL WHEEL.....	3-9
FIG. 3-11 – ENERGY RECOVERY WHEEL - PULLEY SIDE	3-10
FIG. 3-12 – SEGMENT RETAINER.....	3-10
FIG. 3-13 – DIAMETER SEAL ADJUSTMENT	3-10
FIG. 3-14 – OPEN FUSE DISCONNECTS.....	3-12
FIG. 3-15 – SET ID FAN DAMPER	3-13
FIG. 3-16 – CHECK MAIN GAS SUPPLY PRESSURE	3-13
FIG. 3-17 – DRAFT OVER FIRE TEST PORT	3-14
FIG. 3-18 – FLUE (STACK) COMBUSTION TEMPERATURE AND EFFICIENCY TEST PORT	3-14
FIG. 3-19 – DAMPER ACTUATOR.....	3-15
FIG. 3-20 – CONDENSATE DRAIN	3-15
FIG. 3-21 – GAS FURNACE CONDENSATE DRAIN TRAP	3-16
FIG. 3-22 – GAS FURNACE FUEL VENTING SYSTEM	3-20
FIG. 3-23 – GAS FURNACE FUEL VENTING SYSTEM	3-21
FIG. 3-24 – TYPICAL WIRING DIAGRAM.....	3-22
FIG. 3-25 – MINIMUM AIR VELOCITY REQUIRED FOR SAFE OPERATION	3-25
FIG. 3-26 – PRESSURE PROBE DIRECTION	3-26
FIG. 3-27 – AIRFLOW SWITCH CONNECTIONS	3-26
FIG. 3-28 – AIR HANDLER START-UP CHECKLIST	3-27

LIST OF TABLES

TABLE 1 – SEGMENT IDENTIFICATION	17
TABLE 2 – UNIT NOMENCLATURE.....	18
TABLE 1-1 - SPACING REQUIREMENTS FOR OFFLOADING LONG UNITS	1-2
TABLE 3-1 – TORQUE FOR TIGHTENING SETSCREWS	3-3
TABLE 3-2 – NATURAL GAS PRESSURE REQUIREMENTS (INCHES WC)	3-18
TABLE 3-3 – PIPE SIZE REQUIRED.....	3-19
TABLE 3-4 – BURNER TEPERATURE RISE	3-23
TABLE 3-5 – INSPECTION REQUIREMENTS	3-29

THIS PAGE INTENTIONALLY LEFT BLANK

INTRODUCTION

GENERAL

This manual has been prepared as a guide for installing, operating and maintaining YORK Solution Air Handling Units. Johnson Controls has produced a quality product that is adaptable to almost any comfort or industrial application. However, proper installation, operation and maintenance must be followed to realize the full capacity and life of the units.

This instruction contains general recommendations, but specific requirements may apply to the individual installation. Such requirements are outlined in federal, state and local safety codes. Strict compliance with these codes and strict adherence to these instructions are the responsibility of the user. Particular attention should be given to electrical wiring and other safety elements such as design working pressures and requirements of the Government Clean Air Act Amendments as it applies to refrigerant types and charges. General safety practices are covered in AMCA Publication 410-90.

Read the entire instruction before installing or operating the air handler. Specific details and requirements apply that require careful consideration to avoid damage to the equipment and injury to the installer or operator.

The YORK Solution features segmented construction and is factory assembled. Segment arrangements will vary to suit job application (*see Fig. 1*). Heavy gauge galvanized steel is used on the exterior and interior of the unit. Access doors are provided for accessibility to the various sections. Removable access panels are standard in lieu of doors on Commercial Performance units. Panels, doors and structural frame are insulated with spray-injected foam.

TYPICAL YORK SOLUTION OPERATION IN “HVAC” SYSTEM

The operation of these units can be divided into systems:

1. Ventilation system.
2. Economizer system (return air/mixing box section).
3. Heating system.
4. Cooling system.

Ventilation System

A ventilation system simply replaces the air in a given space. Usually the purpose is to remove air that is substandard to creature comfort or a process and replace it with suitable air. Depending on the application the system will operate at various specified rates, volumes and conditions. A ventilation system may employ an air handler with a supply fan working in conjunction with other remote exhaust fan(s). A more effective method would employ both a supply fan and an exhaust fan in the air handler.

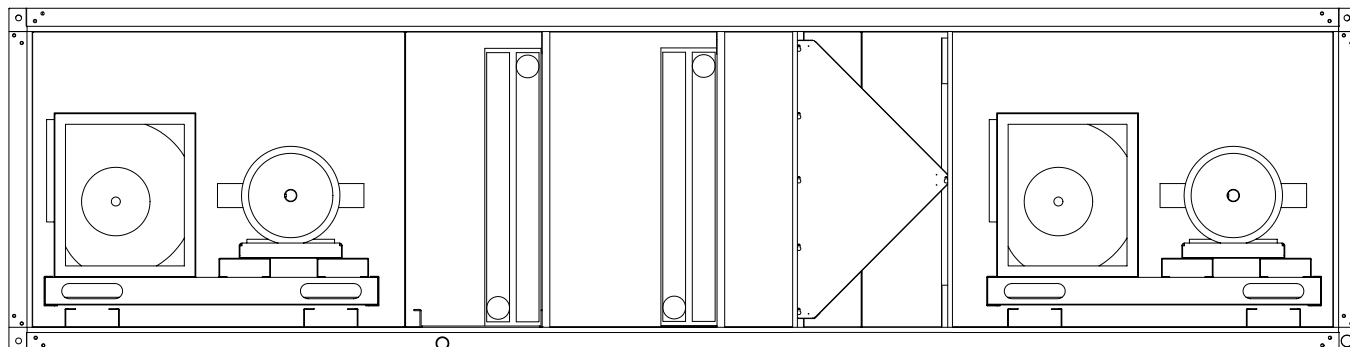

FIG. 1 – CUTAWAY OF YORK SOLUTION SHOWING VARIOUS SEGMENTS

LD13764

Economizer System - Typical

The Economizer system could typically consist of:

- Outdoor and return air dampers.
- Damper actuator.
- Enthalpy control.
- Minimum outdoor air adjustment.
- Exhaust air control.

The Economizer system provides the first stage of cooling whenever the outdoor air is cool and dry enough to satisfy the internal cooling demand. The outdoor and the return air dampers are operated by individual actuators. As the outdoor air dampers are opened by the damper actuator, the return air dampers are closed.

If the economizer operation cannot satisfy the space demand for cooling, stages can be energized as needed.

Heating Operation

Various types of heating may be applied. Hot water or steam coils maybe specified typically. Electric heat and fuel burner heat are available.

Cooling Operation

Various types of cooling may be utilized. Factory mounted chilled water coils or direct expansion refrigerant coils may be specified for the YORK Solution unit.

HAND IDENTIFICATION

Coil connections and other components are located and described as left or right hand. The proper orientation to describe the proper hand is when airflow is at your back, as shown in Fig. 2.

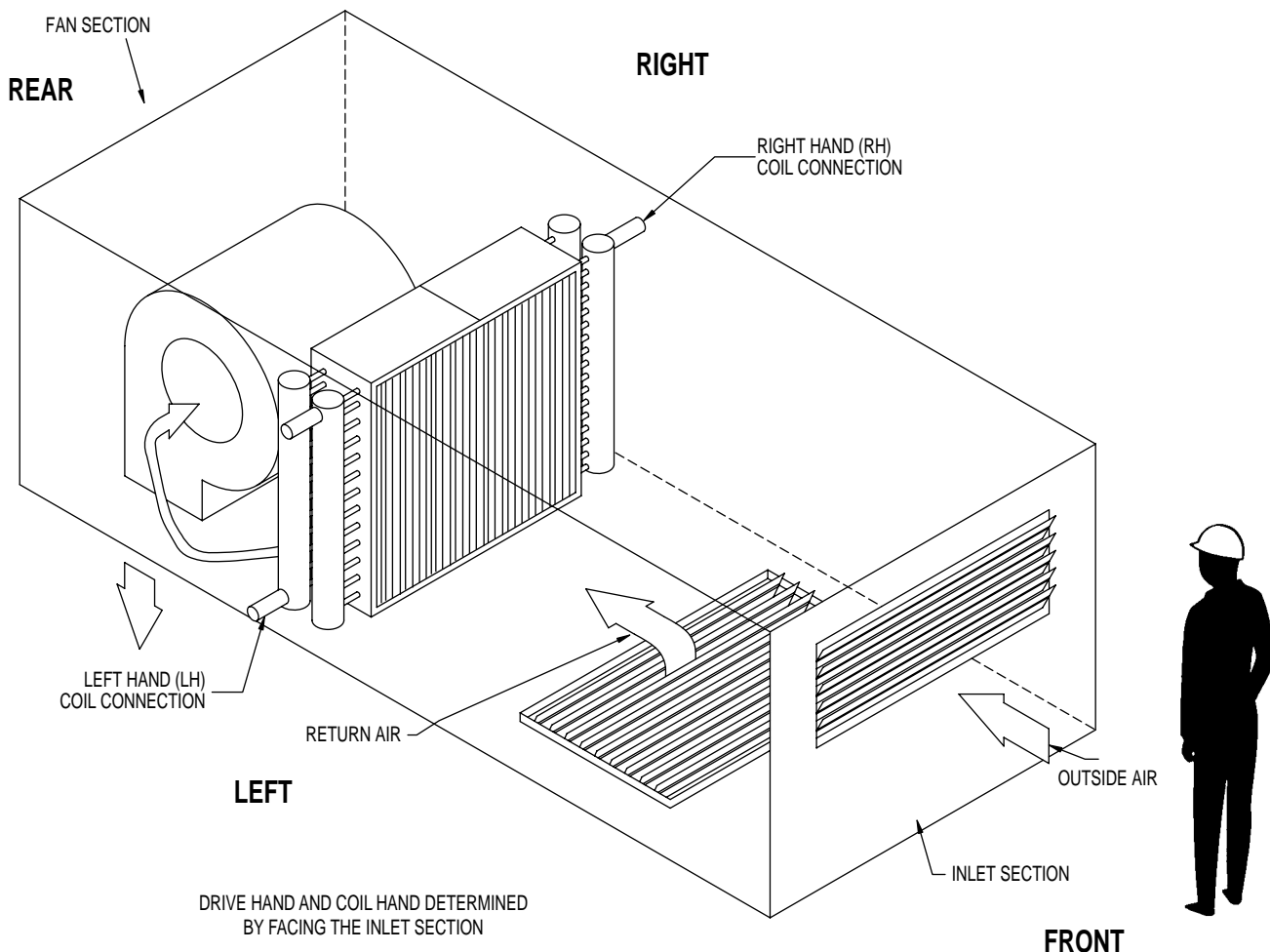

LD08004

FIG. 2 – UNIT AND COIL HAND IDENTIFICATION

SEGMENT IDENTIFICATION

Refer to Tables 1 and 2 for segment identification and nomenclature.

TABLE 1 – SEGMENT IDENTIFICATION

<p>FAN SEGMENTS</p> <ul style="list-style-type: none"> • FS – SUPPLY <ul style="list-style-type: none"> • FORWARD CURVED • AIRFOIL • INDUSTRIAL AIRFOIL • SWSI PLENUM (BELT AND DIRECT DRIVE) • FR – RETURN <ul style="list-style-type: none"> • FORWARD CURVED • AIRFOIL • INDUSTRIAL AIRFOIL • SWSI PLENUM (BELT AND DIRECT DRIVE) • FE – EXHAUST <ul style="list-style-type: none"> • FORWARD CURVED • AIRFOIL • INDUSTRIAL AIRFOIL • SWSI PLENUM (BELT AND DIRECT DRIVE) <p>COIL SEGMENTS</p> <ul style="list-style-type: none"> • CC – COOLING COIL • HC – HEATING COIL • VC – VERTICAL COIL • MZ - MULTIZONE <p>HEAT SEGMENTS</p> <ul style="list-style-type: none"> • IC – INTEGRAL FACE & BYPASS COIL • IG – INDIRECT GAS FIRED FURNACE • EH – ELECTRIC HEATER <p>ENERGY RECOVERY</p> <ul style="list-style-type: none"> • ER – ENERGY RECOVERY 	<p>FILTER SEGMENTS</p> <ul style="list-style-type: none"> • FF – FLAT FILTER (2" OR 4") • AF – ANGLE FILTER (2" & 4") • RF – HIGH EFFICIENCY FILTER <ul style="list-style-type: none"> • RIGID FILTER (12") • BAG FILTER (21") • MINI-PLEAT FILTER (4") • HF – HEPA FILTER <p>INLET SEGMENTS</p> <ul style="list-style-type: none"> • MB – MIXING BOX • FM – FILTER/MIXING BOX • EF – FILTER/ECONOMIZER • EE – ECONOMIZER • IP – INLET PLENUM • VE – VERTICAL ECONOMIZER • VF – VERTICAL FILTER/ECONOMIZER <p>ACCESSORY SEGMENTS</p> <ul style="list-style-type: none"> • VP – VERTICAL PLENUM • DP – DISCHARGE PLENUM • TN – TURNING PLENUM • DI – DIFFUSER • XA – ACCESS SEGMENT • AB- AIR BLENDER • EB – EXTERNAL BYPASS • IB – INTERNAL BYPASS • FD – FACE DAMPER • AT – ATTENUATOR • HM - HUMIDIFIER • UV - UVC LAMPS
---	--

TABLE 2 – UNIT NOMENCLATURE

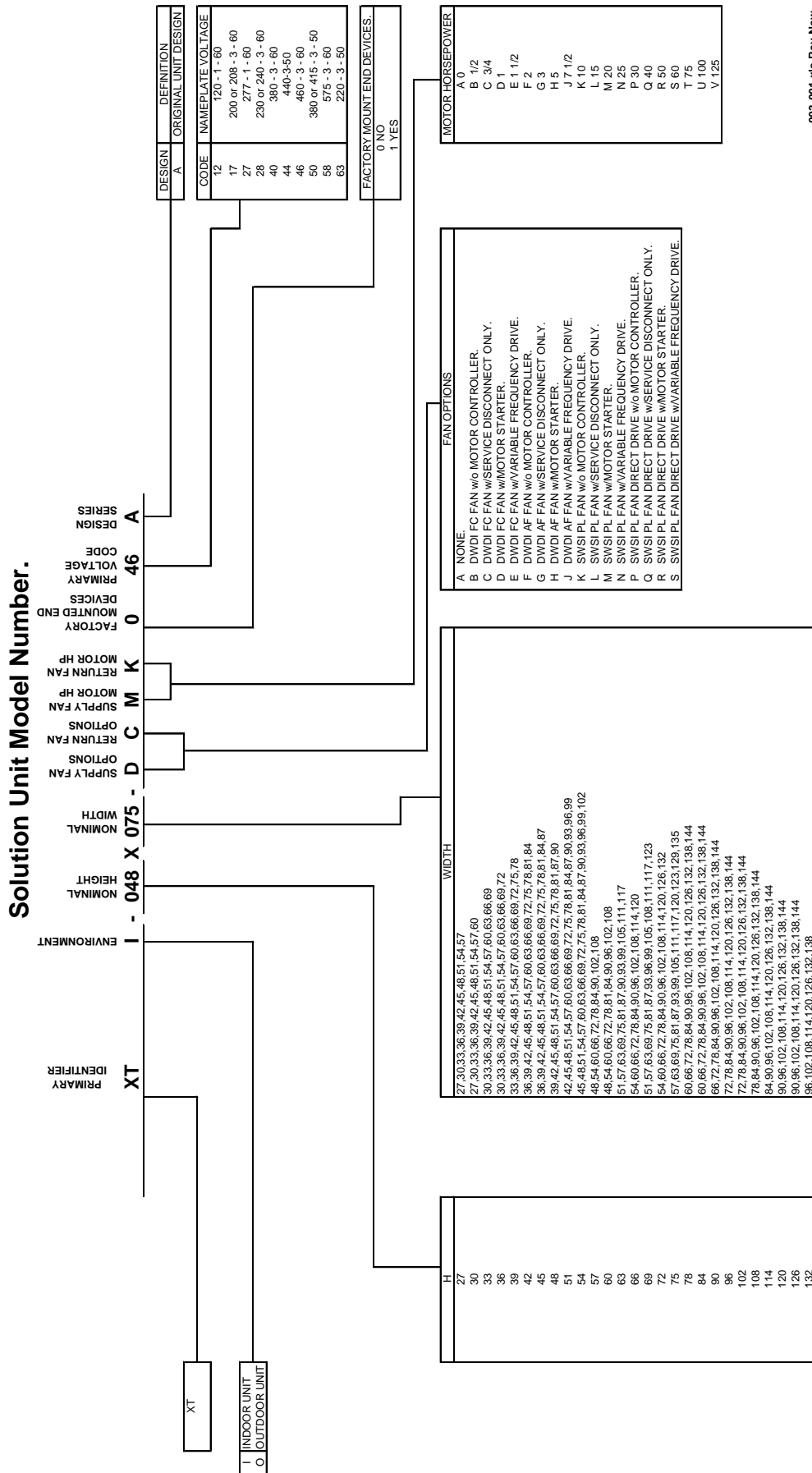

HEIGHT

27 30 33 36 39 42 45 48 51 54 57 60 63 66 69 72 75 78 81 84 87 90 93 96 99 102 108 111 114 117 120 123 126 132 138 144

WIDTH

27 30 33 36 39 42 45 48 51 54 57 60 63 66 69 72 75 78 81 84 87 90 93 96 102 108 111 114 117 120 123 126 132 138 144

003-001.xls Rev New

LD13350

Notes: 1. The height and width numbers only correspond to each other in the same row.
 2. The height and width numbers will always be (3) characters long in the model number.

Unit Identification

Both indoor and outdoor units are labeled with a Unit ID Label, Skid ID Labels and Loose Component ID Labels. Indoor units are shrink wrapped with Skid ID Labels on the outside of the wrapping as well as on each skid.



YORK Solution		
UNIT ID.	THIS PRODUCT MANUFACTURED FOR	OUTDOOR USE
MODEL #		COM: 117817
XTO-108X120-JJRN046A		
SERIAL # / DATE CODE		JOB IDENTIFICATION #
CHTM XT0085		08-179121-01-01
SEGMENT IDENTIFICATION		
(FS)(CC-HM)(XA-IC-XA-RF)(EE)(FR)		
# OF SKIDS	UNIT TAG #	
5	AHU 9-10	
ELECTRICAL RATINGS		
TOTAL RATINGS (COMBINED LOADS)		
VOLTS / PH / HZ	M.C.A.	MAX. O.C. PROT.
460/3/60		
SUPPLY FAN MOTOR RATING (INDIVIDUAL LOAD)		
HP	FLA	M.C.A.
50	72	90
MAX. O.C. PROT.		
150		
RETURN FAN MOTOR RATING (INDIVIDUAL LOAD)		
HP	FLA	M.C.A.
25	38	47.5
MAX. O.C. PROT.		
80		
HEAT RECOVERY WHEEL MOTOR RATING (INDIVIDUAL LOAD)		
HP	FLA	M.C.A.
N/A	N/A	N/A
MAX. O.C. PROT.		
N/A		
ELECTRIC HEAT RATINGS		GAS HEAT RATINGS
N/A		N/A
LIGHTS & OUTLETS		
VOLTS / PH / HZ	M.C.A.	MAX. O.C. PROT.
120/1/60	20	20
COIL DATA		
HOT WATER COIL MAX. INLET WATER TEMP.	200 F	
STEAM COIL MAX. OPERATING PRESSURE.	50	
EVAPORATOR COIL DESIGN PRESSURE.	325 PSI	
EVAPORATOR COIL REFRIGERANT USED.		
EVAPORATOR COIL REFRIGERANT OIL USED.		
SUITABLE FOR USE WITH REMOTE CONDENSER; AIR-COOLED, WATER-COOLED, OR VAPORATIVE. THE DESIGN PRESSURE MARKED ABOVE SHALL NOT BE LESS THAN THE DESIGN PRESSURE MARKED ON THE REMOTE CONDENSING UNIT.		
MANUFACTURING LOCATION		
YORK INTERNATIONAL -	East York	FACILITY
1499 E PHILADELPHIA ST		
YORK	PA	17403
USE COPPER WIRES ONLY. CLEARANCE FROM COMBUSTIBLE SURFACE: UNIT IS 0 INCHES, DUCT IS 0 INCHES. MAXIMUM INLET TEMPERATURE: 100° F / MAXIMUM OUTLET TEMPERATURE: 200° F. EXTERNAL STATIC PRESSURE RANGE OF 0.25" - 5.00" WG. CONFORMS TO UL STD 1995 AND CERTIFIED TO CSA STD C22.2 NO 236		
  		

FIG. 3 – UNIT ID LABEL

LD11728A

Unit ID Label

The Unit ID Label contains the Model number, Serial/ Date Code, Job Identification number, Segment Identification, the number of Skids, Unit Tag number, Electrical Ratings, Coil Data and Manufacturing Location (see Fig. 3).

Skid ID Label

Each skid in a multi piece unit is marked with a Skid ID Label, which indicates its order of assembly in the direction of airflow (see Fig. 4).

YORK Solution	
MODEL #	COM: 117817
XTO-108X120-JJRN046A	
SERIAL # / DATE CODE	JOB IDENTIFICATION #
CHTM XT0085	08-179121-01-01
SEGMENT IDENTIFICATION	
(FS)(CC-HM)(XA-IC-XA-RF)(EE)(FR)	
SKID 1 of 5	UNIT TAG
	AHU 9-10
JOB NAME	SKID OVERALL SIZE
Owens Corning BLDG-21	116 H x 120 W x 59 L
AHU 9-10	
Estimated Weight: 4,100 pounds	

See Fig. 5 for Segment ID explanation

(FR) Bolded indicates skid 1 of 5 is a Return Fan and is placed first in the direction of airflow. See Segment ID box example.

FIG. 4 – SKID ID LABEL

LD11729A

Segment Identification Box

The Segment Identification box indicates the skids and segments* used on a multi piece unit. The contents of each skid are indicated by segment(s) surrounded by parenthesis (see Fig. 5 below).

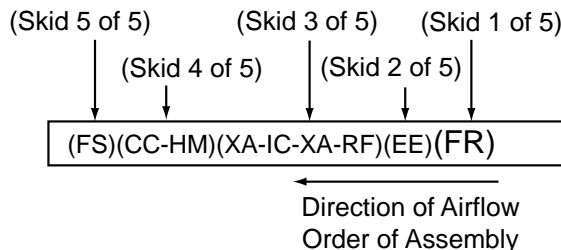

* See Table 1 for Segment Identification

LD11752A

FIG. 5 – SEGMENT ID BOX EXAMPLE

Loose Component ID Label

Each loose component has a label showing where it is to be installed on the unit. The segment identification box on the label will show the skid that it is installed on. If the loose component goes on only one segment on that skid the segment in the box will be bolded (see Fig. 6).

OA Moisture Eliminator installed on (EE) skid/segment.

LD11730

One of six hoods installed on (EE) skid/segment.

LD11751A

FIG. 6 – LOOSE COMPONENT ID LABELS

Filter ID Label

Figure 7 shows a typical Filter Label with Filter Segment and Filter List.

Filters		
026-32406-001	FLTR,PERFPLT,30%EFF,12W_24H_2D	Qty: 4
026-32406-003	FLTR,PERFPLT,30%EFF,24W_24H_2D	Qty: 16
026-32404-009	FLTR,VCL_SH,12W_24H_12D,80-85%	Qty: 4
026-32404-010	FLTR,VCL_SH,24W_24H_12D,80-85%	Qty: 16
Spare Filters		
026-32406-001	FLTR,PERFPLT,30%EFF,12W_24H_2D	Qty: 8
026-32406-003	FLTR,PERFPLT,30%EFF,24W_24H_2D	Qty: 32
026-32404-009	FLTR,VCL_SH,12W_24H_12D,80-85%	Qty: 4
026-32404-010	FLTR,VCL_SH,24W_24H_12D,80-85%	Qty: 16

FIG. 7 – FILTER LABELS

LD13942

Direction of Airflow

The direction of airflow is always read from right to left.

1.0 PRE-INSTALLATION

RECEIVING

All units leaving the plant have been inspected to ensure the shipment of quality products. All reasonable means are utilized to properly package the air handling units.

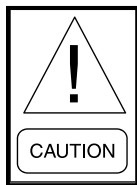

Johnson Controls will NOT be responsible for any damage or loss of parts in shipments or at the job site. Receiver is solely responsible for noting Bill of Lading and filing freight claims IMMEDIATELY. Refer to Shipping Damage Claims Form 50.15-NM available from Johnson Controls Sales representative.

RIGGING OF INDOOR AND OUTDOOR UNITS



All lifting points must be used to avoid personal injury or death and to avoid damage to the equipment.

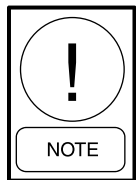

SHIPPED LOOSE DAMPERS. When large units are ordered with MZ segments in rear discharge location (on the end of the unit), the units will ship with the top section (hot deck) separated. In these cases, the complete multizone damper assembly (hot deck and cold deck together) will ship loose.

1

SPREADER BARS MUST BE WIDER THAN THE UNIT WIDTH TO PREVENT DAMAGE TO THE HOUSING & ROOF EDGE.

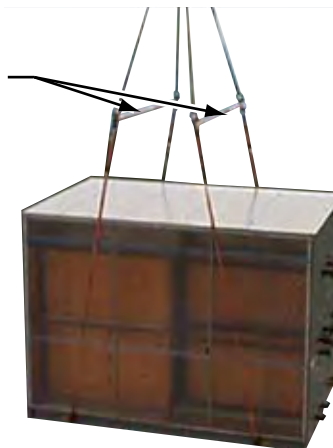

LD13769

FIG. 1-1 – RECOMMENDED LIFTING WITH FOUR LIFTING POINTS

SPREADER BARS MUST BE WIDER THAN THE UNIT WIDTH TO PREVENT DAMAGE TO THE HOUSING & ROOF EDGE.

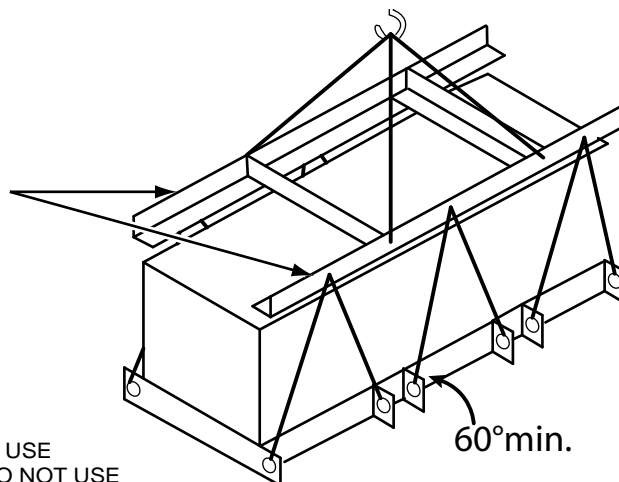

RIGGING INSTRUCTIONS

FOR LIFTING AIR HANDLERS WITH LIFTING LUGS, USE SPREADER BARS AND CABLES AS INDICATED. DO NOT USE A FORKLIFT. ALL LIFTING LUGS MUST BE USED TO AVOID DAMAGE.

LD13765B

FIG. 1-2 – RECOMMENDED LIFTING WITH MULTIPLE POINTS

Off-Loading

Proper rigging and handling of the equipment is mandatory during unloading and setting it into position to retain warranty status.

Care must be taken to keep the unit in the upright position during rigging and to prevent damage to the air and watertight seams in the unit casing. Prevent unnecessary jarring or rough handling.

For lifting air handling units with lifting lugs or corner connectors; proper spreader bars and hoisting line must be used when rigging to prevent damage to the unit casing (see Fig. 1-1). When lifting long units a special system must be used to insure a minimum 60° angle between lifting lug and spreader bar/frame (see Fig. 1-2 and Table 1-1). It is also mandatory that an experienced and reliable rigger be selected to handle unloading and final placement of the equipment. The rigger must be advised that the unit contains internal components and that it be handled in an upright position. Care must be exercised to avoid twisting the equipment structure.

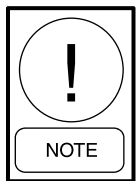

Refer to the submittal for the section weights.

TABLE 1-1 - SPACING REQUIREMENTS FOR OFFLOADING LONG UNITS

UNIT HT.	MAX. LIFTING LUG SPACING	MIN. LIFTING STRAP LENGTH
≤ 72"	120"	120"
> 72"	192"	192"

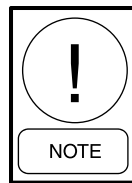

All lifting lugs must be used to avoid damage to unit. If unit does not have lifting lugs, use bottom corner connectors and intermediate raceway lifting lugs. Do not use top corner connectors.

Unit section weights are furnished on the job submittal. Due to the variance in weight of each unit design, it is not possible to list unit weights in this instruction. The submittal must be referred to when selecting a crane for rigging and figuring roof weight loads. Contact your Johnson Controls Sales representative if you have any questions regarding unit weights.

Crane And Spreader Bars

See Fig's 1-1 and 1-2.

Fork Lift

Forklifts should not be used to off-load air handlers except in special circumstances. If moving air handling equipment with a fork lift or similar means becomes necessary, always make sure the lifting forks are long enough to reach from the fork truck to the opposite side and slightly beyond. It is helpful to leave the shipping blocks attached to the bottom of the equipment until in its final location. There is no structural support under the equipment except what is visible from the perimeter.

Come-A-Longs or Power Pull

See Fig1-3 below

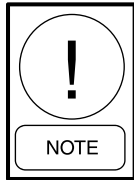

FIG. 1-3 – TYPICAL COME-A-LONG TYPES

LD09613

Shackles

Refer to Fig. 1-4 for proper lifting with hook and shackle at corners. Refer to Fig. 1-5 for proper lifting with hook and shackle at lifting lugs.



Figures 1-4 and 1-5 show YORK Solution unit without baserails. When baserails are present, always use all lifting lugs pre-mounted on baserails. Do not lift by corners.



FIG. 1-4 – PROPER LIFTING WITH SHACKLE AT CORNER



FIG. 1-5 – PROPER LIFTING WITH SHACKLE AT LIFTING LUG



FIG. 1-6 – RECOMMENDED LIFTING WITH BASERAIL

INSPECTION

Check For Damage

Receiver Responsibility

Receiver is solely responsible for noting freight bill and filling freight claims IMMEDIATELY (see "Receiving" in this section).

Visible damage should be noted on the signed and dated bill of lading with a request that the carrier inspect the damage within 72 HRS. of notification. The shipping wrapper must be removed and replaced with a tarp or similar protective covering. Any concealed damaged reported after 15 days will compromise a claim settlement. Inspection requests may be done by telephone or in person, but should be confirmed in writing. If assistance is needed with the claim process, contact your Johnson Controls Sales representative.

Indoor Units

It is Johnson Controls intention that a shipping wrapper be applied to unpainted indoor units for protection from weather, road dirt, etc. during inland transit and that the wrapper be removed at the time of delivery to allow for a thorough inspection, both inside and out.

Outdoor Units

Outdoor units are not fully wrapped. Exposed openings are covered for protection from weather, road dirt, etc. during inland transit. A thorough inspection, both inside and out, should be done at the time of delivery.

Checking for Non Mounted Parts

- Check the packing list for non-mounted ship loose parts. (Check inside all segments.)
- Packing list will note how many and type of parts.
- Shortages must be reported within 10 days after receipt of order.

See Ship Loose Parts, Fig 2-8 thru 2-14.

STORAGE

Short-Term Storage



Indoor Units:

Under no circumstances should outdoor storage be used

Outdoor Units:

Be sure all shipping covers are re-applied after inspection, or tarps are used during storage.

Short-term storage is considered six (6) months or less from date of shipment. Storage maintenance during this time is usually limited to the following.

- Rotate fans every four (4) weeks beginning upon arrival to prevent moisture from damaging bearings.
- If the units are to be stored out-of-doors, prior to installation, special care must be taken to cover and protect the units from dust, rain, snow and rodents. The units must be protected from constant exposure to rain and snow.
- Store on a firm, flat surface to prevent distortion. Block the unit off the ground to protect components from water.



Protect all parts and porous materials from rain and other sources of moisture. Decontaminate or replace as needed to ensure microbial growth is not introduced to the air handler.

- The unit must also be protected from damage to the exterior of the cabinet or coil connections by construction vehicles and personnel.

Long-Term Storage

Long-term storage is considered any period beyond six (6) months from date of shipment. If long-term storage is anticipated, **contact the Johnson Controls Sales representative for the proper instructions and requirements for long-term storage.** It is mandatory that a detailed record be maintained during this long-term period, such as, but not limited to: proper sealing of the cabinet, rotation of the blowers and bearings, and protection of all motors from moisture. *Refer to Form 50.20-NM3 "Long Term Storage Requirement - Field Preparation" and Form 50.20-CL3 "Long Term Storage Periodic Checklist and Logs", copies of which is included in this section.*

Preventive Maintenance Prior to Long Term Storage

The following precautions should be taken prior to extended storage:

- Fan and motor bearings are to be greased per the manufacturer's specifications.
- Motors and sheaves must be protected from free moisture or high humidity. This may be accomplished by 1) spraying components with an anti-rust solution (P/N 026-37707-000) or 2) disconnecting the belts and wrapping the sheaves and motor and sealing them with plastic. Insert a desiccant to absorb moisture that may penetrate the plastic protection.
- The fan motor windings should be megged at this time and recorded for comparison prior to placing in service.
- If the fan housing was supplied with a drain connection, this plug should be removed to prevent moisture from accumulating in this portion of the fan during storage.

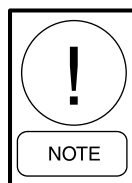

Long-term storage is considered to be any period beyond six (6) months from date of shipment. If long-term storage is anticipated, contact Johnson Controls Sales representative at time of order entry for the proper instructions and requirements for long-term storage. Refer to Form 50.20-NM3.

Periodic Fan Check

On a monthly basis, the fan and motor should be rotated several times to replenish the bearing surfaces with fresh grease.

The fan impeller should be left at approximately 180 degrees from that of the previous month to prevent the belts from taking a set position.



It will be the responsibility of the customer to submit a monthly log sheet (MS577) showing the condition of the unit and noting any discrepancies. A copy of the log sheet should be sent to the Johnson Controls Office, attn.: Sales Representative.



Failure to perform the long-term storage requirements will void the warranty.

 BY JOHNSON CONTROLS	LONG-TERM STORAGE REQUIREMENT - FIELD PREPARATION AIR HANDLING UNITS	
	SERVICE POLICY & PROCEDURES	Supersedes 50.20-NM3 (307)

Failure to comply with these requirements will render any written or implied YORK warranty null and void.



Upon completion of the long term storage period, the warranty commences:

- *Solution - 18 months parts only. (not to exceed 36 months from ship date with delayed start up).*
- *Custom - 18 months factory parts (not to exceed 18 months from ship date).*
- *Labor 12 months only w/ delayed start up.*

I. Supplementary Documentation

The following documentation is required to FULLY COMPLY with the Long-Term Storage requirements.

- A. Long-Term Storage Requirements – GENERAL (refer to Form 50.20-NM1)
- B. Long-Term Storage – PERIODIC CHECKLIST AND LOGS, AIR HANDLING UNITS (refer to Form 50.20-CL3).

II. Field Preparation for Long-Term Storage

A. GENERAL

1. Remove and dispose of shipping materials.
2. Perform a visual inspection of the equipment.

Indoor Units

It is Johnson Controls' intention that a shipping wrapper be applied to unpainted indoor units for protection from weather, road dirt, etc. during inland transit and that the wrapper be removed at the time of delivery to allow for a thorough inspection, both inside and out. Visible damage should be noted on the signed and dated bill of lading with a request that the carrier inspect the damage within 72 hrs of notification. The shipping wrapper must be removed and replaced with a tarp or similar protective covering. Any concealed damaged reported after 15 days will compromise a claim settlement. Inspection requests may be done by telephone or in person, but should be confirmed in writing. If assistance is needed with the claim process, contact your Johnson Controls Sales person.

Outdoor Units

Outdoor units are not fully wrapped. Exposed openings are covered for protection from weather, road dirt, etc. during inland transit. A thorough inspection, both inside and out, should be done at the time of delivery. Visible damage should be noted on the signed and dated bill of lading with a request that the carrier inspect the damage within 72 hrs of notification. Concealed damage must be reported within 15 days of delivery with a request that the carrier inspect the damage within 72 hrs of notification. Any concealed damaged reported after 15 days will compromise a claim settlement. Inspection requests may be done by telephone or in person, but should be confirmed in writing. If assistance is needed with the claim process, contact your Johnson Controls Sales person.

FIG. 1-7 – LONG-TERM STORAGE REQUIREMENT - FIELD PREPARATION, FORM 50.23-NM3

 BY JOHNSON CONTROLS	LONG-TERM STORAGE PERIODIC CHECKLIST AND LOGS AIR HANDLING UNITS	
	SERVICE POLICY & PROCEDURES	Supersedes: 50.20-CL3 (507)

Contract No.	_____	Date Delivered	_____
Job Name	_____	Date of Storage Prep.	_____
Serial No	_____	Condition of Unit Delivered	_____
Unit Model No	_____	Explain:	_____
	_____		_____
	_____		_____

Failure to comply with these requirements will render any written or implied Johnson Controls warranty null and void.

I. Supplementary Documentation

The following documentation is required to FULLY COMPLY with the long term storage requirements.

- A. Long-Term Storage Requirements - GENERAL (refer to Form 50.20-NM1).
- B. Long-Term Storage Requirement - LONG -TERM STORAGE REQUIREMENT FIELD PREPARATION, AIR HANDLING UNITS (refer to Form 50.20-NM3).

II. Checks

1.0 Monthly Checks

- 1.1 Visually inspect Air Handler for damage.
 - 1.1.1 Motors/Drives - The motors and sheaves should be inspected externally for evidence of damage to the protective covering. An inspection is necessary only if it is apparent that the control protection has been disturbed. If this is found, the motor should be re-protected by wrapping and tightly sealing the control with plastic and inserting a desiccant to absorb moisture.
- 1.2 Refrigerant Coils - Check holding charge pressure monthly to be sure that the pressure has not dropped. If pressure has dropped, the unit should be inspected for signs of visible damage which may have caused the loss of pressure. If pressure drops more than 2 psi, the unit should be pressure tested to locate the leak, the leak repaired, and the unit recharged with nitrogen to 5 psig pressure. Note this in the comments section of the monthly log sheet (see page 2 of this document).
- 1.3 Rotate fan shaft several revolutions by hand every month.

FIG. 1-8 – LONG-TERM STORAGE PERIODIC CHECKLIST AND LOGS, FORM 50.23-CL3

THIS PAGE INTENTIONALLY LEFT BLANK

2.0 INSTALLATION



Do not weld or use torches on the exterior or interior of the unit housing. The housing contains polyurethane insulation, which under combustion will produce harmful, toxic gases resulting in personal injury or death.

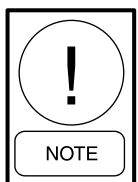

This instruction is written to provide general information. The product line allows many variations and the installer is fully responsible for adjusting his actions as needed. If any questions regarding the content of this manual, or if any information is not covered, contact local Johnson Controls Service.



Surface must be level on all installations.



If your unit has HEPA filters the filter frames, filter bulkheads and filter segment panels are factory sealed and must remain sealed for NO air bypass.

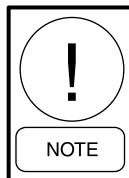

Never use silicone caulk/sealant or caulk/sealant containing silicone in or on any air handling equipment. [Only exception is when provided (high temperature) with gas heat venting].

SITE PREPARATION

Outdoor Units (Site Prep)

Location of unit(s) should be away from building flue stacks or exhaust ventilators to prevent possible introduction of contaminated air through the outside air intakes (see Fig. 2-1 for service clearances).



Allow sufficient space around the unit for removing the access panels and various parts of the unit. A minimum clearance equal to the width of the unit must be provided on one side of the unit for removing the coil or fan assembly. Add dimension of pipe chase, air hoods, ducts, control/electrical panels, etc. to minimum clearances. Allow additional clearance as required by local and national codes. Consider Coil Access Panel for coil removal on outdoor units.

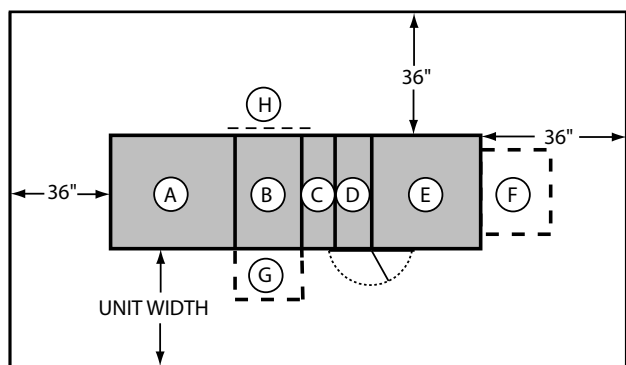

FIG. 2-1 – MINIMUM SERVICE CLEARANCES

MIN. CLEARANCE DIMENSIONS

- (A) Fan Section
- (B) Coil Section
- (C) Face and Bypass Damper Section
- (D) Filter Section - Door should open 180°
- (E) Inlet Section
- (F) Rain Hood (add to unit width or length)
- (G) Pipe Chase Enclosure (add to unit width)
- (H) Coil Access Panel on Outdoor Unit (allow clearance = to unit width)

Mounting

Units must be installed in such a manner as to provide enough elevation for properly designed condensate traps (see Section 2 “Drain - Condensate Drain Trap”).



Installation Site: Area of roof on which curb is to be installed must be structurally adequate to support the combined weight of curb, unit and system fluids.

With these combined weights in place, the resting surface for the unit MUST be flat and level.

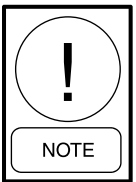

Concrete pads often are not as flat as they should be. Shimming and/or grouting may be necessary. Whether under the unit base or under the curb, this is to ensure the unit base is on a perfectly flat plane.

Curb

The curb, which supports the unit, will be shipped unassembled. It will be necessary to assemble the curb parts on the job site. Assembly drawing and a hardware package are shipped with each curb package. It is important the curb be installed square. If applicable, ensure pitch orientation is correct.

This “Curb Assembly and Installation Instruction” is typical. Use it in conjunction with the specific drawing supplied with each curb.

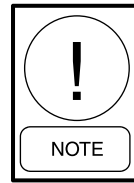

Should there be any questions as to the number of pieces of curb parts or assembling of the curb, notify Johnson Controls immediately.

Curb, nailer, and gasket are supplied. All other parts such as wood or fiber cant strips, roofing felts, roofing material, caulking and curb-to-roof fasteners are to be field supplied.

Be sure the supporting structures will not obstruct the duct, piping or wiring connections.

Curb Assembly and Installation Instructions

See Fig. 2-2

1. Unpack shipping package, layout pieces and parts according to the exploded views and check against Bill of Materials.
2. Layout all channel pieces as shown. Make certain that all channel tabs are located on inside of mating channel

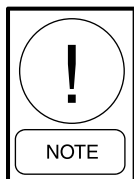

Make certain that all curb walls accessories and flanges, which may have been distorted in handling, are straightened before assembly.

3. Attach curb walls together to form rectangular perimeter as shown, leaving bolts loose.



After the curb is set in place, ensure proper consideration has been given to the air duct openings through the roof.

4. The curb installation drawing (see Fig. 2-2) shows a gasket that is mounted between the curb and the unit. This gasket is shipped with the curb parts. Install the curb gasket before setting the unit on the curb. The gasket forms an air seal between the unit and the curb and serves as a dampener, preventing metal-to-metal contact between the unit and curb. However, the gasket should not be used as a vibration isolator where the prevention of noise and vibration transmission into the building is critical.

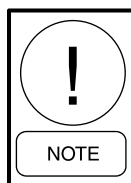

When unit is shipped in sections, the curb gasket is to be replaced with caulk provided by contractor.

5. After verifying curb is square and level, tighten all bolts and then anchor as appropriate.

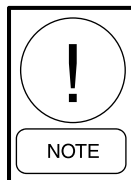

If bolts are tightened after anchoring, curb will be pulled, twisted and torqued out of square.

6. Pipe Chase Curb Assembly - once curb is square and level mark the exact location for the pipe chase curb. Drill and assemble.

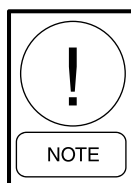

***Pipe Chase Curb Location:
Unit submittal drawing package has a Johnson Controls curb drawing showing dimensions of curb and pipe chase.***

7. The curb should be insulated and roofed as required. Refer to SMACNA for counter flash.

Steel Frame

When a steel frame is used to support the unit, it must be level, flat without uneven steel frame joints, and support the unit around the full perimeter. As a general rule, cross members should be placed every 96" in addition to every shipping split.

Indoor Units (Site Prep)

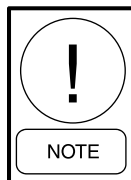

Concrete pads often are not as flat as they should be. Shimming and/or grouting may be necessary. This is to ensure the unit base is on a perfectly flat plane.

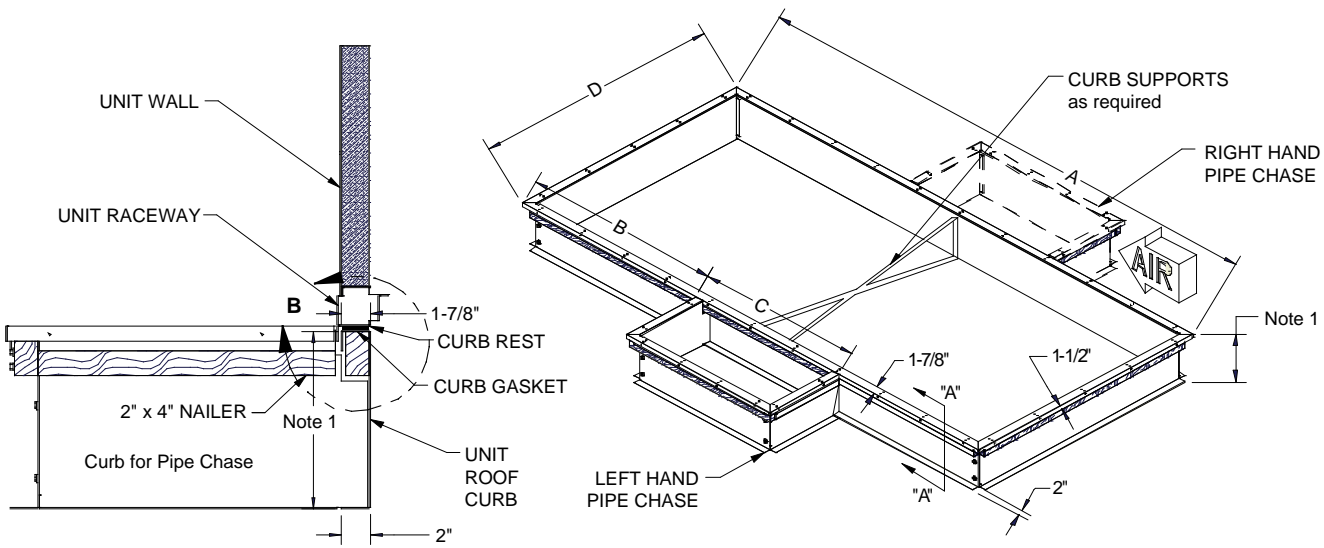

PIPE CHASE SECTION VIEW SECTION "A-A"

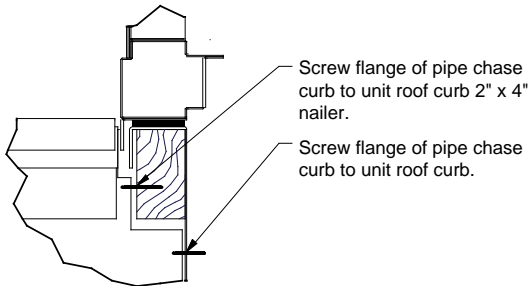

**DETAIL B
PIPE CHASE CURB CONNECTION TO UNIT CURB**

CURB CALCULATION FOR OUTSIDE DIMENSIONS

- A = Total unit length from YORKworks minus 0.875"
- B = Pipe chase location distance from unit discharge end.
Pipe chase Mtg. holes will not be included on the pipe chase curb. Mtg. will be field located.
- C = Pipe chase length minus 0.875"
- D = Total unit width from YORKworks minus 0.875"

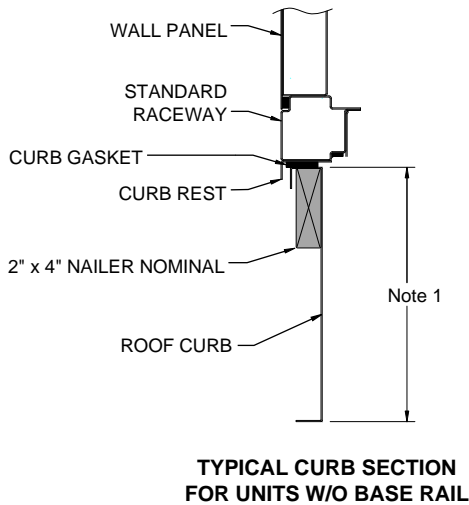

TYPICAL CURB SECTION FOR UNITS W/O BASE RAIL

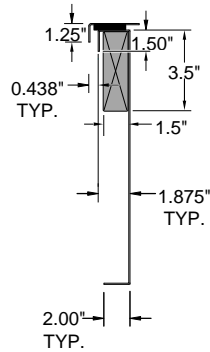

DIMENSIONS

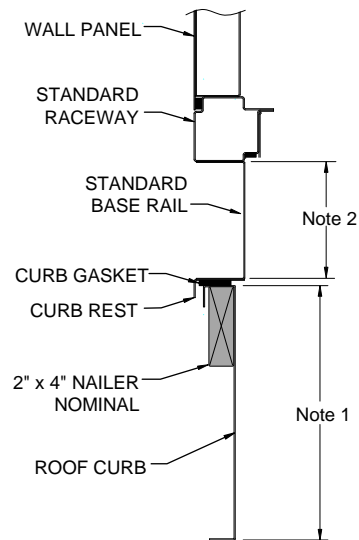

TYPICAL CURB SECTION FOR UNITS WITH BASE RAIL

- Notes:
1. Curbs available in 14", 18", 22", 26", 30" & 34" heights
 2. Outdoor Base Rails are available in 6", 8" & 10" heights.
Contractor is responsible for providing ductwork to include Base Rail height.

3. Curb material is galvanized steel, unpainted, and may vary in gage based on the unit load and the Qty. of cross bracing provided.
4. If curb space used as plenum, Seal all joints and seams with suitable sealer such as urethane caulk (YORK P/N 013-02966-011)

LD09616G

FIG. 2-2 – TYPICAL CURB ASSEMBLY

Clearance

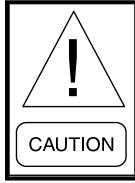

Allow sufficient space around the unit for removing the access panels and various parts of the unit. A minimum clearance equal to the width of the unit must be provided on one side of the unit for removing the coil or fan assembly.

Mounting

Units must be installed in such a manner as to provide enough elevation for properly designed condensate traps.

See Section 2 “Piping Connections - Condensate Drain Trap.”

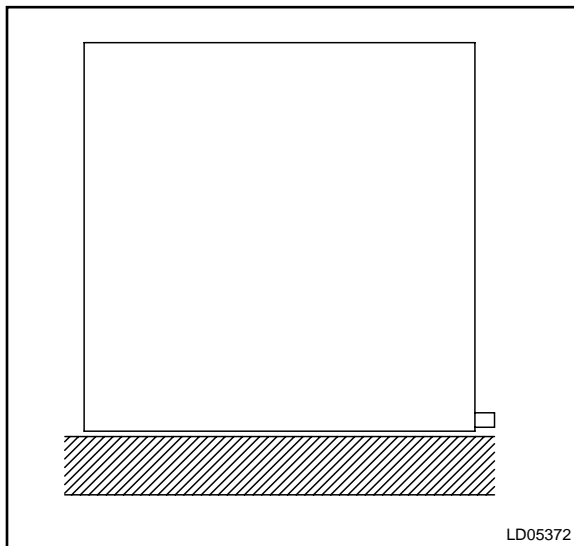

FIG. 2-3 – NO BASERAIL – HOUSEKEEPING PAD REQUIRED TO ACCOMMODATE TRAP HEIGHT

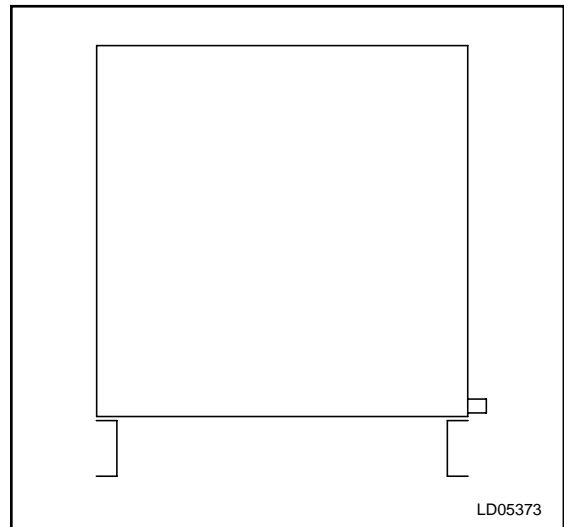

FIG. 2-4 – NO HOUSEKEEPING PAD – BASERAIL REQUIRED TO ACCOMMODATE TRAP HEIGHT

Floor

The floor must be flat and level.

Housekeeping Pad

The housekeeping pad must be flat and level (*see Fig's 2-3, 2-4 and 2-5*).

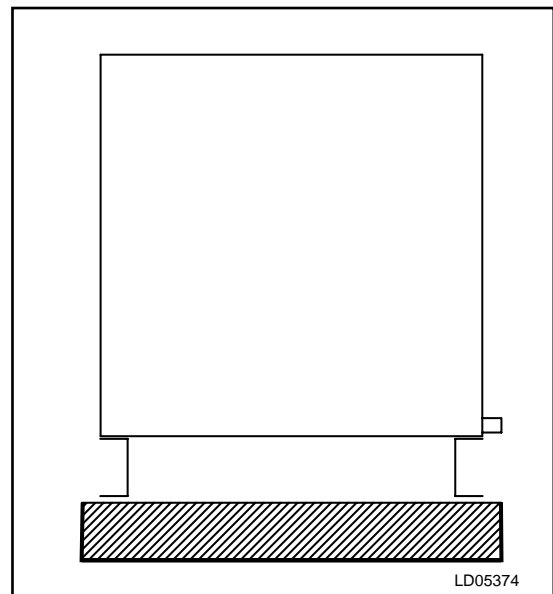

FIG. 2-5 – WITH BASERAIL AND HOUSEKEEPING PAD

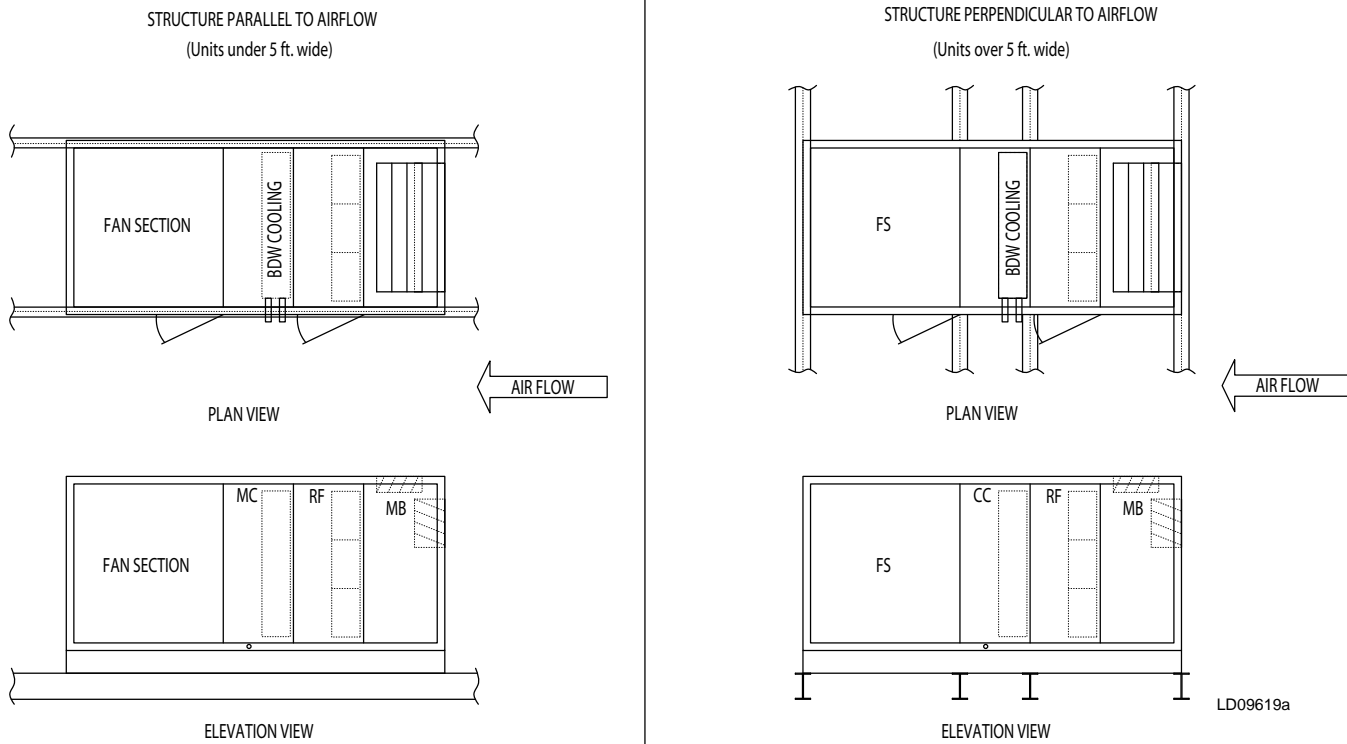

FIG. 2-6 – CEILING SUSPENDED UNIT

Ceiling Suspended Units



It is recommended that support is structurally engineered to prevent flexing, sagging or twisting of air handlers.

Refer to Fig. 2-6 “Ceiling Suspended Unit” for proper support of unit in the direction of airflow and/or perpendicular to the direction of airflow.

General Requirements

Johnson Controls recommends that ceiling suspension of units be accomplished in the field with the following:

Structure Positioned Perpendicular to Airflow

The units must be supported (at a minimum) in the following locations:

- Both ends.
- At each shipping split.
- Upstream and downstream of each cooling coil segment.

- Under heavy components like fans, attenuators, and heating segment.

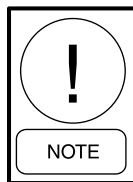

Do not obstruct door operation, filter access, piping, electrical or control connections with suspension members.

Structure Positioned In the Direction of Airflow
The unit base must be supported continuously, on both sides of the unit.

UNIT INSTALLATION

Tools Needed



FIG. 2-7 – TOOLS TYPICALLY USED FOR ASSEMBLY OF SHIPPING SPLITS

See Fig. 2-7.

- Drill with adjustable torque.
- No. 3 Phillips bit.
- Allen wrench set.
- Nut setter - Sizes 1/4", 5/16", 3/8" and 9/16" or socket set.
- Wire cutters.
- Power pulls or come-a-longs.
- Slings.
- Pry bar.
- Drift pins and awls.
- Common hand tools.
- Caulking gun.

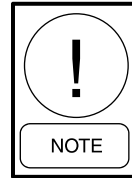

Material not provided by Johnson Controls. When unit is shipped in sections, the gasket provided with the curb is to be replaced with caulk provided by contractor. Gaskets on curbs can pose a problem when sliding sections together for the final connection of each shipping split.

Ship Loose Parts

Look for label “Installation Instructions and Ship Loose Items Inside”. This label is normally located on the access door of the first fan section in the air stream. Only the parts listed in this section which are required for your unit are included.

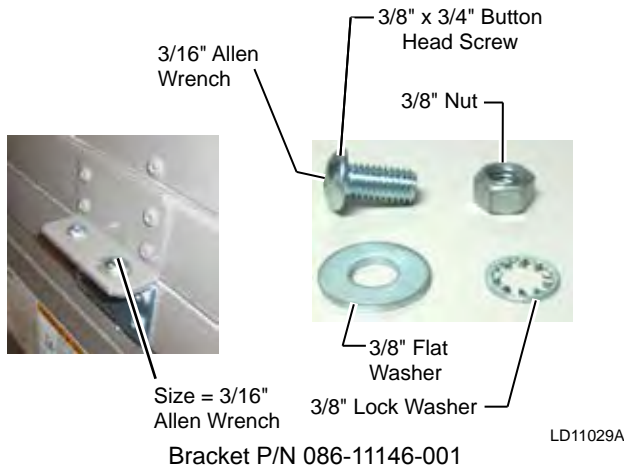

FIG. 2-8 – SECOND TIER TIE-DOWN FASTENER PACK
P/N 386-03419-000 (4 each per pack)



Baserail Lifting Lugs Assembled

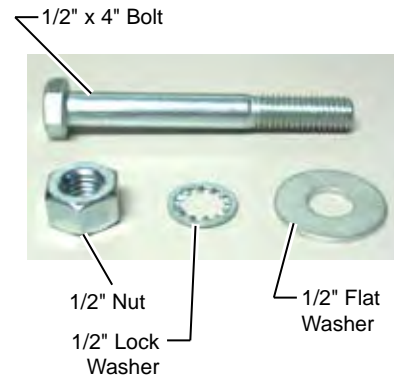

FIG. 2-10 – BASERAIL SHIPPING SPLIT FASTENER PACK
P/N 386-03417-000 (4 each per pack)



Raceway Lifting Lug (at shipping split)

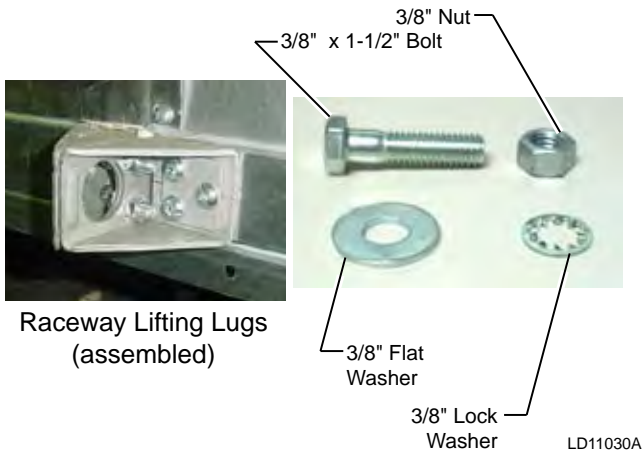
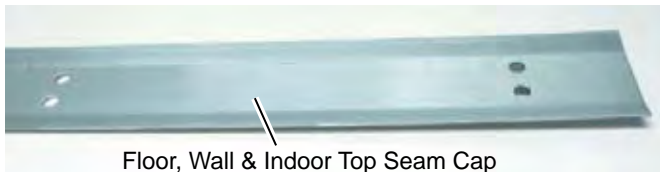

FIG. 2-9 – BOTTOM RACEWAY SHIPPING SPLIT FASTENER PACK
P/N 386-03418-000 (4 each per pack)



FIG. 2-11 – TOP RACEWAY SPLIT FASTENER PACK
P/N 386-04747-000 (2 each per pack)



Floor, Wall & Indoor Top Seam Cap



SEAM CAP

- 1/4" x 2" Neoprene Gasket, P/N 028-15954-010
- 1/4"-14 x 1" Phillips Pan Head Tek Screw, P/N 021-19560-000
- 1/4"-14 x 1" Hex Head w/ Washer & Gasket Tek Screw P/N 021-30530-052 for Outdoor Wall.



Roof Seam Cap (Outdoor)



ROOF SEAM CAP

- 1/4" x 2" Neoprene Gasket, P/N 028-15954-010
- 1/4"-14 x 1" Hex Head w/ Washer & Gasket Tek Screw P/N 021-30530-052 for Outdoor Roof.

Apply 2" Gasket & Caulk



Apply 2" Gasket & Caulk

PIPE CHASE

- 1/4" x 2" Neoprene Gasket, P/N 028-15954-010
- 1/4"-14 x 1" Hex Head w/ Washer & Gasket Tek Screw P/N 021-30530-052



PIPE CHASE TRIM ANGLE

- 1/4"-14 x 1" Hex Head w/ Washer & Gasket Tek Screw P/N 021-30530-052
- 1/4" x 2" Neoprene Gasket, P/N 028-15954-010

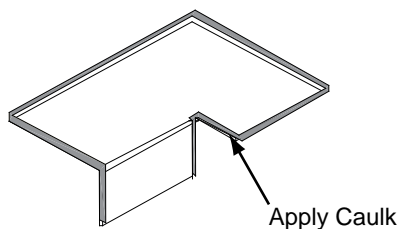

Apply Caulk

PIPE CHASE BASERAIL COVER
P/N 086-23998-001

Apply Butyl

Apply Caulk

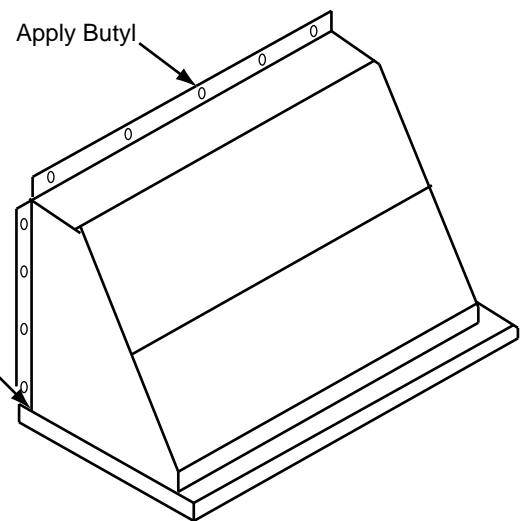

HOOD

- 1/4"-14 x 1" Hex Head w/ Washer & Gasket Tek Screw
- 3/16" x 3/4" Butyl Tape

LD13770A

FIG. 2-12 – PIPE CHASE, HOODS & SEAM CAPS

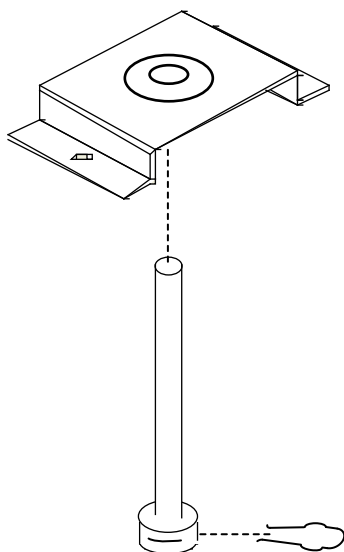

DAMPER SHAFT EXTENSION KIT
P/N 026-33715-002

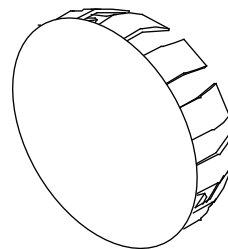

CORNER CONNECTOR HOLE PLUG
P/N 021-19568-000

HUMIDIFIERS

Optional Steam humidifiers, when selected are provided with dispersion equipment factory mounted inside the air handling unit. The steam injection or generating equipment, metering devices and sundries are shipped loose.

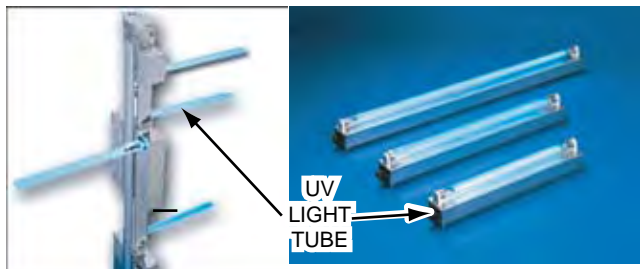

UV LIGHT TUBES to be installed by contractor.

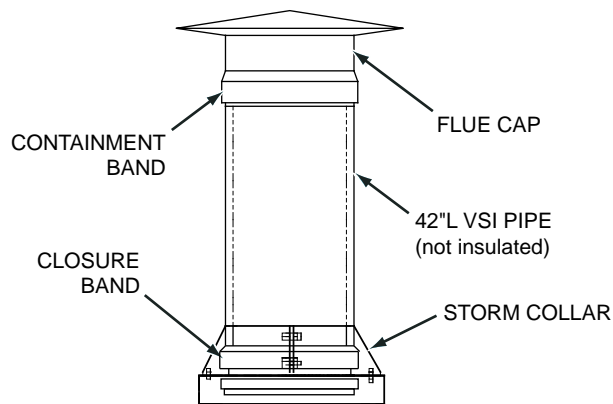

GAS FURNACE FUEL VENTING PARTS



DO NOT touch UV Lamps (tubes) with bare hands or leather gloves as oils will damage the tubes. Use clean cotton rags, clean jersey or latex gloves to handle the lamps (tubes).

LD13788

FIG. 2-13 – MISCELLANEOUS PARTS FOR OPTIONS



POLYURETHANE CAULK
 P/N 013-02966-011 GREY,
 P/N 013-03317-040 CHAMPAGNE



12 OZ. TOUCH-UP SPRAY
 P/N 013-03322-000

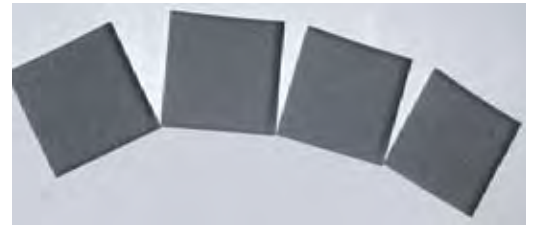

1/4" X 3-1/2" x 3-1/2" SHIPPING SPLIT
 CORNER GASKET
 P/N 028-11883-010
 (Outdoor Only)

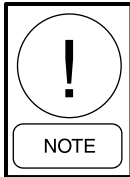

Never use silicone caulk/sealant or caulk/sealant containing silicone in or on any air handling equipment. Only exception is when provided (high temperature) with gas heat venting.



1/4" X 3/4" X 35' NEOPRENE
 GRAY GASKET
 P/N 028-11873-010



1/4" X 2" X 25' NEOPRENE GASKET
 P/N 028-15954-010



3/16" X 3/4" X 40' BUTYL TAPE
 P/N 013E-03327-010



1/4"-14 X 1"
 PHILLIPS PAN HEAD
 SELF DRILLING SCREW
 P/N 021-19560-000



SPARE FAN BELT
 (Attached to Fan)



1/4"-14 X 1"
 HEX HEAD
 SELF DRILLING SCREW
 W/ EDPM WASHER
 P/N 021-30530-052

LD13771

FIG. 2-14 – HARDWARE, GASKETING, CAULK, PAINT AND TAPE

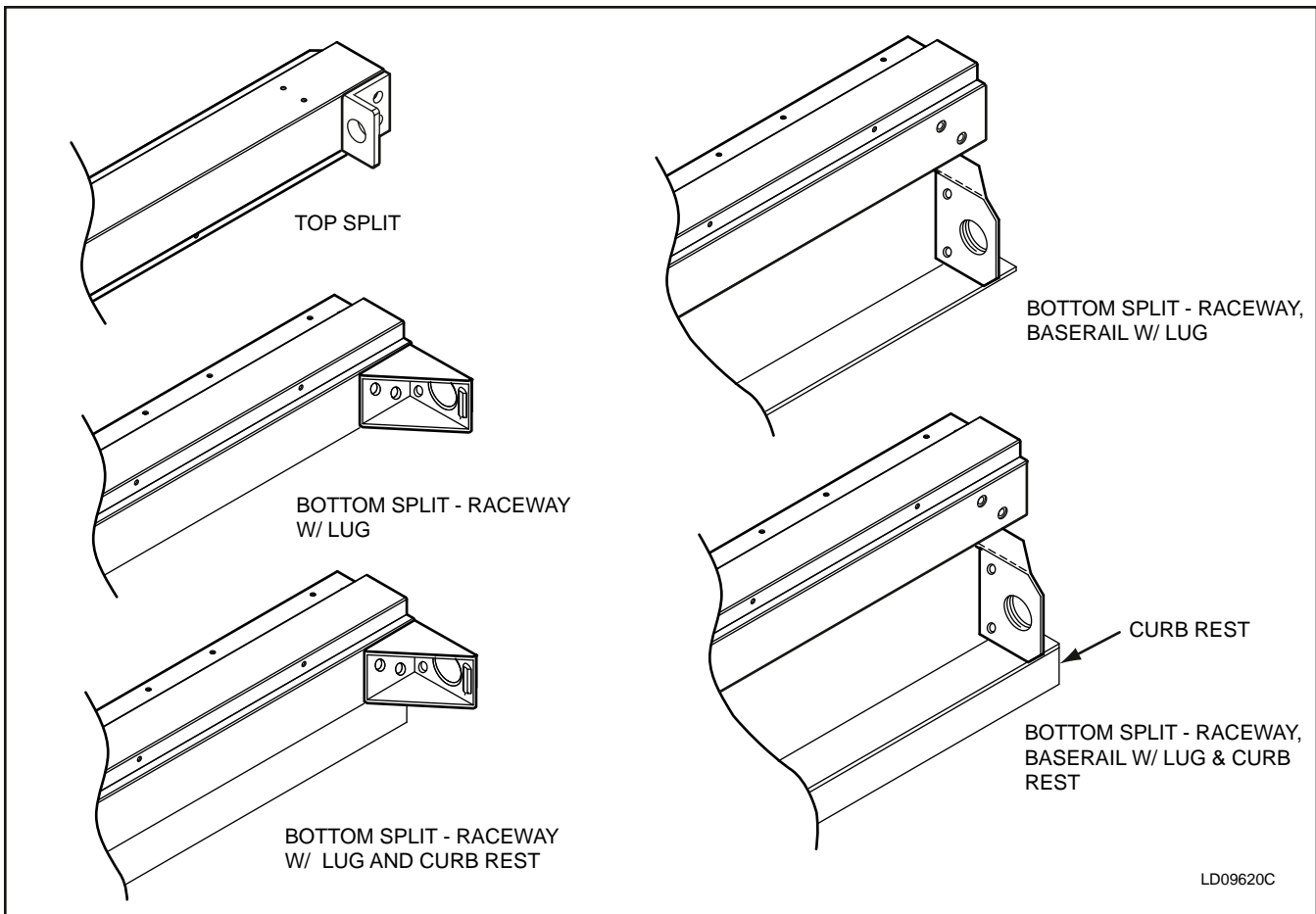

LD09620C

FIG. 2-15 – SHIPPING SPLIT EXAMPLES

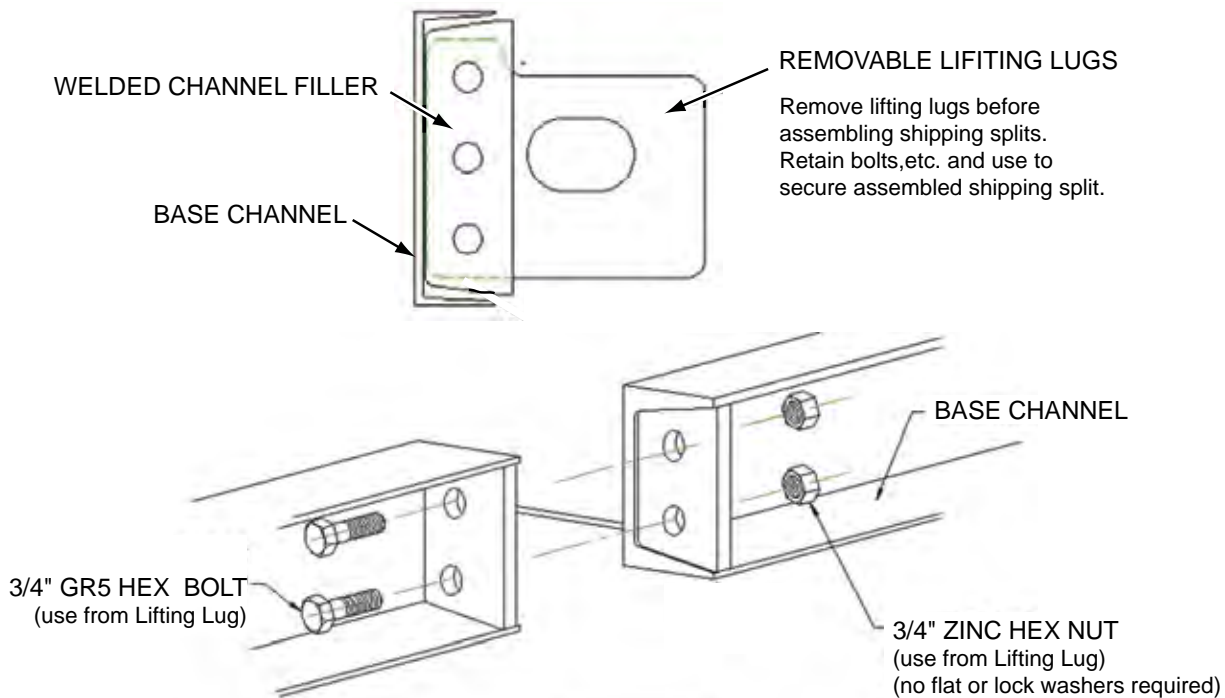

LD14263

FIG. 2-16 – SHIPPING SPLIT EXAMPLES FOR EXPANDED CABINET

Assembly of Outdoor Unit

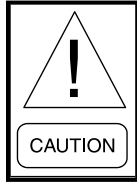

See rigging suggestions and details in Section 1. Failure to follow these guidelines may result in damage to equipment.

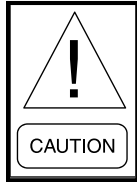

Do not damage factory installed pipe chase, electrical cabinet, hoods, pipe stubs, door handles or roof overhang.

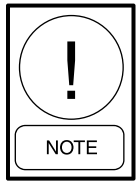

See “Ship Loose Parts” to identify gaskets and hardware items.

Installing Single Piece Outdoor Unit

- Units should not be moved on a roof surface but should be lifted from the ground onto the curb or support framework. Remove the wood shipping material from bottom of unit.

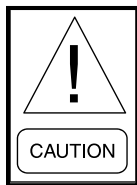

The curb gasket, which is provided, must be installed before the unit is lowered onto the curb. The gasket is shipped with the curb package.

- SEAL (to curbing): When setting the unit onto the curb, the installer should ensure that a sealing gasket is positioned between the unit and curb to provide a continuous airtight and watertight connection.
- Installation should be in accordance with local code requirements.

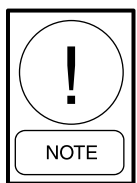

When installing on steel or slab, eliminate seal unless specified.

Installing Multiple Piece Outdoor Unit

See Fig. 2-15 and 2-16 for Shipping Split Examples.

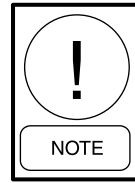

If applicable, remove metal bracket screwed to the cross channel and wood shipping blocks before assembling shipping splits.

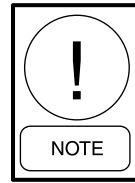

When unit is provided with shipping splits, use construction grade caulk (not provided) in place of curb top gasket. Apply the caulk on top of curb just before each section is placed on the curb. Apply the caulk with a 1/2" diameter bead to assure seal after sections are pulled together. Positive seal must be achieved. Disregard this note if shipping splits are assembled prior to placing the unit on curb.

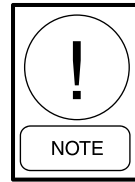

If assembly is done prior to setting unit sections on a curb, be sure to have units on a flat surface during the assembly process. Do not remove shipping blocks from under unit until assembled unit is ready to be lifted and placed.

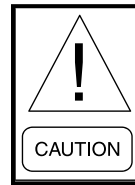

Make sure top of curb is flat and shims added where/if needed to ensure curb will remain flat.

- Before placing sections on the curb:
 - Verify the correct sections and orientation of each section.
 - Remove cross brace(s) (shipping supports) from each section's shipping split.
 - Remove plastic shipping covers and their supports.
 - Remove screws from curb rest to release wood shipping blocks. Leave blocks under unit sections until lifted. Be sure that no debris clings to the bottom of each section when lifted for placement.

- e) Make sure all wiring and/or control tubing connection pig tails are secured out of the path of the shipping split mating surfaces to prevent damage.
- f) Apply 3.5" x 3.5" separate gasket squares, placing one square at each corner of the face of one section. Apply 1/4" x 2" foam gasket to face perimeter from 3.5" square to 3.5" square. Apply this gasket 1/4" from outside edge of mating surface (nearest to exterior of air handler). This is to allow for a 1/4" bead of caulk. Refer to Fig. 2-17.

- 6. Place the next section on the curb about 4" from the section already placed.
- 7. At this time feed the electrical and control connections from section to section and ensure that they will be accessible after the sections are joined. Assemble the electrical connectors and/or pneumatic tubes each according to their labels. Do this before joining sections if access will be a problem later. Refer to Fig. 2-18.

Butt joints to raceway gasket.
Caulked at joints.



The gasket application should provide a continuous seal from side to side and the top of the unit roof to the bottom of the unit base where it meets the curb. LD13372A

FIG. 2-17 – APPLYING GASKET

- g) Apply a 1/2" thick bead of caulk (not provided), to curb top surface only where the first section will be placed.
2. Place the first section on the curb while positioning it so that the overhanging curb rest is spaced evenly from the curb on each side and end.
 3. After the first section is placed in position, anchor or block it before setting the next section.
 4. Attach power pulls or come-a-longs to the first section. Use lifting lugs on the baserail (not at the shipping split) or holes in the two outside corners.
 5. Apply a 1/2" thick bead of caulk to curb top surface only where the next section will be placed, plus about 4".



FIG. 2-18 – ELECTRICAL CONNECTIONS

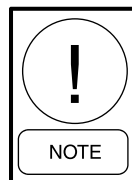

All lighting and 3-phase wires must be hard wired when no plug-ins are provided.

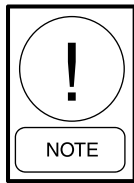

After wiring connections are made and before proceeding with assembly, the top shipping split angle will need to be removed and repositioned (see Fig. 2-19).

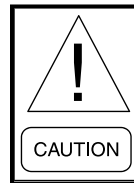

Ensure chain does not apply pressure to drain connection. Improper positioning of chain may cause damage to unit.

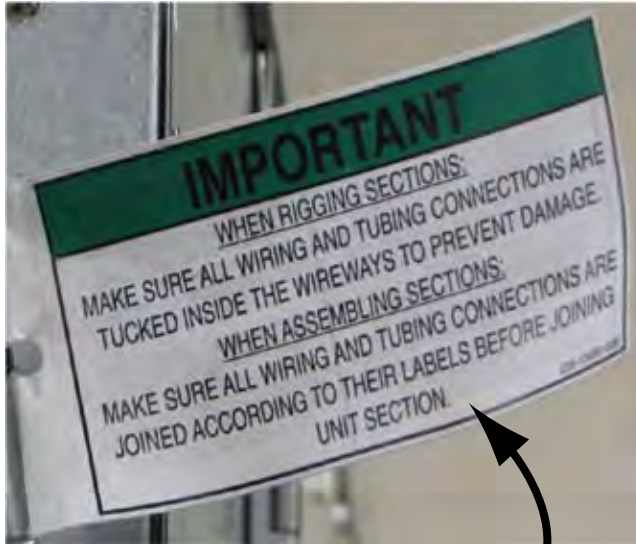
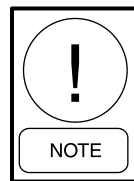

FIG. 2-19 – REMOVE AND REPOSITION SHIPPING SPLIT ANGLE

8. Attach the power pulls or come-a-longs to the far end of the next section.

9. Start pulling this section toward the first section. Pull evenly on both sides.
 - a) Be sure all of the electrical or control wires or tubes are clear.
 - b) Guide the top raceways together by placing rods or drift pins through the holes in the top guide angles. When the raceways are close enough, install the long bolts provided.
 - c) Guide the bottom raceways together using rods or drift pins through the bolt holes in the lifting lugs on opposite sections. Do this on each side of the unit simultaneously.
 - d) If any difficulty aligning due to racking of one section or the other, use another come-a-long diagonally on the inside of that section, at or close to the shipping split. Straps may be used across the unit roof.
 - e) If any difficulty due to top and bottom not pulling together evenly or simultaneously, the curb is probably not installed flat. Apply shims under the curb or roof decking to compensate for irregularities of the roof deck.

10. Complete pulling the sections together.



Use come-a-longs to pull the sections together. The bolts are to hold the sections tight after they are pulled together.

11. Fasten bottom lifting lugs together using 1/2" x 4" bolts provided.
12. Fasten top raceway bracket using 1/2" x 5-1/2" bolts.



FIG. 2-20 – BRINGING SECTIONS TOGETHER

13. Apply a 1/4" bead of caulking to the exterior of the seam. Trowel the bead level with the air handler exterior. This is to be done on roof and both sides (see Fig. 2-20).
14. Apply 1/4" bead of caulking to the seam inside the unit on the floor.
15. Apply 1/4" x 2" foam gasket to the underside of the seam caps and install them over the joints using 1/4"-14 x 1" hex head screws provided. Painted seam caps are applied over the joints on the sides and roof of the exterior and galvanized seam caps are applied on the floor of the interior only.

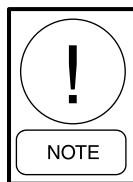

If a roof seam cap has a tab on one end only, the end without the tab goes above the pipe chase location.

16. Repeat this procedure for each additional section to be placed in making up the complete unit.

17. Install 1-1/2" Corner Connector Plugs on bottom raceway corners.

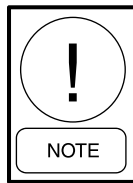

Only needed on units or sections without baserails.

Assembly of Indoor Unit

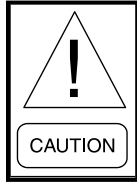

See rigging suggestions and details in Section 1. Failure to follow these guidelines may result in damage to equipment.



Do not damage factory installed pipe chase, electrical cabinet, hoods, pipe stubs, door handles or roof overhang.

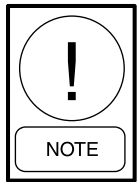

See “Ship Loose Parts” to identify gaskets and hardware items.

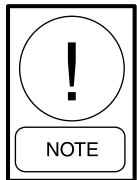

If the unit or unit sections are too large to fit through an opening, contact the local Johnson Controls office for assistance. Technical instruction is available for Disassembly and Reassembly.

Installing Multiple Piece Indoor Unit

See Fig. 2-15 and 2-16 for Shipping Split Examples.

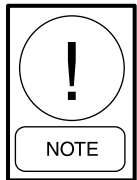

If applicable, remove metal tab screwed to the cross channel and wood shipping blocks before assembling shipping splits.

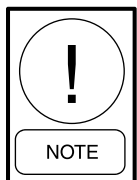

If assembly is done prior to placing unit sections, be sure to have sections on a flat surface during the assembly process.

1. Before placing sections:

- a) Verify the correct sections and orientation of each section.
- b) Remove cross brace(s) (shipping supports) from each section's shipping split.
- c) Remove plastic shipping covers and their supports.

- d) Make sure all wiring and/or control tubing connection pig tails are secured out of the path of the shipping split mating surfaces to prevent damage.
- e) Apply 1/4" x 2" neoprene gasket material **TO ONE SIDE ONLY** of each shipping split. Be sure the entire perimeter is covered with gasket material, including the foamed corners. Any void, depression or protrusion will allow air or water leakage. Gasket must be continuous through the corners. Make any splices on a straight run. Refer to Fig. 2-21 and 2-22.

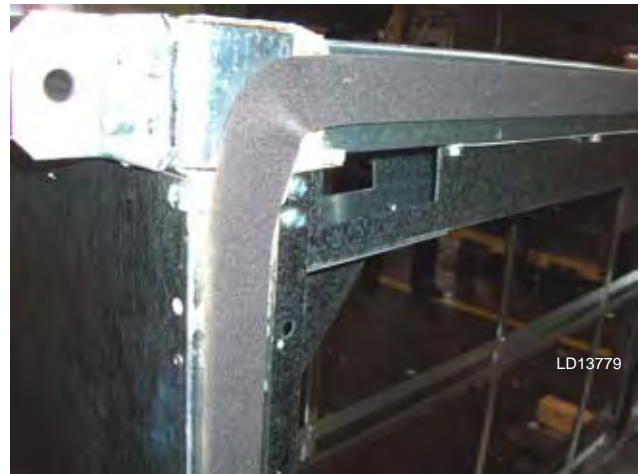

FIG. 2-21 – APPLYING GASKET TO SHIPPING SPLIT

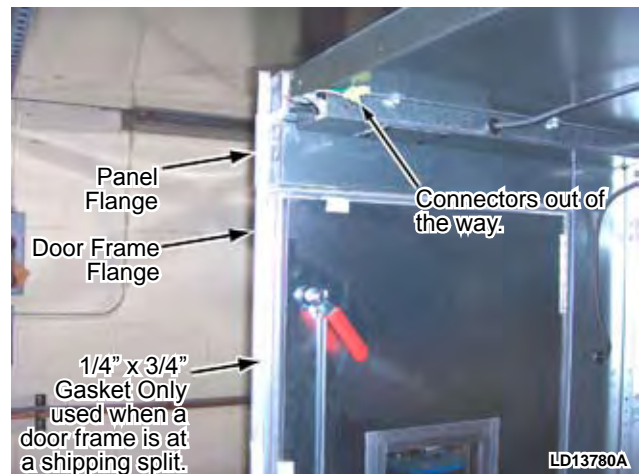

FIG. 2-22 – APPLYING GASKET TO DOOR FRAME WHEN AT SHIPPING SPLIT

- f) For expanded cabinet with end channel shipping split see fig. 2-23

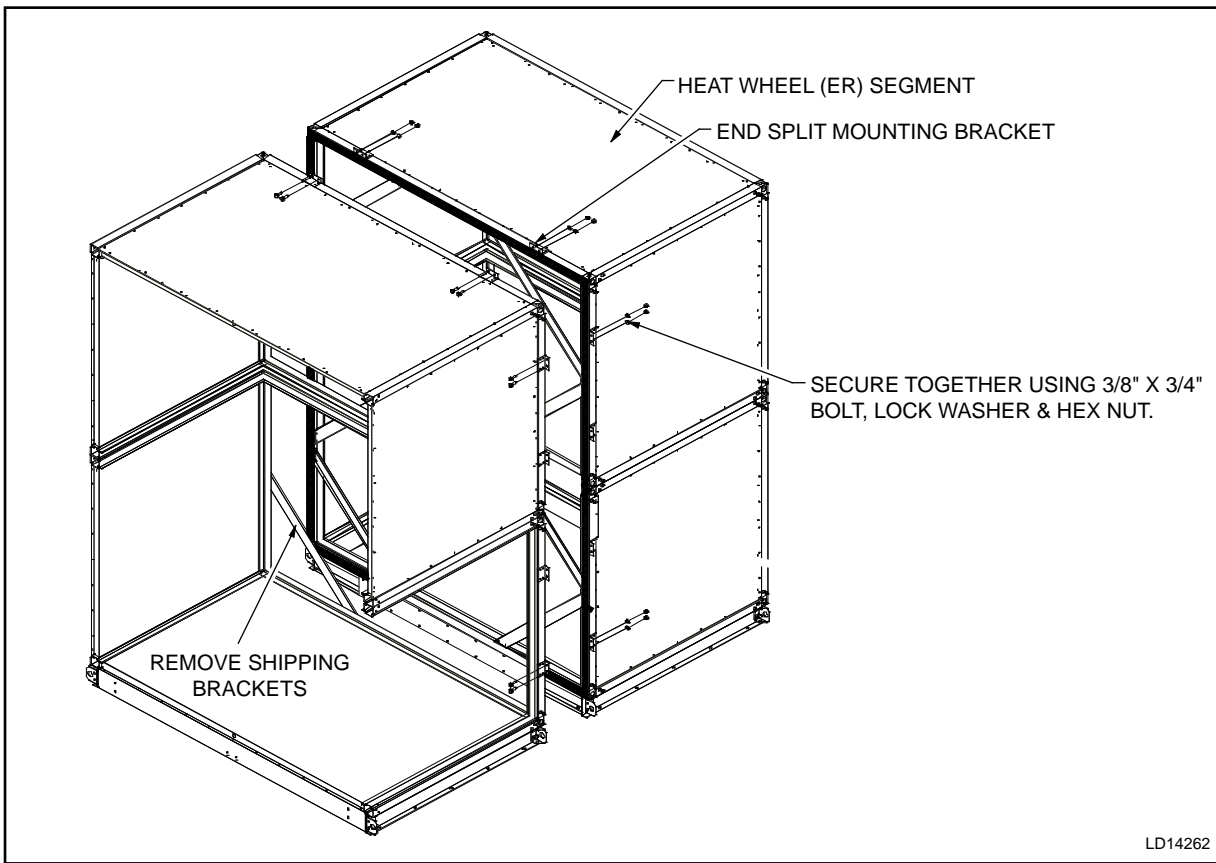
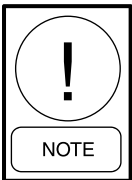

FIG. 2-23 – ASSEMBLY OF END CHANNEL SHIPPING SPLIT (EXPANDED CABINET)

2. Place the first section in its final position and anchor or block it before placing the next section (see Fig. 2-25).



After wiring connections are made and before proceeding with assembly, the top shipping split angle will need to be removed and repositioned (see Fig. 2-24).

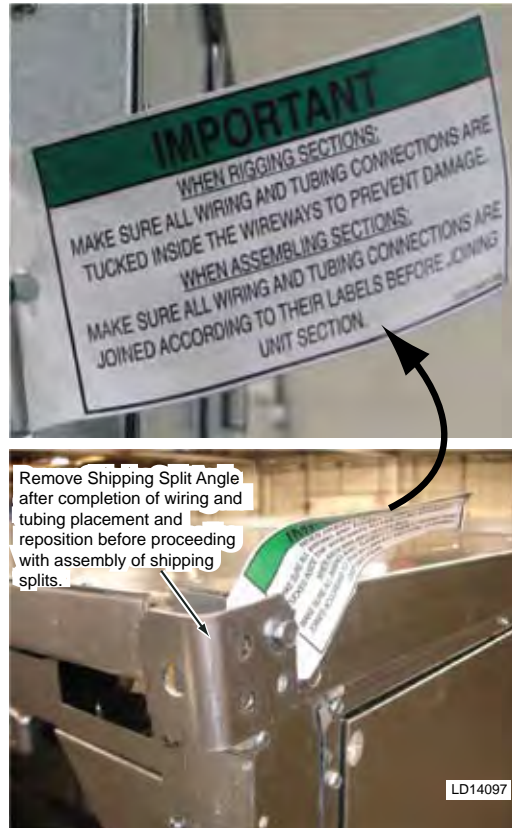

FIG. 2-24 – REMOVE AND REPOSITION SHIPPING SPLIT ANGLE

3. Attach power pulls or come-a-longs to the first section. Use the lifting lugs on baserail (not at the shipping split) or holes in the two outside corners (see Fig. 2-25).

For expanded cabinet with structural steel base remove lifting lugs within the shipping split. retain bolts and nuts (see Fig. 2-26).

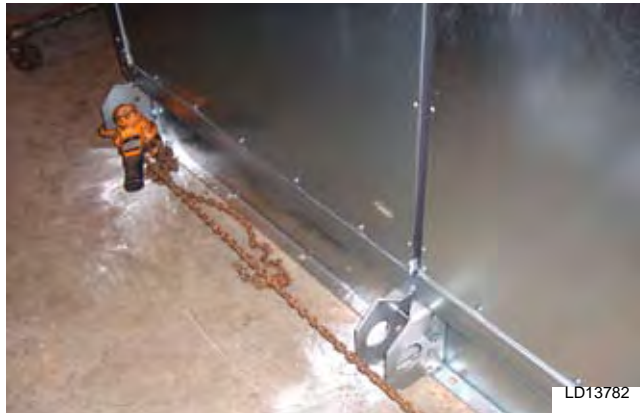

FIG. 2-25 – PLACING AND ANCHORING FIRST SECTION AND ATTACHING COME-A-LONGS

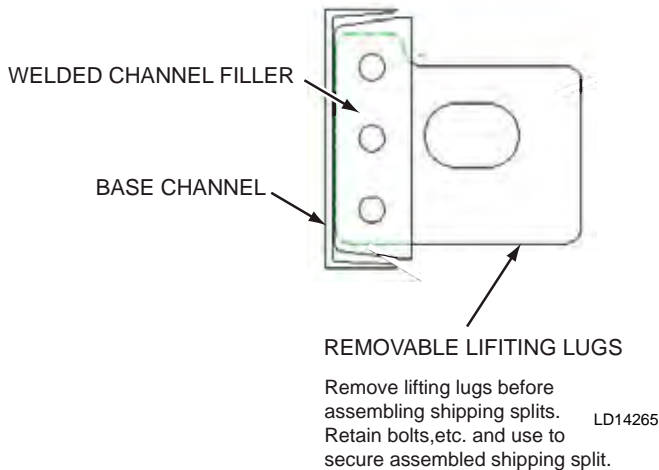
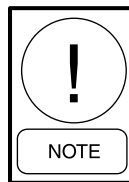

FIG. 2-26 – REMOVE LIFTING LUGS AND SAVE HARDWARE

4. Place the next section about 8" from the section(s) already placed.
5. At this time feed the electrical and control connections from section to section and ensure that they will be accessible after the sections are joined. If any will not be accessible, assemble the electrical connectors and/or pneumatic tubes each according to their labels before joining of sections is complete. Refer to Fig. 2-27.



FIG. 2-27 – ELECTRICAL CONNECTIONS



All lighting and 3-phase wires must be hard wired when no plug-ins are provided.

6. Attach the power pulls or come-a-longs to the far end of the next section.



Ensure chain does not apply pressure to drain connection. Improper positioning of chain may cause damage to unit.

7. Start pulling the sections together. Pull evenly on both sides.
 - a) Be sure all of the electrical or control wires or tubes are clear.
 - b) Guide the top raceways together by placing rods or drift pins through the holes in the top guide angles. When the raceways are together, install the long bolts provided.
 - c) Guide the bottom raceway/baserails together using rods or drift pins through the holes in the lifting lugs on opposing sections. Do this on each side of the unit simultaneously.
 - d) If any difficulty aligning due to racking of one section or the other, use another come-a-long diagonally on the inside of that section at the shipping split or across the tops of opposing sections..
 - e) If any difficulty aligning due to top and bottom not pulling together simultaneously, apply shims under the unit sections as needed to compensate for uneven placement area.
8. Complete pulling the sections together.
9. Fasten bottom, lifting lugs together with 1/2" x 4" bolts provided. *See Fig. 2-28.*

10. Fasten top raceway brackets with 1/2" x 5-1/2" bolts.
11. Apply 1/4" x 2" foam gasket to the underside of the seam caps and install them over the joints using 1/4"-14 x 1" hex head screws provided. Seam caps are provided for sides, top and floors.
12. Repeat previous steps for each additional section to be placed in making up the complete unit.
13. Install 1-1/2" Corner Connector Plugs in bottom raceway corners.

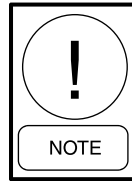

Only needed on units or sections without baserails.



Use come-a-longs to pull the sections together. The bolts are to hold the sections tight after they are pulled together.

FIG. 2-28 – INSTALLING BOLTS AFTER PULLING UNITS TIGHT TOGETHER

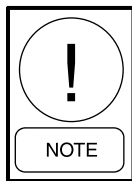

FIG. 2-29 – TIERED UNIT

LD09624



See complete rigging instructions explained in detail in Section 1.



See “Ship Loose Parts” in this section of the Manual to identify gaskets and hardware items.

Installation of Tiered Unit

A Tiered Unit may not be factory assembled. Field assembled units are shipped with the top-tier segment skidded. This top-tier segment is equipped with brackets bolted to the bottom raceway (see Fig. 2-30). The bottom-tier segment is equipped with brackets bolted to the top raceway.

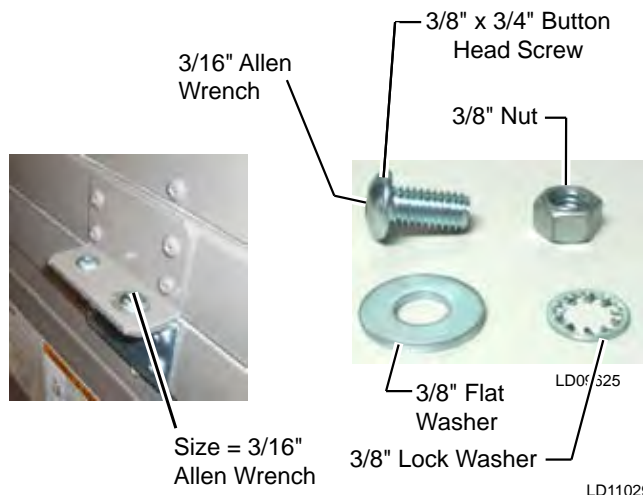

FIG. 2-30 – TIERED UNIT SECURED WITH BRACKETS

These brackets are used to secure the top segment to the bottom segment. After final alignment, bolt the two brackets with hardware supplied.

1. Before placing top tier:
 - a) Verify the correct orientation of top and bottom tier.
 - b) Remove cross brace(s) (shipping supports) from top tier.
 - c) Remove plastic shipping covers and their supports.
 - d) Make sure all wiring and/or control tubing connection pigtails are secured out of the path of the mating surfaces to prevent damage during rigging.
 - e) Ensure 1/4" x 2" neoprene gasket properly installed on bottom tier. If the top tier is shorter in direction of airflow than the bottom tier, apply gasket material on the top panel of the bottom tier from raceway to raceway but not on top of raceways (see Fig. 2-31).

2

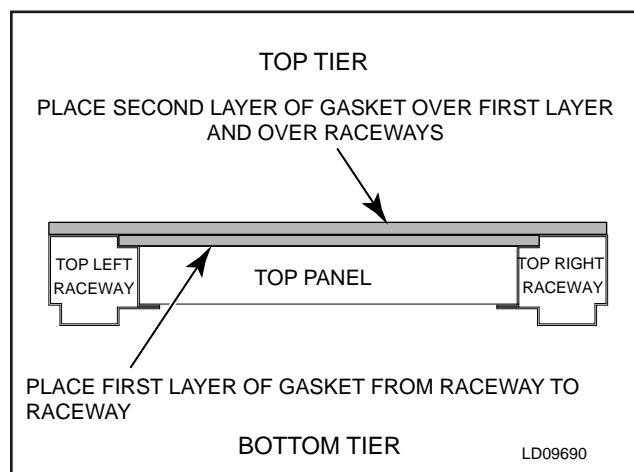

FIG. 2-31 – APPLY GASKETS TO TOP PANEL BOTTOM TIER

- f) Apply second layer of 1/4" x 2" gasket over top of that applied in step (e) but include the raceways. Steps (e) and (f) are necessary because the top panel of the bottom tier is slightly recessed below the height of its raceways.
- g) If top tier has shipping splits, refer to “Installing Multiple Piece Indoor Unit” for correct assembly procedure.



Be sure all of the electrical or control wires or tubes in both tiers are clear.

2. Install (4) shackles, one in each bottom corner connector or raceway lifting lug.
3. Fasten sling/chain to shackles.
4. Fasten other end of sling/chain to spreader bar (as needed).
5. Lift top tier assembly with crane or overhead lift.
6. At this time feed the electrical and control connections from top tier to bottom tier and ensure that they will be accessible after the sections are joined. If any will not be accessible, assemble the electrical connectors and/or pneumatic tubes each according to their labels before joining the top and bottom tier.

7. Lower the top tier onto bottom tier so that mounting brackets mate. Guide brackets together using rods or drift pins through the bolt holes (*see Fig. 2-32*).



LD09626

FIG. 2-32 – GUIDING BRACKETS TOGETHER

8. Carefully place each section of the top tier without disturbing the gaskets on the bottom tier.
9. Secure the top tier to bottom tier with 3/8" x .75" Allen head bolts.
10. Install 1-1/2" Corner Connector Plugs in bottom raceway corners.

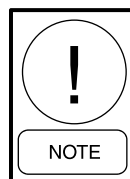

Only needed on units or sections without baserail

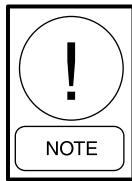

See “Ship Loose Parts” to identify gaskets and hardware items.

Assembly of End Channel Shipping Split

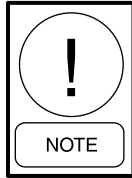

The assembly is the same regardless of what sections are being connected together. The vertical Energy Recovery Wheel shown in Fig. 2-33 is a common example

Prior to pulling sections together:

1. Remove baserail support plate (large units).
2. Remove shipping brackets in corners.
3. Remove screws in raceway corners at ends of all segments joining together (as shown in Detail A of Fig. 2-33).
4. Clean the metal surface where gasket is to be applied with mineral spirits or rubbing alcohol.

5. Apply 1/4" x 2" neoprene gasket to all raceway mating surfaces of one mating section. Include two gaskets side by side on intermediate raceway surfaces (large units).
6. Ensure that the sections are not racked and will line up properly.

Attach sections as follows:

1. Make sure assembly surface is clean and level to allow the sections to slide freely. If surface is irregular, use metal shims under sections as necessary to align mating surfaces.
2. Pull sections together using a come along, drawing the base together.
3. Attach the sides of the sections. Beginning at the bottom of the sections secure the end channel assembly brackets together using 3/8" x 3/4" Allen head bolts, lock washers & hex nuts at each bracket. Continue securing the end channel assembly brackets together, working from bottom to top, pulling the sections tight.
4. After the sides are secured, secure the brackets on top of the unit with the same hardware mentioned in step 3.

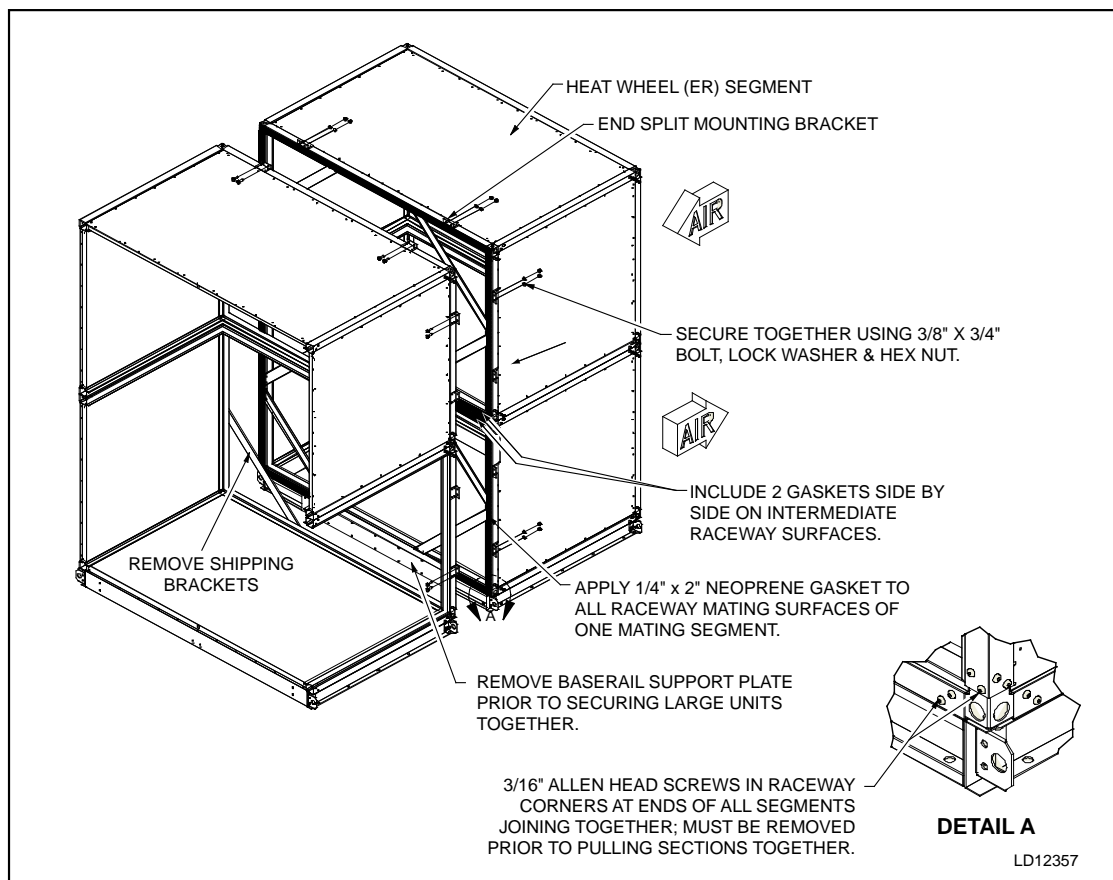

FIG. 2-33 – ASSEMBLY OF END CHANNEL SHIPPING SPLIT (ENERGY RECOVERY WHEEL SHOWN)

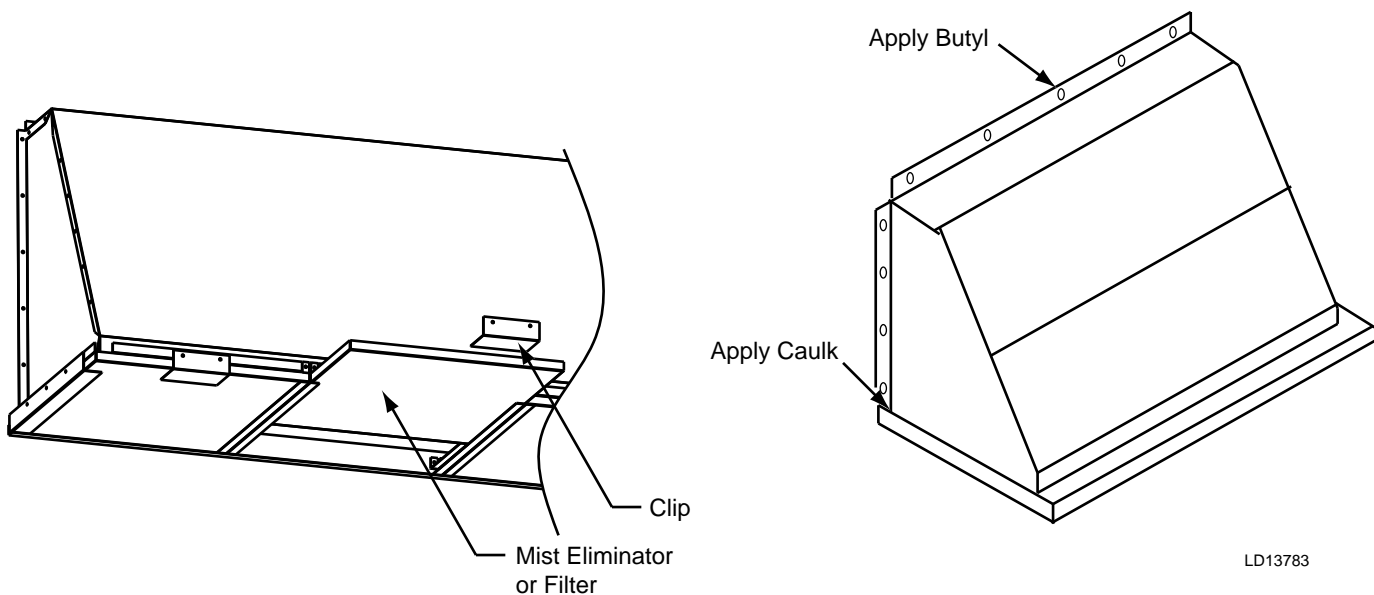
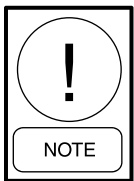

FIG. 2-34 – HOOD INSTALLATION WITH OPTIONAL MIST ELIMINATORS

HOOD INSTALLATION WITH OPTIONAL MIST ELIMINATORS



See “Ship Loose Parts” for identification of gaskets and hardware.

1. Identify correct hood and respective location (see example on Fig 5 “Loose Component ID Labels” found in the Unit Identification section of this Manual). Each hood is labeled for easy identification.
2. Correct orientation is with the tracks or bird screens to the bottom. The mounting flanges are predrilled.
3. Each hood is fitted with a factory installed bird screen unless mist eliminator option is selected.
4. Apply provided 3/16" x 3/4" Butyl tape to the predrilled hood flanges and back wall angle that contact the unit panels.
5. Use 1/4"-14 x 1" Hex Head Self Drilling Screws w/EPDM washer provided.
6. Each damper opening in the unit panels should be completely covered by its respective hood. The bottom of the hood should extend approximately 6" below the opening in the unit panel.

7. Each hood is to be centered over the width of the opening. All hoods, especially those containing barometric dampers, MUST be installed square.
8. Seal each hood gutter to the unit panel with Polyurethane Caulk provided.
9. When multiple hoods are installed in a stack space the hoods approx. 1.5" apart so the bottom hood will extend 6" below the bottom of the opening.
10. Install optional mist eliminators.
 - a) Remove the clip(s) from the leading edge of the hood.
 - b) Insert the proper size mist eliminator or filter into the tracks.
 - c) Reinstall the clip(s) on the leading edge of the hood.

OUTDOOR AIR TEMPERATURE AND/OR HUMIDITY SENSORS

When Outside Air Hoods are shipped loose on units that include Factory Packaged Controls, these sensors will be dismantled and pulled back into the air handler. The contractor is to find them secured with tape inside and put them through their respective penetration to the exterior and mount them to the bracket provided.

ACTUATOR INSTALLATION

See Fig. 2-35

1. Remove the bearing plate from the damper frame and jackshaft.
2. Slide the damper actuator onto the open end of the shaft making sure that the proper spring return position on the face of the actuator matches the damper shafts rotation. If not, then reinstall the actuator with it flipped over.
3. Reinstall the bearing plate to the damper frame and jackshaft. Make sure spring hose clamps hold the jackshaft securely.
4. Slide the damper actuator mounting bracket into the actuator mounting grooves and fasten to the damper frame using self drilling screws.
5. Tighten the actuator shaft clamp to the damper jackshaft. Make sure at this point, the damper shaft is completely rotated to its proper position.
6. Manually operate the actuator to its fully actuated position using the crank arm provided with the actuator. Then release the spring to allow the damper to go back to its original position. This will verify the actuators spring rotation and stroke.
7. Set the damper actuators rotation selector switch to the proper rotation required to actuate the damper.

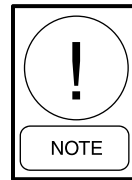

Damper actuator rotation will always be opposite the spring return rotation.

2

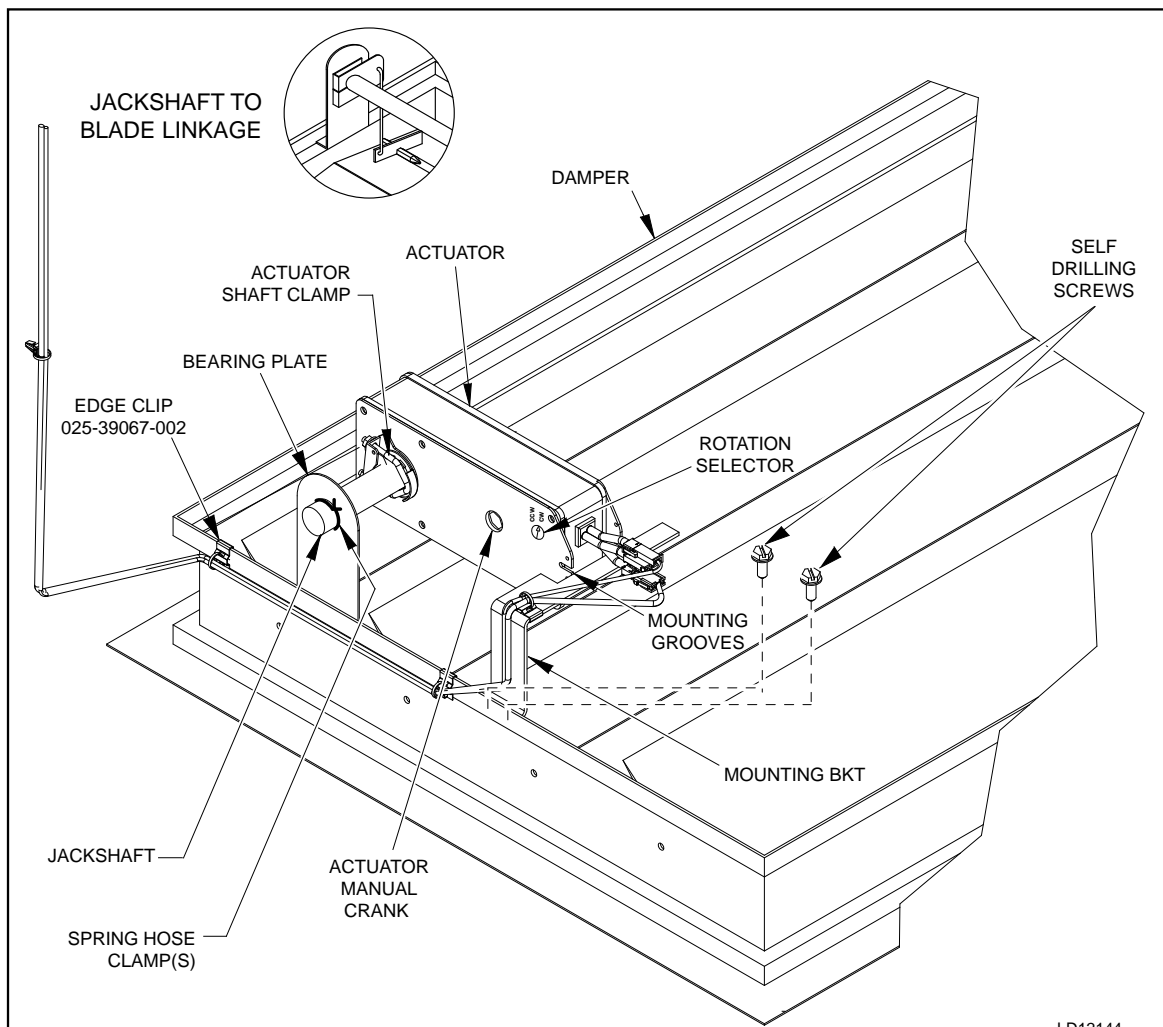
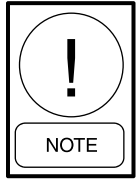

FIG. 2-35 – DIRECT COUPLED ON JACKSHAFT

INSTALLATION OF MULTIZONE (MZ) DAMPERS

See Fig. 2-36



SHIPPED LOOSE MZ DAMPERS. If the MZ segment has a shipping split, a rear discharge (end of unit), and a multizone damper, then the multizone damper will be shipped loose.

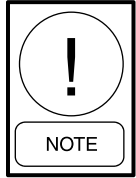

See “Ship Loose Parts” to identify gaskets and hardware items.

Damper Installation

1. After the unit top tier is assembled to the unit bottom tier and sealed, install MZ damper assembly. The assembly includes both hot deck and cold deck damper banks, already connected at each blade.

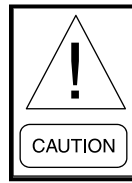

Distortion will result in unreliable blade operation.

2. Remove 16 gauge shipping plate from air entering side ONLY. Plate is located between hot and cold decks.
3. Apply provided 1/4" x 2" neoprene gasket to the mounting flanges of the damper assembly.
4. Center the damper assembly over the discharge openings of the hot deck (top) and cold deck (bottom).
5. Attach the damper assembly to the unit outer perimeter mounting flange using 1/4"-14 x 1" self-drilling screws provided.
6. Remove 16 gauge shipping plate from air leaving side.
7. Install screws through mounting flanges found between hot and cold decks.

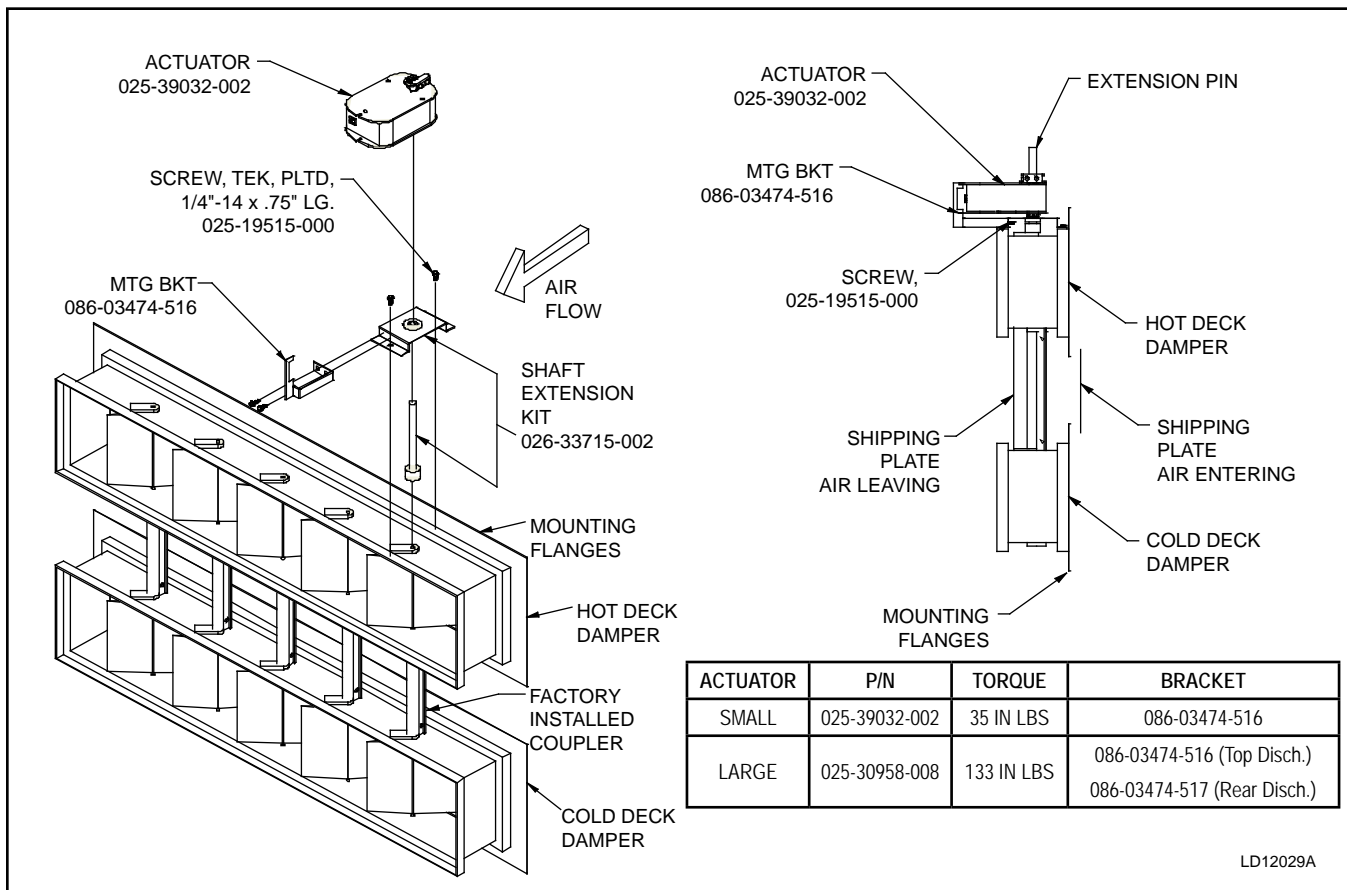
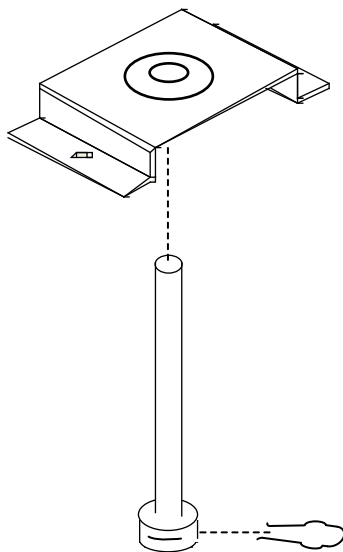

FIG. 2-36 – MZ DAMPER/ACTUATOR ASSEMBLY

Actuator Installation Multizone (MZ) - Field Supplied

When actuators are field supplied on multizone dampers, the following information is intended to aid in sizing and selection:

- Torque required is 7 inch pounds per square foot of damper area up to 2500 FPM velocity.
- Damper blades are 6" wide and vary in height.
- Calculate the torque by number and size of blades in each individual zone. Remember there are hot deck blades directly connected to cold deck blades.
- Blades per zone are to be determined by system CFM and static pressure requirements for each zone by the Engineer's construction documents.
- The blade linkage (flat rods) connecting all blades of each deck are to be cut at the appropriate places to divide the decks into correct size zones. These blade linkage rods are mounted externally on the assembly. Be sure to cut a section of the flat connecting rod out. This is to prevent interference when zones modulate in opposite directions.
- One Damper Shaft Extension Kit is provided for each zone per the Factory Order Form (*see Fig. 2-37*).



DAMPER SHAFT EXTENSION KIT
P/N 026-33715-002

LD13784

FIG. 2-37 – DAMPER SHAFT EXTENSION KIT

- Actuators and actuator mounting brackets are to be supplied by the contractor. Part numbers available upon request.
- On rear mount (discharge through end of unit); always mount the actuators on the top of the upper (hot) deck.
- Do not allow duct insulation to restrict damper blades or external linkage.
- Direct coupled actuators are recommended.
- Duct connections are to be made at the zone dividers without damper blade restriction.

INERTIA FAN BASE FILL INSTRUCTION

Inertia fan bases are pre-engineered according to fan and motor size. Each cavity having a pre-installed corrugated bottom is to be filled to the top with wet concrete. The contractor must take care not to get concrete mix on the bolts and adjusting parts of the adjustable motor base, sheaves, belts or on the floor under the edges of the isolated fan base. The amount of concrete can be calculated by measuring the overall length and width of the fan base assembly cavities that have the corrugated metal bottoms. The standard depth of the cavity is 4 inches.

HUMIDIFIERS

Optional Steam humidifiers, when selected are provided with dispersion equipment factory mounted inside the air handling unit. The steam injection or generating equipment, metering devices and sundries are shipped loose with the unit. Humidifier manufacturer's installation, operation and maintenance information is packaged with the respective humidifier. It is the responsibility of the installing contractor(s) to make use of the instructions and preserve same for turn-over to the end user. All required steam supply piping, condensate piping and wiring are the responsibility of the installing contractor(s).

UVC EMITTER LIGHTS

When UV Lights are provided, the contractor is responsible for installing UV Lamps (tubes) and connecting a 120 volt power supply. The YORK Solution factory provides internal wiring with a magnetic door safety switch, a lockable disconnect switch with “Press to Test” pilot light and a latching circuit that has to be manually re-energized on the air handler exterior after a door has been opened and closed. This is all pre-wired. The UV Lamps (tubes) are shipped loose, but in protective packaging for installation by the contractor.



DO NOT touch UV Lamps (tubes) with bare hands or leather gloves as oils will damage the tubes. Use clean cotton rags, clean jersey or latex gloves to handle the lamps (tubes).

There three different types of lamps used in YORK Solution Air Handlers: V-Mod, V-Ray and V-Flex.

V-Mod lamps are installed in the same manner as standard fluorescent lamps with 2 contact prongs on each end. Engage the prongs into the slotted fixtures and rotate the lamp (tube) 90 degrees.

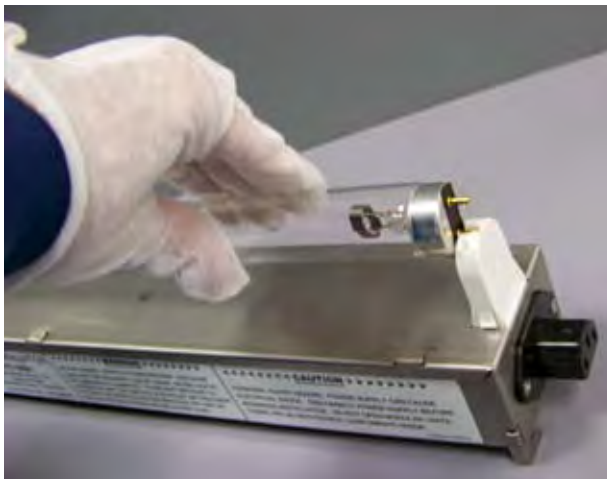

FIG. 2-38 – V-MOD INSTALLATION

V-Ray lamps (tubes) have all four contact prongs on one end of the lamp (tube). The lamp fits into clamps mounted in the air handler UV segment where a pre-wired pig tail is installed. Simply engage the plug on the pig tail with the prongs on the end of the lamp.



FIG. 2-39 – V-RAY INSTALLATION

V-Flex lamps (tubes) fit inside the opening at a slight angle (with the pins aligned with the lamp holder). You then “snap” the lamp base in by holding with slight pressure the end of the lamp you have placed inside the module with one hand and straightening up the other end of the lamp with your other hand until you hear the click.

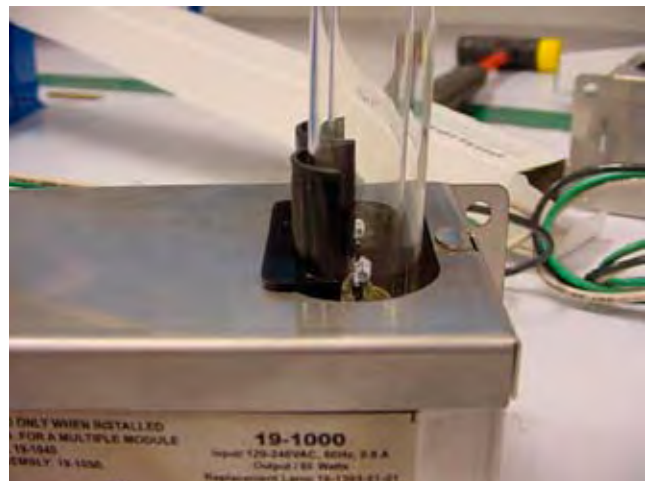

FIG. 2-40 – V-FLEX INSTALLATION

AIR MEASURING DEVICE CONNECTIONS (WHEN PROVIDED)

Air Measuring at The Fan Inlets

COMETER is a probe attached to the fan bearing support on Comefri Forward Curve fans from size 7 x 7 up to 18 x 18. The probe is located on the outboard side of the DWDI fan assembly. The probe is piped to the negative (-) port of a factory mounted transducer on the fan wall. The positive (+) port is left open to the fan section. Wiring is not provided to the transducer unless factory packaged controls were selected.

PIEZORING (PIEZOMETER) is a series of fittings in the inlet cone(s) of DWDI fans larger than 18 x 18 and all sizes of Plenum fans that are combined into a single connection piped to the negative (-) port of a factory mounted transducer on the fan wall. The positive (+) port is left open to the fan section. Wiring is not provided to the transducer unless factory packaged controls were selected.

Air Measuring at Unit Inlets

AMS-60 used on Indoor YORK Solution air handlers usually to measure outside air. This can be provided with one or two pairs of positive (+) and negative (-) connections. Connect (+) and (-) ports respectively to the (+) and (-) ports of the transducer(s). Wiring and transducer are not provided unless factory packaged controls were selected.

EAML used on Outdoor YORK Solution air handlers usually to measure outside air. This can be provided with one or two pairs of positive (+) and negative (-) connections. Connect (+) and (-) ports respectively to the (+) and (-) ports of the transducer(s). Wiring and transducer are not provided unless factory packaged controls were selected.

PIPE CHASE INSTALLATION

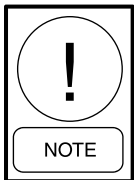

See “Ship Loose Parts” to identify gaskets and hardware items.

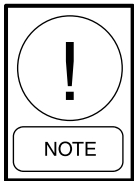

Pipe chase should be installed before piping is connected.

Tools Required

- Screw Gun
- Complete set of mechanics hand tools.

Materials Required

- Shipped loose package containing 1/4"-14 x 1" Self-drilling Screws w/gasket, Caulking, 1/4" x 2" Neoprene Gasket.
- *When unit purchased with Baserail:* Pipe Chase Baserail Covers, 3/8"-16 x 1-1/2" Bolts and Lock Washers.

Procedure

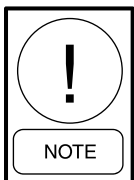

Never use silicone caulk/sealant or caulk/sealant containing silicone in or on any air handling equipment. [Only exception is when provided (high temperature) with gas heat venting]

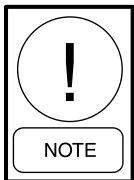

The top and bottom flanges are inside pipe chase. Separate cover angles are used on external vertical seams.

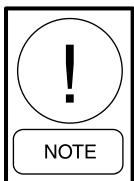

Before installing pipe chase, remove any self-drilling screws from the top and bottom raceway and side panel that may interfere with the installation of the pipe chase or trim angles.

1. Preparation

- a) Pinpoint the exact location to attach the pipe chase.
- b) Ensure enough space will remain to apply pipe fittings with insulation, inside the pipe chase.
- c) The pipe chase height should align with the unit height.

2. Apply Gaskets

- a) Apply provided 1/4" x 2" neoprene gasket to the underside of the air handler roof overhang (see Fig. 2-41).



FIG. 2-41 – INSTALL GASKET UNDER ROOF OVERHANG

- b) Apply gasket provided by curb vendor to top of curb.
- c) Apply 1/4" x 2" neoprene gasket to the pipe chase (vertical gaskets first, then horizontal gaskets). Keep the gasket aligned with the outside edges of the pipe chase housing (see Fig. 2-42).

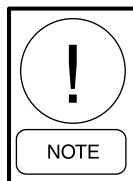

Horizontal gaskets must completely overlap vertical gaskets in all four corners (see Fig. 2-42).

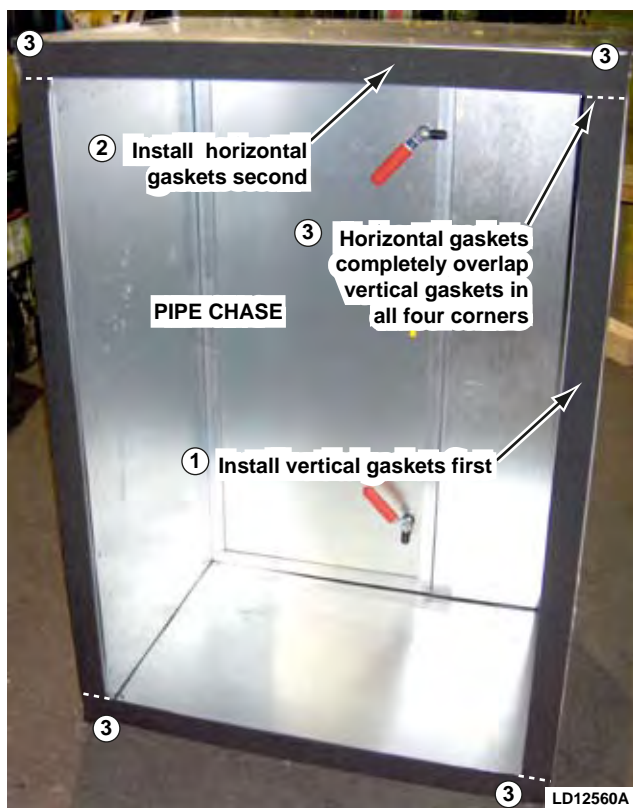

FIG. 2-42 – APPLY GASKET TO PIPE CHASE

3. Attach Pipe Chase

- a) Set the pipe chase on the pipe chase curb three inches away from the air handler.
- b) Tilt the top of the pipe chase toward the air handler. Work it under the air handler roof overhang, being careful not to damage the neoprene gaskets. Lift the pipe chase slightly to clear the gasket on the curb and swing the bottom against the air handler.
- c) If there is a baserail, attach the baserail of the pipe chase to the baserail of the air handler. Use 3/8" bolts and lock washers provided; placing bolts through the pipe chase baserail brackets into the threaded holes in the air handler baserail (see Fig. 2-43).
- d) Make sure the pipe chase is square and the door(s) close and open without rubbing or binding.
- e) Secure the pipe chase to the top and bottom raceways (heavy gauge metal) of the air handler through the pre-punched holes of the inside top and bottom flanges of the pipe chase. Use 1/4"-14 x 1" hex head self-drilling screws (see Fig. 2-44).

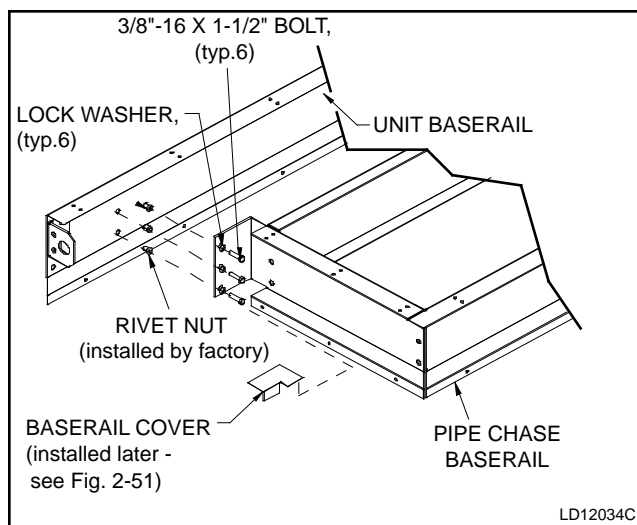

FIG. 2-43 – PIPE CHASE BASERAIL TO UNIT BASERAIL INSTALLATION (When Purchased)

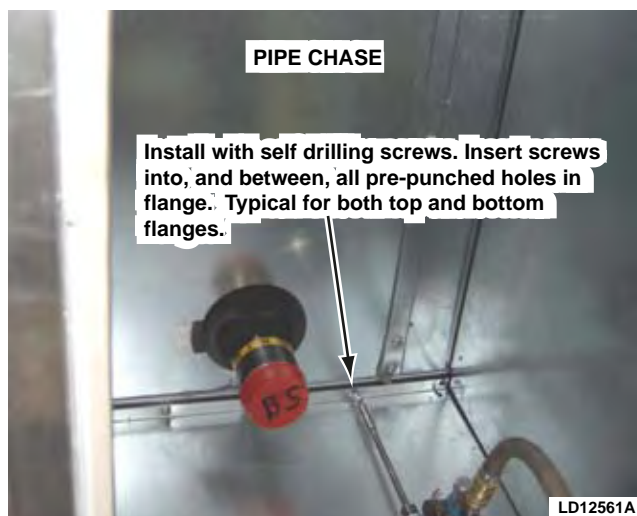
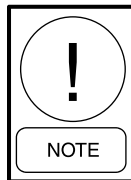

FIG. 2-44 – SCREW PIPE CHASE TOP AND BOTTOM INTERNAL FLANGES TO AIR HANDLER



Do not over tighten or strip self-drilling screws. Screws in top and bottom flanges go into heavier gauge metal than screws in cover angles.

- f) Check to be sure door closes and latches properly. If not, loosen self-drilling screws, re-align pipe chase and re-tighten screws. Occasionally the curb under the pipe chase may be uneven, depending on installation.
- ### 4. Seal Pipe Chase to Air Handler.
- a) Apply caulking to all exterior joints between pipe chase and air handler baserails (when purchased) (see Fig. 2-45).

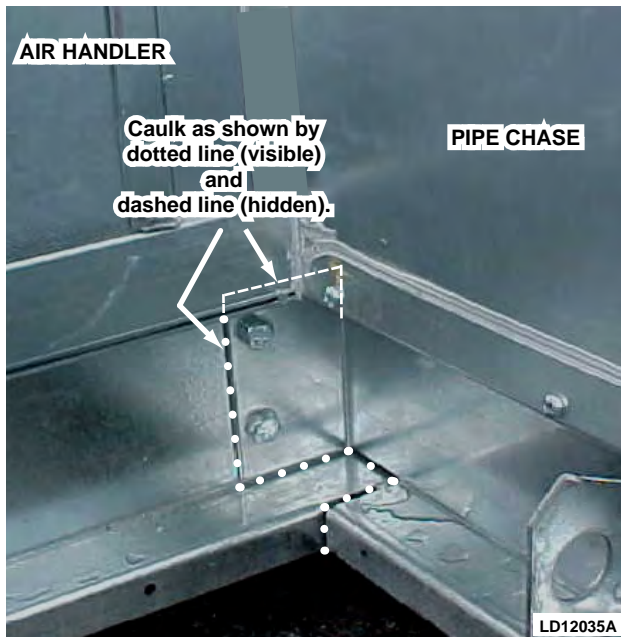

FIG. 2-45 – BASERAIL CAULK APPLICATION

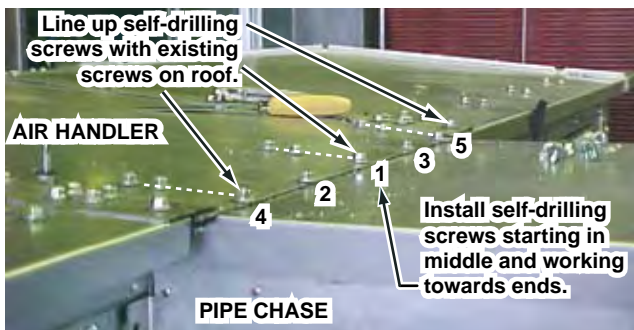

FIG. 2-46 – PIPE CHASE TO ROOF INSTALLATION

b) Add a small bead of caulking to the exterior vertical seam between the air handler and the pipe chase to insure complete seal. Pay special attention to the top and bottom corners, raceway and baserail engagements and under the roof overhang (see Fig.'s 2-45 and 2-47).

c) Starting at the center, and working toward each end, run 1/4"-14 x 1" hex head self-drilling screws down through the air handler overhang into the top of the pipe chase through the gasket. Use caution not to strip the 20-gage housing with the screws. Line up self-drilling screws with double row of screws on top of unit raceway, plus one spaced evenly between each (see Fig. 2-46) (No caulking required here.)

5. Install the Cover Angles
(See Fig. 2-48)

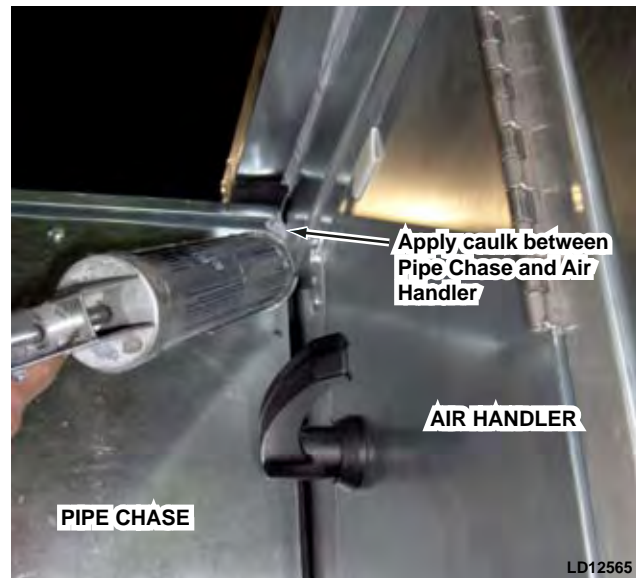
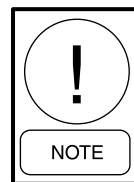

FIG. 2-47 – PIPE CHASE TO AIR HANDLER CAULK APPLICATION



Cover angles must be installed before the caulk from step 4 dries.

- a) Apply 1/4" x 2" neoprene gasket to contact side of cover angle.
- b) Remove top and bottom self-drilling screws from pipe chase and set aside for later use.
- c) Place cover angles in vertical corners of pipe chase and unit wall.

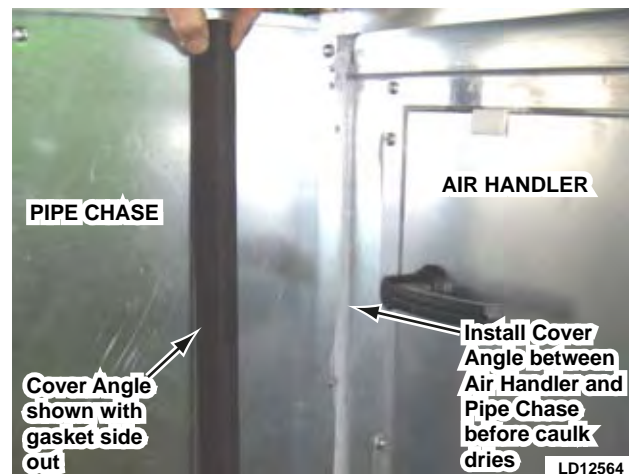
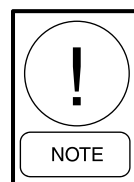

FIG. 2-48 – INSTALL COVER ANGLE



Notch on cover angle must be on the air handler side (see Fig. 2-48).

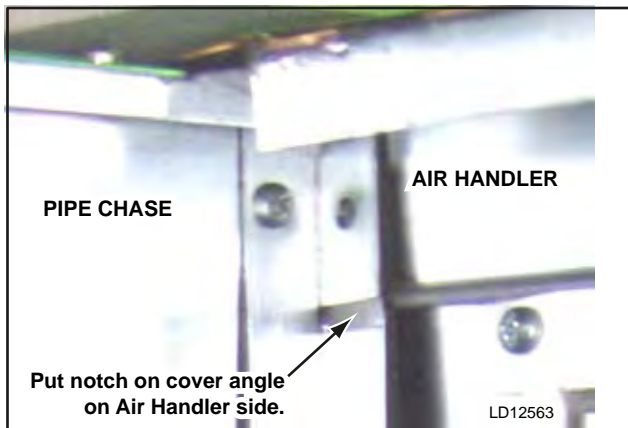
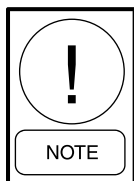

FIG. 2-49 – PROPER POSITIONING OF COVER ANGLE WITH NOTCH ON AIR HANDLER SIDE

- d) Attach the cover angle to the air handler and pipe chase panels. Install self drilling screws removed earlier to top and bottom holes on cover angle.
- e) Starting at the top and alternating between the air handler and pipe chase, continue installing self drilling screws until reaching the bottom. Use caution not to strip the housing (see Fig.2-50).

6. Install the Pipe Chase Baseraill Covers
(See Fig. 2-51)

- a) On the perimeter of the cover, caulk the underside as shown.
- b) Apply cover to exposed baseraill seam between pipe chase and air handler (both sides) (no screws required).



All pipe chase floor penetrations must be flashed, sealed and insulated to prevent condensation entering building.

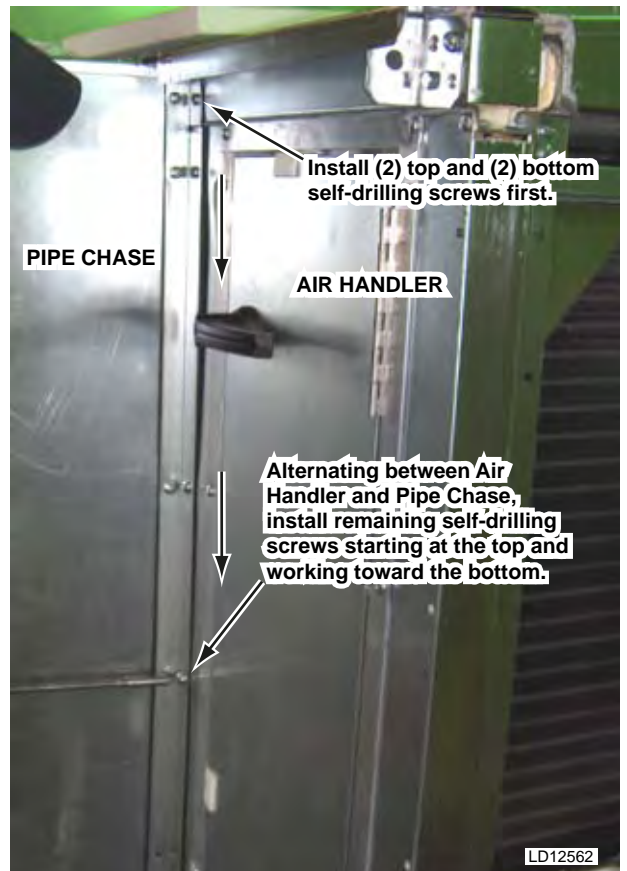

FIG. 2-50 – PROPER PATTERN FOR INSTALLING SELF-DRILLING SCREWS TO COVER ANGLE

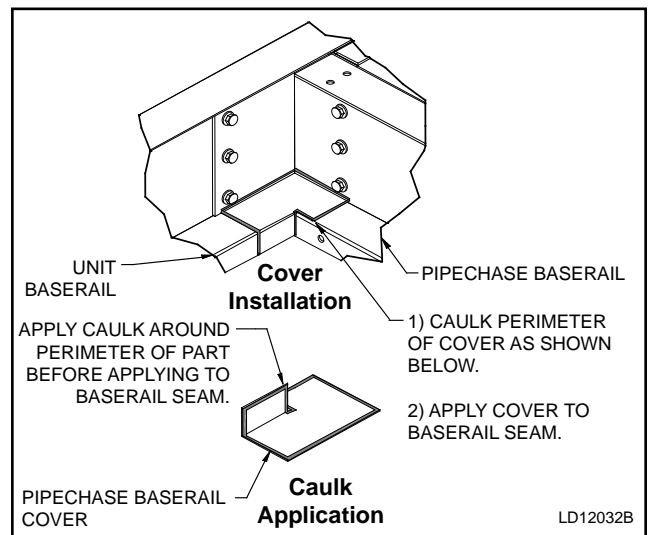
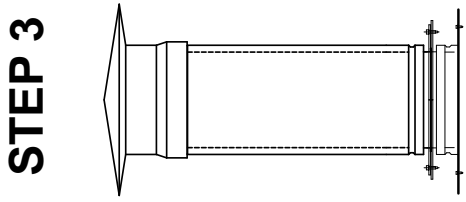
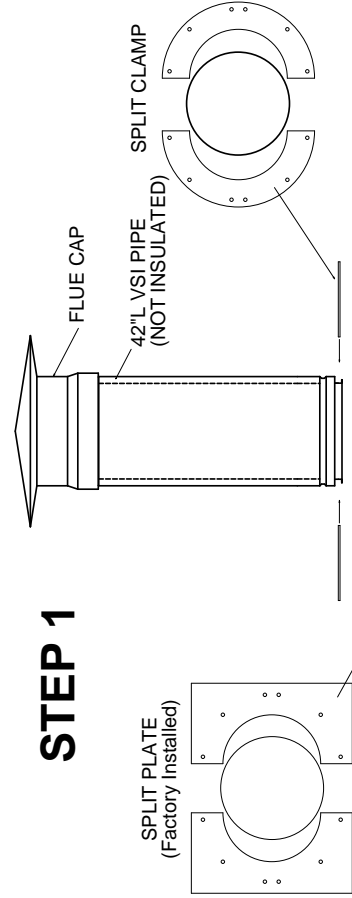
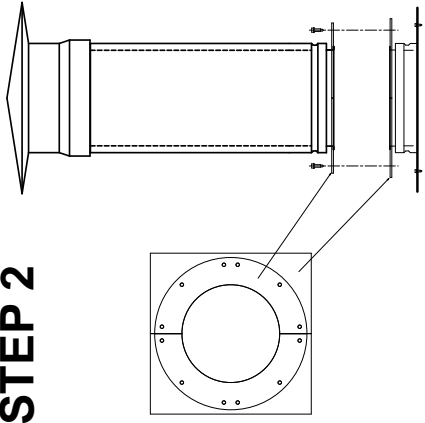

FIG. 2-51 – BASERAIL COVER APPLICATION

LD13326



STEP 2



STEP 4

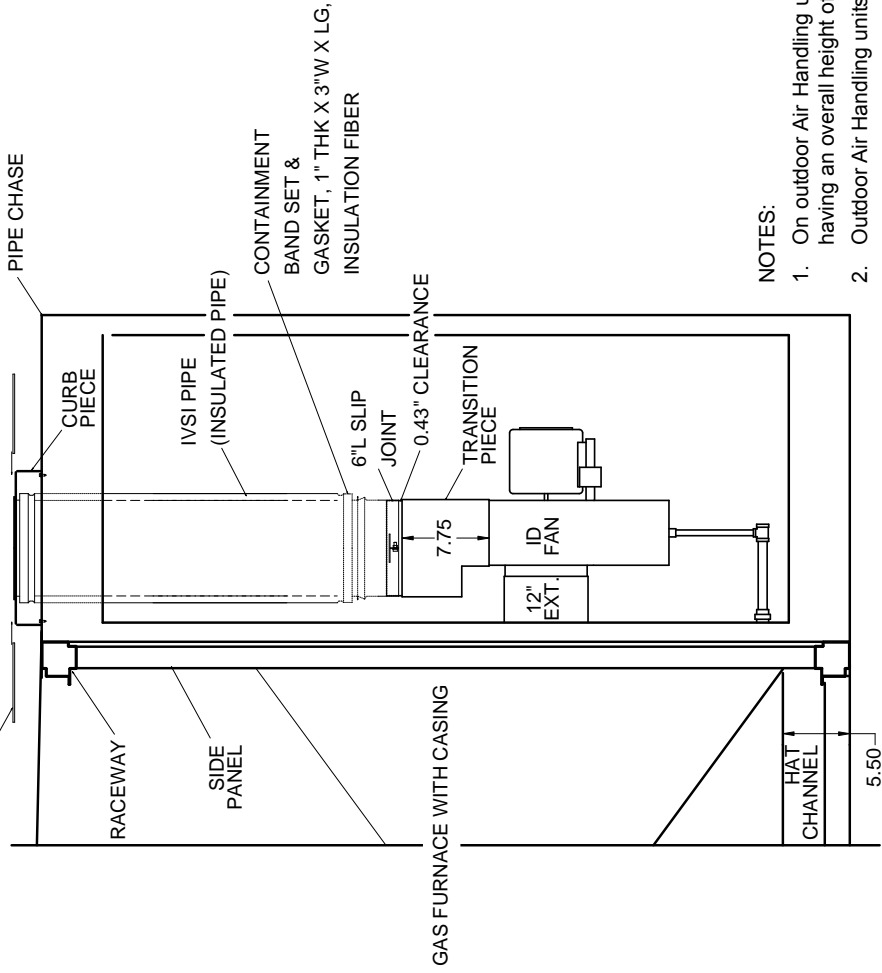
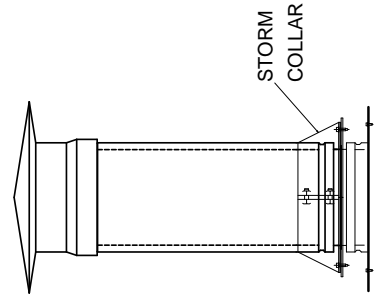

NOTES:

1. On outdoor Air Handling units the external flue/vent piping parts above the pipe chase are factory installed on units having an overall height of less than 102", including the vent piping.
2. Outdoor Air Handling units over 102" high will have the external vent piping parts shipped loose for field mounting.
3. On all outdoor Air Handling units the vent piping parts internal to the pipe chase will be factory mounted.

FIG. 2-52 – GAS FURNACE FUEL VENTING SYSTEM

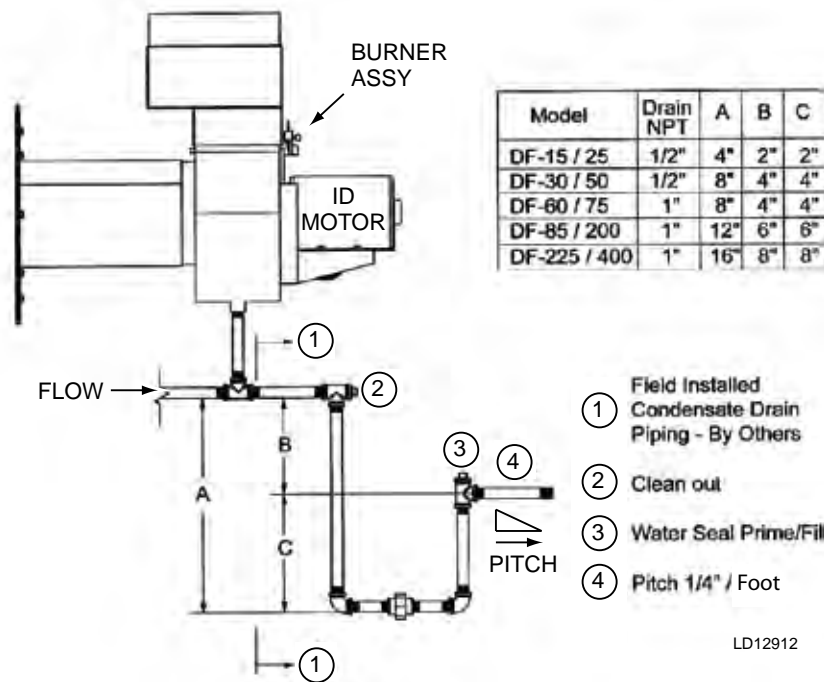
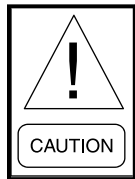

FIG. 2-53 – GAS FURNACE CONDENSATE DRAIN TRAP

Condensate Drain Arrangement

The YORK Solution Indirect Fired gas heat exchanger has the potential to create highly acidic condensation, particularly during extended operation at low capacity or low firing rate conditions. To insure proper drainage the following guidelines should be followed (See Fig. 2-53).



When constructing the condensate trap for the heat exchanger drainage system, make sure the trap is tall enough to handle the Total Static Pressure of the ID Blower at Low Fire times 2.

Example: TSP is 6" at Low Fire - construct trap 12" tall (See Table in Fig. 2-53).



Failure to follow these guidelines may cause excessive condensation build up resulting in water damage to the facility and/or a cracked heat exchanger.

1. Observe local jurisdiction codes for gravity condensate drainage requirements.
2. Be sure the air handler is installed at an elevation that enables proper condensate drainage and trapping dimensions as provided in Fig.2-53. Minimum trap dimensions MUST be accommodated.

3. Condensate drain line size must be the full line size of the heat exchanger drain connection.
4. Drain lines, fittings and supports should conform to local codes and be suitable for the application.
5. Condensate drain and trap discharge should be pitched away from the equipment at a slope of 1/4" per linear foot or as local code dictates.
6. For outdoor or unconditioned space installations local climate may dictate the need to heat trace and/or insulate the exposed drain lines and trap. Frozen drain lines and/or trap will cause build up of condensate inside the heat exchanger resulting in leakage and damage to the air handler and possibly to the facility.
7. Provide unions in drain lines to allow removal of trap for periodic cleaning of drain lines as well as the trap. When the burner is operated at low capacity for extended periods, more condensate is generated and with it deposits of solids in the condensate drainage system.
8. Provide the ability to prime the trap. During initial and seasonal start up, trap inspection and priming is required. Condensate in the trap will evaporate during long periods of non-use.

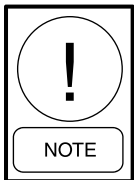
ELECTRICAL - GENERAL

All field wiring must conform to the National Electrical Code (N.E.C.) and possible local codes that may be in addition to N.E.C.

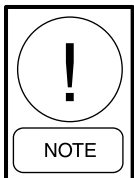

Unit is E.T.L. Listed. Some components are U.L. labeled. Any changes in the field may affect their validity.



***DO NOT PENETRATE any main or auxiliary drain pan.
DO NOT PENETRATE roof of outdoor unit.***



DO NOT PENETRATE WIREWAYS in any manner. These sheet metal channels, which run along the top panel, contain electrical wires and connections. Electrical shock and/or damage to the unit may result.

The current characteristics, phase, cycle and voltage are stamped on the nameplate of each component.

Electrical conduit connections made to exposed boxes on units should be made on the bottom of the box. Installation should comply with code requirements. Outdoor installation must be made watertight.

The installing contractor is responsible for electrical conduit penetrations through the building roof.

Penetrations through panels must be sealed (*see IOM Section 5 "Penetrations and Grommet Details"*).



Electrical conduits that penetrate the exterior (walls, pipe chase or floors) of the unit will need to be externally and internally sealed so that unconditioned air will not be drawn into the unit through and around conduit. This unconditioned air will result in condensation that will fail components prematurely.



All accessible electrical connections must be checked for tightness prior to the actual startup. Many of the connections contain several strands of wire, and while they were tightened at the time of assembly, they should be checked and re-tightened if needed. The danger of a poor connection is overheating and component failure.

Electrical drawings are provided in the information packet on the inside of a unit access door. Major optional components will have specific electrical and IOM information packed inside their control panels or attached. *See IOM Section 6 for generic electrical drawings.*

POWER CONNECTIONS

Single Point Power

Single Point Power when ordered provides the installer with a main disconnect switch. The line side of this switch (top) is where the installer is to land his main power wires. Devices included in the Single Point Power option are Supply Fan, Return Fan, Exhaust Fan, Energy Recovery Wheel, Gas Heat, Electric Heat and Ultra-violet Lights. Special Quoted devices may be purchased with the air handler that are NOT included in the Single Point Power option. These items will require separate, additional power wiring by the installer. When Single Point Power is NOT purchased the installer is responsible for wiring to each electrical component.

Motors for Supply Fan, Return Fan, Exhaust Fan

A motor connection diagram may be found on the inside of the motor terminal box or on a tag attached to the motor. Be sure to make a flexible conduit connection at the motor to permit fan belt adjustment and movement of spring isolated fan assembly. Refer to Motor Data Nameplate for all motor specifications (see Fig. 2-54).

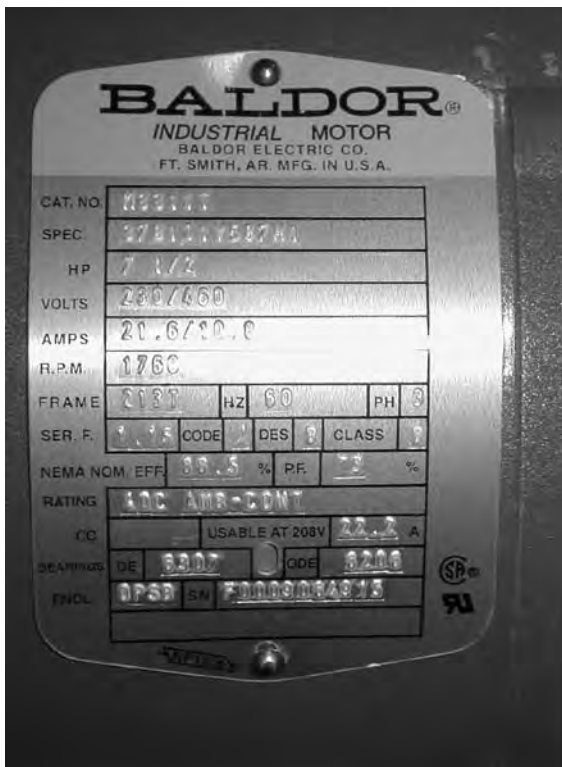

00495VIP

FIG. 2-54 – TYPICAL MOTOR DATA / NAMEPLATE

Energy Recovery Wheel Option

Wiring of this device is the responsibility of the installer if Single Point Power was not selected. Use of the attached plug and/or pigtail is optional. YORK does not provide pre-wired mating cables.

On wheels of 52" diameter and smaller the motor comes with a cord. Single Phase motors have a 3-pin standard AMP connector on the cord. Three Phase and VFD models have a 4-pin standard AMP connector on the cord.

On wheels of 54" diameter and larger the motor does not come with a cord.

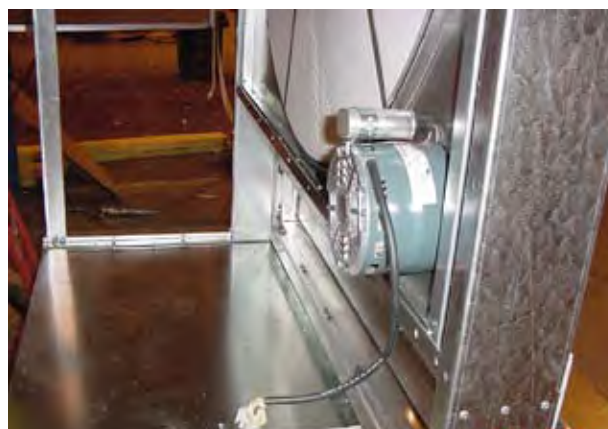

LD11591

FIG. 2-55 – TYPICAL POWER WIRING OF ENERGY RECOVERY WHEEL

Gas Heat Option

Wiring of this device is the responsibility of the installer if Single Point Power was not selected.

Panel locations and sizes vary based upon unit size and burner configurations.

Burner voltage is selected to match primary unit voltage.

Modulation control voltage to be 2-10 VDC as standard.

Electrical penetrations can come through the floor or side wall panels. Any penetration will have to be drilled and must be properly sealed to keep out moisture. Refer to IOM Section 5 “Field Penetrations for Piping and Electrical Connections”.

Make power connections per wiring diagrams, provided inside burner control panel. Also see generic diagrams in IOM Section 6. Refer to Fig. 2-56 and Fig. 2-57 for Gas Burner component locations.



LD11597

FIG. 2-57 – MAIN POWER AND CONTROL PANEL W/ COVER OPEN

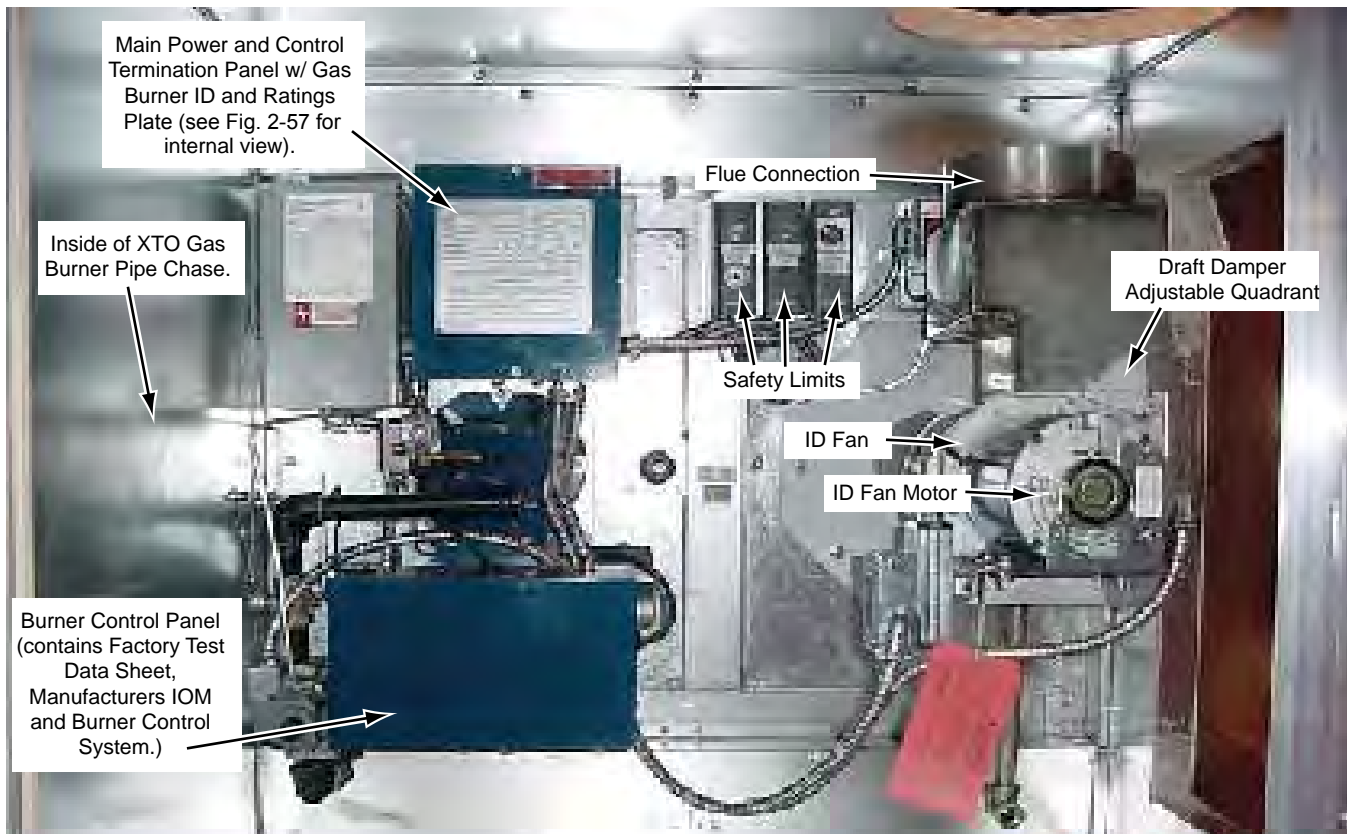

LD11596B

FIG. 2-56 – GAS BURNER COMPONENT LOCATIONS

Electric Heat Option

Wiring of this device is the responsibility of the installer if Single Point Power was not selected.

Available Power Options

- 460V-3PH.
- 208/230V-3PH.
- 380V-3PH.
- 575V-3PH.

Electric Heat Disconnect Switch Options

- Fused Disconnect.
- Non-fused Disconnect.

Knockouts are provided on the top and bottom of the enclosure for field penetrations. The YORK Solution foam panel will have to be drilled to utilize these knockout locations. Refer to IOM Section 5 “Field Penetrations for Piping and Electrical Connections”.

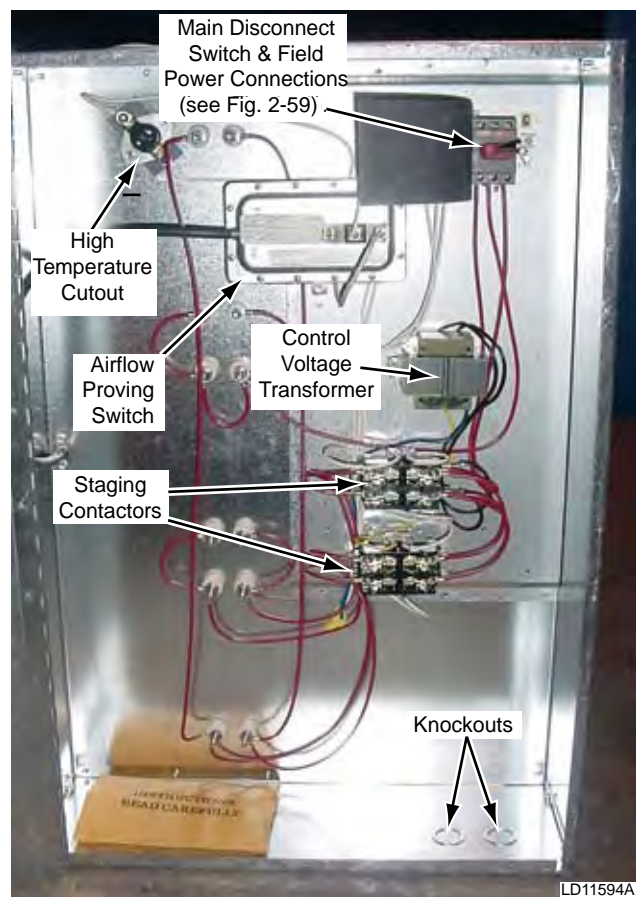

FIG. 2-58 – TYPICAL ELECTRIC HEAT CONTROL PANEL INTERIOR WIRING AND COMPONENTS

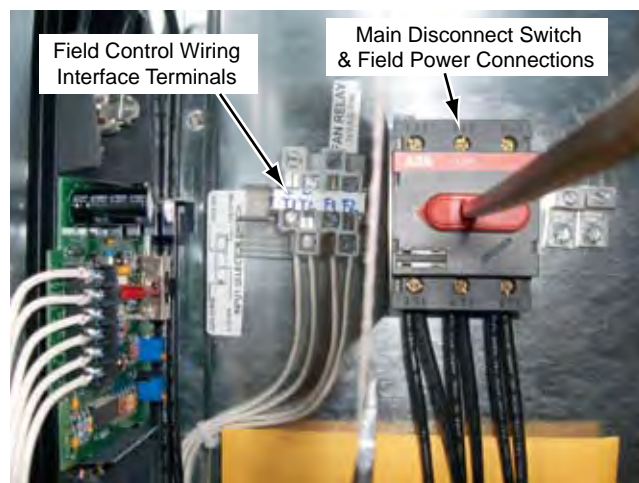

FIG. 2-59 – TYPICAL FIELD CONTROL AND POWER CONNECTIONS

Hook up power (see Fig. 2-59 for power terminals and Fig. 2-58 for control panel component location). Terminals shown are for a 2 stage 24 VAC control interface. Terminals may also require 120VAC control interface based upon options selected. See wiring diagram on inside cover of electric heat control panel.



Electrical conduits that penetrate the exterior (walls, pipe chase or floors) of the unit will need to be externally and internally sealed so that unconditioned air will not be drawn into the unit through and around conduit. This unconditioned air will result in condensation that will fail components prematurely.

All accessible electrical connections must be checked for tightness prior to the actual startup. Many of the connections contain several strands of wire, and while they were tightened at the time of assembly, they should be checked and re-tightened if needed. The danger of a poor connection is overheating and component failure.

DO NOT PENETRATE any main or auxiliary drain pan.

Available Control Options

- Staging - No controller, but contactors are energized by providing control power to each contactor from external BMS source.
- Step Controller - device to receive a 0- to 10 VDC or 4 to 20 mA signal and step on heat stages.
- Vernier SCR - completely electronically controlled by varying signal and varying output between stages. Increases power to a stage by modulation until another stage is needed. Energizes another stage and modulates power until another stage is needed. 0 to 10 VDC or 4 TO 20 mA. Less expensive than Full SCR. This system utilizes a step controller and one SCR that modulates and resets for each stage.
- Full SCR - completely electronically controlled by varying signal and varying output of a controller. Like a VFD for electric heat. 0 to 10 VDC or 4 to 20 mA. The controller modulates a separate SCR for each stage.

Installation



Rotating parts and electrical shock hazards exist. Lock out and tag out the fan motor(s) and heat power disconnects before servicing. FOLLOW THE LATEST "LOCKOUT TAGOUT" PROCEDURE. Failure to follow proper safety precautions may result in serious injury or death

APPLICATION INFORMATION

1. Follow the procedure given in this instruction to find the minimum air velocity for safe operation (see Fig. 3-25). At least this minimum velocity must be provided at all points over the heater face area. Failure to meet this requirement may result in serious damage or nuisance thermal cutout tripping.

2. The maximum air inlet temperature for open coil heaters is 100°F, and for finned tubular heaters, 80°F.
3. Sufficient working space must be provided per paragraph 110-26 of the NEC.
4. This electric heater is not designed for or intended to be used for temporary heat prior to system startup / balancing.

MECHANICAL INSTALLATION

1. All heaters will contain an adjustable airflow switch in the heater control panel. This switch will be preset to close at a differential pressure of approximately 0.3" W.C.

In all cases the switch will be connected to a pressure probe positioned in the airstream. This probe has an arrow stamped on it that is viewable from inside of the control panel. When the heater is located upstream of the fan this arrow will point away from the fan. When the heater is located on the downstream side of the fan the arrow will again point away from the fan or with airflow.

If it is incorrectly installed, remove the (2) screws holding the pressure probe in place and rotate 180° and reinstall. The airflow switch pressure port that is not connected to this pressure probe will be run to the exterior of the air handling unit to source a reference differential pressure. In some situations it may be necessary to adjust this airflow switch setting to allow for proper operation. Precautions must be made at this time to make sure that the airflow switch does not provide a false indication of airflow. Failure to meet this requirement may result in serious damage or nuisance thermal cutout tripping (see Fig. 2-60 and 2-61).

2. A visual inspection of the heater elements should be made prior to use of the heater. If physical damage is evident, a Megohm test should be used to validate the heater elements are safe for use. If a minimum value of 10 megohms is not achieved then any damaged elements or ceramic insulators must be replaced prior to operation.

TOP VIEW OF UNIT

POSITIVE PRESSURE / AIR BLOWN THROUGH HEATER

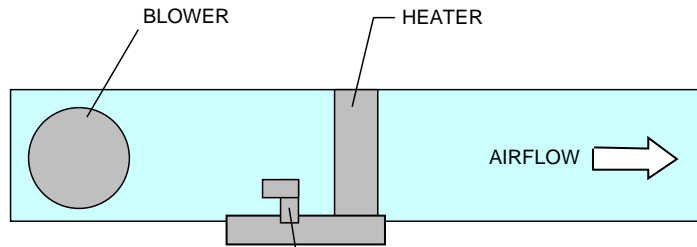

PICK UP TUBE TOWARDS BLOWER
ATTACHED TO "HIGH" PORT OF AIRFLOW SWITCH

NEGATIVE PRESSURE / AIR DRAWN THROUGH HEATER

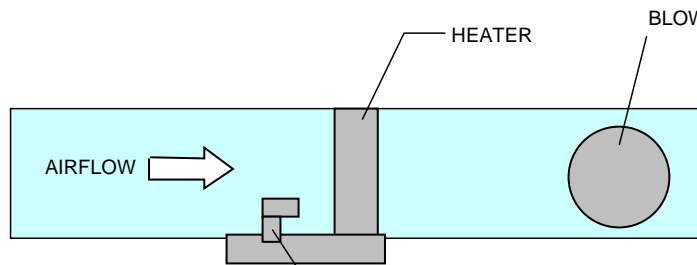

PICK UP TUBE TOWARDS BLOWER
ATTACHED TO "LOW" PORT OF AIRFLOW SWITCH

2

LD14268

FIG. 2-60 – PRESSURE PROBE DIRECTION

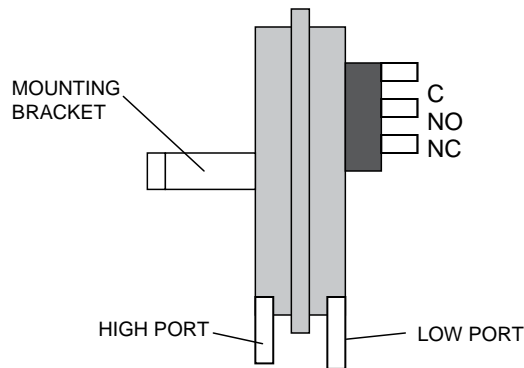

LD14270

FIG. 2-61 – AIRFLOW SWITCH CONNECTIONS

ELECTRICAL INSTALLATION

1. Follow the wiring diagram on the inside of the terminal box.
2. Supply connections must be made with copper wiring rated for 75° C minimum.
3. If supply connections are for 250 volts or greater, all wiring must be insulated for 600 volts.
4. When making line connections to heater element terminals FOR FINNED TUBULAR HEATERS ONLY, apply a 1/4" wrench to flat section of terminal immediately below threads. Otherwise damage to terminal may result.
5. Supply conductors for heaters rated less than 50 KW, must be sized at 125% of rated load. On heaters rated 50 KW and more, the supply conductors may be sized at 100% of rated load, if indicated on the wiring diagram. The line current for either a single or three phase load is calculated as follows:

$$\text{Single Phase Line Current} = \frac{\text{KW} \times 1000}{\text{Voltage}}$$

$$\text{Three Phase Line Current} = \frac{\text{KW} \times 1000}{\text{Voltage} \times 1.73}$$

6. The following table shows the maximum current for 75 °C copper wire with not more than 3 conductors in a raceway. It is based on the National Electrical Code Table 310-16. The amperages shown are for 125% and 100% wire sizing. If there are more than 3 conductors in a raceway, derate these amperages per Table 310-15(b)(2)(a).

MAXIMUM CURRENT FOR COPPER WIRING								
AMPS		WIRE SIZE AWG/ MCM	AMPS		WIRE SIZE AWG/ MCM	AMPS		WIRE SIZE AWG/ MCM
125%	100%		125%	100%		125%	100%	
12		14	80	100	3	184	230	4/0
16		12	92	115	2	204	255	250
24		10	104	130	1	228	285	300
40		8	120	150	0	248	310	350
52	65	6	140	175	2/0	268	335	400
68	85	4	160	200	3/0	304	380	500

7. When connecting heaters with more than one stage, wire stage No. 1 so that it is the first stage on and the last stage off.
8. The heater must be wired so that it cannot operate unless air is flowing over it. This can be accomplished by using a built-in airflow switch and a remote interlock. *See the accompanying wiring diagram for the method used with this heater and provide appropriate interlock wiring as illustrated.* This diagram will be located inside of the electric heater control panel.
9. If not supplied as part of this heater, install a line disconnect switch or main circuit breaker in accordance with the National Electrical Code. Depending upon the heater's location and accessibility, a built-in disconnect switch may meet this requirement.
10. All electrical connections in the heater, including both field and factory made connections, should be checked for tightness before operating the heater. In addition, after a short period of operation, all connections should again be checked for tightness.
11. If heater is wired to a heating / cooling thermostat, use a thermostat with isolating circuits to prevent possible interconnection of Class 2 outputs.
12. If the heating elements are divided into several sections with resistance wire between two or more sections, maximum KW per sq. ft. should be calculated as follows:

$$\frac{\text{Heater nameplate KW}}{\text{Number of heated sections} \times \text{area of one heated section}}$$

Humidifier Option (Electric)

Wiring this device is the responsibility of the installer. This device is not included in any Single Point Power options. Fig. 2-62 represents a typical electric humidifier panel layout. The supply power knockout is located in the bottom of the electrical panel as seen in Fig. 2-63. All conduit beginning or ending inside pressurized or conditioned areas (i.e. air handler) must have all openings of conduit sealed to prevent air from passing through. All air handling unit penetrations must be sealed to prevent air and water leakage (*see IOM Section 5 “Penetrations and Grommet Details”*). Field provided disconnects must provide circuit protection according to the humidifier nameplate. All field wiring to the humidifier must be in accordance with NEC and local codes and by laws.



KNOCKOUTS

LD11727

2

FIG. 2-63 – SUPPLY POWER KNOCKOUTS



LD11726

FIG. 2-62 – TYPICAL HUMIDIFIER PANEL LAYOUT

Humidifier Option

Control wiring diagrams are located in the humidifier manufacturer's IOM found inside control panel or attached. Factory package control drawings may not include humidifier points.

If humidifier IOM cannot be located inside humidifier, call Johnson Controls Airside Product Support for information on receiving an electronic version of the IOM.



LD11725

FIG. 2-64 – HUMIDIFIER POINTS

PIPING CONNECTIONS

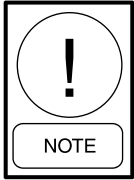

Do not remove bottom panel in pipe chase.

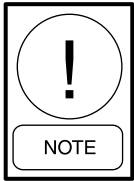

When extended piping to or from coils, humidifiers, etc., is present inside the air handler, field provided and installed insulation is required.

Whenever possible, piping should be brought down through outdoor units within the pipe chase (see Fig. 2-65).

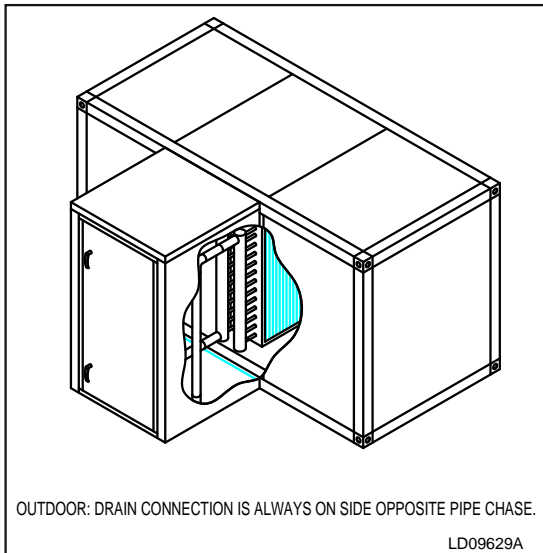

Usable working clearance is approximately the depth of the pipe chase minus 5".
All dimensions are approximate and not certified for construction.

FIG. 2-65 – PIPE CHASE ENCLOSURE

Penetrations through pipe chase floor must be flashed and sealed. Penetrations through panels must be sealed (see IOM Section 5 “Penetrations and Grommet Details”).

Where piping is insulated, insulation should not be installed until after the flashing has been completed.

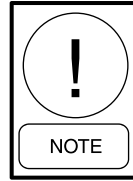

Pipe chase should be installed before piping is connected.

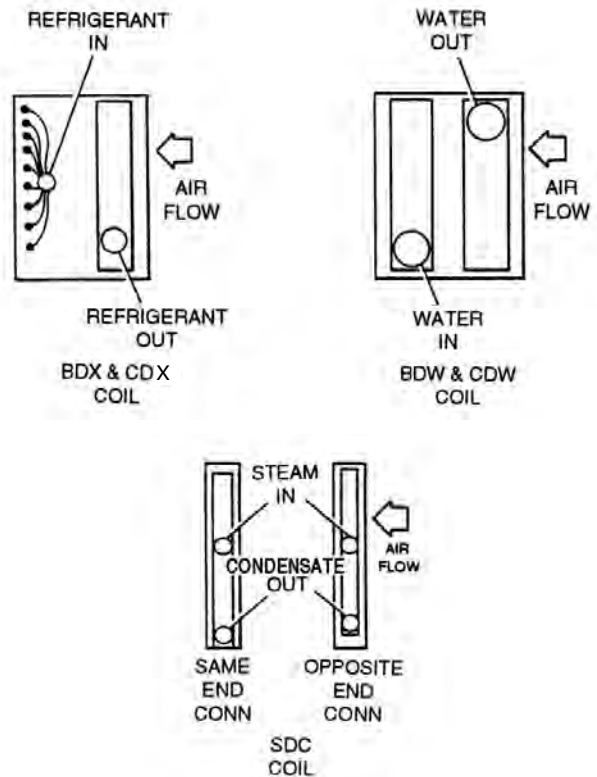

LD06340-1

FIG. 2-66 – FACTORY COIL CONNECTIONS

Coil Piping

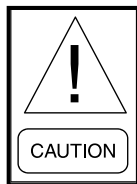

Do not test, clean and flush piping through this equipment.

Isolate this equipment from pressure testing of water, steam gas and air piping.

Consult the job specifications and submittal drawings for specific piping requirements, coil connection sizes and location. The unit should be level to assure proper venting and draining of coils. The piping arrangements must provide for a balanced flow in multiple coil installations (*see Fig. 2-66 showing factory coil connections*).

Support all connecting piping independently of the coils. Provide swing joints or flexible fittings in all piping connections, particularly adjacent to heating coils, to absorb expansion and contraction strains. Rigid piping connections can cause coil damage.

The coil supply and the return pipe connections are labeled. When attaching piping to the coil header, make the connection only tight enough to prevent leaks. Excessive tightening may cause damage to the header. A backup wrench should be firmly held on the coil connection so that in tightening the connecting piping the torque is not transmitted to the coil header, thus damaging the coil connection.

Application Notes - All connections are male piping thread except DX coils, which are solder. Drain and vent taps on water coils are pipe thread shipped with plugs installed. These taps are installed approximately two inches back from the end of the threaded connections.



Pipe for balanced flow and assure even airflow.

Staggered Coils

Staggered Coils in Expanded Cabinet size units will have connections brought to the unit exterior for liquid or steam coils. DX coils are not included.

- The external connections are either threaded pipe or grooved pipe for the contractor to make his connections when the media is liquid.
- The external connections are threaded pipe for the contractor to make his connections when the media is steam.
- The installing contractor is responsible for insulating piping extensions we provided inside the air handler.

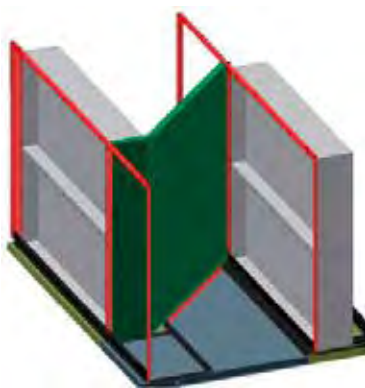

STAGGERED COIL – ANGLE WALL

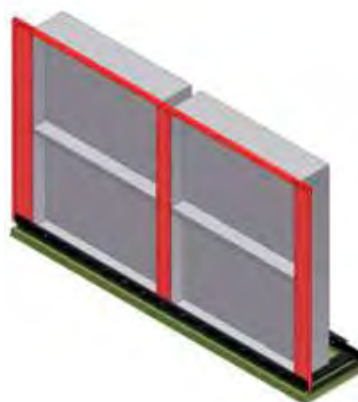

STAGGERED COIL – OPPOSITE SIDE CONNECTIONS

FIG. 2-67 – STAGGERED COIL CONFIGURATIONS

Water

Water Coils - Hot Water and Chilled Water

Connect the water supply to the header connection on the leaving air side of the coil to achieve the counter flow of water and air. The return pipe will be connected to the remaining coil connection.

Install an air vent in place of the top pipe plug on the return header. In order to provide for drainage, install a drain line and shutoff valve in the supply near the coil or in place of the plug in the supply connection. See Figs 2-68, 2-69 and 2-70 for typical piping diagrams.

Hot and Chilled Water Coil Performance

The temperature rise of the air (hot water coil) or temperature fall of the air (chilled water coil) leaving the coil is dependent on the airflow across the coil, the gallons of water flow through the coil and the entering water temperature into the coil. Consult the submittal for each job for the specific information.

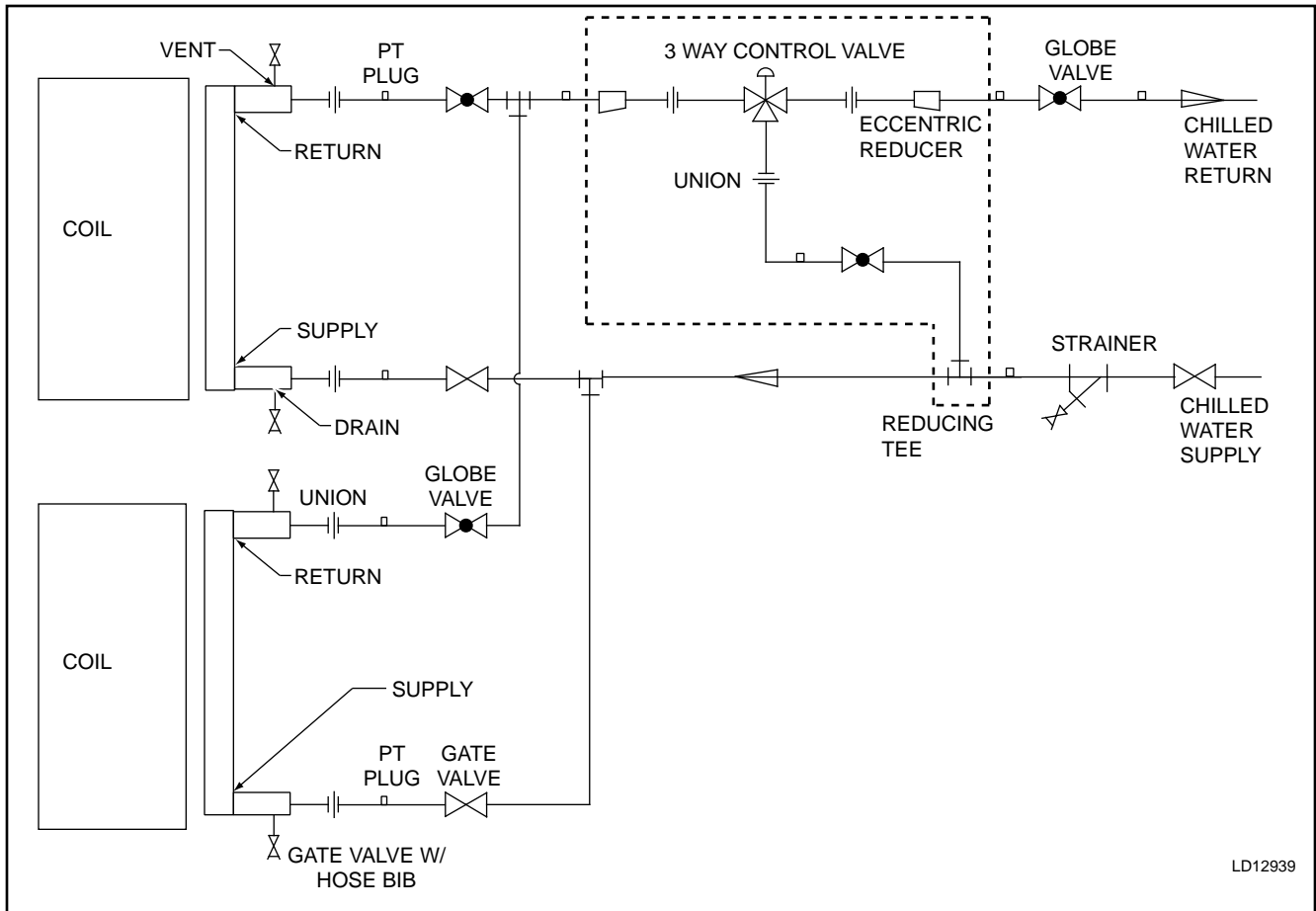

FIG. 2-68 – CHILLED WATER COIL CONNECTIONS Example - NOT for construction

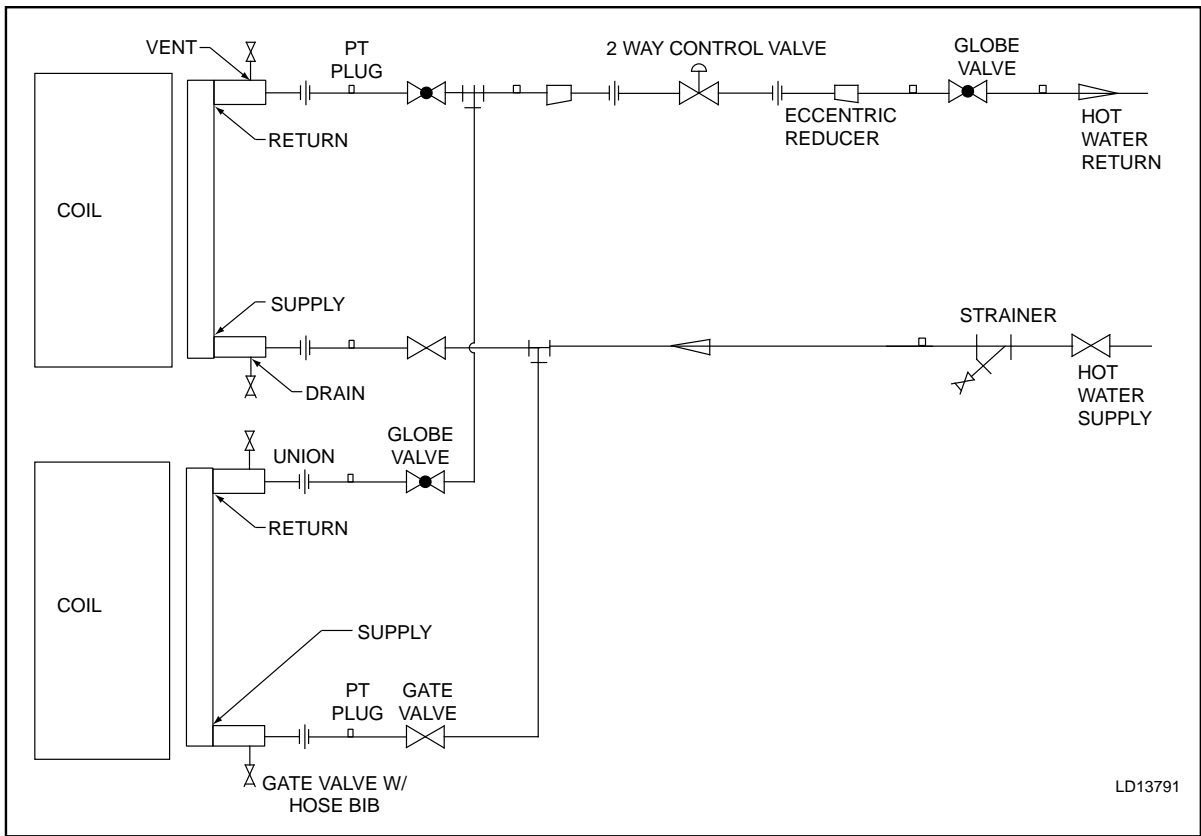

FIG. 2-69 – HOT WATER PIPING - 2 WAY VALVE Example - NOT for construction

2

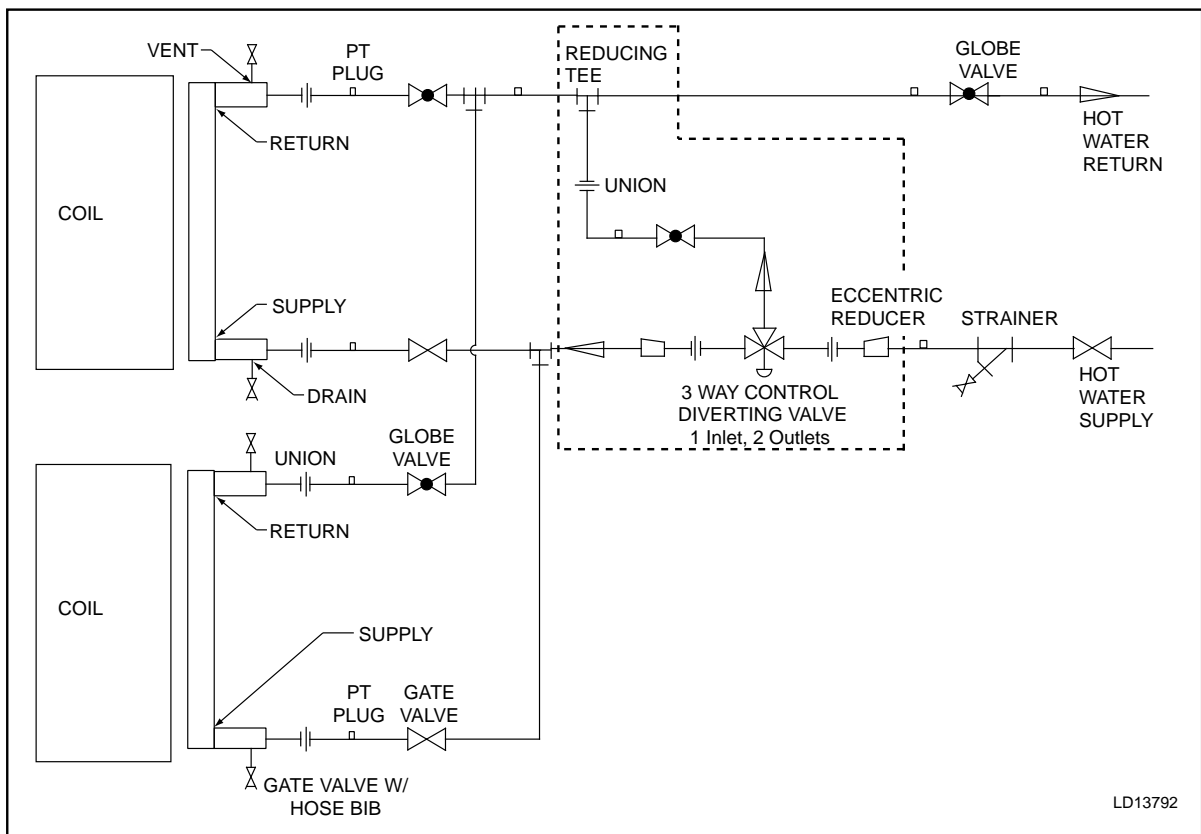

FIG. 2-70 – HOT WATER PIPING WITH DIVERTING VALVE Example - NOT for construction

Water Treatment

Any copper tube coils may be attacked by acid condensate. The practice of boiler water treatment should include CO₂ removal to assure longer tube life.

Freeze Protection

Chilled water, hot water and steam coils can be damaged during freezing weather. Precautionary measures must be taken to prevent freezing such as:

- Positive coil freeze protection must be used in installations where any part of the water coil is subjected to temperatures of 32°F or lower. This may be accomplished by using a suitable antifreeze solution. If the coil is not in use, it is recommended that the coil be completely drained and the inside of the tubes blown dry with compressed air.
- After draining, flush coils with an antifreeze solution such as glycol. A solution of 50% glycol and 50% water will protect from freezing to approximately 35°F below zero at sea level. *Also, refer to ASHRAE and ARI guidelines.*
- During winter operation due to the possibility of shutdowns such as power failure, night shutdown and weekend shutdown, the controls should be installed so the return air dampers will go to the full open position, and all fresh air dampers go to the full closed position. A source of auxiliary heat must be maintained inside the unit cabinet.
- Other means of protection such as various electro-mechanical switches and the full constant flow of water can be used; however, Johnson Controls will not be responsible for any coils damaged by freezing.

Steam

Refer to Fig. 2-71 "Steam Coil Piping Arrangements."

Steam Coils

The operation of steam coils is dependent on airflow quantity and temperature. Consult the submittal issued for each specific unit for above information.

Steam Distributing Coils

Do not bush or reduce the coil return pipe size. Use a full size return pipe to the bottom of a dirt pocket. The supply pipe may be reduced at the coil connection if necessary. Install the coil casing level with the return down. A coil must be sufficiently elevated to allow a 12 inch minimum drop between the return connection on the coil and the trap. A greater than 2 inch drop is required for protection from freezing. The return main should be located below the trap. *Refer to Fig. 2-71.*

Steam Control

Continuous steam supply ensures long coil life and minimizes potential trapping, venting and freezing problems. A rapid cycling of the modulating steam supply or a frequent on-off steam supply control results in repeated thermal and piping stresses which will shorten the coil life. Modulating steam control valves must not be oversized but must be carefully selected. A substantial variation in the supply pressure will require the installation of a pressure-reducing valve ahead of the automatic control valve.

Light load operation with a modulated steam supply can be improved by the installation of a vacuum breaker check valve. An open relief line to the atmosphere from the return line near the coil is desirable, except on vacuum systems.

With a modulated steam supply, it is not practical to lift the condensate to an overhead return. Locate the coil well above the return, or provide condensate unit, or a boiler return trap below the coil.

Individual control valves are required on each coil installed in series with respect to airflow. When a modulating steam valve supplies two or more coils in parallel, with respect to airflow, the piping must be designed to provide for uniform steam distribution to each of the coils.

Steam Traps

Float and Thermostatic (F and T) traps are recommended for all low or medium pressure applications. Use thermostatic traps only for air venting, for outdoor applications where an F and T trap might be subject to freezing. Use bucket traps only for a non-modulated steam supply. Size the steam traps in accordance with the manufacturer's recommendations (usually several times the steady state steam flow). Use the actual operating conditions (coil pressure vs. return pressure) for the selection of a trap.

It is preferable to provide an individual trap for each coil but a single trap may be used for coils operating in parallel with respect to the airflow. Coils in series with respect to airflow must be supplied with individual traps. Locate the trap at least 12 inches below the coil return connection and even lower when freeze protection is required. Do not attempt to lift condensate modulated steam supply.

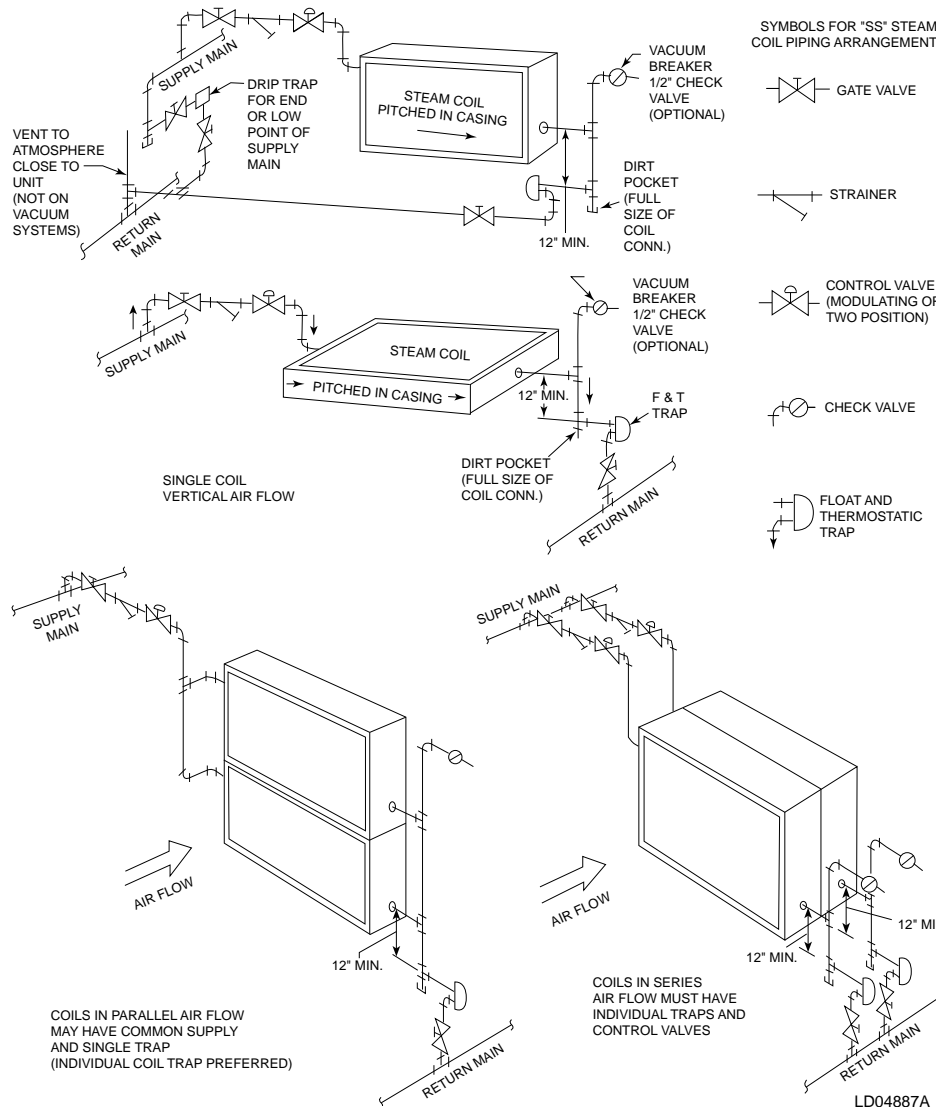
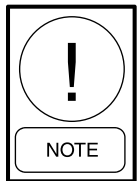

FIG. 2-71 – STEAM COIL PIPING ARRANGEMENTS



FIG. 2-72 – INTEGRAL FACE AND BYPASS COIL (HORIZONTAL; TUBES, STEAM SHOWN)

VIFB and IFB



A complete IOM is provided with each IFB or VIFB coil unit.

Below 35°F, the Vertical Tube Integral Face and Bypass (VIFB) or Integral Face and Bypass (IFB) operates with full steam pressure or full water flow at all times. This prevents freeze-up and temperature stratification.



VIFB lower header must be free to float. After coil has been piped, remove yellow colored bolts to allow header to float. Always “back up” on the coil connections when installing fittings.

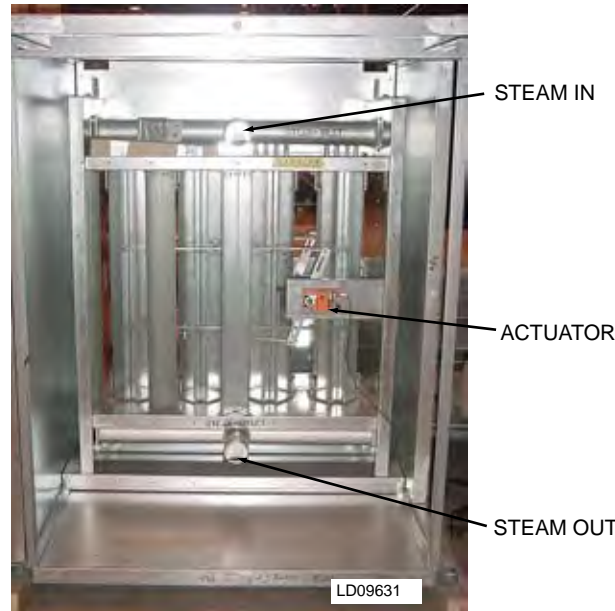
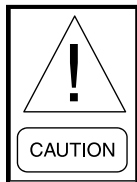
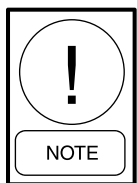

FIG. 2-73 – VERTICAL INTEGRAL FACE AND BYPASS COIL (FACE MOUNTED ACTUATOR SHOWN)



VIFB Warranty will be voided should return piping on lower header (inlet and return on two-row header) not include flexible connector(s) and if lower header(s) bolts are not removed prior to use.



See IFB/VIFB manufacturer's IOM for additional piping details. Factory does NOT pipe connections to unit exterior.

Shipping Bolts (VIFB Only)

Return steam condensate headers or hot water supply and return headers are securely bolted to lower mounting brackets to prevent damage to header and tubes during shipment and piping of the coils. These bolts **MUST** be removed before applying steam or hot water but after all piping connections are made.

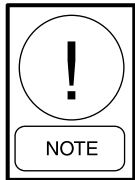
Piping Suggestions (VIFB and IFB)

See IOM Section 5, “Field Penetrations for Piping and Electrical Connections”.

Steam and hot water field piping must be supported separately after the flexible connector to isolate piping strains and additional expansion from the coils.

Internal steam manifolds and piping should be insulated.

Steam traps should be sized for three times the calculated condensate loading at the coil design conditions, based on the pressure differential across the trap, **not the boiler pressure**. Traps should be of types that pass condensate and air at saturated steam temperature. Inverted bucket traps should incorporate thermostatic air vents.

Make return connection full size as required and reduce only at trap. Do not use reducing bushing on coil return connection.

Flexible Connectors (VIFB Only)

Return steam condensate headers, hot water supply, and return headers must be free to float. A flexible connector **MUST** be installed as close as possible to the coil to accommodate a minimum of 1/2” expansion movement of the headers.

Failure to install connectors will restrict expansion of the headers. This can result in bowing of tubes, bending of fins, interference with damper operation, or eventually tube breakage.

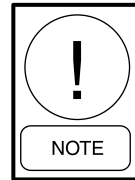
Freezing Conditions

Anti-stratification baffles are standard on all IFB and VIFB coils mounted in YORK Solution units.

The outside air and return air must be thoroughly mixed before passing over the coil. When freezing air enters only part of the coil, it creates a greater hazard than when the airflow entering the coil is of a uniform temperature.

Coils used in series with respect to the airflow must have individual controls with ample space between the coils for sensing devices, when required. Coils with two or more rows are more sensitive to freezing than single row coils.

On 100% outside air capable applications, locate low limit at least 24" downstream of leaving edge of VIFB/IFB casing. Low limit element must cross both face and bypass areas, parallel to headers.

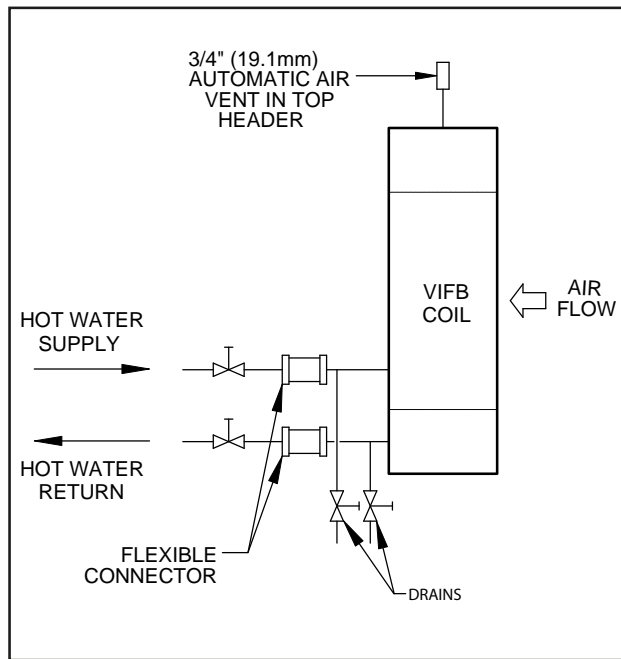

FIG. 2-74 – HOT WATER PIPING FOR 2 ROW COIL VIFB

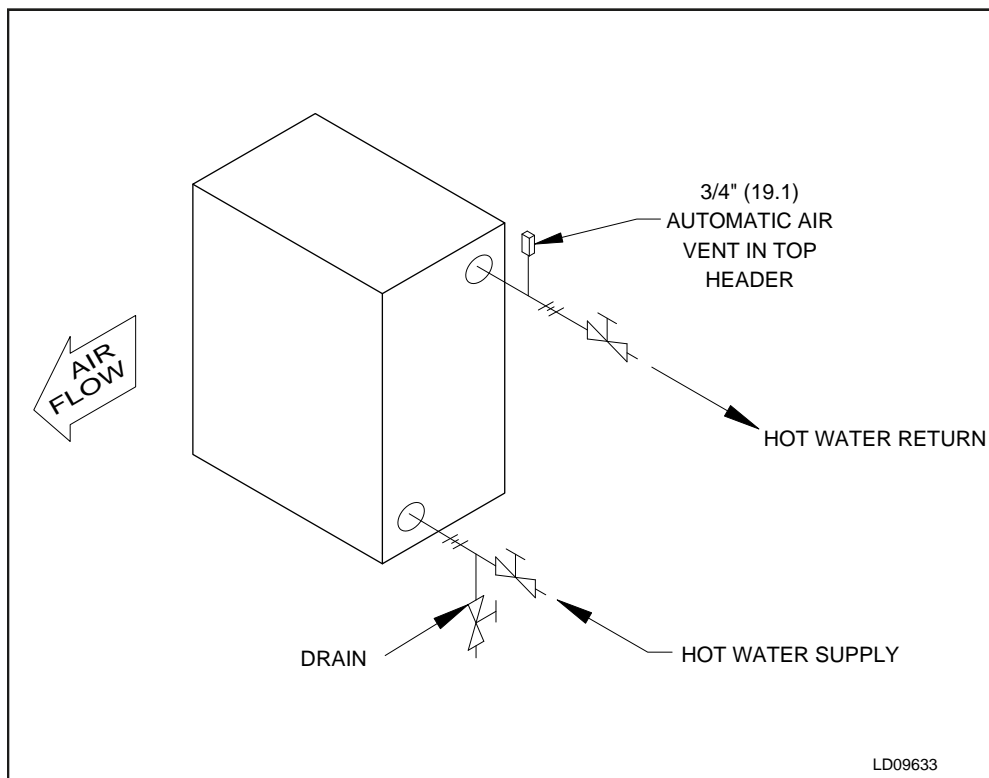

FIG. 2-75 – HOT WATER PIPING FOR IFB

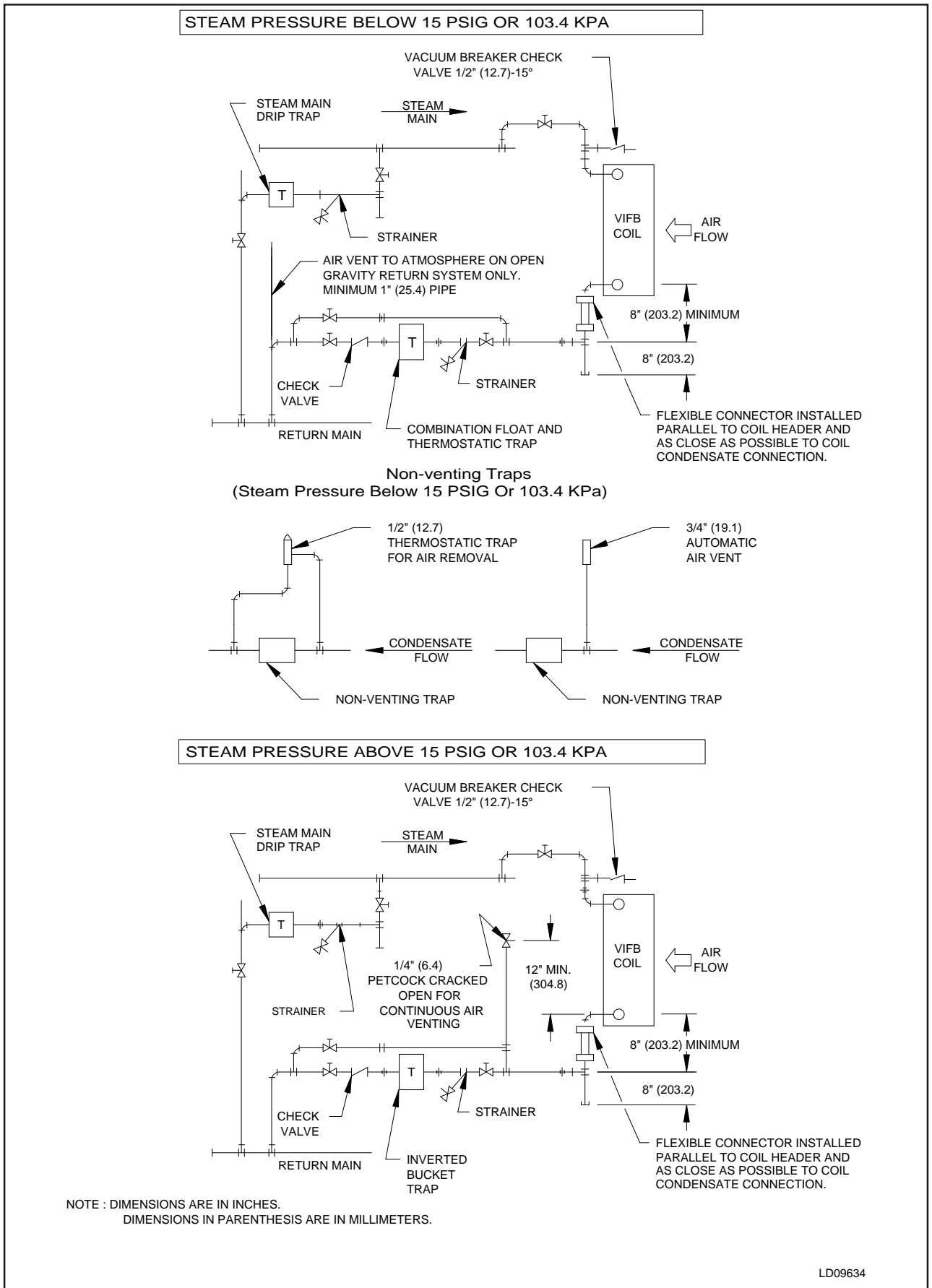

FIG. 2-76 – STEAM PIPING FOR VIFB COIL

Refrigeration

Direct Expansion Coils (DX)

DX coils are divided into splits depending upon the unit size and coil circuiting. Each split requires its own distributor nozzle, expansion valve and suction piping. Suction headers are on the air entering side with suction connection at bottom end of headers when the coil is properly installed. Matching distributor connections for each coil refrigeration circuit are on the air leaving side. See certified drawing and/or connection labeling to ensure correct matching of suction and distributor connections.

Do not leave piping open to the atmosphere unnecessarily. Water and water vapor are detrimental to the refrigerant system. Until the piping is complete, recap the system and charge with nitrogen at the end of each workday. Clean all piping connections before brazing joints.

The orientation of the refrigerant distributor is not critical but the distributor tubes must not be kinked or bent in a non-uniform configuration. For this and other piping and sundry tips, refer to Fig. 2-77.

The orientation of the refrigerant distributor is not critical but the distributor tubes must not be kinked or bent in a non-uniform configuration. For this and other piping and sundry tips, refer to Fig. 2-77.

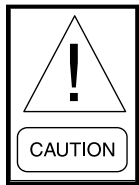

Direct-expansion coils are shipped charged with nitrogen.

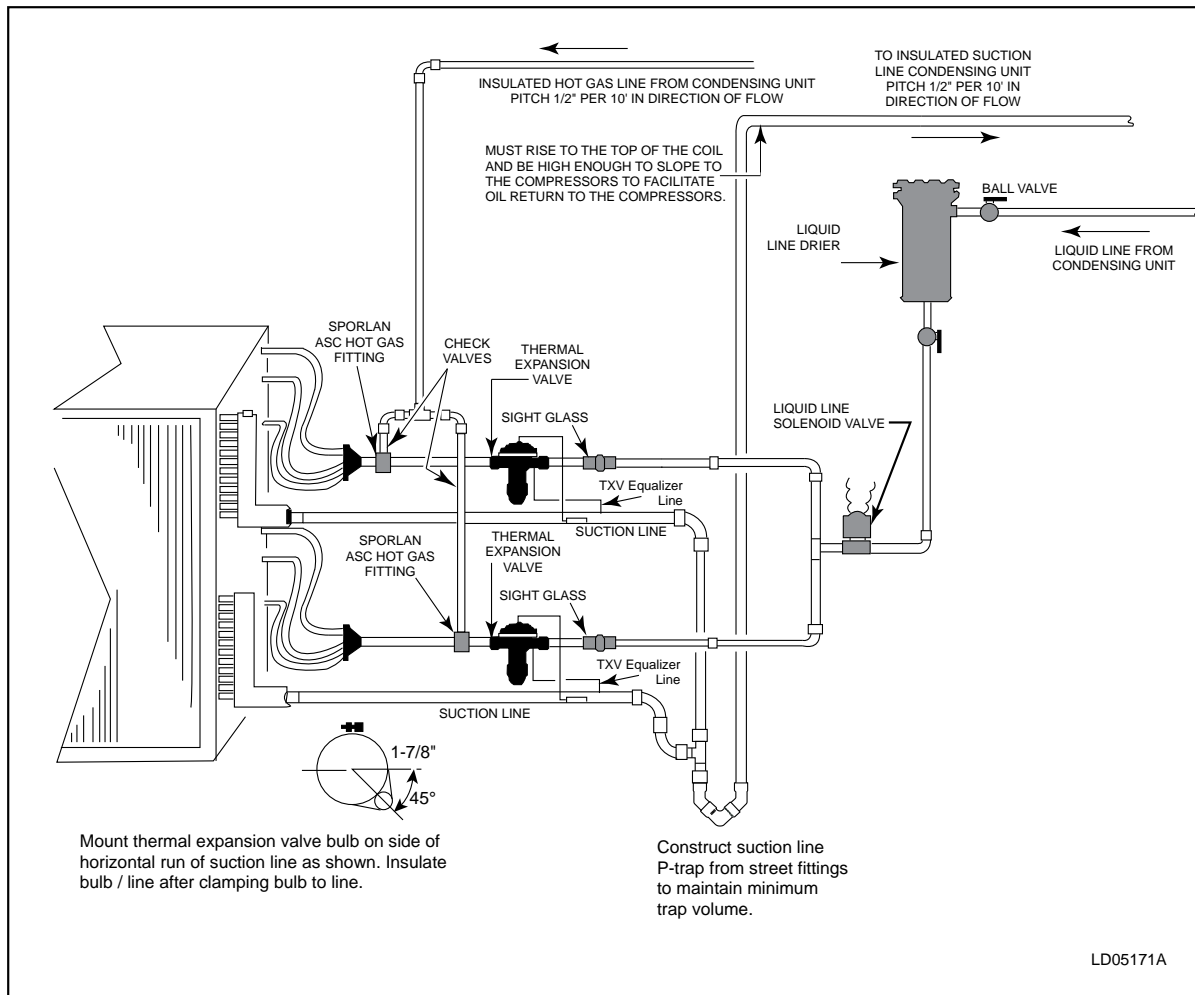

FIG. 2-77 – TYPICAL PIPING AND SUNDRIES AT THE DX COIL

DX Coil Types

There are three basic types of coil arrangements used in field erected split systems, interlaced, row split and face split.

Interlaced

Interlaced coils are the most desirable type of coil “field erected” designs. Interlaced coils ensure the entire face of the coil is active with any number of compressors operating. Interlaced circuitry interweaves coil tubing in both circuits across the entire face of the coil assuring uniform cooling of the air by the refrigerant. This type of coil also allows one circuit to operate while the other circuit is turned off. Interlaced coils provide excellent temperature control at full and part loads as well as good TXV superheat control. TXV control is essential for compressor reliability.

Row Split

Row split coils arrangements place coils back to back in the air stream. Air passes through one coil before passing through the next. Generally, the last coil in the air stream is activated first. Each circuit may be controlled independently in this arrangement. When both coils are operating, the coil closest to the leaving air will operate at a lower temperature. This type of coil may not permit lead lag of the circuits and it may be difficult to balance the capacity between the coils

Face Split

On a face split coil, the circuiting is divided between two separate coils. In field-erected systems, this arrangement may suffer from TXV superheat control problems and compressor reliability. At low airflow, low load situations, the TXV may have difficulty controlling system superheat.

Air stratification, poor humidity control and condensation on downstream components can also occur when using face split coils. One way to address TXV control at part load is to provide a face damper to shutoff airflow when a coil face is inactive.

Combined Coil Types

Coil types may be combined in some systems. This requires special care. Control sequences and piping tying the multiple systems and coils together should be well thought out and advice from an experienced design engineer is necessary.

DX Coil Circuiting

On many coil banks, two, or even all three of the methods of circuiting may be combined depending upon the cooling capacity and the level of control required. However, coil sections must be married or combined so that they provide for full-face operation (see Fig. 2-78).

There are numerous coil arrangements available from the Coil Marketing group as either standard designs or contract engineering SQ optional designs. The coil designs fall into the two following categories.

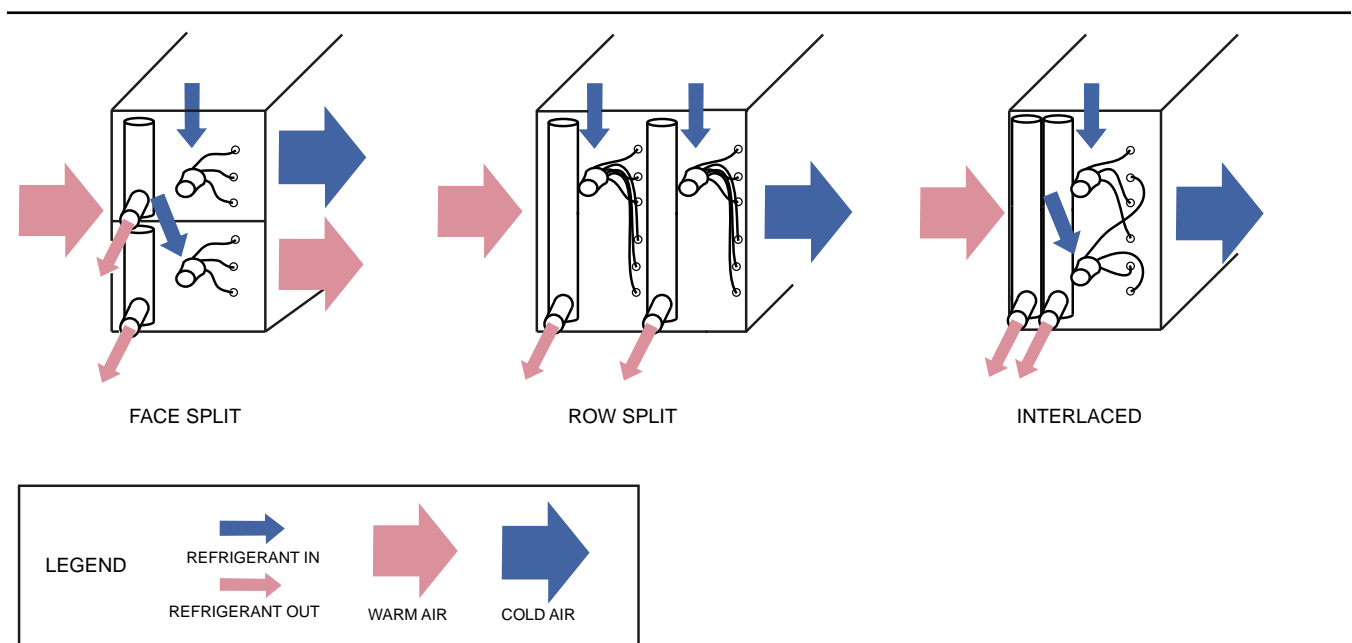
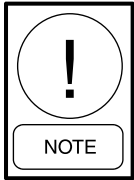

FIG. 2-78 – DX COIL CIRCUITING TYPES

LD13319B

Coil Design	Fin Height
Non-stacked	48" and less
Stacked	Greater than 48"

Figs. 2-79 through 2-83 illustrate the available coil arrangements. Contact Coil Marketing for other arrangements not shown.



Face-split DX coils must be configured to provide full-face coverage at all condensing unit load steps. Johnson Controls assumes no responsibility for compressor failure if full-face coverage is not applied. Consult the factory, if application assistance is needed to convert split face to full-face operation.

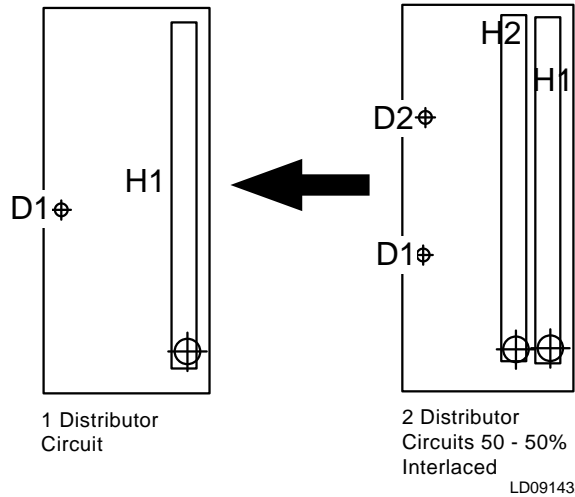

FIG. 2-80 – NON-STACKED COIL DESIGN - STANDARD

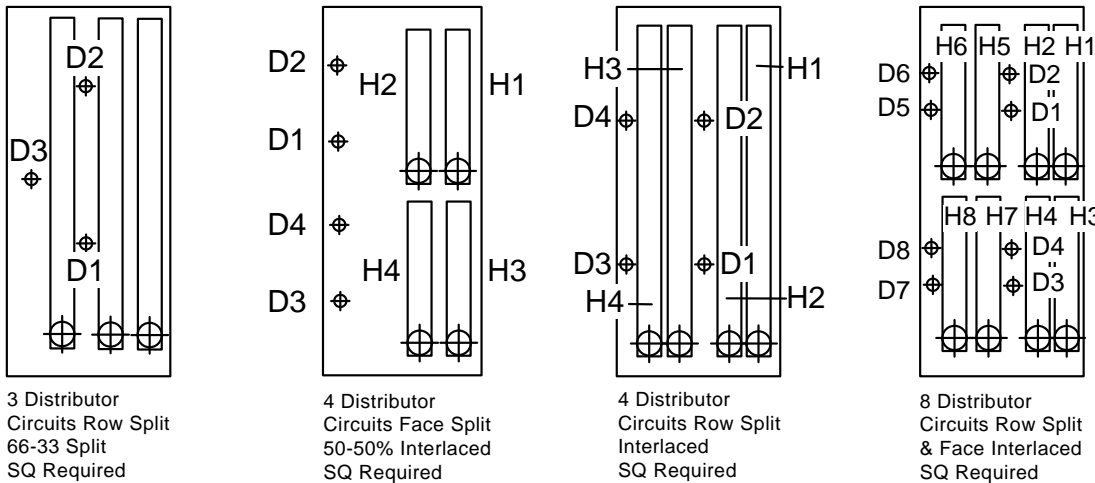
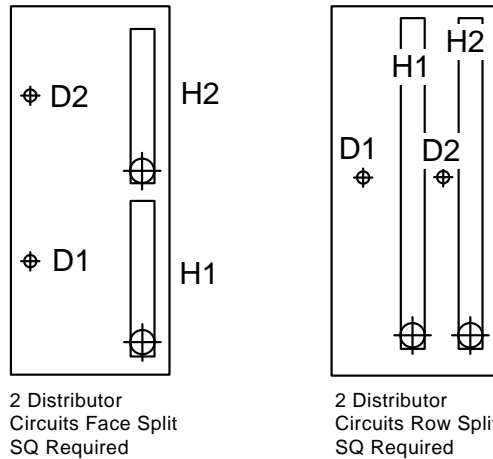

FIG. 2-79 – NON-STACKED COIL DESIGN - SQ SPECIAL

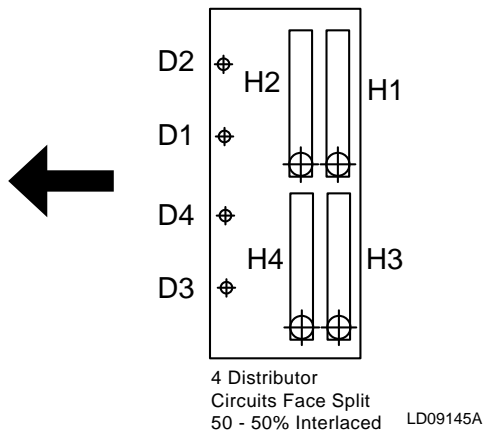

FIG. 2-81 – STACKED COIL DESIGN - STANDARD

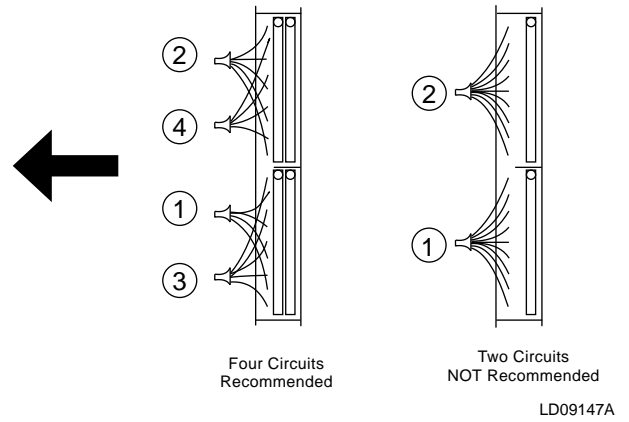

FIG. 2-83 – STACKED COIL CIRCUITING

DX Coil Circuiting And Staging

On stacked coils, a minimum of four coil circuits should be used to achieve full-face control (Fig. 2-83). Each coil distributor circuit requires its own Thermostatic Expansion Valve (TXV). Each condensing unit circuit requires its own liquid line solenoid valve (LLSV). When the condensing unit has two compressors per refrigerant circuit, either one or two coil circuits may be used for each refrigerant circuit depending upon the cooling capacity.

If one coil circuit is used (Fig. 2-84), the LLSV and TXV must be sized to handle the full capacity of the refrigerant circuit. When two coil circuits are used per refrigerant circuit (Fig. 2-85), each TXV should be sized to handle half of the capacity of the refrigerant circuit and the LLSV should be sized to handle the full capacity of the refrigerant circuit.

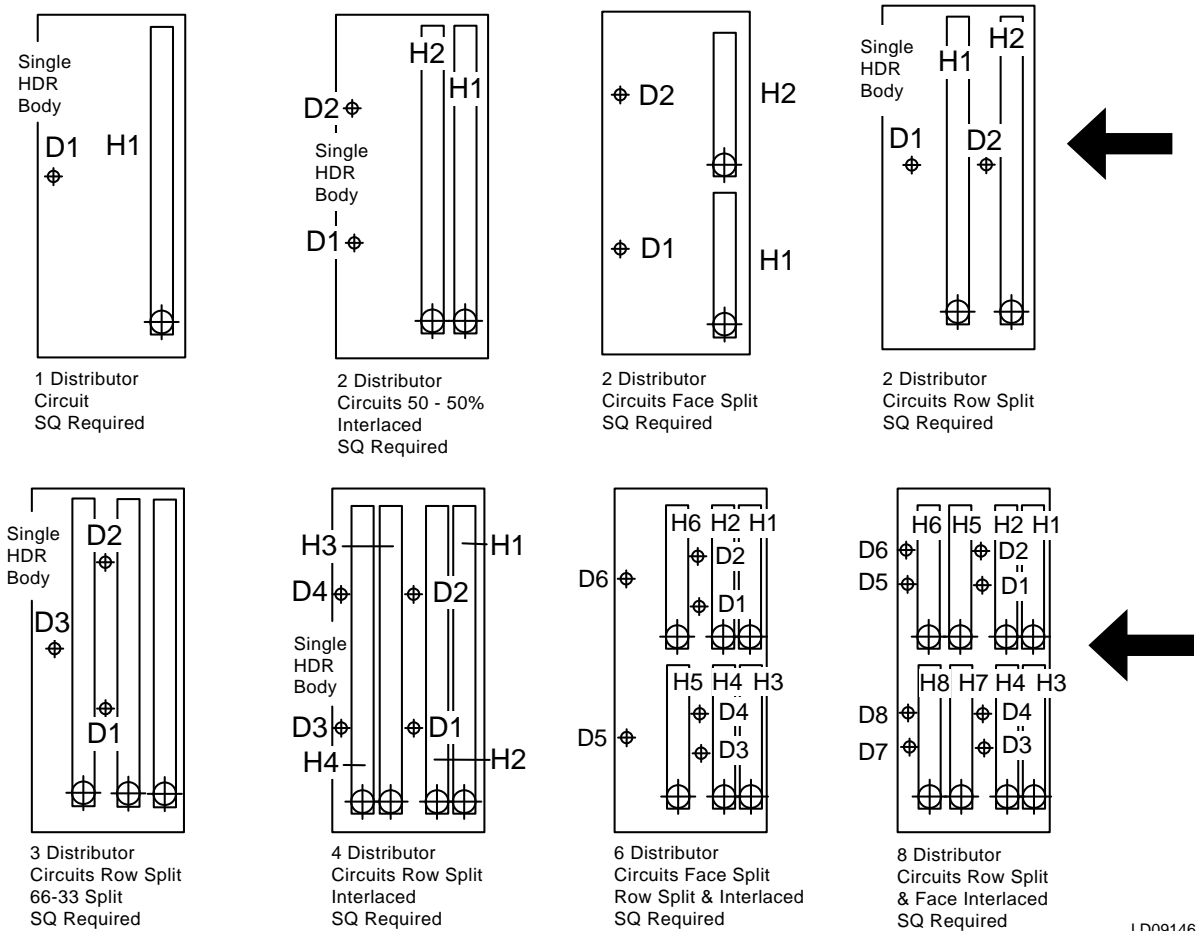

FIG. 2-82 – STACKED COIL DESIGNS - SQ SPECIAL

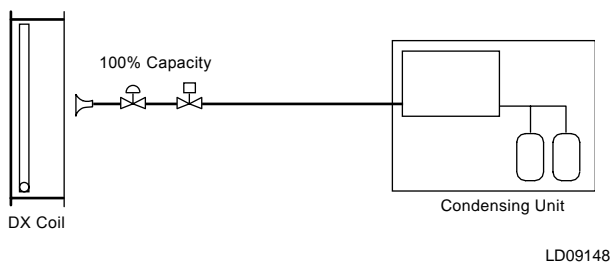

FIG. 2-84 – ONE COIL CIRCUIT PER REFRIGERANT CIRCUIT

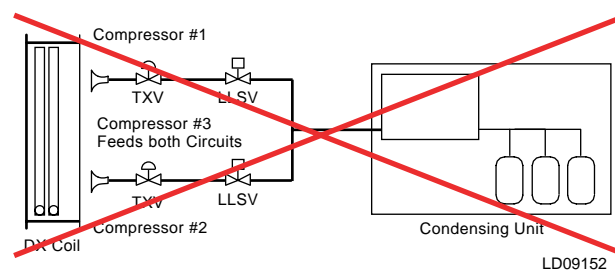

FIG. 2-88 – DO NOT USE THE ABOVE CONFIGURATION.

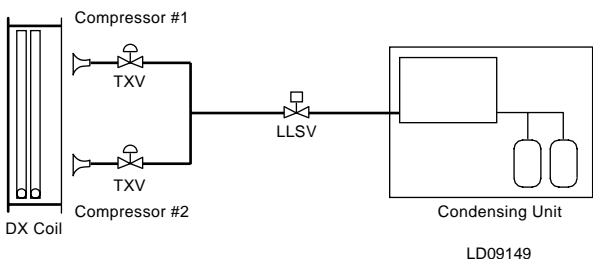
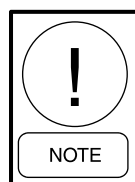

FIG. 2-85 – TWO COIL CIRCUITS PER REFRIGERANT CIRCUIT



When sizing TXV's, each TXV must be sized for the refrigerant circuit tonnage divided by the number of DX coil liquid distributors. The TXV should be equal to or smaller than the calculated value.

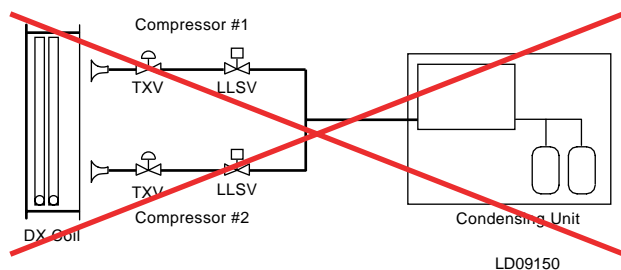

FIG. 2-86 – DO NOT USE THE ABOVE CONFIGURATION.

The first three compressors (see Fig. 2-89) would be tied into LLSV1, TXV1 and TXV2. This would provide full-face control of the coil at even the lowest cooling loads. Both distributors on each of the coil circuits would include auxiliary side connectors for HGBP.

The second set of 3 compressors would be tied into LLSV2, TXV3 and TXV4 to maintain full-face control at higher loads. Reference Form 050.40-ES3 Section 9 for compressor staging solutions.

When the condensing unit has three compressors per circuit, two coil circuits should be used for each refrigerant circuit (Fig. 2-87). Each coil circuit must have a dedicated TXV and distributor to handle one coil circuit and the LLSV should be sized to handle the full capacity of the refrigerant circuit. The hot gas bypass line should be connected to all of the distributors in the coil circuit.

The more control stages used, the more precise the control of the air temperature will be. Smaller incremental changes in capacity will result in a more consistent DX coil leaving air temperature. This will eliminate temperature swings in the conditioned space and improve the comfort level, but more importantly, a consistent space temperature is crucial to many process applications. The smaller changes in capacity that result from using a greater number of control stages will also extend equipment life. The most important thing to remember is to maintain full-face control of the coil at all cooling loads. When row split coils are used, make sure that the first LLSV is energized with the last coil circuit in the leaving air stream. This is always the last one de-energized too.

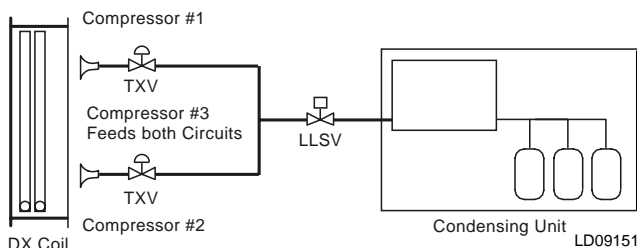

FIG. 2-87 – THREE COMPRESSOR YCUL

In the case of a stacked coil with four coil circuits piped to a condenser with six compressors, the coil circuits would be face-split and interlaced with two interlaced circuits on the lower coil section and two on the upper (Fig. 2-89).

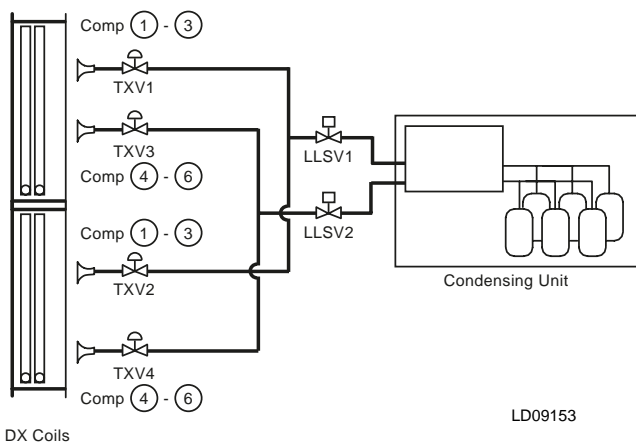

FIG. 2-89 – SIX COMPRESSOR YCUL

Thermostatic Expansion Valves (TXV)

Each coil distributor circuit requires its own Thermostatic Expansion Valve (TXV). Each condensing unit circuit requires its own liquid line solenoid valve (LLSV). TXV's are to be equipped with external equalizer tubes that are field connected to the suction line. The valve should be sized in accordance with the valve manufacturer's recommendations, allowing approximately 35 PSI pressure drop throughout the coil and distributor at full load. Do not oversize the valve. Follow the valve manufacturer's instructions on the location of the thermostatic bulb. Proper expansion valve operation is necessary in order to realize the rated coil capacity.

When a DX type coil is operated with a suction temperature below 32°F, a buildup of frost will occur on the finned surface. It is, not recommended therefore, to operate DX coils for air conditioning purposes at below freezing suction temperatures. If the full load operating point for the coil is selected at a "safe" temperature, a system analysis is required to check for the lowest probable suction temperature at light load conditions.

Hot Gas Bypass

When using discharge air temperature control or systems with outside air economizer cooling, always include hot gas bypass (HGBP). It is not as critical to use HGBP with return duct air temperature control, or suction pressure control, but it provides better capacity control at low loads.

The venturi type distributor furnished with YORK DX coils may be ordered for field application of a hot gas bypass valve. The connection may be made through a tee installed in the field between the expansion valve and distributor. The system balance point and control adjustments must assure compressor cooling and avoid excessive compressor cycling. *Refer to Form 50.40-ES3, Section 3.*

Maintaining Adequate Airflow

An electrical interlock between the air handler and the condenser must be included for permissive run of the condenser. In addition, a differential pressure switch mounted across the supply fan must always be included to ensure airflow across the coil before the condensing unit is energized. The condenser must never be operated unless the air handler fan is operating and air is flowing across the active coil. Insufficient airflow will result in liquid refrigerant returning to the condensing unit, which could damage the compressors by liquid slugging or washing oil from the bearing surfaces.



In variable volume systems, the minimum acceptable airflow for fixed speed or VAV systems is 350 FPM face velocity across each DX coil, as applied to split DX systems. This is critical to assure that the TXV does not overfeed, causing compressor failure.

The air velocity flowing through chilled water and direct expansion coils must not exceed specific recommended values, to prevent water carryover.

VAV Systems

Overhead variable air volume systems have been the preferred method of air distribution since the early 1970 's. Overhead VAV systems offered greater energy efficiency and better control of building diversity than constant volume systems. Unlike a constant volume system, in which the leaving air temperature is adjusted to satisfy the cooling load, in a VAV system the air temperature remains constant and the air volume is varied to meet the cooling requirements.

There are four basic components in a VAV system - an air-handling unit with airflow control (i.e. variable-speed drives), VAV boxes, zone thermostats and duct static pressure sensors. All of these components must work together to provide good temperature control and a comfortable environment. The zone thermostats control the VAV boxes. As the zone temperature increases, the VAV boxes open to allow greater airflow into the space and as the zone temperature decreases, the VAV boxes close to decrease the airflow to the space.

As the VAV boxes in the system open and close the static pressure in the ductwork changes. When a box opens, the duct static pressure decreases, and when a box closes, the duct static pressure increases. The duct static pressure sensor controls the air handling unit supply fan. Since an increase in duct pressure relates to a decrease in the zone airflow required, the supply fan volume decreases in response. Conversely, a lower duct static pressure indicates a need for increased zone airflow; therefore, the supply fan volume increases in response. The change in supply air volume is accomplished using a Variable Frequency Drive or similar device.

In the air-handling unit a decrease in airflow through the DX coil will result in a corresponding decrease in the suction gas pressure while an increase in airflow will result in an increase in the suction gas pressure. Since the system is designed to maintain a constant suction gas pressure, the compressors will be staged on or off as needed to meet the increase or decrease in load demand. The system should be designed to operate smoothly avoiding transients that could upset system balance and cause liquid flood back.

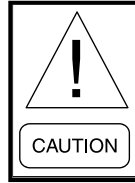

Problems can arise if the airflow decreases more quickly than the compressor control can respond to the load change. Therefore, airflow should never change at a rate faster than 3% per minute on VAV systems.

This limitation will promote stable control of the system and minimize fluctuations in zone temperature. Under any circumstances, a minimum of 350 FPM face velocity across the coil must be maintained for DX split systems.

Drains And Traps

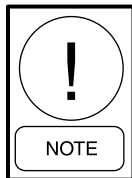

Heat trace and insulate traps where there is a risk of freezing to prevent blockage and/or damage due to freezing of the liquid in the trap.

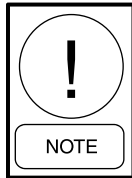

Auxiliary drain pans may not require traps. If the trap is not in constant use the water seal may evaporate causing air passage into or out of the air handler. In such cases it is recommended to cap the drain in a manner that allows opening or closing of the drain depending on its use.

Condensate Drain Piping

The majority of cooling coils are located in the units so that the supply air is drawn through them. This results in the condensate being subjected to negative (-) static pressure. Unless some means of pressure equalization is provided in the condensate drain, the air rushing back through the drainpipe will cause the condensate to build up in the drain pan. As the unit continues to operate, the accumulated water will be carried with the air stream, overflowing the drain pan causing possible water leaks into the supply duct and/or causing water damage in the building. A trap must be installed to prevent this condensate water build-up (see Figs 2-90 and 2-91).

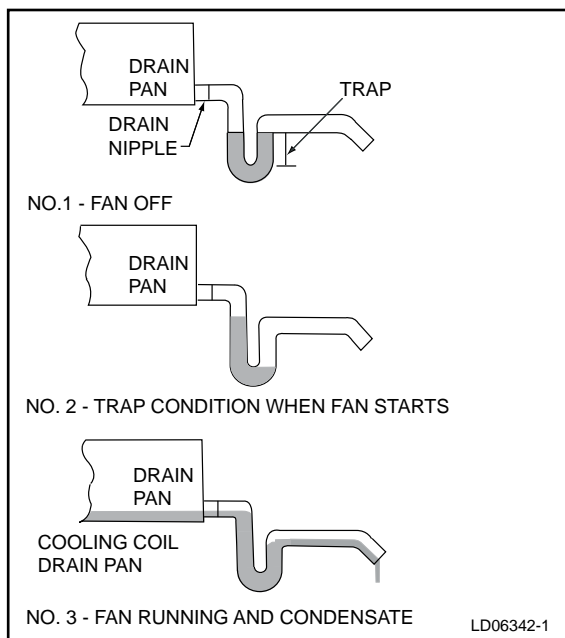

FIG. 2-90 – DRAIN TRAP SHOWING WATER LOCATION DURING DRAW THROUGH OPERATION STAGES

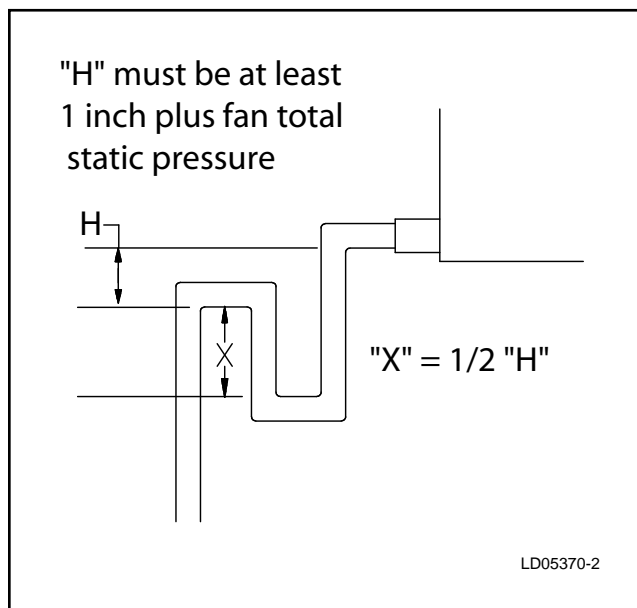

FIG. 2-91 – TRAP DETAIL FOR DRAW THROUGH APPLICATION

Condensate Drain Trap

For "Draw Through" applications install a trapped condensate drain line at unit drain connection (see Fig. 2-91) according to all governing codes. "H" dimension must be at least 1 inch greater than design Total Static Pressure (TSP) of fan. This ensures proper drainage even if filters clog or dampers malfunction.

For "Blow Through" applications, the same principles apply, but the leaving pipe must be as shown in Fig. 2-92 for proper trap design.

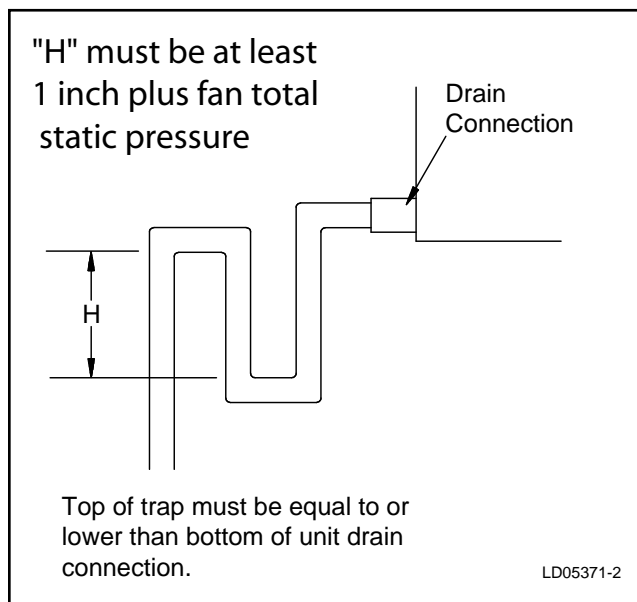

FIG. 2-92 – TRAP DETAIL FOR BLOW THROUGH APPLICATION

Two or more drains on same side of unit must be trapped individually before drain lines can be combined and routed to a suitable drain (see Fig. 2-93).

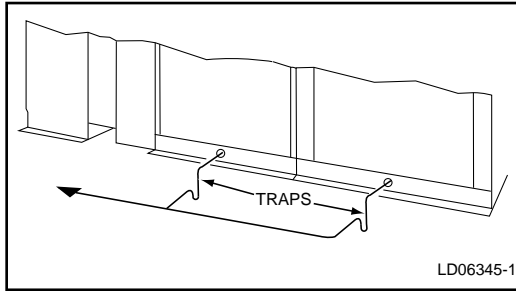

FIG. 2-93 – COMBINING DRAIN LINES

If distance from drain pan outlet to trap exceeds 10', install additional clean outs for each 10' segment of horizontal drain line (min. 1/4 in. per foot fall required).

On initial startup, it may be necessary to fill the trap manually.

Elevating Unit for Gravity Floor Drain Connections

On indoor units, the installer must provide a means of pumping or draining coil condensate water away from the unit. The installer may have to elevate the unit to provide space below the condensate drain of the unit to install properly designed drain trap(s) to permit gravity flow of condensate water from the drain pan (see Figs 2-3, 2-4 and 2-5).

Duct Connections

NOTE Duct must have positive seal to unit openings. Outdoor baserails are available in 3", 6", 8" and 10" heights. Contractor is responsible for providing ductwork to include baserail height.

NOTE All ductwork should be supported independently from the unit.

Duct Connection Guidelines

See Fig. 2-94.

Duct connections to the unit may be made directly except when the unit has external isolation. Then duct connections should be flexible material and should be installed so they are sufficiently loose. Duct connections should be designed and installed according to AMCA Standards 200 and 201 as a minimum. Duct turns and transitions must be made carefully to hold friction loss to a minimum. Avoid short turns. Duct elbows should contain splitters or turning vanes.

The Effective Duct Length connected to the fan or unit discharge should run in a straight line for at least 2.5 Equivalent Discharge Diameters* for up to 2500 FPM fan outlet velocity and one additional diameter for each additional 1000 FPM fan outlet velocity. This ductwork should be no greater than 105.5% or no less than 85.5% of the discharge area. In addition, the slope of the transition elements should not be greater than 15% for converging elements, or greater than 7% for diverging elements.

* To find the Equivalent Discharge Diameter:

$$EDD = \sqrt{4ab/\pi}$$

The letters "a" and "b" represent the height and width of the discharge.

A duct turn should be in the same direction as the fan rotation. Never deadhead the discharge into the flat surface of a plenum.

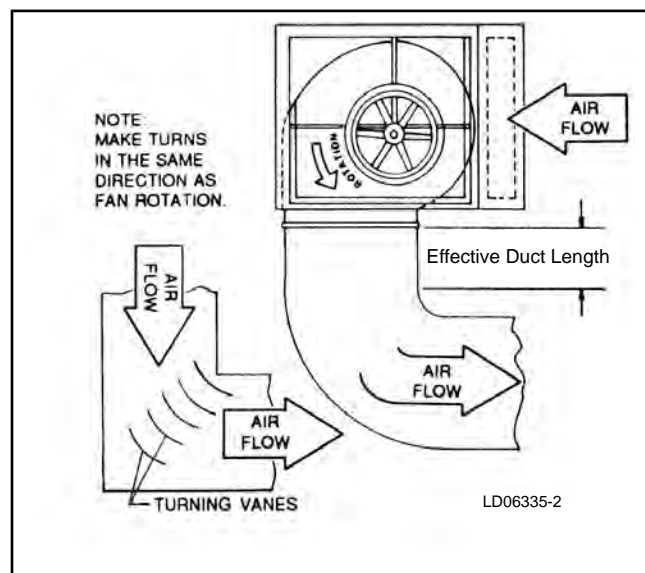
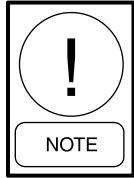

FIG. 2-94 – RECOMMENDED DISCHARGE DUCT ARRANGEMENT WHEN TURNS ARE REQUIRED

Duct Connections



Ducts must have positive seal to unit openings. Installer is responsible for providing ductwork to include baserail height for curb mounted units.

All duct work is to be supported independent of the connection to the unit. If the entire unit is mounted on isolation, the duct connection is to be flexible. This instruction is suitable for bottom, end, side and top connections. Top connections on Outdoor units are not recommended.

Flanged Ducts or Sleeves

To use flanged duct or sleeves, be sure there will be access on all four sides to fasten the flange completely.

Flanged ducts can be connected with self drilling screws directly to the unit with gasket or sealant between unit and duct flange.

A flanged sleeve may be dropped through the opening, provided there is access to seal and fasten the flange to the unit interior surface.

Raw or Straight Edge Ducts or Sleeves

The duct opening on the unit is located in a panel that is approximately 2" thick. The inside of the opening (2" surface) is suitable for attaching ducts.

If access is not available from inside the unit, access may have to be from inside the duct or sleeve.

Raw or straight edge ducts can be connected with self drilling screws directly to the unit with gasket or sealant between unit and duct.

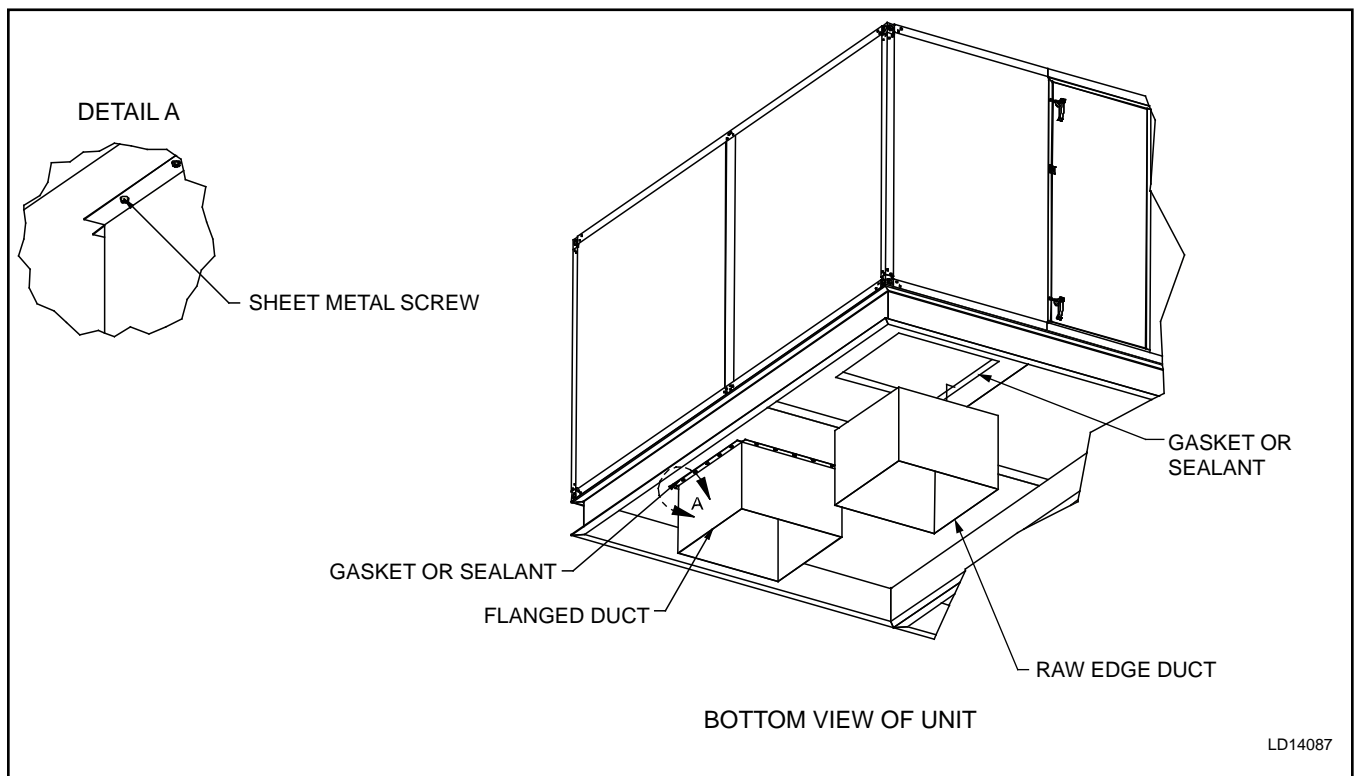
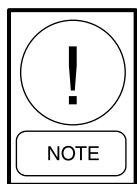

FIG. 2-95 – RECOMMENDED DISCHARGE DUCT ARRANGEMENT WHEN TURNS ARE REQUIRED

The performance ratings of coils will be met only if the airflow is uniform over the face of the coils. High air velocity spots on the coil may cause the carry-over of moisture from the coil. High or low air velocity areas of the coil will not deliver the published ratings. The duct connections must be designed to provide for uniform flow of air across the face of the coil. The entering duct must provide a smooth transition from any high velocity effects. Stratifications of outside and return air, especially where below freezing outside air enters, must be avoided to prevent coil freeze-up or nuisance low limit trips.

Sound and Vibration Transmission

All roof mounted air-handling units generate some sound and vibration that may or may not require some special treatment of the air-conditioned space. The noise generated by the air-handling unit is dependent on the speed of the fan, the amount of air the fan is moving, the fan type and the static efficiency of the fan. In applications where sound and vibration transmissions may be objectionable, good acoustical engineering practices must be incorporated in the system design.



On units with return fans, it is especially important to consider the effects of sound transmission into the conditioned space.

When a unit is used with a ceiling plenum return air system, sound may be transmitted from the unit through the ceiling to the conditioned space. For such applications, there should be a sound absorption chamber installed near the unit return air inlet. Various reference sources are available regarding acoustic design.

Front and Rear Discharge Outdoor Unit Duct Installation

- Roof penetrations by ducts should utilize counter flashed curbs. (Typical arrangements are shown in Fig. 2-96.)
- All penetrations into ducts should be sealed watertight. Attachment of supports should use a minimum number of duct penetrations.
- Duct systems should not be pressurized without sufficient time for curing of sealant systems. Follow sealant manufacturer's recommendations for application of the sealant.

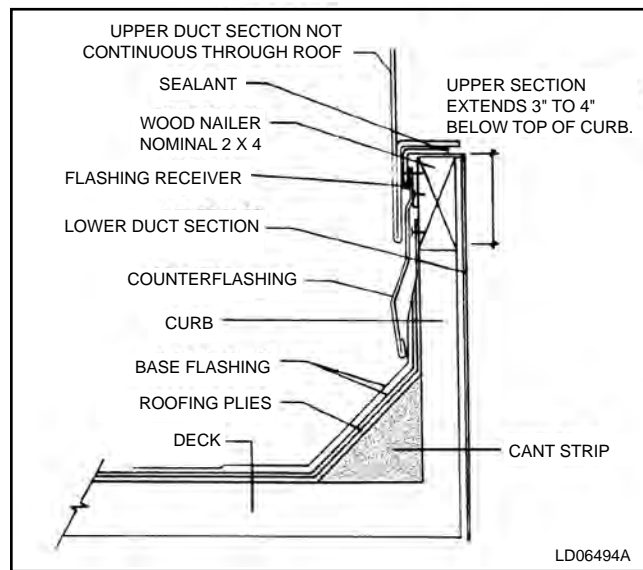

FIG. 2-96 – DUCT PENETRATION OF ROOF

- Adequate clearances between ducts and roof penetration openings should be provided.
- Ducts should be supported to avoid transfer of duct weight across flexible connections (*see Fig. 2-97*).
- Horizontal ducts should be pitched and provided with drainage outlets as illustrated (by the system designer).
- Ducts should be installed at a height sufficient to install roofing and flashing.
- *See Duct connection guidelines on previous page.*

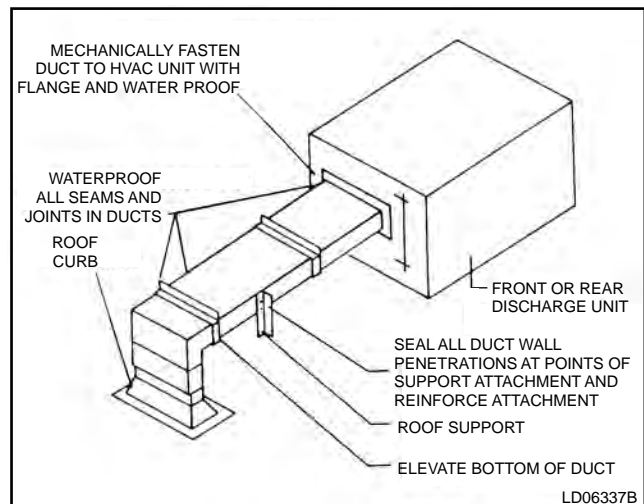
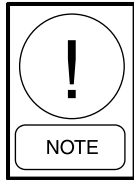

FIG. 2-97 – ROOF TO DUCT INSTALLATION - HORIZONTAL DISCHARGE

Air Filters

It is mandatory that filters be in place in the filter frames of each unit before putting the unit into operation to protect the coils and keep them clean.

Due to the wide variety of filters, it is not possible to cover all of them in this section.



Be sure to install all filters in the correct orientation with regard to airflow and with pleats or pockets vertical wherever possible. See IOM Section 4, "Filter Segments".

Most YORK Solution air handling units will be shipped without filters. The Johnson Controls Sales office is responsible for the order and delivery of filters in a timely manner. It is important for the contractor or commissioning agent to be in touch with Johnson Controls regarding this issue. Various filter types will have different lead times.

Filter clips if required will be shipped with the first filter shipment, except for HEPA filters, in which case the filter clips will be attached to the filter racks inside the unit. Filter clips are not required for side load filter arrangements.

Contractor is responsible for installation of filters. Contractor is responsible for freight claim if filters arrive damaged. Other issues such as size, type, spares, replacements or quantity should be addressed with the Johnson Controls Sales office or project manager.

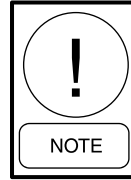

A list of filter part numbers, sizes and quantities are shown on a label located on each filter segment of each air handler.



If your unit has HEPA filters the filter frames, filter bulkheads and filter segment panels are factory sealed and must remain sealed for NO air bypass.

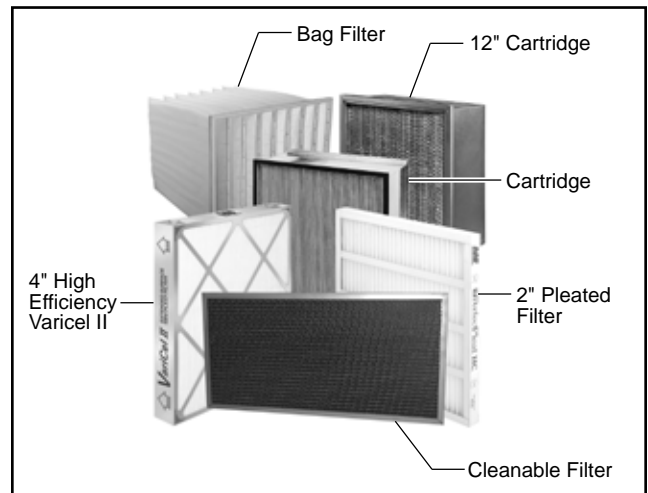

LD09650

FIG. 2-97A – TYPICAL FILTERS

Filter Types

The following filter types are used:

- Flat
- Angle
- Rigid
- Bag
- HEPA
- Charcoal.

Maintenance and Replacement

Every month, check the cleanliness of the filters and replace. Filters should be replaced when the pressure drop, measured by a manometer, reaches the prescribed limits for the installation.

FILTER LATCHES

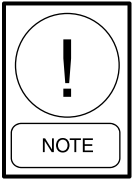

Typically when filters are by others, so are the filter clips.

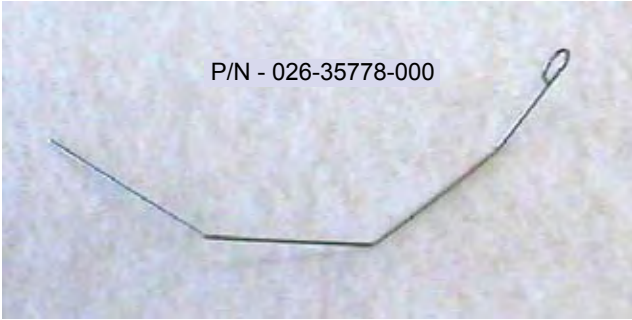

Used with 2" Perfectpleat, Premium or Premium HM and SH Single Headered Filters.



Used with 2" (C86) and 4" (C89)" Amair 300 X Pleated Prefilter in combination with a Single Header Final Filter.



Used with 2" and 4" Prefilter in combination with a Double Header Final Filter and Varicel DH Double Headered Filter.

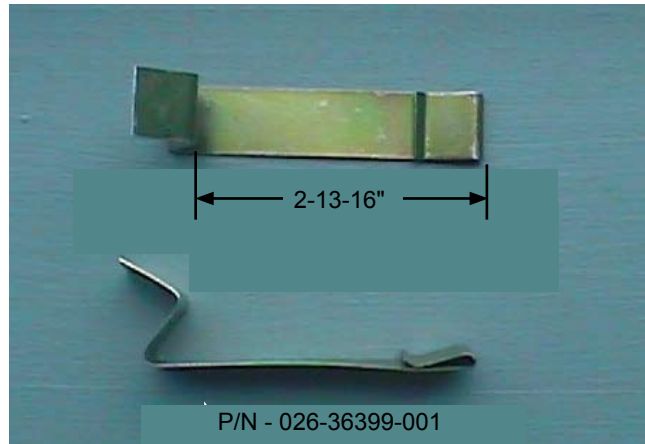

Used with 2" Prefilter in combination with a Double Header Final Filter.

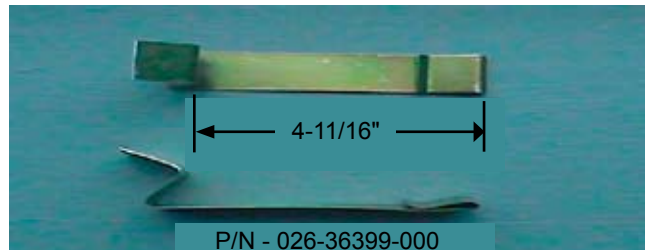

Used with 4" Prefilter in combination with a Double Header Final Filter.

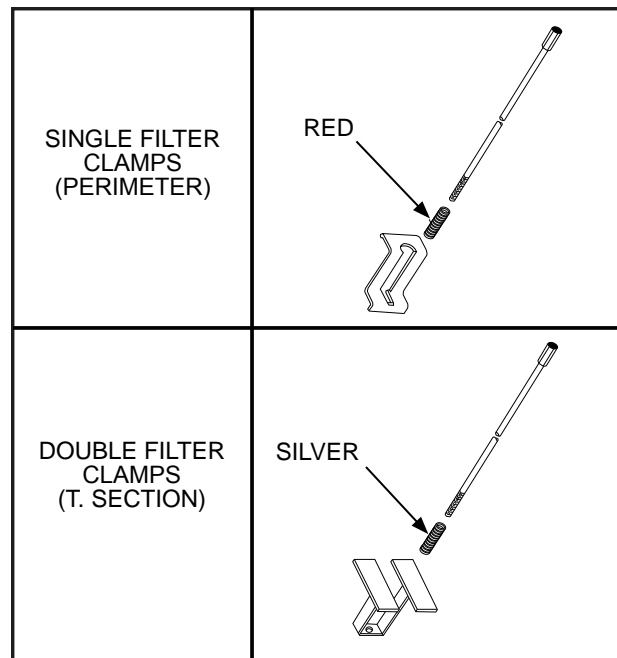

Used to attach HEPA Filters to Holding Frame.

FIG. 2-98 – FILTER LATCHES

YORK MATRIX: FILTERS AND FILTER FRAMES / LATCHES

Single Filter Application				
	2" PerfectPleat, Premium or Premium HM	4" AmAir 300X	VariCel SH or DriPak 2000	VariCel DH
FILTER FRAME 12x24 - 16 ga. Galvanized				
P/N 026-35778-000	X		X	
P/N 026-35778-007		X		
P/N 026-35778-006				X
FILTER FRAME 24X24 - 16 ga. Galvanized				
P/N 026-35778-000	X		X	
P/N 026-35778-007		X		
P/N 026-35778-006				X

Prefilter / Final Filter Application				
	PerfectPleat, Premium or HM <u>AND</u> VariCel SH or DriPak 2000	PerfectPleat, Premium or HM <u>AND</u> VariCel DH	4" AmAir 300X <u>AND</u> VariCel SH or DriPak 2000	4" AmAir 300X <u>AND</u> VariCel DH
FILTER FRAME 12x24 - 16 ga. Galvanized				
P/N 026-35778-007 & 026-35778-000	X			
P/N 026-35778-006 & 026-36339-001		X		
P/N 026-35778-007, 026-35778-008 & 026-35778-000			X	
P/N 026-35778-006 & 026-36339-000				X
FILTER FRAME 24X24 - 16 ga. Galvanized				
P/N 026-35778-007 & 026-35778-000	X			
P/N 026-35778-006 & 026-36339-001		X		
P/N 026-35778-007, 026-35778-008 & 026-35778-000			X	
P/N 026-35778-006 & 026-36339-000				X

NOTE: Typically when filters are by others, so are the filter clips.

Installation of 2” PerfectPleat, Premium or Premium HM

These instructions are for installing a 2” filter (typically PerfectPleat) into 16 ga. galvanized holding frames.

- Latches needed for these applications are four (4) P/N 026-35778-000, as shown in Fig.2-98.
- A single latch should be installed at each of the four (4) corners of the frame.
- The latch fits into the set of knockouts, which consists of two (2) rows of three (3) knockouts. The row of knockouts closest to the gasketing should be used for nominal 1” filters or filters with a 13/16” single header. The second set of knockouts should be used for nominal 2” filters.

Installation of Spring Latches

1. Insert the straight end of the latch between the two (2) knockouts furthest from the corner.
2. Using a moderate amount of pressure, force the latch over the third knockout.
3. The latch installation should now be complete. The latch should now be “trapped” within the three (3) knockouts, but should be able to freely rotate (see Fig.2-99).



FIG. 2-99 – CORRECTLY INSTALLED LATCH P/N 026-35778-000.

4. Repeat the installation process with the remaining latches in the other three corners.
5. Rotate all of the latches outward, and insert the filter into the frame.
6. After the filter has been placed into the frame, grasp the circular end of the latch and rotate it across the corner of the filter.
Push the end of the latch towards the filter, until the latch catches beneath the knockout on the frame.
Repeat for the remaining latches.
7. The filter should now be securely installed into the frame (see Fig.2-100).

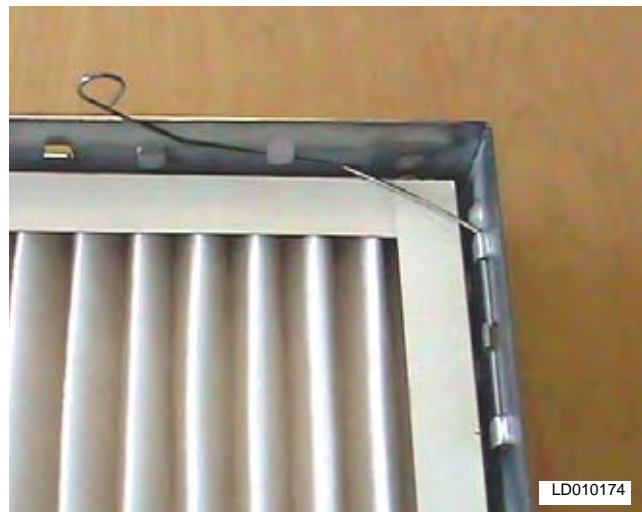

FIG. 2-100 – FULLY INSTALLED FILTER

Installation of 4" Amair 300x Pleated Filter

These instructions are for installing a four inch (4") filter (typically AmAir 300X pleated filter) into 16 ga. galvanized holding frames.

- Latches needed for these applications are four (4) P/N 026-35778-007, as shown in Fig. 2-98.
- A single latch should be installed at each of the four (4) corners of the frame.
- The latch fits into the set of knockouts, which consists of two (2) rows of three (3) knockouts. The row of knockouts closest to the gasketing should be used for filters with a 13/16" single header in combination with a nominal 2" prefilter. The second set of knockouts should be used for nominal 4" filters.

Installation of Spring Latches

1. Insert the straight end of the latch between the two (2) knockouts furthest from the corner.
2. Using a moderate amount of pressure, force the latch over the third knockout.
3. The latch installation is now complete. The latch should now be "trapped" within the three (3) knockouts (see Fig.2-101).

Repeat the installation process with the remaining latches.



FIG. 2-101 – CORRECTLY INSTALLED LATCH P/N 026-35778-007

4. Insert the filter into the frame.
5. After the filter has been placed into the frame, grasp the loose end of the latch and place it over the filter frame, so that the latch secures the filter into the frame (see Fig.2-102).

Repeat for the remaining latches.



FIG. 2-102 – PLACE THE END OF THE LATCH OVER THE FILTER FRAME, SECURING THE FILTER TO THE FRAME.

6. The filter should now be securely installed into the frame.

Installation of SH Single Headered Filters

These instructions are for installing single header filter (typically VariCel SH or DriPak 2000 filter) into 16 ga. galvanized holding frames.

- Latches needed for these applications are four (4) P/N 026-35778-000, *as shown in Fig.2-98.*
- A single latch should be installed at each of the four (4) corners of the frame.
- The latch fits into the set of knockouts, which consists of two (2) rows of three (3) knockouts. The row of knockouts closest to the gasketing should be used for nominal 1” filters or filters with a 13/16” single header. The second set of knockouts should be used for nominal 2” filters.

Installation of Latches

1. Insert the straight end of the latch between the two (2) knockouts furthest from the corner.
2. Using a moderate amount of pressure, force the latch over the third knockout.
3. The latch installation should now be complete. The latch should now be “trapped” within the three (3) knockouts, but should be able to freely rotate. Repeat the installation process with the remaining latches.
4. Rotate all of the latches outward, and insert the SH filter into the frame. The bulk of the filter should be inserted through the frame, protruding out the backside. Only the header of the filter should be contacting the flange of the frame.
5. After the filter has been placed into the frame, grasp the circular end of the latch and rotate it across the corner of the filter. Push the end of the latch towards the filter, until the latch catches beneath the knockout on the frame. Repeat for the remaining latches.
6. The filter should now be securely installed into the frame (*see Fig.2-103*).

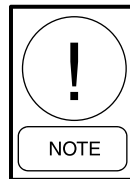

FIG. 2-103 – INSTALLED CARTRIDGE FILTER

Installation of a 2” Prefilter In Combination with a Single Header Final Filter

These instructions are for installing a 2” prefilter, (typically PerfectPleat, Premium or Premium HM pleated filter) used in combination with a single header final filter (typically VariCel SH or DriPak 2000) into 16 ga. galvanized holding frames.

- Latches needed for this application are four (4) P/N 026-35778-000 and four (4) 026-35778-007 *as shown in Fig.2-98.*



Follow instructions for Single Headered (SH) filters then proceed with this procedure for 2” Pre-filters.

Installation of Latches

1. Insert the straight end of the latch (P/N 026-35778-007) between the two (2) knockouts furthest from the corner.



FIG. 2-104 – INSTALL LATCH P//N 026-35778-007

2. Using a moderate amount of pressure, force the latch over the third knockout (*See Fig. 2-104*).
3. After both filters have been placed into the frame, grasp the loose end of the latch and place it over the prefilter frame, so that the latch secures the prefilter to the SH filter. Repeat for the remaining latches.
4. The filters should now be securely installed into the frame, *as shown in Fig.2-105*.



FIG. 2-105 – INSTALLED CARTRIGE W/PLEATS

Installation of a VariCel DH Double Headered Filter

These instructions are for the installation of a VariCel DH filter (nominal 12" deep double header) into 16 ga. galvanized holding frames.

- The latches needed for this application are four (4) spring latches, P/N 026-35778-006 (as shown in Fig.2-98).
- Two latches should be attached on each side of the filter frame.
- The latches should only be installed, two (2) per side of the frame. There should be no latches used on the top or bottom. This is done to match the holes in the filter frame, used to secure the latch to the filter. See Fig.2-106 for the sets of knockouts that should be used for the latches.

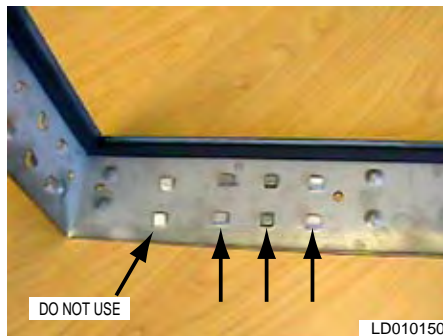

FIG. 2-106 – CORRECT USE OF KNOCKOUTS

Installation of Spring Latches

1. Insert the straight end of the latch between the knockouts furthest from the corner.
2. Using a moderate amount of pressure, force the latch over the third knockout.
3. The latch installation should now be complete. The latch should now be “trapped” within the three (3) knockouts.



FIG. 2-107 – CORRECT LATCH/KNOCKOUT CONFIGURATION.

4. Repeat the latch installation with the remaining latches. Note the orientation of the latch to the knockouts in Fig.2-107.

After the latches have been installed, the frame should be configured like that shown in Fig.2-108.



FIG. 2-108 – FRAME WITH 4 LATCHES INSTALLED.

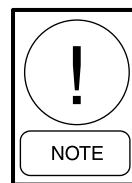

The frame contains 2 latches per side, none on the top or bottom.

5. Insert the VariCel DH filter into the frame. While holding the filter in the frame, grasp the loop on the end of the latch and pull it until it stretches over the header and rests into the pre-drilled hole in the header of the filter (see Fig.2-109). Repeat this with the remaining latches.
6. The filter should now be securely installed into the frame.



FIG. 2-109 – SPRING LATCH SHOULD BE PULLED AND FASTENED IN HOLE IN THE HEADER OF THE FILTER.

Installation of a 2" and 4" Prefilter in Combination With a Double Header Final Filter

These instructions are for installing either a 2" or 4" prefilter (typically PerfectPleat, Premium or Premium HM pleated filters) used in combination with a VariCel DH (nominal 12" deep) final filter into 16 ga. galvanized holding frames.

- Two sets of latches are needed for these applications. Four (4) spring latches, P/N 026-35778-006 are used to hold the VariCel DH into the frame. In addition, four (4) prefilter latches, P/N 026-36339-001 are used to hold the 2" and P/N 026-36339-000 are used to hold the 4" prefilter onto the face of the VariCel DH filter.
- For the spring latches, two (2) latches should be attached on each side of the filter frame.
- The latches should only be installed, two (2) per side of the frame. There should be no latches used on the top or bottom. This is done to match the holes in the filter frame, used to secure the latch to the filter.

Installation of Spring Latches

1. Insert the straight end of the latch between the knockouts furthest from the corner.
2. Using a moderate amount of pressure, force the latch over the third knockout.
3. The latch installation should now be complete. The latch should now be "trapped" within the 3 knockouts (see Fig.2-110).

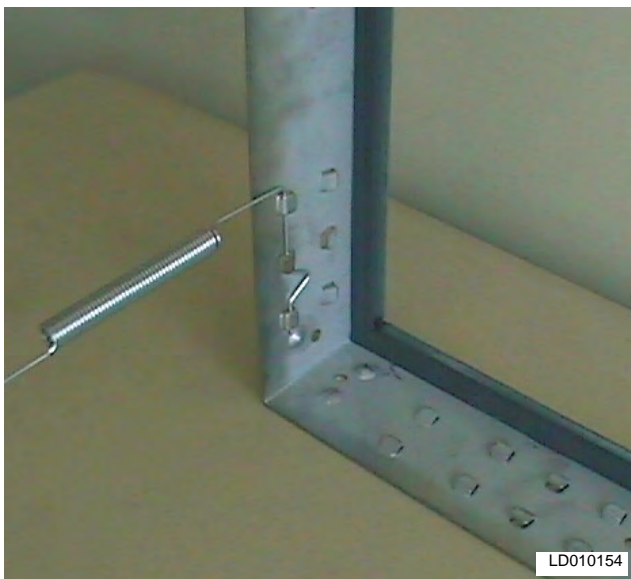

FIG. 2-110 – CORRECT LATCH/KNOCKOUT CONFIGURATION. P/N 026-35778-006

4. Repeat the latch installation with the remaining latches; *note the orientation of the latch to the knockouts on Fig.2-110.*
5. Insert the VariCel DH filter into the frame. While holding the filter in the frame, grasp the loop on the end of the latch and pull it until it stretches over the header and rests into the pre-drilled hole in the header of the filter (see Fig.2-111). Repeat this with the remaining latches.



FIG. 2-111 – FRAME WITH 4 LATCHES INSTALLED

Installation of Prefilter Latches

6. To install the prefilter latches, slide the end of the latch with the 180 ° turn, over the edge of the header, as shown in Fig.2-112. The latch should be installed at the approximate midpoint of the filter leg.

The prefilter latch should be slid over the header as shown in Fig.2-112.



FIG. 2-112 – PREFILTER LATCH AFTER INSTALLATION ONTO FILTER HEADER.

7. Repeat the installation for the remaining prefilter latches.
8. Place the prefilter against the face of the VariCel DH filter. The prefilter latches may have to be re-positioned *as shown in Fig.2-113*, to allow the proper placement of the prefilter.



FIG. 2-113 – POSITION PREFILTER IN FRONT OF THE FINAL FILTER. (2" W/026-36339-000 LATCH SHOWN)

9. Grasp the end of the prefilter latch and “spring” it so that it fits over the edge of the prefilter. Repeat with the remaining latches.

After all remaining prefilter latches have been placed around the prefilter; the finished assembly should look like that in *Fig.2-115*.



FIG. 2-114 – SPRING THE END OF THE LATCH SO THAT IT FITS OVER THE EDGE OF THE PREFILTER. (4" W/026-36339-000 LATCH SHOWN)

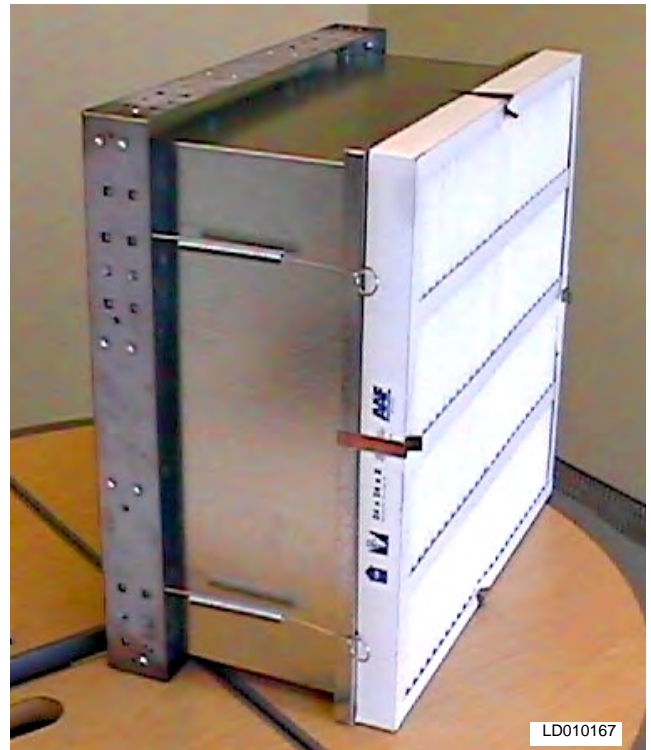

FIG. 2-115 – COMPLETED ASSEMBLY

VISUAL CONTROL FILTER CLAMPS FOR HEPA FILTERS		
Part Number	Latch Model Number	Length (L)
029-22081-000	Latch, HEPA Single	11-1/2"
Application: Holds one Astrocel I 11.5" D filter along frame sides. (See Fig. 2-117, 2-118 & 2-119 for application)		
029-22082	Latch, HEPA Double	11-1/2"
Application: Holds one Astrocel I 11.5" D filter along frame middle. (See Fig. 2-117, 2-118 & 2-119 for application)		

HEPA Filters

Welded Bevel Seal Frame

Extruded Aluminum Frames for Gasketed HEPA Filter Installations

The Bevel Seal frame is a factory welded, extruded aluminum frame developed specifically for High Efficiency Particulate Air (HEPA) filter installations. Standard Bevel Seal frames accommodate multiple sizes of gasketed HEPA filters 11-1/2" deep. (See Fig. 2-116, 2-118 and 2-119.)

Two Stage Gasket Compression Prevents Leakage

The Bevel Seal frame features a two level sealing surface connected by a bevel. This causes the filter gasket to be compressed in two stages as clamping pressure is applied. The outer edge of the gasket is compressed to a greater degree than the inner portion of the gasket. (See Fig. 2-119.)

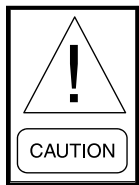

In the event excessive clamping pressure is applied, the individual cells in the gasket material can be fractured causing the gasket to relax, allowing leakage.

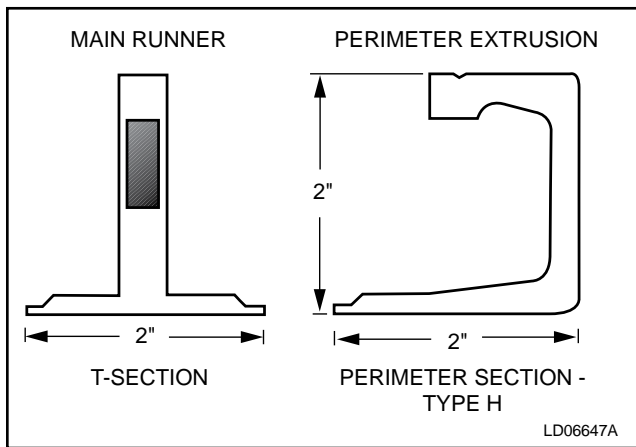

FIG. 2-116 – HEPA FILTER FRAME CROSS SECTION VIEW

Visual Control Filter Clamps

(See Fig. 2-117.)

HEPA Filter Applications

Visual Control clamps are designed for use with any conventional gasketed HEPA filter. Located at midpoint of each filter edge, the calibrated spring-loaded clamps maintain up to 100 pounds pressure against the filter at each clamping point. Four clamps are used per filter to assure uniform pressure against the gasket. The clamps have a 1-1/2" wide bearing surface.

Easy Clamp Installation

No special tools are required for proper clamp installation. **Tighten the bolt head until it is flush with the clamp face** to achieve the prescribed compression. Proper clamping pressure is created indefinitely by the calibrated spring.

Single filter clamps are used around the perimeter of the frame bank. Double clamps are used along main runners to secure a filter on either side of the T-section. (See Fig. 2-117, 2-118 and 2-119.)

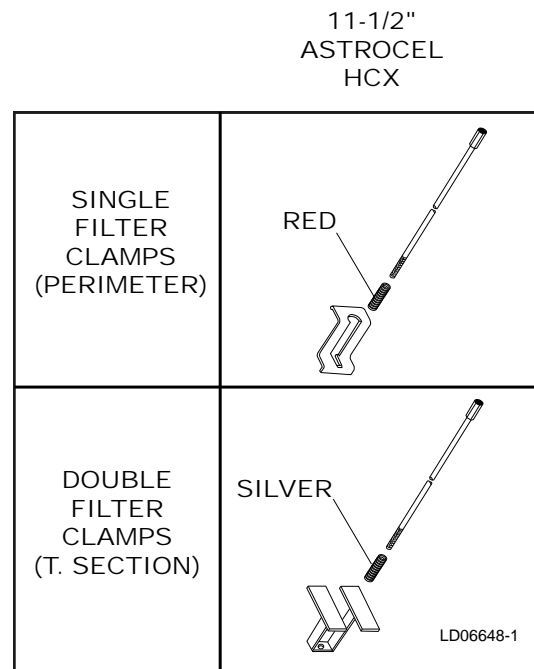

FIG. 2-117 – VISUAL CONTROL FILTER CLAMPS

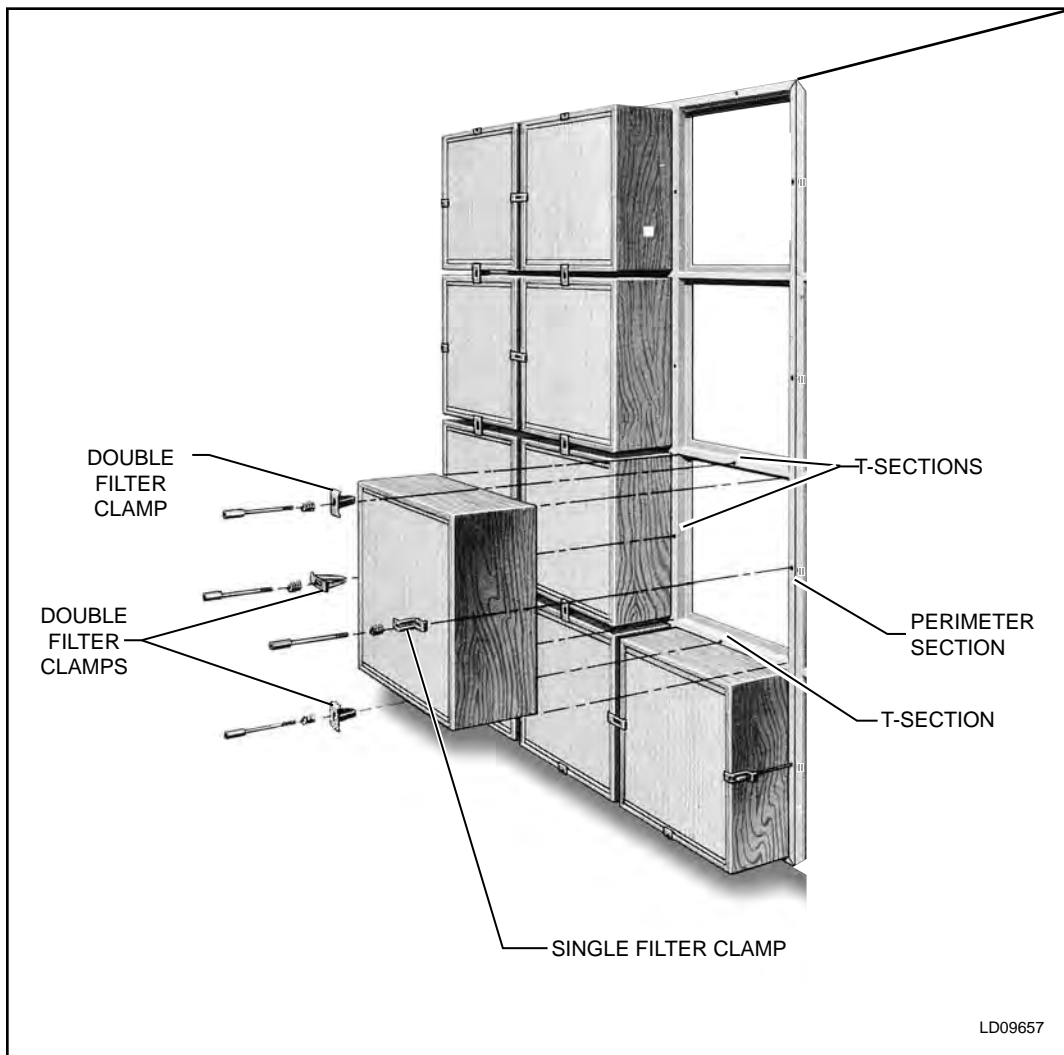

FIG. 2-118 – HEPA FILTER INSTALLATION

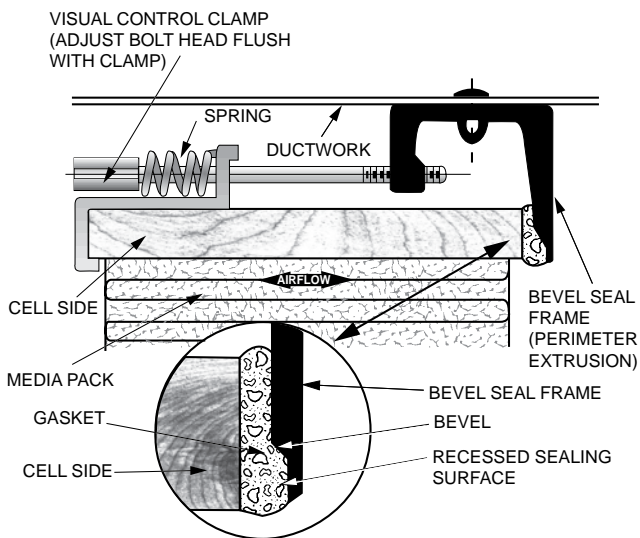

FIG. 2-119 – WELDED BEVEL SEAL FILTER INSTALLATION

THIS PAGE INTENTIONALLY LEFT BLANK

3.0 STARTUP



Rotating parts and electrical shock hazards exist. Lock out and tag out the fan motor(s) and heat power disconnects before servicing. FOLLOW THE LATEST "LOCKOUT TAGOUT" PROCEDURE. Failure to follow proper safety precautions may result in serious injury or death. Refer to general safety guidelines and safety symbols located at the front of this Manual.

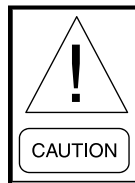

While it is a common practice to operate the fan as soon as possible (air movement during construction is always preferred by contractors) on the job site, the incomplete ductwork and missing diffuser grilles will greatly reduce air resistance and will allow the fan to operate beyond design parameters. This practice may result in water carry over and flooding of the unit. Also, the motor may over Amp and become damaged.



Always replace metal tab on access doors that provide access to moving parts. This mechanical protection from moving parts is required by UL-1995.

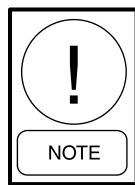

Fan manufacturers describe the rotation of the fan impeller as being "clockwise" or "counterclockwise" for centrifugal fans when viewing the drive side (see AMCA Standard 2406).

When internal safety catch is not used, always replace metal tab on access doors that provide access to pressurized areas. This mechanical protection is to prevent accidental release of access doors under positive pressure.



If your unit has HEPA filters the filter frames, filter bulkheads and filter segment panels are factory sealed and must remain sealed for NO air bypass.



Serious damage to the AHU and/or system is eminent if the AHU is operated under any of the following conditions:

- *Without proper control of dampers.*
- *With smoke dampers closed.*
- *During a fire alarm or smoke purge test.*
- *Any airflow restriction greater than normal.*
- *Fluctuating or incorrect voltage power supply*

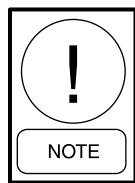

Never use silicone caulk/sealant or caulk/sealant containing silicone in or on any air handling equipment. [Only exception is when provided (high temperature) with gas heat venting].

PRE START-UP

Refer to air handler start-up checklist, Form 100.00. CL1 provided with information package shipped with unit. Perform a general inspection. Identify and perform appropriate “lock out/tag out” and safety rules. For details on points below, see appropriate section of this Installation Instruction and IOM 102.20-NOM1. For VFD equipped air handlers, refer to the VFD literature for additional start-up requirements.

1. Verify equipment received as ordered.
2. Check for damage to the interior and exterior of unit.
3. Verify unit installed on flat and level surface.
4. Ensure terminal screws and wiring connections secure in control, electric and Air Modulator panels.
5. Verify air hoods field installed properly.
6. Verify condensate drain properly trapped.
7. Verify all wiring and tubing connections complete at shipping splits.
8. Verify all field-piping connections complete.
9. Verify all shipped loose parts installed.
10. Verify all ductwork is complete and available for full airflow.
11. Verify unit installed with proper clearances.



Verify installer has removed all dirt, debris, hardware, mold, etc. from interior of air handler and ducts.

12. Visually inspect roof curb for tight seal around unit.
13. Ensure clean air filters installed properly and secured (see IOM Section 4).
14. Verify filter gauge set to zero.
15. Inspect all field provided wiring for completeness.
16. Verify all shipping splits sealed and secured properly.
17. Verify pipe chase floor sealed at penetrations.
18. Verify all shipping bolts and other materials have been removed.

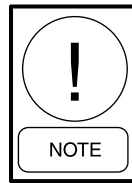

Do not remove functional bolts from seismic isolators (see Fig. 3-6).

19. Ensure damper linkage is tight and in correct “power off” position.

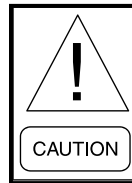

Return air dampers may be closed for shipping. Loosen actuator or crank arm on jackshaft, open dampers, and retighten actuator or crank arm.

20. Verify controls installation complete.
 - a) Contractor Furnished Controls - Controls contractor is responsible for safe and proper control of air handler.
 - b) Factory Furnished Controls - See *Factory Engineered Controls/Factory Packaged Controls (FEC/FPC)*.
21. The termination chart is attached to the inside of control enclosure door (see Fig. 3-1).



FIG. 3-1 – TERMINATION CHART INSIDE ENCLOSURE DOOR

PRE START UP FAN ASSEMBLY INSPECTION

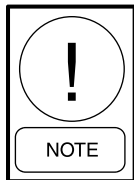

When the unit is removed from long-term storage moisture laden bearing grease should be purged and replenished with fresh grease per lubrication decal. The motor should be meggered to verify that the resistance is still at a satisfactory level compared to the value recorded prior to storage.

1. Check the bearings and locking collars (refer to Table 3-1, "Torque for Tightening Setscrews").

TABLE 3-1 – TORQUE FOR TIGHTENING SETSCREWS

SETSCREW DIA.	HEX. SIZE ACROSS FLATS	MIN. RECOMMENDED TORQUE	
		INCH LBS.	FOOT LBS.
1/4	1/8	66 - 85	5.5 - 7.08
5/16	5/32	126 - 164	10.5 - 13.7
3/8	3/16	228 - 296	19.0 - 24.7
7/16	7/32	348 - 452	29.0 - 35.7
1/2	1/4	504 - 655	42.0 - 54.6
5/8	5/16	1104 - 1435	92.0 - 119.6

2. Verify fan wheel properly aligned, tight on shaft and freely moving.
3. Ensure fan bearings properly lubricated (see Fan label or IOM Section 4, "Fan Bearing Lubrication").
4. Belts and Sheaves

- a) Verify sheaves properly aligned and tight on shaft. Improper sheave alignment and belt tension are potential causes of excessive noise and vibration, as well as shortened belt and bearing life (see IOM Section 4, "Sheaves Alignment").
- b) Check belt tension. If not familiar with the process (see IOM Section 4, "Belts" and "Adjustable Motor Base Operation").

It is normal for belts to loosen after start up. The new belts will "run in" or "take a set" by seating slightly deeper into the grooves of the sheaves. Recheck tension after one day and three days.

- c) Ensure motor mounting bolts and adjustable motor base bolts are tight.
5. Verify tie down bolts removed from 4 corners of fan base assembly.

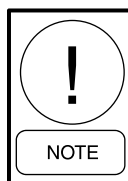

In small units the tie down bolts may only be applied to three corners of the fan base since one corner is not accessible.

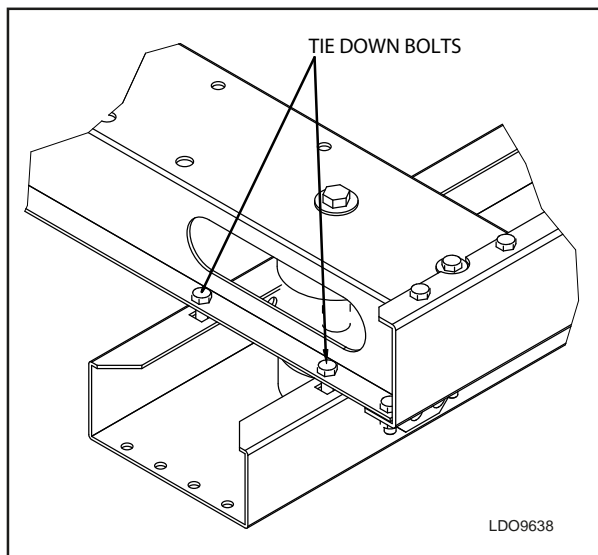

FIG. 3-2 – FAN AND MOTOR ISOLATOR SUPPORT FRAME.

3

Motors - ODP vs. TEFC

See Fig. 3-3 for ODP.



FIG. 3-3 – ODP (OPEN DRIP PROOF)

See Fig. 3-4 for TEFC.



LDO9639

FIG. 3-4 – TEFC (TOTALLY ENCLOSED FAN COOLED)

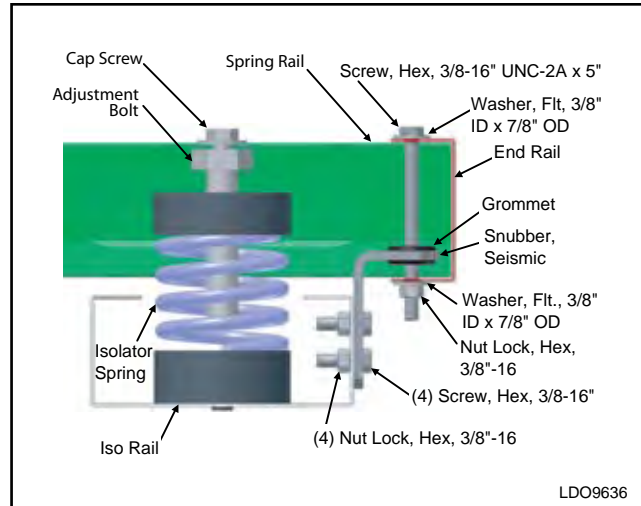

LDO9636

FIG. 3-6 – SEISMIC SNUBBER

Isolators

Check fan base isolators and thrust restraints for proper adjustment.

1. Standard fan isolation consists of spring isolators (see Fig. 3-5) mounted under the internal fan assembly.

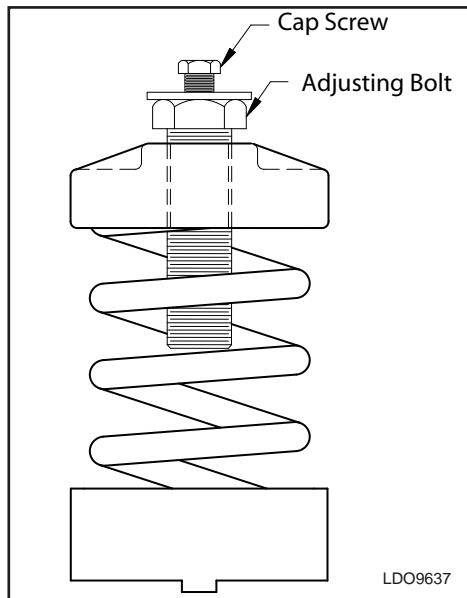

LDO9637

FIG. 3-5 – SPRING ISOLATOR

2. For thrust restraint adjustment procedures, when applied, (see IOM Section 5.0).
3. Fig. 3-6 shows isolator with seismic snubber restraint option.

Preparing Fan Isolators for Operation

1. After tie down bolts are removed from the internal fan assembly check blower/motor frame for correct height and that the frame is level.
2. To adjust isolators (see Fig. 3-5): First loosen cap screws on top of adjustment bolt. Then turn adjusting bolt. Next, check operational height and level of frame. Repeat this procedure until operational height and frame is level. Finally, tighten cap screws. (See IOM Section 5, "Isolator Adjustment" for additional instructions).
3. Verify the fan is aligned with unit discharge.
4. Re-adjust as necessary with isolators.

START-UP



Temporary Operation: *This equipment should not be operated until after complete Start-up as outlined in this guide. Do not allow the unit to run on temporary power that is not reliable and could be off/on periodically or rapidly. Also, protect it from irregular voltages and surges.*

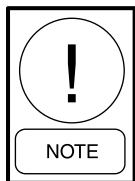

We strongly recommend the startup technician use the checklist provided and record the gathered information in the appropriate fields. If there are any specific questions refer to the document list on the checklist. Also, at the end of Section 3 is located a list of references for various check points on the checklist (Inspection Requirements). This is a guide to "How To" information in this and other documents.

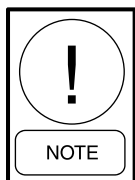

Filter media must be installed prior to Start-up. Use media provided or temporary media that will adequately protect the components in the air stream and duct system.

Check Operation of Fans

1. Energize power to the unit disconnect switch.
2. Verify correct voltage, phase and cycles.
3. Energize fan motor(s), briefly (bump) and check for correct fan rotation.

If rotation is incorrect:

1. On three-phase equipment reverse any 2 motor leads at the load side of last starter component.
2. On single-phase equipment, follow wiring diagram on motor housing or inside motor terminal box.
3. Re-check for correct fan rotation.

Check Operation of Dampers

Ensure unit will not operate with all dampers closed.

Linkage design and/or damper linkage may not be provided by Johnson Controls. Airflow control dampers may be operated with pneumatic or electric actuator/controllers.



Prior to occupancy, test ventilation system to ensure that outdoor air dampers operate properly in accordance with the system design.

Airflow Control Dampers

Many combinations of damper sizes are available to control the flow, the mixing of return air and outside air in the air inlet section of the unit may be supplied as follows:

- One hundred percent outside air, 100% return air.
- One hundred percent outside air, 0% return air.
- Zero percent outside air, 100% return air.
- Economizer Section - 100% outside air, 100% return air, 100% exhaust air or mixed air.



On dampers with actuators, interconnecting damper linkage is only provided when selected by Sales.

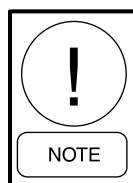

Dampers, actuators, controls and linkage must be checked prior to applying power to the operators making sure nothing will obstruct the operation of the dampers. Do not overdrive damper actuators as this may cause damage to the dampers.



Return air dampers may be closed for shipping. Loosen actuator or crank arm on jackshaft, open dampers, and retighten actuator or crank arm. Field is responsible for adjustments.

Typical Actuators Locations

Johnson Controls standard actuators are direct coupled on damper jackshaft.

Basic Actuators Installation

A basic procedure for installing Johnson Controls actuators is included in Section 2 "Installation".

Damper Blade Orientation

Return Air and Mixing Dampers with Power Off

Position the blades so that they will be open once the actuator is installed. This will be the dampers spring return position. Note whether the damper shaft is rotated fully clockwise or counter clockwise.

Outside Air and Exhaust Air Dampers

Position the damper blades so that they will be closed with power off. This will be the dampers spring return position. Note whether the damper shaft is rotated fully clockwise or counter clockwise.

With the actuator shaft clamp tightened to the damper jackshaft, and the damper shaft is completely rotated to its proper position, manually operate the actuator to its fully actuated position using the crank arm provided with the actuator. Then release the spring to allow the damper to go back to its original position. This will verify the actuators spring rotation and stroke. Set the damper actuators rotation selector switch to the proper rotation required to actuate the damper.

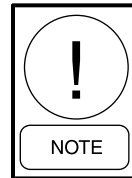

Damper actuator will always be opposite the spring return rotation.

Energize Fan Motor(s)

1. Observe fan(s) for smooth operation.
2. Check motor nameplate Full Load Amp rating.
3. Immediately, check current draw of each leg of each motor.

Variable Speed Drive (VSD)

YORK Air-Modulator (Variable Frequency Drive)



YORK Air Modulators are provided with Start-up service. See Installation and Start-up Guide provided with the YORK Air Modulator.

SWEEP BALANCE RESULTS:

The values listed below exceed the peak to peak tolerance through the sweep balance. When programming the Variable Speed Drive, lock-out or skip these frequency ranges during fan start up and shut down. If the peak is marked as N/A, it was within tolerance and does not need to be locked out or skipped.

Lock-out (Skip) Freq. Range(s)

PEAK #1	975-1025 (RPM)
	27.9-29.3 (Hertz)
PEAK #2	1348-1407 (RPM)
	38.5-40.2 (Hertz)
PEAK #3	(RPM)
	(Hertz)

FIG. 3-7 – EXAMPLE OF SWEEP BALANCE RESULTS

Set Up of a Non-Factory Mounted VFD

Refer to manufacturers Start Up Guide.

The Variable Frequency Drive (VFD) that controls the speed of a YORK Solution air handler fan needs to be set up so the fan does not run at resonant frequencies. Improper adjustment may damage the equipment. To determine which speeds are detrimental to the YORK equipment, refer to the document (058-008-002) supplied with the YORK Solution air handler. This information can also be found on the label located on the blower housing (see Fig. 3-7). This document lists any frequencies and the bandwidths that need to be jumped (skipped) by the VFD. The installer needs to program the jump (skip) frequencies and the bandwidths referenced in document (058-008-002) into the VFD. Failure to properly set the VFD before applying power to the motor will void the fan and motor warranty.

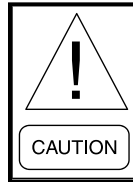

If the skip frequencies are not available to the installing contractor, the contractor must have the fan analyzed by a professional balancer before the VFD can be set and power is supplied to the fan.

Check Doors and Latches for Proper Adjustment

See IOM Section 5 "Door Handle/Latch Replacement and Adjustment".



Plastic spacers must be removed between doors and doorframes before Start-up.

Sheaves



If optional adjustable sheaves provided, we strongly recommend they be replaced with correctly sized fixed sheave immediately after system air balance is performed. It is not unusual for an adjustable sheave at some point in time to create damaging vibration in the fan assembly.

General Guidelines for Replacing an Adjustable Sheave with a Fixed Sheave:

- Measure the outside diameter of a belt while it is seated into at least one half the circumference of an adjustable sheave groove. Use this measurement as the sheave "pitch diameter". Order a sheave or sheave and bushing combination that matches pitch diameter, belt cross section and bore size. Order a sheave of good quality and require that it is prebalanced.
- *Reference Airside Parts - phone (800) 545-7814 to purchase new sheaves.*
 - Provide the following information:
 - Drive tag information (see Fig 3-8).
 - New fan RPM
 - Measurement of pitch diameter adjustable sheave is set at.
 - Job ID number from YORK Solution Unit ID Label.
- A new driver (motor) sheave or sheave and bushing are usually all that is required to directly replace the present adjustable driver sheave.



FIG. 3-8 – TYPICAL DRIVE KIT DATA TAG

Energy Recovery Wheel

Unit Configuration

Indoor Units

All indoor units will accommodate vertical Energy Recovery Wheel segments on horizontal (see Fig. 3-9).

Outdoor Units

All outdoor units will accommodate horizontal Energy Recovery Wheel segments in a low-profile, single unit arrangement (see Fig. 3-10).

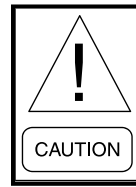

**Keep hands away from rotating wheel!
Contact with rotating wheel can cause physical injury.**

Start-Up Procedure for Energy Recovery Wheel

1. With power off, by hand, turn wheel clockwise (as viewed from the pulley side), to verify wheel turns freely through 360° rotation (see Fig. 3-11).

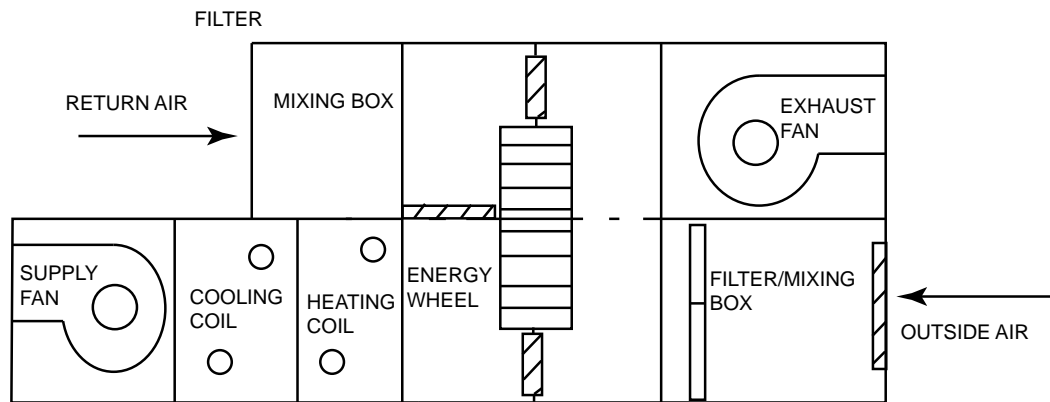

FIG. 3-9 – INDOOR UNIT - VERTICAL WHEEL

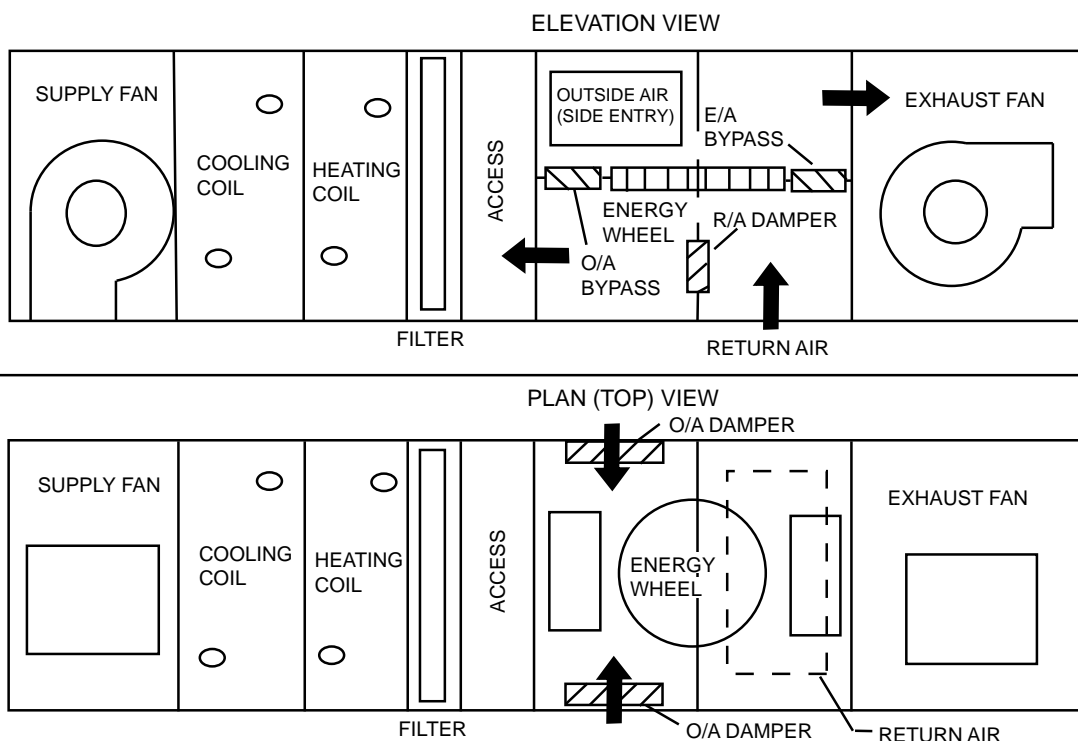

FIG. 3-10 – OUTDOOR UNIT - HORIZONTAL WHEEL

LD09641B

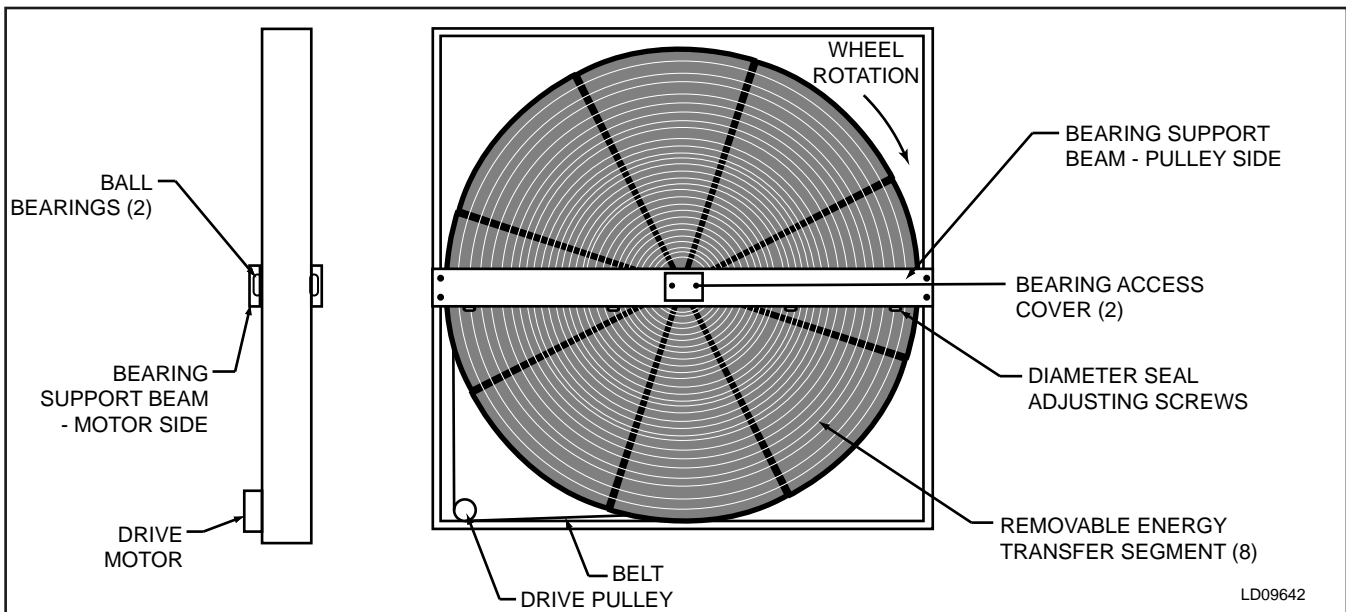

FIG. 3-11 – ENERGY RECOVERY WHEEL - PULLEY SIDE

2. Before applying power to drive motor, confirm wheel segments are fully engaged in wheel frame and segment retainers are completely fastened (see Fig. 3-12).
3. With hands and objects away from moving parts, activate unit and confirm wheel rotation. Wheel rotates clockwise (as viewed from the pulley side).
4. If wheel has difficulty starting, turn power off and inspect for excessive interference between the wheel surface and each of the four (4) diameter seals. To correct, loosen diameter seal adjusting screws and back adjustable diameter seals away from surface of wheel. Apply power to confirm wheel is free to rotate, then re-adjust and tighten hub and diameter seals (see Fig. 3-13).

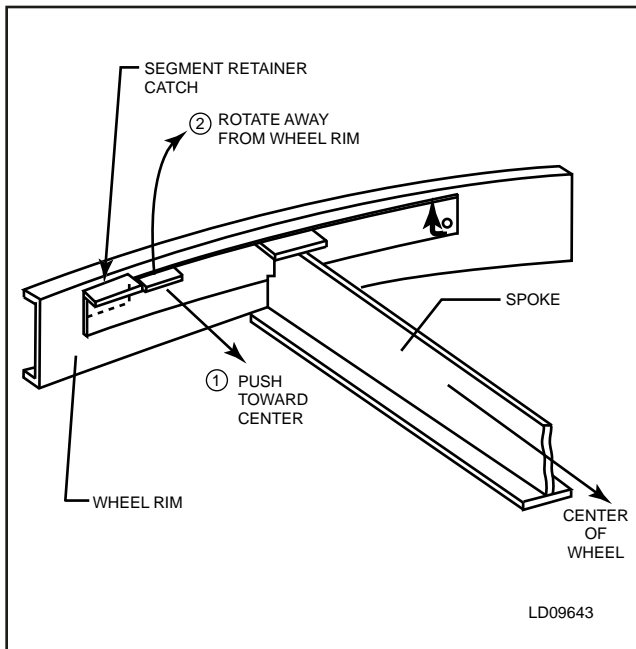

FIG. 3-12 – SEGMENT RETAINER

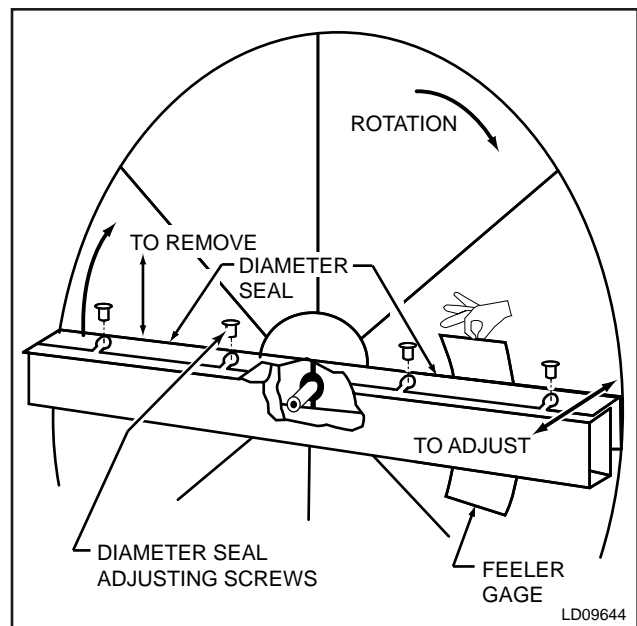
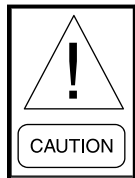

FIG. 3-13 – DIAMETER SEAL ADJUSTMENT

Indirect Fired Gas Heat Start Up



For your safety and satisfaction, this product requires check, test and start-up adjustment by a qualified HVAC technician. Do not use for temporary heat prior to start-up.



Review burner control literature, including wiring, piping, cut sheets and drawings before attempting to start this unit.

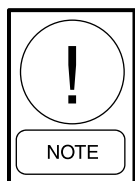

All factory test start up burner specifications are located on a laminated “Factory Specification Sheet” located on the inside of the control panel door”.

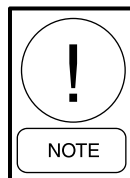

Your gas burner has been carefully inspected and tested at the factory; however, different conditions at the jobsite, including controls that have been added at time of installation, require careful testing and final adjustment for satisfactory operation. The Burner Test Report / Factory Specification Sheet in each unit shows the general data recorded during the operation and safety tests at the factory. This data should be used as a general guide; with final data recorded on the start-up form. Do not exceed 550°F flue temperature at the ID fan inlet. Do not exceed 200°F supply air temperature.

Introduction

This guideline describes the basic steps a technician would take in starting an Eclipse Gas Burner 10:1 - 25:1 turndown and Powerflame Gas Burner 3:1 - 10:1 turndown indirect fired gas heat system on a YORK Solution Air Handler for the first time.

Each gas burner has been test run and inspected at the factory. Adjustments to component settings are typically not required. However, measurements of system parameters should be taken and compared to the measurements recorded on the “Burner Test Report” to ensure safe and reliable operation. The “Burner Test Report” is laminated to the inside of the burner control door.

Identify the Unit Type

Two types of Indirect Fired gas burners are used on YORK Solution Air Handlers: The Powerflame series and the Eclipse series. The Powerflame series offers a turndown (modulating ratio) of 3:1 or 10:1. The Powerflame is easily identifiable by the motorized gas valve with external linkage connecting the air dampers on the burner air inlet.

The Eclipse series uses an air/gas ratio regulator with no external linkage, and has a turndown range of 10:1 to 25:1 (sometimes greater). A visible external plastic tube is used to transmit gas pressure from the burner to the regulator. No external linkage is used.

Both burners utilize a combustion air blower. YORK Solution Air Handlers also use an exhaust blower, called an induced draft (ID) blower. This exhaust blower keeps the combustion chamber at a slight negative pressure. Verification of this negative pressure and other system parameters is part of a proper start up procedure.

Preliminary Coordination

Contact contractor/customer who requested start-up.

- Verify air handler has had proper start-up.
- Ensure air handler and system is capable of design airflow for gas heat start-up.
- Ensure reliable power is available.
- Verify gas lines are purged of air to equipment valve.
- Verify controls are complete.
- Verify flue (stack) is correctly installed if parts were shipped loose (see Fig's 3-22 and 3-23).

Tools Recommended

- **Electrical Multimeter w/ Amprobe**
- **Heating Unit Installation and Operation Instruction.** - One is provided with every heating unit for technical information and troubleshooting.
- **Magnehelic Gauge 0" To .25" WC, Dwyer Series 2000 or Model 1227 Dual Range Manometer.** - For checking pressure over fire (draft).
- **Control Signal Generator, 0 to 20 mA (Aitek-234 or 334A)** - For 2 to 10 VDC signal add 500 ohms in series with signal generator.
- **Magnehelic Gauge 0" to 15" WC and 0 to 3 lbs. (Dwyer series-2000) or Monometer (Dwyer-1227) Dual Range Monometer.** - For checking supply gas pressure and manifold gas pressure or pilot gas pressure.
- **Honeywell - S7800A Test Module** - For use on (Honeywell-7800) Series Relay Module. (Available through Airside Parts - 800-545-7814, Ext.12).
- **Flue Gas Analyzer (CO₂ and O₂)**
- **Stack Thermometer (0°F - 1000°F approx.)**
- **Digital Manometer (replaces Magnehelic Gauge).**
Digital Manometer
Cat. #475-1 FM-AV
Series: 475-1 Mark III
Range: 0 to 19.99 In. W.C.
Dwyer Instruments, Inc.

Air Handler Pre Start Checks

- Verify air handler has had proper start up and airflow is at design maximum for heating cycle (refer to air balance report).
- Set bypass damper if provided in air handler.
- Airflow proving switch for main supply fan installed and operational.
- Check with Control Technician: two-minute post-purge programmed in air handler controller. Upon call for air handler unit stop, burner cycles off then air handler fan cycles off two minutes later.

Burner Pre Start Checks

1. Open fuse disconnects before working on burner (see Fig. 3-14).

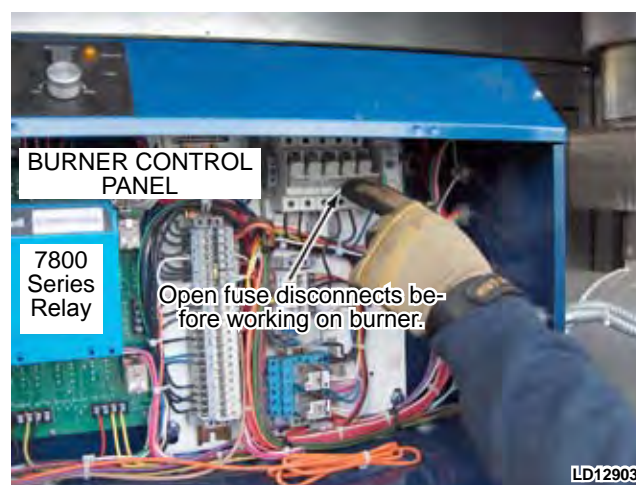

FIG. 3-14 – OPEN FUSE DISCONNECTS

2. Check all wire terminations for tightness.
3. Check that the incoming voltage(s) are correct. Compare measured voltages to burner motor and ID motor nameplates and the "Burner Test Report". Reset fuse disconnects.
4. Check for correct rotation of 3 phase burner motor and ID motor.
5. Verify that contractor has purged new gas lines of air up to manual valve on gas train.
6. Valves which have been closed for shipping must be opened accordingly. Check that all manual valves operate without leaks.

- The flue (stack) damper is located at the discharge of the ID blower and closed for shipping. Release the locking mechanism and set the damper to match the position indicated by the scribed markings. Lock in place (see Fig. 3-15).

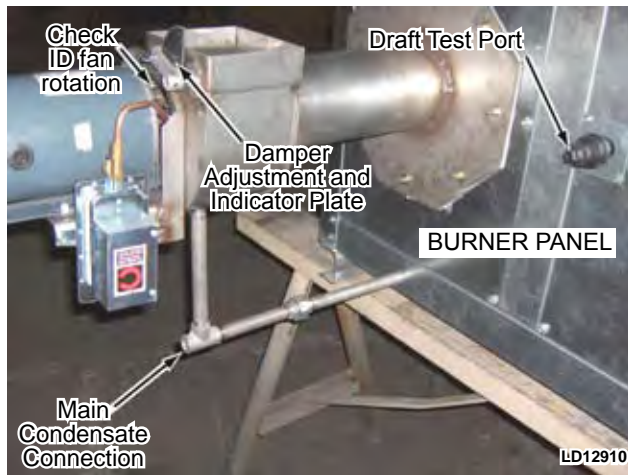

FIG. 3-15 – SET ID FAN DAMPER

- Inspect condensate drain trap to see that it is large enough, as described in this guideline (see Fig. 3-21).
- Measure the gas supply pressure coming into the gas train (see Fig. 3-16). Gas pressure can be greater than shown on the “Burner Test Report”, but it must be between the min/max values listed in Table 3-2.

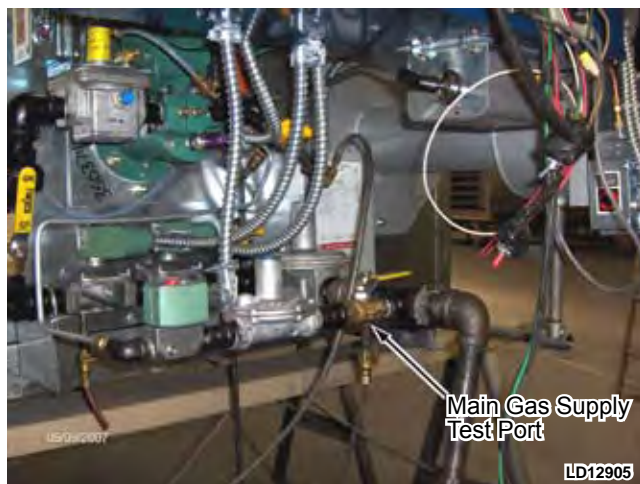
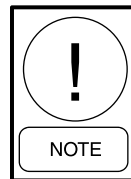
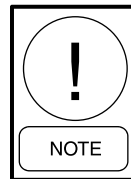

FIG. 3-16 – CHECK MAIN GAS SUPPLY PRESSURE

- Visually check that the high temperature safety limit is set for a 200-230°F range. The limit switch is typically mounted behind the burner control panel.
- Connect a 0-15" gas pressure gauge or other suitable instrument to the gas manifold port. The gas pressure will be measured when running (refer to step 4 of Burner Start-up Procedure).



On Powerflame burners this test port is downstream of the main regulator, typically on a standard tee fitting in the main gas line.



On Eclipse burners, this test port is located on the backside of the burner, just below the spark igniter. A small valve is provided at this test port.

- Connect a manometer or other suitable device to the Heat Exchanger Draft Port located on the side of the unit near the burner. The expected draft should read slightly negative – about -.03" WC. The draft port is typically made of 3/4" steel pipe and may be plugged. Remove plug and add a small stop valve and a nipple for a rubber tube (see Fig. 3-15 and 3-17).
- Install the Honeywell S7800 Test Module (display), if available.
- Connect signal generator (0-20mA) to terminals in place of modulation control signal (for 2-10 VDC signal add a 500 Ω resistor in series). See Fig. 3-24.
- Visually check that the flue (stack) is secure and connected properly. Typical connections are shown at the end of this guideline (see Fig.'s 3-22 and 3-23).
- Burner panel off/on switch should be “off”

System is now ready for start up.

Burner Start-Up Procedure

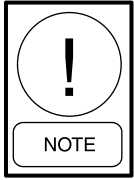

Prior to starting burner, technician must verify incoming gas pressure. A minimum pressure is listed on the “Burner Test Report”. The maximum pressure is listed in Table 3-2.

1. Open manual gas valves on gas supply and pilot line.
2. Initiate a call for heat or use jumper to create call for heat (see Fig. 3-24 for typical wiring diagram).
3. Turn burner panel off-on switch to on.

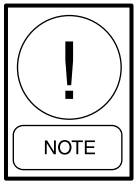

Once there is a call for heat, a 30 second pre-purge period is initiated to remove any gases from the heat exchanger. The burner will then go through a second purge before ignition.

4. The burner will automatically go to Low Fire at start up. After proof of Low Fire, the burner will modulate up to High Fire. This may take 15 seconds for a Powerflame burner and 90 to 180 seconds for the Eclipse burner. After the burner operates at High Fire use the manometer connected to the Heat Exchanger Draft Port (see Fig. 3-17), observe the reading. A negative pressure of about $-.03$ " WC is expected for draft overfire. Readings may differ slightly from those shown on the “Burner Test Report”.

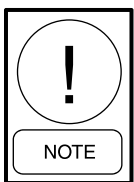

For valid readings, before making any adjustments, allow the burner to fire at least 20 minutes to allow the heat exchanger to come up to operating temperature.

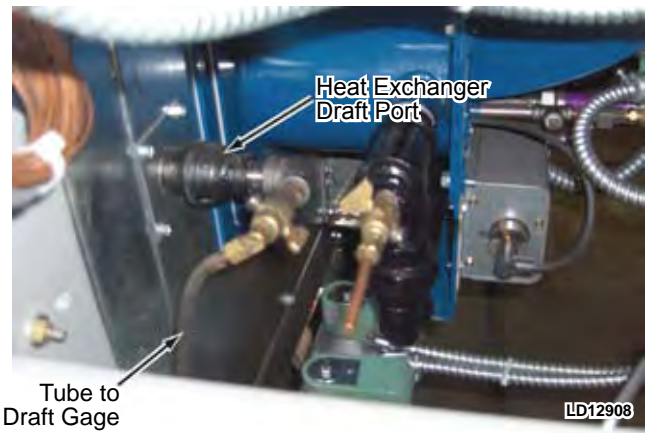
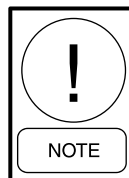

FIG. 3-17 – DRAFT OVER FIRE TEST PORT

5. Observe the gas manifold pressure and compare to data on the “Burner Test Report” under both High Fire and Low Fire conditions.
6. Check the flue (stack) combustion temperature at the ID Blower Housing Test Port. Make sure the test probe is inserted half way into the ID Inlet Tube (see Fig. 3-18). Compare results to the “Burner Test Report”.



FIG. 3-18 – FLUE (STACK) COMBUSTION TEMPERATURE AND EFFICIENCY TEST PORT



Ignition transformer is intermittent. Pilot continues to burn after ignition transformer is de-energized.

- Using the signal generator, cycle the burner to check capacity modulation. Observe valve/damper actuator operation.

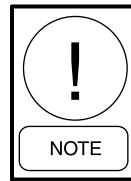

FIG. 3-19 – DAMPER ACTUATOR

- Using the standard operating controls, cycle the burner several times to assure proper sequencing of start-up, firing, and capacity modulation, plus operation of all safety and monitoring controls.
- Test 180°F. high temperature safety by running burner with airflow off or diverted. Burner will shut down at 180°F. Turn air handler on as quickly as possible to remove heat from the heat exchanger.
- Burner efficiency testing should be done last. The burner should be running at High Fire rate for 30 minutes before efficiency testing is done.
- Efficiency at High Fire is pre-determined, but may be checked by flue gas analysis at the entrance to the ID Blower Housing Test Port. At High Fire CO₂ should be between 8-1/2 and 10 %; O₂ should be between 7-1/2 and 4%. With these ranges, efficiency is 80% plus or minus 2% (see Fig. 3-18).
- Contact contractor, facilities manager or customer to inform successful start-up has been completed.



In the unlikely event that adjustment is required; it is done at High Fire and must NOT retard Low Fire light-off.



Do not change set up of factory preset air inlet dampers on Power Flame burner.

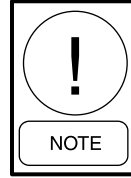

Any questions should be directed to your local Service office or Johnson Controls Product Tech Support, before contacting the burner manufacturer.



FIG. 3-20 – CONDENSATE DRAIN

Condensate Drain Arrangement

The YORK Solution Indirect Fired gas heat exchanger has the potential to create highly acidic condensation, particularly during extended operation at low capacity or low firing rate conditions. To insure proper drainage the following guidelines should be followed (See Fig. 3-21).



When constructing the condensate trap for the heat exchanger drainage system, make sure the trap is tall enough to handle the Total Static Pressure of the ID Blower at Low Fire times 2.

Example: TSP is 6" at Low Fire - construct trap 12" tall (See Table in Fig. 3-21).

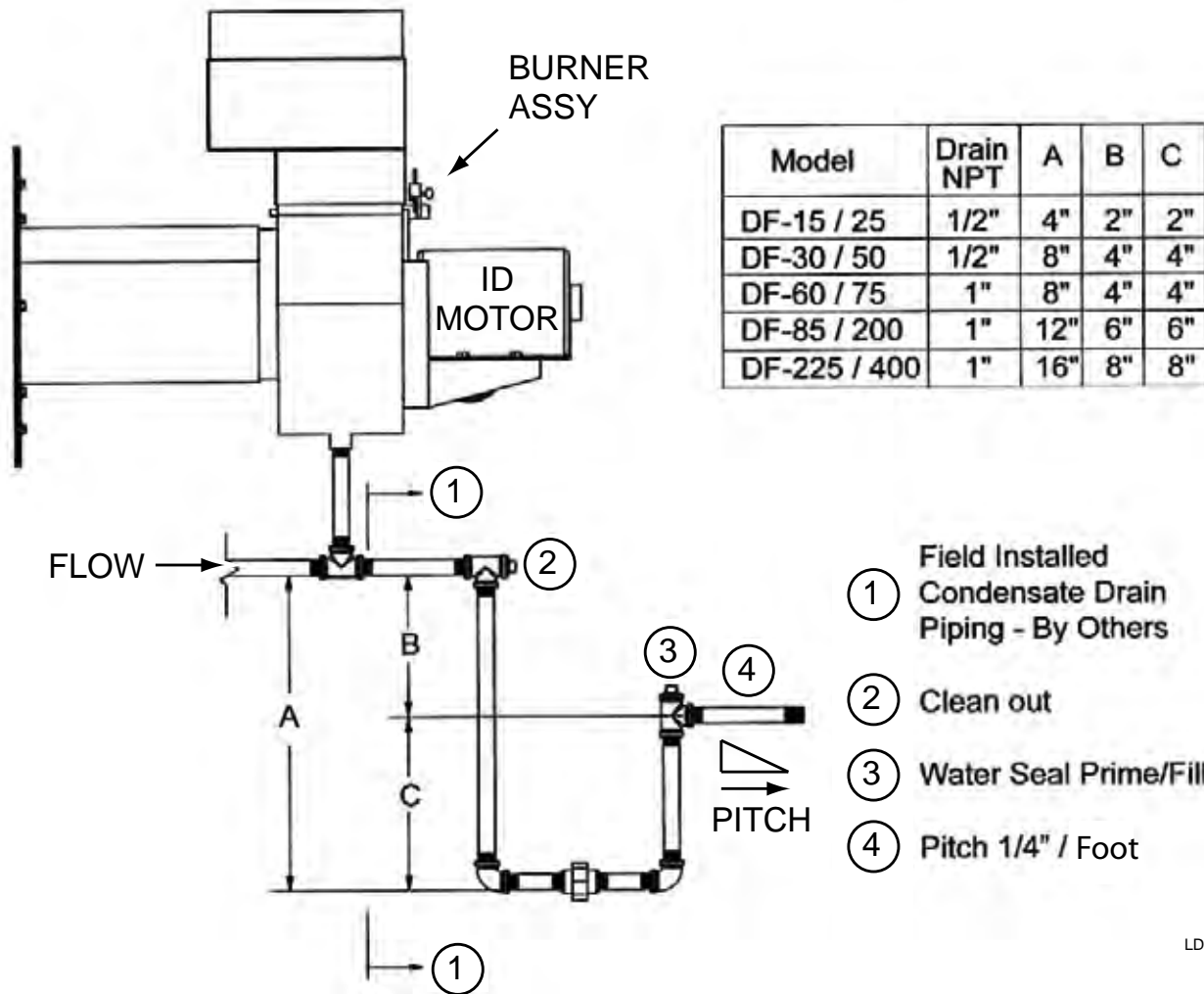

LD12912

FIG. 3-21 – GAS FURNACE CONDENSATE DRAIN TRAP



Failure to follow these guidelines may cause excessive condensation build up resulting in water damage to the facility and/or a cracked heat exchanger.

1. Observe local jurisdiction codes for gravity condensate drainage requirements.
2. Be sure the air handler is installed at an elevation that enables proper condensate drainage and trapping dimensions as provided in Fig. 3-21. Minimum trap dimensions MUST be accommodated.
3. Condensate drain line size must be the full line size of the heat exchanger drain connection.
4. Drain lines, fittings and supports should conform to local codes and be suitable for the application.
5. Condensate drain and trap discharge should be pitched away from the equipment at a slope of 1/4" per linear foot or as local code dictates.
6. For outdoor or unconditioned space installations local climate may dictate the need to heat trace and/or insulate the exposed drain lines and trap. Frozen drain lines and/or trap will cause build up of condensate inside the heat exchanger resulting in leakage and damage to the air handler and possibly to the facility.
7. Provide unions in drain lines to allow removal of trap for periodic cleaning of drain lines as well as the trap. When the burner is operated at low capacity for extended periods, more condensate is generated and with it deposits of solids in the condensate drainage system.
8. Provide the ability to prime the trap. During initial and seasonal start up, trap inspection and priming is required. Condensate in the trap will evaporate during long periods of non-use.

GAS HEAT SEGMENT MODEL NUMBER NOMENCLATURE

B REV LEVEL	100 DF SIZE/ CAPACITY MBH	U CODE COMPLIANCE	3 BURNER TDR	L UNIT HAND YORK DESIGNATION	G ID FAN HOUSING	G UNIT VOLTAGE	A CONTROL VOLTAGE (I ^{STAT} VOLTAGE)	A BURNER MOD CONTROL
A	15	A	3	L	Galvanized	A	A	A
B	20	U	10	R	Stainless	B	B	B
C	25	F	25			C		C
	30	R				D		
	35					E		
	40					F		
	45					G		
	50					H		
	60					J		
	75					K		
	85							
	100							
	125							
	150							
	175							
	200							
	225							
	250							
	275							
	300							
	325							
	350							
	375							
	400							

GAS { GAS LP = 2,500 BTU/ CU FT.
NATURAL = 1,000 BTU/ CU FT.
Output is approx. 80% of input BTU's

TABLE 3-2 – NATURAL GAS PRESSURE REQUIREMENTS (INCHES WC)

NOMENCLATURE FEATURE	MAXIMUM ALLOW INLET PRESSURE										MINIMUM INLET PRESSURE TO FIRE													
	A03	U03	F03	R03	A10	U10	F10	R10	A25	U25	F25	R25	A03	U03	F03	R03	A10	U10	F10	R10	A25	U25	F25	R25
	GAS BURNER PIPING/GAS BURNER TD										GAS BURNER TD													
OPTION	ANSI 3	UL 3	FM 3	IRI 3	ANSI 10	UL 10	FM 10	IRI 10	ANSI 25	UL 25	FM 25	IRI 25	ANSI 3	UL 3	FM 3	IRI 3	ANSI 10	UL 10	FM 10	IRI 10	ANSI 25	UL 25	FM 25	IRI 25
FURNACE OUTPUT (X10K)	ANSI 3:1	UL 3:1	FM 3:1	IRI 3:1	ANSI 10:1	UL 10:1	FM 10:1	IRI 10:1	ANSI 25:1	UL 25:1	FM 25:1	IRI 25:1	ANSI 3:1	UL 3:1	FM 3:1	IRI 3:1	ANSI 10:1	UL 10:1	FM 10:1	IRI 10:1	ANSI 25:1	UL 25:1	FM 25:1	IRI 25:1
015	14.00	NA	NA	NA	27.00	NA	NA	NA	NA	NA	NA	NA	4.00	NA	NA	NA	13.00	NA	NA	NA	NA	NA	NA	NA
020	14.00	NA	NA	NA	27.00	NA	NA	NA	NA	NA	NA	NA	4.00	NA	NA	NA	13.00	NA	NA	NA	NA	NA	NA	NA
025	14.00	NA	NA	NA	27.00	NA	NA	NA	NA	NA	NA	NA	4.00	NA	NA	NA	13.00	NA	NA	NA	NA	NA	NA	NA
030	14.00	NA	NA	NA	27.00	NA	NA	NA	NA	NA	NA	NA	4.00	NA	NA	NA	13.00	NA	NA	NA	NA	NA	NA	NA
035	NA	14.00	NA	27.00	NA	27.00	NA	27.00	NA	NA	NA	NA	NA	5.00	NA	4.00	NA	4.00	NA	4.00	NA	NA	NA	NA
040	NA	14.00	NA	27.00	NA	27.00	NA	27.00	NA	27.00	NA	27.00	NA	5.00	NA	5.00	NA	5.00	NA	5.00	NA	18.00	NA	18.00
045	NA	14.00	NA	27.00	NA	27.00	NA	27.00	NA	27.00	NA	27.00	NA	5.00	NA	5.00	NA	5.00	NA	5.00	NA	18.00	NA	18.00
050	NA	14.00	NA	27.00	NA	27.00	NA	27.00	NA	27.00	NA	27.00	NA	5.00	NA	5.00	NA	5.00	NA	5.00	NA	18.00	NA	18.00
060	NA	27.00	NA	27.00	NA	27.00	NA	27.00	NA	27.00	NA	27.00	NA	6.00	NA	6.00	NA	6.00	NA	6.00	NA	19.00	NA	19.00
075	NA	27.00	NA	27.00	NA	27.00	NA	27.00	NA	27.00	NA	27.00	NA	6.00	NA	7.00	NA	6.00	NA	7.00	NA	19.00	NA	19.00
085	NA	27.00	NA	27.00	NA	27.00	NA	27.00	NA	27.00	NA	27.00	NA	9.00	NA	8.00	NA	9.00	NA	8.00	NA	19.00	NA	19.00
100	NA	27.00	NA	27.00	NA	27.00	NA	27.00	NA	27.00	NA	27.00	NA	11.00	NA	9.00	NA	11.00	NA	9.00	NA	20.00	NA	20.00
125	NA	27.00	NA	27.00	NA	27.00	NA	27.00	NA	27.00	NA	27.00	NA	8.00	NA	7.00	NA	8.00	NA	7.00	NA	20.00	NA	20.00
150	NA	27.00	NA	27.00	NA	27.00	NA	27.00	NA	27.00	NA	27.00	NA	11.00	NA	9.00	NA	11.00	NA	9.00	NA	20.00	NA	20.00
175	NA	27.00	NA	27.00	NA	27.00	NA	27.00	NA	27.00	NA	27.00	NA	15.00	NA	12.00	NA	15.00	NA	12.00	NA	34.00	NA	34.00
200	NA	27.00	NA	27.00	NA	27.00	NA	27.00	NA	27.00	NA	27.00	NA	15.00	NA	12.00	NA	15.00	NA	12.00	NA	38.00	NA	38.00
225	NA	NA	27.00	27.00	NA	NA	27.00	27.00	NA	NA	55.00	55.00	NA	NA	8.00	11.00	NA	NA	8.00	11.00	NA	NA	34.00	34.00
250	NA	NA	27.00	27.00	NA	NA	27.00	27.00	NA	NA	55.00	55.00	NA	NA	8.00	11.00	NA	NA	8.00	11.00	NA	NA	35.00	35.00
275	NA	NA	27.00	27.00	NA	NA	27.00	27.00	NA	NA	55.00	55.00	NA	NA	11.00	10.00	NA	NA	11.00	10.00	NA	NA	39.00	39.00
300	NA	NA	27.00	27.00	NA	NA	27.00	27.00	NA	NA	55.00	55.00	NA	NA	11.00	11.00	NA	NA	11.00	11.00	NA	NA	40.00	40.00
325	NA	NA	27.00	27.00	NA	NA	27.00	27.00	NA	NA	55.00	55.00	NA	NA	8.00	9.00	NA	NA	8.00	9.00	NA	NA	41.00	41.00
350	NA	NA	27.00	27.00	NA	NA	27.00	27.00	NA	NA	55.00	55.00	NA	NA	8.00	9.00	NA	NA	8.00	9.00	NA	NA	48.00	48.00
375	NA	NA	27.00	27.00	NA	NA	27.00	27.00	NA	NA	55.00	55.00	NA	NA	8.00	10.00	NA	NA	8.00	10.00	NA	NA	49.00	49.00
400	NA	NA	27.00	27.00	NA	NA	27.00	27.00	NA	NA	55.00	55.00	NA	NA	9.00	10.00	NA	NA	9.00	10.00	NA	NA	48.00	48.00

Note: Gas pressure requirements at the inlet to the main manual shutoff cock of the gas train.

TABLE 3-3 – PIPE SIZE REQUIRED

INLET SIZE (NPT)												
	A03	U03	F03	R03	A10	U10	F10	R10	A25	U25	F25	R25
GAS BURNER PIPING/GAS BURNER TURN DOWN												
	ANSI 3	UL 3	FM 3	IRI 3	ANSI 10	UL 10	FM 10	IRI 10	ANSI 25	UL 25	FM 25	IRI 25
FURNACE OUTPUT (X10K)	ANSI 3:1	UL 3:1	FM 3:1	IRI 3:1	ANSI 10:1	UL 10:1	FM 10:1	IRI 10:1	ANSI 25:1	UL 25:1	FM 25:1	IRI 25:1
015	0.75	NA	NA	NA	1.00	NA	NA	NA	NA	NA	NA	NA
020	0.75	NA	NA	NA	1.00	NA	NA	NA	NA	NA	NA	NA
025	0.75	NA	NA	NA	1.00	NA	NA	NA	NA	NA	NA	NA
030	0.75	NA	NA	NA	1.00	NA	NA	NA	NA	NA	NA	NA
035	NA	1.00	NA	1.00	NA	1.00	NA	1.00	NA	NA	NA	NA
040	NA	1.00	NA	1.00	NA	1.00	NA	1.00	NA	1.00	NA	1.00
045	NA	1.00	NA	1.00	NA	1.00	NA	1.00	NA	1.00	NA	1.00
050	NA	1.00	NA	1.00	NA	1.00	NA	1.00	NA	1.00	NA	1.00
060	NA	1.00	NA	1.00	NA	1.00	NA	1.00	NA	1.00	NA	1.00
075	NA	1.00	NA	1.00	NA	1.00	NA	1.00	NA	1.25	NA	1.25
085	NA	1.00	NA	1.00	NA	1.00	NA	1.00	NA	1.25	NA	1.25
100	NA	1.00	NA	1.00	NA	1.00	NA	1.00	NA	1.25	NA	1.25
125	NA	1.25	NA	1.25	NA	1.25	NA	1.25	NA	1.50	NA	1.50
150	NA	1.25	NA	1.25	NA	1.25	NA	1.25	NA	1.50	NA	1.50
175	NA	1.25	NA	1.25	NA	1.25	NA	1.25	NA	1.50	NA	1.50
200	NA	1.50	NA	1.50	NA	1.50	NA	1.50	NA	1.50	NA	1.50
225	NA	NA	2.00	1.50	NA	NA	2.00	1.50	NA	NA	2.00	2.00
250	NA	NA	2.00	1.50	NA	NA	2.00	1.50	NA	NA	2.00	2.00
275	NA	NA	2.00	1.50	NA	NA	2.00	2.00	NA	NA	2.00	2.00
300	NA	NA	2.00	1.50	NA	NA	2.00	2.00	NA	NA	2.00	2.00
325	NA	NA	2.50	2.50	NA	NA	2.50	2.50	NA	NA	2.50	2.50
350	NA	NA	2.50	2.50	NA	NA	2.50	2.50	NA	NA	2.50	2.50
375	NA	NA	2.50	2.50	NA	NA	2.50	2.50	NA	NA	2.50	2.50
400	NA	NA	2.50	2.50	NA	NA	2.50	2.50	NA	NA	2.50	2.50

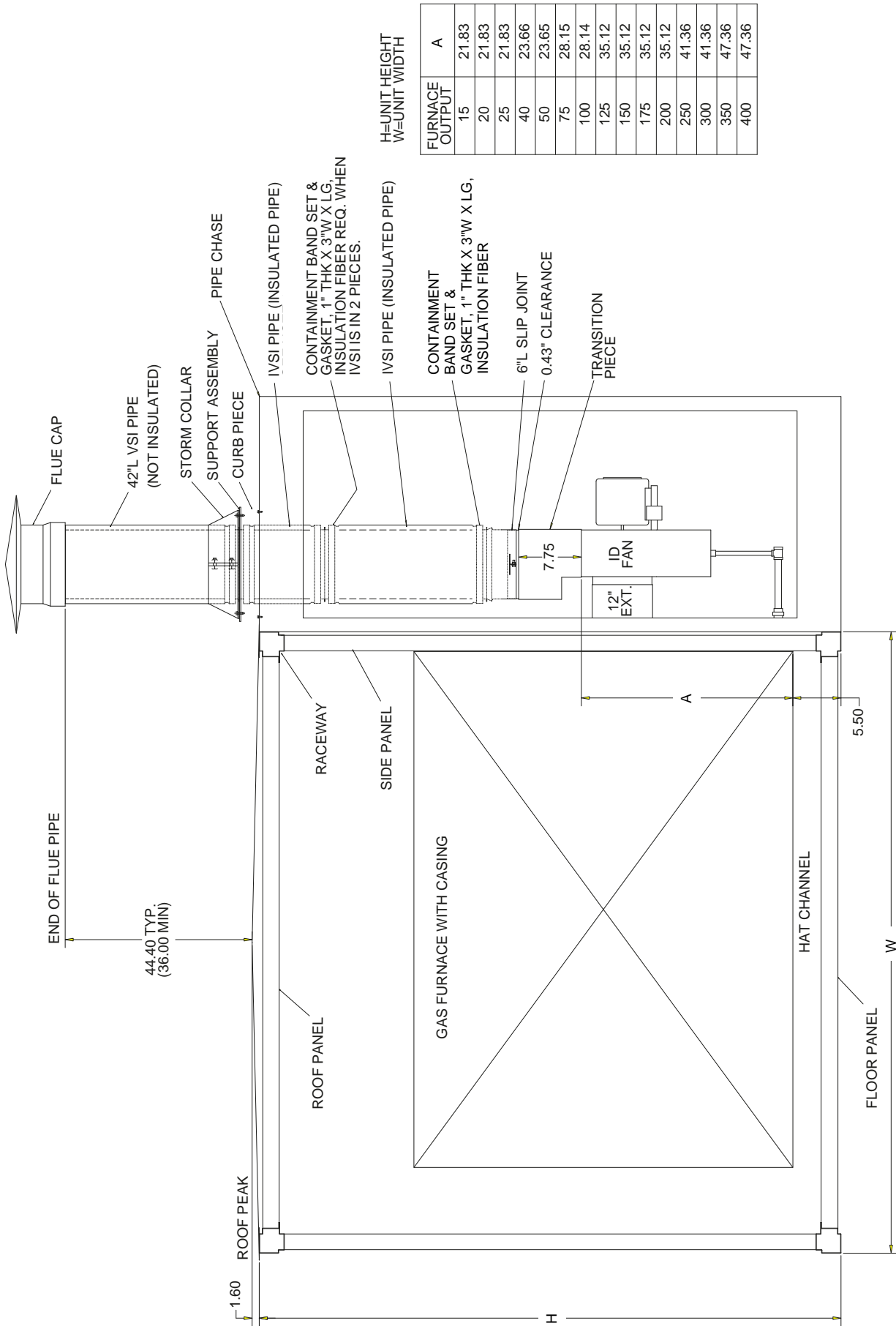

FURNACE OUTPUT	H	W
15	21.83	A
20	21.83	
25	21.83	
40	23.66	
50	23.66	
75	28.15	
100	28.14	
125	35.12	
150	35.12	
175	35.12	
200	35.12	
250	41.36	
300	41.36	
350	47.36	
400	47.36	

LD13304

FIG. 3-22 – GAS FURNACE FUEL VENTING SYSTEM

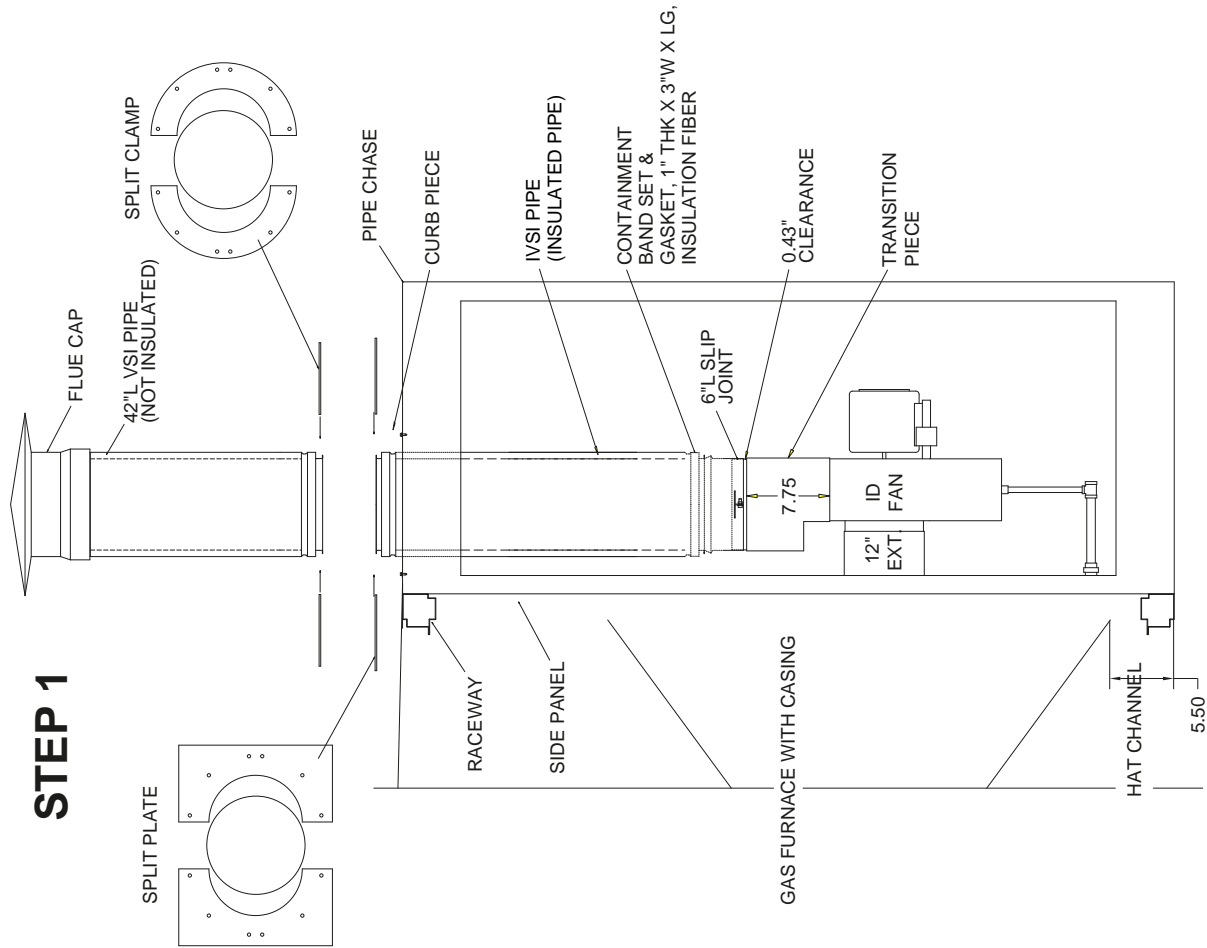
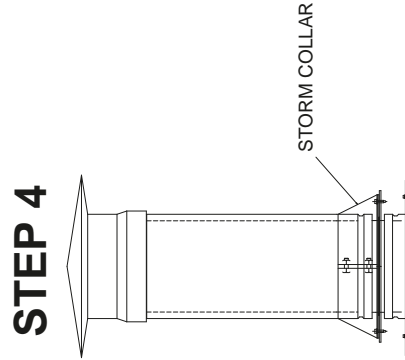
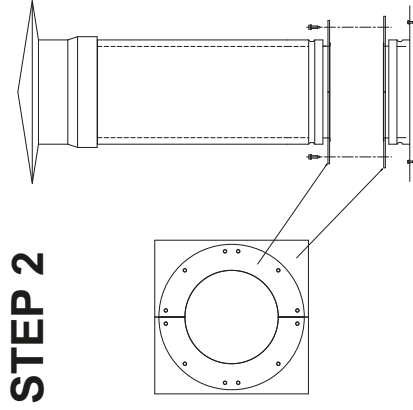
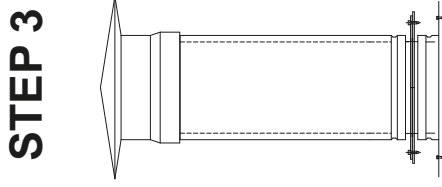

FIG. 3-23 – GAS FURNACE FUEL VENTING SYSTEM

FOR REFERENCE ONLY

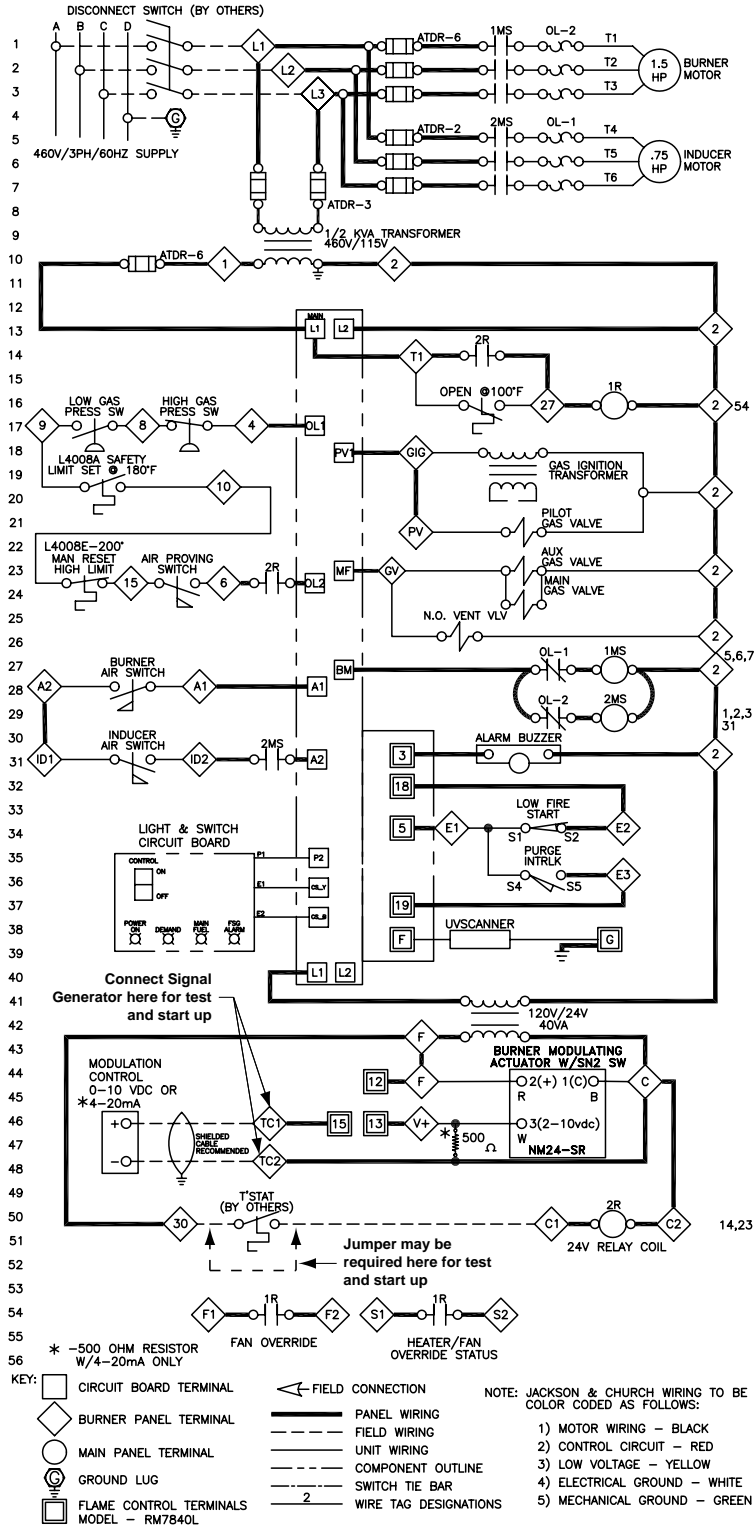

FIG. 3-24 – TYPICAL WIRING DIAGRAM

LD13315

TABLE 3-4 – BURNER TEMPERATURE RISE

CFM	TEMPERATURE RISE (°F)			INTERNAL PRESSURE DROP “ WC
	DF- 15	DF- 20	DF- 25	
1,500	91	--	--	0.17
2,000	68	91	--	0.29
2,500	55	73	91	0.46
3,000	46	61	76	0.65
3,500	40	52	65	0.89
4,000	35	46	57	1.17
4,500	31	41	51	1.47
5,248	26	35	44	2
	DF- 30	DF- 35	DF- 40	
3,000	95	--	--	0.22
3,500	82	91	--	0.31
4,000	71	79	95	0.41
4,500	63	70	85	0.54
5,000	57	63	76	0.66
5,500	52	57	69	0.84
6,000	47	53	63	1
6,500	43	47	58	1.2
7,000	40	46	54	1.45
8,440	32.9	38.4	43.9	2
	DF- 45	DF- 50		
4,500	88	--		0.39
5,000	80	90		0.47
5,500	72	82		0.55
6,000	66	75		0.65
6,500	61	69		0.75
7,000	57	64		0.86
7,500	53	60		0.98
8,000	50	56		1.1
8,500	47	53		1.23
9,000	46	50		1.38
10,725	38.8	43.2		2

CFM	TEMPERATURE RISE (°F)			INTERNAL PRESSURE DROP “ WC
	DF- 60	DF- 75		
6,000	91	--		0.44
6,500	84	--		0.52
7,000	78	--		0.6
7,500	73	91		0.68
8,000	68	85		0.78
9,000	61	76		0.98
10,000	55	68		1.2
11,000	50	62		1.4
12,000	46	57		1.7
12,900	43	53.8		2
	DF- 85	DF- 100		
8,500	91	--		0.47
9,000	86	--		0.52
9,500	81	--		0.58
10,000	77	91		0.64
10,500	74	87		0.7
11,000	70	83		0.76
12,000	64	76		0.9
13,000	59	70		1.05
14,000	55	65		1.25
15,000	51	61		1.4
16,000	49	57		1.6
17,000	46	54		1.75
17,825	44	52		2

TABLE 3-4 - BURNER TEMPERATURE RISE (CONT)

CFM	TEMPERATURE RISE (°F)				INTERNAL PRESSURE DROP " WC
	DF-125	DF-150			
13,000	89	--			0.48
14,000	83	--			0.56
15,000	77	93			0.65
16,000	72	87			0.73
17,000	68	82			0.82
18,000	64	77			0.92
19,000	61	73			1.03
20,000	58	69			1.13
21,000	55	66			1.25
22,000	52	63			1.35
23,000	50	60			1.5
24,000	48	58			1.3
25,000	46	55			1.75
26,315	43.6	52			2
	DF-175	DF-200			
17,000	95	--			0.45
18,000	90	--			0.52
19,000	85	--			0.57
20,000	81	93			0.63
21,000	77	88			0.7
22,000	74	85			0.76
23,000	71	81			0.82
24,000	68	78			0.9
26,000	62	71			1.05
28,000	58	66			1.25
30,000	54	62			1.4
32,000	51	58			1.6
34,000	48	54			1.8
35,635	45.5	52			2

CFM	TEMPERATURE RISE (°F)				INTERNAL PRESSURE DROP " WC
	DF-225	DF-250	DF-275	DF-300	
24,000	87	--	--	--	0.337
27,000	77	86	92.5	--	0.427
30,000	69	77	83.3	90.8	0.527
33,000	63	70	75.8	82.5	0.637
36,000	58	64	69.5	75.7	0.758
39,000	53	59	64	70	0.89
42,000	50	55	59.5	65	1.035
45,000	46	51	55.6	60.6	1.185
48,000	43	48	52.1	55.8	1.35
51,000	41	45	50	53.5	1.525
54,000	39	43	47	50.5	1.71
58,475	35	39.5	43.5	47.5	2
	DF-325	DF-350	DF-375	DF-400	
31,565	95	--	--	--	0.4
35,290	85	92	--	--	0.5
41,755	72	78	83	89	0.7
47,345	64	68	73	78	0.9
52,340	57	62	66	71	1.1
54,665	55	59	64	68	1.2
59,045	51	55	59	63	1.4
63,125	48	51	55	59	1.6
66,950	45	48	52	55	1.8
70,573	42.6	45.9	49.2	52.4	2

Electric Heat Startup



Rotating parts and electrical shock hazards exist. Lock out and tag out the fan motor(s) and heat power disconnects before servicing. FOLLOW THE LATEST "LOCKOUT TAGOUT" PROCEDURE. Failure to follow proper safety precautions may result in serious injury or death

All electrical connections in the heater, including both field and factory made connections, should be checked for tightness before operating the heater. In addition, after a short period of operation, all connections should again be checked for tightness.



DO NOT operate electric heat below the minimum airflow requirement.

A visual inspection of the heater elements should be made prior to use of the heater. If physical damage is evident, a Megohm test should be used to validate the heater elements are safe for use. If a minimum value of 10 megohms is not achieved then any damaged elements or ceramic insulators must be replaced prior to operation.

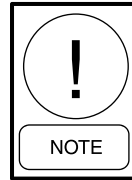

Ensure filters are clean and airflow is at minimum requirement or greater. Preferably 100 % for this start up procedure.

To operate this heater make sure all associated control equipment is on, energize main supply disconnect and set controlling thermostat above ambient temperature. This heater is equipped with automatic and manual reset temperature limiting controls. If it fails to operate, make sure manual resets are operative by pushing reset buttons.

Airflow Requirements

See Fig. 3-25

Calculate KW per square foot of duct area as:

$$\frac{\text{heater nameplate KW}}{\text{duct area (Sq.Ft.)}}$$

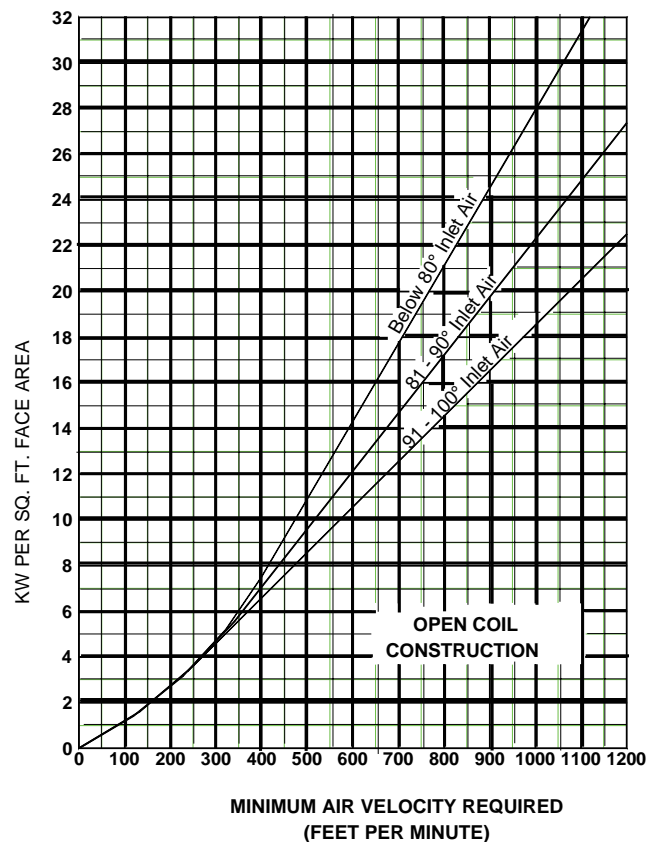
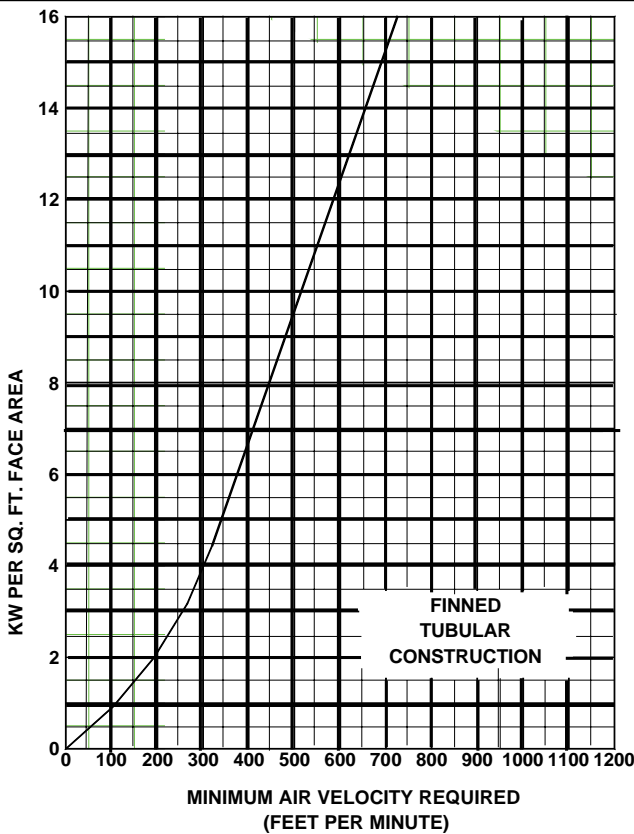
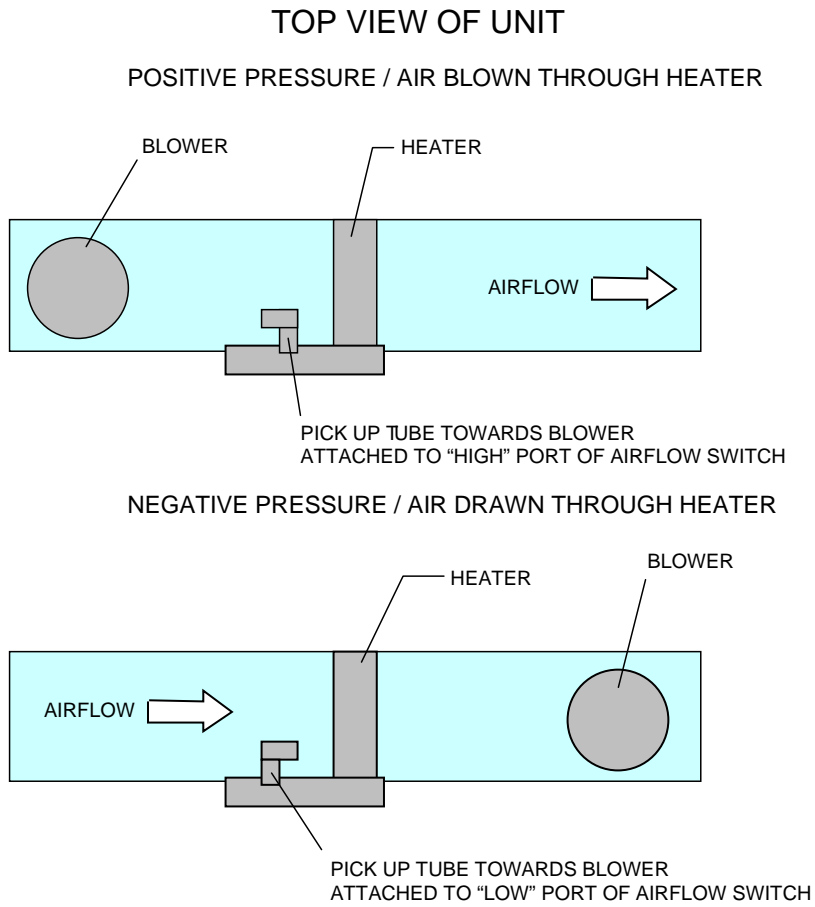
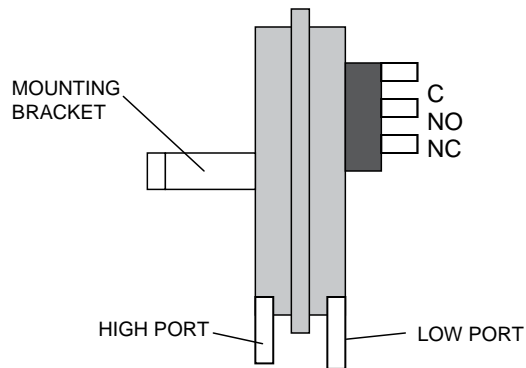

FIG. 3-25 – MINIMUM AIR VELOCITY REQUIRED FOR SAFE OPERATION



LD14268

FIG. 3-26 – PRESSURE PROBE DIRECTION



LD14270

FIG. 3-27 – AIRFLOW SWITCH CONNECTIONS

 BY JOHNSON CONTROLS	AIR HANDLING UNITS
START-UP CHECKLIST	Supersedes: 100.00-CL1 (309) Form 100.00-CL1 (909)

AIR HANDLER START-UP CHECKLIST

OFFICE LOCATION _____	UNIT TAG # _____
QUALIFIED TECHNICIAN _____	UNIT MODEL # _____
JOB NAME _____	UNIT SERIAL # _____
YORK JOB ID OR CONTRACT # _____	START DATE _____
JOB SITE LOCATION _____	
JOB SITE CONTACT AND PHONE # _____	

IMPORTANT SAFETY REQUIREMENT: FOLLOW THE LATEST "LOCK OUT TAG OUT" PROCEDURE.

PRE START-UP

GENERAL UNIT INSPECTION

Identify and perform appropriate "lock out/tag out" and safety rules. For details on points below see appropriate section of the Installation Instruction provided with each air handler.

For VFD equipped air handlers, refer to the VFD forms for additional requirements.



Serious damage to the AHU and/or system is eminent if the AHU is operated under any of the following conditions:

- Without proper control of dampers.

- With smoke dampers closed.
- During a fire alarm or smoke purge test.
- Any airflow restriction greater than normal.

Solution	AH Units	Form 102.20-NOM1	Air Modulator	VFD	Form 100.41-NO1
Custom	AH Units	Form 100.31-NOM1			

<input type="checkbox"/> Equipment received as ordered.	<input type="checkbox"/> Verify all ductwork is complete and available for full air flow.
<input type="checkbox"/> Unit checked for damage to interior and exterior.	<input type="checkbox"/> Unit installed with proper clearances.
<input type="checkbox"/> Unit installed on flat and level surface. Outdoor unit mounted within roof slope limitations where applicable.	<input type="checkbox"/> Visually inspect roof curb for tight seal around unit.
<input type="checkbox"/> Terminal screws and wiring connections secure in control, electric and Air Modulator panels.	<input type="checkbox"/> Clean air filters installed properly and secured.
<input type="checkbox"/> Air hoods installed properly.	<input type="checkbox"/> Filter gauge set to zero.
<input type="checkbox"/> Condensate drain properly trapped.	<input type="checkbox"/> All field wiring complete and inspected.
<input type="checkbox"/> All wiring and tubing connections made at shipping splits.	<input type="checkbox"/> All shipping splits sealed and secured properly.
<input type="checkbox"/> All field piping connections complete.	<input type="checkbox"/> Pipe chase floor sealed at penetrations.
<input type="checkbox"/> All shipped loose parts installed.	<input type="checkbox"/> All shipping bolts and other material have been removed. (Fan, VIFB, Energy Recovery Wheel, Damper).
<input type="checkbox"/> Installer has cleaned out interior.	<input type="checkbox"/> Damper linkage is tight and in correct "power off" position.
<input type="checkbox"/> Verify all plug-ins and wire connections are tight on UV equipment.	<input type="checkbox"/> Controls installation complete.
<input type="checkbox"/> Verify Energy Recovery Wheel turns freely and wheel segments are fully engaged.	<input type="checkbox"/> Verify correct piping of split system. Reference Section 2 of Solution IOM & Split System Application Guide (050.40-ES3).

FAN INSPECTION

<input type="checkbox"/> Check bearings and locking collars for properly tightened setscrews, bolts and nuts.	<input type="checkbox"/> Fan wheel properly aligned, tight on shaft and freely moving.
<input type="checkbox"/> Sheaves properly aligned and tight on shaft.	<input type="checkbox"/> Check fan base isolators and thrust restraints for proper adjustment. Note: Do not remove functional bolts from seismic isolators.
<input type="checkbox"/> Belt tension adjusted properly per drive pkg. label on fan.	<input type="checkbox"/> Fan bearings have been re-lubricated properly.
<input type="checkbox"/> Check fan alignment with unit discharge. Adjust with isolation.	

FIG. 3-28 – AIR HANDLER START-UP CHECKLIST, FORM 100.00-CL1

TABLE 3-5 – INSPECTION REQUIREMENTS

ITEM	YORK SOLUTION INSTRUCTION LOCATION
Pre Start-up	
Equipment received as ordered.	Section 1, Inspection
Unit checked for damage interior and exterior.	Section 1, Inspection
Verify unit installed on flat and level surface. Outdoor unit mounted within roof slope limitations where applicable.	Section 2, Site Preparation
Terminal screws and wiring connections tightened in control, electric and Air Modulator panels.	Section 2, Electrical Connections Section 3, Pre-Startup
Air hoods installed properly.	Section 2, Hood Installation with Optional Mist Eliminators
Condensate drain properly trapped.	Section 2, Condensate Drain Trap
All wiring and tubing connections made at shipping splits.	Section 2, Assembly of Outdoor Units and Assembly of Indoor Units
All field piping connections complete.	Section 2, Coil Piping
All shipped loose parts installed.	Section 1, Checking For Non Mounted Parts
Installer has cleaned out interior.	
Make sure all ductwork is complete and available for full airflow.	Section 2, Duct Connections Section 3, Startup
Unit installed with proper clearances.	Section 2, Outdoor Units Site Prep. Section 2, Indoor Units Site Prep.
Visually inspect roof curb for tight seal around unit.	Section 2, Curb; Assembly & Installation Instructions
Clean air filters installed properly and secured.	Section 2, Air Filters
Filter gauge set to zero.	
All field wiring complete and inspected.	<i>See Notes in General Safety Guidelines, Pre-installation & Installation.</i> Section 2, Electrical Connections IOM Section 6, Wiring Diagrams
All shipping splits sealed and secured properly.	Section 2, Installing Multiple Piece Outdoor Unit Installing Multiple Piece Indoor Unit and Installation of Tiered Unit
Pipe chase floor sealed at penetrations.	Section 2, Pipe Chase Installation
All shipping bolts and other material have been removed. (Fan, VIFB, Energy Recovery Wheel, Damper). Note: Do not remove functional bolts from seismic isolators.	Section 2, VIFB & IFB Section 3, Pre Start-up
Damper linkage is tight and in correct "power off" position.	Section 3, Pre Start-up
Verify correct piping of split system.	Section 2 & Split System Application Guide (050.40-ES3).
FAN INSPECTION	
Check bearings and locking collars.	Section 3, Pre Start-up Fan Assembly Inspection
Sheaves properly aligned and tight on shaft.	Section 3, Belts & Sheaves IOM Section 4, Sheave Alignment
Belt tension adjusted properly per drive pkg. label on fan.	IOM Section 4, Belts
Check fan alignment with unit discharge. Adjust with isolator.	Section 3, Preparing Fan Isolators for Operation
Fan wheel properly aligned, tight on shaft and freely moving.	IOM Section 5, Fan Repair

TABLE 3-5 - INSPECTION REQUIREMENTS (CONT.)

ITEM	YORK SOLUTION INSTRUCTIONS
Check fan base isolators and thrust restraints for proper adjustment.	Section 3, Isolators IOM Section 5, Isolator Adjustment IOM Section 5, Thrust Restraint Replacement & Adjustment
Fan bearings properly lubricated.	IOM Section 4, Fan Bearing Lubrication
START-UP	
Energize power to the unit disconnect switch.	Section 3, Start-up
Verify correct voltage, phase and cycles.	Section 2, Electrical Connections
Energize fan motor(s) briefly (bump) and check for correct fan rotation.	Section 3, Start-up
Check operation of dampers. Insure unit will not operate with all dampers closed.	Section 3, Start-up
Energize fan motor(s). Observe fan(s) for smooth operation.	Section 3, Start-up-Energize Fan Motor
Check motor nameplate Full Load Amp rating.	Section 3, Start-up-Energize Fan Motor Section 2, Electrical Connections
Immediately check current draw of each leg of each motor.	Section 3, Start-up-Energize Fan Motor Section 2, Electrical Connections
VFD, <i>refer to manufactures start engine guide.</i>	Section 3, Setup of Non-factory Mounted VFD IOM Section 4, Dynamic Balance
Check damper operation.	Section 3, Start-up-Check Operation of Dampers IOM Section 4, Economizer Segment
Check doors and latches for proper adjustment.	IOM Section 4, Air Handler Cabinet-Hardware Check IOM Section 5, Door Handle/latch Replacement And Adjustment
Check doors for air leaks.	IOM Section 5, Door Replacement IOM Section 5, Door Gasket Replacement
Controls installation complete.	Section 3, Pre Start-Up
Verify Energy Recovery Wheel turns freely and wheel segments are fully engaged.	Section 3, Start-up Procedure For Energy Recovery Wheel



 BY JOHNSON CONTROLS	Form No.: 102.20-N1 (LS01)	509
	Supersedes: New Release	
LITERATURE SUPPLEMENT	File with:	102.20-N1 (1108) 102.20-NOM1(105)
Subject: Installation, Operating and Maintenance Instructions for Electric Heat Applications in Air Handling Products. (Listed or Certified to UL 1995.)		



Rotating parts and electrical shock hazards exist. Lock out and tag out the fan motor(s) and heat power disconnects before servicing. FOLLOW THE LATEST "LOCKOUT TAGOUT" PROCEDURE. Failure to follow proper safety precautions may result in serious injury or death

APPLICATION INFORMATION

1. Follow the procedure given in this instruction to find the minimum air velocity for safe operation (see Fig. 1). At least this minimum velocity must be provided at all points over the heater face area. Failure to meet this requirement may result in serious damage or nuisance thermal cutout tripping.
2. The maximum air inlet temperature for open coil heaters is 100° F, and for finned tubular heaters, 80° F.
3. Sufficient working space must be provided per paragraph 110-26 of the NEC.
4. This electric heater is not designed for or intended to be used for temporary heat prior to system startup / balancing.

MECHANICAL INSTALLATION

1. All heaters will contain an adjustable airflow switch in the heater control panel. This switch will be preset to close at a differential pressure of approximately 0.3" W.C. In all cases the switch will be connected to a pressure probe positioned in the airstream. This probe has an arrow stamped on it that is viewable from inside of the control panel. When the heater is located upstream of the fan this arrow will point away from the fan. When

the heater is located on the downstream side of the fan the arrow will again point away from the fan or with airflow. If it is incorrectly installed, remove the (2) screws holding the pressure probe in place and rotate 180° and reinstall. The airflow switch pressure port that is not connected to this pressure probe will be run to the exterior of the air handling unit to source a reference differential pressure. In some situations it may be necessary to adjust this airflow switch setting to allow for proper operation. Precautions must be made at this time to make sure that the airflow switch does not provide a false indication of airflow. Failure to meet this requirement may result in serious damage or nuisance thermal cutout tripping.

2. A visual inspection of the heater elements should be made prior to use of the heater. If physical damage is evident, a Megohm test should be used to validate the heater elements are safe for use. If a minimum value of 10 megohms is not achieved then any damaged elements or ceramic insulators must be replaced prior to operation.

ELECTRICAL INSTALLATION

1. Follow the wiring diagram on the inside of the terminal box.
2. Supply connections must be made with copper wiring rated for 75° C minimum.
3. If supply connections are for 250 volts or greater, all wiring must be insulated for 600 volts.
4. When making line connections to heater element terminals FOR FINNED TUBULAR HEATERS ONLY, apply a 1/4" wrench to flat section of terminal immediately below threads. Otherwise damage to terminal may result.

5. Supply conductors for heaters rated less than 50 KW, must be sized at 125% of rated load. On heaters rated 50 KW and more, the supply conductors may be sized at 100% of rated load, if indicated on the wiring diagram. The line current for either a single or three phase load is calculated as follows:

$$\text{Single Phase Line Current} = \frac{\text{KW} \times 1000}{\text{Voltage}}$$

$$\text{Three Phase Line Current} = \frac{\text{KW} \times 1000}{\text{Voltage} \times 1.73}$$

6. The following table shows the maximum current for 75 °C copper wire with not more than 3 conductors in a raceway. It is based on the National Electrical Code Table 310-16. The amperages shown are for 125% and 100% wire sizing. If there are more than 3 conductors in a raceway, derate these amperages per Table 310-15(b)(2)(a).

AMPS		WIRE SIZE AWG/ MCM	AMPS		WIRE SIZE AWG/ MCM	AMPS		WIRE SIZE AWG/ MCM
125%	100%		125%	100%		125%	100%	
12		14	80	100	3	184	230	4/0
16		12	92	115	2	204	255	250
24		10	104	130	1	228	285	300
40		8	120	150	0	248	310	350
52	65	6	140	175	2/0	268	335	400
68	85	4	160	200	3/0	304	380	500

7. When connecting heaters with more than one stage, wire stage No. 1 so that it is the first stage on and the last stage off.
8. The heater must be wired so that it cannot operate unless air is flowing over it. This can be accomplished by using a built-in airflow switch and a remote interlock. *See the accompanying wiring diagram for the method used with this heater and provide appropriate interlock wiring as illustrated.* This diagram will be located inside of the electric heater control panel.
9. If not supplied as part of this heater, install a line disconnect switch or main circuit breaker in accordance with the National Electrical Code. Depending upon the heater's location and accessibility, a built-in disconnect switch may meet this requirement.
10. All electrical connections in the heater, including both field and factory made connections, should be checked for tightness before operating the heater. In addition, after a short period of operation, all connections should again be checked for tightness.
11. If heater is wired to a heating / cooling thermostat, use a thermostat with isolating circuits to prevent possible interconnection of Class 2 outputs.
12. If the heating elements are divided into several sections with resistance wire between two or more sections, maximum KW per sq. ft. should be calculated as follows:

$$\frac{\text{Heater nameplate KW}}{\text{Number of heated sections} \times \text{area of one heated section}}$$

AIR FLOW REQUIREMENTS

Calculate KW per square foot of duct area as: $\frac{\text{heater nameplate KW}}{\text{duct area (Sq.Ft.)}}$ (see step 12)

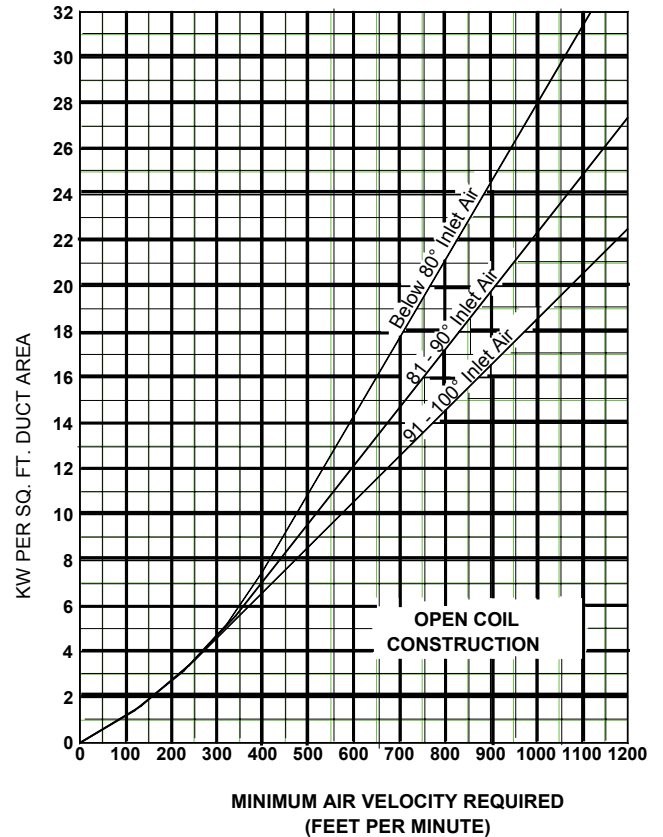
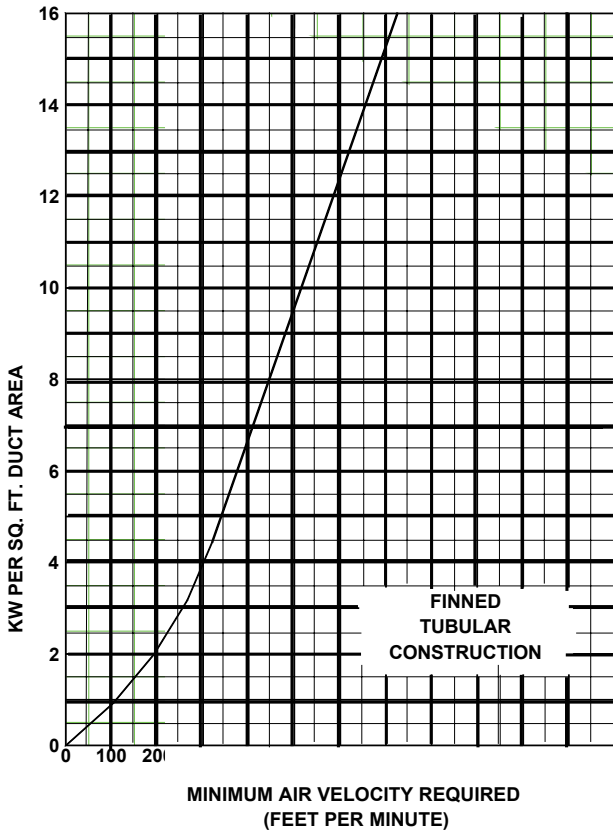
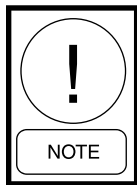

FIG. 1 - MINIMUM AIR VELOCITY REQUIRED FOR SAFE OPERATION

OPERATION & MAINTENANCE



All sources of supply must be disconnected before working on this equipment

To operate this heater make sure all associated control equipment is on, energize main supply disconnect and set controlling thermostat above ambient temperature. This heater is equipped with automatic and manual reset temperature limiting controls. If it fails to operate, make sure manual resets are operative by pushing reset buttons.

The only routine maintenance required is to check all electrical connections, including field and factory made connections, for tightness at least once each year or operating season. In addition, of course, any filters in the airstream must be kept clean so that adequate airflow is maintained.

