

LG *VOLT*[™]

User Guide



Table of Contents

Get Started.....	1
Your Phone at a Glance.....	1
Set Up Your Phone	2
Install the battery.....	2
Charge your battery	3
Activation and Service	4
Complete the Setup Screens	4
Set Up Voicemail.....	5
Phone Basics	6
Your Phone's Layout.....	6
Turn Your Phone On and Off	7
Turn Your Screen On and Off	7
Touchscreen Navigation	8
Lock and Unlock Your Phone	12
Guest Mode.....	13
Setting Up Guest Mode.....	13
Using Guest Mode	14
Your Home Screen.....	14
Home Screen Overview	14
Customize Your Home Screen	14
Add and Remove Widgets on the Home Screen	15
Change the Phone's Wallpaper	16
Customize Applications Icons on the Home Screen.....	17
Access Recently-Used Applications	18
Home Screen Clean View	18
Quick Access	18
Change the Screen Orientation	19
Status Bar	19
Enter Text With the On-screen Keyboard.....	22
Phone Calls.....	25
Make Phone Calls	25
Call Using the Phone Dialer.....	25

Call from Call Logs.....	25
Call from Contacts	26
Call Using a Speed Dial Number	26
Call a Number in a Text Message or Email Message	26
Call Emergency Numbers	26
Receive Phone Calls.....	27
Voicemail.....	28
Voicemail Setup	28
Voicemail Notification.....	28
Retrieve Your Voicemail Messages	29
Visual Voicemail.....	30
Set Up Visual Voicemail.....	30
Review Visual Voicemail.....	30
Listen to Multiple Voicemail Messages	31
Visual Voicemail Options	31
Configure Visual Voicemail Settings	32
Change Your Main Greeting via the Voicemail Menu.....	33
Edit the Display Name via the Voicemail Menu	33
Phone Call Options	33
In-call Options	34
Caller ID	35
Call Waiting.....	35
Conference Calling	36
Call Forwarding.....	37
Set Up Speed Dialing.....	38
Call Logs	38
Call Settings	39
Voicemail Settings	39
Call Reject.....	39
TTY Mode	40
Roaming Settings.....	40
Roaming Mode.....	40
Roaming Guard.....	41
Data Roam Guard.....	41
Contacts	43

Get Started with Contacts	43
Access Contacts	43
The Contacts List	43
Contacts List Options	44
Add a Contact	45
Save a Phone Number.....	46
Edit a Contact Entry	46
Communicate with Your Contacts.....	49
Import, Export, and Share Contacts.....	51
Import Contacts From Your Internal Storage.....	51
Export Contacts to Your Internal Storage	51
Share a Contact	51
Joining and Separating Contacts	52
Accounts and Messaging	53
Gmail / Google	53
Create a Google Account.....	53
Sign In to Your Google Account.....	54
Access Gmail	54
Send a Gmail Message.....	55
Read and Reply to Gmail Messages	55
Email	56
Add an Email Account (POP3 or IMAP)	56
Corporate Email (Outlook)	57
Open Email	58
Create and Send Email.....	58
Reply to or Delete an Email Message	59
Configure and Sync Corporate Email Settings	59
Text and Multimedia Messaging	61
Send a Text Message	61
Send a Multimedia Message (MMS).....	62
Save and Resume a Draft Message.....	64
New Messages Notification.....	64
Manage Message Conversations	64
Text and Multimedia Message Options	66
Apps and Entertainment.....	69

Google Play Store	69
Find and Install an App	69
Create a Google Wallet Account	70
Request a Refund for a Paid App	70
Open an Installed App	70
Uninstall an App	71
Get Help with Google Play	71
Navigation	71
Google Maps	71
Music	72
Music Player	72
Google Play Music App	72
Web and Data	73
Connect Wi-Fi	73
Turn Wi-Fi On and Connect to a Network	73
Add a Wi-Fi Network	74
Data Services General Information (3G and Sprint Spark LTE Networks)	74
Sprint Spark LTE	75
Your Data Services User Name	75
Data Connection Status and Indicators	75
Virtual Private Networks (VPN)	76
Prepare Your Phone for VPN Connection	76
Set Up Secure Credential Storage	76
Add a VPN Connection	77
Connect to or Disconnect from a VPN	77
Browser	77
Launch the Web Browser	77
Learn to Navigate the Browser	78
Browser Menu	79
Select Text on a Web Page	80
Go to a Specific Website	80
Adjust Browser Settings	80
Create Website Settings	81
Reset the Browser to Default	81
Set the Browser Home Page	81

Create Bookmarks	81
Create a New Homepage	82
Add Bookmarks to Your Home Screen	82
Camera and Video	83
Take Pictures	83
Open or Close the Camera	83
Viewfinder Screen in Camera mode	83
Take a Picture	84
Multi-point Auto Focus	84
Super Zooming	85
Light Frame	85
Review Screen	85
Record Videos.....	86
Viewfinder Screen in Video mode.....	86
Record videos	86
Camera Settings	87
Video Camera Settings	88
View Pictures and Videos Using Gallery.....	89
Open or Close Gallery	89
View Pictures and Videos	89
Zoom In or Out on a Picture.....	90
Watch a Video.....	90
Video Gallery Options	90
Live Zoom	91
Work with Pictures	91
Share Pictures and Videos	92
Send Pictures or Videos by Email	92
Send a Picture or Video by Multimedia Message	93
Send Pictures or Videos Using Bluetooth.....	93
Tools and Calendar.....	94
QSlide	94
QuickMemo	94
QuickRemote	96
Voice Mate	96
Voice Command.....	97

Calendar.....	98
Change Calendar View	98
View Event Details	101
Create an Event	101
Edit or Delete an Event	102
Set an Event Reminder	102
Respond to an Event Reminder.....	103
Display and Synchronize Calendars	103
Change Calendar Settings.....	103
Folders	104
Alarm/Clock.....	105
Tasks.....	107
Calculator	109
File Manager	109
File Manager Options.....	110
Searching in File Manager	110
Using QSlide	110
Bluetooth	110
Turn Bluetooth On and Off.....	110
Bluetooth Settings Menu.....	111
Change the Device Name.....	112
Pairing Bluetooth Devices.....	112
Disconnect or Unpair from a Bluetooth Device.....	113
Send Items via Bluetooth	113
Disconnect Bluetooth Connection During an Active Call	114
SmartShare	114
Enjoying content via a variety of devices	114
Enjoying the content from Nearby devices	115
Near Field Communication (NFC) Technology.....	115
microSD Card.....	115
Insert a microSD Card	116
Remove a microSD Card	117
View microSD Card Memory.....	117
Format the microSD Card	117
Unmount the microSD Card.....	118

Use the Phone's microSD Card as a USB Drive	118
Transfer User Contents From an Android Phone to Your LG Volt	119
Transfer Via PC or Laptop	119
Transfer Via Bluetooth Connection	120
Update Your Phone.....	120
Update Your Phone Firmware	120
Update Your LG Software.....	122
Update Your Profile.....	122
Update Your PRL.....	122
Settings	123
Wireless Networks	123
Airplane Mode	123
Wi-Fi Settings.....	123
Bluetooth Settings.....	124
Mobile Data	124
Call Settings.....	124
Voicemail Settings	124
North American Dialing	124
Incoming Voice Call Pop-up.....	124
Call Reject.....	124
Decline with Message	125
Privacy Keeper.....	125
Home Button Answers Call	125
Auto Answer.....	125
TTY Mode	125
Hearing Aids.....	125
Proximity Sensor	126
Voice Clarity	126
Save Unknown Numbers	126
Power Button Ends Call	126
Share & Connect.....	127
NFC Settings.....	127
Android Beam	127
SmartShare Beam	127
Miracast.....	127

Wireless Storage.....	128
More Settings	128
Bluetooth Tethering.....	128
Mobile Networks Settings	128
VPN Settings.....	129
Device Settings	130
Sound Settings.....	130
Ringtone & Vibration Settings	131
Display Settings	133
Home Screen	136
Lock Screen	137
Gestures.....	140
One-handed Operation	141
Storage.....	142
Battery.....	142
Apps	143
Tap & Pay	143
Personal Settings.....	143
Accounts & Sync.....	144
Guest Mode.....	144
Location.....	144
Security	145
Language & Input Settings.....	146
Backup & Reset	147
System Settings	148
Date & Time	148
Accessibility.....	148
PC Connection.....	150
Accessory.....	150
Activate This Device	151
System Updates.....	151
Printing	152
About Phone	152
Copyright Information.....	153
Index.....	154

Get Started

The following topics give you all the information you need to set up your phone and service the first time.

Your Phone at a Glance

The following illustration outlines your phone's primary external features and buttons.



Set Up Your Phone

You must first install and charge the battery to begin setting up your phone.

Install the battery

Follow the steps below to install the battery.

1. Insert your fingernail into the slot on the left side of the back cover and lift the cover up gently.

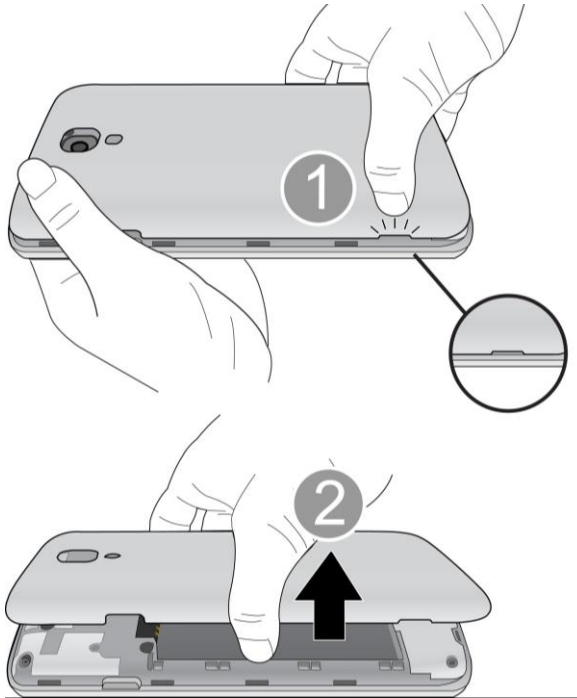

2. Insert the battery, contacts end first, and gently press the battery into place.

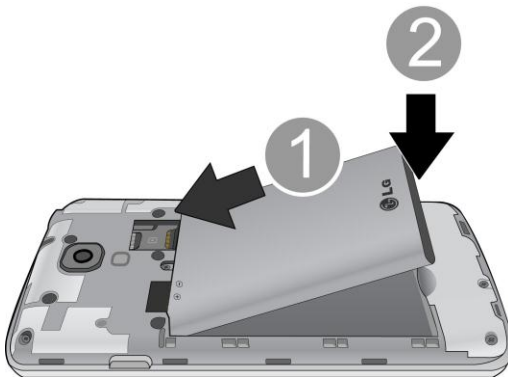

3. Replace the battery compartment cover, making sure all the tabs are secure and there are no gaps around the cover.

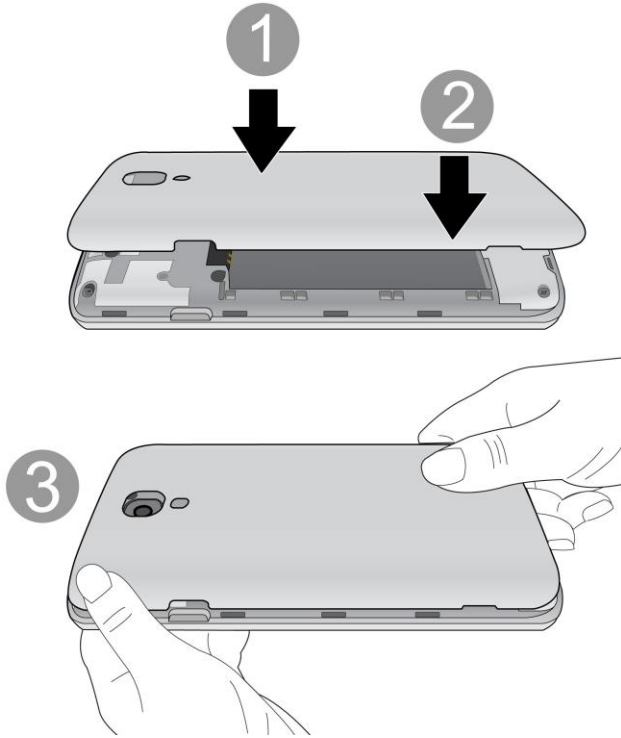

Charge your battery

Follow the steps below to charge your battery.

1. Plug the USB connector into the charger/accessory port at the bottom of your phone.

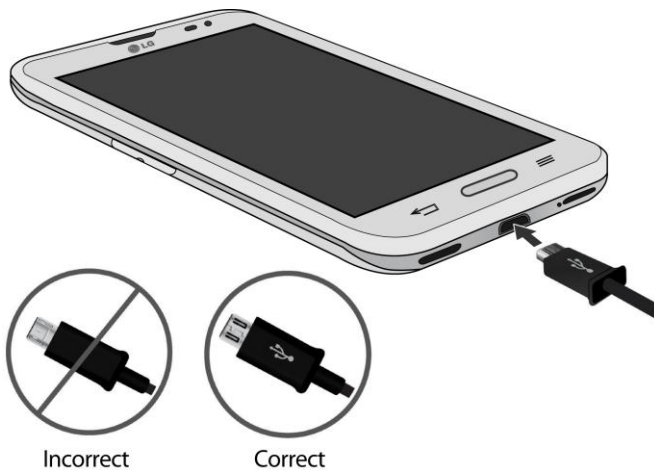

2. Plug the AC adapter into an electrical outlet. Fully charging a battery may take up to three hours.

Note: Your phone's battery should have enough charge for the phone to turn on and find a signal, run the setup application, set up voicemail, and make a call. You should fully charge the battery as soon as possible.

3. Press and hold the **Power/Lock Button**  to turn the phone on.
 - If your phone is activated, it will turn on, search for service, and begin the setup process.
 - If your phone is not yet activated, see [Activate Your Phone](#) for more information.

Activation and Service

Follow the instructions below to activate your phone and Sprint Prepaid service.

Register Your Phone on Sprint Prepaid

1. From your computer, visit sprint.com/prepaidactivate.
2. Choose an activation option and click **Next**. Then enter your zip code and click **Next**.
3. When prompted, enter the serial number (MEID DEC) printed on the label on your phone's packaging.
4. Follow the instructions to select a plan and payment method.
 - If you're swapping phones or bringing your number over from a different carrier, follow the prompts to sign in or provide additional information.
5. Continue to follow the instructions to program your phone. Once you see the "Congrats" page, your phone and plan are activated.
 - To confirm activation, make a phone call. If your phone is still not activated, visit sprint.com/prepaidsupport for assistance. If you do not have access to the Internet, call Sprint Customer Service at **1-855-639-4644** from another phone.

Note: If you are having any difficulty with activation, visit sprint.com/prepaidsupport for assistance.

Activate Your Phone

After completing the account setup on sprint.com/prepaidactivate, simply turn your phone on. It is designed to activate automatically.

- Press and hold the **Power** button to turn your phone on.
- Your phone is designed to activate automatically. When you turn the phone on for the first time, you should see a Hands Free Activation screen, which may be followed by a PRL Update screen and a Firmware Update screen. Follow the onscreen instructions to continue.

If your phone is still not activated, visit sprint.com/prepaidsupport for assistance. If you do not have access to the Internet, call Sprint Customer Service at 1-855-639-4644 from another phone.

Complete the Setup Screens

The setup screens help you set up certain features and preferences on your phone. Once your phone has been turned on, you will see a Welcome message. You can then complete the setup process.

Note: You may be able to complete the setup screens before your phone has been activated on your account.



Note: During or after setup, you may see a **Connections Optimizer** notice. Read the notice and touch **I Agree** to allow your phone to connect automatically to the best available data network, including Wi-Fi.

To turn Connections Optimizer off at any time, press  >  > **System settings** > **More...** > **Mobile networks** > **Connections Optimizer** and uncheck the box. See [Connections Optimizer](#) for details.

1. Before activation, you can turn on the TalkBack voice navigation feature for the visually impaired. Double tap the center of the screen to activate this feature. To enable other features, tap **Accessibility settings**. To continue the activation process, tap **Next**.
2. Enter your phone name. This will be used as your phone name in Bluetooth, Wi-Fi Direct, etc. Then enter a phone number to call if the phone is lost. It will be displayed on the Lock screen.
3. Your initial setup is complete. You can now enjoy your phone and personalize it to your liking.

Set Up Voicemail

You should set up your voicemail and personal greeting as soon as your phone is activated. Always use a password to protect against unauthorized access. Your phone automatically transfers all unanswered calls to your voicemail, even if your phone is in use or turned off.

1. Press  and tap  > **Voicemail** .
2. Tap **Personalize now**.
3. Follow the system prompts to:
 - Create your password.
 - Record your name announcement.
 - Record your greeting.

Important: Voicemail Password – It is strongly recommended that you create a password when setting up your voicemail to protect against unauthorized access. Without a password, anyone who has access to your phone is able to access your voicemail messages.

For more information about voicemail, see [Voicemail](#) or [Visual Voicemail](#).

Phone Basics



Your phone is packed with features that simplify your life and expand your ability to stay connected to the people and information that are important to you. The following topics will introduce the basic functions and features of your phone.

Your Phone's Layout

The illustrations and descriptions below outline your phone's basic layout.



Key Functions

- **Earpiece** lets you hear the caller and automated prompts.
- **Back Key**  lets you return to the previous screen, or close a dialog box, options menu, the Notifications panel, or onscreen keyboard.
- **Speaker** lets you hear the different ringtones and sounds. The speaker also lets you hear the caller's voice in speakerphone mode.
- **Menu Key**  allows you to access the options available for the current app, feature, function, or screen.
- **Home Button**  returns you to the Home screen. Press and hold to open the recently-used applications window.
- **Power/Lock Button** lets you turn the phone on or off or turn the screen on or off, or switch your phone to silent mode, vibration mode, or airplane mode.

- **Front-Facing Camera Lens** takes pictures and records videos while facing the screen, and allows you to video conference.
- **Proximity Sensor** detects how close an object is to the surface of the screen. This is typically used to detect when your face is pressed up against the screen, such as during a phone call.
 - While talking on the phone, the sensor detects talk activity and locks the keypad to prevent accidental keypresses.
- **Charger/Accessory Port** allows you to connect the phone charger or the USB cable (included).
- **NFC Antenna** allows you to use features such as NFC and Android Beam to send and receive data wirelessly.
- **Volume Buttons** allows you to adjust the ringtone or media volume or adjust the voice volume during a call.
- **Flash** helps illuminate subjects in low-light environments when the camera is focusing and capturing a picture or video.
- **Back-Facing Camera Lens** lets you take pictures and videos.
- **3.5 mm Headset Jack** allows you to plug in either a stereo headset or an optional headset for convenient, hands-free conversations.
- **IR (infrared) LED** allows you to use the QuickRemote app to control your TV and cable box.

CAUTION! Inserting an accessory into the incorrect jack may damage the phone.

Turn Your Phone On and Off

The instructions below explain how to turn your phone on and off.

Turn Your Phone On

- Press and hold the **Power/Lock Button**.

Turn Your Phone Off

1. Press and hold the **Power/Lock Button** to open the phone options menu.
2. Touch **Power off**, then **OK** to turn the phone off.

Your screen remains blank while your phone is off (unless the battery is charging).

Turn Your Screen On and Off

Your phone allows you to quickly turn the screen off when not in use and to turn it back on and unlock it when you need it.

Turn the Screen Off When Not in Use

- To quickly turn the screen off, press the **Power/Lock Button**. Pressing the **Power/Lock Button** again or receiving an incoming call will turn on your phone screen and show the lock screen.

To save battery power, the phone automatically turns off the screen after a certain period of time when you leave it idle. You will still be able to receive messages and calls while the phone's screen is off.

Note: For information on how to adjust the time before the screen turns off, see [Screen timeout](#).

Turn the Screen On and Unlock It

1. To turn the screen on, press the **Power/Lock Button**.
2. Swipe your finger across the screen to unlock it.
 - If you have set up a screen lock, you will be prompted to enter it. See [Lock screen](#).

Turning the screen on using the KnockON feature

The KnockON feature allows you to double-tap the screen to easily turn the screen on or off.



- Quickly double-tap the center of the screen to turn the screen on.
- Quickly double-tap the Status Bar, an empty area on the Home screen, or the Lock screen to turn the screen off.

Note: The KnockON feature can be turned on and off in the Gestures menu. From the Home screen, press  >  > **System settings** > **Gestures** > remove the checkmark from the **Screen on/off** checkbox.

Unlocking your screen using the Knock Code feature

The Knock Code feature allows you to create your own unlock code using a combination of knocks (or taps) on the screen.

- While the screen is off, tap the same sequence you established anywhere on the screen. The Home screen will be accessed directly.

Note: The Knock Code feature can be turned on and off in the Lock screen settings. From the Home screen, press  >  > **Lock screen settings** > **Select screen lock** > **Knock Code**. Then follow the instructions to create your unlock sequence, as well as a Backup PIN in case you forget your unlock sequence. Please note that KnockON is disabled when Knock Code is in use.

Touchscreen Navigation

Your device is a touch-sensitive phone which allows you to select an on-screen option with a single touch and to easily scroll through long lists. Simply slide up and down through the display with your fingertip.

Touch

When you want to type using the onscreen keyboard, select items onscreen such as application and settings icons, or press onscreen buttons, simply touch them with your finger.



Touch and Hold

To open the available options for an item (for example, a contact or link in a Web page), touch and hold the item.

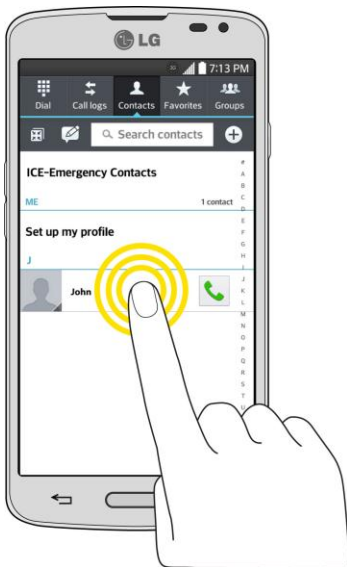

Swipe or Slide

To swipe or slide means to quickly drag your finger vertically or horizontally across the screen.



Drag

To drag, press and hold your finger with some pressure before you start to move your finger. While dragging, do not release your finger until you have reached the target position.



Flick

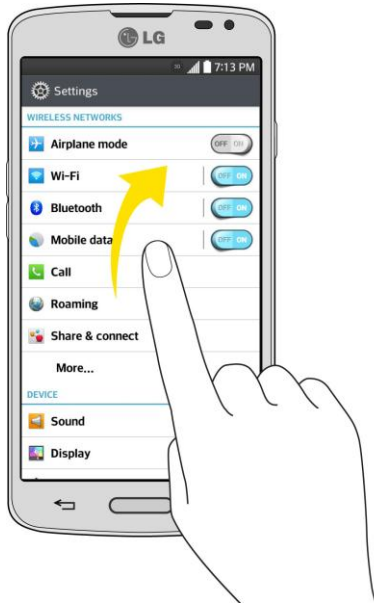

Flicking the screen is similar to swiping, except that you need to swipe your finger in light, quick strokes. This finger gesture is always in a vertical direction, such as when flicking the contacts or message list.

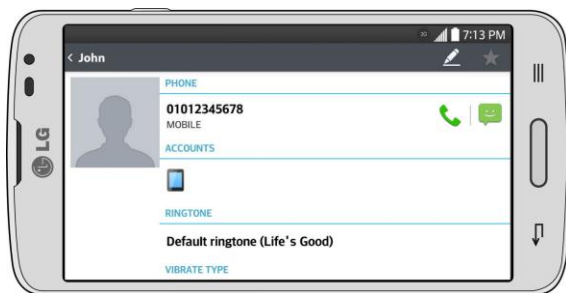

Rotate

For most screens, you can automatically change the screen orientation from portrait to landscape by turning the phone sideways. When entering text, you can turn the phone sideways to bring up a bigger keyboard.



Note: The Auto-rotate check box needs to be selected for the screen orientation to automatically change. Press  >  > **System settings** > **Display** > **Auto-rotate screen**.

Tip: You can also access the screen rotation setting from the Notifications screen. Pull down the Notifications bar and touch **Rotation** to select or deselect the option.

Pinch and Spread

“Pinch” the screen using your thumb and forefinger to zoom out or “spread” the screen to zoom in when viewing a picture or a Web page. (Move fingers inward to zoom out and outward to zoom in.)

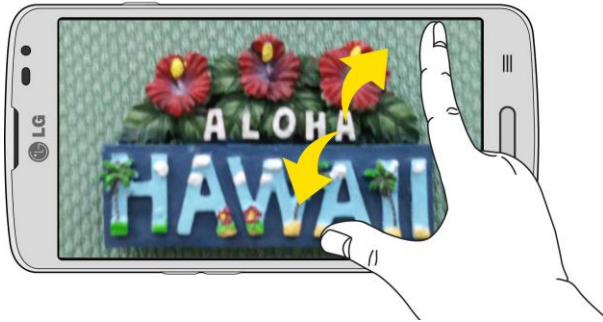

Lock and Unlock Your Phone

You can prevent accidental screen touches from activating phone functions by locking your phone.

Lock Your Phone

When your phone is locked, you can only receive incoming calls or make calls to 9-1-1.

- Press the **Power/Lock Button** .

Unlock Your Phone

1. Press the **Power/Lock Button**  to wake up the phone.
2. Swipe the screen to any direction to unlock it.

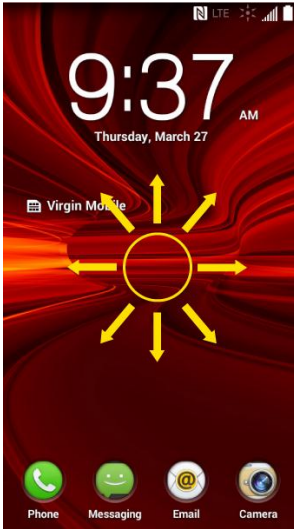

Note: The default Lock screen simply locks the screen to prevent unintentional actions. For more security to guard against unauthorized use, you can set an unlock requirement (such as a pattern, PIN, or password) that will need to be entered to unlock it.





Guest Mode

Use Guest mode when you let someone else use your phone. They will only be able to use the applications that you've selected. Once you set it up, you can easily put your phone in Guest mode by drawing the guest pattern on the Lock screen that you set, which is different from your normal unlock pattern.

Note: Guests can also use applications that your selected applications link to.

Setting Up Guest Mode

This section teaches you how to set up Guest Mode if another person uses your phone.

1. Press  >  > **System settings** > **Guest mode**.
2. Tap **Set pattern**, then set the pattern you want to use to put your device in Guest mode.
3. Tap **Set apps** to view which apps can be accessed in Guest mode. Tap the **Add** icon  in the upper right corner of the screen to change the Guest apps list.
 - Checkmark the apps that can be accessed.
 - Remove checkmarks from the apps that you don't want to be accessed.
 - Tap **OK** after selecting all of the apps you want to make available for guests.
4. Tap  at the top right corner to activate Guest Mode.
 - If your Lock screen is not set to Pattern, tap **OK**, then tap **Pattern** and enter your normal lock screen pattern as necessary.

Note: If your unlock sequence is set to a PIN or password, you will need to enter it to be able set the unlock pattern.

Using Guest Mode

After you've set up and enabled Guest mode, lock the screen so that you can enter your Guest mode pattern. The Guest mode Home screen is displayed with only the apps you've selected for guest access. To exit Guest mode, enter your normal unlock pattern on the Lock screen.

Note: Guest mode is automatically disabled if your lock sequence is changed from Pattern. Otherwise, manually disable it if you no longer want to allow guest access.

Your Home Screen

The home screen is the starting point for your phone's applications, functions, and menus. You can customize your home screen by adding application icons, shortcuts, folders, widgets, and more.

Home Screen Overview

Your home screen extends beyond the initial screen. Swipe the screen left or right to display additional screens.

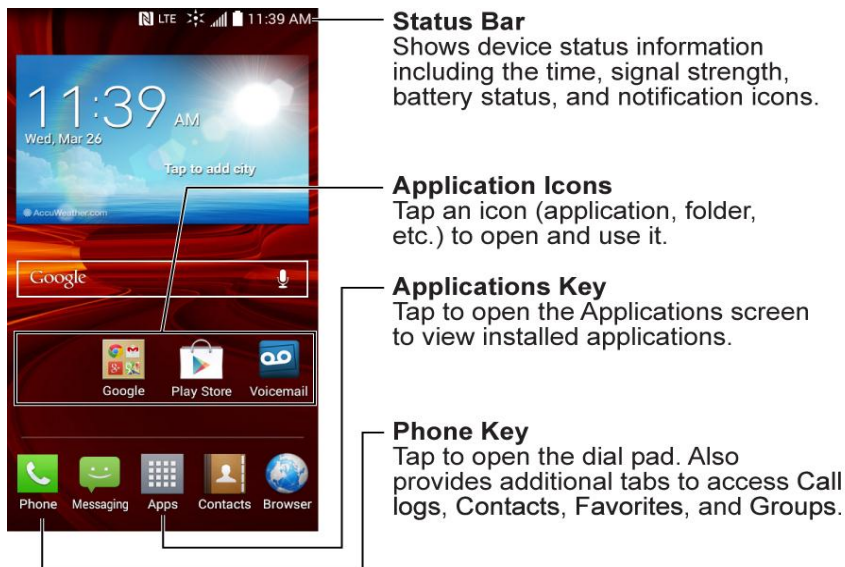

Note: The small rectangles above the primary shortcuts let you know your current screen position.

Tip: Press  to return to the main home screen from any other screen.

Customize Your Home Screen

You can customize your Home screen when you do the following.



- Create Shortcuts
- Add Widgets
- Create Contact shortcuts

- Change the Background (Wallpaper)
- Customize Application Icons

Create Shortcuts

Shortcuts are different from the Home screen Widgets. Shortcuts can access a specific contact, activate a feature, action, or launch an application.

To add a shortcut from the Applications screen:

1. Press  to access the Home screen.
2. Select a location (canvas) for your new shortcut by scrolling across your available canvases until you reach the desired one.
3. Tap  to reveal all your current applications. By default, the applications are listed in a grid view.
4. Scroll left or right through the list and locate your desired application.
5. Touch and hold the on-screen icon. This creates an immediate shortcut of the selected icon and closes the Applications screen. The new shortcut then appears to hover over the Home screen.



Note: The same shortcut can be added to any of the available canvases (Home or Extended). The application you add to the canvas will still appear within the Applications screen.

6. While holding the on-screen icon, position it on the current canvas. Once complete, release the screen to lock the shortcut into its new position.

To add a shortcut via the Home screen:

1. Press  to access the Home screen.
2. Touch and hold on an empty area of the screen.
3. Tap either **Apps**, or **Widgets**.
4. Touch and hold a selection from the list and drag it to your Home screen.

To delete a shortcut:

1. Press  to access the Home screen.
2. Touch and hold the desired shortcut. This unlocks it from its location on the current screen.
3. Drag the icon over **Remove**  and release it.

Add and Remove Widgets on the Home Screen

Widgets are self-contained applications that can be accessed through your Applications screen or on the Home or Extended screens. Unlike a shortcut, this Widget appears as an on-screen application.

To add a Widget:

1. Press  to access the Home screen.
2. Touch and hold on an empty area of the screen.
3. Tap the **Widgets** tab.
4. Touch and hold an available Widget and drag it to your current screen.

To remove a Widget:





1. Go to the Home screen canvas on which the widget is located.
2. Touch and hold the widget. This unlocks it from its location on the current screen.
3. Drag the widget over **Remove**  and release it.
 - This action does not delete the Widget. It just removes it from the current canvas.



To place a Widget onto a different screen:

1. Touch and hold the widget you want to move.
2. Drag the widget to the edge of the screen (the left side if moving to a screen located on the left, right side if moving to a screen located on the right).
3. After about one second, the current screen will change. Repeat until you get to the desired screen.

Change the Phone's Wallpaper

You can select and assign your phone's background wallpaper.

1. From the Home screen, tap  > **Home screen settings** > **Wallpaper**.
– or –
Touch and hold an empty spot on the Home screen, then tap the **Wallpapers** tab.
2. Tap **Gallery**, **ID wallpapers**, **Live Wallpapers**, **Multi-photo**, **Photos**, or **Wallpapers gallery**.
 -  **Gallery** to use a picture saved on your phone as a wallpaper. You can crop the picture before setting it as a wallpaper.
 -  **ID wallpapers** to open the available wallpapers that were included in your Sprint ID pack.
 -  **Live Wallpapers** to open a list of animated wallpapers installed on your phone. Live wallpapers can be animated or even interactive. More Live wallpapers are available in the Play Store.

-  **Multi-photo** to combine and use pictures saved on your phone as a wallpaper. You can crop the picture before setting it as a wallpaper.
 -  **Photos** to view the available wallpapers in the wallpaper gallery.
 -  **Wallpapers gallery** to view the available wallpapers in the wallpaper gallery.
3. Depending on the type of wallpaper, tap **Crop**, **Set wallpaper** or **Apply**.

Customize Applications Icons on the Home Screen

You can customize each application icon on the Home screen.

1. Touch and hold an application icon until it's unlocked from its current position. Then drop it on the screen. The editing icon  will appear in the upper right corner of the application.



2. Tap the application icon again and select a preloaded icon sign from the **Theme icon** tab.

– or –

Tap the **Photo icon** tab to create a new icon using images from the Gallery.

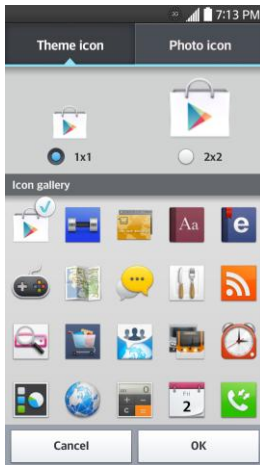

Tip: Tap **1x1** or **2x2** to change the icon size.

Access Recently-Used Applications

Your phone keeps a running list of your most recently used applications.

1. Press and hold  to open the recently-used applications window.
2. Tap an icon to open the related application.

Tip: Swipe an application preview to the left or right to remove it from the recently-used applications list.

Home Screen Clean View

You can see the wallpaper without items on the Home screen by pinching out. Pinch in or tap  to see applications and widgets again.

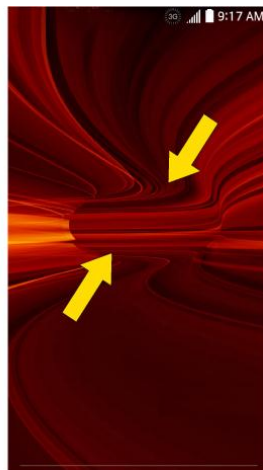

Quick Access

To view the quick access items, touch anywhere in the front key area and drag up. The following options are available: Voice Mate, Google Now, and QuickMemo.





Change the Screen Orientation

This phone is capable of changing the orientation of screen content when the orientation of the phone itself has changed. The phone's built-in accelerometer senses movement and changes its angle/orientation. Note that some of the screens, applications and widgets do not support orientation changes.

The automatic screen orientation feature can be manually enabled to change the orientation for all enabled screens when rotation is detected.

Note: An example of a screen that automatically re-ori-ents by moving the phone is the Messaging screen. This only requires you turn the phone to a horizontal position.

1. Press  >  > **System settings > Display.**
2. Tap **Auto-rotate screen** to enable (a blue checkmark displays) or disable the screen auto-rotation.



Status Bar



The Status Bar appears at the top of the screen. It displays icons indicating that you've received notifications (on the left) and icons indicating the phone's status (on the right), along with the current time.

If you have more notifications than can fit in the Status Bar, the icon  prompts you to open the Status Bar to view them all.

The following list identifies the symbols you'll see on your phone's display screen:























Status Icons

Icon	Status
	Signal Strength – Shows your current signal strength (the more bars there are, the stronger the signal is).
	No Service – Your phone cannot find a usable signal.

Icon	Status
	4G Connected – Indicates that 4G data service is available.
	4G In Use – Indicates that 4G data service is in use.
	3G/1x Connected – Indicates that 3G/1x data service is available.
	3G/1x In Use – Indicates that 3G/1x data service is in use.
	Wi-Fi Connected – Indicates that Wi-Fi is in use.
	Bluetooth On – Indicates that Bluetooth is on.
	GPS On – Indicates that GPS is on.
	GPS Communicating – Indicates that the phone is receiving location data from GPS.
	Airplane Mode – Indicates that the phone is in Airplane Mode.
	No SIM card – No SIM card is inserted.
	Speakerphone On – Indicates that Speakerphone is on.
	Vibrate Mode – Indicates that the ringer volume is set to vibrate and any sounds are silenced.
	Ringer Silenced – Indicates that all sounds are turned off.
	Very Low Battery – Indicates that battery is very low.
	Low Battery – Indicates that battery is low.
	Battery Drained (40%) – Indicates that battery is partially drained.
	Battery Full – Shows your current battery charge level. (Icon shown is fully charged.)
	Battery Charging – Indicates that battery is charging.
	Alarm Clock – Indicates that an alarm is set.
	NFC Activated – Indicates that NFC is activated.

Notification Icons

Icon	Notification
	New Gmail™ Message – Indicates a new Gmail message.

Icon	Notification
	New Email – Indicates a new Email message.
	New Text or Multimedia Message – Indicates you have received a new text or multimedia message.
	High Priority Text or Multimedia Message - Indicates you have received a high priority text or multimedia message.
	New Voicemail – Indicates you have received a new voicemail message.
	Upcoming Event – Alerts you to an upcoming event.
	New Hangouts Message – Indicates a new Hangouts message.
	Data Is Syncing – Application sync is active and synchronization is in progress for Gmail, Calendar, and Contacts.
	Problem With Sign-In Or Sync – There has been an issue with your connection to the Google server, or you were not properly signed into your account. In order to use Google application or sync features, you must set up and sign into an active Google Account.
	Full Internal Storage – Indicates that internal storage is full.
	USB Connected – The phone has detected an active USB connection.
	More Notifications Not Displayed – Indicates that there are more notifications which are not displayed in the Status Bar.
	Call In Progress – Indicates that a call is in progress.
	Call In Progress Using Bluetooth Headset – Indicates that a call is in progress using the Bluetooth headset.
	Missed Call – Indicates that you have missed calls.
	Uploading Data – Indicates that your phone is uploading data.
	Downloading Data – Indicates that your phone is downloading data.
	Download Finished – Indicates that a download is complete.
	Connected To VPN – Indicates that the phone is connected to a Virtual Private Network.
	Disconnected From VPN – Indicates that the phone is disconnected from the Virtual Private Network.
	Song Is Playing – Indicates that a song is playing.
	Carrier data – Data use threshold approaching or exceeded.
	TTY – Indicates that your phone is operating in TTY mode.

Enter Text With the On-screen Keyboard

The on-screen keyboard displays automatically when you tap a text entry field. To manually display the keyboard, simply tap a text field where you want to enter text.

By default, there are 2 types of touchscreen keyboards: **QWERTY keyboard**, and **Phone keyboard**.

To change the keyboard between **QWERTY keyboard** and **Phone keyboard**.

1. Touch  on the LG Keyboard.
2. Tap **Input language and type**, then tap  next to the desired input language.
3. Tap the desired keyboard type and tap  repeatedly to go back to the entry screen.



QWERTY Keyboard

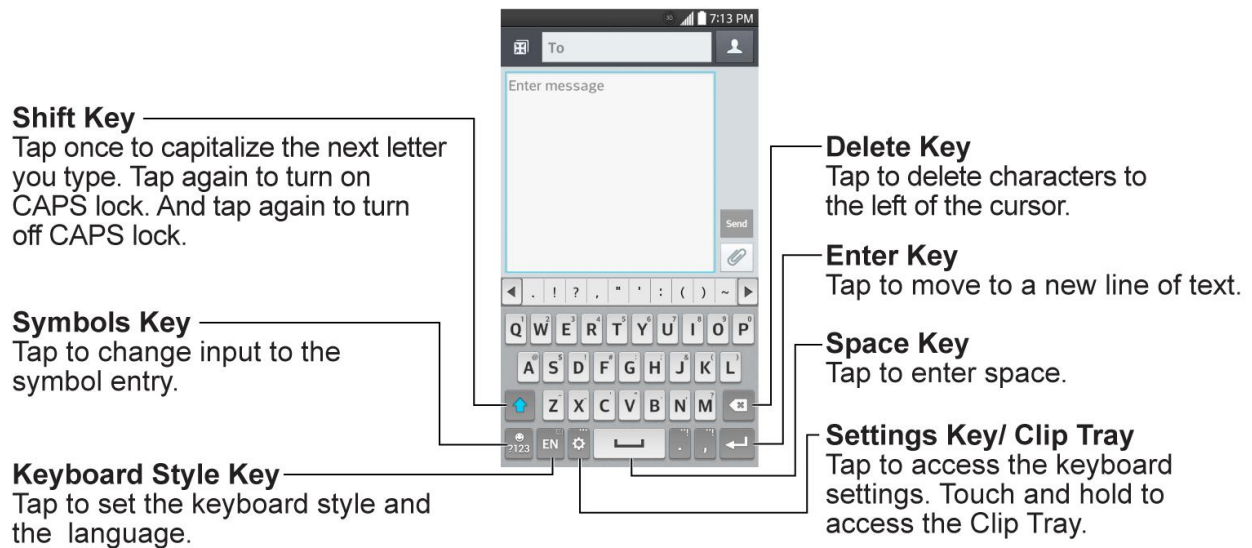

Letters and Numbers Entry Keyboard

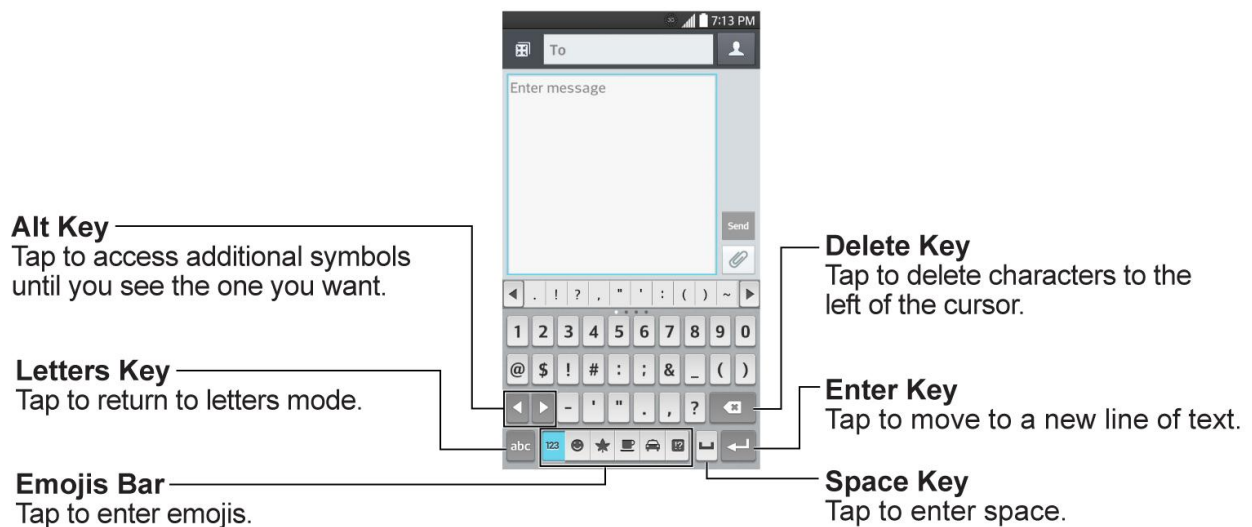

Symbols and Numbers Entry Keyboard



1. Tap a text field where you want to enter text.
2. Enter the desired text.
 - To enter numbers, symbols, and emojis, tap .
 - To enter letters again, tap .

Note: If you do not want the screen to change orientations automatically, uncheck the Auto-rotate screen. Press  >  > **System settings > Display** and deselect **Auto-rotate screen**.

- When you have finished typing, tap  to close the keyboard.

Phone Keyboard

To enter text, tap the key labeled with the desired letter until it appears on the screen. For example, tap  once for "a", twice for "b", or three times for "c".

Letters and Numbers Entry Keyboard

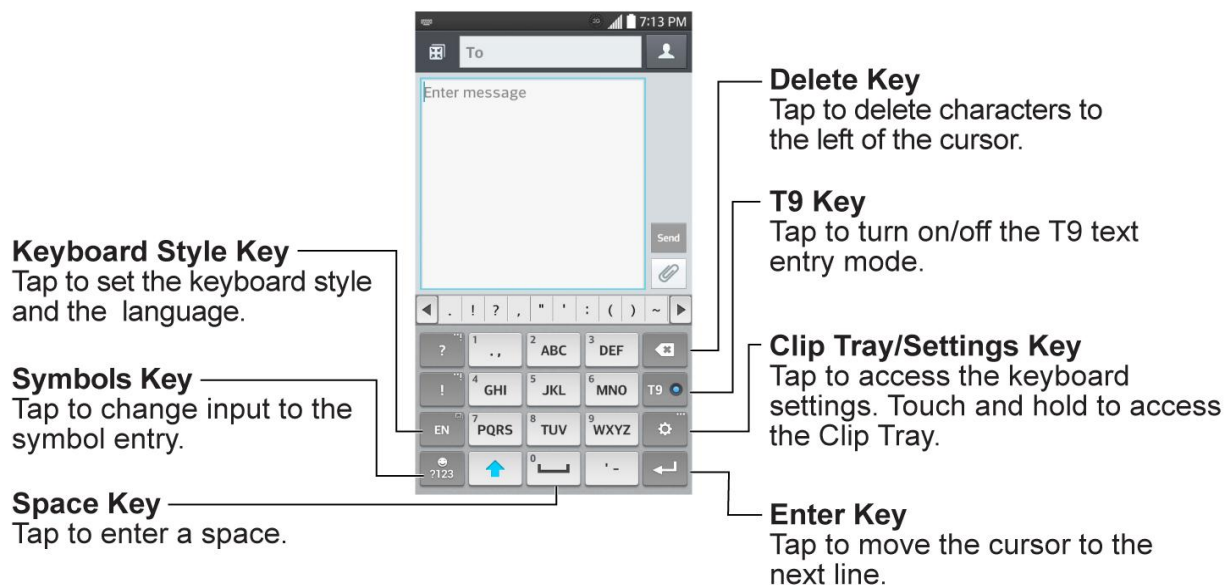

Symbols and Numbers Entry Keyboard

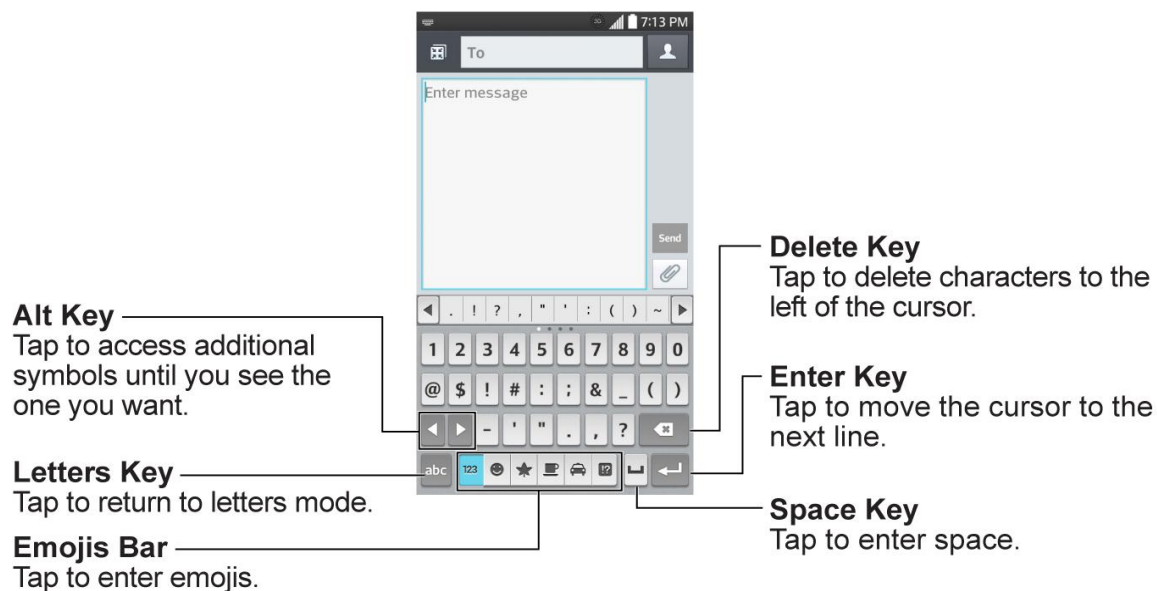

Phone Calls



With mobile service and your phone's calling features, you can enjoy clear phone calls across the country.

Make Phone Calls

There are several convenient ways to place calls from your phone.

Call Using the Phone Dialer

The most "traditional" way to place a call is by using the phone's dialer screen.

1. Press  >  to display the dial pad.
2. Touch the number keys on the dialpad to enter the phone number.
 - As you enter digits, Smart Dial searches for contacts that match. If you see the number you want to dial, touch it to place the call immediately without entering the rest of the number.
3. Touch  to call the number.

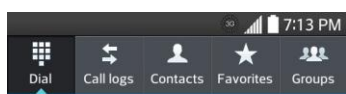

 010

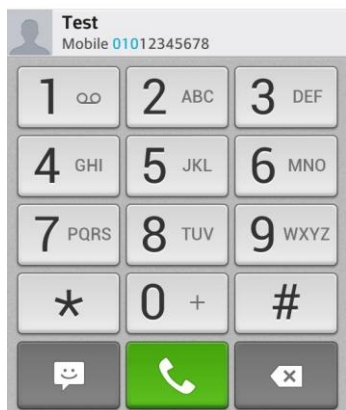

4. To end the call, touch .

Call from Call Logs



The Call logs list lets you quickly place calls to recent incoming, outgoing, or missed numbers.

1. Press  >  to display the dial pad.

2. Touch **Call logs** to display the Call logs list.
3. Touch an entry to display the call details.
4. Touch the phone icon  to place a call.
 - For additional options, touch the name or number.



Call from Contacts

You can place phone calls directly from entries in your Contacts list.

1. Press  >  to display your contacts.
2. Touch a contact and then touch  next to the number you want to call to place a call.
 - For additional information on Contacts, see [Contacts](#).





Call Using a Speed Dial Number

Speed dial numbers let you dial numbers by touching and holding a single number on the dialpad. See [Set Up Speed Dialing](#) for information on assigning speed dial numbers.

1. Press  >  to display the dial pad.
2. Touch and hold the speed dial key on the dialpad. The display confirms that you have dialed the number when it shows “Dialing” on the upper right side of the screen.

Call a Number in a Text Message or Email Message





While viewing a text message or email message, you can place a call to a number that is in the body of the message.

1. Press  >  > **Messaging**  or **Email** .
2. Touch the message with the phone number, and then touch the phone number.
3. Touch **Call** to place the call.







Call Emergency Numbers

You can place calls to 9-1-1 even if the phone’s screen is locked or your account is restricted.

To call the 9-1-1 emergency number when the phone’s screen is locked with a screen lock:

1. Unlock the screen. For more information, see [Turn Your Screen On and Off](#).
2. Touch **Emergency call** on the screen.
3. Touch    .

To call the 9-1-1 emergency number normally or when your account is restricted:

1. Unlock the screen. For more information, see [Turn Your Screen On and Off](#).
2. Press  > .
3. Touch    .

Enhanced 9-1-1 (E911) Information

This phone features an embedded Global Positioning System (GPS) chip necessary for utilizing E911 emergency location services where available.

When you place an emergency 9-1-1 call, the GPS feature of your phone seeks information to calculate your approximate location. Depending on several variables, including availability and access to satellite signals, it may take up to 30 seconds or more to determine and report your approximate location.

Important: Always report your location to the 9-1-1 operator when placing an emergency call. Some designated emergency call takers, known as Public Safety Answering Points (PSAPs), may not be equipped to receive GPS location information from your phone.

Receive Phone Calls

The following information lets you know how to answer incoming calls, mute the ringer on incoming calls, reject incoming calls, and more.

When you receive a phone call from a contact, the Incoming call screen appears and displays the caller ID icon, name, and phone number of the calling party. When you receive a phone call from someone who is not stored in People, only the default caller ID icon and phone number appear on the Incoming call screen.

Note: If your phone is turned off, all calls automatically go to voicemail.

Answer an Incoming Call

- Swipe the answer call icon in any direction to answer the call.



Mute the Ringing Sound

To mute the ringer without rejecting the call, you can do any of the following:

- Press the volume button down.
- Place the phone face down on a level surface.

Reject an Incoming Call

- Swipe the reject call icon in any direction to reject the call.

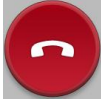

The call will be sent directly to voicemail.

Reject a Call and Send a Text Message

You can reject an incoming call and automatically send a text message to the caller.

- Drag the **Decline with message** tab up from the bottom of the screen. Touch **Send** next to one of the reject messages to send it to the caller.
 - You can edit the reject messages through the Call settings menu. From the dial pad, touch  > **Call settings** > **Decline with message** and edit or create the reject messages.



Voicemail

You should set up your voicemail and personal greeting as soon as your phone is activated. Always use a password to protect against unauthorized access. Your phone automatically transfers all unanswered calls to your voicemail, even if your phone is in use or turned off.

Note: Your phone also supports the [Visual Voicemail app](#). For information on setting up and using [Visual Voicemail](#), see [Visual Voicemail](#).

Voicemail Setup

The following steps guide you through the process of setting up your standard voicemail.

1. Press  > .
2. Touch and hold  to dial your voicemail number.
3. Follow the system prompts to:
 - Create your password.
 - Record your name announcement.
 - Record your greeting.

Important: Voicemail Password – It is strongly recommended that you create a password when setting up your voicemail to protect against unauthorized access. Without a password, anyone who has access to your phone is able to access your voicemail messages.

Tip: For information on using the [Visual Voicemail app](#), see [Visual Voicemail](#).

Voicemail Notification

There are a couple of different ways your phone alerts you to a new voicemail message.

- By sounding the assigned ringer type.

- By displaying  within the Notifications area of the Status bar when a single new unheard voicemail message is received.



Note: When you are off network, you may not receive notification of new voicemail messages. It is recommended that you periodically check your voicemail by dialing 1 + area code + your wireless phone number. When your voicemail answers, touch  and enter your password.

Note: Your phone accepts messages even when it is turned off. However, your phone notifies you of new messages only when it is turned on and you are in a network service area.

Retrieve Your Voicemail Messages

You can review your messages directly from your wireless phone (using either traditional voicemail or Visual Voicemail) or from any other touch-tone phone.

Use Traditional Voicemail to Access Your Messages

1. Press  > .
2. Touch and hold . If prompted, enter your voicemail password.
3. Follow the voice prompts to listen to and manage your voicemail messages.

Use Visual Voicemail to Access Your Messages

1. Press  >  > **Voicemail** .
2. Touch an entry to listen to the message.

Use Another Phone to Access Messages

1. Dial your wireless phone number.
2. When your voicemail answers, press the asterisk key on the phone (*).
3. Enter your password.

Use Visual Voicemail to Delete Your Messages

1. Press  >  > **Voicemail** .
2. Open a message and touch .

Tip: You can restore messages you have sent to the trash folder. Touch **Inbox** (at the top right corner of the screen) > **Trash**, touch and hold the message you want to restore to the inbox, and then touch the restore icon.



Visual Voicemail

Visual Voicemail gives you a quick and easy way to access your voicemail. Now you can find exactly the message you are looking for without having to listen to every voicemail message first. This new feature periodically goes out to your voicemail, and gathers the caller information from all of the current voicemails. It then populates a list with the caller name and number, along with the length of time and priority level of the voicemail message.

Set Up Visual Voicemail

Setting up Visual Voicemail follows many of the same procedures as setting up traditional voicemail. You should set up your voicemail and personal greeting as soon as your phone is activated. Your phone automatically transfers all unanswered calls to your voicemail, even if your phone is in use or turned off.

Note: To set up your traditional voicemail box, see [Voicemail Setup](#).

1. Press  >  > **Voicemail** . You'll see a Personalize your voicemail prompt.

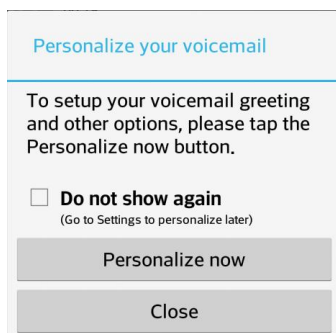

2. Touch **Personalize now** and follow the system prompts to:
 - Create a password (part of standard voicemail).
 - Record your name announcement.
 - Record your greeting.

Important: Voicemail Password – It is strongly recommended that you create a password when setting up your voicemail to protect against unauthorized access. Without a password, anyone who has access to your phone is able to access your voicemail messages.

3. Touch the Welcome to Voicemail message on the screen to play a brief explanation of the voicemail services.

Review Visual Voicemail

Visual Voicemail lets you easily access and select which messages you want to review.

1. Press  >  > **Voicemail** . You will see the voicemail inbox.

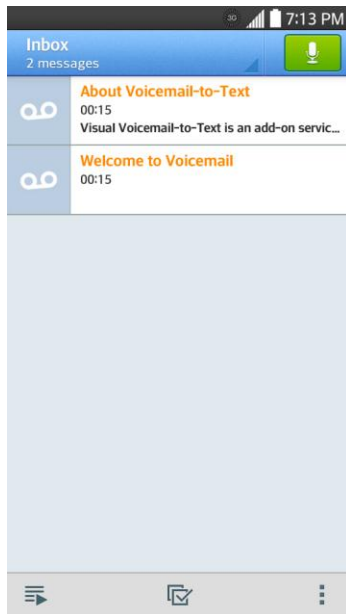

2. Touch a message to review it.

Tip: There are several icons at the bottom of the review screen for maintenance, storage, messaging, and other options. For an explanation of all your options, touch  > **Help > Visual Voicemail Menu > Visual Voicemail Menu.**

Listen to Multiple Voicemail Messages



When you are done listening to a voicemail message you can easily access other voicemail messages without returning to the main voicemail screen.

1. Listen to the current voicemail message.
2. Swipe your finger left or right to display the next or previous message. (It will begin playing automatically.)





You can navigate through voicemail messages as frequently as you'd like. You can even move to the next or previous message before you're finished listening to the current one.

Visual Voicemail Options

Your visual voicemail options appear as icons at the bottom of the voicemail review screen.





1. Press  >  > **Voicemail** .
2. Touch a message to review it. The following options are available while reviewing a voicemail message:

Note: Not all options are available for all messages.



- **Subscribe** to subscribe to the premium Voice-to-Text transcription service. (Requires an additional monthly charge.)
-  **Delete** to delete selected messages from your current list of available voicemail messages.
-  **Call** to call the number the message came from.
-  **Share** to send the message via any of the available apps.
-  **Reply** to reply to the message via text or voice message.

Configure Visual Voicemail Settings

The Visual Voicemail settings menu lets you access settings for notifications, pictures, greetings, and more.





1. Press  >  > **Voicemail** .
2. Touch  > **Settings**. Select an option to change its settings.
 - **Manage subscription** to subscribe and unsubscribe from the visual voicemail premium monthly subscription service. This may take a minute.
 - **Auto forward** to email to send a copy of new messages to an email address of your choice.
 - **Personalize voicemail** to change your voicemail greeting for incoming calls and update password.
 - **Notifications** to determine how you are notified of new voicemails. Set the notification sound and vibrate option.
 - **Transcription language**: Choose the language you want to use to transcribe messages.
 - **Delete messages** to set Visual Voicemail to permanently delete messages from the Trash folder after a specific number of days.
 - **Display name** to enter a name to identify yourself to people when replying or forwarding messages.
 - **Speakerphone** to automatically turn the speaker on or off.
 - **Transcriptions displayed** to transcribe Voicemails from voice to text.
 - **Themes** to choose the type of theme used for the application.
 - **View quick tips tutorial** to view a visual tutorial about Visual Voicemail.
 - **Help** to see the Sprint visual voicemail help.
 - **Send feedback** to send some feedback to the Voicemail Feedback team.

- **Updates** to search for an upgrade to your Visual message software.
- **About Voicemail** to view build information about the current visual voicemail application.

Note: Voicemail settings can also be accessed by pressing  >  > **System settings** > **Call** > **Voicemail**.





Change Your Main Greeting via the Voicemail Menu

Your main greeting can be changed directly via the Visual Voicemail system. This direct access saves you from having to navigate within the voicemail menu.

1. Press  >  > **Voicemail** .
2. Touch  > **Settings** > **Personalize voicemail**.
3. Touch **OK** to connect to the voicemail system. Follow the prompts to change your current greeting.

Edit the Display Name via the Voicemail Menu

From your Visual Voicemail menu, you can quickly change the name or number attached to your voice messages.

1. Press  >  > **Voicemail** .
2. Touch  > **Settings** > **Display name**.
3. Touch the existing identification field and enter a new identifying name or number (used to identify you to recipients of your voice messages).
4. Touch **OK** to save your information.

Phone Call Options

Your phone application provides many useful features and options to help you make the most of your calling experience's

In-call Options

While you're on a call, you will see a number of onscreen options. Touch an option to select it.



- **Add call:** Touch and hold to initiate a conference call (3-way call).
- **Merge:** Join two currently active calls (conference).
- **End last call:** Ends the last call you dialed during a conference call.
- **Dialpad/Hide:** Toggle the appearance of the onscreen keypad.
- **End call:** End the current call.
- **Speaker:** Route the phone's audio through the speaker (On) or through the earpiece (Off).
 - Activate Speaker to route the phone's audio through the speaker.
 - Deactivate Speaker to use the phone's earpiece.

Warning: Because of higher volume levels, do not place the phone near your ear during speakerphone use.

- **Mute:** Mute the microphone during an active call. Touch again to unmute the microphone.

Note: If Mute is activated, the speaker mode is deactivated.

- **Bluetooth:** Route the phone's audio through a connected Bluetooth headset (On) or through the speaker (Off).
 - When the call is routed to a Bluetooth headset, the current call area shows the Bluetooth call icon (📞).

Note: The Headset button is activated to show the current call is routed to the connected Bluetooth headset.







- To route the current call back to the phone, touch **Bluetooth** to temporarily use the phone. Touch it again to route the call back to the connected Bluetooth headset.
- When Bluetooth or the Bluetooth headset is turned off, the call is routed through either the earpiece or speaker and shows .
- **Dialpad:** Use the onscreen dialpad to enter additional numbers, for example, an extension or access code.
 - For example: When you call your bank's 800 number, use your dialpad to enter your account number and PIN.

Touch  during a call to display a list of additional in-call features. Touch an option to select it.

- **Add call:** Allows you to add another call.
- **Contacts:** Display your contacts list.
- **Memo:** Create a new memo while remaining on the call.
- **Messaging:** Access the Messaging app while remaining on the call.
- **Voice clarity:** Activates the voice clarity feature.

Caller ID

Caller ID identifies a caller before you answer the phone by displaying the number of the incoming call. If you do not want your number displayed when you make a call, follow these steps.

1. Press  > .
2. Touch   .
3. Enter a phone number.
4. Touch .

To permanently block your number, call Sprint customer care.

Call Waiting

When you're on a call, Call Waiting alerts you to incoming calls by sounding two beeps. Your phone's screen informs you that another call is coming in and displays the caller's phone number (if it is available).

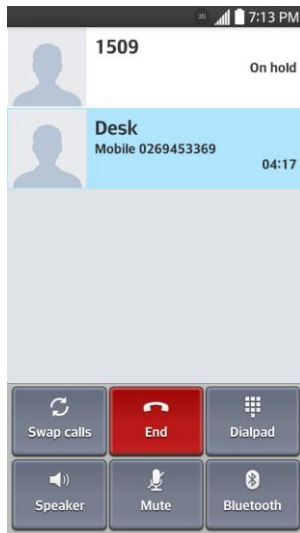

To respond to an incoming call while you're on a call:

- Swipe  in any direction. (This puts the first caller on hold and answers the second call.)



To switch back to the first caller:

- Touch **Swap calls**.

Note: For those calls where you don't want to be interrupted, you can temporarily disable Call Waiting by pressing    before placing your call. Call Waiting is automatically reactivated once you end the call.

Conference Calling

With conference calling, also known as 3-way calling, you can talk to two people at the same time. When using this feature, the normal airtime rates will be charged for each of the two calls.

1. On the Phone screen, enter a number and touch  (or place a call from Log or Contacts).
2. Once you have established the connection, touch **Add call**, and dial the second number (or place the call from Logs or Contacts).
 - This puts the first caller on hold and dials the second number.
3. When you're connected to the second party, touch **Merge calls**. Your conference call is now in session.

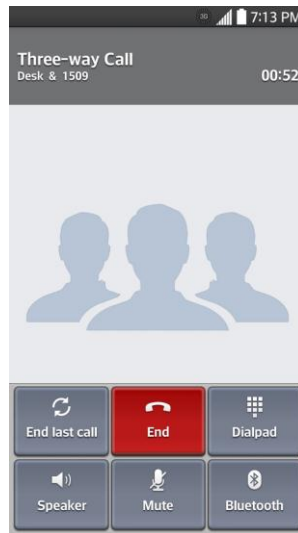
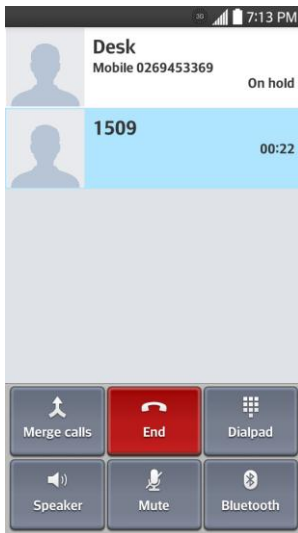

Note: If one of the people you called hangs up during your call, you and the remaining caller stay connected. If you initiated the call and are the first to hang up, all callers are disconnected.







4. To end the three-way call, touch . To end only the last dialed call, touch .

Call Forwarding

Call Forwarding lets you forward all your incoming calls to another phone number – even when your phone is turned off. You can continue to make calls from your phone when you have activated Call Forwarding.

Note: You are charged a higher rate for calls you have forwarded.

To activate Call Forwarding:

1. Press  > .
2. Touch   .
3. Enter the area code and phone number to which you want your calls forwarded.
4. Touch . (You will hear a tone to confirm the activation of Call Forwarding.)



To deactivate Call Forwarding:

1. Press  > .
2. Touch    .
3. Touch . (You will hear a tone to confirm the deactivation.)

Set Up Speed Dialing

Your phone can store up to 99 phone numbers in speed dial locations.

To assign a speed dial number to a contact:



1. Press  > .
2. Touch and hold the contact whose phone number you want to store speed dial locations.
3. Tap **Edit contact**.
4. Tap .
5. Tap a desired speed dial location number from 2 to 99.
6. Tap **Save**.

Note: If you assign a number to an already in-use speed dial location, you will be prompted to confirm that you want to replace the previous speed dial assignment.

Call Logs

The Logs tab of the Phone application lists all recent incoming, outgoing, and missed calls.



View Call Logs

1. Press  >  to display the dial pad.
2. Touch **Call logs** to display the call log list.
 - To filter the call logs, touch  > **Filter** and choose from **Received calls**, **Dialed calls**, and **Missed calls**.

Call Log Options

- To make a call from the call log, see [Call from Call Logs](#).



For additional options:

1. Press  >  to display the dial pad.
2. Touch **Call logs** to display the call log.
3. Touch and hold a listing to display the options list.
 - **Add to Contacts** (for entries not saved in Contacts) to save the number to Contacts.
 - **View contact** (for entries saved in Contacts) to view contact information.
 - **Edit number before call** to edit a number before you redial.

- **Copy call number** to copy the call number.
- **Reject call** to add to the call reject list.
- **Delete call logs** to delete all the call logs.
- **Delete all logs** of this number to delete all the logs of this number only."

Clear Call Logs

Use the menu option to clear your call log.

1. Press  >  to display the dial pad.
2. Touch **Call logs** to display the call log.
3. Touch  > **Delete**.
4. Touch individual entries or the check box next to **Select all**.
5. Touch **Delete** and then touch **OK** to clear the selected logs.



Tip: You can also delete all of the call logs at once by tapping  > **Delete all** > **Yes**.

Call Settings

Your phone's Call Settings menu lets you configure your voicemail options and a number of other settings for the phone application.



Voicemail Settings

If you need to adjust your voicemail provider or access settings, use the Voicemail settings menu.

1. Press  > .
2. Touch  > **Call settings** > **Voicemail**.
3. Configure your options.

Call Reject

The Call rejection menu lets you set options to automatically reject calls from certain numbers.



1. Press  > .
2. Touch  > **Call settings** > **Call reject**.
3. Configure your options.

TTY Mode

A TTY (teletypewriter, also known as a TDD or Text Telephone) is a telecommunications device that allows people who are deaf, hard of hearing, or who have speech or language disabilities, to communicate by telephone.

Your phone is compatible with select TTY devices. Please check with the manufacturer of your TTY device to ensure that it supports digital wireless transmission. Your phone and TTY device will connect using a special cable that plugs into your phone's headset jack. If this cable was not provided with your TTY device, contact your TTY device manufacturer to purchase the connector cable.

To turn TTY Mode on or off:

1. Press  >  > **System settings** > **Call** > **TTY mode**.
2. Touch **TTY Full**, **TTY HCO**, or **TTY VCO** to turn TTY mode on.

– or –

Touch **TTY Off** to turn TTY mode off.

To access the state Telecommunications Relay Service (TRS) for assistance with TTY calls:

- Dial to reach an operator.

Note: In TTY Mode, your phone will display the TTY access icon. When enabled, TTY mode may impair the audio quality of non-TTY devices connected to the headset jack.

Warning: 9-1-1 Emergency Calling

It is recommended that TTY users make emergency calls by other means, including Telecommunications Relay Services (TRS), analog cellular, and landline communications. Wireless TTY calls to 9-1-1 may be corrupted when received by public safety answering points (PSAPs), rendering some communications unintelligible. The problem encountered appears related to TTY equipment or software used by PSAPs. This matter has been brought to the attention of the FCC, and the wireless industry and the PSAP community are currently working to resolve this.



Roaming Settings

You can make phone calls and use wireless data services around the globe on compatible CDMA and GSM/UMTS networks.

Roaming Mode

Depending on your Sprint Prepaid plan, your device may be allowed to use roaming networks. Your phone allows you to control your roaming capabilities. By using the Roaming menu option, you can determine which signals your phone accepts.

Choose from two different settings on your dual-band phone to control your roaming experience.

1. Press  >  > **System settings** > **Roaming**.
2. Tap **System select** to change the CDMA roaming mode.



- **Home only** to access only the home area mobile network, which is the Nationwide Sprint Network. This option also prevents roaming on other networks.
 - **Automatic** to seek service off the Nationwide Sprint Network. When Sprint service is unavailable, the phone searches for an alternate system.
3. Tap each Domestic roaming option and International roaming option to place a checkmark and connect to voice and data service while roaming.

Note: With Data roaming unchecked, you can still transmit data with a Wi-Fi connection. See [Connect Wi-Fi](#).

Roaming Guard



Roaming guard makes it easy to manage your roaming by requiring confirmation before placing or answering a roaming call.

To turn Call Guard on or off:

1. Press  >  > **System settings > Roaming > Roaming guard.**
2. Tap each roaming guard option activate or deactivate this function. When active, an extra key press is required for dialing when in a roaming area.

Note: Call Guard is turned on by default on your phone. Voice dialing and speed dialing are not available when you are roaming with Call Guard enabled.

To place roaming calls with Call Guard on:

1. Press  > .
2. Enter 1 + area code + the seven-digit number and tap .

To answer incoming roaming calls with Call Guard on:

1. Swipe  in any direction. A message will be displayed notifying you that roaming charges will apply.
2. Tap **Yes**.

Data Roam Guard

Depending on service availability and roaming agreements, your phone may be able to access data services while roaming on certain digital systems. You can set your phone to alert you when you are roaming off the Nationwide Sprint Network and try to use data services such as messaging.

Note: Data Roam Guard is turned on by default on your phone.

To set your Data Roam Guard notification:

1. Press  >  > **System settings > Roaming > Roaming guard.**

2. Tap the **Domestic data roaming**, **International data roaming** checkboxes or both to place a checkmark and activate the function.

To use data services when Data Roam Guard is active:

- When a pop-up notification appears informing you that data roam charges may apply, tap **Connect** or **Always Connect** to connect.

Contacts

The Contacts application lets you store and manage contacts from a variety of sources, including contacts you enter and save directly in your phone as well as contacts synchronized with your Google Account, your PC, compatible email programs (including Exchange Server), and your Facebook friends.

Get Started with Contacts

Before using Contacts, it's best to learn a few basics.

Your phone automatically sorts the Contacts entries alphabetically. You can create a Google contact, a phone contact, or a Corporate (Microsoft Exchange ActiveSync) contact.

- **Google** contacts are synchronized between your phone and a Google Account you set up on your phone.
- **Microsoft Exchange ActiveSync** contacts are synchronized between your phone and an Exchange Server or Microsoft® Outlook® account set up on your phone.
- **Phone** contacts are stored locally on the phone.

Note: If the phone is ever reset to its factory default parameters, locally stored contacts (phone contacts) can be lost.

Access Contacts

There are a few ways to display Contacts.

- Press  >  > **Contacts** tab.

– or –

- Press  >  > **Contacts** .

– or –

Touch  (the contacts shortcut) on the home screen.

- To add a shortcut to the Contacts app to the home screen, touch and hold an empty spot on one of the home screens and touch the **Apps** tab. Touch and hold the **Contacts** icon , drag the icon to the home screen, and release the icon to place it.

The Contacts List

Learn how to view and navigate through your phone's Contacts list.

- Press  > . You will see the Contacts list.

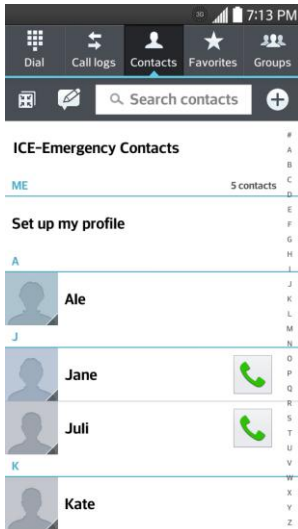



- **Contacts List:** The Contacts list displays all contacts currently stored in your phone, including Google contacts, Exchange ActiveSync contacts, Phone contacts, and Facebook contacts.
- **Create Contacts:** Touch  to add a contact.
- **Groups:** Create groups of contacts, such as friends, family, or coworkers.

Scroll through the list to view all your contacts. To see a specific entry, scroll to it and touch it.

Tip: If you have a lot of contacts stored, you'll see a slider on the right when you're flicking up or down the list. To go directly to a letter, touch and hold the slider and drag it to a letter.

Contacts List Options





The **Menu Key** () provides access to optional features in the Contacts list.

1. Press  > .
2. Touch  to display the main contacts list options.
 - **Delete:** Allows you to delete contacts.
 - **Share:** Allows you to share contacts.
 - **Send message:** Allows you to send a message to a contact.
 - **Send email:** Allows you to send an email to a contact.
 - **Speed dial:** Allows you to add a speed dial to your contacts.
 - **Join contacts:** Allows you to join duplicate contacts.

- **Import/Export:** Allows you to import or export contacts to your internal storage.
- **Edit tabs:** Allows you to edit the tabs, including rearranging them.
- **Settings:** Allows you to set various contact settings.

Add a Contact

You can add contacts by using the Phone application. Enter details such as name, phone numbers, email addresses, mailing addresses, and more.

1. Press  > .
2. Touch  to add a contact.
3. If you have multiple account types associated with your phone, select a contact type.
 - Select **Google** if you want to save contacts to your Google Account; these will be synced automatically with your Google Account online.
 - Select **Phone** as the sync account if you want your contacts on your phone only; they will not be synced with your Google Account.
4. Use the keyboard to enter as much information as you want.
 - : Touch the picture icon to assign a picture to the contact.
 - **Add another field:** Touch **Add another field** to include additional information such as IM, Notes, Nickname, Website, etc.

Note: To select a type (label) for a phone number, email address, or postal address (such as Mobile, Home, Work, etc.), touch the type to the right of the field and select the appropriate type.

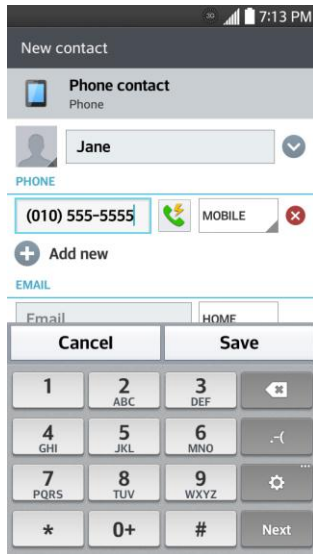

Note: To add more phone numbers, email addresses, etc., touch  below the phone number field.

5. When you have finished adding information, touch **Save**.



Save a Phone Number

You can save a phone number to Contacts directly from the phone dialpad.

1. Press  > .
2. Enter a phone number.
3. To add the number to an existing contact, touch **Update contact**. To add a new contact, touch **New contact**.
 - For an existing contact, touch the contact name, select a number type for the new number, and then touch **Save**.
 - For a new contact, enter the name and any additional information, and then touch **Save**. See [Add a Contact](#).



Edit a Contact Entry

You can change or add details saved in your contact entries, such as setting specific ringtones to specific contacts or setting calls from specific contacts to divert to your voicemail. Some contact entries contain information from multiple sources: information that you added manually, information joined from multiple accounts to consolidate duplicates, etc.

If you find duplicate entries in Contacts, you can join them into a single entry. If you find that unrelated contacts were joined in error, you can separate them.



Changes made to information from one source do not automatically change the information on the other sources. For example, if you have information about a contact from a Google Account and an Exchange account and both are configured to sync contacts, changes to the contact from the Google Account are synced to that account on the web, but the information from the Exchange account will remain unchanged.

Edit a Contact





1. Press  >  > .
2. Touch and hold the contact whose details you want to edit.
3. Tap **Edit contact**.
4. Edit the desired contact information.
5. Tap **Save**.

Change a Contact's Default Phone Number





The default phone number is used when you initiate a call or send a text message using the context menu (by touching and holding a contact).

1. Press  >  > .
2. Tap the name of a contact to view its details.
3. Touch and hold the phone number you want to set as the contact's default phone number.
4. Tap **Set as default number**. (A checkmark will appear next to the default phone number.)

Select a Ringtone for a Contact





1. Press  >  > .
2. Tap the name of a contact to view its details.
3. Tap .
4. Tap the **RINGTONE** field and tap a ringtone to select it.
5. Tap **Save**.

Delete Contacts



1. Press  >  > .
2. Tap the name of a contact.
3. Tap  > **Delete**.
 - If the contact contains information from a read-only account, you will not be able to delete it; you will only be able to change the sync settings for that account or delete the account itself.
 - If the contact contains information joined from a read-only account, a dialog box will inform you that you must separate the contact entry into individual contacts to delete the contact.

4. Tap **Yes** to confirm that you want to delete the contact.

Add a Number to a Contact



1. Press  >  > .
2. Touch and hold the contact's entry.
3. Tap **Edit contact** in the menu that opens.
4. Tap  under the Phone section.
5. Tap the label button to the right of the phone number field and select the relevant label.
 - To create your own label, tap **CUSTOM**.
6. Enter a phone number and tap **Save**.

Edit a Contact's Number

1. Press  >  > .
2. Touch and hold a contact's entry.
3. Tap **Edit contact**.
4. Tap a phone number to edit.
5. Re-enter or edit the number and tap **Save**.

Assign Direct Dialing Numbers

Besides speed dialing, you are also able to directly save a contact to your Home screen.

1. Press  >  > .
2. Touch and hold a contact's entry.
3. Tap **Add to Home screen > Direct dial**. The contact will be shown on the Home screen.





Note: If there is no available space on a particular Home screen canvas, you must delete or remove an item before you can add another item. In this case, you have the option of switching to another Home screen canvas.

Use Direct Dial

To use Direct Dial, simply tap the contact on the Home screen.

Assign a Picture to an Entry

Assign a picture to display each time a certain contact calls you.



1. Press  >  > .
2. Touch and hold the contact's entry.
3. Tap **Edit contact**.
4. Tap .
5. Tap **Take photo** to take a new picture. The camera will launch.

– or –

Tap **Select from Gallery** to select a picture from the Gallery.

6. After cropping the picture as you want, tap **Save**.

Find Contacts by Name

1. Press  >  > .
2. Tap the **Search contacts** field.
3. Start entering the name of the contact you're searching for. As you type, contacts with matching names will appear below the search box.
4. Tap a matching contact in the list to open its entry.

Communicate with Your Contacts

From the Contacts or Favorites tab, you can quickly call or send a text (SMS) or multimedia message (MMS) message to a contact's default phone number. You can also open a menu to access different methods of communicating with that contact.

The Contacts application shares your contacts with many other applications, such as Gmail (see [Gmail](#)) and messaging (see [Text and Multimedia Messaging](#)).

To connect by using Quick Contact for Android™:

1. Tap a contact's picture to open Quick Contact for Android.

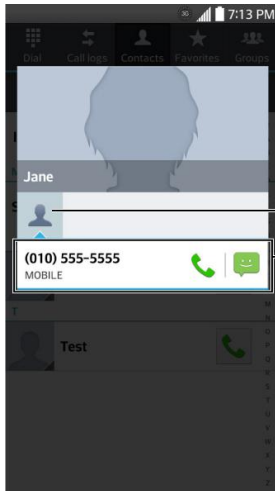





Tap contact's picture.

Tap the icon that corresponds to the method you want to communicate with the contact.

2. Tap the icon corresponding to the type of communication you want to start.





Depending on the contact information saved, the available actions will be displayed above the name.

To communicate with a contact:

1. Press  >  > .
2. Tap the contact's entry.
3. In the contact's details screen, tap the method you wish to communicate with the contact.
 - Tap  next to the number you want to call to directly.
 - Tap  next to the number you want to message.

Note: Anytime you see the green Call Key  next to a number, such as in your Favorites or Call logs, just tap it to call that number.

To call a contact's default number:

1. Press  >  > .
2. Tap  next to the contact entry.
3. If multiple numbers are stored, a pop-up window to select the number will open.

(For more information about placing phone calls, see [Make Phone Calls.](#))

For more information about sending text and multimedia messages, see [Text and Multimedia Messaging.](#)





Import, Export, and Share Contacts

If you have contacts stored in vCard format on the phone's internal storage, you can import them into your Contacts application on your phone. You can also export contacts in vCard format onto the phone internal storage. Export your contacts to back them up to a computer or another phone.

Import Contacts From Your Internal Storage





You can import contacts from your internal storage directly to your phone.

Note: See [Transfer Via PC or Laptop](#) for details about copying files to your phone from your computer.

1. Copy the vCard files to your phone from your computer.
2. Press  >  > .
3. Tap  > **Import/Export** > **Import from internal storage**.
4. If you have more than one account on your phone, tap the account into which you want to import the contacts.
5. Tap the files you wish to import and tap **Import** and **Yes** to confirm.

Export Contacts to Your Internal Storage

You can export all of the contacts on your phone, as vCard files. You can then copy this file to a computer or another phone that is compatible with this format, such as an address book application. (See [Transfer Via PC or Laptop](#).)

1. Press  >  > .
2. Tap  > **Import/Export**.
3. Tap **Export to internal storage**.
4. Tap the contacts you want to export, then tap **Export** and **Yes** to confirm.
5. Enter a file name and tap **OK**.





Share a Contact

You can share a contact with someone by sending it to the person as a vCard file.

1. Press  >  > .
2. Open the contact you want to share.
3. Tap  > **Share**.
4. Choose the method for sending.

Joining and Separating Contacts

When you have two or more entries for the same contact, you can join them into a single entry. You can also separate contacts that were joined.

1. Press  >  > .
2. Tap  > **Join contacts**.
3. Select a tab at the top of the screen.
 - Tap **Join suggestion** to select entries to merge.
 - Tap **Joined contacts** to select entries to separate.
4. Checkmark the entry (or entries) you want, then tap **Join** or **Separate**.

Accounts and Messaging

With wireless service and your phone's messaging capabilities, you have the opportunity to share information through many different channels and accounts, including Gmail (Google), personal and corporate email, text and multimedia messaging, social networking accounts, and Hangouts.

Gmail / Google

You will need a Google Account to access several phone features such as Gmail, Google Maps, Hangouts, and the Google Play applications. Before you are able to access Google applications, you must enter your account information. These applications sync between your phone and your online Google Account.

Create a Google Account





If you do not already have a Google Account, you can create one online or using your phone.

Note: Although you need a Gmail account to use certain features of your phone, such as Google Play, you do not need to use Gmail as the default account for your phone.

Create a Google Account Online



1. From a computer, launch a Web browser and navigate to google.com.
2. On the main page, click **Sign-in > Create an account now**.
3. Follow the onscreen prompts to create your free account.
4. Look for an email from Google in the email box you provided, and respond to the email to confirm and activate your new account.

Create a Google Account Using Your Phone

1. Press  >  > **System settings > Accounts & sync > Add account**.
2. Touch **Google** and then touch **New**.
3. Enter your **First name** and **Last name**, and then touch .
4. Enter a desired **Username**, and then touch .
5. When prompted, enter and reenter a password.
6. Create a security question and answer, enter a secondary email address to help you recover your password if you ever lose it, and then touch .



Note: When setting up a new Google Account, either on your phone or online, you will be prompted to add a secondary email address. Enter a second Gmail address or any other email address from which you currently send and receive email. This address is used to authenticate your account should you ever

encounter problems or forget your password. It is strongly encouraged for Android users so you can regain access to Google services and purchases on your phone.

7. On the Finish account screen, select your web history and additional Google Play options and then touch .
8. Enter the letters from the Authenticating screen and then touch .
9. After your phone connects with the Google servers, select the items you would like to sync with your phone and then touch **Sync now**.
10. Touch **Finish setup** and your phone will synchronize the selected items.



Sign In to Your Google Account

If you have a Google Account but have not yet signed in with your phone, follow these instructions to sign in to your Google Account.

1. Press  >  > **System settings > Accounts & sync > Add account**.
2. Touch **Google**, and then touch **Existing**.
3. Enter your Gmail username and password, and then touch .
4. After your phone connects with the Google servers, select the items you would like to sync with your phone and then touch **Sync now**.
5. Touch **Finish setup** and your phone will synchronize the selected items.





Access Gmail

Access your personal Gmail account directly on your phone.

1. Press  >  > **Gmail** .
2. Do any of the following:
 - View more email messages: If the inbox is full, swipe your finger up the screen to view more messages and conversations.
 - Read a new email message: Touch the unread message or the conversation with an unread message (just-arrived items display in bold).
 - Select messages and conversations: Touch the letter image or contact's picture to the left of the email or conversation.
 - View the inbox of your other Gmail account:
 - Touch the account name at the top of the inbox, and then touch the account you want to view.

Send a Gmail Message

Use your phone to send Gmail messages.

1. Press  >  > **Gmail** .
2. In the inbox, touch **Compose** .
3. Enter the message recipient's email address in the **To** field. If you are sending the email message to several recipients, separate the email addresses with a comma. As you enter email addresses, any matching addresses from your contacts list are displayed. Touch a match to enter that address directly.
4. If you want to send a carbon copy (Cc) or a blind carbon copy (Bcc) of the email to other recipients, touch  > **Add Cc/Bcc**.
5. Enter the email subject, and then compose your email.

Note: If you want to attach a picture, touch  and then touch **Attach file**. Locate and then touch the picture you want to attach.

6. After composing your message, touch **Send** .

Note: While composing the message, touch  > **Save as draft** or touch  to save it as a draft. To view your draft email messages, in the inbox, touch  > **Drafts**.



Note: To view your sent messages, in the inbox, touch  > **Sent**.

Read and Reply to Gmail Messages

Your phone allows you to access, read, and reply to all your Gmail messages.

1. Press  >  > **Gmail** .
2. Touch a message to display it.

Tip: You can also access new messages through the Notifications Panel. When a new Gmail message arrives, you'll see the  icon in the Status Bar. Touch and hold the bar and slide it down access the Notifications Panel and display notifications. Touch a message to display it.

3. To reply to or forward a message, touch **Reply**  to open a reply message. For reply to all or forward, touch **Reply** from the open message and then touch **Reply to all**, or **Forward**.
 - For **Reply** or **Reply to all**, enter an additional message.
 - For **Forward**, enter or select recipients and then enter an additional message.
4. After composing your message, touch **Send** .

Email

Use the Email application to send and receive emails from your webmail or other accounts, using POP3 or IMAP, or access your Exchange ActiveSync account for your corporate email needs.

Although there is a separate Gmail application, the Email application can manage both Internet based email services (Gmail and Yahoo!™) and Corporate Work Email (Outlook®). The phone can also be manually configured to connect to other email systems.

Note: If you have multiple email accounts, you must configure each account with its own settings.

- If you want to send and receive email messages through an ISP (Internet Service Provider) account (such as Outlook), you will first need to set up an IMAP or POP account.
- Internet Message Access Protocol (IMAP) – This mail retrieval protocol is frequently used in large networks and commercial and institutional settings. IMAP4 is the current standard.
- Post Office Protocol (POP) - This protocol is supported by most ISPs and is currently more common among consumer applications. POP3 is the current standard.

Note: For more information, review your email carrier's support documents or contact your IT administrator.

Email Icons/Shortcuts



- Email shortcut



- Gmail shortcut

Status Bar - Notifications







- New Email message received



- New Gmail message received

Add an Email Account (POP3 or IMAP)

The Email application only reveals all currently added email accounts. To view additional email accounts within the main Email screen, they must first be added.

1. Press  >  > **Email** .
2. Do one of the following:
 - If this is your first time to add an email account, tap **Yahoo** or **Other** on the Select email provider screen.
 - If you have already added an email account in Email, tap  > **Settings** > **Add account** . If the Select email provider screen is displayed, tap **Other**.

3. Enter the **Email address** and **Password** for your email account and then tap **Next**.
 - Tap **Manual setup** to configure your connection settings manually (POP3 , IMAP, or Exchange). Follow the on-screen prompts and enter the information specific to your carrier.

Important: If the account type you want to set up is not in the phone database, you will be asked to enter more details. You should get all pertinent information for the email account, such as incoming and outgoing server settings, before you proceed.



4. Enter the account name and your name and tap **Done**.

Corporate Email (Outlook)

The Email application also provides access to your Outlook Exchange server via your phone. If your company uses Microsoft Exchange Server 2003, 2007 and 2010 as the corporate email system, you can use this email application to wirelessly synchronize your email, Contacts and directly with your company's Exchange server.

Important: This Outlook application does not utilize Microsoft® ActiveSync to synchronize the phone to your remote Exchange Server. This synchronization is done wirelessly over the air (OTA) and not via a direct connection.

Set Up a Corporate Email

1. Press  >  > **Email** .
2. Tap **Microsoft Exchange** (from the add new email account screen).
3. Enter your **Email address** and **Password** information, then tap **Next**. Consult your Network Administrator for further details.
 - **Email address:** Your Outlook work email address.
 - **Password:** Typically your network access password (case-sensitive).
4. Enter a **Server address, Domain** and tap **Next**.
 - **Server:** Your exchange server remote email address. Typically starts with mail.XXX.com. Obtain this information from your company network administrator.
 - **Domain:** Enter your network domain\login username.
 - If your network requires SSL encryption, tap the **Use secure connection (SSL)** box to place a checkmark and activate this additional level of security.
 - If your exchange server requires this feature, leaving this field unchecked can prevent connection.

Note: Signal interruptions or incorrect username or password information can cause completion issues.

5. Configure your **Update schedule, Days to sync email** (days to synchronize between your phone and server), and activate any other email settings, then tap **Next**.

6. Read the on-screen activation disclaimer and, if prompted, tap **Activate**.

Note: Depending on the type of account, you might be required to enable security to sync the account.





7. Identify your new account with a unique name and provide the outgoing name, then tap **Done**.

Important: You can synchronize over the air (not directly) with an Exchange Server running Microsoft Exchange Server 2003 Service Pack 2 (SP2) or Microsoft Exchange Server 2010.

Note: You can have multiple Work Email (Microsoft Exchange) accounts active on your phone.

Open Email

Reading and replying to email on your phone is as simple as on your computer.

1. Press  >  > **Email** .
2. Tap a message to read, manage, or reply to.
 - From your Inbox screen, tap  to select the following options: **Refresh**, **Folders**, **Sort by**, **Downloads**, and **Settings**.
 - While in a message, the options described in the image below are available.

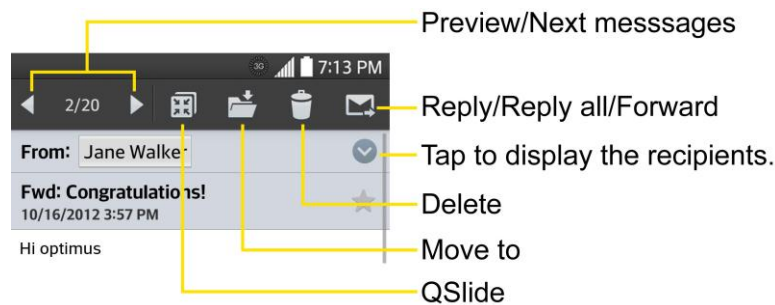

Create and Send Email

Create and send email using any account you have set up on your phone. Increase your productivity by attaching files such as pictures, videos, or documents to email messages.

1. From the Inbox, tap .
2. Enter the recipient's email address in the **To** field.
 - You can add as many message recipients as you want.

Note: To send an additional carbon copy (Cc) or a blind carbon copy (Bcc) of the current email to other recipients, enter the recipients in the **Cc/Bcc** field.

3. Tap the **Subject** field and enter the email subject.
4. Tap the **Body** field and compose your email.

- To add an attachment (such as picture, video, contact, event, audio, etc), tap .
- You can access the internal storage and navigate to the file you wish to attach.
- Tap the file you wish to attach.



5. Tap  to send the email.

Note: If you close the messaging window before sending it, it is stored in Drafts.

Reply to or Delete an Email Message

Replying to or deleting an email is also simple.

Reply to an Email

1. From the Inbox, tap an email message to view it.
2. With the email message displayed, tap  and choose **Reply**, or **Reply all**.
 - If you select **Forward**, you must specify the message's recipients.
3. Enter a new message and tap .

Delete an Email Message

- Touch and hold an email (from your inbox list) and tap **Delete** from the pop-up context menu.



– or –

With the email message displayed, tap .

Configure and Sync Corporate Email Settings

You can sync and configure various settings for your corporate email and create a corporate email signature.

Sync Your Accounts

1. Press  >  > **System settings** > **Accounts & sync**.
2. Tap **Microsoft Exchange**, then select the Corporate account to reveal the account's synchronization settings screen.
3. Place a checkmark next to each option if you want the phone to automatically synchronize. If you want to manually synchronize, tap  > **Sync now**.

Configure Corporate Email

1. Press  >  > **System settings** > **Accounts & sync**.



2. Tap **Microsoft Exchange**, then select **Email Settings** and tap the desired account to reveal the account's synchronization settings screen.
3. The following settings are available.
 - **Account name:** Displays the name used by the phone to track the account.
 - **Your name:** Displays your name. Tap this to change it.
 - **Use signature:** To add a signature or other information to outgoing email.
 - **Signature:** Displays a signature. Tap this to change it.
 - **Update schedule:** Choose the update schedule.
 - **Folders to sync:** Select the folders you want to synchronize.
 - **Days to sync email:** Choose how many days of email you want to sync.
 - **Message format:** Select the format you want to view email messages in.
 - **Message size limit:** Allows you to set the size limit for messages.
 - **Download over Wi-Fi:** Attachments will be queued until Wi-Fi is connected.
 - **File size to download over Wi-Fi:** Choose the limit for files required to be downloaded over Wi-Fi.
 - **Account & sync:** Goes back to Accounts & sync screen.
 - **SMS sync:** Synchronizes your SMS with the Email app.
 - **Calendar events to sync:** Choose how many weeks of calendar events you want to sync.
 - **Auto resend times:** Set the number of tries to resend a failed email message.
 - **Always CC/Bcc me:** Allows you to copy yourself to emails sent out.
 - **Out of office settings:** Allows you to set your out of office settings and message.
 - **Security settings:** Set digital signatures and encryption to secure email.
 - **Corporate directory:** Searches online directory for the recipient input.
 - **Server policy:** View the server policy currently applied.
 - **Notifications:** Allows you to decide whether to notify you of new email.
 - **Notification sound:** Allows you to select the notification sound for new emails.
 - **Vibrate:** Allows you to configure vibrate options for new emails.
 - **Vibrate Type:** Allows you to select the vibration type for new emails.
 - **Exchange server settings:** Allows you to change the server settings for your account.

- **Remove account:** Allows you to remove the account.

4. Tap  to return to the previous screen.

For more detailed Corporate email information, see [Corporate Email \(Outlook\)](#). For more information on Corporate Calendar synchronizing.

Configure General Email Settings

1. Press  >  > **System settings** > **Accounts & sync**.
2. Tap **Email** to display the account's synchronization settings screen.
3. Tap **Email Settings** and select **General settings** to set the following settings.
 - **Set default account:** Allows you to set the default account.
 - **Select download storage:** Allows you to choose where to store your downloads.
 - **Email preview:** Allows you to set how much lines of email to display as a preview in the mailbox.
 - **Conversation view:** View email messages sent or received with the same subject in one thread.
 - **Split view:** Allows you to email list with email contents in landscape orientation.
 - **Load linked images:** Select when you want to load linked images.
 - **Ask before deleting:** Checkmark to set the phone to ask before deleting email.
 - **Auto-advance:** Select which screen to display after deleting an email.
 - **Resize image:** Set the default size for image attached while composing.
 - **Trusted certificates:** Trusted certificate information is available.
4. Tap  to return to the previous screen.

Text and Multimedia Messaging





With Text Messaging (SMS), you can send and receive instant text messages between your wireless phone and another messaging-ready phone.

Multimedia messages, or MMS, can contain text and pictures, recorded voice, audio or video files, picture slideshows, contact cards (vCard), or appointments (vCalendar).

See your service plan for applicable charges for messaging.

Send a Text Message

Quickly compose and send text messages on your phone.

1. Press  >  > **Messaging** .
2. On the Messaging screen, touch **Compose** . The Compose screen opens.
3. Fill in one or more recipients. You can:
 - Enter phone numbers directly in the **To** field. If you're sending the message to several phone numbers, separate the phone numbers with a comma. As you enter information, any matching phone numbers from your contacts list are displayed. Touch a match to enter that number or address directly.
 - Touch the  icon, and then select the contacts to whom you want to send the message. You can also select contact groups as recipients. When you have selected all the message recipients, touch **Done**.
4. Touch the "Enter message" box and then start composing your message.

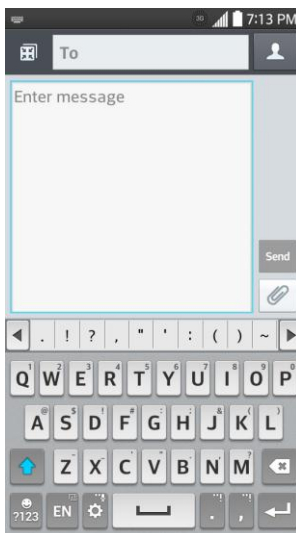





Note: A counter appears above the **Send** button () to tell you how many characters you have entered and how many characters are left. Once you go over the 160-character limit, a new message is created but automatically joined into one when received.

5. When done, touch **Send**  to send the text message.



Send a Multimedia Message (MMS)

When you need to add a little more to a text message, you can send a multimedia message (MMS) with pictures, voice recordings, audio or video files, contact cards (vCard), or appointments (vCalendar).

1. Press  >  > **Messaging** .
2. On the Messaging screen, touch **Compose** . The Compose screen opens.
3. Fill in one or more recipients. You can:







- Enter phone numbers directly in the **To** field. If you're sending the message to several phone numbers, separate the phone numbers with a comma. As you enter information, any matching phone numbers from your contacts list are displayed. Touch a match to enter that number or address directly.
- Touch the  icon, and then select the contacts to whom you want to send the message. You can also select contact groups as recipients. When you have selected all the message recipients, touch **Done**.

Note: You can add a subject line by touching  > **Add subject**.

4. Touch the "Enter message" box, and then start composing your message.
5. Touch  and select the type of attachment you want to add.
6. In the Attach window, select from the following file attachments:
7. Touch **Send MMS**  to send the MMS message.

Create a Slideshow

In a multimedia message, you can add slides, each containing a picture, video, or audio.





1. In the multimedia message you're composing, touch  > **Slide** to add space for a new slide.
2. Touch the space for the slide.
3. To compose your slideshow, do any of the following:
 - **Add a picture:** Touch  > **Image** and select a picture.
 - **Add a video:** Touch  > **Video** and select a video. (You cannot add both a picture and a video on the same slide.)
 - **Add music or a voice recording:** Touch  > **Audio** and select a file.
 - **Add a caption:** Enter the text below the attachment.
 - **View the next or previous slide:** Touch the compose field and drag the screen up and down.
 - **Preview your slideshow:** Touch  > **Preview**.
 - For more options, touch  and select an option.
4. When you have finished composing the multimedia message, touch **Send MMS** .

Tip: To compose a slide show, you can also simply attach multiple items separately to the MMS message. Touch  and select a file type, location, and file and then repeat it for additional slides. Your phone will automatically compile a slide show.

Save and Resume a Draft Message



While composing a text or multimedia message, touch  to automatically save your message as a draft.

To resume composing the message:

1. Press  >  > **Messaging** .
2. Touch the message with the  icon to resume editing it.

New Messages Notification

Depending on your notification settings, the phone will play a ringtone, vibrate, or display the message briefly in the Status Bar when you receive a new text or multimedia message. To change the notification for new text and multimedia messages, see [Text and Multimedia Message Options](#) for details.

A new message icon () also appears in the notifications area of the Status Bar to notify you of a new text or multimedia message. The Messages application icon (if shown on the Home screen) also displays the number of new messages .

To open the message, touch and hold the Status Bar, and then slide the Status Bar down to open the Notifications Panel. Touch the new message to open and read it. For information on reading and replying to messages see “Manage Message Conversations” below.

Manage Message Conversations

Text and multimedia messages that are sent to and received from a contact (or a number) are grouped into conversations or message threads in the Messaging screen. Threaded text or multimedia messages let you see exchanged messages (similar to a chat program) with a contact on the screen.

Read a Text Message

- Do one of the following:
 - On the Messaging screen, touch the text message or message thread to open and read it.
 - If you have a new message notification, touch and hold the Status Bar, and then slide the Status Bar down to open the Notifications Panel, Touch the new message to open and read it.



To return to the Messaging screen from a text message thread, touch .

Note: To view the details of a particular message, in the message thread, touch and hold the message to open the options menu, and then touch **View message details**.

Note: If a message contains a link to a Web page, touch the message and then touch the link to open it in the Web browser.

Note: If a message contains a phone number, touch the message and then touch the phone number to dial the number or add it to your contacts.





View a Multimedia Message (MMS)

1. Press  >  > **Messaging** .
2. On the Messaging screen, touch a multimedia message or message thread to open it.
3. Touch the attachment to open it. If the attachment is a vCard contact, it is imported to your phone's contacts list. For more information, see [Contacts](#). If the attachment is a vCalendar file, you can choose the calendar where you want to save the event. For information on using Calendar, see [Calendar](#).
4. To save the attachment to the storage card, touch and hold the attachment and touch **Save attachment**.

Note: When Auto-retrieve in MMS settings is disabled, only the message header is downloaded. To download the entire message, touch the **Download** button at the right side of the message. For details, see [Text and Multimedia Message Options](#).

Note: If you are concerned about the size of your data downloads, check the multimedia message size before you download it.



Reply to a Message

1. Press  >  > **Messaging** .
2. On the Messaging screen, touch a text or multimedia message thread to open it.
3. Touch the text box at the bottom of the screen, enter your reply message, and then touch **Send** .

Note: To reply to a text message with a multimedia message, open the text message, touch . The text message is automatically converted into a multimedia message.

Protect (Lock) a Message





You can lock a message so that it will not be deleted even if you delete the other messages in the conversation.

1. Press  >  > **Messaging** .
2. On the Messaging screen, touch a message thread.
3. Touch and hold the message that you want to lock.
4. Touch **Lock message** on the options menu. A lock icon is displayed at the right hand side of the message.





Delete a Single Message

1. While viewing a message thread, touch and hold the message that you want to delete.
2. Touch **Delete message** on the options menu.
3. When prompted to confirm, touch **Yes**. If the message is locked, you will be prompted that the locked message will be deleted.

Delete Multiple Messages

1. Press  >  > **Messaging** .
2. On the Messaging screen, touch the message thread that you want to delete.
3. Touch  > **Delete**.
4. Touch the messages you want to delete, then touch **Delete**.
5. When prompted to confirm, touch **Yes**. Any locked messages in the thread will not be deleted unless you select the **Delete locked messages** check box.

Delete Multiple Message Threads





1. Press  >  > **Messaging** .
2. On the Messaging screen, touch  > **Delete**.
3. Select the message threads you want to delete.
4. Touch **Delete** and then touch **Yes** to confirm. Any locked messages will not be deleted, unless you select the **Delete locked messages** check box.

View Contact Information from a Message

When you have received a message from someone in your stored contacts, you can touch the contact's picture or icon in the message thread to open a menu of options. Depending on the stored contact information, you can view the contact details, phone or send an email message to the contact, and more.

Text and Multimedia Message Options

The messages settings menu lets you control options for your text and multimedia messages including message limits, size settings, and notifications.

1. Press  >  > **Messaging** .
2. On the Messaging screen, touch  and then touch **Settings**. You can set the following:

Messaging Settings

- **Set default message app:** Enable this option to set Messaging as your default SMS app to turn on all features.
- **Storage**
 - **Delete old messages:** Enable this option to delete older text messages when the limit for maximum number of text messages is exceeded.
 - **Text message limit:** Sets the maximum number of text messages that can be stored on the phone (per conversation).
 - **Multimedia message limit:** Sets the maximum number of multimedia messages that can be stored on the phone (per conversation).
 - **Attachment storage:** Tap this to select the desired storage for attachment.
 - **Signature:** Tap this to automatically add signature (blue checkmark displays).
- **Text message**
 - **Priority:** Select **Normal** or **High**.
 - **Message reassembly:** Enable this option (blue checkmark displays) so that multi-segment messages can be reassembled and shown as a single message. Each segment will still count toward your usage.
- **Multimedia message**
 - **Auto-retrieve:** Enable this option to automatically retrieve the entire content of your multimedia message. When checked, the multimedia message header, message body, and any attachments will automatically download to your phone.
 - If you disable this option, only the multimedia message header will be retrieved and displayed.
 - **Roaming auto-retrieve:** Automatically retrieves messages while roaming.
 - **Priority:** Select **Low**, **Normal**, or **High**.
- **Conversation theme:** Allows you to select the desired conversation theme for the conversation wallpaper and message bubbles.
- **Notification**
 - **Notifications:** Enable this option if you wish to receive a notification in the Status Bar when a new text or multimedia message arrives.
 - **New message pop-up:** Enable this option if you wish to see a new message as a pop-up.
 - **Preview:** Enable this option if you wish to preview the contents of messages when new messages arrive.

- **Notification sound:** Allows you to select a ringer to sound when a new message is received. Tap this option, and then select a ringtone that is specific to new text and multimedia messages. A sample will briefly be played upon selection.
- **Vibrate:** Enable this option if you want the phone to vibrate when a new text or multimedia message is received.
- **Vibrate type:** Choose what type of vibration you wish to apply to new messages.
- **Quick message:** Tap this to add or edit quick messages. Quick message is the specified text message to send out when you want to ignore an incoming call and respond to the caller with instead.
- **Send message with Enter key:** Enable this option if you want to send messages by tapping the Enter key on the keyboard.
- **Emergency alerts**
 - **Presidential alerts:** This setting allows presidential alert to be always presented. This setting is greyed-out because it cannot be changed.
 - **Extreme alerts:** Enable this option to receive extreme alerts.
 - **Severe alerts:** Enable this option to receive severe alerts.
 - **AMBER alerts:** Enable this option to receive AMBER alerts on child abduction.

Apps and Entertainment

All your phone's features are accessible through the Apps list.

Note: Available applications and services are subject to change at any time.

Google Play Store





Google Play™ is the place to go to find new Android apps, books, movies, and music for your phone. Choose from a wide variety of free and paid content ranging from productivity apps and games to bestselling books and blockbuster movies and music. When you find what you want, you can easily download and install it on your phone.

To access the Google Play store app, you must first connect to the Internet using your phone's Wi-Fi, 4G, or data connection and sign in to your Google Account. See [Web and Data](#) and [Sign In to Your Google Account](#) for details.

Important: Third-party applications may access your personal information or require Sprint to disclose your customer information to the third-party application provider. To find out how a third-party application will collect, access, use, or disclose your personal information, check the application provider's policies, which can usually be found on their website. If you aren't comfortable with the third-party application's policies, don't use the application.

Find and Install an App

When you install apps from Google Play app and use them on your phone, they may require access to your personal information (such as your location, contact data, and more) or access to certain functions or settings of your phone. Download and install only apps that you trust.

1. Press  >  > **Play Store** .
2. When you open the Google Play store app for the first time, the Terms of Service window will appear. Touch **Accept** to continue.
3. Browse through the categories (**Apps, Games, Movies & TV, Music, Books, and Newsstand**), find an app you're interested in, and touch the name.
 - **Browse through featured apps:** Scroll through the list of featured apps when you open Google Play.
 - **Search for an app:** Touch  on the Play Store home screen, enter the name or type of app you're looking for, and then touch  on the keyboard.
4. Touch an app to read a description about the app and user reviews.
5. Touch **INSTALL** (for free applications) or the **Price** button (for paid applications).

Note: You need a Google Wallet account to purchase items on Google Play. See [Create a Google Wallet Account](#) to set up a Google Wallet account if you do not have one.

- The subsequent screen notifies you whether the app will require access to your personal information or access to certain functions or settings of your phone. If you agree to the conditions, touch **ACCEPT** to begin downloading and installing the app.
 - If you selected a paid application, after touching **OK**, you're redirected to the Google Wallet screen to pay for the application before it's downloaded to your phone.

Warning: Read the notification carefully! Be especially cautious with applications that have access to many functions or a significant amount of your data. Once you touch **ACCEPT** on this screen, you are responsible for the results of using this item on your phone.

Create a Google Wallet Account

You must have a Google Wallet account associated with your Google Account to purchase items from the Google Play Store app.

Do one of the following:

- On your computer, go to google.com/wallet to create a Google Wallet account.

– or –





- The first time you use your phone to buy an item from Google Play, you're prompted to enter your billing information to set up a Google Wallet account.

Warning: When you've used Google Wallet once to purchase an application from the Google Play Store app, the phone remembers your password, so you don't need to enter it the next time. For this reason, you should secure your phone to prevent others from using it without your permission. (For more information, see [Select Screen Lock](#).)

Request a Refund for a Paid App

If you are not satisfied with an app, you can ask for a refund within 15 minutes of the purchase. Your credit card is not charged and the app is uninstalled from your phone.

If you change your mind, you can install the app again, but you can't request a refund a second time.





- Press  >  > **Play Store** .
- Touch  > **My apps**.
- Touch the app to uninstall for a refund. The details screen for the app opens.
- Touch **Refund**, and then touch **Yes** to confirm. Your app is uninstalled and the charge is cancelled.

Open an Installed App

There are options for opening an installed app.





- Press  > , locate the app, and then touch its icon.

– or –

1. Press  >  > **Play Store** .
2. Touch  > **My apps** > **INSTALLED** tab.
3. Touch the app and then touch **Open** to open it.

Uninstall an App

You can uninstall any app that you have downloaded and installed from Google Play.

1. Press  >  > **Play Store** .
2. Touch  > **My apps**.
3. On the Installed screen, touch the app you want to uninstall, and then touch **UNINSTALL**.
4. When prompted, touch **OK** to remove the app from your phone.

Get Help with Google Play

The Google Play store app offers an online help option if you have questions or want to know more about the app.

- Touch  > **Help**. The Web browser will take you to the Google Play Help Web page.

Navigation



Your phone offers a number of location-based navigation programs to help you figure out where you are and get you where you're going.

Google Maps

Use the Google Maps app to determine your location, find directions, browse local businesses and attractions, rate and review places, and more.

Enable Location Services on Your Phone

Before using any location-based services, you must enable your phone's GPS location feature. For more information about location services.

1. Press  >  > **System settings** > **Location**.
2. Touch the  switch to turn Location services ON.
 - **Mode:** Select **High accuracy**, **Battery saving**, or **Device sensors only**.

- **Recent Location Requests:** Displays apps that have recently requested your location information.
- **Location services**
 - **Google Location Reporting:** Allows you to configure your Google location settings.

Use Google Maps

- Press  >  > **Maps** .

Music

Your phone lets you discover, download, and listen to your favorite music through a variety of applications.

Music Player

Your phone's built-in music player app lets you listen to and organize music files you have loaded into your phone's memory or microSD card.

Note: For information about loading music onto your phone.

Listen to Music Using the Music Player

- Press  >  > **Music** .

Google Play Music App

The Google Play Music app lets you browse, shop, and play back songs purchased from Google Play as well as songs you have loaded from your own music library. The music you choose is automatically stored in your Google Play Music library and instantly ready to play via streaming or download.

For more information about Google Play Music, visit play.google.com/about/music.

Note: For information about loading music onto your phone.

Play Music with Google Play

- Press  >  > **Play Music** .

Web and Data

Your phone's data capabilities let you wirelessly access the Internet or your corporate network through a variety of connections, including Wi-Fi, 4G, Data Services (3G Network), and Virtual Private Networks (VPN).

The following topics address your phone's data connections and the built-in Web browser. Additional data-related features can be found in [Accounts and Messaging](#), [Apps and Entertainment](#), and [Tools and Calendar](#).

Connect Wi-Fi

Wi-Fi is a wireless networking technology that can provide Internet access at distances of up to 100 meters, depending on the Wi-Fi router and your surroundings.



To use Wi-Fi on your phone, you must connect to a wireless access point, or hotspot. Some access points are open and you can simply connect to them without entering any information. Others are hidden or implement other security features, so you must configure your phone to connect to them.

Turn off Wi-Fi when you're not using it to extend the life of your battery.

When you connect to a Wi-Fi network, the phone obtains a network address and other information it needs from the network, using the DHCP protocol. To configure the phone with a static IP address and other advanced settings, tap  > **Advanced Wi-Fi** from the Wi-Fi settings menu.

Turn Wi-Fi On and Connect to a Network

Use the Wi-Fi menu to enable your phone's Wi-Fi radio and connect to an available Wi-Fi network.

1. Press  >  > **System settings** > **Wi-Fi**.
2. Tap the **Wi-Fi** switch  to turn Wi-Fi on and scan for available Wi-Fi networks.
 - A list of available Wi-Fi networks will be displayed. Secured networks are indicated by a lock icon.
 - If the phone finds a network that you have connected to previously, it automatically connects to it.
3. Tap a network to connect to it.
 - If the network is secured, you will be prompted to enter a password. (Ask your network administrator for details.)
 - When you're connected to a network, you can tap the network name in the Wi-Fi settings screen for details about the speed, security, address, and related settings.

To receive notifications when open or secured networks are in range:

By default, when Wi-Fi is on, you receive notifications in the Status Bar when your phone detects an open Wi-Fi network.

1. Turn on Wi-Fi, if it's not already on.
2. From the Wi-Fi settings screen, tap  > **Advanced Wi-Fi**, then tap the **Network notification** check box to activate the feature.

Add a Wi-Fi Network

You can add a Wi-Fi network manually if it does not broadcast its name (SSID) or if you want to add a Wi-Fi network when you are out of its range.

To add a secured network, you need to contact the network's administrator to obtain the password or other required security credentials.

1. Turn on Wi-Fi, if it's not already on.
2. From the Wi-Fi settings screen, tap  > **Add network**.
3. Enter the **Network SSID** (name) of the network. If the network is secured, tap the **Security** drop-down menu and tap the type of security used for the network.
4. Enter the required passwords and security credentials.
5. Tap **Connect**.

The phone will connect to the wireless network. Any credentials that you entered are saved, so you are connected automatically the next time you come within range of this network.

To forget a Wi-Fi network:

You can also make the phone forget about the details of a Wi-Fi network that you have added. For example, if you don't want the phone to connect to it automatically or if it is a network that you no longer use.

1. Turn on Wi-Fi, if it's not already on.
2. In the Wi-Fi settings screen, touch and hold the name of the network.
3. Tap **Forget network**.

Data Services General Information (3G and Sprint Spark LTE Networks)

The following topics will help you learn the basics of using your data services, including managing your user name, launching a data connection, and navigating the Web with your phone.

Important: Certain data services requests may require additional time to process. While your phone is loading the requested service, the touchscreen or QWERTY keyboard may appear unresponsive when in fact they are functioning properly. Allow the phone some time to process your data usage request.



Sprint Spark LTE

The Sprint Spark enhanced LTE network provides your phone with wireless Internet access over greater distances than Wi-Fi and delivers data transfer rates of up to 60 Mbps. To connect your phone to Sprint Spark, you need to be in an area covered by the Sprint Spark enhanced LTE network.

For more information about the availability of Sprint Spark in your location, visit sprint.com/activate.

Note: The availability and range of the network depends on a number of factors including your distance to the base station, and infrastructure and other objects through which the signal passes.



Set Your Network Options

1. Press  >  > **System settings** > **More...** > **Mobile networks** > **Network mode**.
2. Select **LTE/CDMA**. The phone will scan for the 4G network and will automatically connect to it. If **CDMA** is selected, the phone will scan for CDMA only.

When your phone is connected via Sprint Spark, the Sprint Spark icon () appears in the Status Bar.

Note: The Sprint Spark network is self-discoverable, which means no additional steps are required for your phone to connect to it.

Check Your Network Status

1. Press  >  > **System settings** > **More...** > **Mobile networks**.
2. Touch **4G settings**. The network provider name and IP address are displayed.

Your Data Services User Name

When you buy your phone and sign up for service, you're automatically assigned a user name, which is typically based on your name and a number.

When you use data services, your user name is submitted to identify you to the network. Your user name is automatically programmed into your phone. You don't have to enter it.

Update Your User Name

If you choose to change your user name and select a new one online, or make any changes to your services, you must then update the profile on your phone.

- Press  >  > **System settings** > **System updates** > **Update profile**.

Data Connection Status and Indicators

Your phone displays the current status of your data connection through indicators at the top of the screen. The following symbols are used:



Your phone is connected to the Sprint Spark network. When the signal bands are animated, your phone is scanning and connecting. During data transfer, the animated icon is not used (for example, when you are opening a Web page).

When the signal bands are gray, your phone is connected to the network, signal is weak.

When both the bands and the LTE icon are gray, you there is no coverage and you are disconnected from the Sprint Spark enhanced LTE network.



Your phone is connected to the 3G Mobile Broadband Network (3G). When the signal bands are animated, your phone is transferring data (for example, when you are opening a Web page); when the signal bands are gray, your phone is connected to the network but is not currently transferring data (for example, when you are viewing a Web page that is completely open). In either state, you can receive incoming calls.

If you do not see an indicator, your phone does not have a current data connection.

Virtual Private Networks (VPN)

From your phone, you can add, set up, and manage virtual private networks (VPNs) that allow you to connect and access resources inside a secured local network, such as your corporate network.

Prepare Your Phone for VPN Connection

Depending on the type of VPN you are using at work, you may be required to enter your login credentials or install security certificates before you can connect to your company's local network. You can get this information from your network administrator.

Before you can initiate a VPN connection, your phone must first establish a Wi-Fi or data connection. For information about setting up and using these connections on your phone, see [Turn Wi-Fi On and Connect to a Network](#).

Set Up Secure Credential Storage



If your network administrator instructs you to download and install security certificates, you must first set up the phone's secure credential storage.

1. Press > > **System settings** > **Lock screen**, and then touch **Select screen lock** > **Password**.
2. Enter a new password (at least eight characters without any spaces) for the credential storage, scroll down and confirm the password, and then touch **OK**.
3. Touch to return to the main settings menu, and then touch **Security**.
4. Touch **Trusted credentials** and then touch your preferred system and user credentials.

You can then download and install the certificates needed to access your local network. Your network administrator can tell you how to do this.

Add a VPN Connection

Use the Wireless & networks settings menu to add a VPN connection to your phone.



1. Press  >  > **System settings** > **More...** > **VPN**.
2. Touch **Add Basic VPN network**, and then enter the information for the VPN you want to add.
 - Information may include Name, Type, Server address, PPP encryption (MPPE), and advanced options.
 - Set up all options according to the security details you have obtained from your network administrator.
3. Touch **Save**.

The VPN is then added to the VPNs section of the VPN settings screen.

Connect to or Disconnect from a VPN

Once you have set up a VPN connection, connecting and disconnecting from the VPN is easy.

Connect to a VPN

1. Press  >  > **System settings** > **More...** > **VPN**.
2. In the VPNs section, touch the VPN that you want to connect to.
3. When prompted, enter your login credentials, and then touch **Connect**. When you are connected, a VPN connected icon appears in the notification area.
4. Open the Web browser to access resources such as intranet sites on your corporate network. (For more information about browsing the Web, see [Learn to Navigate the Browser.](#))

Disconnect from a VPN

1. Drag the title bar down to open the Notifications Panel.
2. Touch the VPN connection to return to the VPN settings screen, and then touch the VPN connection to disconnect from it.

When your phone has disconnected from the VPN, you will see a VPN disconnected icon in the notification area of the title bar.



Browser

Your phone's Web browser gives you full access to both mobile and traditional websites on the go, using 3G, 4G, or Wi-Fi data connections.

Launch the Web Browser

Launching the browser is as easy as touching an icon.

- From the Home screen, touch **Browser** .

Tip: If Browser isn't one of your phone's primary shortcuts, press  >  > **Browser**  to launch the browser.

Tip: Your phone may support additional Web browsers, such as Google Chrome.

Learn to Navigate the Browser

Navigating through menus and websites during a data session is easy once you have learned a few basics.

Note: Before you access the default home page, you may be asked to enter your 10-digit wireless phone number and touch **OK**. Entering your phone number is not required for access to other Web pages.

Scrolling

As with other parts of your phone's menu, you'll have to drag up and down to see everything on some websites.

To scroll through a website's page:

- In a single motion, touch and drag across or up and down a page.

Selecting

To select onscreen items or links:

- Drag across a page, and then touch an item or touch an onscreen link to select the link.

Links, which are displayed as underlined text, allow you to jump to Web pages, select special functions, or even place phone calls.

Pinching and Zooming

Zooming in and out on a Web page can be done now without the need of an onscreen zoom tool. Just use your fingers to pinch in or spread out on the screen.

To zoom in:

1. Place your thumb and index finger on the screen.
2. Expand them outward (spread) to zoom in.

To zoom out:

1. Place your thumb and index finger on the screen.
2. Bring them together (pinch) to zoom out.

Go Back

To go back one page:

- Touch  on your phone. Repeat this process to keep going back through your Web page history of recently visited pages.

Tip: You can use  for deleting text (like a BACKSPACE key) when you are entering text.

Go to a Web Page





1. Touch the Address field (top of the browser window) and enter a new Web address.
 - As you enter the address, possible matches are displayed within an onscreen list. Touch an entry to launch the desired website.
2. Touch **Go** to launch the new page.

Browser Menu

The browser menu offers additional options to expand your use of the Web on your phone.

Open the Browser Menu

The browser menu may be opened anytime you have an active data session, from any page you are viewing.

1. Press  >  > **Browser** .
2. From any open Web page, touch . You will see the browser menu.



Options available within the browser menu may include:

- **Forward:** Allows you to go one page backed.
- **New tab:** Allows you to add new browser tab.
- **Bookmarks:** Allows you to set up and use custom bookmarks.
- **Add to bookmarks:** Allows you to add the current page to your bookmarks
- **Homepage:** Allows you to go to the homepage.
- **History:** Allows you to show the history what you visited.
- **Share page:** Allows you to send a URL via Bluetooth, Email, Gmail, and Messaging.
- **Find on page:** Allows you to search the current Web page for a word.
- **Desktop view:** Allows you to view the current page in desktop view.
- **Save for offline reading:** Allows you to save the current page for reading offline.
- **Capture plus:** Allows you to capture current web page from top to bottom without cutting.
- **Settings:** Allows you to configure and manage your Browser settings.

- **Exit:** Allows you to completely exit the Browser.

Select Text on a Web Page

You can highlight text on a Web page and copy it, search for it, or share it.

1. Press  >  > **Browser**  and navigate to a Web page.
2. Touch and hold to the area of the page containing the desired text.
3. Touch and drag across the screen and highlight the desired text. Any selected text will appear highlighted.
4. Select an option:
 - **Select all** to select all the text in the current Web page.
 - **Copy** to copy the selected text.
 - **Share** to share the selected message using your favorite services like Email, Messaging, and others.
 - **Find** to search for all instances of the selected text in the current Web page.
 - **Web search** to search for the selected text on the web.

Go to a Specific Website





Follow the instructions to go to a particular website by entering a URL (website address).

1. Touch the **URL** field and enter a website address.
 - As you type the address, if your desired website appears within the suggested sites list, touch the entry to begin surfing.
2. Touch **Go**.

Note: Not all websites are viewable on your phone.

Adjust Browser Settings





You can control many of the settings for your browser through the browser settings menu, including general page settings, privacy and security, accessibility settings, advanced settings such as Javascript and plug-ins, and bandwidth management.

1. Press  >  > **Browser** .
2. From any open Web page, touch  > **Settings**. You will see the browser settings menu.
3. You can access the following settings menus:
 - **General**
 - Set the homepage, Form auto-fill and Auto-fill text.

- **Privacy & Security**
 - Settings for managing personal data from web browsing and usage.
- **Accessibility**
 - Adjust the text size and rendering options.
- **Advanced**
 - Adjust JavaScript and other web content settings.
- **Bandwidth management**
 - Settings for Search result preloading and image loading.





Create Website Settings

You can create settings for individual websites.

1. Press  >  > **Browser** .
2. From any open Web page, touch  > **Settings** > **Advanced** > **Website settings**.
3. Select the settings you want to configure for the current website.



Reset the Browser to Default

You always have the option to restore your browser to its default settings.

1. Press  >  > **Browser** .
2. From any open Web page, touch  > **Settings** > **Advanced** > **Reset to default**.
3. Touch **OK** to complete the process.

Set the Browser Home Page

Customize your Web experience by setting your browser's home page.

1. Press  >  > **Browser** .
2. From any open Web page, touch  > **Settings** > **General** > **Set homepage**.
3. Select one of the available options and enter the necessary information.

Create Bookmarks

Make browsing easier by setting up and using custom bookmarks.

1. From any open web page, tap  to open the option menu.
2. Tap **Bookmarks**. Three tabs are revealed:

- **Bookmarks:** Displays a list of your current bookmarks.
- **History:** Displays a record of your browsing history. These records are organized into folders such as: **Today, Yesterday, Last 7 days, Last month, and Most visited.**
- **Saved pages:** Displays the pages you've saved for offline reading.

3. In the Bookmarks tab, tap  > **Add bookmark.**
4. Enter a descriptive name and URL for the new bookmark.
5. Tap **OK** to store the new entry to your Bookmarks list.

Create Bookmarks from Other Tabs

1. From any open web page, tap  to open the option menu and tap **Bookmarks.**
2. Tap the **History** tab.
3. Tap the star icon adjacent to a web page entry. Enter the desired information and tap **OK.**

- or -

Touch and hold an entry from the list to display a context menu. Then, tap **Add to bookmarks** to add the selected entry to your current list of bookmarks.

Create a New Homepage

Select any previously visited Web page to display as your home page.

1. From any open web page, tap  to open the option menu and tap **Bookmarks.**
2. Tap either the **Bookmarks** or **History** tab.
3. Touch and hold an entry from the list to display a context menu.
4. Tap **Set as homepage** to assign the selected entry as your new homepage.

Add Bookmarks to Your Home Screen

You can add Web bookmarks to your phone's home screen for quick access.

1. From any open web page, tap  to open the option menu and tap **Bookmarks.**
2. Touch and hold an existing entry from the list to display a context menu.
3. Tap **Add shortcut to home** to add the selected entry to your Home screen.

Camera and Video

You can use the camera or camcorder to take and share pictures and videos. Your phone comes with a 8 megapixel camera with an autofocus feature that lets you capture sharp pictures and videos.

Take Pictures

The following topics teach you how to take pictures with your phone's camera.

Open or Close the Camera

You can open the camera through the applications list and close it from the camera menu. In addition to using the applications list to open the camera, you may be able to launch the camera from within other applications such as Contacts or Messaging.

Open the Camera

- To open the camera in picture mode and take pictures, press  >  > **Camera** .



Close the Camera

- On the camera screen, press  or .

Viewfinder Screen in Camera mode

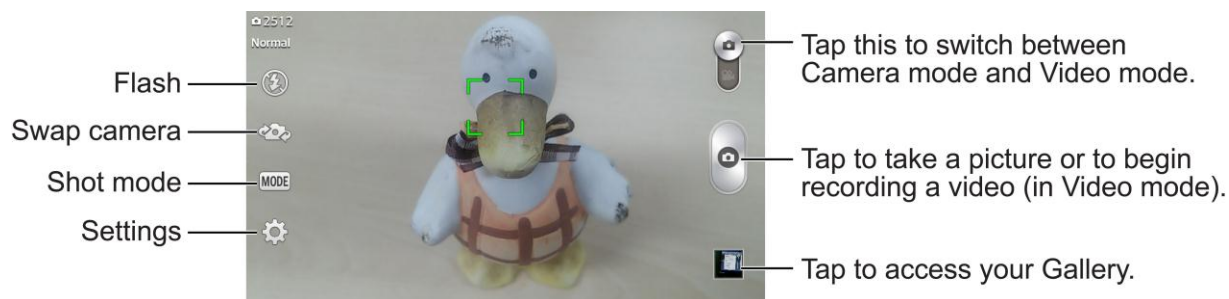
The Viewfinder screen lets you view your subject and access camera controls and options.







-  **Flash:** Select a flash mode for the camera.
-  **Swap camera:** Switch between the back-facing camera lens and the front-facing camera lens (for self portraits, video chatting, etc.).
-  **Shot mode** to select the shot mode from the following options:
 - **Normal:** Captures a normal photo shot.
 - **Dynamic tone (HDR):** Combines photos taken at multiple exposures into one optimal photo to get a better photo in tricky lighting situations.

- **Panorama:** Creates a wide photo of a panoramic view. Hold the phone horizontally, press the shutter to start and slowly sweep the camera across the scene.
- **Continuous shot:** Takes 6 shots in rapid sequence.
- **Time catch shot:** Captures the missing moment before pressing the shutter.
- **Sports:** Captures fast-moving images without blur.
-  **Settings:** Opens the camera settings menu and lets you change additional camera settings. See [Camera Settings](#).

Take a Picture

You can take high-resolution pictures using your phone's camera.

1. Press  >  > **Camera** .
2. Before taking the picture, you can zoom in on your subject.
 - To zoom in, “spread” the screen with your thumb and finger.
 - To zoom out, “pinch” the screen.
3. On the Viewfinder screen, touch the flash icon  to select a camera flash mode depending on your lighting conditions.
4. Frame your subject on the screen.

Tip: Hold the phone vertically when taking portrait shots or hold the phone horizontally when taking landscape shots.

5. You can either let the camera autofocus on the center of the screen, or you can touch another area on the screen that you want to focus on.
6. Touch  to take the picture.
7. Choose what you want to do with the picture you've just taken. See [Review Screen](#) for details.

Multi-point Auto Focus

When you take a picture, the Multi-point Auto Focus (AF) function will operate automatically and will allow you to see a clear image.

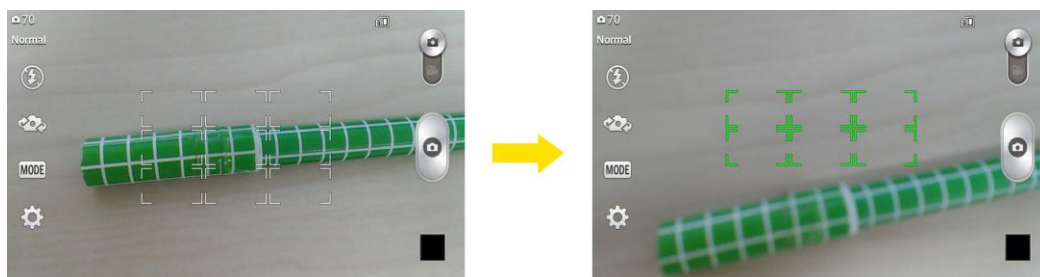

Super Zooming

You can use a zoom up to 4 times while taking pictures.





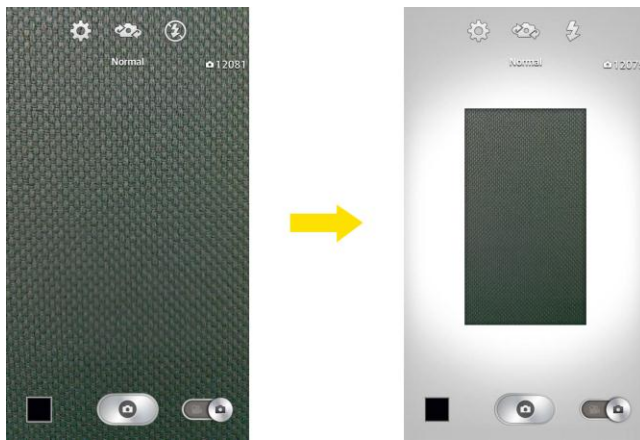

Tip: This function operates automatically while zooming in and out.

Note: Use a steady hand. This feature does not work with some functions. Objects can be overlapped when taking a picture of fast-moving subjects.

Light Frame

This feature allows you to take capture a brighter photo when using the front camera in dark lighting conditions.



1. Press  >  > **Camera** .
2. Tap  to change to Front Camera mode.
3. On the Viewfinder screen, touch  to select a Light Frame mode.
 - When touch , the Viewfinder screen area get downsized and white frame will be displayed surrounding this area. At this time, the white frame functions as lighting and so you can get more brighter photos.
4. Touch  to take the picture.





Note: Light Frame is supported in the Front Camera mode only.

The viewfinder screen area in Light Frame mode looks smaller than in normal Front Camera mode. However, the image size and resolution are the same as the normal Front Camera mode.

Review Screen

After capturing a picture or video, touch the thumbnail image to see the item in the review screen. From there, you can access options such as save, view, send, or delete the picture or video.

-  **SmartShare** to share the media via SmartShare.

-  **Camera** to return to the live camera screen.
-  **Share via** to share the picture or video.
-  **Delete** to delete the current picture or video. Touch **Yes** to confirm.
- Tap a picture in an album then tap  for the following options: **Set image as**, **Move**, **Copy**, **Copy to Clip Tray**, **Rename**, **Rotate left**, **Rotate right**, **Crop**, **Edit**, **Slideshow**, **Add location**, and **Details**.



Record Videos

The following topics teach you how to record videos with your phone's video camera.

Viewfinder Screen in Video mode

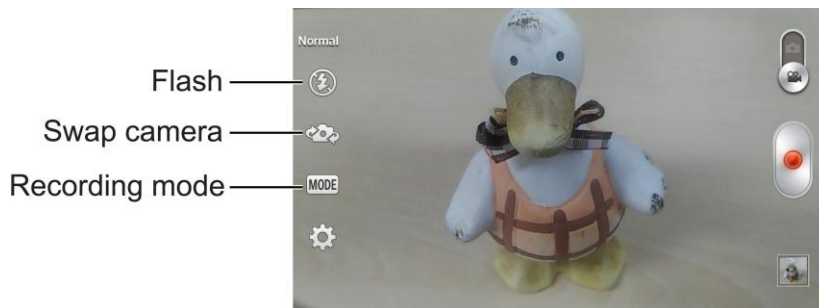



The Viewfinder screen lets you view your subject and access video controls and options.



-  **Flash** Taps to turn the flash **On**, **Off** or set it to **Auto**.
-  **Swap camera** to swap between the back-facing camera lens and the front-facing camera lens.
-  **Recording mode** to set the recording mode to any of the following options.
 - **Normal**: Records a normal video.
 - **Live effect**: Provides various visual effects when recording a video.



Record videos

Record high-quality videos using your phone's video camera.

1. Press  >  > **Camera** .
2. Move the selection slider to video camera .
3. Select **MMS video** to record a short video for email or messaging or **Long video**.

4. Point the lens to frame the scene where you want to start.
5. Tap  to start recording the video. The length of the recording is displayed at the top of the screen.

Note: Tap  to take pictures while recording long video.

6. Tap  to pause recording video. You can resume recording again tapping .





– or –

Tap  to stop recording. Your video will be automatically saved to the Gallery.

7. Choose what you want to do with the video you've just captured. See [Review Screen](#) for details.

Camera Settings





You can adjust your camera's settings using the icons on the main camera screen and the full camera settings menu.

1. Press  >  > **Camera** .
2. Touch **Settings**  to display the Settings menu and access all your camera settings. You can change the following settings from the Settings menu:
 - **Cheese shutter:** Allows you to take pictures with voice commands. When on, you just say "Cheese", "Smile", "Whiskey", "Kimchi", or "LG" to take a picture.
 - **Brightness:** Adjusts the brightness setting compatible with the environment.
 - **Focus:** Set a focus mode. Choose from **Auto**, **Manual** or **Face tracking**.
 - **Image size:** Set the size of your picture. Choose from **8M 3264x2448 (4:3)**, **W6M 3264x1836(16:9)**, **5M 2560x1920 (4:3)** or **1M 1280x960 (4:3)**.
 - **ISO:** Control the camera's sensitivity to light. Choose from **Auto**, **100**, **200**, **400**, or **800**.
 - **White balance:** Select how the camera adjusts colors in different kinds of light in order to achieve the most natural-looking colors for your pictures. Choose from **Auto**, **Incandescent**, **Sunny**, **Fluorescent**, or **Cloudy**.
 - **Color effect:** Apply different color effects to your pictures. Choose from **None**, **Mono**, **Sepia**, or **Negative**.
 - **Timer:** Set your camera's timer. This is ideal if you want to be a part of the picture.
 - **Auto review:** Set whether to view the picture that was just taken. Choose from **Off**, **On**, **2 sec**, or **5 sec**.

- **Geotagging:** Use your phone's location-based services. Take pictures wherever you are and tag them with the location. If you upload tagged pictures to a blog that supports geotagging, you can see the pictures displayed on a map.
- **Shutter sound:** Adjust the sound the shutter makes when taking a picture.
- **Volume key:** Set how to use the volume key. Choose from **Capture** or **Zoom**.
- **Storage:** Set the storage location for your pictures. Choose from **Internal storage** and **SD card**.
- **Help:** Allows you to learn how a function works. This icon will provide you with a quick guide.
- **Reset:** Restore all camera default settings.

Video Camera Settings

You can adjust your video camera settings using the icons on the main video camera screen and the full video camera settings menu.

1. Press  >  > **Camera** .
2. Move the selection slider to video camera .
3. Touch **Settings**  to display the Settings menu and access all your video camera settings. You can change the following settings from the Settings menu:
 - **Video size:** Set the size of your video. Choose from **FHD 1920x1080 (30fps)**, **HD 1280x720**, **QVGA 320x240 (MMS)** or **QCIF 176x144 (MMS)**.
 - **Brightness:** Adjust the brightness setting compatible with the environment.
 - **White balance:** Select how the camcorder adjusts colors in different kinds of light in order to achieve the most natural-looking colors for your videos. Choose from **Auto**, **Incandescent**, **Sunny**, **Fluorescent**, or **Cloudy**.
 - **Color effect:** Apply different color effects to your videos. Choose from **None**, **Mono**, **Sepia**, or **Negative**.
 - **Auto review:** Enable auto review of your video.
 - **Geotagging:** Use your phone's location-based services. Record videos wherever you are and tag them with the location. If you upload tagged videos to a blog that supports geotagging, you can see the videos displayed on a map.
 - **Volume key:** Set how to use the volume key. Choose from **Record** or **Zoom**.
 - **Storage:** Set the storage location for your recordings. Choose from Internal storage and SD card.
 - **Help:** Allows you to learn how a function works. This icon will provide you with a quick guide.

- **Reset:** Restore all video camera default settings.

View Pictures and Videos Using Gallery



Using the Gallery application, you can view pictures and watch videos that you've taken with your phone's camera, downloaded, or copied onto your storage card or phone memory.

For pictures that are on your storage card or phone memory, you can do basic editing such as rotating and cropping. You can also easily assign a picture as your contact picture or wallpaper and share pictures with your friends.

Open or Close Gallery

The Gallery app opens in the Albums tab where your pictures and videos are organized by albums for easy viewing.

Open the Gallery App

1. Press  >  > **Gallery** .
2. Touch a folder location (such as Camera), and then touch an image to view the picture.

If you stored your files in folders (directories) on the microSD card or phone memory, Gallery will display these folders as separate albums.

Folders in your storage card or phone memory that contain pictures and videos will also be treated as albums. The actual folder names will be used as the album names. If you have downloaded any pictures and videos, these will be placed in the download album.

When viewing pictures in Gallery, you can press the gallery icon in the upper left corner to return to Album view. Touch an album to view the pictures or videos in that album.



Note: Depending on the number of pictures stored, it may take some time for Gallery to load all your pictures on the screen.

Close the Gallery App

- To close the Gallery app and return to the home page, press .

View Pictures and Videos

You can access and view all your stored pictures and videos from your phone's Gallery.

1. Press  >  > **Gallery** .
2. Touch an album (such as Camera), and then touch an image to view the picture.

After selecting an album from the Albums tab, you can browse through the pictures and videos of that album. Touch a picture or video to view it in full screen. By default, the pictures and videos in an album are displayed in grid view.

Note: When viewing pictures, you can touch and hold on a picture or video to open a selection menu and choose what to do with the picture or video.

Note: If you want to select another album, touch  to return to the Albums tab.



Zoom In or Out on a Picture

There are two ways you can zoom in or out of a picture.

- Touch the screen twice quickly to zoom in, and then touch the screen twice quickly again to zoom out.
– or –
- Use pinch and spread to zoom in or out. “Spread” the screen using your thumb and forefinger to zoom in when viewing a picture. “Pinch” the screen to zoom out. (Move fingers outward to zoom in and inward to zoom out.)

Watch a Video

The screen automatically switches to portrait mode when you play a video. Use the onscreen controls to play, pause, or stop the video.

1. Press  >  > **Gallery** 
 - Scroll left or right to view more albums.
2. Tap an album to open it and view its contents. (The pictures and videos in the album are displayed in chronological order.)
3. Tap a video in an album to play.
 - Tap the video to view the playback controls.



Note: While a video is playing, slide the left side of the screen up or down to adjust the screen brightness. While a video is playing, slide the right side of the screen up or down to adjust the sound.

Note: While playing a video, tap the timeline point to jump to that part of the video.







Note: While playing a video, slide your finger from left to right (or vice versa) to fast-forward and rewind.

Video Gallery Options

The Gallery is where you can access the Gallery of stored videos. You can view them, share them with your friends, and delete and edit them.

1. Press  >  >  **Gallery** to view the videos stored in the phone.
 - Scroll left or right to view more albums.
2. Tap an album to open it and view its contents. (The pictures and videos in the album are displayed in chronological order.)

3. Tap a video to view it. You can access the following options:

-  **QSlide**: Enables an overlay on your phone's display for easy multitasking.
-  **SmartShare**: Enjoy content via a variety of devices.
-  **Lock/Unlock**: Locks the touch keys to prevent unintentional touches.
-  **Screen ratio**: Allows you to adjust the screen ratio. (Best fit, Full screen or Original size)
-  **Captures** a screen shot while playing a video.
- Tap  to access **Subtitles, Share, Trim, Delete, Settings, Details, and Help**.

Live Zoom

Live Zoom allows you to zoom in or zoom out on a portion of a video that is being played to make the desired section appear larger or smaller.

When viewing a video, use your index finger and thumb in a pinching or spreading motion to zoom in or out.

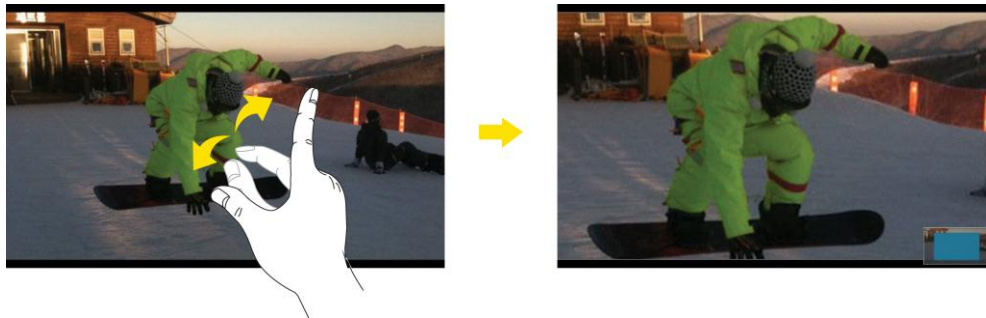





Note: Do not press too hard; the touch screen is sensitive enough to pick up a light, but firm touch.





Work with Pictures

Whether you're browsing pictures in filmstrip or grid view in the Gallery application, you can touch and hold on a picture to open a selection menu and choose to delete the picture, rotate or crop it, and more.

Rotate and Save a Picture

1. Press  >  > **Gallery** .
2. Touch an album.
3. Touch the picture you want to rotate.
4. Touch  and then select either **Rotate left** or **Rotate right**.

Crop a Picture

1. Press  >  > **Gallery** .
2. Touch an album.
3. Touch the picture you want to crop.
4. Touch  > **Crop**. A crop box then appears on the picture.
5. To adjust the crop box size, touch and hold the edge of the box. When directional arrows appear, drag your finger inward to or outward to resize the crop box.
6. To move the crop box to the part of the picture that you want to crop, drag the crop box to the desired size and position.
7. Touch **OK** to apply the changes to the picture.







The cropped picture is saved in the album as a copy. The original picture remains unedited.

Share Pictures and Videos

The Gallery application lets you send pictures and videos using email or multimedia messages. You can share pictures on your social networks (such as Facebook, Flickr, Picasa, and Twitter) and share videos on YouTube. You can also send them to another phone or your computer using Bluetooth.

Send Pictures or Videos by Email

You can send several pictures, videos, or both in an email or Gmail message. They are added as file attachments in your email. For more information about using email and Gmail, see [Create and Send Email](#) or [Send a Gmail Message](#).







1. Press  >  > **Gallery** .
2. Touch the album that contains the pictures or videos you want to share.
3. Touch the pictures or videos you want to share.
 - To select multiple items, touch  while viewing an album and select all of the items you want to include.
4. Touch  and then touch **Email** or **Gmail**.
5. Address and compose your message and then touch **Send** ( or .

Note: If you selected Email and you have multiple email accounts, the default email account will be used.

For more information about using email and Gmail, see [Create and Send Email](#) or [Send a Gmail Message](#).

Send a Picture or Video by Multimedia Message





Multimedia Messaging (MMS) lets you send pictures and videos using your phone's messaging app. Although you can send several pictures or videos in a multimedia message, it may be better to just send one at a time, especially if the files are large in size.

1. Press  >  > **Gallery** .
2. Touch the album that contains the pictures or videos you want to share.
3. Touch the pictures or videos you want to share.
 - To select multiple items, touch  while viewing an album and select all of the items you want to include.
4. Touch  and then touch **Messaging**.
5. Compose your message and then touch **Send MMS** .

For more information about sending multimedia messages, see [Send a Multimedia Message \(MMS\)](#).

Send Pictures or Videos Using Bluetooth

You can select several pictures, videos, or both and send them to someone's phone or your computer using Bluetooth.

1. Press  >  > **Gallery** .
2. Touch the album that contains the pictures or videos you want to share.
3. Touch the pictures or videos you want to share.
 - To select multiple items, touch  while viewing an album and select all of the items you want to include.
4. Touch  and then touch **Bluetooth**.
5. In the next few screens, you'll be asked to turn on Bluetooth on your phone and connect to the receiving Bluetooth device so the files can be sent. For more information, see [Bluetooth](#).

Tools and Calendar

Learn how to use many of your phone's productivity-enhancing features.

QSlide

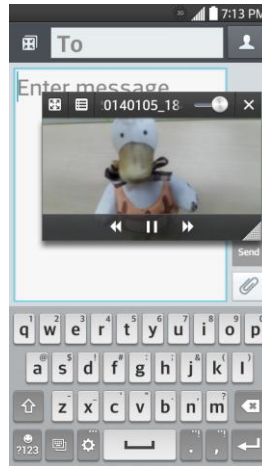

The QSlide function enables an overlay on your phone's display for easy multitasking.

1. While using an app that supports QSlide, tap  to access QSlide.



– or –

Open the Notifications Panel and touch an app from the **QSlide apps** section.

2. Use the slider  to adjust the transparency of the overlay.
3. You can make a call, or choose other phone options.
 - Tap  to exit the QSlide function.

Note: The QSlide function can support up to two windows at the same time.

QuickMemo

The QuickMemo feature allows you to create memos and capture screen shots. You can use QuickMemo to easily and efficiently create memos during a call, with a saved picture or on the current phone screen.

1. Access QuickMemo from the [Quick Access](#) items.

– or –



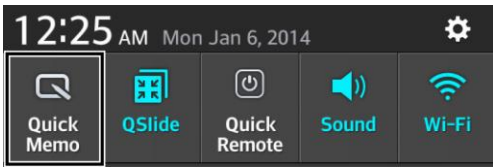



While viewing the screen you want to capture and create a memo on, slide the Status Bar down and tap .



2. Create a memo using the following options:

- : Tap to enable an overlay on your phone's display for easy multi-tasking while keeping the memo in the background.

Note: Tap  to exit the overlay mode and go back to the QuickMemo.

- : Tap to select what type of background to use.
- : Tap to undo the most recent action.
- : Tap to redo the most recently deleted action.
- : Tap to select the pen type and color or to crop the image.
- : Tap to use the eraser to erase the memo that you created.
- : Tap to share the memo with others via any of the available applications.
- : Tap to save the memo you've created.

Note: Please use a fingertip while using the QuickMemo feature. Do not use your fingernail.

3. Tap  to save the current memo to the Gallery.

Discard QuickMemos:

- Tap  until you exit QuickMemo.

View the Saved QuickMemo

Your QuickMemos are saved in the Gallery application.

To view QuickMemos saved in your Gallery:

- Press  >  > **Gallery**  and select the **QuickMemo** album.

QuickRemote

QuickRemote turns your phone into a Universal Remote for your home TV and cable box.

1. From the Home screen, tap  > **QuickRemote**  > .

– or –

Touch and slide the Status Bar downwards and touch  > **ADD REMOTE**.

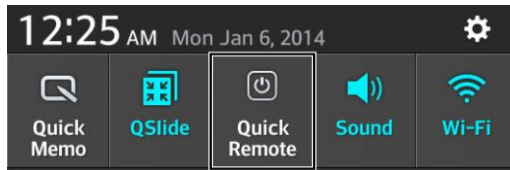

2. Select the type and brand of device, then follow the on-screen instructions to configure the device(s).

Tip: To quickly use the QuickRemote feature, touch and slide the Status Bar downward and tap  on the Quick Settings bar to activate it.

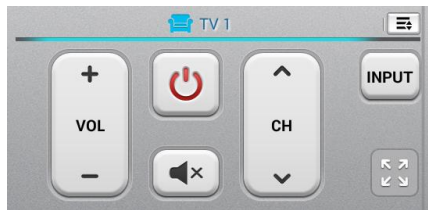

Touch the **Menu Key**  to select **Magic Remote setting**, **Edit remote name**, **Move remote**, **Delete remote**, **Edit room**, **Settings**, and **Help**.

Note: QuickRemote features an ordinary remote control and infrared (IR) signals to operate the same way. Therefore, be careful not to cover the infrared sensor when you use the QuickRemote feature. This function may not be supported depending on the model, the manufacturer or service company.

Voice Mate

You can ask **Voice Mate** to perform phone functions using your voice, such as calling a contact, setting alarms, or searching the web. When you access Voice Mate for the first time, it displays help information to assist you in learning how to use this function.

To open the Voice Mate application

- From the Home screen, tap  > **Voice Mate** .

Using the Voice Mate application



1. Open the **Voice Mate** application.

2. Tap the **Speak** icon  (at the bottom of the screen) to turn it on. Say what you want it to do for you.
 - If you say “Call Rachel”, Voice Mate will call your contact Rachel.

Note: Access the Voice Mate settings to checkmark **Skip confirmation** so that found exact name (or number) match requests will be executed without confirming it first.

Voice Mate Icons

The following Voice Mate icons are displayed at the bottom of the screen:

-  Tap to display the Voice Mate QSlide window on the Home screen.
-  Tap to say a voice command to execute.
-  Tap to type a command to execute.

Voice Mate Options menu

Tap the **Menu Key**  (in the Front Touch Keys bar) to access the Options menu to select **Settings** or **Help**.

Voice Mate settings

The Voice Mate settings include **Skip confirmation**, **Voice feedback**, **User name**, **Save events to**, **Voice activation**, **Button vibration**, **Voice launch command**, **Voice launch when charging**, **Voice launch on Lock screen**, **Skip Lock screen**, **Facebook** (log in), and **Twitter** (log in).

Notes: When the language setting for Voice Mate is not the same as the default language setting on your phone, some commands such as launching apps may not work.

When entering text, you can only use letters or numbers.



Voice Mate recognizes your speech better when you speak slowly.

You can view examples of various commands by swiping the Voice Mate main screen to the left.

Voice Command

You can search for and dial a contact by speaking, rather than by manually dialing a contact or opening installed applications.

Place a Call by Speaking

1. Press  >  > **Voice Command** .
2. Say one of the following commands:
 - **Call** [Name or Phone Number]
 - **Send Text** [Name or Phone Number]



- **Redial** [Latest number]
- **Open** [App Name]
- **Play Music** [Music name]
- **Check** [Item]

3. If Voice Command finds a match, it performs the requested action, otherwise, it will display options.

Calendar

With the Calendar application you can view the events you have scheduled in the coming days, weeks, or months.

Open the Calendar

- Press  >  > **Calendar** . If you have created or subscribed to more than one calendar through Google Calendar™ on the web, events from each calendar are displayed in a different color. (For information about which calendars are displayed on your phone, see [Display and Synchronize Calendars](#).)

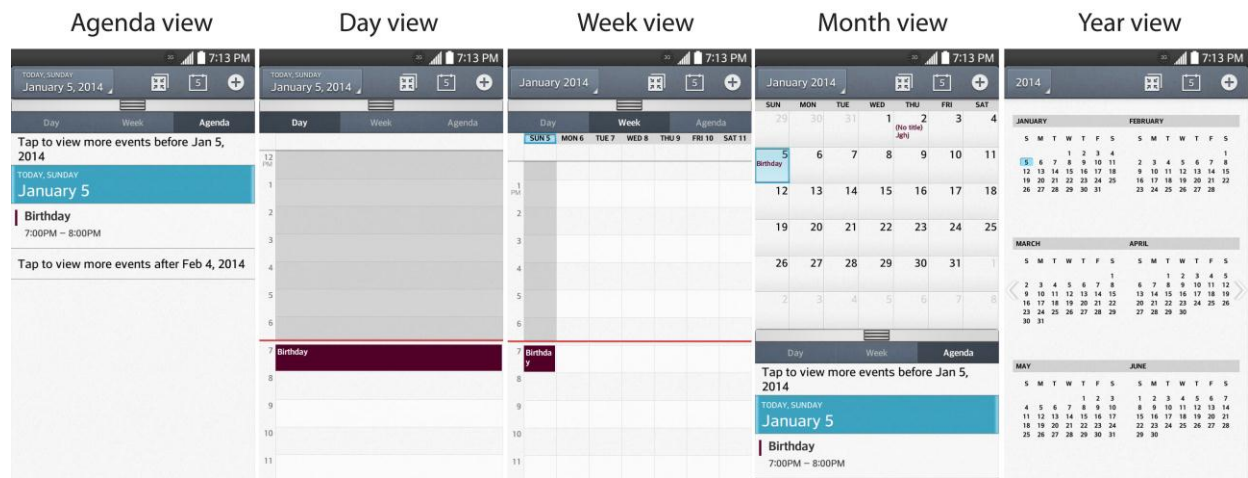

In Agenda, Day, Week view, or Month view, tap an event to view its details.

Tap a month in Year view to display Month view for that month.

Note: To go to any day in any Calendar view, tap  > **Go to date**.

Change Calendar View

You can change the calendar view.

- Tap  > **Day, Week, Month, Year, Agenda**. Each view displays the events in your calendar for the period of time that you specify.

- **Day View**

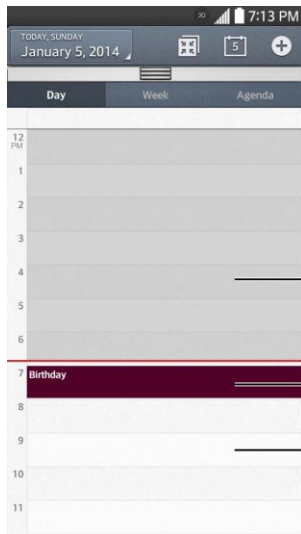

— Drag left or right to view earlier or later days.

— Tap an event to view its details.

— Touch and hold a time slot or an event to create a new event at that time.

- **Week View**



— Touch and hold a time slot or an event to create a new event at that time.

— Tap an event to view its details.

— Drag the screen left or right to view previous or future weeks.

- **Month View**



— Tap a day to view the events of that day.

— Drag the screen up or down to view previous or future months.

- **Year View**



— Tap a month to move to the month.

— Flick the screen left or right to view previous and future years.

- **Agenda View**



Tap an event to view its details.

Drag the screen up or down to view earlier or later events.

View Event Details

You can view more information about an event in a number of ways, depending on the current view.

- In **Agenda**, **Day**, **Week view**, **Year view**, or **Month view**, tap an event to view its details.

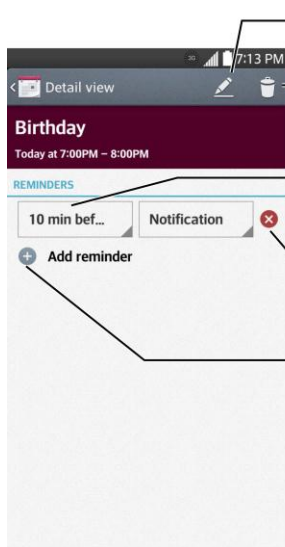

Tap to edit this event.

Tap to delete this event.

Tap to set reminders.

Tap to delete reminders.

Tap to add another reminder.

Create an Event

You can use the Calendar tool on your phone to create events that appear on your phone and in your Google Calendar on the web.

1. Open the Calendar, and tap .

 - You can also touch and hold a spot in **Day**, **Week**, or **Month** view to open the new event screen with that day and time already entered.

2. Add details about the event.
 - Enter a name, and other optional details about the event, just as you would on Google Calendar (on the web). If you have more than one calendar, you can choose the calendar to which to add the event. Tap  to add more reminders. (See [Set an Event Reminder.](#))
3. Invite guests to the event.
 - In the **Guests** field, enter the email addresses of everyone you want to invite to the event. Separate multiple addresses with commas (,). If the people to whom you send invitations use Google Calendar, they'll receive an invitation through their Google Calendar and by email.
4. Scroll to the bottom of the screen and tap **Save**.
 - The event will be added to your Calendar. You can also access and configure the event from Google Calendar on the web.

Edit or Delete an Event

You can edit or delete an event that you created on the phone or on the web. You can also edit or delete events created by others, if they have given you permission.

Edit an Event

1. Open **Calendar** and tap the event to open it. (See [View Event Details.](#))
2. Tap . (For information on how to create or change event information, see [Create an Event.](#))
3. Make your changes to the event.
4. Tap **Save**.

Delete an Event

- Tap an event to view the event details. Then, tap . Tap **OK** to confirm.

Set an Event Reminder

You can set one or more reminders for an event, whether or not you created the event or have permission to edit its other details.

1. Open **Calendar** and tap the event to open it. (See [View Event Details.](#))
2. Tap **Add reminder**  to add a reminder.
3. Tap the reminder time to display a pop-up menu and choose your desired setting.
 - At the designated time, you will receive a notification to remind you about the event (See [Respond to an Event Reminder.](#)). You can also use Google Calendar (on the web) to configure additional reminders.

Delete an Event Reminder

1. Open **Calendar** and tap the event to open it.
2. Tap  to remove a reminder.

Respond to an Event Reminder

If you set a reminder for an event, the reminder notification appears in the Status Bar when the reminder time arrives.

1. If you receive notifications in the Status Bar, drag the Notifications Panel down to your notifications. Tap the event notification to open the list of Calendar notifications.
2. Tap an event in the Calendar Notifications list to view more information about that event.
3. Tap **Snooze** in the Calendar Notifications list to receive the reminder again 5 minutes later.

– or –

Tap **Dismiss** in the Calendar Notifications list to delete all reminders in the list.

4. Tap  when viewing the Calendar Notifications list to keep the reminders. The reminders will remain in the Status Bar.

Display and Synchronize Calendars

Initially, all calendars that you create or subscribe to through Google Calendar on the web are also displayed in the Calendar application on your phone. You can select which calendars to show or hide on the phone, and which to keep synchronized.

Only the calendars that you've created or subscribed to on the web are shown in the Calendar list.

To select calendars to display:

1. Tap  > **Calendars to display**.
2. Checkmark the desired accounts to display those calendars.

Change Calendar Settings

You can change the settings for how the Calendar application displays events and how it notifies you of upcoming events.

- Open the Calendar, and tap  > **Settings** > **Calendar settings**.
 - **Week starts on:** Opens a dialog box to configure from when the week starts on.
 - **Hide declined events:** When checkmarked, declined events so that they are not displayed in your calendar views. Tap to remove the checkmark and display all events in your calendar views.

- **Weather:** Enable to set to show weather info on Calendar.
- **Show events by:** Select event display type **Event brief** or **Timeline**.
- **Show week number:** Displays the week number out of the year.
- **Lock default time zone:** Lock event times and dates to default time zone.
 - **Default time zone :** Enable to set the default time zone.
- **Clear search history:** Allows you to remove all the searches you have performed.
- **About calendar:** Display calendar application version.
- Open the Calendar, and tap  > **Settings** > **Event notification settings**.
 - **Default reminder time:** Allows you to select the default time set for event reminders.
 - **Notifications:** Checkmark to allow notifications of new events. When Notifications is set, you can select the notification type, notification sound, vibrate or vibrate type, and whether to pop-up the notification or not.
 - **Quick responses:** Edit default responses when emailing guests.

Folders

Folders allow you to organize other Home screen shortcuts and icons, or folders that contain all your contacts, contacts with phone numbers, or starred contacts. Your folder's contents are kept up to date automatically. Organizing in folders can create space to add more shortcuts, widgets, or applications on the Home screen.

Add a Folder

1. Drag and drop an app icon over another app icon.
2. A folder will be created with both app icons in it.

Rename a Folder

1. Tap the folder icon to open it.
2. Tap .
3. Enter the new folder name and tap **OK**.

Note: You can also change the folder color.

Organize Items in a Folder

- Just drag a shortcut, an icon, or a folder and drop in a folder.

Alarm/Clock

You can use Alarm/Clock application to monitor several types of information at once, in addition to the current date and time.

Open the Alarm

The Alarm/Clock application also allows you to set alarms.

1. Press  >  > **Alarm/Clock** .

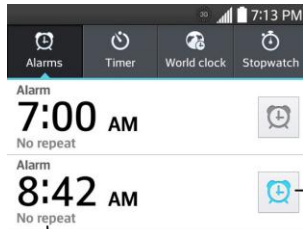

Tap to turn an alarm on or off.

Tap to configure the alarm.

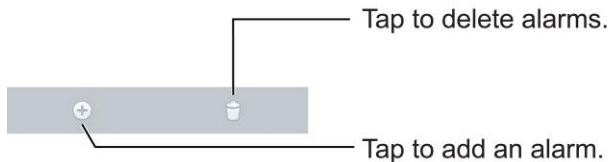





Tap to delete alarms.

Tap to add an alarm.









2. Tap an existing alarm to change its time and other attributes or tap **Add alarm**  to add a new one.
3. Set the time of the alarm. You can change the time by scrolling up/down the hour and minute and AM/PM field or tap the hour and minutes fields to enter the time with the keyboard.
4. Tap **Repeat** to set the days when you want the alarm to sound. (If you don't set a repeat, the alarm will only sound on the assigned day.)
5. Tap **Snooze duration** to open a dialog box to set the amount of time to wait before sounding the alarm again if it is not dismissed. You can set the alarm to ring repeatedly from 5 minutes up to 1 hour.
6. Tap **Vibration** to have the phone vibrate, in addition to playing the ringtone.
7. Tap **Alarm sound** to select a ringtone for the alarm. The ringtone plays briefly when you select it.
8. Slide the button on the **Alarm volume** slider to the right to increase the alarm volume and to the left to decrease it.

9. Tap **Auto app starter** to set the application you want to automatically open when you stop the alarm.
10. Tap **Puzzle lock** to checkmark the setting, which requires you to wake up enough to solve a simple puzzle to dismiss the alarm.
11. Tap **Memo** to enter a name for the alarm.
12. When you're finished, tap **Save**.

Change Alarm/Clock Settings

1. Press  >  > **Alarm/Clock** .
2. Tap  > **Settings**.
3. You can set the following options:
 - **Alarm in silent mode:** Tap to place a checkmark and allow your phone to play alarms even when it is in Silent mode.
 - **Volume button behavior:** Allows you to set the desired behavior of the volume buttons when pressed during an alarm.
 - **Puzzle lock:** Allows you to choose the puzzle type to use during the puzzle lock.
 - **Vibrate type:** Allows you to set the vibrate type.

Set a Timer

1. Press  >  > **Alarm/Clock**  > **Timer tab** .
2. Tap the **Hour/Minute/Second** sections to set the timer.
3. Tap  to set the following options:
 - **Vibration:** Set the phone vibrate along with the alert sound. (A blue checkmark appears.)
 - **Alert sound:** Select the alert sound.
 - **Alert volume:** Set the alert volume.
4. Tap  to start the timer. To stop it, tap .
5. Tap  to reset the timer.

Set World Clock







1. Press  >  > **Alarm/Clock**  > **World clock tab** .

2. Tap  to add a city.
3. Enter the city name in the search field and tap **Done** on the keyboard.
As you enter letters, the cities which starts from the letters are displayed.

– or –

Scroll through the cities list and tap the city.
4. You can add cities as many as you want. Repeat steps 2 and 3.

Play Stopwatch



1. Press  >  > **Alarm/Clock**  > **Stopwatch tab** .
2. Tap  to start stopwatch time.
3. Tap  to stop the stopwatch.

Tip: While measuring time, tap  to view lap times.





Tasks

You can add your tasks in Tasks application and synchronize with MS Exchange account.

Synchronize MS Exchange

1. Press  >  > **System settings** > **Accounts & sync**.
2. Tap **Add account**.
3. Tap **Microsoft Exchange** to enter your email address and password information.
4. For further information about adding a Microsoft Exchange account, see [Set Up a Corporate Email](#).
5. Make sure that you place a checkmark on **Sync Tasks**.

Add a Task

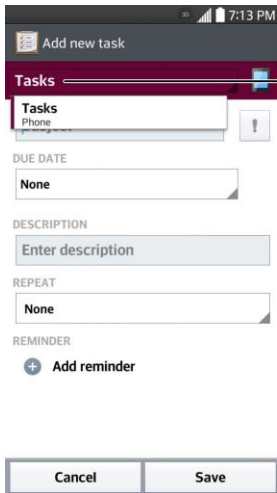

1. Press  >  > **Tasks** .
2. Tap  to add a new task.



Select an account to save this task item, either to the phone or MS Exchange account.

3. Tap **Tasks** and select an account to save the current task.
4. Enter the corresponding information on each field and tap **Save**.

Tasks Options

1. Press  >  > **Tasks** .
2. The following options are available.

: Tap to view all tasks or tasks from individual accounts.

: Tap to search for tasks.

: Tap to create a new task.

– or –

Tap  to access the following options.

- **Sync now:** Tap to sync your Microsoft Exchange account tasks.
- **Sort by:** Allows you to sort tasks by Due date, Priority and Creation order.
- **Delete:** Allows you to delete tasks.
- **View completed tasks:** Allows you to view completed tasks.
- **Lists to display:** Allows you to select task lists to be shown.
- **Settings:** Allows you to set the following settings.
 - **Notifications:** Allows you to enable or disable reminder notifications.
 - **Notification sound:** Allows you to set the reminder notification sound.

- **Vibrate:** Allows you to set the vibrate setting for reminder notifications.
- **Pop-up notification:** Checkmark to display a pop-up reminder notification.
- **Add account:** Allows you to add an MS Exchange account.









– or –

The following options are available when you touch and hold a task in the tasks list.

- **Edit:** Allows you to edit the task.
- **Move:** Allows you to move the task to other lists.
- **Delete:** Allows you to delete the task.
- **Share:** Allows you to share the task with others.

Calculator



Your phone's convenient built-in calculator lets you perform basic mathematical equations.

1. Press  >  > **Calculator** .
2. Enter numbers and arithmetic operators on the screen.
 - Tap  to use the QSlide for easy multitasking.
 - Touch and hold the Calculator's display to open a menu where you can copy what you've entered and access other tools.
 - Tap  to delete the last number or operator you entered. Touch and hold  to delete numbers repeatedly.
 - Tap  to clear the screen.
 - Tap  to view your calculation(s) history, change between the scientific and basic calculators, and access the calculator settings.

File Manager

Use the **File Manager** application to manage your applications and documents stored in your phone.





To open the File Manager application

- Press  >  > **File Manager** .

File Manager Options

File Manager makes it easy to view and manage your files. Simply tap a file type (**All files**, **Music**, **Image**, **Video**, **Document**, or **Dropbox**), then tap the necessary folders to find your files.

Open the **File Manager** application, tap **All files**, then tap the **Internal storage** folder to access to the following File Manager options (at the bottom of the screen):

-  : Allows you to create a new folder.
-  : Allows you to move files and folders to another folder.
-  : Allows you to copy files and folders to another folder.
-  : Allows you to delete files and folders.

Touch  to access the following options:

- **Sort by:** Allows you to sort files and folders by Name, Size, Date, or Type.
- **View by:** Allows you to display your files as a List or in a Grid.
- **Share:** Allows you to select files and folders to share with others.
- **Upload:** Allows you to upload files.
- **Zip:** Allows you to select files and folders to compress into a .zip file.
- **Show/Hide hidden files:** Allows you to show hidden files or hide them.
- **Exit:** Exits the application.

Searching in File Manager

Tap the **Search** icon  (in the top right corner of the File Manager screen) to search for your files or information.

Using QSlide

While viewing All Files, tap the **QSlide** icon  to open File Manager in a QSlide window.

Bluetooth





Bluetooth is a short-range communications technology that allows you to connect wirelessly to a number of Bluetooth phones, such as headsets and hands-free car kits, Bluetooth-enabled handhelds, computers, printers, and wireless phones. The Bluetooth communication range is usually up to approximately 30 feet.

Turn Bluetooth On and Off

By default, your phone's Bluetooth feature is set to off.

Note: Activating Bluetooth can drain your battery faster and reduce your available usage times. To conserve your phone's battery, turn off Bluetooth when not in use. Always turn off your Bluetooth when you are in locations that prohibit its use.

Turn Bluetooth On

1. Press  >  > **System settings > Bluetooth.**
2. Tap  to activate the feature. When active,  appears within the Status Bar.

Turn Bluetooth Off

1. Press  >  > **System settings > Bluetooth.**
2. Tap  to deactivate Bluetooth.

Bluetooth Status Indicators

The following icons show your Bluetooth connection status at a glance:



– Bluetooth is active



– Bluetooth is connected





Bluetooth Settings Menu

The Bluetooth settings menu allows you to set up many of the characteristics of your phone's Bluetooth service.

Includes the following:

1. Entering or changing the name your phone uses for Bluetooth communication
2. Setting your phone's visibility (or “discoverability”) for other Bluetooth phones





To access the Bluetooth Settings menu:

1. Press  >  > **System settings > Bluetooth.**
2. Tap  to activate the feature. When active,  appears within the Status Bar.
3. The following options are available:
 - **LG Volt:** Checkmark to allow other Bluetooth devices to see your phone for pairing and connection. This name changes if you change the name for the device.

Note: Your phone is visible for up to 2 minutes. This value appears as a countdown within this field. You can change the visibility timeout. From the Bluetooth settings screen, tap  > **Visibility timeout**, then tap your preference.



- **AVAILABLE DEVICES**

The list of all of the available in-range Bluetooth devices.

- Touch **Search for devices** to search for other visible in-range Bluetooth devices.
- Touch  > **Edit phone name** to rename your phone for Bluetooth access.
- Touch  > **Visibility timeout** to set your visibility timeout for Bluetooth.
- Touch  > **Show received** files to view all files you have received via Bluetooth.
- Touch  > **Help** to view help information for the Bluetooth feature.

Change the Device Name

The device name identifies your phone to other devices.

1. Press  >  > **System settings** > **Bluetooth**.
2. Touch  > **Edit phone name** (Bluetooth must be turned on).
3. Enter the name for your phone in the dialog box, and then touch **Save**.

Pairing Bluetooth Devices

The Bluetooth pairing process allows you to establish trusted connections between your phone and another Bluetooth device. When you pair devices, they share a passkey, allowing for fast, secure connections while bypassing the discovery and authentication process.

Pair Your Phone

1. Verify your Bluetooth is active.
2. From the Bluetooth settings page, tap the check box next to your device name to make your phone visible. Your phone must be visible to successfully pair with an external device. If you want to search a new device, you also need to make that device visible. (See the instruction manual from the manufacturer.)
3. Tap **Search for devices**. (Your phone will display a list of discovered in-range Bluetooth devices.)
4. Tap a device from the list to initiate pairing.
5. Depending on the device, you might have to tap **Pair** to accept the passkey (if they match), confirm matching passkeys, or enter the passkey or PIN Code.
6. Tap **Done** > **OK** if you entered a passkey or PIN code.
7. The external device will then have to accept the connection and enter your phone's PIN code.



Note: Due to different specifications and features of other Bluetooth-compatible phones, display and operations may be different, and functions such as transfer or exchange may not be possible with all Bluetooth compatible phones.

Pairing between two Bluetooth phones is a one-time process. Once a pairing has been created, the phones will continue to recognize their partnership and exchange information without having to re-enter a passcode again.

Disconnect or Unpair from a Bluetooth Device



You can manually disconnect or unpair from a Bluetooth device through the Bluetooth settings menu.

Disconnect a Bluetooth Device

1. Press  >  > **System settings** > **Bluetooth**.
2. In the Bluetooth devices section, touch the device name to disconnect.
3. Touch **Disconnect**.

Unpair from a Bluetooth Device

You can make your phone forget its pairing connection with another Bluetooth device. To connect to the other device again, you may need to enter or confirm a passcode again.





1. Press  >  > **System settings** > **Bluetooth**.
2. In the Bluetooth devices section, touch .
3. Touch **Unpair**.

Send Items via Bluetooth





Depending on your paired phone's settings and capabilities, you may be able to send pictures, videos, Contacts information, or other items using a Bluetooth connection.

Note: Prior to using this feature, Bluetooth must first be enabled, and the recipient's phone must be visible. If no phones are detected, tap **Search for devices** to begin a new search.

Send Contact Information



1. Press  >  > **Contacts** .
2. Tap an entry to open its details page.
3. Tap  > **Share** > **Bluetooth**.
4. Tap a paired phone.
 - The external Bluetooth phone must be visible and communicating for the pairing to be successful.

Send Pictures and/or Videos

1. Press  >  > **Gallery** .
2. Tap an album to open it and view its contents. (The pictures and videos in the album are displayed in chronological order.)
3. Tap , then checkmark pictures and/or videos to share.
4. Tap **Share** > **Bluetooth**.
5. Tap a paired phone.
 - The external Bluetooth phone must be visible and communicating for the pairing to be successful.

Disconnect Bluetooth Connection During an Active Call

You can manually disconnect or unpair from a Bluetooth phone through the Bluetooth settings menu.

- During an active call, where the audio is being routed through a connected Bluetooth phone (headset or hands-free connection), tap **Bluetooth** to route the phone's audio through the connected Bluetooth headset (On) or through the earpiece (Off).
 - When the call is routed to a Bluetooth headset, the current call area is surrounded by a green box, the **Bluetooth** button indicates it's on, and the **Bluetooth** call icon  is displayed in the Status Bar.
 - When Bluetooth is turned off, the call is routed through either the earpiece or speaker, the call area is surrounded by a green box, the **Bluetooth** button indicates it's off, and the **Call** icon  is displayed in the Status Bar.

Note: Communication can be toggled between the Bluetooth headset and the phone earpiece or speaker by tapping the Bluetooth button On or Off.

SmartShare

You can use the SmartShare feature easily in the Gallery, Music, Video apps, etc.

Enjoying content via a variety of devices

You can share your phone's content with a variety of devices. Tap  to share the content in the Gallery, Music, Videos.

Playing/Sending

- **Play:** You can play the content via a TV, a Bluetooth speaker or etc.
- **Beam:** You can send the content to the device of Bluetooth and SmartShare Beam supported.

- **SmartShare Beam:** Transferring the content feature fast via Wi-Fi Direct.

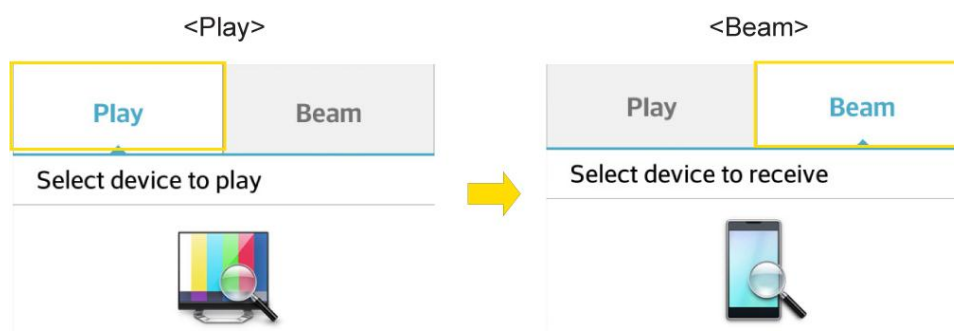

Enjoying the content from Nearby devices

You can enjoy the content from nearby devices (i.e. PC.NAS, Mobile) in the Gallery, Music, Videos app.

Connecting devices

Connect your device and other DLNA-supported devices in the same Wi-Fi network.

Searching other devices

1. Tap **Nearby devices** to view the available nearby DLNA-supported devices.
2. Connect to the device to view the content.

Near Field Communication (NFC) Technology

NFC (Near Field Communication) technology is a short-range, wireless technology that lets you quickly and wirelessly exchange information between your phone and other NFC-enabled smartphones, smart accessories, and NFC-enabled access points. You can also use NFC technology to save, view, create, or change smart tags.

Depending on the apps that you have added to your phone, you might be able to use your phone as a transit pass or as an access pass, by tapping the back of your phone against an NFC-enabled access point, subject to applicable terms and conditions from the particular vendor.

To use NFC technology on your phone, your phone must be within approximately 0.78 in. (2 cm) of the NFC-enabled smartphone, smart accessory, NFC-enabled access point, or smart tag that you want to exchange information with. When information is transferred over an NFC connection, your smartphone vibrates.

Notice: The NFC antenna for this model is on the back cover and this back cover is the only one that is offered with the device.

microSD Card

A microSD™ card (sold separately) is an optional accessory that allows you to store images, videos, music, documents, and voice data on your phone.

Insert a microSD Card

Remove the battery cover and battery to insert a compatible microSD card into your phone.

1. Insert your fingernail into the slot on the left side of the back cover and lift the cover up gently.

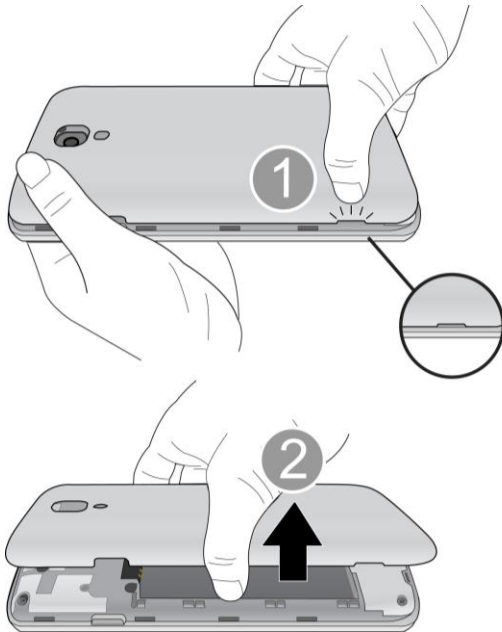

2. Carefully insert the microSD card into the slot. The label side should face up.

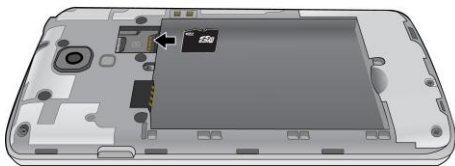
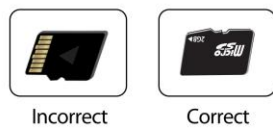

3. Re-install the back cover.

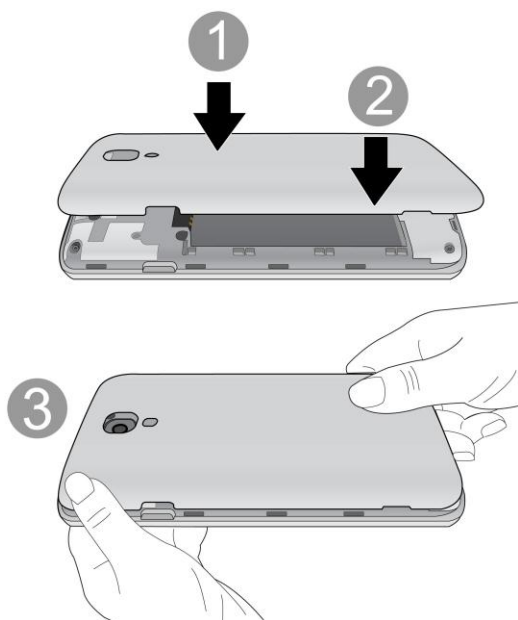

Remove a microSD Card

Before removing your phone's microSD card, use the Storage settings menu to unmount the card.

1. Insert your fingernail into the slot on the left side of the back cover and lift the cover up gently.
2. Gently pull the microSD card out from the slot.
3. Replace the back cover.

Note: You can easily damage the microSD card by improper operation. Please be careful when inserting, removing, or handling the microSD card.

Note: If the microSD card is installed in your phone, please remove it from the upper slot before trying to remove the SIM card.

Note: Make sure your battery is fully charged before using the microSD card. Your data may become damaged or unusable if the battery runs out while using the microSD card.



View microSD Card Memory

The Storage settings menu gives you access to your microSD card memory information.

- With the microSD card inserted, press  >  > **System settings** > **Storage**. (The total and available memory space will be displayed.)

Format the microSD Card

Formatting a microSD card permanently removes all files stored on the card.



1. Press  >  > **System settings** > **Storage**.
2. Scroll down the screen, touch **Erase SD card** > **Erase SD card**.

3. Touch **Erase everything** to confirm the process.

Note: The formatting procedure erases all the data on the microSD card, after which the files **CANNOT** be retrieved. To prevent the loss of important data, please check the contents before you format the card.

Unmount the microSD Card

When you need to remove the microSD card, you must unmount the microSD card first to prevent corrupting the data stored on it or damaging the microSD card. Since you will remove the battery first before you can remove the microSD card, close all running applications on your phone and save any data first.

1. Press  >  > **System settings** > **Storage**.
2. Touch **Unmount SD card**.
3. Remove the microSD card. See [Remove a microSD Card](#).

Use the Phone's microSD Card as a USB Drive

To transfer music, pictures, and other files from your computer to your phone's microSD card, you need to set the phone's microSD card as a USB drive. For more details about transferring content between your phone and a computer, see [Transfer Via PC or Laptop](#).

1. Connect the phone to your computer using the supplied USB cable.
2. Select **Media sync (MTP)** on your phone.
3. On your computer, the connected phone is recognized as a removable disk. Navigate to this removable disk and open it.
4. Do one of the following:
 - Copy files from the computer to the root folder on the phone's storage card.
 - Copy files from the phone's storage card to a folder on your computer or computer desktop.
5. After copying the files, unmount the removable disk (that is, the connected phone) as required by your computer's operating system to safely remove your phone, and do either of the following:
 - Disconnect the phone from the computer.
 - If you want to keep the phone connected to the computer but want the phone to be able to access and use the storage card, open the Notifications panel, touch **USB connected** > **Charge phone**.

Note: The phone will not recognize the microSD card when it is connected to a computer as a disk drive. You will not be able to use some of the phone's applications such as the camera or Music.

Transfer User Contents From an Android Phone to Your LG Volt

If you want to transfer your user contents (i.e., pictures) from an Android phone to your LG Volt, you can perform one of the following steps.

Transfer Via PC or Laptop

You can transfer user contents via a desktop or laptop using a USB cable.

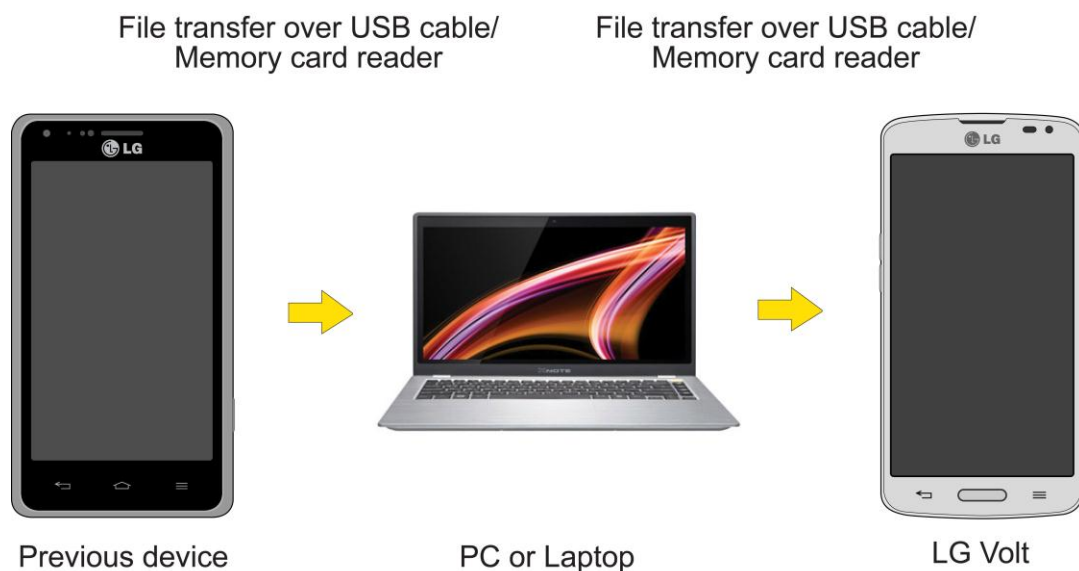

1. Connect the Android phone to a computer using a USB cable. Then open the Android phone's Notifications Panel.
2. Tap **USB connected**, then (depending on the phone) tap **Charge phone**, **Media sync (MTP)** or **Send images (PTP)**.
3. On the computer, open **My computer** (or **Windows Explorer**), click the removable drive associated with your phone, then transfer all of the files you want to the computer.
4. On the computer, safely stop/remove the USB Phone. For example, for Windows[®] XP, use the Safely Remove Hardware option.
5. On the Android phone, open the Notifications Panel, tap **USB connected** > **Charge phone** (or **Turn off USB storage**) then disconnect the previous Android Phone from the computer.
6. Connect the LG Volt to the computer using the supplied USB cable.
7. In the USB connection type menu on the LG Volt, tap **Media sync (MTP)**.



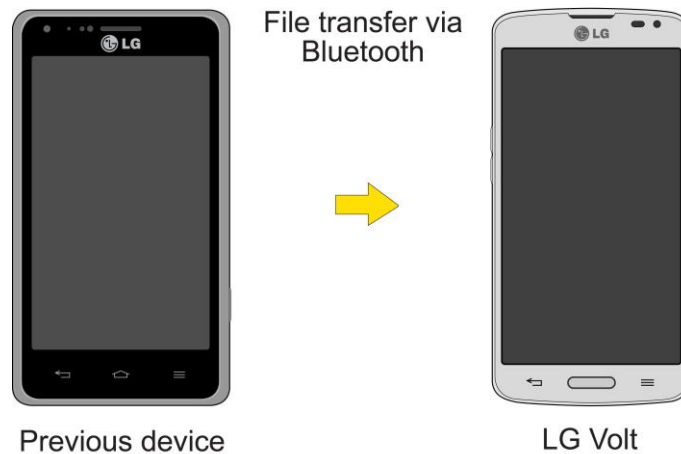

- On the computer, organize the files in the folder, transfer the files into the LG Volt folder, then safely stop/remove the USB Phone.
- On the LG Volt, open the Notifications Panel, tap **USB connected** > **Charge phone**, then disconnect it from the computer.

Transfer Via Bluetooth Connection

You can transfer user contents between Bluetooth-enabled phones via Bluetooth connection.



For example, to transfer pictures and videos:

- Press  >  >  **Gallery**.
- Tap , then choose the file you want to send (or check **Select all** to send all files).
- Tap **Share** > **Bluetooth**. The Bluetooth menu appears.
- Tap **Search for devices** at the bottom of the screen to find the phone you want to send the file to.

Then tap the phone and pair the devices to start the transfer.

- or -

If the phone that may receive your file was already paired, it would be on the list of PAIRED DEVICES. Tap the phone to start the transfer.

Note: Any applications supporting **Share**, such as **Music** and **ThinkFree Viewer**, can send files via Bluetooth.

Update Your Phone

From time to time, updates may become available for your phone. You can download and apply updates through the **System settings** > **System updates** menu.

Update Your Phone Firmware



You can update your phone's software using the **Update Firmware** option.

Before Updating Your Firmware

Updating your phone firmware will erase all user data from your phone. You must back up all critical information before updating your phone firmware.

Back Up All Data Prior to Update



To back up your data using LG Backup

1. Press  >  > **LG Backup**  > **Backup**.
2. Checkmark the items you want to back up and tap **Next**.
3. Select the location you want to save the backup file and tap **Next**.



Note: It is recommended that you save the backup file to an SD card. If you save it to the internal storage, a factory reset or software upgrade might delete the backup file from your device and you will lose all of your saved data.

4. Tap **Start**. All of your data will be backed up.

To restore a backup file





1. Press  >  > **LG Backup**  > **File restore and management**.
2. Tap the backup file you want to restore.
3. Checkmark the items you want to restore and tap **Next**.
4. Read the information on the screen and tap **Start**. Your device will restore the backed up data and reboot.

To back up your email accounts:

1. Press  >  > **System settings** > **Accounts & sync**.
2. Touch the **Auto-sync data** option to enable the feature (checkmark).
 - If the Auto-sync option is on, email, Calendar and Contacts automatically synchronize whenever a change is made.
 - If the Auto-sync option is off, touch the account to reveal the account's synchronization settings screen and then touch an account field to sync now.

To back up your Google apps:

Your Google app purchases are reloaded remotely and can be re-installed after the update is applied.



1. Press  >  > **Play Store** .
2. Touch  > **My apps** > **All** tab.

3. Scroll through the list of previously downloaded Google apps and choose those you wish to reinstall.
4. Follow the onscreen instructions.



As an added precaution, to preserve any data on your microSD card, please unmount it from your phone prior to starting the update process. Press  >  > **System settings** > **Storage** > **Unmount SD card**.

Update Your Phone Firmware

Once you have backed up all your data, use the **Update Firmware** option to update your phone firmware.



1. Press  >  > **System settings** > **System updates**.
2. Touch **Update Firmware**. (Your phone automatically downloads and installs any available updates. You may be required to power your phone off and back on to complete the software upgrade.)

Confirm Your Current Phone Firmware

1. Press  >  > **System settings** > **About phone**.
2. Touch **Software information**.



Update Your LG Software

This option allows you to update the Android Operating System (OS) on your phone via an over-the-air connection.

1. Press  >  > **System settings** > **System updates** > **Update LG software**.
2. Follow the onscreen instructions.

Update Your Profile



This option allows you to automatically update your online user profile information. If you choose to change your user name and select a new one online, you must then update the user name on your phone.

1. Press  >  > **System settings** > **System updates** > **Update profile**.
2. Follow the onscreen instructions.

Note: If your data services or account syncing ever seems to go out unexpectedly, use this feature to reconnect with the network.

Update Your PRL

This option allows you to download and update the PRL (preferred roaming list) automatically.

1. Press  >  > **System settings** > **System updates** > **Update PRL**.
2. Follow the onscreen instructions.

Settings

The following topics provide an overview of items you can change using your phone's Settings menus.

Wireless Networks

This group of settings lets you control your phone's Wi-Fi settings, Bluetooth, Tethering, VPN, and Mobile networks.





Airplane Mode

Airplane Mode (Flight mode) allows you to use many of your phone's features, such as games, and music when you are in an airplane or in any other area where making or receiving calls or data is prohibited. When you set your phone to Airplane Mode, it cannot send or receive any calls or access online data.

Activate Airplane Mode

1. Press and hold the **Power/Lock Button**  to display the phone options.
2. Tap **Turn on Airplane mode**.



– or –

1. Press  >  > **System settings**.
2. Tap the **Airplane mode** switch  to turn the function on. While in Airplane Mode, your phone's Status Bar will display .

Deactivate Airplane Mode

1. Press and hold the **Power/Lock Button**  to reveal the phone options.
2. Tap **Turn off Airplane mode**.

– or –

1. Press  >  > **System settings**.
2. Tap the **Airplane mode** switch  to turn the function off.

Wi-Fi Settings

Your phone lets you take advantage of Wi-Fi hotspots for high-speed data access using available computer networks. For details on your phone's Wi-Fi features and settings, see [Connect Wi-Fi](#).



Bluetooth Settings

Your phone's Bluetooth capabilities let you use wireless headsets, send and receive pictures and files, and more. For details on your phone's Bluetooth settings, see [Bluetooth Settings Menu](#).

Mobile Data

You can check the current data usage, set to enable/disable mobile data, or set the mobile data limit.

Turn Mobile Data On or Off

1. Press  >  > **System settings** > **Mobile data**.
2. Tap the **Mobile data** switch  to turn it on or off.

Call Settings



Your phone's Call settings menu lets you configure International call options and TTY mode.

Voicemail Settings

You can configure your voicemail settings. For details on Voicemail settings, see [Configure Visual Voicemail Settings](#).

North American Dialing



Replace + code as needed for outgoing calls.

1. Press  >  > **System settings** > **Call**.
2. Tap the **North American dialing** checkbox to enable/disable the feature.

Note: At this time, Sprint Prepaid does not support outgoing International calls to areas outside of North America.



Incoming Voice Call Pop-up

Activate to display the incoming call pop-up when using an application.

1. Press  >  > **System settings** > **Call**.
2. Tap the **Incoming voice call pop-up** checkbox to enable/disable the feature.



Call Reject

You can set call rejection and manage the reject list.

1. Press  >  > **System settings** > **Call** > **Call reject**.
2. Tap **Call reject mode** and set an option.
3. Tap **Reject calls from** to set up the rejection list.

Decline with Message

You can send out a simple text message when you want to ignore an incoming call and respond to the caller with a text instead. You can add or edit quick messages.

1. Press  >  > **System settings** > **Call** > **Decline with message**.
2. Tap a quick message to edit it.



– or –

Tap  to add a new quick message.

3. Enter a message and tap **Save**.

Privacy Keeper



You can set whether the phone to display the caller's information or not when you receive a call.

1. Press  >  > **System settings** > **Call** > **Privacy keeper**.
2. Tap **Hide all info**, **Show number only**, or **Disable**.

Home Button Answers Call



You can set the phone to answer calls with the Home Button: in addition to on the call screen.

To set to end calls with the Home Button:

1. Press  >  > **System settings** > **Call**.
2. Tap **Home button answers call** to enable it. (A blue checkmark will appear.)

Auto Answer

Activate to set auto answer with handsfree.



1. Press  >  > **System settings** > **Call** > **Auto answer**.
2. Tap **Disable**, **1 second**, **3 seconds**, or **5 seconds**.

TTY Mode

A TTY (also known as a TDD or Text Telephone) is a telecommunications phone that allows people who are deaf, hard of hearing, or who have speech or language disabilities, to communicate by telephone. Your phone is compatible with select TTY phones. Please check with the manufacturer of your TTY phone to ensure that it is compatible with digital cell phones. Your phone and TTY phone will connect via a special cable that plugs into your phone's headset jack. If this cable was not provided with your TTY phone, contact your TTY phone manufacturer to purchase the connector cable.

Hearing Aids

Activate to turn on hearing aid compatibility.



1. Press  >  > **System settings** > **Call**.
2. Tap the **Hearing aids** checkbox to enable/disable the feature.

Proximity Sensor

You can access the proximity sensor through the Call Settings menu.

When receiving and making calls, this sensor automatically turns the backlight off and locks the touch keypad by sensing when the phone is near your ear. This extends battery life and prevents the touch keypad from activating unintentionally during calls.



To enable the Proximity Sensor:

1. Press  >  > **System settings** > **Call**.
2. Tap the **Proximity Sensor** checkbox to enable it. (A blue checkmark will appear.)

Voice Clarity

You can set the phone to enhance voice clarity in noisy environments so you can hear more clearly.



To set noise reduction:

1. Press  >  > **System settings** > **Call**.
2. Tap the **Voice clarity** checkbox to turn it on. (A blue checkmark will appear.)

Save Unknown Numbers

You can set the phone to save the phone numbers not saved in Contacts yet.



To save unknown numbers:

1. Press  >  > **System settings** > **Call**.
2. Tap the **Save unknown numbers** checkbox to turn it on. (A blue checkmark will appear.)

Power Button Ends Call

You can set the phone to end calls with **Power/Lock Button** , in addition to  on the call screen.

To set to end calls with Power button:

1. Press  >  > **System settings** > **Call**.
2. Tap **Power button ends call** to enable it. (A blue checkmark will appear.)



Share & Connect

Your phone lets you use the wireless technology that enables data transmission between devices using NFC, Wi-Fi and etc.

NFC Settings

NFC (Near Field Communication) is a wireless technology that enables data transmission between two objects when they are brought within a few inches of each other. When you enable NFC on your phone, it can exchange data with other NFC-enabled devices or read information from smart tags embedded in posters, stickers, and other products. From the NFC settings menu, you can manage direct sharing and pairing.

Turn On NFC



1. Press  >  > **System settings** > **Share & connect**.
2. Tap the **NFC** switch  to activate the feature.

Android Beam

When this feature is turned on, you can beam app content to another NFC-capable device by holding the devices close together.

For example, you can beam Browser pages, YouTube videos, contacts, and more. Just bring the devices together (typically back to back) and then touch your screen. The app determines what gets beamed.



Turn On Android Beam

1. Press  >  > **System settings** > **Share & connect**.
2. Tap the **Android Beam** switch  to activate the feature. (NFC turns on automatically)

SmartShare Beam

Turn on to receive multimedia contents via SmartShare Beam from LG phones or tablets.

Turn On SmartShare Beam

1. Press  >  > **System settings** > **Share & connect** > **SmartShare Beam**.
2. Tap the **SmartShare Beam** switch  to activate the feature.
3. Turn on the SmartShare Beam feature on other LG phones or tablets supporting SmartShare Beam to send/receive photos, musics, videos and documents.

Miracast

You can mirror phone screen and sound onto LG Miracast dongle or TV wirelessly.

1. Press  >  > **System settings** > **Share & connect** > **Miracast**.



2. Tap the **Miracast** switch  to turn on this feature.
3. Turn on the Miracast feature on your TV or connect to a LG Miracast dongle.

Tips: To start the Miracast feature quickly, tap the Miracast icon  in the Notifications Panel. While mirroring, Wi-Fi cannot be used simultaneously.

Wireless Storage

To manage files on your phone in the computer or copy files to the phone from the computer without a USB connection.

Turn On Wireless Storage

1. Press  >  > **System settings** > **Share & connect**.
2. Tap the **Wireless Storage** switch  to activate the feature.
3. Connect to a network, then select the devices to allow connection.
4. Enter the URL shown on your phone in the address bar of the browser on your computer to access your phone's photos and other files wirelessly from your computer.



More Settings

You can change more settings in the Wireless Networks category.

Bluetooth Tethering

This feature allows you to connect other devices to your phone via Bluetooth and share its internet connection.

Turn on Bluetooth tethering

1. Press  >  > **System settings** > **More....**
2. Tap the **Bluetooth tethering** switch  to activate.

Help

Displays help information for Bluetooth tethering.

Mobile Networks Settings

You can choose whether to turn on or off the LTE radio band. You can also set whether to enable or disable data access on your phone.



Data enabled

1. Press  >  > **System settings** > **More...** > **Mobile networks**.

2. Tap the **Data enabled** checkbox to enable/disable the feature.



4G Settings

Allows you to view your 4G network provider and IP address.

1. Press  >  > **System settings** > **More...** > **Mobile networks**.
2. Tap **4G settings** to check your network provider and IP address.



Network Mode

Allows you to choose your preferred network mode.

1. Press  >  > **System settings** > **More...** > **Mobile networks** > **Network mode**.
2. Choose from the following options:
 - Tap **LTE/CDMA** to turn on the LTE/CDMA radio band.
 - Tap **CDMA** to turn on the CDMA radio band.



Connections Optimizer

Your phone can be set to automatically connect you to Wi-Fi networks on your device's remembered list and, if applicable, to the 4G Network.

1. Press  >  > **System settings** > **More...**
2. Tap **Mobile networks** > **Connections Optimizer**.
3. Read the message and tap **I agree**.

Default SMS app

This menu allows you to choose which app you want to use as your default messaging app.

1. Press  >  > **System settings** > **More...**
2. Tap **Default SMS app** and select the app you would like to use.

VPN Settings

From your phone, you can add, set up, and manage virtual private networks (VPNs) that allow you to connect and access resources inside a secured local network, such as your corporate network. For details on your phone's VPN settings, see [Virtual Private Networks \(VPN\)](#).

Note: Mobile Hotspot is currently not supported on Sprint Prepaid.



Device Settings

This group of settings lets you configure your phone's sound, display, gestures, power saver, apps, and more.



Sound Settings

In the Sound settings menu, you can configure call and notification ringtones, audio volumes, as well as some related settings.

Sound Profile

1. Press  >  > **System settings**.
2. From the DEVICE section, tap **Sound** > **Sound profile**.
3. Tap one of the three options.

To switch to silent mode:



1. Press  >  > **System settings**.
2. From the DEVICE section, tap **Sound** > **Sound profile**.
3. Tap **Silent**.

– or –

Press the **Volume Down Button** until you see  on the screen.

Volumes



Adjust your phone's volume settings to suit your needs and your environment.

1. Press  >  > **System settings**.
2. From the DEVICE section, tap **Sound** > **Volumes**.
3. Adjust each volume level.
 - **Ringtone:** Changes the volume of your call ringtones (if applicable).
 - **Notifications:** Allows you to set this volume level. This is the volume of the ringtone when you receive a notification.
 - **Touch feedback & system:** Changes the volume for feedback taps and system notifications.
 - **Music, video, games & other media:** Changes the volume of your music, videos and other media.
4. Tap **OK**.

Tip: You can adjust the ringer volume on the Home screen or Applications screen, or almost any screen by using the Volume Buttons. In other applications such as Music, YouTube, spoken directions, and other audio, the Volume Buttons control the volume of the application.

Quiet Mode

You can set the days and times to automatically turn off all sounds except alarms and media.

1. Press  >  > **System settings**.
2. From the DEVICE section, tap **Sound** > **Quiet mode**.
3. Tap the **Set quiet time** switch  to activate the feature.
4. Set the time, days, vibrate option, and incoming call settings.



Ringtone & Vibration Settings

You can select and assign ringtones and notifications for your incoming calls.

Phone Ringtone



The phone ringtones alert you of incoming calls.

To select a ringtone for voice calls:

1. Press  >  > **System settings**.
2. From the DEVICE section, tap **Sound** > **Phone ringtone**.
3. Tap a ringtone to select it and to hear it. If you want to set the ringtone, tap **OK**. If not, select another ringtone or tap **Cancel**.

To use a song as a ringtone:

You can use a song as your phone ringtone, in place of one of the ringtones that come with the phone.

1. Press  >  > **System settings**.
2. From the DEVICE section, tap **Sound** > **Phone ringtone**.
3. Tap  and tap a song.

For details about using the Music Player application, see [Music](#).

Ringtone with Vibration



To set the phone to vibrate accompanying the ringtone.

1. Press  >  > **System settings**.
2. From the DEVICE section, tap **Sound**.

3. Tap the **Ringtone with vibration** checkbox to turn on the feature. (A blue checkmark will appear.)

Vibrate Type

To set a vibrate type for incoming calls, messages receipt, Email receipt, alarm, and calendar event.



1. Press  >  > **System settings**.
2. From the DEVICE section, tap **Sound** > **Vibrate type**.

Note: **Vibrate type** can only be selected when **Vibrate only** is selected as the sound profile or **Ringtone with vibration** option is checked in the Sound screen.

3. Tap each vibrate type to select it.
4. Tap **OK**.



Voice Notifications

To read out the incoming call and the message event automatically.

1. Press  >  > **System settings** > **Sound**.
2. From the DEVICE section, tap **Sound** > **Voice notifications**.
3. Tap  to turn the feature on and set the desired options.

Notification Sound



When you receive a notification such as the arrival of new messages, calendar events, or alarms, the phone sounds a ringtone.

1. Press  >  > **System settings** > **Sound**.
2. From the DEVICE section, tap **Sound** > **Notification sound**.
3. Tap a sound to select it and to hear it. If you want to set the sound, tap **OK**. If not, select another sound or tap **Cancel**.



Touch Feedback & System

The Touch Feedback & System menu lets you select whether you hear tones when touching numbers on the dialpad, selecting on-screen options, and more.



To hear tones when you use the dialpad to dial a number:

1. Press  >  > **System settings**.
2. From the DEVICE section, tap **Sound** > **Touch feedback & system**.
3. Tap the **Dial pad touch tones** checkbox. (A blue checkmark will appear.)



To hear sound when you tap buttons, icons, and other on-screen items:

1. Press  >  > **System settings**.
2. From the DEVICE section, tap **Sound > Touch feedback & system**.
3. Tap the **Touch sounds** checkbox. (A blue checkmark will appear.)



To hear sound when the screen is locked or unlocked:

1. Press  >  > **System settings**.
2. From the DEVICE section, tap **Sound > Touch feedback & system**.
3. Tap the **Screen lock sound** checkbox. (A blue checkmark will appear.)

To set behavior when an emergency call is placed.

1. Press  >  > **System settings**.
2. From the DEVICE section, tap **Sound > Touch feedback & system > Emergency tone**.
3. Tap the desired option.

To set your phone to vibrate when touching buttons and keys:



1. Press  >  > **System settings**.
2. From the DEVICE section, tap **Sound > Touch feedback & system**.
3. Tap the **Vibrate on touch** checkbox. (A blue checkmark will appear.)

Display Settings

Adjusting your phone's display settings not only helps you see what you want, it can also help increase battery life.

Brightness

Adjust your screen's contrast (brightness) to suit your surroundings.



1. Press  >  > **System settings**.
2. From the DEVICE section, tap **Display > Brightness**.
3. Use the slider to set a brightness level.

Note: For the best battery performance, use the dimmer levels. You can also set **Night brightness** to adjust the brightness level to 0% automatically between 12:00 AM ~ 6:00 AM.

4. Tap **OK**.

Screen Timeout



Select how long the display screen remains backlit after you touch the screen or press a key before the screen darkens.

1. Press  >  > **System settings**.
2. From the DEVICE section, tap **Display** > **Screen timeout**.
3. Tap **15 sec**, **30 sec**, **1 min**, **2 min**, **5 min**, **10 min**, **15 min**, or **Keep screen turned on**.

Note: Long backlight settings reduce the battery's talk and standby times. For the best battery performance, use the shortest convenient timeout.

Screen-off Effect



Select the screen-off effect when locking and turning off the screen.

1. Press  >  > **System settings**.
2. From the DEVICE section, tap **Display** > **Screen-off effect**.
3. Tap the desired option.
4. Tap **OK**.

Note: To preview the screen-off effect, tap **Preview**.

Auto-Rotate Screen

Choose whether the phone automatically switches the orientation of the screen as you turn it sideways or even upside down.

1. Press  >  > **System settings**.
2. From the DEVICE section, tap **Display**.
3. Tap the **Auto-rotate screen** checkbox to automatically rotate the screen (a blue checkmark will appear).



– or –

To disable the auto-rotate feature, tap the **Auto-rotate screen** checkbox again so that the checkmark is removed.

Note: Some applications on your phone do not support the Auto-rotate feature.



Daydream

Screensaver will be on when the phone is sleeping while docked and/or charging.

1. Press  >  > **System settings**.
2. From the DEVICE section, tap **Display > Daydream**.
3. To activate daydream feature, tap the **Daydream** switch .
4. Tap each item to set up them.



Font Type

Choose the desired font type for device menus.

1. Press  >  > **System settings**.
2. From the DEVICE section, tap **Display > Font type**.
3. Tap a desired font type.



Font Size

Choose the desired font size for device menus.

1. Press  >  > **System settings**.
2. From the DEVICE section, tap **Display > Font size**.
3. Tap a desired font size.



Smart Screen

Keep the screen on when device detects your eyes looking at the screen.

1. Press  >  > **System settings**.
2. From the DEVICE section, tap **Display > Smart screen** (A blue checkmark will appear).

Smart Video

Video pauses when the phone detects you are not looking at the screen.

1. Press  >  > **System settings**.
2. From the DEVICE section, tap **Display > Smart video** (A blue checkmark will appear).

Front Touch Key Light

Configure the Front touch keys options.



To select front touch key's combination:

1. Press  >  > **System settings**.

2. From the DEVICE section, tap **Display > Front touch key light > Turn on front touch key light**.
3. Tap **Front touch key light duration** to set how long you want to front touch key light to stay on.

Home Button LED

Configures the notification LED options.



1. Press  >  > **System settings**.
2. From the DEVICE section, tap **Display > Home button LED**.
3. To activate LED light for notification, tap the **Home button LED** switch .
4. Tap each item to receive notification with LED light flash.

Home Screen

Configure your phone's home screen settings.



Select Home

Allows you to select the default Home screen launcher.

1. Press  >  > **System settings**.
2. From the DEVICE section, tap **Home screen > Select Home**.
3. Tap the desired option.



Theme

Choose the desired theme.

1. Press  >  > **System settings**.
2. From the DEVICE section, tap **Home screen > Theme**.
3. Select the desired theme and tap **Apply**.



Wallpaper

Choose the desired wallpaper.

1. Press  >  > **System settings**.
2. From the DEVICE section, tap **Home screen > Wallpaper**.
3. Choose a location and select the desired wallpaper.
4. Tap **Set wallpaper** or **Apply** to set it as the wallpaper.



Screen Swipe Effect

Choose the desired type of effect to display when you swipe from one Home screen canvas to the next.

1. Press  >  > **System settings**.
2. From the DEVICE section, tap **Home screen** > **Screen swipe effect**.
3. Tap the desired effect and then tap **OK**.



Allow Home Screen Looping

Displays the first screen after the last screen when scrolling.

1. Press  >  > **System settings**.
2. From the DEVICE section, tap **Home screen**.
3. Tap the **Allow Home screen looping** checkbox. (A blue checkmark will appear.)



Portrait View Only

Allows the wallpaper to scroll with the screen instead of having it as a static image.

1. Press  >  > **System settings**.
2. From the DEVICE section, tap **Home screen**.
3. Tap the **Portrait view only** checkbox. (A blue checkmark will appear.)

Home Backup & Restore

You can backup and restore app/widget configurations and the theme.

1. Press  >  > **System settings**.
2. From the DEVICE section, tap **Home screen**.
3. Tap **Home backup & restore** > **Backup** or **Restore**.

Help

Allows you to view help tips for the Home screen.



Lock Screen

Lock screen menu lets you configure screen lock options and when to be locked.

Select Screen Lock

You can increase your phone's security by face unlock, creating a screen unlock pattern, creating a PIN, or choosing a password. When these features are enabled, you must show your face, draw the correct

unlock pattern, enter the PIN, or enter the password on the screen to unlock and regain access to the phone.

1. Press  >  > **System settings**.
2. From the DEVICE section, tap **Lock screen** > **Select screen lock**.
3. Select the desired screen lock option from the following options.
 - **None:** No lock screen.
 - **Swipe:** Swipe any part of the screen to unlock the screen.
 - **Knock Code:** You can unlock the screen when screen is off by tapping the correct area and sequence. You have to create a Backup PIN as a safety measure in case you forget your unlock sequence (refer to [Unlocking your screen using the Knock Code feature](#)).

Note: KnockON is disabled when Knock Code is in use.

- **Face Unlock:** Unlocks the screen through facial recognition. Follow the prompts. You are asked to set a Pattern and/or PIN as a backup.
- **Pattern:** Opens a set of screens that guide you through drawing a screen unlock pattern. It's recommended that you enter backup PIN as well in case that you might lost the pattern. Then, you can set vibrate on touch or whether to make the pattern visible.
- **PIN:** Enter a numeric PIN to unlock screen.
- **Password:** Enter a password to unlock screen.

From then on, any time you wish to turn the phone on or unlock the screen, you must draw your unlock pattern or enter the PIN or password to unlock the screen.

If you have set up Unlock PIN or Unlock Password, enter the Unlock PIN or Unlock Password. After entering it, tap **OK**. The last screen you were working on opens.

Note: You have five opportunities to enter your unlock Pattern, PIN or Password. If you've entered the wrong information five times, you must wait 30 seconds before you can attempt again.





If you've set up a Google Account on the phone, tap the **Forgot pattern?** button. You will be able to unlock the phone with your Google Account username and password or entering you Backup PIN.

If you haven't created a Google Account on the phone, you must perform a factory reset.

CAUTION! If you perform a factory reset, all user applications and user data will be deleted. Please remember to back up any important data before performing a factory reset.



When you can't recall your unlock Pattern, PIN or Password:

1. Turn the phone off.
2. Press and hold the following keys: **Volume Down Key**  + **Power/Lock Key** .

3. Release the keys as soon as the Factory reset processing screen is displayed.
4. Press the **Volume Down Key**  to scroll to **wipe data/factory reset**. Then press the **Power/Lock Key**  to select it.
5. Press the **Volume Down Key**  to scroll to **Yes -- delete all user data**. Then press the **Power/Lock Key**  to select it.
6. The phone will perform a factory reset.
7. Make sure that **reboot system now** is highlighted and press the **Power/Lock Key**  to make the selection and reboot your phone.



Screen Swipe Effect

Choose the desired screen effect when you swipe the screen to unlock the phone.

1. Press  >  > **System settings**.
2. From the DEVICE section, tap **Lock screen** > **Screen swipe effect**.
3. Select **Dewdrop** or **White hole**.



Wallpaper

Select the wallpaper to display for your lock screen.

1. Press  >  > **System settings**.
2. From the DEVICE section, tap **Lock screen** > **Wallpaper**.
3. Select **Gallery** or **Wallpaper gallery**.
4. Select the desired wallpaper and tap **Yes** or **Set wallpaper**.

Shortcuts

Customize clocks and shortcuts on the lock screen.

1. Press  >  > **System settings**.
2. From the DEVICE section, tap **Lock screen** > **Shortcuts**.
3. Tap each shortcut key to select the desired shortcut key.
4. After personalizing, tap **Save**.

Contact Info For Lost Phone



Select whether to display the owner information on the lock screen and customize the owner information.

1. Press  >  > **System settings**.

2. From the **DEVICE** section, tap **Lock screen**.
3. Tap the **Contact info for lost phone** checkbox to show owner information on the lock screen. (A blue checkmark will appear.)
4. Tap  to enter the owner information.



Lock Timer

Choose the amount of time before the screen automatically locks after the screen has timed-out.

1. Press  >  > **System settings**.
2. From the **DEVICE** section, tap **Lock screen > Lock timer**.
3. Tap the desired time.

Power Button Instantly Locks

Allows you to instantly lock the screen when you press the **Power/Lock Button** .

1. Press  >  > **System settings**.
2. From the **DEVICE** section, tap **Lock screen**.
3. Tap the **Power button instantly locks** checkbox to turn on the feature. (A blue checkmark will appear.)



Gestures

You can configure various gestures options.

Screen On/Off

You can set the phone to turn the screen on by quickly double-tapping the phone.





1. Press  >  > **System settings**.
2. From the **DEVICE** section, tap **Gestures**.

3. Tap the **Screen on/off** checkbox to set this feature on. (A blue checkmark will appear.)



Silence Incoming Calls

You can set the phone to silence incoming calls by just flipping the phone.

1. Press  >  > **System settings**.
2. From the DEVICE section, tap **Gestures**.
3. Tap the **Silence incoming calls** checkbox to set this feature on. (A blue checkmark will appear.)



Snooze or Turn off Alarm

You can set the phone to snooze or stop the alarm by just flipping the phone.

1. Press  >  > **System settings**.
2. From the DEVICE section, tap **Gestures**.
3. Tap the **Snooze or turn off alarm** checkbox to set this feature on. (A blue checkmark will appear.)

Pause Video

You can set the phone to pause the video by just flipping the phone.



1. Press  >  > **System settings**.
2. From the DEVICE section, tap **Gestures**.
3. Tap the **Pause video** checkbox to set this feature on. (A blue checkmark will appear.)

Help

Allows you to view help information for the available gestures.

Motion Sensor Calibration

Improves the accuracy of the tilt and speed of the sensor.



1. Press  >  > **System settings**.
2. From the DEVICE section, tap **Gestures**.
3. Tap **Motion sensor calibration**.
4. Place the phone on a flat surface and tap **Calibrate sensor**.

One-handed Operation

You can configure various one-handed operation options.



Dial Keypad

To adjust the position of the dial keypad to the left or right.

1. Press  >  > **System settings**.
2. From the DEVICE section, tap **One-handed operation**.
3. Tap the **Dial keypad** checkbox to set this feature on. (A blue checkmark will appear.)



LG Keyboard

To adjust the position of the LG keypad to the left or right.

1. Press  >  > **System settings**.
2. From the DEVICE section, tap **One-handed operation**.
3. Tap the **LG keyboard** checkbox to set this feature on. (A blue checkmark will appear.)

Lock Screen

To adjust the position of the PIN entry to the left or right.



1. Press  >  > **System settings**.
2. From the DEVICE section, tap **One-handed operation**.
3. Tap the **Lock screen** checkbox to set this feature on. (A blue checkmark will appear.)

Help

Allows you to view help information for one-handed operation features.



Storage

The Storage menu lets you monitor the used and available space on the system memory.

1. Press  >  > **System settings**.
2. From the DEVICE section, tap **Storage**.

Battery

The Battery menu lets you view any battery information and configure options.



1. Press  >  > **System settings**.
2. From the DEVICE section, tap **Battery**.
3. Tap **Battery percentage on status bar** to display the battery percentage indicator on the Status Bar.

4. Tap **Battery saver** to set the Battery saver feature on or off and select which functions are changed when the feature is activated.
5. Tap **Help** to view tips about the Battery saver feature.



Apps

This menu lets you view details about the applications installed on your phone, manage their data, force them to stop, and set whether you want to permit installation of applications that you obtain from websites and email.



To view details about the applications:

1. Press  >  > **System settings** > **Apps**.
2. Tap the **DOWNLOADED**, **RUNNING**, or **ALL** tab to view your apps.
3. Tap the desired app to view its information.

To force applications to stop:

1. Press  >  > **System settings** > **Apps**.
2. Tap the **RUNNING** tab.
3. Find the application to force stop and tap the application.
4. Tap **Force stop**.
5. Read the disclaimer and tap **OK**.

To uninstall a downloaded application:

1. Press  >  > **System settings** > **Apps**.
2. Tap the **DOWNLOADED** tab.
3. Find the application you want to uninstall and tap it.
4. Tap **Uninstall**.
5. Read the disclaimer and tap **OK**.

Tap & Pay



When NFC is turned on, you can use the Tap & pay feature to pay for items just by touching your phone to a reader at a register. If your device doesn't have a default app, you can browse Google Play for other payment apps.

Personal Settings

This group of settings lets you configure accounts & sync, cloud, guest mode, location access, security, language & input, and backup & reset settings.

Accounts & Sync

Use the Accounts & sync settings menu to add, remove, and manage your Google™ and other supported accounts. You also use these settings to control how and whether all applications send, receive, and sync data on their own schedules and whether all applications can synchronize user data automatically. Gmail, Calendar, and other applications may also have their own settings to control how they synchronize data; see the sections on those applications for details. Tap **Add account** to add new account.

1. Press  >  > **System settings**.
2. From the PERSONAL section, tap **Accounts & sync**.



Note: Tap **Auto-sync data** to automatically sync your account data.

Guest Mode



Use Guest mode when showing your phone to others. Only pre-selected apps will appear on a separate Home screen. You can enter Guest mode by drawing the mode pattern on the Lock screen.

Note: To use Guest mode, set the Lock screen to pattern lock. Guest can also use apps not pre-selected but linked to pre-selected apps.



Use Guest Mode

1. Press  >  > **System settings** > **Guest mode**.
2. To activate Guest mode, tap the **Guest mode** switch .
3. If not set, draw the pattern to use for Guest Mode.

Set the Guest Mode Pattern

1. Press  >  > **System settings** > **Guest mode**.
2. Tap **Set pattern** to set the drawing pattern to unlock for Guest mode.

Set the Apps Available for Guests

1. Press  >  > **System settings** > **Guest mode**.
2. Tap **Set apps** to select apps to be viewed in Guest mode.

Help



Displays help and use information for the Guest Mode feature.

Location

Use the Location access menu to set your preferences for using and sharing your location when you search for information and use location-based applications, such as Maps.

Access to My Location

You can use information from Wi-Fi and mobile networks to determine your approximate location, used while searching in Google Maps and other applications. When you checkmark this option, you're asked whether you consent to sharing your location anonymously with Google's location service.

1. Press  >  > **System settings > Location.**
2. Tap the switch  to activate it.
3. When you turn on this option, you're asked whether you consent to sharing your location anonymously with Google's location service.
4. Read the disclaimer and, if you agree, tap **Agree.**
5. Tap **Mode** and choose the level of accuracy desired for location estimates.

Security

Use the Security settings to configure how to help secure your phone and its data.

Encrypt Phone

Opens a screen that encrypts data on the phone for security. You will be required to enter a PIN or password to decrypt your phone each time you power it on.

Encrypt SD card storage

Allows you to encrypt SD card storage and keep data unavailable for other devices.

Password Typing Visible

Checkmark to briefly show each character of passwords as you enter them so that you can see what you enter.

Phone Administrators

Add or remove phone administrators.

Unknown Sources

Allow installation of non-Play Store applications.

Verify Apps

Disallow or warn before installation of apps that may cause harm.

Storage Type

Allows you to see the storage type for credential storage.

Trusted Credentials

Checkmark to allow applications to access your phone's encrypted store of secure certificates and related passwords and other credentials. You use credential storage to establish some kinds of VPN and Wi-Fi connections. If you have not set a password for the secure credential storage, this setting is dimmed.

Install from Storage

Touch to install a secure certificate from storage.

Clear Credentials



Deletes all secure certificates and related credentials and erases the secure storage's own password, after prompting you to confirm that you want to do this.

Language & Input Settings

Your phone's Language & input settings let you select a language for the device's screens and menus, as well as manage a personal user dictionary. The Keyboard settings let you select a preferred input method, control keyboard settings, and more.

Language

You can choose to display your device's on-screen menus in multiple languages.

1. Press  >  > **System settings** > **Language & input** > **Language**.
2. Select a language from the list.

Spelling Correction

Allows spelling correction when using the on-screen keyboard.

Personal Dictionary

Allows you to view, edit, and add words to your personal dictionary.

Keyboard & Input Methods

Shows the default keyboard type. Checkmark the keyboard you want to use from **Android Keyboard (AOSP)**, **Google voice typing**, **LG Keyboard** or **Swype**. Tap  to configure each keyboard's settings.

Voice Search

Tap to configure the Voice Search settings.

Text-to-Speech Output

Tap to set the preferred engine or general settings for text-to-speech output.

Pointer Speed



Adjust the pointer speed. (e.g., mouse, trackpad).

Backup & Reset

The privacy settings on your device allow you to back-up your data, automatically restore data, and erase all the data on your phone.



Back up My Data

You can back up app data, Wi-Fi passwords, and other settings to Google servers.

1. Press  >  > **System settings** > **Backup & reset**.
2. Check if the Backup account is correct.
3. Tap the **Back up my data** checkbox. (A blue checkmark will appear.)
4. To set to automatically restore the backups, tap the **Automatic restore** checkbox. (A blue checkmark will appear.)



Backup Account

Allows you to choose an account to use to back up data.

1. Press  >  > **System settings** > **Backup & reset**.
2. Set the **Backup account**.



Automatic Restore

When reinstalling an app, enabling this option restores backed up settings and data.

1. Press  >  > **System settings** > **Backup & reset**.
2. Tap the **Automatic restore** checkbox. (A blue checkmark will appear.)

LG Backup Service

Backs up all information on the device and restores it in the event of data loss or replacement.



1. Press  >  > **System settings** > **Backup & reset** > **LG Backup service**.
2. Read the LG apps rights agreement and tap the check box (if necessary).

Note: Tap  > **Help** to learn more about LG Backup Service.

Factory Data Reset

Resetting the phone restores all the factory defaults, including personal data from internal phone storage, information about your Google Account, any other accounts, your system and application settings, and

any downloaded applications. Resetting the phone does not erase any system software updates you've downloaded or any files you have saved, such as music, pictures, or applications. After resetting the phone, the next time you turn on the phone, you're prompted to reenter the same kind of information as when you first started the phone. See [Activate Your Phone](#).

1. Press  >  > **System settings** > **Backup & reset**.
2. If you are certain that you would like to restore all factory settings, tap **Factory data reset**.
3. Tap **Reset phone**.
4. Enter your unlock sequence if you have configured one, then tap **Erase everything** and **OK** to confirm.

System Settings

This group of settings lets you configure date & time, accessibility and PC connection. You can activate the phone, update the phone, or view the phone information.

Date & Time

Set your preferences for how the date and time is displayed. You can also select a time zone.

- Press  >  > **System settings** > **Date & time**.

Accessibility



Use the Accessibility settings to configure any accessibility plug-ins you have installed on your phone.

Note: Requires additional plug-ins to become selectable.

TalkBack



Allows you to set up the TalkBack function which assists people with impaired vision by providing verbal feedback.

To turn on the TalkBack function:

1. Press  >  > **System settings** > **Accessibility** > **TalkBack**.
2. Tap the **TalkBack** switch  to turn it on.
3. Tap **Settings** at the bottom of the screen to adjust the TalkBack settings.

Vision



Allows you to configure the following visual options.

1. Press  >  > **System settings** > **Accessibility**.
2. Set the following options as you want.

- **Large text:** Checkmark to increase the size of the text.
- **Invert colors:** Set the color contrast for better screen viewing.
- **Color adjustment:** Allows you to adjust the screen and content colors. Tap **Color adjustment**, then tap the switch  to turn the feature on. Drag your finger across the screen image provided to adjust the screen color.
- **Touch zoom:** Zoom in or out by triple tapping the screen.
- **Screen shades:** Set the brightness to 0% to save power and help with low vision.
- **Persistent alerts:** Alerts you with a sound repeatedly when there is an unread notification for certain apps.
- **Text-to-speech output:** Text-to-speech output provides audible readout of text, for example, the contents of text messages, and the Caller ID for incoming calls.



Hearing

Allows you to configure the following hearing options.

1. Press  >  > **System settings** > **Accessibility**.
2. Set the following features as you want.
 - **Audio type:** Sets the audio route. Choose Mono or Stereo.
 - **Sound balance:** Move the slider along the bar to set the balance between the left and right sound channel.
 - **Captions:** Allows the customizing of caption settings for those with hearing impairments.





Physical and Motor

Allows you to configure the following physical and motor options.

1. Press  >  > **System settings** > **Accessibility**.
2. Set the following options as you want.
 - **Touch feedback time:** Allows you to set the touch and hold delay (short, medium, or long).
 - **Universal touch:** Provide a touch board with easy use for general buttons or gestures to access in short. Tap the Universal touch icon to be able to tap its **Power** button, **Home** button, **Volume** down button, **Volume** up button, and **Pinch** button. Draw a "C" on the board to automatically display the Dial tab. Draw an "M" on the board to automatically display the Messaging application. Draw a "W" on the board to automatically launch the browser application.

System

Allows you to configure the following system options.

1. Press  >  > **System settings** > **Accessibility**.
2. Set the following options as you want.
 - **Auto-rotate screen:** Checkmark to allow the device to rotate the screen depending on the device orientation (portrait or landscape).
 - **Read passwords:** Checkmark to allow voice confirmations of characters when entering passwords.
 - **Power key ends call:** Checkmark so that you can end voice calls by pressing the **Power/Lock Button** . When this option is enabled, pressing the Power/Lock Button during a call does not lock the screen.
 - **Accessibility settings shortcut:** Sets quick, easy access to selected features when you triple-tap the Home button . Choose Off, Show all, TalkBack, Invert colors, Universal touch, or Accessibility settings.

PC Connection

Your phone's PC connection menu lets you configure your USB connection settings.

Select USB Connection Method

Opens a dialog box to choose the default connection mode when connecting your phone to a PC via USB. Choose from **Charge phone**, **Media sync (MTP)**, or **Send images (PTP)**.

Note: For Windows® XP, the MTP driver is not installed by default. If Windows Media Player(WMP) over version 10.x is installed on the PC, the MTP driver may be installed. For Windows® 7 except for N edition, the driver is installed.

Ask Upon Connecting

Checkmark to have the phone ask you to choose which USB connection mode it should connect with to a PC.

Help

Displays help information about the available USB connection methods.

Accessory

Keep in mind that turning on these accessory settings may result in irregular device behavior.

QuickWindow Case



Activate the QuickWindow case to use functions available on the small view window.

Earphone Plug & Pop

Activate to display the app panel automatically when earphone is connected to the phone. Tap the check box next to each app you want to display when connecting an earphone.

Activate This Device

Follow the onscreen instructions to activate your phone.



1. Press  >  > **System settings > Activate this device.**
2. Follow the on-screen instructions.

System Updates

From time to time, updates may become available for your phone. You can download and apply updates through the Settings menu.



Update PRL

This option allows you to download and update the PRL (Preferred Roaming List) automatically.

1. Press  >  > **System settings > System updates > Update PRL.**
2. Follow the on-screen instructions.



Update Profile

This option allows you to automatically update your online user profile information. If you choose to change your user name and select a new one online, you must then update the user name on your phone.

1. Press  >  > **System settings > System updates > Update profile.**
2. Follow the on-screen instructions.



Update Firmware

This option allows you to download and update the Firmware for your device.

1. Press  >  > **System settings > System updates > Update Firmware.**
2. Follow the on-screen instructions.



Update LG software

This option allows you to download and update the LG software.

1. Press  >  > **System settings > System updates > Update LG software.**
2. Follow the on-screen instructions.

UICC Unlock

This option allows you to unlock the client initiated UICC.



1. Press  >  > **System settings** > **System updates** > **UICC Unlock**.
2. Follow the on-screen instructions.

Printing

This menu allows you to manage your Google Cloud Print settings and print jobs.

About Phone

Display information about the network, phone identity, battery, hardware, software, legal, and regulations and safety.

1. Press  >  > **System settings** > **About phone**.
2. Tap the desired menu.

Copyright Information

©2014 Sprint. Sprint and the logo are trademarks of Sprint. Other marks are trademarks of their respective owners.

All materials in this guide including, without limitation, the design, the text, and any marks are the property of LG Electronics, Inc. Copyright © 2014 LG Electronics, Inc. ALL RIGHTS RESERVED. LG and the LG logo are registered trademarks of LG Electronics, Inc. LG G3 is a trademark of LG Electronics, Inc. The Bluetooth® word mark and logos are registered trademarks owned by Bluetooth SIG, Inc. microSD™ is a trademark of SanDisk. Other trademarks and trade names are those of their respective owners. Unless otherwise specified herein, all accessories referenced herein are sold separately. All features, functionality, and other product specifications are subject to change. Screen shots are simulated and subject to change.



ABOUT DIVX VIDEO: DivX® is a digital video format created by DivX, LLC, a subsidiary of Rovi Corporation. This is an official DivX Certified® device that has passed rigorous testing to verify that it plays DivX video. Visit divx.com for more information and software tools to convert your files into DivX videos.

ABOUT DIVX VIDEO-ON-DEMAND: This DivX Certified® device must be registered in order to play purchased DivX Video on- Demand (VOD) movies. To obtain your registration code, locate the DivX VOD section in your device setup menu. Go to vod.divx.com for more information on how to complete your registration.

DivX Certified® to play DivX® video up to HD 720p, including premium content.
DivX®, DivX Certified® and associated logos are trademarks of Rovi Corporation or its subsidiaries and are used under license.

Note

• Open Source Software

To obtain the corresponding source code under GPL, LGPL, MPL and other open source licences, please visit <http://opensource.lge.com>. All referred licence terms, disclaimers and notices are available for download with the source code.

Index

- About Phone, 152
- Access Contacts, 43
- Access Gmail, 54
- Access Recently-Used Applications, 18
- Accessibility, 148
- Accessory, 150
- Accounts & Sync, 144
- Activate This Device, 151
- Activate Your Phone, 4
- Activation and Service, 4
- Add a Contact, 45
- Add a VPN Connection, 77
- Add a Wi-Fi Network, 74
- Add an Email Account (POP3 or IMAP), 56
- Add and Remove Widgets on the Home Screen, 15
- Add Bookmarks to Your Home Screen, 82
- Adjust Browser Settings, 80
- Airplane Mode, 123
- Alarm/Clock, 105
- Android Beam, 127
- Apps, 143
- Auto Answer, 125
- Backup & Reset, 147
- Battery, 142
- Bluetooth, 110
- Bluetooth Settings, 124
- Bluetooth Settings Menu, 111
- Bluetooth Tethering, 128
- Browser Menu, 79
- Calculator, 109
- Calendar, 98
- Call Emergency Numbers, 26
- Call Forwarding, 37
- Call from Call Logs, 25
- Call from Contacts, 26
- Call Logs, 38
- Call Reject, 39, 124
- Call Settings, 39, 124
- Call Using a Speed Dial Number, 26
- Call Using the Phone Dialer, 25
- Call Waiting, 35
- Caller ID, 35
- Camera Settings, 87
- Change Calendar Settings, 103
- Change Calendar View, 98
- Change the Device Name, 112
- Change the Phone's Wallpaper, 16
- Change the Screen Orientation, 19
- Change Your Main Greeting via the Voicemail Menu, 33
- Charge your battery, 3
- Communicate with Your Contacts, 49
- Complete the Setup Screens, 4
- Conference Calling, 36
- Configure and Sync Corporate Email Settings, 59
- Configure Visual Voicemail Settings, 32
- Connect to or Disconnect from a VPN, 77
- Connect Wi-Fi, 73
- Contacts List Options, 44
- Corporate Email (Outlook), 57
- Create a Google Account, 53
- Create a Google Wallet Account, 70
- Create a New Homepage, 82
- Create an Event, 101
- Create and Send Email, 58
- Create Bookmarks, 81
- Create Website Settings, 81
- Customize Applications Icons on the Home Screen, 17
- Customize Your Home Screen, 14
- Data Connection Status and Indicators, 75
- Data Roam Guard, 41
- Data Services General Information (3G and Sprint Spark LTE Networks), 74
- Date & Time, 148
- Decline with Message, 125
- Device Settings, 130
- Disconnect Bluetooth Connection During an Active Call, 114
- Disconnect or Unpair from a Bluetooth Device, 113
- Display and Synchronize Calendars, 103
- Display Settings, 133
- Edit a Contact Entry, 46
- Edit or Delete an Event, 102

Edit the Display Name via the Voicemail Menu, 33
 Email, 56
 Enhanced 911 (E911), 27
 Enjoying content via a variety of devices, 114
 Enjoying the content from Nearby devices, 115
 Enter Text With the On-screen Keyboard, 22
 Export Contacts to Your Internal Storage, 51
 File Manager, 109
 File Manager Options, 110
 Find and Install an App, 69
 Folders, 104
 Format the microSD Card, 117
 Gestures, 140
 Get Help with Google Play, 71
 Get Started with Contacts, 43
 Gmail / Google, 53
 Go to a Specific Website, 80
 Google Maps, 71
 Google Play Music App, 72
 Google Play Store, 69
 Guest Mode, 13, 144
 Hearing Aids, 125
 Home Button Answers Call, 125
 Home Screen, 136
 Home Screen Clean View, 18
 Home Screen Overview, 14
 Import Contacts From Your Internal Storage, 51
 Import, Export, and Share Contacts, 51
 In-call Options, 34
 Incoming Voice Call Pop-up, 124
 Insert a microSD Card, 116
 Install the battery, 2
 Joining and Separating Contacts, 52
 Language & Input Settings, 146
 Launch the Web Browser, 77
 Learn to Navigate the Browser, 78
 Light Frame, 85
 Listen to Multiple Voicemail Messages, 31
 Live Zoom, 91
 Location, 144
 Lock and Unlock Your Phone, 12
 Lock Screen, 137
 Make Phone Calls, 25
 Manage Message Conversations, 64
 microSD Card, 115
 Miracast, 127
 Mobile Data, 124
 Mobile Networks Settings, 128
 More Settings, 128
 Multi-point Auto Focus, 84
 Music, 72
 Music Player, 72
 Navigation, 71
 Near Field Communication (NFC) Technology, 115
 New Messages Notification, 64
 NFC Settings, 127
 North American Dialing, 124
 One-handed Operation, 141
 Open an Installed App, 70
 Open Email, 58
 Open or Close Gallery, 89
 Open or Close the Camera, 83
 Pairing Bluetooth Devices, 112
 PC Connection, 150
 Personal Settings, 143
 Phone Call Options, 33
 Phone Calls, 25
 Power Button Ends Call, 126
 Prepare Your Phone for VPN Connection, 76
 Printing, 152
 Privacy Keeper, 125
 Proximity Sensor, 126
 QSlide, 94
 Quick Access, 18
 QuickMemo, 94
 QuickRemote, 96
 Read and Reply to Gmail Messages, 55
 Receive Phone Calls, 27
 Record videos, 86
 Record Videos, 86
 Register Your Phone on Sprint Prepaid, 4
 Remove a microSD Card, 117
 Reply to or Delete an Email Message, 59
 Request a Refund for a Paid App, 70
 Reset the Browser to Default, 81
 Respond to an Event Reminder, 103
 Retrieve Your Voicemail Messages, 29
 Review Screen, 85
 Review Visual Voicemail, 30
 Ringtone & Vibration Settings, 131
 Roaming Guard, 41
 Roaming Mode, 40
 Roaming Settings, 40
 Save a Phone Number, 46
 Save and Resume a Draft Message, 64
 Save Unknown Numbers, 126

Searching in File Manager, 110
 Security, 145
 Select Text on a Web Page, 80
 Send a Gmail Message, 55
 Send a Multimedia Message (MMS), 62
 Send a Picture or Video by Multimedia Message, 93
 Send a Text Message, 61
 Send Items via Bluetooth, 113
 Send Pictures or Videos by Email, 92
 Send Pictures or Videos Using Bluetooth, 93
 Set an Event Reminder, 102
 Set the Browser Home Page, 81
 Set Up Secure Credential Storage, 76
 Set Up Speed Dialing, 38
 Set Up Visual Voicemail, 30
 Set Up Voicemail, 5
 Set Up Your Phone, 2
 Setting Up Guest Mode, 13
 Share & Connect, 127
 Share a Contact, 51
 Share Pictures and Videos, 92
 Sign In to Your Google Account, 54
 SmartShare, 114
 SmartShare Beam, 127
 Sound Settings, 130
 Sprint Spark LTE, 75
 Status Bar, 19
 Storage, 142
 Super Zooming, 85
 System Settings, 148
 System Updates, 151
 Take a Picture, 84
 Take Pictures, 83
 Tap & Pay, 143
 Tasks, 107
 Text and Multimedia Message Options, 66
 Text and Multimedia Messaging, 61
 The Contacts List, 43
 Touchscreen Navigation, 8
 Transfer User Contents From an Android Phone to Your LG Volt, 119
 Transfer Via Bluetooth Connection, 120
 Transfer Via PC or Laptop, 119
 TTY Mode, 40, 125
 Turn Bluetooth On and Off, 110
 Turn Wi-Fi On and Connect to a Network, 73
 Turn Your Phone On and Off, 7
 Turn Your Screen On and Off, 7
 Uninstall an App, 71
 Unmount the microSD Card, 118
 Update Your LG Software, 122
 Update Your Phone, 120
 Update Your Phone Firmware, 120
 Update Your PRL, 122
 Update Your Profile, 122
 Use the Phone's microSD Card as a USB Drive, 118
 Using Guest Mode, 14
 Using QSlide, 110
 Video Camera Settings, 88
 Video Gallery Options, 90
 View Event Details, 101
 View microSD Card Memory, 117
 View Pictures and Videos, 89
 View Pictures and Videos Using Gallery, 89
 Viewfinder Screen in Camera mode, 83
 Viewfinder Screen in Video mode, 86
 Virtual Private Networks (VPN), 76
 Visual Voicemail, 30
 Visual Voicemail Options, 31
 Voice Clarity, 126
 Voice Command, 97
 Voice Mate, 96
 Voicemail, 28
 Voicemail Notification, 28
 Voicemail Settings, 39, 124
 Voicemail Setup, 28
 VPN Settings, 129
 Watch a Video, 90
 Wi-Fi Settings, 123
 Wireless Networks, 123
 Wireless Storage, 128
 Work with Pictures, 91
 Your Data Services User Name, 75
 Your Home Screen, 14
 Your Phone at a Glance, 1
 Your Phone's Layout, 6
 Zoom In or Out on a Picture, 90