

Lumin User Manual

Part Number: 15-2500-074

Rev: A, April - 2016



All rights reserved. Reproduction, adaptation, or translation without permission is prohibited, except as allowed under copyright laws. Printed in the U.S.A.

Updated Information

The information contained in this document is subject to change without notice.

Trademarks

The companies indicated own the following trademarks: Teledyne Tekmar

Tekmar Teledyne Instruments, Inc.

All other brands or product names are trademarks or registered trademarks of their respective owners.

4736 Socialville Foster Road
Mason, OH 45040 U.S.A
www.teledynetekmar.com

Toll Free: 800-543-4461

Sales/Support: 800-874-2004

Main: 513-229-7000

Fax: 513-229-7050



Lumin User Manual

Table of Contents

Preface

P.1 Warranty	P-1
P.2 Teledyne Tekmar Customer Support Center	P-1
P.3 Essential Instructions	P-1
P.4 Notations and Hazard Severity Levels	P-2
P.5 Lumin Safety Symbols	P-3
P.6 Lumin Safety Labels	P-5
P.7 Working Safely	P-6

Chapter 1: Introduction

1.1 Purge and Trap Background	1-1
1.1.1 Purge and Trap Fundamentals	1-1
1.1.2 Brief History	1-2
1.2 Purge and Trap Operation Overview	1-2
1.2.1 Trapping, Adsorption and Desorption	1-3
1.3 Lumin Specifications	1-4
1.4 Lumin Component Overview	1-7
1.4.1 Sample Mount and Sparger	1-8
1.4.2 Guardian™ Foam Sensor & Eliminator (Optional)	1-8
1.4.3 Status Light	1-9
1.4.4 Sample Purge Gas Inlet	1-9
1.4.5 Mass Flow Controller (MFC)	1-10
1.4.6 Sample Pathway	1-10
1.4.7 Analytical Trap	1-11
1.4.8 Moisture Control System (MCS)	1-11
1.4.9 Carrier Gas Inlet Line/Heated Sample Transfer Line	1-12
1.4.10 Valving	1-13
1.4.11 24VDC Power Supply	1-15
1.4.12 5VDC Power Supply	1-15
1.4.13 Multi-Channel Temperature Control Board	1-16
1.4.14 CPU Communication Board (Master Board)	1-17
1.4.15 DC Valve Control Board	1-18
1.5 Optional Autosampler	1-19
1.6 Optional Guardian™ Foam Sensor and Foam Eliminator	1-19

Chapter 2: Installation and Setup

2.1 Pre-Installation	2-1
2.1.1 Overview	2-1
2.1.2 Operating Environment	2-1
2.1.3 Work Surface Requirements	2-1
2.1.4 Electrical Requirements	2-2
2.1.5 Gas Supply Requirements	2-2
2.1.6 Minimum Computer Requirements	2-4
2.1.7 Required Tools and Supplies for Installation	2-4
2.2 Unpacking the Lumin	2-5
2.3 Installation Kit Box	2-5
2.4 Concentrator Overview	2-6
2.5 Electrical and Data Connections	2-9
2.5.1 AC Power Cord	2-9

2.5.2	Connect the USB Interface Cable	2-10
2.5.3	GC I/O (Input/Output) Connection	2-10
2.6	Connecting the Lumin Sample Purge Gas Supply	2-11
2.7	Lumin Carrier Gas and Sample Transfer Line Connection to the Gas Chromatograph (GC)	2-12
2.8	Routing the Drain Tubing	2-14
2.9	Install Lumin TekLink Software	2-15
2.9.1	Microsoft® SQL Server Installation	2-16
2.9.2	.Net Installation	2-17
2.10	USB Driver Installation	2-17
2.11	Create an Instrument Profile	2-18
2.12	Autosampler Setup and Connection	2-22
2.12.1	Communication Cable Connection	2-22
2.12.2	Aqueous Transfer Line Installation	2-22
2.12.3	Autosampler Method Configuration	2-23
2.13	Guardian™ Foam Sensor and Foam Eliminator (Optional)	2-23
2.13.1	Configuring the Guardian™ Foam Sensor & Eliminator	2-25

Chapter 3: Lumin TekLink Software Overview

3.1	About Lumin TekLink Software	3-1
3.2	The Lumin TekLink Software Environment	3-1
3.2.1	Touchscreen Capability	3-1
3.2.2	“Pinnable” Screens	3-2
3.2.3	Title Bar	3-2
3.2.4	Open, Save, Load, and Print Buttons	3-3
3.2.5	Instrument Control Buttons	3-4
3.2.6	Delete at Next Archive Check-Box	3-4
3.3	Primary Screens	3-5
3.3.1	The Home Screen	3-5
3.3.2	Instrument Status Panel	3-6
3.4	Methods Screen	3-7
3.4.1	Standby Tab	3-7
3.4.2	Purge Tab	3-8
3.4.3	Desorb Tab	3-10
3.4.4	Bake Tab	3-11
3.4.5	AQUATEk 100 Tab	3-12
3.5	Schedules Screen	3-14
3.6	Tools Screen	3-15
3.6.1	Prime Menu	3-16
3.6.2	Commands Menu	3-16
3.6.3	System Menu	3-18
3.6.4	About	3-28
3.6.5	Diagnostics	3-28
3.7	Create an Instrument Profile	3-32
3.8	Connect to an Instrument Profile	3-35
3.9	Deactivate an Instrument Profile	3-36
3.10	Creating a Method	3-37
3.10.1	Save the Method	3-38
3.11	Open a Method	3-39
3.11.1	Print a Method	3-41
3.12	Creating a Schedule	3-42
3.12.1	Save Schedule	3-45
3.12.2	Load (Run) the Schedule	3-46
3.12.3	Abort a Sample or Schedule	3-47

Chapter 4: Instrument Operations

4.1 Concentrator Mode Descriptions	4-1
4.2 Lumin Valve Output Chart	4-3
4.3 Lumin with AQUATek 100 Valve Output Chart	4-6
4.4 Optimization	4-10
4.4.1 Temperatures	4-10
4.4.2 Standby Mode.	4-10
4.4.3 Purge Ready Mode.	4-11
4.4.4 Pre-Purge Mode	4-11
4.4.5 Sample Temperature and Pre-Heat Mode	4-11
4.4.6 Purge Mode	4-12
4.4.7 Dry Purge Mode	4-12
4.4.8 Desorb Ready Mode.	4-12
4.4.9 Desorb Pre-Heat Mode.	4-12
4.4.10 Desorb Mode	4-13
4.4.11 Bake Mode	4-13
4.4.12 Analytical Trap Recommended Conditioning Settings	4-13
4.4.13 Analytical Trap Recommended Operating Conditions	4-14

Chapter 5: Maintenance and Troubleshooting

5.1 Replacing Parts	5-1
5.2 Preventative Maintenance Checks.	5-2
5.2.1 Daily Maintenance Checks	5-2
5.2.2 Weekly Maintenance Checks	5-2
5.2.3 Monthly Maintenance Checks.	5-2
5.3 Preventative Maintenance Chart	5-3
5.4 GC/IO Cable and GC Type Reference.	5-4
5.5 Instrument Access Panels	5-5
5.6 Plumbing Overview	5-8
5.7 Electrical Overview.	5-10
5.7.1 Power Supplies.	5-10
5.7.2 Printed Circuit Boards.	5-11
5.8 Glassware Cleaning Procedures	5-12
5.9 Sparger Replacement	5-13
5.10 Analytical Trap Replacement	5-15
5.11 Analytical Trap Conditioning	5-17
5.12 Analytical Trap Heater Jacket	5-18
5.13 Analytical Trap Cooling Fan.	5-21
5.14 MCS Cooling Fan.	5-25
5.15 Pencil Filter Replacement	5-27
5.16 Check Valve	5-28
5.17 Valve Manifold Replacement	5-30
5.18 Valve Replacement	5-31
5.19 Moisture Control System (MCS)	5-33
5.20 Mass Flow Controller (MFC)	5-35
5.21 6-Port Valve	5-37
5.22 Power Entry Module (PEM) Fuse Replacement	5-38
5.23 Multi-Channel Temperature Control Board Fuse Replacement.	5-41
5.23.1 Main Fuse.	5-41
5.23.2 Heater Output Fuses	5-44
5.24 Multi-Channel Temperature Control PCB Replacement	5-47
5.25 CPU Communication (Master) PCB Replacement.	5-50
5.26 DC Valve Control PCB Replacement.	5-53
5.27 5VDC Power Supply Replacement	5-56
5.28 24VDC Power Supply Replacement	5-58

5.29 Upgrade Firmware	5-59
5.29.1 Download Firmware	5-59
5.29.2 Upgrade Board Firmware	5-59
5.30 Upgrade Software	5-59
5.31 Troubleshooting	5-60
5.31.1 Benchmark Test	5-60
5.31.2 Initial Leak Checking	5-62
5.31.3 Advanced Leak Check Guidelines	5-64
5.31.4 Advanced Leak Checking Flow Chart	5-67
5.31.5 No Power Flow Chart	5-68
5.31.6 Top-of-Trap (TOT) Injection Port.	5-69
5.31.7 No Response Flow Chart	5-73
5.31.8 Low Response Flow Chart	5-74
5.31.9 Carryover Contamination Flow Chart.	5-75
5.32 Returning the Lumin	5-75
5.33 Unit and Parts Disposal	5-76
5.34 Technical Assistance	5-76
5.34.1 Teledyne Tekmar Customer Support	5-76

Appendix A: Diagrams

A.1 Lumin Electrical Schematic	A-1
A.2 Lumin Plumbing Diagram	A-2
A.3 Lumin Flow Diagrams	A-3
A.3.1 Lumin - Basic Flow Diagram	A-3
A.3.2 Lumin - Standby Dry Purge Flow Diagram	A-4
A.3.3 Lumin Purge Flow Diagram	A-5
A.3.4 Lumin Desorb Flow Diagram	A-6
A.3.5 Lumin Bake Flow Diagram	A-7
A.4 Lumin With Guardian™ Foam Sensor (GFS) & Eliminator Flow Diagrams	A-8
A.4.1 Lumin With GFS & Eliminator - Basic Flow Diagram	A-8
A.4.2 Lumin With GFS & Eliminator - Standby/Dry Purge Flow Diagram	A-9
A.4.3 Lumin With GFS & Eliminator - Eliminator Ready Flow Diagram	A-10
A.4.4 Lumin With GFS & Eliminator - Purge Flow Diagram	A-11
A.4.5 Lumin With GFS & Eliminator - Add Defoamer Flow Diagram	A-12
A.4.6 Lumin With GFS & Eliminator - Eliminator Rinse Flow Diagram	A-13
A.4.7 Lumin With GFS & Eliminator - Desorb Flow Diagram	A-14
A.4.8 Lumin With GFS & Eliminator - Bake Flow Diagram	A-15

List of Figures

1-1 Headspace Equilibrium Diagram	1-2
1-2 Sample Mount and Sparger	1-8
1-3 Unit Status Light/Mode Indicator	1-9
1-4 Mass Flow Controller	1-10
1-5 Lumin Analytical Trap Compartment	1-11
1-6 Moisture Control System	1-12
1-7 Carrier Gas Inlet Line and Heated Sample Transfer Line	1-12
1-8 Lumin Valve Manifold and Solenoid Valves	1-13
1-9 Heated 6-Port Valve	1-13
1-10 3-Port Sample Valve	1-14
1-11 24VDC Power Supply	1-15
1-12 5VDC Power Supply	1-15
1-13 Multi-Channel Temperature Control Board	1-16
1-14 Multi-Channel Temperature Control Board	1-16
1-15 CPU Communication Board (Master Board)	1-17

1-16 CPU Communication Board Location	1-17
1-17 DC Valve Control Board.	1-18
1-18 DC Valve Control Board Location	1-18
2-1 Installation Kit Box Diagram.	2-5
2-2 Front of Lumin	2-6
2-3 Back of Lumin	2-7
2-4 Right Side of Lumin	2-8
2-5 Left Side of the Lumin	2-8
2-6 Lumin Power Entry Module	2-9
2-7 Lumin USB Connection	2-10
2-8 Rear of Lumin - Sample Purge Gas Connection	2-12
2-9 Connecting to the GC Carrier Gas.	2-13
2-10 Lumin TekLink Installation Wizard	2-15
2-11 Microsoft® SQL Server Installation Notification Message	2-16
2-12 .NET Setup Installation Notification Message	2-16
2-13 Microsoft SQL Server Installation Wizard	2-17
2-14 Creating an Instrument Profile	2-19
2-15 Options Tab	2-20
2-16 Leak Check Tab.	2-20
2-17 Instrument Manager - Profile Set to Default.	2-21
2-18 Aqueous Transfer Line Access Point.	2-23
2-19 Configuration Dialog- Guardian™ Foam Sensor	2-25
3-1 On-Screen Keyboard	3-2
3-2 Pin Function	3-2
3-3 Schedules Screen Title Bar	3-3
3-4 Open, Save, Load, and Print Buttons	3-3
3-5 Control Buttons	3-4
3-6 Delete at Next Archive Check-Box - Schedule Screen	3-4
3-7 Open Dialog Source Drop-down Menu	3-5
3-8 Home Screen	3-5
3-9 Instrument Status Panel.	3-6
3-10 Instrument Status Zone Display Options	3-7
3-11 Methods Screen - Standby Tab	3-8
3-12 Methods Screen - Purge Tab	3-9
3-13 Methods Screen - Desorb Tab	3-11
3-14 Methods Screen - Bake Tab	3-12
3-15 AQUATek 100 Tab.	3-13
3-16 Schedules Screen	3-15
3-17 Tools Screen	3-15
3-18 Leak Check Dialog.	3-16
3-19 Bake Dialog	3-17
3-20 Tools - Configuration - General Tab	3-19
3-21 Tools - Configuration - Options Tab.	3-20
3-22 Tools - Configuration - Leak Check Tab	3-21
3-23 Tools - Instrument Manager.	3-22
3-24 System Properties Dialog	3-22
3-25 System Properties - Email Server Tab.	3-23
3-26 System Properties - Email Alerts Tab	3-24
3-27 History Filter for Email Events Dialog	3-25
3-28 System Properties - Data Tab	3-26
3-29 System Properties - Connection Tab.	3-27
3-30 System Properties - Misc Tab	3-27
3-31 About Dialog	3-28
3-32 Diagnostics - Valves and Flows	3-29
3-33 AQUATek100 Dialog	3-30

3-34	History Form - Instrument History	3-30
3-35	History Form Filter - Instrument History	3-31
3-36	Upgrade Firmware Dialog	3-31
3-37	Creating an Instrument Profile	3-33
3-38	Options Tab	3-34
3-39	Leak Check Tab	3-34
3-40	Instrument Manager	3-36
3-41	Methods Screen	3-37
3-42	Save Method As Dialog	3-38
3-43	New method Saved - Name in Title Bar	3-39
3-44	Methods Screen	3-40
3-45	Open Method Dialog	3-40
3-46	25 mL Method Open	3-41
3-47	Method Print Dialog	3-41
3-48	Blank Schedule	3-42
3-49	Zero in Vial Column Becomes Blank	3-43
3-50	Standards Drop-Down	3-44
3-51	Schedules Screen Right-Click Options	3-45
3-52	Save Schedule	3-45
3-53	Schedule Loaded	3-46
3-54	Instrument Status Panel Updated	3-46
3-55	Aborted Schedule	3-47
3-56	Confirm Selected, Schedule Aborted	3-48
3-57	Schedule Hold - Instrument Status Panel	3-49
5-1	Front of the Lumin	5-5
5-2	Analytical Trap Compartment and Sparger Panel Open	5-6
5-3	Right Side of Lumin	5-6
5-4	Left Side of Lumin	5-7
5-5	Plumbing Components	5-8
5-6	Plumbing Components	5-9
5-7	5 VDC (Left) and 24 VDC (Right) Power Supplies	5-10
5-8	Printed Circuit Board Locations	5-11
5-9	Sparger Connections	5-13
5-10	Analytical Trap Compartment	5-15
5-11	Analytical Trap Diagram	5-15
5-12	Trap Heater and RTD Plugs	5-16
5-13	Analytical Trap Connections	5-17
5-14	Bake Dialog	5-18
5-15	Analytical Trap Compartment	5-19
5-16	Analytical Trap Diagram	5-19
5-17	Trap Heater and RTD Plugs	5-20
5-18	Analytical Trap Cooling Fan	5-21
5-19	DC Valve Printed Circuit Board (PCB)	5-22
5-20	Analytical Cooling Fan Mounting Bracket	5-23
5-21	Analytical Trap Cooling Fan Opening at Insulation Box	5-24
5-22	MCS Cooling Fan	5-25
5-23	DC Valve Printed Circuit Board (PCB)	5-26
5-24	MCS Cooling Fan Cable Routing	5-27
5-25	Pencil Filter	5-28
5-26	Check Valve	5-29
5-27	Front and Back Valve Manifold	5-30
5-28	Front and Back Valve Manifold	5-32
5-29	Analytical Trap Connections to the MCS	5-34
5-30	MCS Cover Plate Removal	5-34
5-31	MCS	5-35

5-32	Mass Flow Controller	5-36
5-33	6-Port Valve	5-38
5-34	Lumin Power Entry Module (PEM).	5-39
5-35	PEM Fuse Module Cover Open	5-39
5-36	Fuse Module Removed	5-40
5-37	Fuse Orientation in Fuse Module.	5-40
5-38	Multi-Channel Temperature Control Board	5-42
5-39	Multi-Channel Temperature Control Board Diagram - Main Fuse	5-43
5-40	Multi-Channel Temperature Control Board	5-45
5-41	Multi-Channel Temperature Control Board Diagram - Heater Output Fuses	5-46
5-42	Multi-Channel Temperature Control Board	5-47
5-43	Multi-Channel Temperature Control Board	5-48
5-44	Multi-Channel Temperature Control Board Diagram	5-49
5-45	CPU Communication Board (Master Board)	5-50
5-46	CPU Communication Board (Master Board)	5-51
5-47	CPU Communication Board (Master Board) Diagram	5-52
5-48	DC Valve Control Board.	5-53
5-49	DC Valve Control Board.	5-54
5-50	DC Valve Control Board.	5-55
5-51	5 V DC Power Supply	5-56
5-52	5VDC Power Supply	5-56
5-53	24VDC Power Supply	5-58
5-54	Upgrade Firmware Dialog	5-59
5-55	Benchmark Test.	5-60
5-56	Benchmark Test Prompt	5-61
5-57	Print Benchmark Results	5-61
5-58	Instrument Status During Leak Check	5-62
5-59	Leak Checking Flow Chart.	5-63
5-60	6-Port Valve	5-64
5-61	4-Way Tee	5-65
5-62	Analytical Trap	5-65
5-63	Sample Valve.	5-66
5-64	Purge Valve NO Tee	5-66
5-65	No Power Flow Chart.	5-68
5-66	Disassembled TOT Injection Port	5-69
5-67	Valco™ Plug Nut in Sample Mount	5-70
5-68	Figure 5-9: TOT Injection Port Assembled and Installed	5-71
5-69	Model Drop-Down Menu	5-71
5-70	No Response Flow Chart.	5-73
5-71	Low Response Flow Chart.	5-74
5-72	Carryover Contamination Flow Chart.	5-75
A-1	Lumin Electrical Schematic	A-1
A-2	Lumin Plumbing Diagram	A-2
A-3	Lumin - Basic Flow Diagram	A-3
A-4	Lumin - Standby/Dry Purge Flow Diagram	A-4
A-5	Lumin - Purge Flow Diagram.	A-5
A-6	Lumin - Desorb Flow Diagram.	A-6
A-7	Lumin - Bake Flow Diagram	A-7
A-8	Lumin With GFS & Eliminator - Basic Flow Diagram.	A-8
A-9	Lumin With GFS & Eliminator - Standby/Dry Purge Flow Diagram	A-9
A-10	Lumin With GFS & Eliminator - Eliminator Ready Flow Diagram	A-10
A-11	Lumin With GFS & Eliminator - Purge Flow Diagram	A-11
A-12	Lumin With GFS & Eliminator - Add Defoamer Flow Diagram	A-12
A-13	Lumin With GFS & Eliminator - Eliminator Rinse Flow Diagram	A-13

A-14 Lumin With GFS & Eliminator - Desorb Flow Diagram	A-14
A-15 Lumin With GFS & Eliminator - Bake Flow Diagram	A-15

List of Tables

1-1 General Specifications	1-4
1-2 Performance Specifications	1-4
1-3 Methods, Applications, and Certifications.	1-5
1-4 Temperatures	1-5
1-5 Liquid Handling.	1-6
1-6 Sample Gas Requirements	1-6
1-7 Electrical Requirements	1-6
1-8 Valving	1-6
1-9 Computer Requirements	1-6
1-10 Other Features	1-6
1-11 Lumin Components	1-7
1-12 Unit Status Light Indications.	1-9
1-13 Valves and Functions.	1-14
2-1 Minimum Computer Requirements.	2-4
4-1 Lumin Mode Descriptions.	4-2
4-2 Lumin Valve Output Chart	4-3
4-3 Lumin with AQUATek 100 - Valve Output Chart	4-6
4-4 Analytical Trap Recommended Conditioning Temperatures and Times	4-13
4-5 Analytical Trap Recommended Operating Conditions	4-14
5-1 Daily Maintenance Checklist	5-2
5-2 Weekly Maintenance Checklist.	5-2
5-3 Monthly Maintenance Checklist	5-2
5-4 Preventative Maintenance Chart	5-3
5-5 GC/IO Cable and GC System Reference.	5-4
5-6 Lumin Fuse Ratings (2 IEC 5 x 20 mm Fuses).	5-40
5-7 Main Fuse.	5-44
5-8 Heater Output Fuses	5-47

Lumin User Manual

Preface

P.1 Warranty

Refer to www.teledynetekmar.com for the Terms and Conditions of Sale and the product warranty. Any questions regarding this policy and its application should be directed to:

P.2 Teledyne Tekmar Customer Support Center

U.S. Phone: (800) 874-2004

U.S. Email: tekmarsupport@teledyne.com

International (Outside the U.S.): Country Code + 1 (513) 229-7000

International Email: Tekmar_Intltech@teledyne.com



NOTE

For technical troubleshooting also review the procedures in Section 5.34 "Technical Assistance".

P.3 Essential Instructions



NOTE

It is important that you read this page before proceeding!

Teledyne Tekmar designs, manufactures, and tests its products to meet many national and international standards. The Lumin is a sophisticated technical product and must be properly installed, used, and maintained to ensure that it operates within normal specifications. You must adhere to and integrate the following instructions into your safety program when installing, using, and maintaining the Lumin. Failure to follow the proper instructions may invalidate the warranty.

- Read all instructions prior to installing, operating, and servicing the product. Follow all warnings, cautions, and instructions marked on, and supplied with the product and this manual. If you do not understand any of the instructions, contact your Teledyne Tekmar representative for clarification.
- Educate your personnel in the proper installation, operation, and maintenance of the product. Only qualified personnel should install, operate, update, program, and maintain the product.
- Install your equipment as specified in Chapter 2: "Installation and Setup" of this manual and according to applicable local and national codes. Connect all products to the proper electrical and pressure sources.
- Install all instruments and accessories connected to the Lumin according to the procedures provided in their specific *User Manuals*. Guidance included in this manual on external connections is for general reference.

- Only trained service personnel should replace blown fuses, and only after identifying and correcting the problem which caused the fuse(s) to blow. For continued protection, replace only with same type and fuse rating of fuse.
- When replacement parts are required, ensure that qualified individuals use replacement parts specified by Teledyne Tekmar. Unauthorized parts and products can affect the product's performance and jeopardize safety. Using look-alike substitutions may result in fire, electrical hazards, or improper operation.
- Ensure that all equipment doors are closed and protective covers are in place (except when maintenance is being performed by qualified personnel) to prevent electrical shock and personal injury.

P.4 Notations and Hazard Severity Levels

This manual uses **Notations** and **Hazard Severity Levels** to emphasize information that is important for instrument functionality and user and instrument safety. The four levels consist of:



Note is used for information and descriptions to ensure correct usage to prevent damage of the instrument.



Cautions identify a potential hazard, which if not avoided, may result in minor or moderate injury. This category can also warn you of unsafe practices, or conditions that may cause property damage.



Warnings identify a potentially hazardous condition, which if not avoided, could result in death or serious injury.



DANGER is limited to the most extreme situations to identify an imminent hazard, which if not avoided, will result in death or serious injury.

P.5 Lumin Safety Symbols

The Lumin instrument is labeled in compliance with the marking and nomenclature specified in the EN61010-1:2010 safety standard. The following symbols and their associated signal words are used in the manual and on instrument labels.

L'instrument Lumin est étiqueté en conformité avec le marquage et la nomenclature spécifiés dans le standard de sécurité EN61010-1:2010. Les étiquettes ci-dessous et leurs marquages associés sont utilisés dans le manuel et sur l'étiquetage de l'instrument.



Electrical Hazard!
Risque électrique!



Warning/Caution! A hazardous or potentially hazardous situation that, if not avoided, will result in product and/or property damage and possible injury and/or death.

Danger/Attention! Un risque ou une situation potentielle à risque, qui n'est pas respectée, résultera dans le dommage du produit et/ou des biens et la possibilité de blessures et/ou de mort



Fire Hazard!

Risque de feu!



Burn hazard. Hot surface inside. Allow this area to cool before servicing.

Risque de brûlure. Surface chaude à l'intérieur. Attendre le refroidissement de cette zone avant entretien



Read the Appropriate Documentation!

Lire la documentation appropriée



Skin Contact Hazard! Use protective gloves and other appropriate PPE.

Risque au contact de la peau. Utiliser des gants de protection ou autres équipements de protection personnel appropriés.



High Pressure Hazard!

Risque de haute pression!



Risk of Eye Injury. Wear safety glasses and other appropriate PPE.

Risque de blessures aux yeux. Porter des lunettes de sécurité et autres équipements de protection personnel appropriés

P.6 Lumin Safety Labels



Electrical Ground

Prise de terre



WARNING: Electrical shock hazard. Do not operate without cover.

DANGER - Risque d'électrocution. Ne pas utiliser sans capot.



WARNING: To avoid electrical shock, disconnect supply before changing fuses.

DANGER - Pour éviter le risque d'électrocution, débrancher l'alimentation avant de remplacer les fusibles.



WARNING: For continued fire protection, replace with same type and rating of fuses.

DANGER - Pour prévenir le risque d'incendie, remplacer avec des fusibles de même type et de même caractéristique.



WARNING: Remove the power cable before performing maintenance and/or servicing the instrument.

DANGER - Débrancher le câble d'alimentation avant toutes interventions de maintenance et/ou d'entretien sur l'instrument.



CAUTION: Maximum pressure for carrier gas is 200 PSI (13.8 bar)

ATTENTION: La pression maximale pour le gaz porteur est de 200 PSI (13.8 bar).



CAUTION: Inlet pressure recommended for sample gas is a minimum of 65 PSI to maximum of 100 PSI (4.5 to 6.9 bar).

ATTENTION: La pression d'entrée recommandée pour le gaz échantillonné doit être comprise entre 65 PSI et 100PSI (4.5 to 6.9 bar).



Power entry module requires:

La puissance de module d'entrée nécessite:

2 IEC 5 x 20 mm fuses

100V operation

T 10.0A – 250v

115V operation

T 10.0A – 250v

230V operation

T 5.0A – 250v

P.7 Working Safely



DANGER

If the equipment is used in a manner not specified herein, the protection provided by the equipment may be impaired!



The Lumin weighs 27 lbs (12.2 kg). If this weight exceeds your lifting ability, lift and position the Lumin with two people. Lift and position the Lumin by the base only.

Route tubing drain lines to slope downward only. Do not extend tubing into the waste bottle more than 3 to 5" (7.6 to 12.7 cm). Failure to follow these directions may result in improper drainage of the Lumin.

Please be aware that if the Lumin, its components, and/or accessories are used in a manner not specified by Teledyne Tekmar, protection by the equipment may be impaired.

Only use replacement parts supplied or approved by Teledyne Tekmar when performing maintenance on the Lumin. Use of unapproved parts could result in damage to the instrument, as well as personal injury.

Running an improper method may damage the Lumin. Setting up a new method should be performed by personnel who are properly trained, knowledgeable, and well acquainted with the Lumin.

Ensure that the installation location allows the concentrator to be easily turned off and the power cord disconnected, in the event of an emergency.



The circuit used to power the Lumin should be protected by a Certified/Listed 15/20 Circuit Breaker for short circuit protection.

Do not plug the Lumin into an extension cord. An extension cord may overheat and cause a fire.

Do not replace the Lumin mains supply AC power cable with a cable of any other type or rating. Ensure the power cable is routed away from, and is not capable of contacting, any hot surface.

Only replace fuses with those of the same type and rating. Refer to Section 5.22 "Power Entry Module (PEM) Fuse Replacement".

To avoid the risk of fire and maintain optimum instrument performance, install the concentrator on a non-flammable surface and maintain a minimum 6" (15.24 cm) perimeter around the unit that is unobstructed by flammable material or other equipment.

NEVER use hydrogen or other flammable gas with the Lumin. Venting of this gas creates an explosion hazard. Follow the manufacturer's directions for safe handling of gas and chemicals. Also refer to the Safety Data Sheets (SDSs) for information on specific chemicals.



To avoid injury to yourself or damage to the Lumin, do not exceed the recommended pressure settings. Observe safety regulations when handling pressurized gas. For more information see Matheson™ Gases Data Book (available from the Matheson Company, East Rutherford, New Jersey)



Sample and associated waste may contain hazardous and toxic substances. Follow the proper safety and health practices, as well as anticipating all regulatory limitations before using or disposing of chemicals.



To avoid electrical shock:

- Do not operate without the panels, covers and guards installed.
- Plug the power cord into a properly grounded outlet.
- The Lumin uses extremely high voltage! To avoid electrical shock, turn OFF and unplug before servicing.



To maintain fire protection, always replace fuses with the same type and rating of fuse.



Risk of Eye Injury. Wear safety glasses and other appropriate PPE. It is recommended that safety glasses be worn at all times in the presence of pressurized gases.



This instrument contains heated components. Touching any heated zone during the operation of the instrument can cause a burn. To prevent injury, allow areas with this label to cool before servicing.

When accessing the sample mount, 4-way tee, moisture control system (MCS), analytical trap compartment or 6-port valve (in the valve oven area), allow the components to cool to room temperature.



Analytical Trap

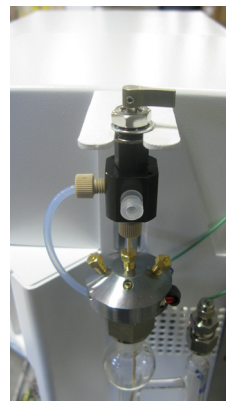

Sample Mount

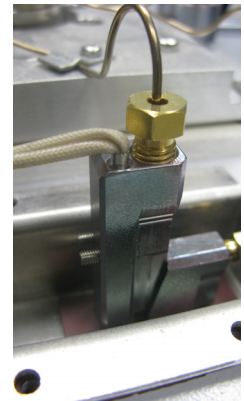

MCS



6-Port Valve

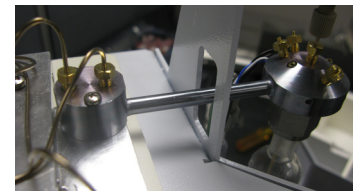

4-Way Tee

Lumin User Manual

Chapter 1: Introduction

The Lumin is a modern laboratory instrument designed to concentrate Volatile Organic Compounds (VOCs) from samples using the Purge and Trap (P&T) technique. The Lumin uses advanced P&T technology that allows accelerated automatic processing of liquid samples for analysis by Gas Chromatograph (GC). The Lumin purges VOCs from liquids onto an analytical trap. The trap is then rapidly heated and the analytes are swept with carrier gas onto the column for separation and detection.

1.1 Purge and Trap Background

1.1.1 Purge and Trap Fundamentals

When using a concentrator system, it is not essential to understand how it works. However, a good grasp of the fundamentals helps you prevent problems and assists you when you are faced with tasks such as method development and troubleshooting. This section is not intended to be a full theoretical evaluation of P&T gas chromatography.

The primary purpose of this section is to help develop an understanding of how and why compounds are concentrated. While gas chromatography is a very powerful analytical tool, it does have several limitations. Many different techniques have gradually been developed to overcome these limitations. These techniques are for a wide variety of sample types. The limitations which P&T concentration is designed to overcome, include:

1. Lack of sensitivity

GC detectors provide remarkable sensitivity. However, there are a number of areas where greater sensitivity is necessary. These include:

- Environmental Analysis - Many pollutants must be measured at low levels; sometimes, in the sub-part per billion (ppb) range.
- Flavor and Fragrance Analysis - The human nose is one of the most sensitive detectors in existence. To provide an analytical system with comparable sensitivity, some method of concentration is required.

2. Inability to tolerate water injections

Many GC columns and detectors do not perform well in the presence of water. Water may drastically reduce the lifetime of the column and adversely affect the detector performance.

3. The sample must be in vapor or vaporizable form

Gas chromatography operates as an interaction between vapor and liquid phases. The sample must start out as a vapor. For this reason, there are many samples, such as pollutants in soil or flavors in solid food, which cannot be directly introduced into a GC.

The ability to analyze VOCs is a vital part of environmental monitoring, outgassing studies, flavor or fragrance analysis, among others. P&T is a technique that separates the VOCs from a matrix. After separation, the VOCs are then concentrated and injected into the GC for separation and detection.

1.1.2 Brief History

In the 1960's, P&T was used in the study of bodily fluids. In the mid-to-late 1970's, P&T became a technique that was well-known and widely applied due the need to monitor VOCs in drinking water. Using this technique, it was possible to detect sub-ppm level VOCs of a wide variety. Today, P&T is routinely applied in the environmental area for the analysis of VOCs in soil and water. The arrival of microprocessor-driven systems allows the concentrator to be more precise and automated, giving the operator more time for other projects.

1.2 Purge and Trap Operation Overview

A measured amount of sample is placed in a sealed vessel. The sample is purged with inert gas, causing VOCs to be swept out of the sample. The VOCs are retained in an analytical trap, which allows the purge gas to pass through to vent. The VOCs are then desorbed by heating the trap, injected into the GC by back-flushing the trap with carrier gas, and separated and detected by normal GC operation.

While purging and sweeping the sample with an inert gas sounds simple, it is in reality a very complex process. Purging a sample to extract analytes is a gas extraction. There are many factors that affect the efficiency of this extraction. The amount of each compound purged is proportional to both its vapor pressure and its solubility in the sample. Both of these are, in turn, affected by the sample temperature. Consider the case of a sample sealed in a closed vial. Above the sample is a vapor space, which is usually referred to as the headspace. If you allow the sample sufficient time, VOCs in the sample will migrate into the vapor space. After a certain period of time at a constant temperature, the concentration of the volatile compounds in each phase will be stabilized, the chemical system will have reached equilibrium (Figure 1-1).

Figure 1-1 Headspace Equilibrium Diagram

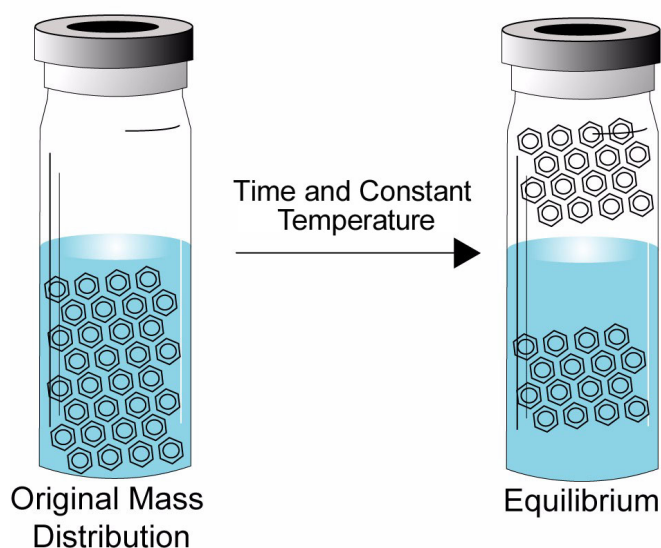

At this point a portion of the headspace can be removed and injected into the GC for analysis. This technique is known as Equilibrium Analysis or Static Headspace Analysis. The amount of material in the vapor phase will be proportional to the partial pressure of the component. The equation below describes the phase distribution of sample.

$$P_T = P_1 + P_2 + P_3 + \dots + P_n = X_1P_1^\circ + X_2P_2^\circ + X_3P_3^\circ + \dots + X_nP_n^\circ$$

where:

P_T = total vapor pressure of system

P_1 , etc. = partial pressure of each compound

P_1° , etc. = vapor pressures of the pure compounds

X_1 , etc. = mole fractions of each compound

In purging a sample, the system is no longer at equilibrium. This is because the VOCs that move into the vapor phase are constantly being removed by the purge gas. Under these circumstances, there is no migration of components from the vapor to liquid phase. This means that the partial pressure of any individual component above the sample at any time is essentially zero. This encourages even greater migration of the VOCs into the vapor phase, extracting the VOC from the sample more efficiently. Purging a sample for 10 minutes with helium (at a flow rate of 50 ml/min.) results in a more efficient extraction of volatiles than equilibrium, using 500 ml headspace. This purging technique is called Dynamic Headspace Analysis. For aqueous matrices, the increase in efficiency can be upwards of 100 fold, using dynamic versus static headspace analysis.

Extraction efficiency increases with an increase in sweep volume. Sweep volume, a function of sweep time and flow rate, is the amount of purge gas used to extract the analytes. Since the analytes are being trapped on a sorbent bed, there are limitations to the sweep times and flow rates that can be used. These limitations are determined by the compounds of interest in the sample and the sorbent material used in the trap.

1.2.1 Trapping, Adsorption and Desorption

An analytical trap is essentially a short gas chromatograph column. Compounds entering the trap will slowly elute with a measurable retention volume. Retention volume is the amount of purge gas that passes through the trap before the elution of the analytes from the sorbent materials.

The requirements of a trap are as follows:

- At low temperatures, it must retain the analytes of interest while allowing oxygen and water to pass through unimpeded.
- Upon heating, it must release the analytes quickly and efficiently.
- When heated, it must show stability and not contribute to volatiles.
- It must operate without causing any catalytic reactions.
- It should have a reasonable price and lifetime.

At lower trap temperatures, retention volumes are high. At higher desorption temperatures, retention volumes are much smaller, allowing rapid transfer to the GC.

When elution does occur, it is usually referred to as breakthrough, and the retention volume, at which breakthrough occurs, is often referred to as the breakthrough volume. Sorbent materials are usually chosen so that the breakthrough volume is high for the analytes of interest and low for water. Care must be taken that the sorbent chosen does not retain the analytes too strongly or efficient desorption may not be possible. Traps containing combinations of sorbents are often used to enhance performance. The trap is packed with the weaker sorbent on top. The stronger sorbent is placed below the weaker sorbent. Less volatile analytes are retained by the weaker sorbent as they are not effectively desorbed if they are trapped on the stronger sorbent. Therefore, the less volatile analytes fail to reach the stronger sorbent. Only the more volatile analytes reach the stronger sorbent; and because of their volatility, these analytes can be efficiently desorbed. The desorption is carried out by back-flushing the trap, ensuring that the less volatile, or heavier, analytes never come in contact with the stronger sorbent.

1.3 Lumin Specifications

For additional information on installation requirements refer to Chapter 2: "Installation and Setup".

Table 1-1 General Specifications	
Part Numbers	Lumin (100-115 VAC): 15-2500-100 Lumin (220-240 VAC): 15-2500-200 Lumin (100-115 VAC) w/Guardian™ Foam Sensor and Foam Eliminator: 15-2500-1E0 Lumin (220-240 VAC) w/Guardian™ Foam Sensor and Foam Eliminator: 15-2500-2E0
Dimensions	Height: 17.2 in (43.7 cm) Width: 8.9 in (22.6 cm) Depth: 18.7 in (47.5 cm)
Weight	27 lbs (12.2 kg)
Environmental Specifications	Operating Temperature: The system is capable of operating in lab temperatures between 10 ° and 30 °C (50 ° and 86 °F). Relative Humidity: 10% to 90%
Corrosion	The cover is corrosion resistant to waters within a pH range of 1-10
GC Interface	Designed to Interface with virtually all commercially available GC instruments.
Column Compatibility	Teledyne Tekmar recommends the use of 20 m x 0.18 mm ID Fast Volatiles columns.

Table 1-2 Performance Specifications	
Cycle Time	The cycle time for the unit is ≤ 15 minutes when using an 11 minute purge time. This time includes purge, desorb, bake and cool down to "purge ready" for the Lumin only. Note: This specification assumes an ambient room temperature between 20-22 °C (68 °-71.6 °F).
Maximum Sample Concentration	1 ppm. High level samples should be pre-screened with HT3 or Versa Headspace Sampler.

Table 1-3 Methods, Applications, and Certifications

Official Methods	USEPA 502.1, 502.2, 524.2, 524.3, 524.4, 503.1
	USEPA 601,602, 603, 624
	USEPA 8010, 8015, 8020, 8021, 8030, 8240, 8260
	ASTM and Standard Methods
	Massachusetts VPH and GRO Methods
Applications	Environmental
	Food and Beverage
	Petrochemical
	Plastics and Polymers
Certifications	The unit has successfully completed all appropriate EMC, EMI, and safety requirements per UL, FCC, CSA, and IEC.
	IEC 61326-1 Issued: 2012/07/10 Edition 2
	IEC 61010-1 Issued: 2010/06/10 Edition 3
	UL 61010-1 Issued: 2012/05/11 Edition 3
	IEC 61010-2-010 Issued: 2014/09/25 Edition 3
	CAN/CSA C22.2# 61010-1 Issued: 2012/05/11 Edition 3
	Designed and manufactured under a quality system registered to ISO 9001:2008. A Declaration of Conformity is available upon request.

Table 1-4 Temperatures

Trap Heater Cooling	Trap Heater cools from 250 °C to 40 °C in 70 seconds
Maximum Temperature Ranges	
6-Port Valve Oven	Temperature controlled up to 250°C
External Transfer Line	250 °C
Trap Heater	350 °C
Sample Mount	90 °C
MCS (Condenser)	200 °C
Sample Heater Assembly for Glass-ware (optional)	90 °C
Temperature Zone Equilibrium	For all zones other than the sample heater, temperature changes equilibrate within 10 minutes or at 10°C/min, whichever is longer.
Uniformity	Temperatures will be within 10% of measured temperatures after 30 minutes of equilibration.

Table 1-5 Liquid Handling

Sparger	Standard 5 mL fritted sparger. Optional spargers include: 25 mL fritted sparger, 5 or 25 mL fritless sparger, 5 or 25 mL needle sparger, and 25 mL disposable test tubes.
Sample Pathway	Inert coated tubing and fittings. Transfer line heated up to 250 °C.

Table 1-6 Sample Gas Requirements

Sample Gas Requirements	Nitrogen or helium of 99.999%, and < 0.5 ppm hydrocarbon tested.
Gas Pressure	65 - 100 psi (4.48 bar -6.89 bar)
Electronic Mass Flow Controller	Patented (US 7,651,866) system is capable of controlling flow rates from 5mL/min to 500 mL/min. Each mode is independently controlled.
Electronic Pressure Monitor	Automatic leak check and over-pressure sensing capability.

Table 1-7 Electrical Requirements

Voltage Requirements	100-115 VAC +/- 5%, 50/60Hz, 10 amps, 1150 watts 220-240 VAC +/- 5%, 50/60Hz, 5 amps, 1150 watts
External Circuits	The circuit used to power the Lumin should be protected by a Certified/Listed 15/20 Circuit Breaker for short circuit protection. The AC Power Cable supplied with the Lumin is compliant with applicable safety standards. Supplied USB communication cables are of proper type jacketing.

Table 1-8 Valving

Valving	24VDC Motor-Actuated 6-Port Valve
System Solenoid Valves (4)	24VDC Rocker-style Valves
Optional Guardian™ Foam Sensor and Eliminator Solenoid Valves (2)	24VDC Rocker-style Valves

Table 1-9 Computer Requirements

Operating System	PC Interface through Windows® 7 or higher. Windows® 10 is recommended.
Instrument Control	Lumin TekLink software via USB cable

Table 1-10 Other Features

Unit status light indicator. The color of the rhombi on the front will change to indicate standby, schedule running and error states.
Optional Sample Heater Assembly for all glassware types.
Optional Guardian™ Foam Sensor and Foam Eliminator senses foam, stops purge, and adds defoaming agent for samples prone to foaming.
Optional Teledyne Tekmar AQUATEk 100 liquid autosampler.

1.4 Lumin Component Overview

Table 1-11 Lumin Components

Component	Function
Sample Mount /Sparger	Sample gas is passed through the sample in the sparger and then conveyed through the sample mount.
Sample Heater Jacket Assembly for all Glassware Types (Optional)	Heats the sparger between the range of 20-90 °C.
Guardian™ Foam Sensor and Foam Eliminator (Optional)	Recognizes foaming during sample purge, adds defoaming agent and rinses the sample lines prior to attempting to rerun the sample. Two additional solenoid valves and an additional pressure regulator add anti-foam to foaming samples and rinse the anti-foam lines between samples.
Unit Status Light	Indicates standby, schedule running and error states.
Sample/Purge Gas Inlet	The inlet introduces the sample gas (Helium or Nitrogen) from the blue 1/8" sample gas tubing to the sparger. The sample gas then carries VOCs onto the analytical trap.
Mass Flow Controller (MFC)	Monitors and precisely controls the gas flow rates throughout the entire purge and trap process.
Sample Pathway	An inert sample pathway with treated fittings.
Analytical Trap	Captures VOCs by adsorption. The trap is then heated causing VOCs to desorb from the trap and be carried to the column of the GC.
Analytical Trap Heater Jacket and Resistance Temperature Detector (RTD)	The analytical trap heating jacket heats the analytical trap to a consistent temperature defined in the Lumin TekLink software. The Resistance Temperature Detector (RTD) in the heating jacket verifies this temperature to the software.
Moisture Control System (MCS)	Allows water in the sample gas to be condensed and then removed prior to introduction to the GC column.
Carrier Gas Inlet	The inert tubing that runs down the side of the heated transfer line from the GC. The Carrier gas is used to desorb VOCs off the analytical trap.
Heated Sample Transfer Line to GC	The inert tubing that runs next to the carrier gas line to the GC. Carrier gas in the sample transfer line carries desorbed VOCs back to the GC.
Solenoid Valves	Valves mounted to the valve manifold and actuated according to the mode of analysis (Purge, Bake, Drain and Vent). If the system is equipped with the Foam Eliminator option the valve manifold will have two additional solenoid valves.
6-Port Valve	The 6-Port Valve is a two-position valve that routes the purge and trap concentrator flows according to each mode of operation. The 6-Port Valve is actuated by the two-position actuator control module.
4-Way Heated Tee	Directs flow of purge gas from the sample mount.
24VDC Power Supply	Supplies 24V Direct Current to the Lumin's valves and motors.
5 VDC Power Supply	Supplies 5V Direct Current to the Lumin's Printed Circuit Boards (PCBs).
Multi-Channel Temperature Control Board	Responsible for all AC control and RTD feedback for the standard temperature zones.
CPU Communication Board (Master Board)	Communications to the GC via GC I/O cable, controlling PC via the USB Port or ethernet connection, and interfaces with the AQUATek 100 autosampler.
DC Valve Control Board	Actuates the Lumin's solenoid valves as well as the analytical trap and the Moisture Control System (MCS) cooling fans.
Optional Autosampler	The AQUATek 100. A purge and trap autosampler that automates liquid sample preparation steps.
Communication Cables	Conveys data from the Lumin to Lumin TekLink software installed on the controlling PC.

1.4.1 Sample Mount and Sparger

The front panel contains a heated sample mount and glass sparge vessel. The Sample Mount is heated via the 6-port valve oven plate on one end and a cartridge heater inside of the mount itself. A standard 5 mL frit sparger is included with the Lumin. The following options are also available:

- 25 mL frit sparger
- 5 or 25 mL fritless sparger
- 5 or 25 mL needle sparger
- 25 mL disposable test tubes

Figure 1-2 Sample Mount and Sparger

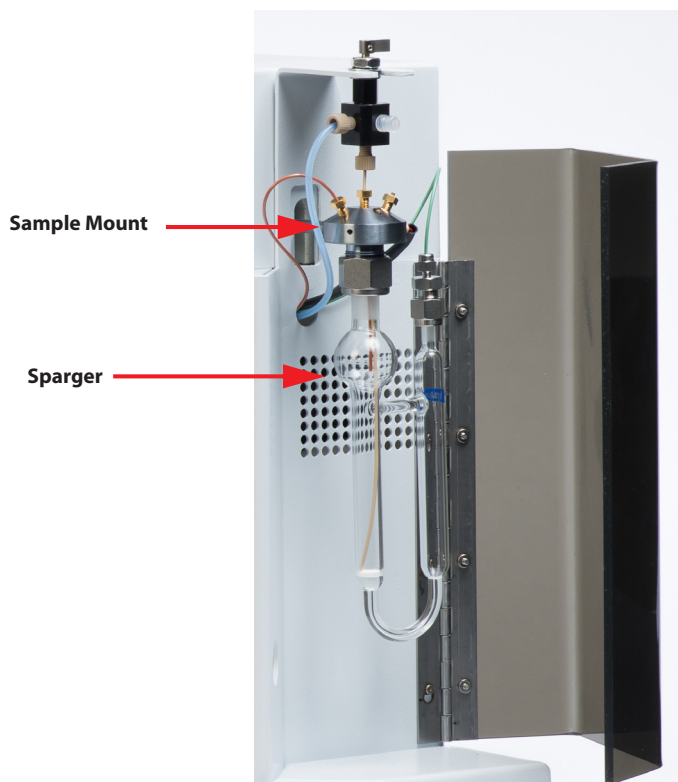

1.4.2 Guardian™ Foam Sensor & Eliminator (Optional)

A photodiode-based sensor monitors the purging process at the sparger to ensure that foaming samples are processed properly for analysis. By sensing foam in the headspace, the Eliminator will automatically stop the purge, add an anti-foaming agent, and then rerun the sample up to two additional attempts. If the sensor is tripped a third time, the system will drain the sample to prevent instrument contamination. This safeguard monitoring takes place automatically, allowing overnight or extended runs.

1.4.3 Status Light

The Teledyne Logo, the rhombi on the front of the Lumin, changes color to indicate the concentrator's state. Table 1-12 below correlates the relationship of color to indication. The rhombi is lit using an LED board behind the panel.

Table 1-12 Unit Status Light Indications	
Color	Indication
Blue	Standby
Green	Schedule Running
Red	Error

Figure 1-3 Unit Status Light/Mode Indicator



1.4.4 Sample Purge Gas Inlet

Sample gas, ultra-high purity (99.999%) helium or nitrogen, flows through the sparger to carry VOCs onto the trap. Nitrogen can be used as sample gas, but it may contain more impurities. The helium or nitrogen enters the back panel through the blue 1/8" tubing labeled "Sample Gas". The sample gas is also used for the Dry Purge and Bake Modes.



NOTE

Teledyne Tekmar recommends a sample gas flow of 40mL/min. ±5mL for 11 minutes to achieve a 440 mL purge volume.

1.4.5 Mass Flow Controller (MFC)

The Lumin incorporates a patented (US 7,651,866) mass flow controller to monitor and control the gas flow rates throughout the entire purge and trap process. Once set, the parameters remain precisely controlled throughout all modes of operation and achieve highly repeatable analyses. Flow rates are set via the Lumin TekLink software.

Figure 1-4 Mass Flow Controller



1.4.6 Sample Pathway

When dealing with active, polar, and high-boiling compounds, it is imperative to keep the sample contained in an inert sample pathway. The Lumin utilizes inert tubing and treated fittings throughout the sample path. This ensures resistance to corrosion and prevents loss of compounds.

1.4.7 Analytical Trap

The analytical trap is used to capture and release VOCs swept out of the sample by the purge gas. Once VOCs are captured, the trap is heated, causing the VOCs to desorb. The trap is then back-flushed with carrier gas carrying the VOCs to the GC for analysis. The analytical trap is heated using a heating jacket which surrounds it and cooled by a fan at the top of the analytical trap compartment. The temperature of the trap is verified by a Resistance Temperature Detector (RTD) inside the trap heating jacket.

Figure 1-5 Lumin Analytical Trap Compartment

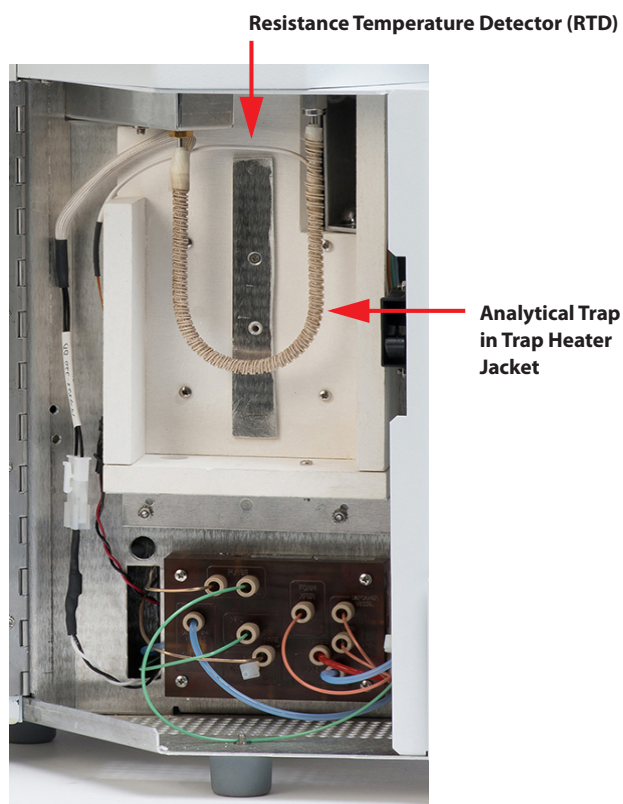

1.4.8 Moisture Control System (MCS)

The Moisture Control System (MCS) is located above the analytical trap at the inlet to the analytical trap. The MCS block contains a cartridge heater and a Resistance Temperature Detector (RTD) for heating to temperature set-points. The MCS is typically cooled during the Purge Mode to ensure that the MCS is cool during the Desorb Mode. This allows water to be condensed, prior to introduction to the GC column. The MCS is then heated during the Bake Mode to remove any water condensed during the Desorb Mode.



NOTE

The user may elect to keep the MCS hot during all modes to effectively bypass any moisture removal.

Figure 1-6 Moisture Control System

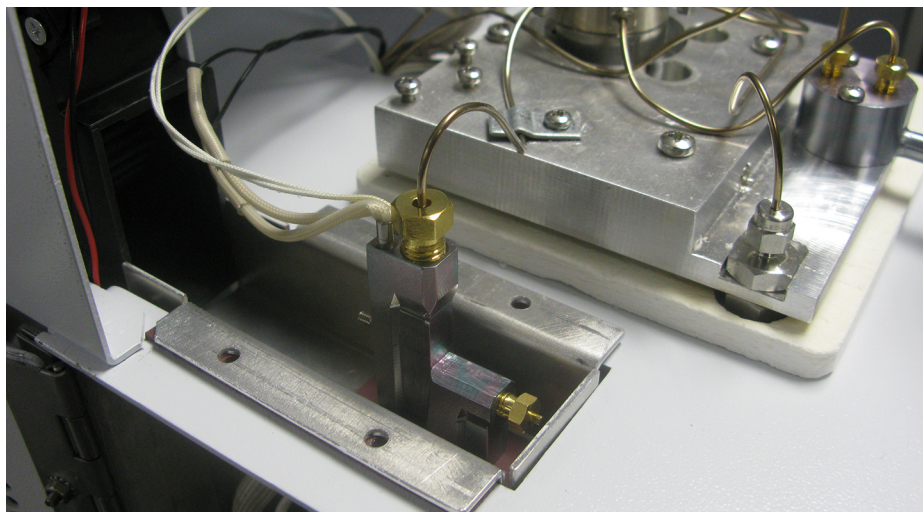

1.4.9 Carrier Gas Inlet Line/Heated Sample Transfer Line

The Carrier Gas Inlet line is the inert tubing that runs down the side of the heated sample transfer line from the GC. Carrier gas is used to desorb VOCs off the analytical trap and carry them through the sample transfer line back to the GC.

The sample transfer line is the inert piece of tubing that runs down the center of the transfer line heater to ensure the VOCs being transferred to the GC column stay in their gaseous state. Carrier gas makes a passive loop through the Lumin and returns, unchanged to the GC through the transfer line. GC carrier gas is independently controlled through the GC or an External Pressure Control (EPC).

Figure 1-7 Carrier Gas Inlet Line and Heated Sample Transfer Line

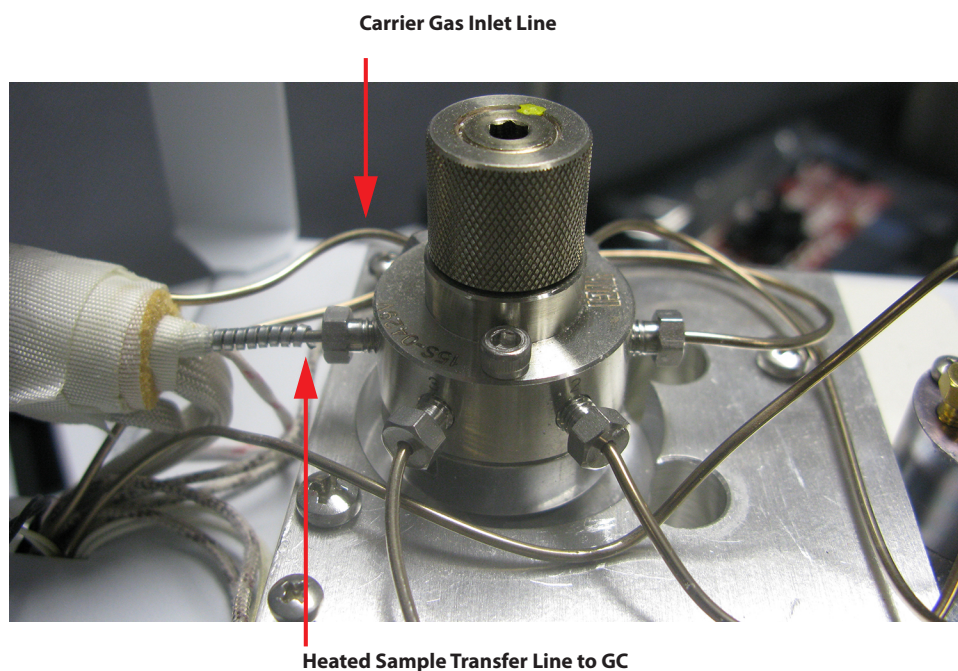

1.4.10 Valving



NOTE

Each valve and its function is detailed in Table 1-8 "Valving".

Solenoid Valves

The Purge Valve, Bake Valve, Drain Valve and Vent Valve are mounted on a Valve Manifold, which supplies gas to various locations within the system.

If the system is equipped with the Foam Eliminator option, the valve manifold will have two additional solenoid valves used to add anti-foam to foaming samples and rinse the anti-foam lines between samples. The manifold will also be equipped with a pressure regulator to control pressure within the eliminator system vessels.

Figure 1-8 Lumin Valve Manifold and Solenoid Valves

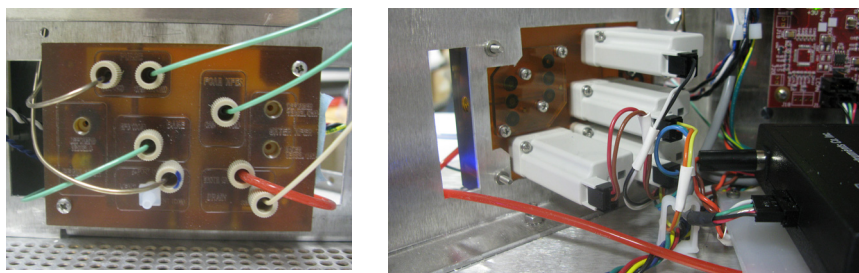

Heated 6-Port Valve

The 6-Port Valve is a two-position valve that routes the purge and trap concentrator flows according to each mode of operation. The valve is located in the "valve oven" that heats the valve to a set temperature.

Figure 1-9 Heated 6-Port Valve

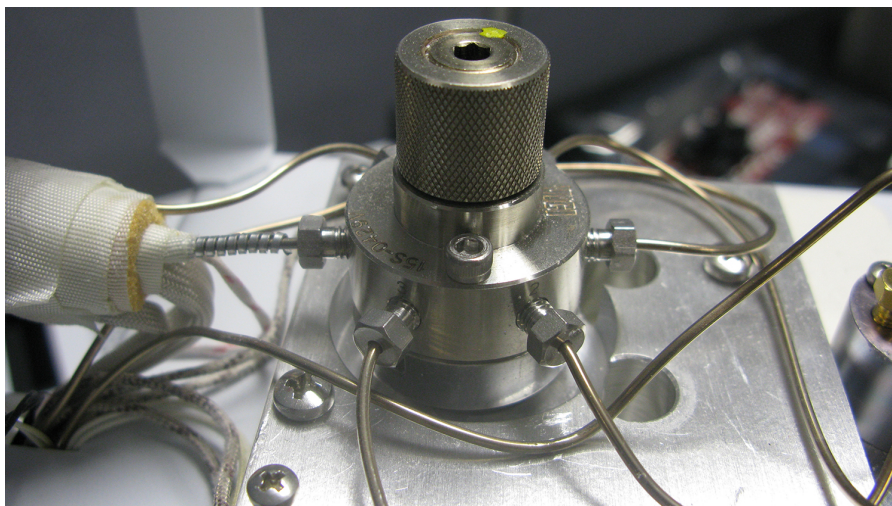

Three-Port Sample Valve

The three-port sample valve controls the flow between the sparger and the drain line and is used for standalone operation of the Lumin as well as for troubleshooting.

Figure 1-10 3-Port Sample Valve

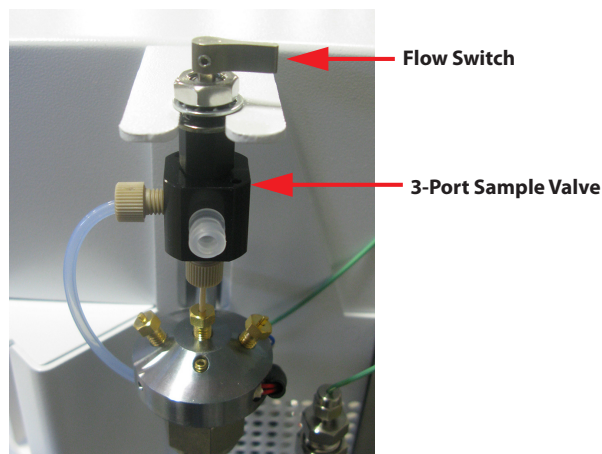

Table 1-13 Valves and Functions

Valve	Function	Actions	
		Off	On
Bake Valve	The Bake Valve receives inlet flow from the Mass Flow Controller.	Flow moves to the Purge Valve.	Allows the trap to be back-flushed and baked.
Purge Valve	The Purge Valve receives sample gas flow from the Bake Valve.	Sample gas flow is routed around the sparger.	Routes the sample gas through the Sparger.
Vent Valve	The Vent Valve receives vent flow from the 6-port Valve.	Closes the system.	Allows flow out the vent.
Drain Valve	The Drain Valve receives waste flow from the Sample Valve.	Drain Line is closed.	Liquid or gas flows from the sparger, out the sparger drain line, and to the red 1/8" concentrator drain line.
Foam Transfer Valve (Optional)	Used on configurations with the Guardian™ Foam Sensor and Foam Eliminator.	N/A	Adds a defoaming agent to the sparger.
H ₂ O Transfer Valve (optional)	Used on configurations with the Guardian Foam Sensor and Foam Eliminator.	N/A	Rinses the sample path with water prior to rerunning the sample.
6-Port Valve	The 6-Port Valve is a two position valve consisting of a stator, which is stationary, and a rotor that rotates to one of two positions. In one configuration the rotor allows ports 1&2, 3&4, and 5&6 to be connected, while in the other position the rotor allows ports 2&3, 4&5, and 6&1 to be connected. This valve allows for the trap to be loaded during the Purge Mode by connecting the trap to the sparger and, in the second position, to be in series with the GC to allow desorption onto the column.		
Mass Flow Controller	The MFC controls the sample gas flow by regulating the exhaust port with a proportional valve to allow an exact mass of gas to pass through the unit.		
Three-Port Sample Valve	The Three-port sample valve controls the flow between the sparger and the drain line. When the flow switch (valve handle) is turned to center or left positions, the opening to the drain line is closed. When the valve handle is turned to the right, the valve is open to the drain line.		

1.4.11 24VDC Power Supply

The 24VDC Power Supply is located on the left side of the Lumin. The 24VDC power supply is identified by its brown/orange wiring. This power supply powers motors and valves within the Lumin including the 6-Port valve and solenoid valves.

Figure 1-11 24VDC Power Supply

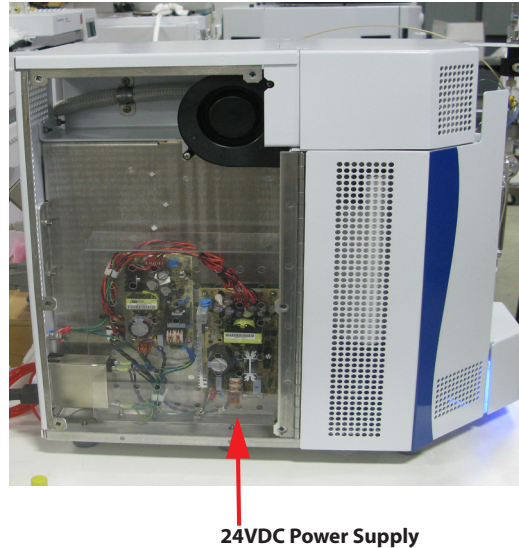

1.4.12 5VDC Power Supply

The 5VDC Power Supply is located on the left side of the Lumin. The 5VDC power supply is identified by its black/red wiring. This power supply powers the status light and other boards within the Lumin (Multi-Channel Temperature Board, CPU Communication Master Board, and DC Valve Control Board).

Figure 1-12 5VDC Power Supply

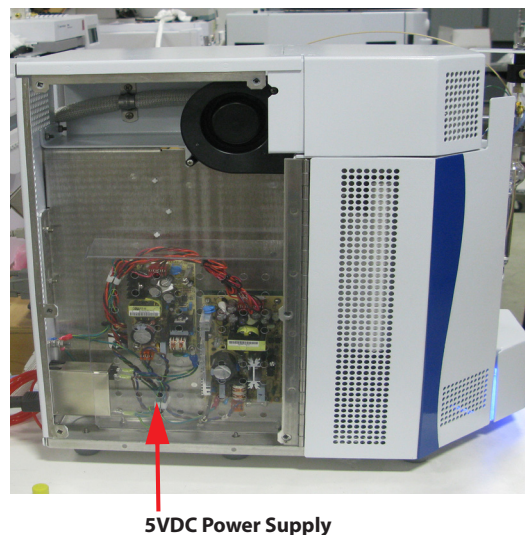

1.4.13 Multi-Channel Temperature Control Board

The Multi-Channel Temperature Control Board is located in the right side of the concentrator. It is responsible for all AC control and RTD feedback for the standard temperature zones (6-Port Valve Oven, heated sample mount, heated analytical trap, sample transfer line heater and optional sample heater assembly for sparger glassware).

Figure 1-13 Multi-Channel Temperature Control Board

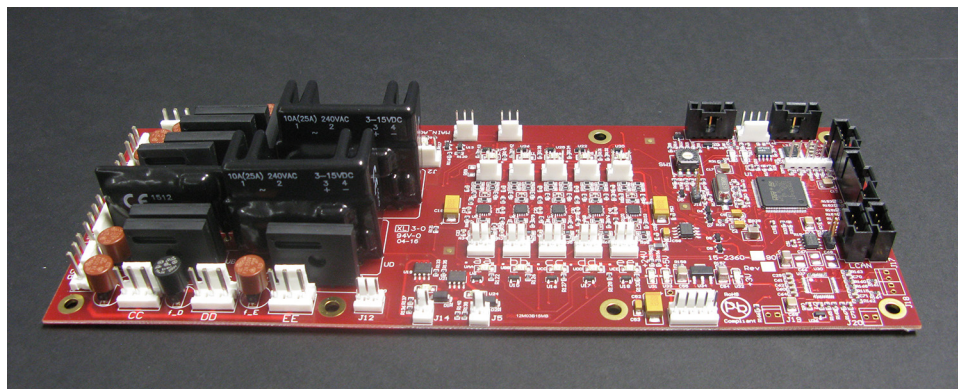
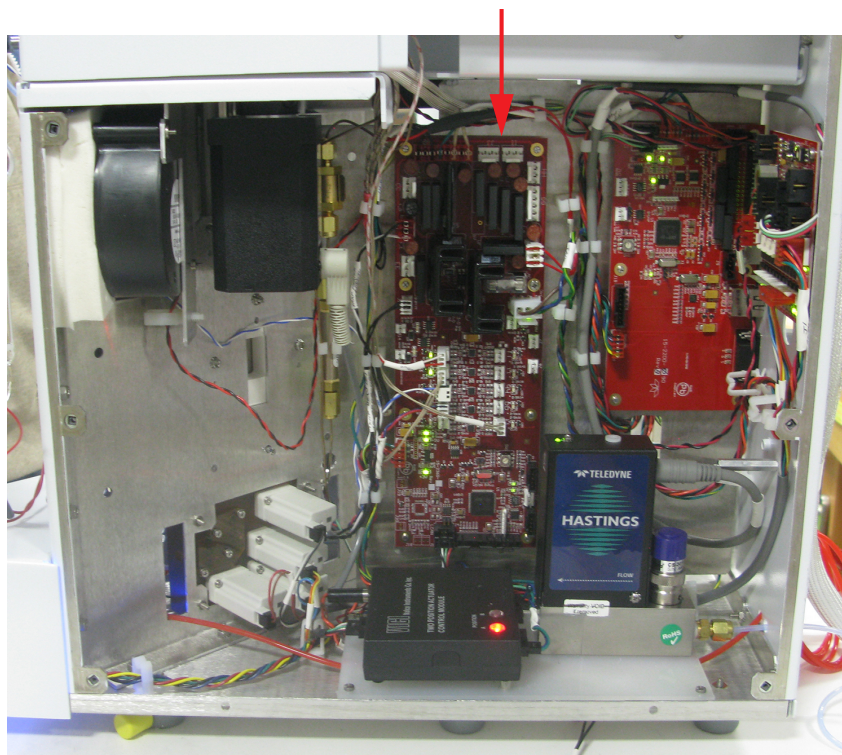

Figure 1-14 Multi-Channel Temperature Control Board

Multi-Channel Temperature Control Board



1.4.14 CPU Communication Board (Master Board)

The CPU Communication Board (Master Board) is located on the rear wall of the concentrator's right side. This board has a 25-pin, Sub-D connector for communications to the GC via GC I/O cable, USB Port for external communication to the controlling PC and interface for the AQUATek 100 autosampler.

Figure 1-15 CPU Communication Board (Master Board)

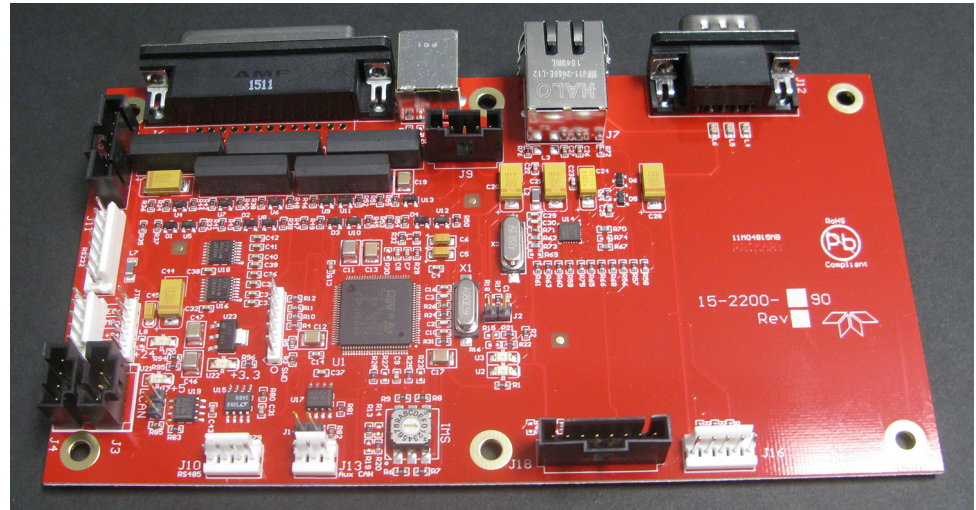
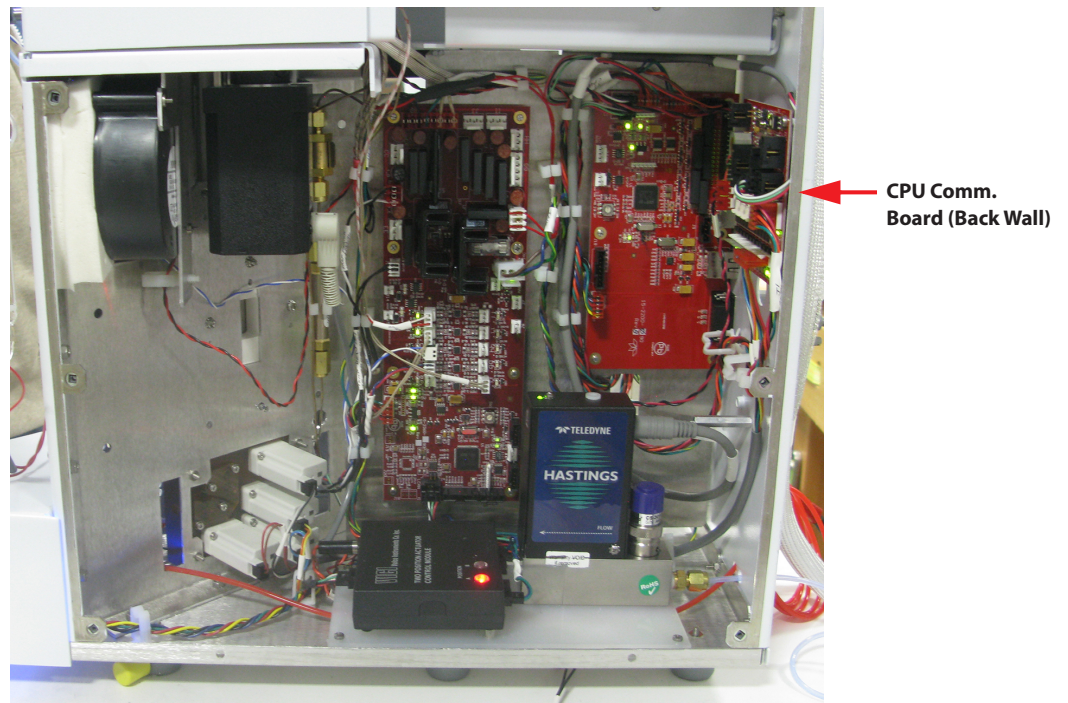

Figure 1-16 CPU Communication Board Location



1.4.15 DC Valve Control Board

The DC Valve Control Board is located in the right side of the concentrator. This board controls all DC valve outputs.

Figure 1-17 DC Valve Control Board

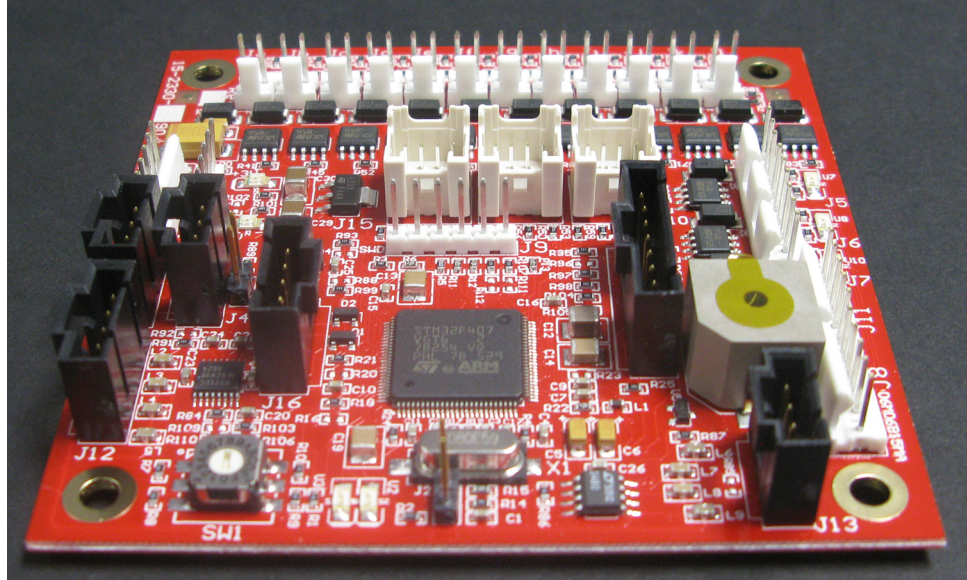
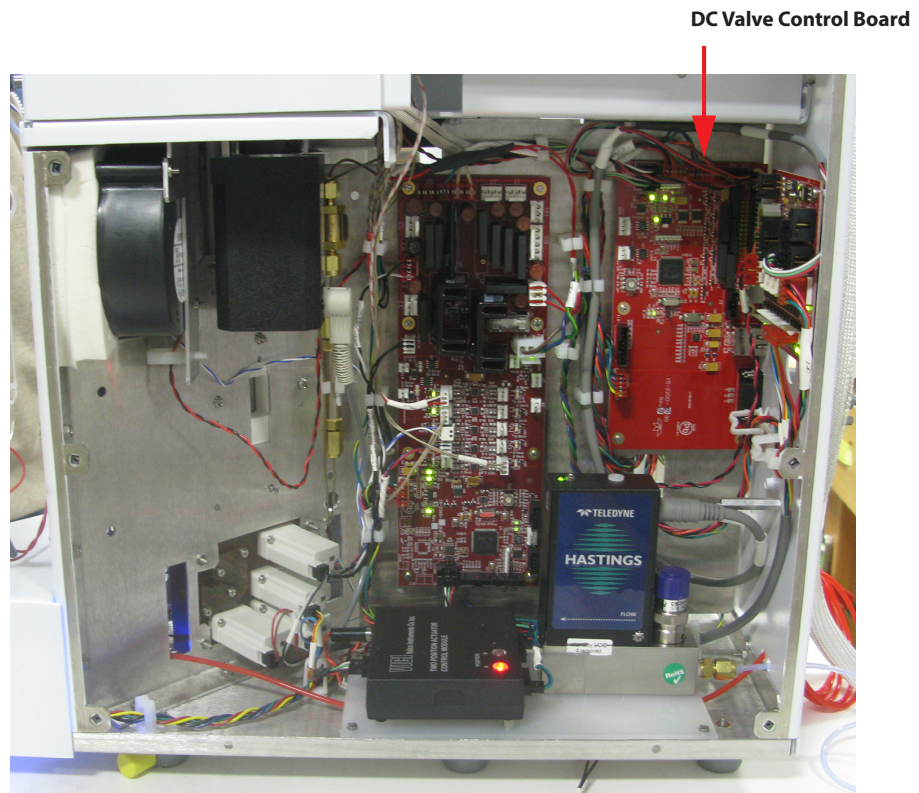

Figure 1-18 DC Valve Control Board Location



DC Valve Control Board

1.5 Optional Autosampler

For automated sample analysis, the Lumin was designed to be combined with the Teledyne Tekmar AQUATEk100 autosampler and can process up to 100 liquid samples without manual intervention. The AQUATEk 100 is a purge and trap autosampler that automates the sample preparation steps for the analysis of liquid samples utilizing a fixed volume sample loop filled using a pressurization gas. Two independent volume programmable internal standards are then added to the sample and the entire aliquot is transferred to the Lumin for compound concentration and subsequent separation and detection using a GC/GC-MS quantification system.

1.6 Optional Guardian™ Foam Sensor and Foam Eliminator

An optional foam sensing and eliminating system to safeguard the Lumin from the adverse effects of liquid entering the gas pathway. The Lumin can be equipped with only the foam sensor to trigger an alert or the sensor and eliminator to trigger an alert, remove the foam from the sample, and rerun.

Lumin User Manual

Chapter 2: Installation and Setup

2.1 Pre-Installation

2.1.1 Overview

This chapter contains information on:

- Pre-installation requirements including electric, gas and software/computer.
- Unpacking the concentrator and checking for shipping damage and/or missing items.
- Concentrator overview
- Installation procedures including gas, electrical, data, and GC connection.
- Optional accessories for the Lumin.



NOTE

Use the images in Section 2.4 "Concentrator Overview" to identify and locate the components on the instrument described in the installation procedures.

2.1.2 Operating Environment

The Lumin operates at temperatures between 10 °C and 30 °C (50 °F and 86 °F) with humidity levels between 10% and 90%. These temperatures and humidity levels are consistent with a standard lab environment and should pose no difficulty.



NOTE

To avoid material and/or component damage keep the concentrator away from corrosive substances.

2.1.3 Work Surface Requirements

The Lumin is 17.2" (43.7 cm) high, 8.9" (22.6 cm) wide, 18.7" (47.5 cm) deep, and weighs 27 lbs (12.2 kg).

Make sure the surface where you place the Lumin is capable of supporting the unit's weight, has a clear surface area with no shelves or overhanging obstruction, and allows the unit to sit firmly and evenly on the surface.



WARNING

To avoid the risk of fire and maintain optimum instrument performance, install the concentrator on a non-flammable surface and maintain a minimum 6" (15.24 cm) perimeter around the unit that is unobstructed by flammable material or other equipment.



WARNING

Ensure that the installation location allows the concentrator to be easily turned off and the power cord disconnected, in the event of an emergency.

2.1.4 Electrical Requirements

After selecting and clearing a location for the concentrator, check the availability of the required grounded outlets. The Lumin requires:

- 100-115 VAC +/- 5%, 50/60Hz, 10 amps, 1150 watts **or** 220-240 VAC +/- 5%, 50/60Hz, 5 amps, 1150 watts.
- One grounded, three-pronged receptacle for the main power cord.



WARNING

The circuit used to power the Lumin should be protected by a Certified/Listed 15/20 Circuit Breaker for short circuit protection.



NOTE

Additional accessories may also require one or more grounded outlets.

2.1.5 Gas Supply Requirements

The Lumin requires two independent gasflows:

1. Sample Purge Gas of Helium or Nitrogen
2. Carrier Gas supplied from the GC or carrier gas source.



NOTE

If you plan to use an autosampler, refer to the autosampler user manual for carrier gas connection instructions.

Ultra high-purity nitrogen or helium should be used as the sample purge gas. Verify that the following items are in compliance:

1. Nitrogen or helium purity must be 99.999%, and < 0.5 ppm hydrocarbon tested.
2. Gas pressure at the source must be high enough to:
 - Allow at least a 65 psi (4.48 bar) pressure drop at every flow or pressure regulator.
 - Travel the distance from the source to the concentrator.
 - Provide the required gas pressure at the concentrator. Operation of the Lumin requires helium or nitrogen at an incoming (supply) pressure of 65 - 100 psi (4.48 - 6.89 bar)

3. The diameter of the tubing that supplies the gas depends on the maximum pressure drop allowable for the configuration.
 - If the helium supply is close to the concentrator, use the pre-installed 1/8" blue tubing on the concentrator.
 - If the gas supply is a significant distance from the concentrator, a single source supplies several instruments, or a single source is subject to high demand for gas, you may want to reduce pressure by replacing the supply line from the gas source with 1/4" tubing:
4. Gas supply tubing lengths must be adequate. Be generous when cutting lengths of tubing for local supply lines. A relatively long coil of tubing between the supply and the Lumin allows you to move the instrument without disconnecting the plumbing. The system is supplied with 5' (0.91 m) of tubing. Additional tubing can be added to increase the length as needed.
5. It is essential that gas line fittings and regulators are the correct size and type. Consult your local gas supplier for type and size of cylinder valves, and then select compatible pressure regulators based on the required valves. Keep these considerations in mind:
 - Use good quality pressure regulators with stainless steel diaphragms. This reduces a high source pressure to that required by the concentrator.

**NOTE**

Teledyne Tekmar recommends using a single, two-stage regulator rather than two single-stage pressure regulators to meet the concentrator's pressure specifications.

- ON/OFF valves, while not essential, are very useful when mounted on the outlet fitting of a two-stage regulator.
- If pipe thread connections are required in your gas supply lines, seal them with instrument-grade PTFE tape.

**NOTE**

Always use instrument-grade PTFE tape to seal thread connections. Do not use pipe dope or lower grades of PTFE tape. Volatile materials in the dope and/or low grade tape will contaminate the tubing!

2.1.6 Minimum Computer Requirements

Connect the Lumin to a computer that meets or exceeds the specifications shown in Table 2-1 "Minimum Computer Requirements":

Table 2-1 Minimum Computer Requirements	
Component	Specification
Processor	300 MHz Pentium II (Or Equivalent)
Memory	512MB
Hard Drive Space	6.4MB
Display	VGA
Drive	4x CD-ROM
Operating System	PC Interface through Windows® 7 or higher. Windows® 10 is recommended.
Input Devices	Mouse
	Compatible speakers and sound system

2.1.7 Required Tools and Supplies for Installation

The following tools and supplies will be required for the installation of the Lumin:

- Tubing Cutters
- 3/8" Open-ended wrench (if changing the standard Vocab® 3000 trap)
- 7/16" Open-ended wrenches (2)
- 5/16" Open-ended wrenches (2)
- Waste container
- Ultra-Pure Helium or Nitrogen supply, regulated prior to the concentrator to 50 -100 psi (3.44 -6.89 bar)
- Carrier Gas Regulator if not connecting to regulated GC carrier gas supply.
- Luer Lock Gas Tight Syringes (5 or 25 mL)
- Gas Tight Syringes (10 µL)
- Volumetric Flasks
- Purge and Trap (P&T) Grade Methanol
- VOC Standards
- GC/IO Cable

2.2 Unpacking the Lumin

Unpack the Lumin, Lumin Installation Kit Box, optional components, and accessories, and inspect the contents against the packing list.



NOTE

Installation Kit Box parts and their location are identified on the diagram on the inside of the Installation Kit Box lid.

If there are any damaged or missing items contact Teledyne Tekmar customer service, using the information in Section P.2 "Teledyne Tekmar Customer Support Center", immediately. Claims for loss of a package or shipping damage should be promptly filed with the carrier.

2.3 Installation Kit Box

The Lumin is provided with an Installation Kit Box that contains parts for completing the concentrator installation. Throughout the installation procedure obtain parts from the Installation Kit Box when necessary.

Figure 2-1 Installation Kit Box Diagram

FLANGELESS NUT EXTENDER (14-7679-000) NUT EXTENDER INSTRUCTION SHEET (14-7679-074)		 TELEDYNE TEKMAR Everywheretheyoulook™ (800) 874-2004 (513) 229-7000 www.teledynetekmar.com		SEPTA, THERMLITE 7MM (14-8909-043)	P/N: 14-9800-233 Rev.D TOT Injection Assembly (14-9849-000)
Nut, 1/16", Short, Gold Plated (14-0243-116) Qty 2	Ferrule, 1/16", SS (14-0241-016) Qty 2	Nut, 1/16", Peek (14-7695-016)	Ferrule, 1/16", Peek (14-7671-016)	1/8", Brass Tee (12-0070-016)	1/8", Vespel Ferrule (15-0285-016)
	Washer, Teflon (14-7201-009)	Ferrule, 1/2" Set, Teflon (14-1301-016)	Union, 1/16 - 1/16 SS (14-0051-016)	Plug Nut, 1/4 - 28, Tefzel, Flat Bottom (14-8470-016)	Nut, Male Plug, 1/16", Zero Dead Volume, Gold Plated (14-1590-116)
	Fuse, 10A, 250V, 5 x 20mm (14-5180-034) Qty 2 (Only included with 115V systems)	Fuse, 5A, 250V, 5 x 20mm (14-5665-034) Qty 2 (Only included with 230V systems)	Cap Fuse, 2A (14-9432-034)	Cap Fuse, 3.15A (14-9433-034)	Cap Fuse, 5A, (14-9434-034)

2.4 Concentrator Overview

Figure 2-2 Front of Lumin

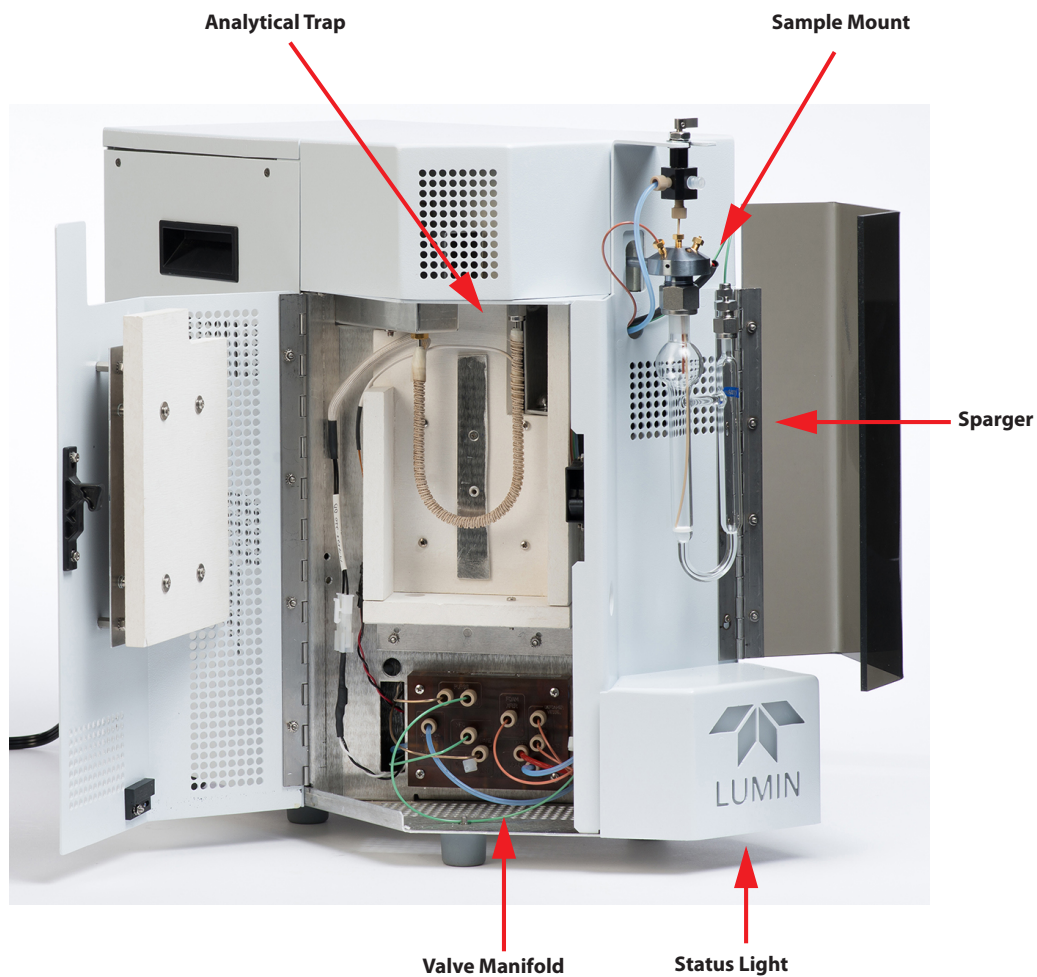

Figure 2-3 Back of Lumin

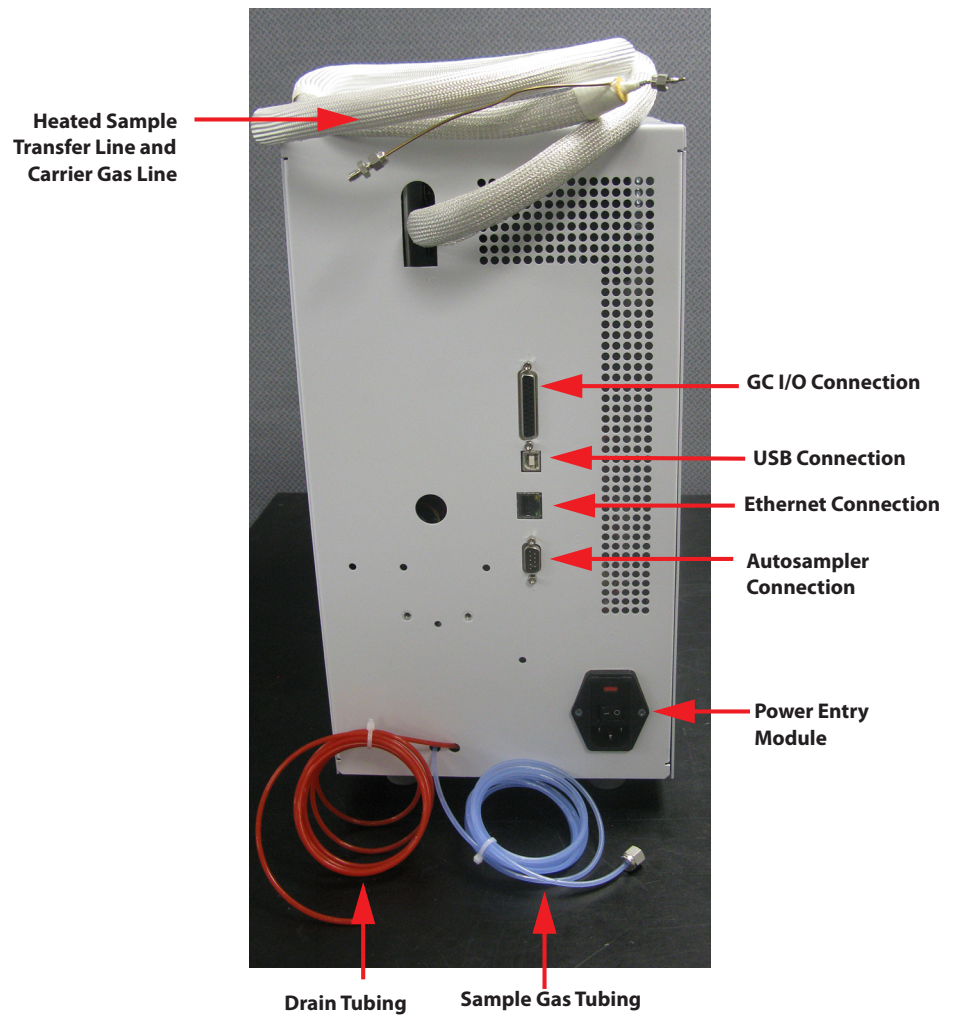
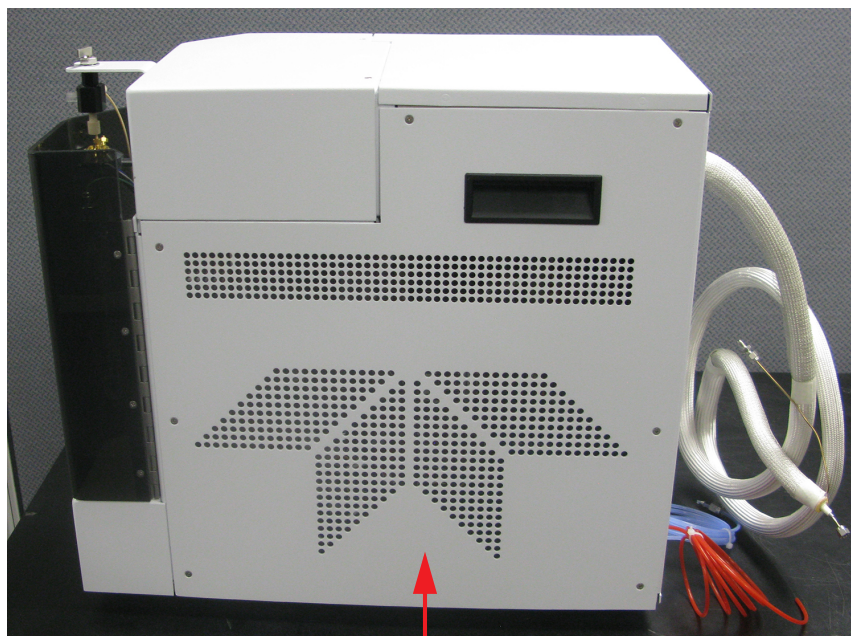
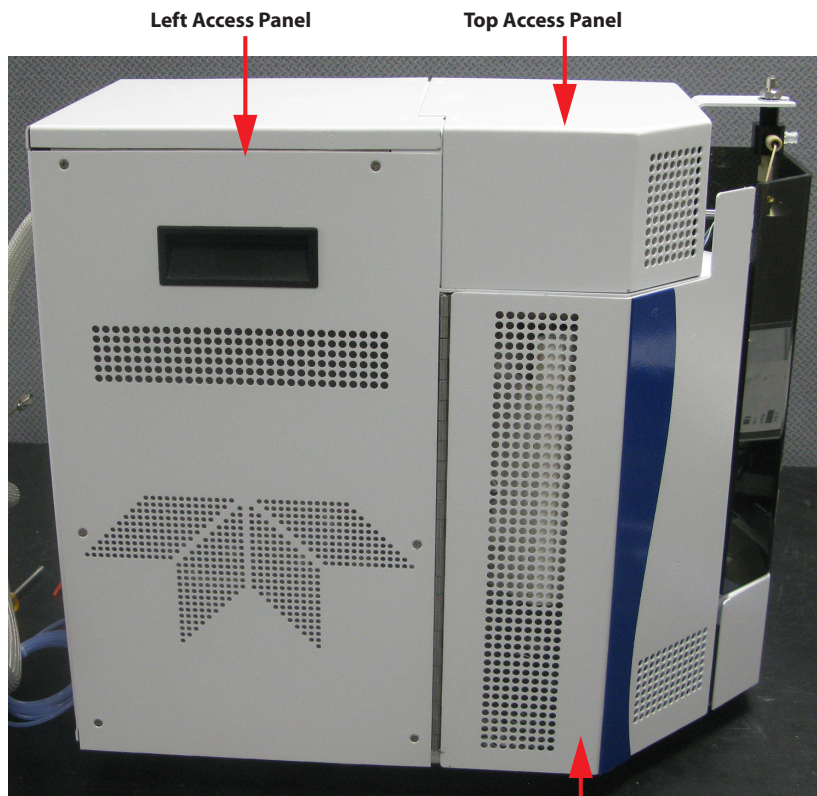

Figure 2-4 Right Side of Lumin



Right Access Panel

Figure 2-5 Left Side of the Lumin



Analytical Trap Access Door

2.5 Electrical and Data Connections

2.5.1 AC Power Cord



NOTE

For electrical requirements refer to Section 2.1.4 "Electrical Requirements".

1. Ensure the switch on the Power Entry Module (PEM) is in the OFF (O) position.
2. Plug the AC power cord into the PEM and connect it to a properly rated and grounded AC receptacle.



WARNING

The circuit used to power the Lumin should be protected by a Certified/Listed 15/20 Circuit Breaker for short circuit protection.



WARNING

Ensure the power cable is routed away from, and is not capable of contacting, any hot surface.

Figure 2-6 Lumin Power Entry Module



2.5.2 Connect the USB Interface Cable

The Lumin is connected to a controlling computer with Lumin TekLink installed using the supplied USB cable. Connect the cable to the USB port at the back of the Lumin to a USB port on the computer.



NOTE

If the Lumin is disconnected from the USB port on the controlling computer, and then reconnected to another USB port, USB drivers will need to be reinstalled and the USB connection reselected via Tools Screen>Configuration Dialog>General Tab.

Figure 2-7 Lumin USB Connection

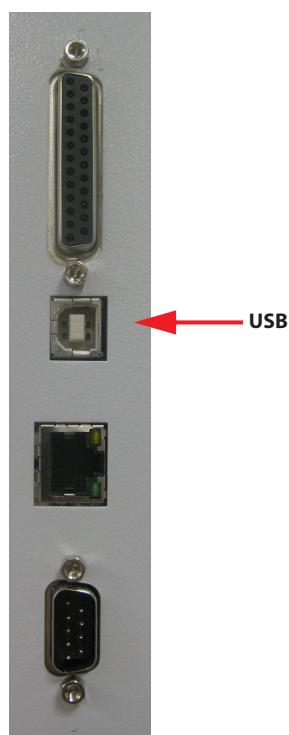

2.5.3 GC I/O (Input/Output) Connection



NOTE

Also refer to the Instruction Sheet provided with the GC I/O cable and the GC instructions for information on connecting the GC I/O cable to the gas chromatograph.

1. Connect the GC I/O cable to the GC I/O port on the back of the Lumin.
2. Once connected, communication to the GC should be configured via the TOOLS>CONFIGURATION SCREEN in Lumin TekLink. For information on configuring

Lumin TekLink for the GC, refer to Section 2.11 "Create an Instrument Profile".

2.6 Connecting the Lumin Sample Purge Gas Supply



NOTE

For sample gas requirements refer to Section 2.1.5 "Gas Supply Requirements".

Helium or nitrogen sample purge gas enters the back panel through the blue 1/8" tubing labeled "Sample Gas". The sample purge gas connected to the Lumin is used during Purge Mode to strip VOCs from the sample and deposit them on the analytical trap, and also during Bake Mode to clean the analytical trap between samples. Figure 2-8 shows the rear panel of the Lumin with the gas inlet for sample purge gas.

Sample purge gas is usually supplied through a tee union from the main GC carrier gas supply tank.

- Connect the 1/8" brass tee found in the Installation Kit Box to the carrier gas supply line and the GC as shown in Figure 2-2.
- Route and attach the blue sample gas line from the Lumin to the tee.



WARNING

Ensure the sample gas line is not within 10" of any heated components.

Figure 2-8 Rear of Lumin - Sample Purge Gas Connection



2.7 Lumin Carrier Gas and Sample Transfer Line Connection to the Gas Chromatograph (GC)

The Lumin makes two gas tubing connections to the Gas Chromatograph:

1. Carrier Gas Supply

Lumin carrier gas is supplied either from the regulated carrier gas flow of the GC or directly from the unregulated carrier gas supply.

2. Sample Transfer Line

After the Lumin has processed the sample, the carrier gas with sample returns to the GC via the sample transfer line. The sample transfer line is then connected to the GC injection port or directly to the GC column.



NOTE

How the connections are made can vary according to gas supply and GC manufacturer. Follow the procedures below according to your installation, as well as referring to the *GC User Manual*.

Procedure

In the standard installation configuration the GC supplies and controls carrier gas flow to the Lumin. The Lumin sample transfer line is then connected to the GC injection port. Follow the instructions below to connect the Lumin to the GC.

Figure 2-9 Connecting to the GC Carrier Gas

Standard Configuration: Direct Injection Port Interface GC Regulated Carrier Gas

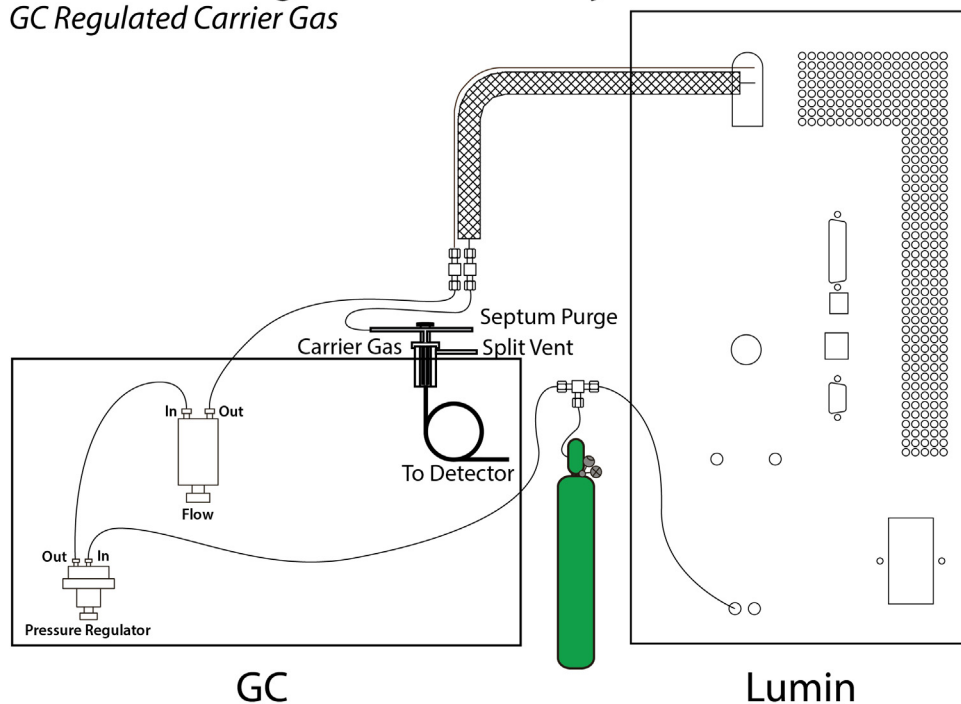

Warning! - Hot surface! Allow the injection port to cool prior to beginning work on the transfer line installation.

1. Route the GC carrier gas line and sample transfer line from the Lumin to the GC.



Ensure there is at least 10" of clearance between the heated jacket of the sample transfer line and any other object.

2. Select an injection port on the GC. It may be necessary to remove the covers around the injection port to expose the line that supplies the GC carrier gas.



NOTE

Some injection ports have multiple pieces of tubing connecting to the Injection Port. Do not cut any lines until you are certain that you know which line is the carrier gas inlet line.

3. Connect to the GC carrier gas inlet line between the GC control pneumatics and the GC injection port (approximately one inch from the injection port).
 - If a union connects tubing from the GC carrier gas inlet line to the GC injection port carrier gas inlet, disconnect the union. Install an additional 1/16" Swagelok® union so that both lines can connect to the Lumin.
 - If there is no union, cut the line and install a 1/16" Swagelok® union from the Installation Kit Box on each tubing lines.
4. Connect the Lumin carrier gas line to the 1/16" Swagelok® union on the GC injection port carrier gas inlet line coming from the GC control pneumatics.
5. Connect the tubing going to the injection port inlet to the Lumin Sample Transfer Line.

2.8 Routing the Drain Tubing

Route the red drain tubing to a waste bottle of suitable size and construction. Make sure the drain tubing is not crimped or blocked in any way and that the waste container is lower than the concentrator.

2.9 Install Lumin TekLink Software



NOTE

For computer requirements refer to Section 2.1.6 "Minimum Computer Requirements".

1. Ensure the controlling computer is connected to the Lumin with the supplied USB cable.
2. Power on the concentrator and the controlling computer.
3. Insert the Lumin TekLink Software Installation CD into the controlling computer's disc drive. The LUMIN TEKLINK INSTALLATION MENU will be displayed.
4. Highlight INSTALL LUMIN TEKLINK from the installation menu and then select the INSTALL BUTTON.
5. The Lumin TekLink software installation wizard will begin. Follow the prompts to complete the software installation.

Figure 2-10 Lumin TekLink Installation Wizard

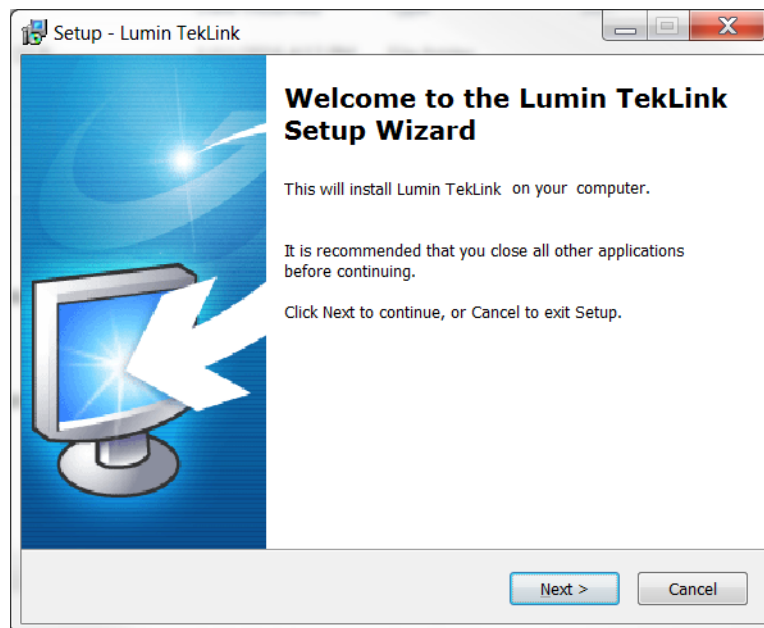

NOTE

If a "Install Microsoft SQL" notification message is displayed, install Microsoft® SQL Server according to Section 2.9.1 "Microsoft® SQL Server Installation" prior to installing Lumin TekLink.

Figure 2-11 Microsoft® SQL Server Installation Notification Message

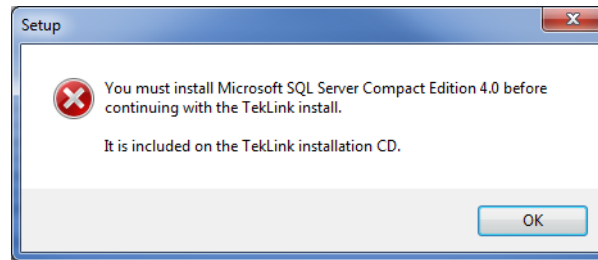

If a .NET setup error is displayed, install the .NET Framework for x86 Architecture according to Section 2.9.2 ".Net Installation".

Figure 2-12 .NET Setup Installation Notification Message

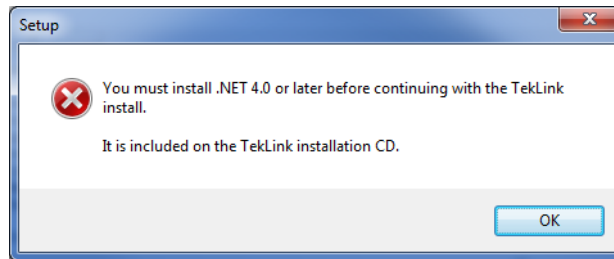

Follow the installation prompts to the completion of the Lumin TekLink software installation.

2.9.1 Microsoft® SQL Server Installation

Microsoft® SQL Server must be installed for Lumin TekLink to function properly. To install the Microsoft SQL Server:

1. If necessary, return to the Lumin TekLink SOFTWARE INSTALLATION MENU.
2. Highlight MICROSOFT SQL SERVER in the installation menu.



Microsoft® SQL Server can be installed as a 32-bit or 64-bit version. Install the version appropriate for your installation of Windows®. To find out what version of Windows® is installed, select the Windows® Start icon, then right-click Computer, and then select Properties. The version will be listed under "System Type".

3. Click the INSTALL BUTTON and follow the prompts through the installation.
4. Return to the Lumin TekLink SOFTWARE INSTALLATION MENU and install Lumin TekLink.

Figure 2-13 Microsoft SQL Server Installation Wizard

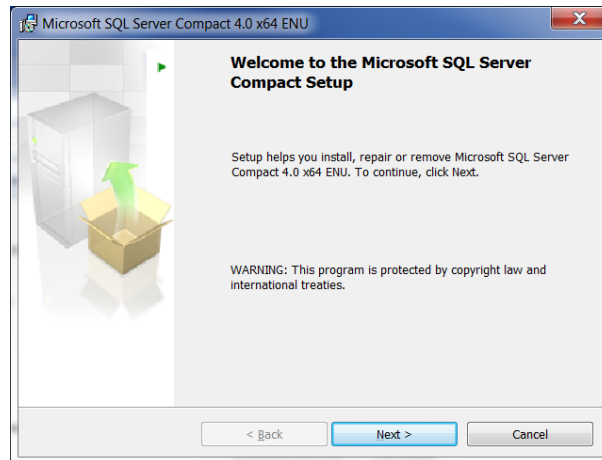

2.9.2 .Net Installation

.NET Framework for x86 architecture must be installed for Lumin TekLink to function properly. To install the .NET Framework:

1. If necessary, return to the Lumin TekLink SOFTWARE INSTALLATION MENU.
2. Highlight .NET FRAMEWORK FOR X86 ARCHITECTURE in the installation menu.
3. Click the INSTALL BUTTON and follow the prompts through the installation.
4. Return to the Lumin TekLink SOFTWARE INSTALLATION MENU and install Lumin TekLink.

2.10 USB Driver Installation

USB drivers must be installed to allow the controlling computer to communicate with the Lumin concentrator. Follow the procedures below to install the drivers:

Windows 7

1. Navigate to START BUTTON>CONTROL PANEL>HARDWARE & SOUND>DEVICES & PRINTERS on the controlling computer. Double-click the LUMIN MAIN icon.
2. Choose the HARDWARE TAB. Then click on PROPERTIES.
3. Click UPDATE DRIVER, and select Browse my computer for driver software. BROWSE TO THE INSTALL CD, then select the NEXT BUTTON.
4. A Windows® security screen will appear. Choose INSTALL THIS DRIVER SOFTWARE ANYWAY. The driver software will begin installing.
5. Once the drivers are installed successfully, close out of all windows and cycle the Lumin off then on. Lumin TekLink should now show a connection to the Lumin concentrator on the INSTRUMENT STATUS PANEL.



NOTE

If the Lumin is replaced or a second Lumin added, the USB connection will need to be reselected via Tools Screen>Configuration Dialog>General Tab.

**NOTE**

If the Lumin is disconnected from the USB port on the controlling computer, and then reconnected to another USB port, USB drivers will need to be reinstalled and the USB connection reselected via Tools Screen>Configuration Dialog>General Tab.

2.11 Create an Instrument Profile

Once the Lumin TekLink software has been installed and its connection to the Lumin concentrator confirmed, an instrument profile will need to be created. Follow the procedures below:

**NOTE**

All methods, schedules, TekLink software configurations and software settings are profile specific.

1. When Lumin TekLink is first opened, a NO DEFAULT INSTRUMENT CONFIGURED NOTIFICATION MESSAGE will be displayed. Clicking the OK BUTTON of the notification will display the CONFIGURATION DIALOG to create a new instrument profile. Once selections have been made on the General, Options, and Leak Check Tabs of the Configuration Dialog, select the OK Button to create the instrument profile.
2. On the GENERAL TAB:
 - Enter a name for the instrument.

**NOTE**

If your lab has multiple Lumin, use the name and description to differentiate one concentrator from another. This will assist when defining system properties for email alerts, archive settings, and remote connection settings.

- Enter a description so the instrument is easily identified.
- Select the MODEL from the MODEL DROP-DOWN MENU (LUMIN or LUMIN/AQUATEK 100).

Figure 2-14 Creating an Instrument Profile

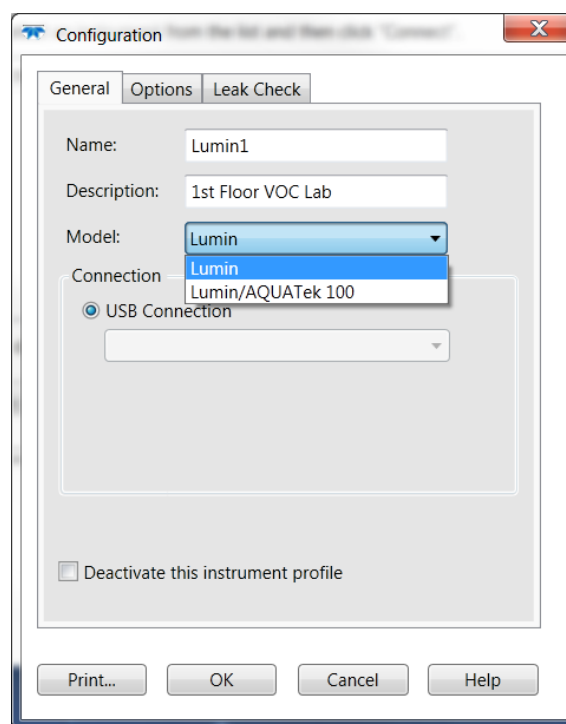

- Select the default USB CONNECTION check-box, then choose the available USB connection from the drop-down menu.



NOTE

If no USB connections are shown in the drop-down menu, USB drivers have not been installed. Refer to Section 2.10 "USB Driver Installation".

- Select the OK BUTTON to save the instrument profile.
3. On the OPTIONS TAB:
- If you would like the concentrator to make an audible noise to notify of errors ENABLE BEEPER.
 - Select ENABLE SAMPLE ID COLUMN IN SCHEDULES to add a SAMPLE ID column to the SAMPLE SCHEDULE TABLE.
 - If the configuration includes an AQUATEk 100 autosampler equipped with a PH probe, select the pH PROBE CHECK-BOX.
 - If an optional Guardian™ Foam Sensor and/or Eliminator is installed, select ENABLE GUARDIAN FOAM SENSOR. Choose the configuration and action from the drop-down menu.
 - Select the appropriate PURGE GAS from the PURGE GAS DROP-DOWN MENU.
 - Select the CHROMATOGRAPH (GC TYPE) from the GC MODEL DROP-DOWN MENU. If the specific model of the GC is not shown in the drop-down menu, use the STANDARD TYPE:63 or USER TYPE:31 check-box according to the GC I/O cable instruction sheet or GC manufacturer's instructions.

Figure 2-15 Options Tab

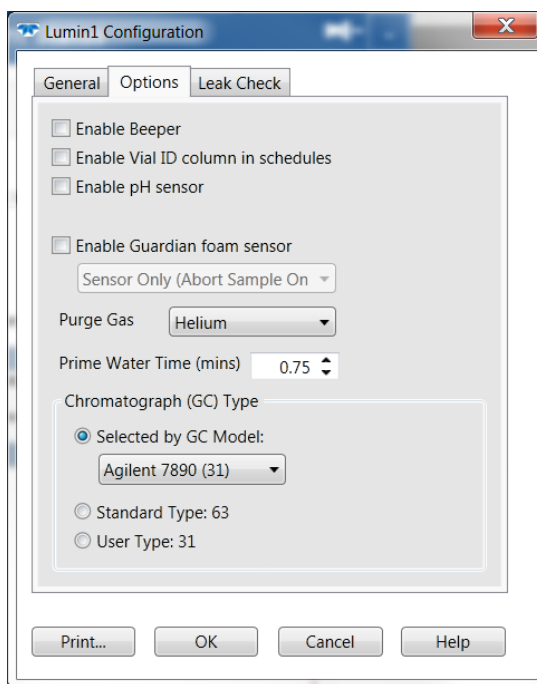

4. On the LEAK CHECK TAB:

- Customize LEAK CHECK PRESSURIZE TIME, LEAK CHECK FLOW pressure settings, and LEAK CHECK DELTA (amount of change in pressurization that indicates a leak).

Figure 2-16 Leak Check Tab

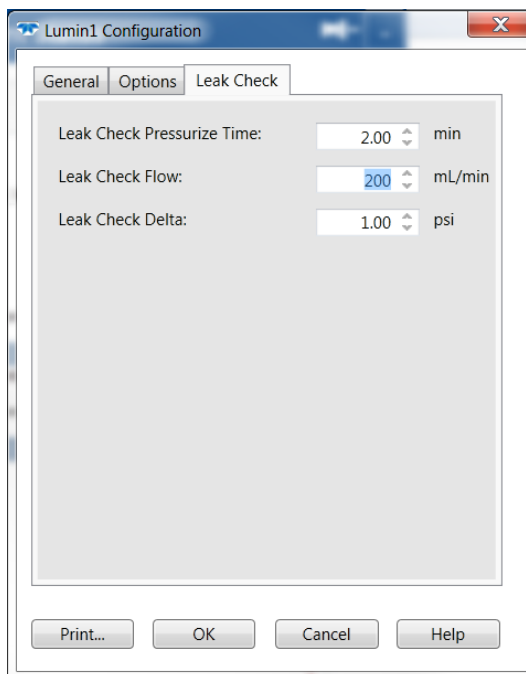

- Select the OK BUTTON to create the instrument profile. Lumin TekLink will automatically connect to the new profile, and the INSTRUMENT STATUS PANEL, METHODS SCREEN and SCHEDULES SCREEN will display the connected instrument profile name.

Once a profile is created, methods, schedules, system properties, and preferences can be saved to that profile when it is connected.



Once an instrument profile has been created it cannot be deleted. "Deactivating" an instrument profile removes the instrument profile from the list of active profiles in the Instrument Manager Dialog. For information on deactivating an instrument profile, refer to 3.9 "Deactivate an Instrument Profile".

- If the instrument profile will be the default profile, set the instrument profile as the default profile via TOOLS>INSTRUMENT MANAGER>DEFAULT RADIO BUTTON.

Figure 2-17 Instrument Manager - Profile Set to Default

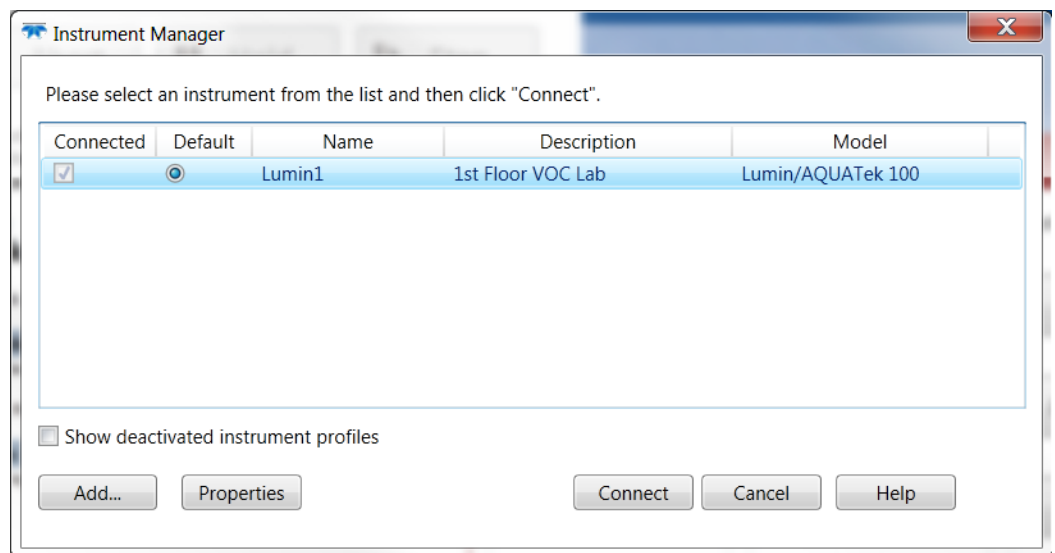

2.12 Autosampler Setup and Connection



NOTE

If the configuration includes an AQUATek 100 autosampler, ensure that the “Model” is set to “Lumin/AQUATek 100” in the Instrument Configuration Dialog’s General Tab.

2.12.1 Communication Cable Connection

The Lumin will control the AQUATek 100 autosampler via a 9-pin autosampler communication cable. Refer to the AQUATek 100 Autosampler *User Manual* for installation information.



NOTE

All other autosamplers are treated as external systems, which are not supported in the Lumin TekLink and must be controlled via their own external software.

2.12.2 Aqueous Transfer Line Installation



NOTE

Refer to the appropriate Autosampler User Manual for identification of the aqueous transfer line that connects to the Lumin’s sample mount.

Connect the aqueous transfer line from the autosampler to the tubing access point into the Lumin’s sample mount (Figure 2-18).

1. Remove the plug nut from the aqueous transfer line access point on the right side of the sample mount.
2. Locate the 1/16” (.016 cm) (o.d.) Valco nut and ferrule in the Installation Kit box.
3. Pass the aqueous transfer line through the nut and then the ferrule.
4. Insert the tubing and ferrule into the access point in the Lumin sample mount and then tighten.

Figure 2-18 Aqueous Transfer Line Access Point

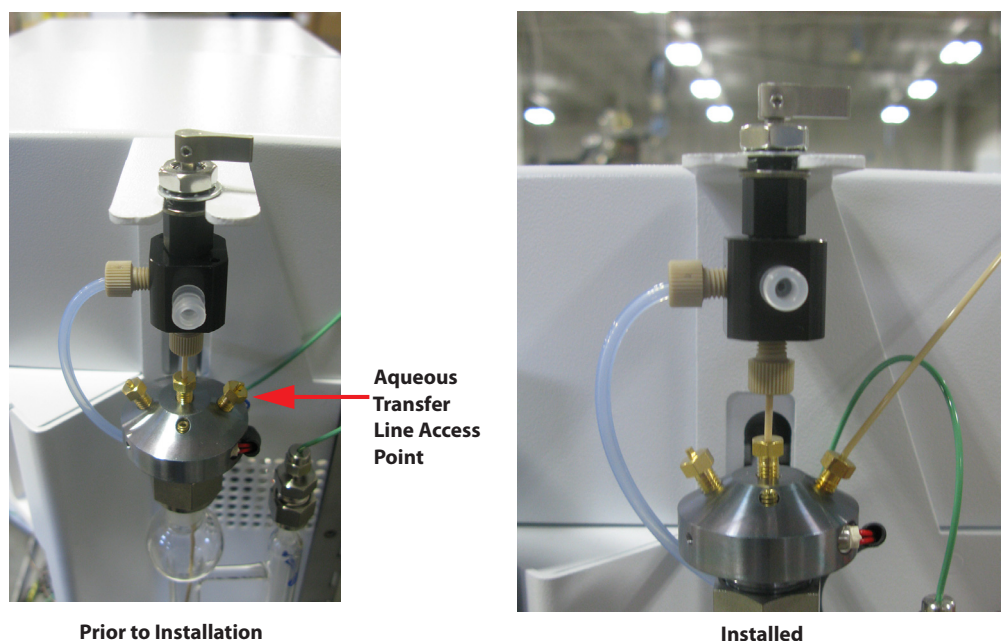

2.12.3 Autosampler Method Configuration

Method parameters for the AQUATEk 100 autosampler are configured on the AQUATEK 100 TAB of the Lumin TekLink METHODS SCREEN. For more information refer to Section 3.4.5 "AQUATEk 100 Tab".

2.13 Guardian™ Foam Sensor and Foam Eliminator (Optional)

The Guardian™ Foam Sensor and Foam Eliminator are designed to safeguard the Lumin from the adverse effects of liquid entering the gas pathway. The foam sensor uses a photo sensor mounted on the outside of the sparger to detect the presence of foam in the neck of the sparger. Upon detection, the foam sensor immediately stops the purge gas flow and contains the foaming sample in the sparger before it reaches the Lumin's gas pathway. When combined with the optional foam eliminator, a defoamer is added to the sample.

If ordered with the Lumin, the Guardian™ Foam Sensor and/or Foam Eliminator will be installed. To retrofit a Lumin with the Guardian™ Foam Sensor and/or Foam Eliminator refer to the installation instruction sheet included with the Guardian™ Foam Sensor and Foam Eliminator.

Guardian™ Foam Sensor and the Eliminator actions vary according to the concentrator configuration (with or without autosampler), installation of the foam sensor with or without foam eliminator, and sensor/eliminator settings in TOOLS>CONFIGURATION>OPTIONS TAB.

Lumin with Guardian™ Foam Sensor

1. When foam is sensed, the Lumin shuts off the purge gas and drains the sample.
2. YES will be displayed in the FOAM COLUMN of the sample schedule, and the event will be recorded in the SAMPLE HISTORY LOG (TOOLS>VIEW HISTORY LOG>SAMPLE HISTORY TAB).

Lumin With Guardian™ Foam Sensor and Foam Eliminator

1. When foam is sensed, the Lumin shuts off the purge gas. The purge clock is stopped and the Foam Transfer Valve is activated to add a defoaming agent.
2. The purge gas and purge clock are reactivated. If the sensor does not trip again, the Lumin will proceed with the sequence.
3. If the sensor is tripped a second time, the defoaming procedure is repeated.
4. If the sensor is tripped a third time, YES will be displayed in the FOAM COLUMN of the sample schedule and the event recorded in the SAMPLE HISTORY LOG (TOOLS>VIEW HISTORY LOG>SAMPLE HISTORY TAB).

Lumin and AQUATek 100 Autosampler with Guardian™ Foam Sensor

1. When foam is sensed, the Lumin shuts off the purge gas and aborts the sample.
2. If ABORT SAMPLE is selected in the TOOLS>CONFIGURATION>OPTIONS TAB:
 - The sample will be aborted. The Lumin will report that there was a foaming sample. ABORTED will be displayed in the STATUS COLUMN, and YES will be displayed in the FOAM COLUMN beside the sample that foamed.
 - Once drained, the Lumin steps to the Desorb Preheat Mode to keep the GC sequence correct.
 - The next line of the sample schedule will be run.
3. If ABORT SCHEDULE is selected in TOOLS>CONFIGURATION>OPTIONS TAB:
 - The Lumin will go into Abort Mode and perform a system cleanup.
 - ABORTED will be displayed in the STATUS COLUMN of the foaming sample and all pending samples. YES will be displayed in the FOAM COLUMN beside the ONE sample that did foam.

Lumin and AQUATek 100 Autosampler with Guardian™ Foam Sensor and Foam Eliminator

1. When foam is sensed, the Lumin shuts off the purge gas. The purge clock is stopped and the Foam Transfer Valve is activated to add a defoaming agent.
2. The purge gas and purge clock are reactivated. If the sensor does not trip again, the Lumin will proceed with the sequence.
3. If the sensor is tripped a second time, the defoaming procedure is repeated.
4. If the sensor is tripped a third time, the system gives an error that is written to the SAMPLE HISTORY LOG (TOOLS>VIEW HISTORY LOG>SAMPLE HISTORY TAB).
5. If ABORT SAMPLE is selected in the TOOLS>CONFIGURATION>OPTIONS TAB:
 - The sample will be aborted. The Lumin will go to Desorb Preheat Mode to keep the GC schedule correct. ABORTED will be displayed in the STATUS COLUMN and YES in the sample's FOAM COLUMN.
 - The schedule will continue with the next sample.
6. If ABORT SCHEDULE is selected in TOOLS>CONFIGURATION>OPTIONS TAB:
 - The current sample and all remaining samples in the schedule will be aborted. The Lumin will report that there was a foaming sample. ABORTED will be displayed in the STATUS COLUMN of the foaming sample and all pending samples. YES will be displayed in the FOAM COLUMN beside the ONE sample that did foam.

2.13.1 Configuring the Guardian™ Foam Sensor & Eliminator

To activate and configure the Guardian™ Foam Sensor and Foam Eliminator:

1. Navigate to TOOLS>CONFIGURATION>OPTIONS TAB.
2. Select the check-box beside ENABLE GUARDIAN FOAM SENSOR.
3. Use the drop-down menu to configure the Guardian™ Foam Sensor and Eliminator actions.

Figure 2-19 Configuration Dialog- Guardian™ Foam Sensor

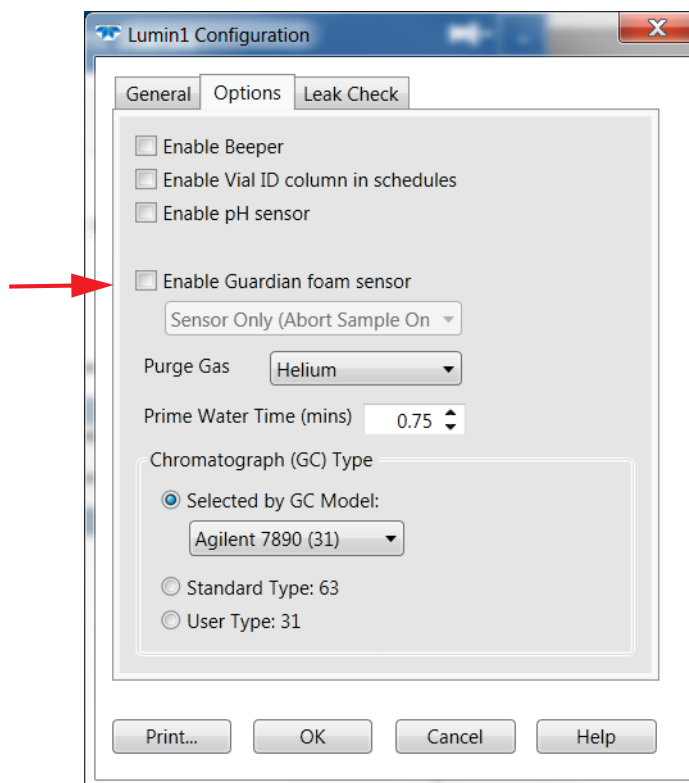

Lumin User Manual

Chapter 3: Lumin TekLink Software Overview



NOTE

For Lumin TekLink computer requirements refer to Section 2.1.6 "Minimum Computer Requirements". For information on installing Lumin TekLink refer to Section 2.9 "Install Lumin TekLink Software".

3.1 About Lumin TekLink Software

Lumin Teklink is a software user interface designed for the following functions:

- Define custom methods or operating sequences that meet analytical requirements by defining Standby, Purge, Desorb and Bake parameters.
- Build multi-sample schedules when using an autosampler.
- Load (Start), Hold and Abort a sample schedule.



NOTE

When a schedule is "loaded" the concentrator will immediately begin heating temperature controlled zones to method parameters. Once set-points are attained, it will automatically begin running the schedule.

- Troubleshoot and perform diagnostics on the concentrator using advanced diagnostics.

3.2 The Lumin TekLink Software Environment

Lumin TekLink software is designed for convenient monitoring of the concentrator while it is running. The sections below detail the primary user features of the software.

3.2.1 Touchscreen Capability

Lumin TekLink software is designed to be used with touchscreen computers. All screens have active hot-spots, check-box selections or drop-down menus. An optional on-screen alpha-numeric keyboard can be enabled via **TOOLS>SYSTEM PROPERTIES>MISC TAB**.

Figure 3-1 On-Screen Keyboard



3.2.2 “Pinnable” Screens

All screens can be “pinned” so that they remain in view when the HOME SCREEN is reduced. Use the pin in the upper right-hand corner of the screen to “pin” and “unpin” each screen.

- When the pin is horizontal, the screen will be reduced from view when the home screen is reduced.
- When the pin is vertical the screen will remain visible when the HOME SCREEN is reduced. The screen can still be reduced using the REDUCE SCREEN BUTTON.

Figure 3-2 Pin Function



3.2.3 Title Bar

The title bar of the METHODS and SCHEDULES SCREEN displays information on the active Instrument Profile, and the Active Schedule or Method (according to screen).

Figure 3-3 Schedules Screen Title Bar

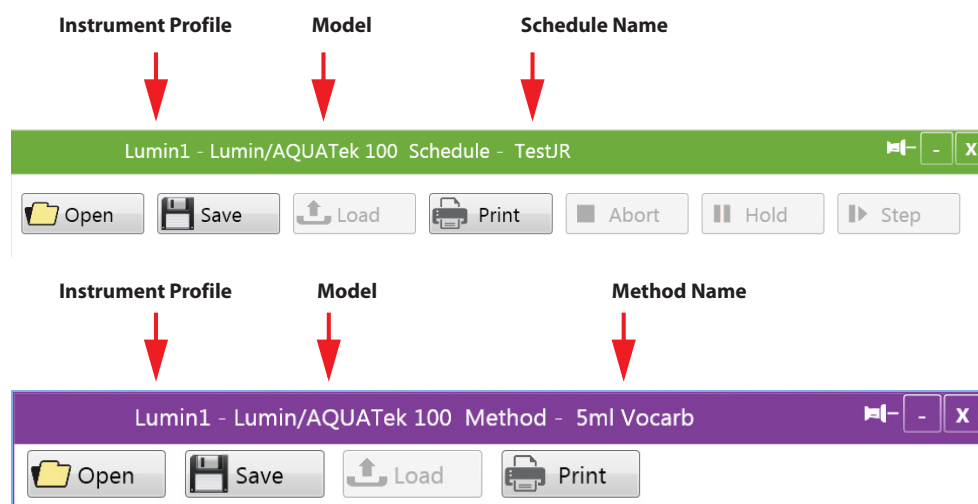

3.2.4 Open, Save, Load, and Print Buttons

Figure 3-4 Open, Save, Load, and Print Buttons



- **OPEN BUTTON** - Opens a previously saved method or schedule. The OPEN METHOD/SCHEDULE DIALOG shows saved methods and schedules by name and last modified date. To open a method or schedule that has been archived, select the Archive from the SOURCE DROP-DOWN in the OPEN METHOD/SCHEDULE DIALOG. Multiple methods may be opened for comparison.



Methods and schedules are saved according to instrument profile and will not be available under a different instrument profile from which they were created/saved.

- **SAVE BUTTON** - Save the currently open method or schedule.



Lumin TekLink includes default methods that cannot be over-written.

- **LOAD BUTTON** - Load the currently open method or schedule to the concentrator.

When a method is loaded, the concentrator will begin heating to temperature set-points as defined in the method. Once temperature set-points are achieved, the schedule will begin to run.

- PRINT BUTTON - Print the currently open method or schedule.

3.2.5 Instrument Control Buttons

The INSTRUMENT STATUS PANEL and the SCHEDULES SCREEN have control buttons that are used to ABORT or HOLD a schedule, or STEP through concentrator modes.

Figure 3-5 Control Buttons



3.2.6 Delete at Next Archive Check-Box

The DELETE AT NEXT ARCHIVE CHECK-BOX is available on both the METHODS and SCHEDULES SCREENS. When selected, the method or schedule will be deleted from the list of CURRENT methods or schedules in the OPEN METHOD/SCHEDULE DIALOGS and saved to the “archive” location.

Figure 3-6 Delete at Next Archive Check-Box - Schedule Screen

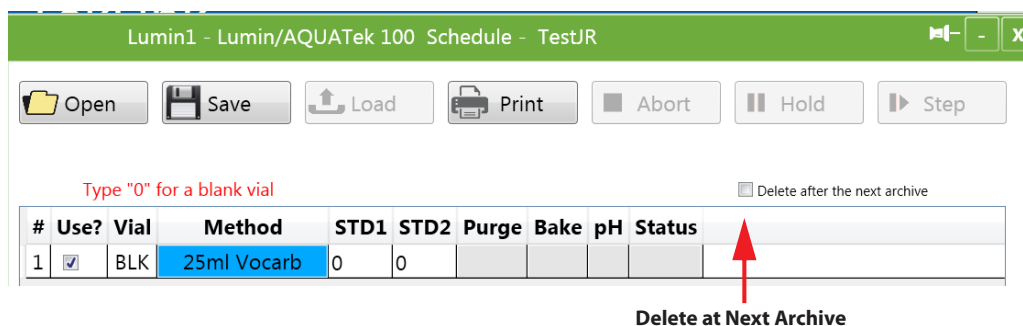

Once archived, the method or schedule can then be viewed by selecting ARCHIVE in the OPEN SCHEDULE DIALOG’S SOURCE DROP-DOWN MENU (Figure 3-7).



Archive settings and the Archive Now command are located under Tools>System Properties>Data Tab.

Figure 3-7 Open Dialog Source Drop-down Menu

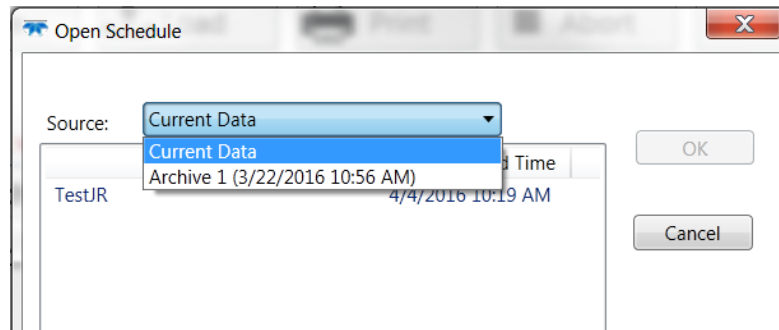

3.3 Primary Screens

3.3.1 The Home Screen

The HOME SCREEN contains buttons to navigate to TekLink’s three primary screens and the Lumin TekLink Help:

- METHODS SCREEN - used for defining Standby, Purge, Desorb and Bake method parameters as well as opening, saving, loading, and printing methods.
- SCHEDULES SCREEN- used for creating and saving new sample schedules, opening previously created schedules, and printing an open schedule. Schedules are then loaded from the SCHEDULES SCREEN to the concentrator and the sample run begun.
- TOOLS SCREEN - used for direct control of the concentrator’s functions for troubleshooting and diagnostics, contains software configuration options and settings, and sample, instrument, and error logs.
- HELP - Lumin TekLink Help is context sensitive and provides information on the software and instrument functionality.

Figure 3-8 Home Screen

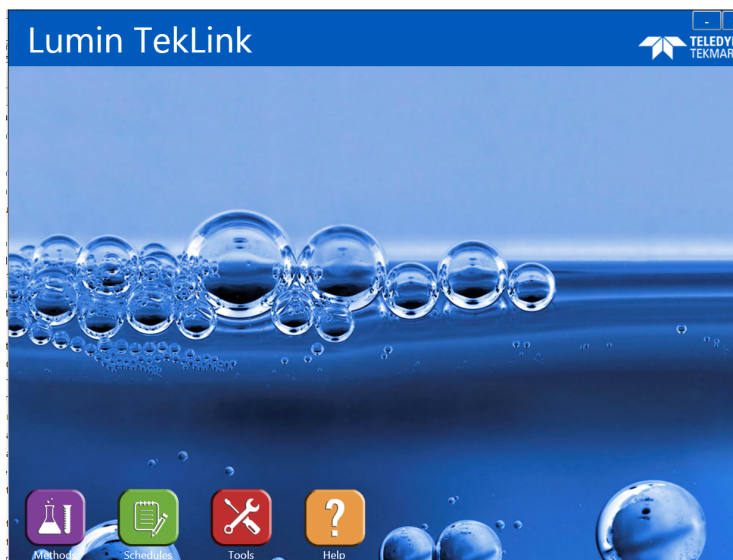

3.3.2 Instrument Status Panel

The INSTRUMENT STATUS PANEL contains information related to the activities of the concentrator including the schedule that is running, the current method, the current position in the schedule being run, as well as the mode and time remaining. Similar to the SCHEDULES SCREEN, control buttons can be used to ABORT or HOLD a schedule or STEP through concentrator modes.

Figure 3-9 Instrument Status Panel

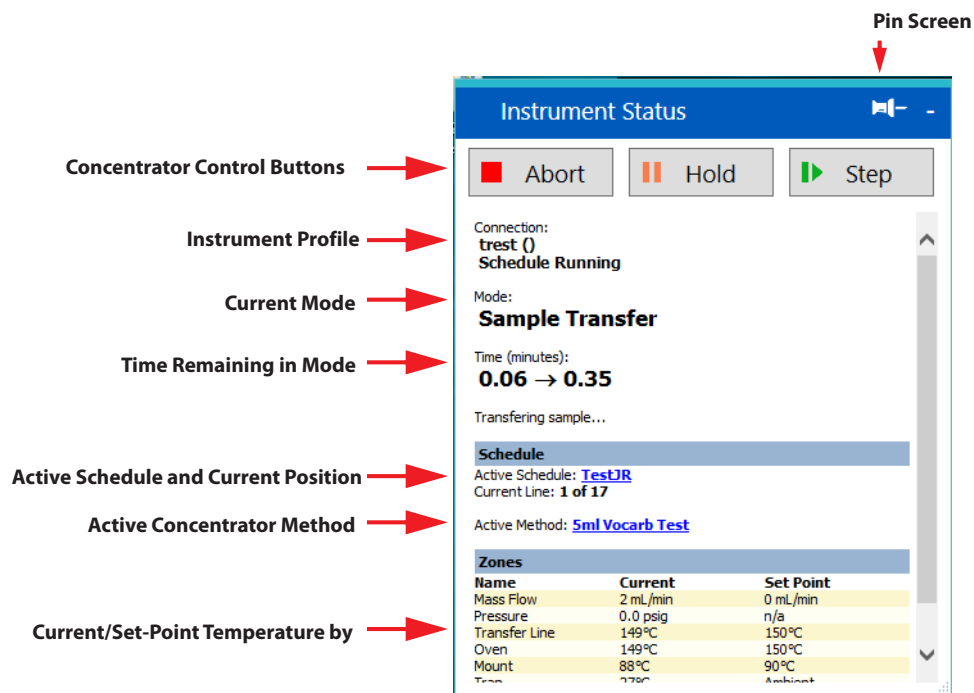

NOTE

Right-clicking on the Zones Panel of the Instrument Status Screen will show additional display options.

Figure 3-10 Instrument Status Zone Display Options

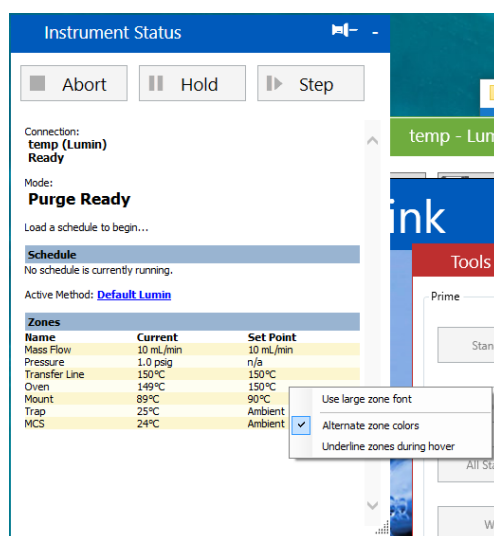

3.4 Methods Screen

The METHODS SCREEN contains STANDBY, PURGE, DESORB and BAKE TABS for defining method parameters.



NOTE

Also refer to 4.4.13 "Analytical Trap Recommended Operating Conditions".



NOTE

Multiple Methods Screens can be opened for comparison of one method to another.

3.4.1 Standby Tab

The STANDBY TAB is used to set the concentrator's standby temperatures and flows:

- VALVE OVEN TEMP

The temperature set-point for the 6-port valve. The temperature should be high enough to prevent cross-contamination, but not so high as to decompose analytes.

- TRANSFER LINE TEMP

The temperature set-point for the sample transfer line. The temperature should be high enough to prevent cross-contamination or carry-over, but not so high as to decompose analytes.

- SAMPLE MOUNT TEMP

The temperature set-point for the sample mount heater. The sample mount heater eliminates cold spots in the sample path that could lead to analyte adsorption, carryover and reduced sensitivity.

- **STANDBY FLOW**
The amount of carrier gas flow sweeping the sample pathway while the concentrator is idle.
- **PURGE READY TEMP**
The temperature set-point for the analytical trap that must be reached before stepping to Purge Mode. Set approximately 10-20 degrees higher than ambient air temperature to decrease cycle time.
- **MOISTURE CONTROL SYSTEM (MCS) PURGE TEMP**
The standby and purge temperature set-point for the MCS. 20 °C is the recommended set-point temperature ensuring that the heater remains off during Purge Mode to reduce the moisture transfer to the analytical trap.

Figure 3-11 Methods Screen - Standby Tab

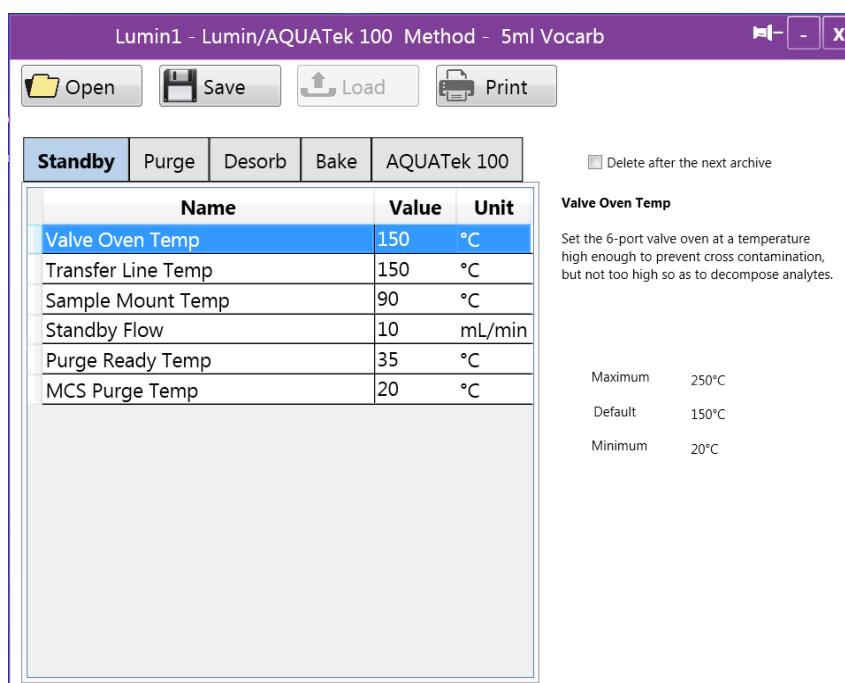

Lumin1 - Lumin/AQUATek 100 Method - 5ml Vocarb

Open Save Load Print

Standby Purge Desorb Bake AQUATek 100 Delete after the next archive

Name	Value	Unit
Valve Oven Temp	150	°C
Transfer Line Temp	150	°C
Sample Mount Temp	90	°C
Standby Flow	10	mL/min
Purge Ready Temp	35	°C
MCS Purge Temp	20	°C

Valve Oven Temp
Set the 6-port valve oven at a temperature high enough to prevent cross contamination, but not too high so as to decompose analytes.

Maximum 250°C
Default 150°C
Minimum 20°C

3.4.2 Purge Tab

The PURGE TAB is used to define the time, flow and temperature of the Purge Mode. Click in the VALUE COLUMN to revise the method's purge parameters.

NOTE

The MCS purge temperature is also the temperature the MCS remains at during Standby Mode. The MCS Purge Temp is set on the Methods Screen's Standby Tab.

The following settings can be made on the PURGE TAB:

- **PURGE TIME**
The amount of time gas is passed through the sample to concentrate the analytes on the trap.
- **PURGE FLOW**
The flow rate at which the sample is purged with gas and analytes are collected on the trap.
- **DRY PURGE TEMP**
The analytical trap temperature during the Dry Purge Mode. 20 °C is the recommended set-point. This ensures the heater is off and that the trap remains cool. Heating the trap can lead to loss of analytes before the Desorb Mode.
- **DRY PURGE TIME**
The time that dry gas is passed through the analytical trap during Dry Purge Mode. Allowing dry gas to pass through the analytical trap prior to desorb reduces the amount of water transfer during Desorb Mode.
- **DRY PURGE FLOW**
Flow rate at which dry gas is passed through the analytical trap during Dry Purge Mode.
- **SAMPLE HEATER ENABLE**
Select the **SAMPLE HEATER ENABLE** check-box to add additional parameters to the PURGE TAB when a sample heater is installed on the sparger.

Figure 3-12 Methods Screen - Purge Tab

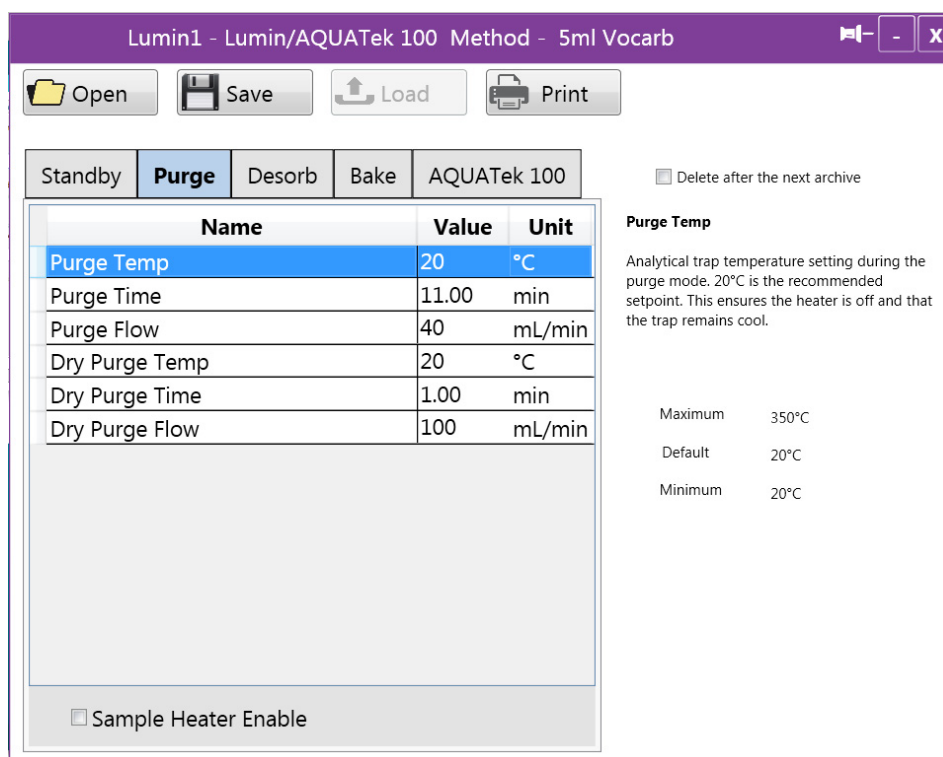

Lumin1 - Lumin/AQUATEk 100 Method - 5ml Vocab

Open Save Load Print

Standby **Purge** Desorb Bake AQUATEk 100 Delete after the next archive

Name	Value	Unit
Purge Temp	20	°C
Purge Time	11.00	min
Purge Flow	40	mL/min
Dry Purge Temp	20	°C
Dry Purge Time	1.00	min
Dry Purge Flow	100	mL/min

Purge Temp
Analytical trap temperature setting during the purge mode. 20°C is the recommended setpoint. This ensures the heater is off and that the trap remains cool.

Maximum 350°C
Default 20°C
Minimum 20°C

Sample Heater Enable

**NOTE**

The following parameters are only shown on the Purge Tab when the Enable Sample Heater Check-box is selected.

- **SAMPLE TEMP (Sample Heater Enabled)**
The sample temperature range is 20-90 °C. For environmental samples, the typical range is 40-60 °C. Flavor and fragrance analysis may have much higher temperatures.
- **PRE-PURGE TIME (Sample Heater Enabled)**
The amount of time the sparger is swept with purge gas to remove oxygen in the headspace, prior to heating the sample. Usually pre-purge time combined with pre-purge flow allows the volume of the glassware to be swept three times.
- **PRE-PURGE FLOW (Sample Heater Enabled)**
The amount of purge gas flow sweeping the sparger to remove oxygen in the headspace, prior to heating the sample. Usually pre-purge flow combined with pre-purge time allows the volume of the glassware to be swept three times.
- **PREHEAT TIME (Sample Heater Enabled)**
Pre-heat time is used to allow the heaters to reach their temperature set-points before Purge to ensure that all samples are purged under the desired conditions.

3.4.3 Desorb Tab

The DESORB TAB is used to define the time, flow and temperature of the Desorb Mode. Click in the VALUE COLUMN to revise the method's desorb parameters.

The following settings can be made on the Desorb Tab:

- **DESORB PREHEAT TEMP**
The temperature of the analytical trap in desorb preheat. Setting will be trap dependent; use temperature slightly below (5-10 degrees) the recommend desorb temperature for the sorbent trap. This allows the analytes to release from the sorbent trap prior to moving to the GC during desorb.
- **DESORB TEMP**
Temperature set-point of the analytical trap during Desorb Mode. Use the recommended temperature for the sorbent trap installed.
- **DESORB TIME**
The amount of time over-which the analytical trap is desorbed. Set the time as low as possible to minimize water transfer, but long enough to completely transfer analytes to the GC. The time is dependent on the GC carrier gas flow rate and split ratio.
- **DRAIN FLOW**
The amount of flow used to drain the sparge vessel during Desorb Mode.

Figure 3-13 Methods Screen - Desorb Tab

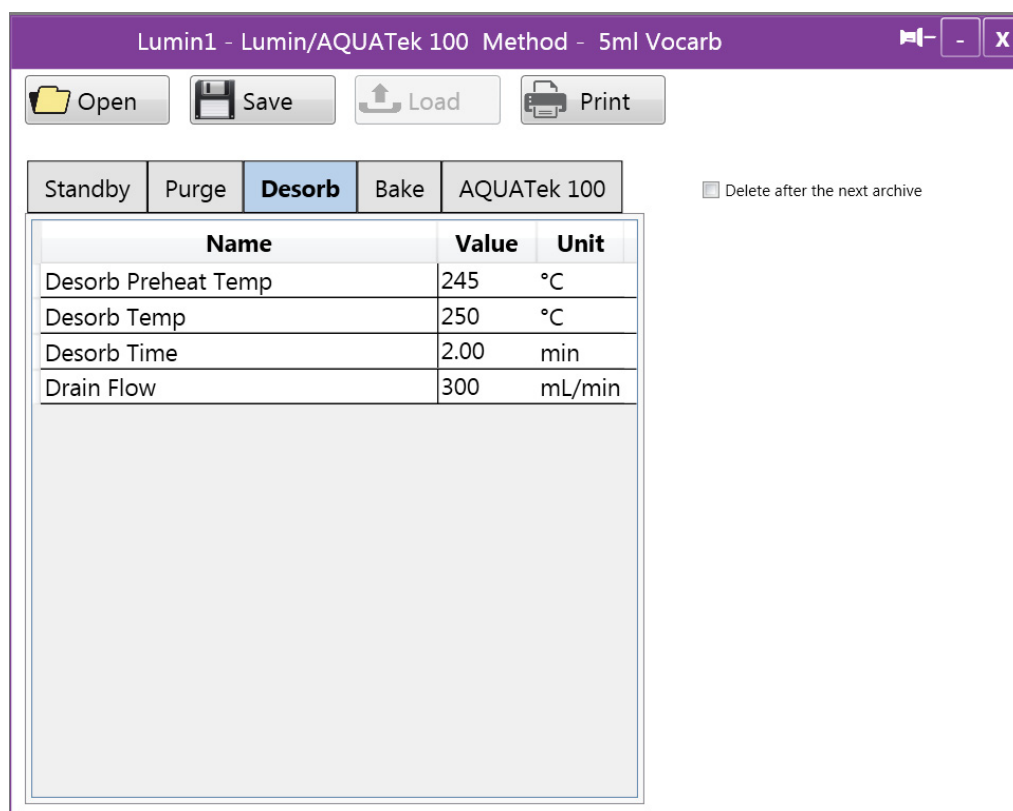

3.4.4 Bake Tab

The BAKE TAB is used to define the time, flow and temperature of the Bake Mode. Click in the VALUE COLUMN to revise the method's bake parameters.

The following settings can be made on the Bake Tab:

- BAKE TIME

The time the analytical trap and the Moisture Control System (MCS) remain at bake temperature setting. Allow enough time to reduce the carryover between runs and remove residual moisture from the MCS.

- BAKE TEMP

Temperature of the analytical trap during the Bake Mode. This setting is trap dependent and the temperature should be set according to the trap manufacturer's recommendation.

- MCS BAKE TEMP

Temperature of the MCS during Bake Mode. Use the recommended set-point to effectively remove residual moisture from MCS.

- BAKE FLOW

Amount of gas flow through the analytical trap and MCS during Bake Mode.

Figure 3-14 Methods Screen - Bake Tab

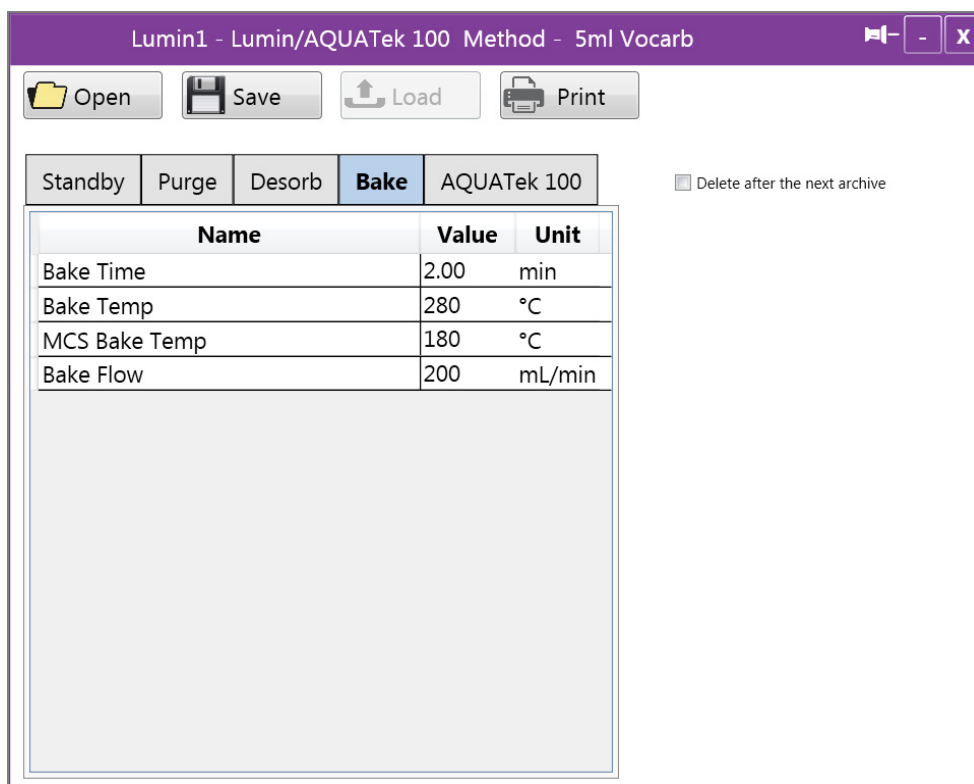

3.4.5 AQUATek 100 Tab

If an AQUATek 100 autosampler is installed, the METHODS SCREEN will have an additional AQUATEK TAB. The AQUATEK TAB is used to define the time and water temperature parameters for the AQUATEk 100 autosampler. Click in the VALUE COLUMN to revise the autosampler's parameters.

Figure 3-15 AQUATek 100 Tab

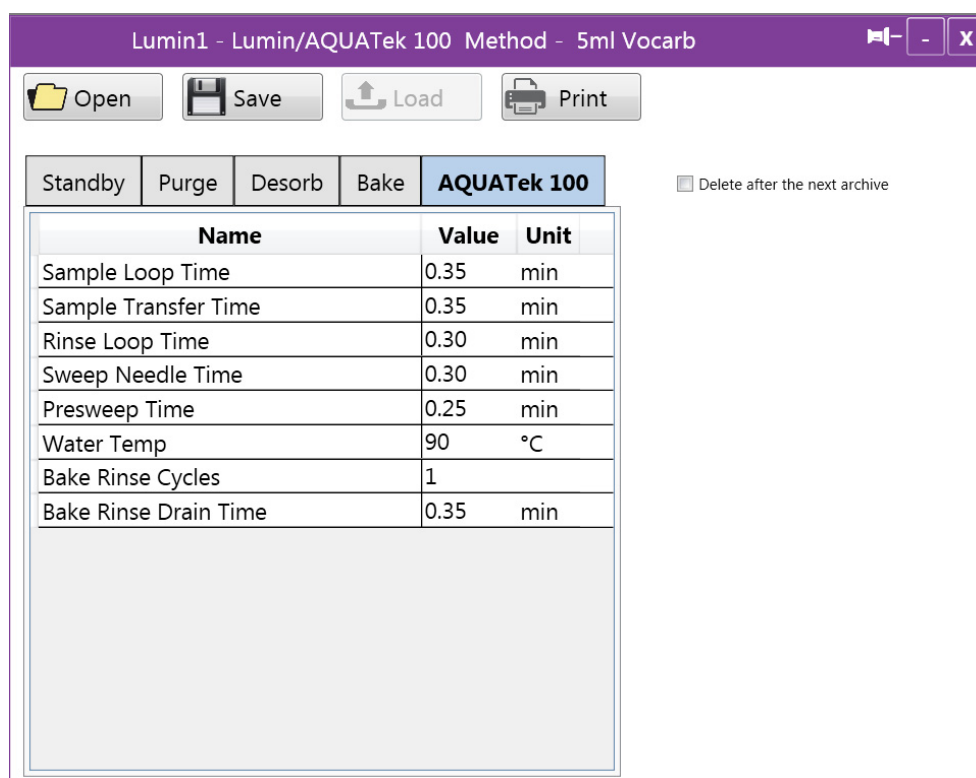

The following settings can be made on the AquaTek Tab:

- **SAMPLE LOOP TIME**
The amount of time the vial is pressurized to allow for the sample to be displaced to fill the sample loop
- **SAMPLE TRANSFER TIME**
The amount of time the sample and standards are swept to the sparge vessel of the concentrator.
- **RINSE LOOP TIME**
The amount of time the sample loop and stage #1 of the sample needle is rinsed with hot water.
- **SWEEP NEEDLE TIME**
The amount of time stage #2 of the sample needle is flushed with inert gas.
- **PRE-SWEEP TIME**
The amount of time the sample lines and needle are swept with inert gas prior to filling the sample loop.
- **WATER TEMP**
Water temperature for rinsing the sample pathway, sample needle, and sparger. Temperature set-points below 35 °C do not control the heater and the set-point will be displayed as "Ambient".
- **BAKE RINSE CYCLES**
The total number of Bake Rinses between samples.
- **BAKE RINSE DRAIN TIME**
The amount of time allowed to drain the bake rinse water from the sparge vessel.

3.5 Schedules Screen

The SCHEDULES SCREEN is used for creating and saving new sample schedules, opening previously created schedules, and printing an open schedule. Schedules are “loaded” using the LOAD BUTTON on the SCHEDULES SCREEN. Once a schedule is loaded, the concentrator will begin heating to temperature set-points as defined in the method. Once set-points are achieved the sample schedule will begin to run.

Control buttons on the right are used to ABORT or HOLD a schedule once it has been loaded, or to STEP through concentrator modes as the concentrator runs each line of the schedule.

The columns of the SCHEDULE TABLE are used for the following:

- # - The line number of the sample/blank.
- USE - Selecting/deselecting the Use check-box includes/excludes that item from the schedule. The USE check-box allows the convenient revision of a previously saved schedule.
- VIAL - The autosampler vial position that corresponds to that line of the schedule. Blanks can be added to the schedule by entering “0” in the vial position and hitting <Enter>.
- METHOD - A drop-down menu allows the selection of any method saved in the Current Data folder.
- SAMPLE ID (Optional) - A Sample ID column can be added to the Schedule Table via TOOLS>SYSTEM>CONFIGURATION>OPTIONS TAB.



NOTE

Archived Methods will not be available until they are copied from the “archive” folder to the “current” data folder.

- STD1 and STD2 - These columns permit the addition of two check and/or internal standards to the schedule, when the Lumin is connected to the AQUATEk 100.
- PURGE - Records the amount of back-flow pressure through the analytical trap, during Purge Mode. This value can be used as a diagnostic and troubleshooting tool.
- BAKE - Records the amount of back-flow pressure through the analytical trap during Bake Mode. This value can be used as a diagnostic and troubleshooting tool.
- pH - If pH sensor is installed on the AQUATEk 100, and enabled in TOOLS>CONFIGURATION>OPTIONS, the sample schedule will have a pH column.
- Foam- If the Guardian Foam Sensor has been enabled in TOOLS>CONFIGURATION>OPTIONS, the sample schedule will have a Foam Column. If a sample (or schedule) is aborted, the Foam Column will display ABORTED.
- STATUS - The status of the sample being run. Status will indicate PENDING, COMPLETED, ABORTED, and HOLD.

Figure 3-16 Schedules Screen

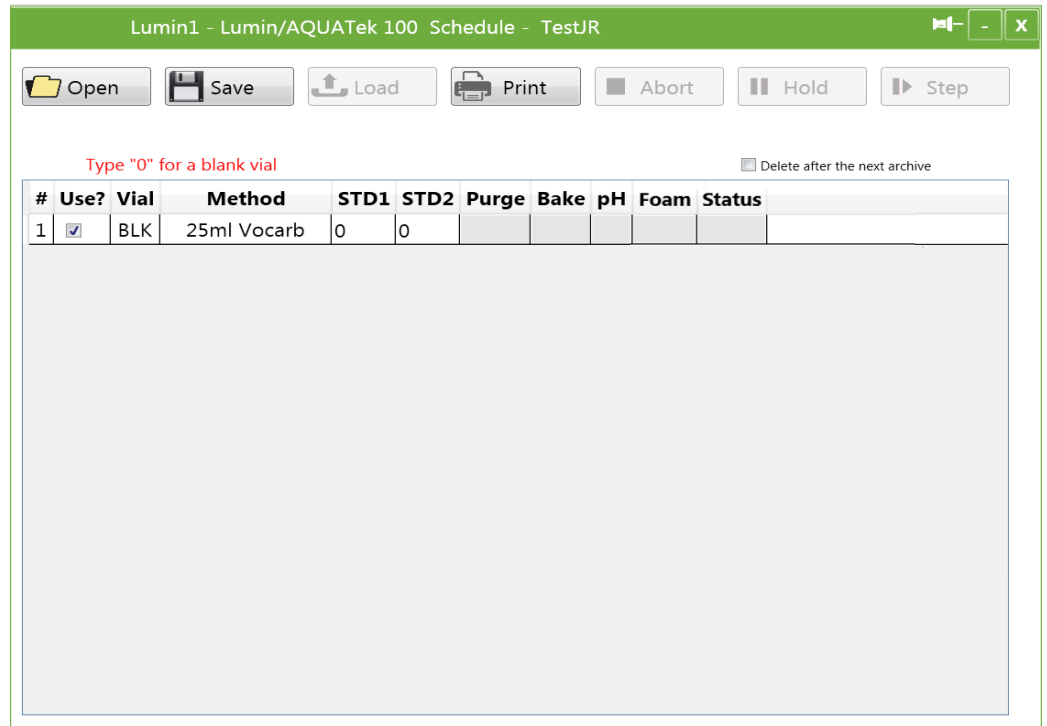

3.6 Tools Screen

The TOOLS SCREEN is used for direct control of the concentrator’s functions for troubleshooting and diagnostics. It also contains software configuration options and settings as well as sample, instrument, and error logs.

Figure 3-17 Tools Screen

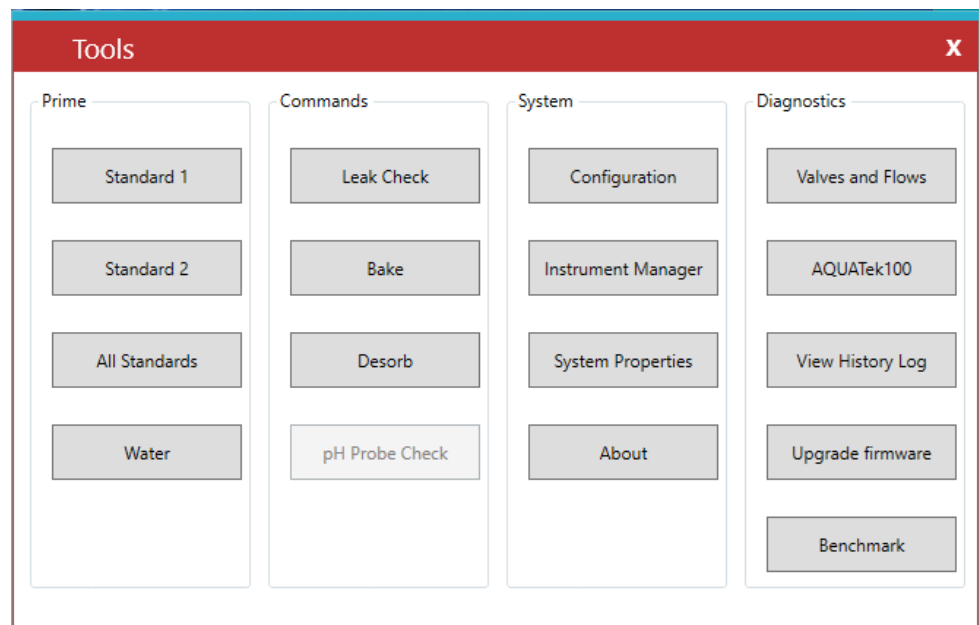

3.6.1 Prime Menu

The PRIME MENU contains functions related to priming the AQUATek 100 standards and DI water supply tubing.

☑
NOTE

Priming removes air from the tubing lines and should be performed whenever the standard addition vials or DI water supply has been disconnected.

- STANDARD 1 BUTTON- Prime Standard 1 vial tubing on the AQUATek 100 Autosampler.
- STANDARD 2 BUTTON - Prime Standard 2 vial tubing on the AQUATek 100 Autosampler.
- ALL STANDARDS BUTTON - Primes Standards 1 and 2 vial tubing on the AQUATek 100 Autosampler.
- WATER BUTTON - Prime the DI Water Supply tubing on the AQUATek 100 Autosampler.

3.6.2 Commands Menu

⚠
Caution

Exercise caution when manually overriding concentrator functions. Damage to the concentrator can result.

Leak Check

Figure 3-18 Leak Check Dialog

Instrument Status
⏪ -

■ Abort

⏸ Hold

▶ Step

Connection:
Lumin A-100 (Lumin/AQUATek 100)
Ready

Mode:
Leak Check Pressurize

Time (minutes):
0.06 → 2.00

Pressurizing System to 25 psig

Schedule
No schedule is currently running.

Active Method: [5ml Vocarb](#)

Zones		
Name	Current	Set Point
Mass Flow	154 mL/min	200 mL/min
Pressure	4.5 psig	n/a
Transfer Line	150°C	150°C
Oven	149°C	150°C
Mount	89°C	90°C
Trap	22°C	Ambient
MCS	23°C	Ambient
Water	89°C	90°C

- Activates the Lumin leak check function. The concentrator performs a leak check by closing certain valves and shutting down the Mass Flow Controller (MFC) to isolate the pressurized system. Once isolated, the Lumin will take pressure readings to identify any pressure loss that would indicate a leak.



NOTE

Leak check settings (Check Pressurize Time, Flow and Delta) are defined on the Tools>Configuration>Leak Check Tab.

Bake

Figure 3-19 Bake Dialog

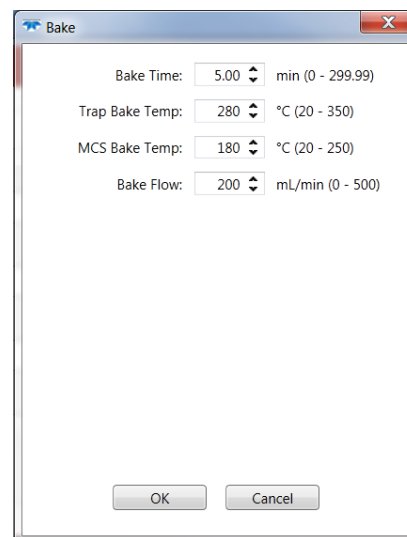

The BAKE BUTTON will display the BAKE DIALOG. The BAKE DIALOG permits the manual configuration of Bake Mode settings and automatically steps the concentrator to BAKE MODE.



NOTE

Manually activated bake settings are typically used to condition a new analytical trap. Refer to Section 5.11 "Analytical Trap Conditioning" and recommended trap conditioning settings from the trap manufacturer.

Permits the manual override of the following:

- Bake Time
- Trap Bake Temperature
- Mass Flow Controller Bake Temperature
- Bake Flow
- Perform Bake Rinse(s) - Set the number of bake rinse cycles (up to 3) and bake rinse volume.

Desorb

The DESORB BUTTON manually steps the concentrator to Desorb Mode. The concentrator will use the desorb settings as configured in the currently active method.



NOTE

The Desorb Button is typically used for diagnostic and troubleshooting functions when using Top of Trap (TOT) injections.

pH Probe Check

Checks the pH probe (if installed) on the AQUATek 100.

3.6.3 System Menu

Configuration - General Tab

The GENERAL TAB displays information related to the instrument profile and connection



NOTE

The General Tab is also used to create new instrument profiles.

- NAME - Name of the active or selected instrument.
- DESCRIPTION - A user-defined, brief set of text identifying the instrument.
- MODEL - The instrument/configuration. Choose between a stand-alone Lumin concentrator or a Lumin concentrator with an AQUATek 100 autosampler.
- CONNECTION - Defaults to USB
- DEACTIVATE THIS INSTRUMENT PROFILE CHECK-BOX - disables the instrument profile.



NOTE

When an instrument profile has been “deactivated” it will not show in the selection of instrument profiles available via Tools>Instrument Manager unless the “Show deactivated instrument profiles” Check-Box is selected in that dialog.

Figure 3-20 Tools - Configuration - General Tab

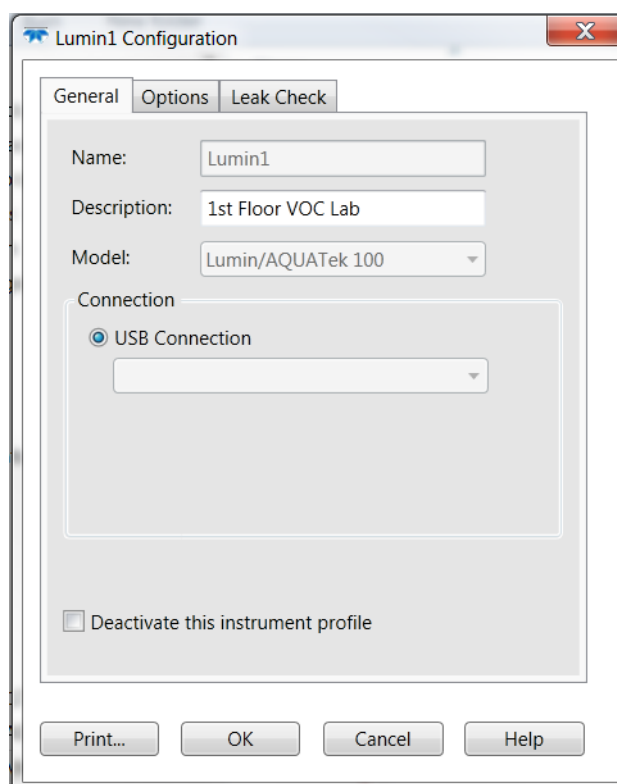

Configuration - Options Tab

- **ENABLE BEEPER** - Enables/disables the concentrator beeper for instrument errors.
- **ENABLE VIAL ID COLUMN IN SCHEDULES** - Adds/removes a SAMPLE ID column to the SCHEDULE TABLE on the SCHEDULES SCREEN.
- **ENABLE PH SENSOR** - Enables/disables the optional pH sensor on the AQUATek 100 autosampler.

When selected, a pH COLUMN will be added to the Sample Schedule.

- **ENABLE GUARDIAN FOAM SENSOR** - Enables/disables Guardian Foam Sensor functionality as well as defining the sensor and eliminator actions. Use the drop-down menu to choose from the following actions:
 - Sensor Only (Abort Sample Only)
 - Sensor Only (Abort Schedule)
 - Eliminator (Abort Sample Only)
 - Eliminator (Abort Schedule)

When selected, an additional FOAM COLUMN will be added to the Sample Schedule that will display ABORTED when a sample or sample Schedule is aborted due to foam.



NOTE

For more information on Guardian Foam Sensor and Eliminator actions according to instrument configuration, refer to 2.13 "Guardian™ Foam Sensor and Foam Eliminator (Optional)".

- PURGE GAS - Specifies the type of carrier gas. Choose between Ultra-high purity helium or nitrogen. The default gas is helium.



NOTE

If this configuration is made incorrectly, the gas flow from the Mass Flow Controller (MFC) will not be accurate.

- GAS CHROMATOGRAPH TYPE - Use the SELECT BY GC MODEL DROP-DOWN MENU to select the GC. If the model is not found from the drop-down list, refer to the GC manufacturer's instructions and use the STANDARD TYPE:63 or USER TYPE:31 RADIO BUTTONS.

Figure 3-21 Tools - Configuration - Options Tab

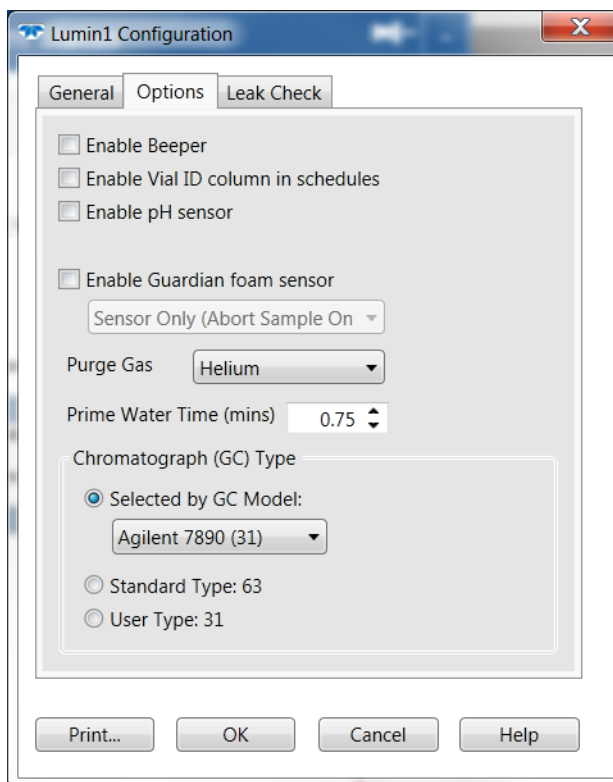

Configuration - Leak Check Tab

LEAK CHECK TAB options Include:

- LEAK CHECK PRESSURIZE TIME - the amount of time allowed for the system to become fully pressured.



If using 25 mL sparger, change the Leak Check Pressurize Time to 2 minutes.

- LEAK CHECK FLOW - the flow rate for the pressurization of the system during leak check.
- LEAK CHECK DELTA - the allowable difference in pressure readings that indicates a leak.

Figure 3-22 Tools - Configuration - Leak Check Tab

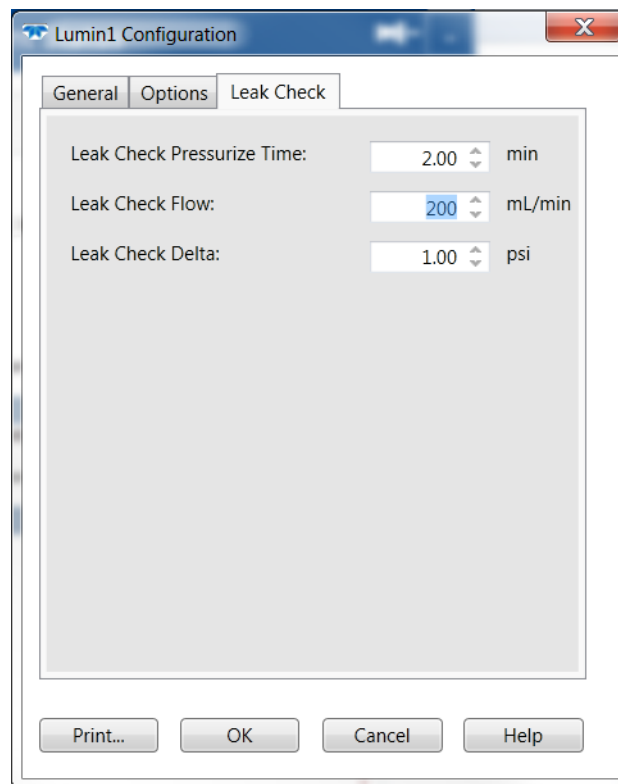

Instrument Manager

The INSTRUMENT MANAGER DIALOG is used to create, connect and view the properties of instrument profiles.

Figure 3-23 Tools - Instrument Manager

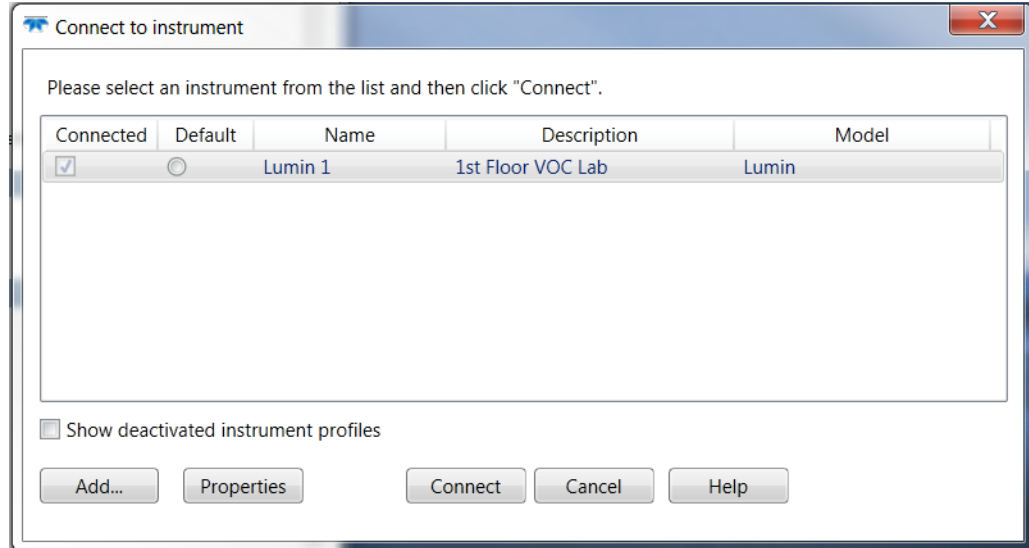

System Properties

The SYSTEM PROPERTIES DIALOG contains settings and information related to data and communication. Email alerts, archive settings with archive now command, and server settings are configured here. The DATA TAB displays the location where methods, schedules, configurations, history and archives are stored.

Figure 3-24 System Properties Dialog

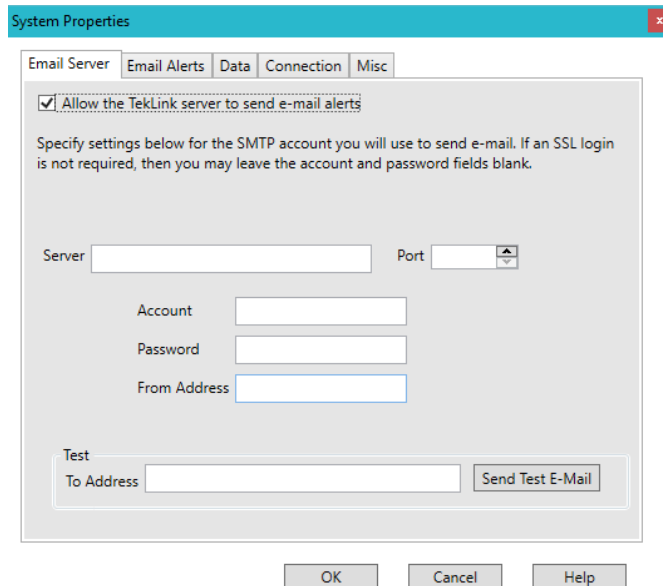

Email Server Tab

The EMAIL SERVER TAB is used to configure Lumin TekLink to send email alerts. Enter the SMTP server from which the email will be sent, along with its corresponding port. If the mail account uses a Secure Sockets Layer (SSL) security login enter the Account (User Name) and Password for the account. If a login is not required, leave the account and password fields blank. Enter the email address of the account e-mails will be sent from. Test the configuration using the TEST section of the dialog.

Figure 3-25 System Properties - Email Server Tab

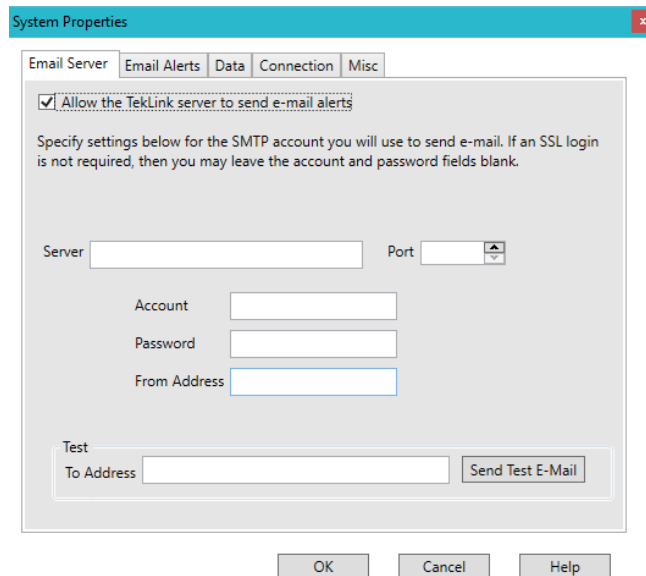

 **NOTE**

Once the Lumin TekLink email server settings are configured, email alerts can be sent for events configured on the EMAIL ALERTS TAB of the SYSTEM PROPERTIES DIALOG.

 **NOTE**

When configuring email alerts consult an IT professional to assist in configuring the alerts in a network environment.

Email Alerts Tab

The EMAIL ALERTS TAB is used to choose events for email alerts and designate to whom the alerts will be sent.



NOTE

To enable email alerts, ensure “Allow the TekLink server to send email alerts” is selected on the Email Server Tab of the System Properties Dialog.

Figure 3-26 System Properties - Email Alerts Tab

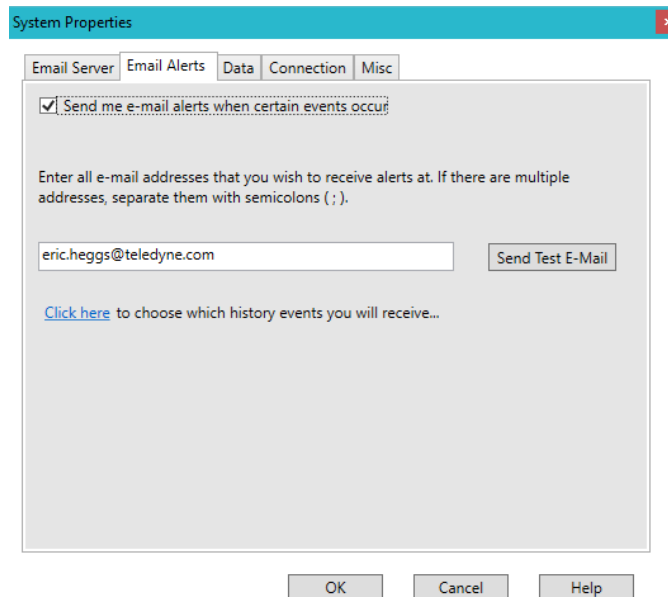

- Enable email alerts by selecting the SEND ME E-MAIL ALERTS WHEN CERTAIN EVENTS OCCUR CHECK-BOX.
- Enter all email addresses to which alerts will be sent. Separate multiple addresses using a semi-colon.
- To configure which events will trigger an email alert, select CLICK HERE TO CHOOSE WHICH HISTORY EVENTS YOU WILL RECEIVE to display the HISTORY FILTER FOR EMAIL EVENTS DIALOG.

Figure 3-27 History Filter for Email Events Dialog

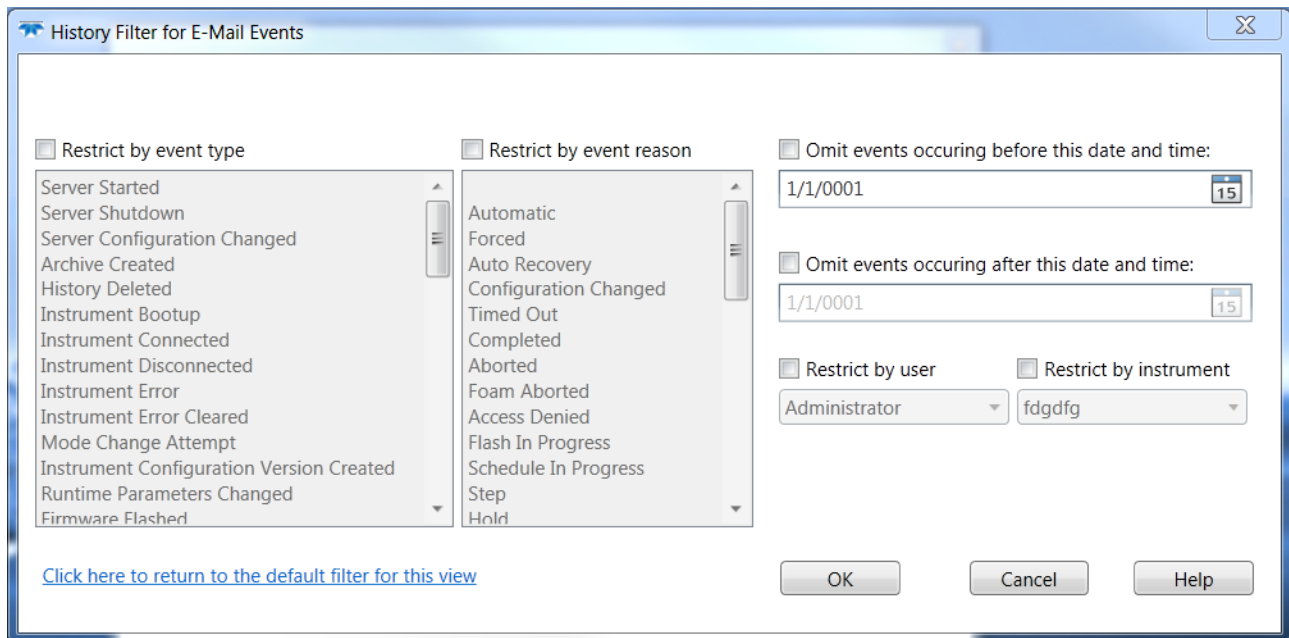

Data Tab

The DATA TAB displays the default location where Lumin TekLink stores methods, schedules, configurations, instrument history, and archived data.



The data storage location is not editable.

Archive data immediately by selecting the “archive data right now” command or schedule regular intervals for archiving information.



Data cannot be archived when a schedule is running.

Archives are full backups of all current data used by Lumin TekLink. Data included in the archive (methods, schedules, and history) can be viewed from Lumin TekLink at any time by using the OPEN BUTTON on the SCHEDULE or METHODS SCREENS and selecting the SOURCE to ARCHIVE.

Figure 3-28 System Properties - Data Tab

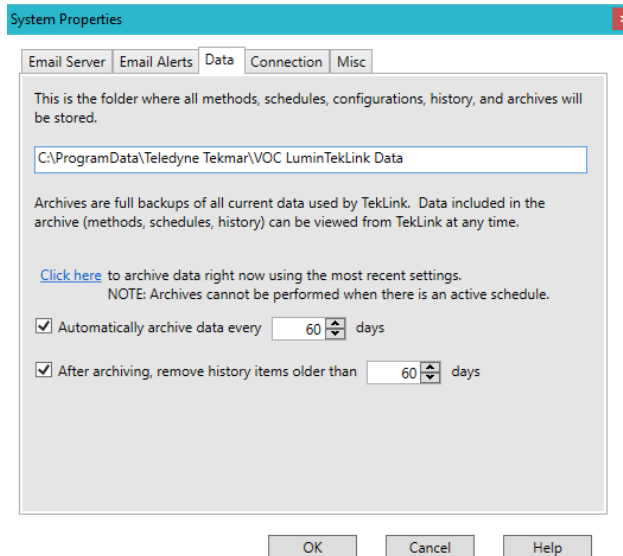

Connection Tab

The CONNECTION TAB is used to accept controlling computer connections through a network, allowing remote access to Lumin TekLink. Connections are made according to instrument profiles created via TOOLS>SYSTEM PROPERTIES. The two radio buttons designate whether the system will accept connections from other computers on the same network or only from the server computer itself. A connection from Anywhere on the same network requires a Listening Port.



NOTE

Windows User Privilege Level can affect accessibility. Consult an IT professional to assist in configuring the Client-Server Connection.

Figure 3-29 System Properties - Connection Tab

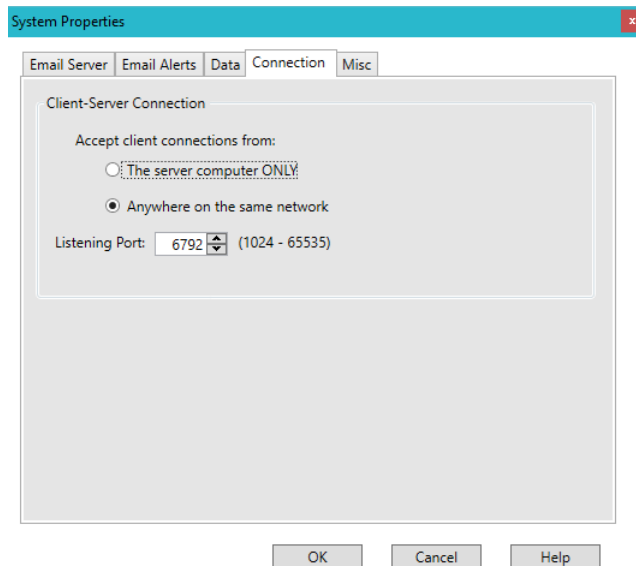

Miscellaneous Tab

The MISCELLANEOUS TAB contains settings to enable/disable the on-screen alpha-numeric keyboard for use with a touchscreen computer.



The keyboard can be reduced and closed. If closed it will be available again when the software is re-opened.

Figure 3-30 System Properties - Misc Tab

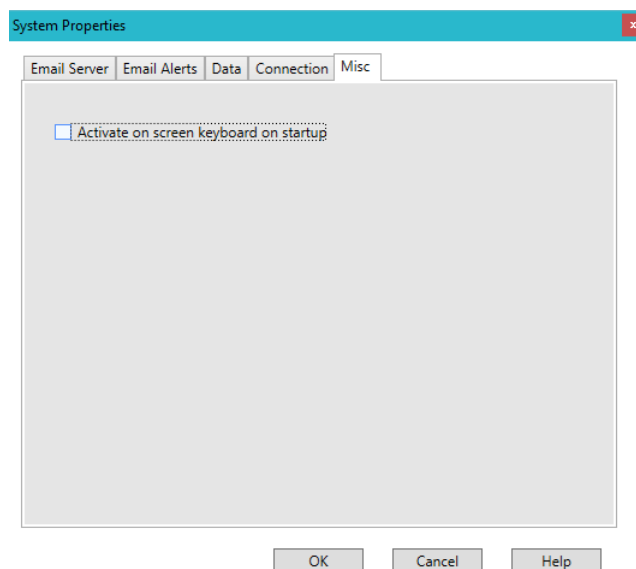

3.6.4 About

The ABOUT DIALOG shows details about the Lumin TekLink software and the firmware installed on the Lumin concentrator. When troubleshooting, information from the ABOUT DIALOG may be requested by a Teledyne Tekmar Customer Service representative.

Information in the ABOUT DIALOG can be printed by using the PRINT BUTTON at the bottom left of the dialog box.

Figure 3-31 About Dialog

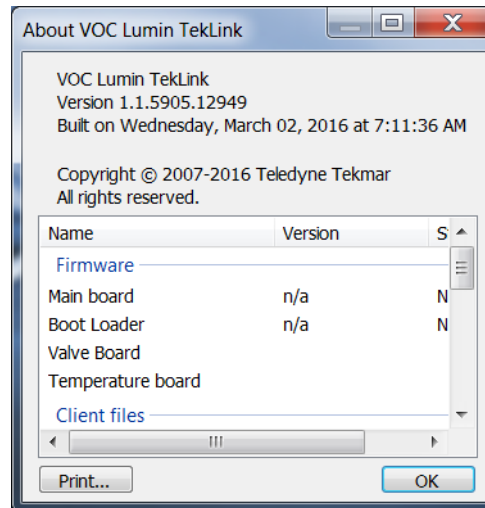

3.6.5 Diagnostics

Valves and Flows

The VALVES AND FLOWS DIALOG provides discrete control of the concentrator's valves for diagnostics and troubleshooting. The 6-port valve can be toggled to its two positions or initialized. The Mass Flow Controller (MFC) can also be tested. The flow rate can be manually set and the actual flow and pressure can be observed.



The Valves and Flows controls are for diagnostic and troubleshooting purposes and should only be used by someone who understands their functions. Exercise caution when manually turning on the concentrator's valves. Damage to the concentrator can result.

Figure 3-32 Diagnostics - Valves and Flows

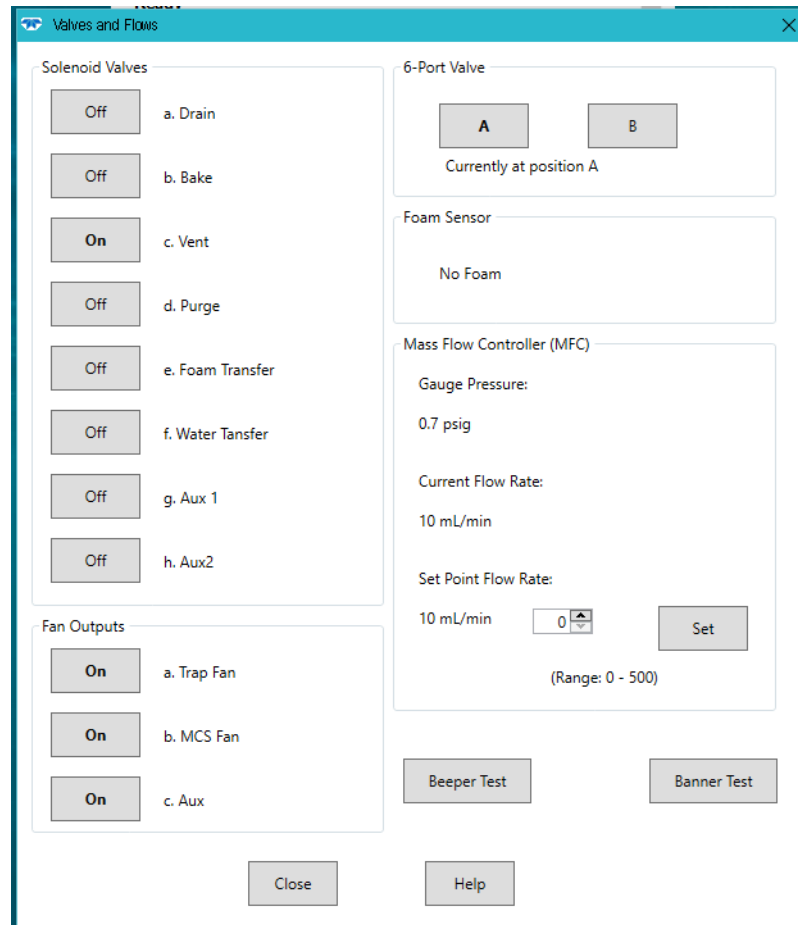

AQUATEk 100

The AQUATEK 100 DIALOG provides manual control of the AQUATEk 100 autosampler and should be only be used for diagnostics and troubleshooting.



Exercise caution when using the motor diagnostics. Damage to the AQUATEk 100 autosampler can result.

Figure 3-33 AQUATek100 Dialog

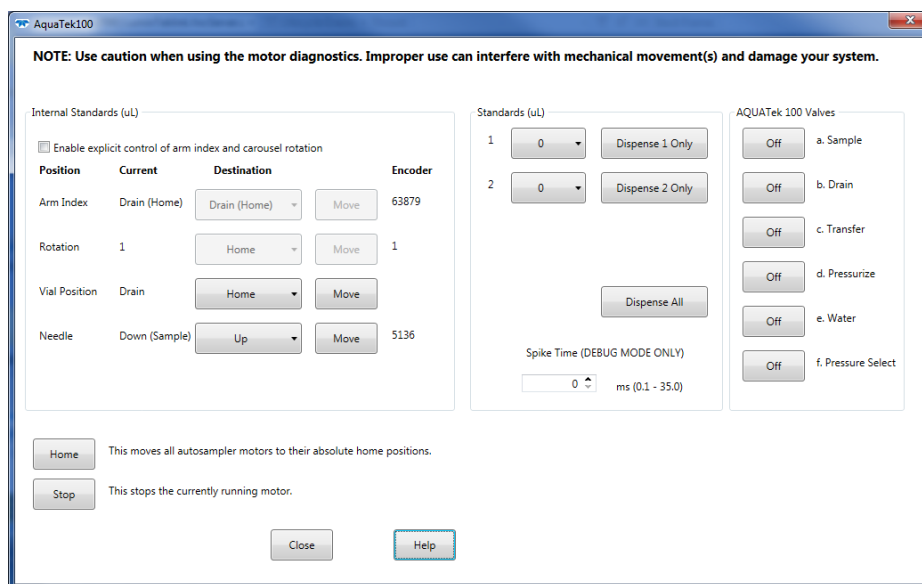

View History Log

The VIEW HISTORY LOG displays the HISTORY FORM DIALOG. The SAMPLE HISTORY TAB, INSTRUMENT HISTORY TAB and ERROR HISTORY TAB display their respective events.

Figure 3-34 History Form - Instrument History

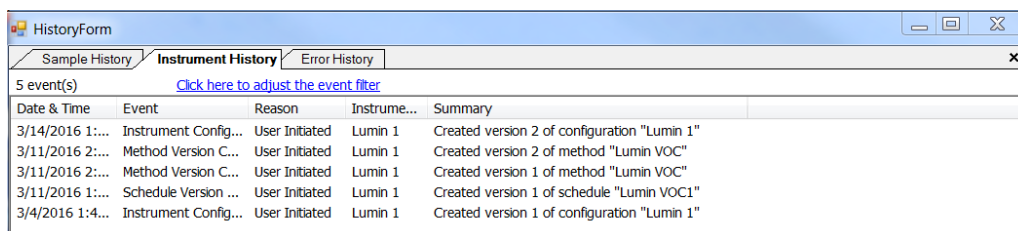

Sample, instrument, and error events can be filtered so that they are included/excluded using the CLICK HERE TO ADJUST THE EVENT FILTER LINK on each tab. Events can be filtered according to:

- SOURCE - Select the event source (current data or archive).
- LIMIT - the amount of events displayed.
- EVENT TYPE - Restrict the events displayed by the selected events.
- EVENT REASON - Restrict the events displayed by the selected event reasons.
- DATE RANGE - Omit events occurring before or after a certain date. Selecting the down arrow will display a calendar.
- USER - Restrict events according to the privilege levels of users.
- INSTRUMENT PROFILE - Restrict events according to each instrument profile.
- SUMMARY TEXT - Restrict events displayed according to the text entered.

NOTE

Event filters can be returned to their default settings by using the “Click here to return to the default filter for this view link”.

Figure 3-35 History Form Filter - Instrument History

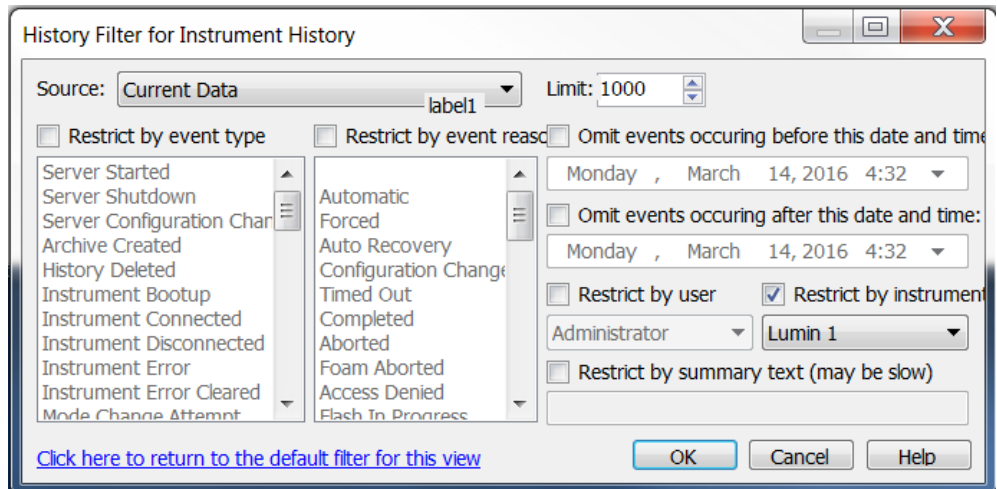

Upgrade Firmware

The UPGRADE FIRMWARE BUTTON is used to upgrade the firmware for the concentrator's Printed Circuit Boards (PCB).

NOTE

The current firmware version can be viewed via Tools>About Button.

Figure 3-36 Upgrade Firmware Dialog

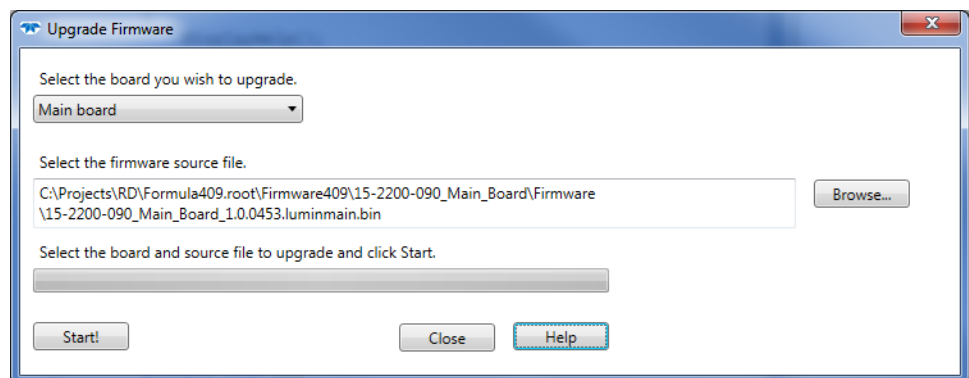

For information on upgrading firmware refer to Section 5.29 "Upgrade Firmware".

Benchmark

The BENCHMARK BUTTON starts the Benchmark function. The benchmark test is an interactive program that tests heaters, LEDs, and the continuity of inputs and outputs on the CPU board. During the benchmark test the system will present a series of questions to the user.

The results of the benchmark test are saved in the INSTRUMENT HISTORY LOG using the name entered before starting the benchmark test. To access a saved benchmark test select TOOLS>VIEW HISTORY LOG>INSTRUMENT HISTORY.



NOTE

For information on using the benchmark test function refer to Section 5.31.1 "Benchmark Test".

3.7 Create an Instrument Profile



NOTE

All methods, schedules, TekLink software configurations and software settings profile specific.

1. From the HOME SCREEN select the TOOLS BUTTON to display the TOOLS SCREEN. On the TOOLS SCREEN select the CONFIGURATION BUTTON to display the CONFIGURATION DIALOG.
2. Complete the following in the CONFIGURATION DIALOG:

On the GENERAL TAB:

- Enter a name for the instrument.



NOTE

If the lab has multiple Lumin concentrators, use the name and description to differentiate one concentrator from another. This will assist when defining system properties for email alerts, archive settings, and remote connection settings.

- Enter a description so the instrument is easily identified.
- Select the MODEL from the MODEL DROP-DOWN MENU (LUMIN or LUMIN WITH AQUATEK 100).

Figure 3-37 Creating an Instrument Profile

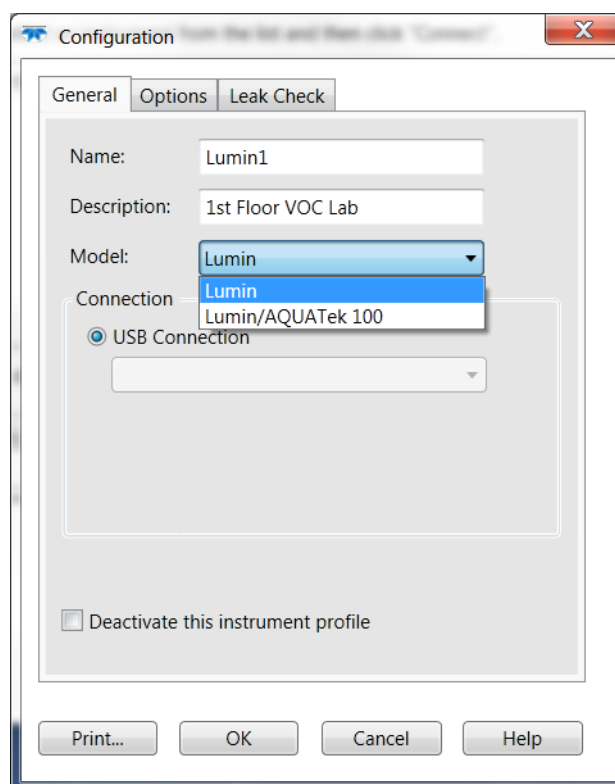

- Select the default USB Connection check-box.
- Select the OK BUTTON to save the instrument profile.

On the OPTIONS TAB:

- If you would like the concentrator to notify you of errors enable the beeper option.
- If you would like a Sample ID column available on the Schedule Table enable this option.
- If an optional Guardian™ Foam and/or Eliminator is installed place a check mark in the selection box. Choose the exact configuration from the drop-down menu.
- Select the appropriate purge gas from the Purge Gas Drop-Down Menu.
- Select the CHROMATOGRAPH (GC TYPE) from the GC MODEL DROP-DOWN MENU. If the specific model of the GC is not shown in the drop-down menu, use the STANDARD TYPE:63 or USER TYPE:31 check-box according to the GC manufacturer's User Manual instructions.

Figure 3-38 Options Tab

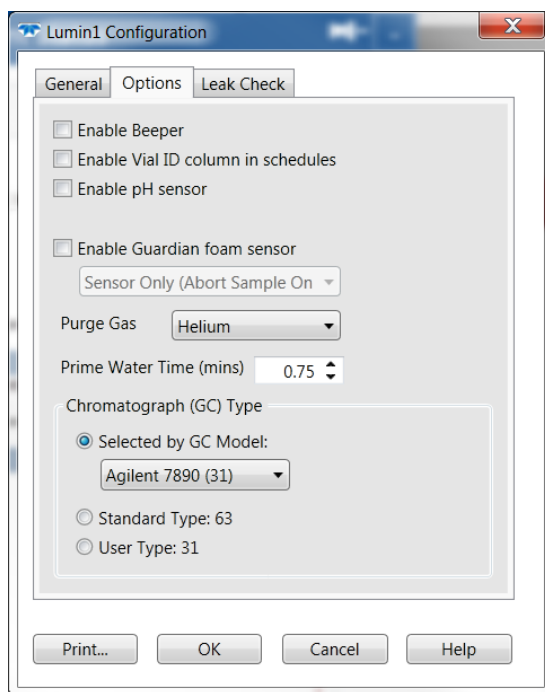

On the LEAK CHECK TAB:

- Customize Leak Check Time, pressure settings and delta, or use the default settings.

Figure 3-39 Leak Check Tab

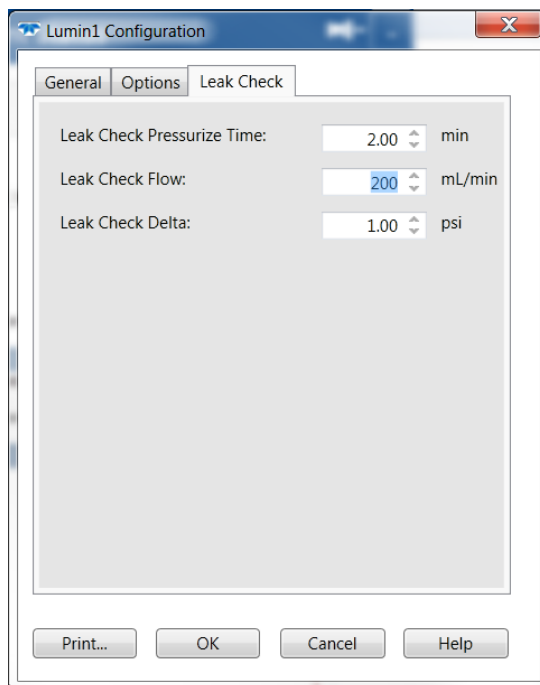

3. Select the OK BUTTON to create the Instrument Profile.

Lumin TekLink will automatically connect to the new profile, and the INSTRUMENT STATUS PANEL, METHODS SCREEN and SCHEDULES SCREEN will display the connected instrument profile name. Once a profile is created, methods, schedules, system properties, and preferences can be saved to that profile when it is connected.



NOTE

Once an instrument profile has been created it cannot be deleted. "Deactivating" an instrument profile removes the instrument profile from the list of active profiles in the Instrument Manager Dialog. For information on deactivating an instrument profile, refer to 3.9 "Deactivate an Instrument Profile".

3.8 Connect to an Instrument Profile



NOTE

An instrument profile must be previously created in order to make a connection. Refer to Section 3.8 "Connect to an Instrument Profile".

1. From the HOME SCREEN select the TOOLS BUTTON to display the TOOLS SCREEN.
2. Select the INSTRUMENT MANAGER BUTTON to display the CONNECT TO INSTRUMENT DIALOG.
3. Highlight the instrument profile desired.



NOTE

If the profile is not shown, it may be deactivated. Select the Show deactivated instrument profiles check-box to display deactivated instrument profiles.

4. If the instrument profile will be used as a "default profile" select the DEFAULT RADIO BUTTON.

Figure 3-40 Instrument Manager

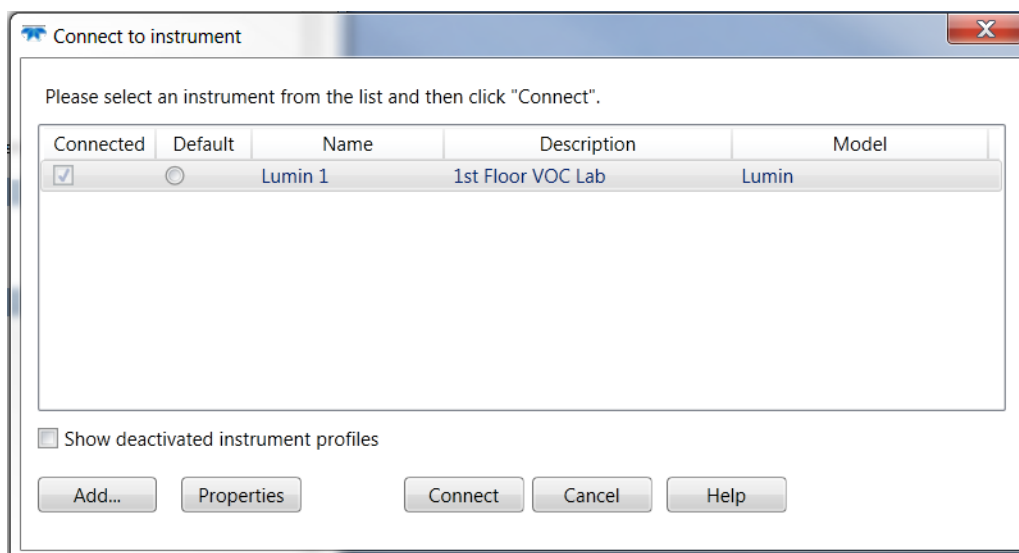

5. Select the CONNECT BUTTON to connect to the profile.
6. Once connected, a check mark will appear in the box beside the profile.



The Instrument Status Panel and the title bar on the Method and Schedules Screens will display the instrument profile name.

3.9 Deactivate an Instrument Profile



Instrument Profiles cannot be deleted. When an instrument profile is deactivated it will be removed from the list of available instruments on the Connect to Instrument Dialog unless the “Show deactivated instrument profiles” check-box is selected.

1. From the HOME SCREEN select the TOOLS BUTTON to display the TOOLS SCREEN.
2. Select the CONFIGURATION BUTTON to display the CONFIGURATION DIALOG.
3. Select the INSTRUMENT MANAGER BUTTON to display the CONNECT TO INSTRUMENT DIALOG.
4. Highlight the instrument profile to be deactivated, then select the PROPERTIES BUTTON TO SHOW THE CONFIGURATION DIALOG.
5. Place a check-mark in the DEACTIVATE THIS INSTRUMENT PROFILE check-box.
6. Select the OK BUTTON to save the change.

3.10 Creating a Method



NOTE

The Lumin Default method cannot be overwritten. If it is opened and revised, it must be saved under a different name.

If necessary connect to the appropriate instrument profile. The current instrument profile is shown on the INSTRUMENT STATUS PANEL and the title bar of the METHODS and SCHEDULES SCREENS. Refer to Section 3.8 "Connect to an Instrument Profile".



NOTE

Methods are specific (saved) to each Instrument Profile and cannot be opened from other instrument profiles.

From the HOME SCREEN select the METHODS BUTTON to display the METHODS SCREEN.

Figure 3-41 Methods Screen

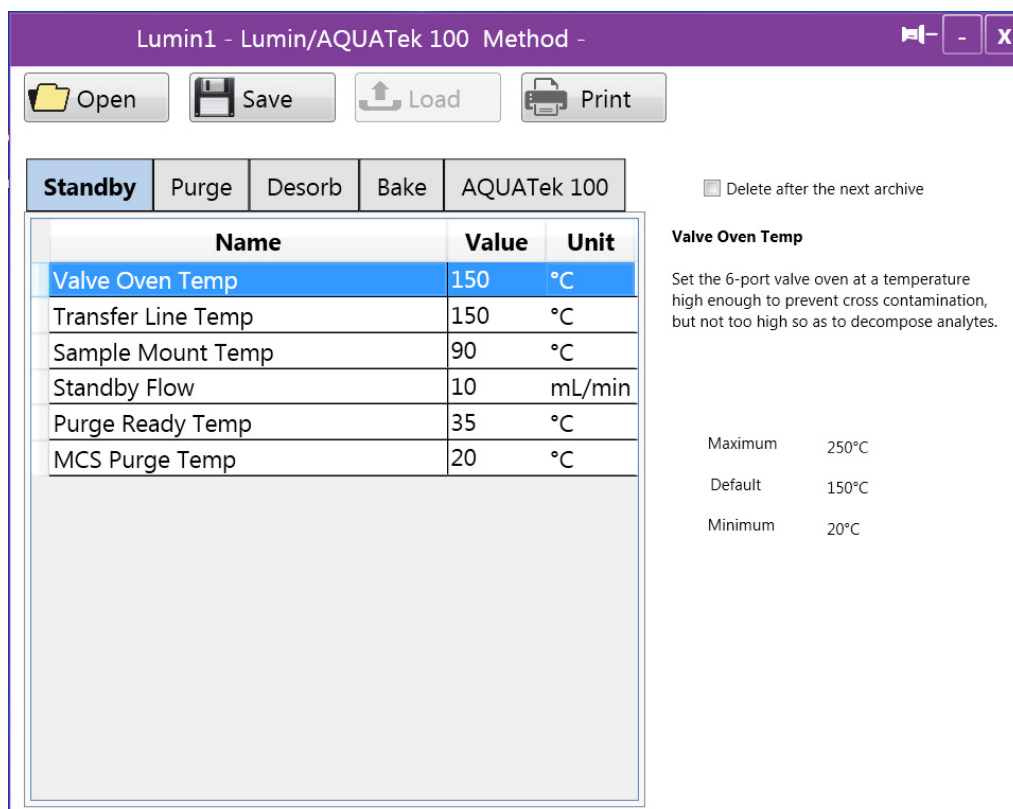

Alter parameters on the STANDBY, PURGE, DESORB, and BAKE TABS by double-clicking in the VALUE COLUMN and inputting the parameter values.

3.10.1 Save the Method



The Lumin default method cannot be overwritten. If it is opened and revised it must be saved under a different method name.

1. Save the new method by selecting the SAVE BUTTON. Name the method, then select the OK BUTTON.



Note that the title bar on the Methods Screen updates with the method name.

Figure 3-42 Save Method As Dialog

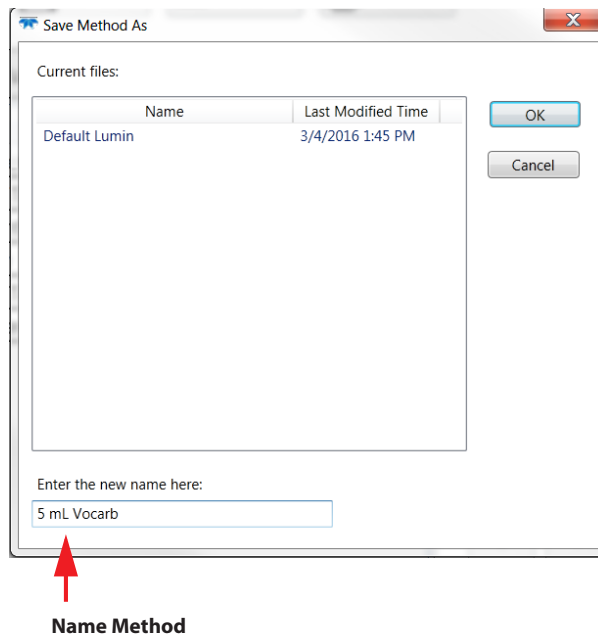
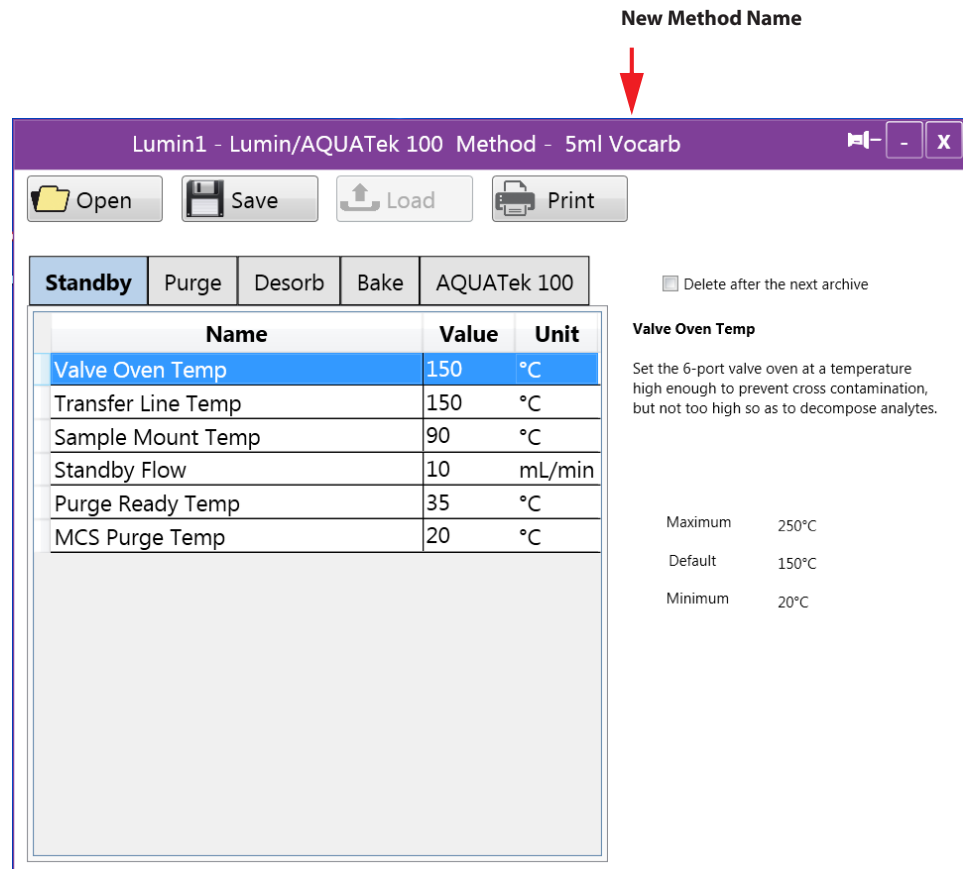

Figure 3-43 New method Saved - Name in Title Bar



3.11 Open a Method

Use the OPEN BUTTON on the METHODS SCREEN to open an existing or archived method. Use the SOURCE DROP-DOWN MENU to select the current or archived location.



Methods are specific (saved) to each Instrument Profile and cannot be opened from other instrument profiles.

Figure 3-44 Methods Screen

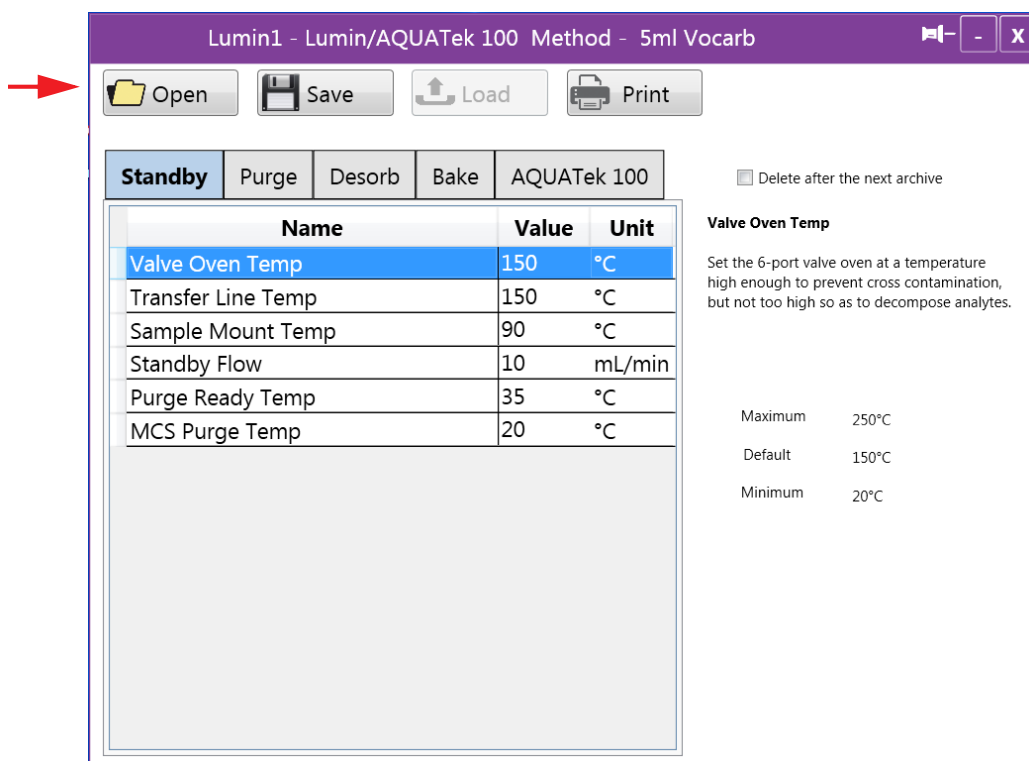
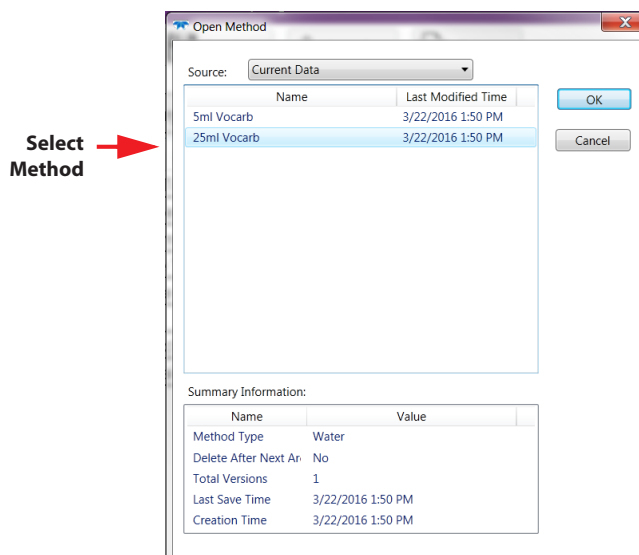

Figure 3-45 Open Method Dialog



NOTE

The Instrument Status Panel and the title bar on the Methods and Schedules Screens will display the opened method.

Figure 3-46 25 mL Method Open

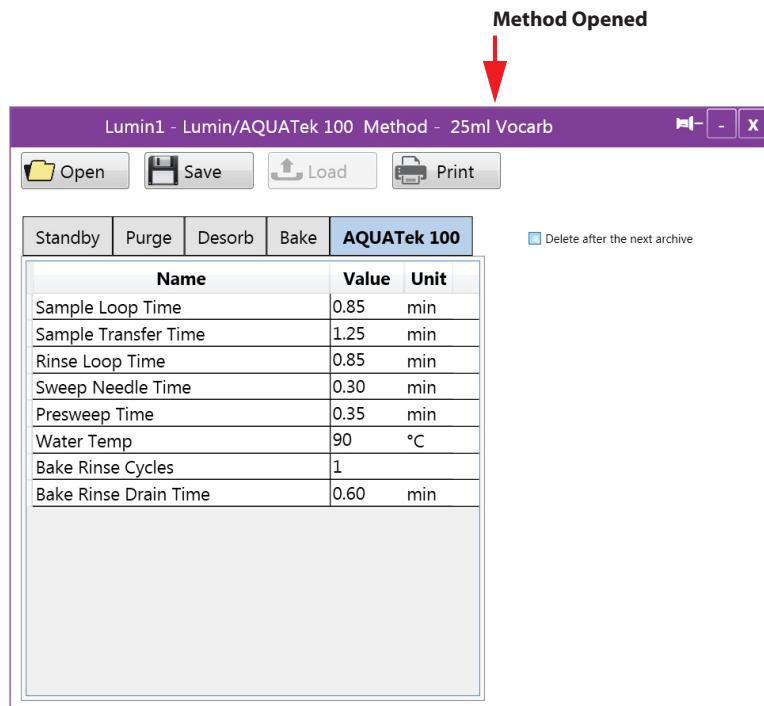

3.11.1 Print a Method

Print Method

Use the PRINT BUTTON on the METHODS SCREEN to print the current or completed method. A PRINT DIALOG will be displayed.

Figure 3-47 Method Print Dialog

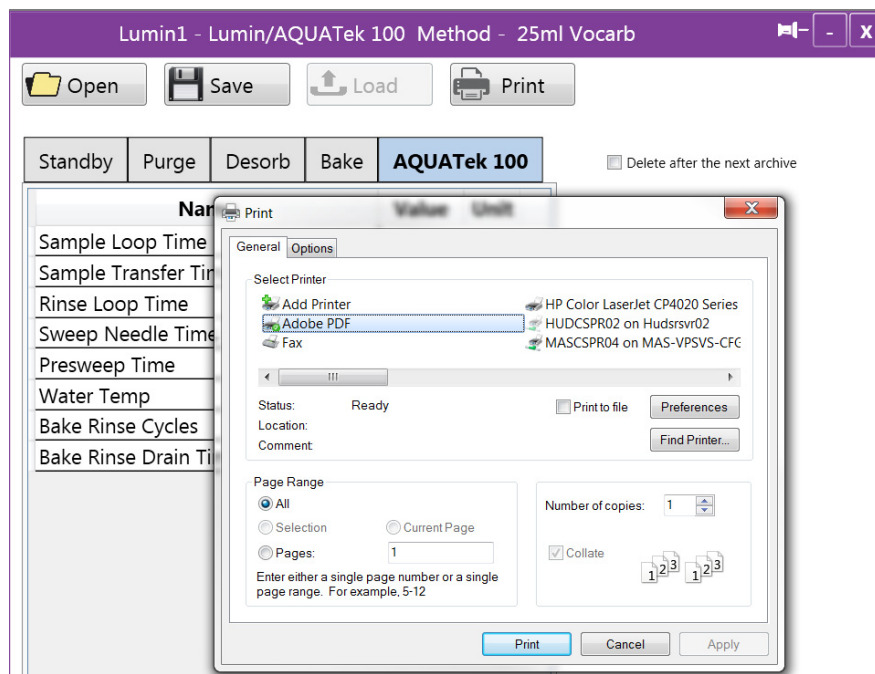

3.12 Creating a Schedule

NOTE

Multi-line schedules can only be created when the Lumin is combined with the AQUATek 100 autosampler. If no autosampler is installed, schedules are limited to one line.

NOTE

The schedule is created using a combination of manual entries, drop-down menus and right-click options on each line. Right-click options are a particularly simple way to create and revise schedule lines.

1. If necessary, connect to the appropriate instrument profile. The current instrument profile is shown on the INSTRUMENT STATUS PANEL and the title bar of the METHODS and SCHEDULES SCREENS. Refer to Section 3.8 "Connect to an Instrument Profile".

NOTE

Schedules are specific (saved) to each Instrument Profile and cannot be opened from other instrument profiles.

2. From the HOME SCREEN select the SCHEDULES BUTTON to display the SCHEDULES SCREEN.

Figure 3-48 Blank Schedule

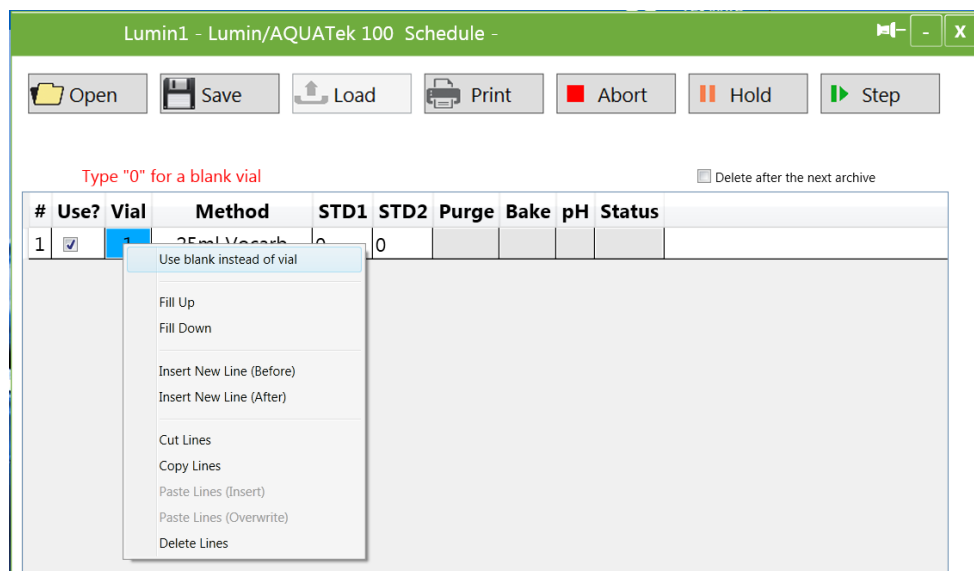

3. Use the following commands to build the schedule:



A Sample ID column can be added via Tools>Options.

Use Column

Select or deselect the USE CHECK-BOX to include/exclude the schedule line from the current schedule. The use check-box is an easy way to easily modify a previously created schedule.

Add a Vial to the Schedule

The vial number will automatically fill and increment. When blanks are added, the vial numbers will increment “around” them.

Add a Blank to the Schedule

Add a blank to the schedule using either of these methods:

1. Enter zero in the VIAL COLUMN and press <Enter>. The zero will turn to BLK indicating a blank in the schedule line selected (Line 1 in Figure 3-49).
2. Right-click in the VIAL COLUMN and select USE BLANK INSTEAD OF VIAL

Figure 3-49 Zero in Vial Column Becomes Blank

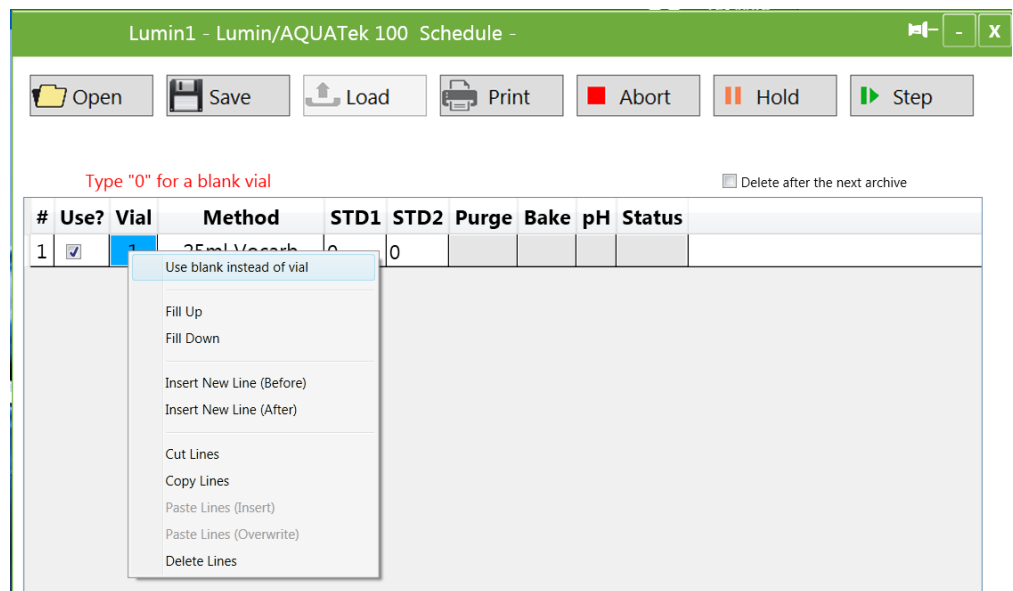

Choose Method

The method for each line of the schedule can be chosen in one of two ways:

1. Double-click in the method column to display the OPEN METHOD DIALOG.
2. Right-click in the METHOD COLUMN and select CHOOSE METHOD to display the OPEN METHOD DIALOG.

Choose the appropriate method from a current or archived source and then select the OK BUTTON.

Add Standards to the Schedule

The STD1 and STD2 COLUMNS are only available if an AQUATEk 100 autosampler is installed. Add a standard by double-clicking in the STD1 and/or STD2 cells. Select the standard volume (in µL) from the drop-down menu.

Figure 3-50 Standards Drop-Down

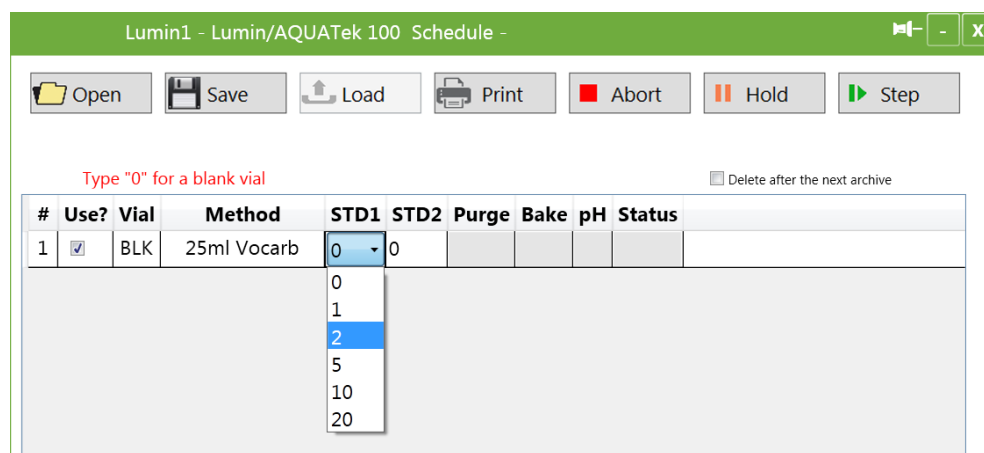

Add Additional Lines to the Schedule

Lines can be added by:

1. Clicking in the current schedule line and then using the down arrow key.
2. Right-click on the current schedule line and select INSERT NEW LINE (ABOVE or BELOW) (Figure 3-51).

Fill Up/Down

Highlight a schedule line and then drag down or up to highlight other lines. Right-click and choose FILL DOWN or FILL UP to auto-fill the other lines (Figure 3-51). Vial Positions will increment while blanks, method and standard choices will auto-fill.

Figure 3-51 Schedules Screen Right-Click Options

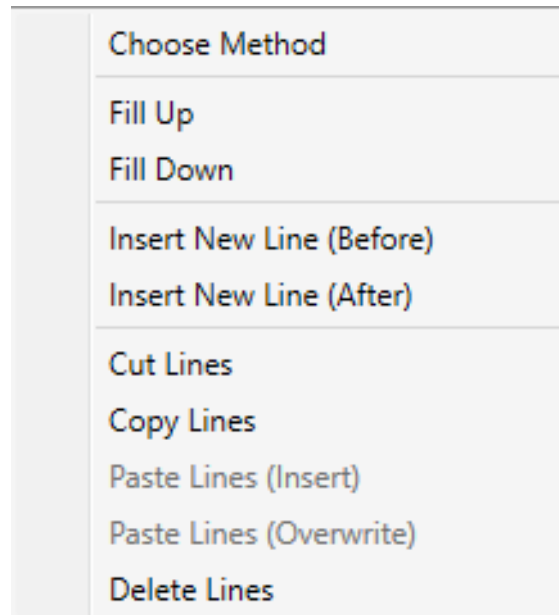

3.12.1 Save Schedule

Use the SAVE BUTTON to save the active schedule. The SAVE BUTTON will display the SAVE SCHEDULE AS DIALOG where a name for the schedule can be entered. Select the OK BUTTON to save the schedule.

Figure 3-52 Save Schedule

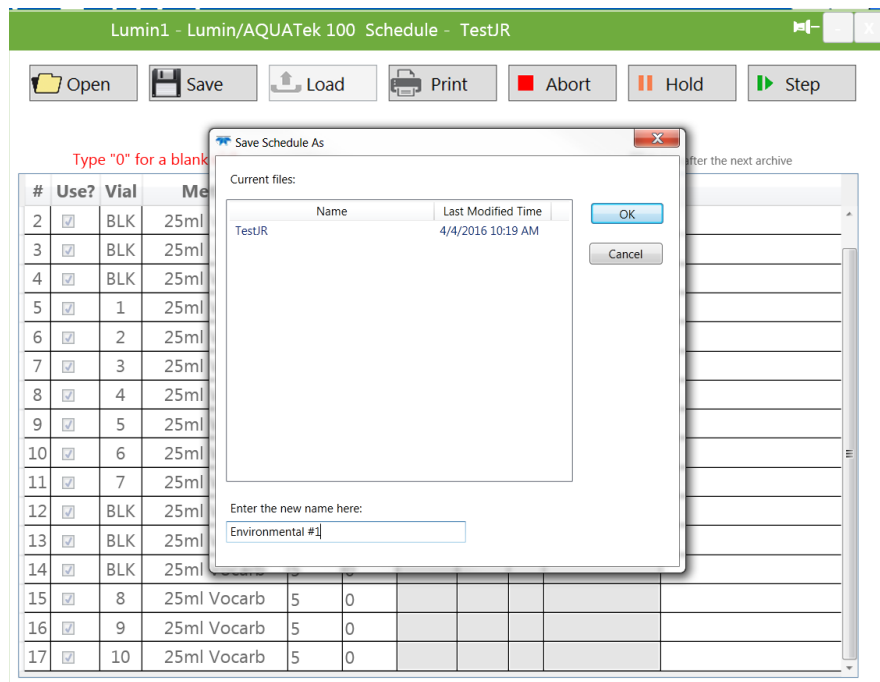

3.12.2 Load (Run) the Schedule

To run the schedule, select the LOAD BUTTON on the SCHEDULES SCREEN. The STATUS COLUMN will update to PENDING, indicating that the concentrator is heating to temperature set-points. The INSTRUMENT STATUS PANEL will update with the current mode, time, and action.

Figure 3-53 Schedule Loaded

#	Use?	Vial	Method	STD1	STD2	Purge	Bake	pH	Status
2	<input checked="" type="checkbox"/>	BLK	25ml Vocarb	5	0				Pending
3	<input checked="" type="checkbox"/>	BLK	25ml Vocarb	5	0				Pending
4	<input checked="" type="checkbox"/>	BLK	25ml Vocarb	5	0				Pending
5	<input checked="" type="checkbox"/>	1	25ml Vocarb	5	0				Pending
6	<input checked="" type="checkbox"/>	2	25ml Vocarb	5	0				Pending
7	<input checked="" type="checkbox"/>	3	25ml Vocarb	5	0				Pending
8	<input checked="" type="checkbox"/>	4	25ml Vocarb	5	0				Pending
9	<input checked="" type="checkbox"/>	5	25ml Vocarb	5	0				Pending
10	<input checked="" type="checkbox"/>	6	25ml Vocarb	5	0				Pending
11	<input checked="" type="checkbox"/>	7	25ml Vocarb	5	0				Pending
12	<input checked="" type="checkbox"/>	BLK	25ml Vocarb	5	0				Pending
13	<input checked="" type="checkbox"/>	BLK	25ml Vocarb	5	0				Pending
14	<input checked="" type="checkbox"/>	BLK	25ml Vocarb	5	0				Pending
15	<input checked="" type="checkbox"/>	8	25ml Vocarb	5	0				Pending
16	<input checked="" type="checkbox"/>	9	25ml Vocarb	5	0				Pending
17	<input checked="" type="checkbox"/>	10	25ml Vocarb	5	0				Pending

Figure 3-54 Instrument Status Panel Updated

Instrument Status

Connection:
Lumin 1
Schedule Running

Mode:
Sample Transfer

Time (minutes):
0.06 → 0.35

Transferring sample...

Schedule
 Active Schedule: **Environmental #1**
 Current Line: **1 of 17**

Active Method: **25ml Vocarb**

Zones		
Name	Current	Set Point
Mass Flow	2 mL/min	0 mL/min
Pressure	0.0 psig	n/a
Transfer Line	149°C	150°C
Oven	149°C	150°C
Mount	88°C	90°C
Trap	75°C	Ambient

3.12.3 Abort a Sample or Schedule

1. To Abort a sample or schedule that has been loaded to the concentrator use the ABORT BUTTON on the SCHEDULES SCREEN or the INSTRUMENT STATUS PANEL.
2. Once aborted, Lumin TekLink will ask if the abort command is for:
 1. THE ENTIRE SCHEDULE
 2. THE CURRENT SAMPLE ONLY
 3. THE ENTIRE SCHEDULE AFTER CURRENT SAMPLE

Figure 3-55 Aborted Schedule

The screenshot shows the Lumin1 software interface for a schedule titled "Lumin1 - Lumin/AQUATEk 100 Schedule - Environmental #1". At the top, there are control buttons: Open, Save, Load, Print, Abort (red square), Hold (orange bars), and Step (green play button). Below these buttons, there is a red instruction: "Type '0' for a blank vial" and a checkbox for "Delete after the next archive".

#	Use?	Vial	Method	STD1	STD2	Purge	Bake	pH	Status
2	<input checked="" type="checkbox"/>	BLK	25ml Vocarb	5	0				Completed
3	<input checked="" type="checkbox"/>	BLK	25ml Vocarb	5	0				Active
4	<input checked="" type="checkbox"/>	BLK	25ml Vocarb	5	0				Pending
5	<input checked="" type="checkbox"/>	1	25ml Vocarb	5	0				Pending
6	<input checked="" type="checkbox"/>	2	25ml Vocarb	5	0				Pending
7	<input checked="" type="checkbox"/>	3	25ml Vocarb	5	0				Pending
8	<input checked="" type="checkbox"/>	4	25ml Vocarb	5	0				Pending
9	<input checked="" type="checkbox"/>	5	25ml Vocarb	5	0				Pending
10	<input checked="" type="checkbox"/>	6	25ml Vocarb	5	0				Pending
11	<input checked="" type="checkbox"/>	7	25ml Vocarb	5	0				Pending
12	<input checked="" type="checkbox"/>	BLK	25ml Vocarb	5	0				Pending
13	<input checked="" type="checkbox"/>	BLK	25ml Vocarb	5	0				Pending
14	<input checked="" type="checkbox"/>	BLK	25ml Vocarb	5	0				Pending
15	<input checked="" type="checkbox"/>	8	25ml Vocarb	5	0				Pending
16	<input checked="" type="checkbox"/>	9	25ml Vocarb	5	0				Pending
17	<input checked="" type="checkbox"/>	10	25ml Vocarb	5	0				Pending

An "Abort" dialog box is overlaid on the table, containing three buttons: "Entire Schedule", "Current Sample Only", and "Entire Schedule after Current Sample".

3. Once the type of abort has been selected, Lumin TekLink will prompt to confirm the abort command using the Confirm Button on the SCHEDULES SCREEN or the INSTRUMENT STATUS PANEL.

Figure 3-56 Confirm Selected, Schedule Aborted

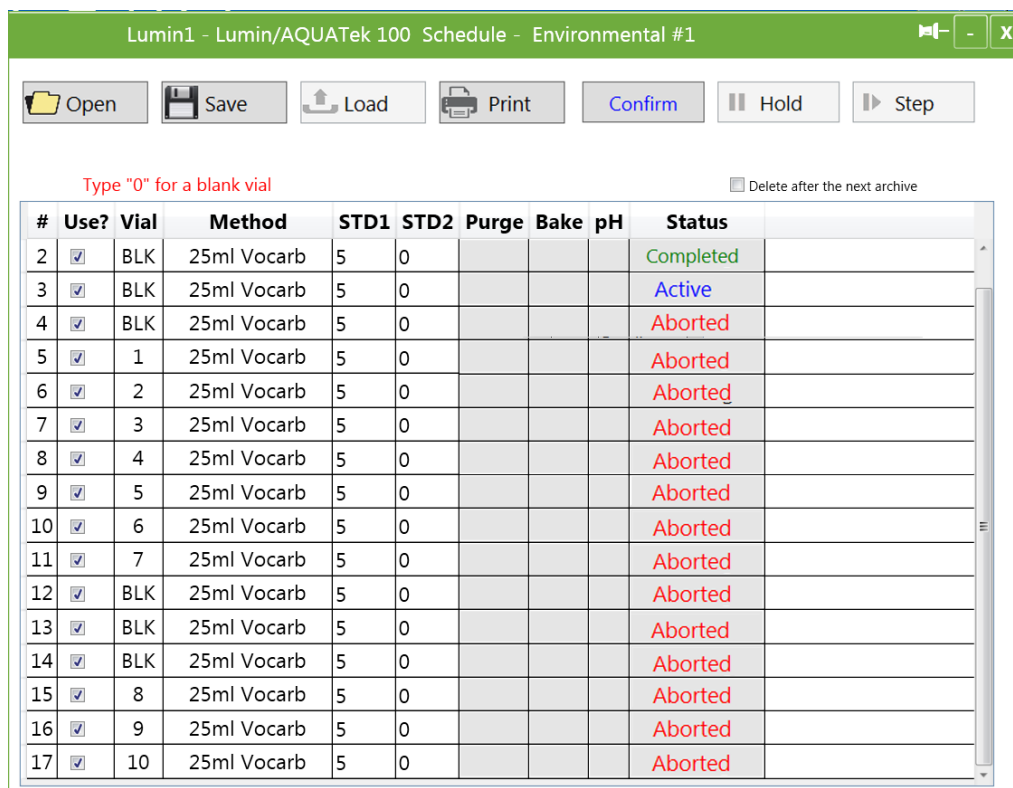

Step Schedule

Use the STEP BUTTON to sequentially move through each of the concentrator's modes. When using the STEP BUTTON, use the INSTRUMENT STATUS PANEL to view the current mode of the concentrator.

Hold Schedule

Once the schedule has been loaded to the concentrator the HOLD BUTTON can be used to hold the schedule at its current position. The HOLD BUTTON on the INSTRUMENT STATUS PANEL will change to an AUTO BUTTON, that when selected, begins the schedule again.

Figure 3-57 Schedule Hold - Instrument Status Panel

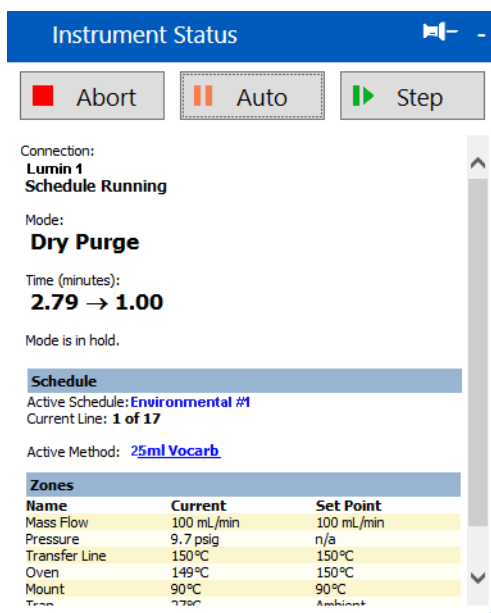

Print Schedule

Use the PRINT BUTTON on the SCHEDULES SCREEN to print the current or completed schedule. A PRINT DIALOG will be displayed.

Open Schedule

Use the OPEN BUTTON on the SCHEDULES SCREEN to open an existing or archived schedule. Use the SOURCE DROP-DOWN MENU to select the current or archived location.

Lumin User Manual

Chapter 4: Instrument Operations

4.1 Concentrator Mode Descriptions

The concentrator system performs a programmed series of operating steps. These steps are referred to as modes and vary depending on installed equipment and your system configuration. Mode descriptions are provided in Table 4-1 "Lumin Mode Descriptions" and more specific descriptions for the Lumin combined with the AQUATek 100 autosampler are given in Table 4-3 "Lumin with AQUATek 100 - Valve Output Chart".



NOTE

For Flow Diagrams for each mode, refer to Appendix A: "Diagrams".

Table 4-1 Lumin Mode Descriptions

Mode	Description
Standby	This mode indicates that the system is waiting for all temperature zones and flow rates to reach their set-points.
Purge Ready	This mode indicates all method set-points are at equilibrium and the concentrator is ready to analyze samples.
Pressurize	When the Lumin is connected to an AQUATEk 100, this mode allows an aliquot to be removed from the sample vial and directed to a sample loop.
Fill Internal Standard	When the Lumin is connected to an AQUATEk 100, this mode allows the internal standard to be directed to a standard addition Manifold.
Sample Transfer	When the Lumin is connected to a liquid autosampler, this mode indicates that a liquid sample is being introduced into the sparging vessel. The time required for this step is autosampler dependant. Please refer to the autosampler's operating manual for further assistance.
Pre-Purge	When the Lumin is working in conjunction with an external sample heater, this mode directs purge gas to the vessel to remove excess oxygen prior to heating and subsequent purging.
Preheat	When the Lumin is working in conjunction with an external sample heater, this mode allows the sample to reach a uniform programmed temperature prior to sample purging.
Purge	<p>This mode is the VOC extraction step in which the inert gas (such as helium) is dispersed through the sample matrix in the sparger for a preset time and flow. The gas containing the analytes is directed to an analytical trap for concentration.</p> <p>Note: The gas passes through the trap, deposits the analytes, and is vented to the atmosphere.</p>
Rinse Loop	When the Lumin is connected to an AQUATEk 100, this mode allows time for the sample loop to be rinsed with hot water.
Purge Loop	When the Lumin is connected to an AQUATEk 100, this mode allows time for the sample loop to be purged with dry gas.
Dry Purge	This mode is used to drive excess water from the analytical trap. The inert gas is directed to the analytical trap without passing through the sparger. This process ensures that no additional moisture is added to the trap.
Desorb Ready	This mode indicates that the concentrator is waiting for a GC ready signal to allow it to step to desorb.
Desorb Preheat	This mode heats the analytical trap to a preset temperature in a static state, allowing the analytes to release from the sorbent.
Desorb	This mode heats the analytical trap to its final point and rotates the 6-port valve so that the carrier gas is back-flushed through the trap and over to the GC for separation and subsequent detection. This mode will also start the GC column program and, depending on your selection, drain the sample from the sparger.
Bake Fill	When the Lumin is connected to an AQUATEk 100, this mode allows hot water to be introduced to the sample loop for subsequent delivery to the concentrator's sparger.
Bake Transfer	When the Lumin is connected to an AQUATEk 100, this mode allows the autosampler to introduce water into the sparger for sparger and line rinsing. For more information on this cleaning process, please consult your autosampler's operating manual.
Bake Drain	When the Lumin is connected to an AQUATEk 100, this mode drains the water, introduced to the sparger during the Bake transfer mode, from the system.

4.2 Lumin Valve Output Chart

Table 4-2 Lumin Valve Output Chart

Mode	Description	Variables	Default	Min	Max	Unit	MFC	Purge	Vent	Drain	Aux	6-port	Fan
Standby With Flow	This mode indicates that the system is waiting for all temperature zones to meet their set-points prior to starting a sample run. While the system is waiting, there is a low flow forced through the unit to allow the system to maintain positive pressure.	MFC	10	0	500	mL/min	ON	OFF	ON	OFF	OFF	Purge (A)	ON
		Trap Temp	35	20	350	°C							
		Transfer Line	150	20	250	°C							
		Valve Oven	150	20	250	°C							
		Condenser	40	20	200	°C							
Mount	90	20	90	°C									
Purge Ready	This mode indicates to the user that all set-points have been reached and the system is ready to begin running samples.	-	-	-	-	-	ON/OFF ^a	OFF	ON	OFF	OFF	Purge (A)	ON
Pre-Purge	When the Lumin is working in conjunction with an external sample heater, this mode sweeps the headspace of the sample to remove any oxygen prior to heating the sample. This mode is typically only used when running soil samples.	Pre-Purge Time	1	0	299	min	ON	ON	ON	OFF	OFF	Purge (A)	ON
		Pre-Purge Flow	40	0	500	mL/min							

Table 4-2 Lumin Valve Output Chart (Continued)

Mode	Description	Variables	Default	Min	Max	Unit	MFC	Purge	Vent	Drain	Aux	6-port	Fan
Preheat	When the Lumin is working in conjunction with an external sample heater, this mode allows for the sample to be heated prior to purging the sample.	Preheat Time	1	0	299	min	OFF	ON	ON	OFF	OFF	Purge (A)	ON
		Preheat Temp	40	20	90	°C							
Purge	This mode is used to extract the volatiles from the sample and deposit them on the analytical trap.	Purge Time	11	0	299	min	ON	ON	ON	OFF	OFF	Purge (A)	ON
		Purge Flow	40	0	500	mL/min							
		Purge Temp (Trap) ^b	0	0	350	°C							
		Purge Temp (Condenser) ^c	20	20	250	°C							
Dry Purge	This mode is used to remove any excess water deposited in the analytical trap.	Dry Purge Time	0	0	299	min	ON	OFF	ON	OFF	OFF	Purge (A)	ON
		Dry Purge Flow	0	0	500	mL/min							
		Dry Purge Temp	20	0	350	°C							
Desorb Ready	This mode indicates to the user that the analytical trap is loaded and ready to be transferred to the GC.	-	-	-	-	-	OFF	OFF	OFF	OFF	OFF	Purge (A)	ON
Desorb Preheat	This mode indicates that the analytical trap is heated to a preset temperature in a static state. This allows the analytes to release from the sorbent and move forward.	Desorb Preheat Temp (Trap)	245	20	350	°C	OFF	OFF	OFF	OFF	OFF	Purge (A)	OFF
Desorb	This mode is used to flush the sample from the analytical trap onto the GC column.	Desorb Time	1	0	299	min	ON	ON	OFF	ON	OFF	Desorb (B)	OFF
		Desorb Temp	250	20	350	°C							

Table 4-2 Lumin Valve Output Chart (Continued)

Mode	Description	Variables	Default	Min	Max	Unit	MFC	Purge	Vent	Drain	Aux	6-port	Fan
Drain	This mode is used to drain the sample from the sparger and send it to a waste container. This mode occurs during Desorb and is only used with water samples.	Drain Flow	400	0	500	mL/min	ON	OFF	OFF	ON	ON	Desorb (B)	OFF
Bake	This mode is used to heat and backflush the analytical trap and condenser with gas to prevent cross contamination of samples.	Bake Time	2	0	299	min	ON	OFF	OFF	ON	ON	Purge (A)	OFF
		Bake Flow	400	0	500	mL/min							
		Trap Temp	270	20	350	°C							
		Condenser	180	20	200	°C							

- The MFC would be set to OFF for zero flow.
- Temperatures below 35 °C are not controlled and the heater remains off.
- Temperatures below 35 °C are not controlled and the heater remains off.

4.3 Lumin with AQUATek 100 Valve Output Chart

Table 4-3 Lumin with AQUATek 100 - Valve Output Chart

Mode	Description	Variables	Default	Min	Max	Unit	MFC	Purge	Vent	Drain	Bake	6-port	Fan
Standby With Flow	This modes indicates that the system is waiting for all temperature zones to meet their set-points prior to starting a sample run. While the system is waiting, there is a low flow forced through the unit to allow the system to maintain positive pressure.	MFC	10	0	500	mL/min	ON	OFF	OFF	OFF	OFF	Purge (A)	ON
		Trap Temp	35	20	350	°C							
		Transfer Line	150	20	250	°C							
		Valve Oven	150	20	250	°C							
		Condenser	40	20	200	°C							
		Mount	90	20	90	°C							
Purge Ready	This mode indicates to the user that all set-points have been reached and the system is ready to begin running samples.	-	-	-	-	-	ON/ OFF*	OFF	ON	OFF	OFF	Purge (A)	ON
Pressurize	When the Lumin is connected to a liquid autosampler, this mode allows sample to be removed from the sample vial and directed to a sample loop.	Pressurize Time	0.25	0	299	min	ON	OFF	ON	OFF	OFF	Purge (A)	ON
Fill I.S.^a	When the Lumin is connected to a liquid autosampler, this mode allows internal standards to be directed to a valve addition mechanism.	I.S. Fill Time	0.04	0	299	min	ON	OFF	ON	OFF	OFF	Purge (A)	ON

Table 4-3 Lumin with AQUATek 100 - Valve Output Chart (Continued)

Mode	Description	Variables	Default	Min	Max	Unit	MFC	Purge	Vent	Drain	Bake	6-port	Fan
Sample Transfer	When the Lumin is connected to a liquid autosampler, this mode indicates that a liquid sample is being introduced into the sparging vessel. The time required for this step is autosampler dependant. Please refer to your autosampler's operating manual for further assistance.	Sample Transfer Time	0.25	0	299	min	OFF	OFF	ON	OFF	OFF	Purge (A)	ON
Preheat	When the Lumin is working in conjunction with an external sample heater, this mode allows for the sample to be heated prior to purging the sample.	Preheat Time	1	0	299	min	OFF	OFF	ON	OFF	OFF	Purge (A)	ON
		Preheat Temp	40	20	90	°C							
Purge	This mode is used to extract the volatiles from the sample and deposit them on the analytical trap.	Purge Time	11	0	299	min	ON	ON	ON	OFF	OFF	Purge (A)	ON
		Purge Flow	40	0	500	mL/min							
		Purge Temp (Trap) ^b	0	0	350	°C							
		Purge Temp (Condenser) ^c	20	20	250	°C							
Rinse Loop (during purge)	When the Lumin is connected to a liquid autosampler, this mode allows time for the sample loop to be rinsed with hot water.	Loop Rinse Time	0.25	0	299	min	ON	ON	ON	OFF	OFF	Desorb (B)	ON

Table 4-3 Lumin with AQUATek 100 - Valve Output Chart (Continued)

Mode	Description	Variables	Default	Min	Max	Unit	MFC	Purge	Vent	Drain	Bake	6-port	Fan
Purge Loop (during purge)	When the Lumin is connected to a liquid autosampler, this mode allows time for the sample loop to be purged with dry gas.	Loop Purge Time	0.25	0	299	min	ON	ON	ON	OFF	OFF	Desorb (B)	ON
Dry Purge	This mode is used to remove any excess water deposited in the analytical trap.	Dry Purge Time	1	0	299	min	ON	OFF	ON	OFF	OFF	Purge (A)	ON
		Dry Purge Flow	200	0	500	mL/min							
		Dry Purge Temp (Trap)	0	20	350	°C							
Desorb Ready	This mode indicates to the user that the analytical trap is loaded and ready to be transferred to the GC.	-	-	-	-	-	OFF	OFF	OFF	OFF	OFF	Purge (A)	ON
Desorb Preheat	This mode is used to flush the sample from the analytical trap onto the GC column.	Desorb Time	1	0	299	min	OFF	OFF	OFF	OFF	OFF	Desorb (B)	OFF
		Desorb Temp	245	20	350	°C							
Desorb	This mode is used to flush the sample from the analytical trap onto the GC column.	Desorb Time	1	0	299	min	ON	ON	OFF	ON	OFF	Desorb (B)	OFF
		Desorb Temp	250	20	350	°C							
Drain	This mode, occurs during Desorb and is used only with water samples. This mode drains the sample from the sparger to a waste container.	Drain Flow	400	0	500	mL/min	ON	OFF	OFF	ON	ON	Desorb (B)	OFF

Table 4-3 Lumin with AQUATek 100 - Valve Output Chart (Continued)

Mode	Description	Variables	Default	Min	Max	Unit	MFC	Purge	Vent	Drain	Bake	6-port	Fan
Bake Fill	When the Lumin is connected to a liquid autosampler, this mode allows hot water to be introduced to the sample loop for subsequent delivery to the concentrator's sparger.	Bake Fill Time	0.25	0	299	min	ON	OFF	OFF	ON	OFF	Purge (A)	OFF
Bake Transfer	When the Lumin is connected to a liquid autosampler, this mode allows the autosampler to introduce water into the sparge vessel for sparger and line rinsing. For more information on this cleaning process please consult your autosampler's operating manual.	Bake Transfer Time	0.25	0	299	min	ON	OFF	ON	OFF	OFF	Purge (A)	OFF
Bake Drain	When the Lumin is connected to a liquid autosampler, this mode drains the water that was introduced to the sparger from the system.	Bake Drain Time	0.5	0	299	min	ON	ON	OFF	ON	ON	Purge (A)	OFF
		Bake Drain Flow	400	0	500	mL/min							

Table 4-3 Lumin with AQUATek 100 - Valve Output Chart (Continued)

Mode	Description	Variables	Default	Min	Max	Unit	MFC	Purge	Vent	Drain	Bake	6-port	Fan
Bake	This mode is used to heat and backflush the analytical trap and condenser with gas to prevent cross contamination of samples.	Bake Time	2	0	299	min	ON	OFF	OFF	ON	ON	Purge (A)	OFF
		Bake Flow	400	0	500	mL/min							
		Trap Temp	280	20	350	°C							

- a. This parameter is fixed and cannot be changed. 0.04 is set by the firmware.
- b. Temperatures below 35 °C are not controlled and the heater remains off.
- c. Temperatures below 35 °C are not controlled and the heater remains off.

4.4 Optimization



Also refer to 4.4.13 "Analytical Trap Recommended Operating Conditions".

4.4.1 Temperatures

Temperature settings are common to all modes of operations. Therefore, when developing a method, determine temperature settings first.

The temperature range for the Lumin sample transfer line and 6-port valve oven is 20-250 °C. These temperatures control the temperature of the sample transfer line to the GC and the 6-port valve oven area, respectively. For environmental samples, the most common temperature for the sample transfer line and 6-port valve oven is 150 °C. Flavor and fragrance samples are usually run at higher line and valve temperatures.

The temperature range for the Lumin sample mount is 20-90 °C. This temperature controls the heated zone where the sparger connects to the Lumin sample mount. The typical sample mount temperature is 90 °C. In some cases the sample mount will be set to ambient temperature to allow for condensation of water prior to entering the sample pathway.

4.4.2 Standby Mode

The Standby Mode temperatures are for the analytical trap and the condenser. The Lumin will not automatically advance from standby to purge ready if the trap & condenser temperatures are above the set Standby temperatures. The standby temperature range is 20-350 °C for the trap and 20-200 °C for the condenser. However, the typical setting is between 30-45 °C for the trap. This is to prevent a sample from purging on to a hot trap, which may result in incomplete trapping. The typical temperature setting for the condenser is 40-45 °C when using the condenser for water removal. If the condenser is not being used as a condensate trap, it is typical to set the temperature the same as the sample transfer line and 6-port valve oven temperature. The condenser works most efficiently with lower temperatures. However, you may use higher temperatures to reduce the possibility of removing highly polar compounds such as ethanol.

If an autosampler is being used in conjunction with the Lumin, a higher standby temperature may be selected for the trap and condenser since these zones will continue to cool after the Lumin has advanced to purge ready. This can be done since the autosampler will require a period of time to prepare the next sample. If this is done, the user should insure that there is enough time for the Lumin to reach the desired purge temperature prior to the sample being purged.

The standby flow can be set on the Lumin to allow the system to have continual gas flow while the unit is sitting idle. This flow keeps the Lumin under positive pressure, which prevents lab air contamination to the system, and prevents oxygen from being introduced to the trap and tubing, which can result in deterioration. Typical standby Flows are set between 0-10 mL/min.

4.4.3 Purge Ready Mode

Purge Ready Mode indicates the trap and condenser have cooled below their respective set Standby temperatures and all other temperature set-points have been reached. Once the unit has reached this mode, the user can initiate the run.

4.4.4 Pre-Purge Mode

Pre-Purge Mode is only operational when the sample heater is installed. Pre-purge allows the sparger to be swept with purge gas to remove oxygen in the headspace prior to heating the sample. Usually, pre-purge time allows the volume of the sparger to be swept three times.



NOTE

Pre-purge Flow should not exceed Purge Flow.

The volumes of a 5mL and 25mL sparger are 11mL and 34 mL, respectively. Use the calculation below to find the pre-purge time:

$$\frac{3 \times \text{Actual Volume of Sparger (mL)}}{\text{Pre-purge Flow (mL/min)}} = \text{Pre-Purge Time}$$

4.4.5 Sample Temperature and Pre-Heat Mode

Sample temperature and preheat time are not used unless the sample heater is installed. The sample temperature range is 20-90 °C. For environmental samples, the typical range is 40-60 °C. Flavor and fragrance analysis may have much higher temperatures. preheat time is used to allow the heaters to reach their temperature set-points before purge. This insures that all samples are purged under the desired conditions.

4.4.6 Purge Mode

During Purge Mode, gas is passed through the sample. This causes volatiles to be removed for analysis. Purge has two controlling factors: the duration of purging and the flow rate of the gas. This determines the total amount of gas passed through the sample referred to as the purge volume. In most applications, the purge volume should never exceed 600 mL.

The recommended flow rate is 40 mL/min for 11 minutes or 440 mL purge volume. There are some applications where slower flow rates are helpful. For example, if you are looking for very light compounds, a slower flow rate will improve trapping efficiency.

The purge volume for most applications should be between 400-500 mL. To deliver the correct purge volume, you must determine the correct purge time.

The recommended setting for the trap purge temperature is 0 °C. A higher temperature decreases water adsorption, but can also significantly decrease trapping efficiency for the target compounds.

The typical temperature setting for the condenser during purge is 20 °C when using the condenser for water removal. If the condenser is not being used as a condensate trap then it is typical to set a temperature the same as the sample transfer line and 6-port valve oven temperature. The condenser works most efficiently with lower temperatures. However, you may use higher temperatures to reduce the possibility of removing highly polar compounds such as ethanol.

4.4.7 Dry Purge Mode

Dry Purge Mode is used to remove water from the trap and can be used when a #1, #7, #8, #9, Vocab® 3000, or Vocab® 4000 trap is installed (because they are hydrophobic). Dry purge should also be used any time the Moisture Control System (MCS) is not being used as a condensate trap.

Dry purge causes “dry” purge gas to pass through the trap, pushing water off the trap and out to vent. In this mode the trap is already loaded with the compounds of interest, so dry purging for too long, too fast, or at too high of a temperature may result in a lower response due to breakthrough. Usually, the duration of dry purge is 0.5 to 6 minutes. A 0.5 to 2 minute dry purge time should be used to achieve the highest efficiency. The dry purge flow range is 5-500 mL/min; however, it is not recommended to exceed 300mL/min. The recommended trap temperature is between 0-45°C. A higher temperature will improve water removal, but will reduce the volume of purge gas that can be passed through the trap before significant loss of target compounds occurs.

4.4.8 Desorb Ready Mode

Desorb Ready Mode indicates that the trap has been loaded with VOCs and the Lumin is ready to desorb. If the GC is not ready, the Lumin will wait for the GC during this mode. While the Lumin is in this mode, there is no flow through the trap; the Lumin is in a static state.

4.4.9 Desorb Pre-Heat Mode

Desorb Preheat Mode is used to heat up the trap, without flow, to release the analytes from the sorbents. This is done to get a very tight “slug” or band of analytes to the GC. The goal is to introduce the “slug”, in as little time as possible, resembling a direct injection. A typical desorb preheat temperature is 5°C below the desorb temperature. The Lumin will hold in this mode for 0.33 min to ensure full heat transfer to the center of the trap.

4.4.10 Desorb Mode

In desorb, the 6-port valve rotates to backflush analytes from the analytical trap to the GC. You must select time and temperature values for desorb. The temperature should be selected on the basis of what type of trap you are using. The desorb temperature range is 20-350 °C. Typical values range between 180-260 °C. The duration of desorb must be selected with column I.D. and flow rate in mind. You must consider flow rate because the trap is desorbed with carrier gas flow. Allow enough time to fully desorb the compound with the highest boiling point. Time values range from 0.5-8 minutes, depending on flow rates. The desorb flow rate should be set to 200-300 mL/min if the desorb drain is set to “ON”. This flow rate is regulated by the MFC to allow the sample to be drained from the sparger prior to stepping to Bake. The desorb flow rate should be set high enough to ensure that the sample is completely drained during the mode. If the sample is not fully removed, it will continue to drain during Bake Mode.

4.4.11 Bake Mode

Bake Mode is used to regenerate the trap and condenser for the next run. This removes any volatiles remaining on the trap and any water in the system. During bake, flow is passed through the sample pathway with temperatures for the analytical trap and the condenser elevated to help clean the system. Trap bake temperatures should be selected based upon the type of trap being used in the Lumin; typical trap bake temperatures can range from 270-300 °C. If the condenser has been used as a condensate trap, the temperature will typically be set to between 150-200 °C for bake. If the condenser is not being used to remove water, it will be held steady with the sample transfer line and 6-port valve oven temperatures. Flow rates for bake can range between 5-500 mL/min. If cycle time is being minimized, a flow rate of 300-400 mL/min is recommended for 2-4 minutes. Too short of bake time can result in higher carryover.

4.4.12 Analytical Trap Recommended Conditioning Settings

Table 4-4 Analytical Trap Recommended Conditioning Temperatures and Times

Description	Part #	Conditioning Temperature (°C)	Conditioning Time (Min)
(#1) Tenax®	12-0083-403	225	180
(#1A) Tenax® ^a	12-0083-503	225	180
(#2) Tenax®/Silica Gel	12-0084-403	225	180
(#3) Tenax®/Silica Gel/Charcoal	14-0124-403	225	180
(#4) Tenax®/Charcoal	14-1457-403	225	180
(#5) OV®-1/Tenax®/Silica Gel/Charcoal	14-2366-403	225	180
(#6) OV®-1/Tenax®/Silica Gel	14-1755-403	225	180
(#7) OV®-1/Tenax®	14-3347-403	225	180
(#8) Carbopack™ B/Carbosieve® S-III	14-3928-403	260	90
(#9) Trap (Proprietary)	14-9908-403	270	120
(#10) Tenax®/Silica Gel/Carbosieve® S-III	14-9909-403	225	180
(#11) VPH Trap (Proprietary)	15-0884-403	270	120
(K) Vocarb® 3000	14-5864-403	270	120
Vocarb® 4000	14-5865-403	270	120
BTEX™	14-5866-403	270	120
BTEX™ + MTBE	14-9333-403	270	120

a. Uses a different mesh size.

4.4.13 Analytical Trap Recommended Operating Conditions

Table 4-5 Analytical Trap Recommended Operating Conditions								
Description	Part #	Standby Temp	Dry Purge Flow	Dry Purge Time	Dry Purge Temp	Desorb Preheat Temp	Desorb Temp	Bake Temp
(#1) Tenax®	12-0083-403	35	100	2	20	220	225	230
(#1A) Tenax® ^a	12-0083-503	35	100	2	20	220	225	230
(#2) Tenax®/Silica Gel	12-0084-403	35	0	0	N/A	220	225	230
(#3) Tenax®/Silica Gel/Charcoal	14-0124-403	35	0	0	N/A	220	225	230
(#4) Tenax®/Charcoal	14-1457-403	35	100	2	20	220	225	230
(#5) OV®-1/Tenax®/Silica Gel/Charcoal	14-2366-403	35	0	0	N/A	220	225	230
(#6) OV®-1/Tenax®/Silica Gel	14-1755-403	35	0	0	N/A	220	225	230
(#7) OV®-1/Tenax®	14-3347-403	35	100	2	20	220	225	230
(#8) Carbopack™ B/Carbosieve® S-III	14-3928-403	35	100	2	20	245	250	260
(#9) Trap (Proprietary)	14-9908-403	35	100	2	20	245	250	260
(#10) Tenax®/Silica Gel/Carbosieve® S-III	14-9909-403	35	0	0	N/A	220	225	230
(#11) VPH Trap (Proprietary)	15-0884-403	35	100	2	20	245	250	260
(K) Vocarb® 3000	14-5864-403	35	100	2	20	245	250	260
Vocarb® 4000	14-5865-403	35	100	2	20	245	250	260
BTEX™	14-5866-403	35	100	2	20	245	250	260
BTEX™ + MTBE	14-9333-403	35	100	2	20	245	250	260

a. Uses a different mesh size.

Lumin User Manual

Chapter 5: Maintenance and Troubleshooting



NOTE

Caution and Warning Symbols are defined in Section P.5 "Lumin Safety Symbols" and Section P.6 "Lumin Safety Labels".

Les symboles d'Alerte et de Danger sont définis dans la section P.5 "Symboles Sécurité Lumin" la section P.6 "Label Sécurité Lumin" (Section P.5 "Lumin Safety Symbols" and Section P.6 "Lumin Safety Labels").



DANGER

WARNING: Remove the power cable before performing maintenance and/or servicing the instrument.

DANGER - Débrancher le câble d'alimentation avant toutes interventions de maintenance et/ou d'entretien sur l'instrument.

5.1 Replacing Parts

For replacement part numbers contact Teledyne Tekmar Customer Support using the information in Section 5.34 "Technical Assistance".



WARNING

Only use replacement parts supplied or approved by Teledyne Tekmar when performing maintenance on the Lumin. Use of unapproved parts could result in damage to the instrument, as well as personal injury.



DANGER

Do not replace the Lumin mains supply AC power cable with a cable of any other type or rating. Only replace fuses with those of the same type and rating. Refer to Section 5.22 "Power Entry Module (PEM) Fuse Replacement".

5.2 Preventative Maintenance Checks

The following checklists outline the preventative maintenance required for continued successful operation of the Lumin.

5.2.1 Daily Maintenance Checks

Table 5-1 Daily Maintenance Checklist	
Sample Purge Gas Supply	Verify the gas source is supplying an input pressure of 65 -100 psi (4.48 bar -6.89 bar) to the Lumin. If you are using a gas cylinder, verify the cylinder is at greater than 500 psi (34.5 bar). If not, replace the cylinder.
Waste	Verify that the waste container has sufficient volume to contain the waste generated. Empty if necessary.
DI Water Supply (If using an AQUATek 100 Autosampler)	Replace the DI water supply with fresh DI water. Make sure the DI water supply is sufficient for sample analysis (1L minimum).
Leak Check	Run a leak check to ensure that the unit is leak tight.

5.2.2 Weekly Maintenance Checks

Table 5-2 Weekly Maintenance Checklist	
Perform Daily Checks	
Purge Pressure Stability	Scan through the sample history log to verify that the purge pressures are staying consistent throughout the daily runs.

5.2.3 Monthly Maintenance Checks

Table 5-3 Monthly Maintenance Checklist	
Perform Daily and Weekly Checks	
Inspect Sparger	Inspect sparger glassware for damage and the frit for discoloration that could restrict flow or cause contamination. Clean and replace as necessary.



NOTE

The Installation Kit Box includes most of the items needed for routine maintenance of the Lumin.

5.3 Preventative Maintenance Chart

Table 5-4 Preventative Maintenance Chart								
Rate	Action	Check When Completed						
Daily	Sample Purge Gas: 500+ psi (34.5+ bar) from tank							
	Verify stage 2 pressure: 65 - 100 psi (4.48 bar -6.89 bar)							
	Waste container has sufficient volume							
	DI Water: fresh and ample supply							
	Leak Check							
	Initials & Date							
Weekly	Daily Maintenance Items							
	Purge Pressure Stability							
	Initials & Date							
Monthly	Daily & Weekly Maintenance Items							
	Inspect Sparger							
	Initials & Date							

5.4 GC/IO Cable and GC Type Reference



NOTE

If Table 5-5 "GC/IO Cable and GC System Reference" does not contain your GC System, contact Teledyne Tekmar Customer Support using the contact information in Section 5.34 "Technical Assistance".

Table 5-5 GC/IO Cable and GC System Reference

Part Number	GC System	GC Type
14-2371-000	Varian Vista Series with 401 or 402 Data System	Standard
14-2372-000	Shimadzu 9A	User
14-2377-100	Hewlett-Packard (HP) 5700 Series (excluding 5710/30/90)	Standard
14-3054-000	HP 5983/93/95 with SIDS Data System	Standard
14-3168-000	HP 5710/30/90 or 5790 with MSD and Chemstation/ Quicksilver software	Standard
14-3170-000	HP 5840A/80A	User
14-3171-000	HP 5890	User
14-3172-000	Perkin-Elmer Sigma Series	User
14-3176-000	Tracor 540/800 Series MS	Standard
14-3312-000	HP5890 with RTE and HP-1000 GC/MS software with 5970MSD or 5988 MS	Standard
14-3315-000	General; Any GC/MS that has electronic READY and REMOTE START signals	See Instructions
14-3316-100	Varian 3700	Standard
14-3319-000	HP 5995 GC/MS with Chemstation/Quicksilver software	Standard
14-3320-000	General HP GC/MS with RTE Software	User
14-3335-000	Perkin-Elmer 8000 Series or 9000 Autosystem	Standard
14-3569-000	Varian 3300, 3400, and 3600 Series without Serial I/O	Standard
14-4009-100	Finnagin 5100	Standard
14-4188-074	HP 5890 with 5970 MSD or 5988 MS with Unix or Pascal based Chemstation	Standard
14-4610-074	Shimadzu 14A, 15A, and 17A	Standard
14-4652-074	HP 5890 with 5971 MSD (MS/DOS) or HP Engine GC	User
14-4655-074	2 units to a Tracor 540/800 Series MS	Standard
14-4830-074	2 units to a HP 5890	Standard
14-4938-074	Carlo Erba Vega/Mega or 8000	Standard
14-5044-074	1 or 2 units to a Varian 3400/3600/Data System/Integrator (with Serial I/O)	Standard
14-5397-074	2 units to a Perkin-Elmer 8000 Series or 9000 Autosystem	Standard
14-6689-074	HP 6890	User

5.5 Instrument Access Panels

The Lumin has the following access panels:

- Sparger Panel Door
- Analytical Trap Door
- Left-Side Access Panel
- Right-Side Access Panel
- Top Access Panel

Access panels are secured to the instrument chassis with phillips-head screws and locator pins. Remove the Phillips screw from the side panel that is being removed.



The Lumin is designed to keep liquid spills from coming in contact with electronics inside the unit. The Lumin access panels must be installed prior to turning the instrument ON.

Figure 5-1 Front of the Lumin



Figure 5-2 Analytical Trap Compartment and Sparger Panel Open

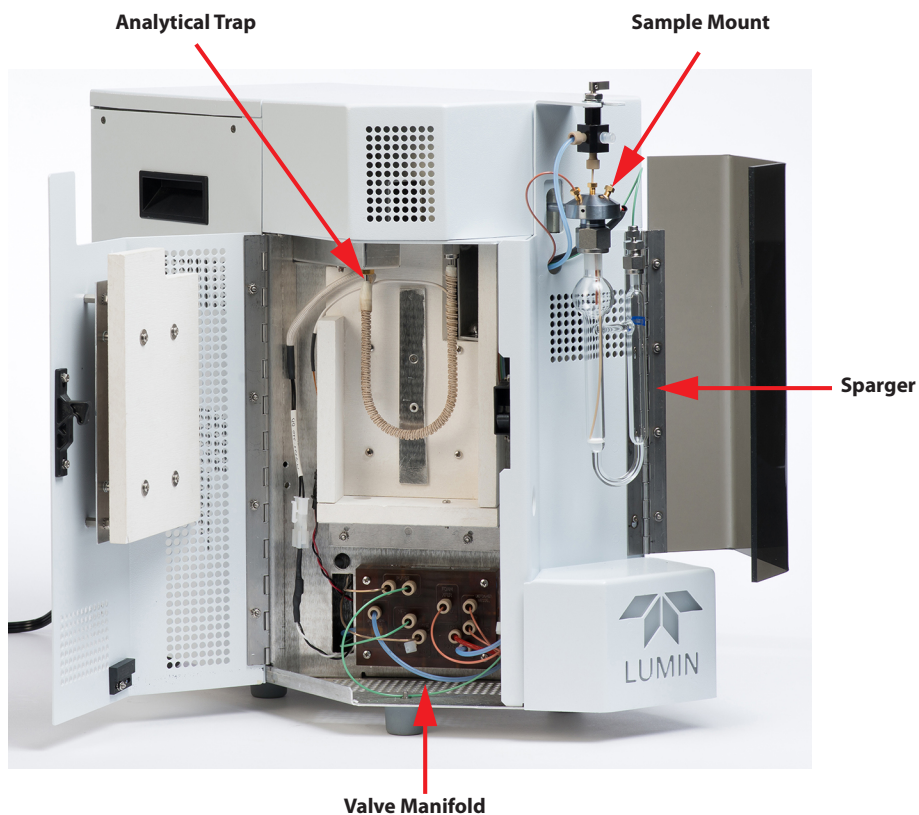

Figure 5-3 Right Side of Lumin

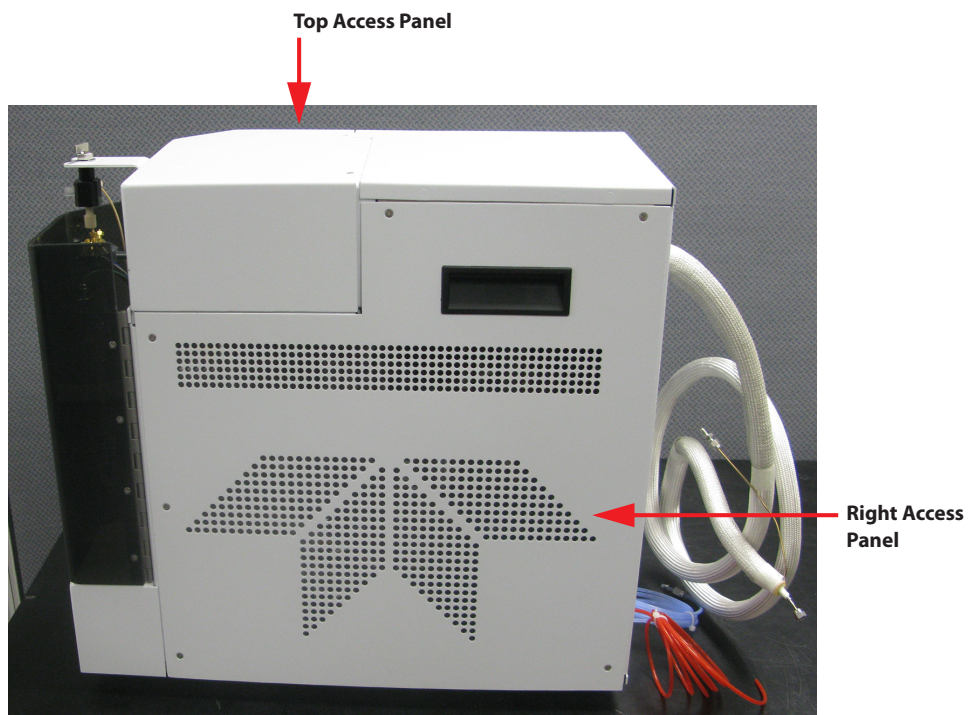
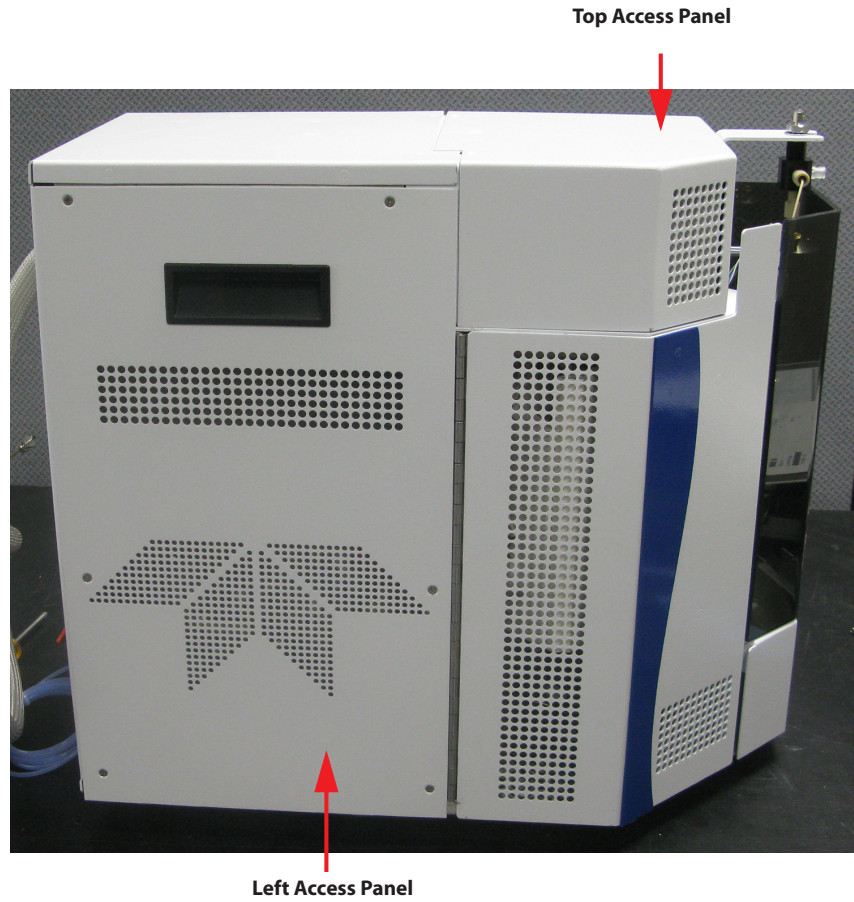

Figure 5-4 Left Side of Lumin



5.6 Plumbing Overview



NOTE

Also refer to Section A.2 "Lumin Plumbing Diagram".

Figure 5-5 Plumbing Components



Sample Mount and Sparger

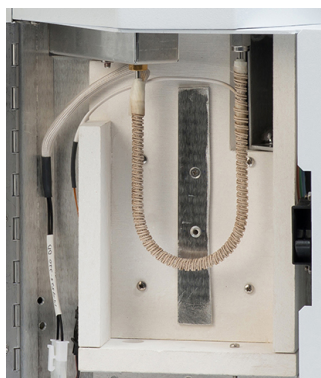

Analytical Trap

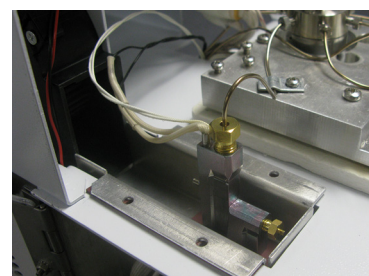

Moisture Control System

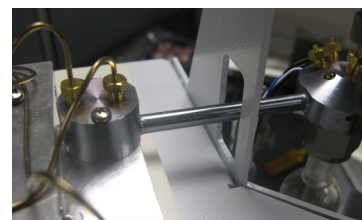

4-Way Tee

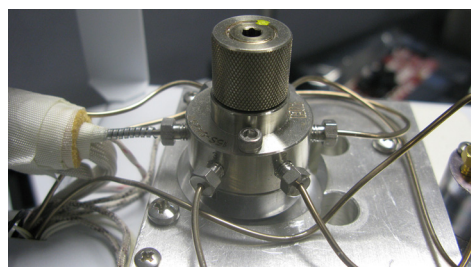

6-Port Valve

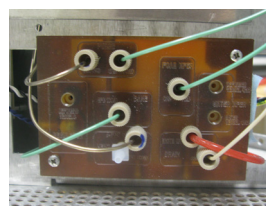

Valve Manifold

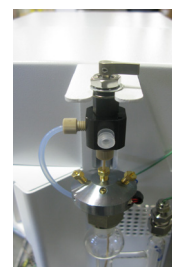

3-Port Sample Valve

Figure 5-6 Plumbing Components

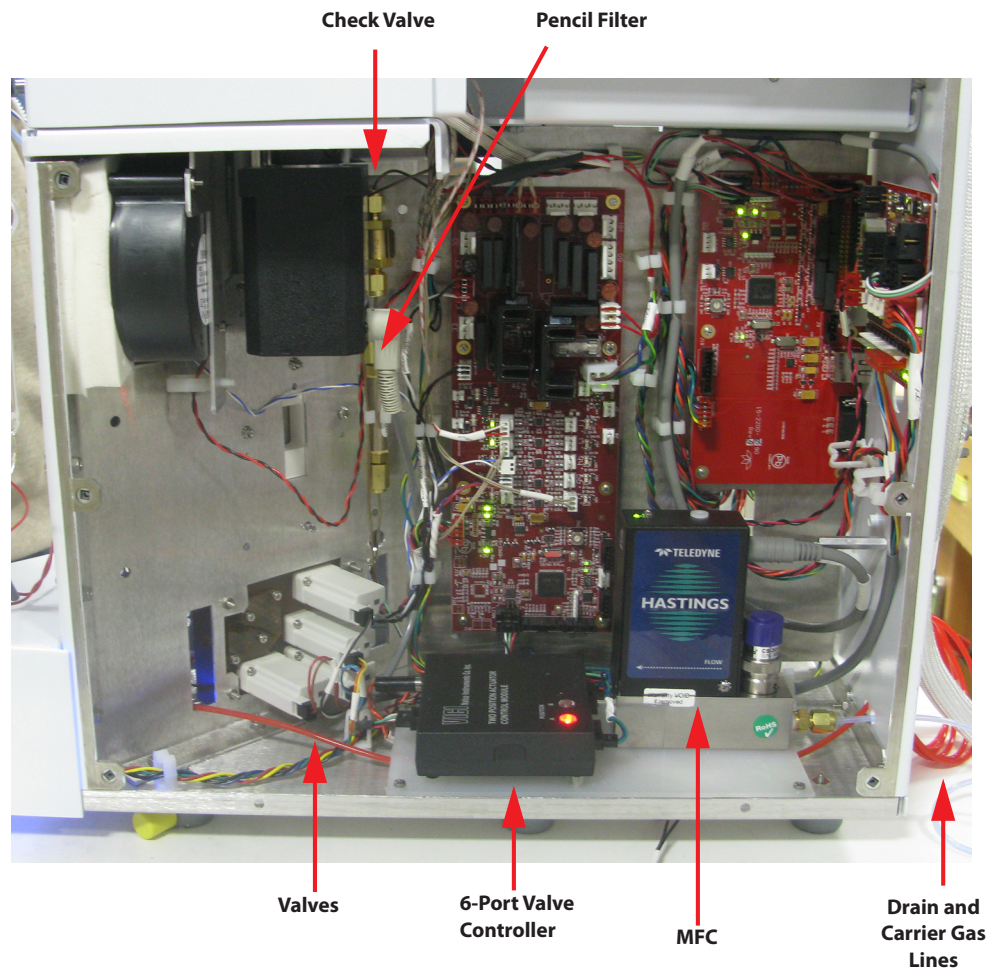

5.7 Electrical Overview



NOTE

Also refer to Section A.1 "Lumin Electrical Schematic".

5.7.1 Power Supplies

Figure 5-7 5 VDC (Left) and 24 VDC (Right) Power Supplies

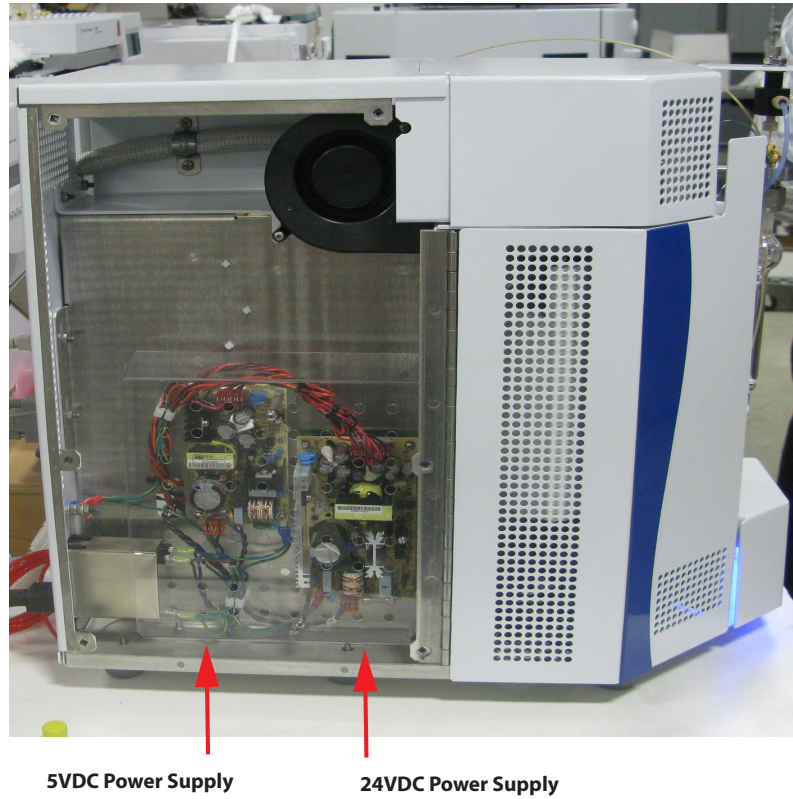

5.7.2 Printed Circuit Boards

The Lumin has three primary Printed Circuit Boards (PCB):

- Multi-Channel Temperature Control Board
- DC Valve Control Board
- CPU Communication Board

Locations of the boards are shown in Figure 5-8. Diagrams of the boards are affixed to the interior of the concentrator, as well as shown in relevant maintenance procedures.

Figure 5-8 Printed Circuit Board Locations

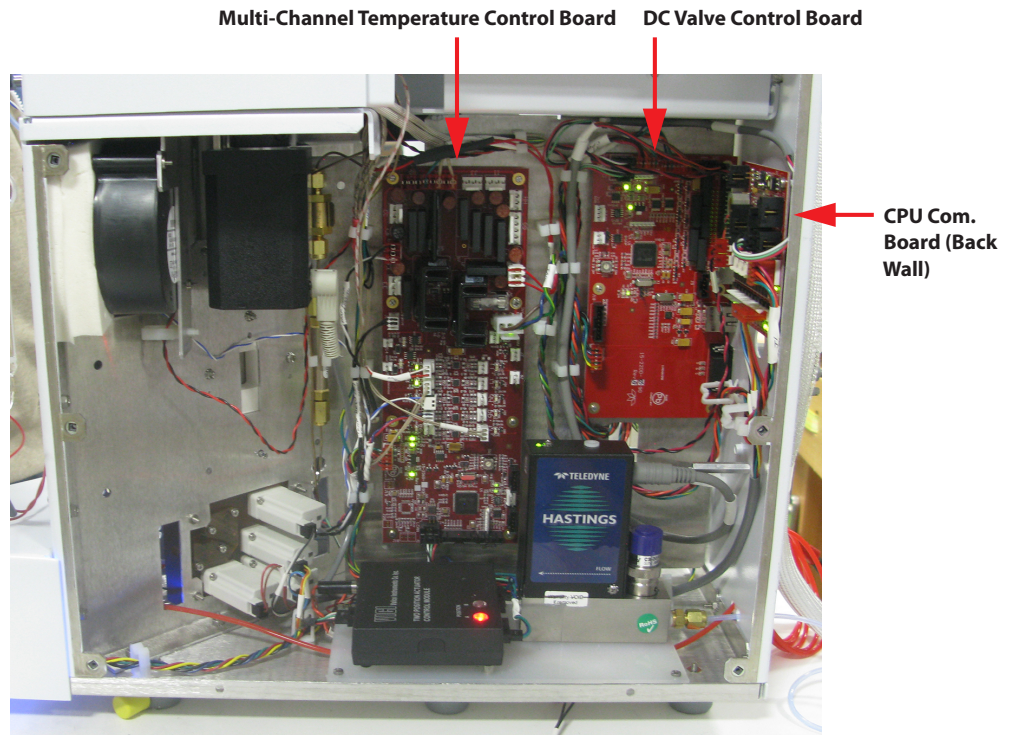

5.8 Glassware Cleaning Procedures

Clean glassware is essential for trouble-free analyses. This glassware includes samplers, flasks, cylinders - anything used in handling samples, standards, or blank water.



NOTE

Glassware used for other procedures, such as extractions, is usually not clean enough to use for trace applications.

Consult your laboratory's standard operating procedures for keeping glassware clean. In addition to your standard glassware protocol Teledyne Tekmar recommends the following:

- Clean only with DI water and do not use soaps or cleaning products which could introduce contamination.
- Use Dedicated Glassware
Dedicated glassware is glassware that is used for concentrator work only.
- Sparger Cleaning



Always wear safety glasses and appropriate Personal Protective Equipment (PPE) when working with Methanol. Consult the Methanol SDS and/or manufacturer's information for containment and cleanup methods and materials and disposal procedures.

Use a methanol rinse followed by DI water to clean contamination from the sparger.



NOTE

If sparger contamination cannot be removed, the sparger should be replaced.



Caution

When using Methanol ensure it does not come into contact with any plastic or rubber instrument components.

5.9 Sparger Replacement

Tools Required

- 1/2" Open-ended Wrench
- 1/4" Open-ended Wrench

Procedure



Warning! - Hot surface! Turn OFF power to the Lumin and remove the AC power line from the back of the instrument. Allow the Sample Mount and surrounding area to cool to room temperature.

Figure 5-9 Sparger Connections

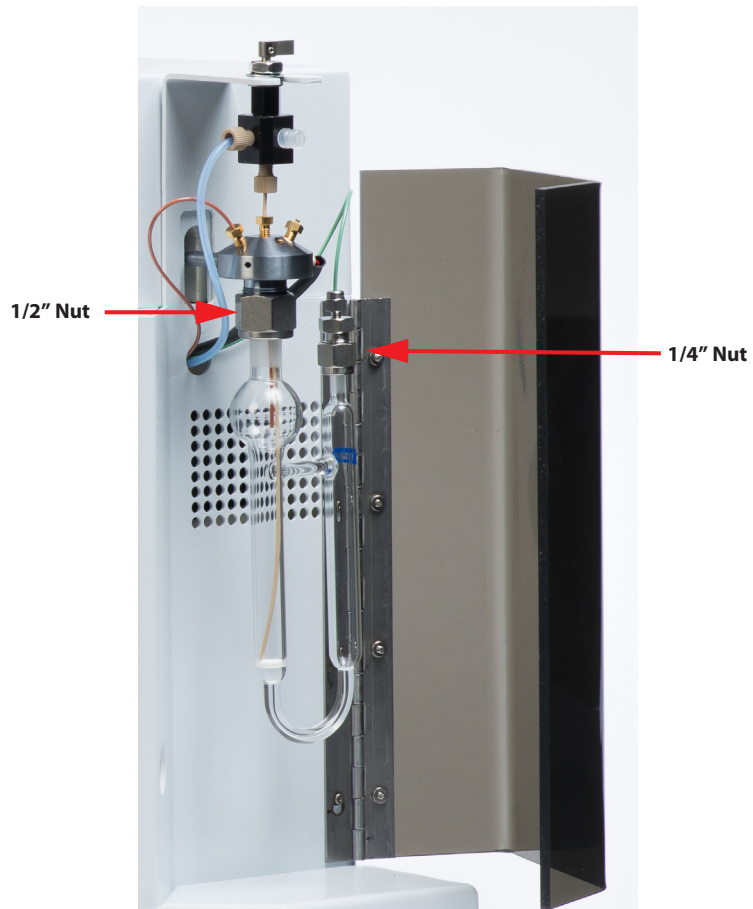

1. Turn the unit off, remove the AC power cord and allow the Sample Mount and surrounding areas to cool.
2. Open the Sparger Panel Door on the front of the Lumin concentrator.

**NOTE**

The guard has a keyhole slotted hinge that can be removed by lifting the guard up and out if necessary.

3. Loosen the 1/4" nut located on the small side of the U-shaped sparger glassware and slide the union off of the glassware neck (Figure 5-9).
4. Locate the 1/2" nut just above the bubble on the sparger glassware (Figure 5-9). Support the glassware in one hand while loosening the nut. When the nut is loose, slide the glassware out of the sample mount (See Figure 5-9).
5. Install the new Sparger by sliding it through the loosened 1/2" nut attached to the bottom of the sample mount. Insert the glassware completely and tighten the nut just enough to allow it to hold the glassware without manual support. Twist the glassware so that the glassware is backed off the mount 1 mm-2 mm. Finger-tighten the nut then use a wrench to tighten further with no more than a 1/2 turn.
6. Replace the union on the small side of the U-shaped glassware. Finger-tighten the nut then use a wrench to tighten further with no more than a 1/2 turn.
7. Connect the AC power cord and turn the unit ON.
8. Start the Lumin TekLink software, if necessary.
9. Perform a Leak Check according to Section 5.31.2 "Initial Leak Checking".

5.10 Analytical Trap Replacement

Tools Required

- Phillips-head Screwdriver
- 3/8" Open-ended Wrench
- 7/16" Open-ended Wrench

Figure 5-10 Analytical Trap Compartment

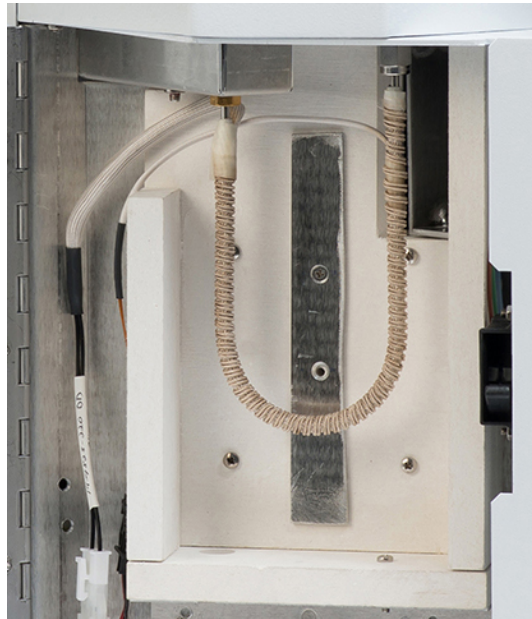
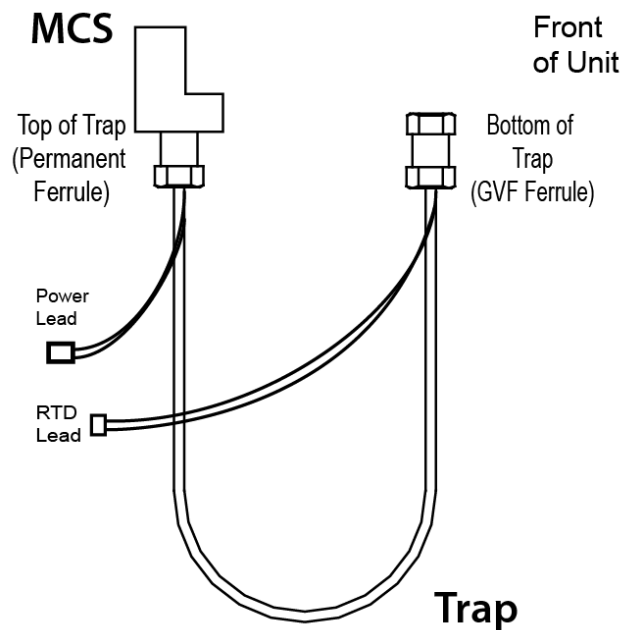

Figure 5-11 Analytical Trap Diagram



Procedure



Warning! - Hot surface! The trap and surrounding areas can be extremely hot. Allow adequate time to cool.



Warning! - To avoid electrical shock turn OFF and unplug the Lumin before servicing.

1. Turn the unit off, remove the power cord, and allow the instrument to cool to room temperature.
2. Open the analytical trap compartment door.

Figure 5-12 Trap Heater and RTD Plugs



- The analytical trap is connected at the top of the compartment using a 3/8" male nut on one side and a 7/16" female nut on the other. Using an open-ended wrench loosen both nuts and remove the analytical trap.

Figure 5-13 Analytical Trap Connections

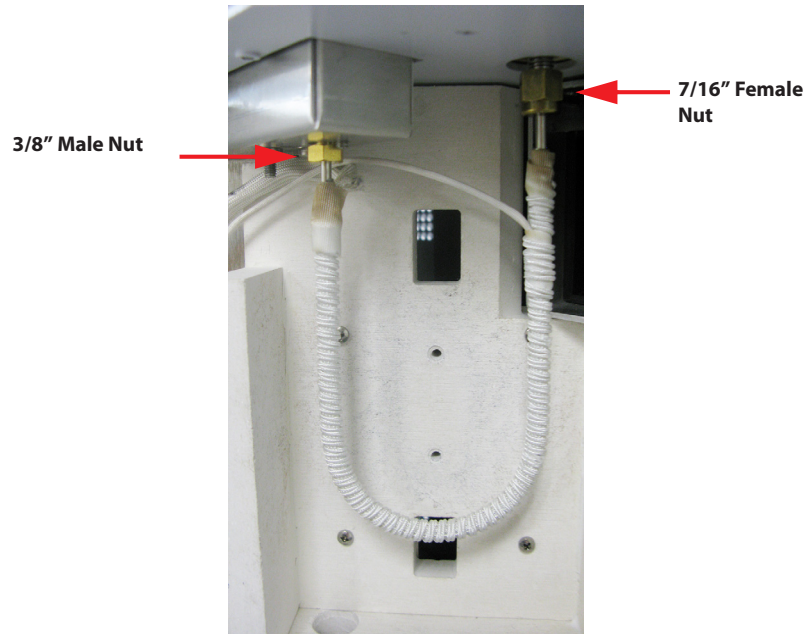

- With the trap removed slide the 7/16" female nut and ferrule off of the trap then remove the trap heater jacket and RTD. Retain the 7/16" nut and ferrule.
- Slide the trap heater jacket and RTD onto the new analytical trap. The RTD should be oriented toward the right side of the trap.
- Using the 3/8" male nut on the new trap and the 7/16" nut and ferrule removed previously, reattach the new trap at the top of the compartment. Tighten, but do not over-tighten.
- Close the analytical trap compartment door.
- Connect the AC power cord and turn the unit ON.
- Start the Lumin TekLink software, if necessary.
- Perform a Leak Check according to Section 5.31.2 "Initial Leak Checking".
- Condition the Analytical Trap according to Section 5.11 "Analytical Trap Conditioning".

5.11 Analytical Trap Conditioning



NOTE

Refer to 4.4.12 "Analytical Trap Recommended Conditioning Settings" or the trap manufacturer's instructions for conditioning.

- From the HOME SCREEN select the TOOLS BUTTON to display the TOOLS SCREEN. Select the BAKE BUTTON to display the BAKE DIALOG.

2. In the BAKE DIALOG, enter the recommended trap conditioning settings from the trap manufacturer.
3. Select the OK BUTTON to begin conditioning the trap.

Figure 5-14 Bake Dialog

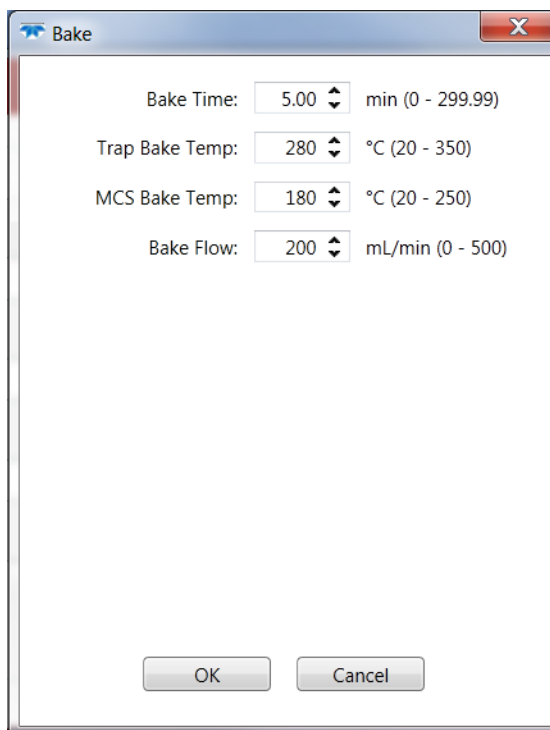

5.12 Analytical Trap Heater Jacket

Tools Required

- 3/8" Open-ended Wrench
- 7/16" Open-ended Wrench

Figure 5-15 Analytical Trap Compartment

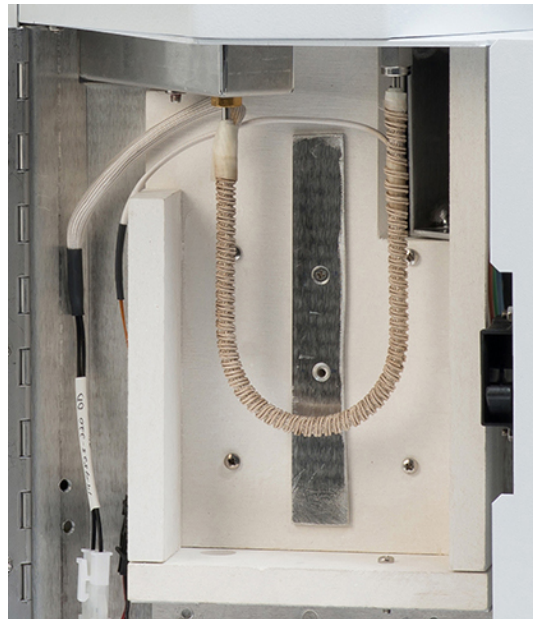
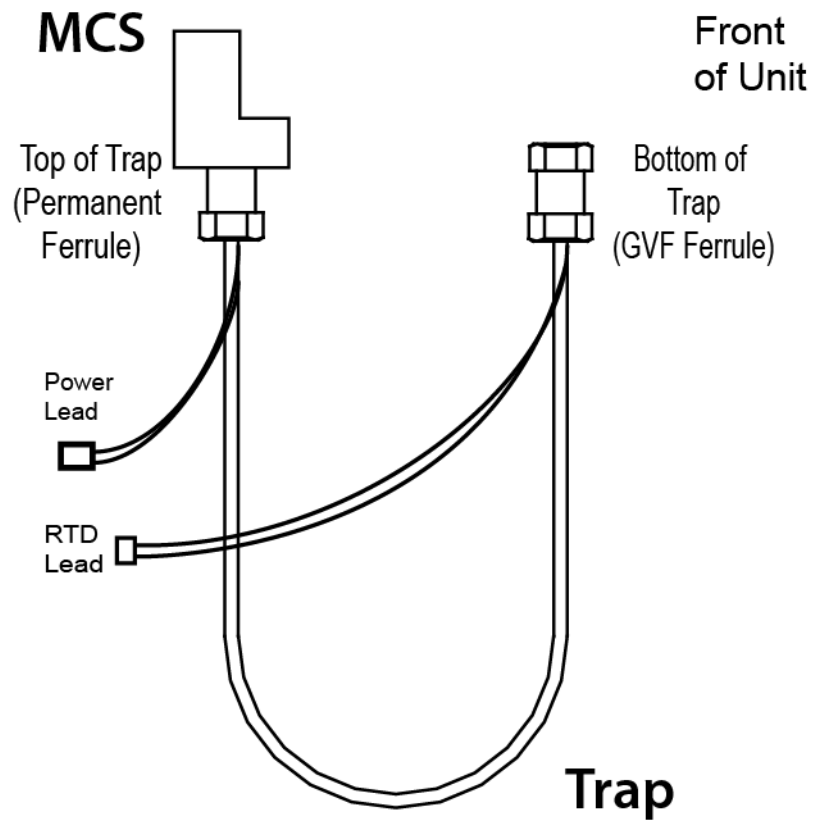

Figure 5-16 Analytical Trap Diagram



Procedure



Warning! - Hot surface! The trap and surrounding areas can be extremely hot. Allow adequate time to cool.



Warning! - To avoid electrical shock turn OFF and unplug the Lumin before servicing.

1. Turn the unit off, remove the power cord, and allow the instrument to cool to room temperature.
2. Open the analytical trap door.
3. Disconnect the trap heater jacket and the RTD plugs at the left side of the compartment.

Figure 5-17 Trap Heater and RTD Plugs

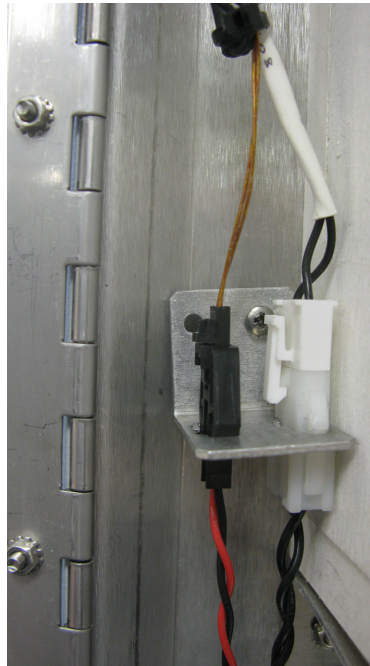

4. Remove the analytical trap according to Section 5.10 "Analytical Trap Replacement", then remove the trap heater jacket.
5. Slide the new trap heater jacket over the analytical trap.
6. Install the trap according to Section 5.10 "Analytical Trap Replacement".
7. Connect the new trap heater jacket and RTD plugs at the left side of the compartment.
8. Connect the AC power cord and turn the unit ON.

9. Start the Lumin TekLink software, if necessary.
10. Perform a Leak Check according to Section 5.31.2 "Initial Leak Checking".

5.13 Analytical Trap Cooling Fan

Figure 5-18 Analytical Trap Cooling Fan

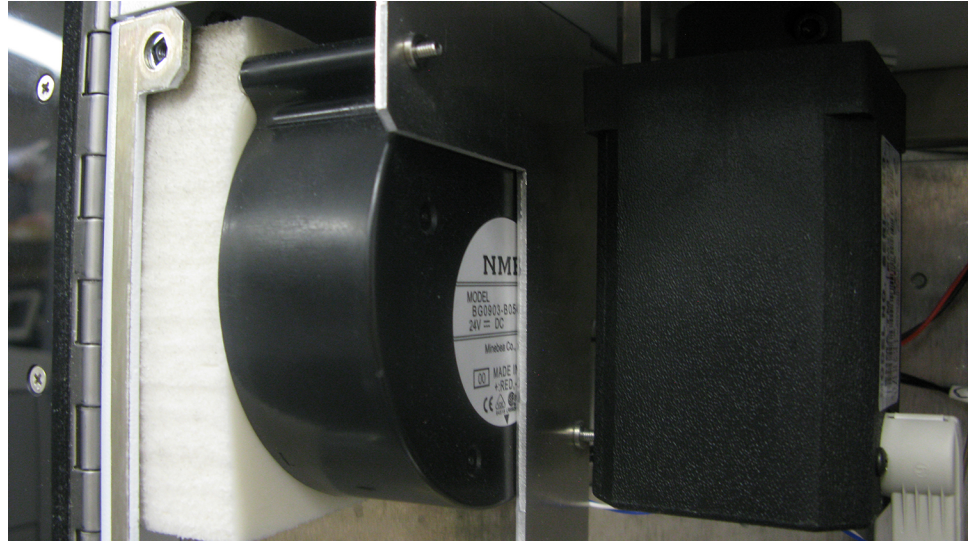

Tools Required

- Phillips-head Screwdriver
- M4 Nut-Driver or Open-Ended Wrench
- Wire Clippers

Procedure



Warning! - To avoid electrical shock turn OFF and unplug the Lumin before servicing.

1. Turn the unit off and remove the AC power cord.
2. Remove the right access panel (Figure 5-25).
3. Disconnect the fan electrical connection from the Valve Printed Circuit Board (PCB) at J5.

Figure 5-19 DC Valve Printed Circuit Board (PCB)

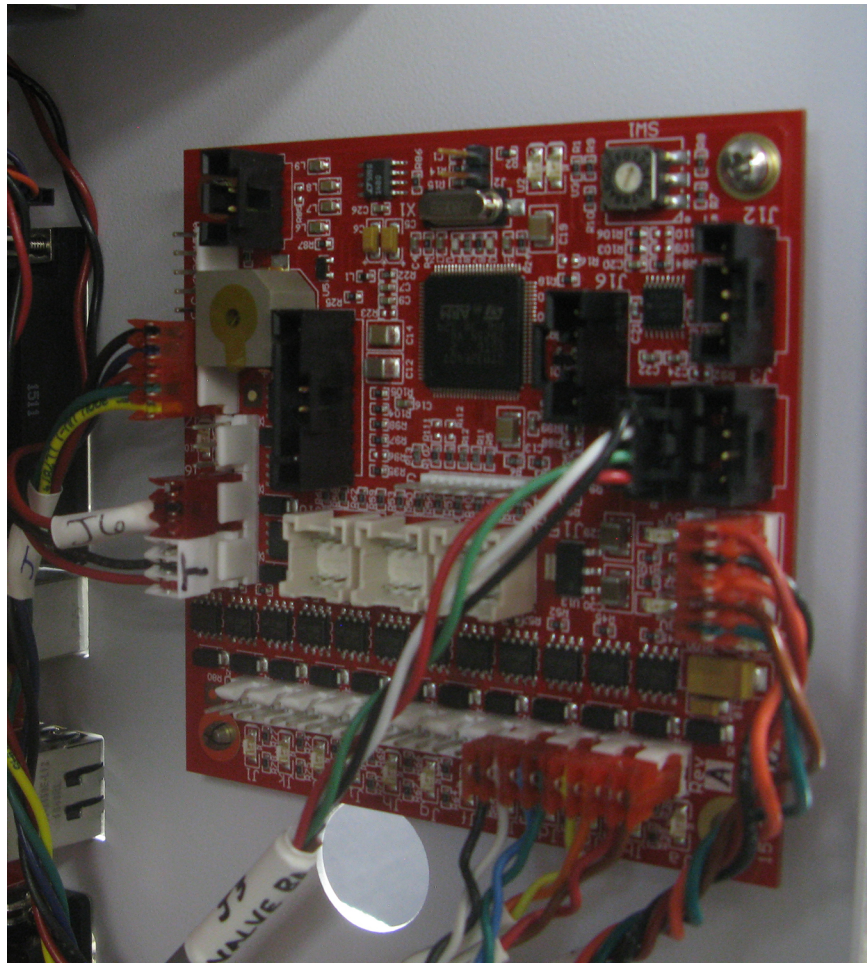

4. Clip any wire ties binding the fan electric cable to other wiring, so that it can be removed.
5. Remove the two M4 kep-nuts that secure the fan mounting bracket to the ceiling of the right compartment.



NOTE

Leave the fan gaskets installed on the front panel standoffs.

Figure 5-20 Analytical Cooling Fan Mounting Bracket



6. Remove the two phillips securing the fan to the mounting bracket.
7. Secure the new fan to the fan mounting bracket using the previously removed phillips-head screws.
8. Install the fan mounting bracket to the ceiling of the right compartment using the previously removed M4 kep-nuts. The fan output should be oriented toward the opening in the trap compartment insulation box. The input side of the fan should press against the fan gaskets installed on the front panel standoffs so that it does not draw air from inside the right compartment.



Caution

Exercise caution when placing the fan output against the trap compartment insulation box. Too much pressure from the fan can break the insulation box.

Figure 5-21 Analytical Trap Cooling Fan Opening at Insulation Box



9. Route the fan electrical cable toward the back of the concentrator and plug it into location J5 on the Valve Printed Circuit Board (PCB). Tuck the cable into any wire holders and install new wire ties to secure the cable.
10. Reinstall the right access panel.
11. Connect the AC power cord and turn the unit ON.
12. Start the Lumin TekLink software, if necessary.

5.14 MCS Cooling Fan

Figure 5-22 MCS Cooling Fan

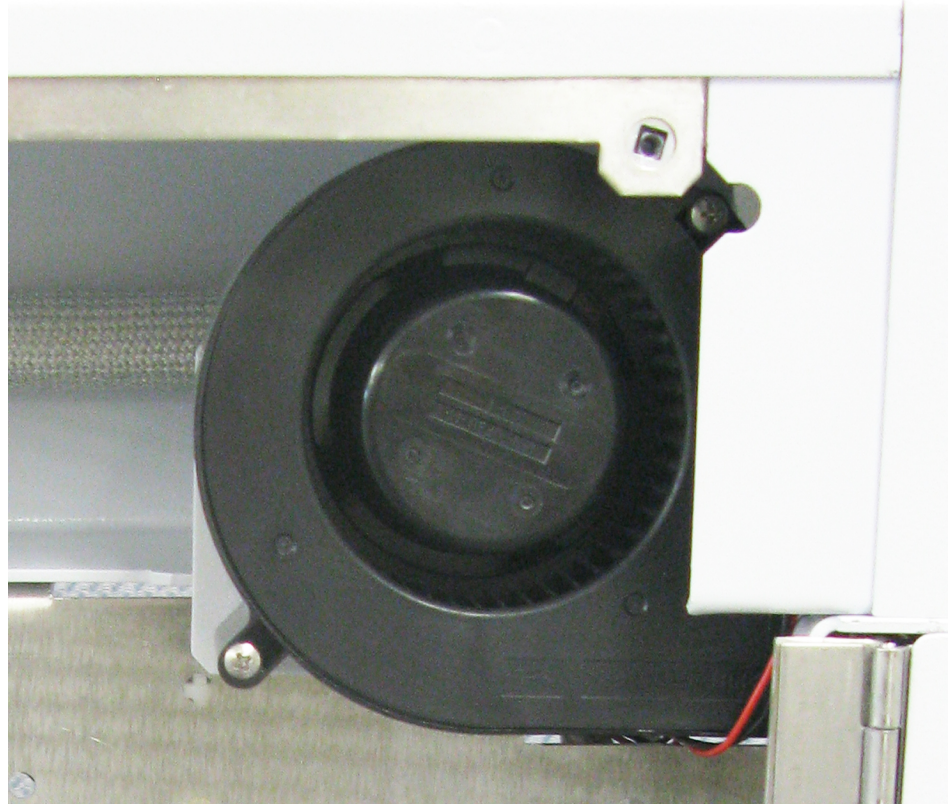

Tools Required

- Phillips-head Screwdriver
- Wire clippers

Procedure



Warning! - To avoid electrical shock turn OFF and unplug the Lumin before servicing.

1. Turn the unit off and remove the AC power cord.
2. Remove the left, right and top access panels.
3. Inside of the right compartment, disconnect the fan electrical connection from the Valve Printed Circuit Board (PCB) at J6.

Figure 5-23 DC Valve Printed Circuit Board (PCB)

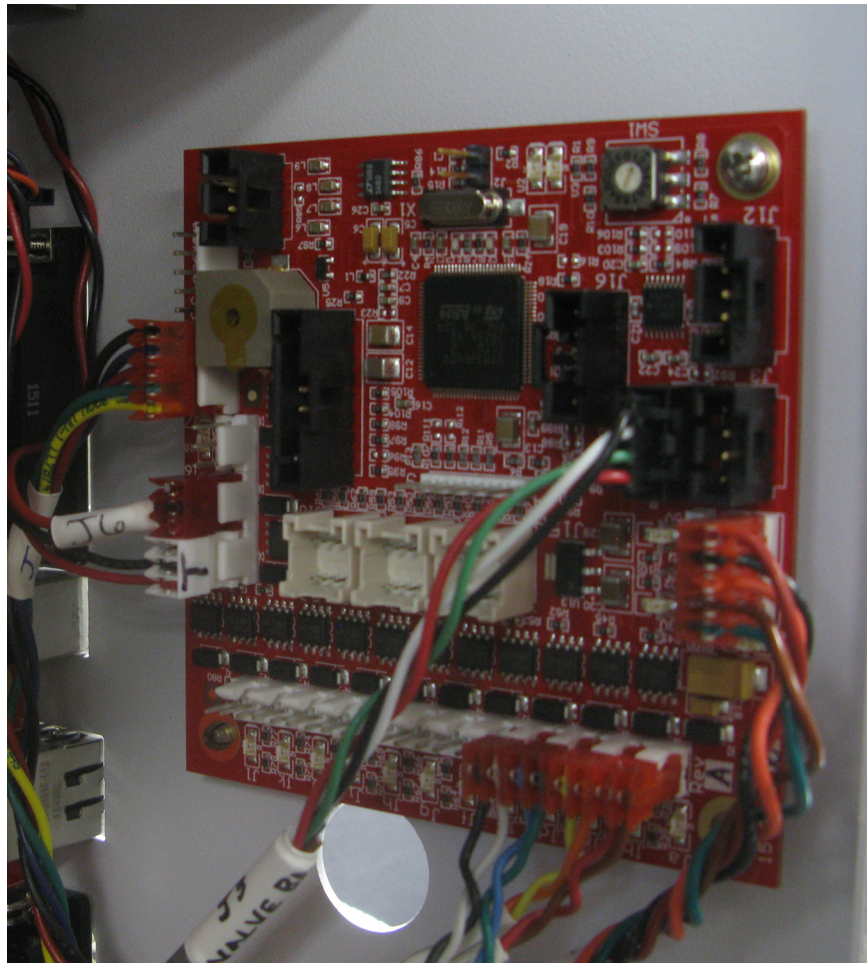

4. Clip any wire ties binding the fan electric cable to other wiring, so that it can be removed.
5. Remove the two phillips securing the fan, then pull the fan and electric cable from the chassis.
6. Thread the new fan electric cable through the hole in the center wall of the chassis so that it can be connected to the DC Valve Printed Circuit Board located on the back wall of the right compartment.
7. Secure the new fan using the previously removed phillips-head screws. The fan output should be oriented toward the opening in the Moisture Control System. The input side of the fan should be oriented toward the left access panel ventilation holes.



Caution

When mounting the fan ensure the fan electric cable and MCS electric cables are not pinched.

Figure 5-24 MCS Cooling Fan Cable Routing

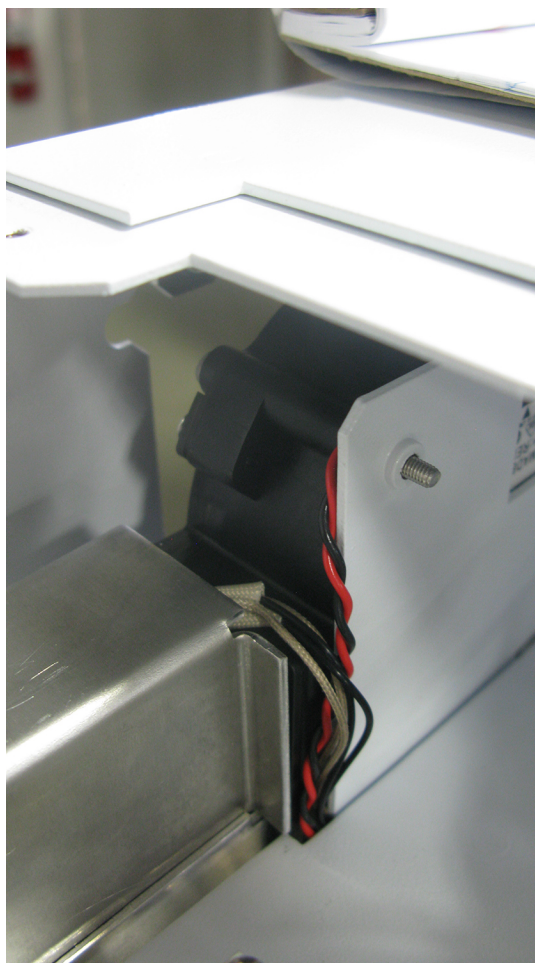

8. Route the fan electrical cable toward the back of the concentrator and plug it into location J6 on the Valve Printed Circuit Board (PCB). Tuck the cable into any wire holders and install new wire ties to secure the cable.
9. Reinstall the left, right, and top access panels.
10. Connect the AC power cord and turn the unit ON.
11. Start the Lumin TekLink software, if necessary.

5.15 Pencil Filter Replacement

Tools Required

- Phillips-head Screwdriver
- Two 7/16" Open-ended Wrenches

The Pencil Filter removes impurities from the carrier gas. When ghost peaks start appearing in the chromatograms, often the pencil filter needs to be replaced.

Procedure



Warning! - To avoid electrical shock turn OFF and unplug the Lumin before servicing.

1. Turn the unit off and remove the AC power cord.
2. Remove the right access panel and locate the pencil filter (Figure 5-25).

Figure 5-25 Pencil Filter

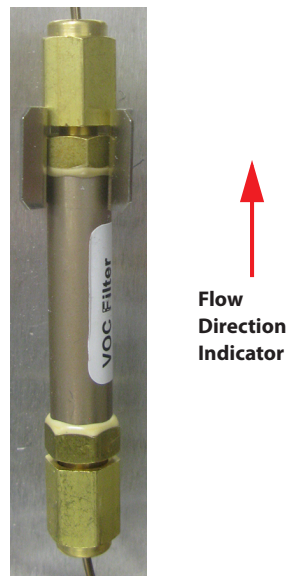

3. Using two 7/16" open-ended wrenches, unscrew the connections at both sides of the pencil filter.
4. Remove the old pencil filter and replace with a new pencil filter, making sure that the flow direction indicator on the filter points towards the check valve.
5. Tighten the nuts, but do not over-tighten.
6. Connect the AC power cord and turn the unit ON.
7. Start the Lumin TekLink software, if necessary.
8. Perform a Leak Check according to Section 5.31.2 "Initial Leak Checking".

5.16 Check Valve

The check valve prevents back flow into the pencil filter and beyond. A common symptom that the check valve needs to be replaced is when a high level of carryover is observed.

Tools Required

- Phillips-head Screwdriver
- 7/16" Open-ended Wrench

- 5/8" Open-ended Wrench

Procedure



Warning! - To avoid electrical shock turn OFF and unplug the Lumin before servicing.

1. Turn the unit off and remove AC power cord.
2. Remove the right access panel of the unit, and locate the check valve.

Figure 5-26 Check Valve

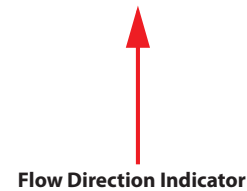
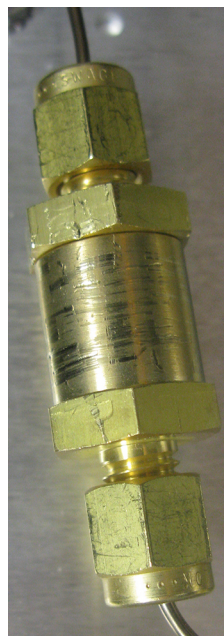

3. Using a 7/16" and a 5/8" wrench, unscrew both sides of the check valve.
4. Remove the old check valve and replace with a new check valve, making sure that the flow direction indicator points away from the valve manifold assembly.
5. Tighten the nuts, but do not over-tighten.
6. Reinstall the right access panel.
7. Connect the AC power cord and turn the unit ON.
8. Start the Lumin TekLink software, if necessary.
9. Perform a Leak Check according to Section 5.31.2 "Initial Leak Checking".

5.17 Valve Manifold Replacement

Tools Required

- Phillips-head Screwdriver



Warning! - To avoid electrical shock turn OFF and unplug the Lumin before servicing.

Turn the unit off and remove the AC power cord.

1. Open the analytical trap door, remove the right-side panel, and locate the valve manifold (Figure 5-27).

Figure 5-27 Front and Back Valve Manifold

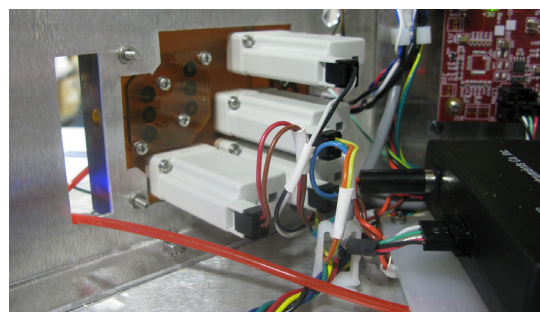
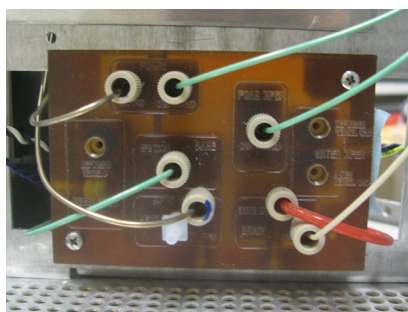

2. Disconnect the electrical connections at the back of the valves by pulling them straight out. Note that the connections are labeled.



NOTE

Take care to avoid bending the pins otherwise it may be very difficult to replace the connection later.

3. Label and disconnect all of the tubing lines from the face of the valve manifold. Remove the two screws at the corners of the valve manifold and retain.
4. Remove the valve manifold from the analytical trap compartment.
5. Label and remove the valves by unscrewing the two phillips-head screws at the corners of the valve. Retain the valve gaskets. Retain the phillips mounting screws.



NOTE

Do not remove the hex screws!

NOTE

If you are replacing a bad valve, make sure you replace the correct one based on the troubleshooting symptoms and the labels on the Valve Manifold.

6. Reinstall the valves and valve gaskets to the new valve manifold using the retained phillips-head screws.
7. Once the valves are installed, place the valve manifold into the valve manifold slot and secure with the two screws removed earlier.
8. Reconnect the tubing to the proper inlet and outlets on the face of the valve manifold.
9. Reconnect the electrical connections at the back of the valves in the proper order.

NOTE

Again, take care to avoid bending the pins.

10. Close the trap access door and replace the right access panel.
11. Connect the AC power cord and turn the unit ON.
12. Start the Lumin TekLink software, if necessary.
13. Perform a Leak Check according to Section 5.31.2 "Initial Leak Checking".

5.18 Valve Replacement

Tools Required

- Phillips-head Screwdriver

Procedure



Warning! - To avoid electrical shock turn OFF and unplug the Lumin before servicing.

Turn the unit off and remove the AC power cord.

1. Open the analytical trap door, remove the right-side panel, and locate the valve manifold (Figure 5-27).

Figure 5-28 Front and Back Valve Manifold

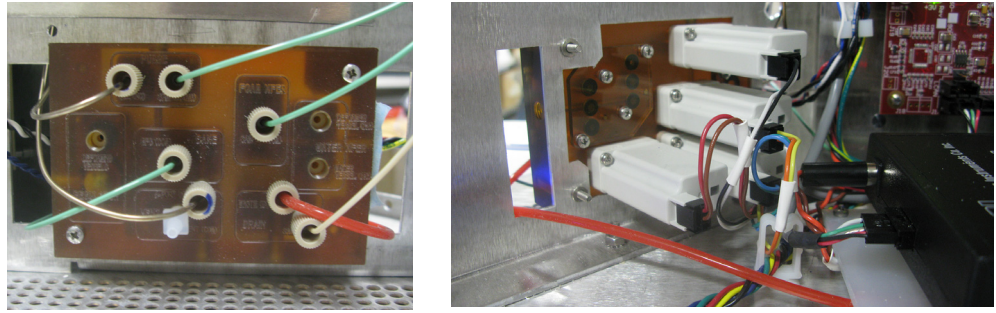

2. Identify the valve to be replaced.



NOTE

Make sure you replace the correct valve based on the troubleshooting symptoms and the labels on the Valve Manifold.

3. Disconnect the electrical connections at the back of the valve to be replaced by pulling it straight out. Note that the connections are labeled.



NOTE

Take care to avoid bending the pins otherwise it may be very difficult to replace the connection later.

4. Remove the valve by unscrewing the two phillips-head screws at the corners of the valve.



NOTE

Do not remove the hex screws!

5. Remove the valve and the valve gasket from the valve manifold.
6. Attach the new valve and valve gasket to the valve manifold using the two retained phillips-head screws.
7. Reconnect the electrical cable at the back of the valve.



NOTE

Again, take care to avoid bending the pins.

8. Close the trap access door and replace the right access panel.
9. Connect the AC power cord and turn the unit ON.
10. Start the Lumin TekLink software, if necessary.

11. Perform a Leak Check according to Section 5.31.2 "Initial Leak Checking".

5.19 Moisture Control System (MCS)

Tools Required

- Phillips-head screwdriver
- 3 mm Hex wrench
- 3/8" Open-ended wrench

Procedure



Warning! - Hot surface! The trap and surrounding areas can be extremely hot. Allow the Analytical Trap and MCS to cool to room temperature.



Warning! - To avoid electrical shock turn OFF and unplug the Lumin before servicing.

1. Turn the unit off, remove the AC power cord, and allow the MCS and surrounding areas to cool.
2. Remove the 6-Port valve oven cover and open the analytical trap compartment door.
3. Just below the MCS, remove the 3/8" male nut that connects the analytical trap to the MCS.

Figure 5-29 Analytical Trap Connections to the MCS

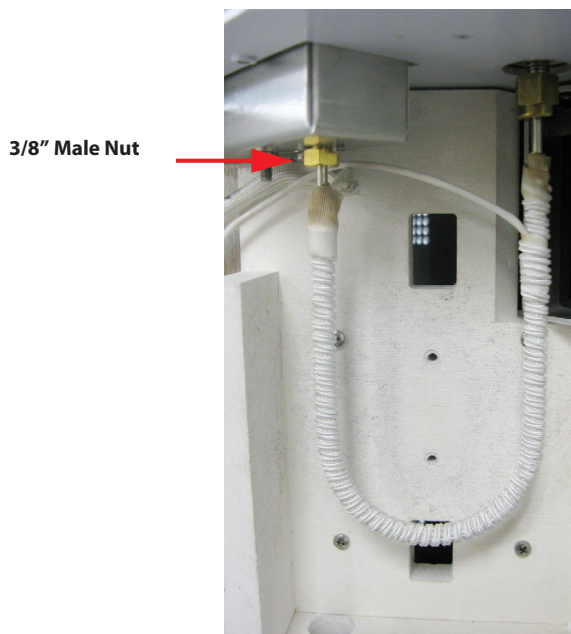

4. Remove the MCS cover plate, by removing the screws that secure it (Figure 5-30).

Figure 5-30 MCS Cover Plate Removal

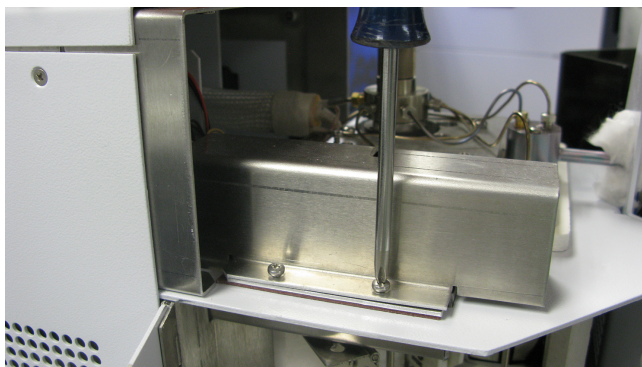

5. Remove the nut on the top of the MCS that connects the 6-port valve tubing to the MCS (Figure 5-31).
6. Loosen the two hex set screws that secure the RTD and cartridge heater in the MCS block (Figure 5-31). Gently pull the RTD and cartridge heater from the block.

Figure 5-31 MCS

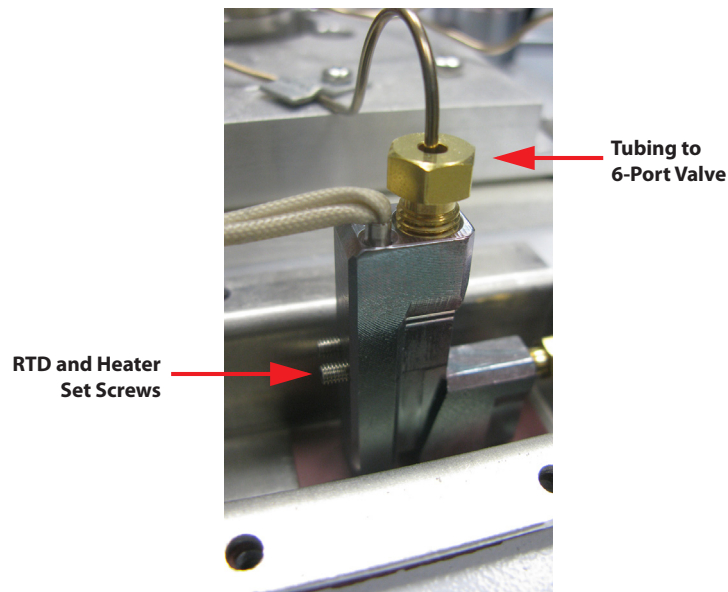

7. Remove the MCS by removing the screws that secure the MCS to the chassis from below. Retain the mounting screws.
8. Attach the new MCS to the chassis using the mounting screws that were removed, making sure that the thermal isolation plate is between the MCS and the chassis.
9. Reconnect the 6-port valve tubing to the MCS.
10. Reinstall the RTD and cartridge heater into the MCS and then secure with the set screws removed earlier.
11. Reattach the analytical trap to the MCS using the 3/8" male nut on the analytical trap.
12. Reinstall the MCS cover plate using the screws that secure it.
13. Reinstall the 6-Port valve oven cover using the screws that secure it, and close the analytical trap door.
14. Connect the AC power cord and turn the unit ON.
15. Start the Lumin TekLink software, if necessary.
16. Perform a Leak Check according to Section 5.31.2 "Initial Leak Checking".

5.20 Mass Flow Controller (MFC)

Tools Required

- Phillips-head Screwdriver
- 5/16" Open-ended Wrench
- 7/16" Open-ended Wrench

Procedure



Warning! - To avoid electrical shock turn OFF and unplug the Lumin before servicing.

1. Turn the unit off, unplug the AC power cord, and turn off the gas supply to the unit.
2. Take off the right access panel of the unit and locate the MFC.
3. Disconnect the gray power and communication cable (Figure 5-32).

Figure 5-32 Mass Flow Controller

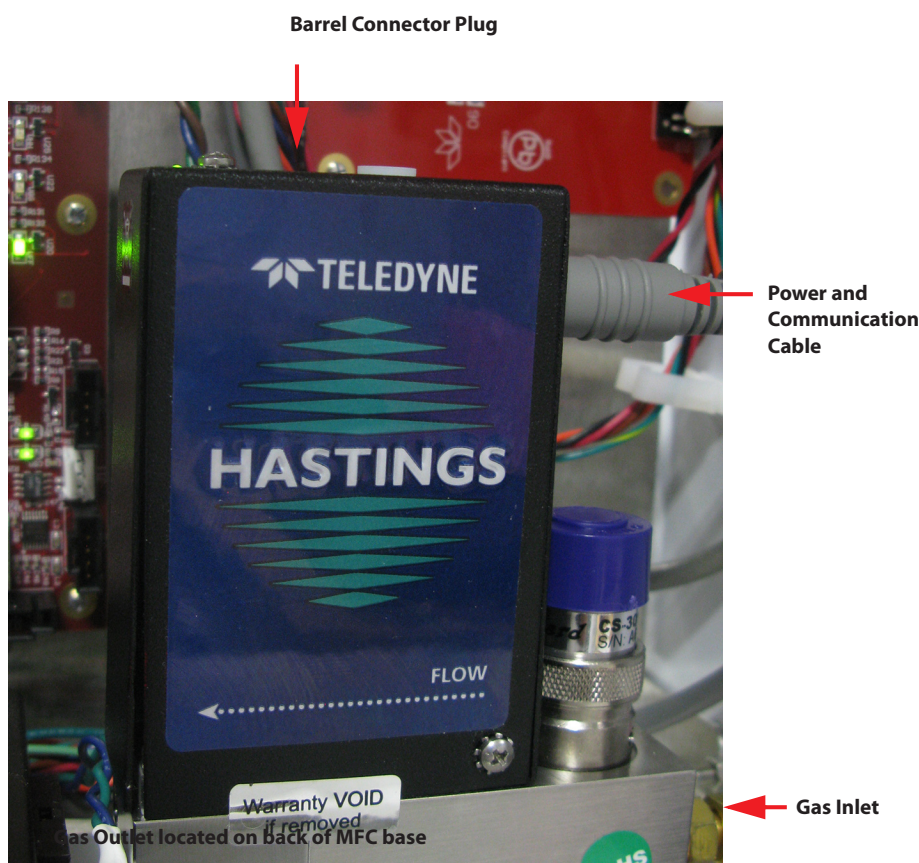

4. Disconnect the blue gas supply line using a 7/16" wrench and the out gas line using a 5/16" wrench.
5. Remove the three mounting screws at each corner of the base plate and remove the MFC.
6. Remove the barrel connector plug on the top of the MFC and insert it into the barrel connector opening on the top of the new MFC.



NOTE

Failure to transfer the barrel connector to the new MFC will result in unstable MFC readings in the status screen.

7. Install the new MFC and attach the three screws,
8. Reconnect the blue gas supply line to the gas inlet and the tubing to the gas outlet.
9. Reconnect the gray power and communication cable
10. Turn the gas supply on at the source.
11. Connect the AC power cord and turn the unit ON.
12. Start the Lumin TekLink software, if necessary.
13. Perform a Leak Check according to Section 5.31.2 "Initial Leak Checking".

5.21 6-Port Valve

Tools Required

- Phillips-head Screwdriver
- 1/4" Open-ended Wrench
- Allen Wrench

Procedure



Warning! - Hot surface! The 6-port valve and surrounding areas can be extremely hot. Allow the 6-port valve to cool to room temperature.



Warning! - To avoid electrical shock turn OFF and unplug the Lumin before servicing.

1. Turn the unit off, unplug the AC power cord, and allow the instrument to cool to room temperature.
2. Use a 1/4" open-ended wrench to disconnect the six Valco™ nuts from the 6-port valve and mark each line, referencing the port it was attached to, to ensure proper reinstallation.

Figure 5-33 6-Port Valve

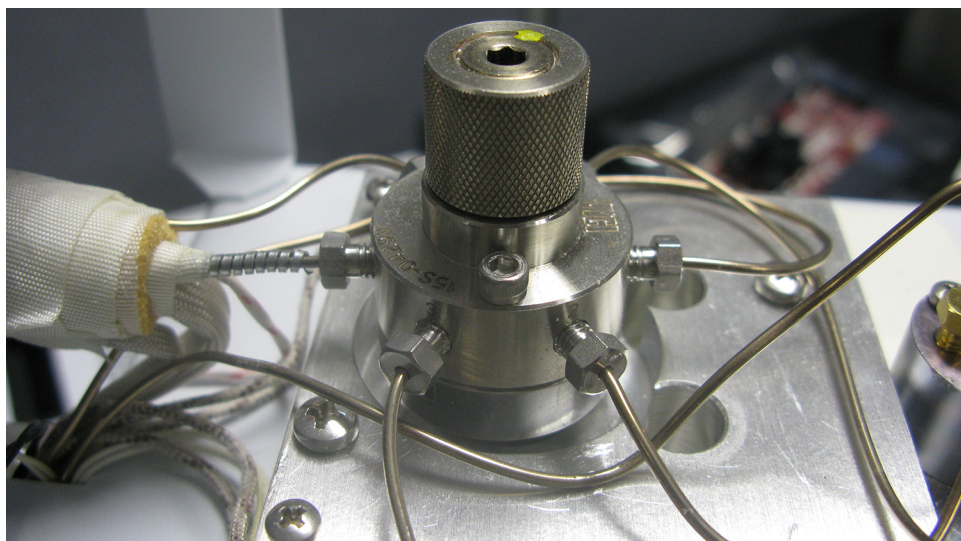

3. Use an Allen wrench to take out the two allen screws and gently lift the 6-port valve while observing the underside so that proper alignment can be achieved later.
4. Install the new 6-port valve so that the underside alignment matches that of the old 6-port valve that was taken out.



NOTE

Port 1 of the 6-port valve must face the front of the instrument (sparge tube).

5. Reattach the six Valco™ nuts, previously labeled above, to their respective ports.
6. Connect the AC power cord and turn the unit ON.
7. Start the Lumin TekLink software, if necessary.
8. Perform a Leak Check according to Section 5.31.2 "Initial Leak Checking".

5.22 Power Entry Module (PEM) Fuse Replacement



NOTE

This section explains the procedure for replacing blown fuses. If a fuse has blown, the root cause of the blown fuse should be determined before repowering the instrument. If you require assistance, contact Teledyne Tekmar Customer Service using information in Section 5.34 "Technical Assistance".

The PEM requires two IEC 5 x 20 mm fuses. To replace the fuses, follow the steps below. Fuses according to electrical standard are shown Table 5-6 "Lumin Fuse Ratings (2 IEC 5 x 20 mm Fuses)".

Figure 5-34 Lumin Power Entry Module (PEM)



To avoid electrical shock turn OFF and unplug the Lumin before servicing.

1. Ensure the Lumin is OFF and the AC power cable removed from the back of the unit.
2. Open the hinged fuse module cover by inserting a small flat-head screwdriver at the top, and then pulling the cover down.

Figure 5-35 PEM Fuse Module Cover Open

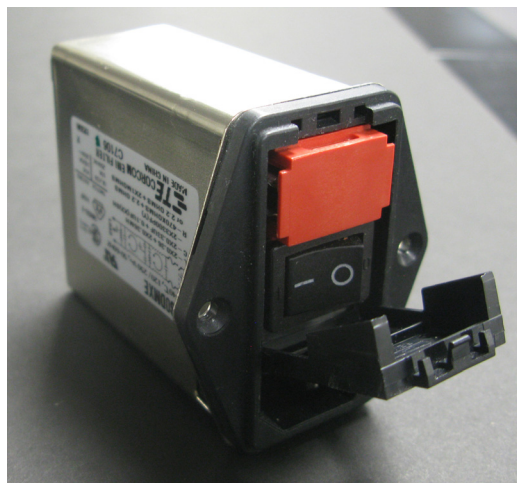

3. Remove the fuse module from the PEM.

Figure 5-36 Fuse Module Removed

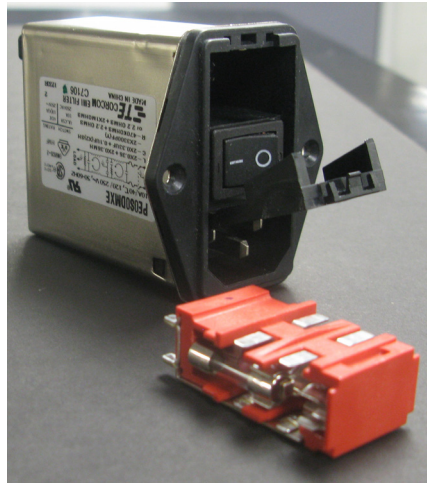

4. Remove the blown fuse(s).
5. Install fuses by pressing them into the fuse module. The correct fuse ratings and specifications are listed on the back of the instrument below the PEM as well as in Table 5-6 "Lumin Fuse Ratings (2 IEC 5 x 20 mm Fuses)". Fuses should be installed toward the rear of the module (toward the electrical contacts).

 **DANGER**

The fuses are rated 5A for 230V and 10A for 115V. Only replace fuses with those of the same type and rating.

Table 5-6 Lumin Fuse Ratings (2 IEC 5 x 20 mm Fuses)		
Electrical Configuration	Rating	Description
100VAC Operation	T 10.0A – 250v	Time Delay Fuse
115VAC Operation	T 10.0A – 250v	Time Delay Fuse
230VAC Operation	T 5.0A – 250v	Time Delay Fuse

Figure 5-37 Fuse Orientation in Fuse Module

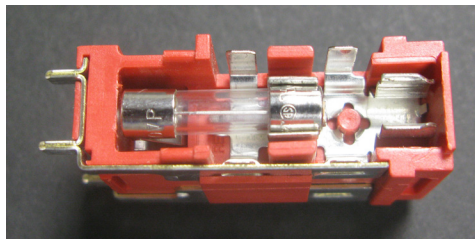

6. Push the fuse module back into the PEM until fully seated. Close the cover over the fuse module.

7. Connect the AC power cord and turn the unit ON.
8. Start the Lumin TekLink software, if necessary.

5.23 Multi-Channel Temperature Control Board Fuse Replacement

Tools Required

- Phillips-head screwdriver
- Insulated Flat-head screwdriver

Procedure



Warning! - To avoid electrical shock turn OFF and unplug the Lumin before servicing.

5.23.1 Main Fuse

1. Turn the unit off, remove the AC power cord, remove the right access panel, and locate the Temperature Control Board.

Figure 5-38 Multi-Channel Temperature Control Board

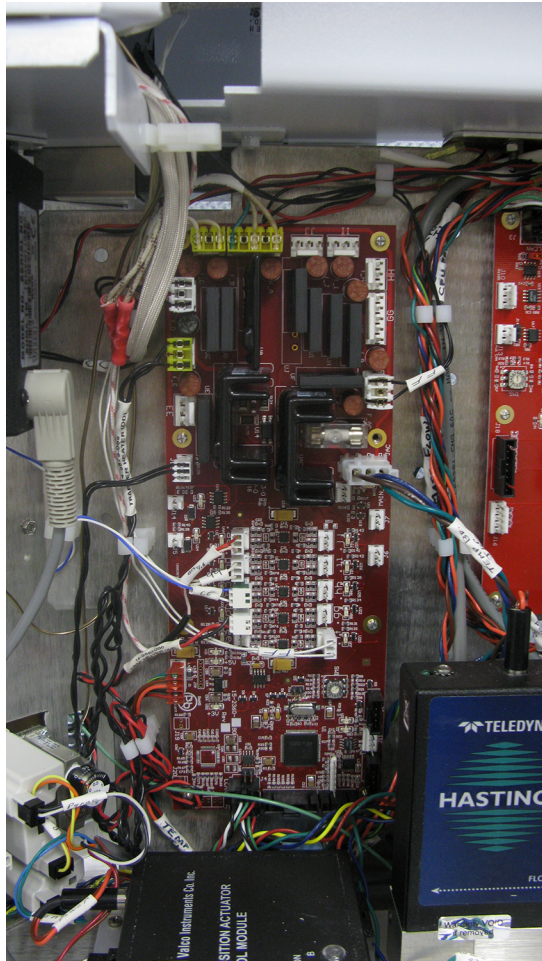

2. Using a properly insulated flathead screwdriver, pry the plastic cover off of the main fuse compartment.

Figure 5-39 Multi-Channel Temperature Control Board Diagram - Main Fuse

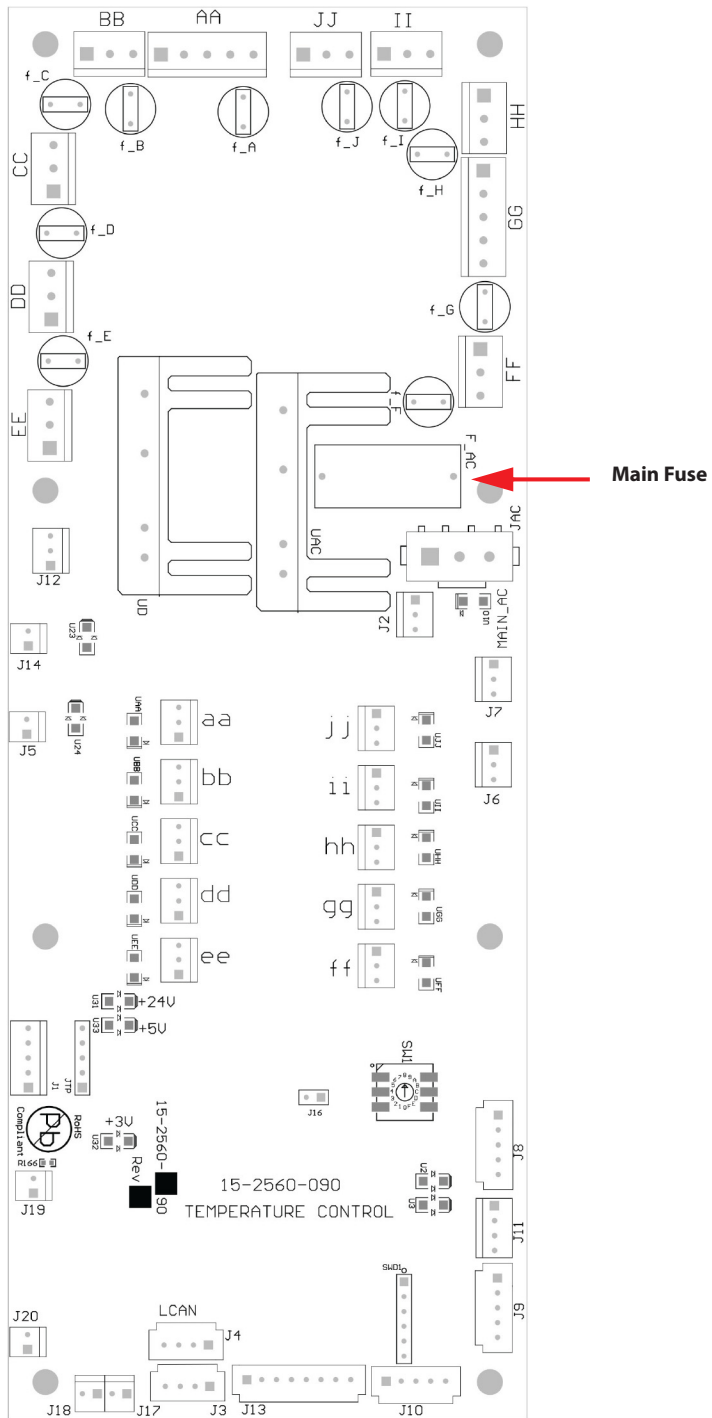

3. Carefully pry the fuse at location “F_AC” from the fuse compartment.

- Carefully insert a new fuse, rated according to Table 5-7 "Main Fuse", in the fuse compartment.

Table 5-7 Main Fuse		
Heated Zone	Fuse Location	Fuse Rating
J_AC	F_AC	10 Amps



Do not use a fuse of any other rating.

- Replace the plastic cover.
- Reinstall the right access panel.
- Connect the AC power cord and turn the unit ON.
- Start the Lumin TekLink software, if necessary.

5.23.2 Heater Output Fuses

- Turn the unit off, remove the AC power cord, remove the right access panel and locate the Temperature Control Board.

Figure 5-40 Multi-Channel Temperature Control Board

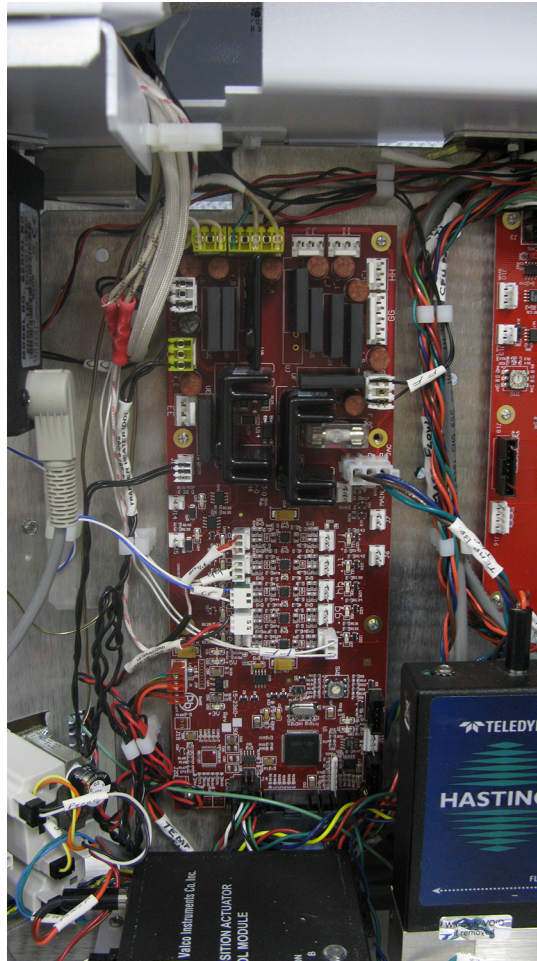

2. Refer to Figure 5-41 to locate the appropriate heater output fuse(s). Heater output fuses are cylinder shaped fuses located adjacent to each heated zone at the top of the board. Heated zones are identified on the board (AA, JJ, etc.) The fuse that corresponds to each zone will have the same letter identifier prefixed by the letter "F". Pull the appropriate 2-prong fuse(s) out.

Figure 5-41 Multi-Channel Temperature Control Board
Diagram - Heater Output Fuses

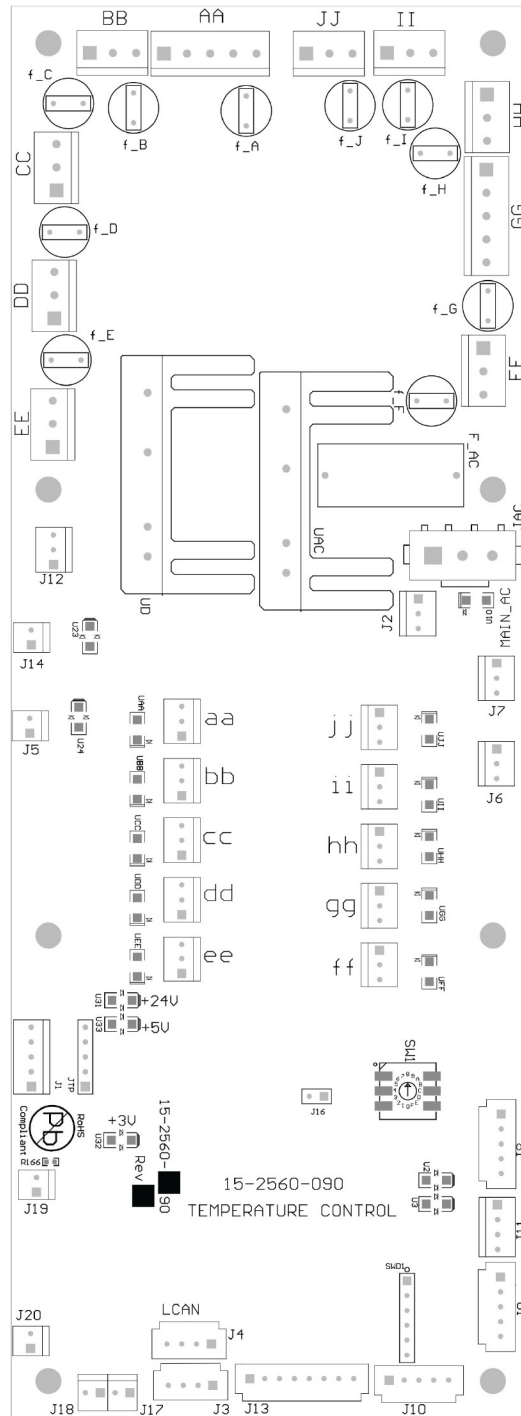

3. Carefully pry the fuse out of the board at appropriate location.

- Carefully insert a new fuse, rated according to Table 5-8 "Heater Output Fuses", into the board ensuring both pins of the fuse are aligned with the receiving holes.

Table 5-8 Heater Output Fuses		
Heated Zone	Fuse Location	Fuse Rating
AA	F_A	3.1 Amps
BB	F_B	2 Amps
CC	F_C	2 Amps
DD	F_D	5 Amps
EE	F_E	2 Amps
FF	F_F	2 Amps
GG	F_G	2 Amps
HH	F_H	2 Amps
II	F_I	2 Amps
JJ	F_J	2 Amps



Do not use a fuse of any other rating.

- Reinstall the right access panel.
- Connect the AC power cord and turn the unit ON.
- Start the Lumin TekLink software, if necessary.

5.24 Multi-Channel Temperature Control PCB Replacement

Figure 5-42 Multi-Channel Temperature Control Board

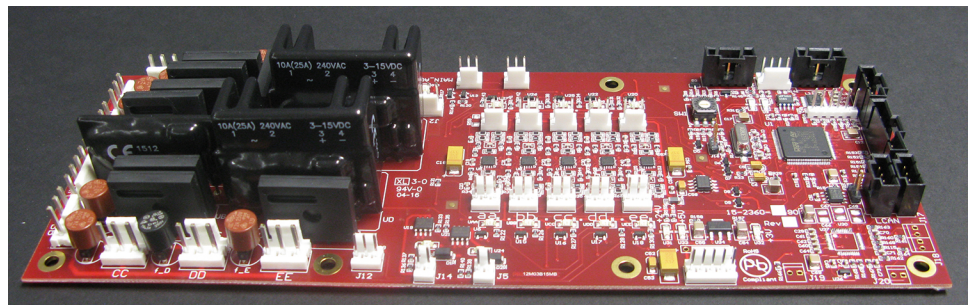

Tools Required

- Phillips-head screwdriver
- Grounding strap

Procedure



Warning! - To avoid electrical shock turn OFF and unplug the Lumin before servicing.

1. Turn the unit off and remove the AC power cord.
2. Remove the right access panel and locate the Multi-Channel Temperature Control Board.

Figure 5-43 Multi-Channel Temperature Control Board

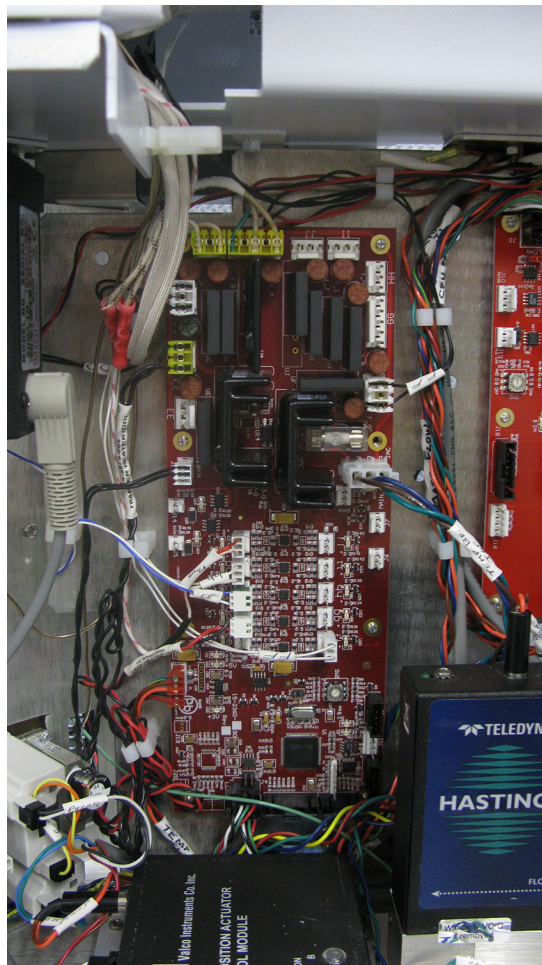
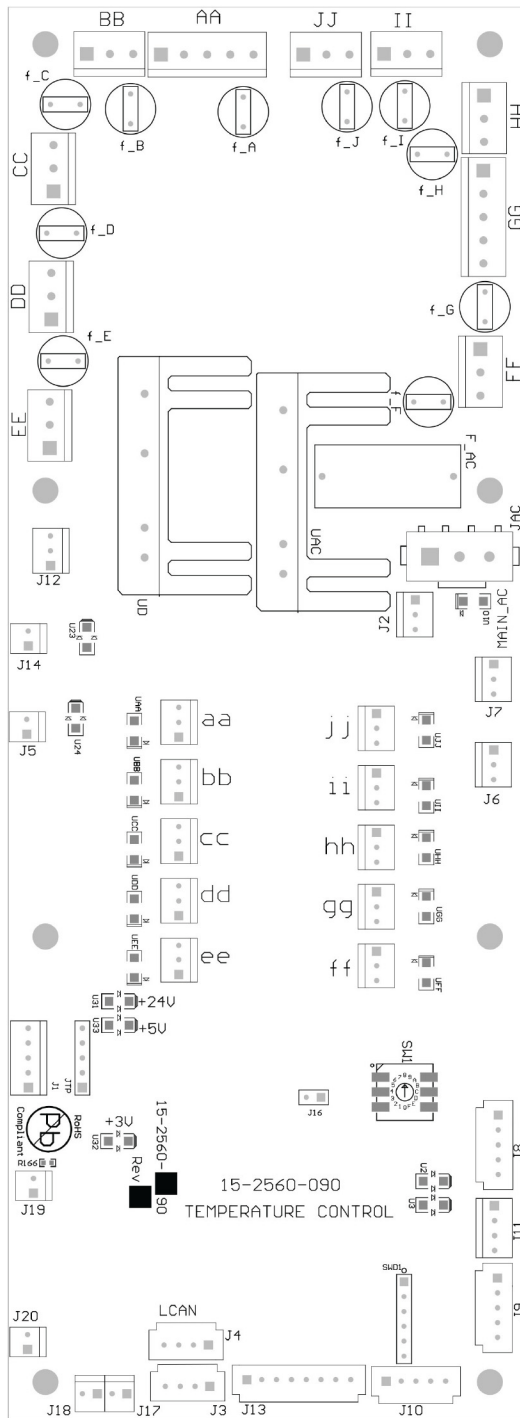

Figure 5-44 Multi-Channel Temperature Control Board Diagram





NOTE

Use a grounding strap during the removal/installation procedure to prevent electrostatic discharge.

3. Disconnect all electrical connections from the Multi-Channel Temperature Control Board.



NOTE

Note the location of the electrical connections. There are multiple identical connections on this board. Make sure that the labels on the connectors are visible or make your own label with a piece of tape.

4. Remove the PCB retaining screw and retain for reinstallation.
5. Remove the PCB by pulling it away from the mounting studs.
6. Install the new PCB using the retaining screw removed earlier in this procedure.
7. Reconnect the PCB electrical connections. Refer to the electrical diagram on the inside of the left access panel if needed.
8. Reinstall the right access panel by replacing the screws that secure it.
9. Connect the AC power cord and turn the unit ON.
10. Start the Lumin TekLink software, if necessary.

5.25 CPU Communication (Master) PCB Replacement

Figure 5-45 CPU Communication Board (Master Board)

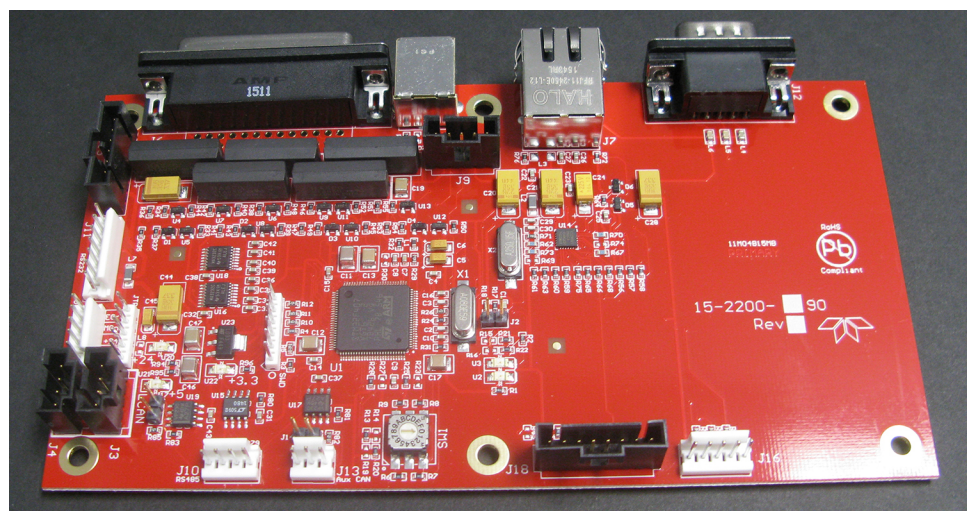

Tools Required

- Phillips-head screwdriver
- Grounding strap

Procedure



Warning! - To avoid electrical shock turn OFF and unplug the Lumin before servicing.

1. Turn the unit off and remove the AC power cord.
2. Remove the right access panel and locate the CPU Communication Board (Master Board) (See Figure 5-11).

Figure 5-46 CPU Communication Board (Master Board)

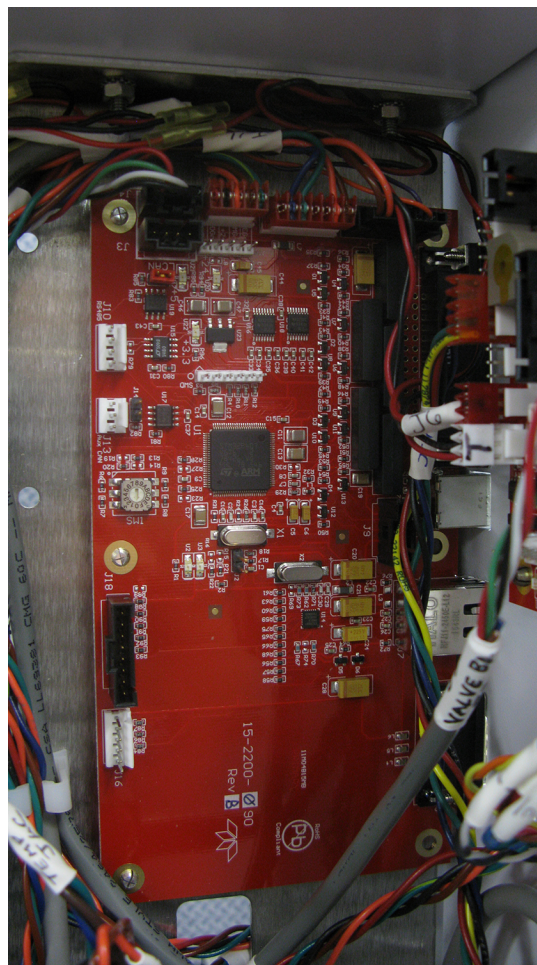
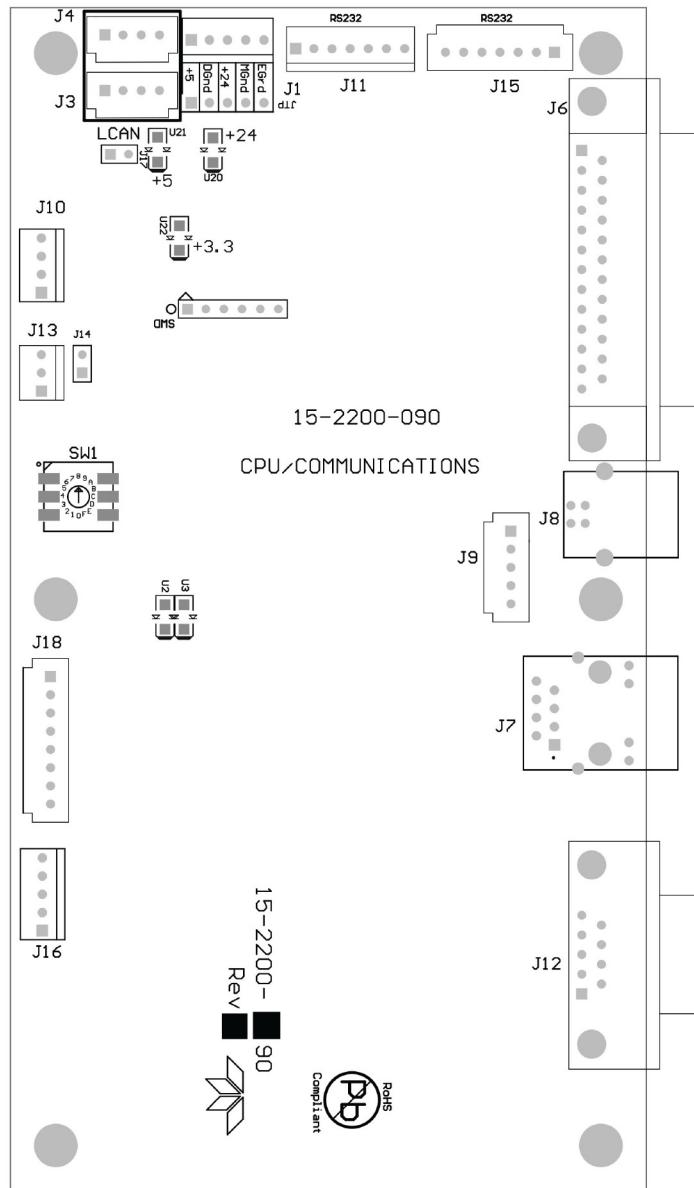

Figure 5-47 CPU Communication Board (Master Board) Diagram



NOTE

Use a grounding strap during the removal/installation procedure to prevent electrostatic discharge.

3. Disconnect all external connections to the CPU Communication Board (Master Board) at the rear of the unit (USB, GC/IO, Autosampler, etc.) and remove the cable mounting hex nut studs that the exterior cable connections screw into.
4. Disconnect all electrical connections from the CPU Communication Board (Master Board).



NOTE

Note the location of the electrical connections.

5. Remove the PCB retaining screw and retain for reinstallation.
6. Remove the PCB by pulling it away from the mounting studs.
7. Install the new PCB using the retaining screw removed earlier in this procedure.
8. Reconnect the PCB electrical connections. Refer to the electrical diagram on the inside of the left access panel if needed.
9. Reinstall the right access panel by replacing the screws that secure it.
10. Connect the AC power cord and turn the unit ON.
11. Start the Lumin TekLink software, if necessary.

5.26 DC Valve Control PCB Replacement

Figure 5-48 DC Valve Control Board

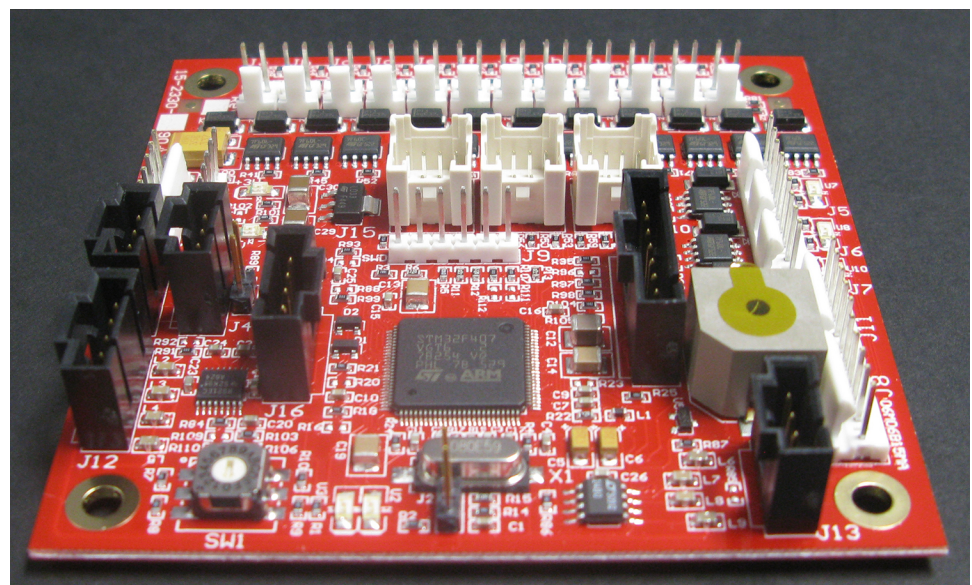

Tools Required

- Phillips-head screwdriver
- Grounding strap

Procedure



Warning! - To avoid electrical shock turn OFF and unplug the Lumin before servicing.

1. Turn the unit off and remove the AC power cord.
2. Remove the right access panel and locate the DC Output Board.

Figure 5-49 DC Valve Control Board

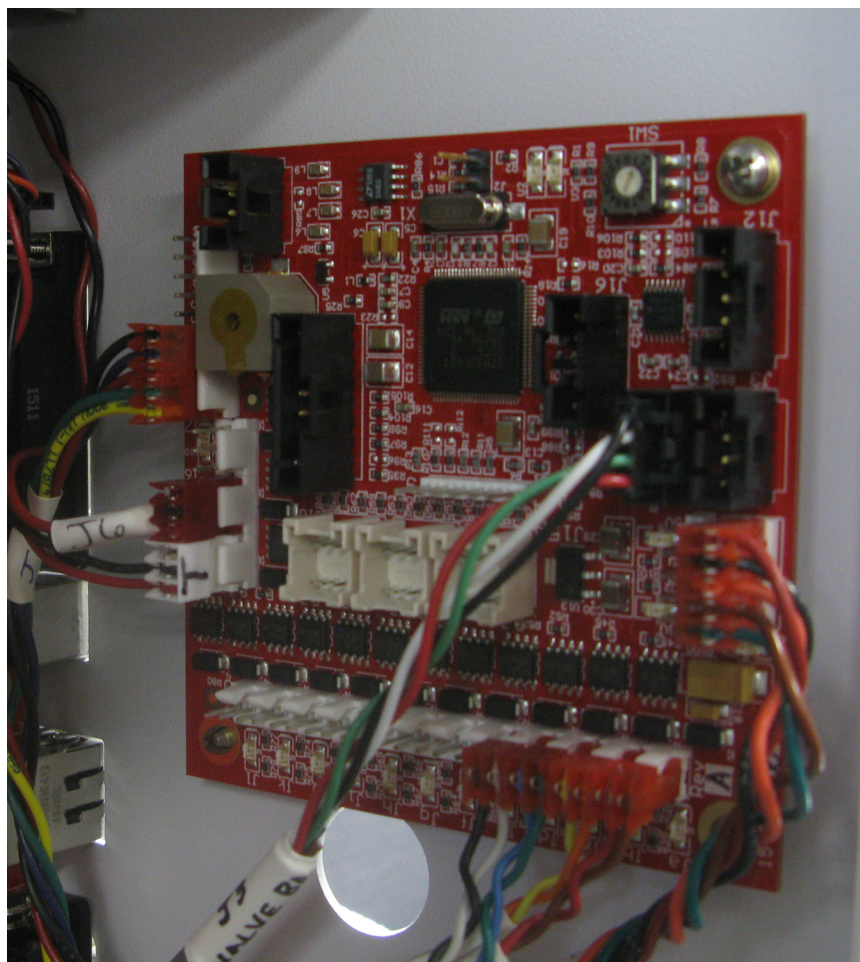
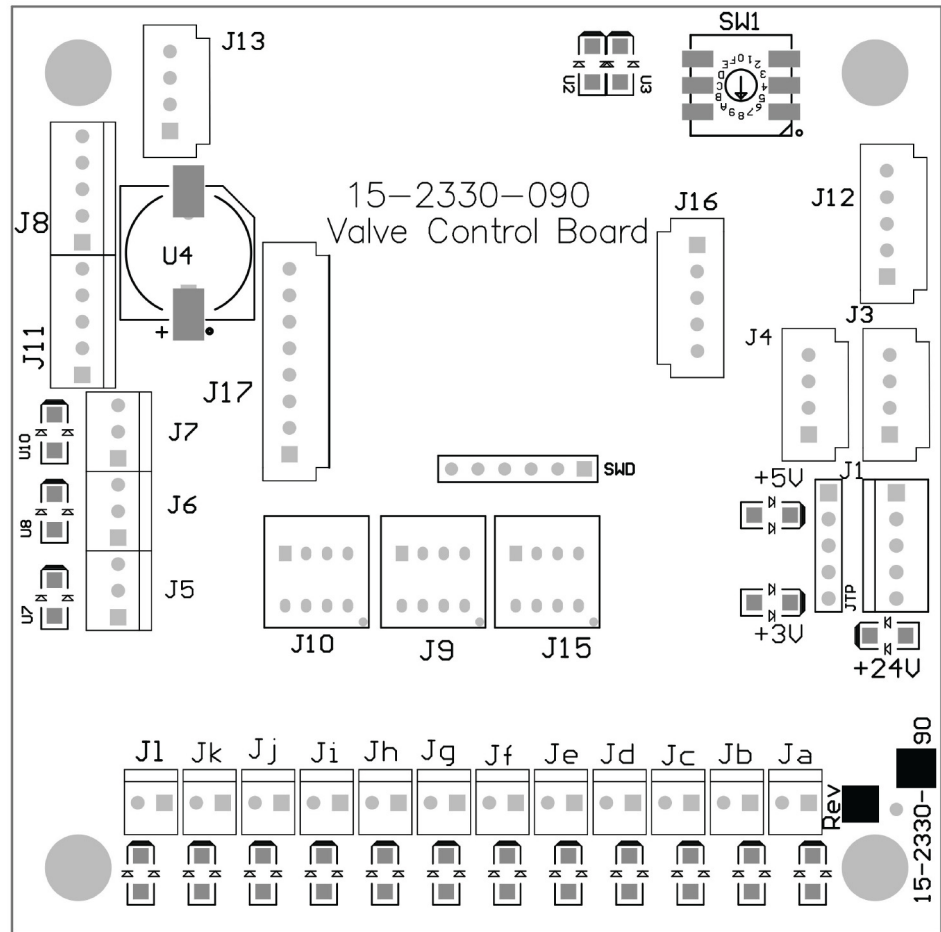

Figure 5-50 DC Valve Control Board



NOTE

Use a grounding strap during the removal/installation procedure to prevent electrostatic discharge.

3. Disconnect all electrical connections from the DC Valve Control Board.

NOTE

Note the location of the electrical connections. There are multiple identical connections on this board. Make sure that the labels on the connectors are visible or make your own label with a piece of tape.

4. Remove the screws securing the board and gently pull the DC Valve Control Board from the stand-offs.
5. Reconnect the PCB electrical connections. Refer to the electrical diagram on the inside of the left access panel if needed.
6. Reinstall the right access panel by replacing the screws that secure it.
7. Connect the AC power cord and turn the unit ON.
8. Start the Lumin TekLink software, if necessary.

5.27 5VDC Power Supply Replacement

Tools Required

- Phillips-head screwdriver
- Grounding strap

Procedure



Warning! - To avoid electrical shock turn OFF and unplug the Lumin before servicing.

Figure 5-51 5 VDC Power Supply

1. Turn the unit off and remove the AC power cord.
2. Remove the left access Panel and locate the 5 VDC Power Supply.
3. Remove the protective cover over the power supply by removing the screws that secure it.

Figure 5-52 5VDC Power Supply

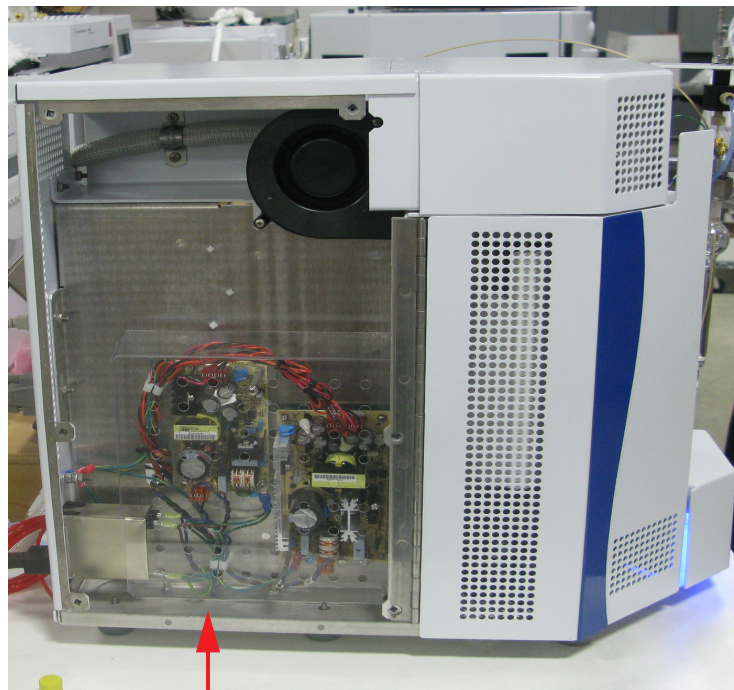

5VDC Power Supply

**NOTE**

Use a grounding strap during the removal/installation procedure to prevent electrostatic discharge.

4. Disconnect all electrical connections from the 5VDC Power Supply,

**NOTE**

Note the location of the electrical connections.

5. Remove the power supply retaining screw and retain for reinstallation.
6. Remove the power supply by pulling it away from the mounting studs.
7. Install the new power supply using the retaining screw removed earlier in this procedure.
8. Reconnect the power supply electrical connections. Refer to the electrical diagram on the inside of the left access panel if needed.
9. Reinstall the protective cover over the power supply by installing the screws that secure it.
10. Reinstall the left access panel by replacing the screws that secure it.
11. Connect the AC power cord and turn the unit ON.
12. Start the Lumin TekLink software, if necessary.

5.28 24VDC Power Supply Replacement

1. Turn the unit off and remove the AC power cord.
2. Remove the left access panel and locate the 24VDC Power Supply.
3. Remove the protective cover over the power supply by removing the screws that secure it.

Figure 5-53 24VDC Power Supply



24VDC Power Supply



NOTE

Use a grounding strap during the removal/installation procedure to prevent electrostatic discharge.

4. Disconnect all electrical connections from the 24VDC Power Supply,



NOTE

Note the location of the electrical connections.

5. Remove the power supply retaining screw and retain for reinstallation.
6. Remove the power supply by pulling it away from the mounting studs.
7. Install the new power supply using the retaining screw removed earlier in this procedure.
8. Reconnect the power supply electrical connections.
9. Reinstall the protective cover over the power supply by installing the screws that secure it.
10. Reinstall the left access panel by replacing the screws that secure it.
11. Connect the AC power cord and turn the unit ON.
12. Start the Lumin TekLink software, if necessary.

5.29 Upgrade Firmware

First download the firmware and then install it according to the directions below.

5.29.1 Download Firmware

1. Click this hyperlink: Software Downloads (www.teledynetekmar.com/resources/downloads) or go to the software downloads page at www.teledynetekmar.com
2. Under VOC Firmware and Software, find the appropriate firmware update.
3. Follow all prompts to download the new firmware.

5.29.2 Upgrade Board Firmware

1. Navigate to **TOOLS>UPGRADE FIRMWARE**.

Figure 5-54 Upgrade Firmware Dialog

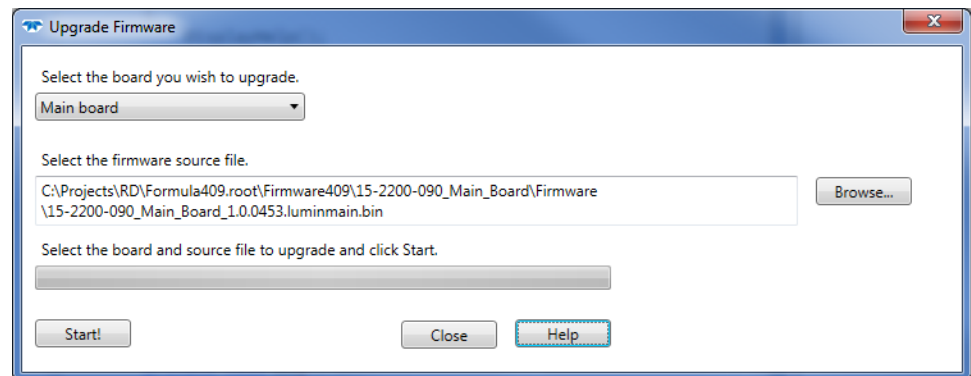

2. In the **UPGRADE FIRMWARE DIALOG**, select the board to upgrade from the **BOARD DROP-DOWN MENU**.
3. **SELECT THE FIRMWARE SOURCE FILE** that was downloaded.
4. Select the **START BUTTON** and follow all installation prompts.

5.30 Upgrade Software

1. Click this hyperlink: Software Downloads (www.teledynetekmar.com/resources/downloads) or go to the software downloads page at www.teledynetekmar.com
2. Under VOC Firmware and Software, find the appropriate software update.
3. Follow all prompts to download the new firmware.
4. Select the downloaded software executable file to start the software upgrade. Follow all installation prompts.

5.31 Troubleshooting

5.31.1 Benchmark Test

The BENCHMARK SELF TEST is a troubleshooting tool that tests the components and software routines (heaters, LEDs, continuity of inputs and outputs on the CPU board, etc.) to ensure that the concentrator is in working order. If any sequence of the benchmark test fails, the failure should be addressed before analysis of samples is attempted.

Some tests will be completed automatically, while others will require user response. The benchmark test may be stopped at any time by clicking the STOP BENCHMARK BUTTON in the BENCHMARK DIALOG. Advance to a specific section of the test by selecting the item in the TEST SEQUENCE WINDOW.



Make sure to give the concentrator the necessary time to complete the task

The results of the benchmark test can be printed at the completion of the test and are automatically saved in the INSTRUMENT HISTORY LOG using the name entered at the beginning of the test.

1. From the HOME SCREEN select the TOOLS BUTTON. On the TOOLS SCREEN select the BENCHMARK TEST BUTTON to start the benchmark function.
2. Name the benchmark test, then select the START BENCHMARK BUTTON.

Figure 5-55 Benchmark Test

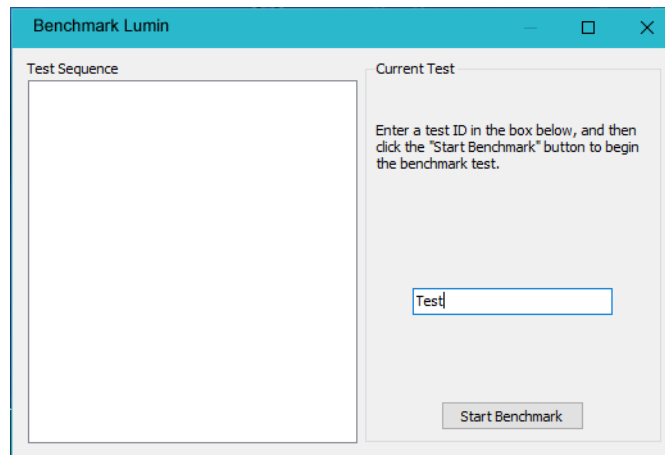

3. Once started, the TEST SEQUENCE WINDOW will display the actions of the benchmark test. The CURRENT TEST section of the dialog will explain the item being tested and prompt the user to respond. The INSTRUMENT STATUS PANEL will also indicate that a benchmark test is being conducted.

Figure 5-56 Benchmark Test Prompt

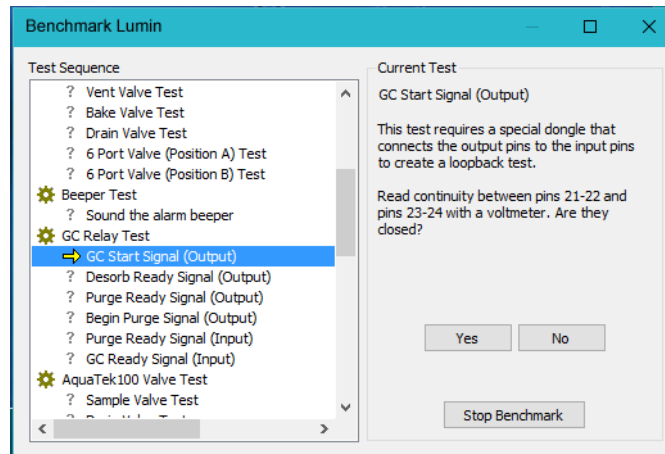

4. As the benchmark test is conducted, Lumin TekLink will prompt the user for responses. Read the prompt and respond accordingly using the buttons in the BENCHMARK TEST WINDOW.
5. Prior to completion of the test, Lumin TekLink will prompt if the benchmark test results should be printed. Once completed, results of the test are saved in the INSTRUMENT HISTORY LOG. To access a saved benchmark test, go to TOOLS>VIEW HISTORY LOG>INSTRUMENT HISTORY TAB.

Figure 5-57 Print Benchmark Results

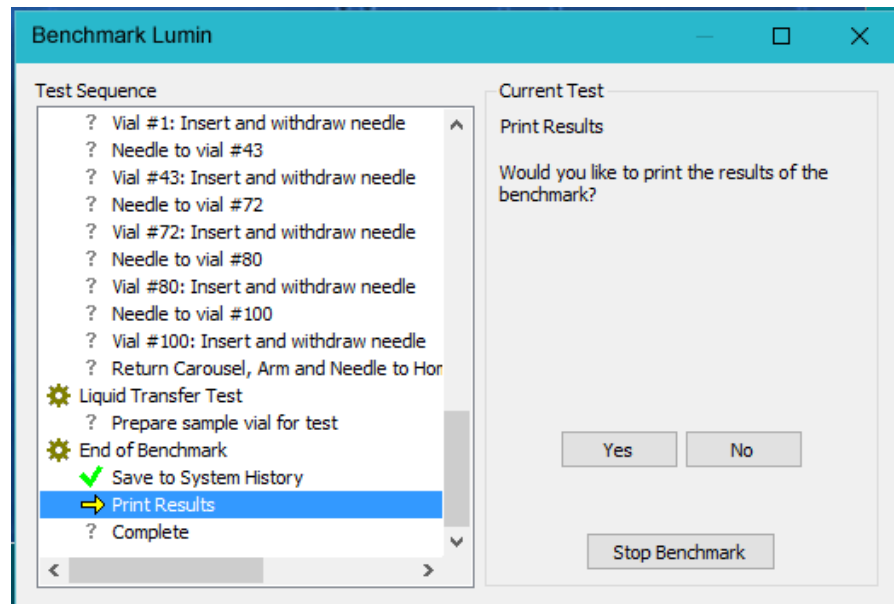

5.31.2 Initial Leak Checking

A leak check can be initiated by navigating to TOOLS>LEAK CHECK BUTTON. Once initiated, the INSTRUMENT STATUS SCREEN will indicate that the leak Check is in progress.

Figure 5-58 Instrument Status During Leak Check

Instrument Status

Abort Hold Step

Connection:
Lumin A-100 (Lumin/AQUATEk 100)
Ready

Mode:
Leak Check Pressurize

Time (minutes):
0.06 → 2.00

Pressurizing System to 25 psig

Schedule
No schedule is currently running.

Active Method: [5ml Vocarb](#)

Zones		
Name	Current	Set Point
Mass Flow	154 mL/min	200 mL/min
Pressure	4.5 psig	n/a
Transfer Line	150°C	150°C
Oven	149°C	150°C
Mount	89°C	90°C
Trap	22°C	Ambient
MCS	29°C	Ambient
Water	89°C	90°C

Figure 5-59 illustrates the path of events that occur during a Leak Check sequence. If the instrument fails this basic leak checking procedure, then proceed to Section 5.31.3 "Advanced Leak Check Guidelines".

Figure 5-59 Leak Checking Flow Chart

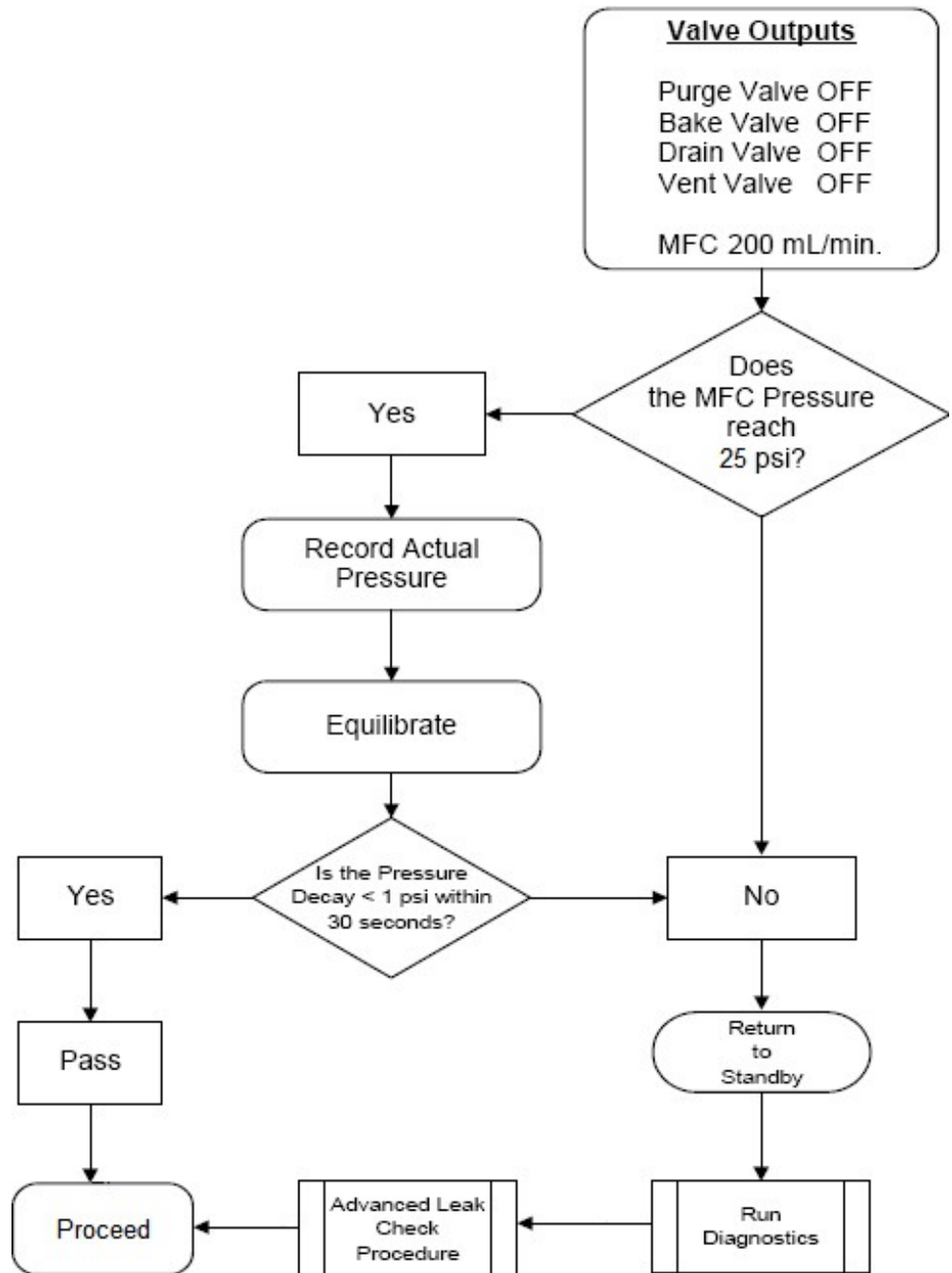

5.31.3 Advanced Leak Check Guidelines

If the instrument fails the leak checking sequence as outlined in Section 5.31.2 "Initial Leak Checking", the Advanced Leak Check should be performed to isolate the problem area. The Advanced Leak Check manually isolates sections of the pressurized system and then checks the integrity of each component connection.

1. Start the LEAK CHECK MODE. Go to the DIAGNOSTICS SCREEN and toggle the 6-port valve to POSITION "B". Continue the test.
 - If the unit passes, check position three on the 6-Port valve, position six on the 6-port valve, analytical trap.
 - If the system fails, examine the sparger, sample mount, 4-way tee, and vent valve on the valve manifold, then proceed to step 2:
2. Isolate the drain valve and drain line by turning the handle on the three-port sample valve to the left position (closed).
 - If the unit fails the Leak Check proceed to step 3.
 - If the unit passes, check the drain line or valve for a leak.
3. Locate an Upchurch plug (#14-8470-016) in the Lumin Installation Kit Box. Insert this plug in the Normally Open tee (NO) on the Purge Valve and click RETEST.
 - If the system passes, then the leak is between the Mass Flow Controller (MFC) and Valve Manifold.
 - If the system fails, then the leak is between the valve manifold and port three on the 6-Port Valve. After each attempt to correct the problem, retest and, if it passes, reconnect the purge valve. For further information, refer to Section 5.31.4 "Advanced Leak Checking Flow Chart".

Figure 5-60 6-Port Valve

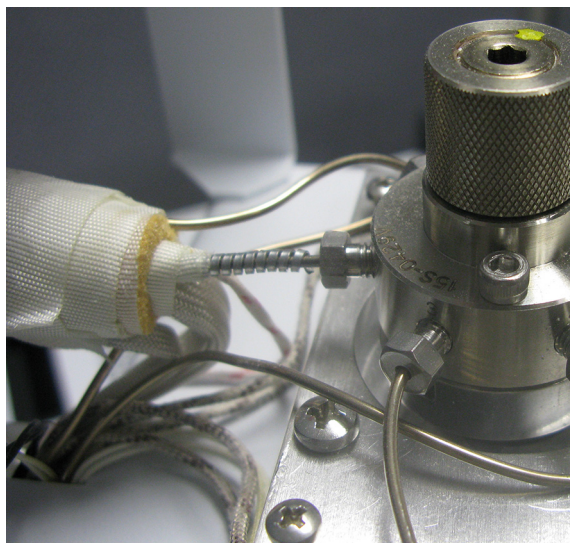

Figure 5-61 4-Way Tee

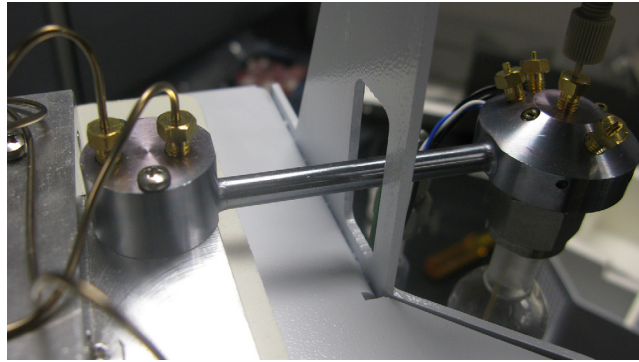

Figure 5-62 Analytical Trap

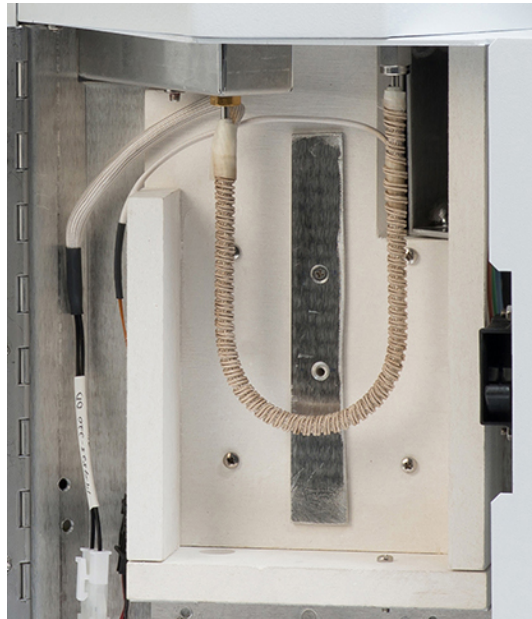

Figure 5-63 Sample Valve

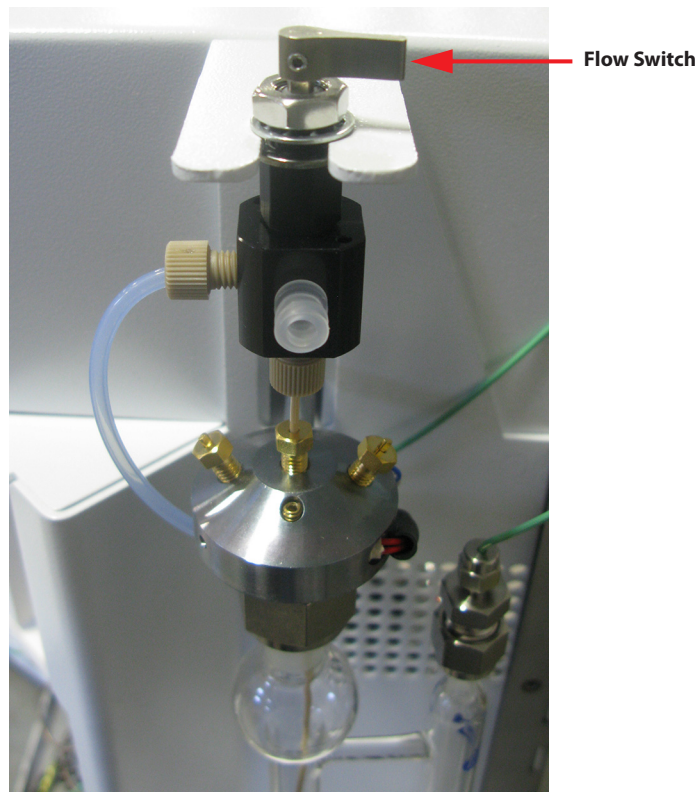
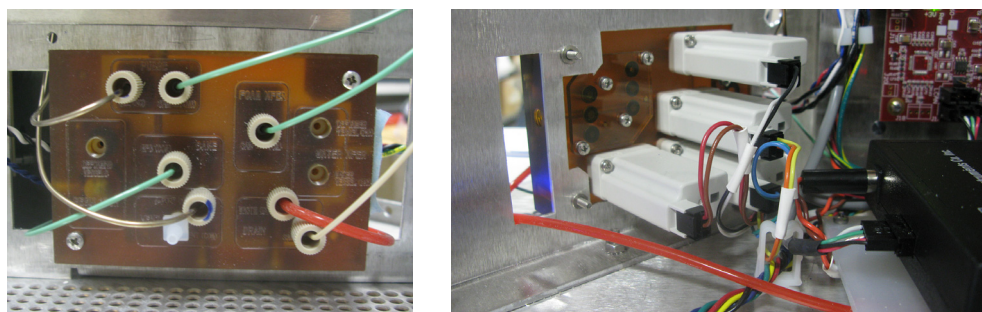
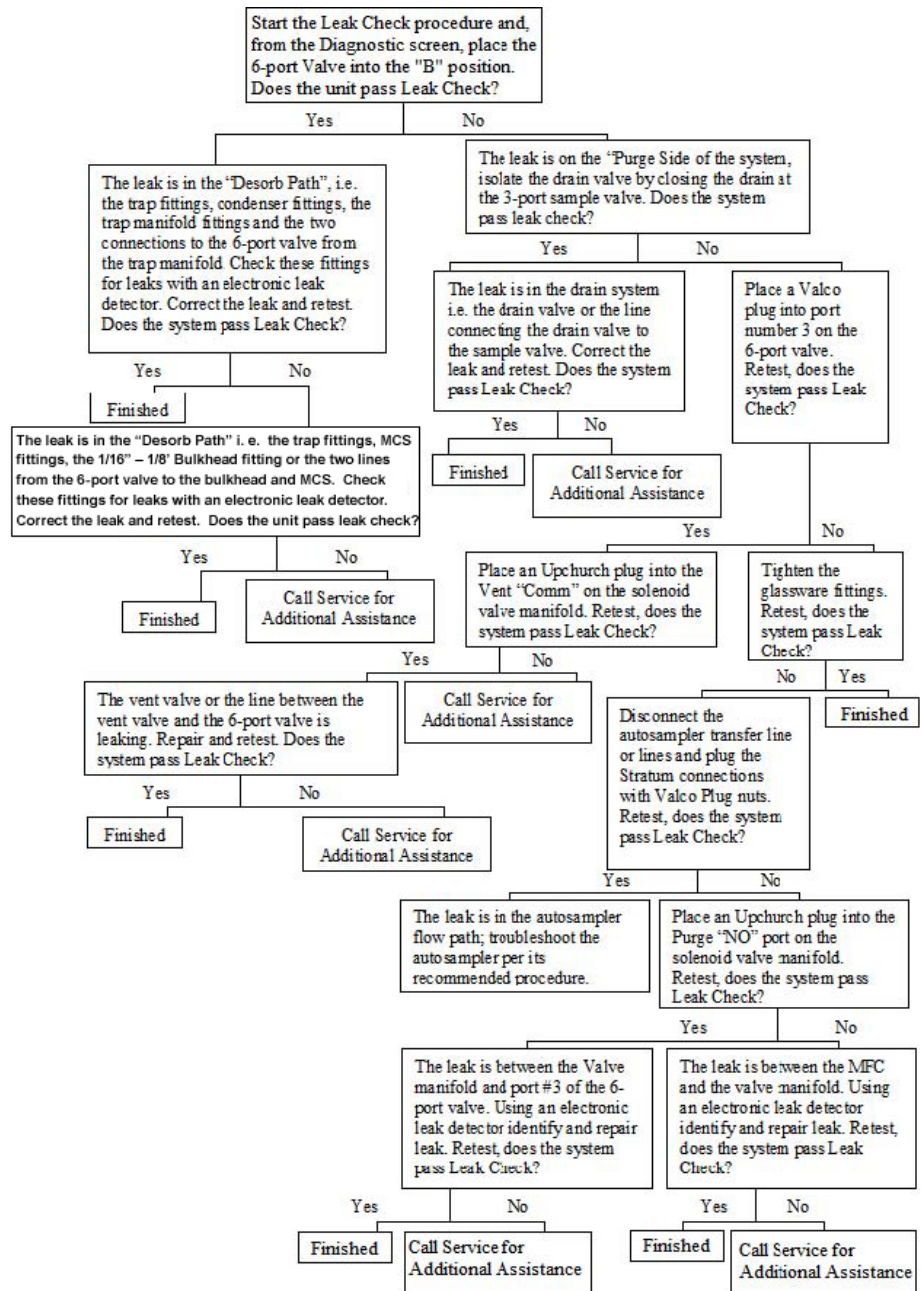

Figure 5-64 Purge Valve NO Tee



5.31.4 Advanced Leak Checking Flow Chart



5.31.5 No Power Flow Chart

NOTE

Refer to Section 5.22 "Power Entry Module (PEM) Fuse Replacement" for information on accessing the PEM fuses.

Figure 5-65 No Power Flow Chart

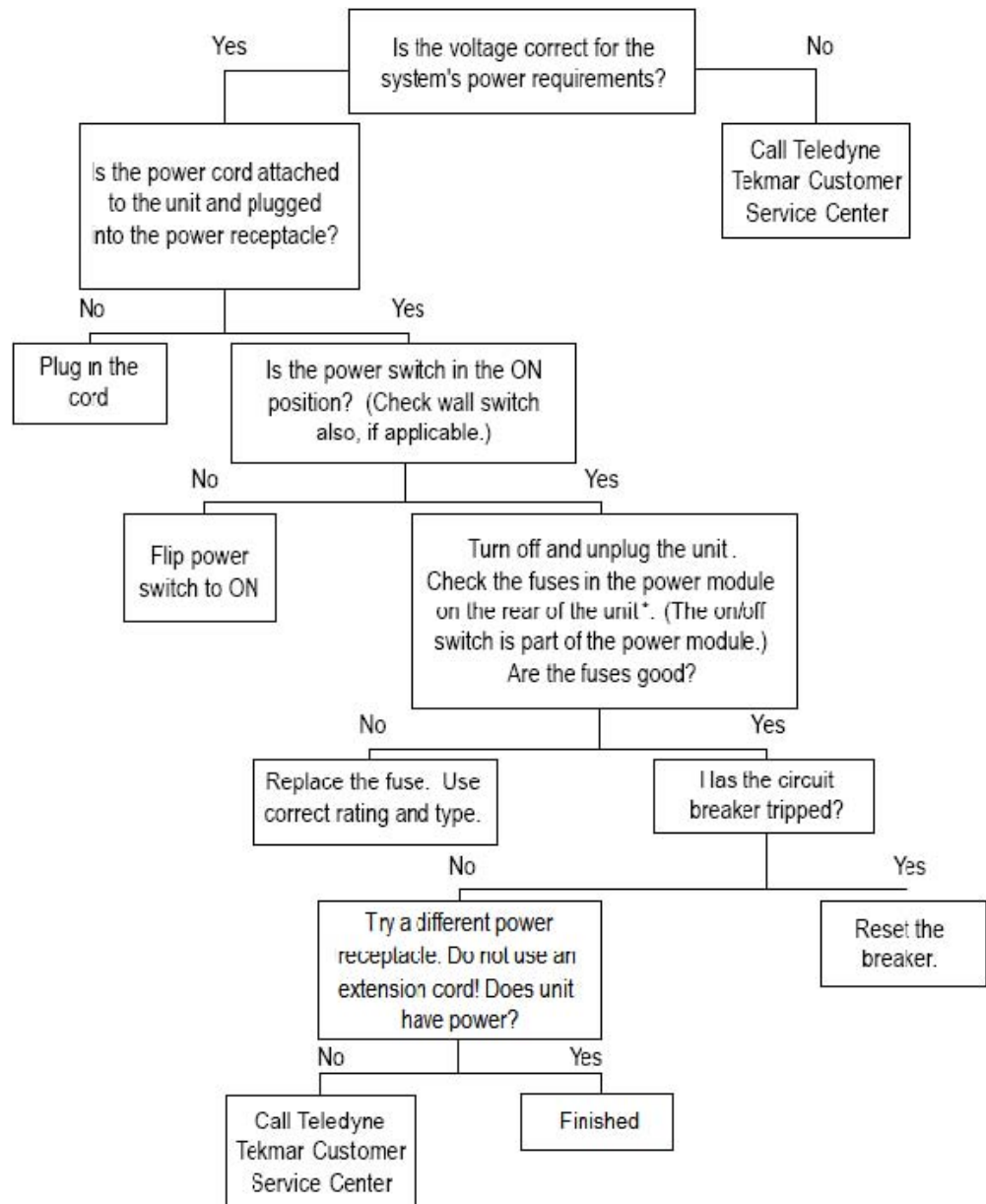

5.31.6 Top-of-Trap (TOT) Injection Port



NOTE

It is recommended that a Leak Check be performed according to Section 5.31.2 "Initial Leak Checking" before the TOT injection port is installed to confirm that the system is leak tight.

A TOT injection port can be installed into the Sample Mount of the Lumin to aid in troubleshooting potential problems associated with the concentrator or in the evaluation of purge efficiencies of target analytes. While the TOT injection port does not allow for a true direct injection onto the top of the adsorbent bed of the trap itself, it does bypass purging the sample in the sparger and aids in evaluating the adsorption and desorption of the trap without opening the unit to atmosphere. It will also assist in evaluating the inertness and cleanliness of the desorption pathway, Sample Mount, and 4-way Tee.

Tools Required

- 1/4" Open-ended wrench

Figure 5-66 Disassembled TOT Injection Port

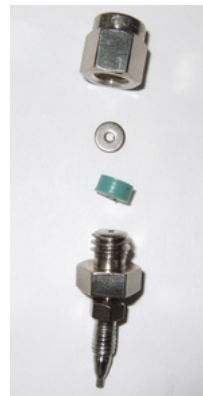

TOT Injection Port Assembly Procedure

1. Locate the TOT injection port parts in the Lumin Installation Kit Box and assemble in the order shown in Figure 5-66.

Install the Assembled TOT Injection Port



NOTE

If both an autosampler and the foam eliminator are installed on the unit, one of them must be removed. Otherwise, the autosampler can remain in place and the TOT injection port can be installed into the other available mount fitting.

1. Remove the 1/16" Valco™ plug nut from the sample mount.

Figure 5-67 Valco™ Plug Nut in Sample Mount

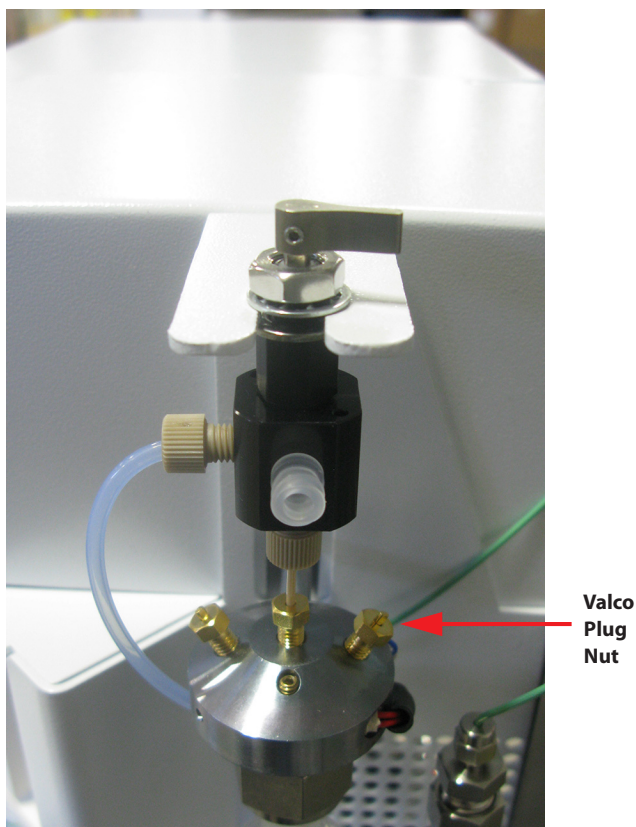

2. After installation, perform a Leak Check.
3. If the Leak Check fails:
 1. Check that the septum inside the fitting has not been compromised and replace if necessary.
 2. Hand-tighten the 1/8" nut holding the septum in place.
 3. Tighten the 1/16" fitting into the sample mount using a 1/4" open-ended wrench.

Figure 5-68 Figure 5-9: TOT Injection Port Assembled and Installed

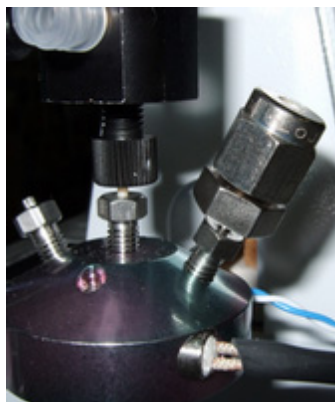

Software Configuration

Once the TOT Injection Port fitting has been installed and is leak tight, perform the analyses in a standalone configuration (without autosampler).



NOTE

For SolaTek 72, Non-Tekmar Autosamplers or No Autosamplers the unit is already configured as a standalone unit.

Configure the Concentrator as a Stand-alone Unit (AQUATEk 100 Only):

1. Open the INSTRUMENT CONFIGURATION SCREEN by clicking TOOLS>CONFIGURE.
2. In the MODEL DROP-DOWN MENU, change LUMIN/AQUATEk 100 to only LUMIN (Figure 5-69). Select the OK BUTTON to save the configuration change.

Figure 5-69 Model Drop-Down Menu

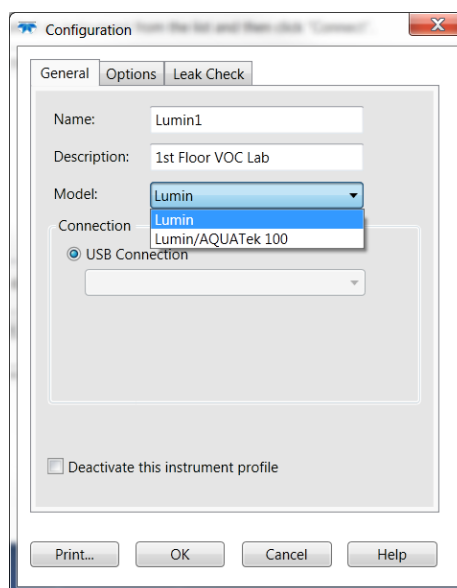

**NOTE**

The software will warn that methods will no longer be available because the instrument configuration has changed.

Create Schedule and Method

1. Set the GC system to acquire a sample as it normally would, and allow it to stabilize and enter the READY MODE.
2. Create a default method with temperatures applicable for the analytical trap installed. If necessary refer to Section 3.10 "Creating a Method".
3. Build a single line schedule using this method. If necessary refer to Section 3.12 "Creating a Schedule".
4. Load the schedule by selecting the LOAD BUTTON on the Schedules Screen.
5. Once the concentrator goes into Purge Mode, make the injection via the TOT injection port. Insert the syringe fully into the TOT fitting to ensure that the needle tip is completely through the septum and inject the sample into the Sample Mount.

**NOTE**

Teledyne Tekmar recommends the use of a 10 µL syringe or smaller for TOT injection to prevent the injection port septum from being "cored" and, subsequently, causing a leak.

6. Wait 1 to 2 minutes for the injection to be swept onto the analytical trap.
7. Navigate to TOOLS>DESORB. The concentrator will begin Desorb Mode.

5.31.7 No Response Flow Chart

Figure 5-70 No Response Flow Chart

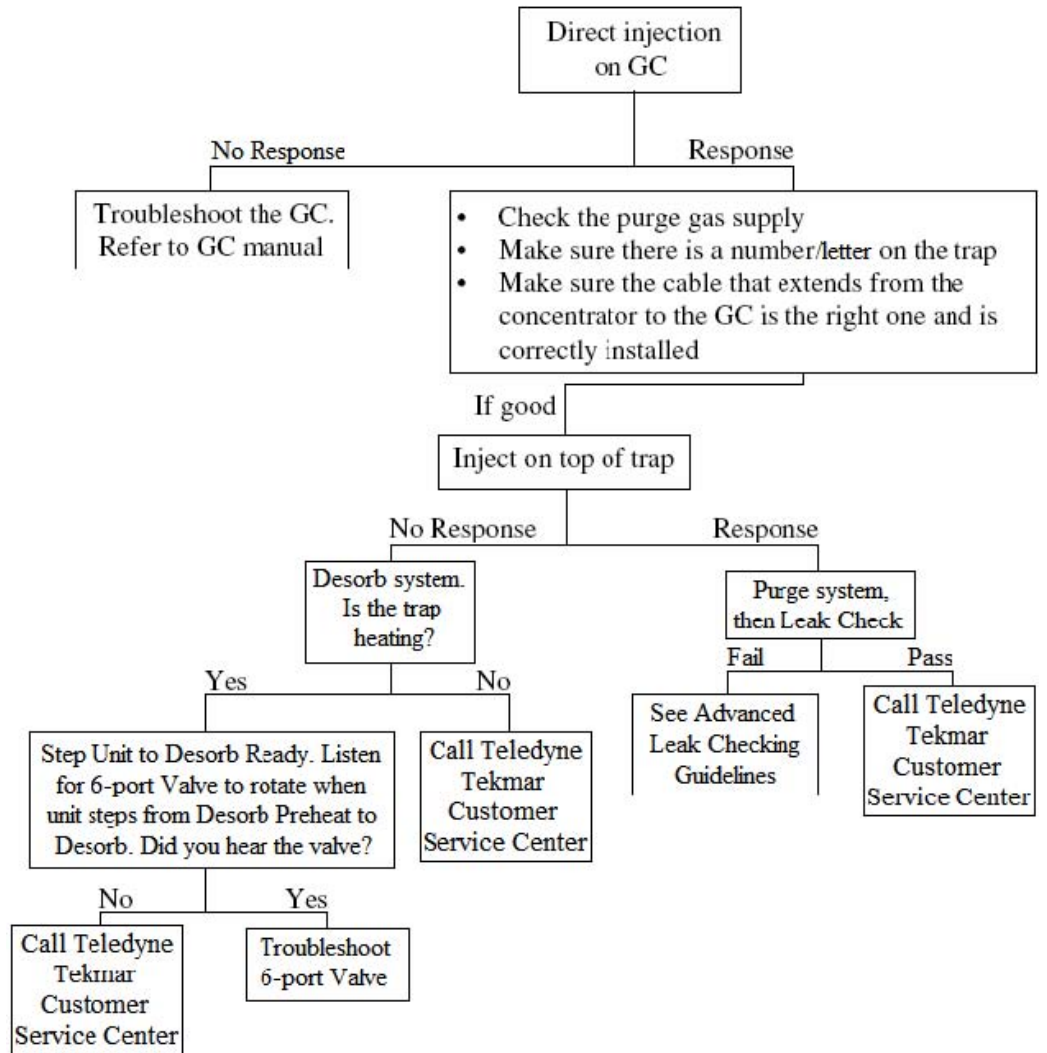

5.31.8 Low Response Flow Chart

Figure 5-71 Low Response Flow Chart

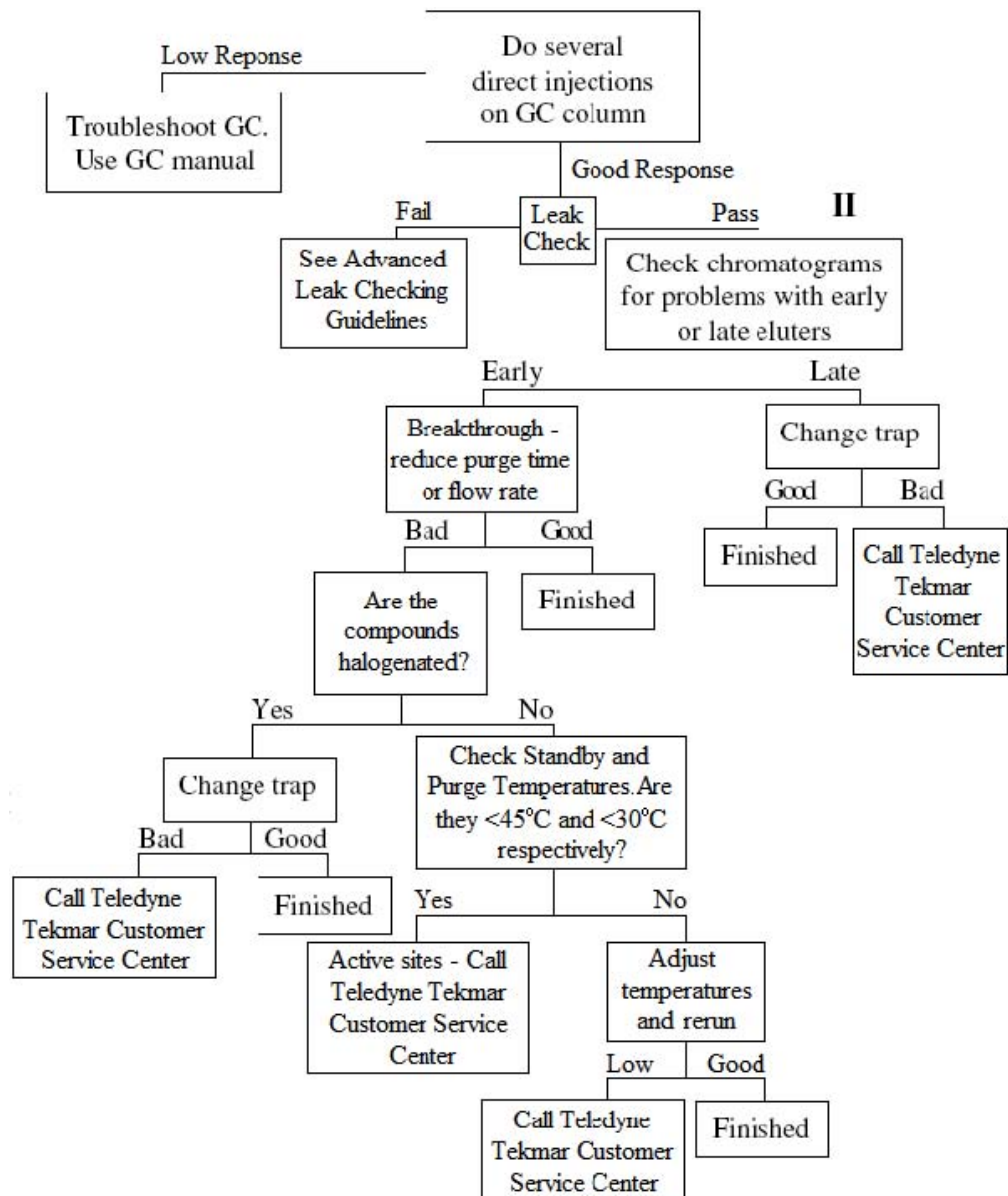

5.31.9 Carryover Contamination Flow Chart

Figure 5-72 Carryover Contamination Flow Chart

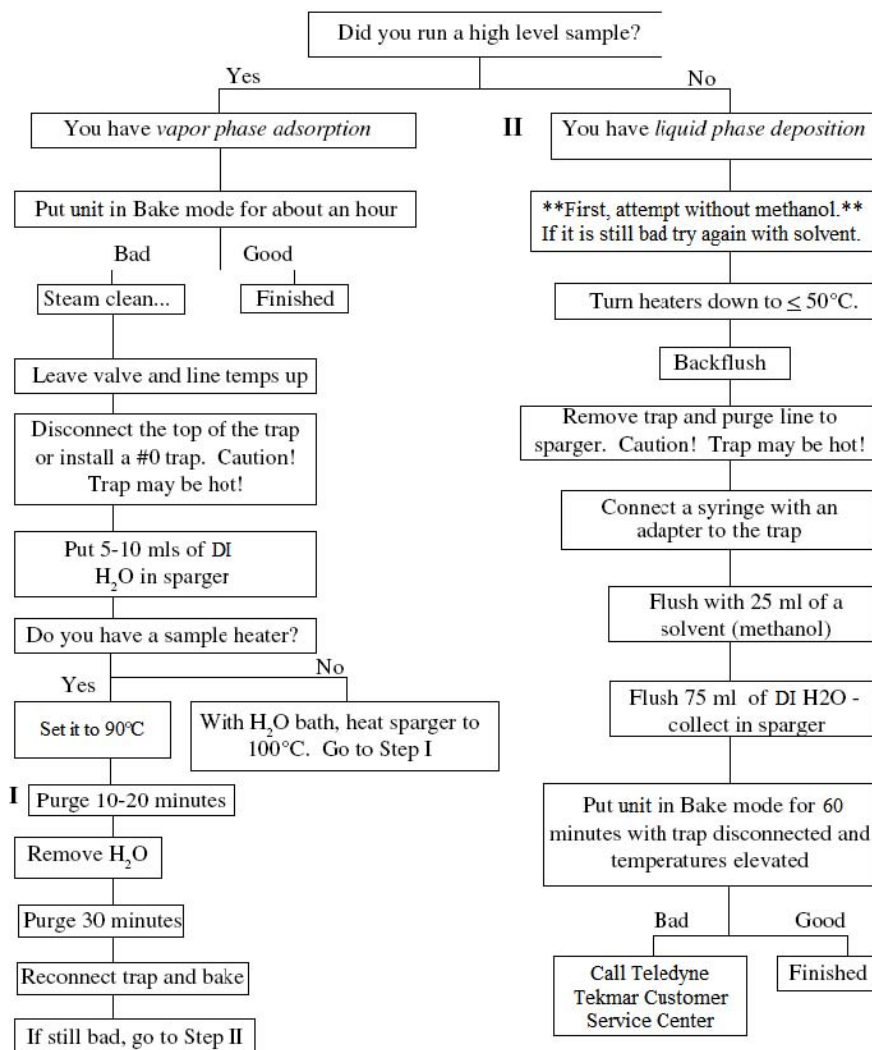

5.32 Returning the Lumin

Do not return the Lumin unless a Teledyne Tekmar representative authorizes you to do so. A service representative may be able to help you solve the problem over the telephone. If the instrument must be returned, the representative can tell you how to prevent damage during shipment. The representative must give you a return authorization number and instructions on how to return the instrument properly.

5.33 Unit and Parts Disposal



Please contact Teledyne Tekmar or your local distributor for instructions on returning the system for proper disassembly and disposal. Contact Teledyne Tekmar Customer Support using information in Section 5.34.1 "Teledyne Tekmar Customer Support".

5.34 Technical Assistance

If you need assistance solving a problem, follow the steps below:

1. Write down the model name, model number, and serial number of the instrument.
2. Note the type of problem you are having. Write down the conditions under which the problem occurred, the display, mode of operation, activity, or result that indicated the presence of a problem.
3. Have an electronic or paper copy of this manual, and any other pertinent information, accessible from the telephone. Your service representative may refer to diagrams or other information contained in this manual.
4. Call Teledyne Tekmar using Section 5.34.1 "Teledyne Tekmar Customer Support".

5.34.1 Teledyne Tekmar Customer Support

U.S. Phone: (800) 874-2004

U.S. Email: tekmarsupport@teledyne.com

International (Outside the U.S.) Phone: Country Code + 1 (513) 229-7000

International Email: Tekmar_Intltech@teledyne.com

Lumin User Manual

Appendix A: Diagrams

A.1 Lumin Electrical Schematic

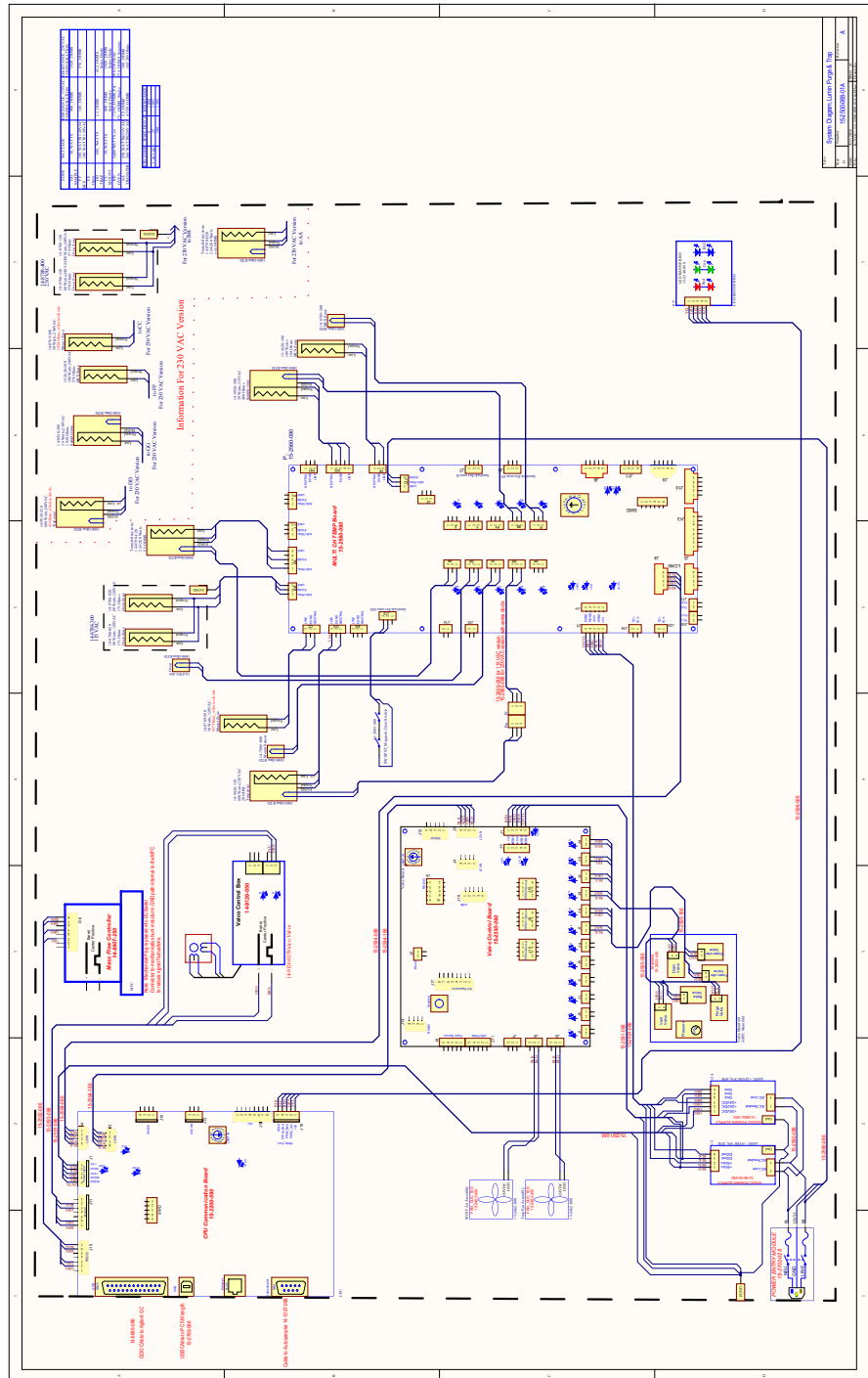

Figure A-1 Lumin Electrical Schematic

A.2 Lumin Plumbing Diagram

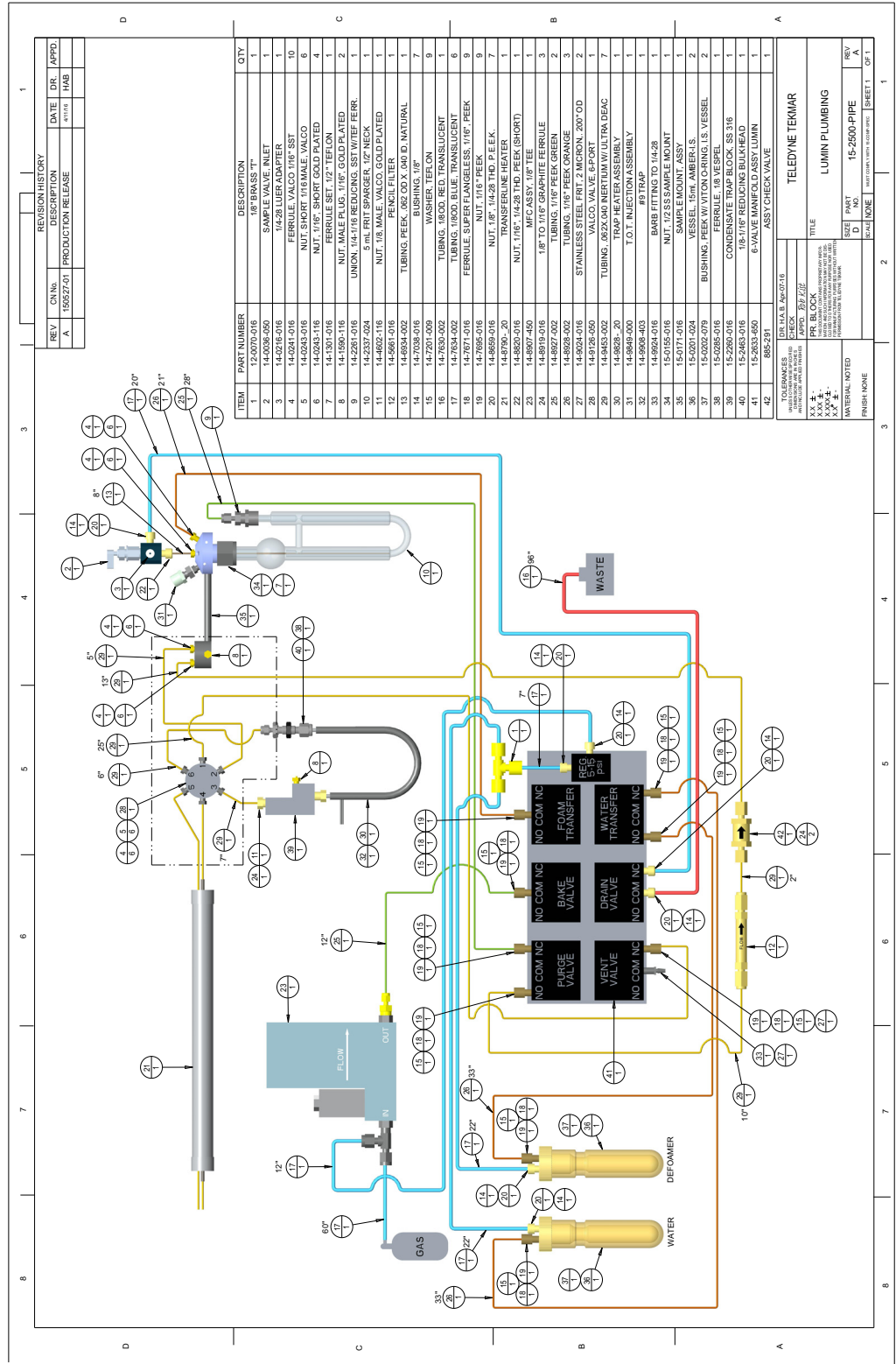

Figure A-2 Lumin Plumbing Diagram

A.3 Lumin Flow Diagrams

A.3.1 Lumin - Basic Flow Diagram

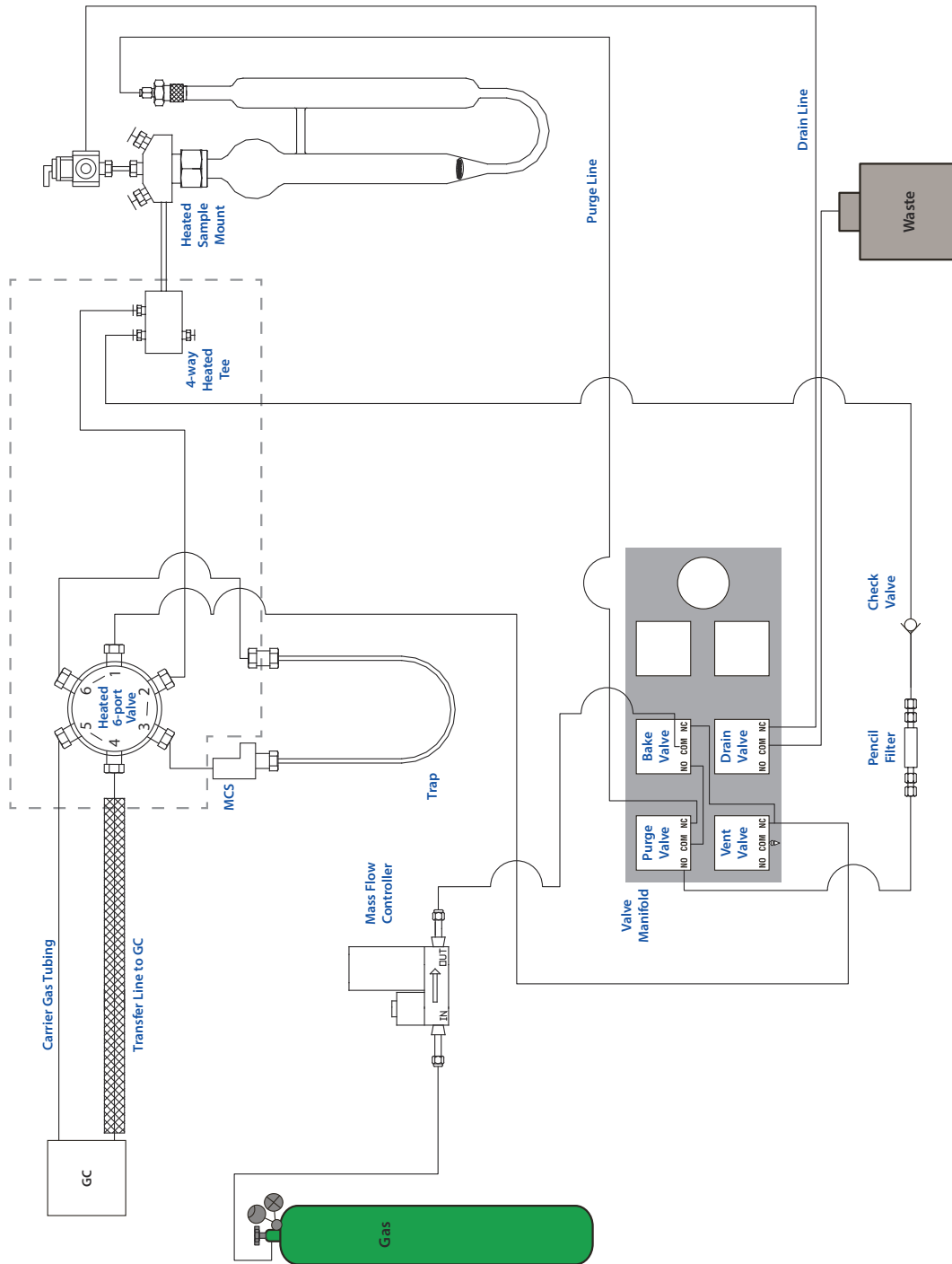

Figure A-3 Lumin - Basic Flow Diagram

A.3.2 Lumin - Standby Dry Purge Flow Diagram

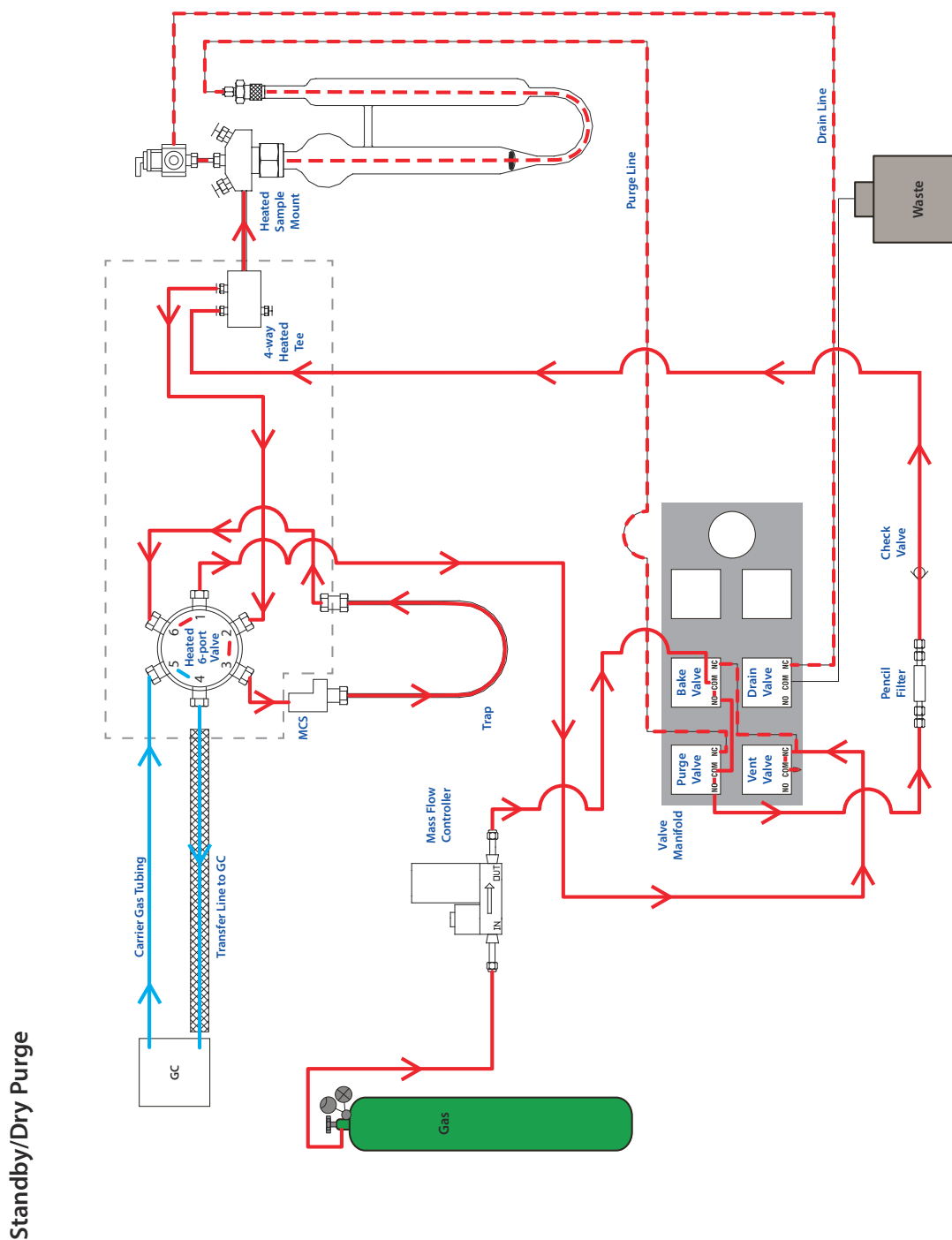

Figure A-4 Lumin - Standby/Dry Purge Flow Diagram

A.3.3 Lumin Purge Flow Diagram

Purge

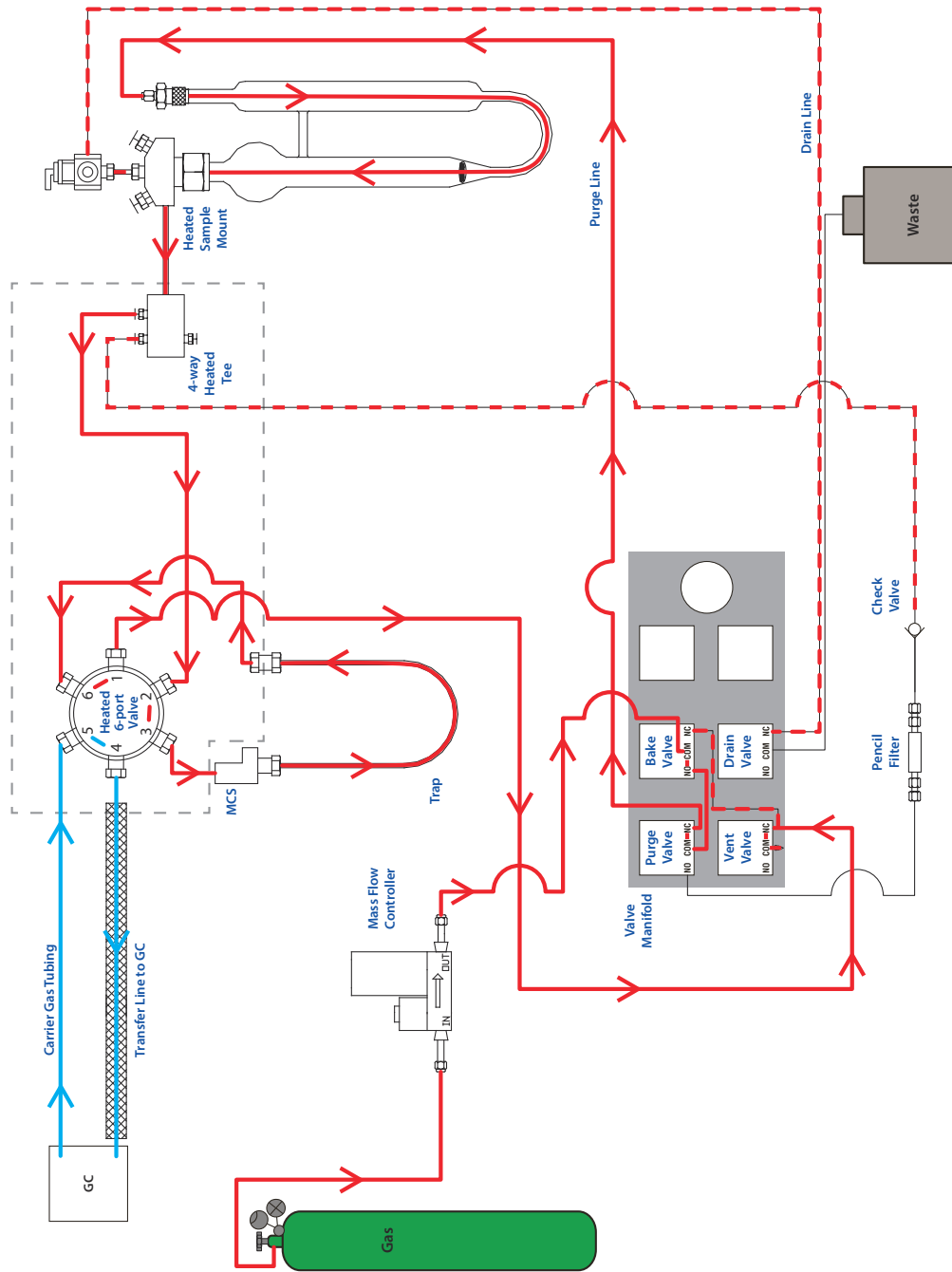

Figure A-5 Lumin - Purge Flow Diagram

A.3.4 Lumin Desorb Flow Diagram

Desorb

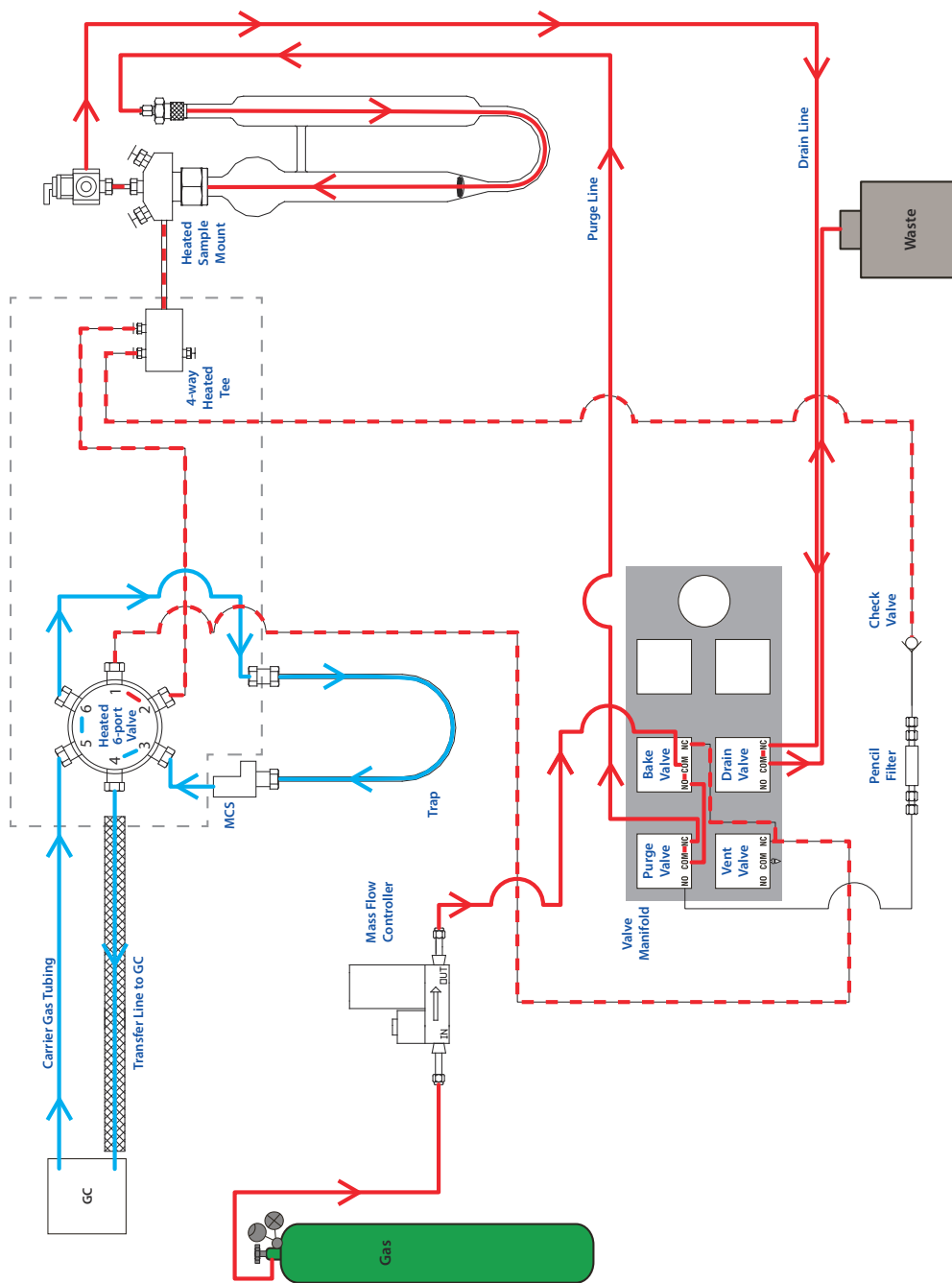

Figure A-6 Lumin - Desorb Flow Diagram

A.3.5 Lumin Bake Flow Diagram

Bake

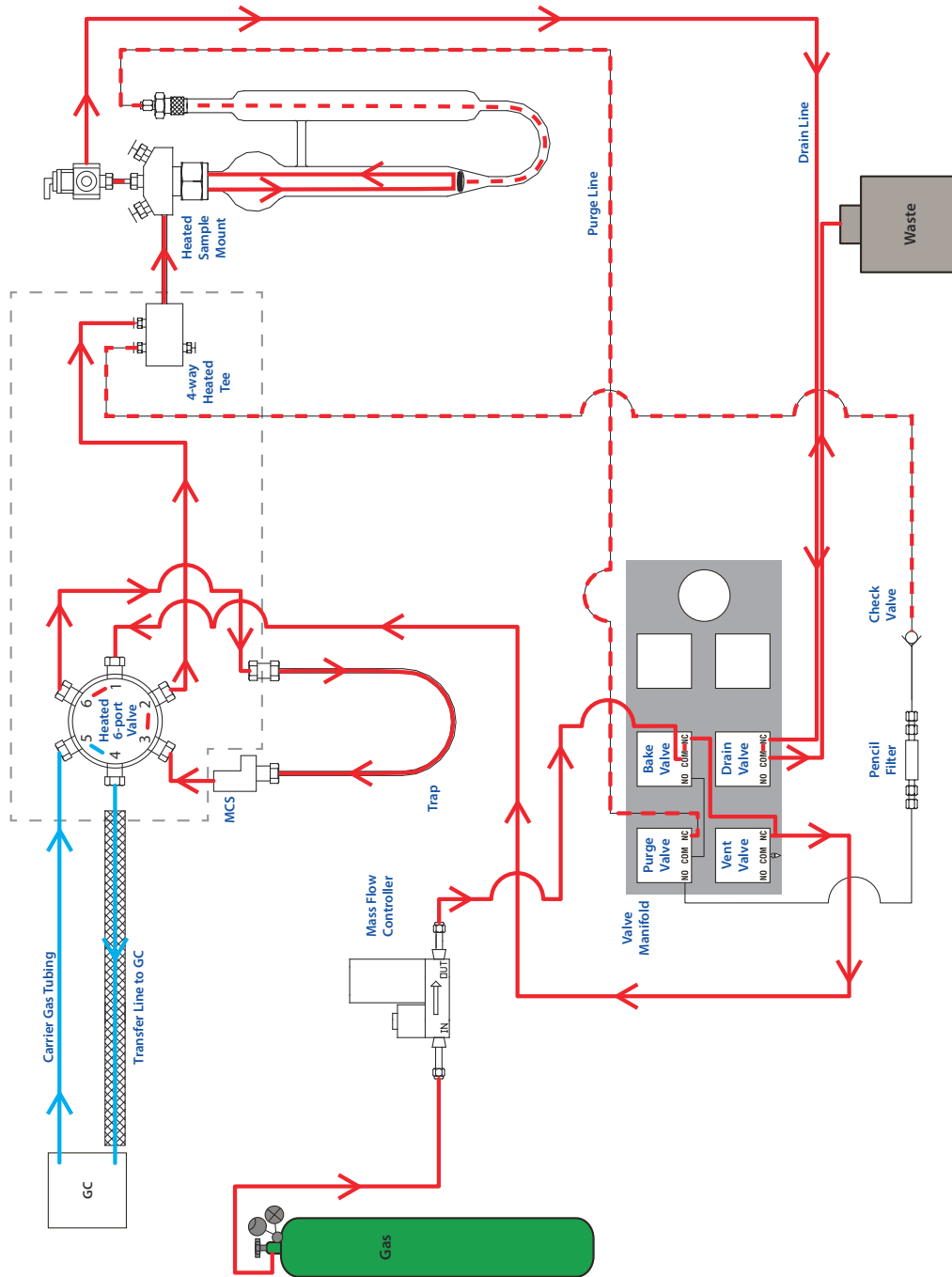

Figure A-7 Lumin - Bake Flow Diagram

A.4 Lumin With Guardian™ Foam Sensor (GFS) & Eliminator Flow Diagrams

A.4.1 Lumin With GFS & Eliminator - Basic Flow Diagram

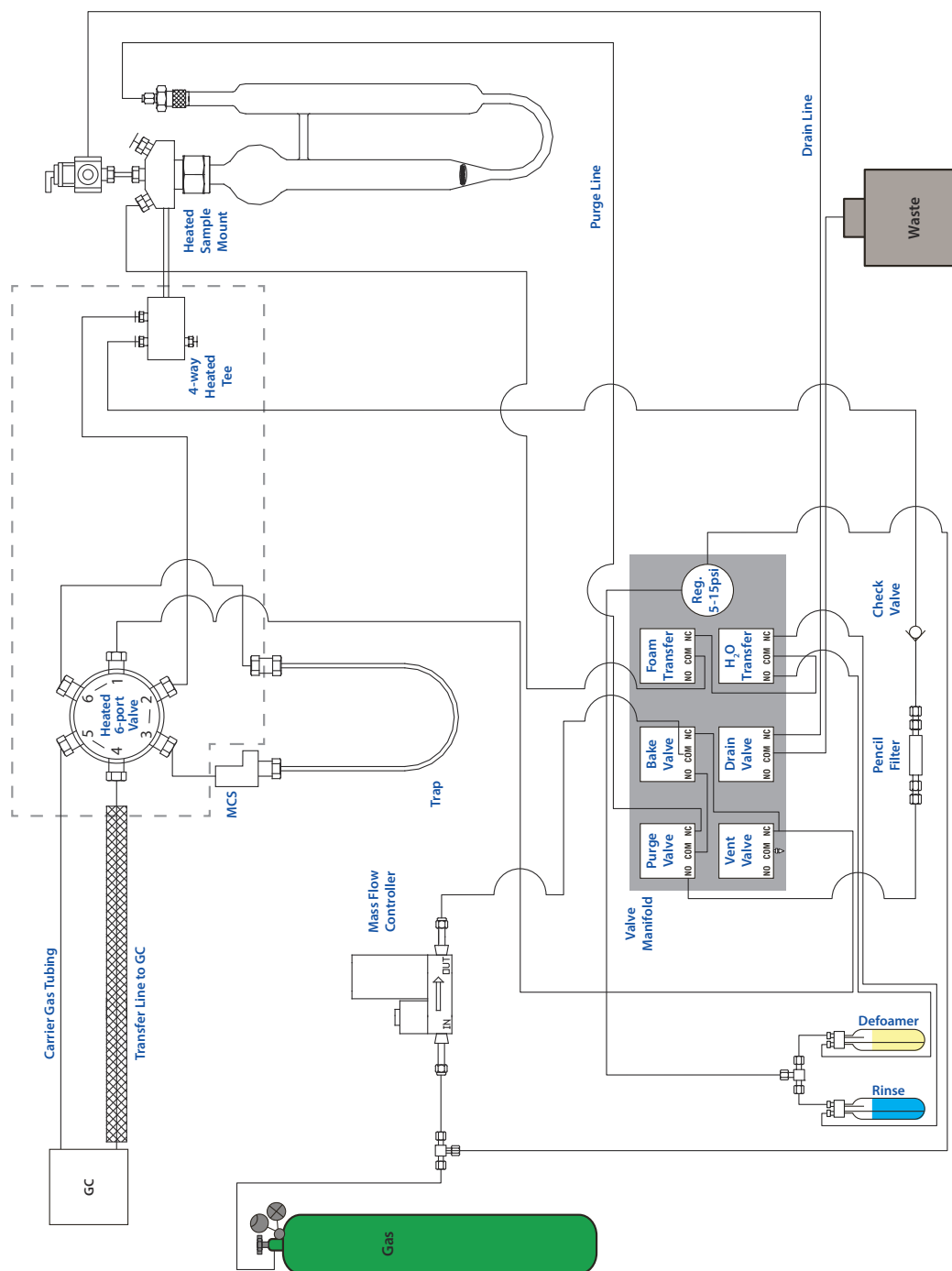

Figure A-8 Lumin With GFS & Eliminator - Basic Flow Diagram

A.4.2 Lumin With GFS & Eliminator - Standby/Dry Purge Flow Diagram

Standby/Dry Purge

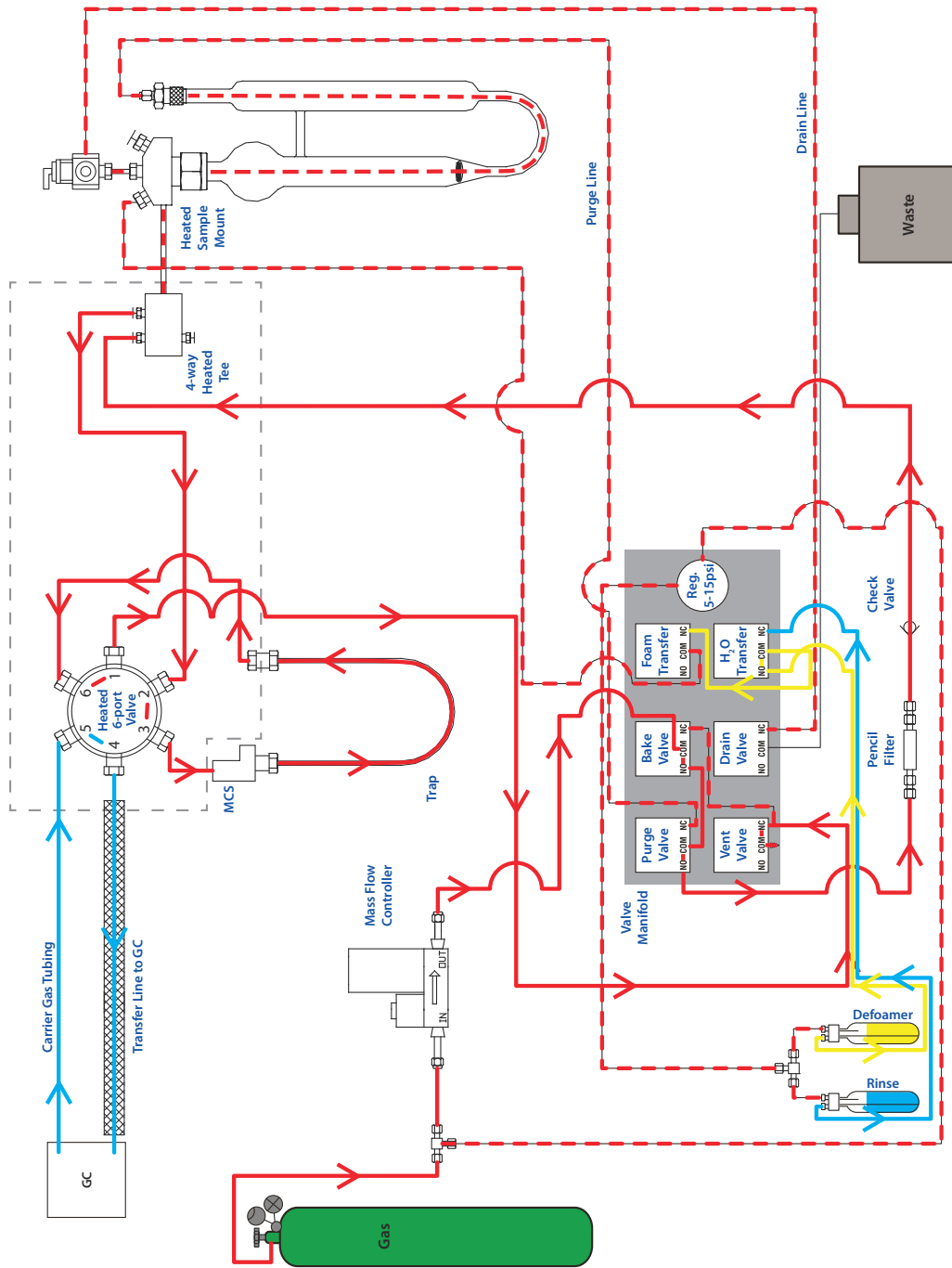

Figure A-9 Lumin With GFS & Eliminator - Standby/Dry Purge Flow Diagram

A.4.3 Lumin With GFS & Eliminator - Eliminator Ready Flow Diagram

Eliminator Ready

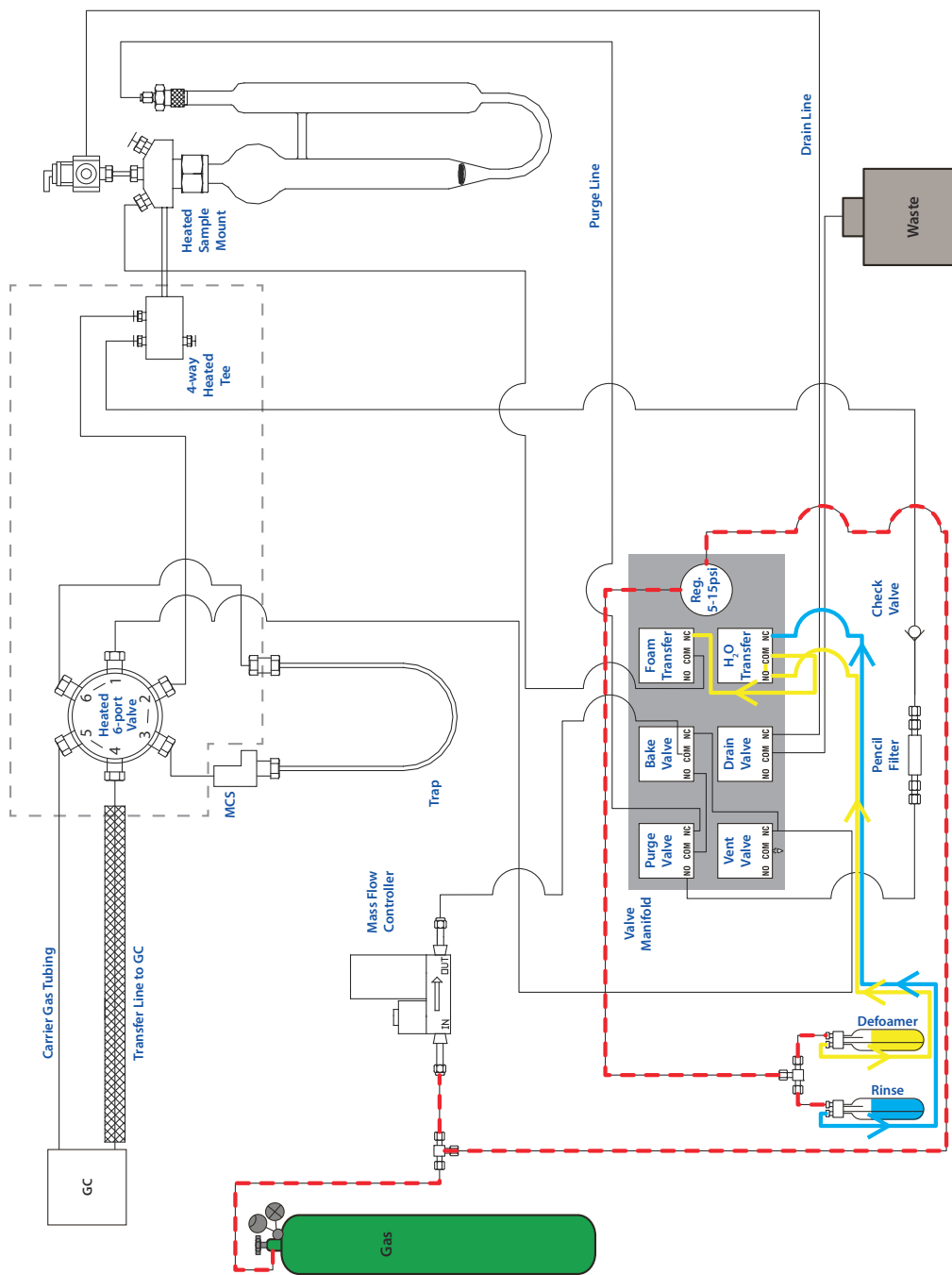

Figure A-10 Lumin With GFS & Eliminator - Eliminator Ready Flow Diagram

A.4.4 Lumin With GFS & Eliminator - Purge Flow Diagram

Purge

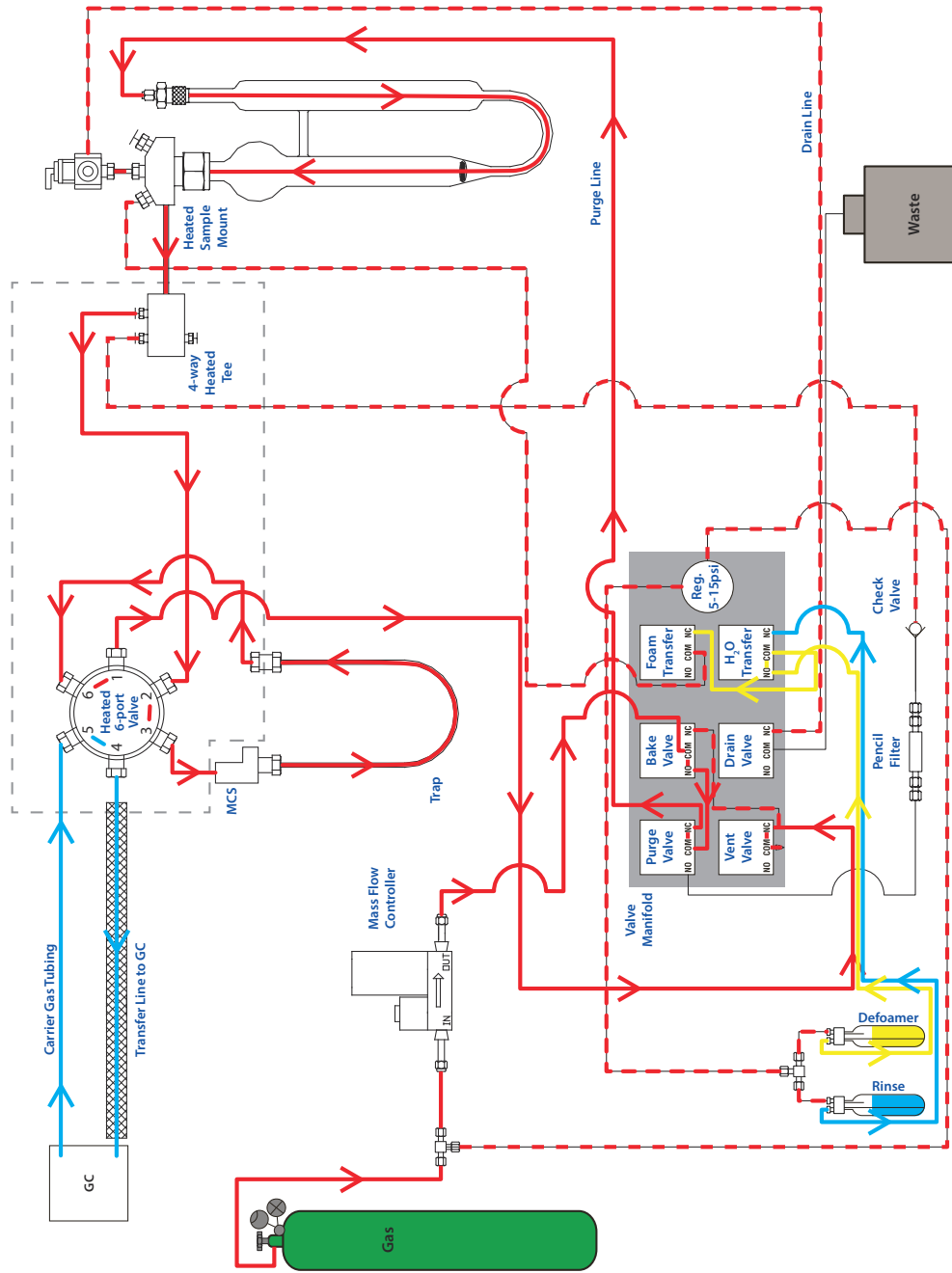

Figure A-11 Lumin With GFS & Eliminator - Purge Flow Diagram

A.4.5 Lumin With GFS & Eliminator - Add Defoamer Flow Diagram

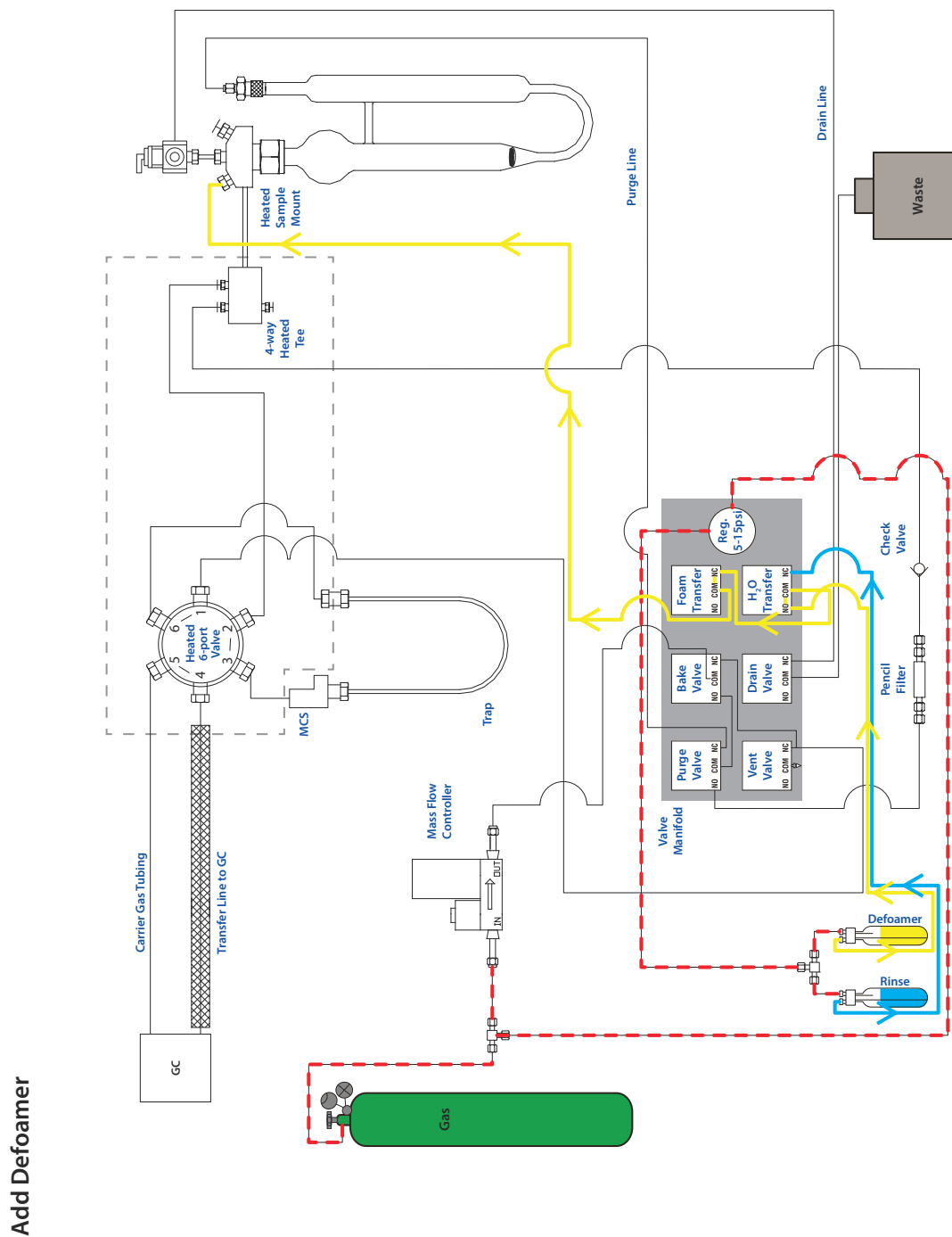

Figure A-12 Lumin With GFS & Eliminator - Add Defoamer Flow Diagram

A.4.6 Lumin With GFS & Eliminator - Eliminator Rinse Flow Diagram

Eliminator Rinse

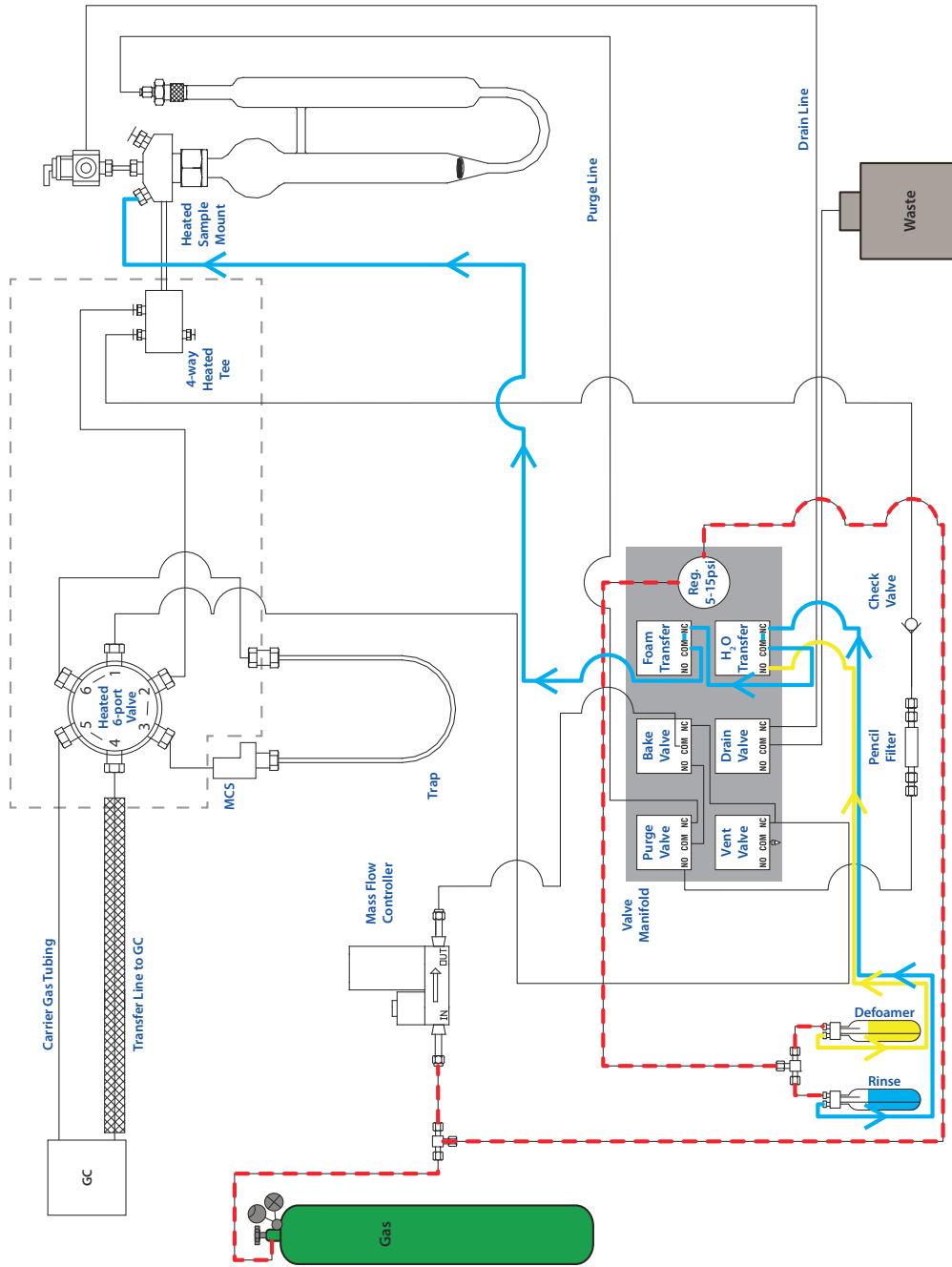

Figure A-13 Lumin With GFS & Eliminator - Eliminator Rinse Flow Diagram

A.4.7 Lumin With GFS & Eliminator - Desorb Flow Diagram

Desorb

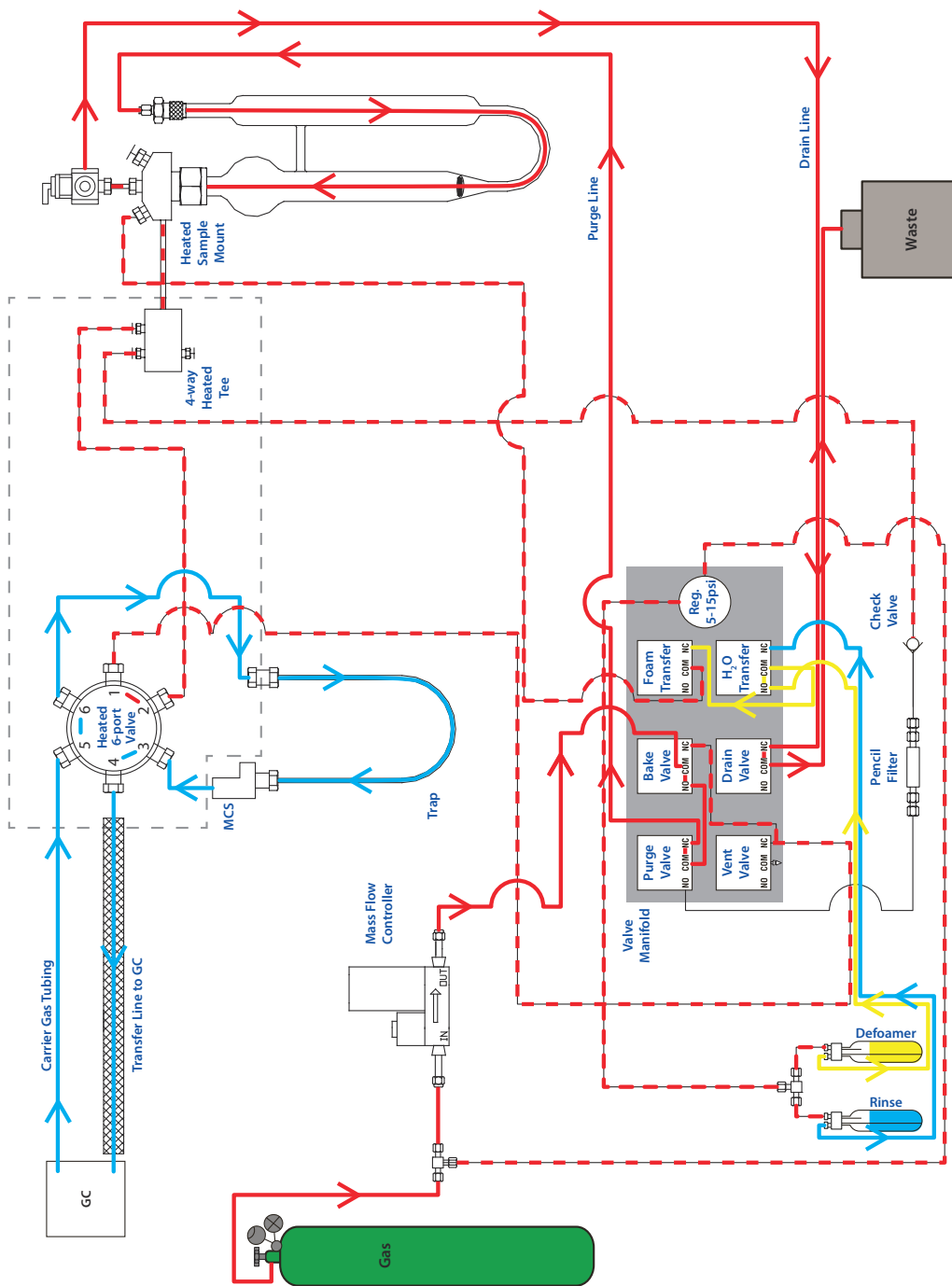
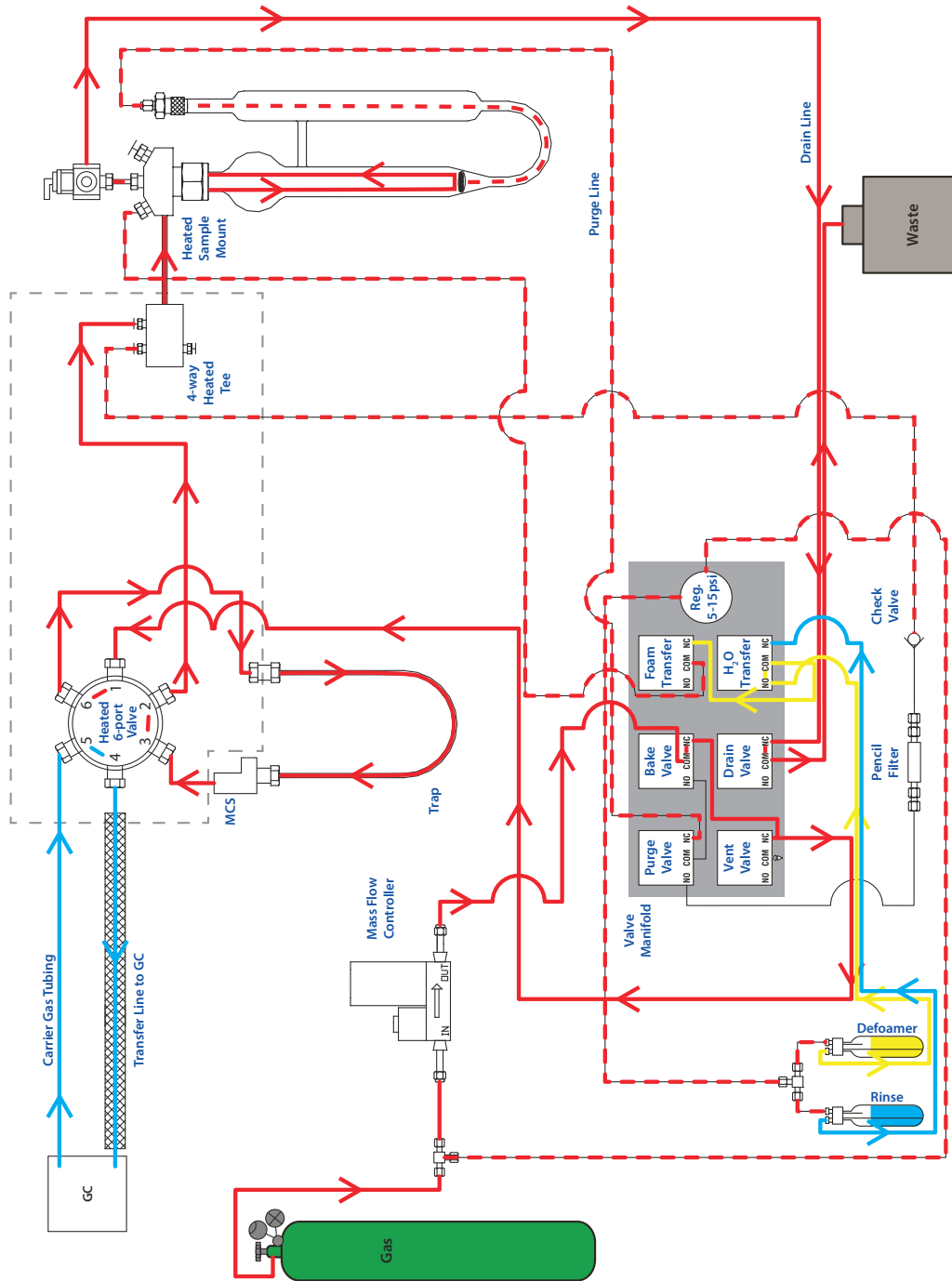

Figure A-14 Lumin With GFS & Eliminator - Desorb Flow Diagram

A.4.8 Lumin With GFS & Eliminator - Bake Flow Diagram



Bake

Figure A-15 Lumin With GFS & Eliminator - Bake Flow Diagram

Lumin User Manual

Index

Symbols

.NET Installation, 2-17

Numerics

24VDC Power Supply, 1-15

Replacement, 5-58

5VDC Power Supply, 1-15

Replacement, 5-56

6-Port Valve, 1-13

A

Abort Schedule, 3-47

Analytical Trap, 1-11

Conditioning, 3-17, 5-17

Conditioning Temperatures and Times, 4-13

Cooling Fan Replacement, 5-21

Heater Jacket Replacement, 5-18

Recommended Operating Conditions, 4-14

Replacement, 5-15

Applications, 1-5

AQUATek 100, 1-19, 3-12

Aqueous Transfer Line Installation, 2-22

Communication Cable Connection, 2-22

Method Configuration, 2-23

pH Probe Check, 3-18

pH Sensor Enable/Disable, 3-19

Prime, 3-16

Setup, 2-22

Tab, 3-12

Archive

Delete at Next Archive, 3-4

Settings, 3-25

Autosampler, 1-19, 2-22

Aqueous Transfer Line Installation, 2-22

Communication Cable Connection, 2-22

Method Configuration, 2-23

B

Bake, 3-11, 4-13

Bake Tab, 3-11

Beeper

Enable/Disable, 3-19

Benchmark Test, 3-32, 5-60

C

Carryover

Carryover Contamination Flow Chart, 5-75

Certifications, 1-5

Check Valve

Replacement, 5-28

Communication

Connection to Gas Chromatograph, 2-10

Components, 1-7

Computer Requirements, 1-6, 2-4

Concentrator Overview, 2-6

Condition Trap

Bake Settings, 3-17

Conditioning Analytical Trap, 4-13

Connect to Instrument Profile, 3-22

Contamination

Carryover Contamination Flow Chart, 5-75

CPU Communication Board (Master Board), 1-17

Customer Support, P-1, 5-76

D

Data

Connections, 2-9

Storage Location, 3-25

USB Interface Cable, 2-10

DC Valve Control Board, 1-18

Desorb, 3-10, 4-13

Pre-Heat, 4-12

Ready, 4-12

Tab, 3-10

DI Water

Prime, 3-16

Diagrams

Electrical, A-1

Flow, A-1

Plumbing, A-2

Dimensions, 1-4

Disposal

of Concentrator, 5-76

of Parts, 5-76

Drain Line

Installation, 2-14

Dry Purge, 4-12

E

Electrical

24VDC Power Supply, 1-15

5VDC Power Supply, 1-15

Connections, 2-9

Overview, 5-10

Requirements, 1-6, 2-2

Schematic, A-1

Troubleshooting

No Power Flow Chart, 5-68

Email

- Alert
 - Settings, 3-24
- Settings, 3-24
- Environmental Specifications, 1-4

F

- Firmware
 - Upgrade, 3-31, 5-59
- Flow
 - Manual Control, 3-28
- Flow Diagrams, A-1
 - Lumin
 - Bake, A-7
 - Basic Flow Diagram, A-3
 - Desorb, A-6
 - Purge, A-5
 - Standby Dry Purge, A-4
 - Lumin With Guardian™ Foam Sensor and Eliminator, A-8
 - Add Defoamer Flow Diagram, A-12
 - Bake Flow Diagram, A-15
 - Basic Flow Diagram, A-8
 - Desorb Flow Diagram, A-14
 - Eliminator Rinse Flow Diagram, A-13
 - Purge Flow Diagram, A-11
 - Ready Flow Diagram, A-10
 - Standby/Dry Purge Flow Diagram, A-9
- Fuse
 - Multi-Channel Temperature Control Board, 5-41
 - Replacement, 5-38

G

- Gas
 - Inlet, 1-9
 - Purge Gas Connection, 2-11
 - Purge Gas Settings, 3-19
 - Requirements, 1-6, 2-2
- Gas Chromatograph
 - Carrier Gas Connection to Lumin, 2-12
 - Carrier Gas Inlet, 1-12
 - Configure Type, 3-19
 - GC I/O Connection to Lumin, 2-10
 - GC/IO Cable and GC Type Reference, 5-4
 - Heated Sample Transfer Line, 1-12
 - Sample Transfer Line to Lumin, 2-12
 - Type
 - 31, 3-19
 - 63, 3-19
- Glassware
 - Cleaning Procedures, 5-12
- Guardian™ Foam Sensor and Foam Eliminator, 1-8, 1-19, 2-23
 - Enable/Disable, 3-19

H

- Heated Zones
 - Temperatures, 1-5
- Helium

- Purge Gas Setting, 3-19
- History Log, 3-30
- Home Screen, 3-5

I

- Installation
 - .Net Installation, 2-17
 - Autosampler
 - Aqueous Transfer Line Installation, 2-22
 - Communication Cable Connection, 2-22
 - Method Configuration, 2-23
 - Autosampler Setup, 2-22
 - Carrier Gas Supply Connection, 2-12
 - Connecting to Gas Chromatograph, 2-12
 - Create Instrument Profile, 2-18
 - Drain Line, 2-14
 - Electrical and Data Connections, 2-9
 - GC I/O Connection to Gas Chromatograph, 2-10
 - Guardian™ Foam Sensor and Foam Eliminator, 1-19, 2-23
 - Installation Kit Box, 2-5
 - Microsoft® SQL Server Installation, 2-16
 - Power Cord, 2-9
 - Pre-Installation, 2-1
 - Purge Gas Connection, 2-11
 - Required Tools and Supplies, 2-4
 - Sample Transfer Line Installation, 2-12
 - Unpacking, 2-5
 - USB Driver Installation, 2-17
 - USB Interface Cable, 2-10
- Installation Kit Box
 - Contents, 2-5
- Instrument Access Panels, 5-5
- Instrument Manager, 3-22
- Instrument Part Number, 1-4
- Instrument Profile, 3-18
 - Connect, 3-22, 3-35
 - Connect to, 3-22
 - Create, 3-32
 - Create Profile, 3-22
 - Creation, 2-18
 - Deactivate, 3-22, 3-36
 - Properties, 3-22
- Instrument Status Panel, 3-6

L

- Leak Check, 3-16, 5-64
 - Advanced, 5-64
 - Flow Chart, 5-67
 - Initial, 5-62
 - Settings, 3-21
 - Tab, 3-21
- Load Schedule, 3-46
- Lumin
 - Analytical Trap, 1-11
 - Recommended Operating Conditions, 4-14
 - Applications, 1-5
 - Carrier Gas Inlet, 1-12
 - Certifications, 1-5

- Component Overview, 1-7
- Computer Requirements, 1-6, 2-4
- Configuration, 3-18
- Dimensions, 1-4
- Electrical
 - Overview, 5-10
 - Requirements, 1-6, 2-2
 - Schematic, A-1
- Environmental Specifications, 1-4
- Essential Instructions, P-1
- Features, 1-6
- Flow Diagram
 - Bake, A-7
 - Basic, A-3
 - Purge, A-5
 - Standby Dry Purge, A-4
- Flow Diagrams, A-3
- Gas Requirements, 2-2
- General Specifications, 1-4
- Guardian™ Foam Sensor and Foam Eliminator, 1-8, 1-19
 - Configure, 2-23
- Heated Sample Transfer Line, 1-12
- Leak Check
 - Advanced, 5-64
 - Flow Chart, 5-67
 - Initial, 5-62
- Liquid Handling Specifications, 1-6
- Mass Flow Controller, 1-10
- Methods, 1-5
- Mode Descriptions, 4-1
- Moisture Control System, 1-11
- Operating Environment, 2-1
- Optimization, 4-10
- Optional Autosampler, 1-19
- Overview, 2-6
- Part Numbers, 1-4
- Performance Specifications, 1-4
- Plumbing
 - Diagram, A-2
 - Overview, 5-8
- Power Supply, 5-10
- Pre-Installation, 2-1
- Printed Circuit Boards, 5-11
- Return Procedure, 5-75
- Safety Labels, P-5
- Safety Symbols, P-3
- Sample Mount and Sparger, 1-8
- Sample Pathway, 1-10
- Sample Purge Gas Inlet, 1-9
- Sample Purge Gas Requirements, 1-6
- Specifications, 1-4
- Status Light, 1-9
- Temperatures, 1-5
- Troubleshooting, 5-60
- Unit and Parts Disposal, 5-76
- Valves
 - Output Chart, 4-3
- Valving, 1-6, 1-13
- Warranty, P-1
- Work Surface Requirements, 2-1
- Working Safely, P-6
- Lumin TekLink, 3-1
 - .NET Installation, 2-17
 - Abort, Hold and Step Buttons, 3-4
 - About, 3-28
 - AQUATek 100 Tab, 3-12
 - Archive Settings, 3-25
 - Bake Mode, 3-17
 - Bake Tab, 3-11
 - Benchmark Test, 3-32
 - Client-Server Settings, 3-26
 - Configuration, 3-18
 - Configure Gas Chromatograph, 3-19
 - Configure Guardian Foam Sensor, 3-19
 - Create Instrument Profile, 2-18
 - Data Storage Settings, 3-25
 - Delete at Next Archive, 3-4
 - Desorb Mode, 3-18
 - Desorb Tab, 3-10
 - Diagnostics, 3-28
 - Email Alert Settings, 3-24
 - Email Alerts, 3-24
 - Email Setting, 3-23
 - History Log, 3-30
 - Home Screen, 3-5
 - Instrument Control Buttons, 3-4
 - Instrument Manager, 3-22
 - Instrument Profile
 - Connect, 3-35
 - Create, 3-32
 - Deactivate, 3-36
 - Instrument Status Panel, 3-6
 - Leak Check, 3-16
 - Manual Overrides, 3-28
 - Method
 - Creating, 3-37
 - Opening, 3-39
 - Printing, 3-41
 - Methods Screen, 3-7
 - Microsoft® SQL Server Installation, 2-16
 - Open, Save, Load, and Print Buttons, 3-3
 - Options, 3-19
 - pH Probe Check, 3-18
 - Pinning Screens, 3-2
 - Primary Screens, 3-5
 - Prime, 3-16
 - Purge Tab, 3-8
 - Remote Connection, 3-26
 - Schedule
 - Creating, 3-42
 - Schedules Screen, 3-14
 - Standby Tab, 3-7
 - System Properties, 3-22
 - Title Bar Information, 3-2
 - Tools Screen, 3-15
 - Touchscreen Capability, 3-1
 - Enable On-screen Keyboard, 3-27
 - Upgrade Firmware, 3-31, 5-59
 - Upgrade Software, 5-59

- USB Driver Installation, 2-17
- User Interface Overview, 3-1
- Valves and Flows, 3-28
- Version, 3-28
- Lumin with AQUATek 100
 - Valves
 - Output Chart, 4-6
- Lumin with GFSE
 - Flow Diagram
 - Add Defoamer, A-12
 - Bake, A-15
 - Basic, A-8
 - Desorb, A-14
 - Eliminator Rinse, A-13
 - Purge, A-11
 - Ready, A-10
 - Standby/Dry Purge, A-9

M

- Maintenance
 - 24VDC Power Supply Replacement, 5-58
 - 5VDC Power Supply Replacement, 5-56
 - 6-Port Valve, 5-37
 - Analytical Trap
 - Conditioning, 4-13, 5-17
 - Cooling Fan Replacement, 5-21
 - Heater Jacket Replacement, 5-18
 - Replacement, 5-15
 - Check Valve Replacement, 5-28
 - CPU Communication (Master) PCB Replacement, 5-50
 - Daily Maintenance Checks, 5-2
 - DC Valve Control PCB Replacement, 5-53
 - Electrical Overview, 5-10
 - Electrical Schematic, A-1
 - Instrument Access Panels, 5-5
 - Mass Flow Controller Replacement, 5-35
 - Moisture Control System
 - Cooling Fan Replacement, 5-25
 - Replacement, 5-33
 - Monthly Maintenance Checks, 5-2
 - Multi-Channel Temperature Control PCB
 - Fuse Replacement, 5-41
 - Replacement, 5-47
 - Pencil Filter Replacement, 5-27
 - Plumbing Diagram, A-2
 - Plumbing Overview, 5-8
 - Power Entry Module Fuse Replacement, 5-38
 - Preventative Maintenance
 - Chart, 5-3
 - Checks, 5-2
 - Preventative Maintenance Chart, 5-3
 - Replacing Parts, 5-1
 - Sparger Replacement, 5-13
 - Valve Manifold Replacement, 5-30
 - Valve Replacement, 5-31
 - Weekly Maintenance Checks, 5-2
- Mass Flow Controller, 1-10
 - Replacement, 5-35

- Method
 - Bake
 - Optimization, 4-13
 - Creating a, 3-37
 - Desorb
 - Optimization, 4-13
 - Desorb Pre-Heat
 - Optimization, 4-12
 - Desorb Ready
 - Optimization, 4-12
 - Dry Purge
 - Optimization, 4-12
 - Opening, 3-39
 - Optimizing Parameters, 4-10
 - Pre-Purge
 - Optimization, 4-11
 - Printing, 3-41
 - Purge
 - Optimization, 4-12
 - Purge Ready
 - Optimization, 4-11
 - Sample Pre-Heat Time, 4-11
 - Sample Temperature, 4-11
 - Standby
 - Optimization, 4-10
 - Temperature Optimization, 4-10
- Method Parameters
 - AQUATek 100, 3-12
 - Bake, 3-11
 - Desorb, 3-10
 - Purge, 3-8
 - Standby, 3-7
- Methods, 1-5
- Methods Screen, 3-7
- Microsoft® SQL Server Installation, 2-16
- Modes
 - Bake, 4-13
 - Descriptions, 4-1
 - Desorb, 4-13
 - Desorb Pre-Heat, 4-12
 - Desorb Ready, 4-12
 - Dry Purge, 4-12
 - Pre-Heat, 4-11
 - Pre-Purge, 4-11
 - Purge, 4-12
 - Purge Ready, 4-11
 - Standby, 4-10
 - Step to Next, 3-48
- Moisture Control System, 1-11
 - Fan Replacement, 5-25
 - Replacement, 5-33

N

- Nitrogen
 - Purge Gas Setting, 3-19
- Notations and Hazard Severity Levels, P-2

O

- On-Screen Keyboard, 3-27

Optimization
 Bake, 4-13
 Desorb, 4-13
 Desorb Pre-Heat, 4-12
 Desorb Ready, 4-12
 Dry Purge, 4-12
 Pre-Heat
 Temperature and Pre-Heat Time, 4-11
 Pre-Purge
 Optimization, 4-11
 Purge, 4-12
 Purge Ready, 4-11
 Sample Temperature, 4-11
 Standby
 Flow, 4-10
 Temperature, 4-10
 Temperatures, 4-10

P

Parameters
 Optimization, 4-10
 Pencil Filter
 Replacement, 5-27
 pH Sensor
 Enable/Disable and Configure, 3-19
 Plumbing
 Diagram, A-2
 Overview, 5-8
 Power Entry Module
 Fuse Replacement, 5-38
 Power Supply, 5-10
 Pre-Installation, 2-1
 Pre-Purge, 4-11
 Preventative Maintenance
 Daily Maintenance Checks, 5-2
 Monthly Maintenance Checks, 5-2
 Weekly Maintenance Checks, 5-2
 Printed Circuit Boards
 CPU Communication (Master) PCB Replacement, 5-50
 CPU Communication Board (Master Board), 1-17
 DC Valve Control Board, 1-18, 5-53
 Multi-Channel Temperature Control Board, 1-16
 Fuse Replacement, 5-41
 Multi-Channel Temperature Control PCB, 5-47
 Overview, 5-11
 Upgrade Firmware, 3-31, 5-59
 Purge, 3-8, 4-12
 Recommended Flow Rate, 4-12
 Purge and Trap
 Background, 1-1
 History, 1-2
 Overview, 1-2
 Trapping, Adsorption, Desorption, 1-3
 Purge Gas Setting, 3-19
 Purge Tab, 3-8

R

Replacement Parts, 5-1

Replacing Parts, 5-1
 Returning the Lumin, 5-75
 Run Schedule, 3-46

S

Safety
 Essential Instructions, P-1
 Notations and Hazard Severity Levels, P-2
 Safety Labeling, P-5
 Safety Symbols, P-3
 Working Safely, P-6
 Sample Mount, 1-8
 Sample Pathway, 1-10
 Sample Pre-Heat Time
 Optimization, 4-11
 Sample Purge Gas Inlet, 1-9
 Sample Temperature
 Optimization, 4-11
 Schedule, 3-14
 Abort Schedule, 3-47
 Add Blank, 3-43
 Add Lines, 3-44
 Add Standard, 3-44
 Add Vial, 3-43
 Choose Method, 3-44
 Creating a, 3-42
 Fill Up/Fill Down, 3-44
 Hold Schedule, 3-48
 Load Schedule, 3-46
 Print Schedule, 3-49
 Step Schedule, 3-48
 Use Check-box, 3-43
 Schedules Screen, 3-14
 Solenoid Valves, 1-13
 Sparger
 Options, 1-8
 Replacement, 5-13
 Standards
 Prime, 3-16
 Standby, 3-7, 4-10
 Optimization, 4-10
 Standby Tab, 3-7
 Status Light, 1-9
 Step Control Button, 3-48
 System Properties, 3-22

T

Technical Assistance, 5-76
 Teledyne Tekmar
 Contact Information, P-1
 Temperature, 4-10
 Optimization, 4-10
 Temperature Control Board, 1-16
 Tools Screen, 3-15
 Top-of-Trap (TOT) Injection Port, 5-69
 Trap, 1-11
 Conditioning, 5-17
 Recommended Operating Conditions, 4-14
 Replacement, 5-15

Troubleshooting, 5-60
Benchmark Test, 3-32, 5-60
Carryover Contamination Flow Chart, 5-75
Desorb Mode, 3-18
Diagnostics, 3-28
Flow Diagrams, A-1
Leak Check, 3-16, 5-64
 Flow Chart, 5-67
 Initial, 5-62
Leak Check Settings, 3-21
Low Response Flow Chart, 5-74
Lumin TekLink Version Details, 3-28
Manual Control of Valves and Flows, 3-28
No Power Flow Chart, 5-68
No Response Flow Chart, 5-73
Technical Assistance, 5-76
Top-of-Trap (TOT) Injection Port, 5-69

U

Upgrade Firmware, 3-31, 5-59
Upgrade Software, 5-59
USB
 Driver Installation, 2-17
 Interface Cable, 2-10

V

Valves, 1-6, 1-13
 6-Port Valve Replacement, 5-37
 Lumin
 Output Chart, 4-3
 Lumin with AQUATEk 100
 Output Chart, 4-6
 Manifold Replacement, 5-30
 Manual Control, 3-28
 Solenoid Valve Replacement, 5-31
 Valves and Functions, 1-14
Vial Column
 Add/Remove, 3-19

W

Warranty, P-1