

Panasonic®



Microwave Cookery Book & Operating Instructions

Model Number: NN-CF778S

Standard Conversion Chart

Weight

1/2oz	–	15g
1oz	–	25g
2oz	–	50g
3oz	–	75g
4oz	–	100g
5oz	–	150g
6oz	–	175g
7oz	–	200g
8oz	–	225g
9oz	–	250g
10oz	–	275g
11oz	–	300g
12oz	–	350g
13oz	–	375g
14oz	–	400g
15oz	–	425g
1lb/16oz	–	450g

Capacity

1/2tsp	–	3ml
1tsp	–	5ml
1tbsp	–	15ml
1/4pt	–	150ml
1/2pt	–	300ml
3/4pt	–	450ml
1pt	–	600ml
1 3/4pt	–	1 litre

When using recipes in this book always follow metric or imperial measurements. Do not combine the two. In some recipes the conversions are not a direct equivalent due to recipe result.

Important Notice



Microwave symbol

The IEC (60705) power output (watts)

The heating category for small packs of food

Your oven is rated 1000 Watts (IEC). When using other cookbooks remember to adjust cooking times accordingly. The symbol above, which is displayed on your oven door, indicates the heating category for your oven when cooking or reheating convenience foods.

Your oven is rated 'E', which is very efficient. It is therefore very important that you refer carefully to the packet instructions on convenience foods. Some packet instructions only display information for B or D rated ovens. We therefore provide additional guidelines for reheating on pages 60-77 of this book. ALWAYS check the progress of the food as it cooks or reheats by simply opening the door and after checking the progress of the foods press START to continue the cooking time.

Failure to follow the instructions given in this Cookbook and Operating Instructions, may affect the recipe result and in some instances may be dangerous.



COOKERY ADVICE LINE 01344 862108

Customer Care Centre 0844 8443899

Selected Spares and Accessories:

Order direct on line at

www.panasonic.co.uk or by telephoning the Customer Care Centre number above.

- Important safety instructions. Before operating this oven, please read these instructions carefully and keep for future reference.
- This appliance can be used by children aged from 8 years and above and persons with reduced physical, sensory and mental capabilities or lack of experience and knowledge if they have been given supervision or instruction by a person responsible for their safety concerning the use of the appliance in a safe way and understand the hazards involved. Children shall not play with the appliance. Cleaning and user maintenance shall not be made by children without supervision. Keep the appliance and its cord out of reach of children less than 8 years.
- When this oven is installed, it should be easy to isolate the appliance from the electricity supply by pulling out the plug or operating a circuit breaker.
- If the supply cord is damaged, it must be replaced by the manufacturer or its service agent or a similarly qualified person in order to avoid a hazard.

- **Warning!** The appliance should be inspected for damage to the door seals and door seal areas and if these areas are damaged the appliance should not be operated until it has been repaired by a service technician trained by the manufacturer.
- **Warning!** Do not attempt to tamper with or make any adjustments or repairs to the door, control panel housing, safety interlock switches or any other part of the oven. Do not remove the outer panel from the oven which gives protection against exposure to microwave energy. Repairs should only be by a qualified service person.
- Liquids and other foods must not be heated in sealed containers since they are liable to explode.
- **Warning!** Do not place this oven near an electric or gas cooker range.
- **Warning!** Only allow children to use the oven without supervision when adequate instructions have been given so that the child is able to use the oven in a safe way and understands the hazards of improper use.

- This oven is intended for Counter-top and Built-in use only. It is not intended for use inside a cupboard. This oven may be Built into a wall cabinet by using the proper trim kit, which may be purchased from a local Panasonic dealer.

For Countertop use:

- The oven must be placed on a flat, stable surface 85 cm above the floor, with rear of oven placed against a back wall. For proper operation the oven must have sufficient air flow. At least 15cm/6" should be clear over the top of the oven, and one side of the oven should be kept open.
- When heating food in plastic or paper containers, check the oven frequently as these types of containers ignite if overheated.
- If smoke is emitted or a fire occurs in the oven, press Stop/Cancel button and leave the door closed in order to stifle any flames. Disconnect the power cord, or shut off power at fuse or circuit breaker panel.

- When heating liquids, e.g. soup, sauces and beverages in your oven, overheating the liquid beyond boiling point can occur without evidence of bubbling. This could result in a sudden boil over of the hot liquid.
- The contents of feeding bottles and baby food jars are to be stirred or shaken. The temperature has to be checked before consumption to avoid burns.
- Do not cook eggs in their shells and whole hard-boiled eggs by MICROWAVE. Pressure may build up and the eggs may explode, even after the microwave heating has ended.
- Clean the inside of the oven, door seals and door seal areas regularly. When food splatters or spilled liquids adhere to the oven walls, door seals and door seal areas wipe off with a damp cloth. Mild detergent may be used if they get very dirty. The use of harsh detergent or abrasive is not recommended.
- **DO NOT USE COMMERCIAL OVEN CLEANERS.**

- When using the GRILL or COMBINATION mode, some foods may inevitably splatter grease on to the oven walls. If the oven is not cleaned occasionally, it may start to “smoke” during use.
- Failure to maintain the oven in a clean condition could lead to deterioration of surfaces that could affect the life of the appliance and possibly result in a hazardous situation.
- **Warning!** The accessible parts may become hot in combination use. Young children should be kept away. Children less than 8 years of age should only use the oven under continuous adult supervision due to the temperatures generated.
- A steam cleaner is not to be used for cleaning.
- Do not use harsh, abrasive cleaners or sharp metal scrapers to clean the oven door glass since they can scratch the surface, which may result in shattering of the glass.

- Exterior oven surfaces, including air vents on the cabinet and the oven door will get hot during COMBINATION and GRILLING, take care when opening or closing the door and when inserting or removing food and accessories.
- This appliance is not intended to be operated by means of an external timer or separate remote-control system.
- Only use utensils that are suitable for use in microwave ovens.
- Please refer to page 14 for indication of correct installation of the shelf accessory.
- The oven has three heaters situated in the top and back of the oven. After using the CONVECTION, COMBINATION and GRILL function, care should be taken to avoid touching the inside surfaces of the oven as these will be very hot. Care should be taken to avoid the heating element inside the oven.

Welcome to Panasonic Microwave Cooking

Thank you for purchasing a Panasonic Microwave Oven. Even if this is not your first microwave oven, do please read the opening chapters of this cookbook to achieve perfect results every time.



This microwave oven has the benefit of the Inverter System Inside. This technology has been in use with microwave ovens in Japan for many years, improving the cooking performance of the oven. It also means that you benefit from having more space inside your oven, without taking up more room on your work surface.

Microwaves leave most foods tastier and leave you with less washing up, but don't expect to become a perfect microwave cook overnight – some of the methods are very different to those used in conventional cooking. Home Economists program the ovens especially for the UK market. The recipes are also tested many times to ensure you achieve successful results at home.

We hope you enjoy using your new oven but should you require any further help or explanation, phone our:

☎ COOKERY ADVICE LINE 01344 862108

Home economists will provide friendly guidance on queries relating to recipes and cooking in your microwave. Alternatively write to the address below, or contact us online at:

test.kitchen@panasonic.co.uk

Alternatively visit our website at:

www.theideaskitchen.co.uk

Home Appliance Innovation Centre

Panasonic U.K.

A branch of Panasonic Marketing Europe GmbH

Panasonic House

Willoughby Road

Bracknell

Berkshire

RG12 8FP

When writing, be sure to state your model number and daytime telephone number.

CONTENTS

Important Safety Instructions	8-9
Unpacking your oven	9
Placement of your oven	10
Maintenance of your oven	10
Before using your oven	11
Care and Cleaning	12
Parts of your oven	13-14
Important Information	15-17
Microwaving Principles	18
Important notes	19
General Guidelines	20-23
Containers to use	24-26
Control Panel	27
Operating Instructions	
• Demonstration Mode	28
• Child Lock	28
• Eco Mode	29
• Setting the Clock	29
• Microwaving/defrosting	30-34
• Defrosting Charts	35-37
• Delay Stand	38
• Memory	39
• Grilling	40-41
• Convection cooking	42-45
• TURBO-BAKE cooking	46-48
• Combination Cooking	49-59
Auto Weight Programs	60-65
Cooking and Reheating Guidelines	65-66
Reheating Charts	67-73
Cooking Charts	74-83
Adapting Recipes	84



RECIPES

Soups and Starters	85-89
Fish	90-95
Meat and Poultry	96-110
Vegetables/Vegetarian	111-122
Pasta, Rice & Beans	123-126
Cheese and Egg Dishes	127-130
Sauces	131-135
Pastry	136-141
Desserts and Baking	142-158
Bread and Pizza	159-161
Questions and Answers	162
Technical Specifications	163
Information on disposal	163

Important safety instructions

Please read carefully and keep for future reference

This appliance is supplied with a moulded three pin mains plug for your safety and convenience. A 13 amp fuse is fitted in this plug. Should the fuse need to be replaced, please ensure that the replacement fuse has a rating of 13 amps and that it is approved by ASTA or BSI to BS1362.

Check for the ASTA mark  or the BSI mark  on the body of the fuse.

If the fuse cover is detachable, never use the plug with the cover omitted. If a replacement fuse cover is required, ensure it is the same colour as that visible on the pin face of the plug.

A replacement fuse cover can be purchased from your local Panasonic Dealer.

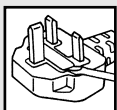

HOW TO REPLACE THE FUSE

Open the fuse compartment with a screwdriver and replace the fuse.

IF THE FITTED MOULDED PLUG IS UNSUITABLE FOR THE SOCKET OUTLET IN YOUR HOME THEN THE FUSE SHOULD BE REMOVED AND THE PLUG CUT OFF AND DISPOSED OF SAFELY AND AN APPROPRIATE ONE FITTED. THERE IS A DANGER OF SEVERE ELECTRICAL SHOCK IF THE CUT OFF PLUG IS INSERTED INTO ANY 13 AMP SOCKET.

If a new plug is to be fitted, please observe the wiring code as shown opposite. If in any doubt, please consult a qualified electrician (For U.K. Models only).

WARNING: THIS APPLIANCE MUST BE EARTHED.

IMPORTANT: The wires in this mains lead are coloured in accordance with the following code: Green-and-yellow: Earth, Blue: Neutral, Brown: Live.

As the colours of the wire in the mains lead of this appliance may not correspond with the coloured markings identifying the terminals in your plug, proceed as follows:

The wire which is coloured GREEN-AND-YELLOW must be connected to the terminal in the plug which is marked with the letter E or by the Earth symbol  or coloured GREEN or GREEN-AND-YELLOW.

The wire which is coloured BLUE must be connected to the terminal in the plug which is marked with the letter N or coloured BLACK.

The wire which is coloured BROWN must be connected to the terminal in the plug which is marked with the letter L or coloured RED.

When this oven is installed it should be easy to isolate the appliance from the electricity supply by pulling out the plug or operating a circuit breaker.

Voltage & Power

The voltage used must be the same as specified on this microwave oven. Using a higher voltage than that which is specified is dangerous and may result in a fire or other type of accident causing damage.

Do not immerse cord, plug or oven in water. Keep cord away from heated surfaces. Do not let cord hang over the edge of table or work top. Do not plug your oven in via an extension cable as this can be dangerous. It is important to plug the oven directly into a wall socket.

The back of the appliance heats up during use. Do not allow the cord to be in contact with the back of the appliance or cabinet surface.

Important safety instructions

Please read carefully and keep for future reference

Caution: Hot surfaces



1. Hot Surfaces

Exterior oven surfaces, including air vents on the cabinet and the oven door, will get hot during CONVECTION, COMBINATION and GRILLING. Use care when opening or closing door and when inserting or removing food and accessories. The oven has three heaters situated in the top and rear of the oven. After using the CONVECTION, COMBINATION and GRILL functions the roof and walls will be very hot.

Care should be taken to avoid touching the heating elements inside the oven.

2. The accessible parts may become hot in combination use. Young children should be kept away. Children less than 8 years of age should only use the oven under continuous adult supervision due to the temperatures generated.

Unpacking your oven

1. Examine Your Oven

Unpack oven, remove all packing material, and examine the oven for any damage such as dents, broken door latches or cracks in the door. Notify dealer immediately if unit is damaged. Do NOT install if unit is damaged.

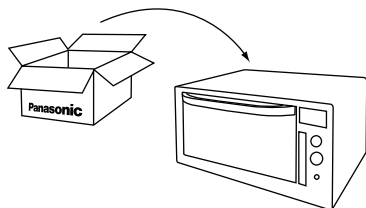

2. Guarantee

Your receipt is your guarantee, please keep safely.

3. Cord

If the supply cord of this appliance is damaged, it must be replaced by the manufacturer or its service agent or a similarly qualified person in order to avoid a hazard.

N.B. The appliance should be inspected for damage to the door seals and door seal areas. If these areas are damaged the appliance should not be operated until it has been repaired by a service technician trained by the manufacturer.

Placement of your oven

1. This oven is intended for Counter-top and Built-in use only. It is not intended for use inside a cupboard. This oven may be Built into a wall cabinet by using the proper trim kit, which may be purchased from a local Panasonic dealer. Refer to building-in your oven on page 162.

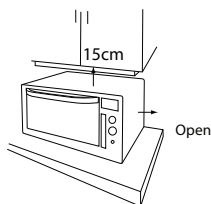

2. Counter top use

The oven must be placed on a flat, stable surface 85 cm above the floor, with rear of oven placed against a back wall. For proper operation the oven must have sufficient air flow. At least 15cm/6" should be clear over the top of the oven, and one side of the oven should be kept open.

3. Do not place the microwave oven on a shelf directly above a gas or electric hob. This may be a safety hazard and the oven may be damaged.
4. Do not block air vents on the rear and bottom or top of the cabinet. Do not place any articles on the top of the oven over the vents. If air vents are blocked during operation, the oven may overheat. If the oven overheats, a thermal safety device will turn the oven off. The oven will remain inoperable with blank display until it has cooled.
5. Do not use outdoors.

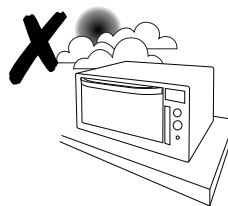

Maintenance of your oven

1. Service

WHEN YOUR OVEN REQUIRES A SERVICE call your local Panasonic engineer (Customer Communications Centre on 0844 844 3899 can recommend an engineer). It is hazardous for anyone other than a competent person to carry out any service or repair operation which involves the removal of a cover which gives protection against exposure to microwave energy.

2. Door Seals

Do not attempt to tamper with or make any adjustments or repairs to door, control panel housing, safety interlock switches or any other part of the oven. Do not remove outer panel from oven.

The door seals and door seal areas should always be kept clean – use a damp cloth.

N.B. The appliance should be inspected for damage to the door seals and door seal areas. If these areas are damaged the appliance should not be operated until it has been repaired by a service technician trained by the manufacturer.

3. Oven Light

The oven lamp must be replaced by a service technician trained by the manufacturer. DO NOT attempt to remove the outer casing from the oven.

4. Selected Spares and Accessories

These may be ordered direct; on line at www.panasonic.co.uk or by telephoning the Customer Communications Centre 0844 844 3899. Most major credit and debit cards accepted. Ensure you quote the correct model number.

Before using your oven

1. Exterior oven surfaces, including air vents on the cabinet and the oven door will get hot during CONVECTION, COMBINATION and GRILLING, take care when opening or closing the door and when inserting or removing food and accessories.
2. The oven has two grill heaters situated in the top of the oven and a convection heater situated in the back of the oven. After using either the GRILL, CONVECTION or COMBINATION functions, the inside surfaces of the oven will be very hot. Care should be taken to avoid touching the heating elements inside the oven.
N.B. After cooking by these modes, the oven accessories will be very hot.
3. The accessible parts may become hot in combination use. Young children should be kept away.
4. Only allow children to use the oven without supervision when adequate instructions have been given so that the child is able to use the oven in a safe way and understands the hazards of improper use. Ensure that children do not touch the hot outer casing after operation of the oven.
5. This appliance can be used by children aged from 8 years and above and persons with reduced physical, sensory and mental capabilities or lack of experience and knowledge if they have been given supervision or instruction by a person responsible for their safety concerning the use of the appliance in a safe way and understand the hazards involved. Children shall not play with the appliance. Cleaning and user maintenance shall not be made by children without supervision. Keep the appliance and its cord out of reach of children less than 8 years.
6. **Storage of Accessories**
Do not store any objects other than oven accessories inside the oven in case it is accidentally turned on. In case of electronic failure, oven can only be turned off at wall socket.
7. **Before Use**
Before using CONVECTION, COMBINATION or GRILL function for the first time operate the oven without food and accessories on CONVECTION 250°C for 5 mins. This will allow the oil that is used for rust protection to be burned off. This is the only time that the oven is operated completely empty.

CAUTION: Grill element and oven will be hot. DO NOT OPERATE THE OVEN EMPTY apart from point 7 above. The appliance must not be operated by Microwave or Combination including microwave WITHOUT FOOD IN THE OVEN. Operation when empty will damage the appliance.

8. **WARNING: When the appliance is operated in the COMBINATION mode, Children should only use the oven under adult supervision due to the temperatures generated.**

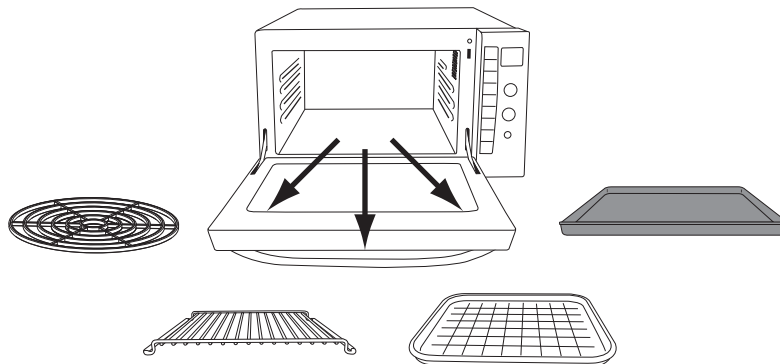

Care & Cleaning of your Microwave Oven -

IMPORTANT

It is essential for the safe operation of the oven that it is kept clean, and wiped out after each use. Failure to maintain the oven in a clean condition could lead to deterioration of a surface that could adversely affect the life of the appliance and possibly result in a hazardous situation

1. **Switch the oven off** before cleaning and unplug at socket if possible.
2. **Keep the inside of the oven, door seals and door seal areas clean.** When food splatters or spilled liquids adhere to oven walls, door seals and door seal areas wipe off with a damp cloth. Mild detergent may be used if they get very dirty. The use of harsh detergent or abrasives is not recommended.
3. The back of the oven has a **self-clean catalytic lining**. It is therefore not necessary to clean this area.
4. **After using CONVECTION, GRILL or COMBINATION cooking** the walls of the oven should be cleaned with a soft cloth squeezed in soapy water. Particular care should be taken to keep the window area clean particularly after cooking by CONVECTION, GRILL or COMBINATION. Stubborn spots inside the oven can be removed by using a small amount of branded conventional oven-cleaner sprayed onto a soft damp cloth. Wipe onto problem spots, leave for recommended time and then wipe off. **DO NOT SPRAY DIRECTLY INSIDE THE OVEN.**
5. Do not use harsh abrasive cleaners or sharp metal scrapers to clean the **oven door glass** since they may scratch the surface, which may result in shattering of the glass.
6. The **outside oven surface** should be cleaned with a damp cloth. To prevent damage to the operating parts inside the oven, water should not be allowed to seep into the ventilation openings.
7. If the **Control Panel** becomes dirty, clean with a soft, dry cloth. Do not use harsh detergents or abrasives on Control Panel. When cleaning the Control Panel, leave the oven door open to prevent the oven from accidentally turning on. After cleaning touch STOP/CANCEL Pad to clear display window.
8. **If steam accumulates** inside or around the outside of the oven door, wipe with a soft cloth. This may occur when the microwave oven is operated under high humidity conditions and in no way indicates a malfunction of the unit or microwave leakage.
9. The **oven cavity floor** should be cleaned regularly. Simply wipe the bottom surface of the oven with mild detergent and hot water then dry with a clean cloth.
Cooking vapours collect during repeated use but in no way affect the bottom surface.
10. **When GRILLING or cooking by COMBINATION or CONVECTION** some foods may splatter grease onto the oven walls. If the oven is not cleaned to eliminate this grease, it can accumulate and cause the oven to 'SMOKE' during use. These marks will be more difficult to clean later. **There is no need to clean the catalytic lining at the back of the oven.**
11. A **steam cleaner** is not to be used for cleaning.
12. Ensure all **accessories** are kept scrupulously clean, especially when using microwave or combination programs.

Parts of Your Oven

1. Do not cook directly on oven cavity floor. Always place food in a microwave safe dish.
2. The metal accessories provided must **ONLY** be used as directed for GRILLING, CONVECTION and COMBINATION cooking. **Never use metal accessories when cooking in microwave only mode.** Do not use if operating the oven with less than 200 g (7 oz) of food on a manual Combination program. **Use the Enamel Shelf on CONVECTION and GRILL mode only.** The maximum weight that can be used on the enamel shelf is 4 kg (8 lb 14 oz). **FAILURE TO USE ACCESSORIES CORRECTLY COULD DAMAGE YOUR OVEN.**
3. Arcing may occur if the incorrect weight of food is used, a metal container has been used incorrectly, or the accessories have been damaged. If this occurs, stop the machine immediately. You can continue to cook by GRILL OR CONVECTION ONLY.
4. Always refer to instructions for correct accessories to use on all programs.

Glass Dish

1. The Glass dish can be used directly on the ceramic plate to cook in MICROWAVE mode only. Do not place food directly on the ceramic plate on the oven cavity floor.
2. The Glass dish can be used directly on the wire shelf (in either of the shelf positions) for cooking in GRILL, CONVECTION or COMBINATION modes.
3. If the Glass dish is hot, let it cool before cleaning or placing in cold water, as this could crack or shatter the dish.

Anti Spark Ring

Place the anti spark ring on top of the wire shelf, then place any metal container. Your metal containers can then be used in COMBINATION mode without arcing.

Wire Shelf

1. The wire shelf can be used in the upper shelf position for GRILLING foods. It can be used in the upper or lower shelf positions for CONVECTION or COMBINATION cooking.
2. Do not use any metal container directly on the Wire Shelf in COMBINATION with MICROWAVE. (Refer to paragraph about anti-spark ring).
3. Do not use the Wire Shelf in MICROWAVE mode only.
4. The maximum weight that can be placed on the Wire shelf is 4kg (8lb 14oz) (this includes total weight of food and dish).

Enamel Shelf

1. The Enamel Shelf is for cooking on CONVECTION or GRILL mode. Do not use on MICROWAVE or COMBINATION modes.
2. For 2 level CONVECTION cooking, the Enamel Shelf can be used as the lower level and the wire shelf can be used as the upper level.
3. The maximum weight that can be placed on the Enamel shelf is 4kg (8lb 14oz) (this includes total weight of food and dish).

Drip Tray

The oven is fitted with a drip tray to collect excess water. To clean the drip tray remove by gently easing forwards holding with both hands. After emptying wash in warm soapy water or alternatively use a dishwasher. To re-position click back into position on the legs.

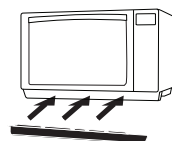
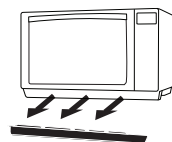

Parts of Your Oven

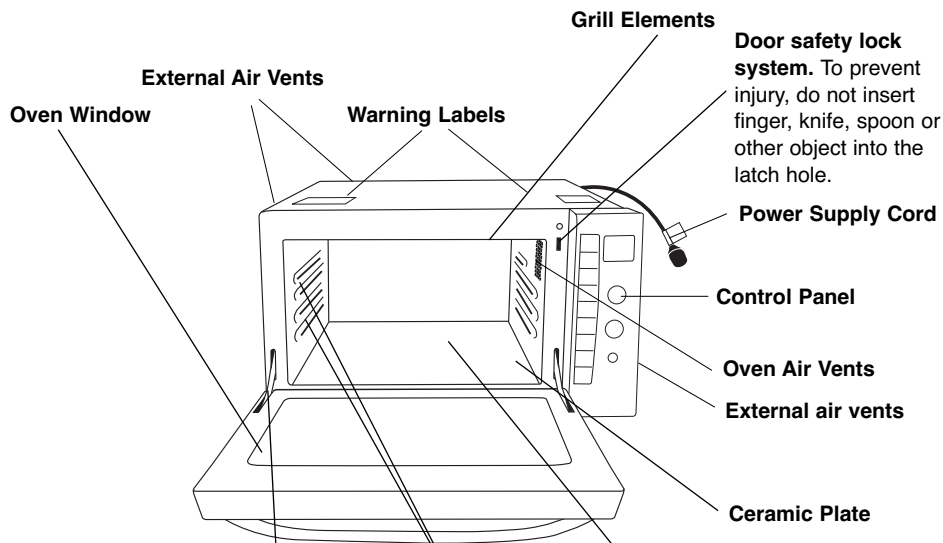

Door safety lock system. To prevent injury, do not insert finger, knife, spoon or other object into the latch hole.

Oven Window

External Air Vents

Warning Labels

Grill Elements

Power Supply Cord

Control Panel

Oven Air Vents

External air vents

Ceramic Plate

Pull Down Door

Pull the door handle downwards to open. Opening the door during cooking will stop the cooking process without cancelling the program. Cooking resumes as soon as the door is closed and Start Button is pressed. The oven light will turn on and stay on whenever the door is opened.

Door Hinge

Ensure care is taken when closing the door to prevent injury caused by trapping fingers.

Shelf Positions

Bottom microwave feeding

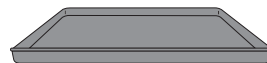

Enamel shelf

Use on CONVECTION, GRILL or TURBO BAKE (Convection and Grill) mode only. Do not use in MICROWAVE only or COMBINATION cooking modes.

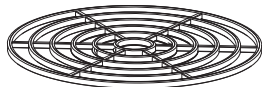

Anti-spark Ring

Use on COMBINATION mode when using metal bakeware only. Place anti-spark ring on wire shelf with metal bakeware on top. Do not use on MICROWAVE, GRILL or CONVECTION only mode.

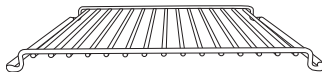

Wire Shelf

Use on CONVECTION, GRILL or TURBO BAKE (Convection & Grill) and COMBINATION modes only. Do not use in MICROWAVE only mode.

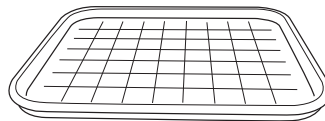

Glass Dish



Drip Tray

For fitting and cleaning information, please refer to previous page.

Important Information – Read Carefully

Safety

If smoke or a fire occurs in the oven, press Stop/Cancel pad and leave the door closed in order to stifle any flames.

Disconnect the power cord, or shut off power at the fuse or the circuit breaker panel.

Short Cooking Times

As microwave cooking times are much shorter than other cooking methods it is essential that recommended cooking times are not exceeded without first checking the food.

Cooking times given in the cookbook are approximate. Factors that may affect cooking times are: preferred degree of cooking, starting temperature, altitude, volume, size and shape of foods and utensils used. As you become familiar with the oven, you will be able to adjust these factors.

It is better to undercook rather than overcook foods. If food is undercooked, it can always be returned to the oven for further cooking. If food is overcooked, nothing can be done. Always start with minimum cooking times.

Important.

If the recommended cooking times are exceeded the food will be spoiled and in extreme circumstances could catch fire and possibly damage the interior of the oven.

1. Small Quantities of Food.

Take care when heating small quantities of food as these can easily burn, dry out or catch fire if cooked too long. Always set short cooking times and check the food frequently.

NEVER OPERATE THE OVEN WITHOUT FOOD INSIDE ON MICROWAVE OR COMBINATION MODE INVOLVING MICROWAVE

2. Foods Low in Moisture.

Take care when heating foods low in moisture, e.g. bread items, chocolate, biscuits and pastries. These can easily burn, dry out or catch on fire if cooked too long. We do not recommend heating foods low in moisture such as popcorn or poppodums. This oven has been developed for food use. We do not

recommend that it is used for heating non-food items such as wheat bags or hot water bottles.

3. Christmas Pudding.

Christmas puddings and other foods high in fats or sugar, e.g. jam, mince pies, must not be over heated. These foods must never be left unattended as with over cooking these foods can ignite.

4. Boiled Eggs.

Eggs in their shell and whole hard-boiled eggs should not be heated in microwave ovens since they may explode even after microwave heating has ended.

5. Foods with Skins.

Potatoes, apples, egg yolk, whole vegetables and sausages are examples of food with non porous skins. These must be pierced using a fork before cooking to prevent bursting.

6. Liquids.

Liquids and other foods must not be heated in sealed containers since they are liable to explode. When heating liquids, eg soup, sauces and beverages in your microwave oven, overheating the liquid beyond boiling point can occur without evidence of bubbling.

This could result in a sudden boil over of the hot liquid. To prevent this possibility the following steps should be taken:

- a. Avoid using straight-sided containers with narrow necks.
- b. Do not overheat.
- c. Stir the liquid before placing the container in the oven and again halfway through the heating time.
- d. After heating, allow to stand in the oven for a short time, stirring again before carefully removing the container.
- e. Microwave heating of beverages can result in delayed eruptive boiling, therefore care should be taken when handling the container.

Important Information – Read Carefully

7. Lids.

Always remove the lids of jars and containers and takeaway food containers before you microwave them. If you don't then steam and pressure might build up inside and cause an explosion even after the microwave cooking has stopped.

8. Deep Fat Frying.

Do not attempt to deep fat fry in your oven.

9. Meat Thermometer.

Use a meat thermometer to check the degree of cooking of roasts and poultry only when meat has been removed from the microwave. If undercooked, return to the oven and cook for a few more minutes at the recommended power level. Do not leave a conventional meat thermometer in the oven when microwaving.

10. Paper, Plastic.

When heating food in plastic or paper containers, keep an eye on the oven due to the possibility of ignition. Do not use wire twist-ties with roasting bags as arcing will occur.

Do not use re-cycled paper products, e.g. Kitchen roll unless they say they are specifically designed for use in a microwave oven.

These products contain impurities which may cause sparks and/or fires when used.

11. Reheating.

It is essential that reheated food is served "piping hot".

Remove the food from the oven and check that it is "piping hot", i.e. steam is being emitted from all parts and any sauce is bubbling. (If you wish you may choose to check the food has reached 72°C with a food thermometer – but remember do not use this thermometer inside the microwave.)

For foods that cannot be stirred, e.g. lasagne, shepherds pie, the centre should be cut with a knife to test it is well heated through. Even if a manufacturer's packet instructions have been followed always check the food is piping hot before serving and if in doubt return your food to the oven for further heating.

12. Standing Time.

Standing time refers to the period at the end of cooking or reheating when food is left before being eaten, i.e. it is a rest time which allows the heat in the food to continue to conduct to the centre, thus eliminating cold spots.

Important Information – Read Carefully

13. Keeping Your Oven Clean.

It is essential for the safe operation of the oven that it is wiped out regularly. Use warm soapy water, squeeze the cloth out well and use to remove any grease or food from the interior. Pay particular attention to the door seal area. The oven should be unplugged when cleaning. The catalytic lining at the back does not need to be cleaned.

14. Grilling.

The oven will only operate on the GRILL function with the door closed.

15. Fan Motor Operation.

After using the microwave oven, the fan motor may operate to cool the electric components. This is normal and you can take out food even though the fan motor operates. You can continue using the oven during this time.

16. Containers.

Before use check that utensils/containers are suitable for use in microwave ovens.

17. Babies Bottles and Food Jars.

When reheating babies bottles always remove top and teat. Liquid at the top of the bottle will be much hotter than that at the bottom and must be shaken thoroughly before checking the temperature. The lid must also be removed from babies food jars, the contents must also be stirred or shaken before the temperature is checked. This should be carried out before consumption in order to avoid burns.

18. Arcing

Arcing may occur if a metal container has been used incorrectly, if the incorrect weight of food is used, or if the accessories have been damaged. Arcing is when blue flashes of light are seen in the microwave oven. If this occurs, stop the machine immediately. If the oven is left unattended and this continues it can damage the machine.

You can continue to cook by GRILL OR CONVECTION ONLY.

Microwaving Principles

Microwave energy has been used in this country to cook and reheat food since early experiments with RADAR in World War II. Microwaves are present in the atmosphere all the time, both naturally and from manmade sources.

Manmade sources include radar, radio, television, telecommunication links and car phones.

How Microwaves cook food

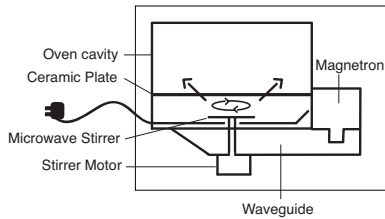

In a microwave oven, electricity is converted into microwaves by the **MAGNETRON**.

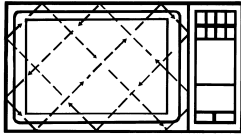

REFLECTION

The microwaves bounce off the metal walls and the metal door screen.



TRANSMISSION

Then they pass through the cooking containers to be absorbed by the water molecules in the food, all foods contain water to a more or lesser extent.

The microwaves cause the water molecules to vibrate which causes **FRICTION**, i.e. **HEAT**. This heat then cooks the food. Microwaves are also attracted to fat and sugar particles, and foods high in these will cook more quickly.

Microwaves can only penetrate to a depth of 1½ -2 inches (4-5 cm) and as heat spreads through the food by conduction, just as in a traditional oven, the food cooks from the outside inwards.

Important Notes

The dish used to cook or reheat the food will get warm during cooking, as the heat conducts from the food. Even in microwaving, oven gloves are required!

MICROWAVES CANNOT PASS THROUGH METAL AND THEREFORE METAL COOKING UTENSILS CAN NEVER BE USED IN A MICROWAVE, FOR COOKING ON MICROWAVE ONLY

Foods Not Suitable for Cooking by Microwave Only

Yorkshire Puddings, Souffles, Double Crust Pastry Pies.

Because these foods rely on dry external heat to cook correctly, do not attempt to cook by microwave.

Foods that require deep fat frying cannot be cooked either.

Standing Time

When a microwave oven is switched off, the food will continue to cook by conduction – NOT BY MICROWAVE ENERGY. Hence STANDING TIME is very important in microwaving, particularly for dense foods i.e. meat, cakes and reheated meals (refer to page 20).

Bottom Feeding Technology

Please note that this product uses bottom feeding technology for microwave distribution which differs from traditional turntable side feeding methods and creates more useable space for a variety of different sized dishes.

This microwave feeding style can give a difference in heating times (in microwave mode) when compared against side feeding appliances. This is quite normal and should not cause any concern. Please refer to the reheating and cooking charts on pages 67-83.

Boiled Eggs

Do not boil eggs in your microwave. Raw eggs boiled in their shells can explode and cause serious injury

General Guidelines

STANDING TIME



Dense foods e.g. meat, jacket potatoes and cakes, require a **STANDING TIME** (inside or outside of the oven) after cooking, to allow heat to finish conducting through the food.

- **Meat Joints** – Stand 15 mins. wrapped in aluminium foil.
- **Jacket Potatoes** – Stand 5 mins. wrapped in aluminium foil when cooked by microwave only. It is not necessary to stand jacket potatoes cooked in **COMBINATION** mode.
- **Light Cakes** – Stand 5 mins. before removing from dish.
- **Rich Dense Cakes** – Stand 15-20 mins.
- **Fish** – Stand 2-3 mins.
- **Egg Dishes** – Stand 1-2 mins.
- **Precooked Convenience Foods** – Stand for 2-3 mins.
- **Plated Meals** – Stand for 2-3 mins.
- **Vegetables** – Boiled potatoes benefit from standing 1-2 mins., however most other types of vegetables can be served immediately.
- **Defrosting** – It is essential to allow standing time to complete the process. This can vary from 5 mins. e.g. raspberries, to up to 1 hour for a joint of meat.

If food is not cooked after **STANDING TIME**, return to oven and cook for additional time.

General Guidelines



Piercing

The skin or membrane on some foods will cause steam to build up during cooking. These foods must be pierced or a strip of skin should be peeled off before cooking to allow the steam to escape. Eggs, potatoes, apples, sausages etc, will all need to be pierced before cooking. **DO NOT ATTEMPT TO BOIL EGGS IN THEIR SHELLS.**



Moisture Content

Many fresh foods e.g. vegetables and fruit, vary in moisture content throughout the season. Jacket potatoes are a particular example of this. For this reason cooking times may have to be adjusted throughout the year. Dry ingredients e.g. rice, pasta, can dry out further during storage and cooking times may differ from ingredients freshly purchased.



Cling film

Cling film helps keep the food moist and the trapped steam assists in speeding up cooking times. However it should be pierced before cooking, to allow excess steam to escape. Always take care when removing cling film from a dish as the build-up of steam will be very hot. Always purchase cling film that states on the packet "suitable for microwave cooking" and use as a covering only. Do not line dishes with cling film. Do not cover foods when cooking by COMBINATION, CONVECTION or GRILL.



Dish Size

Follow the dish sizes given in the recipes, as these affect the cooking and reheating times. A quantity of food spread in a bigger dish cooks and reheats more quickly.

General Guidelines

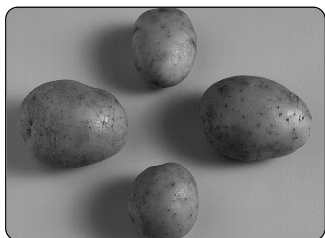

Quantity

Small quantities cook faster than large quantities, also small meals will reheat more quickly than large portions.

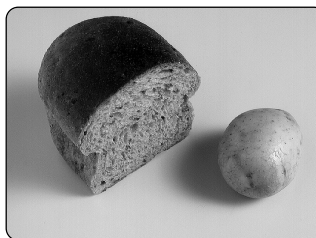

Density

Porous airy foods heat more quickly than dense heavy foods.



Shape

Even shapes cook evenly.

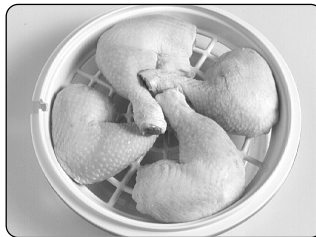

Arranging

Individual foods e.g. chicken portions or chops, should be placed on a dish so that the thicker parts are to the outside.



Spacing

Foods cook more quickly and evenly if spaced apart. NEVER pile foods on top of each other

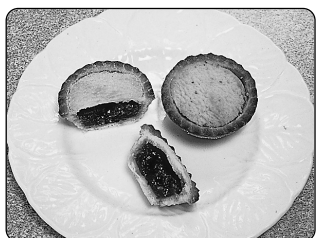

Ingredients

Foods containing fat, sugar or salt heat up very quickly. The filling may be much hotter than the pastry. Take care when eating. Do not overheat even if the pastry does not appear to be very hot.

General Guidelines



Starting Temperature

The colder the food, the longer it takes to heat up. Food from a fridge takes longer to reheat than food at room temperature. Food temperature should be between 5-8°C before cooking.



Covering

Cover foods with microwave cling film or a self-fitting lid. Cover fish, vegetables, casseroles, soups. Do not cover cakes, sauces, jacket potatoes, pastry items. Please refer to cooking charts and recipes for more information.



Turning and Stirring

Some foods require stirring during cooking. Meat and poultry should be turned after half the cooking time.

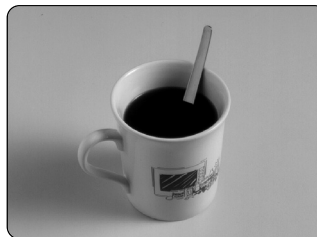

Liquids

All liquids must be stirred **before, during and after heating**. Water especially must be stirred before and during heating, to avoid eruption. Do not heat liquids that have previously been boiled. **DO NOT OVERHEAT**. Stir before serving.



Checking Food

It is essential that food is checked during and after a recommended cooking time, even if an **AUTO PROGRAM** has been used (just as you would check food cooked in a conventional oven). Return the food to the oven for further cooking if necessary.



Cleaning

As microwaves work on food particles, keep your oven clean at all times. Stubborn spots of food can be removed by using a branded oven cleaner, sprayed onto a soft cloth. Always wipe the oven dry after cleaning. Avoid any plastic parts and door area. The catalytic lining at the back of the oven is self cleaning.

Containers to use

Choosing the correct container is a very important factor in deciding the success or failure of your cooking.

Testing Dishes for Suitability - For Microwave Cooking Only.

When unsure that a cooking container is suitable for use in your microwave, check by the following test:



1. Fill a microwave safe measuring jug with 300ml (½ pt) cold water.
2. Place it on the base of the oven alongside the dish to be tested. If the dish you are testing is a large dish, then stand the measuring jug on top of the empty dish.
3. Heat on HIGH power for 1 minute.

Result

If the dish is suitable for microwaving, it will remain cool, whilst the water in the jug will begin to feel warm. If the testing dish feels warm, do not use as it is obviously absorbing microwave energy.

N.B. This test does not apply to plastic or metal based containers e.g. Le Creuset® style dishes, which should not be used as they are cast iron covered with enamel.

Quick Check Guide to Cooking Utensils



Oven Glass

Everyday glass that is heat resistant e.g. Glass, is ideal for Microwave, Convection or Combination cooking. Do not use delicate glass or lead crystal which may crack or arc.



China and Ceramic

Everyday glazed china, porcelain or ceramic plates, bowls, mugs and cups can be used if they are heat resistant. Fine bone china should only be used for reheating for short periods. Do not use dishes with a metal rim or pattern. Do not use jugs or mugs with glued handles, since the glue can melt. If dishes are heat resistant they may be used on Convection and Combination but not directly under the Grill.

Containers to use



Pottery, Earthenware, Stoneware

If completely glazed, these dishes are suitable. Do not use if partially glazed or unglazed, since they are able to absorb water which in turn absorbs microwave energy, making the container very hot and slows down the cooking of food.



Foil/Metal Containers

NEVER ATTEMPT TO COOK IN FOIL OR METAL containers on Microwave only as the microwaves cannot pass through and the food will not heat evenly, it may also damage your oven. Foil and metal containers can be used on grill and convection modes and may be used with care during certain combination cooking as long as they are not damaged or dented.



Plastic

Many plastic containers are designed for microwave use, but do not use for cooking foods high in sugar or fat or for foods that require long cooking times e.g. brown rice. Only use Tupperware® containers if they are designed for microwave use.



Do not use Melamine. Never cook in margarine cartons or yogurt pots, as these will melt with the heat from the food. If heatproof they can be used for Convection or Combination cooking. DO NOT USE UNDER THE GRILL.

Containers to use



Wicker, Wood, Straw Baskets

Dishes will crack and could ignite.
Do not use wooden dishes in your microwave.
DO NOT USE ON ANY COOKING MODE.

Roasting Bags

Roasting bags are useful when slit up one side to tent a joint, for roasting by power and time.
Do not use the metal twists supplied, when using Microwave or Combination.

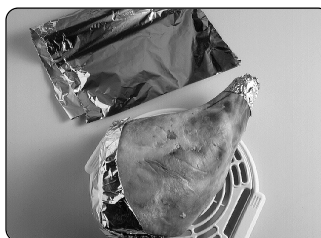

Aluminium Foil

Small amounts of smooth aluminium foil can be used to SHIELD joints of meat during defrosting and cooking by Microwave, as the microwaves cannot pass through the foil, this prevents the parts shielded from overcooking or overdefrosting. Take care that the foil does not touch the sides or roof of the oven, as this may cause arcing and damage your oven. Aluminium foil can be used for Convection cooking.



Cling Film

Microwave cling film can only be used for covering food that is reheated by microwave. It is also useful for covering food to be cooked, but care should be taken to avoid the film being in direct contact with the food. **DO NOT USE ON ANY OTHER COOKING MODE.**



Paper

Plain white absorbent kitchen paper (kitchen towel) can only be used for microwave cooking e.g. covering blind pastry cases and for covering bacon to prevent splattering. **ONLY USE FOR SHORT COOKING TIMES. NEVER RE-USE A PIECE OF KITCHEN TOWEL. ALWAYS USE A FRESH PIECE OF PAPER FOR EACH DISH.**

Avoid kitchen paper containing manmade fibres. If you are using branded re-cycled kitchen towel, check first that it is recommended for microwave use. Do not use waxed or plastic coated cups or plates as the finish may melt. Greaseproof paper can be used to line the base of dishes and to cover fatty foods e.g. bacon rashers, to stop splattering. White paper plates can be used for **SHORT REHEATING TIMES**, on Microwave only.

Control Panel

NN-CF778S

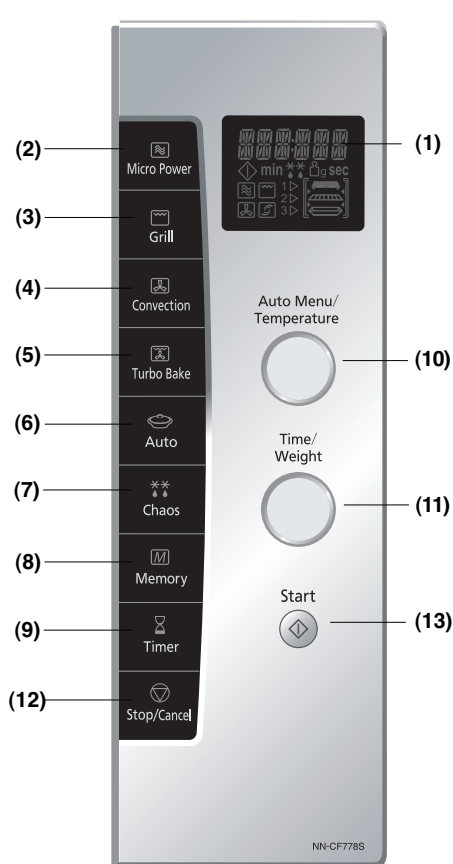

- (1) Display Window
- (2) Microwave Power Pad
- (3) Grill Pad
- (4) Convection Pad
- (5) Turbo-bake Pad
- (6) Auto Weight Programs Pad
- (7) Auto Weight Defrost Programs (Chaos Defrost)

(8) Memory Pad

(9) **Timer Pad:**
This can be used to delay a cooking program for up to 9 hrs 99 mins; or used as a timer or for standing (non-cooking) time. It is also used to set the clock.

(10) **Auto Menu/Temperature/Microwave Wattage/Grill Level/Convection Heat Selector Dial.**

(11) **Time/Weight Dial**

(12) **Stop/Cancel Pad:**

Before Cooking:
one press clears your instructions.

During Cooking:
one press temporarily stops the cooking program. Another press cancels all your instructions and the time of day will appear in the display.

(13) **Start Button:**

Press to start operating the oven.
If during cooking the door is opened or Stop/Cancel Pad is pressed once, Start Button has to be pressed again to continue cooking.

Note:

If an operation is set and Start Button is not pressed, after 6 minutes, the oven will automatically cancel the operation. The display will revert back to Clock Mode or Eco Mode.

Beep Sound:

A beep sounds when a pad is pressed. If this beep does not sound, the setting is incorrect. When the oven changes from one function to another, two beeps sound. After completion of cooking, five beeps sound.

Let's Start to Use your Oven

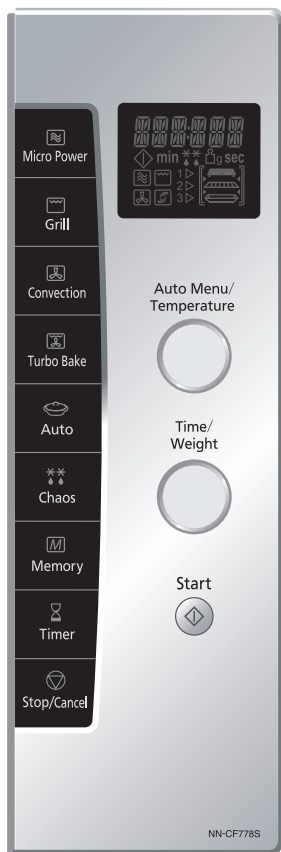

1 Plug in

Plug into a 13 amp fused electrical socket. You will be reminded to read your operating instructions.

2 Press Timer Pad twice to set clock

Set clock as a 24 hr clock. (See page 29 for details).

3 Press Convection Pad

() will appear in the display window with the oven temperature)(this procedure is to burn off the oil used for rust protection in the oven.) Turn the Auto Menu/Temperature dial until 250 C is in the display window. Remove all accessories from the oven.

4 Enter Time

Turn Time/Weight dial until 5 minutes is displayed in the window.

5 Press Start Button

The time will be displayed in the window and count down. The oven will beep at the end of the program. The oven is now ready to use.

Caution: Grill elements and oven will be hot.

6 Demonstration Mode

This is to enable you to experiment setting various programs. (The letter D will always appear in the display window. This is to confirm that there is no microwave power produced and it is safe to use the oven without any food). To set Demonstration Mode: press micro power once, then press Stop/Cancel 4 times. To cancel Demonstration Mode press Micro power once, then press Stop/Cancel 4 times.

7 Child Lock

To operate the child lock facility press the Start Button three times, this will deactivate the microwave. "Lock" will appear in the display and none of the controls will operate. To clear child lock facility press Stop/Cancel pad three times.

Controls and Operation Procedure

One of the features of this oven is the energy save function.

There are two options available - Eco Mode which is pre-set and Clock Mode.

Eco Mode:

The oven is pre-set with Eco Mode activated.

NOTE:

1. The clock does not appear in the display when the Eco Mode is on.
2. After 6 minutes without operation in Eco Mode the oven powers down.
It is necessary to open and close the oven door before operating the oven.
3. The oven will remain in Eco Mode, even after disconnecting and re-connecting the power cord.

To Cancel:

To cancel Eco Mode, follow clock setting instruction.

To set:

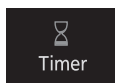

- Press Timer Pad three times.
- Press Stop/Cancel Pad once.

The Eco Mode is on and 'E-SAVE ON' appears in the display.

Clock Setting:

IMPORTANT:

After 6 minutes without operation in clock mode, the oven powers down slightly and the display will dim. It is necessary to open and close the oven door before operating the oven.

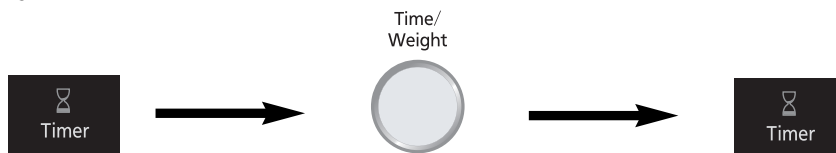

- **Press Timer Pad Twice**
"SET TIME" will appear in the display window and the colon starts to blink.
- **Enter the time by turning the Time/Weight Dial.**
Enter time of day by using Time/Weight Dial
e.g. 1.25pm (24 hr clock).
- **Press Timer Pad.**
The colon stops blinking and the time of day is entered.
'E-SAVE OFF' scrolls in the display.

NOTE:

1. To reset the time of day repeat all the above steps.
2. The clock will keep the time of day as long as the oven is plugged in and electricity is supplied.
3. **This is a 24 hour clock**
4. Setting the clock will automatically cancel the pre-set Eco-Mode.
5. If the clock is set and the plug is disconnected, when plugging in again, Eco-Mode is activated.

Microwave Cooking and Defrosting

There are 6 different microwave power levels available.

Do not place food directly on the ceramic plate. Place on Glass dish supplied with the oven or use your own dishes, plates or bowls directly on the ceramic plate.

Selecting Microwave Power Level:

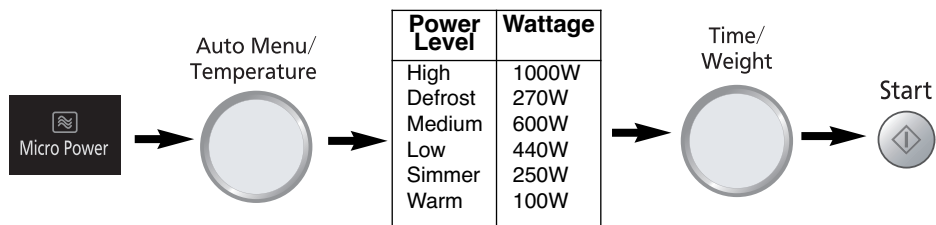

- Select  Microwave power cooking mode.
- Select Microwave power level by turning the Auto Menu/Temperature Dial to the left. The Microwave power level appears in the display.
- Select the cooking time using the Time/Weight Dial.
- Press Start Button.

N.B.

1. Maximum time that can be set on HIGH power is 30 min.
2. On all Power Levels, except HIGH power, the maximum time that can be set is 1hr 30 mins.
3. You can add to the cooking time during cooking, if required. Turn Time/ Weight Dial to increase the cooking time. (Time can be increased/decreased in 10 second increments, up to 10 minutes. This is only the case for one stage cooking).
4. DO NOT attempt to use microwave only with any metal accessory in the oven.
5. DO NOT place food directly onto the oven cavity floor. Place in a microwave or Glass dish. Foods reheated or cooked by MICROWAVE only are normally covered with a lid or cling film, unless otherwise stated.

Two Stage Cooking:

e.g. High power 10 minutes followed by Simmer power 20 minutes; Select High power and program 10 minutes then select second power (Simmer) with second cooking time (20 minutes) then press Start.

Three Stage Cooking:

e.g. High power 5 minutes, Delay 5 minutes, High power 2 minutes; Select first Power level and cooking time, then press Timer and time, then select final power level and final cooking time. Then press Start.

Auto Weight Defrost - Chaos Defrost

With this feature you can defrost frozen foods according to the weight. Select the category and set the weight of the food. The weight starts from the minimum weight for each category.

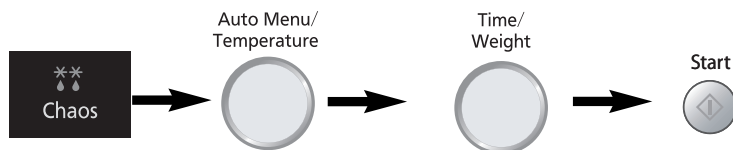

- Press the Chaos Defrost Pad.
- Turn the Auto Menu/ Temperature dial clockwise select the desired program.
- Set the weight of the food by using the Time/Weight Dial.
- Press Start Button.

Program	Weight Range	Suitable
1 Bread	100 - 900g	Bread and rolls. Place on a plate. Turn at beep.
2 Mince/Chops	200 - 1200g	Small pieces of meat, minced meat, chicken portions, steaks, chops. Place on a plate or shallow dish. Turn at beeps.
3 Meat Joints	400 - 2000g	Whole chicken, meat joints. Place on a plate on an upturned saucer. Turn at beeps and shield.

Auto Weight Defrost Programs

This feature allows you to defrost minced meat, chops, chicken portions, meat joints and bread.

The CHAOS defrost pad and then the Auto Menu/Temperature Dial should be turned to select the correct defrost category and then enter in the weight of the food in grams (see page 31).

Foods should be placed in a suitable dish, whole chickens and joints of meat should be on an upturned saucer or on a microwave safe rack. Chops, chicken portions and slices of bread should be placed in a single layer. It is not necessary to cover the foods.

The **CHAOS Theory** principle is used in Auto Weight defrost programs to give you a quick and more even defrost.

The CHAOS system uses a random sequence of pulsing microwave energy which speeds up the defrosting process.



During the program the oven will beep to remind you to check the food.

IT IS ESSENTIAL THAT YOU TURN AND STIR THE FOOD FREQUENTLY AND SHIELD IF NECESSARY.

On hearing the first beep you should **TURN** and **SHIELD** (if possible). On the second beep you should turn the food or break it up.

1st Beep



Turn or Shield

1st Beep

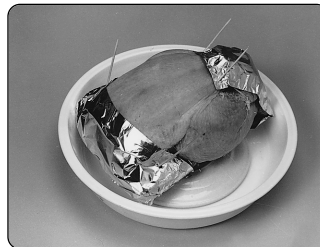

Turn or Shield

2nd Beep



Turn or break up

Auto Weight Defrost Programs

CHAOS DEFROST

Category 1 Bread

The Bread Program is suitable for defrosting small items e.g. rolls, buns and slices of bread which are required for immediate use. Small items may feel warm immediately after defrosting. Loaves can also be defrosted on this program but these will require standing time to allow the centre to thaw out. Standing time can be shortened if slices are separated and buns and loaves cut in half. Items should be turned halfway during defrosting. THIS PROGRAM IS NOT SUITABLE FOR CREAM CAKES OR DESSERTS e.g. cheesecake.

Category 2 Meat iteas (Mince/Chops/Chicken Portions)

It is necessary for mince to be broken up frequently during defrosting and this is best carried out in a large shallow dish. Chops and chicken portions should be arranged in a single layer and turned frequently.

Category 3 Meat Joints/Whole Chickens

Meat joints and chickens will require shielding during defrosting especially if they are particularly fatty pieces. This is to prevent over defrosting on the outside edges. Smooth foil secured with cocktail sticks should be used. DO NOT ALLOW THE FOIL TO TOUCH THE WALLS OF THE OVEN. Back fat of joints, legs, wings and breast bones need shielding (see photograph page 32). Standing time of at least 1 hour should be allowed (rolled joints may require longer) before cooking to ensure the centre is fully defrosted.

Defrosting Guidelines

TIPS:

1. Check foods during defrosting. Foods vary in their defrosting speed.
2. It is not necessary to cover the food.
3. Always turn or stir the food especially when the oven "beeps". Shield if necessary (see point 5).
4. Minced meat/chops/chicken portions should be broken up or separated as soon as possible and placed in a single layer.
5. Shielding prevents food cooking. It is essential when defrosting chickens and joints of meat. The outside thaws out first, so protect wings/breast/fat with smooth pieces of aluminium foil secured with cocktail sticks.
6. Allow standing time so that the centre of the food thaws out.
(minimum 1 hour for joints of meat and whole chickens)

Defrosting Guidelines

By selecting the DEFROST power level from the microwave power pad and setting a time, you can defrost food in your microwave. The biggest problem is getting the inside defrosted before the outside starts to cook.

For this reason a defrost program alternates between a defrost power and a standing time. The name for this type of defrost is cyclic. During the standing stages there is not any microwave power in the oven, although the light will remain on.

The automatic stand times ensure a more even defrost but it is still necessary to allow for standing time before use. Place foods in a suitable container. Meat joints and chickens should be placed on an upturned saucer or on a plastic rack if you have one.



Separate chops and small items e.g. bread slices where possible.

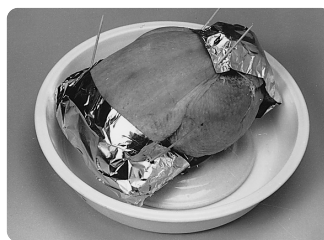

Chickens and joints of meat will require shielding during defrosting.



Turn dense foods and meat 2/3 times during defrosting.



Break up small items e.g. minced meat, frequently during defrosting.

Defrosting Foods Using Defrost Power & Time

The times given below are a guideline only. Always check the progress of the food by opening the oven door and then re-starting. For larger quantities adjust times accordingly. Food should not be covered during defrosting.

Food	Weight	Defrosting Time	Method	Standing Time
MEAT				
Beef/Lamb/Pork Joint	700g (1lb 8oz)	20 mins	Place in a suitable dish or on an upturned saucer or use a rack. Turn 3 - 4 times.	60 mins
Beef/Lamb/Pork Joint	1.0 Kg (2lb 4oz)	25-30 mins	Place in a suitable dish or on an upturned saucer or use a rack. Turn 3 - 4 times.	60 mins
Sirloin/Rump Steak	500g (1lb 2oz)	15 mins	Place in a suitable dish. Separate and turn twice.	15 mins
Beefburgers	100 g 4oz (x1) 227 g 8oz (x4) 350 g 12oz (x2)	3 mins 4-5 mins 5-6 mins	Place in a suitable dish. Turn. Place in a suitable dish. Separate and turn twice. Place in a suitable dish. Separate and turn twice.	2 mins 5 mins 10 mins
Minced Beef	500g (1lb 2oz)	15 mins	Place in a suitable dish. Break up and turn 3-4 times.	15 mins
Stewing Steak	500g (1lb 2oz)	12 mins	Place in a suitable dish in a single layer. Break up and turn twice.	20 mins
Lamb Chops	500g (1lb 2oz)	10 mins	Place in a suitable dish in a single layer. Turn twice.	15 mins
Lamb Fillets	300g (11oz)	8 mins	Place in a suitable dish in a single layer. Turn twice.	10 mins

Defrosting Foods Using Defrost Power & Time

The times given below are a guideline only. Always check the progress of the food by opening the oven door and then re-starting. For larger quantities adjust times accordingly. Food should not be covered during defrosting.

Food	Weight	Defrosting Time	Method	Standing Time
MEAT				
Lamb Shanks x 2	900g (1lb12 oz)	20 mins	Place in a suitable dish in a single layer. Separate and turn twice. Shield if necessary.	45 mins
Pork Ribs	700g (1lb 8oz)	15 mins	Place in a suitable dish. Separate and turn twice.	30 mins
Pork Chops	350g (12oz)	8 mins	Place in a suitable dish. Separate and turn twice.	15 mins
Bacon	250g (9oz)	8 mins	Place in a suitable dish. Separate and turn 2-3 times.	15 mins
Sausages	100g (4oz)(2) 500g (1lb2oz)(8)	2½ mins 8 mins	Place in a suitable dish. Turn. Place in a suitable dish. Turn twice.	5 mins 10 mins
Whole Chicken	1.5 Kg (3lb 5oz)	30 mins	Place in a suitable dish or on an upturned saucer or use a rack. Turn 3 - 4 times. Shield if necessary	60 mins
Chicken Portions x 1 x 2 x 3/4	150g (5oz) 350g (12oz) 500-600 g (1 lb 2 oz- 1lb 5oz)	5 mins 7 mins 9 mins	Place in a suitable dish. Turn. Place in a suitable dish. Turn twice. Place in a suitable dish. Turn twice.	10 mins 15 mins 20 mins
Duck Breast Fillets	450g (1lb)	12 mins	Place in a suitable dish. Turn twice.	20 mins

Defrosting Foods Using Defrost Power & Time

The times given below are a guideline only. Always check the progress of the food by opening the oven door and then re-starting. For larger quantities adjust times accordingly. Food should not be covered during defrosting.

Food	Weight	Defrosting Time	Method	Standing Time
MEAT				
Whole Fish x 1	150-225g (5-8oz)	7 mins	Place in a suitable dish. Turn twice.	15 mins
Whole Fish x 2	500g (1lb 2oz)	16 mins	Place in a suitable dish. Turn twice separate if necessary.	20 mins
Fish Fillets	100 - 150g (4-5oz) 350g (12oz)	5 mins 10-12 mins	Place in a suitable dish. Separate if necessary and turn twice.	5 mins 10 mins
Fish Steaks	100g (4oz) 250g (9oz)	3-4mins 6-7 mins	Place in a suitable dish. Turn. Place in a suitable dish. Separate if necessary and turn twice.	10 mins 15 mins
Prawns	400g (14oz) 450g (1lb)	10-12 mins 15 mins	Place in a suitable dish. Separate if necessary and turn twice. Place in a suitable dish. Stir twice during defrosting.	20mins 15 mins
GENERAL				
Sliced bread	400g (14oz)	6 mins	Place on the trivet. Separate and arrange during defrosting.	10 mins
Slice of Bread	30g (1oz)	10 secs	Place on the trivet.	1-2 mins
Soft fruit	500g (1lb 2oz)	10 mins	Place in a suitable dish. Stir twice during defrosting.	20 mins
Gateau	350g (12oz)	3-4 mins	Place on a plate.	15 mins
Cheesecake	400g (14 oz)	5 mins	Place on a plate.	15 mins
Meringue dessert	450g (1lb)	2-3 mins	Place on a plate.	15 mins
Butter	250 g (9oz)	2 mins	Place on a plate.	10 mins
Shortcrust /Puff pastry	500g (1lb2oz)	4-5 mins	Place on a plate. Turn halfway	15 mins

Using the Delay/Stand Feature

The Timer Pad is used as a timing pad either before, during or after a cooking program. When the Timer Pad is selected with a time, there is no microwave power in the oven during this time.

1. To Set a Standing Time:

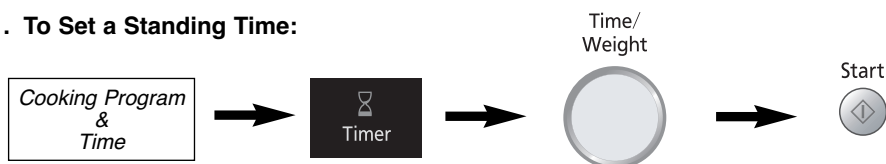

- Set the desired Cooking Program, by selecting cooking option and time required.
- Then Press the Timer Pad.
- Set desired standing time (max 9 hrs). An "H" will appear in the display to denote hours.
- Press Start Button. Cooking program will commence after which the standing time will count down.

2. To Set a Delay Start:

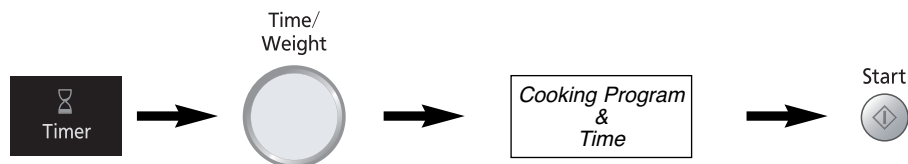

- Press the Timer pad.
- Set Delay time (max 9hrs). An "H" will appear in the display to denote hours.
- Set the complete cooking program, by entering cooking option and time required.
- Press Start Button. Delayed time will count down then the cooking program will start.

NB

1. If the oven door is opened during the stand or delay time, the time in the display window will continue to count down.
2. Delay Start cannot be used before an Auto Program.

Memory

This feature allows you to pre-program your oven for regular reheating or cooking tasks. You are able to pre-program your oven for a specific power level and time that is convenient for you. You are able to pre-program three memory tasks.

To set a Memory Program

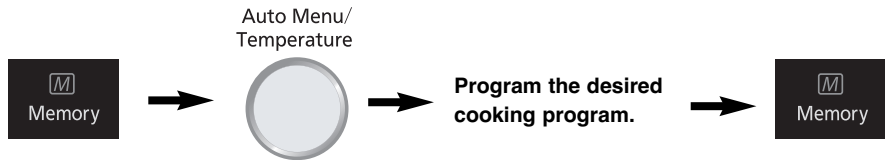

- Press Memory Pad.
- The oven is automatically pre-set to memory 1. To select memory 2 or 3, turn Auto Menu Selector Dial clockwise.
- Press Memory Button to store this task or press Start Button to start cooking in this sequence.

To use a Memory Program

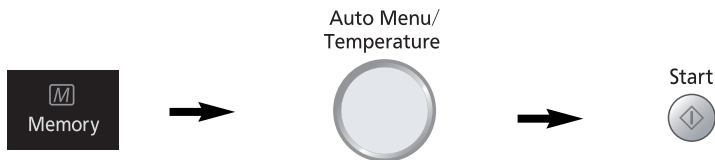

- Press Memory Pad.
- The oven is automatically pre-set to memory 1. To select memory 2 or 3, turn Auto Menu Selector Dial clockwise.
- Press Start Button to begin cooking.

NOTE:

1. Auto programs cannot be programmed into memory.
2. Convection pre-heat mode cannot be programmed into memory.
3. Memory can only store 1 stage cooking. It is not possible to store 2 or 3 stage cooking.
4. Setting a new cooking program into memory will cancel the cooking program previously stored.
5. Memory program will be cancelled if the power supply is off or the plug gets disconnected.

Grilling

The Quartz Grill system on the oven gives fast efficient cooking for a wide variety of foods e.g. chops, sausages, steak, toast, oven chips etc.

DO NOT PREHEAT THE GRILL BEFORE USE.

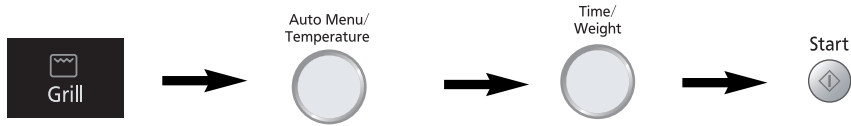

- **Press Grill Pad.**
- **Turn Auto menu/ Temperature Dial** to change Grill level. The oven is automatically pre-set to Grill 1 (High). Rotate left for Grill 2 (Medium), or for Grill 3 (Low). The grill  symbol will also appear.
- **Turn Time/Weight Dial** to enter cooking time. Maximum time is 90 mins.
- **Press Start Button.** The cooking program will start and the time in the display will count down.

NOTE:

1. The Grill will only operate with the oven door closed.
2. There is no microwave power on the GRILL only program.
3. You can add to the cooking time during cooking, if required. Turn Time/Weight Dial to increase the cooking time. A maximum time of 10 minutes can be added.
4. After pressing Start Button, the selected grill level can be recalled and changed. Press Grill Pad once to indicate the grill level in the display window. While the level is recalled, you can change it by turning the Auto/Temperature Dial.

Grilling Times

When using the grill to cook foods, the cooking times will be similar to traditional grilling. Most foods will require turning halfway through the cooking time (see section on oven accessories page 41).

The Grill has three settings, Grill 1 (High), Grill 2 (Medium) and Grill 3 (Low). Grill 1 will be the hottest.

CAUTIONS:

THE ACCESSORIES AND SURROUNDING OVEN WILL GET VERY HOT. USE OVEN GLOVES.

Grilling

Oven accessories to use

When grilling foods the Wire Shelf should be in the top shelf position and the enamel shelf should be in the bottom shelf position or you can use the enamel shelf in the top shelf position.

When positioning the wire shelf, the vertical wires of the shelf should sit higher than the sides of the shelf.

Place food on Wire Shelf.



The Wire Shelf will allow fat and juices to drip through into the Enamel Shelf to reduce excess splatter and smoke when grilling.

Most foods require turning halfway during cooking. When turning food, open oven door and CAREFULLY remove the shelf by holding the accessories firmly.

Use oven gloves when removing accessories as they will be very hot, and so will the roof and walls of the oven.

After turning, return food to the oven, close door and press START. The oven will continue to count down the remaining cooking time. It is quite safe to open the oven door at any time to check the progress of the food as it is grilling.

If grilling fish, chops or small items, place the enamel shelf in the upper position.



Guidelines

1. There is no microwave power on the GRILL only program.
2. Use the accessories provided, as explained above.
3. The Grill will only operate with the oven door closed.
4. Most meat items e.g. bacon, sausages, chops can be cooked on the hottest setting - GRILL 1. This setting is also suitable for toasting bread, muffins and teacakes etc.
5. GRILL 2 and GRILL 3 are used for more delicate foods or those that require a longer grill time e.g. fish or chicken portions.
6. DO NOT PREHEAT THE GRILL.
7. NEVER COVER THE FOOD WHEN GRILLING.
8. ALWAYS USE OVEN GLOVES WHEN REMOVING THE FOOD AND ACCESSORIES AFTER GRILLING AS THE OVEN AND ACCESSORIES WILL BE VERY HOT.
9. After Grilling it is important that the Grill accessories are removed for cleaning before reuse and that the oven walls and floor are wiped with a cloth squeezed in hot soapy water to remove any grease. DO NOT PUT ACCESSORIES IN DISH WASHER. It is not necessary to clean the back of the oven which has a catalytic self clean lining.

Convection Cooking

Your Combination Oven can be used as a conventional oven using the CONVECTION mode which incorporates a heating element with a fan.

For best results always place food in a preheated oven. The grill will come on when the oven is preheating.

You can cook in three ways when using convection cooking -

1. On the Enamel shelf in the lower or upper shelf position.
2. On the Wire rack shelf in the lower or upper shelf position.
3. Both of the above at the same time, to use the oven for two level cooking.

See individual guidelines on pages 37 for recommended accessories to use.

You can preheat with or without the Enamel shelf or Wire shelf in position.

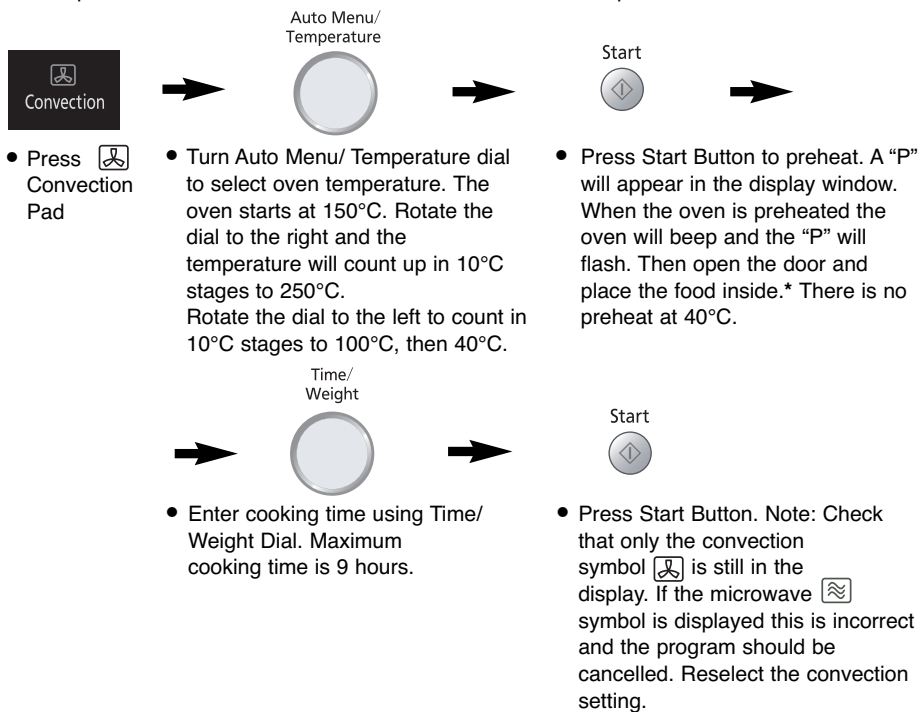

NOTE:

1. Open the door using the Pull Down Door, because if the Stop/Cancel Pad is pressed the program may be cancelled.
 2. You can add to the cooking time during cooking, if required. Turn Time/Weight Dial to increase the cooking time. A maximum time of 10 minutes can be added.
- The oven will maintain the selected preheated temperature for approximately 30 minutes. If no food has been placed inside the oven or a cooking time set, then it will automatically cancel the cooking program and revert to time of day.

CAUTIONS:

THE ACCESSORIES AND THE SURROUNDING OVEN WILL GET VERY HOT. USE OVEN GLOVES.

Convection Cooking

Guidelines

When using the oven as a **CONVECTION** oven, there is **NO MICROWAVE POWER**, i.e. the oven is operating as a conventional oven and you can use all your standard metal baking tins and ovenware.

It is possible to cook on one or two levels when using convection cooking.

Oven accessories to use:

ONE LEVEL COOKING

If cooking on one level, you can use the Enamel Shelf or Wire Shelf in the lower or upper shelf position.

Roasting Meat: Wire shelf in lower position.



Baking: Enamel shelf in lower position.



You can use the Enamel Shelf as a baking dish for roasting potatoes or vegetables, and for baking fairy cakes, scones and cookies. It is also ideal for re-heating pre-cooked convenience pastry items.

Roasting Veg / Potatoes: Enamel Shelf.



Reheating: Enamel Shelf.

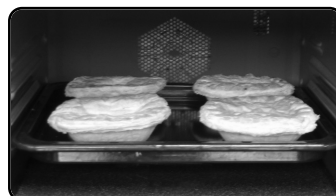

Two level cooking

When cooking on two levels use the Enamel shelf on the lower shelf position and the Wire shelf in the upper shelf position.

Depending on the recipe, you can preheat with or without the accessories in position. See individual recipes for details.

Batch Baking: Fairy Cakes



Cooking a complete meal: Frozen pizza on upper level, frozen oven chips on lower level



Two level cooking is ideal for:

1. Batch baking, fairy cakes, cookies and scones on two levels.
2. Cooking a complete meal together. Frozen pizza on the upper level and frozen chips on the lower level.
3. Cooking roast potatoes on the upper level and roast vegetables on the lower level.
4. Re-heating small pastry items in large batches- Sausage rolls, pastry pies, quiches (all pre-cooked). Ensure that the shelves are inserted correctly, and are secure before use. Do not place a dish of food weighing more than 4 Kg (8 lb 14 oz) on the shelf.

ALWAYS USE OVEN GLOVES WHEN REMOVING THE FOOD AND ACCESSORIES AFTER COOKING AS THE OVEN AND ACCESSORIES WILL BE VERY HOT.

MAKE SURE THAT YOU HOLD THE DISH AND/OR SHELF FIRMLY WITH BOTH HANDS WHEN YOU ARE REMOVING THEM FROM THE OVEN.

Guideline to Oven Temperatures

Temp °c	Use	Temp °f	Gas mark
40°C	Proving Bread	90°F	1/8
100°C	Pavlova	200°F	¼
110°C	Meringues	225°F	¼
140°C	Rich Fruit Cake	275°F	1
150°C	Lemon Meringue, Meringue Roulade, Cheesecake	300°F	2
160/170°C	Casseroles, Gingerbread, Small Tarts, Cookies	325°F	3
180°C	Souffle, Strudel, Victoria Sandwich, Fairy Cakes, Meat Joints	350°F	4
190°C	Filo Pastry, Quiche, Gratins, Lasagne, Pastry pies, Chicken	375°F	5
200°C	Stuffed Peppers, Scones, Eclairs, Swiss Roll, Muffins	400°F	6
220°C	Vegetable parcels, Yorkshire Puddings, Bread	425°F	7
230°C	Garlic Bread	450°F	8
240/250°C	Roast Potatoes	475°F	9
250°C	Baking Pizza	-	-

For best results always place food in a preheated oven.

Don't forget that for ease of programming of the most commonly used temperatures, your oven will start at 150°C and count up in 10°C stages to 250°C, then back to down to 100°C then 40°C. Food is generally cooked UNCOVERED - unless it is a casserole or you wish to use roasting bags for joints.

Your Microwave Oven keeps above 200°C oven temperature for initial 20min. After 20 min., oven temperature reduces to around 200°C automatically. This is unlikely to result in reduced effectiveness but please ensure that cooking times are adjusted according to your preference.

Convection + Grill (Turbo-Bake Cooking)

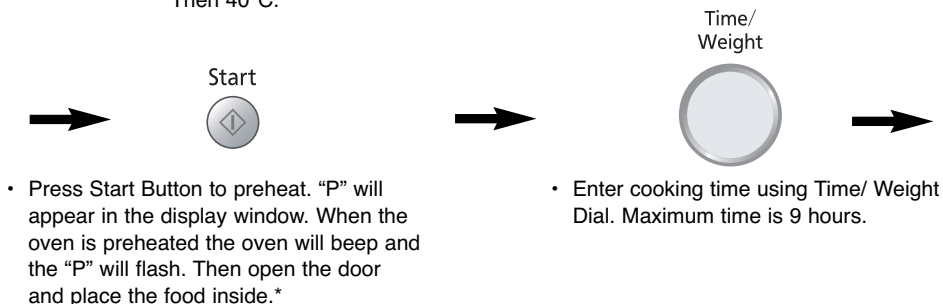
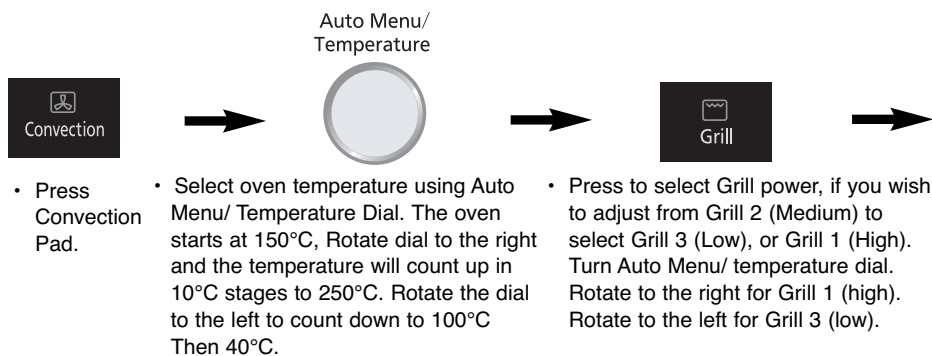

The oven can be programmed to cook or reheat food by the grill and the convection oven working simultaneously, to give foods that extra crispness and colour. This is known as Turbo-Bake and can often reduce traditional oven cooking times.

ALWAYS PREHEAT BEFORE USE.



Start

Press Start Button.

Note: Check that just the grill  and convection  symbols are still in the display. If the microwave symbol  is displayed this is incorrect and the program should be cancelled. Reselect the Convection and Grill (TURBO-BAKE) setting.

NOTE:

1. Open the door using the Pull Down Door, because if the STOP/CANCEL pad is pressed the program may be cancelled. Then if the time was entered the oven would revert to cooking on Microwave only.
2. The oven will maintain the selected temperature for approximately 30 minutes. If no food has been placed inside the oven or a cooking time set, then it will automatically cancel the cooking program and revert to time of day.

CAUTION:

THE ACCESSORIES AND THE SURROUNDING OVEN WILL GET VERY HOT. USE OVEN GLOVES.

Convection + Grill (Turbo-Bake Cooking)

Oven accessories to use:

Use the Enamel Shelf OR WIRE RACK SHELF for Turbo-Bake cooking.



Joints of meat are placed on the enamel shelf in the lower shelf position. Items of meat are placed on the enamel shelf in the upper position.



Pizza can be placed directly on the wire shelf in the upper shelf position.

Guidelines

Always place food in a preheated oven.
Food is cooked UNCOVERED.
DO NOT USE PLASTIC CONTAINERS.

Turbo-Bake (Quick Start Grill/Convection)

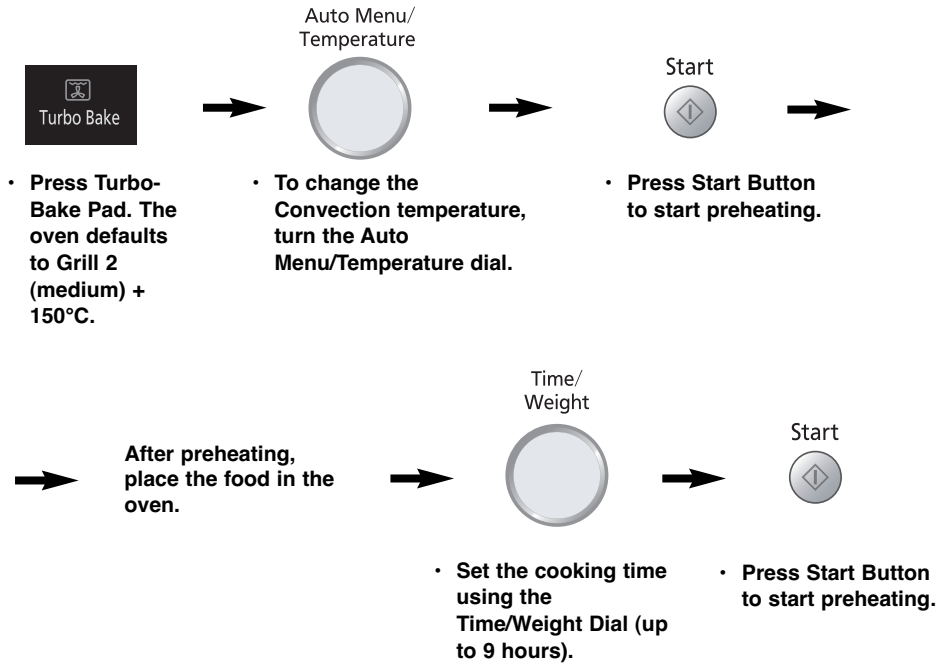

NOTE:

Using the Turbo-Bake Pad, it is not possible to change the Grill Level. Use the Convection + Grill sequence on page 46-47 if using Grill 1 or 3.

Combination Cooking

Your oven has three methods of cooking by Combination.

1. Convection and Microwave
2. Grill and Microwave
3. Convection, Grill and Microwave

COMBINATION cooking is ideal for many foods. The microwave power cooks them quickly, whilst the oven, grill or both gives the traditional browning and crispness.

All this happens simultaneously resulting in most foods being cooked in $\frac{1}{2}$ - $\frac{2}{3}$ of the conventional cooking time.

There is no need to preheat on COMBINATION programs, **EXCEPT when cooking pastry.**

It is possible to use smooth seamed metal tins and foil containers on COMBINATION. They must be placed directly on the anti spark ring, on the wire shelf. They must not be placed directly onto the wire shelf or arcing will occur.

If you experience arcing, which is when you see blue sparks or hear crackling noises, the metal container is unsuitable or you have insufficient food in the oven. You should stop the program immediately and change the container or re-program to CONVECTION only.

To cook successfully by COMBINATION you should always use a minimum of 200 g (7oz) food. Small quantities should be cooked by Convection, Grill or Turbo-Bake.

NOTE: THE ENAMEL SHELF CANNOT BE USED FOR COMBINATION COOKING.

Combination Cooking

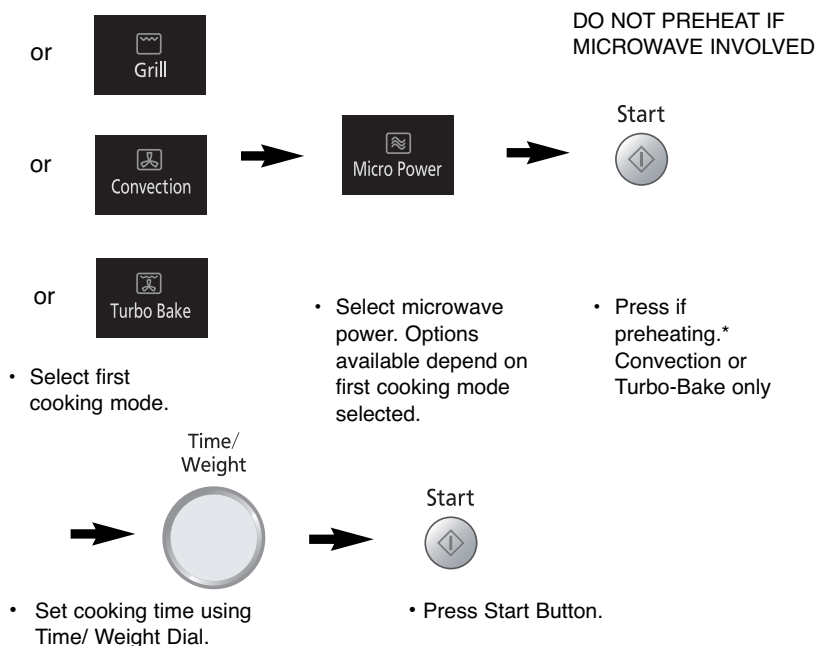

CAUTION:

Take care to use oven gloves when removing dishes from the oven - especially when turning or stirring foods as the oven walls and roof will be very hot.

NOTE:

- When placing food in the oven after preheating, just pull down door because if STOP/CANCEL Pad is pressed the program may be cancelled. Then, if the time was entered, the oven would revert to cooking on microwave only.
- You can add to the cooking time during cooking, if required. Turn Time/Weight Dial to increase the cooking time. A maximum time of 10 minutes can be added.

Containers to use

DO NOT use plastic MICROWAVE containers on Combination Programs (unless suitable for combination cooking). Dishes must be able to withstand the heat of the top grill - heatproof glass e.g. Glass or ceramic are ideal. But do not put dishes on wire rack in upper shelf position directly under the grill. Place the wire rack in the lower shelf position.

Oven accessories

When using any Combination cooking program the wire shelf may be used in the upper or lower shelf position. Do not place metal containers directly on the wire shelf when cooking on combination mode. Use the anti-spark ring on top of the wire shelf, then place any metal container. Your metal containers can then be used in combination mode without arcing. DO NOT USE THE ENAMEL SHELF ON COMBINATION COOKING.

Combination 1. Convection and Microwave

This is the most popular combination mode combining convection heat with microwave power. Casseroles, meat joints, jacket potatoes and pastries are very successful using this combination. Unsuitable foods are those which contain whisked eggs, meringues, rich fruit cakes, biscuits and yorkshire puddings.

It is not necessary to preheat on combination except when cooking pastry dishes, to achieve a better result. For pastry dishes preheat oven to 210°C on Convection so that the oven is hot, and then select the desired Combination program.

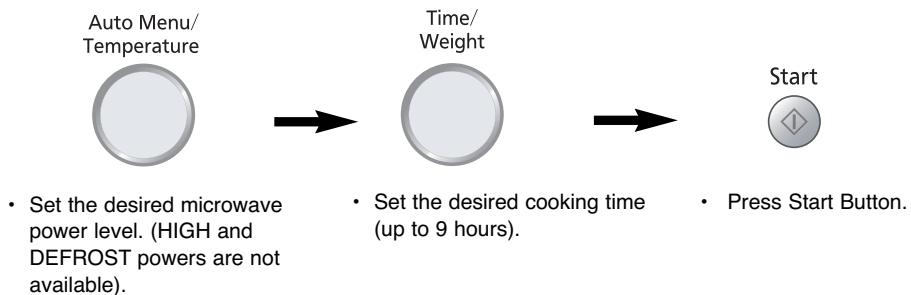
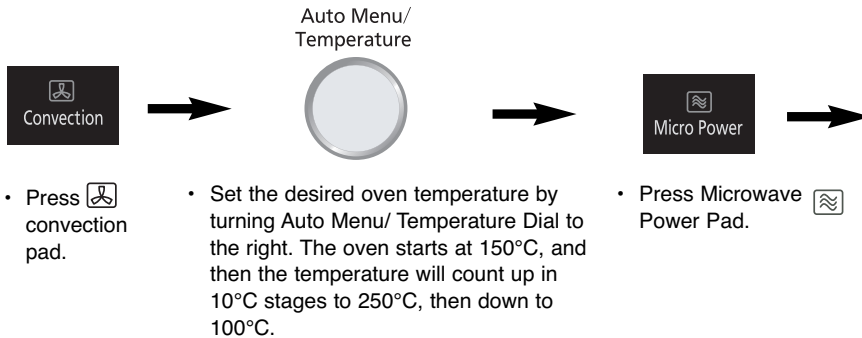

Combination 1. Convection and Microwave

Oven accessories to use

DO NOT USE THE ENAMEL SHELF FOR COMBINATION COOKING.



Non-metallic dishes or items of food can be placed directly onto wire shelf in the lower shelf position.



Joints and portions of meat should be placed in a Glass Dish on the wire shelf in the lower shelf position. Very large joints can be placed in a Glass Dish on the ceramic plate.



Recipes using foil or metal containers e.g. cakes and pastries should not be placed directly on the wire shelf. Use the anti-spark ring on top of the wire shelf, then place any metal container.

Combination 1. Convection and Microwave

Guidelines

- Food is usually cooked UNCOVERED.
- After cooking it is important that the accessories are removed for cleaning before re-use and that the oven walls and floor are wiped with a cloth squeezed in hot soapy water to remove any grease. It is not necessary to clean the back of the oven which has a catalytic self clean lining. **DO NOT PUT ACCESSORIES IN THE DISHWASHER.**

The chart below gives suggestions for Combination programs. For cooking times refer to cooking charts or a similar recipe in the book. It is not possible to use HIGH or DEFROST Microwave Power in this mode.

Oven Temperature	Microwave Power	Use
230°C	WARM	Crumble
220°C	SIMMER Cheese quiche	Cauliflower cheese and macaroni
220°C	WARM	Frozen Lasagne, chilled rice pudding
190°C	SIMMER	Whole Chicken/Turkey
160°C	WARM	Cakes, Casseroles

Foods should always be cooked until browned and piping hot.

CAUTION:

ALWAYS USE OVEN GLOVES WHEN REMOVING DISHES FROM THE OVEN - ESPECIALLY WHEN TURNING OR STIRRING FOODS, AS THE ACCESSORIES AND SURROUNDING OVEN WILL GET VERY HOT.

Combination 2. Grill and Microwave



This Combination mode is suitable for foods which are normally grilled and for reheating small savoury items.

Do not use this program with less than 200 g (7 oz) of food.

It is NOT necessary to preheat when using this Combination mode and food should always be cooked uncovered.

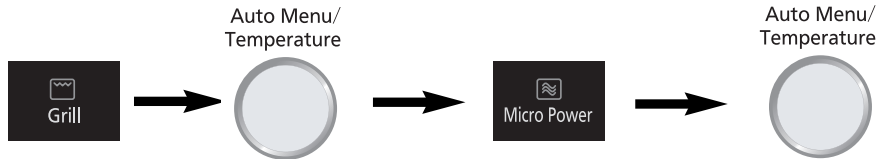
The Grill will glow on and off during cooking - this is normal.



- Press the Grill  Power Pad.
 - Select the desired grill setting using the Auto Menu/ Temperature Dial. If you wish to adjust from Grill 2 (Medium) to select Grill 3 (Low), or Grill 1 (High), turn Auto Menu/ temperature dial. Rotate to the right for Grill 1 (high). Rotate to the left for Grill 3 (low).
 - Press the microwave  power pad.
 - Select the desired microwave setting using the Auto Menu/ Temperature Dial. Options available depend on Grill Power selected. (High and Defrost are not available).
- Grill 1 - HIGH
Grill 2 - MEDIUM
Grill 3 - LOW

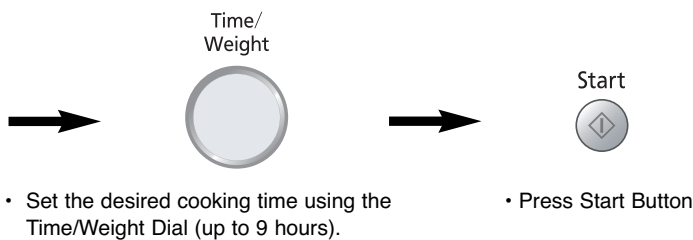

- Set the desired cooking time using the Time/Weight Dial (up to 9 hours).
- Press Start Button

Combination 2. Grill and Microwave

Oven accessories to use

DO NOT USE THE ENAMEL SHELF FOR COMBINATION COOKING.



Food should be placed directly onto the wire shelf in the upper or lower shelf position. The Glass Dish can be placed underneath to catch any drips.

When cooking fish or small items, food can be placed directly in the Glass Dish on the wire shelf.



Guidelines

- Food is always cooked UNCOVERED.
- To turn food just pull down door, remove the accessories, turn the food, return to the oven, close the door and press START pad. The oven will continue to countdown the remaining cooking time.
- After Grilling it is important that the Grill accessories are removed for cleaning before re-use and that the oven walls and floor are wiped with a cloth squeezed in hot soapy water to remove any grease. It is not necessary to clean the back of the oven which has a catalytic self clean lining. **DO NOT PUT THE SHELVES IN THE DISHWASHER.**

For advice on cooking times refer to cooking charts and recipes in this book. Foods should always be cooked until browned and piping hot.

CAUTION:

ALWAYS USE OVEN GLOVES WHEN REMOVING DISHES FROM THE OVEN - ESPECIALLY WHEN TURNING OR STIRRING FOODS, AS THE ACCESSORIES AND SURROUNDING OVEN WILL GET VERY HOT.

Containers to use

DO NOT use plastic MICROWAVE containers on Combination Programs (unless suitable for combination cooking). Dishes must be able to withstand the heat of the top grill - heatproof glass e.g. Glass or ceramic are ideal.

Combination 3. Convection, Grill or Turbo bake and Microwave.

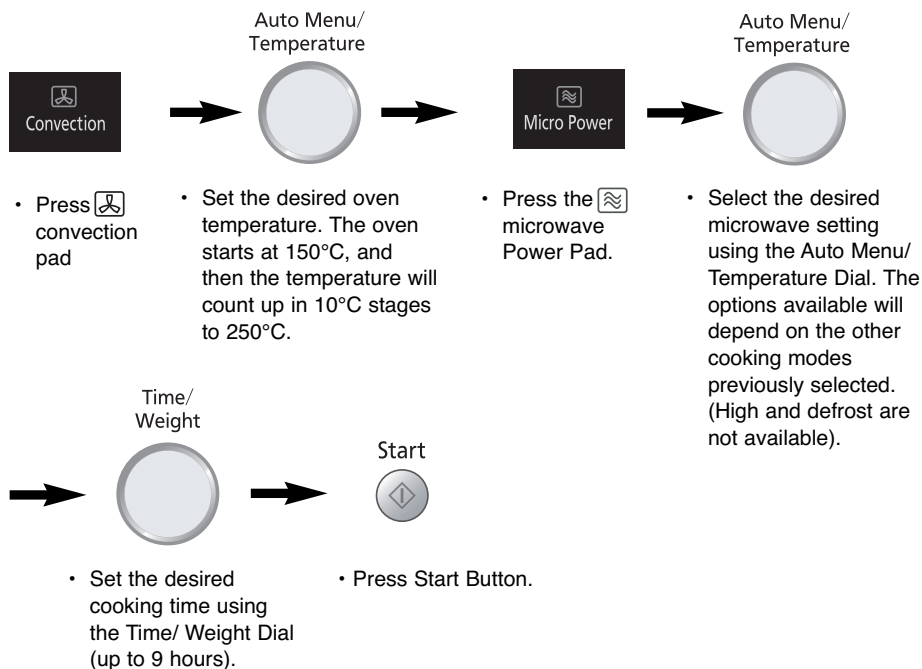

This Combination mode is very useful for foods which require quick browning or crisping. Unsuitable foods are, cakes, meringues, foods containing whisked eggs and yorkshire puddings. It is not necessary to preheat and food should always be cooked uncovered.

NOTE: Grill setting is automatically on GRILL 2

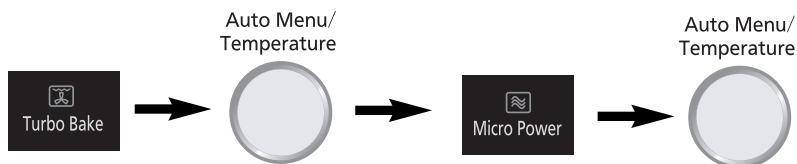

Combination 3. Convection, Grill or Turbo bake and Microwave.



- Press  Turbo Bake pad
- Set the desired oven temperature. The oven starts at 150°C, and then the temperature will count up in 10°C stages to 250°C.
- Press  Microwave pad. Set microwave power
- Select the desired microwave setting using the Auto Menu/ Temperature Dial. The options available will depend on the other cooking modes previously selected. (High/defrost not available).

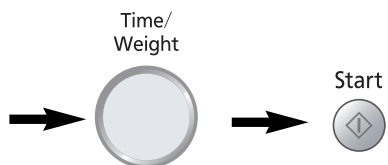

- Set the desired cooking time using the Time/ Weight Dial (up to 9 hours).
- Press Start button.

Combination 3. Convection, Grill or Turbo bake and Microwave.

Oven accessories to use

DO NOT USE THE ENAMEL SHELF FOR COMBINATION COOKING.



Non-metallic dishes or items of food can be placed directly onto the wire shelf in the lower shelf position.



Food should be placed directly onto the wire shelf in the upper or lower shelf position. The Glass Dish can be placed underneath to catch any drips.



When cooking small items or fish, food should be placed directly on to the Glass Dish in the upper or lower shelf position.

Guidelines

- Food is always cooked UNCOVERED.
- After cooking it is important that the accessories are removed for cleaning before re-use and that the oven walls and floor are wiped with a cloth squeezed in hot soapy water to remove any grease. It is not necessary to clean the back of the oven which has a catalytic self clean lining. **DO NOT PUT THE SHELVES IN THE DISHWASHER.**

Combination 3. Convection, Grill or Turbo bake and Microwave.

We suggest the following options for this Combination mode.

Convection (Oven temp)	Grill	Microwave Power	Use
250°C	1	SIMMER	Jacket potatoes
250°C	1	WARM	Bread rolls, ciabatta
240°C	1	LOW	Thin and crispy pizza
230°C	1	WARM	Fresh breaded fish fillets
*230°C	2	SIMMER	Frozen scampi, reheat meat pies and pasties, larger lasagne
230°C	3	SIMMER	Frozen breaded fish fillets
220°C	1	SIMMER	Lasagne, cauliflower cheese, Quorn® escalopes
*220°C	2	SIMMER	Reheat large meat pies, quiche, fruit pies
220°C	3	SIMMER	Frozen thin and crispy pizza

For advice on cooking times refer to cooking charts and recipes in this book.
Foods should always be cooked until browned and piping hot.

CAUTION:

ALWAYS USE OVEN GLOVES WHEN REMOVING DISHES FROM THE OVEN - ESPECIALLY WHEN TURNING OR STIRRING FOODS, AS THE ACCESSORIES AND SURROUNDING OVEN WILL GET VERY HOT.

* Turbo Bake is preset for GRILL 2

Auto Weight Cook Programs

This feature allows you to cook or reheat most of your favourite foods by setting the weight only. The oven determines the Microwave power level and/or Combination setting, then the cooking time automatically. Select the category of food and then just enter the weight. Only enter the weight of the food. Do not include the weight of any added water or the container weight.

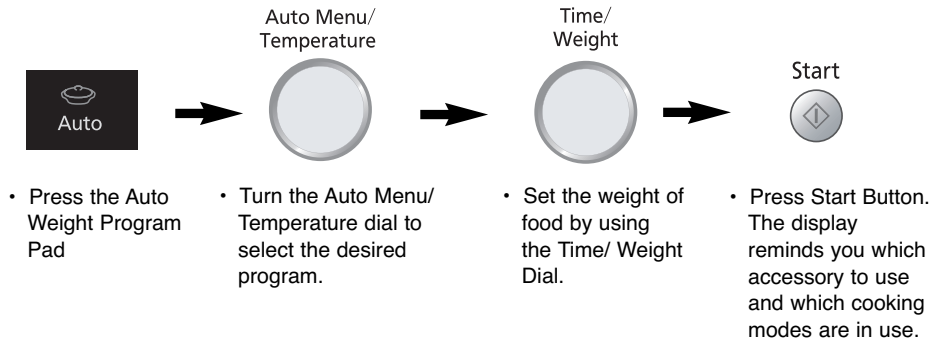

When you select an automatic program symbols will appear in the display to show the cooking mode that will be used and the accessories that are needed. See below to identify the symbols:-



Microwave



Convection



Enamel shelf



Grill



Turbo-bake



Wire shelf



Square glass tray

Guidelines for Use

The Auto Weight Programs are designed to take the guesswork out of cooking or reheating your food. They must **ONLY** be used for the foods described.

1. Only cook foods within the weight ranges described (see table below).
2. Only use the accessories as indicated on page 60.
3. **DO NOT** cover food unless stated. Combination auto programs use a Combination of Microwave and Grill and/or Convection and covering will prevent the food browning. The heat of the grill will also melt any plastic covering.
4. Most foods benefit from a **STANDING** time after cooking on an Auto Program, to allow heat to continue conducting to the centre.
5. To allow for some variations that occur in food, check that food is thoroughly cooked and piping hot before serving.
6. **ALWAYS** weigh the chicken for the whole chicken Auto program. **DO NOT** rely on the packet weight.

Minimum/Maximum Weights to use on Auto Weight Programs

Program	Minimum	Maximum
4. Fresh Vegetables	200 g	1000 g
5. Frozen Vegetables	200 g	1000 g
6. Fresh Fish	200 g	1000 g
7. Boiled Potatoes	200 g	1000 g
8. Jacket Potatoes	200 g	1500 g
9. Frozen Potato Products	200 g	500 g
10. Breaded Fish	100 g	800 g
11. Whole Chicken	1000 g	1900 g
12. Chicken Pieces	200 g	1000 g
13. Crispy Top	350 g	600 g
14. Chilled Pizza	100 g	600 g
15. Frozen Pizza	100 g	600 g
16. Pastry Items	100 g	650 g

Auto Weight Cook Programs

Auto Programs must ONLY be used for the foods described below.

4. Fresh Vegetables



To cook FRESH vegetables. Place prepared vegetables into a shallow container. Add 15 ml (1tbsp) of water per 100 g of vegetables. Cover with pierced cling film or lid. Place the container on the ceramic plate on the base of the oven. Select program number 4. Enter the weight. Press START. Stir halfway through cooking.

5. Frozen Vegetables



To cook FROZEN vegetables like frozen peas, sweetcorn or mixed vegetables. Place prepared vegetables into a container. Add 30 ml (2 tbsp) of water. Cover with pierced cling film or lid. Place the container on the ceramic plate on the base of the oven. Select program number 5. Enter the weight. Press START. Stir halfway through cooking.

6. Fresh Fish



To cook FRESH fish. Shield the thinner portions. Place in a shallow container. Add 30 ml (2tbsp) water. Cover with pierced cling film or lid. Place the container on the ceramic plate on the base of the oven. Select program number 6. Enter the weight. Press START.

7. Boiled Potatoes



Prepare potatoes and cut into even sized pieces. For under 500 g, place potatoes into a container with 90 ml (6 tbsp) of water. For over 500g, place potatoes into a container with 150 ml (10 tbsp) of water. Cover with pierced cling film or lid. Place the container on the ceramic plate on the base of the oven. Select program number 7. Enter the weight. Press START. Stir halfway through cooking.

M = Microwave cooking only **C** = Combination e.g. Convection + Micro power or Grill + Micro Power

Auto Weight Cook Programs

8. Jacket Potatoes

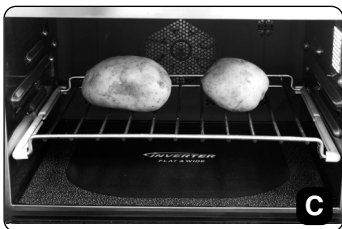

To cook jacket potatoes with a crisper drier skin. Choose medium sized potatoes 200-250 g (7-9 oz), for best results. Wash and dry potatoes and prick with a fork several times. Place potatoes on wire shelf in lower shelf position. Select program number 8. Enter total weight of potatoes, then press START.

9. Frozen Potato Products



To cook FROZEN oven chips and potato products, e.g. Hash Browns, Croquettes, etc., that are suitable for GRILLING. Place potato products on glass dish on wire shelf in lower shelf position. Select program number 9. Enter the weight. Press START. Turn during cooking. For best results cook in a single layer.

NOTE: Potato products vary considerably. We suggest checking a few minutes before the end of cooking to assess personal browning.

10. Breaded Fish



To cook precooked FROZEN breaded fish. Place frozen breaded fish on Glass dish on wire shelf in lower shelf position. Select program number 10. Enter total weight of frozen breaded fish. Press START.

11. Whole Chicken

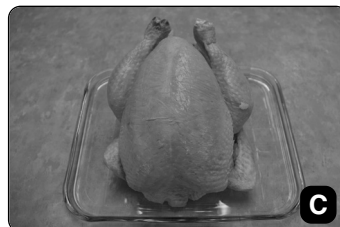

To cook WHOLE FRESH unstuffed chickens. Cook stuffing separately. Place chicken on Glass Dish on base of the oven. Select program number 11. Enter in the weight of chicken, then press START. Start cooking breast side down and turn halfway, taking care with hot juices. Stand for 5 minutes.

M = Microwave cooking only **C** = Combination e.g. Convection + Micro power or Grill + Micro Power

Auto Weight Cook Programs

Auto programs must ONLY be used for the foods described below.

12. Chicken Pieces (with bone)



To cook FRESH chicken pieces. Place chicken, skin side up, on Glass dish on wire shelf in lower shelf position. Select program number 12. Enter weight. Take care with hot juices. Stand for 5 minutes.

13. Crispy Top



For heating and browning CHILLED purchased savoury dishes e.g. lasagne, sheperds pie, fish pie etc. Remove any lid or covering. If in a foil container transfer to a similar sized heatproof dish and place on wire shelf in lower shelf position. If using heatproof plastic based dish that food is purchased in, take care and support underneath when removing. Select program number 13. Enter weight. Press START. DO NOT COVER. Stand for 1 minute before serving. Ensure the food is piping hot.

14 Chilled Pizza



For reheating and browning chilled, purchased pizza. Remove all packaging and place on wire shelf in lower shelf position. Select program number 14. Enter weight. Press START.

M = Microwave cooking only **C** = Combination e.g. Convection + Micro power or Grill + Micro Power

Auto Weight Cook Programs

15 Frozen Pizza



For reheating and browning frozen, purchased pizza. Remove all packaging and place on wire shelf in lower shelf position. Select program number 15. Enter weight. Press START. Please note this program is not suitable for very deep pan pizzas.

16 Pastry Items



For reheating and browning purchased pastry items eg. meat or vegetable pies, sausage rolls or pasties. Do not use for large deep filled family pies. Remove all packaging and place on glass dish on wire shelf in lower position. Select program number 16. Enter weight. Press START. DO NOT COVER.

M = Microwave Power only **C** = Combination e.g. Convection + Micro Power or Grill + Micro Power

Cooking and Reheating Guidelines

Most foods reheat very quickly in your oven by HIGH power. Meals can be brought back to serving temperature in just minutes and will taste freshly cooked and NOT leftover. Always check food is piping hot and return to oven if necessary.

As a general rule, always cover wet foods, e.g. soups, casseroles and plated meals.

Do not cover dry foods e.g. bread rolls, mince pies, sausage rolls etc.

The charts on pages 67-83 show you the best way to cook or reheat your favourite foods. The best method depends on the type of food.

Remember when cooking or reheating any food that it should be stirred or turned wherever possible. This ensures even cooking or reheating on the outside and in the centre.

When is food reheated?

Food that has been reheated or cooked should be served "piping hot" i.e. steam should be visibly emitted from all parts. As long as good hygiene practices have been followed during the preparation and storage of the food, then cooking or reheating presents no safety risks.

Foods that cannot be stirred should be cut with a knife to test that they are adequately heated throughout. Even if a manufacturer's instructions or the times in the cookbook have been followed, it is still important to check the food is heated thoroughly. If in doubt, always return to the oven for further reheating.

If you cannot find the equivalent food in the chart then choose a similar type and size listed and adjust the cooking time if necessary.

Cooking and Reheating Guidelines

Plated Meals

Everyone's appetite varies and reheat times depend on meal contents. Dense items e.g. mashed potato, should be spread out well. If a lot of gravy is added, extra time may be required. Place denser items to the outside of the plate. Between 3-5 mins. on HIGH power will reheat an average portion. If stacking two meals, heat on HIGH power for 6-7 mins. and change the meals over halfway.

Canned Foods

Remove foods from can and place in a suitable dish before heating.

Soups

Use a bowl and stir before heating and at least once through reheat time and again at the end.

Casseroles

Stir halfway through and again at the end of heating.

Mince Pies

REMEMBER even if the pastry is cold to the touch, the filling will be piping hot and will warm the pastry through. Take care not to overheat otherwise burning can occur due to the high fat and sugar content of the filling. Check the temperature of the filling before consuming to avoid burning your mouth.

Christmas Puddings and Liquids

Take great care when reheating these items. See Page 72.

Do not leave unattended.

Do not add extra alcohol.

Babies' Bottles - Caution

Milk or formula MUST be shaken thoroughly before heating and again at the end and tested carefully before feeding a baby. See page 61 for details.

WE DO NOT RECOMMEND THAT YOU USE YOUR MICROWAVE TO STERILISE BABIES' BOTTLES. If you have a special microwave steriliser we urge extreme caution, due to the low quantity of water involved. It is vital to follow the manufacturers instructions implicitly.

The times given in the charts below are a guideline only, and will vary depending on **STARTING** temperature, dish size and quantity. Pastry or Bread items reheated by microwave will be soft not crisp.

HEATING CATEGORY

Your oven is Heating Category E and this is displayed on the front of your oven door. The information on this label will assist you in using new instructions on food packs to enable you to program the best heating time in your oven.

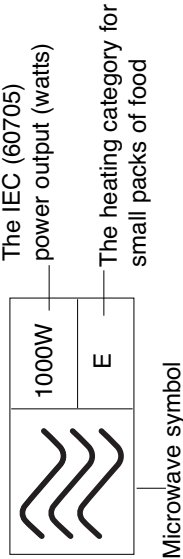

Water tank; Remember when using steam, the water tank must be filled.

BABIES BOTTLES – CAUTION

After heating by Microwave liquid at the top of a bottle will be much hotter than at the bottom of the bottle and must be shaken thoroughly before checking the temperature. When testing the temperature of the milk, squirt a little onto your inner wrist. The milk droplets on your skin should feel warm, not hot.

For 250ml of milk from fridge temperature, remove top and teat. Heat on **HIGH Power** for 30 secs. **CHECK CAREFULLY**
 For 100ml of milk from fridge temperature, remove top and teat. Heat on **HIGH Power** for 10-15 secs. **CHECK CAREFULLY**

Food	Weight / Quantity	Power Level	Time	Instructions/ Guidelines
Croissants / Brioche	1	HIGH Micro	15-20 secs	Place on Glass dish on base. Do not cover
	4	HIGH Micro	30-40 secs	Place on Glass dish on base. Do not cover
	any	200°C	2-3 mins	Preheat oven with enamel shelf in lower position
CANNED PASTA				
Ravioli	400g	HIGH Micro	3 - 3½ mins	Place in a heatproof bowl on base. Cover and stir halfway
Macaroni Cheese	400g	HIGH Micro	3 mins	Place in a heatproof bowl on base. Cover and stir halfway
Spaghetti	400g	HIGH Micro	3 mins	Place in a heatproof bowl on base. Cover and stir halfway

POINTS FOR CHECKING

Always check that food is piping hot after reheating in the microwave. Foods reheated on microwave only will require a stand time, especially if they cannot be stirred. The denser the food the longer the stand time.

Reheating Charts

Food	Weight / Quantity	Power Level	Time	Instructions/ Guidelines
CANNED PUDDINGS				
Rice Pudding	150g 425g	HIGH Micro HIGH Micro	1 min 2-2½ mins	Place in a heatproof bowl on base. Cover and stir halfway Place in a heatproof bowl on base. Cover and stir halfway
Sponge Pudding	300g	MEDIUM Micro	3 mins	Place in a heatproof bowl on base.
Custard - Small Jug	250g 500g	HIGH Micro HIGH Micro	1½ mins 3 mins	Place in a heatproof bowl on base. Cover and stir halfway Place in a heatproof bowl on base. Cover and stir halfway
CANNED SOUPS				
Condensed	295g	HIGH Micro	6 mins	Place in a heatproof bowl and stir in one can of water. Cover and place on base stirring halfway.
Healthy Option	415g	HIGH Micro	2½ mins	Place in a heatproof bowl on base. Cover and stir halfway
Luxury/Vegetable /Broth	400/415g	HIGH Micro	3 mins	Place in a heatproof bowl on base. Cover and stir halfway
Creamed	300g	HIGH Micro	2½ mins	Place in a heatproof bowl on base. Cover and stir halfway
CHILLED SOUPS				
1 Portion	250ml	HIGH Micro	2 mins	Place in microwave safe bowl. Cover and stir halfway
2 Portion	500ml	HIGH Micro	4 mins	Place in microwave safe bowl. Cover and stir halfway
CANNED VEGETABLES				
Baked Beans Baked Beans	415g 200g	HIGH Micro HIGH Micro	2½ mins 1 -1½ mins	Place in a shallow heatproof bowl on base. Cover and stir halfway Place in a shallow heatproof bowl on base. Cover and stir halfway

Reheating Charts

Food	Weight / Quantity	Power Level	Time	Instructions/ Guidelines
Baked Beans with Sausages	200g	HIGH Micro	2-2½ mins	Place in a shallow heatproof bowl on base. Cover and stir halfway
Broad Beans	300g	HIGH Micro	2 mins	Place in a shallow heatproof bowl on base. Cover
Butter Beans	220g	HIGH Micro	1½ mins	Place in a shallow heatproof bowl on base. Cover
Carrots, sliced	300g	MEDIUM Micro	3 mins	Place in a heatproof bowl on base. Cover and stir halfway
Green Beans	200g	MEDIUM Micro	3 mins	Place in a shallow heatproof bowl on base. Cover
Mushrooms	290g	HIGH Micro	2 mins	Place in a shallow heatproof bowl on base. Cover
Peas, mushy	400g	HIGH Micro	3 mins	Place in a heatproof bowl on base. Cover and stir halfway
Peas, petit pois	200g	HIGH Micro	1½ mins	Place in a shallow heatproof bowl on base. Cover
Peas, garden	300g	HIGH Micro	2 mins	Place in a shallow heatproof bowl on base. Cover
Peas, marrowfat	300g	MEDIUM Micro	3-3½ mins	Place in a heatproof bowl on base. Cover and stir halfway
Sweetcorn	200g 330g	MEDIUM Micro MEDIUM Micro	2-2½ mins 3½ mins	Place in a shallow heatproof bowl on base. Cover Place in a shallow heatproof bowl on base. Cover
Tomatoes	400g	MEDIUM Micro	5 mins	Place in a heatproof bowl on base. Cover and stir halfway
PLATED MEAL - ROOM TEMPERATURE				
Small - child portion	1	MEDIUM Micro	3 - 4 mins	Place on base. Cover
Large - adult portion	1	MEDIUM Micro	5 - 6 mins	Place on base. Cover
DRINKS				
1 Mug Cold Milk	235ml	HIGH Micro	2½ mins	Place in a heatproof mug on base. Stir halfway and after reheating
1 Jug Cold Milk	568ml (1 pint)	HIGH Micro	5 mins	Place in a heatproof Jug on base. Stir halfway and after reheating
1 Mug Cold Coffee/Tea	235ml	HIGH Micro	1½ mins	Place in a heatproof mug on base. Stir halfway and after reheating
1 Mug Cold Milky Coffee	235ml	HIGH Micro	1 min 10 sec	Place in a heatproof mug on base. Stir halfway and after reheating

Reheating Charts

Food	Weight / Quantity	Power Level	Time	Instructions/ Guidelines
SAVOURY PASTRY PRODUCTS - PRECOOKED				
PASTRIES REHEATED BY MICROWAVE WILL HAVE A SOFT BASE				
Pasties/Slices	150/165g 165g 225g	HIGH Micro 230C+GRILL 1+ WARM Micro 230C+GRILL 1+ SIMMER Micro	60-70 secs 10 mins 10 mins	Place on Glass tray on base. Place on Glass tray on wire shelf on lower level Place on Glass tray on wire shelf on lower level
Meat Pies	150g 150g 150g x 2 250g 600g	HIGH Micro 230C+GRILL 2+ SIMMER Micro 230C+GRILL 2+SIMMER Micro 220C+GRILL 2+SIMMER Micro 220C+GRILL 2+SIMMER Micro	60-70 secs 8-10 mins 12 mins 13-15 mins 18 mins	Place on Glass tray on wire shelf on lower level Place in foil container on anti-spark ring on wire shelf on lower level Place in foil containers (making sure the containers do not touch) on anti-spark ring on wire shelf on lower level Place in foil container on anti-spark ring on wire shelf on lower level Place in foil container on anti-spark ring on wire shelf on lower level
Quiche	175g 400g	220C+GRILL 2+SIMMER Micro 220C+SIMMER Micro	10 mins 12 - 15 mins	Place in foil container on anti-spark ring on wire shelf on lower level Place in foil container on anti-spark ring on wire shelf on lower level
Sausage Rolls- x1 - Snack size x6	150g 200g	HIGH Micro or 230C+GRILL 2+ WARM Micro 230C+GRILL 2+ WARM Micro	1 min 8 mins 8-9 mins	Place on Glass tray on base. Place on Glass tray on wire shelf on lower level Place on Glass tray on wire shelf on lower level
Suet Puddings	435g	LOW Micro	10 mins	Place on base. Pierce film lid.

Reheating Charts

Food	Weight/ Quantity	Choice of Cooking Modes	Time (mins.)	Instructions/ Guidelines
PUDDINGS AND DESSERTS- WHERE MICROWAVE ONLY IS INVOLVED TRANSFER FOOD FROM FOIL CONTAINER TO A SIMILAR SIZED HEATPROOF DISH HOWEVER A FOIL CONTAINER MAY BE USED IN COMBINATION WITH MICROWAVE IF THE ANTI-SPARK RING IS USED.				
Bread & Butter Pudding	395g	250C+GRILL 2+WARM Micro	15 mins	Place on wire shelf in lower position.
Chilled Custard	500g	HIGH Micro	4-5 mins	Place in large jug on base. Cover and stir halfway.
Chilled Rice Pudding	150g	HIGH Micro	50 secs	Place on base.
	500g	220C+WARM Micro	15 mins	Place on wire shelf in lower position.
Fruit Crumble	600g	230C+WARM Micro	16-18 mins	Place on wire shelf in lower position.
Fruit Pie - Large - Individual x 1	700g	220C+GRILL 2+SIMMER Micro	15 mins	Place in foil container on anti-spark ring on wire shelf on lower level
		HIGH Micro	10-15 secs	Place on Glass tray on base.
Mince Pies - x 2		HIGH Micro	20-30 secs	Place on micro-safe plate on base.
Pancakes	200g	MEDIUM Micro	2 mins	Pierce packet and place on Glass tray on base.
Spotted Dick	120g	MEDIUM Micro	1 min	Pierce lid and place on base
Sponge Pudding- Large Individual	300g	MEDIUM Micro	3-4 mins	Pierce lid and place on base.
	120g	MEDIUM Micro	50-60 secs	Pierce lid and place on base.

Reheating Charts

Food	Weight/ Quantity	Choice of Cooking Modes	Time (mins.)	Instructions/ Guidelines
CHRISTMAS PUDDING: Do not leave unattended as overheating can cause the food to ignite. Reheating with Steam Micro power will give a moister result.				
Small/Slice	100g	MEDIUM Micro	1 ½ mins	Place on base. Pierce film lid.
Medium	227g	MEDIUM Micro or HIGH Micro	3 mins 1 ½ - 2 mins	Place on base. Pierce film lid. Place on base. Pierce film lid.
Large	454g	STEAM MEDIUM or HIGH Micro	5 mins 3 mins	Place on base. Pierce film lid. Place on base. Pierce film lid.
READY MEALS - Chilled. Transfer food from foil container to a similar sized heatproof dish. Healthy eating options will only slightly brown on combination because of the lower fat content.				
Cauliflower Cheese	350g	220C+GRILL 1+SIMMER Micro	11-12 mins	Place on wire shelf on the lower level.
Cottage/Shepherds Pie	500g	HIGH Micro	7-8 mins	Place on base.
	1.2 Kg	230C+GRILL 1+SIMMER Micro	15 mins	Place on wire shelf on the lower level.
		230C+GRILL 1 +SIMMER Micro	22 mins	Place on wire shelf on the lower level.
Fish/Veg Bake	450g	HIGH Micro or	7 mins	Place on base.
	950g	230C+GRILL 1+SIMMER Micro	14 mins	Place on wire shelf on the lower level.
		230C + GRILL 1 + LOW Micro	16-18mins	Place on wire shelf on the lower level.
Onion Bhajjis/Samosas	300g	250C + GRILL 1 + WARM Micro	10 mins	Place on Glass dish on wire shelf on lower level. Turn halfway.
Lasagne	400g	HIGH Micro or	6 mins	Place on base.
	550g	220C+GRILL 1+SIMMER Micro	12 mins	Place on wire shelf on the lower level.
		950g	220C+GRILL 1+SIMMER Micro 230C+GRILL 2+SIMMER Micro	15-16 mins 18 mins
Macaroni Cheese	400g 1.2 Kg	220C+ GRILL 1+ SIMMER Micro 220C +GRILL 3+ SIMMER Micro	10 mins 18 mins	Place on wire shelf on the lower level. Place on wire shelf on the lower level.

Reheating Charts

Food	Weight/ Quantity	Choice of Cooking Modes	Time (mins.)	Instructions/ Guidelines
READY MEALS - Chilled.				
Transfer food from foil container to a similar sized heatproof dish. Healthy eating options will only slightly brown on combination because of the lower fat content.				
Chilled Mashed Potato	450g	MEDIUM Micro	6-7 mins	Pierce lid and place on base.
Carrot and Swede Mash	500g	MEDIUM Micro	6-7 mins	Pierce lid and place on base.
Spring Rolls x 6	130g	250C+GRILL 1+WARM Micro	5 mins	Place on Glass dish on wire shelf on lower level.
READY MEALS - Frozen.				
Transfer food from foil container to a similar sized heatproof dish. Remove any covering/lid film lid.				
Cauliflower Cheese	400g	220C + SIMMER Micro	20 mins	Place on wire shelf in lower position.
Cottage/Fish/Shepherds Pie	450g	HIGH Micro 230C + GRILL 2 + LOW Micro	12 mins 20 mins	Place on base. Place on wire shelf in lower position.
Lasagne/Cannelloni	400g	HIGH Micro 230C + GRILL 2 + LOW Micro	10-12 mins 20-22 mins	Place on base Place on wire shelf in lower position.
Macaroni Cheese	400g	HIGH Micro 220C + SIMMER Micro	10-12 mins 18-20 mins	Place on base. Place on wire shelf in lower position.
QUORN®				
Burgers	200g (4)	MEDIUM Micro	3-4mins	Place on Glass dish.
Escalopes	240g	220C+GRILL 1+SIMMER Micro	8-10 mins	Place on Glass dish on wire shelf in lower position.

Cooking Charts

Food	Weight/ Quantity	Choice of Cooking Modes	Time (mins.)	Instructions/ Guidelines
BREAD				
Part-baked rolls	300g (6)	250°C+GRILL 1+WARM Micro	10 mins	Place on Glass dish on wire shelf in lower position.
Part-baked Garlic Baguette/ Ciabatta	210g	250°C+GRILL 1+ WARM Micro	9-10 mins	Place on Glass dish on wire shelf in lower position.
Garlic doughballs x 16	195g	250°C+GRILL 1+WARM Micro	10 mins	Place on Glass dish on wire shelf in lower position.
BACON AND PORK - from raw - CAUTION: Hot fat! Remove accessories with care.				
Rashers	228g (8)	HIGH Micro or GRILL 1	4-6 mins or 50 secs per rasher 10-12 mins	Place on micro-safe rack or plate on base and cover with kitchen towel to minimise splatter. Place on enamel tray in upper shelf position.
Gammon steaks x2	500g	MEDIUM Micro	8 -10Mins	Place on a Glass dish and cover with pierced clingfilm.
Pork joint		250°C Followed by 190°C	for 30 mins then 30 mins per 500g	Preheat oven with wire shelf in lower position. Place joint in roasting dish. Leave for 10 mins after cooking and before carving.
Pork loin steaks	450g (3)	GRILL 1	15-16 mins	Place on enamel tray in upper shelf position. Turn halfway.
Gammon joint	750g	HIGH Micro followed by STEAM MEDIUM	10 mins 20 mins	Place on Glass tray.
BEANS & PULSES - should be pre-soaked in cold water overnight (boiling water split yellow peas) except lentils which do not need to be pre-soaked.				
Black eyed peas	250g	HIGH Micro then SIMMER Micro	10 mins then 40 mins	Use 600 ml (1pt) boiling water in a large bowl. Cover.
Chick peas	250g	HIGH Micro then SIMMER Micro	10 mins then 40 mins	Use 600 ml (1pt) boiling water in a large bowl. Cover.
Haricot beans	250g	HIGH Micro then SIMMER Micro	10 mins then 40 mins	Use 600 ml (1pt) boiling water in a large bowl. Cover.

Cooking Charts

Food	Weight/ Quantity	Choice of Cooking Modes	Time (mins.)	Instructions/ Guidelines
BEANS & PULSES - should be pre-soaked in cold water overnight (boiling water split yellow peas) except lentils which do not need to be pre-soaked				
Lentils	250g	HIGH Micro	10 mins	Use 600 ml (1pt) boiling water in a large bowl. Cover.
Marrowfat peas	250g	HIGH Micro then SIMMER Micro	3 mins then 40 mins	Use 600 ml (1pt) boiling water in a large bowl. Cover.
Red kidney beans	250g	HIGH Micro then SIMMER Micro	15 mins then 40 mins	Use 600 ml (1pt) boiling water in a large bowl. Cover. Must boil for at least 12 mins to destroy toxic enzymes.
Split yellow peas	250g	HIGH Micro then SIMMER Micro	10 mins then 30 mins	Use 600 ml (1pt) boiling water in a large bowl. Cover.
10 Bean mix	250g	HIGH Micro then SIMMER Micro	12 mins then 40 mins	Use 600 ml (1pt) boiling water in a large bowl. Cover. Must boil for at least 12 mins to destroy toxic enzymes.
BEEF - CAUTION: Hot fat! Remove dish with care. Recommended temperatures for beef are: Rare 60°C; medium 70°C; well done 80°C.				
Beef burgers (fresh)	225g (2)	HIGH Micro or GRILL 1	3-4 mins 10-12 mins	Place on micro-safe rack or plate on base. Cover. Place on enamel shelf in upper position.
Beef burgers (frozen raw)	240g (2)	GRILL 1	15-16 mins	Place on enamel shelf in upper position.
Joint		250°C followed by 180°C	20 mins then per 450g/lb Rare: 20 mins Medium: 40 mins Well done: 50-60 mins	Place in roasting dish on wire shelf in lower position. Turn halfway.
Mince		HIGH then MEDIUM Micro	10 mins then 15 mins per 450g	Place in micro safe dish with stock and seasonings. Cover and stir halfway.
Rump/ Sirloin	400g	GRILL 1	Medium: 12 mins Well done: 16 mins	Place on enamel tray in upper shelf position. Turn halfway.

Cooking Charts

Food	Weight/ Quantity	Choice of Cooking Modes	Time (mins.)	Instructions/ Guidelines
BEEF - CAUTION: Hot fat! Remove dish with care.				
Stewing Steak	450-675g	HIGH then SIMMER Micro or 160°C + WARM Micro	10 mins then 60 mins 1hr - 1hr 30 mins	Place in micro-safe dish on base. Add stock and vegetables. Cover and stir halfway. Place in casserole dish with lid, add stock and vegetables. Place on base. Cover and stir halfway.
CHICKEN from raw - CAUTION: Hot fat! Remove accessory with care.				
Breasts, boneless and skinless	200g 500g 500g	MEDIUM Micro MEDIUM Micro 250°C+GRILL 1	5 mins 12 mins 16-17 mins	Place on plastic trivet on Glass dish. Place on plastic trivet on Glass dish. Preheat oven. Place on enamel shelf in lower position.
Coated Chicken Breast	270g	240°C+GRILL 1 WARM Micro	16-17 Mins	Place on Glass tray on wire shelf in lower position.
Chicken legs	1.0 kg	MEDIUM Micro or 250°C + GRILL 1	15 mins 25 mins	Place on Glass tray on base of the oven. Cover. Place on enamel shelf in lower position. Turn halfway.
Drumsticks/ Thighs	600g (5)	MEDIUM Micro or GRILL 1 or 250°C + GRILL 1	12 mins 25 mins 15-20 mins	Place on on Glass dish on base of oven. Place on enamel shelf in upper position. Turn half way. Preheat oven. Place on enamel shelf in upper position. Turn halfway.
Kiev (fresh)	285g (2)	230°C + GRILL 1 + SIMMER Micro	11 mins	Place on Glass tray on wire shelf in lower position.
Whole		MEDIUM Micro or	8 mins per 450g	Place on micro-safe dish on base. Cover.
Whole/ Breast joints		190°C + SIMMER Micro	12-13 mins per 450g	Place chicken breast side down on an upturned saucer on Glass tray on base of oven. Turn halfway.

Cooking Charts

Food	Weight/ Quantity	Choice of Cooking Modes	Time (mins.)	Instructions/ Guidelines
EGGS - Poached.				
1 Egg	45ml water	HIGH Micro then MEDIUM Micro	1 min 10 secs 50 secs	- Place water in a shallow dish and heat for 1st cooking time. - Add egg (size 3). - Pierce yolk and white. - Cover. - Cook for 2nd cooking time. - Then leave to stand for 1 min.
2 Eggs	90ml water	HIGH Micro then MEDIUM Micro	1 min 40 secs 1 min 30 secs	
4 Eggs	180ml water	HIGH Micro then MEDIUM Micro	3 mins 3 mins 30 secs	
EGGS - Scrambled. Use microwave safe bowl.				
1 Egg		HIGH Micro	30 secs	- Add 1 tbsp of milk for each egg used.
2 Eggs		HIGH Micro	30 secs 1 min	- Beat eggs, milk and knob of butter together. - Place bowl on base
4 Eggs		HIGH Micro	30 secs 1 min 30 secs 1 min	- Cook for 1st cooking time then stir. - Cook for 2nd cooking time stirring halfway then stand for 1 min.
FISH - FRESH from raw.				
Lightly dusted fillets	280g	230C + GRILL 2 + WARM Micro	15 mins	Place on Glass dish on wire shelf in lower position.
Breaded Fillets	350g (x2)	230°C+GRILL 1 + WARM Micro	15 mins	Place on Glass dish on wire shelf in lower position.
Cakes	200g (x2)	230°C+GRILL 1 + WARM Micro	10-12 mins	Place on Glass dish on wire shelf in lower position.
Calamari	250g	250°C+ GRILL 1 + WARM Micro	8-10 mins	Place on Glass dish on wire shelf in lower position. Turn halfway.
Fillets	300g 700g	MEDIUM Micro MEDIUM Micro	4-5 mins 10 mins	Place on Glass dish. Place on Glass tray.
Scampi	200g	230°C+ GRILL 1 + WARM Micro	10-12 mins	Place on Glass dish on wire shelf in lower position.

Cooking Charts

Food	Weight/ Quantity	Choice of Cooking Modes	Time (mins.)	Instructions/ Guidelines
FISH - FRESH from raw.				
Steaks	300g (x2)	190°C+SIMMER Micro	12-15 mins	Place on Glass dish on wire shelf in lower position.
Whole x1	225g/300g	HIGH Micro or	4-5 mins	Place in micro-safe dish and pierce skin. Add 30 ml of liquid. Cover.
Whole x2	400-500g	180°C+ SIMMER Micro	10-12 mins	Place on Glass dish on wire shelf in lower position.
FISH - FROZEN from raw .				
Breaded Fillets	350g (2)	230°C+GRILL 2 + SIMMER Micro	15 mins	Place on Glass dish on wire shelf in lower position. Turn halfway.
Cakes	200g (2)	250°C+GRILL 2 +WARM Micro	15-16 mins	Place on Glass dish on wire shelf in lower position. Turn halfway.
Fish Fingers	125g (4)	250°C+GRILL 1+ SIMMER Micro	12 mins	Place on Glass dish on wire shelf in lower position.
	250g (8)	250°C + GRILL 1 + SIMMER Micro	15 mins	Place on Glass dish on wire shelf in lower position.
Fillets	200g	MEDIUM Micro	6-8 mins	Place on Glass dish, and cover with cling film.
Scampi	300g	230°C + GRILL 2 + SIMMER Micro	10-12 mins	Place on Glass dish on wire shelf in lower position.
Boil in the Bag	150g	MEDIUM Micro	6 mins	Place bag sauce side down on Glass dish. Slash top. Shake bag halfway through.
FRUIT - Peel, slice, chop into even sized pieces. Place in shallow heatproof dish on base.				
Baked Apple-cored	200g	MEDIUM Micro	5-6½ mins	Place on Glass dish on base.
Apples - stewed	500g	MEDIUM Micro	10-11 mins	Add 15ml (1tbsp) water. Cover.
Apricots-stewed	300g	MEDIUM Micro	5-6 mins	Add 15ml (1tbsp) water. Cover.
Pears - stewed	500g	MEDIUM Micro	10-12 mins	Add 15ml (1tbsp) water. Cover.
Plums - poached	400g	HIGH MICRO	8 mins	Add 300 ml (½ pt) of water. Only half fill dish. Cover.
Plums - stewed	400g	MEDIUM Micro	7-8 mins	Add 15ml (1tbsp) water. Cover.
Rhubarb - stewed	450g	MEDIUM Micro	6 mins	Add 15ml (1tbsp) water. Cover.
GAME- Caution: Hot fat! Remove dish with care.				
Duck Breast Filets	360g	200°C	30-40 mins	Preheat oven. Prick the skin and place in roasting dish on wire shelf on lower level.
Duck, whole		190°C	30 mins per 450g	Preheat oven. Prick the skin and place in roasting dish on wire shelf on lower level.
Crispy Duck-reheat	500g	250°C	20 mins	Preheat oven and place duck on enamel shelf in lower position.

Cooking Charts

Food	Weight/ Quantity	Choice of Cooking Modes	Time (mins.)	Instructions/ Guidelines
GAME- Caution: Hot fat! Remove dish with care.				
Pheasant, whole		180°C	20-25 mins per 450g plus 20 mins	Pre-heat oven. Place wire shelf on lower level. Place pheasant in roasting tin and place on shelf.
LAMB - from raw - CAUTION: Hot Fat! Remove accessory with care.				
Joint		180°C	Medium: 25 mins per 450g plus 25 minutes or Well done: 30 mins per 450g plus 30 minutes.	Pre-heat oven. Place joint in roasting dish and place on wire shelf in lower position. Turn Halfway. Once cooked allow the joint to stand for 10 minutes - this will make the joint easier to carve.
Loin/ Leg Steaks	600g (4)	GRILL 1	Medium: 19-20 mins Well Done: 22-25 mins	Place on enamel shelf in upper position. Turn halfway.
Chops/Cutlets	400g (4)	GRILL 1	Medium: 12-14 mins Well Done: 16-18 mins	Place on enamel shelf in upper position. Turn halfway.
Casserole/Stewing Lamb		160°C+WARM Micro	1hr 20-1hr 30 mins	Place in casserole, add stock and vegetables, cover with lid and place on base. Stir halfway.
PASTA.				
Fusilli/ Macaroni/ Penne	200g	HIGH Micro	12 mins	Use 550ml (1 pint) boiling water. Add 15 ml oil. Cover. Stir halfway.
Lasagne	250g	HIGH Micro	8 mins	Use 550ml (1 pint) boiling water. Add 15 ml oil. Cover. Stir halfway.
Linguine/Tagliatelle	250g	HIGH Micro	10-12 mins	Use 700ml (1¼ pt) boiling water. Add 15 ml oil. Cover. Stir halfway.
Spaghetti	250g	HIGH Micro	8-10 mins	Use 700ml (1¼ pt) boiling water. Add 15 ml oil. Cover. Stir halfway.
Steam Pasta	150g	HIGH Micro	1½ mins	Place on Glass dish on base.
PIZZA - FRESH chilled - N.B. Remove all packaging. Pizzas will have a soft base if cooked by microwave only.				
Deep Pan	555g	240°C+GRILL1+LOW Micro	10-12 mins	Place directly on wire shelf in lower position.

Cooking Charts

Food	Weight/ Quantity	Choice of Cooking Modes	Time (mins.)	Instructions/ Guidelines
PIZZA - FRESH chilled - N.B. Remove all packaging. Pizzas will have a soft base if cooked by microwave only.				
Thin and Crispy	140g 180g 250g 440g	240°C+GRILL 1+LOW Micro 240°C+GRILL 1+LOW Micro 240°C+GRILL 1+LOW Micro 240°C+GRILL 1+LOW Micro	4-5½ mins 4-5 mins 5-6 mins 8-9 mins	Place pizza directly on wire shelf in lower position. Place pizza directly on wire shelf in lower position. Place pizza directly on wire shelf in lower position. Place pizza directly on wire shelf in lower position.
PIZZA - FROZEN - N.B. Remove all packaging.				
Deep Pan	450g	240°C+Grill 1 + LOW Micro	10-12 mins	Place directly on wire shelf in lower position.
Individual deep	240g (x2)	240°C+Grill 1+LOW Micro	10 mins	Place directly on wire shelf in lower position.
Thin and crispy	340g	240°C+Grill 1+MEDIUM Micro	8-9 mins	Place directly on wire shelf in lower position.
PORRIDGE - N.B: Use a large bowl.				
1 serving	25g oats 150ml (¼ pt) milk	HIGH Micro	1½-2 mins	Place on base and stir halfway.
2 servings	50g oats 275ml (½ pt) milk	HIGH Micro	2½-3 mins	Place on base and stir halfway.
4 servings	100g oats 550ml (1 pt) milk	HIGH Micro	4-4½ mins	Place on base and stir halfway.
POTATO PRODUCTS part cooked - FROZEN				
Croquettes/Smiley Faces		250°C+GRILL 1	10-12 mins	Place on enamel shelf in upper position.
Hash Browns		250°C+GRILL 1	10-12 mins	Preheat oven. Place on enamel shelf in upper position.
Oven Fries		250°C+GRILL 1	10-12 mins	Place on enamel shelf in upper position.
Potato Wedges		250°C	12-14 mins	Preheat oven. Place on enamel shelf in upper position.
Southern Fries		250°C	15 mins	Preheat oven. Place on enamel shelf in upper position.
Waffles		250°C+GRILL 1	10-12 mins	Place on enamel shelf in upper position.

Cooking Charts

Food	Weight/ Quantity	Choice of Cooking Modes	Time (mins.)	Instructions/ Guidelines
RICE				
Basmati	250g	HIGH Micro	8-10 mins	Use 550 ml (1pt) boiling water. Cover and stir halfway.
Easy cook Long Grain	250g	HIGH Micro	12-14 mins	Use 550 ml (1pt) boiling water. Cover and stir halfway.
Long Grain White	250g	HIGH Micro	8-9 mins	Use 550 ml (1pt) boiling water. Cover and stir halfway.
Steam Rice	200g	HIGH Micro	3-4 mins	Place on Glass dish.
SAUSAGES from raw - CAUTION: Hot Fat! Remove accessory with care.				
Chunky sausages	450g (4)	220°C+ GRILL 1	20 mins	Place on enamel shelf in lower position. Turn halfway.
Cocktail sausages	340g (24)	GRILL 1	14 mins	Place on enamel shelf in lower position. Turn halfway.
Thick	454g (8)	GRILL 1	12-15 mins	Place on enamel shelf in lower position. Turn halfway.
Thin	340g (12)	GRILL 1	16 mins	Place on enamel shelf in lower position. Turn halfway.
Vegetarian	250g (5)	GRILL 1	15 mins	Place on enamel shelf in lower position. Turn halfway.
TURKEY				
Breasts, boneless and skinless	500g	MEDIUM Micro	10 mins	Place on Glass dish.
Whole		190°C + SIMMER Micro	13-14 min. per 450g	Place on a Glass dish on an upturned saucer on base of oven. Turn Halfway.
FRESH VEGETABLES - Place in shallow micro-safe dish.				
Asparagus	200g	MEDIUM Micro	4½ -5 mins	Add 45ml (3 tbsp) water and cover.
Baby Corn	200g	MEDIUM Micro	10 mins	Add 45ml (3 tbsp) water and cover.
Broad Beans	200g	MEDIUM Micro	8 mins	Add 45ml (3 tbsp) water and cover.
Runner Beans	150g	MEDIUM Micro	8 mins	Add 45ml (3 tbsp) water and cover.
Beetroot	450g	MEDIUM Micro	15 mins	Add 45ml (3 tbsp) water and cover.
Broccoli	250g	MEDIUM Micro	8 mins	Add 45ml (3 tbsp) water and cover.
Brussel Sprouts	200g	MEDIUM Micro	8 mins	Add 45ml (3 tbsp) water and cover.
Butternut Squash	300g	MEDIUM Micro	8 mins	Add 45ml (3 tbsp) water and cover.
Cabbage - sliced	300g	MEDIUM Micro	10 mins	Add 45ml (3 tbsp) water and cover.
Carrots - sliced	200g	MEDIUM Micro	6 mins	Add 45ml (3 tbsp) water and cover.

Cooking Charts

Food	Weight/ Quantity	Choice of Cooking Modes	Time (mins.)	Instructions/ Guidelines
FRESH VEGETABLES - Place in shallow micro-safe dish.				
Cauliflower - florets	400g	MEDIUM Micro	10 mins	Add 45ml (3 tbsp) water and cover.
Courgettes	250g	MEDIUM Micro	5 mins	Add 45ml (3 tbsp) water and cover.
Corn on the Cob	x2	MEDIUM Micro	8 mins	Add 45ml (3 tbsp) water and cover.
Leeks - sliced	350g (4)	MEDIUM Micro	8 mins	Add 45ml (3 tbsp) water and cover.
Parsnips - parboiled for roasting sliced	300g 300g	MEDIUM Micro MEDIUM Micro	5-6 mins 10 mins	Add 45ml (3 tbsp) water and cover. Add 45ml (3 tbsp) water and cover.
Peas	200g	MEDIUM Micro	5 mins	Add 45ml (3 tbsp) water and cover.
Potatoes - boiled	500g	MEDIUM Micro	10-12 mins	Add 45ml (3 tbsp) water and cover.
Potatoes - par-boiled	500g	MEDIUM Micro	6-7 mins	Add 45ml (3 tbsp) water and cover.
Jacket Potatoes - 250g each	x1	HIGH MICRO OR 250°C+GRILL1+SIMMER MICRO	7-8 mins 20 mins	Place on Glass dish. Place on wire shelf in lower position.
	x2	HIGH MICRO	12 mins	Place on Glass dish.
	x4	250°C+GRILL1+SIMMER MICRO	25 mins	Place on wire shelf in lower position.
	x6	HIGH MICRO 250°C+GRILL1+SIMMER HIGH MICRO 250°C+GRILL1+SIMMER	20 mins 30 mins 25 mins 35 mins	Place on Glass dish. Place on wire shelf in lower position. Place on Glass dish. Place on wire shelf in lower position.
Spinach	300g	MEDIUM Micro	5-6 mins	Add 45ml (3 tbsp) water and cover.
Sugar Snap peas	300g	MEDIUM Micro	8 mins	Add 45ml (3 tbsp) water and cover.
Swede - cubed	450g	MEDIUM Micro	10 - 12 mins	Add 45ml (3 tbsp) water and cover.
- diced for mashing	450g	MEDIUM Micro	19 mins	Add 45ml (3 tbsp) water and cover.
Sweet Potato	400g	MEDIUM Micro	10 mins	Add 45ml (3 tbsp) water and cover.
Turnip	300g	MEDIUM Micro	12 mins	Add 45ml (3 tbsp) water and cover.
FROZEN VEGETABLES - Place in shallow micro-safe dish.				
Battered Onion Rings	250g	250°C	15 mins	Place on enamel shelf in upper position.

Cooking Charts

Food	Weight/ Quantity	Choice of Cooking Modes	Time (mins.)	Instructions/ Guidelines
FROZEN VEGETABLES - Place in shallow micro-safe dish.				
Beans - broad	200g	MEDIUM Micro	7-8 mins	Add 30 ml (2tbsp) water. Cover.
Beans - green	200g	MEDIUM Micro	8-9 mins	Add 30 ml (2tbsp) water. Cover.
Broccoli - florets	250g	MEDIUM Micro	8-9 mins	Add 30 ml (2tbsp) water. Cover.
Carrots - sliced	200g	HIGH Micro	4 mins	Add 30 ml (2tbsp) water. Cover.
Cauliflower	250g	MEDIUM Micro	9-10 mins	Add 30 ml (2tbsp) water. Cover.
Mixed Vegetables	200g	MEDIUM Micro	8 mins	Add 30 ml (2tbsp) water. Cover.
Peas	200g	MEDIUM Micro	6-7 mins	Add 30 ml (2tbsp) water. Cover.
Soya Beans	200g	HIGH Micro	3-4 mins	Add 30 ml (2tbsp) water. Cover.
Steam Vegetables	80g 125g	HIGH Micro HIGH Micro	2-2 mins 30 secs 3 mins	Place on Glass dish. Place on Glass dish.
Sweetcorn	200g	MEDIUM Micro	6 mins	Add 30ml (2 tbsp) water. Cover.

Increasing and Decreasing Recipes

Increasing Recipes

To increase a recipe from 4 to 6 servings

- Increase each ingredient listed by half. To double the quantity, simply double every ingredient listed.
- Do not forget that large quantities will require a larger dish. Make sure that it is deep enough to prevent the recipe from boiling over during cooking.
- Cover as directed in the recipe. Stir or rearrange foods as recommended.
- Increase the stand times by 5 mins. per lb.
- Always check the recipe during cooking.
- When increasing the ingredients to 6 servings, add an extra one third of the original cooking time, i.e.. 30 mins. on MEDIUM power for 4 servings will become 40 mins. on MEDIUM power for 6 servings.

When doubling a recipe from 4 to 8

- Add on half the original cooking time, i.e. 30 mins. on MEDIUM power for 4 servings will become 45 mins. on MEDIUM power for 8 servings.

Decreasing Recipes

- To decrease a recipe from 4 servings to 2 servings, halve the ingredients listed.
- Choose a dish that is proportionally smaller than the one recommended in the recipe, however make sure it is deep enough to stop food boiling over.
- Allow half to two-thirds of the original cooking time, i.e. 30 mins. on MEDIUM power for 4 servings will become 15-20 mins. on MEDIUM power for 2 servings.

Using Recipes from Other Books

The best way to convert a family favourite dish is to find a similar recipe in a cookery book to give you a guide to the correct method and timings to use.

Many cookbooks refer to 650W ovens, however since 1990 oven output powers have been set by a new standard (IEC). When using

other cookbooks, the 1000 W output power of your oven must be allowed for. Use the same power level suggested e.g. HIGH or MEDIUM and select the same cooking time suggested, however CHECK the progress of the food during cooking and adjust the time if necessary.

Cooking for One

- For one serving quarter ALL ingredients listed.
- Choose a dish that is proportionally smaller than the one recommended in the recipe.
- Use the same cooking power recommended in the original recipe.
- Start by cooking for one quarter of the recommended cooking time, although extra time in most cases will be required.
- Always check the food during cooking.
- There is not a great saving for reduced quantities of soups, casseroles, stews and rice, as a minimum time is required to tenderise meats and blend flavours.
- When cooking for one it often makes sense to cook for two and plate up both meals. Freeze one meal for a later date.

Soups and Starters

Carrot & Orange Soup



Serves 4

Dish: 3 litre (6 pt) bowl

Ingredients

25g (1oz) butter
 1 medium onion, coarsely chopped
 700g (1½ lb) peeled carrots, sliced
 700ml (1¼ pints) vegetable stock
 grated zest of ½ orange
 90ml (6tbsp) orange juice
 60ml (4tbsp) crème fraiche
 salt & black pepper
 15ml (1tbsp) fresh chives, cut into pieces

Place the butter and onion in a large bowl. Place on base of oven and cook on **MEDIUM MICROWAVE** for 4 mins. or until soft. Add the carrots and cook on **MEDIUM MICROWAVE** for 10 mins. and stir halfway. Add stock and orange zest and juice. Cover and cook on **MEDIUM MICROWAVE** for 16-18 mins. or until the carrots are soft, stirring halfway. Cool. Place in liquidiser and puree until smooth. Stir in the crème fraiche and season to taste. Cover and cook on **MEDIUM MICROWAVE** for 3 mins. or until piping hot. Garnish with fresh chives.

Thai Butternut Squash Soup



Serves 6

accessory: Glass tray on base
 dish: 6pint Glass mixing bowl

Ingredients

1-3 green chillies
 3" piece of root ginger peeled and finely chopped
 2-3 lemongrass sticks – just the soft middle part finely chopped
 1 small pack of fresh coriander stalks only –keep leaves for garnish
 1 ½ tsp Chinese five spice
 1tsp ground cumin
 2tbsp olive oil
 1 onion sliced
 1 small pumpkin around 1.1 kg whole weight
 1 pint/600ml vegetable stock
 400g tin of low fat coconut milk
 2 limes
 salt and pepper

Make the spicy paste by combining the first seven ingredients. Use a food processor or a pestle and mortar to do this. Add onion to the paste. Put in a large glass mixing bowl, cover with pierced cling film and cook on **HIGH MICROWAVE** for 5 mins. Peel and chop butternut squash scraping out all seeds and stringy bits. Add butternut squash and hot stock to the mixing bowl. Cook on **HIGH MICROWAVE** for 15-20mins or until butternut squash is soft, stirring once during cooking time. Add coconut milk, juice of limes, salt and pepper. Liquidise. Stir and serve with coriander leaves.

Soups and Starters

Sweet Potato Soup



Serves 4

Dish: 3 litre (6 pt) bowl

Ingredients

15ml (1tbsp) olive oil
 1 medium onion, coarsely chopped
 2 cloves garlic, crushed
 700g (1½ lb) sweet potatoes,
 peeled and chopped
 1 large red pepper, deseeded and
 chopped
 725ml (1¼ pints) vegetable stock
 150ml (¼ pt) coconut milk
 salt and pepper

Place the oil, onion and garlic in a large bowl. Place on base of oven and cook on **MEDIUM MICROWAVE** for 3 mins. or until soft. Add the potato and pepper and cook on **MEDIUM MICROWAVE** for 5 mins. Add stock, cover and cook on **MEDIUM MICROWAVE** for 15 mins. or until the potatoes are soft, stirring halfway. Cool. Place in liquidiser and puree until smooth. Stir in the coconut milk and season to taste. Cover and cook on **MEDIUM MICROWAVE** for 3 mins. or until piping hot.

Pork and Liver Terrine



Serves 4-6

Dish: bowl, 600ml (1 pint) earthenware terrine
 or Glass loaf dish

Ingredients

250g (9oz) streaky bacon, de-rinded
 225g (8oz) minced pork
 225g (8oz) pigs liver, chopped
 ½tsp (3ml) rosemary
 ½tsp (3ml) thyme
 ½tsp (3ml) ground mace
 ½tsp (3ml) allspice
 salt & freshly milled black pepper
 30ml (2tbsp) dry white wine
 15g (½ oz) butter
 2 shallots, finely chopped
 1 clove garlic, crushed
 1 egg, beaten
 1tbsp plain flour

Line base and sides of dish with bacon rashers, stretching each rasher slightly with a knife. Place the minced pork, chopped liver, herbs, spices, seasoning and wine in a non metallic bowl and marinate for 2 hours in the fridge. Place butter, shallots and garlic in bowl. Place on base of oven and cook on **HIGH MICROWAVE** for 2 mins. Cool. Combine the meat marinade with the onion mixture. Add the egg and flour and mix well. Turn into the bacon lined dish. Smooth the top and fold over the bacon. Cover with greaseproof paper, place on base of oven and cook on **CONVECTION 160°C + WARM MICROWAVE** for 40-45 mins

Soups and Starters

Garlic Mushrooms with herbs



Serves 4

Dish: bowl

Oven Accessory: no accessory then Glass tray

Ingredients

50g (2oz) butter
1 garlic clove, crushed
15ml (1tbsp) dried mixed herbs
salt & pepper
8 field mushrooms approx 225g
(8oz)

Put butter, garlic, herbs and seasoning into a bowl. Place on base of oven and soften on **MEDIUM MICROWAVE** for 20 secs. Place the mushrooms on the Glass tray and spoon butter mixture over them. Place Glass tray on base of oven and cook on **MEDIUM MICROWAVE** for 8-10 minutes or until just tender.

Prawn & Salmon Filo Parcels



Serves 4

Dish: greased baking sheet 32 x 23cm (12½ x 9 inches)

Oven Accessory: wire shelf in lower position

Ingredients

250g (9oz) tail end of salmon, boned, skinned, and cut into bite-sized pieces.
125g (4 ½oz) cooked peeled prawns
juice of ½ lemon
salt & black pepper
125g (4 ½oz) filo pastry
50g (2oz) butter, melted

Combine salmon and prawns. Sprinkle with lemon juice and season to taste. Preheat the oven empty on **CONVECTION 190°C**. Cut the filo pastry into 8 squares measuring 18cm (7 in). Brush 2 squares with the melted butter, covering the remaining squares with a damp tea towel. Place ¼ of the salmon & prawn mixture in the middle of one buttered filo square. Fold 2 sides of the filo to form a rectangle. Fold one of the open ends over the filling and the other one underneath. Place this parcel on the second buttered square and draw up the edges and seal the parcel. Repeat steps 4-7 three more times. Place parcels on baking sheet, brush with melted butter and place on wire shelf. Cook on **CONVECTION 190°C** for 20 mins. or until crisp and golden.

Soups and Starters

Onion & Feta Cheese Tartlets



Serves 6

Dish: 3 litre (6 pint) bowl and 2 greased baking sheets 32 x 23cm (12½ x 9 inches)

Oven Accessory: no accessory then enamel shelf in lower position + wire shelf in upper position

Ingredients

250g (9oz) ready made puff pastry
15 ml (1tbsp) olive oil
225g (8oz) onions peeled & sliced
25g (1oz) pine nuts
100g (4oz) feta cheese crumbled
25g (1oz) pitted black olives roughly chopped
75g (3oz) sun-dried tomatoes, roughly chopped
15g (½ oz) capers
salt and freshly ground black pepper
fresh oregano sprigs to garnish

Roll out the puff pastry and cut out 6 circles each 10cm (4 inches) in diameter. Chill pastry for 30 mins. Put oil and onions into large bowl. Place on base of oven and cook on **MEDIUM MICROWAVE** for 15 mins. Cool for 5 mins. Preheat oven on **CONVECTION 230°C** with shelves in position. Stir nuts, cheese, olives, sun-dried tomatoes and capers into onion mixture. Season well. Place 3 pastry circles on each baking sheet and prick with a fork. Divide the onion mixture among the pastry circles. Place baking sheets on shelves and cook the tarts on **CONVECTION 230°C** for 10-15 mins. or until golden brown.

Red Pepper & Mushroom Bruschetta



Serves 4

Dish: bowl

Oven Accessory: no accessory then enamel shelf in upper position then wire shelf in Lower position with Glass tray.

Ingredients

200g (7oz) or 4-5 large flat mushrooms
10ml (2 tsp) olive oil
8 slices ciabatta
25g (1oz) softened butter beaten with 1 chopped clove of garlic
150g (5oz) jar roasted red peppers, sliced if necessary
100g (4oz) firm goat's cheese

Slice mushrooms, place in a bowl and drizzle with olive oil. Place on base of oven and cook on **MEDIUM MICROWAVE** for 5 mins. Leave to cool slightly. Spread one side of each slice of ciabatta with garlic butter. Place the ciabatta slices on the enamel shelf and toast on **GRILL 1** for 5 mins. Remove enamel shelf. Turn the ciabatta slices over and place on Glass tray. Layer mushrooms and pepper on top of ciabatta slices. Cut the goat's cheese into 8 slices and put one slice on top of each stack. Place Glass tray on wire shelf and cook on **GRILL 1 + SIMMER MICROWAVE** for 4-5 mins.

Soups and Starters

Pear and Stilton Crostini



Serves 4

Oven Accessory: wire shelf in upper position with Glass tray on oven base

Ingredients

8 slices of French baguette
100g stilton sliced
2 fresh pears peeled, cored, sliced and dipped in lemon juice or 4 tinned pear halves in juice
Crushed walnuts

Place the slices of baguette on the wire shelf and cook on **GRILL 1** for 2 ½ mins. or until lightly toasted. Turn the slices over and cover with stilton, making sure that it covers each slice right to the edge. Top with sliced pear. Cook on **COMBINATION: GRILL 1 + Warm** power for 4-5mins. Open the door a minute before the end of the cooking time and top with walnuts. Close the door and press start to finish cooking.

Tip: This recipe also works well with brie and cranberry sauce or goat's cheese and figs

Asparagus in Parma Ham



Serves 4

Oven accessory: Glass dish and wire shelf on lower level

Ingredients

16 asparagus spears
8 slices parma ham
2tsp olive oil

Trim the ends of the asparagus spears. Cut each slice of parma ham in half lengthwise. Wrap the asparagus in the ham, starting from the stem, leaving the tip exposed. Put the wrapped asparagus on the glass tray and pour over the olive oil. Cook on **COMBINATION: CONVECTION 200°C + LOW MICROWAVE** for 15mins.

Fish

Fish cooks very well by **MICROWAVE** as it stays very moist.

LIQUID- Fresh or frozen fish should always be sprinkled with 30 ml (2 tbsp) of lemon juice, white wine or water for even cooking.

Do not sprinkle salt onto fish before cooking as this may make the fish dry.

WHEN IS FISH COOKED?- Fish is cooked when it flakes easily and becomes opaque. For fish with a strong odour, eliminate the smell after cooking by placing 600 ml (1pt) of boiling water and 1 sliced lemon in a large bowl and cook on **SIMMER MICROWAVE** for 20 mins. Wipe out oven with a dry cloth.

ARRANGING- If cooking 2 whole fish together, they should be arranged head to tail for even cooking. Fish steaks should be arranged in a circle, thicker part to the outside. Cover with cling film or lid.

NOISE- During cooking, popping sounds may be heard. This is due to moisture trapped between the flesh, particularly with oily fish such as salmon and mackerel. This can be minimised when cooking if the skin and flesh is pierced several times with a cocktail stick.

Mixed Seafood Gratin



Ingredients

50g (2oz) onion
 2 garlic cloves
 50g (2oz) butter
 25g (1oz) plain flour
 100 ml (4fl.oz) white wine
 100 ml (4fl.oz) milk
 150 ml (¼ pt) single cream
 100g (4oz) Emmental cheese
 450g (1lb) mixed cooked seafood
 salt & pepper to season
 100g (4oz) Tortilla chips
 100g (4oz) breadcrumbs

Serves 4

Dish: 24 cm (9") round gratin dish

Oven Accessory: no accessory then wire shelf in lower position

Chop the onion and garlic and put in dish with butter. Place on base of oven and cook on **MEDIUM MICROWAVE** for 3 mins. Add the flour and pour in the wine and milk gradually. Stir well. Cook on **HIGH MICROWAVE** for 2 mins, stirring halfway. Add the cream and cheese and cook on **HIGH MICROWAVE** for 2 mins. Add the seafood to the sauce and mix well. Season to taste. Top with the crushed tortilla chips and breadcrumbs. Place on wire shelf and cook on **CONVECTION 230°C + GRILL 3 + LOW MICROWAVE** for 15 mins or until crisp and piping hot.

Fish

Special occasion Fish Pie



Serves 4

Dish: shallow oval dish, large bowl

Oven Accessory: Glass tray then no accessory then wire shelf in lower position

Ingredients

450g (1lb) white fish
 50g (2oz) butter
 50g (2oz) flour
 450ml (3/4 pt) milk
 300ml (1/2 pt) white wine
 450g (1lb) mixed seafood
 6 gherkins, diced
 15ml (1tbsp) fresh parsley
 10ml (2tsp) dill
 salt and pepper
Rosti topping:
 900g (2 lb) potatoes
 15ml (1tbsp) capers
 50g (2oz) butter, melted
 50g (2oz) cheddar cheese, grated

Place the white fish on Glass tray on base of oven. Cook on **AUTO FRESH FISH PROGRAM** or on **MEDIUM MICROWAVE** for 5 mins. Skin, bone and flake the fish. Place potatoes in a large shallow dish with 3 tbsps water and cover. Place on base of oven and par-boil on **MEDIUM MICROWAVE** for 10 mins. and then allow to cool slightly. Put butter in a large bowl. Place on base of oven and cook on **HIGH MICROWAVE** for 1 min. and then stir in flour to make a roux. Mix in the milk and wine gradually, stirring continuously until well combined and cook on **HIGH MICROWAVE** for 3 mins. Stir and cook for a further 2-3 mins. on **HIGH MICROWAVE** stirring halfway. Mix in the fish, mixed seafood, gherkins and herbs. Season and pour into the bowl. Grate the potatoes and mix in the capers, melted butter and grated cheese. Pile onto fish sauce without pressing firmly to keep the grated form. Place on wire shelf and cook on **CONVECTION 220°C + SIMMER MICROWAVE** for 30-35 mins. or until piping hot and golden.

Stuffed Citrus Trout



Serves 2

Oven Accessory: Glass tray + wire shelf in lower position

Ingredients

2 trout, 250-300g (8-10oz) each
Stuffing:
 4 spring onions, finely chopped
 50g (2oz) button mushrooms, finely sliced
 2.5 cm (1") fresh root ginger, finely grated
 15ml (1tbsp) soy sauce
 juice of 1 lime
 salt & pepper

Wash the fish and pat dry. Fill the fish cavities with the onions, mushrooms and ginger and arrange the fish on the Glass tray. Pour over the soy sauce and lime juice. Season and marinade for one hour in the fridge. Place Glass tray on low rack and cook on **CONVECTION 200°C + LOW MICROWAVE** for 15 mins.

Fish

Steamed Mussels with Garlic



Ingredients

900 g (2lb) mussels (weight in shells)
 15ml (1tbsp) olive oil
 1 onion finely chopped
 2 garlic cloves, crushed
 150ml (¼ of a pint) dry white wine
 1 bunch flat-leaf parsley, finely chopped

Serves 2

Dish: large rectangular dish

Scrub mussels and pull off any beards discarding any broken or open shells. Place oil, onion and garlic in a dish. Place on base of oven and cook on **HIGH MICROWAVE** for 2 mins. Add wine and cook on **HIGH MICROWAVE** for 3 mins. Add the mussels cover dish with cling film and pierce, and cook on **MEDIUM MICROWAVE** for 5-6 mins. Discard any unopened shells. Add the parsley and stir before serving.

Prawn and haddock Pie



Ingredients

For the sauce:

15g (½ oz) butter
 15g (½ oz) flour
 275ml (½ pint) milk
 350g (12oz) fresh haddock fillet
 350g (12oz) fresh undyed smoked haddock
 100g (4oz) prawns
 salt & pepper
 1tbsp chopped flat leaf parsley

For the topping:

700g (1lb 8oz) potatoes, peeled, chopped into small chunks
 450g (1lb) Swede, diced
 50g (2oz) butter

Serves 6

Dish: large jug, shallow oval dish

Oven Accessory: no accessory then trivet and Glass tray then no accessory then wire shelf in lower position

Put butter in large jug, place on base of oven and cook on **HIGH MICROWAVE** for 30 secs. and stir in flour to make a roux. Then add the milk gradually, stirring continuously until well combined and cook for 2 mins. on **HIGH MICROWAVE**. Stir and cook for a further 2 mins. on **HIGH MICROWAVE** stirring halfway. Season and set aside. Place fresh and smoked haddock on Glass tray directly on base of oven. Cook fish on **AUTO FRESH FISH PROGRAM** or on **MEDIUM MICROWAVE** for 10 mins. Flake the fish into a shallow oval dish and scatter the prawns over. Pour over the sauce, season and sprinkle with chopped parsley. Place potatoes in a dish with 3tbsp water. Place on base of oven, cover and cook on **AUTO POTATO PROGRAM** or on **MEDIUM MICROWAVE** for 10-12 mins until soft. Drain. Place Swede in a dish with 3tbsp water. Cover and cook on **MEDIUM MICROWAVE** for 15 mins. Mash potato with 25g (1oz) butter. Mash Swede with 25g (1oz) butter and mix in 2 tbsps of mashed potato. Spoon alternate lines of potato and Swede over the top of the fish mixture to cover. Fluff up with a fork. Place on wire shelf and cook on **CONVECTION 230°C + GRILL 3 + LOW MICROWAVE** for 15-20 mins.

Fish

Salmon with Mango Salsa



Ingredients

4 salmon fillets each 100-150g (4-6oz)

marinade:

45ml (3tbsp) white wine

1 garlic clove, crushed

2.5 cm (1") fresh root ginger, finely grated

mango salsa:

2 red chillies, seeds removed, thinly sliced

100g (4oz) peeled, cooked prawns

4 spring onions, thinly sliced

1 small garlic clove, finely chopped

1 ripe but firm avocado, peeled and chopped

½ ripe mango, peeled and chopped

1 lime, juice of

Serves 4

Dish: shallow dish

Oven Accessory: Glass dish

Mix the marinade ingredients together. Pour marinade over salmon in dish and leave to marinate for 2-3 hrs in the fridge. Mix all the salsa ingredients together and chill in fridge. Place the salmon in the Glass dish directly on base of oven. Pour over half the marinade and cook salmon on **MEDIUM MICROWAVE** for 3 mins. Pour the remaining marinade over the salmon and continue cooking on **MEDIUM MICROWAVE** for 3-4 mins. Serve salmon with the salsa.

NOTE: For 2 fillets the marinade and salsa quantities should be halved and total cooking time on **MEDIUM MICROWAVE** should be reduced to 6-8 mins.

*Alternatively the Salmon may be grilled. Place salmon skin side up on the Enamel shelf in the upper position and cook on **GRILL 1** for 10 mins. Turn halfway.

Creamy Cod & Leek Chowder



Ingredients

500g (1lb 2oz) potatoes, peeled, cut into 1cm (½") cubes

25g (1oz) butter

2 large leeks, thickly sliced

15ml (1tbsp) plain flour

275ml (½ pt) tub fresh fish stock

275ml (½ pt) water

bay leaf

275ml (½ pt) milk

250g (9oz) cod fillet, cubed

10 tiger prawns, peeled

Serves 4

Dish: large shallow dish and large bowl

Place potatoes in a large shallow dish with 3tbsps water and cover. Place on base of oven and cook on **MEDIUM MICROWAVE** for 7 mins. Place the butter and leeks in a large bowl. Place on the base of oven and cook on **HIGH MICROWAVE** for 2-3 mins. and then add the potatoes. Stir in the flour and gradually add the fish stock, water and bay leaf. Cook on **HIGH MICROWAVE** power for 8-10 mins or until the potato is tender. Stir halfway. Then stir in the milk and fish. Cook on **MEDIUM MICROWAVE** power for 7-8 mins or until the fish is cooked. Remove the bay leaf and season to taste. Serve immediately.

Fish

Salmon with Hollandaise Sauce



Serves 4

Dish: shallow dish, 1 litre (2 pt) jug

Ingredients

4 salmon fillets or steaks each 100-150g (4-6oz)

30ml (2tbsp) white wine

Sauce:

3 egg yolks

30 ml (2tbsp) white wine vinegar

150g (5oz) chilled, unsalted butter, cut into cubes

pepper

Place salmon in dish with wine. Place on base of oven, cover and cook on **MEDIUM MICROWAVE** for 7 mins. Leave to stand and make sauce. Place egg yolks and vinegar in a jug. Beat well. Drop cubes of butter on top. Place jug on base of oven and cook on **HIGH MICROWAVE** for 30 secs. Whisk. Cook on **HIGH MICROWAVE** for 10 secs. Whisk again and cook on **HIGH MICROWAVE** for 10 secs. Repeat 10 sec. stages until sauce is thick and creamy. Season and serve immediately with salmon steaks or asparagus spears.
N.B. This sauce must not boil or the eggs will curdle.

Soy and Honey Steamed Salmon



Serves 4

Dish: shallow dish

Oven Accessory: Glass dish

Ingredients

4 salmon fillets each 100-150g (4-6oz)

Marinade:

15ml (1 tbsp) honey

30ml (2tbsp) dark soy sauce

15ml (1tbsp) sherry

1 garlic clove, crushed

5ml (1tsp) fresh root ginger, grated

Mix the marinade ingredients together. Pour marinade over salmon in dish and leave to marinate for 2-3 hrs in the fridge. Place the salmon directly on base of oven and place on the Glass dish. Pour over half the marinade and cook salmon on **MEDIUM MICROWAVE** for 5 mins. Pour the remaining marinade over the salmon and continue cooking on **MEDIUM MICROWAVE** for 5-6 mins.

NOTE: For 2 fillets the marinade quantities should be halved and total cooking time on **MEDIUM MICROWAVE** should be reduced to 6-8 mins.

Fish

Sun Dried Tomato Fish Bake



Ingredients

60ml (4tbsp) natural low fat yogurt
 30ml (2tbsp) sun-dried tomato pesto
 30ml (2tbsp) chopped fresh parsley
 or dill
 2 x 175g (6oz) cod or haddock
 fillets, skinned

Serves 2

Oven Accessory: Glass tray and wire shelf in upper position

Mix the yoghurt, pesto and 1 tbsp of the parsley or dill and season well. Place fish fillets on Glass tray and pour over the yoghurt sauce. Place on wire shelf and cook on **GRILL 2 + MEDIUM MICROWAVE** for 8-9 mins. Sprinkle the remaining parsley or dill over the dish and serve with salad and crusty bread.

Mediterranean Fish Bake



Ingredients

juice of ½ lemon
 100g (4oz) fresh pesto sauce
 salt & pepper
 4 x 175g (6oz) thick cut haddock,
 cod or salmon fillets
 700g (1lb 8oz) waxy new potatoes
 (such as charlotte)
 2 medium red onions
 1 red pepper, seeded
 1 yellow pepper, seeded
 1 orange pepper, seeded
 2 garlic cloves, crushed
 30ml (2tbsp) extra virgin olive oil
 100g (4oz) black olives, chopped
 (optional)
 lemon wedges and crisp green
 salad, to serve

Serves 4

Dish: large ovenproof rectangular dish
Oven Accessory: wire shelf in lower position

Mix lemon juice, pesto and seasoning together and spoon over the fish. Leave to marinade in the fridge for 1-2 hours. Cut vegetables into even sized chunks and toss with the garlic and oil. Place in the ovenproof dish on the wire shelf and cook on **CONVECTION 220°C + GRILL 2 + SIMMER MICROWAVE** for 15 mins. Turn. Cook on **CONVECTION 220°C + GRILL 2 + SIMMER MICROWAVE** for a further 15 mins. Scatter the black olives over the vegetables and place the fish and marinade on top of the vegetables. Cook on **CONVECTION 220°C + GRILL 3 + LOW MICROWAVE** for 15-20 mins. or until cooked through.

Meat and Poultry

Defrosted joints

If the meat has previously been frozen, ensure it is properly thawed before cooking. Defrosted joints of meat must be allowed to STAND for up to an hour before cooking to ensure the centre is fully defrosted.

Fat

Large amounts of fat absorb microwave energy and can cause the meat next to it to overcook. Always choose meat that isn't excessively fatty. Braised and stewed meat cooked in a microwave has a slightly firm texture and therefore it is essential to purchase good quality meats.

Standing time

Meat and poultry joints require a minimum of 15 mins. **STANDING TIME**. Roast meat is always easier to carve after **STANDING** and the meat will continue to cook during the **STAND TIME**.

Turning

Joints and poultry should be turned over halfway through cooking.

Roasting bags

Roasting bags are useful when split up one side to tent a joint for roasting by microwave and time. Do not use the metal twists supplied when operating with microwave.

Chicken Casserole



Serves 4

Dish: 3 litre (6 pt) large casserole with lid

Ingredients

4 x 225g (8oz) boneless skinless chicken breasts, cut into small chunks
 50g (2oz) plain flour
 15ml (1tbsp) oil
 15g (½ oz) butter
 1 garlic clove, crushed
 4 shallots, chopped
 150g (5oz) mushrooms, sliced
 15ml (1tbsp) Dijon mustard
 200 ml (7 fl.oz) hot chicken or vegetable stock
 200 ml (7 fl.oz) dry white wine
 225g (8oz) baby new potatoes, halved
 225g (8oz) baby carrots halved
 100g (4oz) asparagus tips
 100g (4oz) frozen broad beans
 45ml (3tbsp) double cream
 30ml (2tbsp) mixed fresh parsley and tarragon, chopped
 crusty bread, to serve

Coat chicken with flour and place in fridge. Place oil, butter, garlic, shallots and mushrooms into casserole. Place on base of oven and cook on **HIGH MICROWAVE** for 3 mins. Stir in Dijon mustard and add chicken. Then stir in stock and wine. Add potatoes and carrots. Cover casserole, place on base of oven and cook on **CONVECTION 160°C + WARM MICROWAVE** for 1 hr stirring halfway. Stir in asparagus, broad beans and cream and cook on **CONVECTION 160°C + WARM MICROWAVE** for a further 30 mins. Stir in herbs and serve with crusty bread.

Meat and Poultry

Sticky Ribs



Serves 4

Dish: 20 x 25 cm (8 x 10 inch) rectangular dish, large bowl

Oven Accessory: no accessory then wire shelf in lower position.

Ingredients

1 kg (2lb2oz) pork spare ribs
150 ml (¼ pt) water

For the glaze

150g (5oz) orange marmalade preferably shred less or fine shred
25g (1oz) dark muscovado sugar
100ml (4fl.oz) fresh orange juice
5cm (2 inch) piece fresh root ginger, peeled and coarsely grated
75ml (5 tbsp) tomato ketchup
30ml (2 tbsp) white wine vinegar

Place the ribs in a single layer in dish with the water. Cover and place on base of oven and cook on **MEDIUM MICROWAVE** for 10 mins. Drain. Meanwhile, mix together all the ingredients for the glaze in a large bowl. Place on base of oven and cook on **HIGH MICROWAVE** for 5 mins. Pour glaze over ribs and place dish on shelf. Cook on Combination: **230°C + GRILL 3 + LOW MICROWAVE** for 20-25 mins. Turn halfway and baste..

Pork with Herby Dumplings



Serves 4

Dish: 3 litre (6 pt) large casserole with lid

Ingredients

30 ml (2tbsp) oil
1 medium onion, chopped
1 green pepper, deseeded and chopped
225g (8oz) carrots, sliced
450g (1lb) lean pork, cubed
30 ml (2tbsp) seasoned flour
5 ml (1tsp) ground bay leaves
5 ml (1tsp) dried sage
salt and pepper
300 ml (½ pt) dry cider

Dumplings:

175g (6oz) self raising flour
75g (3oz) suet
pinch of salt
5 ml (1tsp) mustard powder
15 ml (1tbsp) fresh parsley, chopped
150 ml (¼ pt) cold water

Place oil, onion, green pepper and carrots in casserole. Cover and place on base of oven and cook on **MEDIUM MICROWAVE** for 5 mins. Toss pork in seasoned flour and add to onion mixture. Stir in all other ingredients. Place on base of oven and cook on **CONVECTION 160°C + WARM MICROWAVE** for 1hr or until pork is tender. Whilst cooking make the dumplings by combining the flour, suet, salt, mustard and parsley. Add the water to make a stiff dough. Shape dough into 8 round dumplings. When pork is cooked, uncover and place dumplings around the edge of dish. Cook uncovered on **CONVECTION 160°C + WARM MICROWAVE** for 15 mins. or until dumplings are cooked through.

Meat and Poultry

Toad in the Hole



Ingredients

150g (5oz) plain flour
 3 ml (½ tsp) salt
 2 eggs
 150 ml (¼ pt) milk
 150 ml (¼ pt) water
 15-30 ml (1-2tbsp) oil
 450g (1lb) sausages

Serves 4

Dish: 27 x 22 cm (10½" x 8½") oblong tin

Oven Accessory: enamel shelf in lower position

Preheat oven on **CONVECTION 220°C**. Sift flour and salt in a bowl. Add eggs and half the liquid. Beat until smooth and gradually stir in remaining liquid. Put oil and sausages in tin and place on enamel shelf. Cook on **CONVECTION 220°C** for 15 mins. Pour in the batter and cook on **CONVECTION 220°C** for a further 30-35 mins. or until the batter is well risen and golden brown.

Spicy Lamb Tagine



Ingredients

100g (¾ cup) ground ginger
 3ml (½ tsp) coarsely ground black pepper
 8ml (1 ½ tsp) ground cinnamon
 10ml (¾ tsp) turmeric
 15 ml (1tbsp) paprika
 3ml (½ tsp) chilli powder/flakes
 800g (1lb12oz) cubed boneless lamb
 30ml (2tbsp) oil
 300g (11oz) onions, chopped
 2 crushed garlic cloves
 3ml (½ tsp) salt
 150g (5oz) sliced carrots
 150g (5oz) ready to eat dried apricots, chopped
 40g (1 ½ oz) sultanas or seedless raisins
 65g (2 ½ oz) toasted flaked almonds
 10ml (¾ tsp) honey
 150 ml (¼ pint) tomato juice
 400g (14oz) can chopped tomatoes
 300ml (½ pint) vegetable stock

Serves 6

Dish: 3 litre (6 pt) large casserole with lid

Put spices into bowl and mix well. Add lamb and evenly coat with spices. Place oil, onions and garlic in casserole. Place on base of oven and cook on **MEDIUM MICROWAVE** for 5 mins. Add lamb mixture and mix thoroughly. Stir in remaining ingredients and cover. Cook on **CONVECTION 160°C + WARM MICROWAVE** for 1-1 ½ hours or until tender, stir halfway.

Meat and Poultry

Thai Lamb Curry



Serves 4

Dish: 1.5 litre (3pt) casserole with lid

Ingredients

50g (2oz) creamed coconut
 275ml (½ pt) boiling water
 500g (1lb2oz) lamb fillet, cut into strips about 4cm (1 ½ ") long
 2 garlic cloves
 2.5 cm (1") fresh root ginger, finely grated
 30ml (2tbsp) Thai green curry paste
 1 lime, grated rind and juice
 30ml (2tbsp) fresh coriander

Mix the coconut with the boiling water. Mix all the remaining ingredients except the coriander with the lamb and leave to marinate in the fridge for 30 mins. Combine the coconut and the lamb mixture and stir well. Cover, place on base of oven and cook on **CONVECTION 160°C + WARM MICROWAVE** for 55-60 mins stirring halfway. Garnish with fresh coriander.

Marinated Chicken Breasts



Serves 4

Dish: shallow dish

Ingredients

4 x chicken breasts 600g (1lb 5oz), boneless and skinless

Suggested Marinades:

Ginger and Soy

10ml (2tsp) sesame oil
 30ml (2tbsp) light soy sauce
 15ml (1tbsp) white wine
 1 garlic clove, crushed
 5ml (1tsp) fresh root ginger, grated

Lemon and Honey

2 lemons, juice and zest
 30ml (2tbsp) honey
 1 garlic clove, crushed

Lemon and Thyme

1 lemon, juice and zest
 45ml (3tbsp) white wine
 thyme, 4-5 sprigs

Sesame and Honey

30ml (2tbsp) honey
 15ml (1tbsp) dark soy sauce
 25g (1oz) toasted sesame seeds

Mix the selected marinade ingredients together. Pour marinade over chicken directly in dish and leave to marinate for 2-3 hrs in the fridge. Place the chicken in an oven proof dish. Pour over half the marinade cover. Cook chicken on **LOW MICROWAVE** for 7 mins. Pour the remaining marinade over the chicken and continue cooking on **LOW MICROWAVE** for 8-10 mins.

NOTE: For 2 chicken breasts 300g (10oz) the marinade quantities should be halved and total cooking time on **LOW MICROWAVE** should be reduced to 10 mins.

Meat and Poultry

Madras Curry



Ingredients

15 ml (1tbsp) oil
 1 large onion, sliced
 3 cloves garlic, crushed
 10 ml (2tsp) ground coriander
 3ml (½ tsp) chilli powder, ground
 cardamom, ground cloves
 15ml (1tbsp) garam masala
 15ml (1tbsp) ground turmeric
 5ml (1tsp) ground cumin
 25g (1oz) flour
 15 ml (1tbsp) tomato puree
 450g (1lb) shoulder of lamb, cubed
 juice of 1 lemon
 5 ml (1tsp) sugar
 25g (1oz) sultanas
 pinch of salt
 450 ml (¾ pt) hot stock

Serves 4

Dish: 3 litre (6pt) large casserole with lid

Place the oil, onion and garlic in casserole dish. Place on base of oven and cook on **MEDIUM MICROWAVE** for 3 mins. Blend in all the spices and stir in the flour and tomato puree. Add all other ingredients and blend in hot stock. Cover and cook on **CONVECTION 160°C + WARM MICROWAVE** for 1hr-1hr 30 mins. until meat is tender, stirring occasionally. Serve with boiled rice and lemon or lime wedges and poppadoms.

Cheesy Chicken Breasts



Ingredients

100g (4oz) ciabatta breadcrumbs
 75g (3oz) gruyere cheese, grated
 salt and pepper
 4 x 150g chicken breast fillets,
 boneless and skinless
 50g (2oz) garlic mayonnaise

Serves 4

Oven Accessory: Glass tray + wire shelf in lower position

Mix the breadcrumbs with the cheese and season well. Dip each chicken breast in the garlic mayonnaise and then the crumbs until coated. Place on the Glass tray on the wire shelf and cook on **CONVECTION 240°C + GRILL 3 + SIMMER MICROWAVE** for 20-25 mins. Slice the chicken and serve.

Meat and Poultry

Chicken Pasanda



Serves 4

Dish: 3 litre (6pt) large casserole with lid

Ingredients

3 cardamom pods
 ½ cinnamon stick
 3ml (½ tsp) cumin seeds
 5ml (1tsp) garam masala
 5ml (1tsp) chilli flakes
 2.5cm (1") fresh root ginger
 1garlic clove, crushed
 25g (1oz) ground almonds
 45ml (3tbsp) natural yoghurt
 600g (1lb5oz) skinless chicken breast, cut into chunks
 15ml (1tbsp) olive oil
 2 onions, finely chopped
 150ml (¼ pt) single cream
 30ml (2tbsp) coriander, chopped

Place the cardamom, cinnamon, cumin, garam masala, chilli, ginger, garlic, almonds and yoghurt into a non metallic bowl. Add chicken and stir well. Leave to marinate in the fridge for 2-3 hours. Place oil and onions in casserole. Place on base of oven and cook on **HIGH MICROWAVE** for 2 mins. Stir chicken into onions. Place casserole on base and cook on **MEDIUM MICROWAVE** for 15 mins. Stir. Cook for a further 10-15 mins on **SIMMER MICROWAVE**. Stir in cream and coriander and cook on **MEDIUM MICROWAVE** for 3 mins. or until hot.

Savoury mince



Serves 4

Dish: 1.5 litre (3 pt) casserole dish with lid

Ingredients

1 onion, chopped
 1 clove garlic, crushed
 5 ml (1tsp) oil
 400g (14oz) can chopped tomatoes
 150ml (5fl.oz) red wine
 30 ml (2tbsp) tomato puree
 5 ml (1tsp) mixed herbs
 500g (1lb1oz) mince
 salt and pepper

Place onion, garlic and oil in casserole. Place on base of oven and cook on **MEDIUM MICROWAVE** for 3 mins. Place all other ingredients in casserole. Stir well. Cover, cook on **HIGH MICROWAVE** for 10 mins. then **MEDIUM MICROWAVE** for 15-20 mins. or until cooked.

Variation: Chilli Con Carne

Add 400g (14oz) can red kidney beans drained, 5-10 ml (1-2tsp) chilli powder and 1 diced green pepper with the onion garlic and oil.

Meat and Poultry

Shepherd's Pie



Serves 4

Dish: shallow dish, large rectangular dish
Oven Accessory: no accessory then wire shelf in lower position

Ingredients

700g (1½ lb) potatoes, cubed
30ml (2tbsp) milk
1 medium onion, chopped
2 carrots, chopped
25g (1oz) butter
350g (12oz) beef or lamb, minced
275ml (½ pt) hot beef stock
3ml (½ tsp) Worcestershire sauce
15ml (1tbsp) gravy thickening
5ml (1tsp) tomato puree
salt and pepper
25g (1oz) cheese

Place potatoes in a dish with 3tbsp water. Cover, place on base of oven and cook on **AUTO POTATO PROGRAM** or on **MEDIUM MICROWAVE** for 10-12 mins until soft. Drain and mash well with the milk. Place onion, carrots and butter into dish. Place on base of oven and cook on **MEDIUM MICROWAVE** for 5 mins. or until soft. Add minced meat to vegetables. Then add stock, Worcestershire sauce, gravy thickening and tomato puree and season to taste. Cook on **HIGH MICROWAVE** for 15 mins then spread potato on top of the meat, using a fork to make a pattern on top. Sprinkle with cheese. Place dish on wire shelf and cook on **CONVECTION 190°C + WARM MICROWAVE** for approximately 25-30 mins. or until top is crisp and golden..

Stuffed Aubergines



Serves 4

Dish: 1.5 litre (3 pt) casserole dish with lid
Oven Accessory: enamel shelf in lower position then no accessory then Glass tray + wire shelf in lower position.

Ingredients

2 large aubergines
1 garlic clove, crushed
1 medium onion, chopped
250g (9oz) minced beef
400g (14oz) tin chopped tomatoes
25g (1oz) pitted black olives, chopped
2tsp dried oregano
2tbsp tomato puree
100g (4oz) sliced crusty bread
50g (2oz) parmesan freshly grated

Preheat oven on **CONVECTION 220°C**. Place the whole aubergines on the enamel shelf and cook on **CONVECTION 220°C** for 15 mins. or until soft. Remove from oven and cool. Cut the aubergines in half horizontally, leaving the stalks attached. Scoop out the flesh and chop finely. Place garlic and onion in dish. Place on base of oven and cook on **MEDIUM MICROWAVE** for 3 mins. Add beef, tomatoes, aubergine flesh, olives, oregano, and tomato puree. Cover and cook on **HIGH MICROWAVE** for 12 mins. Use the bread to make breadcrumbs. Mix 40g (1½ oz) of the parmesan with the breadcrumbs and add to beef mixture. Fill the aubergine skins with the filling. Place aubergines on Glass tray and sprinkle with the remaining parmesan. Place tray on wire shelf and cook on **CONVECTION 220°C + GRILL 1 + WARM MICROWAVE** for 20-25 mins.

Meat and Poultry

Belgian Beef Casserole

Serves 4

Dish: 3 litre (6pt) large casserole with lid



Ingredients

675g (1½ lb) braising steak, cubed
50g (2oz) seasoned flour
2 large onions, sliced thinly
1 clove garlic, crushed
575ml (1 pint) cream stout
15g (½ oz) brown sugar
15 ml (1tbsp) wine vinegar
5 ml (1tsp) mixed herbs

Coat the beef in the seasoned flour and place in casserole. Add the remaining casserole ingredients. Cover with lid, place on base of oven and cook on **CONVECTION 160°C + WARM MICROWAVE** for 1¼ - 1½ hrs or until tender. Stir halfway.

Steak and Mushroom Pudding

Dish: 1.5 litre (3 pt) casserole with lid + 1.2 litre (2 pt) pudding basin



Ingredients

Filling:

450g (1 lb) braising steak, cubed
25g (1oz) seasoned flour
150g (5oz) mushrooms, sliced
1 onion, chopped
1 clove garlic, crushed
5ml (1tsp) thyme
275ml (½ pt) hot beef stock
275ml (½ pt) cream stout

Pudding:

175g (6oz) self-raising flour
pinch salt
75g (3oz) suet
cold water to mix
15 ml (1tbsp) cornflour

Coat the steak in seasoned flour and add to casserole with all the filling ingredients. Cover, place on base of oven and cook on **CONVECTION 160°C + WARM MICROWAVE** for 1hr 15 mins. Mix flour, salt and suet together. Mix to a firm dough with cold water. Roll out ¾ of the pastry to line basin. Remove meat with a slotted spoon and fill basin. Mix cornflour with water and stir into the gravy. Place on base of oven and cook on **HIGH MICROWAVE** for 2 mins. stirring once, or until gravy has thickened. Pour 60 ml (4tbsp) of gravy over the meat and reserve the rest for serving. Roll remaining pastry to form a lid, moisten the edges and seal over the top of the meat. Place on base of oven and cook on **MEDIUM MICROWAVE** for 10-12 mins. or until pastry looks dry.

Meat and Poultry

Hungarian Goulash



Ingredients

700g (1½lb) braising steak, cubed
 50g (2oz) seasoned flour
 1 large onion, diced
 1 red pepper, deseeded and chopped
 400g (14oz) canned, chopped tomatoes
 175g (6oz) mushrooms, sliced
 600ml (1pt) hot beef stock
 45ml (3tbsp) tomato puree
 30ml (2tbsp) paprika
 5ml (1tsp) sugar
 60ml (4tbsp) soured cream

Serves 4

Dish: 3 litre (6pt) large casserole with lid

Toss meat in the flour. Combine all ingredients except the soured cream in casserole dish.

Cover, place on base of oven and cook on **CONVECTION 160°C + WARM MICROWAVE** for 1hr 30 mins, or until the meat is tender, stirring occasionally. Remove from oven and immediately stir in the soured cream.

Lamb Hotpot



Ingredients

450g (1lb) lamb fillet, cut into slices
 50g (2oz) plain flour
 salt and pepper
 2.5ml (½tsp) thyme
 1 medium onion, thinly sliced
 250g (9oz) carrots, sliced
 450g (1lb) potatoes, thinly sliced
 500ml (1 pint) stock

Serves 4

Dish: 3 litre (6pt) casserole with lid

Coat the pieces of lamb in seasoned thyme flour and place in casserole dish. Layer the onions and carrots then the potatoes on top. Pour in the stock. Cover, place on base of oven and cook on **CONVECTION 160°C + WARM MICROWAVE** for 1 hour 30 mins.

Meat and Poultry

Greek Lamb stew



Ingredients

700g (1lb 8oz) lamb fillet, cut into chunks
 2 onions, chopped
 1 red chilli
 2 cloves garlic, crushed
 1 sprig rosemary
 275ml (½ pt) white wine
 400g can chopped tomatoes
 45ml (3tbsp) Sliced Black Olives
 100g (4oz) linguine, broken into small pieces
 150g (5oz) feta cheese cubed
 15g (½ oz) fresh mint chopped

Serves 4

Dish: 3 litre (6pt) casserole with lid

Place the lamb and onion in casserole. Place on base of oven and cook on **MEDIUM MICROWAVE** for 10 mins. Split the chilli along its length leaving the top intact, (remove seeds) - this adds flavour to the stew without too much heat. Stir the chilli, garlic, rosemary, wine and tomatoes into the lamb, with a lid on. Cook on **CONVECTION 160°C + WARM MICROWAVE** for 1 hr stirring halfway. Stir in the black olives and linguine and continue to cook on **CONVECTION 160°C + WARM MICROWAVE** for a further 20 mins or until the linguine is cooked. Remove the chilli and rosemary, and discard. Stir in feta cheese and mint before serving.

Moussaka



Ingredients

700g (1lb 8oz) lamb fillet, cut into chunks
 2 onions, chopped
 1 red chilli
 2 cloves garlic, crushed
 1 sprig rosemary
 275ml (½ pt) white wine
 400g can chopped tomatoes
 45ml (3tbsp) Sliced Black Olives
 100g (4oz) linguine, broken into small pieces
 150g (5oz) feta cheese
 15g (½ oz) fresh mint

Serves 4

Dish: bowl, 1.5 litre (3pt) casserole with lid, large shallow rectangular or oval dish

Oven Accessory: no accessory then wire shelf in lower position

Place aubergines in a large colander and sprinkle liberally with salt. Stand for 20 mins. or until bitter juices run out. Rinse well under cold water and drain. Place oil, garlic and onion in a bowl. Place on base of oven and cook on **MEDIUM MICROWAVE** for 2 mins. Add lamb, tomatoes and puree and mix well. Cover and cook on **HIGH MICROWAVE** for 10 mins. Place aubergine in a dish with 3tbsp water. Cover, place on base of oven and cook on **MEDIUM MICROWAVE** for 4 mins. Whisk eggs, cream and cheddar together. Arrange ½ the aubergine slices in the base of dish and spoon over ½ the lamb mixture and repeat process again. Spread the cheese mixture over the top and sprinkle with Parmesan cheese. Place on wire shelf and cook on **CONVECTION 190°C + SIMMER MICROWAVE** for 15-20 mins. or until topping is puffed and golden.

Meat and Poultry

Layered Chicken Puff



Serves 4-6

Dish: shallow dish and greased baking tray

Oven Accessory: Glass tray then wire shelf in lower position

Ingredients

600g (1lb 5oz) boneless skinless chicken breasts
 30ml (2tbsp) lemon juice
 5ml (1tsp) fresh thyme
 salt and pepper
 200g (7oz) jar of red peppers, drained
 150g (5oz) ripe brie
 350g (12oz) ready made puff pastry
 1 egg, beaten to glaze
 25g (1oz) freshly grated parmesan

Slice the chicken breasts into strips and place between plastic film and flatten using a rolling pin. Put chicken into dish with lemon juice, thyme and seasoning. Allow to marinate for 2-3 hours in the fridge. Place chicken in dish and cover. Cook on **LOW MICROWAVE** for 15 mins or until cooked through. Remove chicken and allow to cool slightly. Roll out pastry to a 28 x 36cm (11" x 14") rectangle. Place ½ of the chicken on the centre third of the pastry. Cover with ½ of the peppers, then all of the brie then the rest of the peppers and finally the remaining chicken. Brush the edges of the pastry with beaten egg and draw up the two longer sides together over the filling and press the edges firmly together to seal. Flute the edges. Pre-heat the oven on **CONVECTION 200°C**. Transfer the pastry onto the baking tray and brush with beaten egg. Sprinkle with parmesan cheese. Place on wire shelf and cook on **CONVECTION 200°C** for 30-35 min turning tray around halfway. Until the pastry is crisp and golden.

Creamy Chicken Gratin



Serves 4

Dish: large bowl, rectangular dish

Oven Accessory: no accessory then wire shelf in lower position

Ingredients

350g (12oz) leeks, trimmed
 25g (1oz) butter
 25g (1oz) plain flour
 275 ml (½ pt) milk
 225g (8oz) cooked chicken, chopped
 100g (4oz) ham, chopped
 150g (5oz) gruyere cheese, grated
 Salt and pepper

Slice the leeks and place in a large bowl with the butter. Place on base of oven and cook on **MEDIUM MICROWAVE** for 10 mins. or until softened. Add the flour and mix well. Stir in the milk and heat on **HIGH MICROWAVE** for 4-5 mins. or until thickened stirring halfway. Add the chicken, ham and cheese then season and mix well. Pour into the dish. Place on wire shelf and cook on **CONVECTION 230°C + GRILL 3 + LOW MICROWAVE** for 15-20 mins or until piping hot and golden.

Meat and Poultry

Coq Au Vin



Ingredients

100g (4oz) streaky bacon
 5ml (1tsp) mixed herbs
 1 clove garlic, crushed
 4 chicken portions approx. 1.2 kg
 (2 ½lb) in weight, skin removed
 salt and pepper
 100g (4oz) button mushrooms
 450g (1lb) whole shallots
 30ml (2tbsp) brandy
 275ml (½ pt) red wine
 150ml (¼ pt) chicken stock
 cornflour to thicken
 parsley, chopped

Serves 4

Dish: 3 litre (6 pt) large casserole with lid

Place bacon, herbs and garlic in casserole. Place on base of oven and cook on **HIGH MICROWAVE** for 2 mins. Place remaining ingredients in casserole dish and cover. Place on base and cook on **CONVECTION 160°C + WARM MICROWAVE** for 1hr 30 mins. or until cooked through. Skim off any excess fat. Thicken using a little cornflour mixed with water. Serve sprinkled with chopped parsley.

Chicken Broth



Ingredients

1 medium onion, finely chopped
 450g (1lb) chicken breast skinless
 and boneless
 725ml (1¼ pts) chicken stock
 150g (5oz) pearl barley
 3ml (½ tsp) season all (optional)
 450g (1lb) carrots - sliced
Dumplings
 175g (6oz) self raising flour
 75g (3oz) suet
 pinch of salt
 150ml (¼ pt) water

Serves 4

Dish: 3 litre (6pt) large casserole with lid

Place onion and chicken in casserole and cover. Place on base of oven and cook on **LOW MICROWAVE** for 10 mins stirring halfway. Add stock, pearl barley, season all and carrots. Cover, place on base and cook on **CONVECTION 160°C+WARM MICROWAVE** for 60 mins. Stir halfway. Whilst cooking make the dumplings by mixing all the ingredients together. Place dumplings around the edge of the casserole and cook on **CONVECTION 160°C + WARM MICROWAVE** for 15 mins or until dumplings are cooked through.

Meat and Poultry

Chicken Satay



Serves 4-6

Dish: bowl, Rectangular dish

Oven Accessory: no accessory

Ingredients

100ml (4fl.oz) coconut milk
 45ml (3tbsp) lemon juice
 30ml (2tbsp) soy sauce
 2 garlic cloves, crushed
 5ml (1tsp) ground turmeric
 5ml (1tsp) five-spice powder
 5ml (1tsp) coriander seeds
 5ml (1tsp) cumin seeds
 600g (1lb 5oz) boneless skinless chicken breasts
 90ml (6tbsp) crunchy peanut butter
 50g (2oz) creamed coconut

Place chicken breasts in a rectangular dish. In a bowl, mix together coconut milk, 30 ml (2tbsp) lemon juice and 15ml (1tbsp) soy sauce, garlic, turmeric, five spice, coriander and cumin. Pour over the chicken and leave to marinate in the fridge for 2-3 hours or overnight. For the serving sauce: Mix the peanut butter and creamed coconut with 15 ml (1tbsp) of the lemon juice, 15ml (1tbsp) of the soy sauce, and 300 ml (½ pt) water. Place on base of oven and cook on **HIGH MICROWAVE** for 5 mins. or until the sauce boils and thickens, stirring frequently. Turn into a serving bowl. Cook the marinated chicken on **LOW MICROWAVE** for 15-17mins. Serve with sauce for dipping.

Lasagne



Serves 4

Dish: large rectangular dish

Oven Accessory: wire shelf in lower position

Ingredients

1 quantity of Savoury Mince see page 100
 double quantity of White Pouring Sauce see page 131
 100g (4oz) grated cheese
 5ml (1tsp) mustard
 salt & pepper
 12 sheets pre-cooked lasagne (or sufficient for 3 layers)
 50g (2oz) Parmesan cheese

Cover the base of the dish with a layer of white sauce, then a layer of lasagne, then a layer of hot meat mixture. Continue with a layer of lasagne then meat, ending with a layer of white sauce. Sprinkle grated cheese over the top. Place on wire shelf and cook on **CONVECTION 190°C + GRILL 2 + SIMMER MICROWAVE** for 18-20 mins.

Meat and Poultry

Mini Boeuf En Croute



Serves 4

Dish: large bowl, greased enamel shelf

Oven Accessory: no accessory then enamel shelf in lower position then wire shelf in lower position

Ingredients

Filling:

15g (½ oz) dried porcini mushrooms
 15g (½ oz) butter
 225g (8oz) mushrooms
 1 large onion, peeled and finely chopped
 150ml (¼ pt) red wine
 4 fillet steaks, roughly 150g (6oz) each
 375g (11oz) puff pastry
 15ml (1tbsp) brandy
 1 large egg, beaten
 salt & pepper

Soak porcini mushrooms in boiling water for 20 mins. Drain and finely chop. Put the butter, all the mushrooms and onions in a bowl. Place on base of oven and cook on **HIGH MICROWAVE** for 3 mins. Add wine and brandy to the mushroom mixture and cook on **HIGH MICROWAVE** for 7-8 mins. Preheat oven on **CONVECTION 220°C**. Place the fillets on the enamel shelf and cook on **CONVECTION 220°C** for 20 mins. Allow to cool. Cut the pastry into 4 pieces and roll each piece out to a 15cm x 15cm (7 in.) square and brush with beaten egg. Place a ¼ of the mushroom mixture into the centre of each pastry square and place a fillet on top. Season. Bring the corners of the pastry to the centre and place on a greased enamel tray. Brush with beaten egg. Place on wire shelf and cook on **CONVECTION 220°C** for 15 mins for medium rare, 20 mins for medium and 25 mins for well done.

Gazed Gammon



Serves 4

Dish: 3 litre (6pt) large casserole with lid

Oven Accessory: no accessory then enamel shelf in lower position

Ingredients

900g (2 lb) unsmoked gammon joint, cold water to cover
 300 ml (½ pt) white wine (optional)
 1 onion, peeled
 4 whole cloves
 10 peppercorns
 45 ml (3tbsp) honey
 30 ml (2tbsp) orange juice
 15g (½ oz) Demerara sugar
 15 ml (1tbsp) Dijon mustard
 12 whole cloves

Place gammon in a large casserole dish. Add onion stuck with cloves and peppercorns. Place on base of oven and cook on **HIGH MICROWAVE** for 15 mins. then **MEDIUM MICROWAVE** for 15-20 mins. per 450g (1lb), or until cooked. Drain. Mix together the honey, juice, sugar and mustard. Cook on **HIGH MICROWAVE** for 1 min. Leave to cool. Remove the gammon rind. Score the fat in a lattice pattern and stud with cloves. Brush over half of the glaze.

Preheat oven on **CONVECTION 180°C + GRILL 1**. Place gammon on enamel shelf and cook on **CONVECTION 180°C + GRILL 1** for 10-15 mins until golden spreading over the remaining glaze halfway through cooking time.

Meat and Poultry

Paprika Pork Casserole



Serves 4

Dish: 3 litre (6 pt) large casserole with lid

Ingredients

700g (1½ lb) pork fillet, sliced
 25g (1oz) plain flour
 salt & pepper
 15ml (1tbsp) paprika
 1 onion, chopped
 250ml (9fl.oz) stock
 60ml (4tbsp) sherry
 150g (5oz) mushrooms, sliced
 150ml (¼ pt) soured cream

Coat the pork in the seasoned paprika flour and add to the onion. Place on base of oven and cook on **MEDIUM MICROWAVE** for 10 mins. Add the stock, sherry and mushrooms and stir thoroughly. Cover and cook on **CONVECTION 160°C + WARM MICROWAVE** for 1-1¼ hours or until the meat is tender stirring halfway. Stir in the soured cream and serve.

Sweet & Sour Pork



Serves 4

Dish: bowl, 3 litre (6pt) large casserole with lid

Ingredients

450g (1lb) pork fillet, diced
For sauce:
 15ml (1tbsp) olive oil
 1 carrot, cut into matchsticks
 1 spring onion, thinly sliced
 1 pepper, deseeded and cut into strips
 225g (8oz) can pineapple chunks, drained but reserve juice
 15g (½ oz) soft brown sugar
 10ml (2tsp) cornflour
 10ml (2tsp) cider vinegar
 15ml (1tbsp) soy sauce
 10ml (2tsp) tomato ketchup

Place oil, carrot, onion and pepper in a bowl. Place on base of oven and cook on **MEDIUM MICROWAVE** for 5 mins. Place pork in dish and cook on **LOW MICROWAVE** for 10 mins. Mix the reserved juice with the remaining ingredients except pineapple. Place on base of oven, cover and cook on **HIGH MICROWAVE** for 3 mins or until clear and thickened stirring halfway. Mix together the pork, vegetables, and sauce and stir in the pineapple mixing well and cook on **MEDIUM MICROWAVE** for 5 mins.

Vegetables and Vegetarian

- Root vegetables. i.e. Swede, carrots should be cut into slices, strips or cubes.
- Do not mix fresh and frozen vegetables as the cooking times may be different.
- Never add salt to vegetables before microwaving.
- Always cook vegetables in a dish that is a suitable size. Use flat dishes not basins. Always cover with microwave cling film or a lid.
- Certain vegetables i.e. broccoli and asparagus, should be arranged so that the tips are in the centre of the dish, as these require less cooking.

Roast Potatoes



Ingredients

500g (1lb) potatoes, peeled and quartered
30 ml (2tbsp) oil

JACKET POTATOES – Cooking by MICROWAVE only

Varieties of potatoes vary in their suitability for cooking by **MICROWAVE**. The cooking times given may need adjustment for other varieties. The ideal size of potato to be cooked by **MICROWAVE** is 175g - 250g (6-9oz).

Before Cooking: Wash potatoes and prick skins several times. Spread around edge of oven base.

After Cooking: Remove from oven and wrap in aluminium foil to retain the heat. Leave to stand for 5 mins.

Serves 4

Dish: shallow ovenproof dish

Oven Accessory: No accessory then Glass tray on wire shelf in lower position

Place potatoes in dish with 3tbsps water. Cover, place on base of oven and par-boil on **MEDIUM MICROWAVE** for 6 min. Drain. Place potatoes and oil on Glass tray and place on wire shelf. Cook on **CONVECTION 250°C + GRILL 1 + WARM MICROWAVE** for 30 mins. turning and basting potatoes during cooking, or until crisp and brown

Veggie Burgers



Ingredients

100g (4oz) mushrooms, sliced
100g (4oz) onion, finely chopped
1 garlic clove
175g (6oz) fresh wholemeal breadcrumbs
100g (4oz) ground cashew nuts
1 egg

Serves 4

Dish: large bowl

Oven Accessory: Glass tray + wire shelf in upper position

Place mushrooms, onion and garlic in a bowl on the base of the oven and cook on **MEDIUM MICROWAVE** for 5mins. Add 150g (5oz) breadcrumbs and the nuts to the mushroom and add enough egg to bind the mixture. Divide into four. Roll into balls, dip in the remaining breadcrumbs and make into burger shapes. Place on Glass tray on wire shelf and cook on **GRILL 1 + WARM MICROWAVE** for 15 mins. or until browned. Turn halfway.

Vegetables and Vegetarian

Roast Vegetable Parcels



Serves 4-6

Dish: 2 litre (4 pt) ovenproof dish

Oven Accessory: no accessory then Glass tray on wire shelf in lower position then greased enamel shelf in lower position.

Ingredients

200g (7oz) can chopped tomatoes
10 ml (2tsp) tomato puree
700g (1lb 8oz) mixed vegetables
e.g. sweet potato, red pepper, leeks,
aubergine,
1 clove garlic, crushed
15 ml (1tbsp) olive oil
25g (1oz) pine nuts
50g (2oz) gruyere cheese, grated
100g (4oz) Boursin® cheese
15 ml (1tbsp) single cream
350g (12oz) ready made puff pastry
1 beaten egg to glaze

Place the chopped tomatoes and puree in a bowl. Place on base of oven and cook on **HIGH MICROWAVE** for 5 mins then **MEDIUM MICROWAVE** for 7-8 mins or until mixture is reduced in volume and thickened. Cut vegetables into even sized chunks and toss with the garlic and oil. Place on the Glass tray on the wire shelf and cook on **CONVECTION 220°C + GRILL 2 + SIMMER MICROWAVE** for 15mins. Cook for a further 15 mins on **CONVECTION 220°C + GRILL 2 + SIMMER MICROWAVE**. Mix the tomato sauce with the cooked vegetables and pine nuts. Preheat oven empty on **CONVECTION 220°C**. Mix together the gruyere cheese, Boursin® and single cream. Roll out pastry until it measures approx 30cm (12")square. Divide into 4 equal squares. Place ¼ of the vegetable mixture in the centre of the square and top with ¼ of the cheese mixture. Bring the corners of the pastry to the centre, pressing the edges together. Seal with water and glaze with beaten egg. Place parcels on enamel shelf and cook on **CONVECTION 220°C** for 20-25 mins or until golden and cooked through.

Gratin Dauphinois



Serves 4-6

Dish: 20 cm (8") shallow dish

Oven Accessory: No accessory then shelf in lower position

Ingredients

1 clove of garlic, Crushed
700g (1½ lb) potatoes, halved
salt and pepper
pinch nutmeg
150 ml (¼ pt) double cream
25g (1oz) butter

Place potatoes in dish with 3tbsps water. Cover, place on base of oven and par-boil on **MEDIUM MICROWAVE** for 6 mins. Drain. Slice thinly. Layer the potato slices in the dish, seasoning with salt and pepper and nutmeg between each layer. Mix garlic with cream. Pour the cream evenly over the top of the potatoes and dot with butter. Place dish on wire shelf and cook on **CONVECTION 190°C + SIMMER MICROWAVE** for 25-30 mins. or until potatoes are cooked.

Vegetables and Vegetarian

Goats Cheese & Onion Tart



Serves 4

Dish: large bowl, enamel shelf greased

Oven Accessory: wire shelf

Ingredients

375g ready rolled puff pastry
30ml (2tbsp) olive oil
1kg (2lb2oz) red onions, peeled & thinly sliced
15ml (1tbp) fresh thyme
90ml (6tbsp) balsamic vinegar
10ml (2tsp) muscovado sugar
salt and freshly ground black pepper
balsamic glaze for decoration
200g (7oz) soft goat's cheese, cut into slices

Pre-heat oven on **CONVECTION 200°C**.

Line the flan dish with the pastry and make an incision 2cm from each edge all the way round, prick the base with a fork and chill for 15 mins. in the fridge. Place the oil, onions and thyme into a large bowl. Place on base and cook on **HIGH MICROWAVE** for 5 mins. Add balsamic, stir and cook on **HIGH MICROWAVE** for 10 mins. Stir halfway and season. Pre-heat oven on **CONVECTION 200°C**. Place the onions on the pastry. Decorate with cheese and cook on **CONVECTION 200°C** for 10-12 mins.

Cauliflower Cheese



Serves 4

Dish: bowl, shallow round or oval casserole dish

Oven Accessory: No accessory then wire shelf in lower position

Ingredients

1 cauliflower, Cut into florets
90 ml (6tbsp) water
25g (1oz) butter
25g (1oz) plain flour
3 ml (½ tsp) French mustard
275 ml (½ pt) milk
seasoning to taste
Topping:
75g (3oz) grated cheese
15 ml (1tbsp) brown breadcrumbs

Place cauliflower upside down in a bowl. Add 3 tbsps water, cover and place on base of oven. Cook on **MEDIUM MICROWAVE** for 10 mins. Drain. Place butter in bowl, place on base and cook on **HIGH MICROWAVE** for 15-30 secs. Stir in flour and mustard. Cook on **HIGH MICROWAVE** for a further 15 secs. Add milk gradually. Stir well and season. Cook on **HIGH MICROWAVE** for 2-3 mins. or until sauce is thick and bubbling. Stir halfway. Stir in 60g (2½ oz) grated cheese. Pour the sauce over the cauliflower. Top with remaining cheese and breadcrumbs. Place dish on wire shelf and cook on **CONVECTION 220°C + GRILL 2 + WARM MICROWAVE** for 10-15 mins. or until golden brown.

Vegetables and Vegetarian

Spicy Beans



Serves 4

Dish: 1.5 litre (3 pt) casserole dish

Ingredients

15ml (1tbsp) olive oil
 1 onion, finely chopped
 15ml (1tbsp) rosemary
 5ml (1tsp) paprika
 400g (14oz) cannellini beans,
 drained and rinsed
 15g (½oz) soft muscovado sugar
 15ml (1tbsp) Worcestershire sauce
 75ml (3fl.oz) red wine
 75ml (3fl.oz) vegetable stock
 salt & pepper

Place oil, onion, rosemary and paprika in casserole. Place on base of oven and cook on **HIGH MICROWAVE** for 2 mins. Add remaining ingredients and cook on **HIGH MICROWAVE** for 3 mins. Stir. Cover and cook on **SIMMER MICROWAVE** for 12-15 mins. Serve on toast or with a jacket potato.

Ratatouille



Serves 4

Dish: 20 cm (8") casserole

Ingredients

1 aubergine, sliced
 5 ml (1tsp) salt
 1 courgette, sliced
 1 onion, sliced
 1 green pepper, cut into chunks
 1 red pepper, cut into chunks
 1 clove of garlic, peeled and
 crushed
 396g (14oz) can of tomatoes
 salt and pepper to taste

In a colander sprinkle aubergine slices with salt and leave for 30 mins. to remove bitter juices. Rinse with cold water. Combine all ingredients in a casserole dish. Place on base of oven and cook on **MEDIUM MICROWAVE** for 15 mins. or until vegetables are soft. Stir halfway through cooking time.

Vegetables and Vegetarian

Stuffed Peppers



Serves 6

Dish: large white rectangular dish

Oven Accessory: wire shelf in lower position

Ingredients

3 red and 3 yellow peppers
 1 courgette, sliced
 1 bunch spring onions sliced thinly
 100g (4oz) mushrooms, sliced
 2 cloves garlic, crushed
 15ml (1tbsp) oil from sundried tomato jar
 200g (8oz) cous cous
 325-350ml (½ pt) hot vegetable stock
 50g (2oz) pine nuts
 100g (4oz) cherry tomatoes, halved or 100g sundried tomatoes
 50-100g (2-4oz) black olives, halved
 100g (4oz) feta cheese, diced
 salt and pepper
 handful each of parsley and basil, chopped

Halve the peppers and put to one side. Remove the seeds and rinse out. Place courgette, mushroom, oil and garlic into a large ovenproof dish and stir together. Cook on **HIGH MICROWAVE** for 3 mins. c

Soak the cous cous in hot stock for 5 mins.

Allow to cool slightly and then stir in the vegetable mixture, pine nuts and tomatoes. Season well and stir in cheese. Fill peppers with mixture, place in ovenproof dish and put on wire shelf. Cook on **CONVECTION 200°C + GRILL 2 + LOW MICROWAVE** for 10 -15 mins.

Vegetable Lasagne



Serves 4-6

Dish: casserole dish, large rectangular dish

Oven Accessory: no accessory then wire shelf in lower position

Ingredients

1 large onion, chopped
 1 clove of garlic, crushed
 25g (1oz) butter
 225g (8oz) each of diced carrots, diced leeks, diced courgettes
 1 green pepper, chopped
 150 ml (¼ pt) hot vegetable stock
 salt and pepper to taste
 275 ml (½ pt) prepared tomato sauce see page 104
 175g (6oz) pre-cooked lasagne
 225g (8oz) Mozzarella cheese
 100g (4oz) Cheddar cheese (grated)
 25g (1oz) parmesan (finely grated)

Place onion, garlic and butter in a casserole dish. Place on base of oven and cook on **HIGH MICROWAVE** for 2 mins. Add vegetables and stock. Cover and cook on **HIGH MICROWAVE** for 8-10 mins. or until vegetables are soft. Season to taste. Cover dish with a thin layer of tomato sauce, then a layer of lasagne on top then a layer of vegetable mixture. Thinly slice the Mozzarella cheese and layer on top of vegetables. Continue layering until ingredients are all used ending with a tomato sauce layer. Sprinkle the Cheddar cheese and then the Parmesan cheese over the top. Place on wire shelf and cook on **CONVECTION 190°C + SIMMER MICROWAVE** for 30-35 mins. or until the pasta is cooked.

Vegetables and Vegetarian

Roasted Vegetable Moussaka



Serves 4-6

Dish: 2 litre (4 pt) ovenproof dish

Oven Accessory: wire shelf in lower position

Ingredients

1 red onion, cut into strips
 2 red peppers, deseeded and cubed
 1 aubergine, cubed
 2 courgettes, cubed
 350g (12oz) sweet potato, peeled and cubed
 4 garlic cloves, whole
 45 ml (3tbsp) olive oil
 salt and pepper
 400g (14oz) canned, chopped tomatoes
 25g (1oz) sun-dried tomatoes, chopped
 225g (8oz) cottage cheese
 3 large eggs
 175g (6oz) cheddar cheese, grated
 45 ml (3tbsp) natural yoghurt

Toss the prepared vegetables with the garlic and oil.

Place in dish on wire shelf and cook on **AUTO**

PROGRAM VEGETABLES ROASTED or **CONVECTION 220°C + GRILL 2 + SIMMER**

MICROWAVE for 15 mins. Turn halfway. If not using Auto

Program cook for a further 15 mins on **CONVECTION**

220°C + GRILL 2 + SIMMER MICROWAVE. Stir in the

tomatoes and sun-dried tomatoes. Season to taste. Beat

together the cottage cheese, eggs, cheddar cheese and

yoghurt, then season. Pour over the vegetables. Place

on wire shelf and cook on **CONVECTION 250°C +**

GRILL 1 + WARM MICROWAVE for 15 mins. or until

golden brown.

Vegetarian Chilli



Serves 4

Dish: 3 litre (6 pt) large casserole with lid

Ingredients

15 ml (1tbsp) oil
 1 onion, finely chopped
 1 green pepper, chopped
 1 chilli, chopped
 2 carrots, diced
 5 ml (1tsp) chilli powder
 3 ml (½ tsp) cumin
 175g (6oz) bulgar wheat
 396g (14oz) can chopped tomatoes
 30 ml (2tbsp) tomato puree
 450 ml (3/4 pt) water
 396g (14oz) can red kidney beans, drained

Place oil, onion, pepper, chilli and carrots in a large

casserole. Cover, place on base of oven and cook on

HIGH MICROWAVE for 4-5 mins. or until softened. Add

chilli and cumin. Stir in bulgar wheat, chopped tomatoes,

tomato puree and water. Cover and cook on base of

oven **HIGH MICROWAVE** for 10 mins. Stir in red kidney

beans, cover and cook on **HIGH MICROWAVE** for 3-4

mins.

Vegetables and Vegetarian

Quorn® Casserole



Ingredients

15ml (1tbsp) oil
 15g (½ oz) butter
 1 garlic clove, crushed
 4 shallots, chopped
 150g (5oz) mushrooms, sliced
 15ml (1tbsp) Dijon mustard
 300g (10oz) Quorn®
 150 ml (¼ pt) hot chicken or vegetable stock
 150 ml (¼ pt) dry white wine
 225g (8oz) baby new potatoes, halved
 225g (8oz) baby carrots halved
 100g (4oz) asparagus tips
 100g (4oz) shelled, fresh or frozen broad beans
 45ml (3tbsp) double cream
 30ml (2tbsp) mixed fresh parsley and tarragon, chopped
 crusty bread, to serve

Leek & Potato Gratin



Ingredients

450g (1lb) potatoes, halved
 450g (1lb) leeks, sliced thinly
 150g (5oz) blue cheese
 225g (8oz) Greek yoghurt
 75 ml (5tbsp) double cream
 50g (2oz) brown breadcrumbs
 salt and pepper

Serves 4

Dish: 3 litre (6 pt) large casserole with lid

Place oil, butter, garlic, shallots and mushrooms into casserole dish. Place on base of oven and cook on **HIGH MICROWAVE** for 3 mins. Stir in Dijon mustard and add Quorn®. Then stir in stock and wine. Add potatoes and carrots. Cover casserole, place on base of oven and cook on **CONVECTION 160°C + WARM MICROWAVE** for 45 mins stirring halfway. Stir in asparagus, broad beans and cream and cook on **CONVECTION 160°C + WARM MICROWAVE** for a further 30 mins. Stir in herbs and serve with crusty bread.

Serves 4

Dish: shallow ovenproof dish

Oven Accessory: no accessory then wire shelf in lower position

Place potatoes in the dish with 3tbsp. water. Cover, place on base of oven and par-boil on **MEDIUM MICROWAVE** for 6 mins. Slice thinly. Place leeks in dish with sliced potatoes and with 3tbsp. water. Cover, place on base of oven and cook on **MEDIUM MICROWAVE** for 8 mins. Crumble or finely chop the cheese into a bowl and gradually blend in the yoghurt and the double cream. Drain the vegetables and arrange in dish. Season and pour over the blue cheese cream mixture. Sprinkle with breadcrumbs. Place on wire shelf and cook on **CONVECTION 230°C + GRILL 3 + LOW MICROWAVE** for 10 mins. or until golden brown.

Vegetables and Vegetarian

Lentil Bake



Serves 4

Dish: 3 litre (6 pt) large casserole with lid

Ingredients

15 ml (2tbsp) olive oil
 2 onions, chopped
 2 celery sticks, chopped
 3 carrots, diced
 400g (14oz) can chopped tomatoes
 425 ml (3/4 pint) vegetable stock
 30 ml (2tbsp) tomato puree
 100g (4oz) red lentils
 salt and pepper
 30-45 ml (2-3tbsp) green pesto

For the Topping:

1 kg (2lb 2oz) potatoes, peeled
 1 bunch spring onions, chopped
 105ml (7tbsp) milk
 freshly grated nutmeg
 25g (1oz) butter
 100g (4oz) cheddar or gruyere, grated

Place the oil in a large bowl with the onions. Place on base of oven and cook on **HIGH MICROWAVE** for 3 mins. Add celery, carrots, tomatoes, stock, tomato puree and lentils. Cover and cook on **HIGH MICROWAVE** for 10 mins. Stir and then cook on **SIMMER MICROWAVE** for 10 mins. Season well. Stir in the pesto if desired and place in an ovenproof dish. Place potatoes in dish with 3tbsps water. Cover, place on base and cook on **AUTO BOILED POTATO PROGRAM** or on **MEDIUM MICROWAVE** for 12-14 mins. or until soft. Drain. Place spring onions, milk and nutmeg into a bowl and cook on **HIGH MICROWAVE** for 2mins. Mash the potatoes and add spring onions, flavoured milk, butter and 2/3 of the cheese and season well. Spoon the mash over the filling and smooth over with a fork. Sprinkle with remaining cheese. Place dish on wire shelf and cook on **CONVECTION 220°C + GRILL 1 and SIMMER MICROWAVE** for 10-15 mins. or until golden brown and piping hot.

Vegetable Curry



Serves 4

Dish: 3 litre (6 pt) casserole

Ingredients

1 medium aubergine, diced
 salt
 2 cloves of garlic, chopped
 15 ml (1tbsp) oil
 pinch cayenne pepper
 10 ml (2tsp) ground coriander
 5 ml (1tsp) ground cumin
 5 ml (1tsp) turmeric
 2.5 cm (1") root ginger, peeled and sliced
 1 small cauliflower, divided into florets
 2 medium potatoes, diced
 100g (4oz) green beans, sliced
 1 fresh chilli, deseeded and sliced
 150 ml (1/4 pt) vegetable stock
 397g (14oz) can chopped tomatoes
 100g (4oz) cashew nuts

Sprinkle the aubergine liberally with salt in a colander. Stand for 30 mins. to remove bitter juices. Rinse well under cold water and drain. Combine garlic, oil and spices in casserole dish. Cover, place on base of oven and cook on **HIGH MICROWAVE** for 1 min. Add aubergine and all other ingredients to casserole, except cashews. Cover and cook on **HIGH MICROWAVE** for 10 mins. then **SIMMER MICROWAVE** for 40-50 mins. or until vegetables are soft. Stir occasionally. Sprinkle with cashews and serve with boiled rice.
N.B. This recipe is best cooked in advance, chilled and then reheated to allow the flavours to develop.

Vegetables and Vegetarian

Pepper & honey roasted Roots



Ingredients

3tbsp olive oil
5 medium carrots, peeled and cut into batons
5 parsnips, peeled and cut into batons
2tbsp clear honey
2tsp black peppercorns

Serves 4

Oven Accessory: Enamel shelf in lower position

Place the vegetables into a bowl, add 6tbsp water and cover, cook on **HIGH MICROWAVE** for 5-7mins. Drain and cool slightly. Preheat oven empty on **CONVECTION 220°C**. Put the olive oil and the vegetables onto the enamel shelf. Place the enamel shelf into the oven and cook on **CONVECTION 220°C** for 25-30 mins, shaking occasionally for until golden brown and soft. Stir the honey, pepper and a sprinkling of salt into the vegetables, then return to the oven for 5mins to warm honey through. Toss vegetables half way through.

Spicy Potatoes



Ingredients

350g (12oz) potatoes, cubed
45 ml (3tbsp) natural yoghurt
10 ml (2tsp) mango chutney
3 ml (½ tsp) cumin, coriander and garam masala
3 ml (½ tsp) turmeric
10 ml (2tsp) fresh coriander
pinch chilli powder
15g (½ oz) sultanas
salt and pepper

Serves 4

Dish: 1 litre (2 pt) dish

Place potatoes in dish with 3tbsp water. Cover, place on base of oven and cook on **MEDIUM MICROWAVE** for 8 mins. Drain. Mix the remaining ingredients together. Add the potatoes, mix well and cook on **MEDIUM MICROWAVE** for 4-5 mins.

Vegetables and Vegetarian

Summer Vegetable Flan



Serves 6

Dish: bowl, 23 cm (9") flan tin/dish

Oven Accessory: wire shelf in lower position then no accessory then anti-spark ring and wire shelf in lower position

Ingredients

350g (12oz) ready made shortcrust pastry
 100g (6oz) courgettes, thinly sliced
 1 garlic clove, crushed
 100g (6oz) broccoli
 50g (2oz) peas
 50g (6oz) asparagus
 50g (4oz) tomatoes
 100g (4oz) full fat soft cheese
 150 ml (¼ pt) single cream
 2 eggs plus 1 egg yolk
 40g (1½ oz) mature cheddar

Preheat oven on **CONVECTION 210°C**. Line the flan dish with the pastry, prick the base with a fork and chill for 15 mins. in the fridge. Place flan on wire shelf and bake blind on **CONVECTION 210°C** for 15 mins. with baking beans. Remove baking beans and lining after 10 mins. Place the courgettes, garlic, broccoli and peas in a bowl with 3 tbsp of water. Cover, place on base of oven and cook on **MEDIUM MICROWAVE** for 6 mins. Drain. Place in the pastry case with the asparagus and quartered tomatoes. Beat the soft cheese with the cream and eggs, pour over the vegetables and sprinkle with cheddar. Place the flan dish on anti-spark ring on wire shelf and cook on **CONVECTION 180°C + WARM MICROWAVE** for 30 mins or until just set.

Nut Roast



Serves 4

Dish: bowl, 1lb Glass loaf dish lined with greaseproof paper.

Oven Accessory: no accessory then wire shelf in lower position

Ingredients

50g (2oz) butter
 1 medium onion, chopped
 1 stick celery, chopped
 5ml (1tsp) mixed dried herbs
 225g (8oz) mixed nuts, coarsely chopped
 400g (14oz) can of tomatoes
 175g (6oz) fresh wholemeal breadcrumbs
 salt and pepper
 2ml (¼ tsp) ground chilli
 2 eggs, lightly beaten

Put butter, onion, celery and herbs in the bowl. Place on base of oven and cook on **HIGH MICROWAVE** for 3 mins to soften. Add the nuts, tomatoes, breadcrumbs, salt, pepper and chilli to the onion mixture. Stir well and then add the eggs. Mix to an even consistency. Spoon the mixture into the loaf dish and smooth the top. Place on wire shelf and cook on **CONVECTION 180°C + SIMMER MICROWAVE** for 30 min.

Vegetables and Vegetarian

Mushroom Stroganoff



Serves 4

Dish: 3 litre (6 pt) dish

Ingredients

1 large onion, finely chopped
4 sticks of celery, finely chopped
15 ml (1tbsp) olive oil
350g (12oz) sliced mushrooms
275 ml (½ pt) water
5 ml (1tsp) Marmite®
3 ml (½ tsp) thyme
Pinch ground bay leaf
150 ml (¼ pt) sour cream

Place the onion and celery in dish with the oil. Place on base of oven and cook on **MEDIUM MICROWAVE** for 5 mins. Add all other ingredients, except the cream, mix well and cook on **MEDIUM MICROWAVE** for 10 mins stirring halfway. When cooked stir in the sour cream and serve.

Vegetables and Vegetarian

Tabbouleh



Serves 4

Dish: large mixing bowl

Ingredients

175g quinoa
600ml boiling water
10 cherry tomatoes on the vine halved
¼ cucumber diced
3 spring onions finely chopped
Juice of half a lemon
2 tbsp olive oil
4tbsp fresh mint torn
4tbsp fresh coriander chopped
4tbsp fresh parsley chopped
Salt and pepper

Put the quinoa and boiling water into the bowl. Cover with pierced clingfilm and cook on **HIGH MICROWAVE** for 15 mins. Stand and allow to cool. Drain if necessary. Add all other ingredients and season to taste.

Pasta, Rice & Beans

Spicy Tomato Pasta



Ingredients

350g (12oz) dried pasta
 15 ml (1tbsp) oil
 3ml (½ tsp) salt
 2 red peppers, seeded and cut into chunks
 2 red onions cut into wedges
 2 mild red chillies, seeded and diced
 3 garlic cloves, coarsely chopped
 5 ml (1tsp) golden caster sugar
 30 ml (2tbsp) olive oil
 salt & pepper
 1 kg (2lb 2oz) small ripe tomatoes, quartered
 handful fresh basil leaves
 25g (1oz) grated parmesan

Serves 4

Dish: 3 litre (6 pt) bowl + large ovenproof dish
Oven Accessory: no accessory then wire shelf in lower position

Put pasta in a bowl. Add salt, oil and 1 litre of boiling water. Place on base of oven, cover and cook on **HIGH MICROWAVE** for 10-12 mins. Drain well. Pre-heat oven on **CONVECTION 230°C + GRILL 1**. Place peppers red onions, chillies and garlic in a large ovenproof dish. Sprinkle with sugar, drizzle over the oil and season well with salt and pepper. Cook on **CONVECTION 230°C + GRILL 1** for 15 mins. Add tomatoes, stir and cook on **CONVECTION 230°C + GRILL 1** for 10 mins. or until golden and starting to soften. Remove the vegetables from the oven. Stir in the pasta and cook on **CONVECTION 230°C + GRILL 2 + WARM MICROWAVE** for 5 mins. Tear the basil leaves on top and sprinkle with parmesan to serve.

Bulgur Wheat Salad with chick peas and halloumi



Ingredients

100g 3 ½ oz bulgar wheat
 200ml hot vegetable stock
 ½ small red onion finely chopped
 1 clove garlic finely chopped
 2 tbsp of each fresh mint, fresh coriander, fresh parsley
 ½ cucumber diced skin on
 4 tomatoes diced
 400g can chick peas drained and rinsed
 Very tiny pinch of cumin and cayenne pepper
 Large pinch of ground cinnamon
 Grated rind and juice of a lemon
 1cm piece of fresh ginger peeled and grated
 250g pack halloumi cheese sliced into 8 pieces

Serves 4

Dish: large mixing bowl
Oven Accessory: Enamel shelf upper level

Place the bulgar wheat in a pan and pour over the stock. Cover with pierced cling film and cook on **HIGH MICROWAVE** for 5mins. Allow to stand for a minute and then fluff up with a fork. Add all the other ingredients except the cheese. Preheat the oven on **TURBO-BAKE 250°C + Grill 1**. When oven has preheated, put the 8 slices of halloumi onto the enamel shelf on the upper level. Cook for 4-5 mins then turn and continue to cook for 2-3mins.

Pasta, Rice & Beans

Lemon & Asparagus Risotto



Serves 4

Dish: small bowl + large bowl

Ingredients

1 bunch asparagus
(approx. 250g/9oz)
450ml (3/4 pt) hot vegetable stock
2 leeks, trimmed and finely sliced
40g (1 1/2 oz) butter
200g (7oz) risotto rice
100g (4oz) frozen peas
Finely shredded zest and juice 1/2
lemon
Salt & pepper to taste
40g (1 1/2oz) fresh parmesan
cheese
handful fresh basil

Cut off asparagus tips with 2.5cm (1") stem attached. Add 30ml (2 tbsps) stock and place in bowl. Cover, place on base and cook on **MEDIUM MICROWAVE** power for 3 mins. Chop remaining asparagus stems into 1cm pieces and leave to one side. Place leeks and 25g (1oz) butter in a large bowl. Place on base of oven and cook on **HIGH MICROWAVE** for 2 mins. Add the rice to the leeks and stir in the hot vegetable stock. Cover and cook on **HIGH MICROWAVE** for 10 mins. Add chopped asparagus stems and cook on **MEDIUM MICROWAVE** for a further 2 mins. Stir in the peas, lemon zest and juice and cook on **MEDIUM MICROWAVE** for 2 mins. Stir in the cooked asparagus tips, basil, remaining butter and 25g (1oz) Parmesan cheese. Cook on **MEDIUM MICROWAVE** for 3 mins. Serve in warmed bowls sprinkled with a few whole basil leaves and the rest of the Parmesan cheese.

Wild Mushroom Risotto



Serves 4

Dish: small bowl + large bowl

Ingredients

25g (1oz) dried porcini,
1 litre (1 1/2 pints) hot chicken or
vegetable stock
50g (2oz) butter
2 shallots, finely chopped
300g (11oz) risotto rice
125ml (4 fl.oz) dry white wine
salt & pepper to taste
200g white or chestnut mushrooms,
sliced
25g (1oz) freshly grated parmesan
cheese plus extra for garnish

Soak mushrooms in 300ml (1/2 pint) stock for 20 mins. Strain the porcini mushrooms and coarsely chop. Add the soaking liquid to the remaining stock. Place the butter and shallots in a large bowl. Place on base of oven and cook on **MEDIUM MICROWAVE** for 3 mins. or until softened. Stir the rice into the mixture. Add the stock, wine and seasoning. Cover and cook on **HIGH MICROWAVE** for 10 mins. Add the mushrooms and porcini and cook on **MEDIUM MICROWAVE** for 10 mins. stirring halfway. Mix in the parmesan cheese. Cover and leave to stand for about 2-3 mins. before serving on warm plates sprinkled with extra parmesan cheese.

Pasta, Rice & Beans

Prawn Risotto



Serves 4

Dish: large bowl

Ingredients

1 onion, finely chopped
 1 garlic clove, crushed
 25g (1oz) butter
 225g (8oz) brown cap mushrooms, quartered
 225g (8oz) Arborio (risotto) rice
 juice and rind of 1 lemon
 2ml (¼ tsp) saffron strands, crushed
 300ml (½ pt) hot vegetable stock
 300ml (½ pt) white wine
 100g (4oz) frozen peas
 300g (11oz) cooked, peeled prawns
 30ml (2tbsp) finely chopped chives

Put the onion, garlic, butter and mushroom in a large bowl. Cover, place on base of oven and cook on **MEDIUM MICROWAVE** for 4 mins. Add rice, juice and rind of the lemon, saffron, stock and wine to the mushroom mixture. Cover and cook on **HIGH MICROWAVE** for 7 mins. Stir the risotto. Add peas, re-cover and cook on **HIGH MICROWAVE** for 6 mins. Add the prawns and chives and cook on **MEDIUM MICROWAVE** for 5 mins. Leave to stand for 2-3 mins and serve.

Tuna Pasta



Serves 4

large bowl, jug, 3 litre (6 pt) casserole dish

Oven Accessory: no accessory then wire shelf in lower position

Ingredients

225g (8oz) mixed dried pasta i.e. twists, shells
 1 litre (1 ¾ pt) boiling water
 15 ml (1tbsp) oil
 3 ml (½ tsp) salt
 25g (1oz) butter
 100g (4oz) mushrooms, peeled and sliced
 198g (7oz) can tuna, drained
Sauce:
 40g (1 ½ oz) butter
 40g (1 ½ oz) flour
 600 ml (1 pt) milk
 salt & pepper to taste
 25g (1oz) cheese, grated
 25g (1oz) breadcrumbs

Cook pasta in water with oil and salt covered on **HIGH MICROWAVE** for 10-12 mins. or until soft. Leave to stand for 2-3 mins. Drain. Place butter and mushrooms in bowl. Place on base of oven and cook on **HIGH MICROWAVE** for 3 mins. To make sauce, place butter in a jug and melt on **HIGH MICROWAVE** for 30-40 secs. Stir in flour to make a roux. gradually whisk in milk until well combined. Cook on **HIGH MICROWAVE** for 3-5 mins. or until smooth and glossy. Stir halfway through cooking. Combine pasta, tuna and mushrooms in dish. Pour sauce over and stir to mix thoroughly. Sprinkle with cheese and breadcrumbs. Place on wire shelf and cook on **CONVECTION 230°C + GRILL 3 + LOW MICROWAVE** for 10-15 mins. or until golden brown.

Pasta, Rice & Beans

Lentil Biryani



Serves 4-6

Dish: bowl, 3 litre (6 pt) large casserole with lid

Ingredients

100g (4oz) green lentils
 450g (1lb) basmati rice
 15 ml (1tbsp) oil
 1 large onion, sliced
 5 ml (1tsp) root ginger, grated
 1 garlic clove, crushed
 3 ml (½ tsp) turmeric
 5 ml (1tsp) chilli powder
 10 ml (2 tsp) curry powder
 150 ml (¼ pt) natural yoghurt
 100g (4oz) mushrooms, sliced
 2 tomatoes, peeled and chopped
 300 ml (½ pt) hot water
 50g (2oz) cashew nuts

Garnish:

hard boiled egg slices and coriander leaves

Soak the lentils in cold water for 1 hour then drain them. Place rice in bowl. Cover, place on base of oven and cook on **AUTO RICE PROGRAM** or place rice in bowl with 550 ml (1pt) boiling water and cook on **HIGH MICROWAVE** for 8-10 mins and stir halfway.

Place the oil and onion in the casserole dish. Place on base of oven and cook on **HIGH MICROWAVE** for 3 mins. or until softened. Add the ginger, garlic, turmeric, chilli and curry powder and cook on **HIGH MICROWAVE** for 2 mins. Add the yoghurt, mushrooms, tomatoes, water and lentils. Cover and cook on **HIGH MICROWAVE** for 25-30 mins. or until the lentils are tender and the liquid has evaporated. Add the lentil mixture and cashew nuts to the cooked rice and mix thoroughly. Cook on **MEDIUM MICROWAVE** for 3-4 mins. Garnish and serve.

Vegetable & Chick Pea Casserole



Serves 4

Dish: 3 litre (6pt) large casserole with lid

Ingredients

1 medium onion, chopped
 10ml (2 tsp) vegetable oil
 2 medium courgettes, sliced thickly
 1 red pepper, seeded and chopped
 2 medium carrots, peeled and thinly sliced
 1 small cauliflower, cut into florets
 100g (4oz) dried apricots, halved
 2 cloves garlic, crushed
 425g (15oz) can chick peas, drained
 3ml (½ tsp) each: ground turmeric, ground coriander, ground cumin
 5ml (1tsp) paprika
 2.5cm (1") fresh root ginger, peeled and finely chopped
 salt & pepper
 450 ml (¾ pt) hot vegetable stock
 chopped parsley to garnish

Place the onion and oil in the casserole. Place on the base of oven and cook on **HIGH MICROWAVE** for 2 mins. or until starting to soften. Add the prepared vegetables, apricots, garlic, chick peas and stir in the spices, salt, pepper and stock. Cover and cook on **HIGH MICROWAVE** for 15-20 mins, or until vegetables are soft. Stir two or three times during cooking. Serve with couscous or rice and garnish with parsley.

TIP

To prepare couscous: Place 300 ml (½ pt) vegetable stock in a bowl and 1.5 ml (¼ tsp) turmeric. Place on base of oven and cook on **HIGH MICROWAVE** for 4 mins. or until boiling. Add 175g (6oz) couscous and allow to stand for 5 mins. Fluff up with a fork before serving.

Cheese & Egg dishes

Cheese & Red Pesto Tarlets



Ingredients

350g (12oz) readymade short crust pastry
 90g (3½ oz) red pesto or sun-dried tomato puree
 2 medium sized tomatoes, peeled, seeded and chopped
 25g (1oz) black olives, chopped
 125g (4½oz) Fontina or Mozzarella cheese grated
 1garlic clove crushed
 25g (1oz) parmesan cheese, grated
 5 ml (1tsp) dried oregano

Serves 4

Dish: 2 bun tins 32cm x 24cm (12½" x 9½") lightly greased

Oven Accessory: enamel shelf in lower position + wire shelf in upper position

Roll out the short crust pastry to a thickness of approximately 3 mm. (1/8"). Cut out 24 circles using a 7.5cm. (3") pastry cutter. Place in bun tins. Chill pastry for 30 mins. Preheat oven on **CONVECTION 200°C** with both enamel and wire shelf in position. Mix the red pesto, tomatoes, black olives, mozzarella and garlic together in a bowl. Fill the tins with mixture. Sprinkle the parmesan and oregano over the tarlets. Place tins on shelves and cook on **CONVECTION 200°C** for 18-20 mins. or until golden brown.

Baked Soufflé



Ingredients

25g (1oz) butter
 25g (1oz) flour
 150ml (¼ pt) milk
 3 eggs, separated
 salt & pepper
 75g (3oz) cheese, grated

Serves 4

Dish: 15 cm (6") soufflé dish

Oven Accessory: no accessory then wire shelf in lower position

Place butter in bowl, place on base and cook on **HIGH MICROWAVE** for 30 secs. Stir in flour. Cook on **HIGH MICROWAVE** for 30 secs. Stir in milk gradually, whisk until smooth. Cook on **HIGH MICROWAVE** for 2 mins. or until thickened. Beat well. Cool. Preheat oven on **CONVECTION 180°C**. Add egg yolks one at a time to the white sauce. Season and mix in cheese. Whisk the egg whites until stiff and fold into cheese mixture. Place on wire shelf and cook on **CONVECTION 180°C** for 20-25 mins. until risen and brown.

Cheese & Egg dishes

Quiche Lorraine



Ingredients

250g (9oz) shortcrust pastry
 15 ml (1tbsp) oil
 1 medium onion, chopped
 6 streaky bacon rashers or 100g (4oz) ham cut into strips
 2 eggs
 150 ml (¼ pt) single cream
 salt & pepper to taste
 50g (2oz) cheddar cheese, grated

Serves 4

Dish: 23 cm (9") metal tin, bowl

Oven Accessory: wire shelf in lower position then no accessory then anti-spark ring + wire shelf in lower position

Pre-heat oven on **CONVECTION 210°C**. Line the flan dish with the pastry, prick the base with a fork and chill for 15 mins. in the fridge. Place on wire shelf and bake blind on **CONVECTION 210°C** for 15 mins. Remove baking beans and lining after 10 mins. Place the oil, onion and bacon in a bowl. Place on base and cook on **HIGH MICROWAVE** for 4 mins. or until onion is soft. Drain and place in bottom of flan case. Beat the eggs, cream, salt and pepper and pour over the bacon. Sprinkle with cheese. Place flan on anti-spark ring on wire shelf and cook on **CONVECTION 190°C + WARM MICROWAVE** for 20-25 mins. or until just set and browned.

Macaroni Cheese



Ingredients

200g (7oz) quick cooking macaroni
 40g (1½ oz) butter
 1 small onion, finely chopped
 100g (4oz) bacon, chopped
 40g (1½ oz) flour
 575ml (1pt) milk
 5 ml (1tsp) French mustard
 150g (5oz) cheddar cheese, grated
 salt & pepper
 25g ml (1oz) fresh brown breadcrumbs

Serves 4

Dish: large dish and jug

Oven Accessory: no accessory then wire shelf in lower position

Put macaroni in 550 ml (1 pt) boiling water. Cover, place on base and cook on **HIGH MICROWAVE** for 10-12 mins. or until soft. Drain. Place butter, onion and bacon in a jug. Place on base and cook on **HIGH MICROWAVE** for 5 mins. or until onion is soft. Stir halfway through cooking. Stir in flour and cook for 30 secs. on **HIGH MICROWAVE**. Gradually add milk, stir well and season. Cook on **HIGH MICROWAVE** for 5-6 mins. or until sauce is thick and bubbling. Stir twice during cooking. Add mustard and 100g (4oz) grated cheese. Add macaroni and season. Place the macaroni mixture in a large dish. Sprinkle with breadcrumbs and remaining cheese. Place on wire shelf and cook on **CONVECTION 230°C + GRILL 3 + LOW MICROWAVE** for 10-12 mins. or until cheese starts to melt.

Cheese & Egg dishes

Cheese, Onion & Olive Scones

Dish: bowl, greased baking sheet x 2
Oven Accessory: no accessory then enamel shelf in lower position and wire shelf in upper position

Ingredients

1 medium onion, finely diced
 10 ml (2 tsp) olive oil
 175g (6oz) self-raising flour
 3 ml (½ tsp) salt
 3 ml (½ tsp) mustard powder
 3 ml (½ tsp) cayenne pepper seasoning
 25g (1oz) butter
 40g (1½ oz) strong cheddar cheese, grated
 40g (1½ oz) Parmesan cheese
 25g (1oz) black olives, stoned and chopped
 1 egg, beaten
 45 ml (3tbsp) milk
 1 beaten egg for glazing

Place onion and oil in a bowl. Place on base and cook on **HIGH MICROWAVE** for 2 mins. or until softened. Preheat oven on **CONVECTION 200°C** with shelves in position. Sift together the flour, salt, mustard and cayenne with seasoning. Rub in the butter. Mix in onion, cheeses and olives. Beat egg and milk together. Add enough of the egg and milk to form a soft dough. On a floured surface roll out dough to approx. 2 cm thick. Cut out rounds using a 5 cm pastry cutter and brush with beaten egg. Place the scones on the baking sheets. Place on shelves and cook on **CONVECTION 200°C** for 15-20 mins. or until cooked and golden brown.

Croque Monsieur



Serves 4

Dish: 15 cm (6") soufflé dish

Oven Accessory: no accessory then wire shelf in lower position

Ingredients

4 slices bread, buttered
 5 ml (1tsp) Dijon mustard
 2 slices smoked ham
 100g (4oz) sliced cheese

Place the bread, buttered side up on the Glass tray and cook on **GRILL 1** for 3-4 mins. or until browning. On 2 slices of the bread, spread the untoasted sides with mustard and top with ham and cheese. Cover with the other slices, browned side uppermost. Place back on the tray and cook on **GRILL 2 + SIMMER MICROWAVE** for 1-2 mins. or until the cheese has melted.

Cheese & Egg dishes

Yorkshire Puddings



Serves 4-6

Dish: 12 section bun tin

Oven Accessory: wire shelf in lower position

Ingredients

75g (3oz) plain flour
pinch of salt
1 egg
75 ml (2½ fl.oz) milk
75 ml (2½ fl.oz) water
oil for tin

Place flour and salt in a mixing bowl. Make a well in the centre and break in egg. Beat egg into flour and gradually add milk and water, beating well until smooth. Stand until required. Place 5ml (1tsp) oil in each section of Yorkshire Pudding bun tins. Place on shelf and preheat oven on **CONVECTION 220°C**. Pour batter into heated oil in tins. Place on wire shelf and cook on **CONVECTION 220°C** for 20-25 mins. or until well risen and brown.

Tasty Potato Bake



Serves 4-6

Dish: shallow dish, bowl, oval heatproof dish, buttered

Oven Accessory: no accessory then wire shelf on lower level

Ingredients

1kg (2lb 2oz) baking potatoes, peeled and halved
1 onion, finely chopped
225g (8oz) smoked back bacon, cut into strips
225g (8oz) brie
142ml (¼ pt) single cream

Place potatoes in a dish with 3 tbsp. water. Cover, place on base and par-boil on **MEDIUM MICROWAVE** for 15 mins. Place onion and bacon in bowl and cook on **HIGH MICROWAVE** for 5 mins. Stir halfway. Chop cheese into chunks. Layer half the potatoes in the buttered ovenproof dish. Scatter over half of the onion, bacon & cheese. Lightly season with salt & pepper. Repeat layers, then pour cream evenly over the top. Place on shelf and cook on **CONVECTION 240°C + GRILL 2 + MEDIUM MICROWAVE** for 20 mins. or until golden brown. and brown.

Sauces & Preserves

Sauces

Container size

To avoid boil over always use a container at least twice the capacity of the sauce.

Covering

DO NOT cover sauces when cooking.

Stirring - important

Sauces/gravy should be thoroughly stirred before, during and after cooking, to avoid any eruptions and to result in a smooth sauce.

Reheating

Sauces can be made in advance and reheated by MICROWAVE. Reheat on HIGH

MICROWAVE and stir halfway.

Microwave level

Most sauces require HIGH MICROWAVE for cooking. Sauces containing eggs should be cooked on SIMMER MICROWAVE.

Wooden spoons

Do not leave wooden spoons in the sauce when cooking. The wood may dry out and burn. NEVER LEAVE metal spoons in the sauce.

White Pouring Sauce

Dish: 1 litre (2 pt) jug

Ingredients

25g (1oz) butter
25g (1oz) flour
575 ml (1pt) milk

Place butter in jug on base of oven and melt on **HIGH MICROWAVE** for 30-40 secs. Stir in the flour to make a roux. Add the milk gradually, stirring continuously until well combined. Cook on **HIGH MICROWAVE** for 2 mins. Stir and cook for a further 3 mins. Sauce should be smooth and glossy and coat the back of a spoon.

Variations of White Sauce

Parsley

Stir 60 ml (4tbsp) chopped parsley and 15 ml (1tbsp) lemon juice into sauce halfway through cooking time.

Onion

Cook an onion in the butter for 30 secs. on HIGH MICROWAVE before adding flour.

Cheese

Stir in 75g (3oz) grated cheese at the end of the cooking time.

Sauces & Preserves

Custard

Dish: 1 litre (2 pt) jug

Ingredients

30 ml (2tbsp) custard powder
15 ml (1tbsp) sugar
575 ml (1 pt) cold milk

Mix together the custard powder, sugar and a little milk to form a smooth paste. Blend in the remaining milk, whisking well. Place on base and cook on **HIGH MICROWAVE** for 4-6 mins. Stir halfway through cooking time and again at the end.

Hollandaise Sauce

Dish: 1 litre (2 pt) jug

Ingredients

3 egg yolks
30 ml (2tbsp) white wine vinegar
150g (5oz) chilled, unsalted butter,
cut into cubes
pepper

Place egg yolks and vinegar in a jug. Beat well. Drop cubes of butter on top. Place jug on base of oven and cook on **HIGH MICROWAVE** for 30 secs. Whisk. Cook on **HIGH MICROWAVE** for 10 secs. Whisk again and cook on **HIGH MICROWAVE** for 10 secs. Repeat 10 sec. stages until sauce is thick and creamy. Season and serve immediately with salmon steaks or asparagus spears.

N.B. This sauce must not boil or the eggs will curdle.

Tomato Sauce

Serves 4

Dish: large casserole

Ingredients

1 medium onion, finely chopped
1 celery stick, finely chopped
1 carrot, finely chopped
25g (1oz) butter
2 cloves garlic, crushed
2 x 396g (14oz) cans of tomatoes
3ml (½ tsp) each of basil, oregano
and ground bay leaves
150ml (¼ pt) red wine or vegetable
stock
salt & pepper

Place onion, celery, carrot, butter and garlic in casserole. Place on base of oven and cook on **HIGH MICROWAVE** for 4 mins. Add the tomatoes, herbs and wine or stock. Cover and cook on **MEDIUM MICROWAVE** for 15 mins. Stir halfway. Liquidise then press through a sieve for a smooth sauce. Season to taste.

Sauces & Preserves

Chocolate Sauce

Ingredients

25g (1oz) butter
75g (3oz) caster sugar
75g (3oz) soft brown sugar
50g (2oz) cocoa powder
3ml (½ tsp) vanilla essence
275ml (½ pt) milk

Dish: 1 litre (2 pt) jug

Place butter in a jug on base of oven and melt on **HIGH MICROWAVE** for 20-30 secs. Stir in sugars, cocoa powder and vanilla essence. Gradually add milk, stirring well.

Cook on **HIGH MICROWAVE** for 2 mins. Stir well. Cook on **HIGH MICROWAVE** for 1 min. Stir and repeat this process until you achieve a smooth and glossy consistency that coats the back of a spoon.

Custard Sauce

Ingredients

2 eggs
50g (2oz) caster sugar
275ml (½ pt) milk
5ml (1tsp) vanilla essence

Dish: 1 litre (2 pt) jug

Beat eggs with sugar and then add milk and vanilla.

Place jug on base of oven and cook on **HIGH MICROWAVE** for 2 mins. Stir. Continue to cook on **HIGH MICROWAVE** for 30 secs at a time, keep stirring well, until the sauce coats the back of a spoon.

Butterscotch Sauce

Ingredients

150g (5oz) soft muscovado sugar
75ml (3fl.oz) double cream
75g (3oz) butter

Dish: 1 litre (2 pt) jug

Put all ingredients in a jug. Place on base of oven and cook on **HIGH MICROWAVE** for 1 min. Stir and continue cooking on **HIGH MICROWAVE** for 2-3 mins or until smooth and hot.

Gravy

Ingredients

meat or poultry dripping with sediment
25g (1oz) flour
275ml (½ pt) stock
salt & pepper

Dish: 1 litre (2 pt) jug

Scrape dripping and sediment from roasting dish into the jug. Stir flour into dripping and then gradually blend in stock. Place on base of oven and cook on **HIGH MICROWAVE** for 2-3 mins. stirring halfway through. Season and serve.

Sauces & Preserves

Preserves

Sterilizing jars

Jam jars can be sterilized by MICROWAVE ready for your jam. Half fill with water and heat them on HIGH MICROWAVE until water boils (approx. 4 mins. for 2 jars). Empty and drain upside down on kitchen paper. The jars should be warm when filled with jam.

If you wish to cook larger quantities than given in the recipes below, revert to the traditional hob method, using a traditional recipe.

Dish size

Always use a very large bowl. DO NOT attempt to use jam pans or saucepans in your microwave. DO NOT LEAVE JAMS UNATTENDED DURING COOKING BECAUSE OF THE HIGH SUGAR CONTENT.

Covering

Do not cover preserves whilst cooking, apart from if recommended in the recipe.

Do not seal preserving jars in your MICROWAVE

Setting point

To determine whether setting point is reached, place a couple of drops of jam or marmalade on a cold saucer (put one in the fridge whilst making the jam). Leave to cool. The jam should wrinkle on the surface when your finger pushes across the top.

Soft Fruit Jam

Makes approx. 1 ½ lbs jam

Dish: large bowl

Ingredients

450g (1lb) soft fruit, washed
450g (1lb) jam sugar
30 ml (2tbsp) lemon juice
5 ml (1tsp) butter

Place all ingredients in a large bowl and stir. Place on base of oven and cook on **HIGH MICROWAVE** for 5 mins stirring frequently. Continue to cook on **HIGH MICROWAVE** in one minute intervals until sugar has dissolved. Wash down any sugar crystals from around the bowl. Bring mixture to the boil and continue to cook on **HIGH MICROWAVE** until setting point is reached - approx. 10-20 mins. Test regularly for setting point.

Lemon Curd

Makes 2 lbs

Dish: large bowl

Ingredients

4 lemons, grated rind and juice of
450g (1lb) caster sugar
4 eggs, beaten
100g (4oz) butter

Place all ingredients in bowl. Mix well. Place on base of oven and cook on **HIGH MICROWAVE** for 2 mins. Stir and continue to cook on **HIGH MICROWAVE** in 1 minute stages until mixture starts to thicken (approx 10 mins), then cook for 30 secs. at a time until mixture coats back of spoon (the eggs will curdle if overcooked). The mixture will thicken on cooling. Pour into warm jars and cover with a circle of waxed paper and a jam pot cover.

Sauces & Preserves

Plum Jam

Makes approx. 2-2 ½ lbs jam

Dish: large bowl

Ingredients

675g (1½ lb) plums or damsons
200 ml (7fl.oz) water
675g (1½ lb) jam sugar
30 ml (2tbsp) lemon juice
5 ml (1tsp) butter

Prick the plums and place in a large bowl with the water. Place on base of oven and cook on **MEDIUM MICROWAVE** for 10 mins. or until the fruit is soft. Add the rest of the ingredients and cook on **HIGH MICROWAVE** for 5 mins stirring frequently. Wash down any sugar crystals from around the bowl and bring to the boil on **HIGH MICROWAVE**. Continue to cook on **HIGH MICROWAVE** until setting point is reached - approx. 25-30 mins. Leave to cool slightly, remove the stones, then pot, seal and label.

Tomato Chutney

Makes approx. 2 lbs

Dish: large bowl

Ingredients

675g (1½ lb) tomatoes
225g (8oz) cooking apples, peeled and sliced
1 medium onion, chopped
100g (4oz) granulated sugar
30 ml (2tbsp) tomato puree
5 ml (1tsp) salt
200 ml (7 fl.oz) white distilled vinegar
10 ml (2tsp) ground ginger
2 ml (¼ tsp) cayenne pepper
3 ml (½ tsp) mustard powder

Prick the tomatoes and place in a bowl. Cover with boiling water and leave for 5 mins. Drain. Peel off skin and roughly chop flesh. Blend apple and onion in a food processor to a thick puree. Combine all ingredients together in a bowl. Cover, place on base of oven and cook on **HIGH MICROWAVE** for 25-30 mins. stirring occasionally, or until the mixture is thick with no excess liquid. Leave to stand for 10 mins. then stir and pour into sterilized jars. Cover and label.

Red Onion Marmalade

Dish: large bowl

Makes 1 ½ lb

Ingredients

45ml (3tbsp) olive oil
4 large red onions halved and thinly sliced
50g (2oz) Demerara sugar
100g (4oz) sultanas
275ml (½ pint) red wine
125ml (4fl.oz) red wine vinegar

Put oil in bowl with onions cover with a lid or pierced cling film. Place on base of oven and cook on **MEDIUM MICROWAVE** for 30-35 mins. stirring halfway. Add all other ingredients and mix well. Cover and cook on **MEDIUM MICROWAVE** for 30-35 mins. Cool slightly, then pour into a clean, sterilized jar. Allow to cool thoroughly before chilling.

Pastry

Shortcrust Pastry

Ingredients

225g (8oz) plain flour
pinch salt
100g (4oz) margarine
45 ml (3tbsp) cold water

Dish: Large Glass bowl

Place flour and salt into a mixing bowl. Rub the margarine into the flour until the mixture resembles fine breadcrumbs. Add enough water so that when the mixture is kneaded lightly for a few seconds a firm, smooth dough is formed. If possible, rest for 15 mins. before rolling out.

Choux Pastry

Ingredients

50g (2oz) butter
150 ml (¼ pt) water
65g (2½ oz) plain flour, sifted
2 eggs, lightly beaten

Dish: Large Jug

Place butter and water in a large jug. Place on base and cook on **HIGH MICROWAVE** for 2-3 mins. or until boiling. Immediately tip in all the flour and beat well until mixture is smooth. Cool slightly. Beat in eggs one at a time, beating vigorously until mixture is smooth and glossy.

Suetcrust Pastry

Ingredients

225g (8oz) self-raising flour
3 ml (½ tsp) salt
100g (4oz) shredded suet
105 ml (7tbsp) cold water

Dish: Large Bowl

Mix together flour, salt and suet. Add water and mix to a soft dough. Knead lightly until smooth.

Pastry

Mince Beef and Onion Pie



Serves 4

Dish: large casserole with lid + 20 cm (8") pie plate

Accessory: no accessory then anti-spark ring + wire shelf on lower level

Ingredients

350g (12oz) lean minced steak
 1 medium onion, chopped
 450 ml (3/4 pt) hot beef stock
 15 ml (1tbsp) tomato puree
 5 ml (1tsp) yeast extract (Marmite®)
 salt & pepper
 10 ml (2tsp) gravy thickening
 350g (12oz) shortcrust pastry (See page 198)
 beaten egg to glaze

Combine all filling ingredients except thickening in casserole dish. Cover, place on base of oven and cook on **HIGH MICROWAVE** for 5 mins. then **MEDIUM MICROWAVE** for 15 mins. Mix gravy thickening with water and stir into meat. Leave to cool. Preheat oven on **CONVECTION 210°C**. Roll out half the pastry to fit pie plate. Remove mince with a slotted spoon, reserving gravy for serving and place on pastry base. Roll out remaining pastry for a lid and place on top of mince, sealing the edges with water. Cut 2 slits in top of pastry and glaze top with egg. Place on anti-spark ring on wire shelf and cook on **CONVECTION 220°C + SIMMER MICROWAVE** for 20 mins. or until cooked. Turn pie half way through cooking.

Chicken & Stilton Pie



Serves 4

Dish: bowl, 22.5 cm (9") gratin dish

Oven Accessory: no accessory then wire shelf in lower position

Ingredients

25g (1oz) butter
 200g (7oz) leeks, sliced
 50g (2oz) plain flour
 450 ml (3/4 pt) milk
 150g (5oz) stilton
 400g (14oz) cooked chicken, cubed
 250g (9oz) shortcrust pastry, chilled (See page 198)

Place the butter and leeks in dish and cover with a lid or pierced cling film. Place on base of oven and cook on **MEDIUM MICROWAVE** for 8 minutes or until soft. Add the flour, stir well, then gradually add the milk and cook on **HIGH MICROWAVE** for 4 mins stirring throughout or until the sauce has thickened. Preheat the oven on **CONVECTION 210°C**. Finely chop the cheese and add to the sauce, mix in the chicken. Grate the pastry on top of the chicken mixture. Place on shelf and cook on **CONVECTION 210°C + SIMMER MICROWAVE** for 20-25 mins. or until cooked and browned.

Pastry

Apple Pie



Serves 4-6

Dish: 20 cm (8") pie plate

Accessory: anti-spark ring + wire shelf on lower level

Ingredients

25g (1oz) caster sugar
5 ml (1tsp) cinnamon
50g (2oz) sultanas
2 cooking apples, peeled, cored and sliced
15 ml (1tbsp) lemon juice
350g (12oz) puff pastry

Preheat oven on **CONVECTION 210°C**. Mix together sugar, cinnamon and sultanas. Toss apples in lemon juice. Sprinkle sugar mixture over. Divide pastry in half. Roll out half and line base of plate. Place apple filling on top of pastry. Roll out remainder of pastry and cut to a circle for lid. Seal edges, crimp and brush top with egg. Pierce top once. Place pie on anti-spark ring on wire shelf and cook on **CONVECTION 220°C + SIMMER MICROWAVE** for 18-20 mins. or until cooked. Turn pie half way through cooking.

Savoury Potato Plait



Serves 4-6

Dish: shallow dish, Glass tray, greased

Accessory: no accessory then wire shelf in lower position

Ingredients

1 small potato, thinly sliced
200g (7oz) puff pastry
1 small onion, sliced
small apple, peeled, cored and sliced
salt & pepper to taste
75g (3oz) cheese, grated or crumbled, e.g. Stilton, Roule etc.
1 egg, beaten

Place potato in a shallow dish with 3tbsp water. Cover, place on base of oven and cook on **HIGH MICROWAVE** for 3 mins. Drain. Roll out the pastry to an oblong 25 x 27 cm (10 x 11"). Lift onto baking sheet. With a knife, cut each side of the long edges diagonally at 2.5 cm (1") intervals, to give strips which will become plaits. Arrange layers of potato, onion and apple down the centre of the pastry. Season. Sprinkle over the cheese. Brush the pastry strips with beaten egg and fold alternately over the mixture to form a plait. Preheat oven on **CONVECTION 210°C**. Place potato plait on Glass tray and glaze with beaten egg. Place tray on wire shelf and cook on **CONVECTION 230°C + SIMMER MICROWAVE** for 15 mins. or until crisp and golden.

Pastry

Baked Jam Roly Poly Pudding



Serves 4

Dish: 1 kg (2 lb) glass loaf dish

Accessory: wire shelf in lower position

Ingredients

1 quantity of suet pastry
(see page 136)
75 ml (5tbsp) seedless raspberry jam
milk to glaze

Roll out pastry to approx. 23 x 32 cm (9" x 13"). Spread the jam over the pastry leaving 1cm (½") border all round. Brush the edges with milk and roll the pastry up evenly, starting at one short side and sealing the edges well. Brush top with milk and place in loaf dish. Place on shelf and cook on **CONVECTION 200°C + LOW MICROWAVE** for 15 mins. or until golden.

Chocolate Éclairs



Makes 12

Dish: baking sheet x2, greased and slightly damp

Oven Accessory: enamel shelf in lower position + wire shelf in upper position

Ingredients

1 quantity of choux pastry
(see page 136)
150 ml (¼ pt) whipping cream
10 ml (2tsp) cocoa powder
15 ml (1tbsp) hot water
100g (4oz) icing sugar, sieved

Preheat the oven empty on **CONVECTION 200°C**. Place the choux pastry into a forcing bag fitted with a plain 2 cm (¾ ") nozzle. Pipe 6 fingers 9 cm (3½ ") long on each baking sheet. Place on shelves and cook on **CONVECTION 200°C** for approximately 30 mins. Pierce each éclair and return for a further 5 mins. to crisp if necessary. When cooked cool on a wire rack. Whip the cream until stiff and fill the éclairs. Dissolve cocoa in hot water and stir into icing sugar, beating well until smooth, add extra water if required. Ice the filled éclairs and leave until set.

Pastry

Lemon Meringue Pie



Serves 6

Dish: 25 cm (10") flan dish

Oven Accessory: wire shelf in lower position
then no accessory then wire shelf in lower position

Ingredients

Pastry:

250g (8oz) plain flour
25g (1oz) icing sugar
125g (4oz) butter
1 egg yolk
30ml (2tbsp) water

Filling:

90g (3oz) cornflour
600 ml (1pt) water
4 lemons, juice and grated rind of
175g (6oz) sugar
4 egg yolks

Meringue:

225g (8oz) caster sugar
5 egg whites

Preheat oven on **CONVECTION 210°C**. Rub butter into the flour until the mixture resembles fine breadcrumbs and stir in sugar. Add egg and enough water so that when the mixture is kneaded lightly for a few seconds a firm, smooth dough is formed. Line the flan dish with the pastry, prick the base with a fork and chill for 15 mins. in the fridge. Place flan on wire shelf and bake blind on **CONVECTION 210°C** for 15 mins. with baking beans. Remove baking beans and lining after 10 mins. Leave to cool. Place cornflour, water and lemon juice and rind in a jug. Place on base of oven and heat on **HIGH MICROWAVE** for 2 mins. Stir and cook on **HIGH MICROWAVE** for 2 mins. or until smooth, glossy and thickened. Add sugar. Cool slightly. Add egg yolks. Mix well. Pour into pastry case. Preheat oven on **CONVECTION 150°C**. Whisk egg whites stiffly. Add sugar gradually - whisking after each addition. Pile meringue onto lemon filling. Place flan on shelf and cook on **CONVECTION 150°C** for 35-40 mins. or until lightly browned. Turn pie around half way.

Custard Tarts



Serves 6

Dish: 22.5cm (9") ceramic flan dish

Oven accessory: Wire shelf on lower level

Ingredients

1 ready made shortcrust pastry circle
450ml (3/4pint) milk
1tsp vanilla extract
4 eggs
50g caster sugar

Line a lightly greased flan dish with the pastry. Prick pastry with a fork and chill for 15mins. Bake blind for 10 mins on **CONVECTION:180°C** on the wire shelf. Remove baking beans and continue cooking for a further 10 mins. Remove the wire shelf. Mix the milk and vanilla and heat on **HIGH MICROWAVE** for 3mins. Mix together eggs and sugar. Gradually add the milk to the egg mixture and stir well. Strain the egg mixture into the flan case and sprinkle with nutmeg. Put the wire shelf into the oven on the lower level. Cook on **COMBINATION: 180°C + WARM MICROWAVE** for 15-20 mins or until set.

Pastry

Apple Strudel



Serves 4

Oven Accessory: enamel shelf greased in lower position

Ingredients

600g (1lb 5oz) dessert apples-
Granny Smith's, cored, peeled and
roughly chopped
juice of ½ lemon
50g (2oz) golden caster sugar
50g (2oz) walnuts, roughly chopped
50g (2oz) sultanas
5 ml (1tsp) ground cinnamon
50g (2oz) ground almonds
225g (8oz) filo pastry
50g (2oz) butter, melted
icing sugar to serve

Preheat the oven empty on **CONVECTION 180°C**. Put the apples and juice into a bowl and toss together. Add the sugar, walnuts, sultanas, cinnamon and almonds and mix together. Take three sheets of filo pastry and brush with melted butter. Place each one with the shortest edge towards you. Overlap the 2nd sheet onto the 1st sheet by 5-6 cms along the long edge and repeat with the 3rd sheet overlapping the second. Place three more sheets of filo on top, in the same way as in step 4. Spread the apple filling along the front edge of the filo pastry just 2.5cms from the edge and 2.5cms from each side. Fold the sides in over the filling and brush with butter. Roll up from the long front edge buttering the final long edge to seal the strudel. Place on enamel shelf, seam-side down. Brush with melted butter and cook on **CONVECTION 180°C** for 35 mins. Dust with icing sugar to serve.

Desserts & Baking

Creamy Rice Pudding



Serves 4

Dish: large Round casserole dish, greased

Ingredients

100g (4oz) pudding rice
1 litre (13/4 pts) milk
50g (2oz) caster sugar
2ml (1/4 tsp) grated nutmeg

Mix all the ingredients together and pour into casserole dish. Cover and place on base of oven and cook on **HIGH MICROWAVE** for 10-12 mins. or until the milk is boiling. Stir. Cook on **CONVECTION 180°C + SIMMER MICROWAVE** for 15 mins. Stir pudding to break up any lumps. Cook on **CONVECTION 180°C + SIMMER MICROWAVE** for a further 15-20 mins. Leave to stand for 5 mins. to thicken further before serving.

Steamed Suet Sponge Pudding



Serves 4

Dish: 1 litre (2 pt) pudding basin

Ingredients

150g (5oz) self-raising flour sieved
pinch of salt
50g (2oz) caster sugar
50g (2oz) suet
1 egg
150 ml (1/4 pt) milk
30 ml (2tbsp) jam or golden syrup

Mix the sieved flour and salt and stir in sugar and suet. Make a well in the centre and add beaten egg and milk. Mix to a soft dropping consistency. Put the jam or syrup in the base of the greased pudding basin and pour pudding mixture over. Place on base of oven and cook on **MEDIUM MICROWAVE** for 7 mins.

Spotted Dick



Serves 4

Dish: 1 kg (2 lb) glass loaf dish

Accessory: wire shelf in lower position

Ingredients

100g (4oz) self raising flour
pinch of salt
75g (3oz) shredded suet
75g (3oz) fresh breadcrumbs
50g (2oz) caster sugar
175g (6oz) currants
grated zest of 1 lemon
60ml (4tbsp) milk

Mix all of the dry ingredients, including the grated lemon zest together. Add enough milk to produce soft dough. Turn out onto a floured surface and roll out the mixture to produce a roll approximately 15cm (6 in) long and 5cm (2 in) in diameter. Brush top with milk and place in loaf dish. Place on shelf and cook on **CONVECTION 180°C + LOW MICROWAVE** for 15 mins. or until golden.

Desserts & Baking

Syrup Sponge Pudding



Serves 4

Dish: 1 litre (2 pt) pudding basin

Ingredients

75g (3oz) golden syrup or jam
100g (4oz) margarine
100g (4oz) caster sugar
2 eggs
100g (4oz) self-raising flour
30 ml (2tbsp) milk

Place syrup or jam in base of bowl. Cream together the margarine and sugar until light and fluffy. Beat in the eggs gradually. Fold in the flour and mix to a soft consistency with the milk. Spoon the mixture over the syrup or jam. Place on base of oven and cook on **MEDIUM MICROWAVE** for 5½ mins. Leave to cool slightly before turning upside down on a serving plate.

Pineapple Upside Down Pudding



Serves 4

Dish: 20 cm (8") round dish, lightly greased

Oven Accessory: wire shelf in lower position

Ingredients

15 ml (1tbsp) brown sugar
small can of pineapple slices,
drained
4 glace cherries, halved
100g (4oz) margarine
100g (4oz) caster sugar
2 eggs
100g (4oz) self-raising flour
30 ml (2tbsp) milk

Sprinkle brown sugar on base of dish, arrange pineapple slices and cherry halves on top of sugar in the base. Cream together the margarine and sugar until light and fluffy. Beat in the eggs gradually. Fold in the flour and mix to a soft consistency with the milk. Spoon the mixture over the pineapple. Place on shelf and cook on **CONVECTION 170°C + WARM MICROWAVE** for 25-30 mins. or until cooked and golden brown. Leave to cool slightly before turning upside down on a serving plate.

Desserts & Baking

Eve's Pudding



Serves 4

Dish: shallow ovenproof dish, lightly greased
Oven Accessory: no accessory then wire shelf in lower position

Ingredients

500g (1lb) cooking apples, peeled, cored and sliced
 90g (3oz) Demerara sugar
 100g (4oz) margarine
 100g (4oz) caster sugar
 2 eggs
 100g (4oz) ground almonds
 30 ml (2tbsp) milk

Place apple in dish with 15ml (1tbsp) of water. Cover, place on base of oven and cook on **MEDIUM MICROWAVE** for 5 mins. Stir in the Demerara sugar. Cream together the margarine and sugar until light and fluffy. Beat in the eggs gradually. Fold in the almonds and mix to a soft consistency with the milk. Spoon the mixture over the apple. Place on shelf and cook on **CONVECTION 180°C + WARM MICROWAVE** for 30-40 mins. or until cooked and golden brown. Leave to cool slightly before turning upside down on a serving plate.

Sticky Pudding with Toffee sauce

Dish: 20cm (8") pudding basin, greased and lined, jug

Ingredients

175g (6oz) fresh or ready to eat dates, stoned and finely chopped
 50g (2oz) butter
 175g (6oz) caster sugar
 2 eggs, lightly beaten
 175g (6oz) self raising flour
 5ml (1tsp) bicarbonate of soda
 3ml (½tsp) grated nutmeg
 3ml (½ tsp) ground ginger
Sauce:
 150g (5oz) muscovado sugar
 75ml (3fl.oz) double cream
 75g (3oz) butter

Pour 300ml (1/2 pt) boiling water over the chopped dates and set aside to cool. Cream the butter and sugar until light and fluffy. Beat in the eggs a little at a time. Fold in the flour, bicarbonate of soda, spices and the dates with the liquid. Pour mixture into the basin. Place on base of oven and cook on **MEDIUM MICROWAVE** for 10 mins. or until cooked. To make the sauce, place all the ingredients in a large jug and cook on **HIGH MICROWAVE** for 1 minute or until the sugar has dissolved. Stir and continue to cook on **HIGH MICROWAVE** for 1-2 mins or until smooth and hot. Drizzle the hot sauce over the sponge and serve with whipped cream.

Desserts & Baking

Crème Caramel



Serves 4

Dish: 15 cm (6") soufflé dish

Ingredients

150 ml (¼ pt) water
100g (4oz) caster sugar
4 eggs
5ml (1tsp) vanilla essence
50g (2oz) caster sugar
575 ml (1 pt) cold milk

Put water and the 100g (4oz) of sugar in a soufflé dish. Place on base of oven and cook on **HIGH MICROWAVE** for 2 mins. or until sugar has dissolved. Continue cooking on **HIGH MICROWAVE** for 12-15 mins. until sugar has caramelised, keeping a close watch as it can burn easily. **CAUTION** - Remove from oven very carefully (the base will be extremely hot) and cool. Beat eggs, vanilla essence, caster sugar and milk together and strain over caramel. Place dish on base of oven and cook on **SIMMER MICROWAVE** for 25-30 mins. or until starting to set round edge of dish. The custard will continue to set on cooling. Refrigerate for several hours before turning out.

Strawberry Roulade



Dish: Swiss roll tin 23 x 33cm (13"x 9"),
greased and lined with
baking parchment

Oven Accessory: wire shelf in lower position

Ingredients

4 medium egg whites
200g (7oz) caster sugar
5 ml (1tsp) cornflour
5 ml (1tsp) malt vinegar
5 ml (1tsp) vanilla extract
40g (1½) flaked almonds
Filling:
300ml (½ pt) double cream, softly
whipped
250g (9oz) strawberries, sliced

Preheat the oven on **CONVECTION 150°C**. Whisk the egg whites until stiff but not dry. Slowly whisk in the sugar until the mixture is thick and glossy. Blend the cornflour, vinegar and vanilla extract to a smooth paste, in a separate bowl and then whisk into egg whites. Spoon into the tin and gently level the top. Sprinkle with flaked almonds. Place on wire shelf and cook on **CONVECTION 150°C** for 30 mins. Remove meringue from oven and cover with damp greaseproof paper. After 10 minutes remove greaseproof paper from the meringue and turn out onto a sheet dusted with icing sugar and carefully peel off the lining paper. Spread cream all over the meringue and scatter the strawberries on top. Roll up the roulade from one of the short edges using the baking parchment paper to help you. Chill in the fridge for 30 mins and then lightly dust with icing sugar before serving.

Desserts & Baking

Bread & Butter Pudding



Serves 4

Dish:

Oven Accessory: Wire shelf on lower level

Ingredients

4 Hot Cross buns sliced in half and buttered
 or 10 slices fruit bread buttered & cut on the diagonal
 100g mixed dried fruit
 1 pint milk
 4 eggs, beaten
 75g caster sugar
 1 tbsp Demerara sugar
 nutmeg

Butter the dish. Place the buttered slices of buns or bread in the dish overlapping them. Sprinkle over dried fruit. Heat milk in jug on **MEDIUM MICROWAVE** for 3 mins. Mix the beaten eggs, sugar together and gradually add warm milk. Pour over the bread. Allow the dish to stand for 10-15 minutes to allow the bread to soak up the egg custard. Sprinkle over the Demerara sugar and nutmeg. Bake on the low shelf level on **COMBINATION: 250+ WARM** micro power for 18-20minutes or until golden brown and set. Serve warm with custard.

Apricot & Marzipan Baked Apples



Serves 2

Dish: 20cm (8") shallow dish

Ingredients

4 medium sized cooking apples
 50g (2oz) marzipan
 200g (7oz) can apricot halves

Roll out marzipan and cut into 4 circles with an 8½ cm (3¼") cutter. Core the apples and cut in half horizontally. Cover the bottom half of each of the apples with a circle of marzipan and 3 apricot halves. Place the other half of each apple on top. Fill the centre of each apple with apricots and place in a shallow dish. Place on base of oven and cook on **MEDIUM MICROWAVE** for 8-10 mins. Stand for 2-3 mins before serving.

NB The apples will look quite green when removed from the oven, but they should feel slightly soft when tested with a sharp knife. During the standing time, the colour will become dull and the apples will be tender. The apples will overcook very easily, so take care to undercook slightly.

Desserts & Baking

Fruit Crumble



Ingredients

675g (1lb 8oz) fresh fruit, prepared
(e.g. apples, plums, rhubarb,
blackcurrants)
sugar to taste

Crumble Topping:

100g (4oz) butter
200g (7oz) plain flour
100g (4oz) light soft brown sugar

Serves 4

Dish: shallow ovenproof dish

Oven Accessory: no accessory then wire shelf
in lower position

Layer prepared fruit in the dish. Place on base of oven and cook on **MEDIUM MICROWAVE** for 3 mins. Add sugar to taste, depending on the sharpness of the fruit. Rub butter into the flour until mixture resembles fine breadcrumbs. Stir in the sugar. Sprinkle the crumble over the fruit, so that it is completely covered. Place on shelf and cook on **CONVECTION 230°C + SIMMER MICROWAVE** for 15 - 20 minutes, or until golden brown.

Red fruit Compote



Ingredients

225g (8oz) plums, halved and
stoned
225g (8oz) cherries, stoned
225g (8oz) blueberries
225g (8oz) strawberries
225g (8oz) raspberries
50g (2oz) golden caster sugar

Serves 4

Dish: large shallow ovenproof dish

Place the plums, cherries and blueberries in dish. Place on base of oven and cook on **LOW MICROWAVE** for 10 mins. Stir in the strawberries and cook on **LOW MICROWAVE** for a further 5 mins. Stir the raspberries and sugar into the hot fruit and allow to cool before serving.

Chocolate Cheesecake



Ingredients

100g (4oz) butter
225g (8oz) digestive biscuits,
crushed
225g (8oz) plain chocolate
30ml (2 tbsp) milk
700g (1½ lb) soft cheese
175g (6oz) soft brown sugar
3 medium eggs
5ml (1tsp) vanilla essence

Serves 8-10

Dish: bowl, 23cm (9") flan tin, greased

Accessory: no accessory then wire shelf in
lower position

Put butter in bowl. Place on base of oven and heat on **HIGH MICROWAVE** for 40-50 secs. Stir in biscuits and press into base of flan. Melt chocolate with milk on **HIGH MICROWAVE** for 2 mins. Preheat oven on **CONVECTION 150°C**. Mix all the remaining ingredients and stir in chocolate. Pour over biscuit base. Place tin on shelf and cook on **CONVECTION 150°C** for 30-40 mins.

Desserts & Baking

Christmas Pudding



Serves 6-8

Dish: 1.3 litre (2 ½ pt) pudding basin lightly greased

Ingredients

1 carrot, peeled and grated
 1 orange, juice and grated rind of
 400g (14oz) mixed dried fruit
 45 ml (3tbsp) brandy
 15 ml (1tbsp) black treacle
 50g (2oz) self-raising flour
 pinch of salt
 15 ml (1tbsp) cocoa
 5 ml (1tsp) mixed spice
 3 ml (½ tsp) nutmeg
 100g (4oz) shredded suet
 150g (5oz) fresh breadcrumbs
 50g (2oz) mixed peel
 50g (2oz) flaked almonds
 2 eggs, beaten

Place carrot in a large bowl. Place on base of oven and cook on **HIGH MICROWAVE** for 5 mins. Beat well to make a thick puree. Stir in juice, rind and mixed fruit. Cook on **HIGH MICROWAVE** for 2 mins. Stir in brandy and treacle. Stand for 5 mins. Beat in rest of ingredients. Press into the pudding basin. Cover, place on base of oven and cook on **MEDIUM MICROWAVE** for 5 mins. Stand for 5 mins. Cook on **MEDIUM MICROWAVE** for another 3 mins. or until just firm.

NOTE. One of the advantages of using your **MICROWAVE** to make this traditional pudding is that it can be made the week before Christmas and stored in a cool dry place. Do not attempt to make the pudding earlier than this, since the flavour will not improve with keeping, unlike a traditionally steamed pudding.

Pears poached in Cider



Serves 4

Dish: 7"17.5cm soufflé dish

Ingredients

225ml sweet cider
 50g 2oz caster sugar
 Rind and juice of 1 lemon
 Pinch of ground nutmeg
 4 firm pears (eg conference) peeled with stalks in tact

Put the cider, sugar, lemon rind and juice and nutmeg into the soufflé dish and cook on **HIGH MICROWAVE** for 2mins to dissolve the sugar. Lay the pears in the cider mixture. Cover the dish with pierced clingfilm and cook on **HIGH MICROWAVE** in 3 minute stages for a total of 15 mins. Turn regularly. Remove clingfilm and pears. Cook remaining liquid on **HIGH MICROWAVE** until it reduces and becomes syrupy. This will take about 12 mins. Serve pears with syrup and ice-cream or Chantilly cream.

Desserts & Baking

Baking

Dish Size /shape

Always use the exact dish size stated in the following recipes, otherwise cooking times and results will be affected.

Eggs

The following recipes have been tested using medium eggs. Using a different size of egg may affect cooking times.

Celebration Cake

Ingredients

200g (8oz) butter or margarine
 200g (8oz) dark muscovado sugar
 200g (8oz) plain flour
 4 eggs, beaten
 50g (2oz) ground almonds
 100ml (3½ fl.oz) sherry
 75g (3oz) candied peel
 75g (3oz) glace cherries, roughly chopped
 250g (9oz) currants
 250g (9oz) raisins
 100g (4oz) pecan nuts, broken into pieces
 finely grated zest of 1 lemon
 7.5 ml (1½ tsp) mixed spice
 2.5ml (½ tsp) vanilla extract
 2.5ml (½ tsp) baking powder

Dish: 20cm (8") round tin, greased and lined
Oven Accessory: wire shelf on lower level

Preheat oven on **CONVECTION 140°C**. Prepare the tin by lining with a double layer of greaseproof paper on the inside and tie a double band of brown paper around the outside.

Cream the butter and sugar until pale and fluffy. Add the eggs one at a time, beating well after each addition. Fold in half the flour using a metal spoon, then fold in the rest. Stir in the almonds. Mix in the sherry, and then add the peel, cherries, raisins, currants, nuts, lemon zest, spice and vanilla. Stir in the baking powder. Spoon mixture into the tin and spread evenly, removing all air pockets. Make a small dip in the centre. Place tin on shelf and cook on **CONVECTION 140°C** for 2-2¼ hrs. until a skewer inserted in the middle comes out clean. Leave cake to cool in tin. When completely cold wrap well in cling film and foil to store until ready to decorate. The cake will keep for several months.

Victoria Sandwich

Ingredients

175g (6oz) butter or margarine
 175g (6oz) caster sugar
 3 eggs
 175g (6oz) self-raising flour

Dish: 2 x 18 cm (7") cake tins, greased and lined
Oven Accessory: enamel shelf in lower position + wire shelf in upper position

Preheat oven on **CONVECTION 180°C**. Cream butter and sugar until pale and fluffy. Add the eggs a little at a time beating well after each addition. Fold in half the flour, using a metal spoon, then fold in the remaining flour. Spoon the mixture into the tins and level with a knife. Place one tin in the centre of the enamel shelf and one tin in the centre of the wire shelf. Cook on **CONVECTION 180°C** for 20-25 mins. or until cooked. Sandwich together with cream and jam and dust with icing sugar or with a filling of your choice.

Desserts & Baking

Victoria Sandwich

Dish: 2 x 18 cm (7") cake tins, greased and lined

Oven Accessory: enamel shelf in lower position + wire shelf in upper position

Ingredients

175g (6oz) butter or margarine
175g (6oz) caster sugar
3 eggs
175g (6oz) self-raising flour

Preheat oven on **CONVECTION 180°C**. Cream butter and sugar until pale and fluffy. Add the eggs a little at a time beating well after each addition. Fold in half the flour, using a metal spoon, then fold in the remaining flour. Spoon the mixture into the tins and level with a knife. Place one tin in the centre of the enamel shelf and one tin in the centre of the wire shelf. Cook on **CONVECTION 180°C** for 20-25 mins. or until cooked. Sandwich together with cream and jam and dust with icing sugar or with a filling of your choice.

Gingerbread

Dish: bowl, 18 cm (7") square tin lined with 2 strips of greaseproof paper to form a cross shape.

Oven Accessory: no accessory then anti-spark ring + wire shelf in lower position

Ingredients

225g (8oz) plain flour
pinch salt
10 ml (2tsp) ground ginger
10 ml (2tsp) baking powder
3 ml (½ tsp) bicarbonate of soda
100g (4oz) soft brown sugar
75g (3oz) butter or margarine
75g (3oz) treacle
75g (3oz) golden syrup
150 ml (¼ pt) milk
1 egg, beaten

Sift the flour, salt, ginger, baking powder and bicarbonate of soda into a bowl. Place the sugar, butter, treacle and syrup in a bowl. Place on base of oven and cook on **HIGH MICROWAVE** for 30-60 secs. Whisk the milk and egg together. Make a well in the centre of the dry ingredients and pour in the liquid and syrup, mixing thoroughly. Pour the mixture into the cake tin. Place tin on the anti-spark ring and cook on **CONVECTION 160°C + SIMMER MICROWAVE** for 20 mins. or until just firm.

Desserts & Baking

Fruity Cream-Cheese Cake

Dish: 20 cm (8") round cake tin, greased and lined

Oven Accessory: anti-spark ring + wire shelf in lower position

Ingredients

150g (5oz) butter
 10 ml (2tsp) grated lemon rind
 150g (5oz) packet of cream cheese
 225g (8oz) caster sugar
 3 eggs, beaten
 100g (4oz) plain flour
 100g (4oz) self-raising flour
 150g (5oz) sultanas
 150g (5oz) glace cherries

Cream together butter, lemon rind, cream cheese and sugar until light and fluffy. Add eggs a little at a time beating well after each addition. Fold in sifted flours, sultanas and quartered cherries. Spread mixture into tin. Place tin on the anti-spark ring and cook on **CONVECTION 160°C + WARM MICROWAVE** for 35-40 mins. or until cooked.

Carrot Cake

Dish: 18 cm (7") square tin, base lined

Oven Accessory: anti-spark ring + wire shelf in lower position

Ingredients

150 ml (¼ pt) sunflower oil
 250g (9oz) wholemeal self-raising flour
 10 ml (2tsp) baking powder
 10 ml (2tsp) cinnamon
 5 ml (1tsp) nutmeg
 150g (5oz) light muscovado sugar
 50g (2oz) walnuts, coarsely chopped
 125g (4oz) carrots, grated
 2 ripe bananas, mashed
 2 eggs, beaten
Cream Cheese Topping:
 250g (8oz) cream cheese
 10ml (2tsp) honey
 5ml (1tsp) lemon juice
 chopped walnuts to decorate

Place all the cake ingredients in a large bowl and mix well. Spoon into the lined tin. Place tin on anti-spark ring and cook on **CONVECTION 160°C + WARM MICROWAVE** for 40 mins. or until cooked and well risen. Allow to cool in the tin. To make the topping mix the cheese, honey and lemon. Decorate the cooled cake with the cream cheese topping and walnuts.

Desserts & Baking

Banana Cake

Dish: bowl, 18 cm (7") cake tin, lined with greaseproof paper
Oven Accessory: no accessory then anti-spark ring + wire shelf in lower position

Ingredients

1 banana, large
 3 ml (½ tsp) vanilla flavouring
 75g (3oz) butter
 100g (4oz) granulated sugar
 150g (5oz) self-raising flour
 3 ml (½ tsp) salt
 1 ½ ml (¼ tsp) bicarbonate of soda
 2 eggs

Peel the banana and mash until smooth with the vanilla flavouring. Place the butter and sugar in a bowl. Place on base of oven and melt on **HIGH MICROWAVE** for 1 minute, or until soft. Stir in the flour, salt and bicarbonate of soda. Beat in the eggs and mashed banana. Spoon into the prepared cake tin. Place tin on anti-spark ring on shelf and cook on **CONVECTION 160°C + WARM MICROWAVE** for 20 minutes, or until cooked.

Dundee Cake

Dish: 20 cm (8") round tin, greased and lined
Oven Accessory: anti-spark ring + wire shelf in lower position

Ingredients

100g (4oz) currants
 100g (4oz) sultanas
 100g (4oz) raisins
 50g (2oz) whole almonds, blanched and chopped, reserve 6 whole for decoration
 225g (8oz) butter or margarine
 225g (8oz) soft brown sugar
 grated rind of one lemon
 4 eggs
 275g (10oz) plain flour
 100g (4oz) chopped mixed peel.

Mix the chopped nuts, fruit, peel and flour together. Cream the fat, sugar and lemon rind until pale and fluffy. Beat in the eggs one at a time. Fold in the dry ingredients. Spoon mixture into tin and hollow out the centre slightly. Split the reserve almonds, and arrange on top. Place tin on anti-spark ring and cook on **CONVECTION 160°C + WARM MICROWAVE** for 50-60 mins.

Desserts & Baking

Coffee and Walnut Cake

Dish: 18 cm (7") round cake tin, greased and lined

Oven Accessory: anti-spark ring + wire shelf in lower position

Ingredients

175g (6oz) soft margarine
 175g (6oz) caster sugar
 3 eggs, beaten
 200g (7oz) self raising flour
 3ml (½ tsp) salt
 5ml (1 tsp) mixed spice
 45 ml (3tbsp) Camp coffee essence
 45 ml (3tbsp) milk
 15ml (1tbsp) black treacle
 75g (3oz) chopped walnuts

Icing:

50g (2oz) soft margarine
 225g (8oz) icing sugar
 15 ml (1½ tbsp) Camp coffee essence
 15 ml (1tbsp) water

Cream margarine and sugar until light and fluffy. Gradually beat in the eggs. Fold in the dry ingredients. Add coffee essence, milk, treacle and walnuts. Stir well. Spoon into tin. Place tin on anti-spark ring and cook on **CONVECTION 160°C + WARM MICROWAVE** for 30-40 mins. Cool. Cut in half. Beat all icing ingredients together until smooth. Sandwich cake together with half the icing and spread the remainder over the top. Decorate with whole walnuts.

Rhubarb, Ginger and Orange Crumble

Dish: Large shallow oven proof dish

Oven Accessory: Wire shelf on lower level

Ingredients

Ingredients

700g (1lb 8oz) rhubarb
 3tbsp ginger jam
 3 oranges segmented

Topping

300g plain flour
 150g Softened butter
 150g Demerara sugar
 Ground ginger to taste

Chop rhubarb. Microwave on **HIGH MICROWAVE** with 1tbsp water for 6 mins. Put rhubarb into the dish. Dot around the jam and add the orange segments. Rub butter into the flour until the mixture resembles breadcrumbs. Stir in the sugar. Add spices to taste. Sprinkle the crumble over the fruit. Put the wire shelf on the lower level and cook on **CONVECTION 230°C +** Simmer for 20 mins.

Tip: Alternatively swap rhubarb, ginger jam and oranges for apple and sultanas. Swap ground ginger for mixed spice and cinnamon.

Desserts & Baking

Pecan Sour Cream Cake

Dish: 23cm (9") cake tin, lined with greaseproof paper

Oven Accessory: anti-spark ring + wire shelf in lower position

Ingredients

250g (9oz) butter
 5 ml (1tsp) vanilla essence
 150g (5oz) caster sugar
 2 eggs, beaten
 284ml (½ pt) cream
 225g (8oz) plain flour
 75g (3oz) self raising flour
 5 ml (1tsp) bicarbonate of soda
 100g (4oz) pecan nuts, finely chopped
 25g (1oz) brown sugar
 3 ml (½ tsp) ground cinnamon
 100g (4oz) pecan nuts, whole
 60 ml (4tbsp) maple syrup

Cream together butter, essence and sugar until light and fluffy. Add the eggs a little at a time, beating well after each addition. Stir in the soured cream and then fold in the sifted flours and soda. Spread half the cake mixture into the prepared tin. Sprinkle over the combined pecan nuts, brown sugar and cinnamon. Cover with the remaining cake mixture.

Arrange the whole pecan nuts on the top. Place tin on anti-spark ring and cook on **CONVECTION 160°C + WARM MICROWAVE** for 35-40 mins. or until cooked. Brush with maple syrup and allow to cool in the tin.

Swiss Roll

Ingredients

3 large eggs, beaten
 125g (4½oz) caster sugar
 100g ((4oz)) plain flour
 25g (1oz) cocoa powder
Filling
 200g (8oz) fresh raspberries
 250ml (½ pt) double cream
 icing sugar to dredge

Dish: enamel shelf greased and lined with baking parchment

Oven Accessory: wire shelf in lower position

Preheat oven on **CONVECTION 200°C**.

Whisk eggs and sugar together in a heatproof bowl until blended. Stand bowl over hot water and continue to whisk eggs and sugar until pale and creamy, and mixture leaves a trail on the surface when the whisk is lifted.

Remove from hot water and whisk until cool and thick.

Carefully fold in half of the sifted flour, then fold in the other half. Fold in 15ml (1tbsp) of hot water. Tip the tin to allow mixture to run into corners. Turn halfway. Place tin on shelf and cook on **CONVECTION 200°C** for 8-9 mins. Place sheet of greaseproof paper on a damp tea towel and dredge paper with caster sugar. Quickly turn the Swiss roll out onto the greaseproof and carefully remove the baking parchment.

Desserts & Baking

Boiled Fruit Cake

Dish: bowl, 20cm (8") cake tin, greased and lined with greaseproof paper
Oven Accessory: no accessory then anti-spark ring + wire shelf in lower position

Ingredients

175g (6oz) golden syrup
 150g (5oz) margarine
 150ml (¼ pt) milk
 450g (1lb) mixed dried fruit
 225g (8oz) plain flour
 10ml (2tsp) mixed spice
 pinch salt
 10ml (2tsp) baking powder
 2 eggs, beaten
 25g (1oz) demerara sugar (optional)

Place syrup, margarine, milk and fruit in a bowl. Place on base of oven and heat on **HIGH MICROWAVE** for 5 mins. stirring twice. Cool slightly. Sieve in dry ingredients and mix in eggs. Beat well. Pour into tin and sprinkle with Demerara sugar. Place tin on anti-spark ring and cook on **CONVECTION 160°C + WARM MICROWAVE** for 35-40 mins. or until cooked.

Millionaires shortbread

Dish: 18 cm (7") round cake tin, greased and lined
Oven Accessory: anti-spark ring + wire shelf in lower position

Ingredients

Shortbread
 225g plain flour
 75g (3oz) caster sugar
 175g unsalted butter
 Caramel
 200g butter
 397g unsweetened condensed milk
 60ml (4tbsp) golden syrup
 Topping
 400g dark chocolate in chunks
 30ml (2tbsp) vegetable oil

Preheat oven on **CONVECTION 170°C**. Place flour and sugar in a bowl and rub in butter. Press dough into tin. Prick shortbread with a fork and cook on **CONVECTION 170°C** for 5 mins, then reduce temperature to 150°C for 30-40 mins. Remove from oven when shortbread has a golden colour and leave to cool in tin. Place butter for caramel in a bowl and melt on **HIGH MICROWAVE** for 2-3 mins. Add condensed milk and syrup. Whisk until thoroughly mixed and cook on **HIGH MICROWAVE** for 8 mins. Stir mixture every minute to prevent burning. Caramel should have thickened in this time. Pour caramel over shortbread. Place chocolate and oil in a large bowl and melt on **HIGH MICROWAVE** for 1min 30secs. Stir. Pour chocolate on caramel and chill.

Desserts & Baking

American Cookies

Ingredients

Basic Cookie Dough:

100g (4oz) butter
100g (4oz) caster sugar
1 egg, beaten
175g (6oz) plain flour

Variations:

White Chocolate and Pistachio Nut

100g (4oz) white chocolate, chopped
50g (2oz) pistachio nuts, chopped

Marzipan and Cherry

100g (4oz) glaze cherries
50g (2oz) marzipan, chopped

Peanut Butter

100g (4oz) peanuts
50g (2oz) peanut butter, crunchy

Chocolate Chunk

75g (3oz) white chocolate, chopped
75g (3oz) dark chocolate, chopped

Dish: 2 greased baking trays 30 x 21.5 cms (11 ½ x 8")

Oven Accessory: enamel shelf in lower position + wire shelf in upper position

Preheat oven on **CONVECTION 170°C**. Cream together the butter and sugar until pale, then beat in the egg. Mix in the flour until well combined and add the chosen additions. Place walnut-sized spoonfuls of dough well apart on greased baking trays, flatten slightly with a fork. Place in oven and cook on **CONVECTION 170°C** for 10-15 mins. or until golden. Remove from baking sheets and allow to cool on a wire rack.

Fruit Scones



Ingredients

225g (8oz) self-raising flour
pinch salt
5 ml (1tsp) baking powder
50g (2oz) butter
25g (1oz) caster sugar
50g (2oz) sultanas
75 ml (5tbsp) milk
beaten egg to glaze

Makes 10

Dish: baking tray 30 x 21.5cms (12" x 8"), greased

Oven Accessory: wire shelf in lower position

Preheat oven on **CONVECTION 210°C**. Sift the flour, salt and baking powder together. Rub in fat until the mixture resembles fine breadcrumbs. Add sugar and sultanas. Make a well in the centre and stir in enough milk to form a soft dough. Knead lightly. Pat out to 2cm (¾") thick and cut into 10 rounds with a 5 cm (2") cutter. Place on baking sheet and brush with beaten egg. Place on shelf and cook on **CONVECTION 210°C** for 15 mins. or until well risen and golden brown.

Desserts & Baking

Chocolate Brownies

Dish: bowl, 30x20x3.5cm (12" x 8" x 1½") tin lined with lightly buttered greaseproof paper
Oven Accessory: no accessory then anti-spark ring + wire shelf in lower position

Ingredients

250g (9oz) plain chocolate
 250g (9oz) unsalted butter
 175g (6oz) plain flour
 5ml (1tsp) baking powder
 300g (11oz) caster sugar
 4 large eggs, lightly beaten
 1tsp vanilla essence
 75g (3oz) pecans, broken into pieces
 75g (3oz) milk chocolate, cut into large chunks
 75g (3oz) white chocolate, cut into large chunks

Put the plain chocolate and butter in a large bowl. Place on base and melt on **HIGH MICROWAVE** for 3-4 mins. Leave to cool slightly. Sieve the flour and baking powder into a bowl and set aside. Stir the sugar into the chocolate. Add the eggs and vanilla essence. Fold in the flour, nuts and chocolate. Pour the chocolate mixture into the prepared cake tin. Place on anti-spark ring on wire shelf and cook on **CONVECTION 180°C + SIMMER MICROWAVE** for 20 mins. The middle should feel soft when cooked. Allow to cool in the tin. Remove the brownies from the tin and cut into squares.

Fairy Cakes



Makes 24

Dish: 2 x 12 hole bun tins 32cm x 24cm (12½" x 9½") + 24 paper cake cases
Oven Accessory: enamel shelf in lower position + wire shelf in upper position

Ingredients

175g (6oz) butter
 175g (6oz) caster sugar
 3 eggs, beaten
 175g (6oz) self raising flour
 5ml (1tsp) vanilla essence

Preheat oven on **CONVECTION 180°C** with shelves in position. Cream together butter and sugar until light and fluffy. Add the eggs a little at a time, beating well after each addition. Fold in the flour. Fill the paper cases two thirds full with mixture. Cook on **CONVECTION 180°C** for 15 mins, turning the enamel shelf and wire shelf around half way. Cook until golden and firm to touch.

Variation: Queen Cakes

Add 75g (3oz) sultanas in with the flour and cook as above.

Desserts & Baking

Streusel Topped Fruit Muffins



Makes 12

Dish: bowl, 2 x 6 hole muffin tins + 12 paper muffin cases

Oven Accessory: no accessory then enamel shelf in lower position + wire shelf in upper position

Ingredients

Streusel Topping

50g (2oz) butter
75g (3oz) plain flour
30ml (2tbsp) granulated sugar
15ml (1tbsp) ground mixed spice

Muffins

200g (7oz) plain flour
3 ml (½ tsp) bicarbonate of soda
10 ml (2tsp) baking powder
pinch salt
75g (3oz) caster sugar
75g (3oz) butter
200ml (7fl.oz) buttermilk
1 medium egg, beaten
175g (6oz) fresh or frozen berries, raspberries or blueberries are ideal

Make streusel topping. Place butter in a bowl and place on base of oven. Melt on **HIGH MICROWAVE** for 10-20 secs. Add the remaining topping ingredients and combine to make a soft dough. Chill. Sift together the flour, bicarbonate soda, baking powder and salt. Stir in the sugar. Melt butter for the muffins on **HIGH MICROWAVE** for 20-30 secs. Cool slightly then mix in the buttermilk and egg. Preheat oven on **CONVECTION 200°C**. Lightly stir the buttermilk mixture into the flour mixture. Fold in the fruit. Divide mixture equally between 12 muffin cases. Crumble small amounts of streusel topping over each muffin. Place a muffin tin on each shelf and cook on **CONVECTION 200°C** for 20-25 mins. or until browned and well risen.

Flapjack

Dish: bowl, 30x20x3.5cm (12" x 8" x ½") tin lined with lightly

buttered greaseproof paper

Oven Accessory: no accessory then wire shelf in lower position

Ingredients

250g (9oz) butter
275g (10oz) golden syrup
75g (3oz) light muscovado sugar
425g (15oz) porridge oats

Place the butter, syrup and sugar into bowl and melt on **MEDIUM MICROWAVE** for 4-5 mins. Pre-heat the oven on **CONVECTION 180°C**. Stir the oats into the butter and press the mixture into the tin. Place tin on wire shelf and cook on **CONVECTION 180°C** for 20-25 mins. Leave to cool in the tin for 5 mins. then mark into 18 pieces. Allow to cool completely before removing from the tin.

Bread & Pizza

To prove dough

Prove on **CONVECTION 40°C** until doubled in size.

The microwave is also useful for defrosting and warming frozen bread products, taking individual slices or items from the freezer as required.

Standard/Whole Bread



Makes 2 loaves or 12 rolls

Dish: 2 x 450g (1lb) loaf tin, lightly greased

Oven Accessory: wire shelf in lower position

Ingredients

450g (1lb) strong bread flour
1 sachet dried yeast
5ml (1tsp) salt
15g (1tbsp) fat
275ml (½ pt) warm water

For Wholemeal/Granary bread

Use 225g (8oz) each of wholemeal and strong white bread flour.

Granary Bread

Use 450g (1lb) granary flour instead of strong white bread flour.

In a large bowl, combine the flour, yeast and salt. Rub in the fat. Add the warm water then mix to a dough. Turn onto a floured surface and knead for 10 mins. Divide into two and place in the loaf tins. Cover and prove until the dough has doubled in size in a warm place or on **CONVECTION 40°C**. Preheat the oven on **CONVECTION 220°C**. Place the two loaf tins side by side on the wire shelf. Cook on **CONVECTION 220°C** for 12 mins.

Bread Rolls



Makes 12 rolls

Dish: 2 x Baking sheets 32 x 23 cm(13" x 9")greased

Oven Accessory: enamel shelf in lower position and wire shelf in upper position.

For rolls refer to previous page for ingredients and method of making dough.

Follow steps above to produce a dough. Divide into 12 and shape into rolls. Place six on a baking sheet and six on the enamel shelf. Cover and allow to prove in a warm place or on **CONVECTION 40°C** until doubled in size. Preheat oven on **CONVECTION 220°C**. Glaze rolls with beaten egg and sprinkle with seeds, if desired. Place baking sheets in oven and cook on **CONVECTION 220°C** for 24-26 mins. or until golden brown.

Bread & Pizza

Focaccia



Ingredients

450g (1lb) strong white bread flour
1 sachets dried yeast
5ml (1tsp) sugar
5ml (1tsp) salt
275 ml (½ pt) warm water

Topping

- 1 small red onion sliced and softened with 5ml (1tsp) olive oil and 5ml (1tsp) balsamic vinegar. (Do this in a bowl covered in cling film in the microwave for 1-2min).
- 30ml (2tbsp) chopped black or green olives.
- 2 chopped cloves of garlic, sea salt and cracked black pepper corns.
- 30ml (2tbsp) sundried tomatoes, chopped

Serves 4-6

Oven Accessory: greased enamel shelf in lower position

In a large bowl, combine the flour, yeast, sugar and salt. Gradually add the warm water until you have a soft dough. Turn onto a floured surface and knead for 10 mins. Roll and press the dough into a 40cm x 30cm rectangle (15" x12") and place on enamel shelf. Cover and prove until the dough has doubled in size in a warm place or on **CONVECTION 40°C**. Dimple the surface of the dough. Add one of the above toppings and drizzle with olive oil. Preheat oven on **CONVECTION 220°C**. Place shelf in oven and cook on **CONVECTION 220°C** for 10-15 mins.

Sun Dried Tomato Roll



Ingredients

250g (9oz) strong bread flour
5ml (1tsp) sachet dried yeast
5ml (1tsp) salt
25g (1oz) sun-dried tomatoes, roughly chopped
45ml (3tbsp) olive oil
75ml (3fl.oz) passata
75ml (3fl.oz) warm water
5ml (1tsp) olive oil

Makes 6 rolls

Oven Accessory: greased enamel shelf in lower position

In a large bowl, combine the flour, yeast and salt and stir in the tomatoes. Add the oil, passata and enough warm water to form a soft dough. Turn onto a floured surface and knead for 10 mins. Divide dough into 6 and place on enamel shelf. Cover and prove until the dough has doubled in size in a warm place or on **CONVECTION 40°C**. Preheat the oven on **CONVECTION 220°C**. Glaze rolls with olive oil. Place the enamel shelf in oven and cook on **CONVECTION 220°C** for 15- 20 mins.

Bread & Pizza

Pizza Alle Cipole



Serves 4-6

Dish: bowl

Oven Accessory: Enamel shelf Greased in lower position

Ingredients

250g (9oz) strong bread flour
 5ml (1tsp) sachet dried yeast
 3 ml (½tsp) salt
 10ml (2tsp) olive oil
 150ml (¼ pt) warm water

Topping

1 red onion, cut into rings
 2 cloves garlic, crushed
 400g (14oz) tomatoes on the vine
 12 pitted black olives
 16 capers
 30ml (2tbsp) olive oil
 5ml (1tsp) chilli flakes
 5ml (1tsp) mixed herbs
 12 basil leaves
 150g (5oz) mozzarella, grated

In a large bowl combine the flour, yeast and salt. Add the oil and gradually add enough warm water until you have a soft dough. Turn onto a floured surface and knead for 10 mins. Roll out to a 25cm (10") circle. Cover, and prove until the dough has doubled in size in a warm place or on **CONVECTION 40°C**. Place the onion and garlic in a bowl on glass turntable and cook on **HIGH MICROWAVE** for 3 mins. Add the tomatoes, olives, capers and olive oil. Cook on **HIGH MICROWAVE** for 5 mins. Preheat oven on **CONVECTION 230°C**. Spread the topping over the dough and sprinkle with remaining ingredients. Place on low rack and cook on **CONVECTION 230°C** for 15-20 mins.

Tip: Other toppings to try are: salami, mozzarella and black olives; beef tomatoes, mozzarella and pesto; mozzarella, yellow pepper and mushroom; anchovy, black olives, capers and mozzarella.

Questions and Answers

- Q** My microwave oven causes interference with my TV, is this normal?
- A** Some radio and TV interference might occur when you cook with the microwave oven. This interference is similar to the interference caused by small appliances such as mixers, vacuums, hair dryers, etc. It does not indicate a problem with your oven.
- Q** My oven has an odour and generates smoke when using the CONVECTION, COMBINATION and GRILL function. Why?
- A** It is essential that your oven is wiped out regularly particularly after cooking by COMBINATION or GRILL. Any fat and grease that builds up will begin to smoke if not cleaned.
- Q** Sometimes warm air comes from the oven vents. Why?
- A** The heat given off from the cooking food warms the air in the oven cavity. This warmed air is carried out of the oven by the air flow pattern in the oven. There isn't an airtight seal to the air therefore steam can escape. There are no microwaves in the air, or steam. The oven vents should never be blocked during cooking.

1. In case of fitting into an oven housing, please use Panasonic's Trim Kit.
NN-TKF78S - Stainless
2. Microwave ovens should **not be built** into a unit **directly above** a top front venting conventional cooker. This will invalidate your one year guarantee.
3. A microwave which is built in must be more than 850 mm above floor level. Read Trim-Kit instructions carefully before installation.

It is recommended that the microwave oven is placed below a conventional oven to avoid heat damage to the fascia of the microwave.

Technical Specifications

Rated Voltage:	230-240 V 50 Hz
Operating Frequency:	2,450 MHz
Input Power:	Max 2700 W
	Microwave 950 W
	Grill 1330 W
	Convection 1400 W
Output Power:	1000 W (IEC-60705)
	Grill 1300 W
	Convection 1350 W
Outer Dimensions:	531 mm (W) x 534 mm (D) x 328 mm (H)
Oven Cavity Dimensions:	354 mm (W) x 343 mm (D) x 205 mm (H)
Weight:	17.2 kg (without internal accessories)
Noise:	56 dB

Weight and Dimensions are approximate.

This product is an equipment that fulfills the European standard for EMC disturbances (EMC = Electromagnetic Compatibility) EN 55011. According to this standard this product is an equipment of group 2, class B and is within required limits. Group 2 means that radio-frequency energy is intentionally generated in the form of electromagnetic radiation for warming up of foods. Class B means that this product may be used in normal household areas.

Information on Disposal for Users of Waste Electrical & Electronic Equipment (private households)



This symbol on the products and/or accompanying documents means that used electrical and electronic products should not be mixed with general household waste.

For proper treatment, recovery and recycling, please take these products to designated collection points, where they will be accepted on a free of charge basis. Alternatively, in some countries you may be able to return your products to your local retailer upon the purchase of an equivalent new product.

Disposing of this product correctly will help to save valuable resources and prevent any potential negative effects on human health and the environment which could otherwise arise from inappropriate waste handling. Please contact your local authority for further details of your nearest designated collection point. Penalties may be applicable for incorrect disposal of this waste, in accordance with national legislation.

For business users in the European Union

If you wish to discard electrical and electronic equipment, please contact your dealer or supplier for further information.

Information on Disposal in other Countries outside the European Union

This symbol is only valid in the European Union.

If you wish to discard this product, please contact your local authorities or dealer and ask for the correct method of disposal.

Manufactured by Panasonic Appliances Microwave Oven (Shanghai) Co.,Ltd.
888, 898 Longdong Road, Pudong, Shanghai, 201203, China.

Distributed within European Community by Pursuant to the directive 2004/108/EC, article 9(2)
Panasonic Testing Centre, Panasonic Service Europe, a division of Panasonic Marketing Europe GmbH, Winsbergring 15,22525 Hamburg, F.R.Germany

Cookery Advice Line

For **COOKERY ADVICE** call: **01344 862108**

Open Monday to Friday 9am–12pm

Home Economists will provide friendly guidance on queries relating to recipes and cooking in your microwave.

**the ideas
kitchen**

Visit Panasonic's **The Ideas Kitchen** website for Microwave advice, recipes, cooking tips and offers:

www.theideaskitchen.co.uk



learn



cook



share

**PHONE OUR
CUSTOMER CARE CENTRE**

0844 844 3899

For service or spares.

Or order spares direct on line at

www.panasonic.co.uk