

Ultra high voltage transmission

Alternative scenarios for long distance bulk power transmission – 800kV HVDC and 1000kV HVAC

Gunnar Asplund

Not only is global energy consumption steadily growing, but energy is increasingly being drawn from resources located far from the place of usage. The topic of transporting energy over long distances is growing in importance.

Oil is often shipped in super-tankers and gas in pipelines. Coal for electricity production uses rail transportation, a solution that can require the costly reinforcement of tracks. It may be more economical to generate the

electricity close to the source of the coal and transmit it to the consumers. As many renewable energy sources such as hydropower, wind and sun, are location-dependent in their production, there is often no alternative to long-distance transmission.

The transmission of electrical energy is thus set to play an important and growing role. In this article, ABB Review looks at a recent development in the area of bulk power transmission.

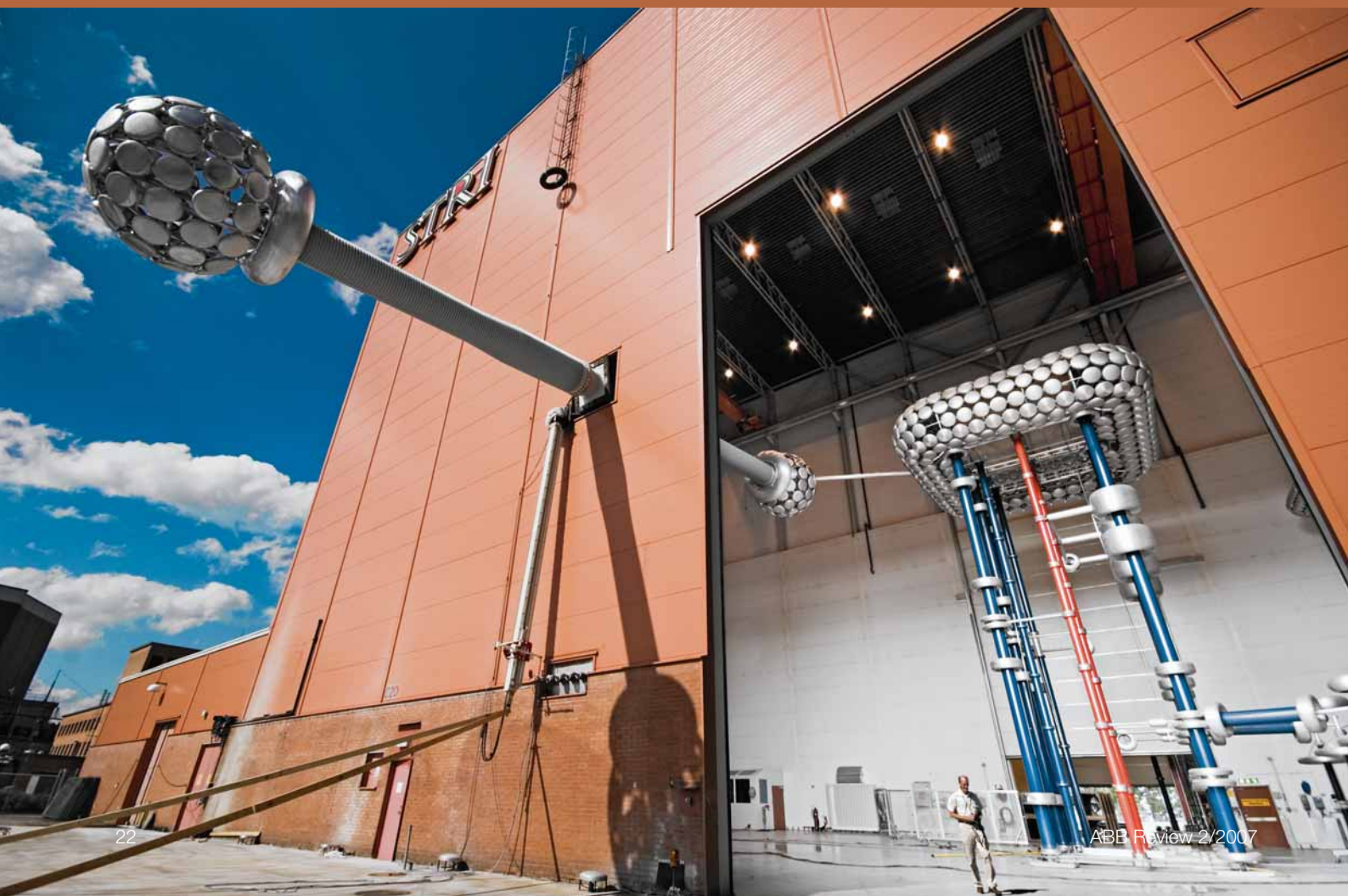

From the advent of electrical transmission, AC has established itself as leading technology in electrical networks. Its advantage lay in the possibility of using transformers to raise it to higher voltage levels, facilitating economical transmission. Both AC and DC generators produce electricity at a relatively low voltage level. If this voltage were used for transmission over long distances, high and prohibitively expensive losses would ensue.

AC technology is also very flexible when connecting different locations to form an electric grid, permitting a very robust and reliable electric supply to the consumers. In its early days, the question of reliability of supply was predominant: As generation took place relatively close to consumption, priority was not focused on transmitting large power quantities over large distances.

To render AC more suitable for such bulk transmission, a typical measure was the adoption of series compensation for lines. This works quite well when power is transmitted from one point to another, but is normally not used inside a meshed grid as the flow of power is more unpredictable.

The development of AC systems has seen continuing increases in transmission voltage. When power consumption is low, voltage can also be low. Typically, doubling the voltage quadruples the power transfer capability. Consequently, the evolution of grids in most countries is characterized by the addition of network layers of higher and higher voltages.

In OECD countries there was an almost exponential increase of electric power consumption until the oil crisis at the beginning of the 1970s. The impact of this crisis halted plans to go for higher voltages such as 800, 1000 and even 1200 kV.

- 1 The capability of an AC line degrades with increasing length: This graph is for a 1000 kV line with max. 70 percent compensation and 30 degree angle between terminals

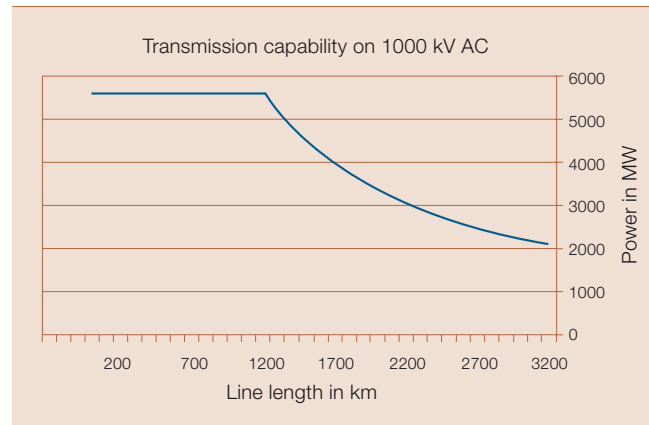

Thirty years ago, the capacity of grids was largely in balance with demand. With the growth in consumption, this situation changed. Generation has increased in new places: For example, wind power parks are normally constructed in locations where the grid is weak. Deregulation of power generation has also led to increased trade with more electric power transmitted over longer distances. This poses more stringent requirements on the transmission system.

The evolution of grids in most countries is characterized by the addition of network layers of higher and higher voltages.

In developing countries the situation is very different. It is more akin to the situation in OECD countries in the 1950s and 1960s. However, the rate of development is much higher, especially in China and India. Technology has advanced in the last thirty years, and solutions adopted do not necessarily

have to follow the example set by OECD countries.

In developing countries, AC is being adopted for new grids, as indeed it was in other countries. It is, however, also used to some extent for transmission of power from distant generation sources.

AC transmission over long distances

Prerequisites for a line built to transfer power over long distances are stability and the ability to survive faults such as lightning strikes. The design criterion that must be

fulfilled is defined as $N-i$ with $i=1$ ¹⁾. This means that the maximum power that can be lost without the stability of the AC system as such being compromised is equal to the power of the largest generating unit or the line with the highest capacity. If all power from a distant generating plant is transmitted on a single line, the AC system has to withstand the loss of all this power. If larger amounts of power are to be transmitted, several parallel lines must be used that are interconnected every 300 to 400 km to increase reliability.

AC lines have quite high power handling capability if short. The capability is dependent on the voltage and the thermal rating of the conductors. Longer lines have higher impedance and this reduces the power transfer capability. The equation for transfer of active power is:

$$P = \frac{U_1 U_2 \sin(\delta)}{X}$$

Where P is the active power, U_1 and U_2 the voltage at each end of the line,

- 2 Six parallel AC lines in six sections with series and shunt compensation. The line can continue to function despite the failure of individual components

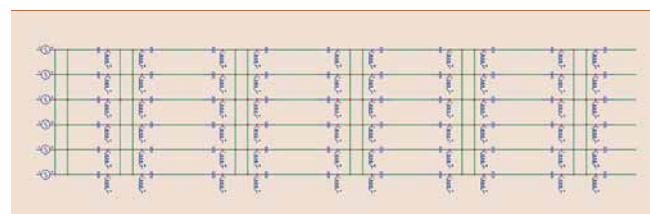

Footnote

¹⁾ The design criterion $N-i$ defines the number of elements whose failure can be tolerated before the overall system loses functionality. Applying this to electricity networks, N represents the number of major components in the network (ie, generators, substations, lines etc), and i the number of these components that can fail at the same time without leading to instability in the network.

Energy efficient grids

δ the phase angle between the two ends and X the line impedance.

As the length of the line increases, the impedance of the line increases with it. For the transfer power to be maintained, the angle δ must be increased. This is possible up to an angle of around 30 degrees, after which problems with dynamic stability can be encountered. The best way to overcome this problem is to reduce the impedance by series compensation. This can be done without significant problems up to a compensation of around 70 percent. At higher levels of compensation the system will be less robust **1**.

When a line is loaded below SIL (surge impedance loading) it will produce reactive power; if shunt compensation is not added the voltage can rise excessively. If the line is loaded above SIL, it will consume reactive power and the voltage can drop too far. From a reliability point of view, it is necessary to build an AC transmission in sections with both series and shunt compensation as well as interconnection between the sections **2** in order to assure that full power transmission is possible at all times.

3 Alternative converter configurations for 800 kV HVDC line

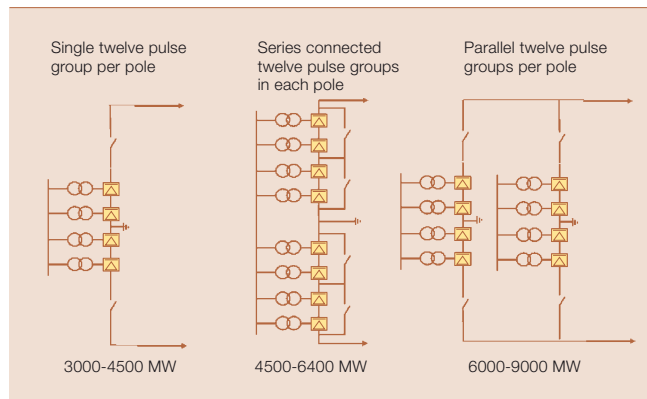

Technical challenges

1000 kV and 1200 kV AC has been tested in several test-installations and even short-time commercial applications but is not currently used in any commercial application²⁾. There are several challenges involved in building such lines and new equipment needing to be developed includes transformers, breakers, arresters, shunt reactors, series capacitors, current and voltage transformers, and connecting and ground switches.

There are also special requirements in the domain of control and protection. At single phase earth faults, the challenge is to clear the fault without opening the breakers of all three phases. The problem lies with the high capacitive current generated by the operating phases that flows into

the fault. This can be achieved with the help of tuned reactors that minimize the induced current.

800 kV AC is fully commercial and all equipment are available. Development is ongoing for all equipment of 1000 kV AC.

800 kV DC transmission

System aspects

The principle of DC transmission lies in converting

AC to DC in a rectifier station, transmitting the power in a DC bipolar line and converting the power back to AC in an inverter station.

Thirty years ago, the capacity of grids was largely in balance with demand. With the growth in consumption, this situation changed.

From a system point of view, DC is a simpler technology for transmission over long distances. The rectifier and inverter stations can control current and voltage very quickly and are therefore suitable for the control of power flow. The phase angle differ-

4 Using 800 kV HVDC, power transfer of up to 18000 MW is possible on a single right of way.

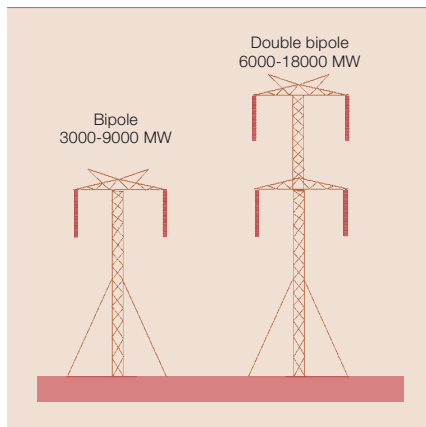

5 Extensive equipment testing is required before commercial 800kV HVDC can be offered commercially. These pictures show the transformer **a**, the transformer bushing **b** and the valve hall bushing (title photo, page 22) being tested in Ludvika, Sweden.



Footnote

²⁾ 1200kV AC was commercially operated on a line connecting Russia and Kazakhstan from 1989 to 1996. The line was taken out of operation due to the collapse of the Soviet Union.

ence between the sending and receiving end is of no importance if the only connection is DC. In fact, the connected networks can even be asynchronous as DC has no phase angles and does not depend on the frequency.

Faults on DC lines or in converters will give rise to increased frequency at the generating end and decreasing frequency at the receiving end – unless there is sufficient overload capability in the remaining pole, and parallel DC lines are available to handle the power difference. If the fault is permanent, a scheme to trip the generators should be implemented in order to maintain frequency stability in the sending network. This is normally only a problem if parallel synchronous AC lines exist; especially if their power rating is much lower than that of the DC lines – such lines can trip when the phase angles increase too much.

Configurations

For 800 kV HVDC, several converter configurations are possible [3]. Possible line configurations are shown in [4].

Technical challenges

The highest voltage of HVDC today is 600 kV. The Itaipu project was commissioned more than 20 years ago and is operating two bipoles of ±600 kV and transmitting 6300 MW over a distance of 800 km. 800 kV HVDC requires development of transformers, transformer bushings, valve hall wall

bushings, thyristor valves, arresters, voltage dividers, DC filter capacitors and support insulators.

Technical achievements

Development has been going on at ABB for several years and all equipment that must be exposed to 800 kV has been designed, manufactured and tested. Some examples are discussed below:

Transformer prototype

A simplified transformer prototype has been manufactured, including all the insulation details for an 800 kV converter transformer [5a]. The initial testing of the transformer prototype included:

- DC withstand 1250 kV
- AC withstand 900 kV

The tests were successfully passed.

Transformer bushing

A prototype of the transformer bushing for the highest 6-pulse group has been produced [5b]. The bushing has passed all type and routine tests, including:

- DC withstand 1450 kV
- AC withstand 1050 kV

Wall bushings

The wall bushing is based on the well-proven design for the recent installations at 500 kV. Besides the electrical requirements, the 18m length of the wall bushing (title picture page 22) has been a mechanical challenge. However, all electrical and mechanical type and routine tests have been

passed successfully. Also the seismic withstand has been verified by calculations. The design and manufacture of the 800 kV wall bushing is completed, and the bushing is installed in the 800 kV test circuit, including:

- DC withstand 1250 kV
- AC withstand 910 kV

Deregulation of power generation has led to increased trade with more electric power transmitted over longer distances. This poses more stringent requirements on the transmission system.

Long term test circuit

As a final demonstration of its feasibility, a long term test station has been built and put into operation. Here, all equipment is tested at 855 kV for at least half a year [6].

Station design

When designing 800 kV HVDC with a power of 6000 MW, it is important to design the station so that a failure of a single critical component results in a loss of only a fraction of the power. [7] [8] shows a station with four power blocks. This can be configured in one of the following manners:

- Two poles each consisting of two series connected groups
- Two poles each consisting of two parallel groups.

6 Voltage withstand endurance testing on the 800 kV test circuit at STRI, Ludvika

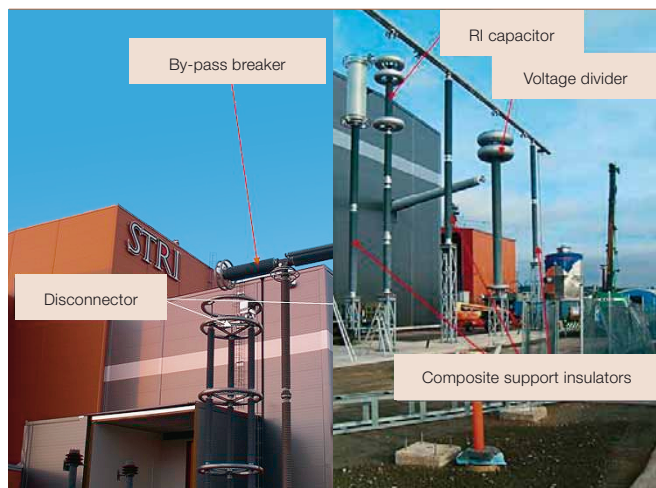

Factbox 1 The ability of a combined AC and DC transmission to maintain stability despite the loss of DC links: scenario 1 [11a] with strong AC link

		Number of parallel 500 kV lines									
		1	2	3	4	5	6	7	8	9	10
Number of lost DC groups	1	yes	yes	yes	yes	yes	yes	yes	yes	yes	yes
	2	yes	yes	yes	yes	yes	yes	yes	yes	yes	yes
	3	no	yes	yes	yes	yes	yes	yes	yes	yes	yes
	4	no	no	no	no	yes	yes	yes	yes	yes	yes
	5	no	no	no	no	no	no	no	yes	yes	yes
	6	no	no	no	no	no	no	no	no	no	no
	7	no	no	no	no	no	no	no	no	no	no
	8	no	no	no	no	no	no	no	no	no	no

Energy efficient grids

Successful testing

Based on all development work made the conclusion is that 800 kV is now available for commercial transmissions.

Comparison of AC and DC

Cost

10 provides a cost comparison between transmitting 12,000 MW over a distance of 2,000 km with AC and DC. 800 kV HVDC gives the lowest overall cost and the optimum is at the lowest losses in the line.

Advantages and disadvantages of AC

The major advantage of AC is the flexibility with which loads and generation along the route can be connected. This is especially important if the transmission route passes through a highly populated area and if genera-

tion facilities are located at many places along the route.

One disadvantage of AC is its cost. The system described above is quite expensive as, in reality, a full electric infrastructure has to be built along the route.

Another disadvantage is the requirement of land and right of way. As AC transmission cannot fully utilize the thermal capacity of each line when the line is very long, a line in parallel will have to be installed.

Advantages and disadvantages of DC

One major advantage of HVDC is its low cost for transmission of very high power over very long distances.

A second great advantage is that the losses are quite low. The total losses in the transmission of power over

2,000 km are in the order of five percent. The third major advantage is that fewer lines are needed with less right of way requirement. As mentioned above, transmission of 12,000 MW can be achieved with two lines using 800 kV HVDC. Transmitting the same power with 800 kV AC would require eight lines.

The main disadvantage of HVDC is that power is transmitted from one point to the other and that it is quite costly to build tapping stations (although it is possible and has been done).

The major advantage of AC is the flexibility with which loads and generation along the route can be connected. This is especially important if the transmission route passes through a highly populated area and if generation facilities are located at many places along the route.

Combined AC and DC transmission

As mentioned above, the main disadvantage with HVDC is the high cost of the tapping of power along the line. However, a combination of low cost bulk power HVDC transmission in parallel with a lower voltage AC network could in many cases become the optimal solution in providing both low cost and high flexibility and the



7 An HVDC converter station with four power blocks – the configuration is chosen to minimize the effects of individual component failures



8 An HVDC converter station with two poles each consisting of two series connected groups

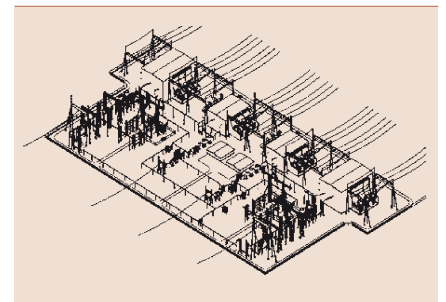

9 An artist's impression of the station of 8



10 The cost of stations, lines and losses as a function of the line losses

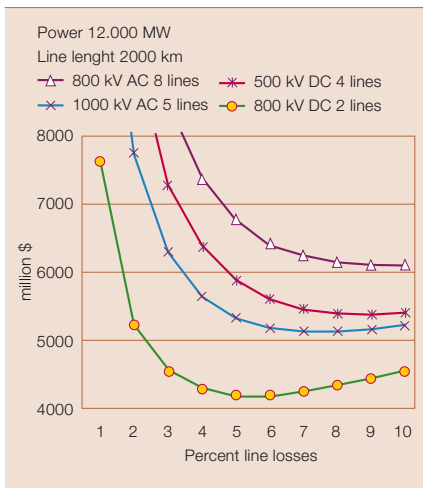

11 Three alternatives for combining AC and DC to connect two networks. In a, a strong AC link supports the DC, in b, the two AC networks are separated and in c, the gap is bridged by an HVDC back to back link

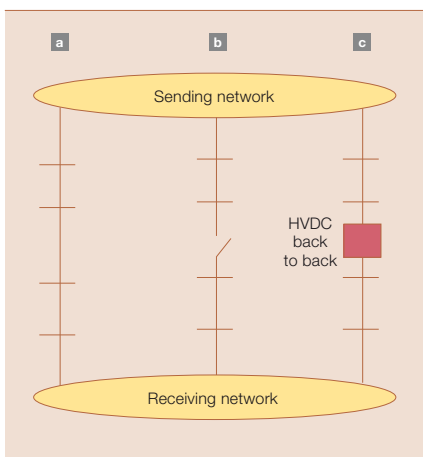

ability to supply customer along the route.

There are however some technical problems with the combined AC and DC solution. Disturbances in the DC transmission will in many cases trip the AC connection as the phase angles becomes too large. This problem can be solved in various ways as is shown in 11.

Alternative 1

Option 11a uses a fairly strong AC connection that can withstand most disturbances in the DC connection without having to disconnect.

As an illustration, it is assumed that the HVDC transmits 12,000 MW over 2,000 km in two bipoles with each four converter groups. It is assumed that the HVDC can take a temporary overload of 50 percent if one or more groups should trip. Further, it is assumed that there is a parallel AC net of 500 kV lines that will have to pick up the power that the HVDC cannot transmit. The results in are shown in Factbox 1.

This table shows the system will remain dynamically stable after the loss of several DC groups. Each DC group has a power of 1500 MW. The outcome is dependent on the preloading of the AC-lines. Here it is assumed they are loaded up to 34 percent before the fault.

Alternative 2

Option 11b permits the two networks to operate asynchronously, each feed-

ing half of the customers along the route. In this case there are no stability problems as the systems are asynchronous.

Alternative 3

Option 11c is the same as 11b but uses an HVDC back to back connection to increase the flexibility of power supply without needing to synchronize the two systems. Preferably this back to back is a Voltage Source Converter (HVDC Light), which will stabilize the voltages and increase the power transfer of the AC lines.

Conclusions

In order to transmit bulk power over long distances (more than 500–1000 km), 800 kV HVDC is normally the most cost efficient alternative. The biggest drawback of HVDC is the high cost of tapping power along the route. A combination, where the bulk power is fed by HVDC and the power needed along the route is fed by AC seems to be the most cost effective and flexible solution. 1000 kV AC is more suitable as an overlay net to existing 400 or 500 kV AC nets in densely populated areas.

Gunnar Asplund

ABB Power Technologies, Power Systems DC
Ludvika, Sweden
gunnar.asplund@se.abb.com