

HDBaseT EXTENDER
B-520-TX-230-IR
B-520-TX-330-IR

BINARY

INSTALLATION MANUAL



FC CE

IMPORTANT SAFETY INSTRUCTIONS

To reduce the risk of fire or electric shock, read and follow all instructions and warnings in this manual. Keep this manual for future reference.

1. Do not expose this apparatus to rain or moisture. Do not expose this equipment to dripping or splashing, and ensure that no objects filled with liquids, such as vases, are placed on the equipment. Do not use this apparatus near water.
2. Do not remove cover.
3. Clean only with a dry cloth.
4. Do not block any ventilation openings. Install according to manufacturer's instructions.
5. Do not install near any heat sources, such as radiators, heat registers, stoves, or other apparatus (including amplifiers) that produce heat.
6. Do not override the safety purpose of the polarized or grounding plug. A polarized plug has two blades, one of which is wider than the other. A grounding plug has two matching blades and a third grounding prong. The wide blade or the third prong is provided for your safety. If the provided plug does not fit into your outlet, consult an electrician for replacement of the obsolete outlet.
7. Protect the power cord from being walked on or pinched, particularly at the plug end and where the power cord is attached to the apparatus.
8. Only use attachments and accessories specified by the manufacturer.
9. Refer all servicing to qualified service personnel. Servicing is required when the apparatus has been damaged in any way, such as when the power supply cord or plug is damaged, liquid has been spilled on or objects have fallen into the apparatus, the apparatus has been exposed to rain or moisture, the apparatus does not operate normally, or it has been dropped.
10. To completely disconnect this equipment from power, disconnect the power supply cord from the power outlet.



The lightning flash with arrowhead symbol within an equilateral triangle is intended to alert the user to the presence of uninsulated dangerous voltage within the product's enclosure that may be of sufficient magnitude to constitute a risk of electric shock to persons.



The exclamation point within an equilateral triangle is intended to alert the user to the presence of important operating and maintenance (servicing) instructions in the literature accompanying the appliance.



CONTENTS

1. Product Overview	4
2. Features.....	4
3. Package Contents.....	5
4. Device Layout.....	6
5. Installation.....	8
6. Applications	8
6.1. HDBaseT Link (RJ45) Connection.....	9
6.2. IR Control Connections	10
6.2.1. Point-to-Point IR Control -IR Receiver In Using 3.5mm (1/8") Stereo ..11	
6.2.2. Control System - IR Receiver In Using 3.5mm (1/8") Mono	11
6.2.3. IR Flasher Out - 3.5 mm Mono	11
6.3. Firmware Update Operation	12
6.4. HDMI Out (Transmitter).....	12
6.5. EDID Configuration.....	12
6.5.1. Auto EDID	12
6.5.2. HDBT EDID	12
6.6. Thread-Locking Power Supply	13
7. Specifications	14
8. Support	16
9. Warranty.....	16

1. PRODUCT OVERVIEW

Welcome to Binary™. This product is engineered to provide years of exceptional reliability. We appreciate your business, and we stand committed to providing our customers with the highest degree of quality and service in the industry.

This device extends HDMI over a single category cable using HDBaseT technology allowing video and audio transmission to remote displays. In addition, the device is equipped with bidirectional IR over the same category cable.

This unit supports all HDMI defined audio and video formats, up to 4K2K@30 Hz. Additionally, the design has been improved to solve the clock-stretching issue that can arise with cable boxes when used with HDBaseT extenders.

2. FEATURES

- Improved design to support clock-stretching issue
- Extends all HDMI formats up to:

	B-520-TX-230-IR		B-520-TX-330-IR
Resolution	Cat 5e/6	Cat 6a/7	Cat 5e/6/6a/7
1080i/720p 24-bit color	200'	230'	330'
Full HD 1080p 24-bit color	200'	230'	330'
Full HD 1080p 36-bit color	200'	230'	330'
Ultra HD 4K2K@30 Hz	115'	130'	330'

- Supports all HDMI supported audio formats, including DTS-HD Master and Dolby TrueHD
- Two selectable EDIDs options: Auto/HDBaseT output
- Bi-directional IR

3. PACKAGE CONTENTS

- 1x B-520-TX-230-IR / B-520-TX-330-IR Transmitter
- 1x 12V DC, 2A Power Supply
- 2x Mounting Ears
- 2x Mounting Screws
- 4x Rubber Feet
- 1x Installation Manual
- 1x Power Supply Label

4. DEVICE LAYOUT

4.1. B-520-TX-230-IR/B-520-TX-330-IR Transmitter

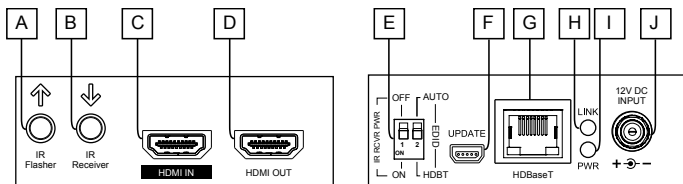

FIGURE 1: Transmitter Layout

- A. IR Flasher**
IR output to connect to IR Flasher
- B. IR Receiver**
IR input to connect to IR Receiver or to output of a control system
- C. HDMI In**
HDMI Input to connect to the HDMI output of a source
- D. HDMI Out**
HDMI Output to connect to the HDMI input of a sink (display)
- E. DIP Switches**
IR RCVR PWR OFF/ON
ON to connect to IR Receiver | OFF to connect to control system
AUTO EDID/HDBT EDID
AUTO to set EDID to lowest common resolution | HDBT to set EDID to resolution of sink at receiver
- F. Update (mini USB port)**
To connect mini USB cable when updating firmware
- G. HDBaseT RJ45**
To connect to the HDBaseT RJ45 port on receiver
- H. Link LED**
Lights up green when synced with receiver
- I. Power LED**
Lights up blue when the unit has power
- J. Thread-locking Power Connector**
Connect to the included 12V DC, 2A power supply

5. INSTALLATION

⚠CAUTION: Do not connect power to the device until all other connections are made and the unit is installed.

5.1. B-520-TX-230-IR / B-520-TX-330-IR Installation

1. Run category cable from the location of the transmitter to the remote location of the receiver.
2. Mount the transmitter in the desired location.
3. Connect HDMI In on the transmitter with an HDMI cable from HDMI Out of Source.
4. Connect HDMI Out on the transmitter with an HDMI Cable to HDMI In of local/ remote TV.
5. Connect an IR receiver and/or IR flasher if being used. Refer to Section 6.2.
6. Connect the 12V DC, 2A power supply to the thread-locking power jack. Do not plug the power supply into an AC outlet until receiver installation is completed.

6. APPLICATIONS

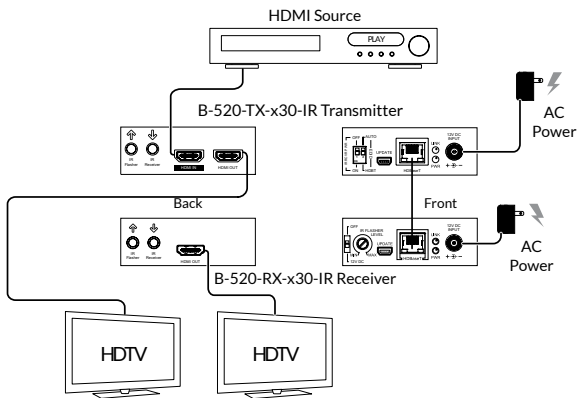

v

FIGURE 2: Application Diagram

6.1. HDBaseT Link (RJ45) Connection

This device is specified to operate with Cat 5e/6/6a/7 cables for communication between the transmitter and receiving unit. The transmission path may include a maximum of two keystones and two patch cables, as long as the total length does not exceed certain lengths. For B-520-TX-230-IR, max. is 200' for Cat5e/6 and 230' for Cat6a/7. For B-520-TX-330-IR, max. is 330' for Cat5e/6/6a/7

TIA/EIA Standard 568-B (Gold Pins Facing Up)

Pin 1	White/Orange	Pin 5	White/Blue
Pin 2	Orange	Pin 6	Green
Pin 3	White/Green	Pin 7	White/Brown
Pin 4	Blue	Pin 8	Brown

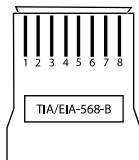

FIGURE 3: RJ45 Connections

6.2. IR Control Connections

Bidirectional IR signals can be transmitted between transmitter and an HDBaseT receiver through category cable. The IR signal can be generated either from a powered receiver or from a control system. The following section describes these two use cases.

⚠CAUTION: Pinout configurations for IR receivers and control systems vary. Before connecting to this input, review this section carefully in order to match the pinouts for the device.

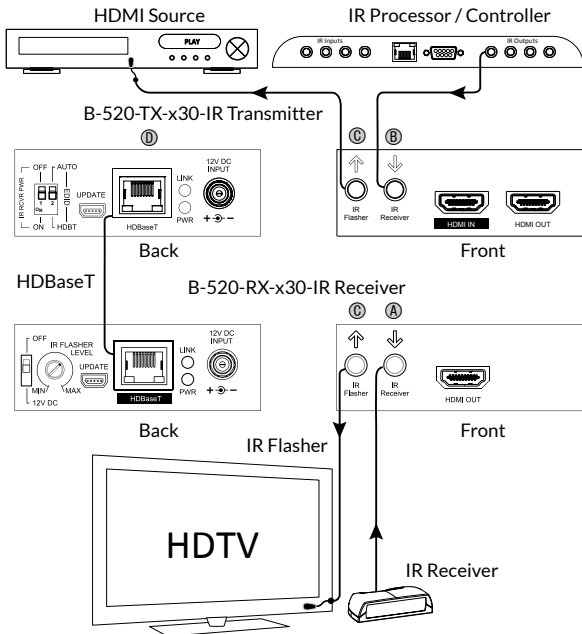

FIGURE 4: IR Connections

NOTE: Arrow direction indicates signal flow.

- Ⓐ IR Receiver In 3.5 mm (1/8") Mono - See Section 6.2.2
- Ⓑ IR Receiver In 3.5 mm (1/8") Stereo - See Section 6.2.1
- Ⓒ IR Flasher Out 3.5mm Mono - See Section 6.2.3
- Ⓓ HDBaseT Link Cat 5e/6/6a (RJ45) - See Section 6.1

6.2.1. Point-to-Point IR Control - Stereo (3.5mm) IR Receiver

When using a powered IR receiver, the IR RCVR PWR DIP switch should be set to ON. In this case a 3.5mm (1/8") stereo jack has to be used to send 9V DC power to the receiver.

CAUTION: Do not connect a mono cable to this connection as damage may occur.

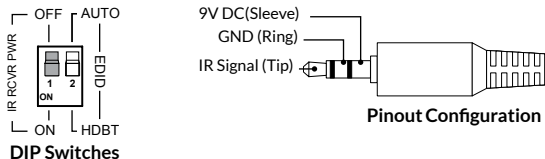

FIGURE 5: Point-to-Point IR Settings

6.2.2. Control System - Mono (3.5mm) IR

When using a control system that generates the signal through a mono jack, the IR RCVR PWR switch should be in the OFF position.

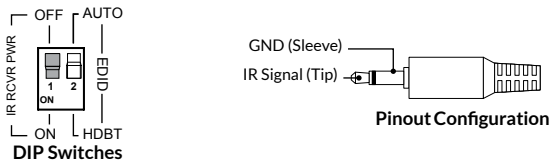

FIGURE 6: Control System IR Settings

6.2.3. IR Flasher Out-3.5mm Mono

The IR Flasher level adjusts the intensity of the IR Flasher output (select extenders only).

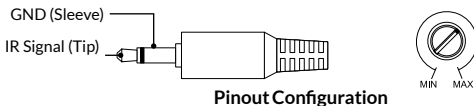

FIGURE 7: IR Flasher Out

6.3. Firmware Update Operation

Detailed instructions and updated firmware will be posted to www.SnapAV.com as they are released.

6.4. HDMI Out (Transmitter)

We recommend using an HDMI cable that is 1 meter or less to ensure the highest signal quality. This HDMI Out is used to connect to local TV/displays.

6.5. EDID Configuration

There are two EDID operating modes available for HDMI loopout. The EDID setting determines if the source connected to the HDMI input chooses the EDID from the display connected to the HDMI out on the transmitter and/or the display connected to the HDMI out on the HDBaseT receiver.

6.5.1. Auto EDID

When the EDID DIP switch is set to AUTO, the lowest common EDID setting between the display connected to the transmitter and the display connected to the HDBaseT receiver will be applied to both displays.

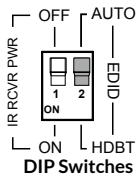

FIGURE 8: Auto EDID Mode

6.5.2. HDBT EDID

When the EDID DIP switch is set to HDBT, the EDID from the display connected to the HDBaseT receiver will be applied to both displays.

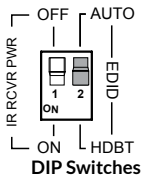

FIGURE 9: HDBT EDID Mode

6.6. Thread-Locking Power Supply

This transmitter is powered by the included power supply.

⚠CAUTION: Do not connect the power supply to the device until it is completely installed and all connections have been made.

⚠CAUTION: Do not connect a third party power supply to the device unless the voltage and amperage matches the power supply provided with the transmitter.

SPECIFICATIONS

Technical

HDMI Compliance	HDMI 3D	
HDCP Compliance	Yes	
Video Bandwidth	10.2 Gbps	
B-520-TX-330-IR HDMI over UTP Transmission	Cat 5e/6/6a/7	1080i/720p 24-bit color: 330' Full HD 1080p 24-bit color: 330' Full HD 1080p 36-bit color: 330' Ultra HD 4K2K@30 Hz 330'
Input TMDS Signal	1.2V (peak-to-peak)	
Input DDC Signal	5V (peak-to-peak, TTL)	
ESD Protection	(1) Human body model: $\pm 5\text{kV}$ (air-gap discharge) & $\pm 8\text{kV}$ (contact discharge) (2) Core chipset – $\pm 8\text{kV}$	
IR Signal (Bidirectional)	Carrier frequency: 20–60kHz	

Connections

HDBaseT Link	1x RJ45z
HDMI	1x HDMI Type A (19-pin female)
IR Receiver (In)	1x 3.5mm Mono/Stereo
IR Flasher (Out)	1x 3.5mm Mono
Power	Thread-Locking

Controls

DIP switch 1	IR RCVR PWR OFF/ON
DIP switch 2	EDID – AUTO/HDBT EDID

Mechanical

Housing	Metal enclosure
Dimensions	6.25"x3.1"x1.3"
Weight	1.1 lbs.
Power Supply	12V DC, 2A
Power Consumption	12W (max)
Operation Temperature	32-104°F
Storage Temperature	-4-140°F
Relative Humidity	20-90% RH (no condensation)
Certifications and Compliance	Product: CE, FCC, RoHS
	Power Supply: CE, FCC, RoHS, UL

8. SUPPORT

Need Help? Contact Tech Support!

If you need further clarification, please call tech support at **866.838.5052**, or email **support@snapav.com**. For other information, instructional videos, support documentation, or ideas, visit our website and view your item's product page at **www.SnapAV.com**.

9. WARRANTY

2-Year Limited Warranty

This Binary™ product has a 2-Year limited warranty. This warranty includes parts and labor repairs on all components found to be defective in material or workmanship under normal conditions of use. This warranty shall not apply to products that have been abused, modified or disassembled. Products to be repaired under this warranty must be returned to SnapAV or a designated service center with prior notification and an assigned return authorization (RA) number.

BINARY

Rev: 150806-1300

© 2015 Binary