

fordowner.com  
ford.ca

2013 **MUSTANG** Owner's Manual

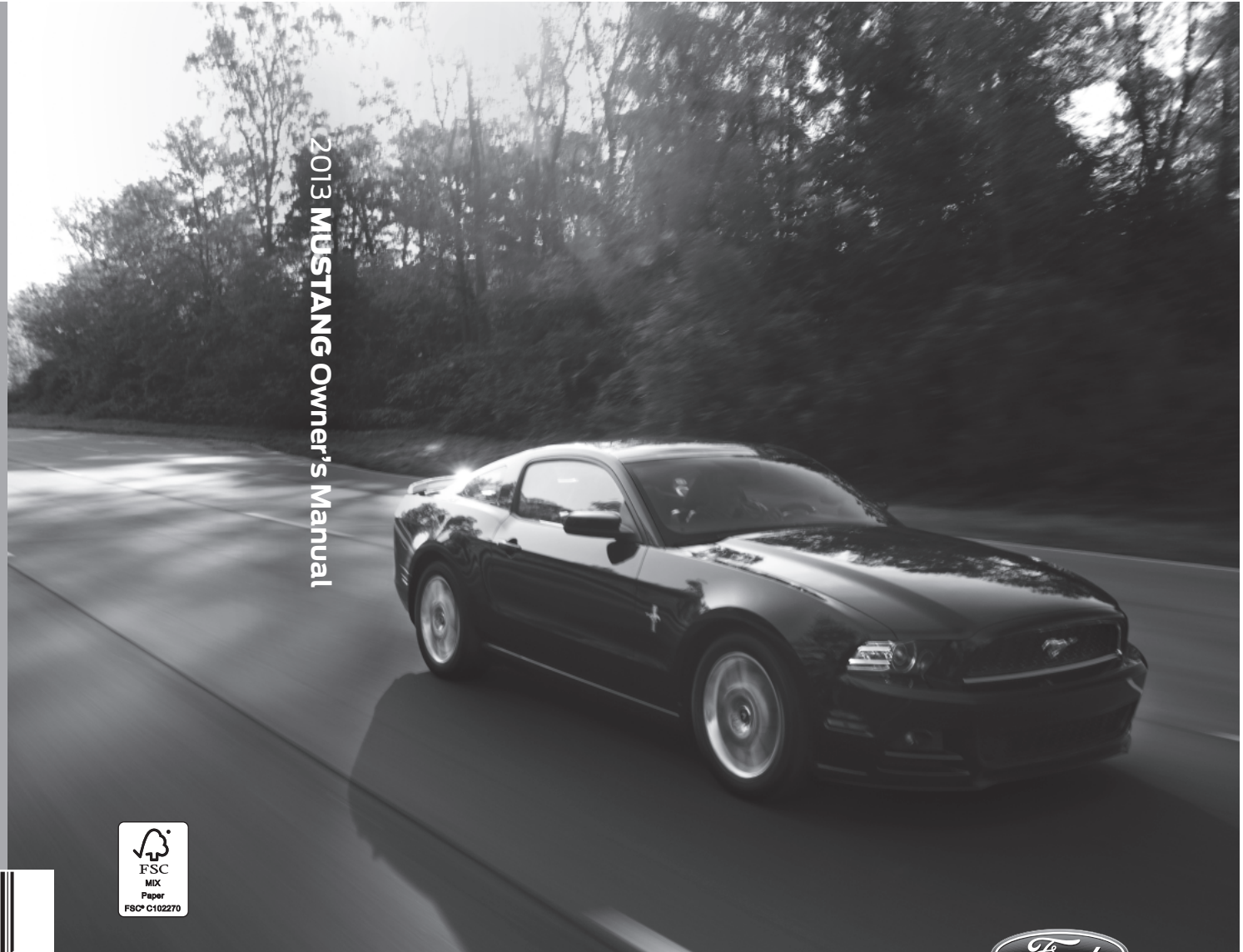

<b>Table of Contents</b>	<b>1</b>
<b>Introduction</b>	<b>9</b>
<b>Child Safety</b>	<b>17</b>
Child seats . . . . .	.19
Child seat positioning . . . . .	.19
Booster seats . . . . .	.21
Installing child safety seats . . . . .	.24
<b>Safety Belts</b>	<b>33</b>
Fastening the safety belts . . . . .	.35
Safety belt warning light and indicator chime . . . . .	.38
Safety belt-minder . . . . .	.39
Child restraint and safety belt maintenance . . . . .	.41
<b>Personal Safety System</b>	<b>42</b>
<b>Supplementary Restraints System</b>	<b>43</b>
Driver and passenger airbags . . . . .	.45
Front passenger sensing system . . . . .	.47
Side airbags . . . . .	.50
Crash sensors and airbag indicator . . . . .	.52
Airbag disposal . . . . .	.53
<b>Keys and Remote Control</b>	<b>54</b>
General information on radio frequencies . . . . .	.54
Remote control . . . . .	.55
Keys . . . . .	.55
Replacing a lost key or remote control . . . . .	.56
<b>MyKey</b>	<b>57</b>
Settings, MyKey . . . . .	.57
Creating . . . . .	.58
Clearing . . . . .	.59
System status . . . . .	.60
Remote start, MyKey . . . . .	.60
Troubleshooting, MyKey . . . . .	.62

<b>Locks</b>	<b>64</b>
Locking and unlocking . . . . .	.64
Interior luggage compartment release . . . . .	.68
<b>Security</b>	<b>69</b>
SecuriLock® passive anti-theft system . . . . .	.69
Anti-theft system . . . . .	.71
<b>Steering Wheel</b>	<b>74</b>
Adjusting the steering wheel . . . . .	.74
Steering wheel controls . . . . .	.74
<b>Wipers and Washers</b>	<b>77</b>
Windshield wipers . . . . .	.77
Windshield washers . . . . .	.77
<b>Lighting</b>	<b>78</b>
Lighting control . . . . .	.78
Autolamps . . . . .	.79
Instrument lighting dimmer . . . . .	.79
Headlamp exit delay . . . . .	.80
Daytime running lamps . . . . .	.81
Front fog lamps . . . . .	.81
Direction indicators . . . . .	.82
Interior lamps . . . . .	.82
<b>Windows and Mirrors</b>	<b>83</b>
Power windows . . . . .	.83
Exterior mirrors . . . . .	.85
Interior mirrors . . . . .	.87
Sun visors . . . . .	.87
Sunshade . . . . .	.89

## Table of Contents 3

<b>Instrument Cluster</b>	<b>90</b>
Gauges . . . . .	.90
Warning lamps and indicators . . . . .	.92
Audible warnings and indicators . . . . .	.96
<b>Information Displays</b>	<b>97</b>
Controls. . . . .	.97
Information messages . . . . .	.111
<b>Audio System</b>	<b>117</b>
AM/FM stereo with CD/MP3 . . . . .	.119
Auxiliary input jack . . . . .	.122
USB port . . . . .	.124
Satellite radio information . . . . .	.125
<b>Climate Control</b>	<b>128</b>
Manual heating and air conditioning. . . . .	.128
Navigation system based climate control . . . . .	.130
Rear window defroster . . . . .	.133
Cabin air filter . . . . .	.134
<b>Seats</b>	<b>135</b>
Sitting in the correct position . . . . .	.135
Head restraints. . . . .	.136
Manual seats . . . . .	.138
Power seats . . . . .	.139
Heated seats . . . . .	.140
Rear seats . . . . .	.141
<b>Universal Garage Door Opener (If Equipped)</b>	<b>143</b>
HomeLink® wireless control system . . . . .	.144
<b>Auxiliary Power Points</b>	<b>148</b>

<b>Storage Compartments</b>	<b>149</b>
Center console . . . . .	149
<b>Starting and Stopping the Engine</b>	<b>150</b>
Ignition switch . . . . .	151
Engine block heater . . . . .	152
<b>Fuel and Refueling</b>	<b>154</b>
Fuel quality . . . . .	155
Running out of fuel . . . . .	156
Refueling . . . . .	157
Fuel consumption . . . . .	159
<b>Transmission</b>	<b>163</b>
Transmission operation . . . . .	163
Automatic transmission . . . . .	164
Manual transmission . . . . .	167
Hill start assist . . . . .	170
<b>Brakes</b>	<b>173</b>
Brakes . . . . .	173
Hints on driving with anti-lock brakes . . . . .	174
Parking brake . . . . .	174
<b>Traction Control</b>	<b>175</b>
Traction Control™ . . . . .	175
<b>Stability Control</b>	<b>176</b>
AdvanceTrac® . . . . .	177
<b>Parking Aids</b>	<b>179</b>
Sensing system . . . . .	179
Rear-view camera system . . . . .	180



**Table of Contents** **5**

---

<b>Cruise Control</b>	<b>183</b>
<b>Driving Aids</b>	<b>185</b>
Steering . . . . .	.185
<b>Load Carrying</b>	<b>187</b>
Vehicle loading . . . . .	.187
<b>Towing</b>	<b>194</b>
Trailer towing . . . . .	.194
Wrecker towing . . . . .	.198
Recreational towing . . . . .	.199
<b>Convertible Top (If Equipped)</b>	<b>200</b>
<b>Driving Hints</b>	<b>205</b>
Economical driving . . . . .	.205
Driving through water . . . . .	.206
Floor mats . . . . .	.207
<b>Roadside Emergencies</b>	<b>209</b>
Getting roadside assistance . . . . .	.209
Hazard warning flashers . . . . .	.210
Fuel cut-off switch . . . . .	.210
Jump-starting the vehicle . . . . .	.211
<b>Customer Assistance</b>	<b>214</b>
Reporting safety defects (U.S. only) . . . . .	.221
Reporting safety defects (Canada only) . . . . .	.221
<b>Fuses</b>	<b>222</b>
Changing a fuse . . . . .	.222
Fuse specification chart . . . . .	.223

<b>Maintenance</b>	<b>230</b>
General information . . . . .	.230
Opening and closing the hood . . . . .	.231
Under hood overview . . . . .	.232
Engine compartment. . . . .	.232
Engine oil dipstick . . . . .	.234
Engine oil check. . . . .	.234
Engine coolant check . . . . .	.235
Automatic transmission fluid check . . . . .	.239
Brake fluid check . . . . .	.240
Power steering fluid check . . . . .	.240
Washer fluid check . . . . .	.241
Battery . . . . .	.241
Checking the wiper blades . . . . .	.243
Air filter(s) . . . . .	.244
Adjusting the headlamps. . . . .	.245
Changing a bulb . . . . .	.246
<b>Vehicle Care</b>	<b>252</b>
Cleaning products. . . . .	.252
Cleaning the exterior . . . . .	.252
Waxing. . . . .	.254
Repairing minor paint damage. . . . .	.254
Cleaning the engine . . . . .	.254
Cleaning the windows and wiper blades . . . . .	.255
Cleaning the interior . . . . .	.255
Cleaning the instrument panel and instrument cluster lens . . . . .	.256
Cleaning leather seats. . . . .	.257
Cleaning the alloy wheels . . . . .	.257
Vehicle storage. . . . .	.258

## Table of Contents

7

---

<b>Wheels and Tires</b>	<b>261</b>
Tire care . . . . .	.261
Tire Pressure Monitoring System (TPMS) . . . . .	.277
Changing a road wheel . . . . .	.281
Temporary mobility kit . . . . .	.286
Technical specifications . . . . .	.294
Wheel lug nut torque . . . . .	.294
<b>Capacities and Specifications</b>	<b>295</b>
Engine specifications . . . . .	.295
Engine drivebelt . . . . .	.295
Part numbers . . . . .	.300
Vehicle identification number . . . . .	.301
Vehicle certification label . . . . .	.302
Transmission code designation . . . . .	.302
<b>Accessories</b>	<b>303</b>
Accessories . . . . .	.303
<b>Ford Extended Service Plan</b>	<b>305</b>
<b>Scheduled Maintenance</b>	<b>308</b>
Normal scheduled maintenance and log . . . . .	.313
<b>SYNC®</b>	<b>325</b>
Pairing your phone for the first time . . . . .	.330
911 Assist™ . . . . .	.341
Vehicle Health Report . . . . .	.343

*2013 05+ Mustang (197)  
Owners Guide gf, 3rd Printing  
USA (fus)*



## 8 Table of Contents

---

<b>Navigation System (If Equipped)</b>	<b>362</b>
Status bars . . . . .	.368
Loading pictures . . . . .	.368
Voice recognition . . . . .	.370
Accessing media features . . . . .	.375
Jukebox features . . . . .	.392
Recording (saving) music to your jukebox . . . . .	.393
Accessing the music in your jukebox . . . . .	.393
Creating a playlist . . . . .	.394
Where am I? . . . . .	.397
Accessing the help screen . . . . .	.400
Navigation features . . . . .	.401
<b>Appendices</b>	<b>422</b>
<b>Index</b>	<b>440</b>

The information contained in this publication was correct at the time of going to print. In the interest of continuous development, we reserve the right to change specifications, design or equipment at any time without notice or obligation. No part of this publication may be reproduced, transmitted, stored in a retrieval system or translated into any language in any form by any means without our written permission. Errors and omissions excepted.

© Ford Motor Company 2012

**2013 05+ Mustang (197)**  
**Owners Guide gf, 3rd Printing**  
**USA (fus)**

**ABOUT THIS MANUAL**

Thank you for choosing Ford. We recommend that you take some time to get to know your vehicle by reading this manual. The more that you know about it, the greater the safety and pleasure you will get from driving it.



**WARNING:** Always drive with due care and attention when using and operating the controls and features on your vehicle.

**Note:** This manual describes a range of product features and options, sometimes before they are generally available. Therefore, you may find options in this manual that are not found on your vehicle.

**Note:** Some of the illustrations in this manual may be used for different models, so they may appear different than your vehicle. However, the essential information in the illustrations is always correct.

**Note:** Always use and operate your vehicle in line with all applicable laws and regulations.

**Note:** Pass on this manual when selling your vehicle. It is an integral part of the vehicle.

This manual may qualify the location of a component as left-hand side or right-hand side. The side is determined when facing forward in the seat.

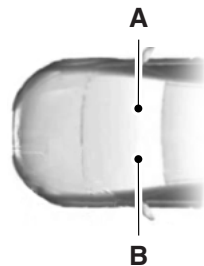

A. Right-hand side

B. Left-hand side

**Protecting the Environment**

You must play your part in protecting the environment. Correct vehicle usage and the authorized disposal of waste, cleaning and lubrication materials are significant steps toward this aim.





















2013 05+ Mustang (197)  
Owners Guide gf, 3rd Printing  
USA (fus)

## SYMBOL GLOSSARY

 **WARNING:** You risk death or serious injury to yourself and others if you do not follow the instruction highlighted by the warning symbol.

These are some of the symbols you may see on your vehicle.

Symbol	Description	Symbol	Description	Symbol	Description
	Safety alert		See Owner's Manual		Anti-lock braking system
	Avoid smoking, flames, or sparks		Battery		Battery acid
	Brake fluid – non petroleum base		Brake system		Cabin air filter
	Check fuel cap		Child Safety Door Lock and Unlock		Child seat lower anchor
	Child seat tether anchor		Cruise control		Do not open when hot
	Engine air filter		Engine coolant		Engine coolant temperature
	Engine oil		Explosive gas		Fan warning
	Fasten safety belt		Front airbag		Front fog lamps

Symbol	Description	Symbol	Description	Symbol	Description
	Fuel pump reset		Fuse compartment		Hazard warning flasher
	Heated rear window		Interior luggage compartment release		Jack
	Lighting control		Low tire pressure warning		Maintain correct fluid level
	Panic alarm		Parking aid system		Parking brake system
	Power steering fluid		Power windows front and rear		Power window lockout
	Service engine soon		Side airbag		Stability control
	Windshield defrost and demist		Windshield washer and wiper		

## DATA RECORDING

### Service Data Recording

Service data recorders in your vehicle are capable of collecting and storing diagnostic information about your vehicle. This potentially includes information about the performance or status of various systems and modules in the vehicle, such as engine, throttle, steering or brake systems. In order to properly diagnose and service your vehicle, Ford Motor Company, Ford of Canada, and service and repair facilities may access or share among them vehicle diagnostic information received through a direct connection to your vehicle when diagnosing or servicing your vehicle. Additionally, when your vehicle is in for service or repair,

Ford Motor Company, Ford of Canada, and service and repair facilities may access or share among them data for vehicle improvement purposes. For U.S. only (if equipped), if you choose to use the SYNC® Vehicle Health Report, you consent that certain diagnostic information may also be accessed electronically by Ford Motor Company and Ford authorized service facilities, and that the diagnostic information may be used for any purpose. See the *SYNC®* chapter for more information.

### Event Data Recording

**This vehicle is equipped with an event data recorder (EDR). The main purpose of an EDR is to record, in certain crash or near crash-like situations, such as an airbag deployment or hitting a road obstacle; this data will assist in understanding how a vehicle's systems performed. The EDR is designed to record data related to vehicle dynamics and safety systems for a short period of time, typically 30 seconds or less. The EDR in this vehicle is designed to record such data as:**

- **How various systems in your vehicle were operating;**
- **Whether or not the driver and passenger safety belts were buckled/fastened;**
- **How far (if at all) the driver was depressing the accelerator and/or the brake pedal;**
- **How fast the vehicle was travelling;**
- **Where the driver was positioning the steering wheel (if equipped).**

**This data can help provide a better understanding of the circumstances in which crashes and injuries occur.**

**Note: EDR data is recorded by your vehicle only if a non-trivial crash situation occurs; no data is recorded by the EDR under normal driving conditions and no personal data or information (e.g., name, gender, age, and crash location) is recorded (see limitations regarding 911 Assist and Traffic, Directions and Information privacy below). However, parties, such as law enforcement, could combine the EDR data with the type of personally identifying data routinely acquired during a crash investigation.**

To read data recorded by an EDR, special equipment is required, and access to the vehicle or the EDR is needed. In addition to the vehicle manufacturer, other parties, such as law enforcement, that have such special equipment, can read the information if they have access to the vehicle or the EDR. Ford Motor Company and Ford of Canada do not access event data recorder information without obtaining consent, unless pursuant to court order or where required by law enforcement, other government authorities or other third parties acting with lawful authority. Other parties may seek to access the information independently of Ford Motor Company and Ford of Canada.

**Note:** Including to the extent that any law pertaining to Event Data Recorders applies to SYNC® or its features, please note the following: Once 911 Assist (if equipped) is enabled (set ON), 911 Assist may, through any paired and connected cell phone, disclose to emergency services that the vehicle has been in a crash involving the deployment of an airbag or, in certain vehicles, the activation of the fuel pump shut-off. Certain versions or updates to 911 Assist may also be capable of being used to electronically or verbally provide to 911 operators the vehicle location (such as latitude and longitude), and/or other details about the vehicle or crash or personal information about the occupants to assist 911 operators to provide the most appropriate emergency services. If you do not want to disclose this information, do not activate the 911 Assist feature. See your SYNC® chapter for more information.

Additionally, when you connect to Traffic, Directions and Information (if equipped, U.S. only), the service uses GPS technology and advanced vehicle sensors to collect the vehicle's current location, travel direction, and speed ("vehicle travel information"), only to help provide you with the directions, traffic reports, or business searches that you request. If you do not want Ford or its vendors to receive this information, do not activate the service. Ford Motor Company and the vendors it uses to provide you with this information do not store your vehicle travel information. For more information, see Traffic, Directions and Information, Terms and Conditions. See your SYNC® supplement for more information.

**CALIFORNIA PROPOSITION 65**

**WARNING:** Some constituents of engine exhaust, certain vehicle components, certain fluids contained in vehicles and certain products of component wear contain or emit chemicals known to the State of California to cause cancer and birth defects or other reproductive harm.

**PERCHLORATE MATERIAL**

**Note:** Certain components in your vehicle, such as airbag modules, safety belt pretensioners, and remote control batteries, may contain perchlorate material. Special handling may apply for service or vehicle end of life disposal. See [www.dtsc.ca.gov/hazardouswaste/perchlorate](http://www.dtsc.ca.gov/hazardouswaste/perchlorate) for more information.

**FORD CREDIT (U.S. ONLY)**

Ford Credit offers a full range of financing and lease plans to help you acquire your vehicle. If you have financed or leased your vehicle through Ford Credit, thank you for your business.

For your convenience, we offer a number of ways to contact us, as well as help manage your account.

Phone: 1-800-727-7000

For more information regarding Ford Credit, as well as access to Account Manager, please go to [www.fordcredit.com](http://www.fordcredit.com).

**REPLACEMENT PARTS RECOMMENDATION**

Your vehicle has been built to the highest standards using quality parts. We recommend that you demand the use of genuine Ford and Motorcraft parts whenever your vehicle requires scheduled maintenance or repair. You can clearly identify genuine Ford and Motorcraft parts by looking for the Ford, FoMoCo or Motorcraft branding on the parts or their packaging.

**Scheduled Maintenance and Mechanical Repairs**

One of the best ways for you to make sure that your vehicle provides years of service is to have it maintained in line with our recommendations using parts that conform to the specifications detailed in this owner's manual. Genuine Ford and Motorcraft parts meet or exceed these specifications.

**Collision Repairs**

We hope that you never experience a collision, but accidents do happen. Genuine Ford replacement collision parts meet our stringent requirements for fit, finish, structural integrity, corrosion protection and dent resistance. During vehicle development, we validate that these parts deliver the intended level of protection as a whole system. A great way to know for sure you are getting this level of protection is to use genuine Ford replacement collision parts.

**Warranty on Replacement Parts**

Genuine Ford and Motorcraft replacement parts are the only replacement parts that benefit from a Ford Warranty. Damage caused to your vehicle as a result of the failure of non-Ford parts may not be covered by the Ford Warranty. For additional information, see the terms and conditions of the Ford Warranty.

**SPECIAL NOTICES****New Vehicle Limited Warranty**

For a detailed description of what is covered and what is not covered by your vehicle's New Vehicle Limited Warranty, see the warranty information that is provided to you along with your owner's manual.

**Special Instructions**

For your added safety, your vehicle is fitted with sophisticated electronic controls.



**WARNING:** Please read the *Supplementary Restraints System* chapter. Failure to follow the specific warnings and instructions could result in personal injury.



**WARNING:** Front seat mounted rear-facing child or infant seats should **NEVER** be placed in front of an active passenger airbag.





**MOBILE COMMUNICATIONS EQUIPMENT**

Using mobile communications equipment is becoming increasingly important in the conduct of business and personal affairs. However, you must not compromise your own or others' safety when using such equipment. Mobile communications can enhance personal safety and security when appropriately used, particularly in emergency situations. Safety must be paramount when using mobile communications equipment to avoid negating these benefits.

Mobile communication equipment includes, but is not limited to, cellular phones, pagers, portable email devices, text messaging devices and portable two-way radios.



**WARNING:** Driving while distracted can result in loss of vehicle control, accident and injury. Ford strongly recommends that you use extreme caution when using any device or feature that may take your focus off the road. Your primary responsibility is the safe operation of your vehicle. We recommend against the use of any handheld device while driving, encourage the use of voice operated systems when possible and that you become aware of applicable state and local laws that may affect use of electronic devices while driving.

**EXPORT UNIQUE (NON-UNITED STATES/CANADA) VEHICLE SPECIFIC INFORMATION**

For your particular global region, your vehicle may be equipped with features and options that are different from the features and options that are described in this owner's manual. A market unique supplement may be supplied that complements this book. By referring to the market unique supplement, if provided, you can properly identify those features, recommendations and specifications that are unique to your vehicle. This owner's manual is written primarily for the U.S. and Canadian Markets. Features or equipment listed as standard may be different on units built for Export. **See this owner's manual for all other required information and warnings.**



**GENERAL INFORMATION**

See the following sections for directions on how to properly use safety restraints for children.

 **WARNING:** Always make sure your child is secured properly in a device that is appropriate for their height, age and weight. Child safety restraints must be bought separately from your vehicle. Failure to follow these instructions and guidelines may result in an increased risk of serious injury or death to your child.

 **WARNING:** All children are shaped differently. The recommendations for safety restraints are based on probable child height, age and weight thresholds from NHTSA and other safety organizations, or are the minimum requirements of law. Ford recommends checking with a NHTSA Certified Child Passenger Safety Technician and consulting your pediatrician to make sure your child seat is appropriate for your child, and is compatible with and properly installed in your vehicle. To locate a child seat fitting station and CPST, contact the NHTSA toll free at 1-888-327-4236 or locate NHTSA on the internet. In Canada, check with your local St. John Ambulance office for referral to a CPST or for further information, contact your provincial ministry of transportation, or locate your local St. John Ambulance office by searching for St. John Ambulance on the internet, or Transport Canada at 1-800-333-0371 (<http://www.tc.gc.ca>). Failure to properly restrain children in safety seats made especially for their height, age, and weight may result in an increased risk of serious injury or death to your child.

Recommendations for Safety Restraints for Children		
	Child size, height, weight, or age	Recommended restraint type
Infants or toddlers	Children weighing 40 lb (18 kg) or less (generally age four or younger).	Use a child safety seat (sometimes called an infant carrier, convertible seat, or toddler seat).

Recommendations for Safety Restraints for Children		
	Child size, height, weight, or age	Recommended restraint type
Small children	Children who have outgrown or no longer properly fit in a child safety seat (generally children who are less than 4 ft. 9 in. (1.45 m) tall, are greater than age four (4) and less than age twelve (12), and between 40 lb (18 kg) and 80 lb (36 kg) and upward to 100 lb (45 kg) if recommended by your child restraint manufacturer).	Use a belt-positioning booster seat.
Larger children	Children who have outgrown or no longer properly fit in a belt-positioning booster seat (generally children who are at least 4 ft. 9 in. (1.45 m) tall or greater than 80 lb (36 kg) or 100 lb (45 kg) if recommended by child restraint manufacturer).	Use a vehicle safety belt having the lap belt snug and low across the hips, shoulder belt centered across the shoulder and chest, and seat back upright.

- You are required by law to properly use safety seats for infants and toddlers in the United States and Canada.
- Many states and provinces require that small children use approved booster seats until they reach age eight, a height of 4 feet 9 inches (1.45 meters) tall, or 80 pounds (36 kilograms). Check your local and state or provincial laws for specific requirements about the safety of children in your vehicle.
- When possible, always properly restrain children twelve (12) years of age and under in a rear seating position of your vehicle. Accident statistics suggest that children are safer when properly restrained in the rear seating positions than in a front seating position. See *Front Passenger Sensing System* in the *Supplementary Restraints System* chapter for more information.

**CHILD SEATS**

Use a child safety seat (sometimes called an infant carrier, convertible seat, or toddler seat) for infants, toddlers or children weighing 40 pounds (18 kilograms) or less (generally age four or younger).

**CHILD SEAT POSITIONING**

**!** **WARNING:** Airbags can kill or injure a child in a child seat. NEVER place a rear-facing child seat in front of an active airbag. If you must use a forward-facing child seat in the front seat, move your vehicle seat all the way back. When possible, all children age 12 and under should be properly restrained in a rear seating position. If all children cannot be seated and restrained properly in a rear seating position, properly restrain the largest child in the front seat.

**!** **WARNING:** Always carefully follow the instructions and warnings provided by the manufacturer of any child restraint to determine if the restraint device is appropriate for your child's size, height, weight, or age. Follow the child restraint manufacturer's instructions and warnings provided for installation and use in conjunction with the instructions and warnings provided by your vehicle manufacturer. A safety seat that is improperly installed or utilized, is inappropriate for your child's height, age, or weight or does not properly fit the child may increase the risk of serious injury or death.

**!** **WARNING:** Never let a passenger hold a child on his or her lap while your vehicle is moving. The passenger cannot protect the child from injury in a crash, which may result in serious injury or death.

**!** **WARNING:** Never use pillows, books, or towels to boost a child. They can slide around and increase the likelihood of injury or death in a crash.

 **WARNING:** Always restrain an unoccupied child seat or booster seat. These objects may become projectiles in a crash or sudden stop, which may increase the risk of serious injury.

 **WARNING:** Never place, or allow a child to place, the shoulder belt under a child's arm or behind the back because it reduces the protection for the upper part of the body and may increase the risk of injury or death in a crash.

 **WARNING:** Do not leave children, unreliable adults, or pets unattended in your vehicle.

Restraint Type	Child Weight	Use any attachment method as indicated below by X				
		LATCH (lower anchors and top tether anchor)	LATCH (lower anchors only)	Safety belt and top tether anchor	Safety belt and LATCH (lower anchors and top tether anchor)	Safety belt only
Rear-facing child seat	Up to 48 lb (21 kg)		X			X
Forward-facing child seat	Up to 48 lb (21 kg)	X		X	X	
Forward-facing child seat	Over 48 lb (21 kg)			X	X	

**Note:** The child seat must rest tightly against your vehicle seat. See the *Seats* chapter for information on head restraints.

**BOOSTER SEATS**

 **WARNING:** Never place, or allow a child to place, the shoulder belt under a child’s arm or behind the back because it reduces the protection for the upper part of the body and may increase the risk of injury or death in a crash.

Use a belt-positioning booster seat for children who have outgrown or no longer properly fit in a child safety seat (generally children who are less than 4 feet 9 inches (1.45 meters) tall, are greater than age four (4) and less than age twelve (12), and between 40 pounds (18 kilograms) and 80 pounds (36 kilograms) and upward to 100 pounds (45 kilograms) if recommended by your child restraint manufacturer). Many state and provincial laws require that children use approved booster seats until they reach age eight (8), a height of 4 feet 9 inches (1.45 meters) tall, or 80 pounds (36 kilograms).

Booster seats should be used until you can answer YES to ALL of these questions when the child is seated without a booster seat.

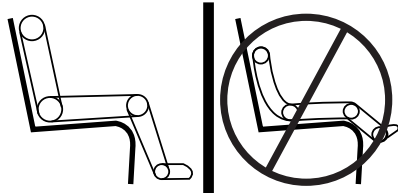

- Can the child sit all the way back against your vehicle seat back with knees bent comfortably at the edge of the seat cushion?
- Can the child sit without slouching?
- Does the lap belt rest low across the hips?
- Is the shoulder belt centered on the shoulder and chest?
- Can the child stay seated like this for the whole trip?

Always use booster seats in conjunction with your vehicle lap and shoulder belt.

**Types of Booster Seats**

- Backless booster seats

If your backless booster seat has a removable shield, remove the shield. If a vehicle seating position has a low seat back or no head restraint, a backless booster seat may place your child's head (as measured at the tops of the ears) above the top of the seat. In this case, move the backless booster to another seating position with a higher seat back or head restraint and lap and shoulder belts, or consider using a high back booster seat.



- High back booster seats

If, with a backless booster seat, you cannot find a seating position that adequately supports your child's head, a high back booster seat would be a better choice.

Children and booster seats vary in size and shape. Choose a booster that keeps the lap belt low and snug across the hips, never up across the stomach, and lets you adjust the shoulder belt to cross the chest and rest snugly near the center of the shoulder. The following drawings compare the ideal fit (center) to a shoulder belt uncomfortably close to the neck and a shoulder belt that could slip off the shoulder. The drawings also show how the lap belt should be low and snug across the child's hips.

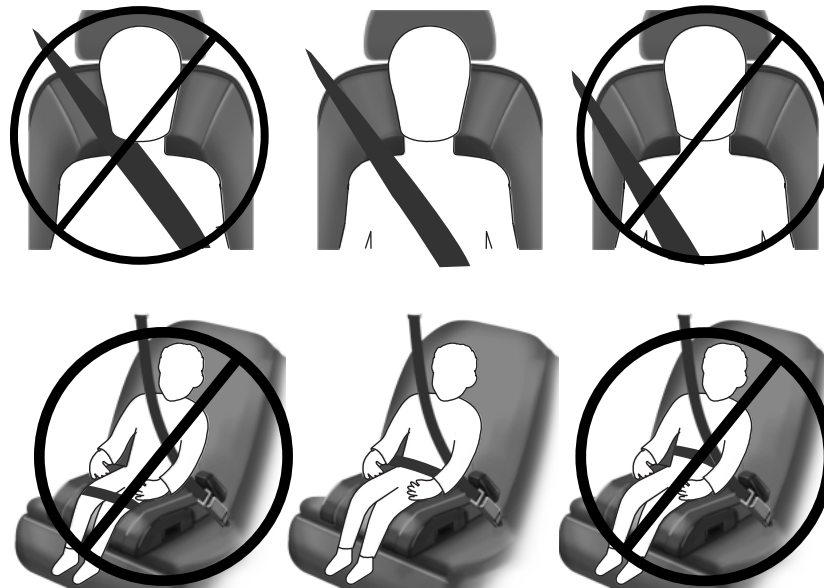

If the booster seat slides on your vehicle seat, placing a rubberized mesh sold as shelf or carpet liner under the booster seat may improve this condition. Do not introduce any item thicker than this under the booster seat. Check with the booster seat manufacturer's instructions.



---

**INSTALLING CHILD SEATS****Using Lap and Shoulder Belts**

**WARNING:** Airbags can kill or injure a child in a child seat. **NEVER** place a rear-facing child seat in front of an active airbag. If you must use a forward-facing child seat in the front seat, move the seat all the way back.



**WARNING:** Children 12 and under should be properly restrained in the rear seat whenever possible.



**WARNING:** Depending on where you secure a child restraint, and depending on the child restraint design, you may block access to certain safety belt buckle assemblies or LATCH lower anchors, rendering those features potentially unusable. To avoid risk of injury, occupants should only use seating positions where they are able to be properly restrained.

When installing a child safety seat with combination lap and shoulder belts:

- Use the correct safety belt buckle for that seating position.
- Insert the belt tongue into the proper buckle until you hear a snap and feel it latch. Make sure the tongue is securely fastened in the buckle.
- Keep the buckle release button pointing up and away from the safety seat, with the tongue between the child seat and the release button, to prevent accidental unbuckling.
- Place your vehicle seat back in the upright position.
- Put the safety belt in the automatic locking mode. See Step 5. This vehicle does not require the use of a locking clip.



Perform the following steps when installing the child seat with combination lap and shoulder belts:

**Note:** Although the child seat illustrated is a forward-facing child seat, the steps are the same for installing a rear-facing child seat.



1. Position the child safety seat in a seat with a combination lap and shoulder belt.

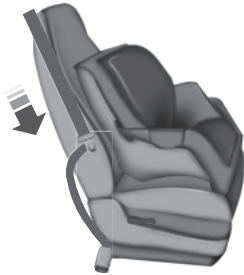

2. Pull down on the shoulder belt and then grasp the shoulder belt and lap belt together.

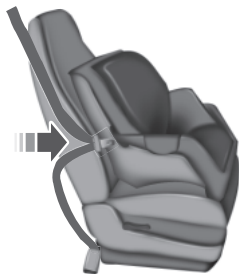

3. While holding the shoulder and lap belt portions together, route the tongue through the child seat according to the child seat manufacturer's instructions. Be sure the belt webbing is not twisted.

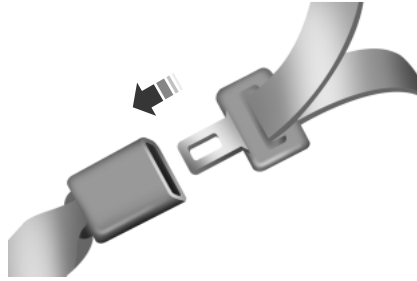

4. Insert the belt tongue into the proper buckle (the buckle closest to the direction the tongue is coming from) for that seating position until you hear a snap and feel the latch engage. Make sure the tongue is latched securely by pulling on it.



5. To put the retractor in the automatic locking mode, grasp the shoulder portion of the belt and pull downward until all of the belt is pulled out.

**Note:** The automatic locking mode is available on the front passenger and rear seats. This vehicle does not require the use of a locking clip.

6. Allow the belt to retract to remove slack. The belt will click as it retracts to indicate it is in the automatic locking mode.

7. Try to pull the belt out of the retractor to make sure the retractor is in the automatic locking mode. You should not be able to pull more belt out. If the retractor is not locked, unbuckle the belt and repeat Steps 5 and 6.

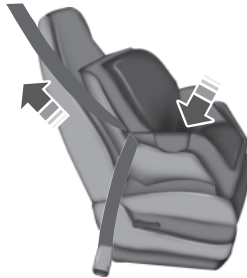

8. Remove remaining slack from the belt. Force the seat down with extra weight, for example, by pressing down or kneeling on the child restraint while pulling up on the shoulder belt in order to force slack from the belt.

This is necessary to remove the remaining slack that will exist once the extra weight of the child is added to the child restraint. It also helps to achieve the proper snugness of the child seat to your vehicle. Sometimes, a slight lean toward the buckle will additionally help to remove remaining slack from the belt.

9. Attach the tether strap (if the child seat is equipped). See *Using Tether Straps* later in this chapter.

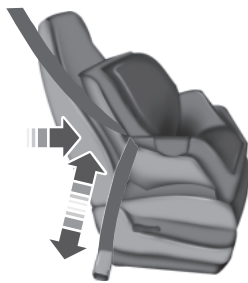

10. Before placing the child in the seat, forcibly move the seat forward and back to make sure the seat is securely held in place.

To check this, grab the seat at the belt path and attempt to move it side to side and forward and back. There should be no more than 1 inch (2.5 centimeters) of movement for proper installation.

Ford recommends checking with a NHTSA Certified Child Passenger Safety Technician (CPST) to make certain the child restraint is properly installed. In Canada, check with your local St. John Ambulance office for referral to a CPST.

**Using Lower Anchors and Tethers for Children (LATCH)**

**!** **WARNING:** Never attach two child safety seats to the same anchor. In a crash, one anchor may not be strong enough to hold two child safety seat attachments and may break, causing serious injury or death.

**!** **WARNING:** Depending on where you secure a child restraint, and depending on the child restraint design, you may block access to certain safety belt buckle assemblies or LATCH lower anchors, rendering those features potentially unusable. To avoid risk of injury, occupants should only use seating positions where they are able to be properly restrained.

**⚠ WARNING:** The center of the rear seat is NOT designed as a seating position and is not equipped with safety belts. The LATCH anchors were not designed to be used with a child seat in the center position and there is no tether anchor available at the center. Attempted use of the center as a seating position will increase the risk of injury or death in the event of a crash.

The LATCH system is composed of three vehicle anchor points: two lower anchors located where your vehicle seat back and seat cushion meet (called the seat bight) and one top tether anchor located behind that seating position.

LATCH compatible child safety seats have two rigid or webbing mounted attachments that connect to the two lower anchors at the LATCH equipped seating positions in your vehicle. This type of attachment method eliminates the need to use safety belts to attach the child seat, however the safety belt can still be used to attach the child seat. For forward-facing child seats, the top tether strap must also be attached to the proper top tether anchor, if a top tether strap has been provided with your child seat.

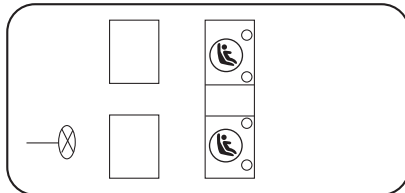

Your vehicle has LATCH lower anchors for child seat installation at the seating positions marked with the child seat symbol.

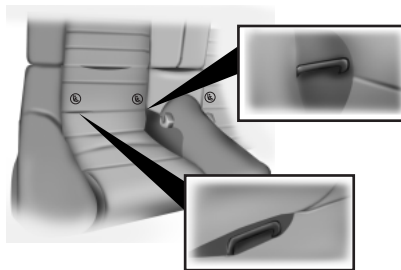

The LATCH anchors are located at the rear section of the rear seat between the cushion and seat back below the symbols as shown. Follow the child seat manufacturer's instructions to properly install a child seat with LATCH attachments.

Follow the instructions on attaching child safety seats with tether straps. See *Using Tether Straps* later in this chapter.

Attach LATCH lower attachments of the child seat only to the anchors shown.

**Combining Safety Belt and LATCH Lower Anchors for Attaching Child Safety Seats**

When used in combination, either the safety belt or the LATCH lower anchors may be attached first, provided a proper installation is achieved. Attach the tether strap afterward, if included with the child seat.

**Using Tether Straps**



Many forward-facing child safety seats include a tether strap which extends from the back of the child safety seat and hooks to an anchoring point called the top tether anchor. Tether straps are available as an accessory for many older safety seats.

Contact the manufacturer of your child seat for information about ordering a tether strap, or to obtain a longer tether strap if the tether strap on your safety seat does not reach the appropriate top tether anchor in the vehicle.

Once the child safety seat has been installed using either the safety belt, the lower anchors of the LATCH system, or both, you can attach the top tether strap.

The tether strap anchors in your vehicle are in the following positions (shown from top view):

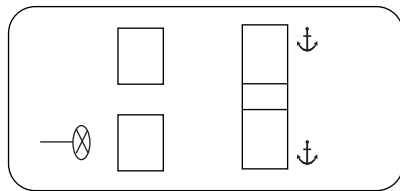

- **Vehicles with rear seats**

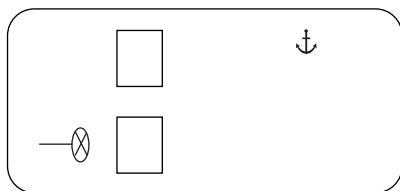

- **Vehicles without rear seats**

Perform the following steps to attach a child safety seat to the tether anchor:

**For coupe:**

1. Route the tether strap over the top of the head restraint.
2. Locate the correct anchor for the selected seating position.
3. Open the tether anchor cover.



4. Clip the tether strap to the anchor as shown.  
If the tether strap is clipped incorrectly, the child safety seat may not be retained properly in the event of a collision.

5. Tighten the child safety seat tether strap according to the manufacturer's instructions.

If the safety seat is not anchored properly, the risk of a child being injured in a collision greatly increases.

**For convertible:**

1. Route the child safety seat tether strap over the top of the head restraint.

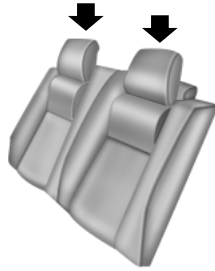

The tether anchors are located rearward of the seat back in the convertible top sling.

**Note:** For easier access, attach the tether with the convertible top up.

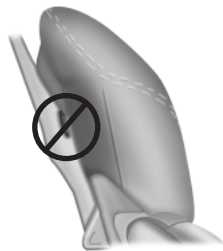

**Note:** The attachments for the convertible boot located on the back of the head restraints are not tether anchors.



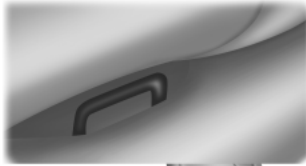

2. Access tether anchors located behind the seat back under the vinyl tag marked with the child tether anchor symbol.

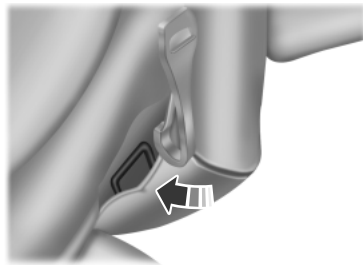
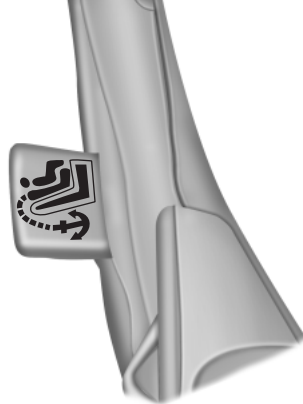

3. Clip the tether strap to the anchor as shown.

If the tether strap is clipped incorrectly, the child safety seat may not be retained properly in the event of a collision.

4. Tighten the child safety seat tether strap according to the manufacturer's instructions.

If the safety seat is not anchored properly, the risk of a child being injured in a collision greatly increases.

If your child restraint system is equipped with a tether strap, and the child restraint manufacturer recommends its use, Ford also recommends its use.

### PRINCIPLES OF OPERATION



**WARNING:** Always drive and ride with your seat back upright and the lap belt snug and low across the hips



**WARNING:** To reduce the risk of injury, make sure children sit where they can be properly restrained.



**WARNING:** Never let a passenger hold a child on his or her lap while the vehicle is moving. The passenger cannot protect the child from injury in a collision.



**WARNING:** All occupants of the vehicle, including the driver, should always properly wear their safety belts, even when an airbag supplemental restraint system is provided.



**WARNING:** It is extremely dangerous to ride in a cargo area, inside or outside of a vehicle. In a collision, people riding in these areas are more likely to be seriously injured or killed. Do not allow people to ride in any area of your vehicle that is not equipped with seats and safety belts. Be sure everyone in your vehicle is in a seat and using a safety belt properly.



**WARNING:** In a rollover crash, an unbelted person is significantly more likely to die than a person wearing a safety belt.



**WARNING:** Each seating position in your vehicle has a specific safety belt assembly which is made up of one buckle and one tongue that are designed to be used as a pair. 1) Use the shoulder belt on the outside shoulder only. Never wear the shoulder belt under the arm. 2) Never swing the safety belt around your neck over the inside shoulder. 3) Never use a single belt for more than one person.



**WARNING:** When possible, all children 12 years old and under should be properly restrained in a rear seating position.



**WARNING:** Safety belts and seats can become hot in a vehicle that has been closed up in sunny weather; they could burn a small child. Check seat covers and buckles before you place a child anywhere near them.





**WARNING:** Front and rear seat occupants, including pregnant women, should wear safety belts for optimum protection in an accident.



**WARNING:** The center of the rear seat is not designed as a seating position and is not equipped with safety belts. The LATCH anchors were not designed to be used with a child seat in the center position and there is no tether anchor available at the center. Attempted use of the center as a seating position will increase the risk of injury or death in the event of a crash.

All seating positions in this vehicle have lap and shoulder safety belts. All occupants of the vehicle should always properly wear their safety belts, even when an airbag supplemental restraint system is provided.

The safety belt system consists of:

- lap and shoulder safety belts.
- shoulder safety belt with automatic locking mode, (except driver safety belt).
- retractor pretensioner at the front outboard seating positions.
- belt tension sensor at the front outboard passenger seating position.
-  Safety belt warning light and chime. See *Safety Belt Warning Light and Indicator Chime* later in this chapter.
-  Crash sensors and monitoring system with readiness indicator. See *Crash Sensors and Airbag Indicator* in the *Supplemental Restraint System* chapter.

The safety belt pretensioners are designed to activate in frontal, near-frontal and side crashes. The safety belt pretensioners at the front seating positions are designed to tighten the safety belts firmly against the occupant's body when activated. This helps increase the effectiveness of the safety belts. In frontal crashes, the safety belt pretensioners can be activated alone or, if the crash is of sufficient severity, together with the front airbags.

### FASTENING THE SAFETY BELTS

The front outboard and rear safety restraints in your vehicle are combination lap and shoulder belts.

The presenter arm (available on the coupe only) is intended to improve access to the safety belt and to allow access to the rear seat.



Rotate the presenter arm toward the front of the vehicle until it locks into place. This allows easier access to the front safety belt for the front seat occupant.

To access the second row seats, rotate the arm back to its original position against the trim panel.

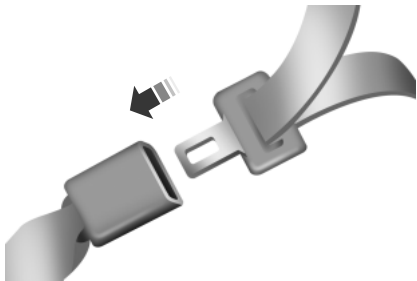

1. Insert the belt tongue into the proper buckle (the buckle closest to the direction the tongue is coming from) until you hear a snap and feel it latch. Make sure the tongue is securely fastened in the buckle.

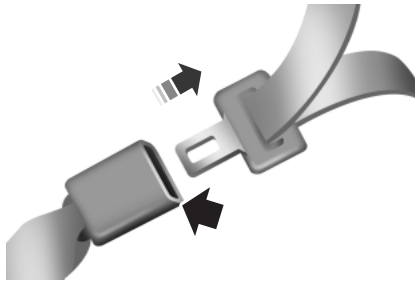

2. To unfasten, press the release button and remove the tongue from the buckle.

**Restraint of Pregnant Women**

 **WARNING:** Always ride and drive with your seat back upright and the safety belt properly fastened. The lap portion of the safety belt should fit snug and be positioned low across the hips. The shoulder portion of the safety belt should be positioned across the chest. Pregnant women should also follow this practice. See the following figure.

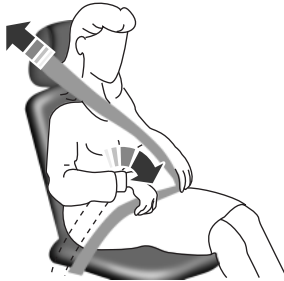

Pregnant women should always wear their safety belts. The lap belt portion of a combination lap and shoulder belt should be positioned low across the hips below the belly and worn as tight as comfort will allow. The shoulder belt should be positioned to cross the middle of the shoulder and the center of the chest.

**Safety Belt Locking Modes**

 **WARNING:** After any vehicle crash, the safety belt system at all passenger seating positions must be checked by an authorized dealer to verify that the automatic locking retractor feature for child seats is still functioning properly. In addition, all safety belts should be checked for proper function.

 **WARNING:** BELT AND RETRACTOR ASSEMBLY MUST BE REPLACED if the safety belt assembly automatic locking retractor feature or any other safety belt function is not operating properly when checked by an authorized dealer. Failure to replace the belt and retractor assembly could increase the risk of injury in crashes.

All safety restraints in the vehicle are combination lap and shoulder belts. The driver safety belt has the first type of locking mode, and the front outboard passenger and rear seat safety belts have both types of locking modes described as follows:

### **Vehicle Sensitive Mode**

This is the normal retractor mode, which allows free shoulder belt length adjustment to your movements and locking in response to vehicle movement. For example, if the driver brakes suddenly or turns a corner sharply, or the vehicle receives an impact of approximately 5 mph (8 km/h) or more, the combination safety belts will lock to help reduce forward movement of the driver and passengers.

In addition, the retractor is designed to lock if the webbing is pulled out too quickly. If this occurs, let the belt retract slightly and pull webbing out again in a slow and controlled manner.

### **Automatic Locking Mode**

In this mode, the shoulder belt is automatically pre-locked. The belt will still retract to remove any slack in the shoulder belt. The automatic locking mode is not available on the driver safety belt.

### **When to Use the Automatic Locking Mode**

This mode should be used any time a child safety seat, except a booster, is installed in passenger front or rear seating positions. Children 12 years old and under should be properly restrained in a rear seating position whenever possible. See the *Child Safety* chapter.

### **How to Use the Automatic Locking Mode**



1. Buckle the combination lap and shoulder belt.
2. Grasp the shoulder portion and pull downward until the entire belt is pulled out.
3. Allow the belt to retract. As the belt retracts, you will hear a clicking sound. This indicates the safety belt is now in the automatic locking mode.

### **How to Disengage the Automatic Locking Mode**

Disconnect the combination lap and shoulder belt and allow it to retract completely to disengage the automatic locking mode and activate the vehicle sensitive (emergency) locking mode.

**Safety Belt Extension Assembly**

**WARNING:** Do not use extensions to change the fit of the shoulder belt across the torso.

If the safety belt is too short when fully extended, you can obtain a safety belt extension assembly from an authorized dealer.

Use only extensions manufactured by the same supplier as the safety belt. Manufacturer identification is located at the end of the webbing on the label. Also, use the safety belt extension only if the safety belt is too short for you when fully extended.

**SAFETY BELT WARNING LIGHT AND INDICATOR CHIME**

This lamp illuminates and an audible warning will sound if the driver's safety belt has not been fastened when the vehicle's ignition is turned on.

**Conditions of Operation**

<b>If...</b>	<b>Then...</b>
The driver's safety belt is not buckled before the ignition switch is turned to the on position...	The safety belt warning light illuminates 1-2 minutes and the warning chime sounds 4-8 seconds.
The driver's safety belt is buckled while the indicator light is illuminated and the warning chime is sounding...	The safety belt warning light and warning chime turn off.
The driver's safety belt is buckled before the ignition switch is turned to the on position...	The safety belt warning light and indicator chime remain off.

**SAFETY BELT-MINDER®**

This feature supplements the safety belt warning function by providing additional reminders by intermittently sounding a chime and illuminating the safety belt warning light when the driver's or front passenger's seat is occupied and the safety belt is unbuckled.

The system uses information from the front passenger sensing system to determine if a front seat passenger is present and therefore potentially in need of a warning. To avoid activating the Belt-Minder® feature for objects placed in the front passenger seat, warnings will only be given to front seat occupants as determined by the front passenger sensing system.

If the Belt-Minder® warnings have expired (warnings for approximately five minutes) for one occupant (driver or front passenger), the other occupant can still activate the Belt-Minder® feature.

If...	Then...
The driver's and front passenger's safety belts are buckled before the ignition switch is turned to the on position or less than 1-2 minutes have elapsed since the ignition switch has been turned to on...	The Belt-Minder® feature will not activate.
The driver's or front passenger's safety belt is not buckled when the vehicle has reached at least 6 mph (9.7 km/h) and 1-2 minutes have elapsed since the ignition switch has been turned to on...	The Belt-Minder® feature is activated - the safety belt warning light illuminates and the warning chime sounds for six seconds every 25 seconds, repeating for approximately five minutes or until the safety belts are buckled.
The driver's or front passenger's safety belt becomes unbuckled for approximately one minute while the vehicle is traveling at least 6 mph (9.7 km/h) and more than 1-2 minutes have elapsed since the ignition switch has been turned to on...	The Belt-Minder® feature is activated - the safety belt warning light illuminates and the warning chime sounds for six seconds every 25 seconds, repeating for approximately five minutes or until the safety belts are buckled.



**Deactivating and Activating the Belt-Minder® Feature**

**WARNING:** While the design allows you to deactivate your Belt-Minder®, this system is designed to improve your chances of being safely belted and surviving an accident. We recommend you leave the Belt-Minder® system activated for yourself and others who may use the vehicle. To reduce the risk of injury, do not deactivate or activate the Belt-Minder® feature while driving the vehicle.

**Note:** The driver and front passenger Belt-Minder® are deactivated and activated independently. When deactivating or activating one seating position, do not buckle the other position as this will terminate the process.

**Note:** If you are using MyKey®, the Belt-Minder® cannot be disabled. Also, if the Belt-Minder® has been previously disabled, it will be re-enabled during the use of MyKey®. See the *MyKey®* chapter.

*Read Steps 1 - 4 thoroughly before proceeding with the deactivation or activation programming procedure.*

The driver and front passenger Belt-Minder® features can be deactivated or activated by performing the following procedure:

Before following the procedure, make sure that:

- the parking brake is set
  - the transmission selector lever is in position **P** (automatic transmission) or **N** (manual transmission)
  - the ignition is on
  - the driver and front passenger safety belts are unbuckled.
1. Turn the ignition on. DO NOT START THE ENGINE.
  2. Wait until the safety belt warning light turns off (approximately one minute).
- Step 3 must be completed within 30 seconds after the safety belt warning light turns off.

3. For the seating position being disabled, buckle then unbuckle the safety belt three times at a moderate speed, ending in the unbuckled state. Step 3 must be completed within 30 seconds after the safety belt warning light turns off.

- After Step 3, the restraint system warning light (airbag light) will be turned on for three seconds.

4. Within approximately seven seconds of the light turning off, buckle then unbuckle the safety belt.

- This will disable the Belt-Minder® feature for that seating position if it is currently enabled.
- This will enable the Belt-Minder® feature for that seating position if it is currently disabled.

#### **CHILD RESTRAINT AND SAFETY BELT MAINTENANCE**

Inspect the vehicle safety belts and child safety seat systems periodically to make sure they work properly and are not damaged. Inspect the vehicle and child seat safety belts to make sure there are no nicks, tears or cuts. Replace if necessary. All vehicle safety belt assemblies, including retractors, buckles, front safety belt buckle assemblies, buckle support assemblies (slide bar-if equipped), shoulder belt height adjusters (if equipped), shoulder belt guide on seat back (if equipped), child safety seat LATCH and tether anchors, and attaching hardware, should be inspected after a crash. Read the child restraint manufacturer's instructions for additional inspection and maintenance information specific to the child restraint. Ford Motor Company recommends that all safety belt assemblies in use in vehicles involved in a crash be replaced. However, if the crash was minor and an authorized dealer finds that the belts do not show damage and continue to operate properly, they do not need to be replaced. Safety belt assemblies not in use during a crash should also be inspected and replaced if either damage or improper operation is noted.

For proper care of soiled safety belts, see *Cleaning the Interior* in the *Vehicle Care* chapter.

**PERSONAL SAFETY SYSTEM™**

The Personal Safety System provides an improved overall level of frontal crash protection to front seat occupants and is designed to help further reduce the risk of airbag-related injuries. The system is able to analyze different occupant conditions and crash severity before activating the appropriate safety devices to help better protect a range of occupants in a variety of frontal crash situations.

Your vehicle's Personal Safety System consists of:

- Driver and passenger dual-stage airbag supplemental restraints.
- Front outboard safety belts with pretensioners, energy management retractors (first row only), and safety belt usage sensors.
- Driver's seat position sensor.
- Front passenger sensing system.
- Passenger airbag off and on indicator lamp.
- Front crash severity sensors.
- Restraints control module with impact and safing sensors.
- Restraint system warning light and backup tone.
- The electrical wiring for the airbags, crash sensor(s), safety belt pretensioners, front safety belt usage sensors, driver seat position sensor, front passenger sensing system, and indicator lights.

**How Does the Personal Safety System Work?**

The Personal Safety System can adapt the deployment strategy of your vehicle's safety devices according to crash severity and occupant conditions. A collection of crash and occupant sensors provides information to the restraints control module. During a crash, the restraints control module may activate the safety belt pretensioners and/or either one or both stages of the dual-stage airbag supplemental restraints based on crash severity and occupant conditions.

**PRINCIPLES OF OPERATION**

 **WARNING:** Airbags do not inflate slowly or gently, and the risk of injury from a deploying airbag is the greatest close to the trim covering the airbag module.

 **WARNING:** All occupants of your vehicle, including the driver, should always properly wear their safety belts, even when an airbag supplemental restraint system is provided.

 **WARNING:** Always transport children 12 years old and under in the back seat and always properly use appropriate child restraints.

 **WARNING:** Never place your arm over the airbag module as a deploying airbag can result in serious arm fractures or other injuries.

 **WARNING:** Airbags can kill or injure a child in a child seat. NEVER place a rear-facing child seat in front of an active airbag. If you must use a forward-facing child seat in the front seat, move the seat all the way back.

 **WARNING:** Do not attempt to service, repair, or modify the airbag supplemental restraint systems or its fuses. Contact your authorized dealer as soon as possible.

 **WARNING:** Several airbag system components get hot after inflation. Do not touch them after inflation.

 **WARNING:** If the airbag has deployed, the airbag will not function again and must be replaced immediately. If the airbag is not replaced, the unrepaired area will increase the risk of injury in a crash.

## 44                    **Supplementary Restraints System**

---

The airbags are a supplemental restraint system and are designed to work with the safety belts to help protect the driver and right front passenger from certain upper body injuries. Airbags do not inflate slowly; there is a risk of injury from a deploying airbag.

**Note:** You will hear a loud bang and see a cloud of harmless powdery residue if an airbag deploys. This is normal.

The airbags inflate and deflate rapidly upon activation. After airbag deployment, it is normal to notice a smoke-like, powdery residue or smell the burnt propellant. This may consist of cornstarch, talcum powder (to lubricate the bag) or sodium compounds (for example, baking soda) that result from the combustion process that inflates the airbag. Small amounts of sodium hydroxide may be present which may irritate the skin and eyes, but none of the residue is toxic. While the system is designed to help reduce serious injuries, contact with a deploying airbag may also cause abrasions or swelling. Temporary hearing loss is also a possibility as a result of the noise associated with a deploying airbag. Because airbags must inflate rapidly and with considerable force, there is the risk of death or serious injuries, such as fractures, facial and eye injuries or internal injuries, particularly to occupants who are not properly restrained or are otherwise out of position at the time of airbag deployment. Thus, it is extremely important that occupants be properly restrained as far away from the airbag module as possible while maintaining vehicle control.

Routine maintenance of the airbags is not required.

### **SOS POST-CRASH ALERT SYSTEM™**

The system flashes the turn signal lamps and sounds the horn (intermittently) in the event of a serious impact that deploys an airbag equipped on your vehicle, such as front, side, side curtain or Safety Canopy®.

The horn and lamps will turn off when:

- the hazard control button is pressed
- the panic button (if equipped) is pressed on the remote entry transmitter, or
- your vehicle runs out of power.

**DRIVER AND PASSENGER AIRBAGS**

 **WARNING:** Never place your arm or any objects over an airbag module. Placing your arm over a deploying airbag can result in serious arm fractures or other injuries. Objects placed on or over the airbag inflation area may cause those objects to be propelled by the airbag into your face and torso causing serious injury.

 **WARNING:** Airbags can kill or injure a child in a child seat. Never place a rear-facing child seat in front of an active airbag. If you must use a forward-facing child seat in the front seat, move the seat all the way back.

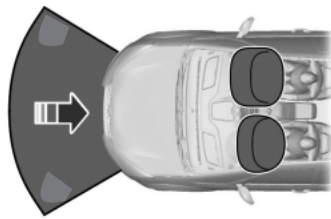

The driver and front passenger airbags will deploy during significant frontal and near-frontal crashes.

The driver and passenger front airbag system consists of the following:

- Driver and passenger airbag modules.
-  • Crash sensors and monitoring system with readiness indicator. See *Crash Sensors and Airbag Indicator* later in this chapter.
- Front passenger sensing system.

## 46 Supplementary Restraints System

### Proper Driver and Front Passenger Seating Adjustment

 **WARNING:** The National Highway Traffic Safety Administration recommends a minimum distance of at least 10 inches (25 centimeters) between an occupant's chest and the driver airbag module.

To properly position yourself away from the airbag:

- Move your seat to the rear as far as you can while still reaching the pedals comfortably.
- Recline the seat slightly (one or two degrees) from the upright position.

After all occupants have adjusted their seats and put on safety belts, it is very important that they continue to sit properly. A properly seated occupant sits upright, leaning against the seat back, and centered on the seat cushion, with their feet comfortably extended on the floor. Sitting improperly can increase the chance of injury in a crash event. For example, if an occupant slouches, lies down, turns sideways, sits forward, leans forward or sideways, or puts one or both feet up, the chance of injury during a crash is greatly increased.

### Children and Airbags

 **WARNING:** Airbags can kill or injure a child in a child seat. NEVER place a rear-facing child seat in front of an active airbag. If you must use a forward-facing child seat in the front seat, move the seat all the way back.



Children must always be properly restrained. Accident statistics suggest that children are safer when properly restrained in the rear seating positions than in the front seating position. Failure to follow these instructions may increase the risk of injury in a crash.

### FRONT PASSENGER SENSING SYSTEM



**WARNING:** Even with Advanced Restraints Systems, children 12 and under should be properly restrained in a rear seating position.



**WARNING:** Sitting improperly out of position or with the seat back reclined too far can take off weight from the seat cushion and affect the decision of the front passenger sensing system, resulting in serious injury or death in a crash.  
Always sit upright against your seat back, with your feet on the floor.



**WARNING:** To reduce the risk of possible serious injury:  
Do not stow objects in seat back map pocket or hang objects off seat back if a child is in the front passenger seat.  
Do not place objects underneath the front passenger seat or between the seat and the center console.  
Check the passenger airbag off or pass airbag off indicator lamp for proper airbag status.  
Failure to follow these instructions may interfere with the passenger seat sensing system.



**WARNING:** Any alteration or modification to the front passenger seat may affect the performance of the front passenger sensing system.

This system works with sensors that are part of the front passenger's seat and safety belt to detect the presence of a properly-seated occupant and determine if the front passenger's frontal airbag should be enabled (may inflate) or not.







The front passenger sensing system uses a passenger airbag off or pass airbag off indicator which will illuminate and stay lit to remind you that the front passenger frontal airbag is disabled. The indicator

lamp is located on the front edge of the map lamps.

**Note:** The indicator lamp will illuminate for a short period of time when the ignition is turned to the on position to confirm it is functional.

When the front passenger seat is not occupied (empty seat) or in the event that the front passenger frontal airbag is enabled (may inflate), the indicator lamp will be unlit.

The front passenger sensing system is designed to disable (will not inflate) the front passenger's frontal airbag when a rear-facing infant seat, a forward-facing child restraint, or a booster seat is detected. Even with this technology, parents are **STRONGLY** encouraged to always properly restrain children in the rear seat. The sensor also turns off the passenger front airbag and seat-mounted side airbag when the passenger seat is empty.

- When the front passenger sensing system disables (will not inflate) the front passenger frontal airbag, the indicator lamp will illuminate and stay lit to remind you that the front passenger frontal airbag is disabled.
- If the child restraint has been installed and the indicator lamp is not lit, then turn your vehicle off, remove the child restraint from your vehicle and reinstall the restraint following the child restraint manufacturer's instructions.

The front passenger sensing system is designed to enable (may inflate) the front passenger's frontal airbag anytime the system senses that a person of adult size is sitting properly in the front passenger seat.

- When the front passenger sensing system enables the front passenger frontal airbag (may inflate), the indicator will be unlit and stay unlit.

If a person of adult size is sitting in the front passenger's seat, but the passenger airbag off or pass airbag off indicator lamp is lit, it is possible that the person is not sitting properly in the seat. If this happens:

- Turn your vehicle off and ask the person to place the seat back in the full upright position.
- Have the person sit upright in the seat, centered on the seat cushion, with the person's legs comfortably extended.

- Restart your vehicle and have the person remain in this position for about two minutes. This will allow the system to detect that person and enable the passenger’s frontal airbag.
- If the indicator lamp remains lit even after this, the person should be advised to ride in the rear seat.

<b>Occupant</b>	<b>Pass Airbag Off Indicator Lamp</b>	<b>Passenger Airbag</b>
Empty seat	Unlit	Disabled
Small child	Lit	Disabled
Adult	Unlit	Enabled

After all occupants have adjusted their seats and put on safety belts, it is very important that they continue to sit properly. A properly seated occupant sits upright, leaning against the seat back, and centered on the seat cushion, with their feet comfortably extended on the floor. Sitting improperly can increase the chance of injury in a crash event. For example, if an occupant slouches, lies down, turns sideways, sits forward, leans forward or sideways, or puts one or both feet up, the chance of injury during a crash is greatly increased.

The front passenger sensing system may detect small or medium objects placed on the seat cushion. For most objects that are in the front passenger seat, the passenger airbag will be disabled. Even though the passenger airbag is disabled, the pass airbag off lamp may or may not be illuminated.

If you think that the status of the passenger airbag off indicator lamp is incorrect, check for the following:

- objects lodged underneath the seat
- objects between the seat cushion and the center console (if equipped)
- objects hanging off the seat back
- objects stowed in the seat back map pocket (if equipped)
- objects placed on the occupant’s lap
- cargo interference with the seat
- other passengers pushing or pulling on the seat
- rear passenger feet and knees resting or pushing on the seat

The conditions listed above may cause the weight of a properly seated occupant to be incorrectly interpreted by the front passenger sensing system. The person in the front passenger seat may appear heavier or lighter due to the conditions described in the list above.



To know if the front passenger sensing system is operating properly, see *Crash Sensors and Airbag Indicator* later in this chapter.

If the airbag readiness lamp is lit, do the following:

The driver or adult passengers should check for any objects that may be lodged underneath the front passenger seat or cargo interfering with the seat.

If objects are lodged or cargo is interfering with the seat; please take the following steps to remove the obstruction:

- Pull your vehicle over.
- Turn your vehicle off.
- Driver or adult passengers should check for any objects lodged underneath the front passenger seat or cargo interfering with the seat.
- Remove the obstruction(s) (if found).
- Restart your vehicle.
- Wait at least two minutes and verify that the airbag readiness light is no longer illuminated.
- If the airbag readiness lamp remains illuminated, this may or may not be a problem due to the front passenger sensing system.

Do not attempt to repair or service the system; take your vehicle immediately to an authorized dealer.

If it is necessary to modify an advanced front airbag system to accommodate a person with disabilities, contact the Ford Customer Relationship Center at the phone number shown in the *Customer Assistance* section of this owner's manual.

### SIDE AIRBAGS



**WARNING:** Do not place objects or mount equipment on or near the airbag cover, on the side of the seat backs (of the front seats), or in front seat areas that may come into contact with a deploying airbag. Failure to follow these instructions may increase the risk of personal injury in the event of a crash.



**WARNING:** Do not use accessory seat covers. The use of accessory seat covers may prevent the deployment of the side airbags and increase the risk of injury in an accident.





**WARNING:** Do not lean your head on the door. The side airbag could injure you as it deploys from the side of the seat back.



**WARNING:** Do not attempt to service, repair, or modify the airbag, its fuses or the seat cover on a seat containing an airbag. Contact your authorized dealer as soon as possible.



**WARNING:** If the side airbag has deployed, the airbag will not function again. The side airbag system (including the seat) must be inspected and serviced by an authorized dealer. If the airbag is not replaced, the unrepaired area will increase the risk of injury in a crash.

The side airbags are located on the outboard side of the seat backs of the front seats. In certain lateral crashes, the airbag on the side affected by the crash will be inflated. The airbag was designed to inflate between the door panel and occupant to further enhance the protection provided occupants in side impact crashes.



The system consists of the following:

- a tag on the seat back indicating that side airbags are found on your vehicle
- side airbags located inside the seat back of the driver and front passenger seats.



- Crash sensors and monitoring system with readiness indicator. See *Crash Sensors and Airbag Indicator* later in this chapter.

- Front passenger sensing system.

**Note:** The passenger sensing system will deactivate the passenger seat-mounted side airbag if it detects an empty, unbuckled passenger seat.

The design and development of the side airbag system included recommended testing procedures that were developed by a group of automotive safety experts known as the Side Airbag Technical Working Group. These recommended testing procedures help reduce the risk of injuries related to the deployment of side airbags.

## 52      **Supplementary Restraints System**

---

### **CRASH SENSORS AND AIRBAG INDICATOR**



**WARNING:** Modifying or adding equipment to the front end of your vehicle (including frame, bumper, front end body structure and tow hooks) may affect the performance of the airbag system, increasing the risk of injury. Do not modify the front end of your vehicle.

Your vehicle has a collection of crash and occupant sensors which provide information to the restraints control module which deploys (activates) the front safety belt pretensioners, driver airbag, passenger airbag and seat mounted side airbags. Based on the type of accident (frontal impact, side impact or rollover) the restraints control module will deploy the appropriate safety devices.

The restraints control module also monitors the readiness of the above safety devices plus the crash and occupant sensors. The readiness of the safety system is indicated by a warning indicator light in the instrument cluster or by a backup tone if the warning light is not working. See the *Instrument Cluster* chapter. Routine maintenance of the airbag is not required.

A difficulty with the system is indicated by one or more of the following:



- The readiness light will either flash or stay lit.
- The readiness light will not illuminate immediately after the ignition is turned on.
- A series of five beeps will be heard. The tone pattern will repeat periodically until the problem and/or light are repaired.

If any of these things happen, even intermittently, have the supplemental restraint system serviced at an authorized dealer immediately. Unless serviced, the system may not function properly in the event of a crash.

The safety belt pretensioners and the airbag supplemental restraint system are designed to activate when the vehicle sustains longitudinal or lateral deceleration sufficient to cause the restraints control module to deploy a safety device.

The fact that the safety belt pretensioners or airbags did not activate for both front seat occupants in a crash does not mean that something is wrong with the system. Rather, it means the restraints control module determined the accident conditions (such as crash severity, belt usage) were not appropriate to activate these safety devices.

- Front airbags are designed to activate only in frontal and near-frontal crashes (not rollovers, side impacts or rear impacts) unless the crash causes sufficient longitudinal deceleration.
- The safety belt pretensioners are designed to activate in frontal, near-frontal and side crashes.
- Side airbags are designed to inflate in side impact crashes, not rollovers, rear impacts, frontal or near-frontal crashes, unless the crash causes sufficient lateral deceleration.

### **AIRBAG DISPOSAL**

Contact your authorized dealer as soon as possible. Airbags **MUST BE** disposed of by qualified personnel.

**PRINCIPLE OF OPERATION**

The remote control allows you to:

- remotely lock or unlock the vehicle doors
- remotely open the trunk
- arm and disarm the anti-theft system (if equipped)
- activate the panic alarm

**GENERAL INFORMATION ON RADIO FREQUENCIES**

This device complies with part 15 of the FCC Rules and with Industry Canada license-exempt RSS standard(s). Operation is subject to the following two conditions: (1) This device may not cause harmful interference, and (2) This device must accept any interference received, including interference that may cause undesired operation.

**Note:** Changes or modifications not expressly approved by the party responsible for compliance could void the user's authority to operate the equipment. The term **IC** before the radio certification number only signifies that Industry Canada technical specifications were met.

The typical operating range for your transmitter is approximately 33 feet (10 meters). Vehicles with the remote start feature will have a greater range. A decrease in operating range could be caused by:

- weather conditions
- nearby radio towers
- structures around your vehicle
- other vehicles parked next to your vehicle.

The radio frequency used by your remote control can also be used by other short distance radio transmissions (e.g. amateur radios, medical equipment, wireless headphones, remote controls and alarm systems). If the frequencies are jammed, you will not be able to use your remote control. You can lock and unlock the doors with the key.

**Note:** Make sure your vehicle is locked before leaving it unattended.

**Note:** If you are in range, the remote control will operate if you press any button unintentionally.

### REMOTE CONTROL

#### Integrated Keyhead Transmitters

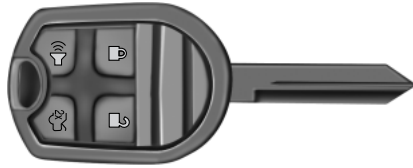

The key blade is used to start the vehicle and unlock or lock the driver's door from outside the vehicle. The transmitter portion functions as the remote control.

**Note:** If the vehicle is not equipped with active anti-theft system, locking the driver door with the key does not lock the passenger door. Use the power door lock, remote control or manually lock the passenger door to ensure the vehicle is properly secured.



**Note:** Your vehicle's keys were issued with a security label that provides important vehicle key cut information. Keep the label in a safe place for future reference.

#### Car Finder



Press the button twice within three seconds. The horn will chirp and the turn signals will flash. It is recommended that this method be used to locate your vehicle, rather than using the panic alarm.

#### Sounding a Panic Alarm



Press the button to activate the alarm. Press the button again or turn the ignition on to deactivate.

**Note:** The panic alarm will only operate when the ignition is off.



**Replacing the Battery**

**Note:** Refer to local regulations when disposing of transmitter batteries.

**Note:** Do not wipe off any grease on the battery terminals or on the back surface of the circuit board.

**Note:** Replacing the battery will not delete the transmitter from the vehicle. The transmitter should operate normally.

The remote control uses one coin-type three-volt lithium battery CR2032 or equivalent.

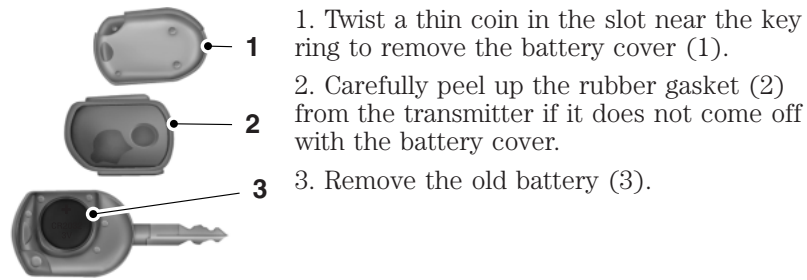
**Integrated Keyhead Transmitter**

4. Insert the new battery. Refer to the instructions inside the integrated keyhead transmitter for the correct orientation of the battery. Press the battery down to ensure that the battery is fully seated in the battery housing cavity.

5. Reinstall the rubber gasket.

6. Snap the battery cover back onto the key.

**REPLACING A LOST KEY OR REMOTE CONTROL**

Replacement or additional keys or remote controls can be purchased from your authorized dealer. Your dealer can program the transmitters to your vehicle or you may be able to program them yourself. See the *Security* chapter for information on programming your transmitters.

---

**PRINCIPLES OF OPERATION**

MyKey® allows you to program keys with restricted driving modes to promote good driving habits. All but one of the keys programmed to the vehicle can be activated with these restricted modes. Any keys that have not been programmed are referred to as an administrator key or admin key which can be used to:

- create a restricted key
- program optional MyKey settings
- clear all MyKey features altogether.

Once a key has been programmed, you can access the following information using the information display control:

- How many admin keys and MyKeys are programmed to the vehicle.
- The total distance the vehicle has been driven with a MyKey.

For vehicles equipped with intelligent access (push button start), when both a MyKey and an admin intelligent access key (fob) are present, the admin fob will be recognized by the vehicle to start the engine.

**Standard Settings**

These settings cannot be changed.

- Belt-Minder. This cannot be disabled and the five-minute timer does not expire. The audio system is muted when MyKey Belt-Minder is activated.
- Early low fuel. Warnings are displayed in the information display control followed by an audible tone when the estimated remaining fuel in the tank will allow 75 miles (121 kilometers) of travel or less.
- Driver assist features, if equipped on your vehicle, are forced on: parking aid, blind spot information system (BLIS) with cross traffic alert and the collision warning system.

**Optional Settings**

These settings can be configured right after a MyKey is first created or changed afterward with an admin key.

- Vehicle speed limit of 80 mph (130 km/h). Visual warnings are displayed followed by an audible tone when vehicle speed has reached 80 mph (130 km/h).
- Vehicle speed warning of 45, 55 or 65 mph (75, 90, or 105 km/h). Visual warnings are displayed followed by an audible tone when the preselected vehicle speed is exceeded.

- Audio system maximum volume of 45%. A message in the audio system is displayed when attempting to exceed the limited volume.
- AdvanceTrac. The system cannot be turned off when Always-on has been set.

### CREATING A MYKEY

Use the information display controls to create a MyKey.

For Type 1 information display controls:

1. Insert the key you want to program into the ignition or, if the vehicle is equipped with push button start, put the Intelligent Access key in the backup slot; see the *Starting and Stopping the Engine* chapter for the backup slot location.
2. Turn the ignition on.
3. Press SETUP using the information display buttons until PRESS RESET TO CREATE MYKEY is displayed.
4. Press and release the RESET button. HOLD RESET TO CONFIRM MYKEY will be displayed.
5. Press and hold the RESET button for two seconds until MARK THIS AS RESTRICTED is displayed. Wait until KEY RESTRICTED AT NEXT START is displayed.

The key is successfully programmed. Make sure you label it so you can distinguish it from the admin keys.

For Type 2 information display controls:

1. Insert the key you want to program into the ignition or, if the vehicle is equipped with push button start, put the Intelligent Access key in the backup slot; see the *Starting and Stopping the Engine* chapter for the backup slot location.
2. Turn the ignition on.
3. At the main menu screen select SETTING then MYKEY by pressing OK or the right arrow key.
4. Press OK to select CREATE MYKEY.
5. Hold OK as prompted until you see MARK THIS KEY AS RESTRICTED.

The key is successfully programmed. Make sure you label it so you can distinguish it from the admin keys.

To program optional settings for the key(s), see the *Programming/Changing Optional Settings* chapter.

### Programming/Changing Optional Settings

**Note:** All programmed keys can be cleared within the same key cycle in which a key was programmed, otherwise an admin key is required to clear the keys. To clear all keys, see *Clearing all MyKeys*.

You can access the optional settings through the information display controls.

For Type 1 information display settings

1. Press SETUP until RESET FOR MYKEY SETTINGS is displayed.
2. Press and release the RESET button to display MyKey setup menus.
3. Press the SETUP button to display the next menu to scroll through your choices.
4. On any of the menus, press RESET to highlight your choice with the <...>.
5. Press SETUP to enter your choice. The next optional setting will be displayed.
6. Repeat Steps 4 and 5 until you are done changing the optional settings.

For Type 2 information display settings

1. Turn the ignition on using an admin key.
2. Access the main menu and select Settings, then MyKey.
3. Use the arrow buttons to get to an optional feature.
4. Press OK or > to scroll through settings.
5. Press OK or > to make a selection.

### CLEARING ALL MYKEYS

**Note:** All programmed MyKeys can be cleared within the same key cycle in which a MyKey was created, otherwise an admin key is required to clear the keys.

To clear all MyKeys (which removes all restrictions and returns them to admin key status), use the information display controls to do the following:

For Type 1 information display settings

1. Press SETUP until PRESS RESET TO CLEAR MYKEY is displayed.
2. Press and release the RESET button. HOLD RESET TO CONFIRM CLEAR is displayed.
3. Press and hold the RESET button for two seconds until ALL MYKEYS CLEARED is displayed.

For Type 2 information display settings

1. Access the main menu and select Settings, then MyKey.
2. Scroll to Clear All and press the OK button.
3. Hold the OK button until ALL MYKEYS CLEARED is displayed.

**CHECKING MYKEY SYSTEM STATUS**

The information display controls provide information about keys programmed to the vehicle:

- **MYKEY MILES:** Tracks mileage when a MyKey is used. If mileage does not accumulate as expected, then the MyKey is not being used by the intended user. The only way to reset this to zero is by clearing MyKeys. If the mileage is lower than the last time you checked, then the key system has been recently reset.
- **# MYKEY(S):** Indicates how many MyKeys are programmed to the vehicle. Can also be used to detect deletion of a MyKey.
- **# ADMIN KEY(S):** Indicates how many admin keys are programmed to the vehicle. Can also be used to detect if an additional key has been programmed to the vehicle.

**USING MYKEY WITH REMOTE START SYSTEMS**

MyKey is NOT compatible with non-Ford-approved aftermarket remote start systems. If you choose to install a remote start system, please see your Ford authorized dealer for a Ford-approved remote start system.

The following information MAY help customers who choose to use a non-Ford-approved remote start system. The actions provided below do NOT make MyKey compatible with non-Ford-approved remote start system, but it MAY help you to retain some MyKey functions.

**Vehicles Equipped with Traditional Keys**

When using a non-Ford-approved remote start system, the default settings may recognize the remote start system as an additional admin key with its associated privileges. It is NOT compatible with MyKey. Restart the engine when you insert a key into the ignition cylinder; it may help you to retain some MyKey functions.

In addition to the key that has been programmed as a MyKey, owners of vehicles equipped with traditional keys have the option to program the non-Ford-approved remote start system as a MyKey if the remote start fob is used by the MyKey driver.

To program a non-Ford-approved remote start system as a MyKey, do the following:

1. Enter the vehicle and close all doors.
2. Remote start the vehicle using a non-Ford approved remote start fob.
3. Follow Steps 1-5 in the *Creating a MyKey* section.

**Vehicles Equipped with Intelligent Access Key (Push Button Start)**

**Note:** It is not possible to program the remote start system as a MyKey on vehicles equipped with intelligent access key (push button start). Therefore, you should treat the remote start fob as you would any other admin key. When the vehicle is started using remote start, the system will stall the engine when you either enter the vehicle or shift the vehicle into gear. Prior to the engine stall, the vehicle will have administrative privileges. When you restart the engine, the vehicle will identify the user as an admin or MyKey driver depending on the settings of the actual key used to start the vehicle.

**Note:** For all vehicles, the number of MYKEY(S) PROGRAMMED or ADMIN KEYS PROGRAMMED that is displayed in the MyKey system status menu, may include the non-Ford-approved remote start system as an additional key in the total count. See the *Checking System Status* section.

For all vehicles with a non-Ford-approved remote start installed, it is possible to program all real keys as MyKeys, in which case, you will need to use your remote start system to clear all MyKeys (which removes all restrictions and returns them to admin key status) by doing the following:

1. Enter the vehicle and close all doors.
2. Remote start the vehicle using your non-Ford-approved remote start fob.
3. Follow Steps 1-3 in the *Clearing all MyKeys* section.

## MYKEY TROUBLESHOOTING

Condition	Potential Causes
I cannot program a key.	<ul style="list-style-type: none"> <li>• The key in the ignition does not have admin privileges.</li> <li>• The key in the ignition is the only admin key (there always has to be at least one admin key).</li> <li>• The intelligent access key is not in the backup slot (vehicles with push button start).</li> <li>• SecuriLock passive anti-theft system is disabled or in unlimited mode.</li> <li>• The vehicle has been started using a remote start system that is not programmed with admin privileges. See the <i>Using MyKey with Remote Start Systems</i> chapter.</li> </ul>
I cannot program the optional settings.	<ul style="list-style-type: none"> <li>• The key in the ignition does not have admin privileges.</li> <li>• No keys are programmed to the vehicle. See the <i>Creating a MyKey</i> chapter.</li> <li>• The vehicle has been started using a remote start system that is not programmed with admin privileges. See the <i>Using MyKey with Remote Start System</i> chapter.</li> </ul>
I cannot clear the restricted keys.	<ul style="list-style-type: none"> <li>• Key in the ignition does not have admin privileges.</li> <li>• No restricted keys are programmed to the vehicle. See the <i>Creating a MyKey</i> chapter.</li> <li>• The vehicle has been started using a remote start system that is not programmed with admin privileges. See the <i>Using MyKey with Remote Start System</i> chapter.</li> </ul>
I lost the only admin key.	<ul style="list-style-type: none"> <li>• Purchase a new key from your authorized dealer.</li> </ul>
I lost a key.	<ul style="list-style-type: none"> <li>• Program spare keys as outlined under <i>SecuriLock</i> in the <i>Security</i> chapter.</li> </ul>

Condition	Potential Causes
I accidentally programmed all keys as restricted keys.	<ul style="list-style-type: none"> <li>• The vehicle has a remote start system that is recognized as an admin key. See the <i>Using MyKey with Remote Start System</i> chapter to reset all restricted keys using remote start.</li> </ul>
No restricted key functions with intelligent access key (push button start).	<ul style="list-style-type: none"> <li>• An admin key is present at engine start-up.</li> <li>• No restricted keys are programmed to the vehicle. See the <i>Creating a MyKey</i> chapter.</li> </ul>
Restricted key programmed total includes one additional key.	<ul style="list-style-type: none"> <li>• An unknown key has been programmed to the vehicle as a restricted key.</li> <li>• The vehicle is equipped with a remote start system. See the <i>Using MyKey with Remote Start Systems</i> chapter.</li> </ul>
Admin keys programmed total includes one additional key.	<ul style="list-style-type: none"> <li>• An unknown key has been programmed to the vehicle as an admin key.</li> <li>• Vehicle is equipped with a remote start system. See the <i>Using MyKey with remote start systems</i> chapter.</li> </ul>
MyKey miles do not accumulate.	<ul style="list-style-type: none"> <li>• The restricted key is not being used by the intended user.</li> <li>• The key system has been reset.</li> </ul>



**LOCKING AND UNLOCKING**

You can use the power door lock control or the remote control to lock and unlock the vehicle.

**Power Door Locks**

The power door lock control is located on the driver and front passenger door panels.

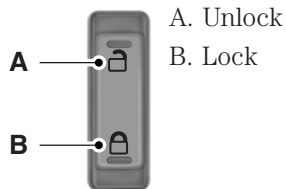
**Remote Control**

The remote control can be used anytime the vehicle is not running.

**Unlocking the Doors (Two-Stage Unlock)**

Press the button to unlock the driver's door.

Press the button again within three seconds to unlock all doors. The turn signals will flash.

To disable or enable two-stage unlocking, press and hold both the lock and unlock buttons on the remote control for four seconds. Disabling two-stage unlocking allows all vehicle doors to unlock with one press of the button. The turn signals will flash twice to indicate the unlocking mode was changed.

**Locking the Doors**

Press the button to lock all the doors. The turn signals will illuminate.

Press the button again within three seconds to confirm that all the doors are closed. The doors will lock again, the horn will chirp and the turn signals will illuminate if all the doors and the trunk are closed.

**Note:** If any door or the trunk is not closed, or if the hood is not closed on vehicles equipped with an anti-theft alarm or remote start, the horn will chirp twice and the lamps will not illuminate.

**Opening the Trunk**

Press the button twice within three seconds to open the trunk.

Make sure the trunk is closed and latched before driving your vehicle. An unlatched trunk may cause objects to fall out or block the driver's rear view.

**Smart Locks**

This feature helps prevent you from locking yourself out of the vehicle if your key is still in the ignition.

When you open the driver's door and you lock the vehicle with the power door lock control, all the doors will lock, then the driver's door will automatically unlock reminding you that your key is still in the ignition.

The vehicle can still be locked, with the key in the ignition, using the manual lock button on the door, locking the driver's door with a key or using the lock button on the remote entry transmitter.

**Autolock (If Equipped)**

The autolock feature will automatically lock all the doors when:

- all the doors are closed,
- the ignition on,
- you shift into any gear putting the vehicle in motion, (for manual transmission, the parking brake should not be engaged) and
- the vehicle attains a speed greater than 12 mph (20 km/h).

The autolock feature repeats when:

- any door is opened then closed while the ignition is on and the vehicle speed is 9 mph (15 km/h) or lower, and
- the vehicle attains a speed greater than 12 mph (20 km/h).

**Autounlock (If Equipped)**

The autounlock feature will unlock all the doors when:

- the ignition is on, all the doors are closed, and the vehicle has been in motion at a speed greater than 12 mph (20 km/h);
- the vehicle has then come to a stop and the ignition is switched off or to accessory; and

- the driver door is opened within 10 minutes of the ignition being switched off or to accessory.

**Note:** The doors will not autounlock if the vehicle has been electronically locked before the driver door is opened.

#### ***Enabling or Disabling Autolock and Autounlock***

**Note:** The autolock and autounlock features can be activated or deactivated independently of each other:

- through your authorized dealer
- by using the information display.

Before following the activation or deactivation procedures, make sure that the active anti-theft system is not armed, the ignition is off, and all vehicle doors are closed.

#### **Illuminated Entry**

The interior lamps and turn signal lamps illuminate when the integrated keyhead transmitter is used to unlock the door(s).

The illuminated entry system will turn off the interior lights if:

- the ignition switch is turned to the on position, or
- the integrated keyhead transmitter lock control is pressed, or
- after 25 seconds of illumination.

The inside lights will not turn off if:

- they have been turned on with the dimmer control, or
- any door is open.

#### **Illuminated Exit**

- When all vehicle doors are closed and the key is removed from the ignition, the interior dome lamp and the turn signal lamps will illuminate.

The lights will turn off if all the doors remain closed and:

- 25 seconds elapse, or
- the key is inserted in the ignition.

#### **Battery Saver**

The battery saver will shut off the interior lamps 10 minutes after the ignition has been turned to the off position and a door is left open, and in 30 minutes if the dome lamp control is left on and the ignition has been turned to the off position. The battery saver will also shut off the trunk lamps in 30 minutes if the trunk is left open.

**TRUNK RELEASE**

The remote trunk release button is located on the center console. Press the button to unlatch the trunk.

**Interior Trunk Control Lockout (Convertible Vehicles Only)**

This feature disables the interior trunk control. It helps prevent unauthorized access to the trunk when the convertible top is open.

To disable the interior trunk control:

1. Make sure the vehicle is off and accessory power delay is not active.
2. Lock the vehicle using the remote control or the power door lock switch.

To enable the interior trunk control:

- use the remote control to unlock the vehicle
- switch the ignition on.

The interior trunk control will now work normally.

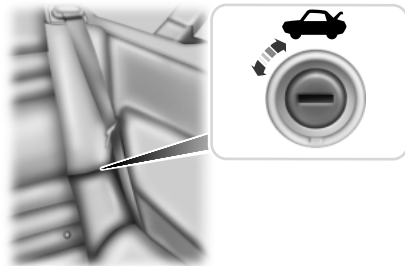
**Manual Trunk Release (Convertible Vehicles Only)**

In the event of battery failure, you can open the trunk using your master key. The key cylinder is located between the rear seatback cushions on the driver's side.

**INTERIOR LUGGAGE COMPARTMENT RELEASE**

 **WARNING:** Keep vehicle doors and luggage compartment locked and keep keys and remote transmitters out of a child's reach. Unsupervised children could lock themselves in the trunk and risk injury. Children should be taught not to play in vehicles.

 **WARNING:** Do not leave children, unreliable adults, or animals unattended in the vehicle. On hot days, the temperature in the trunk or vehicle interior can rise very quickly. Exposure of people or animals to these high temperatures for even a short time can cause death or serious heat-related injuries, including brain damage. Small children are particularly at risk.

Your vehicle is equipped with a release handle that provides a means of escape for children and adults if they become locked inside the luggage compartment.

Adults should familiarize themselves with the operation and location of the release handle.

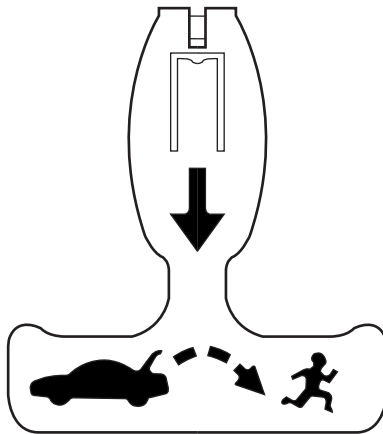

The handle is located inside the luggage compartment either on the luggage compartment door (lid) or near the tail lamps. It is composed of a material that will glow for hours in darkness following brief exposure to ambient light.

Pull the handle and push up on the luggage compartment door (lid) to open from within the luggage compartment.

**SECURILOCK® PASSIVE ANTI-THEFT SYSTEM**

**Note:** The system is not compatible with non-Ford aftermarket remote start systems. Use of these systems may result in vehicle starting problems and a loss of security protection.

**Note:** Metallic objects, electronic devices or a second coded key on the same key chain may cause vehicle starting issues if they are too close to the key when starting the engine. Prevent these objects from touching the coded key while starting the engine. Switch the ignition off, move all objects on the key chain away from the coded key and restart the engine if a problem occurs.

**Note:** Do not leave a duplicate coded key in the vehicle. Always take your keys and lock all doors when leaving the vehicle.

The system is an engine immobilization system. It is designed to help prevent the engine from being started unless a coded key programmed to your vehicle is used. Using the wrong key may prevent the engine from starting. A message may appear in the information display.

If you are unable to start the engine with a correctly coded key, a malfunction has happened and a message may appear in the information display.

**Automatic Arming**

The vehicle is armed immediately after switching the ignition off.

**Anti-Theft Indicator**

The anti-theft indicator is located in the instrument cluster.



- When the ignition is off, the indicator will flash once every two seconds to indicate the SecuriLock system is functioning as a theft deterrent.
- When the ignition is on, the indicator will glow for three seconds, then turn off to indicate normal system functionality.

If a problem occurs with the SecuriLock system, the indicator will flash rapidly or glow steadily when the ignition is on. If this occurs, switch the ignition off then back on to make sure there was no electronic interference with the programmed key. If your vehicle does not start, try to start it with the second programmed key and if successful contact your authorized dealership for key replacement. If the indicator still flashes rapidly or glows steadily, your vehicle will not start. Contact your authorized dealer as soon as possible for service.

**Automatic Disarming**

Switching the ignition on with a coded key disarms the vehicle.

**Replacement of Integrated Keyhead Transmitters and Coded Keys**

**Note:** Your vehicle comes equipped with two integrated keyhead transmitters.

The integrated keyhead transmitter functions as both a programmed ignition key that operates all the locks and starts your vehicle, as well as a remote keyless entry transmitter. A maximum of eight coded keys can be programmed to your vehicle; only four of these eight keys can be integrated keyhead transmitters with remote entry functionality.

If your integrated keyhead transmitters or standard SecuriLock coded keys are lost or stolen and you don't have an extra coded key, you will need to have your vehicle towed to an authorized dealer. The key codes need to be erased from your vehicle and new coded keys will need to be programmed.

Replacing coded keys can be very costly. Store an extra programmed key away from your vehicle in a safe place to help prevent any inconveniences. Please visit an authorized dealer to purchase additional spare or replacement keys.

***Programming a Spare Key***

**Note:** A maximum of eight coded keys can be programmed to your vehicle. Only four of these eight can be integrated keyhead transmitters.

You can program your own integrated keyhead transmitters or standard SecuriLock coded keys to your vehicle. This procedure will program both the engine immobilizer key code and the remote entry portion of the remote control to your vehicle.

Only use integrated keyhead transmitters or standard SecuriLock keys.

You must have two previously programmed coded keys and the new unprogrammed key readily accessible. See your authorized dealer to have the spare key programmed if two previously programmed coded keys are not available.

Read and understand the entire procedure before you begin.

1. Insert the first previously programmed coded key into the ignition.
2. Turn the ignition from off to on. Keep the ignition on for at least three seconds, but no more than 10 seconds.
3. Turn the ignition off and remove the first coded key from the ignition.
4. After three seconds but within 10 seconds of turning the ignition off, insert the second previously coded key into the ignition.

5. Turn the ignition from off to on. Keep the ignition on for at least three seconds, but no more than 10 seconds.
6. Turn the ignition off and remove the second previously programmed coded key from the ignition.
7. After three seconds but within 20 seconds of turning the ignition off and removing the previously programmed coded key, insert the new unprogrammed key into the ignition.
8. Turn the ignition from off to on. Keep the ignition on for at least six seconds.
9. Remove the newly programmed coded key from the ignition.

The key will start the vehicle's engine and will operate the remote entry system (if the new key is an integrated keyhead transmitter) if it has been successfully programmed. The theft indicator light will illuminate for three seconds and then go out to indicate successful programming.

If the key was not successfully programmed, the theft indicator light may flash on and off. Wait 20 seconds and repeat Steps 1 through 8. Take your vehicle to your authorized dealer to have the new key programmed if you are still unsuccessful.

Wait 20 seconds and then repeat this procedure from Step 1 to program an additional key.

#### **ANTI-THEFT ALARM (IF EQUIPPED)**

The active anti-theft system is designed to warn you in the event of unauthorized vehicle entry and is also designed to help prevent unwanted towing of the vehicle.

You can choose what is monitored by arming the system in different ways.

#### **Partial Monitor Mode**

To monitor the following:

- Doors
- Hood
- Trunk

Lock the vehicle using the key in the driver door key cylinder.



**Full Monitor Mode**

To monitor the following:

- Doors
- Hood
- Trunk
- Movement inside the vehicle (for convertible models, top must be fully closed)
- Change in vehicle inclination (such as unwanted towing)

Lock the vehicle using the remote control or the power door lock control with the accompanying door open and then close all doors.

**Note:** Do not choose full monitor mode if movement within the vehicle is likely to occur or when the vehicle is in transport.

**Note:** For proper operation of the interior motion detection system, ensure all windows are closed prior to arming the system. This will help prevent accidental alarm activation due to external influences and ensure proper interior motion detection. Additionally, the interior motion sensing system will not arm if either door or the trunk is ajar.

If there is any potential perimeter anti-theft problem with your vehicle, ensure all integrated keyhead transmitters are brought to the authorized dealer to aid in troubleshooting.

**Arming the System**

When armed, the active anti-theft system is designed to notify you of an unauthorized entry. When unauthorized entry or towing occurs, the system will flash the turn signal lamps and interior lamps and will sound the horn.

The system is ready to arm whenever the key is out of the ignition. Any of the following actions will arm the alarm system:

- Press the lock button on the remote control.
- Lock all doors using the interior power lock switch while the driver or passenger door is open and then becomes closed.
- Lock the driver door with the key in the key lock cylinder (this will not, however, arm the interior motion or vehicle incline sensing systems).

There is a 20 second countdown when any of the above actions occur before the vehicle becomes armed.

Each door, the hood or the trunk is armed individually, and if any are open, they must be closed for the system to enter the 20 second countdown.

The turn signal lamps will flash once when all doors, the hood and the trunk are closed indicating the vehicle is locked and entering the 20 second countdown. If any closure is not properly closed, the turn signal lamps will not flash and that closure will not be armed.

### **Disarming the System**

You can disarm the system by any of the following actions:

- Unlock the doors by using the remote entry transmitter portion of your integrated keyhead transmitter.
- Turn ignition to the on position with a valid programmed SecuriLock key or integrated keyhead transmitter.
- Press the panic control on the remote entry transmitter portion of your integrated keyhead transmitter. This will only shut off the horn and turn lamps when the alarm is sounding. The alarm system will still be armed.
- Use a key in the driver door to unlock the vehicle.

Pressing the power door unlock control within the 20 second prearmed mode will return the vehicle to a disarmed state.

**Note:** Unlocking the trunk inhibits the motion sensing system but the system continues to monitor the doors, hood and vehicle incline. Once the trunk becomes closed the motion sensing system will rearm.

### **Triggering the Anti-Theft System**

The armed system will be triggered if:

- Any door, the hood or the trunk is opened without using the remote entry transmitter portion of your integrated keyhead transmitter or key in driver door cylinder.
- The ignition is turned to the on position with an invalid unprogrammed SecuriLock key or integrated keyhead transmitter.
- The vehicle is towed or inclined.
- Motion is detected in the interior passenger compartment.

**ADJUSTING THE STEERING WHEEL**

**WARNING:** Do not adjust the steering wheel when your vehicle is moving.

**Note:** Make sure that you are sitting in the correct position. See *Sitting in the Correct Position* in the *Seats* chapter.

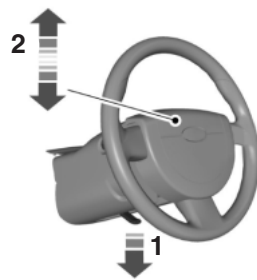

1. Unlock the steering column.
2. Adjust the steering wheel to the desired position.

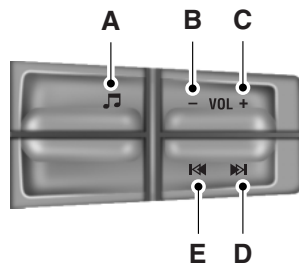

3. Lock the steering column.

**AUDIO CONTROL (IF EQUIPPED)**

- A. Media
- B. Volume down
- C. Volume up
- D. Seek up or next
- E. Seek down or previous

Press the media button repeatedly to scroll through available audio modes.

Press the seek buttons to select the next or previous stored preset or track. Press and hold to select the next or previous frequency or seek through a track.

#### VOICE CONTROL (IF EQUIPPED)

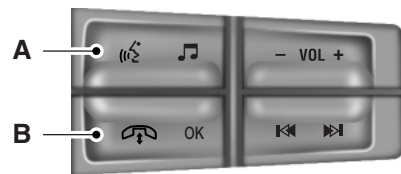

A. Voice recognition

B. Phone mode

See the *SYNC* or *Navigation System* chapter.

#### CRUISE CONTROL

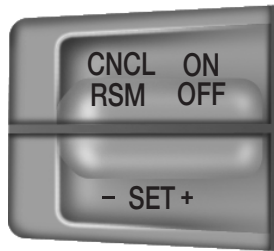

See the *Cruise Control* chapter.

---

**INFORMATION DISPLAY CONTROL****Type 1****Type 2**

See the *Information Displays* chapter.



### WINDSHIELD WIPERS

**Note:** Fully defrost the windshield in icy conditions before turning on the windshield wipers.

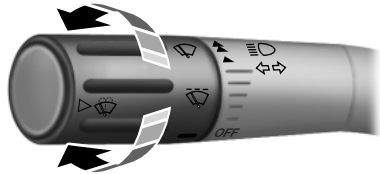

Rotate the end of the control away from you to increase the speed of the wipers. Rotate toward you to decrease the speed of the wipers.

### WINDSHIELD WASHERS

**Note:** Do not operate the wipers on a dry windshield. This may scratch the glass, damage the wiper blades or cause the wiper motor to burn out. Always use the windshield washer before wiping a dry windshield.

**Note:** Do not operate the washer when the washer reservoir is empty. This may cause the washer pump to overheat.



Press the end of the stalk to activate the washer.

- A brief press causes a single wipe without washer fluid.
- A quick press and hold causes the wipers to swipe three times with washer fluid.
- A long press and hold will activate the wipers and washer fluid for up to 10 seconds.

A wipe will occur a few seconds after washing to clear any remaining washer fluid.

## LIGHTING CONTROL

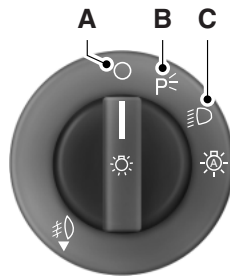

- A. Off
- B. Parking lamps, instrument panel lamps, license plate lamps and tail lamps
- C. Headlamps

## High Beams

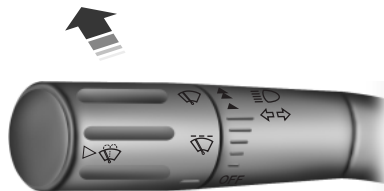

- Push the lever toward the instrument panel to activate.
- Pull the lever toward you to deactivate.

## Headlamp Flasher

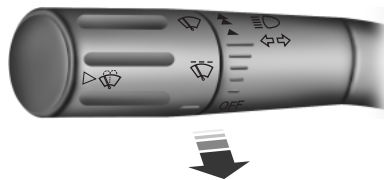

- Pull toward you slightly to activate and release to deactivate.

**AUTOLAMPS (If equipped)**

**WARNING:** In severe weather conditions, it may be necessary to switch your headlamps on manually.

**Note:** If the vehicle is equipped with autolamps, it will have the *windshield wiper rainlamp feature*. When the windshield wipers are turned to low- or high-speed wiping during daylight, and the headlamp control is in the autolamp position, the exterior lamps will turn on after a brief delay and will remain on until the wipers are turned off.

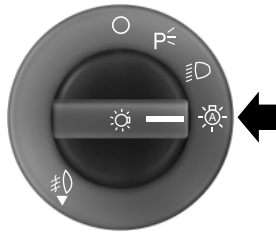

The autolamp system provides light sensitive automatic on-off control of the exterior lights normally controlled by the headlamp control.

The headlamps will remain on for a period of time after you switch the ignition off. You can adjust the time delay using the display controls in the instrument cluster. See the *Information Displays* chapter.

**INSTRUMENT LIGHTING DIMMER**

- Move the control up or down to adjust the intensity of the panel lighting.
- Move the control to the full upright position, past detent, to turn on the interior lamps.
- Move the control down, past detent, to turn off the interior lights.

**Note:** The panel dimmer control works only in nighttime illumination mode. It has no effect in daytime illumination mode. Also, selectable features, such as gauge color and halo color, will not be available in daytime illumination mode.

**Note:** If the battery is disconnected, discharged, or a new battery is installed, the dimmer switch requires re-calibration. Rotate the dimmer switch from the full dim position to the full dome On position to reset. This will ensure that your displays are visible under all lighting conditions.



**HEADLAMP EXIT DELAY**

You can set the delay time to keep the headlamps on for up to three minutes after the ignition is turned off.

Follow the steps below to change the delay time (Steps 1 through 6 must be done within 10 seconds):

1. Turn the ignition off.
  2. Turn the lighting control to the autolamp position.
  3. Turn the lighting control to the off position.
  4. Turn the ignition on.
  5. Turn the ignition off.
  6. Turn the lighting control to the autolamp position. The headlamps and parking lamps will turn on.
  7. Turn the lighting control to the off position when the desired delay time has been reached. The headlamps and parking lamps will turn off.
- You can set the headlamp exit delay to one of the following settings:

- Off
- 10 seconds
- 20 seconds
- 30 seconds
- 60 seconds
- 90 seconds
- 120 seconds
- 180 seconds.

**Note:** You can also adjust the time delay using the display controls in the instrument cluster. See the *Information Displays* chapter.

**DAYTIME RUNNING LAMPS (IF EQUIPPED)**

 **WARNING:** Always remember to turn on your headlamps at dusk or during inclement weather. The Daytime Running Lamp (DRL) system does not activate the tail lamps and generally may not provide adequate lighting during these conditions. Failure to activate your headlamps under these conditions may result in a collision.

The system switches the headlamps on with a reduced output (vehicles equipped with halogen headlamps) or turns the front fog lamps on (vehicles equipped with HID headlamps) in low light situations.

To switch the system on:

1. Switch the ignition on.
2. Switch the lighting control to the off, autolamp or parking lamp position.
3. Make sure the transmission selector lever is not in position P.
4. Make sure the parking brake is disengaged.

**FRONT FOG LAMPS**

The fog lamps can be turned on when the lighting control is pulled toward you and in the headlamps, parking lamps or autolamps positions.

The fog lamps will not operate when the high beams are active.

**DIRECTION INDICATORS**

- Push down to activate the left turn signal.
- Push up to activate the right turn signal.

**Note:** An outage of any front turn signal lamp or the inner most of the three-compartment rear turn signal lamps will result in a rapid flash rate.

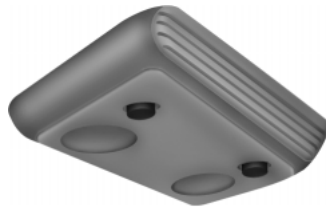
**INTERIOR LAMPS****Dome/Map lamps**

The dome lamp lights when:

- Any door is opened.
- Any of the remote entry controls are pressed and the ignition is off.
- The instrument panel dimmer switch is rotated up, past the detent, until the courtesy lamps come on.

The map lamps are activated by pressing the controls on either side of the lamp.

**POWER WINDOWS**

 **WARNING:** Do not leave children unattended in the vehicle and do not let children play with the power windows. They may seriously injure themselves.

 **WARNING:** When closing the power windows, you should verify they are free of obstructions and make sure that children and pets are not in the proximity of the window openings.

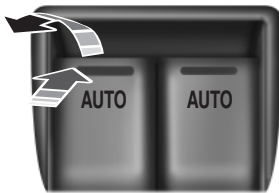

Press or lift the switches to operate the windows.

- Press the switch to the first detent and hold to open the window.
- Lift the switch to the first detent and hold to close the window.

**One-Touch Up or Down (Front Windows)**

This feature automatically opens or closes the window.

Press or lift the switch completely and release. The window will fully open or close. Press or lift it again to stop the window.

***Restoring the One-Touch Up Functionality***

**Note:** Perform one-touch up re-calibration with the door closed. Calibrating with the door open will cause the window to continuously bounce back.

Functionality may be lost under low battery power conditions.

To reset this function after restoring full battery power:

1. Pull the switch to the one-touch up position.
2. Hold the switch until the glass reaches the stall position and continue to hold for two seconds.
3. Press the switch down and operate the window to the full down position. One-touch up will now be functional.

**Bounce-Back**

The window will stop automatically while closing and reverse some distance if there is an obstacle in the way.

***Overriding the Bounce-Back Feature***

Pull up the window switch and hold within two seconds of the window reaching the bounce-back position. The window will travel up with no bounce-back protection. The window will stop if the switch is released before the window is fully closed.

**Short Drop Glass (Front Windows)**

This feature lowers the glass when either door is opened to improve door efforts and sealing. The glass returns to its closed position when the door is closed.

***Re-Calibrating a Window***

**Note:** Perform short drop re-calibration with the doors closed.

Re-calibrating with doors open will cause the window to continuously bounce back.

If a window will not raise again when the door is closed, use the switch to fully raise the window, then hold the switch up for two seconds.

If a window will not lower when the door is opened:

1. Use the switch to fully lower the window, then hold the switch down for two seconds.
2. Immediately after releasing the switch, pull the switch up to fully raise the window and hold the switch up for two seconds.

**Rear Power Windows (Convertible Only)**

The rear quarter windows are operated by a single switch located at the driver's door window controls.

- Press and hold the switch to open the windows.
- Pull up and hold the switch to close the windows.

***Manual Override***

The rear quarter window switch will not operate when:

- the convertible top is moving
- the convertible top is not completely up or down.

The rear quarter windows can be manually raised if the switch does not operate when the convertible top is completely up or down.

The following procedure must be performed within two minutes:

1. Switch the ignition off, then back on.
2. Press the rear window switch down three times.
3. Switch the ignition off, then back on.
4. Pull the rear window switch up and hold it for three seconds. The rear windows will begin to start moving up.

### Accessory Delay

You can use the window switches for several minutes after you switch the ignition off, or until either front door is opened.

## EXTERIOR MIRRORS

### Power Exterior Mirrors



**WARNING:** Do not adjust the mirror while the vehicle is in motion.

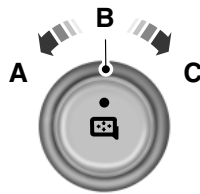

- A. Left mirror
- B. Off
- C. Right mirror

To adjust your mirrors:

1. Select the mirror you want to adjust.
2. Move the control in the direction you want to tilt the mirror.
3. Return the control to the center position to lock mirrors in place.

### Heated Exterior Mirror (If Equipped)

The heated exterior mirrors switch on with the heated rear window. See *Heated Windows and Mirrors* in the *Climate Control* chapter.

### Pony Projection Lights (If Equipped)

**Note:** Moisture, frost and ice build-up (or other types of contamination) on the surface of the light lens can cause some non-permanent distortion or reduced brightness of the image. Do not use abrasive materials to clean the lens.

The lights are located on the bottom of the mirror housings.

This feature will project an image onto the ground a short distance from the vehicle whenever illuminated entry and exit is activated.

### Integrated Blind Spot Mirrors (If Equipped)



**WARNING:** Objects in the blind spot mirror are closer than they appear.

Blind spot mirrors have an integrated convex mirror built into the upper outboard corner of the exterior mirrors. They are designed to assist you by increasing visibility along the side of your vehicle.

Check the main mirror first before a lane change, then check the blind spot mirror. If no vehicles are present in the blind spot mirror and the traffic in the adjacent lane is at a safe distance, signal that you are going to change lanes. Glance over your shoulder to verify traffic is clear, and carefully change lanes.

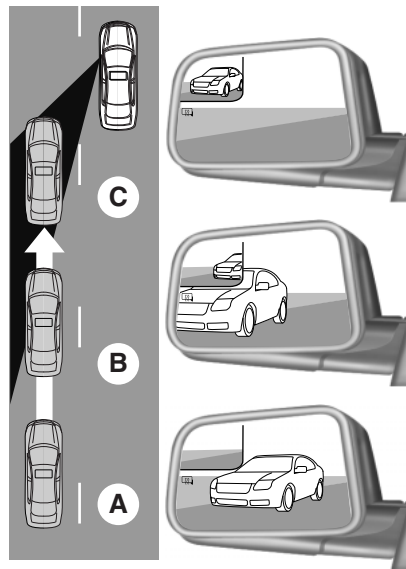

The image of the approaching vehicle is small and near the inboard edge of the main mirror when it is at a distance. The image becomes larger and begins to move outboard across the main mirror as the vehicle approaches (A). The image will transition from the main mirror and begin to appear in the blind spot mirror as the vehicle approaches (B). The vehicle will transition to your peripheral field of view as it leaves the blind spot mirror (C).

**INTERIOR MIRROR**

**WARNING:** Do not adjust the mirror when your vehicle is moving.

**Note:** Do not clean the housing or glass of any mirror with harsh abrasives, fuel or other petroleum or ammonia based cleaning products.

You can adjust the interior mirror to your preference. Some mirrors also have a second pivot point. This lets you move the mirror head up or down and from side to side.

Pull the tab below the mirror toward you to reduce glare at night.

**Auto-Dimming Mirror (If Equipped)**

**Note:** Do not block the sensors on the front and back of the mirror. Mirror performance may be affected. A rear center passenger or raised rear center head restraint may also block light from reaching the sensor.

The mirror will dim automatically to reduce glare when bright lights are detected from behind your vehicle. It will automatically return to normal reflection when you select reverse gear to make sure you have a clear view when backing up.

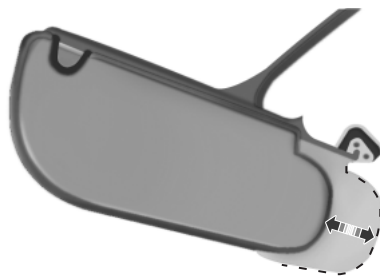
**SUN VISORS****Slide-On-Rod**

Rotate the visor toward the side window and extend it rearward for extra sunlight coverage.

Retract the visor before moving it back toward the windshield and storing it.





**Illuminated Visor Vanity Mirror**

Lift the cover to switch on the lamp.

**Flexible Visor Storage System**

The system can accommodate various storage accessories. A sunglasses clip and multi-function clip are provided.

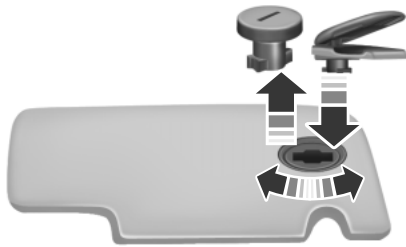

To attach one of the accessories, do the following:

1. Insert the provided removal tool (on the accessory holder) or a coin into the slot on the plug and rotate one-quarter turn in either direction to remove. It may be necessary to rotate the visor until the plug drops away from the opening. Place the plug in the provided holder when not in use.
2. Remove the accessory from the holder and insert the end of the storage accessory into the visor opening. Rotate one-quarter turn in either direction until the accessory snaps into place. Make sure the open end of the accessory is facing away from the windshield.
3. Reverse the procedure to remove the accessory and replace the cap or change to a different accessory.

Additional accessories are available from your authorized dealer. See the *Accessories* chapter for more information.

### SUNSHADE (IF EQUIPPED)

Use the sunshade to cover the glass roof inside your vehicle.

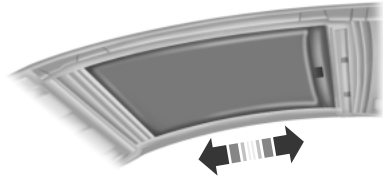

Use the center-mounted cup handle to slide the shade open or closed.

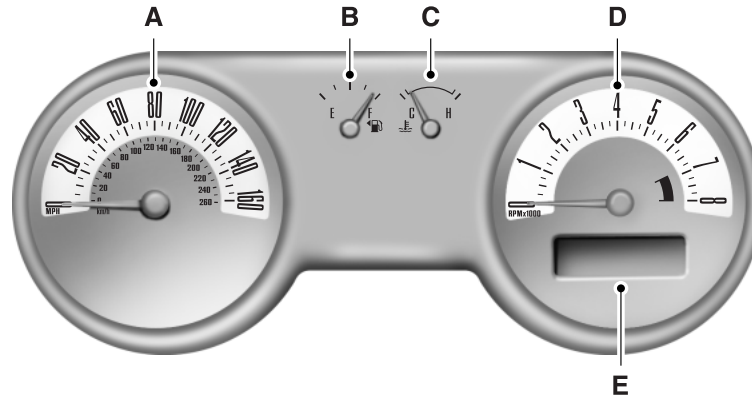
**GAUGES****Type 1**

Cluster shown in standard measure. Metric similar.

- A. Speedometer
- B. Fuel gauge
- C. Engine coolant temperature gauge
- D. Tachometer
- E. Information display. See *Information displays* for more information.

**Fuel Gauge**

Indicates approximately how much fuel is left in the fuel tank (when the ignition is on). The fuel gauge may vary slightly when the vehicle is in motion or on a grade. The fuel icon and arrow indicates which side of the vehicle the fuel filler door is located.

**Engine Coolant Temperature Gauge**

Indicates engine coolant temperature. At normal operating temperature, the level indicator will be in the normal range. If the engine coolant temperature exceeds the normal range, stop the vehicle as soon as safely possible, switch off the engine and let the engine cool.



**WARNING:** Never remove the coolant reservoir cap while the engine is running or hot.

## Type 2

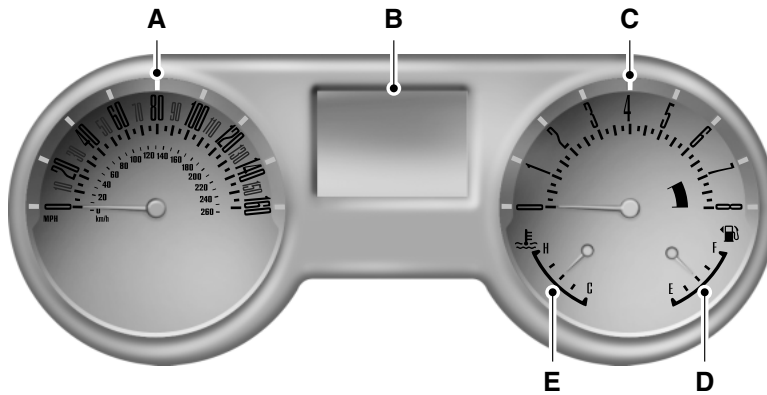

Cluster shown in standard measure. Metric similar.

- A. Speedometer
- B. Information display. See the *Information Displays* chapter for more information.
- C. Tachometer
- D. Fuel gauge
- E. Engine coolant temperature gauge

**Note:** The instrument cluster gauges are backlit with white backlighting when the headlamps are off. When the headlamps are on, you can select one of the preset colors for the nighttime gauge backlighting or create up to three custom colors using the MyColor® feature (if equipped). Ambient color and halo color are also selectable. See the *Information Displays* chapter for more information. When certain gauges enter a warning state, they will be backlit in red.

### Fuel Gauge

Indicates approximately how much fuel is left in the fuel tank (when the ignition is on). The fuel gauge may vary slightly when the vehicle is in motion or on a grade. The fuel icon and arrow indicates which side of the vehicle the fuel filler door is located.

**Engine Coolant Temperature Gauge**

Indicates engine coolant temperature. At normal operating temperature, the level indicator will be in the normal range. If the engine coolant temperature exceeds the normal range, stop the vehicle as soon as safely possible, switch off the engine and let the engine cool.



**WARNING:** Never remove the coolant reservoir cap while the engine is running or hot.

**WARNING LAMPS AND INDICATORS**

These indicators can alert you to a vehicle condition that may become serious enough to cause expensive repairs. Many lights will illuminate when you start your vehicle to make sure they work. If any light remains on after starting the vehicle, refer to the respective system warning light for additional information.

**Airbag Readiness**

If this light fails to illuminate when the ignition is turned on, continues to flash or remains on, contact your authorized dealer as soon as possible. A chime will sound when there is a malfunction in the indicator light.

**Anti-lock Brake System**

If the ABS light stays illuminated or continues to flash, a malfunction has been detected. Contact your authorized dealer as soon as possible. Normal braking is still functional unless the brake warning light also is illuminated.

**Anti-theft System**

Flashes when the SecuriLock® passive anti-theft system has been activated.



**Brake System Warning Light**

To confirm the brake system warning light is functional, it will momentarily illuminate when the ignition is turned to the on position when the engine is not running, or in a position between on and start, or by applying the parking brake when the ignition is turned to the on position.

If it illuminates when you are driving, check that the parking brake is not engaged. If the parking brake is not engaged, this indicates low brake fluid level or a brake system malfunction. Have the system checked immediately by your authorized dealer.



**WARNING:** Driving a vehicle with the brake system warning light on is dangerous. A significant decrease in braking performance may occur. It will take you longer to stop the vehicle. Have the vehicle checked by your authorized dealer as soon as possible. Driving extended distances with the parking brake engaged can cause brake failure and the risk of personal injury.

**Charging System**

Illuminates when the battery is not charging properly. If it stays on while the engine is running, there may be a malfunction with the charging system. Contact your authorized dealer as soon as possible. This indicates a problem with the electrical system or a related component.

**Door Ajar**

Illuminates when the ignition is on and any door is not completely closed.

**Engine Oil Pressure**

Illuminates when the oil pressure falls below the normal range.

**Engine Coolant Temperature**

Illuminates when the engine coolant temperature is high. Stop the vehicle as soon as possible, switch off the engine and let it cool.

**High Beams**

Illuminates when the high beam headlamps are on.

**Low Fuel**

Illuminates when the fuel level in the fuel tank is at or near empty.

**Low Tire Pressure Warning**

Illuminates when your tire pressure is low. If the light remains on at start-up or while driving, the tire pressure should be checked. When the ignition is first turned to on, the light will illuminate for three seconds to ensure the bulb is working. If the light does not turn on or begins to flash, contact your authorized dealer as soon as possible.

**Powertrain Malfunction/Reduced Power**

Illuminates when a powertrain fault has been detected. Contact your authorized dealer as soon as possible.

**Safety Belt**

Reminds you to fasten your safety belt. A Belt-Minder® chime will also sound to remind you to fasten your safety belt.

**Service Engine Soon**

The *service engine soon* indicator light illuminates when the ignition is first turned to the on position to check the bulb and to indicate whether the vehicle is ready for Inspection/Maintenance (I/M) testing. Normally, the service engine soon light will stay on until the engine is cranked, then turn itself off if no malfunctions are present. However, if after 15 seconds the service engine soon light blinks eight times, it means that the vehicle is not ready for I/M testing. See the *Readiness for Inspection/Maintenance (I/M) testing* in the *Fuel and Refueling* chapter.

Solid illumination after the engine is started indicates the on-board diagnostics system (OBD-II) has detected a malfunction. See *On-board Diagnostics (OBD-II)* in the *Fuel and Refueling* chapter. If the light is blinking, engine misfire is occurring which could damage your catalytic converter. Drive in a moderate fashion (avoid heavy acceleration and deceleration) and have your vehicle serviced immediately by your authorized dealer.



**WARNING:** Under engine misfire conditions, excessive exhaust temperatures could damage the catalytic converter, the fuel system, interior floor coverings or other vehicle components, possibly causing a fire.

**Speed Control (if equipped)**

The speed control system indicator light changes color to indicate what mode the system is in:

- On (amber light): Illuminates when the speed control system is turned on. Turns off when the speed control system is turned off.
- Engaged (green light): Illuminates when the speed control system is engaged. Turns off when the speed control system is disengaged.

**Stability Control System**

Illuminates when the AdvanceTrac®/Traction control is active. If the light remains on, have the system serviced immediately.



**Stability Control System Off**

Illuminates when AdvanceTrac®/Traction control has been disabled by the driver.

**Turn Signal**

Illuminates when the left or right turn signal or the hazard warning flasher is turned on. If the indicators stay on or flash faster, check for a burned out bulb.

**Upshift (if equipped)**

To maximize fuel economy, this light illuminates when the manual transmission should be shifted to the next highest gear.

**AUDIBLE WARNINGS AND INDICATORS****Key In Ignition Warning Chime**

Sounds when the key is left in the ignition in the off or accessory position and the driver's door is opened.

**Keyless Warning Alert (If Equipped)**

Sounds when the keyless vehicle is in RUN and the driver's door is opened.

**Headlamps On Warning Chime**

Sounds when the headlamps or parking lamps are on, the ignition is off (the key is not in the ignition) and the driver's door is opened.

**Parking Brake On Warning Chime**

Sounds when you have left the parking brake on and drive your vehicle. If the warning chime remains on after you have released the parking brake, have the system checked by your authorized dealer immediately.

**GENERAL INFORMATION**

 **WARNING:** Driving while distracted can result in loss of vehicle control, accident and injury. Ford strongly recommends that drivers use extreme caution when using any device or feature that may take their focus off the road. Your primary responsibility is the safe operation of the vehicle. We recommend against the use of any handheld device while driving and that you comply with all applicable laws.

Various systems on your vehicle can be controlled using the information display controls located on the steering wheel. Corresponding information is displayed in the information display.

**Information Display Controls (Type 1)**

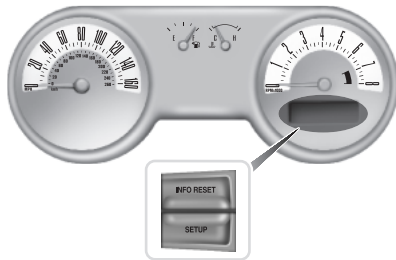

- Press the INFO button to scroll through trip, fuel usage and MyKey® information.
- Press the SETUP button to scroll through various vehicle feature settings.
- Press the RESET button to choose settings, reset information and confirm messages.

**Info**



Press INFO repeatedly to cycle through the following features:

**TRIP A/B**

Registers the distance of individual journeys. Press and release INFO until the A or B trip appears in the display (this represents the trip mode). Press and release RESET to reset trip information .

**MYKEY MILES (km)**

For more information, see the *MyKey*® chapter.

**MILES (km) TO E**

This displays an estimate of approximately how far you can drive with the fuel remaining in your tank under normal driving conditions. Remember to turn the ignition off when refueling to allow this feature to correctly detect the added fuel.

**AVG MPG (L/100 km)**

Average fuel economy displays your average fuel economy in miles/gallon or liters/100 km.

**MPG (L/km) ↑ ↓**

This displays instantaneous fuel economy as a bar graph ranging from ↓ poor economy to ↑ excellent economy.

Your vehicle must be moving to calculate instantaneous fuel economy. When your vehicle is not moving, this function shows ↓, one or no bars illuminated. Instantaneous fuel economy cannot be reset.

**TIMER**

Timer displays the trip elapsed drive time.

To operate, do the following:

1. Press and release RESET in order to start the timer.
2. Press and release RESET to pause the timer.
3. Press and hold RESET until the timer resets.

**Blank Screen**

The display will be blank after cycling through all of the Info menu items.

**System Check and Vehicle Feature Customization**

Press the SETUP button repeatedly to cycle through the following features:

**Note:** Not all personalization items will appear unless your vehicle is so equipped.



### RESET FOR SYSTEM CHECK

When this message appears, press the RESET button and the information display will begin to cycle through the following systems and provide a status of the item if needed.

1. XXX% OIL LIFE
2. CHARGING SYSTEM
3. DOORS STATUS
4. TRUNK STATUS
5. BRAKE SYSTEM
6. FUEL LEVEL
7. MYKEY DISTANCE (if MyKey® is programmed)
8. MYKEY(S) PROGRAMMED
9. ADMIN KEYS PROGRAMMED

**Note:** Some systems show a message only if a condition is present.

### OIL LIFE

This displays the remaining oil life.

An oil change is required whenever indicated by the information center and according to the recommended maintenance schedule. USE ONLY RECOMMENDED ENGINE OILS.

To reset the oil monitoring system to 100% after each oil change perform the following:

1. Press and release SETUP to display OIL LIFE XXX% HOLD RESET = NEW.
2. Press and hold RESET for two seconds and release to reset the oil life to 100%.

### STEERING FEEL

This feature allows three modes of steering feel.

Press RESET to cycle through the settings of:

- **STANDARD**– Provides a balance between a comfort and sport feel.
- **SPORT**– Slightly higher effort required for steering with more road force felt through the steering wheel. See note below.
- **COMFORT**– Slightly less effort required for steering with less road force felt through the steering wheel.

**Note:** When AdvanceTrac® sport mode is on or when AdvanceTrac® and traction control are off, the steering feel will be locked in sport mode. The display will show STEERING FEEL <SPORT> LOCKED and the steering feel will not be selectable.

**HALO LIGHT**

Turns the halo lighting around the gauges on or off.

Press and hold RESET to turn the feature on or off.

**AMBIENT LIGHT**

Turns the ambient lighting on or off. Ambient lighting provides accent lighting in various locations, such as footwell areas, cup holders and the center console bin. The parking lamps or headlamps must be on to use ambient lighting.

Press and hold RESET to turn the feature on or off.

**AMBIENT DIM**

Use this to adjust the brightness of the ambient lighting.

Press RESET to choose the various settings.

**GAUGE COLOR, AMBIENT COLOR, HALO COLOR**

**GAUGE COLOR:** The instrument cluster gauges are backlit with white backlighting when the headlamps are off. When the headlamps are on, you can select one of the preset colors for the nighttime gauge backlighting.

**Note:** A gauge in a warning condition will be lit red when the headlamps are on.

**AMBIENT COLOR:** You can select one of the preset colors for ambient lighting.

**HALO COLOR:** You can select one of the preset colors for halo lighting.

**Note:** Headlamps or parking lamps must be on to set up colors.

To choose colors for the gauges, halo color or ambient lighting do the following:

1. Press SETUP to reach the GAUGE COLOR, AMBIENT COLOR, or HALO COLOR menu.
2. Press RESET to scroll through the following color options:
  - ICE BLUE
  - WHITE
  - GREEN
  - PURPLE
  - BLUE
  - ORANGE
  - RED

### **UNITS**

Displays the current units English or Metric.

Press RESET to change from English to Metric.

### **AUTOLAMP (SEC)**

This feature keeps your headlights on for up to three minutes after the ignition is switched off.

Press RESET to select the new autolamp delay values of 0, 10, 20, 30, 60, 90, 120 or 180 seconds.

### **AUTOLOCK**

This feature automatically locks all vehicle doors when the vehicle is shifted into any gear and driven.

Press RESET to turn autolock on or off.

### **AUTOUNLOCK**

This feature automatically unlocks all vehicle doors when the driver's door is opened within 10 minutes of the ignition being turned off.

Press RESET to turn autounlock on or off.

### **REAR PARK AID**

This feature sounds a warning tone to warn the driver of obstacles near the rear bumper, and functions only when the transmission is in **R**.

Press RESET to turn it off or on.

### **CREATE MYKEY / MYKEY SETUP/ CLEAR MYKEY**

For more information, see the *MyKey*® chapter.

### **LANGUAGE = ENGLISH / SPANISH / FRENCH**

Allows you to choose which language for the information display. Selectable languages are English, Spanish, or French.

Waiting four seconds or pressing the RESET button cycles through each of the language choices.

Press and hold RESET for two seconds to set the language choice.

**Information Messages**

See *Information Messages* later in this chapter for more information.

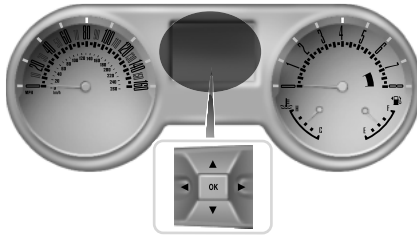
**Information Display Controls (Type 2)**

- Press the up and down arrow buttons to scroll through and highlight the options within a menu.
- Press the right arrow button to enter a sub-menu.
- Press the left arrow button to exit a menu.
- Press the OK button to choose and confirm a setting or message

**Main Menu**

You can access the menus using the information display control.



- Gauge Mode



- Trip A/B



- Fuel Economy



- Track Apps (Track use only)



- Settings



- Information

†Gauge Mode		
Gauges Detail	Air/Fuel Ratio	Virtual gauge shown
	Vacuum inHG / Boost psi (Shelby® GT500®)	Virtual gauge shown
	Cyl Head	Virtual gauge shown
	Inlet Air	Virtual gauge shown
	Oil Press.	No virtual gauge available
	Oil Temp.	Virtual gauge shown
	Trans temp (auto transmission only)	Virtual gauge shown
	Voltage	Virtual gauge shown
	†See <i>Virtual Gauges</i> later in this section for more information.	
†Trip A / B		
Trip time		
Trip distance		
Fuel used		
Avg mpg(L/100km)		
Odometer (displays in lower line and may display in other menus)		
†See <i>Trip Computer</i> later in this section for more information.		
Fuel Economy		
Fuel Econ.	Instant MPG (L/100km)	
	mi (km) to E	
	AVG MPG (L/100km)	
Fuel Hist.: shows fuel usage as a bar graph based on time. The duration time can be changed.	Duration: 5 Minutes, 10 Minutes, 30 Minutes, Last 5 Resets. The graph is updated each minute with the fuel economy that was achieved during the prior 5, 10, 30 minutes of driving.	



†Track Apps			
Accelerometer			
Acceleration timer			
Brake Performance			
Dashboard Screen (Shelby® GT500®)	Launch Control (Shelby® GT500®)	Off/On / RPM Setting	
View/Clear Results			
†See <i>Track apps</i> later in this section for more information.			
Settings			
Driver Assist	Rear Park Aid	On/Off	
Vehicle	Autolamp Delay	Off or XXX seconds	
	Locks	Autolock	On/Off
		Autounlock	On/Off
	Menu Control	Standard: With standard set, pressing the up/down arrows from a lower level menu will escape to the main menu. Memory On: With memory on set, pressing the up/down arrows will navigate to the previous lower level menu.	
	Oil Life Reset	Set to XXX% (Hold OK to Reset)	
	Shiftpoint (Shelby® GT500®)	Shiftlamp	On/Off
Shiftpoint		1500–7000 RPM	
Shifftone		On/Off	

Settings			
Vehicle	Dampers (Shelby® GT500®)	Sport / Normal	
	Steering Feel	Standard	
		Sport	Sport Locked: This will display when AdvanceTrac® sport mode is on or when AdvanceTrac® and traction control are off. The steering feel will be locked in sport mode and steering feel will not be selectable.
		Comfort	

Settings				
†MyColor (if equipped)	Gauge Color	Ice Blue, White, Green, Purple, Blue, Orange, Red, MyColor 1, 2, 3		
	Halo	Halo Light	On/Off	
		Halo Color	Ice Blue, White, Green, Purple, Blue, Orange, Red, MyColor 1, 2, 3	
	Ambient Light	Ambient Light	On/Off	
		Ambient Dim	High/Low	
		Ambient Color	Ice Blue, White, Green, Purple, Blue, Orange, Red, MyColor 1, 2, 3	
	Set MyColor 1, 2, 3 (create your own color by adjusting the levels (1–5) of the three primary colors – red, green, and blue)	Red	1–5	
Green				
Blue				
MyKey	Create MyKey	Hold OK to create MyKey		
	*The following only display if MyKey is programmed:			
	*AdvanceTrac	Always On / Selectable		
	*MAX Speed	80 MPH (130 km/h) or Off		
	*Speed Warning	45, 55 or 65 MPH (75, 90 or 105 km/h), or Off		
	*Volume Limiter	On/Off		
	*Clear MyKey	Hold OK to Clear MyKey		
*Language	English, Español, Français			

Settings	
Units	English or Metric
System Reset	Hold OK to Reset System to Factory Default
†The instrument cluster gauges are backlit white when the headlamps are off. When the headlamps are on, you can select one of the preset colors or MyColor 1, 2, 3 for the nighttime gauge backlighting. A gauge in a warning condition will be backlit red when the headlamps are on.	
*Track Application features and messages in the information display are only available in English.	
Information	
MyKey	Admin Keys (Number of admin keys)
	MyKeys (Number of MyKeys programmed)
	MyKey Miles (km) (Distance traveled using a programmed MyKey)
System Check	Some items will only display during a system check if a problem has been detected. If an issue exists on one of the monitored systems, the number of warnings that need immediate attention will display in red and the number of informational warnings will display in amber. Use the up/down arrow buttons to scroll through the list; press the right arrow button to display specific information on the highlighted warning.

**TRIP COMPUTER (Trip A and B)**

***Resetting or Pausing the Trip Computer***

- Press OK to pause the Trip A or B screen, press again to un-pause.
- Press and hold OK to reset the currently displayed trip information.

***Trip Time***

Registers the time of individual journeys.

***Trip Distance***

Registers the mileage of individual journeys.

***Fuel Used***

Shows the amount of fuel used for a given trip.

**Average MPG (L/100km)**

Shows the average distance traveled per unit of fuel used for a given trip.

**Odometer**

Registers the total mileage of the vehicle.

**VIRTUAL GAUGES**

**Note:** In order to provide real-time values, some gauges may display more value fluctuation than others during normal operation.

Some gauges shown in standard measure. Metric similar.

**AIR FUEL RATIO**

Displays the current air to fuel mixture in the engine.

**VACUUM inHG / BOOST psi (Shelby® GT500®)**

See the *Shelby GT500 Supplement*.

**CYLINDER HEAD TEMP (IF EQUIPPED)**

Displays the engine's cylinder head temperature.

**INLET AIR TEMP**



Displays the temperature of the air in the cold air inlet tube.

**OIL TEMP**



Displays the engine oil temperature. If the temperature rises to the red area, stop in a safe place and let the vehicle cool. If the problem persists, see your authorized dealer.

**TRANS TEMP (Automatic Transmission only)**



Displays the transmission fluid operating temperature. If the temperature rises to the red area, stop in a safe place and let the transmission cool. If the problem persists, see your authorized dealer.

**VOLTS**



Displays the vehicle's battery voltage. If the voltage is consistently too high or very low, see your authorized dealer.

**TRACK APPS (IF EQUIPPED)**

**WARNING:** Track Apps is for track use only. Remember that even advanced technology cannot defy the laws of physics. It is always possible to lose control of a vehicle due to inappropriate driver input for the conditions. Aggressive driving on any road condition can cause you to lose control of your vehicle increasing the risk of personal injury or property damage.

**Note:** Track Apps are for track use only. They are not to be used under any other driving conditions.

**Note:** Viewed or cleared results cannot be used unless the vehicle is at a complete stop. The right arrow on the display menu will be inactive. 1/4 mile results may not be displayed if the vehicle does not reach 100 mph (160 km/h) during the track run.

**Accelerometer**

Displays the vehicle rate of acceleration/deceleration.

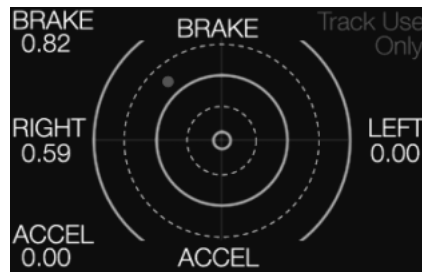

- The red dot will move toward the area of acceleration/deceleration. When accelerating/decelerating left, the red dot will move to the right on the accelerometer. This is considered LEFT acceleration/deceleration. When accelerating/decelerating right, the red dot will move to the left on the accelerometer. This is considered RIGHT acceleration/deceleration.
- The rates of acceleration/deceleration are shown on the screen.

**Acceleration Timer**

Displays the vehicle's rate of acceleration.

1. Choose desired speed or distance.
2. Choose Automatic Start or Countdown Start.
3. Follow the on-screen prompts.

**Brake Performance**

Displays the vehicle’s rate of deceleration.

1. Choose desired speed to start recording data.
2. Follow the on-screen prompts.

**Dashboard Screen (Shelby® GT500®)**

For dashboard screen information, see the *Shelby GT500 Supplement*.

**Launch Control (Shelby® GT500®)**

For launch control information, see the *Shelby GT500 Supplement*.

**INFORMATION MESSAGES**

**Note:** Depending on the vehicle options equipped with your vehicle, not all of the messages will display or be available. Certain messages may be abbreviated or shortened depending upon which cluster type you have.

Press the RESET button for Type 1 displays or the OK button for Type 2 displays to acknowledge and remove some messages from the information display. Other messages will be removed automatically after a short time. Certain messages need to be confirmed before you can access the menus.

AdvanceTrac® / Traction Control Messages	Action / Description
<b>SERVICE ADVANCETRAC</b>	Displayed when the AdvanceTrac® system has detected a condition that requires service. Contact your authorized dealer as soon as possible.
<b>ADVANCETRAC OFF</b>	Displayed when the AdvanceTrac® system has been disabled by the driver.
<b>ADVANCETRAC ON</b>	Displayed when the AdvanceTrac® system has been enabled by the driver.
<b>TRACTION CONTROL OFF</b>	Displayed when the traction control system has been turned off.



## Information Displays

<b>Alarm/Security Messages</b>	<b>Action / Description</b>
<b>TO STOP ALARM START VEHICLE</b>	Displayed when the perimeter alarm system is armed and the vehicle is entered using the key on the driver's side door. In order to prevent the perimeter alarm system from triggering, the ignition must be turned to start or on before the 12 second chime expires.
<b>SECURITY EVENT OCCURRED</b>	Displayed when the active anti-theft system was activated since the prior ignition cycle.
<b>Battery and Charging System Messages</b>	<b>Action / Description</b>
<b>CHECK CHARGING SYSTEM</b>	Displayed when the charging system needs servicing. If the warning stays on or continues to come on, contact your authorized dealer as soon as possible.
<b>Brake System Messages</b>	<b>Action / Description</b>
<b>BRAKE FLUID LEVEL LOW</b>	Indicates the brake fluid level is low and the brake system should be inspected immediately.
<b>CHECK BRAKE SYSTEM</b>	Displayed when the brake system needs servicing. If the warning stays on or continues to come on, contact your authorized dealer as soon as possible.
<b>PARK BRAKE ENGAGED</b>	Displayed when the parking brake is set and the vehicle is in motion.
<b>Door Messages</b>	<b>Action / Description</b>
<b>X DOOR AJAR</b>	Displayed when the corresponding door is not completely closed.
<b>TRUNK AJAR</b>	Displayed when the trunk is not completely closed.

Fuel Messages	Action / Description
<b>CHECK FUEL FILL INLET</b>	Displayed when the fuel fill inlet may not be properly closed.
<b>FUEL LEVEL LOW</b>	Displayed as an early reminder of a low fuel condition.
Key Messages	Action / Description
<b>COULD NOT PROGRAM INTEGRATED KEY</b>	Displayed when an attempt is made to program a fifth integrated key. For more information, see the <i>Security</i> chapter.
Maintenance Messages	Action / Description
<b>ENGINE OIL CHANGE SOON</b>	Displayed when the engine oil life is nearing its end.
<b>OIL CHANGE REQUIRED</b>	Displayed when the oil life left reaches 0%.
<b>ENGINE OIL LEVEL LOW</b>	Displayed when the oil level is low. Stop the vehicle in a safe place and check the oil level. Refill if needed. If the oil level remains low or becomes low again, see your authorized dealer.
<b>SERVICE POWER STEERING</b>	The power steering system has detected a condition that requires service. See your authorized dealer.
<b>SERVICE POWER STEERING NOW</b>	The power steering system has detected a condition within the power steering system that requires service immediately. See your authorized dealer.
<b>POWER STEERING ASSIST FAULT</b>	The power steering system has disabled power steering assist due to a system error. See your authorized dealer.

<b>MyKey® Messages</b>	<b>Action / Description</b>
<b>MYKEY ACTIVE DRIVE SAFELY</b>	Displayed when MyKey® is active.
<b>ADVTRAC ON MYKEY SETTING</b>	Displayed when a MyKey® is in use when trying to disable the AdvanceTrac® system and the optional setting is on.
<b>VEHICLE SPEED 80 MPH MAX</b>	Displayed when a MyKey® is in use and the MyKey speed limit is on and the vehicle speed is 80 mph (130 km/h).
<b>VEHICLE NEAR TOP SPEED</b>	Displayed when a MyKey® is in use and the MyKey speed limit is on and the vehicle speed is approaching 80 mph (130 km/h).
<b>TOP SPEED MYKEY SETTING</b>	Displayed when a MyKey® is in use and the MyKey speed limit is on and the vehicle speed is 80 mph (130 km/h).
<b>SPEED LIMITED TO 80 MPH</b>	Displayed when starting the vehicle and MyKey® is in use and the MyKey speed limit is on.
<b>CHECK SPEED DRIVE SAFELY</b>	Displayed when a MyKey® is in use and the optional setting is on and the vehicle exceeds a preselected speed.
<b>BUCKLE UP TO UNMUTE AUDIO</b>	Displayed when a MyKey® is in use and Belt-Minder® is activated.
<b>MYKEY COULD NOT PROGRAM</b>	Displayed when an attempt is made to program a spare key using two existing MyKeys.
<b>Park Aid Messages</b>	<b>Action / Description</b>
<b>CHECK REAR PARK AID</b>	Displayed when the transmission is in R (Reverse) and the park aid is disabled.

Tire Messages	Action / Description
<b>LOW TIRE PRESSURE</b>	Displays when one or more tires on your vehicle have low tire pressure.
<b>TIRE PRESSURE MONITOR FAULT</b>	Displays when the tire pressure monitoring system is malfunctioning. If the warning stays on or continues to come on, contact your authorized dealer.
<b>TIRE PRESSURE SENSOR FAULT</b>	Displayed when a tire pressure sensor is malfunctioning, or your spare tire is in use. For more information on how the system operates under these conditions. If the warning stays on or continues to come on, contact your authorized dealer as soon as possible.
Track Key Messages	Action / Description
<b>TRACKKEY ACTIVE TRACK USE ONLY</b>	Displayed when a trackkey is in use. See the <i>Boss® 302</i> supplement for more information.
<b>TRACKKEY IDLE ENABLED</b>	Displayed when a trackkey is in use. See the <i>Boss® 302</i> supplement for more information.

**ELECTRONIC COMPASS**

The compass heading displays in the center-integrated display.

**Note:** Driving near large buildings, bridges, power lines and powerful broadcast antenna may affect the compass reading. Magnetic or metallic objects placed in, on or near your vehicle may also affect compass accuracy.

Usually, when something affects the compass readings, the compass corrects itself after a few days of operating your vehicle in normal conditions. If the compass still appears to be inaccurate, a manual calibration may be necessary. See *Compass calibration adjustment*.

### Compass Zone Adjustment

When something affects the compass readings, typically the compass corrects itself after a few days of operating your vehicle in normal conditions. If the compass still appears to be inaccurate, a manual calibration may be necessary.

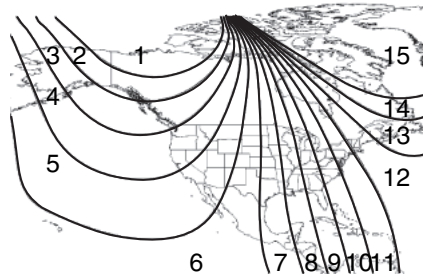

1. Determine which magnetic zone you are in for your geographic location by referring to the zone map.
2. Turn ignition to the on position.
3. Press and hold the 7 and 9 radio preset buttons together for approximately five seconds until ZONE XX appears.
4. Press and release the 7 and 9 radio preset buttons together, repeatedly until ZONE XX changes to the correct zone (1–15).
5. The direction displays, and the zone updates, when you release the buttons.

### Compass Calibration Adjustment

Most geographic areas (zones) have a magnetic north compass point that varies slightly from the northerly direction on maps. This variation is four degrees between adjacent zones and becomes noticeable as your vehicle crosses multiple zones. A correct zone setting eliminates this error.

Perform compass calibration in an open area free from steel structures and high voltage lines. For optimum calibration, turn off all electrical accessories (such as the heater, air conditioning or wipers) and make sure no vehicle doors are open.

1. Start your vehicle.
2. Press and hold the 7 and 9 radio preset buttons together for approximately 10 seconds until CAL appears. Release the buttons.
3. Drive your vehicle in a circle slowly (under than 3 mph [5 km/h]); it may take up to five circles to complete calibration.
4. Calibration is complete when the CAL display changes to the direction value (such as N, S, E or W).

**GENERAL AUDIO INFORMATION**

**Radio Frequencies and Reception Factors**

AM and FM frequencies are established by the Federal Communications Commission (FCC) and the Canadian Radio and Telecommunications Commission (CRTC). Those frequencies are:

AM: 530, 540–1700, 1710 kHz

FM: 87.9–107.7, 107.9 MHz

Radio reception factors	
<b>Distance and Strength</b>	The further you travel from an FM station, the weaker the signal and the weaker the reception.
<b>Terrain</b>	Hills, mountains, tall buildings, bridges, tunnels, freeway overpasses, parking garages, dense tree foliage and thunderstorms can interfere with your reception.
<b>Station Overload</b>	When you pass a ground-based broadcast repeating tower, a stronger signal may overtake a weaker one and result in the audio system muting.

**CD and CD Player Information**

**Note:** CD units play commercially pressed 4.75-inch (12 centimeter) audio compact discs only. Due to technical incompatibility, certain recordable and re-recordable compact discs may not function correctly when used in Ford CD players.

**Note:** Do not insert CDs with homemade paper (adhesive) labels into the CD player as the label may peel and cause the CD to become jammed. You should use a permanent felt tip marker rather than adhesive labels on your homemade CDs. Ballpoint pens may damage CDs. Please contact your authorized dealer for further information.

**Note:** Do not use any irregularly shaped discs or discs with a scratch protection film attached.

Always handle discs by their edges only. Clean the disc with an approved CD cleaner only. Wipe it from the center of the disc toward the edge. Do not clean in a circular motion.

Do not expose discs to direct sunlight or heat sources for extended periods.

**MP3 Track and Folder Structure**

Audio systems capable of recognizing and playing MP3 individual tracks and folder structures work as follows:

- There are two different modes for MP3 disc playback: MP3 track mode (system default) and MP3 folder mode.
- MP3 track mode ignores any folder structure on the MP3 disc. The player numbers each MP3 track on the disc (noted by the .mp3 file extension) from T001 to a maximum of T255. **Note:** The maximum number of playable MP3 files may be less depending on the structure of the CD and exact model of radio present.
- MP3 folder mode represents a folder structure consisting of one level of folders. The CD player numbers all MP3 tracks on the disc (noted by the .mp3 file extension) and all folders containing MP3 files, from F001 (folder) T001 (track) to F253 T255.
- Creating discs with only one level of folders helps with navigation through the disc files.

If you are burning your own MP3 discs, it is important to understand how the system reads the structures you create. While various files may be present, (files with extensions other than mp3), only files with the .mp3 extension are played; other files are ignored by the system. This enables you to use the same MP3 disc for a variety of tasks on your work computer, home computer and your in-vehicle system.

In track mode, the system displays and plays the structure as if it were only one level deep (all .mp3 files play, regardless of being in a specific folder). In folder mode, the system only plays the .mp3 files in the current folder.

## AM/FM/CD/SIRIUS SATELLITE RADIO

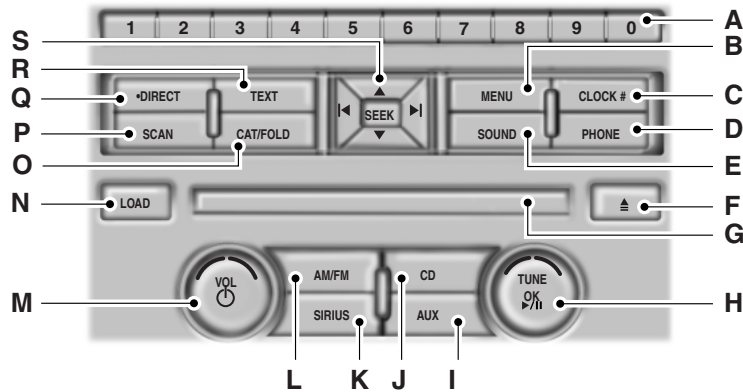

**WARNING:** Driving while distracted can result in loss of vehicle control, accident and injury. Ford strongly recommends that you use extreme caution when using any device or feature that may take your focus off the road. Your primary responsibility is the safe operation of your vehicle. We recommend against the use of any handheld device while driving, encourage the use of voice-operated systems when possible and that you become aware of applicable state and local laws that may affect use of electronic devices while driving.

**Note:** Some features, such as SIRIUS satellite radio, may not be available in your location. Check with your authorized dealer.

### A. Memory presets:

- Store your favorite stations for later access. When tuned to any station, press and hold a preset button until sound returns and PRESET # SAVED appears in the display.
- Save presets automatically by using the autoset feature. Press MENU repeatedly until AUTO PRESET ON/OFF appears in the display. Use the SEEK buttons to turn AUTO PRESET to ON, and either wait five seconds for the search to initiate or press **OK** to immediately start the search. If you press another control within those five seconds, the search does not start. The system fills the presets with the 10 strongest stations; the station stored in preset 1 begins playing. If there are fewer than 10 strong stations, the system stores the last one in the remaining presets.

**Note:** Autoset does not delete your original preset stations.

2013 05+ Mustang (197)  
 Owners Guide gf, 3rd Printing  
 USA (fus)



**Note:** In order to re-run the autosest features, you must first turn it off before turning it back on.

B. **MENU:** Press this button to access different audio features:

- **Compression** brings the soft and loud CD passages together for a more consistent listening level.
- **Shuffle** plays the current CD tracks in random order.
- **RDS Radio** allows you to search RDS-equipped stations for a certain category of music format such as CLASSIC, COUNTRY, JAZZ/RB or ROCK.
- **SIRIUS** allows you to access different satellite radio options.

C. **CLOCK:** Press this button to set the time. Use the memory presets buttons to enter the time, and then press **OK**.

D. **PHONE:** Press this button to access the phone features of the SYNC® system. See the SYNC® chapter for more information. If your vehicle is not equipped with SYNC®, the display reads NO PHONE.

E. **SOUND:** Press this button to access settings for Treble, Middle, Bass, Balance and Fade. Use the **SEEK** or **TUNE** controls to change the settings.

- **Bass** levels can be increased or decreased.
- **Treble** levels can be increased or decreased.
- **Balance** adjusts the sound between left and right speakers.
- **Fade** adjusts the sound between the front and back speakers.
- **Speed Compensated Volume** adjusts the volume to compensate for speed and wind noise. You can set the system between off and +7.
- **All Seat Mode/Driver Seat Mode/Top Down Mode (if equipped)** optimizes sound quality for the chosen seating position.
- **DSP Mode (if equipped)** allows you to choose between STEREO SURROUND mode and STEREO mode.

F. **Eject:** Press this button to eject a CD.

G. **CD slot:** Insert a CD.

H. **TUNE/OK/Play/Pause:**

- In radio mode, turn the control to manually search through the radio frequency band.
- In SIRIUS mode, turn the control to find the next or previous available satellite radio station.
- **OK** allows you to confirm commands with phone and media features. If your vehicle is equipped with SYNC®, see the SYNC® chapter for more information.
- Play/Pause allows you to play or pause a track when listening to a CD.

I. **AUX:** Press this button to access media through your auxiliary input jack. If your vehicle is equipped with SYNC®, see the SYNC® chapter for more information.

J. **CD:** Press the CD button to access CD and MP3 modes.

- The disc begins to play where it left off. If no CD is loaded, NO DISC appears in the display.
- Press the **SEEK** buttons to access the previous or next track. Press and hold the **SEEK** buttons to quickly reverse or fast forward within the same track.

K. **SIRIUS:** Press this button to access different satellite radio modes.

**Note:** SIRIUS® satellite radio is available only with a valid SIRIUS® radio subscription. Check with your authorized dealer for availability.

L. **AM/FM:** Press this button to select a frequency band.

M. **On/Off/VOL:** Press the power control to turn the system on and off. Turn to adjust the volume.

- Press this button to switch the system off and on.
- Turn it to adjust the volume.

N. **LOAD:** This control is not operational. To load a CD, insert the disc, label side up, into the CD slot.

O. **CAT/FOLD:**

- In SIRIUS mode, press this button to switch between turning the most recently selected satellite radio category off or on.
- In MP3 mode, press this button, then use the **SEEK** buttons to access the previous or next folder.

P. **SCAN:**

- In radio mode, press this button to hear a brief sampling of all radio stations.
- In SIRIUS mode, press this button to hear a brief sampling of all available channels. If you select a specific category, press **SCAN** for a brief sampling of all available channels within the selected category.
- In CD and MP3 modes, press this button to hear a brief sampling of all tracks on the current disc or MP3 folder.

Q. **DIRECT:**

- In radio mode, press this button to select the desired radio frequency (such as 93.9) using the memory preset numbers (0–9).
- In SIRIUS mode, press this button to enter the desired channel (such as 002) using the memory preset buttons. If you only enter one digit, and press **OK**, the system goes to that channel. If you enter three digits, the system automatically goes to that channel, if available. You may cancel your entry by pressing **DIRECT**. If you enter an invalid station number, **INVALID CHANNEL** appears in the display and the system continues playing the current station.

- In CD mode, press this button to enter the desired track number using the memory preset buttons. The system then begins playing that track.
- In MP3 mode, press this button to enter a memory preset button of the desired folder. The system advances to that specific folder.

**R. TEXT:**

- MP3 mode, press this button to view Album (AL), Folder (FL), Song (SO) and Artist (AR) in the display, if available.
- In text mode, sometimes the display requires additional text to show. When the < / > indicator is on, press this button, then use the **SEEK** buttons to view the additional text.

**S. SEEK:**

- In radio mode, select a frequency band and press one of these buttons. The system stops at the first station it finds in that direction.
- In SIRIUS mode, press one of these buttons to select the previous or next channel. If a specific category is selected (such as Jazz, Rock or News), use these buttons to find the previous or next channel in the selected category.
- In CD and MP3 modes, press one of these buttons to select the previous or next track.

**AUXILIARY INPUT JACK**

**WARNING:** Driving while distracted can result in loss of vehicle control, accident and injury. Ford strongly recommends that you use extreme caution when using any device or feature that may take your focus off the road. Your primary responsibility is the safe operation of your vehicle. We recommend against the use of any handheld device while driving, encourage the use of voice-operated systems when possible and that you become aware of applicable state and local laws that may affect use of electronic devices while driving.



**WARNING:** For safety reasons, do not connect or adjust the settings on your portable music player while your vehicle is moving.





**WARNING:** Store the portable music player in a secure location, such as the center console or the glove box, when your vehicle is moving. Hard objects may become projectiles in a collision or sudden stop, which may increase the risk of serious injury. The audio extension cable must be long enough to allow the portable music player to be safely stored while your vehicle is moving.



The auxiliary input jack (AIJ) allows you to connect and play music from your portable music player through your vehicle speakers. You can use any portable music player designed for use with headphones. Your audio extension cable must have male 1/8-inch (3.5 millimeter) connectors at each end.

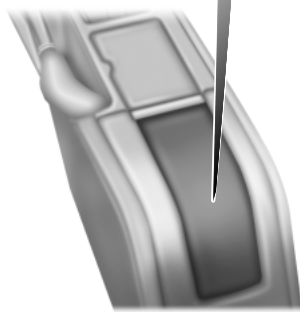

1. Make sure your vehicle, radio and portable music player are turned off and the transmission is in position **P**.
2. Plug the extension cable from the portable music player into the AIJ.
3. Turn on the radio. Select either a tuned FM station or a CD.
4. Adjust the volume as desired.
5. Turn on your portable music player and adjust its volume to 1/2 the maximum.
6. Press AUX until LINE or LINE IN appears in the display. You should hear music from your device even if it is low.
7. Adjust the volume on your portable music player until it reaches the volume level of the FM station or CD. Do this by switching back and forth between the AUX and FM or CD controls.

**USB PORT (IF EQUIPPED)**

**WARNING:** Driving while distracted can result in loss of vehicle control, accident and injury. Ford strongly recommends that you use extreme caution when using any device or feature that may take your focus off the road. Your primary responsibility is the safe operation of your vehicle. We recommend against the use of any handheld device while driving, encourage the use of voice-operated systems when possible and that you become aware of applicable state and local laws that may affect use of electronic devices while driving.



The USB port allows you to plug in media playing devices, memory sticks and charge devices (if supported). See the *SYNC* chapter for more information.

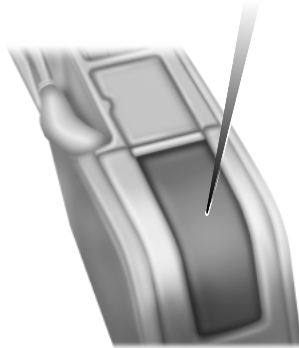

**SATELLITE RADIO INFORMATION (IF EQUIPPED)**

**Satellite Radio Channels**

SIRIUS® broadcasts a variety of music, news, sports, weather, traffic and entertainment satellite radio channels. For more information and a complete list of SIRIUS® satellite radio channels, visit [www.siriusxm.com](http://www.siriusxm.com) in the United States, [www.sirius.ca](http://www.sirius.ca) in Canada, or call SIRIUS® at 1-888-539-7474.

**Satellite Radio Reception Factors**

<b>Potential Satellite Radio Reception Issues</b>	
<b>Antenna obstructions</b>	For optimal reception performance, keep the antenna clear of snow and ice build-up and keep luggage and other material as far away from the antenna as possible.
<b>Terrain</b>	Hills, mountains, tall buildings, bridges, tunnels, freeway overpasses, parking garages, dense tree foliage and thunderstorms can interfere with your reception.
<b>Station overload</b>	When you pass a ground-based broadcast repeating tower, a stronger signal may overtake a weaker one and the audio system may mute.
<b>Satellite radio signal interference</b>	Your display may show ACQUIRING . . . to indicate the interference and the audio system may mute.

**SIRIUS® Satellite Radio Service**

**Note:** SIRIUS® reserves the unrestricted right to change, rearrange, add or delete programming including canceling, moving or adding particular channels, and its prices, at any time, with or without notice to you. Ford Motor Company shall not be responsible for any such programming changes.



SIRIUS® satellite radio is a subscription-based satellite radio service that broadcasts a variety of music, sports, news, weather, traffic and entertainment programming. Your factory-installed SIRIUS® satellite radio system includes

hardware and a limited subscription term which begins on the date of sale or lease of your vehicle. See your authorized dealer for availability.

For more information on extended subscription terms (a service fee is required), the online media player and a complete list of SIRIUS® satellite radio channels, and other features, please visit [www.siriusxm.com](http://www.siriusxm.com) in the United States, [www.sirius.ca](http://www.sirius.ca) in Canada, or call SIRIUS® at 1-888-539-7474.

**Satellite Radio Electronic Serial Number (ESN)**

You need your ESN to activate, modify or track your satellite radio account. When in satellite radio mode, you can view this number by pressing SIRIUS and memory preset 1 at the same time.

**Troubleshooting**

<b>SIRIUS® Troubleshooting Tips</b>		
<b>Radio Display</b>	<b>Condition</b>	<b>Possible Action</b>
Acquiring	Radio requires more than two seconds to produce audio for the selected channel.	No action required. This message should disappear shortly.
Sat Fault/SIRIUS® system failure	There is an internal module or system failure present.	If this message does not clear shortly, or with an ignition key cycle, your receiver may have a fault. See your authorized dealer for service.

<b>SIRIUS® Troubleshooting Tips</b>		
<b>Radio Display</b>	<b>Condition</b>	<b>Possible Action</b>
Invalid Channel	The channel is no longer available.	Tune to another channel or choose another preset.
Unsubscribed Channel	Your subscription does not include this channel.	Contact SIRIUS® at 1-888-539-7474 to subscribe to the channel, or tune to another channel.
No Signal	The signal is lost from the SIRIUS satellite or SIRIUS tower to your vehicle antenna.	The signal is blocked. When you move into an open area, the signal should return.
Updating	Update of channel programming in progress.	No action required. The process may take up to three minutes.
Call SIRIUS® 1-888-539-7474	Your satellite service is no longer available.	Call SIRIUS at 1-888-539-7474 to resolve subscription issues.
No Channels Available	All the channels in the selected channels are either skipped or locked.	Use the channel guide to turn off the Lock or Skip function on that station.
Subscription Updated	SIRIUS has updated the channels available for your vehicle.	No action required.



## MANUAL HEATING AND AIR CONDITIONING SYSTEM

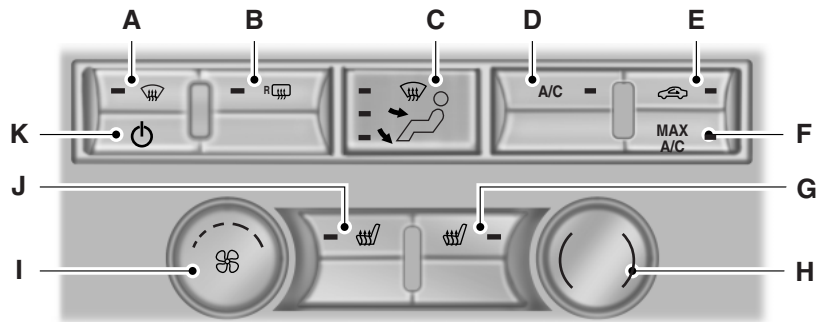

**A. Defrost:** Distributes air through the windshield defroster vents and demister vents. This setting can also be used to defog and clear the windshield of a thin covering of ice.

**B. Rear defrost:** Turns the heated windows and mirrors on and off. See *Heated windows and mirrors* later in this chapter for more information.

**C. Air distribution control:** You can set the air distribution control to any position between the symbols.



Distributes air through the windshield defroster vents, demister vents and floor vents.



Distributes air through the instrument panel vents.



Distributes air through the instrument panel vents, floor vents, and demister vents.



Distributes air through the floor vents.

D. **A/C:** Press to turn air conditioning on or off. Air conditioning cools the vehicle using outside air. To improve air conditioning when starting your vehicle, drive with the windows slightly open for two to three minutes.

E. **Recirculated air:** Press to switch between outside air and recirculated air. When the LED on the button is lit, the air currently in the passenger compartment is being recirculated. Using recirculated air can reduce the time needed to cool the interior and reduce unwanted odors from entering your vehicle.

F. **MAX A/C:** Distributes recirculated air through the instrument panel vents to cool the vehicle. This position is more economical and efficient than normal A/C.

G. **Passenger heated seat control (if equipped):** Turns the passenger heated seat on and off. See *Heated seats* in the *Seats* chapter for more information.

H. **Temperature control:** Controls the temperature of the air circulated in your vehicle. Turn to select the desired temperature.

I. **Fan speed control:** Controls the volume of air circulated in your vehicle. Turn to select the desired fan speed or switch off. If you switch the fan off, the windshield may fog up.

J. **Driver heated seat control (if equipped):** Turns the driver heated seat on and off. See *Heated seats* in the *Seats* chapter for more information.

K. **Power:** Press to turn the system on and off. When the system is off, outside air is prevented from entering the vehicle.

### DUAL ZONE AUTOMATIC TEMPERATURE CONTROL SYSTEM (WITH NAVIGATION SYSTEM)



**Note:** To use the touchscreen controls, see the *Touchscreen climate controls* in the *Navigation System* chapter.

A. **CLIMATE:** Control the system through the touchscreen display. See *Touchscreen functions* later in this section.

B. **Rear defrost:** Turns the heated windows and mirrors on and off. See *Heated windows and mirrors* later in this chapter for more information. If your vehicle is equipped with heated mirrors, this button turns them on also.

C. **A/C:** Press to turn air conditioning on or off. Air conditioning cools the vehicle using outside air. To improve air conditioning when starting your vehicle, drive with the windows slightly open for two to three minutes.

Use A/C with recirculated air to improve cooling performance and efficiency.

**Note:** A/C turns on automatically in MAX A/C, Defrost and Floor/Defrost.

D. **Passenger temperature control:** Press to increase or decrease the air temperature on the passenger side of the vehicle.

E. **Passenger heated seat control (if equipped):** Turn the passenger heated seat on and off. See *Heated seats* in the *Seats* chapter for more information.

F. **Recirculated air:** Press to switch between outside air and recirculated air. When the LED on the button is lit, the air currently in the passenger compartment is being recirculated. Using recirculated air can reduce the time needed to cool the interior and reduce unwanted odors from entering your vehicle.

**Note:** Recirculated air engages automatically when MAX A/C is selected or can be turned on manually in any airflow mode except Defrost.

G. **Fan speed control:** Press + or - to increase or decrease the volume of air circulated in your vehicle.

H. **AUTO:** Press to turn on fully automatic operation. Select the desired temperature using the temperature control. The system automatically determines fan speed, air distribution, A/C operation, and outside or recirculated air, to heat or cool the vehicle to maintain the selected temperature.

I. **Driver temperature control:** Press to increase or decrease the air temperature on the driver side of the vehicle. This control also adjusts the passenger side temperature when dual zone operation is disengaged.

J. **Driver heated seat control (if equipped):** Turn the driver heated seat on and off. See *Heated seats* in the *Seats* chapter for more information.

K. **Power:** Press to turn the climate control system on and off. When the system is off, outside air is prevented from entering the vehicle. The system status in the touchscreen is also turned off. When the power is turned back on, the system defaults to fully automatic control.

L. **Defrost:** Distributes air through the windshield defroster vents and demister vents. This setting can also be used to defog and clear the windshield of a thin covering of ice.

## GENERAL OPERATING TIPS

### Manual Heating and Air Conditioning System

- To reduce fog build-up on the windshield during humid weather, select Defrost. Temperature and fan speed can also be increased to improve clearing.
- To reduce humidity build-up inside the vehicle, do not drive with the system off or with recirculated air engaged.
- Do not put objects under the front seats that will interfere with the airflow to the back seats.
- Remove any snow, ice or leaves from the air intake area at the base of the windshield.

- To improve the A/C cool down, drive with the windows slightly open for 2-3 minutes after start-up or until the vehicle has been aired out.
- A small amount of air may be felt from the floor vent regardless of the air distribution setting that is selected.

During extreme high ambient temperatures when idling stationary for extended periods of time in gear, it is recommended to run the A/C in the MAX A/C mode, adjust the blower fan speed to the lowest setting and put the vehicle's transmission into position **P** (vehicles equipped with an automatic transmission) to continue to receive cool air from your A/C system.

For maximum cooling performance in A/C mode, press MAX A/C.

For maximum cooling performance in panel or panel/floor modes:

1. Move temperature control to the coolest setting.
2. Select A/C and recirculated air to provide colder airflow.
3. Set the fan to the highest speed initially, then adjust to maintain comfort.

To aid in side window defogging and demisting in cold or humid weather:

1. Select Floor/Panel.
2. Select A/C.
3. Adjust the temperature control to maintain comfort.
4. Set the fan speed to the highest setting.
5. Direct the outer instrument panel vents toward the side windows.
6. To increase airflow to the outer instrument panel vents, close the vents located in the middle of the instrument panel.

#### **Dual Zone Automatic Temperature Control**

- To reduce fog build-up on the windshield during humid weather, select Defrost. Temperature and fan speed can also be increased to improve clearing.
- To reduce humidity build-up inside the vehicle, do not drive with the system off or with recirculated air engaged.
- Do not put objects under the front seats that will interfere with the airflow to the back seats.
- Remove any snow, ice or leaves from the air intake area at the base of the windshield.
- To improve the A/C cool down, drive with the windows slightly open for 2-3 minutes after start-up or until the vehicle has been aired out.
- A small amount of air may be felt from the floor vent regardless of the air distribution setting that is selected.

During extreme high ambient temperatures when idling stationary for extended periods of time in gear, it is recommended to run the A/C in the MAX A/C mode, adjust the blower fan speed to the lowest setting and put the vehicle's transmission into position **P** (vehicles equipped with an automatic transmission) to continue to receive cool air from your A/C system.

For maximum cooling performance in AUTO mode, press MAX A/C.

For maximum cooling performance in manual override control:

1. Choose Panel, A/C, and recirc controls.
2. Set the temperature to LO.
3. Set the fan to the highest blower setting.

To aid in side window defogging and demisting in cold or humid weather:

1. Select Floor/Panel.
2. Select A/C.
3. Adjust the temperature control to maintain comfort.
4. Set the fan speed to the highest setting.
5. Direct the outer instrument panel vents toward the side windows.
6. To increase airflow to the outer instrument panel vents, close the vents located in the middle of the instrument panel.

## HEATED WINDOWS AND MIRRORS (IF EQUIPPED)

### Heated Rear Window

**Note:** The vehicle must be running to use this feature.

Press the control to clear the rear window of thin ice and fog. Press the control again within 15 minutes to switch it off. It turns off automatically after approximately 15 minutes, or when you switch the ignition off.

**Do not use razor blades or other sharp objects to clean the inside of the rear window or to remove decals from the inside of the rear window. This may cause damage to the heated grid lines and will not be covered by your warranty.**

### Heated Exterior Mirror (If Equipped)

**Note:** Do not remove ice from the mirrors with a scraper or attempt to readjust the mirror glass if it is frozen in place. These actions could cause damage to the glass and mirrors.

**Note:** Do not clean the housing or glass of any mirror with harsh abrasives, fuel or other petroleum-based cleaning products.

Both mirrors are heated to remove ice, mist and fog when the rear window defroster is activated.

**CABIN AIR FILTER**

**Note:** A cabin air filter must be installed at all times to prevent foreign objects from entering the system. Running the system without a filter in place could result in degradation or damage to the system.

Your vehicle is equipped with a cabin air filter, which is located just in front of the windshield under the cowl grille on the passenger side of the vehicle.

The particulate air filtration system is designed to reduce the concentration of airborne particles, such as dust, spores and pollen, in the air being supplied to the interior of the vehicle. The particulate filtration system gives the following benefits to customers:

- Improves the customer's driving comfort by reducing particle concentration.
- Improves the interior compartment cleanliness.
- Protects the climate control components from particle deposits.

For more information regarding the interval at which you should replace the cabin air filter, see the *Scheduled Maintenance* chapter.

For additional cabin air filter information, or to replace the filter, see an authorized dealer.



**SITTING IN THE CORRECT POSITION**

**!** **WARNING:** Sitting improperly out of position or with the seat back reclined too far can take off weight from the seat cushion and affect the decision of the passenger sensing system, resulting in serious injury or death in a crash. Always sit upright against your seat back, with your feet on the floor.

**!** **WARNING:** Do not recline the seat back as this can cause the occupant to slide under the seat's safety belt, resulting in severe personal injury in the event of a crash.

**!** **WARNING:** Do not place objects higher than the seat backs to reduce the risk of injury in a crash or during heavy braking or when stopping suddenly.

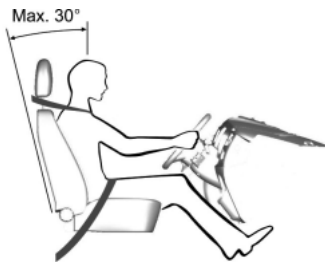

When you use them properly, the seat, head restraint, safety belt and airbags will provide optimum protection in the event of a crash.

We recommend that you follow these guidelines:

- Do not recline the seat back more than 30 degrees from vertical.

- Sit in an upright position with the base of your spine as far back as possible.
- Adjust the head restraint so that the top of it is level with the top of your head and as far forward as possible, remaining comfortable.
- Keep sufficient distance between yourself and the steering wheel. We recommend a minimum of 10 inches (250 millimeters) between your breastbone and the airbag cover.
- Hold the steering wheel with your arms slightly bent.
- Bend your legs slightly so that you can press the pedals fully.
- Position the shoulder strap of the safety belt over the center of your shoulder and position the lap strap tightly across your hips.

Make sure that your driving position is comfortable and that you can maintain full control of your vehicle.



**HEAD RESTRAINTS**

**WARNING:** To minimize the risk of neck injury in the event of a crash, the driver and passenger occupants should not sit in or operate the vehicle, until the head restraint is placed in its proper position. The driver should never adjust the head restraint while the vehicle is in motion.

**WARNING:** The adjustable head restraint is a safety device. Whenever possible it should be installed and properly adjusted when the seat is occupied.

**WARNING:** Install the head restraint properly to minimize the risk of neck injury in the event of a crash.

**Note:** Before adjusting any head restraint, adjust the seat back to an upright driving or riding position. Properly adjust the head restraint so that the top of the head restraint is even with the top of your head and positioned as close as possible to the back of your head. For occupants of extremely tall stature, adjust the head restraint to its full up position.

To adjust the head restraint, do the following:

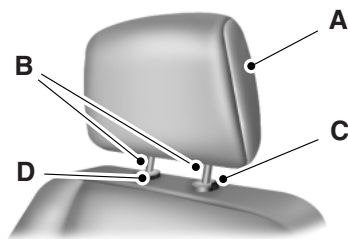
**Front Seat Head Restraints (If Equipped)**

The head restraints consist of:

- A. An energy absorbing head restraint
- B. Two steel stems
- C. Guide sleeve adjust and release button
- D. Guide sleeve unlock and remove button

- Raise: Pull up on the head restraint (A).
- Lower: Press and hold the guide sleeve adjust and release button (C) and push down on the head restraint (A).
- Remove: Pull up the head restraint until it reaches the highest adjustment position and then press and hold both the adjust and release button (C) and the unlock and remove button (D), then pull up on the head restraint.

- Reinstall: Align the steel stems into the guide sleeves and push the head restraint down until it locks.

**Front Seat Non-adjustable Head Restraints (If Equipped)**

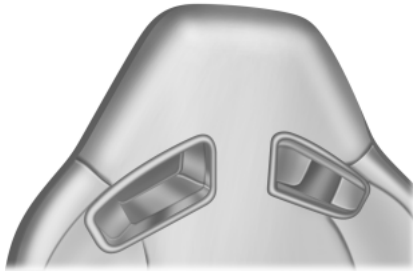

The non-adjustable head restraints consist of a trimmed foam covering over the upper structure of the seat back.

Properly adjust the seat back to an upright driving/riding position, so that the head restraint is positioned as close as possible to the back of your head.

**Rear Seat Non-adjustable Outboard Head Restraints**

The second row outboard non-adjustable head restraints can be rotated forward to improve rear vision when there are no rear occupants.

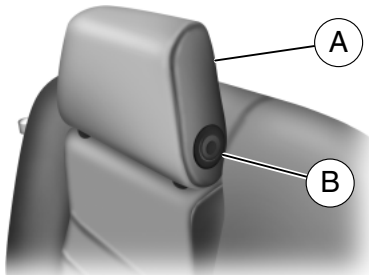

The non-adjustable head restraints consist of:

- A. a trimmed energy absorbing foam and structure
- B. a rotation button.

Press the rotation button to rotate the head restraint forward in order to improve rear vision when there are no rear seat occupants.

Properly adjust the head restraint to an upright driving or riding position by lifting up on the head restraint until it locks into its original position.

**Tilting Head Restraints (If Equipped)**

The front head restraints may have a tilting feature for extra comfort. To tilt the head restraint, do the following:



1. Adjust the seat back to an upright driving or riding position.
2. Tilt the head restraint forward by gently pulling the top of the head restraint.

Once it is in its forward-most position, tilt it forward once more to release it to the upright position.

**Note:** Do not attempt to force the head restraint backward after it is tilted. Instead, continue tilting it forward until the head restraint releases to the upright position.

**MANUAL SEATS**

**WARNING:** Do not adjust the driver's seat or seat back while the vehicle is moving.



**WARNING:** Rock the seat backwards and forwards after releasing the lever to make sure that it is fully engaged.

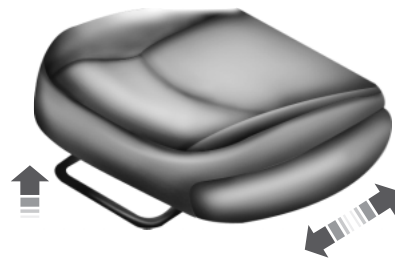

**Moving the seats backward and forward**

**Recline adjustment**

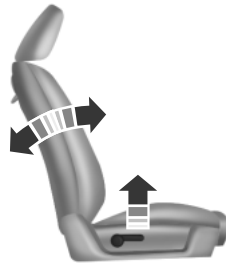

**!** **WARNING:** Always drive and ride with your seat back upright and the lap belt snug and low across the hips.

**Adjusting the height of the driver's seat**

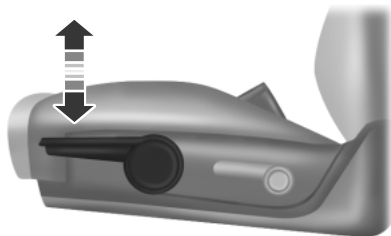

**POWER SEATS (IF EQUIPPED)**

**!** **WARNING:** Never adjust the driver's seat or seat back when the vehicle is moving.

**!** **WARNING:** Before returning the seat back to its original position, make sure that cargo or any objects are not trapped behind the seat back.

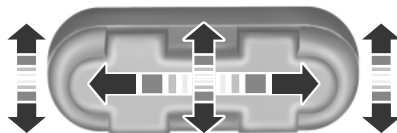

The power seat control is located on the outboard side of the seat. Move the switch in the direction of the arrows to raise or lower the seat cushion or to move the seat forward, backward, up or down.

**Power Lumbar (If Equipped)**

The power lumbar control is located on the top of the driver's seat side shield.

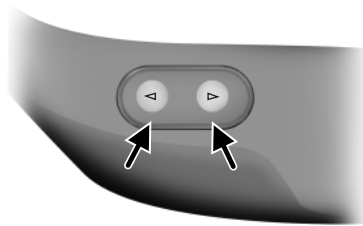

- Press one side of the control to increase lower back firmness.
- Press the other side of the control to decrease lower back firmness.

**HEATED SEATS (IF EQUIPPED)**

**⚠ WARNING:** Persons who are unable to feel pain to the skin because of advanced age, chronic illness, diabetes, spinal cord injury, medication, alcohol use, exhaustion, or other physical conditions, must exercise care when using the seat heater. The seat heater may cause burns even at low temperatures, especially if used for long periods of time. Do not place anything on the seat that insulates against heat, such as a blanket or cushion, because this may cause the seat heater to overheat. Do not puncture the seat with pins, needles, or other pointed objects because this may damage the heating element which may cause the seat heater to overheat. An overheated seat may cause serious personal injury.

The heated seats will only function when the ignition is in the on position.

**Note:** Do not do the following:

- place heavy objects on the seat.
- operate the seat heater if water or any other liquid is spilled on the seat. Allow the seat to dry thoroughly.

The heated seat control is located in the lower center of the instrument panel.

To operate the heated seats:



- Press to activate.
- Press again to deactivate.

**REAR SEATS**

**Rear Seat Entry and Exit**



Use the seat back release to fold the back of the front seat forward for rear seat access. This release handle is located on the upper back of the front seat. The seat back locks automatically when returned to the normal position.

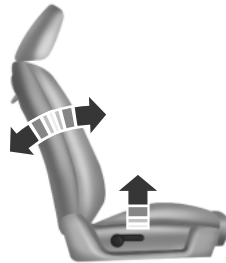

Use the recliner handle to return the seat back to the desired position.

**2nd Row Seat/Split-Folding Rear Seat (If Equipped)**

 **WARNING:** Before returning the seat back to its original position, make sure that cargo or any objects are not trapped behind the seat back. After returning the seat back to its original position, pull on the seat back to ensure that it has fully latched. An unlatched seat may become dangerous in the event of a sudden stop or crash.

One or both rear seat backs (coupe only) can be folded down to provide additional cargo space.





To lower the seat back(s) from inside the vehicle, be sure the head restraint is in the upright position, pull the strap to release the seat back and then fold the seat back down.

When raising the seat back(s), make sure you hear the seat latch into place. Pull down on the seat back to ensure that it has latched.

## Universal Garage Door Opener (If Equipped) 143

### HOMELINK® WIRELESS CONTROL SYSTEM (IF EQUIPPED)

 **WARNING:** Make sure that the garage door and security device are free from obstruction when you are programming. Do not program the system with the vehicle in the garage.

 **WARNING:** Do not use the system with any garage door opener that does not have the safety stop and reverse feature as required by U.S. Federal Safety Standards (this includes any garage door opener manufactured before April 1, 1982).

**Note:** Make sure you keep the original remote control transmitter for use in other vehicles as well as for future system programming.

**Note:** We recommend that upon the sale or lease termination of your vehicle, you erase the programmed function buttons for security reasons. See *Erasing the function button codes* later in this section.

**Note:** You can program a maximum of three devices. To change or replace any of the three devices after it has been initially programmed, you must first erase the current settings. See *Erasing the function button codes* later in this section.



The universal garage door opener replaces the common hand-held garage door opener with a three-button transmitter that is integrated into the driver's sun visor.

The system includes two primary features, a garage door opener and a platform for remote activation of devices with the home. As well as being programmed for garage doors, the system transmitter can be programmed to operate entry gate operators, security systems, entry door locks, and home or office lighting.

Additional system information can be found on-line at [www.homelink.com](http://www.homelink.com) or by calling the toll-free help line on 1-800-355-3515.

2013 05+ Mustang (197)  
Owners Guide gf, 3rd Printing  
USA (fus)



## 144 Universal Garage Door Opener (If Equipped)

### Programming

**Note:** Put a new battery in the hand-held transmitter. This will ensure quicker training and accurate transmission of the radio-frequency signal.

1. With your vehicle parked outside of the garage and your key in the ignition, turn the key so that it is in the on position.

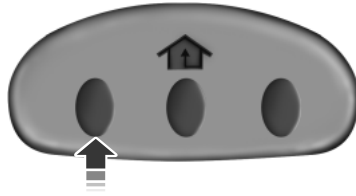

2. Hold your hand-held, garage door transmitter 1–3 inches (2–8 centimeters) away from the HomeLink button you want to program.

3. Press and hold both the HomeLink button you want to program and the hand-held

transmitter button until the HomeLink indicator light changes from flashing slowly to rapidly, then release.

4. Press and hold the HomeLink button you programmed for 5 seconds, then release. You may need to do this twice to activate the door. If your garage door does not operate, watch the HomeLink indicator light.

If the indicator light stays on, the programming is complete. Press and release the programmed HomeLink button, and then begin programming your garage door opener. See below for Steps 5 – 7.

If the indicator light flashes rapidly for two seconds and then turns to a constant light, the HomeLink button is not programmed yet. Do the following:

Press and hold the HomeLink button while you press and release the hand-held transmitter button every 2 seconds. The HomeLink indicator light will flash slowly and then rapidly once the HomeLink function button recognizes and accepts the hand-held transmitter's radio frequency signal.

After programming the HomeLink button, follow Steps 5 – 7 as listed below to program your garage door opener.

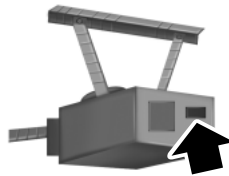

**Note:** You may need a ladder to reach the unit and you may need to remove the cover or lamp lens on your garage door opener.

5. Press the learn button on the garage door opener motor, and then you have 30 seconds to complete the next step.

## Universal Garage Door Opener (If Equipped) 145

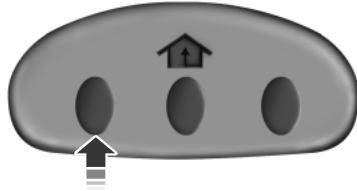

6. Return to your car.
7. Press and hold the function button you want to program for 2 seconds, then release. Repeat this step. Depending on your brand of garage door opener, you may need to repeat this sequence a third time.

To program additional buttons, repeat Steps one through four.

For questions or comments, please contact HomeLink® at [www.homelink.com](http://www.homelink.com) or 1-800-355-3515.

### Erasing the Function Button Codes

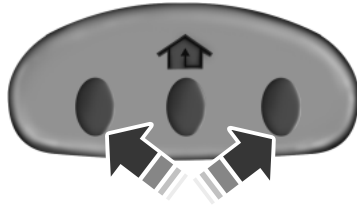

**Note:** You cannot erase individual buttons.

1. Press and hold the outer two function buttons simultaneously for approximately 20 seconds until the indicator lights above the buttons flash rapidly.
2. When the indicator lights flash, release the buttons. The codes for all buttons are erased.

### Reprogramming a single button

To program a device to a previously trained button, follow these steps:

1. Press and hold the desired button. **Do NOT** release the button.
2. The indicator light will begin to flash after 20 seconds. Without releasing the button, follow Step 1 in the *Programming* section.

For questions or comments, contact HomeLink® at [www.homelink.com](http://www.homelink.com) or 1-800-355-3515.

## 146 Universal Garage Door Opener (If Equipped)

### Programming HomeLink® to a Genie Intellicode® 2 garage door opener

**Note:** The Genie Intellicode® 2 transmitter must already be programmed to operate with the garage door opener.

#### Programing the transmitters

To program HomeLink® to the transmitter you must first put the transmitter into programming mode. To do this

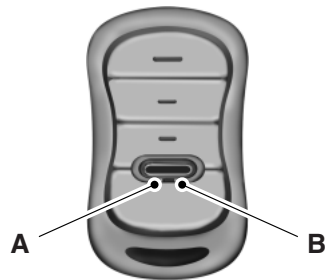

- A. Red LED
- B. Green LED

1. Press and hold one of the buttons on the hand-held transmitter for 10 seconds. The LED light will change from green to green and red.
2. Press the same button twice to confirm the change to Programming mode. If done properly the LED light will appear red.
3. Hold the transmitter within 1–3 inches (2–8 centimeters) of the button on the sun visor you want to program.
4. Press and hold both the programmed Genie button on the hand-held transmitter and the button on the sun visor you want to program. The indicator light on the sun visor will flash rapidly when the programming is successful.

**Note:** the Genie transmitter will transmit for up to 30 seconds. If HomeLink® does not program within 30 seconds the Genie transmitter will need to be pressed again. If the Genie transmitter LED displays green and red, release the button until the LED turns off before pressing the button again.

Once HomeLink® has been programmed successfully, the Genie transmitter must be changed out of program mode. To do this:

1. Press and hold the previously programmed Genie button on the hand-held transmitter for 10 seconds. The indicator light will change from red to red and green.
2. Press the same button twice to confirm the change. If done correctly the LED will turn green.

## Universal Garage Door Opener (If Equipped) 147

### **Programming HomeLink® to the Genie Intellicode® garage door opener motor**

**Note:** You may need a ladder to access the garage door opener motor.

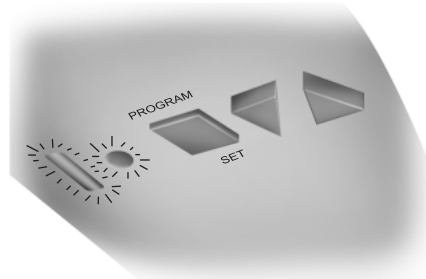

To program HomeLink® to the garage door opener motor.

1. Press and hold the PROGRAM button on the garage door opener motor until both blue LED's turn on.
2. Release the PROGRAM button. Only the smaller round LED should be on.
3. Press and release the program button. The larger purple LED will flash.  
**Note:** The next two steps must be completed in 30 seconds.
4. Press and release the Genie Intellicode 2 hand-held transmitter's previously programmed button. Both indicator lights on the garage door opener motor unit should now flash purple.
5. Press and hold the previously programmed button on the sun visor for 2 seconds. Repeat this step up to 3 times until the garage door moves. Programming is now complete.

At this point, programming is complete.

### **Clearing a HomeLink® device**

To erase programming from the three HomeLink® buttons, press and hold the two outer HomeLink® buttons until the indicator light begins to flash. The LED will begin flashing in 10 to 20 seconds, at which time both buttons should be released. Programming has now been erased, and the led should blink slowly to indicate the device is in train mode when any of the three HomeLink buttons are pressed.

### **FCC and RSS-210 Industry Canada Compliance**

This device complies with Part 15 of the FCC Rules and with RSS-210 of Industry Canada. Operation is subject to the following two conditions: (1) this device may not cause harmful interference, and (2) this device must accept any interference received, including interference that may cause undesired operation.

Changes or modifications to your device not expressly approved by the party responsible for compliance can void the user's authority to operate the equipment.

**2013 05+ Mustang (197)  
Owners Guide gf, 3rd Printing  
USA (fus)**

**AUXILIARY POWER POINTS**

**WARNING:** Do not plug optional electrical accessories into the cigarette lighter socket (if equipped). Improper use of the lighter can cause damage not covered by your warranty, and can result in fire or serious injury.

**Note:** If used when the engine is not running, the battery will discharge. There may be insufficient power to restart your engine.

**Note:** Do not insert objects other than an accessory plug into the power point. This will damage the outlet and blow the fuse.

**Note:** Do not hang any type of accessory or accessory bracket from the plug.

**Note:** Do not use the power point over the vehicle capacity of 12 volt DC 180 watts or a fuse may blow.

**Note:** Do not use the power point for operating a cigarette lighter element.

**Note:** Improper use of the power outlet can cause damage not covered by your warranty.

**Note:** Always keep the power point caps closed when not in use.

Run the engine for full capacity use of the power point. To prevent the battery from being discharged:

- Do not use the power point longer than necessary when the engine is not running.
- Do not leave devices plugged in overnight or when the vehicle is parked for extended periods.

**Locations**

Power points may be found:

- on the instrument panel
- in the center console storage compartment.



**CENTER CONSOLE**

**WARNING:** Use only soft cups in the cupholder. Hard objects can injure you in a collision.



Your vehicle may be equipped with a variety of console features.

- Cupholders in the front of the console (Pull the door open to access.)  
Remove the spacer from the cupholder to hold deeper cups.
- Lockable storage bin (Use the ignition key to lock or unlock the console bin and press the latch to open the console.)
- Auxiliary power point
- Coin holder slots
- Audio input jack
- USB port (if equipped)





## 150 Starting and Stopping the Engine

---

### GENERAL INFORMATION

 **WARNING:** Extended idling at high engine speeds can produce very high temperatures in the engine and exhaust system, creating the risk of fire or other damage.

 **WARNING:** Do not park, idle, or drive your vehicle on dry grass or other dry ground cover. The emission system heats up the engine compartment and exhaust system, which can start a fire.

 **WARNING:** Do not start your vehicle in a closed garage or in other enclosed areas. Exhaust fumes can be toxic. Always open the garage door before you start the engine.

 **WARNING:** If you smell exhaust fumes inside your vehicle, have your vehicle checked by an authorized dealer immediately. Do not drive if you smell exhaust fumes.

If you disconnect the battery, your vehicle may exhibit some unusual driving characteristics for approximately 5 miles (8 kilometers) after you connect it. This is because the engine management system must realign itself with the engine. You may disregard any unusual driving characteristics during this period.

The powertrain control system meets all Canadian interference-causing equipment standard requirements regulating the impulse electrical field strength of radio noise.

When starting your vehicle, avoid pressing the accelerator pedal before and during operation. Only use the accelerator pedal when you have difficulty starting the engine.

**IGNITION SWITCH**

**Note:** Do not store the key in the ignition after the vehicle is turned off and you have left the vehicle. This could cause a drain on the battery.

**Note:** In order to switch off the engine while the vehicle is in motion, shift to neutral and use the brakes to bring the vehicle to a safe stop. After the vehicle has stopped, shift into park and turn the engine off. Then, turn the key to the accessory or off position.

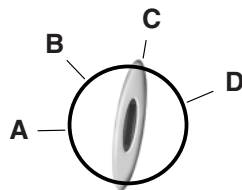

A. **Off:** The ignition is off.

B. **Accessory:** Allows the electrical accessories, such as the radio, to operate while the engine is not running.

C. **On:** All the electrical circuits are operational. Warning lights are illuminated. This is the key position when driving.

D. **Start:** Cranks the engine. The engine may continue cranking for up to 10 seconds or until the vehicle starts. Release the key as soon as the engine starts.

**STARTING A GASOLINE ENGINE**

When the engine starts, the idle RPM runs faster to warm the engine. If the engine idle speed does not slow down automatically, have the vehicle checked.

Before starting the vehicle:

- Make sure all occupants buckle their safety belts.
- Make sure the headlamps and electrical accessories are off.
- If starting a vehicle with an automatic transmission, make sure the gearshift is in position **P** and the parking brake is set.
- If starting a vehicle with a manual transmission, make sure the parking brake is set, then push the clutch pedal to the floor.
- Turn the key to on without turning the key to start.

Some warning lights briefly illuminate.

**Note:** Do not touch the accelerator pedal.

1. Fully press the brake pedal.



## 152 Starting and Stopping the Engine

---

2. Select position **P** or **N**.
3. Turn the key to start the engine. The engine may continue cranking for up to 15 seconds or until the vehicle starts.

**Note:** If the engine does not start on the first try, wait for a short period of time and try again.

If you have difficulty starting the engine when the temperature is below  $-13^{\circ}\text{F}$  ( $-25^{\circ}\text{C}$ ), press the accelerator pedal slightly and try again.

If the engine does not start after three attempts, wait 10 seconds and follow this flooded engine procedure.

1. Fully press the brake pedal.
2. Fully press the accelerator pedal and hold it there.
3. Select position **P** or **N**.
4. Start the engine.

### Guarding Against Exhaust Fumes



**WARNING:** If you smell exhaust fumes inside your vehicle, have this checked immediately. Do not drive your vehicle if you smell exhaust fumes. Carbon monoxide is present in exhaust fumes. Take precautions to avoid its dangerous effects.

### Important Ventilating Information

If you stop your vehicle and leave the engine idling for long periods of time, we recommend that you do one of the following:

- Open the windows at least 1 inch (2.5 centimeters).
- Set your climate control to outside air.

### ENGINE BLOCK HEATER (IF EQUIPPED)



**WARNING:** Failure to follow engine block heater instructions could result in property damage or physical injury.



**WARNING:** Do not use your heater with ungrounded electrical systems or two-pronged (cheater) adapters. There is a risk of electrical shock.

**Note:** The heater is most effective when outdoor temperatures are below  $0^{\circ}\text{F}$  ( $-18^{\circ}\text{C}$ ).



The heater acts as a starting aid by warming the engine coolant. This allows the climate control system to respond quickly. The equipment includes a heater element (installed in the engine block) and a wire harness. You can connect the system to a grounded 120 volt A/C electrical source.

We recommend that you do the following for safe and correct operation:

- Use a 16-gauge outdoor extension cord that is product certified by Underwriter's Laboratory or Canadian Standards Association. This extension cord must be able to be used outdoors, in cold temperatures, and be clearly marked *Suitable for Use with Outdoor Appliances*. Never use an indoor extension cord outdoors; it could result in an electric shock or become a fire hazard.
- Use as short an extension cord as possible.
- Do not use multiple extension cords.
- Make sure that when in operation, the extension cord plug and the heater cord plug connections are free and clear of water. This could cause an electric shock or fire.
- Make sure your vehicle is parked in a clean area, clear of combustibles.
- Make sure the heater, heater cord and extension cord are firmly connected.
- Check for heat anywhere in the electrical hookup once the system has been operating for approximately 30 minutes.
- Make sure the system is unplugged and properly stowed before driving your vehicle. Make sure the protective cover seals the prongs of the block heater cord plug when not in use.
- Make sure the heater system is checked for proper operation before winter.

### Using the Engine Block Heater

Make sure the receptacle terminals are clean and dry prior to use. Clean them with a dry cloth, if necessary.

The heater uses 0.4 to 1.0 kilowatt-hours of energy per hour of use. The system does not have a thermostat. It achieves maximum temperature after approximately three hours of operation. Using the heater longer than three hours does not improve system performance and unnecessarily uses electricity.

**SAFETY PRECAUTIONS**

**WARNING:** Do not overfill the fuel tank. The pressure in an overfilled tank may cause leakage and lead to fuel spray and fire.



**WARNING:** The fuel system may be under pressure. If you hear a hissing sound near the fuel filler inlet, do not refuel until the sound stops. Otherwise, fuel may spray out, which could cause serious personal injury.



**WARNING:** Automotive fuels can cause serious injury or death if misused or mishandled.



**WARNING:** The flow of fuel through a fuel pump nozzle can produce static electricity, which can cause a fire if fuel is pumped into an ungrounded fuel container.



**WARNING:** Fuel ethanol and gasoline may contain benzene, which is a cancer-causing agent.



**WARNING:** When refueling always shut the engine off and never allow sparks or open flames near the filler neck. Never smoke while refueling. Fuel vapor is extremely hazardous under certain conditions. Care should be taken to avoid inhaling excess fumes.

Observe the following guidelines when handling automotive fuel:

- Extinguish all smoking materials and any open flames before refueling your vehicle.
- Always turn off the vehicle before refueling.
- Automotive fuels can be harmful or fatal if swallowed. Fuel, such as gasoline, is highly toxic and if swallowed can cause death or permanent injury. If fuel is swallowed, call a physician immediately, even if no symptoms are immediately apparent. The toxic effects of fuel may not be visible for hours.
- Avoid inhaling fuel vapors. Inhaling too much fuel vapor of any kind can lead to eye and respiratory tract irritation. In severe cases, excessive or prolonged breathing of fuel vapor can cause serious illness and permanent injury.



- Avoid getting fuel liquid in your eyes. If fuel is splashed in the eyes, remove contact lenses (if worn), flush with water for 15 minutes and seek medical attention. Failure to seek proper medical attention could lead to permanent injury.
- Fuels can also be harmful if absorbed through the skin. If fuel is splashed on the skin or clothing, promptly remove contaminated clothing and wash skin thoroughly with soap and water. Repeated or prolonged skin contact with fuel liquid or vapor causes skin irritation.
- Be particularly careful if you are taking Antabuse or other forms of disulfiram for the treatment of alcoholism. Breathing gasoline vapors, or skin contact could cause an adverse reaction. In sensitive individuals, serious personal injury or sickness may result. If fuel is splashed on the skin, promptly wash skin thoroughly with soap and water. Consult a physician immediately if you experience an adverse reaction.

### FUEL QUALITY

**Note:** Use of any fuel other than those recommended may cause powertrain damage, a loss of vehicle performance, and repairs may not be covered under warranty.

### Choosing the Right Fuel

Use only UNLEADED fuel or UNLEADED fuel blended with a maximum of 15% ethanol. Do not use fuel ethanol (E85), diesel fuel, fuel-methanol, leaded fuel or any other fuel because it could damage or impair the emission control system. The use of leaded fuel is prohibited by law.

### Octane Recommendations

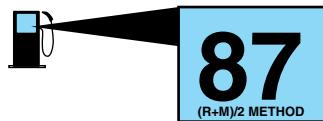

- 3.7L V6 engine

Regular unleaded gasoline with a pump (R+M)/2 octane rating of 87 is recommended. Some stations offer fuels posted as Regular with an octane rating below 87, particularly in high altitude areas. Fuels with octane levels below 87 are not recommended.

- 5.0L V8 engine

Regular unleaded gasoline with a pump (R+M)/2 octane rating of 87 is recommended. Some stations offer fuels posted as "Regular" with an octane rating below 87, particularly in high altitude areas. Fuels with

octane levels below 87 are not recommended. Premium fuel will provide improved performance and is recommended for severe duty usage, such as trailer tow.

- For Shelby GT500 octane requirements, see the Shelby GT500 Supplement.
- For Boss® 302 octane requirements, see the Boss® 302 Supplement.

Do not be concerned if your engine sometimes knocks lightly. However, if it knocks heavily while you are using fuel with the recommended octane rating, see your authorized dealer to prevent any engine damage.

### RUNNING OUT OF FUEL

Avoid running out of fuel because this situation may have an adverse effect on powertrain components.

If you have run out of fuel:

- You may need to cycle the ignition from off to on several times after refueling to allow the fuel system to pump the fuel from the tank to the engine. On restarting, crank time will take a few seconds longer than normal. With keyless ignition, just start the engine. Crank time will be longer than usual.
- Normally, adding 1 gallon (3.8L) of fuel is enough to restart the engine. If the vehicle is out of fuel and on a steep grade, more than 1 gallon (3.8L) may be required.
- The service engine soon indicator may come on. For more information on the service engine soon indicator, see to *Warning Lamps and Indicators* in the *Instrument Cluster* chapter.

### Refilling with a Portable Fuel Container



**WARNING:** Do not insert the nozzle of portable fuel containers or aftermarket funnels into the capless fuel system. This could damage the fuel system and its seal, and may cause fuel to run onto the ground instead of filling the tank, which could result in serious personal injury.



**WARNING:** Do not try to pry open or push open the capless fuel system with foreign objects. This could damage the fuel system and its seal and cause injury to you or others.



**Note:** Do not use aftermarket funnels; they will not work with the capless fuel system and can damage it. The included funnel has been specially designed to work safely with your vehicle.

When filling the vehicle's fuel tank from a portable fuel container, use the funnel included with the vehicle.

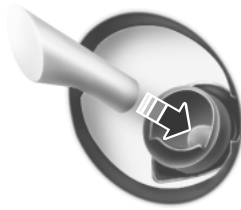

1. Locate the white plastic funnel in the spare tire compartment.
2. Slowly insert the funnel into the capless fuel system.
3. Fill the vehicle with fuel from the portable fuel container.

4. When done, clean the funnel or properly dispose of it. Extra funnels can be purchased from your authorized dealer if you choose to dispose of the funnel.

### REFUELING



**WARNING:** Fuel vapor burns violently and a fuel fire can cause severe injuries. To help avoid injuries to you and others:

- Read and follow all the instructions on the pump island;
- Turn off your engine when you are refueling;
- Do not smoke if you are near fuel or refueling your vehicle;
- Keep sparks, flames and smoking materials away from fuel;
- Stay outside your vehicle and do not leave the fuel pump unattended when refueling your vehicle - this is against the law in some places;
- Keep children away from the fuel pump; never let children pump fuel;
- Do not use personal electronic devices while refueling.

Use the following guidelines to avoid electrostatic charge build-up when filling an ungrounded fuel container:

- Place approved fuel container on the ground.
- DO NOT fill a fuel container while it is in the vehicle (including the cargo area).
- Keep the fuel pump nozzle in contact with the fuel container while filling.
- DO NOT use a device that would hold the fuel pump handle in the fill position.

**Easy Fuel® No Cap Fuel System**

**WARNING:** The fuel system may be under pressure. If you hear a hissing sound near the fuel filler door, do not refuel until the sound stops. Otherwise, fuel may spray out, which could cause serious personal injury.

When fueling your vehicle:

1. Turn the engine off.
2. Open the fuel filler door by pressing the center of the door about one inch from the door's rear edge.
3. Slowly insert the fuel filler nozzle fully into the fuel system, and leave the nozzle fully inserted until you are done pumping.
4. After you are done pumping fuel, slowly remove the fuel filler nozzle—allow about ten seconds after pumping fuel before removing the fuel filler nozzle. This allows residual fuel to drain back into the fuel tank and not spill onto the vehicle.

**Note:** A fuel spillage concern may occur if overfilling the fuel tank. Do not overfill the tank to the point that the fuel is able to bypass the fuel filler nozzle. The overfilled fuel may run down the drain located within the fuel filler housing and to the ground.

If the fuel fill inlet was not properly closed, a Check Fuel Fill Inlet message may appear on the information display.

At the next opportunity, do the following:

1. Safely pull off the road.
2. Turn off the engine.
3. Open the fuel filler door and remove any visible debris from the fuel fill opening.
4. Insert either the fuel fill nozzle or the fuel fill funnel provided with the vehicle several times to dislodge any debris and allow the inlet to close properly.

If this action corrects the problem, the message may not reset immediately. It may take several driving cycles for the message to turn off. A driving cycle consists of an engine start-up (after four or more hours with the engine off) followed by city or highway driving. Continuing to drive with the message on may cause the service engine soon lamp to turn on as well.



**FUEL CONSUMPTION****Filling the Tank**

The advertised capacity is the indicated capacity and the empty reserve combined. Indicated capacity is the difference in the amount of fuel in a full tank and a tank when the fuel gauge indicates empty. Empty reserve is the amount of fuel in the tank after the fuel gauge indicates empty.

**Note:** The amount of usable fuel in the empty reserve varies and should not be relied upon to increase driving range. When refueling your vehicle after the fuel gauge indicates empty, you might not be able to refuel the full amount of the advertised capacity of the fuel tank due to the empty reserve still present in the tank.

For consistent results when filling the fuel tank:

- Turn the ignition off before fueling; an inaccurate reading results if the engine is left running.
- Use the same fill rate (low–medium–high) each time the tank is filled.
- Allow no more than two automatic click–offs when filling.

Results are most accurate when the filling method is consistent.

**Calculating Fuel Economy**

Do not measure fuel economy during the first 1000 miles (1600 kilometers) of driving (this is your engine's break-in period); a more accurate measurement is obtained after 2000 miles–3000 miles (3200 kilometers–4800 kilometers). Also, fuel expense, frequency of fill-ups or fuel gauge readings are not accurate ways to measure fuel economy.

1. Fill the fuel tank completely and record the initial odometer reading.
2. Each time you fill the tank, record the amount of fuel added.
3. After at least three to five tank fill-ups, fill the fuel tank and record the current odometer reading.
4. Subtract your initial odometer reading from the current odometer reading.
5. Calculate fuel economy as follows:

Standard: Divide miles traveled by gallons used.

Metric: Multiply liters used by 100, then divide by kilometers traveled.

Keep a record for at least one month and record the type of driving (city or highway). This provides an accurate estimate of the vehicle's fuel economy under current driving conditions. Additionally, keeping records during summer and winter show how temperature impacts fuel economy. In general, lower temperatures mean lower fuel economy.



**EMISSION CONTROL SYSTEM**

**WARNING:** Do not park, idle, or drive your vehicle in dry grass or other dry ground cover. The emission system heats up the engine compartment and exhaust system, which can start a fire.



**WARNING:** Exhaust leaks may result in entry of harmful and potentially lethal fumes into the passenger compartment. If you smell exhaust fumes inside your vehicle, have your dealer inspect your vehicle immediately. Do not drive if you smell exhaust fumes.

Your vehicle is equipped with various emission control components and a catalytic converter which will enable your vehicle to comply with applicable exhaust emission standards. To make sure that the catalytic converter and other emission control components continue to work properly:

- Use only the specified fuel listed.
- Avoid running out of fuel.
- Do not turn off the ignition while your vehicle is moving, especially at high speeds.
- Have the items listed in *Scheduled Maintenance Information* performed according to the specified schedule.

The scheduled maintenance items listed in *Scheduled Maintenance Information* are essential to the life and performance of your vehicle and to its emissions system.

If other than Ford, Motorcraft® or Ford-authorized parts are used for maintenance replacements or for service of components affecting emission control, such non-Ford parts should be equivalent to genuine Ford Motor Company parts in performance and durability.

Illumination of the service engine soon indicator, charging system warning light or the temperature warning light, fluid leaks, strange odors, smoke or loss of engine power could indicate that the emission control system is not working properly.

An improperly operating or damaged exhaust system may allow exhaust to enter the vehicle. Have a damaged or improperly operating exhaust system inspected and repaired immediately.



Do not make any unauthorized changes to your vehicle or engine. By law, vehicle owners and anyone who manufactures, repairs, services, sells, leases, trades vehicles, or supervises a fleet of vehicles are not permitted to intentionally remove an emission control device or prevent it from working. Information about your vehicle's emission system is on the Vehicle Emission Control Information Decal located on or near the engine. This decal also lists engine displacement.

Please consult your warranty information for complete emission warranty information.

### On-board Diagnostics (OBD-II)

Your vehicle is equipped with a computer that monitors the engine's emission control system. This system is commonly known as the on-board diagnostics system (OBD-II). The OBD-II system protects the environment by ensuring that your vehicle continues to meet government emission standards. The OBD-II system also assists your authorized dealer in properly servicing your vehicle.



When the service engine soon indicator illuminates, the OBD-II system has detected a malfunction. Temporary malfunctions may cause the service engine soon indicator to illuminate.

Examples are:

1. The vehicle has run out of fuel—the engine may misfire or run poorly.
2. Poor fuel quality or water in the fuel—the engine may misfire or run poorly.
3. The fuel fill inlet may not have been properly closed. See *Easy Fuel® No Cap Fuel System* in this chapter.
4. Driving through deep water—the electrical system may be wet.

These temporary malfunctions can be corrected by filling the fuel tank with good quality fuel, properly closing the fuel fill inlet or letting the electrical system dry out. After three driving cycles without these or any other temporary malfunctions present, the service engine soon indicator should stay off the next time the engine is started. A driving cycle consists of a cold engine start-up followed by mixed city or highway driving. No additional vehicle service is required.

If the service engine soon indicator remains on, have your vehicle serviced at the first available opportunity. Although some malfunctions detected by the OBD-II may not have symptoms that are apparent, continued driving with the service engine soon indicator on can result in increased emissions, lower fuel economy, reduced engine and transmission smoothness, and lead to more costly repairs.

**Readiness for Inspection/Maintenance (I/M) Testing**

Some state, provincial and local governments may have Inspection/Maintenance (I/M) programs to inspect the emission control equipment on your vehicle. Failure to pass this inspection could prevent you from getting a vehicle registration.



If the service engine soon indicator is on or the bulb does not work, the vehicle may need to be serviced. See *On-board Diagnostics (OBD-II)* in this chapter.

Your vehicle may not pass the I/M test if the service engine soon indicator is on or not working properly (bulb is burned out), or if the OBD-II system has determined that some of the emission control systems have not been properly checked. In this case, the vehicle is considered not ready for I/M testing.

If the vehicle's engine or transmission has just been serviced, or the battery has recently run down or been replaced, the OBD-II system may indicate that the vehicle is not ready for I/M testing. To determine if the vehicle is ready for I/M testing, turn the ignition key to the on position for 15 seconds without cranking the engine. If the service engine soon indicator blinks eight times, it means that the vehicle is not ready for I/M testing; if the service engine soon indicator stays on solid, it means that the vehicle is ready for I/M testing.

The OBD-II system is designed to check the emission control system during normal driving. A complete check may take several days. If the vehicle is not ready for I/M testing, the following driving cycle consisting of mixed city and highway driving may be performed:

15 minutes of steady driving on an expressway or highway followed by 20 minutes of stop-and-go driving with at least four 30-second idle periods.

Allow the vehicle to sit for at least eight hours without starting the engine. Then, start the engine and complete the above driving cycle. The engine must warm up to its normal operating temperature. Once started, do not turn off the engine until the above driving cycle is complete. If the vehicle is still not ready for I/M testing, the above driving cycle will have to be repeated.

**AUTOMATIC TRANSMISSION (IF EQUIPPED)**

**WARNING:** Always set the parking brake fully and make sure the gearshift is latched in position P. Turn the ignition off and remove the key whenever you leave your vehicle.

Your vehicle has been designed to improve fuel economy by reducing fuel usage while coasting or decelerating. When you take your foot off the accelerator pedal and the vehicle begins to slow down, the torque converter clutch locks up and aggressively shuts off fuel flow to the engine while decelerating. This fuel economy benefit may be perceived as a light to medium braking sensation when removing your foot from the accelerator pedal.

**Position P**

This position locks the transmission and prevents the front wheels from turning.

To put your vehicle in gear:

- Press the brake pedal.
- Move the gearshift lever into the desired gear.

To put your vehicle in position P:

- Come to a complete stop.
- Move the gearshift lever and securely latch it in position P.

**Position R**

With the gearshift lever in position R, the vehicle will move backward. Always come to a complete stop before shifting into and out of position R.

**Position N**

With the gearshift lever in position N, the vehicle can be started and is free to roll. Hold the brake pedal down while in this position.

**Position D with overdrive**

The normal driving position for the best fuel economy. The transmission operates in gears one through six. The automatic transmission shift strategy has the ability to detect hilly terrain or mountainous areas and will provide a limited amount of grade assist features automatically.

**Position S**

Moving the gearshift lever to position:

- Provides additional grade (engine) braking and extends lower gear operation to enhance performance for uphill climbs, hilly terrain or mountainous areas. This will increase engine RPM during engine braking.
- Provides additional lower gear operation through the automatic transmission shift strategy which reacts to vehicle inputs (vehicle acceleration, accelerator pedal, brake pedal and vehicle speed).
- Gears are selected more quickly and at higher engine speeds.

**Note:** The system will stay in position S until the gear shift lever is moved into another gear for example position P or position D.

**SelectShift Automatic® Transmission**

Your SelectShift automatic transmission gives you the ability to manually change gears if you would like. To use SelectShift, move the gearshift lever into position S. Now you can use the thumb toggle on the side of your gearshift lever to select gears.



- Press (+) on the gearshift lever to manually upshift the transmission.
- Press (-) on the gearshift lever to manually downshift the transmission.

The information display in the instrument cluster will show the selected gear you are currently in.

In order to prevent the engine from running at too low an RPM, which may cause it to stall, SelectShift will automatically make some downshifts even if it has determined that you have not downshifted in time.

Although the SelectShift will make some downshifts for you, it will still allow you to downshift at any time as long as the SelectShift determines that the engine will not be damaged from over-revving.

**Note:** Engine damage may occur if excessive engine revving is held without shifting.

**Note:** Some models have a blink feature (if equipped). If manually selecting a gear that is out of the current vehicle speed range, the vehicle will not make the requested shift and will blink the current gear.

### Brake-shift interlock



**WARNING:** Do not drive your vehicle until you verify that the brakelamps are working.



**WARNING:** When doing this procedure, you will be taking the vehicle out of park which means the vehicle can roll freely. To avoid unwanted vehicle movement, always fully set the parking brake prior to doing this procedure. Use wheel chocks if appropriate.



**WARNING:** If the parking brake is fully released, but the brake warning lamp remains illuminated, the brakes may not be working properly. Contact your authorized dealer as soon as possible to have the system serviced immediately.

This vehicle is equipped with a brake-shift interlock feature that prevents the gearshift lever from being moved from **P** (Park) when the ignition is in the on position unless the brake pedal is pressed.

If you cannot move the gearshift lever out of **P** (Park) with the ignition on and the brake pedal pressed:

1. Apply the parking brake.

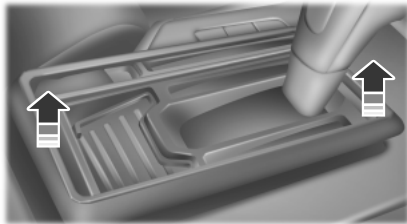

2. Using a flat head screwdriver or similar tool, remove the chrome bezel at the base of the gearshift lever.

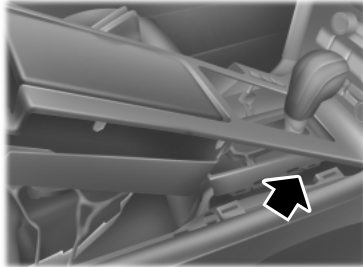

3. Lift the center console upward to access the base of the gear shifter assembly and locate the brakeshift interlock override lever.

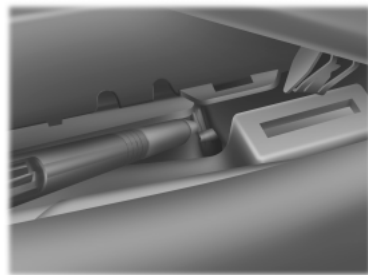

4. Press and hold the lever forward while pulling the gearshift lever out of the **P** (Park) position and into the **N** (Neutral) position.

5. Reinstall the console and chrome bezel.

6. Start the vehicle.

If it is necessary to use the above procedure to move the gearshift lever, it is possible that a fuse has blown or the vehicle's brake lamps are not operating properly. Refer to the *Fuses* chapter.

#### **If Your Vehicle Gets Stuck in Mud or Snow**

**Note:** Do not rock the vehicle if the engine is not at normal operating temperature or damage to the transmission may occur.

**Note:** Do not rock the vehicle for more than a minute or damage to the transmission and tires may occur, or the engine may overheat.

If your vehicle gets stuck in mud or snow, it may be rocked out by shifting between forward and reverse gears, stopping between shifts in a steady pattern. Press lightly on the accelerator in each gear.

**MANUAL TRANSMISSION (IF EQUIPPED)****Using the Clutch**

Manual transmission vehicles have a starter interlock that prevents starting the engine unless the clutch pedal is fully pressed.

To start the vehicle:

1. Make sure the parking brake is fully set.
2. Press the clutch pedal to the floor, then put the gearshift lever in the neutral position.
3. Start the engine.
4. Press the brake pedal and move the gearshift lever to the desired gear; position 1 or position R .
5. Release the parking brake, then slowly release the clutch pedal while slowly pressing on the accelerator.

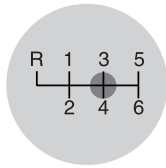

During each shift, the clutch pedal must be fully pressed to the floor. Make sure the floor mat is properly positioned so it does not interfere with the full extension of the clutch pedal.

**Note:** Failure to fully press the clutch pedal to the floor may cause increased shift efforts, prematurely wear transmission components or damage the transmission.

**Note:** Do not drive with your foot resting on the clutch pedal or use the clutch pedal to hold your vehicle at a standstill while waiting on a hill. These actions will reduce the life of the clutch.



**Recommended Shift Speeds**

**Note:** Do not downshift into position 1 when your vehicle is moving faster than 15 mph (24 km/h). This may damage the clutch or transmission.

Upshift according to the following charts.

For the 3.7L V6 with 2.73 axle ratio, shift according to the following chart:

<b>Upshifts when accelerating (recommended for best fuel economy)</b>	
Shift from:	
1 - 2	15 mph (24 km/h)
2 - 3	25 mph (40 km/h)
3 - 4	40 mph (64 km/h)
4 - 5	45 mph (72 km/h)
5 - 6	50 mph (80 km/h)

For the 3.7L V6 with 3.31 axle ratio, shift according to the following chart:

<b>Upshifts when accelerating (recommended for best fuel economy)</b>	
Shift from:	
1 - 2	13 mph (21 km/h)
2 - 3	26 mph (42 km/h)
3 - 4	37 mph (59 km/h)
4 - 5	43 mph (69 km/h)
5 - 6	59 mph (95 km/h)

For the 5.0L V8, shift according to the following chart:

<b>Upshifts when accelerating (recommended for best fuel economy)</b>	
Shift from:	
1 - 2	12 mph (27 km/h)
2 - 3	24 mph (40 km/h)
3 - 4	31 mph (64 km/h)
4 - 5	39 mph (72 km/h)
5 - 6	43 mph (80 km/h)

**Reverse**

**Note:** The gearshift lever can only be moved to position R by pushing the knob down before shifting to reverse. This is a lockout feature which protects the transmission from accidentally engaging position R when intending to select position 1.

1. Make sure that your vehicle is at a complete stop before you shift into position R . Failure to do so may damage the transmission.
2. Press the clutch pedal to the floor to disengage clutch.

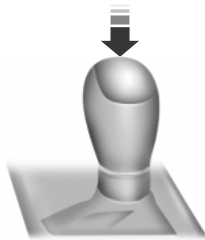

3. Shift into position R by pushing the gearshift knob down, then moving the lever fully to the left, then forward.

**Note:** Do not press down on the shifter during any operation other than shifting to position R, as you may be inhibited from selecting your desired gear.

If position R is not fully engaged, press the clutch pedal down and return the gearshift to the neutral position. Release the clutch pedal for a moment, then press it down and shift to position R again.

**Parking Your Vehicle**

**WARNING:** Do not park your vehicle in Neutral, it may move unexpectedly and injure someone. Use 1 (First) gear and set the parking brake fully.

To park your vehicle:

1. Apply the brake and shift into the neutral position.
2. Fully apply the parking brake, hold the clutch pedal down, then shift into position 1.
3. Turn the ignition off.

**AXLE INFORMATION****Traction-Lok™ Axle (If Equipped)**

This axle provides added traction on slippery surfaces, particularly when one wheel is on a poor traction surface. Under normal conditions, the Traction-Lok™ axle functions like a standard rear axle.

Extended use of other than the manufacturer's specified size tires on a Traction-Lok™ rear axle could result in a permanent reduction in effectiveness. This loss of effectiveness does not affect normal driving and should not be noticeable to the driver.

**Axle with TORSEN® Differential (If Equipped)**

This axle provides added traction on slippery surfaces, particularly when one wheel is on a poor traction surface. Under normal conditions, the axle equipped with a TORSEN® differential functions like a standard rear axle.

Extended use of other than the manufacturer's specified size tires on a rear axle equipped with a TORSEN® differential could result in a permanent reduction in effectiveness. This loss of effectiveness does not affect normal driving and should not be noticeable to the driver.

**HILL START ASSIST (IF EQUIPPED)**

**WARNING:** The hill start assist feature does not replace the parking brake. When you leave the vehicle, always apply the parking brake and shift the transmission into position P for automatic transmission or position 1 for manual transmissions.



**WARNING:** You must remain in the vehicle once you have activated the hill start assist feature.



**WARNING:** During all times, you are responsible for controlling the vehicle, supervising the hill start assist system and intervening, if required.



**WARNING:** If the engine is revved excessively, or if a malfunction is detected when the hill start assist feature is active, the hill start assist feature will be deactivated.



This feature makes it easier to pull away when the vehicle is on a slope without the need to use the parking brake. When this feature is active, the vehicle will remain stationary on the slope for two to three seconds after you release the brake pedal. This allows you time to move your foot from the brake to the accelerator pedal. The brakes are released automatically once the engine has developed sufficient drive to prevent the vehicle from rolling down the slope. This is an advantage when pulling away on a slope, (for example from a car park ramp, traffic lights or when reversing uphill into a parking space).

This feature is activated automatically on any slope that can result in significant vehicle rollback. This feature will not operate if the parking brake is activated.

### Using Hill Start Assist

**Note:** If the engine is revved excessively, hill start assist will be deactivated.

1. Press the brake pedal to bring the vehicle to a complete standstill. Keep the brake pedal pressed.
2. If the sensors detect that the vehicle is on a slope, the hill start assist feature will be activated automatically.
3. When you remove your foot from the brake pedal, the vehicle will remain on the slope without rolling away for approximately two or three seconds. This hold time will automatically be extended if you are in the process of driving off.
4. Drive off in the normal manner. The brakes will be released automatically.

### Disabling and Enabling the Hill Start Assist Feature

Your vehicle comes with hill start assist already enabled. If desired, you can disable the feature by following the procedure below.

The following procedure must be completed within 45 seconds or the process will have to be repeated. Begin this procedure with the ignition turned off. This procedure is for both disabling and enabling the hill start assist system.

1. Apply the parking brake to make sure the vehicle is not moving.
2. Turn the ignition on.
3. Place the vehicle in neutral gear.

4. Slowly press and release the brake pedal five times – make sure the brake pedal is completely released each time.
5. Rotate the steering wheel at least one full turn to the right and return the steering wheel to the original starting position.
6. Rotate the steering wheel at least one full turn to the left and return the steering wheel to the original starting position.
7. Slowly press and release the brake pedal five times – ensure the brake pedal is completely released each time.

When the procedure has been completed successfully, the ABS icon in the instrument cluster will flash:

- three times indicating that the feature has been disabled.
- twice indicating it has been enabled.

Once the feature is programmed as desired, it will remain in that mode until the above procedure is repeated.

**Note:** When the AdvanceTrac® system is disabled (see the *Traction Control* chapter in your *owner's manual* for information on how to do this), the hill start assist feature is also disabled for the duration that the AdvanceTrac® system is in that mode. Re-enabling AdvanceTrac® will also re-enable hill start assist.

**Note:** If you have used the above procedure to disable the hill start assist feature, then enabling or disabling AdvanceTrac® will not effect the hill start assist system.



**GENERAL INFORMATION**

**Note:** Occasional brake noise is normal. If a metal-to-metal, continuous grinding or continuous squeal sound is present, the brake linings may be worn-out and should be inspected by an authorized dealer. If your vehicle has continuous vibration or shudder in the steering wheel while braking, it should be inspected by an authorized dealer.

**Note:** Brake dust may accumulate on the wheels, even under normal driving conditions. Some dust is inevitable as the brakes wear and does not contribute to brake noise. See the *Vehicle Care* chapter for wheel cleaning instructions.



See the *Instrument Cluster* chapter for information on the brake system warning light.

Wet brakes result in reduced braking efficiency. Gently press the brake pedal a few times when driving from a car wash or standing water to dry the brakes.

**Brake Over Accelerator**

If the accelerator pedal becomes stuck or entrapped, apply steady and firm pressure to the brake pedal to slow your vehicle and reduce engine power. If you experience this condition, apply the brakes and bring your vehicle to a safe stop. Turn the engine off, shift to position **P** and apply the parking brake, then inspect the accelerator pedal for any interferences. If none are found and the condition persists, have your vehicle towed to the nearest authorized dealer.

**Anti-Lock Brake System**

This system helps you maintain steering control during emergency stops by keeping the brakes from locking.



The anti-lock brake system lamp momentarily illuminates when the ignition is turned on. If the light does not illuminate during start-up, remains on or flashes, the anti-lock brake system may be disabled and may need to be serviced.



If the anti-lock brake system is disabled, normal braking is still effective. If the brake warning lamp illuminates with the parking brake released, have your brake system serviced immediately.

**HINTS ON DRIVING WITH ANTI-LOCK BRAKES**

When the system is operating, the brake pedal will pulse and may travel further. Maintain pressure on the brake pedal. You may also hear a noise from the system. This is normal.

The ABS will not eliminate the dangers inherent when:

- you drive too closely to the vehicle in front of you.
- your vehicle is hydroplaning.
- you take corners too fast.
- the road surface is poor.

**PARKING BRAKE**

**WARNING:** If the parking brake is fully released, but the brake warning lamp remains illuminated, the brakes may not be working properly. See your authorized dealer as soon as possible.



**WARNING:** Always set the parking brake fully and make sure that the transmission selector lever is securely latched in position **P** (automatic transmission) or position **1** (manual transmission).

To set the parking brake, pull the parking brake handle up as far as possible.

To release the parking brake:

1. Press and hold the button located at the end of the parking brake handle.
2. Pull the handle up slightly, then push the handle down.



**PRINCIPLES OF OPERATION**

The traction control system helps avoid drive wheel spin and loss of traction.

If your vehicle begins to slide, the system applies the brakes to individual wheels and, when needed, reduces engine power at the same time. If the wheels spin when accelerating on slippery or loose surfaces, the system reduces engine power in order to increase traction.

**USING TRACTION CONTROL**

In certain situations (for example, stuck in snow or mud), turning the traction control off may be beneficial as this allows the wheels to spin with full engine power. Turn off the traction control system by pressing the stability control button located on the center console.

**System Indicator Lights and Messages**

**WARNING:** If a failure has been detected within the AdvanceTrac® system, the stability control light and the stability control off light will illuminate steadily. Verify that the traction control system was not manually disabled through the information display. If the stability control light still illuminates steadily, have the system serviced by an authorized dealer immediately. Operating your vehicle with AdvanceTrac® disabled could lead to an increased risk of loss of vehicle control, vehicle rollover, personal injury and death.



The stability control light temporarily illuminates on engine start-up and flashes when a driving condition activates the stability system.





The stability control off light temporarily illuminates on engine start-up and stays on when the system is in sport mode, the traction control system is turned off, or AdvanceTrac® is turned off.

When the traction control system is turned off or on, a message appears in the information display showing system status.



**PRINCIPLES OF OPERATION**

 **WARNING:** Vehicle modifications involving braking system, aftermarket roof racks, suspension, steering system, tire construction and wheel or tire size may change the handling characteristics of the vehicle and may adversely affect the performance of the AdvanceTrac® system. In addition, installing any stereo loudspeakers may interfere with and adversely affect the AdvanceTrac® system. Install any aftermarket stereo loudspeaker as far as possible from the front center console, the tunnel, and the front seats in order to minimize the risk of interfering with the AdvanceTrac® sensors. Reducing the effectiveness of the AdvanceTrac® system could lead to an increased risk of loss of vehicle control, vehicle rollover, personal injury and death.

 **WARNING:** Remember that even advanced technology cannot defy the laws of physics. It is always possible to lose control of a vehicle due to inappropriate driver input for the conditions. Aggressive driving on any road condition can cause you to lose control of your vehicle increasing the risk of personal injury or property damage. Activation of the AdvanceTrac® system is an indication that at least some of the tires have exceeded their ability to grip the road; this could reduce the operator's ability to control the vehicle potentially resulting in a loss of vehicle control, vehicle rollover, personal injury and death. If your AdvanceTrac® system activates, SLOW DOWN.

The AdvanceTrac® system helps you keep control of your vehicle when on a slippery surface. The electronic stability control portion of the system helps avoid skids and lateral slides and the traction control system helps avoid drive wheel spin and loss of traction. See the *Traction Control* chapter for details on traction control system operation.

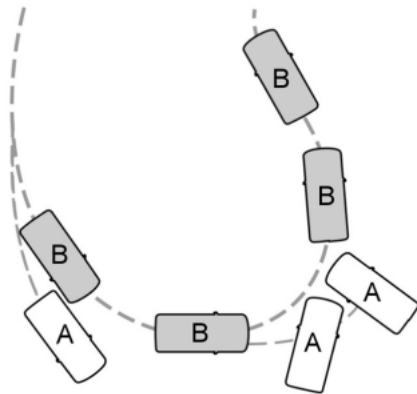

**A** Vehicle without AdvanceTrac® skidding off its intended route.

**B** Vehicle with AdvanceTrac® maintaining control on a slippery surface.

**USING ADVANCETRAC®**

The system automatically is enabled when you start your engine. The electronic stability control portion of the system is disabled when the transmission is in position **R** or, on some models, if the stability control button is pressed and held for more than five seconds when the brakes are applied and the vehicle is at a stop. The traction control portion of the system can be turned off independently. See the *Traction Control* chapter.

AdvanceTrac® Features				
Button functions	Mode	Icon status	ESC	TCS
Default at start-up	—	On during bulb check	Enabled	Enabled
Button pressed momentarily	Traction control off	On	Enabled	Disabled

AdvanceTrac® Features				
Button functions	Mode	Icon status	ESC	TCS
Button pressed twice; brakes applied	Sport mode (if equipped)	On	Enabled	Enabled
Button pressed and held more than 5 seconds; brakes applied; no throttle	AdvanceTrac® Disabled	On	Disabled	Disabled
Button pressed again after deactivation	AdvanceTrac® fully enabled	Off	Enabled	Enabled

**Note:** Sport mode is not intended to be used on public roadways.

Some models may also come equipped with a sport mode which allows the driver to reduce normal AdvanceTrac® system intervention and provide a more spirited driving experience. To enter sport mode, press the stability control button twice rapidly with the brakes applied. The message appears in the information display that the system is now in sport mode.

### SENSING SYSTEM (IF EQUIPPED)

 **WARNING:** To help avoid personal injury, please read and understand the limitations of the system as contained in this section. Sensing is only an aid for some (generally large and fixed) objects when moving in reverse on a flat surface at parking speeds. Traffic control systems, inclement weather, air brakes, and external motors and fans may also affect the function of the sensing system; this may include reduced performance or a false activation.

 **WARNING:** To help avoid personal injury, always use caution when the transmission is in **R** and when using the sensing system.

 **WARNING:** This system is not designed to prevent contact with small or moving objects. The system is designed to provide a warning to assist the driver in detecting large stationary objects to avoid damaging the vehicle. The system may not detect smaller objects, particularly those close to the ground.

 **WARNING:** Certain add-on devices, such as large trailer hitches, bike or surfboard racks and any device that may block the normal detection zone of the system, may create false beeps.

**Note:** Keep the sensors (located on the bumper/fascia) free from snow, ice and large accumulations of dirt. If the sensors are covered, the system's accuracy can be affected. Do not clean the sensors with sharp objects.

**Note:** If your vehicle sustains damage to the bumper/fascia, leaving it misaligned or bent, the sensing zone may be altered causing inaccurate measurement of obstacles or false alarms.

The sensing system warns the driver of obstacles within a certain range of the bumper area. The system turns on automatically whenever the ignition is switched on.

When receiving a detection warning, the radio volume is reduced to a predetermined level. After the warning goes away, the radio volume returns to the previous level.

The system can be turned off using the information display control. See the *Information Display* chapter. If a fault is present in the system, a warning message appears in the information display and does not allow the driver to switch the faulted system on.

### Using the Rear Sensing System

The rear sensors are only active when the transmission is in **R**. As the vehicle moves closer to the obstacle, the rate of the audible warning increases. When the obstacle is fewer than 12 inches (30 centimeters) away, the warning sounds continuously. If a stationary or receding object is detected farther than 12 inches (30 centimeters) from the side of the vehicle, the tone sounds for only three seconds. Once the system detects an object approaching, the warning sounds again.

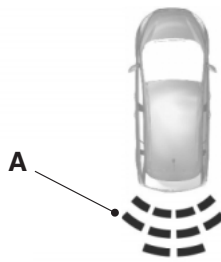

A. Coverage area of up to 6 feet (2 meters) from the rear bumper (with a decreased coverage area at the outer corners of the bumper).

The system detects certain objects while the transmission is in **R**:

- and moving toward a stationary object at a speed of 3 mph (5 km/h) or less.
- but not moving, and a moving object is approaching the rear of the vehicle at a speed of 3 mph (5 km/h) or less.
- and moving at a speed of less than 3 mph (5 km/h) and a moving object is approaching the rear of the vehicle at a speed of less than 3 mph (5 km/h).

### REAR VIEW CAMERA SYSTEM (IF EQUIPPED)



**WARNING:** The rear view camera system is a reverse aid supplement device that still requires the driver to use it in conjunction with the interior and exterior mirrors for maximum coverage.



**WARNING:** Objects that are close to either corner of the bumper or under the bumper, might not be seen on the screen due to the limited coverage of the camera system.



**WARNING:** Back up as slow as possible since higher speeds might limit your reaction time to stop the vehicle.

 **WARNING:** Use caution when using the rear video camera and the trunk is ajar. If the trunk is ajar, the camera will be out of position and the video image may be incorrect. All guidelines (if enabled) have been removed when the trunk is ajar.

 **WARNING:** Use caution when turning camera features on or off while the transmission is in **R**. Make sure the vehicle is not moving.

The rear view camera system provides a video image of the area behind the vehicle.

During operation, lines appear in the display which represent your vehicle's path and proximity to objects behind the vehicle.



The camera is located on the trunk.

**Using the Rear View Camera System**

The rear view camera system displays what is behind your vehicle when you place the transmission in **R**. The system uses fixed guidelines which show the actual path the vehicle is moving in while reversing in a straight line. This can be helpful when backing into a parking space or aligning the vehicle with another object behind the vehicle.

**Note:** Do not use the camera system if the trunk is ajar.

**Note:** If the image comes on while the transmission is not in **R**, have the system inspected by your authorized dealer.

**Note:** When towing, the camera only sees what is being towed behind the vehicle. This might not provide adequate coverage as it usually provides in normal operation and some objects might not be seen. In some vehicles, the guidelines may disappear once the trailer tow connector is engaged.

**Note:** The camera may not operate correctly under the following conditions:

- Nighttime or dark areas if one or both reverse lamps are not operating.
- The camera's view is obstructed by mud, water or debris. Clean the lens with a soft, lint-free cloth and non-abrasive cleaner.
- The rear of the vehicle is hit or damaged, causing the camera to become misaligned.

### Guidelines

**Note:** The guidelines are only available when the transmission is in **R**.

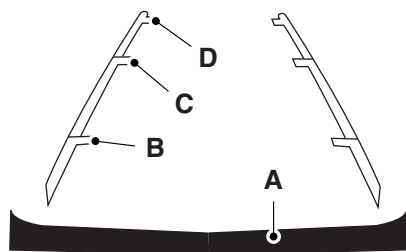

- A. Rear bumper
- B. Fixed guideline: Red zone
- C. Fixed guideline: Yellow zone
- D. Fixed guideline: Green zone

The fixed guidelines fade in and out depending on the steering wheel position.

Always use caution while reversing. Objects in the red zone are closest to your vehicle and objects in the green zone are further away. Objects are getting closer to your vehicle as they move from the green zone to the yellow or red zones. Use the side view mirrors and rear view mirror to get better coverage on both sides and rear of the vehicle.

### Rear Camera Delay

**On vehicles without a navigation system,** the camera image in the rear view mirror remains on for a few seconds to assist in parking or attaching a trailer.

**On vehicles with a navigation system,** the camera image remains in the display until the vehicle speed reaches 5 mph (8 km/h). This occurs when the rear camera delay feature is on, or until a radio button is selected. Selectable settings for this feature are ON and OFF. The default setting for the rear camera delay is OFF.

**PRINCIPLES OF OPERATION**

Cruise control lets you maintain a set speed without keeping your foot on the accelerator pedal.

**USING CRUISE CONTROL**

**WARNING:** Do not use cruise control in heavy traffic or on roads that are winding, slippery or unpaved.

**Note:** Vehicle speed may vary momentarily when driving up or down a steep hill. Apply the brakes if the vehicle speed increases above the set speed while driving downhill.

**Note:** Cruise control will disengage if the vehicle speed decreases more than 10 mph (16 km/h) below your set speed while driving uphill.

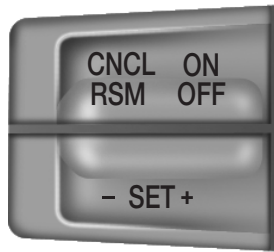

The cruise controls are located on the steering wheel.

**Switching Cruise Control On**

Press and release **ON**.



The indicator will appear in the instrument cluster.

**Setting a Speed**

1. Accelerate to the desired speed.
2. Press and release **SET+**.
3. Take your foot off the accelerator pedal.

The indicator will change colors in the instrument cluster.



**Changing the Set Speed**

**Note:** If you accelerate by pressing the accelerator pedal, the set speed will not change. When you release the accelerator pedal, you will return to the speed that you previously set.

- Press and hold **SET+** or **SET-**. Release the control when you reach the desired speed.
- Press and release **SET+** or **SET-**. The set speed will change in approximately 1 mph (2 km/h) increments.
- Press the accelerator or brake pedal until you reach the desired speed. Press and release **SET+**.

**Canceling the Set Speed**

Press **CNCL** or tap the brake pedal. You will not erase the set speed.

**Resuming the Set Speed**

Press and release **RSM**.

**Switching Cruise Control Off**

**Note:** You will erase the set speed if you switch the system off.

Press and release **OFF** or switch the ignition off.



**STEERING****Electric Power Steering**

**WARNING:** The electric power steering system has diagnostic checks that continuously monitor the system to ensure proper operation. When a system error is detected a steering message will appear in the information display.



**WARNING:** The electric power steering system has diagnostic checks that continuously monitor the system to ensure proper operation of the electronic system. When an electronic error is detected, a message will be displayed in the information display. If this happens, stop the vehicle in a safe place, and turn off the engine. After at least 10 seconds, reset the system by restarting the engine, and watch the information display for a steering message. If a steering message returns, or returns while driving, take the vehicle to your dealer to have it checked.



**WARNING:** Obtain immediate service if a system error is detected. You may not notice any difference in the feel of your steering, but a serious condition may exist. Failure to do so may result in loss of steering control.

Your vehicle is equipped with an electric power-assisted steering system. There is no fluid reservoir to check or fill.

If your vehicle loses electrical power while you are driving (or if the ignition is turned off), you can steer the vehicle manually, but it takes more effort. Extreme continuous steering may increase the effort it takes for you to steer. This occurs to prevent internal overheating and permanent damage to your steering system. If this should occur, you will neither lose the ability to steer the vehicle manually nor will it cause permanent damage. Typical steering and driving maneuvers will allow the system to cool and steering assist will return to normal.

When a steering system error is detected, steering messages may appear in the information display.

**Steering Tips**

If the steering wanders or pulls, check for:

- an improperly inflated tire
- uneven tire wear
- loose or worn suspension components
- loose or worn steering components
- improper vehicle alignment

A high crown in the road or high crosswinds may also make the steering seem to wander/pull.

**Selectable Steering**

**Note:** The steering setting defaults to standard if the battery is disconnected or removed.

See the *Information Displays* chapter.

You can select the desired steering feel using the information display control. The settings are:

- Standard: Default factory setting.
- Sport: Slightly higher effort required for steering with more road force felt through the steering wheel.
- Comfort: Slightly less effort required for steering with less road force felt through the steering wheel.

After selecting the desired setting, you may feel a soft feedback bump in the steering wheel when the changeover occurs.

**LOAD LIMIT****Vehicle Loading – With and Without a Trailer**

This section will guide you in the proper loading of your vehicle and/or trailer, to keep your loaded vehicle weight within its design rating capability, with or without a trailer. Properly loading your vehicle will provide maximum return of vehicle design performance. Before loading your vehicle, familiarize yourself with the following terms for determining your vehicle's weight ratings, with or without a trailer, from the vehicle's Tire Label or Safety Compliance Certification Label:

**Base Curb Weight** – is the weight of the vehicle including a full tank of fuel and all standard equipment. It does not include passengers, cargo, or optional equipment.

**Vehicle Curb Weight** – is the weight of your new vehicle when you picked it up from your authorized dealer plus any aftermarket equipment.

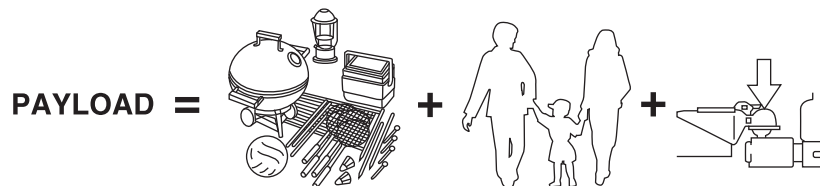

**Payload** – is the combined weight of cargo and passengers that the vehicle is carrying. The maximum payload for your vehicle can be found on the Tire Label on the B-Pillar or the edge of the driver's door (vehicles exported outside the US and Canada may not have a Tire Label). Look for **“THE COMBINED WEIGHT OF OCCUPANTS AND CARGO SHOULD NEVER EXCEED XXX kg OR XXX lb.”** for maximum payload. The payload listed on the Tire Label is the maximum payload for the vehicle as built by the assembly plant. If any aftermarket or authorized-dealer installed equipment has been installed on the vehicle, the weight of the equipment must be subtracted from the payload listed on the Tire Label in order to determine the new payload.

2013 05+ Mustang (197)  
Owners Guide gf, 3rd Printing  
USA (fus)

**⚠ WARNING:** The appropriate loading capacity of your vehicle can be limited either by volume capacity (how much space is available) or by payload capacity (how much weight the vehicle should carry). Once you have reached the maximum payload of your vehicle, do not add more cargo, even if there is space available. Overloading or improperly loading your vehicle can contribute to loss of vehicle control and vehicle rollover.

**Example only:**

**TIRE AND LOADING INFORMATION**

SEATING CAPACITY TOTAL 5 FRONT 2 REAR 3

The combined weight of occupants and cargo should never exceed : XXX kg or XXX lbs.

TIRE	SIZE	COLD TIRE PRESSURE	SEE OWNER'S MANUAL FOR ADDITIONAL INFORMATION
FRONT	LT225/75R 16.5E	200 KPA, 29 PSI	
REAR	LT225/75R 16.5E	200 KPA, 29 PSI	
SPARE	T145/80D16 P225/60R17	420 KPA, 60 PSI 200 KPA, 29 PSI	

**TIRE AND LOADING INFORMATION**  
**RENSEIGNEMENTS SUR LES PNEUS ET LE CHARGEMENT**

SEATING CAPACITY TOTAL 5 FRONT 2 REAR 3  
NOMBRE DE PLACES TOTAL 5 AVANT 2 ARRIERE 3

The combined weight of occupants and cargo should never exceed 492 kg or 1085 lbs.  
Le poids total des occupants et du chargement ne doit jamais dépasser 492 kg ou 1085 lb.

TIRE PNEU	SIZE DIMENSIONS	COLD TIRE PRESSURE PRESSION DES PNEUS A FROID	SEE OWNER'S MANUAL FOR ADDITIONAL INFORMATION VOIR LE MANUEL DE L'USAGER POUR PLUS DE RENSEIGNEMENTS
FRONT AVANT	P235/70R16	240 KPA, 35 PSI	
REAR ARRIERE	P235/70R16	240 KPA, 35 PSI	
SPARE DE SECOURS	T145/90R17	415 KPA, 60 PSI	

2013 05+ Mustang (197)  
Owners Guide gf, 3rd Printing  
USA (fus)



**Cargo Weight** – includes all weight added to the Base Curb Weight, including cargo and optional equipment. When towing, trailer tongue load weight is also part of cargo weight.

**GAW (Gross Axle Weight)** – is the total weight placed on each axle (front and rear) – including vehicle curb weight and all payload.

**GAWR (Gross Axle Weight Rating)** – is the maximum allowable weight that can be carried by a single axle (front or rear). **These numbers are shown on the Safety Compliance Certification Label. The label shall be affixed to either the door hinge pillar, door-latch post, or the door edge that meets the door-latch post, next to the driver’s seating position. The total load on each axle must never exceed its GAWR.**

**Note:** For trailer towing information refer to *Trailer towing* found in this chapter or the *RV and Trailer Towing Guide* provided by your authorized dealer.

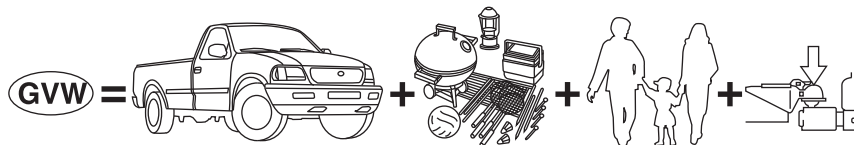

**GVW (Gross Vehicle Weight)** – is the Vehicle Curb Weight + cargo + passengers.

**GVWR (Gross Vehicle Weight Rating)** – is the maximum allowable weight of the fully loaded vehicle (including all options, equipment, passengers and cargo). **The GVWR is shown on the Safety Compliance Certification Label. The label shall be affixed to either the door hinge pillar, door-latch post, or the door edge that meets the door-latch post, next to the driver’s seating position. The GVW must never exceed the GVWR.**

- Example only:

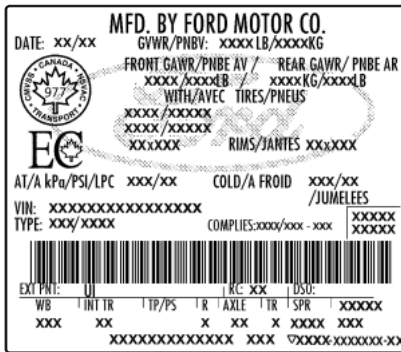
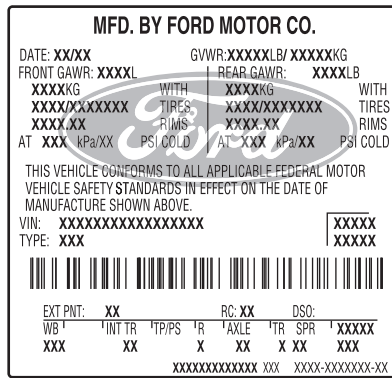

 **WARNING:** Exceeding the Safety Compliance Certification Label vehicle weight rating limits could result in substandard vehicle handling or performance, engine, transmission and/or structural damage, serious damage to the vehicle, loss of control and personal injury.



**GCW (Gross Combined Weight)** – is the weight of the loaded vehicle (GVW) plus the weight of the fully loaded trailer.

**GCWR (Gross Combined Weight Rating)** – is the maximum allowable weight of the vehicle and the loaded trailer – including all cargo and passengers – that the vehicle can handle without risking damage.

(Important: The towing vehicle's braking system is rated for operation at GVWR, not at GCWR. Separate functional brakes should be used for safe control of towed vehicles and for trailers where the GCW of the towing vehicle plus the trailer exceed the GVWR of the towing vehicle. **The GCW must never exceed the GCWR.**

**Maximum Loaded Trailer Weight** – is the highest possible weight of a fully loaded trailer the vehicle can tow. It assumes a vehicle with only mandatory options, no cargo (internal or external), a tongue load of 10–15% (conventional trailer), and driver only (150 lb. [68 kg]). **Consult your authorized dealer (or the *RV and Trailer Towing Guide* provided by your authorized dealer) for more detailed information.**



**WARNING:** Do not exceed the GVWR or the GAWR specified on the Safety Compliance Certification Label.



**WARNING:** Do not use replacement tires with lower load carrying capacities than the original tires because they may lower the vehicle's GVWR and GAWR limitations. Replacement tires with a higher limit than the original tires do not increase the GVWR and GAWR limitations.



**WARNING:** Exceeding any vehicle weight rating limitation could result in serious damage to the vehicle and/or personal injury.





**Steps for determining the correct load limit:**

1. Locate the statement “The combined weight of occupants and cargo should never exceed XXX kg or XXX lbs.” on your vehicle’s placard.
2. Determine the combined weight of the driver and passengers that will be riding in your vehicle.
3. Subtract the combined weight of the driver and passengers from XXX kg or XXX lbs.
4. The resulting figure equals the available amount of cargo and luggage load capacity. For example, if the “XXX” amount equals 1,400 lbs. and there will be five 150 lb. passengers in your vehicle, the amount of available cargo and luggage load capacity is 650 lbs. ( $1400 - 750$  ( $5 \times 150$ ) = 650 lb.). In metric units ( $635 - 340$  ( $5 \times 68$ ) = 295 kg.)
5. Determine the combined weight of luggage and cargo being loaded on the vehicle. That weight may not safely exceed the available cargo and luggage load capacity calculated in Step 4.
6. If your vehicle will be towing a trailer, load from your trailer will be transferred to your vehicle. Consult this manual to determine how this reduces the available cargo and luggage load capacity of your vehicle.

The following gives you a few examples on how to calculate the available amount of cargo and luggage load capacity:

- Suppose your vehicle has a 1400 lb. (635 kg) cargo and luggage capacity. You decide to go golfing. Is there enough load capacity to carry you, 4 of your friends and all the golf bags? You and four friends average 220 lb. (99 kg) each and the golf bags weigh approximately 30 lb. (13.5 kg) each. The calculation would be:  $1,400 - (5 \times 220) - (5 \times 30) = 1,400 - 1,100 - 150 = 150$  lb. Yes, you have enough load capacity in your vehicle to transport four friends and your golf bags. In metric units, the calculation would be:  $635 \text{ kg} - (5 \times 99 \text{ kg}) - (5 \times 13.5 \text{ kg}) = 635 - 495 - 67.5 = 72.5$  kg.



- Suppose your vehicle has a 1400 lb. (635 kg) cargo and luggage capacity. You and one of your friends decide to pick up cement from the local home improvement store to finish that patio you have been planning for the past 2 years. Measuring the inside of the vehicle with the rear seat folded down, you have room for 12-100 lb. (45 kg) bags of cement. Do you have enough load capacity to transport the cement to your home? If you and your friend each weigh 220 lb. (99 kg), the calculation would be:  $1,400 - (2 \times 220) - (12 \times 100) = 1,400 - 440 - 1,200 = -240$  lb. No, you do not have enough cargo capacity to carry that much weight. In metric units, the calculation would be:  $635 \text{ kg} - (2 \times 99 \text{ kg}) - (12 \times 45 \text{ kg}) = 635 - 198 - 540 = -103$  kg. You will need to reduce the load weight by at least 240 lb. (104 kg). If you remove 3-100 lb. (45 kg) cement bags, then the load calculation would be:  
 $1,400 - (2 \times 220) - (9 \times 100) = 1,400 - 440 - 900 = 60$  lb. Now you have the load capacity to transport the cement and your friend home. In metric units, the calculation would be:  $635 \text{ kg} - (2 \times 99 \text{ kg}) - (9 \times 45 \text{ kg}) = 635 - 198 - 405 = 32$  kg.

The above calculations also assume that the loads are positioned in your vehicle in a manner that does not overload the Front or the Rear Gross Axle Weight Rating specified for your vehicle on the Safety Compliance Certification Label. The label shall be affixed to either the door hinge pillar, door-latch post, or the door edge that meets the door-latch post, next to the driver's seating position.



**TOWING A TRAILER**

**WARNING:** Do not exceed the GVWR or the GAWR specified on the certification label.



**WARNING:** Towing trailers beyond the maximum recommended gross trailer weight exceeds the limit of the vehicle and could result in engine damage, transmission damage, structural damage, loss of vehicle control, vehicle rollover and personal injury.

**Note:** For information on electrical items such as fuses or relays, see the *Fuses* chapter.

Your vehicle's load capacity is designated by weight, not by volume, so you cannot necessarily use all available space when loading a vehicle.

Towing a trailer places an additional load on your vehicle's engine, transmission, axle, brakes, tires and suspension. Inspect these components periodically during, and after, any towing operation.

**Load Placement**

To help minimize how trailer movement affects the vehicle when driving:

- Load the heaviest items closest to the trailer floor.
- Load the heaviest items so they are centered between the left and right side trailer tires.
- Load the heaviest items above the trailer axles or just slightly forward toward the trailer tongue. Do not allow the final trailer tongue weight to go above or below 10–15% of the loaded trailer weight.
- Select a tow bar with the correct rise or drop. When both the loaded vehicle and trailer are connected, the trailer frame should be level, or slightly angled down toward the vehicle, when viewed from the side.

When driving with a trailer or payload, a slight takeoff vibration or shudder may be present due to the increased payload weight. Additional information regarding proper trailer loading and setting your vehicle up for towing is noted under *Load limit* in the *Load Carrying* chapter and in the *RV & Trailer Towing Guide*, available at your authorized dealer.



**RECOMMENDED TOWING WEIGHTS**

**Note: Do not tow** with the Boss 302, Boss 302 Laguna Seca, GT Deluxe or Shelby GT500 models; they are not rated to tow a trailer.

**Note:** Do not exceed the trailer weight for your vehicle configuration listed in the chart below.

**Note:** Make sure to take into consideration trailer frontal area. Do not exceed:

- 12 feet<sup>2</sup> (1.11 meters<sup>2</sup>) trailer frontal area.

**Note:** For high altitude operation, reduce the gross combined weight by 2% per 1000 feet (300 meters) starting at the 1000 foot (300 meter) elevation point.

**Note:** Certain states require electric trailer brakes for trailers over a specified weight. Be sure to check state regulations for this specified weight. The maximum trailer weights listed may be limited to this specified weight, as the vehicle's electrical system may not include the wiring connector needed to activate electric trailer brakes.

Your vehicle may tow a Class I trailer provided the maximum trailer weight is less than or equal to the maximum trailer weight listed for your vehicle configuration on the following chart.

Powertrain	Maximum Trailer Weight - lb (kg)
3.7L TiVCT	1000 (454)
5.0L TiVCT	1000 (454)

**ESSENTIAL TOWING CHECKS**

Follow these guidelines for safe towing:

- Do not tow a trailer until your vehicle has been driven at least 1000 miles (1600 kilometers).
- Consult your local motor vehicle laws for towing a trailer.
- See the instructions included with towing accessories for the proper installation and adjustment specifications.
- Service your vehicle more frequently if you tow a trailer. See your scheduled maintenance information.
- If you use a rental trailer, follow the instructions the rental agency gives you.

For load specification terms found on the tire label and Safety Compliance label and for instructions on calculating your vehicle's load, refer to *Load limit* in the *Load Carrying* chapter.

Remember to account for the trailer tongue weight as part of the vehicle load when calculating the total vehicle weight.

**Hitches**

Do not use a hitch that either clamps onto the bumper or attaches to the axle.

Distribute the trailer load so 10-15% of the total trailer weight is on the tongue.

**Safety Chains**

**Note:** Never attach safety chains to the bumper.

Always connect the safety chains to the hook retainers of the vehicle hitch.

To connect the safety chains, cross them under the trailer tongue and allow enough slack for turning tight corners. Do not allow the chains to drag on the ground.

**Trailer Brakes**

**WARNING:** Do not connect a trailer's hydraulic brake system directly to your vehicle's brake system. Your vehicle may not have enough braking power and your chances of having a collision greatly increase.

Electric brakes and manual, automatic or surge-type trailer brakes are safe if installed properly and adjusted to the manufacturer's specifications. The trailer brakes must meet local and Federal regulations.

**The braking system of the tow vehicle is rated for operation at the GVWR not GCWR.**

**Separate functioning brake systems are required for safe control of towed vehicles and trailers weighing more than 1500 pounds (680 kilograms) when loaded.**

**Trailer Lamps**

Trailer lamps are required on most towed vehicles. Make sure all running lights, brake lights, turn signals and hazard lights are working. Contact your authorized dealer or trailer rental agency for proper instructions and equipment for hooking up the lamps.

**Before Towing a Trailer**

Practice turning, stopping and backing up to get the feel of the vehicle-trailer combination before starting on a trip. When turning, make wider turns so the trailer wheels will clear curbs and other obstacles.

**When Towing a Trailer**

- Do not drive faster than 70 mph (113 km/h) during the first 500 miles (800 kilometers).
- Do not make full-throttle starts.
- Check your hitch, electrical connections and trailer wheel lug nuts thoroughly after you have traveled 50 miles (80 kilometers).
- When stopped in congested or heavy traffic during hot weather, place the gearshift in position **P** to aid engine and transmission cooling and to help A/C performance.
- Turn off the speed control with heavy loads or in hilly terrain. The speed control may turn off automatically when you are towing on long, steep grades.
- Shift to a lower gear when driving down a long or steep hill. Do not apply the brakes continuously, as they may overheat and become less effective.
- If your transmission is equipped with a Grade Assist or Tow/Haul feature, use this feature when towing. This provides engine braking and helps eliminate excessive transmission shifting for optimum fuel economy and transmission cooling.
- Allow more distance for stopping with a trailer attached; anticipate stops and brake gradually.
- Avoid parking on a grade. However, if you must park on a grade:
  1. Turn the steering wheel to point the vehicle tires away from traffic flow.
  2. Set the vehicle parking brake.
  3. Place the automatic transmission in position **P** or manual transmission in a high gear.
  4. Place wheel chocks in front and back of the trailer wheels. (Chocks not equipped with vehicle.)

**Launching or Retrieving a Boat or Personal Watercraft (PWC)**

**Note:** Disconnect the wiring to the trailer **before** backing the trailer into the water.

**Note:** Reconnect the wiring to the trailer after the trailer is removed from the water.

When backing down a ramp during boat launching or retrieval:

- Do not allow the static water level to rise above the bottom edge of the rear bumper.
- Do not allow waves to break higher than 6 inches (15 centimeters) above the bottom edge of the rear bumper.

Exceeding these limits may allow water to enter vehicle components:

- Causing internal damage to the components.
- Affecting driveability, emissions, and reliability.

Replace the rear axle lubricant anytime the rear axle has been submerged in water. Water may have contaminated the rear axle lubricant, which is not normally checked or changed unless a leak is suspected or other axle repair is required.

### WRECKER TOWING

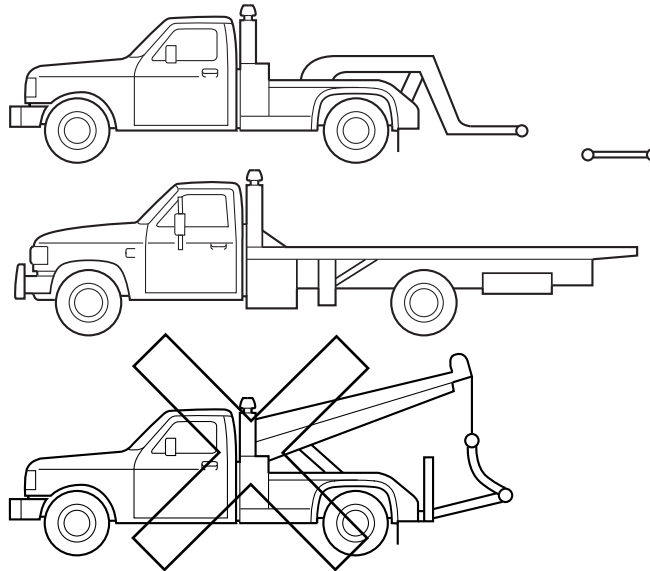

If you need to have your vehicle towed, contact a professional towing service or, if you are a member of a roadside assistance program, your roadside assistance service provider.

It is recommended that your vehicle be towed with a wheel lift and dollies or flatbed equipment. Do not tow with a slingbelt. Ford Motor Company has not approved a slingbelt towing procedure. If the vehicle is towed incorrectly, or by any other means, vehicle damage may occur.

Ford Motor Company produces a towing manual for all authorized tow truck operators. Have your tow truck operator refer to this manual for proper hook-up and towing procedures for your vehicle.

If your vehicle is to be towed from the front using wheel lift equipment, the rear wheels (drive wheels) must be placed on a dolly to prevent damage to the transmission.

If your vehicle is to be towed from the rear using wheel lift equipment, it is recommended that the front wheels be placed on a dolly to prevent damage to the front fascia.

## TOWING THE VEHICLE ON FOUR WHEELS

### Emergency Towing

In the event your vehicle becomes disabled (without access to wheel dollies, car-hauling trailer, or flatbed transport vehicle), it can be flat-towed (all wheels on the ground, regardless of the powertrain/transmission configuration) under the following conditions:

- The vehicle is facing forward so that it is towed in a forward direction.
- The transmission is placed in position **N**. See *Automatic transmission* in the *Transmission* chapter if you cannot move the transmission into **N**.
- Maximum speed is 35 mph (56 km/h).
- Maximum distance is 50 miles (80 kilometers).

### Recreational Towing

**Note:** Put your climate control system in recirculated air mode to prevent exhaust fumes from entering the vehicle. See the *Climate Control* chapter.

Follow these guidelines if you have a need for recreational (RV) towing. An example of recreational towing would be towing your vehicle behind a motorhome. These guidelines are designed to ensure that your transmission is not damaged.

Do not tow your vehicle with any wheels on the ground, as vehicle or transmission damage may occur. It is recommended to tow your vehicle with all four (4) wheels off the ground, such as when using a car-hauling trailer. Otherwise, no recreational towing is permitted.





**OPENING THE CONVERTIBLE TOP**

**Note:** Do not store articles behind rear seat. Articles stored in the convertible top stowage compartment may break the rear glass window when the top is opened.

**Note:** Opening the convertible top when the top material is wet may cause mold or mildew.

The convertible top can be opened with the side windows down. The windows will automatically lower when opening or closing the top.

The convertible top will not operate unless the vehicle is stationary or traveling under 3 mph (5 km/h).

To open the convertible top:

1. Bring the vehicle to a complete stop. The ignition must be on. It is recommended that the engine is running when opening the top to prevent draining the battery.
2. Check the convertible top stowage compartment behind the rear seat to be sure it is empty. Make sure the convertible top outer surface is free of debris.

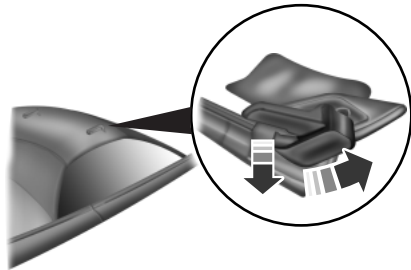

**Note:** The latch handles must be pulled downward fully to allow the latch to fully rotate into the open position.

3. Unclamp the top from the windshield header by pulling each latch handle down and then rotating the latch to the rear until it clears the header.

**Note:** If the top has not been opened for some time and sticks to the windshield header, push the front of the top up slightly with your hand to loosen it.

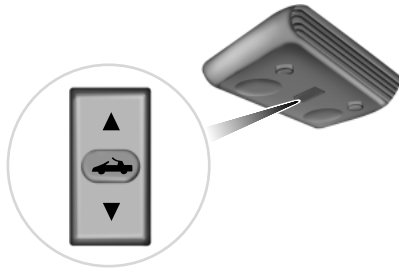

4. Press and hold the convertible top switch on the overhead console until the windows are completely down and the top is completely stored.

**USING THE BOOT****Installing the Boot**

**WARNING:** Always secure the retaining clips and boot straps on the vehicle or the boot may come loose while driving.

**Note:** Be sure the boot is secure on the vehicle before driving. Improper installation can result in loss or damage of the boot.

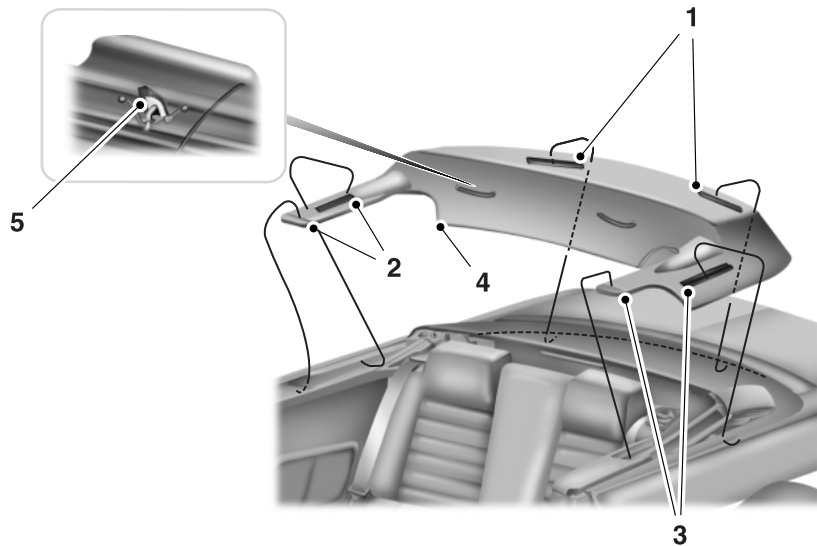

1. Install the boot on the vehicle by hooking the boot retaining clips on the back panel.
2. Install the boot on the right side tucking in the front part of the boot in the quarter panel and hooking the retaining clip on the side.
3. Install the boot on the left side tucking in the front part of the boot in the quarter panel and hooking the retaining clip on the side.
4. Tuck the boot corners behind the shoulder belts.
5. Secure the boot straps on the rear seat hooks behind the rear seat.

### Removing the Boot

1. Unhook the boot straps from the rear seat hooks.
2. Push the boot down unhooking the boot retaining clips.
3. Lift the boot off the vehicle.

### Storing the Boot

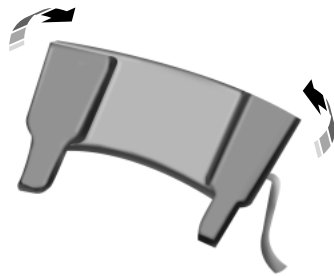

1. Position the boot right-side up and fold each side of the boot inward.

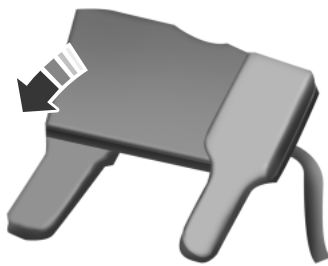

2. Turn the boot upside down and fold the left side of the boot inward.

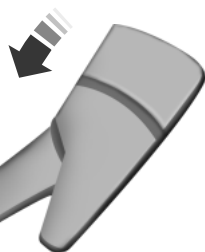

3. Fold the right side inward and secure the boot with the strap.  
Stow the boot in the trunk.

**CLOSING THE CONVERTIBLE TOP**

**Note:** The convertible top will not operate unless the vehicle is stationary or traveling under 3 mph (5 kmh).

**Note:** Make sure that the latch handles are pulled down and in the fully opened position before the top makes contact with the windshield header. This allows for hand clearance and proper closure of the top.

To close the convertible top:

1. Bring the vehicle to a complete stop. The ignition must be on. It is recommended that the engine is running when opening the top to prevent draining the battery.

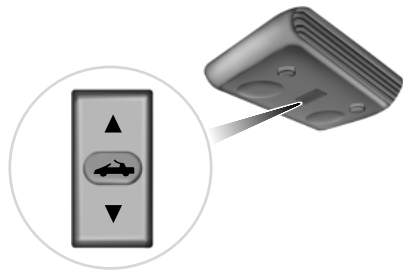

2. Press and hold the convertible top switch until the windows lower completely and the top unfolds and moves forward toward the windshield header.

Make sure the latch handles are pulled down and in the fully opened position before the top and the windshield header make contact.

3. Continue pressing the convertible top switch to close the top completely. The top must be flush with the header.

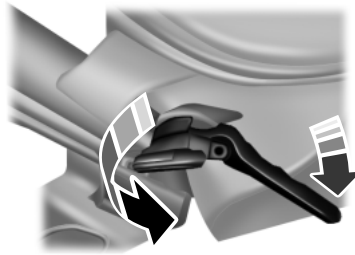

4. Pull down on the drivers latch handle and rotate it all the way forward into the windshield header.

5. Press the latch handle up into the stowed position to secure the latch.

6. Pull down on the passengers side latch handle and rotate it all the way forward into the windshield header.

7. Press the latch handle up into the stowed position to secure the latch.

**Note:** If the top has been open for an extended period of time or if the temperature is low, the top material may shrink slightly. If this happens, pull on the latch handles or the center grip to fasten to top

**BREAKING-IN**

You need to break in new tires for approximately 300 mi (480 km). During this time, your vehicle may exhibit some unique driving characteristics. Avoid driving too fast during the first 1000 mi (1600 km). Vary your speed frequently and change up through the gears early. Do not labor the engine. Do not tow during the first 1000 miles (1600 km).

**ECONOMICAL DRIVING**

Fuel economy is affected by several things, such as how you drive, the conditions you drive under and how you maintain your vehicle.

There are some things to keep in mind that may improve your fuel economy:

- Accelerate and slow down in a smooth, moderate fashion.
- Drive at steady speeds without stopping.
- Anticipate stops; slowing down may eliminate the need to stop.
- Combine errands and minimize stop-and-go driving.
- Close the windows for high-speed driving.
- Drive at reasonable speeds (traveling at 55 mph [88 km/h] uses 15% less fuel than traveling at 65 mph [105 km/h]).
- Keep the tires properly inflated and use only the recommended size.
- Use the recommended engine oil.
- Perform all regularly scheduled maintenance.

There are also some things you may not want to do because they may reduce your fuel economy:

- Sudden or hard accelerations.
- Rev the engine before turning it off.
- Idle for periods longer than one minute.
- Warm up your vehicle on cold mornings.
- Use the air conditioner or front defroster.
- Use the speed control in hilly terrain.
- Rest your foot on the brake pedal while driving.

- Drive a heavily loaded vehicle or tow a trailer.
- Carry unnecessary weight (approximately 1 mpg [0.4 km/L] is lost for every 400 pounds [180 kilograms] of weight carried).
- Add particular accessories to your vehicle (e.g.; bug deflectors, rollbars or light bars, running boards, ski racks).
- Drive with the wheels out of alignment.

### DRIVING THROUGH WATER



**WARNING:** Drive through water in an emergency only, and not as part of normal driving.



**WARNING:** Engine damage can occur if water enters the air filter.

**Note:** Driving through deep water may allow water into the transmission or air intake and can cause internal vehicle damage or cause it to stall.

**Note:** Once through the water, always dry the brakes by moving your vehicle slowly while applying light pressure on the brake pedal.

If driving through deep or standing water is unavoidable, proceed very slowly. Never drive through water that is higher than the bottom of the wheel rims (for cars) or the bottom of the hubs (for trucks).

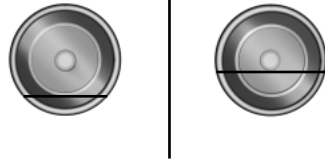

When driving through water, traction or brake capability may be limited. Also, water may enter your engine's air intake and severely damage your engine or your vehicle may stall.

Wet brakes do not stop the vehicle as quickly as dry brakes.

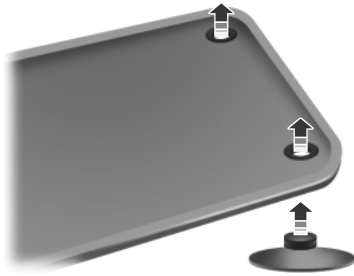
**FLOOR MATS**

**WARNING:** Always use floor mats that are designed to fit the footwell of your vehicle. Only use floor mats that leave the pedal area unobstructed. Only use floor mats that are firmly secured to retention posts so that they cannot slip out of position and interfere with the pedals or impair safe operation of your vehicle in other ways.

- Pedals that cannot move freely can cause loss of vehicle control and increase the risk of serious personal injury.
- Always make sure that the floor mats are properly attached to the retention posts in the carpet that are supplied with your vehicle. Floor mats must be properly secured to both retention posts to ensure mats do not shift out of position.
- Never place floor mats or any other covering in the vehicle footwell that cannot be properly secured to prevent them from moving and interfering with the pedals or the ability to control the vehicle.
- Never place floor mats or any other covering on top of already installed floor mats. Floor mats should always rest on top of the vehicle carpeting surface and not another floor mat or other covering. Additional floor mats or any other covering will reduce the pedal clearance and potentially interfere with pedal operation.
- Check attachment of floor mats on a regular basis. Always properly reinstall and secure floor mats that have been removed for cleaning or replacement.
- Always make sure that objects cannot fall into the driver footwell while the vehicle is moving. Objects that are loose can become trapped under the pedals causing a loss of vehicle control.



**WARNING** *(Continued)*

- Failure to properly follow floor mat installation or attachment instructions can potentially cause interference with pedal operation causing loss of control of vehicle.
- To install floor mats, position the floor mat so that the eyelet is over the retention post and press down to lock in.
- To remove the floor mat, reverse the installation procedure.



**ROADSIDE ASSISTANCE****Vehicles Sold in the U.S. : Getting Roadside Assistance**

To fully assist you should you have a vehicle concern, Ford Motor Company offers a complimentary roadside assistance program. This program is separate from the New Vehicle Limited Warranty. The service is available:

- 24-hours a day, seven days a week
- for the coverage period listed on the Roadside Assistance Card included in your owner's manual portfolio.

Roadside assistance will cover:

- a flat tire change with a good spare (except vehicles that have been supplied with a tire inflation kit).
- battery jump start.
- lock-out assistance (key replacement cost is the customer's responsibility).
- fuel delivery – Independent Service Contractors, if not prohibited by state, local or municipal law shall deliver up to 2.0 gallons (7.5 liters) of gasoline or 5.0 gallons (18.9 liters) of diesel fuel to a disabled vehicle. Fuel delivery service is limited to two no-charge occurrences within a 12-month period.
- winch out – available within 100 feet (30.5 meters) of a paved or county maintained road, no recoveries.
- towing – Ford and Lincoln eligible vehicles towed to an authorized dealer within 35 miles (56 kilometers) of the disablement location or to the nearest authorized dealer. If a member requests to be towed to an authorized dealer more than 35 miles (56 kilometers) from the disablement location, the member shall be responsible for any mileage costs in excess of 35 miles (56 kilometers).

Trailers shall be covered up to \$200 if the disabled eligible vehicle requires service at the nearest authorized dealer. If the trailer is disabled, but the towing vehicle is operational, the trailer does not qualify for any roadside services.

**Vehicles Sold in the U.S. : Using Roadside Assistance**

Complete the roadside assistance identification card and place it in your wallet for quick reference. This card is found in the owner's manual portfolio in the glove compartment.

U.S. Ford vehicle customers who require Roadside Assistance, call 1-800-241-3673.

If you need to arrange roadside assistance for yourself, Ford Motor Company will reimburse a reasonable amount for towing to the nearest dealership within 35 miles (56 kilometers). To obtain reimbursement information, U.S. Ford vehicle customers call 1-800-241-3673. Customers will be asked to submit their original receipts.

**Vehicles Sold in Canada : Getting Roadside Assistance**

Canadian customers who require roadside assistance, call 1-800-665-2006.

**Vehicles Sold in Canada : Using Roadside Assistance**

Complete the roadside assistance identification card and place it in your wallet for quick reference. In Canada, the card is found in the warranty information in the glove box.

Canadian Roadside coverage and benefits may differ from the U.S. coverage. Please see your warranty information or visit our website at [www.ford.ca](http://www.ford.ca) for information on Canadian services and benefits.

Canadian customers who need to obtain roadside information, call 1-800-665-2006 or visit our website at [www.ford.ca](http://www.ford.ca).

**HAZARD WARNING FLASHERS**

The hazard flasher control is located on the center console next to the gearshift lever. Use it when your vehicle is disabled and is creating a safety hazard for other motorists.

- Press the flasher control and all front and rear direction signals will flash.
- Press the flasher control again to turn them off.

**Note:** With extended use, the flasher may run down your battery.

**FUEL CUT-OFF SWITCH**

**WARNING:** Failure to inspect and if necessary repair fuel leaks after a collision may increase the risk of fire and serious injury.

Ford Motor Company recommends that the fuel system be inspected by an authorized dealer after any collision.

In the event of a moderate to severe collision, this vehicle is equipped with a fuel pump shut-off feature that stops the flow of fuel to the engine. Not every impact will cause a shut-off.



Should your vehicle shut off after a collision, you may restart your vehicle by doing the following:

1. Turn the ignition off and wait approximately 10 seconds.
2. Turn the ignition on.
3. Repeat steps 1 and 2 to re-enable the fuel pump.

### JUMP-STARTING THE VEHICLE



**WARNING:** The gases around the battery can explode if exposed to flames, sparks, or lit cigarettes. An explosion could result in injury or vehicle damage.



**WARNING:** Batteries contain sulfuric acid which can burn skin, eyes and clothing, if contacted.

Do not attempt to push-start your automatic transmission vehicle. Automatic transmissions do not have push-start capability. Attempting to push-start a vehicle with an automatic transmission may cause transmission damage.

When the battery is disconnected or a new battery is installed, the automatic transmission must relearn its shift strategy. As a result, the transmission may exhibit a combination of firm and soft shifts. This operation is considered normal and will not affect function or durability of the transmission. Over time, the adaptive learning process will fully update transmission operation.

### Preparing Your Vehicle

**Note:** Use only a 12 volt supply to start your vehicle.

**Note:** Do not disconnect the battery of the disabled vehicle as this could damage the vehicle's electrical system.

1. Park the booster vehicle close to the hood of the disabled vehicle making sure the two vehicles do not touch. Set the parking brake on both vehicles and stay clear of the engine cooling fan and other moving parts.
2. Check all battery terminals and remove any excessive corrosion before you attach the battery cables. Ensure that vent caps are tight and level.
3. Turn the heater fan on in both vehicles to protect from any electrical surges. Turn all other accessories off.



### Connecting the Jumper Cables



**WARNING:** Do not connect the end of the second cable to the negative (-) terminal of the battery to be jumped. A spark may cause an explosion of the gases that surround the battery.

**Note:** Do not attach the negative (-) cable to fuel lines, engine rocker covers, the intake manifold or electrical components as grounding points.

**Note:** In the illustration, the vehicle on the bottom is used to designate the assisting (boosting) battery.

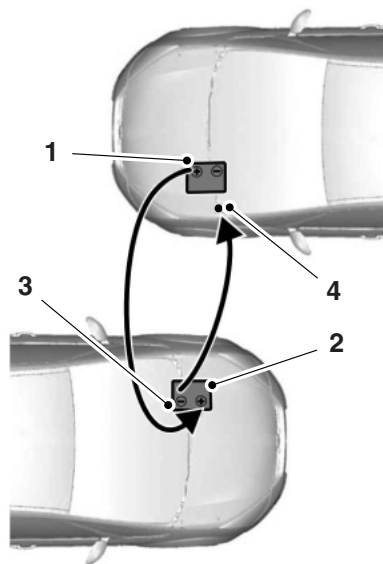

1. Connect the positive (+) jumper cable to the positive (+) terminal of the discharged battery.

2. Connect the other end of the positive (+) cable to the positive (+) terminal of the assisting battery.

3. Connect the negative (-) cable to the negative (-) terminal of the assisting battery.

4. Make the final connection of the negative (-) cable to an exposed metal part of the stalled vehicle's engine, away from the battery and the carburetor or fuel injection system.

Ensure that the cables are clear of fan blades, belts, moving parts of both engines, or any fuel delivery system parts.

**Jump Starting**

1. Start the engine of the booster vehicle and run the engine at a moderately increased speed.
2. Start the engine of the disabled vehicle.
3. Once the disabled vehicle has been started, run both engines for an additional three minutes before disconnecting the jumper cables.

**Removing the Jumper Cables**

**Note:** In the illustration, the vehicle on the bottom is used to designate the assisting (boosting) battery.

Remove the jumper cables in the reverse order that they were connected.

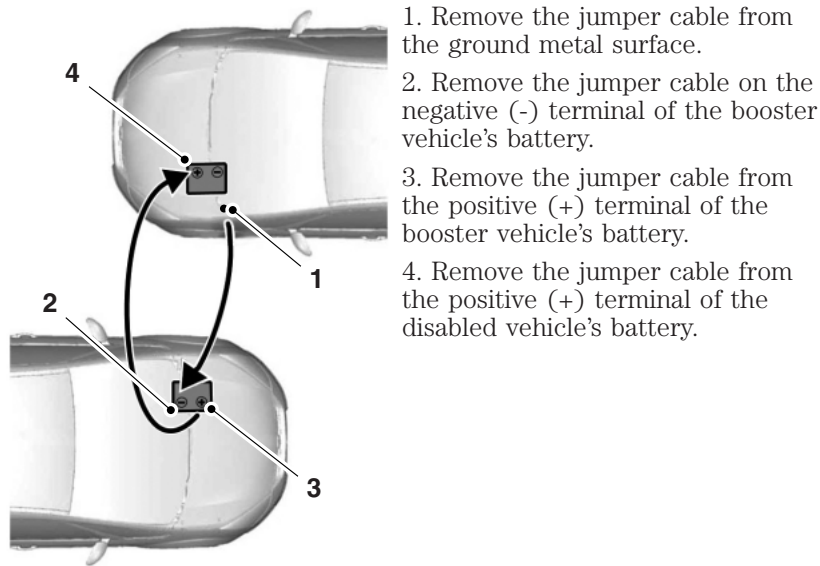

After the disabled vehicle has been started and the jumper cables removed, allow it to idle for several minutes so the engine computer can relearn its idle conditions.

**GETTING THE SERVICES YOU NEED**

Warranty repairs to your vehicle must be performed by an authorized dealer. While any authorized dealer handling your vehicle line will provide warranty service, we recommend you return to your selling authorized dealer who wants to ensure your continued satisfaction.

Please note that certain warranty repairs require special training, equipment or both, so not all authorized dealers are authorized to perform all warranty repairs. This means that, depending on the warranty repair needed, you may have to take your vehicle to another authorized dealer.

A reasonable time must be allowed to perform a repair after taking your vehicle to the authorized dealer. Repairs will be made using Ford or Motorcraft parts, or remanufactured or other parts that are authorized by Ford.

**Away from Home**

If you are away from home when your vehicle needs service, contact the Ford Customer Relationship Center or use the online resources listed below to find the nearest authorized dealer.

In the United States:

**Mailing Address**

Ford Motor Company  
Customer Relationship Center  
P.O. Box 6248  
Dearborn, MI 48121

**Telephone**

1-800-392-3673 (FORD)  
(TDD for the hearing impaired: 1-800-232-5952)

**Online**

Additional information and resources are available online at [www.fordowner.com](http://www.fordowner.com).

These are some of the items that can be found online:

- U.S. Dealer Locator by Dealer Name, City/State, or Zip Code
- Owner Manuals
- Maintenance Schedules
- Recalls
- Ford Extended Service Plans

- Ford Genuine Accessories
- Service specials and promotions.

In Canada:

**Mailing address**

Customer Relationship Centre  
Ford Motor Company of Canada, Limited  
P.O. Box 2000  
Oakville, Ontario L6J 5E4

**Telephone**

1-800-565-3673 (FORD)

**Online**

[www.ford.ca](http://www.ford.ca)

**Additional Assistance**

If you have questions or concerns, or are unsatisfied with the service you are receiving, follow these steps:

1. Contact your Sales Representative or Service Advisor at your selling or servicing authorized dealer.
2. If your inquiry or concern remains unresolved, contact the Sales Manager, Service Manager or Customer Relations Manager.
3. If you require assistance or clarification on Ford Motor Company policies, please contact the Ford Customer Relationship Center.

In order to help serve you better, please have the following information available when contacting a Customer Relationship Center:

- Vehicle Identification Number (VIN)
- Your telephone number (home and business)
- The name of the authorized dealer and city where located
- The vehicle's current odometer reading.

In some states, you must directly notify Ford in writing before pursuing remedies under your state's warranty laws. Ford is also allowed a final repair attempt in some states.

In the United States, a warranty dispute must be submitted to the BBB AUTO LINE before taking action under the Magnuson-Moss Warranty Act, or to the extent allowed by state law, before pursuing replacement or repurchase remedies provided by certain state laws. This dispute handling procedure is not required prior to enforcing state created rights or other rights which are independent of the Magnuson-Moss Warranty Act or state replacement or repurchase laws.

**2013 05+ Mustang (197)**  
**Owners Guide gf, 3rd Printing**  
**USA (fus)**



**IN CALIFORNIA (U.S. ONLY)**

California Civil Code Section 1793.2(d) requires that, if a manufacturer or its representative is unable to repair a motor vehicle to conform to the vehicle's applicable express warranty after a reasonable number of attempts, the manufacturer shall be required to either replace the vehicle with one substantially identical or repurchase the vehicle and reimburse the buyer in an amount equal to the actual price paid or payable by the consumer (less a reasonable allowance for consumer use). The consumer has the right to choose whether to receive a refund or replacement vehicle.

California Civil Code Section 1793.22(b) presumes that the manufacturer has had a reasonable number of attempts to conform the vehicle to its applicable express warranties if, within the first 18 months of ownership of a new vehicle or the first 18000 mi (29 000 km), whichever occurs first:

1. Two or more repair attempts are made on the same nonconformity likely to cause death or serious bodily injury OR
2. Four or more repair attempts are made on the same nonconformity (a defect or condition that substantially impairs the use, value or safety of the vehicle) OR
3. The vehicle is out of service for repair of nonconformities for a total of more than 30 calendar days (not necessarily all at one time).

In the case of 1 or 2 above, the consumer must also notify the manufacturer of the need for the repair of the nonconformity at the following address:

Ford Motor Company  
16800 Executive Plaza Drive  
Mail Drop 3NE-B  
Dearborn, MI 48126

You are required to submit your warranty dispute to BBB AUTO LINE before asserting in court any rights or remedies conferred by California Civil Code Section 1793.22(b). You are also required to use BBB AUTO LINE before exercising rights or seeking remedies created by the Federal Magnuson-Moss Warranty Act, 15 U.S.C. sec. 2301 et seq. If you choose to seek redress by pursuing rights and remedies not created by California Civil Code Section 1793.22(b) or the Magnuson-Moss Warranty Act, resorting to BBB AUTO LINE is not required by those statutes.

**THE BETTER BUSINESS BUREAU (BBB) AUTO LINE PROGRAM  
(U.S. ONLY)**

Your satisfaction is important to Ford Motor Company and to your dealer. If a warranty concern has not been resolved using the three-step procedure outlined earlier in this chapter in the *Getting the Services You Need* section, you may be eligible to participate in the BBB AUTO LINE program.

The BBB AUTO LINE program consists of two parts – mediation and arbitration. During mediation, a representative of the BBB will contact both you and Ford Motor Company to explore options for settlement of the claim. If an agreement is not reached during mediation or you do not want to participate in mediation, and if your claim is eligible, you may participate in the arbitration process. An arbitration hearing will be scheduled so that you can present your case in an informal setting before an impartial person. The arbitrator will consider the testimony provided and make a decision after the hearing.

Disputes submitted to the BBB AUTO LINE program are usually decided within 40 days after you file your claim with the BBB. You are not bound by the decision, and may reject the decision and proceed to court where all findings of the BBB Auto Line dispute, and decision, are admissible in the court action. Should you choose to accept the BBB AUTO LINE decision, Ford is then bound by the decision, and must comply with the decision within 30 days of receipt of your acceptance letter.

BBB AUTO LINE Application: Using the information provided below, please call or write to request a program application. You will be asked for your name and address, general information about your new vehicle, information about your warranty concerns, and any steps you have already taken to try to resolve them. A Customer Claim Form will be mailed that will need to be completed, signed and returned to the BBB along with proof of ownership. Upon receipt, the BBB will review the claim for eligibility under the Program Summary Guidelines.

**You can get more information by calling BBB AUTO LINE at 1-800-955-5100, or writing to:**

**BBB AUTO LINE  
3033 Wilson Boulevard, Suite 600  
Arlington, Virginia 22201**

BBB AUTO LINE applications can also be requested by calling the Ford Motor Company Customer Relationship Center at 1-800-392-3673.

**Note:** Ford Motor Company reserves the right to change eligibility limitations, modify procedures, or to discontinue this process at any time without notice and without obligation.

*2013 05+ Mustang (197)  
Owners Guide gf, 3rd Printing  
USA (fus)*

**UTILIZING THE MEDIATION or ARBITRATION PROGRAM  
(CANADA ONLY)**

This pertains to vehicles delivered to authorized Canadian dealers. In those cases, where you continue to feel that the efforts by Ford of Canada and the authorized dealer to resolve a factory-related vehicle service concern have been unsatisfactory, Ford of Canada participates in an impartial third party mediation or arbitration program administered by the Canadian Motor Vehicle Arbitration Plan (CAMVAP).

The CAMVAP program is a straightforward and relatively speedy alternative to resolve a disagreement when all other efforts to produce a settlement have failed. This procedure is without cost to you and is designed to eliminate the need for lengthy and expensive legal proceedings.

In the CAMVAP program, impartial third-party arbitrators conduct hearings at mutually convenient times and places in an informal environment. These impartial arbitrators review the positions of the parties, make decisions and, when appropriate, render awards to resolve disputes. CAMVAP decisions are fast, fair, and final as the arbitrator's award is binding on both you and Ford of Canada.

CAMVAP services are available in all Canadian territories and provinces. For more information, without charge or obligation, call your CAMVAP Provincial Administrator directly at 1-800-207-0685 or visit [www.camvap.ca](http://www.camvap.ca).

**GETTING ASSISTANCE OUTSIDE THE U.S. AND CANADA**

Before exporting your vehicle to a foreign country, contact the appropriate foreign embassy or consulate. These officials can inform you of local vehicle registration regulations and where to find unleaded fuel.

If you cannot find unleaded fuel or can only get fuel with an anti-knock index lower than is recommended for your vehicle, contact a regional office or owner relations/customer relationship office.

The use of leaded fuel in your vehicle without proper conversion may damage the effectiveness of your emission control system and may cause engine knocking or serious engine damage. Ford Motor Company or Ford of Canada is not responsible for any damage caused by use of improper fuel. Using leaded fuel may also result in difficulty importing your vehicle back into the United States.

**If your vehicle must be serviced while you are traveling or living in Asia-Pacific Region, Sub-Saharan Africa, U.S. Virgin Islands, Central America, the Caribbean, and Israel, contact the nearest authorized dealer. If the authorized dealer cannot help you, contact:**

FORD MOTOR COMPANY  
FORD EXPORT OPERATIONS & GLOBAL INITIATIVES  
1555 Fairlane Drive  
Fairlane Business Park #3  
Allen Park, Michigan 48101  
U.S.A.  
Telephone: (313) 594-4857

**For customers in Guam, the Commonwealth of the Northern Mariana Islands (CNMI), America Samoa, and the U.S. Virgin Islands, please feel free to call our Toll-Free Number:**  
(800) 841-FORD (3673).  
FAX: (313) 390-0804  
Email: expcac@ford.com

**If your vehicle must be serviced while you are traveling or living in Puerto Rico, contact the nearest authorized dealer. If the authorized dealer cannot help you, contact:**

Ford International Business Development Inc.  
Customer Relationship Center  
P.O. Box 11957  
Caparra Heights Station  
San Juan, Puerto Rico 00922-1937  
Telephone: (800) 841-FORD (3673)  
FAX: (313) 390-0804  
Email: prcac@ford.com  
www.ford.com.pr

**If your vehicle must be serviced while you are traveling or living in the Middle East, contact the nearest authorized dealer. If the authorized dealer cannot help you, contact:**

Ford Middle East  
Customer Relationship Center  
P.O. Box 21470  
Dubai, United Arab Emirates  
Telephone: +971 4 3326084  
Toll-Free Number for the Kingdom of Saudi Arabia: 800 8971409  
Local Telephone Number for Kuwait: 24810575  
FAX: +971 4 3327299  
Email: menacac@ford.com  
www.me.ford.com

**2013 05+ Mustang (197)  
Owners Guide gf, 3rd Printing  
USA (fus)**

If you buy your vehicle in North America and then relocate to any of the above locations, register your vehicle identification number (VIN) and new address with Ford Motor Company Export Operations & Global Growth Initiatives by emailing [expcac@ford.com](mailto:expcac@ford.com).

**If you are in another foreign country, contact the nearest authorized dealer. If the authorized dealer employees cannot help you, they can direct you to the nearest Ford affiliate office.**

**Customers in the U.S. should call 1-800-392-3673.**

#### **ORDERING ADDITIONAL OWNER'S LITERATURE**

To order the publications in this portfolio, contact Helm, Incorporated at:

HELM, INCORPORATED  
47911 Halyard Drive  
Plymouth, Michigan 48170  
Attention: Customer Service

Or to order a free publication catalog, call toll free: 1-800-782-4356

Monday-Friday 8:00 a.m. - 6:00 p.m. EST

Helm, Incorporated can also be reached by their website:  
[www.helminc.com](http://www.helminc.com).

*(Items in this catalog may be purchased by credit card, check or money order.)*

#### **Obtaining a French Owner's Manual**

A French owner's manual can be obtained from your authorized dealer or by contacting Helm, Incorporated using the contact information listed previously in this section.

**REPORTING SAFETY DEFECTS (U.S. ONLY)**

If you believe that your vehicle has a defect which could cause a crash or could cause injury or death, you should immediately inform the National Highway Traffic Safety

Administration (NHTSA) in addition to notifying Ford Motor Company.

If NHTSA receives similar complaints, it may open an investigation, and if it finds that a safety defect exists in a group of vehicles, it may order a recall and remedy campaign. However, NHTSA cannot become involved in individual problems between you, your dealer, or Ford Motor Company.

To contact NHTSA, you may call the Vehicle Safety Hotline toll-free at 1-888-327-4236 (TTY: 1-800-424-9153); go to <http://www.safercar.gov>; or write to:

Administrator  
1200 New Jersey Avenue, Southeast  
Washington, D.C. 20590

You can also obtain other information about motor vehicle safety from <http://www.safercar.gov>.

**REPORTING SAFETY DEFECTS (CANADA ONLY)**

If you believe that your vehicle has a defect which could cause a crash or could cause injury or death, you should immediately inform Transport Canada, using their toll-free number: 1-800-333-0510, or online at: <https://wwwapps.tc.gc.ca/Saf-Sec-Sur/7/PCDB-BDPP/Index.aspx>.



**CHANGING A FUSE****Fuses**

**WARNING:** Always replace a fuse with one that has the specified amperage rating. Using a fuse with a higher amperage rating can cause severe wire damage and could start a fire.

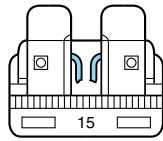

If electrical components in the vehicle are not working, a fuse may have blown. Blown fuses are identified by a broken wire within the fuse. Check the appropriate fuses before replacing any electrical components.

**Standard Fuse Amperage Rating and Color**

COLOR					
Fuse rating	Mini fuses	Standard fuses	Maxi fuses	Cartridge maxi fuses	Fuse link cartridge
2A	Grey	Grey	—	—	—
3A	Violet	Violet	—	—	—
4A	Pink	Pink	—	—	—
5A	Tan	Tan	—	—	—
7.5A	Brown	Brown	—	—	—
10A	Red	Red	—	—	—
15A	Blue	Blue	—	—	—
20A	Yellow	Yellow	Yellow	Blue	Blue
25A	Natural	Natural	—	Natural	Natural
30A	Green	Green	Green	Pink	Pink
40A	—	—	Orange	Green	Green
50A	—	—	Red	Red	Red
60A	—	—	Blue	Yellow	Yellow
70A	—	—	Tan	—	Brown
80A	—	—	Natural	Black	Black

**FUSE SPECIFICATION CHART**

**Power Distribution Box**



**WARNING:** Always disconnect the battery before servicing high current fuses.



**WARNING:** To reduce risk of electrical shock, always replace the cover to the power distribution box before reconnecting the battery or refilling fluid reservoirs.

The power distribution box is located in the engine compartment. It has high-current fuses that protect your vehicle's main electrical systems from overloads.

If the battery has been disconnected and reconnected, see *Changing the Vehicle Battery* in the *Maintenance* chapter.

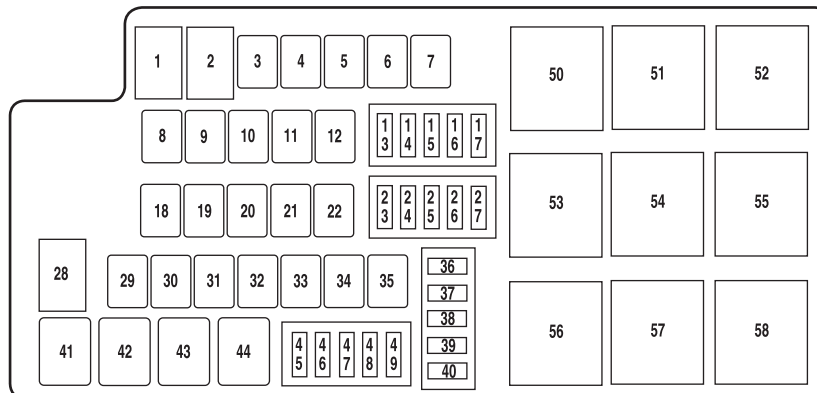

The high-current fuses are coded as follows:

Fuse or relay number	Fuse amp rating	Protected components
1	80A*	Passenger compartment fuse panel
2	—	Not used



Fuse or relay number	Fuse amp rating	Protected components
3	—	Not used
4	30A*	Blower motor relay
5	20A*	Power point (body)
6	40A*	Rear defroster relay
7	40A*	Cooling fan relay
8	40A*	Anti-lock brake system pump
9	30A*	Wipers
10	30A*	Anti-lock brake system valve
11	—	Not used
12	20A*	Differential fluid pump (Shelby only)
13	20A**	Fuel pump relay (non-Shelby)
	25A**	Fuel pump relay (Shelby only)
14	20A**	Fuel pump relay #2 (Shelby only)
15	10A**	Intercooler pump relay (Shelby only)
16	20A**	Heated seats
17	10A**	Alternator sense
18	20A*	Auxiliary body module
19	30A*	Starter relay
20	30A*	Rear amplifier (Shaker Pro radio)
21	30A*	Powertrain relay
22	20A*	Power point (instrument panel)
23	10A**	Powertrain control module keep-alive power
24	10A**	Brake on/off power
25	10A**	A/C compressor relay
26	20A**	Left high intensity discharge headlamp relay
27	20A**	Right high intensity discharge headlamp relay
28	—	Not used



## Fuses

225

Fuse or relay number	Fuse amp rating	Protected components
29	30A*	Passenger front window
30	—	Not used
31	30A*	Passenger power seat
32	30A*	Driver power seat
33	30A*	Front amplifier (Shaker radio)
34	30A*	Driver front window motor
35	40A*	Convertible top motor
36	Diode	Fuel diode
37	—	Not used
38	15A**	Fuel injectors (Shelby only)
39	5A**	Heated mirrors
40	15A**	Powertrain control module vehicle power 4 – ignition coil
41	G8VA relay	Fuel pump relay
42	G8VA relay	Intercooler pump relay (Shelby only)
43	G8VA relay	A/C compressor relay
44	G8VA relay	Fuel pump relay #2 (Shelby only)
45	5A**	Powertrain control module run/start
46	5A**	Powertrain control module vehicle power 3 – general powertrain components
47	15A**	Powertrain control module vehicle power 1
48	15A**	Powertrain control module vehicle power 5
49	15A**	Powertrain control module vehicle power 2 – emissions related powertrain components
50	Full ISO relay	Cooling fan relay (high)
51	Full ISO relay	Blower motor relay

2013 05+ Mustang (197)  
 Owners Guide gf, 3rd Printing  
 USA (fus)

Fuse or relay number	Fuse amp rating	Protected components
52	Full ISO relay	Starter relay
53	Full ISO relay	Rear defroster relay
54	Full ISO relay	Front wiper relay
55	Full ISO relay	Cooling fan relay (low)
56	—	Not used
57	Full ISO relay	Powertrain control module relay
58	High current relay	Differential fluid pump (Shelby only)
* Cartridge Fuses ** Mini Fuses		

#### Passenger Compartment Fuse Panel

The fuse panel is located in the lower passenger side area behind the kick panel. Open the trim panel door and remove the fuse cover to access the fuses.

Use the provided fuse puller tool to remove a fuse. It is located inside the fuse cover.

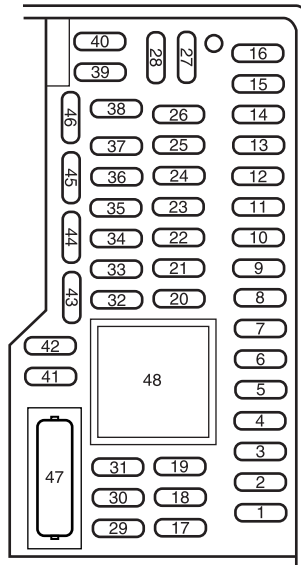

The fuses are coded as follows:

Fuse or relay number	Fuse amp rating	Protected components
1	30A	Driver rear window (convertible only)
2	15A	Not used (spare)
3	15A	SYNC
4	30A	Passenger rear window (convertible only)
5	10A	Brake transmission shift interlock
6	20A	Turn signals, Hazard flashers
7	10A	Left low beam headlamp
8	10A	Right low beam headlamp
9	15A	Courtesy lamps
10	15A	Switch illumination, Pony projection lights

Fuse or relay number	Fuse amp rating	Protected components
11	10A	Security module
12	7.5A	Power mirrors
13	5A	Not used (spare)
14	10A	Center information display, Electronic finish panel, Global position system
15	10A	Climate control
16	15A	Not used (spare)
17	20A	Power door locks, Trunk release
18	20A	Not used (spare)
19	25A	Not used (spare)
20	15A	Diagnostic connector
21	15A	Fog lamps
22	15A	Park lamps, License lamps
23	15A	High beam headlamps
24	20A	Horn
25	10A	Demand lighting (battery saver), Visor vanity lamps
26	10A	Cluster (battery)
27	20A	Ignition switch feed
28	5A	Audio mute (start)
29	5A	Camera (run/start)
30	5A	Temperature sensor motor
31	10A	Restraints control module
32	10A	Reverse parking aid (non-Shelby), Vehicle dynamics control module (Shelby only)
33	10A	Not used (spare)
34	5A	Electronic stability control
35	10A	Auxiliary body module run/start
36	5A	Anti-theft system
37	10A	Rear defroster relay coil

Fuse or relay number	Fuse amp rating	Protected components
38	20A	Not used (spare)
39	20A	Radio/Navigation
40	20A	Not used (spare)
41	15A	Accessory delay (windows, automatic dimming rear view mirror [including microphone and compass] and door switch III)
42	10A	Not used (spare)
43	10A	Heated seat relay coils
44	10A	Not used (spare)
45	5A	Wiper relay and module, Blower relay
46	7.5A	Passenger airbag deactivation indicator, Occupant classification sensor
47	30A Circuit Breaker	Not used (spare)
48	Relay	Accessory delay relay (windows, automatic dimming rear view mirror [including microphone and compass] and door switch III)

**Auxiliary Relay with Heated Seats (If Equipped)**

Vehicles equipped with heated seats have a relay box located under the driver seat. This box contains two relays for the driver and passenger heated seats.

**GENERAL INFORMATION**

Have your vehicle serviced regularly to help maintain its roadworthiness and resale value. There is a large network of Ford authorized dealers that are there to help you with their professional servicing expertise. We believe that their specially trained technicians are best qualified to service your vehicle properly and expertly. They are supported by a wide range of highly specialized tools developed specifically for servicing your vehicle.

To help you service your vehicle, we provide *Scheduled Maintenance Information* which makes tracking routine service easy.

If your vehicle requires professional service, your authorized dealer can provide the necessary parts and service. Check your warranty information to find out which parts and services are covered.

Use only recommended fuels, lubricants, fluids and service parts conforming to specifications. Motorcraft® parts are designed and built to provide the best performance in your vehicle.

**Precautions**

- Do not work on a hot engine.
- Make sure that nothing gets caught in moving parts.
- Do not work on a vehicle with the engine running in an enclosed space, unless you are sure you have enough ventilation.
- Keep all open flames and other burning material (such as cigarettes) away from the battery and all fuel related parts.

**Working with the Engine Off**

1. Set the parking brake and shift to P (Park).
2. Turn off the engine and remove the key (if equipped).
3. Block the wheels.

**Working with the Engine On**

**WARNING:** To reduce the risk of vehicle damage or personal burn injuries, do not start your engine with the air cleaner removed and do not remove it while the engine is running.

1. Set the parking brake and shift to position P.
2. Block the wheels.

**OPENING AND CLOSING THE HOOD**



1. Inside the vehicle, pull the hood release handle located on the driver's side kick panel.

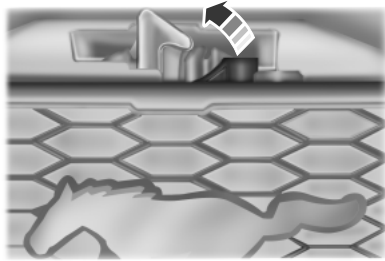

2. Go to the front of the vehicle and release the auxiliary latch that is located under the front center of the hood.

3. Lift the hood and secure it with the prop rod.

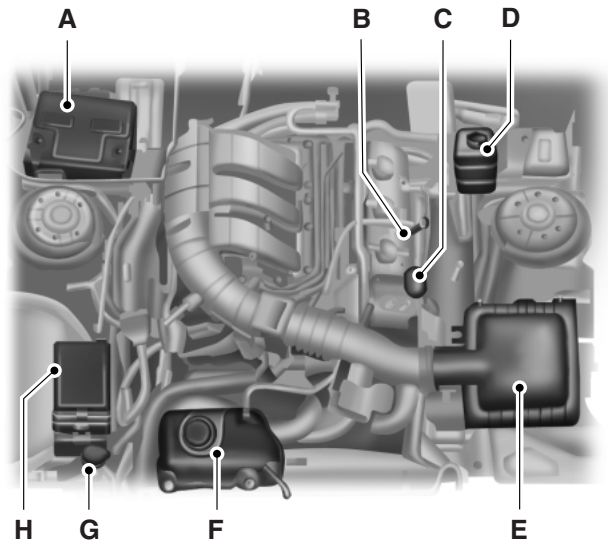

---

**UNDER HOOD OVERVIEW****3.7L V6 Engine**

- A. Battery
- B. Engine oil dipstick
- C. Engine oil filler cap
- D. Brake fluid reservoir
- E. Air filter assembly
- F. Engine coolant reservoir
- G. Windshield washer fluid reservoir
- H. Power distribution box

## 5.0L V8 Engine

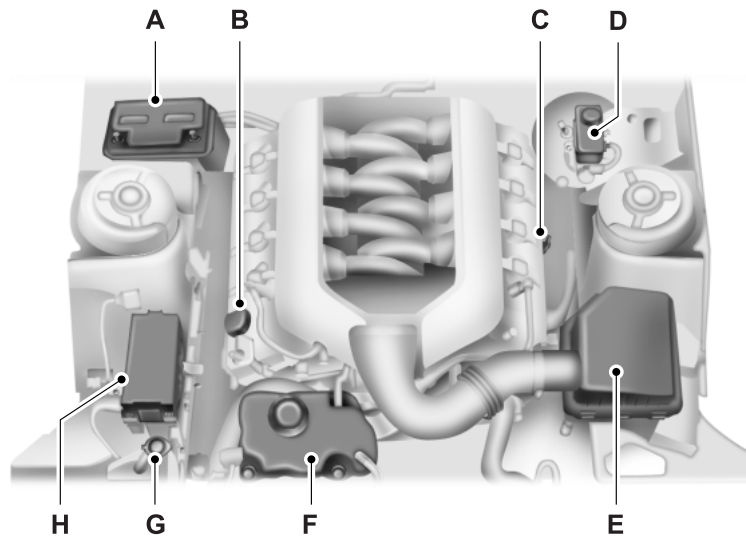

- A. Battery
- B. Engine oil filler cap
- C. Engine oil dipstick
- D. Brake fluid reservoir
- E. Air filter assembly
- F. Engine coolant reservoir
- G. Windshield washer fluid reservoir
- H. Power distribution box

**2013 05+ Mustang (197)**  
**Owners Guide gf, 3rd Printing**  
**USA (fus)**



Information Provided by:  
**DEALER**  
E-PROCESS

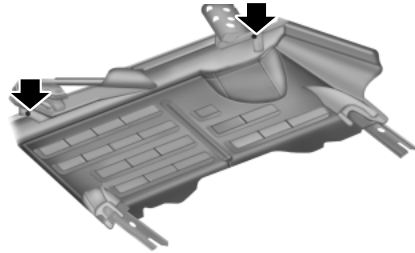

**DEALER**  
DIGITAL  
MARKETING

**Engine Shield**

Some vehicles may be equipped with an aero-shield under the engine. Remove the front fasteners of the shield to gain access for service. This includes oil and filter changes.

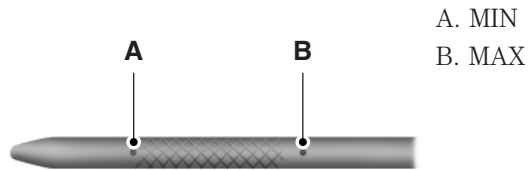
**ENGINE OIL DIPSTICK****ENGINE OIL CHECK**

**Note:** Check the level before starting the engine.

**Note:** Make sure that the level is between the MIN and MAX marks.

1. Make sure that your vehicle is on level ground.
2. Turn the engine off and wait 10 minutes for the oil to drain into the oil pan.
3. Remove the dipstick and wipe it with a clean, lint-free cloth. Replace the dipstick and remove it again to check the oil level.

If the level is at the MIN mark, add oil immediately.

**Adding Engine Oil**

**Note:** Do not remove the filler cap when the engine is running.

**Note:** Do not add engine oil further than the MAX mark. Oil levels above the MAX mark may cause engine damage.



Only use oils certified for gasoline engines by the American Petroleum Institute (API). An oil with this trademark symbol conforms to the current engine and emission system protection standards and fuel economy requirements of the International Lubricants Specification Advisory Council (ILSAC), comprised of U.S. and Japanese automobile manufacturers.

1. Remove the filler cap.
2. Add engine oil that meets Ford specifications. See *Capacities and Specifications* for more information.
3. Replace the filler cap. Turn it until you feel a strong resistance.

## ENGINE COOLANT CHECK

### Checking the Engine Coolant

The concentration and level of engine coolant should be checked at the intervals listed in *Scheduled Maintenance Information*.

**Note:** Make sure that the level is at the FULL COLD level or within the COLD FILL RANGE in the coolant reservoir.

**Note:** Coolant expands when it is hot. The level may extend beyond the COLD FILL RANGE.

If the level is below the COLD FILL RANGE, add coolant immediately. See *Adding Engine Coolant* in this chapter.

The coolant concentration should be maintained within 48% to 50%, which equates to a freeze point between -30°F (-34°C) and -34°F (-37°C).

**Note:** For best results, coolant concentration should be tested with a refractometer such as Rotunda tool 300ROB75240 available from your dealer. Ford does not recommend the use of hydrometers or coolant test strips for measuring coolant concentrations.

**Note:** Automotive fluids are not interchangeable; do not use engine coolant/antifreeze or windshield washer fluid outside of its specified function and vehicle location.

### Adding Engine Coolant



**WARNING:** Do not add engine coolant when the engine is hot. Steam and scalding liquids released from a hot cooling system can burn you badly. Also, you can be burned if you spill coolant on hot engine parts.



**WARNING:** Do not put engine coolant in the windshield washer fluid container. If sprayed on the windshield, engine coolant could make it difficult to see through the windshield.



**WARNING:** To reduce the risk of personal injury, make sure the engine is cool before unscrewing the coolant pressure relief cap. The cooling system is under pressure; steam and hot liquid can come out forcefully when the cap is loosened slightly.



**WARNING:** Do not add coolant further than the MAX mark of the COLD FILL RANGE.

**Note:** Do not use stop leak pellets or cooling system sealants or additives as they can cause damage to the engine cooling and or heating systems. This damage would not be covered under your vehicle's warranty.

**Note:** During normal vehicle operation, the engine coolant may change color from orange to pink or light red. As long as the engine coolant is clear and uncontaminated, this color change does not indicate the engine coolant has degraded nor does it require the engine coolant to be drained, the system to be flushed, or the engine coolant to be replaced.

- DO NOT MIX different colors or types of coolant in your vehicle. Make sure the correct coolant is used. Mixing of engine coolants may harm your engine's cooling system. The use of an improper coolant may harm engine and cooling system components and may void the warranty.
- A large amount of water without engine coolant may be added, in case of emergency, to reach a vehicle service location. In this instance, the cooling system must be drained, chemically cleaned with Motorcraft® Premium Cooling System Flush, and refilled with prediluted engine coolant as soon as possible. Water alone (without engine coolant) can cause engine damage from corrosion, overheating or freezing.
- Do not use alcohol, methanol, brine or any engine coolants mixed with alcohol or methanol antifreeze (coolant). Alcohol and other liquids can cause engine damage from overheating or freezing.
- Do not add extra inhibitors or additives to the coolant. These can be harmful and compromise the corrosion protection of the engine coolant.



Unscrew the cap slowly. Any pressure will escape as you unscrew the cap.

Add prediluted engine coolant meeting the Ford specification. See the technical specifications chart in the *Capacities and Specifications* chapter.

Whenever coolant has been added, the coolant level in the coolant reservoir should be checked the next few times you drive the vehicle. If necessary, add enough prediluted engine coolant to bring the coolant level to the proper level.

### Recycled Engine Coolant

Ford Motor Company does NOT recommend the use of recycled engine coolant since a Ford-approved recycling process is not yet available.



Used engine coolant should be disposed of in an appropriate manner. Follow your community's regulations and standards for recycling and disposing of automotive fluids.

### Severe Climates

If you drive in extremely cold climates:

- It may be necessary to have a Ford authorized dealer increase the coolant concentration above 50%.
- A coolant concentration of 60% will provide improved freeze point protection. Increased engine coolant concentrations above 60% will decrease the overheat protection characteristics of the engine coolant and may cause engine damage.

If you drive in extremely hot climates:

- It may be necessary to have a Ford authorized dealer decrease the coolant concentration to 40%.
- A coolant concentration of 40% will provide improved overheat protection. Decreased engine coolant concentrations below 40% will decrease the corrosion and freeze protection characteristics of the engine coolant and may cause engine damage.

Vehicles driven year-round in non-extreme climates should use prediluted engine coolant for optimum cooling system and engine protection.

**What You Should Know About Fail-Safe Cooling**

If the engine coolant supply is depleted, this feature allows the vehicle to be driven temporarily before incremental component damage is incurred. The fail-safe distance depends on ambient temperatures, vehicle load and terrain.

**How Fail-Safe Cooling Works**

If the engine begins to overheat:

- The engine coolant temperature gauge will move to the red (hot) area.



- The service engine soon indicator will illuminate.



- The coolant temperature warning light will illuminate.

If the engine reaches a preset over-temperature condition, the engine will automatically switch to alternating cylinder operation. Each disabled cylinder acts as an air pump and cools the engine.

When this occurs the vehicle will still operate. However:

- The engine power will be limited.
- The air conditioning system will be disabled.

Continued operation will increase the engine temperature and the engine will completely shut down, causing steering and braking effort to increase.

Once the engine temperature cools, the engine can be re-started. Take your vehicle to an authorized dealer as soon as possible to minimize engine damage.

**When Fail-Safe Mode is Activated**

You have limited engine power when in the fail-safe mode, so drive the vehicle with caution. The vehicle will not be able to maintain high-speed operation and the engine will run rough. Remember that the engine is capable of completely shutting down automatically to prevent engine damage, therefore:

1. Pull off the road as soon as safely possible and turn off the engine.
2. Arrange for the vehicle to be taken to an authorized dealer.
3. If this is not possible, wait a short period for the engine to cool.
4. Check the coolant level and replenish if low.



**WARNING:** Fail-safe mode is for use during emergencies only.

Operate the vehicle in fail-safe mode only as long as necessary to bring the vehicle to rest in a safe location and seek immediate repairs. When in fail-safe mode, the vehicle will have limited power, will not be able to maintain high-speed operation, and may completely shut down without warning, potentially losing engine power, power steering assist, and power brake assist, which may increase the possibility of a crash resulting in serious injury.



**WARNING:** Never remove the coolant reservoir cap while the engine is running or hot. The hot coolant is under pressure and may cause serious burns.

5. Re-start the engine and take your vehicle to an authorized dealer.

**Note:** Driving the vehicle without repairing the engine problem increases the chance of engine damage. Take your vehicle to an authorized dealer as soon as possible.

## TRANSMISSION FLUID CHECK

### Checking Automatic Transmission Fluid

**Note:** Transmission fluid should be checked and, if required, added by an authorized dealer.

The automatic transmission does not have a transmission fluid dipstick.

See your *Scheduled Maintenance Information* for scheduled intervals for fluid checks and changes. Your transmission does not consume fluid. However, the fluid level should be checked if the transmission is not working properly, (i.e., if the transmission slips or shifts slowly) or if you notice some sign of fluid leakage.

Do not use supplemental transmission fluid additives, treatments or cleaning agents. The use of these materials may affect transmission operation and result in damage to internal transmission components.



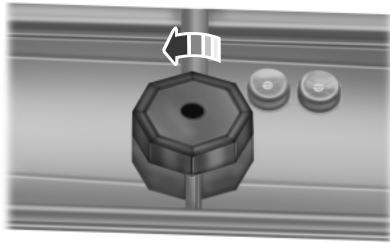

**Checking and Adding Manual Transmission Fluid (if equipped)**

1. Clean the filler plug. It is located on the passenger side of the transmission.
2. Remove the filler plug and inspect the fluid level.

3. For vehicles equipped with a **V6** engine, the correct manual transmission fill level is at the lower edge of the filler hole. For vehicles equipped with a **V8** engine, the correct manual transmission fill level is 1/2 in (1.3 cm) below the edge of the filler hole.

4. Add enough fluid through the filler opening to bring the fluid up to the recommended levels.

5. Install and tighten the fill plug securely.

Use only fluid that meets Ford specifications. See the technical specifications chart in the *Capacities and Specifications* chapter.

**BRAKE AND CLUTCH FLUID CHECK**

Brake and clutch (if equipped) systems are supplied from the same reservoir.

Fluid levels between the MIN and MAX lines are within the normal operating range; there is no need to add fluid. If the fluid levels are outside of the normal operating range, the performance of the system could be compromised; seek service from your authorized dealer immediately.

**POWER STEERING FLUID CHECK**

Your vehicle is equipped with an electric power steering (EPS) system. There is no fluid reservoir to check or fill.

**FUEL FILTER**

Your vehicle is equipped with a lifetime fuel filter that is integrated with the fuel tank. Regular maintenance or replacement is not needed.

For Shelby fuel filter requirements, see the *Shelby GT500 Supplement*.

**WASHER FLUID CHECK**

 **WARNING:** If you operate your vehicle in temperatures below 40°F (5°C), use washer fluid with antifreeze protection. Failure to use washer fluid with antifreeze protection in cold weather could result in impaired windshield vision and increase the risk of injury or accident.

Add fluid to fill the reservoir if the level is low. Only use a washer fluid that meets Ford specifications. See the technical specifications chart in the *Capacities and Specifications* chapter.

State or local regulations on volatile organic compounds may restrict the use of methanol, a common windshield washer antifreeze additive. Washer fluids containing non-methanol antifreeze agents should be used only if they provide cold weather protection without damaging the vehicle's paint finish, wiper blades or washer system.

**CHANGING THE VEHICLE BATTERY**

 **WARNING:** Batteries normally produce explosive gases which can cause personal injury. Therefore, do not allow flames, sparks or lighted substances to come near the battery. When working near the battery, always shield your face and protect your eyes. Always provide proper ventilation.

 **WARNING:** When lifting a plastic-cased battery, excessive pressure on the end walls could cause acid to flow through the vent caps, resulting in personal injury and damage to the vehicle or battery. Lift the battery with a battery carrier or with your hands on opposite corners.

 **WARNING:** Keep batteries out of reach of children. Batteries contain sulfuric acid. Avoid contact with skin, eyes or clothing. Shield your eyes when working near the battery to protect against possible splashing of acid solution. In case of acid contact with skin or eyes, flush immediately with water for a minimum of 15 minutes and get prompt medical attention. If acid is swallowed, call a physician immediately.



**WARNING:** Battery posts, terminals and related accessories contain lead and lead compounds. Wash hands after handling.

Your vehicle is equipped with a Motorcraft® maintenance-free battery which normally does not require additional water during its life of service.

**Note:** If your battery has a cover or a shield, make sure it is reinstalled after the battery has been cleaned or replaced.

For longer, trouble-free operation, keep the top of the battery clean and dry. Also, make certain the battery cables are always tightly fastened to the battery terminals.

If you see any corrosion on the battery or terminals, remove the cables from the terminals and clean with a wire brush. You can neutralize the acid with a solution of baking soda and water.

It is recommended that the negative battery cable terminal be disconnected from the battery if you plan to store your vehicle for an extended period of time.

### Battery Relearn

Because your vehicle's engine is electronically controlled by a computer, some control conditions are maintained by power from the battery. When the battery is disconnected or a new battery is installed, the engine must relearn its idle and fuel trim strategy for optimum driveability and performance. To begin this process:

1. With the vehicle at a complete stop, set the parking brake.
  2. Put the gearshift in position P (automatic transmission) or the neutral position (manual transmission), turn off all accessories and start the engine.
  3. Run the engine until it reaches normal operating temperature.
  4. Allow the engine to idle for at least one minute.
  5. Turn the A/C on and allow the engine to idle for at least one minute.
  6. Drive the vehicle to complete the relearning process.
- The vehicle may need to be driven 10 mi (16 km) or more to relearn the idle and fuel trim strategy.
  - **Note:** If you do not allow the engine to relearn its idle trim, the idle quality of your vehicle may be adversely affected until the idle trim is eventually relearned.

When the battery is disconnected or a new battery installed, the transmission must relearn its adaptive strategy. As a result of this, the transmission may shift firmly. This operation is considered normal and will not affect function or durability of the transmission. Over time the adaptive learning process will fully update transmission operation to its optimum shift feel.

If the battery has been disconnected or a new battery has been installed, the clock and the preset radio stations must be reset once the battery is reconnected.

Always dispose of automotive batteries in a responsible manner. Follow your local authorized standards for disposal. Call your local authorized recycling center to find out more about recycling automotive batteries.

### CHECKING THE WIPER BLADES

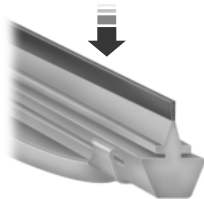

Run the tip of your fingers over the edge of the blade to check for roughness.

Clean the wiper blades with washer fluid or water applied with a soft sponge or cloth.

### CHANGING THE WIPER BLADES

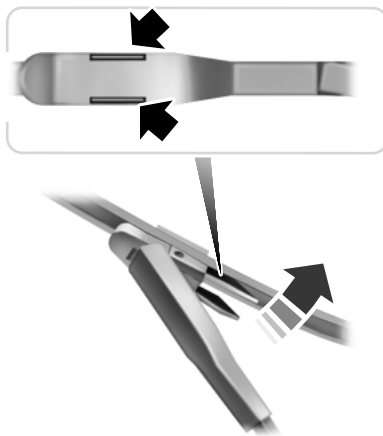

1. Pull the wiper blade and arm away from the glass.
2. Squeeze the locking tabs to release the blade from the arm and pull the blade away from the arm to remove it.
3. Attach the new blade to the arm and snap it into place.

Replace wiper blades at least once per year for optimum performance.

Poor wiper quality can be improved by cleaning the wiper blades and the windshield.

To prolong the life of the wiper blades, it is highly recommended to scrape off the ice on the windshield

before turning on the wipers. The layer of ice has many sharp edges and can damage the micro edge of the wiper rubber element.

**AIR FILTER CHECK**

**WARNING:** To reduce the risk of vehicle damage and or personal burn injuries, do not start your engine with the air cleaner removed and do not remove it while the engine is running.

**Note:** Failure to use the correct air filter element may result in severe engine damage. The customer warranty may be void for any damage to the engine if the correct air filter element is not used.

When changing the air filter element, use only the air filter element listed. See *Motorcraft® Part Numbers* in the *Capacities and Specifications* chapter.

See *Scheduled Maintenance Information* for the appropriate intervals for changing the air filter element.

**Note:** Failure to use the correct air filter element may result in severe engine damage. The customer warranty may be void for any damage to the engine if the correct air filter element is not used.

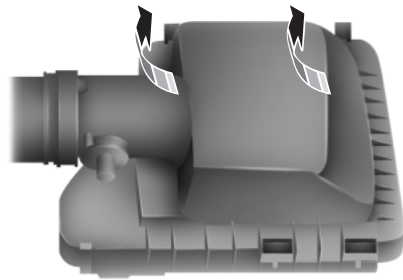

V6 engine

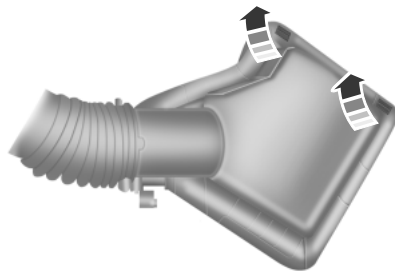

V8 engine

1. Release the clamps that secure the air filter housing cover.
2. Remove the air filter element from the air filter housing.



3. Wipe the air filter housing and cover clean to remove any dirt or debris and to ensure good sealing.
4. Install a new air filter element. Be careful not to crimp the filter element edges between the air filter housing and cover. This could cause filter damage and allow unfiltered air to enter the engine if not properly seated.
5. Replace the air filter housing cover and secure the clamps. Be sure that the air cleaner cover tabs are engaged into the slots of the air cleaner housing.

### ADJUSTING THE HEADLAMPS

The headlamps on your vehicle are properly aimed at the assembly plant. If your vehicle has been in an accident, the alignment of your headlamps should be checked by your authorized dealer.

#### Vertical Aim Adjustment

1. Park the vehicle directly in front of a wall or screen on a level surface, approximately 25 ft (7.6 m) away.

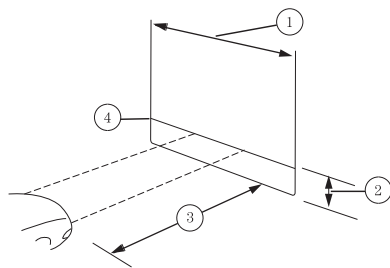

- (1) 8 ft (2.4 m)
- (2) Center height of lamp to ground
- (3) 25 ft (7.6 m)
- (4) Horizontal reference line

2. Measure the height from the center of your headlamp to the ground and mark an 8 ft (2.4 m) horizontal reference line on the vertical wall or screen at this height

(a piece of masking tape works well). The center of the lamp is marked by a 3 millimeter circle on the headlamp lens.

3. Turn on the low beam headlamps to illuminate the wall or screen and open the hood. To see a clearer light pattern for adjusting, block the light from one headlamp while adjusting the other.

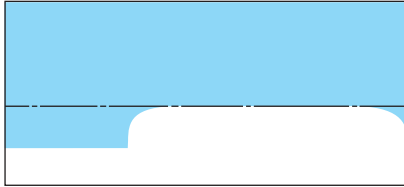

On the wall or screen, you will observe a flat zone of high intensity light located at the top of the right hand portion of the beam pattern. If the top edge of the high intensity light zone is not at the horizontal reference line, the headlamp will need to be adjusted.

4. Locate the vertical adjuster on each headlamp.

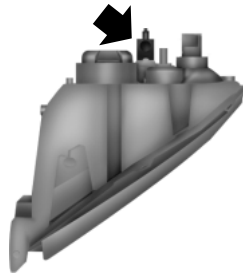

5. Then use a 7 mm Allen wrench or a Phillips screwdriver to adjust the vertical aim of the headlamp. HORIZONTAL AIM IS NOT REQUIRED FOR THIS VEHICLE AND IS NON-ADJUSTABLE.

6. Close the hood and turn off the lamps.

## CHANGING A BULB

### Lamp Assembly Condensation

Exterior lamps are vented to accommodate normal changes in pressure. Condensation can be a natural by-product of this design. When moist air enters the lamp assembly through the vents, there is a possibility that condensation can occur when the temperature is cold. When normal condensation occurs, a thin film of mist can form on the interior of the lens. The thin mist eventually clears and exits through the vents during normal operation. Clearing time may take as long as 48 hours under dry weather conditions.

These are examples of acceptable condensation:

- Presence of thin mist (no streaks, drip marks or droplets).
- Fine mist covers less than 50% of the lens.

These are examples of unacceptable moisture (usually caused by a lamp water leak):

- Water puddle inside the lamp.
- Large water droplets, drip marks or streaks present on the interior of the lens.

Take your vehicle to a dealer for service if any of the above conditions of unacceptable moisture are present.

### Replacing HID Headlamp Bulbs

The headlamps on your vehicle use a high intensity discharge source. These lamps operate at a high voltage. When the bulb is burned out, the bulb and starter capsule assembly must be replaced by your authorized dealer.

### Replacing Front Parking Lamp/Turn Signal Bulbs

1. Make sure the headlamp control is in the off position and open the hood.
2. Remove the hex head screws attaching the beauty shield at the top, forward edge of the engine compartment just aft of the headlamps.
3. Remove the beauty shield to gain access to the front parking lamp and turn signal assembly.

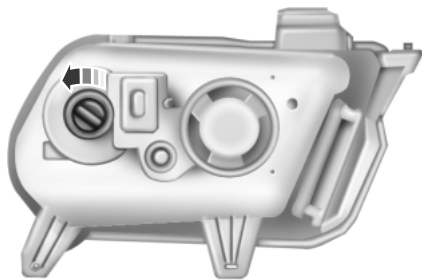

4. Rotate the socket counterclockwise and remove from the lamp assembly.

5. Carefully pull the bulb straight out of socket.

Install the new bulb in reverse order.



**Replacing Front Sidemarkers Bulb**

1. Make sure the headlamp control is in the off position.

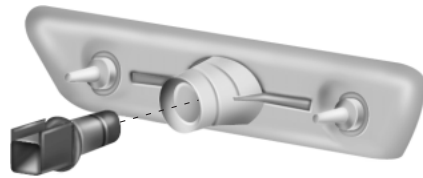

2. Remove the hex head screws attaching the underbody forward aeroshield.

3. Remove the underbody forward aeroshield to gain access to the front sidemarkers assembly.

4. Rotate the socket counterclockwise and remove from the lamp assembly.

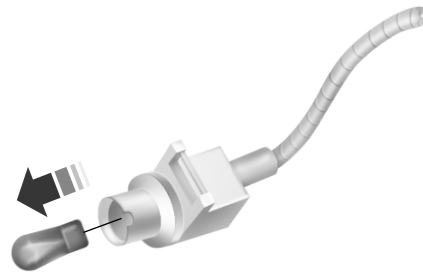

5. Carefully pull the bulb straight out of socket.

**Replacing Fog Lamp Bulbs (V6) (if equipped)**

1. Make sure the headlamp control is in the off position and open the hood.



2. Remove the hex head screws attaching the underbody forward aeroshield.

3. Remove the underbody forward aeroshield to gain access to the fog lamp assembly.

4. Disconnect the electrical connector from the bulb by pulling it straight off.

5. Rotate the bulb counterclockwise and remove from the lamp assembly. Install the new bulb in reverse order.

**Replacing Fog Lamp Bulbs (GT)**

Your vehicle is equipped with LED fog lamp bulbs. It is designed to last the life of the vehicle. If replacement is required, it is recommended that you see your authorized dealer.

**Replacing Tail Lamp/Brake/Rear Turn Signal Lamps**

Your vehicle is equipped with LED tail lamp, brake and rear turn signal lamps. It is designed to last the life of the vehicle. If replacement is required, it is recommended that you see your authorized dealer.

**Replacing Backup Bulbs**

Your vehicle is equipped with LED backup lamps. They are designed to last the life of the vehicle. If replacement is required, it is recommended that you see your authorized dealer.

**Replacing Rear Sidemarkers Lamp Bulbs**

1. Make sure the headlamp switch is in the off position and locate the sidemarker on the rear bumper fascia.
2. Insert a flathead screwdriver between the rear of the sidemarker lens and the bumper fascia.
3. Push the screwdriver to the front of the vehicle and then slide it towards you to pop out the lamp assembly.

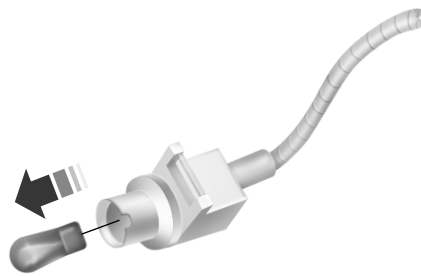

4. Carefully pull the bulb straight out of socket.

Install the new bulb in reverse order.

**Replacing License Plate Lamp Bulbs**

1. Make sure the headlamp switch is in the off position.



2. Remove the 2 screws and the lens from the license plate lamp assembly.

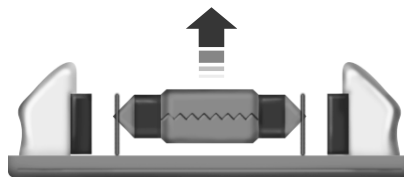

3. Carefully pull the bulb straight out from the lamp assembly.

Install the new bulb(s) in reverse order.

**BULB SPECIFICATION CHART**

Replacement bulbs are specified in the chart below. Headlamp bulbs must be marked with an authorized D.O.T. for North America and an E for Europe to ensure lamp performance, light brightness and pattern and safe visibility. The correct bulbs will not damage the lamp assembly or void the lamp assembly warranty and will provide quality bulb burn time.

<b>Function</b>	<b>Trade Number</b>
* HID (high intensity discharge) headlamp	D3S
Front park/turn lamp	7444NA (amber)
Sidemarkers (front/rear)	194
Fog lamp	LED (GT)
	H11 (V6)
* Tail lamp, brake lamp, turn lamp (LED)	LED
* High-mount stoplamp (LED)	LED
* Backup lamp	LED
License plate lamp	C5WL
Dome/Map lamp	168
All replacement bulbs are clear in color except where noted.	
To replace all instrument panel lights - see your authorized dealer.	
* To replace these lamps - see your authorized dealer.	

**GENERAL INFORMATION**

Your Ford or Lincoln authorized dealer has many quality products available to clean your vehicle and protect its finishes.

**CLEANING PRODUCTS**

For best results, use the following products or products of equivalent quality:

- Motorcraft® Bug and Tar Remover (ZC-42)
- Motorcraft® Custom Bright Metal Cleaner (ZC-15)
- Motorcraft® Detail Wash (ZC-3-A)
- Motorcraft® Dusting Cloth (ZC-24)
- Motorcraft® Engine Shampoo and Degreaser (U.S. only) (ZC-20)
- Motorcraft® Engine Shampoo (Canada only) (CXC-66-A)
- Motorcraft® Multi-Purpose Cleaner (Canada only) (CXC-101)
- Motorcraft® Premium Glass Cleaner (Canada only) (CXC-100)
- Motorcraft® Premium Quality Windshield Washer Fluid (Canada only) [CXC-37-(A, B, D or F)]
- Motorcraft® Premium Windshield Washer Concentrate (U.S. only) (ZC-32-A)
- Motorcraft® Professional Strength Carpet & Upholstery Cleaner (ZC-54)
- Motorcraft® Spot and Stain Remover (U.S. only) (ZC-14)
- Motorcraft® Ultra-Clear Spray Glass Cleaner (ZC-23)
- Motorcraft® Vinyl Cleaner (Canada only) (CXC-93)
- Motorcraft® Wheel and Tire Cleaner (ZC-37-A)

**CLEANING THE EXTERIOR**

Wash your vehicle regularly with cool or lukewarm water and a neutral pH shampoo, such as Motorcraft® Detail Wash.

- Never use strong household detergents or soap, such as dish washing or laundry liquid. These products can discolor and spot painted surfaces.
- Never wash a vehicle that is hot to the touch or during exposure to strong, direct sunlight.
- Dry the vehicle with a chamois or soft terry cloth towel in order to eliminate water spotting.

- Immediately remove items such as gasoline, diesel fuel, bird droppings and insect deposits because they can cause damage to the vehicle's paintwork and trim over time. Use Motorcraft® Bug and Tar Remover.
- **Note:** Suntan lotions and insect repellents can damage any painted surface; if these substances come in contact with your vehicle, wash off as soon as possible.
- Remove any exterior accessories before entering a car wash.

### Exterior Chrome

**Note:** Never use abrasive materials such as steel wool or plastic pads as they can scratch the chrome surface.

**Note:** Do not use chrome cleaner, metal cleaner or polish on wheels and wheel covers.

- Wash the vehicle first, using cool or lukewarm water and a neutral pH shampoo, such as Motorcraft® Detail Wash.
- Use Motorcraft® Custom Bright Metal Cleaner. Apply the product as you would a wax to clean bumpers and other chrome parts; allow the cleaner to dry for a few minutes, then wipe off the haze with a clean, dry rag.
- Do not apply cleaning product to hot surfaces and do not leave cleaning product on chrome surfaces for a period of time exceeding that which is recommended.
- **Note:** Using other non-recommended cleaners can result in severe and permanent cosmetic damage.

### Underbody

Flush the complete underside of your vehicle frequently. Keep body and door drain holes free from packed dirt.

### Cleaning Plastic Exterior Parts

Use only approved products to clean plastic parts.

- For routine cleaning, use Motorcraft® Detail Wash.
- If tar or grease spots are present, use Motorcraft® Bug and Tar Remover.

### Convertible Top and Padded Molding

For vinyl tops, wash with Motorcraft® Detail Wash.

For cloth tops, wash with a high quality convertible top cleaner and protectant.

- Do not use stiff bristle brushes or abrasive materials or cleaners.

- Hot waxes applied by commercial car washes can affect the cleanability of vinyl material.
- Using high water pressure or wand-type car washes against the convertible top and windows may cause water leaks and possible seal damage.

**WAXING**

- Wash the vehicle first.
- Use a quality wax that does not contain abrasives.
- Do not allow paint sealant to come in contact with any non-body (low-gloss black) colored trim, such as grained door handles, roof racks, bumpers, side moldings, mirror housings or the windshield cowl area. The paint sealant will grey or stain the parts over time.

**REPAIRING MINOR PAINT DAMAGE**

Your authorized dealer has touch-up paint to match your vehicle's color. Take your color code (printed on a sticker in the driver's door jamb) to your authorized dealer to make sure you get the correct color.

- Remove particles, such as bird droppings, tree sap, insect deposits, tar spots, road salt and industrial fallout, before repairing paint chips.
- Always read the instructions before using the products.

**CLEANING THE ENGINE**

Engines are more efficient when they are clean because grease and dirt buildup keep the engine warmer than normal.

When washing:

- Take care when using a power washer to clean the engine. The high-pressure fluid could penetrate the sealed parts and cause damage.
- Do not spray a hot engine with cold water to avoid cracking the engine block or other engine components.
- Spray Motorcraft® Engine Shampoo and Degreaser on all parts that require cleaning and pressure rinse clean. In Canada, use Motorcraft® Engine Shampoo.
- Never wash or rinse the engine while it is hot or running; water in the running engine may cause internal damage.
- Never wash or rinse any ignition coil, spark plug wire or spark plug well, or the area in and around these locations.
- Cover the battery, power distribution box, and air filter assembly to prevent water damage when cleaning the engine.

**CLEANING THE WINDOWS AND WIPER BLADES**

The windows and wiper blades should be cleaned regularly. If the wipers do not wipe properly, substances on the vehicle's glass or the wiper blades may be the cause. These may include hot wax treatments used by commercial car washes, water repellent coatings, tree sap, or other organic contamination; these contaminants may cause squeaking or chatter noise from the blades, and streaking and smearing of the windshield. To clean these items, follow these tips:

- The windows may be cleaned with a non-abrasive cleaner such as Motorcraft® Ultra-Clear Spray Glass Cleaner.
- The wiper blades can be cleaned with isopropyl (rubbing) alcohol or Motorcraft® Premium Windshield Washer Concentrate in the U.S., or Premium Quality Windshield Washer Fluid in Canada. Be sure to replace wiper blades when they appear worn or do not function properly.
- Do not use abrasives, as they may cause scratches.
- Do not use fuel, kerosene, or paint thinner to clean any parts.

If you cannot remove those streaks after cleaning with the glass cleaner or if the wipers chatter and move in a jerky motion, clean the outer surface of the windshield and the wiper blades using a sponge or soft cloth with a neutral detergent or mild-abrasive cleaning solution. After cleaning, rinse the windshield and wiper blades with clean water. The windshield is clean if beads do not form when you rinse the windshield with water.

**CLEANING THE INTERIOR**

**WARNING:** Do not use cleaning solvents, bleach or dye on the vehicle's safety belts, as these actions may weaken the belt webbing.



**WARNING:** On vehicles equipped with seat-mounted airbags, do not use chemical solvents or strong detergents. Such products could contaminate the side airbag system and affect performance of the side airbag in a collision.

For fabric, carpets, cloth seats, safety belts and seats equipped with side airbags:

- Remove dust and loose dirt with a vacuum cleaner.
- Remove light stains and soil with Motorcraft® Professional Strength Carpet & Upholstery Cleaner.

**2013 05+ Mustang (197)**  
**Owners Guide gf, 3rd Printing**  
**USA (fus)**



Information Provided by:

**DEALER**  
E-PROCESS



**PG** DEALER  
DIGITAL  
MARKETING



- If grease or tar is present on the material, spot-clean the area first with Motorcraft® Spot and Stain Remover. In Canada, use Motorcraft® Multi-Purpose Cleaner.
- If a ring forms on the fabric after spot cleaning, clean the entire area immediately (but do not oversaturate) or the ring will set.
- Do not use household cleaning products or glass cleaners, which can stain and discolor the fabric and affect the flame retardant abilities of the seat materials.

### CLEANING THE INSTRUMENT PANEL AND INSTRUMENT CLUSTER LENS



**WARNING:** Do not use chemical solvents or strong detergents when cleaning the steering wheel or instrument panel to avoid contamination of the airbag system.

Clean the instrument panel and cluster lens with a clean, damp, white, cotton cloth, then use a clean and dry, white, cotton cloth to dry these areas.

- Avoid cleaners or polishes that increase the gloss of the upper portion of the instrument panel. The dull finish in this area helps protect the driver from undesirable windshield reflection.
- Be certain to wash or wipe your hands clean if you have been in contact with certain products, such as insect repellent and suntan lotion, in order to avoid possible damage to the interior painted surfaces.
- Do not use household or glass cleaners as these may damage the finish of the instrument panel, interior trim and cluster lens.
- Do not allow air fresheners and hand sanitizers to spill on interior surfaces. If a spill occurs, wipe off immediately. Damage may not be covered by your warranty.

If a staining liquid like coffee or juice has been spilled on the instrument panel or on interior trim surfaces, clean as follows:

1. Wipe up spilled liquid using a clean, white, cotton cloth.
2. Wipe the surface with a damp, clean, white, cotton cloth. For more thorough cleaning, use a mild soap and water solution. If the spot cannot be completely cleaned by this method, the area may be cleaned using a commercially available cleaning product designed for automotive interiors.
3. If necessary, apply more soap and water solution or cleaning product to a clean, white, cotton cloth and press the cloth onto the soiled area—allow this to set at room temperature for 30 minutes.

4. Remove the soaked cloth, and if it is not soiled badly, use this cloth to clean the area by using a rubbing motion for 60 seconds.
5. Following this, wipe area dry with a clean, white, cotton cloth.

**CLEANING LEATHER SEATS (IF EQUIPPED)**

- Remove dust and loose dirt with a vacuum cleaner.
- Clean spills and stains as quickly as possible.
- For routine cleaning, wipe the surface with a soft, damp cloth. For more thorough cleaning, wipe the surface with a mild soap and water solution. In Canada, use Motorcraft® Vinyl Cleaner. Dry the area with a soft cloth.
- If the leather cannot be completely cleaned using a mild soap and water solution, the leather may be cleaned using a commercially available leather cleaning product designed for automotive interiors.
- To check for compatibility, first test any cleaner or stain remover on an inconspicuous part of the leather.
- Do not use household cleaning products, alcohol solutions, solvents or cleaners intended for rubber, vinyl and plastics or petroleum-based leather conditioners. These products may cause premature wearing or damage to the leather.

**CLEANING THE ALLOY WHEELS**

**Note:** Do not use chrome cleaner, metal cleaner or polish on wheels and wheel covers.

Aluminum wheels and wheel covers are coated with a clear coat paint finish. In order to maintain their shine:

- Clean weekly with Motorcraft® Wheel and Tire Cleaner. Heavy dirt and brake dust accumulation may require agitation with a sponge. Rinse thoroughly with a strong stream of water.
- Never apply any cleaning chemical to hot or warm wheel rims or covers.
- Some automatic car washes may cause damage to the finish on your wheel rims or covers. Industrial-strength (heavy-duty) cleaners, or cleaning chemicals, in combination with brush agitation to remove brake dust and dirt, could wear away the clear coat finish over time.
- Do not use hydrofluoric acid-based or high caustic-based wheel cleaners, steel wool, fuels or strong household detergent.
- To remove tar and grease, use Motorcraft® Bug and Tar Remover.

**2013 05+ Mustang (197)**  
**Owners Guide gf, 3rd Printing**  
**USA (fus)**

**VEHICLE STORAGE**

If you plan on storing your vehicle for an extended period of time (30 days or more), read the following maintenance recommendations to make sure your vehicle stays in good operating condition.

All motor vehicles and their components were engineered and tested for reliable, regular driving. Long term storage under various conditions may lead to component degradation or failure unless specific precautions are taken to preserve the components.

*General*

- Store all vehicles in a dry, ventilated place.
- Protect from sunlight, if possible.
- If vehicles are stored outside, they require regular maintenance to protect against rust and damage.

*Body*

- Wash vehicle thoroughly to remove dirt, grease, oil, tar or mud from exterior surfaces, rear-wheel housing and underside of front fenders.
- Periodically wash vehicles stored in exposed locations.
- Touch-up raw or primed metal to prevent rust.
- Cover chrome and stainless steel parts with a thick coat of auto wax to prevent discoloration. Re-wax as necessary when the vehicle is washed.
- Lubricate all hood, door and trunk lid hinges, and latches with a light grade oil.
- Cover interior trim to prevent fading.
- Keep all rubber parts free from oil and solvents.

*Engine*

- The engine oil and filter should be changed prior to storage, as used engine oil contains contaminants that may cause engine damage.
- Start the engine every 15 days. Run at fast idle until it reaches normal operating temperature.
- With your foot on the brake, shift through all the gears while the engine is running.

*Fuel system*

- Fill the fuel tank with high-quality fuel until the first automatic shutoff of the fuel pump nozzle.

**Note:** During extended periods of vehicle storage (30 days or more), fuel may deteriorate due to oxidation. Add a quality gas stabilizer product to the vehicle fuel system whenever actual or expected storage periods exceed 30 days. Follow the instructions on the additive label. The vehicle should then be operated at idle speed to circulate the additive throughout the fuel system.

*Cooling system*

- Protect against freezing temperatures.
- When removing vehicle from storage, check coolant fluid level. Confirm there are no cooling system leaks, and fluid is at the recommended level.

*Battery*

- Check and recharge as necessary. Keep connections clean.
- If storing your vehicle for more than 30 days without recharging the battery, it may be advisable to disconnect the battery cables to ensure battery charge is maintained for quick starting.

**Note:** If battery cables are disconnected, it will be necessary to reset memory features.

*Brakes*

- Make sure brakes and parking brake are fully released.

*Tires*

- Maintain recommended air pressure.

*Miscellaneous*

- Make sure all linkages, cables, levers and pins under vehicle are covered with grease to prevent rust.
- Move vehicles at least 25 ft (8 m) every 15 days to lubricate working parts and prevent corrosion.

**Removing Vehicle from Storage**

When your vehicle is ready to come out of storage, do the following:

- Wash your vehicle to remove any dirt or grease film build-up on window surfaces.
- Check windshield wipers for any deterioration.
- Check under the hood for any foreign material that may have collected during storage (mice/squirrel nests).
- Check the exhaust for any foreign material that may have collected during storage.
- Check tire pressures and set tire inflation per the Tire Label.
- Check brake pedal operation. Drive the vehicle 15 feet (4.5 meters) back and forth to remove rust build-up.
- Check fluid levels (including coolant, oil and gas) to make sure there are no leaks and fluids are at recommended levels.
- If the battery was removed, clean the battery cable ends and inspect.

Contact your authorized dealer if you have any concerns or issues.



**TIRE CARE****Information About Uniform Tire Quality Grading**

Tire Quality Grades apply to new pneumatic passenger car tires. The Quality grades can be found where applicable on the tire sidewall between tread shoulder and maximum section width. For example:

- **Treadwear 200 Traction AA Temperature A**

These Tire Quality Grades are determined by standards that the United States Department of Transportation has set.

Tire Quality Grades apply to new pneumatic passenger car tires. They do not apply to deep tread, winter-type snow tires, space-saver or temporary use spare tires, light truck or LT type tires, tires with nominal rim diameters of 10 to 12 inches or limited production tires as defined in Title 49 Code of Federal Regulations Part 575.104(c)(2).

**U.S. Department of Transportation-Tire quality grades:** The U.S. Department of Transportation requires Ford Motor Company to give you the following information about tire grades exactly as the government has written it.

**Treadwear**

The treadwear grade is a comparative rating based on the wear rate of the tire when tested under controlled conditions on a specified government test course. For example, a tire graded 150 would wear 1½ times as well on the government course as a tire graded 100. The relative performance of tires depends upon the actual conditions of their use, however, and may depart significantly from the norm due to variations in driving habits, service practices, and differences in road characteristics and climate.

**Traction AA A B C**

**WARNING:** The traction grade assigned to this tire is based on straight-ahead braking traction tests, and does not include acceleration, cornering, hydroplaning or peak traction characteristics.

The traction grades, from highest to lowest are AA, A, B, and C. The grades represent the tire's ability to stop on wet pavement as measured under controlled conditions on specified government test surfaces of asphalt and concrete. A tire marked C may have poor traction performance.

**Temperature A B C**

**WARNING:** The temperature grade for this tire is established for a tire that is properly inflated and not overloaded. Excessive speed, underinflation, or excessive loading, either separately or in combination, can cause heat buildup and possible tire failure.

The temperature grades are A (the highest), B and C, representing the tire's resistance to the generation of heat and its ability to dissipate heat when tested under controlled conditions on a specified indoor laboratory test wheel. Sustained high temperature can cause the material of the tire to degenerate and reduce tire life, and excessive temperature can lead to sudden tire failure. The grade C corresponds to a level of performance which all passenger car tires must meet under the Federal Motor Vehicle Safety Standard No. 139. Grades B and A represent higher levels of performance on the laboratory test wheel than the minimum required by law.

**Glossary of Tire Terminology**

- **Tire label:** A label showing the OE (Original Equipment) tire sizes, recommended inflation pressure and the maximum weight the vehicle can carry.
- **Tire Identification Number (TIN):** A number on the sidewall of each tire providing information about the tire brand and manufacturing plant, tire size and date of manufacture. Also referred to as DOT code.



- **Inflation pressure:** A measure of the amount of air in a tire.
- **Standard load:** A class of P-metric or Metric tires designed to carry a maximum load at 35 psi [37 psi (2.5 bar) for Metric tires]. Increasing the inflation pressure beyond this pressure will not increase the tire's load carrying capability.
- **Extra load:** A class of P-metric or Metric tires designed to carry a heavier maximum load at 41 psi [43 psi (2.9 bar) for Metric tires]. Increasing the inflation pressure beyond this pressure will not increase the tire's load carrying capability.
- **kPa:** Kilopascal, a metric unit of air pressure.
- **PSI:** Pounds per square inch, a standard unit of air pressure.
- **Cold tire pressure:** The tire pressure when the vehicle has been stationary and out of direct sunlight for an hour or more and prior to the vehicle being driven for 1 mile (1.6 kilometers).
- **Recommended inflation pressure:** The cold inflation pressure found on the Safety Compliance Certification Label (affixed to either the door hinge pillar, door-latch post, or the door edge that meets the door-latch post, next to the driver's seating position), or Tire Label located on the B-Pillar or the edge of the driver's door.
- **B-pillar:** The structural member at the side of the vehicle behind the front door.
- **Bead area of the tire:** Area of the tire next to the rim.
- **Sidewall of the tire:** Area between the bead area and the tread.
- **Tread area of the tire:** Area of the perimeter of the tire that contacts the road when mounted on the vehicle.
- **Rim:** The metal support (wheel) for a tire or a tire and tube assembly upon which the tire beads are seated.





**INFORMATION CONTAINED ON THE TIRE SIDEWALL**

Both U.S. and Canada Federal regulations require tire manufacturers to place standardized information on the sidewall of all tires. This information identifies and describes the fundamental characteristics of the tire and also provides a U.S. DOT Tire Identification Number for safety standard certification and in case of a recall.

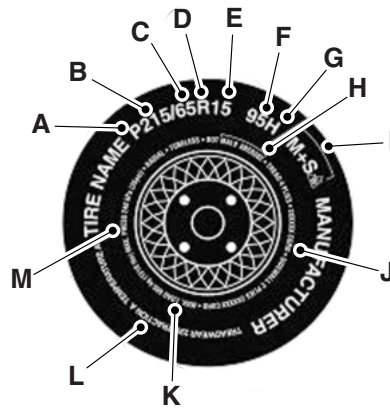
**Information on P Type Tires**

P215/65R15 95H is an example of a tire size, load index and speed rating. The definitions of these items are listed below. (Note that the tire size, load index and speed rating for your vehicle may be different from this example.)

A. **P:** Indicates a tire, designated by the Tire and Rim Association (T&RA), that may be used for service on cars, SUVs, minivans and light trucks.

**Note:** If your tire size does not begin with a letter, this may mean it is designated by either ETRTO (European Tire and Rim Technical Organization) or JATMA (Japan Tire Manufacturing Association).

B. **215:** Indicates the nominal width of the tire in millimeters from sidewall edge to sidewall edge. In general, the larger the number, the wider the tire.

C. **65:** Indicates the aspect ratio which gives the tire's ratio of height to width.

D. **R:** Indicates a radial type tire.

**E. 15:** Indicates the wheel or rim diameter in inches. If you change your wheel size, you will have to purchase new tires to match the new wheel diameter.

**F. 95:** Indicates the tire's load index. It is an index that relates to how much weight a tire can carry. You may find this information in your owner's manual. If not, contact a local tire dealer.

**Note:** You may not find this information on all tires because it is not required by federal law.

**G. H:** Indicates the tire's speed rating. The speed rating denotes the speed at which a tire is designed to be driven for extended periods of time under a standard condition of load and inflation pressure. The tires on your vehicle may operate at different conditions for load and inflation pressure. These speed ratings may need to be adjusted for the difference in conditions. The ratings range from 81 mph (130 km/h) to 186 mph (299 km/h). These ratings are listed in the following chart.

**Note:** You may not find this information on all tires because it is not required by federal law.

Letter rating	Speed rating - mph (km/h)
M	81 mph (130 km/h)
N	87 mph (140 km/h)
Q	99 mph (159 km/h)
R	106 mph (171 km/h)
S	112 mph (180 km/h)
T	118 mph (190 km/h)
U	124 mph (200 km/h)
H	130 mph (210 km/h)
V	149 mph (240 km/h)
W	168 mph (270 km/h)
Y	186 mph (299 km/h)

**Note:** For tires with a maximum speed capability over 149 mph (240 km/h), tire manufacturers sometimes use the letters ZR. For those with a maximum speed capability over 186 mph (299 km/h), tire manufacturers always use the letters ZR.

**H. U.S. DOT Tire Identification Number (TIN):** This begins with the letters DOT and indicates that the tire meets all federal standards. The next two numbers or letters are the plant code designating where it was manufactured, the next two are the tire size code and the last four numbers represent the week and year the tire was built. For example, the numbers 317 mean the 31st week of 1997. After 2000 the numbers go to four digits. For example, 2501 means the 25th week of 2001. The numbers in between are identification codes used for traceability. This information is used to contact customers if a tire defect requires a recall.

**I. M+S or M/S:** Mud and Snow, or

**AT:** All Terrain, or

**AS:** All Season.

**J. Tire Ply Composition and Material Used:** Indicates the number of plies or the number of layers of rubber-coated fabric in the tire tread and sidewall. Tire manufacturers also must indicate the ply materials in the tire and the sidewall, which include steel, nylon, polyester, and others.

**K. Maximum Load:** Indicates the maximum load in kilograms and pounds that can be carried by the tire. See the Safety Compliance Certification Label (affixed to either the door hinge pillar, door-latch post, or the door edge that meets the door-latch post, next to the driver's seating position), for the correct tire pressure for your vehicle.

**L. Treadwear, Traction and Temperature Grades**

- **Treadwear:** The treadwear grade is a comparative rating based on the wear rate of the tire when tested under controlled conditions on a specified government test course. For example, a tire graded 150 would wear one and one-half (1½) times as well on the government course as a tire graded 100.
- **Traction:** The traction grades, from highest to lowest are AA, A, B, and C. The grades represent the tire's ability to stop on wet pavement as measured under controlled conditions on specified government test surfaces of asphalt and concrete. A tire marked C may have poor traction performance.
- **Temperature:** The temperature grades are A (the highest), B and C, representing the tire's resistance to the generation of heat and its ability to dissipate heat when tested under controlled conditions on a specified indoor laboratory test wheel.

**M. Maximum Inflation Pressure:** Indicates the tire manufacturers' maximum permissible pressure and/or the pressure at which the maximum load can be carried by the tire. This pressure is normally higher than the manufacturer's recommended cold inflation pressure which can be found on the Safety Compliance Certification Label (affixed to either the door hinge pillar, door-latch post, or the door edge that meets the door-latch post, next to the driver's seating position), or Tire Label which is located on the B-Pillar or the edge of the driver's door. The cold inflation pressure should never be set lower than the recommended pressure on the vehicle label.

The tire suppliers may have additional markings, notes or warnings, such as standard load, radial tubeless, etc.

#### **Additional Information Contained on the Tire Sidewall for LT Type Tires**

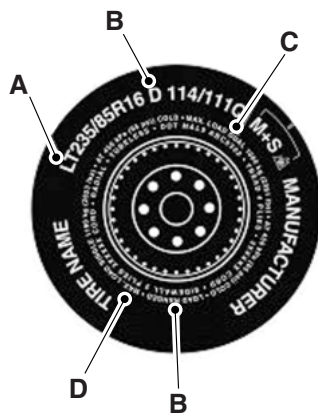

LT type tires have some additional information beyond those of P type tires. These differences are described below.

**Note:** Tire Quality Grades do not apply to this type of tire.

**A. LT:** Indicates a tire, designated by the Tire and Rim Association, that is intended for service on light trucks.

**B. Load Range/Load Inflation Limits:** Indicates the tire's load-carrying capabilities and its inflation limits.

**C. Maximum Load Dual lb (kg) at psi (kPa) cold:** Indicates the maximum load and tire pressure when the tire is used as a dual; defined as four tires on the rear axle (a total of six or more tires on the vehicle).

**D. Maximum Load Single lb (kg) at psi (kPa) cold:** Indicates the maximum load and tire pressure when the tire is used as a single; defined as two tires (total) on the rear axle.

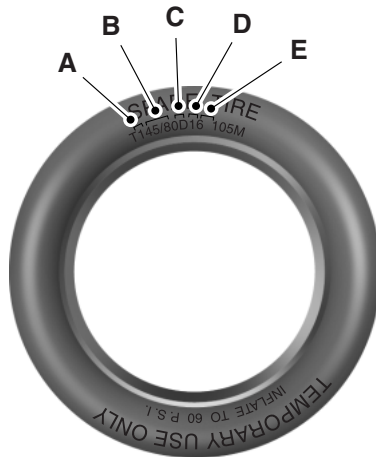
**Information on T Type Tires**

T type tires have some additional information beyond those of P type tires. These differences are described below.

T145/80D16 is an example of a tire size.

**Note:** The temporary tire size for your vehicle may be different from this example. Tire Quality Grades do not apply to this type of tire.

A. **T:** Indicates a type of tire, designated by the Tire and Rim Association, that is intended for temporary service on cars, sport-utility vehicles, minivans and light trucks.

B. **145:** Indicates the nominal width of the tire in millimeters from sidewall edge to sidewall edge. In general, the larger the number, the wider the tire.

C. **80:** Indicates the aspect ratio which gives the tire's ratio of height to width. Numbers of 70 or lower indicate a short sidewall.

D. **D:** Indicates a diagonal type tire.

**R:** Indicates a radial type tire.

E. **16:** Indicates the wheel or rim diameter in inches. If you change your wheel size, you will have to purchase new tires to match the new wheel diameter.

**Location of the Tire Label**

You will find a Tire Label containing tire inflation pressure by tire size and other important information located on the B-Pillar or the edge of the driver's door. See the payload description and graphic in the *Load Carrying* chapter.

**INFLATING YOUR TIRES**

Safe operation of your vehicle requires that your tires are properly inflated. Remember that a tire can lose up to half of its air pressure without appearing flat.

Every day before you drive, check your tires. If one looks lower than the others, use a tire gauge to check pressure of all tires and adjust if required.

At least once a month and before long trips, inspect each tire and check the tire pressure with a tire gauge (including spare, if equipped). Inflate all tires to the inflation pressure recommended by Ford Motor Company.



**WARNING:** Under-inflation is the most common cause of tire failures and may result in severe tire cracking, tread separation or blowout, with unexpected loss of vehicle control and increased risk of injury. Under-inflation increases sidewall flexing and rolling resistance, resulting in heat build-up and internal damage to the tire. It also may result in unnecessary tire stress, irregular wear, loss of vehicle control and accidents. A tire can lose up to half of its air pressure and not appear to be flat!

You are strongly urged to buy a reliable tire pressure gauge, as automatic service station gauges may be inaccurate. Ford recommends the use of a digital or dial-type tire pressure gauge rather than a stick-type tire pressure gauge.

Use the recommended cold inflation pressure for optimum tire performance and wear. Under-inflation or over-inflation may cause uneven treadwear patterns.

Always inflate your tires to the Ford recommended inflation pressure even if it is less than the maximum inflation pressure information found on the tire. The Ford recommended tire inflation pressure is found on the Safety Compliance Certification Label (affixed to either the door hinge pillar, door-latch post, or the door edge that meets the door-latch post, next to the driver's seating position), or Tire Label which is located on the B-Pillar or the edge of the driver's door. Failure to follow the tire pressure recommendations can cause uneven treadwear patterns and adversely affect the way your vehicle handles.

**Maximum Inflation Pressure** is the tire manufacturer's maximum permissible pressure or the pressure at which the maximum load can be carried by the tire. This pressure is normally higher than the manufacturer's recommended cold inflation pressure which can be found



on the Safety Compliance Certification Label (affixed to either the door hinge pillar, door-latch post, or the door edge that meets the door-latch post, next to the driver's seating position), or Tire Label which is located on the B-Pillar or the edge of the driver's door. The cold inflation pressure should never be set lower than the recommended pressure on the Safety Compliance Certification Label or Tire Label.

When weather temperature changes occur, tire inflation pressures also change. A 10°F (6°C) temperature drop can cause a corresponding drop of 1 psi (7 kPa) in inflation pressure. Check your tire pressures frequently and adjust them to the proper pressure which can be found on the Safety Compliance Certification Label or Tire Label.

To check the pressure in your tire(s):

1. Make sure the tires are cool, meaning they are not hot from driving even a mile.

**Note:** If you are checking tire pressure when the tire is hot (for example, driven more than 1 mile [1.6 kilometers]), never bleed or reduce air pressure. The tires are hot from driving and it is normal for pressures to increase above recommended cold pressures. A hot tire at or below recommended cold inflation pressure could be significantly under-inflated.

**Note:** If you have to drive a distance to get air for your tire(s), check and record the tire pressure first and add the appropriate air pressure when you get to the pump. It is normal for tires to heat up and the air pressure inside to go up as you drive.

2. Remove the cap from the valve on one tire, then firmly press the tire gauge onto the valve and measure the pressure.

3. Add enough air to reach the recommended air pressure.

**Note:** If you overfill the tire, release air by pressing on the metal stem in the center of the valve. Then recheck the pressure with your tire gauge.

4. Replace the valve cap.

5. Repeat this procedure for each tire, including the spare.

**Note:** Some spare tires operate at a higher inflation pressure than the other tires. For T-type mini-spare tires, see the *Dissimilar Spare Tire and Wheel Assembly Information* section. Store and maintain at 60 psi (4.15 bar). For full-size and dissimilar spare tires, see the *Dissimilar Spare Tire and Wheel Assembly Information* section. Store and maintain at the higher of the front and rear inflation pressure as shown on the Tire Label.

6. Visually inspect the tires to make sure there are no nails or other objects embedded that could poke a hole in the tire and cause an air leak.
7. Check the sidewalls to make sure there are no gouges, cuts or bulges.

### Inspecting Your Tires and Wheel Valve Stems

Periodically inspect the tire treads for uneven or excessive wear and remove objects such as stones, nails or glass that may be wedged in the tread grooves. Check the tire and valve stems for holes, cracks, or cuts that may permit air leakage and repair or replace the tire and replace the valve stem. Inspect the tire sidewalls for cracking, cuts, bruises and other signs of damage or excessive wear. If internal damage to the tire is suspected, have the tire demounted and inspected in case it needs to be repaired or replaced. For your safety, tires that are damaged or show signs of excessive wear should not be used because they are more likely to blow out or fail.

Improper or inadequate vehicle maintenance can cause tires to wear abnormally. Inspect all your tires, including the spare, frequently, and replace them if one or more of the following conditions exist:

#### Tire Wear

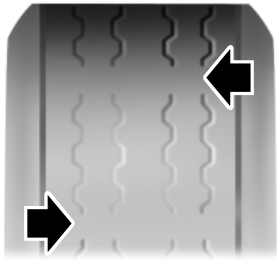

When the tread is worn down to 1/16th of an inch (2 millimeters), tires must be replaced to help prevent your vehicle from skidding and hydroplaning. Built-in treadwear indicators, or wear bars, which look like narrow strips of smooth rubber across the tread will appear on the tire when the tread is worn down to 1/16th of an inch (2 millimeters).

When the tire tread wears down to the same height as these wear bars, the tire is worn out and must be replaced.



**Damage**

Periodically inspect the tire treads and sidewalls for damage (such as bulges in the tread or sidewalls, cracks in the tread groove and separation in the tread or sidewall). If damage is observed or suspected, have the tire inspected by a tire professional. Tires can be damaged during off-road use, so inspection after off-road use is also recommended.

**WARNING: Age**

Tires degrade over time depending on many factors such as weather, storage conditions, and conditions of use (such as load, speed, inflation pressure) the tires experience throughout their lives.

In general, tires should be replaced after six years regardless of tread wear. However, heat caused by hot climates or frequent high loading conditions can accelerate the aging process and may require tires to be replaced more frequently.

You should replace your spare tire when you replace the road tires or after six years due to aging even if it has not been used.

**U.S. DOT Tire Identification Number**

Both U.S. and Canada Federal regulations require tire manufacturers to place standardized information on the sidewall of all tires. This information identifies and describes the fundamental characteristics of the tire and also provides a U.S. DOT Tire Identification Number for safety standard certification and in case of a recall.

This begins with the letters DOT and indicates that the tire meets all federal standards. The next two numbers or letters are the plant code designating where it was manufactured, the next two are the tire size code and the last four numbers represent the week and year the tire was built. For example, the numbers 317 mean the 31st week of 1997. After 2000 the numbers go to four digits. For example, 2501 means the 25th week of 2001. The numbers in between are identification codes used for traceability. This information is used to contact customers if a tire defect requires a recall.



**Tire Replacement Requirements**

**WARNING:** Only use replacement tires and wheels that are the same size, load index, speed rating and type (such as P-metric versus LT-metric or all-season versus all-terrain) as those originally provided by Ford. The recommended tire and wheel size may be found on either the Safety Compliance Certification Label (affixed to either the door hinge pillar, door-latch post, or the door edge that meets the door-latch post, next to the driver's seating position), or the Tire Label which is located on the B-Pillar or edge of the driver's door. If this information is not found on these labels, then you should contact your authorized dealer as soon as possible. Use of any tire or wheel not recommended by Ford can affect the safety and performance of your vehicle, which could result in an increased risk of loss of vehicle control, vehicle rollover, personal injury and death. Additionally the use of non-recommended tires and wheels could cause steering, suspension, axle, transfer case or power transfer unit failure. If you have questions regarding tire replacement, contact your authorized dealer as soon as possible.



**WARNING:** When mounting replacement tires and wheels, you should not exceed the maximum pressure indicated on the sidewall of the tire to set the beads without additional precautions listed below. If the beads do not seat at the maximum pressure indicated, re-lubricate and try again.

When inflating the tire for mounting pressures up to 20 psi (1.38 bar) greater than the maximum pressure on the tire sidewall, the following precautions must be taken to protect the person mounting the tire:

1. Make sure that you have the correct tire and wheel size.
2. Lubricate the tire bead and wheel bead seat area again.
3. Stand at a minimum of 12 feet (3.66 meters) away from the tire wheel assembly.
4. Use both eye and ear protection.

For a mounting pressure more than 20 psi (1.38 bar) greater than the maximum pressure, a Ford dealer or other tire service professional should do the mounting.

Always inflate steel carcass tires with a remote air fill with the person inflating standing at a minimum of 12 feet (3.66 meters) away from the tire wheel assembly.

Your vehicle is equipped with tires designed to provide a safe ride and handling capability.



**Important:** Remember to replace the wheel valve stems when the road tires are replaced on your vehicle.

The two front tires or two rear tires should generally be replaced as a pair.

The tire pressure sensors mounted in the wheels (originally installed on your vehicle) are not designed to be used in aftermarket wheels.

The use of wheels or tires not recommended by Ford Motor Company may affect the operation of your tire pressure monitoring system.

If the tire pressure monitoring system indicator is flashing, the system is malfunctioning. Your replacement tire might be incompatible with your tire pressure monitoring system, or some component of the system may be damaged.

### Safety Practices



**WARNING:** If your vehicle is stuck in snow, mud, or sand, do not rapidly spin the tires. Spinning the tires can tear the tire and cause an explosion. A tire can explode in as little as three to five seconds.



**WARNING:** Do not spin the wheels at over 35 mph (56 km/h). The tires may fail and injure a passenger or bystander.

Driving habits have a great deal to do with your tire mileage and safety.

- Observe posted speed limits.
- Avoid fast starts, stops and turns.
- Avoid potholes and objects on the road.
- Do not run over curbs or hit the tire against a curb when parking.

### Highway Hazards

No matter how carefully you drive, there is always the possibility that you may eventually have a flat tire on the highway. Drive slowly to the closest safe area out of traffic. This may further damage the flat tire, but your safety is more important.

If you feel a sudden vibration or ride disturbance while driving, or you suspect your tire or vehicle has been damaged, immediately reduce your speed. Drive with caution until you can safely pull off the road. Stop and inspect the tires for damage. If a tire is under-inflated or damaged, deflate it, remove the wheel and replace it with your spare tire and wheel. If you cannot detect a cause, have the vehicle towed to the nearest repair facility or tire dealer to have the vehicle inspected.



### Tire and Wheel Alignment

A bad jolt from hitting a curb or pothole can cause the front end of your vehicle to become misaligned or cause damage to your tires. If your vehicle seems to pull to one side when you are driving, the wheels may be out of alignment. Have an authorized dealer check the wheel alignment periodically.

Wheel misalignment in the front or the rear can cause uneven and rapid treadwear of your tires and should be corrected by an authorized dealer. Front-wheel drive vehicles and those with an independent rear suspension may require alignment of all four wheels.

The tires should also be balanced periodically. An unbalanced tire and wheel assembly may result in irregular tire wear.

### Tire Rotation

**Note:** If your tires show uneven wear, ask an authorized dealer to check for and correct any wheel misalignment, tire imbalance or mechanical problem involved before tire rotation.

**Note:** Your vehicle may be equipped with a dissimilar spare tire and wheel assembly. A dissimilar spare tire and wheel assembly is defined as a spare tire and wheel that is different in brand, size or appearance from the road tires and wheels. If you have a dissimilar spare tire and wheel assembly, it is intended for temporary use only and should not be used in a tire rotation.

**Note:** After having your tires rotated, inflation pressure must be checked and adjusted to the vehicle requirements.

Rotating your tires at the recommended interval (as indicated in the scheduled maintenance information) will help your tires wear more evenly, providing better tire performance and longer tire life.

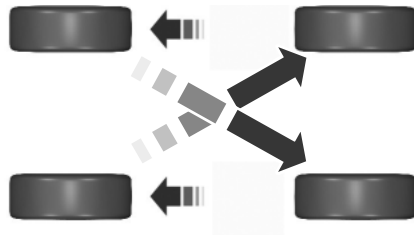

- Rear-wheel drive vehicles (front tires at left of diagram)

Sometimes irregular tire wear can be corrected by rotating the tires.

**SUMMER TIRES (IF EQUIPPED)**

Summer tires provide superior performance on wet and dry roads. Summer tires do not have the Mud and Snow (M+S or M/S) tire traction rating on the tire side wall. Since summer tires do not have the same traction performance as All-season or Snow tires, Ford does not recommend using summer tires when temperatures drop to approximately 40°F (5°C) or below (depending on tire wear and environmental conditions) or in snow and ice conditions. Like any tire, summer tire performance is affected by tire wear and environmental conditions. If you must drive in those conditions, Ford recommends using Mud and Snow (M+S, M/S), All-season or Snow tires.

**USING SNOW CHAINS**

**WARNING:** Driving too fast for conditions creates the possibility of loss of vehicle control. Driving at very high speeds for extended periods of time may result in damage to vehicle components.



**WARNING:** Snow tires must be the same size, load index, speed rating as those originally provided by Ford. Use of any tire or wheel not recommended by Ford can affect the safety and performance of your vehicle, which could result in an increased risk of loss of vehicle control, vehicle rollover, personal injury and death. Additionally, the use of non-recommended tires and wheels could cause steering, suspension, axle, transfer case or power transfer unit failure.

The tires on your vehicle may have all-weather treads to provide traction in rain and snow. However, in some climates, you may need to use snow tires and chains. Use chains on the tires only in an emergency or if the law requires them.

**Note:** The suspension insulation and bumpers will help prevent vehicle damage. Do not remove these components from your vehicle when using snow tires and chains.

Follow these guidelines when using snow tires and chains:

- If possible, avoid fully loading your vehicle.
- Chains may damage aluminum wheels.
- Use only SAE Class S chains with P225/60R17 tires on the rear of the vehicle only.
- Do not use tire chains with any other size tires. Use of SAE Class S chains or other chain types on tires other than a P225/60R17 will damage the vehicle.



- Install chains securely, verifying that the chains do not touch any wiring, brake lines or fuel lines.
- Drive cautiously. If you hear the chains rub or bang against your vehicle, stop and retighten the chains. If this does not work, remove the chains to prevent damage to your vehicle.
- Remove the tire chains when they are no longer needed. Do not use tire chains on dry roads.

### TIRE PRESSURE MONITORING SYSTEM



**WARNING:** The tire pressure monitoring system is not a substitute for manually checking tire pressure. The tire pressure should be checked periodically (at least monthly) using a tire gauge. See *Inflating Your Tires* in this chapter. Failure to properly maintain your tire pressure could increase the risk of tire failure, loss of control, vehicle rollover and personal injury.



Each tire, including the spare (if provided), should be checked monthly when cold and inflated to the inflation pressure recommended by the vehicle manufacturer on the vehicle placard or tire inflation pressure label. (If your vehicle has tires of a different size than the size indicated on the vehicle placard or tire inflation pressure label, you should determine the proper tire inflation pressure for those tires.)

As an added safety feature, your vehicle has been equipped with a tire pressure monitoring system that illuminates a low tire pressure telltale when one or more of your tires is significantly under-inflated. When the low tire pressure telltale illuminates, you should stop and check your tires as soon as possible, and inflate them to the proper pressure. Driving on a significantly under-inflated tire causes the tire to overheat and can lead to tire failure. Under-inflation also reduces fuel efficiency and tire tread life, and may affect the vehicle's handling and stopping ability.

The tire pressure monitoring system is not a substitute for proper tire maintenance, and it is the driver's responsibility to maintain correct tire pressure, even if under-inflation has not reached the level to trigger illumination of the system low tire pressure telltale.

Your vehicle has also been equipped with a tire pressure monitoring system malfunction indicator to indicate when the system is not operating properly. The system malfunction indicator is combined with the low tire pressure telltale. When the system detects a malfunction, the



telltale will flash for approximately one minute and then remain continuously illuminated. This sequence will continue upon subsequent vehicle start-ups as long as the malfunction exists.

When the malfunction indicator is illuminated, the system may not be able to detect or signal low tire pressure as intended. System malfunctions may occur for a variety of reasons, including the installation of replacement or alternate tires or wheels on the vehicle that prevent the system from functioning properly. Always check the system malfunction telltale after replacing one or more tires or wheels on your vehicle to ensure that the replacement or alternate tires and wheels allow the system to continue to function properly.

The tire pressure monitoring system complies with part 15 of the FCC rules and with RSS-210 of Industry Canada. Operation is subject to the following two conditions: (1) This device may not cause harmful interference, and (2) This device must accept any interference received, including interference that may cause undesired operation.

#### Changing Tires with a Tire Pressure Monitoring System



**Note:** Each road tire is equipped with a tire pressure sensor located inside the tire and wheel assembly cavity. The pressure sensor is attached to the valve stem. The pressure sensor is covered by the tire and is not visible unless the tire is removed. Take care when changing the tire to avoid damaging the sensor.

You should always have your tires serviced by an authorized dealer.

Check the tire pressure periodically (at least monthly) using an accurate tire gauge. See *Inflating Your Tires* in this chapter.

#### Understanding Your Tire Pressure Monitoring System

The tire pressure monitoring system measures pressure in your four road tires and sends the tire pressure readings to your vehicle. The low tire pressure warning light will turn on if the tire pressure is significantly low. Once the light is illuminated, your tires are under-inflated and need to be inflated to the manufacturer's recommended tire pressure. Even if the light turns on and a short time later turns off, your tire pressure still needs to be checked.

**When Your Temporary Spare Tire Is Installed**

When one of your road tires needs to be replaced with the temporary spare, the system will continue to identify an issue to remind you that the damaged road wheel and tire assembly needs to be repaired and put back on your vehicle.

To restore the full function of the tire pressure monitoring system, have the damaged road wheel and tire assembly repaired and remounted on your vehicle. For additional information, see *Changing Tires with a Tire Pressure Monitoring System* in this section.

**When You Believe Your System Is Not Operating Properly**

The main function of the tire pressure monitoring system is to warn you when your tires need air. It can also warn you in the event the system is no longer capable of functioning as intended. See the following chart for information concerning your tire pressure monitoring system:

Low tire pressure warning light	Possible cause	Customer action required
Solid warning light	Tire(s) under-inflated	1. Make sure tires are at the proper pressure. See <i>Inflating Your Tires</i> in this chapter. 2. After inflating your tires to the manufacturer's recommended pressure as shown on the Tire Label (located on the edge of driver's door or the B-Pillar), the vehicle must be driven for at least two minutes over 20 mph (32 km/h) before the light turns off.
	Spare tire in use	Repair the damaged road wheel and tire and reinstall it on the vehicle to restore system function. For a description on how the system functions, see <i>When Your Temporary Spare Tire is Installed</i> in this section.
	TPMS malfunction	If the tires are properly inflated and the spare tire is not in use but the light remains on, contact your authorized dealer as soon as possible.



Low tire pressure warning light	Possible cause	Customer action required
Flashing warning light	Spare tire in use	Repair the damaged road wheel and tire and reinstall it on the vehicle to restore system function. For a description on how the system functions, see <i>When Your Temporary Spare Tire is Installed</i> in this section.
	TPMS malfunction	If the tires are properly inflated and the spare tire is not in use but the light remains on, contact your authorized dealer as soon as possible.

### **When Inflating Your Tires**

When putting air into your tires (such as at a gas station or in your garage), the tire pressure monitoring system may not respond immediately to the air added to your tires.

It may take up to two minutes of driving over 20 mph (32 km/h) for the light to turn off after you have filled your tires to the recommended inflation pressure.

### **How Temperature Affects Your Tire Pressure**

The tire pressure monitoring system monitors tire pressure in each pneumatic tire. While driving in a normal manner, a typical passenger tire inflation pressure may increase about 2 to 4 psi (14 to 28 kPa) from a cold start situation. If the vehicle is stationary overnight with the outside temperature significantly lower than the daytime temperature, the tire pressure may decrease approximately 3 psi (21 kPa) for a drop of 30°F (17°C) in ambient temperature. This lower pressure value may be detected by the tire pressure monitoring system as being significantly lower than the recommended inflation pressure and activate the system warning light for low tire pressure. If the low tire pressure warning light is on, visually check each tire to verify that no tire is flat. If one or more tires are flat, repair as necessary. Check the air pressure in the road tires. If any tire is under-inflated, carefully drive the vehicle to the nearest location where air can be added to the tires. Inflate all the tires to the recommended inflation pressure.

**CHANGING A ROAD WHEEL**

 **WARNING:** The use of tire sealants may damage your tire pressure monitoring system and should not be used. However, if you must use a sealant, the tire pressure monitoring system sensor and valve stem on the wheel must be replaced by an authorized Ford dealer.

 **WARNING:** See *Tire Pressure Monitoring System* in this chapter for important information. If the tire pressure monitor sensor becomes damaged, it will no longer function.

**Note:** The tire pressure monitoring system indicator light will illuminate when the spare tire is in use. To restore the full function of the monitoring system, all road wheels equipped with tire pressure monitoring sensors must be mounted on the vehicle.

If you get a flat tire while driving, do not apply the brake heavily. Instead, gradually decrease your speed. Hold the steering wheel firmly and slowly move to a safe place on the side of the road.

Have a flat serviced by an authorized dealer in order to prevent damage to the system sensors. See *Tire Pressure Monitoring System* earlier in the chapter. Replace the spare tire with a road tire as soon as possible. During repairing or replacing of the flat tire, have the authorized dealer inspect the tire pressure monitoring system sensor for damage.

**Dissimilar Spare Tire and Wheel Assembly Information**

 **WARNING:** Failure to follow these guidelines could result in an increased risk of loss of vehicle control, injury or death.

If you have a dissimilar spare tire and wheel assembly, then it is intended for temporary use only. This means that if you need to use it, you should replace it as soon as possible with a road tire and wheel assembly that is the same size and type as the road tires and wheels that were originally provided by Ford. If the dissimilar spare tire or wheel is damaged, it should be replaced rather than repaired.

A dissimilar spare tire and wheel assembly is defined as a spare tire or wheel that is different in brand, size or appearance from the road tires and wheels and can be one of three types:

1. **T-type mini-spare:** This spare tire begins with the letter T for tire size and may have Temporary Use Only molded in the sidewall.

2. **Full-size dissimilar spare with label on wheel:** This spare tire has a label on the wheel that states: THIS TIRE AND WHEEL FOR TEMPORARY USE ONLY

When driving with one of the dissimilar spare tires listed above, do not:

- exceed 50 mph (80 km/h).
- load the vehicle beyond maximum vehicle load rating listed on the Safety Compliance Label.
- tow a trailer.
- use snow chains on the end of the vehicle with the dissimilar spare tire.
- use more than one dissimilar spare tire at a time.
- use commercial car washing equipment.
- try to repair the dissimilar spare tire.

Use of one of the dissimilar spare tires listed above at any one wheel location can lead to impairment of the following:

- Handling, stability and braking performance
- Comfort and noise
- Ground clearance and parking at curbs
- Winter weather driving capability
- Wet weather driving capability
- All-wheel driving capability

3. **Full-size dissimilar spare without label on wheel**

When driving with the full-size dissimilar spare tire and wheel assembly, do not:

- exceed 70 mph (113 km/h).
- use more than one dissimilar spare tire and wheel at a time.
- use commercial car washing equipment.
- use snow chains on the end of the vehicle with the dissimilar spare tire and wheel.

The usage of a full-size dissimilar spare tire and wheel assembly can lead to impairment of the following:

- Handling, stability and braking performance
- Comfort and noise

- Ground clearance and parking at curbs
- Winter weather driving capability
- Wet weather driving capability
- All-wheel driving capability (if applicable)
- Load leveling adjustment (if applicable)

When driving with the full-size dissimilar spare tire and wheel assembly, additional caution should be given to:

- towing a trailer.
- driving vehicles equipped with a camper body.
- driving vehicles with a load on the cargo rack.

Drive cautiously when using a full-size dissimilar spare tire and wheel, and seek service as soon as possible.

#### Tire Change Procedure



**WARNING:** When one of the front wheels is off the ground, the transmission alone will not prevent the vehicle from moving or slipping off the jack, even if the transmission selector lever is in position **P** or **N**.



**WARNING:** To help prevent the vehicle from moving when you change a tire, be sure to place the transmission selector lever in position **P** or **N**, set the parking brake and block (in both directions) the wheel that is diagonally opposite (other side and end of the vehicle) to the tire being changed.



**WARNING:** Never get underneath a vehicle that is supported only by a jack. If the vehicle slips off the jack, you or someone else could be seriously injured.



**WARNING:** Do not attempt to change a tire on the side of the vehicle close to moving traffic. Pull far enough off the road to avoid the danger of being hit when operating the jack or changing the wheel.



**WARNING:** Always use the jack provided as original equipment with your vehicle. If using a jack other than the one provided as original equipment with your vehicle, make sure the jack capacity is adequate for the vehicle weight, including any vehicle cargo or modifications.

**Note:** Passengers should not remain in the vehicle when the vehicle is being jacked.

1. Park on a level surface, set the parking brake and activate the hazard flashers.
2. Place the transmission selector lever in position **P** or **N** and turn the engine off.

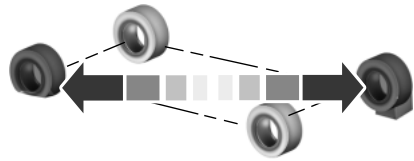

3. Block both the front and rear of the wheel diagonally opposite the flat tire. For example, if the left front tire is flat, block the right rear wheel.

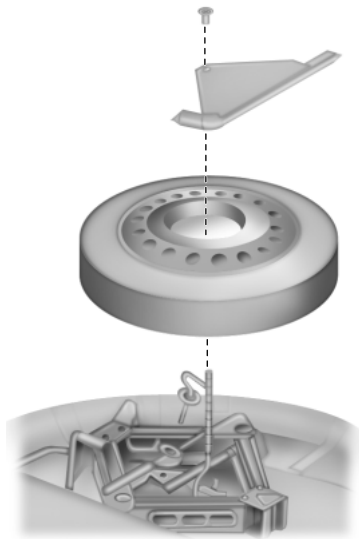

4. Remove the lug wrench, spare tire and jack.
5. Remove the center ornament from the wheel. Loosen each wheel lug nut one-half turn counterclockwise but do not remove them until the wheel is raised off the ground.





6. The vehicle jacking points are shown here, and can be identified by the triangle markings on the vehicle. Details are depicted on the yellow warning label on the jack.

**Note:** Jack at the specified locations to avoid damage to the vehicle.

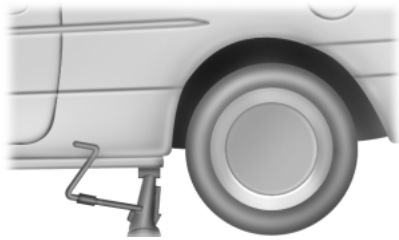

7. Put the jack in the jack notch next to the tire you are changing. Turn the jack handle clockwise until the wheel is completely off the ground.

8. Remove the lug nuts with the lug wrench.

9. Replace the flat tire with the spare tire, making sure the valve stem is facing outward. Reinstall lug

nuts until the wheel is snug against the hub. Do not fully tighten the lug nuts until the wheel has been lowered.

If you are using the temporary tire, the lug nut washers will not appear to be flush with the rim. This is normal only when using the temporary spare tire.

10. Lower the wheel by turning the jack handle counterclockwise.

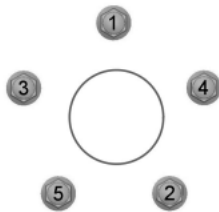

11. Remove the jack and fully tighten the lug nuts in the order shown. See *Wheel Lug Nut Torque Specifications* later in this chapter for the proper lug nut torque specification.

12. Put flat tire, wheel ornament, jack and lug wrench away. Make sure the jack is fastened so it does not rattle when you drive.

13. Unblock the wheel.

**TEMPORARY MOBILITY KIT (IF EQUIPPED)**

**Note:** The temporary mobility kit sealant compound in the canister is to be used for one tire only. See your Ford authorized dealer for additional replacement sealant canisters.

The kit is located in the spare tire well in the trunk. The kit consists of an air compressor to reinflate the tire and a sealing compound in a canister that will effectively seal most punctures caused by nails or similar objects. This kit will provide a temporary seal allowing you to drive your vehicle up to 120 miles (200 kilometers) at a maximum speed of 50 mph (80 km/h).

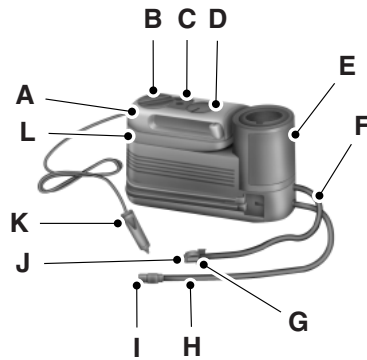

- A. Air compressor (inside)
- B. Diverter knob
- C. On/Off button
- D. Air pressure gauge
- E. Sealant bottle/canister
- F. Sealant filling clear tube
- G. Sealant tube – tire valve connector
- H. Yellow cap tool
- I. Air compressor hose
- J. Air hose – tire valve connector
- K. Accessory power plug
- L. Casing/housing

**General Information**

**WARNING:** Failure to follow these guidelines could result in an increased risk of loss of vehicle control, injury or death.

**Note:** Do not use the temporary mobility kit if a tire has become severely damaged by driving the vehicle with a tire that has insufficient air pressure. Only punctured areas located within the tire tread can be sealed with the temporary mobility kit.

Do not attempt to repair punctures larger than ¼ inch (6.4 millimeters) or damage to the tire's sidewall. The tire may not completely seal.

Loss of air pressure may adversely affect tire performance. For this reason:

- **Note:** Do not drive the vehicle above 50 mph (80 km/h).
- **Note:** Do not drive further than 120 miles (200 kilometers). Drive only to the closest Ford Motor Company authorized dealer or tire repair shop to have your tire inspected.
- Drive carefully and avoid abrupt steering maneuvers.
- Periodically monitor tire inflation pressure in the affected tire; if the tire is losing pressure, have the vehicle towed.
- Read the information in the *Tips for Use of the Temporary Mobility Kit* section to ensure safe operation of the temporary mobility kit and your vehicle.

#### **Tips for Use of the Temporary Mobility Kit**

Read the following list of tips to ensure safe operation of the temporary mobility kit:

- Before operating the temporary mobility kit, make sure your vehicle is safely off the road and away from moving traffic. Turn on the hazard lights.
- Always set the parking brake to ensure the vehicle does not move unexpectedly.
- Do not remove any foreign objects, such as nails or screws, from the tire.
- When using the temporary mobility kit, leave the engine running (only if the vehicle is outdoors or in a well-ventilated area) so the compressor does not drain the vehicle's battery.
- Do not allow the compressor to operate continuously for more than 15 minutes; this will help prevent the compressor from overheating.
- Never leave the temporary mobility kit unattended when it is operating.
- Sealant compound contains latex. Make sure that you use the non-latex gloves provided to avoid an allergic reaction.
- Keep the temporary mobility kit away from children.
- Only use the temporary mobility kit when the ambient temperature is between -22°F (-30°C) and 158°F (70°C).
- Only use the sealing compound before the use by date. The use by date is on the lower right hand corner of the label located on the sealant canister (bottle). **Note:** Check the use by date regularly and replace the canister after four years.



- Do not store the temporary mobility kit unsecured inside the passenger compartment of the vehicle as it may cause injury during a sudden stop or collision. Always store the kit in its original location.
- After sealant use, the TPMS sensor and valve stem on the wheel must be replaced by an authorized Ford dealer.
- When inflating a tire or other objects, use the black air hose only. Do not use the transparent hose which is designed for sealant application only.
- Operating the temporary mobility kit could cause an electrical disturbance in radio, CD, and DVD player operation (if equipped).

### What to Do When a Tire Is Punctured

A tire puncture within the tire's tread area can be repaired in two stages with the temporary mobility kit:

- In the first stage, the tire will be reinflated with a sealing compound and air. After the tire has been reinflated, you will need to drive the vehicle a short distance (approximately 4 miles [6 kilometers]) to distribute the sealant in the tire.
- In the second stage, you will need to check the tire pressure and adjust, if necessary, to the vehicle's tire inflation pressure.

### First Stage: Reinflating the Tire with Sealing Compound and Air



**WARNING:** Do not stand directly over the temporary mobility kit while inflating the tire. If you notice any unusual bulges or deformations in the tire's sidewall during inflation, stop and call roadside assistance.



**WARNING:** If the tire does not inflate to the recommended tire pressure within 15 minutes, stop and call roadside assistance.

### Preparation

Park the vehicle in a safe, level and secure area, away from moving traffic. Turn the hazard lights on. Apply the parking brake and turn the engine off. Inspect the flat tire for visible damage.

Sealant compound contains latex. To avoid any allergic reactions, use the non-latex gloves located in the accessory box on the underside of the temporary mobility kit housing.

Do not remove any foreign object that has pierced the tire. If a puncture is located in the tire sidewall, stop and call roadside assistance.



1. Remove the valve cap from the tire valve.
2. Unwrap the clear tube from the compressor housing.
3. Remove the tube cap and fasten the metal connector of the tube to the tire valve, turning clockwise. Make sure the connection is tightly fastened.



4. Plug the power cable into the 12-volt power point in the vehicle.

5. Remove the warning sticker found on the canister and place it on the top of the instrument panel or the center of the dash.
6. **Note:** Start the engine only if the vehicle is outdoors or in a well-ventilated area.

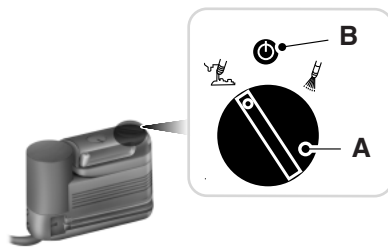

7. Push and turn dial (A) counterclockwise to the sealant position. Turn on the kit by pressing the on button (B).

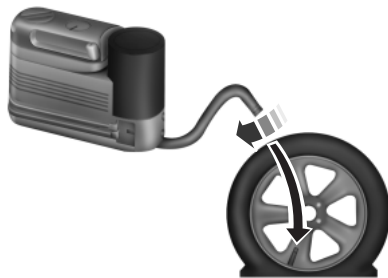

8. Inflate the tire to the pressure listed on the Tire Label located on the driver's door or the door jamb area.

**Note:** When the sealing compound is first added into the tire, the air pressure gauge reading on the compressor unit may indicate a higher value; this is normal and should be no reason for concern. The pressure will drop after about 30 seconds of operation. The tire pressure has to be checked with the compressor in the OFF position to get the correct tire pressure reading.

9. When the recommended tire pressure is reached, turn off the kit by pressing the on and off button; disconnect the kit from the tire valve and the power point. Re-install the valve cap on the tire valve, place the tube cap on the metal connector, and return the kit to the stowage area.

10. **Note:** Immediately and cautiously, drive the vehicle 4 miles (6 kilometers) to distribute the sealant evenly inside the tire. Do not exceed 50 mph (80 km/h).

**Note:** If you experience any unusual vibration, ride disturbance or noise while driving, reduce your speed until you can safely pull off to the side of the road to call for roadside assistance. **Note:** Do not proceed to the second stage of this operation.

11. After 4 miles (6 kilometers), stop and check the tire pressure. See *Second Stage: Checking Tire Pressure*.

### Second Stage: Checking Tire Pressure



**WARNING:** If you are proceeding from the *First Stage:*

*Reinflating the Tire with Sealing Compound and Air* section and have injected sealant in the tire and the pressure is below 20 psi (1.4 bar), stop and call roadside assistance. If tire pressure is above 20 psi (1.4 bar), continue to the next step.



**WARNING:** The power plug may get hot after use and should be handled carefully while unplugging.

Check the air pressure of your tires as follows:

1. Remove the valve cap from the tire valve.
2. Unhook the black hose from the side of the compressor and fasten firmly on the valve stem by turning clockwise.
3. Press down and turn the dial clockwise to the air position. Turn on the kit by pressing the on/off button.



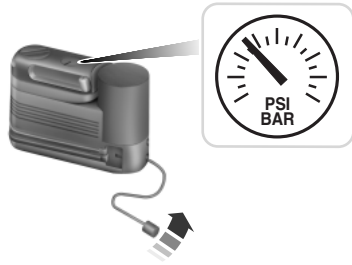

4. Adjust the tire to the recommended inflation pressure from the Tire Label located on the driver's door or door jamb area.

**Note:** The tire pressure has to be checked with the compressor in the OFF position to get the correct tire pressure reading.

5. Turn the compressor off by pressing the on/off button.

6. Unplug the hoses, re-install the valve cap on the tire and return the kit to the stowage area.

#### What To Do After the Tire Has Been Sealed

After using the temporary mobility kit to seal your tire, you will need to replace the sealant canister and clear tube (hose). Sealing compound and spare parts can be obtained and replaced at an authorized Ford Motor Company dealership or tire dealer. Empty sealant bottles may be disposed of at home. However, liquid residue from the sealing compound should be disposed by your local Ford Motor Company dealership or tire dealer, or in accordance with local waste disposal regulations.

**Note:** After the sealing compound has been used, the maximum vehicle speed is 50 mph (80 km/h) and the maximum driving distance is 120 miles (200 kilometers). The sealed tire should be inspected immediately.

**Note:** After sealant use, the tire pressure monitoring system sensor and valve stem on the wheel must be replaced by an authorized Ford dealer.

You can check the tire pressure anytime within the 120 miles (200 kilometers) by performing the procedure from *Second Stage: Checking Tire Pressure* listed previously.

Removal of the sealant canister from the temporary mobility kit:

1. Unwrap the clear tube from the compressor housing.



2. Locate the yellow cap at the end of the clear tube.



3. Using the yellow cap tool, press the tab located on the temporary mobility kit compressor housing while pulling up on the sealant canister.



Installation of the sealant canister to the temporary mobility kit:

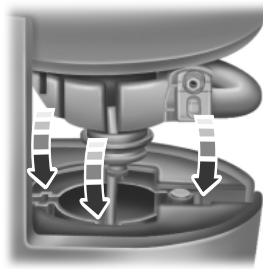

1. Align the sealant canister with the temporary mobility kit housing.



2. Once aligned, seat the sealant canister by lightly pushing down until you hear an audible click.

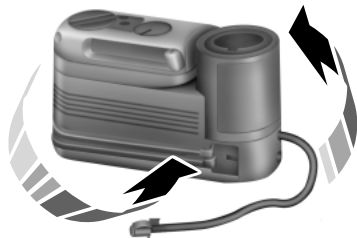

3. Wrap the clear tube around the compressor housing.

**Note:** If you experience any difficulties with the removal or installation of the sealant canister, consult your Ford Motor Company authorized dealer for assistance.

**Use By / Utiliser avant:**

(bottle). The sealant canister should be replaced after four years.

Be sure to check the sealant compound's use-by date regularly. The use-by date is on the lower right hand corner of the label located on the sealant canister

**TECHNICAL SPECIFICATIONS****Wheel Lug Nut Torque Specifications**

**!** **WARNING:** When a wheel is installed, always remove any corrosion, dirt or foreign materials present on the mounting surfaces of the wheel or the surface of the wheel hub, brake drum or brake disc that contacts the wheel. Make sure that any fasteners that attach the rotor to the hub are secured so they do not interfere with the mounting surfaces of the wheel. Installing wheels without correct metal-to-metal contact at the wheel mounting surfaces can cause the wheel nuts to loosen and the wheel to come off while the vehicle is in motion, resulting in loss of control.

Retighten the lug nuts to the specified torque within 100 miles (160 kilometers) after any wheel disturbance (such as rotation, flat tire, wheel removal).

Lug nut socket size/Bolt size	Wheel lug nut torque*	
	ft-lb	N•m
1/2 x 20	100	135

\* Torque specifications are for nut and bolt threads free of dirt and rust. Use only Ford recommended replacement fasteners.



**Note:** Inspect the wheel pilot hole and mounting surface prior to installation. Remove any visible corrosion or loose particles.

**ENGINE SPECIFICATIONS**

Engine	3.7L V6 Engine	5.0L V8 Engine
Cubic inches	227	302
Required fuel	Minimum 87 octane	Minimum 87 octane
Firing order	1-4-2-5-3-6	1-5-4-8-6-3-7-2
Ignition system	Coil on plug	Coil on plug
Spark plug gap	0.049–0.053 in (1.25–1.35 mm)	0.049–0.053 in (1.25–1.35 mm)
Compression ratio	10.5:1	11.0:1

For Shelby GT500 octane requirements, see the *Shelby GT500 Supplement*.

**DRIVEBELT ROUTING**

1. The short drivebelt is on the first pulley groove closest to engine.
2. The long drivebelt is on the second pulley groove farthest from engine.

**3.7L V6 engine**

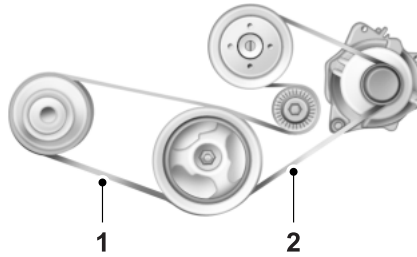

**5.0L V8 engine**

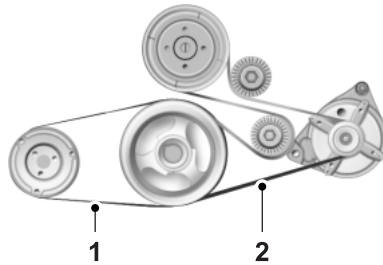



## TECHNICAL SPECIFICATIONS

Item	Capacity	Ford part name or equivalent	Ford part number / Ford Specification
Brake fluid and (clutch fluid-if equipped)	Between MIN and MAX lines on reservoir	Motorcraft® High Performance DOT 3 or DOT 4 LV Motor Vehicle Brake Fluid	PM-1C (US), CPM1C (Canada)/ WSS-M6C65-A1 or PM-20 / WSS-M6C65-A2
Door weatherstrips	—	Silicone Lubricant	XL-6 / ESR-M13P4-A
Door latch, hood latch, auxiliary hood latch, striker plates, seat tracks and fuel filler door hinge	—	Multi-Purpose Grease	Motorcraft® XL-5 (aerosol) or CRCA® SL3151/ WSS-M1C93-B
Engine coolant <sup>3</sup>	12.4 quarts (11.7L) (3.7L engine)	Motorcraft® Orange Antifreeze/Coolant Prediluted	<ul style="list-style-type: none"> <li>• VC-3DIL-B (US)</li> <li>• CVC-3DIL-B (Canada) / WSS-M97B44-D2</li> </ul>
	13.0 quarts (12.3L) (5.0L engine)		
	15.2 quarts (14.4L) (5.0L engine with Track Pack)		



Item	Capacity	Ford part name or equivalent	Ford part number / Ford Specification
Engine oil without Track Pack <sup>6</sup>	6.0 quarts (5.7L) (3.7L engine)	<ul style="list-style-type: none"> <li>• Motorcraft® SAE 5W-20 Premium Synthetic Blend Motor Oil (US)</li> <li>• Motorcraft® SAE 5W-20 Full Synthetic Motor Oil (US)</li> <li>• Motorcraft® SAE 5W-20 Super Premium Motor Oil (Canada)</li> <li>• Motorcraft® SAE 5W-20 Synthetic Motor Oil (Canada)</li> </ul>	<ul style="list-style-type: none"> <li>• XO-5W20-QSP (US)</li> <li>• XO-5W20-QFS (US)</li> <li>• CXO-5W20-LSP12 (Canada)</li> <li>• CXO-5W20-LFS12 (Canada) / WSS-M2C945-A with API Certification Mark</li> </ul>
	8.0 quarts (7.6L) (5.0L engine)	<ul style="list-style-type: none"> <li>• Motorcraft® Full Synthetic 5W-50 Motor Oil</li> </ul>	XO-5W50-QGT / WSS-M2C931-B with API Certification Mark
Lock cylinders	—	Motorcraft® Penetrating and Lock Lubricant	XL-1 / None
Rear axle fluid <sup>1</sup>	4.0 pints (1.9L)	Motorcraft® SAE 75W-140 Synthetic Rear Axle Lubricant	XY-75W140-QL / WSP-M2C192-A
Automatic transmission fluid <sup>2,4</sup>	11.9 quarts (11.2L)	Motorcraft® MERCON® LV ATF	XT-10-QLV / MERCON® LV

Item	Capacity	Ford part name or equivalent	Ford part number / Ford Specification
Manual transmission fluid (3.7L engine) <sup>5</sup>	2.7 quarts (2.6L)	Motorcraft® Dual Clutch Transmission Fluid	XT-11-QDC / WSS-M2C200-D2
Manual transmission fluid (5.0L engine) <sup>5</sup>			
Windshield washer fluid	Fill as required	Motorcraft® Premium Windshield Washer Concentrate (US) Premium Quality Windshield Washer Fluid (Canada)	ZC-32-A (US) CXC-37-(A, B, D and F) (Canada) / WSB-M8B16-A2/- -
Fuel tank	16.0 gallons (60.6L)	—	—

<sup>1</sup>Add 4 oz. (118 ml) of Additive Friction Modifier XL-3 or equivalent meeting Ford specification EST-M2C118-A for complete refill of Traction-Lok or TORSEN® axles.

Ford design rear axles contain a synthetic lubricant that does not require changing unless the axle has been submerged in water.

When subjecting your car to high-speed or competition use, the axle fluid and friction modifier should be changed after the initial (first) hour of high-speed operation or if the vehicle is subjected to track or competition conditions; thereafter changing the axle lubricant and friction modifier every 12 hours (under these conditions).

Item	Capacity	Ford part name or equivalent	Ford part number / Ford Specification
<p><sup>2</sup>Automatic transmissions that require MERCON® LV should only use MERCON® LV fluid. See <i>Scheduled Maintenance Information</i> to determine the correct service interval. Use of any fluid other than the recommended fluid may cause transmission damage.</p>			
<p><sup>3</sup>Add the coolant type originally equipped in your vehicle.</p>			
<p><sup>4</sup>Approximate dry capacity, including cooler and tubes. Fluid level should be checked by an authorized dealer.</p>			
<p><sup>5</sup>Service refill capacity is covered under <i>Checking and Adding Manual Transmission Fluid</i> in this chapter.</p>			
<p><sup>6</sup>Use of synthetic or synthetic blend motor oil is not mandatory. Engine oil need only meet the requirements of Ford specification WSS-M2C945-A and display the API Certification Mark. Your engine has been designed to be used with Ford engine oil, which gives a fuel economy benefit while maintaining the durability of your engine. Using oils other than the one specified can result in longer engine cranking periods, reduced engine performance, reduced fuel economy and increased emission levels.</p>			
<p><sup>7</sup>Your engine has been designed to be used with Ford engine oil, which gives a fuel economy benefit while maintaining the durability of your engine. Using oils other than the one specified can result in longer engine cranking periods, reduced engine performance, reduced fuel economy and increased emission levels.</p>			

## 300 Capacities and Specifications

### MOTORCRAFT PART NUMBERS

Component	3.7L V6 engine	5.0L V8 engine
Air filter element	FA-1897	FA-1897
Battery <sup>2</sup>	BXT-96R-590	BXT-96R-590
Oil filter	FL-500-S	FL-500-S
Spark plugs <sup>1</sup>	SP520	SP519
Cabin air filter	FP53	FP53
Windshield wiper blade	WW-2201-PF (driver side) WW-2001-PF (passenger side)	

<sup>1</sup>For spark plug replacement, see your authorized dealer. See *Scheduled Maintenance Information* for the appropriate intervals for changing the spark plugs.

**Replace the spark plugs with ones that meet Ford material and design specifications for your vehicle, such as Motorcraft® or equivalent replacement parts. The customer warranty may be void for any damage to the engine if such spark plugs are not used.**

<sup>2</sup>For battery replacement of the Mustang Boss 302, use Motorcraft® battery BXT-96R-500.

**VEHICLE IDENTIFICATION NUMBER**

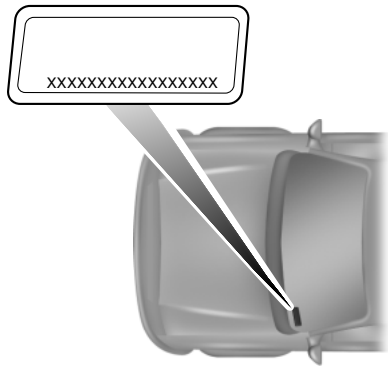

The vehicle identification number is located on the driver side instrument panel.

Please note that in the graphic, XXXX is representative of your vehicle identification number.

The Vehicle Identification Number (VIN) contains the following information:

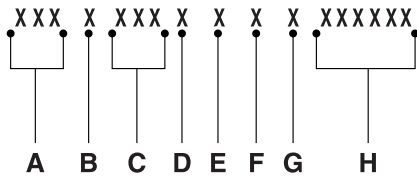

- A. World manufacturer identifier
- B. Brake system / Gross Vehicle Weight Rating (GVWR) / Restraint Devices and their location
- C. Make, vehicle line, series, body type
- D. Engine type
- E. Check digit
- F. Model year

- G. Assembly plant
- H. Production sequence number.

**VEHICLE CERTIFICATION LABEL**

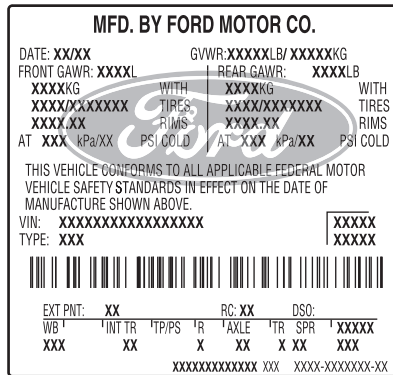

The National Highway Traffic Safety Administration Regulations require that a Safety Compliance Certification Label be affixed to a vehicle and prescribe where the Safety Compliance Certification Label may be located. The Safety Compliance Certification Label shall be affixed to either the door hinge pillar, the door latch post, or the edge of the door near the door latch, next to the driver's seating position.

**TRANSMISSION CODE DESIGNATION**

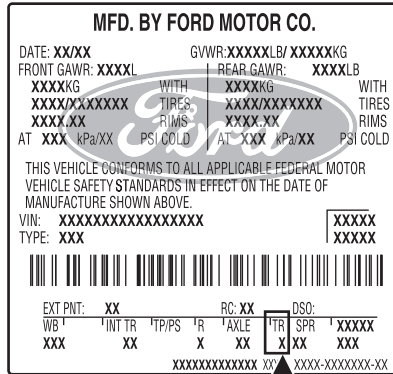

You can find a transmission code on the Safety Compliance Certification Label. The following table tells you which transmission each code represents.

Description	Code
Six-speed manual transmission (MT82)	X
Six-speed automatic transmission (6R80)	3

**ACCESSORIES**

For a complete listing of the accessories that are available for your vehicle, please contact your dealer or visit our online store at:

**Accessories.Ford.com** (U.S. only).

Ford Custom Accessories are available for your vehicle through your local Ford or Ford of Canada dealer. Ford Motor Company will repair or replace any properly dealer-installed Ford Custom Accessories found to be defective in factory-supplied materials or workmanship during the warranty period, as well as any component damaged by the defective accessories. The accessories will be warranted for whichever provides you the greatest benefit:

- 12 months or 12000 miles (20000 kilometers) (whichever occurs first), or
- the remainder of your new vehicle limited warranty.

Contact your dealer for details and a copy of the warranty.

**Exterior style**

- Quarter window louvers
- Front end covers
- Grille inserts
- Hood vents
- Graphic stripes
- Rear spoilers
- Splash guards
- Side window deflectors
- Wheels
- Custom graphics\*
- Side scoops
- Body kits

**Interior style**

- Floor mats
- Sport pedals
- Flexible visor storage system (tissue dispenser, organizer, CD holder)
- Auto dimming rearview mirror with compass and temperature
- Illuminated gear shift knob\*
- Illuminated door sill plates

**Lifestyle**

- Ash cup / smoker's package
- Soft cargo organizers
- Cargo net
- Cargo area protectors

**2013 05+ Mustang (197)**  
**Owners Guide gf, 3rd Printing**  
**USA (fus)**



**Peace of mind**

- Remote start
- Vehicle security systems
- Wheel locks
- Bumper mounted parking assist system\*
- Full vehicle covers
- Keyless entry keypad
- Locking fuel plug

\*Ford Licensed Accessories (FLA) are warranted by the accessory manufacturer's warranty. Ford Licensed Accessories are fully designed and developed by the accessory manufacturer and have not been designed or tested to Ford Motor Company engineering requirements. Contact your Ford dealer for details regarding the manufacturer's limited warranty and/or a copy of the FLA product limited warranty offered by the accessory manufacturer.

For maximum vehicle performance, keep the following information in mind when adding accessories or equipment to your vehicle:

- When adding accessories, equipment, passengers and luggage to your vehicle, do not exceed the total weight capacity of the vehicle or of the front or rear axle (GVWR or GAWR as indicated on the Safety Compliance Certification label). Consult your authorized dealer for specific weight information.
- The Federal Communications Commission (FCC) and Canadian Radio Telecommunications Commission (CRTC) regulate the use of mobile communications systems — such as two-way radios, telephones and theft alarms - that are equipped with radio transmitters. Any such equipment installed in your vehicle should comply with FCC or CRTC regulations and should be installed only by a qualified service technician.
- Mobile communications systems may harm the operation of your vehicle, particularly if they are not properly designed for automotive use.
- To avoid interference with other vehicle functions, such as anti-lock braking systems, amateur radio users who install radios and antennas onto their vehicle should not locate the amateur radio antennas in the area of the driver's side hood.
- Any non-Ford custom electrical or electronic accessories or components that are added to the vehicle by the authorized dealer or the owner, may adversely affect battery performance and durability, and may also adversely affect the performance of other electrical systems in the vehicle.

**FORD ESP EXTENDED SERVICE PLANS (U.S. ONLY)**

More than 32 million Ford and Lincoln owners have discovered the powerful protection of Ford ESP. It is the only extended service plan backed by Ford Motor Company, and provides “peace of mind” protection beyond the New Vehicle Limited Warranty coverage.

***Up to 500+ Covered Vehicle Components***

There are four, new-vehicle Extended Service Plans with different levels of coverage. Ask your dealer for details.

**PremiumCare** – Our most comprehensive coverage. With over 500 covered components, this plan is so complete that we generally only discuss what is not covered!

**ExtraCare** – Covers 113 components, and includes many high-tech items.

**BaseCare** – Covers 84 components.

**PowertrainCare** – Covers 29 critical components.

**Ford ESP is honored by all Ford and Lincoln Dealers in the U.S. and Canada.** It is the only extended service plan authorized and backed by Ford Motor Company. That means you get:

- Reliable, quality service anywhere you go.
- **Factory-trained technicians.**
- **Ford Authorized Parts used with every covered repair.**

***Rental Car Reimbursement***

**If your vehicle is kept overnight for covered repairs,** you are eligible for rental car coverage, including Bumper-to-Bumper warranty repairs, or manufacturer’s recalls.

***Transferable Coverage***

If you sell your vehicle before your Ford ESP coverage expires, you can transfer any remaining coverage to the new owner. Whenever you are ready to sell your car, prospective buyers may feel better about taking a risk on your used vehicle. Ford ESP may add resale value!

Plus, **exclusive 24/7 roadside assistance,** including:

- Towing, flat-tire change and battery jump starts.
- Out-of-fuel and lock-out assistance.
- Travel expense reimbursement for lodging, meals and rental car.
- Destination assistance for taxi, shuttle, rental car coverage and emergency transportation.

**2013 05+ Mustang (197)**  
**Owners Guide gf, 3rd Printing**  
**USA (fus)**

***Ford ESP Can Quickly Pay for Itself***

One service bill – the cost of parts and labor – can easily exceed the price of your Ford ESP Service Contract. With Ford ESP, you minimize your risk for unexpected repair bills and rising repair costs.

***Avoid the rising cost of properly maintaining your vehicle!***

Ford ESP also offers a Premium Maintenance Plan that covers items that **routinely wear out**.

The coverage is prepaid, so you never have to worry about affording your vehicle maintenance. It covers regular checkups, routine inspections, preventive care and replacement of items that require periodic attention for **normal wear**:

- **Wiper blades**
- **Spark plugs  
(except California)**
- **Clutch disc**
- **Brake pads and linings**
- **Shock absorbers**
- **Belts and hoses.**

Contact your selling Ford or Lincoln dealership today so they can customize a Ford Extended Service Plan that fits your driving lifestyle and budget.

***Interest Free Finance Options Available***

Take advantage of our installment payment plan, just a 10% down payment will provide you with an affordable no interest, no-fee payment opportunity.

**Protect Yourself from the Rising Cost of Vehicle Repairs with a Ford Extended Service Plan**

To learn more, call our Ford ESP specialists at 800-367-3377, and do not forget to ask about our interest free payment program, allowing you all the security and benefits Ford ESP has to offer while paying over time. You're pre-approved with no credit checks, no hassles!

Or, mail your name, address, city, state and zip code to:

Ford ESP  
P.O. Box 8072  
Royal Oak, MI 48068-9933

**FORD ESP EXTENDED SERVICE PLANS (CANADA ONLY)**

You can get more protection for your vehicle by purchasing a Ford Extended Service Plan (ESP). Ford ESP is the only service contract backed by Ford Motor Company of Canada, Limited. Depending on the plan you purchase, Ford ESP provides benefits such as:

- rental reimbursement
- coverage for certain maintenance and wear items
- protection against repair costs after your New Vehicle Limited Warranty Coverage expires
- Roadside Assistance benefits.

There are several Ford ESP plans available in various time, distance and deductible combinations. Each plan is tailored to fit your own driving needs, including reimbursement for towing and rental.

When you purchase Ford ESP, you receive added peace of mind protection throughout Canada and the United States, provided by a network of participating Ford Motor Company dealers. The Lincoln Maintenance Protection Plan is honored at authorized Lincoln dealers.

**Note:** Repairs performed outside of Canada and the United States are not eligible for Ford ESP coverage.

This information is subject to change.

For more information, visit your local Ford of Canada dealer or [www.ford.ca](http://www.ford.ca) to find the Ford Extended Service Plan that is right for you.

**GENERAL MAINTENANCE INFORMATION****Why Maintain Your Vehicle?**

Carefully following the maintenance schedule helps protect against major repair expenses resulting from neglect or inadequate maintenance and may also help to increase the value of your vehicle when you sell or trade it. Keep all receipts for completed maintenance with the vehicle.

Regular maintenance intervals for your vehicle have been established based upon rigorous testing. It is important that you have your vehicle serviced at the proper times. These intervals serve two purposes; one is to maintain the reliability of your vehicle and the second is to keep your cost of owning the vehicle down.

It is your responsibility to see that all scheduled maintenance is performed and that the materials used meet the specifications identified in the *Capacities and Specifications* chapter. Failure to perform scheduled maintenance invalidates warranty coverage on parts affected by the lack of maintenance.

**Why Maintain Your Vehicle at Your Dealership?*****Factory-Trained Technicians***

Service technicians participate in extensive factory-sponsored certification training to help them become experts on the operation of your vehicle. Ask your dealership about the training and certification their technicians have received.

***Genuine Ford and Motorcraft® Replacement Parts***

Dealerships stock Ford, Motorcraft® and Ford-authorized branded remanufactured replacement parts. These parts meet or exceed Ford Motor Company's specifications. Parts installed at your dealership carry a nationwide, 12 month/12000 mile (20000 kilometer) parts and labor limited warranty. If you do not use Ford authorized parts, they may not meet Ford specifications and, depending on the part, it could affect emissions compliance.

***Convenience***

Many dealerships have extended evening and Saturday hours to make your service visit more convenient and they offer one stop shopping. They can perform any services that are required on your vehicle, from general maintenance to collision repairs.

**Note:** Not all dealers have extended hours or bodyshops. Please contact your dealer for details.



### Protecting Your Investment

Maintenance is an investment that will pay dividends in the form of improved reliability, durability and resale value. To maintain the proper performance of your vehicle and its emission control systems, it is imperative that scheduled maintenance be completed at the designated intervals.

Your vehicle is equipped with the Intelligent Oil Life Monitor® (IOLM) system which displays a message in the information display at the proper oil change service interval; this interval may be up to one year or 10000 miles (16000 kilometers). When ENGINE OIL CHANGE DUE or OIL CHANGE REQUIRED appears in the information display, it's time for an oil change; the oil change must be done within two weeks or 500 miles (800 kilometers) of the ENGINE OIL CHANGE DUE or OIL CHANGE REQUIRED message appearing. The Intelligent Oil Life Monitor® must be reset after each oil change; see the *Instrument Cluster* chapter.

If your message center is prematurely reset or becomes inoperative, you should perform the oil change interval at six months or 5000 miles (8000 kilometers) from your last oil change. Never exceed one year or 10000 miles (16000 kilometers) between oil change intervals.

**Note:** The Shelby® GT500® does not have an IOLM system; see your *Shelby GT500* supplement for oil change service intervals.

Your vehicle is very sophisticated and built with multiple, complex, performance systems. Every manufacturer develops these systems using different specifications and performance features. That is why it is important to rely upon your dealership to properly diagnose and repair your vehicle.

Ford strongly recommends the use of genuine Ford replacement parts. Parts other than Ford, Motorcraft® or Ford-authorized remanufactured parts that are used for maintenance replacement or for the service of components affecting emission control must be equivalent to genuine Ford Motor Company parts in performance and durability. It is the owner's responsibility to determine the equivalency of such parts. Please consult your *Warranty Guide* for complete warranty information.

Ford strongly recommends the use of only genuine Ford, Motorcraft® or Ford-authorized remanufactured replacement parts because they are engineered for your vehicle.

### Additives and Chemicals

Ford Motor Company recommended additives and chemicals are listed in the owner manual and in the Ford Workshop Manual. Additional chemicals or additives not approved by Ford are not recommended as part of normal maintenance. Please consult your warranty information.

**Oils, fluids and flushing**

In many cases, fluid discoloration is a normal operating characteristic and, by itself, does not necessarily indicate a concern or that the fluid needs to be changed. However, discolored fluids that also show signs of overheating and foreign material contamination should be inspected immediately by a qualified expert, such as the factory-trained technicians at your dealership. Your vehicle's oils and fluids should be changed at the specified intervals or in conjunction with a repair. Flushing is a viable way to change fluid for many vehicle sub-systems during scheduled maintenance. It is critical that systems are flushed only with new fluid that is the same as that required to fill and operate the system, or using a Ford-approved flushing chemical.

**Owner Checks and Services**

Certain basic maintenance checks and inspections should be performed every month or at six month intervals.

<b>Check Every Month</b>
Engine oil level.
Function of all interior and exterior lights.
Tires (including spare) for wear and proper pressure.
Windshield washer fluid level.
<b>Check Every Six Months</b>
Battery connections. Clean if necessary.
Body and door drain holes for obstructions. Clean if necessary.
Cooling system fluid level and coolant strength.
Door weatherstrips for wear. Lubricate if necessary.
Hinges, latches and outside locks for proper operation. Lubricate if necessary.
Parking brake for proper operation.
Safety belts and seat latches for wear and function.
Safety warning lamps (brake, ABS, airbag, safety belt) for operation.
Washer spray and wiper operation. Clean or replace blades as necessary.

**Multi-point Inspection**

In order to keep your vehicle running right, it is important to have the systems on your vehicle checked regularly. This can help identify potential issues and prevent major problems. Ford Motor Company recommends the following multi-point inspection be performed at every scheduled maintenance interval to help make sure your vehicle keeps running great.

Multi-point Inspection	
Accessory drive belt(s)	Half-shaft dust boots
Battery performance	Horn operation
Clutch operation (if equipped)	Radiator, cooler, heater and A/C hoses
Engine air filter	Suspension components for leaks or damage
Exhaust system	Steering and linkage
Exterior lamps and hazard warning system operation	Tires (including spare) for wear and proper pressure**
Fluid levels*; fill if necessary	Windshield for cracks, chips or pits
For oil and fluid leaks	Washer spray and wiper operation

\*Brake, coolant recovery reservoir, manual transmission, automatic transmission and window washer.

\*\*If your vehicle is equipped with a temporary mobility kit, check the tire sealant expiration Use By date on the canister. Replace as needed.

Be sure to ask your dealership service advisor or technician about the multi-point vehicle inspection. It is a comprehensive way to perform a thorough inspection of your vehicle. It is your checklist that gives you immediate feedback on the overall condition of your vehicle. You will know what has been checked, what is okay, as well as those things that may require future or immediate attention. The multi-point vehicle inspection is one more way to keep your vehicle running great!





**NORMAL SCHEDULED MAINTENANCE AND LOG**

**Intelligent Oil-Life Monitor® – 3.7L and 5.0L Engines**

Your vehicle is equipped with an Intelligent Oil-Life Monitor® that determines when the engine oil needs to be changed based on how your vehicle is used. By using several important factors in its calculations, the monitor helps reduce the cost of owning your vehicle and reduce environmental waste at the same time. This means you won't have to remember to change the oil on a mileage-based schedule; the vehicle lets you know when an oil change is due by displaying OIL CHANGE REQUIRED in the information display. The following table is intended to provide examples of vehicle use and its impact on engine oil change intervals; it is provided as a guideline only. Actual engine oil change intervals depend on several factors and generally decrease with severity of use.

**Note:** The Shelby® GT500® information display is NOT equipped with this feature. Refer to your *Shelby GT500* supplement for oil change service intervals.

When to expect the OIL CHANGE REQUIRED message	
Miles (km)	Vehicle use and examples
7500-10000 (12000-16000)	<b>Normal</b>
	<ul style="list-style-type: none"> <li>- Normal commuting with highway driving</li> <li>- No, or moderate, load or towing</li> <li>- Flat to moderately hilly roads</li> <li>- No extended idling</li> </ul>
5000-7499 (8000-11999)	<b>Severe</b>
	<ul style="list-style-type: none"> <li>- Moderate to heavy load or towing</li> <li>- Mountainous or off-road conditions</li> <li>- Extended idling</li> <li>- Extended hot or cold operation</li> </ul>
3000-4999 (4000-7999)	<b>Extreme</b>
	<ul style="list-style-type: none"> <li>- Maximum load or towing</li> <li>- Extreme hot or cold operation</li> </ul>

Normal Scheduled Maintenance*	
At every oil change interval as indicated by the information display	Change engine oil and filter.**
	Rotate tires, inspect tire wear and measure tread depth.
	Perform multi-point inspection (recommended).
	Inspect automatic transmission fluid level. Consult dealer for requirements.
	Inspect brake pads, shoes, rotors, drums, brake linings, hoses and parking brake.
	Inspect engine cooling system strength and hoses.
	Inspect exhaust system and heat shields.
	Inspect half-shaft boots.
	Inspect rear axle and U-joints. Lubricate if equipped with grease fittings.
	Inspect steering linkage, ball joints, suspension, tie-rod ends, driveshaft and U-joints. Lubricate if equipped with grease fittings.
	Inspect wheels and related components for abnormal noise, wear, looseness or drag.

\*Do not exceed one year or 10000 miles (16000 kilometers) between service intervals.

\*\*Reset your Intelligent Oil-Life Monitor after each engine oil and filter change. See the *Instrument Cluster* chapter.

<b>Additional Maintenance Items<sup>1</sup></b>	
Every 20000 miles (32000 km)	Replace cabin air filter (if equipped).
Every 30000 miles (48000 km)	Replace engine air filter.
At 100000 miles (160000 km)	Change engine coolant. <sup>2</sup>
Every 100000 miles (160000 km)	Replace spark plugs.
	Inspect accessory drive belt(s). <sup>3</sup>
Every 150000 miles (240000 km)	Change automatic transmission fluid and filter.
	Change manual transmission fluid.
	Replace accessory drive belt(s) if not replaced within the last 100000 miles (160000 km).

<sup>1</sup>Additional maintenance items can be performed within 3000 miles (4800 kilometers) of the last oil change. Do not exceed the designated distance for the interval.

<sup>2</sup>Initial replacement at six years or 100000 miles (160000 kilometers), then every three years or 50000 miles (80000 kilometers).

<sup>3</sup>After initial inspection, inspect every other oil change until replaced.

Maintenance Schedule Log

<p style="text-align: center;">DEALER VALIDATION:</p>  <p>RO#: P&amp;A CODE:          HOURS:          DATE: MILEAGE:</p>	<p style="text-align: center;">DEALER VALIDATION:</p>  <p>RO#: P&amp;A CODE:          HOURS:          DATE: MILEAGE:</p>
<p style="text-align: center;">DEALER VALIDATION:</p>  <p>RO#: P&amp;A CODE:          HOURS:          DATE: MILEAGE:</p>	<p style="text-align: center;">DEALER VALIDATION:</p>  <p>RO#: P&amp;A CODE:          HOURS:          DATE: MILEAGE:</p>
<p style="text-align: center;">DEALER VALIDATION:</p>  <p>RO#: P&amp;A CODE:          HOURS:          DATE: MILEAGE:</p>	<p style="text-align: center;">DEALER VALIDATION:</p>  <p>RO#: P&amp;A CODE:          HOURS:          DATE: MILEAGE:</p>
<p style="text-align: center;">DEALER VALIDATION:</p>  <p>RO#: P&amp;A CODE:          HOURS:          DATE: MILEAGE:</p>	<p style="text-align: center;">DEALER VALIDATION:</p>  <p>RO#: P&amp;A CODE:          HOURS:          DATE: MILEAGE:</p>
<p style="text-align: center;">DEALER VALIDATION:</p>  <p>RO#: P&amp;A CODE:          HOURS:          DATE: MILEAGE:</p>	<p style="text-align: center;">DEALER VALIDATION:</p>  <p>RO#: P&amp;A CODE:          HOURS:          DATE: MILEAGE:</p>

## Scheduled Maintenance

317

<p style="text-align: center;">DEALER VALIDATION:</p>  <p style="text-align: center;">P&amp;A CODE:</p> <p>RO#:                    HOURS:</p> <p>DATE:                  MILEAGE:</p>	<p style="text-align: center;">DEALER VALIDATION:</p>  <p style="text-align: center;">P&amp;A CODE:</p> <p>RO#:                    HOURS:</p> <p>DATE:                  MILEAGE:</p>
<p style="text-align: center;">DEALER VALIDATION:</p>  <p style="text-align: center;">P&amp;A CODE:</p> <p>RO#:                    HOURS:</p> <p>DATE:                  MILEAGE:</p>	<p style="text-align: center;">DEALER VALIDATION:</p>  <p style="text-align: center;">P&amp;A CODE:</p> <p>RO#:                    HOURS:</p> <p>DATE:                  MILEAGE:</p>
<p style="text-align: center;">DEALER VALIDATION:</p>  <p style="text-align: center;">P&amp;A CODE:</p> <p>RO#:                    HOURS:</p> <p>DATE:                  MILEAGE:</p>	<p style="text-align: center;">DEALER VALIDATION:</p>  <p style="text-align: center;">P&amp;A CODE:</p> <p>RO#:                    HOURS:</p> <p>DATE:                  MILEAGE:</p>
<p style="text-align: center;">DEALER VALIDATION:</p>  <p style="text-align: center;">P&amp;A CODE:</p> <p>RO#:                    HOURS:</p> <p>DATE:                  MILEAGE:</p>	<p style="text-align: center;">DEALER VALIDATION:</p>  <p style="text-align: center;">P&amp;A CODE:</p> <p>RO#:                    HOURS:</p> <p>DATE:                  MILEAGE:</p>
<p style="text-align: center;">DEALER VALIDATION:</p>  <p style="text-align: center;">P&amp;A CODE:</p> <p>RO#:                    HOURS:</p> <p>DATE:                  MILEAGE:</p>	<p style="text-align: center;">DEALER VALIDATION:</p>  <p style="text-align: center;">P&amp;A CODE:</p> <p>RO#:                    HOURS:</p> <p>DATE:                  MILEAGE:</p>

2013 05+ Mustang (197)  
 Owners Guide gf, 3rd Printing  
 USA (fus)

**Scheduled Maintenance**

<p style="text-align: center;">DEALER VALIDATION:</p>  <p style="text-align: center;">P&amp;A CODE:</p> <p>RO#:            HOURS:</p> <p>DATE:           MILEAGE:</p>	<p style="text-align: center;">DEALER VALIDATION:</p>  <p style="text-align: center;">P&amp;A CODE:</p> <p>RO#:            HOURS:</p> <p>DATE:           MILEAGE:</p>
<p style="text-align: center;">DEALER VALIDATION:</p>  <p style="text-align: center;">P&amp;A CODE:</p> <p>RO#:            HOURS:</p> <p>DATE:           MILEAGE:</p>	<p style="text-align: center;">DEALER VALIDATION:</p>  <p style="text-align: center;">P&amp;A CODE:</p> <p>RO#:            HOURS:</p> <p>DATE:           MILEAGE:</p>
<p style="text-align: center;">DEALER VALIDATION:</p>  <p style="text-align: center;">P&amp;A CODE:</p> <p>RO#:            HOURS:</p> <p>DATE:           MILEAGE:</p>	<p style="text-align: center;">DEALER VALIDATION:</p>  <p style="text-align: center;">P&amp;A CODE:</p> <p>RO#:            HOURS:</p> <p>DATE:           MILEAGE:</p>
<p style="text-align: center;">DEALER VALIDATION:</p>  <p style="text-align: center;">P&amp;A CODE:</p> <p>RO#:            HOURS:</p> <p>DATE:           MILEAGE:</p>	<p style="text-align: center;">DEALER VALIDATION:</p>  <p style="text-align: center;">P&amp;A CODE:</p> <p>RO#:            HOURS:</p> <p>DATE:           MILEAGE:</p>
<p style="text-align: center;">DEALER VALIDATION:</p>  <p style="text-align: center;">P&amp;A CODE:</p> <p>RO#:            HOURS:</p> <p>DATE:           MILEAGE:</p>	<p style="text-align: center;">DEALER VALIDATION:</p>  <p style="text-align: center;">P&amp;A CODE:</p> <p>RO#:            HOURS:</p> <p>DATE:           MILEAGE:</p>

**SPECIAL OPERATING CONDITIONS – 3.7L AND 5.0L ENGINES**

If you operate your vehicle **primarily** in any of the following conditions, you need to perform additional maintenance as indicated. If you **occasionally** operate your vehicle under any of these conditions, it is not necessary to perform the additional maintenance. For specific recommendations, see your dealership service advisor or technician.

Perform the services in the preceding table when specified or within 3000 miles (4800 kilometers) of the OIL CHANGE REQUIRED message appearing in the information display.

**Example #1:** The OIL CHANGE REQUIRED message comes on at 28751 miles (46270 kilometers); perform the 30000 mile (48000 kilometers) automatic transmission fluid replacement.

**Example #2:** The OIL CHANGE REQUIRED message has **not** come on, but the odometer reads 30000 miles (48000 kilometers); perform the engine air filter replacement. (i.e., Intelligent Oil-Life Monitor was reset at 25000 miles [40000 kilometers].)

<b>Towing a Trailer or Using a Camper or Car-top Carrier</b>	
As required	Change engine oil and filter as indicated by information display and perform services listed in Normal Scheduled Maintenance chart
Inspect frequently, service as required	Inspect and lubricate U-joints. See axle maintenance items under <i>Exceptions</i> .
Every 60,000 miles (96,000 km)	Change manual transmission fluid.



<b>Extensive Idling and Low-speed Driving for Long Distances as in Heavy Commercial Use (i.e., Delivery, Taxi, Patrol car or Livery)</b>	
As required	Change engine oil and filter as indicated by information display and perform services listed in Normal Scheduled Maintenance chart.
Inspect frequently, service as required	Replace cabin air filter (if equipped).
	Replace engine air filter.
Every 60,000 miles (96,000 km)	Replace spark plugs.
<b>Operating in Dusty or Sandy Conditions Such as Unpaved or Dusty Roads</b>	
Inspect frequently, service as required	Replace cabin air filter (if equipped).
	Replace engine air filter.
Every 5,000 miles (8,000 km)	Inspect the wheels and related components for abnormal noise, wear, looseness or drag.
	Rotate tires, inspect tires for wear and measure tread depth.
Every 5,000 miles (8,000 km) or 6 months	Change engine oil and filter.
Every 50,000 miles (80,000 km)	Change manual transmission fluid.
Reset your Intelligent Oil-Life Monitor after each engine oil and filter change. See the <i>Instrument Displays</i> chapter.	
<b>Exclusive Use of E85 (Flex Fuel Vehicles only)</b>	
Every oil change	If ran exclusively on E85, fill the fuel tank full with regular unleaded fuel.

## Scheduled Maintenance

321

### Special Operating Condition Log

<p style="text-align: center;">DEALER VALIDATION:</p> <p>RO#:                    P&amp;A CODE:                                      HOURS:            DATE:                MILEAGE:</p>	<p style="text-align: center;">DEALER VALIDATION:</p> <p>RO#:                    P&amp;A CODE:                                      HOURS:            DATE:                MILEAGE:</p>
<p style="text-align: center;">DEALER VALIDATION:</p> <p>RO#:                    P&amp;A CODE:                                      HOURS:            DATE:                MILEAGE:</p>	<p style="text-align: center;">DEALER VALIDATION:</p> <p>RO#:                    P&amp;A CODE:                                      HOURS:            DATE:                MILEAGE:</p>
<p style="text-align: center;">DEALER VALIDATION:</p> <p>RO#:                    P&amp;A CODE:                                      HOURS:            DATE:                MILEAGE:</p>	<p style="text-align: center;">DEALER VALIDATION:</p> <p>RO#:                    P&amp;A CODE:                                      HOURS:            DATE:                MILEAGE:</p>
<p style="text-align: center;">DEALER VALIDATION:</p> <p>RO#:                    P&amp;A CODE:                                      HOURS:            DATE:                MILEAGE:</p>	<p style="text-align: center;">DEALER VALIDATION:</p> <p>RO#:                    P&amp;A CODE:                                      HOURS:            DATE:                MILEAGE:</p>
<p style="text-align: center;">DEALER VALIDATION:</p> <p>RO#:                    P&amp;A CODE:                                      HOURS:            DATE:                MILEAGE:</p>	<p style="text-align: center;">DEALER VALIDATION:</p> <p>RO#:                    P&amp;A CODE:                                      HOURS:            DATE:                MILEAGE:</p>

*2013 05+ Mustang (197)  
 Owners Guide gf, 3rd Printing  
 USA (fus)*

**Scheduled Maintenance**

<p style="text-align: center;">DEALER VALIDATION:</p>  <p style="text-align: center;">P&amp;A CODE:</p> <p>RO#:            HOURS:</p> <p>DATE:           MILEAGE:</p>	<p style="text-align: center;">DEALER VALIDATION:</p>  <p style="text-align: center;">P&amp;A CODE:</p> <p>RO#:            HOURS:</p> <p>DATE:           MILEAGE:</p>
<p style="text-align: center;">DEALER VALIDATION:</p>  <p style="text-align: center;">P&amp;A CODE:</p> <p>RO#:            HOURS:</p> <p>DATE:           MILEAGE:</p>	<p style="text-align: center;">DEALER VALIDATION:</p>  <p style="text-align: center;">P&amp;A CODE:</p> <p>RO#:            HOURS:</p> <p>DATE:           MILEAGE:</p>
<p style="text-align: center;">DEALER VALIDATION:</p>  <p style="text-align: center;">P&amp;A CODE:</p> <p>RO#:            HOURS:</p> <p>DATE:           MILEAGE:</p>	<p style="text-align: center;">DEALER VALIDATION:</p>  <p style="text-align: center;">P&amp;A CODE:</p> <p>RO#:            HOURS:</p> <p>DATE:           MILEAGE:</p>
<p style="text-align: center;">DEALER VALIDATION:</p>  <p style="text-align: center;">P&amp;A CODE:</p> <p>RO#:            HOURS:</p> <p>DATE:           MILEAGE:</p>	<p style="text-align: center;">DEALER VALIDATION:</p>  <p style="text-align: center;">P&amp;A CODE:</p> <p>RO#:            HOURS:</p> <p>DATE:           MILEAGE:</p>
<p style="text-align: center;">DEALER VALIDATION:</p>  <p style="text-align: center;">P&amp;A CODE:</p> <p>RO#:            HOURS:</p> <p>DATE:           MILEAGE:</p>	<p style="text-align: center;">DEALER VALIDATION:</p>  <p style="text-align: center;">P&amp;A CODE:</p> <p>RO#:            HOURS:</p> <p>DATE:           MILEAGE:</p>

**EXCEPTIONS**

**Normal vehicle axle maintenance:** Rear axles and power take-off (PTO) units with synthetic fluid and light-duty trucks equipped with Ford-design axles are lubricated for life; do not check or change fluid unless a leak is suspected, service is required or the assembly has been submerged in water. During long periods of trailer towing with outside temperatures above 70°F (21°C) and at wide-open throttle for long periods above 45 mph (72 km/h), non-synthetic rear axle fluids should be changed every 3000 miles (4800 kilometers) or three months, whichever comes first. This interval can be waived if the axle is filled with 75W140 synthetic gear fluid meeting Ford specification WSL-M2C192-A, part number F1TZ-19580-B or equivalent. Add friction modifier XL-3 (EST-M2C118-A) or equivalent for complete refill of Traction-Lok rear axles (see *Technical specifications* in the *Capacities and Specifications* chapter for details).

**Police/Taxi/Livery vehicle axle maintenance:** Change rear axle fluid every 100000 miles (160000 km). Rear axle fluid change may be waived if the axle was filled with 75W140 synthetic gear fluid meeting Ford specification WSL-M2C192-A, part number FITZ-19580-B or equivalent. Add four ounces (118 mL) of additive friction modifier XL-3 (EST-M2C118-A) or equivalent for complete refill of Traction-Lok rear axles. The axle fluid should be changed anytime the axle has been submerged in water.

**California fuel filter replacement:** If the vehicle is registered in California, the California Air Resources Board has determined that the failure to perform this maintenance item will not nullify the emission warranty or limit recall liability prior to the completion of the vehicle's useful life. Ford Motor Company, however, urges you to have all recommended maintenance services performed at the specified intervals and to record all vehicle service.

**Hot climate oil change intervals:** Vehicles operating in the Middle East, North Africa, Sub-Saharan Africa or locations with similar climates using an American Petroleum Institute (API) Certified for Gasoline Engines (Certification mark) oil of SM or SN quality, the normal oil change interval is 5000 miles (8000 kilometers). If the available API SM or SN oils are not available, then the oil change service interval is 3000 miles (4800 kilometers).

**Engine air filter and cabin air filter replacement:** Engine air filter and cabin air filter life are dependent on exposure to dusty and dirty conditions. Vehicles operated in these conditions require frequent inspection and replacement of the engine air filter and cabin air filter.

2013 05+ Mustang (197)  
Owners Guide gf, 3rd Printing  
USA (fus)

**ENGINE COOLANT CHANGE RECORD**

<b>3.7L and 5.0L Engines*</b>	
Initial change	Six years or 100000 miles (160000 km) (whichever comes first)
After initial change	Every three years or 50000 miles (80000 km)

\*Shelby GT500 owners: See the *Shelby GT500* supplement.

**Engine Coolant Change Log**

<p>DEALER VALIDATION:</p>  <p>P&amp;A CODE:</p> <p>RO#:        HOURS:</p> <p>DATE:       MILEAGE:</p>	<p>DEALER VALIDATION:</p>  <p>P&amp;A CODE:</p> <p>RO#:        HOURS:</p> <p>DATE:       MILEAGE:</p>
<p>DEALER VALIDATION:</p>  <p>P&amp;A CODE:</p> <p>RO#:        HOURS:</p> <p>DATE:       MILEAGE:</p>	<p>DEALER VALIDATION:</p>  <p>P&amp;A CODE:</p> <p>RO#:        HOURS:</p> <p>DATE:       MILEAGE:</p>
<p>DEALER VALIDATION:</p>  <p>P&amp;A CODE:</p> <p>RO#:        HOURS:</p> <p>DATE:       MILEAGE:</p>	<p>DEALER VALIDATION:</p>  <p>P&amp;A CODE:</p> <p>RO#:        HOURS:</p> <p>DATE:       MILEAGE:</p>

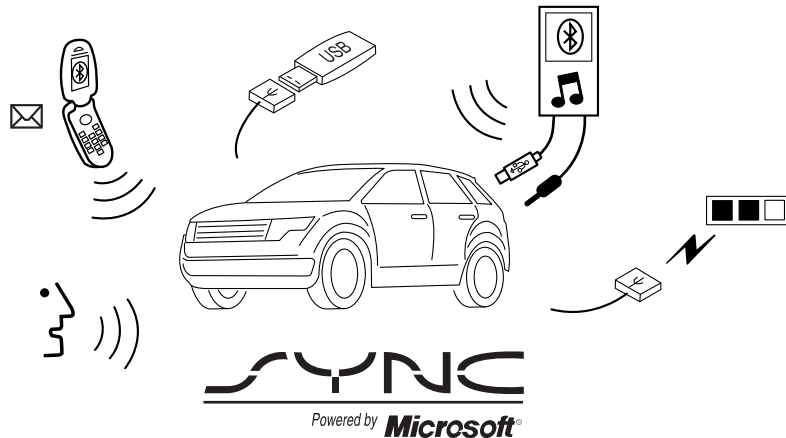

SYNC is an in-vehicle communications system that works with your Bluetooth-enabled cellular phone and portable media player. This allows you to:

- Make and receive calls.
- Access and play music from your portable music player.
- Use 911 Assist®, Vehicle Health Report and SYNC Services (Traffic, Directions & Information) (if equipped).
- Use applications, such as Pandora and Stitcher, via SYNC AppLink™ (if applicable).
- Access phonebook contacts and music via voice commands.
- Stream music from your connected phone.
- Text message.
- Use the advanced voice recognition system.
- USB device charging (if your device supports this).

**2013 05+ Mustang (197)**  
**Owners Guide gf, 3rd Printing**  
**USA (fus)**

**GENERAL INFORMATION**

Ensure that you review your device's user guide before using it with SYNC.

**Support**

The SYNC support team is available to help you with any questions you cannot answer on your own.

Monday-Saturday, 8:30am-8:00pm EST

In the United States, call: 1-888-270-1055

In Canada, call: 1-800-565-3673

Times are subject to change due to holidays.

**SYNC Owner Account**

Why do I need a SYNC owner account?

- Required to activate Vehicle Health Report and to view the reports online.
- Required to activate the subscription-based SYNC Services and to personalize your Saved Points and Favorites.
- Essential for keeping up with the latest software downloads available for SYNC.
- Access to customer support for any questions you may have.

**Driving Restrictions**

For your safety, certain features are speed-dependent and restricted when your vehicle is traveling over 3 mph (5 km/h).

**Safety Information**

**WARNING:** Driving while distracted can result in loss of vehicle control, accident and injury. Ford strongly recommends that drivers use extreme caution when using any device that may take their focus off the road. Your primary responsibility is the safe operation of the vehicle. We recommend against the use of any handheld device while driving, encourage the use of voice-operated systems when possible and that you become aware of applicable state and local laws that may affect use of electronic devices while driving.

When using SYNC:

- Do not operate playing devices if the power cords or cables are broken, split or damaged. Place cords and cables out of the way, so they do not interfere with the operation of pedals, seats, compartments or safe driving abilities.

- Do not leave playing devices in your vehicle during extreme conditions as it could cause them damage. See your device's user guide for further information.
- Do not attempt to service or repair the system. See your authorized dealer.

For your safety, some SYNC functions are speed-dependent. Their use is limited to when your vehicle is traveling at speeds under 3 mph (5 km/h).

Make sure that you review your device's user guide before using it with SYNC.

### Privacy Information

When a cellular phone is connected to SYNC, the system creates a profile within your vehicle that is linked to that cellular phone. This profile is created in order to offer you more cellular features and to operate more efficiently. Among other things, this profile may contain data about your cellular phone book, text messages (read and unread), and call history, including history of calls when your cell phone was not connected to the system. In addition, if you connect a media device, the system creates and retains an index of supported media content. The system also records a short development log of approximately 10 minutes of all recent system activity. The log profile and other system data may be used to improve the system and help diagnose any problems that may occur.

The cellular profile, media device index, and development log remain in the vehicle unless you delete them and are generally accessible only in the vehicle when the cellular phone or media player is connected. If you no longer plan to use the system or the vehicle, we recommend you perform a Master Reset to erase all stored information.

System data cannot be accessed without special equipment and access to the vehicle's SYNC module. Ford Motor Company and Ford of Canada do not access the system data for any purpose other than as described absent consent, a court order, or where required by law enforcement, other government authorities, or other third parties acting with lawful authority. Other parties may seek to access the information independently of Ford Motor Company and Ford of Canada. For further privacy information, see the sections on 911 Assist®, Vehicle Health Report, and Traffic, Directions and Information.



### USING VOICE RECOGNITION

This system helps you control many features using voice commands. This allows you to keep your hands on the wheel and focus on what is in front of you.

#### Initiating a Voice Session



Push the voice icon; a tone sounds and Listening appears in the display. Say any of the following:

Say:	If you want to:
“Phone”	Make calls.
“USB”	Access the device connected to your USB port.
“Bluetooth Audio”	Stream audio from your phone.
“Line in”	Access the device connected to the auxiliary input jack.
“Cancel”	Cancel the requested action.
“SYNC”	Return to the main menu.
“Voice settings”	Adjust the level of voice interaction and feedback.
“Vehicle Health Report”	Run a vehicle health report.*
“Services”	Access the SYNC Services portal.*
“Mobile apps”	Access mobile applications.*
“Help”	Hear a list of voice commands available in the current mode.

\*If equipped, U.S. only.

#### System Interaction and Feedback

The system provides feedback through audible tones, prompts, questions and spoken confirmations depending on the situation and the chosen level of interaction (voice settings). You can customize the voice recognition system to provide more or less instruction and feedback.

The default setting is to a higher level of interaction in order to help you learn to use the system. You can change these settings at any time.

**Adjusting the Interaction Level**



Push the voice icon; when prompted, say “Voice settings”, then any of the following:

When you say:	The system:
“Interaction mode standard”	Provides more detailed interaction and guidance.
“Interaction mode advanced”	Provides less audible interaction and more tone prompts.

The system defaults to the standard interaction mode.

Confirmation prompts are short questions the system asks when it is not sure of your request or when there are multiple possible responses to your request. (For example, the system may ask “Phone, is that correct?”) If turned off, the system simply makes a best guess as to what you requested and you may still occasionally be asked to confirm settings.

“Confirmation prompts on”
“Confirmation prompts off”

The system creates candidate lists when it has the same confidence level of several options based on your voice command. When turned on, you may be prompted with as many as four possibilities for clarification.

For example, “Say 1 after the tone to call John Doe at home. Say 2 after the tone to call Johnny Doe on mobile. Say 3 after the tone to call Jane Doe at home.” Or, “Say 1 after the tone to play John Doe, Say 2 after the tone to play Johnny Doe.”

“Phone candidate lists on”
“Phone candidate lists off”
“Media candidate lists on”
“Media candidate lists off”

**Helpful Hints**

- Make sure the interior of the vehicle is as quiet as possible. Wind noise from open windows and road vibrations may prevent the system from correctly recognizing spoken commands.
- After pressing the voice icon, wait until after the tone sounds and Listening appears before saying a command. Any command spoken prior to this does not register with the system.

- Speak naturally, without long pauses between words.
- At any time you can interrupt the system while it is speaking by pressing the voice icon.

### USING SYNC WITH YOUR PHONE

Hands-free calling is one of the main features of SYNC. While the system supports a variety of features, many are dependent on your cellular phone's functionality. At a minimum, most cellular phones with Bluetooth wireless technology support the following functions:

- Answering an incoming call.
- Ending a call.
- Using privacy mode.
- Dialing a number.
- Redialing.
- Call waiting notification.
- Caller ID.

Other features, such as text messaging using Bluetooth and automatic phonebook download, are phone-dependent features. To check your phone's compatibility, see your phone's user manual and visit [www.SYNCMYRide.com](http://www.SYNCMYRide.com), [www.SYNCMYRide.ca](http://www.SYNCMYRide.ca) or [www.syncmaroute.ca](http://www.syncmaroute.ca).

### Pairing a Phone for the First Time

**Note:** Make sure the vehicle ignition and radio are turned on and the transmission is in position **P** (vehicles equipped with an automatic transmission) or 1st gear (vehicles equipped with a manual transmission).

Wirelessly pairing your phone with SYNC allows you to make and receive hands-free calls.

1. Press the PHONE hard button; when the display indicates no phone is paired, press the Settings tab, then Add.
2. If Bluetooth is on, SYNC begins the pairing process between your Bluetooth-enabled phone or device and SYNC. See your phone's user guide if necessary.
3. When prompted on your phone's display, enter the six-digit PIN provided by SYNC in the radio display.
4. The display indicates when the pairing is successful.
5. Depending on your phone's capability and your market, the system may prompt you with questions such as setting the current phone as the primary phone (the phone SYNC automatically tries to connect with first upon vehicle start-up), downloading your phone book, etc.

**Pairing Subsequent Phones**

**Note:** Make sure the vehicle ignition and radio are turned on and the transmission is in position **P** (vehicles equipped with an automatic transmission) or 1st gear (vehicles equipped with a manual transmission).

**Note:** SYNC can store up to 12 previously paired phones.

1. Press the PHONE hard button; select the Settings tab, then Add.
2. When prompted on your phone’s display, enter the six-digit PIN provided by SYNC in the radio display. The display indicates when the pairing is successful.
3. The system then prompts with questions such as if you would like to set the current phone as the primary phone (the phone SYNC automatically tries to connect with first upon vehicle start-up), download your phone book, etc.

**Phone Voice Commands**



Press the voice button and say any of the following:

<b>“PHONE”</b>
“Call <name>”
“Call <name> at home”
“Call <name> at work” OR “Call <name> in office”
“Call <name> on other”
“Call <name> on mobile OR cell”
“Dial”*

\*If you have said “Dial”, see the “Dial” table below.

<b>“DIAL”</b>
“411” (four-one-one), “911” (nine-one-one), etc.
“700 (seven hundred)” (seven hundred)
“800 (eight hundred)” (eight hundred)
“900 (nine hundred)” (nine hundred)
“#” “/” (pound, slash)
“<number> 0-9”
“Asterisk” (*)
“Clear” (deletes all entered digits)
“Delete” (deletes one digit)

<b>“DIAL”</b>
“Plus”
“Star”

**Note:** To exit dial mode, press and hold the phone button or press MENU to go to the PHONE menu.

At any time, you can say the following global commands:

<b>GLOBAL COMMANDS</b>
“Exit”
“Help”
“Phone”
“Services” *
“Vehicle Health Report”*
“Voice settings”

\*If equipped, U.S. only.

### Making Calls Using the Touchscreen

Press the PHONE hard button, then choose between three ways to make a call:

1. Use the keypad on the Phone tab to manually enter a phone number and press SEND.
2. Select the Phonebook tab (if the desired number is saved in the downloaded phone book information). Use the directory buttons to browse to the desired contact, then press DIAL. (This is a phone-dependent feature.)
3. Select the Call History tab (if the desired number is saved in the downloaded call history information), then press DIAL. (This is a phone-dependent feature.)

### Making Calls Using Voice Commands

Press the voice button and when prompted say “Phone”.

1. Say “Call <phone book contact name>” or “Dial”, then the desired number.
2. When the system confirms the number, say “Dial” or “Call” to initiate the call.

To erase the last spoken digit, say “Delete”; to erase all spoken digits, say “Clear”.

To end the call, press and hold the phone button.

**Receiving Calls**

When receiving a call, you can:

- Answer the call by pressing the phone button.
- Reject the call by pressing and holding the phone button.
- Ignore the call by doing nothing.

**Phone Options during an Active Call**

During an active call, you have additional menu features which become available such as putting a call on hold, joining calls, etc.

To access:

1. Press the PHONE hard button.
2. Select from the following options:

When you select:	You can:
<b>Send</b>	Receive an incoming call, make an outgoing call or redial.
<b>End</b>	End or ignore a call.
<b>Privacy Mode*</b>	Switch a call from an active hands-free environment to your cellular phone for a more private conversation.
<b>Hold Call*</b>	Put an active call on hold. Press OK when Place Call on Hold? appears.
<b>Join Calls*</b>	Join two separate calls.
<b>Quick Dial</b>	Save frequently called numbers for quick access. You can select and save numbers from the Phonebook or Call History tabs.

\* This is a phone-dependent feature.

### Accessing Features through the Phone Menu

SYNC's phone menu allows you to redial a number, access your call history and phone book and send text messages as well as access phone and system settings. You can also access advanced features, such as 911 Assist™, Vehicle Health Report and SYNC Apps.

1. Press the PHONE hard button.
2. Select from the following:

When you select:	You can:
<b>Phone</b>	Access basic options such as making calls, ending calls and joining calls.
<b>Phonebook*</b>	Allows you to access your downloaded phonebook. SYNC categorizes your contacts alphabetically in the Quick Sort buttons on the right of the screen. The buttons are highlighted if there are contacts stored in that category. Press the highlighted category to access those listings.
<b>Call History**</b>	Allows you to access any previously dialed, received or missed calls while your phone has been connected to the system.
<b>Text Messaging</b>	Allows you to send, download and delete text messages.
<b>Settings</b>	Access Bluetooth Devices menu listings (add, connect, set as primary, on/off, delete) as well as Advanced menu listings (911 Assist, Vehicle Health Report, factory defaults, master reset, etc.).
<b>SYNC Apps</b>	Access the SYNC services portal where you can request various types of information, traffic reports and directions.

\*This is a speed-dependent and phone-dependent feature.

\*\*This is a phone-dependent feature.

### Text Messaging

**Note:** This is a phone-dependent feature.

SYNC allows you to receive, send, download and delete text messages. The system can also read incoming text messages to you so that you do not have to take your eyes off the road.

#### **Receiving a Text Message**

**Note:** This is a phone-dependent feature. Your phone must support downloading text messages using Bluetooth to receive incoming text messages.

**Note:** Forwarding a text message is a speed-dependent feature and can only be done when the vehicle is traveling at 3 mph (5 km/h) or less.

**Note:** Only one recipient is allowed per text message.

When a new message arrives, an audible tone sounds and the display indicates you have a new message. You have these options:

1. Press View to receive and open the text message.
2. Press Listen to have SYNC read the message to you.
3. Press Reply to send a message back to the sender.
4. Press Dial to call the sender.
5. Press Cancel to exit the screen.

If you select View, you can:

- Listen as SYNC reads the message to you aloud.
- Compose your own message.\*
- Reply to the message.\*
- Forward the text message to someone in your phone book or to a phone number.\*

\*This is a speed-dependent feature.

#### **Sending Text Messages**

Text messaging is a phone-dependent feature. If your phone is compatible, SYNC allows you to receive, send, download and delete text messages.

1. Press the PHONE hard button.
2. Select the Text Messaging tab, then press Compose.
3. Scroll to select from the following options:



**Send Text Message?** enables you to send a new text message based on a pre-defined set of 15 messages.

1. Press OK to select. If the system detects your phone does not support this feature, Unsupported appears in the display and SYNC returns to the main menu.
2. Scroll to cycle through the message options in the following chart.
3. Select the desired text message. Each text message is sent with the following signature: "This message was sent from my <Ford or Lincoln>".
4. Press Recipients, then choose who to send it to using the Phone Book or Phone Number.

<b>Pre-defined text message options</b>
Be there in 10 minutes
Be there in 20 minutes
Call me
Call you later
Can't talk right now
Can't wait to see you
I love you
I need more directions
I'm stuck in traffic
No
Thanks
Too funny
Where R you?
Why?
Yes

**Accessing Your Phone Settings**

These are phone-dependent features. Your phone settings allow you to access and adjust features such as your ring tone, text message notification, modify your phone book and also set up automatic download.

1. Press the phone button.
2. Scroll until Phone Settings appears, then press OK.
3. Scroll to select from the following options:

When you select:	You can:
<b>Phone Status</b>	See the provider, name, signal power, battery power and roaming status of your connected phone. Press OK to select and scroll to view the information. When done, press OK again to return to the phone status menu.
<b>Set Ringer</b>	Select which ring tone sounds during an incoming call (one of the system's or your phone's). 1. Press OK to select and scroll to hear Ringer 1, Ringer 2, Ringer 3 and Phone Ringer. 2. Press OK to select. <b>Note:</b> If your phone supports in-band ringing, your phone's ringer sounds when Phone Ringer is chosen.
<b>Message Notification</b>	Have the option of hearing an audible tone to notify you when a text message arrives. 1. Press OK to select and scroll between Message Notification On or Message Notification Off. 2. Press OK to select.

When you select:	You can:
<b>Modify Phonebook</b>	<p>Modify the contents of your phone book (i.e., add, delete, download). Press OK to select and scroll between:</p> <p>Add Contacts: Press OK to add more contacts from your phone book. Push the desired contact(s) on your phone. See your phone's user guide on how to push contacts.</p> <p>Delete Phonebook: Press OK to delete the current phone book and call history. When Delete Phonebook appears, press OK to confirm. SYNC takes you back to the Phone Settings menu.</p> <p>Download Phonebook: Press OK to select and press OK again when Confirm Download? appears.</p>
<b>Auto Download</b>	<p>Automatically download your phone book each time your phone connects to SYNC. Press OK to select. When Auto Download On? appears, press OK to have your phonebook automatically downloaded each time.</p> <p>Select Off to NOT download your phonebook every time your phone connects to SYNC. Your phonebook, call history and text messages can only be accessed when your specific phone is connected to SYNC.</p> <p><b>Note:</b> Downloading times are phone- and quantity-dependent.</p> <p><b>Note:</b> When auto download is on, any changes, additions or deletions saved since your last download are deleted.</p>
<b>Return</b>	Exit the current menu.

**System Settings**

System Settings provide access to your Bluetooth Devices and Advanced menu features.

The Bluetooth Devices menu allows you to add, connect, delete and set a phone as primary as well as turn your Bluetooth feature on and off.

The Advanced menu allows you to access and set prompts, languages, defaults, perform a master reset, install an application and view system information.

**Bluetooth Devices Menu Options**

This menu allows you to add, connect, delete, set a phone as primary, and turn Bluetooth on or off.

1. Press the phone button to enter the Phone Menu.
2. Scroll until System Settings appears and press OK.
3. Scroll until Bluetooth Devices appears and select OK.
4. Scroll to select from the following options:

If you select:	You can:
<b>Add Bluetooth Device*</b>	See <i>Using SYNC with your phone</i> earlier in this chapter for pairing instructions.
<b>Connect Bluetooth Device</b>	Connect a previously paired Bluetooth-enabled phone. 1. Press OK to select and view a list of previously paired phones. 2. Scroll until the desired device is chosen, then press OK to connect the phone. <b>Note:</b> Only one device can be connected at a time. When another phone is connected, the previous one is disconnected.
<b>Set Primary Phone</b>	Set a previously paired phone as your primary phone. Press OK to select and scroll to select the desired phone. Press OK to confirm. <b>Note:</b> SYNC attempts to connect with the primary phone at every ignition cycle. When a phone is selected as primary, it appears first in the list and is marked with an *.

If you select:	You can:
<b>Set Bluetooth On/Off</b>	Turn the Bluetooth feature on and off. Press OK and scroll to toggle between On and Off. When the desired selection is chosen, press OK. <b>Note:</b> Turning Bluetooth off disconnects all Bluetooth devices and deactivates all Bluetooth features.
<b>Delete Device</b>	Delete a paired phone. Press OK and scroll to select the device. Press OK to confirm.
<b>Delete All Devices</b>	Delete all previously paired phones (and all information originally saved with those phones). Press OK to select.
<b>Return</b>	Exit the current menu.

\*This is a speed-dependent feature.

### **Advanced Menu Options**

This menu allows you to access settings such as prompts, languages, defaults, perform a master reset, install an application and view system information.

1. Press the PHONE hard button.
2. Select the Settings tab, then Advanced.
3. Use the arrow buttons to choose between things like Bluetooth On/Off, 911 Assist, Vehicle Health Report, Incoming Call Ringer, etc.

### **SYNC APPLICATIONS AND SERVICES (IF EQUIPPED)**

**Note:** In order for the following features to work, your cellular phone must be compatible with SYNC. To check your phone's compatibility, visit [www.SYNCMYride.com](http://www.SYNCMYride.com), [www.SYNCMYride.ca](http://www.SYNCMYride.ca) or [www.syncmaroute.ca](http://www.syncmaroute.ca).

- SYNC Services (if equipped, U.S. only): Provides access to traffic, directions and information such as travel, horoscopes, stock prices and more.
- 911 Assist®: Can alert 911 in the event of an emergency.
- Vehicle Health Report (if equipped, U.S. only): Provides a diagnostic and maintenance report card of your vehicle.
- SYNC AppLink™: Allows you to connect to and use certain applications such as Pandora and Stitcher (if your phone is compatible).

**911 Assist®**

 **WARNING:** Unless the 911 Assist setting is set on prior to a crash, the system will not dial for help which could delay response time, potentially increasing the risk of serious injury or death after a crash.

 **WARNING:** Do not wait for 911 Assist to make an emergency call if you can do it yourself. Dial emergency services immediately to avoid delayed response time which could increase the risk of serious injury or death after a crash. If you do not hear 911 Assist within five seconds of the crash, the system or phone may be damaged or non-functional.

 **WARNING:** Always place your phone in a secure location in the vehicle so it does not becoming a projectile or get damaged in a collision. Failure to do so may cause serious injury to someone or damage the phone which could prevent 911 Assist from working properly.

**Note:** SYNC 911 Assist feature must be set on prior to the incident.

**Note:** Before setting this feature on, ensure that you read the 911 Assist privacy notice later in this section for important information.

**Note:** If 911 Assist is turned on or off by any user, that setting applies for all paired phones. If 911 Assist is turned off, a voice message plays and/or a display message/icon comes on when the vehicle is started after a previously paired phone connects.

**Note:** Every phone operates differently. While SYNC 911 Assist works with most cellular phones, some may have trouble using this feature.

If a crash deploys an airbag (excludes knee airbags and rear inflatable safety belts [if equipped]) or activates the fuel pump shut-off, your SYNC equipped vehicle may be able to contact emergency services by dialing 911 through a paired and connected Bluetooth-enabled phone. For more information about 911 Assist, visit [www.SYNCMYRide.com](http://www.SYNCMYRide.com), [www.SYNCMYRide.ca](http://www.SYNCMYRide.ca) or [www.syncmaroute.ca](http://www.syncmaroute.ca).

- For information on airbag deployment, see the *Supplementary Restraints System* chapter.
- For information on the fuel pump shut-off, see the *Roadside Emergencies* chapter.

**Setting 911 Assist On**

If your vehicle **is not** equipped with a navigation system, perform the following:

1. Press the phone button to enter the Phone Menu.
2. Scroll until 911 Assist appears in the display.
3. Scroll to select ON, then press OK. Set On appears in the display.

If your vehicle **is** equipped with a navigation system, perform the following:

1. Press the PHONE hard button.
2. Select the Settings tab.
3. Press Advanced. Select 911 Assist, then turn the system on.

To make sure that 911 Assist works properly:

- SYNC must be powered and working properly at the time of the incident and throughout feature activation and use.
- SYNC 911 Assist feature must be set on prior to the incident.
- A Bluetooth-enabled and compatible phone has to be paired and connected to SYNC.
- A connected Bluetooth-enabled phone must have the ability to make and maintain an outgoing call at the time of the incident.
- A connected Bluetooth-enabled phone must have adequate network coverage, battery power and signal strength.
- The vehicle must have battery power and be located in the U.S., Canada or in a territory in which 911 is the emergency number.

**In the Event of a Crash**

Not all crashes deploy an airbag or activate the fuel pump shut-off (which would activate 911 Assist); however, if 911 Assist is triggered, SYNC tries to contact emergency services. If a connected phone is damaged or loses connection to SYNC, SYNC searches for, and tries to connect to, any available previously paired phone and tries to make the call to 911.

Before making the call:

- SYNC provides a short window of time (about 10 seconds) to cancel the call. Failure to cancel the call results in SYNC attempting to dial 911.
- SYNC says the following, or a similar message: “SYNC will attempt to call 911, to cancel the call, press Cancel on your screen or press and hold the phone button on your steering wheel.”

If the call is not cancelled and a successful call is made, a pre-recorded message is played for the 911 operator, then the occupant(s) in the vehicle is able to talk with the operator. Be prepared to provide your

name, phone number and location immediately, because not all 911 systems are capable of receiving this information electronically.

**911 Assist May Not Work If**

- Your cellular phone or 911 Assist hardware was damaged in a crash.
- The vehicle's battery or SYNC system has no power.
- The phone(s) paired and connected to the system was thrown from the vehicle.

**911 Assist Privacy Notice**

Once 911 Assist is set on, it may disclose to emergency services that the vehicle has been in a crash involving the deployment of an airbag or activation of the fuel pump shut-off. Certain versions or updates to 911 Assist may also be capable of electronically or verbally disclosing to 911 operators the vehicle location, and/or other details about the vehicle or crash to assist 911 operators to provide the most appropriate emergency services. If you do not want to disclose this information, do not turn the feature on.

**Vehicle Health Report**

**WARNING:** Always follow scheduled maintenance instructions, regularly inspect your vehicle, and seek repair for any damage or problem you suspect. Vehicle Health Report supplements, but cannot replace normal maintenance and vehicle inspection. Vehicle Health Report only monitors certain systems that are electronically monitored by the vehicle and will not monitor or report the status of any other system, (i.e., brake lining wear). Failure to perform scheduled maintenance and regularly inspect your vehicle may result in vehicle damage and serious injury.

**Note:** Your Vehicle Health Report feature requires activation prior to use. Visit [www.SYNCMYride.com](http://www.SYNCMYride.com) to register. There is no fee or subscription associated with Vehicle Health Report, but you must register to use this feature.

**Note:** This feature may not function properly if you have enabled caller ID blocking on your mobile phone. Before running a report, review the *Vehicle Health Report privacy notice*.

**Note:** In order to allow a break-in period for your vehicle, you may not be able to create a Vehicle Health Report until your vehicle odometer has reached 200 miles.

**2013 05+ Mustang (197)**  
**Owners Guide gf, 3rd Printing**  
**USA (fus)**



Register for Vehicle Health Report and set your report preferences at [www.SYNCMYRide.com](http://www.SYNCMYRide.com). After registering, you can request a Vehicle Health Report (inside your vehicle). Return to your account at [www.SYNCMYRide.com](http://www.SYNCMYRide.com) to view your report. You can also choose for SYNC to automatically remind you to run reports at specific mileage intervals. Cellular phone airtime usage may apply when reporting.

The system allows you to check your vehicle's overall health in the form of a diagnostic report card. The vehicle health report contains valuable information such as:

- Vehicle Diagnostic Information
- Scheduled maintenance
- Open Recalls and Field Service Actions
- Unserviced items from vehicle inspections by your authorized dealer.

You can run a report (after the vehicle has been running a minimum of 60 seconds) by pressing the voice button and saying "Vehicle health report", or pressing the phone button.

To run a report using the phone button and your vehicle **is not** equipped with a navigation system,

1. Press the phone button to enter the Phone Menu.
2. Scroll until Vehicle Health appears in the display, then press OK.
3. Select from one of the options listed in the following table.

To run a report using the phone button and your vehicle **is** equipped with a navigation system::

1. Press the PHONE hard button.
2. Select the Settings tab.
3. Press Advanced, then select Vehicle Health Report.
4. Select from one of the options listed in the following table.

Vehicle Health Report Options	
<b>Automatic Reports</b>	Press OK and select on or off. Select On to have SYNC automatically prompt you to run a health report at certain mileage intervals. <b>Note:</b> You must first turn this feature on before you can select the mileage intervals at which you would like to be prompted.
<b>Mileage Intervals</b>	Press OK. Scroll to select between 5000, 7500 or 10000 mile intervals and press OK to make your selection.

Vehicle Health Report Options	
<b>Run Report?</b>	Press OK for SYNC to run a health report of your vehicle's diagnostic systems and send the results to Ford where it is combined with scheduled maintenance information, open recalls and other field service actions and unserviced vehicle inspection items from your authorized dealer.

**Vehicle Health Report Privacy Notice**

When you run a Vehicle Health Report, Ford Motor Company may collect your cellular phone number (to process your report request) and diagnostic information about your vehicle. Certain versions or updates to Vehicle Health Report may also collect additional vehicle information. Ford may use the vehicle information it collects for any purpose. If you do not want to disclose your cellular phone number or vehicle information, do not run the feature or set up your Vehicle Health Report profile at [www.SYNCMYRide.com](http://www.SYNCMYRide.com). See [www.SYNCMYRide.com](http://www.SYNCMYRide.com) - Vehicle Health Report Terms and Conditions, and Privacy Statement - for more information.

**SYNC Services: Traffic, Directions & Information (TDI)**

**Note:** SYNC Services requires activation prior to use. Visit [www.SYNCMYRide.com](http://www.SYNCMYRide.com) to register and check your eligibility for complimentary services. Standard phone and message rates may apply. Subscription may be required. You must also have the active SYNC Services Bluetooth-enabled cellular phone paired and connected to the system in order to connect to, and use, SYNC Services. See *Using SYNC with your phone* for pairing instructions.

**Note:** This feature does not function properly if you have enabled caller ID blocking on your mobile phone. Make sure your mobile phone is not blocking caller ID before using SYNC Services.

**Note:** The driver is ultimately responsible for the safe operation of the vehicle, and therefore, must evaluate whether it is safe to follow the suggested directions. Any navigation features are provided only as an aid. Make your driving decisions based on your observations of local conditions and existing traffic regulations. Do not follow the route suggestions if doing so would result in an unsafe or illegal maneuver, if you would be placed in an unsafe situation, or if you would be directed into an area that you consider unsafe. Maps used by this system may be inaccurate because of errors, changes in roads, traffic conditions or driving conditions.

2013 05+ Mustang (197)  
 Owners Guide gf, 3rd Printing  
 USA (fus)

**Note:** When you connect, the service uses GPS technology and advanced vehicle sensors to collect the vehicle's current location, travel direction and speed to help provide you with the directions, traffic reports, or business searches you request. Further, to provide the services you request and for continuous improvement, the service may collect and record call details and voice communications. For more information, see SYNC Services Terms and Conditions at [www.SYNCMyRide.com](http://www.SYNCMyRide.com). If you do not want Ford or its service providers to collect the vehicle travel information or other information identified in the Terms and Conditions, do not activate or use the service.

SYNC Services uses advanced vehicle sensors, integrated GPS technology and comprehensive map and traffic data, to give you personalized traffic reports, precise turn-by-turn directions, business search, news, sports, weather and more. For a complete list of services, or to learn more, please visit [www.SYNCMyRide.com](http://www.SYNCMyRide.com).

#### ***Connecting to SYNC Services Using Voice Commands***

1. Press the voice button.
2. When prompted, say "Services". This initiates an outgoing call to SYNC Services using your paired and connected Bluetooth-enabled cellular phone.
3. Once you are connected to the service, follow the voice prompts to request the desired service, such as "Traffic" or "Directions". You can also say "What are my choices?" to receive a complete list of available services from which to choose.
4. Say "Services" to return to the services main menu or for help, say "Help".

#### ***Connecting to SYNC Services Using the Phone Menu***

1. Press the phone button to enter the Phone Menu.
2. Scroll until *Services* appears in the display.
3. Press OK to confirm and enter the Services menu. The display indicates the system is connecting.
4. Press OK. SYNC initiates the call to the Services portal.
5. Once connected, follow the voice prompts to request your desired Service, such as Traffic or Directions. You can also say "What are my choices?" to receive a complete list of available services from which to choose.
6. To return to the Services menu, say "Services" or for help, say "Help".

#### ***Receiving Turn-by-Turn Directions***

1. When connected to SYNC Services, say "Directions" or "Business search". To find the closest business or type of business to your

current location, just say “Business search” and then “Search near me”. If you need further assistance in finding a location you can say “Operator” at any time within a Directions or Business search to speak with a live operator. You may also be prompted to speak with an operator when the automatic system has difficulty matching your voice request. The live operator can assist you by searching for businesses by name or by category, residential addresses by street address or by name or specific street intersections. Operator Assist is a feature of your SYNC Services subscription. For more information on Operator Assist visit [www.SYNCMYRide.com/support](http://www.SYNCMYRide.com/support).

2. Follow the voice prompts to select your destination. Once your destination is selected, your current vehicle location is uploaded and a route based on current traffic conditions is calculated and sent back to your vehicle. After the route download is complete, the phone call is automatically ended. You then receive audible and visual driving instructions as you travel toward your destination.
3. While on an active route, you can select or say “Route summary” or “Route status” to view the Route Summary turn list or the Route Status ETA. You can also turn voice guidance on or off, cancel the route or update the route.

If you miss a turn, SYNC automatically asks if you want the route updated. Just say, “Yes” when prompted and a new route will be delivered to your vehicle.

**Disconnecting from SYNC Services**

1. Press and hold the phone button on the steering wheel.
2. Say “Good-bye” from the SYNC Services main menu.

<b>SYNC Services Quick Tips</b>	
<b>Personalizing</b>	You can personalize your Services feature to provide quicker access to your most used or favorite information. You can save address points such as work or home. You can also save favorite information like sports teams or a news category. To learn more, log onto <a href="http://www.SYNCMYRide.com">www.SYNCMYRide.com</a> .
<b>Push to interrupt</b>	Press the voice button at any time (while you are connected to SYNC TDI Services) to interrupt a voice prompt or an audio clip (such as a sports report), wait for the listening tone, and say your voice command.

SYNC Services Quick Tips	
<b>Portable</b>	Your subscription is associated with your Bluetooth-enabled cellular phone number, not your VIN (Vehicle Identification Number). You can pair and connect your phone to any vehicle equipped with Traffic, Directions and Information and continue enjoying your personalized services. You can even access your account outside the vehicle. Just use the number on your phone's call history. Traffic and Directions features do not function properly but information services and the 411 connect and text message features are available.

### SYNC AppLink™

**Note:** Your smartphone must be paired and connected to SYNC to access AppLink.

**Note:** iPhone® users need to connect the phone to the USB port in order to start the application. It is recommended to lock your iPhone® after starting an application.

**Note:** The AppLink feature is not available if your vehicle is equipped with the MyFord Touch® or MyLincoln Touch™ system.

Depending on your display type, you can access AppLink from the media menu, the phone menu, or by using voice commands. Once an app is running through AppLink, you can control main features of the app through voice commands and steering wheel controls.

#### To Access Using the Phone Menu

1. Press the Phone button.
2. Browse to Mobile Applications and press OK.
3. Browse to your desired app and press OK.
4. Once an app is running through SYNC, you can access an app's menu by pressing the MENU button to first access the SYNC menu.
5. Scroll until "<App name> Menu" is displayed (i.e., Pandora Menu), then press OK. From here, you can access an application's features, such as Thumbs up, Thumbs down, etc. For more information, please visit [www.SYNCMYRide.com](http://www.SYNCMYRide.com).

**To Access Using the Media Menu**

1. Press the AUX button to access the SYNC menu.
2. Press the Menu button to access the SYNC Media menu.
3. Browse to Mobile Applications and press OK.
4. Browse to your desired app and press OK.
5. Once an app is running through SYNC, you can access an app's menu by pressing the MENU button to first access the SYNC menu.
6. Scroll until "<App name> Menu" is displayed (i.e., Pandora Menu), then press OK. From here, you can access an application's features, such as Thumbs up, Thumbs down, etc. For more information, please visit [www.SYNCMyRide.com](http://www.SYNCMyRide.com).

**To Access Using the Navigation Screen (If Equipped)**

1. Press the Phone button.
2. Press the SYNC Apps tab.
3. Press Mobile Apps.
4. Select the app to start it.

**To Access Using Voice Commands**

1. Press the voice icon.
2. When prompted, say "Mobile Apps".
3. Say the name of the application after the tone.
4. The app should start. While an app is running through SYNC, you can press the voice button and speak commands specific to the app, such as "Play Station Quickmix". Say "Help" to discover available voice commands.

**USING SYNC WITH YOUR MEDIA PLAYER**

You can access and play music from your digital music player over the vehicle's speaker system using the system's media menu or voice commands. You can also sort and play your music by specific categories, such as artists, albums, etc.

SYNC is capable of hosting nearly any digital media player including: iPod®, Zune™, Plays from device players, and most USB drives. SYNC also supports audio formats such as MP3, WMA, WAV and ACC.

**Connecting Your Digital Media Player to the USB Port**

**Note:** If your digital media player has a power switch, make sure that the device is turned on.

To connect using voice commands:

1. Plug the device into the vehicle's USB port.

2. Press the voice icon and when prompted, say “User device”.
3. You can now play music by saying any of the appropriate voice commands, such as:
  - Play All
  - Play Artist <name>
  - Play Album <name>
  - Play Genre <name>
  - Play Playlist <name>
  - Play Track <name>.

To connect using the system menu:

1. Plug the device into the vehicle’s USB port.
2. Press the MEDIA hard button.
3. Select the User Device tab, the press Source repeatedly until USB appears.
4. Press Music Library.
5. Select from the listed features.

Once connected, the system indexes any readable media files. (The time required to complete this depends on the size of the media content being indexed.) If Autoplay is on, you can access media files randomly as they are indexed. If turned off, indexed media is not available until the indexing process is complete. SYNC is capable of indexing thousands of average size media and notifies you if the maximum indexing file size is reached.

### What’s Playing?



At any time when a track is playing, you can press the voice icon and ask the system, “What’s playing?”. The system reads the metadata tags (if populated) of the playing track to you.

### Media Voice Commands



Press the voice icon and, when prompted, say “User Device” then any of the following:

<b>“User Device”</b>
“Autoplay off”
“Autoplay on”
“Pause”
“Play”
“Play album <name>” <sup>1,3</sup>

“User Device”
“Play all”
“Play artist <name>” <sup>1,3</sup>
“Play genre <name>” <sup>1,3</sup>
“Play next folder” <sup>2</sup>
“Play next track”
“Play playlist <name>” <sup>1,3</sup>
“Play previous folder” <sup>2</sup>
“Play previous track”
“Play track <name>” <sup>1,3</sup>
“Repeat off”
“Repeat on”
“Shuffle off”
“Shuffle on”
“Similar music”
“Voice settings”

<sup>1</sup> “<name>” is a dynamic listing, meaning that it could be the name of any desired group, artist, etc.

<sup>2</sup> Voice commands which are only available in folder mode.

<sup>3</sup> Voice commands which are not available until indexing is complete.

**Supported Media Players, Formats and Metadata Information**

SYNC® is capable of hosting nearly any digital media player, including iPod®, Zune™, Plays from device players, and most USB drives. Supported audio formats include MP3, WMA, WAV and AAC.

You are also able to organize your indexed media from your playing device by metadata tags. Metadata tags are descriptive software identifiers embedded in the media files which provide information about the file.

If your indexed media files contain no information embedded in these metadata tags, SYNC may classify the empty metadata tags as *Unknown*.



### Media Menu Sources and Features

The User Device menu allows you to select your media source and how to play your music (by artist, genre, shuffle, repeat, etc.).

1. Make sure your USB device is plugged in to your system.
2. Press the MEDIA hard button.
3. Select the User Device tab, then press Source repeatedly to cycle through USB, BT Audio and Line In:

When you select:	You can:
<b>Music Library</b>	Access SYNC's many media features, such as: Play All, Play Artists, Play Albums, Play Tracks, Play Playlists, and Explore the USB.
<b>Similar Music</b>	Play music similar to what is currently playing from the USB port. The system uses the metadata information of each song to compile a playlist for you. The system creates a new list of similar songs and begins playing. The metadata tags must be populated for this feature to include each track.
<b>Repeat</b>	Repeat any song.
<b>Shuffle</b>	Randomly play available media files in the current playlist.
<b>Settings</b>	Access Bluetooth Devices menu listings (add, connect, set as primary, on/off, delete) as well as Advanced menu listings (prompts, languages, defaults, master reset, install application and system information).
<b>Text</b>	View additional information, if available.

### Accessing the Media Music Library

This menu allows you to select and play your media by artist, album, genre, playlist, track, similar music or even to explore what is on your USB device.

1. Make sure that your device is plugged into the USB port and is turned on.
2. Press the MEDIA hard button.
3. Select the User Device tab, then press Source repeatedly until USB appears.
4. Select Music Library.

If there are no media files to access, the display indicates there is no media. If there are media files, you have the following options to scroll through and select from:

When you select:	You can:
<b>Play All</b>	Play all indexed media (tracks) from your playing device in flat file mode, one at a time in numerical order.
<b>Artists</b>	Sort all indexed media by artist. Once selected, the system lists and then plays all artists and tracks alphabetically. If there are less than 255 indexed artists, they are listed alphabetically in flat file mode. If there are more, they are categorized in alphabetical categories.
<b>Albums</b>	Sort all indexed media by albums. If there are less than 255 indexed albums, they are listed alphabetically in flat file mode. If there are more, they are organized into alphabetical categories.
<b>Genres</b>	Sort indexed music by genre (category) type. SYNC lists the genres alphabetically in flat file mode. If there are more than 255, SYNC automatically organizes them into alphabetical categories.
<b>Playlists</b>	Access your playlists (from formats, such as ASX, .M3U, .WPL, .MTP.). The system lists your playlists alphabetically in flat file mode. If there are more than 255, they are organized into alphabetical categories.
<b>Tracks</b>	Search for and play a specific track which has been indexed. SYNC lists your tracks alphabetically in flat file mode. If there are more than 255, SYNC automatically organizes them into alphabetical categories.
<b>Explore USB</b>	Explore all supported digital media on your media device connected to the USB port. You can only view media content which is compatible with SYNC; other files saved are not visible.

**Bluetooth Audio**

Your system allows you to stream audio over your vehicle's speakers from your connected, Bluetooth-enabled cellular phone.

To access:

1. Make sure your paired phone is in streaming mode.
2. Press the MEDIA hard button.
3. Select the User Device tab, then press Source repeatedly until BT Audio appears.

**Line In (Auxiliary Input Jack)**

Your system allows you to select and play music from your portable music player over the vehicle's speakers.

To access:

1. Make sure your paired phone is in streaming mode.
2. Press the MEDIA hard button.
3. Select the User Device tab, then press Source repeatedly until Line In appears.

**System Settings**

System settings provide access to your Bluetooth devices and Advanced menu features.

The Bluetooth menu allows you to add, connect and delete a device as well as turn the Bluetooth feature on and off.

The Advanced menu allows you to access and set prompts, languages, defaults and perform a master reset.

**Bluetooth Devices Menu Options**

This menu allows you to add, connect and delete devices as well as turn Bluetooth on and off.

1. Press the MEDIA hard button.
2. Select the User Device tab, then BT Devices.
3. Select from:

When you select:	You can:
<b>Connect</b>	Connect a previously paired Bluetooth-enabled phone.
<b>Add</b>	Add a device through Discovery and Discoverable modes.

When you select:	You can:
<b>Delete</b>	Delete a paired media device.
<b>Advanced</b>	Access menu listings (prompts, languages, defaults, master reset, install application and system information).

**TROUBLESHOOTING**

Your SYNC system is easy to use. However, should questions arise, see the tables below.

Use the website at any time to check your phone’s compatibility, register your account and set preferences as well as access a customer representative via an online chat (during certain hours). Visit [www.SYNCMYride.com](http://www.SYNCMYride.com), [www.SYNCMYride.ca](http://www.SYNCMYride.ca) or [www.syncmaroute.ca](http://www.syncmaroute.ca) for more information.

Phone Issues		
Issue	Possible Cause(s)	Possible Solution(s)
Excessive background noise during a phone call.	The audio control settings on your phone may be affecting SYNC performance.	Review your phone’s user guide regarding audio adjustments.
During a call, I can hear the other person but they cannot hear me.	Possible phone malfunction.	Try turning off the device, resetting the device, removing the device’s battery, then trying again.

Phone Issues		
Issue	Possible Cause(s)	Possible Solution(s)
SYNC is not able to download my phonebook.	<ul style="list-style-type: none"> <li>• This is a phone-dependent feature, OR</li> <li>• Possible phone malfunction.</li> </ul>	<ul style="list-style-type: none"> <li>• Go to the website to review your phone's compatibility.</li> <li>• Try turning off the device, resetting the device or removing the device's battery, then trying again.</li> <li>• Try pushing your phonebook contacts to SYNC by using the Add Contacts feature.</li> <li>• Use the SYNCmyphone feature available on the website.</li> </ul>
The system says Phonebook Downloaded but my phonebook in SYNC is empty or is missing contacts.	Limitations on your phone's capability.	<ul style="list-style-type: none"> <li>• Try pushing your phonebook contacts to SYNC by using the Add Contacts feature.</li> <li>• If the missing contacts are stored on your SIM card, try moving them to the device memory.</li> <li>• Remove any pictures or special ring tones associated with the missing contact.</li> </ul>



Phone Issues		
Issue	Possible Cause(s)	Possible Solution(s)
I am having trouble connecting my phone to SYNC.	<ul style="list-style-type: none"> <li>• This is a phone-dependent feature, OR</li> <li>• Possible phone malfunction.</li> </ul>	<ul style="list-style-type: none"> <li>• Go to the website to review your phone's compatibility.</li> <li>• Try turning off the device, resetting the device or removing the device's battery, then trying again.</li> <li>• Try deleting your device from SYNC, deleting SYNC from your device and trying again.</li> <li>• Check the security and auto accept/prompt always settings relative to the SYNC Bluetooth connection on your phone.</li> <li>• Update your device's software firmware.</li> <li>• Turn off the Auto phonebook download setting.</li> </ul>
Text messaging is not working on SYNC.	<ul style="list-style-type: none"> <li>• This is a phone-dependent feature, OR</li> <li>• Possible phone malfunction.</li> </ul>	<ul style="list-style-type: none"> <li>• Go to the website to review your phone's compatibility.</li> <li>• Try turning off the device, resetting the device or removing the device's battery, then trying again.</li> </ul>

USB/Media Issues		
Issue	Possible Cause(s)	Possible Solution(s)
I am having trouble connecting my device.	Possible device malfunction.	<ul style="list-style-type: none"> <li>• Try turning off the device, resetting the device or removing the device's battery, then trying again.</li> <li>• Make sure you are using the manufacturer's cable.</li> <li>• Make sure the USB cable is properly inserted into the device and the vehicle's USB port.</li> <li>• Make sure that the device does not have an auto-install program or active security settings.</li> </ul>
SYNC does not recognize my device when I turn on the car.	This is a device limitation.	Make sure you are not leaving the device in your vehicle during very hot or cold temperatures.
Bluetooth audio does not stream.	<ul style="list-style-type: none"> <li>• This is a phone-dependent feature, OR</li> <li>• The device is not connected.</li> </ul>	Make sure the device is connected to SYNC and that you have pressed play on your device.
SYNC does not recognize music that is on my device.	<ul style="list-style-type: none"> <li>• Your music files may not contain the proper artist, song title, album or genre information, OR</li> <li>• The file may be corrupted, OR</li> <li>• The song may have copyright protection which does not allow it to play.</li> </ul>	<ul style="list-style-type: none"> <li>• Make sure that all song details are populated.</li> <li>• Some devices require you to change the USB settings from mass storage to MTP class.</li> </ul>



<b>Vehicle Health Report/Services (Traffic, Directions and Information) Issues</b>		
<b>Issue</b>	<b>Possible Cause(s)</b>	<b>Possible Solution(s)</b>
I received a text that the Vehicle Health Report is not activated.	<ul style="list-style-type: none"> <li>Your account may not be activated on the website, OR</li> <li>You may have the wrong VIN (vehicle identification number) listed.</li> </ul>	<ul style="list-style-type: none"> <li>This is a free feature, but you must first register online to use it.</li> <li>Make sure that your VIN is correctly listed in your account.</li> </ul>
I am unable to retrieve the report on the website, or I receive a system error.	The preferred dealer information did not load correctly.	When you register your account, you must list a preferred dealer. If one is already listed, try selecting another dealer and logging out. Log back in and change it back to your preferred dealer and retrieve the report.
I am unable to submit a report.	<ul style="list-style-type: none"> <li>This could be due to your phone's compatibility, OR</li> <li>Bad signal strength, OR</li> <li>Your phone may not be activated on the website.</li> </ul>	<ul style="list-style-type: none"> <li>Update your mobile number in your account on the website.</li> <li>Make sure you have full signal strength and that your <i>Bluetooth</i> volume level has been turned up.</li> <li>Try deleting your phone and performing a clean pairing.</li> </ul>
I heard a commercial when I tried to use Traffic, Directions and Information.	<ul style="list-style-type: none"> <li>The phone in use is not activated, OR</li> <li>Your phone has ID blocker active.</li> </ul>	<ul style="list-style-type: none"> <li>This is a free feature, but you must first register online to use it.</li> <li>Turn off ID blocker on your phone as the system recognizes you by your phone number.</li> <li>Make sure the currently connected phone is the same one that is registered on your SyncMyRide account.</li> </ul>



Voice Command Issues		
Issue	Possible Cause(s)	Possible Solution(s)
SYNC does not understand what I am saying.	<ul style="list-style-type: none"> <li>You may be using the wrong voice commands, OR</li> <li>You may be speaking too soon or at the wrong time.</li> </ul>	<ul style="list-style-type: none"> <li>Review the Phone voice commands and the Media voice commands at the beginning of their respective sections.</li> <li>Be aware that SYNC's microphone is either in your rear view mirror or in the headliner just above the windshield.</li> </ul>
SYNC does not understand the name of a song or artist.	<ul style="list-style-type: none"> <li>You may be using the wrong voice commands, OR</li> <li>You may not be saying the name exactly as it is saved, OR</li> <li>The system may not be reading the name the same way you are saying it.</li> </ul>	<ul style="list-style-type: none"> <li>Review the media voice commands at the beginning of the media section.</li> <li>Say the song or artist exactly as listed. If you say, "Play Artist Prince", the system does not play music by Prince and the Revolution or Prince and the New Power Generation.</li> <li>Make sure you are saying the complete title, such as "California remix featuring Jennifer Nettles".</li> <li>If the songs are saved in all CAPS, you have to spell them. LOLA requires you to say, "Play L-O-L-A".</li> <li>Do not use special characters in the title as the system does not recognize them.</li> </ul>

Voice Command Issues		
Issue	Possible Cause(s)	Possible Solution(s)
<p>SYNC does not understand or is calling the wrong contact when I want to make a call.</p>	<ul style="list-style-type: none"> <li>• You may be using the wrong voice commands, OR</li> <li>• You may not be saying the name exactly as it is saved, OR</li> <li>• Contacts in your phonebook may be very short and similar, or they may contain special characters, OR</li> <li>• Your phonebook contacts may be saved in CAPS.</li> </ul>	<ul style="list-style-type: none"> <li>• Review the phone voice commands at the beginning of the phone section.</li> <li>• Make sure you are saying the contacts exactly as listed. For example, if a contact is saved as Joe Wilson, say “Call Joe Wilson”.</li> <li>• The system works better if you list full names, such as “Joe Wilson” rather than “Joe”.</li> <li>• Do not use special characters such as 123 or ICE, as the system does not recognize them.</li> <li>• If contacts are saved in CAPS, you have to spell them. JAKE requires you to say, “Call J-A-K-E”.</li> </ul>

## 362 Navigation System (If Equipped)

### NAVIGATION CONTROLS

#### Type 1

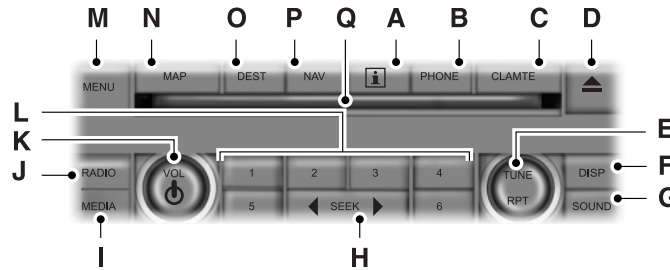

**WARNING:** Driving while distracted can result in loss of vehicle control, accident and injury. Ford strongly recommends that drivers use extreme caution when using any device or feature that may take their focus off the road. Your primary responsibility is the safe operation of your vehicle. We recommend against the use of any handheld device while driving, encourage the use of voice-operated systems when possible and that you become aware of applicable state and local laws that may affect use of electronic devices while driving.

The system divides the screen in two sections after it initializes:

- **Status bars:** This is the top and bottom portion of the screen. It displays the clock or date and other useful information, depending on which mode you are in.
- **Display area:** The touchscreen changes depending on current system operation. Different buttons display in this area, depending on which mode you are in.

**Note:** Some features, such as SIRIUS satellite radio, may not be available in your location. Check with your authorized dealer.

- A. **I (Information):** Press this button to access features such as Where am I?, SIRIUS® Travel Link™, Calendar, System Info and Help.
- B. **PHONE:** Press this button to access the SYNC phone menu.
- C. **CLIMATE:** Press this button to access the climate control menu.
- D. **Eject:** Press this button to eject a CD or DVD from the system.

**E. TUNE RPT:**

- In radio or satellite radio mode, turn the control to advance in individual increments up or down the frequency band to the desired station.
- In MP3 mode, turn the control to advance to the next or previous folder.
- In navigation mode, press this button to hear the last spoken navigation guidance prompt.

**F. DISP:** Press this button to select a display mode: On, Status Bar Only, and Off.

**G. SOUND:**

- Press this button to access the sound menu.
- Press while the sound menu is active to access the menu tabs of Bass/Treble, Balance/Fade, SCV (Speed Compensated Volume), DSP (Digital Signal Processing) and Visualizer.

**H. SEEK:**

- In radio and satellite radio mode, press the arrow buttons to find previous or next available stations or channels within the currently selected Category or Genre.
- In CD and DVD modes, press the arrow buttons to select the previous or next track or chapter.

**I. MEDIA:**

- Press this button to access the media menu.
- Press while the media menu is active to access the available sources of CD/DVD, Jukebox and User Device.

**J. RADIO:**

- Press this button to access the radio menu.
- Press while the radio menu is active to access the available sources of AM, FM1, FM2, SAT1, SAT2, and SAT3.

**K. VOL:** Press and hold this button to turn the system off and on. Turn the control to adjust the volume.

**Note:** If a navigation route is active when the navigation system is off, the system resumes the route when you turn the system on.

## 364 Navigation System (If Equipped)

---

### L. **Memory presets:**

- Store your favorite radio stations. To store a radio station, tune to the station, then press and hold a preset button until sound returns.
- In radio and satellite radio mode, press a button to access your saved presets or channels.

### M. **MENU:**

- Press this button to access the system menu.
- Press while the system menu is active to access the menu tabs of Display, Clock, Feedback Settings, System Settings and Valet Mode.

### N. **MAP:**

- Press this button to access the navigation map.
- Press while the map display is active to center the map on the current vehicle position. Press while the map display and route are active to see the different map guidance views.

### O. **DEST:**

- Press this button to access the destination entry menu.
- Press while the destination entry menu is active to show additional destination entry techniques.

### P. **NAV:**

- Press this button to access the navigation menu.
- Press while the navigation menu is active to access the navigation menu tabs.

### Q. **CD and DVD slot:** Insert a CD or DVD, label side up.



Type 2

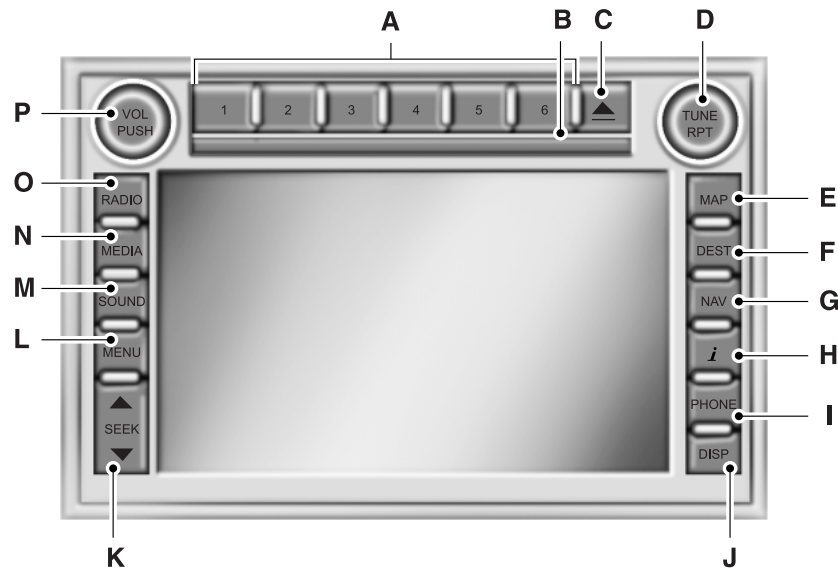

**WARNING:** Driving while distracted can result in loss of vehicle control, accident and injury. Ford strongly recommends that drivers use extreme caution when using any device or feature that may take their focus off the road. Your primary responsibility is the safe operation of your vehicle. We recommend against the use of any handheld device while driving, encourage the use of voice-operated systems when possible and that you become aware of applicable state and local laws that may affect use of electronic devices while driving.

- The system divides the screen in two sections after it initializes:
- **Status bars:** This is the top and bottom portion of the screen. It displays the clock or date and other useful information, depending on which mode you are in.
  - **Display area:** The touchscreen changes depending on current system operation. Different buttons display in this area, depending on which mode you are in.

**Note:** Some features, such as SIRIUS satellite radio, may not be available in your location. Check with your authorized dealer.

## 366 Navigation System (If Equipped)

---

### A. **Memory presets:**

- Store your favorite radio stations. To store a radio station, tune to the station, then press and hold a preset button until sound returns.
- In radio and satellite radio mode, press a button to access your saved presets or channels.

### B. **CD and DVD slot:** Insert a CD or DVD, label side up.

### C. **Eject:** Press this button to eject a CD or DVD from the system.

### D. **TUNE RPT:**

- In radio or satellite radio mode, turn the control to advance in individual increments up or down the frequency band to the desired station.
- In MP3 mode, turn the control to advance to the next or previous folder.
- In navigation mode, press this button to hear the last spoken navigation guidance prompt.

### E. **MAP:**

- Press this button to access the navigation map.
- Press while the map display is active to center the map on the current vehicle position. Press while the map display and route are active to see the different map guidance views.

### F. **DEST:**

- Press this button to access the destination entry menu.
- Press while the destination entry menu is active to show additional destination entry techniques.

### G. **NAV:**

- Press this button to access the navigation menu.
- Press while the navigation menu is active to access the navigation menu tabs.

### H. **I (Information):** Press this button to access features such as Where am I?, SIRIUS® Travel Link™, Calendar, System Info and Help.

### I. **PHONE:** Press this button to access the SYNC phone menu.

### J. **DISP:** Press this button to select a display mode: On, Status Bar Only, and Off.

### K. **SEEK:**

- In radio and satellite radio mode, press the arrow buttons to find previous or next available stations or channels within the currently selected Category or Genre.
- In CD and DVD modes, press the arrow buttons to select the previous or next track or chapter.

**L. MENU:**

- Press this button to access the system menu.
- Press while the system menu is active to access the menu tabs of Display, Clock, Feedback Settings, System Settings and Valet Mode.

**M. SOUND:**

- Press this button to access the sound menu.
- Press while the sound menu is active to access the menu tabs of Bass/Treble, Balance/Fade, SCV (Speed Compensated Volume), DSP (Digital Signal Processing) and Visualizer.

**N. MEDIA:**

- Press this button to access the media menu.
- Press while the media menu is active to access the available sources of CD/DVD, Jukebox and User Device.

**O. RADIO:**

- Press this button to access the radio menu.
- Press while the radio menu is active to access the available sources of AM, FM1, FM2, SAT1, SAT2, and SAT3.

**P. VOL:** Press and hold this button to turn the system off and on. Turn the control to adjust the volume.

**Note:** If a navigation route is active when the navigation system is off, the system resumes the route when you turn the system on.

**DISPLAY MODE**

You can choose to turn your screen on or off and if you would like to view the status bars on the top and bottom of the screen. Press DISP to see the options.

**Display Mode Voice Commands**



The following voice commands are available in display mode. If you are not in display mode, press the voice button on the steering wheel. When prompted, say “Display mode” and then any of the following commands.

Display mode voice commands
“Display on”
“Display off”
“Status bar”
“Brighter”
“Dimmer”
“Day”



## 368 Navigation System (If Equipped)

Display mode voice commands
“Night”
“Auto”
“Help”

### STATUS BARS



The top status bar shows the current mode, exterior temperature, time and display icons if you have enabled Bluetooth or other options.



The bottom status bar shows the Home icon and may also show the current driver and passenger selected temperatures, fan speed and air flow direction, the current mode being used, the Artist and Title of the currently playing CD, Artist and Title for Jukebox and radio.

**Note:** As climate controls are vehicle-dependent, some vehicles may not display climate readings in the status bar.

### Customizing Your Home Screen

Depending on your vehicle's option package and software, your screens may vary in appearance from the screens shown in this section. Your features may also be limited depending on your market. Check with your authorized dealer for availability.



Press the house icon to access the home screen. Here you can:

- Save or view pictures.
- View your current audio and climate control settings.
- Display the audio visualizer.

You can split the screen in to two or three different sections, or you can choose to have one main view.

- The left side displays an uploaded photo or the map screen.
- The right side can also display the uploaded photo. The upper right panel only displays the current audio settings. The lower right panel displays your vehicle's climate settings or the visualizer.

### Loading Photos

**Note:** The system is not compatible with discs written in Packet Write mode. Your system allows you to upload and view up to 32 photos.

Only the photograph(s), which meets the following conditions, display:

- The file must be 1.5MB or smaller.
- The file extension must be .jpe, .jpg or .jpeg.
- The file path must be 255 characters or fewer.
- Up to 256 files or folders can display in one folder.
- The CD or DVD must be ISO 9660 format. UDF format is not supported.

To load photos:

1. Touch the left side of the home screen.
2. Touch the Add button. When the disclaimer appears asking to confirm the supported photo formats, press OK.
3. Insert a CD-ROM that contains your photos.
4. Touch OK. The right side of the screen displays a list of the photos.
5. Select either Add or Add All to save photos to the hard drive.

#### ***Editing and Deleting Photos***

To edit photos, go to the home screen, then:

1. Touch the current photo on the home screen.
2. Select the Edit button.
3. Adjust the photo by zooming in or out, moving right, left, up or down and rotating left or right.

**Note:** Press the Reset button to return to the original image.

To delete a photo, select the Delete button.

To delete all photos:

1. Press the Menu hard button.
2. Select the System Settings tab on the touchscreen.
3. Press the View button for Delete Stored Items.
4. Select Saved photos.

#### **Using the Touch-sensitive Controls on Your System**

To turn a feature on and off, just touch the graphic with your finger. To get the best performance from the touch-sensitive controls:

- Make sure your hands are clean and dry.
- Since the touchscreen operates based on the touch of a finger, you may have trouble using it if you are wearing gloves.
- Use your bare finger to touch the center of a touch-control graphic. Touching off-center of the graphic may affect operation of a nearby control.

## 370 Navigation System (If Equipped)

- Do not press hard on the controls. They are sensitive to light touch.
- Keep metal and other conductive material away from the surface of the touchscreen as this may cause electronic interference (for example, inadvertently turning on a feature other than the one you meant to turn on).

### Cleaning the Touchscreen Display

Use a clean, soft cloth such as one used for cleaning glasses. If dirt or fingerprints are still visible, apply a small amount of alcohol to the cloth. Do not pour or spray alcohol onto the display. Do not use detergent or any type of solvent to clean the display.

### USING VOICE RECOGNITION

This system helps you control many features using voice commands. This allows you to keep your hands on the wheel and focus on what is in front of you. The system provides feedback through audible tones, prompts, questions and spoken confirmations depending on the situation and the chosen level of interaction (voice settings).

The system also asks short questions (confirmation prompts) when it is not sure of your request or when there are multiple possible responses to your request.

When using voice commands, words and icons may appear in the lower left status bar indicating the status of the voice session (such as Listening, Success, Failed, Paused or Try Again).

### How To Use Voice Commands with Your System



Press the voice icon; after the tone, speak your command clearly.

You can say these commands at any time.	
“Audio”	“Navigation”
“CD”	“Radio”
“Climate”	“SYNC”*
“Disc”	“Tutorial”
“Display mode”	“User profile”
“DVD”	“Video CD”
“Jukebox”	“Voice settings”

You can say these commands at any time.	
“Line in”	“Help”
“Mobile apps”*	

\*See the SYNC chapter for more information on these features.

To access a list of all available voice commands, press the I hard button. Select the Help tab on the touchscreen, then the Voice Commands tab and choose the desired category.

**Helpful Hints**

- Make sure the interior of your vehicle is as quiet as possible. Wind noise from open windows and road vibrations may prevent the system from correctly recognizing spoken commands.
- After pressing the voice icon, wait until after the tone sounds and Listening appears before saying a command. Any command spoken prior to this does not register with the system.
- Speak naturally, without long pauses between words.
- At any time, you can interrupt the system while it is speaking by pressing the voice icon.

**Voice Settings**

Voice settings allow you to customize the level of system interaction, help and feedback. The system defaults to standard interaction, which uses candidate lists, and confirmation prompts as these provide the highest level of guidance and feedback.

**Interaction Mode:** Novice mode provides detailed interaction and guidance while the advanced mode has less audible interaction and more tone prompts.

**Confirmation Prompts:** The system uses these short questions to confirm your voice request. If turned off, the system simply makes a best guess as to what you requested. The system may still occasionally ask you to confirm settings.

## 372 Navigation System (If Equipped)

### SYSTEM MENU FEATURES

Your system offers many menu features, such as allowing you to adjust the touchscreen brightness, time and language, feedback and system settings. You can access these options by pressing the MENU hard button.

If you select:	You can:
<b>Display</b>	<b>Brightness</b> allows you to adjust screen brightness by touching + or -.
	<b>Contrast</b> allows you to adjust screen contrast by touching + or -.
	<b>Day/Night Mode</b> allows you to select Day mode, Night mode or have the system automatically switch for you by selecting Auto mode.
	<b>Daytime Color</b> allows you to select a light or dark color for daytime screen lighting. <b>Note:</b> When the headlamps are on under very bright outdoor light conditions, the system remains in day mode, even if night is selected.
<b>Clock</b>	<b>Display Clock</b> allows you to turn the clock on or off. <b>Note:</b> If your vehicle is equipped with an in-dash analog clock, you can set the time on this screen, but it may not appear in the status bar for viewing purposes.
	<b>Format</b> allows you to switch between 12- and 24-hour clock display.
	<b>Auto Time Zone</b> allows you to have the system automatically switch the time whenever you enter a new time zone. <b>Note:</b> The system does not implement daylight savings time.
	<b>Restore Defaults</b> allows you to restore system defaults.

If you select:	You can:
<p><b>Feedback</b></p>	<p><b>Touch Screen Button Beep</b> allows you to select when the system sounds an audible tone: All Buttons (whenever any system button is touched), Touch Screen (only when touchscreen selections are made) or Off (no audible tones at all).</p>
	<p><b>Voice Volume</b> allows you to change navigation voice and audible tone volume by touching + or -.</p>
	<p><b>Satellite Radio Channel Name</b> allows you to choose to display the satellite radio channel name.</p>
	<p><b>Voice Recognition Interaction Mode</b> allows you to choose the level of system interaction and feedback. Standard is the default and provides the most interaction and feedback using prompts. Advanced uses less feedback and prompts.</p>
	<p><b>Voice Recognition Confirmation</b> allows you to choose level of voice command confirmation. Selecting On causes the system to always ask to confirm a command. Selecting Off causes the system to ask for confirmation less frequently.</p>
	<p><b>Voice Recognition User Profile</b> allows you to switch between user profiles. Train the system to better recognize your voice. Two profiles can be created; see <i>Using voice recognition</i> earlier in this section.</p>

## 374 Navigation System (If Equipped)

If you select:	You can:
<b>System Settings</b>	<b>Language</b> allows you to choose between English, Spanish and French.
	<b>Units</b> allows you to choose between English and Metric measurements.
	<b>Keyboard Layout</b> allows you to choose between an ABC or QWERTY keyboard.
	<b>Delete Stored Items</b> allows you to choose to delete all of the entries from Address Book, Previous Destinations, Avoid Areas, Saved Photos and Voice Recognition Profiles. Touch View to see what entries have been stored.
	<b>Restore Factory Default Settings</b> allows you to restore factory default settings.
<b>Valet Mode</b>	Lock and unlock the system using a four-digit PIN. <b>Note:</b> The PIN can be reset by simultaneously pressing and holding presets 1 and 5 while on the PIN entry screen. After approximately five seconds, the system transitions to the valet mode screen indicating that the PIN is reset. Once you have reset the PIN, the system then allows you to set a new PIN.
<b>Voice Control</b>	Set the system to automatically listen for USB or SYNC voice commands first. This eliminates the need to say “USB” or “User Device” before any SYNC media commands.

**ENTERTAINMENT**

Your system offers many media options. You can access these options using the touchscreen or voice commands.

**AM/FM Radio**



Press the RADIO hard button.

To change between AM, FM1 and FM2, touch the AM or FM tab.

When you select:	You can:
<b>Show Options</b>	<b>Scan</b> allows you to hear a brief sampling of all radio stations.
	<b>Scan Presets</b> allows you to hear a brief sampling of all stations stored in the memory presets.
	<b>Autoset Presets</b> allows you to store the strongest local stations available in the AM and FM frequency bands.
	<b>HD Radio</b> turns HD radio on. This allows you to receive radio broadcasts digitally (where available), providing free, crystal-clear sound. See the <i>HD Radio™ information</i> in the following section.*
	<b>Multicast</b> allows you to choose which HD radio broadcast you would like to receive. When HD Radio broadcasts are available, this button appears if the selected station has more than one digital broadcast. HD1 signifies the main programming status and is available in analog and digital broadcasts. Any additional multicast stations (HD2 through HD8) broadcast digitally. You can access these by pressing Multicast. See the <i>HD Radio™ information</i> in the following section.**



## 376 Navigation System (If Equipped)

When you select:	You can:
<b>Show Presets</b>	View the preset stations. Save a station by pressing and holding one of the memory preset areas. There is a brief mute while the radio saves the station. Sound returns when finished.
<b>Set PTY/All</b>	Select a category of music you would like to search for and then choose to either seek or scan for the stations.** <b>Note:</b> The system scans the frequency band three times for the chosen program type. If the program type is unavailable in your reception range, the system returns to the previous station.

\*This feature is only available in the United States.

\*\*This feature is only available on the FM1 and FM2 radio tabs in the United States.

### Audio and Radio Voice Commands



If you are listening to the audio system, press the voice button on the steering wheel control. When prompted, say any of the commands in the following chart.

If you are not listening to the audio system, press the voice button and, after the tone, say "Audio", then any of the commands in the following chart.

"AUDIO"		
"CD"	"Line in"	"Sirius"
"Disc"	"Off "	"SYNC"
"DVD"	"On"	"USB"
"Headphones"	"Phone"	"User Device"
"Headphones off"	"Radio"	"Video CD"
"Jukebox"	"Read Message"	"Help"



If you are listening to the radio, press the voice button on the steering wheel control. When prompted, say any of the commands in the following chart.

If you are not listening to the radio, press the voice button and, after the tone, say “Radio”, then any of the commands in the following chart.

“RADIO”		
“<530-1710>”	“FM2”	“Store preset <1-6>”
“<87.7-107.9>”	“FM2 preset <1-6>”	“Store AM preset <1-6>”
“AM”	“Off ”	“Store FM 1 preset <1-6>”
“AM <530-1710>”	“On”	“Store FM 2 preset <1-6>”
“AM preset <1-6>”	“Preset <1-6>”	“Store autoset presets”
“FM <87.7-107.9>”	“Seek down”	“Tune”**
“FM1”	“Seek up”	“Help”
“FM1 preset <1-6>”	“Store”*	

\*If you have said, “Store”, see the following “Store” chart.

\*\*If you have said, “Tune”, see the following “Tune” chart.

“TUNE”		
“<530-1710>”	“AM preset <1-6>”	“FM2”
“<87.7-107.9>”	“FM <87.7-107.9>”	“FM2 preset <1-6>”
“AM”	“FM1”	“Preset <1-6>”
“AM <530-1710>”	“FM1 preset <1-6>”	“Help”

“STORE”
“Preset <1-6>”
“AM preset <1-6>”
“FM 1 preset <#>”
“FM 2 preset <#>”
“Autoset presets”

## 378 Navigation System (If Equipped)

### **HD Radio™ Information (If Available)**

**Note:** HD Radio broadcasts are not available in all markets.

HD Radio technology is the digital evolution of analog AM/FM radio. Your system has a special receiver that allows it to receive digital broadcasts (where available) in addition to the analog broadcasts, it already receives. Digital broadcasts provide a better sound quality than analog broadcasts with free, crystal-clear audio and no static or distortion. For more information, and a guide to available stations and programming, please visit [www.hdradio.com](http://www.hdradio.com).

When HD Radio is on and you tune to a station broadcasting HD Radio technology, you may notice the following indicators on your screen:



**HD) logo** blinks when acquiring a digital station and stays solid when digital audio is playing. When this logo is available, you may also see Title and Artist fields on-screen.

**Multicast indicator** appears in FM mode (only) if the current station is broadcasting multiple digital broadcasts. The highlighted numbers signify available digital channels where new or different content is available. HD1 signifies the main programming status and is available in analog and digital broadcasts. Other multicast stations (HD2 through HD7) are only available digitally.

When HD Radio broadcasts are active, you can access the following functions:

<b>When you select:</b>	<b>You can:</b>
<b>Scan</b>	Hear a brief sampling of all available stations. This feature still works when HD Radio reception is on, although it does not scan for HD2-HD7 channels. You may see the HD logo appear if the station has a digital broadcast.
<b>Seek</b>	Hear the next strong radio station. If the current station has multiple digital broadcasts, the multicast indicator appears. Press Seek repeatedly to advance through all available broadcasts. If you are on the last multicast channel, press Seek to advance to the next strong station.

When you select:	You can:
<b>Tune</b>	Go up and down the frequency in individual increments. If the current station has multiple digital broadcasts, the multicast indicator appears. Press Tune repeatedly to advance through all available broadcasts. If you are on the last broadcast channel, press to advance to the next frequency on the band.
<b>Set PTY/All</b>	Select a category of music you would like to search for and then choose to either seek or scan for the stations. <b>Note:</b> The system scans the frequency band three times for the chosen program type. If the program type is unavailable in your reception range, the system returns to the previous station.
<b>Multicast</b>	Allows you to choose which HD radio broadcast you would like to receive. When HD Radio broadcasts are available, this button appears if the selected station has more than one digital broadcast. HD1 signifies the main programming status and is available in analog and digital broadcasts. Any additional multicast stations (HD2 through HD8) broadcast digitally. You can access these by pressing Multicast.
To save a multicast station as a preset	When the channel is active on-screen, press and hold a memory preset slot until the sound returns. There is a brief mute while the radio saves the station. Sound returns when finished. When recalling a HD2 or HD3 memory preset, there is a mute before the digital audio plays, as the system must once again acquire the digital signal. As with any saved radio station, you cannot access the saved station if your vehicle is outside the station's reception area.

## 380 Navigation System (If Equipped)

### **HD Radio Reception and Station Troubleshooting**

<b>Potential Reception Issues</b>	
<b>Reception area</b>	<p>If you are listening to a multicast station and you are on the fringe of the reception area, the station may mute due to weak signal strength.</p> <p>If you are listening to HD1, the system switches back to the analog broadcast until the digital broadcast is available again.</p> <p>However, if you are listening to any of the possible HD2-HD7 multicast channels, the station mutes and stay muted unless it is able to connect to the digital signal again.</p>
<b>Station blending</b>	<p>When the system first receives a station (aside from HD2-HD7 multicast stations), it first plays the station in the analog version. Once the receiver verifies the station is an HD Radio station, it shifts to the digital version. Depending on the station quality, you may hear a slight sound change when the station changes from analog to digital. Blending is the shift from analog to digital sound or digital back to analog sound.</p>

In order to provide the best possible experience, use the contact form to report any station issues found while listening to a station broadcasting with HD Radio technology. Independent entities own and operate each station. These stations are responsible for ensuring all audio streams and data fields are accurate.

<b>Potential Station Issues</b>		
<b>Issue</b>	<b>Cause</b>	<b>Action</b>
Echo, stutter, skip or repeat in audio. Increase or decrease in audio volume.	This is poor time alignment by the radio broadcaster.	No action required. This is a broadcast issue.

Potential Station Issues		
Issue	Cause	Action
Sound fading or blending in and out.	The radio is shifting between analog and digital audio.	No action required. The reception issue may clear up as you continue to drive.
There is an audio mute delay when selecting HD2 or HD3, multicast preset or Direct Tune.	The digital multicast is not available until the HD Radio broadcast is decoded. Once decoded, the audio is available.	No action required. This is normal behavior. Wait until the audio is available.
Cannot access HD2 or HD3 multicast channel when recalling a preset or from a direct tune.	The previously stored multicast preset or direct tune is not available in your current reception area.	No action required. The station is not available in your current location.
Text information does not match currently playing audio.	Data service issue by the radio broadcaster.	Fill out the station issue form at website listed below.*
There is no text information shown for currently selected frequency.	Data service issue by the radio broadcaster	Fill out the station issue form at website listed below.*
HD2-HD7 stations not found when Scan is pressed.	Pressing Scan disables HD2-HD7 channel search.	No action required. This is normal behavior.

\*[http://www.ibiquity.com/automotive/report\\_radio\\_station\\_experiences](http://www.ibiquity.com/automotive/report_radio_station_experiences)

HD Radio Technology manufactured under license from iBiquity Digital Corp. U.S. and foreign patents. HD Radio and the HD and HD Radio logos are proprietary trademarks of iBiquity Digital Corp. Ford Motor Company and iBiquity Digital Corp. are not responsible for the content sent using HD Radio technology. Content may be changed, added or deleted at any time at the station owner's discretion.

## 382 Navigation System (If Equipped)

### HD Radio Voice Commands



If you are listening to the radio, press the voice button on the steering wheel control. When prompted, say any of the commands in the following chart.

If you are not listening to the radio, press the voice button and, after the tone, say “Radio”, then any of the commands in the following chart.

<b>“RADIO”</b>
“<87.7 - 107.9> HD <1-8>”
“FM <87.7-107.9> HD <1-8>”
“Tune”*
“Help”

\*If you have said, “Tune”, see the following “Tune” chart.

<b>“TUNE”</b>
“<87.7 - 107.9> HD <1-8>”
“FM <87.7-107.9> HD <1-8>”
“Tune HD <1-8>”
“Help”

### SIRIUS® Satellite Radio (If Activated)



Press the RADIO hard button, then select SAT on the touchscreen.

<b>When you select:</b>	<b>You can:</b>
<b>SAT123</b>	Press this button to access three different satellite radio modes (SAT1, SAT2 or SAT3).
<b>Scan</b>	Press this button to hear a brief sampling of all satellite radio channels within the current genre.
<b>Scan Presets</b>	Press these buttons to hear a brief sampling of all channels stored in the memory presets.

<b>When you select:</b>	<b>You can:</b>
<b>Channel Guide</b>	See a list of channels sorted by genre and also skip or lock out certain channels. Select the desired genre and choose a channel by pressing the channel name button. You can then choose to Skip or Lock a certain channel. A skipped channel is not accessible using the tune knob, scan or seek functions. (To access the skipped channel, select Direct Tune and enter the channel number.) You can only access a locked channel by entering the Channel Guide and then entering the system's PIN.
<b>Direct Tune</b>	Enter the desired satellite channel number using the on-screen keypad.
<b>Set Genre</b>	Press this button to choose from a list of genres. Once you choose a genre, and you press SEEK, it only looks for channels in that genre.



When you select:	You can:
<b>Memo</b>	<p>Press this button to save a song title and artist to the system. When the saved song is playing on any satellite radio channel, the system alerts you with a pop-up in the lower status bar. You can either tune to the station or ignore the pop-up. When you are in the Memo screen, the following options are available:</p> <p><b>Refresh</b> allows you to refresh the current artist and title information.</p> <p><b>Song Alert</b> allows you to store the song information displayed in the Title Field. When the stored song next plays, the system displays an audio and visual notification.</p> <p><b>Artist Alert</b> allows you to store the artist information currently displayed in the Artist Field. When that artist next plays, the system alerts you with a pop-up.</p> <p><b>Alert On/Off</b> allows you to select Artists and Titles that you would like the system to alert you to when they are playing on other channels.</p> <p><b>Note:</b> SIRIUS® does not support the Alert feature on all channels. Ford Motor Company shall not be responsible for Alert feature variation.</p>
<b>Show Presets</b>	Display presets at the bottom of the screen.

**SIRIUS® Satellite Radio Voice Commands**



If you are listening to SIRIUS satellite radio, press the voice button on the steering wheel control. When prompted, say any of the commands in the following chart.

If you are not listening to SIRIUS satellite radio, press the voice button and, after the tone, say “Sirius”, then any of the commands in the following chart.

“SIRIUS”	
“<0-233>”	“Seek up”
“<Channel name>”	“Sirius off”
“Preset <#>”	“Sirius On”
“SAT 1”	“Store”*
“SAT 1 preset <#>”	“Store preset <1-6>”
“SAT 2”	“Store SAT1 preset <1-6>”
“SAT 2 preset <#>”	“Store SAT2 preset <1-6>”
“SAT 3”	“Store SAT3 preset <1-6>”
“SAT 3 preset <#>”	“Tune”**
“Seek down ”	“Help”

\*If you have said, “Store”, see the following “Store” chart.

\*\*If you have said, “Tune”, see the following “Tune” chart.

“STORE”
“Preset <1-6>”
“SAT1 preset <1-6>”
“SAT2 preset <1-6>”
“SAT3 preset <1-6>”

“TUNE”	
“<0-233>”	“SAT 2”
“<Channel name>”	“SAT 2 preset <#>”
“Preset <#>”	“SAT 3”
“SAT 1”	“SAT 3 preset <#>”
“SAT 1 preset <#>”	“Help”

## 386 Navigation System (If Equipped)

### **SIRIUS® Information**

**Note:** SIRIUS reserves the unrestricted right to change, rearrange, add or delete programming including canceling, moving or adding particular channels, and its prices, at any time, with or without notice to you. Ford Motor Company shall not be responsible for any such programming changes



SIRIUS satellite radio is a subscription-based satellite radio service that broadcasts a variety of music, sports, news, weather, traffic and entertainment programming. Your factory-installed SIRIUS satellite radio system includes

hardware and a limited subscription term that begins on the date of sale or lease of your vehicle. See your authorized dealer for availability.

For more information on extended subscription terms (a service fee is required), the online media player and a list of SIRIUS satellite radio channels, and other features, please visit [www.siriusxm.com](http://www.siriusxm.com) in the United States, [www.sirius.ca](http://www.sirius.ca) in Canada, or call SIRIUS at 1-888-539-7474.

**Satellite radio electronic serial number (ESN):** You need your ESN to turn on, modify or track your satellite radio account. The ESN is on the System Information Screen (SR ESN: XXXXXXXXXXXX). To access your ESN, touch the I button on the navigation screen, and then select the System Info tab.

Potential reception issues	
<b>Antenna obstructions</b>	For optimal reception performance, keep the antenna clear of snow and ice build-up and keep luggage and other materials as far away from the antenna as possible.
<b>Terrain</b>	Hills, mountains, tall buildings, bridges, tunnels, freeway overpasses, parking garages, dense tree foliage and thunderstorms can interfere with your reception.

<b>Potential reception issues</b>		
<b>Station overload</b>	When you pass a ground-based broadcast-repeating tower, a stronger signal may overtake a weaker one and the audio system may mute.	
<b>Satellite radio signal interference</b>	Your display may show ACQUIRING... to indicate the interference and the audio system may mute.	
<b>Troubleshooting tips</b>		
<b>Radio Display</b>	<b>Condition</b>	<b>Possible Action</b>
Acquiring...	Radio requires more than two seconds to produce audio for the selected channel.	No action required. This message should disappear shortly.
Sat Fault/SIRIUS System Failure	There is an internal module or system failure present.	If this message does not clear shortly, or with an ignition key cycle, your receiver may have a fault. See your authorized dealer for service.
Invalid Channel.	The channel is no longer available.	Tune to another channel or choose another preset.
Unsubscribed Channel.	Your subscription does not include this channel.	Contact SIRIUS at 1-888-539-7474 to subscribe to the channel, or tune to another channel.
No Signal.	The signal is lost from the SIRIUS satellite or SIRIUS tower to your vehicle antenna.	The signal is blocked. When you move into an open area, the signal should return.

## 388 Navigation System (If Equipped)

Troubleshooting tips		
Radio Display	Condition	Possible Action
Updating.	Update of channel programming in progress.	No action required. The process may take up to three minutes.
Call SIRIUS 1-888-539-7474.	Your satellite service is no longer available.	Contact SIRIUS at 1-888-539-7474 to resolve subscription issues.
No Channels Available.	All the channels in the selected channels are either skipped or locked.	Use the channel guide to turn off the <b>Lock</b> or <b>Skip</b> function on that station.
Subscription Updated.	SIRIUS has updated the channels available for your vehicle.	No action required.

### CD



Press the MEDIA hard button, and then select the CD tab on the touchscreen. If there is no disc in the system, NO DISC appears in the status bar and you cannot access the CD screen.

Once a disc is loaded, you can choose from Scan, Compress, Repeat, Shuffle, Track List and Record.

When you select:	You can:
<b>Scan</b>	Hear a brief sampling of all listenable tracks.
<b>Compress</b>	Turn the compression feature on and off. This feature boosts more quiet music and lowers louder music to minimize the need for volume adjustment.
<b>Repeat</b>	Hear the selected track continuously.
<b>Shuffle</b>	Play the tracks in a random order.
<b>Track List</b>	View a list of the tracks.
<b>Record</b>	Save the CD or CD tracks into the Jukebox to hear them played later.

**CD Voice Commands**



If you are listening to a CD, press the voice button on the steering wheel control. When prompted, say any of the commands in the following chart.

If you are not listening to a CD, press the voice button and, after the tone, say “CD”, then any of the commands in the following chart.

“CD”		
“Folder mode”	“Play next folder”	“Repeat folder”
“Folder mode off”	“Play next track”	“Repeat off”
“Pause”	“Play previous folder”	“Repeat track”
“Play”	“Play previous track”	“Shuffle”
“Play folder <1-255>”	“Play track <1-512>”	“Shuffle off”
“Play folder <1-255> track <1-512>”	“Repeat”	“Help”

**MP3**



Press the MEDIA hard button, and then select the CD tab on the touchscreen. If there is no disc in the system, NO DISC appears in the status bar and you cannot access the CD screen.

Once a disc is loaded, you can choose from Scan, Compress, Repeat, Shuffle, Folder Mode and Folder List.

When you select:	You can:
<b>Scan</b>	Hear a brief sampling of all listenable tracks.
<b>Compress</b>	Turn the compression feature on and off. This feature boosts more quiet music and lowers louder music to minimize the need for volume adjustment.
<b>Repeat</b>	Hear the selected track continuously.
<b>Shuffle</b>	Play the tracks in a random order.
<b>Folder Mode</b>	Listen to and seek through songs within the current folder.
<b>Folder List</b>	Press this button to access and view folders on the disc. Select the root folder (if available), then any other folder on the disc.

## 390 Navigation System (If Equipped)

### DVD

**Note:** Your system only plays NTSC formatted discs. The system does not support PAL format.

Your system allows you to play DVD audio and video discs. Make sure your vehicle is in position **P** (vehicles equipped with an automatic transmission) or the parking brake is engaged (vehicles equipped with a manual transmission). This allows you to be able to view and hear the DVD. If your vehicle is moving, the video does not play.

When you select:	You can:
<b>Title</b>	Go to the disc's main title screen.
<b>Menu</b>	Go to the disc's main menu.
<b>Cursor Controls</b>	Navigate to the desired menu selections.
<b>Settings</b>	<b>Video Display Settings</b> allows you to adjust the brightness and contrast. You can also choose to return to the default settings by pressing Restore Default.
	<b>Audio Language</b> allows you to choose which language you would like the DVD audio track to play in.
	<b>Subtitle Display</b> allows you to turn subtitles off and on.
	<b>Subtitle Language</b> allows you to choose the subtitle language.
	<b>Aspect Ratio</b> allows you to choose wide, full, normal or cinema display.
	<b>Angle Mark Notification</b> allows you to have more viewing angles from which to select. Once you have made your selection, press ENTER to confirm.
<b>Search</b>	Go to a specific title or chapter using the keypad.

**Note:** Some of the above settings are disc-dependent and availability and operation may vary.



During disc play, you can also touch the screen to access the virtual remote, which allows you to Move Controls on the screen, as well as use the cursor controls, Enter and Return to navigate and select within the menus.

Dolby® noise reduction is manufactured under license from Dolby® Laboratories Licensing Corporation. Dolby® and the double-D symbol are registered trademarks of Dolby® Laboratories Licensing Corporation.

**Disc Voice Commands**



If you are listening to or watching a disc, press the voice button on the steering wheel control. When prompted, say any of the commands in the following chart.

If you are not listening to or watching a disc, press the voice button and, after the tone, say “Disc”, then any of the commands in the following chart.

“Disc”		
“Folder mode”	“Play next chapter”	“Play previous track”
“Folder mode off”	“Play next folder”	“Play title <1-99>”
“Menu”	“Play next group”	“Play track <1-512>”
“Pause”	“Play next title”	“Repeat”
“Play”	“Play next track”	“Repeat off”
“Play chapter <1-999>”	“Play previous chapter”	“Shuffle”
“Play folder <1-255>”	“Play previous folder”	“Shuffle off”
“Play folder <1-255> track <1-512>”	“Play previous group”	“Title menu”
“Play group <1-9>”	“Play previous title”	“Help”



## 392 Navigation System (If Equipped)

### DVD Voice Commands



If you are watching a DVD, press the voice button on the steering wheel control. When prompted, say any of the commands in the following chart.

If you are not watching a DVD, press the voice button and, after the tone, say “DVD”, then any of the commands in the following chart.

“DVD”	
“Menu”	“Play next title”
“Menu title”	“Play next track <1-512>”
“Pause”	“Play previous chapter”
“Play”	“Play previous title”
“Play chapter <1-999>”	“Play previous track”
“Play group <1-9>”	“Play title <1-99>”
“Play next chapter”	“Repeat”
“Play next group”	“Repeat off”

### Video CD Voice Commands



If you are watching a video CD, press the voice button on the steering wheel control. When prompted, say any of the commands in the following chart.

If you are not watching a video CD, press the voice button and, after the tone, say “Video CD”, then any of the commands in the following chart.

Video CD voice commands
“Play”
“Pause”
“Play next track”
“Play previous track”
“Play track <1-512>”
“Help”

### Jukebox

Your system has a Jukebox feature, which allows you to save desired tracks or CDs to the hard drive for later access. The hard drive can store up to 10 GB\* (164 hours; approximately 2472 tracks) of music. The system contains a Gracenote® media database that allows for display of song title, album title, and album cover art. After saving music to the hard drive, you can

access and play your music by specific tracks, artists, albums or genres. You can even choose to create and access your own playlists.

**\*Note:** 1 GB equals one billion bytes (1000000000B).

**Recording Music to Your Jukebox**

To record music to your jukebox:

1. Insert a CD, and then select Record on the touchscreen.
2. Select individual tracks or press Select All to record the entire CD.  
**Note:** The system automatically saves all tracks if you do not select any.
3. Press the Start Recording button.

The progress shows at the bottom of the screen.

**Note:** If you are not actively listening to the disc during recording, the record rate is much quicker (as fast as five minutes).

**Accessing the Music in Your Jukebox**

Once you have saved music to your jukebox, you can then choose different ways to play the music.

1. Press the MEDIA hard button on the navigation system.
2. Select the Jukebox tab on the touchscreen. You can then select from the following options:

When you select:	You can:
<b>Scan</b>	Hear a brief sampling of all listenable tracks.
<b>Repeat</b>	Hear the selected track continuously.
<b>Shuffle</b>	Play the tracks in a random order.
<b>Music library</b>	Access all of your saved music. You can choose to view or play the material in the following ways:
	<b>Play All Tracks</b> allows you to play all tracks saved in the jukebox.
	<b>Playlist</b> allows you to play your own playlist.
	<b>Play genre</b> allows you to have the system play only music from a specific genre.
	<b>Play artist</b> allows you to have the system play only music by a specific artist.
	<b>Play album</b> allows you to have the system play only music from a specific album.

When you select:	You can:
<b>Options</b>	<b>Edit Playlists</b> allows you to edit your playlists.
	<b>Edit Music Library Contents</b> allows you to make changes to the content in your music library.
	<b>Update Album Information from CD Database</b> allows you to update the residing album information from the Gracenote® database after a recent software update.
	<b>Hard Disk Drive Information</b> allows you to access the system's hard drive disc information, such as used space, free space and total capacity.
	<b>CD Database Information</b> allows you to access the CD database information.

### ***Creating a Playlist***

Press the MEDIA hard button, and then select the Jukebox tab on the touchscreen.

1. Select Options.
2. Select Edit Playlists, then which playlist you would like to create.
3. Select which category you would like to access from your saved music.
4. Select the desired songs and then press Add. The system shows you the currently selected songs. You can choose to Edit Name to change the name of the playlist, Delete Playlist to remove it, Add Tracks to the playlist or Sort Playlist.
5. After you change the playlist, select Edit Name to rename your playlist.

**Jukebox Voice Commands**



If you are listening to music stored in the jukebox, press the voice button on the steering wheel control. When prompted, say any of the commands in the following chart.

If you are not listening to music stored in the jukebox, press the voice button and, after the tone, say “Jukebox”, then any of the commands in the following chart.

“JUKEBOX”		
“Pause”	“Play playlist <name>”	“Search album <name>” <sup>3</sup>
“Play” <sup>1</sup>	“Play previous track”	“Search artist <name>” <sup>3</sup>
“Play album <name>” <sup>1</sup>	“Play track <name>” <sup>1</sup>	“Search genre <name>” <sup>3</sup>
“Play artist <name>” <sup>1</sup>	“Refine album <name>” <sup>2</sup>	“Search track <name>” <sup>3</sup>
“Play genre <name>”	“Refine artist <name>” <sup>2</sup>	“Shuffle”
“Play next track”	“Repeat”	“Shuffle off”
“Play playlist <1-5>”	“Repeat off”	“Help”

<sup>1</sup>You can say these commands at any time during listening to the jukebox and after any of the search and refine commands.

<sup>2</sup>You can narrow your search beyond the “Search” command by using these commands.

<sup>3</sup>While listening to the jukebox, press the voice button on the steering wheel control. When prompted, you may say any of these commands.

**User Device**

If your vehicle is equipped with SYNC®, there is a User Device tab. For more information, see the SYNC® chapter.

**Line In (Auxiliary Input Jack)**

Your vehicle is equipped with an audio input jack, which allows you to plug a portable audio device into your vehicle’s audio system. To turn this feature on, press the MEDIA hard button on the system.

For more information on the auxiliary input jack, see *Auxiliary input jack* in the *Audio Systems* chapter.

## 396 Navigation System (If Equipped)

### TOUCHSCREEN CLIMATE CONTROLS

Press the CLIMATE hard button to access your climate control features. Depending on your vehicle line and option package, your climate screen may look different from the screen shown here.

Climate Control Features	
<b>Driver temperature</b>	Touch the arrows to increase or decrease the temperature.
<b>Manual controls</b>	Select any of the following airflow distribution modes: <b>Floor and Defrost</b> distributes air through the windshield defroster vents, demister vents, floor vents and rear seat floor vents, and provides outside air to reduce window fogging. <b>Panel</b> distributes air through the instrument panel vents. <b>Panel and Floor</b> distributes air through the instrument panel vents, demister vents, floor vents and rear seat floor vents. <b>Floor</b> distributes air through the demister vents, floor vents and rear seat floor vents. <b>Defrost</b> distributes air through the windshield defroster vents and demister vents. Touch to clear the windshield of fog and thin ice. Touch again to return to the previous airflow selection.
<b>Fan speed</b>	Touch + or – to increase or decrease fan speed.
<b>Passenger temperature</b>	Touch the arrows to increase or decrease the temperature.
<b>Dual</b>	Touch to turn on the passenger temperature control.
<b>MAX A/C</b>	Touch to cool your vehicle with recirculated air. Touch again for normal A/C operation. MAX A/C is more economical and efficient than normal A/C mode.

**Climate Control Voice Commands**



If you are not viewing the climate control screen, press the voice button and, after the tone, say “Climate”, then any of the commands in the following chart.

“CLIMATE”		
“A/C off”	“Fan speed increase”	“Recirc”
“A/C on”	“Max A/C off”	“Recirc off”
“Automatic”	“Max A/C on”	“Temperature <16.0–32.0>”
“Defrost”	“Off”	“Temperature <60–90>”
“Defrost off”	“On”	“Temperature decrease”
“Dual off”	“Rear defrost”	“Temperature increase”
“Fan speed decrease”	“Rear defrost off”	“Help”

**INFORMATION**

Under the Information menu, you can access features such as Where Am I? and SIRIUS® Travel Link™, view your calendar, see system information and get basic system help.

Press the I (Information) hard button to access these features.

**Where Am I?**

Press the I button and select the Where Am I? tab. The system gives you your current GPS location (latitude and longitude), the current street you are on as well as the street in front and behind your vehicle position along with distance information.

**Note:** Not all tab selections shown here are available in all markets. Check with your authorized dealer for availability.

## 398 Navigation System (If Equipped)

### SIRIUS® Travel Link™

 **WARNING:** Driving while distracted can result in loss of vehicle control, accident and injury. Ford strongly recommends that drivers use extreme caution when using any device or feature that may take their focus off the road. Your primary responsibility is the safe operation of your vehicle. We recommend against the use of any handheld device while driving, encourage the use of voice-operated systems when possible and that you become aware of applicable state and local laws that may affect use of electronic devices while driving.

**Note:** A paid subscription is required to access and use these features. Go to [www.siriusxm.com/travellink](http://www.siriusxm.com/travellink) for more information.

SIRIUS Travel Link can help you locate the best gas prices, find movie listings, get current traffic alerts, access the current weather map, get accurate ski conditions and scores to current sports games.



Press the I (information) button, then select Sirius Travel Link. Choose from any of the following services:

When you select:	You can:
<b>Traffic On Route</b>	Identify traffic incidents on your route, nearby your vehicle's current location or near any of your favorite places (if programmed).
<b>Traffic Nearby</b>	
<b>My Places</b>	
<b>Weather</b>	View the nearby weather, current weather, or the 5-day forecast for the chosen area. Select Weather Map to see storms, radar information, charts and winds. Select Area to select from a listing of weather locations. In addition, you can view ski conditions for a specific area.
<b>Fuel Prices</b>	View fuel prices at stations close to your vehicle's location or on an active navigation route.
<b>Movie Listings</b>	View nearby movie theaters and their show times (if available).
<b>Sports Info.</b>	View scores and schedules from a variety of sports. You can also save up to 10 favorite teams for easier access. The score automatically refreshes when a game is in progress.

**SIRIUS Travel Link Voice Commands**



Press the voice button and, after the tone, say “Travel Link”, then any of the commands in the following chart:

<b>“TRAVEL LINK”</b>	
“5–day weather forecast”	“NBA schedule”
“Baseball schedule”	“NBA scores”
“Baseball scores”	“NFL schedule”
“College basketball schedule”	“NFL scores”
“College basketball scores”	“NHL schedule”
“College football schedule”	“NHL scores”
“College football scores”	“Sports schedule”*
“Fuel prices”	“Sports scores”**
“Golf leaders”	“Traffic”
“Golf schedule”	“Travel link help”
“Motor sports order”	“Weather”
“Motor sports schedule”	“Weather map”
“Movie listings”	

\*If you have said, “Sports schedule”, you may say any of the commands in the “Sports schedule” chart:

\*\*If you have said, “Sports scores”, you may say any of the commands in the “Sports scores” chart:

<b>“SPORTS SCHEDULES”</b>	
“Baseball schedule”	“NBA schedule”
“College basketball schedule”	“NFL schedule”
“College football schedule”	“NHL schedule”
“Golf schedule”	“Travel link help”
“Motor sports schedule”	

<b>“SPORTS SCORES”</b>	
“Baseball scores”	“NBA scores”
“College basketball scores”	“NFL scores”
“College football scores”	“NHL scores”
“Golf leaderboard”	“Travel link help”
“Motor sports results”	



## 400 Navigation System (If Equipped)

### Calendar



Press the I (information) button, then select Calendar. You can then select which month you would like to view by using the arrow buttons or selecting Go to Today.

You can view calendars from one previous year and the next 10 years.

**Note:** Not all tab selections may be available in all markets. Check with your authorized dealer for availability.

### System Information



Press the I (information) button, then select System Information.

In this screen, you can view the following options:

- Phone number for your Customer Service Center
- Current system versions installed
- Current SIRIUS® Radio ESN
- SIRIUS® Travel Link™ ESN.

**Note:** Not all tab selections may be available in all markets. Check with your authorized dealer for availability.

### Help

The Help screen allows you to view basic information about controls and driving restrictions as well as traffic legend information and basic voice commands available in various modes.

If you select:	You can:
<b>Basic Operation</b>	View hard buttons on your navigation system. Press the desired icon to view the button description.
<b>Driving Restriction</b>	View the system's driving restriction.
<b>Traffic Legend</b>	View the color code for the Speed and Flow of roads on the navigation system. You can also select Traffic Incidents to help you differentiate between viewed and unviewed incidents.
<b>Voice Commands</b>	View a brief listing of possible voice commands in a specific mode.

**SOUND**

The sound menu allows you to access and adjust settings, such as Bass, Treble, Fade, Balance, Speed Compensated Volume (SCV) and the visualizer. Press the SOUND hard button.

When you select:	You can:
<b>Bass/Treble</b>	Increase or decrease levels by pressing + or -.
<b>Balance/Fade</b>	Adjust the sound between the left and right speakers and front and rear speakers.
<b>SCV</b>	Have the system automatically adjust radio volume according to vehicle speed to compensate for road and wind noise. Select a level of compensation between 1 and 7 by pressing the corresponding button.
<b>Visualizer</b>	Turn the audio visualizer display on or off. <b>Note:</b> Turning the visualizer setting to off does not remove the visualizer on the home screen. You need to select a different view in order to remove the visualizer.

**NAVIGATION SYSTEM**

Your navigation system allows you to set a destination by using your touchscreen or voice commands.

The navigation system contains map coverage for the United States, Puerto Rico and U.S. Virgin Islands, Canada and Mexico.

**Disclaimer**

A disclaimer appears once per ignition cycle when the **DEST** button is pressed. Press **Accept** to agree to the terms and access navigation functions. If you do not press Accept, you only have access to non-navigation functions. The disclaimer has information similar to the following:

- Always obey local traffic regulations.
- We recommend you program the system only when your vehicle is at a stop.
- Some functions are unavailable while your vehicle is moving to help minimize distraction.
- Periodic map updates are available at an additional cost.

## 402 Navigation System (If Equipped)

### Route Guidance in Incompletely Mapped Areas

There are some rural areas in the map database without fully verified roads. When the system is in route guidance mode, and the navigation system encounters these incompletely mapped areas, the system alerts you by:

- announcing, “Entering an area with incomplete map data; please follow with caution”
- saying, “with caution” in the first route guidance instruction before each turn
- highlighting the route on the map in yellow
- highlighting the incomplete mapped streets in yellow on the turn list
- coloring the guidance arrows yellow.

Please drive using extra caution when driving in these areas as the mapping information may be somewhat inaccurate.

### Programming a Destination Using the Touchscreen

1. Press the **DEST** hard button.
2. Select from the following:

Quick	
<b>Cancel Route</b>	Touch this button to cancel the current route.
<b>Emergency</b>	Touch this button to find hospitals and police stations close to your vehicle’s location. The system may display up to 25 locations.
<b>Favorite Destinations</b>	This feature stores your home location and up to five address book entries. To set an entry, touch a preset button, and then follow the screen prompts. The system displays the icon and name associated with the location.

<b>Quick</b>	
<b>Find Nearest POI</b>	<p>Select up to five different points of interest (POI) favorites that you can search for while your vehicle is moving. You can change these categories at any time but the default icons are:</p> <ul style="list-style-type: none"> <li>• Gas Station</li> <li>• ATM</li> <li>• Restaurant</li> <li>• Accommodations</li> <li>• Parking Garage</li> </ul> <p>When you select a category, the system displays a list in order of distance from your vehicle's location. The Quick POI search range automatically increases to a 50 mile (80 km) radius if no point of interest is found within the default 25 mile (40 km) radius. You also have the option to select List All Categories, which displays a list of all categories.</p>
<b>Previous Destination</b>	Touch this button to select one of your previous destinations.
<b>Address Book</b>	Touch this button to set an entry in your address book as your destination.
<b>Standard</b>	
<p><b>Note:</b> Items on this screen are selectable only when your vehicle is moving at speeds slower than 5 mph (8 km/h).</p>	
<b>Address Book</b>	You can store up to 25 entries, which you can use as destinations, waypoints and areas to avoid. You can sort the entries alphabetically, by date or icon.*
<b>Previous Destination</b>	You can store up to 20 recently used destinations and waypoints. Duplicate entries do not appear in the list. Adding a new entry deletes the oldest one from the list.*

## Navigation System (If Equipped)

<b>Standard</b>	
<p><b>Note:</b> Items on this screen are selectable only when your vehicle is moving at speeds slower than 5 mph (8 km/h).</p>	
<b>Phone Number</b>	Touch this button to search for a destination using the phone number of a saved point of interest or address book entry. Use the keypad on the screen to enter the phone number.
<b>Map</b>	Touch this button to select a point on the map as a destination or waypoint by using the map cursor.
<b>Street Address</b>	<p>Touch this button to select a street address on the map as a destination or waypoint.</p> <ul style="list-style-type: none"> <li>• <b>State/Prov</b> lets you use the keyboard to type or you can select the area to search from a list. The system bases the search on your vehicle's current position or the previous selection. You can set the Auto Fill feature on to have the system fill in some information for you based on readings from your vehicle's GPS. Depending on your settings, the system may automatically fill some of the location information for you.</li> <li>• <b>City</b> is the name of the city you can search.</li> <li>• <b>Street</b> is the name of the street you can search. You can search for street names, which include numbers, such as Second Street, if the name is entered using digits or a spelling of the number. This is valid for street names containing numbers 1 (One) through 20 (Twenty) or 1st (First) through 20th (Twentieth) only.</li> <li>• <b>Number</b> is the address number you can search.</li> <li>• <b>List</b> is where you can view and select from a list of State, Province, Territories, Cities and Names. The system provides a list based on the first letter you type into a field.</li> </ul>



<b>Standard</b>	
<b>Note:</b> Items on this screen are selectable only when your vehicle is moving at speeds slower than 5 mph (8 km/h).	
<b>Point of Interest (POI)</b>	<p>Touch this button to select a point of interest on the map as a destination or waypoint. There are three ways to search for a point of interest:</p> <ol style="list-style-type: none"> <li>1. Enter a city name in the City field.</li> <li>2. Enter the point of interest name in the Name field.</li> <li>3. Choose a category from the point of interest listing by selecting <b>Category</b>.</li> </ol> <ul style="list-style-type: none"> <li>• <b>State/Prov</b> lets you use the keyboard to type or you can select the area to search from a list. The system bases the search on your vehicle's current position or the previous selection. You can set the Auto Fill feature on to have the system fill in some information for you. Depending on your settings, the system may automatically fill some of the location information for you.</li> <li>• <b>City</b> is the name of the city you can search.</li> <li>• <b>Category</b> is where you select the desired point of interest category or subcategory.</li> <li>• <b>Name</b> is where you select to search for a point of interest using a full or partial name.</li> <li>• <b>List</b> is where you can view and select from a list of State, Province, Territories, Cities and Names. The system provides a list based on the first letter you type into a field.</li> </ul>

<b>Standard</b>	
<b>Note:</b> Items on this screen are selectable only when your vehicle is moving at speeds slower than 5 mph (8 km/h).	
<b>Freeway Entrance/Exit</b>	<p>Touch this button to select an entrance and exit point to a freeway you select. You can sort the entrance and exit point alphabetically or in order of distance from your vehicle's position. You can then select the point you choose as a destination or waypoint.</p> <ul style="list-style-type: none"> <li>• <b>State/Prov</b> lets you use the keyboard to type or you can select the area to search from a list. The system bases the search on your vehicle's current position or the previous selection. You can set the Auto Fill feature on to have the system fill in some information for you. Depending on your settings, the system may automatically fill some of the location information for you.</li> <li>• <b>Freeway</b> is the name of the freeway you can search.</li> <li>• <b>List</b> is where you can view and select from a list of State, Province, Territories, Cities and Names. The system provides a list based on the first letter you type into a field.</li> </ul>

<b>Standard</b>	
<p><b>Note:</b> Items on this screen are selectable only when your vehicle is moving at speeds slower than 5 mph (8 km/h).</p>	
<b>Intersection</b>	<p>Touch this button to select an intersection point. Enter the name of the first street, then the first letter of the second street. The system displays possible intersection matches based on the first letter of the second street. Once you choose the intersection, you can sort the list alphabetically or in order of distance from your vehicle's position.</p> <ul style="list-style-type: none"> <li>• <b>State/Prov</b> lets you use the keyboard to type or you can select the area to search from a list. The system bases the search on your vehicle's current position or the previous selection. You can set the Auto Fill feature on to have the system fill in some information for you. Depending on your settings, the system may automatically fill some of the location information for you.</li> <li>• <b>City</b> is the name of the city you can search.</li> <li>• <b>Street # 1</b> is the name of the first street you can search. You can search for street names, which include numbers, such as Second Street, if the name is entered using digits or a spelling of the number. This is valid for street names containing numbers 1 (One) through 20 (Twenty) or 1st (First) through 20th (Twentieth) only.</li> <li>• <b>Street # 2</b> is the field where you enter the first letter of the second street to search.</li> <li>• <b>List</b> is where you can view and select from a list of State, Province, Territories, Cities and Names. The system provides a list based on the first letter you type into a field.</li> </ul>

- \*To delete all stored Address Book and Previous Destination entries at once:
1. Press the **MENU** hard button.
  2. Select the **System Settings** tab.



## 408 Navigation System (If Equipped)

3. Press the **View** button for **Delete Stored Items**.
4. Select **Address Book** or **Previous Destinations**.

<b>Edit Route</b>	
<b>Cancel Route</b>	Touch this button to cancel the current route.
<b>Detour</b>	Touch this button to avoid an area on the current route.
<b>View Route</b>	Touch this button to view the entire current route. You can select from the following options: <ul style="list-style-type: none"> <li>• <b>View Destination</b> displays a close-up view of the destination and surrounding area.</li> <li>• <b>View Next Waypoint</b> displays a close-up view of next waypoint and surrounding area.</li> <li>• <b>View Turn List</b> displays the turn list for the current destination. You can also select a road on the turn list to avoid, if you choose.</li> </ul>
<b>Edit Route Preferences</b>	Once you select a route as the fastest or shortest route, you can also select from to: <ul style="list-style-type: none"> <li>• Avoid Freeways</li> <li>• Avoid Tollroads</li> <li>• Avoid Ferries</li> <li>• Avoid Time Restrictions</li> <li>• Avoid HOV Lanes</li> </ul>
<b>Edit Traffic Preferences</b>	Touch this button to edit traffic preferences.*
<b>Edit Destination/Waypoints</b>	Touch this button to edit the destination or waypoints of a defined route.
<b>Edit Turn List</b>	Touch this button to delete or avoid a road in the current turn list.

\*This feature requires activation of SIRIUS® Travel Link™, which is only available in the United States.

**Programming a Destination Using Voice Commands**

Press the voice button on the steering wheel.

<b>If you want to:</b>	<b>Say:</b>
Enter an address.	“Destination street address”
Enter an intersection.	“Destination intersection”
Find a point of interest (POI) by its category.	“Destination nearest <POI category>” or “Destination nearest POI”
Find a point of interest (POI) by its name.	“Destination POI”
Go to a previous destination.	“Destination previous destination”
Go to your home location.	“Destination home”
Use a nametag from your address book.	“Destination <nametag>”
Get help.	“Help”

**Note:** If you set the system language to French or Spanish, you need to spell out the city and street names. When in Spelling Mode, you may speak letters or say, “Line #”. The system works even if you have made a spelling error.

**Route Selection Screen**

After you program a destination using the Quick or Standard method, a route selection screen appears. The screen displays three route choices for you: Fastest, Shortest and Unrestricted.

The navigation system considers **Avoid Areas** selections when calculating the Fastest and Shortest route choices. Check the Avoid Areas selections by pressing the **NAV** hard button, then **Avoid Areas**.

- **Fastest** considers the fastest moving roads possible.
- **Shortest** considers minimum distance as its priority.
- **Unrestricted** does not consider any items to avoid, if any are set through the **Route Prefs** screen.

**Note:** If you turn off all the items to avoid in the **Route Prefs** screen and the **Avoid Areas** screen is empty, or you turn the selections off, you do not have the choice of an unrestricted route.

## 410 Navigation System (If Equipped)

### Route Selection Screen Icons

Icons, located above the route selection choices, represent features on the routes.

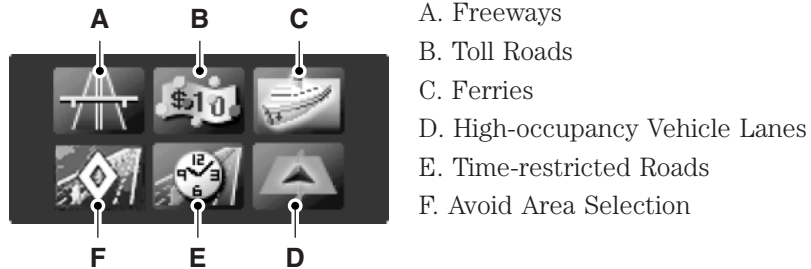

If you select the fastest route, and the freeways icon is illuminated, this means that the route uses freeways. However, even if you select to Avoid Freeways in your route, the route presented may include freeways simply because there is no other way to get to the destination.

Once you select a route, you can either **Start Route** to begin the route, or **Cancel Route** to exit and start over.

To delete all stored **Avoid Areas** at once:

1. Press the **MENU** hard button.
2. Select the **System Settings** tab.
3. Press the **View** button for **Delete Stored Items**.
4. Select **Avoid Areas**.

### POI Categories

Your system offers a variety of POI (Point of Interest) categories.

Main Categories	
Food/Drink & Dining	Automotive
Travel & Transportation	Shopping
Financial	Entertainment & Arts
Emergency	Recreation & Sports
Community	Government
Health & Medicine	Domestic Services

Within these main categories, there are subcategories, which contain more listings:

Subcategories
Restaurant
Auto Dealership
Parking
Public Transit
Home & Garden
Education
Personal Care Services

**Setting Your Navigation Preferences**

Select settings for the system to take into account when planning your route. Press the **NAV** hard button.

Map Preferences	
<b>Map Content</b>	<b>Street Name</b> displays current street name during route guidance.
	<b>Time to Dest</b> displays the distance to your destination and the estimated time of arrival.
	<b>Speed Limit</b> displays the speed limit of major roads during route guidance.
	<b>Breadcrumbs</b> displays your vehicle’s previously traveled route with white dots. The dots display for about the last 140 miles (225 km) driven.
	<b>Point of Interest (POI) Icons</b> displays point of interest icons on the map.
<b>Map View</b>	<b>Full Map</b> displays the map in full screen with turn icons in the upper right corner.
	<b>Arrow/Map</b> divides the screen in two. The map is on the left and upcoming turn information on the right.
	<b>Turn List/Map</b> divides the screen in two. The map is on the left and turn list on the right.

## 412 Navigation System (If Equipped)

<b>Map Preferences</b>	
<b>Bird's Eye View</b>	<b>ON</b> provides an elevated map perspective.
	<b>OFF</b> turns the feature off.
	<b>Adjust Angle</b> offers six different map angles.
<b>Turn List Format</b>	<b>Top-to-Bottom</b> starts the turn instructions from the top.
	<b>Bottom-to-Top</b> starts the turn instructions from the bottom.
<b>Route Preferences</b>	
<b>Shortest Distance</b>	Have the system display the shortest route first.
<b>Fastest Time</b>	Have the system display the fastest route first.
<b>Avoid Freeways</b>	Have the system avoid freeways when calculating a route.
<b>Avoid Tollroads</b>	Have the system avoid tollroads when calculating a route.
<b>Avoid Ferries</b>	Have the system avoid ferries when calculating a route.
<b>Avoid HOV Lanes</b>	Have the system avoid high-occupancy lanes when calculating a route. Also known as carpool lanes or diamond lanes, these are reserved for carpools, vanpools or buses.
<b>Avoid Time Restricted Roads</b>	Have the system avoid time-restricted roads when calculating a route. These roads may have turn, lane or entrance restrictions based on local traffic conditions or seasonal restrictions.

Traffic Preferences*	
<b>Traffic Icons to overlay on Map</b>	Touch this button to display a list of map icons that you can turn off and on. The list of icons includes: <ul style="list-style-type: none"> <li>• Weather related incidents</li> <li>• Road work</li> <li>• Incident</li> <li>• Accident</li> <li>• Closed road</li> </ul>
<b>Traffic Flow Overlay</b>	Touch this button to have the map show traffic flow coloring on major roads. Roads display in green (all clear), yellow (reduced speed) and red (stopped).
<b>Traffic Alert Notification</b>	Touch this button to have the system traffic incidents notifications along your programmed route. If you select <b>Yes</b> , a traffic incident pop-up asks you to consider or ignore the traffic incident. If you select <b>Yes</b> again, this makes the system recalculate a new route for you. If you select <b>Ignore</b> , this closes the pop-up window..

\*This feature requires activation of SIRIUS® Travel Link™, which is only available in the United States.

Navigation Preferences	
<b>Guidance Prompts</b>	<b>Voice</b> guides you with tones and voice prompts only.
	<b>Tone only</b> guides you with tones only.
	<b>OFF</b> turns off any voice or tone prompts.
<b>Auto-Fill State/Province</b>	When this feature is on, the system automatically fills in the state or province information based on your vehicle's GPS location. If you live in a border area, you may not want this feature on.

**Navigation System (If Equipped)**

<b>Navigation Preferences</b>	
<b>Avg. Speed: Residential</b>	When this feature is on, the system displays the average speed on a residential road, initially set to 25 mph (40 km/h). You can change the setting for your driving preferences. This setting helps estimate your arrival time at a destination based on your driving preferences.
<b>Avg. Speed: Main Roads</b>	When this feature is on, the system displays the average speed on a main road, initially set to 45 mph (72 km/h). You can change the setting for specific roads and for your driving preferences. This setting helps estimate your arrival time at a destination based on your driving preferences.
<b>Avg. Speed: Freeways</b>	When this feature is on, the system displays the average speed on a freeway, initially set to 65 mph (105 km/h). You can change the setting for specific roads and for your driving preferences. This setting helps estimate your arrival time at a destination based on your driving preferences.
<b>Parking POI Notification</b>	When this feature is on, the system displays available parking accommodations around a destination that is part of your route.
<b>Low Fuel POI Notification</b>	When this feature is on, the system displays gas station icons when the fuel level is low.
<b>Fuel Price Display</b>	When this feature is on, the system displays fuel prices at local stations. You can choose to display prices for <b>Unleaded</b> or <b>Diesel</b> .*



Navigation Preferences	
<b>Calibrate</b>	<b>Position</b> allows you to adjust the direction of your vehicle by pressing the arrow buttons on the screen.
	<b>Distance</b> allows you to recalibrate the distance to the destination while your vehicle is moving.
<b>Restore Default Settings</b>	Touch the <b>Reset</b> button to return the settings to factory defaults.

\*This feature requires activation of SIRIUS® Travel Link™, which is only available in the United States.

Avoid Areas	
<b>Add</b>	Add items and areas that you want the system to avoid when creating a route for you. The system does its best to avoid these.*

\*There may be some situations where it is impossible to avoid the selection(s) completely. For example, if a destination or waypoint is located in the area that is set to avoid, the system cannot avoid it.

**Map Mode**

Press the **MAP** hard button to view map mode. When in map mode, an icon appears on the upper left side of the screen; this is a toggle button to change the view of the map display.

Roads on the map display in a variety of colors. Building footprints display areas of major buildings in the 20 largest cities in the U.S. These areas may be displayed depending on their size and the map zoom level.



**Heading Up** always shows the direction of forward travel to be upward on the screen. This view is available for map scales up to 2.5 miles (4 kilometers). The system remembers this setting for larger map scales, but shows the map in North Up only. If the scale returns below this level, the system restores Heading Up.



**North Up** always shows the northern direction to be upward on the screen.



## 416 Navigation System (If Equipped)

---

### Map Icons



**Vehicle mark** shows the current location of your vehicle. It stays in the center of the map display, except when in scroll mode.



**Scroll cursor** allows you to scroll the map; the fixed icon is in the center of the screen. The map position closest to the cursor is in a window on the top center part of the screen.



**Address book entry default icon(s)** indicates the location on the map of an address book entry. This is the default symbol shown after the entry has been stored to the Address Book by any method other than the map. You can select from any of the 22 icons available. You can use each icon more than once.



**Home** indicates the location on the map currently stored as the home position. You can only save one address from the Address Book as your Home entry. You cannot change this icon.



**POI (Point Of Interest) icons** display on the map and can be turned on or turned off. Up to about 56 subcategories can display on the map one at a time.



**Starting point** indicates the starting point of a planned route.



**Waypoints** indicate the location of a waypoint on the map. The number inside the circle is different for each waypoint and represents the position of the waypoint in the route list.



**Destination symbol** indicates the ending point of a planned route.

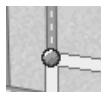

**Next maneuver point** indicates the location of the next turn on the planned route.



**No GPS symbol** indicates that insufficient GPS satellite signals are available for accurate map positioning. This icon may display under normal operation in an area with poor GPS access.

**Map Scale**



The map display scale has 17 levels, ranging from 0.02 miles (.03 kilometers) to 1000 miles (1600 kilometers). The system synchronizes the zoom scales for North Up, Heading Up and 3D Map views.

In Map Mode, you can zoom in or out, changing the display scale, by touching an arrow button on the left side of the screen.

In Full Screen Map Mode, touch this button to use the Zoom Direct buttons. The Zoom Direct buttons represent the most common map scales. Touch a button to show the map at the desired scale. The scale is approximate and based on the width of the map scale button. The size of the scale varies based on the screen size.

**Map Scrolling**

**Single scroll mode** allows you to press and release on the map display to bring the pressed position to the center of the screen. The scroll mode times out after five minutes of inactivity.

**Continuous scroll mode** allows you to touch and hold the map to begin scrolling continuously in one of eight directions closest to the point that is touched. The scroll continues until you release the map, and increases in speed after three seconds. This is not possible if your vehicle is moving. The scroll mode times out after five minutes of inactivity.

**Quick-touch Buttons**

When in map mode, touch anywhere on the map display to access the following options:

When you select:	You can:
<b>Set as Dest</b>	Select a scrolled location on the map as your destination. You may scroll the map by pressing your index finger on the map display. When you reach the desired location, simply let go and then press Set as Dest.
<b>Set as Waypoint</b>	Set the current location as a waypoint.
<b>Save to Address Book</b>	Save the current location to the address book.

## 418 Navigation System (If Equipped)

When you select:	You can:
<b>POI Icons On/Off</b>	Select point of interest icons to display on the map. You can select up to three icons to display on the map at the same time.
<b>View Traffic</b>	Adjust the map display to the right scale. This scale allows the entire route to be visible in the screen.
<b>View/Edit Route</b>	Access these features when a route is active: Cancel route. Edit route preferences. Edit destination/waypoints. View route. Edit traffic preferences.* Edit turn list.

\*This feature requires activation of SIRIUS® Travel Link™, which is only available in the United States.

Navteq is the digital map provider for the navigation application. If you find map data errors, you may report them directly to Navteq by going to <http://mapreporter.navteq.com>. Navteq evaluates all reported map errors and responds with the result of their investigation by e-mail.

### Navigation Map Updates

Annual navigation map updates are available for purchase through your dealership, by calling 1-800-NAVMAPS (in Mexico, call 01-800-557-5539) or going to [www.navigation.com/ford](http://www.navigation.com/ford). You need to specify the make and model of your vehicle to determine if there is an update available.

### Navigation Voice Commands



When in navigation mode, press the voice button on the steering wheel control. After the tone, say “Navigation”, then any of the following commands:

“NAVIGATION”	
“Cancel next waypoint”	“Show destination”
“Cancel route”	“Show heading up”
“Destination”*	“Show map”
“Destination <nametag>”	“Show next waypoint”

<b>“NAVIGATION”</b>	
“Destination <POI category>”	“Show north up”
“Destination home”	“Show route”
“Destination intersection”	“Show turn list”
“Destination nearest <POI category>”	“Voice off”
“Destination nearest POI”	“Voice on”
“Destination POI”	“Voice volume decrease”
“Destination previous destination”	“Voice volume increase”
“Destination street address”	“Zoom in”
“Detour”	“Zoom out”
“Play nametags”	“Help”
“Repeat instruction”	

\*If you have said the command, “Destination”, you may say any of the above commands or commands in the following Destination chart.

<b>“DESTINATION”</b>
“<nametag>”
“<POI category>”
“Home”
“Intersection”
“Nearest <POI category>”
“Nearest POI”
“POI”
“POI category”
“Previous destination”
“Street address”
“Help”

## 420 Navigation System (If Equipped)

### Troubleshooting

Symptoms	Possible Cause	Action
Focus error.	The system is not able to play a reproduced disc.	Contact your authorized dealer.
Bad disc.	You inserted the disc upside down or the system is unable to read the information on the disc.	The system automatically ejects the disc.
Track error.	The system is unable to reproduce a corrupt MP3 file.	The system skips the corrupted track.
Invalid disc detected.	The disc is either dirty or contains an unsupported format.	Wipe the disc with a dry, soft cloth from the center to the outer edge of the disc.
A pop-up window displays “Address not found” or “Address range does not exist. Show the midpoint of the street?”	The house number entered does not exist in the map database.	Press <b>NO</b> and enter a valid number for the specified street, or press <b>YES</b> to view the middle point of the street.
A pop-up window displays “Navigation fault. A system fault has been detected that may cause the navigation to perform abnormally. Please contact your dealership.”	There is a system hardware or software error.	Contact your authorized dealer.

## Navigation System (If Equipped)

421

Symptoms	Possible Cause	Action
A pop-up window displays "Error. PINs did not match. Please re-enter."	You entered the wrong PIN to unlock the system for valet mode.	Press <b>OK</b> and try entering your PIN again. If it does not work, contact your authorized dealer.
A pop-up window displays "Invalid PIN. Please Re-enter."	You entered the wrong PIN.	Press <b>OK</b> and try entering your PIN again to lock the system.



**GENERAL INFORMATION****SYNC® End User License Agreement (EULA)**

- You have acquired a device (“DEVICE”) that includes software licensed by FORD MOTOR COMPANY from an affiliate of Microsoft Corporation (“MS”). Those installed software products of MS origin, as well as associated media, printed materials, and “online” or electronic documentation (“MS SOFTWARE”) are protected by international intellectual property laws and treaties. The MS SOFTWARE is licensed, not sold. All rights reserved.
- The MS SOFTWARE may interface with and/or communicate with, or may be later upgraded to interface with and/or communicate with additional software and/or systems provided by FORD MOTOR COMPANY. The additional software and systems of FORD MOTOR COMPANY origin, as well as associated media, printed materials, and “online” or electronic documentation (“FORD SOFTWARE”) are protected by international intellectual property laws and treaties. The FORD SOFTWARE is licensed, not sold. All rights reserved.
- The MS SOFTWARE and/or FORD SOFTWARE may interface with and/or communicate with, or may be later upgraded to interface with and/or communicate with additional software and/or systems provided by third party software and service suppliers. The additional software and services of third party origin, as well as associated media, printed materials, and “online” or electronic documentation (“THIRD PARTY SOFTWARE”) are protected by international intellectual property laws and treaties. The THIRD PARTY SOFTWARE is licensed, not sold. All rights reserved.
- The MS SOFTWARE, FORD SOFTWARE and THIRD PARTY SOFTWARE hereinafter collectively and individually will be referred to as “SOFTWARE.”

**IF YOU DO NOT AGREE TO THIS END USER LICENSE AGREEMENT (“EULA”), DO NOT USE THE DEVICE OR COPY THE SOFTWARE. ANY USE OF THE SOFTWARE, INCLUDING BUT NOT LIMITED TO USE ON THE DEVICE, WILL CONSTITUTE YOUR AGREEMENT TO THIS EULA (OR RATIFICATION OF ANY PREVIOUS CONSENT).**

**GRANT OF SOFTWARE LICENSE:** This EULA grants you the following license:

- You may use the SOFTWARE as installed on the DEVICE and as otherwise interfacing with systems and/or services provide by or through FORD MOTOR COMPANY or its third party software and service providers.

**DESCRIPTION OF OTHER RIGHTS AND LIMITATIONS:**

- **Speech Recognition:** If the SOFTWARE includes speech recognition component(s), you should understand that speech recognition is an inherently statistical process and that recognition errors are inherent in the process. Neither FORD MOTOR COMPANY nor its suppliers shall be liable for any damages arising out of errors in the speech recognition process.
- **Limitations on Reverse Engineering, Decompilation and Disassembly:** You may not reverse engineer, decompile, or disassemble nor permit others to reverse engineer, decompile or disassemble the SOFTWARE, except and only to the extent that such activity is expressly permitted by applicable law notwithstanding this limitation.
- **Limitations on Distributing, Copying, Modifying and Creating Derivative Works:** You may not distribute, copy, make modifications to or create derivative works based on the SOFTWARE, except and only to the extent that such activity is expressly permitted by applicable law notwithstanding this limitation.
- **Single EULA:** The end user documentation for the DEVICE and related systems and services may contain multiple EULAs, such as multiple translations and/or multiple media versions (e.g., in the user documentation and in the software). Even if you receive multiple EULAs, you are licensed to use only one (1) copy of the SOFTWARE.
- **SOFTWARE Transfer:** You may permanently transfer your rights under this EULA only as part of a sale or transfer of the DEVICE, provided you retain no copies, you transfer all of the SOFTWARE (including all component parts, the media and printed materials, any upgrades, and, if applicable, the Certificate(s) of Authenticity), and the recipient agrees to the terms of this EULA. If the SOFTWARE is an upgrade, any transfer must include all prior versions of the SOFTWARE.
- **Termination:** Without prejudice to any other rights, FORD MOTOR COMPANY or MS may terminate this EULA if you fail to comply with the terms and conditions of this EULA.
- **Security Updates/Digital Rights Management:** Content owners use the WMDRM technology included in your DEVICE to protect their intellectual property, included copyrighted content. Portions of the SOFTWARE on your DEVICE use WMDRM software to access WMDRM-protected content. If the WMDRM software fails to protect the content, content owners may ask Microsoft to revoke the



SOFTWARE's ability to use WMDRM to play or copy protected content. This action does not affect unprotected content. When your DEVICE downloads licenses for protected content, you agree that Microsoft may include a revocation list with the licenses. Content owners may require you to upgrade the SOFTWARE on your DEVICE to access their content. If you decline an upgrade, you will not be able to access content that requires the upgrade.

- **Consent to Use of Data:** You agree that MS, Microsoft Corporation, FORD MOTOR COMPANY, third party software and systems suppliers, their affiliates and/or their designated agent may collect and use technical information gathered in any manner as part of product support services related to the SOFTWARE or related services. MS, Microsoft Corporation, FORD MOTOR COMPANY, third party software and services suppliers, their affiliates and/or their designated agent may use this information solely to improve their products or to provide customized services or technologies to you. MS, Microsoft Corporation, FORD MOTOR COMPANY, third party software and systems suppliers, their affiliates and/or their designated agent may disclose this information to others, but not in a form that personally identifies you.
- **Internet-Based Services Components:** The SOFTWARE may contain components that enable and facilitate the use of certain Internet-based services. You acknowledge and agree that MS, Microsoft Corporation, FORD MOTOR COMPANY, third party software and service suppliers, their affiliates and/or their designated agent may automatically check the version of the SOFTWARE and/or its components that you are utilizing and may provide upgrades or supplements to the SOFTWARE that may be automatically downloaded to your DEVICE.
- **Additional Software/Services:** The SOFTWARE may permit FORD MOTOR COMPANY, third party software and service suppliers, MS, Microsoft Corporation, their affiliates and/or their designated agent to provide or make available to you SOFTWARE updates, supplements, add-on components, or Internet-based services components of the SOFTWARE after the date you obtain your initial copy of the SOFTWARE ("Supplemental Components").

If FORD MOTOR COMPANY or third party software and services suppliers provide or make available to you Supplemental Components and no other EULA terms are provided along with the Supplemental Components, then the terms of this EULA shall apply.

If MS, Microsoft Corporation, their affiliates and/or their designated agent make available Supplemental Components, and no other EULA terms are

provided, then the terms of this EULA shall apply, except that the MS, Microsoft Corporation or affiliate entity providing the Supplemental Component(s) shall be the licensor of the Supplemental Component(s).

FORD MOTOR COMPANY, MS, Microsoft Corporation, their affiliates and/or their designated agent reserve the right to discontinue without liability any Internet-based services provided to you or made available to you through the use of the SOFTWARE.

- **Links to Third Party Sites:** The MS SOFTWARE may provide you with the ability to link to third party sites through the use of the SOFTWARE. The third party sites are not under the control of MS, Microsoft Corporation, their affiliates and/or their designated agent. Neither MS nor Microsoft Corporation nor their affiliates nor their designated agent are responsible for (i) the contents of any third party sites, any links contained in third party sites, or any changes or updates to third party sites, or (ii) webcasting or any other form of transmission received from any third party sites. If the SOFTWARE provides links to third party sites, those links are provided to you only as a convenience, and the inclusion of any link does not imply an endorsement of the third party site by MS, Microsoft Corporation, their affiliates and/or their designated agent.
- **Obligation to Drive Responsibly:** You recognize your obligation to drive responsibly and keep attention on the road. You will read and abide with the DEVICE operating instructions particularly as they pertain to safety and assumes any risk associated with the use of the DEVICE.

**UPGRADES AND RECOVERY MEDIA:** If the SOFTWARE is provided by FORD MOTOR COMPANY separate from the DEVICE on media such as a ROM chip, CD ROM disk(s) or via web download or other means, and is labeled “For Upgrade Purposes Only” or “For Recovery Purposes Only” you may install one (1) copy of such SOFTWARE onto the DEVICE as a replacement copy for the existing SOFTWARE, and use it in accordance with this EULA, including any additional EULA terms accompanying the upgrade SOFTWARE.

**INTELLECTUAL PROPERTY RIGHTS:** All title and intellectual property rights in and to the SOFTWARE (including but not limited to any images, photographs, animations, video, audio, music, text and “applets,” incorporated into the SOFTWARE), the accompanying printed materials, and any copies of the SOFTWARE, are owned by MS, Microsoft Corporation, FORD MOTOR COMPANY, or their affiliates or suppliers. The SOFTWARE is licensed, not sold. You may not copy the printed materials accompanying the SOFTWARE. All title and intellectual

property rights in and to the content which may be accessed through use of the SOFTWARE is the property of the respective content owner and may be protected by applicable copyright or other intellectual property laws and treaties. This EULA grants you no rights to use such content. All rights not specifically granted under this EULA are reserved by MS, Microsoft Corporation, FORD MOTOR COMPANY, third party software and service providers, their affiliates and suppliers. Use of any on-line services which may be accessed through the SOFTWARE may be governed by the respective terms of use relating to such services. If this SOFTWARE contains documentation that is provided only in electronic form, you may print one copy of such electronic documentation.

**EXPORT RESTRICTIONS:** You acknowledge that the SOFTWARE is subject to U.S. and European Union export jurisdiction. You agree to comply with all applicable international and national laws that apply to the SOFTWARE, including the U.S. Export Administration Regulations, as well as end-user, end-use and destination restrictions issued by U.S. and other governments. For additional information, see <http://www.microsoft.com/exporting/>.

**TRADEMARKS:** This EULA does not grant you any rights in connection with any trademarks or service marks of FORD MOTOR COMPANY, MS, Microsoft Corporation, third party software or service providers, their affiliates or suppliers.

**PRODUCT SUPPORT:** Product support for the SOFTWARE is not provided by MS, its parent corporation Microsoft Corporation, or their affiliates or subsidiaries. For product support, please refer to FORD MOTOR COMPANY instructions provided in the documentation for the DEVICE. Should you have any questions concerning this EULA, or if you desire to contact FORD MOTOR COMPANY for any other reason, please refer to the address provided in the documentation for the DEVICE.

**No Liability for Certain Damages:** EXCEPT AS PROHIBITED BY LAW, FORD MOTOR COMPANY, ANY THIRD PARTY SOFTWARE OR SERVICES SUPPLIERS, MS, MICROSOFT CORPORATION AND THEIR AFFILIATES SHALL HAVE NO LIABILITY FOR ANY INDIRECT, SPECIAL, CONSEQUENTIAL OR INCIDENTAL DAMAGES ARISING FROM OR IN CONNECTION WITH THE USE OR PERFORMANCE OF THE SOFTWARE. THIS LIMITATION SHALL APPLY EVEN IF ANY REMEDY FAILS OF ITS ESSENTIAL PURPOSE. IN NO EVENT SHALL MS, MICROSOFT CORPORATION AND/OR THEIR AFFILIATES BE LIABLE FOR ANY AMOUNT IN EXCESS OF U.S. TWO HUNDRED FIFTY DOLLARS (U.S.\$250.00).

- THERE ARE NO WARRANTIES OTHER THAN THOSE THAT MAY EXPRESSLY BE PROVIDED FOR YOUR NEW VEHICLE.

**End user notice****Microsoft® Windows® Mobile for Automotive Important Safety Information**

This system Ford SYNC™ contains software that is licensed to Manufacturer FORD MOTOR COMPANY by an affiliate of Microsoft Corporation pursuant to a license agreement. Any removal, reproduction, reverse engineering or other unauthorized use of the software from this system in violation of the license agreement is strictly prohibited and may subject you to legal action.

**Read and follow instructions**

Before using your Windows Automotive-based system, read and follow all instructions and safety information provided in this end user manual (“User’s Guide”). Not following precautions found in this User’s Guide can lead to an accident or other serious consequences.

**Keep User’s Guide in Vehicle**

When kept in the vehicle, the User’s Guide will be a ready reference for you and other users unfamiliar with the Windows Automotive-based system. Please make certain that before using the system for the first time, all persons have access to the User’s Guide and read its instructions and safety information carefully.



**WARNING:** Operating certain parts of this system while driving can distract your attention away from the road, and possibly cause an accident or other serious consequences. Do not change system settings or enter data non-verbally (using your hands) while driving. Stop the vehicle in a safe and legal manner before attempting these operations. This is important since while setting up or changing some functions you might be required to distract your attention away from the road and remove your hands from the wheel.

**General Operation****Voice Command Control**

Functions within the Windows Automotive-based system may be accomplished using only voice commands. Using voice commands while driving allows you to operate the system without removing your hands from the wheel.

**Prolonged Views of Screen**

Do not access any function requiring a prolonged view of the screen while you are driving. Pull over in a safe and legal manner before attempting to



access a function of the system requiring prolonged attention. Even occasional short scans to the screen may be hazardous if your attention has been diverted away from your driving task at a critical time.

**Volume Setting**

Do not raise the volume excessively. Keep the volume at a level where you can still hear outside traffic and emergency signals while driving. Driving while unable to hear these sounds could cause an accident.

**Use of Speech Recognition Functions**

Speech recognition software is inherently a statistical process which is subject to errors. It is your responsibility to monitor any speech recognition functions included in the system and address any errors.

**Navigation Features**

Any navigation features included in the system are intended to provide turn by turn instructions to get you to a desired destination. Please make certain all persons using this system carefully read and follow instructions and safety information fully.

**Distraction Hazard**

Any navigation features may require manual (non-verbal) setup. Attempting to perform such set-up or insert data while driving can seriously distract your attention and could cause an accident or other serious consequences. Stop the vehicle in a safe and legal manner before attempting these operations.

**Let Your Judgment Prevail**

Any navigation features are provided only as an aid. Make your driving decisions based on your observations of local conditions and existing traffic regulations. Any such feature is not a substitute for your personal judgment. Any route suggestions made by this system should never replace any local traffic regulations or your personal judgment or knowledge of safe driving practices.

**Route Safety**

Do not follow the route suggestions if doing so would result in an unsafe or illegal maneuver, if you would be placed in an unsafe situation, or if you would be directed into an area that you consider unsafe. The driver is ultimately responsible for the safe operation of the vehicle and therefore, must evaluate whether it is safe to follow the suggested directions.

**Potential Map Inaccuracy**

Maps used by this system may be inaccurate because of changes in roads, traffic controls or driving conditions. Always use good judgment and common sense when following the suggested routes.

**Emergency Services**

Do not rely on any navigation features included in the system to route you to emergency services. Ask local authorities or an emergency services operator for these locations. Not all emergency services such as police, fire stations, hospitals and clinics are likely to be contained in the map database for such navigation features.

**TeleNav Software End User License Agreement**

*Please read these terms and conditions carefully before you use the TeleNav Software. Your use of the TeleNav Software indicates that you accept these terms and conditions. If you do not accept these terms and conditions, do not break the seal of the package, launch, or otherwise use the TeleNav Software.*

TeleNav may revise this Agreement and the privacy policy at any time, with or without notice to you. You agree to visit <http://www.telenav.com> from time to time to review the then current version of this Agreement and of the privacy policy.

**1. Safe and Lawful Use**

You acknowledge that devoting attention to the TeleNav Software may pose a risk of injury or death to you and others in situations that otherwise require your undivided attention, and you therefore agree to comply with the following when using the TeleNav Software: (a) observe all traffic laws and otherwise drive safely; (b) use your own personal judgment while driving. If you feel that a route suggested by the TeleNav Software instructs you to perform an unsafe or illegal maneuver, places you in an unsafe situation, or directs you into an area that you consider to be unsafe, do not follow such instructions; (c) do not input destinations, or otherwise manipulate the TeleNav Software, unless your vehicle is stationary and parked; (d) do not use the TeleNav Software for any illegal, unauthorized, unintended, unsafe, hazardous, or unlawful purposes, or in any manner inconsistent with this Agreement; (e) arrange all GPS and wireless devices and cables necessary for use of the TeleNav Software in a secure manner in your vehicle so that they will not interfere with your driving and will not prevent the operation of any safety device (such as an airbag).

You agree to indemnify and hold TeleNav harmless against all claims resulting from any dangerous or otherwise inappropriate use of the TeleNav Software in any moving vehicle, including as a result of your failure to comply with the directions above.

**2013 05+ Mustang (197)**  
**Owners Guide gf, 3rd Printing**  
**USA (fus)**

**2. Account Information**

You agree: (a) when registering the TeleNav Software, to provide TeleNav with true, accurate, current, and complete information about yourself, and (b) to inform TeleNav promptly of any changes to such information, and to keep it true, accurate, current and complete.

**3. Software License**

Subject to your compliance with the terms of this Agreement, TeleNav hereby grants to you a personal, non-exclusive, non-transferable license (except as expressly permitted below in connection with your permanent transfer of the TeleNav Software license), without the right to sublicense, to use the TeleNav Software (in object code form only) in order to access and use the TeleNav Software. This license shall terminate upon any termination or expiration of this Agreement. You agree that you will use the TeleNav Software only for your personal business or leisure purposes, and not to provide commercial navigation services to other parties.

**3.1 License limitations**

You agree not to do any of the following: (a) reverse engineer, decompile, disassemble, translate, modify, alter or otherwise change the TeleNav Software or any part thereof; (b) attempt to derive the source code, audio library or structure of the TeleNav Software without the prior express written consent of TeleNav; (c) remove from the TeleNav Software, or alter, any of TeleNav's or its suppliers' trademarks, trade names, logos, patent or copyright notices, or other notices or markings; (d) distribute, sublicense or otherwise transfer the TeleNav Software to others, except as part of your permanent transfer of the TeleNav Software; or (e) use the TeleNav Software in any manner that (i) infringes the intellectual property or proprietary rights, rights of publicity or privacy or other rights of any party, (ii) violates any law, statute, ordinance or regulation, including but not limited to laws and regulations related to spamming, privacy, consumer and child protection, obscenity or defamation, or (iii) is harmful, threatening, abusive, harassing, tortuous, defamatory, vulgar, obscene, libelous, or otherwise objectionable; and (f) lease, rent out, or otherwise permit unauthorized access by third parties to the TeleNav Software without advanced written permission of TeleNav.

**4. Disclaimers**

To the fullest extent permissible pursuant to applicable law, in no event will TeleNav, its licensors and suppliers, or agents or employees of any of the foregoing, be liable for any decision made or action taken by you or anyone else in reliance on the information provided by the TeleNav

Software. TeleNav also does not warrant the accuracy of the map or other data used for the TeleNav Software. Such data may not always reflect reality due to, among other things, road closures, construction, weather, new roads and other changing conditions. You are responsible for the entire risk arising out of your use of the TeleNav Software. For example but without limitation, you agree not to rely on the TeleNav Software for critical navigation in areas where the well-being or survival of you or others is dependent on the accuracy of navigation, as the maps or functionality of the TeleNav Software are not intended to support such high risk applications, especially in more remote geographical areas. TELENAV EXPRESSLY DISCLAIMS AND EXCLUDES ALL WARRANTIES IN CONNECTION WITH THE TELENAV SOFTWARE, WHETHER STATUTORY, EXPRESS OR IMPLIED, INCLUDING ALL WARRANTIES WHICH MAY ARISE FROM COURSE OF DEALING, CUSTOM OR TRADE AND INCLUDING, BUT NOT LIMITED TO, THE IMPLIED WARRANTIES OF MERCHANTABILITY, FITNESS FOR A PARTICULAR PURPOSE AND NON-INFRINGEMENT OF THIRD PARTY RIGHTS WITH RESPECT TO THE TELENAV SOFTWARE. Certain jurisdictions do not permit the disclaimer of certain warranties, so this limitation may not apply to you.

**5. Limitation of Liability**

TO THE EXTENT PERMITTED UNDER APPLICABLE LAW, UNDER NO CIRCUMSTANCES SHALL TELENAV OR ITS LICENSORS AND SUPPLIERS BE LIABLE TO YOU OR TO ANY THIRD PARTY FOR ANY INDIRECT, INCIDENTAL, CONSEQUENTIAL, SPECIAL OR EXEMPLARY DAMAGES (INCLUDING IN EACH CASE, BUT NOT LIMITED TO, DAMAGES FOR THE INABILITY TO USE THE EQUIPMENT OR ACCESS DATA, LOSS OF DATA, LOSS OF BUSINESS, LOSS OF PROFITS, BUSINESS INTERRUPTION OR THE LIKE) ARISING OUT OF THE USE OF OR INABILITY TO USE THE TELENAV SOFTWARE, EVEN IF TELENAV HAS BEEN ADVISED OF THE POSSIBILITY OF SUCH DAMAGES.

NOTWITHSTANDING ANY DAMAGES THAT YOU MIGHT INCUR FOR ANY REASON WHATSOEVER (INCLUDING, WITHOUT LIMITATION, ALL DAMAGES REFERENCED HEREIN AND ALL DIRECT OR GENERAL DAMAGES IN CONTRACT, TORT (INCLUDING NEGLIGENCE) OR OTHERWISE), THE ENTIRE LIABILITY OF TELENAV AND OF ALL OF TELENAV'S SUPPLIERS SHALL BE LIMITED TO THE AMOUNT ACTUALLY PAID BY YOU FOR THE TELENAV SOFTWARE. SOME STATES AND/OR JURISDICTIONS DO NOT ALLOW THE EXCLUSION OR LIMITATION OF INCIDENTAL OR CONSEQUENTIAL DAMAGES, SO THE ABOVE LIMITATIONS OR EXCLUSIONS MAY NOT APPLY TO YOU.

**2013 05+ Mustang (197)**  
**Owners Guide gf, 3rd Printing**  
**USA (fus)**



**6. Arbitration and Governing Law**

You agree that any dispute, claim or controversy arising out of or relating to this Agreement or the TeleNav Software shall be settled by independent arbitration involving a neutral arbitrator and administered by the American Arbitration Association in the County of Santa Clara, California. The arbitrator shall apply the Commercial Arbitration Rules of the American Arbitration Association, and the judgment upon the award rendered by the arbitrator may be entered by any court having jurisdiction. Note that there is no judge or jury in an arbitration proceeding and the decision of the arbitrator shall be binding upon both parties. You expressly agree to waive your right to a jury trial. This Agreement and performance hereunder will be governed by and construed in accordance with the laws of the State of California, without giving effect to its conflict of laws provisions. To the extent judicial action is necessary in connection with the binding arbitration, both TeleNav and you agree to submit to the exclusive jurisdiction of the courts of the County of Santa Clara, California. The United Nations Convention on Contracts for the International Sale of Goods shall not apply.

**7. Assignment**

You may not resell, assign, or transfer this Agreement or any of your rights or obligations, except in totality, in connection with your permanent transfer of the TeleNav Software, and expressly conditioned upon the new user of the TeleNav Software agreeing to be bound by the terms and conditions of this Agreement. Any such sale, assignment or transfer that is not expressly permitted under this paragraph will result in immediate termination of this Agreement, without liability to TeleNav, in which case you and all other parties shall immediately cease all use of the TeleNav Software. Notwithstanding the foregoing, TeleNav may assign this Agreement to any other party at any time without notice, provided the assignee remains bound by this Agreement.

**8. Miscellaneous**

8.1 This Agreement constitutes the entire agreement between TeleNav and you with respect to the subject matter hereof.

8.2 Except for the limited licenses expressly granted in this Agreement, TeleNav retains all right, title and interest in and to the TeleNav Software, including without limitation all related intellectual property rights. No licenses or other rights which are not expressly granted in this Agreement are intended to, or shall be, granted or conferred by implication, statute, inducement, estoppel or otherwise, and TeleNav and its suppliers and licensors hereby reserve all of their respective rights other than the licenses explicitly granted in this Agreement.

8.3 By using the TeleNav Software, you consent to receive from TeleNav all communications, including notices, agreements, legally required disclosures or other information in connection with the TeleNav Software (collectively, “Notices”) electronically. TeleNav may provide such Notices by posting them on TeleNav’s Website or by downloading such Notices to your wireless device. If you desire to withdraw your consent to receive Notices electronically, you must discontinue your use of the TeleNav Software.

8.4 TeleNav’s or your failure to require performance of any provision shall not affect that party’s right to require performance at any time thereafter, nor shall a waiver of any breach or default of this Agreement constitute a waiver of any subsequent breach or default or a waiver of the provision itself.

8.5 If any provision herein is held unenforceable, then such provision will be modified to reflect the intention of the parties, and the remaining provisions of this Agreement will remain in full force and effect.

8.6 The headings in this Agreement are for convenience of reference only, will not be deemed to be a part of this Agreement, and will not be referred to in connection with the construction or interpretation of this Agreement. As used in this Agreement, the words “include” and “including,” and variations thereof, will not be deemed to be terms of limitation, but rather will be deemed to be followed by the words “without limitation.”

**9. Other Vendors Terms and Conditions**

*The TeleNav Software utilizes map and other data licensed to TeleNav by third party vendors for the benefit of you and other end users. This Agreement includes end-user terms applicable to these companies (included at the end of this Agreement), and thus your use of the TeleNav Software is also subject to such terms. You agree to comply with the following additional terms and conditions, which are applicable to TeleNav’s third party vendor licensors:*

**NavTeq End User License Agreement**

**END USER TERMS**

The content provided (“Data”) is licensed, not sold. By opening this package, or installing, copying, or otherwise using the Data, you agree to be bound by the terms of this agreement. If you do not agree to the terms of this agreement, you are not permitted to install, copy, use, resell or transfer the Data. If you wish to reject the terms of this agreement, and have not installed, copied, or used the Data, you must contact your retailer or NAVTEQ North America, LLC (“NT”) within thirty (30) days of purchase for a refund of your purchase price. To contact NT, please visit [www.navteq.com](http://www.navteq.com).

**2013 05+ Mustang (197)  
Owners Guide gf, 3rd Printing  
USA (fus)**

The Data is provided for your personal, internal use only and may not be resold. It is protected by copyright, and is subject to the following terms (this “End User License Agreement”) and conditions which are agreed to by you, on the one hand, and NAVTEQ North America, LLC (“NT”) and its licensors (including their licensors and suppliers) on the other hand.

The Data for areas of Canada includes information taken with permission from Canadian authorities, including: © Her Majesty the Queen in Right of Canada, © Queen’s Printer for Ontario, © Canada Post Corporation, GeoBase ®.

NT holds a nonexclusive license from the United States Postal Service ® to publish and sell ZIP+4 ® information.

© United States Postal Service ® 2009. Prices are not established, controlled or approved by the United States Postal Service ®. The following trademarks and registrations are owned by the USPS: United States Postal Service, USPS, and ZIP+4.

The Data for Mexico includes certain Data from Instituto Nacional de Estadística y Geografía.

#### TERMS AND CONDITIONS

**License Limitations on Use:** You agree that your license to use this Data is limited to and conditioned on use for solely personal, noncommercial purposes, and not for service bureau, timesharing or other similar purposes. Except as otherwise set forth herein, you agree not to otherwise reproduce, copy, modify, decompile, disassemble or reverse engineer any portion of this Data, and may not transfer or distribute it in any form, for any purpose, except to the extent permitted by mandatory laws.

**License Limitations on Transfer:** Your limited license does not allow transfer or resale of the Data, except on the condition that you may transfer the Data and all accompanying materials on a permanent basis if: (a) you retain no copies of the Data; (b) the recipient agrees to the terms of this End User License Agreement; and (c) you transfer the Data in the exact same form as you purchased it by physically transferring the original media (e.g., the CD-ROM or DVD you purchased), all original packaging, all Manuals and other documentation. Specifically, Multi-disc sets may only be transferred or sold as a complete set as provided to you and not as a subset thereof.

**Additional License Limitations:** Except where you have been specifically licensed to do so by NT in a separate written agreement, and without limiting the preceding paragraph, your license is conditioned on use of the Data as prescribed in this agreement, and you may not (a) use this Data with any products, systems, or applications installed or otherwise connected to or in communication with vehicles capable of vehicle navigation, positioning, dispatch, real time route guidance, fleet management or similar applications; or (b) with, or in communication with, including without limitation, cellular phones, palmtop and handheld computers, pagers, and personal digital assistants or PDAs.



**WARNING:** This Data may contain inaccurate or incomplete information due to the passage of time, changing circumstances, sources used and the nature of collecting comprehensive geographic Data, any of which may lead to incorrect results.

**No Warranty:** This Data is provided to you “as is”, and you agree to use it at your own risk. NT and its licensors (and their licensors and suppliers) make no guarantees, representations or warranties of any kind, express or implied, arising by law or otherwise, including but not limited to, content, quality, accuracy, completeness, effectiveness, reliability, fitness for a particular purpose, usefulness, use or results to be obtained from this Data, or that the Data or server will be uninterrupted or error free.

**Disclaimer of Warranty:** NT AND ITS LICENSORS (INCLUDING THEIR LICENSORS AND SUPPLIERS) DISCLAIM ANY WARRANTIES, EXPRESS OR IMPLIED, OF QUALITY, PERFORMANCE, MERCHANTABILITY, FITNESS FOR A PARTICULAR PURPOSE OR NON-INFRINGEMENT. Some States, Territories and Countries do not allow certain warranty exclusions, so to that extent the above exclusion may not apply to you.

**Disclaimer of Liability:** NT AND ITS LICENSORS (INCLUDING THEIR LICENSORS AND SUPPLIERS) SHALL NOT BE LIABLE TO YOU IN RESPECT OF ANY CLAIM, DEMAND OR ACTION, IRRESPECTIVE OF THE NATURE OF THE CAUSE OF THE CLAIM, DEMAND OR ACTION ALLEGING ANY LOSS, INJURY OR DAMAGES, DIRECT OR INDIRECT, WHICH MAY RESULT FROM THE USE OR POSSESSION OF THIS DATA; OR FOR ANY LOSS OF PROFIT, REVENUE, CONTRACTS OR

*2013 05+ Mustang (197)*  
*Owners Guide gf, 3rd Printing*  
*USA (fus)*

SAVINGS, OR ANY OTHER DIRECT, INDIRECT, INCIDENTAL, SPECIAL OR CONSEQUENTIAL DAMAGES ARISING OUT OF YOUR USE OF OR INABILITY TO USE THIS DATA, ANY DEFECT IN THIS DATA, OR THE BREACH OF THESE TERMS OR CONDITIONS, WHETHER IN AN ACTION IN CONTRACT OR TORT OR BASED ON A WARRANTY, EVEN IF NT OR ITS LICENSORS HAVE BEEN ADVISED OF THE POSSIBILITY OF SUCH DAMAGES. Some States, Territories and Countries do not allow certain liability exclusions or damages limitations, so to that extent the above may not apply to you.

**Export Control:** You agree not to export from anywhere any part of the Data or any direct product thereof except in compliance with, and with all licenses and approvals required under, applicable export laws, rules and regulations, including but not limited to the laws, rules and regulations administered by the Office of Foreign Assets Control of the U.S. Department of Commerce and the Bureau of Industry and Security of the U.S. Department of Commerce. To the extent that any such export laws, rules or regulations prohibit NT from complying with any of its obligations hereunder to deliver or distribute Data, such failure shall be excused and shall not constitute a breach of this Agreement.

**Entire Agreement:** These terms and conditions constitute the entire agreement between NT (and its licensors, including their licensors and suppliers) and you pertaining to the subject matter hereof, and supersedes in their entirety any and all written or oral agreements previously existing between us with respect to such subject matter.

**Severability:** You and NT agree that if any portion of this agreement is found illegal or unenforceable, that portion shall be severed and the remainder of the Agreement shall be given full force and effect.

**Governing Law:** The above terms and conditions shall be governed by the laws of the State of Illinois, without giving effect to (i) its conflict of laws provisions, or (ii) the United Nations Convention for Contracts for the International Sale of Goods, which is explicitly excluded. You agree to submit to the personal jurisdiction of the State of Illinois for any and all disputes, claims and actions arising from or in connection with the Data provided to you hereunder.

**Government End Users:** If the Data is being acquired by or on behalf of the United States government or any other entity seeking or applying rights similar to those customarily claimed by the United States government, this Data is a “commercial item” as that term is defined at 48 C.F.R. (“FAR”) 2.101, is licensed in accordance with this End User License Agreement, and each copy of Data delivered or otherwise

furnished shall be marked and embedded as appropriate with the following “Notice of Use”, and be treated in accordance with such Notice:

**NOTICE OF USE**

CONTRACTOR (MANUFACTURER/ SUPPLIER)

NAME:

**NAVTEQ**

CONTRACTOR (MANUFACTURER/SUPPLIER)

ADDRESS:

**425 West Randolph Street, Chicago, IL 60606.**

This Data is a commercial item as defined in FAR 2.101 and is subject to the EndUser License Agreement under which this Data was provided.

© 2011 NAVTEQ. All rights reserved.

If the Contracting Officer, federal government agency, or any federal official refuses to use the legend provided herein, the Contracting Officer, federal government agency, or any federal official must notify NAVTEQ prior to seeking additional or alternative rights in the Data.

Wi-Fi hotspot data provided by JiWire ©2013 JiWire.

**Gracenote® Copyright**

CD and music — related data from Gracenote, Inc., copyright © 2000–2007 Gracenote. Gracenote Software, copyright © 2000–2007 Gracenote. This product and service may practice one or more of the following U.S. Patents #5,987,525; #6,061,680; #6,154,773, #6,161,132, #6,230,192, #6,230,207, #6,240,459, #6,330,593, and other patents issued or pending. Some services supplied under license from Open Globe, Inc. for U.S. Patent: #6,304,523.

Gracenote and CDDB are registered trademarks of Gracenote. The Gracenote logo and logotype, and the “Powered by Gracenote™” logo are trademarks of Gracenote.

**Gracenote® End User License Agreement (EULA)**

This device contains software from Gracenote, Inc. of 2000 Powell Street Emeryville, California 94608 (“Gracenote”).

The software from Gracenote (the “Gracenote Software”) enables this device to do disc and music file identification and obtain music-related information, including name, artist, track, and title information (“Gracenote Data”) from online servers (“Gracenote Servers”), and to

perform other functions. You may use Gracenote Data only by means of the intended End User functions of this device

This device may contain content belonging to Gracenote's providers. If so, all of the restrictions set forth herein with respect to Gracenote Data shall also apply to such content and such content providers shall be entitled to all of the benefits and protections set forth herein that are available to Gracenote.

You agree that you will use the content from Gracenote ("Gracenote Content"), Gracenote Data, the Gracenote Software, and Gracenote Servers for your own personal, non-commercial use only. You agree not to assign, copy, transfer or transmit the Gracenote Content, Gracenote Software or any Gracenote Data (except in a Tag associated with a music file) to any third party. **YOU AGREE NOT TO USE OR EXPLOIT GRACENOTE CONTENT, GRACENOTE DATA, THE GRACENOTE SOFTWARE, OR GRACENOTE SERVERS, EXCEPT AS EXPRESSLY PERMITTED HEREIN.**

You agree that your non-exclusive licenses to use the Gracenote Content, Gracenote Data, the Gracenote Software, and Gracenote Servers will terminate if you violate these restrictions. If your licenses terminate, you agree to cease any and all use of the Gracenote Content, Gracenote Data, the Gracenote Software, and Gracenote Servers. Gracenote, respectively, reserve all rights in Gracenote Data, the Gracenote Software, and the Gracenote Servers and Gracenote Content, including all ownership rights. Under no circumstances will either Gracenote become liable for any payment to you for any information that you provide, including any copyrighted material or music file information. You agree that Gracenote may enforce its respective rights, collectively or separately, under this agreement against you, directly in each company's own name.

Gracenote uses a unique identifier to track queries for statistical purposes. The purpose of a randomly assigned numeric identifier is to allow Gracenote to count queries without knowing anything about who you are. For more information, see the web page at [www.gracenote.com](http://www.gracenote.com) for the Gracenote Privacy Policy

**THE GRACENOTE SOFTWARE, EACH ITEM OF GRACENOTE DATA AND THE GRACENOTE CONTENT ARE LICENSED TO YOU "AS IS." NEITHER GRACENOTE MAKES ANY REPRESENTATIONS OR WARRANTIES, EXPRESS OR IMPLIED, REGARDING THE ACCURACY OF ANY GRACENOTE DATA FROM THE GRACENOTE SERVERS OR GRACENOTE CONTENT. GRACENOTE COLLECTIVELY AND SEPARATELY RESERVE THE RIGHT TO DELETE DATA AND/OR**

CONTENT FROM THE COMPANIES' RESPECTIVE SERVERS OR, IN THE CASE OF GRACENOTE, CHANGE DATA CATEGORIES FOR ANY CAUSE THAT GRACENOTE DEEMS SUFFICIENT. NO WARRANTY IS MADE THAT EITHER GRACENOTE CONTENT OR THE GRACENOTE SOFTWARE OR GRACENOTE SERVERS ARE ERROR-FREE OR THAT THE FUNCTIONING OF THE GRACENOTE SOFTWARE OR GRACENOTE SERVERS WILL BE UNINTERRUPTED. GRACENOTE IS NOT OBLIGATED TO PROVIDE YOU WITH ANY ENHANCED OR ADDITIONAL DATA TYPES THAT GRACENOTE MAY CHOOSE TO PROVIDE IN THE FUTURE AND IS FREE TO DISCONTINUE ITS ONLINE SERVICES AT ANY TIME. GRACENOTE DISCLAIM ALL WARRANTIES EXPRESS OR IMPLIED, INCLUDING, BUT NOT LIMITED TO, IMPLIED WARRANTIES OF MERCHANTABILITY, FITNESS FOR A PARTICULAR PURPOSE, TITLE, AND NON-INFRINGEMENT. NEITHER GRACENOTE WARRANTS THE RESULTS THAT WILL BE OBTAINED BY YOUR USE OF THE GRACENOTE SOFTWARE OR ANY GRACENOTE SERVER. IN NO CASE WILL GRACENOTE BE LIABLE FOR ANY CONSEQUENTIAL OR INCIDENTAL DAMAGES OR FOR ANY LOST PROFITS OR LOST REVENUES FOR ANY REASON WHATSOEVER.

© Gracenote 2007

**2013 05+ Mustang (197)**  
**Owners Guide gf, 3rd Printing**  
**USA (fus)**



- 911 Assist™ .....341
- A**
- ABS (see Brakes) .....173
- Accessing call history/phone book during active call .....333
- Accessing the help screen .....400
- Accessing the music in your jukebox .....393
- Accessing your media menu features .....352
- Accessing your phone menu features .....334
- Accessory delay .....85
- Active call menu options .....333
- Advanced menu options .....340
- Advanced menu options (prompts, languages, defaults, master reset, installing applications) .....340
- Airbag supplemental restraint system .....45
- and child safety seats .....46
- description .....45
- disposal .....53
- driver airbag .....45
- passenger airbag .....45
- side airbag .....45, 50
- Air cleaner filter .....244–245, 300
- Air conditioning .....128
- manual heating and air conditioning system .....128
- Air filter, cabin .....134
- AM/FM .....375
- Antifreeze (see Engine coolant) .....235
- Anti-lock brake system (see Brakes) .....173
- Anti-theft system .....69, 71
- arming the system .....69, 72
- disarming a triggered system ..73
- AppLink™ .....348
- Audio system
- CD-MP3 .....119
- Audio system (see Radio) .....119
- Automatic transmission .....163
- driving an automatic overdrive .....164
- fluid, adding .....239
- fluid, checking .....239
- fluid, refill capacities .....296
- fluid, specification .....296
- Selectshift (SST) .....164
- Auxiliary input jack (Line in) ..122
- Auxiliary powerpoint .....148
- Axle
- lubricant specifications .....296
- refill capacities .....296
- traction lok .....170
- B**
- Battery .....241
- acid, treating emergencies ....241
- jumping a disabled battery ....211
- maintenance-free .....241
- replacement, specifications ...300
- servicing .....241
- Booster seats .....22
- Brakes .....173
- anti-lock .....173
- anti-lock brake system (ABS) warning light .....173
- brake warning light .....173
- fluid, checking and adding ....240



- fluid, refill capacities .....296  
 fluid, specifications .....296  
 lubricant specifications .....296  
 parking .....174  
 shift interlock .....165  
 trailer .....196
- C**
- Capacities for refilling fluids ....296  
 CD .....119  
 CD player .....117  
 CD voice commands .....389,  
 391–392  
 Cell phone use .....16  
 Changing a tire .....281  
 Child safety restraints .....27, 29  
 Child safety seats  
   attaching with tether straps ....29  
   automatic locking mode  
   (retractor) .....36  
   LATCH .....27  
 Child safety seats -  
 booster seats .....22  
 Cleaning the touchscreen .....370  
 Cleaning your vehicle .....252  
   engine compartment .....254  
   instrument panel .....256  
   interior .....255  
   interior trim .....351  
   plastic parts .....253  
   washing .....252  
   waxing .....254  
   wheels .....257  
   wiper blades .....255  
 Climate control (see Air  
 conditioning or Heating) .....128  
 Clock .....119
- Clutch  
 fluid .....240  
 operation while driving .....167  
 recommended shift speeds ....168
- Compass, electronic .....115  
 calibration .....116  
 set zone adjustment .....116
- Connecting a digital media  
 player to SYNC® .....349
- Console .....149
- Convertible  
 cleaning .....253  
 closing the top .....204  
 installation of the boot .....202  
 opening the top .....200
- Coolant .....235  
 checking and adding .....235  
 refill capacities .....296  
 specifications .....296
- Creating a playlist .....394
- Customer Assistance .....209  
 Ford Extended Service  
 Plan .....305, 307  
 Getting roadside assistance ...209  
 Getting the service you  
 need .....214  
 Ordering additional owner's  
 literature .....220  
 Utilizing the  
 Mediation/Arbitration  
 Program .....218
- Customizing your home  
 screen .....368
- D**
- Defrost .....128, 130  
 rear window .....133

- Dipstick  
 automatic transmission  
 fluid .....239  
 engine oil .....234
- Driving under special  
 conditions .....166  
 through water .....206
- Dual automatic temperature  
 control (DATC) .....130
- E**
- Electronic message center .....97
- Electronic stability control .....177
- Emergencies, roadside  
 jump-starting .....211  
 running out of fuel .....156
- Emission control system .....160
- End user license agreement ....422
- Engine .....295  
 cleaning .....254  
 coolant .....235  
 fail-safe cooling .....238  
 idle speed control .....241  
 lubrication specifications .....296  
 refill capacities .....296  
 service points .....232-233
- Engine block heater .....152
- Engine oil  
 checking and adding .....234  
 dipstick .....234  
 filter, specifications .....300  
 refill capacities .....296  
 specifications .....296
- Event data recording .....12
- Exhaust fumes .....152
- F**
- Fail safe cooling .....238
- Fleet MyKey programming .....57
- Flexible Fuel Vehicle (FFV) ....154
- Floor mats .....207
- Fluid capacities .....296
- Fuel  
 calculating fuel economy .....98  
 cap .....158  
 capacity .....296  
 choosing the right fuel .....155  
 filler funnel .....156  
 filling your vehicle with fuel ..158  
 filter, specifications .....240, 300  
 fuel pump shut-off .....210  
 octane rating .....155, 295  
 quality .....155  
 running out of fuel .....156  
 safety information relating to  
 automotive fuels .....154
- Fuel and distance computer ....107  
 outside temperature  
 indicator .....107  
 to empty indicator .....107  
 trip distance .....107  
 trip/reset button .....107
- Fuel - flex fuel vehicle  
 (FFV) .....154
- Fuses .....222-223
- G**
- Garage door opener .....143
- Gas cap (see Fuel cap) .....158
- Gauges .....90-91, 108  
 odometer .....107  
 trip odometer .....107

**H**

Hazard flashers .....	210
HD Radio™ .....	378
Headlamps	
aiming .....	245
bulb specifications .....	251
flash to pass .....	78
high beam .....	78
Head restraints .....	136
Heating .....	128, 130
Hill start assist .....	170
Homelink wireless control system .....	143
Hood .....	231

**I**

Ignition .....	151, 295
Illuminated visor mirror .....	87–88
Information displays .....	97
Inspection/maintenance (I/M) testing .....	162
Instrument panel	
cleaning .....	256
cluster .....	92

**J**

Jack .....	281
positioning .....	281
storage .....	281
Joining two calls (multiparty/conference call) .....	333
Jukebox features .....	392
Jump-starting your vehicle .....	211

**K**

Keyless entry system	
autolock .....	65
Keys .....	55, 70
positions of the ignition .....	151

**L**

Lamps	
bulb replacement	
specifications chart .....	251
headlamps, flash to pass .....	78
interior lamps .....	82
LATCH anchors .....	27
Lights, warning and indicator .....	92
Limited slip axle (see Traction Loc) .....	170
Loading pictures .....	368
Load limits .....	187
Locks	
autolock .....	65
doors .....	64
Lubricant specifications .....	296
Lug nuts .....	294

**M**

Manual transmission .....	167
fluid capacities .....	296
lubricant specifications .....	296
reverse .....	169
Map icons .....	416
Map mode .....	415
Map updates .....	418
Media Bluetooth menu options (adding, connecting, deleting, turning on/off) .....	354

- Message center .....97  
 display color .....102  
 english/metric button .....102  
 MyColor display .....102  
 system check button .....102  
 warning messages .....102, 111
- Mirrors .....85, 87  
 side view mirrors (power) .....85
- Motorcraft® parts .....252, 300
- MyKey .....57
- N**
- Navigation features .....401
- O**
- Octane rating .....155
- P**
- Pairing other phones .....331
- Pairing your phone for the  
 first time .....330
- Parental MyKey programming ...57
- Parking brake .....174
- Parts  
 (see Motorcraft® parts) .....300
- Phone Bluetooth menu options  
 (adding, connecting, deleting,  
 turning on/off) .....339
- Phone redial .....334
- Playing music (by artist,  
 album, genre, playlist, tracks,  
 similar) .....352
- POI categories .....410
- Point of Interest (POI) .....410
- Power distribution box  
 (see Fuses) .....223
- Power door locks .....64
- Power mirrors .....85
- Powerpoint .....148
- Power steering .....185
- Power Windows .....83
- Privacy information .....327
- Putting a call on/off hold .....333
- Q**
- Quick touch buttons .....417
- R**
- Radio .....119  
 CD-MP3 .....119
- Radio reception .....117
- Radio voice commands .....376, 382
- Rear view camera display .....180
- Rear window defroster .....128, 130
- Receiving a text message .....335
- Recommendations for  
 attaching safety restraints for  
 children .....24
- Relays .....222–223
- Remote entry system  
 illuminated entry .....66  
 locking/unlocking doors .....64  
 opening the trunk .....65  
 replacing the batteries .....56
- Reverse sensing system .....180
- Roadside assistance .....209

- S**
- Safety Belt Maintenance .....41
  - Safety belts  
(see Safety restraints) .....35
  - Safety defects, reporting .....221
  - Safety information .....326
  - Safety restraints .....35–36
    - Belt-Minder® .....38
    - extension assembly .....38
    - for adults .....35–36
    - for children .....19, 24
    - safety belt maintenance .....41
    - seat belt maintenance .....41
    - warning light and chime .....38
  - Safety restraints -  
LATCH anchors .....27
  - Safety seats for children .....19, 24
  - Safety Compliance  
Certification Label .....302
  - Satellite Radio .....119, 386
  - Scheduled Maintenance Guide
    - Normal Scheduled  
Maintenance and Log .....313
  - SD card .....401
  - Seat belts  
(see Safety restraints) .....35
  - Seats .....141
    - child safety seats .....19, 24
    - front seats .....138–139
    - heated .....140
    - second row seats .....141
  - SecuriLock passive anti-theft  
system .....69
  - Selecting your media source  
(USB, Line in, BT audio) .....352
  - Setting a destination .....401
  - Setting the clock .....119
  - SIRIUS® satellite  
radio .....119, 382, 401
  - SIRIUS satellite radio voice  
commands .....385
  - SIRIUS Travel Link .....398
  - SOS Post Crash Alert .....44
  - Spark plugs,  
specifications .....295, 300
  - Specification chart,  
lubricants .....296
  - Stability system .....177
  - Starting your vehicle .....151
    - jump starting .....211
  - Status bars .....368
  - Steering wheel .....74
    - controls .....74
    - tilting .....74
  - Sunshade .....89
  - Supplemental Restraint System  
(SRS) (see airbags) .....45
  - Supported media file types .....351
  - SYNC® AppLink™ .....348
  - SYNC® customer support .....326
  - SYNC® Services .....345
  - System overview .....362, 365
- T**
- Temperature control  
(see Climate control) .....128, 130
  - Temporary mobility kit .....286
  - Text messaging .....335
  - Text messaging (sending,  
downloading, deleting) .....335, 337

- Tilt steering wheel .....74
- Tires .....261–262, 281  
 alignment .....275  
 care .....261  
 changing .....281, 283  
 checking the pressure .....271  
 inflating .....269  
 label .....268  
 replacing .....273  
 rotating .....275  
 safety practices .....274  
 sidewall information .....264  
 snow tires and chains .....276  
 spare tire .....281  
 Temporary mobility kit .....286  
 terminology .....262  
 tire grades .....262  
 treadwear .....261, 271
- Touchscreen features  
 (climate) .....396
- Towing .....194, 198–199  
 recreational towing .....199  
 trailer towing .....194  
 wrecker .....198
- Traction control .....175
- Traction-lok rear axle .....170
- Traffic, Directions and  
 Information .....345
- Transmission  
 automatic operation .....163  
 brake-shift interlock (BSI) ....165  
 fluid, checking and adding  
 (automatic) .....239  
 fluid, checking and adding  
 (manual) .....240  
 fluid, refill capacities .....296  
 lubricant specifications .....296
- Troubleshooting .....420
- Trunk .....68
- remote release .....65, 67
- Turn signal .....82
- U**
- USB port .....124, 349
- Using privacy mode .....333
- V**
- Vehicle health report .....343
- Vehicle Identification Number  
 (VIN) .....301
- Vehicle loading .....187
- Ventilating your vehicle .....152
- Visor storage system .....88
- Voice commands in media  
 mode .....350
- Voice commands in phone  
 mode .....331
- Voice recognition .....370
- W**
- Warning lights (see Lights) .....92
- Washer fluid .....241
- Water, Driving through .....206
- Where am I? .....397
- Windows  
 power .....83
- Windshield washer fluid and  
 wipers .....77  
 checking and adding fluid ....241  
 replacing wiper blades .....243
- Wrecker towing .....198