

IMPERIAL IMI MAILBOX SYSTEMS





STANDARD COLORS

Custom Colors and Logos Available

STANDARD COLORS

Black



Bronze



Green



Almond



Verde



Grey



White



Custom Logo





Curb Appeal. These two words are often repeated during the planning stages of a residential development. Guidelines and restrictions are placed on homebuilders and owners to ensure the quality and aesthetic value of each home constructed. The shutters, trim, doors, even the lawns of each home have carefully outlined procedures to protect the value and pattern of the development. Imperial Mailbox Systems continues this careful attention to detail in this beautification and standardization process by providing the highest quality **U.S.P.S.** and **D.O.T. Approved** mailboxes and street signage.

As members of several national housing organizations, such as the **National Association of Home Builders** and the **National Golf Foundation**, Imperial Mailbox Systems has provided planned developments and communities across the United States with quality cast-aluminum mailboxes, street signage, and patio light poles. Our selection, illustrated in this catalogue, is designed to complement and standardize all of your curbside and traffic sign needs. All of our products are rust-free and are Postmaster and Department of Transportation approved.

It is our mission to serve you by providing U.S.P.S. approved mailboxes, and matching D.O.T. approved street signs. Leading the industry, Imperial has proven itself through partnerships with both organizations, and have a proven ISO 9001:2000 compliant system to continue to improve our products, services, and customer satisfaction.

Contact our customer service department today at **1-800-647-0777**, or visit us online at **www.imperialmailboxsystems.com**, for more information about how Imperial products are right for your project, or to find more information about U.S. Postal or D.O.T standards and requirements. Give yourself the opportunity to realize the added value of your development's curb appeal with mailboxes, street signs, and light poles from Imperial Mailbox Systems!





IMPERIAL MAILBOX SYSTEMS COMPONENT SHEET

Mailbox Posts

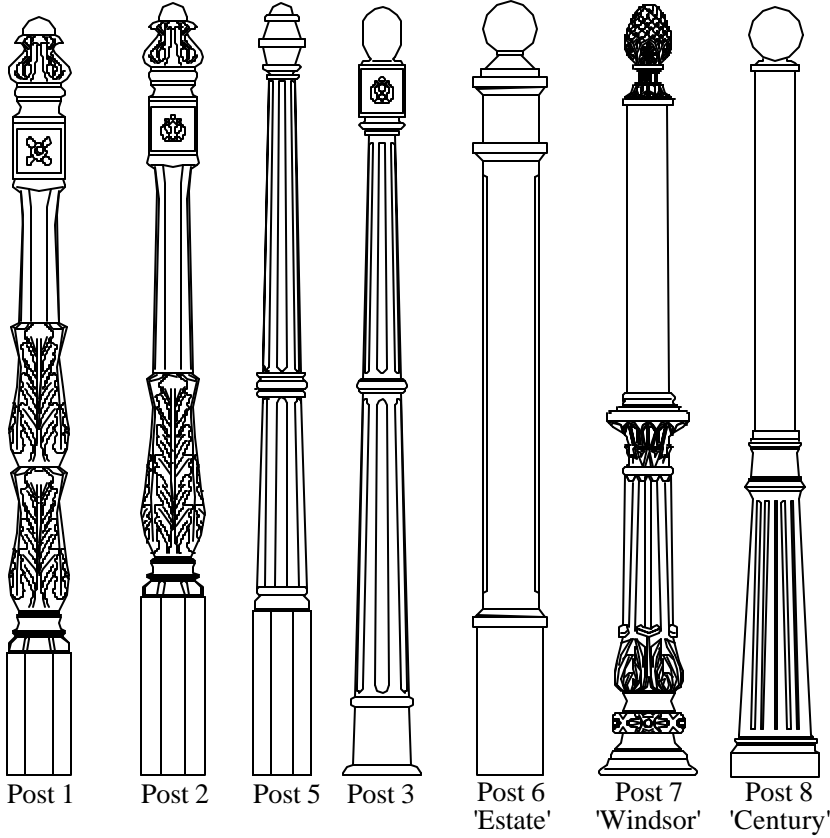

Mailboxes

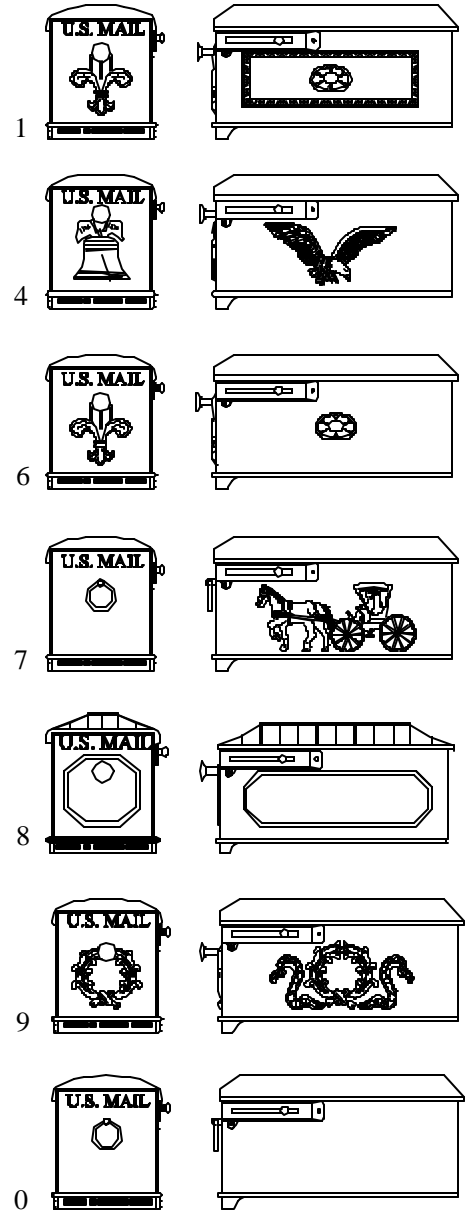

Mailbox Accessories

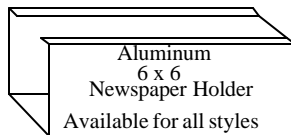
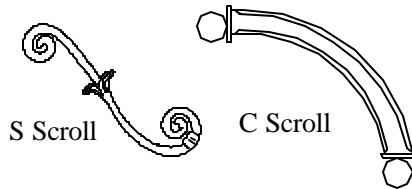

Number Plate

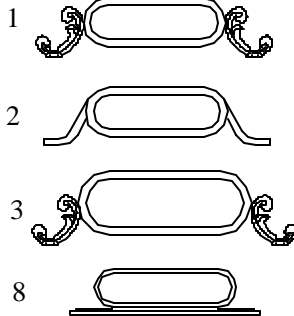

1, 2, 3, 4, 5, 6, 7, 8, 9, 0
2" and 3" Brass Numerals

ALL MAILBOXES EQUIPPED WITH KNOB
OR RING PULL FOR FRONT DOOR



CUSTOM LOGOS AVAILABLE!



USPS STD 7B Approved Mailboxes Are Required for all Residential Developments.

Tel: 800-647-0777 :: Fax: 334.285.6635 :: www.imperialmailboxsystems.com



HOW TO ORDER IMPERIAL MAILBOX SYSTEMS SYSTEM CODE SPECIFICATION

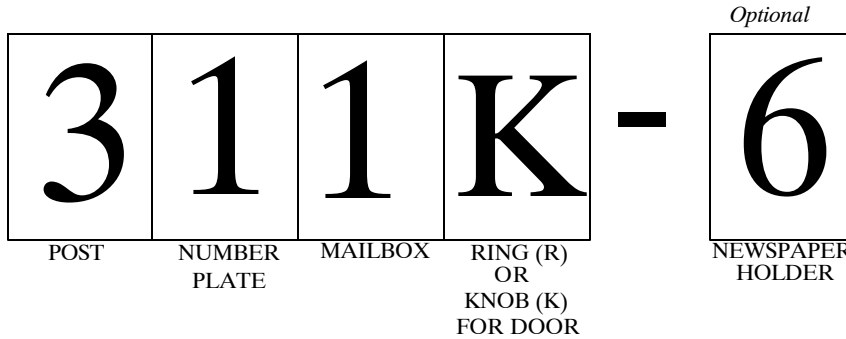

Sample System:

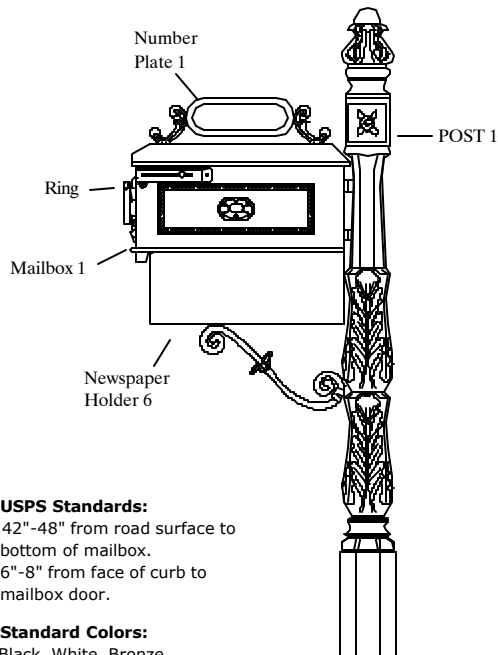
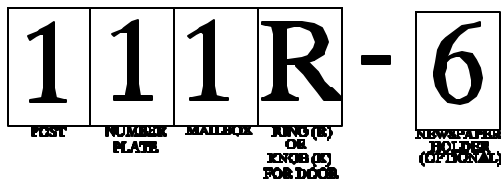

USPS Standards:
 42"-48" from road surface to bottom of mailbox.
 6"-8" from face of curb to mailbox door.

Standard Colors:
 Black, White, Bronze, Green, Grey, and Almond.

SPECIFICATIONS

-All Systems Include 'S' Scroll Support Brace
 *Note: Estate Systems featuring #6 Post use C - Scroll

-Mailbox 8 and Number Plate 8 can only be used together.
 Example:

~~388K~~, ~~328K~~, ~~384K~~

1 2 3 4 5 6 7 8 9 0

-2" Brass Numerals Available For Number Plates 1, 2, and 8.

-3" Brass Numerals Available For Number Plate 3

-All Systems Designed For Direct Ground Burial.



USPS STD 7B Approved Mailboxes Are Required for all Residential Developments.

Tel: 800-647-0777 :: Fax: 334.285.6635 :: www.imperialmailboxsystems.com



SAMPLE CONFIGURATIONS OF MAILBOX SYSTEMS

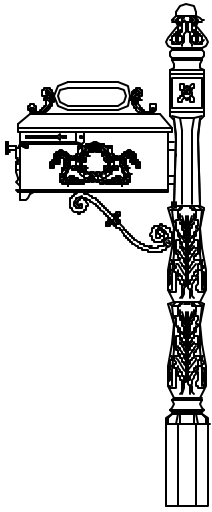

119K

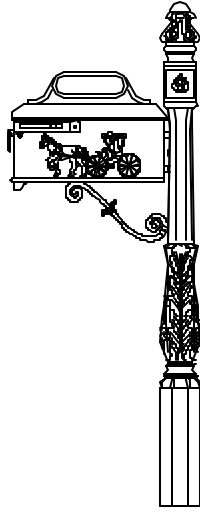

227R

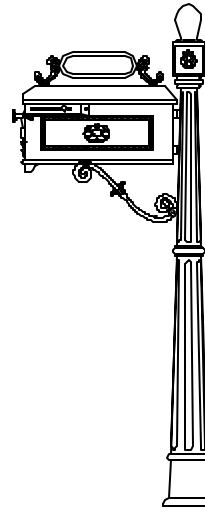

311K

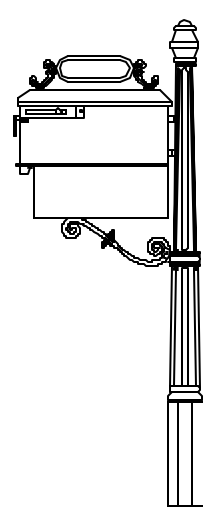

510R-6

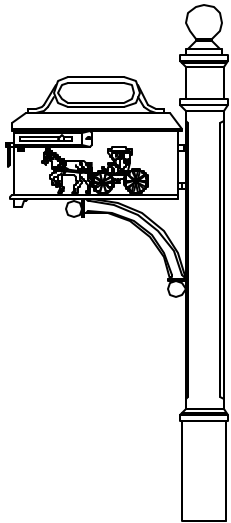

627R

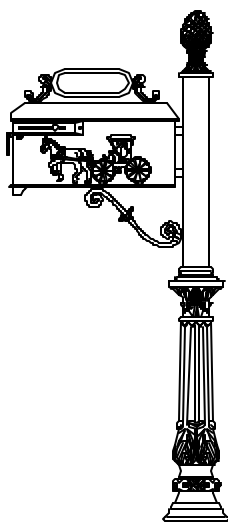

717R

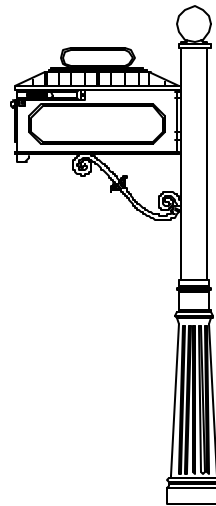

888K

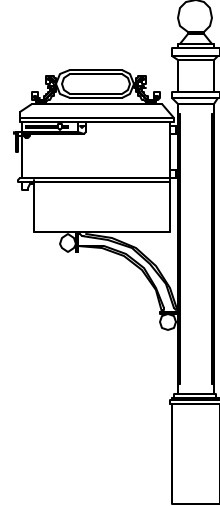

610R-6

Many options are available for you to choose from. Estate Series Mailboxes are 45 % larger than standard Imperial mailboxes, and are not available as twin systems. Matching Street Signs and Light Poles are available for every configuration! Call us today at 800.647.0777 or visit us online at www.imperialmailboxsystems.com and see how we can assist you in beautifying your development with our exclusive product line.

Looking for a specific configuration?
Call us at 800.647.0777 and request a
drawing to be emailed to you today!



USPS STD 7B Approved Mailboxes Are Required for all Residential Developments.

Tel: 800-647-0777 :: Fax: 334.285.6635 :: www.imperialmailboxsystems.com



"ESTATE SERIES" MAILBOX SYSTEMS
FEATURING POST 6 AND EXTRA-LARGE ESTATE MAILBOX

SYSTEM CODE SPECIFICATION

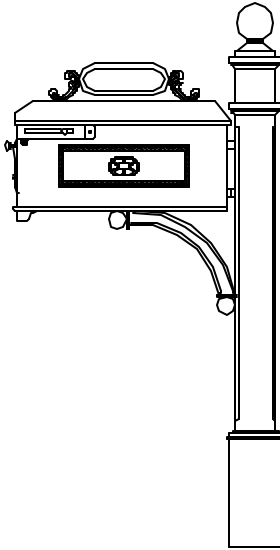
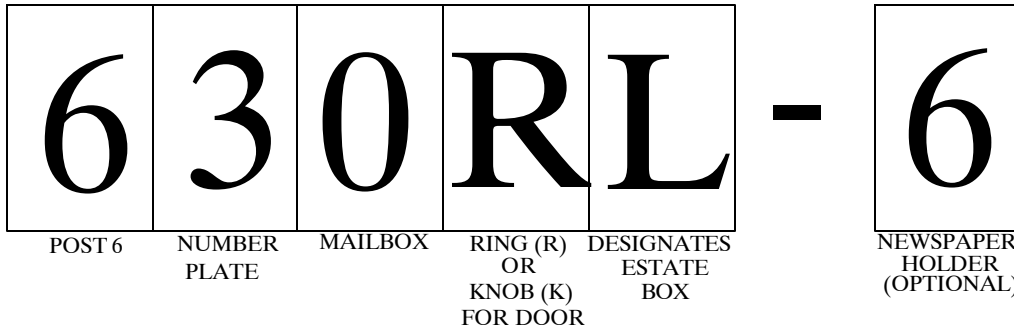

631KL

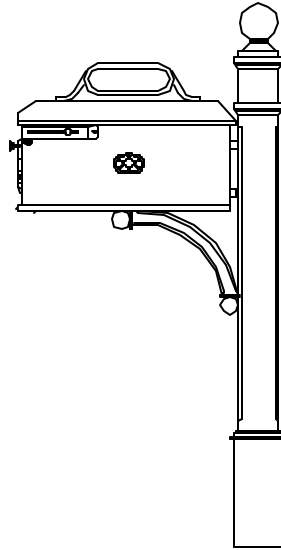

626KL

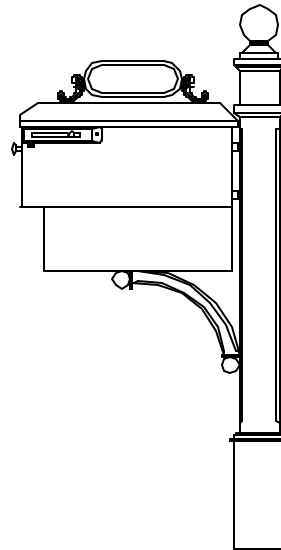

630KL-6

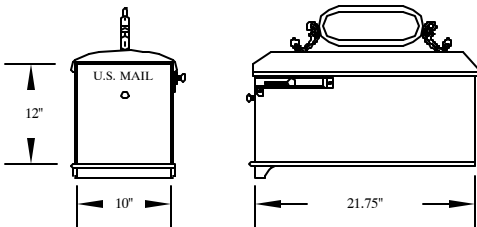

ESTATE SERIES MAILBOXES
ARE 45% LARGER THAN STANDARD
IMPERIAL MAILBOXES

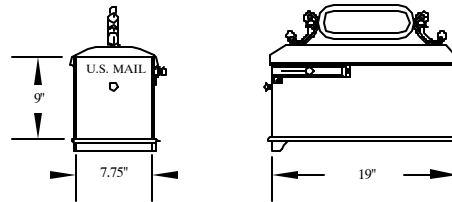

STANDARD IMPERIAL MAILBOX

Looking for a specific configuration?
Call us at 800.647.0777 and request a
drawing to be emailed to you today!



USPS STD 7B Approved Mailboxes Are Required for all Residential Developments.

Tel: 800-647-0777 :: Fax: 334.285.6635 :: www.imperialmailboxsystems.com



"TWIN" CAST ALUMINUM MAILBOX SYSTEMS FEATURES TWO MAILBOXES ON ONE POST

SYSTEM CODE SPECIFICATION

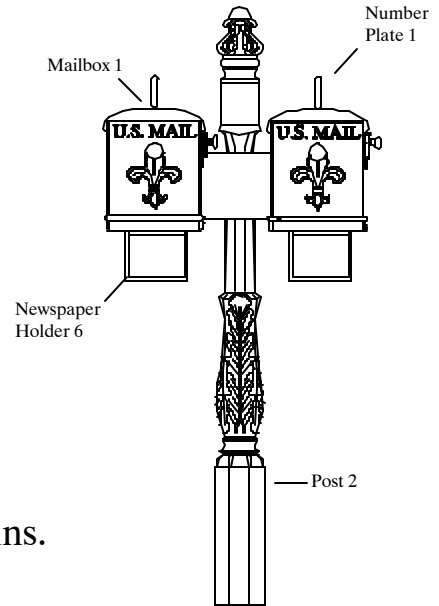
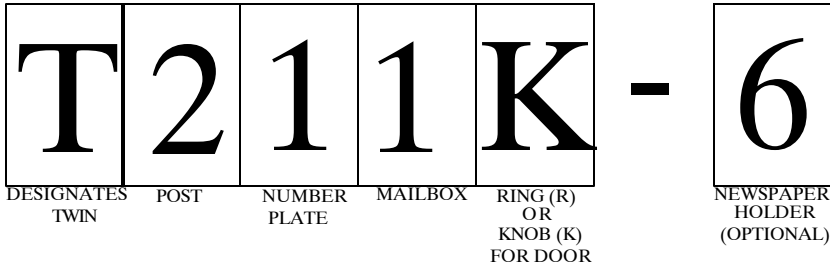

Twin systems are available with Imperial Series,
Century Series, and Estate Series Mailbox Systems.
Extra-large Estate mailboxes are not available as twins.

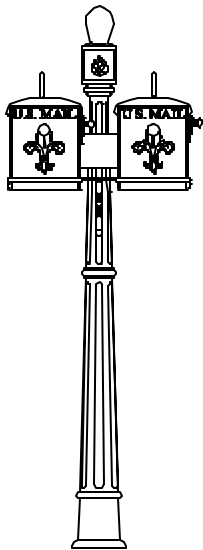

T321K

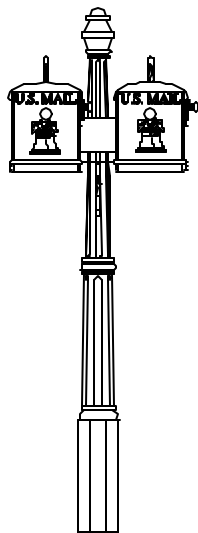

T514K

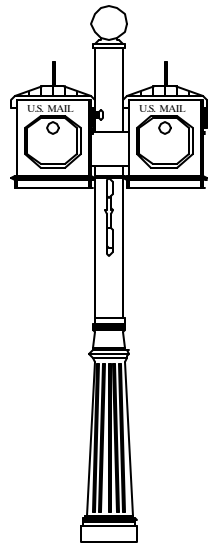

T888K

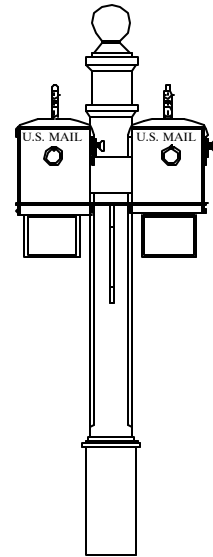

T630R-6

Looking for a specific configuration?
Call us at 800.647.0777 and request a
drawing to be emailed to you today!



USPS STD 7B Approved Mailboxes Are Required for all Residential Developments.

Tel: 800-647-0777 :: Fax: 334.285.6635 :: www.imperialmailboxsystems.com



IMPERIAL POST SYSTEMS COMPONENT SHEET

Imperial post systems feature a decorative post and brace combination with your choice of base and finial styles. They are designed for use with standard, Post Office approved rural mailboxes.

POSTS

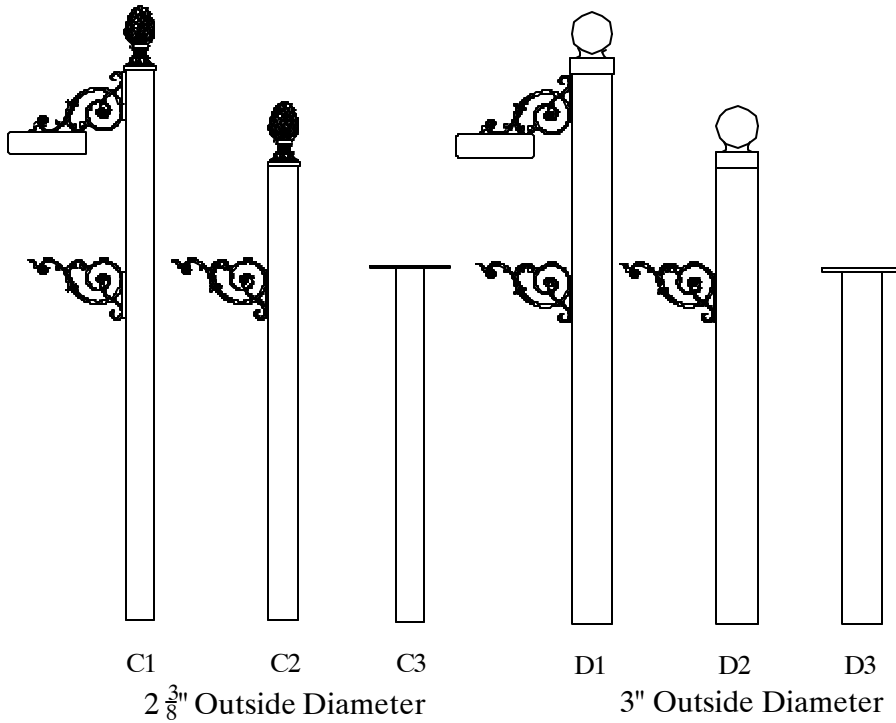

BASES

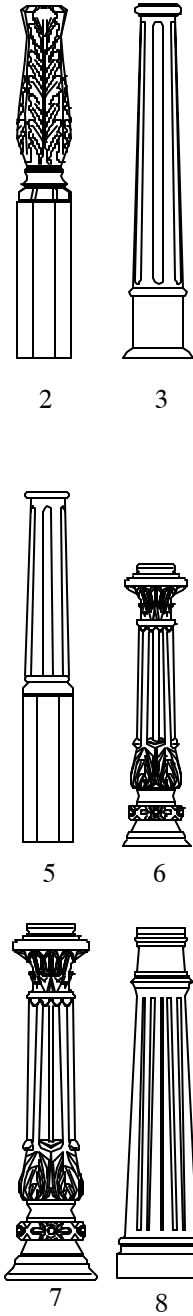

FINIALS

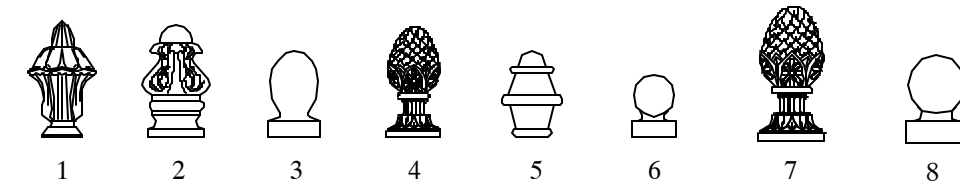

Number Plate 4



H

Newspaper Holder 7

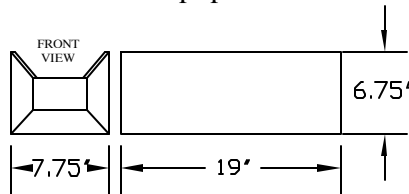
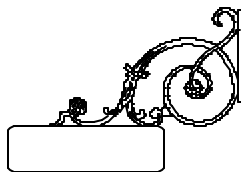

Designed for use with large size rural mailboxes

Base 7-8 and Finial 7-8 are only available in "D" series posts.



USPS STD 7B Approved Mailboxes Are Required for all Residential Developments.

Tel: 800-647-0777 :: Fax: 334.285.6635 :: www.imperialmailboxsystems.com



HOW TO ORDER 'C' AND 'D' SERIES POST SYSTEMS SYSTEM CODE SPECIFICATION

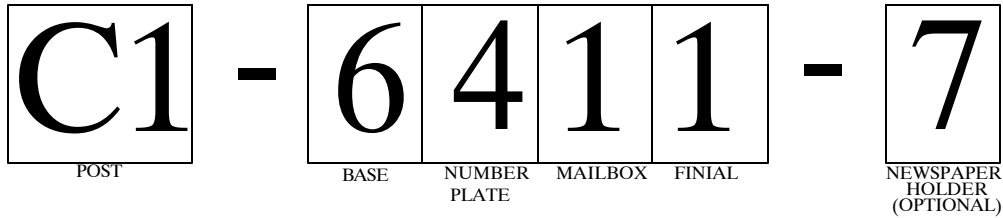

SYSTEM RENDERING FROM
CODE SPECIFIED ABOVE:

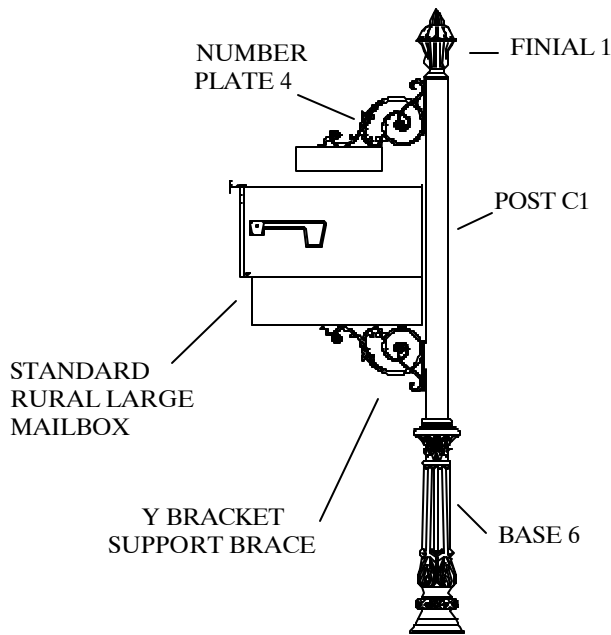

USPS Standards:

42"-48" from road surface to bottom of mailbox.
6"-8" from face of curb to mailbox door.

Standard Colors:

Black, White, Bronze, Green, Grey, and Almond.

SPECIFICATIONS

- Bases, finials, and address plates are die cast using high grade aluminum providing strength, durability, and unsurpassed quality.
- Post Systems utilize an extruded aluminum pole.
- Every post has a wall thickness of .109" and meets all ASTM Standards.
- Number Plate 4 is featured only on C1 and D1 systems.
- C2/D2, and C3/D3 systems are available with Number Plates: 1, 2, and 3 (see page 2 for illustration)
- 3" Brass Numerals Available For Number Plates 3 and 4.
- All Systems Designed for Direct Ground Burial.



USPS STD 7B Approved Mailboxes Are Required for all Residential Developments.

Tel: 800-647-0777 :: Fax: 334.285.6635 :: www.imperialmailboxsystems.com



IMI SAMPLE IMPERIAL POST SYSTEM CONFIGURATION

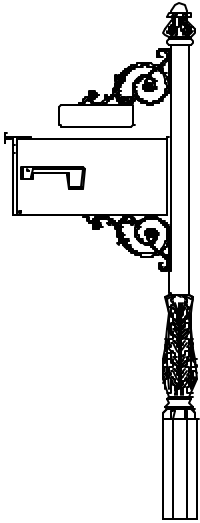

C1-2412

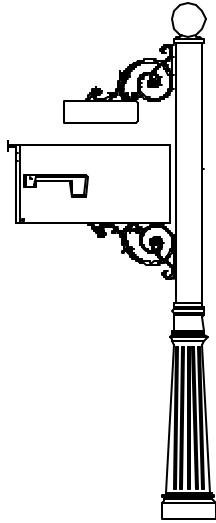

D1-8418

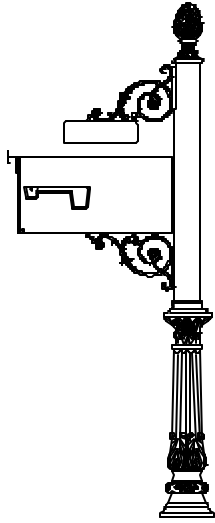

D1-7417

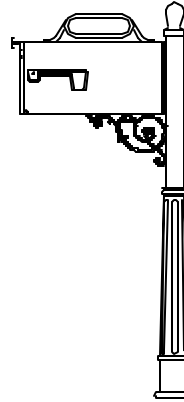

C2-3213

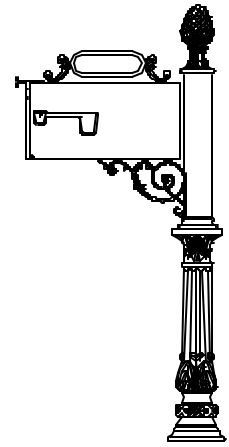

D2-7117

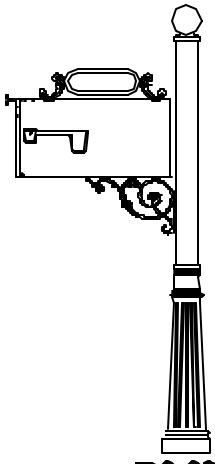

D2-8218

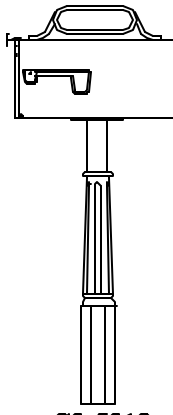

C2-5210

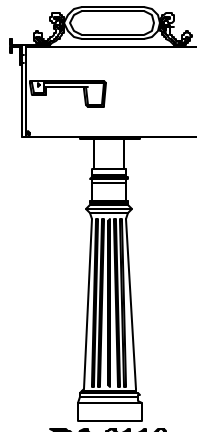

D3-8110

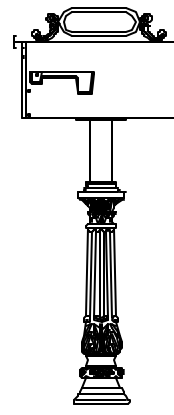

D3-7110

Many options are available for you to choose from. All Post Systems featured are depicted with a Solar Box Type S1 (optional). Matching Street Signs and Light Poles are available for every configuration! Call us today at 800.647.0777 or visit us online at www.imperialmailboxsystems.com and see how we can assist you in beautifying your development with our exclusive product line.

Looking for a specific configuration?
Call us at 800.647.0777 and request a
drawing to be emailed to you today!



USPS STD 7B Approved Mailboxes Are Required for all Residential Developments.

Tel: 800-647-0777 :: Fax: 334.285.6635 :: www.imperialmailboxsystems.com



TWIN IMPERIAL POST SYSTEMS

AVAILABLE WITH C2, D2, C3, AND D3 POSTS

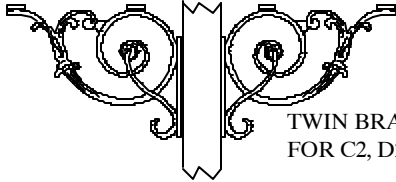

TWIN BRACKETS
FOR C2, D2 POLES

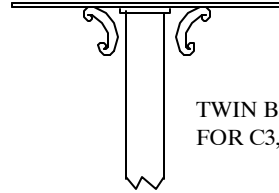

TWIN BRACKETS
FOR C3, D3 POLES

SYSTEM CODE SPECIFICATION

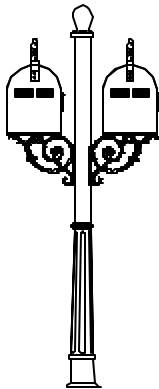
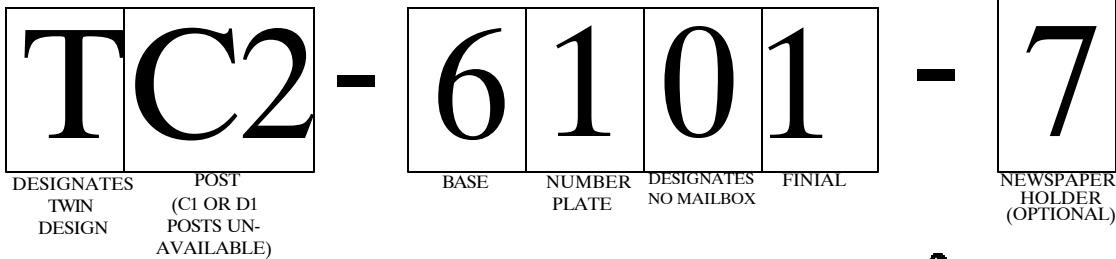

TC2-3113

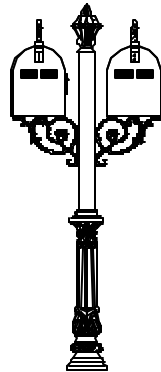

TC2-6112

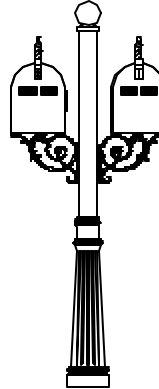

TD2-8118

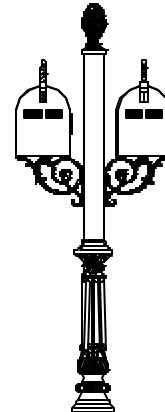

TD2-7117

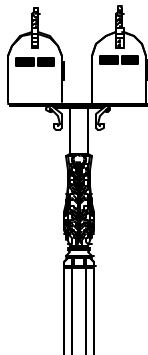

TC3-2110

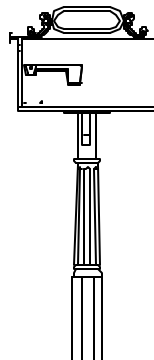

TC3-5110

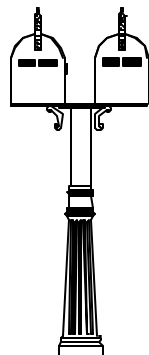

TD3-8110

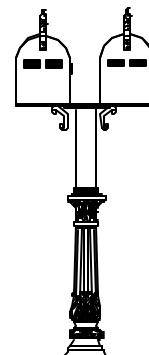

TD3-7110



USPS STD 7B Approved Mailboxes Are Required for all Residential Developments.

Tel: 800-647-0777 :: Fax: 334.285.6635 :: www.imperialmailboxsystems.com



"CARSON SERIES" POST SYSTEMS
Features C3 or D3 posts with an Imperial mailbox 8.

SYSTEM CODE SPECIFICATION

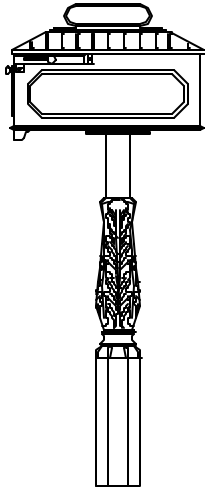
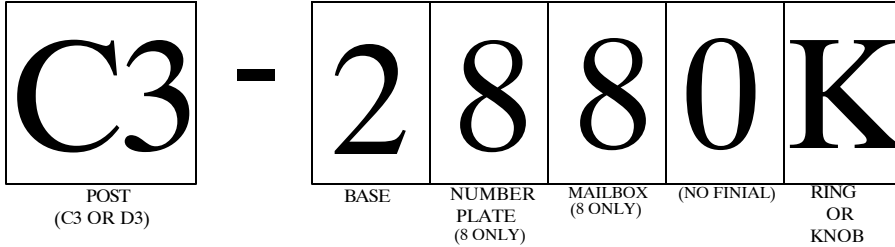

C3-2880K

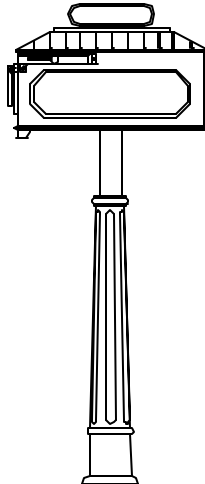

C3-3880R

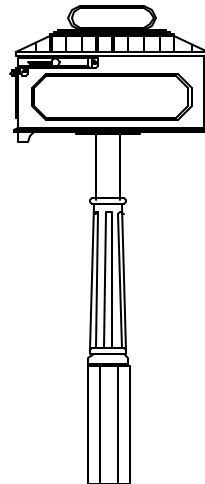

C3-5880K

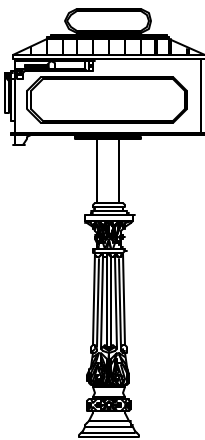

C3-6880R

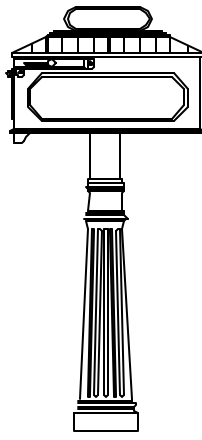

D3-8880K

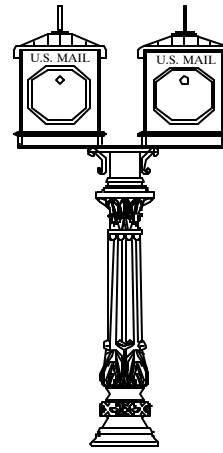

TD3-7880K

ALSO AVAILABLE
IN A TWIN DESIGN

NEWSPAPER HOLDERS ARE NOT AVAILABLE
FOR CARSON SERIES SYSTEMS



USPS STD 7B Approved Mailboxes Are Required for all Residential Developments.

Tel: 800-647-0777 :: Fax: 334.285.6635 :: www.imperialmailboxsystems.com



M-SERIES SYSTEMS

SYSTEM CODE SPECIFICATION

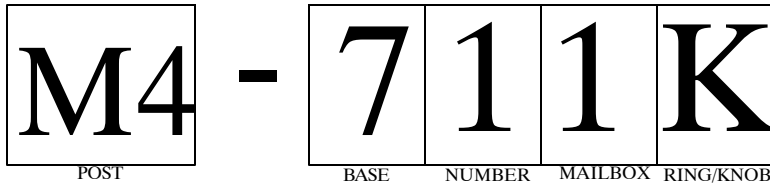

-M-SERIES SYSTEMS ARE AVAILABLE WITH CENTURY, ESTATE, OR WINDSOR POSTS.

-ALL IMPERIAL MAILBOXES AND NUMBER PLATES ARE AVAILABLE.

-MAXIMUM 6 MAILBOXES PER SHELF

-SYSTEMS CANNOT BE CONFIGURED WITH A NEWSPAPER HOLDER

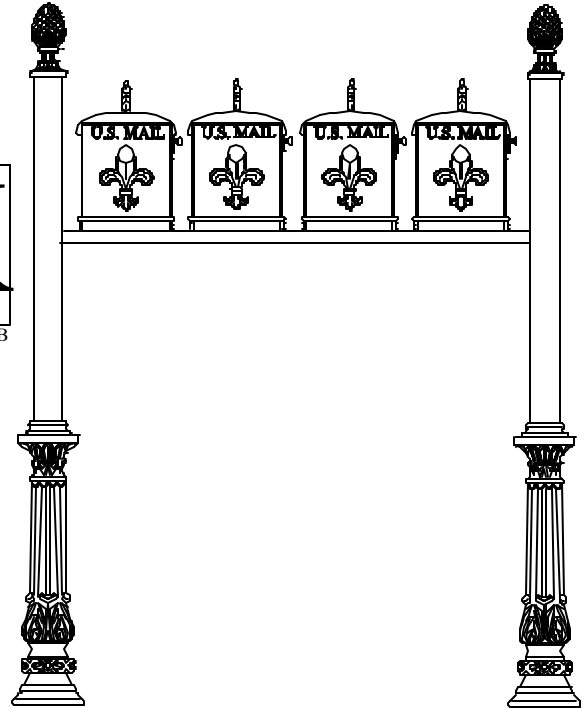

M4-711K

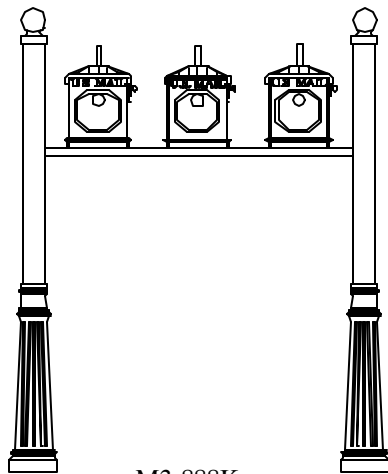

M3-888K

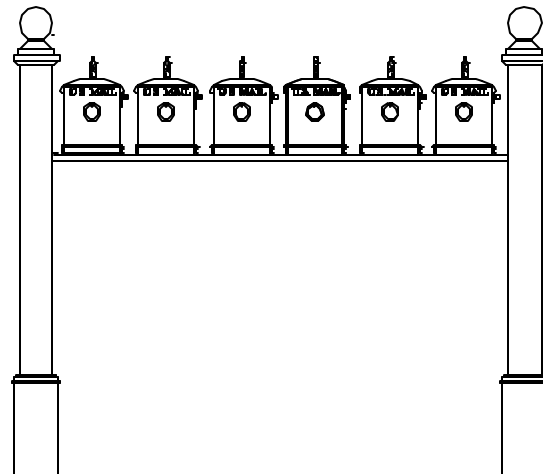

M6-610R



USPS STD 7B Approved Mailboxes Are Required for all Residential Developments.

Tel: 800-647-0777 :: Fax: 334.285.6635 :: www.imperialmailboxsystems.com



DECORATIVE POSTS FOR CBU SYSTEMS

SYSTEM CODE SPECIFICATION

CBU	6	PM
CLUSTER BOX UNIT	POST	INSTALLATION TYPE

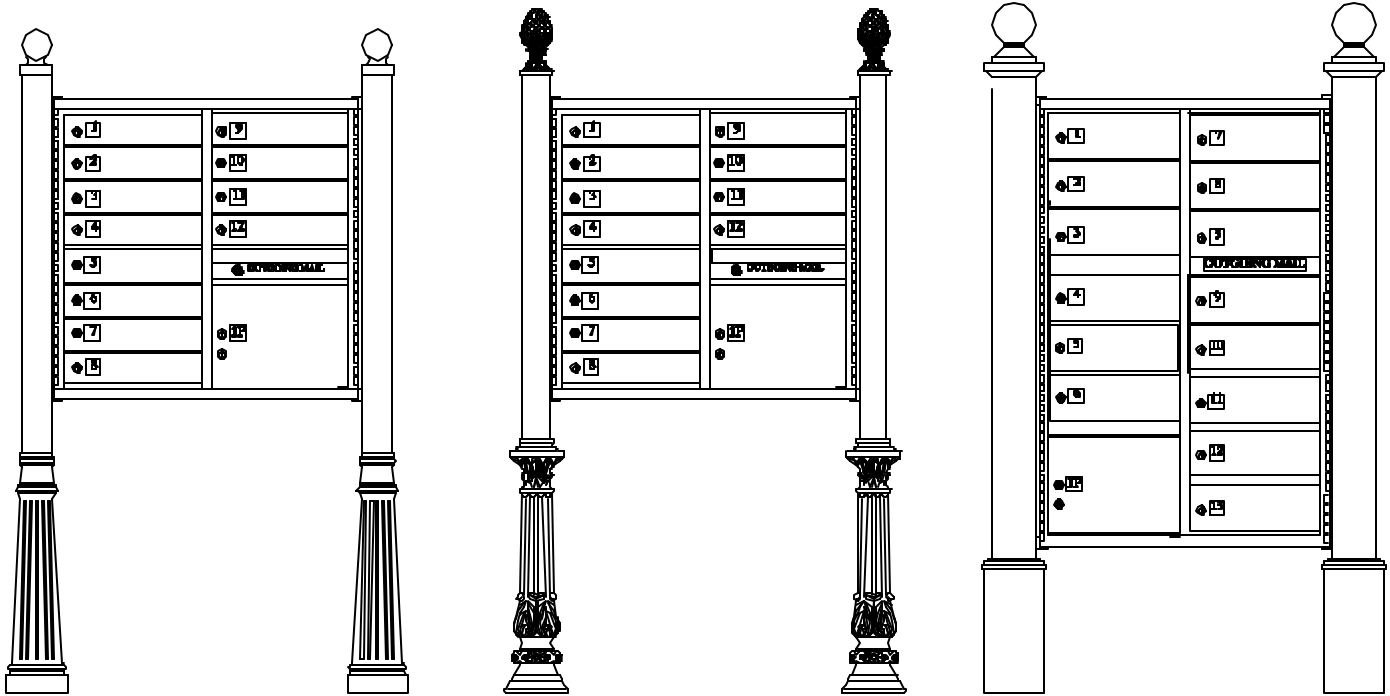

Our Decorative Post Systems offer an attractive option for the installation of CBU's as required by the U.S.P.S., such as: apartment complexes, industrial and business centers, or university locations. Decorative Posts for CBU Systems are available in Century, Estate, or Windsor Series. Options Include Direct Ground Burial (DB), or Pier-Mounted (PM).

USPS STD 7B Approved Mailboxes Are Required for all Residential Developments.

Tel: 800-647-0777 :: Fax: 334.285.6635 :: www.imperialmailboxsystems.com



IMPERIAL AND ESTATE SIGN SYSTEMS

Imperial has three standard pole lengths designed to meet the industry standard height-to-grade requirements of seven feet.

POLE LENGTH 1 = 14' 6"
POLE LENGTH 2 = 12'
POLE LENGTH 3 = 11'

CUSTOM POLE LENGTHS ARE AVAILABLE,
CONTACT A SALES REPRESENTATIVE
FOR A QUOTE.

IMPERIAL SIGN POLES:

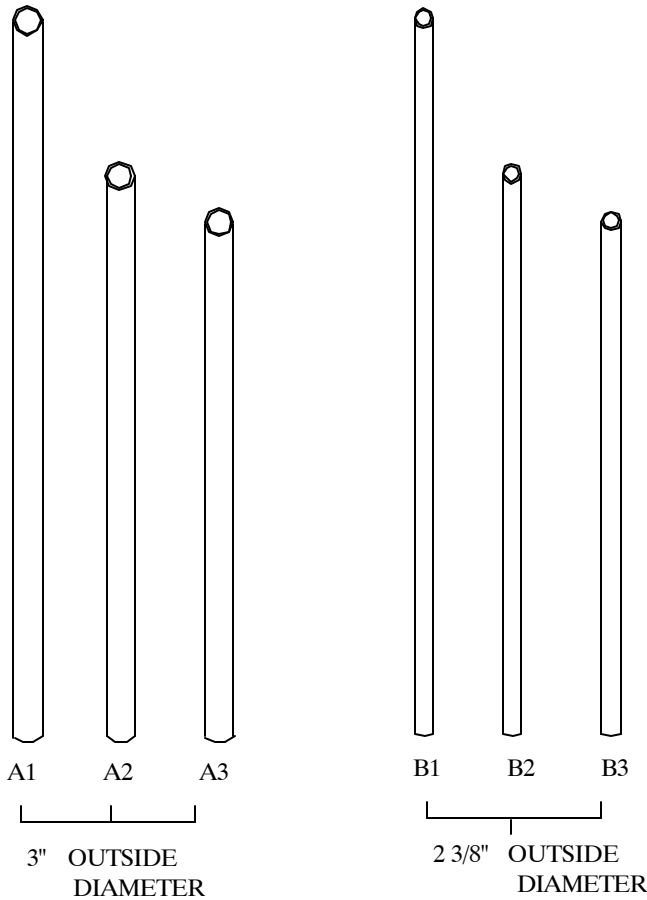

ALL BASE AND FINIAL STYLES FEATURED ON PAGE (7) ARE AVAILABLE FOR CENTURY AND IMPERIAL SIGN SYSTEMS.

ESTATE SIGN POLES:

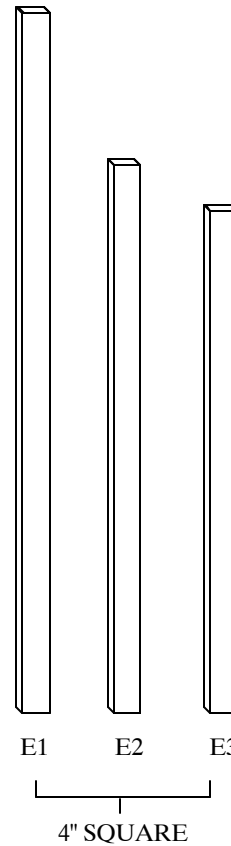

SQUARE BASE AND FINIAL STYLE FEATURED BELOW ARE AVAILABLE FOR ESTATE SIGN SYSTEMS.

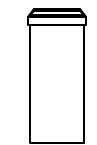

BASE 6 SQ



FINIAL 6 SQ





HOW TO ORDER SIGN SYSTEMS

SYSTEM CODE SPECIFICATION

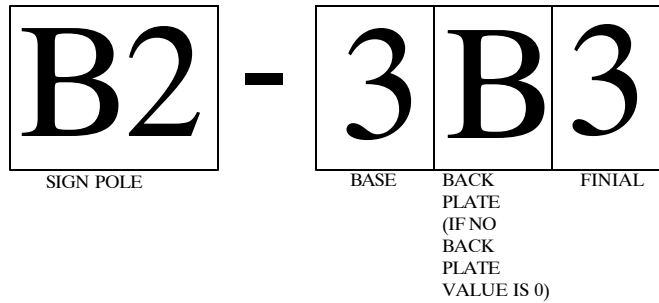

SYSTEM RENDERING FROM
CODE SPECIFIED ABOVE:

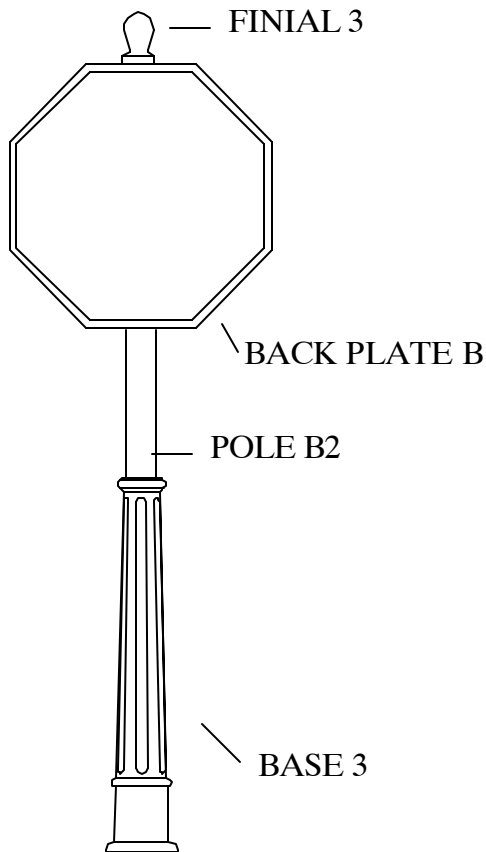

SPECIFICATIONS

-D.O.T. Standard And Custom Sign Faces And Street Name Signs Available.

-All Sign Systems utilize an extruded aluminum pole meeting ASTM Standards. Century Poles are Schedule 80, Imperial Poles are Schedule 10, Estate Poles have a wall thickness of .109".

- All Systems Designed for Direct Ground Burial.

- All Street Signs Are Finished Using A Premium Enamel Paint Ensuring Continuity Of Service.





IMPERIAL SIGN SYSTEMS

SIGN BACK PLATES

Imperial's solid cast back plates are designed to accommodate Department of Transportation standard stop, yield, and information signs.

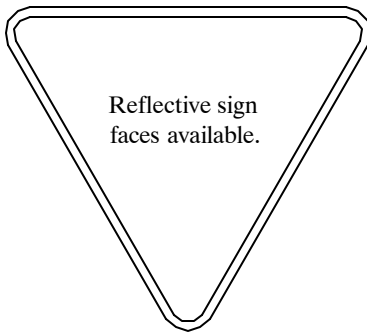

CODE	SIZE
A	30"

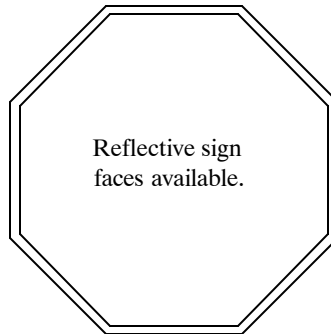

CODE	SIZE
B	30"
C	24"
D	18"



CODE	SIZE
E	30"
F	24"
U	18"

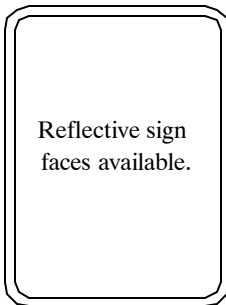

CODE	SIZE
K	24" x 30"
N	18" x 24"
T	12" x 18"



CODE	SIZE
I	30" x 30"
L	24" x 24"
P	18" x 18"

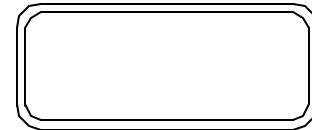

CODE	SIZE
H	36" x 12"

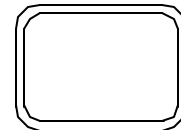

CODE	SIZE
R	12" x 6"

CUSTOM BACK PLATE SIZES AVAILABLE, CONTACT A SALES REPRESENTATIVE FOR A QUOTE.





RAISED LETTER BLADES AND THE LANDMARK FRAME SYSTEM

These exclusive designs add style and strength to any standard street name sign.



RLB Designates Raised Letter Blade
FRB Designates Landmark Frame

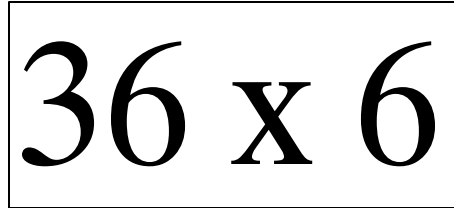

Length and Height of RLB or Frame

RAISED LETTER BLADES ARE DIE CAST FOR AN ELEGANT TOUCH OF CLASS. FRAMES ARE CONSTRUCTED OF EXTRUDED ALUMINUM.

RAISED LETTER BLADE LENGTHS ARE 30" AND 36"
RAISED LETTER BLADE HEIGHTS ARE 6" ONLY

ALL FRAMES ARE DESIGNED TO ACCOMMODATE STANDARD DEPARTMENT OF TRANSPORTATION STREET NAME SIGNS.

FRAME LENGTHS ARE 24", 30", 36", AND 42"
FRAME HEIGHTS ARE 6" AND 9"
CUSTOM SIZES ARE AVAILABLE.



For additional appeal, add a decorative scroll to your Landmark Frame or Raised Letter Blade.

RAISED LETTER BLADE WITH SCROLL ATTACHED

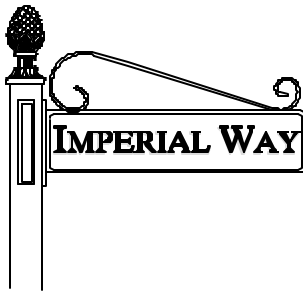

LANDMARK FRAME WITH SCROLL ATTACHED

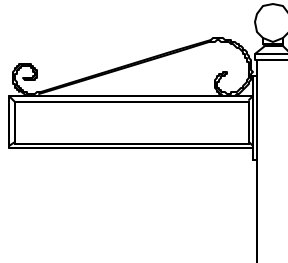

HANGING FRAME WITH SCROLL ARM

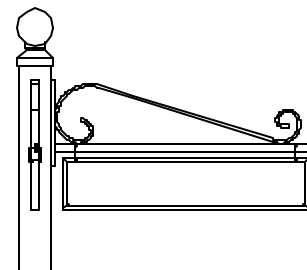



SAMPLE CONFIGURATIONS OF STREET SIGN SYSTEMS

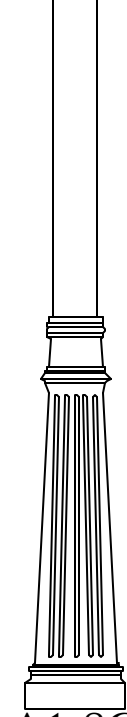
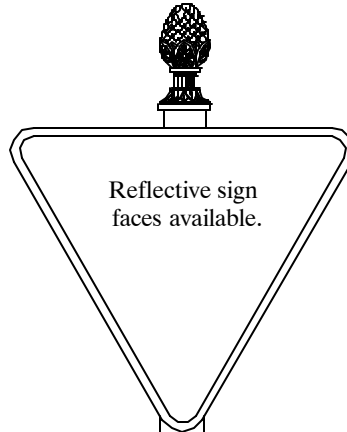
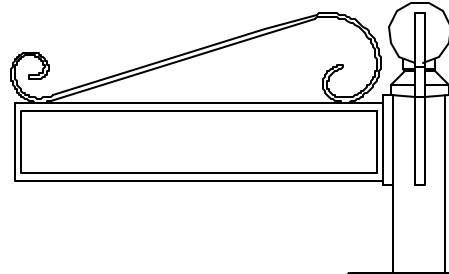
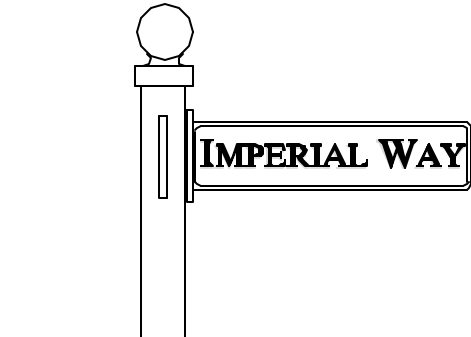

A1-8C8

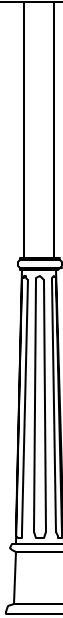

B3-3N3

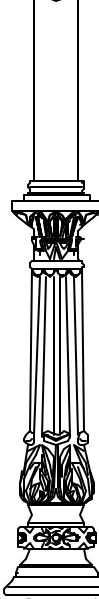

A2-7A7

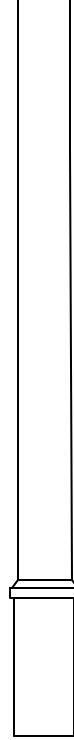

E1-6B6





DECORATIVE LIGHT POLES

Imperial's line of decorative light poles are the perfect accent to any landscape. The poles are made for use with standard gas or electric lights available in your area.

SYSTEM CODE SPECIFICATION

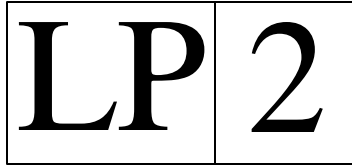

DESIGNATES
LIGHT POLE

BASE
(STYLES FOUND
ON PAGE 7)

SYSTEM RENDERING FROM
CODE SPECIFIED ABOVE:

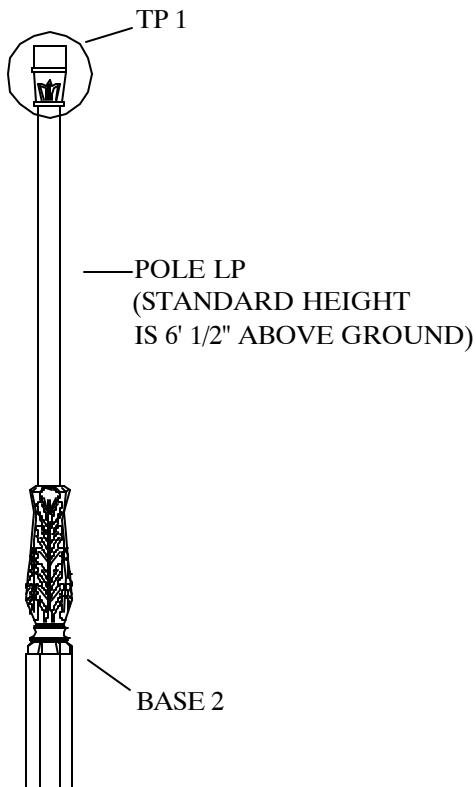

- ALL 2 3/8" OD LIGHT POLES ARE
EQUIPPED WITH A DECORATIVE
TRANSITION PIECE (TP 1) TO
ACCOMMODATE A 3" LIGHT FIXTURE.

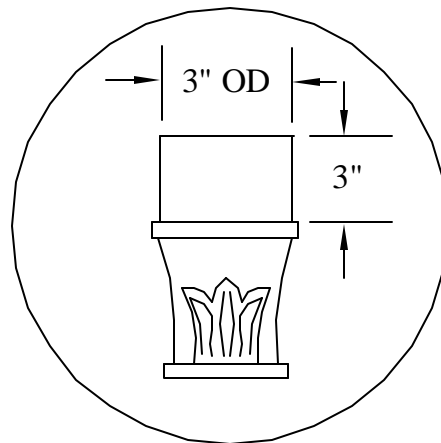

- 3" OD LIGHT POLES (USED WITH
BASE 7 OR 8) DO NOT INCLUDE THE
TRANSITION PIECE.

* LIGHT FIXTURES
SHOWN SOLD SEPERATELY





DECORATIVE LIGHT POLES

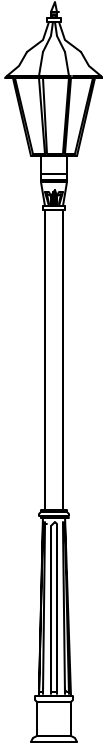

LP 3

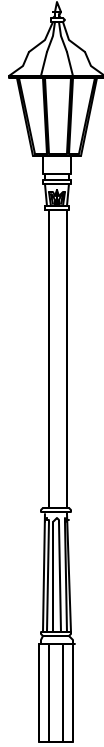

LP 5

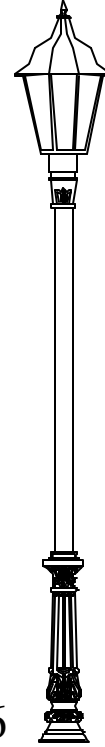

LP 6

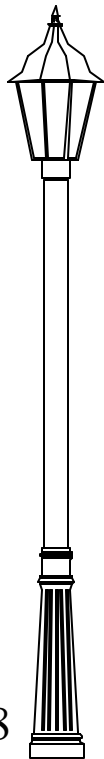

LP 8

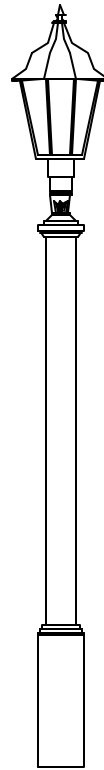

LP 6 SQ



USPS APPROVED
IMPERIAL
IMI Mailbox Systems



U.S. D.O.T.
APPROVED

* LIGHT FIXTURES
SHOWN SOLD
SEPERATELY.



LIGHT POLE MAILBOX SYSTEMS

Imperial mailboxes can be mounted to light poles to combine two streetscape solutions.

SYSTEM CODE SPECIFICATION

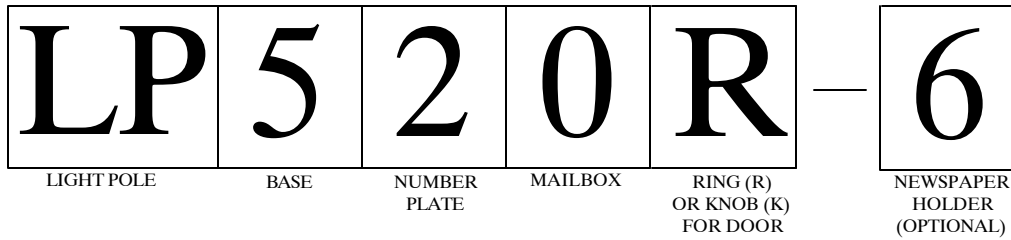

SYSTEM RENDERING FROM
CODE SPECIFIED ABOVE:

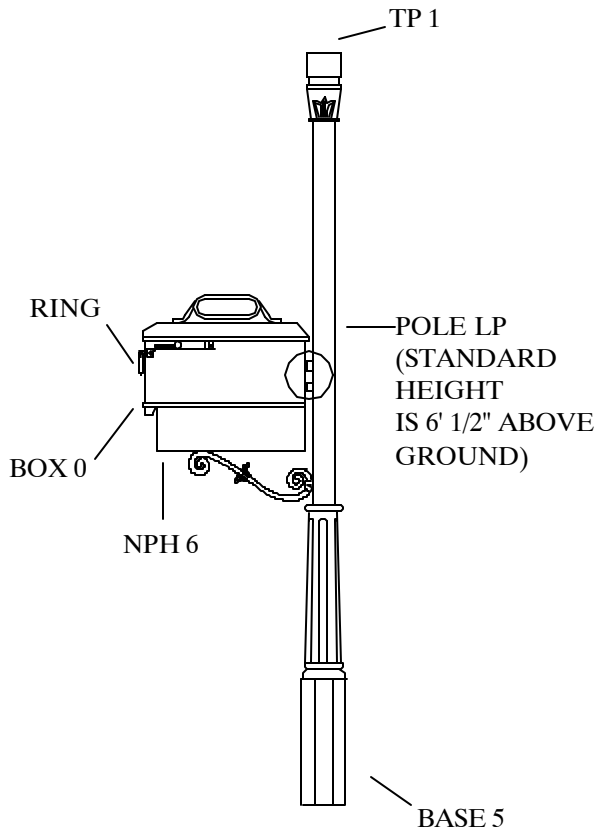

- MAILBOXES ARE MOUNTED
DIRECTLY TO THE LIGHT
POLE WITH LIGHT POLE (LP)
BRACKETS.

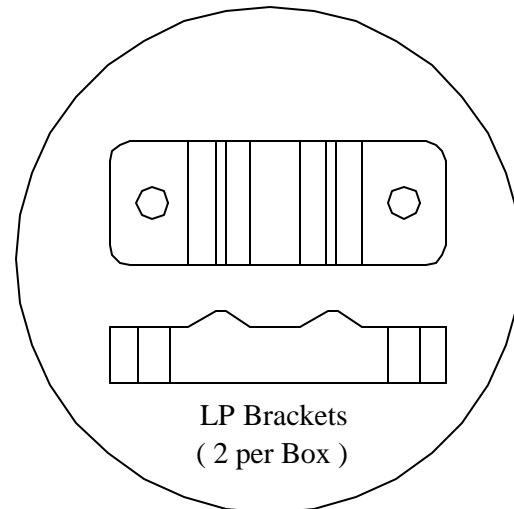

* LIGHT FIXTURES
SHOWN SOLD
SEPERATELY.



LIGHT POLE MAILBOX SYSTEMS

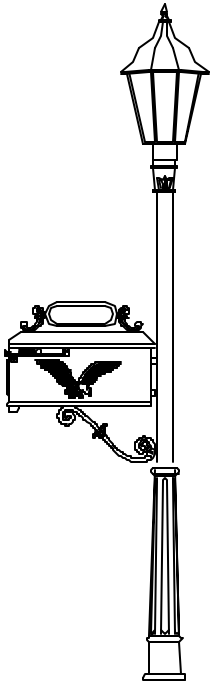

LP 314K

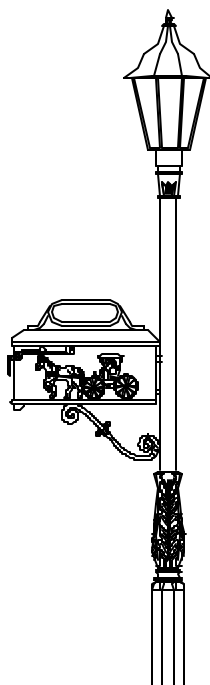

LP 227R

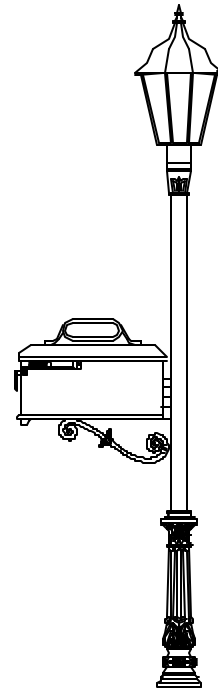

LP 620R

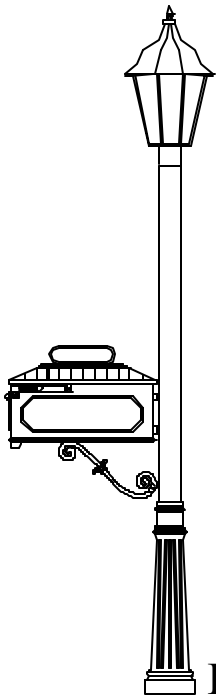

LP 888K

* ESTATE MAILBOXES
ARE NOT AVAILABLE
AS LIGHT POLE
MAILBOX SYSTEMS.

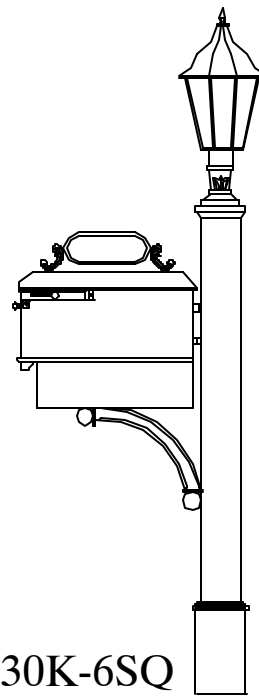

LP 630K-6SQ

* LIGHT FIXTURES
SHOWN SOLD
SEPERATELY.





IMPERIAL MAILBOX SYSTEMS

Call one of our Customer Service Representatives today, and see how we can provide your community the finest quality cast-aluminum "rust free" mailboxes, street signs, and light poles.

1-800-647-0777

www.imperialmailboxsystems.com

OFFICE HOURS

Monday Through Friday
8:00 AM – 4:30 PM CST

DEALERS NATIONWIDE

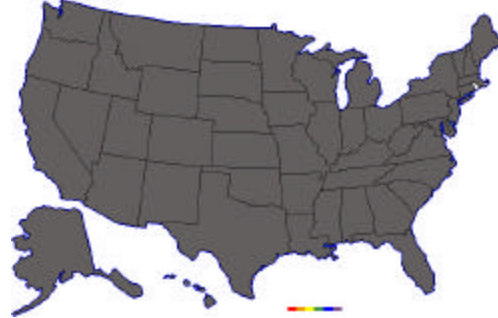

Terms and Conditions

Shipping Terms: All prices are F.O.B. point of origin. Freight charges must be prepaid at time of order placement. Freight collect requires prior approval.

Delivery: Most items in this cataloged are stocked and ready to be shipped within (5) business days. Custom and large orders may vary in shipping times (between 2-8 weeks, please call for a quote), and may be drop shipped to various locations. Specific shipping dates are not guaranteed. Most items ship via UPS ground or FED-EX Freight. Before accepting any shipment, the extent of any damages or shortages should be noted in writing on the bill of lading before you sign for the shipment. Claims are the responsibility of the purchaser.

Materials: All descriptions and specifications contained in this catalogue were in effect at the time of publication. Imperial Mailbox Systems reserves the right to change specifications and/or designs without notice or incurring liability.

Installation: Most products require minor assembly. Consult local postal or D.O.T. authorities regarding any local requirements.

Quotations: Individual quotations are valid for (30) days. Imperial Mailbox Systems reserves the right to alter a quote at any time and for any reason, as well as the right to decline an order for any reason.

Dealers: Imperial Mailbox Systems primarily sells through our dealers: call 800.647.0777 to find the nearest dealer in your area. Dealers are not employed by Imperial Mailbox Systems.

Returns: Returned products will not be accepted without prior authorization from Imperial Mailbox Systems, and must be shipped prepaid to Imperial Mailbox Systems. All returns are subject to a 25% restocking fee. Items must be inspected and reported of any nonconforming issue within (5) business days. Shipping charges are non-refundable.

Copyright: All catalogue products, graphics, and text are © 2007 Imperial Mailbox Systems. ALL RIGHTS RESERVED.

Warranty: Imperial Mailbox Systems provides a (1) year limited warranty to the original purchaser covering defects in material and workmanship if reported in writing to Imperial Mailbox Systems within (1) year of the delivery date. Whether a condition is a defect is determined solely by Imperial Mailbox Systems. This warranty is limited to the cost of the products, and does not include installation fees, transportation neglect or costs, vandalism, misuse, or alterations by the customer. It is the option of Imperial to replace or repair defective products. Imperfections in sand cast products are a part of the natural aesthetics and not considered a defect. Wear and tear is not covered. Purchaser assumes all liability and risk upon purchase of goods.

IMPERIAL
IMI MAILBOX SYSTEMS



Beautifying America, One Mailbox At A Time!

