

**eQuality™ 506DN
Vital Signs Monitor
Service Manual**

**Cat. No. 1557
Date 01/09**

**CE 0413
Part No. 39184B101
Revision 0**

Copyright

COPYRIGHT © CRITICARE SYSTEMS, INC., 2009

CRITICARE SYSTEMS, INC. (Criticare) owns all rights to this unpublished work and intends to maintain this work as confidential. Criticare may also seek to maintain this work as an unpublished copyright. This publication is to be used solely for the purposes of reference, operation, maintenance, or repair of Criticare equipment. No part of this publication may be reproduced in any manner or disseminated for other purposes.

In the event of inadvertent or deliberate publication, Criticare intends to enforce its rights to this work under copyright laws as a published work. Those having access to this work may not copy, use, or disclose the information in this work unless expressly authorized by Criticare to do so.

All product specifications, as well as information contained in this publication, are subject to change without notice.

All information contained in this publication is believed to be correct. Criticare Systems, Inc., shall not be liable for errors contained herein nor for incidental or consequential damages in connection with the furnishing, performance, or use of this material.

This publication may refer to information and products protected by copyrights or patents and does not convey any license under the patent rights of Criticare Systems, Inc., nor the rights of others. Criticare Systems, Inc., does not assume any liability arising out of any infringements of patents or other rights of third parties.

PROPERTY OF CRITICARE SYSTEMS, INC. ALL RIGHTS RESERVED

eQuality™ Vital Signs Monitor, DOX™ Digital Oximetry, ComfortCuff™ NIBP and Multi-Site™ SpO₂ Sensors are trademarks of Criticare Systems, Inc.

Contents

Copyright.....	ii
Contents.....	iii
Warranty.....	vii
Service Return Policy.....	viii
EC Declaration of Conformity.....	ix

Section 1 – Introduction

Description.....	1-1
Intended Use.....	1-1
Non-Invasive Blood Pressure (NIBP).....	1-2
ComfortCuff® Technology.....	1-2
Description of NIBP Measurement.....	1-2
NIBP Clinical Testing and Accuracy.....	1-3
Cuff Inflation and Pressure Protection.....	1-3
Heart Rate.....	1-4
DOX™ Pulse Oximetry Measurement (SpO ₂).....	1-5
Definition.....	1-5
DOX™ Digital Oximetry.....	1-5
Method.....	1-5
SpO ₂ Clinical Testing and Accuracy.....	1-6
Specifications.....	1-7
Symbols.....	1-10
Safety.....	1-12
Software Error Related Hazard Mediation.....	1-14
Potential Interference.....	1-14
Leakage Current.....	1-14
Voltage Fluctuations.....	1-15
Equipotential Ground.....	1-15
Defibrillation, HF, and Electronic Device Protection.....	1-15
Biocompatibility.....	1-15
Latex Content.....	1-15
DEHP Content.....	1-15

Section 2 – Service Menus

Introduction.....	2-1
Service Mode.....	2-1
Service Mode Window.....	2-1
Service Menus.....	2-2
Revisions Menu.....	2-2
Test Menu.....	2-3
Default Setups.....	2-4
Board Setups.....	2-5
NIBP Calibration Menu.....	2-6
Setting User Defaults.....	2-7
Setting User Defaults.....	2-7
Power Up in Service Mode.....	2-7

Factory Defaults	2-9
Main Menu	2-9
Alarm Menu	2-9
Configuration Menu	2-10
Communication Menu	2-10
Patient Data Menu	2-11
NIBP Cycle Menu	2-11
Main Menu	2-12
Patient Size	2-12
Alarm Volume	2-12
Pulse Volume	2-12
Enable MAP	2-12
Alarm Menu	2-13
High Pulse	2-13
Low Pulse	2-13
High SpO ₂	2-13
Low SpO ₂	2-13
High Systolic	2-14
Low Systolic	2-14
High Diastolic	2-14
Low Diastolic	2-14
High MAP	2-14
Low MAP	2-14
Configuration Menu	2-15
Time	2-15
Hour	2-15
Minute	2-15
Day	2-15
Month	2-15
Year	2-15
Contrast	2-15
Brightness	2-15
Reverse Video	2-15
NIBP	2-15
SpO ₂	2-15
Units	2-15
Language	2-15
Communication Menu	2-16
On NIBP	2-16
On Alarm	2-16
Interval	2-16
Patient Data	2-16
Print To	2-16
Serial	2-16
Baud Rate	2-16
Patient Data	2-17
Weight	2-17
Height	2-17
Respiration	2-17
Pain	2-17

Section 3 – Theory of Operation

System Architecture	3-1
Module Architecture	3-2
Main Board	3-2
NIBP Module	3-2
DOX SpO ₂ Module	3-2
Block Diagram	3-3

Section 4 – Cleaning and Disinfecting

Cleaning and Disinfecting 4-1
 Pulse Oximeter Sensors 4-1
 Blood Pressure Cuffs 4-2
 Accidental Wetting 4-3

Section 5 – Preventative Maintenance

Incoming Inspection 5-1
 Maintenance Schedule 5-1
 Long-Term Storage 5-1
 Disposal 5-1
 Service Checks 5-2
 Calibration 5-2
 Serviceable Components 5-3
 Battery Removal/Replacement 5-3
 Fuse Removal/Replacement 5-5
 Annual Testing 5-6
 Accessory Testing 5-6
 Functional and Safety Testing 5-6
 Equipment and Tools 5-7
 Test Fixtures 5-8
 Electrical Safety Tests 5-10
 Withstanding Voltage Test (Hi-pot) 5-10
 Equipment Needed 5-10
 Setup Hi-pot Tester 5-10
 Hi-pot Performance Test 5-11
 Leakage Testing 5-11
 Setup Procedure (Self-Test) 5-11
 Leakage Procedure 5-12
 Functional Tests 5-14
 System Check 5-14
 Speaker Performance, Alarms Verification 5-15
 Power Supply Performance 5-15
 Monitoring Module Verification 5-16
 NIBP Verification 5-16
 NIBP Seal Test 5-17
 SpO₂ Verification 5-18
 Functional and Safety Testing Checklist 5-19

Section 6 – Service Testing & Calibration

Monitor Testing 6-1
 Service Checks 6-1
 Field Service Testing 6-1
 Equipment and Tools 6-2
 Communication Testing 6-3
 Equipment Required 6-3
 Pinout Chart 6-3
 Procedure 6-3
 Nurse Call 6-4
 DOX SpO₂ Performance Testing 6-5
 Programming the SmartSat Analyzer 6-5
 Test Procedure 6-5

NIBP Calibration	6-6
Equipment Required	6-6
Installing the PC Service Program	6-6
Configuring the Ports	6-6
Setup	6-7
Calibrate	6-9
Safety Test	6-11
Speed Test	6-14
Leak Test	6-16
Accuracy Test	6-20

Section 7 – Disassembly

Before You Begin	7-1
Service Safety	7-1
Electrostatic Discharge Protection	7-2
Tools Needed	7-2
Disconnect and Remove Battery	7-3
Detach Bezel Assembly from Housing Assembly	7-3
Bezel Disassembly	7-4
Replace Speaker	7-4
Replace LCD Display	7-5
Replace Membrane	7-6
Replace Main Board	7-7
Replace DOX SpO ₂ Board	7-9
Replace NIBP Module	7-10
Housing Disassembly	7-11
Replace Power Supply	7-11
Completion of Service	7-12

Section 8 – Troubleshooting

Troubleshooting Guide	8-1
-----------------------------	-----

Section 9 – Drawings and Schematics

List of Drawings	9-1
Assembly Parts Lists	9-1
PCB Drawings List	9-1
506DN Final Assembly	9-2
NIBP Module	9-3
506DN Monitor	9-3

Warranty

Workmanship & Materials

Criticare Systems, Inc. (CSI) warranties new equipment to be free from defects in workmanship and materials for a period of two (2) years from date of shipment under normal use and service. The 940 Series Multi-Site™ Sensor carries a six month warranty. CSI's obligation under this warranty is limited to repairing or replacing, at CSI's option, any part which upon CSI's examination proves defective.

EXCEPT AS DESCRIBED IN THE PARAGRAPH ABOVE, CSI MAKES NO WARRANTIES, EXPRESS OR IMPLIED, INCLUDING ANY WARRANTY OF MERCHANTABILITY OR FITNESS FOR A PARTICULAR PURPOSE.

Exemptions

CSI's obligation or liability under this warranty does not include any transportation or other charges or liability for direct, indirect or consequential damages or delay resulting from the improper use or application of the product or the substitution upon it of parts or accessories not approved by CSI or repair by anyone other than a CSI authorized representative.

This warranty shall not extend to any instrument which has been subjected to misuse, negligence or accident; any instrument from which CSI's original serial number tag or product identification markings have been altered or removed; or any product of any other manufacturer.

Safety, Reliability & Performance

Criticare Systems, Inc. is not responsible for the effects on safety, reliability and performance of the 506DN Patient Monitor if: assembly operations, extensions, readjustments, modifications or repairs are carried out by persons other than those authorized by Criticare Systems, Inc., or

the 506DN Patient Monitor is not used in accordance with the instructions for use, or

the electrical installation of the relevant room does not comply with NFPA 70: National Electric Code or NFPA 99: Standard for Health Care Facilities (Outside the United States, the relevant room must comply with all electrical installation regulations mandated by the local and regional bodies of government).

In Case of Emergency Contact



CRITICARE SYSTEMS, INC.
20925 Crossroads Circle
Suite 100
Waukesha, WI 53186
USA

Telephone: (262) 798-8282
Tech Support: (800) 458-2697
Orders: (800) 458-4615
Fax: (262) 798-8290

Internet: www.csiusa.com

Service Return Policy

Return Procedure



In the event that it becomes necessary to return a unit to Criticare Systems, Inc., the following procedure should be followed:

Obtain return authorization. Contact the CSI Service Department at 800-458-2697 to obtain a Customer Service Authorization (CSA) number. (Outside the US, call 001-262-798-8282.) The CSA number must appear on the outside of the shipping container. Return shipments will not be accepted if the CSA number is not clearly visible. Please provide the model number, serial number, and a brief description of the reason for return.

Freight policy. The customer is responsible for freight charges when equipment is shipped to CSI for service (this includes customs charges).

Loaner service. In the U.S. If it is necessary to provide a loaner system, CSI will ship a loaner by overnight courier. The loaner system must be returned to CSI at the customer's expense within one week after receipt of the repaired goods. If the unit is not returned to CSI within that time, the customer will be invoiced for the full purchase price of the equipment.

Outside the U.S. No loaners are available from CSI internationally. Contact your local CSI representative.

Incoming Inspection

The following incoming inspection is required whether it is a first time arrival or a return from service. Prior to clinical use, the instrument should be inspected for the following.

1. The quality inspection seal on the instrument should be unbroken. This seal indicates that the instrument has been tested according to manufacturers specifications.
2. No physical damage is observed.
3. The instrument's battery is to be charged by connecting the instrument to a power outlet for a minimum of 6 hours prior to clinical use.
4. When connecting the instrument to a power outlet and then turning the instrument on, all displays appear to function correctly and no system errors occur.

If a discrepancy to these inspection items is observed, do not use the instrument and immediately report the discrepancy to the CSI Service Department.

EC Declaration of Conformity

eQuality™ 506DN Patient Monitor

To view the Declaration of Conformity, visit the Criticare website at www.csiusa.com. A copy of the Declaration can also be faxed. Contact Criticare's customer service department at (262) 798-8282 to obtain a faxed copy of the Declaration.

Representative in the European Union

Criticare Systems Limited
c/o Wright Hassall
9 Clarendon Place
Leamington Spa
Warwickshire
CV 32 5QP – United Kingdom

T: 0044 (0) 1926 886688

F: 0044 (0) 1926 885588

For the Attention of: Ref. 45 (or) Mr. L. A. Heizler

Section 1 — Introduction

Description

The 506DN patient monitor is a compact vital signs monitor that measures heart rate, blood oxygen saturation (SpO₂) and non-invasive blood pressure (NIBP). Heart rate is measured primarily by the plethysmographic waveform but when the oximeter is not in use, heart rate is determined from the blood pressure data using an oscillometric method that measures during inflation.

Intended Use

The 506DN monitor is intended to monitor physiological parameters of patients within clinical care settings and can be used in transport. It is intended that the user is a professional health care provider. Physiological data, systems alarms, and patient data analysis are available to the care provider from the monitor.

The user is responsible for the interpretation of the monitored data that is made available. Physiological data should be reviewed by qualified clinical personnel prior to any medical intervention.

The monitor is designed to be used with only one patient at a time. The monitor (including accessories) is capable of monitoring a full range of patients from neonate to adult.

Non-Invasive Blood Pressure (NIBP)

The 506DN monitor uses ComfortCuff[®] technology to determine non-invasive blood pressure by means of oscillometry. The oscillometric method detects volume displacements within the artery and senses pressure variations within the blood pressure cuff during inflation. The monitor uses cuffs ranging in size from neonate cuffs to adult thigh cuffs.

ComfortCuff[®] Technology

ComfortCuff technology measures NIBP while the cuff inflates. Consequently, a measurement is obtained more quickly and with less discomfort than with monitors, which measure NIBP during cuff deflation.

Description of NIBP Measurement

The NIBP cuff begins to inflate at the beginning of the NIBP measurement cycle. As the cuff pressure approaches the diastolic pressure of the patient, the cuff pressure waveform begins to indicate the pulse waveform. The cuff pressure at this point is equal to the patient's diastolic pressure, which is stored by the monitor.

As cuff pressure continues to increase, the pulse waveform (as measured from BP cuff pressure fluctuation) becomes stronger reaching its maximum at the patient's mean arterial pressure (i.e., when cuff pressure = mean BP). The monitor stores this value as mean pressure.

As cuff pressure increases further, it approaches the patient's systolic pressure, and the cuff's pulse waveform decreases in amplitude. The cuff pulse waveform disappears at the point where cuff pressure is equal to the patient's systolic pressure.

When the monitor determines that the cuff waveform has decreased to zero amplitude, it stores the cuff pressure value as the systolic pressure, and releases the pressure from the cuff. This typically occurs at about 10 mmHg over the patient's systolic pressure. The cuff then rapidly deflates.

Dynamic Measurement Ranges

	Systolic (mmHg)	Diastolic (mmHg)	MAP (mmHg)
Adult	50-280	30-225	35-245
Pediatric	50-280	30-225	35-245
Neonate	50-135	20-100	30-120

NIBP Clinical Testing and Accuracy

This device was clinically tested per the requirements of EN 1060 and AAMI SP-10. The NIBP module as installed in the 506DN patient monitor has been tested to meet the performance specifications listed in this manual.

Cuff Inflation and Pressure Protection

The maximum cuff inflation rate is 15 mmHg/second. The software limits inflation to 300 mmHg adult, 300 mmHg pediatric or 150 mmHg neonate. A secondary circuit limits maximum possible cuff pressure to 330 mmHg in adult/pediatric mode and 165 mmHg in neonatal mode. Cuff pressure is allowed to remain above 300 mmHg for a maximum of two minutes.

The monitor automatically deflates the cuff if the time limit is violated. The monitor contains hardware protection for overpressure conditions, pressure transducer failures, and microprocessor and pump control circuit failures.

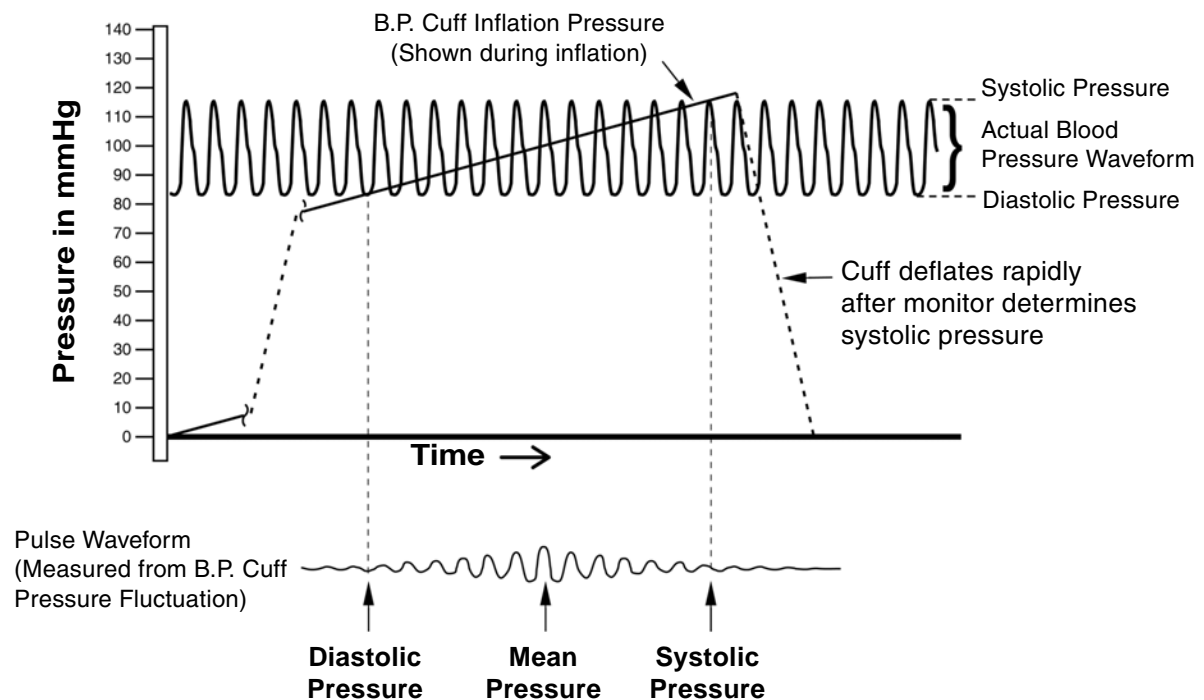

Figure 1-1: NIBP Cuff Pressure and Pulse Over Time

Heart Rate

Heart rate measurement is determined primarily by the plethysmographic (SpO₂) waveform. When the oximeter is not in use, heart rate is determined from the blood pressure data by using an oscillometric method that measures during inflation. The unit of measurement is beats per minute.

Under conditions where the plethysmographic based heart rate and oscillometric heart rate are both beyond the detectable limits of the monitor, no heart rate is reported. Also, no heart rate is reported where the amplitude of the plethysmographic waveform and oscillometric waveform are beyond the detectable limits. The monitor reports error messages if valid measurements cannot be obtained. The monitor continues to look for valid SpO₂ based heart rate measurements and attempts a second NIBP measurement if the first attempt fails.

DOX™ Pulse Oximetry Measurement (SpO₂)

The 506DN patient monitor comes with Digital Oximetry (DOX) technology to measure blood oxygen saturation (SpO₂).

Definition Hemoglobin exists in the blood in several forms:

- Oxygenated (Oxyhemoglobin)
- Reduced (Deoxyhemoglobin)
- Dyshemoglobins (Carboxyhemoglobin and Methemoglobin)

In the monitor, SpO₂ (pulse arterial saturation) is the ratio of oxygenated hemoglobin to the sum of oxygenated hemoglobin plus hemoglobin which is available for binding to oxygen, as expressed in the following formula:

$$\text{percent oxygen saturation} = \frac{\text{oxyhemoglobin}}{\text{oxyhemoglobin} + \text{deoxyhemoglobin}} \times 100$$

Dyshemoglobins, such as carboxyhemoglobin and methemoglobin, are not directly measured and therefore are not factored into the measurement.

DOX™ Digital Oximetry

The monitor does not use analog circuitry for signal processing. Digital signal processing in the microprocessor results in lower noise from circuitry components, resulting in a cleaner signal and better performance under low perfusion conditions. There is also improved rejection of noise from the patient and environment, due to the availability of the “true,” unfiltered sensor signal for digital signal processing.

Method The digital pulse oximeter measures oxygen saturation and pulse rate using the principles of spectrophotometry and plethysmography. The sensor is completely non-invasive, and there is no heat source that could burn the patient.

The pulse oximeter sensor contains two types of LEDs. Each type emits a specific wavelength of light. Since oxygenated hemoglobin and deoxygenated hemoglobin absorb light selectively and predictably, the amounts of these two compounds can be determined by measuring the intensity of each wavelength that passes through the measuring site.

The light from the LEDs shines into a pulsating vascular bed. A photodetector located opposite of alongside the LEDs measures the intensity of each wavelength transmitted through the monitoring site. The light intensity is converted to an electrical signal, which is input to the monitor. The effects of skin pigmentation, venous blood, and other tissue constituents are eliminated by separating out the average pulsating absorption data.

SpO₂ is calculated with every pulse and averaged with the results from previous pulses to arrive at the current numeric display value. The display is updated at least once per second with the numeric values that were calculated during the intervening period.

The plethysmographic pulse wave is not auto-gained. The amplitude display of the plethysmographic pulse is proportional to the pulse volume changes occurring in the tissue illuminated by the SpO₂ sensor.

SpO₂ Clinical Testing and Accuracy

All Criticare oximeter's (DOX-compatible) have SpO₂ calibration tables which were originally generated by monitoring desaturated human patients or volunteers and matching their displayed SpO₂ value to the value determined by sampling arterial blood and measuring functional SaO₂ with a clinical laboratory grade multi wavelength optical oximeter (i.e., CO-oximeter). The final SpO₂ calibration curve was then generated based upon numerous patients' data over the range of 40 to 99% SaO₂. All accepted data were taken from patients with dyshemoglobin (i.e., carboxyhemoglobin or methemoglobin) concentrations near zero.

This oximeter is a two-wavelength device, which is calibrated to measure functional SpO₂ only when dyshemoglobin concentrations are near zero. The accuracy specifications of this device will not be met with high concentrations of dyshemoglobins. Significant concentrations of carboxyhemoglobin results in a higher displayed SpO₂ value than is actually present in the patient.

SpO₂ clinical accuracy validation to CO-oximeter SaO₂ readings was performed for the sensors using a DOX-compatible monitor.

The personal demographics of the study participants for the SpO₂ clinical accuracy validation include a mix of adult males and females from 18 to 45 years of age. All were healthy during the course of the study. Physical characteristics and skin tone were by chance with a mix from slight to stout and light to dark. Clinical testing for neonatal participants was conducted per U.S. FDA recommended clinical protocols.

Specifications**DOX SpO₂**

Range:	1-99%
Resolution:	1%
Accuracy:	70 to 99%: $\pm 2\%$ 50 to 69%: $\pm 3\%$ <50%: Unspecified Statistical, represents one st. dev. (~66%) of clinical samples
Indications:	Plethysmographic, Numerical, Audible (pulse tone pitch varies with SpO ₂)
Method:	Dual wavelength LED
Modes:	Adult/Pediatric/Neonatal
Operation:	Continuous Use
Sensor Wavelength:	660nm/905nm
Sensor Power:	<80mW

ComfortCuff NIBP

Technique:	Oscillometric measure upon inflation
Average Measurement Time:	<30 seconds
Automatic Measurement Cycles:	1, 2, 3, 5, 10, 15, 30, 45, 60 min; 2, 4 hrs
Inflation Pressure Range:	Adult: 30 to 300 mmHg Pediatric: 30 to 300 mmHg Neonate: 20 to 150 mmHg
Max Inflation:	Adult: 300 Pediatric: 150 Neonate: 150
NIBP Pulse Rate Range:	30 to 240
Resolution:	1 mmHg
NIBP Pulse Rate Accuracy:	± 1 bpm or 1%
STAT Mode:	5 min. of consecutive readings
Clinical Accuracy:	SP10:2002
Clinical Mean Error:	Less than ± 5 mmHg
Clinical Standard Deviation:	Less than ± 6.93 mmHg
Static Transducer Accuracy:	± 2 mmHg

Heart Rate

Source:	Plethysmograph or oscillometric NIBP data
Accuracy Range:	30 to 240 (for all parameters)
Accuracy:	± 1 bpm or 1% (for all parameters)

Alarms

Characteristics:	EN 475, Adjustable
Indication:	Audible; Visual
Minimum Duration of Alarm	
Conditions for Indication:	At least 1 second for Audible and Visual alarms
Levels:	High, Medium, Low, Informational
Alarm Modes:	Adult, Pediatric, Neonate
Volume:	User Adjustable
Silence:	Yes; 2 minutes or permanent

Communications

Com Port:	RS232 serial port
Nurse Call:	Contact switch; audio jack 3.5 mm, 24V @ 100 ma maximum switching

Displays Controls

Display:	LCD; 3.25 in (W) x 2.4 in (H)
Status Indicators:	Alarm Silence, Battery Status, Sensor, AC Power, Patient Size
Keys:	9, membrane activated
Languages:	English, Spanish

Trend Reports & Memory

Types:	Tabular Mini-Trend Report
Trend Report Length:	24 hours max; selectable intervals
Review Mode:	On-panel review of trend reports
Interval (Review Mode):	Every valid NIBP measurement
Data Types:	NIBP (Systolic, Diastolic, Mean), SpO ₂ percent, Heart Rate

Mechanical/Electrical











Weight:	4.5 lbs
Size:	8 in. (H) x 5.5 in (W) x 5.75 in (D)
Battery:	Rechargeable; Sealed lead acid battery
Rating:	6V, 7.2 Amp Hours
Battery Life:	8 hours, with NIBP every 5 minutes
Recharge Time:	6 hours
Power Requirements:	100 - 240 VAC ($\pm 10\%$), 50/60 Hz







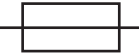



Environmental

Operating Temperature:	0° to 40° C (32° to 104° F)
Storage Temperature:	-20° to 65° C (-4° to 149° F)
Operating and Storage Humidity:	5% to 95%, non-condensing
Medical Device:	Class II Equipment
Electrical Protection:	Class I Equipment
Degree of Protection:	CF, Defibrillator-Proof
Protection against ingress:	IPX1 rating, Drip-Proof Equipment

All specifications are subject to change without notice.

Symbols

Symbol	Definition
	Refer to Operator's Manual for Information
	Shock Hazard
	Equipotential Terminal
	European Community Mark of Approval
	Electrical Testing Laboratories (ETL) Mark
IPX1	Identifies the degree of protection against fluid as drip proof
	Type CF Equipment, defib proof
	Do not dispose of in municipal waste. Wheeled bin symbol indicates separate collection for electrical and electronic equipment (WEEE Directive 2002/96/EEC)
	Alternating Current (AC)
	Fuse
	Technical Support Phone Number

Symbol	Definition
	Non-Invasive Blood Pressure, Connection
	SpO ₂ Sensor Mounting, Connection
	Communication Transmit/Receive Port
	Not a Sensor Connection
	Alarm Port (Nurse Call)
	Serial Number
	Part Reference Number
	Placement of cuff over the brachial artery. (Blood Pressure Cuff)
	Single use device only. Do not reuse.
	Recycle cardboard/paper packaging.

Safety

Definitions for Warning and Caution symbols:



Designates a possible dangerous situation. Non-observance may lead to death or the most severe injuries.



Designates a possible dangerous situation. Non-observance may lead to minor injuries or damage to the product.

NOTE: Indicates that important information follows, a tip that can help you recover from an error, or point you to related details in the manual.



- Read this manual entirely before attempting clinical use of the monitor.
- A possible explosion hazard exists! Do not use this monitor in the presence of flammable anesthetics.
- Cables, cords, and leadwires may present a risk of entanglement or strangulation! Verify safe and proper positioning of these items after patient application.
- Unapproved modifications to the monitor may cause unexpected results and present a hazard to the patient.
- Risk of electrical shock! Do not remove cover. Refer servicing to qualified personnel.
- U.S. Federal law restricts this device to sale by or on the order of a physician.



⚠ CAUTION ⚠

- Use the monitor only with recommended accessories! Use of unapproved accessories may cause inaccurate readings.
- Equipment accuracy may be affected at extreme temperatures.
- Do not store equipment at extreme temperature. Temperatures exceeding specified storage temperatures could damage the system.
- Do not press on the keys with surgical instruments or other tools. Sharp or hard objects could damage the keys. Use only your fingertips to press on the keys.
- Changes or modifications not expressly approved by Criticare Systems, Inc., may void the user's authority to operate the equipment and may also void the warranty.
- Setting alarm limits to extreme values may render the alarm system useless.
- A functional tester cannot be used to assess the accuracy of a pulse oximeter probe or pulse oximeter monitor. If there is independent demonstration that a particular calibration curve is accurate for the combination of a pulse oximeter monitor and a pulse oximeter probe, then a functional tester can measure the contribution of a monitor to the total error of a monitor/probe system. The functional tester can then measure how accurately a particular pulse oximeter monitor is reproducing that calibration curve.

Software Error Related Hazard Mediation Criticare Systems, Inc., has quality control practices and procedures in place to review potential hazards as they relate to software.

The monitor is Year 2000 Compliant and utilizes a 4 digit year for all date, time and leap year calculations.

Potential Interference This device has been successfully tested to IEC 601-1-2 specified levels for emissions of and resistance to electromagnetic energy fields. External disturbances which exceed these levels may cause operational issues with this device. Other devices which are sensitive to a lower level of emissions than those allowed by IEC 601-1-2 may experience operational issues when used in proximity to this device.

MAGNETIC FIELDS

Use of the monitor in an MRI environment may interfere with MRI image quality. Use of MRI may interfere with the monitor.

The 506DN patient monitor is not intended for use in MRI environments.

RADIO FREQUENTLY INTERFERENCE

The monitor conforms with IEC 61000-4-3 for radio frequency interference, and will operate with negligible effects.

CONDUCTED TRANSIENTS

The monitor conforms to IEC 61000-4-4, and IEC 61000-4-5 for conducted transients, and will operate with negligible adverse effects.

X-RAY

The monitor will operate with negligible adverse effects in an X-ray environment. However, the monitor should not be placed directly in the x-ray beam, which could damage the internal electronics of the monitor.

OTHER INTERFERENCE

There is a negligible adverse effect to the monitor from electrocautery, electrosurgery, infrared energy, pacemakers, or defibrillation.

Leakage Current The monitor complies with leakage current limits required by medical safety standards for patient-connected devices. Standards include the International Electrotechnical Commission (IEC) 60601-1, 2nd edition, 1988 Part 1. A hazard caused by the summation of leakage currents is possible, when several pieces of equipment are interconnected.

Voltage Fluctuations The monitor is suitable for connection to AC (mains) voltage as defined by EN 61000-3-3 and EN 61000-4-11. When operated in the line voltage range specified in this manual any fluctuation will have a negligible effect. Very low line voltage will cause the monitor to revert to battery power. Very high line voltage will cause damage to the charger circuits. The monitor is designed with circuitry that will turn the unit off before spurious readings can be caused by a low battery connection.

Equipotential Ground Health care providers and patients are subject to dangerous, uncontrollable compensating currents for electrical equipment. These currents are due to the potential differences between connected equipment and touchable conducting parts found in medical rooms..

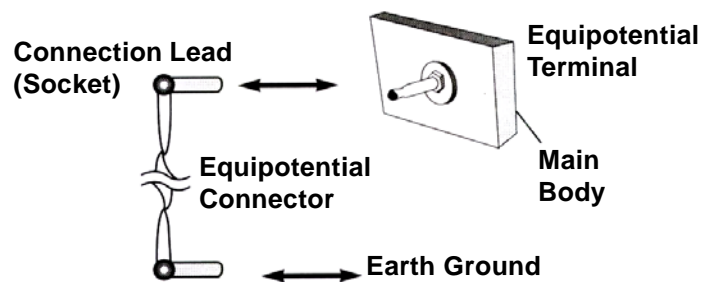

Defibrillation, HF, and Electronic Device Protection The monitor when used with its recommended accessories is protected against the effects of the discharge of a defibrillator and the use of HF electrosurgical equipment. The monitor presents no known adverse effects to pacemakers or other medical safety equipment.

Biocompatibility All patient-contact or user-contact materials in this monitor and its accessories have passed ISO 10993-5, -10 and -11 biocompatibility tests or have been in use in clinical environments in large numbers over an extended period of time predating these standards.

Latex Content All Criticare Systems, Inc., products, including patient monitors and accessories, are free from latex in any location that may result in patient contact.

DEHP Content All Criticare Systems, Inc., products currently shipping are free of DBP and DEHP in any areas that would be intended for patient contact with blood, mucous membranes, or continuous skin and/or tissue contact.

Section 2 — Service Menus

Introduction

There is one primary service boot that uses the DOWN arrow at power up takes the monitor into Service Mode. A secondary service boot uses the NIBP START/STAT/STOP key at power up and takes the monitor into *NIBP Calibration Mode*. These service software tools allow downloading of software upgrades for the 506DN operating system and for calibration of the NIBP module in the field.

To exit the *SERVICE MENU* power cycle the monitor.

Service Mode

Service Mode Window

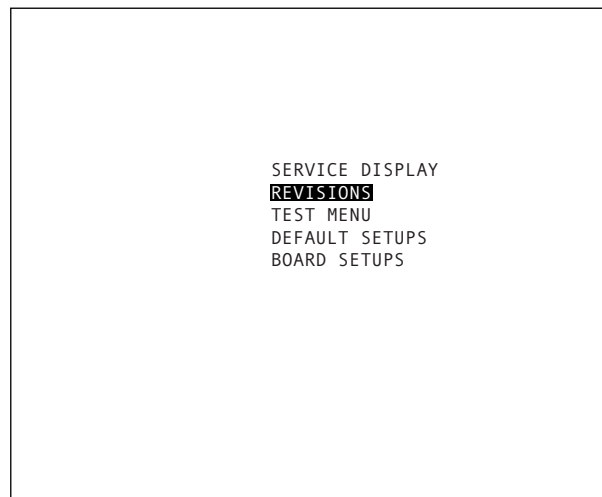

Figure 2-1: 506DN Service Mode Window

⚠ WARNING ⚠

- Never service a monitor while it is attached to a patient.
- Never enter the service menu while monitoring a patient.

Service Menu

The Service Menu is displayed when the DOWN ARROW is held when during power up and no upgrade tool is attached the external serial port.

The Service Menu contains four submenus:

- Revisions
- Test Menu
- Default Setups
- Board Setups

These submenus are accessed by using the arrow keys and then pressing the MENU key when the desired menu is highlighted.

Revisions Menu The revisions menu contains the revisions of the software and module components. Exit the *REVISIONS* menu by pressing and holding the MENU key. The monitor will return to the main service menu.

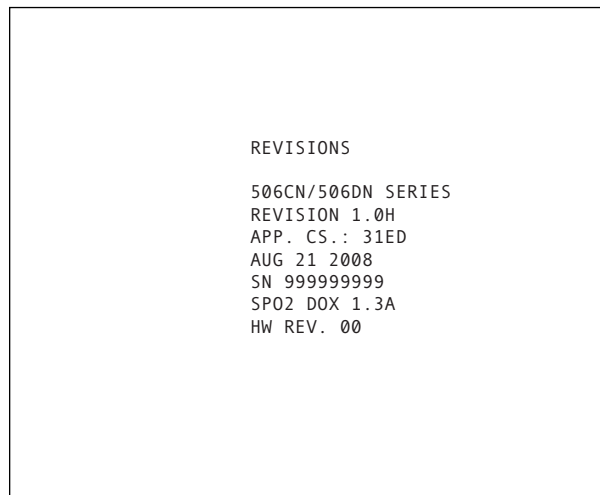

Figure 2-2: 506DN Revisions Menu

Test Menu The *TEST MENU* contains the monitor's NIBP Seal self test.

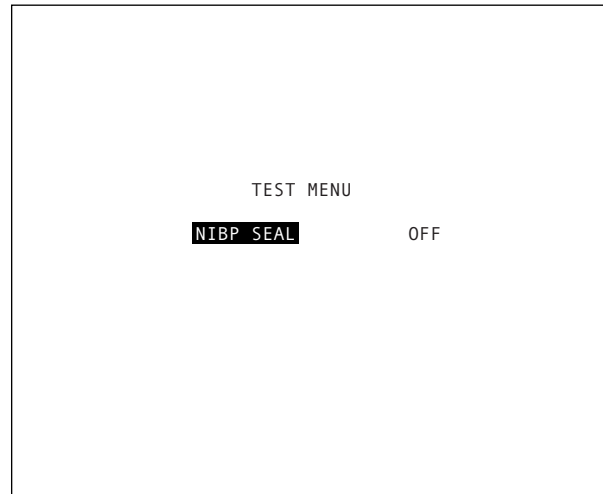

Figure 2-3: 506DN Test Menu

To perform the *NIBP SEAL* self test:

1. Press the MENU key to shift the cursor to *OFF*.
2. Press the either arrow key to change *OFF* to *ON*.
3. Press the MENU key to begin the test.

The following message will appear.

"START" TO SEAL
XXXX.X mmHg

The valves close so that the pneumatic circuit can be checked for leaks. This provides a simple field test for verifying the safety and static pressure accuracy of the NIBP transducer.

The current pressure is displayed on the second line of the message displayed on the LCD screen. All pressures from 0 to 300 mmHg have an accuracy of $\pm 2\%$. The message format allows for the display of negative numbers to indicate negative zero offsets.

Press the MENU key a second time to terminate the test.

Default Setups The *DEFAULT SETUPS* menu contains options for setting the default values which will take effect when the monitor is turned on with the MENU key pressed and held during power up.

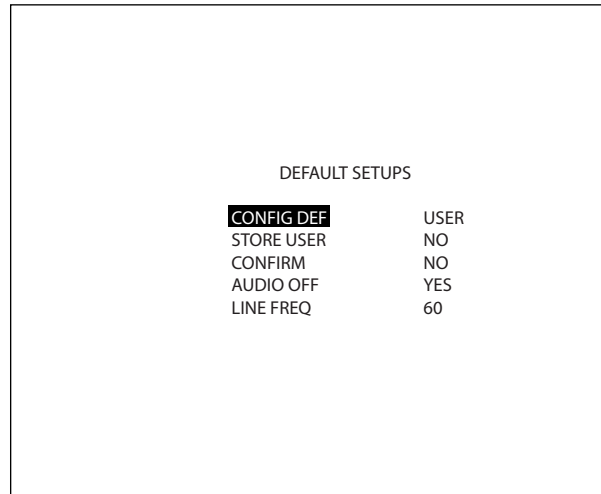

Figure 2-4: 506DN Defaults Setup Menu

CONFIG USER

This selects the which type of configuration defaults are restored following a MENU power up. Choices are *USER*, *HOSP.* (hospital), and *ALT C.* (alternate care).

STORE USER

This allows the monitor's current configuration settings to be stored as the *USER* defaults. The options for this setting are *Yes* and *No*.

Pressing the MENU key with *Yes* selected causes the *CONFIRM* setting to become available. Select *Yes* for *CONFIRM* to store the current settings as the user defaults.

AUDIO OFF

This selects the nature of the *Alarm Volume* setting of *OFF* in the *ALARMS MENU*. Choosing *Yes* indicates true silencing of the audio alarm. Choosing *No* causes the audio not to announce alarms but sounds a double beep every two minutes for verification that the audio circuit still functions.

LINE FREQUENCY

The monitor has a *60 Hz* setting for domestic U.S. use and a *50 Hz* setting for international use. The frequency must be set correctly to the local AC (Mains) power frequency for the monitor to function correctly. Contact the local CSI distributor for more information about which setting to use.

Board Setups The *BOARD SETUPS* menu provides settings for the monitoring modules installed on the monitor.

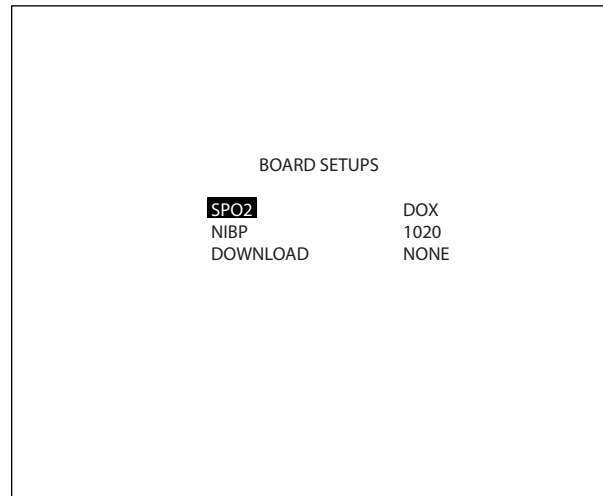

Figure 2-5: 506DN Board Setups Menu

SPO2

Selects which type of SpO₂ module is installed in the monitor. Choices are *DOX* and *SEQL (SEQUEL)*.

NIBP

Selects which type of NIBP module is installed in the monitor. Choices are *1020 (ComfortCuff)* and *None*.

DOWNLOAD

Use this menu item to download software. Choices are *None*, *DOX*, *1020 (ComfortCuff)*, and *Main*. Selecting a processor will cause the monitor to search for a software download tool.

Software downloads are sent to the monitor by opening the software file on an external computer and sending the application to the monitor via the COM1 port.

NIBP Calibration Mode

To enter the NIBP Calibration mode:

1. Press the POWER key and the NIBP/START/STAT/STOP key at the same time.
2. The 506DN monitor attempts to connect to extended NIBP calibration tools through the external serial port, identifying itself as a 506DN monitor.
3. The message *CHECKING FOR NIBP TOOLS...* should appear in the LCD message bar.

A service calibration application, called NIBP SERVICE (pn 97082A003), may be run on a connected PC. See “NIBP Calibration” in Section 6 for testing details.

Setting User Defaults

This is a default setting profile that can be set for a facility's special needs. The user defaults are initially set to the same settings as the *HOSP* (hospital) defaults. User defaults setup should be performed by qualified personnel.

Setting User Defaults A facility can save setting in *USER* default setting. Once the settings are made, the settings can be saved under a *USER* setting profile on the monitor.

To set user defaults:

1. Power up the monitor.
2. Press the MENU key to access the *MAIN MENU*.
3. Use the MENU and ARROW keys to access the different submenus and adjust the settings for each patient size.

NOTE: It is not possible for to store *USER* defaults for *LOW SPO2* below 85%, *NIBP ON/OFF*, *SPO2 ON/OFF*, and *LANGUAGE*. Each of the ignored user defaults is controlled independently of the *USER* default settings. *LOW SPO2* returns to a default value of 85% if the current setting is below 85%.

4. Verify all settings are correct and power off the monitor.

Power Up in Service Mode The monitor needs to be powered up in the Service Mode to finish setting the user defaults. To power up the monitor in Service Mode:

1. While holding the DOWN arrow key, press the ON/OFF (power) key.
2. Continue holding the DOWN arrow key until *SERVICE DISPLAY* menu appears on the LCD display.

3. Use the arrow keys to highlight *DEFAULT SETUPS* and press the MENU key to enter the Default Setups Menu.

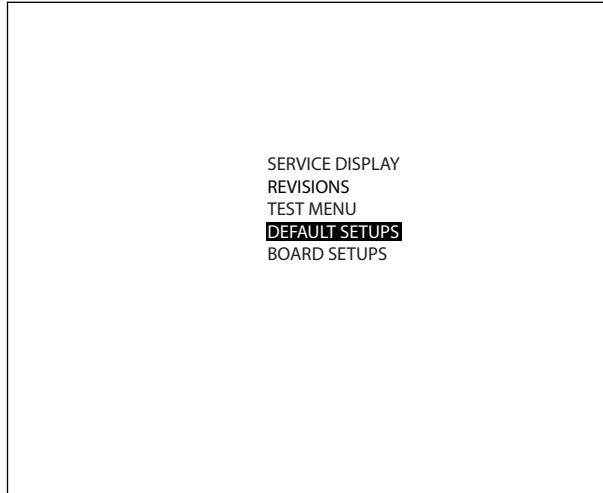

Figure 2-6: Select Default Setups

4. Use the arrow keys to highlight *STORE USER* and press the MENU key to move the cursor to the Store User settings.

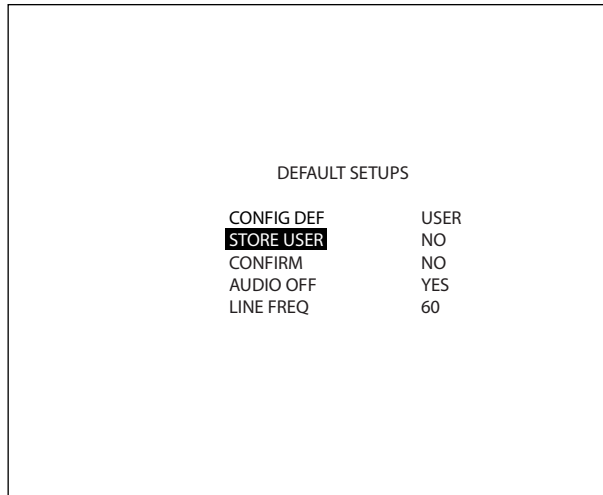

Figure 2-7: Select STORE USER

5. Select *YES* and press the MENU key.

The *CONFIRM* submenu item now becomes active. Use the arrow keys to select *YES* and press the MENU key to confirm the new User Default settings.

6. The new User Default settings are now saved on the monitor.

Factory Defaults

To recall factory defaults from memory, hold the MENU key while you press the POWER key to turn on the monitor. Settings affect the *MAIN MENU*, *ALARM*, *CONFIGURATION*, *COMMUNICATION*, *PATIENT DATA*, and the *NIBP CYCLE* Menus.

NOTE: The Main Menu and Alarm, Configuration, Communication, and Patient Data submenus are all accessed through the MENU key on the front panel. The NIBP Cycle Menu is entered through the NIBP CYCLE key on the front panel.

Main Menu

Setting	Options	Factory Default Values
Size	Adult, Pediatric (Ped.), Neonate (Neo.)	Adult
Alarm Volume	1 to 10, OFF	4
Pulse Volume	1 to 10, OFF	OFF
Enable MAP	ON, OFF	ON

Alarm Menu

Alarm	Type	Range	Hospital	Alternate Care
Pulse Rate	High	80 to 240, OFF	150 (Adult) 150 (Pediatric) 180 (Neonate)	150 (Adult) 150 (Pediatric) 180 (Neonate)
Pulse Rate	Low	20 to 150, OFF	40 (Adult) 40 (Pediatric) 90 (Neonate)	40 (Adult) 40 (Pediatric) 90 (Neonate)
SpO ₂	High	70 to 98, OFF	OFF (Adult) OFF (Pediatric) OFF (Neonate)	OFF (Adult) OFF (Pediatric) OFF (Neonate)
SpO ₂	Low	1 to 98, OFF	90 ‡ (Adult) 90 ‡ (Pediatric) 90 ‡ (Neonate)	90 ‡ (Adult) 90 ‡ (Pediatric) 90 ‡ (Neonate)
NIBP Systolic	High	75 to 240, OFF	200 (Adult) 200 (Pediatric) 140 (Neonate)	200 (Adult) 200 (Pediatric) 140 (Neonate)
NIBP Systolic	Low	50 to 150, OFF	50 (Adult) 50 (Pediatric) 50 (Neonate)	50 (Adult) 50 (Pediatric) 50 (Neonate)
NIBP Diastolic	High	50 to 180, OFF	100 (Adult) 100 (Pediatric) 80 (Neonate)	100 (Adult) 100 (Pediatric) 80 (Neonate)
NIBP Diastolic	Low	15 to 50, OFF	30 (Adult) 30 (Pediatric) 30 (Neonate)	40 (Adult) 40 (Pediatric) 30 (Neonate)
NIBP Mean	High	70 to 200, OFF	150 (Adult) 150 (Pediatric) 100 (Neonate)	OFF * (Adult) OFF * (Pediatric) OFF * (Neonate)
NIBP Mean	Low	25 to 125, OFF	50 (Adult) 50 (Pediatric) 40 (Neonate)	OFF * (Adult) OFF * (Pediatric) OFF * (Neonate)

‡ The monitor returns a minimum low value of 85 on power up.

* Mean values only appear if MAP is enabled in the main menu.

Configuration Menu

Setting	Options	Hospital Default Value	Alternate Care Default Value
Time	24-Hour, AM/PM	24-Hour	AM/PM
Hour	0 - 23	N/A	N/A
Minute	0 - 59	N/A	N/A
Day	1 - 31	N/A	N/A
Month	JAN - DEC	N/A	N/A
Year	00 - 99	N/A	N/A
Contrast	5 - 95 %	70 %	70 %
Brightness	5 - 95 %	50 %	50 %
NIBP Tone	None, Begin, End, Both	None	None
Reverse Video	ON, OFF	OFF	OFF
NIBP	ON, OFF	ON †	ON †
SpO ₂	ON, OFF	ON †	ON †
Units	English, Metric	English	English
Language *	English, Spanish	N/A	N/A

† The monitor returns to this setting on power up.

N/A This setting does not have a factory default value.

* This setting is only available after a MENU power up.

Communication Menu

Setting	Options	Factory Default Value
Print on NIBP	ON, OFF	ON
Print on alarm	ON, OFF	OFF
Interval	Spot; BPT; 1, 2, 5, 10, 15, 30, 60 minutes 2, 4, 8, 12, 24 hours; OFF	OFF
Patient Data	ON, OFF	OFF
Print To	Serial, OFF	Serial
Serial	Text, CSV, CUSP, OFF	Text
Baud Rate	2400, 4800, 9600, 19200, 38400	19200

Patient Data Menu

Setting	Options	Factory Default Value
Weight	2 - 500 lbs	100 lbs
Height	5 - 100 in	60 in
Respiration	1 to 99 /min	20 /min
Pain	1 to 10	1

NIBP Cycle Menu

Setting	Options	Factory Default Value
NIBP Cycle	1, 2, 3, 5 10, 15, 30, 45, 60 minutes; 2 or 4 hours; Off	Off

NOTE: The *NIBP CYCLE* menu is accessed using the NIBP CYCLE key located on the front panel. All other default settings are accessed using the MENU key with the UP/DOWN keys.

Main Menu

Press the MENU key to enter the Main Menu. Use the arrow keys to select the main settings and submenus and press the MENU key to access them. Use the arrow and MENU keys to change settings as desired.

- Patient Size** The patient size can be set to *Adult*, *Pediatric (Ped.)* and *Neonate (Neo.)*.
- Alarm Volume** The alarm volume can be set from 1 to 10 and off. If the volume is set to off or 1 it returns to 2 if the monitor is power cycled. The factory default is 4.
- Pulse Volume** The pulse volume can be set from 1 to 10 and off. The pulse volume setting will remain if the monitor is power cycled.
- Enable MAP** The NIBP MAP display can be turned on and off in the main menu.

Alarm Menu

Press the MENU key to enter the Main Menu. Use the arrow keys to highlight *ALARM MENU* and press the MENU key to access it.

Use the arrow keys to move through the alarm submenu and highlight the setting you desire to change. Press the MENU key to access the settings for the desired item. When the setting is changed as desired, press the MENU key to save the setting.

Alarm limits are set separately for adult, pediatric, and neonatal modes and are saved independently.

To set adult alarm limits, enter the *ALARM MENU* while in adult mode. Patient size mode is set in the Main Menu. Confirm that "ADULT" appears in the bottom right corner of the display. Set all desired alarm limits for adult monitoring conditions.

Change the patient size to pediatric and set all desired alarm limits for pediatric monitoring conditions.

Change the patient size to neonate and set all desired alarm limits for neonate monitoring conditions.

High Pulse Select the high alarm limit for pulse rate. Choices are 80 through 240 bpm and off. Resolution is 2 bpm. The factory default value is 40 for Adult and Pediatric modes and 180 for Neonate mode.

Low Pulse Select the low alarm limit for pulse rate. Choices are 20 through 150 bpm and off. Resolution is 2 bpm. The factory default value is 40 for Adult and Pediatric modes and 90 for Neonate mode.

High SpO₂ Select the high alarm limit for SpO₂. Choices are 70 through 98% and off. The resolution is 1% blood oxygen saturation. The factory default is off for all patient size modes.

Low SpO₂ Select the low alarm limit for SpO₂. Choices are 1 through 98% and off. The factory default value is 90% for all patient size modes.

If *Low SpO₂* is set to 98%, the *High SpO₂* alarm may not be changed from the off setting.

The *Low SpO₂* setting returns to a minimum value of 85% after a power cycle.

- High Systolic** Select the high alarm limit for systolic blood pressure. Choices are 75 through 240 mmHg and off. The factory default value is 200 for Adult and Pediatric modes and 140 for Neonate mode.
- Low Systolic** Select the low alarm limit for systolic blood pressure. Choices are 50 through 150 mmHg and off. The factory default value is 50 for all patient modes.
- High Diastolic** Select the high alarm limit for diastolic blood pressure. Choices are 50 through 180 mmHg and off. The factory default value is 100 for Adult and Pediatric modes and 80 for Neonate mode.
- Low Diastolic** Select the low alarm limit for diastolic blood pressure. Choices are 15 through 50 mmHg an off. The factory hospital default is 30 for all patient size modes. The factory alternate care default is 40 for Adult and Pediatric modes and 30 for Neonate mode.
- High MAP** Select the high alarm limit for mean arterial blood pressure. Choices are 70 through 200 mmHg and off. The factory hospital default value is 150 for Adult and Pediatric modes and 100 for Neonate mode. The factory alternate care default value is off for all patient size modes.
- Low MAP** Select the low alarm limit for mean arterial blood pressure. Choices are 25 through 125 mmHg and off. The factory hospital default value is 50 for Adult and Pediatric modes and 40 for Neonate mode. The factory alternate care default value is off for all patient size modes.

Configuration Menu

Press the MENU key to enter the Main Menu. Use the arrow keys to highlight *CONFIGURATION* and press the MENU key to access it.

Use the arrow keys to move through the configuration submenu and highlight the setting you desire to change. Press the MENU key to access the settings for the desired item. When the setting is changed as desired, press the MENU key to save the setting.

- Time** Sets the monitor time to *24-Hour* or *AM/PM*. The hospital default is *24-Hour*. The alternate care default is *AM/PM*.
- Hour** Set the current hour. *Hour* is always set in 24-hour format to establish the correct *AM/PM* time.
- Minute** Sets the current minute.
- Day** Sets the current day.
- Month** Sets the current month.
- Year** Sets the current year.
- Contrast** Adjusts the LCD display from 5% to 95% in 5% increments. The contrast changes as the adjustment is made. The factory default value is 70%.
- Brightness** Adjusts the LCD brightness from 5% to 95% in 5% increments. The brightness changes as the adjustment is made. The factory default value is 50%.
- Reverse Video** The LCD display can be set to reverse video. The factory default value is *Off*.
- NIBP** Turns the NIBP function *On* or *Off*. This automatically resets to *On* when restarting the monitor.
- SpO₂** Turns the SpO₂ function *On* or *Off*. This automatically resets to *On* when restarting the monitor.
- Units** The monitor can display units in English and Metric. The factory default is English.
- Language** The monitor has language settings available in English and Spanish. The monitor must be restarted before the language setting change activates.

NOTE: This setting is only available after a MENU power up.

Communication Menu

Press the MENU key to enter the Main Menu. Use the arrow keys to highlight *COMMUNICATION* and press the MENU key to access it.

Use the arrow keys to move through the communication submenu and highlight the setting you desire to change. Press the MENU key to access the settings for the desired item. When the setting is changed as desired, press the MENU key to save the setting.

- On NIBP** The monitor prints data when an NIBP reading is taken. Choices are *On* or *Off*. The factory default setting is *Off*.
- On Alarm** The monitor prints data during a medium or high level alarm limit violation. Choices are *On* or *Off*. The factory default value is *Off*.
- Interval** This sets the time interval for automatic interval printing of vital signs data. Choices are *10, 20 or 30 seconds; 1, 2, 5, 10, 15, 30, or 60 minutes; 2, 4, 8, 12, or 24 hours; and Off*. The factory default value is *Off*.
- Patient Data** Selecting *On* causes the patient data to print when a demand print is requested.
- Print To** Sets the output device of the monitor. Choices are *Serial* and *Off*. The factory default value is *Serial*.
- Serial** Sets the data format for the external serial port (for sending data to an external device). The choices are *Text, CSV, CUSP, and Off*. The factory default value is *Text*.
- Baud Rate** Sets the baud rate of the monitor. The choices are *2400, 4800, 9600, 19200, and 38400*. The factory default value is *19200*.

Patient Data

Press the MENU key to enter the Main Menu. Use the arrow keys to highlight *PATIENT DATA* and press the MENU key to access it.

Use the arrow keys to move through the patient data submenu and highlight the setting you desire to change. Press the MENU key to access the settings for the desired item. When the setting is changed as desired, press the MENU key to save the setting.

Weight Sets the patient's weight.

Height Sets the patient's height.

Respiration Sets the patient's respiration rate.

Pain Sets the patient's pain level.

Section 3 — Theory of Operation

System Architecture

The 506DN monitor's circuitry consists of a Main Board, LCD Module, SpO₂ Module, and NIBP Module.

The Main Board, SpO₂ Module and NIBP Module are considered the Main Module. This module is located in the monitor's front bezel. The LCD display mounts to the main board, which in turn mounts to the front bezel.

Affixed to the front bezel is the membrane switch and overlay that connects directly to the main board.

The rear housing contains the 6-Volt lead acid battery and AC-to-DC Power Supply.

The lead acid battery is contained in a compartment accessible with a tool. The design of the compartment prevents the 506DN circuitry from being exposed when the battery compartment is opened. Thus the 506DN does not require recalibration or functional testing due to a possible tampering of critical electronics.

External connectors consist of:

- An RS-232 COM port
- AC (Mains) Power
- NIBP ComfortCuff (pneumatic)
- SpO₂ Sensor

Electrical isolation of patient connections observes EN60601-1. On this end, isolated DC power supplies are contained by the DOX SpO₂ technology. Additional isolation is incorporated through a medical grade AC-to-DC power supply conforming to 4000VAC isolation and an isolated supply for the external COM function. This supply conforms to 4000VAC isolation.

Module Architecture

Main Board
(pn 91410A001)

The hardware design of the 506DN monitor relies on multiple serial communication channels wherein the Main Board functions as the hub. Signal and display processing is off-loaded to the various vital signs technology modules, the Display Board, and the LCD Module. The Main Board collects the vital signs information, then stores, formats, and outputs the data either electronically through the external serial port or in hardcopy via the optional internal printer module.

There is a power supply section of the Main Board wherein regulated DC voltages are generated for various logic and analog functions as well as the battery charging function.

NIBP Module
(pn 95597A005)

This module connects to the Main Board. The upgraded NIBP algorithm firmware installed conforms to EN1060.

DOX SpO₂ Module
(pn 91391A002)

This module is the Criticare Digital Oximetry circuit. The DOX Module provides electrical isolation of 1500VAC minimum through power and serial interface connections. The DOX SpO₂ sensor connector is mounted directly onto the Module.

Block Diagram

The following block diagram is provided for the general understanding of the 506DN monitoring system.

The diagram below shows the system module interconnections.

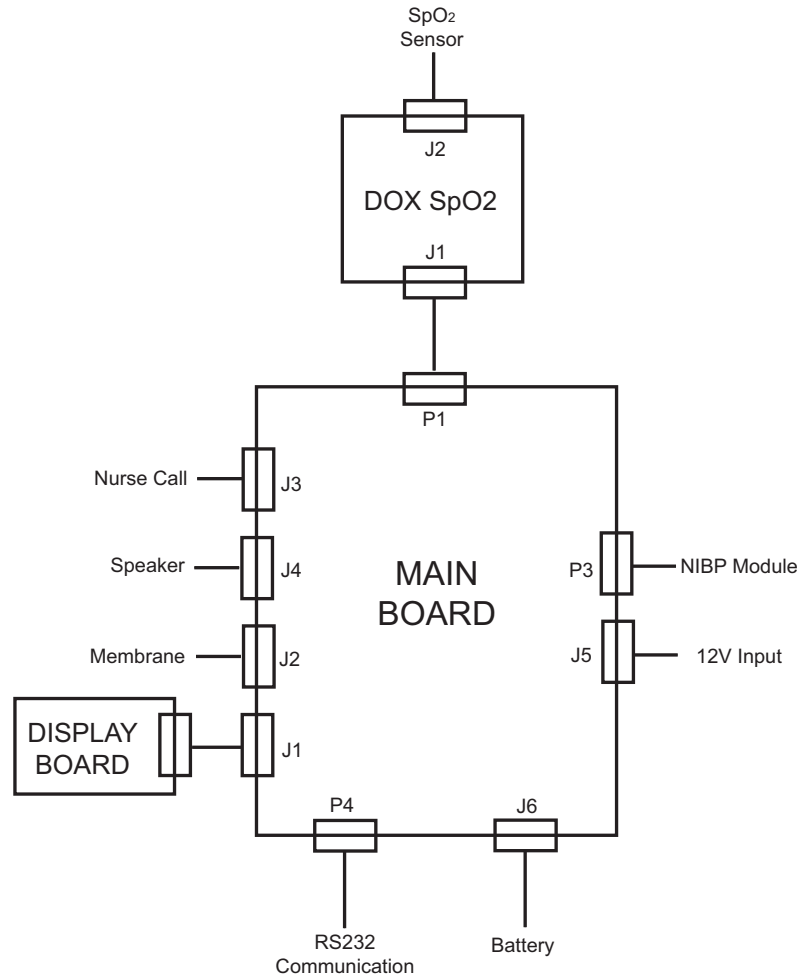

Figure 3-3: 506DN Board Interconnect Block Diagram

Section 4 — Cleaning and Disinfecting

Cleaning and Disinfecting



WARNING

- Shock Hazard! Turn the power off and disconnect the AC power before cleaning the monitor and accessories.
- Shock Hazard! Never immerse the monitor. The monitor has an internal power source that is active when the unit is unplugged.

Do not use abrasive cleaners on the monitor or on any sensors or probes. Abrasive cleaners can damage the monitor and accessories.

The exterior surface of the monitor, except for the display screen, you may wipe clean with alcohol and dry with a soft, dry cloth. It is best to use a cotton cloth to clean the monitor. Paper towels or tissues can scratch the surface of the display.

Do not use full strength alcohol on the LCD display. Repeated use of strong cleaners can damage the screen. Clean the display window by wiping it with a clean, soft, lint-free cloth sprayed with common glass cleaner. Do not spray glass cleaner directly on the display.

Pulse Oximeter Sensors

CAUTION

- Do not immerse any Criticare pulse oximeter sensor connector in any liquid. Doing so may damage the connector.

The SpO₂ sensor may be wiped clean with alcohol. The SpO₂ sensor may be disinfected by placing the paddles and cable in a 2% glutaraldehyde solution. Place only the sensor paddles and cable in the solution.

Blood Pressure Cuffs To clean the reusable blood pressure cuff wipe it with a damp cloth or sponge. If necessary, disinfect the cuff with 70% alcohol, mild bleach solution, or other disinfectant. Disposable blood pressure cuffs are for single patient use and are not intended to be disinfected.

Sterilize the cloth cuff and neoprene bag with commercially available disinfectants such as ethylene oxide (EtO). Rinse thoroughly to remove any residual disinfectants. Do not allow liquids to enter the neoprene bag. You may sterilize the cloth cuff in an autoclave.

If the cuffs become grossly soiled with blood or other body fluids, you should launder the cloth cuffs by hand or machine. Remove the neoprene inflation bag before you launder or sterilize the dacron cloth cuff. Feed the inflation tube back through the hole and then pull out the cloth flap.



Figure 4-1: Remove the Inflation Bag

Roll up the inflation bag and slide it out the open slot in the cloth cuff. Be sure to observe the following laundering precautions (do NOT launder disposable cuffs and neoprene inserts.):

- Remove the inflatable bag from the cuff before you launder or sterilize the cuff.
- Strong bleach solutions will damage the cuff.
- Temperatures over 275° F (135° C) will damage the cuff.
- Close the Velcro® fastener before you launder the cuff.
- Soaking the cuff in dark-colored solutions may stain or discolor the cuff.

Hand laundering (as opposed to machine laundering) prolongs the life of the cuff. Wash the cuff in warm, soapy water. Rinse the cuff thoroughly. After cleaning the cuff, allow the cuff to air dry, then insert the inflation bag in the cuff.

Accidental Wetting

WARNING

- Shock Hazard! The monitor is an AC powered device and an immersed monitor presents a danger to anyone who handles the device.

The action to be taken following accidental wetting of the equipment is as follows:



1. Turn the power off! Disconnect the AC power from the monitor.
2. If monitoring a patient, transfer the patient to another monitor as quickly as possible.
3. Use a clean, dry towel or cloth to remove the liquid from the monitor housing.
4. A service technician should inspect the monitor as soon as possible.
5. If the internal mechanism is saturated, allow the liquid to drain out for 24 hours before shipping.
6. If liquid has entered the monitor, it needs to be dried and cleaned internally. Full testing is required before the monitor can be used. Contact the Criticare Service Department as soon as possible.

Time is critical! The longer any liquid remains in the monitor, the more damage it can do. It is important to service the monitor immediately after any liquid is spilled into it.

Section 5 — Preventative Maintenance

Incoming Inspection

All new monitors should be inspected upon arrival for shipping damage before being placed into operation. The monitor should be free from dents, cracks, or other physical damage. The quality inspection seal of the monitor should be unbroken; this indicates that the monitor has been tested according to the manufacturer's specifications.

If further incoming inspection or testing is desired, the manufacturer recommends you use "Speaker Performance, Alarms Verification" in this section as an incoming inspection test. You may perform additional electrical safety testing with "Electrical Safety Tests" in this section as part of an incoming inspection in accordance with the policies of the health care provider.

Maintenance Schedule

Every Patient	<ul style="list-style-type: none">• Clean and disinfect the NIBP cuff and the SpO₂ cable as needed.• Inspect the accessories and charger for damage.
Every Day	<ul style="list-style-type: none">• Charge the monitor's battery as necessary.
Every 3 Months	<ul style="list-style-type: none">• Clean the exterior of the unit (or clean as needed).• Inspect the monitor and AC (mains) cord for damage.
Every Year	<ul style="list-style-type: none">• Perform the annual safety tests that are described in this section.

Long-Term Storage

No special preparation is necessary for long term storage of the monitor. Although the battery does not have to be removed from the monitor for long term storage, the battery does drain to an unrecoverable state after 3 months without periodic charging.

Disposal

At the end of its useful life, the monitor and its accessories may be disposed of according to your institution's policies and procedures for disposal of patient-contact medical waste.

Alternately, the monitor and its accessories may be returned to Criticare Systems, Inc., for safe disposal. The shipping address is:

Criticare Systems, Inc.
20925 Crossroads Circle
Waukesha, WI 53186

Service Checks

If the monitor shows any signs of physical damage, contact the Criticare Service Department for repair.

Technical Service (US): (800) 458-2697

International Customer Service: (262) 798-8282

Calibration

No periodic calibration of the monitor is necessary. It is recommended to perform an NIBP calibration verification as part of the annual safety testing.

Serviceable Components

The only user-serviceable parts inside the monitor are the battery and the fuses. Refer all other maintenance inside the monitor to a qualified technician.

For more information about troubleshooting power problems, refer to “Troubleshooting” in Section 8.

Battery Removal/ Replacement

BATTERY SAFETY

Although the battery requires no maintenance, you should allow the battery to fully charge at least once every three months.

For optimal battery performance, the battery should never be left in a drained state for any period longer than 24 hours.

⚠ CAUTION ⚠



- Do not open the case. Sensitive electronic components may be damaged by electrostatic discharge. Opening the case requires an electrostatic discharge (ESD) protected work bench.
- Shock hazard. The interior of the case contains exposed circuitry.
- Do not short circuit the battery terminals! The resulting high-current discharge can cause burns.
- Charge the battery completely after extended battery use to ensure a fully-charged battery is available for the next use.
- Explosion hazard! Keep lighted cigarettes, sparks, and flames away from the battery.
- The battery contains sulfuric acid electrolyte which can cause severe burns and eye damage, as well as illness from sulfur oxide fumes.
- Do not crack, cut, burn, or dissolve (with solvents) the battery case. Damaging the battery case can cause the release of sulfuric acid. If sulfuric acid is released from the battery, wear eye protection and rubber gloves to handle the battery, and use a solution of baking soda in water to neutralize the sulfuric acid.
- The used battery is a potential environmental hazard and must be disposed of properly. Dispose the old battery in accordance with local and federal laws. Do not incinerate.

REMOVE THE BATTERY

1. Turn the monitor off and disconnect the monitor from the AC (Mains) power source.
2. Remove the two (2) Phillips screws from the battery cover on the back of the monitor. Remove the battery cover.



Remove screws

Figure 5-1: Remove Screws

3. Remove the battery (P/N MISC10004) from the monitor.



Disconnect
Battery

Figure 5-2: Remove Battery

4. Label and remove the cables connected to the battery.

NOTE: Printing faces inward.

REPLACE THE BATTERY

1. Attach the battery cables to the new battery (P/N MISC10004).

IMPORTANT: Connect the red battery cable to the positive battery terminal and the black cable to the negative battery terminal.

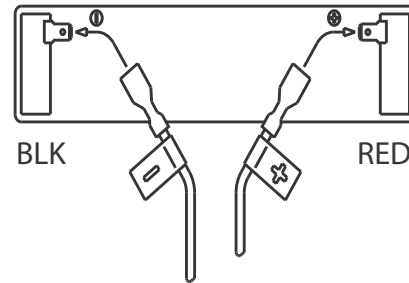

Figure 5-3: Connecting the Battery

2. Slide battery into the battery bay.
3. Reattach the battery cover with the two (2) screws removed earlier. Torque to 5 in lbs.

Fuse Removal/ Replacement

There are two AC power fuses located at the rear of the monitor directly below the AC power entry socket.

- Use 250V time delay fuses (FUSE T TIME LAG .5mA L 250V 5X20; P/N 82013B002).
1. With a flat blade screwdriver, turn the fuse cover(s) out.
 2. Gently pull the fuse cover(s) with fuse(s) out of the fuse assembly.
 3. Gently pull the fuse(s) out of the fuse cover(s).
 4. Reassemble in reverse order.

Annual Testing

You may perform the following tests as part of a periodic safety check. The following safety tests are designed so that the monitor's quality/warranty seal does not need to be broken. If the monitor fails any portion of these tests contact Criticare Support for additional information.

Descriptions of service tests can be found in "Service Testing & Calibration" in Section 6. Some tests may require specialized equipment.

Accessory Testing Check the patient cables monthly for damage, loose wires/connections, loose connectors, cracked housing, etc. Check the cuffs for leakage as part of the NIBP verification.

Functional and Safety Testing Annual testing should include electrical safety testing, the withstanding voltage, and electrical leakage tests. Additional functional tests and verifications are provided that you may perform as designated by hospital protocols or as necessary.

A complete list of functional and safety tests are included here.

1. Electrical Safety Tests
 - a. Withstanding Voltage (Hi-Pot)
 - b. Electrical Leakage
2. Functional Tests
 - a. System Check
 - b. Speaker Performance and Alarm Verification
 - c. Power Supply Performance
3. Vital Sign Modules Verifications
 - a. NIBP
 - b. Oximeter (SpO₂)

Equipment and Tools The following procedures assume that the technician has an ESD safe workbench available, a set of electronic hand tools, and a digital multimeter with a 10 amp setting. You need a withstanding voltage tester (Hi-Pot), an oscilloscope, and an electrical leakage tester for safety testing. At the beginning of each test special equipment may be listed. You may also need a variety of customized cables, clips, and test fixtures to complete all the tests.

The following tools are needed for these procedures:

- Set of hand tools
- Digital multimeter (10A)
- Oscilloscope
- Power supply
- Setra 350-1 (or equivalent) manometer with Tee
- Dynatech 232D (or equivalent) leakage tester
- Dynatech cufflink NIBP simulator with neonatal and adult cuffs
- 7512DT Associated Research withstanding voltage tester (or equivalent)
- Smart Sat SS-100A pulse oximetry analyzer (or equivalent)
- Computer with CSI NIBP Service program (P/N 97082A003) and WFSDLOAD program (P/N 97134A002)
- SpO2 Hi-Pot Test Fixture (see “Test Fixtures” in this section)
- SpO2 Leakage Test Fixture (see “Test Fixtures” in this section)
- Nurse Call Box (see “Test Fixtures” in this section)
- Screw in order to Hi-Pot to case
- Serial cable with null modem (P/N 87016B002)
- AC (Mains) Power cord
- 700 cc factory test block
- Cat 511SD finger sensor (or equivalent) with optical load (foam packing peanut)

Test Fixtures SPO2 HI-POT TEST FIXTURE

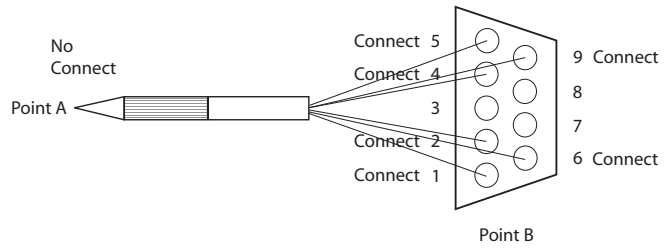

SPO2 LEAKAGE TEST FIXTURE

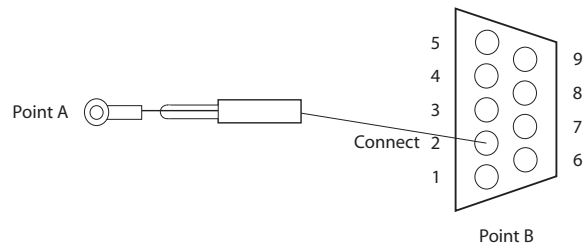

NURSE CALL BOX

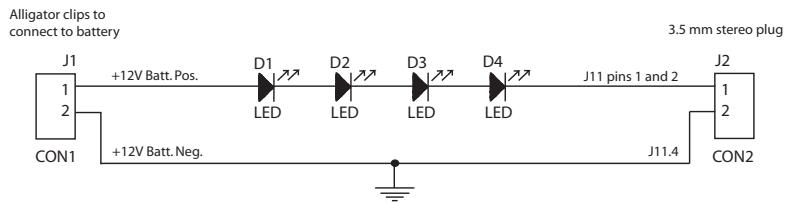

HOT/NEUTRAL TO GROUND HI-POT FIXTURE



Note: At Point A
Hot/Nuetral are
soldered together.

NURSE CALL HI-POT FIXTURE



Electrical Safety Tests

Perform this test whenever the monitor housing is opened before using the monitor on patients.

Withstanding Voltage Test (Hi-Pot)



WARNING

- High Voltage! The following test procedure requires working with exposed electrical circuits and should only be attempted by experienced technicians.

Equipment Needed

This test requires a Kikusui 7512DT Associated Research (or equivalent) Hi-Pot tester. The tester should be rated for 4000 VAC maximum.

Setup Hi-Pot Tester

- Hi limit = 1mA
- Lo Limit =0.0uA
- Arc Fail = OFF
- Arc Sense = 5
- Ramp Hi = Off
- Charge Lo = 0.0 uA
- Ramp Time = 1 second
- Dwell Time =1 second
- AC/DC =DC

- Hi-Pot Performance Test** **NOTE:** Do not power up the 506DN monitor during the Hi-Pot steps.
1. Connect the 506DN monitor to the measurement receptacle of the Hi-Pot tester. Test “Hot/Neutral” to “Ground” at **2500VDC**.
 2. Install a screw into the roll stand-mounting insert located on the rear of the enclosure. Attach the ground test lead of the Hi-Pot tester to the screw and the red test lead to “Hot/Neutral.” Test at **2500VDC**.
 3. Connect the DOX SpO₂ Hi-Pot cable to the ground test lead of the Hi-Pot tester and connect to the SpO₂ connector on the monitor. Attach the red test lead to “Hot/Neutral” and test at **4242VDC**.
 4. Connect the DOX SpO₂ Hi-Pot cable to the red lead of the Hi-Pot tester and connect the ground test lead to the Hi-Pot tester to the DB9 shell of the 506DN. Test at **2500VDC**.
 5. Connect red lead of the Hi-Pot tester to “Hot/Neutral” and the black lead to the Nurse Call cable. Test at **2500VDC**.

Leakage Testing This test requires a Dynatech 232D Safety Analyzer (or equivalent) leakage testing device.

Setup Procedure (Self-Test) Perform a self test, if applicable, to ensure proper operation of the leakage tester. If the self test fails, don't proceed with this test.

For Dynatech 232D only:

1. Perform a self test on the Dynatech 232D. Set the MODE switch to SELF test. The display should read 1000 (± 20) and the CURRENT SOURCE ACTIVE lamp should be on.

⚠ CAUTION ⚠

- If these conditions are not met do not continue with the leakage test.
2. Set the MODE switch on the Dynatech to L1-L2. The display should read 220 to 240 VAC (or 110 to 130 VAC if supply voltage is 120 VAC). Set the MODE switch to L1-GND. The display should read no more than 5% of the previous line voltage measurement. Set the MODE switch to L2-GND. This reading should be the same as the first reading, ± 5 VAC.

Leakage Procedure **NOTE:** The monitor must be on throughout the leakage test. This test should be performed at a supply voltage of 230VAC. If supply voltage is 120VAC, then acceptable leakage current limits are one-half the value stipulated.

NOTE: If attaching acceptable leakage measurements to the check sheet, check "PASS" on each step completed.

1. Connect the monitor to the measurement receptacle of the leakage tester.
2. Configure the leakage tester to test internal case leakage (Dynatech 232D: MODE = CASE LEAKAGE/GROUND CONDUCTOR). Record measurements on the check sheet for the following:
 - Normal Polarity (<50uA)(<100uA)
 - Reverse Polarity (<50uA)(<100uA)
 - Normal Polarity, Open Ground (<250uA)(<500uA)
 - Reverse Polarity, Open Ground (<250uA)(<500uA)
3. Configure the leakage tester to test external case leakage (Dynatech 232D: MODE = CASE LEAKAGE/EXT. LEAD). Clip the external leakage test lead to the DB9 shell of the monitor. Record measurements on the check sheet for the following:
 - Normal Polarity (<50uA)(<100uA)
 - Reverse Polarity (<50uA)(<100uA)
 - Normal Polarity, Open Ground (<250uA)(<500uA)
 - Reverse Polarity, Open Ground (<250uA)(<500uA)

4. Connect the SpO₂ leakage cable to the LA terminal on leakage tester.

Record the measurement on the check sheet or attach print out of the acceptable test result to the check sheet and test.

Configure the leakage tester to measure the patient connection to GND leakage. (Dynatech 232D: MODE = ECG, LEADS = ALL TO GND).

- Normal Polarity (<5uA)(<10uA)
- Normal Polarity, Open Ground (<25uA)(<50uA)

5. Remove the SpO₂ cable

⚠ WARNING ⚠

- Hazardous voltage are present on the test leads. Do not touch these leads or the monitor while performing this test.

6. Connect the SpO₂ leakage cable to the LA terminal on leakage tester.

Record the measurement on the check sheet or attach print out of the acceptable test result to the check sheet and test.

Configure the leakage tester to measure patient isolation. (Dynatech 232D: MODE = ECG, LEADS = ISOLATION TEST)

- Normal Polarity (<50uA) Press the isolation button.

Functional Tests

System Check Confirm the proper start up of the monitor. No cable should be attached to the external serial port during this test.

1. Press the POWER key to start the monitor. The alarm icon displays and the sensor is detected.

The monitor displays the following messages:

CRITICARE SYSTEMS INC.

506DN SERIES

REVISION x.x (C) 200X

2. Hold the MENU key while you restart the monitor. The reset to defaults message appears. Depending on configuration of the unit, this message may appear as *USER DEFAULTS*, *HOSPITAL DEFAULTS*, or *ALT. C. DEFAULTS*.
3. Press the MENU key and press the UP/DOWN arrow keys to scroll to the *CONFIGURATION* menu. Press the MENU key to enter the *CONFIGURATION* menu.
4. Press the UP/DOWN arrow keys to scroll to *CONTRAST*. Check the LCD *CONTRAST* setting. Adjust the contrast as necessary.
5. Continue in the *CONFIGURATION* menu. Ensure the time and date are correct.

**Speaker Performance,
Alarms Verification**

To verify alarm circuitry:

1. Set the alarm volume to 10 in the *ALARMS* menu.
2. With no cuff attached press the NIBP START/STAT/STOP key. The monitor attempts to inflate and responds with a message: *BP: CHECK CUFF*.
3. Listen for the low level alarm tone. It is a burst of two pulses at the same pitch. The bursts should repeat every 10 seconds.
4. Set the alarm level to 1 and cause another *CHECK CUFF* alarm. The volume should be decreased but still audible.
5. Set the alarm volume to OFF and cause another *CHECK CUFF* alarm. No alarm tone should be audible. Confirm that the alarm bell indicator appears.
6. Return the alarm volume setting to 4.
7. In the *CONFIGURATION* menu, turn on the temperature module and turn off the NIBP monitoring module. The NIBP numerics should not display on the LCD main screen.
8. Restart the monitor to reset the NIBP module to ON.

Power Supply Performance

1. Verify the green AC LED lights up the AC power symbol on the front membrane when the monitor is plugged into the AC inlet.
2. Verify the monitor powers up on AC only.
3. Verify the monitor powers up on DC only with a battery.

Monitoring Module Verification

NIBP Verification The NIBP verification requires Dynatech Nevada NIBP Analyzer. Connect the 506DN monitor to a Dynatech Nevada NIBP Analyzer set for the following operation.

NIBP Analyzer Settings

Adult 120/80 (90); Heart Rate 120 bpm

Pressure Adjustments: Gain 100%; Shift 4

Use a tee connection with an adult dummy cuff. Connect to the 0-300 mmHg port of the NIBP analyzer. A neonatal dummy cuff is also required for complete testing.

It is recommended that the actual cuffs (to be used with the monitor) are setup as dummy cuffs for this verification. Wrap the cuff snug with bubblewrap around a sturdy cylinder.

1. Connect the monitor to an AC power source and turn on the monitor. Set the monitor to the *ADULT* Mode (Adult Patient).
2. Press the NIBP START/STAT/STOP key and allow the monitor to take at least four (4) readings. The systolic, diastolic and mean readings should not vary by more than $\pm 4\%$ or $\pm 4\text{mmHg}$ (whichever is greater) from the calculated average. Each reading shall not vary more than 8 mmHg from the simulator setting.

Leave the monitor connected to the NIBP analyzer. Change the NIBP analyzer setting to the neonate configuration with a simulator setting of 80/50 (62) mmHg; Heart Rate 80 bpm. A neonatal dummy cuff must be used during this test.

1. Set the monitor to *NEONATE* Mode in the Main Menu.
2. Press the NIBP START/STAT/STOP key and allow the monitor to take at least four (4) readings. The systolic, diastolic and mean readings should not vary by more than $\pm 4\%$ or $\pm 4\text{mmHg}$ (whichever is greater) from the calculated average. Each reading shall not vary more than 8 mmHg from the simulator setting.
3. If the monitor continues to fail verification contact the Criticare Technical Support Department.

NIBP Seal Test EQUIPMENT REQUIRED

- Digital manometer, calibrated (accuracy of $\pm 0.05\%$)
- Manual squeeze bulb with valve
- “Tee” connector

SETUP

1. Connect the manual squeeze bulb to the “tee” connector.
2. Connect the digital manometer to the “tee” connector.
3. Connect the “tee” connector to the NIBP connector on the monitor.

PROCEDURE

The 506DN monitor has a simple test mode for checking the seal and pressure transducer. The instructions are as follows:

1. Press the POWER key while holding the DOWN arrow key.
2. The monitor begins its normal boot sequence but enters the Service Mode instead. The LCD shows the message *SERVICE DISPLAY*.
3. Press the DOWN arrow to scroll through the menu options to *TEST MENU*.
4. Press the DOWN arrow to scroll through the test menu options to *NIBP SEAL <-- OFF*.
5. Press the MENU key. The display should read *NIBP SEAL --> OFF*.
6. Press the DOWN arrow once to turn the test to *ON*.
7. Press the MENU key to start the test.

The monitor will then function as a plain pressure meter allowing the technician to manual test the pressure transducer with a manometer.

Pump up the manual squeeze bulb. Verify that the manometer readings agree with the monitor readings. The accuracy of the pressure transducer for static pressure measurements should be within ± 2 mmHg or $\pm 2\%$ of reading, whichever is greater. The current pressure will be displayed in the LCD window.

SpO₂ Verification

1. Using a SpO₂ finger sensor, verify heart rate and plethysmograph operation displayed on the LED's within 15 seconds. Verify no SpO₂ error messages appear (alarm violations may occur depending on individual readings and monitor set-up).
2. Remove your finger from the sensor and verify *SPO2: SENSOR* message is displayed when the finger sensor is plugged in, but with no finger inserted in the sensor.
3. Verify *SPO2: HIGH AMBIENT* message appears by introducing a higher than normal amount of ambient light on the SpO₂ sensor detector.
4. Disconnect the DOX SpO₂ sensor from the unit after power up.
5. Verify a *SPO2:NO SENSOR* displays on the LCD.

Functional and Safety Testing Checklist

Use the checklist on the following pages to record the successful completion of the annual safety tests and verification.

Functional and Safety Testing Checklist (Page 1 of 2)

Copy this checklist as needed to record results.

Model _____

Unit serial number _____

Software Rev. _____

Tested by _____

Date _____

Electrical Safety Tests

Hi-Pot Tests

PASS **FAIL**

Hi-Pot Hot/Neutral to Ground @ 2500VDC	_____	_____
Hi-Pot Hot/Neutral to Metal Case @ 2500VDC	_____	_____
Hi-Pot Hot/Neutral to DOX SpO ₂ Gnd @ 4242VDC	_____	_____
Hi-Pot DOX SpO ₂ to DB-9 shell @ 2500VDC	_____	_____
Hi-Pot/Neutral to Nurse Call @ 2500VDC	_____	_____

Leakage Tests

PASS **FAIL**

Perform Self Test on Leakage Tester	_____	_____
Leakage GND CONDUCTOR Normal Polarity (<50/<100uA)	_____ uA	_____ uA
Leakage GND CONDUCTOR Normal Reverse (<50/<100uA)	_____ uA	_____ uA
Leakage Open GND and Normal Polarity (<250/<500uA)	_____ uA	_____ uA
Leakage Open GND and Reverse Polarity (<250/<500uA)	_____ uA	_____ uA
Leakage Case Normal Polarity (<50/<100uA)	_____ uA	_____ uA
Leakage Case Reverse Polarity (<50/<100uA)	_____ uA	_____ uA
Leakage Case Normal Polarity Open Ground (<250/<500uA)	_____ uA	_____ uA
Leakage Case Reverse Polarity Open Ground (<250/<500uA)	_____ uA	_____ uA
DOX SpO ₂ LEAKAGE Normal Polarity (<5/<10uA)	_____ uA	_____ uA
DOX SpO ₂ LEAKAGE Normal Polarity Open GND (<25/<50uA)	_____ uA	_____ uA
Isolation test DOX SpO ₂ (<25/<50uA)	_____ uA	_____ uA

Functional and Safety Testing Checklist (Page 2 of 2)

PASS FAIL

Functional Tests

Alarm Functions

- Verify Pulse volume operation from 0 to 10 _____
- Verify Alarm volume operation from 0 to 10 _____
- Verify 2 minute Alarm Silence function _____
- Verify permanent Alarm Silence function _____
- Verify Nurse Call lights up when alarm is triggered _____

Display Functions

- Verify Green Charge LED w/AC power connected _____

Powerup Function

- Verify unit powers up with AC plug in _____
- Verify unit powers up on battery _____

NIBP Function

Simulator set to Adult mode @120/80 – 1 min cycle
 (Each reading does not vary by more than ±4% or ±4mmHg (whichever is greater) from the calculated average.)

_____/_____, _____/_____, _____/_____, _____/_____
 Average: ____/____ _____

Simulator set to Neonate mode @80/50 – Stat mode
 (Each reading does not vary by more than ±4% or ±4mmHg (whichever is greater) from the calculated average.)

_____/_____, _____/_____, _____/_____, _____/_____
 Average: ____/____ _____

Seal Test _____

SpO₂ Functions

- Verify SPO2: NO SENSOR condition _____
- Verify SPO2: SENSOR condition _____
- Verify SPO2: HIGH AMBIENT condition _____
- Take SPO2 & HR readings _____
- Verify LED Bargraph _____
- Sensor symbol operation _____
- Verify SPO2: LOST condition _____

CERTIFICATION THAT THE UNIT IS CALIBRATED AND FUNCTIONING PROPERLY

NAME _____

COMMENTS _____

Section 6 —Service Testing & Calibration

Monitor Testing

If the monitor fails any portion of these tests contact the Criticare Service Department for additional information. See “Functional and Safety Testing” in Section 5 for functional and electrical safety tests. Monitoring module verifications are also located in “Service Checks” in Section 5.

Service Checks If the monitor shows any signs of physical damage return it to Criticare for repair.

WARNING

- If the unit fails any tests, contact Criticare. Do not use the monitor for patient monitoring until you fix the problem.
- No user-serviceable parts exist inside the monitor. Do not remove the cover. Refer all servicing to a qualified technician.

Field Service Testing

WARNING



- Service testing procedures require working with exposed electrical circuits and only experienced electrical or biomedical technicians should attempt these procedures.
- Any time a monitor is altered through repair or hardware adjustment, you should fully test it before use.

CAUTION



- Always follow ESD precautions when you perform any of the procedures discussed in this section.
- The manufacturer recommends that a serviced monitor be allowed to run for 24 hours before you place the monitor back into operation.
- Modules and PCBs that you have repaired may require more extensive testing than what is described in this manual.

The following tests are designated for monitors that require service repairs. Opening the monitor may void your warranty, so it is important to contact Criticare customer service before you attempt any repair.

The pre-assembly testing of printed circuit boards (PCBs) is not covered in this manual. Disassembly of surface mounted components on PCBs is not recommended. Tests provided here are only for the identification of damaged or degraded PCBs.

Any time you open a monitor’s case you should perform the electrical safety tests before you return the monitor to operation. If you serviced the monitor you should also perform the associated functional tests.

Additional tests that are specific to modules and assemblies you should perform when you service, adjust, calibrate, or otherwise disassemble any assemblies. See the following table.

Field Service Testing	Withstanding Voltage (Hi-Pot)	Electrical Leakage	Functional Testing	SpO2 Verification	NIBP Verification	Communication Testing	SpO2 Performance Testing	NIBP Module Calibration	Power Supply Calibration
No Fault (case opened)	✓	●	✓						
Battery			✓						
NIBP Module	✓	●	✓		●			●	
DOX SpO2 Board	✓	●	✓	●			●		
Main Board	✓	●	●	✓	✓	✓	●		●
LCD Display	✓	●	●	✓	✓	✓			
Keypad	✓	●	●		✓	✓			
Front Enclosure Disassembled	✓	●	●		✓	✓			
Monitor Dropped	✓	✓	✓	✓	✓	✓			
Software Download			●	✓	✓				
Annual Safety Test	●	●	✓	✓	✓				

Equipment and Tools The following procedures assume that the technician has available an ESD safe workbench, a set of electronic hand tools, and a digital multimeter with a 10-amp setting. Servicing of the NIBP module requires a calibration work station. At the beginning of each test special equipment may be listed. A variety of customized cables, clips, and test fixtures may also be needed to complete all the tests. Contact Criticare Service for additional information.

Communication Testing

Equipment Required

- Windows-compatible computer with DB-9 serial port

NOTE: If your computer uses USB ports instead of a serial port a USB/Serial converter with software is needed to complete this procedure. Install the converter and software on the computer as directed by the converter manufacturer. The following adapters are recommended.

- IOmega USB to Serial/PDA Converter CableGUC232A
- Keyspan USB Serial AdapterUSA-19HS
- Serial download cable (pn 87016B002)
- A common computer terminal program

Pinout Chart

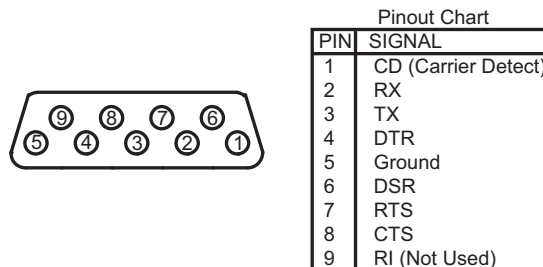

Figure 6-1: Pinout Chart

Procedure

1. Set *PRINT TO* to *SERIAL* in the *COMMUNICATION* menu.
2. Set *SERIAL* to *TEXT*.
3. Connect the COM port to the serial port on the computer or the USB port (with adapter) on the laptop.
4. Start Hyper Terminal from the Accessories|Communication menu on the PC. Settings: 19200 bps, 8-N-1, or Auto Detect.

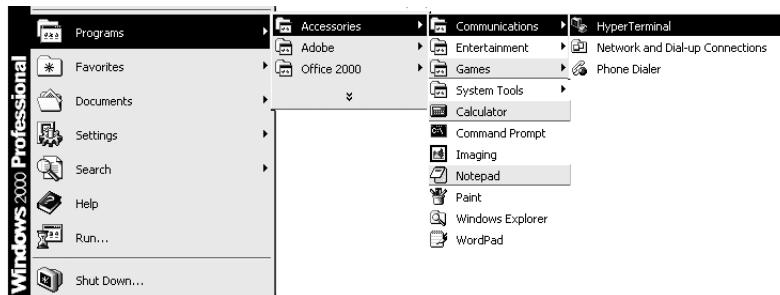
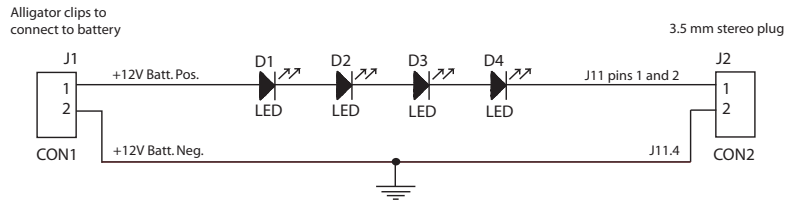

Figure 6-2: PC HyperTerminal

5. Press the SEND key on the monitor to initiate a print of data.
6. Ensure data prints to the computer.

Nurse Call This test requires the use of a Nurse Call fixture. This fixture may be created by using the schematic below:



1. Connect the Smart Sat and monitor all levels.
2. Connect the Nurse Call fixture into the side of the monitor while the Smart Sat simulator runs.
3. Create an alarm state with the Smart Sat, and verify that the lights on the Nurse Call fixture go on.
4. Press the *Alarm Silence* button, and verify that the two minute alarm silence is indicated on the LCD display and that the lights on the Nurse Call fixture go off and remain so for two minutes while in the alarm state.
5. Press and hold the *Alarm Silence* button. The Nurse Call fixture should go off and remain off regardless of changing alarm states.

NOTE: While in the 2 minute Alarm Silence, if the alarm states change, the Nurse Call fixture lights will come back on. While in permanent alarm silence, the lights on the Nurse Call fixture should remain off regardless of changing alarm states.

DOX SpO₂ Performance Testing

This test requires a SmartSat Pulse Oximetry Analyzer, Model SS-100A. The SmartSat is a programmable simulator and probe analyzer. The SmartSat is the recommended device for testing the DOX SpO₂ module. The SmartSat, model SS-100A, is available from Clinical Dynamics Corp. of Wallingford, CT.

The SmartSat comes standard with a Lemo style connection. The Cat. No. 913A adapter that converts Lemo to DB-9 style SpO₂ connections is needed for the 506N3 Series monitor. The analyzer also has a custom port designed for testing DOX™ SpO₂ sensors.

Programming the SmartSat Analyzer

The SmartSat can be used for spot checking SpO₂ values using the manual settings. The manufacturer recommends using a timed and programmed sequence to ensure that there is optimal performance.

Auto Seq: Model 506DN			Oximeter	DOX
Level	SPO2	Limits	Heart rate	Limits

Test Procedure

1. Verify the SpO₂ module as described in “SpO₂ Verification” in Section 5.
2. Attach the monitor to the SmartSat.
3. Start the SmartSat programmed sequence: *SmartSat Auto Sequence*. Verify that the monitor’s reported SpO₂ values are within the limits specified.

Level	Saturation (%)	Limits (%)	Heart Rate (bpm)	Limits (bpm)
1	98	97 - 99	40	39-41
2	96	94 - 98	60	59-61
3	90	88 - 92	80	79-81
4	78	76 - 80	100	99-101
5	61	58 - 64	120	119-121
6	52	49 - 55	180	179-181
7	40	37 - 43	300	297-303

4. Even if the monitor fails only one level, rerun the sequence after 30 seconds. Only if the monitor is successful the second time, do you pass the monitor.
5. If the monitor fails again, contact the CSI Service Department.

NIBP Calibration

The manufacturer recommends that NIBP calibration be performed only at authorized service facilities. The NIBP calibration procedures require specialized equipment (Cat. No. 454-G Calibration Kit) necessary for proper calibration testing.

Equipment Required

- Windows-compatible computer with DB-9 serial port
- USB ports: a USB/Serial converter with software is needed to complete this procedure. Install the converter and software on the computer as directed by the converter manufacturer.
- Digital manometer, calibrated (accuracy of $\pm 0.05\%$)
- ESD Protected Work Bench
- Calibration Kit (Cat. No. 454-G), includes:
 - Serial null modem cable DB9F-DB9F 6-foot null modem cable (pn 87016B002)
 - Calibration fixture with 700cc reservoir and tee connector
 - Service program software CD-ROM (pn 97082A003, revision 2 or higher)

Installing the PC Service Program

The NIBP Service Program is provided on a self-installing CD-ROM disk. If the CD-ROM does not run automatically you may need to click on the CD-ROM drive icon.

Run the auto-installation disk. The program NIBPSvc.exe will be loaded into the Program Files directory. The new folders CSI\Tools will be created. A launch icon will also be placed on the desktop of the computer.

Configuring the Ports

The Service Program is designed to operate using a serial COM1, COM3 or COM4 port. If your computer uses USB ports instead of a serial port an adapter will be required. The following adapters are recommended.

- IOmega USB to Serial/PDA Converter CableGUC232A
- Keyspan USB Serial AdapterUSA-19HS

If COM1, COM3 or COM4 is not available as a free port, the ports will need to be reconfigured in the computer's device manager. Go to *Control Panel\System\Hardware* and select *Device Manager*. Select *Ports* and reassign the alternate port or the USB to Serial Adapter to COM1, COM3 or COM4. *For laptops using a USB adapter, select COM 4 or an alternate COM port as necessary.*

Setup

1. Turn off the power and disconnect the AC (Mains) power.
2. Place the monitor on a ESD protected workbench. Observe all ESD protection procedures as described in “Electrostatic Discharge Protection” in Section 7.
3. Connect the download cable to the DB-9 serial connection of the monitor’s front bezel. Connect the other end to the DB-9 serial port of the computer.
4. Open the service tool on the computer. Select *Start > Programs > CSI NIBP Service > NIBPSvc* (or click on the shortcut on the PC desktop).
5. Select *COM1* for the port.



For laptops using a USB adapter, select COM 4 or an alternate COM port as necessary.

6. Select *506CN* in the drop-down menu box.



Figure 6-3: Select the COM Port and Model

7. Plug the monitor back to the AC (Mains) source.
8. Power up the unit while holding the NIBP START/STAT/ STOP key.
9. On the display of the unit, verify that the message *CHECKING FOR NIBP TOOLS....* appears.

10. Select the *Connection* from the drop-down menu. Select *Open in Service Mode*.

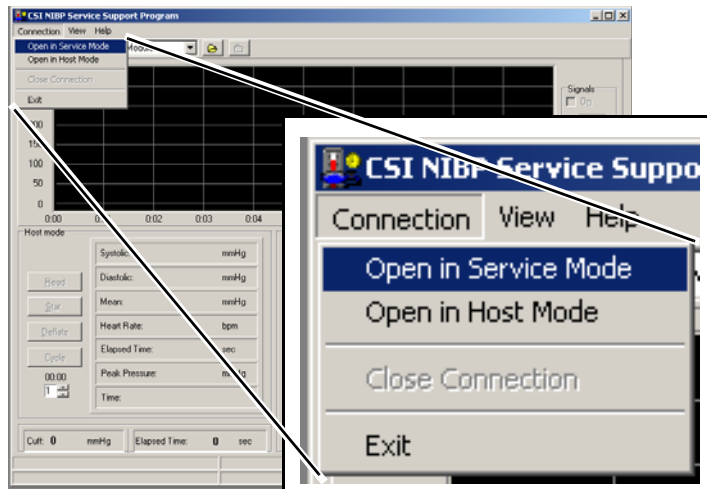

Figure 6-4: Select *Open in Service Mode*

11. If communication has been established, the following screen should appear. When this message appears, communication with the PC is established.



Figure 6-5: Communication Established

Calibrate

1. Select *Calibrate* from the service tool screen on the PC.

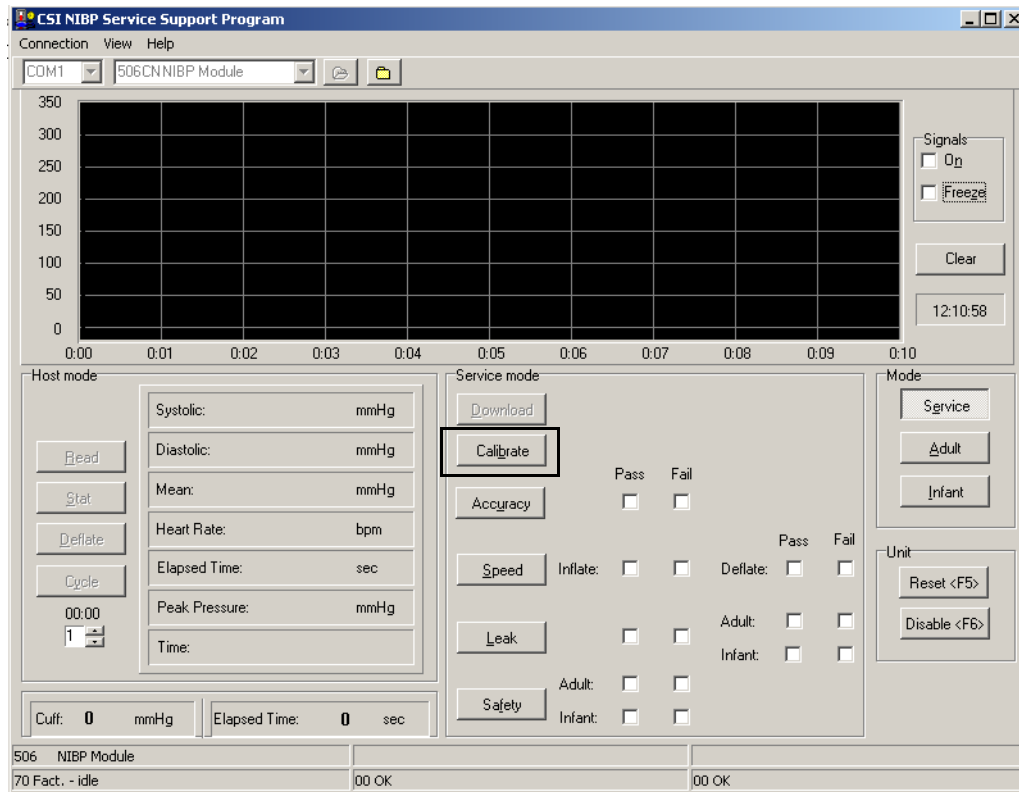

Figure 6-6: Select *Calibrate*

2. A box appears as shown. Verify that the pressure at the cuff is “0mmHg” \pm 2mmHg.

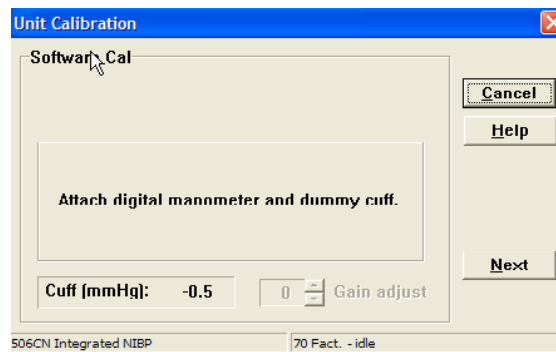

Figure 6-7: Verify Cuff Pressure

- Click *Next* and verify that the pressure at the cuff is “0 mmHg” ± 2 mmHg.

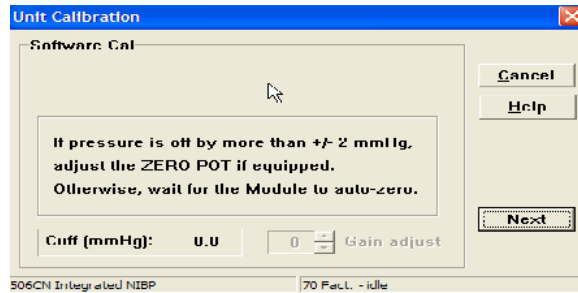

Figure 6-8: Verify Cuff Pressure

- Connect a manometer to power. Connect the open tube to the fitting on the back of the manometer. Connect a 700cc block into on of the tubes.

Connect the fitting from the manometer onto the NIBP fitting on the unit. Click *Next* again. The pump should inflate to 250 mmHg and then settle. Use the *UP* or *DOWN* buttons to adjust the gain to match the manometer pressure with the cuff pressure.

- When Manometer and cuff match, select *Finish*.

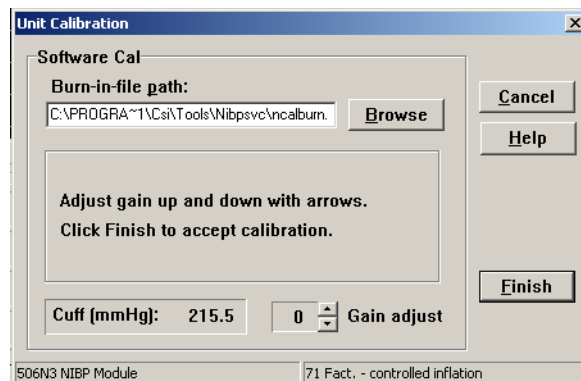

Figure 6-9: Finish Calibration

- The cal information will be downloaded into the E2 and “Calibration Complete” should appear.

Safety Test

1. Using the mouse, click on the *Safety* test button.

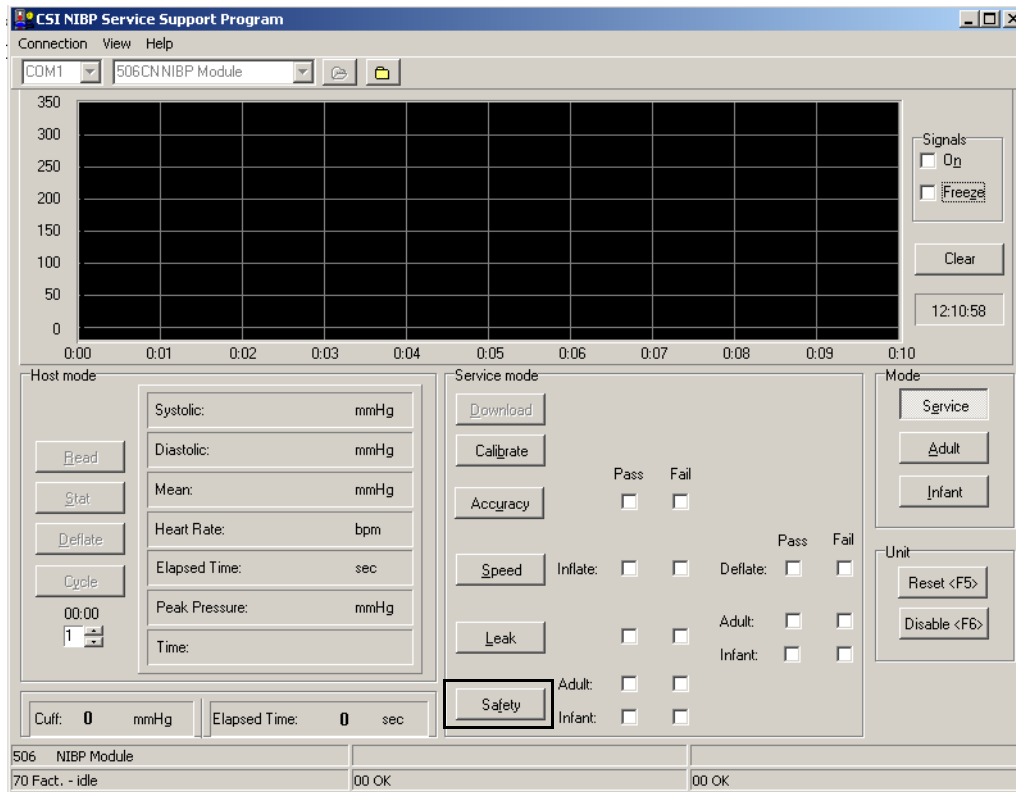

Figure 6-10: Select Safety

2. A *High Pressure Safety Test* window opens. Click on *Start*.

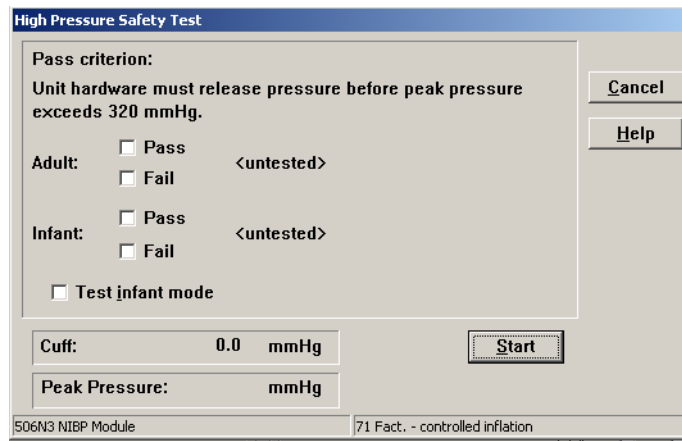

Figure 6-11: High Pressure Safety Test window

- The cuff pressure should increase until approximately 300-315 mmHg. Verify that the *Pass* box for *Adult* contains a checkmark.

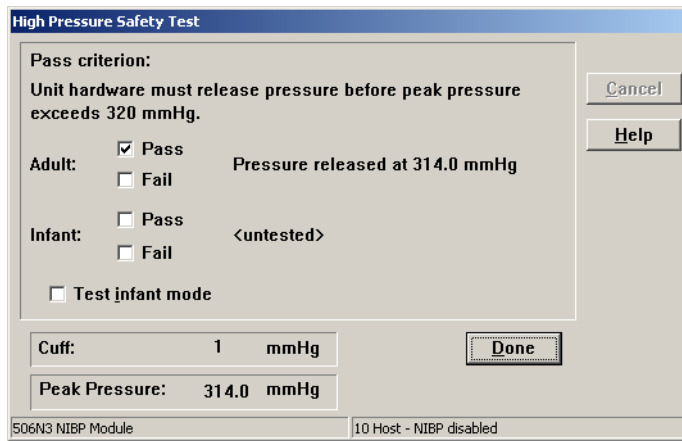

Figure 6-12: Adult Test Pass

- Click on the *Test Infant Mode*. A checkmark should appear in the box before it. Click *Start*.

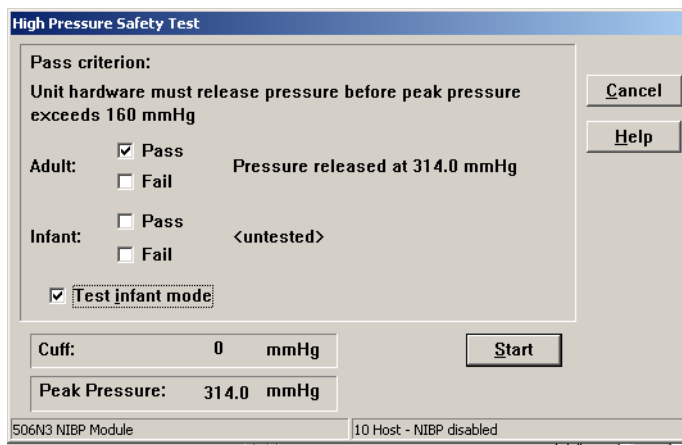

Figure 6-13: Test Infant Mode

- Verify that the *Pass* box in the *Infant* field contains a checkmark.

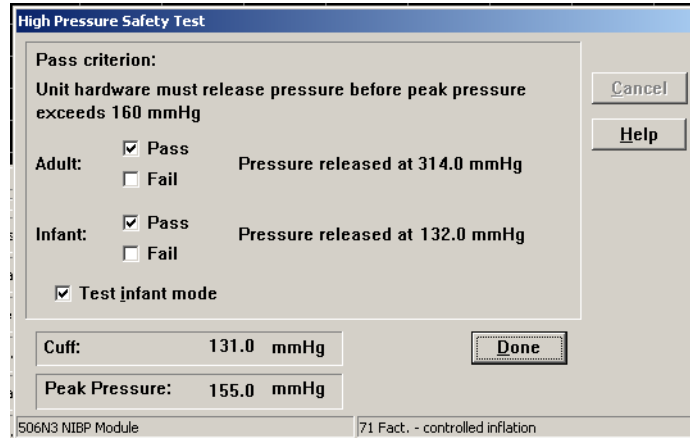

Figure 6-14: Test Infant Mode Pass

- Click *Done* if a checkmark appears in the *Pass* box. The main screen displays checkmarks indicating a *Pass* of the *Safety* tests.

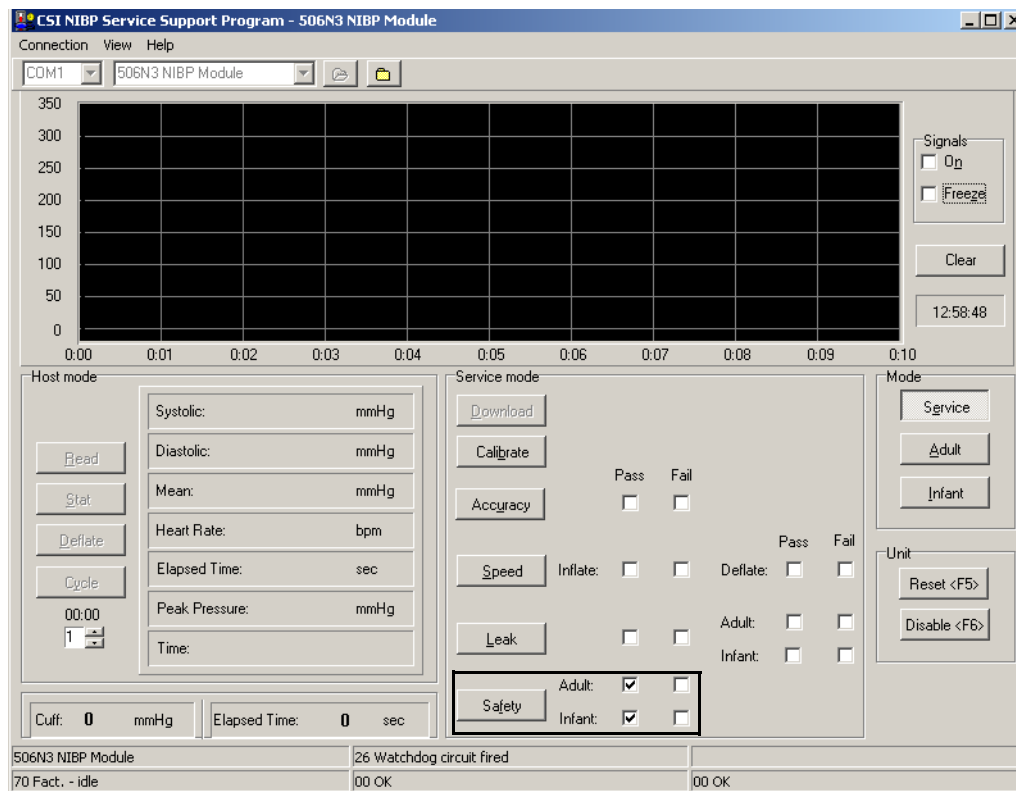

Figure 6-15: Safety Test Pass

Speed Test 1. Click on *Speed*.

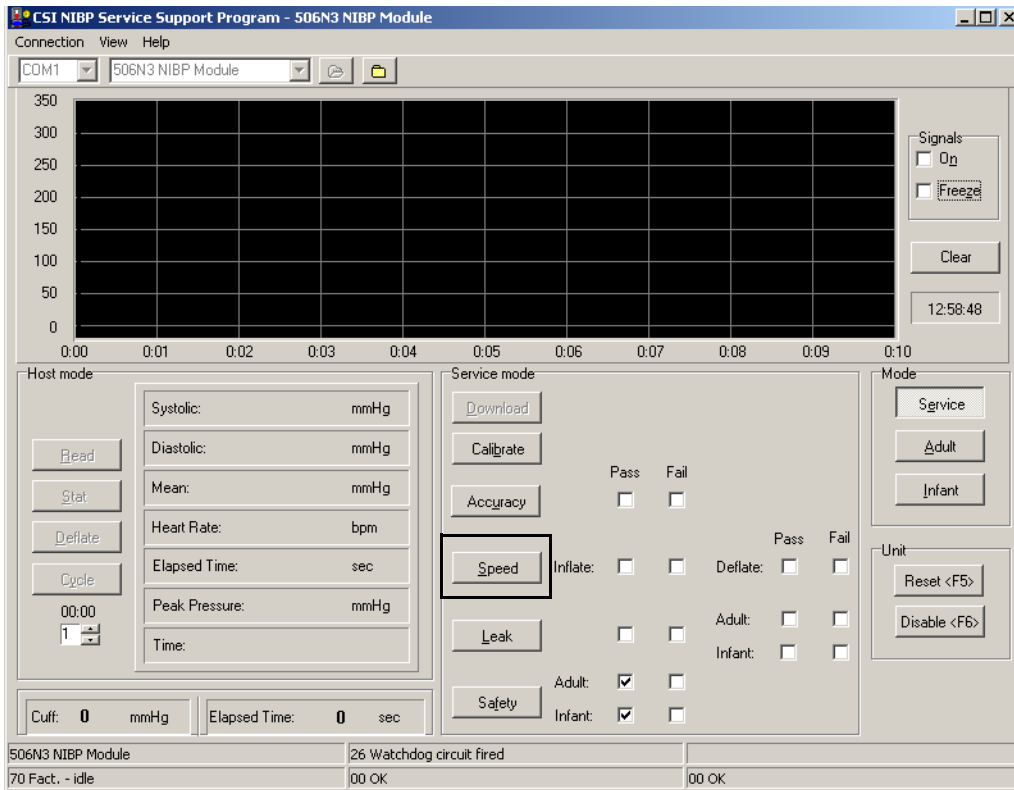

Figure 6-16: Select Speed

2. A *Factory Speed Test* window opens. Click on *Start*.

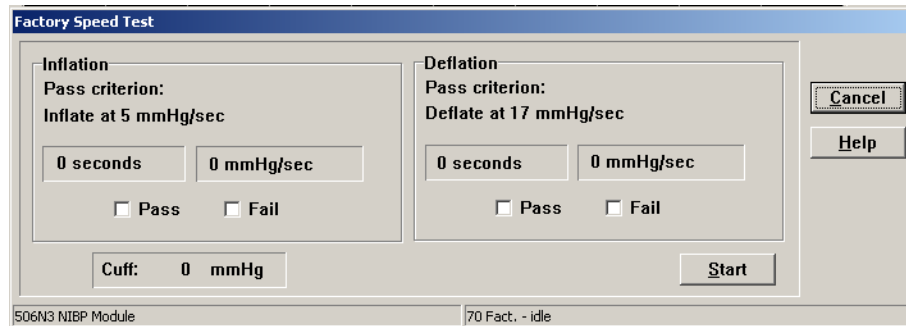

Figure 6-17: Factory Speed Test Window

- Verify that the *Inflation* and *Deflation* indicates a *Pass* with checkmarks in the boxes.

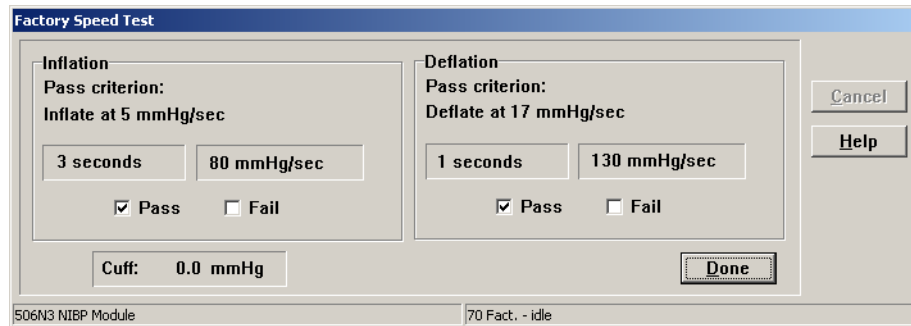

Figure 6-18: Factory Speed Test Pass

- If each *Pass* box has a checkmark, click on the *Done* button.
- The main screen displays checkmarks indicating a *Pass* of the *Speed* tests.

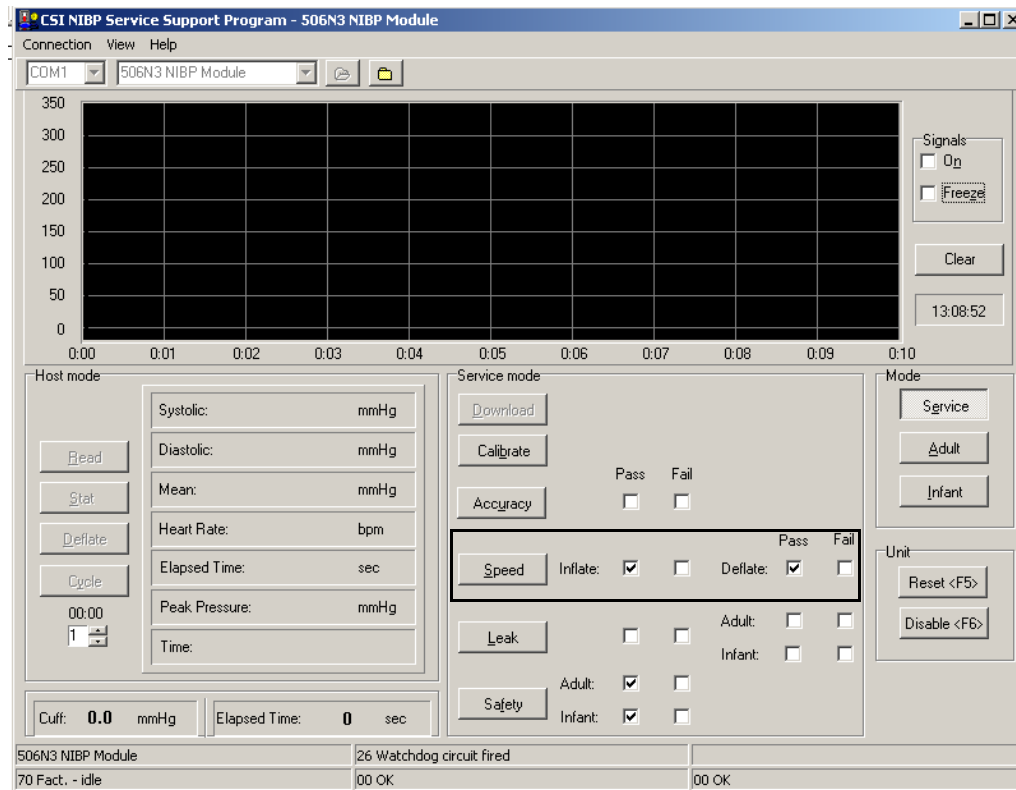

Figure 6-19: Speed Test Pass

Leak Test 1. Click on the *Leak* test button.

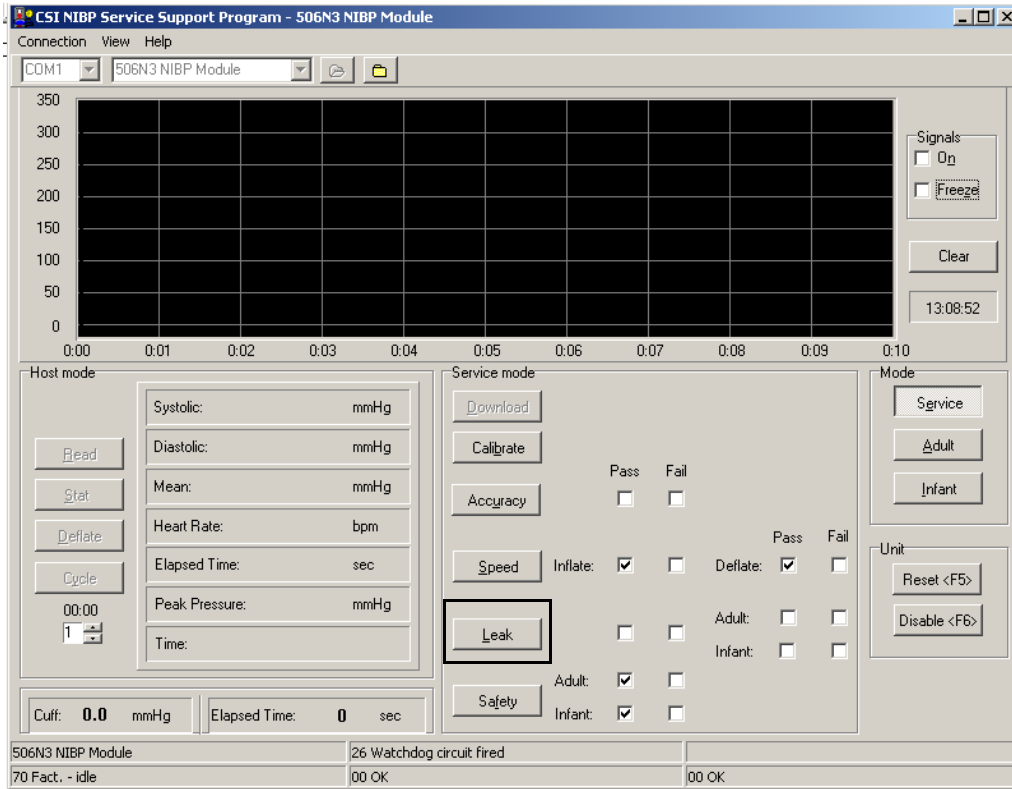

Figure 6-20: Select Leak

2. A *Leak and High Time Test* window appears. Click *Start*.

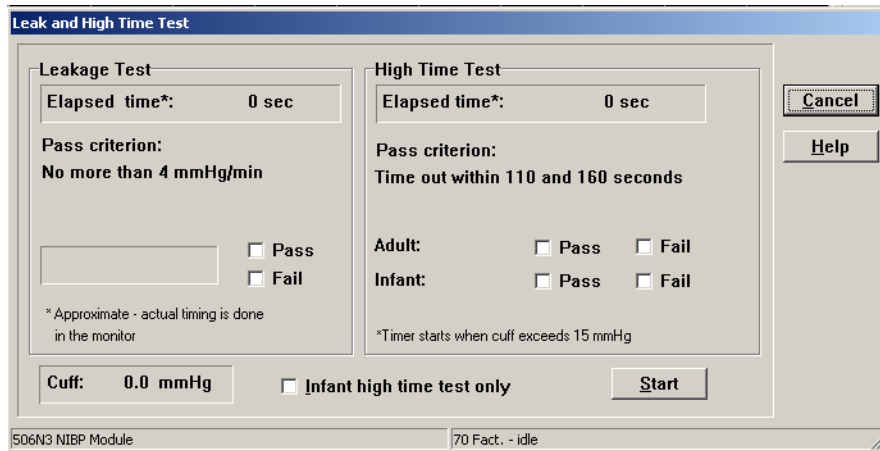

Figure 6-21: Leak and High Time Test Window

3. Verify that the *Pass criterion*: indicates a *Pass* for the *Leakage Test* by having a checkmark next to it in the box.

Leak and High Time Test

Leakage Test
 Elapsed time*: 59 sec
 Pass criterion:
 No more than 4 mmHg/min
 2 mmHg over 60 seconds:
 2 mmHg/min Pass Fail
 * Approximate - actual timing is done in the monitor

High Time Test
 Elapsed time*: 80 sec
 Pass criterion:
 Time out within 110 and 160 seconds
 Adult: Pass Fail
 Infant: Pass Fail
 *Timer starts when cuff exceeds 15 mmHg

Cuff: 238.0 mmHg Infant high time test only

506N3 NIBP Module 7A Fact. - leakage test measurement

Figure 6-22: Leakage Test Pass

4. Verify that the *High Time Test* indicates a *Pass* for *Adult* with a checkmark in the box.

Leak and High Time Test

Leakage Test
 Elapsed time*: 59 sec
 Pass criterion:
 No more than 4 mmHg/min
 2 mmHg over 60 seconds:
 2 mmHg/min Pass Fail
 * Approximate - actual timing is done in the monitor

High Time Test
 Elapsed time*: 127 sec
 Pass criterion:
 Time out within 110 and 160 seconds
 Adult: Pass Fail
 Infant: Pass Fail
 *Timer starts when cuff exceeds 15 mmHg

Cuff: 0 mmHg Infant high time test only

506N3 NIBP Module 10 Host - NIBP disabled

Figure 6-23: High Time Test, Adult

- Click on the *Infant high time test only*. A checkmark appears in the box. Click *Start*.

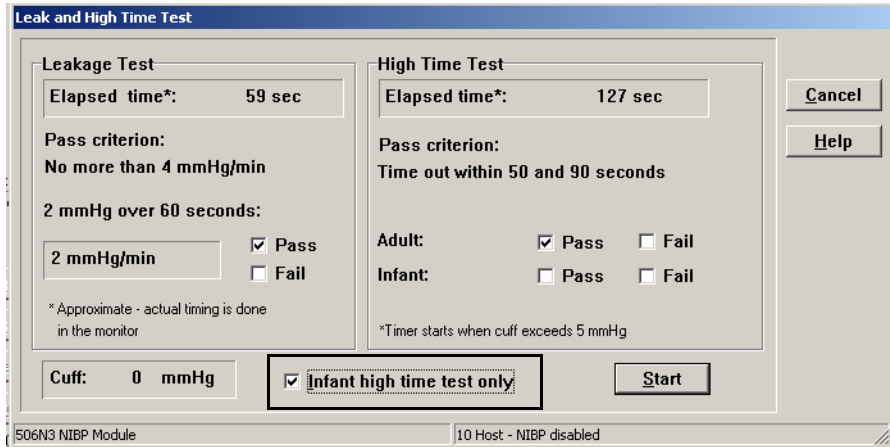

Figure 6-24: Infant High Time Test Only

- After approximately 60 seconds, the box next to *Pass* should contain a checkmark in front of it.

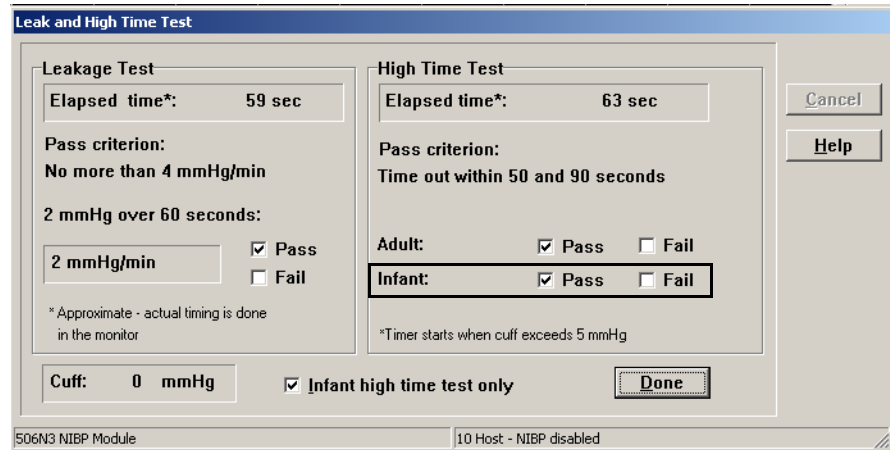

Figure 6-25: Infant High Time Test Pass

- If each *Pass* box has a checkmark, click on the *Done* button.

8. The main screen displays checkmarks indicating a *Pass* of the *Leak* tests.

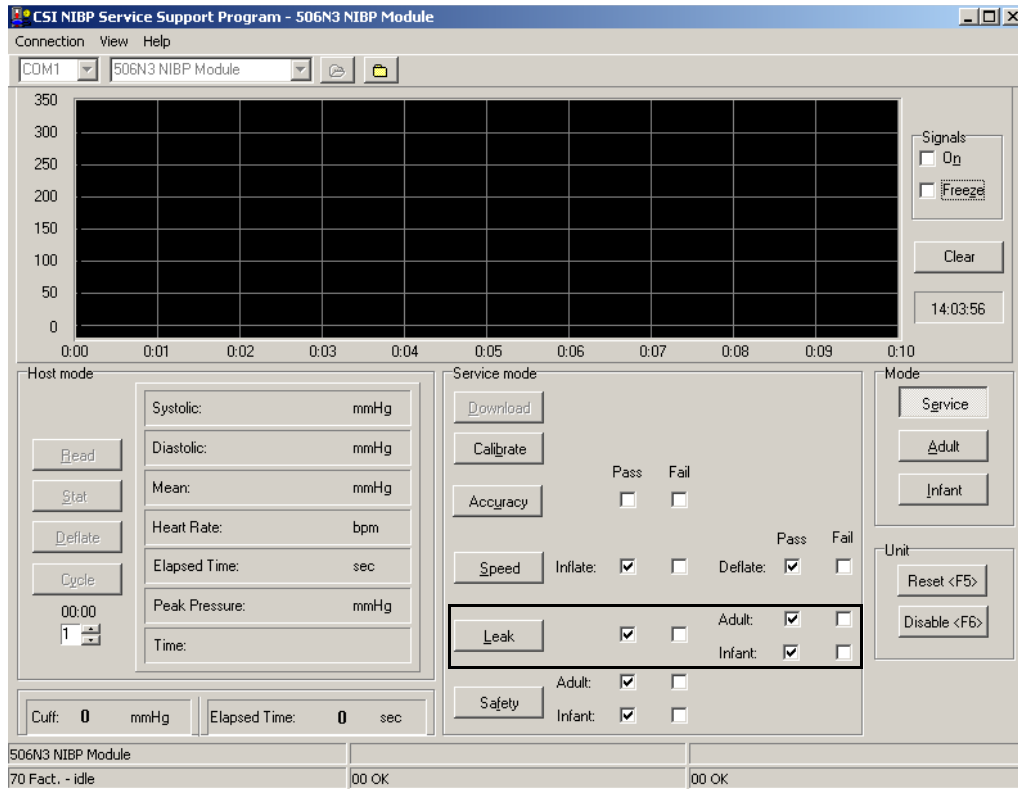

Figure 6-26: Leak Test Pass

Accuracy Test 1. Click on *Accuracy*.

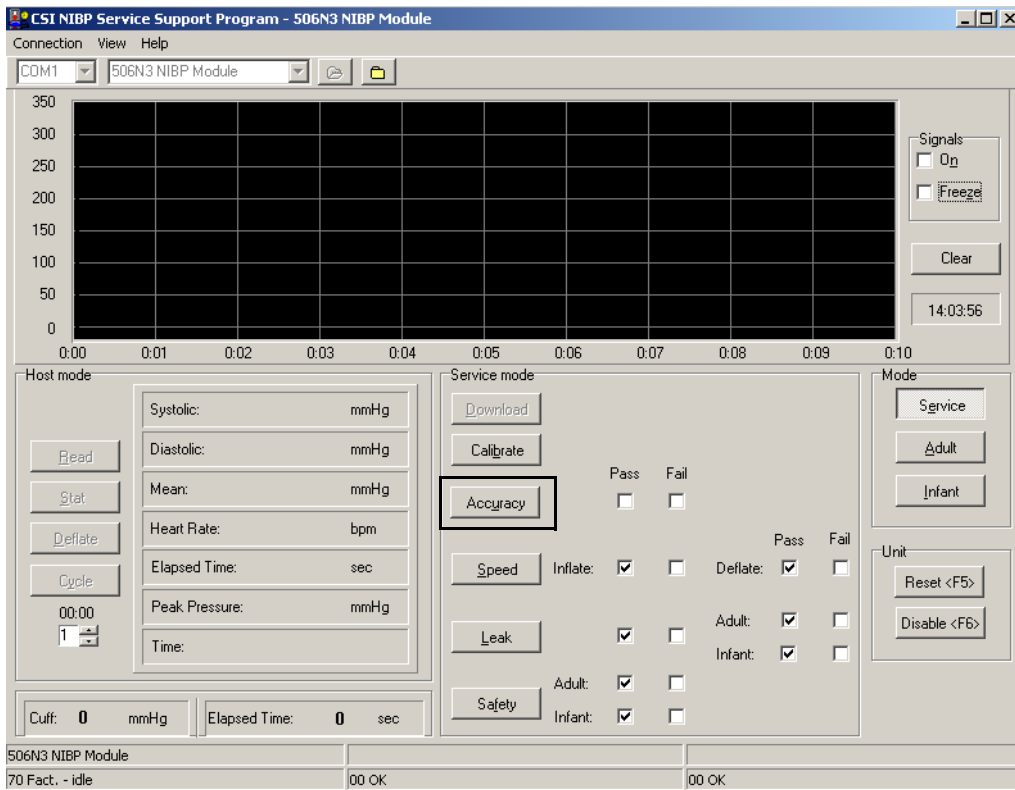

Figure 6-27: Select Accuracy

2. A *Pressure Accuracy Test* window appears. Click *Start*.

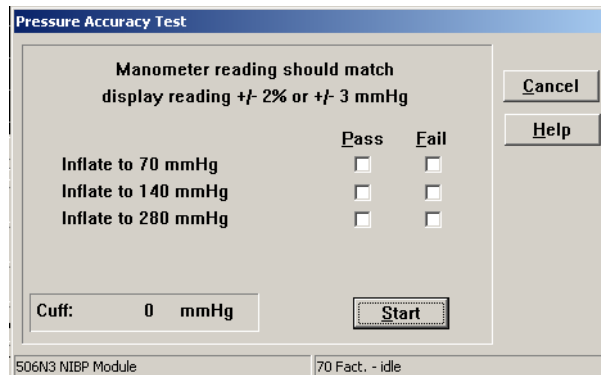

Figure 6-28: Pressure Accuracy Test Window

3. Check the manometer and the cuff pressure. Pressure will inflate to 70 mmHg. Verify that the pressure is within $\pm 2\%$ or ± 3 mmHg. If OK click on the *Pass* box to place a checkmark in the box. Click *Next*.

	Pass	Fail
✓ Inflate to 70 mmHg	<input checked="" type="checkbox"/>	<input type="checkbox"/>
✓ Inflate to 140 mmHg	<input type="checkbox"/>	<input type="checkbox"/>
Inflate to 280 mmHg	<input type="checkbox"/>	<input type="checkbox"/>

Cuff: 109.0 mmHg

Figure 6-29: Pressure Accuracy Test, 70 mmHg

4. Repeat for 140 and 280 mmHg.

	Pass	Fail
✓ Inflate to 70 mmHg	<input checked="" type="checkbox"/>	<input type="checkbox"/>
✓ Inflate to 140 mmHg	<input checked="" type="checkbox"/>	<input type="checkbox"/>
Inflate to 280 mmHg	<input type="checkbox"/>	<input type="checkbox"/>

Cuff: 133.0 mmHg

Figure 6-30: Pressure Accuracy Test, 140 mmHg

	Pass	Fail
✓ Inflate to 70 mmHg	<input checked="" type="checkbox"/>	<input type="checkbox"/>
✓ Inflate to 140 mmHg	<input checked="" type="checkbox"/>	<input type="checkbox"/>
✓ Inflate to 280 mmHg	<input checked="" type="checkbox"/>	<input type="checkbox"/>

Cuff: 273.0 mmHg

Figure 6-31: Pressure Accuracy Test, 280 mmHg

5. Click *Done* if the test passes after the 280 mmHg test.
6. Turn off power and remove serial cable and manometer fixture.

Section 7 — Disassembly

Before You Begin

Opening a monitor and breaking the quality seal can void the manufacturer warranty! Contact the Criticare Service Department before breaking the seal on any monitor.

The following procedures are intended to be used by qualified biomedical engineering or field service personnel for replacement of PCB assemblies. These procedures are not intended to be used for component-level troubleshooting and repair of the PCB assemblies.

The repair procedures for the 506DN monitor are included here for the determination of damaged or unusable assemblies. The manufacturer does not recommend attempting field repair of the printed circuit boards.

See the 506DN Final Assembly drawing in Section 9.

Service Safety

WARNING

- The following procedures require working with exposed electrical circuits. Repair should only be attempted by experienced electronics technicians.
- Do not short circuit the battery terminals! The resulting high current discharge can cause burns.
- Remove the battery before disassembly to avoid electrical shock.
- Electronic components are selected for specific performance characteristics. Use of substitute replacement parts may cause inaccurate performance or damage the monitor. Order replacement components by their catalog or part number from an authorized dealer.
- Any time an electrical circuit board is altered through repair or adjustment, it must be fully tested before use.

CAUTION

- Replacement of surface mount components is beyond the scope of this manual. Attempting to remove surface mount components with a soldering iron can result in the overheating of the board and damage to tracings. Damaged laminated circuit boards cannot be repaired and require replacement.
- Any electronic repair should be done in compliance with ANSI/IPC-A-610 manufacturing standards for medical equipment. Failure to use standard ANSI/IPC assembly practices can result in permanent damage to the monitor.

Electrostatic Discharge Protection

The procedures in this section require the handling of electrostatic sensitive components. Microprocessors and other electronic components can be permanently damaged by attempting repairs at an unprotected workstation.



Use all electrostatic discharge (ESD) precautions as described below!

1. Perform the disassembly procedures on an antistatic mat that is grounded. Check the ground cable to insure that it is connected to a good earth ground.
2. Always use a grounded soldering iron.
3. Wear a wrist-grounding strap.
4. The wrist strap and mat should both be connected through a resistor (1 mega-ohm typical) to the same ground source.
5. Wrist-ground straps should be tested on a daily basis.
6. Components should be temporarily stored in metal or antistatic containers. Never store components in plastic dishes.
7. Circuit boards should be stored in sealed antistatic bags or covered antistatic boxes. Never store electronic boards directly in cardboard boxes.

Tools Needed

The following is a list of tools needed for disassembly and reassembly of the eQuality 506DN monitor.

- Set of hand tools
- Up to 7 in. torque screwdriver with accessories
- #10 socket
- 5/16 in. nutdriver
- 1/4 in. nutdriver

Disconnect and Remove Battery

The battery must be disconnected and removed from the monitor before any further disassembly of the monitor may be performed.

1. Follow the caution for static-sensitive devices in “Electrostatic Discharge Protection” on page 7-2.
2. Open the battery door by unscrewing the two (2) screws (PHMS #4-40 X .25 GEM Gray; P/N 42745B001) securing it to the back of the monitor.
3. Pull the battery (P/N MISC10004) from the door and disconnect the battery cables from the terminals.
4. Reassemble in reverse order. Torque to 5 in lbs.

Detach Bezel Assembly from Housing Assembly

To open the monitor for repairs, detach the bezel assembly from the housing assembly.

1. Follow the caution for static-sensitive devices in “Electrostatic Discharge Protection” on page 7-2.
2. Detach the bezel assembly from the housing assembly, remove the four (4) screws (PHMS #6-32 X .50 LG SS; P/N 42435B002) securing them together.
3. Disconnect the battery cable from **J6** the main board (on the bezel assembly).
4. Disconnect the cable from **J5** on the main board.
5. Reassemble in reverse order.

CAUTION

- When reattaching the bezel and housing assemblies, make sure the AC and battery cable wires do not get pinched between the two assemblies. This will damage the wires.
- Do not allow the battery cable ferrites to coil on the main board.

Reassemble the monitor and perform the “Completion of Service” procedure at the end of this section.

Bezel Disassembly

Replace Speaker

1. Follow the caution for static-sensitive devices in “Electrostatic Discharge Protection” on page 7-2.
2. Detach bezel assembly from housing assembly (See “Detach Bezel Assembly from Housing Assembly” on page 7-3).
3. On the bezel assembly, disconnect the speaker cable **J4** from on the main board.
4. Remove the speaker from the rail on the bezel.
5. Slide the new speaker (P/N 90929A001) under the NIBP assembly and into the rail of the bezel.

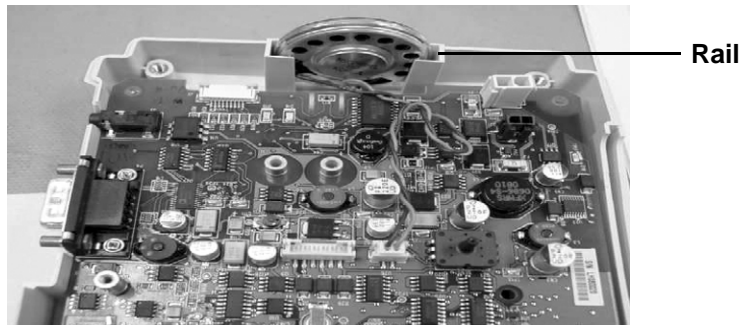

Figure 7-1: Reinsert Speaker

6. Connect the speaker cable to the main board at **J4**.

Reassemble the monitor and perform the “Completion of Service” procedure at the end of this section.

Replace LCD Display

1. Follow the caution for static-sensitive devices in “Electrostatic Discharge Protection” on page 7-2.
2. Detach bezel assembly from housing assembly (See “Detach Bezel Assembly from Housing Assembly” on page 7-3).
3. Detach the PCB/NIBP assembly from the bezel by removing the two(2) screws (PHMS SEMS #4-40 X .25 LG; P/N 40995B004).
4. Disconnect all of the tubing and remove the connector from **P3**.
5. On the bezel assembly, disconnect the speaker cable from **J4** on the main board.
6. Remove speaker from the rail on the bezel.
7. Remove the two (2) screws (PHMS 4-40 X .312 SEMS; P/N 40995B011) that secure the DOX SpO₂ board.
8. Remove the two (2) plastic screws that secure the DOX PCB.
9. Lift and remove the DOX board and insulator.
10. Remove the four (4) screws (PHMS 4-40 X .25 SEMS; P/N 40995B005) that secure the main board.
11. Disconnect the LCD display’s ribbon cable from **J1** on the main board.
12. Unlock the membrane tail from **J2** on the main board.
13. Lift and remove the main board.
14. Detach LCD display and display shield from the bezel by removing the four (4) screws (PHMS SEMS #4-40 X .25 LG; P/N 40995B005).
15. Lift the display shield (P/N 83401B002) from the bezel.
16. Remove and replace the LCD display (81521B001).
17. Reassemble in reverse order. See assembly drawings for torque instructions.

Perform the “Completion of Service” procedure at the end of this section.

Replace Membrane

1. Follow the caution for static-sensitive devices in “Electrostatic Discharge Protection” on page 7-2.
2. Detach bezel assembly from housing assembly (See “Detach Bezel Assembly from Housing Assembly” on page 7-3).
3. Unlock the membrane tail from the connector at **J2** on the main board.
4. Remove the old membrane from the bezel.
5. Once removed, clean the bezel with alcohol to remove any residue from the bezel surface.
6. Obtain a new membrane (P/N 45214B001).
7. Slide the membrane tail through the bezel and remove the paper backing from the membrane.
8. Place the membrane flush with the bezel and press firmly around the bezel to ensure that the membrane is flat and no air bubbles are apparent.
9. Reassemble in reverse order.

Perform the “Completion of Service” procedure at the end of this section.

Replace Main Board

1. Follow the caution for static-sensitive devices in “Electrostatic Discharge Protection” on page 7-2.
2. Detach bezel assembly from housing assembly (See “Detach Bezel Assembly from Housing Assembly” on page 7-3).
3. Detach the NIBP module from the main board by removing the two (2) screws (PHMS SEMS #4-40 X .44 LG; P/N 40995B009) located in the lower middle of the main board.
4. Disconnect the NIBP module from the NIBP fitting (P/N 42014B001) on the side panel (P/N 45225B001).
5. Disconnect the NIBP module’s ribbon cable from **P3** on the main board.
6. Disconnect the NIBP module’s open tube from the **SENS1** connector on the main board.
7. Remove SpO₂ board by removing the four (4) screws.

NOTE: Two different types of screws are used to attach the SpO₂ board to the insulator board. The two (2) screws (PHMS #4-40 X .25 LG, NYLON; P/N 42744B001) on the left side of the board differ from the two (2) screws (PHMS SEMS #4-40 X .44 LG; P/N 40995B011) on the right side of the board.

8. Detach the insulator board (P/N 42740B001) by breaking the solder point between the insulator and main boards. (See 506DN assembly drawing in Section 9.)
9. Detach the PCB/NIBP assembly from the bezel by removing the four (4) screws (PHMS SEMS #4-40 X .25 LG; P/N 40995B005).
10. Unlock the membrane tail from the connector at **J2** on the main board.
11. Disconnect the LCD display’s ribbon cable from **J1** on the main board.
12. Remove main board from bezel.
13. On the bezel assembly, disconnect the speaker cable from **J4** on the main board.
14. Remove the speaker from the rail on the bezel.
15. Remove the two (2) standoffs (STANDOFF M/F #4-40 X .375 LG, NYLON; P/N 42742B001) and two (2) hex nuts (HEX NUT #4-40, NYLON; P/N 42743B001) from the old main board.

16. Obtain a new main board (P/N 91410A001).
17. Reassemble in reverse order. Refer to 506DN assembly drawing in Section 9 for solder point when connecting the main and insulator boards.

NOTE: When reassembling, after the NIBP module and SpO₂ board are mounted, route the NIBP tube as shown below. It must be around the sensor and valves.

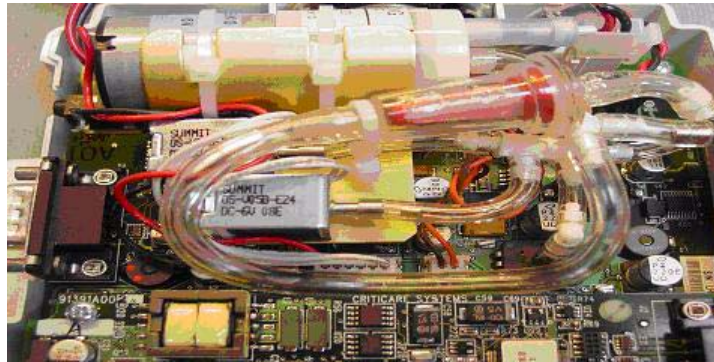

Figure 7-2: NIBP Tubing

Perform the “Completion of Service” procedure at the end of this section.

Replace DOX SpO₂ Board

1. Follow the caution for static-sensitive devices in “Electrostatic Discharge Protection” on page 7-2.
2. Disconnect and remove the battery from the monitor (See “Disconnect and Remove Battery” on page 7-3).
3. Detach bezel assembly from housing assembly (See “Detach Bezel Assembly from Housing Assembly” on page 7-3).
4. Remove old SpO₂ board by removing the four (4) screws holding it to the insulator board.

NOTE: Two different types of screws are used to attach the SpO₂ board to the insulator board. The two (2) screws (PHMS #4-40 X .25 LG, NYLON; P/N 42744B001) on the left side of the board differ from the two (2) screws (PHMS SEMS #4-40 X .44 LG; P/N 40995B011) on the right side of the board.

5. Obtain a new SpO₂ board (P/N 91391A002).
6. Reassemble in reverse order.

NOTE: When reassembling, after the NIBP module and SpO₂ board are mounted, route the NIBP tube as shown below. It must be around the sensor and valves.

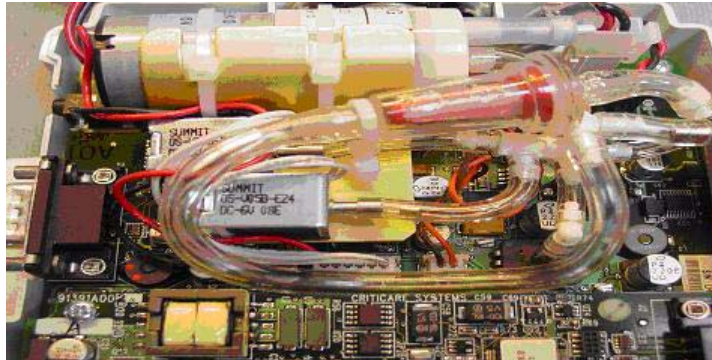

Figure 7-3: NIBP Tubing

Perform the “Completion of Service” procedure at the end of this section.

Replace NIBP Module

1. Follow the caution for static-sensitive devices in “Electrostatic Discharge Protection” on page 7-2.
2. Detach bezel assembly from housing assembly (See “Detach Bezel Assembly from Housing Assembly” on page 7-3).
3. Detach the NIBP module from the main board by removing the two (2) screws (PHMS SEMS #4-40 X .44 LG; P/N 40995B009) located in the lower middle of the main board.
4. Disconnect the NIBP module’s ribbon cable from **P3** on the main board.
5. Disconnect the NIBP module’s open tube from the **SENS1** connector on the main board.
6. Disconnect the NIBP module from the NIBP fitting (P/N 42014B001) on the side panel (P/N 45225B001).
7. Obtain a new NIBP module (P/N 95597A005).
8. Reassemble in reverse order.

NOTE: When reassembling, after the NIBP module and SpO₂ board are mounted, route the NIBP tube as shown below. It must be around the sensor and valves.

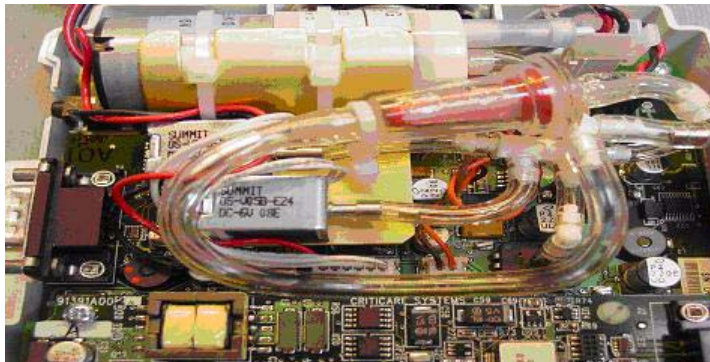

Figure 7-4: NIBP Tubing

Perform the “Completion of Service” procedure at the end of this section.

Housing Disassembly

Replace Power Supply

1. Follow the caution for static-sensitive devices in “Electrostatic Discharge Protection” on page 7-2.
2. Detach bezel assembly from housing assembly (See “Detach Bezel Assembly from Housing Assembly” on page 7-3).
3. Remove the three (3) screws (PMHS SEMS #4-40 X .25 LG; P/N 40995B005) holding the insulator (P/N 42740B002) to the power supply bracket and chassis.
4. Pull out the power supply and bracket and disconnect the power supply cable (P/N 90927A003) from **CON 2** on the power supply.
5. Disconnect the AC power inlet cable from **CON 1** on the power supply.
6. Disconnect the ground wire from the AC inlet cable from the power supply bracket by removing the keps nut (P/N 40284B002).
7. Disconnect the power supply from the bracket (P/N 45213B001) by removing the four (4) screws (PHMS 4-40 X .438 SEMS; P/N 40995B011) holding them together.
8. Obtain a new power supply (P/N PWRS10000).
9. Reassemble in reverse order. See assembly drawings for torque instructions.

Perform the “Completion of Service” procedure at the end of this section.

Completion of Service

1. Verify all connections are secure.
2. Reconnect the battery (See “Disconnect and Remove Battery” on page 7-3).
3. Perform the functional tests in “Functional and Safety Testing” in Section 5.
4. Perform the electrical safety tests in “Electrical Safety Tests” in Section 5.

Section 8 — Troubleshooting

Troubleshooting Guide

Symptom	Problem	Solution
Unit won't power up	<ul style="list-style-type: none"> Battery is discharged No AC power at outlet Main power fuse is blown Poor keypad cable connect Bad keypad switch Bad Main Board 	Connect AC power cord Use alternate outlet Replace power fuse(s) by the AC input Reposition ribbon cable into Main Board Replace keypad membrane Replace Main Board and software
Monitor shuts off	<ul style="list-style-type: none"> Automatic shutoff after 30min. Drained battery Bad software Bad Main Board 	Press the ON/OFF key Connect to AC power Update software Replace Main Board and reprogram
Functions not available	<ul style="list-style-type: none"> Default settings wrong Incorrect software Degraded software 	Return to factory default settings Update software Replace software
LCD display blank	<ul style="list-style-type: none"> Contrast is misadjusted Bad LCD Board connection Bad LCD Board 	Adjust <i>CONTRAST</i> in the <i>CONFIGURATION</i> menu Check pins and reconnect Replace LCD Board
Leaks in NIBP system	<ul style="list-style-type: none"> Defective cuff Defective hose Damaged/loose NIBP fitting Stripped insulator Leaky pneumatics & pump 	Replace cuff Replace hose Replace/tighten Quick-Connect fitting Replace nylon insulator and O-ring Replace NIBP mechanical assembly
Fails performance test	<ul style="list-style-type: none"> Leaks in NIBP system Poor calibration Defective pump or valves Bad transducer 	See above Recalibrate NIBP Replace NIBP mechanical assembly Replace NIBP mechanical assembly
NIBP not functioning	<ul style="list-style-type: none"> NIBP module turned off Bad NIBP switch Pump not running Failed pump motor Bad Main Board Bad NIBP Board 	Turn on NIBP in the <i>CONFIGURATION</i> menu or ensure <i>1020</i> is selected for the <i>NIBP</i> setting in <i>BOARD SETUPS</i> in the service menu. Check pump wires to NIBP Board Check pins on NIBP Board & reconnect Replace pump Replace Main Board and software Replace NIBP Board and software

Symptom	Problem	Solution
SpO ₂ not functioning.	<ul style="list-style-type: none"> • Using incorrect sensor. • SpO₂ module turned off • Bad sensor • SpO₂ board disconnected • Bad SpO₂ board • Bad Main Board/SpO₂ Cable 	<p>Verify the correct sensor is used for the monitor Turn on SpO₂ in the <i>CONFIGURATION</i> menu or ensure the proper setting is selected for the <i>SPO2</i> setting in <i>BOARD SETUPS</i> in the service menu. Replace sensor. Reconnect SpO₂ board Replace SpO₂ board Replace Main Board/SpO₂ Cable</p>
Unit intermittently missing blood pressure measurements	<ul style="list-style-type: none"> • Cuff size changed • Wrong cuff size or poor/loose cuff placement • Poor connection of NIBP module • Incorrect Patient Size selected 	<p>Unit adapts to cuff size on next attempt Check cuff selection and placement</p> <p>Check pins and clean connection of the NIBP module to the Main Board or replace module/board if necessary. Change patient size</p>
No sound from speaker	<ul style="list-style-type: none"> • Speaker wire disconnected • Speaker wire broken • Bad Main Board 	<p>Reconnect Replace speaker Replace Main Board</p>
No communications	<ul style="list-style-type: none"> • Serial settings not correct • Bad serial cable (external) • Bad Main Board 	<p>Check MENU settings Replace external serial cable Replace Main Board</p>

Section 9 — Drawings and Schematics

List of Drawings

Assembly Parts Lists	Title	Drawing Number
	FINAL AY 506DN DOX	93987A001
	NIBP MODULE 6 PIN CONN	95597A005
	506DN MONITOR	CAT 506DN-X
PCB Drawing List	PCB AY DIG SPO2	91391A002
	PCB AY DIG SPO2 SCHEMATIC	91391S002
	506CN MAIN BOARD	91410A001
	506DN MAIN BOARD SCHEMATIC	91410S001

506DN Final Assembly 93987A001 FINAL AY 506DN DOX

Item #	CSI Part #	Description
01	91410A001	PCB AY, 506CN MAIN BOARD
02	42742B001	STANDOFF M/F #4-40 X .375 LG NYLON
03	42743B001	HEX NUT #4-40 NYLON
04	42744B001	P.H.M.S. #4-40 X .25 LG NYLON
06	42740B002	INSULATOR CHASSIS
07	42740B001	INSULATOR DOX MAIN BRD
08	91391A002	PCB AY, DIG SPO2, 506DN
09	95597A005	NIBP MODULE 6 PIN CONN
10	45225B001	SIDE PANEL
11	42014B001	FITING, QUICK CON. HH NIBP
12	40995B011	P.H.M.S. 4-40 X .438 SEMS
13	40284B005	NUT 10-32 KEPS PL
14	45211B001	BEZEL 506CN
15	45214B001	MEMBRANE 506CN
16	81521B001	DISP/LCD PNL GRAPHIC/320X240
17	42127B004	WINDOW FILTER 506CN
18	83401B002	EMI SHIELD
21	40995B005	P.H.M.S. 4-40 X .25 SEMS
22	95257A003	SPEAKER CABLE AY 1.5" DIA
23	90929A001	CABLE ASSY BATTERY TO MAIN BRD
24	45210B001	HOUSING 506CN
25	87277B001	FOOT .50 OD X .19 H
26	40284B001	NUT 4-40 KEPS PL
27	83476B001	AC POWER INLET
28	82013B001	FUSE TIME LG 500MA L 250V 5X20
29	42064B003	F.H.M.S. 4-40 X .312 PH PL
30	90968A005	CABLE AY AC INLET
31	41158B001	TERMINAL EQUIPOTENTIAL
32	41164B001	NUT M6 X 1.0 KEPS PL
33	90927A003	CABLE AY POWER SUPPLY TO MAIN BD
34	PWRS10000	PWRSUP 40W 9VDC 90-264VAC 47-63 HZ
35	45213B001	BRACKET POWER SUPPLY
36	83378B001	SHOCK PAD .75DIA X .188TH
38	42435B002	P.H.M.S. 6-32 X .375 316SS
39	MISC10004	BATT/LA 6V 4.5AH 70X48X110MM
40	45212B001	BATTERY DOOR 506CN
41	42745B001	F.H.M.S. #4-40 X .25 COATED GREY
43	40284B002	NUT 6-32 KEPS PL
44	40067B001	CABLE TIE 4.0
45	40294B001	HOLDER TIE WRAP ADH-BK SM
46	40132B001	TAPE MICROFOAM ADH-BACKED
47	41157B001	THRDLOCK ASSURE SURF CUR
48	41891B004	DUST COVER, CLEAR, DB9P
49	40995B009	P.H.M.S. 4-40 X .625 SEMS

NIBP Module

95597A005 NIBP MODULE 6 PIN CONN

Item #	CSI Part #	Description
01	40067B002	CABLE TIE 5.6
02	40296B002	TUBING SILC BLU .125 X .250
03	41700B001	TUBING POLYU .094ID X .187O
04	41579B003	CHECK VALVE
05	42069B001	TUBING 1/4 X 1/8 POLYU COIL
06	42081B002	ORIFACE RESTRICTOR .0125
07	42104B003	BRACKET
08	42111B001	SCREW M2-.4X3 PH BINDER
09	95576A007	ASSEMBLY PUMP WITH WIRES
10	95586A006	AY OKEN VALVE WITH CRIMPS
11	40132B001	TAPE MICROFOAM ADH-BACKED
12	41700B002	TUBE POLYU .125 X .250 85DU
13	40324B013	TEE CONNECTOR PLASTIC, .125 X .125 X .125
14	42749B001	FITTING ELBOW 1/8 TO 3/32
15	40633B001	FILTER 130U RED NY ELEM
16	87283B003	CONN CBL HSNJ JST PHR-6 6-POS 2MM
17	42750B001	FITTING ELBOW 3/32
18	42751B001	FITTING DBL ELBOW
19	40067B001	CABLE TIE 4.0

506DN Monitor

506DN-X MONITOR SPO2/NIBP (DOX)

Item #	CSI Part #	Description
01	93987A001	FINAL AY 506DN DOX
02	95795A001	LBL SET 506 DN/CN (ENGLISH)
	95795A005	LBL SET 506 DN/CN (SPANISH)
03	46426B001	LBL MAIN PRODUCT REV 1
05	46158B002	LABEL QUAL SEAL OVAL WHT

REVISIONS			
REV.	DATE	DESCRIPTION	BY
1	9/18/08	SEE ECN #10308	DBL
2	1/13/09	SEE ECN #10359	DBL

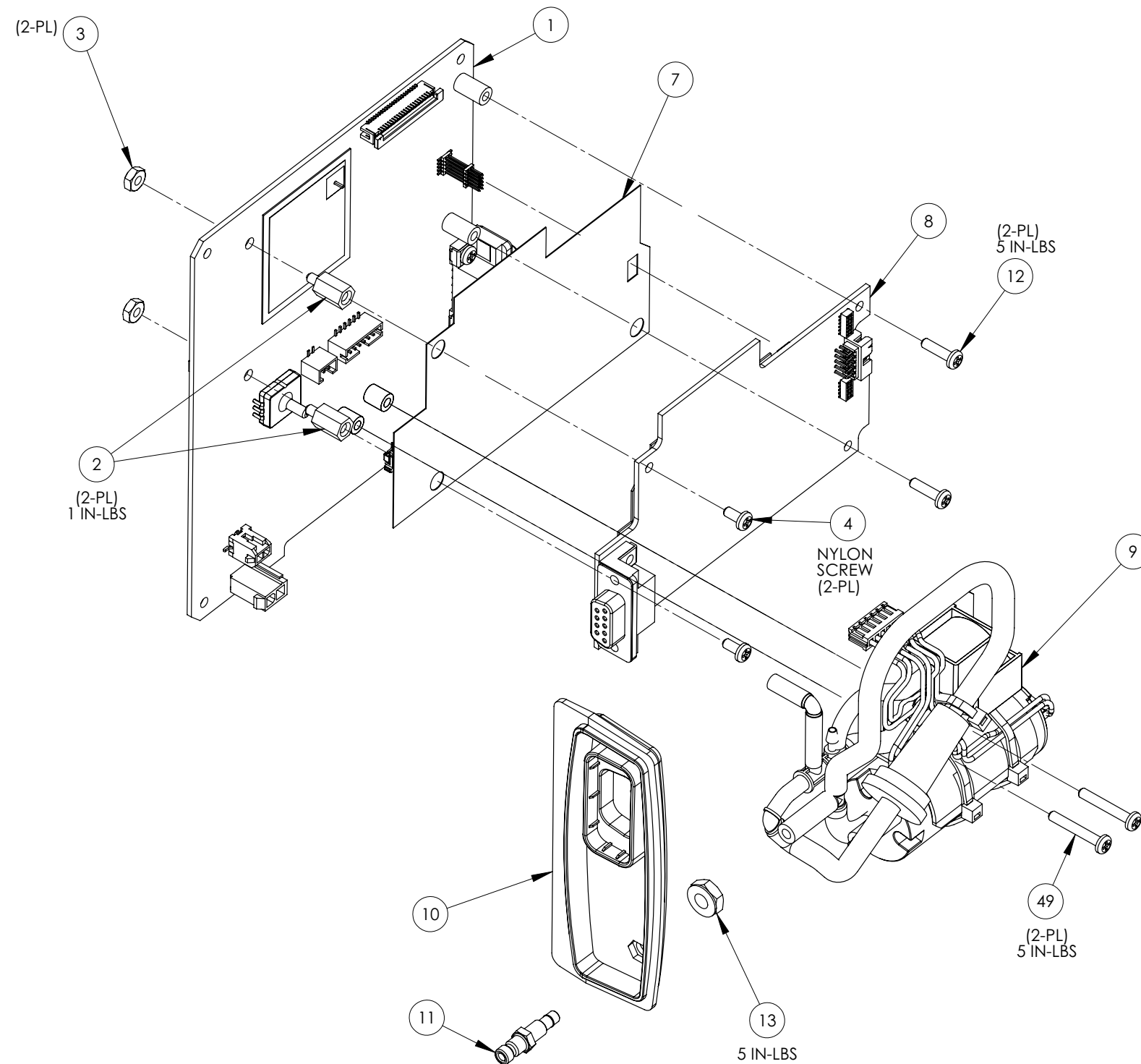

VENDOR SHOULD COMPLY WITH THE FOLLOWING CSI QUALITY REQUIREMENTS: Q1, Q2, Q4, Q5, Q6, Q7, Q10, Q11 AND Q16. IN ADDITION THE QUALITY REQUIREMENTS Q9, Q13 AND Q17 APPLY. SEE CSI WEB SITE (www.csiusa.com/pdf/QA_Requirements.pdf) FOR THE DEFINITION OF THE QUALITY REQUIREMENTS.

SW



DRAWN BY: SC	CHECK BY:	ENG. APPR.:
DATE: 04-04-08	RELEASE DATE:	Q.A. APPR.:
SCALE: 1:1	DO NOT SCALE PRINT	MFG. APPR.:
TOLERANCE UNLESS OTHERWISE SPECIFIED: XX: +/- .020 XXX: +/- .005 ANGLES: +/- 1 DEGREE		CONFIDENTIAL: THIS DOCUMENT CONTAINS CONFIDENTIAL INFORMATION AND MAY NOT BE COPIED OR DIVULGED WITHOUT WRITTEN CONSENT OF CRITICARE SYSTEMS, INC.
TITLE: FINAL ASSEMBLY 506DN		PART NO.: 93987A001
DIST: -		REV. 2
SHEET 1 OF 4		

RELEASED DOCUMENT

REVISIONS			
REV.	DATE	DESCRIPTION	BY

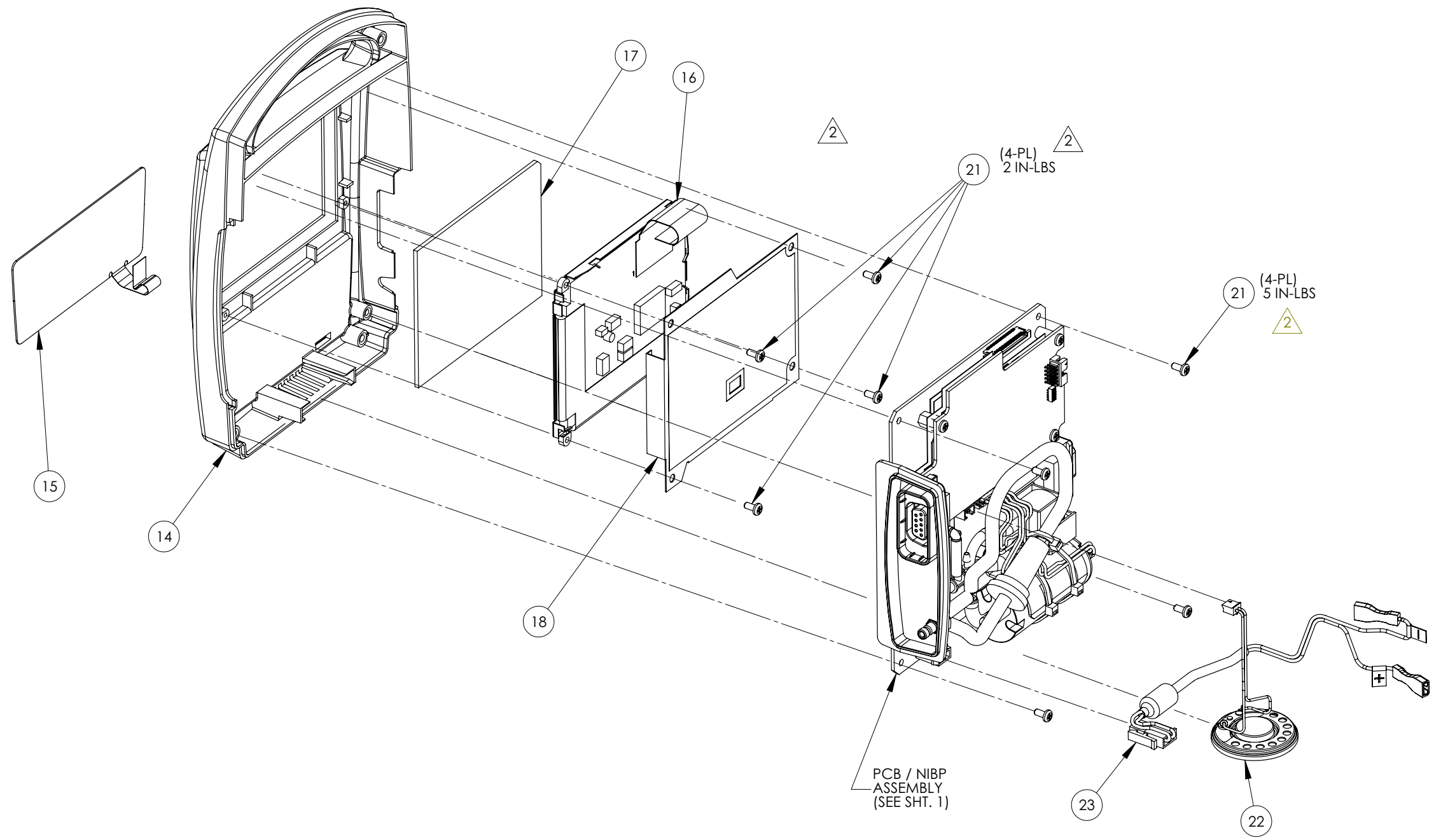

VENDOR SHOULD COMPLY WITH THE FOLLOWING CSI QUALITY REQUIREMENTS: Q1, Q2, Q4, Q5, Q6, Q7, Q10, Q11 AND Q16. IN ADDITION THE QUALITY REQUIREMENTS Q9, Q13 AND Q17 APPLY. SEE CSI WEB SITE (www.csiusa.com/pdf/QA_Requirements.pdf) FOR THE DEFINITION OF THE QUALITY REQUIREMENTS.

SW



DRAWN BY: SC	CHECK BY:	ENG. APPR.:
DATE: 04-04-08	RELEASE DATE:	Q.A. APPR.:
SCALE: 1:1	DO NOT SCALE PRINT	MFG. APPR.:
TOLERANCE UNLESS OTHERWISE SPECIFIED: XX: +/- .020 XXX: +/- .005 ANGLES: +/- 1 DEGREE		CONFIDENTIAL: THIS DOCUMENT CONTAINS CONFIDENTIAL INFORMATION AND MAY NOT BE COPIED OR DIVULGED WITHOUT WRITTEN CONSENT OF CRITICARE SYSTEMS, INC.
TITLE: FINAL ASSEMBLY 506DN		PART NO.: 93987A001
DIST: -		REV. 2
SHEET 2 OF 4		

REVISIONS			
REV.	DATE	DESCRIPTION	BY

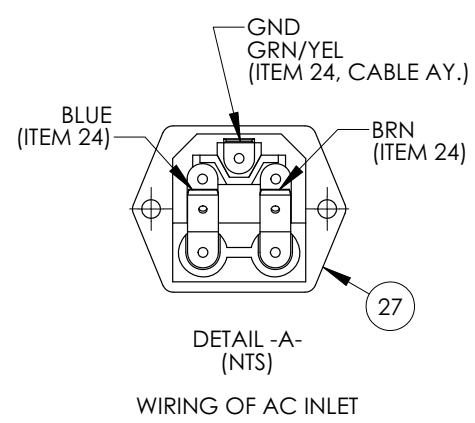
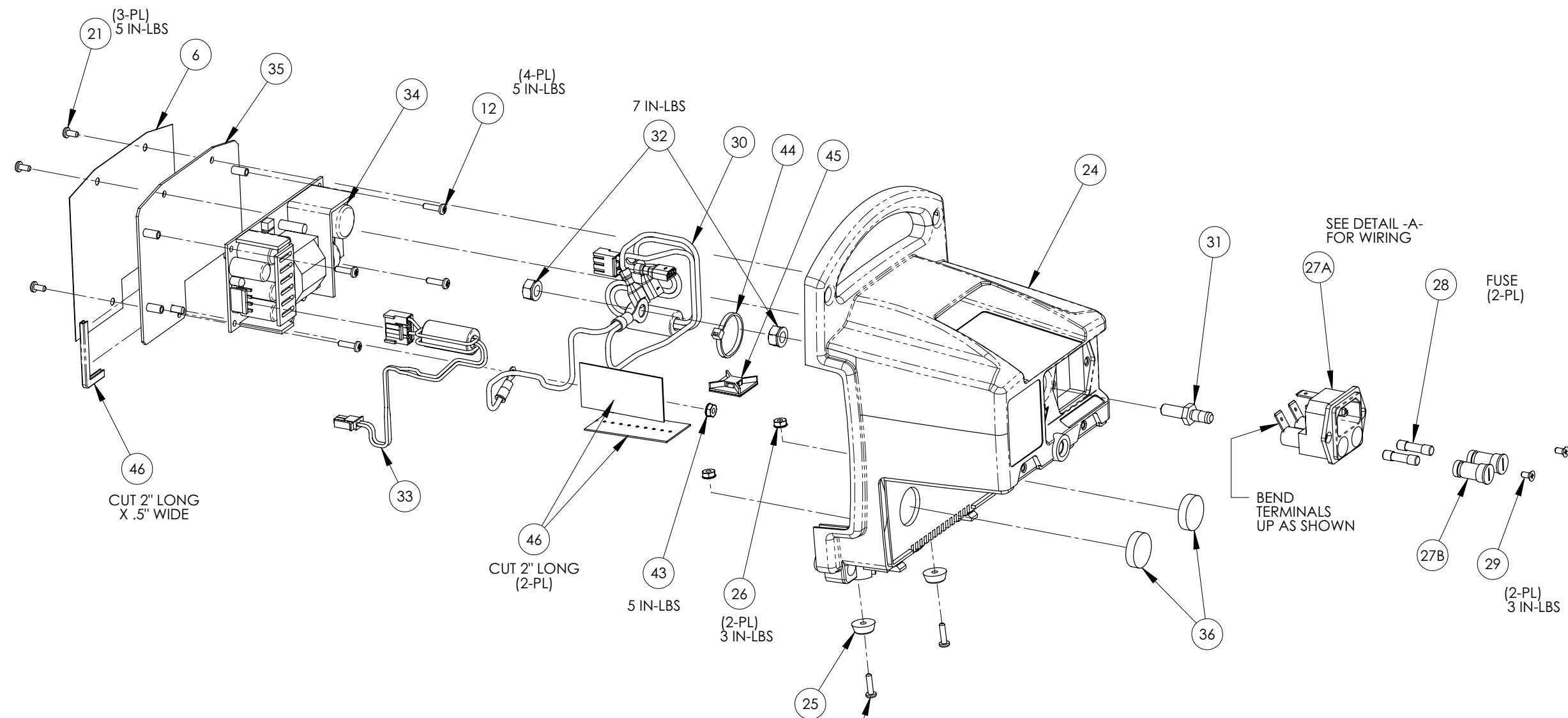

- NOTES:
1. APPLY LOCTITE (ITEM #47) TO FOOT MOUNTING SCREWS (ITEM #12, 2-PL).
 2. USE PROCEDURE 93987PXXX TO ASSEMBLE UNIT.

VENDOR SHOULD COMPLY WITH THE FOLLOWING CSI QUALITY REQUIREMENTS: Q1, Q2, Q4, Q5, Q6, Q7, Q10, Q11 AND Q16. IN ADDITION THE QUALITY REQUIREMENTS Q9, Q13 AND Q17 APPLY. SEE CSI WEB SITE (www.csiusa.com/pdf/QA_Requirements.pdf) FOR THE DEFINITION OF THE QUALITY REQUIREMENTS.

SW

CSI CRITICARE SYSTEMS, INC.		
DRAWN BY: SC	CHECK BY:	ENG. APPR.:
DATE: 04-04-08	RELEASE DATE:	Q.A. APPR.:
SCALE: 1:1	DO NOT SCALE PRINT	
TOLERANCE UNLESS OTHERWISE SPECIFIED: XX: +/- .020 XXX: +/- .005 ANGLES: +/- 1 DEGREE		CONFIDENTIAL: THIS DOCUMENT CONTAINS CONFIDENTIAL INFORMATION AND MAY NOT BE COPIED OR DIVULGED WITHOUT WRITTEN CONSENT OF CRITICARE SYSTEMS, INC.
TITLE: FINAL ASSEMBLY 596DN	PART NO.: 93987A001	REV.: 2
DIST: -		SHEET 3 OF 4

REVISIONS			
REV.	DATE	DESCRIPTION	BY

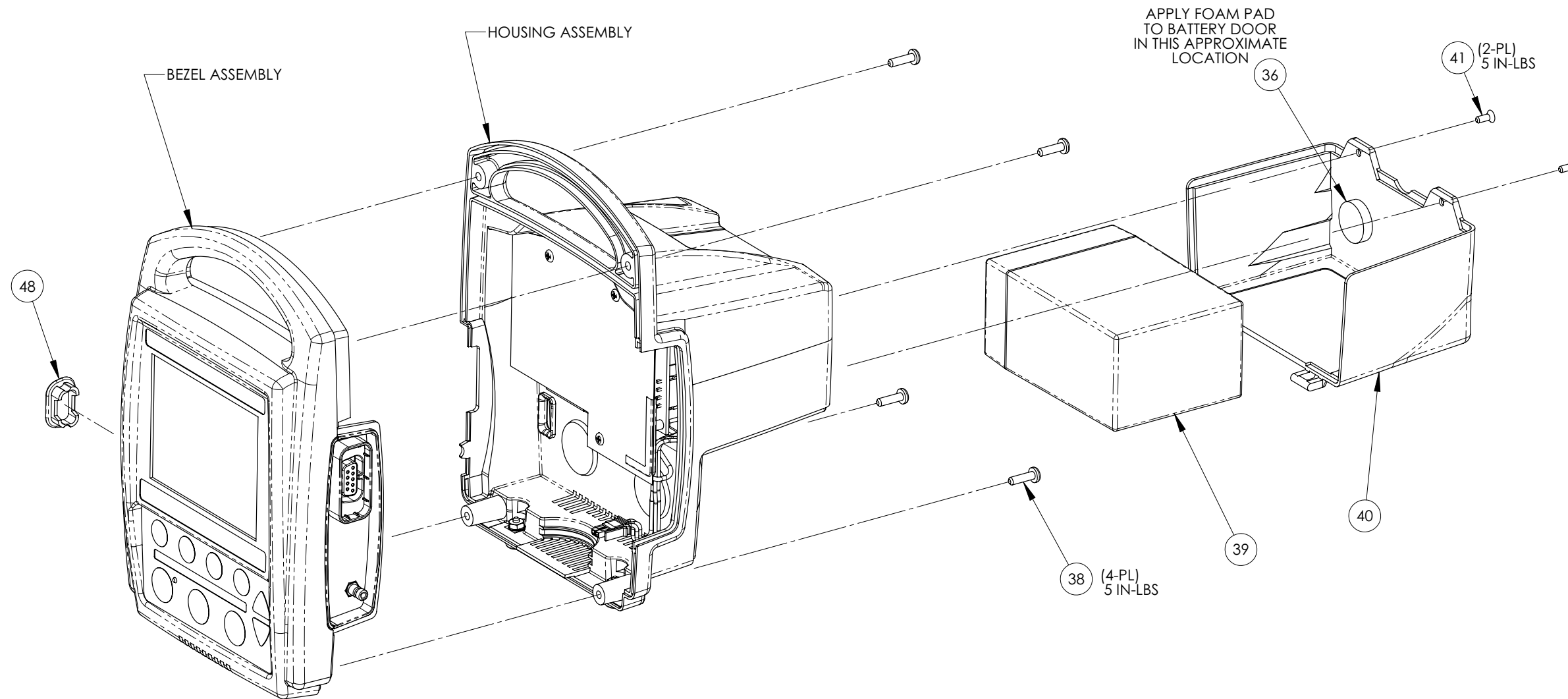

VENDOR SHOULD COMPLY WITH THE FOLLOWING CSI QUALITY REQUIREMENTS: Q1, Q2, Q4, Q5, Q6, Q7, Q10, Q11 AND Q16. IN ADDITION THE QUALITY REQUIREMENTS Q9, Q13 AND Q17 APPLY. SEE CSI WEB SITE (www.csiusa.com/pdf/QA_Requirements.pdf) FOR THE DEFINITION OF THE QUALITY REQUIREMENTS.

SW



DRAWN BY: SC	CHECK BY:	ENG. APPR.:
DATE: 04-04-08	RELEASE DATE:	Q.A. APPR.:
SCALE: 1:1	DO NOT SCALE PRINT	
TOLERANCE UNLESS OTHERWISE SPECIFIED: XX: +/- .020 XXX: +/- .005 ANGLES: +/- 1 DEGREE	CONFIDENTIAL: THIS DOCUMENT CONTAINS CONFIDENTIAL INFORMATION AND MAY NOT BE COPIED OR DIVULGED WITHOUT WRITTEN CONSENT OF CRITICARE SYSTEMS, INC.	
TITLE: FINAL ASSEMBLY 506DN	PART NO.: 93987A001	REV.: 2
DIST: -	SHEET 4 OF 4	

REVISIONS			
REV.	DATE	DESCRIPTION	BY

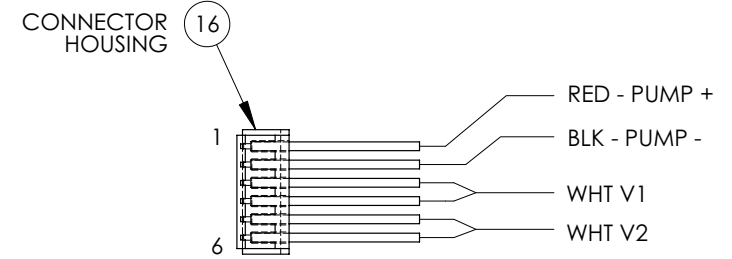
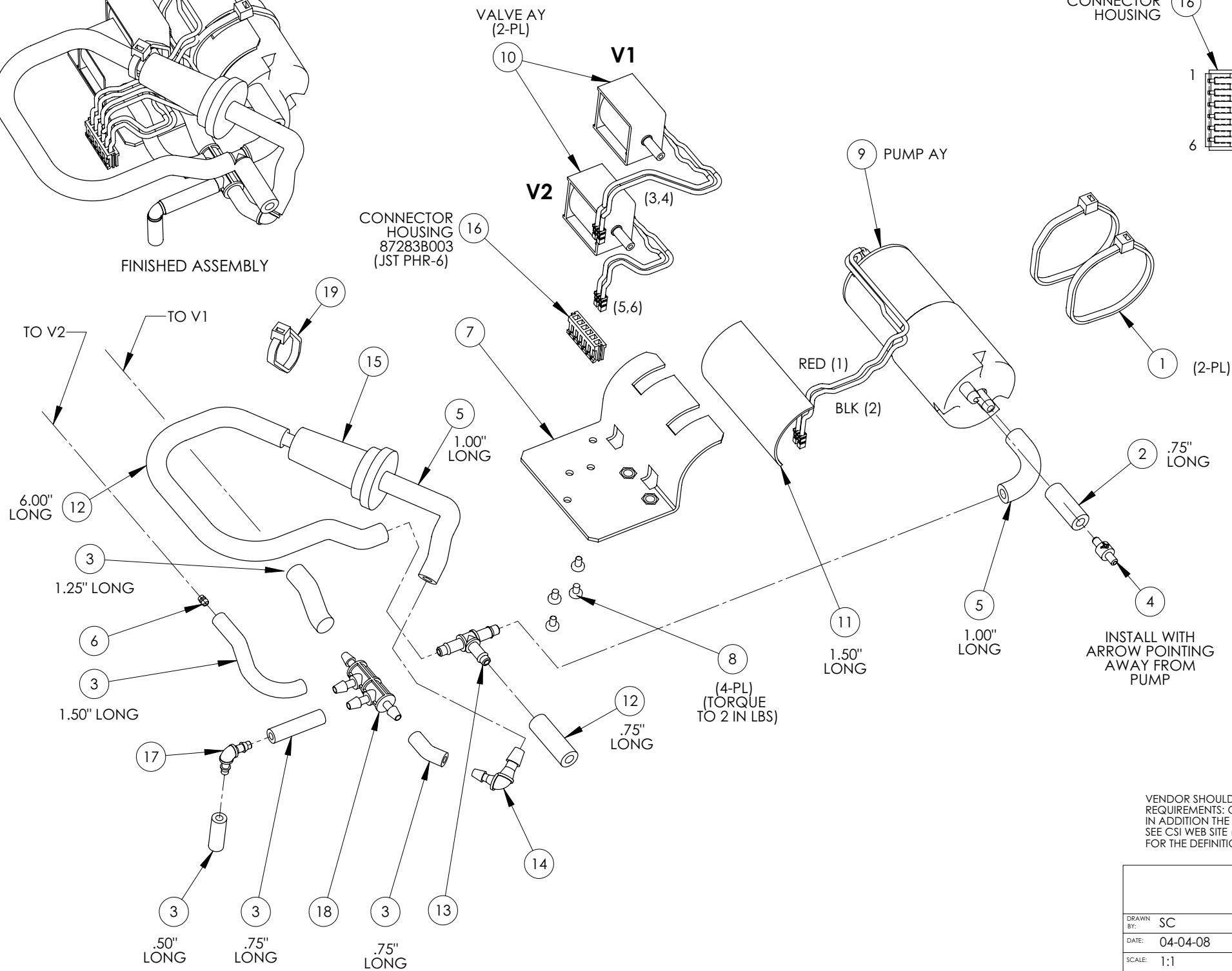
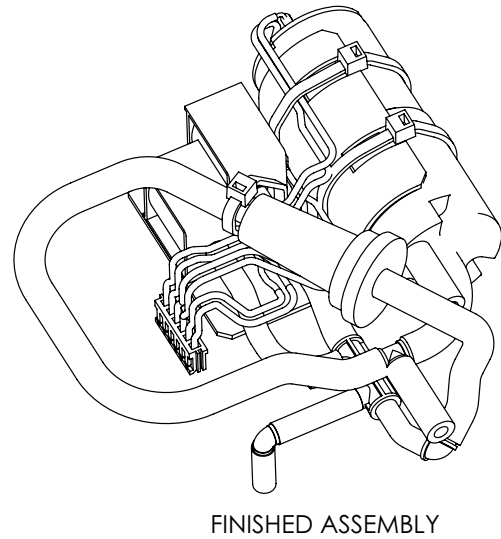

CONNECTOR WIRING DETAIL

NOTES:

1. REFER TO ASSEMBLY PROCEDURE FOR 95597P005 ASSEMBLY SEQUENCE AND INSTRUCTIONS.

INSTALL WITH ARROW POINTING AWAY FROM PUMP

VENDOR SHOULD COMPLY WITH THE FOLLOWING CSI QUALITY REQUIREMENTS: Q1, Q2, Q4, Q5, Q6, Q7, Q10, Q11 AND Q16. IN ADDITION THE QUALITY REQUIREMENTS Q9, Q13 AND Q17 APPLY. SEE CSI WEB SITE (www.csiusa.com/pdf/QA_Requirements.pdf) FOR THE DEFINITION OF THE QUALITY REQUIREMENTS.

SW



DRAWN BY: SC	CHECK BY:	ENG. APPR.:
DATE: 04-04-08	RELEASE DATE:	G.A. APPR.:
SCALE: 1:1	DO NOT SCALE PRINT	MFG. APPR.:

TOLERANCE UNLESS OTHERWISE SPECIFIED:
 XX: +/- .020
 XXX: +/- .005
 ANGLES: +/- 1 DEGREE

CONFIDENTIAL: THIS DOCUMENT CONTAINS CONFIDENTIAL INFORMATION AND MAY NOT BE COPIED OR DIVULGED WITHOUT WRITTEN CONSENT OF CRITICARE SYSTEMS, INC.

TITLE: NIBP MODULE 6 PIN CONN	PART NO.: 95597A005	REV.: 0
DIST: -		SHEET 1 OF 1

RELEASED DOCUMENT
 CRITICARE SYSTEMS, INC.

REVISIONS			
REV.	DATE	DESCRIPTION	BY
1	1/14/09	SEE ECN # 10359	DBL

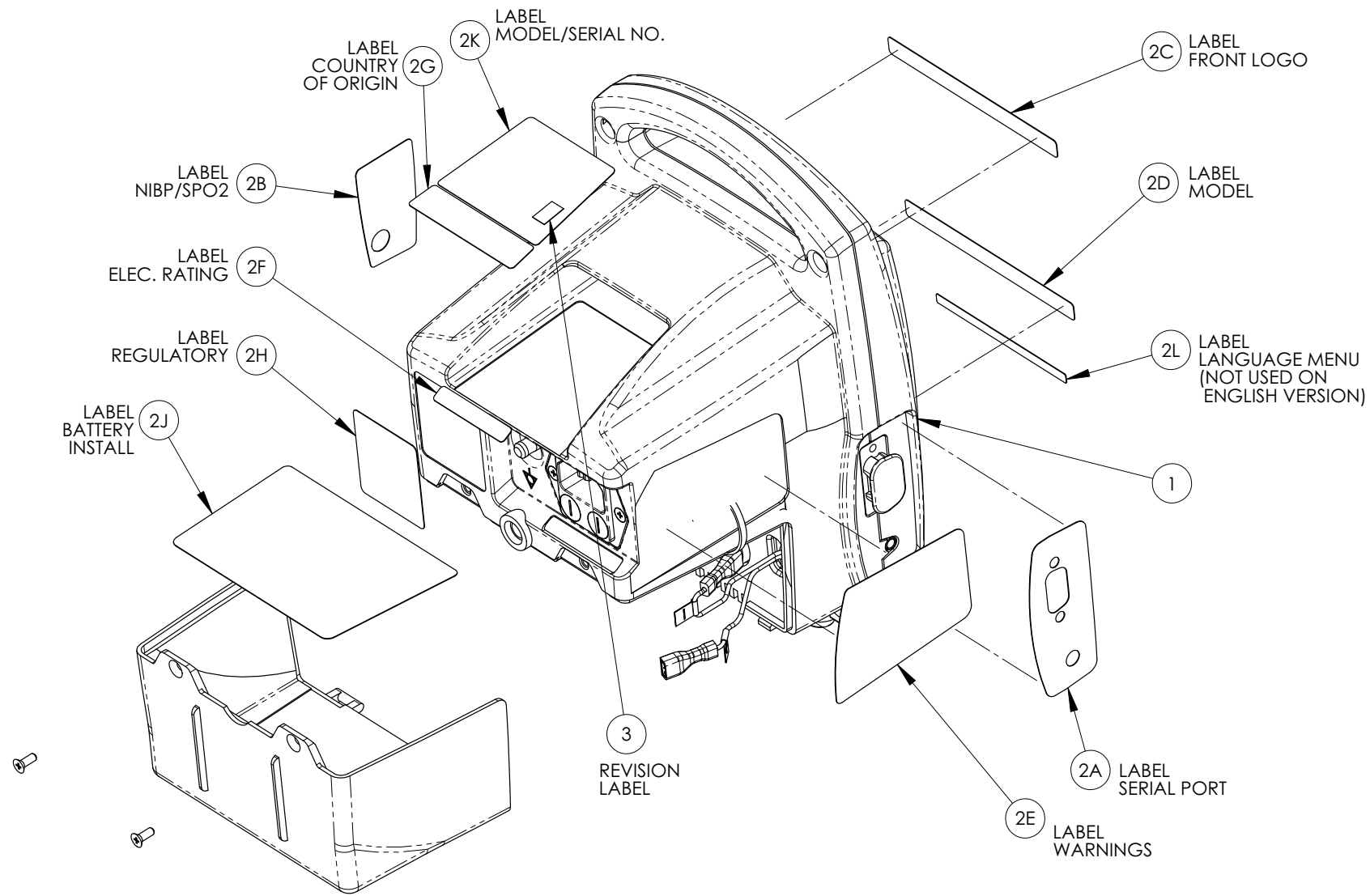

NOTES:

1. NOT SHOWN:

- ITEM #4, SHIPPING ASSEMBLY (PACKAGING)
- ITEM #5, 46036B101 CSI LOGO QUALITY SEAL LABEL

VENDOR SHOULD COMPLY WITH THE FOLLOWING CSI QUALITY REQUIREMENTS: Q1, Q2, Q4, Q5, Q6, Q7, Q10, Q11 AND Q16. IN ADDITION THE QUALITY REQUIREMENTS Q9, Q13 AND Q17 APPLY. SEE CSI WEB SITE (www.csiusa.com/pdf/QA_Requirements.pdf) FOR THE DEFINITION OF THE QUALITY REQUIREMENTS.

SW



DRAWN BY: SC	CHECK BY:	ENG. APPR.:
DATE: 04-10-08	RELEASE DATE:	Q.A. APPR.:
SCALE: NTS	DO NOT SCALE PRINT	MFG. APPR.:
TOLERANCE UNLESS OTHERWISE SPECIFIED: XX: +/- .020 XXX: +/- .005 ANGLES: +/- 1 DEGREE	CONFIDENTIAL: THIS DOCUMENT CONTAINS CONFIDENTIAL INFORMATION AND MAY NOT BE COPIED OR DIVULGED WITHOUT WRITTEN CONSENT OF CRITICARE SYSTEMS, INC.	
TITLE: MONITOR NIBP, WITH DOX/SQL SPO2	PART NO.: CAT 506XN-X	REV. 1
DIST: -		SHEET 1 OF 1

REVISIONS			
REV.	DATE	DESCRIPTION	BY
1	8/26/08	SEE ECN #10262	DBL
2	11/20/08	SEE ECN #10325	RWK

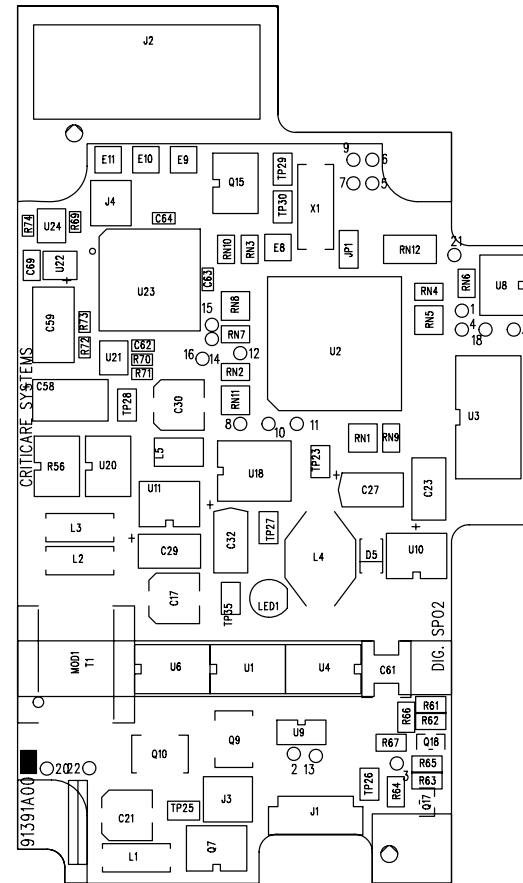

COMPONENT SIDE

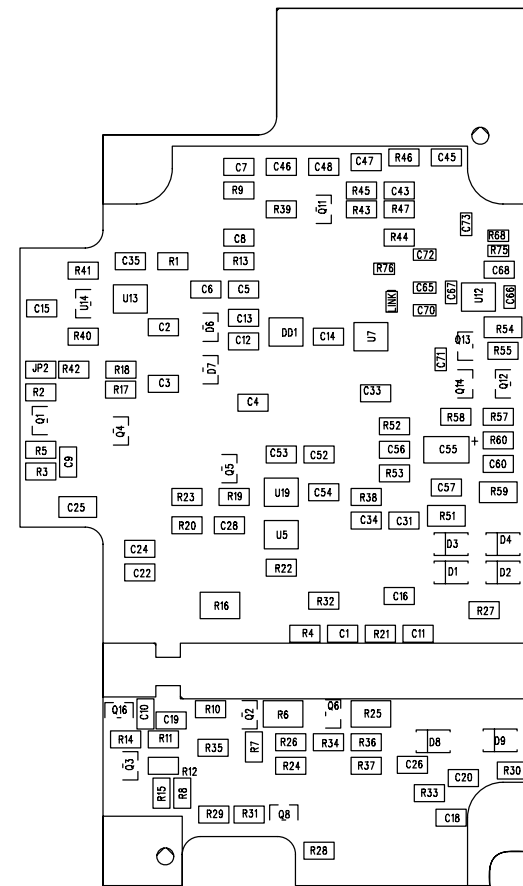

SOLDER SIDE

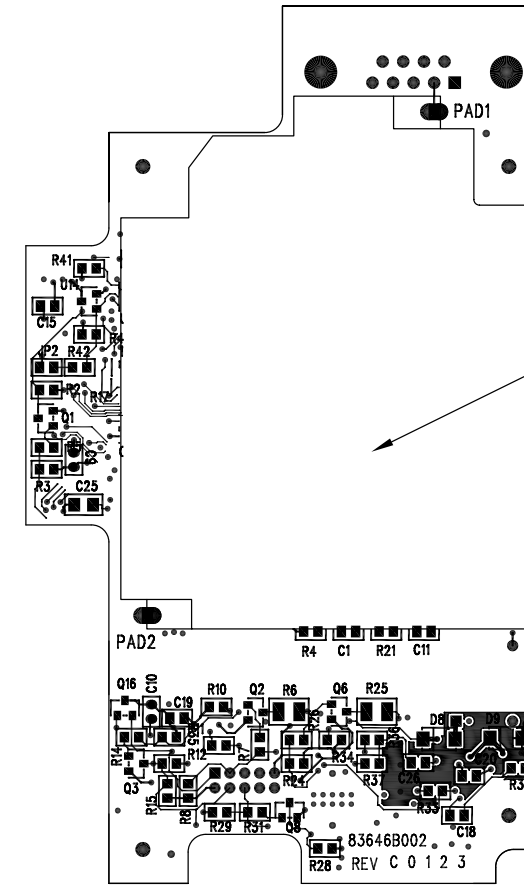

SOLDER SIDE

NOTES:

- 1.) THIS PCB ASSEMBLY SHALL MEET CURRENT IPC-A-610 SPECIFICATION, CLASS 2.
- 2.) FINISHED BOARD THICKNESS SHALL BE .062+/- .010.
- 3.) BARE BOARD 83646B002 TO BE USED ON ASSEMBLY 91391A002.
- 4.) BOARD TO BE FABRICATED WITH RAILS OR IN MULTIPLE UP PANELS TO AID AND OPTIMIZE COMPONENT ASSEMBLY. CONTACT CSI'S CONTRACT MANUFACTURER FOR THE PREFERRED LAYOUT. CSI TO APPROVE LAYOUT BEFORE FABRICATION.
- 5.) LABELING MUST BE NON-CONDUCTIVE
- 6.) CSI RESERVES THE RIGHT TO INSPECT THIS ITEM AT THE VENDORS FACILITY. VENDORS INSPECTION SYSTEM AND MANUFACTURING PROCESS ARE SUBJECT TO REVIEW/APPROVAL, VERIFICATION AND ANALYSIS BY AUTHORIZED CSI REPRESENTATIVES. ALL CHANGES IN DESIGN, COMPONENTS, PROCESSES OR FABRICATION MUST BE AUTHORIZED IN WRITING BY CSI PRIOR TO IMPLEMENTATION. ALL DEVIATIONS FROM DRAWINGS, SPECIFICATIONS, OR OTHER REQUIREMENTS MUST BE REPORTED TO CSI FOR APPROVAL PRIOR TO SHIPMENT. ALL RAW MATERIALS USED TO PRODUCE THIS PART SHALL BE TRACEABLE TO AT LEAST A LOT LEVEL. ALL TRACEABILITY AND INSPECTION RECORDS MUST BE IDENTIFIABLE TO THE RAW MATERIALS, PARTS, ASSEMBLIES, OR DEVICES TO WHICH THEY APPLY AND SHALL BE AVAILABLE UPON REQUEST OR AUDIT BY CSI REPRESENTATIVE.

FIRST ARTICLES MUST BE INSPECTED AND ACCEPTED BY A CSI QUALITY REPRESENTATIVE PRIOR TO A PRODUCTION SHIPMENT, UNLESS OTHERWISE AUTHORIZED BY CSI. THE FIRST ARTICLES MUST BE INSPECTED AND OR TESTED FOR COMPLIANCE TO THE REQUIREMENT OF APPLICABLE ENGINEERING DRAWINGS AND SPECIFICATIONS. FIRST ARTICLES MUST BE SO MARKED AND IDENTIFIED WITH A PART NUMBER. ANY MAJOR TOOLING, PROCESS, OR COMPONENT CHANGE WILL REQUIRE A NEW FIRST ARTICLE EVALUATION.

EACH LOT OF PARTS SHALL BE ACCOMPANIED BY A LEGIBLE COPY OF A CERTIFICATE OF COMPLIANCE LISTING THE DRAWING, SPECIFICATION, PROCESS AND APPLICABLE REVISION TO WHICH THE PARTS COMPLY AND BE SIGNED OFF BY THE VENDORS QA REPRESENTATIVE.

EACH ASSEMBLY SHALL BE IDENTIFIED WITH THE CSI PART NUMBER AND REVISION FOR THE ASSEMBLY, AND A UNIQUE SERIAL NUMBER IN HUMAN-READABLE FORMAT. SERIAL NUMBERS SHALL NOT BE DUPLICATED. THE FORMAT FOR THE SERIAL NUMBER SHALL CONTAIN AT LEAST 2 ALPHABETICAL PREFIX CHARACTERS THAT ARE RELEVANT TO THE VENDOR TO DISTINGUISH BETWEEN MULTIPLE VENDORS. THE ASSEMBLY PART NUMBER, REVISION AND SERIAL NUMBER SHALL ALSO BE LABELED ON THE PCB ASSEMBLY IN BARCODE FORMAT USING CODE 39 (PREFERRED) OR CODE 128.

- 7.) AFTER THE BOARD HAS BEEN TESTED, ATTACH ITEM 02 (SHIELD) AND SOLDER PAD1 AND PAD2.



VENDOR SHOULD COMPLY WITH THE FOLLOWING CSI QUALITY REQUIREMENTS: Q1, Q2, Q4, Q5, Q6, Q7, Q10, Q11 AND Q16. IN ADDITION THE QUALITY REQUIREMENTS Q9, Q13 AND Q17 APPLY. SEE CSI WEB SITE (www.csiusa.com/pdf/QA_Requirements.pdf) FOR THE DEFINITION OF THE QUALITY REQUIREMENTS

CS CRITICARE SYSTEMS, INC.		
DRAWN BY: DBL	CHECK BY: 4/25/08	ENG. APPR.:
DATE: 4/25/08	RELEASE DATE:	Q.A. APPR.:
SCALE: 1:1.5	DO NOT SCALE PRINT	MFG. APPR.:
TOLERANCE UNLESS OTHERWISE SPECIFIED: XX: +/- .020 XXX: +/- .005 ANGLES: +/- 1 DEGREE	CONFIDENTIAL: THIS DOCUMENT CONTAINS CONFIDENTIAL INFORMATION AND MAY NOT BE COPIED OR DIVULGED WITHOUT WRITTEN CONSENT OF CRITICARE SYSTEMS, INC.	
TITLE: ASSY, DIGITAL SP02 (DOX) MODULE	PART NO.: 91391A002	REV.: 2
DIST: --	SHEET 1 OF 1	

REV	DATE	ECN #

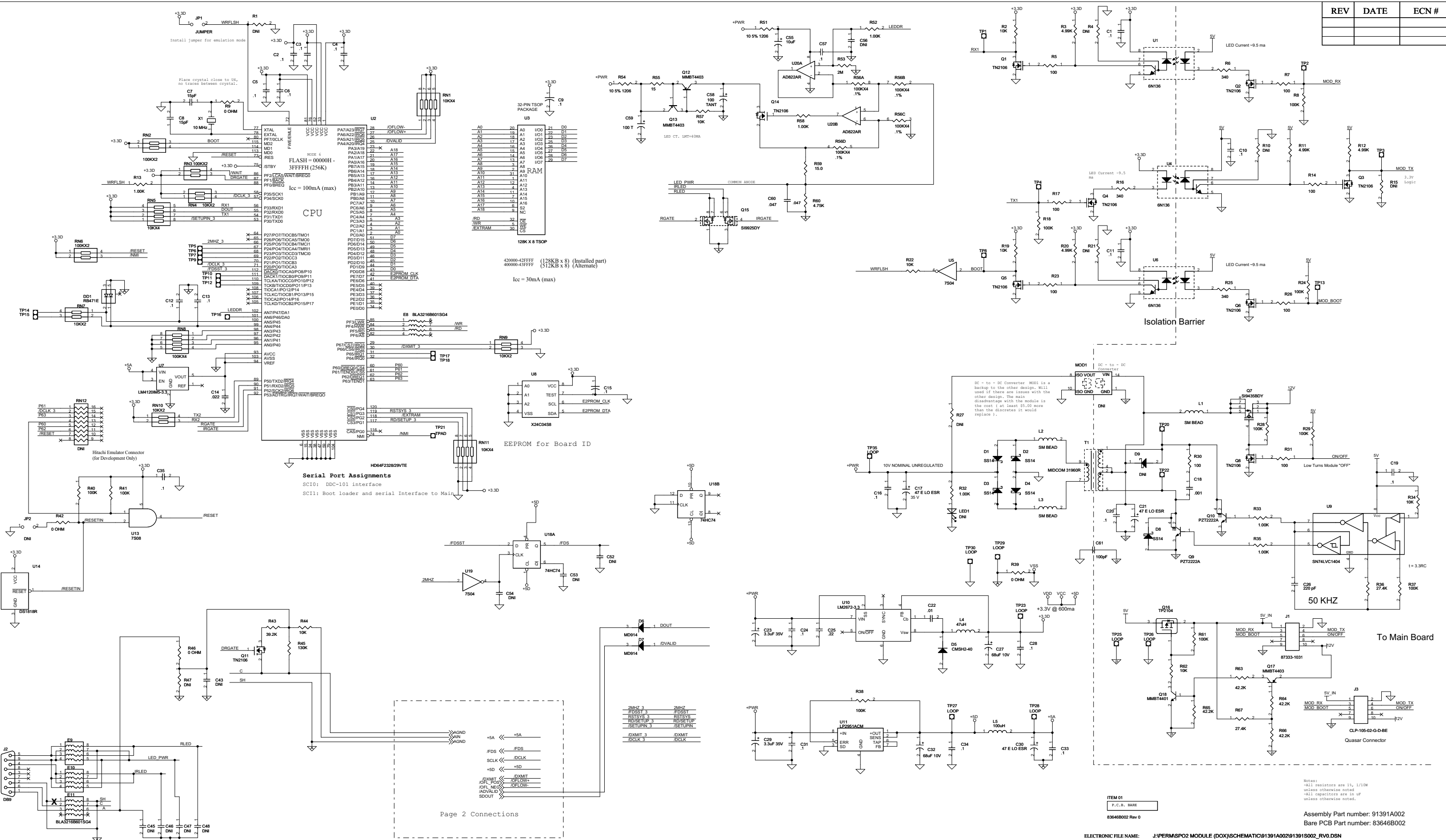

Notes:
 -All resistors are 1%, 1/16W unless otherwise noted.
 -All capacitors are in uF unless otherwise noted.

Assembly Part number: 91391A002
 Bare PCB Part number: 83646B002

ELECTRONIC FILE NAME: J:\PERM\SP02 MODULE (DOX)\SCHEMATIC\91391A002\91391S002_RV0.DSN	
CS CRITICARE SYSTEMS INC. 20925 Crossroads Circle, Waukesha, WI 53186	CONFIDENTIAL: This document contains confidential information and may not be copied or divulged without written consent of CRITICARE SYSTEMS INC.
DRAWN BY: DJR	ENG. APPR. ELECTRONICALLY SIGNED IN ORIFY
CREATION DATE: 3/24/08	PART NUMBER: 91391S002
LAST MODIFIED DATE: Friday, June 27, 2008	Q.A. APPR. ELECTRONICALLY SIGNED IN ORIFY
CHECKED BY:	MFG. APPR. ELECTRONICALLY SIGNED IN ORIFY
TITLE: Digital SpO2 Module	SHEET SIZE: D
SHEET NUMBER: 306	DIST: 306
SHEET 1 OF 2	REV. 0



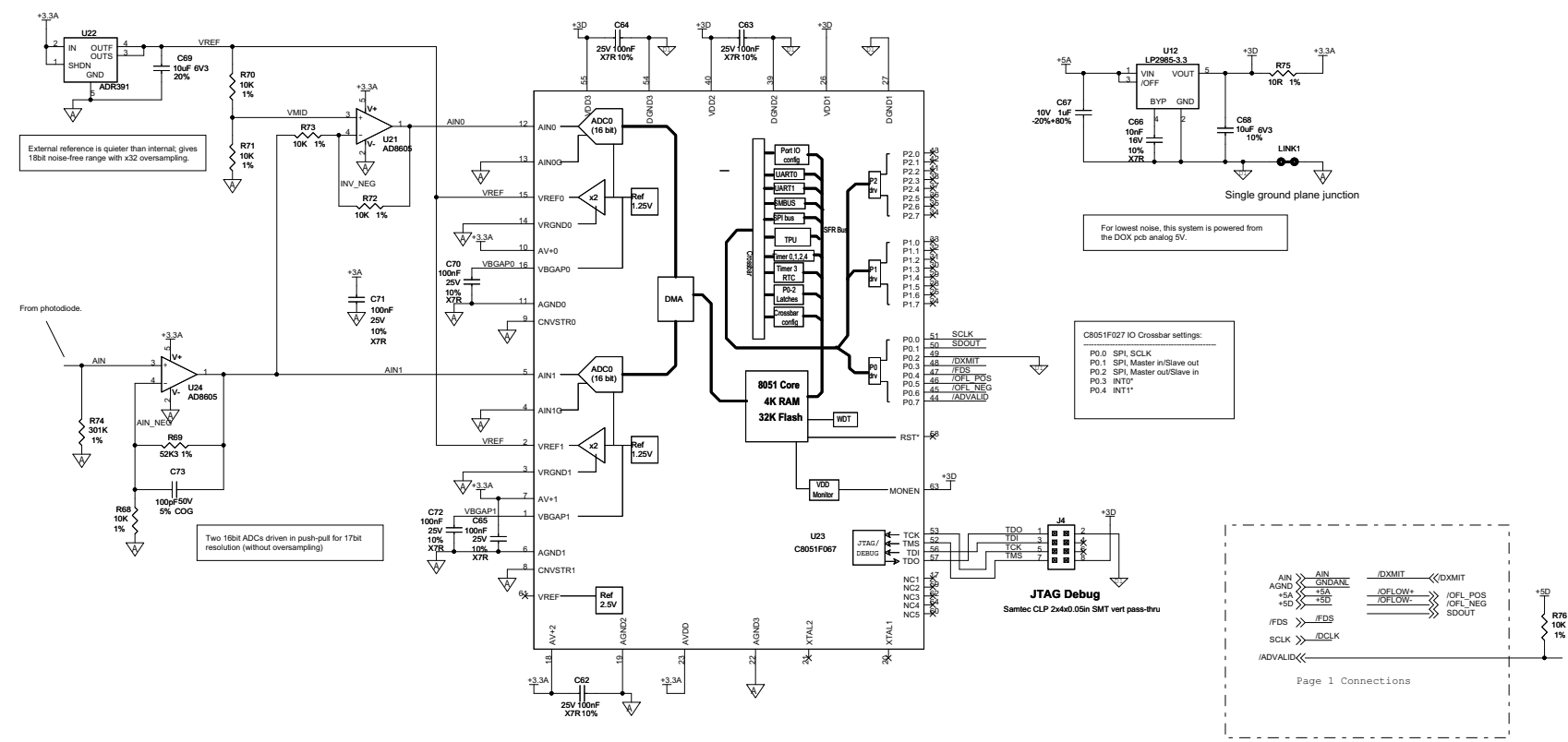

ELECTRONIC FILE NAME: J:\PERM\SP02 MODULE (DOX)\SCHEMATIC\91391A002\91391S002_RV0.DSN

		20925 Crossroads Circle Waukesha, WI 53186 Copyright ©2008		CONFIDENTIAL: This document contains confidential information and may not be copied or divulged without written consent of CRITICARE SYSTEMS INC.	
PCB NUMBER: 83646B002 R0	ENG. APPR.:	PART NUMBER: 91391S002	REV. 0		
DRAWN BY: DJR	ELECTRONICALLY SIGNED IN OMNIFY				
LAST MODIFIED DATE: Wednesday, June 18, 2008	Q.A. APPR.:	TITLE: DOX A/D Processor			
CHECKED BY:	MFG APPR.:	SHEET SIZE: D	DIST: 306	SHEET 2 OF 2	
		ELECTRONICALLY SIGNED IN OMNIFY			

REVISIONS			
REV.	DATE	DESCRIPTION	BY
*0	6-06-2008	PRE-PRODUCTION ISSUE	JEG
1	6-30-2008	INITIAL RELEASE	JEG
2	8/26/08	SEE ECN #10277	DBL
3	1/13/09	SEE ECN #10359	DBL

INSTALL ITEMS 1 AND 2 THIS SIDE

PLACE REVISION AND S/N LABELS HERE. SEE NOTES 3 AND 6.

ITEM 2

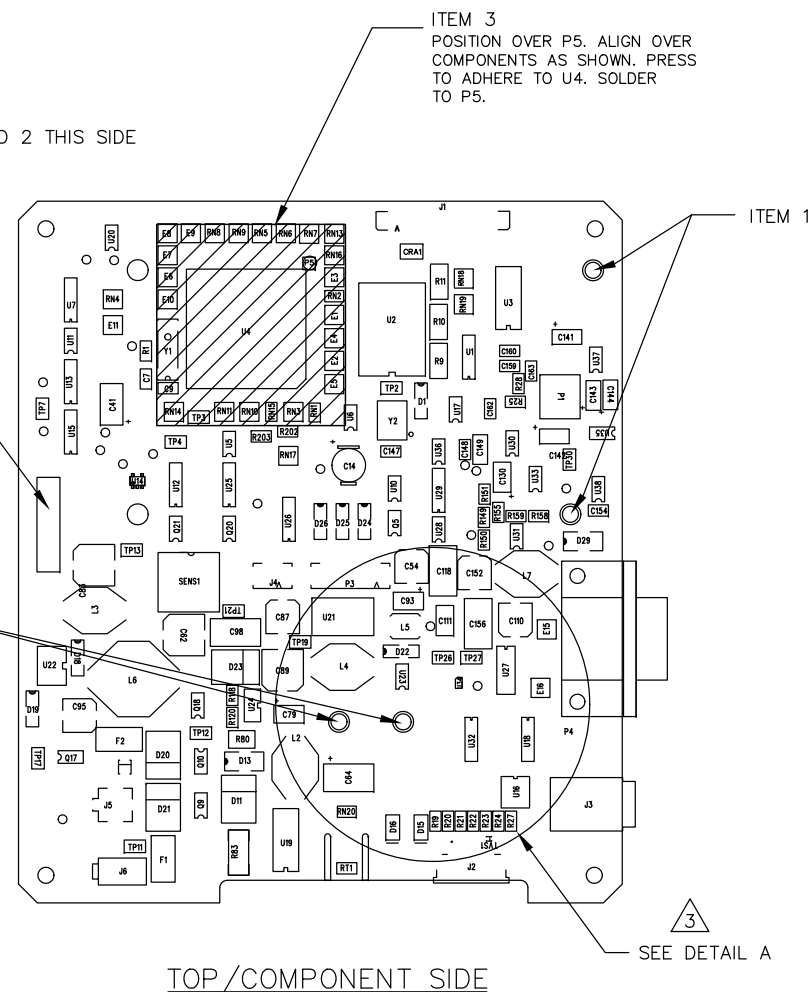

TOP/COMPONENT SIDE

SEE DETAIL A

CURRENT PWB REVISION

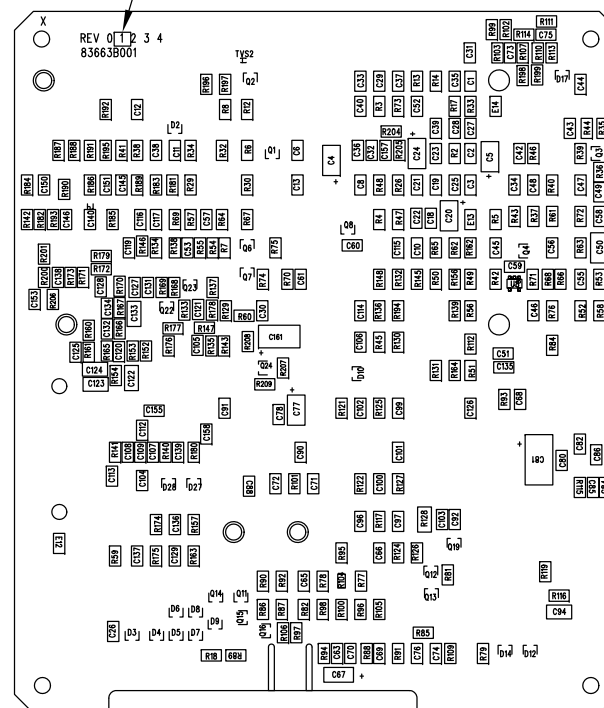

BOTTOM/SOLDER SIDE

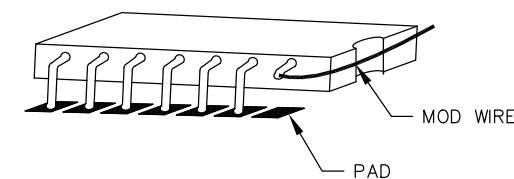
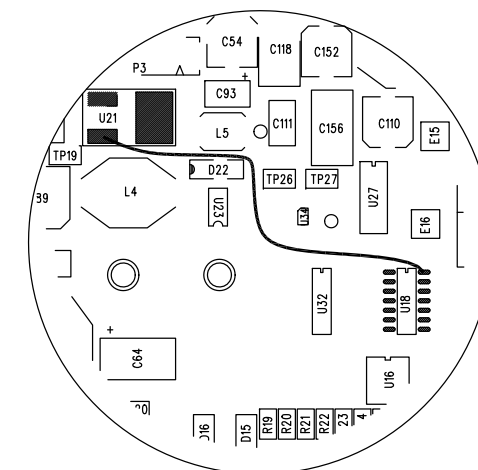

DETAIL A

3

NOTES:

- THIS PCB ASSEMBLY SHALL MEET CURRENT IPC-A-610 SPECIFICATION, CLASS 2.
- APPLIED LABELS MUST BE NON-CONDUCTIVE.
- PLACE REVISION AND SERIAL NUMBER LABEL(S) ON COMPONENT SIDE, NOT COVERING ANY MOUNTING HOLES, VIAS, OR SOLDER JOINTS. BOTH NUMBERS MAY APPEAR ON THE SAME LABEL.
- REFER TO BILL OF MATERIAL FOR COMPLETE LISTING OF COMPONENTS NOT INSTALLED (DNI).
- MICROPROCESSOR MUST BE PROGRAMMED WITH SOFTWARE PRIOR TO FUNCTIONAL TESTING OF PCB ASSEMBLY. FIRMWARE REVISION LABEL MUST BE AFFIXED TO MICROPROCESSOR.
- EACH ASSEMBLY SHALL BE IDENTIFIED WITH THE CSI PART NUMBER AND REVISION FOR THE ASSEMBLY, AND A UNIQUE SERIAL NUMBER IN HUMAN-READABLE FORMAT. SERIAL NUMBERS SHALL NOT BE DUPLICATED. THE FORMAT FOR THE SERIAL NUMBER SHALL CONTAIN AT LEAST 2 ALPHABETICAL PREFIX CHARACTERS THAT ARE RELEVANT TO THE VENDOR TO DISTINGUISH BETWEEN MULTIPLE VENDORS. THE ASSEMBLY PART NUMBER, REVISION AND SERIAL NUMBER SHALL ALSO BE LABELED ON THE PCB ASSEMBLY IN BARCODE FORMAT USING CODE 39 (PREFERRED) OR CODE 128.
- CSI RESERVES THE RIGHT TO INSPECT THIS ITEM AT THE VENDORS FACILITY. VENDORS INSPECTION SYSTEM AND MANUFACTURING PROCESS ARE SUBJECT TO REVIEW/APPROVAL, VERIFICATION AND ANALYSIS BY AUTHORIZED CSI REPRESENTATIVES. ALL CHANGES IN DESIGN, COMPONENTS, PROCESSES OR FABRICATION MUST BE AUTHORIZED IN WRITING BY CSI PRIOR TO IMPLEMENTATION. ALL DEVIATIONS FROM DRAWINGS, SPECIFICATIONS, OR OTHER REQUIREMENTS MUST BE REPORTED TO CSI FOR APPROVAL PRIOR TO SHIPMENT. ALL RAW MATERIALS USED TO PRODUCE THIS PART SHALL BE TRACEABLE TO AT LEAST A LOT LEVEL. ALL TRACEABILITY AND INSPECTION RECORDS MUST BE IDENTIFIABLE TO THE RAW MATERIALS, PARTS, ASSEMBLIES, OR DEVICES TO WHICH THEY APPLY AND SHALL BE AVAILABLE UPON REQUEST OR AUDIT BY CSI REPRESENTATIVE.

FIRST ARTICLES MUST BE INSPECTED AND ACCEPTED BY A CSI QUALITY REPRESENTATIVE PRIOR TO A PRODUCTION SHIPMENT, UNLESS OTHERWISE AUTHORIZED BY CSI. THE FIRST ARTICLES MUST BE INSPECTED AND OR TESTED FOR COMPLIANCE TO THE REQUIREMENT OF APPLICABLE ENGINEERING DRAWINGS AND SPECIFICATIONS. FIRST ARTICLES MUST BE SO MARKED AND IDENTIFIED WITH A PART NUMBER. ANY MAJOR TOOLING, PROCESS, OR COMPONENT CHANGE WILL REQUIRE A NEW FIRST ARTICLE EVALUATION.

EACH LOT OF PARTS SHALL BE ACCOMPANIED BY A LEGIBLE COPY OF A CERTIFICATE OF COMPLIANCE LISTING THE DRAWING, SPECIFICATION, PROCESS AND APPLICABLE REVISION TO WHICH THE PARTS COMPLY AND BE SIGNED OFF BY THE VENDORS QA REPRESENTATIVE.

VENDOR SHALL FURNISH A COPY OF ACTUAL INSPECTION/TEST RESULTS ASSOCIATED WITH EACH SERIALIZED ITEM. INSPECTION AND TEST PARAMETERS (OPERATIONAL, MECHANICAL, ELECTRICAL, ENVIRONMENTAL, ETC) SHALL BE DEFINED BY BY CSI MANUFACTURING ENGINEERING.
- EACH INDIVIDUAL, ASSEMBLED PCB SHALL BE PACKAGED IN CONDUCTIVE, STATIC SHIELDING BAGS OR CONTAINERS AND IDENTIFIED WITH ESD WARNING LABELS.
- SEE DETAIL A. LIFT 18.14 AND SOLDER WIRE (30AWG) PN: 40577B001 TO PIN 14 AND JUMPER TO U21.3.

ASSEMBLY FILES	
DESCRIPTION	ELECTRONIC FILENAME
TOP STENCIL/PASTE	91410A001_R1_TSP.PHO
BOTTOM STENCIL/PASTE	91410A001_R1_BSP.PHO
PLACEMENT/CENTROID	91410A001_R1.PLC

VENDOR SHOULD COMPLY WITH THE FOLLOWING CSI QUALITY REQUIREMENTS: Q1, Q2, Q4, Q5, Q6, Q7, Q10, Q11 AND Q16. IN ADDITION THE QUALITY REQUIREMENTS Q9, Q13 AND Q17 APPLY. SEE CSI WEB SITE (www.csiusa.com/pdf/QA_Requirements.pdf) FOR THE DEFINITION OF THE QUALITY REQUIREMENTS

DRAWN BY: JEG	CHECK BY:	END APPR.: SEE OMNIFY
DATE: 06-09-2008	RELEASE DATE: SEE OMNIFY	Q.A. APPR.: SEE OMNIFY
SCALE: NONE	DO NOT SCALE PRINT	MFG. APPR.: SEE OMNIFY
TOLERANCE UNLESS OTHERWISE SPECIFIED: XX: +/- .020 XXX: +/- .005 ANGLES: +/- 1 DEGREE	CONFIDENTIAL: THIS DOCUMENT CONTAINS CONFIDENTIAL INFORMATION AND MAY NOT BE COPIED OR DIVULGED WITHOUT WRITTEN CONSENT OF CRITICARE SYSTEMS, INC.	
TITLE: ASSY, 506CN MAIN BOARD	PART NO.: 91410A001	REV. 3
DIST: --	SHEET 1 OF 1	

RELEASED DOCUMENT

REV	DATE	DESCRIPTION
G	11-28-2007	First prototype layout source.
0	5-30-2008	Second prototype layout source and Pre-Production
1	7-01-2008	Production Release
2	01-15-2009	SEE ECN 10359

NOTE: U4 MUST BE PROGRAMMED.
SEE REF1 ON BOM FOR CORRECT
SOFTWARE AND REVISION LEVEL.

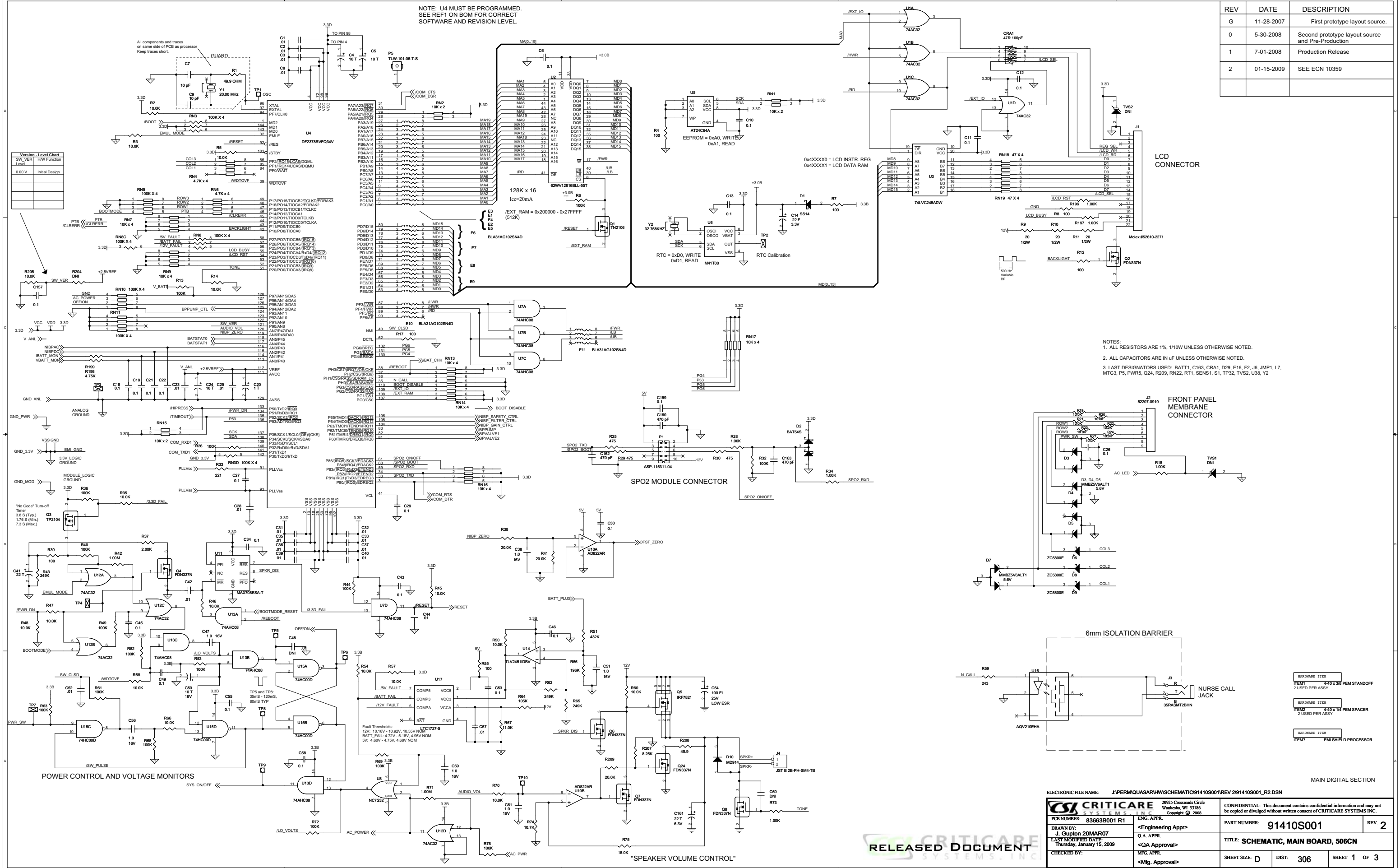

- NOTES:
- ALL RESISTORS ARE 1%, 1/10W UNLESS OTHERWISE NOTED.
 - ALL CAPACITORS ARE IN uF UNLESS OTHERWISE NOTED.
 - LAST DESIGNATORS USED: BATT1, C163, CRA1, D29, E16, F2, J6, JMP1, L7, MTG3, P5, PWR5, Q24, R209, RN22, R11, SENS1, S1, TP32, TVS2, U38, Y2

ELECTRONIC FILE NAME: J:\PERMQUASAR\HWSCHEMATIC\91410S001\REV 2\91410S001_R2.DSN		CONFIDENTIAL: This document contains confidential information and may not be copied or divulged without written consent of CRITICARE SYSTEMS INC.	
PCB NUMBER: 83663B001 R1	ENG. APPR: <Engineering Appr>	PART NUMBER: 91410S001	REV 2
DRAWN BY: J. Gupton 20MAR07	Q.A. APPR: <QA Approval>	TITLE: SCHEMATIC, MAIN BOARD, 506CN	
LAST MODIFIED DATE: Thursday, January 15, 2009	MFG. APPR: <Mfg. Approval>	SHEET SIZE: D	DIST: 306
CHECKED BY:			SHEET 1 OF 3



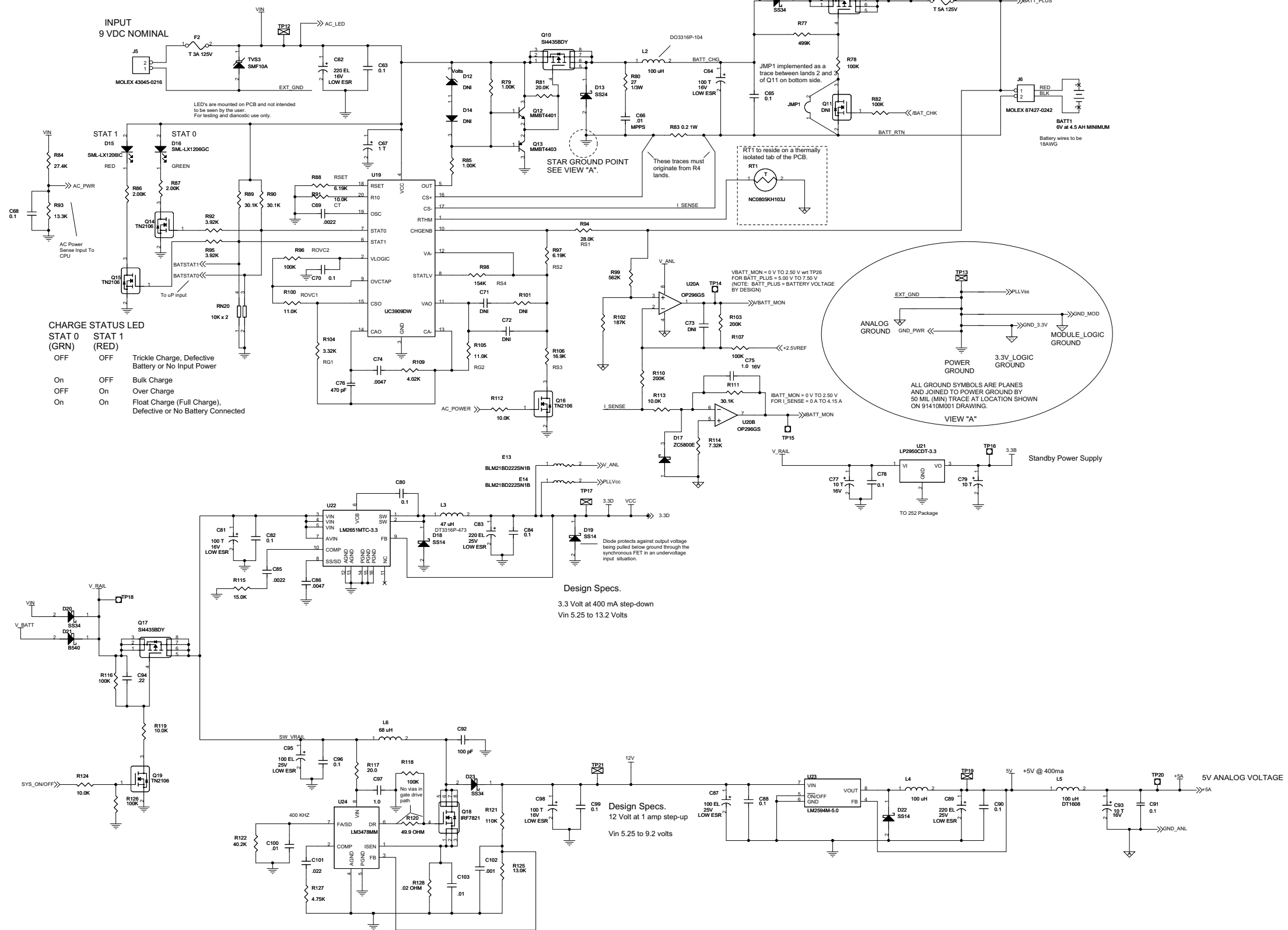

POWER SUPPLY SECTIONS

<p>20925 Crossroads Circle Waukesha, WI 53186 Copyright © 2008</p>	CONFIDENTIAL: This document contains confidential information and may not be copied or divulged without written consent of CRITICARE SYSTEMS INC.	
	PART NUMBER: 91410S001	REV: 2
	TITLE: SCHEMATIC, MAIN BOARD, 506CN	
	SHEET SIZE: D	DIST: 306

CREATION DATE: 20MAR07
 LAST MODIFIED DATE: Thursday, January 15, 2009

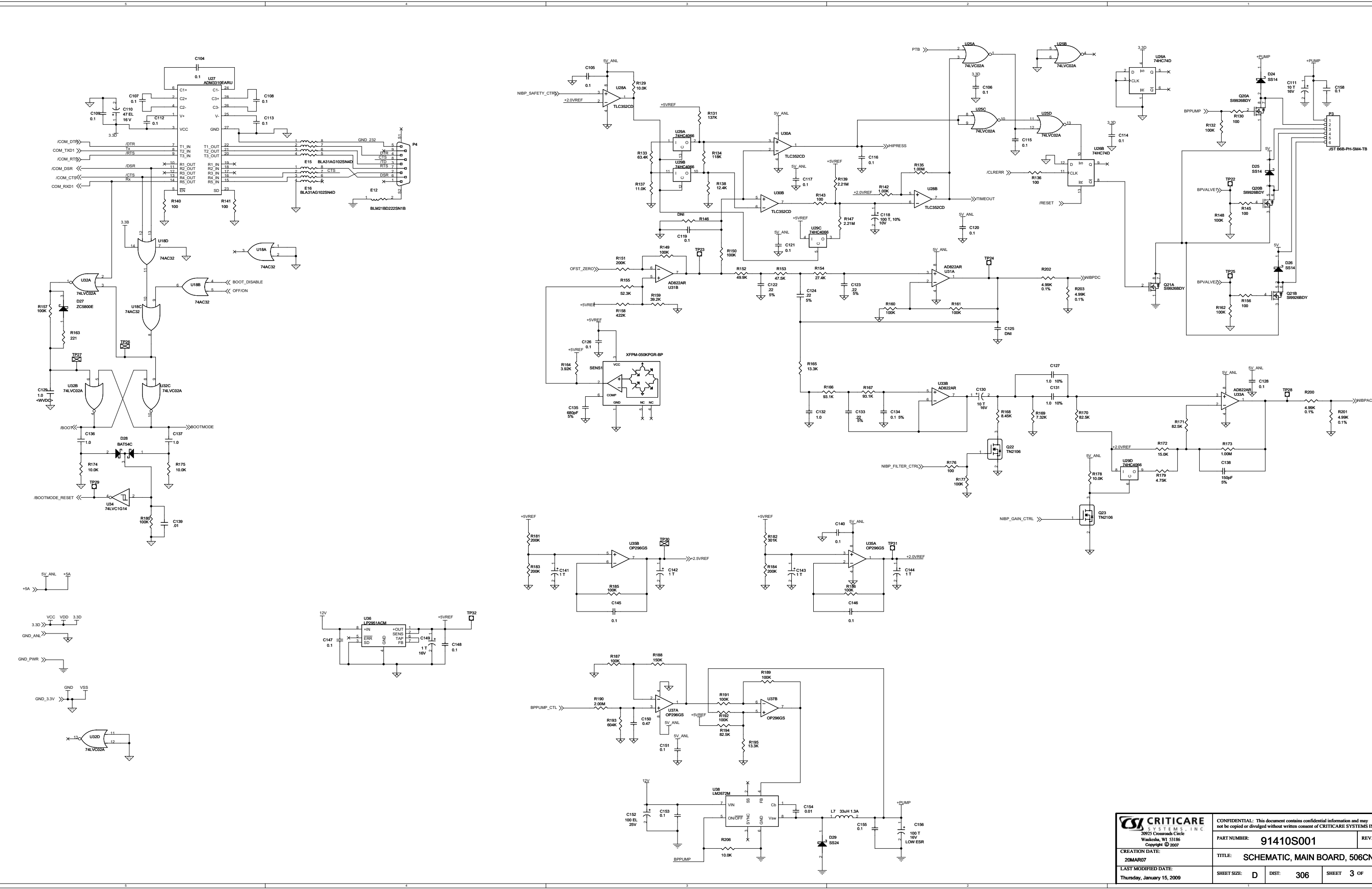

 20925 Crossroads Circle Waukesha, WI 53186 Copyright © 2007	CONFIDENTIAL: This document contains confidential information and may not be copied or divulged without written consent of CRITICARE SYSTEMS, INC.	
	PART NUMBER: 91410S001	REV: 2
CREATION DATE: 20MAR07	TITLE: SCHEMATIC, MAIN BOARD, 506CN	
LAST MODIFIED DATE: Thursday, January 15, 2009	SHEET SIZE: D	DIST: 306
		SHEET 3 OF 3