



Magnum HVAC Version 17

Rev. 2.3.5 - REV-2021-06-02

View Changes made since last Version Release, see page 2

5580 Enterprise Pkwy.
Fort Myers, FL 33905

Office: 239-694-0089
Fax: 239-694-0031

www.mcscontrols.com

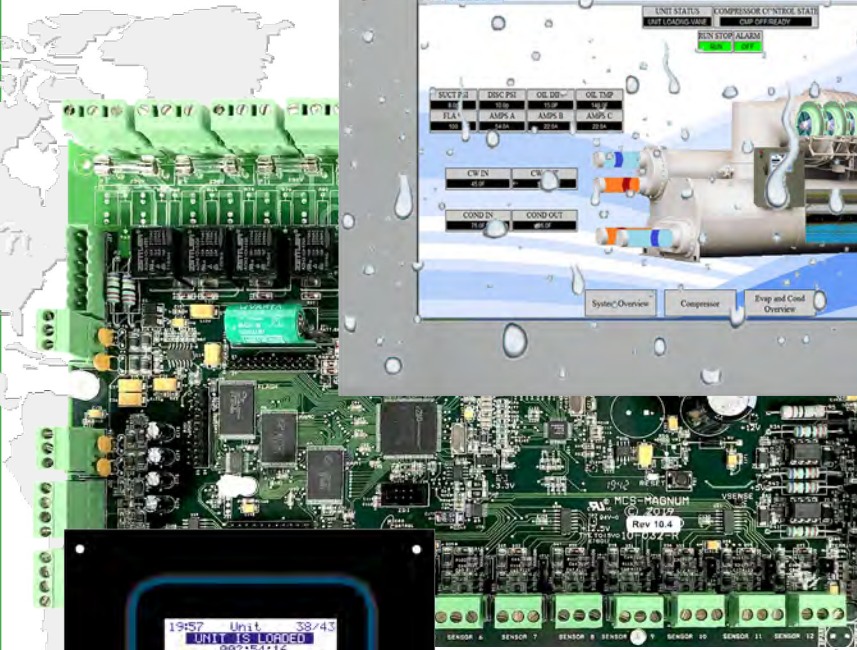

Magnum / Compressor
Control States
BMS Protocols, Set Points,
Alarms & Safeties

**MCS Total
Solution
for all your
Control
Needs**



**Energy Efficient and
RoHS Compliant**

HVAC Manual additions / changes since last revision:

Rev. 2.3.3 - edition of the HVAC Manual contains a number of updates and additions since the last HVAC manual release 2.3.1.

1. Chapter 17 - Setpoint Functions

- a. Voltage Sensor Input - Unbalanced Volts - How to setup

2. Chapter 32 - Change descriptions for setpoints 218 - 222

3. Chapter 8 - Compressor Control States

- a. 8.41 UNLOAD DELAY- RECIP/VFD COMPRESSORS- Firmware Ver. 18.01Y
- b. 8.42. EMERGENCY STOP RELAY - CIRCUIT BASE - Firmware Ver. 18.01Y

4. Chapter 8 - Section - 8.43

Screw Compressor Oil Boost based on Load and Time

The MCS Commitment is to provide practical solutions for the industries needs and to be both a leader and partner in the effective use of microprocessor controls.

Micro Control Systems, Inc.
5580 Enterprise Parkway
Fort Myers, Florida 33905
PH:(239) 694-0089 FAX:(239) 694-0031
www.mcscontrols.com

All information contained within this document is considered to be proprietary information of Micro Control Systems, Inc. No information or data from this document shall be published, used, reproduced, transmitted, or disclosed to others outside your organization without the prior expressed written consent of Micro Control Systems, Inc. This document and the information contained herein shall be treated as proprietary. Reasonable provisions shall be provided to ensure that this information remains proprietary by your employees, agents, and other personnel that may have access to this document.

Copyright ©2021

Table of Contents

Chapter - 1. Introduction to the Magnum	12
About the Magnum	12
Magnum Hardware Supported by Magnum V17 Software	12
Software	12
Magnum V17 Software Control Point Capacity	12
Chapter - 2. PC Software for the Magnum	13
2.1. MCS-Config	13
2.2. MCS-CONNECT	14
2.2.1 HVAC STATUS Display (MCS-Connect)	14
2.3. Authorization Function	17
Chapter - 3. MCS-MAGNUM-N and Expansion Boards	19
3.1. MCS-Magnum Revision 9.1 (revised to 10.4, see next pages)	19
3.2. MCS-SI16-A04- Version 1.3	21
3.3. MCS-RO10 - Version 1.2.....	21
3.4. MCS-Magnum-N-12 Revision 10.4.....	22
3.4.1 Optional Single Output Power Supply	22
3.5. MCS-IO-BASE and MCS-IO-EXT.....	23
3.6. MCS-RO-BASE and MCS-RO-EXT	26
3.7. MCS-SI-BASE and MCS-SI-EXT	27
Chapter - 4. MCS-MAGNUM DISPLAYS	28
4.1. MCS- MAGNUM KEYPAD - Keys and their functions	28
4.1.1 Magnum Keypad and Display	29
4.1.1.1. Menu Screen.....	29
4.1.1.2. Introduction to Status Screens	29
4.1.1.3. Unit Status.....	29
4.1.1.4. Unit Tonnage and KW Information	29
4.2.1.1. Purge Status Screen (only if Purge cycles are active)	30
4.2.1.2. Compressor status	30
4.2.1.3. Compressor status (only CENT)	30
4.2.1.4. EXV status	30
4.3. MCS TOUCHSCREENS.....	31
4.2. MCS-CONNECT and your Touchscreen	32
Chapter - 5. NETWORK CONNECTIONS	33
5.1. MCS 485 Network	33
5.2. ETHERNET	34
5.2.1 RJ45 using a Crossover Ethernet Cable	34
5.3. Remote using Ethernet.....	35
Chapter - 6. Magnum Control States	36
6.1. UNIT IN POWER UP (0).....	36
6.2. NO RUN- I/O LOST (2).....	36
6.3. UNIT IN LOCKOUT (3).....	36
6.4. UNIT IS OFF (4)	36
6.5. UNIT IS HOLDING (5).....	36
6.6. UNIT UNLOADING (6) Only HVAC software.....	37
6.7. UNIT IS LOADING (7) Only HVAC software.....	37
6.8. OFF-SMOKE ALARM (8).....	37
6.9. RUN/STOP SW OFF (9).....	37
6.10. SCHEDULED OFF (10).....	37
6.11. OFF- NO FLOW (11)	37
6.12. AMBIENT OFF (13)	37
6.13. UNIT IS UNLOADED (15)	37
6.14. UNIT IS LOADED (16).....	38

6.15.	OFF TMP-ICE MADE (17)	38
6.16.	ECONOMIZER ONLY (18)	38
6.17.	SWITCHING MODES (19)	38
6.18.	UNIT SMOKE UNLDG (20)	38
6.19.	UNIT OFF UNLDING (21)	38
6.20.	UNIT DMD UNLDING (22)	38
6.21.	UNIT HEAT UNLDING (23)	38
6.22.	UNLDING RUN CMP (24) Only with HVAC Software with TurboCor	39
6.23.	OPENING BYV VLV (25) Only with HVAC Software with TurboCor	39
6.24.	CMP RAMPING UP (26) Only with HVAC Software with TurboCor	39
6.25.	CLOSING BYV VLV (27) Only with HVAC Software with TurboCor	39
6.26.	FACTORY STARTUP (28) Only with HVAC Software	39
6.27.	MAXIMUM RUN TIME (29) Only with HVAC Software	39
6.28.	ESTABLISHING COM (34) Only with HVAC Software	39
6.29.	RS-STARTING COMP (35) Only with HVAC Software	39
6.30.	RS-LOADING (36) Only with HVAC Software	39
6.31.	RS-HOLDING (37) Only with HVAC Software	39
6.32.	UNIT IS OFF/TEMP (38)	39
Chapter - 7.	Heat Recovery Logic	40
7.1.	Theory of Heat Recovery:	40
7.2.	General Description for MCS-Magnum Heat Recovery:	40
7.3.	Unit Type – Heat Recovery	40
7.4.	Heating and Cooling Control Sensors	41
Chapter - 8.	Compressor Control States (number)	42
8.1.	LOST IO LOCKED	42
8.2.	CMP LOCKED OUT	42
8.3.	SWITCHED OFF	42
8.4.	UNLD and PMPDWN	42
8.5.	CMP ANTICYCE	42
8.6.	CMP OFF/READY	42
8.7.	OIL PMP LUBING	42
8.8.	NOT USED	43
8.9.	CMP UNLOADED	43
8.10.	CMP UNLD STEP1 Only HVAC Software	43
8.11.	CMP UNLD STEP2 Only HVAC Software	43
8.12.	CMP IS HOLDING	44
8.13.	CMP IS LOADING Only HVAC Software	44
8.14.	CMP IS UNLDING Only HVAC Software	44
8.15.	CMP IS RUNNING	44
8.16.	FAST UNLOADING	44
8.17.	LO SUCT UNLOAD	44
8.18.	LO SUCT HOLD	44
8.19.	HI DISC UNLOAD	45
8.20.	HI DISC HOLD	45
8.21.	SAFETY TRIPPED	45
8.22.	LO TMP UNLOAD	45
8.23.	LO TMP HOLD	45
8.24.	HI AMP HOLD	45
8.25.	HI DIS TMP HLD	45
8.26.	CMP IS AT 40% Only HVAC Software	45
8.27.	CMP IS AT 70% Only HVAC Software	46
8.28.	HI WATER HOLD	46
8.29.	EXTRA 70% STEP Only HVAC Software	46
8.30.	OFF-LO OIL TMP	46
8.31.	HI AMP UNLDING	46
8.32.	DEF PREPMP OUT Only HVAC Software	46

8.33.	DEFROSTING (32) Only HVAC Software	46
8.34.	DEF PUMP DOWN Only HVAC Software	46
8.35.	HI TEMP UNLOAD Only with HVAC Software	46
8.36.	HI TEMP HOLD Only with HVAC Software	46
8.37.	SCROLL STEP 1 Only with HVAC Software	46
8.38.	SCROLL STEP 2 Only with HVAC Software	46
8.39.	SCROLL STEP 3 Only with HVAC Software	47
8.40.	SCROLL STEP 4 Only with HVAC Software	47
8.41.	UNLOAD DELAY- RECIP/VFD COMPRESSORS.....	47
8.42.	EMERGENCY STOP RELAY - CIRCUIT BASE	48
8.43.	Screw Compressor Oil Boost based on Load and Time.....	48
Chapter - 9.	SHARED VFD	49
9.1.	Compressor Modes	49
9.1.1	Compressor Modes	49
9.1.2	Compressor Startup/Loading Sequence	49
9.1.3	VFD Fault/Emergency Mode	50
Chapter - 10.	Standard Control Options	51
10.1.	General Options	51
10.2.	Magnum Control Zone Logic	51
10.3.	Common Definitions	51
10.3.1	Target	51
10.3.2	Control Zone.....	51
10.3.2.1.	Control Sensor	51
10.3.2.2.	Control Input Rate of Change	52
10.3.2.3.	Step Delay and Sensitivity	52
10.3.2.4.	Last step Temperature On.....	52
10.3.2.5.	Low temperature off	52
10.4.	Voltage Step Control Logic	52
10.5.	Variable Capacity Control Method	53
10.5.1	Screw Compressor with slide piston	53
10.5.2	Compressor with a Variable Frequency Drive (VFD).....	53
10.5.3	Example of a system with 3 variable Step Compressors	53
10.6.	Compressor Types	54
10.7.	Compressor Setup and Options	54
10.7.1	Compressor Information setup	54
10.7.2	For additional fine tuning, four setpoints have been added to provide flexibility:	55
10.8.	Compressor Setup and Options	55
10.8.1	General Information.....	55
10.8.2	Compressor Information setup	56
10.8.3	Circuit Base setup	56
10.8.4	Modbus Fault Sensors	57
10.9.	Relay Output Information Screen setup	58
10.10.	Special Pattern for Scroll Compressors.....	58
10.10.1	The following is a sample of the four-compressor setup:	59
10.10.2	Pattern of the four-compressor setup:.....	59
10.10.3	The three-compressor type will be setup as follows:.....	59
10.10.4	Pattern of the three-compressor setup:.....	60
10.10.5	Safeties are the same for both compressor types	60
10.11.	Compressor Auto Rotation	61
10.12.	Expanded Compressor Rotation to Check for Maximum Run Time	61
10.13.	Run Hour Lockout.....	62
10.14.	Custom Rotation.....	62
10.15.	Compressor Anti-Cycle Logic	63
10.16.	Part Wind and Star Delta Starters	63
10.17.	Full Load Amp (FLA) calculation and slide positioning	64
10.18.	Chiller Barrel Heater	64

10.19.	Hot Gas Bypass.....	64
10.20.	Chilled Water Reset.....	64
10.21.	Turbocor Chillers - New Options:.....	65
10.21.1	Balancing Valve Control :	65
10.21.2	Stage valve control:.....	65
Chapter - 11.	Oil Control Options	66
11.1.	Oil Equalization Option	66
11.2.	Liquid Injection Option	66
11.3.	Oil Cooler Option	66
11.4.	Oil Pump Control Option.....	66
11.5.	Oil Differential Calculation	67
11.6.	On/Off Switches.....	67
11.7.	MCS-Magnum Oil Recovery Logic Tandem Variable Speed & Fix Speed Scroll comps.....	67
11.7.1	Purpose:	67
11.7.2	Requirements:	67
11.8.	Primary/Secondary Tandem Scroll Option:.....	69
11.8.1	Oil Recovery Logic:	69
11.8.2	Balance Mode:	69
11.8.3	Boost Mode:	69
11.9.	Setpoint #139 Low Oil Level safety	69
11.9.1	Setpoint Descriptions Only	70
11.10.	Low Suction Unloading and Holding.....	70
11.11.	High Discharge Pressure Unloading and Holding	70
11.12.	High Discharge Temperature Unloading and Holding	71
11.13.	High Ampere Unloading and Holding	71
11.14.	Low Water Temperature Unloading and Holding	71
11.15.	Energy Efficient Compressor Staging.....	72
11.16.	Chilled Water Pump Control	72
11.16.1	Special Rotation for Chiller Pump Rotation	72
11.16.2	Special Rotation For Process Pumps Rotation.	73
11.17.	Process Pump (Heat Exchanger) Control	73
11.18.	Control Power Relay (No Stop)	74
11.19.	Low and High Ambient Shutdown.....	74
11.20.	Imperial, Metric, and Combined Unit sensor readings.....	74
11.21.	Warning and Alarm Relay Outputs	75
11.22.	Vi Port Control Logic (Open Drive Screw only)	75
11.23.	Operating Schedules	75
11.24.	Mod-Motor Limit Control for Flooded Chiller.....	75
11.25.	Hot Gas Reheat (Humidity) Control.....	76
11.26.	Extra Liquid Line Solenoid Control	77
11.27.	Outside Air Economizer/Fluid Cooler with Analog	77
11.27.1	Output Control	77
11.27.2	Economizer Set up	77
11.27.3	Sequence of Operation	78
11.27.4	Outside Air Supply Economizer.....	79
11.27.5	Mechanical Cooling Enabled.....	79
11.27.6	Example: Fluid Cooler with VFD condenser fan.....	79
11.27.7	Example: Fluid Cooler with condenser compressor fans	80
11.27.7	The economizer AO has been selected and there are no separate economizer fans.	79
11.28.	High Suction Superheat Safety	82
11.29.	Low Temperature Safety and Unload (Low Saturated Suction Temperature).....	82
Chapter - 12.	Using Lookup Tables	83
12.1.	Lookup tables used with MCS-MAGNUM controls.....	83
12.1.1	Setting up a Lookup table using MCS-CONFIG.....	83
12.1.2	Setting up Lookup table #1 - see screen 3 below:	84
12.1.3	Viewing the Lookup Table in MCS-Connect	85

12.1.3.1. Using as Control Temperature Sensor	85
Chapter - 13. Ice Making Capabilities	86
13.1. HVAC/R unit using the cooling target reset	86
13.1.1 Target (SP #1) Reset Sensor.....	86
13.1.2 Reset Sensor Type 'Target Reset'	86
13.1.3 Reset Sensor Type 'Network Target Reset'	86
13.2. Ice Making Mode	87
13.2.1 Terminating of ice making mode.....	87
13.3. System as a pure ice making unit, Turbo Ice Machine	87
13.3.1 The # Liquid Line Solenoids	87
13.3.2 Required set points for defrost cycles	88
13.4. Turbo Ice Machine Operation	88
Chapter - 14. VFD Controlled Screw Compressors	90
14.1. INTRODUCTION.....	90
14.2. STARTUP CONTROL.....	90
14.3. OPERATING CONTROL.....	90
14.4. COMPRESSOR LOADING / UNLOADING	90
14.5. COMPRESSOR SHUTDOWN	90
14.6. Screw Compressor with VFD	91
Chapter - 15. Rapid Start	93
15.1. Purpose of Change.....	93
15.2. Existing Config Parameters.....	93
15.3. New Config Parameters	93
15.4. Calculated Values.....	94
15.5. Logic Requirements.....	94
15.6. Modification to Magnum Status Screen.....	94
Chapter - 16. Relay Output Sequences	96
16.1. Reciprocating Compressors (Recip Comp w/Oil) and (Recip Comp w/o Oil).....	96
16.2. Screw Compressor with Oil (Screw Comp w/Oil)	96
16.3. Reciprocating Compressors (Recip Comp w/Oil) and (Recip Comp w/o Oil).....	97
16.4. Screw Compressor with Oil (Screw Comp w/Oil)	97
16.5. Scroll Compressor (Scroll Comp).....	98
16.6. Hitachi Screw Compressor (Hitachi Screw Comp).....	98
16.7. Carlyle Screw (Carlyle Screw).....	99
16.8. Hanbell Screw Compressor, McQuay Frame 4 Compressor, Bitzer Screw Compressor, Hartford Screw Compressor, and Fu Sheng Compressor (McQuay Frame 4), (Fu Sheng), (Hanbell-Load NO), (Bitzer Screw Comp), (Hartford Screw Comp), and (Hanbell-Load NC).....	99
16.9. Hanbell-3 Solenoid (Hanbell-3 Solenoid [50-100%]).....	100
16.10. Hanbell Fixed Step (Hanbell Step)	100
16.11. Mitsubishi Screw (Mitsubishi Screw)	101
16.12. Trane Scroll with 3 Compressor Sets (Trane Trio)	101
16.13. Trane Scroll with 4 Compressor Sets (Trane Quad).....	102
Chapter - 17. Setpoint Functions	103
17.1. Voltage Sensor Input	103
17.1.1 Set up the sensor type	103
17.1.2 UNBALANCED Voltage Setpoint.....	104
17.2. Motor Amps	104
17.2.1 Add an Amp Imbalance Safety Test to the existing Amp Safeties.....	104
17.3. Custom display description of circuit	105
17.4. User Logic RO Delay Before Off	105
17.5. Additional Information Messages	105
17.6. Pump Rotation.....	105
17.7. Process Pump Addition and Rotation	105
17.8. MOP Control Option to EXV Logic	105
17.9. Delta Temperature Evaporator	105

17.10.	Condenser Low Ambient	105
17.11.	New Pressure Sensor Supported	105
17.12.	Centrifugal Vane Control	105
17.13.	External Centrifugal Purge Control.....	105
17.14.	MCS Touch Screens Interface	105
17.15.	Sensor Averaging	105
17.16.	Virtual Points Separated From Real Points	106
17.17.	MDP to EXV Control Logic	106
17.18.	Low Discharge Superheat Adjustment to EXV Logic.....	106
17.19.	Normal Condenser Discharge Control Bypass.....	106
17.20.	Test for Voltage Out of Balance	106
17.21.	Expanded Testing of Low and High Off	106
17.22.	Expanded Compressor Rotation to Check for Maximum Run Time	106
17.23.	New Option to test for Low Superheat on Suction or Discharge PSI	107
17.24.	New Large Character Screen Displaying Control Information.....	107
17.25.	Circuit Amp Value added to Circuit Status Screen	107
17.26.	Low Discharge Superheat Test to Economizer.....	107
17.27.	Tonnage and KW Information	107
17.27.1	KW Sensors.....	107
17.27.2	Tonnage Sensors	108
17.27.3	Configuring KW and Tonnage.....	108
17.28.	Oil Flow Safety	110
17.29.	RTC Access to User Logic.....	110
Chapter - 18.	Condenser Control Logic	111
No Condenser		111
RO Step Common.....		111
RO Step Individual		111
RO Step Combined.....		111
Modulating Common		111
Modulating Step Common		111
Modulating Individual		111
RO Shared		112
Dual V8		112
Common VFD Fan with Bypass.....		112
Modulating Step Common		112
Evap Individual.....		112
Evap Common		112
RO Adaptive Bank– Air cooled Condenser Fan Control		113
RO Adaptive Common – Air Cooled Condenser Fan Control		113
PID MOD Individual		113
PID Step Common		113
18.1.	Condenser Introduction	113
18.1.1	RO Step Condenser Cut In – Out Logic.....	113
18.1.2	RO Step Condenser with Variable Speed Fan	114
18.1.3	Condenser Control	114
18.1.3.1.	Common Terms.....	114
18.1.3.2.	Control Discharge Pressure Calculation	114
18.1.3.3.	Condenser Reset	116
18.1.3.4.	Condenser Low Ambient	116
18.1.3.5.	Condenser Related Setpoints	117
18.2.	CONDENSER TYPES	117
18.2.1	No Condenser	117
18.2.2	RO Step Common	117
18.2.2.1.	RO Step Common with a Fan AO and Condenser Faults.....	118
18.2.3	RO Step Individual	119
18.2.4	RO Step Combined	120
18.2.5	Modulating.....	120

18.2.5.1. Modulating Common	120
18.2.6 Modulating Step Common	122
18.2.6.1. Modulating Individual	122
18.2.7 RO Shared	123
18.2.8 Dual V8.....	123
18.2.9 Common VFD Fan w/Bypass	123
18.2.10 Evaporative types of Condenser Control.....	125
18.2.11 RO Adaptive Bank– Air cooled Condenser Fan Control.....	126
18.2.12 RO Adaptive Common – Air Cooled Condenser Fan Control.....	127
18.2.12.1. Adaptive Condenser Control Setpoints	127
18.2.12.2. Adaptive Control Logic.....	128
18.2.12.3. Adaptive Rotation Logic	128
18.2.12.4. Viewing on MCS-CONNECT and MCS-MAGNUM LCD KEYPAD.....	128
18.2.13 PID MOD Individual.....	129
18.2.14 PID Step Common	130
18.3. PID CONTROL	131
Chapter - 19. Electronic Expansion Valve Control	132
19.1. Electronic Expansion Valve Control Logic (EXV)	132
19.1.1 EXV Control States	136
19.1.2 EXV Maximum Operating Pressure	137
19.1.3 Tandem EXV Setup	137
19.2. 'Evaporator or Condenser Refrigerant Level Control	139
19.2.3.1. Minimum Refrigerant Level target (HVAC ONLY)	139
19.2.3.2. Evaporator Level Control	139
19.2.3.3. Condenser Level Control	139
19.2.1 EXV control methods for Step Loading Compressors.....	139
Chapter - 20. Sub Cooler EXV Control Logic	141
20.1. New Sensor Inputs	141
20.2. New Analog Outputs	141
20.3. Existing Relay Outputs	141
20.4. Calculated Values.....	141
20.5. New Config Parameters	142
20.6. Logic Requirements.....	142
Chapter - 21. EXV Control SSH, SSH2	144
21.1. Fast Suction Superheat (Fast SSH)	144
21.2. Fast Suction Superheat 2 (Fast SSH2)	144
21.3. Selecting Fast SSH or Fast SSH2 in MCS-Config	144
21.4. Circuit Base	145
21.4.1 Selecting the 'EXV Control' tab you are prompted with the following:.....	146
21.4.2 Selection Options	146
21.4.3 Compressor EXV Results.....	147
21.4.4 Subcooler EXV Results	147
21.4.5 MCS EXV Factory Default Set Point	148
21.4.5.1. Fast SSH2, Suction Superheat, Plate HX.....	148
21.4.5.2. Fast SSH2, Suction Superheat, DX Coil.....	148
21.4.5.3. Fast SSH, Suction Superheat, DX Barrel.....	148
21.4.5.4. Fast SSH2, Discharge Superheat, DX Barrel	148
21.4.5.5. Fast SSH, Suction Superheat, DX Barrel.....	149
21.4.5.6. Suct Spht, Suction Superheat, DX Barrel	149
21.5. Set Point Descriptions (Fast SSH & Fast SSH2).....	149
21.5.1 Set Point Adjustments	151
21.5.2 Low Suction Multiplier-SP 13	151
21.5.2.1. Low Superheat Adjustment-SP 15	151
21.5.2.2. EXV Startup Time-SP 20	151
21.5.2.3. EXV Compressor Start Delay-SP 20	151
21.5.2.4. EXV Target & EXV Fast Zone-SP 9	151

21.6.	Fast SSH States	152
21.6.1	FAST SSH2 State Format	152
Chapter - 22.	General Introduction to EXV PID	153
22.1.	MCS PID REQUIREMENTS.....	153
22.2.	Calculations for the adjustment to EXV valve.....	153
22.3.	EXV PID Firmware	153
22.4.	MCS PID REQUIREMENTS.....	154
22.5.	Selecting PID in MCS-CONFIG.....	154
22.6.	Circuit Base	154
22.7.	Selecting the 'EXV Control' tab you are prompted with the following:.....	155
22.8.	Selection Options	156
22.9.	Compressor EXV Results.....	156
22.10.	Set Point Descriptions (PID).....	157
22.11.	PID Example Setpoint Defaults	158
22.11.1	Subcooler EXV Results	159
22.12.	EXV PID Ki Delay Timer and Ki Accumulator	161
22.13.	Logic to Determine which K Multipliers to Use	162
22.13.1.1.	Switching to Fast K multipliers is based on:.....	162
22.13.1.2.	Switching to Slow K multipliers is based on:	162
22.13.1	Rate of Change_ Moving too Fast	163
22.13.2	Rate of Change - Moving Slow Enough	163
22.14.	MCS-Connect Evaporator EXV PID Status.....	164
22.15.	Allowing an Adjustments to the EXV Valve.....	164
Chapter - 23.	EXV Level Control using PID	165
23.1.	Setting up EXV Level Control.....	165
23.1.1	Setting up EXV Level Control – User Defined.....	165
23.1.2	Circuit Base Setup.....	167
23.1.3	Setup using EXV CONTROL WIZARD.....	167
23.1.4	Low Discharge Superheat EXV Target Adjust Logic.....	168
23.1.4.1.	The Low Discharge Superheat logic:.....	168
Chapter - 24.	Analog Output Control using PID	170
Chapter - 25.	Network Protocols	172
25.1.	Protocols MCS controllers support:.....	172
25.2.	MCS-MAGNUM USING RS-485	173
25.3.	MCS-MAGNUM USING ETHERNET	174
25.4.	EXAMPLE NETWORK	175
25.4.1	Standalone MCS-Magnum.....	175
25.4.2	MULTIPLE MCS-MAGNUM Industrial Control Panels.....	176
25.5.	MULTIPLE MCS-MAGNUM BMS RS485 WIRING DIAGRAM.....	177
Chapter - 26.	MODBUS RTU	178
26.1.	Setup the Modbus from MCS-Config's Magnum Setup Screen(see below):.....	178
26.2.	From MCS-Connect's Service Window RS485 tab (see below):.....	179
26.3.	From MCS-Magnum LCD/Keypad(see below):.....	179
26.4.	In MCS-CONFIG you can see & print a list of the Modbus Registers (see below):.....	180
Chapter - 27.	BMS Communication Protocols	181
27.1.	MCS-Magnum to BMS Connections	181
27.2.	Sensor Input Points	182
27.3.	Relay Output Points.....	183
27.4.	Setpoints.....	184
27.5.	Chiller/Compressor States.....	184
27.6.	Chiller/Compressor Points.....	185
27.7.	Unit Alarms	189
27.8.	Compressor Alarms	190
27.9.	Network inputs to MCS-Magnum.....	196
27.10.	MCS-MAGNUM BMS PROTOCOLS.....	197

27.10.1 BACNET OVER IP PROTOCOL	197
27.10.2 ETHERNET NETWORK PROTOCOL.....	197
27.10.3 MODBUS RTU PROTOCOL	198
27.11. PROTOCOLS USING MCS-BMS-GATEWAY	198
27.11.1 MODBUS TCP/IP PROTOCOL.....	198
27.12. PROTOCOLS USING MCS-BMS-GATEWAY	199
Chapter - 28. HVAC Unit and Compressor State Chart	200
Chapter - 29. Reading Alarm Points For MCS-MAGNUM	202
29.1. Reading Alarm Points For MCS-MAGNUM.....	203
29.2. BMS ALARM TYPES.....	204
29.3. BMS Points Alarms Chart.....	214
Chapter - 30. Magnum Alarms and Safeties	218
30.1. Information Only Alarms	218
30.1.1 System Generated Alarms	218
30.1.2 User Initiated Alarms	218
30.1.3 Automatic Alarms	219
30.2. Magnum System Alarms.....	219
30.2.1 Configuration Alarms	219
30.2.2 MCS Local Network Alarms.....	219
30.2.3 Key Sensors Alarms.....	219
30.2.4 Emergency Stop Alarm.....	220
30.3. Setpoint safety alarms.....	220
30.3.1 Sensor Inputs Used With Magnum Setpoint Safeties:	220
30.3.2 Setpoint safeties.....	220
Voltage Sensor (08.00-R).....	222
Motor Amps (08.00-R)	222
Add an Amp Imbalance Safety Test to the existing Amp Safeties.(17.35)	222
30.4. TurboCor Compressor Alarms.....	222
Chapter - 31. Troubleshooting Quick Reference	225
Chapter - 32. Magnum Setpoints	227
32.1. Setpoint Types.....	228
32.1.1 SETPOINT.....	228
32.1.2 LOCKOUT	228
32.1.3 ALARM	228
32.1.4 Time.....	228
32.1.5 Target	228
32.1.6 Delay	228
32.2. Window/Safety extension	229
32.2.1 Time and seconds to ignore for setpoints.....	229
32.3. Setpoints for Magnum HVAC.....	230

Chapter - 1. Introduction to the Magnum

About the Magnum

The Magnum controller is a microprocessor-based control system designed to provide complete control of many different types of compressors of both fixed and variable capacity, as well as many additional features. Supported control options include multiple liquid line solenoids, electronic expansion valves (EXVs), liquid injection, economizer, hot gas bypass, variable frequency drives for compressors (VFDs), digital scrolls, and many more.

Applications vary from control of a single compressor to complex multiple compressor systems.

In all applications, however, safety and operating efficiency is of primary importance.

The controller interface is made to be informative and meaningful, with built-in logic to prevent unsafe conditions from occurring. This helps reduce or even completely eliminate nuisance alarms.

Magnum Industrial Control Panels

Industrial Control Panels are available configured with many different options including a Keypad or a 15.4 Touchscreen installed with MCS-CONNECT using graphics designed for your controller.

Control Panels are available in three sizes, Small Panel, Medium Large Panel and Large Panel. Standard Panels are Nema rated Type 1 for inside installation and Nema rated Type 4 for installations for areas which may be regularly hosed down or are in very wet or oily conditions. The control panel provides protection from dust, dirt, oil and water.

Magnum Hardware Supported by Magnum V17 Software

The following MCS boards can be connected together through the MCS-I/O communications terminal block:

- MCS-Magnum (10 RO's, 12 SI's, 4 Digital SI's, and 4 AO's)
- MCS-RO-Base (10 RO's) and MCS-RO-EXT (10 RO's)
- MCS-SI-Base (16 SI and 4 AO) and MCS-SI-EXT (16 SI and 4 AO)

The versatility of the Magnum offers the user much flexibility in configuring the controls in an economical way. The limitation is not the number of boards but the total number of set points.

Software

HVAC V17—This software supports all types of compressors except centrifugal. It supports the configuration type 106 Chiller V17 CFG, as well as 109 Loop Control CFG. If this software is loaded into a Magnum with a different type of configuration file, an invalid configuration type message will be generated.

Magnum V17 Software Control Point Capacity

- Circuits (compressors) up to 20
- Steps per Compressor up to 4
- Relay Outputs up to 80
- Analog Outputs up to 28
- Sensor Inputs up to 112
- Setpoints 255
- Alarms 100

Chapter - 2. PC Software for the Magnum

2.1. MCS-Config

Provides the configuration file (.cfg), which includes the input/output points list, Setpoints, circuit information, etc., for all versions of software. This program is designed to assist and make the task of building the configuration file as simple as possible.

- Windows 7 or later operating system or
- Linux operating system
- Minimum 1GB of RAM
- Minimum 4GB Drive
- 14.4k baud modem or higher for remote
- Communications
- 1280 x 800 pixel or higher display

The screenshot shows the 'Magnum System Information Screen' in a software application. The interface includes a menu bar (File, Edit, Window, Help) and a toolbar with icons for File, Edit, and Print. Below the toolbar is a navigation bar with tabs: System, Setup, ROs, SIs, AOs, MAG HVAC, Circuit Base, Circuit SI, Setpoints, Auth, Schedule, BMS Points, and Lookup Table. The main area contains a form with the following fields:

Name	TrainingClass	Config Month	9
Company Name	MicroControlSys	Config Day of Month	29
Unit Model #	HanbellRC2-200B	Config Year	17
Install Date Month	9	Config Hour	11
Install Date Day	23	Config Minute	55
Install Date Year	15	Load Month	9
Serial Number		Load Day of Month	29
Config Version	17	Load Year	17
Config Type	HVAC Mag	Load Hour	11
Config Type Value	106	Load Minute	55
Technician Initials	MCS	Revision #	A
		Firmware Version	

Below the form, a status bar indicates: "The Date and Time this file was last modified was on 9/29/17 at 11:55 AM". There are two buttons: "Load Bitmap Logo" and "Save Logo as Bitmap File". A large logo for "MICRO CONTROL SYSTEMS" and "Magnum" is displayed. At the bottom, there is a text box: "This button will copy the Comment File data from another config and import it to this one." and a button labeled "Import Comment File". A blue box on the right side of the screen contains the text "MCS-CONFIG INFORMATION SCREEN".

2.2. MCS-CONNECT

Provides both local and remote communications to the Magnum independent of software type. Local communications can be either through an RS485 or Ethernet connection. This program displays the status of the controller, and changes can be made to the system with proper authorization. Configuration files can be transmitted to or received from a Magnum unit. The Magnum automatically performs history logging and this program allows the data to be presented in a useful graph form.

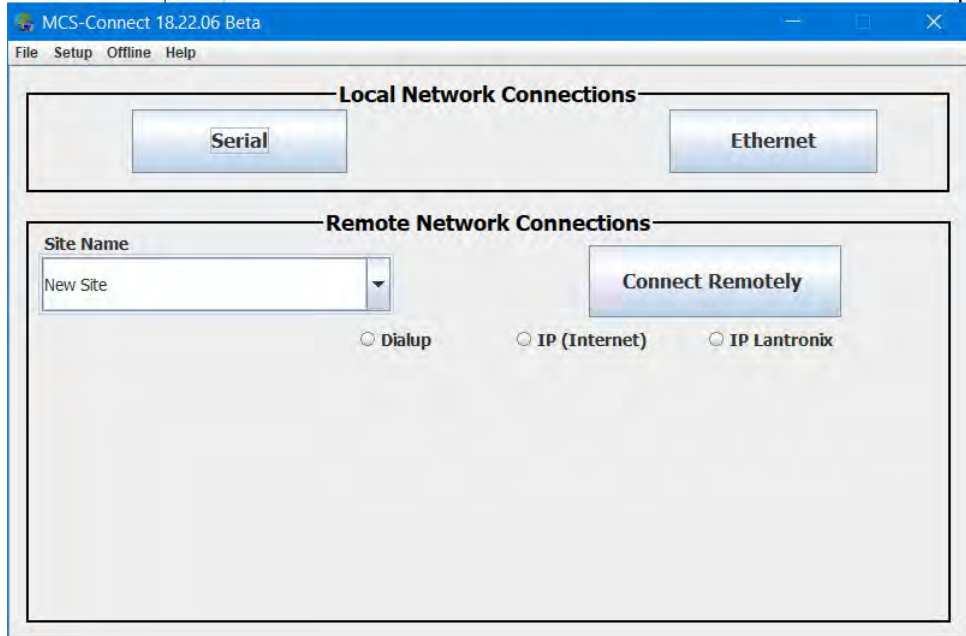

2.2.1 HVAC STATUS Display (MCS-Connect)

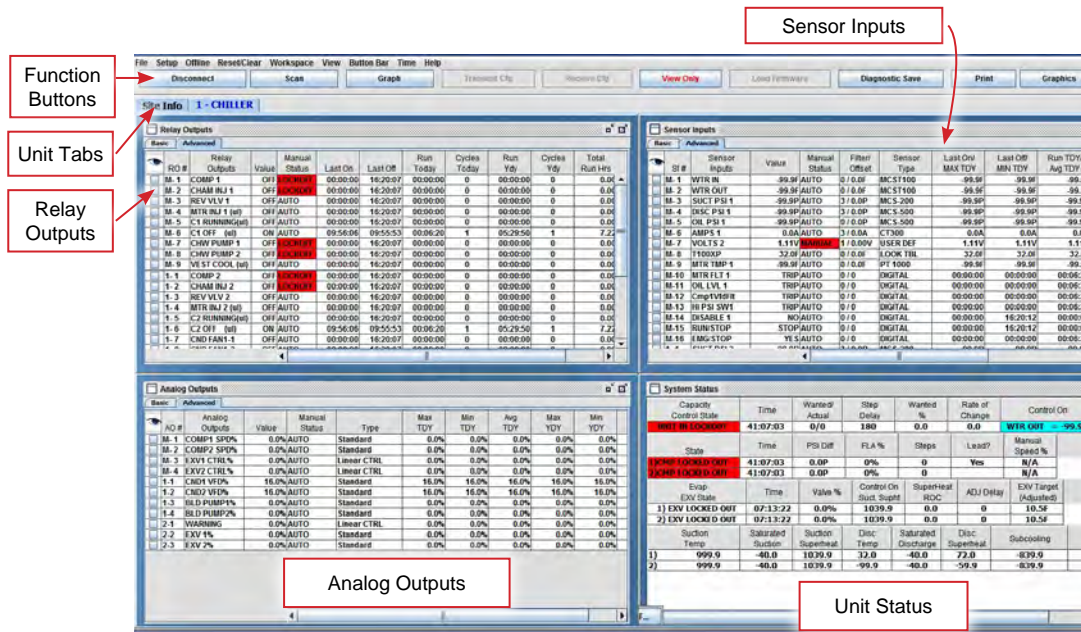

The screen shot above shows the following features:

- The top row of buttons provides function selection within MCS-Connect.
- The authorization level button is located in this row; it will automatically update to display the current authorization level. The example above is at a factory level authorization.
- Just below the top row of buttons, there is a row of tabs. The first is the Site Information screen which will show you details of all the Magnum controllers available to establish a connection, the remaining tabs allow you to access to each one respectively.

- There are four quadrants of information displayed for each Magnum controller, namely: Relay Outputs, Analog Outputs, Sensor Inputs, and Unit Status (with six sub-menus of Status, Alarms, Setpoints, Reset/Clear, Schedule, and Service). Note: these screens may not always be displayed in the same position; MCS-Connect will automatically adjust the screen arrangement for optimum display information.

The status of the Capacity Control States, Compressor Control States and EXV Control States can be viewed from MCS-Connect by clicking the “Status” screen in the Unit Status quadrant. The following screen will be displayed:

Capacity Control State	Time	Wanted/ Actual	Step Delay	Wanted %	Rate of Change	Control On	Mode	Ref Type
UNIT IS UNLOADED	03:12:00	0/0	240	50.0	0.0	SUPPLY AIR= 55.0F	COOLING	R22
State	Time	PSI Diff	FLA %	Steps	Lead?	Manual FLA %		
1)CMP OFF/READY	03:11:25	230.0P	72%	0		N/A		
2)CMP OFF/READY	03:36:37	230.0P	72%	0		N/A		
3)CMP OFF/READY	04:01:49	230.0P	72%	0		N/A		
4)CMP OFF/READY	04:27:01	230.0P	72%	0	Yes	N/A		
Evap EXV State	Time	Valve %	Control On Suct. Supht	SuperHeat ROC	ADJ Delay	EXV Target (Adjusted)		
1) EXV IS CLOSED	03:11:31	0.0%	9.1	0.0	48	10.0F		
2) EXV IS CLOSED	03:36:43	0.0%	9.1	0.0	48	10.0F		
3) EXV IS CLOSED	04:01:55	0.0%	9.1	0.0	48	10.0F		
4) EXV IS CLOSED	04:27:07	0.0%	9.1	0.0	48	10.0F		
Suction Temp	Saturated Suction	Suction Superheat	Disc Temp	Saturated Discharge	Disc Superheat			
1) 50.0	40.9	9.1	140.0	101.3	38.7			
2) 50.0	40.9	9.1	140.0	101.3	38.7			
3) 50.0	40.9	9.1	140.0	101.3	38.7			
4) 50.0	40.9	9.1	140.0	101.3	38.7			

System (unit) information is shown in the top section:

- Capacity Control State**–State of chiller
- Time**–Time spent in current state. If the state is UNIT IN POWER UP time will count down to zero.
- Wanted / Actual**–Number of capacity steps Wanted On versus Actual On.
- Step Delay** – Value that is counted down. The sensitivity and difference between the control sensor and control zone will determine the speed of the countdown. When this value reaches zero, the controller will determine if a change in the system capacity is required.
- Wanted %**–Wanted slide percentage.
- Rate Of Change** – Rate of Change of control sensor.
- Control On**–The control sensor value. The name and the reading will be displayed, with color to indicate its relationship to the target Setpoint.
- Mode**–The mode can be either COOLING or HEATING.

Compressor information (all active compressors will be displayed):

- State**–Compressor number and state. The default Compressor number can be changed in MCS-Config with a 3 character entry in the “Comp Name/ID” column of the Circuit Base screen.
- Time**–Time spent in current state. If the state is CMP ANTICYCLE time will count down to zero.
- Oil Diff**–Oil differential pressure. It is calculated as follows:
 Semi hermetic screws.....Oil PSI–Suction PSI
 ORDischarge PSI–Suction PSI
 Open drive horizontal and Carlyle screw compressor ..Oil PSI–Discharge PSI
 Reciprocating compressorsOil PSI–Suction PSI
 All OthersOil PSI–Discharge PSI
- FLA %**–Full Load Amps based on the compressor’s respective Setpoint. For screw compressors this calculation is based current operating conditions.
- Steps**–Indicates number of steps associated with this compressor that are turned on.
- Lead?**–YES will be displayed for the lead compressor.

Compressor Superheat information:

- **Suction Temp**—Compressor number and Suction Temperature, if available.
- **Saturated Suction**—Calculated Suction Saturated Temperature (R22, R134a, R407c, and R410a are supported).
- **Suction Superheat**—Calculated Suction Superheat, only available if both the Suction Temperature and the Suction Pressure are used. Suction Superheat = Suction Temperature—Suction Saturated Temperature.
- **Disc Temp**—Discharge Temperature, if available.
- **Saturated Discharge**—Calculated Discharge Saturated Temperature (R22, R134a, R407c, and R410a are supported).
- **Disc Superheat**—Discharge Superheat is available only if both the Discharge Temperature and the Discharge Pressure are used. Discharge Superheat = Discharge Temperature—Discharge Saturated Temperature.
- **Ref Type** – Refrigerant type used.
- CTRL LIFT – Control Lift = Saturated Discharge Temperature—Saturated Suction Temperature (OR) Turbine Input PSI (converted to temperature).

Compressor information (all active compressors will be displayed):

- **State**—Compressor number and state. The default Compressor number can be changed in MCS-Config with a 3 character entry in the “Comp Name/ID” column of the Circuit Base screen.
- **Time**—Time spent in current state. If the state is CMP ANTICYCLE time will count down to zero.
- **Oil Diff**—Oil differential pressure. It is calculated as follows:
- Centrifugal compressors: Oil Pressure – Pre-oil Filter Pressure
- **FLA %**—Full Load Amps based on the compressor’s respective Setpoint.
- **Steps**—Indicates number of steps associated with this compressor that are turned on.
- **Lead?**—YES will be displayed for the lead compressor.
- **Staging** – This field will display “VANES” for centrifugal compressors
- **Lift Temp** – If an Inlet Pressure sensor is specified in the configuration, then this value will equal Saturated Discharge Temperature – Inlet PSI (converted to temperature). If no Inlet Pressure sensor is present, this value will equal Saturated Discharge Temperature—Saturated Suction Temperature.
- **Lift ROC’s** – Current lift Rate Of Change/ Last lift Rate Of Change
- **Amp/Lift Surges** – This field is a counter for the number of amp and lift surges respectively.

2.3. Authorization Function

The authorization code is a special four-character code that enables access to the Magnum controller.

The code may consist of any valid alpha/numeric characters if the system is being accessed through MCS-Connect, however, the code must be numeric with values between 1 and 8 if it is to be entered through the Keypad/Display. Each Magnum can have up to 10 different authorization codes, with four levels of authorization which provide differing levels of functionality. The authorization code and the associated level cannot be viewed or changed through the Keypad/Display or MCS-Connect, but only when the configuration file is opened in MCS-Config. The authorization codes should be protected and remain confidential, or unauthorized personnel may gain access to the system and perhaps cause irreparable damage.

From the Keypad/Display the following changes can be made based upon the authorization level:

FUNCTION	VIEW	USER	SERVICE	SUPERVISOR	FACTORY	ADMIN
Sensor offsets	NO	NO	YES	YES	YES	YES
Sensor diagnostics	NO	NO	YES	YES	YES	YES
Clear alarm history	NO	NO	NO	NO	NO	YES
Clear point information	NO	NO	NO	NO	NO	YES
Date and time set	NO	YES	YES	YES	YES	YES
Day of week set	NO	YES	YES	YES	YES	YES
Change No Flow Lockout or shut down	NO	NO	NO	NO	YES	YES
Change rotate Yes or No	NO	NO	NO	NO	YES	YES
Change Manual/Auto settings	NO	NO	NO	YES	YES	YES
Change setpoint values	NO	*	*	*	YES	YES
Change operating schedules	NO	YES	YES	YES	YES	YES
Change holiday dates	NO	YES	YES	YES	YES	YES
Lockout Reset	NO	**	**	**	YES	YES
*** Change RS485 network settings	NO	NO	YES	YES	YES	YES
Change Ethernet network settings	NO	NO	YES	YES	YES	YES
Adjust Keypad/Display contrast	YES	YES	YES	YES	YES	YES
Transmit Software	NO	NO	YES	YES	YES	YES
Transmit/Receive Configuration	NO	NO	YES	YES	YES	YES

* Setpoints may have individual authorization levels; you must have the proper authorization to view or edit them.

**See the Setup screen of the configuration for authorization level(s) that are allowed unlimited resets per day. Authorization levels below 'Auth Level Bypass' are allowed only a limited number of resets. Authorization levels at and above 'Auth Level Bypass' are allowed unlimited lockout resets.

***Firmware Version 17.62M, 'Change RS485 network settings - **SERVICE** or greater.'

To get authorized through the Keypad/Display do the following:

1. Press 'Menu'
2. Using ↑ ↓, →, or ← keys, move cursor to 'Passwords'

3. Press ←key.
4. Enter 4 digit password and press ←
5. The authorization will be displayed.
6. Press 'Menu' to make next selection.

To get authorized through MCS-Connect do the following:

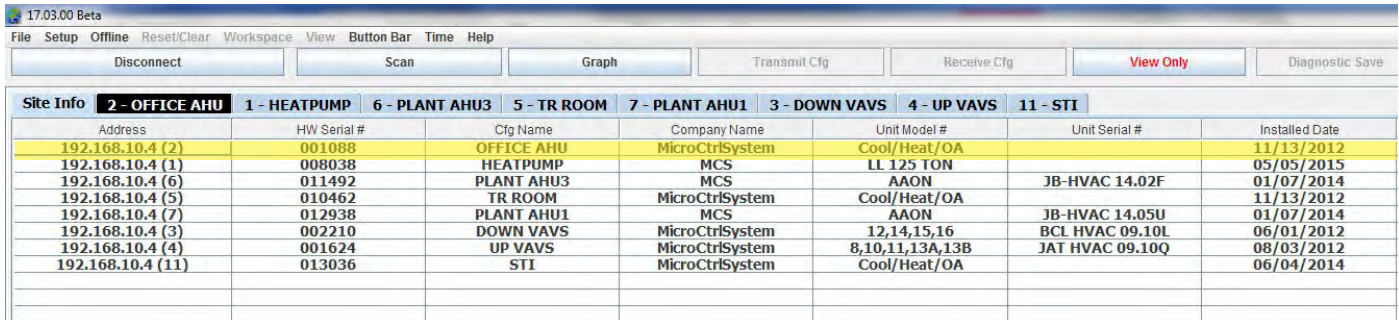

Site Info						
Address	HW Serial #	Cfg Name	Company Name	Unit Model #	Unit Serial #	Installed Date
192.168.10.4 (2)	001088	OFFICE AHU	MicroCtrlSystem	Cool/Heat/OA		11/13/2012
192.168.10.4 (1)	008038	HEATPUMP	MCS	LL 125 TON		05/05/2015
192.168.10.4 (6)	011492	PLANT AHU3	MCS	AAON	JB-HVAC 14.02F	01/07/2014
192.168.10.4 (5)	010462	TR ROOM	MicroCtrlSystem	Cool/Heat/OA		11/13/2012
192.168.10.4 (7)	012938	PLANT AHU1	MCS	AAON	JB-HVAC 14.05U	01/07/2014
192.168.10.4 (3)	002210	DOWN VAVS	MicroCtrlSystem	12,14,15,16	BCL HVAC 09.10L	06/01/2012
192.168.10.4 (4)	001624	UP VAVS	MicroCtrlSystem	8,10,11,13A,13B	JAT HVAC 09.10Q	08/03/2012
192.168.10.4 (11)	013036	STI	MicroCtrlSystem	Cool/Heat/OA		06/04/2014

1. Click **View Only** on desired Magnum in the Site Information screen.
2. Click button.
3. Enter the 4 digit code into the pop-up box and click ok (or press the enter key).
4. Depending on the authorization level, the button will change to one of the following displays, indicating if the code was accepted or not.



Chapter - 3. MCS-MAGNUM-N and Expansion Boards

3.1. MCS-Magnum Revision 9.1 (revised to 10.4, see next pages)



MCS-MAGNUM-N 115-230vac-Selectable Power

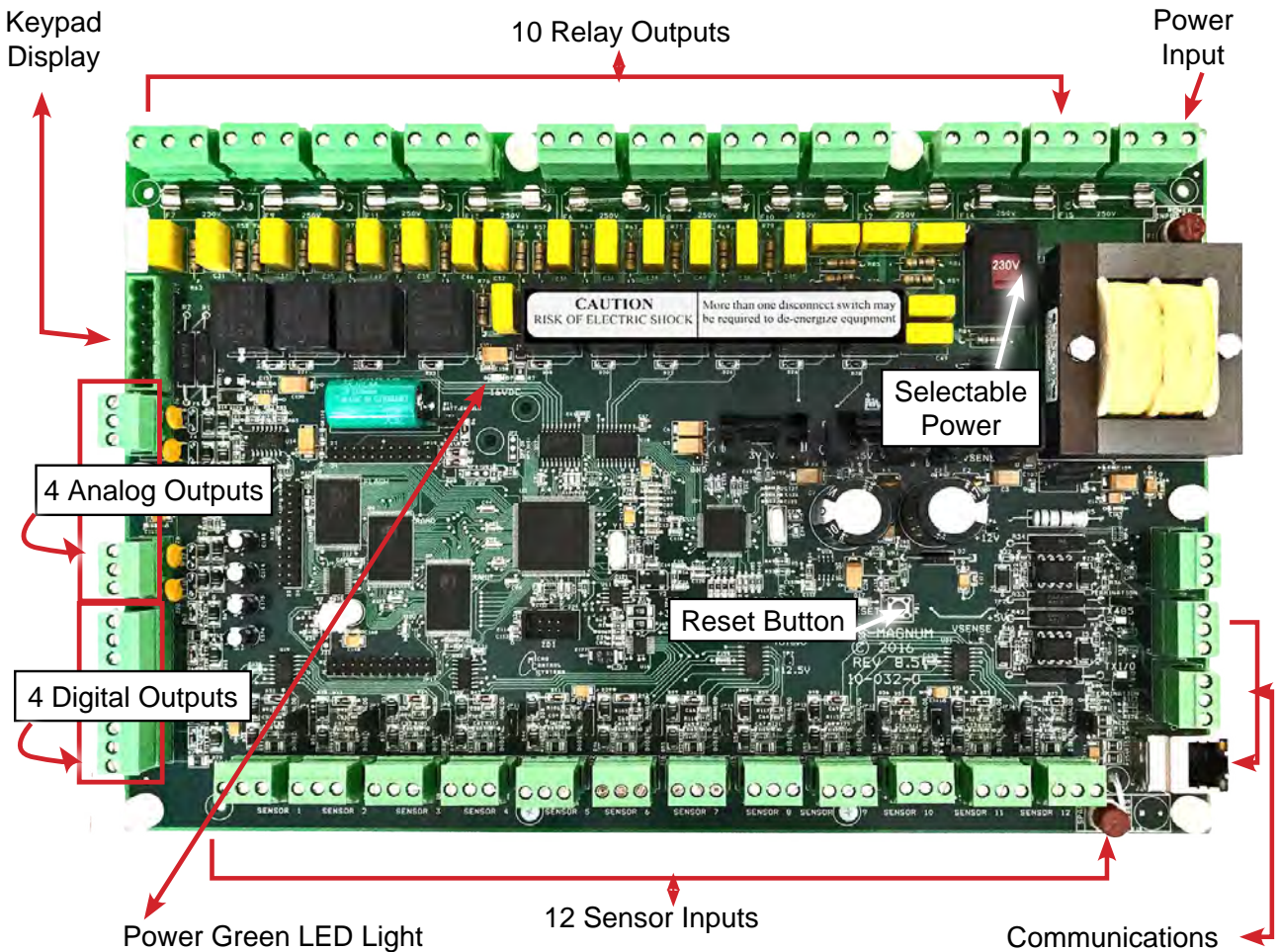

Controller Specifications

Dimensions..... 12.0”w, 8.0”h, 2.0”d
 Mounting Holes..... Mounts on a backplane using eight #6 sheet metal screws
 Operating Temperature-40°F to +176°F (-40°C to +80°C)
 Storage Temperature-40°F to +176°F (-40°C to +80°C)
 MicroprocessorZilog eZ80 Acclaim! @ 50mhz
 Sensor Inputs (SI)..... 12 inputs 0-5vdc (10-bit A/D)
 Digital Inputs.....4 inputs 0 or 5vdc only
 Relay Outputs (RO)..... 10 outputs 6.3amps @ 230vac
 Analog Outputs (AO)4 outputs 0-10vdc
 Printed Circuit BoardSix layer with separate power and ground planes

Input Power (Standard) 115 or 230vac ±10% 50/60Hz
 @ 77°F (25°C) ambient, 20VA max (Voltage is field selectable)
 MCS-I/O Comm Port1 @ 38,400 baud
 RS-485 Comm Port1 @ 19,200 baud
 Ethernet..... 10/100 Mbps Ethernet
 Real Time ClockBattery backup
 Power DetectionAutomatic power fail reset

Options

-24 24vac input power ±10%
 50/60Hz @ 77°F (25°C) ambient

MCS-MAGNUM HARDWARE

REV. 9.1

- ◆ MCS-MAGNUM hardware has been modified and its new revision number is - 9.1
- ◆ Hardware modification - Ethernet PHY chip was replaced due to obsolescent of the old Ethernet PHY chip by the manufacturer.
- ◆ **NEW ETHERNET PHY CHIP REQUIRES NEW FIRMWARE TO FUNCTION.**

FOLLOWING FIRMWARE VERSIONS (OR GREATER) ARE REQUIRED FOR MAGNUM HARDWARE VERSION 9.1

V7:

HVAC 07.03-V	CENT 17.26-A or greater
CENT 07.03-V	REFR
REFR 07.03-V	RTUM 17.26-A or greater
	PAO 17.26-A or greater
	ACU 17.26-A or greater

V9:

HVAC 09.14-P
CENT 09.14-P
REFR 09.14-P
RTUM 09.14-P
PAO 09.14-P
ACU 09.14-P

V16:

HVAC 16.11-G
CENT 16.11-G
REFR 16.11-G
RTUM 16.11-G
PAO 16.11-G
ACU 16.11-G

V17:

HVAC 17.26-A or greater

3.2. MCS-SI16-A04- Version 1.3

The MCS-SI16-A04 provides a flexible and cost effective way to allow sensor input and analog output expansion for MCS MAGNUM and MicroMag controllers

Input Power (Standard) 115 or 230vac $\pm 10\%$ 50/60Hz
Optional 24vac input power $\pm 10\%$ 50/60Hz

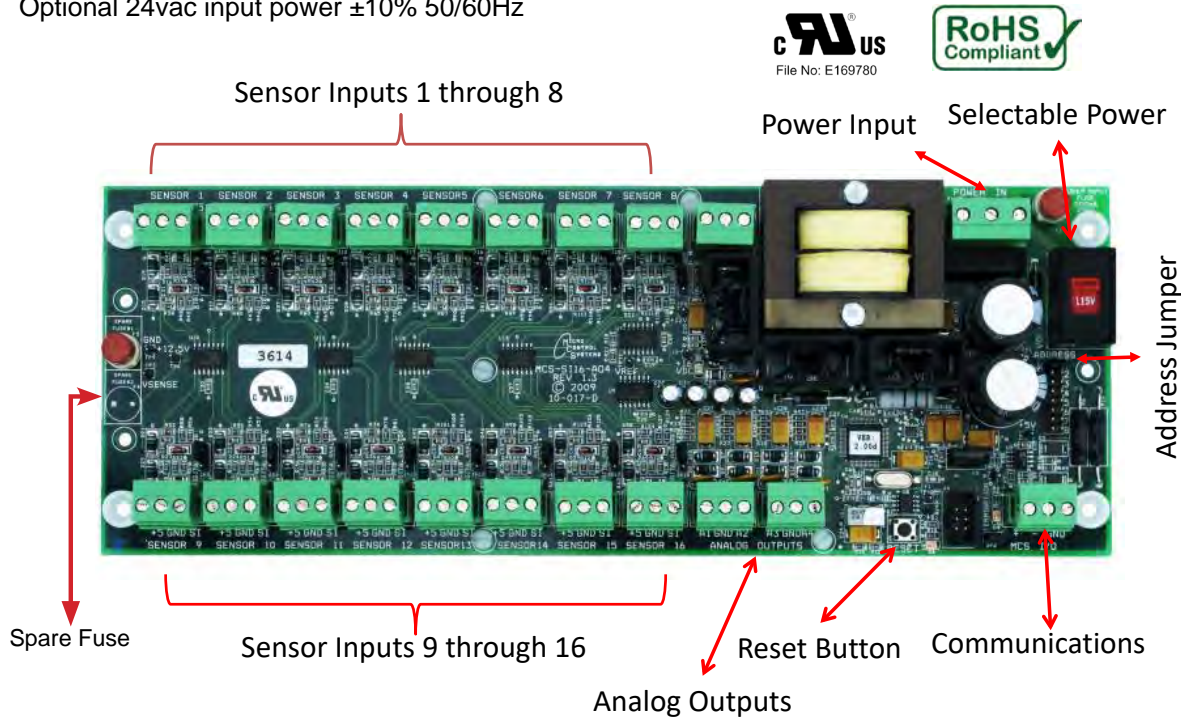

3.3. MCS-RO10 - Version 1.2

The MCS-RO10 provides a flexible and cost effective way to allow relay output expansion for MCS-MAGNUM and 1MicroMag controllers.

Input Power (Standard) 115 or 230vac $\pm 10\%$ 50/60Hz
Optional 24vac input power $\pm 10\%$ 50/60Hz

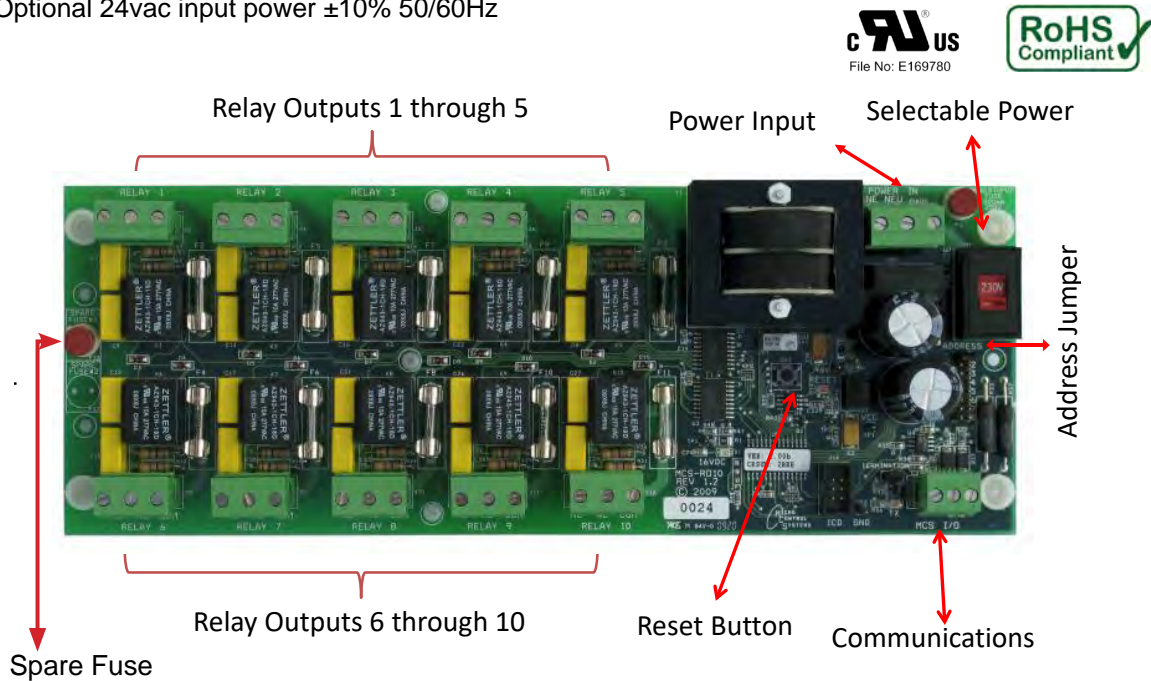

3.4. MCS-Magnum-N-12 Revision 10.4

Input Power (Standard) +12vdc power in board from 95 - 265vac switching power supply

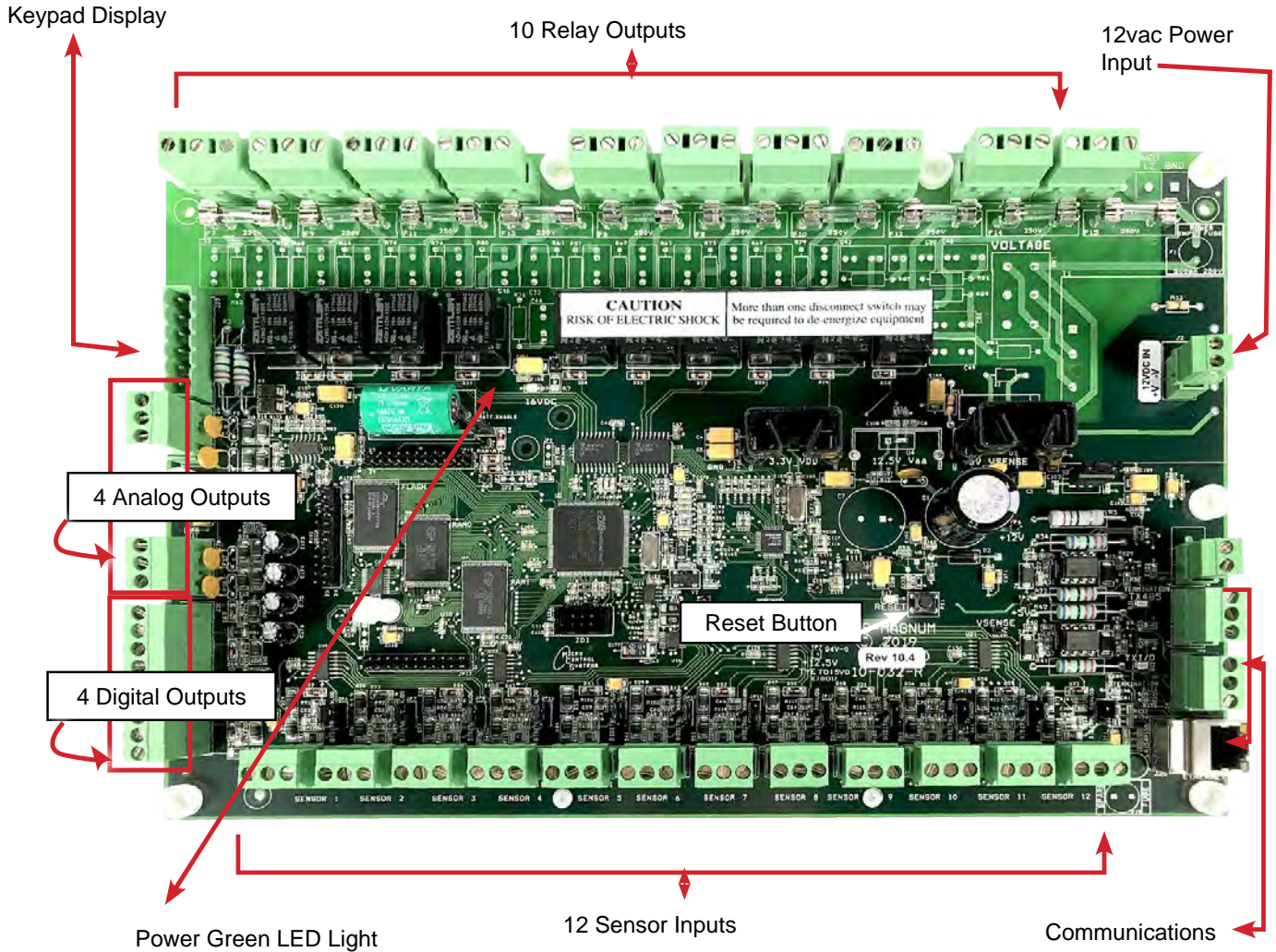

3.4.1 Optional Single Output Power Supply



90W 12VDC Enclosed Switching Power Supply

Input Voltage: 88 VAC to 264 VAC

Output Voltage: 12 VDC @ 7.5Amps

Input Current: 3A / 115 AC

1.6A / 230AC

Output Rated Current: 7.5A

Size: 2.76" x 3.54" x 2.14 (W*H*D) (70*90*54.5mm)

3.5. MCS-IO-BASE and MCS-IO-EXT

The MCS-IO-BASE provides a flexible and cost effective way to allow relay output, sensor input and analog output expansion for MCS MAGNUM-N-12.

Using a Single Output Power Supply the MCS-IO can be used with 115-230 or 24 volt MCS-MAGNUM-N or MicroMag systems.

Using the stackable MCS-IO-EXT you can double the number of inputs and outputs in the same footprint in your control panel or mounted to a backplane.

Photo below shows MCS-IO-BASE and MCS-IO-EXT mounted in a stackable array.

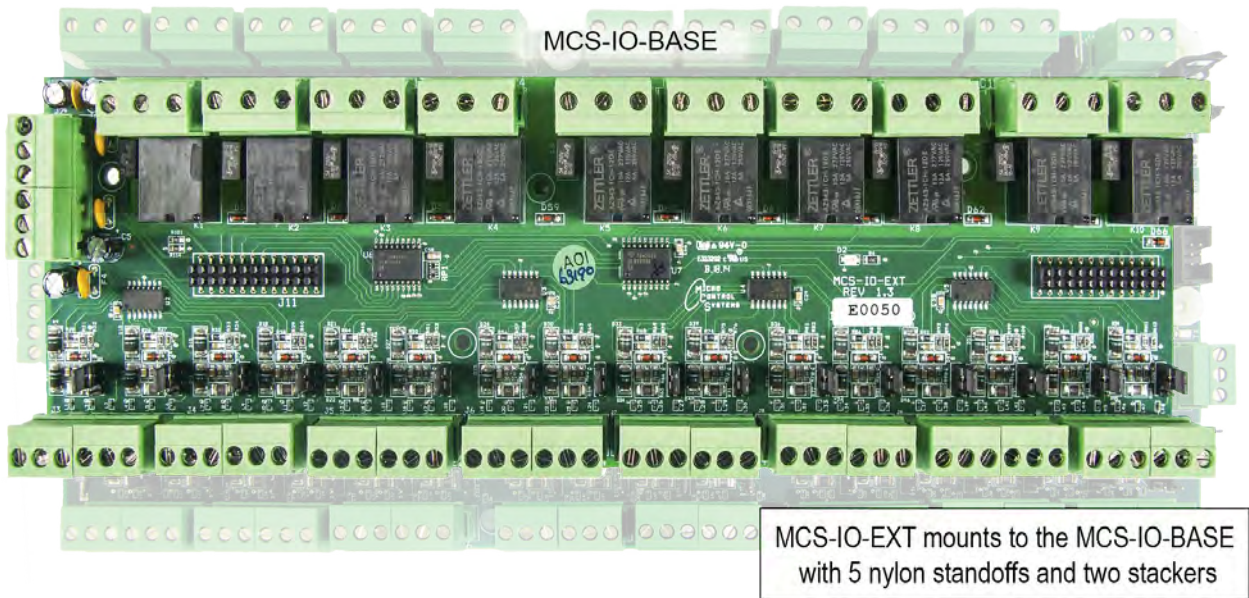

MCS-RO-BASE and MCS-RO-EXT

Dimensions 10.7”l, x 3.5”w, 2.50”h

MCS-IO-BASE Mounts on a backplane using six #6 sheet metal screws

MCS-IO-EXT. Mounts on top of the MCS-IO-BASE on top of the MCS-IO-BASE by 5 nylon standoffs and 2 stackers headers (included on MCS-IO-BASE)

Operating Temperature -40°F to +158°F (-40°C to +70°C)

Operating Humidity..... 0-95% Non-Condensing

Storage Temperature -40°F to +158°F (-40°C to +70°C)

Sensor Inputs..... 32 inputs 0-5vdc (total with MCS-IO-EXT)

Analog Output 20 outputs 5amps @ 230VAC (total with MCS-IO-EXT)

Printed Circuit Board..... Four layer with separate power and ground planes

Input Power..... Powered by MCS-IO-BASE Power

Power Detection..... Automatic Power Fail Reset on MCS-IO-BASE

Theory for settings one MCS-IO-BASE plus extension boards

1. Address settings for installing MCS-IO-BASE and MCS-IO-EXT expansion boards:

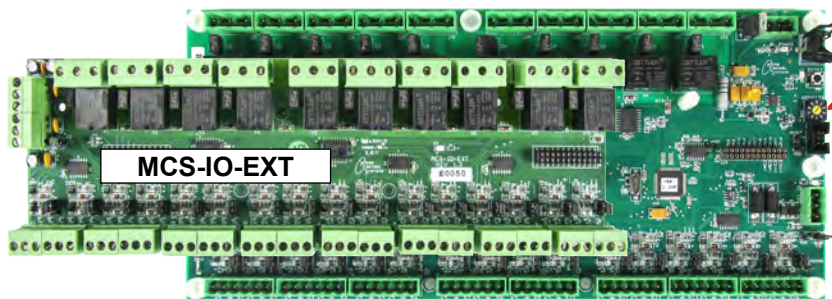

MCS-IO-Base - Set to #1
***Mount a MCS-IO-EXT
address automatically
is assigned #2***

2. Adding MCS-RO-BASE, MCS-RO-EXT

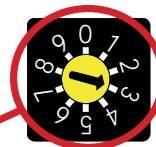
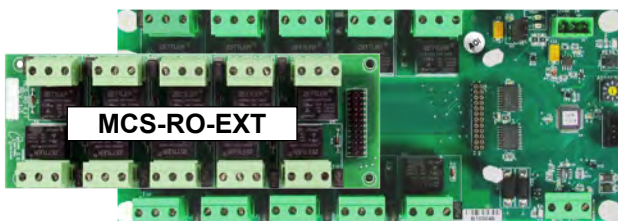

MCS-RO-Base - Set to #3
***Mount a MCS-RO-EXT
address automatically
is assigned #4***

3. Adding MCS-SI-BASE, MCS-SI-EXT

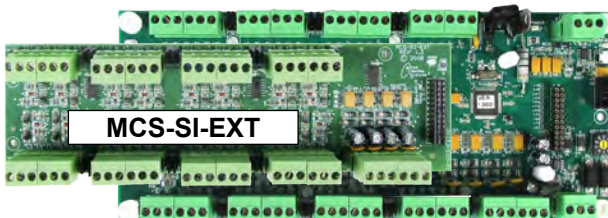

MCS-SI-Base - Set to #3
***Mount a MCS-SI-EXT
address automatically
is assigned #4***

SEE NEXT PAGE - ADDING A SECOND MCS-IO-BASE

Theory for settings two MCS-IO-BASE boards plus extension board

4. Address settings for installing MCS-IO-BASE and MCS-IO-EXT expansion boards:

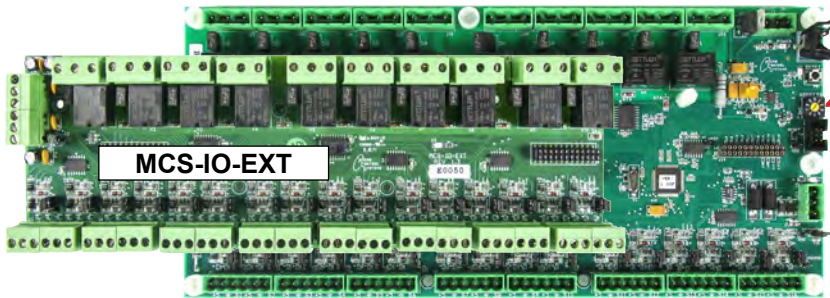

MCS-IO-BASE #1

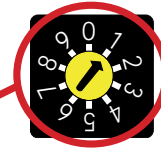

MCS-IO-Base - Set to #1
***Mount a MCS-IO-EXT
address automatically
is assigned #2***

5. Adding second MCS-IO-BASE



MCS-IO-BASE #2



MCS-IO-Base - Set to #3

3.6. MCS-RO-BASE and MCS-RO-EXT

The MCS-RO-BASE provides a flexible and cost effective way to allow relay output expansion for MCS MAGNUM-N-12.

Using a Single Output Power Supply the MCS-RO can be used with 115-230 or 24 volt MCS-MAGNUM-N or MicroMag systems.

Using the stackable MCS-RO-EXT you can double the number of inputs and outputs in the same footprint in your control panel or mounted to a backplane.

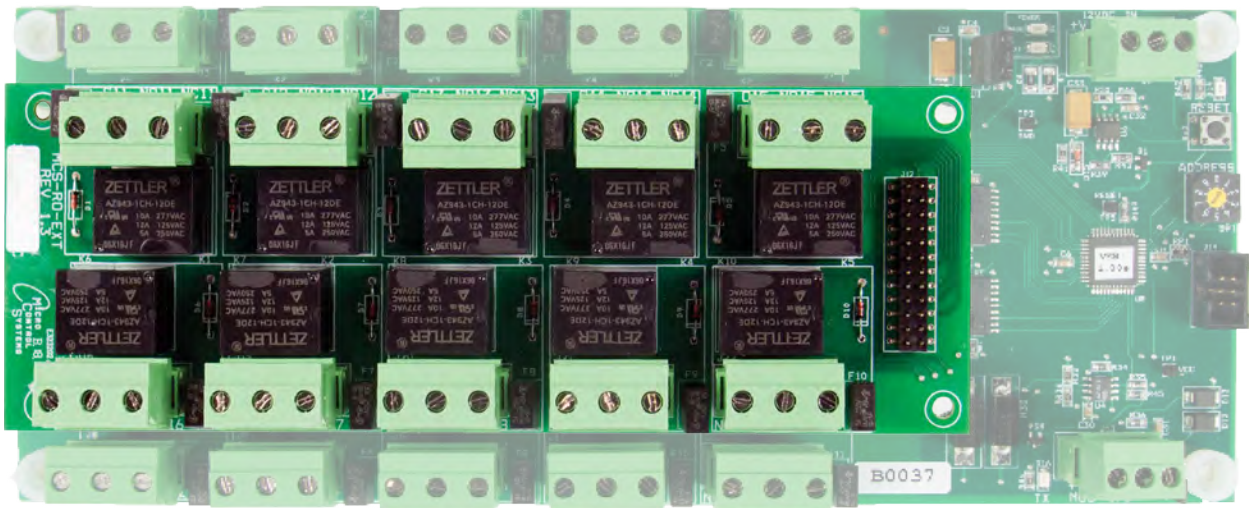

MCS-RO-BASE and MCS-RO-EXT

- Dimensions9.5"l, 4.00"w, 2.50"h
- MCS-RO-BASEMounts on a backplane using four #6 sheet metal screws
- MCS-RO-EXTMounts on top of the MCS-RO-BASE by 4 nylon standoffs and a stacker header (included on MCS-RO-BASE)
- Operating Temperature-40°F to +158°F (-40°C to +70°C)
- Operating Humidit0-95% Non-Condensing
- Storage Temperature.-40°F to +158°F (-40°C to +70°C)
- MicroprocessorMicrochip PIC16F883 @ 8mhz
- Relay Outputs (RO)20 outputs 5amps @ 230VAC (total with MCS-RO-EXT)
- Printed Circuit BoardFour layer with separate power and ground planes
- Input Power (Standard 12VDC input power ±10% @ 77°F (25°C) ambient, 12VA max
- MCS-I/O Comm Port.....1 @ 38,400 Baud
- Power Detection.....Automatic power fail reset

3.7. MCS-SI-BASE and MCS-SI-EXT

The MCS-SI-BASE provides a flexible and cost effective way to allow sensor input expansion for MCS MAGNUM-N-12.

Using a Single Output Power Supply the MCS-SI can be used with 115-230 or 24 volt MCS-MAGNUM-N or MicroMag systems.

Using the stackable MCS-SI-EXT you can double the number of inputs and outputs in the same footprint in your control panel or mounted to a backplane.

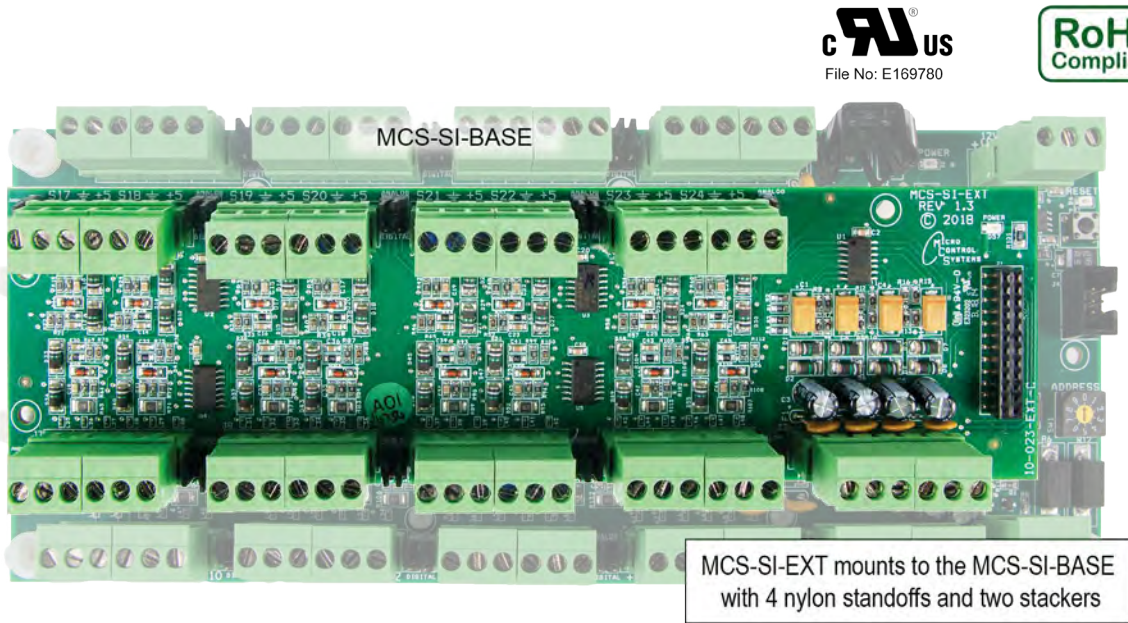

Dimensions	8.7”l, x 2.50”w, x 2.50”h
MCS-SI-BASE	Mounts on a backplane using four #6 sheet metal screws
MCS-SI-EXT	Mounts on top of the MCS-SI-BASE by 4 nylon standoffs and stacker headers (included on MCS-SI-BASE)
Operating Temperature	-40°F to +158°F (-40°C to +70°C)
Operating Humidity	0-95% Non-Condensing
Storage Temperature	-40°F to +158°F (-40°C to +70°C)
Sensor Inputs	32 inputs 0-5vdc
Analog Outputs	16 outputs 0-10vdc
Printed Circuit Board	Four layer with separate power and ground planes
Input Power	Powered by MCS-SI-BASE Power
Power Detection	Automatic Power Fail - Reset on MCS-SI-BASE

Chapter - 4. MCS-MAGNUM DISPLAYS

4.1. MCS- MAGNUM KEYPAD - Keys and their functions

- **LCD DISPLAY** - displays current condition of controller. Pressing the Menu key, displays the 10 available Menu items.
- **FUNCTION KEYS** - F1, F2, F3 are used to Page Up and Page Down as shown below, F2 - PG↑(page up), F3 - PG↓(page down). Function keys are also used when an numerical digit is needed, F1 = 1, F2 = 2, F3 = 3.
- **ARROW KEYS** - ↑ ↓ ← → used to move between items on screen and also as numerical digits are needed.
- **ENTER KEY** ↵ - used to accept highlighted item on screen and to move to next screen.
- **MENU KEY** - used to move to main menu, also used as numerical digit 8.

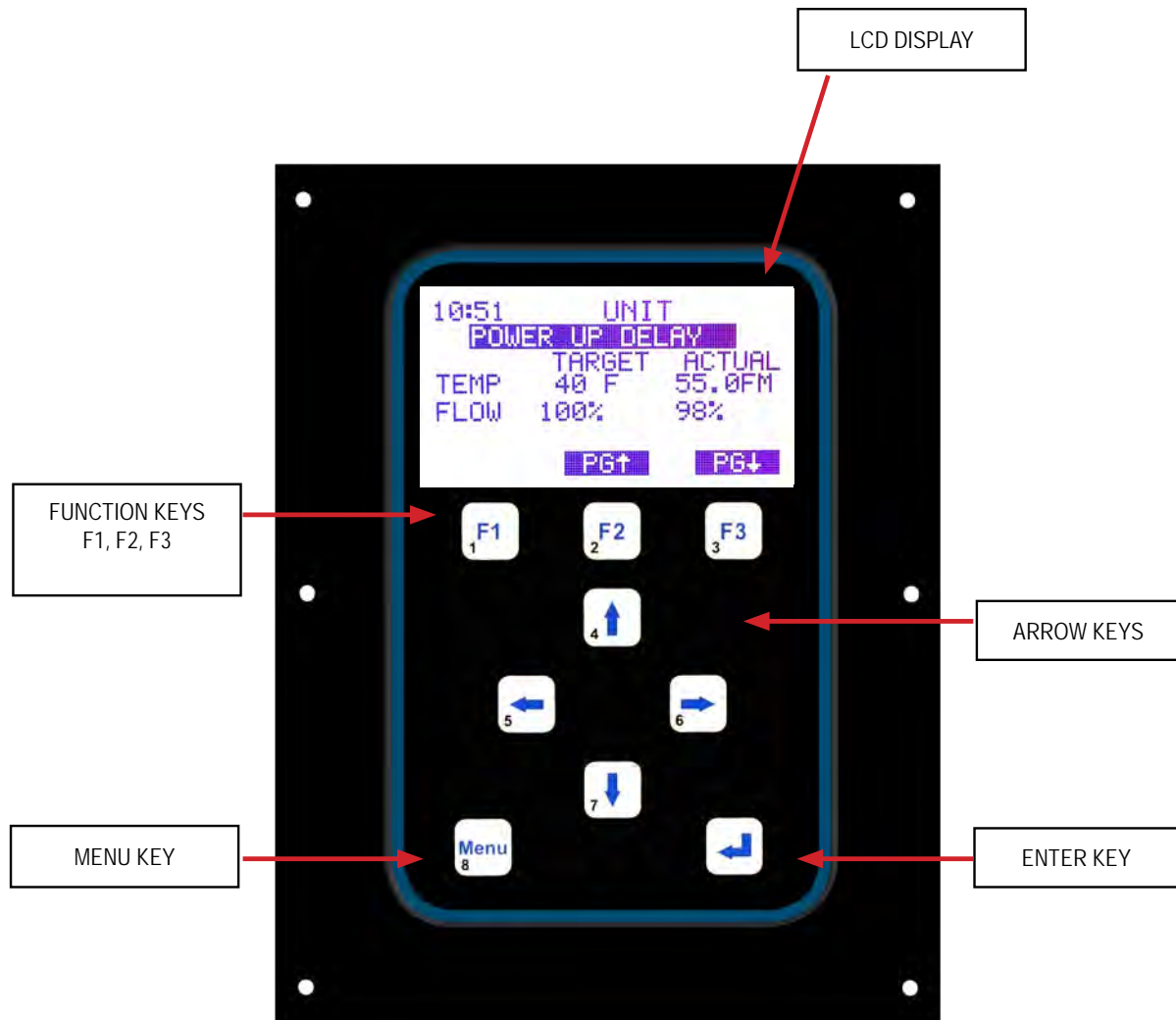

Additional information on the use of the MCS-KEYPAD can be found in a presentation available on our web site at:

<http://www.mcscontrols.com/presentations.html>

The following is an examination of all the information screens that can be accessed through both the Magnum keypad and MCS-Connect program.

4.1.1 Magnum Keypad and Display

4.1.1.1. Menu Screen

The main menu is accessed by pressing the “Menu” key.

<u>ACTUAL DISPLAY</u>	<u>DESCRIPTION</u>
09:55 Main Menu -Status -Setpoints -Outputs -Serv Tools -Inputs -Lckout RST -Alarms -Lckout ALM -Graphs -Passwords Help LARGE	HH:MM Main Menu -Control Status Display -Setpoint Display -Relay and Analog Output Display -Service Tools Display -Sensor Input Display -Lockout Reset Display -Alarm Display -Lockout Alarms Display -Graph Display -Password Display Menu Navigation Help Screen Enlarged Control On Display

4.1.1.2. Introduction to Status Screens

The current status of the unit and compressors is displayed by selecting the “Status” option from the “Menu” screen. This following screen will be displayed. By pressing the PG or PG function keys you will get additional information on each compressor.

4.1.1.3. Unit Status

<u>ACTUAL DISPLAY</u>	<u>DESCRIPTION</u>																				
09:55 Unit 45/54 UNIT IS UNLOADED 025:42:33 <table border="0" style="width: 100%;"> <tr> <td style="text-align: center;"><u>WTD</u></td> <td style="text-align: center;"><u>ACT</u></td> <td style="text-align: center;"><u>WTD%</u></td> <td style="text-align: center;"><u>DLY</u></td> <td style="text-align: center;"><u>ROC</u></td> </tr> <tr> <td style="text-align: center;">0</td> <td style="text-align: center;">0</td> <td style="text-align: center;">40%</td> <td style="text-align: center;">180</td> <td style="text-align: center;">0.0</td> </tr> </table> TARGET=45.0 (ADJ +0.0) PG PG	<u>WTD</u>	<u>ACT</u>	<u>WTD%</u>	<u>DLY</u>	<u>ROC</u>	0	0	40%	180	0.0	HH:MM CHILLER UNIT LEV/ENT CURRENT CONTROL STATE TIME IN CURRENT STATE <table border="0" style="width: 100%;"> <tr> <td style="text-align: center;"><u>WANTED</u></td> <td style="text-align: center;"><u>ACTUAL</u></td> <td style="text-align: center;"><u>WANTED%</u></td> <td style="text-align: center;"><u>DELAY</u></td> <td style="text-align: center;"><u>SLOPE</u></td> </tr> <tr> <td style="text-align: center;">#STEPS</td> <td style="text-align: center;">#STEPS</td> <td style="text-align: center;">ACTUAL%</td> <td style="text-align: center;">NEXT CHG</td> <td style="text-align: center;">DIRECTION</td> </tr> </table> TARGET SETPOINT + TARGET RESET PAGE UP PAGE DOWN	<u>WANTED</u>	<u>ACTUAL</u>	<u>WANTED%</u>	<u>DELAY</u>	<u>SLOPE</u>	#STEPS	#STEPS	ACTUAL%	NEXT CHG	DIRECTION
<u>WTD</u>	<u>ACT</u>	<u>WTD%</u>	<u>DLY</u>	<u>ROC</u>																	
0	0	40%	180	0.0																	
<u>WANTED</u>	<u>ACTUAL</u>	<u>WANTED%</u>	<u>DELAY</u>	<u>SLOPE</u>																	
#STEPS	#STEPS	ACTUAL%	NEXT CHG	DIRECTION																	

4.1.1.4. Unit Tonnage and KW Information

If tonnage/KW information is available the following screen is added to the status screens:

The above screen is based upon flow of 230 GPM and power factor (PF) of 1. All other values in the calcula-

<u>ACTUAL DISPLAY</u>	<u>DESCRIPTION</u>																		
09:55 Unit 60/65 UNIT IS UNLOADED 025:42:33 <table border="0" style="width: 100%;"> <tr> <td style="text-align: center;"><u>AMP&VLT</u></td> <td style="text-align: center;"><u>KW&TON</u></td> <td style="text-align: center;"><u>KW/TON</u></td> </tr> <tr> <td style="text-align: center;">110.0A</td> <td style="text-align: center;">73.8K</td> <td style="text-align: center;">0.15</td> </tr> <tr> <td style="text-align: center;">388.0V</td> <td style="text-align: center;">479T</td> <td></td> </tr> </table> PG PG	<u>AMP&VLT</u>	<u>KW&TON</u>	<u>KW/TON</u>	110.0A	73.8K	0.15	388.0V	479T		HH:MM CHILLER UNIT LEV/ENT TMP CURRENT CONTROL STATE TIME IN CURRENT STATE <table border="0" style="width: 100%;"> <tr> <td style="text-align: center;"><u>AMPandVLT</u></td> <td style="text-align: center;"><u>KwandTON</u></td> <td style="text-align: center;"><u>KW/TON</u></td> </tr> <tr> <td style="text-align: center;">Amps</td> <td style="text-align: center;">KW</td> <td style="text-align: center;">KW/TON with 2 decimals</td> </tr> <tr> <td style="text-align: center;">Voltage</td> <td style="text-align: center;">Tons</td> <td></td> </tr> </table> PAGE UP PAGE DOWN	<u>AMPandVLT</u>	<u>KwandTON</u>	<u>KW/TON</u>	Amps	KW	KW/TON with 2 decimals	Voltage	Tons	
<u>AMP&VLT</u>	<u>KW&TON</u>	<u>KW/TON</u>																	
110.0A	73.8K	0.15																	
388.0V	479T																		
<u>AMPandVLT</u>	<u>KwandTON</u>	<u>KW/TON</u>																	
Amps	KW	KW/TON with 2 decimals																	
Voltage	Tons																		

tion are displayed on the screen.

4.2.1.1. Purge Status Screen (only if Purge cycles are active)

<u>ACTUAL DISPLAY</u>				<u>DESCRIPTION</u>		
09:55	PRG 1	45/54		HH:MM	Purge Circuit	LEV/ENT TMP
	A-PRG OFF				CURRENT PURGE STATE	
	000:00:42	MODE COOL			TIME IN CURRENT STATE	UNIT MODE
<u>SUC-LT</u>	<u>FLOAT</u>	<u>24TMR</u>		<u>SUC-LT</u>	<u>FLOAT</u>	<u>24 TMR</u>
20F	NORMAL	27mi		Temperature of suction line	Safety Float Status	Purge Run Time in last 24 hours
	PG↑	PG↓			PAGE UP	PAGE DOWN

4.2.1.2. Compressor status

<u>ACTUAL DISPLAY</u>				<u>DESCRIPTION</u>			
09:56	CMP #1	45/54		HH:MM	COMPRESSOR	LEV/ENT TMP	
	CMP OFF/READY				CURRENT CONTROL STATE		
	000:00:30				TIME IN CURRENT STATE		
<u>SUCT</u>	<u>DISC</u>	<u>OPD</u>	<u>MOTOR</u>	<u>SUCTION</u>	<u>DISCHARGE</u>	<u>OIL DIFFERENTIAL</u>	<u>MOTOR</u>
66P	190P	134P	0%	Pressure	Pressure	Pressure	Amp %
55F	177F	----	OK	Temperature	Temperature	----	Status
	PG↑	PG↓			PAGE UP	PAGE DOWN	

<u>ACTUAL DISPLAY</u>				<u>DESCRIPTION</u>			
09:55	CMP #1	45/54		HH:MM	COMPRESSOR	LEV/ENT TMP	
	CMP OFF/READY				CURRENT CONTROL STATE		
	000:00:42				TIME IN CURRENT STATE		
<u>SST</u>	<u>SSH</u>	<u>SCT</u>	<u>DSH</u>	<u>SAT.SUCTION</u>	<u>SUCT SHEAT</u>	<u>SAT.COND.</u>	<u>DISC S.HEAT</u>
38	16.9	97	79.2	Temperature	Temperature	Temperature	Temperature
	PG↑	PG↓			PAGE UP	PAGE DOWN	

4.2.1.3. Compressor status (only CENT)

<u>ACTUAL DISPLAY</u>				<u>DESCRIPTION</u>			
09:55	CMP #1	45/54		HH:MM	COMPRESSOR	LEV/ENT TMP	
	CMP OFF/READY				CURRENT CONTROL STATE		
	000:00:42				TIME IN CURRENT STATE		
<u>AROC</u>	<u>LROC</u>	<u>CNT</u>	<u>LIFT</u>	<u>AROC</u>	<u>LROC</u>	<u>CNT</u>	<u>LIFT</u>
0.0A	0.0P	0c	45F	Current Comp.	Current Amp	Lift	Current Lift
0.0A	0.0P	0c	0.8F	Amp R.O.C.	Lift R.O.C.	Count	
	PG↑	PG↓		Last Comp.	Last	Lift	
				Amp R.O.C.	Lift R.O.C.	Count	Lift Ratio
					PAGE UP	PAGE DOWN	

4.2.1.4. EXV status

<u>ACTUAL DISPLAY</u>				<u>DESCRIPTION</u>			
09:55	EXV #1	45/54		HH:MM	ELECTRONIC EXP VLV	LEV/ENT TMP	
	IS HOLDING				CURRENT CONTROL STATE		
	000:36:42				TIME IN CURRENT STATE		
<u>VLV%</u>	<u>DELAY</u>	<u>SPHT</u>	<u>ROC</u>	<u>VLV OPEN%</u>	<u>TIME DELAY</u>	<u>SUCT SHEAT</u>	<u>ROC</u>
27	60	12.2	0.0	Percent	Delay To	Temperature	Rate Of
	PG↑	PG↓			Next Change		Change
					PAGE UP	PAGE DOWN	

4.3. MCS TOUCHSCREENS

The MCS-TOUCHSCREENS were designed to simplify user access with the MCS-MAGNUM and MicroMag. The Touchscreen is available in three sizes:

MCS-TOUCH 7'

MCS-TOUCH 10.1"

MCS-TOUCH 15.4"

MCS-CONNECT can be utilized to provide both graphics and service mode access for technicians.

Information and graphics on the MCS-TOUCH are shown on high resolution (1280x800) LCD display with LED back lighting, which guarantees long-life operation.

OEM'S using the MCS-GRAPHICS BUILDER* can customize the installation with multiple windows to monitor all aspects of your chiller.



MCS also offers several different Industrial Control Panels to fit your installation needs. This includes upgrading to a New Magnum Industrial Control Panel which can hold the new Touch-15.4 screens.

Industrial Control Panels range in size from:

- Small Industrial Control Panel
- Medium Large Industrial Control Panel
- Large Industrial Control Panel
- Large Industrial Control Panel-NEMA4 - with 15.4 Touch which offers the installer a choice for indoor or outdoor installation where water or other harsh environments may exist.
- Remote 15.4 Panel with the Touchscreen is available with or without NEMA4.



*MCS GRAPHICS BUILDER IS LICENSED FOR OEM USE ONLY.



New Waterproof Silicone Seal for areas subject to weather, etc.

4.2. MCS-CONNECT and your Touchscreen

MCS-CONNECT is installed on every MCS-TOUCHSCREEN. Its purpose is to provide both local and remote communication for MCS Micro Controllers either by themselves or as part of a network.

MCS-CONNECT permits the user to monitor the status of the Micro Controller in real time and, with proper authorization, changes can be made to the system. In as fast as 10 seconds configuration files can be transmitted to or received from a MCS Micro Controller.

Another powerful feature of MCS-CONNECT is its ability to graph event history. Since MCS controllers automatically perform history logging, the user can select which inputs or outputs to graph and view the results either in REAL TIME or over a user selectable period of time.



MCS-TOUCHSCREENS come standard with custom display screens allowing users to acknowledge alarms, change set points and force points on selected screens. Transitioning from screen to screen is fast and easy by tapping the touch screen or using the stylus on the touchscreen.

PERFORMANCE MANAGEMENT

The MCS-TOUCHSCREEN display continuously captures data and provides trending capability for power and chiller performance, and chilled and condenser water parameters for precise energy management.



Chapter - 5. NETWORK CONNECTIONS

The next few pages show recommended network setups for communication to your controller using products from MCS.

5.1. MCS 485 Network

The MCS 485 Network can support up to 20 Magnums and their associated I/O boards. Access to this network can be remotely through a 14.4K Baud modem. When using the dialup connection through a modem there is no degradation in the performance of the network.

Each Magnum in the network must be assigned a unique address in the configuration file. This address will be the key in establishing communications with the appropriate Magnum system. It can be viewed or changed from the LCD / key-pad of the unit with Factory authorization.

RS485 transmissions should not exceed 1 mile without a repeater.

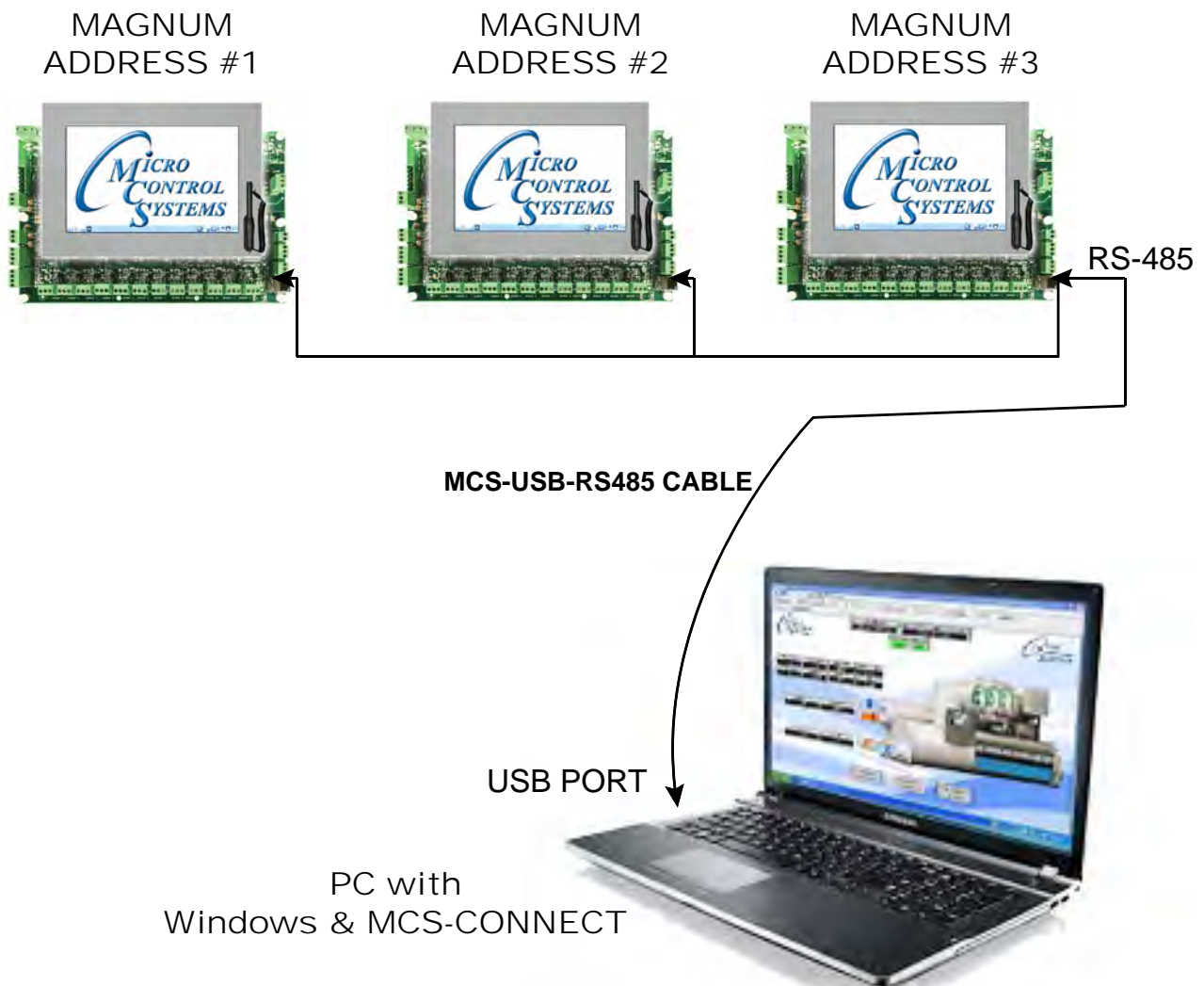

5.2. ETHERNET

5.2.1 RJ45 using a Crossover Ethernet Cable

When connecting directly through the 10 MBPS Ethernet port on the Magnum from a PC it is necessary to use a crossover Ethernet cable.

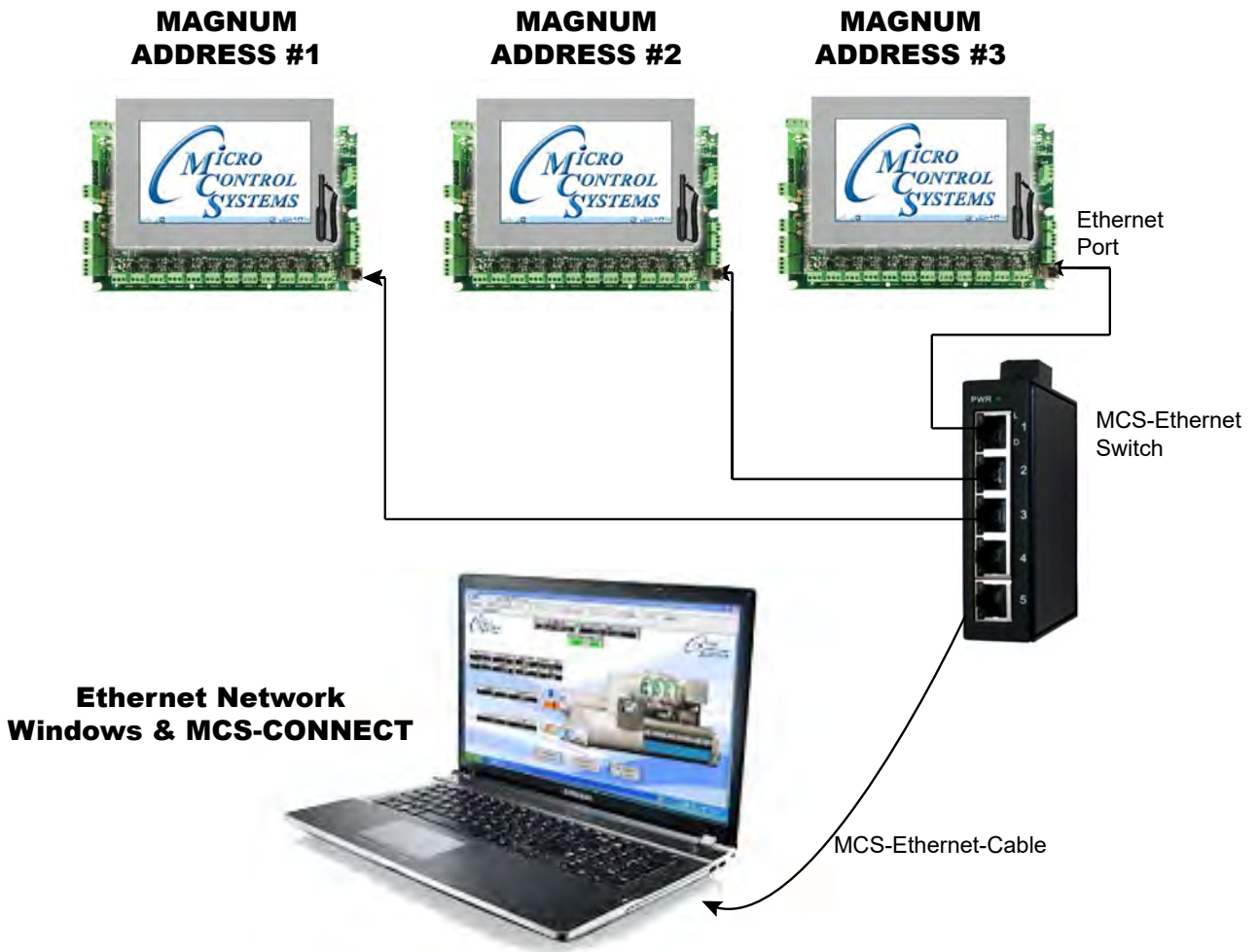

5.3. Remote using Ethernet

When connecting directly through the 10 MBPS Ethernet port on the Magnum from a PC it is necessary to use a crossover Ethernet cable to the MCS-WIRELESS MODEM.

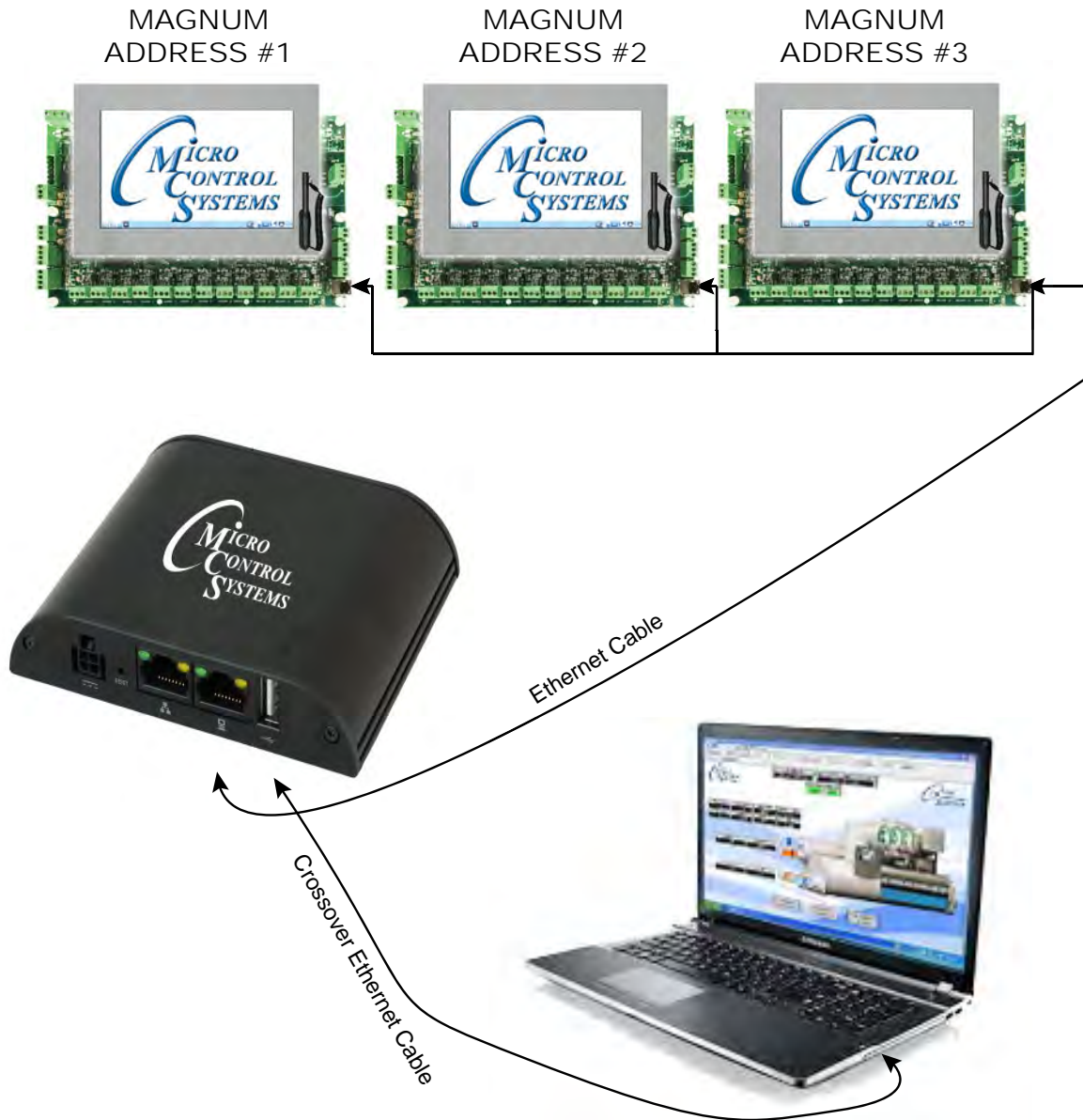

See Label for Actual Setting

MCS-WIRELESS MODEM is shipped from the factory with the IP address configured for you. Instructions on how to setup your PC to communicate with the MCS-WIRELESS MODEM will be included.

Chapter - 6. Magnum Control States

The Magnum controller is a state computer, that is, decisions are made based upon Set points, timers and Sensor Inputs, the controller moves from one state to another. The controller will change states to ensure the proper functioning of the chiller package.

As we review the various states, we must remember that a chiller package consists of a number of different parts or functions: the compressors and their related items such as unloaders hot gas bypasses, etc.; evaporator; and condensing functions.

Both the Capacity Control States and Compressor Control States are displayed in the Status screens on the Keypad Display. To view the state of the chiller, select the Status option from the menu on the Keypad. You can then view the entire status by using the page up / down function keys. The information can also be accessed through MCS-Connect under status screen by clicking on the CONTROL STATUS button.

Unit Control States (number)

Note: All User Logic points can now access the Unit Control State. The value accessed is the number listed in parenthesis in the following headings.

6.1. UNIT IN POWER UP (0)

This state is entered when the Magnum is powered up or the system has been reset. The system will remain in this state for the time specified in Setpoint #23 "POWER DELAY" or for 60 seconds if not active. In this state all Relay Outputs are turned off. This time delay is to insure the microprocessor has stable power before starting the algorithm.

6.2. NO RUN- I/O LOST (2)

This state will be entered whenever the Magnum loses communications with any of the I/O boards that are connected through the MCS I/O network. When this state is entered the Magnum will generate an MCS I/O offline alarm, which identifies which I/O is offline and a lost I/O shutdown alarm which locks out the unit. Once locked out, if there are ten consecutive successful I/O reads the Magnum will reset and attempt to run. When this occurs a "LOST I/O RESTART" will be generated. Or, the lockout-reset key can be pressed to reset the Magnum, after the lost I/O has been corrected. This will generate a "LOCKOUT RESET." In this state all RO's except ALARM and OIL HEATER are turned OFF.

6.3. UNIT IN LOCKOUT (3)

This state is entered whenever a critical situation is encountered that could cause harm to the chiller package. Items such as freeze protect and emergency stop will force the system into this state. Lockouts can be reset without authorization from the keypad or MCS-Connect program; however if the lockout condition has not been corrected, the system will again be forced into the LOCKOUT state. In this state, all RO's except ALARM and OIL HEATER (for screws with an oil pump) are turned OFF and placed in the "LOCKOUT" state. Note: If the Lockout Reset is pressed more than the programmed allowable number of times in one day the unit cannot be reset during the current day except through MCS-Connect and requires Factory authorization. This number is selected from a drop down menu under the Setup Information button, with a range of 2 to 12.

In Cent Firmware only, Close Vane RO will stay energized for 5 minutes after compressor lockout.

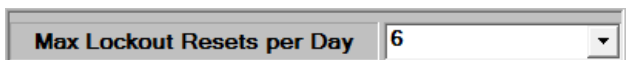

6.4. UNIT IS OFF (4)

This state is entered when the system has finished a STARTUP, DISABLE, LOCKOUT, or NO RUN- I/O LOST state. The chiller is now ready to move into an active state to meet the capacity required.

6.5. UNIT IS HOLDING (5)

This state is entered when one of three conditions exists:

1. The control sensor reading is being maintained within the control zone.
2. Control sensor reading is above the control zone but the Rate of Change is less than the value in the (MAX ROC-, #27) Setpoint. This indicates that the temperature is decreasing toward the target at an acceptable speed. Therefore, no additional cooling is needed at this time.
3. The temperature is below the control zone but the Rate of Change is greater than the (MAX ROC+, #28) Setpoint.

This indicates that the temperature is increasing toward the target. Therefore, no reduction in cooling is needed at this time. This state indicates that there is no need to adjust the capacity of the chiller package. This state will end when more or less capacity is required.

4. Step Wanted Greater than Steps Turned On - When the controlling temp sensor is in the control zone and if step wanted on is greater than steps turned on, set steps wanted on equal to steps turned on. This logic is enabled by setting setpoint #25 TYPE column to a "TIME" type and TIME column to a value of 1.

6.6. UNIT UNLOADING (6) Only HVAC software

This state is entered when less capacity is required. Every second an adjustment is made to the step delay. When the delay reaches zero, the counter "steps wanted" on is decreased by 1.

6.7. UNIT IS LOADING (7) Only HVAC software

This state is entered when more capacity is required. Every second an adjustment is made to the step delay. When the delay reaches zero, the counter "steps wanted on" is increased by 1.

6.8. OFF-SMOKE ALARM (8)

This state is entered when a smoke alarm has been detected. In the MCS-Configuration file the Smoke Alarm Indicator must be selected in the General Information panel under the MAGNUM screen. When this sensor is trips, an error message "OFF-SMOKE ALARM" is generated and the unit state is changed. In this state all RO's except ALARM and OIL HEATER are turned OFF.

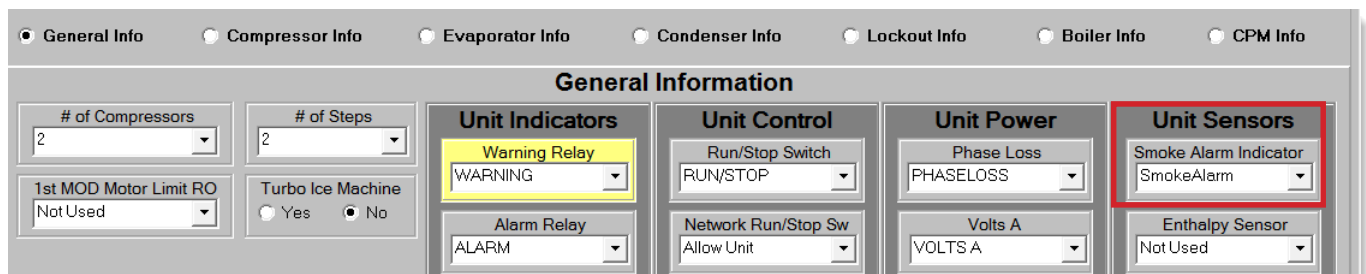

6.9. RUN/STOP SW OFF (9)

This state is entered when the run stop switch is off, in the stop position. When the chiller is in this state, the individual compressor states if active are moved to the CMP IS OFF state through the normal states. One capacity STEP will be moved per second.

6.10. SCHEDULED OFF (10)

This state is entered when the schedule is calling for the package to be off. When the chiller is in this state, the individual compressor states if active are moved to the CMP IS OFF state through the normal states. One capacity STEP will be moved per second.

6.11. OFF- NO FLOW (11)

This state is entered when the evaporator flow switch is off. When the chiller is in this state, the individual compressor states if active are moved to the CMP IS OFF state through the normal states. One capacity STEP will be moved per second. If the NO FLOW Setpoint is active and set to Lockout the chiller will lockout on no flow.

6.12. AMBIENT OFF (13)

This state is entered when the ambient temperature falls below Setpoint #24 "LOW AMB OFF" or is above Setpoint #26 "HIGH AMB OFF". The system will remain in this state until the ambient temperature if low rises 5.0°F (2.5°C) above the "LOW AMB OFF" Setpoint value or if high drops 5.0°F (2.5°C) below the "HIGH AMB OFF" Setpoint value. When the chiller is in this state, the individual compressor states if active are moved to the CMP IS OFF state through the normal staging function. One capacity STEP will be moved per second.

6.13. UNIT IS UNLOADED (15)

This state is entered when all of the systems available capacity steps are off. The package is providing no cooling capacity, as none is required. The system is ready to react to cooling needs.

6.14. UNIT IS LOADED (16)

This state is entered when all of the system's available capacity steps are on and the package is providing the maximum amount of cooling capacity.

6.15. OFF TMP-ICE MADE (17)

This state is only used in systems when the Ice Mode DI On/Off option has been selected. When the system is in the ICE MAKING mode and the control temperature sensor's temperature is less than the target temperature, set point #1, This state is entered. In this state the mode will remain ICE MAKING, all stages of cooling will be staged off and remain off until the ice making mode is exited. Refer to section on 'Ice Making Capabilities'.

6.16. ECONOMIZER ONLY (18)

This state is entered when mechanical cooling is off and the economizer has been specified in the MCS-Configuration setup and it is being used for cooling. Refer to section about Economizers.

6.17. SWITCHING MODES (19)

This state is entered when the unit is switching between cooling mode and heating mode. Only heat pump units or units with electric heat and a Sensor Input selects either the cooling or heating mode will enter this state. Select this information under the MAGNUM screen.

The screenshot displays the 'General Information' panel with the following settings:

- General Info:** # of Compressors: 2, # of Steps: 2, 1st MOD Motor Limit RO: Not Used, Turbo Ice Machine: No.
- Unit Indicators:** Warning Relay: WARNING, Alarm Relay: ALARM, Control Relay: Not Used, Lag Unit ON/OFF Relay: Not Used, Unit Status Relay: Not Used.
- Unit Control:** Run/Stop Switch: RUN/STOP, Network Run/Stop Sw: Allow Unit, Emergency Stop Switch: EMG/STOP, Heat Control: Heat Mode Indicator: HEAT ENABL, Common Rev. Valve: Not Used.
- Unit Power:** Phase Loss: PHASELOSS, Volts A: VOLTS A, Volts B: VOLTS B, Volts C: VOLTS C, Unit Amps: UNIT AMPS, Unit KW: SPARE4-9.
- Unit Sensors:** Smoke Alarm Indicator: SmokeAlarm, Enthalpy Sensor: Not Used, Ambient Temperature: AMBIENT, Ambient Humidity: Not Used, Demand Limit FLA %: Not Used, Demand Limit Steps: Not Used.
- Lost BMS Communication:** Run, Stop, No Change.
- Unit Type:** Cooling Only, HeatPump (selected), Electric Heat.

6.18. UNIT SMOKE UNLDG (20)

This state is entered when the system is unloading because a smoke alarm sensor has tripped. When this sensor is on, an error message "OFF-SMOKE ALARM" is generated and the unit state is changed.

6.19. UNIT OFF UNLDING (21)

This state is entered when the unit has been disabled. It will force a quick unload of the system.

6.20. UNIT DMD UNLDING (22)

This state is only entered when the demand limiting input has been selected. The demand limit sensor must be selected in the General Information panel under the MAGNUM screen and its type must be "485 Dmd Step". This input will indicate the maximum number of steps that the unit can run. If this value is less than the number of steps that are currently on, the unit will unload to meet this value.

6.21. UNIT HEAT UNLDING (23)

This state will be entered and will begin unloading the system if it is in heating mode and the control temperature is greater than the control temperature Setpoint plus Setpoint #164 "HP CTL ZONE +" and the system is not already fully unloaded.

6.22. UNLOADING RUN COMP (24) Only with HVAC Software with TurboCor

This state is entered when a TurboCor compressor is being unloaded and the start stage is either unload or pump down that compressor prior to starting another compressor.

6.23. OPENING BYPASS VALVE (25) Only with HVAC Software with TurboCor

This state is entered when a TurboCor compressor is being unloaded and the start stage is opening the bypass valve for that compressor prior to starting another compressor.

6.24. COMP RAMPING UP (26) Only with HVAC Software with TurboCor

This state is entered when a TurboCor compressor is being unloaded and the start stage is waiting for that compressor prior to starting another compressor.

6.25. CLOSING BYPASS VALVE (27) Only with HVAC Software with TurboCor

This state is entered when a TurboCor compressor is being unloaded and the start stage is closing the bypass valve for that compressor prior to starting another compressor.

6.26. FACTORY STARTUP (28) Only with HVAC Software

A factory startup has been specified. The system cannot be commissioned until the proper authorization has been entered and the factory startup performed.

6.27. MAXIMUM RUN TIME (29) Only with HVAC Software

The maximum run time option has been specified and a compressor run time has surpassed this limit. All functions will remain off until the proper authorization has been entered.

6.28. ESTABLISHING COMMUNICATIONS (34) Only with HVAC Software

If the unit is to be part of the CPM network, this state will be sent to CPM Master controller while establishing communications.

6.29. RAPID-STARTING COMPRESSOR (35) Only with HVAC Software

Used only if unit has the Rapid Start option active. In this state the system will turn on the number of compressors allowed in the rapid start.

6.30. RAPID-LOADING (36) Only with HVAC Software

Used only if unit has the Rapid Start option active. All compressors available for the Rapid Start option have been turned on. In this state the unit capacity will be increased as long as additional capacity is needed, once it is at its maximum an additional compressor if available will be turned on and the capacity will be set to its minimum value.

6.31. RAPID-HOLDING (37) Only with HVAC Software

Used only if unit has the Rapid Start option active. In this state the capacity will not be increased as the control temperature and slope are within target.

6.32. UNIT IS OFF/TEMPERATURE (38)

This state is only used if the low temperature option has been specified. Set point #151 is active and it is a TARGET type of set point. When the steps wanted is zero, no mechanical stages of cooling is on and the control temperature is below the off temperature this state will be entered. Once the control temperature is above this value the unit state will be loading.

Chapter - 7. Heat Recovery Logic

- HVAC only
- HVAC Firmware 17.60H4 or greater
- Config program 18.010 or later

7.1. Theory of Heat Recovery:

During cooling only operation, the chiller produces a controlled source of chilled water leaving the evaporator while dissipating heat through the condenser and ultimately to the environment. When there is a simultaneous need for chilled water and hot water, these chillers have the capability to operate in heat recovery mode. The recovered heat can be redirected for various heating applications, which saves energy while maintaining conditions.

7.2. General Description for MCS-Magnum Heat Recovery:

Heat Recovery logic is a new MCS-Magnum control option for chillers. When this option is enabled the MCS-Magnum capacity control will dynamically select control mode Heat or Cooling for staging the unit. When in cooling mode the capacity control state logic will use the chilled water out sensor and setpoint #1 for staging the unit. When in Heating mode the capacity control state logic will use the condenser water out sensor and setpoint #163 for staging the unit.

The heat recovery logic allows chillers to switch between heating and cooling on the fly and works as follows.

7.3. Unit Type – Heat Recovery

Heat Recovery needs to be selected in the general info page for the heat/cool automatic change overs to take effect.

The screenshot displays the 'Magnum HVAC Information Screen' with the 'Information Panel Selector' set to 'General Info'. The 'General Information' section is active, showing various unit parameters and controls. A red box highlights the 'Unit Type' section, which includes radio buttons for 'Cooling Only', 'Electric Heat', 'Heat Pump', and 'Heat Recovery'. A red arrow points to the 'Heat Recovery' option, which is currently selected. Other sections visible include 'Unit Indicators', 'Unit Control', 'Unit Power', 'Unit Sensors', and 'Vestibule Control'.

7.4. Heating and Cooling Control Sensors

- Under the evaporator info tab you'll be able to select your heating/cooling entering and leaving sensors and select which one you want to control on when in heating or cooling mode.

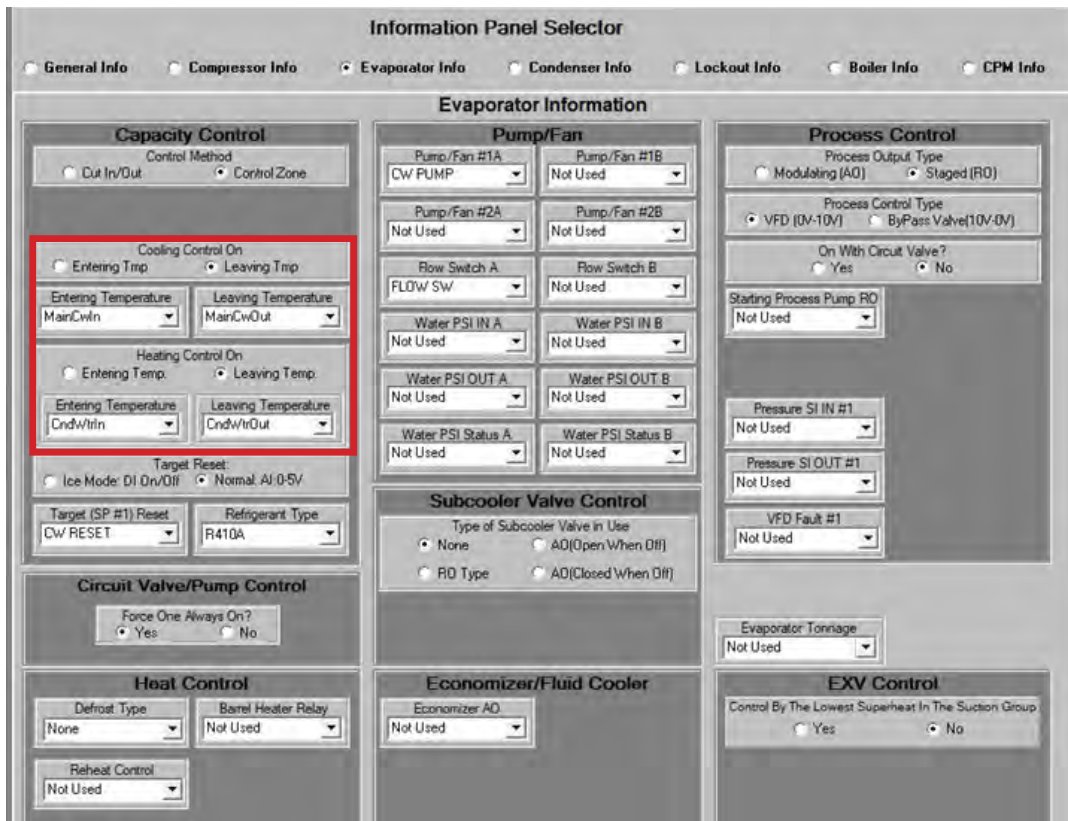

- The mode will be decided based on the controlling sensor nearest to its target.

If both heating and cooling are in their target zones, then we won't switch modes until heating or cooling needs to unload based on going outside its control zone. Otherwise we control based on closest to target when each sensor requires loading of the unit.

Setpoints 1-3 are used for cooling control target and zones

Setpoints 163-165 are used for heating control target and zones

1	CW OUT TRGT	44	42	60	0.5	0	0	0	0	Active	...	TEMP	View Only	Setpoint
2	CTRL ZONE+	2	0.5	5	0.5	0	0	0	0	Active	...	TEMP	View Only	Setpoint
3	CTRL ZONE-	1	0.5	1	0.1	0	0	0	0	Active	...	TEMP	View Only	Setpoint

163	HP HEAT TARG	95	75	120	1	0	0	0	0	Active	...	TEMP	View Only	Setpoint
164	HP CTL ZONE+	2	0.5	3	0.5	0	0	0	0	Active	...	TEMP	View Only	Setpoint
165	HP CTL ZONE-	2	0.5	3	0.5	0	0	0	0	Active	...	TEMP	View Only	Setpoint

Chapter - 8. Compressor Control States (number)



All User Logic points can now access the Compressor Control State. The value accessed is the number listed in parenthesis in the following headings.

The action of the compressor control states may result in an increase or decrease in capacity. The Unit Control States may affect or change the Compressor Control States or supersede them altogether.

8.1. LOST IO LOCKED

This state is entered when the Capacity Control State is NO RUN- I/O LOST. Resetting the lockout will move the compressor to the CMP OFF/READY state.

8.2. CMP LOCKED OUT

This state is entered when the Capacity Control State is in UNIT IN LOCKOUT or a safety trip has occurred for this compressor (Examples of safety Setpoints include #77 "LOW SUCTION" and #81 "HI DISC PSI"). Lockouts can be reset without authorization from the keypad or MCS-Connect program, however if the condition causing the lockout has not been corrected, the compressor will again be forced into the LOCKOUT State.

8.3. SWITCHED OFF

This state is entered when the compressor is off due to the pump down switch being on or the compressor flow switch being off. In this state the compressor and all related points, including the liquid line solenoid are off. The compressor will not leave this state unless the pump down switch is turned off. If the pump down switch is turned off, the compressor state will be changed to the CMP OFF/READY state.

8.4. UNLD and PMPDWN

This state is entered when the pump down switch has been turned on or if this compressor is no longer Wanted On. The compressor remains on while the liquid line solenoid is closed. This state is active until the suction pressure reaches Setpoint #61 "PMP DWN OFF" or the time has exceeded Setpoint #62 "PMP DWN DELY". The compressor will then move to the CMP ANTICYCE state.

8.5. CMP ANTICYCE

This state is entered when the UNLD and PMPDWN state has been completed. The compressor will stay in this state with all compressor points off for the period of time contained in Setpoint #59 "ACYC OFF-> ON" or Setpoint #63 "ACYC ON -> ON", whichever is longer. The compressor will then move to the OFF state. NOTE: "ACYC ON -> ON" can be used to set the maximum number of compressor starts per hour.

8.6. CMP OFF/READY

This state is entered when no capacity is required from this compressor, or the last state was CMP ANTICYCE, LOST I/O LOCKED, or SWITCHED OFF. In this state the compressor is ready to provide capacity if needed. The compressor will remain in this state for a minimum of 60 seconds.

8.7. OIL PMP LUBING

Screw, centrifugal, and compressors with external oil pumps all use this state. This state is used to ensure proper oil flow prior to compressor startup. Options that affect this state are setup in Compressor Information button under the MAGNUM screen and in the Setpoints screen:

In this state the following Relay Outputs, if present, are set as follows:

1. Compressor relay(s) are OFF.
2. Oil pump is ON.

3. If suction group running is either 1 or 2 the hot gas solenoid is OFF.
4. Fast unloader is ON.
5. First 120 seconds or until the unload switch is ON the unloader is ON else it is OFF.
6. Loader is OFF.
7. VI increase and decrease are OFF.
8. Start unloader is OFF.
9. Low discharge superheat relay is OFF.
10. All liquid line solenoids are OFF.
11. Oil equalization relay is ON.
12. All unloaders are OFF if they are load type else they are ON.
13. All turbo ice relays are off.
14. Oil heater is controlled to maintain oil temperature

All of the following conditions must be met within the time allowed in Setpoint #41 "LUBE DELAY". If the compressor type is centrifugal an additional 10 seconds will be allowed for these conditions to be met.

1. Oil differential must be equal to or greater than the value in Setpoint #40 "LUBE OIL PSI". If this Setpoint is not active this test is bypassed.
2. Oil temperature must be equal to or greater than the calculated oil temperature target. If Setpoint #39 "LUBE OIL TEMP" is not active this test is bypassed. If the compressor type is centrifugal and the option to use the saturated temperature is indicated, then the value of the saturated temperature will be added to Setpoint #39 "LUBE OIL TEMP", else the value of Setpoint #39 will be used by itself as the calculated oil temperature target.
3. The compressor must be unloaded. If there is an unloaded indicator it must be on. If it is a centrifugal compressor, it is forced to stay in this state for minimum of 15 seconds. If the compressor has no unloaded indicator it must stay in this state for a minimum of 10 seconds less than Setpoint #41 "LUBE DELAY".

If all of these conditions are met within the allotted time, the compressor will move to another state.

If a fixed step compressor with an external oil pump the state will either be UNLOADED or LOADED, depending if there are multiple compressor steps.

If a variable step compressor, then the percentage wanted on will be checked. If it is less than Setpoint #31 "MIN SLIDE %", or option "Use Min FLA" has been selected, the percentage wanted will be set to the value in Setpoint #31 "MIN SLIDE %" and the state will be set to HOLDING.

Any associated EXV will be adjusted to allow for additional capacity.

If the compressor does not meet all of the conditions it will be LOCKED OUT and an error message will be generated indicating the reason for the failure: pressure, temperature or time.

8.8. NOT USED

8.9. CMP UNLOADED

For variable step compressors, this state occurs when the slide is fully unloaded (indicated by unloaded input or after the unloader is pulsed for 30 seconds with no change). For fixed step compressors, this state occurs when the compressor is on and fully unloaded. In this state the compressor is supplying its minimum cooling capacity.

8.10. CMP UNLD STEP1 Only HVAC Software

This state only applies for fixed step capacity compressors with a Hot Gas Bypass solenoid. In this state the Hot Gas Bypass solenoid is off and all unloaders in the compressor are on.

8.11. CMP UNLD STEP2 Only HVAC Software

This state only applies for fixed step compressors with two unloaders. This state occurs when the Hot Gas Bypass solenoid, if present, is off, the first unloader solenoid is off, and the second unloader solenoid is on.

8.12. CMP IS HOLDING

This state only applies for variable step compressors. In this state, the required refrigeration capacity of system is being met; no movement of the slide valve is required.

8.13. CMP IS LOADING Only HVAC Software

For variable step compressors, this state occurs when the load solenoid is being pulsed to increase the capacity of the compressor. The duration of the pulse is specified in the Setpoint #37 "LOAD PULSE" and the frequency of the pulse is determined by Setpoint #56 "PULSE DELAY". The Setpoint "PULSE DELAY" should be a value of between 3 and 5 seconds to allow the amp sensor to reflect the change.

8.14. CMP IS UNLOADING Only HVAC Software

For variable step compressors, this state is when the unload solenoid is being pulsed to reduce the capacity of the compressor. The duration of the pulse is specified in Setpoint #38 "UNLOAD PULSE" and the frequency of the pulse is determined by Setpoint #56 "PULSE DELAY". The Setpoint "PULSE DELAY" should be a value of between 3 and 5 seconds to allow the refrigerant to enter the chamber slowly enough to not cause oil foaming.

8.15. CMP IS RUNNING

For fixed capacity compressors only, this state occurs when the compressor is fully loaded. In this state, the compressor is providing the maximum amount of cooling capacity.

8.16. FAST UNLOADING

For screw compressors only, this state is entered when the compressor is turned on. All load solenoids will be turned off and all unload solenoids will be turned on to ensure the screw is fully unloaded. If an oil pump is included in the system it will be turned on during this state. The time in this state is set in the "Fast Unload Delay" cell under the Compressor Information button in the MAGNUM screen.

Compressor Information			
Compressor Type Hanbell Step		Lube State Oil Setpoint <input checked="" type="radio"/> Sat. Suct Offset <input type="radio"/> Actual Temp Value	
Keep Running Comp at 100% when starting next? <input type="radio"/> Yes <input checked="" type="radio"/> No	Pre-Pump Out <input checked="" type="radio"/> Yes <input type="radio"/> No	Oil Heater Control Setpoint <input checked="" type="radio"/> Sat. Suct Offset <input type="radio"/> Actual Temp Value	
Fast Unload Delay (30-120) 30 Seconds	Unload Compressor before Starting Next (0-120) 0 Seconds	Wanted FLA-starting next Compressor <input checked="" type="radio"/> Calculated FLA <input type="radio"/> Use Min FLA-(Stpt #31)	
Last Stage to 100% (Override Setpoint) <input type="radio"/> Yes <input checked="" type="radio"/> No	Minimum Delay Between Compressor Starts 0 Seconds	Control of Oil Pump <input checked="" type="radio"/> Always ON <input type="radio"/> Cycle/Needed <input type="radio"/> Only Lube State	

8.17. LO SUCT UNLOAD

Refer to Setpoints #77 "LOW SUCTION"; #78 "LO SUCT UNLD"; and #79 "LO SUCT RELD".

For variable step compressors only. The capacity is being unloaded due to low suction pressure. The compressor will stay in this state until the suction pressure is above Setpoint #79 "LO SUCT RELD". The system will then move to the LO SUCT HOLD state.

8.18. LO SUCT HOLD

Refer to Setpoints #77 "LOW SUCTION"; #78 "LO SUCT UNLD"; and #79 "LO SUCT RELD".

Fixed step compressors—This state is entered when a fully loaded compressor that has more than one step is unloading due to low suction pressure. One step of capacity is turned off. The compressor will remain in this state for a minimum of five minutes before returning to the LOADED state if the low suction condition has been corrected.

Variable Step Compressors—Capacity is being held due to low suction pressure. Once the suction pressure returns to a normal operating level the compressor will return to its normal running state.

8.19. HI DISC UNLOAD

Refer to Setpoints #81 "HI DISC PSI"; #82 "HI DISC UNLD"; #83 "HI DISC RELD"; #87 "HI DISC TMP"; #88 "HI DISC UNLD"; #89 "HI DISC RELD", and #84 "LO DISC SHEAT".

For variable step compressors only. The capacity is being unloaded due to a high discharge pressure, high discharge temperature, or low discharge superheat. The compressor will stay in this state until the pressure or temperature has dropped below the corresponding Setpoint. The system will then move to the HI DISC HOLD state.

8.20. HI DISC HOLD

Refer to Setpoints #81 "HI DISC PSI"; #82 "HI DISC UNLD"; #83 "HI DISC RELD"; #87 "HI DISC TMP"; #88 "HI DISC UNLD"; and #89 "HI DISC RELD".

Fixed Step Compressors—This state is entered when a fully loaded compressor that has more than one step is unloading due to high discharge pressure or temperature. One step of capacity will be turned off. The compressor will remain in this state for a minimum of five minutes before returning to the LOADED state if the high discharge condition has been corrected.

Variable Step Compressors—Capacity is being held due to high discharge temperature or pressure. Once the discharge returns to normal operating levels the compressor will return to its normal running state.

8.21. SAFETY TRIPPED

This state is entered when a safety trip occurs but a lockout is not generated. An alarm is generated but the system will automatically restart after the delay specified in the corresponding Setpoint. If a second trip occurs within the time specified in the Setpoint, the compressor will be placed in the CMP LOCKED OUT state.

8.22. LO TMP UNLOAD

The following two conditions can cause this state to be entered and the system to begin unloading:

- 1) The leaving liquid temperature is within 1.5°F of the Setpoint #111 "FREEZE "
- 2) The refrigerant temperature is less than Setpoint #155 "LO REF TMP" if this Setpoint is active.

8.23. LO TMP HOLD

Reload from the "LO TMP UNLOAD" occurs when the leaving liquid temperature is 3.0° F above Setpoint #111 "FREEZE "and the refrigerant temperature sensor, if present, is greater than Setpoint #155 "LO REF TMP" plus twice the value of Setpoint #156 "LO REF TMP". Until this temperature is reached the system will remain in the LO TMP HOLD State.

8.24. HI AMP HOLD

Fixed step compressors—This state occurs when a fully loaded compressor experiences an abnormally high amp draw. Refer to Setpoints #171-190 for FLA per compressor (compressors 1-20 respectively) and #75 "HI AMPS %". In this state, one step of capacity will be turned off. The compressor will remain in this state for a minimum of five minutes before returning to the LOADED state if the high amp draw condition has been corrected.

Variable Step Compressors—This state occurs after HI AMP UNLDING. It will remain in this state for the time specified in Setpoint #101 "SAFETY HOLD DELAY". If the amp draw is less than the FLA Setpoint for this compressor, it will return to the normal operating state and the compressor will be able to load if necessary. In this state the compressor will not load but it can be unloaded if needed.

8.25. HI DISC TMP HLD

Refer to Setpoints #87 "HI DISC TMP"; #88 "HI DISC UNLD"; and #89 "HI DISC RELD".

This state is entered when a fully loaded compressor that has more than one step encounters a high discharge temperature. One step of capacity will be turned off. The compressor will then remain in this state for a minimum of five minutes before returning to the LOADED state if the high discharge temperature has returned to normal.

8.26. CMP IS AT 40% Only HVAC Software

For Mitsubishi Screw compressors only. This compressor does not provide variable capacity but has two solenoids used to regulate the compressor capacity. This state occurs when the compressor is providing 40% capacity. In this state, the Relay Output to activate the 40% valve is turned on.

8.27. CMP IS AT 70% Only HVAC Software

For Mitsubishi Screw compressors only. This compressor does not provide variable capacity but has two solenoids used to regulate the compressor capacity. This state occurs when the compressor is providing 70% capacity. In this state, the Relay Output to activate the 70% valve is turned on.

8.28. HI WATER HOLD

When the compressor is running and Setpoint #86 "HI RETURN TEMP" is active, the Magnum will check for high water temperature. If the control temperature is greater than Setpoint #86 for the time specified the Magnum will place the compressor in this state. The system will be unable to load when in this state.

8.29. EXTRA 70% STEP Only HVAC Software

For Mitsubishi Screw compressors only. This compressor does not provide variable capacity but has two solenoids used to regulate the compressor capacity. This will move an extra step for this type of screw compressor.

8.30. OFF-LO OIL TMP

In this state the compressor is disabled. The oil temperature will be checked only if the compressor type is a centrifugal or screw.

Screw compressors – If the temperature is less than the value in Setpoint #39 "LUBE OIL TEMP" this state will be entered.

8.31. HI AMP UNLDING

For variable step compressors this state is entered when the amp draw is greater than the respective FLA Setpoint plus half the value in Setpoint #75, "HI AMPS". This action is to prevent a high amps safety trip from occurring. Once the amp draw has been reduced the system state will change to HI AMP HOLD.

8.32. DEF PREPMP OUT Only HVAC Software

This state is only entered if the defrost type is any condition other than NONE. Hot gas will be used to perform the defrosting. This is selected in Compressor Information button under the MAGNUM screen. When a defrost cycle begins this state is entered and an alarm message is generated. The liquid line solenoid will be closed and the compressor will remain in this state and continue running until the suction pressure is less than Setpoint #61 "PMP DWN OFF" or the time in this state is greater than Setpoint #62 "PMP DWN DELY". The compressor will then move to the DEFROSTING state.

8.33. DEFROSTING (32) Only HVAC Software

Refer to DEF PREPMP OUT state. In this state the hot gas solenoid is opened. The compressor will remain in this state until both coil temperatures are greater than Setpoint #161 "DEF TERM TMP" or the time in this state is greater than the value in Setpoint #162 "DEF TERM DEL". The compressor will then move to the DEF PUMP DOWN state.

8.34. DEF PUMP DOWN Only HVAC Software

Refer to DEFROSTING state. In this state the hot gas solenoid is closed. The compressor will remain in this state until the suction pressure is less than Setpoint #61 "PMP DWN OFF" or the time in this state is greater than Setpoint #62 "PMP DWN DELY". The compressor will then move to the CMP IS HOLDING state.

8.35. HI TEMP UNLOAD Only with HVAC Software

This state is only used when in Heating Mode. The system will unload if Setpoint #152 "HP OVERHEAT" is active and the leaving temperature is greater than the value in Setpoint #152 minus 15°F (8°C). The compressor will then move to the HI TEMP HOLD state when the temperature drops below the value in Setpoint #152 minus 30°F (16°C).

8.36. HI TEMP HOLD Only with HVAC Software

Refer to HI TEMP UNLOAD state. When the temperature drops below Setpoint #152 minus 45°F (24°C) the compressor will return to a normal state.

8.37. SCROLL STEP 1 Only with HVAC Software

Only used with special patterns for Trane Trio and Quad compressors. These compressors provide special staging as follows:

If Trane Trio then COMP C is on and COMP A and B are off.

If Trane Quad then COMP A is on and COMP B, C, and D are off.

8.38. SCROLL STEP 2 Only with HVAC Software

Only used with special patterns for Trane Trio and Quad compressors. These compressors provide special staging as follows:

If Trane Trio then COMP A and B are on and COMP C is off.

If Trane Quad then COMP C and D are on and COMP A and B are off.

8.39. SCROLL STEP 3 Only with HVAC Software

Only used with special patterns for Trane Trio and Quad compressors. These compressors provide special staging as follows:

If Trane Trio then COMP A, B, and C are on.

If Trane Quad then COMP B, C, and D are on and COMP A is off.

8.40. SCROLL STEP 4 Only with HVAC Software

Only used with special patterns for Trane Quad compressors. These compressors provide special staging as follows:

If Trane Quad then COMP A, B, C, and D are on.

8.41. UNLOAD DELAY- RECIP/VFD COMPRESSORS

Firmware Version: 18.01Y or later

On the MAGNUM HVAC/RTU compressor screen, a new cell was added for setting the unload delay before pumpdown. If there's a value greater than "0" in this cell, the logic will enter the "Unload&PumpDown" state when calling for the compressor to shut down. In this state, it will wait the amount of time in that cell, before closing the LLS & or Closing the EXV to perform the normal pumpdown operation.

The screenshot displays the 'Magnum HVAC Information Screen' with the 'Compressor Information' panel selected. The panel contains various configuration options for the compressor, including setpoints, control modes, and timing parameters. A red box highlights the 'Unload Time Delay When Stopping Compressor (0-120)' field, which is set to 60 seconds. A red arrow points to this field from the left.

Magnum HVAC Information Screen

Information Panel Selector

- General Info
- Compressor Info**
- Evaporator Info
- Condenser Info
- Lockout Info
- Boiler Info
- CPM Info

Compressor Information

Compressor Type: Scroll or VFD Comp

Keep Running Comp at 100% when starting next? Yes No

Last Stage to 100% (Override Setpoint) Yes No

Fast Unload Delay (30-120) 30 Seconds

Unload Compressor before Starting Next (0-120) 0 Seconds

Minimum Delay Between Compressor Starts (0-300) 0 Seconds

Lube State Oil Setpoint Sat. Suct Offset Actual Temp Value

Oil Heater Control Setpoint Sat. Suct Offset Actual Temp Value

Wanted FLA-starting next Compressor Calculated FLA Use Min FLA-(Stpt #31)

Control of Oil Pump Always ON Cycle/Needed Only Lube State

Unload Running Compressor(s) Before Turning Off A Compressor? Yes No

Oil Recovery

Starting Relay: Not Used

of Recovery Devices: 0

Slide Position Indicator Slide Control Compressor FLA%

Pre-Pump Out Yes No

Compressor Economizer Control (3rd LLS) FLA% Speed(AD)

Rotation Control Run Time First On / First Off

Low Ambient Comp Startup Enabled Disabled

Ambient less than 0

Unload Time Delay When Stopping Compressor (0-120) 60 Seconds

8.42. EMERGENCY STOP RELAY - CIRCUIT BASE

Firmware Version: 18.01Y or later

New logic for “Coast” relay on Bitzer VFD compressors has been added to the Circuit Base on HVAC/RTU firmware. This allows the ability to point to a relay, that will be activated whenever that circuit is in alarm, OR the unit is in safety shutdown due to Phaseloss, Emg/Stop, etc.

Point to the relay as shown below in the Emergency Stop Relay box. (This relay is not a part of the compressor sequence and can be located on any wired point.)

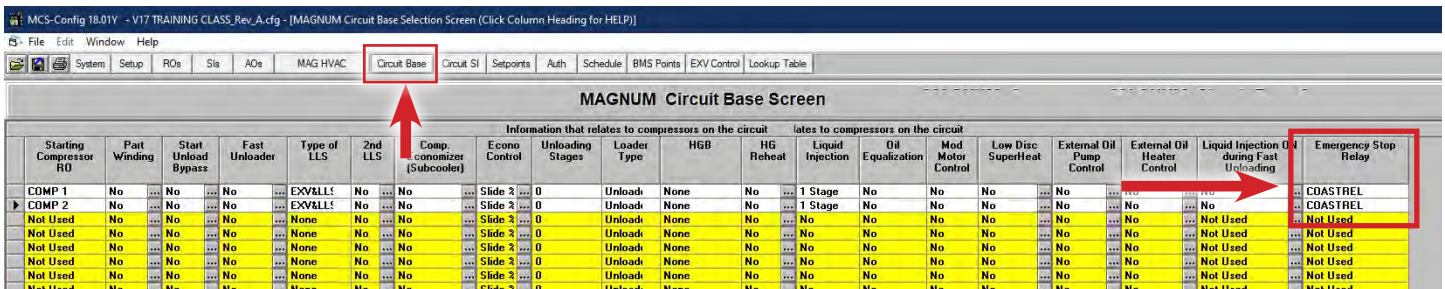

8.43. Screw Compressor Oil Boost based on Load and Time

There are 3 setpoints that need to be set up in order to define the compressor load to activate the boost, the compressor load we'll go to when in a boost, the time between boosts (when compressor load is below setpoint), and the time to remain in a boost.

Setpoint #30 needs to be a “Target” type, and we'll use the “Low Zone” cell. This will define the compressor speed or FLA% for the compressor while running a boost.

Setpoint #31 needs to be a “Target” type, and we'll use the “Low Zone” cell. This will define the compressor speed or FLA% that the compressor must be under, to call for a boost sequence.

#	Name	Value	Min	Max	Adjust Value	Time (SEC)	Max Time Allowed (SEC)	Lockout Delay (HRS)	Safety Down Time(MIN)	Active or Non-Active	Select Value: # decimals & print char	Level Of Auth. To Display	Type of Setpoint	Comments	SEC to Ignore Safety	Window to Ext. Safety Time(SEC)	Safety Time Extension (SEC)	High Zone	Low Zone	Setback
30	MAX SPD%	100	50	110	1	0	0	0	0	Active	... HUMD or %	View Only	Target		---	---	---	0	100	0
31	MIN SPD%	50	40	80	1	30	30	0	0	Active	... HUMD or %	View Only	Target		---	---	---	0	75	5

Setpoint #64 needs to be changed from “Minutes” to “DIGITAL/SW”, and made a “Target” type.

We'll use the “Low Zone” cell to specify the time, in Minutes, that the compressor needs to be running for (below setpoint #31 “Low Zone” value) to call for a boost.

The “High Zone” cell will specify the time, in Seconds, that the compressor will remain in the boost sequence for.

#	Name	Value	Min	Max	Adjust Value	Time (SEC)	Max Time Allowed (SEC)	Lockout Delay (HRS)	Safety Down Time(MIN)	Active or Non-Active	Select Value: # decimals & print char	Level Of Auth. To Display	Type of Setpoint	Comments	SEC to Ignore Safety	Window to Ext. Safety Time(SEC)	Safety Time Extension (SEC)	High Zone	Low Zone	Setback
64	COMP MIN RUN	2	1	5	1	0	0	0	0	Active	... DIGITAL/SW	View Only	Target		---	---	---	60	5	0

If the supply temp falls below the target setpoint – the low zone while in a boost sequence... compressors will begin to be cycled OFF until the supply temp rises back into the zone. Once a boost cycle is finished, the running compressors will be placed back to the running % that they were at before the boost occurred.

All safeties will still be in place while in boost. If a compressor trips, it will not affect the boost cycle of the other compressors.

Chapter - 9. SHARED VFD

HVAC 17.62M or later firmware

The following logic will utilize both unloaders and a VFD at the same time for capacity control

9.1. Compressor Modes

The compressor sequence must follow a predetermined sequence set by selecting Shared VFD for the compressor type. Typical sequence:

COMP
LLS
50% UNLOAD
75% UNLOAD
LIQUID INJ
STRT UNLD
CMP DOL
CMP EMG

The VFD inputs must be in this order:

VFD FAULT
VFD RUN
VFD AMPS

9.1.1 Compressor Modes

1. OFF – Compressor is off
2. VFD – Compressor is on VFD control
3. DOL – Direct Online – Compressor is locked in at 100% through a contactor
4. EMG – If VFD were to fault, all available compressors would run in emergency mode meaning DOL and step control only.

Setpoint #185

This setpoint defines the minimum and maximum wanted percentage for the VFD when the compressor slide is at 50% loaded. Value = Minimum % // Hi zone = Maximum %

Setpoint #186

This setpoint defines the minimum and maximum wanted percentage for the VFD when the compressor slide is at 75% loaded. Value = Minimum % // Hi zone = Maximum %

Setpoint #187

This setpoint defines the minimum and maximum wanted percentage for the VFD when the compressor slide is at 100% loaded. Value = Minimum % // Hi zone = Maximum %

9.1.2 Compressor Startup/Loading Sequence

1. Compressor starts in VFD mode
 - a. All unloaders will be turned on and slide will be at 50% loaded.
 - b. Compressor VFD speed will be set to setpoint #185 value field. The logic will look for a VFD proof input as well as the amps.
2. Compressor will modulate up to the maximum speed defined by setpoint #185 Hi zone.
3. Once compressor speed is at maximum and more capacity is required the following will occur.
 - a. Compressor speed will be backed down to setpoint #186 value field. (This will be the new minimum speed value.)
 - b. 50% unload solenoid will be turned off resulting in slide moving to 75% loaded.
4. Compressor will then begin to load up to the maximum wanted VFD percentage in setpoint #186 Hi zone.

5. Once the maximum VFD percentage is reached and more capacity is needed the following will occur.
 - a. Compressor speed will be backed down to setpoint #187 value field. This will be the new minimum speed value.)
 - b. 75% unload solenoid will be turned off resulting in the slide moving to 100% loaded.
6. Compressor will now continue to load up to the maximum VFD percentage of setpoint #187 Hi zone.
7. If the VFD is at the maximum wanted percentage the following will occur.
 - a. The micro will energize the DOL contacts locking the compressor in at 100% and open the VFD contacts for that compressor. The logic will look for the DOL proof input before removing the VFD signal and moving to the next available compressor and this entire sequence would repeat.

9.1.3 VFD Fault/Emergency Mode

1. If the VFD Fault input comes on the VFD will be bypassed and the compressors will start using the Emergency Run output. The DOL proof will be verified and the compressors will now load using step control and turning on/off the 50% and 75% unloaders.

Chapter - 10. Standard Control Options

The following options are specified in MCS-Config when building the configuration. These options are used to customize the system to meet the individual control requirements.

10.1. General Options

- Control method can be based upon the control zone or a voltage input indicating the number of stages to be on.
- The control temperature sensor can be either the returning or leaving sensor.
- Electronic expansion valves make dynamic adjustments based on capacity changes.
- Chilled water reset from the Building Management System (BMS).
- Condenser control maintaining sufficient discharge superheat for good oil separation.
- Evaporator pump control.
- Anti-cycle timers (OFF to ON and ON to ON).
- Maximum of 20 circuits per Magnum, with selectable compressor rotation.
- Warning RO (turned on for low suction unload, high discharge unload, etc.).
- Alarm RO (turned on whenever an alarm is generated).
- Optional auto rotation for compressors.
- Low and/or high ambient temperature shut down.

10.2. Magnum Control Zone Logic

The control strategy is designed to modulate the compressor(s) capacity to maintain the control sensor reading within the specified control zone. To accomplish this, the Magnum will constantly monitor the control value, its rate of change, and position in relationship to the control zone and make adjustments accordingly.

The strategies for a fixed step system, reciprocating compressor, reciprocating compressor with an inverter, variable (slide) step system, or a screw compressor are all slightly different. The variable step system allows for infinite variations of capacity while the fixed step system does not.

10.3. Common Definitions

10.3.1 Target

The control target is specified in Setpoint #1. This will be the base of developing the control zone.

10.3.2 Control Zone

The control zone is developed by utilizing two more Setpoints to calculate the upper and lower limits. Setpoint #2 is added to the target to determine the deadband to the upper limit, and Setpoint #3 is subtracted from the target to determine the deadband to the lower limit.

Example: Setpoint #1 Target = 45

Setpoint #2 Upper Deadband = 1

Setpoint #3 Lower Deadband = 1

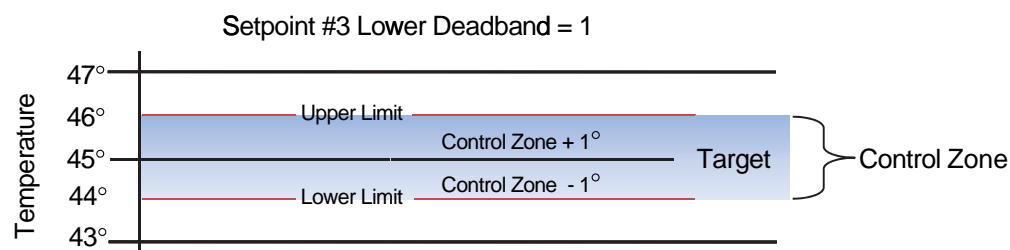

10.3.2.1. Control Sensor

This sensor has been specified in MCS-Config as providing the control value reading. It will normally be the entering temperature, leaving temperature, or suction pressure. The Setpoints must be adjusted according to the type of control measurement selected.

10.3.2.2. Control Input Rate of Change

The Rate of Change is how rapidly the control value changes over a set period of time. If the control value is increasing, the rate will be positive; if it is decreasing, the rate will be a negative value. How quickly the input is changing, its direction, and its distance from the control zone will all be used to determine how the Magnum will respond.

10.3.2.3. Step Delay and Sensitivity

The Magnum will not attempt to take action until the Step Delay counts down to zero. Setpoint #26 contains the initial value. The speed that the counter will decrement by is based on the control input rate of change and the sensitivity that has been specified in Setpoint #25. The purpose of the sensitivity value is to limit how quickly the Magnum reacts to changes indicated by the control sensor. The lower the value of this Setpoint, the faster the Magnum will react to changes of the control sensor.

10.3.2.4. Last step Temperature On

The purpose of this option is to keep the last step of mechanical cooling on until the control temperature is below the Temperature On value.

Set point #151 must be active to enable this option, refer to this set point.

If the safety time of this set point is zero then the value of this set point is used as the Temperature On value.

If the safety time of this set point is not zero then the value of this set point is used as a differential and is subtracted from the control temperature target to develop the Temperature On value.

In the above control zone example, if the set point #151's value is 43.0 and the safety time is zero, then the last stage will remain on until the control temperature is less than 43.0.

In the above control zone example, if the set point #151's value is 3.0 and the safety time is not zero, then the last stage will remain on until the control temperature is less than 42.0. ($45.0 - 3.0 = 42.0$).

10.3.2.5. Low temperature off

The purpose of this option is to keep the first step of mechanical cooling from being turned on until the control temperature is above the Low Temperature Off value. Note this is only checked when the wanted on steps are zero.

Set point #151 must be active and be a TARGET type of set point to enable this option, refer to this set point.

If the safety time of this set point is zero then the value of the Night Setback cell of this set point is used as the Low Temperature Off value.

If the safety time of this set point is not zero then the value of the Night Setback cell of this set point is used as a differential and is added to the control temperature target to develop the Low Temperature Off value.

When the steps wanted on is zero and the control temperature is less than the Low Temperature Off value the unit state will be "UNIT IS OFF/TEMP", refer to the Unit State section. The unit will remain in this state until the control temperature is above the Low Temperature Off value, at this point the state will be changed to loading and the delay counter will be counted down.

In the above control zone example, if the set point #151's Night Setback cell is 47.0 and the safety time is zero, then the first stage of cooling will remain off until the control temperature is greater than 47.0. State will be "UNIT IS OFF/TEMP" and the delay counter will not be decremented.

10.4. Voltage Step Control Logic

An alternate control strategy is based on a variable voltage input to the Magnum board. The different stages of capacity will Cut In or Out depending on the voltage input. This option is selected in the MAGNUM screen under the Evaporator Info tab.

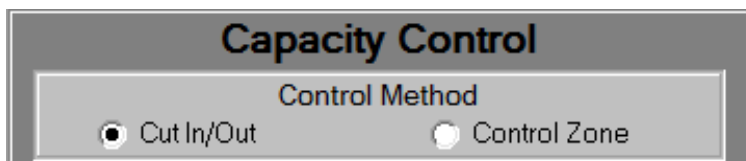

Setpoints #2-18 contain the Cut-In and Cut-Out voltage thresholds. The status screen has been changed

to show the actual voltage on the top line and to indicate voltage control on the bottom line. The step delay between adjustments is based on Setpoint #26 "STEP DELAY".

Note: Liquid Injection and EXV logic are both disabled when this option is used.

10.5. Variable Capacity Control Method

10.5.1 Screw Compressor with slide piston

This option is specified in MCS-Config by selecting the compressor type in the Compressor Information Panel under the MAGNUM screen.

As stated in the previous section, the control strategy is designed to modulate the system capacity to maintain the control sensor reading within the specified control zone. The system capacity will be based upon the number of compressors that are Wanted On. When the first, or an additional compressor, is turned on the system capacity will be set to the calculated value. For the first compressor this will be the value of Setpoint #31 "MIN FLA %". When additional compressors are brought on, their capacity is calculated to provide the same percentage of capacity prior to the change. The Magnum will adjust the required capacity between the calculated and the maximum value as specified in Setpoint #30 "MAX FLA %". All compressors that are on will be adjusted together to meet the system capacity.

When the maximum capacity value of the currently operating compressors has been reached, an additional compressor, if available, will be Wanted On. The number of compressors Wanted On will be increased by one and the system capacity will be set to the calculated value to maintain the same capacity as before the change and the sequence will begin again. Once all available compressors are on, their maximum will be 100% regardless of the value in Setpoint #30 "MAX FLA %".

When the minimum calculated value has been reached, a compressor will be turned off. This will occur when the reduced number of compressors can achieve the same capacity at 90%. The number of compressors Wanted On will be decreased by one and the system capacity will be set to 90% and the sequence will begin again.

The compressor slide control is based upon the amps drawn by that compressor. For example, if Setpoint #31 "MIN FLA %" is set to 30%, that means 30% of the calculated full load amperage for that compressor.

Screw compressors with slide pistons that are turned on can either be loading (load solenoids are pulsed), unloading (unload solenoids are pulsed), or in a hold state (no action is taken). The state of each compressor reflects this action.

10.5.2 Compressor with a Variable Frequency Drive (VFD)

This option is specified in MCS-Config by selecting the Analog Output for the VFD in the "Compr Speed or Modulate Hot Gas AO" cell in the Circuit Base screen.

Select Output and Sensor Inputs per circuit										
Circuit # (reset button)	Alarm Relay	Comp Proof	Compr Speed or Modulate Hot Gas AO	Compressor speed fault	Slide Closed Indicator	Pump Down	EXV Output	Flow	Circuit Pump/Valve	
1	...	Not Used	COMP1 SPD	Not Used	Not Used	DISABLE 1	Not Used	Not Used	Not Used	

The Magnum will control the compressor speed in the same matter as the compressor slide. The same Setpoints will be used. This allows a fixed staged compressor's capacity to be varied. See section for Setpoints associated with variable capacity control logic.

10.5.3 Example of a system with 3 variable Step Compressors

(Example below assumes compressor 1 is the current lead compressor.)

STAGE 1

Compressor 1's startup procedure has begun. Once on, the capacity will be adjusted from the minimum to the maximum. All other compressors will be off. The steps Wanted On / Actual On will be 1 / 1.

STAGE 2

Compressor 2's startup procedure has begun. Once on, the system capacity will be changed to the calculated % and compressor 1 will be unloaded until it matches the calculated system capacity. Both compressors will be varied from the calculated to the maximum. All other compressors will be off. The steps Wanted On / Actual

On will be 2 / 2. If the system capacity has been reduced to 45%, or the calculated % (whichever is larger) and less capacity is needed, a compressor will be turned off and the system capacity will be set to the 90% or the maximum and the system will return to Stage 1.

STAGE 3

Compressor 3's startup procedure has begun. Once on, the system capacity will be changed to the calculated % and compressors 1 and 2 will be unloaded until they equal the required capacity. All compressors will be varied from the calculated to 100%. The steps Wanted On / Actual On will be 3 / 3. If the system capacity has been reduced to 60%, and less capacity is needed, a compressor will be turned off and the system capacity will be set 90% and the system will return to Stage 2.

10.6. Compressor Types

The compressor type is selected from a drop down list in the Compressor Information panel on the MAGNUM screen.

The screenshot displays the 'Compressor Information' panel within the 'Information Panel Selector'. The 'Compressor Type' dropdown is open, showing a list of options including 'Recip Comp With Oil', 'Recip Comp Without Oil', 'Screw Comp With Oil', 'Scroll or VFD Comp', 'Hanbell-Load NO', 'Hanbell-Load NC', 'Hanbell-3 Solenoid(50-100%)', 'Hanbell Step', and 'Hitachi Screw Comp'. The 'Hanbell-3 Solenoid(50-100%)' option is currently selected. Other settings include 'Lube State Oil Setpoint' (radio buttons for 'Sat. Suct Offset' and 'Actual Temp Value'), 'Oil Heater Control Setpoint' (radio buttons for 'Sat. Suct Offset' and 'Actual Temp Value'), 'Wanted FLA-starting next Compressor' (radio buttons for 'Calculated FLA' and 'Use Min FLA-(Stpt #31)'), 'Control of Oil Pump' (radio buttons for 'Always ON', 'Cycle/Needed', and 'Only Lube State'), 'Unload Running Compressor(s) Before Turning Off A Compressor?' (radio buttons for 'Yes' and 'No'), 'Oil Recovery' (dropdown for 'Starting Relay' set to 'Not Used' and a field for '# of Recovery Devices' set to '0'), and 'Vane Control Method' (radio buttons for 'Vane% Sensor Input' and 'Compressor FLA%').

- Reciprocating Compressor with Oil
- Reciprocating Compressor without Oil
- Hanbell-Load NO (load solenoid wired to normal open) Screw Compressor
- Hanbell-Load NC (load solenoid wired to normal close) Screw Compressor
- Hanbell- 3 Solenoid (50-100%) (not variable but 3 fixed step screw) Screw Compressor
- Hanbell- Step (fixed step) Screw Compressor
- Hitachi Screw Compressor
- Bitzer Screw Compressor
- Trane Quad
- Screw Compressor with Oil
- Scroll Compressor
- Hartford Screw Compressor
- Carlyle Screw Compressor
- Centrifugal Compressor
- Mitsubishi Screw Compressor
- TurboCor Compressor
- Trane Screw Compressor
- McQuay Frame 4
- Fu Sheng Compressor
- Trane Trio

The type of compressor will determine how the compressor is controlled and its particular Relay Output sequence.

10.7. Compressor Setup and Options

All setup information and option selection is completed in MCS-Config.

10.7.1 Compressor Information setup

In this screen under the MAGNUM screen, compressor type is selected from a drop down list. Additional information about the compressor and how it will be controlled is also provided in this section. Review all cells and input the proper information.

The type of compressor will determine how the compressor is controlled and its particular Relay Output sequence.

10.7.2 For additional fine tuning, four setpoints have been added to provide flexibility:

Setpoint #191, TEMP DIFF

Setpoint #192, FRZ TEMP DIFF

Setpoint #193, CND H/L ZONE

Setpoint #194, CND 2ND ZONE

10.8. Compressor Setup and Options

All setup information and option selection is completed in MCS-Config.

Information Panel Selector

General Info
 Compressor Info
 Evaporator Info
 Condenser Info
 Lockout Info
 Boiler Info
 CPM Info

Compressor Information

Compressor Type <input type="text" value="Hanbell-3 Solenoid(50-100%)"/>	Lube State Oil Setpoint <input checked="" type="radio"/> Sat. Suct Offset <input type="radio"/> Actual Temp Value	Unload Running Compressor(s) Before Turning Off A Compressor? <input type="radio"/> Yes <input checked="" type="radio"/> No
Keep Running Comp at 100% when starting next? <input type="radio"/> Yes <input checked="" type="radio"/> No	Pre-Pump Out <input checked="" type="radio"/> Yes <input type="radio"/> No	Oil Recovery Starting Relay: <input type="text" value="Not Used"/> # of Recovery Devices: <input type="text" value="0"/>
Fast Unload Delay (30-120) <input type="text" value="30"/> Seconds	Unload Compressor before Starting Next (0-120) <input type="text" value="30"/> Seconds	Oil Heater Control Setpoint <input checked="" type="radio"/> Sat. Suct Offset <input type="radio"/> Actual Temp Value
Last Stage to 100% (Override Setpoint) <input type="radio"/> Yes <input checked="" type="radio"/> No	Minimum Delay Between Compressor Starts <input type="text" value="30"/> Seconds	Wanted FLA-starting next Compressor <input checked="" type="radio"/> Calculated FLA <input type="radio"/> Use Min FLA-(Stpt #31)
Compressor Economizer Control (3rd LLS)		
Control of Oil Pump <input checked="" type="radio"/> Always ON <input type="radio"/> Cycle/Needed <input type="radio"/> Only Lube State		
Vane Control Method <input type="radio"/> Vane% Sensor Input <input checked="" type="radio"/> Compressor FLA%		

10.8.1 General Information

- A maximum of four steps per compressor is supported (compressor plus three additional steps of either compressors, unloaders, or hot gas bypass points). Note: Compressor safeties relate to a circuit. If multiple compressors are on a single circuit and a safety trips, all compressors on that circuit will be turned off (If hot gas bypass, refer to Hot Gas Bypass section).
- If the compressor has an across-the-line start, only one RO point will be allocated for the compressor. If the compressor has a part winding start, two RO points will be used. The first RO will be turned on and the second RO will turn on after Setpoint #73 has been fulfilled.
- Pump down will take place when the compressor is started and when turning off. Note: When the compressor is started the liquid line solenoid is not opened until the suction pressure drops below Setpoint #61 "PMP DWN OFF" or Setpoint #62 "PMP DWN DELY" is exceeded. A liquid line solenoid is required for the pump down to function correctly.
- Up to 3 liquid line solenoids and up to 2 EXV valves are supported for each circuit.

10.8.2 Compressor Information setup

In this screen under the MAGNUM screen, compressor type is selected from a drop down list. Additional information about the compressor and how it will be controlled is also provided in this section. Review all cells and input the proper information.

Information Panel Selector

General Info
 Compressor Info
 Evaporator Info
 Condenser Info
 Lockout Info
 Boiler Info
 CPM Info

Compressor Information

Compressor Type
Hanbell-3 Solenoid(50-100%)

Lube State Oil Setpoint
 Sat. Suct Offset
 Actual Temp Value

Unload Running Compressor(s) Before Turning Off A Compressor?
 Yes
 No

Keep Running Comp at 100% when starting next?
 Yes
 No

Pre-Pump Out
 Yes
 No

Oil Heater Control Setpoint
 Sat. Suct Offset
 Actual Temp Value

Oil Recovery
 Starting Relay: Not Used
 # of Recovery Devices: 0

Fast Unload Delay (30-120)
30 Seconds

Unload Compressor before Starting Next (0-120)
30 Seconds

Wanted FLA-starting next Compressor
 Calculated FLA
 Use Min FLA-(Stpt #31)

Control of Oil Pump
 Always ON
 Cycle/Needed
 Only Lube State

Last Stage to 100% (Override Setpoint)
 Yes
 No

Minimum Delay Between Compressor Starts
30 Seconds

Compressor Economizer Control (3rd LLS)
 FLA%
 Speed(AO)

Vane Control Method
 Vane% Sensor Input
 Compressor FLA%

10.8.3 Circuit Base setup

Compressor information is provided per circuit in this section under the Circuit Base screen. Review all cells and input the proper information about the compressor.

MAGNUM Circuit Base Screen																	
Information that relates to compressors on the circuit																	
Circuit # (reset button)	# of Comp RDs	Starting Compressor RD	Part Winding	Start Unload Bypass	Fast Unloader	Type of LLS	2nd LLS	Economizer	Econo Control	Unloading Stages	Loader Type	HGB	HG Reheat	Liquid Injection	Oil Equalize	Mod Motor Control	
1	6	COMP	No	No	No	LLS only	No	No	Slide %	0	Unloader	On/Off	No	No	No	No	
2	0	Not Used	No	No	No	None	No	No	Slide %	0	Unloader	None	No	No	No	Yes	
3	0	Not Used	No	No	No	None	No	No	Slide %	0	Unloader	None	No	No	No	No	
4	0	Not Used	No	No	No	None	No	No	Slide %	0	Unloader	None	No	No	No	No	
5	0	Not Used	No	No	No	None	No	No	Slide %	0	Unloader	None	No	No	No	No	
6	0	Not Used	No	No	No	None	No	No	Slide %	0	Unloader	None	No	No	No	No	
7	0	Not Used	No	No	No	None	No	No	Slide %	0	Unloader	None	No	No	No	No	
8	0	Not Used	No	No	No	None	No	No	Slide %	0	Unloader	None	No	No	No	No	

Select Output and Sensor Inputs per circuit										
Circuit # (reset button)	Alarm Relay	Comp Proof	Compr Speed or Modulate Hot Gas AD	Compressor speed fault	Slide Closed Indicator	Pump Down	EXV Output	Flow	Circuit Pump/Valve	
1	Not Used	Not Used	Not Used	Not Used	Not Used	Not Used	Not Used	Not Used	Not Used	
2	Not Used	Not Used	Not Used	Not Used	Not Used	Not Used	Not Used	Not Used	Not Used	
3	Not Used	Not Used	Not Used	Not Used	Not Used	Not Used	Not Used	Not Used	Not Used	
4	Not Used	Not Used	Not Used	Not Used	Not Used	Not Used	Not Used	Not Used	Not Used	
5	Not Used	Not Used	Not Used	Not Used	Not Used	Not Used	Not Used	Not Used	Not Used	
6	Not Used	Not Used	Not Used	Not Used	Not Used	Not Used	Not Used	Not Used	Not Used	
7	Not Used	Not Used	Not Used	Not Used	Not Used	Not Used	Not Used	Not Used	Not Used	
8	Not Used	Not Used	Not Used	Not Used	Not Used	Not Used	Not Used	Not Used	Not Used	

Information that relates to condensers on the circuit												
Circuit # (reset button)	# of Cond RDs	Starting Condensor RD	Condensor Fan AD	Starting Condenser Fault	# Cond Faults	Cond Fan Bank	Condenser Coil Temp #1	Condenser Coil Temp #2	Tandem EXV Circuit #	EXV Control	Suction Group	Comp Name/ID
1	0	Not Used	Not Used	Not Used	0	1	Not Used	Not Used	1	Suct SpH	1	1
2	0	Not Used	Not Used	Not Used	0	2	Not Used	Not Used	2	Suct SpH	2	2
3	0	Not Used	Not Used	Not Used	0	3	Not Used	Not Used	3	Suct SpH	3	3
4	0	Not Used	Not Used	Not Used	0	4	Not Used	Not Used	4	Suct SpH	4	4
5	0	Not Used	Not Used	Not Used	0	5	Not Used	Not Used	5	Suct SpH	5	
6	0	Not Used	Not Used	Not Used	0	1	Not Used	Not Used	1	Suct SpH	6	
7	0	Not Used	Not Used	Not Used	0	2	Not Used	Not Used	2	Suct SpH	7	
8	0	Not Used	Not Used	Not Used	0	3	Not Used	Not Used	3	Suct SpH	8	

Columns and Rows that are Yellowed Out will not be used.

10.8.4 Modbus Fault Sensors

If using a MCS-MODBUS I/O to connect a slave to the MCS-MAGNUM for reading register alarms you need to setup the 'Sensor Input Information' '**CIRCUIT INDEX**' column to point to the circuit number the Modbus fault sensor belongs to.

The MCS-Magnum supports several special Modbus fault sensor types for reading multiple alarms from one Modbus register. The following are Modbus Fault sensor types:

1. DBCENT1
2. DBCENT2
3. DBCENT3
4. DanFltHi
5. DanFltLo
6. DanFlt2Hi
7. DanFlt2Lo
8. DWarHi
9. DWarLo
10. DWar2Hi
11. DWar2Lo
12. BitFltHi
13. BitFltLo
14. RKNG F1
15. RKNG F2
16. RKNG F3
17. RKNG F4
18. TurboCorFault

See below example of a two comp turbocor config:

#	Name (1 to 10 char)	Display Type	Offset	Manual Value or NC/NO (select to change)	Display Text (select to change)	Temp. / GPM / CFM / Pwr Factor SI	Humd./PSI/ Temp. Diff. / Enthal. Diff.	Auto/Manual (Click here for all)	Circuit Index	Multiplier
1-1	CMP FAULTA	TurboCorFault	Not Used	Open=OFF	OK/TRIP	Not Used	Not Used	Auto	1	Not Used
1-2	Ctrl ModeA	MODBUS	Not Used	0	Not Used	Not Used	Not Used	Auto	Not Used	1
1-3	IGV OPN%A	MODBUS	0	0	Not Used	Not Used	Not Used	Auto	Not Used	1
1-4	TC_SciPSIA	MODBUS	1	0	Not Used	Not Used	Not Used	Auto	Not Used	1
1-5	TC_DisPSIA	MODBUS	0	0	Not Used	Not Used	Not Used	Auto	Not Used	1
1-6	CavityTmpA	MODBUS	0	0	Not Used	Not Used	Not Used	Auto	Not Used	1
1-7	InvertTmpA	MODBUS	0	0	Not Used	Not Used	Not Used	Auto	Not Used	1
1-8	ChokSpeedA	MODBUS	0	0	Not Used	Not Used	Not Used	Auto	Not Used	1
1-9	SurgSpeedA	MODBUS	0	0	Not Used	Not Used	Not Used	Auto	Not Used	1
1-10	ActSpeedA	MODBUS	0	0	Not Used	Not Used	Not Used	Auto	Not Used	1
1-11	CompSIRatA	MODBUS	0	0	Not Used	Not Used	Not Used	Auto	Not Used	1
1-12	3PhaseCurA	MODBUS	0	0	Not Used	Not Used	Not Used	Auto	Not Used	1
1-13	M IGV1STPA	MODBUS	Not Used	0	Not Used	Not Used	Not Used	Auto	Not Used	1
1-14	SuperHeatA	User Logic	0	0	Not Used	Not Used	Not Used	Auto	Not Used	Not Used
1-15	SubcoolA	User Logic	0	0	Not Used	Not Used	Not Used	Auto	Not Used	Not Used
1-16	Superh A2	User Logic	0	0	Not Used	Not Used	Not Used	Auto	Not Used	Not Used
2-1	CMP FAULTB	TurboCorFault	Not Used	Open=OFF	OK/TRIP	Not Used	Not Used	Auto	2	Not Used
2-2	Ctrl ModeB	MODBUS	Not Used	0	Not Used	Not Used	Not Used	Auto	Not Used	1

10.9. Relay Output Information Screen setup

# w/ HELP Button	Name	Slide Multiple	Slide Division	Slide Offset	Design Suction Pressure	Design Disc Pressure	Nominal Tonnage(of Step)	EXV Start (when lead)	Type	EXV ON Adjust %	EXV OFF Adj	Circuit
M-1	COMP	99	10	2	70	340			Screw NO EXV			1
M-2	LOAD								Standard			
M-3	UNLOAD								Standard			
M-4	SRT UNLD								Standard			
M-5	LLS								Standard			
M-6	HotGasByps								Standard			
M-7	LIQ INJ								User Logic			
M-8	SPAREM-8								Standard			
M-9	WARNING								Standard			
M10	ALARM								Standard			
1-1	CND FAN 1								Standard			

This screen relates to the above example. The compressor is a variable capacity compressor; therefore, the slide information must be provided, this is used in calculating the amp draw of the compressor. Note the 'Type' column, for COMP, the first compressor point, Screw NO EXV was selected from the drop down menu.

This screen is an example of a variable capacity, screw, and compressor with EXV valves. Note the Type column selection. The EXV data must be provided.

# w/ HELP Button	Name	Slide Multiple	Slide Division	Slide Offset	Design Suction Pressure	Design Disc Pressure	Nominal Tonnage(of Step)	EXV Start (when lead)	Type	EXV ON Adjust %	EXV OFF Adj
M-1	COMP 1	70	10	20	37	257	0	15	Screw w\ EXV		
M-2	LOAD 1								Standard		
M-3	UNLOAD 1								Standard		
M-4	LLS 1								Standard		

This information can be viewed and changed, with proper authorization, from MCS Connect. By double clicking on the name field the following will be displayed.

COMP 1

FLA Calc. Constants

Name	Range	Value
Slide Multiply	-32,768 to 32,767	<input type="text" value="82"/>
Slide Divide	-32,768 to 32,767	<input type="text" value="10"/>
Slide Offset	-3,276.8 to 3,276.7	<input type="text" value="30"/>
Design Suct. PSI	-3,276.8 to 3,276.7	<input type="text" value="70"/>
Design Disch. PSI	-3,276.8 to 3,276.7	<input type="text" value="340"/>
Nom. Tonnage(of Step)	-3,276.8 to 3,276.7	<input type="text" value="0"/>
EXV Start(when lead)	-3,276.8 to 3,276.7	<input type="text" value="12"/>
EXV ON Adjust	-32,768 to 32,767	<input type="text" value="1"/>
EXV OFF Adjust	-32,768 to 32,767	<input type="text" value="1"/>

10.10. Special Pattern for Scroll Compressors

Special patterns have been developed for Trane Scroll 3-D compressors. CENT 14.0 software and newer is required for this function. These patterns are for either a 3 or 4 scroll unit. They are specified by selecting either the Trane Trio or Trane Quad package in the Compressor Type selection under the MAGNUM screen. The sequencing will provide proper oil control for the Trane compressors.

The compressors set will be treated as one compressor. There will be one common suction pressure, suction temperature, discharge pressure, and discharge temperature sensor for the package. Each compressor will have an individual amperage sensor. These must be consecutive inputs.

Chiller states have been allocated for these patterns: "SCROLL STEP 1" through "SCROLL STEP 4".

10.10.1 The following is a sample of the four-compressor setup:

Select compressor type:

Compressor Type
Trane Quad

of Compressors and # of steps:

of Circuits: 1 # of Steps: 4

Set up compressor:

MAGNUM Circuit Base Screen																	
Information that relates to compressors on the circuit																	
Circuit # (reset button)	# of Comp ROs	Starting Compressor RO	Part Winding	Start Unload Bypass	Fast Unloader	Type of LLS	2nd LLS	3rd LLS	3rd LLS Control	Unloading Stages	Loader Type	HGB	HG Reheat	Liquid Injection	Oil Equalize	Mod Motor Control	Low Disc Super-Heat
1	5	COMP A	No	No	No	EXV&LLS	No	No	Last Step	3	Loader	None	No	No	No	No	No

Set up Relay Outputs:

Relay Output Information Screen (Magnum)											
# w/ HELP Button	Name	Slide Multiple	Slide Division	Slide Offset	Design Suction PSI	Design Disc PSI	Nominal Tonnage(of Step)	EXV Start (when lead)	EXV off Adj % Diff	Type	
M-1	CND FAN	---	---	---	---	---	---	---	---	Standard	
M-2	SYS PUMP	---	---	---	---	---	---	---	---	Standard	
M-3	COMP A	---	---	---	---	---	15	12	---	Step w\ EXV	
M-4	EEVENABL	---	---	---	---	---	---	---	---	Standard	
M-5	COMP B	---	---	---	---	---	15	12	---	Step w\ EXV	
M-6	COMP C	---	---	---	---	---	15	12	---	Step w\ EXV	
M-7	SpareM-7	---	---	---	---	---	15	12	---	Step w\ EXV	
M-8	SpareM-8	---	---	---	---	---	---	---	---	Standard	
M-9	SpareM-9	---	---	---	---	---	---	---	---	Standard	
M10	AI ARM	---	---	---	---	---	---	---	---	Standard	

10.10.2 Pattern of the four-compressor setup:

Staging sequence

Staging sequence				
	COMP A	COMP B	COMP C	COMP D
Stage 1	ON	OFF	OFF	OFF
Stage 2	OFF	OFF	ON	ON
Stage 3	OFF	ON	ON	ON
Stage 4	ON	ON	ON	ON

10.10.3 The three-compressor type will be setup as follows:

Select the compressor:

Compressor Information

Compressor Type: Trane Trio

Lube State Oil Setpoint: Sat. Suct Offset Actual Temp Value

Unload Running Compressor(s) Before Turning Off A Compressor?: Yes No

of Compressors and # of steps:

General Information

# of Compressors 2	# of Steps 2	Unit Indicators Warning Relay WARNING	Unit Control Run/Stop Switch RUN/STOP	Unit Power Phase Loss PHASELOSS	Unit Sensors Smoke Alarm Indicator SmokeAlarm
-----------------------	-----------------	--	--	--	--

Set up compressor:

MAGNUM Circuit Base Screen

Information that relates to compressors on the circuit

Circuit# (reset button)	# of Comp R/Os	Starting Compressor R/O	Part Winding	Start Unload Bypass	Fast Unloader	Type of LLS	2nd LLS	Comp. Economizer (Subcooler)	Econo Control	Unloading Stages	Loader Type	HGB	HG Reheat	Liquid Injection	Oil Equalization	Mod Motor Control	Low Disc SuperHeat	External Oil Pump Control	External Oil Heater Control	Liquid Injection ON during Fast Unloading	
1	3	COMP1	No	No	No	EXV only	No	No	Slide %	0	Unloader	None	No	1 Stage	No	No	No	No	No	No	Yes
2	3	COMP2	No	No	No	EXV only	No	No	Slide %	0	Unloader	None	No	1 Stage	No	No	No	No	No	No	Yes

Set up Relay Outputs:

Relay Output Information Screen (Magnum)

# w/ HELP Button	Name	Slide Multiple	Slide Division	Slide Offset	Design Suction PSI	Design Disc PSI	Nominal Tonnage(of Step)	EXV Start (when lead)	EXV off Adj % Diff	Type
M-1	CND FAN	---	---	---	---	---	---	---	---	Standard
M-2	SYS PUMP	---	---	---	---	---	---	---	---	Standard
M-3	COMP A	---	---	---	---	---	15	12	---	Step w\ EXV
M-4	EEVENABL	---	---	---	---	---	---	---	---	Standard
M-5	COMP B	---	---	---	---	---	15	12	---	Step w\ EXV
M-6	COMP C	---	---	---	---	---	15	12	---	Step w\ EXV
M-7	SpareM-7	---	---	---	---	---	15	12	---	Step w\ EXV
M-8	SpareM-8	---	---	---	---	---	---	---	---	Standard
M-9	SpareM-9	---	---	---	---	---	---	---	---	Standard
M10	AI ARM	---	---	---	---	---	---	---	---	Standard

10.10.4 Pattern of the three-compressor setup:

Staging sequence			
	COMP A	COMP B	COMP C
Stage 1	OFF	OFF	ON
Stage 2	ON	ON	OFF
Stage 3	ON	ON	ON
Stage 4	ON	ON	ON

10.10.5 Safeties are the same for both compressor types

The standard unloading and holding logic has been incorporated with their compressor state names. When a step is unloaded it will go to the previous step pattern. For example if the compressor is in SCROLL STEP 3 and unloading is required the Relay Output for SCROLL STEP 2 will be used. The state name will reflect why the compressor has unloaded.

The unloading and holding can result from high discharge and low suction pressure and high discharge temperature.

Low and high amp drawn will be check for all compressors that are on. The standard amp safety checks will be made and if one occurs the compressor will be off on a safety or a lock out if the same safety reoccurs.

Note, the standard Setpoints are used for all safety checks, unloading, and holding functions.

10.11. Compressor Auto Rotation

The auto rotation option is selected by setting the value in set point #103, LEAD COMP to zero. If this value is not zero, it will contain the number of the lead circuit (compressor) and auto rotation is disabled. Note this setpoint can be manually changed to force a different compressor as the lead compressor or to enable auto rotation.

When this option is enabled, the system will rotate the compressors based upon the value in set point #104.

Setpoint Information Screen													
#	Name	Value	Min	Max	Adjust Value	Time (SEC)	Max Time Allowed (SEC)	Lockout Delay (HRS)	Safety Down Time(MIN)	Active or Non-Active	Select Value: # decimals & print char	Level Of Auth. To Display	Type of Setpoint
103	LEAD COMP	0	0	2	1	1	1	0	0	Active	... DIGITAL / SM	Superviso	Setpoint
104	CMP ROTATION	0	0	30	1	0	0	0	0	Active	... DAYS	Superviso	Setpoint

CMP ROTATION.

If the value set point #104 is zero, rotation will occur with every complete capacity cycle and the next compressor will be selected as the lead compressor.

103	LEAD COMP	If type is Setpoint: Enables the user to specify the lead compressor. The value of this Setpoint will indicate the lead compressor. If zero, then auto rotation is enabled. 'Time (sec)' field: If non-zero, the compressor with the least amount of run time will become the lead upon rotation. If type is Target and the value is 0: Indicates that special rotation for dual barrel systems will be used. Refer to section on Custom Rotation.
104	COMP ROTATION	Specifies the number of days between rotations (Setpoint #103 must be set to zero to enable auto rotation). If zero, then rotation will occur with every cycle.

If Setpoint # 104 is nonzero, the value is the number of days between rotations. At midnight the Magnum will check if it is time to rotate compressors. If yes, the Magnum will check the run hours on each compressor and select the one with the least amount of run hours to be the lead compressor.

If Setpoint #104 is set up as an ALARM Setpoint type, a compressor rotation message will be generated each time a compressor is rotated.

Else, the value is the number of days between rotations. At midnight the system will check if it is time to rotate compressors. If yes, the system will check the run hours on each compressor and select the one with the least amount of run hours to be the lead compressor.

If set point #103 is set up as an ALARM type of set point, a compressor rotation message will be generated each time a compressor is rotated.

10.12. Expanded Compressor Rotation to Check for Maximum Run Time

In the Compressor Information panel of the Magnum HVAC screen in MCS-Config, there is a check box to select how compressors are to be rotated, based either on Run Time or First On/First Off.

Rotation Control

Run Time
 First On / First Off

10.13. Run Hour Lockout

In MCS CONFIG, in the Setup screen, select the option Run Hour Lockout Required. If enabled, then enter the number compressor run hours that must pass before the run hour lockout is triggered.

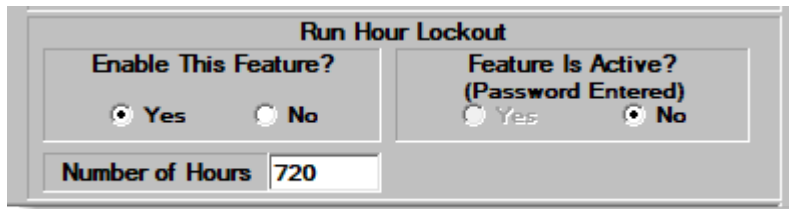

Run Hour Lockout- At midnight if any compressor has reached a set number of run hours, the unit will be disabled until an authorized service call is performed.

Function 2: (Compressor lockout based on run time hours)

If this option has been enabled, at midnight if any single compressor exceeds the number of run hours specified, the system will disable all compressors (circuits) and change the unit state to MAXIMUM RUN TIME. This test will only be made a midnight when new day logic is being executed. In this state the Magnum will not enable normal operations and the only screen that will be available is the Passwords. If the Magnum is reset the chiller state will be MAXIMUM RUN TIME not UNIT IN POWER UP. Once the system state is MAXIMUM RUN TIME the system can be accessed from MCS-Connect but the system will not accept changes to the Relay Output states.

10.14. Custom Rotation

The requirement is to enable rotation only in the first barrel and do not turn ON any compressors associated with the second barrel until all compressors are ON in the first barrel. When decreasing refrigerant capacity, if any compressors in the second barrel are ON, they must first be turned OFF before turning OFF any compressors in the first barrel. Only first ON and first OFF lead rotation strategy can be used.

To activate this option Setpoint #103 "LEAD COMP" must be set up as follows:

Value:	0 (indicates auto rotation, must be 0)
Time (SEC):	0 (indicates first on first off, must be 0)
Select Value:	DIGITAL/SW
Type of Setpoint:	Target (must be Target type)
High Zone:	1 (this is the starting compressor following a reset; usually 1)
Low Zone:	1 (number to rotate, will default to 1)
Night Setback:	8 (number of compressors in the first barrel)

If the Value, Time, and Type cells are not set as indicated, normal rotation using Setpoints #103 "LEAD COMP" and #104 "COMP ROTATION" will be used.

The following examples have 16 compressors, dual barrels with 8 compressors in each. Barrel 1 has compressors 1 through 8 and 9 through 16 are in barrel 2. The wanted/actual ON will function as usual only the rotation and the sequence of turning on the compressors have been changed.

Example 1: Compressor 1 is the lead capacity calls for 4 circuits to be ON (wanted 4/ actual 4), then reduced to 0/0.

Compressors 1, 2, and 3, then 4 will be turned ON. As capacity is reduced, Compressor 1 will be turned OFF and the lead will be rotated to Compressor 2. Then Compressors 2, 3, and 4 will be turned OFF with the lead ending with Compressor 5.

Example 2: Compressor 5 is now the lead and capacity calls for 6 compressors to be ON (6/6) then reduce to 0/0.

Compressors 5, 6, 7, and 8, then 1 and 2 will be turned ON (6/6). As capacity is reduced, Compressors 5, 6, 7, and 8, then 1 and 2 will be turned OFF (0/0) and Compressor 3 will be the lead. Note, compressors in barrel 2 were not turned ON.

Example 3: Compressor 3 is now the lead and capacity calls for 12 compressors to be ON (12/12) then reduce to 0/0.

Compressors 3, 4, 5, 6, 7, and 8, then 1 and 2 will be turned ON (8/8). At this point all compressors in barrel 1 are ON, as more capacity is needed Compressors 9 through 16 will be used. Compressors 9, 10, 11, and 12 will be turned ON to reach 12/12. As capacity is reduced, Compressors 9 then 10, 11, and 12 will be turned OFF (8/8) at this point. Now, all compressors in barrel 2 are OFF and all compressors in barrel 1 can now be turned OFF if less capacity is needed. Compressor 3 followed by 4, 5, 6, 7, 8, and 1 then 2 will be turned OFF (0/0). At this point Compressor 3 is the lead compressor.

10.15. Compressor Anti-Cycle Logic

When a compressor is to be turned off, the Magnum software will make a calculation to determine the amount of time that the compressor will remain in an anti-cycle state. This calculation is based upon how long the compressor has been on and Setpoints #59 “ACYC OFF->ON” and #63 “ACYC ON->ON”.

If the value of Setpoint #63 minus the amount of time that the compressor has been on is greater than the value in Setpoint #59, the compressor will remain in the anti-cycle state for the period of time specified in Setpoint #63. Else the anti-cycle timer will be set to the value in Setpoint #59.

For example:

#59 (ANTI-CYC OFF) = 300 seconds

#63 (ANTI-CYC ON) = 600 seconds

If the compressor had been running for 3 minutes (180 seconds)

600 – 180 = 420 this is greater than Setpoint #59; therefore, the anti-cycle timer will be set to 600 seconds, the value of Setpoint #63.

If the compressor had been running for 12 minutes (720 seconds)

600 – 720 = -120 this is less than Setpoint #59; therefore, the anti-cycle timer will be set to 300 seconds, the value of Setpoint #59.

If the controller loses power, the length of time that the system was down will be taken into consideration when determining whether the compressor should be in an anti-cycle state and for how long.

10.16. Part Wind and Star Delta Starters

Both Part Winding and Star Delta starter types are supported by the Magnum software. This option is specified in the ‘Part Winding’ cell of the Circuit Base screen in MCS-Config and will require two successive Relay Output points. When this option is selected, make Setpoint #73 “STARTER DLAY” active. This Setpoint contains the delay in seconds or transition percentage before the second Relay Output is turned on. This delay is normally 1 second for part winding or 5 seconds for a star delta starter. If using the transition percentage option, after initial startup amp spike, the amps must fall below this percentage of the FLA for the second step to be turned on.

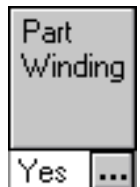

73	STARTER DLAY	<p>This Setpoint controls the start of a compressor’s second relay.</p> <p>If the ‘Select Value: # decimals & print char’ cell is set to ‘HUMD or %’ then logic is: If First Compressor Relay has been on longer than 2 seconds and the FLA% goes below the value of this setpoint or is still above the value but reaches the time value in the safety time field than turn on the second relay. (If the low zone field is zero use the hardcoded 2 seconds delay at start. If greater than zero use that value).</p> <p>Setpoint Information Screen, if the ‘Select Value: # decimals & print char’ cell is set to ‘Seconds’ then the Setpoints value is a time delay between the first and second relay’s start. Used for part wind (typical value of 1) and star delta (typical value of 5) starter.</p>
----	--------------	--

10.17. Full Load Amp (FLA) calculation and slide positioning

For variable capacity compressors the Magnum will calculate a FLA for each compressor and it will be stored in the FLA Setpoints (#171 to #190) for compressors 1 through 20 with every pass of the algorithm. The calculated FLA value will be displayed when viewing the respective compressor Setpoint through the Keypad/Display or MCS-Connect. The calculation is based upon the slide multiplier, divisor and offset values and then adjusted for the difference between the actual and design pressures for suction and discharge. This calculation is then used to determine the slide position by taking the actual amp draw divided the calculated FLA value. The load and unload solenoids will be used to match the compressor slide position with the wanted FLA.

If a FLA Setpoint is changed from MCS Connect both the original and calculated values are displayed in the following screen:

10.18. Chiller Barrel Heater

If a Chiller Barrel Heater is specified, it will be controlled based upon ambient temperature and Setpoint #134 "BARREL HEATER".

10.19. Hot Gas Bypass

Control of the Hot Gas Bypass function will depend on which Setpoints are made active/inactive. Refer to Setpoints #4-#7.

- **Setpoints #4-#7 INACTIVE**—If Setpoints #4-#7 are all inactive, then the HGB is enabled when the machine is unloaded to within 25% of the minimum slide percentage. The HGB is disabled when the machine rises above 30% of the minimum slide percentage. (These are just default values that can be overridden in the "Time(sec)" fields of Setpoints #4 and #5. The "Time(sec)" field of Setpoint #4 contains the minimum slide percentage offset to enable the HGB; the "Time(sec)" field of Setpoint #5 contains the minimum slide percentage offset to disable the HGB. For example, if Setpoint #4 "Time(sec)" field has a value of 10 and Setpoint #5's is 15, then the HGB will enable when the compressors FLA% is within 10% of Setpoint #31 "MIN FLA%" and will disable when FLA% goes above 15%.)

- **Only Setpoints #4-#5 ACTIVE**—The HGB is on when the machine is unloaded and the leaving liquid goes below the Cut In (Setpoint #4 "HGS TEMP ON"). HGB is turned off when the leaving liquid temperature goes above the Cut Out (Setpoint #5 "HGS TEMP OFF") or the machine leaves the unloaded state.

- **Only Setpoints #6-#7 ACTIVE**—The HGB is on when the machine is unloaded and the suction pressure goes below the Cut In (Setpoint #6 "HGS PSI ON"). HGB is turned off when the suction pressure goes above the Cut Out (Setpoint #7 "HGS PSI OFF") or the machine leaves the unloaded state.

- **Setpoints #4-#7 ACTIVE**—If both groups of Setpoints are active, then the HGB is on when the machine is unloaded and either the leaving liquid temperature or the suction pressure goes below the respective Cut In limit. The HGB goes off when the machine leaves the unloaded state or both the leaving liquid temperature and the suction pressure goes above the respective Cut Out limits.

10.20. Chilled Water Reset

Chilled Water Reset (CWR) is a 0 to 5 volts dc Sensor Input (Display Type is TRGTRST) to the MCS micro-processor. The CWR follows the following rules using Setpoint #21 "MAX TRG RESET":

1. If the input is 2.5 volts dc the CWR is zero.
2. At 0 vdc the CWR is a negative value equal to the Setpoint value.
3. At 5 vdc the CWR is a positive value equal to the value in the Setpoint.
4. For values in between 0 – 2.5 and 2.5 – 5.0 the CWR is a plus or minus value which is proportional to the Sensor Input voltage.

10.21. Turbocor Chillers - New Options:

10.21.1 Balancing Valve Control :

Turbocor Settings->Load Balance Valve

Load Bal
▼

Staging Valve AO	Startup RPM
Not Used	Not Used
Not Used	Not Used
Not Used	Not Used
Not Used	Not Used

Startup (This is the same as existing logic)

- i. Open valve to 100% when starting any compressor
- ii. Keep valve open until the comp's pressure ratio drops below STP value.

10.21.2 Stage valve control:

Turbocor Settings->Load Balance Valve

Not Used
▼

Staging Valve AO	Startup RPM
Stag BAL	StartRpm
Not Used	Not Used
Not Used	Not Used
Not Used	Not Used

Startup:

- i. Open Stage valve to 100%
- ii. Write StartSpeed(RPM)over Modbus register 42039

(Need Custom MCS-Modbus-IO CFG file) 2 AOs per CMP

...
2-1	...	DEMAND%	Modbus	NO	...
2-2	...	StartRpm	Modbus	NO	...

If lead CMP use default starting speed from the cfg or Highest Actual speed from running compressors

Relay Output Information Screen				
EXV Load Adjust %	EXV Unld Adjust %	Comments	Starting Speed(RPM)	
—	—		... 10000	

- iii. Stay in the startup routine (Holding State) until the actual RPMs are greater than 0 and the Turbocor control state reads 0x0080 (RampingUp)
- iv. Close Stage valve

Shutdown

- i. Open Stage valve to 100%
- ii. Keep valve open until actual RPMs are equal to 0

Chapter - 11. Oil Control Options

11.1. Oil Equalization Option

Oil equalization occurs with common suction/discharge systems. This feature allows for oil to equalize between compressors by opening a solenoid valve. The oil equalization occurs at compressor startup. Refer to section for Relay Output order and options. If this feature is specified in the Circuit Base screen, the micro will energize the Oil Equalization solenoid valve for 1 minute at compressor startup.

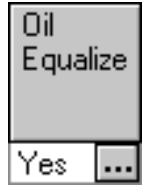

11.2. Liquid Injection Option

This option is specified in the Circuit Base screen:

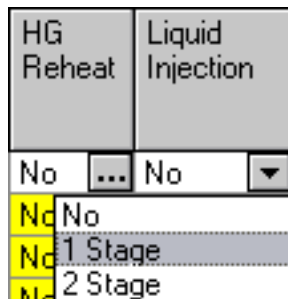

In the Liquid Injection column there is a dropdown menu for each compressor, giving options of No Liquid Injection, 1 Stage, or 2 Stage. If 2 Stage option is selected, the second stage relay must follow the list of available options, it may not necessarily follow the first stage relay. Refer to section for Relay Output order and options.

The first stage will be turned on if either the discharge temperature is greater than Setpoint #8 or suction pressure is less than Setpoint #80 plus 5 psi (.5 Bar). If 2 Stage, the second relay will be turned on if the discharge temperature is greater than Setpoint #8 plus 5.0° F (2.5° C) and the first relay has been on for a time greater that the 'Time (sec)' field of this Setpoint. If the Slide Multiplier cell of the Relay Output for the first stage of liquid injection is non-zero, then this relay will be turned on during the fast unload logic.

11.3. Oil Cooler Option

The oil cooler option can be enabled for compressors with oil. This feature requires an oil seal temperature sensor, a Relay Output to energize the oil cooler, and Setpoint #145 "OIL COOLER ON" to be active. If the oil seal temperature is above Setpoint #145 for longer than the time specified, the oil cooler is energized until the temperature is 5° F below the Setpoint value. Refer to section for Relay Output order and options.

11.4. Oil Pump Control Option

The Magnum supports 3 different types of oil pump control. This option is selected in in the 'Control of Oil Pump' box in the 'Compressor Information' panel under the MAGNUM screen.

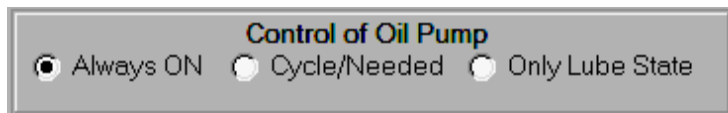

- **OIL PUMP ALWAYS ON** – The oil pump will start before the compressor to build up oil pressure and will always be on when the associated compressor is on. If the oil pressure drops below Setpoint #74 "OIL PUMP OFF", then shut down the associated compressor and generate a LOW DIFFERENTIAL alarm. The oil pump will continue running after the compressor is turned off regardless of the reason, for the time specified in Setpoint #62 "PUMP DOWN DELAY".
- **OIL PUMP CYCLES AS NEEDED** – After the compressor has been running for 2 minutes and when the differential pressure (discharge pressure minus suction pressure) is greater than Setpoint #74 "OIL PUMP OFF", then the oil pump will be turned off. If the differential pressure drops 10 PSI below the value of Setpoint #74, then the oil pump will be turned on again.

- **OIL PUMP LUBE ONLY** – After the compressor has been running for 2 minutes and when the differential pressure (discharge pressure minus the suction pressure) is greater than Setpoint #74 "OIL PUMP OFF", then the oil pump will be turned off. If the differential pressure has not reached Setpoint #74 after 5 minutes, then shut down the associated compressor and generate a LOW DIFFERENTIAL alarm. If the differential pressure has been reached and the oil pump turned off, then if the differential pressure drops 5 psi below the value of Setpoint #74, shut down the associated compressor and generate a LOW DIFFERENTIAL alarm.

11.5. Oil Differential Calculation

For chillers with external oil pumps: Oil Differential = Oil Pressure–Discharge Pressure

For all others: Oil Differential = Oil Pressure–Suction Pressure

If an oil pressure sensor is not available, then discharge pressure can be used in place of it. This is set up in the Circuit SI screen of MCS-Config by selecting the discharge pressure sensor in the oil pressure sensor's column.

11.6. On/Off Switches

The following digital inputs can affect the entire package or individual circuits:

- Flow switch – If OFF the system has no flow. The system will Lockout (if Setpoint #105 is active), or shut down (if Setpoint #105 is inactive).
- Pump down – If ON and the compressor is off, the compressor will not be allowed to start. If the compressor is on, the system moves to the Pump Down state to begin turning off the compressor(s) in normal steps.
- Run/Stop – If OFF the system will not run. If the system is running, the system turns all compressors off in normal steps (If a RUN/STOP and a Network RUN/STOP are both available they operate in series).
- Network Run/Stop – If OFF the system will not run. This input is provided by another system on the network. It functions in the same matter as the Run/Stop switch.
- Emergency Stop – If ON the system will be shut down immediately and will remain disabled until the switch is OFF.

11.7. MCS-Magnum Oil Recovery Logic Tandem Variable Speed & Fix Speed Scroll comps.

MCS-Magnum Firmware: HVAC 17.34B or greater is required

MCS-Connect version: 18.20.08 Beta or greater is required

MCS-Config version: 18.01G1 or greater is required

Config File Example: test only - 2 comp 1 circuit vs & fs_rev_01.cfg

11.7.1 Purpose:

The purpose of the oil recovery logic is to return oil to the variable speed scroll compressor on a tandem refrigeration circuit where there is one variable speed compressor and one fix speed compressor. This logic only works for above compressor setup. No other compressor arrangement is supported, ie. screw compressors, reciprocating compressors, or more than 2 scroll compressors (trios, quads), etc.

If the variable speed compressor runs at low speed for a long period of time it possible the oil in the compressor sump will become too low. Too low of oil condition is indicated by the oil level switch in the variable speed compressor's oil sump. When the variable speed compressor is running and the oil level switch indicates a low condition the MCS-Magnum will enter into the oil recovery logic to collect the oil back into the variable speed oil sump and avoid tripping the compressor on low oil level.

11.7.2 Requirements:

1. Tandem Scroll Compressors, one variable speed and the other fix speed.
2. Variable speed compressor must have an oil sump level switch.
3. MCS-Magnum Config must be setup as follows:

- a. The special oil recovery logic must be disabled – start relay field “Not USED” and # of recovery devices “0”.

Magnum HVAC Information Screen

Information Panel Selector

General Info
 Compressor Info
 Evaporator Info
 Condenser Info
 Lockout Info
 Boiler Info
 CPM Info

Compressor Information

Compressor Type
Scroll or VFD Comp

Lube State Oil Setpoint
 Sat. Suct Offset
 Actual Temp Value

Unload Running Compressor(s) Before Turning Off A Compressor?
 Yes
 No

Keep Running Comp at 100% when starting next?
 Yes
 No

Oil Heater Control Setpoint
 Sat. Suct Offset
 Actual Temp Value

Oil Recovery

Starting Relay: Not Used

of Recovery Devices: 0

Pre-Pump Out
 Yes
 No

Wanted FLA-starting next Compressor
 Calculated FLA
 Use Min FLA-(S/pt #31)

Fast Unload Delay (30-120)
30 Seconds

Unload Compressor before Starting Next (0-120)
0 Seconds

Control of Oil Pump
 Always ON
 Cycle/Needed
 Only Lube State

Rotation Control
 Run Time
 First On / First Off

Last Stage to 100% (Override Setpoint)
 Yes
 No

Minimum Delay Between Compressor Starts (0-300)
0 Seconds

Compressor Economizer Control (3rd LLS)
 FLA%
 Speed(AO)

Slide Position Indicator
 Slide Control
 Compressor FLA%

- b. Setpoints #218 to #222 must be setup.

Setpoint Information Screen

#	Name	Value	Min	Max	Adjust Value	Time (SEC)	Max Time Allowed (SEC)	Lockout Delay (HRS)	Safety Down Time(MIN)	Active or Non-Active	Select Value: # decimals & print char	Level Of Auth. To Display	Type of Setpoint
217	LubIn OnDis	180	170	190	1	0	0	0	0	Non-Active	TEMP	View Only	Setpoint
218	OilRecSpeed	100	50	100	1	5	15	0	0	Active	HUMD or %	View Only	Delay
219	OilRecMaxBal	30	10	240	5	0	0	2	10	Active	SECONDS	View Only	Alarm
220	ToManyOilBal	1	1	20	1	0	0	2	10	Active	MINUTES	View Only	Alarm
221	OilRecMaxBst	2	1	20	10	0	0	2	10	Active	MINUTES	View Only	Alarm
222	ToManyOilBst	45	1	120	10	0	0	2	10	Active	MINUTES	View Only	Lockout

- c. Variable Speed Compressor must be configured with Oil Level Switch sensor input.

MAGNUM Circuit SI Screen

Circuit # (reset button)	Suction Pressure	Discharge Pressure	Suction Temperature	Discharge Temperature	Oil Pressure	Oil Temp	Motor Temp	Oil Flow Switch	Liquid Temp	Liquid Pressure
1	SUCT PSI A	DISC PSI A	Not Used	Not Used	DISC PSI A	Not Used	MTR FLT 1A	Not Used	Not Used	Not Used
2	SUCT PSI B	DISC PSI B	Not Used	Not Used	DISC PSI B	Not Used	MTR FLT 3B	Not Used	Not Used	Not Used
3	SUCT PSI A	DISC PSI A	Not Used	Not Used	DISC PSI A	Not Used	MTR FLT 2A	Not Used	Not Used	Not Used
4	SUCT PSI B	DISC PSI B	Not Used	Not Used	DISC PSI B	Not Used	MTR FLT 4B	Not Used	Not Used	Not Used
5	Not Used	Not Used	Not Used	Not Used	Not Used	Not Used	Not Used	Not Used	Not Used	Not Used
6	Not Used	Not Used	Not Used	Not Used	Not Used	Not Used	Not Used	Not Used	Not Used	Not Used
7	Not Used	Not Used	Not Used	Not Used	Not Used	Not Used	Not Used	Not Used	Not Used	Not Used
8	Not Used	Not Used	Not Used	Not Used	Not Used	Not Used	Not Used	Not Used	Not Used	Not Used
9	Not Used	Not Used	Not Used	Not Used	Not Used	Not Used	Not Used	Not Used	Not Used	Not Used
10	Not Used	Not Used	Not Used	Not Used	Not Used	Not Used	Not Used	Not Used	Not Used	Not Used

Circuit # (reset button)	Oil Seal Temp	Pre Oil Filter	Oil Float	Leaving Temp	Refrigerant Temp	Refrig Level	Refrig. Leak Sensor	Vane Position	Evap Suct Temp	Evap Suct PSI
1	Not Used	Not Used	LowOil 1A	Not Used	Not Used	Not Used	Not Used	Not Used	Not Used	Not Used
2	Not Used	Not Used	LowOil 3B	Not Used	Not Used	Not Used	Not Used	Not Used	Not Used	Not Used

11.8. Primary/Secondary Tandem Scroll Option:

If Setpoint #218 TYPE field is setup as “DELAY”, then the Fix Speed compressor is only allowed to run if the variable speed compressor can run. If the speed compressor is locked out or disabled, the fix speed compressor will be force in the “VFD TANDEM OFF” state and not allowed to run. It is recommended to enable this option.

If setpoint #218 TYPE field is not a “DELAY” type, then the fixed speed compressor can run without the variable speed compressor.

11.8.1 Oil Recovery Logic:

The oil recovery logic has two modes, Balance and Boost.

11.8.2 Balance Mode:

In Balance mode the variable speed compressor speed is set to the value in setpoint #218 “OilRecSpeed” and the fix speed compressor stay off or is forced off. In this mode the variable speed compressor speed is increased to pull oil from the fixed speed compressor oil sump. The variable speed compressor state is set to “OIL REC SPD UP”. If the fixed compressor was running, it state is set to “OIL REC OFF”. If the fixed speed compressor is not running, it will stay in its current state.

The balance mode is entered when the oil level sensor input has tripped for X seconds. X is defined by the time field in setpoint #218. This indicate the level in the oil sump is low and we need to recovery the oil.

When entering the Balance mode, a check is performed to see if time since the last oil recovery action has been too short, indication an issue with the oil or system. If the time of Y (setpoint #222 value) since the boost mode occurred has not passed the compressors are locked out and the alarm “ToManyOilBst” (Too Many Oil Boost actions) is generated. If the time of X min (setpoint #220 value) since the last oil recovery balance mode occurred, the Balance mode is skip and logic goes right to the boost mode. If setpoint #220 is an alarm type, an alarm “ToManyOilBal” (Too Many Oil Balance Actions) is generated.

The balance mode is stopped when:

- a. The oil level sensor input reads OK indicating oil has been recovery to the sump and level is good or,
- b. Time delay specified in setpoint #219 “OilRecMaxBal” value field has been exceeded. If this condition occurs, the oil recovery logic goes to boost mode, or
- c. Run/Stop or flow, etc. wants the unit off, or
- d. Compressor safety trip occurs.

11.8.3 Boost Mode:

In Boost mode the variable speed compressor speed is set to the value in setpoint #218 “OilRecSpeed” and the fix speed compressor is forced on. In this mode both compressors are run to pull the oil back from the refrigeration circuit. Both compressor’s states are set to “OIL REC BOOST “.

The Boost mode is entered when the balance mode did not clear the low oil condition (balance mode max time delay excess before oil level sensor indicator good oil sump level).

The Boost Mode is stopped when:

- a. The oil level sensor input reads OK indicating oil has been recovery to the sump and level is good or,
- b. Time delay specified in setpoint #221 “OilRecMaxBst” value field has been exceeded. If this condition occurs, both compressors are locked out and an “OilRecMaxBst” alarm is generated, or
- c. Run/Stop or flow, etc. wants the unit off, or
- d. Compressor safety trip occurs.

11.9. Setpoint #139 Low Oil Level safety

With oil recovery logic active this setpoint will now be ignored IF a compressor with a VFD has an Oil level. The oil recovery logic will take over and control the compressor and lock it out if necessary.

If a compressor that is fixed speed (On/Off) with an oil level then setpoint #139 will be used to control the low oil level safety and ignore the oil recovery logic.

If all compressors in the config file are VFD compressors with oil levels and none of the fixed compressors have

oil levels than please make setpoint #139 inactive as it serves no purpose.

11.9.1 Setpoint Descriptions Only

#218 – OilRecSpeed – HUMD or % - If setup as “Delay type” Fixed compressor cannot run without the vfd tandem. If not setup as a delay type the fixed compressor will be able to run without the vfd compressor being available.

Value – Speed in % to move the compressor to during an oil balance/boost

Time – Amount of time to wait in seconds after oil level is tripped before entering balance/boost

#219 – OilRecMaxBal – SECONDS - Alarm Type

Value – Max time allowed in seconds to stay in balance mode before moving onto Boost mode

#220 – ToManyOilBal – MINUTES – Alarm Type

Value – If an oil balance occurs twice within this time frame an alarm will be posted and the balance mode will be skipped and will be sent straight to a boost mode.

#221 – OilRecMaxBst – MINUTES – Alarm Type

Value – Max time allowed in minutes to stay in the boost mode before locking out that circuit on an alarm.

#222 – ToManyOilBst – MINUTES – Alarm Type

Value – If an oil boost occurs twice within this time frame an alarm will be posted and the circuit will be locked out.

11.10. Low Suction Unloading and Holding

This option is activated when Setpoint #78 “LO SUCT UNLD” is active. When suction pressure is below the calculated value of Setpoint #77 “LOW SUCTION“ plus Setpoint #78 “LO SUCT UNLD” for the time specified in the ‘Time (sec)’ field, the Magnum will turn on the WARNING Relay Output if specified in MCS-Config and take the following action:

- For fixed step compressors: The Magnum will turn off one step of capacity of the compressor(s) with low suction until all steps except one are unloaded. The circuit state will be LO SUCT HOLD. The compressor will remain in this state until the capacity control indicates that another step is to be unloaded or if the suction pressure has returned to normal after the time in Setpoint #101 “SAFETY HOLD DELAY” has passed.
- For variable step compressors: The Magnum will begin unloading the compressor(s) with low suction until the suction pressure rises above the calculated value. During this time the circuit state is LO SUCT UNLOAD. Once this pressure has been reached, the circuit state will be LO SUCT HOLD. The compressor will remain in this state until the capacity control indicates that another step is to be unloaded or if the suction pressure has returned to normal after the time in Setpoint #101 “SAFETY HOLD DELAY” has passed.

Normal suction pressure is defined as any value greater than Setpoint #77 “LOW SUCTION” plus Setpoint #79 “LO SUCT RELD”. Refer to Setpoints #78 and #79 for additional information.

11.11. High Discharge Pressure Unloading and Holding

This option is activated when the Setpoint #82 “HI DISC UNLD” is active. When the discharge pressure is above the calculated value of Setpoint #81 “HI DISC PSI” minus Setpoint #82 “HI DISC UNLD” for the time specified in the ‘Time (sec)’ field, the Magnum will turn on the WARNING Relay Output if specified in MCS-Config and take the following action:

- For fixed step compressors: The Magnum will turn off one step of capacity of the compressor(s) with high discharge until all steps except one are unloaded. The circuit state will be HI DISC HOLD. The compressor will remain in this state until the capacity control indicates that another step is to be unloaded or if the discharge pressure has returned to normal after the time in Setpoint #101 “SAFETY HOLD DELAY” has passed.

- For variable step compressors: The Magnum will begin unloading the compressor(s) with high discharge until the discharge pressure drops below the calculated value. During this time the circuit state is HI DISC UNLOAD. Once this pressure has been reached, the circuit state will be HI DISC HOLD. The compressor will remain in this state until the capacity control indicates that another step is to be unloaded or if the discharge pressure has returned to normal after the time in Setpoint #101 "SAFETY HOLD DELAY" has passed.

Normal discharge pressure is defined as any value less than the calculated value of Setpoint #81 "HI DISC PSI" minus Setpoint #83 "HI DISC RELD" and greater than Setpoint #85 "LO DISC PSI". Refer to Setpoints #82 and #83 for additional information.

11.12. High Discharge Temperature Unloading and Holding

This option is activated when the Setpoint #88 "DISC TMP UNLD" is active. When the discharge temperature is above the calculated value of Setpoint #87 "HI DISC TMP" minus Setpoint #88 "DISC TMP UNLD" for the time specified in the 'Time (sec)' field, the Magnum will turn on the WARNING Relay Output if specified in MCS-Config and take the following action:

- For fixed step compressors: The Magnum will turn off one step of capacity of the compressor(s) with high discharge temperature until all steps except one are unloaded. The circuit state will be HI DISC HOLD. The compressor will remain in this state until the capacity control indicates that another step is to be unloaded or if the discharge temperature has returned to normal after the time in Setpoint #101 "SAFETY HOLD DELAY" has passed.
- For variable step compressors: The Magnum will begin unloading the compressor(s) with high discharge temperature until the temperature drops below the calculated value. During this time the circuit state is HI DISC UNLOAD. Once this temperature has been reached, the circuit state will be HI DISC HOLD. The compressor will remain in that state until the capacity control indicates that less capacity is needed or if the discharge temperature has returned to normal after the time in Setpoint #101 "SAFETY HOLD DELAY" has passed.

Normal pressure is defined as any value less than the calculated value of Setpoint #87 "HI DISC TMP" minus Setpoint #89 "HI DISC RELD". Refer to Setpoints #88 and #89 for additional information.

11.13. High Ampere Unloading and Holding

This option is activated when the Setpoint #75 "HI AMPS %" is active. Note: This option can only be active for fixed step compressors. When the amp draw is within one-half of the calculated HI AMP safety value, the Magnum will turn on the WARNING Relay Output if specified in MCS-Config and take the following action:

- For fixed step compressors: the Magnum will turn off one step of capacity associated with that compressor until that compressor is in an UNLOADED state that is all steps except one are unloaded. The circuit state will be HI AMP HOLD. The compressor will remain in that state until the capacity control indicates that another step is to be unloaded or if the amp draw has returned to normal after the time in Setpoint #101 "SAFETY HOLD DELAY" has passed.

11.14. Low Water Temperature Unloading and Holding

When the leaving liquid temperature is within 1.5° F (.8° C) of the freeze safety, the Magnum will turn on the WARNING Relay Output if specified in MCS-Config and take the following action:

- For fixed step compressors: The Magnum will turn off one step of capacity of the compressor(s) with low water temperature until all steps except one are unloaded. The circuit state will be LO TMP HOLD. The compressor will remain in that state until the capacity control indicates that another step is to be unloaded or if after 5 minutes the leaving liquid temperature has turned to normal.
- For variable step compressors: The Magnum will begin unloading the compressor(s) with low water temperature until the leaving liquid temperature rises above the calculated value. During this time the circuit state is LO TMP UNLOAD. Once the leaving liquid temperature rises above the calculated temperature the circuit state will change to LO TMP HOLD. The compressor will remain in that state until the capacity control indicates that less capacity is needed or if after 5 minutes the leaving liquid temperature has turned to normal.
- Turn Off All Running Compressors - Turn off all running compressors when the controlling sensor falls below setpoint #1 LOW ZONE column value. This feature is enabled if setpoint #1 TYPE column is set to "TARGET" type.

Normal leaving liquid temperature is defined as any value more than 3.0F (1.6C) above the freeze safety trip value.

11.15. Energy Efficient Compressor Staging

In a multi-screw system, it may be more efficient to run the screws at less than 100% capacity until all compressors have been turned on.

The following Setpoints are used to control the screw compressor staging:

- Setpoint #30 “MAX SLIDE %” contains the maximum slide percentage, based upon amp draw, before the system will bring on the next compressor.
- Setpoint #31 “MIN SLIDE %” contains the minimum slide percentage, based upon amp draw, before the system will reduce the number of compressors wanted on.

For example if “MAX SLIDE %” is 80% and the “MIN SLIDE %” is 40%, the two-screw compressor system would be ramped up as follows:

The Lead compressor will be started at 40% and increased up to 80%. If more capacity is needed the next compressor will be started at 40% and the first compressor decreased to 40%. The two compressors will then have their slide positions changed together. Since there are only two compressors, they will be ramped together up to 100% if required. If both compressors are at 40% and less capacity is needed, one compressor will be turned off and the other increased to 80%.

If running compressors at 100% is not desired, then the “Last Stage to 100% (Override Setpoint)” cell in the Compressor Information panel of the MAGNUM screen should be set to ‘No’. Then the maximum capacity allowed will be the value in Setpoint #30. If ‘Yes’, then all compressors will load to the value in Setpoint #30 until all compressors are on, then they will load to 100% together.

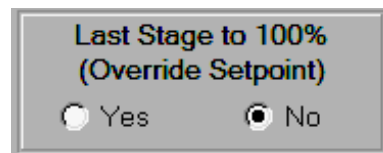

11.16. Chilled Water Pump Control

The current Magnum software will support a chilled water pump plus a backup with rotation logic. These must be set up in MCS-Config. **Setpoint #105** and **Setpoint #106** are used with this control logic.

- If **Setpoint #105** “PUMP FAILURE” is **active**, flow is lost for the period of time contained in the ‘Time (sec)’ field, and only one pump is present, then the system will move to a LOCKED OUT state. If the system has two pumps and flow is lost, then the backup pump will start and the lead pump will be locked out. A Lockout Reset will be required to restart the system or to reactive a locked out pump.
- If **Setpoint #105** is **inactive** and the flow is lost, the system will move to the OFF- NO EVAP FLOW state. When flow is returned the system will automatically restart, no reset is required.

Setpoint #106 “LEAD PUMP” indicates whether the rotation option is active or which pump is the lead pump.

- If **Setpoint #106** is zero, then rotation of the pumps will occur whenever the lead pump is turned off. If no rotation has occurred during the current day, a forced rotation at midnight will occur. This forces at least one rotation per day.
- If **Setpoint #106** is non-zero, then rotation of the pumps is inactive and the value will specify the lead pump. This Setpoint can be changed in a live unit and the appropriate action will be taken.

11.16.1 Special Rotation for Chiller Pump Rotation

This feature is designed to rotate the chiller pumps at midnight with a minimum disruption to the flow.

- **Setpoint #238** must be active and contain the following information:
Type: Delay Value: Not used Safety time: delay between states
- **Set point #106** must be active and contain the following information:
Type: Set point
Value: Number of days between rotation

At mid-night when rotation is required both chiller pumps will be on for the time in the safety time cell of set point #238. Once this time has elapsed, the current lead chiller pump will be turned off and the lead switched to the other chiller pump. Prior to rotation the system will verify that the next chiller pump is available. That chiller pump's status must be AUTO and if a fault is specified it must be off or the rotation will not be made. Rotation is only checked a midnight. If the lead pump fails; normal rotation will occur to the next chiller pump.

11.16.2 Special Rotation For Process Pumps Rotation.

This feature is designed to rotate the process pumps at mid night with a minimum disruption to the flow.

Set point #239 must be active and contain the following information:

- Select Value: HUMD or%
- Type: Delay
- Value: VFD setting of lead process pump during State 1
- Safety time: delay between states 3o
- MIN VFD Opening: setting of lead process pump during State 2 2.0
- MAX VFD Opening: setting of next process pump during State 2 5.;

Set point #197 must be active and contain the following information:

- Type: Set point
- Value: Number of days between rotation 0

At mid-night when rotation is required the lead process pump's VFD will be set to Value of set point #239, this is state 1, the next process pump is off. The process pumps will be in state 1 for the time in the safety time cell of set point #239.

Once this time has elapsed, the current lead process pump's VFD will be set to the value in MIN VFD of set point #239 and the next process pump will be turned on and its VFD will be set to the value in MAX VFD of set point #239, this is state 2. The process pumps will be in state 2 for the time in the safety time cell of set point #239.

Once this time has elapsed, the current lead process pump's VFD will be set to 0 and the process pump turned off. The lead will be switched to the next process pump and normal process pump control will continue.

Prior to rotation the system will verify that the next process pump is available. That process pump's status must be AUTO and if a fault is specified it must be off or the rotation will not be made. Rotation is only checked a midnight. If the lead process pump fails; normal rotation will occur.

11.17. Process Pump (Heat Exchanger) Control

The Magnum software can support either variable or fixed stages of heat exchangers with up to two process pumps with rotation and control based upon pressure or temperature. This option is specified in the Evaporator Information panel in the MAG screen.

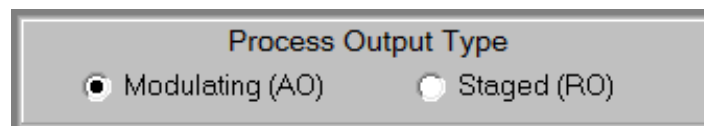

The pump information must be set up in the Evaporator Information Panel under the MAGNUM screen. The following information is required for each pump if used:

- Pump Relay Output
- Pump VFD Analog Output (if used)
- VFD fault (if used)
- Pressure Sensor Input (if used)
- Pressure sensor output (if used)
- Process temperature (if temperature control)

The following Setpoints are required:

- #146 "PROC TARGET"
- #147 "PROC ZONE"
- #148 "PROC DELAY"
- #149 "PROC MAX ROC"
- #150 "Proc MinSpd%"
- #197 "LEAD ProcPmp"
- #198 "PROC PUMP FLT"

See Section on Setpoints for descriptions.

The process pump is on whenever the chilled water pump is on.

11.18. Control Power Relay (No Stop)

This feature provides the capability to interrupt the power supply to the system when a particular compressor continues to draw a specified amperage level when it is called to be OFF. A Relay Output, referred to as the control relay, must be wired so that no power reaches the compressors when it is switched OFF. The Relay Output must be selected in the 'Control Relay' cell of the General Information panel of MCS-Config and Setpoint #112 "NO STOP" must be active. The Magnum will continually monitor the amp draw of compressors that are called to be OFF. If the amp draw is greater than the FLA for that compressor multiplied by the percentage in Setpoint #112 "NO STOP" for the time specified in the 'Time (sec)' field, then the control relay will turn OFF, a NO STOP alarm will be generated, and the system will be Locked Out.

11.19. Low and High Ambient Shutdown

The Magnum software supports both low and high ambient temperature shut downs. This option requires an ambient temperature sensor and one or both of Setpoints #24 "LOW AMB OFF" and #26 "HIGH AMB OFF". The AMBIENT OFF state is entered when the ambient temperature falls below the Setpoint #24 or above Setpoint #26. The system will remain in this state until the ambient temperature rises 5.0F (2.5C) above Setpoint #24 value or drops 5.0F (2.5C) below Setpoint #25. When the chiller is in this state, the individual compressor states are changed to the CMP IS OFF state through the normal staging function.

11.20. Imperial, Metric, and Combined Unit sensor readings

The Magnum software supports Imperial, Metric, and Combined unit sensor readings. This setting is specified in the Setup screen of MCS-Config. All sensor values and all software-coded offsets are automatically converted to the option selected and displayed with the appropriate character. The following table contains the display character:

SENSOR READING	ENGLISH CHARACTER	METRIC CHARACTER	MIXED CHARACTER
Temperature	F	C	C
Pressure – Gage Reading	P	B	P
Pressure – Absolute Reading	p	b	p
Humidity	%	%	%
Digital or Switch			
Amp or CT	A	A	A
Voltage	V	V	V
Refrigeration Level	%	%	%

If the unit type is changed, MCS-Config will give you an option to automatically change the values of all items

in the Setpoints to match the new type and will automatically adjust the display characters.

11.21. Warning and Alarm Relay Outputs

The Warning Relay Output will be turned on whenever the Magnum generates a warning message. These messages are:

- LOW REFR TEMP UNLOAD
- LOW SUCT PSI UNLOAD
- HIGH DISC TEMP UNLOAD
- LOW SUCT RELOAD
- LOW DISC RELOAD
- CICRUIT IS IN A SAFETY STATE

The system will continue to run since no safeties have tripped. The Warning Relay Output will also be turned on whenever a compressor is placed in a safety state.

The Alarm Relay Output will be turned on whenever the Magnum generates an alarm message. This indicates that a safety trip or Lockout has occurred.

11.22. Vi Port Control Logic (Open Drive Screw only)

The internal volume (Vi) of the open drive screw can be dynamically adjusted to achieve maximum efficiency modulating the Vi control solenoids. The duration of each solenoid pulse is contained in Setpoint #114 "Vi PULSE".

The ratio of discharge pressure divided by suction pressure is calculated. This ratio is blocked between 50 and 22. The value of Setpoint #137 "Vi DEADBAND" is added to and subtracted from this ratio to develop a control zone. The control zone will be recalculated based upon the time in Setpoint #138 "Vi DELAY". Refer to Setpoints #117, #118 and #119. The system will pulse the solenoids to keep the Vi reading within the calculated control zone.

11.23. Operating Schedules

Two operating schedules per each day of the week and 8 holidays are supported by the Magnum software. Each schedule contains a start and end time. If the time and day of the Magnum clock is within these limits then the schedule is true and the system will be allowed to run. If not, the system will be off due to schedule.

11.24. Mod-Motor Limit Control for Flooded Chiller

This option was added for Dunham-Bush flooded chillers. The Mod-Motor is a self-contained device that modulates a flooded chiller barrel level control valve based on a level sensor. The Magnum controls two Relay Outputs that change the limits on the movement of the Mod-Motor (The Relay Outputs change resistance to an input on the Mod-Motor). These Relay Outputs must be placed consecutively and specified in the General Information panel under the MAGNUM screen of MCS-Config.

- When one or less compressors are on, the first Mod-Motor Relay Output is turned on and the second Mod-Motor Relay Output is off.
- When 2 or more compressors are on, the first Mod-Motor Relay Output is turned off.
- The second Mod-Motor Relay Output will be turned on if the suction pressure is greater than 85.0 psi (5.8 bar) and the discharge suction pressure differential is less than 30.0 psi (2.0 bar), and the second Mod-Motor Relay Output will stay on as long as the suction pressure is greater than 80.0 psi (5.8 bar) and the discharge suction pressure differential is less than 35.0 psi (2.4 bar). If neither of the above is true, then the second Mod-Motor Relay Output will be turned off.

11.25. Hot Gas Reheat (Humidity) Control

The Hot Gas Reheat Control option is activated by selecting Yes in the 'HGReheat' cell in the Circuit Base Screen.

The hot gas control sensor is specified in the Evaporator Information panel of the MAGNUM screen. Select the input sensor that will be used to control the hot gas reheat function in the 'Reheat Control' cell.

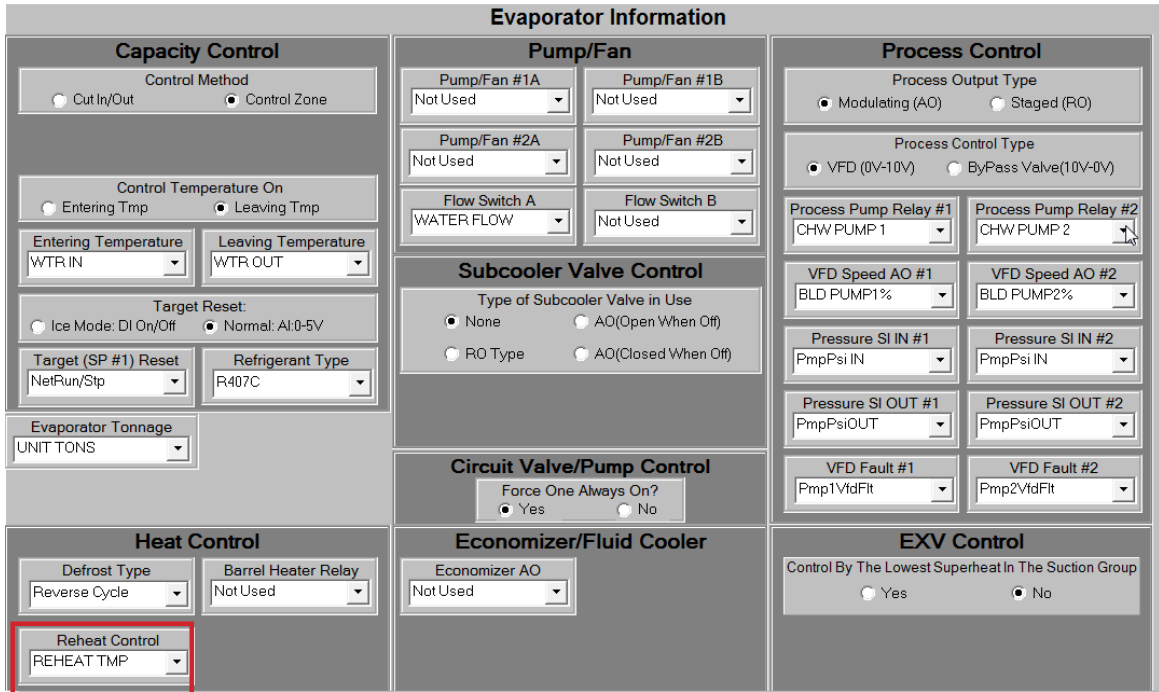

When this option is selected the Reheat Relay Outputs must be setup as follows:

Relay Output Information Screen (Magnum V8)

# w/ HELP Button	Name	Slide Multiple	Slide Division	Slide Offset	Design Suction Pressure
1-1	COMP	-----	-----	-----	-----
1-2	LOAD	-----	-----	-----	-----
1-3	UNLOAD	-----	-----	-----	-----
1-4	LLS	-----	-----	-----	-----
1-5	LID INJ	-----	-----	-----	-----
1-6	REHEAT	-----	-----	-----	-----
1-7	R-Hvalve	-----	-----	-----	-----
1-8	R-Hbleed	-----	-----	-----	-----

These Hot Gas Reheat relays are required and they must be placed in the proper sequence to work correctly. The following Setpoints must be active: #129 "RH CUTIN", #130 "RH CUTOUT ADJ", #131 "RH START DLY", #132 "RH BLEED DLY", #133 "RH STAGE DLY".(see Section full Setpoint descriptions).

Hot Gas Reheat sequence of operations:

(The names in the above example will be used to indicate the status of the relays: 1-6 REHEAT, 1-7 R-Hvalve, and 1-8 R-Hbleed)

Condition	1-6 REHEAT	1-7 R-Hvalve	1-8 R-Hbleed
The reheat state is OFF. The compressor is running and the RH TEMP is greater than Setpoint #129 plus #130.	ON	OFF	OFF
The reheat state is STARTING. The compressor is running and the RH TEMP is less than Setpoint #129. It will remain in this state until the time is greater than Setpoint #131, and then will move to the ON state.	ON	ON	ON
The reheat state is ON. The reheat will remain in this state until the reheat temperature is greater than Setpoint #129 plus #130. When the temperature is greater the state will be changed to BLEED.	OFF	ON	ON
The reheat state is BLEED. It will remain in this state until the time is greater than Setpoint #132, it will then move to the OFF state.	ON	OFF	ON

11.26. Extra Liquid Line Solenoid Control

Second and third Liquid Line Solenoids (economizers) are supported and can be used for extra control. To specify, select the Circuit Base Screen:

The third solenoid (economizer) can be controlled either on the slide wanted percentage or as the last step on for that compressor (Refer to section 13 Setpoints #98 and #99). Liquid line solenoids 2 and 3 will be turned on and off as indicated in their Setpoints.

2nd LLS		Economizer		Econo Control	
Yes	...	Yes	...	Slide %	...
No	...	No	...	Slide %	...
No	...	No	...	Slide %	...

11.27. Outside Air Economizer/Fluid Cooler with Analog

11.27.1 Output Control

The purpose of an economizer/fluid cooler is to take advantage of any available free cooling so as to avoid the need of mechanical cooling. Several options can be specified in MCS-Config to accomplish this.

11.27.2 Economizer Set up

The analog valve that will be modulated is selected in the 'Economizer AO' cell in the Evaporator Information panel. In this example the name is 3 WAY VLV.

If the economizer/fluid cooler has separate fans (not associated with condensers) then answer yes in the 'Separate Economizer Fans?' cell. If Yes, then four additional cells will appear: 'Starting Economizer Fan' (select the first fan Relay Output), '# of Econ Fans' (specify the number of fan points), 'Starting Economizer Fault' (select the first fan fault, this is a Sensor Input), and '# of Econ Faults' (specify the number of faults)

In the above example there are two fans and two faults associated with the economizer/fluid cooler. If there is more than one fan they must be consecutive Relay Outputs. The same is true of the condenser faults.

Evaporator Information

Evap. Tonnage
Not Used

Economizer Control

Economizer AO
3 WAY VLV

Separate Economizer Fans?
 Yes No

Starting Economizer Fan
ECON FAN 1

of Econ Fans
2

Starting Economizer Fault
EcoFanFlt1

of Econ Faults
2

Condenser Information

Condenser Type
RO Step Individual

AO Starting Stage
1

Fluid Cooler Econo?
 Yes No

The condenser fans can also be used to assist in the free cooling function when the system is not using mechanical cooling. To set this up in the condenser information grid, select "Fluid Cooler Econo" equals "Yes", else "No" if condenser fans are not used. All types of condensers can be used. The above example has individual fans per compressor. Whenever a compressor is running the control of its condenser fans will be based solely on the discharge pressure of that compressor, while the condenser fans of compressors that are not running will be controlled by the economizer function. If the type of condenser is common; if any compressor is on all of the fans will be controlled by the highest discharge pressure and not by the economizer function.

The following Setpoints must be set up: #107 "EcoDelayMech", #115 "EcoVFDfanDely", #119 "EcoOffsetON", #120 "Eco Stg Dely", #121 "Eco MIN VLV%", #122 "Eco MAX VLV%", #123 "Eco MAX ADJ", #124 "EcoVlvAdjDly", #125 "Eco StageDly", #126 "Eco MULTI", and #127 "Eco DIVIDE"

(Refer to Chapter 26 for Setpoint descriptions)

11.27.3 Sequence of Operation

The Economizer logic will be enabled whenever the ambient temperature meets the requirement as stated in Setpoint #119 "EcoOffsetON" (Ambient Temperature < Target Temperature–Setpoint #119). For example if the target is 45.0F and Setpoint #119 is 10.0F, then the ambient temperature must be less than 35.0F to enable the economizer function to begin.

If mechanical cooling has not been enabled (no steps are Wanted On or Actual On), when the economizer starts the Unit State will be ECONOMIZER ONLY. In this state mechanical cooling will not be started until the economizer function has reached its maximum capacity (Economizer valve is at maximum opening, all available fans are turned on, and the control temperature is still not in the target zone).

When the economizer logic starts, the Magnum will modulate the Analog Output to the economizer valve to maintain the control sensor reading within the target zone. The valve will be modulated between Setpoint #121 "Eco MIN VLV%" and Setpoint #122 "Eco MAX VLV%" and will wait the time contained in Setpoint #124 "EcoVlvAdjDly" before making each adjustment to the valve opening.

- If control temperature is above the control target, Setpoints #1, and the control temperature rate of change is greater than the value of Setpoint #27 "MAX ROC-":

This indicates that the control temperature is too high and it is not approaching the target fast enough, therefore the valve opening must be increased if possible. The adjustment value will be the difference between the target (Setpoint #1) and the control sensor temperature multiplied by Setpoint #126 "Eco MULTI" and divided by Setpoint #127 "Eco DIVIDE". If the absolute adjustment is greater than the value of Setpoint #123 "Eco MAX ADJ", then it will be limited to this value. The economizer valve opening will be increase by this value.

- If control temperature is below the economizer control zone (Setpoint #1–Setpoint #3) and the control temperature rate of change is less than the value of Setpoint #28 "MAX ROC+":

This indicates that the control temperature is too low and it is not approaching the target fast enough, therefore the valve opening must be decreased if possible. The adjustment value will be the difference between the target (Setpoint #1) and the control sensor temperature multiplied by Setpoint #126 "Eco MULTI" and divided by Setpoint #127 "Eco DIVIDE". If the absolute adjustment is greater than the value of Setpoint #123 "Eco MAX ADJ", then it will be limited to this value. The economizer valve opening will be decrease by this value.

- If control temperature is above the bottom of control zone (Setpoint #1–Setpoint #3) but less than the control target (Setpoint #1) no change to the economizer valve opening will be made.

Once the valve has reached its maximum opening (Setpoint #122), the Magnum will wait the time specified in Setpoint #125 "Eco StageDly" before checking if there are any fans associated with the economizer function. If there are the Magnum will stage the fans to maintain the control temperature with in the target zone. If a fan VFD is present, then this will be modulated in the same manner. The delay between VFD adjustments will be the value in Setpoint #115 "EcoVFDfanDely" if active, else Setpoint #124 will be used. Once all fans associated with the economizer function are on, the Magnum will check if any condenser fans can also be used. If yes, then these fans will then be staged to maintain the control temperature.

Once all the fans and/or VFD have been turned on and the control temperature is still greater than the control zone for the time specified in Setpoint #107 "EcoDelayMech" if active (else the time in Setpoint #125 "Eco StageDly" will be used) then mechanical cooling will be enabled.

- If the ambient temperature rises above the offset in Setpoint #119 during economizer cooling mode, then

the economizer function will be terminated, its valve opening will be set to zero, and mechanical cooling will be enabled.

- If the control temperature is less than the target temperature (Setpoint #1) minus the 3 times value of Setpoint #3, then the economizer function will be terminated, its valve opening will be set to zero, and all fans will be turned off.
- If during mechanical cooling mode the ambient temperature drops below the offset in Setpoint #119, then the economizer function will begin. Note: the Unit State will not change, the economizer valve will be modulated as described above, fans directly associated with the economizer will be used, and no fans associated with the condensers will be used.
- The control rate of change is always checked before an adjustment to the valve is made. The purpose is to not change the valve opening if the temperature is moving toward the target at an acceptable rate.

11.27.4 Outside Air Supply Economizer

If the purpose of the economizer is to provide outside air, then there will be no fans associated with the economizer and no condenser fans will be used. In this setup the economizer valve opening will never be less than the value of Setpoint #121 "Eco MIN VLV%". This is required to supply the minimum of outside air.

11.27.5 Mechanical Cooling Enabled

Once mechanical cooling has been enabled, the economizer will control only the individual compressor condenser fans of compressors that have not been started. The discharge pressure will control all others.

The percentage of the economizer valve opening will not be decreased. It will remain at its maximum setting until all stages of mechanical cooling are off.

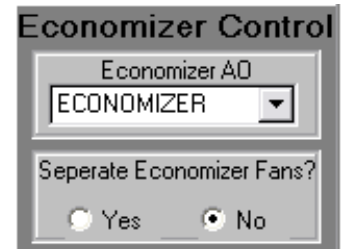

11.27.6 Example: Fluid Cooler with VFD condenser fan

The economizer AO has been selected and there are no separate economizer fans.

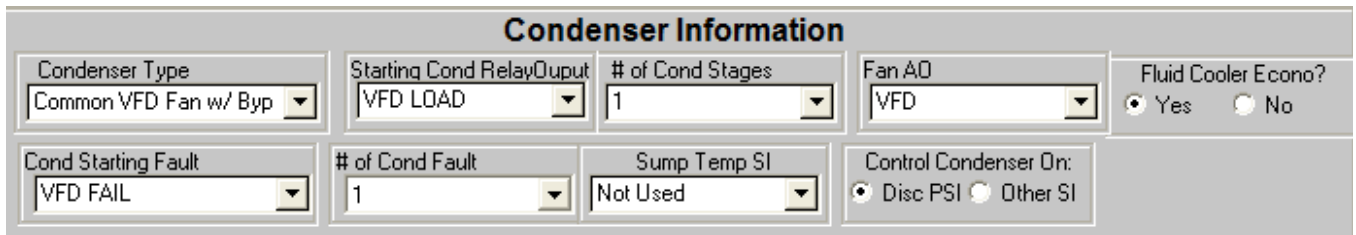

The condenser type is common with VFD control and the Fluid Cooler Economizer option has been enabled. The VFD of the condenser fan will be controlled by the economizer function unless any compressor is running. If a compressor is running the VFD control will be based upon the highest discharge pressure.

Assume the following setup:

Setpoint #	Name	Value
1	SPPLY TRGT	44.0F
2	CTRL ZONE+	2.0F
3	CTRL ZONE-	1.0F
27	MAX ROC-	-.6F
28	MAX ROC+	.6F
54	CND MIN OPEN	20.0%
55	CND MAX OPEN	100.0%

107	ECON-MECHdly	240s
115	EconVFDdelay	45s
119	EcoOffsetON	10.0F
120	EconDelyFans	60s
121	EcoVlvMinVlv	0.0%
122	EcoVlvMaxVlv	100.0%
123	EcoVlvMaxAdj	5.0%

Conditions when the run/stop was set to RUN

Ambient temperature 30.0F

Control temperature 48.5F

The ambient temperature is less than 44.0 (Setpoint #1) – 10.0 (Setpoint #119) and no mechanical cooling steps are on; therefore, the Unit state will be ECONOMIZER ONLY and the economizer function will be enabled.

The AO M-1 “3 WAY VLV” will be opened to its minimum valve of 0% (Setpoint #121) and it will be modulated based upon the control temperature and the target (Setpoint #1). The first adjustment will be $48.5 - 44.0 = 4.5$. This value will be adjusted by multiplier of 3 (Setpoint #126) and divided by 2 (Setpoint #127) to give an adjusted value of 6.7. This value is blocked; maximum allowed adjustment, by Setpoint #123 to allow an adjustment of 5.0%. The economizer valve opening will be increased by this amount if the temperature control rate of change is greater than the value of Setpoint #27.

The economizer function will wait 30 seconds (Setpoint #124) before determining the next adjustment. If the control temperature is now 47.3F; the following adjustment will be calculated.

$47.3 - 44.0 = 3.3 \times 3 / 2 = 4.9$. Since this is less than 5.0 the valve will be open an additional 4.9% if the temperature control rate of change is greater than the value of Setpoint #27.

Each adjustment will be made after a delay of 30 seconds. If the control temperature is below the control target (Setpoint #1) and above the bottom the control zone (43.0F to 44.0F) there will be no change to valve opening.

If the control temperature drops below the control zone the valve opening will be reduced. For example if the control temperature is 42.6F then the following calculation will be made:

$42.6 - 44.0 = 1.4 \times 3 / 2 = 2.1$. Since this is less than 5.0 the valve opening will be reduced an additional 2.1%.

When the valve reaches its maximum opening of 100.0% (Setpoint #122) the economizer function will use other fans if they are available. In this example there are no fans that are associated only with economizer but the VFD fan can now be used. At time delay of 120 seconds (Setpoint #125) be for the VFD will be modulated. Following this initial delay the VFD will be opened to its minimum opening, Setpoint #54 of 20%.

At this point the unit state is ECONOMIZER ONLY, economizer valve is at 100% and VFD will be modulated between its minimum (Setpoint #54) and it maximum (Setpoint #55). The delay between these adjustments will be 45 seconds (Setpoint #115).

Once the VFD opening is equal to its maximum (Setpoint #55) there will be a delay of 240 seconds (Setpoint #107). At this time the unit state will be changed and mechanical cooling will be enabled.

11.27.7 Example: Fluid Cooler with condenser compressor fans

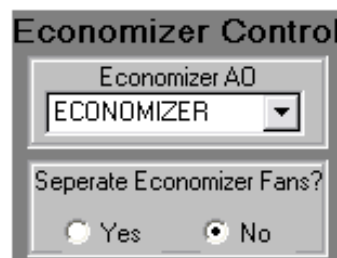

The economizer AO has been selected and there are no separate economizer fans.

The condenser type is RO Step Individual and the Fluid Cooler Economizer option has been enabled. The individual compressor condenser fans will be controlled by the economizer function unless a compressor is running. If a compressor is running, then the condenser fans associated with that compressor will be con-

trolled based upon the discharge pressure of the compressor that is running.

Condenser Information

Condenser Type
RO Step Individual

Fluid Cooler Econo?
 Yes No

Sump Temp SI
Not Used

Control Condenser On:
 Disc PSI Other SI

Assume the following setup:

Setpoint #	Name	Value
1	SPPY TRGT	44.0F
2	CTRL ZONE+	2.0F
3	CTRL ZONE-	1.0F
27	MAX ROC-	-.6F
28	MAX ROC+	.6F
107	ECON-MECHdly	240s
115	EconVFDdelay	45s
119	EcoOffsetON	10.0F
120	EconDelyFans	60s
121	EcoVlvMinVlv	10.0%
122	EcoVlvMaxVlv	100.0%
123	EcoVlvMaxAdj	10.0%
124	EcoVlvDelay	30s
125	EcoVlvMaxDly	120s
126	EcoVlv Mul	2
127	EcoVlv Div	1

Analog output	Name
AO M-1	3 WAY VLV
AO M-2	VFD

Conditions when the run/stop was set to RUN

Ambient temperature 30.0F

Control temperature 49.7

The ambient temperature is less than 44.0 (Setpoint #1) – 10.0 (Setpoint #119) and no mechanical cooling steps are on, therefore the Unit state will be ECONOMIZER ONLY and the economizer function will be enabled.

The AO M-1 “ECONOMIZER” will be opened to its minimum valve of 10% (Setpoint #121) and it will be modulated based upon the control temperature and the target (Setpoint #1). The first adjustment will be $49.7 - 44.0 = 5.7$. This value will be adjusted by multiplier of 2 (Setpoint #126) and divided by 1 (Setpoint #127) to give an adjusted value of 11.4. This value is blocked by the maximum allowed adjustment (Setpoint #123) to 10.0%. The economizer valve opening will be increased by this amount if the temperature control rate of change is greater than the value of Setpoint #27. With Setpoint #126 equal to 2 and #127 equal to 1, the valve will be adjusted by 2% for every degree difference from the target.

The economizer function will wait 30 seconds (Setpoint #124) before calculating the next adjustment. If the control temperature is now 47.3F the following adjustment will be made.

$47.3 - 44.0 = 3.3 \times 2 / 1 = 6.6$. Since this is less than 10.0 the valve will be open an additional 6.6% if the temperature control rate of change is greater than the value of Setpoint #27.

Each adjustment will be made after a delay of 30 seconds. If the control temperature is below the control target (Setpoint #1) and above the bottom the control zone (43.0F to 44.0F) there will be no change to valve opening.

If the control temperature drops below the control zone the valve opening will be reduced. For example if the control temperature is 42.6F then the following calculation will be made:

$42.6 - 44.0 = 1.4 \times 2 / 1 = 2.8$. Since this is less than 10.0 the valve opening will be reduced an additional 2.8%.

When the valve reaches its maximum opening of 100.0% (Setpoint #122) the economizer function will use other fans if they are available. In this example there are no fans that are associated only with economizer but the condenser fans can now be used. After the time delay of 120 seconds (Setpoint #125) the first condenser fan will be turned on (the first fan of the first compressor unless unavailable).

At this point the unit state is ECONOMIZER ONLY, the economizer valve is at 100%, and the compressor fans will be used to aid in the economizer cooling. The delay between starting the condenser fans will be 30 seconds (Setpoint #124). If all condenser fans are available and not manually turned off, the pattern of starting fans will be the first fan on compressor 1, after the delay then the first fan of compressor 2, after the delay then the second fan on compressor 1. This will continue until all available condenser fans have been turned on.

Once all of the condenser fans have been turned on there will be a delay of 240 seconds (Setpoint #107). At this time the Unit State will be changed and mechanical cooling will be enabled. When a compressor is running, its associated condenser fans will be controlled by the discharge pressure of the running compressors.

11.28. High Suction Superheat Safety

To add a high suction superheat safety, make Setpoint #203 "HiSuctSheat" active. If the suction superheat is greater than the value of this Setpoint for the 'Time(sec)' field, an alarm will be generated and the compressor will be shut down with a safety or Lockout state.

11.29. Low Temperature Safety and Unload (Low Saturated Suction Temperature)

The Magnum is set up to check for low refrigerant temperature safety and unload functions. To enable this test make Setpoint #155 "LO REF TMP" active and point to the sensor in the 'Refrigeration Temp' column of the Compressor SI grid in MCS-Config.

This safety will be checked only when the compressor is running. If the sensor value is less than Setpoint #155 for the 'Time(sec)' field, then an alarm message will be generated and the associated compressor will either be placed in a safety or Lockout state.

The Magnum will also determine if a low temperature condition occurs and to stop loading or unload if necessary. If the sensor value is less than the value of Setpoint #155 plus Setpoint #156 "LO REF UNLD", then the compressor state will be LO TMP UNLOAD. Refer to state (21) .

By using the User Logic type sensor, we can test any value for a low condition. For example point the refrigerant temperature index to a User Logic sensor that picks up the saturated suction temperature for that compressor. Make Setpoint #155 active with the low temperature value that will trigger the safety and unload action and you have a low saturated suction temperature condition.

Chapter - 12. Using Lookup Tables

The purpose of Lookup tables is to provide additional capability for entering reference data for reading of sensors. Tables are handy, in that, you do not need to create separate configuration files for each change in the performance curve on a non linear sensor. The Magnum will look at the lookup table to get the right information for that sensor.

12.1. Lookup tables used with MCS-MAGNUM controls

In the sample below, we are using a Temperature sensor. The magnitude of the current is converted to a linear (0-5vdc) output signal which can be read as a standard analog input signal. The signal is used by MCS micro controllers for controlling some of the following:

1. For slide valve positioning on screw machines
2. For high amp motor overload protection
3. For verification of device on / off
4. For reading any temperature, voltage, or current sensors that has typical voltage input which ranges from 0 to 5 Vdc.
5. For reading non linear sensors that use a 4-20mA signal.

12.1.1 Setting up a Lookup table using MCS-CONFIG

1. Setup new temperature sensor in MCS-Config as shown in screen below.

Sensor Input Information Screen							
#	Name (1 to 10 char)	Display Type	Offset	Manual Value or NC/NO (select to change)	Display Text (select to change)	Ter	▲
						C	F
M-1	WTR IN	MCST100	0	55	Not Used	No	
M-2	WTR OUT	MCST100	0	55	Not Used	No	
M-3	SUCT PSI 1	MCS-200	0	33	Not Used	No	
M-4	DISC PSI 1	MCS-500	0	133	Not Used	No	
M-5	OIL PSI 1	MCS-500	0	133	Not Used	No	
M-6	AMPS 1	CT-300	0	21	Not Used	No	
M-7	VOLTS 1	User Defined	0	0	Not Used	No	
▶	M-8 T100XP	Lookup Table SI	0	0	Not Used	No	

Screen 1

2. Using the pull down icon, specified the Lookup table that you will be using for this sensor as shown in screen 2.

Lookup Table SI Form

T100XP

Sensor Display Type (Do this FIRST) TEMP

T100XP =

Lookup Table Input

Type SI

Point Index VOLTS 2

>>>

Lookup Table

Number Lookup Table #1

Convert Method Estimate Weighted Aver.

OK

Cancel

Screen 2

12.1.2 Setting up Lookup table #1 - see screen 3 below:

The sensor we have setup in this example is a temperature sensor. We are entering data into the lookup table using data from the manufacture of the sensor. In the sample table, we have used 17 rows for the data to give us a clear view of the temperature and voltage range of this sensor.

1. In column one, we have entered the number of rows we will use.
2. The second column we have entered Voltage as the Input
3. In the third column we have entered Temp as the output.
4. The fourth column we have shown Volts2 which will allow the example to have two decimal places for the voltage data.

Lookup Table Information Screen

Lookup Tables Setup						
#	Number of Rows	Input Column Name	Output Column Name	Input Column Display Type	Output Column Display Type	Minimum Auth Level
1	17	Voltage	Temp	VOLTS-2Dec	TEMP	Factory Level
2	0	Input #2	Output #2	Spare	Spare	View Only
3	0	Input #3	Output #3	Spare	Spare	View Only
4	0	Input #4	Output #4	Spare	Spare	View Only
5	0	Input #5	Output #5	Spare	Spare	View Only

Lookup Table Number

Lookup Table #1

Lookup Table #1		
#	Input Column Voltage	Output Column Temp
1	0	0
2	1.11	32
3	1.18	35
4	1.21	38
5	1.33	40
6	1.45	45
7	1.62	50
8	1.79	55
9	1.88	58
10	1.94	60
11	2.11	65
12	2.27	70
13	2.44	75
14	2.6	80
15	2.76	85
16	2.9	90
17	3.06	95
18	0	0
19	0	0
20	0	0
21	0	0

Screen 3

5. The last column shows the authorization level needed to make changes in MCS-Connect.

12.1.3 Viewing the Lookup Table in MCS-Connect

In MCS-Connect you can view the sensor example as shown in the screen below, viewing the same information that was setup in MCS-Config. The authorization was setup as 'FACTORY' in MCS-Config for this sensor example.

1. Click on the 'SENSOR' where the lookup table is. (You can view any and all tables that were created in MCS-CONFIG by following the steps below)
2. Click on 'VIEW' at the top of the MCS-CONNECT screen.
3. Click on 'EDIT LOOKUP TABLES'
4. The following pop up will appear showing the table that was setup in MCS-CONFIG.
5. If authorized you can make changes to the table.

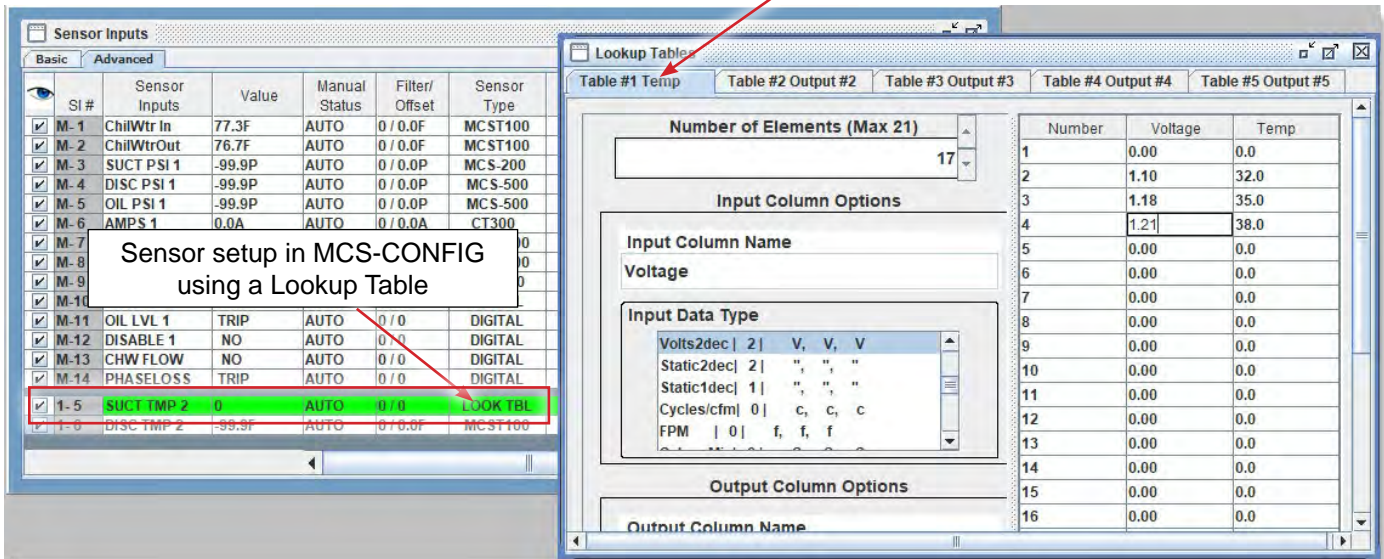
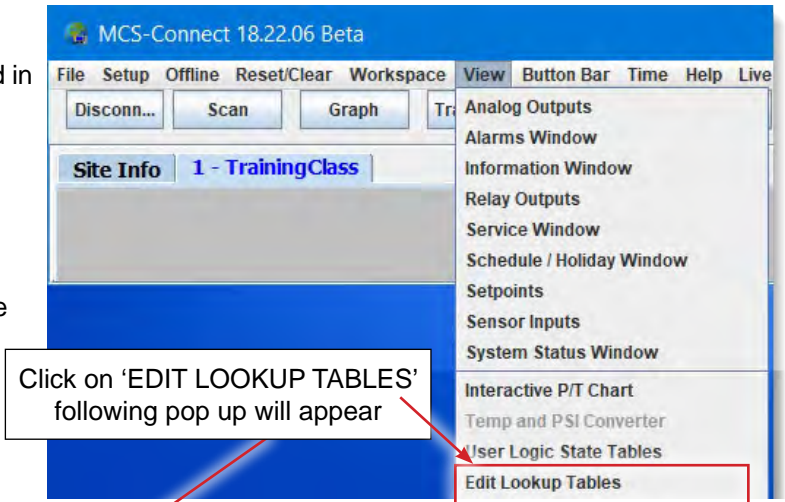

12.1.3.1. Using as Control Temperature Sensor

The example sensor has been specified in MCS-Config as providing the control value reading. It will normally be the entering temperature, leaving temperature, or suction pressure. The Setpoints must be adjusted according to the type of control measurement selected.

Chapter - 13. Ice Making Capabilities

The Magnum offers a number of different options to meet the requirements of providing ice for energy storage tanks. A system can be configured as a standard HVAC/R unit with the capability to adjust its cooling target or it can be configured as a pure ice making unit.

13.1. HVAC/R unit using the cooling target reset

This method is indicated by selecting the Ice Mode DI On/Off option and a sensor in the Target (SP #1) Reset cell in the Evaporator Info screen of the Information Panel Selector screen. The ice making mode will be entered based upon the sensor selected in the Target (SP #1) Reset cell.

The image shows a screenshot of the 'Evaporator Information' configuration screen. The 'Target Reset' section is highlighted with a red box. In this section, the 'Ice Mode: DI On/Off' radio button is selected, and the 'Target (SP #1) Reset' dropdown menu is set to 'ICE MODE'. The 'Refrigerant Type' is set to 'R22'. Other sections include 'Capacity Control' (Control Method: Control Zone, Control Temperature On: Leaving Temp, Entering Temperature: ChillWtrIn, Leaving Temperature: ChillWtrOut), 'Pump/Fan' (Pump/Fan #1A, #1B, #2A, #2B, Flow Switch A, B), 'Process Control' (Process Output Type: Modulating (AO), Process Control Type: VFD (0V-10V), Process Pump Relay #1, #2, VFD Speed AO #1, #2, Pressure SI IN #1, #2, Pressure SI OUT #1, #2, VFD Fault #1, #2), 'Heat Control' (Defrost Type: None, Barrel Heater Relay: Not Used, Reheat Control: Not Used), 'Economizer/Fluid Cooler' (Economizer AO: Not Used), and 'EXV Control' (Control By The Lowest Superheat In The Suction Group: No).

13.1.1 Target (SP #1) Reset Sensor

This sensor will indicate when the system is to enter the ICE MAKING mode.

13.1.2 Reset Sensor Type 'Target Reset'

When this sensor A/D counts are less than 256, voltage of 1.25, ice mode is to be off, if greater than 768, voltage of 3.75, then ice mode is on else there is no change to the mode.

If this type of sensor is selected, the value of set point #21 will be the off set to set point #1. If set point #1 is 39.0F and the ice temperature target is to be 19.0F then the value of set point #21 must be -20.0F. When this sensor indicates that the ice mode should be entered, its value will be changed to the value of set point #21 & set point #1 will be reset by the value of set point #21, the unit mode will be ICE MAKING.

13.1.3 Reset Sensor Type 'Network Target Reset'

If this type of sensor is selected, its value will be the value received from Modbus address 201 from the network. Set point #21 is used as a high/low limit. The value must be greater than the negative value of set point #21 and less than the value of set point #21 else the value will be 0. This sensor will show this value. If the value of this sensor is not zero, the ice mode will be entered. The value of set point #1 will be reset by the value of this sensor, the unit mode will be ICE MAKING.

13.2. Ice Making Mode

When this mode is entered the unit mode will be changed to ICE MAKING, set point #1 will reflect the ice making target, and all steps of cooling will be staged on. The system will remain in this mode as long as the target reset sensor indicates ice making mode.

If the control temperature drops to the value of set point #1 or less, an information alarm, TMP OFF-ICE MADE, will be generated; all steps of cooling will be staged off; unit state will be OFF TMP-ICE MADE; and the unit mode will remain ICE MAKING. The system will remain in this state until the target reset sensor indicates that the ice making mode is to be terminated.

13.2.1 Terminating of ice making mode

Once the target reset sensor indicates that the ice making mode is to end; the mode will be changed to COOLING, the value of set point #1 will be restored to its cooling target, and the unit state will be to a normal state. At this point the system will function to provide cooling as needed.

13.3. System as a pure ice making unit, Turbo Ice Machine

This setup is used to specify a system that is designed to produce and provide a defrost function.

This method is indicated by selecting the Turbo Ice Machine option and the number of liquid line solenoids in the cell in the General Info screen of the Information Panel Selector screen.

General Information

of Compressors: 1

of Steps: 1

1st MOD Motor Limit RO: Not Used

Turbo Ice Machine: Yes No

Liquid Line Solenoid: 4

Lost BMS Communication: Run Stop No Change

Unit Type: Cooling Only HeatPump Electric Heat

Unit Indicators

Warning Relay: Not Used

Alarm Relay: ALARM

Control Relay: Not Used

Lag Unit ON/OFF Relay: Not Used

Unit Status Relay: Not Used

Unit Control

Run/Stop Switch: RUN/STOP

Network Run/Stop Sw: Not Used

Emergency Stop Switch: EMG/STOP

Unit Power

Phase Loss: PHASELOSS

Volts A: Not Used

Volts B: Not Used

Volts C: Not Used

Unit Amps: Not Used

Unit KW: Not Used

Unit Sensors

Smoke Alarm Indicator: Not Used

Enthalpy Sensor: Not Used

Ambient Temperature: Not Used

Ambient Humidity: Not Used

Demand Limit FLA %: Not Used

Demand Limit Steps: Not Used

Vestibule Control

Temp Control Sensor: Not Used

Fan Relay: Not Used

Cooling Relay: Not Used

Heating Relay: Not Used

13.3.1 The # Liquid Line Solenoids

The number may be 1 thru 4 and indicates the number of groups of liquid line solenoids/hot gas defrost solenoids output relays.

Each group must consist of a liquid line solenoid and followed by three hot gas solenoid relays. The first group will follow the normal relay output sequence each additional group must follow the previous group.

The following is an example of relay outputs when 4 liquid line solenoids have been specified.

Note, in this example, in the Circuit Base grid the # of Comp RO's will be 19.

Number	Name	Slide Mult	Slide Div	Slide Off
M-1	COMP	80	10	20
M-2	LOAD			
M-3	UNLOAD			
M-4	LLS1			
M-5	HGDEF1			
M-6	HGDEF2			
M-7	HGDEF3			
M-8	LLS2			
M-9	HGDEF4			
M-10	HGDEF5			
1-1	HGDEF6			
1-2	LLS3			
1-3	HGDEF7			
1-4	HGDEF8			
1-5	HGDEF9			
1-6	LLS4			
1-7	HGDEF10			
1-8	HGDEF11			
1-9	HGDEF12			

Circuit# (reset button)	# of Comp ROs	Starting Compressor RO	Part Winding	Start Unload Bypass	Fast Unloader	Type of LLS	2nd LLS
1	19	COMP 1	No	No	No	EXV&LLS	No
2	6	COMP 2	No	No	No	EXV&LLS	No
3	0	Not Used	No	No	No	None	No

13.3.2 Required set points for defrost cycles

Setpoint #116, if the control sensor's temperature is less than or equal to this value, defrost cycles are required.

Setpoint #117, time that the system will wait before between defrost cycles.

Setpoint #118, time that each hot gas defrost relay will be on.

#	Name	Value	Min	Max	Adjust Value	Time (SEC)	Max Time Allowed (SEC)	Lockout Delay (HRS)	Safety Down Time(MIN)	Active or Non-Active	Select Value: # decimals & print char
116	DEF on Temp	38	30	40	0.5	0	0		0	Active	TEMP
117	DEF on Delay	120	60	600	1	0	0		0	Active	SECONDS
118	DEF on Cycle	60	30	300	1	0	0		0	Active	SECONDS

13.4. Turbo Ice Machine Operation

a) Capacity control

The unit capacity will be increased & decreased to meet the required target temperature in set point #1.

b) Non defrost cycle

When the system is not defrosting all liquid line solenoids will be ON and all hot gas solenoids will be OFF.

c) Defrost cycle initiated

A defrost cycle is required when the control sensor's temperature is less or equal to the value in set point #116, a delay of the value in set point #117 before the defrost cycle begins.

d) Defrost cycle

The defrost cycle will rotate through each group's hot gas solenoids and when all have been accessed then move to the next group.

Following table shows the relay status of a defrost group:

Relays	*1	*2	*3	*4	*5	*6	*7
Liquid Line Solenoid	ON	OFF	ON	OFF	ON	OFF	ON
Hot Gas Solenoid 1	OFF	ON	OFF	OFF	OFF	OFF	OFF
Hot Gas Solenoid 2	OFF	OFF	OFF	ON	OFF	OFF	OFF
Hot Gas Solenoid 3	OFF	OFF	OFF	OFF	OFF	ON	OFF

*1, status prior to defrost cycle.

*2, defrost cycle begins with first hot gas solenoid, state will remain for time in set point #118.

*3, delay between rotations to next hot gas solenoid, state will remain for time in set point #117.

*4, rotation to next hot gas solenoid, #2, state will remain for time in set point #118.

*5, delay between rotations to next hot gas solenoid, state will remain for time in set point #117.

*6, rotation to next hot gas solenoid, #3, state will remain for time in set point #118.

*7, all hot gas solenoids in this group have been accessed. Value of set point #117 will be the time delay before the next group begins a defrost cycle.

e) Terminating a defrost cycle

A defrost cycle will be terminated when the control sensor's temperature is greater or equal to the value in set point #116 plus .5. If another defrost cycle is initiated the cycle will begin where the previous defrost cycle ended.

Chapter - 14. VFD Controlled Screw Compressors

14.1. INTRODUCTION

The MCS Magnum controller is designed to control Variable Frequency Drive (VFD) screw compressors. Its algorithm allows the user to define specific functions to maximize startup and running conditions. It handles all of the following:

1. Startup control
2. DX chiller barrel
3. DX remote coils
4. Flooded chiller barrel
5. Water cooled condenser
6. Air cooled condenser
7. Slide control for starting unloaded
8. EXV startup control
9. EXV Anticipatory loading
10. EXV low suction Anticipatory control



14.2. STARTUP CONTROL

When the compressor is started the state will be 'CMP IN STARTUP'. During this phase the compressor's Analog output will be placed at the percentage specified in the Config for startup and for the length of time specified. If the compressor has a slide valve it will be started unloaded. After a few seconds the slide is moved to the loaded position and all control is via the VFD. In the MCS Config the user can specify the following:

1. The starting frequency of the compressor which is via the compressor's Analog Output.
2. The length of time the compressor is to remain in 'CMP IN STARTUP' state.
3. The starting position of the Electric Expansion Valve (EXV).

14.3. OPERATING CONTROL

When the compressor completes the startup phase it enters normal operating controls. In the normal operating phase the primary function is to maintain the target based on the controlling sensor. (Usually this is Leaving Water Temperature.) To do this the following control functions occur:

1. The compressor Analog output will be adjusted to match the current wanted capacity percent.
2. The EXV position will be adjusted when the compressor speed is adjusted and depending on the current value of its superheat.
3. The compressor slide remains at 100% during normal operating control.

14.4. COMPRESSOR LOADING / UNLOADING

The standard MCS algorithm applies. However for the VFD controlled screw additional set point capabilities have been expanded as follows:

1. On a standard slide operated screw SP 32 'MAX ADJUST %' would usually be set to 4% to 5%. With the VFD it is typical to allow larger adjustments, when required, say to 10%. The loading/unloading algorithm can be set to increase/decrease slowly because the VFD allows exact positing of the capacity.
2. Controlling this adjustment is SP 56, 'COMP ADJ DELAY', which tells the Magnum the frequency to set. The EXV is adjusted at the same time allowing precise superheat control.

14.5. COMPRESSOR SHUTDOWN

Compressor shutdown is a function of the set point values setup at Config time. Normal function would be to shutoff the EXV and pump down based on set points. However if it's a flooded evaporator no pump down is done. When the compressor is off the MCS control system forces the slide vale to its minimum position so at the next start time the compressor is unloaded.

14.6. Screw Compressor with VFD

When using a VFD with a Hanbell Screw compressor the solenoid configuration will be to use the 25% or 33% depending on the model for the fast unloader. This solenoid will be energized at startup and shut down, to ensure the compressor is fully unloaded. The load solenoid will be replaced with a load cap. This allows oil to flow to the piston chamber continuously to load the slide. As soon as the fast unload solenoid is de-energized the slide will move to fully loaded. The compressor will stay fully loaded during the duration of running while the VFD will vary the HZ based on load demand.

Typically the VFD is setup for 0-10 VDC equals 0 hz-60 hz. Set point 30 is the MAX SPEED which equals 100% (60hz). Set point 31 is the MIN SPEED which equals 50% (30 hz). Our standard control logic based on the rate of change and the distance the control sensor is from the target set point is used within set points 25-34 and 56.

25	STEP SENSITIV	The decrements to the time delay between making changes in the control algorithm is based upon the difference between the target and control values. If the difference is greater than 10 the delay will be reduced by 10. If less the delay will be adjusted by the value of this set point. 1 is the fastest response, whereas higher numbers will mean a more gradual response.
26	STEP DELAY	Value: This is the time delay before making adjustments to the system capacity. Refer to set point #25 for how this delay is decremented. 'Time (sec)' field: If used, this will force a minimum time delay between any two compressor starts. This time delay is specified in the 'Minimum Delay Between Compressor Starts' box in the 'Cooling Info' panel under the MAG RTU screen.
27	MAX ROC -	Compares the control value rate of change. Maximum negative Rate of Change allowed before preventing the unit from loading. If the ROC is less than this value the capacity control state is set to HOLDING.
28	MAX ROC +	Compares the control value rate of change. Maximum positive Rate of Change allowed before preventing the unit from unloading. If the ROC is greater than this value the capacity control state is set to HOLDING.
29	ROC INTERV	Seconds between samples used for calculating the Rate of Change. (Maximum 60 seconds)
30	MAX FLA% or MAX SLIDE % or MAX CAPACITY% or MAX VFD %	Indicates the maximum amp draw, slide %, digital scroll load%, or speed allowed. Usually set to 100%, else compressors will load to the value of this Set point until all steps are on, then the system will load to 100%. 'Time (sec)' field: If non-zero, then force individual compressors to stay at maximum capacity when another compressor starts. This option is selected in the 'Keep Running Comp at 100% when starting next?' box in the 'Compressor Information' panel under the MAGNUM screen. 'SEC to Ignore Safety' field (Fully Loaded Screw Compressor logic): If non-zero, turn on the load solenoid every 5 min for 5 seconds when fully loaded. If zero, then do not turn on solenoid for 5 seconds every 5 minutes. 'SEC to Ignore Safety' field (Holding Screw Compressor logic): If non-zero, turn on the load solenoid every 5 min for 5 seconds when holding. If zero, then do not turn on solenoid for 5 seconds every 5 minutes.
31	MIN FLA% or MIN SLIDE % or MIN CAPACITY% or MIN VFD %	Value: Indicates the minimum amp draw, slide %, digital scroll load%, or speed allowed (usually 40%). This is where the slide valve or VFD will be set when the compressor is turned on. This % is a function of actual amp draw relative to the FLA. 'Time (sec)' field: If used, this forces a time delay before unloading all running compressors before the next compressor is started. This time delay is specified in the 'Unload Compressor Before Starting Next' box in the 'Compressor Information' panel under the MAGNUM screen. Will Delay next compressor for this time after EVAP pump/valve is opened. Target: If this set point is setup as a target type the value in the night setback column will be added to the set point VALUE to allow safety unloading all the way down to this value. This replaces a hardcoded 20%. This is also utilized in conjunction with hotgas setpoints #4 and #5 on temperature.

32	MAX ADJUST %	<p>Value of set point contains the maximum percentage change that can be made to the slide valve or VFD.</p> <p>'Time (sec)' field: A zero indicates that the calculated FLA will be used; else the value in set point #31 will be used when starting the next compressor. This value is specified in the 'Wanted FLA starting next Compressor' box in the 'Cooling Info' panel under the MAG RTU screen.</p>
33	MIN ADJUST %	<p>Indicates the minimum percentage change that can be made to the slide valve or the VFD. For Fixed Step Compressors with adjustable speed AO's when returning to 100% after shutting down another compressor, this Set point will be the percent of adjustment along with Set point #56 "PULSE DELAY" which is the time frame between capacity adjustments.</p>
34	SLIDE SENSITY	<p>This controls the sensitivity of the adjustment made to the Wanted Percentage (adjustments are relative to the difference between the current control sensor and target). The larger the value the larger the adjustment (usually 1).</p>
56	PULSE DELAY CMP RELOAD ADJ	<p>Used with variable capacity screws. The number of seconds between load or unload pulses (Usually between 3 and 5. Allows load change to be checked before next pulse and eliminates oil foaming when unloading too fast).</p> <p>'Time (sec)' field: If used, this is the fast unloading state time delay. This option is selected in the 'Fast Unload Delay' box in the 'Compressor Information' panel under the MAGNUM screen.</p> <p>For Fixed Step Compressors with adjustable speed AO's when returning to 100% after shutting down another compressor, this Set point will be the time frame between capacity adjustments along with Set point #33 "MIN ADJUST %" which is the percent of adjustment.</p> <p>IF Target Type: The high zone (pulse on time) and low zone (delay between pulses) will define the safety unloading logic as follows. The low zone timer is calculated from ON to ON. Example: hi zone =2, low zone =5. The unload solenoid will pulse ON for 2 seconds and be OFF for 3 seconds, ON for 2 seconds OFF for 3 seconds during safety unloading.</p>

Chapter - 15. Rapid Start

15.1. Purpose of Change

The purpose of this change is to add Rapid Start logic to MCS-Magnum HVAC Firmware. This logic will be used on process application where the chiller needs to provide cold water quickly after the unit has been off due to a power failure, run stop, unit lockout etc.. This new logic will change the capacity control stage from its normal control setpoints to new dynamic ROC staging logic. The required control temperatures rate of change to bring the control temperature with in the control zone target is developed. Cooling capacity will be added to maintain the needed rate of change. Once the control target zone has been entered the system will return to its normal control logic.

15.2. Existing Config Parameters

Suggest the POWER UP Delay set point #23, PowerUpDelay, have a low value 5-30 seconds depend on application.

15.3. New Config Parameters

The follow items are required to control the Rapid Start Dynamic ROC Loading:

1. Rapid Start Option Enabled
2. Rapid Start Time – this value defines the maximum time the chiller is allowed to be in the ‘RS-ADJ CAPACITY?’ state. When the unit is in this state it will increase the cooling capacity to maintain the needed control rate of change to get the control temperature with in the control zone. This time value is used in the calculation of the Rapid Start Dynamic ROC.
3. Rapid Start Delay – This is use as delay when unit state ‘RS-ADJ CAPACITY?’ between adjustments to the cooling capacity.
4. Rapid Start Adj% - this is used as the amount to increase the cooling capacity.
5. Rapid Start Compressors On – this value contains the number of compressor steps to turn when the unit is in the RS-STARTING COMP state.
6. Rapid Start Acceleration time – this is the time interval in seconds (1-60 only valid values) used to calculated the Rapid Start Dynamic Acceleration.
7. Rapid Start Maximum Acceleration – this is used as the maximum allowable acceleration value. The unit will not increase cooling capacity if the Rapid Start Dynamic Acceleration is less than this field. Note, this must be a negative value indicating a negative rate of change this show a decrease in the control temperature..

These parameters are contained in the following set points:

Set point #247, RS ComprTimers, target type of set point with no decimal places.

Value = Rapid Start Comps On (#5).

Time (SEC) = Delay between turning on compressors. (#5)

High Zone = Rapid Start Time. (#2)

Low Zone = Rapid Start Acceleration time. (#6)

Night Setback = Not used.

Set point #248, RS Adj/ROC, delay type of set point with 1 decimal place.

Value = Rapid Start Adj% (#4).

Time (SEC) = Delay between adjustments. (#3)

MIN VFD Opening = Not used.

MAX VFD Opening = Rapid Start Max Accel. (#7)

MAX Adjustment = Not used.

Set point #247 & Set point #248 both must be active to enable Rapid Start Option. (#1)

15.4. Calculated Values

Rapid Start Dynamic ROC – This value is calculated by taking the control target minus the current chilled water temperature divide by rapid start time. This value is calculated once at completion of the “RS-ADJ CAPACITY?” capacity states. This is the required rate of change of the control temperature to reduce the temperature to within the control zone within the time specified.

Rapid Start Dynamic Acceleration – This value is now fast the rate of change of the control temperature is changing.

15.5. Logic Requirements

1. If the Rapid Start Option is enable when both set points #247 and #248 are active and a power failure, computer reset or any other condition that causes the MCS-Magnum control logic to restart and the control temperature is above the top of the control zone the following occurs:
 - a. The normal capacity control staging logic is bypass until the chilled water out temperature is within the control zone or the time in Rapid Start has exceeded the Rapid Start time In place of the normal capacity control stage logic will be Rapid Start logic that will dynamically load the chiller to achieve control zone within a pre-defined amount of time..
 - b. After normal Power UP delay capacity control state, the capacity control state will go to “RS-STARTING COMP”. All compressors that are available, status is either anti-cycle or off ready will be made ready to be turned on if needed. The first compressor turned on will be the lead compressors. All compressor safeties will be executed during the rapid start time.
 - c. In ‘RS-STARTING COMP’ state a comp will start right away after the power up delay state. Then based upon the time delay in set point #247 a compressor will be started until the number of comps on equals Rapid Start Comp On set point value. Once all the compressors required on are started we need to calculate the Rapid Start Dynamic ROC value and set the capacity control state RS-LOADING CAP’Y.
 - d. In ‘RS-LOADING ‘state the a decision will be made whenever the delay time in set point #248 has been exceeded to increase the unit’s capacity If chilled water ROC is greater than the Rapid Start Dynamic value and Rapid Start Acceleration is greater than max acceleration set point value, the unit capacity will be increased by the value of set point #248. Once the capacity has reached its maximum, if another chiller is available it will be turned on and the capacity wanted will be changed to its minimum.

The delay counter will be reset in after a capacity change.

- e. In ‘RS-HOLDING ‘state no additional capacity is needed at this time. When in this state the needed capacity will be checked with every pass of the algorithm.
- f. Once the chilled water out temperature is inside the control zone or the rapid start time has been exceeded, the Rapid Start logic is disabled and normal capacity control logic takes over.

15.6. **Modification to Magnum Status Screen**

When the system is in a rapid start state the target line of the first screen of the Magnum Status display has been modified to show additional information about the rapid start. Also the delay counter is based upon the rapid start delay which is time of set point #248.

‘RS-STARTING COMP’

X MAX COMP ON IN RS (X is the maximum number of compressors that will be turned on in this state)

In this state the system will turn on the number of compressors allowed in the rapid start.

'RS-LOADING'

ACC = -2.1 TRG = 2.0 (ACC is the actual change in the control temperature and TRG is the Rapid Start Dynamic ROC)

In this state the capacity will be increased, once it is at its maximum an additional compressor if available will be turned on and the capacity will be set to its minimum value.

'RS-HOLDING'

ACC = -2.1 TRG = 2.0 (ACC is the actual change in the control temperature and TRG is the Rapid Start Dynamic ROC)

In this state the capacity will be not be increased.

Example:

Set point #1 (target) = 47.4

Control temperature a start of R-S ADJ CAPACITY? State = 77.0

Set point #247

Value = 3, number of compressors to turn on during RS-STARTING COMP state

Time = 15S, delay between turning on the next compressor

HI zone = 600, number of seconds to bring the control temperature with control zone

LOW zone = 30, delay when calculating the Rapid Start Dynamic Acceleration

Set point #248

Value = 10.0%, adjustment to capacity (Wanted %) when more cooling is needed

Time = 20S, delay between making adjustments to capacity, this will only be reset if an adjustment is made.

MAX VFD = -2.0, maximum dynamic acceleration

Calculate Rapid Start Dynamic ROC at end of **RS-STARTING COMP** State = -1.5 (This is the rate of change that the rapid start logic will try to maintain by increasing or holding the cooling capacity.)

(The rate of change is a negative number; therefore -1.0 is greater than -1.5)

Example #1

If the control temperature rate of change is -0.2 and the Rapid Start Dynamic Acceleration is -0.3.

State will be RS-LOADING, Cooling capacity will be increased by 10.0%, delay will be reset

(Control temperature rate of change is greater than the Rapid Start Dynamic ROC, temperature is not decrease fast enough and the acceleration is greater than the maximum, not exceeded it limit.)

Example #2

If the control temperature rate of change is -1.6 and the Rapid Start Dynamic Acceleration is -1.9.

State will be RS-HOLDING, Cooling capacity will remain constant, delay will not be reset

(Control temperature rate of change is greater than the Rapid Start Dynamic ROC, temperature is decrease fast enough and the acceleration is less than the maximum.)

Example #3

If the control temperature rate of change is -1.4 and the Rapid Start Dynamic Acceleration is -2.1.

State will be RS-HOLDING, Cooling capacity will remain constant, delay will not be reset

(Control temperature rate of change is greater than the Rapid Start Dynamic ROC, temperature is not decrease fast enough however the acceleration is less than the maximum, this indicates hold capacity as the rate of acceleration is moving fast enough at this time.)

Chapter - 16. Relay Output Sequences

The sequence of Relay Outputs must be correctly matched to the particular type of compressor being controlled. Relays are required unless marked as optional. If a relay is optional and it is not used then its position is skipped and the following relays will be moved up. Compressor type selection as displayed in MCS-Config is shown within brackets.

16.1. Reciprocating Compressors (Recip Comp w/Oil) and (Recip Comp w/o Oil)

Compressor relay
 Part winding compressor relay (OPTIONAL)
 Liquid line solenoid
 Unloader 1 (OPTIONAL)
 Unloader 2 (OPTIONAL)
 Unloader 3 (OPTIONAL)
 Oil pump (OPTIONAL, ONLY USED WITH **Recip Comp w/Oil**)
 Oil heater (OPTIONAL, ONLY USED WITH **Recip Comp w/Oil**)
 Hot gas bypass (OPTIONAL)
 Common Hot gas bypass (OPTIONAL)
 Liquid injection (OPTIONAL)
 Fast unloader (OPTIONAL)
 Second liquid line solenoid (OPTIONAL)
 Oil equalization (OPTIONAL)
 Oil seal cooler (OPTIONAL)
 VI increase valve % (OPTIONAL)
 VI decrease valve % (OPTIONAL)
 Start unloader bypass (OPTIONAL)
 Low disc superheat (OPTIONAL)
 Hot gas reheat off (OPTIONAL) If hot gas reheat all 3 hot gas relays are required.
 Hot gas reheat on (OPTIONAL)
 Hot gas reheat bleed (OPTIONAL)
 Third liquid line solenoid (OPTIONAL)
 Reversing valve (heat pump) (OPTIONAL)
 Liquid injection #2 (OPTIONAL)
 Mod motor (OPTIONAL)

16.2. Screw Compressor with Oil (Screw Comp w/Oil)

Compressor relay
 Part winding compressor relay (OPTIONAL)
 Loader
 Unloader
 Oil pump
 Oil heater
 Liquid line solenoid (OPTIONAL)
 Hot gas bypass (OPTIONAL)
 Common Hot gas bypass (OPTIONAL)
 Liquid injection (OPTIONAL)
 Fast unloader (OPTIONAL)
 Second liquid line solenoid (OPTIONAL)
 Oil equalization (OPTIONAL)
 Oil seal cooler (OPTIONAL)
 VI increase valve % (OPTIONAL)
 VI decrease valve % (OPTIONAL)
 Start unloader bypass (OPTIONAL)
 Low disc superheat (OPTIONAL)

The sequence of Relay Outputs must be correctly matched to the particular type of compressor being controlled. Relays are required unless marked as optional. If a relay is optional and it is not used then its position is skipped and the following relays will be moved up. Compressor type selection as displayed in MCS-Config is shown within brackets.

16.3. Reciprocating Compressors (Recip Comp w/Oil) and (Recip Comp w/o Oil)

Compressor relay
 Part winding compressor relay (OPTIONAL)
 Liquid line solenoid
 Unloader 1 (OPTIONAL)
 Unloader 2 (OPTIONAL)
 Unloader 3 (OPTIONAL)
 Oil pump (OPTIONAL, ONLY USED WITH **Recip Comp w/Oil**)
 Oil heater (OPTIONAL, ONLY USED WITH **Recip Comp w/Oil**)
 Hot gas bypass (OPTIONAL)
 Common Hot gas bypass (OPTIONAL)
 Liquid injection (OPTIONAL)
 Fast unloader (OPTIONAL)
 Second liquid line solenoid (OPTIONAL)
 Oil equalization (OPTIONAL)
 Oil seal cooler (OPTIONAL)
 VI increase valve % (OPTIONAL)
 VI decrease valve % (OPTIONAL)
 Start unloader bypass (OPTIONAL)
 Low disc superheat (OPTIONAL)
 Hot gas reheat off (OPTIONAL) If hot gas reheat all 3 hot gas relays are required.
 Hot gas reheat on (OPTIONAL)
 Hot gas reheat bleed (OPTIONAL)
 Third liquid line solenoid (OPTIONAL)
 Reversing valve (heat pump) (OPTIONAL)
 Liquid injection #2 (OPTIONAL)
 Mod motor (OPTIONAL)

16.4. Screw Compressor with Oil (Screw Comp w/Oil)

Compressor relay
 Part winding compressor relay (OPTIONAL)
 Loader
 Unloader
 Oil pump
 Oil heater
 Liquid line solenoid (OPTIONAL)
 Hot gas bypass (OPTIONAL)
 Common Hot gas bypass (OPTIONAL)
 Liquid injection (OPTIONAL)
 Fast unloader (OPTIONAL)
 Second liquid line solenoid (OPTIONAL)
 Oil equalization (OPTIONAL)
 Oil seal cooler (OPTIONAL)
 VI increase valve % (OPTIONAL)
 VI decrease valve % (OPTIONAL)
 Start unloader bypass (OPTIONAL)
 Low disc superheat (OPTIONAL)
 Hot gas reheat off (OPTIONAL) If hot gas reheat all 3 hot gas relays are required.
 Hot gas reheat on (OPTIONAL)
 Hot gas reheat bleed (OPTIONAL)

Third liquid line solenoid (OPTIONAL)
Reversing valve (heat pump) (OPTIONAL)
Liquid injection #2 (OPTIONAL)
Mod motor (OPTIONAL)

16.5. Scroll Compressor (Scroll Comp)

Compressor relay
Part winding compressor relay (OPTIONAL)
Liquid line solenoid
Unloader 1 (OPTIONAL)
Unloader 2 (OPTIONAL)
Unloader 3 (OPTIONAL)
Oil pump
Oil heater
Hot gas bypass (OPTIONAL)
Common Hot gas bypass (OPTIONAL)
Liquid injection (OPTIONAL)
Fast unloader (OPTIONAL)
Second liquid line solenoid (OPTIONAL)
Oil equalization (OPTIONAL)
Oil seal cooler (OPTIONAL)
VI increase valve % (OPTIONAL)
VI decrease valve % (OPTIONAL)
Start unloader bypass (OPTIONAL)
Low disc superheat (OPTIONAL)
Hot gas reheat off (OPTIONAL) If hot gas reheat all 3 hot gas relays are required.
Hot gas reheat on (OPTIONAL)
Hot gas reheat bleed (OPTIONAL)
Third liquid line solenoid (OPTIONAL)
Reversing valve (heat pump) (OPTIONAL)
Liquid injection #2 (OPTIONAL)
Mod motor (OPTIONAL)

16.6. Hitachi Screw Compressor (Hitachi Screw Comp)

Compressor relay
Part winding compressor relay (OPTIONAL)
Loader
Unloader
Fast unloader
Oil pump (OPTIONAL)
Oil heater (OPTIONAL)
Liquid line solenoid (OPTIONAL)
Hot gas bypass (OPTIONAL)
Common Hot gas bypass (OPTIONAL)
Liquid injection (OPTIONAL)
Fast unloader (OPTIONAL)
Second liquid line solenoid (OPTIONAL)
Oil equalization (OPTIONAL)
Oil seal cooler (OPTIONAL)
VI increase valve % (OPTIONAL)
VI decrease valve % (OPTIONAL)
Start unloader bypass (OPTIONAL)
Low disc superheat (OPTIONAL)
Hot gas reheat off (OPTIONAL) If hot gas reheat all 3 hot gas relays are required.
Hot gas reheat on (OPTIONAL)
Hot gas reheat bleed (OPTIONAL)
Third liquid line solenoid (OPTIONAL)

Reversing valve (heat pump) (OPTIONAL)
 Liquid injection #2 (OPTIONAL)
 Mod motor (OPTIONAL)

16.7. Carlyle Screw (Carlyle Screw)

Compressor relay
 Part winding compressor relay (OPTIONAL)
 Liquid line solenoid
 Hot gas bypass (OPTIONAL)
 Common Hot gas bypass (OPTIONAL)
 Liquid injection (OPTIONAL)
 Fast unloader (OPTIONAL)
 Second liquid line solenoid (OPTIONAL)
 Oil equalization (OPTIONAL)
 Oil seal cooler (OPTIONAL)
 VI increase valve % (OPTIONAL)
 VI decrease valve % (OPTIONAL)
 Start unloader bypass (OPTIONAL)
 Low disc superheat (OPTIONAL)
 Hot gas reheat off (OPTIONAL) If hot gas reheat all 3 hot gas relays are required.
 Hot gas reheat on (OPTIONAL)
 Hot gas reheat bleed (OPTIONAL)
 Third liquid line solenoid (OPTIONAL)
 Reversing valve (heat pump) (OPTIONAL)
 Liquid injection #2 (OPTIONAL)
 Mod motor (OPTIONAL)

16.8. Hanbell Screw Compressor, McQuay Frame 4 Compressor, Bitzer Screw Compressor, Hartford Screw Compressor, and Fu Sheng Compressor (McQuay Frame 4), (Fu Sheng), (Hanbell-Load NO), (Bitzer Screw Comp), (Hartford Screw Comp), and (Hanbell-Load NC)

Compressor relay
 Part winding compressor relay (OPTIONAL)
 Loader
 Unloader
 Oil pump (OPTIONAL)
 Oil heater (OPTIONAL)
 Liquid line solenoid (OPTIONAL)
 Hot gas bypass (OPTIONAL)
 Common Hot gas bypass (OPTIONAL)
 Liquid injection (OPTIONAL)
 Fast unloader (OPTIONAL)
 Second liquid line solenoid (OPTIONAL)
 Oil equalization (OPTIONAL)
 Oil seal cooler (OPTIONAL)
 VI increase valve % (OPTIONAL)
 VI decrease valve % (OPTIONAL)
 Start unloader bypass (OPTIONAL)
 Low disc superheat (OPTIONAL)
 Hot gas reheat off (OPTIONAL) If hot gas reheat all 3 hot gas relays are required.
 Hot gas reheat on (OPTIONAL)
 Hot gas reheat bleed (OPTIONAL)
 Third liquid line solenoid (OPTIONAL)
 Reversing valve (heat pump) (OPTIONAL)
 Liquid injection #2 (OPTIONAL)
 Mod motor (OPTIONAL)

16.9. Hanbell-3 Solenoid (Hanbell-3 Solenoid [50-100%])

Compressor relay
Part winding compressor relay (OPTIONAL)
Loader
Unloader
Fast unloader
Oil pump (OPTIONAL)
Oil heater (OPTIONAL)
Liquid line solenoid (OPTIONAL)
Hot gas bypass (OPTIONAL)
Common Hot gas bypass (OPTIONAL)
Liquid injection (OPTIONAL)
Fast unloader (OPTIONAL)
Second liquid line solenoid (OPTIONAL)
Oil equalization (OPTIONAL)
Oil seal cooler (OPTIONAL)
VI increase valve % (OPTIONAL)
VI decrease valve % (OPTIONAL)
Start unloader bypass (OPTIONAL)
Low disc superheat (OPTIONAL)
Hot gas reheat off (OPTIONAL) If hot gas reheat all 3 hot gas relays are required.
Hot gas reheat on (OPTIONAL)
Hot gas reheat bleed (OPTIONAL)
Third liquid line solenoid (OPTIONAL)
Reversing valve (heat pump) (OPTIONAL)
Liquid injection #2 (OPTIONAL)
Mod motor (OPTIONAL)

16.10. Hanbell Fixed Step (Hanbell Step)

Compressor relay
Part winding compressor relay (OPTIONAL)
Unloader 1 (OPTIONAL)
Unloader 2 (OPTIONAL)
Unloader 3 (OPTIONAL)
Liquid line solenoid
Oil pump (OPTIONAL)
Oil heater (OPTIONAL)
Hot gas bypass (OPTIONAL)
Common Hot gas bypass (OPTIONAL)
Liquid injection (OPTIONAL)
Fast unloader (OPTIONAL)
Second liquid line solenoid (OPTIONAL)
Oil equalization (OPTIONAL)
Oil seal cooler (OPTIONAL)
VI increase valve % (OPTIONAL)
VI decrease valve % (OPTIONAL)
Start unloader bypass (OPTIONAL)
Low disc superheat (OPTIONAL)
Hot gas reheat off (OPTIONAL) If hot gas reheat all 3 hot gas relays are required.
Hot gas reheat on (OPTIONAL)
Hot gas reheat bleed (OPTIONAL)
Third liquid line solenoid (OPTIONAL)
Reversing valve (heat pump) (OPTIONAL)
Liquid injection #2 (OPTIONAL)
Mod motor (OPTIONAL)

16.11. Mitsubishi Screw (Mitsubishi Screw)

Compressor relay
 Part winding compressor relay (OPTIONAL)
 Fast unloader
 40 % open
 70 % open
 Liquid line solenoid (OPTIONAL)
 Hot gas bypass (OPTIONAL)
 Common Hot gas bypass (OPTIONAL)
 Liquid injection (OPTIONAL)
 Fast unloader (OPTIONAL)
 Second liquid line solenoid (OPTIONAL)
 Oil equalization (OPTIONAL)
 Oil seal cooler (OPTIONAL)
 VI increase valve % (OPTIONAL)
 VI decrease valve % (OPTIONAL)
 Start unloader bypass (OPTIONAL)
 Low disc superheat (OPTIONAL)
 Hot gas reheat off (OPTIONAL) If hot gas reheat all 3 hot gas relays are required.
 Hot gas reheat on (OPTIONAL)
 Hot gas reheat bleed (OPTIONAL)
 Third liquid line solenoid (OPTIONAL)
 Reversing valve (heat pump) (OPTIONAL)
 Liquid injection #2 (OPTIONAL)
 Mod motor (OPTIONAL)

16.12. Trane Scroll with 3 Compressor Sets (Trane Trio)

Staging sequence			
	COMP A	COMP B	COMP C
Stage 1	OFF	OFF	ON
Stage 2	ON	ON	OFF
Stage 3	ON	ON	ON

Compressor relay for COMP A
 Part winding compressor relay (OPTIONAL)
 Liquid line solenoid
 Compressor relay for COMP B
 Compressor relay for COMP C
 Hot gas bypass (OPTIONAL)
 Common Hot gas bypass (OPTIONAL)
 Liquid injection (OPTIONAL)
 Fast unloader (OPTIONAL)
 Second liquid line solenoid (OPTIONAL)
 Oil equalization (OPTIONAL)
 Oil seal cooler (OPTIONAL)
 VI increase valve % (OPTIONAL)
 VI decrease valve % (OPTIONAL)
 Start unloader bypass (OPTIONAL)
 Low disc superheat (OPTIONAL)
 Hot gas reheat off (OPTIONAL) If hot gas reheat all 3 hot gas relays are required.
 Hot gas reheat on (OPTIONAL)
 Hot gas reheat bleed (OPTIONAL)
 Third liquid line solenoid (OPTIONAL)
 Reversing valve (heat pump) (OPTIONAL)
 Liquid injection #2 (OPTIONAL)
 Mod motor (OPTIONAL)

16.13. Trane Scroll with 4 Compressor Sets (Trane Quad)

Staging sequence				
	COMP A	COMP B	COMP C	COMP D
Stage 1	ON	OFF	OFF	OFF
Stage 2	OFF	OFF	ON	ON
Stage 3	OFF	ON	ON	ON
Stage 4	ON	ON	ON	ON

Compressor relay for COMP A

Part winding compressor relay (OPTIONAL)

Liquid line solenoid

Compressor relay for COMP B

Compressor relay for COMP C

Compressor relay for COMP D

Hot gas bypass (OPTIONAL)

Common Hot gas bypass (OPTIONAL)

Liquid injection (OPTIONAL)

Fast unloader (OPTIONAL)

Second liquid line solenoid (OPTIONAL)

Oil equalization (OPTIONAL)

Oil seal cooler (OPTIONAL)

VI increase valve % (OPTIONAL)

VI decrease valve % (OPTIONAL)

Start unloader bypass (OPTIONAL)

Low disc superheat (OPTIONAL)

Hot gas reheat off (OPTIONAL) If hot gas reheat all 3 hot gas relays are required.

Hot gas reheat on (OPTIONAL)

Hot gas reheat bleed (OPTIONAL)

Third liquid line solenoid (OPTIONAL)

Reversing valve (heat pump) (OPTIONAL)

Liquid injection #2 (OPTIONAL)

Mod motor (OPTIONAL)

Chapter - 17. Setpoint Functions

17.1. Voltage Sensor Input

Up to three sensors that measure voltage input can be specified. If used, a safety condition based upon Setpoint #195 LOW VOLTAGE and Setpoint #196 HI VOLTAGE will be checked. If a safety trip occurs the unit will be placed in a safety hold state.

17.1.1 Set up the sensor type

1. Under **Setup** (MAGNUM Setup Screen) increase number of sensors(3) to add new sensors.
2. Under **SI's** (Sensor Input Info Screen, setup your sensors as shown,

Name	Display Type
a. Volts A	600VAC4
b. Volts B	600VAC4
c. Volts C	600VAC4
3. Point to the Sensors in the **MAG HVAC** (MAGNUM Setup Screen)

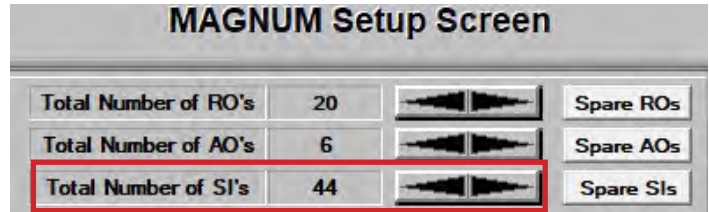

Point Number	Name (1 to 10 char)	Display Type	Offset	Manual Value or NC/NO (select to change)
2-9 ...	UNIT VOLTS	User Logic	0	0
2-10 ...	Volts A	600VAC4	0	0
2-11 ...	Volts B	600VAC4	0	0
2-12 ...	Volts C	600VAC4	0	0

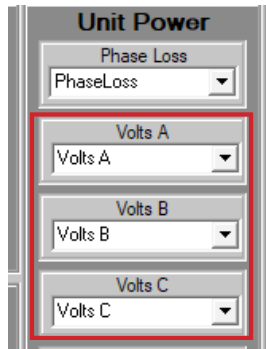

4. Voltage Setpoints

Make setpoints #195, (Low Voltage setting), #196 (High Voltage setting).

#	Name	Value	Min	Max	Adjust Value	Time (SEC)	Max Time Allowed (SEC)	Lockout Delay (HRS)	Safety Down Time(MIN)	Active or Non-Active	Select Value: # decimals & print char	Level Of Auth. To Display	Type of Setpoint
195	Low Voltage	414	400	500	0.5	5	20	2	10	Active	... VOLTS-1Dec	View Only	Lockout
196	High Voltage	506	400	600	0.5	5	20	2	10	Active	... VOLTS-1Dec	View Only	Lockout
207	Unbal Volts	10	0	30	1	5	20	2	10	Active	... VOLTS-1Dec	View Only	Alarm

195	LOW VOLTAGE	If active and the voltage of any one of the voltage sensors is less than the value of this Setpoint for the time specified in the safety time cell, then a Low Voltage alarm will be generated and the unit will be locked out.
196	HI VOLTAGE	If active and the voltage of any one of the voltage sensors is greater than the value of this Setpoint for the time specified in the safety time cell, then a Hi Voltage alarm will be generated and the unit will be locked out.

17.1.2 UNBALANCED Voltage Setpoint

Make setpoint #207 active.

Setpoint Information Screen													
#	Name	Value	Min	Max	Adjust Value	Time (SEC)	Max Time Allowed (SEC)	Lockout Delay (HRS)	Safety Down Time(MIN)	Active or Non-Active	Select Value: # decimals & print char	Level Of Auth. To Display	Type of Setpoint
195	Low Voltage	414	400	500	0.5	5	20	2	10	Active	... VOLTS-1Dec	View Only	Lockout
196	High Voltage	506	400	600	0.5	5	20	2	10	Active	... VOLTS-1Dec	View Only	Lockout
207	Unbal Volts	10	0	30	1	5	20	2	10	Active	... VOLTS-1Dec	View Only	Alarm

207	UNBAL VOLTS	If active, the average of the voltage sensors is calculated. Each individual voltage sensor is compared to this average and if the difference is greater than the value of this setpoint, an alarm is generated and the unit is locked out. After the voltages have returned to normal an automatic lockout reset will occur after the delay in the Safety Down Time(MIN) field.
-----	-------------	--

Example: Assuming Setpoint #207 value field is set to 10v

SI (Sensor Input)	Voltage Sensor Reading
Volts A	460v
Volts B	464v
Volts C	444v
Average Voltage Value	456v
Volts A differential from average = 4v	
Volts B differential from average = 8v	
Volts C differential from average = 12v	
In this example Volts C differential from the average voltage between all three legs of power exceeds our setpoint #207 value of 10 volts which would cause the unit to lockout on unbalanced voltage.	

17.2. Motor Amps

Up to three sensors that measure amperage input can be specified per circuit. If used a safety condition based upon Setpoints #75 HI AMPS and #76 LO AMPS, plus the associated Full Load Amps (FLA) for that circuit will be checked. If a safety trip occurs, that circuit will be placed in a safety hold state.

17.2.1 Add an Amp Imbalance Safety Test to the existing Amp Safeties.

All three Motor Amps (A, B, & C) sensors must be indicated and **setpoint #241** must be active and be setup as a normal safety and contain:

Type: Either Lockout or Alarm

Select Value: HUMD or %

Value: Maximum percentage of deviation

Time: Normal safety

Lockout Delay: Normal safety

Safety Down Time: Normal safety

This safety will be run every second when the compressor is on and the split winding relay is on if one exists (same requirement as other amp safeties).

The three amp sensor values will be totaled and averaged. If any of the amp sensors are more than the percentage of the value of **setpoint #241** difference from the average for more than the time specified in the time cell of **setpoint #241** the compressor will be tripped and the error message will be the name of **setpoint #241** plus the circuit number. The normal 2 trip logic will apply if the set point is a lockout type.

- 17.3. Custom display description of circuit
Instead of displaying the circuit number in the status screens of both the Magnum and MCS-Connect, up to 3 characters can be supplied using MCS-Config to replace the circuit number. For example, if 1-A is entered for circuit 1, then 1-A will be displayed in place of 1. This provides the user additional flexibility in describing a particular circuit.
- 17.4. User Logic RO Delay Before Off
A timer delay before turning off a relay has been added, providing the ability to keep a relay on for a period of time after the condition to turn it off is met.
- 17.5. Additional Information Messages
The messages generated when manually changing the status of a Relay Output or Sensor Input have been expanded. The messages now indicate which relay or sensor was changed and if the change was from AUTO to MANUAL or MANUAL to AUTO.
- 17.6. Pump Rotation
Pump rotation functionality has been added. This is specified with Setpoint #106 LEAD PUMP. If the Setpoint is active and its value is zero, then rotation will occur with each on/off cycle of the pump.
- 17.7. Process Pump Addition and Rotation
The number of process pumps has been expanded to two and rotation functionality has been added. This is specified with Setpoint #197 LEAD ProcPmp. If the Setpoint is active and its value is zero, then rotation will occur with each on/off cycle of the process pump.
- 17.8. MOP Control Option to EXV Logic
Maximum Operating Pressure (MOP) has been added to the EXV control logic. If Setpoint #199 MOP TARG PSI is active then MOP logic will be activated. Refer to section on Electronic Expansion Valve Control Logic.
- 17.9. Delta Temperature Evaporator
If Setpoint #202 DELTA TEMP EVP is active and the delta temperature across the evaporator is greater than the value of this Setpoint the unit will not increase wanted capacity.
- 17.10. Condenser Low Ambient
When a compressor is started its discharge pressure will be used as the controlling pressure for five minutes, enabling that compressor to build head pressure. However, if Setpoint #204 COND LOW AMB is active and there is an ambient temperature sensor reading less than this Setpoint, then this compressor's discharge pressure will remain in control for an additional time as specified in the "Time (sec)" field.
- 17.11. New Pressure Sensor Supported
Two pressure transducers developed by Huba Control designed refrigeration industry. These are the HB-350 and the HB-700.
- 17.12. Centrifugal Vane Control
Vane control now can be based on either a vane position or compressor amp draw Sensor Input.
- 17.13. External Centrifugal Purge Control
Support for the Trane Purifier Purge operation has been added. If Setpoint #163 Purge Target is active, it will activate this feature.
- 17.14. MCS Touch Screens Interface
The interface with the various touch screens has been expanded.
- 17.15. Sensor Averaging
Sensor inputs can now be averaged over a period of time, up to a maximum time of 30 seconds. This will enable sensor smoothing if it is needed. Note: At power up, the initial value of the Sensor Input will be counted as the sensor history for the number of seconds that has been selected as the averaging time (for example,

if the averaging time was selected at 5 seconds, the initial Sensor Input reading at startup will be counted as having already run at that value for 5 seconds previously).

17.16. Virtual Points Separated From Real Points

Virtual points are Sensor Inputs, Relay Outputs, or Analog Outputs that are not connected to an outside device, while a real point is connected with wiring from the input/output to an outside device (sensor, motor, etc.). By placing the virtual points after the real points they will not take up points on an actual hardware board. In the Setup section of MCS-Config the total number of points are specified and the number of Input/Output boards must now be specified. Only the number of I/O boards indicated will be accessed.

17.17. MDP to EXV Control Logic

Minimal (oil) Differential Psi (MDP) requires the following Setpoint #205 be active (Refer to Setpoint #205). The EXV logic will forced the state to "EXV MDP CLOSE" when the all of the following conditions are true:

1. Setpoint #205 "MDP MIN OIL DIFF" is active,
2. The compressor oil differential pressure is less than Setpoint #205 value field,
3. The compressor has been running for less than X mins or X is equal to zero (where X is the value contained in Setpoint #205 "SEC to IGNORE SAFETY" field),
4. The compressor suction pressure is greater than or equal to (Setpoint #77 "LOW SUCTION" value plus Setpoint #79 "LO SUCT RELD" value).

In this state the EXV will be closed by the adjustment value in Setpoint #205 "Lockout Delay" field. If this value is positive the valve is closed, if this value is negative the valve will be opened.

The EXV logic will exit the "EXV MDP CLOSE" state and go to "EXV HOLDING" state when the any of the follow conditions are true:

1. The compressor oil differential pressure is greater than (Setpoint #205 value field plus Setpoint #205 Time field),
2. The compressor has been running for more than X mins and X is not equal to zero (where X is the value contained in Setpoint #205 "SEC to IGNORE SAFETY" field),
3. The compressor suction pressure is less than or equal to (Setpoint #77 "LOW SUCTION" value plus Setpoint #78 "LO SUCT ULLD" value).

17.18. Low Discharge Superheat Adjustment to EXV Logic

Setpoint #110 LOW REFRIGERANT LEVEL TARGET must be active.

If discharge superheat is less than Setpoint #84 LO DISC SUPERHEAT for 1/3 of its safety time and both discharge temperature and pressure sensors are active, then add the value of Setpoint #110 LOW REFRIGERANT LEVEL TARGET to Setpoint #9 EXV TARGET. This function takes precedence over the regular control zone logic.

17.19. Normal Condenser Discharge Control Bypass

Depending on what option was selected in MCS-Config, normal condenser control can either be based upon the compressor with the highest discharge pressure or on the pressure of the most recently started compressor. If control based on newly started compressor was selected then Setpoint #206 may be used to bypass this logic because of a high ambient temperature.

(Refer to Setpoint #206)

17.20. Test for Voltage Out of Balance

This test requires Setpoint #207 to be active. (Refer to Setpoint #207)

Only voltage sensors that are specified in the MAG V8 screen of MCS-Config will be included in the calculation.

17.21. Expanded Testing of Low and High Off

This test requires Setpoints #208 LOW SI OFF and #209 HI SI OFF to be active. (Refer to Setpoints #208 and #209)

17.22. Expanded Compressor Rotation to Check for Maximum Run Time

In the Compressor Information panel of the MAG V8 screen in MCS-Config, there is now a check box to select how compressors are to be rotated, based either on Run Time or First On/First Off.

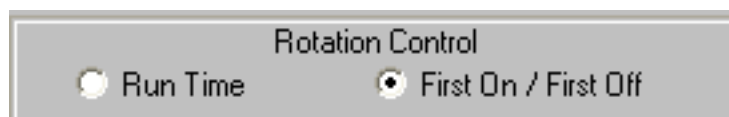

17.23. New Option to test for Low Superheat on Suction or Discharge PSI

In the Circuit Base screen under the EXV Control column select “Disc Sph” to test discharge pressure or “Suct Sph” to test the suction pressure to determine low superheat.

17.24. New Large Character Screen Displaying Control Information

A new information screen has been added with large character size for ease of reading. This screen is accessed from the Main Menu of the Magnum Keypad by pressing the F3 key.

ACTUAL DISPLAY

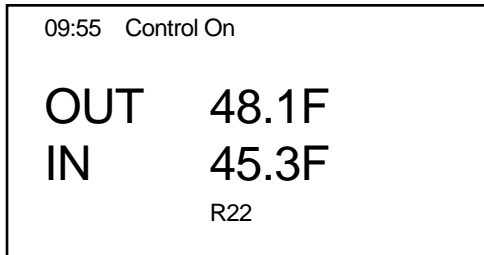

DESCRIPTION

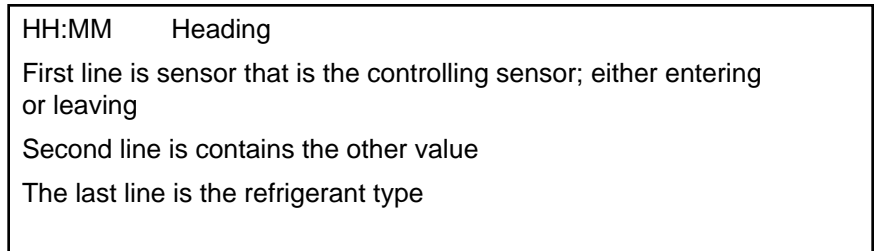

If the “Scrolling Information” option has been selected from MCS-Config, this page will be included in the screen rotation.

17.25. Circuit Amp Value added to Circuit Status Screen

The amp value is now included in the first page of each compressor information screen. Use the right arrow button to access it.

17.26. Low Discharge Superheat Test to Economizer

Requires Setpoint #210 ECO LL3 D-SHT (Refer to Setpoint #210)

17.27. Tonnage and KW Information

17.27.1 KW Sensors

Sensor Input Information Screen										
#	Name (1 to 10 char)	Display Type	Offset	Manual Value or NC/NO (select to change)	Display Text (select to change)	Temp./ GPM / CFM / Pwr Factor SI	Humd./PSI/ Temp. Diff./ Enthal. Diff.	Auto/Manual (Click here for all)		
▶ 1-8	UNIT KW	KW	0	0	Not Used	PWR FACT ▾	Not Used	Auto	...	
1-9	PWR FACTO	User Logic	0	0	Not Used	Not Used	Not Used	Auto	...	
1-10	UNIT VOLTS	0-600 VAC	0	0	Not Used	Not Used	Not Used	Auto	...	
1-11	UNIT AMP	CT-500	0	0	Not Used	Not Used	Not Used	Auto	...	

Unit KW – virtual sensor that calculates the unit Kilowatt usage. The Power Factor (PF) sensor must be selected in the ‘Temp. / GPM / CFM / Pwr Factor SI’ cell.

$$Kw = Amps * Volts * Power Factor * Internal Constant of .00173$$

Power Factor – Virtual sensor tied to a Setpoint where a manual value of the unit’s power factor may be defined.

If not specified, a hardcoded value of .85 will be used.

Unit Volts – Voltage being supplied to the unit. This sensor can be an actual voltage sensor or virtual point that reads a static value from a Setpoint.

Unit Amps – Sensor reading the amperage of the entire unit. If no total unit amp sensor is specified, the software will automatically sum all the individual compressor amp sensors to approximate the unit amps.

17.27.2 Tonnage Sensors

Unit Tons – a virtual sensor that calculates the unit tonnage. The Unit Flow (GPM or CFM) sensor must be selected in the 'Temp. / GPM / CFM / Pwr Factor SI' cell, and the Enthalpy Differential or Temperature Differential sensor (air and water cooling systems respectively) must be selected in the 'Humd. SI / Temp. Diff. / Enthl. Diff.' cell. Also the correct values must be placed in the 'Multiplier' and 'Divisor' cells depending on the type of system; 45 and 10 respectively for air.

Tonnage for water (Fahrenheit) is calculated using a multiplier of 1 and divisor of 24 (refer to picture below).

Tonnage for water (Celsius) is calculated using a multiplier of 9 and divisor of 120.

$$\text{Tonnage (water Fahrenheit)} = \text{Flow (GPM)} * 1 \text{ Temperature Differential} / 24$$

$$\text{Tonnage (water Celsius)} = \text{Flow (GPM)} * 9 \text{ Temperature Differential} / 120$$

$$\text{Tonnage (air)} = \text{Flow (CFM)} * \text{Enthalpy Differential} * 4.5$$

Sensor Input Information Screen														
#	Name (1 to 10 char)	Display Type	Offset	Manual Value or NC/NO (select to change)	Display Text (select to change)	Temp./GPM/CFM/Pwr Factor SI	Humd./PSI/Temp. Diff./Enthal. Diff.	Auto/Manual (Click here for all)	Circuit Index	Multiplier	Divisor	Offset	Select Display Type	
1-12	UNIT TONS	TONS	0	0	Not Used	UNIT GPM	TEMP DIFF	Auto	...	Not Used	1	24	Not Used	Not Used
1-13	UNIT GPM	User Defined	0	0	Not Used	Not Used	Not Used	Auto	...	Not Used	100	1025	28	FPM
1-14	TEMP DIFF	User Logic	0	0	Not Used	Not Used	Not Used	Auto	...	Not Used	Not Used	Not Used	Not Used	TEMP
1-15	WATER IN	MCST100	0	0	Not Used	Not Used	Not Used	Auto	...	Not Used	Not Used	Not Used	Not Used	Not Used
1-16	WATER OUT	MCST100	0	0	Not Used	Not Used	Not Used	Auto	...	Not Used	Not Used	Not Used	Not Used	Not Used

Unit Flow (GPM or CFM) – Gallons per minute (for water) or cubic feet per minute (for air). This can be an actual flow sensor or virtual point that reads a static value from a Setpoint. NOTE: It is essential for a correct calculation that this sensor must be configured so as to have no decimal places.

Water In and Out Temperatures – (Water only) Temperature sensors for Water In and Out.

Temperature Differential – (Water only) User logic that subtracts Water Out Temperature from Water In Temperature.

$$\text{Temp Diff} = \text{Water In} - \text{Water Out}$$

Supply and Return Humidity – (Air only) Humidity sensors for Return and Supply air.

Supply and Return Temperatures – (Air only) Temperature sensors for Return and Supply air.

Return Enthalpy – (Air only) Virtual sensor that calculates enthalpy for Return air. The Return Temperature sensor must be selected in the 'Temp. / GPM / CFM / Pwr Factor SI' cell and the Return Humidity sensor must be selected in the 'Humd. SI / Temp. Diff. / Enthl. Diff.' cell.

Supply Enthalpy – (Air only) Virtual sensor that calculates enthalpy for Supply air. The Supply Temperature sensor must be selected in the 'Temp. / GPM / CFM / Pwr Factor SI' cell and the Supply Humidity sensor must be selected in the 'Humd. SI / Temp. Diff. / Enthl. Diff.' cell.

Enthalpy Differential – (Air only) User logic that subtracts Supply Enthalpy from Return Enthalpy.

$$\text{Enth Diff} = \text{Return Ent} - \text{Supply Ent}$$

17.27.3 Configuring KW and Tonnage

To set up User Logic for Power Factor (or GPM, CFM, or Unit Volts if desired), first go to the Setpoints screen and scroll down to the very bottom. Starting at Setpoint #230 and working your way up, activate the number of Setpoints you will need. Give each point a descriptive name that will help you identify its function, such as the example below. Then input the value you would like that sensor to read, as well as a range that value may vary in and the interval at which you would like to adjust the value. Pay special note to the type of Setpoint selected (as in the example below) in the "Select Value: # decimals & print char" cell so that the values will read and calculate correctly.

Setpoint Information Screen														
#	Name	Value	Min	Max	Adjust Value	Time (SEC)	Max Time Allowed (SEC)	Lockout Delay (HRS)	Safety Down Time(MIN)	Active or Non-Active	Select Value: # decimals & print char	Level Of Auth. To Display	Type of Setpoint	Comments
230	Power Factor	0.05	0	1	0.01	0	0	0	0	Active	...	STATIC-2De	View Only	Setpoint

Once your Setpoints have been defined, go back to the SI screen. Find the respective sensor you wish to tie to a Setpoint and select User Logic in the “Display Type” column. The “User Logic SI V11 Form” screen will pop up. First select the same Display Type as you did in the “Select Value: # decimals & print char” cell for the respective Setpoint. Next, select “Setpoints” in the first dropdown menu of the Operand #1 box, and select the respective Setpoint in the second dropdown menu. Finally, select “None” in the middle dropdown menu (Operators). An example User Logic displaying the value of a Setpoint is shown below:



To set up the User logic for differential calculations, such as for Temperature Differential, first select User Logic as the Display Type for that particular sensor. Again the “User Logic SI V11 Form” screen will pop up. This time you will select the corresponding display type, as well as SI type for Operands #1 and #2. Then select Water In Temperature for Operand #1 and Water Out Temperature for Operand #2 and subtraction from the middle drop down menu (See picture below).

The Unit Tons value is selected in the “Evap. Tonnage” cell in the Evaporator Information panel under the MAG V8 screen.

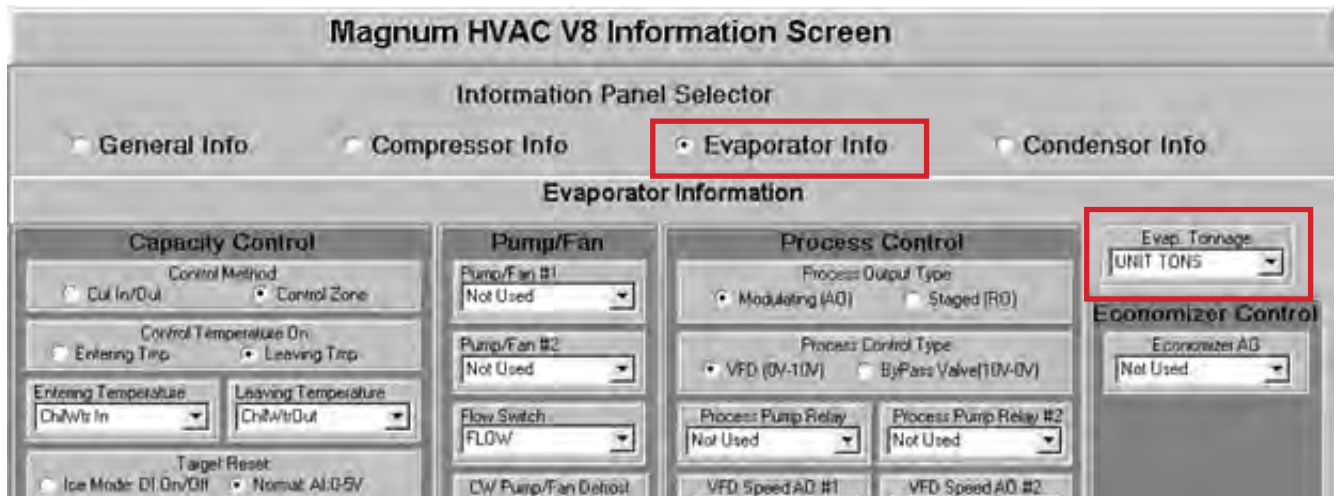

The Unit Volts sensor is selected in the “Volts A” cell in the General Information panel. The Unit Amps sensor is selected in the “Unit Amps” cell (If not used then the “Amps A” cell from each circuit in the Circuit SI screen will be totaled together to calculate the amps value). The Unit KW sensor is selected in the “Unit KW” cell.

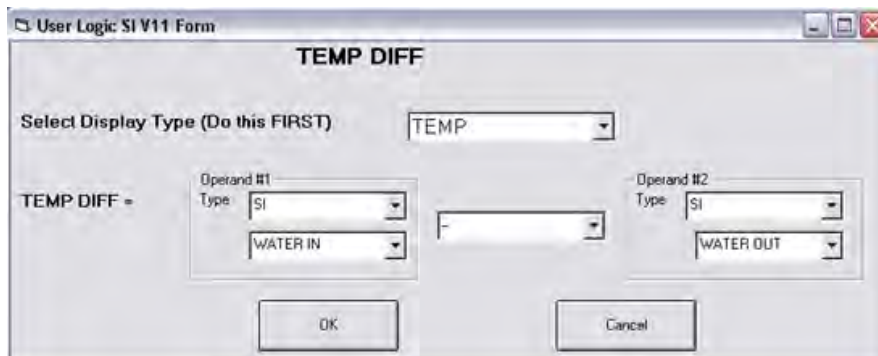

The following screen has been added to the status screens in the keypad display to show Tonnage/KW information (if available):

ACTUAL DISPLAY

09:55	Unit 60/65		
	UNIT IS UNLOADED		
	025:42;33		
<u>AMP&VLT</u>	<u>KW&TO</u>	<u>KW/TON</u>	
110.0A	73.8K	0.15	
388.0V	479T		
	PG↑	PG↓	

DESCRIPTION

HH:MM	CHILLER UNIT LEV/ENT		
	CURRENT CONTROL STATE		
	TIME IN CURRENT STATE		
<u>AMP and VOLT</u>	<u>KW and TON</u>	<u>KW/TON</u>	
AMPS	KW	KW/TON with	
VOLTAGE	TONS	2 decimals	
	PAGE UP	PAGE DN	

17.28. Oil Flow Safety

Requires Setpoint #211 if HVAC configuration type, Setpoint #214 if CENT (Refer to Setpoints #211 and #214).

17.29. RTC Access to User Logic

The real time clock (RTC) can now be accessed in the User Logic.

Chapter - 18. Condenser Control Logic

Many condenser types are supported by the Magnum controller including individual condensers per circuit, shared condensers between multiple circuits, and common condensers for all circuits. The type of condenser plus the number of Relay Outputs needed are specified in MCS-Config.

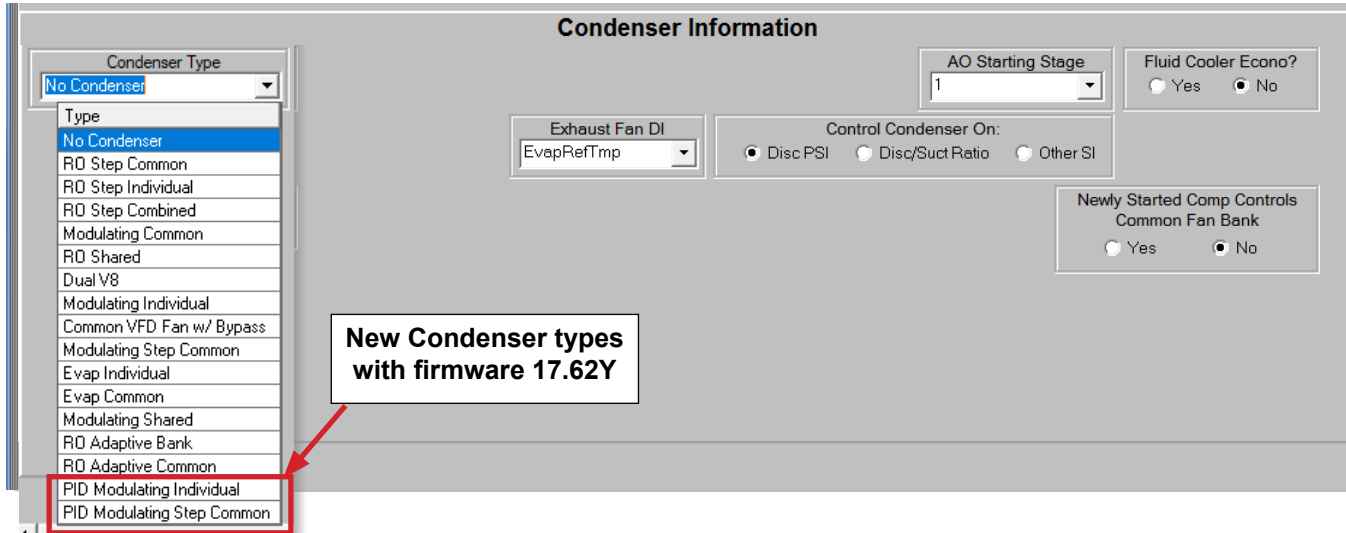

The Magnum supports the following Condenser Types:

- **No Condenser**
No condenser specified.
- **RO Step Common**
The highest discharge pressure from any compressor on the system will be the controlling pressure.
- **RO Step Individual**
Each compressor will have one or more condenser Relay Outputs associated with it. The discharge pressure on that compressor will be the control pressure for its own condenser.
- **RO Step Combined**
The highest discharge pressure from either of the compressors on the shared circuits will be the controlling pressure (circuits 1 and 2 are shared, circuits 3 and 4 are shared, circuits 5 and 6 are shared, and circuits 7 and 8 are shared).
- **Modulating Common**
The highest discharge pressure from any compressor on the system will be the controlling pressure. The Analog Output is modulated based on the Rate of Change of the controlling discharge pressure. It can also be controlled on a selected sensor input.
- **Modulating Step Common**
This type of condenser has a common fan bank for the system. The control will be on the systems highest discharge pressure. The Relay Outputs are also supported along with an Analog Output.
- **Modulating Individual**
Each compressor will have its own condenser Analog Outputs associated with it. The Analog Output for each circuit is modulated based on its own discharge pressure Rate of Change. It can also be controlled on a selected sensor input. You may also select Relay Outputs to be turned ON/OFF while modulating the Analog Output.

- **RO Shared**

This type of condenser will take the highest discharge pressure of circuits 1 and 2, then 2 and 3, then 3 and 4, etc. to use as the control discharge pressure. This condenser type does not have the option to bypass the startup compressor.

- **Dual V8**

This special type of condenser is a common control air condenser with two stages of fans plus a VFD Fan. Control of the fan speed will be different depending on whether one or two stages are on. All compressors are in the same fan bank with the highest discharge pressure being the control.

- **Common VFD Fan with Bypass**

Three consecutive Relay Outputs, an Analog Output, and a VFD fault indicator are required to control this type of condenser. RO's needed:

- 1) VFD LOAD—This relay will be ON indicating the fan can be used.
- 2) VFD BYPS—This relay will be OFF unless a VFD fault has occurred.
- 3) VFD ENAB—This relay will be ON unless a VFD fault has occurred.

During normal operation, VFD LOAD will be on, VFD BYPS will be off, and VFD ENAB will be on. The fan will be modulated as required by the condenser or economizer logic. If a fault occurs, all relays will be turned off and the VFD will be set to 0. The Magnum will wait for the time specified in Setpoint #90 "COND FAULT" before the fan will be run without VFD control if it is needed by the condenser logic (economizer logic will not function in this condition). Once this time has passed and the condenser logic calls for the fan, then VFD BYPS will be turned on thereby turning the fan on, however it will NOT be modulated.

The Magnum can also support a variable speed fan for all three of the air type of condensers. Each compressor can support a variable speed fan. The variable speed must be on the first Relay Output associated with that compressor.

Note 1: The discharge temperature must be at least 117° F and the discharge superheat needs to be at least 20° F to guarantee good oil separation.

Note 2: Condenser staging is critical if the Magnum is to function in different climates. The best option for air-cooled chillers is to have each fan on its own contactor and a frequency drive on fan 1. This configuration allows the most optimum control in all weather.

- **Modulating Step Common**

Similar to the Modulating Common type with the addition of relay outputs. The highest discharge pressure from any compressor on the system will be the controlling pressure. The Analog Output is modulated based on the Rate of Change of the controlling discharge pressure. It can also be controlled on a selected sensor input. When the analog output reaches its maximum value and more cooling is required the next relay will be turned on and the analog output value will be set to its minimum value.

- **Evap Individual**

Evaporative condensers are used to improve the condensers efficiency by spraying water over the condensing coil from above while air is blown up through the coil from below. Each compressor will have its own condenser Analog Outputs associated with it. The Analog Output for each circuit is modulated based on its own discharge pressure Rate of Change. It can also be controlled on a selected sensor input. You may also select Relay Outputs to be turned ON/OFF while modulating the Analog Output.

- **Evap Common**

Evaporative condensers are used to improve the condensers efficiency by spraying water over the condensing coil from above while air is blown up through the coil from below. Similar to the Modulating Common type with the addition of relay outputs. The highest discharge pressure from any compressor on the system will be the controlling pressure. The Analog Output is modulated based on the Rate of Change of the controlling discharge pressure. It can also be controlled on a selected sensor input. When the analog output reaches its maximum value and more cooling is required the next relay will be turned on and the analog output value will be set to its minimum value.

- **RO Adaptive Bank– Air cooled Condenser Fan Control**
 Used to control the condenser fan relay outputs for a single compressor, multiple compressors on the same refrigerant circuit, or a bank of condenser fans for multiple refrigerant circuits. If single compressor the condenser fans are stage on/off based on the compressor discharge pressure. If multiple compressor or refrigerant circuit, then the high discharge of the running compressors is used to stage condenser fans.
- **RO Adaptive Common – Air Cooled Condenser Fan Control**
 Used to control the condenser fan relay outputs for all the refrigerant circuits on the unit. This control logic finds the high discharge pressure on the running compressors and uses it to stage on/off the condenser fan relays.
- **PID MOD Individual**
 Required software:
 Config version 18.01V or later
 Connect version 18.31 or later
 Firmware 17.62Y (all firmware except LWC MAG and CPM MAG)
 Each compressor will have its own condenser Analog Outputs associated with it.
 PID control will turn an analog output into a stand alone PID controlled output. This output will have a controlling sensor that modulates the AO to a maintain target. This logic will run all the time.
- **PID Step Common**
 Required software:
 Config version 18.01V or later
 Connect version 18.31 or later
 Firmware 17.62Y (all firmware except LWC MAG and CPM MAG)
 This type of condenser has a common fan bank for the system. The control will be on the systems highest discharge pressure.
 PID control will turn an analog output into a stand alone PID controlled output. This output will have a controlling sensor that modulates the AO to a maintain target. This logic will run all the time.

18.1. Condenser Introduction

18.1.1 RO Step Condenser Cut In – Out Logic

The Cut In and Cut Out Logic Setpoints are as follows:

- Setpoint #45 “CND STG1 ON” - Condenser stage 1 Cut In (ON).
- Setpoint #46 “CND STG1 OFF” - Condenser stage 1 Cut Out (OFF).
- Setpoint #47 “CND DIFF ON” - Cut In differential for additional condenser stages for (ON).
- Setpoint #48 “CND DIFF OFF” - Cut Out differential for additional condenser stages (OFF).
- Setpoint #49 “CND MIN RUN” - Minimum run time for a condenser stage

Condenser Relay Outputs will be turned on based upon the value in Setpoint #45 “CND STG1 ON”. When discharge pressure reaches this value, the first condenser Relay Output is turned on. If additional condenser outputs are present, they will be turned on when the pressure exceeds the cut in value plus the value contained in Setpoint #47 “CND DIFF ON”. When discharge pressure falls, the condenser outputs will be turned off based upon the Setpoint #46 “CND STG1 OFF” plus the value contained in Setpoint #48 “CND DIFF OFF”. The first step will be turned off when discharge pressure falls below Setpoint #46 “CND STG1 OFF”.

Example: COND FAN 1 ON at 200 psi (Discharge)

Setpoint #45 “CND STG1 ON” = 200 psi	COND FAN 1 OFF at 170 psi
Setpoint #46 “CND STG1 OFF” = 170 psi	
Setpoint #47 “CND DIFF ON” = 20 psi	COND FAN 2 ON at 220 psi (200 + 20)
Setpoint #48 “CND DIFF OFF” = 5 psi	COND FAN 2 OFF at 175 psi (175 + 5)
COND FAN 3 ON at 240 psi (220 + 20)	
COND FAN 3 OFF at 180 psi (175 + 5)	

18.1.2 RO Step Condenser with Variable Speed Fan

The Setpoints for variable speed fan control are as follows:

Setpoint #54 “CND MIN SPD” - Minimum variable speed allowed.

Setpoint #55 “CND MAX SPD” - Maximum variable speed allowed.

The purpose of the variable speed fan is to reduce the cycling of the fans by adjusting the speed of the variable fan point. This control works in conjunction with the Cut In and Cut Out logic of each compressor. When a fan is turned on, the speed of the variable point for that compressor is set to maximum allowed percentage. As the discharge pressure falls, the fan speed is adjusted proportionally. When the minimum is reached the fan will turn off.

18.1.3 Condenser Control

The Condenser Control logic is run with every pass of the algorithm.

18.1.3.1. Common Terms

Information that relates to condensers on the circuit

# Cond Faults	Cond Fan Bank	Condenser Coil Temp #1	Condenser Coil Temp #2	Tandem EXV Circuit #	EXV Control	Suction Group	Comp Name/ID
0	1	Not Used	Not Used	1	Suct Spht	1	1
0	2	Not Used	Not Used	2	Suct Spht	2	2
0	3	Not Used	Not Used	3	Suct Spht	3	3

Condenser Fan Bank:

Indicates which circuits share common condenser fans or are individually controlled.

Suction Group:

Indicates which circuits share a common suction line.

Fluid Cooler Econo?option:

Specifies if the Fluid Cooler Economizer (if used) can use the condenser fans or VFD.



18.1.3.2. Control Discharge Pressure Calculation

If control is based on discharge pressure, all types of condensers will operate in the following sequence. For compressors within the same fan bank or suction group, the compressor with the highest discharge pressure will be held as the control pressure, regardless if the compressors are running or not.

The newly started compressor will have the controlling discharge pressure even if it is not the highest value in order for it to build pressure (startup mode is defined as the compressor has been on for less than 5 minutes and its discharge pressure is less than the value of Setpoint #45 “CND STG1 ON” minus the value of Setpoint #47 “CND DIFF ON”). However, this logic will be overruled if another compressor sharing the same condenser approaches the high discharge safety (if discharge pressure rises above calculated value of Setpoint #81 “HI DISC PSI” minus #83 “HI DISC RELOAD”)

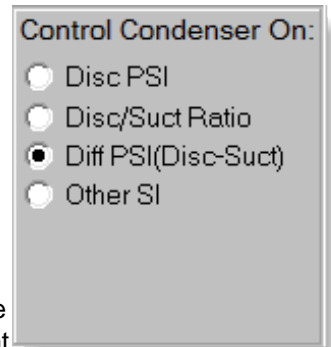

If control is based on Other SI, the value of that sensor is always used as the control discharge pressure.

Control Condenser On:

- **Disc PSI**–The Magnum will check for the compressor with the highest discharge and use that as the controlling pressure.

- **Disc/Suct Ratio** - Control logic will be the same as Disc PSI control except the ratio of the discharge pressure to the suction pressure will be used as the control. Note changes to related set points will be required.

- **Diff PSI(Disc-Suct) -**



HVAC FIRMWARE VERSION 17.34 and up
MCS-CONFIG VERSION 18.01G and up
MCS-CONNECT VERSION 18.20.06 and up
NEW LOGIC ADDED WITH THESE UPDATES

Control Condenser On:

- Disc PSI
- Disc/Suct Ratio
- Diff PSI(Disc-Suct)
- Other SI

Differential Condenser Target Adjustment

If Discharge Superheat <= for Seconds Then
 Increase Differential PSI Target By

If Discharge Superheat >= for Seconds Then
 Decrease Differential PSI Target By

Max Adjustment Allowed

This logic will utilize the calculated differential pressure (Discharge Pressure/Suction Pressure) to control the condenser.

Capacity Control State	Time	Wanted/ Actual	Step Delay	Wanted %	Rate of Change	Control On	
UNIT IS LOADED	00:30:20	2/2	10	100.0	0.0	CHILWTROUT= 55.0F	
State	Time	PSI Diff	FLA %	Steps	Lead?	Manual FLA %	Condenser Adjustment
1)CMP IS HOLDING	00:19:25	265.0P	100%	1	Yes	N/A	40.0P
2)CMP IS HOLDING	00:19:20	200.0P	100%	1		N/A	0.0P
Suction Temp	Saturated Suction	Suction Superheat	Disc Temp	Saturated Discharge	Disc Superheat	Subcooling	
1) 58.0	31.5	26.5	120.0	110.0	10.0	20.0	
2) 58.0	42.9	15.1	130.0	101.6	28.4	11.6	

Differential Condenser Target A...

If Discharge Superheat <= for Seconds Then
 Increase Differential PSI Target By

If Discharge Superheat >= for Seconds Then
 Decrease Differential PSI Target By

Max Adjustment Allowed

CLEAR VALUE

1	2	3
4	5	6
7	8	9
-	0	.

ADJUST CANCEL

All condenser setpoints will remain the same for both modulating and step control.

When Diff PSI is selected the below information will become editable in the config program.

Here you will be able to customize adjustments to the differential target based on discharge superheat being low or high.

In this config example if discharge superheat falls below 20 degrees for 30 seconds then the differential target will be increased by 5 psi. If 30 more seconds goes by and the discharge superheat has not increased above 20 degrees then we will do another increase of 5 psi to the target. The adjustments will continue all the way

up to a maximum of 40 psi defined by our “Max Adjustment Allowed” box. Once discharge superheat is between the high and low settings the adjustment will hold where it’s currently at.

The logic works the same exact way when the discharge superheat rises above 40 degrees only we will decrease the differential every 30 seconds by 5 psi all the way back down to a 0 psi adjustment. The adjustments cannot go to a negative value.

MCS-CONNECT SCREEN ADJUSTMENT - Diff PSI(Disc-Suct)

- **Other SI** - Control logic will be the same as Disc PSI control except the value of the sensor that is specified will be used as the control. Note changes to related set points will be required. When this option is selected a “Other Control Sensor” window will enable the sensor to be selected.



To use ‘Other SI’, the condenser type must be a ‘COMMON TYPE’

The Magnum will not check for the compressor with the highest discharge pressure but will always use the value of the sensor that is selected as the control.

18.1.3.3. Condenser Reset

If Diff PSI(Disc-Suct) is selected as your condenser type in the MCS Config program you’ll have a “Condenser Adjustment” box in your system status window through MCS Connect. Here you will see the adjustments made to your condenser target based on the discharge superheat. If you’re at least “Factory” authorized you can double click the value in the condenser adjustment box, it will open a window as you see in the example which will allow you to make changes to how the adjustments are made.

If sensor is specified its value will be added to the condenser control set points #45, #46 and #50.

18.1.3.4. Condenser Low Ambient

When a compressor is started its discharge pressure will be used as the controlling pressure for five minutes, enabling that compressor to build head pressure. However, if Setpoint #204 COND LOW AMB is active and there is an ambient temperature sensor reading less than this Setpoint, then this compressor’s discharge pressure will remain in control for an additional time as specified in the “Time (sec)” field.

18.1.3.5. Condenser Related Setpoints

The following are Condenser related Setpoints:

45	CND STG1 ON (RO Type)	When the discharge pressure is above this value, turn on the first stage of the condenser fans. 'Time (sec)' field: (Applies to compressors with shared condensers) If non-zero, then the compressor in startup state will not be in sole control of the condenser fans, it will control off of highest discharge pressure. If zero, then compressor in startup will have sole condenser control for 5 minutes. This option is selected in in the 'Newly started Comp Controls Common Fan Bank' box in the 'Condenser Information' panel under the MAGNUM screen.
46	CND STG1 OFF (RO Type)	If stage 1 of condenser capacity is on and the discharge pressure drops below this value, then turn this stage off.
50	CND TRGT (Modulating Type)	Target logic will try to maintain by modulating the AO. SP must be set up as target type. Hi/Low zones are used for setting control zone. If target type in HP mode, setback is added to target.

18.2. CONDENSER TYPES

18.2.1 No Condenser

This option indicates there is no condenser associated with this unit.

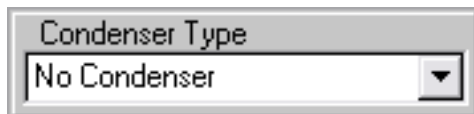

18.2.2 RO Step Common

The RO Step Common of condenser has one bank of fans. Make sure that all compressors in the Circuit Base point to the same common fan bank. The above example does not have a Fan Analog Output and there are three stages of fans starting with CND FAN 1 relay. All stages must be consecutive Relay Outputs.

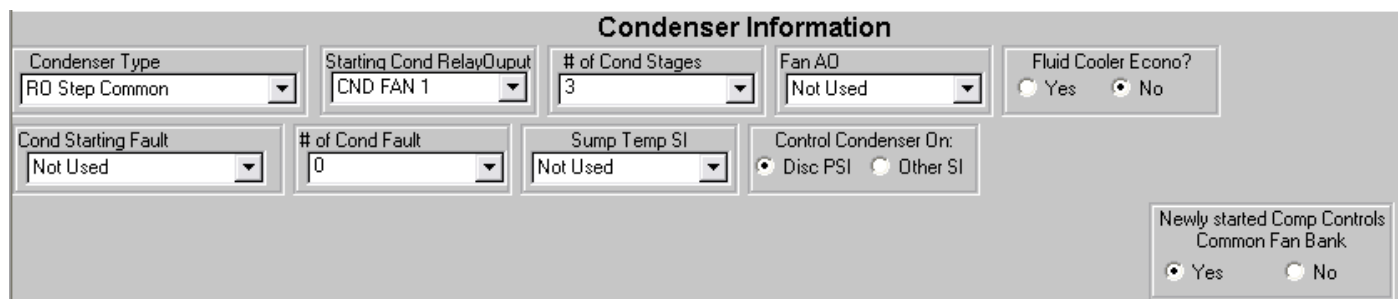

For example:

Setpoint #	Name	Value
45	CND STG1 ON	200.0P
46	CND STG2 OFF	170.0P
47	CND DIFF ON	15.0P
48	CND DIFF OFF	5.0P

Discharge control pressure is 200.0 P, CND FAN 1, first condenser stage will be turned on.

If control pressure is equal to or greater than 215.0 P then the second stage will be turned on. $(200.0 + (15.0 * 1))$

If control pressure is equal to or greater than 230.0 P then the third stage will be turned on. $(200.0 + (15.0 * 2))$

Discharge control pressure is above 230.0 P; all three condenser stages are on.

When the control pressure drops below 180.0P the third condenser stage will be turned off. $(170.0 + (5.0 * 2))$

When the control pressure drops below 175.0P the second condenser stage will be turned off. $(170.0 + (5.0 * 1))$

When the control pressure drops below 170.0P the first condenser stage will be turned off. (170.0)

Condenser Faults

This example has no condenser faults. If used, and any one of the digital inputs are ON for the time specified in Setpoint #90 if active, then the unit will be locked out and an alarm message will be generated.

18.2.2.1. RO Step Common with a Fan AO and Condenser Faults

Condenser Information						
Condenser Type RO Step Common	Starting Cond RO CND FAN1-1	# of Cond Stages 3	Fan AO COMP1 SPD%	AO Starting Stage 1	Fluid Cooler Econo? <input type="radio"/> Yes <input checked="" type="radio"/> No	
Cond Starting Fault Cmp1VfdFit	# of Cond Fault 0	Sump Temperature Not Used	Control Condenser On: <input checked="" type="radio"/> Disc PSI <input type="radio"/> Disc/Suct Ratio <input type="radio"/> Other SI			
Condenser Reset OIL PSI 1						Newly Started Comp Controls Common Fan Bank <input checked="" type="radio"/> Yes <input type="radio"/> No

The above example is the same as the previous example with the addition of a Fan AO and two condenser faults.

Fan AO Control (same for all types of air condenser control)

Two more Setpoints than the previous example are needed to control the speed of the fan:

Setpoint #	Name	Value
54	CND MIN SPD	20.0%
55	CND MAX SPD	100.0%

CND FAN 1 will be turned on when the control pressure is equal to or greater than 200.0, same as in previous example. At this point the Fan AO speed will be set to its maximum value, Setpoint #55. If the pressure changes between 170.0 and 214.9 the fan speed will also be modulated proportionally between its maximum and minimum settings. If the pressure is at 185.0 the fan speed will be set to 61.2%. If the pressure is at 190.0 the fan speed will increase to 75.0%. This will provide precision control in maintaining optimum discharge pressure.

If the pressure increases to 215.0 the condenser's second stage will be turned on and the fan speed will also be at 100.0%. If the pressure changes between 175.0 and 229.9 the fan speed will also be modulated proportionally between its maximum and minimum settings.

If the pressure increases to 230.0 the condenser's third stage will be turned on and the fan speed will also be at 100.0%. If the pressure changes between 180.0 and 229.9 the fan speed will also be modulated proportionally between its maximum and minimum settings. If the pressure is at 230.0 and above the fan speed will be at 100.0%.

As the pressure decreases toward the Cut Out point the fan speed will decrease toward its minimum setting. Once a stage is turned off, the fan speed will be set to 100.0% and again it will be modulated based upon the pressure.

Condenser Faults

This example has two condenser faults. They must be consecutive digital input types starting with FAN FLT 1. If either of these digital inputs are ON for the time specified in Setpoint #90 if active, then the unit will be locked out and an alarm message will be generated.

18.2.3 RO Step Individual

The screenshot shows the 'Condenser Information' configuration screen. The 'Condenser Type' is set to 'RO Step Individual'. The 'AO Starting Stage' is set to '1'. The 'Fluid Cooler Econo?' option is set to 'No'. The 'Sump Temperature' is set to 'Not Used'. The 'Control Condenser On:' options are 'Disc PSI' (selected), 'Disc/Suct Ratio', and 'Other SI'. The 'Condenser Reset' is set to 'OIL PSI 1'. The 'Newly Started Comp Controls Common Fan Bank' option is set to 'Yes'.

The RO Step Individual has a bank of fans for each compressor. The number and location of the fan are specified under the Circuit Base screen.

Information that relates to condensers on the circuit													
Circuit # (reset button)	# of Cond ROs	Starting Condenser RO	Condenser Fan AO	Starting Condenser Fault	# Cond Faults	Cond Fan Bank	Condenser Coil Temp #1	Condenser Coil Temp #2	Tandem EXV Circuit #	EXV Control	Suction Group	Comp Name/ID	
1	...	3	CND FAN 1	Not Used	Not Used	0	1	Not Used	Not Used	1	Suct Spr	1	1
2	...	3	CND FAN 2	Not Used	Not Used	0	2	Not Used	Not Used	2	Suct Spr	2	2

of Cond ROs –Total number of Relay Outputs of each compressor, in this example there are 3. The number of fans in each compressor does not have to be the same.

Starting Condenser RO – The starting condenser Relay Output. All the Relay Outputs specified for each circuit must follow consecutively to this point. In this example CND FAN 1 is the starting Relay Output for circuit 1 and the other 2 fans follow consecutively in the RO screen.

Condenser Fan AO–If a condenser fan AO was specified in this cell it would function as described in the example in section 7.74.3.6 RO Step Common with a Fan AO and Condenser Faults. There is no condenser fan AO in this example.

Starting Condenser Fault–If there were condenser faults specified in this cell they would function as described in the example in section 7.74.3.6 RO Step Common with a Fan AO and Condenser Faults. There are no condenser faults in this example.

Cond Faults – Total number of Condenser Faults.

Cond Fan Bank – In this type of condenser all compressors should have a different fan bank.

The screenshot shows the 'Condenser Information' configuration screen. The 'Condenser Type' is set to 'RO Step Combined'. The 'AO Starting Stage' is set to '1'. The 'Fluid Cooler Econo?' option is set to 'No'. The 'Sump Temperature' is set to 'Not Used'. The 'Control Condenser On:' options are 'Disc PSI' (selected), 'Disc/Suct Ratio', and 'Other SI'. The 'Condenser Reset' is set to 'OIL PSI 1'. The 'Newly Started Comp Controls Common Fan Bank' option is set to 'Yes'.

Each compressor fan bank is controlled individually. The discharge pressure for each compressor is used to control condenser logic.

18.2.4 RO Step Combined

The RO Step Combined has a bank of fans that are shared by two consecutive circuits. The number and location of the fans are specified in the Circuit Base screen. This is similar to the RO Step Individual set up except only every other compressor has a condenser fans associated with it.

Information that relates to condensers on the circuit												
Circuit # (reset button)	# of Cond ROs	Starting Condenser RO	Condenser Fan AO	Starting Condenser Fault	# Cond Faults	Cond Fan Bank	Condenser Coil Temp #1	Condenser Coil Temp #2	Tandem EXV Circuit #	EXV Control	Suction Group	Comp Name/ID
1	...	3	FAN 1&3 #1	Not Used	Not Used	0	1	Not Used	Not Used	1	Suct Spl	1
2	...	0	Not Used	Not Used	Not Used	0	1	Not Used	Not Used	2	Suct Spl	2
3	...	3	FAN 2&4 #1	Not Used	Not Used	0	3	Not Used	Not Used	3	Suct Spl	3
4	...	0	Not Used	Not Used	Not Used	0	3	Not Used	Not Used	4	Suct Spl	4

Circuit 1 and 2 will share the same fan bank specified in the 'Cond Fan Bank' cell. Circuit 3 and 4 will also share the same fan bank specified. The highest discharge pressure between the two compressors on each respective circuit will be used as the control pressure for their fan bank.

Condenser Faults

If any of these digital inputs are ON for the time specified in Setpoint #90 if active, then both compressors sharing that condenser will be locked out and an alarm message will be generated. This example has no condenser faults.

18.2.5 Modulating

18.2.5.1. Modulating Common

Condenser Information

Condenser Type
Modulating Common

AO Modulating Valve
CND1 VFD%

Fluid Cooler Econo?
 Yes No

Sump Temperature
Not Used

Control Condenser On:
 Disc PSI
 Disc/Suct Ratio
 Other SI

Condenser Reset
Cmp2VfdFlt

Start Control on Analog Output:
 Above Control Zone
 Below, But Near, Control Zone

Newly Started Comp Controls
Common Fan Bank
 Yes No

Default Analog Output % When Compressor is OFF

This type of condenser uses water for condenser cooling. The AO Modulating Valve will modulate the cold water valve based upon the system's highest discharge pressure.

48	CND ADJ DELAY (Modulating Type)	If active this is the time in seconds between condenser adjustments to the AO. If inactive, then 30 seconds will be used as the delay. If type is DELAY: (required for condenser relay delays). -MIN VFD Opening cell contains the time delay between turning on a relay and moving the AO to its minimum position (Setpoint #52). -MAX VFD Opening cell contains the time delay between turning off a relay and moving the AO to 100%.
49	CND START % (Modulating Type)	If active, then the value is the starting % for the AO when the RO that is tied to it turns on. The value in the "Time (SEC)" cell is the AO starting stage. If no Relays are used when CMP starts set value.
50	CND TARG (Modulating Type)	Target logic will try to maintain by modulating the AO. SP must be set up as target type. Hi/Low zones are used for setting control zone. If target type in HP mode, setback is added to target.
51	CND ADJ DIV (Modulating Type)	Controls scaling of the amount the AO is adjusted (usually 1). The larger the number the smaller the AO adjustment as the adjustment will be divided by this value.

52	CND MIN % (Modulating Type)	Minimum AO % allowed. If compressor is off, then check the "Time (SEC)" field: If 0, then the AO % will be set to the value of this Setpoint. If 2 and the run/stop is set to run, then set the AO % to 100%, else set the AO % to 0%. This option is selected in the "Default Valve Opening % when Comp. is OFF" box in the condenser information section in the MAG HVAC screen.
53	CND ROC- (Modulating Type)	Maximum negative rate of change allowed. If the rate of change is less than this Setpoint, then stop modulating the AO. The absolute value of this Setpoint also serves as the maximum positive rate of change allowed. If the rate of change is greater than the absolute value of this Setpoint, then stop modulating the AO.
54	CND ADJ MULT (Modulating Type)	Controls scaling of the amount the AO is adjusted. The larger the number the larger the AO adjustment as the adjustment will be multiplied by this value.
55	CND MIN ADJ (Modulating Type)	The value in this Setpoint is the minimum % the AO will be modulated when a change is made.

Note 1: The purpose of Setpoint #193 'CND HI/LO ZONE' and the delays in the MAX AND MIN VFD Opening cells for Setpoint #48 'CND ADJ DELAY' are to prevent repeated cycling of additional stages.

Note 2: The purpose of Setpoint #194 'CND 2nd ZONE' is to prevent the discharge pressure from over shooting the target (Setpoint #50 'CND TARG'). The way the logic works is if the discharge pressure is in the 2nd Zone and the pressure is falling less than twice the CND ROC- (Setpoint #53 'CND ROC-') then a negative adjustment will be made to the AO. If the discharge pressure is raising more than twice the rate of change (Setpoint #53) then a positive adjustment will be made to the AO.

Note 3: The value in the "AO Starting Stage" cell under the MAG HVAC screen in the condenser info section is the stage that has to be turned on to begin modulating the AO.

The following applies to both the modulating common and individual water condenser types:

The 'Default Valve Opening % when Comp. is OFF' cell can be used to set the valve (1) to be completely closed (0%), (2) the value of Setpoint #52 (Valve % defined by Setpoint #52), or (3) completely open (100% if the Run/Stop indicator = ON else = 0%).

The delay timer will be decremented by a standard value of 1 every second, however if the control discharge pressure is more than 15.0 psi (1.5 bar) away from the target Setpoint #50, then the delay will be decremented by 2; if more than 20.0 psi (2.0 bar) away from the target then the delay will be decremented by 4.

When the delay counts down to zero, an adjustment will be made based on the equation:

(Control discharge pressure – Setpoint #50) × Setpoint #54 ÷ Setpoint #51 = Adjustment Value.

When the control discharge pressure is greater than Setpoint #50 plus the value in the high zone:

If the control discharge pressure rate of change is dropping too fast (more than twice the value of Setpoint #53), then close the valve by the calculated adjustment. If the control discharge pressure rate of change is dropping too slowly (more than the value of Setpoint #53), then open the valve by the calculated adjustment. Else make no adjustment.

When the control discharge pressure is less than Setpoint #50 minus the value in the low zone:

If the control discharge pressure rate of change is increasing too fast (more than twice the value of Setpoint #53), then close the valve by the calculated adjustment. If the control discharge pressure rate of change is increasing too slowly (more than the value of Setpoint #53), then open the valve by the calculated adjustment. Else make no adjustment.

When the control discharge pressure is within the zone: If the control discharge pressure rate of change is increasing more than the value of Setpoint #53, then close the valve by 1 percent. If the control discharge pressure change is decreasing more than the value of Setpoint #53, then open the valve by 1 percent.

Modulating Condenser Type: If heat pump and the mode is HEAT (not in defrost) all condenser relays will be turned on and the VFD set to 100% when compressor is turned on. If the control pressure is above the control zone, the condenser will unload; if below the control zone the condenser will load else there will be no change.

18.2.6 Modulating Step Common

Condenser Information					
Condenser Type Modulating Step Common	Starting Cond RO CND FAN1-1	# of Cond Stages 2	Fan AO CND1 VFD%	AO Starting Stage 0	Fluid Cooler Econo? <input type="radio"/> Yes <input checked="" type="radio"/> No
Cond Starting Fault Not Used	# of Cond Fault 1	Sump Temperature Not Used	Control Condenser On: <input checked="" type="radio"/> Disc PSI <input type="radio"/> Disc/Suct Ratio <input type="radio"/> Other SI		
Condenser Reset Cmp2VfdFit	Start Control on Analog Output: <input type="radio"/> Above Control Zone <input checked="" type="radio"/> Below, But Near, Control Zone		Newly Started Comp Controls Common Fan Bank <input checked="" type="radio"/> Yes <input type="radio"/> No		
Default Analog Output % When Compressor is OFF <input checked="" type="radio"/> 0% <input type="radio"/> Analog Output % Defined by Setpoint #52 <input type="radio"/> 100% <input type="radio"/> 100% When Run/Stop = ON Else = 0%					

When a RO is being used with an AO the AO will key off the RO turning on. The RO will turn on when the discharge pressure enters the bottom of the CND HI/LO ZONE (Setpoint #193). At that time the AO will move to its starting % (Setpoint #49). The AO will stay at its starting % until the discharge pressure gets outside the top of the CND HI/LO ZONE (Setpoint #193). At that point the AO will modulate based on Setpoints #51, #53-55. Now if there are 2 RO's tied to the AO and the "AO Starting Stage" is 1 then once the AO gets to 100% the 2nd RO will be turned on after a delay (value in the "MIN VFD Opening" cell for Setpoint #48) and the AO will be set back to its minimum % (Setpoint #52) and then modulate as described above. Now if the pressure begins to fall and goes below the CND HI/LO ZONE (Setpoint #193) the AO will modulate. Once the AO gets to its minimum % (Setpoint #52) the 2nd RO will be turned off after a delay (value in the "MAX VFD Opening" cell for Setpoint #48) and the AO will be set back to 100% and continue to modulate as needed.

If the "AO Starting Stage" is 2 then when the discharge pressure enters the bottom of the CND HI/LO ZONE (Setpoint #193) the 1st RO (stage 1) will be turned on. The 2nd RO will turn on once the discharge pressure gets outside the Heating Info CND HI/LO ZONE (Setpoint #193) and the delay has been met (value in the "MIN VFD Opening cell" for Setpoint #48) at that time AO will be set to its starting % (Setpoint #49). If the discharge falls below the CND HI/LO ZONE (Setpoint #193) the AO will begin to modulate. Once the AO reaches its minimum % (Setpoint #52) it will turn off the associated RO after a delay (value in the "MAX VFD Opening" cell for Setpoint #48). The 1st RO will remain on until the discharge pressure falls below the CND HI/LO ZONE (Setpoint #193) and the delay has been met (value in the "MAX VFD Opening" cell for Setpoint #48).

18.2.6.1. Modulating Individual

Condenser Information	
Condenser Type Modulating Individual	Fluid Cooler Econo? <input type="radio"/> Yes <input checked="" type="radio"/> No
Sump Temp SI Not Used	Control Condenser On: <input checked="" type="radio"/> Disc PSI <input type="radio"/> Other SI
Default Valve Opening % when Comp. is OFF <input type="radio"/> 0% <input checked="" type="radio"/> Valve % defined by Setpoint #52 <input type="radio"/> 100% when Run/Stop = ON else = 0%	
Newly started Comp Controls Common Fan Bank <input checked="" type="radio"/> Yes <input type="radio"/> No	

This type of condenser uses water to provide cooling to the compressors. The AO Modulating Valve will modulate the cold water based upon this discharge pressure for each circuit. You may also select Relay Outputs to be turned ON/OFF while modulating the Analog Output.

The individual condensers must be set up in the Circuit Base screen.

The control will be similar to the Modulating Common type, except that the discharge pressure for each circuit will control its own condenser.

18.2.7 RO Shared

The RO Shared condenser has banks of fans that are shared between two consecutive circuits. The number and location of the fans are specified under the Circuit Base screen. This is similar to the RO Step Individual set up. Circuits 1 and 2 will share the fan bank that is specified in the circuit 1 grid in the Circuit Base screen. The highest discharge pressure of these two compressors will be used to control this bank of fans. Circuits 2 and 3 will share the fan bank that is specified in the circuit 2 grid in the Circuit Base screen. The highest discharge pressure of these two compressors will be used to control this bank of fans. In a unit with three circuits, circuit three will not have a fan bank associated with it. It shares circuit 2’s fan bank.

18.2.8 Dual V8

This is a special type of condenser. It is a common circuit control type with two stages of fans and VFD. The control of the fan speed will be different depending on whether one or two stages are on. All circuits are checked to calculate the control discharge pressure, and should be in the same fan bank.

If the control discharge pressure is less than Setpoint #45, then both condenser stages are off and the fan speed is zero.

If the control discharge pressure is greater than Setpoint #45 and less than Setpoint #46 stage 1 will be on. The fan speed will be equal the value of (Setpoint #55 minus Setpoint #54) divided by (Setpoint #46 minus Setpoint #45) and then multiplied by (control discharge pressure minus Setpoint #46) plus Setpoint #54.

If the control discharge pressure increases while in stage 1 above the value of Setpoint #46 plus Setpoint #48 for the time contain in Setpoint #49 stage 2 will be entered. Both relays will be on and the fan speed will be equal the value of (Setpoint #55 minus Setpoint #54) divided by Setpoint #46 and then multiplied by (control discharge pressure minus Setpoint #46) plus Setpoint #54.

If the speed of the condenser fan is less than Setpoint #54 it will be set to that value or if the speed of the condenser fan is greater than Setpoint #55 it will be set to that value.

18.2.9 Common VFD Fan w/Bypass

The Common VFD Fan with a Bypass type of condenser has one fan. All circuits will use this fan; make sure that all circuits in the Circuit Base point to the same common fan bank. The above setup shows that there is one condenser stage. However this type requires the following three consecutive Relay Outputs to be set up. For example:

1-5	...	VFD LOAD
1-6	...	VFD BYPASS
1-7	...	VFD ENABLE

This type of condenser requires one condenser fault. If the fault occurs then the VFD will be bypassed and the fan will run at 100% if needed.

45	CND STG1 ON (RO Type)	When the discharge pressure is above this value, turn on the first stage of the condenser fans. 'Time (sec)' field: (Applies to compressors with shared condensers) If non-zero, then the compressor in startup state will not be in sole control of the condenser fans, it will control off of highest discharge pressure. If zero, then compressor in startup will have sole condenser control for 5 minutes. This option is selected in the 'Newly started Comp Controls Common Fan Bank' box in the 'Condenser Information' panel under the MAGNUM screen.
	PID MOD Individual PID Step Common	Uses PID condenser control KP (Proportional). Setup as setpoint.
46	CND STG1 OFF (RO Type)	If stage 1 of condenser capacity is on and the discharge pressure drops below this value, then turn this stage off.
	PID MOD Individual PID Step Common	If active, uses Multiplier for Ki adjustments, (Integral Delay). Setup as setpoint
54	CND MIN SPD (RO Type)	Minimum speed percentage for variable speed condenser control.
	CND ADJ MULT (Modulating Type)	Controls scaling of the amount the AO is adjusted. The larger the number the larger the AO adjustment as the adjustment will be multiplied by this value.
55	CND MAX SPD (RO Type)	Maximum speed percentage for variable speed condenser control.
	CND MIN ADJ (Mod- ulating Type)	The value in this Setpoint is the minimum % the AO will be modulated when a change is made.

Fan control when there is no fault:

The highest discharge pressure of all the compressors is the control value.

The first relay, VFD LOAD, is on and the second relay, VFD BYPASS, is off.

When the control discharge pressure is greater than the value of Setpoint #45, then the third relay (VFD ENABLE) will be turned on and the VFD will be set to the value of Setpoint #55. If the control discharge pressure decreases the VFD will be modulated between Setpoints #54 and #55 based upon the control discharge pressure.

Assume Setpoint values:

45	CND STG1 ON	250 psi
46	CND STG1 OFF	170 psi
54	CND MIN SPD	20%
55	CND MAX SPD	100%
90	COND FAULT	30s

When the discharge control pressure is greater than 250 psi the relay VFD ENABLE will be on and the VFD on the fan will be set to 100%. If the discharge control pressure drops to 210, then the fan speed will be set to 60%. The discharge control pressure is half of its Cut In and Cut Out range ($250 - 170 = 80 / 2 = 40 = 170 + 40 = 210$) therefore, the VFD will be positioned to half of its range ($100 - 20 = 80 / 2 = 40 + 20 = 60$). The VFD will continue to be modulated in this manner until the discharge control pressure drops below 170. Then the VFD will be at 0% and relay VFD ENABLE will remain on. If the pressure goes above 170 the VFD will be modulated. For example if the discharge control pressure goes to 190.0 the VFD will be set to 50%.

Fan control when a fault occurs:

If a fault occurs, an alarm message will be generated, relay VFD LOAD will Lock off, relay VFD ENABLE will be off, the VFD speed will be set to 0% and the bypass, VFD BYPASS, will be enabled if needed after waiting for 30 seconds, Setpoint #90. Once the fan bypass is enabled and the discharge control pressure goes above 250 psi the bypass will be turned on enabling the fan to run at 100% and it will remain on regardless of the discharge control pressure.

If the fault resets itself, and is no longer on, the state of VFD LOAD will be set to AUTO, the VFD BYPASS relay will be turned off and VFD will be enabled to control the fan speed if it is needed.

54	CND MIN SPD	20%
55	CND MAX SPD	100%
90	COND FAULT	30s

When the discharge control pressure is greater than 250 psi the relay VFD ENABLE will be on and the VFD on the fan will be set to 100%. If the discharge control pressure drops to 210, then the fan speed will be set to 60%. The discharge control pressure is half of its Cut In and Cut Out range ($250 - 170 = 80 / 2 = 40 = 170 + 40 = 210$) therefore, the VFD will be positioned to half of its range ($100 - 20 = 80 / 2 = 40 + 20 = 60$). The VFD will continue to be modulated in this matter until the discharge control pressure drops below 170. Then the VFD will be at 0% and relay VFD ENABLE will remain on. If the pressure goes above 170 the VFD will be modulated. For example if the discharge control pressure goes to 190.0 the VFD will be set to 50%.

Fan control when a fault occurs:

If a fault occurs, an alarm message will be generated, relay VFD LOAD will Lock off, relay VFD ENABLE will be off, the VFD speed will be set to 0% and the bypass, VFD BYPASS, will be enabled if needed after waiting for 30 seconds, Setpoint #90. Once the fan bypass is enabled and the discharge control pressure goes above 250 psi the bypass will be turned on enabling the fan to run at 100% and it will remain on regardless of the discharge control pressure.

If the fault resets itself, and is no longer on, the state of VFD LOAD will be set to AUTO, the VFD BYPASS relay will be turned off and VFD will be enabled to control the fan speed if it is needed.

18.2.10 Evaporative types of Condenser Control

Evaporative condensers are used to improve the condensers efficiency by spraying water over the condensing coil from above while air is blown up through the coil from below.

Two types are support:

Condenser Information

Condenser Type
Evap Individual

AO Starting Stage
0

Fluid Cooler Econo?
 Yes No

Condenser Reset
Not Used

Sump Temperature
Not Used

Control Condenser On:
 Disc PSI
 Disc/Suct Ratio
 Other SI

Sump Level Indicator
Not Used

Sump Heater Relay
Not Used

Start Control on Analog Output:
 Above Control Zone
 Below, But Near, Control Zone

Newly Started Comp Controls
Common Fan Bank
 Yes No

Default Analog Output % When Compressor is OFF

0%
 Analog Output % Defined by Setpoint #52
 100%
 100% When Run/Stop = ON Else = 0%

- Evap Individual Step, has the same control logic as Modulating Individual.
- Evap Common, has the same control logic as Modulating Common.

In addition to the standard control logic, the evaporative spraying water requires addition input.

Sump Temperature, this sensor will provide the temperature of the sump, area where the spray water is held.

Sump Level Indicator, if set point #249 and a digital input is specified, if it is continually on for the time greater than the value of the safety time of set point #249 a Sump Low Level alarm will be generated and this condenser will be locked off. If the digital goes to an off state and the condenser is locked off, its state will be changed to auto and the condenser will be available.

Sump Heater Relay, if this relay and sump temperature sensor is specified and set point #250 is active, this relay will be turned on and off based upon the values of set point #250.

18.2.11 RO Adaptive Bank- Air cooled Condenser Fan Control

Used to control the condenser fan relay outputs for a single compressor, multiple compressors on the same refrigerant circuit, or a bank of condenser fans for multiple refrigerant circuits. If single compressor the condenser fans are stage on/off based on the compressor discharge pressure. If multiple compressor or refrigerant circuit, then the high discharge of the running compressors is used to stage condenser fans.

Relay Output Information Screen												
Number	Name	Slide Mult.	Slide Div.	Slide Off.	Design Suc.PSI	Design Dis.PSI	Nominal Tonnage(of Step)	EXV Start (When Lead)	Type	EXV L Adjus	Circuit	
1-3	CND FAN 1	---	---	---	---	---	---	---	Standard	---	1	
1-4	CND FAN 2	---	---	---	---	---	---	---	Standard	---		

Singe Compressor

Information that relates to condensers on the circuit

Circuit # (reset button)	# of Cond ROs	Starting Condenser RO	Condenser Fan AO	Starting Condenser Fault	# Cond Faults	Cond Fan Bank	Condenser Coil Temp #1	Condenser Coil Temp #2	Tandem EXV Circuit #	Evaporator EXV Control	Suction Group	Comp Name/ID
1	2	CND FAN 1	Not Used	Not Used	0	1	Not Used	Not Used	1	Suct Spht	1	1

Tandem Compressors

Information that relates to condensers on the circuit

Circuit # (reset button)	# of Cond ROs	Starting Condenser RO	Condenser Fan AO	Starting Condenser Fault	# Cond Faults	Cond Fan Bank	Condenser Coil Temp #1	Condenser Coil Temp #2	Tandem EXV Circuit #	Evaporator EXV Control	Suction Group	Comp Name/ID
1	2	CND FAN 1	Not Used	Not Used	0	1	Not Used	Not Used	1	Suct Spht	1	1
2	0		Not Used	Not Used	0	1	Not Used	Not Used	2	Suct Spht	1	2

Tandem Compressors- 2 Circuits

Circuit 1 and 2 will share the same fan bank specified in the 'Cond Fan Bank' cell. Circuit 3 and 4 will also share the same fan bank specified. The highest discharge pressure between the two compressors on each respective circuit will be used as the control pressure for their fan bank.

Information that relates to condensers on the circuit													
Circuit # (reset button)	# of Cond ROs	Starting Condenser RO	Condenser Fan AO	Starting Condenser Fault	# Cond Faults	Cond Fan Bank	Condenser Coil Temp #1	Condenser Coil Temp #2	Tandem EXV Circuit #	EXV Control	Suction Group	Comp Name/ID	
1	3	FAN 1&3 #1	Not Used	Not Used	0	1	Not Used	Not Used	1	Suct Spht	1	1	
2	0	Not Used	Not Used	Not Used	0	1	Not Used	Not Used	2	Suct Spht	2	2	
3	3	FAN 2&4 #1	Not Used	Not Used	0	3	Not Used	Not Used	3	Suct Spht	3	3	
4	0	Not Used	Not Used	Not Used	0	3	Not Used	Not Used	4	Suct Spht	4	4	

18.2.12 RO Adaptive Common – Air Cooled Condenser Fan Control

Used to control the condenser fan relay outputs for all the refrigerant circuits on the unit. This control logic finds the high discharge pressure on the running compressors and uses it to stage on/off the condenser fan relays.

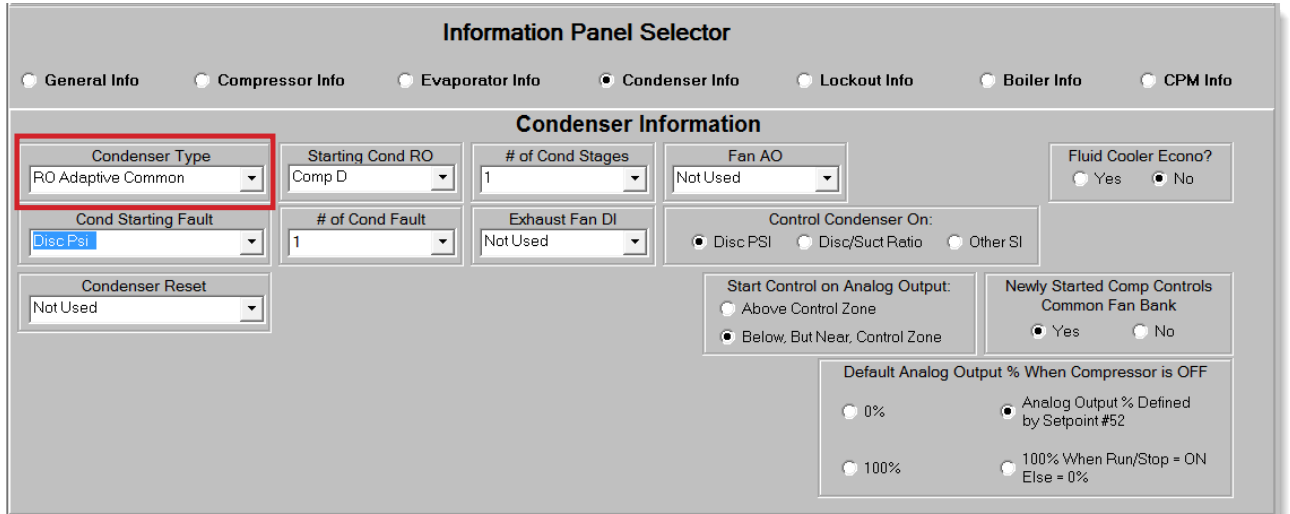

18.2.12.1. Adaptive Condenser Control Setpoints

Setpoint #45 “CND STG1 ON” – contains the value for turning on 1st condenser fan relay.

Setpoint #46 “CND STG2 OFF” – contains the value for turning off the 2nd condenser fan relay.

Setpoint #47 “CND DIFF ON” – contains the differential value for turning on the 2nd condenser fan., plus all the remaining condenser fan stages. This value is added to previous stage on value to calculate when to turn on the next condenser fan.

Setpoint #48 “CND DIFF OFF” – contains the differential value for turn off the 3rd condenser fan relay, plus all the remaining condenser fan stages. This value is added to the previous stage off value to calculate when to turn off the next condenser fan.

Setpoint #49 “CND STG1 OFF” – contains the value for turning off 1st condenser fan relay.

Setpoint #50 “CND TARG PSI” – contains the maximum adjusted value for turning on the last condenser stage.

A compressor must be operating for the condenser fans to operate. The definition of an operating compressor is a, compressor amps >= Low Amp limit or no amp sensor and compressor is in a running control state. The condenser relays (i.e. fans) will turn on based upon the value in setpoint STAGE 1 ON. When the discharge pressure exceeds this value, the first condenser relay is turned on. If additional condenser relays exist, they will be turned on when the pressure exceeds the previous cut in value (Stage 1 ON for the first stage) plus the value contained in STAGE DIFF ON setpoint.

Condenser relays (i.e. fans) will be turned off based upon the value in the setpoint STAGE 2 OFF (Stage 2 turn OFF point). As the discharge pressure is reduced, the condenser relay will be turned off based upon the STAGE 2 OFF setpoint, plus the value in STAGE OFF DIFF setpoint for each stage number above stage 2. Stage 1 of condenser staging will be turned off based upon the value in the setpoint (Stage 1 OFF).

Setpoint Information Screen														
#	Name	Value	Min	Max	Adjust Value	Time (SEC)	Max Time Allowed (SEC)	Lockout Delay (HRS)	Safety Down Time(MIN)	Active or Non-Active	Select Value: # decimals & print char	Level Of Auth. To Display	Type of Setpoint	
45	CND STG1 ON	200	190	220	0.5	0	1	0	0	Active	PSI GAGE	View Only	Setpoint	
46	CNC STG2 OFF	170	170	220	0.5	0	0	0	0	Active	PSI GAGE	View Only	Setpoint	
47	CND DIFF ON	20	10	50	1	0	0	0	0	Active	PSI GAGE	View Only	Setpoint	
48	CND DIFF OFF	10	5	50	1	0	0	0	0	Non-Active	PSI GAGE	View Only	Setpoint	
49	CND STG1OFF	175	170	195	0.5	0	0	0	0	Active	PSI GAGE	View Only	Setpoint	
50	CND TARG PSI	225	220	240	0.5	0	0	0	0	Active	PSI GAGE	View Only	Setpoint	

18.2.12.2. Adaptive Control Logic

The Adaptive Condenser logic is a self-learning fan control. The adaptive self-learning logic offers reduced fan cycling and improved efficiency. The Adaptive Condenser Control Logic automatically adjusts the fan cut-in offset based upon the following criteria:

1. If the last stage fan turned on (including stage 1) is cycled off in 10 minutes or less, then an Adaptive Offset value will be incremented by 5 PSI. This increases the stage 1 turn on value ("CND STG1 ON" plus Adaptive Offset) which in turn increases all the remaining fan on values. The Adaptive Offset will continue to increase, until fan cycling ceases or the adjusted turn on value for the last fan stage is greater than setpoint #50 "LastStgMax".
2. The Adaptive Offset value will be decreased by 5 PSI if the last fan to be turned on has not cycled off within 1 hour. The Adaptive Offset will continue to decrease by 5 PSI every 10 minutes unless fan cycling begins again.

The Adaptive Control Logic will only affect the condenser fan turn on logic, it will not affect the fan turn off logic.

18.2.12.3. Adaptive Rotation Logic

The adaptive condenser logic can be setup to rotate the condenser fans based on first on/first off or the lead condenser fan can be forced to any one of the condenser fans. Setpoint #46 is used to setup/control the type of rotation.

If setpoint #46 is not setup as "TIME" type of setpoint no rotation is done and lead condenser fan is forced to the first condenser fan relay output.

If setpoint #46 is setup as a "TIME" type

- And the value of the "Time" column is Zero, then first on/first off rotation is performed. The rotation occurs when a fan is required to cycle off by the pressure cut out value.
- And the value of the "Time" column is greater than zero and less than the max condenser stages, the lead condenser fan is set to the value in the "Time" field. For example, if the time column contains a 2, then the lead condenser fan is the second condenser fan in the relay output sequence.
- And if the value of the "Time" column is greater than the max condenser stages, the lead condenser fan is forced to first condenser fan in the relay output sequence.

18.2.12.4. Viewing on MCS-CONNECT and MCS-MAGNUM LCD KEYPAD

18.2.12.4.1. MCS-Connect Display

New columns in the compressor section are being added to the control status window where the adaptive offset values will be display.

System Status									
Capacity Control State	Time	Wanted/ Actual	Step Delay	Wanted %	Rate of Change	Control On		Mode	Ref Type
UNIT IS HOLDING	00:04:12	0/0	180	0.0	0.0	ChlWtrOut= 46.0F		COOLING	R22
State	Time	PSI Diff	FLA %	Steps	Lead?	Manual FLA %	Cond. Adap. Cut In Offset		
1)FAST UNLOADING	00:04:12	97.0P	78%	0	Yes	N/A	5.0P		
2)SAFETY TRIPPED	00:04:12	97.0P	78%	0		N/A	0.0P		
Suction Temp	Saturated Suction	Suction Superheat	Disc Temp	Saturated Discharge	Disc Superheat	Subcooling		Liquid Temp	Saturated Liquid Temp
1) 45.0	33.7	136.3	152.0	101.3	50.7	-3.7		105.0F	101.3
2) 50.0	33.7	136.3	152.0	101.3	50.7	-3.7		105.0F	101.3

18.2.12.4.2. MCS-MAGNUM LCD KEYPAD

The adaptive Offset value can be viewed on the MCS-Magnum LCD/Keypad by selecting the “Status” option from the Menu screen. Once in the “Status” screens page down to the compressor 1st screen showing Compressor state, state timer, Suct, Disch, OPD, and Motor values. Then press the right arrow button one time to scroll over to view the AMPS. On the second line below the AMPS heading (not the first line below the heading which displays the comp amps) the Adaptive Offset value is displayed.



18.2.13 PID MOD Individual

Each compressor will have its own condenser Analog Outputs associated with it. The Analog Output for each circuit is modulated based on its own discharge pressure Rate of Change. It can also be controlled on a selected sensor input. You may also select Relay Outputs to be turned ON/OFF while modulating the Analog Output.

PID control will turn an analog output into a stand alone PID controlled output. This output will have a controlling sensor that modulates the AO to a maintain target. This logic will run all the time.

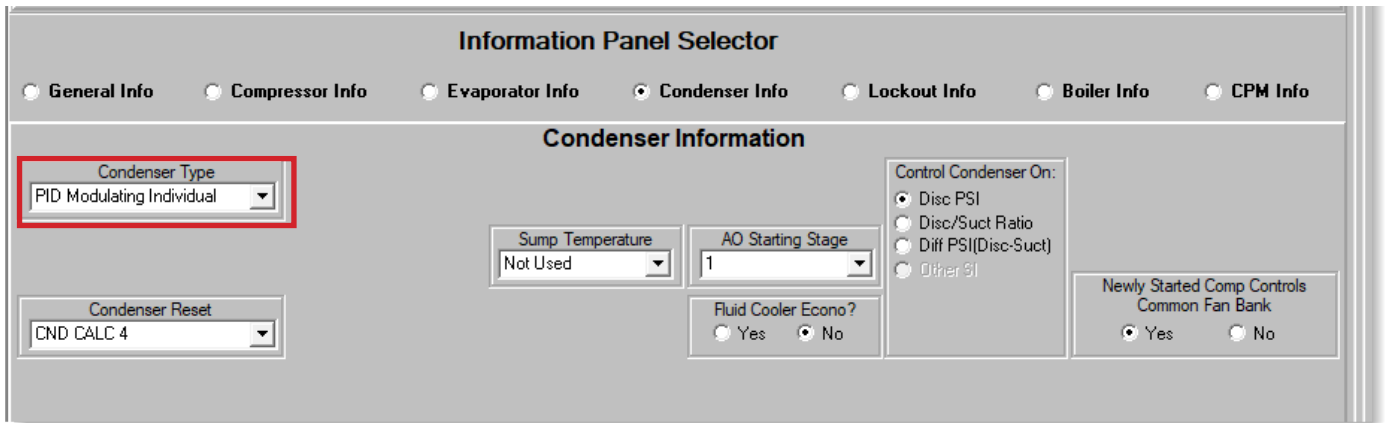

Setpoints used for PID Mod Individual and PID Step Common

45	CND STG1 ON (RO Type)	When the discharge pressure is above this value, turn on the first stage of the condenser fans. 'Time (sec)' field: (Applies to compressors with shared condensers) If non-zero, then the compressor in start-up state will not be in sole control of the condenser fans, it will control off of highest discharge pressure. If zero, then compressor in start-up will have sole condenser control for 5 minutes. This option is selected in the 'Newly started Comp Controls Common Fan Bank' box in the 'Condenser Information' panel under the MAGNUM screen.
	PID MOD Individual PID Step Common	If active, the value is the multiplier for the Proportional(Kp) adjustment, <u>Setup as Setpoint Type</u>
46	CND STG1 OFF (RO Type)	If stage 1 of condenser capacity is on and the discharge pressure drops below this value, then turn this stage off.
	PID MOD Individual PID Step Common	If active, uses Multiplier for Ki adjustments (Integral Time Delay). <u>Setup as Time Field</u>

47	CND DIFF ON (RO Type)	Differential pressure added to Setpoint #45 to set the threshold at which each additional stage of condenser capacity will turn on.
	PID MOD Individual PID Step Common	If active, use Multiplier for Kd adjustments, <u>Setup as Time Field-Time (sec) field is ROC window</u>
50	CND TRGT (Modulating Type)	Target logic will try to maintain modulating the AO. SP must be set up as target type and use the Hi/Low zones for the target control zone. If target type in Heat Pump mode, setback is added to target.
	LO AMB SUMP OFF (RO Type)	If active and ambient temperature is less than the value of this Setpoint, then the sump pump relay will be locked off if it is the starting condenser Relay Output. When the ambient temperature rises above the value of this Setpoint plus two times the value in Setpoint #192 "FRZ TEMP DIFF" if active (hard coded 15°F if inactive), then the sump pump relay will be allowed on again.
52	CND MIN % (Modulating Type)	Minimum AO % allowed. If compressor is off, then check the "Time (SEC)" field: If 0, then the AO % will be set to the value of this Setpoint. If 2 and the run/stop is set to run, then set the AO % to 100%, else set the AO % to 0%. This option is selected in the "Default Valve Opening % when Comp. is OFF" box in the condenser information section in the MAG HVAC screen.
55	CND MAX SPD (RO Type)	Maximum speed percentage for variable speed condenser control.
	CND MIN ADJ (Modulating Type)	The value in this Setpoint is the minimum % the AO will be modulated when a change is made.

Circuit Base settings

MAGNUM Circuit Base Screen													
Information that relates to Condensers and Evaporators on the circuit													
Circuit # [reset button]	# of Cond ROs	Starting Condenser RO	Condenser Fan AO	Starting Condenser Fault	# Cond Faults	Cond Fan Bank	Condenser Coil Temp #1	Condenser Coil Temp #2	Tandem EXV Circuit #	EXV #3 Circuit#	EXV #4 Circuit#	EXV #5 Circuit#	EXV #6 Circuit#
1	2	CND FAN1-1	CND1 VFD%	CND1 V FLT	1	1	CND1 COIL	Not Used	1	1	1	1	1
2	2	CND FAN2-1	CND2 VFD%	CND2 V FLT	1	2	CND2 COIL	Not Used	2	2	2	2	2

18.2.14 PID Step Common

This type of condenser has a common fan bank for the system. The control will be on the systems highest discharge pressure. The Relay Outputs are also supported along with an Analog Output.

PID control will turn an analog output into a stand alone PID controlled output. This output will have a controlling sensor that modulates the AO to a maintain target. This logic will run all the time.

Magnum HVAC Information Screen

Information Panel Selector

General Info
 Compressor Info
 Evaporator Info
 Condenser Info
 Lockout Info
 Boiler Info
 CPM Info

Condenser Information

Condenser Type PID Modulating Step Common	Starting Cond RO Not Used	# of Cond Stages 0	Fan AO Not Used	Control Condenser On: <input checked="" type="radio"/> Disc PSI <input type="radio"/> Disc/Suct Ratio <input type="radio"/> Diff PSI(Disc-Suct) <input type="radio"/> Other SI
Cond Starting Fault Not Used	# of Cond Fault 0	Sump Temperature Not Used	Fluid Cooler Econo? <input type="radio"/> Yes <input checked="" type="radio"/> No	
Condenser Reset Not Used	Newly Started Comp Controls Common Fan Bank <input type="radio"/> Yes <input checked="" type="radio"/> No			

18.3. PID CONTROL

- **Control Target**
SI, AO, or Setpoint used as the target the AO will try to maintain.
- **AO**
Min to Max value the AO can modulate between.
- **Proportional(Kp)**
Multiplier for Kp adjustments.
- **Integral(Ki)**
Multiplier and delay between Ki Adjustments.
- **Derivative(Kd)**
Multiplier and time in seconds interval to calculate Kd.
- **Adjustment Limits**
Min and Max adjustments allowed to the AO per adjustment, both negative and positive.

Under the Analog Outputs window in the MCS Connect software. You'll find an AO PID tab that will show all of the PID CONTROL AOs and all of the calculated adjustments being made to those Analog Outputs. Here you will be able to see all three adjustments being made to the PID. This will assist you in any fine tuning required for the given analog output.

AO #	Analog Outputs	Value	Manual Status	Total Adj.	Proportional Adj.	Integral Delay	Integral Adj.	Derivative Adj.
<input type="checkbox"/> M- 1	COMP1 SPD%	56.5%	AUTO	1773.2	138.94	0	131.25	138.74
<input type="checkbox"/> M- 2	COMP2 SPD%	56.5%	AUTO	1798.6	172.03	0	166.97	123.36
<input type="checkbox"/> M- 3	Exv#1-PID	42.3%	AUTO	1412.9	174.76	0	123.58	125.92
<input type="checkbox"/> M- 4	Exv#2-PID	51.0%	AUTO	1387.4	177.17	0	172.01	138.94
<input type="checkbox"/> 1-1	CND1 VFD%	100.0%	AUTO	261.8	166.94	0	177.18	133.60
<input type="checkbox"/> 1-2	CND2 VFD%	99.6%	AUTO	1233.6	174.57	0	146.59	126.00
<input type="checkbox"/> 1-3	WTR PUMP1%	0.0%	AUTO	1670.6	174.62	0	128.54	141.49
<input type="checkbox"/> 1-4	WTR PUMP2%	100.0%	AUTO	1745.9	169.44	0	123.55	138.94
<input type="checkbox"/> 2-1	SCEXV1-PID	0.0%	AUTO	1746.4	125.93	0	123.56	169.51
<input type="checkbox"/> 2-2	SCEXV2-PID	0.0%	AUTO	1414.9	128.54	0	179.89	174.62

Chapter - 19. Electronic Expansion Valve Control

19.1. Electronic Expansion Valve Control Logic (EXV)

The function of the thermostatic expansion valve is to hold a constant evaporator superheat.

The EXV is set up in MCS-Config as follows:

Relay Output Information Screen											
Number	Name	Slide Mult.	Slide Div.	Slide Off.	Design Suc.PSI	Design Dis.PSI	Nominal Tonnage(of Step)	EXV Start (When Lead)	Type	EXV Load Adjust %	EXV Unld Adjust %
M-1	COMP 1						0	28.5	Step w\ EXV		

For relay outputs for Type of Step w\ EXV:

'EXV Start (when Lead)' cell contains the EXV start percentage if this relay is the lead compressor.

'EXV Load Adjust %' cell contains the percentage of adjustment to the EXV when a step is added.

'EXV Unld Adjust %' cell contains the percentage of adjustment to the EXV when a step is deleted.

MAGNUM Circuit Base Screen																	
Information that relates to compressors on the circuit																	
Circuit # (reset button)	# of Comp ROs	Starting Compressor RO	Part Winding	Start Unload Bypass	Fast Unloader	Type of LLS	2nd LLS	Economizer	Econo Control	Unloading Stages	Loader Type	HGB	HG Reheat	Liquid Injection	Oil Equaliz		
1	5	COMP 1	No	No	No	EXV&LLS	No	No	Slide %	0	Unloader	None	No	No	No		
2	5	COMP 2	No	No	No	EXV&LLS	No	No	Slide %	0	Unloader	None	No	No	No		
3	0	Not Used	No	No	No	None	No	No	Slide %	0	Unloader	None	No	No	No		
4	0	Not Used	No	No	No	LLS only	No	No	Slide %	0	Unloader	None	No	No	No		
5	0	Not Used	No	No	No	EXV&LLS	No	No	Slide %	0	Unloader	None	No	No	No		
6	0	Not Used	No	No	No	EXV only	No	No	Slide %	0	Unloader	None	No	No	No		
7	0	Not Used	No	No	No	None	No	No	Slide %	0	Unloader	None	No	No	No		
8	0	Not Used	No	No	No	None	No	No	Slide %	0	Unloader	None	No	No	No		

Select Output and Sensor Inputs per circuit											
Circuit # (reset button)	Alarm Relay	Comp Proof	Compr Speed or Modulate Hot Gas AD	Compressor speed fault	Slide Closed Indicator	Pump Down	EXV Output	Flow	Circuit Pump/Valve	Loa Valv	
1	Not Used	Not Used	Not Used	Not Used	Not Used	DISABLE 1	EXV1 %	Not Used	Not Used	Not	
2	Not Used	Not Used	Not Used	Not Used	Not Used	DISABLE 2	EXV2 %	Not Used	Not Used	Not	
3	Not Used	Not Used	Not Used	Not Used	Not Used	Not Used	Not Used	Not Used	Not Used	Not	
4	Not Used	Not Used	Not Used	Not Used	Not Used	Not Used	Not Used	Not Used	Not Used	Not	
5	Not Used	Not Used	Not Used	Not Used	Not Used	Not Used	Not Used	Not Used	Not Used	Not	
6	Not Used	Not Used	Not Used	Not Used	Not Used	Not Used	Not Used	Not Used	Not Used	Not	
7	Not Used	Not Used	Not Used	Not Used	Not Used	Not Used	Not Used	Not Used	Not Used	Not	
8	Not Used	Not Used	Not Used	Not Used	Not Used	Not Used	Not Used	Not Used	Not Used	Not	

Information that relates to condensors on the circuit												
Circuit # (reset button)	# of Cond ROs	Starting Condensor RO	Condensor Fan AD	Starting Condenser Fault	# Cond Faults	Cond Fan Bank	Condenser Coil Temp #1	Condenser Coil Temp #2	Tandem EXV Circuit #	EXV Control	Suction Group	Comp Name/ID
1	5	CndFan 1-1	Not Used	Not Used	0	1	Not Used	Not Used	1	Suct Spht		1
2	5	CndFan 2-1	Not Used	Not Used	0	2	Not Used	Not Used	2	Ref Lvl		2

MCS-MAGNUM EXV SUCTION/DISCHARGE SUPERHEAT LOGIC

MCS-MAGNUM EXV Setpoints

#9 SUPERHT TARG = Target temperature setting for Superheat ('Time (sec)' is the seconds between samples used for calculating the Superheat Rate of Change).

#10 SPRHT ZONE+- = This value is added to and subtracted from setpoint #9 to calculate the upper and lower zones of the superheat control zone.

#11 EXV LOAD ADJ = The opening adjustment that will be made to the EXV when the compressor load solenoid is pulsed, or the closing adjustment when the compressor unload solenoid is pulsed.

#12 EXV FINE ADJ = Small Adjustment for the Valve (See Chart).

#13 EXV COURSE = Large Adjustment for the Valve (See Chart).

#14 EXV LOAD DIV = As the compressor amp draw % changes, this divides the EXV % change. It is calculated as follows: (Last FLA % - Current FLA %)/Setpoint #14

#15 EXV MIN% = Minimum Valve % allowed.

#16 EXV MAX% = Maximum Valve % allowed.

#17 LO SUPERHEAT = Temperature setting for Low Superheat.

#18 LOSUCTPSIDLY = Delay (sec) when in Lo Suct PSI Opening

#19 EXV DELAY = Maximum Delay (sec) between valve adjustments.

#20 EXV STRT TME = Delay (sec) to remain in EXV IN STARTUP when the compressor first starts.

#65 EXV ZONE1 DB = When set up as a setpoint or target type, the value field is added to and subtracted from setpoint #9 "Superheat Target" \pm setpoint #10 "Superheat zone" to develop the upper and lower limits for "EXV is Opening" and "EXV is Closing" zones in zone 1. When set up as a target, the night setback field is used as an offset that is added to setpoint #9 (Superheat Target) to calculate the bottom value for the limit of where Low PSI opening is allow to operate.

#66 EXV ZONE2 DB = The offset added to and subtracted from setpoint #9 "Superheat Target" \pm (setpoint #10 "Superheat zone" \times 2 OR setpoint #65 "EXV ZONE1 DB" if active) to develop the upper and lower limit for "EXV Opening 2x" and "EXV Closing 2x" zones in zone 2.

#67 EXV ROC ZN1 = The superheat's Rate Of Change (ROC) holding limit for the "EXV Opening" and "EXV Closing" zone. This setpoint value is entered as a positive number and for "EXV is Opening" zone multiplied by -1. Time in seconds = Minimum time to hold when outside the zone and the ROC is moving in the right direction. The EXV will be forced into a hold state for this minimum time.

#69 EXV ROC ZN2 = The superheat's Rate Of Change (ROC) holding limit for the "EXV Opening 2x" and "EXV Closing 2x" zone. The setpoint value is entered as a positive number and for "EXV Opening 2x" zone multiplied by -1. Time in seconds = Minimum time to hold when outside the zone and the ROC is moving in the right direction. The EXV will be forced into a hold state for this minimum time.

#70 EXV ROC ZN3 = The superheat's Rate Of Change (ROC) holding limit for the "EXV Opening 4x" and "EXV Closing 4x" zone. The setpoint value is entered as a positive number and for "EXV Opening 4x" zone multiplied by -1. Time in seconds = Minimum time to hold when outside the zone and the ROC is moving in the right direction. The EXV will be forced into a hold state for this minimum time.

#71 EXV ROC HD2x = The superheat ROC Opening 2x/Closing 2x limit for the "EXV is HOLDING" zone. The setpoint value is entered as a positive number and for "EXV Opening 2x" tested multiplied by -1. Time in seconds = Minimum time to hold when outside the zone and the ROC is moving in the right direction. The EXV will be forced into a hold state for this minimum time.

#72 EXV ROC HD1x = The superheat ROC Opening/Closing limit for the "EXV is HOLDING" zone. The setpoint value is entered as a positive number and for "EXV Opening" zone multiplied by -1.

#77 LOW SUCTION = Low suction PSI safety (See chart for calculation).

#78 LO SUCT UNLD = Time value is used to delay the comp from going into safety unloading state to allow EXV time to open.

#79 LO SUCT RELD = Low suction reloading (See chart for calculation).

MICRO CONTROL SYSTEMS Inc.	
DATE:	07-23-12 Page 1 of 3
DRAWN BY:	M. Schreiber
REVISION :	G
DWG NAME:	MCS-MAGNUM EXV SUCTION-DISCHARGE SUPERHEAT LOGIC - REV G.DWG

MCS-MAGNUM EXV SUCTION/DISCHARGE SUPERHEAT LOGIC

MCS-MAGNUM EXV Setpoints

#199 MOP TARG PSI = The Maximum Operation Suction pressure (MOP). If the suction pressure is greater than this value plus setpoint #200, then the EXV is forced to close. The EXV state is set to "EXV IS MOP CLS".

#200 MOP PSI ZONE = If the suction pressure is greater than setpoint #199 minus this value, then the EXV is force into "EXV IS MOP HLD" and the EXV will not be allowed to open.

#201 MOP ADJ % TME = This setpoint's value is used as the amount to adjust the EXV closed when in "EXV IS MOP CLS". This setpoint's "Time in sec" column is used as the delay between EXV adjustments when in the "EXV IS MOP CLS" state.

#205 EXV MDP = The Minimum Oil Differential pressure limit. When oil differential is below this value the EXV state will go to "EXV is MDP CLS". The setpoint's 'Time (sec)' column is an offset pressure value to allow the EXV back to normal control (Value is entered with one assumed decimal place. Ex: value of 50 = 5.0 psi offset). The 'Sec. To Ignore Safety' column is the time in minutes for the MDP logic to run after the compressor starts; if zero then MDP logic will run all the time. The 'Lockout Delay Hrs.' column is the adjust amount the EXV will be closed each time the delay reaches zero (Value is entered with one assumed decimal place. Ex: value of 20 = 2.0%).

EXV STARTING % is stored in RO Grid in Compressor row.

MICRO CONTROL SYSTEMS Inc.	
DATE:	07-23-12 Page 2 of 3
DRAWN BY:	M. Schreiber
REVISION :	G
DWG NAME:	MCS-MAGNUM EXV SUCTION-DISCHARGE SUPERHEAT LOGIC - REV G.DWG

Legend:

Calculated
Zone Limit

EXV State = Adjustment to EXV when delay reaches 0, Adjustment to delay every second
Superheat Rate of Change requirement to stay out of HOLD state

If Superheat exceeds the Calculated Zone Limit and the Rate of Change requirement is satisfied then EXV State, EXV Adjust, and Delay Adjust will all equal the corresponding values in the chart below. If those conditions are not met, the EXV state will be set to HOLD.

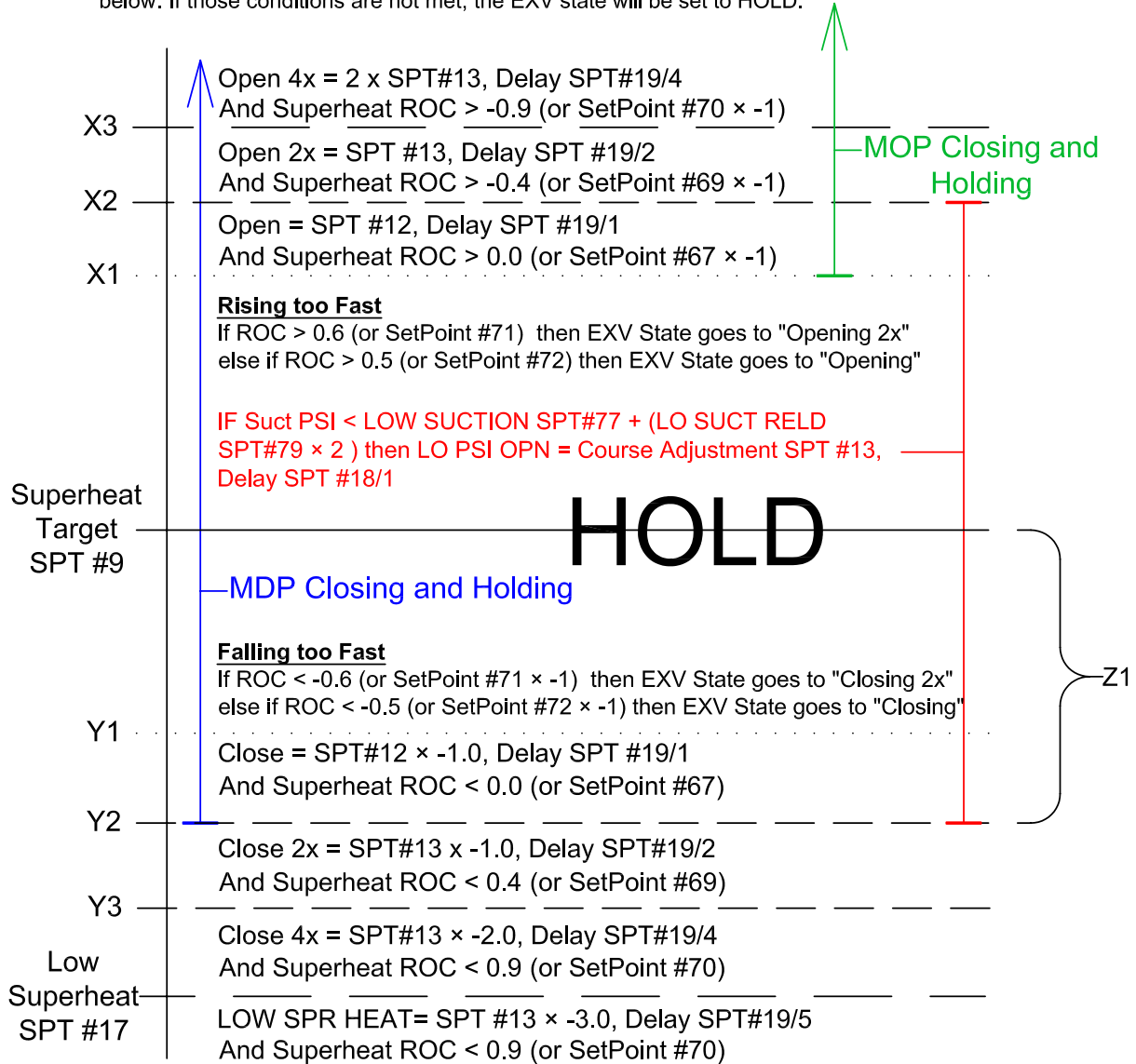

X1 = Stpt #9 + Stpt #10

Y1 = Stpt #9 - Stpt #10

X2 = X1 + Stpt #10

Y2 = Y1 - Stpt #10

or if Setpoint #65 is active
then X2 = X1 + Stpt #65

or if Setpoint #65 is active
then Y2 = Y1 - Stpt #65

X3 = X2 + Stpt #10

Y3 = Y2 - Stpt #10

or if Setpoint #66 is active
then X3 = X2 + Stpt #66

or if Setpoint #66 is active
then Y3 = Y2 - Stpt #66

Z1 = If setpoint #65 is not defined as a "TARGET" type then Y2 is the bottom limit where "LO PSI OPN" logic is allowed to work.

If setpoint #65 is defined as a "TARGET" type then setpoint #65 night setback field is added to setpoint #9 valve to calculate the bottom limit where "LO PSI OPN" logic is allowed to work.

MICRO CONTROL SYSTEMS Inc.	
DATE:	07-23-12 Page 3 of 3
DRAWN BY:	M. Schreiber
REVISION :	G
DWG NAME:	MCS-MAGNUM EXV SUCTION-DISCHARGE SUPERHEAT LOGIC -REV G.DWG

19.1.1 EXV Control States

The EXV Control States show the status of the compressor's expansion valve. If the compressor has an EXV it will be displayed under the Status entry.

Capacity Control State	Time	Wanted/ Actual	Step Delay	Wanted %	Rate of Change	Control On	Mode
UNIT IS HOLDING	00:00:16	1/1	60	100.0	0.0	ChilWtrOut= 55.0F	COOLING
State	Time	Oil Diff	FLA %	Steps	Lead?		
1) FAST UNLOADING	00:00:14	140.0P	97	1	Yes		
2) SAFETY TRIPPED	00:01:15	156.0P	116	0			
Suction Temp	Saturated Suction	Suction Superheat	Disc Temp	Saturated Discharge	Disc Superheat	Ref Type	
1) 45.0	33.0	12.0	152.0	100.6	51.4	R22	
2) 50.0	38.1	11.9	185.0	102.9	82.1	R22	
Valve State	Time	Valve %	SuperHeat	SuperHeat ROC	ADJ Delay		
1) EXV PRE-PMPDWN	00:00:16	15.0	12.0	0.0	0		
2) EXV IS CLOSED	00:01:16	0.0	11.9	0.0	0		

To view the EXV status through the Keypad LCD, select Status from the Main Menu and then page to the EXV screen.

EXV States:

LOCKED OUT	The compressor is in a Lockout state.
IS CLOSED	The associated compressor is OFF and the valve is closed
PRE-PMPDWN	The valve has been in a closed state and the system is now requiring the valve action.
IN STARTUP	At startup the valve will remain in this state for the time in Setpoint #20. At that time the state will be changed to holding, at this point the valve control logic will position the valve.
AT 100%	This state will be entered when the valve opening reaches 100%.
IS HOLDING	Refer to EXV Logic Chart, superheat is in control zone and ROC is acceptable.
IS OPENING	Refer to EXV Logic Chart, superheat is in control zone but rising too fast, ROC less than 1.0.
IS CLOSING	Refer to EXV Logic Chart, superheat is in the control zone and the rate of change is acceptable, ROC greater than -0.5.
LOW SPRHT	Refer to EXV Logic Chart, force a course valve adjustment.
OPENING 4x	Refer to EXV Logic Chart, superheat is above control zone.
OPENING 2x	Refer to EXV Logic Chart, superheat is in control zone but rising too fast, the ROC is greater than 1.0.
LO PSI OPN	Refer to EXV Logic Chart, state indicates that a low suction pressure condition exists. The suction pressure is less than Setpoint #77 "LOW SUCTION" plus twice the value of Setpoint #79 "LOW SUCT RELOAD" and the superheat is greater than Setpoint #9 "SUPERHT TRGT" plus twice the value of Setpoint #10 "SPRHT ZONE+."
CLOSING 2x	Refer to EXV Logic Chart, superheat is in the control zone and the rate of change is acceptable, the ROC is less than -0.5 and greater than -1.0.
CLOSING 4x	Refer to EXV Logic Chart, superheat is in control zone but falling too fast, ROC less than -1.0.
HI LVL CLS	This state indicates that a high refrigerant level. This state is entered if Setpoint #109 "HiRefLevel" is active and the superheat is greater than the value of this Setpoint.
IS MOP CLS	Refer to EXV Logic Chart. Maximum operating pressure option is active and it is forcing the EXV to close. In this state the EXV valve's opening will be reduced.
IS MOP HLD	Refer to EXV Logic Chart. Maximum operating pressure option is active and it is forcing the EXV to hold.

19.1.2 EXV Maximum Operating Pressure

Setpoint #199 "MOP TARG PSI" must be active if the suction pressure is to be checked for maximum operating pressure.

If the suction pressure is above the MOP control zone, then the EXV state will be changed to EXV IS MOP CLS. The EXV valve opening will be closed by the value in Setpoint #201 with each adjustment. The 'Time(sec)' field of Setpoint #201 will be the delay between making adjustments to the EXV valves. The EXV will remain in this state until the suction pressure drops below the top of the MOP control zone. At this point the state will be changed to EXV IS MOP HOLD.

In the EXV IS MOP HOLD state the EXV valve's opening cannot be increased but it can be closed. The EXV will remain in this state until the suction pressure drops below the MOP control zone. At that time the EXV control state will change to EXV IS HOLDING and normal EXV control will resume.

(Refer to Setpoints #199, #200, and #201)

19.1.3 Tandem EXV Setup

Firmware Version HVAC 17.62R
Config Version 18.01T
Connect Version 18.31.15

The Magnum supports up to 6 tandem EXVs per circuit. However, a separate compressor must be set up to support this function. Therefore, the maximum compressors that can be supported with 6 tandem EXVs per circuit would be 3. EXV compressors must follow the active compressors in the system.

In the General Information panel of the MAGNUM screen enter the number of compressors and steps:

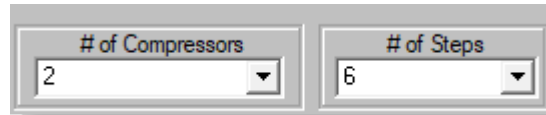

Example: 2 circuits, 2 compressors, 6 EXV's on each circuit

MAGNUM Circuit Base Screen																		
Circuit # [reset button]	# of Cond ROs	Starting Condenser RO	Condenser Fan AD	Starting Condenser Fault	# Cond Faults	Cond Fan Bank	Condenser Coil Temp #1	Condenser Coil Temp #2	Tandem EXV Circuit #	EXV #3 Circuit#	EXV #4 Circuit#	EXV #5 Circuit#	EXV #6 Circuit#	Evaporator EXV Control	Evaporator Type	Suction Group	Pump/Valve Evap Group	Comp Name/ID
1	0	Not Used	Not Used	Not Used	0	1	Not Used	Not Used	3	4	5	6	7	PID SSH	DX Coil	1	1	1
2	0	Not Used	Not Used	Not Used	0	2	Not Used	Not Used	8	9	10	11	12	PID SSH	DX Coil	2	2	2
3	0	Not Used	Not Used	Not Used	0	3	Not Used	Not Used	3	3	3	3	3	PID SSH	DX Coil	3	3	1-2
4	0	Not Used	Not Used	Not Used	0	4	Not Used	Not Used	4	4	4	4	4	PID SSH	DX Coil	4	4	1-3
5	0	Not Used	Not Used	Not Used	0	5	Not Used	Not Used	5	5	5	5	5	PID SSH	DX Coil	5	5	1-4
6	0	Not Used	Not Used	Not Used	0	6	Not Used	Not Used	6	6	6	6	6	PID SSH	DX Coil	6	6	1-5
7	0	Not Used	Not Used	Not Used	0	7	Not Used	Not Used	7	7	7	7	7	PID SSH	DX Coil	7	7	1-6
8	0	Not Used	Not Used	Not Used	0	8	Not Used	Not Used	8	8	8	8	8	PID SSH	DX Coil	8	8	2-2
9	0	Not Used	Not Used	Not Used	0	9	Not Used	Not Used	4	9	9	9	9	PID SSH	DX Coil	9	9	2-3
10	0	Not Used	Not Used	Not Used	0	10	Not Used	Not Used	5	10	10	10	10	PID SSH	DX Coil	10	10	2-4
11	0	Not Used	Not Used	Not Used	0	11	Not Used	Not Used	1	11	11	11	11	PID SSH	DX Coil	11	11	2-5
12	0	Not Used	Not Used	Not Used	0	12	Not Used	Not Used	2	12	12	12	12	PID SSH	DX Coil	12	12	2-6
13	0	Not Used	Not Used	Not Used	0	13	Not Used	Not Used	13	13	13	13	13	PID SSH	DX Coil	13	13	13

The colored fields must match the circuit number as you see above for EXV circuits and suction groups.

The only thing you can change are the Name/ID fields.

MAGNUM Circuit Base Screen																		
Information that relates to compressors on the circuit																		
Circuit# (reset button)	# of Comp ROs	Starting Compressor RO	Part Winding	Start Unload Bypass	Fast Unloader	Type of LLS	2nd LLS	Comp. Economizer (Subcooler)	Econo Control	Unloading Stages	Loader Type	HGB	HG Reheat					
1	4	Comp 1	No	No	No	EXV only	No	No	Slide 2	2	Loader	None	No					
2	4	Comp 2	No	No	No	EXV only	No	No	Slide 2	2	Loader	None	No					
3	0	Not Used	No	No	No	EXV only	No	No	Slide 2	0	Unload	None	No					
4	0	Not Used	No	No	No	EXV only	No	No	Slide 2	0	Unload	None	No					
5	0	Not Used	No	No	No	EXV only	No	No	Slide 2	0	Unload	None	No					
6	0	Not Used	No	No	No	EXV only	No	No	Slide 2	0	Unload	None	No					
7	0	Not Used	No	No	No	EXV only	No	No	Slide 2	0	Unload	None	No					
8	0	Not Used	No	No	No	EXV only	No	No	Slide 2	0	Unload	None	No					

MAGNUM Circuit Base Screen																		
Circuit # (reset button)	# of Cond ROs	Starting Condenser RO	Condenser Fan AD	Starting Condenser Fault	# Cond Faults	Cond Fan Bank	Condenser Coil Temp #1	Condenser Coil Temp #2	Tandem EXV Circuit #	EXV #3 Circuit#	EXV #4 Circuit#	EXV #5 Circuit#	EXV #6 Circuit#	Evaporator E Control				
1	0	Not Used	Not Used	Not Used	0	1	Not Used	Not Used	3	4	5	6	7	PID SSH				
2	0	Not Used	Not Used	Not Used	0	2	Not Used	Not Used	8	9	10	11	12	PID SSH				
3	0	Not Used	Not Used	Not Used	0	3	Not Used	Not Used	3	3	3	3	3	PID SSH				
4	0	Not Used	Not Used	Not Used	0	4	Not Used	Not Used	4	4	4	4	4	PID SSH				
5	0	Not Used	Not Used	Not Used	0	5	Not Used	Not Used	5	5	5	5	5	PID SSH				
6	0	Not Used	Not Used	Not Used	0	6	Not Used	Not Used	6	6	6	6	6	PID SSH				
7	0	Not Used	Not Used	Not Used	0	7	Not Used	Not Used	7	7	7	7	7	PID SSH				
8	0	Not Used	Not Used	Not Used	0	8	Not Used	Not Used	8	8	8	8	8	PID SSH				
9	0	Not Used	Not Used	Not Used	0	9	Not Used	Not Used	4	9	9	9	9	PID SSH				
10	0	Not Used	Not Used	Not Used	0	10	Not Used	Not Used	5	10	10	10	10	PID SSH				
11	0	Not Used	Not Used	Not Used	0	11	Not Used	Not Used	1	11	11	11	11	PID SSH				
12	0	Not Used	Not Used	Not Used	0	12	Not Used	Not Used	2	12	12	12	12	PID SSH				

The first EXV for compressor #1 will be on its own circuit(#1).

The second valve for compressor #1 will be on circuit #3 as that's the first available circuit with no compressor.

The third, fourth, fifth, and sixth EXV will be in sequential order for simplicity 3, 4, 5, 6, and 7 as you see above in the Tandem EXV circuit#, EXV #3 circuit# etc.

For the second compressor the first available circuit will be #8. So those EXV's will use 8, 9, 10, 11, and 12.

Where again the first EXV for that compressor will be used on its own circuit(#2).

The following fields must be used in order for the tandem EXV's to function correctly.

Circuit # (reset button)	Type of LLS	Evaporator EXV Output	Evap Suct Temp	Evap Suct PSI	Circuit # (reset button)	Suction Pressure	Discharge Pressure	Suction Temperature
1	EXV only	EXV 1-1%	EvapTmp1-1	EvapPsi1-1	1	Suct Psi 1	Disc Psi 1	Suct Tmp 1
2	EXV only	EXV 2-1%	EvapTmp2-1	EvapPsi2-1	2	Suct Psi 2	Disc Psi 2	Suct Tmp 2
3	EXV only	EXV 1-2%	EvapTmp1-2	EvapPsi1-2	3	Suct Psi 1	Not Used	Suct Tmp 1
4	EXV only	EXV 1-3%	EvapTmp1-3	EvapPsi1-3	4	Suct Psi 1	Not Used	Suct Tmp 1
5	EXV only	EXV 1-4%	EvapTmp1-4	EvapPsi1-4	5	Suct Psi 1	Not Used	Suct Tmp 1
6	EXV only	EXV 1-5%	EvapTmp1-5	EvapPsi1-5	6	Suct Psi 1	Not Used	Suct Tmp 1
7	EXV only	EXV 1-6%	EvapTmp1-6	EvapPsi1-6	7	Suct Psi 1	Not Used	Suct Tmp 1
8	EXV only	EXV 2-2%	EvapTmp2-2	EvapPsi2-2	8	Suct Psi 2	Not Used	Suct Tmp 2

Type of LLS must be setup as "EXV only" or "EXV&LLS" depending on if the config is using liquid line solenoids or not.

Each circuit must have its own analog output

Each circuit must have its own temperature and pressure to control to.

Each circuit must look at the compressor suction psi and temperature. This is to stop that circuit from tripping on low compressor superheat.

19.2. 'Evaporator or Condenser Refrigerant Level Control

There is an alternate method to control the EXV based on Ref Level.

19.2.3.1. Minimum Refrigerant Level target (HVAC ONLY)

If active and the EXV is controlled by Refrigerant Level, then a new variable level target logic will be activated. As the unit capacity increases, the refrigerant level target will change according to a linear calculation between Setpoint #9 "LEVEL TARGET" (the maximum target level) and Setpoint #217 "LOW EXV TARGET" (the minimum target level). This relationship is explained in the following graph:

In the Compressor SI screen the active compressors information is to be completed as normal, while only the Suction Pressure and Suction Temperature must be entered for the tandem EXV's. The different suction temperature provides separate control for the tandem EXV's.

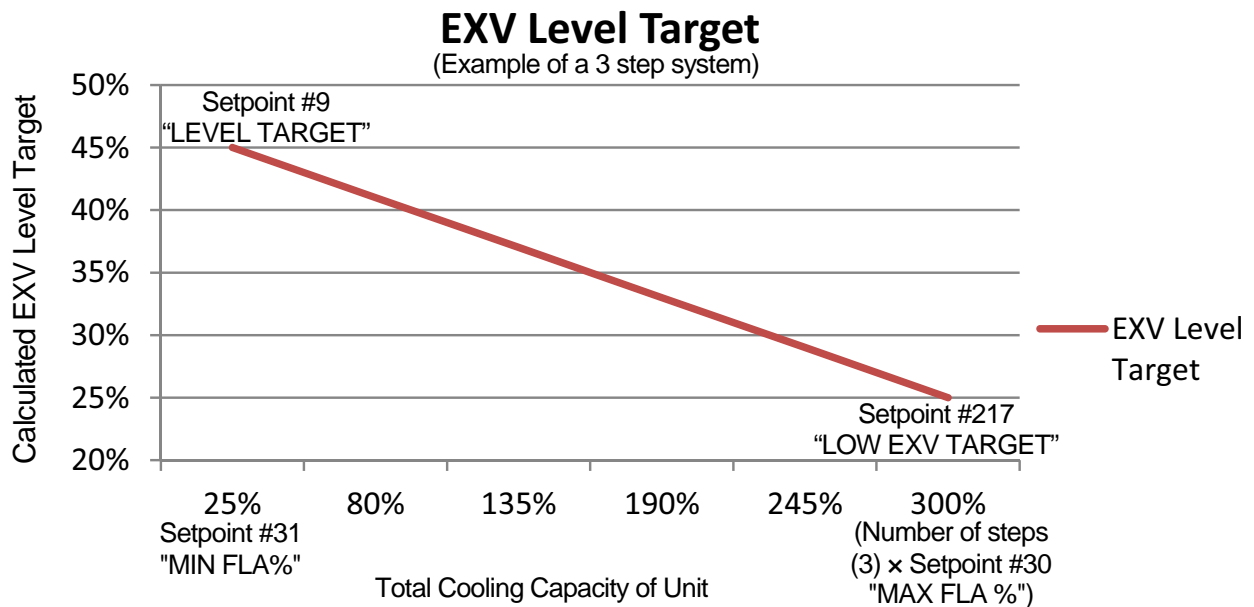

19.2.3.2. Evaporator Level Control

This option will control the EXV based upon the Refig Level sensor which is selected in Circuit SI screen, column Refrig Level. Control will be as indicated in the MCS-MAGNUM EXV SUCTION/DISCHARGE SUPERHEAT LOGIC sections except the EXV states will be the opposite of the SUCTION/DISCHARGE control. When the refrigerant level is above the associated control point the EXV valve will be closed and when it is below the associated control point the EXV valve will be opened.

19.2.3.3. Condenser Level Control

This option will control the EXV based upon the Refig Level sensor which is selected in Circuit SI screen column Refrig Level. This sensor will indicate the refrigerant level in the condenser. Control is the opposite of the Refrigerant Level Control. When the condenser level is above the associated control point the EXV valve will be opened and when it below the associated control point the EXV valve will be closed.

19.2.1 EXV control methods for Step Loading Compressors

Percentage per Step: (Requires Magnum Software HVAC 8.03L and MCS-Config 8.00W or higher)

To control the EXV based on a percentage per step for fixed step compressors, insert the relative load and unload adjustment percentages in the respective fields in the Relay Output screen. The load and unload adjustments will increase or decrease respectively based on a percentage of the current EXV position (not a fixed value)

Here is an example of a Hanbell Screw compressor configured to load by fixed steps:

Relay Output Information Screen						
Number	Name	EXV Start (When Lead)	Type	EXV Load Adjust %	EXV Unld Adjust %	Comments
M-1	COMP 1	25	Step w\ EXV	50	60	
M-2	LLS 1	-----	Standard	-----	-----	
M-3	HotGasByps	0	Step w\ EXV	50	60	
M-4	UNLOAD 50%	0	Step w\ EXV	30	40	
M-5	UNLOAD 75%	0	Step w\ EXV	20	30	

These columns are used for the compressor when there are multiple compressors on a single suction circuit, however, values must be in these fields for this logic to be in effect.

The logic will work as follows: When the compressor starts the EXV will go to the value in the 'EXV Start (when lead)' column, in this example it is 25%. The EXV will then modulate normally according to the controlling superheat or refrigerant level, until the unit is ready to load another step of capacity. Assume the EXV has stayed at 35% when the second step of capacity is ready to engage (turning off the Hot Gas Bypass). The EXV adjustment will be 50% (the amount in the 'EXV Load Adjust' column of the current EXV position

'EXV Load Adjust' column (50%) x current EXV position (35%) = EXV adjustment (17.5%)

$$50\% \times 35\% = 17.5\%$$

$$\text{Current EXV position (35\%)} + \text{EXV adjustment (17.5\%)} = \text{New EXV position (42.5\%)}$$

$$35\% + 17.5\% = 42.5\%$$

Therefore the final EXV valve position would be 42.5%

This same calculation will be repeated every time a new stage of capacity is turned on. Conversely, when the unit is unloading, the EXV adjustment will be subtracted from the current EXV position for every step that turns off. Assume the EXV is at 40% and the compressor is at 100% and is ready to unload a step (turning on Unload 75% solenoid).

'EXV Unld Adjust' column (30%) x current EXV position (40%) = EXV adjustment (12%)

$$30\% \times 40\% = 12\%$$

$$\text{Current EXV position (40\%)} - \text{EXV adjustment (12\%)} = \text{New EXV position (28\%)}$$

$$40\% - 12\% = 28\%$$

Therefore the final EXV valve position would be 28%

The values given in the example are only start points. You will need to adjust the values for your system. The idea is to jump the EXV position so that the superheat would still be above the target slightly, and then the EXV control logic would then adjust the value to achieve the target superheat. We do not want to open the EXV valve too much when loading or close the valve too much when unloading so we do not cause low superheat or liquid flooding to the compressor.

Chapter - 20. Sub Cooler EXV Control Logic

Purpose of Change

The purpose of this change is to add Electronic Expansion Valve (EXV) control logic for Subcooler heat exchanger(s). There can be a subcooler for each refrigeration circuit. If there are multiple compressors on the refrigeration circuit the logic will need to control the EXV when any compressor on the refrigerant circuit is running.

20.1. New Sensor Inputs

Subcooler Suction PSI – Analog sensor input which indicates the suction pressure on the subcooler heat exchanger. This will be the refrigerant gas going to the compressor's economizer port (vapor injection port). There will be one suction pressure per refrigerant circuit.

Subcooler Suction Temperture – Analog sensor input which indicates the suction temperature on the subcooler heat exchanger. This will be the refrigerant gas temperature going to compressor's economizer port) vapor injection port). There will be one suction temperature per refrigerant circuit.

20.2. New Analog Outputs

Subcooler Electronic Expansion Valve – analog output used to control the position of the electronic expansion valve. This must be connected to device (MCS-EXV-DRVIER) to move the EXV. There will be one analog output per refrigerant circuit.

20.3. Existing Relay Outputs

Economizer Solenoid Valve – relay output used to stop the refrigeration gas flow to compressor economizer port (vapor injection port). There will be one relay output per compressor.

If there is only one compressor on the refrigerant circuit and the EXV is capable of closed upon loss of powers, the economizer solenoid valve relay output is optional because the EXV can act as the solenoid valve.

If there are multiple compressors on the refrigerant circuit, then solenoid valve is not optional, no matter what type of EXV. And each compressor will have its own relay output to control its own solenoid valve.

20.4. Calculated Values

Subcooler Saturated Suction Temperature – This value is calculated using the subcooler suction pressure and refrigerant's Pressure to Temperature chart. The subcooler suction pressure is used as the input into the refrigerant's pressure to temperature chart to find the saturated temperature.

Subcooler Superheat Temperature – This value is calculated by subtracting the Subcooler Saturated Suction Temperature from the Subcooler Suction Temperature.

$$\text{Subcooler Superheat} = \text{Subcooler Suction Temperature} - \text{Subcooler Saturated Suction Temperature}$$

Subcooler EXV State – This value is determined by the logic to control the EXV.

Subcooler Time Delay – This value is calculated by the control logic and is used to delay adjustments to the EXV position.

Subcooler Wanted Position – This value is calculated by the control logic is the wanted position of the EXV.

Subcooler Superheat ROC – This value is calculated by the control logic. It is the superheat Rate of Change. It is calculated by subtracting the current superheat value from a previous superheat value. The control logic will need to store the last 60 superheat values.

20.5. New Config Parameters

New setpoints required to control the Subcooler EXV:

1. Subcooler SuperheatTarget – this setpoint define the superheat target the control logic will maintain.
2. Subcooler deadband – this setpoint define the deadband around the superheat target. This setpoint with the target setpoint defines the control zone for subcooler superheat.
3. Subcooler delay – This is the delay between adjustments to the EXV position.
4. Subcooler EXV starting % - This is the start position for the EXV when the subcooler is first turned on.
5. Subcooler EXV starting time – This is the time to remain at the starting EXV position to allow for the subcooler superheat to develop to a real value to control the EXV.
6. All the EXV setpoints? Fine, course, low superheat, MOP, low suction, min/max EXV allowed?
7. MOP, Low suction psi, low suction control setpoints (delay, adjustment multiplier), Others?

20.6. Logic Requirements

1. Subcooler EXV control logic needs to run once a second.
2. There can be only one subcooler heater exchanger per refrigerant circuit. The subcooler heat exchange is an optional feature and maybe not be installed.
 - a. If there is only one compressor on the refrigerant circuit then only when the one compressor is running does the subcooler control logic run to maintain the superheat. And there will be one EXV AO, one Suction Pressure SI, one Suction Temperature and one optional economizer solenoid valve RO. The economizer solenoid valve RO is optional only if the EXV driver can closed the valve on loss of power (EXV acts as solenoid valve – therefore a solenoid valve is not required).
 - b. If there are multiple compressors on the refrigerant circuit then when any compressor on the suction group is running the Subcooler EXV logic need maintain the superheat target. And there will be one EXV AO, one Suction Pressure SI, one Suction Temperature and multiple economizer solenoid valve ROs (one RO per compressor). And the RO is not optional, because we need to turn on solenoid valves for only the compressors that are running on the refrigerant circuit. Compressors not running will have the solenoid valves off.
3. Suggest similar Subcooler EXV state as Evaporator EXV state
 - a. Subcooler EXV LOCKED OUT
 - b. Subcooler EXV CLOSED
 - c. Subcooler EXV Holding
 - d. Subcooler EXV in Startup
 - e. Subcooler EXV Opening 1x
 - f. Subcooler EXV Opening 2x
 - g. Subcooler EXV Opening 4x
 - h. Subcooler EXV Closing 1x
 - i. Subcooler EXV Closing 2x
 - j. Subcooler EXV Closing 4x
 - k. Low Superheat Closing
 - l. MOP Closing, MOP Holding, Low Suction Opening?
 - m. Others?
4. If all the compressors are off:
 - a. The Subcooler EXV analog output is forced to 0.0%
 - b. The Economizer solenoid valve RO is turned off.
 - c. The subcooler control variables, step delay, etc are reset to defaults.
 - d. The state is set to Subcooler EXV Closed.
5. Once any compressor is started and either it's FLA% is greater than setpoint #255 Or the setpoint #255 Is inactive then::
 - a. The Subcooler state is moved from EXV CLOSED to Subcooler EXV in Startup. The subcooler will remain in this state for X seconds (X defined by setpoint valve) with the EXV AO set to percentage

defined by setpoint value. And the compressor solenoid RO is turned on (if one exists).

- b. Once the Startup time delay is satisfied the EXV state will be change to Subcooler Holding and EXV AO will be modulated to maintain the superheat within the control zone and the following logic run:
 - i. If the Subcooler Suction pressure is greater than or equal to the MOP setpoint the state will be set to MOP Closing.
 - ii. If the Subcooler Suction pressure is less than low suction pressure setpoint and the subcooler superheat is in or above control zone the state will be set to Low Suction Opening and the valve will be quickly open.
 - iii. If the Subcooler superheat is within the control zone or ROC is satisfied then state will remain in Subcooler Holding.
 - iv. If the subcooler superheat is above the control zone:
 1. And the ROC is above the ROC- setpoint, the will be set based upon how far above the control zone, Opening 1x, Opening 2x, Opening 4x.
 2. Else if ROC is equal to or below ROC- setpoint then state is set to EXV HoLDING.
 - v. If the subcooler superheat is below the control zone
 1. And superheat ROC is greater than the ROC+ setpoint, the state will be set based upon how far below the control zone, Closing 1x, Closing 2x, Closing 4x.
 2. Else if ROC is rqual to or greater than ROC+ setpoint, the state will be set to ECV HoLDING.
 - vi. The EXV time delay needs to be decrement each second by a variable amount determine by subcooler state until the delay reaches zero. The further away from the target the bigger the adjustment to allow changes faster. Once the delay reaches zero:
 1. If the superheat is inside the control:
 - a. If ROC is between the ROC+ and ROC- setpoint values, then EXV state goes to holding.
 - b. If ROC less than ROC- setpoint then exv states goes to Closing 1x.
 - c. If ROC greater than ROC+ setpoint value then exv state goes to Opening 1x.
 2. if a superheat is outside the control zone then a variable adjustment will be made the Subcooler wanted position. The further away from the target the bigger the adjustment to move the valve faster. And if above the control zone the adjustment will be added to the current wanted % to open the value. If below the control zone the the adjustment will be subtracted to the current wanted % to close the valve. The wanted % is bound-ed by min and max limits defined by new setpoint values in the config.
 3. Last comp on refrigerant circuit is turn off or last econo turn off? Then subcooler exv state goes to exv closed.

Chapter - 21. EXV Control SSH, SSH2

MCS has released two new superheat control systems in addition to its existing EXV Superheat Control Systems.

21.1. Fast Suction Superheat (Fast SSH)

Released with firmware 17.26-B.hex with the following objectives:

- Reduce the number of set points required. (SP 65 through 72 were eliminated)
- Provide only one control zone.
- Anytime the superheat moves outside this zone to recovery within two minutes or less.
- Provide Fast Suction Superheat control for Subcooler's with standard set points.
(SP 65 through 72 were used. (SP 253 through 255 were eliminated)

Provide option to dynamically calculate the EXV starting position

21.2. Fast Suction Superheat 2 (Fast SSH2)

Released with firmware 17.37D1.hex with the following objectives:

- Provide MCS Default set points for all EXV controls types.
- Improve on self learning EXV Valve starting position.
- Provide color coded identification for Fast SSH, Fast SSH2 & Subcooler options in MCS-Config.
- Add an extended SH ROC to allow finer decisions and reduce valve movement.
- Add explicit states for Fast SSH and Fast SSH2.

21.3. Selecting Fast SSH or Fast SSH2 in MCS-Config

In Fast SSH & Fast SSH2 only Set Points 9 through 20 are used to control the EXV valve. If you select Fast SSH or Fast SSH2 as your superheat EXV control and you have a subcooler (an economizer injecting refrigerant into the compression chamber) you will get Fast SSH control on the EXV for the subcooler. The Fast SSH set points for the subcooler are 65 through 72.

Select Type of Control in Relay Output Information Screen. In the RO screen, from the drop down window in 'Type' you select either 'Step w \ EXV' or 'Screw w \ EXV'

Relay Output Information Screen										
Point Number	Name	Slide Mult.	Slide Div.	Slide Off.	Design Suc.PSI	Design Dis.PSI	Nominal Tonnage(of Step)	EXV Start (When Lead)	Type	
M-1 ...	COMP	---	---	---	---	---	0	38	Step w \ EXV	
M-2 ...	REV VALVE	---	---	---	---	---	---	---	Step w \ EXV	
M-3 ...	SUPPLY FAN	---	---	---	---	---	---	---	Screw w \ EXV	
M-4 ...	SPAREM-4	---	---	---	---	---	---	---	Screw NO EXV	
M-5 ...	INV RUN	---	---	---	---	---	---	---	Pulse Relay	
M-6 ...	INV RESET	---	---	---	---	---	---	---	Alm-Emerg Stop	
M-7 ...	GARAGE LT	---	---	---	---	---	---	---	Alm-Freeze Fault	
									Alm-Hi Sump Temp	

21.4. Circuit Base

In the Circuit Base screen you need to select the Analog Output for the EXV.

Select Output and Sensor Inputs per circuit										
Circuit # (reset button)	Alarm Relay	Comp Proof	Compr Speed(%) or Modulate Hot Gas AO	Compressor Speed Fault	Slide Closed Indicator	Pump Down	Evaporator EXV Output	Flow	Circuit Pump/Valve	
1	...	Not Used	Not Used	Not Used	Not Used	Not Used	DISABLE 1	EXV1 %	Not Used	Not Used
2	...	Not Used	Not Used	Not Used	Not Used	Not Used	DISABLE 2	RO		Not Used
3	...	Not Used	Not Used	Not Used	Not Used	Not Used	Not Used	EXV1 %		Not Used
4	...	Not Used	Not Used	Not Used	Not Used	Not Used	Not Used	EXV2 %		Not Used
5	...	Not Used	Not Used	Not Used	Not Used	Not Used	Not Used	CHW PMP1%		Not Used
6	...	Not Used	Not Used	Not Used	Not Used	Not Used	Not Used	CHW PMP2%		Not Used
7	...	Not Used	Not Used	Not Used	Not Used	Not Used	Not Used	CND VFD1%		Not Used
8	...	Not Used	Not Used	Not Used	Not Used	Not Used	Not Used	CND VFD2%		Not Used
9	...	Not Used	Not Used	Not Used	Not Used	Not Used	Not Used	SPARE1-3		Not Used

Next in the Circuit Base screen you need to select 'Fast SSH' or 'Fast SSH2' from the Evaporator EXV Control section drop down menu.

Circuit # (reset button)	# of Cond ROs	Starting Condenser RO	Condenser Fan AO	Starting Condenser Fault	# Cond Faults	Cond Fan Bank	Condenser Coil Temp #1	Condenser Coil Temp #2	Tandem EXV Circuit #	Evaporator EXV Control	
1	...	1	COND FAN	COND CTRL	Not Used	0	1	CONDIN T	Not Used	1	Fast SSH2
2	...	0	Not Used	Not Used	Not Used	0	2	Not Used	Not Used	2	Cond Lvl
3	...	0	Not Used	Not Used	Not Used	0	3	Not Used	Not Used	3	Fast SSH
4	...	0	Not Used	Not Used	Not Used	0	4	Not Used	Not Used	4	Fast SSH2
5	...	0	Not Used	Not Used	Not Used	0	5	Not Used	Not Used	5	Evap Appr
6	...	0	Not Used	Not Used	Not Used	0	1	Not Used	Not Used	1	Fast Evap App
7	...	0	Not Used	Not Used	Not Used	0	2	Not Used	Not Used	2	Fast EvpLvl
8	...	0	Not Used	Not Used	Not Used	0	3	Not Used	Not Used	3	Fast DSH

With the release of Fast SSH2 MCS has released a new MCS-Config to support the new functions. The new MCS-Config provides a new tab, 'EXV Control', where you define your system. This then allows MCS-Config to provide MCS Default Set Point Values for you. The figure below shows the Current 'Circuit Base' tab and the new 'EXV Control' tab.



If you enter data in the EXV portion of the Circuit Base tab or in the EXV Control tab it is carried through to the other tab.

21.4.1 Selecting the 'EXV Control' tab you are prompted with the following:

The screenshot shows the 'EXV Control Wizard' interface. It includes several configuration sections:

- Control Parameter:** Radio buttons for Suction Superheat, Discharge Superheat, Evaporator Level, Condenser Level, and Approach.
- Heat Exchanger Type:** Radio buttons for DX Coil, Plate HX (selected), DX Barrel, and Flooded Barrel.
- Control Method:** Radio buttons for Normal (Original), Fast I, and Fast II.
- Target Modifier:** Checkboxes for Low Discharge Superheat, Oversized Condenser/High Ambient, Maximum Operating Pressure(MOP), Minimum Differential Pressure(MDP), Target Reset, Low Suction, Low/High Level, and Level->CAP.
- Set Values to Default:** A button to reset settings.

Below the configuration sections are two tables:

EXV Control Setpoints

#	Name	Value	Min	Max	Adjust Value	Time (SEC)	Max Time Allowed (SEC)	Lockout Delay (HRS)	Safety Down Time(MIN)	Active or Non-Active	Select Value: # decimals & print char	Level (l) Auth. To Display	Type of Setpoint	Comments	SEC. to Ignore Safety	Window to Est. Safety Time(SEC)	Safety Time Extension (SEC)
9	SHTRG/SHAvg	12	0	18	0.1	1	1	0	0	Active	TEMP	View Only	Time				
10	FAST_ZONE	2	1.6	3	0.1	0	0	0	0	Active	TEMP	View Only	Time				
11	LQAd/REHEAT	0.2	0	1	0.1	0	10	0	0	Active	HUMD or %	View Only	Time				
12	SHMpp/ESPRED	2	1	3	1	1	5	0	0	Active	DIGITAL/5V	View Only	Time				
13	RcMpp/LSMpp	2	1	3	1	3	5	0	0	Active	DIGITAL/5V	View Only	Time				
14	LmZn/LmZn	0.5	0.3	0.5	0.1	0	0	0	0	Active	DECINCH	View Only	Time				
15	VMIN/SHMpp	3	2	50	1	3	5	0	0	Active	HUMD or %	View Only	Time				
16	VMAX/NTUSED	100	60	100	1	0	0	0	0	Active	HUMD or %	View Only	Setpoint				
17	LSnT/TmH	4	2	5	0.1	60	120	2	5	Active	TEMP	View Only	Alarm		0	300	120
18	LSm/AdjTm	5	2	10	1	5	15	0	0	Active	SECONDS	View Only	Time				
19	EXVdy/Spnd	1	1	30	1	0	12	0	0	Active	SECONDS	View Only	Time				
20	EXVTim/Cmpdy	125	30	144	1	0	12	0	0	Active	SECONDS	View Only	Time				

Fast Subcooler Setpoints

#	Name	Value	Min	Max	Adjust Value	Time (SEC)	Max Time Allowed (SEC)	Lockout Delay (HRS)	Safety Down Time(MIN)	Active or Non-Active	Select Value: # decimals & print char	Level (l) Auth. To Display	Type of Setpoint	Comments	SEC. to Ignore Safety	Window to Est. Safety Time(SEC)	Safety Time Extension (SEC)
65	SC FAST TARG	18	12	22	0.5	1	5	0	0	Active	TEMP	View Only	Time				
66	SC FAST ZONE	2	1	3	0.5	2	5	0	0	Active	TEMP	View Only	Time				
67	SC SH/RC ADJ	0.3	0.1	1	0.1	1	50	0	0	Active	DECINCH	View Only	Time				
68	SC FAST LIMT	0.4	0.1	2	0.1	10	20	0	0	Active	DECINCH	View Only	Time				
69	SC MIN/MAX V	2	1	20	1	100	100	0	0	Active	HUMD or %	View Only	Time				
70	SC LOW SH	5	2	10	1	15	60	0	0	Active	TEMP	View Only	Setpoint				
71	SC EXV DELAY	1	1	10	1	0	0	0	0	Active	SECONDS	View Only	Setpoint				
72	SC START TME	5	1	120	1	0	0	0	0	Active	SECONDS	View Only	Setpoint				

Based on your selections will dictate the set points for compressor control. The subcooler set points are only displayed if a subcooler id present.

21.4.2 Selection Options

The diagram shows the 'EXV Control Wizard' interface with several callouts:

- Superheat Control based on ?** points to the 'Control Parameter' section.
- Superheat Control method type ?** points to the 'Control Method' section.
- Config Creation or reset to MCS Defaults** points to the 'Set Values to Default' button.
- Evaporator Type being controlled ?** points to the 'Heat Exchanger Type' section.
- Functions Effecting Superheat control. Some require set points to be active** points to the 'Target Modifier' section.



NOTE: Once you have clicked on the boxes for your setup, be sure to click on 'Set Values to Default'. This will set the values to the default for 'Control Parameter, Heat Exchanger Type and the Control Method. Make note that clicking in the 'Target Modifier' require that some set points must be active.

21.4.3 Compressor EXV Results

EXV Control Setpoints																	
#	Name	Value	Min	Max	Adjust Value	Time (SEC)	Max Time Allowed (SEC)	Lockout Delay (HRS)	Safety Down Time(MIN)	Active or Non-Active	Select Value: # decimals & print char	Level Of Auth. To Display	Type of Setpoint	Comments	SEC to Ignore Safety	Window to Ext. Safety Time(SEC)	Safety Time Extension (SEC)
9	FAST SH TRGT	12	8	20	0.1	3	7	0	0	Active	... TEMP	View Only	Time	...	---	---	---
10	FAST CTL ZN	1.6	1	3	0.1	0	0	0	0	Active	... TEMP	View Only	Time	...	---	---	---
11	EXV LD/UNLD%	0.3	0	0.5	0.1	0	0	0	0	Active	... HUMD or %	View Only	Time	...	---	---	---
12	SH MPY/%SPRD	2	1	3	1	0	0	0	0	Active	... DIGITAL/SW	View Only	Time	...	---	---	---
13	ROC MPY/LSUC	2	1	3	1	3	5	0	0	Active	... DIGITAL/SW	View Only	Time	...	---	---	---
14	LIMIT ADJUST	1	0.1	1.5	0.1	0	0	0	0	Active	... DEC INOCH	View Only	Time	...	---	---	---
15	V MIN LS MPY	3	2	25	1	2	5	0	0	Active	... HUMD or %	View Only	Time	...	---	---	---
16	V MAX	100	50	100	1	0	1	0	0	Active	... HUMD or %	View Only	Setpoint	...	---	---	---
17	LO SUPERHEAT	3.5	2	5	0.1	60	120	2	10	Active	... TEMP	View Only	Alarm	...	0	300	120
18	LOW PSI DELY	5	1	30	1	30	60	0	0	Active	... SECONDS	View Only	Time	...	---	---	---
19	EXV DELAY	1	1	30	1	0	0	0	0	Active	... SECONDS	View Only	Time	...	---	---	---
20	EXV STRT TME	126	1	270	9	10	10	0	0	Active	... SECONDS	View Only	Time	...	---	---	---

- Control on 'Suction Superheat'
- Evaporator Type 'Plate HX'
- Control Method 'Fast SSH2'
- MCS Default 'Selected'
- Degrees F or C are automatic

21.4.4 Subcooler EXV Results

- If you have selected Fast SSH or Fast SSH2 and have a subcooler this will use set points 65 through 72. If you setup 'Subcooler EXV & Subcooler Suction PSI' MCS-Config will automatically complete set points 65 through 72 with MCS standard defaults.
- If this is an existing config and you are converting to Fast SSH or Fast SSH2 set points 253 through 255 will be spared out. (HVAC only)

Fast Subcooler Setpoints																	
#	Name	Value	Min	Max	Adjust Value	Time (SEC)	Max Time Allowed (SEC)	Lockout Delay (HRS)	Safety Down Time(MIN)	Active or Non-Active	Select Value: # decimals & print char	Level Of Auth. To Display	Type of Setpoint	Comments	SEC to Ignore Safety	Window to Ext. Safety Time(SEC)	Safety Time Extension (SEC)
65	SC FAST TARG	18	12	22	0.5	1	5	0	0	Active	... TEMP	View Only	Time	...	---	---	---
66	SC FAST ZONE	2	1	3	0.5	2	5	0	0	Active	... TEMP	View Only	Time	...	---	---	---
67	SC SH/RC ADJ	0.3	0.1	1	0.1	1	50	0	0	Active	... DEC INOCH	View Only	Time	...	---	---	---
68	SC FAST LMT	0.4	0.1	2	0.1	10	20	0	0	Active	... DEC INOCH	View Only	Time	...	---	---	---
69	SC MIN/MAX V	2	1	20	1	100	100	0	0	Active	... HUMD or %	View Only	Time	...	---	---	---
70	SC LOW SH	5	2	10	1	15	60	0	0	Active	... TEMP	View Only	Setpoint	...	---	---	---
71	SC EXV DELAY	1	1	10	1	0	0	0	0	Active	... SECONDS	View Only	Setpoint	...	---	---	---
72	SC START TME	5	1	120	1	0	0	0	0	Active	... SECONDS	View Only	Setpoint	...	---	---	---

- Set Points if Fast SSH or Fast SSH2 selected & you have a Sub Cooler
- Set Points 65 thru 72 are set up
- Degrees F or C are automatic

With this release of MCS-Config MCS has developed Default Set Points for all EXV Types

21.4.5 MCS EXV Factory Default Set Point

21.4.5.1. Fast SSH2, Suction Superheat, Plate HX

EXV Control Setpoints																		
#	Name	Value	Min	Max	Adjust Value	Time (SEC)	Max Time Allowed (SEC)	Lockout Delay (HRS)	Safety Down Time(MIN)	Active or Non-Active	Select Value: # decimals & print char	Level Of Auth. To Display	Type of Setpoint	Comments	SEC to Ignore Safety	Window to Ext. Safety Time(SEC)	Safety Time Extension (SEC)	
9	TARG/S STOP	12	8	20	0.1	2	7	0	0	Active	... TEMP	Factory L1	Time		
10	FAST CTL ZN	2	1.6	3	0.1	0	0	0	0	Active	... TEMP	Factory L1	Time		
11	EXV LD/UNLD%	0	0	0.5	0.1	0	10	0	0	Active	... HUMD or %	Factory L1	Time		
12	SH MPL/%SPRD	1	1	3	1	5	10	0	0	Active	... DIGITAL/Sw	Factory L1	Time		
13	ROC MPY/LSUC	1	1	3	1	4	15	0	0	Active	... DIGITAL/Sw	Factory L1	Time		
14	LIMIT ADJUST	0.5	0.1	1.5	0.1	0	0	0	0	Active	... DECINCH	Factory L1	Time		
15	VMIN/LSH MPY	3	2	25	1	2	15	0	0	Active	... HUMD or %	Factory L1	Time		
16	VMAX	100	50	100	1	0	0	0	0	Active	... HUMD or %	Factory L1	Setpoint		
17	LD SUPERHEAT	3	2	5	0.1	60	300	2	10	Active	... TEMP	Factory L1	Alarm	...	0	300	120	
18	LSUC/LSH DLY	1	1	10	1	1	10	0	0	Active	... SECONDS	Factory L1	Time		
19	E DLY/S CALC	1	1	30	1	0	10	0	0	Active	... SECONDS	Factory L1	Time		
20	E STRT/C DLY	126	1	270	1	8	15	0	0	Active	... SECONDS	Factory L1	Time		

21.4.5.2. Fast SSH2, Suction Superheat, DX Coil

EXV Control Setpoints																		
#	Name	Value	Min	Max	Adjust Value	Time (SEC)	Max Time Allowed (SEC)	Lockout Delay (HRS)	Safety Down Time(MIN)	Active or Non-Active	Select Value: # decimals & print char	Level Of Auth. To Display	Type of Setpoint	Comments	SEC to Ignore Safety	Window to Ext. Safety Time(SEC)	Safety Time Extension (SEC)	
9	TARG/S STOP	10	8	18	0.1	4	7	0	0	Active	... TEMP	Factory L1	Time		
10	FAST CTL ZN	2	1.6	3	0.1	0	0	0	0	Active	... TEMP	Factory L1	Time		
11	EXV LD/UNLD%	0.2	0	3	0.1	0	0	0	0	Active	... HUMD or %	Factory L1	Time		
12	SH MPL/%SPRD	1	1	3	1	0	5	0	0	Active	... DIGITAL/Sw	Factory L1	Time		
13	ROC MPY/LSUC	2	1	3	1	3	5	0	0	Active	... DIGITAL/Sw	Factory L1	Time		
14	LIMIT ADJUST	0.5	0.3	0.5	0.1	0	0	0	0	Active	... DECINCH	Factory L1	Time		
15	VMIN/LSH MPY	3	2	50	1	3	5	0	0	Active	... HUMD or %	Factory L1	Time		
16	VMAX	100	60	100	1	0	0	0	0	Active	... HUMD or %	Factory L1	Setpoint		
17	LD SUPERHEAT	4	2	4	0.1	60	120	2	5	Active	... TEMP	Factory L1	Alarm	...	0	300	120	
18	LSUC/LSH DLY	5	2	15	1	5	15	0	0	Active	... SECONDS	Factory L1	Time		
19	E DLY/S CALC	20	1	60	1	8	12	0	0	Active	... SECONDS	Factory L1	Time		
20	E STRT/C DLY	126	30	180	1	8	12	0	0	Active	... SECONDS	Factory L1	Time		

21.4.5.3. Fast SSH, Suction Superheat, DX Barrel

EXV Control Setpoints																		
#	Name	Value	Min	Max	Adjust Value	Time (SEC)	Max Time Allowed (SEC)	Lockout Delay (HRS)	Safety Down Time(MIN)	Active or Non-Active	Select Value: # decimals & print char	Level Of Auth. To Display	Type of Setpoint	Comments	SEC to Ignore Safety	Window to Ext. Safety Time(SEC)	Safety Time Extension (SEC)	
9	TARG/S STOP	12	8	20	0.1	2	5	0	0	Active	... TEMP	Factory L1	Time		
10	FAST CTL ZN	2	1.6	3	0.1	1	1	0	0	Active	... TEMP	Factory L1	Time		
11	EXV LD/UNLD%	0	0	0.5	0.1	0	10	0	0	Active	... HUMD or %	Factory L1	Time		
12	SH MPL/%SPRD	1	1	3	1	5	10	0	0	Active	... DIGITAL/Sw	Factory L1	Time		
13	ROC MPY/LSUC	1	1	3	1	4	15	0	0	Active	... DIGITAL/Sw	Factory L1	Time		
14	LIMIT ADJUST	0.2	0.1	0.4	0.1	3	6	0	0	Active	... DECINCH	Factory L1	Time		
15	VMIN/LSH MPY	3	2	25	1	2	15	0	0	Active	... HUMD or %	Factory L1	Time		
16	VMAX	100	50	100	1	0	0	0	0	Active	... HUMD or %	Factory L1	Setpoint		
17	LD SUPERHEAT	3	1	5	0.1	120	300	2	10	Active	... TEMP	Factory L1	Alarm	...	0	300	120	
18	LSUC/LSH DLY	1	1	10	1	1	10	0	0	Active	... SECONDS	Factory L1	Time		
19	E DLY/S CALC	1	1	30	1	10	10	0	0	Active	... SECONDS	Factory L1	Time		
20	E STRT/C DLY	126	1	270	1	8	15	0	0	Active	... SECONDS	Factory L1	Time		

(Samples of Fast SSH & Fast SSH2 most often used)

21.4.5.4. Fast SSH2, Discharge Superheat, DX Barrel

EXV Control Setpoints																		
#	Name	Value	Min	Max	Adjust Value	Time (SEC)	Max Time Allowed (SEC)	Lockout Delay (HRS)	Safety Down Time(MIN)	Active or Non-Active	Select Value: # decimals & print char	Level Of Auth. To Display	Type of Setpoint	Comments	SEC to Ignore Safety	Window to Ext. Safety Time(SEC)	Safety Time Extension (SEC)	
9	DshTRG/ShAvg	30	22	40	0.1	1	1	0	0	Active	... TEMP	Factory L1	Time		
10	FAST ZONE	2	1.6	3	0.1	0	0	0	0	Active	... TEMP	Factory L1	Time		
11	LdAdj/REHEAT	0.2	0	3	0.1	0	10	0	0	Active	... HUMD or %	Factory L1	Time		
12	ShMpy/%SPRED	2	1	3	1	0	5	0	0	Active	... DIGITAL/Sw	Factory L1	Time		
13	RcMpy/LSuMpy	2	1	3	1	3	5	0	0	Active	... DIGITAL/Sw	Factory L1	Time		
14	LmZn/LmbZn	0.5	0.3	0.5	0.1	0	0	0	0	Active	... DECINCH	Factory L1	Time		
15	VMIN/LSH Mpy	3	2	50	1	3	5	0	0	Active	... HUMD or %	Factory L1	Time		
16	VMAX/NOTUSED	100	60	100	1	0	0	0	0	Active	... HUMD or %	Factory L1	Setpoint		
17	LSHf/TmFlr	4	2	4	0.1	60	120	2	5	Active	... TEMP	Factory L1	Alarm	...	0	300	120	
18	LsTm/AdjTm	5	2	15	1	5	15	0	0	Active	... SECONDS	Factory L1	Time		
19	EXVDly/Spnd	1	1	60	1	8	12	0	0	Active	... SECONDS	Factory L1	Time		
20	EXVStm/CmpDy	126	30	135	1	8	12	0	0	Active	... SECONDS	Factory L1	Time		

21.4.5.5. Fast SSH, Suction Superheat, DX Barrel

EXV Control Setpoints																	
#	Name	Value	Min	Max	Adjust Value	Time (SEC)	Max Time Allowed (SEC)	Lockout Delay (HRS)	Safety Down Time(MIN)	Active or Non-Active	Select Value: # decimals & print char	Level Of Auth. To Display	Type of Setpoint	Comments	SEC to Ignore Safety	Window to Ext. Safety Time(SEC)	Safety Time Extension (SEC)
9	TARG/S STOP	12	8	20	0.1	2	5	0	0	Active	... TEMP	Factory Lr	Time
10	FAST CTL ZN	2	1.6	3	0.1	1	1	0	0	Active	... TEMP	Factory Lr	Time
11	EXV LD/UNLD%	0	0	0.5	0.1	0	10	0	0	Active	... HUMD or %	Factory Lr	Time
12	SH MPL/ZSPRD	1	1	3	1	5	10	0	0	Active	... DIGITAL/Sv	Factory Lr	Time
13	ROC MPY/LSUC	1	1	3	1	4	15	0	0	Active	... DIGITAL/Sv	Factory Lr	Time
14	LIMIT ADJUST	0.2	0.1	0.4	0.1	3	6	0	0	Active	... DECINCH	Factory Lr	Time
15	VMIN/LSH MPY	3	2	25	1	2	15	0	0	Active	... HUMD or %	Factory Lr	Time
16	VMAX	100	50	100	1	0	0	0	0	Active	... HUMD or %	Factory Lr	Setpoint
17	LO SUPERHEAT	3	1	5	0.1	120	300	2	10	Active	... TEMP	Factory Lr	Alarm	...	0	300	120
18	LSUC/LSH DLY	1	1	10	1	1	10	0	0	Active	... SECONDS	Factory Lr	Time
19	E DLYS CALC	1	1	30	1	10	10	0	0	Active	... SECONDS	Factory Lr	Time
20	E STRT/C DLY	126	1	270	1	8	15	0	0	Active	... SECONDS	Factory Lr	Time

21.4.5.6. Suct Spht, Suction Superheat, DX Barrel

EXV Control Setpoints																	
#	Name	Value	Min	Max	Adjust Value	Time (SEC)	Max Time Allowed (SEC)	Lockout Delay (HRS)	Safety Down Time(MIN)	Active or Non-Active	Select Value: # decimals & print char	Level Of Auth. To Display	Type of Setpoint	Comments	SEC to Ignore Safety	Window to Ext. Safety Time(SEC)	Safety Time Extension (SEC)
9	TARG/S STOP	12	8	20	0.1	2	5	0	0	Active	... TEMP	Factory Lr	Time
10	FAST CTL ZN	2	1.6	3	0.1	1	1	0	0	Active	... TEMP	Factory Lr	Time
11	EXV LD/UNLD%	0	0	0.5	0.1	0	10	0	0	Active	... HUMD or %	Factory Lr	Time
12	SH MPL/ZSPRD	1	1	3	1	5	10	0	0	Active	... DIGITAL/Sv	Factory Lr	Time
13	ROC MPY/LSUC	1	1	3	1	4	15	0	0	Active	... DIGITAL/Sv	Factory Lr	Time
14	LIMIT ADJUST	0.2	0.1	0.4	0.1	3	6	0	0	Active	... DECINCH	Factory Lr	Time
15	VMIN/LSH MPY	3	2	25	1	2	15	0	0	Active	... HUMD or %	Factory Lr	Time
16	VMAX	100	50	100	1	0	0	0	0	Active	... HUMD or %	Factory Lr	Setpoint
17	LO SUPERHEAT	3	1	5	0.1	120	300	2	10	Active	... TEMP	Factory Lr	Alarm	...	0	300	120
18	LSUC/LSH DLY	1	1	10	1	1	10	0	0	Active	... SECONDS	Factory Lr	Time
19	E DLYS CALC	1	1	30	1	10	10	0	0	Active	... SECONDS	Factory Lr	Time
20	E STRT/C DLY	126	1	270	1	8	15	0	0	Active	... SECONDS	Factory Lr	Time

21.5. Set Point Descriptions (Fast SSH & Fast SSH2)

Fast SSH set points **Available in MCS release 17.26-B and later**

Fast SSH2 set points **Available in MCS release 17.41 and later**

SP #	Name	Description
9	EXV Target	(Value Field) – This is the superheat target the system will make adjustments to the Electronic Expansion Valve to maintain. (Time Field) – In Fast SSH when in low suction psi this is the number of seconds the suction psi must be increasing before the systems stops adjusting the valve. (Time Field) - In Fast SSH2 it is the number of seconds to calculate the extended slope. When in low suction, adjustments are stopped when the suction pressure slope is positive for 1 second.
10	EXV Fast Zone	((Value Field) – The system makes adjustments to the EXV Valve percentage to maintain the superheat within this range. (Time Field) – The Time Field is not used.
11	EXV Adjustment made when a modulating compressor's capacity changes	(Value Field) – The opening adjustment that is made to the EXV current valve % when the circuit changes to the loading state or the closing adjustment that is made when the circuit changes to the unloading state. When in the MOP hold state, only closing adjustments are allowed. (Time Field) – When > zero it is used to increase the hold time.
12	Super Heat adjust multiplier	(Value Field) – This value is used to multiply times the calculated value of superheat target – current superheat target value. (The difference from where we want to be verses where we are) (Time Field) – The maximum different between two EXV's on the same circuit allowed once out of startup and under control.

13	Rate of Change adjust multiplier	<p>(Value Field) - This value is used to multiply times the calculated value of current superheat – the superheat value one second ago. (The slope of the current superheat)</p> <p>Time Field) – If set point type = ‘Time’ and Time Field is ≥ 2 and ≤ 100 this is the adjustment multiplier for when the system is in Low Suction. It takes the base valve adjustment of 0.5% and multiplies it with this value. Adjustments stop when the suction psi starts too increase. (See set point 9 time field for additional information.) If the conditions are not met then a value of 0.5 is used. (Delay between adjustments is specified in the value field of SP 17.)</p>
14	Limit of Adjustment	<p>(Value Field) – In FSH this value limits the adjustment while the superheat is $<$ then the Fast Zone times two. In FSH2 this value is the maximum limit of the adjustment.</p> <p>(Time Field) - In FSH this value is the limit of adjustment when the superheat $>$ then two times the Fast Zone. Remember in the value field of this set point you are typically using a value of 0.2 to 0.5. In the time field a value of 7 is equivalent to 0.7.</p> <p>(Time Field) - In FSH2 this field is not used.</p>
15	Minimum EXV Valve %	<p>(Value Field) – The minimum position of the valve. Usually 3%. Will need to be larger if hot gas is on system.</p> <p>(Time Field) - The adjustment multiplier for when the system is in Low Superheat.</p>
16	Maximum EXV Valve %	<p>(Value Field) – The maximum position of the valve allowed. Usually 100%. Sometimes used if valve is oversized.</p> <p>(Time Field) – Not Used</p>
17	Low Superheat	<p>(Value Field) – If the superheat falls below this value and stays below for longer than the number of seconds specified in the Time Field, of this set point, the system will enter a safety, generate an alarm and shut off this compressor then restart if required. If this specifies a lockout then it will follow the lockout rules. In FSH and FSH2 the system will take corrective action to correct this potential problem.</p> <p>(Time Field) – Timer for this set point as described.</p>
18	Low Psi Delay	<p>(Value Field) – The value specifies the number of seconds between valve adjustments, (for Low Suction) trying to correct this situation. Adjustments will continue until the slope of the suction pressure starts to increase.</p> <p>(Time Field) – This value specifies the number of seconds delay between adjustments, (for Low Superheat) trying to correct this situation. Adjustments continue until the superheat is above the Value Field.</p>
19	EXV Delay	<p>(Value field) – The value in this field id decremented by the difference between the absolute value of the current superheat – superheat target. When the result reaches zero the FSH & FSH2 make the current calculated adjustment to the current valve percentage.</p> <p>(Time Field) – The value in the time field determines when control will begin when two EXV’s are on the same circuit. This value times the value field in the fast zone plus the current target defines when control is taken, at startup. If this value is 10 and the value in the fast zone is 2 and the target is 12 the result would be $(10 * 2 + 12) = 32\%$. When both valves are \leq this % control is taken and then kept within the value specified in the time field of set point 12.</p>
20	EXV Startup Time	<p>(Value Field) – EXV starting time in seconds. The following decisions are made on taking control:</p> <ol style="list-style-type: none"> If the current superheat is $>$ target + 5.0 ° & State timer $>$ Startup time / 2 Take control. If the current superheat is $<$ target – Fast zone & State timer $>$ Startup time / 2 Take Control. If the Suct psi is $<$ Low Suct SP + Low unload & State timer $>$ Startup time / 2 Take Control. If the EXV startup time ≥ 90 & a) or b) is true adjust the valve start percentage

21.5.1 Set Point Adjustments

Fast SSH & Fast SSH2 Common adjustments

When using FSH or FSH2 you should not experience a low suction or low superheat alarm unless you are low on refrigerant or have a mechanical problem. (If you bring on too much condenser that causes the head psi to drop too quickly it will also pull the suction psi with it.) Set the multiplier of SP 13 'Time Field' to a value high enough to recover from a low suction.

21.5.2 Low Suction Multiplier-SP 13

'Time Field' is a multiplier for the change being made to adjust for a Low Suction condition. The MCS Default is 2. If a low suction occurs and the system does not recover in time, an a low suction alarm occurs increase SP 13 Time Field by 1.

If a low suction occurs and the system over corrects, (that is the EXV valve opens more than is required) then reduce SP 13 Time Field by 1.

If an alarm occurs you can increase the multiplier and or decrease the time delay between adjustments. (Set Point 18 Value Field)

21.5.2.1. Low Superheat Adjustment-SP 15

'Time Field' is a multiplier for the change being made to adjust for a Low Superheat condition. The MCS Default is 2.

If a low superheat occurs and the system over corrects, (the EXV valve closes more than is required) then reduce SP 15 Time Field by 1.

If an alarm occurs you can increase the multiplier and or decrease the time delay between adjustments. (Set Point 18 Time Field)

21.5.2.2. EXV Startup Time-SP 20

'Value Field' specifies the maximum time the valve will remain in the EXV Startup State. If the value is less than 90 seconds the Magnum will remain in this state for the entire time specified unless it reaches one of the startup exit conditions covered in SP 20. It is not recommended to make this value less than 25 seconds.

If the value is ≥ 90 the Magnum will calculate a new valve opening percentage, if required. When setting a value of 90, or greater it is recommended it be in increments of 9 for Fast SSH. For Fast SSH the Magnum starts evaluating it's position after 44% of its startup time has passed. In Fast SSH2 it starts evaluation after 50% of its startup time has passed.

21.5.2.3. EXV Compressor Start Delay-SP 20

'Time Field' specifies the number of seconds to delay starting the compressor to allow the valve to partially open. MCS recommends 8 to 10 seconds and not more than 15 seconds. Remember this is part of the EXV startup time.

21.5.2.4. EXV Target & EXV Fast Zone-SP 9

'Value Field' specifies the superheat target we want to achieve and SP 10 'Value Field' specifies the Control Zone we are maintaining. The table shows the MCS recommendations for both English and Metric.

Units	English			Metric		
	Low	Standard	High	Low	Standard	High
Superheat	10.0	12.0	14.0	5.6	6.7	7.8
Fast Zone	1.6	2.0	3.0	0.9	1.1	1.7

21.6. Fast SSH States

Listed below shows the format of the states used.

EXV-AA-BB-CCCC

AA	DESC.	BB	DESC	CCCC	DESC.
HD	HOLDING	>T	GREATER TARG	RcSm	RATE OF CHANGE SMALL
OP	OPENING	<T	LESS TARG	RcLg	RATE OF CHANGE LARGE
CL	CLOSING	Sh	SUPERHEAT	ShHi	SUPERHEAT HIGH
				ShSm	SUPERHEAT SMALL
				Rc=0	RATE OF CHANGE EQUALS ZERO
				InDb	IN DEAD BAND
				InZn	IN ZONE

21.6.1 FAST SSH2 State Format

Listed below shows the format of the states used.

EXV-AA-BB-CCCC

AA	DESC.	BB	DESC	CCCC	DESC.
HD	HOLDING	>T	GREATER TARG	EsLo	EXTENDED SLOPE LOW
OP	OPENING	<T	LESS TARG	EsHi	EXTENDED SLOPE HIGH
CL	CLOSING	Es	EXTENDED SLOPE	0 OR 1	EXTENDED SLOPE IS 0 OR 1
		Sh	SUPERHEAT	= T	SUPERHEAT EQUALS TARGET
				ShHi	SUPERHEAT HIGH
				ShLo	SUPERHEAT LOW
				St=5	STATE TIMER EQUALS 5
				RcSm	RATE OF CHANGE SMALL
				RcLg	RATE OF CHANGE LARGE
				Rc=0	RATE OF CHANGE EQUALS ZERO
				InDb	IN DEAD BAND
				InZn	IN ZONE

Chapter - 22. General Introduction to EXV PID

22.1. MCS PID REQUIREMENTS

- FIRMWARE 17.60E4 or greater
- MCS-CONNECT 18.26.11 or greater
- MCS-CONFIG 18.01N or greater

- An EXV PID controller uses information about: PRESENT, PAST and errors to adjust the Expansion Valve.
- EXV PID automatically applies accurate and responsive correction to a control function.

P	PROPORTIONAL (Kp)	Change in Superheat = Current Superheat minus last Superheat from 1 second ago (Rate of Change)
I	INTEGRAL (Ki)	Offset in Superheat = Current Superheat minus Target Superheat (setpoint #9 value field)
D	DERIVATIVE (Kd)	Velocity of Superheat = Current Superheat minus the Superheat from x seconds ago (setpoint #9 time seconds value)
A	ACCELERATION (Ka)	Change in Velocity = Current Kd minus the Kd from x seconds ago (setpoint #9 time seconds value)

22.2. Calculations for the adjustment to EXV valve

MCS EXV PID algorithm uses two different sets of K multipliers to calculate adjustments to EXV on how far the superheat is from the superheat target, (setpoint #9 value field).

#	SetPoints	Value	Time	SEC Ig...	windo...	safety ...	HI zone	LOW z...	Setback
1	COOL TARGET	46.0F	----	----	----	----	----	----	----
2	CTRL ZONE+	0.5F	----	----	----	----	----	----	----
3	CTRL ZONE-	0.5F	----	----	----	----	----	----	----
8	CHAM LIQ INJ	180.0F	----	----	----	----	----	----	----
9	SucSprHtTarg	12.0F	6 S	----	----	----	4.0F	3.5F	0.0F
10	Ki-IntegMult	0.10	0 S	----	----	----	2.20	-2.20	0.10
12	Kp-PropMult	0.30	0 S	----	----	----	0.00	0.00	0.20
13	Kd-DerrMult	0.17	0 S	----	----	----	0.20	-0.20	0.17
14	Ka-AccMult	0.10	0 S	----	----	----	0.00	0.00	0.00
15	ExvMinValve%	5.0%	----	----	----	----	----	----	----
16	ExvMaxValve%	100....	0 S	----	----	----	0.0%	0.0%	15.0%
17	LoSucSuperHt	3.5F	120 S	15	300	60	----	----	----
19	ExvKiDelay	30s	----	----	----	----	----	----	----
20	ExvStartup	10s	5 S	----	----	----	----	----	----

22.3. EXV PID Firmware

Uses information about: PRESENT, PAST and errors to adjust the Expansion Valve.

- Provides extremely fast reaction to changes in superheat caused in part by the following:
 - High ambient chiller running in low ambient conditions.
 - Condenser fans turning on or off creating large changes in discharge and suction pressure .
 - Subcooling going temporarily negative and not having a solid column of liquid for short periods.
 - Large subcooler / economizers coming on and off.

EXV PID Logic supports:

- Suction Superheat, Discharge Superheat, Evaporator Level and Condenser Level Control.

22.4. MCS PID REQUIREMENTS

- FIRMWARE 17.60E4 or greater
- MCS-CONNECT 18.26.11 or greater
- MCS-CONFIG 18.01N or greater

22.5. Selecting PID in MCS-CONFIG

In PID only setpoints 9 through 20 are used to control the EXV valve. If you select PID as your superheat EXV control and you have a subcooler (an economizer injecting refrigerant into the compression chamber) you will get PIP control on the EXV for the subcooler. The PID set points for the subcooler are 65 through 72. Select Type of Control in Relay Output Information Screen. In the RO screen, from the drop down window in 'Type' you select either 'Step w \ EXV' or 'Screw w \ EXV'.

Relay Output Information Screen									
Point Number	Name	Slide Mult.	Slide Div.	Slide Off.	Design Suc.PSI	Design Dis.PSI	Nominal Tonnage(of Step)	EXV Start (When Lead)	Type
4-1	COMP 1	---	---	---	---	---	0	35	Step w \ EXV
4-2	CHAM INJ 1	---	---	---	---	---	---	---	Standard
4-3	ECONO 1	---	---	---	---	---	0	20	Step w \ EXV
4-4	REV VLV 1	---	---	---	---	---	---	---	Standard

22.6. Circuit Base

In the Circuit Base screen you need to select the Analog Output for the EXV.

Select Output and Sensor Inputs per circuit									
Circuit # (reset button)	Alarm Relay	Comp Proof	Compr Speed(%) or Modulate Hot Gas AN	Compressor Speed Fault	Slide Closed Indicator	Pump Down	Evaporator EXV Output	Flow	
1	Not Used	Not Used	COMP1 SPD	Cmp1VrdFl	Not Used	DISABLE 1	Exv#1-PID	COMP1 FLO	N
2	Not Used	Not Used	COMP2 SPD	Cmp2VrdFl	Not Used	DISABLE 2	RO		N
3	Not Used	Not Used	Not Used	Not Used	Not Used	Not Used	SPARE7-5		W
4	Not Used	Not Used	Not Used	Not Used	Not Used	Not Used	SPARE7-6		W
5	Not Used	Not Used	Not Used	Not Used	Not Used	Not Used	SPARE7-7		W
6	Not Used	Not Used	Not Used	Not Used	Not Used	Not Used	SPARE7-8		W
7	Not Used	Not Used	Not Used	Not Used	Not Used	Not Used	SPARE7-9		W
8	Not Used	Not Used	Not Used	Not Used	Not Used	Not Used	SPARE7-10		W
							COMP1 SPD%		
							COMP2 SPD%		
							Exv#1-PID		



Next in the Circuit Base screen you need to select 'PIP SSH' from the Evaporator EXV Control section drop down menu.

NOTE: TANDEM 6 EXV PER CIRCUIT NOT SUPPORTED IN RTU AND CENTRIFUGAL FIRMWARE

Information that relates to Condensers and Evaporators on the circuit										
Starting condenser Fault	# Cond Faults	Cond Fan Bank	Condenser Coil Temp #1	Condenser Coil Temp #2	Tandem EXV Circuit #	EXV #3 Circuit#	EXV #4 Circuit#	EXV #5 Circuit#	EXV #6 Circuit#	Evaporator EXV Control
Used	0	1	Not Used	Not Used	1	1	1	1	1	PID Cond Lvl
Used	0	2	Not Used	Not Used	2	2	2	2	2	PID Cond Lvl

The MAGNUM supports up to 6 tandem EXVs per circuit. **NOT AVAILABLE** with RTU and Centrifugal firmware

With the release of Fast SSH2 AND PID MCS has released a new MCS-Config to support the new functions. The new MCS-Config provides a new tab, 'EXV Control', where you define your system. This then allows MCS-Config to provide MCS Default Set Point Values for you. The figure below shows the Current 'Circuit Base' tab and the new 'EXV Control' tab.

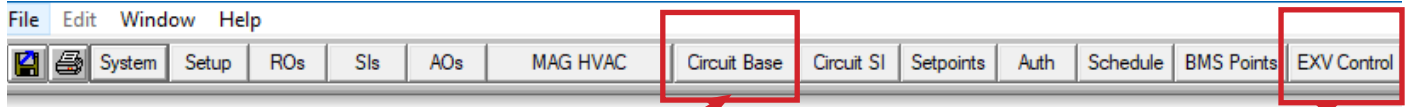

If you enter data in the EXV portion of the Circuit Base tab or in the EXV Control tab it is carried through to the other tab.

22.7. Selecting the 'EXV Control' tab you are prompted with the following:

Selection Option →
(Evaporator and condenser Level not available with Fast I or Fast II Control Method)

EXV Control Wizard

Control Parameter

Suction Superheat

Discharge Superheat

Evaporator Level

Condenser Level

Approach

Heat Exchanger Type

None

DX Coil

Water Coil

DX Barrel

Flooded Barrel

Control Method

Nominal (Original)

Fast I

Fast II

PID

Target Modifier

Low Discharge Superheat

Oversized Condenser/High Ambient

Maximum Operating Pressure(MOP)

Minimum Differential Pressure(MDP)

Target Reset

Low Suction

Low/High Level

Level-CAP

Set Default Values?
Firmware Version 17.56 or Higher Required

EXV Control Setpoints																
#	Name	Value	Min	Max	Adjust Value	Time (SEC)	Max Time Allowed (SEC)	Lockout Delay (HRS)	Safety Down Time(MIN)	Active or Non-Active	Select Value: # decimals & print char	Level Of Auth. To Display	Type of Setpoint	Comments	SEC to Ignore Safety	Win Ext. Tim
9	SucSprHTarg	12	8	20	0.1	6	9	0	0	Active	... TEMP	Service L	Target			
10	Ki-IntegMult	0.15	0	3	0.01	0	0	0	0	Active	... DEC2NOCH	Service L	Target			
11	EXV LD/INLD%	0	0	0.5	0.1	0	0	0	0	Non-Active	... HUMD or %	Service L	Time			
12	Kp-PropMult	0.3	0	3	0.01	0	0	0	0	Active	... DEC2NOCH	Service L	Target			
13	Kd-DerivMult	0.2	0	3	0.01	0	0	0	0	Active	... DEC2NOCH	Service L	Target			
14	Ka-AccelMult	0.1	0	3	0.01	0	0	0	0	Active	... DEC2NOCH	Service L	Target			
15	ExvMinValve%	5	2	25	1	2	10	0	0	Active	... HUMD or %	Service L	Target			
16	ExvMaxValve%	100	50	100	1	0	0	0	0	Active	... HUMD or %	Service L	Target			
17	LD SUPERHEAT	3.5	2	4	0.1	120	180	2	10	Active	... TEMP	Service L	Lockout		15	300
18	LOW PSI DELY	1	1	30	1	3	60	0	0	Non-Active	... SECONDS	Service L	Time			
19	ExvKiDelay	15	1	120	1	0	0	0	0	Active	... SECONDS	Service L	Setpoint			
20	ExvStartup	10	5	45	1	5	10	0	0	Active	... SECONDS	Service L	Time			

EXV Control Setpoints																
#	Name	Value	Min	Max	Adjust Value	Time (SEC)	Max Time Allowed (SEC)	Lockout Delay (HRS)	Safety Down Time(MIN)	Active or Non-Active	Select Value: # decimals & print char	Level Of Auth. To Display	Type of Setpoint	Comments	SEC to Ignore Safety	Win Ext. Tim
65	SCExvTarget	19	12	22	0.5	6	12	0	0	Active	... TEMP	Service L	Target			
66	SCExvIntegr	0.25	0	3	0.01	0	0	0	0	Active	... DEC2NOCH	Service L	Target			
67	SCExvKProp	0.35	0	3	0.01	0	0	0	0	Active	... DEC2NOCH	Service L	Target			
68	SCExvKDeriv	0.25	0	3	0.01	0	0	0	0	Active	... DEC2NOCH	Service L	Target			
69	SCExvKAccel	0.1	0	3	0.01	0	0	0	0	Active	... DEC2NOCH	Service L	Target			
70	SCLowSprht	5	3	8	0.5	120	300	2	10	Active	... TEMP	Service L	Alarm		0	0
71	SCExvKiDelay	10	1	90	1	0	0	0	0	Active	... SECONDS	Service L	Setpoint			
72	SCExvStartup	10	1	120	1	0	0	0	0	Active	... SECONDS	Service L	Setpoint			

Compressor EXV Results →

Subcooler EXV Results →

Based on your selections will dictate the set points for compressor control. The subcooler set points are only displayed if a subcooler id is present.

22.8. Selection Options



NOTE: Once you have clicked on the boxes for your setup, be sure to click on **'Set Values to Default'**. This will set the values to the default for **'Control Parameter, Heat Exchanger Type and the Control Method'**. **Make note that clicking in the 'Target Modifier' require that some set points must be active.**

22.9. Compressor EXV Results

EXV Control Setpoints																	
#	Name	Value	Min	Max	Adjust Value	Time (SEC)	Max Time Allowed (SEC)	Lockout Delay (HRS)	Safety Down Time(MIN)	Active or Non-Active	Select Value: # decimals & print char	Level Of Auth. To Display	Type of Setpoint	Comments	SEC to Ignore Safety	Window to Ext. Safety Time(SEC)	Safety Time Extension (SEC)
9	SucSprHtTarg	12	8	20	0.1	6	9	0	0	Active	... TEMP	Service L	Target		...	-----	-----
10	Ki-IntegMult	0.15	0	3	0.01	0	0	0	0	Active	... DEC2NOCH	Service L	Target		...	-----	-----
11	EXV LD/UNLD%	0	0	0.5	0.1	0	0	0	0	Non-Active	... HUMD or %	Service L	Time		...	-----	-----
12	Kp-PropMult	0.3	0	3	0.01	0	0	0	0	Active	... DEC2NOCH	Service L	Target		...	-----	-----
13	Kd-DerivMult	0.2	0	3	0.01	0	0	0	0	Active	... DEC2NOCH	Service L	Target		...	-----	-----
14	Ka-AccelMult	0.1	0	3	0.01	0	0	0	0	Active	... DEC2NOCH	Service L	Target		...	-----	-----
15	ExvMinValve%	5	2	25	1	2	10	0	0	Active	... HUMD or %	Service L	Setpoint		...	-----	-----
16	ExvMaxValve%	100	50	100	1	0	0	0	0	Active	... HUMD or %	Service L	Target		...	-----	-----
17	LD SUPERHEAT	3.5	2	4	0.1	120	180	2	10	Active	... TEMP	Service L	Lockout		... 15	300	60
18	LDW PSI DELY	1	1	30	1	3	60	0	0	Non-Active	... SECONDS	Service L	Time		...	-----	-----
19	ExvKiDelay	15	1	120	1	0	0	0	0	Active	... SECONDS	Service L	Setpoint		...	-----	-----
20	ExvStartup	10	5	45	1	5	10	0	0	Active	... SECONDS	Service L	Time		...	-----	-----

- Control on 'Suction Superheat'
- Evaporator Type 'Plate HX'
- Control Method 'PID'
- MCS Default 'Selected'
- Degrees F or C are automatic

22.10. Set Point Descriptions (PID)

Set points Available in MCS release 17.26-B and later

SP #	Name	Description
9	SPRHT TARGET or LEVEL TARGET	If EXV control is based upon superheat, this is the Superheat target that the Magnum will control from. If EXV control is based upon refrigerant level, this is the refrigerant level target that the Magnum will control from. 'Low Zone' if nonzero then develop control super heat based upon the lowest superheat of any compressor that is on with in this suction group else use the superheat of this compressor. 'Time (sec)' field: Seconds between samples used for calculating the Superheat Rate of Change.
	STAGE 7 CUT IN (Cut In/Out Control)	Stage 7 cut in, Setpoint value contains the voltage when this stage is turned on.
10	SPRHT ZONE +- Ki-IntegMult	The value in this setpoint is added and subtracted to setpoint #9 to determine the upper and lower limits of the control zone respectively. Refer to section on EXV control. 'Time (sec)' field: If non-zero, skip ROC adjustment logic in the control zone. EXV PID Integral - Offset in Superheat= Current Superheat minus Target Superheat (setpoint #9 value field) Value is the Fast Multiplier for Kp adjustments, setback is the slow multiplier.
	STAGE 8 CUT IN (Cut In/Out Control)	Stage 8 cut in, Setpoint value contains the voltage when this stage is turned on.
12	EXV FINE ADJ Kp-PropMult	The adjustment is made when in the 1st zone above or below the control zone. Refer to section on EXV control. EXV PID Proportional - Change in Superheat = Current Superheat minus last Superheat from 1 second ago (Rate of Change). Value is the Fast Multiplier for Kp adjustments, setback is the slow multiplier.
13	EXV COURSE Kd-DerrMult	If a course adjustment to the EXV when in the 2nd zone above or below the control zone. If the type is TIME and the time (SEC) field is greater than 1 and less than 7 then multiple the value field by the time field else multiple by 2 for adjustment amount. If a course adjustment to the EXV when in the 3rd zone above or below the control zone. Multiple value by the by 2 for adjustment amount. If a course adjustment to the EXV when above or below the 3rd zone the control zone. The value is the adjustment amount. Refer to section on EXV control. If a course adjustment to the EXV when in the 3rd zone above or below the control zone. Multiple value by the by 2 for adjustment amount. If a course adjustment to the EXV when above or below the 3rd zone the control zone. The value is the adjustment amount. Refer to section on EXV control. EXV PID Derivative - Velocity of Superheat = Current Superheat minus the Superheat from x seconds ago (setpoint #9 time seconds value). Value is the Fast Multiplier for Kp adjustments, setback is the slow multiplier.
14	EXV LOAD DIV Ka-AccMult	The EXV slide adjustment can be fined tuned by dividing by the value of this set point. Note the value of this set point is used regardless if the its is active or not. Refer to section on EXV control. EXV PID Acceleration - Change in Velocity = Current Kd minus the Kd from x seconds ago (setpoint #9 time seconds value). Value is the Fast Multiplier for Kp adjustments, setback is the slow multiplier.
	STAGE 12 CUT IN (Cut In/Out Control)	Stage 12 cut in, Setpoint value contains the voltage when this stage is turned on.

15	ExvMinValve%	This is the minimum valve position allowed when modulating the expansion valve. This value should be set so when hot gas is applied the valve opening is adequate. Note the value of this set point is used regardless if it is active or not. Refer to section on EXV control. Note the value of this set point is used regardless if it is active or not. Refer to section on EXV control. Note the value of this set point is used regardless if it is active or not. Refer to section on EXV control.
	STAGE 13 CUT IN (Cut In/Out Control)	Stage 13 cut in, Setpoint value contains the voltage when this stage is turned on.
16	ExvMaxValve%	This is the maximum position allowed when modulating the expansion valve to maintain the superheat target. This value should be the valve % opening at full capacity plus a 10 to 15 % margin. Note the value of this set point is used regardless if the its is active or not. Refer to section on EXV control.
	STAGE 14 CUT IN (Cut In/Out Control)	Stage 14 cut in, Setpoint value contains the voltage when this stage is turned on.
17	LoSucSuperHt	If super heat is less or equal to this value and the control slope is less that the roc for zone 3 make a slide adjustment of 3 times the value of set point #13. If the calculated superheat remains below this value for the time specified in the Time (SEC) cell, the Magnum will generate a LOW SUPERHEAT alarm. Refer to section on EXV control.
	STAGE 15 CUT IN (Cut In/Out Control)	Stage 15 cut in, Setpoint value contains the voltage when this stage is turned on.
19	EXV DELAY	Delay in seconds between valve adjustments. Should not be less than 48. (When adjusting at 4x this will allow 12 seconds for the controller to process the results of the last action before making the next adjustment). Refer to section on EXV control.
	ExvKiDelay	
20	ExvStartup	This is the time in seconds to hold the valve at the start % setpoint when the compressor starts. Since the superheat calculation is not valid when the compressor is not running the EXV logic sets the valve to a given position for a set time to allow the system to develop a valid superheat. 'Time (sec)' field: If zero, then there is no delay when a compressor is ready to start. If non-zero, this is the time delay in which the EXV valve is allowed to open before the compressor starts. Refer to section on EXV control.

22.11. PID Example Setpoint Defaults

Default **Celsius** values for Suction Superheat with DX Chiller Barrel.

#	SETPOINT	VALUE	TIME	SEC ignore	WINDOW EXT	SAFETY EXT	HI ZONE	LOW ZONE	SETBACK	TYPE
9	SucSprHtTarg	6.5C	6 S	-	-	-	3.0C	2.7C	0.0C	TARGET
10	Ki-IntegMult	0.20	0 S	-	-	-	2.20	-2.20	0.10	TARGET
12	Kp-PropMult	0.45	0 S	-	-	-	0.00	0.00	0.20	TARGET
13	Kd-DerrMult	0.15	0 S	-	-	-	0.20	-0.20	0.17	TARGET
14	Ka-AccMult	.10	0 S	-	-	-	0.00	0.00	0.00	TARGET
15	ExvMinValve%	5.0%	-	-	-	-	-	-	-	SETPOINT
16	ExvMaxValve%	100	0 S	-	-	-	0.0%	0.0%	15.0%	TARGET
17	LO SUPERHEAT	1.6F	120 S	15	300	60	-	-	-	LOCKOUT
19	ExvKiDelay	15s	-	-	-	-	-	-	-	SETPOINT
20	ExvStartup	10s	5 S	-	-	-	-	-	-	TIME

Below setpoints are the default **Fahrenheit** values for Suction Superheat with DX Chiller Barrel.

#	SETPOINT	VALUE	TIME	SEC Ignore	WINDOW EXT	SAFETY EXT	HI ZONE	LOW ZONE	SET-BACK	TYPE
9	SucSprHtTarg	12.0F	6 S	-	-	-	4.0F	3.5F	0.0F	TARGET
10	Ki-IntegMult	0.15	0 S	-	-	-	2.20	-2.20	0.10	TARGET
12	Kp-PropMult	0.30	0 S	-	-	-	0.00	0.00	0.20	TARGET
13	Kd-DerrMult	0.20	0 S	-	-	-	0.20	-0.20	0.17	TARGET
14	Ka-AccMult	0.10	0 S	-	-	-	0.00	0.00	0.00	TARGET
15	ExvMinValve%	5.0%	-	-	-	-	-	-	-	SETPOINT
16	ExvMaxValve%	100	0 S	-	-	-	0.0%	0.0%	15.0%	TARGET
17	LO SUPERHEAT	3.5F	120 S	15	300	60	-	-	-	LOCKOUT
19	ExvKiDelay	15s	-	-	-	-	-	-	-	SETPOINT
20	ExvStartup	10s	5 S	-	-	-	-	-	-	TIME

22.11.1 Subcooler EXV Results

- > If you have selected PID and have a subcooler this will use set points 65 through 72. If you setup 'Subcooler EXV & Subcooler Suction PSI' MCS-Config will automatically complete set points 65 through 72 with MCS standard defaults.
- > If this is an existing config and you are converting to PID set points 253 through 255 will be spared out. (HVAC only)

EXV Control Setpoints																					
#	Name	Value	Min	Max	Adjust Value	Time (SEC)	Max Time Allowed (SEC)	Lockout Delay (HRS)	Safety Down Time(MIN)	Active or Non-Active	Select Value: # decimals & print char	Level Of Auth. To Display	Type of Setpoint	Comments	SEC to Ignore Safety	Window to Ext. Safety Time(SEC)	Safety Time Extension (SEC)	High Zone	Low Zone	Setback	Unit
65	SCExvTarget	19	12	22	0.5	6	12	0	0	Active	TEMP	Service L	Target					4	3.5	0	
66	SCExvKIntegr	0.25	0	3	0.01	0	0	0	0	Active	DEC2NOCH	Service L	Target					2	-1	0.2	
67	SCExvKProp	0.35	0	3	0.01	0	0	0	0	Active	DEC2NOCH	Service L	Target					0	0	0.3	
68	SCExvKDeriv	0.25	0	3	0.01	0	0	0	0	Active	DEC2NOCH	Service L	Target					0.5	-0.5	0.2	
69	SCExvKAccel	0.1	0	3	0.01	0	0	0	0	Active	DEC2NOCH	Service L	Target					0	0	0	
70	SCLowSprht	5	3	8	0.5	120	300	2	10	Active	TEMP	Service L	Alarm								
71	SCExvKiDelay	10	1	90	1	0	0	0	0	Active	SECONDS	Service L	Setpoint								
72	SCExvStartup	10	1	120	1	0	0	0	0	Active	SECONDS	Service L	Setpoint								

- Set Points if PID is selected & you have a Sub Cooler
- Set Points 65 thru 72 are set up
- Degrees F or C are automatic

65	EXV ZONE1	Temperature differential used to build the EXV Zone 1 both plus and minus.
	SCExvTarget	SC SUPERHEAT TARGET - SC SUPERHEAT AVERAGE THIS # SECONDS - <u>Setup as Target</u>
66	EXV ZONE2	Temperature differential that is used to build the EXV Zone 2 both plus and minus. Temperatures above this zone are considered in zone 3.
	SCExvKIntegr	SC SUPERHEAT CONTROL ZONE - SC MPLY Ki) FOR VALVE ADJ WHEN IN FAST ZONE- <u>Setup as Target</u>
67		The EXV control logic will compare the value of this Setpoint to the temperature rate of change to determine the valve adjustment when the temperature is within the EXV control zone. 'Safety Down Time (MIN)' field: The minimum time delay between EXV adjustments when in the EXV control zone.
	SCExvKProp	SC SUPERHEAT MULTIPLIER (Kp) -SC RATE OF CHG MULTIPLIER - <u>Setup as Target</u>

68	EXV ROC ZONE1	The EXV control logic will compare the value of this Setpoint to the temperature rate of change to determine the valve adjustment when the temperature is within zone 1. 'Safety Down Time (MIN)' field: This is the minimum time delay between EXV adjustments when in the EXV control zone 1. If this Setpoint is inactive then the ROC for this zone is 0 and the delay is 15 seconds.
	SCExvKDeriv	SC ADJUST LIMIT IN FAST ZONE (Kd) Velocity of Superheat - SC OUTSIDE FAST ZONE ADJ LIMIT
69	EXV ROC ZONE2	The EXV control logic will compare the value of this Setpoint to the temperature rate of change to determine the valve adjustment when the temperature is within zone 2. 'Safety Down Time (MIN)' field: This is the minimum time delay between EXV adjustments when in the EXV control zone 2. If this Setpoint is inactive then the ROC for this zone is 0 and the delay is 15 seconds.
	SCExvKAccel	<u>Setup as Target</u>
70	EXV ROC ZONE3	The EXV control logic will compare the value of this Setpoint to the temperature rate of change to determine the valve adjustment when the temperature is within zone 3. 'Safety Down Time (MIN)' field: This is the minimum time delay between EXV adjustments when in the EXV control zone 3. If this Setpoint is inactive then the ROC for this zone is 0 and the delay is 15 seconds.
	SCLowSprht	SC LOW SUPERHEAT SAFETY - SC LOW SH TIME TO SAFETY - <u>Setup as Alarm</u>
71	EXV TOO FAST	When the superheat is with the control zone, the EXV control logic will compare the value of this Setpoint to the temperature rate of change to determine the valve adjustment when the temperature is within the zone and rising too fast. 'Safety Down Time (MIN)' field: This is the minimum time delay between EXV adjustments if the rate of change is too fast when in EXV control zones 1 or 2. If this Setpoint is inactive then the ROC for this zone is 0 and the delay is 15 seconds.
	SCExvKiDelay	SC SECONDS DELAY BETWEEN ADJUSTMENTS (Ki) - <u>Setup as Setpoint</u>
72	EXV CHANGING	When the superheat is with the control zone, the EXV control logic will compare the value of this Setpoint to the temperature rate of change to determine the valve adjustment when the temperature is within the zone and rising.

22.12. EXV PID Ki Delay Timer and Ki Accumulator

Magnum firmware 17.63 and greater adds support for two new EXV PID Ki adjustment options.

#1 Reset the Ki Delay Timer – only reset the Ki delay when a 0.1 or greater or -0.1 or less adjustment occurs, vs resetting it when Ki is not equal to zero. This is the reset time when the Ki adjustment is enough to actual move the EXV 0.1% or more.

#2 Ki Accumulator – this keeps the second decimal point in the Ki adjustment and accumulator until an actual adjustment is made, adjust is greater 0.1 or less than -0.1.

Both of these change are designed to help Ki adjustments when very close to the target.

Magnum HVAC Information Screen

Information Panel Selector

- General Info
- Compressor Info
- Evaporator Info
- Condenser Info
- Lockout Info
- Boiler Info
- CPM Info

Evaporator Information

Capacity Control

Control Method
 Cut In/Out Control Zone

Cooling Control On
 Entering Temp Leaving Temp

Entering Temperature: WTR IN
 Leaving Temperature: WTR OUT

Heating Control On
 Entering Temp Leaving Temp

Entering Temperature: Not Used
 Leaving Temperature: Not Used

Target Reset:
 Ice Mode: DI On/Off Normal: AI:0-5V

Target (SP #1) Reset: Not Used
 Refrigerant Type: R134A

Circuit Valve/Pump Control

Force One Always On?
 Yes No

Subcooler Valve Control

Type of Subcooler Valve in Use
 None AO(Open When Off)
 RO Type AO(Closed When Off)

Heat Control

Defrost Type: None
 Reheat Control: Not Used
 Barrel Heater Relay: Not Used

EXV Control

Control By The Lowest Superheat In The Suction Group
 Yes No

Ki Adjustment Delay Reset
 Ki Adj. NOT = 0 Ki Adj. >= 0.10 OR <= -0.10

Ki Adjustment Accumulator
 No Accumulator Accumulate Values < 0.10

22.13. Logic to Determine which K Multipliers to Use

- Calculations are done every second

22.13.1.1. Switching to Fast K multipliers is based on:

a. Distance from target

- If current superheat is greater than (setpoint #9 value field plus setpoint #9 high zone field x 2)

Setpoint	Value		Hi Zone		Total
#9 SucSprHtTarg	12.0F	+	4.0F x 2	=	20

EXV PID algorithm will use the fast multipliers (Setpoint Value Field)

- If current superheat value is less than (setpoint #9 value field minus setpoint #9 high zone field)

Setpoint	Current Superheat Value		HI Zone		Total
#9 SucSprHtTarg	12.0F	-	4.0F	=	8

EXV PID algorithm will use the fast multipliers (Setpoint Value Field)

#	SetPoints	Value	Time	SEC Ig...	windo...	safety ...	HI zone	LOW z...	Setback
9	SucSprHtTarg	12.0F	6 S	----	----	----	4.0F	3.5F	0.0F
10	Ki-IntegMult	0.10	0 S	----	----	----	2.20	-2.20	0.10
12	Kp-PropMult	0.30	0 S	----	----	----	0.00	0.00	0.20
13	Kd-DerrMult	0.17	0 S	----	----	----	0.20	-0.20	0.17
14	Ka-AccMult	0.10	0 S	----	----	----	0.00	0.00	0.00

FAST multipliers

22.13.1.2. Switching to Slow K multipliers is based on:

b. Distance from target

- If current superheat is less than (setpoint #9 value field plus setpoint #9 low zone field) but above the fast multiplier switch of 8 (12 - 4)

Setpoint	Value		LOW Zone		Total
#9 SucSprHtTarg	12.0F	+	3.5F	=	15.5F

EXV PID algorithm will use the slow multipliers (Setback Value Field)

- If current superheat is more than (setpoint #9 value field minus setpoint #9 low zone field) and below the fast multiplier switch of 20 (12 + 4 x 2)

Setpoint	Value		LOW Zone		Total
#9 SucSprHtTarg	12.0F	-	3.5F	=	8.5

EXV PID algorithm will use the slow multipliers (Setback Value Field)

#	SetPoints	Value	Time	SEC Ig...	windo...	safety ...	HI zone	LOW z...	Setback
9	SucSprHtTarg	12.0F	6 S	----	----	----	4.0F	3.5F	0.0F
10	Ki-IntegMult	0.10	0 S	----	----	----	2.20	-2.20	0.10
12	Kp-PropMult	0.30	0 S	----	----	----	0.00	0.00	0.20
13	Kd-DerrMult	0.17	0 S	----	----	----	0.20	-0.20	0.17
14	Ka-AccMult	0.10	0 S	----	----	----	0.00	0.00	0.00

SLOW multipliers

22.13.1 Rate of Change_- Moving too Fast

1. If current superheat ROC is greater than setpoint #13 (Kd) high zone and current superheat is above target

Current Superheat ROC	Setpoint #13 High Zone	Current Superheat
0.7	.20	16F

EXV PID algorithm will use the fast multipliers (Setpoint Value Field)

2. If current superheat ROC is greater than setpoint #13 (Kd) low zone and current superheat is below target

Current Superheat ROC	Setpoint #13 Low Zone	Current Superheat value
-0.3	-0.20	8

EXV PID algorithm will use the fast multipliers (Setpoint Value Field)

#	SetPoints	Value	Time	SEC Ig...	windo...	safety ...	HI zone	LOW z...	Setback
9	SucSprHTarg	12.0F	6 S	-----	-----	-----	4.0F	3.5F	0.0F
10	Ki-IntegMult	0.10	0 S	-----	-----	-----	2.20	-2.20	0.10
12	Kp-PropMult	0.30	0 S	-----	-----	-----	0.00	0.00	0.20
13	Kd-DerrMult	0.17	0 S	-----	-----	-----	0.20	-0.20	0.17
14	Ka-AccMult	0.10	0 S	-----	-----	-----	0.00	0.00	0.00

FAST multipliers

22.13.2 Rate of Change - Moving Slow Enough

If current superheat ROC is less than setpoint #13 (Kd) high zone and current superheat is above target

Current Superheat ROC	Setpoint #13 High Zone	Current Superheat
0.1	0.20	15F

EXV PID algorithm will use slow multipliers (Setback Field)

If current superheat ROC is less than setpoint #13 (Kd) low zone and current superheat is below target

Current Superheat ROC	Setpoint #13 Low Zone	Current Superheat
-0.1	-0.20	10

EXV PID algorithm will use slow multipliers (Setback Field)

#	SetPoints	Value	Time	SEC Ig...	windo...	safety ...	HI zone	LOW z...	Setback
9	SucSprHTarg	12.0F	6 S	-----	-----	-----	4.0F	3.5F	0.0F
10	Ki-IntegMult	0.10	0 S	-----	-----	-----	2.20	-2.20	0.10
12	Kp-PropMult	0.30	0 S	-----	-----	-----	0.00	0.00	0.20
13	Kd-DerrMult	0.17	0 S	-----	-----	-----	0.20	-0.20	0.17
14	Ka-AccMult	0.10	0 S	-----	-----	-----	0.00	0.00	0.00

SLOW multipliers

22.14. MCS-Connect Evaporator EXV PID Status

Proportional Adjustment
(Current Superheat minus Superheat from last second) x Kp
Kp = setpoint #12/#67 value (fast) or setback value (slow)

Acceleration Adjustment
(Current Kd minus Kd from x seconds ago) x Ka
Ka = setpoint #14/#69 value (fast) or setback value (slow)

Total Adjust
Adjustment made to current EXV position

System Status

Controlling parameter		Step Delay	Wanted %	Rate of Change	Control On	Mode	Ref Type							
		170	61.0	0.1	WTR OUT = 47.7F	COOLING	R134a							
State	Time	PSI Diff	FLA %	Steps	Lead?	Manual Speed %	Condenser Adjustment							
1) CMP IS RUNNING	00:42:43	86.1P	36%	1		N/A	-							
2) SWITCHED OFF	23:47:26	-9.3P	0%	0	Yes	N/A	-							
Evap EXV State	Time	Valve %	Control On Suct Supht	SuperHeat ROC	ADJ Delay	EXV Target (Adjusted)	Prop. Adj.	Int. Adj.	Der. Adj.	Accel. Adj.	Total Adj.	Kp	Ki	Kd
1) EXV IS OPENING	00:00:03	51.8%	15.5	0.7	15	12.0	0.00	0.00	0.17	0.02	0.1	0.50	0.10	0.25
2) EXV IS CLOSED	00:49:14	0.0%	18.3	-0.1	0	12.0	0.00	0.00	0.00	0.00	0.0	1.00	0.10	0.25
Economizer EXV State	Time	Valve %	Control On Suct Supht	SuperHeat ROC	ADJ Delay									
1) EXV IS CL				0.7	-30									
2) EXV IS CL				0.0	-30									

Integral Adjustment
(Current Superheat minus Superheat Target setpoint #9 value) x Ki
Ki = setpoint #10/#66 value (fast) or setback value (slow)

Derivative Adjustment
(Current Superheat minus Superheat from x seconds ago) x Kd
Kd = setpoint #13/#68 value (fast) or setback value (slow)

Current K multipliers being used

22.15. Allowing an Adjustments to the EXV Valve

(When Ki & Kd are in opposite, we are going in the right direction)

1. When the Proportional adjust, Integral adjust, Derivative adjust and Acceleration all add up to be \geq to .1 or \leq -.1, the adjustment is made based on that number.
2. The Proportional adjust, Derivative adjust and Acceleration all run every second.
3. The Integral adjust uses setpoint #19 (ExvKiDelay) as a delay before posting a value as long as;
 - a. If the current Integral adjust (Ki) is > 0 and the current superheat $>$ the current target plus setpoint #10 high zone field.
 - b. If the current Integral adjust (Ki) is < 0 and the target superheat $<$ the current target plus setpoint #10 low zone.

Ki adjust HiZone
12 plus 2.20 = 14.2

14.2°F

12°F Superheat Target

9.8°F

No Ki Adjust in this area

#	SetPoints	Value	Time	SEC Ig...	windo...	safety ...	HI zone	LOW z...	Setback	MIN VFD	MAX VFD	MAX V...	Type
9	SucSprHtTarg	12.0F	6 S	----	----	----	4.0F	3.5F	0.0F	----	----	----	TARGET
10	Ki-IntegMult	0.10	0 S	----	----	----	2.20	-2.20	0.10	----	----	----	TARGET

Chapter - 23. EXV Level Control using PID

- The following versions of Firmware are needed to setup EXV Level Control:
- MCS-CONFIG – 17.17.00U or later
- MCS-CONNECT – 17.003.11 or later
- MCS-MAGNUM Firmware - 17.16C or later

23.1. Setting up EXV Level Control

- Setup Analog Outputs to control electronic expansion valves.

Analog Output Information Screen									
Point Number	Name	Control Type	Invert	Comments	Modbus Display Type	Feedback Sensor			
M-1	EEV-1	Standard	NO		Spare	Not Used			
M-2	EEV-2	Standard	NO		Spare	Not Used			

- Setup INPUTS to read evaporator or condenser level.

Sensor Input Information Screen									
Point Number	Name (1 to 10 char)	Display Type	Offset	Manual Value or NC/NO (select to change)	Display Text (select to change)	Temp. / GPM / CFM / Pwr Factor SI	Humd./PSI/ Temp. Diff. / Enthal. Diff.	Auto/Manual (Click here for all)	Circuit Index
1-12	REFLVL1	User Defined	0	0	Not Used	Not Used	Not Used	Auto	Not Used
1-13	REFLVL2	User Defined	0	0	Not Used	Not Used	Not Used	Auto	Not Used

23.1.1 Setting up EXV Level Control – User Defined

- Selecting 'User Defined' type

Sensor Input Information Screen									
Point Number	Name (1 to 10 char)	Display Type	Offset	Manual Value or NC/NO (select to change)	Display Text (select to change)	Temp. / GPM / CFM / Pwr Factor SI	Humd./PSI/ Temp. Diff. / Enthal. Diff.	Auto/Manual (Click here for all)	Circuit Index
1-12	REFLVL1	User Defined	0	0	Not Used	Not Used	Not Used	Auto	Not Used
1-13	REFLVL2	User Defined	0	0	Not Used	Not Used	Not Used	Auto	Not Used
1-14	BARLTMP1	User Logic	0	0	Not Used	Not Used	Not Used	Auto	Not Used
1-15	BARLTMP2	VirtualVane%	0	0	Not Used	Not Used	Not Used	Auto	Not Used
1-16	SPARE	VOLT5DC	0	0	Not Used	Not Used	Not Used	Auto	Not Used
2-1	SPARE2-1	0-600 VAC	0	0	Not Used	Not Used	Not Used	Auto	Not Used
		600VAC4	0	0	Not Used	Not Used	Not Used	Auto	Not Used

Under the Display Type, select User Defined

- Screen below will open:

SI Calculation Wizard

Select Display Type (Do this FIRST)

HUMD or %

	Voltage	=	Value
Point #1	1.2	=	0%
Point #2	3.7	=	100%

Calculate Cancel

1. Setting up the Level Sensor
2. Wire the Level Sensor to the designated input.
3. If available, have the Level Sensor loose and manually move the float or submerge in a bucket of liquid to 100% (standpipe full of refrigerant).
4. Record the voltage input, this would be point #2 on the SI Calculation Wizard
(Ex. Voltage = 3.7 Value = 100%)
5. Move the float to 0% (no refrigerant in the standpipe=empty)
6. Record the voltage input. This would be point #1 on the SI calculation wizard
(Ex. Voltage = 1.2 Value = 0%)

NOTE: If Level Sensor is a 4-20ma output, where at 4ma = 0% level and at 20ma = 100% level, you would put the designated input jumper on digital and the SI calculation wizard would be Setup as:

Point #1 .882 vdc = 0%

Point #2 4.41 vdc = 100%

See APP066- 4-20mA Sensor Connection to MCS-Magnum

23.1.2 Circuit Base Setup

- Point to the EXV outputs in the Circuit Base screen.

MAGNUM Circuit Base Screen

Information that relates to compressors on the circuit

Circuit# (reset button)	# of Comp RDs	Starting Compressor RO	Part Winding	Start Unload Bypass	Fast Unloader	Type of LLS	2nd LLS	Comp. Economizer (Subcooler)	Econo Control	Unloading Stages	Loader Type	HGB	HG Reheat	Liquid Injection	Oil Equalization	Mod Motor Control	Low Disc SuperHeat	External Oil Pump Control
1	3	COMP-1	No	No	No	EXV only	No	No	Slide 2	0	Unload	None	No	No	No	No	No	No
2	3	COMP-2	No	No	No	EXV only	No	No	Slide 2	0	Unload	None	No	No	No	No	No	No
3	0	Not Used	No	No	No	None	No	No	Slide 2	0	Unload	None	No	No	No	No	No	No
4	0	Not Used	No	No	No	None	No	No	Slide 2	0	Unload	None	No	No	No	No	No	No
5	0	Not Used	No	No	No	None	No	No	Slide 2	0	Unload	None	No	No	No	No	No	No
6	0	Not Used	No	No	No	None	No	No	Slide 2	0	Unload	None	No	No	No	No	No	No
7	0	Not Used	No	No	No	None	No	No	Slide 2	0	Unload	None	No	No	No	No	No	No
8	0	Not Used	No	No	No	None	No	No	Slide 2	0	Unload	None	No	No	No	No	No	No

Select Output and Sensor Inputs per circuit

Circuit # (reset button)	Alarm Relay	Comp Proof	Compr Speed(%) or Modulate Hot Gas AP	Compressor Speed Fault	Slide Closed Indicator	Pump Down	Evaporator EXV Output	Flow	Pump/Valve Proof	Circuit Pump/Valve	IGV Open %	Reheat Type	Reheat AD	Reheat RO	Amount of RD's	Reh Fat
1	Not Used	Not Used	Not Used	Not Used	Not Used	PUMPDW	EEV-1	WFS+FT	Not Used	Not Used	Not Used	None	Not Used	Not Used	0	Not Us
2	Not Used	Not Used	Not Used	Not Used	Not Used	PUMPDW	EEV-2	WFS+AFT	Not Used	Not Used	Not Used	None	Not Used	Not Used	0	Not Us
3	Not Used	Not Used	Not Used	Not Used	Not Used	Not Used	Not Used	WATER IN	Not Used	Not Used	Not Used	None	Not Used	Not Used	0	Not Us

- Point to the Refrigerant Level inputs in the Circuit SI screen.

MAGNUM Circuit SI Screen

Circuit # (reset button)	Oil Seal Temp	Pre Oil Filter	Oil Float	Leaving Temp	Refrigerant Temp	Refrig Level	Refrig. Leak Sensor	Vane Position	Evap Suct Temp	Eva
1	Not Used	Not Used	OILLVL1	Not Used	BARLTMP1	REFLVL1	Not Used	Not Used	Not Used	Not
2	Not Used	Not Used	OILLVL2	Not Used	BARLTMP2	REFLVL2	Not Used	Not Used	Not Used	Not
3	Not Used	Not Used	Not Used	Not Used	Not Used	Not Used	Not Used	Not Used	Not Used	Not

- Make sure the Discharge Pressure and Discharge Temperature are pointing to correct sensors for the calculation of discharge superheat.

MAGNUM Circuit SI Screen

Circuit # (reset button)	Suction Pressure	Discharge Pressure	Suction Temperature	Discharge Temperature	Oil Pressure	Oil Temp	Motor Temp	Oil Flow Switch	Liquid Temp	L Pre
1	SUCPRES1	DISPRES1	SUCTEMP1	DISTEMP1	Not Used	WIND.TEMP	MP+OL1	Not Used	Not Used	Not U
2	SUCPRES2	DISPRES2	SUCTEMP2	DISTEMP2	Not Used	WIND.TEMP	MP+OL2	Not Used	Not Used	Not U
3	Not Used	Not Used	Not Used	Not Used	Not Used	Not Used	Not Used	Not Used	Not Used	Not U

23.1.3 Setup using EXV CONTROL WIZARD

- Select the EXV Control button and set up for level control with the desired EXV control method.

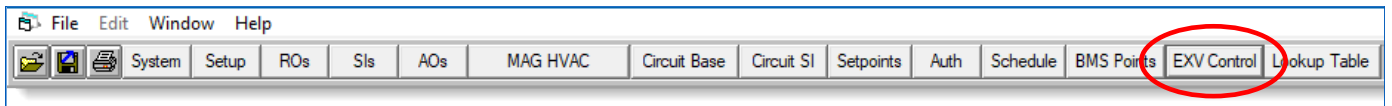

Heat Exchanger Type
Flooded Barrel

EXV Control Wizard

Control Parameter

- Suction Superheat
- Discharge Superheat
- Evaporator Level
- Condenser Level
- Approach

Heat Exchanger Type

- None
- DX Coil
- Plate HX
- DX Barrel
- Flooded Barrel

Control Method

- Normal (Original)
- Fc21
- Fc211
- PID

Target Modifier

- Low Discharge Superheat
- Oversized Condenser/High Ambient
- Maximum Operating Pressure(MOP)
- Minimum Differential Pressure(MDP)
- Target Reset
- Low Suction
- Low/High Level
- Level->CAP

Set Default Values?
Firmware Version 17.56 or Higher Required

MCS Defaults

User Defaults

Create Defaults File

Control Parameter
Select Evaporator Level or Condenser Level

Control Method
PID

Set Default Values
Click MCS DEFAULTS

- The following setpoints will be setup:

Setpoint Information Screen																				
#	Name	Value	Min	Max	Adjust Value	Time (SEC)	Max Time Allowed (SEC)	Lockout Delay (HRS)	Safety Down Time(MIN)	Active or Non-Active	Select Value: # decimals & print char	Level Of Auth. To Display	Type of Setpoint	Comments	SEC to Ignore Safety	Window to Ext. Safety Time(SEC)	Safety Time Extension (SEC)	High Zone	Low Zone	Setback
9	EvpLevelTarg	40	25	70	1	6	9	0	0	Active	... HUMD or %	Service L	Target					0.1	1	0
10	Ki-IntegMult	0.13	0	3	0.01	0	0	0	0	Active	... DEC2NOCH	Service L	Target					1	-1	0.1
11	EXV LD/UNLD%	0	0	0.5	0.1	0	0	0	0	Non-Active	... HUMD or %	Service L	Time							
12	Kp-PropMult	0.15	0	3	0.01	0	0	0	0	Active	... DEC2NOCH	Service L	Target					0	0	0.2
13	Kd-DerivMult	0.03	0	3	0.01	0	0	0	0	Active	... DEC2NOCH	Service L	Target					0.6	-0.6	0.05
14	Ka-AccelMult	0.05	0	3	0.01	0	0	0	0	Active	... DEC2NOCH	Service L	Target					0	0	0
15	ExvMinValve%	5	2	25	1	2	10	0	0	Active	... HUMD or %	Service L	Setpoint							
16	ExvMaxValve%	100	50	100	1	0	0	0	0	Active	... HUMD or %	Service L	Target					0	0	10
17	LO Suc sprht	1	-20	4	0.1	120	900	2	10	Non-Active	... TEMP	Service L	Lockout		15	300	60			
18	LOW PSI DELY	1	1	30	1	3	60	0	0	Non-Active	... SECONDS	Service L	Time							
19	ExvKiDelay	90	1	120	1	0	0	0	0	Active	... SECONDS	Service L	Setpoint							
20	ExvStartup	30	5	45	1	5	10	0	0	Active	... SECONDS	Service L	Time							

- NOTE: If more than one circuit is available and you want to control two independent circuit target levels, make setpoint#9 'Non-Active' in the setpoint screen.
- Make the used FLA setpoints#171-190 a 'target' type and set the level target up in the setback field.

Setpoint Information Screen																				
#	Name	Value	Min	Max	Adjust Value	Time (SEC)	Max Time Allowed (SEC)	Lockout Delay (HRS)	Safety Down Time(MIN)	Active or Non-Active	Select Value: # decimals & print char	Level Of Auth. To Display	Type of Setpoint	Comments	SEC to Ignore Safety	Window to Ext. Safety Time(SEC)	Safety Time Extension (SEC)	High Zone	Low Zone	Setback
171	FLA COMP#1	292	200	300	1	1	1	0	0	Active	... AMPS/CT	Factory L	Target					0	0	42
172	FLA COMP#2	292	200	300	1	1	1	0	0	Active	... AMPS/CT	Factory L	Target					0	0	34

23.1.4 Low Discharge Superheat EXV Target Adjust Logic

- Requires Firmware Version: MCS-MAGNUM Firmware - 17.61-D or later

Below are three enables for the low discharge EXV target adjustment:



7. Comp has been running for 5 minutes, or
8. Discharge temperature is greater than 130F (or 54.5C), or
9. EXV control is setup for PID Evap, PID Cond, Old Evap Level or Old Cond Level control.

- Make setpoint #110 (LoDisSHExvAd) active if you want to dynamically change the EXV target based on Low Discharge Superheat.

Setpoint Information Screen																				
#	Name	Value	Min	Max	Adjust Value	Time (SEC)	Max Time Allowed (SEC)	Lockout Delay (HRS)	Safety Down Time(MIN)	Active or Non-Active	Select Value: # decimals & print char	Level Of Auth. To Display	Type of Setpoint	Comments	SEC to Ignore Safety	Window to Ext. Safety Time(SEC)	Safety Time Extension (SEC)	High Zone	Low Zone	Setback
109	HiRefLevel	95	50	100	1	120	120	2	10	Active	... HUMD or %	Factory L	Lockout		600	300	60			
110	LoDisSHExvAd	0.5	0.1	5	0.1	90	300	0	0	Active	... HUMD or %	Factory L	Target					45	10	30
111	FREEZE	38	36	40	1	3	10	0	0	Active	... TEMP	Factory L	Lockout		0	0	0			

23.1.4.1. The Low Discharge Superheat logic:

- If Setpoint #110 (#164 for REFR) is setup as a "TARGET" type setpoint the following logic occurs (New Logic):

1. If discharge superheat <= setpoint #110 (#164) low zone value and the low discharge superheat adjusted amount is less than the max adjust limit setpoint #110 setback value and the Time (SEC) value has elapsed, then:
 - a. If Evap Level control, setpoint #110 (#164) value field is subtracted from the EXV Target and this value becomes the new EXV target. The value in the Time (SEC) field will count down again and

another adjustment will be made until the max adjust is reached (setpoint #110 setback value) or the discharge superheat goes above setpoint #110 (#164) low zone value.

- b. For Cond Level control method, setpoint #110 (#164) value field is added to the EXV Target and this value becomes the new EXV Target. The value in the Time (SEC) field will count down again and another adjustment will be made until the max adjust is reached (setpoint #110 setback value) or the discharge superheat goes above setpoint #110 (#164) low zone value.
- Else if discharge superheat \geq setpoint #110 (#164) high zone value and the low discharge superheat adjusted amount is greater than 0 and the Time (SEC) value has elapsed, then:
 - a. If Evap Level control, setpoint #110 (#164) value field is added to the EXV Target and this value becomes the new EXV Target. The value in the Time (SEC) field will count down again and another adjustment will be made until the min adjust is reached (0) or the discharge superheat goes below setpoint #110 (#164) high zone value.

NOTE: The EXV Target adjusted value will not go above the original setpoint Target value.

- b. For Cond Level control method, setpoint #110 (#164) value field is subtracted from the EXV Target and this value becomes the new EXV Target. The value in the Time (SEC) field will count down again and another adjustment will be made until the min adjust is reached (0) or the discharge superheat goes below setpoint #110 (#164) high zone value.

NOTE: The EXV Target adjusted value will not go below the original setpoint Target value.

- Else If Setpoint #110 (#164) is not a "TARGET" type setpoint the following logic occurs (Old Logic):
2. If discharge superheat is $<$ Low discharge superheat safety setpoint #84 value, then:
 - a. If Evap Level or Cond Level and not level target by compressor circuit, then set EXV target to setpoint #110 value.
 - b. Else If Evap Level or Cond Level and EXV target is by compressor circuit, then subtract setpoint #110 value from the current EXV target.

Chapter - 24. Analog Output Control using PID

Required to have the software below or later version
 Config version 18.01T
 Connect version 18.31.15
 Firmware HVAC 17.62R2

PID control will turn an analog output into a stand alone PID controlled output. This output will have a controlling sensor that modulates the AO to a maintain target. This logic will run all the time.

Analog Output Information Screen			
Point Number	Name	Control Type	Invert
4-4	ExvTpCtrl1	PID CTRL	NO
5-1	ExvTpCtrl2	Standard	NO
5-2	ExvTpCtrl3	PID CTRL	NO
5-3	SPARE5-3	Linear CTRL	NO
5-4	SPARE5-4	Modbus	NO
6-1	SPARE6-1	Digital Scroll	NO
6-2	SPARE6-2	2-10vdc	NO
		Linear/Modbus	NO

PID CTRL AO User Logic

ExvTpCtrl1 (0% to 100%)

If Relay- is Off, then Output =

Else

Control Sensor		Control Target		Proportional (Kp)	
Point	Value	Point	Value	(-327.68 to 327.67)	
SI	SupplyTmp1	Setpoint Val	AHU1TrgtTmp	Mult.	0.1
Minimum Output (0% to 100%)		Max Output (0% to 100%)		Integral (Ki)	
AO = <input type="text" value="20"/>		To <input type="text" value="100"/>		(-327.68 to 327.67) (0 to 3200)	
				Mult.	0.7
				Delay	60
				Derivative (Kd)	
				(-327.68 to 327.67) (2 to 60)	
				Mult.	0.15
				Interval	6
				Adjustment Limits	
				Min Adj	-5
				Max Adj	5

NOTE

If AO is modulating the wrong direction, simply make all three multipliers negative values to reverse the direction the AO modulates and vice versa.

If Relay-

If a relay is used and is OFF then associated AO will be set to the defined value and not modulate. If 'not used' the logic is ignored.

Control Sensor

AO or SI point to be used as the controlling sensor for the AO.

Control Target

SI, AO, or Setpoint used as the target the AO will try to maintain.

AO

Min to Max value the AO can modulate between.

Proportional(Kp)

Multiplier for Kp adjustments.

Integral(Ki)

Multiplier and delay between Ki Adjustments

Derivative(Kd)

Multiplier and time in seconds interval to calculate Kd.

Adjustment Limits

Min and Max adjustments allowed to the AO per adjustment, both negative and positive.

Under the Analog Outputs window in the MCS Connect software. You'll find an AO PID tab that will show all of the PID CONTROL AOs and all of the calculated adjustments being made to those Analog Outputs. Here you will be able to see all three adjustments being made to the PID. This will assist you in any fine tuning required for the given analog output.

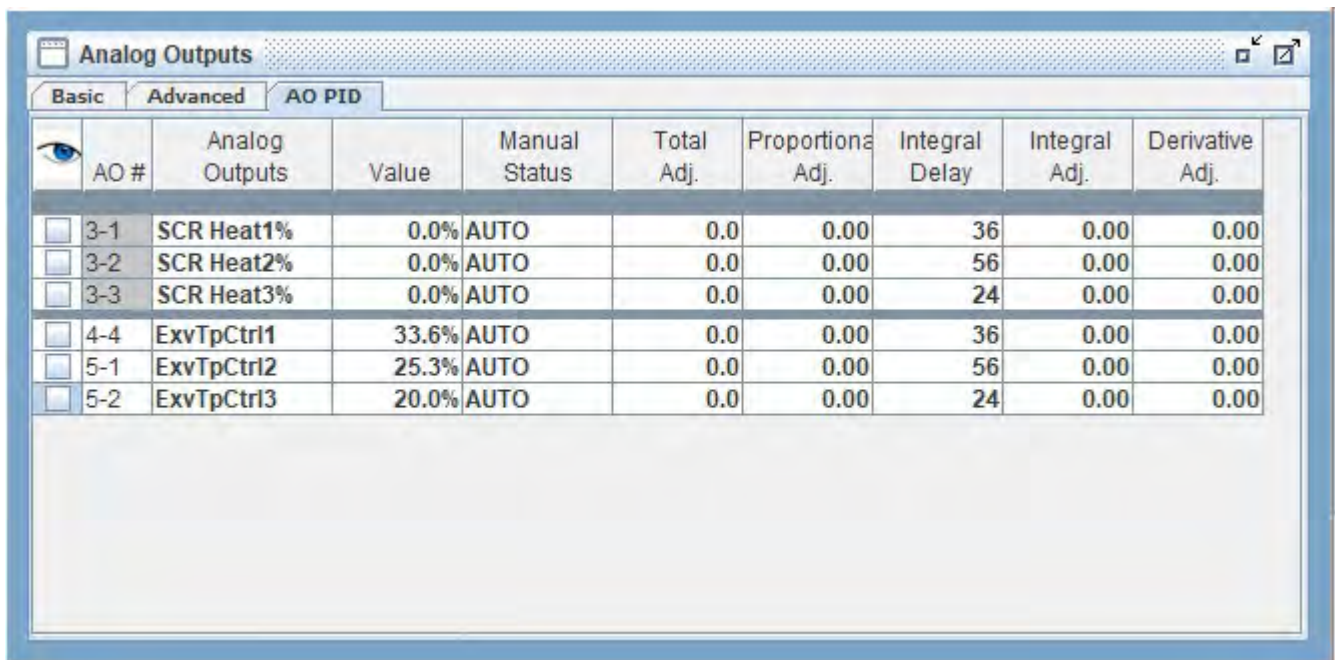

AO #	Analog Outputs	Value	Manual Status	Total Adj.	Proportional Adj.	Integral Delay	Integral Adj.	Derivative Adj.
3-1	SCR Heat1%	0.0%	AUTO	0.0	0.00	36	0.00	0.00
3-2	SCR Heat2%	0.0%	AUTO	0.0	0.00	56	0.00	0.00
3-3	SCR Heat3%	0.0%	AUTO	0.0	0.00	24	0.00	0.00
4-4	ExvTpCtrl1	33.6%	AUTO	0.0	0.00	36	0.00	0.00
5-1	ExvTpCtrl2	25.3%	AUTO	0.0	0.00	56	0.00	0.00
5-2	ExvTpCtrl3	20.0%	AUTO	0.0	0.00	24	0.00	0.00

Chapter - 25. Network Protocols

Network protocols are formatting rules that specify how data is sent and received between devices. Protocols are necessary for devices to interact with each other.

25.1. Protocols MCS controllers support:

1. **BACNET**
2. **MODBUS RTU**
3. **ETHERNET**
4. **MCS**
5. **LONTALK**
6. **JOHNSON N2**

✓ = Built in Support

MCS Network Protocol Support		
	Magnum	MicroMag
Over Ethernet	Bacnet IP	✓ MCS-Bacnet-Router2
	Modbus IP	✓ In Development
	MCS IP	✓ MCS-Ethernet
Over RS485	Modbus RTU	✓
	MCS 485	✓
	Bacnet MS/TP	MCS-BMS-Gateway
Over LonWorks	Johnson N2	MCS-BMS-Gateway
	LonTalk	MCS-BMS-Gateway

Requires MCS-BMS-GATEWAY

25.2. MCS-MAGNUM USING RS-485

Using the RS485, the MCS-Magnum can be connected to the BMS (Modbus RTU or MCS 485)

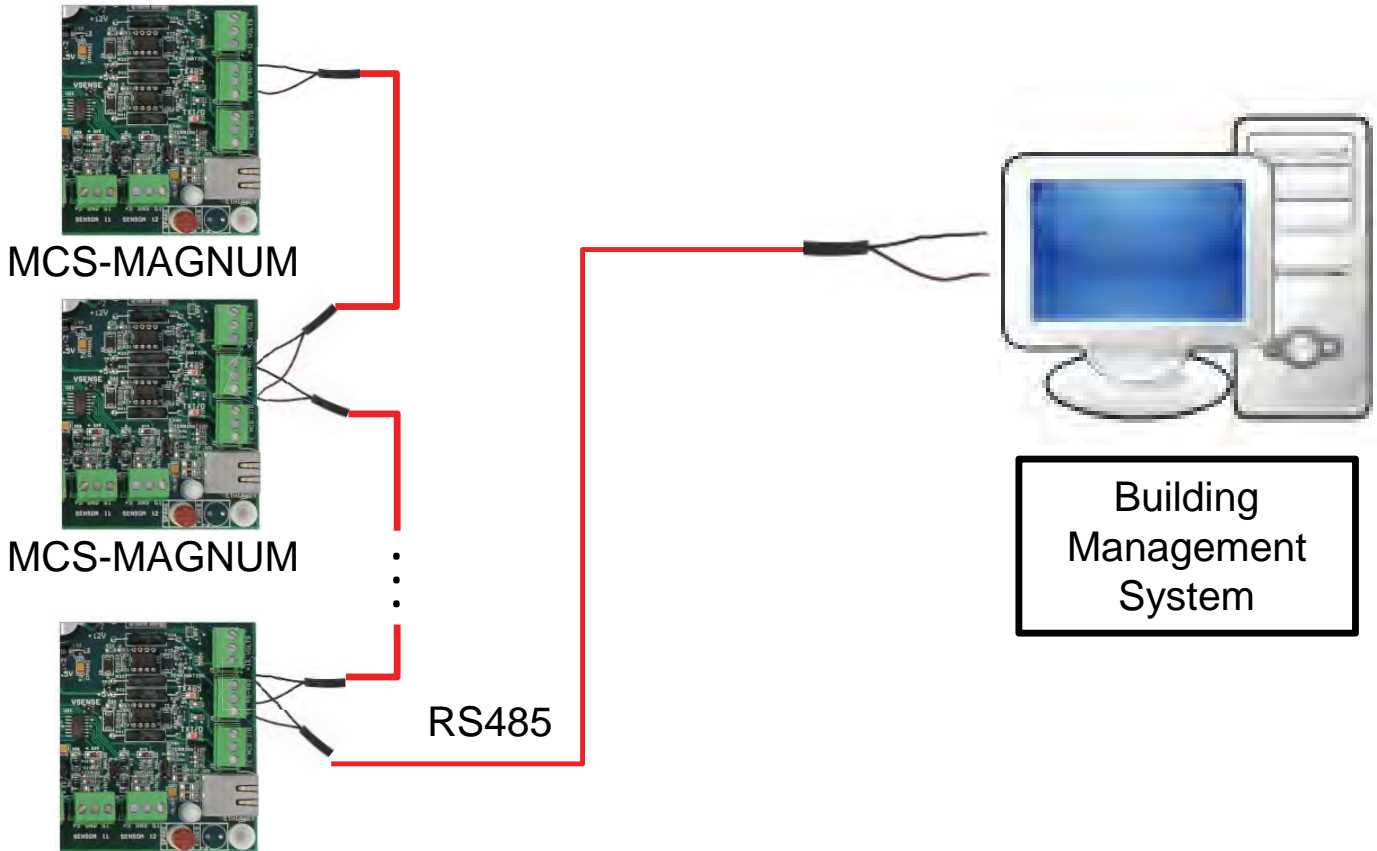

25.3. MCS-MAGNUM USING ETHERNET

- Using the Ethernet, the MCS-Magnum can be connected to:
- BMS (Bacnet IP or Modbus IP)
- MCS-Touch (MCS-Connect)
- PC (MCS-Connect)
- Internet access through router (which allows connection via MCS-Connect from anywhere)

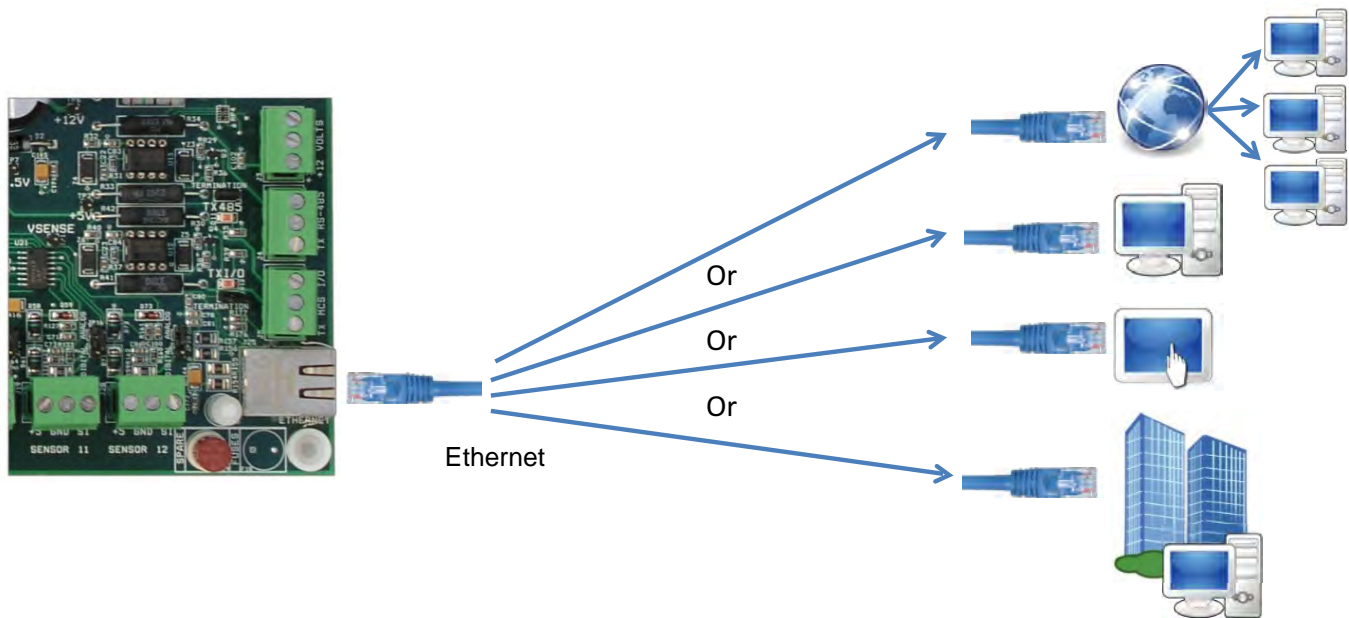

25.4. EXAMPLE NETWORK

25.4.1 Standalone MCS-Magnum

- MCS-Touch
- BMS (Johnson N2 or LonTalk or Bacnet MSTP)
- Internet Access

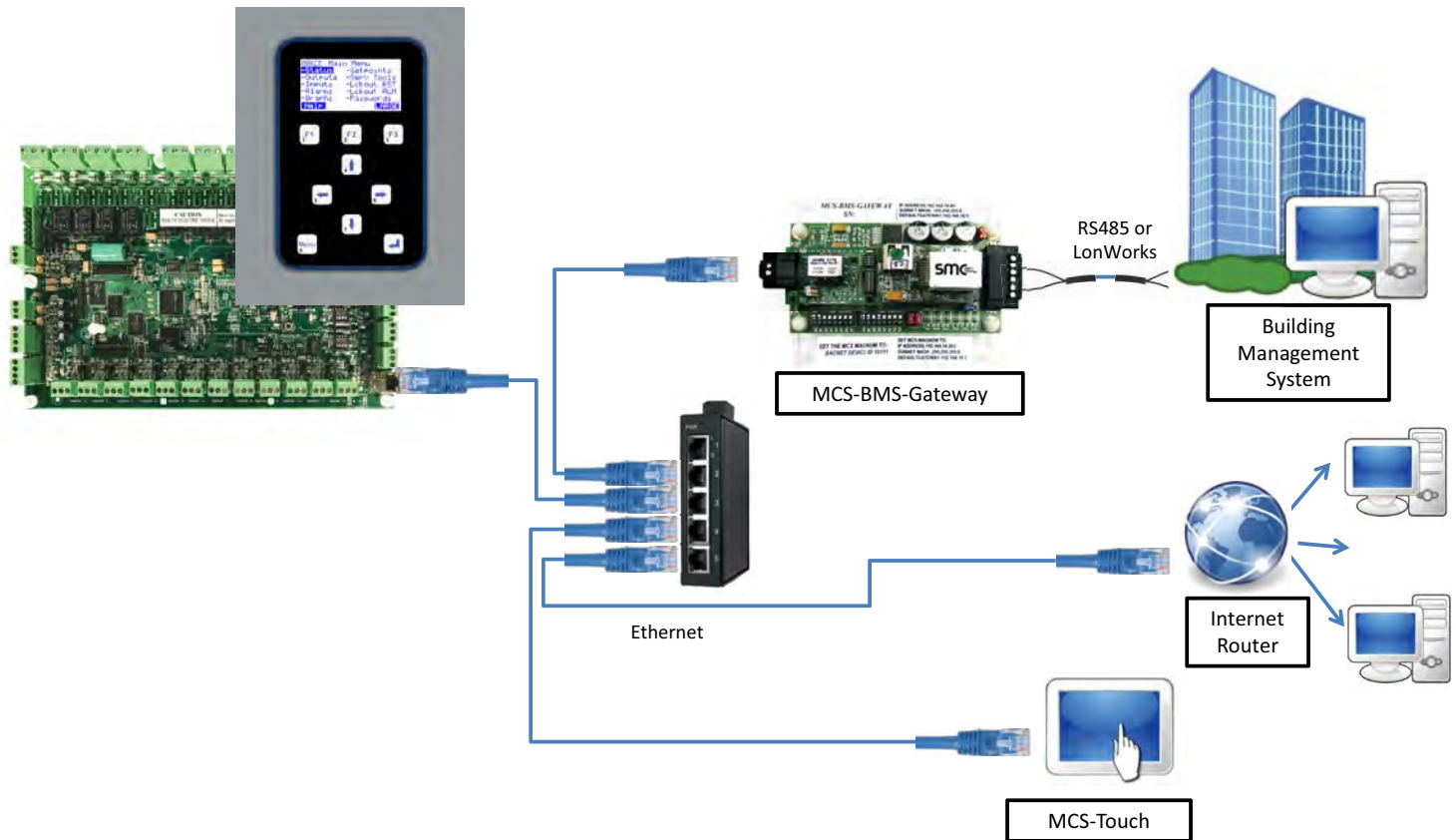

25.4.2 MULTIPLE MCS-MAGNUM Industrial Control Panels

- Internet Access
- BMS (Bacnet IP or Modbus IP)

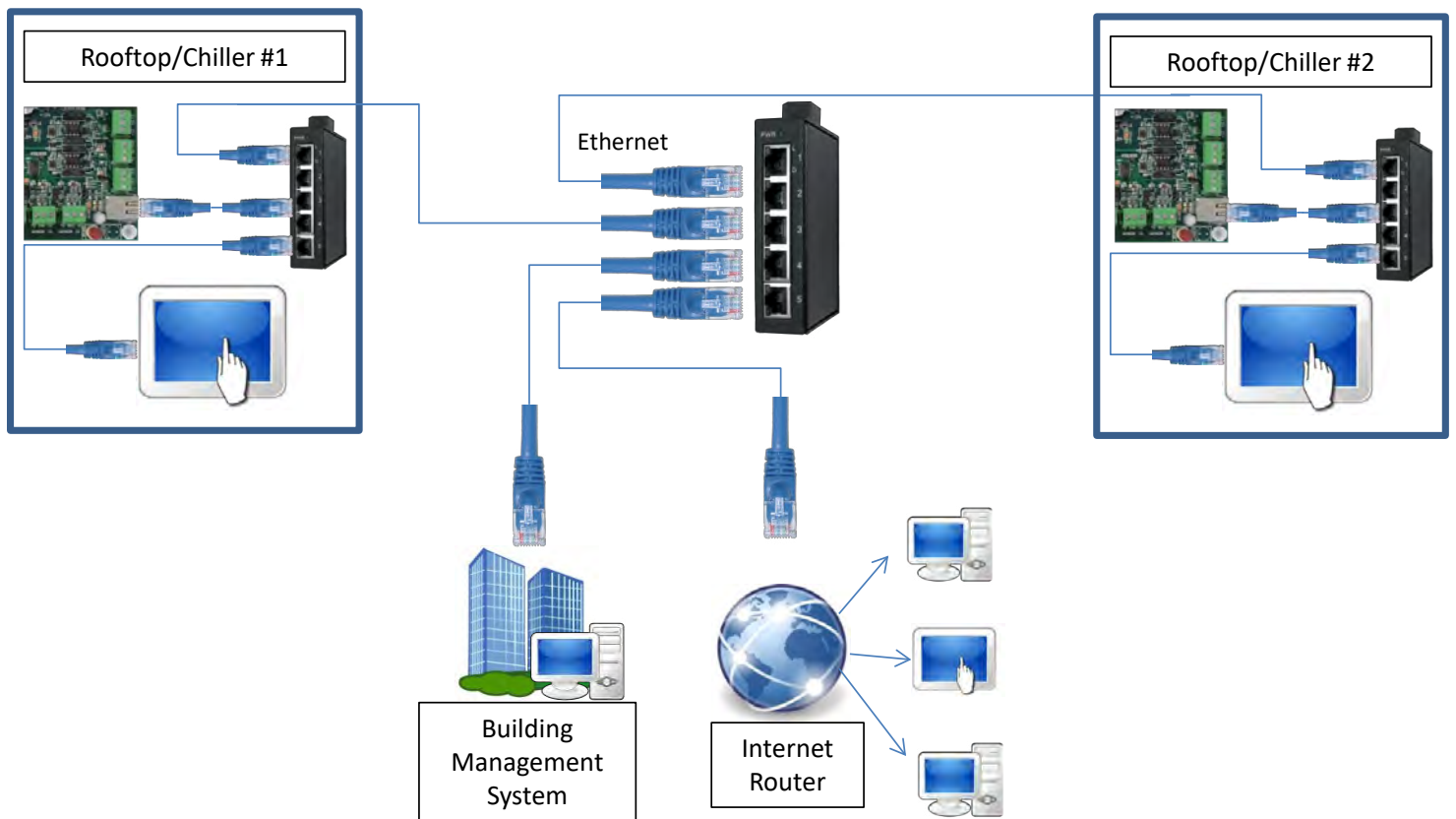

25.5. MULTIPLE MCS-MAGNUM BMS RS485 WIRING DIAGRAM

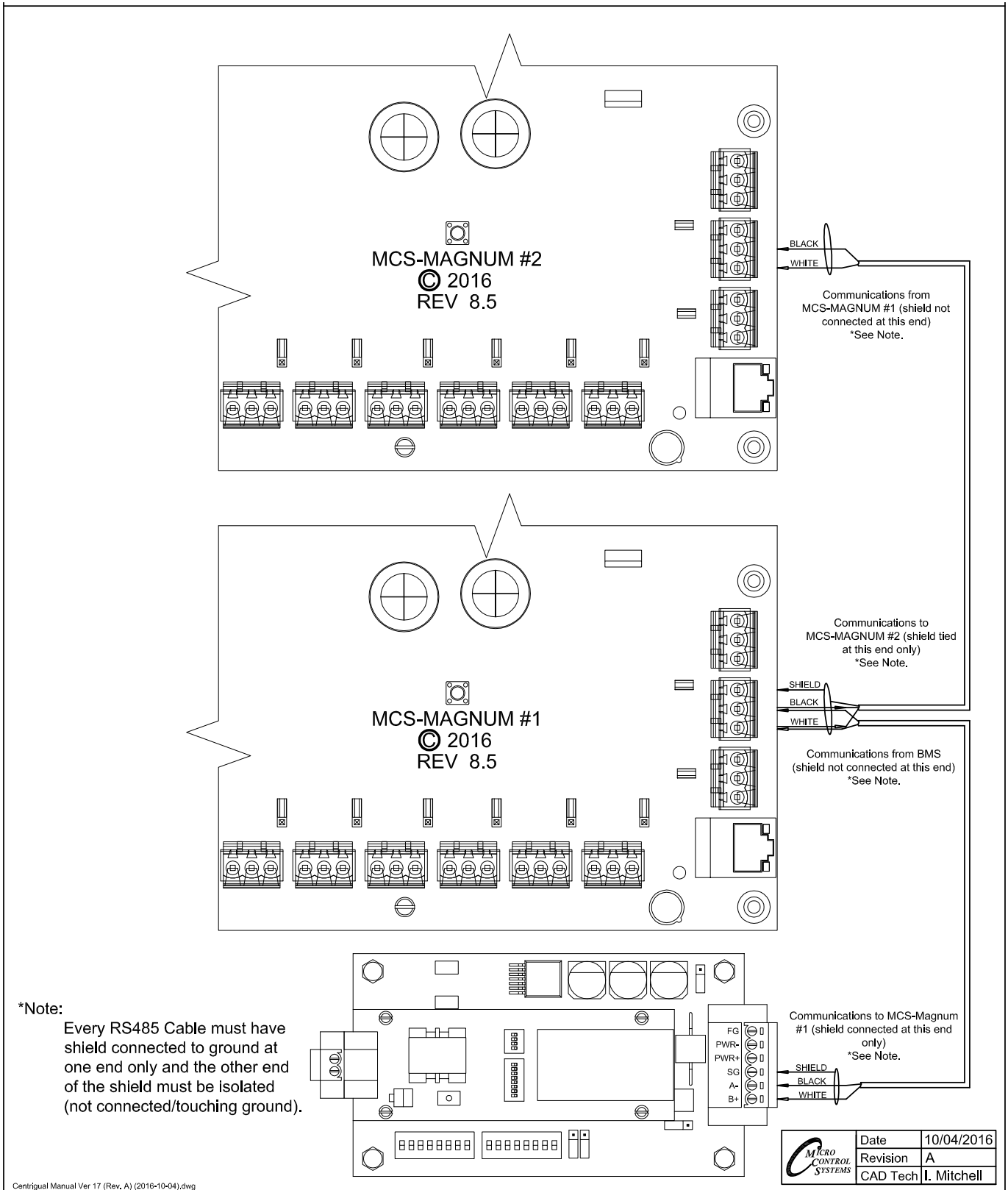

Centrigual Manual Ver 17 (Rev. A) (2016-10-04).dwg

Chapter - 26. MODBUS RTU

Modbus RTU is supported directly by the MCS-Magnum using the RS485 port.

Please note this is the same port you plug into the RS232, so if using Modbus RTU you cannot plug you laptop into RS232 port on the older keypad.

Please note the RS485 follows industry standard, two wire twisted pair in shielded cable.

26.1. Setup the Modbus from MCS-Config's Magnum Setup Screen(see below):

The screenshot displays the 'MAGNUM Setup Screen' with the following configuration details:

- System Navigation:** System, Setup, ROs, SIs, AOs, MAG RTU, Circuit Base, Circuit SI, Setpoints, Auth, Schedule, BM.
- Display Units:** Deg F / PSI
- Default LCD Display:** UNIT STATUS
- Default Display Point:** (Empty)
- Max Lockout Resets per Day:** 6
- Auth Level Bypass:** Supervisor Level
- Lockout Reset SI:** Not Used
- History Sample Rate (Seconds):** 90
- Activate Keypad Cursor Quick Move Feature?:** Yes No
- Generate Alarm for Network Time Synchronization:** Yes No
- Generate Alarm When Configuration is Updated:** Yes No
- Display Alarm Character(a) On Keypad LCD Screen:** Yes No
- Total Number of RO's:** 30
- Total Number of AO's:** 17
- Total Number of SI's:** 81
- Number of RO Boards:** 1
- Number of SI16 boards:** 3
- Type of I/O Boards:** RO-8 & SI-16 & MCS I/O RO-10 & SI-16-A04
- MCS-Thermostat:** Yes No
- Factory Startup:**
 - Enable This Feature?:** Yes No
 - Feature Is Active? (Password Entered):** Yes No
- Run Hour Lockout:**
 - Enable This Feature?:** Yes No
 - Feature Is Active? (Password Entered):** Yes No
- Daylight Savings Time:**
 - Daylight Savings Time Active:** Yes No
 - Daylight Savings Time DOW:** Sunday
 - Daylight Savings Time Hour:** 2
 - Spring Forward Month:** March
 - Spring Forward Begin Date:** 8
 - Spring Forward End Date:** 14
 - Fall Back Month:** November
 - Fall Back Begin Date:** 1
 - Fall Back End Date:** 7
 - Reset to U.S.A Daylight Savings:** (Button)
- RS485 Communication:**
 - RTU Protocol Address:** 1
 - Protocol Type:** MODBUS RTU
 - Baud Rate:** 9600
 - Slave Address:** 1
 - Disable Alarm Grid Pop-Up In MCS-Connect?:** Yes No
- Ethernet Communication:**
 - Static IP:** **Dynamic IP:**
 - IP Address:** 192.168.10.253
 - Subnet Mask:** 255.255.255.0
 - Default Gateway:** 192.168.10.1
 - MCS IP Port:** 5001
 - BACnet Device ID:** 181.02
 - BACnet Port:** 47.808
 - Extended BACnet Device ID:** (Empty)
 - Hardcoded Port Numbers:** Modbus Port = 502, Website Port = 80
 - Used In 9.11 to Present MAG-Softv:** (Empty)
 - BACnet MV Values Start At:** Zero One
- System Graphic Information:**
 - Name of Graphic .html file:** C://MCS/Graphics/ RL134/SystemOverview.html

26.2. From MCS-Connect's Service Window RS485 tab (see below):

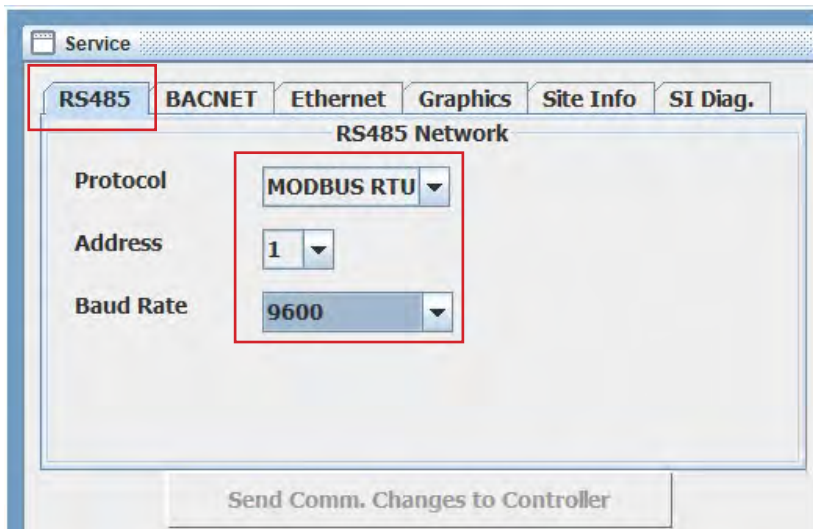

26.3. From MCS-Magnum LCD/Keypad(see below):

Service Tools (RS485 Network)



26.4. In MCS-CONFIG you can see & print a list of the Modbus Registers (see below):

MCS-MAGNUM		BACNET ID		MODBUS IP & RTU	
PT	Name	Object ID	Name	Register	# Assumed Dec
M-1	ChiWtr In	AI:1	ChiWtr In	30001	1
M-2	ChiWtrOut	AI:2	ChiWtrOut	30002	1
M-3	SUCT PSI 1	AI:3	SUCT PSI 1	30003	1
M-4	DISC PSI 1	AI:4	DISC PSI 1	30004	1
M-5	OIL PSI 1	AI:5	OIL PSI 1	30005	1
M-6	AMPS 1	AI:6	AMPS 1	30006	1
M-7	SUCT TMP 1	AI:7	SUCT TMP 1	30007	1
M-8	DISC TMP 1	AI:8	DISC TMP 1	30008	1
M-9	MTR TMP 1	AI:9	MTR TMP 1	30009	1
M10	MTR FLT 1	AI:10	MTR FLT 1	30010	0
M11	OIL LVL 1	AI:11	OIL LVL 1	30011	0
M12	DISABLE 1	AI:12	DISABLE 1	30012	0
M13	CHW FLOW	AI:13	CHW FLOW	30013	0
M14	PHASELOSS	AI:14	PHASELOSS	30014	0
M15	RUN/STOP	AI:15	RUN/STOP	30015	0

The MCS-Magnum Modbus RTU setting allow you to specify the Modbus Slave address, Modbus Baud rate (4800, 9600, 19200, 38400, 57600 are supported).

The number data bit is 8, stop bit is 1 and parity is none (these parameter are not adjustable).

The sensors inputs are 16 bit signed values. (Read input Registers, Function code = 4)

- The analog sensor inputs values typically have 1 assumed decimal place, meaning a value of 12.3 will be transmitted as value 123. The # of decimal point depending on the sensor type define in the MCS-MAGNUM CONFIG. Most sensor types are 1 decimal place.

But take care there are a few 2 decimal and a few zero decimal place types.

The BMS point list has a column which indicates how many assumed decimal are contained in the value.

- The digital sensor inputs values will be 0 or 1, 0 = off and 1 = on.

The analog outputs are 16 bit signed values. (Read Input Registers, Function code = 4)

- The analog output have 1 assumed decimal place, meaning a value of 12.3 will be transmitted as value 123.

The relay outputs are 16 bit packed values. (Read Coil Status , Function code = 1)

- Each bit within the 16 bits can contains a relay output. A bit value of 0 = relay off, 1 = relay on.

The number of packed bit depends on the requesting Modbus message.

If only one coil is asked for, then only bit 0 will contains a relay status value and bit 1 thru 7 are do not care.

If two relays are asked for, then bit 0 and bit 1 will contains values and bit 2 thru 7 are do not care.

The setpoints are 16 bit signed values. (Read Holding Registers, Function code = 3)

- The setpoints values typically have 1 assumed decimal place, meaning a value of 12.3 will be transmitted as value 123.

The # of decimal point depending on the setpoint type defined in the MCS-MAGNUM CONFIG.

Chapter - 27. BMS Communication Protocols

The MCS-Magnum supports as standard: BACnet IP, Modbus RTU, and Modbus TCP/IP protocols.

Using the MCS-BMS-GATEWAY, the MCS-Magnum can also support Johnson N2, LonTalk and Bacnet MSTP.

Supported baud rates for Modbus RTU and Johnson N2 are 4800bps, 9600bps, 19200bps, 38400bps, and 57600bps.

27.1. MCS-Magnum to BMS Connections

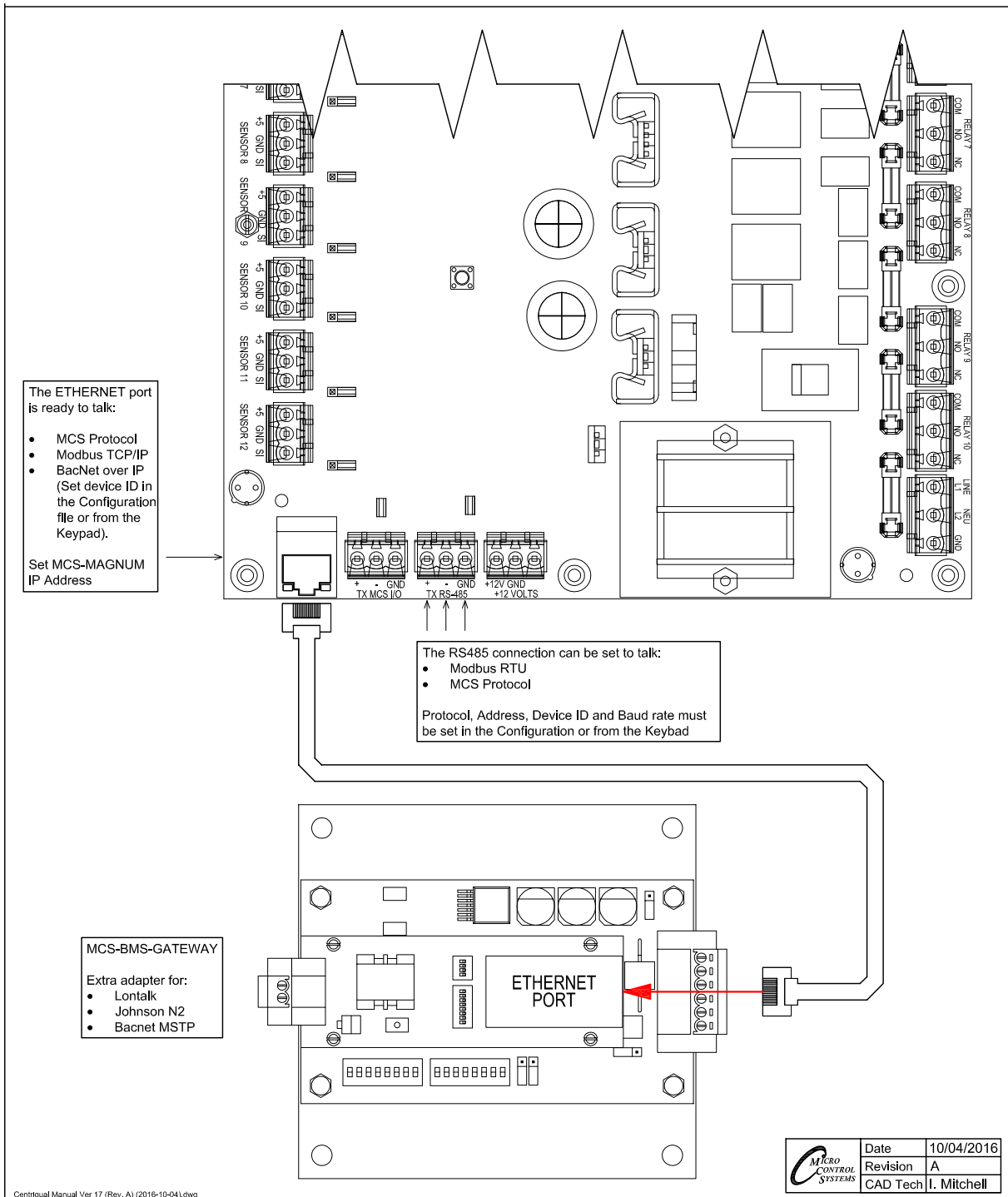

Centrigual Manual Ver 17 (Rev. A) (2016-10-04).dwg

27.2. Sensor Input Points

Sensor numbering is based upon the MCS-MAGNUM or SI16-AO4 hardware type board Notable BACnet properties available: Units

Magnum	BACnet ID	BACnet Name	Modbus Register	N2
Sensor M-1	AI: 1	Refer to Config	*30001	*AI: 1
Sensor M-2	AI: 2	Refer to Config	*30002	*AI: 2
Sensor M-3	AI: 3	Refer to Config	*30003	*AI: 3
Sensor M-4	AI: 4	Refer to Config	*30004	*AI: 4
Sensor M-5	AI: 5	Refer to Config	*30005	*AI: 5
Sensor M-6	AI: 6	Refer to Config	*30006	*AI: 6
Sensor M-7	AI: 7	Refer to Config	*30007	*AI: 7
Sensor M-8	AI: 8	Refer to Config	*30008	*AI: 8
Sensor M-9	AI: 9	Refer to Config	*30009	*AI: 9
Sensor M-10	AI:10	Refer to Config	*30010	*AI: 10
Sensor M-11	AI:11	Refer to Config	*30011	*AI: 11
Sensor M-12	AI:12	Refer to Config	*30012	*AI: 12
Sensor M-13	AI:13	Refer to Config	*30013	*AI: 13
Sensor M-14	AI:14	Refer to Config	*30014	*AI: 14
Sensor M-15	AI:15	Refer to Config	*30015	*AI: 15
Sensor M-16	AI:16	Refer to Config	*30016	*AI: 16
Sensor 1-1	AI:17	Refer to Config	*30017	*AI: 17
Sensor 1-2	AI:18	Refer to Config	*30018	*AI: 18
Sensor 1-3	AI:19	Refer to Config	*30019	*AI: 19
Sensor 1-4	AI:20	Refer to Config	*30020	*AI: 20
Sensor 1-5	AI:21	Refer to Config	*30021	*AI: 21
Sensor 1-6	AI:22	Refer to Config	*30022	*AI: 22
Sensor 1-7	AI:23	Refer to Config	*30023	*AI: 23
Sensor 1-8	AI:24	Refer to Config	*30024	*AI: 24
Sensor 1-9	AI:25	Refer to Config	*30025	*AI: 25
Sensor 1-10	AI:26	Refer to Config	*30026	*AI: 26
Sensor 1-11	AI:27	Refer to Config	*30027	*AI: 27
Sensor 1-12	AI:28	Refer to Config	*30028	*AI: 28
Sensor 1-13	AI:29	Refer to Config	*30029	*AI: 29
Sensor 1-14	AI:30	Refer to Config	*30030	*AI: 30
Sensor 1-15	AI:31	Refer to Config	*30031	*AI: 31
Sensor 1-16	AI:32	Refer to Config	*30032	*AI: 32
Sensor 2-1	AI:33	Refer to Config	*30033	*AI: 33
Sensor 2-2	AI:34	Refer to Config	*30034	*AI: 34
Sensor 2-3	AI:35	Refer to Config	*30035	*AI: 35
Sensor 2-4	AI:36	Refer to Config	*30036	*AI: 36
Sensor 2-5	AI:37	Refer to Config	*30037	*AI: 37
Sensor 2-6	AI:38	Refer to Config	*30038	*AI: 38
Sensor 2-7	AI:39	Refer to Config	*30039	*AI: 39
Sensor 2-8	AI:40	Refer to Config	*30040	*AI: 40

Magnum	BACnet ID	BACnet Name	Modbus Register	N2
Sensor 2-9	AI:41	Refer to Config	*30041	*AI: 41
Sensor 2-10	AI:42	Refer to Config	*30042	*AI: 42
Sensor 2-11	AI:43	Refer to Config	*30043	*AI: 43
Sensor 2-12	AI:44	Refer to Config	*30044	*AI: 44
Sensor 2-13	AI:45	Refer to Config	*30045	*AI: 45
Sensor 2-14	AI:46	Refer to Config	*30046	*AI: 46
Sensor 2-15	AI:47	Refer to Config	*30047	*AI: 47
Sensor 2-16	AI:48	Refer to Config	*30048	*AI: 48
Sensor 3-1	AI:49	Refer to Config	*30049	*AI:49
Sensor 3-2	AI:50	Refer to Config	*30050	*AI: 50
Sensor 3-3	AI:51	Refer to Config	*30051	*AI: 51
Sensor 3-4	AI:52	Refer to Config	*30052	*AI: 52
Sensor 3-5	AI:53	Refer to Config	*30053	*AI: 53
Sensor 3-6	AI:54	Refer to Config	*30054	*AI: 54
Sensor 3-7	AI:55	Refer to Config	*30055	*AI: 55
Sensor 3-8	AI:56	Refer to Config	*30056	*AI: 56
Sensor 3-9	AI:57	Refer to Config	*30057	*AI: 57
Sensor 3-10	AI:58	Refer to Config	*30058	*AI: 58
Sensor 3-11	AI:59	Refer to Config	*30059	*AI: 59
Sensor 3-12	AI:60	Refer to Config	*30060	*AI: 60
Sensor 3-13	AI:61	Refer to Config	*30061	*AI: 61
Sensor 3-14	AI:62	Refer to Config	*30062	*AI: 62
Sensor 3-15	AI:63	Refer to Config	*30063	*AI: 63
Sensor 3-16	AI:64	Refer to Config	*30064	*AI: 64
Sensor 4-1	AI:65	Refer to Config	*30065	*AI: 65
Sensor 4-2	AI:66	Refer to Config	*30066	*AI: 66
Sensor 4-3	AI:67	Refer to Config	*30067	*AI: 67
Sensor 4-4	AI:68	Refer to Config	*30068	*AI: 68
Sensor 4-5	AI:69	Refer to Config	*30069	*AI: 69
Sensor 4-6	AI:70	Refer to Config	*30070	*AI: 70
Sensor 4-7	AI:71	Refer to Config	*30071	*AI: 71
Sensor 4-8	AI:72	Refer to Config	*30072	*AI: 72
Sensor 4-9	AI:73	Refer to Config	*30073	*AI: 73
Sensor 4-10	AI:74	Refer to Config	*30074	*AI: 74
Sensor 4-11	AI:75	Refer to Config	*30075	*AI: 75
Sensor 4-12	AI:76	Refer to Config	*30076	*AI: 76
Sensor 4-13	AI:77	Refer to Config	*30077	*AI: 77
Sensor 4-14	AI:78	Refer to Config	*30078	*AI: 78
Sensor 4-15	AI:79	Refer to Config	*30079	*AI: 79
Sensor 4-16	AI:80	Refer to Config	*30080	*AI: 80

*- Indicates value multiplied by 10 to include one decimal place. (I.e. BMS value of 500 indicates actual value 50.0)

27.3. Relay Output Points

Relay Output points are read-only. Sensor numbering is based upon RO-10 hardware type board

Magnum	BACnet ID	BACnet Name	Modbus	N2
Relay M-1	BO: 1	Refer to Config	00001	BO: 1
Relay M-2	BO: 2	Refer to Config	00002	BO: 2
Relay M-3	BO: 3	Refer to Config	00003	BO: 3
Relay M-4	BO: 4	Refer to Config	00004	BO: 4
Relay M-5	BO: 5	Refer to Config	00005	BO: 5
Relay M-6	BO: 6	Refer to Config	00006	BO: 6
Relay M-7	BO: 7	Refer to Config	00007	BO: 7
Relay M-8	BO: 8	Refer to Config	00008	BO: 8
Relay M-9	BO: 9	Refer to Config	00009	BO: 9
Relay M-10	BO:10	Refer to Config	00010	BO: 10
Relay 1-1	BO:11	Refer to Config	00011	BO: 11
Relay 1-2	BO:12	Refer to Config	00012	BO: 12
Relay 1-3	BO:13	Refer to Config	00013	BO: 13
Relay 1-4	BO:14	Refer to Config	00014	BO: 14
Relay 1-5	BO:15	Refer to Config	00015	BO: 15
Relay 1-6	BO:16	Refer to Config	00016	BO: 16
Relay 1-7	BO:17	Refer to Config	00017	BO: 17
Relay 1-8	BO:18	Refer to Config	00018	BO: 18
Relay 1-9	BO:19	Refer to Config	00019	BO: 19
Relay 1-10	BO:20	Refer to Config	00020	BO: 20
Relay 2-1	BO:21	Refer to Config	00021	BO: 21
Relay 2-2	BO:22	Refer to Config	00022	BO: 22
Relay 2-3	BO:23	Refer to Config	00023	BO: 23
Relay 2-4	BO:24	Refer to Config	00024	BO: 24
Relay 2-5	BO:25	Refer to Config	00025	BO: 25
Relay 2-6	BO:26	Refer to Config	00026	BO: 26
Relay 2-7	BO:27	Refer to Config	00027	BO: 27
Relay 2-8	BO:28	Refer to Config	00028	BO: 28
Relay 2-9	BO:29	Refer to Config	00029	BO: 29
Relay 2-10	BO:30	Refer to Config	00030	BO: 30
Relay 3-1	BO:31	Refer to Config	00031	BO: 31
Relay 3-2	BO:32	Refer to Config	00032	BO: 32
Relay 3-3	BO:33	Refer to Config	00033	BO: 33
Relay 3-4	BO:34	Refer to Config	00034	BO: 34
Relay 3-5	BO:35	Refer to Config	00035	BO: 35
Relay 3-6	BO:36	Refer to Config	00036	BO: 36
Relay 3-7	BO:37	Refer to Config	00037	BO: 37
Relay 3-8	BO:38	Refer to Config	00038	BO: 38
Relay 3-9	BO:39	Refer to Config	00039	BO: 39
Relay 3-10	BO:40	Refer to Config	00040	BO: 40

Magnum	BACnet ID	BACnet Name	Modbus	N2
Relay 4-1	BO:41	Refer to Config	00041	BO: 41
Relay 4-2	BO:42	Refer to Config	00042	BO: 42
Relay 4-3	BO:43	Refer to Config	00043	BO: 43
Relay 4-4	BO:44	Refer to Config	00044	BO: 44
Relay 4-5	BO:45	Refer to Config	00045	BO: 45
Relay 4-6	BO:46	Refer to Config	00046	BO: 46
Relay 4-7	BO:47	Refer to Config	00047	BO: 47
Relay 4-8	BO:48	Refer to Config	00048	BO: 48
Relay 4-9	BO:49	Refer to Config	00049	BO: 49
Relay 4-10	BO:50	Refer to Config	00050	BO: 50
Relay 5-1	BO:51	Refer to Config	00051	BO: 51
Relay 5-2	BO:52	Refer to Config	00052	BO: 52
Relay 5-3	BO:53	Refer to Config	00053	BO: 53
Relay 5-4	BO:54	Refer to Config	00054	BO: 54
Relay 5-5	BO:55	Refer to Config	00055	BO: 55
Relay 5-6	BO:56	Refer to Config	00056	BO: 56
Relay 5-7	BO:57	Refer to Config	00057	BO: 57
Relay 5-8	BO:58	Refer to Config	00058	BO: 58
Relay 5-9	BO:59	Refer to Config	00059	BO: 59
Relay 5-10	BO:60	Refer to Config	00060	BO: 60
Relay 6-1	BO:61	Refer to Config	00061	BO: 61
Relay 6-2	BO:62	Refer to Config	00062	BO: 62
Relay 6-3	BO:63	Refer to Config	00063	BO: 63
Relay 6-4	BO:64	Refer to Config	00064	BO: 64
Relay 6-5	BO:65	Refer to Config	00065	BO: 65
Relay 6-6	BO:66	Refer to Config	00066	BO: 66
Relay 6-7	BO:67	Refer to Config	00067	BO: 67
Relay 6-8	BO:68	Refer to Config	00068	BO: 68
Relay 6-9	BO:69	Refer to Config	00069	BO: 69
Relay 6-10	BO:70	Refer to Config	00760	BO: 70
Relay 7-1	BO:71	Refer to Config	00071	BO: 71
Relay 7-2	BO:72	Refer to Config	00072	BO: 72
Relay 7-3	BO:73	Refer to Config	00073	BO: 73
Relay 7-4	BO:74	Refer to Config	00074	BO: 74
Relay 7-5	BO:75	Refer to Config	00075	BO: 75
Relay 7-6	BO:76	Refer to Config	00076	BO: 76
Relay 7-7	BO:77	Refer to Config	00077	BO: 77
Relay 7-8	BO:78	Refer to Config	00078	BO: 78
Relay 7-9	BO:79	Refer to Config	00079	BO: 79
Relay 7-10	BO:80	Refer to Config	00070	BO: 80

*- Indicates value multiplied by 10 to include one decimal place. (I.e. BMS value of 500 indicates actual value 50.0)

Analog Output Points Analog Output points are read-only. Sensor numbering is based upon SI16-AO4 hardware type board. Notable BACnet properties available: Units

Magnum	BACnet ID	BACnet Name	Modbus Register	N2
Analog Out M-1	AO:1	Refer to Config	*30201	*AO: 1
Analog Out M-2	AO:2	Refer to Config	*30202	*AO: 2
Analog Out M-3	AO:3	Refer to Config	*30203	*AO: 3
Analog Out M-4	AO:4	Refer to Config	*30204	*AO: 4
Analog Out 1-1	AO:5	Refer to Config	*30205	*AO: 5
Analog Out 1-2	AO:6	Refer to Config	*30206	*AO: 6
Analog Out 1-3	AO:7	Refer to Config	*30207	*AO: 7
Analog Out 1-4	AO:7	Refer to Config	*30208	*AO: 8
Analog Out 2-1	AO:8	Refer to Config	*30209	*AO: 9
Analog Out 2-2	AO:10	Refer to Config	*30210	*AO: 10
Analog Out 2-3	AO:11	Refer to Config	*30211	*AO: 11
Analog Out 2-4	AO:12	Refer to Config	*30212	*AO: 12
Analog Out 3-1	AO:13	Refer to Config	*30213	*AO: 13
Analog Out 3-2	AO:14	Refer to Config	*30214	*AO: 14
Analog Out 3-3	AO:15	Refer to Config	*30215	*AO: 15
Analog Out 3-4	AO:16	Refer to Config	*30216	*AO: 16
Analog Out 4-1	AO:17	Refer to Config	*30217	*AO: 17
Analog Out 4-2	AO:18	Refer to Config	*30218	*AO: 18
Analog Out 4-3	AO:19	Refer to Config	*30219	*AO: 19
Analog Out 4-4	AO:20	Refer to Config	*30220	*AO: 20

*- Indicates value multiplied by 10 to include one decimal place. (I.e. BMS value of 500 indicates actual value 50.0)

27.4. Setpoints

Setpoints are read-only. Notable BACnet properties available: Units

Magnum	BACnet ID	BACnet Name	Modbus	N2
Setpoint #1	AV:0	STP# 1-<Setpoint name>	40301	ADF:1
Setpoint #21	AV:88	STP# 21-<Setpoint name>	40321	ADF:89
Setpoint #163	AV:230	STP# 163-<Setpoint name>	40463	ADF:231

*- Indicates value multiplied by 10 to include one decimal place. (I.e. BMS value of 500 indicates actual value 50.0)

27.5. Chiller/Compressor States

State values are read-only. Notable BACnet properties available: Number of States, State-Text (Contains character text of current state)

Magnum	BACnet ID	BACnet Name	Modbus Register	N2
Chiller Unit State	MV:0	CHILLER STATE	30306	BYT:1
Compressor #1 State	MV:1	COMPRESSOR #1 STATE	30307	BYT:2
Compressor #2 State	MV:2	COMPRESSOR #2 STATE	30308	BYT:3
Compressor #3 State	MV:3	COMPRESSOR #3 STATE	30309	BYT:4
Compressor #4 State	MV:4	COMPRESSOR #4 STATE	30310	BYT:5
Compressor #5 State	MV:5	COMPRESSOR #5 STATE	30311	BYT:6
Compressor #6 State	MV:6	COMPRESSOR #6 STATE	30312	BYT:7

Magnum	BACnet ID	BACnet Name	Modbus Register	N2
Compressor #7 State	MV:7	COMPRESSOR #7 STATE	30313	BYT:8
Compressor #8 State	MV:8	COMPRESSOR #8 STATE	30314	BYT:9
Compressor #9 State	MV:130	COMPRESSOR #9 STATE	30560	BYT:131
Compressor #10 State	MV:131	COMPRESSOR #10 STATE	30561	BYT:132
Compressor #11 State	MV:132	COMPRESSOR #11 STATE	30562	BYT:133
Compressor #12 State	MV:133	COMPRESSOR #12 STATE	30563	BYT:134
Compressor #13 State	MV:134	COMPRESSOR #13 STATE	30564	BYT:135
Compressor #14 State	MV:135	COMPRESSOR #14 STATE	30565	BYT:136
Compressor #15 State	MV:136	COMPRESSOR #15 STATE	30566	BYT:137
Compressor #16 State	MV:137	COMPRESSOR #16 STATE	30567	BYT:138
Compressor #17 State	MV:138	COMPRESSOR #17 STATE	30568	BYT:139
Compressor #18 State	MV:139	COMPRESSOR #18 STATE	30569	BYT:140
Compressor #19 State	MV:140	COMPRESSOR #19 STATE	30570	BYT:141
Compressor #20 State	MV:141	COMPRESSOR #20 STATE	30571	BYT:142

27.6. Chiller/Compressor Points

These points are read-only.

Magnum	BACnet ID	BACnet Name	Modbus	N2
Wanted FLA%	AV:3	Wanted FLA%	30318	ADF:4
Steps Wanted	AV:4	Steps Wanted On	30315	ADF:5
Steps On	AV:5	Steps On	30316	ADF:6
Step Delay	AV:6	Step Delay	30317	ADF:7
Compressor #1 FLA%	AV:7	C1_FL A%	*30319	*ADF:8
Compressor #1 Sat Suction	AV:10	C1_Sat Suct	*30327	*ADF:11
Compressor #1 Sat Disch	AV:11	C1_Sat Disch	*30329	*ADF:12
Compressor #1 Disch SH	AV:12	C1_Disch SH	*30330	*ADF:13
Compressor #1 Suct SH	AV:13	C1_Suct SH	*30328	*ADF:14
Compressor #1 Oil Pres Diff	AV:63	C1_Oil Pres Diff	*30375	*ADF:64
Compressor #1 Comp State Timer		C1_Comp State Timer	*32602	
Compressor #2 FLA%	AV:14	C2_FL A%	*30320	*ADF:15
Compressor #2 Sat Suction	AV:17	C2_Sat Suct	*30331	*ADF:18
Compressor #2 Sat Disch	AV:18	C2_Sat Disch	*30333	*ADF:19
Compressor #2 Disch SH	AV:19	C2_Disch SH	*30334	*ADF:20
Compressor #2 Suct SH	AV:20	C2_Suct SH	*30332	*ADF:21
Compressor #2 Oil Pres Diff	AV:64	C2_Oil Pres Diff	*30376	*ADF:65
Compressor #2 Comp State Timer		C2_Comp State Timer	*32603	
Compressor #3 FLA%	AV:21	C3_FL A%	*30321	*ADF:22
Compressor #3 Sat Suction	AV:24	C3_Sat Suct	*30335	*ADF:25
Compressor #3 Sat Disch	AV:25	C3_Sat Disch	*30337	*ADF:26
Compressor #3 Disch SH	AV:26	C3_Disch SH	*30338	*ADF:27
Compressor #3 Suct SH	AV:27	C3_Suct SH	*30336	*ADF:28
Compressor #3 Oil Pres Diff	AV:65	C3_Oil Pres Diff	*30377	*ADF:66
Compressor #3 Comp State Timer		C3_Comp State Timer	*32604	
Compressor #4 FLA%	AV:28	C4_FL A%	*30322	*ADF:29
Compressor #4 Sat Suction	AV:31	C4_Sat Suct	*30339	*ADF:32
Compressor #4 Sat Disch	AV:32	C4_Sat Disch	*30341	*ADF:33
Compressor #4 Disch SH	AV:33	C4_Disch SH	*30342	*ADF:34
Compressor #4 Suct SH	AV:34	C4_Suct SH	*30340	*ADF:35

Magnum	BACnet ID	BACnet Name	Modbus	N2
Compressor #4 Oil Pres Diff	AV:66	C4_Oil Pres Diff	*30378	*ADF:67
Compressor #4 Comp State Timer		C4_Comp State Timer	*32605	
Compressor #5 FLA%	AV:35	C5_FLA%	*30323	*ADF:36
Compressor #5 Sat Suction	AV:38	C5_Sat Suct	*30343	*ADF:39
Compressor #5 Sat Disch	AV:39	C5_Sat Disch	*30345	*ADF:40
Compressor #5 Disch SH	AV:40	C5_Disch SH	*30346	*ADF:41
Compressor #5 Suct SH	AV:41	C5_Suct SH	*30344	*ADF:42
Compressor #5 Oil Pres Diff	AV:67	C5_Oil Pres Diff	*30379	*ADF:68
Compressor #5 Comp State Timer		C5_Comp State Timer	*32606	
Compressor #6 FLA%	AV:42	C6_FLA%	*30324	*ADF:43
Compressor #6 Sat Suction	AV:45	C6_Sat Suct	*30347	*ADF:46
Compressor #6 Sat Disch	AV:46	C6_Sat Disch	*30349	*ADF:47
Compressor #6 Disch SH	AV:47	C6_Disch SH	*30350	*ADF:48
Compressor #6 Suct SH	AV:48	C6_Suct SH	*30348	*ADF:49
Compressor #6 Oil Pres Diff	AV:68	C6_Oil Pres Diff	*30380	*ADF:69
Compressor #6 Comp State Timer		C6_Comp State Timer	*32607	
Compressor #7 FLA%	AV:49	C7_FLA%	*30325	*ADF:50
Compressor #7 Sat Suction	AV:52	C7_Sat Suct	*30351	*ADF:53
Compressor #7 Sat Disch	AV:53	C7_Sat Disch	*30353	*ADF:54
Compressor #7 Disch SH	AV:54	C7_Disch SH	*30354	*ADF:55
Compressor #7 Suct SH	AV:55	C7_Suct SH	*30352	*ADF:56
Compressor #7 Oil Pres Diff	AV:69	C7_Oil Pres Diff	*30381	*ADF:70
Compressor #7 Comp State Timer		C7_Comp State Timer	*32608	
Compressor #8 FLA%	AV:56	C8_FLA%	*30326	*ADF:57
Compressor #8 Sat Suction	AV:59	C8_Sat Suct	*30352	*ADF:53
Compressor #8 Sat Suction	AV:59	C8_Sat Suct	*30355	*ADF:60
Compressor #8 Sat Disch	AV:60	C8_Sat Disch	*30357	*ADF:61
Compressor #8 Disch SH	AV:61	C8_Disch SH	*30358	*ADF:62
Compressor #8 Suct SH	AV:62	C8_Suct SH	*30356	*ADF:63
Compressor #8 Oil Pres Diff	AV:70	C8_Oil Pres Diff	*30382	*ADF:71
Compressor #8 Comp State Timer		C8_Comp State Timer	*32609	
Compressor #9 FLA%	AV:440	C9_FLA%	*30572	*ADF:441
Compressor #9 Sat Suction	AV: 443	C9_Sat Suct	*30584	*ADF: 442
Compressor #9 Sat Disch	AV: 444	C9_Sat Disch	*30586	*ADF: 443
Compressor #9 Disch SH	AV: 445	C9_Disch SH	*30587	*ADF: 444
Compressor #9 Suct SH	AV: 446	C9_Suct SH	*30585	*ADF: 445
Compressor #9 Oil Pres Diff	AV:524	C9_Oil Pres Diff	*30656	*ADF:525
Compressor #9 Comp State Timer		C9_Comp State Timer	*32610	
Compressor #10 FLA%	AV:447	C10_FLA%	*30573	*ADF:448
Compressor #10 Sat Suction	AV: 450	C10_Sat Suct	*30588	*ADF: 451
Compressor #10 Sat Disch	AV: 451	C10_Sat Disch	*30590	*ADF: 452
Compressor #10 Disch SH	AV: 452	C10_Disch SH	*30591	*ADF: 453
Compressor #10 Suct SH	AV: 453	C10_Suct SH	*30589	*ADF: 454
Compressor #10 Oil Pres Diff	AV:525	C10_Oil Pres Diff	*30657	*ADF:526
Compressor #10 Comp State Timer		C10_Comp State Timer	*32611	
Compressor #11 FLA%	AV:454	C11_FLA%	*30574	*ADF:455
Compressor #11 Sat Suction	AV: 457	C11_Sat Suct	*30592	*ADF: 458
Compressor #11 Sat Disch	AV: 458	C11_Sat Disch	*30594	*ADF: 459
Compressor #11 Disch SH	AV: 459	C11_Disch SH	*30595	*ADF: 460
Compressor #11 Suct SH	AV: 460	C11_Suct SH	*30593	*ADF: 461
Compressor #11 Oil Pres Diff	AV: 526	C11_Oil Pres Diff	*30658	*ADF: 527

Magnum	BACnet ID	BACnet Name	Modbus	N2
Compressor #11 Comp State Timer		C11_Comp State Timer	*32612	
Compressor #12 FLA%	AV: 461	C12_FLA%	*30575	*ADF: 462
Compressor #12 Sat Suction	AV: 464	C12_Sat Suct	*30596	*ADF: 465
Compressor #12 Sat Disch	AV: 465	C12_Sat Disch	*30598	*ADF: 466
Compressor #12 Disch SH	AV: 466	C12_Disch SH	*30599	*ADF: 467
Compressor #12 Suct SH	AV: 467	C12_Suct SH	*30597	*ADF: 468
Compressor #12 Oil Pres Diff	AV:527	C12_Oil Pres Diff	*30659	*ADF:528
Compressor #12 Comp State Timer		C12_Comp State Timer	*32613	
Compressor #13 FLA%	AV:468	C13_FLA%	*30576	*ADF:469
Compressor #13 Sat Suction	AV: 471	C13_Sat Suct	*30600	*ADF: 470
Compressor #13 Sat Disch	AV: 472	C13_Sat Disch	*30602	*ADF: 473
Compressor #13 Disch SH	AV: 473	C13_Disch SH	*30603	*ADF: 474
Compressor #13 Suct SH	AV: 474	C13_Suct SH	*30600	*ADF: 475
Compressor #13 Oil Pres Diff	AV: 528	C13_Oil Pres Diff	*30661	*ADF: 529
Compressor #13 Comp State Timer		C13_Comp State Timer	*32614	
Compressor #14 FLA%	AV: 475	C14_FLA%	*30577	*ADF: 476
Compressor #14 Sat Suction	AV: 478	C14_Sat Suct	*30604	*ADF: 479
Compressor #14 Sat Disch	AV: 479	C14_Sat Disch	*30606	*ADF: 480
Compressor #14 Disch SH	AV: 480	C14_Disch SH	*30607	*ADF: 481
Compressor #14 Suct SH	AV: 481	C14_Suct SH	*30605	*ADF: 482
Compressor #14 Oil Pres Diff	AV: 529	C14_Oil Pres Diff	*30661	*ADF: 530
Compressor #14 Comp State Timer		C14_Comp State Timer	*32615	
Compressor #15 FLA%	AV: 482	C15_FLA%	*30578	*ADF: 483
Compressor #15 Sat Suction	AV: 485	C15_Sat Suct	*30608	*ADF: 486
Compressor #15 Sat Disch	AV: 486	C15_Sat Disch	*30610	*ADF: 487
Compressor #15 Disch SH	AV: 487	C15_Disch SH	*30611	*ADF: 488
Compressor #15 Suct SH	AV: 488	C15_Suct SH	*30609	*ADF: 489
Compressor #15 Oil Pres Diff	AV: 530	C15_Oil Pres Diff	*30662	*ADF: 531
Compressor #15 Comp State Timer		C15_Comp State Timer	*32616	
Compressor #16 FLA%	AV: 489	C16_FLA%	*30579	*ADF: 490
Compressor #16 Sat Suction	AV: 492	C16_Sat Suct	*30612	*ADF: 493
Compressor #16 Sat Disch	AV: 493	C16_Sat Disch	*30614	*ADF: 494
Compressor #16 Disch SH	AV: 494	C16_Disch SH	*30615	*ADF: 495
Compressor #16 Suct SH	AV: 495	C16_Suct SH	*30613	*ADF: 496
Compressor #16 Oil Pres Diff	AV: 531	C16_Oil Pres Diff	*30663	*ADF: 532
Compressor #16 Comp State Timer		C16_Comp State Timer	*32617	
Compressor #17 FLA%	AV: 496	C17_FLA%	*30580	*ADF: 497
Compressor #17 Sat Suction	AV: 499	C17_Sat Suct	*30616	*ADF: 500
Compressor #17 Sat Disch	AV: 500	C17_Sat Disch	*30618	*ADF: 501
Compressor #17 Disch SH	AV: 501	C17_Disch SH	*30619	*ADF: 502
Compressor #17 Suct SH	AV: 502	C17_Suct SH	*30617	*ADF: 503
Compressor #17 Oil Pres Diff	AV: 532	C17_Oil Pres Diff	*30664	*ADF: 533
Compressor #17 Comp State Timer		C17_Comp State Timer	*32618	
Compressor #18 FLA%	AV: 503	C18_FLA%	*30581	*ADF: 504
Compressor #18 Sat Suction	AV: 506	C18_Sat Suct	*30620	*ADF: 507
Compressor #18 Sat Disch	AV: 507	C18_Sat Disch	*30622	*ADF: 508
Compressor #18 Disch SH	AV: 508	C18_Disch SH	*30623	*ADF: 509
Compressor #18 Suct SH	AV: 509	C18_Suct SH	*30621	*ADF: 510
Compressor #18 Oil Pres Diff	AV: 533	C18_Oil Pres Diff	*30665	*ADF: 534
Compressor #18 Comp State Timer		C18_Comp State Timer	*32619	
Compressor #19 FLA%	AV: 510	C19_FLA%	*30582	*ADF: 511

Magnum	BACnet ID	BACnet Name	Modbus	N2
Compressor #19 Sat Suction	AV: 513	C19_Sat Suct	*30624	*ADF: 514
Compressor #19 Sat Disch	AV: 514	C19_Sat Disch	*30626	*ADF: 515
Compressor #19 Disch SH	AV: 515	C19_Disch SH	*30627	*ADF: 516
Compressor #19 Suct SH	AV: 516	C19_Suct SH	*30625	*ADF: 517
Compressor #19 Oil Pres Diff	AV: 534	C19_Oil Pres Diff	*30666	*ADF: 535
Compressor #19 Comp State Timer		C19_Comp State Timer	*32620	
Compressor #20 FLA%	AV: 517	C20_FLA%	*30583	*ADF: 518
Compressor #20 Sat Suction	AV: 520	C20_Sat Suct	*30628	*ADF: 521
Compressor #20 Sat Disch	AV: 521	C20_Sat Disch	*30630	*ADF: 522
Compressor #20 Disch SH	AV: 522	C20_Disch SH	*30631	*ADF: 523
Compressor #20 Suct SH	AV: 523	C20_Suct SH	*30629	*ADF: 524
Compressor #20 Oil Pres Diff	AV: 535	C20_Oil Pres Diff	*30667	*ADF: 536
Compressor #20 Comp State Timer		C21_Comp State Timer	*32621	

*- Indicates value multiplied by 10 to include one decimal place. (I.e. BMS value of 500 indicates actual value 50.0)

27.7. Unit Alarms

Unit Alarms	Modbus Info		Bacnet Object Identifier		V17 Firmware		
	Function Type	Register	Bacnet Object Type	Address	Relay output	Modbus	Bacnet
EMERGENCY_STOP	04:input Register	31011	AV: Analog Value	1296	HVAC//RTU	HVAC//RTU	HVAC//RTU
FREEZE_PROTECTION	04:input Register	31012	AV: Analog Value	1297	HVAC//RTU	HVAC//RTU	HVAC//RTU
HIGH_SUMP_TEMP	04:input Register	31013	AV: Analog Value	1298	HVAC//RTU	HVAC//RTU	HVAC//RTU
PHASE_LOSS	04:input Register	31014	AV: Analog Value	1299	HVAC//RTU	HVAC//RTU	HVAC//RTU
HIGH_DELTA_TEMP	04:input Register	31015	AV: Analog Value	1300	HVAC/	HVAC/	HVAC/
VOLTAGE	04:input Register	31016	AV: Analog Value	1301	HVAC//RTU	HVAC//RTU	HVAC//RTU
SMOKE_ALARM	04:input Register	31017	AV: Analog Value	1302	No Support	No Support	No Support
FIRE_ALARM	04:input Register	31018	AV: Analog Value	1303	HVAC//RTU	HVAC//RTU	HVAC//RTU
COMMON_CONDENSER	04:input Register	31019	AV: Analog Value	1304	HVAC//RTU	HVAC//RTU	HVAC//RTU
CIRCUIT_CONDENSER	04:input Register	31020	AV: Analog Value	1305	HVAC//RTU	HVAC//RTU	HVAC//RTU
Fuild Cooler Fan Fault	04:input Register	31021	AV: Analog Value	1306	HVAC//RTU	HVAC//RTU	HVAC//RTU
PUMP_FAILURE	04:input Register	31022	AV: Analog Value	1307	HVAC//RTU	HVAC//RTU	HVAC//RTU
PROCESS_PUMP_FAILURE	04:input Register	31023	AV: Analog Value	1308	HVAC//RTU	HVAC//RTU	HVAC//RTU
PROCESS_PUMP_LOW_FLOW	04:input Register	31024	AV: Analog Value	1309	HVAC	HVAC	HVAC
BOILER_PUMP_FAULT	04:input Register	31025	AV: Analog Value	1310	HVAC	HVAC	HVAC
BOILER_PUMP_HIGH_AMPS	04:input Register	31026	AV: Analog Value	1311	HVAC	HVAC	HVAC
BOILER_PUMP_LOW_AMPS	04:input Register	31027	AV: Analog Value	1312	HVAC	HVAC	HVAC
BOILER_STAGE_FAULT	04:input Register	31028	AV: Analog Value	1313	HVAC	HVAC	HVAC
HIGH_WATER_TEMP	04:input Register	31029	AV: Analog Value	1314	HVAC//RTU	HVAC//RTU	HVAC//RTU
OVERHEAT_PROTECTION	04:input Register	31030	AV: Analog Value	1315	HVAC	HVAC	HVAC
RTU_SUPPLY_DUCT	04:input Register	31031	AV: Analog Value	1316	RTU	RTU	RTU
RTU_EXHAUST_FAN_FAULT	04:input Register	31032	AV: Analog Value	1317	RTU	RTU	RTU
RTU_MOD_GAS_HEATER_FAULT	04:input Register	31033	AV: Analog Value	1318	RTU	RTU	RTU
RTU_SCR_HEATER_FAULT	04:input Register	31034	AV: Analog Value	1319	RTU	RTU	RTU
RTU_CLOGGED_FILTER	04:input Register	31035	AV: Analog Value	1320	RTU	RTU	RTU
RTU_HIGH_STATIC_PRESSURE	04:input Register	31036	AV: Analog Value	1321	RTU	RTU	RTU
RTU_LOW_STATIC_PRESSURE	04:input Register	31037	AV: Analog Value	1322	RTU	RTU	RTU
BOILER_PUMP_FLOW_FAULT	04:input Register	31038	AV: Analog Value	1323	HVAC	HVAC	HVAC
Leaving Water Temp. Sensor Fault	04:input Register	31039	AV: Analog Value	1324	HVAC//RTU	HVAC//RTU	HVAC//RTU
Reutrn Water Temp. Sensor Fault	04:input Register	31040	AV: Analog Value	1325	HVAC//RTU	HVAC//RTU	HVAC//RTU
Evap Water Pressure In #1 Sensor Fault	04:input Register	31041	AV: Analog Value	1326	HVAC//RTU	HVAC//RTU	HVAC//RTU
Evap Water Pressure Out #1 Sensor Fault	04:input Register	31042	AV: Analog Value	1327	HVAC//RTU	HVAC//RTU	HVAC//RTU
Evap Water Pressure In #2 Sensor Fault	04:input Register	31043	AV: Analog Value	1328	HVAC//RTU	HVAC//RTU	HVAC//RTU
Evap Water Pressure Out #2 Sensor Fault	04:input Register	31044	AV: Analog Value	1329	HVAC//RTU	HVAC//RTU	HVAC//RTU
RTU Zone Temp. Sensor Fault	04:input Register	31045	AV: Analog Value	1330	HVAC//RTU	HVAC//RTU	HVAC//RTU
RTU Ambient Temp. Sensor Fault	04:input Register	31046	AV: Analog Value	1331	HVAC//RTU	HVAC//RTU	HVAC//RTU

27.8. Compressor Alarms

Compressor Alarms	V17 Firmware Supporting Alarm Indicators		
	Relay output	Modbus	Bacnet
LOW_SUCTION	HVAC/RTU	HVAC/RTU	HVAC/RTU
UNSAFE_SUCTION	HVAC/RTU	HVAC/RTU	HVAC/RTU
HIGH_DISCHARGE_PSI	HVAC/RTU	HVAC/RTU	HVAC/RTU
HIGH_DISCHARGE_TEMP	HVAC/RTU	HVAC/RTU	HVAC/RTU
LOW_OIL_PSI	HVAC/RTU	HVAC/RTU	HVAC/RTU
UNSAFE_OIL_PSI	HVAC/RTU	HVAC/RTU	HVAC/RTU
HIGH_OIL_TEMP	HVAC/RTU	HVAC/RTU	HVAC/RTU
DIRTY_OIL_FILTER	HVAC/RTU	HVAC/RTU	HVAC/RTU
HIGH_OIL_SEAL_TEMP	HVAC/RTU	HVAC/RTU	HVAC/RTU
NO_CRANK_CASE_HEATER_PROOF	Not Supported	Not Supported	Not Supported
HIGH_AMPS	HVAC/RTU	HVAC/RTU	HVAC/RTU
LOW_AMPS	HVAC/RTU	HVAC/RTU	HVAC/RTU
HIGH_MOTOR_TEMP	HVAC/RTU	HVAC/RTU	HVAC/RTU
NO_COMPRESSOR_PROOF	HVAC/RTU	HVAC/RTU	HVAC/RTU
LOW_OIL_SUPERHEAT (Not Supported -no code)	Not Supported	Not Supported	Not Supported
PUMP_DOWN	HVAC/RTU	HVAC/RTU	HVAC/RTU
LOW_DISCHARGE_PSI	HVAC/RTU	HVAC/RTU	HVAC/RTU
LUBE_OIL_TEMP	HVAC/RTU	HVAC/RTU	HVAC/RTU
LUBE_OIL_PSI	HVAC/RTU	HVAC/RTU	HVAC/RTU
LUBE_OIL_TIME	HVAC/RTU	HVAC/RTU	HVAC/RTU
REFRIGERATION_LEAK	HVAC/RTU	HVAC/RTU	HVAC/RTU
LOW_REFRIGERATION_TEMP	HVAC/RTU	HVAC/RTU	HVAC/RTU
TOO_MANY_PURGES	HVAC/RTU	HVAC/RTU	HVAC/RTU
EXCESS_PURGING_TIME	HVAC/RTU	HVAC/RTU	HVAC/RTU
PURGE_FLOAT_ERROR	Not Supported	Not Supported	Not Supported
LOW_DIFFERENTIAL_PSI_RATIO	HVAC/RTU	HVAC/RTU	HVAC/RTU
LOW_SUPERHEAT	HVAC/RTU	HVAC/RTU	HVAC/RTU
LOW_DISCHARGE_SUPERHEAT	HVAC/RTU	HVAC/RTU	HVAC/RTU
LOST_LEG_PART_WINDING	HVAC/RTU	HVAC/RTU	HVAC/RTU
HIGH_PARTS_PER_MILLION_LEAK	Not Supported	Not Supported	Not Supported
HIGH_REFRIGERATION_LEVEL	HVAC/RTU	HVAC/RTU	HVAC/RTU
LOW_OIL_LEVEL	HVAC/RTU	HVAC/RTU	HVAC/RTU
NO_FLOW	Not Supported	Not Supported	Not Supported
OIL_FLOW	HVAC/RTU	HVAC/RTU	HVAC/RTU
COMPRESSOR_SPEED_FAULT	HVAC/RTU	HVAC/RTU	HVAC/RTU
LOW_TANDEM_SUPERHEAT	Not Supported	Not Supported	Not Supported
HIGH_TANDEM_SUPERHEAT	Not Supported	Not Supported	Not Supported
EXCESS_SURGES	HVAC/RTU	HVAC/RTU	HVAC/RTU

	V17 Firmware Supporting Alarm Indicators		
Compressor Alarms	Relay output	Modbus	Bacnet
HIGH_SUPERHEAT	HVAC/RTU	HVAC/RTU	HVAC/RTU
Suction Temperature Sensor Fault	HVAC/RTU	HVAC/RTU	HVAC/RTU
Discharge Temperature Sensor Fault	HVAC/RTU	HVAC/RTU	HVAC/RTU
Suction Pressure Sensor Fault	HVAC/RTU	HVAC/RTU	HVAC/RTU
Discharge Pressure Sensor Fault	HVAC/RTU	HVAC/RTU	HVAC/RTU
Oil Pressure Sensor Sensor Fault	HVAC/RTU	HVAC/RTU	HVAC/RTU
Oil Temperature Sensor Fault	HVAC/RTU	HVAC/RTU	HVAC/RTU
Motor Temperature Sensor Fault	HVAC/RTU	HVAC/RTU	HVAC/RTU
Evap Refrigerant Temperature Sensor Fault	HVAC/RTU	HVAC/RTU	HVAC/RTU
Evap Refrigerant Level Sensor Fault	HVAC/RTU	HVAC/RTU	HVAC/RTU
Oil Seal Temperature Sensor Fault	HVAC/RTU	HVAC/RTU	HVAC/RTU
Pre-Oil Filter Presssure Sensor Fault	HVAC/RTU	HVAC/RTU	HVAC/RTU
Circuit Leaving Water Sensor Fault	HVAC/RTU	HVAC/RTU	HVAC/RTU

Modbus Register

Alarms	Modbus Function Type	Comp. #1	Comp. #2	Comp. #3	Comp. #4	Comp. #5	Comp. #6	Comp. #7	Comp. #8	Comp. #9	Comp. #10	Comp. #11	Comp. #12	Comp. #13	Comp. #14	Comp. #15	Comp. #16	Comp. #17	Comp. #18	Comp. #19	Comp. #20
LOW_SUCTION	04:input Register	31201	31252	31303	31354	31405	31456	31507	31558	31609	31660	31711	31762	31813	31864	31915	31966	32017	32068	32119	32170
UNSAFE_SUCTION	04:input Register	31202	31253	31304	31355	31406	31457	31508	31559	31610	31661	31712	31763	31814	31865	31916	31967	32018	32069	32120	32171
HIGH_DISCHARGE_PSI	04:input Register	31203	31254	31305	31356	31407	31458	31509	31560	31611	31662	31713	31764	31815	31866	31917	31968	32019	32070	32121	32172
HIGH_DISCHARGE_TEMP	04:input Register	31204	31255	31306	31357	31408	31459	31510	31561	31612	31663	31714	31765	31816	31867	31918	31969	32020	32071	32122	32173
LOW_OIL_PSI	04:input Register	31205	31256	31307	31358	31409	31460	31511	31562	31613	31664	31715	31766	31817	31868	31919	31970	32021	32072	32123	32174
UNSAFE_OIL_PSI	04:input Register	31206	31257	31308	31359	31410	31461	31512	31563	31614	31665	31716	31767	31818	31869	31920	31971	32022	32073	32124	32175
HIGH_OIL_TEMP	04:input Register	31207	31258	31309	31360	31411	31462	31513	31564	31615	31666	31717	31768	31819	31870	31921	31972	32023	32074	32125	32176
DIRTY_OIL_FILTER	04:input Register	31208	31259	31310	31361	31412	31463	31514	31565	31616	31667	31718	31769	31820	31871	31922	31973	32024	32075	32126	32177
HIGH_OIL_SEAL_TEMP	04:input Register	31209	31260	31311	31362	31413	31464	31515	31566	31617	31668	31719	31770	31821	31872	31923	31974	32025	32076	32127	32178
NO_CRANK_CASE_HEATER_PROOF	04:input Register	31210	31261	31312	31363	31414	31465	31516	31567	31618	31669	31720	31771	31822	31873	31924	31975	32026	32077	32128	32179
HIGH_AMPS	04:input Register	31211	31262	31313	31364	31415	31466	31517	31568	31619	31670	31721	31772	31823	31874	31925	31976	32027	32078	32129	32180
LOW_AMPS	04:input Register	31212	31263	31314	31365	31416	31467	31518	31569	31620	31671	31722	31773	31824	31875	31926	31977	32028	32079	32130	32181
HIGH_MOTOR_TEMP	04:input Register	31213	31264	31315	31366	31417	31468	31519	31570	31621	31672	31723	31774	31825	31876	31927	31978	32029	32080	32131	32182
NO_COMPRESSOR_PROOF	04:input Register	31214	31265	31316	31367	31418	31469	31520	31571	31622	31673	31724	31775	31826	31877	31928	31979	32030	32081	32132	32183
LOW_OIL_SUPERHEAT	04:input Register	31215	31266	31317	31368	31419	31470	31521	31572	31623	31674	31725	31776	31827	31878	31929	31980	32031	32082	32133	32184
PUMP_DOWN	04:input Register	31216	31267	31318	31369	31420	31471	31522	31573	31624	31675	31726	31777	31828	31879	31930	31981	32032	32083	32134	32185
LOW_DISCHARGE_PSI	04:input Register	31217	31268	31319	31370	31421	31472	31523	31574	31625	31676	31727	31778	31829	31880	31931	31982	32033	32084	32135	32186
LUBE_OIL_TEMP	04:input Register	31218	31269	31320	31371	31422	31473	31524	31575	31626	31677	31728	31779	31830	31881	31932	31983	32034	32085	32136	32187
LUBE_OIL_PSI	04:input Register	31219	31270	31321	31372	31423	31474	31525	31576	31627	31678	31729	31780	31831	31882	31933	31984	32035	32086	32137	32188
LUBE_OIL_TIME	04:input Register	31220	31271	31322	31373	31424	31475	31526	31577	31628	31679	31730	31781	31832	31883	31934	31985	32036	32087	32138	32189
REFRIGERATION_LEAK	04:input Register	31221	31272	31323	31374	31425	31476	31527	31578	31629	31680	31731	31782	31833	31884	31935	31986	32037	32088	32139	32190
LOW_REFRIGERATION_TEMP	04:input Register	31222	31273	31324	31375	31426	31477	31528	31579	31630	31681	31732	31783	31834	31885	31936	31987	32038	32089	32140	32191
TOO_MANY_PURGES	04:input Register	31223	31274	31325	31376	31427	31478	31529	31580	31631	31682	31733	31784	31835	31886	31937	31988	32039	32090	32141	32192
EXCESS_PURGING_TIME	04:input Register	31224	31275	31326	31377	31428	31479	31530	31581	31632	31683	31734	31785	31836	31887	31938	31989	32040	32091	32142	32193
PURGE_FLOAT_ERROR	04:input Register	31225	31276	31327	31378	31429	31480	31531	31582	31633	31684	31735	31786	31837	31888	31939	31990	32041	32092	32143	32194
LOW_DIFFERENTIAL_PSI_RATIO	04:input Register	31226	31277	31328	31379	31430	31481	31532	31583	31634	31685	31736	31787	31838	31889	31940	31991	32042	32093	32144	32195
LOW_SUPERHEAT	04:input Register	31227	31278	31329	31380	31431	31482	31533	31584	31635	31686	31737	31788	31839	31890	31941	31992	32043	32094	32145	32196
LOW_DISCHARGE_SUPERHEAT	04:input Register	31228	31279	31330	31381	31432	31483	31534	31585	31636	31687	31738	31789	31840	31891	31942	31993	32044	32095	32146	32197
LOST_LEG_PART_WINDING	04:input Register	31229	31280	31331	31382	31433	31484	31535	31586	31637	31688	31739	31790	31841	31892	31943	31994	32045	32096	32147	32198
HIGH_PARTS_PER_MILLION_LEAK	04:input Register	31230	31281	31332	31383	31434	31485	31536	31587	31638	31689	31740	31791	31842	31893	31944	31995	32046	32097	32148	32199
HIGH_REFRIGERATION_LEVEL	04:input Register	31231	31282	31333	31384	31435	31486	31537	31588	31639	31690	31741	31792	31843	31894	31945	31996	32047	32098	32149	32200
LOW_OIL_LEVEL	04:input Register	31232	31283	31334	31385	31436	31487	31538	31589	31640	31691	31742	31793	31844	31895	31946	31997	32048	32099	32150	32201
NO_FLOW	04:input Register	31233	31284	31335	31386	31437	31488	31539	31590	31641	31692	31743	31794	31845	31896	31947	31998	32049	32100	32151	32202
OIL_FLOW	04:input Register	31234	31285	31336	31387	31438	31489	31540	31591	31642	31693	31744	31795	31846	31897	31948	31999	32050	32101	32152	32203

Modbus Register

Alarms	Modbus Function Type	Comp. #1	Comp. #2	Comp. #3	Comp. #4	Comp. #5	Comp. #6	Comp. #7	Comp. #8	Comp. #9	Comp. #10	Comp. #11	Comp. #12	Comp. #13	Comp. #14	Comp. #15	Comp. #16	Comp. #17	Comp. #18	Comp. #19	Comp. #20
COMPRESSOR_SPEED_FAULT	04:input Register	31235	31286	31337	31388	31439	31490	31541	31592	31643	31694	31745	31796	31847	31898	31949	32000	32051	32102	32153	32204
LOW_TANDEM_SUPERHEAT	04:input Register	31236	31287	31338	31389	31440	31491	31542	31593	31644	31695	31746	31797	31848	31899	31950	32001	32052	32103	32154	32205
HIGH_TANDEM_SUPERHEAT	04:input Register	31237	31288	31339	31390	31441	31492	31543	31594	31645	31696	31747	31798	31849	31900	31951	32002	32053	32104	32155	32206
EXCESS_SURGES	04:input Register	31238	31289	31340	31391	31442	31493	31544	31595	31646	31697	31748	31799	31850	31901	31952	32003	32054	32105	32156	32207
HIGH_SUPERHEAT	04:input Register	31239	31290	31341	31392	31443	31494	31545	31596	31647	31698	31749	31800	31851	31902	31953	32004	32055	32106	32157	32208
Suction Temperature Sensor Fault	04:input Register	31240	31291	31342	31393	31444	31495	31546	31597	31648	31699	31750	31801	31852	31903	31954	32005	32056	32107	32158	32209
Discharge Temperature Sensor Fault	04:input Register	31241	31292	31343	31394	31445	31496	31547	31598	31649	31700	31751	31802	31853	31904	31955	32006	32057	32108	32159	32210
Suction Pressure Sensor Fault	04:input Register	31242	31293	31344	31395	31446	31497	31548	31599	31650	31701	31752	31803	31854	31905	31956	32007	32058	32109	32160	32211
Discharge Pressure Sensor Fault	04:input Register	31243	31294	31345	31396	31447	31498	31549	31600	31651	31702	31753	31804	31855	31906	31957	32008	32059	32110	32161	32212
Oil Pressure Sensor Sensor Fault	04:input Register	31244	31295	31346	31397	31448	31499	31550	31601	31652	31703	31754	31805	31856	31907	31958	32009	32060	32111	32162	32213
Oil Temperature Sensor Fault	04:input Register	31245	31296	31347	31398	31449	31500	31551	31602	31653	31704	31755	31806	31857	31908	31959	32010	32061	32112	32163	32214
Motor Temperature Sensor Fault	04:input Register	31246	31297	31348	31399	31450	31501	31552	31603	31654	31705	31756	31807	31858	31909	31960	32011	32062	32113	32164	32215
Evap Refrigerant Temp. Sensor Fault	04:input Register	31247	31298	31349	31400	31451	31502	31553	31604	31655	31706	31757	31808	31859	31910	31961	32012	32063	32114	32165	32216
Evap Refrigerant Level Sensor Fault	04:input Register	31248	31299	31350	31401	31452	31503	31554	31605	31656	31707	31758	31809	31860	31911	31962	32013	32064	32115	32166	32217
Oil Seal Temperature Sensor Fault	04:input Register	31249	31300	31351	31402	31453	31504	31555	31606	31657	31708	31759	31810	31861	31912	31963	32014	32065	32116	32167	32218
Pre-Oil Filter Presssure Sensor Fault	04:input Register	31250	31301	31352	31403	31454	31505	31556	31607	31658	31709	31760	31811	31862	31913	31964	32015	32066	32117	32168	32219
Circuit Leaving Water Sensor Fault	04:input Register	31251	31302	31353	31404	31455	31506	31557	31608	31659	31710	31761	31812	31863	31914	31965	32016	32067	32118	32169	32220

Bacnet Object Identifier

	Bacnet Object Type	Comp. #1	Comp. #2	Comp. #3	Comp. #4	Comp. #5	Comp. #6	Comp. #7	Comp. #8	Comp. #9	Comp. #10	Comp. #11	Comp. #12	Comp. #13	Comp. #14	Comp. #15	Comp. #16	Comp. #17	Comp. #18	Comp. #19	Comp. #20	
Alarms																						
LOW_SUCTION	Analog Value	1396	1447	1498	1549	1600	1651	1702	1753	1804	1855	1906	1957	2008	2059	2110	2161	2212	2263	2314	2365	
UNSAFE_SUCTION	Analog Value	1397	1448	1499	1550	1601	1652	1703	1754	1805	1856	1907	1958	2009	2060	2111	2162	2213	2264	2315	2366	
HIGH_DISCHARGE_PSI	Analog Value	1398	1449	1500	1551	1602	1653	1704	1755	1806	1857	1908	1959	2010	2061	2112	2163	2214	2265	2316	2367	
HIGH_DISCHARGE_TEMP	Analog Value	1399	1450	1501	1552	1603	1654	1705	1756	1807	1858	1909	1960	2011	2062	2113	2164	2215	2266	2317	2368	
LOW_OIL_PSI	Analog Value	1400	1451	1502	1553	1604	1655	1706	1757	1808	1859	1910	1961	2012	2063	2114	2165	2216	2267	2318	2369	
UNSAFE_OIL_PSI	Analog Value	1401	1452	1503	1554	1605	1656	1707	1758	1809	1860	1911	1962	2013	2064	2115	2166	2217	2268	2319	2370	
HIGH_OIL_TEMP	Analog Value	1402	1453	1504	1555	1606	1657	1708	1759	1810	1861	1912	1963	2014	2065	2116	2167	2218	2269	2320	2371	
DIRTY_OIL_FILTER	Analog Value	1403	1454	1505	1556	1607	1658	1709	1760	1811	1862	1913	1964	2015	2066	2117	2168	2219	2270	2321	2372	
HIGH_OIL_SEAL_TEMP	Analog Value	1404	1455	1506	1557	1608	1659	1710	1761	1812	1863	1914	1965	2016	2067	2118	2169	2220	2271	2322	2373	
NO_CRANK_CASE_HEATER_PROOF	Analog Value	1405	1456	1507	1558	1609	1660	1711	1762	1813	1864	1915	1966	2017	2068	2119	2170	2221	2272	2323	2374	
HIGH_AMPS	Analog Value	1406	1457	1508	1559	1610	1661	1712	1763	1814	1865	1916	1967	2018	2069	2120	2171	2222	2273	2324	2375	
LOW_AMPS	Analog Value	1407	1458	1509	1560	1611	1662	1713	1764	1815	1866	1917	1968	2019	2070	2121	2172	2223	2274	2325	2376	
HIGH_MOTOR_TEMP	Analog Value	1408	1459	1510	1561	1612	1663	1714	1765	1816	1867	1918	1969	2020	2071	2122	2173	2224	2275	2326	2377	
NO_COMPRESSOR_PROOF	Analog Value	1409	1460	1511	1562	1613	1664	1715	1766	1817	1868	1919	1970	2021	2072	2123	2174	2225	2276	2327	2378	
LOW_OIL_SUPERHEAT	Analog Value	1410	1461	1512	1563	1614	1665	1716	1767	1818	1869	1920	1971	2022	2073	2124	2175	2226	2277	2328	2379	
PUMP_DOWN	Analog Value	1411	1462	1513	1564	1615	1666	1717	1768	1819	1870	1921	1972	2023	2074	2125	2176	2227	2278	2329	2380	
LOW_DISCHARGE_PSI	Analog Value	1412	1463	1514	1565	1616	1667	1718	1769	1820	1871	1922	1973	2024	2075	2126	2177	2228	2279	2330	2381	
LUBE_OIL_TEMP	Analog Value	1413	1464	1515	1566	1617	1668	1719	1770	1821	1872	1923	1974	2025	2076	2127	2178	2229	2280	2331	2382	
LUBE_OIL_PSI	Analog Value	1414	1465	1516	1567	1618	1669	1720	1771	1822	1873	1924	1975	2026	2077	2128	2179	2230	2281	2332	2383	
LUBE_OIL_TIME	Analog Value	1415	1466	1517	1568	1619	1670	1721	1772	1823	1874	1925	1976	2027	2078	2129	2180	2231	2282	2333	2384	
REFRIGERATION_LEAK	Analog Value	1416	1467	1518	1569	1620	1671	1722	1773	1824	1875	1926	1977	2028	2079	2130	2181	2232	2283	2334	2385	
LOW_REFRIGERATION_TEMP	Analog Value	1417	1468	1519	1570	1621	1672	1723	1774	1825	1876	1927	1978	2029	2080	2131	2182	2233	2284	2335	2386	
TOO_MANY_PURGES	Analog Value	1418	1469	1520	1571	1622	1673	1724	1775	1826	1877	1928	1979	2030	2081	2132	2183	2234	2285	2336	2387	
EXCESS_PURGING_TIME	Analog Value	1419	1470	1521	1572	1623	1674	1725	1776	1827	1878	1929	1980	2031	2082	2133	2184	2235	2286	2337	2388	
PURGE_FLOAT_ERROR	Analog Value	1420	1471	1522	1573	1624	1675	1726	1777	1828	1879	1930	1981	2032	2083	2134	2185	2236	2287	2338	2389	
LOW_DIFFERENTIAL_PSI_RATIO	Analog Value	1421	1472	1523	1574	1625	1676	1727	1778	1829	1880	1931	1982	2033	2084	2135	2186	2237	2288	2339	2390	
LOW_SUPERHEAT	Analog Value	1422	1473	1524	1575	1626	1677	1728	1779	1830	1881	1932	1983	2034	2085	2136	2187	2238	2289	2340	2391	
LOW_DISCHARGE_SUPERHEAT	Analog Value	1423	1474	1525	1576	1627	1678	1729	1780	1831	1882	1933	1984	2035	2086	2137	2188	2239	2290	2341	2392	
LOST_LEG_PART_WINDING	Analog Value	1424	1475	1526	1577	1628	1679	1730	1781	1832	1883	1934	1985	2036	2087	2138	2189	2240	2291	2342	2393	
HIGH_PARTS_PER_MILLION_LEAK	Analog Value	1425	1476	1527	1578	1629	1680	1731	1782	1833	1884	1935	1986	2037	2088	2139	2190	2241	2292	2343	2394	
HIGH_REFRIGERATION_LEVEL	Analog Value	1426	1477	1528	1579	1630	1681	1732	1783	1834	1885	1936	1987	2038	2089	2140	2191	2242	2293	2344	2395	
LOW_OIL_LEVEL	Analog Value	1427	1478	1529	1580	1631	1682	1733	1784	1835	1886	1937	1988	2039	2090	2141	2192	2243	2294	2345	2396	
NO_FLOW	Analog Value	1428	1479	1530	1581	1632	1683	1734	1785	1836	1887	1938	1989	2040	2091	2142	2193	2244	2295	2346	2397	
OIL_FLOW	Analog Value	1429	1480	1531	1582	1633	1684	1735	1786	1837	1888	1939	1990	2041	2092	2143	2194	2245	2296	2347	2398	

Bacnet Object Identifier

Alarms	Bacnet Object Type	Comp. #1	Comp. #2	Comp. #3	Comp. #4	Comp. #5	Comp. #6	Comp. #7	Comp. #8	Comp. #9	Comp. #10	Comp. #11	Comp. #12	Comp. #13	Comp. #14	Comp. #15	Comp. #16	Comp. #17	Comp. #18	Comp. #19	Comp. #20
COMPRESSOR_SPEED_FAULT	Analog Value	1430	1481	1532	1583	1634	1685	1736	1787	1838	1889	1940	1991	2042	2093	2144	2195	2246	2297	2348	2399
LOW_TANDEM_SUPERHEAT	Analog Value	1431	1482	1533	1584	1635	1686	1737	1788	1839	1890	1941	1992	2043	2094	2145	2196	2247	2298	2349	2400
HIGH_TANDEM_SUPERHEAT	Analog Value	1432	1483	1534	1585	1636	1687	1738	1789	1840	1891	1942	1993	2044	2095	2146	2197	2248	2299	2350	2401
EXCESS_SURGES	Analog Value	1433	1484	1535	1586	1637	1688	1739	1790	1841	1892	1943	1994	2045	2096	2147	2198	2249	2300	2351	2402
HIGH_SUPERHEAT	Analog Value	1434	1485	1536	1587	1638	1689	1740	1791	1842	1893	1944	1995	2046	2097	2148	2199	2250	2301	2352	2403
Suction Temperature Sensor Fault	Analog Value	1435	1486	1537	1588	1639	1690	1741	1792	1843	1894	1945	1996	2047	2098	2149	2200	2251	2302	2353	2404
Discharge Temperature Sensor Fault	Analog Value	1436	1487	1538	1589	1640	1691	1742	1793	1844	1895	1946	1997	2048	2099	2150	2201	2252	2303	2354	2405
Suction Pressure Sensor Fault	Analog Value	1437	1488	1539	1590	1641	1692	1743	1794	1845	1896	1947	1998	2049	2100	2151	2202	2253	2304	2355	2406
Discharge Pressure Sensor Fault	Analog Value	1438	1489	1540	1591	1642	1693	1744	1795	1846	1897	1948	1999	2050	2101	2152	2203	2254	2305	2356	2407
Oil Pressure Sensor Sensor Fault	Analog Value	1439	1490	1541	1592	1643	1694	1745	1796	1847	1898	1949	2000	2051	2102	2153	2204	2255	2306	2357	2408
Oil Temperature Sensor Fault	Analog Value	1440	1491	1542	1593	1644	1695	1746	1797	1848	1899	1950	2001	2052	2103	2154	2205	2256	2307	2358	2409
Motor Temperature Sensor Fault	Analog Value	1441	1492	1543	1594	1645	1696	1747	1798	1849	1900	1951	2002	2053	2104	2155	2206	2257	2308	2359	2410
Evap Refrigerant Temp. Sensor Fault	Analog Value	1442	1493	1544	1595	1646	1697	1748	1799	1850	1901	1952	2003	2054	2105	2156	2207	2258	2309	2360	2411
Evap Refrigerant Level Sensor Fault	Analog Value	1443	1494	1545	1596	1647	1698	1749	1800	1851	1902	1953	2004	2055	2106	2157	2208	2259	2310	2361	2412
Oil Seal Temperature Sensor Fault	Analog Value	1444	1495	1546	1597	1648	1699	1750	1801	1852	1903	1954	2005	2056	2107	2158	2209	2260	2311	2362	2413
Pre-Oil Filter Presssure Sensor Fault	Analog Value	1445	1496	1547	1598	1649	1700	1751	1802	1853	1904	1955	2006	2057	2108	2159	2210	2261	2312	2363	2414
Circuit Leaving Water Sensor Fault	Analog Value	1446	1497	1548	1599	1650	1701	1752	1803	1854	1905	1956	2007	2058	2109	2160	2211	2262	2313	2364	2415

27.9. Network inputs to MCS-Magnum

The MCS-Magnum can receive changes from the network to enable or disable the Network Run/Stop, Network Target Reset (adjustments to the Cooling Target, Setpoint #1, based on Setpoint #21), Network Demand FLA, and Network Demand Steps.

The MCS-Magnum must be setup to accept these inputs. The configuration file must contain a Network Run/Stop, Network Target, Network Demand FLA, and Network Demand Steps sensors.

Magnum	BACnet ID	BACnet Name	Modbus	N2
Network Run/Stop	AV:246	Net_R/S	40201	BO:247
Network Target/Reset	AV:247	Net_Tar/Res	40202	AO:248
Network Demand/FLA	AV:248	Net_Demad_FLA	40204	AO:249
Network Demand/Steps	AV:249	Net_Demad_Steps	40205	AO:250

Note the following Information panel has a Network Run/Stop, and /or Network Target Reset sensors inputs indicated. This is an example of how MCS-Config must be setup in the General Information and Evaporator Information panels.



The sensors must be set up as follows (This is only an example)

1-1	BMS R/S	BMS RUN	Not Used	Open=OFF	OFF/ON	Not Used	Not Used	Auto
1-2	BMS TRS	BMS CW RSET	0	0	Not Used	Not Used	Not Used	Auto
1-3	BMSFLA	BMS Dmd FLA%	0	0	Not Used	Not Used	Not Used	Auto
1-4	BMSSteps	BMS Dmd Step	0	0	Not Used	Not Used	Not Used	Auto

27.10. MCS-MAGNUM BMS PROTOCOLS

The following Protocols are available with the Magnum. Changes can be made to the settings using the Keypad or can be made using MCS-CONNECT SERVICE WINDOW.

1. BACnet IP
2. MCS PROTOCOL
3. MODBUS RTU PROTOCOL
4. ETHERNET PROTOCOL (this protocol is always active)
5. MODBUS IP (this protocol is always active)

27.10.1 BACNET OVER IP PROTOCOL

The BACNET DEVICE ID is a five-digit number. The first three digits are based on MCS's Bacnet Vendor ID 181, and the last two are set by the Bacnet/MSTP address.

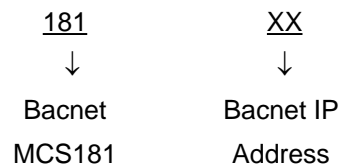

In case the end user would like to set up an ID other than 181-XX, there is an extended BACnet setting that can only be set in MCS Config.

The following changes can be made using the Keypad or can be made using MCS-CONNECT SERVICE WINDOW.

The **BACnet IP** address can be verified and changed (with the proper authorization code) from the Keypad/LCD. The following steps will display the Bacnet IP Network address, and the the TCP/IP port:

- Press the Menu key, select Serv Tools, and then press the Enter key.
- Use **↑** arrow to **BACnet Setting** then press Enter.
- Select address then press Enter. Change the address so it matches the last two digits of the device ID then press Enter.
- Use **↓** arrow to tab to the TCP/IP address.
- Select address then press Enter. Change the address and port to match your device.

27.10.2 ETHERNET NETWORK PROTOCOL

The following steps will display the **ETHERNET NETWORK** settings:

If you are going to manually assign the IP Address, Subnet Mask, and Default Gateway.

- Press the Menu key, select Serv Tools, and then press the Enter key.
- Select Ethernet Network then press Enter.
- Set "DYNAMIC IP" to NO.
- Set the "IP Address".
- Set the "Subnet Mask".
- Set "Default Gateway".
- Reset Magnum for change to take effect.

If you are going to let your network assign the IP Address, Subnet Mask, and Default Gateway.

- Press the Menu key, select Serv Tools, and then press the Enter key.
- Select Ethernet Network then press Enter.
- Set "DYNAMIC IP" to YES.
- Connect the MCS-Magnum to the network and power up the board.

27.10.3 MODBUS RTU PROTOCOL

The Modbus RTU address can be verified and changed (with the proper authorization code) from the keypad/LCD or can be made using MCS-CONNECT SERVICE WINDOW.

The following steps will display the Modbus RTU Network address, and the Baud Rate:

- Press the Menu key, select Serv Tools, and then press the Enter key.
- Select RS485 Network then press Enter.
- Select Protocol then press Enter. Change the protocol to Modbus RTU.
- Select address then press Enter. Change the address then press Enter.
- Select Baud then press Enter. Set the baud rate then press Enter.
- Connect the communication wires to the TX RS485 three-position terminal located above the Ethernet connector.
- Reset Magnum for change to take effect.
- Select Ethernet Network then press Enter.
- Set "DYNAMIC IP" to NO.
- Set the "IP Address".
- Set the "Subnet Mask".
- Set "Default Gateway".
- Reset Magnum for change to take effect.

If you are going to let your network assign the IP Address, Subnet Mask, and Default Gateway.

- Press the Menu key, select Serv Tools, and then press the Enter key.
- Select Ethernet Network then press Enter.
- Set "DYNAMIC IP" to YES.
- Connect the MCS-Magnum to the network and power up the board.

27.11. PROTOCOLS USING MCS-BMS-GATEWAY

The MCS-BMS-GATEWAY is a microprocessor based communication device that provides translation from BACnet IP to LonTalk, BACnet MSTP, or Johnson Control N2.

Information that can be transmitted includes the status of control points, alarm information, digital inputs, analog inputs or setpoints.

For more information on the MCS-BMS-GATEWAY please go to www.mcscontrols.com.

27.11.1 MODBUS TCP/IP PROTOCOL

This protocol is always active.

Make sure the MCS-Magnum network settings are set correctly.

If you are going to manually assign the IP Address, Subnet Mask, and Default Gateway.

Press the Menu key, select Serv Tools, and then press the Enter key.

- Select Ethernet Network then press Enter.
- Set "DYNAMIC IP" to NO.
- Set the "IP Address".
- Set the "Subnet Mask".
- Set "Default Gateway".
- Reset Magnum for change to take effect.

If you are going to let your network assign the IP Address, Subnet Mask, and Default Gateway:

- Press the Menu key, select Serv Tools, and then press the Enter key.
- Select Ethernet Network then press Enter.
- Set "DYNAMIC IP" to YES.
- Connect the MCS-Magnum to the network and power up the board.

27.12. PROTOCOLS USING MCS-BMS-GATEWAY

The MCS-BMS-GATEWAY is a microprocessor based communication device that provides translation from BACnet IP to LonTalk, BACnet MSTP, or Johnson Control N2.

Information that can be transmitted includes the status of control points, alarm information, digital inputs, analog inputs or setpoints.

For more information on the MCS-BMS-GATEWAY please go to www.mcscontrols.com.

Chapter - 28. HVAC Unit and Compressor State Chart

BMS Points Unit State Chart		
State #	State #	State Text/Name
MCS & Modbus	BACnet	
0	1	UNIT IN POWER UP
1	2	POWER LOSS DELAY
2	3	NO RUN- I/O LOST
3	4	UNIT IN LOCKOUT
4	5	UNIT IS OFF
5	6	UNIT IS HOLDING
6	7	UNIT UNLOADING
7	8	UNIT IS LOADING
8	9	OFF-SMOKE ALARM
9	10	RUN/STOP SW OFF
10	11	SCHEDULED OFF
11	12	OFF-NO FLOW(s)
12	13	OFF-WTR PSI FLOW
13	14	AMBIENT OFF
14	15	PROCESS HEAT OFF
15	16	UNIT IS UNLOADED
16	17	UNIT IS LOADED
17	18	OFF TMP-ICE MADE
18	19	ECONOMIZER ONLY
19	20	SWITCHING MODES
20	21	UNIT SMOKE UNLDG
21	22	UNIT OFF UNLDING
22	23	UNIT DMD UNLDING
23	24	UNIT HEAT UNLDNG
24	25	UNLDING RUN CMPS
25	26	OPENING BYV VLV
26	27	CMP RAMPING UP
27	28	CLOSING BYV VLV
28	29	FACTORY STARTUP
29	30	MAXIMUM RUN TIME
30	31	NOT USED
31	32	OFF-FIRE ALARM
32	33	UNIT HEAT HOLDG
33	34	CMP SPD OPTIMIZE
34	35	UNUSED STATE
35	36	RS-STARTING COMP
36	37	RS-LOADING
37	38	RS-HOLDING
38	39	UNIT OFF CTRL SI

BMS Points Unit Mode Chart		
State #	State #	State Text/Name
MCS & Modbus	BACnet	
0	1	CHILLER MODE
1	2	ICE MAKING MODE
2	3	HEATING MODE
3	4	DEHUMID MODE
4	5	VENT ONLY
5	6	DEHUMID MODE
6	7	OFF
7	8	SWITCHING MODES
8	9	COOLING w/HEAT
9	10	HEATING w/COOL
10	11	DEFROSTING

HVAC BMS Points Compressor State Chart

State #	State #	State Text/Name
MCS & Modbus	BACnet	
0	1	LOST IO LOCKED
1	2	CMP LOCKED OUT
2	3	SWITCHED OFF
3	4	UNLD & PMPDWN
4	5	CMP ANTICYCLE
5	6	CMP OFF/READY
6	7	OIL PMP LUBING
7	8	CMP IN STARTUP
8	9	CMP UNLOADED
9	10	CMP UNLD STEP1
10	11	CMP UNLD STEP2
11	12	CMP IS HOLDING
12	13	CMP IS LOADING
13	14	CMP IS UNLDING
14	15	CMP IS RUNNING
15	16	FAST UNLOADING
16	17	LO SUCT UNLOAD
17	18	LO SUCT HOLD
18	19	HI DISC UNLOAD
19	20	HI DISC HOLD
20	21	SAFETY TRIPPED
21	22	LO TEMP UNLOAD
22	23	LO TEMP HOLD
23	24	HI AMP HOLD
24	25	HI DIS TMP HLD
25	26	CMP IS AT 40%

State #	State #	State Text/Name
MCS & Modbus	BACnet	
26	27	CMP IS AT 70%
27	28	HI WATER HOLD
28	29	EXTRA 70% STEP
29	30	OFF-LO OIL TMP
30	31	HI AMP UNLDING
31	32	DEF PREPMP OUT
32	33	DEFROSTING
33	34	DEF PUMP DOWN
34	35	HI TEMP UNLOAD
35	36	HI TEMP HOLD
36	37	SCROLL STEP 1
37	38	SCROLL STEP 2
38	39	SCROLL STEP 3
39	40	SCROLL STEP 4
40	41	ON OIL RECOVERY
41	42	WAIT P-RATIO
42	43	CMP GROUP OFF
43	44	CLOSING VANES
44	45	TimingVaneOpn
45	46	TimingVaneCls
46	47	SURGE HOLD
47	48	OIL REC SPD UP
48	49	OIL REC OFF
49	50	OIL REC BOOST
50	51	VFD TANDEM OFF

Chapter - 29. Reading Alarm Points For MCS-MAGNUM

MCS-MAGNUM can generate 899 different alarms as shown in the **BMS ALARM TYPE** chart on the following pages. In the table below the PT number is either the NAME TYPE or the ALARM POINT NUMBER.

Example: **PT 0** is the **Alarm #1 type** and **PT 1** is the **Alarm #1 Point**.

BMS WILL ONLY SHOW 5 OF THE LATEST ALARMS TYPES AND THE ALARMS POINTS WHICH WAS CREATED BY THE MAGNUM CONTROLLER.

<u>MCS-MAGNUM</u>		<u>BACNET ID</u>		<u>MODBUS IP & RTU</u>
PT	Name	Object ID	Name	Register
0	Alarm #1 Type	MV:142	Alarm #1 Type	30668
1	Alarm #1 Point	MV:147	Alarm #1 Point	30673
2	Alarm #2 Type	MV:143	Alarm #2 Type	30669
3	Alarm #2 Point	MV:148	Alarm #2 Point	30674
4	Alarm #3 Type	MV:144	Alarm #3 Type	30670
5	Alarm #3 Point	MV:149	Alarm #3 Point	30675
6	Alarm #4 Type	MV:145	Alarm #4 Type	30671
7	Alarm #4 Point	MV:150	Alarm #4 Point	30676
8	Alarm #5 Type	MV:146	Alarm #5 Type	30672
9	Alarm #5 Point	MV:151	Alarm #5 Point	30677

For the Building Management System(BMS) to read MCS-MAGNUM alarms, please reference the tables on the following pages.

First look for '**TYPE**' in the '**ALARM TYPE CHART**' and compare the value received from the BMS to the chart named '**Alarm POINTS**'. This will tell you what the alarm is.

This will tell you the number of the referenced component, Setpoint, Sensor Input, Relay Output, or Analog Output that is associated with that alarm.

If an alarm occurs that is NOT associated with a board point,

Setpoint, Sensor Input, Relay Output, or Analog Output,

THEN THE ALARM DETAIL SHOULD BE A '1' for N/A.

29.1. Reading Alarm Points For MCS-MAGNUM

MCS-MAGNUM can generate 899 different alarms as shown in the BMS ALARM TYPE chart on the following pages.

BMS WILL ONLY SHOW

'FIVE (5) OF THE LATEST ALARMS TYPES AND THE ALARMS POINTS' **WHICH WAS CREATED BY THE MAGNUM CONTROLLER**

	<u>MCS-MAGNUM</u>	<u>BACNET ID</u>		<u>MODBUS IP & RTU</u>
	Name	Object ID	Name	Register
ALARM #1 TYPE & POINT	Alarm #1 Type	MV:142	Alarm #1 Type	30668
	Alarm #1 Point	MV:147	Alarm #1 Point	30673
	Alarm #2 Type	MV:143	Alarm #2 Type	30669
	Alarm #2 Point	MV:148	Alarm #2 Point	30674
	Alarm #3 Type	MV:144	Alarm #3 Type	30670
	Alarm #3 Point	MV:149	Alarm #3 Point	30675
	Alarm #4 Type	MV:145	Alarm #4 Type	30671
	Alarm #4 Point	MV:150	Alarm #4 Point	30676
	Alarm #5 Type	MV:146	Alarm #5 Type	30672
	Alarm #5 Point	MV:151	Alarm #5 Point	30677

Power Returned Change Example:

There was a Power Returned Alarm from the MAGNUM to the BMS:

ALARM #1 = BACnet MV142 = #10 ALARM TYPE Name = POWERED RETURNED

ALARM #1 = BACnet MV147 = #1 ALARM POINT Name = N/A

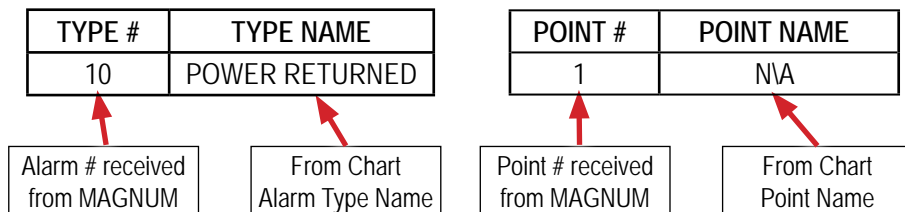

Explanation:
Power has been returned

BMS report for Alarms:

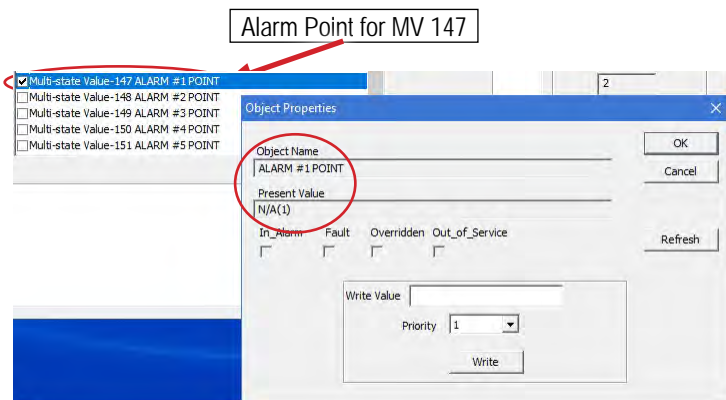
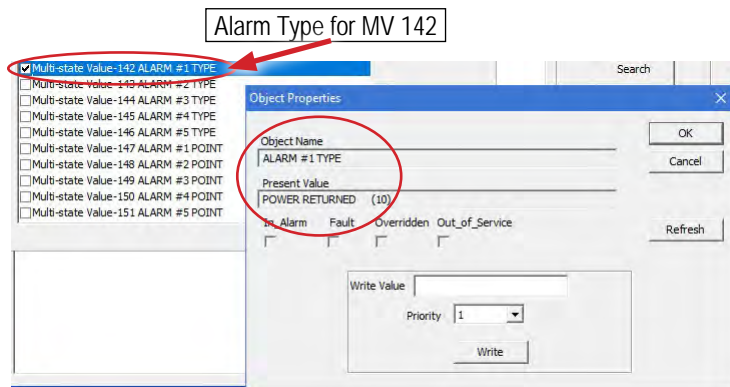

29.2. BMS ALARM TYPES

Type	Name
1	POWER FAILED
2	COMPUTER RESET
3	BATTERY FAILED
4	INVERTER TEMP
5	DISCHARGE TEMP
6	SUCTION PSI
7	DISCHARGE PSI
8	3PHASE OVER AMPS
9	ALARMS CLEARED
10	POWER RETURNED
11	CAVITY TEMP
12	STPT CHANGED
13	RO TO MANON + Point #
14	AO TO MANUAL + Point #
15	SI TO MANUAL + Point #
16	POINT INFO CLEAR
17	CLOCK SET
18	CFG DOWNLOADED
19	ROTATED LEADIO
20	SI OFFSET
21	SI TYPE
22	LEAV FLUID TEMP
23	PRESSURE RATIO
24	BEAR MOTOR CMP
25	CMP SENSOR FLT
26	DAYLIGHT SAVINGS
27	LOCKOUT RESET
28	FIRMWARE LOADED
29	BOOTLOADER ERROR
30	RS485 CHANGED
31	ETHERNET CHANGED
32	INVALID CFG CSUM
33	INVALID CFG VER
34	LOST RO COMM
35	LOST SI COMM
36	BACnet Port Chg
37	WATCHDOG RESET
38	SRC TEMP FAULT
39	EMERGENCY STOP
40	OFF-SMOKE ALARM
41	RO TO AUTO + Point #
42	AO TO AUTO + Point #
43	SI TO AUTO + Point #
44	PHASE LOSS
45	RO TO MANOFF + Point #
46	TURBO LOCK OUT

Type	Name
47	TURBO WIND TMP
48	TURBOCOR SSH FLT
49	TURB RESERVED
50	CND/CTG FAULT
51	LOST IO SHUTDOWN
52	SMOKE PURGE
53	INVALID CFG TYPE
54	ENGY WHEEL ALARM
55	LOST I/O RESTART
56	OFF-FIRE ALARM
57	NO IGNITION
58	PURGE RESTART
59	TMP OFF-ICE MADE
60	LVL OFF-ICE MADE
61	START MAKING ICE
62	INTERNAL RAM
63	EXTERNAL RAM 0
64	EXTERNAL RAM 1
65	LOST A/D CONVTR
66	LOST DISPLAY
67	LOST IO COMP
68	LOST KEYPAD
69	CFG FLASH PTR
70	NETWORK ADDR CHG
71	UPDATED FLASHCFG
72	LOST A/D SHUTDWN
73	CF CARD REMOVED
74	CF CARD INSERTED
75	CF INIT ERROR
76	MCS-STAT OFFLINE
77	BACnet Addr Chg
78	FORCE MCS PROCOL
79	UNUSED ALARM #78
80	UNUSED ALARM #79
81	CHW OUT TRGT
82	CTRL ZONE+
83	CTRL ZONE-
84	HGS TEMP ON
85	HGS TEMP OFF
86	HGS PSI ON
87	HGS PSI OFF
88	ChmbInjOnDis
89	SUPERHT TRGT
90	SPRHT ZONE+-

Type	Name
91	EXV LOAD ADJ
92	EXV FINE ADJ
93	EXV COURSE
94	EXV Load DIV
95	EXV MIN%
96	EXV MAX%
97	LO SUPERHEAT
98	LOSUCTPSIDLY
99	EXV DELAY
100	EXV STRT TME
101	MAX CW RESET
102	LOW AMB. OFF
103	POWERUP DLAY
104	HI AMB. OFF
105	STEP SENSIT
106	STEP DELAY
107	MAX ROC-
108	MAX ROC+
109	ROC INTERVAL
110	MAX FLA %
111	MIN FLA %
112	MAX ADJUST %
113	MIN ADJUST %
114	SLIDE SENSIT
115	AMP DB HI
116	AMP DB LO
117	LOAD PULSE
118	UNLOAD PULSE
119	LUBE OIL TMP
120	LUBE OIL PSI
121	LUBE DELAY
122	HI WATER TMP
123	C-PMPDWN FLA
124	C-PMPDWN TMR
125	CND PUMP ON
126	CND PUMP OFF
127	FAN DIFF ON
128	CND ADJ DLAY
129	CdFanStrt%
130	CND TARG PSI
131	CND ADJ DIV
132	CND MIN SPD
133	CND ROC-
134	CND ADJ MULT
135	CND MIN ADJ
136	PULSE DELAY
137	L-AMB ProcON

Type	Name
138	CFG TEST=0
139	A-CYC OFF-ON
140	PMP DWN ON
141	PMP DWN OFF
142	PMP DWN DLAY
143	A-CYC ON-ON
144	COMP MIN RUN
145	EXV ZONE X1
146	EXV ZONE X2
147	EXVrocZONE1
148	EXV rocZONE1
149	EXV rocZONE2
150	EXV rocZONE3
151	EXV roc FAST
152	EXV roc CHG
153	PartWindDely
154	OILPUMP OFF
155	HI AMPS %
156	LOampNoSTART
157	LOW SUCTION
158	LO SUCT UNLD
159	LO SUCT RELD
160	UNSAFE SUCT
161	HI DISC PSI
162	HI DISC UNLD
163	HI DISC RELD
164	LO DiscSPRHT
165	LO DISC PSI
166	HiReturnTMP
167	HI DISCH TMP
168	DIS TMP UNLD
169	DIS TMP RELD
170	COND FAULT
171	LOW OIL DIF
172	UnsafeOilDif
173	HloilSealTmp
174	MtrModuleFlt
175	HI MOTOR TMP
176	CompProof
177	DIRTY FILTER
178	LLS#2 ON
179	LLS ON%
180	HIGHSumpTmp
181	SafetyHold
182	MAXCMP@MAX%
183	LEAD COMP
184	CMP ROTATION

Type	Name
185	PUMP FAILURE
186	LEAD PUMP
187	DelyEconMech
188	PMP OFF DLAY
189	HiRefLevel
190	LoRefLvlTarg
191	FREEZE
192	NO STOP
193	OilInjDiffTp
194	Oil DiffTp
195	EconVFDdel
196	DEFon Temp
197	DEFon Dela:y
198	DEFon Cycle
199	EcoOffsetON
200	EconDelyFans
201	EcoVlvMinVlv
202	EcoVlvMaxVlv
203	EcoVlvMaxAdj
204	EcoVlvDelay
205	EcoVlvMaxDly
206	EcoVlv Mul
207	EcoVlv Div
208	Lost Leg Alm
209	Reh On
210	Reh Off adj
211	Reh StrtDlay
212	Reh Bld Dlay
213	Reh Stg Dlay
214	Barrel HtrOn
215	Refig Leak
216	Vi Pulse
217	Vi Deadband
218	Vi Delay
219	LOW OIL LVL
220	HiDiscOffset
221	Hi CW Temp
222	ServiceMode
223	Unload%
224	Oil HeaterOn
225	Oil CoolerOn
226	ChwPmpDifTrg
227	ChwPmpZone
228	Pmp Delay
229	Pmp Max ROC
230	Pmp Min Spd%
231	Unloaded Off

Type	Name
232	OverHeat
233	SftyUnld Dly
234	HGB Sfty Adj
235	LO REF TMP
236	LO REF UNLD
237	HP LoSuctAdj
238	DEF TRIG TMP
239	DEF TRIG DEL
240	DEFrevDelay
241	DEF TERM TMP
242	DEF TERMdely
243	HP HEAT TARG
244	HP CTL ZONE+
245	HP CTL ZONE-
246	PHASE LOSS
247	PurgeAlarm
248	Purge Count
249	PurgePSISrt
250	ExcessPurge
251	FLA COMP#1
252	FLA COMP#2
253	FLA COMP#3
254	FLA COMP#4
255	FLA COMP#5
256	FLA COMP#6
257	FLA COMP#7
258	FLA COMP#8
259	FLA COMP#9
260	FLA COMP#10
261	FLA COMP#11
262	FLA COMP#12
263	FLA COMP#13
264	FLA COMP#14
265	FLA COMP#15
266	MotorInj ON
267	MotorInj OFF
268	UNIT GPM
269	POWER FACTOR
270	UNIT VOLTS
271	Temp Diff
272	FRZ TempDiff
273	CndHi/LoZone
274	Cnd2ndZone
275	Low Voltage
276	High Voltage
277	ChwPmpLead
278	ProcPmpFit

Type	Name
279	MOP TRGT PSI
280	MOP PSI ZONE
281	MOP ADJ%TIME
282	Not Used 202
283	Not Used 203
284	Not Used 204
285	Not Used 205
286	Not Used 206
287	Not Used 207
288	Not Used 208
289	Not Used 209
290	Not Used 210
291	Not Used 211
292	Not Used 212
293	ChwFlowFlt
294	Not Used 214
295	TEST AO LO
296	LiqInjOnMtr
297	LiqInj OnDis
298	LiqInjOffDis
299	LiqInj OnMtr
300	LiqInjOffMtr
301	Reserved 221
302	Reserved 222
303	Reserved 223
304	Reserved 224
305	Reserved 225
306	Reserved 226
307	Reserved 227
308	Reserved 228
309	Reserved 229
310	Reserved 220
311	ALARM SI-ChilWtr In
312	ALARM SI-ChilWtrOut
313	ALARM SI-SUCT PSI 1
314	ALARM SI-DISC PSI 1
315	ALARM SI-OIL PSI 1
316	ALARM SI-AMPS 1
317	ALARM SI-SUCT TMP 1
318	ALARM SI-DISC TMP 1
319	ALARM SI-MTR TMP 1
320	ALARM SI-MTR FLT 1
321	ALARM SI-OIL LVL 1
322	ALARM SI-DISABLE 1
323	ALARM SI-CHW FLOW
324	ALARM SI-PHASELOSS
325	ALARM SI-RUN/STOP

Type	Name
326	ALARM SI-EMG/STOP
327	ALARM SI-SUCT PSI 2
328	ALARM SI-DISC PSI 2
329	ALARM SI-OIL PSI 2
330	ALARM SI-AMPS 2
331	ALARM SI-SUCT TMP 2
332	ALARM SI-DISC TMP 2
333	ALARM SI-MTR TMP 2
334	ALARM SI-MTR FLT 2
335	ALARM SI-OIL LVL 2
336	ALARM SI-DISABLE 2
337	ALARM SI-LIQ PSI 1
338	ALARM SI-LIQ TMP 1
339	ALARM SI-LIQ PSI 2
340	ALARM SI-LIQ TMP 2
341	ALARM SI-PmpPsi In
342	ALARM SI-PmpPsiOut
343	ALARM SI-SUBCOOL 1
344	ALARM SI-SUBCOOL 2
345	ALARM SI-KW/TON
346	ALARM SI-UNIT KW
347	ALARM SI-UNIT TONS
348	ALARM SI-CHW DIFF
349	ALARM SI-UNIT GPM
350	ALARM SI-PowerFactr
351	ALARM SI-UNIT VOLTS
352	ALARM SI-SPARE2-10
353	ALARM SI-SPARE2-11
354	ALARM SI-SPARE2-12
355	ALARM SI-SPARE2-13
356	ALARM SI-SPARE2-14
357	ALARM SI-SPARE2-15
358	ALARM SI-SPARE2-16
359	ALARM SI-SPARE3-1
360	ALARM SI-SPARE3-2
361	ALARM SI-SPARE3-3
362	ALARM SI-SPARE3-4
363	ALARM SI-SPARE3-5
364	ALARM SI-SPARE3-6
365	ALARM SI-SPARE3-7
366	ALARM SI-SPARE3-8
367	ALARM SI-SPARE3-9
368	ALARM SI-SPARE3-10
369	ALARM SI-SPARE3-11
370	ALARM SI-SPARE3-12
371	ALARM SI-SPARE3-13
372	ALARM SI-SPARE3-14

Type	Name
373	ALARM SI-SPARE3-15
374	ALARM SI-SPARE3-16
375	ALARM SI-Spare 4-1
376	ALARM SI-Spare 4-2
377	ALARM SI-Spare 4-3
378	ALARM SI-Spare 4-4
379	ALARM SI-Spare 4-5
380	ALARM SI-Spare 4-6
381	ALARM SI-Spare 4-7
382	ALARM SI-Spare 4-8
383	ALARM SI-Spare 4-9
384	ALARM SI-Spare 4-10
385	ALARM SI-Spare 4-11
386	ALARM SI-Spare 4-12
387	ALARM SI-Spare 4-13
388	ALARM SI-Spare 4-14
389	ALARM SI-Spare 4-15
390	ALARM SI-Spare 4-16
391	ALARM SI-SPARE5-1
392	ALARM SI-SPARE5-2
393	ALARM SI-SPARE5-3
394	ALARM SI-SPARE5-4
395	ALARM SI-SPARE5-5
396	ALARM SI-SPARE5-6
397	ALARM SI-SPARE5-7
398	ALARM SI-SPARE5-8
399	ALARM SI-SPARE5-9
400	ALARM SI-SPARE5-10
401	ALARM SI-SPARE5-11
402	ALARM SI-SPARE5-12
403	ALARM SI-SPARE5-13
404	ALARM SI-SPARE5-14
405	ALARM SI-SPARE5-15
406	ALARM SI-SPARE5-16
407	ALARM SI-SPARE6-1
408	ALARM SI-SPARE6-2
409	ALARM SI-SPARE6-3
410	ALARM SI-SPARE6-4
411	ALARM SI-SPARE6-5
412	ALARM SI-SPARE6-6
413	ALARM SI-SPARE6-7
414	ALARM SI-SPARE6-8
415	ALARM SI-SPARE6-9
416	ALARM SI-SPARE6-10
417	ALARM SI-SPARE6-11
418	ALARM SI-SPARE6-12
419	ALARM SI-SPARE6-13

Type	Name
420	ALARM SI-SPARE6-14
421	ALARM SI-SPARE6-15
422	ALARM SI-SPARE6-16
423	BadPoint-SI ALM
424	ALARM RO-COMP 1
425	ALARM RO-LOAD 1
426	ALARM RO-UNLOAD 1
427	ALARM RO-STRT UNLD1
428	ALARM RO-LLS 1
429	ALARM RO-CHMBR INJ1
430	ALARM RO-MOTOR INJ1
431	ALARM RO-CND FAN1-1
432	ALARM RO-WARNING
433	ALARM RO-ALARM
434	ALARM RO-COMP 2
435	ALARM RO-LOAD 2
436	ALARM RO-UNLOAD 2
437	ALARM RO-STRT UNLD2
438	ALARM RO-LLS 2
439	ALARM RO-CHMBR INJ2
440	ALARM RO-MOTOR INJ2
441	ALARM RO-CND FAN2-1
442	ALARM RO-CHW PUMP 1
443	ALARM RO-CHW PUMP 2
444	ALARM RO-SPARE2-1
445	ALARM RO-SPARE2-2
446	ALARM RO-SPARE2-3
447	ALARM RO-SPARE2-4
448	ALARM RO-SPARE2-5
449	ALARM RO-SPARE2-6
450	ALARM RO-SPARE2-7
451	ALARM RO-SPARE2-8
452	ALARM RO-SPARE2-9
453	ALARM RO-SPARE2-10
454	ALARM RO-SPARE3-1
455	ALARM RO-SPARE3-2
456	ALARM RO-SPARE3-3
457	ALARM RO-SPARE3-4
458	ALARM RO-SPARE3-5
459	ALARM RO-SPARE3-6
460	ALARM RO-SPARE3-7
461	ALARM RO-SPARE3-8
462	ALARM RO-SPARE3-9
463	ALARM RO-SPARE3-10
464	ALARM RO-SPARE4-1
465	ALARM RO-SPARE4-2
466	ALARM RO-SPARE4-3

Type	Name
467	ALARM RO-SPARE4-4
468	ALARM RO-SPARE4-5
469	ALARM RO-SPARE4-6
470	ALARM RO-SPARE4-7
471	ALARM RO-SPARE4-8
472	ALARM RO-SPARE4-9
473	ALARM RO-SPARE4-10
474	ALARM RO-SPARE5-1
475	ALARM RO-SPARE5-2
476	ALARM RO-SPARE5-3
477	ALARM RO-SPARE5-4
478	ALARM RO-SPARE5-5
479	ALARM RO-SPARE5-6
480	ALARM RO-SPARE5-7
481	ALARM RO-SPARE5-8
482	ALARM RO-SPARE5-9
483	ALARM RO-SPARE5-10
484	ALARM RO-SPARE6-1
485	ALARM RO-SPARE6-2
486	ALARM RO-SPARE6-3
487	ALARM RO-SPARE6-4
488	ALARM RO-SPARE6-5
489	ALARM RO-SPARE6-6
490	ALARM RO-SPARE6-7
491	ALARM RO-SPARE6-8
492	ALARM RO-SPARE6-9
493	ALARM RO-SPARE6-10
494	ALARM RO-SPARE7-1
495	ALARM RO-SPARE7-2
496	ALARM RO-SPARE7-3
497	ALARM RO-SPARE7-4
498	ALARM RO-SPARE7-5
499	ALARM RO-SPARE7-6
500	ALARM RO-SPARE7-7
501	ALARM RO-SPARE7-8
502	ALARM RO-SPARE7-9
503	ALARM RO-SPARE7-10
504	BadPoint-RO ALM
505	ALARM IS NOT ACTIVE
506	SETPOINT-231
507	SETPOINT-232
508	SETPOINT-233
509	SETPOINT-234
510	SETPOINT-235
511	SETPOINT-236
512	SETPOINT-237
513	SETPOINT-238

Type	Name
514	SETPOINT-239
515	SETPOINT-240
516	SETPOINT-241
517	SETPOINT-242
518	SETPOINT-243
519	SETPOINT-244
520	SETPOINT-245
521	SETPOINT-246
522	SETPOINT-247
523	SETPOINT-248
524	SETPOINT-249
525	SETPOINT-250
526	SETPOINT-251
527	SETPOINT-252
528	SETPOINT-253
529	SETPOINT-254
530	SETPOINT-255
531	BRAKE CHECK
532	POWER CARD TEMP
533	EARTH FAULT
534	CTRL CARD TEMP
535	CTRL WORD TO
536	OVER CURRENT
537	TORQUE LIMIT
538	MOTOR TH OVER
539	MOTOR ETR OVER
540	INVERTER OVERLD
541	DC UNDER VOLT
542	DC OVER VOLT
543	SHORT CIRCUIT
544	INRUSH FAULT
545	MAIN PHASE LOSS
546	AMA NOT OK
547	LIVE ZERO ERROR
548	INTERNAL FAULT
549	BRAKE OVERLOAD
550	U PHASE LOSS
551	V PHASE LOSS
552	W PHASE LOSS
553	FIELD BUS FAULT
554	24V SUPPLY LOW
555	MAINS FAILURE
556	1.8V SUPPLY LOW
557	BRAKE RESISTOR
558	BRAKE IGBT
559	OPTION CHANGE
560	DRIVE INIT

Type	Name
561	SAFE STOP
562	MECH BRAKE LOW
563	SERIAL TIMEOUT
564	MAINS FAILURE
565	ENVELOPE FAULT
566	ENVELOP INIT FLT
567	COMP SHORT CYCLE
568	HIGH OIL TEMP
569	LOW OIL LEVEL
570	UNUSED
571	MOTOR OVERLOAD
572	WRONG PHASE SEQ
573	MTR THERML OVRLD
574	INVERTER FAULT
575	OVER CURRENT
576	OVER VOLTAGE
577	UNDER VOLTAGE
578	FC OVER TEMP
579	HW CONFIG FAULT
580	PWR DATA CFG FLT
581	MTR DATA CFG FLT
582	HARDWARE FAULT
583	UNUSED
584	TEMP SENSOR FLT
585	UNUSED
586	UNUSED
587	UNUSED
588	UNUSED
589	UNUSED
590	UNUSED
591	UNUSED
592	UNUSED
593	UNUSED
594	UNUSED
595	CHILLER OFFLINE
596	UPDATED RAM CFG
597	LUBE-VANES FAULT
598	VANES NOT MOVING
599	CMP NOT OFF-AMPS
600	DMPR MIX AIR FLT
601	DMPR FEEDBCK FLT
602	DMP POS OUTFRANGE
603	DMPR NOT AT MAX
604	DMPR NOT AT MIN
605	DMPR NOT OPENING
606	DMPR NOT CLOSING
607	DMPR STUCK OPEN

Type	Name
608	DMPR STUCK CLOSD
609	DMPR RET=AMB TMP
610	RO TO CMP FIXED%
611	CMP FIXED%notCMP
612	HW/SW/Hall Flt
613	SWPeak/Hw/AC RMS
614	DC OVER VOLTAGE
615	DC UNDER VOLTAGE
616	AC OVER VOLTAGE
617	AC UNDER VOLTAGE
618	UNUSED
619	UNUSED
620	Hi PSI Switch
621	UNUSED
622	UNUSED
623	Invtr OVER TEMP
624	PFC IGBTOverTemp
625	LOST ROTOR
626	UNUSED
627	UNUSED
628	LOW DC VOLTAGE
629	UNUSED
630	EnvTorqueLmtTime
631	PIMFoldBack Time
632	Cur.FoldBackTime
633	UNUSED
634	UNUSED
635	NoCommDataFor30s
636	SI2FitLoTemp/Srt
637	UNUSED
638	UNUSED
639	HI INVERTER TEMP
640	HIGH PFC TEMP
641	No DSP/PFC Comms
642	Comm to DSP Lost
643	UNUSED
644	InvtrAmpsImblnc
645	UNUSED
646	Drive EEPROM Flt
647	UNUSED
648	UNUSED
649	SI1Fit-HiPSI Low
650	CompConfigError
651	HiPsiType Error
652	UNUSED
653	UNUSED
654	UNUSED

Type	Name
655	UNUSED
656	UNUSED
657	UNUSED
658	UNUSED
659	UNUSED
660	UNUSED
661	UNUSED
662	SI2Fit-LoTmpOpen
663	UNUSED
664	UNUSED
665	InvrtrTmpSI Open
666	PFC Temp SI Open
667	UNUSED
668	UNUSED
669	UNUSED
670	UNUSED
671	UNUSED
672	UNUSED
673	UNUSED
674	UNUSED
675	FitLimit Lockout
676	VANE CLS/OPN FLT
677	VANE NOT CLOSING
678	VANE NOT OPENING
679	VANES CALIBRATED
680	NO VANES SENSOR
681	VANE CAL CANCEL
682	CMPs OFF-FLOW A
683	CMPs OFF-FLOW B
684	LowOilPressDrop
685	UndulyLowOilPres
686	UndulyLowOilTemp
687	Hi Bearing Temp
688	UndulyHiBearTemp
689	OilPumpOverload
690	Chl Water Break
691	UndulyLoChlWater
692	Unused 40004.08
693	Unused 40004.09
694	UndulyLoMotorAmp
695	Hi Motr Amps
696	UndulyHiMtrAmps
697	Long StartupTime
698	Coil Overheat
699	Starter Fault
700	Low Evap Press
701	UndulyLoEvapPres

Type	Name
702	Hi Cond Press
703	UndulyHiCondPres
704	IGV Fault
705	Unused 40005.05
706	Unused 40005.06
707	Unused 40005.07
708	Unused 40005.08
709	Unused 40005.09
710	Unused 40005.10
711	Unused 40005.11
712	Unused 40005.12
713	Unused 40005.13
714	Unused 40005.14
715	Unused 40005.15
716	ECDWT Break
717	LCDWT Break
718	ECWT Break
719	LCWT Break
720	OilSumpTempBreak
721	Unused 40006.05
722	Cond Press Break
723	Evap Press Break
724	OilSppllyPSIBreak
725	OilSumpPSIBreak
726	BearingTempBreak
727	IGV Break
728	Unused 40006.12
729	Motor Amp Break
730	Unused 40006.14
731	Unused 40006.15
732	SERVICE TRIP
733	SERVICE TRIP
734	SERVICE TRIP
735	SERVICE TRIP
736	SERVICE TRIP
737	NO FLOW
738	DRY PUMP
739	END OF CURVE
740	BROKEN BELT
741	DISCHARGE HIGH
742	START FAILED
743	SPEED LIMIT
744	EXT INTERLOCK
745	ILLEGAL OPTNCOMB
746	NO SAFETY OPTION
747	UNUSED
748	UNUSED

Type	Name
749	KTY ERROR
750	FANS ERROR
751	ECB ERROR
752	UNUSED
753	UNUSED
754	UNUSED
755	UNUSED
756	UNUSED
757	CURRENT LIMIT
758	UNUSED
759	UNUSED
760	UNUSED
761	ENCODER LOSS
762	PTC THERMISTOR
763	DANGER FAILURE
764	Brake check
765	Pwr card temp
766	Earth Fault
767	Ctrl card temp
768	Ctrl word TO
769	Over Current
770	Torque limit
771	Motor th over
772	Motor ETR over
773	Inverter overld
774	DC under volt
775	DC over volt
776	DC voltage low
777	DC voltage high
778	Mains ph loss
779	No motor
780	Live zero error
781	10V low
782	Brake overload
783	Brake resistor
784	Brake IGBT
785	Speed limit
786	Fieldbus fault
787	24V supply low
788	Mains failure
789	Current limit
790	Low temp
791	Voltage limit
792	Encoder loss
793	Output freq lim
794	SafeStop
795	Extnd stat word

Type	Name
796	Start Delayed
797	Stop Delayed
798	Clock Failure
799	Fire Md was Actv
800	UNUSED
801	No Flow
802	Dry Pump
803	End of Curve
804	Broken Belt
805	Discharge High
806	Multimotor undld
807	Multimotor Ovrlld
808	Cmp Interlock
809	Mech Brk Sliding
810	Safe Opt Warning
811	Auto DC Braking
812	UNUSED
813	KTY warn
814	Fans warn
815	ECB warn
816	UNUSED
817	UNUSED
818	UNUSED
819	UNUSED
820	UNUSED
821	UNUSED
822	UNUSED
823	UNUSED
824	UNUSED
825	UNUSED
826	PTC Thermistor
827	UNUSED
828	ABB-ShortCircuit
829	ABB-OVER CURRENT
830	ABB-DC OVERVOLT
831	ABB-ACS800 TEMP
832	ABB-EARTH FAULT
833	ABB-THERMISTOR
834	ABB-MOTOR TEMP
835	ABB-SYSTEM FAULT
836	ABB-UNDER LOAD
837	ABB-OVER FREQ
838	ABB-UNUSED
839	ABB-UNUSED
840	ABB-UNUSED
841	ABB-UNUSED
842	ABB-UNUSED

Type	Name
843	ABB-UNUSED
844	ABB-SUPPLY PHASE
845	ABB-NO MotorData
846	ABB-DC UNDERVOLT
847	ABB-RESERVED
848	ABB-RUN ENABLE
849	ABB-ENCODER ERR
850	ABB-I/O COMM ERR
851	ABB-CTRL B TEMP
852	ABB-EXTERNAL FLT
853	ABB-OVER SWFREQ
854	ABB-AI<MIN FUNC
855	ABB-PPCC LINK
856	ABB-COMM. MODULE
857	ABB-PANEL LOSS
858	ABB-MOTOR STALL
859	ABB-MOTOR PHASE
860	MOTOR PH OVR AMP
861	DC BUS OVR VOLTS
862	TURB MTR RSV
863	MTR HIGH AMP FLT
864	INV ERR SIG ACT
865	ROTOR MAY BE LCK
866	BEARING FLT ACT
867	TURB MTR RSV
868	OUT VLTS NO AMPS
869	DC VLTS LOW LMT
870	24VDC OUT OF RNG
871	LOW MTR BACK EMF
872	EEPROM CSUM ERR
873	GEN MODE ACTIVE
874	SCR PHASE LOSS
875	CMP IN STARTUP
876	CALIBRATION FAIL
877	STARTUP CK FAIL
878	AX DISPLACEMENT
879	AX STATIC LOAD
880	FRONT RAD DISP X
881	FRONT RAD DISP Y
882	FRNT RD ST LD X
883	FRNT RD ST LD Y
884	REAR RAD DISP X
885	REAR RAD DISP Y
886	REAR RD ST LD X
887	REAR RD ST LD Y
888	TURB BEARING RSV
889	TURB BEARING RSV

Type	Name
890	TURB BEARING RSV
891	TURB BEARING RSV
892	MBC NOT ALIVE
893	MBC NOT READY
894	MBC THD Alarm
895	MBC BEARING1
896	MBC BEARING2
897	MBC NoOkRotate
898	MBC MAX ALARM
899	OilRecovBoostAlm

29.3. BMS Points Alarms Chart

Point #	Name	COMP & BOARDS
1	N/A	
2	Compressor 1 ID = 1	COMPRESSOR NUMBER
3	Compressor 2 ID = 2	
4	Compressor 3 ID = 3	
5	Compressor 4 ID = 4	
6	Compressor 5 ID = 5	
7	Compressor 6 ID = 6	
8	Compressor 7 ID = 7	
9	Compressor 8 ID = 8	
10	Compressor 9 ID = 9	
11	Compressor 10 ID = 10	
12	Compressor 11 ID = 11	
13	Compressor 12 ID = 12	
14	Compressor 13 ID = 13	
15	Compressor 14 ID = 14	
16	Compressor 15 ID = 15	
17	Compressor 16 ID = 16	
18	Compressor 17 ID = 17	
19	Compressor 18 ID = 18	
20	Compressor 19 ID = 19	
21	Compressor 20 ID = 20	
26	M-1	MAIN BOARD SI, RO or AO
27	M-2	
28	M-3	
29	M-4	
30	M-5	
31	M-6	
32	M-7	
33	M-8	
34	M-9	
35	M10	
36	M11	
37	M12	
38	M13	
39	M14	
40	M15	
41	M16	
42	1-1	1ST EXPANSION BOARD SI, RO or AO
43	1-2	
44	1-3	
45	1-4	
46	1-5	
47	1-6	
48	1-7	
49	1-8	
50	1-9	
51	1-10	
52	1-11	
53	1-12	
54	1-13	
55	1-14	
56	1-15	
57	1-16	

Point #	Name	COMP & BOARDS
58	2-1	2ND EXPANSION BOARD SI, RO or AO
59	2-2	
60	2-3	
61	2-4	
62	2-5	
63	2-6	
64	2-7	
65	2-8	
66	2-9	
67	2-10	
68	2-11	
69	2-12	
70	2-13	
71	2-14	
72	2-15	
73	2-16	
74	3-1	3RD EXPANSION BOARD SI, RO or AO
75	3-2	
76	3-3	
77	3-4	
78	3-5	
79	3-6	
80	3-7	
81	3-8	
82	3-9	
83	3-10	
84	3-11	
85	3-12	
86	3-13	
87	3-14	
88	3-15	
89	3-16	
90	4-1	4TH EXPANSION BOARD SI, RO or AO
91	4-2	
92	4-3	
93	4-4	
94	4-5	
95	4-6	
96	4-7	
97	4-8	
98	4-9	
99	4-10	
100	4-11	
101	4-12	
102	4-13	
103	4-14	
104	4-15	
105	4-16	

Point #	Name	COMP & BOARDS	
106	5-1	5TH EXPANSION BOARD SI, RO or AO	
107	5-2		
108	5-3		
109	5-4		
110	5-5		
111	5-6		
112	5-7		
113	5-8		
114	5-9		
115	5-10		
116	5-11		
117	5-12		
118	5-13		
119	5-14		
120	5-15		
121	5-16		
122	6-1		6TH EXPANSION BOARD SI, RO or AO
123	6-2		
124	6-3		
125	6-4		
126	6-5		
127	6-6		
128	6-7		
129	6-8		
130	6-9		
131	6-10		
132	6-11		
133	6-12		
134	6-13		
135	6-14		
136	6-15		
137	6-16		
138	1	SETPOINTS ALARMS	
139	2		
140	3		
141	4		
142	5		
143	6		
144	7		
145	8		
146	9		
147	10		
148	11		
149	12		
150	13		
151	14		
152	15		
153	16		
154	17		
155	18		
156	19		
157	20		
158	21		
159	22		
160	23		
161	24		
162	25		
163	26		

Point #	Name	COMP & BOARDS
164	27	SETPOINTS ALARMS
165	28	
166	29	
167	30	
168	31	
169	32	
170	33	
171	34	
172	35	
173	36	
174	37	
175	38	
176	39	
177	40	
178	41	
179	42	
180	43	
181	44	
182	45	
183	46	
184	47	
185	48	
186	49	
187	50	
188	51	
189	52	
190	53	
191	54	
192	55	
193	56	
194	57	
195	58	
196	59	
197	60	
198	61	
199	62	
200	63	
201	64	
202	65	
203	66	
204	67	
205	68	
206	69	
207	70	
208	71	
209	72	
210	73	
211	74	
212	75	
213	76	
214	77	
215	78	
216	79	
217	80	
218	81	
219	82	
220	83	
221	84	

Point #	Name	COMP & BOARDS
222	85	
223	86	
224	87	
225	88	
226	89	
227	90	
228	91	
229	92	
230	93	
231	94	
232	95	
233	96	
234	97	
235	98	
236	99	
237	100	
238	101	
239	102	
240	103	
241	104	
242	105	
243	106	
244	107	
245	108	
246	109	
247	110	
248	111	
249	112	
250	113	
251	114	
252	115	
253	116	
254	117	
255	118	
256	119	
257	120	
258	121	
259	122	
260	123	
261	124	
262	125	
263	126	
264	127	
265	128	
266	129	
267	130	
268	131	
269	132	
270	133	
271	134	
272	135	
273	136	

SETPOINTS
ALARMS

Point #	Name	COMP & BOARDS
274	137	
275	138	
276	139	
277	140	
278	141	
279	142	
280	143	
281	144	
282	145	
283	146	
284	147	
285	148	
286	149	
287	150	
288	151	
289	152	
290	153	
291	154	
292	155	
293	156	
294	157	
295	158	
296	159	
297	160	
298	161	
299	162	
300	163	
301	164	
302	165	
303	166	
304	167	
305	168	
306	169	
307	170	
308	171	
309	172	
310	173	
311	174	
312	175	
313	176	
314	177	
315	178	
316	179	
317	180	
318	181	
319	182	
320	183	
321	184	
322	185	
323	186	
324	187	
325	188	

SETPOINTS
ALARMS
ALARMS

Point #	Name	COMP & BOARDS
326	189	
327	190	
328	191	
329	192	
330	193	
331	194	
332	195	
333	196	
334	197	
335	198	
336	199	
337	200	
338	201	
339	202	
340	203	
341	204	
342	205	
343	206	
344	207	
345	208	
346	209	
347	210	
348	211	
349	212	
350	213	SETPOINTS
351	214	ALARMS
352	215	
353	216	
354	217	
355	218	
356	219	
357	220	
358	221	
359	222	
360	223	
361	224	
362	225	
363	226	
364	227	
365	228	
366	229	
367	230	
368	231	
369	232	
370	233	
371	234	
372	235	
373	236	
374	237	
375	238	
376	239	
377	240	

Point #	Name	COMP & BOARDS
378	241	
379	242	
380	243	
381	244	
382	245	
383	246	
384	247	
385	248	SETPOINTS
386	249	ALARMS
387	250	
388	251	
389	252	
390	253	
391	254	
392	255	

Chapter - 30. Magnum Alarms and Safeties

There are three types of alarms that are generated by the Magnum control logic:

- Information only alarms,
- Magnum system alarms and
- Chiller Setpoint safety alarms.

All alarms have the same format. The alarm is identified and is date/time stamped. Alarms can be viewed from the Magnum keypad by selecting the 'Alarms' from the main menu, or through MCS-Connect.

30.1. Information Only Alarms

30.1.1 System Generated Alarms

The following alarms are generated to provide information; they will not cause a change in the control algorithm such as a lock out condition or a Relay Output being forced off.

- POWER FAILED – Generated when power to the Magnum was lost.
- POWER RETURNED – Generated when power to the Magnum returned.
- HW DATE INVALID – The date contained/read from the hardware real time clock chip is not valid. Check battery voltage, it should be > 2.0 vdc.
- HW TIME INVALID – The time contained/read from the hardware real time clock chip is not valid. Check battery voltage, it should be > 2.0 vdc.
- SW DATE INVALID – The date contained/read from the software clock is not valid.
- SW TIME INVALID The time contained/read from the software clock is not valid.
- RAM INTEGRITY – the data contained in the battery-backed up RAM memory may be corrupted. This does not stop the Magnum from running. It means the historical data may be incorrect (run times, cycles, min/max values, and trend/graph data).
- WATCHDOG RESET – The Magnum has reset itself because of improper operator of the Magnum board. Please consult the manufacturer if this alarm has occurred.
- LOST A/D CONVTR – The Magnum microprocessor has lost communications to the Analog to Digital converter chip (chip that converts sensor voltages to a digital number). Check for a shorted sensor that may cause
- LOST DISPLAY – Generated when communication to the Keypad/Display is lost.
- CF INIT ERROR – The Compact Flash card that was installed cannot be initialized and therefore cannot be used. Replace the Compact Flash card with one that works.
- BATTERY FAILED – Generated when Magnum is not getting power from the Battery.

30.1.2 User Initiated Alarms

The following alarms indicate that an individual took action: (Most require proper authorization)

- LOCKOUT RESET – Generated when a user resets a compressor other unit from a locked condition.
- COMPUTER RESET – Generated when the manual reset button on the Magnum is pressed.
- ALARMS CLEARED – Generated when a user clears the alarm history.
- STPT CHANGED – Generated when a user makes a change to a Setpoint; the number of the Setpoint will also be displayed with the alarm.
- RO TO (Selected Condition) – Generated when a user manually changes the condition of a Relay Output (either AUTO, MANON, or MANOFF).
- AO TO (Selected Condition) – Generated when a user changes the condition of an Analog Output (either AUTO or MANUAL. If MANUAL, then a dialog box will appear to input the number value).

- SI TO (Selected Condition) – Generated when a user changes the condition of a Sensor Input (If a digital input, then either AUTO, MANON, or MANOFF. If an analog input, then either AUTO or MANUAL. If MANUAL, then a dialog box will appear to input the number value).
- POINT INFO CLEAR – Generated when a user clears all point information (run times, cycles, min/max values, etc.).
- CLOCK SET – Generated when a user makes a change to the Magnum real time clock.
- CFG DOWNLOADED – Generated when a user uploads a new configuration file into the Magnum.
- ETHERNET CHANGE – Generated when a user makes a change to the Ethernet settings through the Keypad/Display.
- RS485 CHANGED – Generated when a user makes changes to the RS485 address through the Keypad/Display.
- CF CARD INSERTED – Generated when a user inserts a Compact Flash memory card into the Magnum.
- CF CARD REMOVED – Generated when a user removes a Compact Flash memory card from the Magnum.

30.1.3 Automatic Alarms

The following alarms indicate an action that the Magnum made automatically:

- ROTATED LEAD – Generated when the Magnum automatically rotates the Lead Compressor.
- DAYLIGHT SAVINGS – Generated when the Magnum automatically changes the real time clock to adjust for Daylight Savings Time.

30.2. Magnum System Alarms

30.2.1 Configuration Alarms

These alarms indicate a problem with the configuration file in the system. The system is not operational and a new configuration must be transmitted to the unit through MCS-Connect.

- INVALID CONFIG – Checksums are incorrect.
- INVALID CFG VER – The version number of the configuration is invalid.
- INVALID CFG TYPE – The configuration type does not match the software type.

30.2.2 MCS Local Network Alarms

These alarms indicate problems with the MCS local network:

- LOST SI COMM #_ / LOST RO COMM #_ –Generated when communications to a Sensor Input or Relay Output board is lost. The number of the board will be displayed with the alarm. The system can be accessed but will be in a NO RUN- I/O LOST state.
- MCS-STAT OFFLINE – The Magnum has lost communications to the MCS-STAT.
- LOST IO SHUTDOWN – Generated when Magnum is running and there are no communications to one or more of the I/O boards. The system can be accessed but will be in a NO RUN- I/O LOST state.
- LOST I/O RESTART – Generated when the Magnum does an automatic reset once I/O communications are restored.

30.2.3 Key Sensors Alarms

These alarms indicate a problem with a key sensor, it is either shorted or open. The alarm will contain ALARM followed by the 10-character name of the sensor. The following sensors related to the entire system are tested:

- Leaving temperature: If failed, then Lock Out the system.
- Returning temperature: If failed, then alarm only no Lock Out.

- Ambient temperature: If failed, then alarm only no Lock Out.

The following compressor sensors are tested. If they fail, then that compressor only is locked out:

- Suction pressure and temperature
- Discharge pressure and temperature
- Oil pressure and temperature
- Motor temperature (if an analog input)

30.2.4 Emergency Stop Alarm

- EMERGENCY STOP – Generated when the emergency stop switch has been turned on. The system can be accessed but is in a Lock Out state.

30.3. Setpoint safety alarms

The Magnum algorithm incorporates a number of safety checks, based on Setpoints, preventing unsafe conditions that could potentially cause damage to the system. When a safety trips the circuit will be in a SAFETY TRIPPED state. The circuit will remain in this state for the time in the 'Safety Down Time (min)' cell and then move to the CMP ANTICYCLE or CMP IS OFF state where the compressor will be allowed to run again if required. If the same safety trip occurs again within the time in the 'Lockout Delay Hrs' cell since the first trip, the circuit will be set to CMP LOCKED OUT state, which requires a manual reset to restart the compressor. If the lockout delay time is set to zero, the Magnum will generate a lockout condition the first time that the safety occurs.

30.3.1 Sensor Inputs Used With Magnum Setpoint Safeties:

- Suction Pressure(Analog or Digital)
- Discharge Pressure (Analog or Digital)
- Oil Pressure (Analog or Digital)
- Oil Differential Pressure (Calculated value)
- Oil Temperature (Analog or Digital)
- Discharge Temperature (Analog or Digital)
- Motor Temperature (Analog or Digital)
- Motor Amps (Analog or Digital)
- Motor Fault (Analog or Digital)
- Liquid Temperature (Analog Only)
- Compress Proof (Digital Only)
- Flow Switch (Digital Only)

30.3.2 Setpoint safeties

For a safety trip to occur, both the Sensor Input and the associated Setpoint must be active. If a safety trips, the alarm name will consist of the Setpoint name plus additional identification such as point number, compressor number, or 30 second history leading up to the trip if applicable.

Note: Most safeties are checked only if the compressor is running, however if the safety is always checked it will be noted.

The following is a list of safeties that are incorporated in the standard chiller algorithm control. These safeties are checked every second. For a system with multiple circuits, each one is tested individually. If a safety trip occurs, only that respective compressor will be affected, the others will continue to function normally.

Freeze Protection (SAFETY IS ALWAYS CHECKED)

If the leaving temperature drops below the Setpoint value then the entire system will Lock Out and a FREEZE alarm will be generated. There is also an option to have one freeze protect for each individual circuit. Refer to Setpoint #111.

No Flow Protection

If a flow switch is used, then the entire system will be Locked Out if Setpoint #105 is active. If the Setpoint is

inactive, the Magnum will determine if there is a second pump, if so it will be started. Else, the system will shut down and automatically restart when the flow switch is on, indicating flow has returned. There is also an option to have a flow switch for each individual circuit. Refer to Setpoint #105.

Phase Loss Protection

Phase loss, as indicated by the phase loss monitor, will result in the entire system being Locked Off and a phase loss alarm will be generated. If Setpoint #166 is inactive the Magnum will wait for 2 seconds before the Lock Out occurs. The alarm will be PHASE LOSS and no restart will be attempted. If Setpoint #166 is active, the name of the Setpoint will be in the message. Refer to Setpoint #166.

Low Differential Oil Pressure

This safety is designed to meet the compressor manufacturer requirements on oil pressure. For the first 5 seconds following a compressor start (60 seconds if Hitachi screw compressor) this safety is NOT checked. For the next 30 seconds, if the oil differential pressure drops below $\frac{1}{2}$ of the value of the Setpoint or the digital input turns ON for the time specified in the 'Time (sec)' field of that Setpoint, then the circuit will be Locked Out and a LOW OIL alarm generated. After this time period, if the oil differential pressure drops below the value of the Setpoint and it remains there for the time specified in the 'Time (sec)' field, then the compressor will be Locked Out and a low oil alarm generated. This safety is checked for when the compressor is on and not in a Pump Down state. Refer to Setpoint #91.

Low Suction Pressure

If the suction pressure drops below the value of the Setpoint or the digital input turns ON for the time specified in the 'Time (sec)' field, the compressor will be locked out and a LOW SUCTION alarm generated. This safety is bypassed when the compressor is in a Pump Down state. This safety can also be used as a freeze protection based upon the suction pressure. When this safety trip occurs, all compressors in the same suction group will react in the same manner. Refer to Setpoint #77.

Unsafe Suction Pressure

This safety is similar to the low suction pressure safety, except it is often set up with a lower value and a shorter safety time. If the suction pressure drops below the value of the Setpoint or the digital input turns ON for the time specified in the 'Time (sec)' field of that Setpoint, then the circuit will be Locked Out and a UNSAFE SUCTION alarm generated. This safety will always cause a Lock Out on the first trip, requiring a manual reset. This safety is bypassed when the compressor is in a Pump Down state. When this safety trip occurs, all compressors in the same suction group will react the same. Refer to Setpoint #80.

High Discharge Pressure (SAFETY IS ALWAYS CHECKED)

If the discharge pressure rises above the value of the Setpoint or the digital input turns ON for the time specified in the 'Time (sec)' field of that Setpoint, then the circuit will be locked out and a HIGH DISCHARGE alarm generated. Refer to Setpoint #81.

Low Discharge Pressure

If the discharge pressure drops below the value of the Setpoint for the time specified in the 'Time (sec)' field, the compressor will be Locked Out and a LOW DISCHARGE alarm generated. Refer to Setpoint #85.

High Discharge Temperature (SAFETY IS ALWAYS CHECKED)

If the discharge temperature analog input rises above the value of the Setpoint or the digital input turns ON for the time specified in the 'Time (sec)' field, the compressor will be Locked Out and a HIGH TEMPERATURE alarm generated. Refer to Setpoint #87.

High Motor Temperature or Motor Fault (SAFETY IS ALWAYS CHECKED)

If the high motor temperature input rises above the value of the Setpoint or the digital input turns ON for the time specified in the 'Time (sec)' field, the circuit will be Locked Out and a HIGH MOTOR TEMPERATURE or MOTOR FAULT alarm generated. Refer to Setpoint #95.

High Oil Temperature

If the oil temperature rises above the value of the Setpoint or the digital input turns ON for the time specified in the Time (sec)' field, the compressor will be locked out and a HIGH OIL TEMPERATURE alarm generated. Refer to section #94.

High Motor Amperage

If the amperage analog input rises above the value of the compressor's respective FLA Setpoint #171 – 190 times the value of Setpoint #75 or the digital input turns ON for the time specified in the Time (sec)' field, then

the circuit will be Locked Out and a HIGH MOTOR AMP alarm generated. Refer to Setpoint #75.

Low Motor Amperage

If the amperage analog input drops below the value of the compressor's respective FLA Setpoint #171 – 190 times the value of Setpoint #76 or the digital input turns ON for the time specified in the Time (sec)' field, then the circuit will be Locked Out and a LOW MOTOR AMP alarm will be generated. Refer to Setpoint #76.

Voltage Sensor (08.00-R)

Up to three sensors that measure voltage input can be specified. If used, a safety condition based upon Setpoint #195 LOW VOLTAGE and Setpoint #196 HI VOLTAGE will be checked. If a safety trip occurs the unit will be placed in a safety hold state.

Motor Amps (08.00-R)

Up to three sensors that measure amperage input can be specified per circuit. If used a safety condition based upon Setpoints #75 HI AMPS and #76 LO AMPS, plus the associated Full Load Amps (FLA) for that circuit will be checked. If a safety trip occurs, that circuit will be placed in a safety hold state.

Add an Amp Imbalance Safety Test to the existing Amp Safeties.(17.35)

All three Motor Amps (A, B, & C) sensors must be indicated and **setpoint #241** must be active and be setup as a normal safety and contain:

- Type: Either Lockout or Alarm
- Select Value: HUMD or %
- Value: Maximum percentage of deviation
- Time: Normal safety
- Lockout Delay: Normal safety
- Safety Down Time: Normal safety

This safety will be run every second when the compressor is on and the split winding relay is on if one exists (same requirement as other amp safeties).

The three amp sensor values will be totaled and averaged. If any of the amp sensors are more than the percentage of the value of **setpoint #241** difference from the average for more than the time specified in the time cell of **setpoint #241** the compressor will be tripped and the error message will be the name of **setpoint #241** plus the circuit number. The normal 2 trip logic will apply if the set point is a lockout type.

No Compressor Proof

If a compressor is called to be on and the compressor proof digital input is OFF, a NO COMP PROOF alarm will be generated. Refer to Setpoint #96.

High Oil Seal Temperature (Screw Compressors only)

If the oil seal temperature analog input rises above the value of the Setpoint for the time specified in the Time (sec)' field, then the circuit will be Locked Out and a HIGH OIL SEAL alarm generated. This safety is bypassed when the compressor is in a Pump Down state. Refer to Setpoint #93.

Dirty Oil Filter (Fixed Step Compressors only)

If the difference between the discharge pressures minus the oil pressure is above the value of the Setpoint for the time specified in the Time (sec)' field, a DIRTY OIL FILTER alarm will generate. Refer to Setpoint #97.

Low Discharge Superheat

If the discharge superheat is below the value in Setpoint for the time specified in the Time (sec)' field, then the circuit will be Locked Out and a LOW DISCHARGE SUPERHEAT alarm will be generated. Refer to Setpoint #84.

30.4. TurboCor Compressor Alarms

Inverter Temperature Fault (Hex code =0x0001)

The measured Inverter Temperature has exceeded either the Alarm or Fault limit, probably due to insufficient inverter cooling.

Discharge Temperature Fault (Hex code =0x0002)

The measured Discharge Temperature has exceeded either the Alarm or Fault limit, probably due to insufficient charge (not enough gas).

Suction Pressure Fault (Hex code =0x0004)

The measured Suction Pressure has exceeded either the Alarm or Fault limit, probably due to insufficient charge or insufficient system load.

Discharge Pressure Fault (Hex code =0x0008)

The measured Discharge Pressure has exceeded either the Alarm or Fault limit, probably due to a faulty condenser. *Instantaneous lock out at fault level.

3 Phase Over Current Fault (Hex code =0x0010)

The estimated Mains Supply voltage has exceeded either the Alarm or Fault limit, probably due to excessive system load on mains supply (usually the compressor is pumping liquid). *Instantaneous lock out at fault level.

Cavity Temperature Fault (Hex code =0x0020)

The measured Cavity Temperature has exceeded either the Alarm or Fault limit, probably due to insufficient motor cooling (shaft cavity).

Leaving Fluid Temperature Fault (Hex code =0x0040)

The measured Air / Water Temperature has exceeded either the Alarm or Fault limit, probably due to insufficient air / water flow.

Pressure Ratio Fault (Hex code =0x0080)

The measured Compression Ratio of Discharge and Suction has exceeded either the Alarm or Fault limit, probably due to faulty condenser or insufficient load on the evaporator.

Generic Bearing/Motor/Compressor Fault (Hex code =0x0100)

If the Motor Fault Word, 40106, or the Bearing Fault Word, 40098, is different from 0, then the Generic Compressor Fault is triggered.

Sensor Fault (Hex code =0x0200)

If the following measured degrees Celsius are surpassed, a Sensor Fault is triggered. The pressure values are in kPa:

40105 Inverter Temperature >100 or < 0

40037 Cavity Temperature >100 or < -20

40034 Suction Temperature >100 or < -30

40036 Discharge Temperature >110 or < -30

40046 Leaving Water Temperature >100 or < -20

40031 Suction Pressure >1200 or < -30

40033 Discharge Pressure >3500 or < -30

SCR Temperature Fault (Hex code =0x0400)

The measured SCR Temperature has exceeded either the Alarm or Fault limit. Probably due to insufficient SCR plate cooling.

Lock Out Fault (Hex code =0x0800)

If any (or a combination of) the Faults listed below occurs more than 3 times (reg. 40262) within 30 minutes (reg. 40263), a "Lock Out Fault" occurs:

- Inverter Temperature trip
- SCR Temperature trip
- Motor Current High trip
- Inverter Error Signal Active trip
- Rotor May Be Locked trip
- Motor Back emf trip

*Instantaneous lock outs:

- Discharge Pressure
- 3 Phase Over-Current

Winding Temperature Fault (Hex code =0x1000)

The measured motor winding temperature has exceeded 155°C.

Superheat Fault (Hex code =0x2000)

The Fault limit is based on the suction pressure and temperature values. There is no time delay on this fault or alarm. The difference between the fault limit and alarm limit is the dead band for the control.

Reserved (Hex code =0x4000)

Reserved (Hex code =0x8000)

Chapter - 31. Troubleshooting Quick Reference

(A more detailed troubleshooting guide is available on our website: www.MCScontrols.com)
Magnum Simplified Description & Troubleshooting Rev 2.5

PROBLEM	POTENTIAL SOLUTION
No Sensor + 5 vdc or sensor +5 vdc output is less than 4.90 vdc.	Indicates a possible shorted input sensor Remove all sensor terminal blocks. Wait about 30 to 60 seconds. If + 5 vdc returns, replace one sensor wire at a time until the + 5 vdc is lost again. This will be the shorted sensor.
A Sensor Input reads -99.9	This indicates an open Sensor Input signal or 5 VDC problem. Check sensor wiring for missing wire or poor connection. Check for faulty sensor. Check + 5 vdc on Sensor Input to ground. If less than 5 VDC is on the sensor 5 VDC terminal block, the problem is with probably a shorted sensor. (A poly fuse protects the board) Remove all Sensor Input terminals. Wait about 1 minute or until 5 VDC restored at Sensor Input. Connect terminals 1 at time until short reappears and fix bad sensor.
A Sensor Input reads +999.9	This indicates a shorted Sensor Input signal. Check sensor wiring for +5VDC shorted to signal etc. Check for faulty sensor.
A pressure sensor is reading more than 1 psi off (The temperature and humidity sensors do not require calibration.)	This indicates the transducer Sensor Input needs to be calibrated through the off-set capability in the software. (Transducers by design need to be calibrated based on construction and altitude.) You must use the MCS-Connect with a valid Authorization code to change sensor offsets See MCS-Connect Interactive section for instructions. (Change SI Status, Manual Value and / or offset.)
Invalid reading on one Sensor Input.	This indicates an input problem with 1 sensor. Verify jumper settings correct for that SI.
Lost I/O	Indicates communications problem. Verify RS485 LED blinking. Verify termination jumper J6 only on at Magnum and last I/O. Verify Magnum and I/O address's set correctly. Verify wiring from Magnum to each I/O correct. Check fuses/120 VAC on I/O units
Lost I/O - Shutdown Alarm	Sensor could be failing giving a Loss I/O shutdown alarm: Possible cause of this alarm is a failing sensor input (SI) where the +5vdc has been reduced to <3vdc. Check the +5 to ground on each sensor board. When you have identified the SI board with the problem remove each SI cable until you get +5vdc back. Replace the failing sensor.

PROBLEM	POTENTIAL SOLUTION
MCS-Connect cannot make changes	<p>This indicates you are not at a proper authorization level. Follow steps below for proper authorization From either the SITE INFO or STATUS screen in MCS-Connect, click the 'View Only' button at the top of the screen, or click on the 'Passwords' menu option on the lower right of your Keypad/LCD display. Follow prompts and enter a valid 4-digit authorization number. The authorization level is displayed at the top of the display and is reflected by the color of the Authorization button.</p> <p>Red = View Only Light Blue = User level Purple = Service level Dark Blue = Supervisor level Green = Factory level Green = Admin</p>
Invalid authorization	<p>This indicates an invalid authorization number. Follow steps below for proper authorization Press Service Diagnostics key until the authorization option appears Press the Enter key From the "Display Status" press keys corresponding to your authorization number. Press Enter</p>
SI from AMPS board 10 A low.	<p>This indicates a problem with this SI only. Jumper setting on this SI in wrong position. Incorrect sensor type used.</p>
INVALID CONFIG VER	<p>Indicates layout of CFG wrong. CFG layout for different version than software</p>
INVALID CONFIG TYPE	<p>Indicates CFG incompatible with software.</p>
INVALID CONFIG CHECKSUM	<p>Indicates Checksum invalid Reload a valid CFG</p>
Sensor input believed invalid (Under Sensor Diagnostic Sub Menu)	<p>Verify Berg jumpers using Quick Reference Sheets Check board version number Check wiring of sensor</p>
Communications to MCS-485-GATEWAY from MCS-Connect not working.	<p>Verify red LED on the gate way is blinking. This indicates that MCS-Connect is talking to the gateway. Verify that the two wire shielded cable is properly wired from the RS-485 connector to the gateway. Verify red LED (Located just to the left of the RS-485 connector on the Magnum board is blinking. This indicates that the Magnum is responding to the gateway. If both of these LED are blinking, check the address of the Magnum and any other Magnums that are on the network. Each must have a unique address. This address can be changed from the Magnum. Proper authorization is required. Enter the UNIT INFORMATION screen by pressing the SERVICE DIAGNOSTIC key and scrolling to this item. Press the enter key and scroll to the NETWORK ADDRESS screen. Change address if needed. Verify + 12 vdc to MCS-485-GATEWAY</p>
INVALID CONFIG	<p>Indicates Checksum invalid Either set to factory defaults on reset settings.</p>

Chapter - 32. Magnum Setpoints

Setpoint Information Screen

#	Name	Value	Min	Max	Adjust Value	Time (SEC)	Max Time Allowed (SEC)	Lockout Delay (HRS)	Safety Down Time(MIN)	Active or Non-Active	Select Value: # decimals & print char	Level Of Auth. To Display	Type of Setpoint	Comments	SEC to Ignore Safety	Window to Ext. Safety Time(SEC)	Safety Time Extension (SEC)
---	------	-------	-----	-----	--------------	------------	------------------------	---------------------	-----------------------	----------------------	---------------------------------------	---------------------------	------------------	----------	----------------------	---------------------------------	-----------------------------

(Number)–From 1 to 255 (maximum number of Setpoints supported). Only active Setpoints will be displayed in MCS-Connect and on the keypad display.

Name–The Setpoint's name consists of up to 12 characters. The name is displayed following the number on the LCD display. The Setpoint name can be changed to make it more meaningful to the current application, however the function of the Setpoint will remain the same.

Value–The value or target of the Setpoint. With proper authorization this value can be changed, within limits that have been established in MCS-Config.

Min–The minimum value that can be set. This field is not displayed and cannot be changed in MCS-Connect or in the keypad display.

Max–The maximum value that can be set. This field is not displayed and cannot be changed in MCS-Connect or in the keypad display.

Adjust Value–The interval that the value field can be changed by. This field is not displayed and cannot be changed in MCS-Connect or in the keypad display.

'Time (sec)' – this field has two purposes:

- 1) In either a LOCKOUT or ALARM type; this is the length of time the Setpoint must be true before it will trip. This time is always in seconds and it is displayed on the keypad display and MCS-Connect if the Setpoint is either a LOCKOUT or ALARM type. This field can be changed in MCS-Connect and through the keypad.
- 2) In a non-safety type Setpoint this field can be used as an extra timer. This will be specified in the Setpoint definition if it is used.

Lockout Delay Hrs. – If a second safety occurs within this time, the unit or compressor will be locked out. This field is not displayed and cannot be changed through MCS-Connect or in the keypad display.

Safety Down Time (min.) – After the first safety occurs the Magnum will wait this number of minutes before the unit or associated compressor is allowed to run again.

Active or Non-Active – Only active Setpoints will be displayed in MCS-Connect or on the keypad display, but only if the needed authorization level has been achieved.

Select Value: # decimals and print char – This indicates the number of decimal places and the unit character that accompanies the value displayed. The number of decimal places is crucial when the Value, Minimum, and Maximum data is entered in MCS-Config.

Level of Auth. To Display – This column indicates what authorization level a user must have in order to view the Setpoint from MCS-Connect or the keypad display.

Comments – This column allows the user to add comments about the function of the Setpoint.

BMS Writeable (Click Here to Disable All) – The Magnum software will enable communications with an outside source, building management system (BMS), to modify the value of a set point. Object is to provide maximum flexibility and capability with an BMS.

32.1. Setpoint Types

There are six different types of Setpoints. The Magnum software determines if a Setpoint contains a target value or is a safety. If it is a safety then its type determines what action the Magnum will take when the safety occurs (either locking out the unit or generating an alarm only).

32.1.1 SETPOINT

This type of Setpoint contains a target or provides information for some action. The time element in this type can be used for an additional counter if specified. This time is not displayed and cannot be changed through MCS-Connect or from the keypad display.

32.1.2 LOCKOUT

This type of Setpoint contains a safety value and the time that the safety must be violated before the safety will trip. Once a safety has tripped the Magnum will take the appropriate action, shutting down the entire package or an individual compressor depending on the purpose of the safety. The Magnum will then wait the Safety Down Time contained in that Setpoint before trying to return the normal. If successful, the system will continue to operate. If a second trip occurs on the same Setpoint with in the Lock Out Delay Time that is contained in that Setpoint the system will move to a LOCKOUT state. If the lockout delay time is set to zero the lockout will occur on the first trip. This requires manual intervention to reset the system. With each safety trip, the Magnum will generate an alarm; refer to Magnum Alarms and Safeties.

Sec. to ignore safety - If this value is not zero, at compressor startup this safety will be ignored for the time in this field.

Window to extend Safety 'Time (sec)' – If this value is not zero, at compressor startup the normal Safety Time will be increased by the value in Safety Time Extension field for the time specified in this field.

Safety Time Extension (Sec) – This is the value that will be added to the Safety Time during the Window to extend Safety Time period.

32.1.3 ALARM

This type of Setpoint has two uses:

- 1) When it is used as a safety, it will be similar to the LOCKOUT Setpoint except it will never cause a lock out. The system will continue to try returning to normal operation after waiting the safety down time. An ALARM Setpoint type will never require manual intervention to reset the system.
- 2) When the Setpoint is being used as a second timer it will be available to change in a live unit. If the type is not changed to ALARM then the time field cannot be viewed or changed from a live unit.

Sec. to ignore safety - If this value is not zero, at compressor startup this safety will be ignored for the time in this field.

Window to extend Safety 'Time (sec)' – If this value is not zero, at compressor startup the normal Safety Time will be increased by the value in Safety Time Extension field for the time specified in this field.

Safety Time Extension (Sec) – This is the value that will be added to the Safety Time during the Window to extend Safety Time period.

32.1.4 Time

This type of Setpoint allows the 'Time (SEC)' value to be displayed and modified in a live unit.

32.1.5 Target

This type of set point is used to develop a target with a high and low zone values.

The decimal characteristics of these values are the same as the Value field

High Zone – The value of this cell is added to the Value cell to create the high zone value.

Low Zone – The value of this cell is subtracted from the Value cell to create the low zone value.

Night Setback – If system has an unoccupied mode, this value is used to modify the value of the 'Value' cell.

32.1.6 Delay

This type of set point is used to develop a target with a high and low zone values.

The decimal characteristics of these values are the same as the Value field

High Zone – The value of this cell is added to the Value cell to create the high zone value.

Low Zone – The value of this cell is subtracted from the Value cell to create the low zone value.

Night Setback – If system has an unoccupied mode, this value is used to modify the value of the 'Value' cell.

32.2. Window/Safety extension

32.2.1 Time and seconds to ignore for setpoints

- Seconds to ignore – This is the time in seconds to ignore the associated safety at compressor start up. **The window to extend safety time and safety time extension fields work together.**
- Window to extend safety – This value in seconds is the time window when the compressor starts that the **safety time extension** is added to the safety **time(sec)** value.
- Safety time extension – This value is the time that is added to the **time(sec)** value during the **window to extend safety time(sec)** time.

Example – Unsafe suction setpoint has a 3 second safety trip. So if we add a 120 to our window to extend safety, we will then be telling the controller at startup we're going to extend that 3 second safety trip for 120 seconds. This is where the Safety time extension comes into play. If we put a 6 in this field we're telling the controller for the first 120 seconds at startup we're extending the safety trip time to 9 seconds (3 second trip plus the 6 second extension). Once the 120 seconds expires we will then revert back to a 3 second trip time for the duration of the compressors run time till the next startup.

System Setup ROs SIs AOs MAG HVAC Circuit Base Circuit SI Setpoints Auth Schedule BMS Points Lookup Table																	
Setpoint Information Screen																	
Name	Value	Min	Max	Adjust Value	Time (SEC)	Max Time Allowed (SEC)	Lockout Delay (HRS)	Safety Down Time(MIN)	Active or Non-Active	Select Value: # decimals & print char	Level Of Auth. To Display	Type of Setpoint	Comments	SEC to Ignore Safety	Window to Ext. Safety Time(SEC)	Safety Time Extension (SEC)	
LOW SUCTION	55	35	65	1	90	120	2	10	Active	...	PSI GAGE	View Only	Lockout	...	5	900	120
LO SUCT UNLD	2	2	6	1	0	0	0	0	Active	...	PSI GAGE	View Only	Setpoint	...	---	---	---
LO SUCT RELD	5	3	8	1	0	0	0	0	Active	...	PSI GAGE	View Only	Setpoint	...	---	---	---
UNSAFE SUCT	10	5	25	1	3	3	0	0	Active	...	PSI GAGE	View Only	Lockout	...	3	120	6

32.3. Setpoints for Magnum HVAC

#	Name	Description
1	CTL TARGET	Control target. This value is used as the base to develop the Control Zone when the unit is in a cooling mode. Refer to setpoints #2 and #3. The control target is used with the control zone and rate of change of the controlling sensor to determine required action for the Magnum. The controlling sensor is usually one of the following: Leaving Temperature – Most common used as a target, fitting for most applications. Return Temperature – Used in sites with large air masses, ice rinks, common areas, etc. Suction Pressure – Used in continuously running process systems. 'Target' - if used. will turn off all running compressors when the controlling sensor falls below LOW ZONE column value. NOTE: If using Setpoint#151, be sure the values don't conflict.
2	CTL ZONE +	Added to the CTL TARGET to create the upper limit of the control zone. 'Time (sec)' field: (Only accessed if CLLC control has been specified.) If this field is not zero then multiple the value by this amount to develop the upper limit of control zone.
	STAGE CUT OUT (Cut In/Out Control)	Offset used in calculating the cut out value. Subtracted from the stage cut in Setpoints #3 through #18. 'Time (sec)' = 0 for fixed staging, 1 for individual offsets
3	CTL ZONE -	Subtracted from the CTL TARGET to create the lower limit of the control zone. 'Time (sec)' field: (Only accessed if CLLC control has been specified.) If this field is not zero then multiply the value by this amount to develop the lower limit of control zone.
	STAGE 1 CUT IN (Cut In/Out Control)	Stage 1 cut in, Setpoint value contains the voltage when this stage is turned on.
4	HGS TEMP ON IF USING OFF-SETS, SETPOINT TYPE IS SET TO 'TIME'	This setpoint is used with compressors with a hot gas bypass solenoid to provide temperature control for turning on the solenoid. When this setpoint is active and the control temperature is less than the CTL TARGET plus the value in this setpoint and there is at least one compressor running in this suction group or the FLA % is within the slide percentage offset (refer to Time cell of this set point) of setpoint #31 "MIN SLIDE%", the hot gas bypass solenoid for the compressor will be turned on. 'Time (sec)' field: Contains the minimum slide percentage offset to enable the HGB. If non-zero, this value is added to setpoint #31 "MIN FLA%" to determine the range in which to enable the HGB. If zero, then the default value of 20 is added. For example, if this value is 10, then the HGB will enable when the compressors FLA% is within 10% of setpoint #31 "MIN FLA%". See setpoint #31 on how to setup as a target type to get the hardcoded 20% out of the way.
	STAGE 2 CUT IN (Cut In/Out Control)	Stage 2 cut in, Setpoint value contains the voltage when this stage is turned on.
5	HGS TEMP OFF IF USING OFF-SETS, SETPOINT TYPE IS SET TO 'TIME'	This setpoint is used with compressors with a hot gas bypass solenoid to provide temperature control for turning off the solenoid. When this setpoint is active and the control temperature is greater than the CTL TARGET plus the value in this setpoint and there is at least one compressor running in this suction group or the FLA % is not within the slide percentage offset (refer to Time cell of this set point) of setpoint #31 "MIN SLIDE%", the hot gas bypass solenoid for the compressor will be turned off. 'Time (sec)' field: Contains the minimum slide percentage offset to disable the HGB. If non-zero, this value is added to setpoint #31 "MIN FLA%" to determine the range in which to disable the HGB. If zero, then the default value of 30 is added. For example, if this value is 15, then the HGB will disable when the compressors FLA% is 15% or more above setpoint #31 "MIN FLA%". See setpoint #31 on how to setup as a target type to get the hardcoded 20% out of the way.
	STAGE 3 CUT IN (Cut In/Out Control)	Stage 3 cut in, Setpoint value contains the voltage when this stage is turned on.

#	Name	Description
6	HGS PSI ON	This setpoint is used with compressors with a hot gas bypass solenoid to provide pressure control for turning on the solenoid. When this setpoint is active and the suction pressure is less than the value of this setpoint and the FLA % is within offset of setpoint #31 "MIN SLIDE%", the hot gas bypass solenoid for the compressor will be turned on. (refer to setpoint #4)
	STAGE 4 CUT IN (Cut In/Out Control)	Stage 4 cut in, Setpoint value contains the voltage when this stage is turned on.
7	HGS PSI OFF	This setpoint is used with compressors with a hot gas bypass solenoid to provide pressure control for turning off the solenoid. When this setpoint is active and the suction pressure is greater than the value of this setpoint or the FLA % is not within 25% of the setpoint #31 "MIN SLIDE%", the hot gas bypass solenoid for the compressor will be turned off. (refer to setpoint #5)
	STAGE 5 CUT IN (Cut In/Out Control)	Stage 5 cut in, Setpoint value contains the voltage when this stage is turned on.
8	L.INJECT.ON	This set point is used to control all stages of liquid injection solenoids. (These must be specified in the Liquid Injection column of the Circuit base screen.) If active and type is TARGET: Value: Liquid injection is turned on when the discharge temperature is greater than or equal to this value, and is turned off when the discharge temperature is less than this value minus the Injection Difference Temperature set point #113. Typically set at 10.0°F (5.5°C). If there are two stages, the Second stage relay will be turned on when the discharge temperature is greater than set point #8 plus 5°F (2.5°C). If the controlling SUPER HEAT is 3x its target, LIQ INJ is turned ON and remains ON until the controlling SUPER HEAT falls below 2x its target. High/Low zone cells are used to adjust these settings: The adjustment multiplier on is the value in the High Zone cell if it is greater than 0; else it is set to 3. The adjustment multiplier off is the value in the Low Zone cell if it is greater than 0; else it is set to 2. If High/Low Zone equal 0: The adjustment multiplier on is fixed at 3. The adjustment multiplier off is fixed at 2. 'Time (sec)' field: If the first liquid injection solenoid has been on for a time greater than this value, then turn on the second liquid injection solenoid. If 0 then there is no delay time.
	STAGE 6 CUT IN (Cut In/Out Control)	Stage 6 cut in, Setpoint value contains the voltage when this stage is turned on.
9	SucSprHtTarg or LEVEL TARGET	If EXV control is based upon superheat, this is the Superheat target that the Magnum will control from. If EXV control is based upon refrigerant level, this is the refrigerant level target that the Magnum will control from. 'Low Zone' if nonzero then develop control super heat based upon the lowest superheat of any compressor that is on with in this suction group else use the superheat of this compressor. 'Time (sec)' field: Seconds between samples used for calculating the Superheat Rate of Change.
	STAGE 7 CUT IN (Cut In/Out Control)	Stage 7 cut in, Setpoint value contains the voltage when this stage is turned on.
10	SPRHT ZONE +- Ki-IntegMult	The value in this setpoint is added and subtracted to setpoint #9 to determine the upper and lower limits of the control zone respectively. Refer to section on EXV control. 'Time (sec)' field: If non-zero, skip ROC adjustment logic in the control zone. EXV PID Integral - Offset in Superheat= Current Superheat minus Target Superheat (setpoint #9 value field) Value is the Fast Multiplier for Kp adjustments, setback is the slow multiplier.
	STAGE 8 CUT IN (Cut In/Out Control)	Stage 8 cut in, Setpoint value contains the voltage when this stage is turned on.

#	Name	Description
11	EXV LOAD ADJ	The opening adjustment that will be made to the EXV percentage when the circuit changes to the Loading state or the closing adjustment that will be made when the circuit changes to the Unloading state. Refer to section on EXV control. Note: In MOP hold state, only closing adjustments are allowed.
	STAGE 9 CUT IN (Cut In/Out Control)	STAGE 9 cut in, Setpoint value contains the voltage when this stage is turned on.
12	EXV FINE ADJ	The adjustment is made when in the 1st zone above or below the control zone. Refer to section on EXV control.
	Kp-PropMult	EXV PID Proportional - Change in Superheat = Current Superheat minus last Superheat from 1 second ago (Rate of Change). Value is the Fast Multiplier for Kp adjustments, setback is the slow multiplier.
	STAGE 10 CUT IN (Cut In/Out Control)	Stage 10 cut in, Setpoint value contains the voltage when this stage is turned on.
13	EXV COURSE	If a course adjustment to the EXV when in the 2nd zone above or below the control zone. If the type is TIME and the time (SEC) field is greater than 1 and less than 7 then multiple the value field by the time field else multiple by 2 for adjustment amount. If a course adjustment to the EXV when in the 3rd zone above or below the control zone. Multiple value by the by 2 for adjustment amount. If a course adjustment to the EXV when above or below the 3rd zone the control zone. The value is the adjustment amount. Refer to section on EXV control. If a course adjustment to the EXV when in the 3rd zone above or below the control zone. Multiple value by the by 2 for adjustment amount. If a course adjustment to the EXV when above or below the 3rd zone the control zone. The value is the adjustment amount. Refer to section on EXV control.
	Kd-DerrMult	EXV PID Derivative - Velocity of Superheat = Current Superheat minus the Superheat from x seconds ago (setpoint #9 time seconds value). Value is the Fast Multiplier for Kp adjustments, setback is the slow multiplier.
	STAGE 11 CUT IN (Cut In/Out Control)	Stage 11 cut in, set point value contains the voltage when this stage is turned on.
14	EXV LOAD DIV	The EXV slide adjustment can be fined tuned by dividing by the value of this set point. Note the value of this set point is used regardless if the its is active or not. Refer to section on EXV control.
	Ka-AccMult	EXV PID Acceleration - Change in Velocity = Current Kd minus the Kd from x seconds ago (setpoint #9 time seconds value). Value is the Fast Multiplier for Kp adjustments, setback is the slow multiplier.
	STAGE 12 CUT IN (Cut In/Out Control)	Stage 12 cut in, Setpoint value contains the voltage when this stage is turned on.
15	ExvMinValve%	This is the minimum valve position allowed when modulating the expansion valve. This value should be set so when hot gas is applied the valve opening is adequate. Note the value of this set point is used regardless if it is active or not. Refer to section on EXV control. Note the value of this set point is used regardless if it is active or not. Refer to section on EXV control. Note the value of this set point is used regardless if it is active or not. Refer to section on EXV control.
	STAGE 13 CUT IN (Cut In/Out Control)	Stage 13 cut in, Setpoint value contains the voltage when this stage is turned on.
16	ExvMaxValve%	This is the maximum position allowed when modulating the expansion valve to maintain the superheat target. This value should be the valve % opening at full capacity plus a 10 to 15 % margin. Note the value of this set point is used regardless if the its is active or not. Refer to section on EXV control.

#	Name	Description
	STAGE 14 CUT IN (Cut In/Out Control)	Stage 14 cut in, Setpoint value contains the voltage when this stage is turned on.
17	LoSucSuperHt	If super heat is less or equal to this value and the control slope is less that the roc for zone 3 make a slide adjustment of 3 times the value of set point #13. If the calculated superheat remains below this value for the time specified in the Time (SEC) cell, the Magnum will generate a LOW SUPERHEAT alarm. Refer to section on EXV control.
	STAGE 15 CUT IN (Cut In/Out Control)	Stage 15 cut in, Setpoint value contains the voltage when this stage is turned on.
18	LOWSUCPSI DLY	Delay in seconds when in 'Low Suction PSI Opening', set point must be active, between adjustments to the EXV valve. Refer to section on EXV control..
	STAGE 16 CUT IN (Cut In/Out Control)	Stage 16 cut in, Setpoint value contains the voltage when this stage is turned on.
19	EXV DELAY	Delay in seconds between valve adjustments. Should not be less than 48. (When adjusting at 4x this will allow 12 seconds for the controller to process the results of the last action before making the next adjustment). Refer to section on EXV control.
	ExvKiDelay	Delays valve from making a change that is set in the value field.
20	ExvStartup	This is the time in seconds to hold the valve at the start % setpoint when the compressor starts. Since the superheat calculation is not valid when the compressor is not running the EXV logic sets the valve to a given position for a set time to allow the system to develop a valid superheat. 'Time (sec)' field: If zero, then there is no delay when a compressor is ready to start. If non-zero, this is the time delay in which the EXV valve is allowed to open before the compressor starts. Refer to section on EXV control.
21	MAX TRG RESET	This set point is used to convert the voltage of a TARGET RESET type of sensor to a temperature value. This value is used to adjust setpoint #1 "CTL TARGET". The Sensor Input value will vary between 0 and 5 volts and the adjustment to the control target will be modulated from negative "MAX TRG RESET" to the positive "MAX TRG RESET" value. This set point is also used for regulating the maximum reset from the BMS. This limits the offset from the target +/- BMS can write.
22	LOW AMP OFF	When set up as a "Setpoint" type... the logic will disable the Chiller when the ambient temp falls below the value of setpoint #22. When set up as a "Delay" type, and a value of "1" is set in the "Max VFD Adjust" cell... the logic will only disable mechanical cooling when the ambient temp falls below the value.
23	POWERUP DELAY	If this set point is active the value will be the time in seconds that the system will remain in the START UP state before moving to the next state. If inactive the startup delay will be 60 seconds. 'Time': When set to CPM control the time field now becomes the delay before defaulting to stand alone control on loss of communication from the CPM. This value can't be set below 30 seconds (hardcoded)
24	HIGH AMP OFF	If active and the ambient temperature is above this value the system will be disabled the compressor(s) and the unit state will be set to AMBIENT OFF. The unit will remain off until the ambient temperature drops below this setpoint value by 5.°F (2.5C) or the value of set point #191 if it is active.

#	Name	Description
25	STEP SENSTIY	The decrements to the time delay between making changes in the control algorithm is based upon the difference between the target and control values. If the difference is greater than 10 the delay will be reduced by 10. If less the delay will be adjusted by the value of this set point. 1 is the fastest response, whereas higher numbers will mean a more gradual response. 'Time'(sec) field- if used, when the controlling temp sensor is in the control zone and if step wanted on is greater than steps turned on, set steps wanted on equal to steps turned on. Set Time column to a value of 1.
26	STEP DELAY	Value: This is the time delay before making adjustments to the system capacity. Refer to set point #25 for how this delay is decremented. 'Time (sec)' field: If used, this will force a minimum time delay between any two compressor starts. This time delay is specified in the 'Minimum Delay Between Compressor Starts' box in the 'Cooling Info' panel under the MAG RTU screen.
27	MAX ROC -	Compares the control value rate of change. Maximum negative Rate of Change allowed before preventing the unit from loading. If the ROC is less than this value the capacity control state is set to HOLDING.
28	MAX ROC +	Compares the control value rate of change. Maximum positive Rate of Change allowed before preventing the unit from unloading. If the ROC is greater than this value the capacity control state is set to HOLDING.
29	ROC INTERV	Seconds between samples used for calculating the Rate of Change. (Maximum 60 seconds)
30	MAX FLA% or MAX SLIDE % or MAX CAPACITY% or MAX VFD %	Indicates the maximum amp draw, slide %, digital scroll load%, or speed allowed. Usually set to 100%, else compressors will load to the value of this Setpoint until all steps are on, then the system will load to 100%. 'Time (sec)' field: If non-zero, then force individual compressors to stay at maximum capacity when another compressor starts. This option is selected in the 'Keep Running Comp at 100% when starting next?' box in the 'Compressor Information' panel under the MAGNUM screen. 'SEC to Ignore Safety' field (Fully Loaded Screw Compressor logic): If non-zero, turn on the load solenoid every 5 min for 5 seconds when fully loaded. If zero, then do not turn on solenoid for 5 seconds every 5 minutes. 'SEC to Ignore Safety' field (Holding Screw Compressor logic): If non-zero, turn on the load solenoid every 5 min for 5 seconds when holding. If zero, then do not turn on solenoid for 5 seconds every 5 minutes.
31	MIN FLA% or MIN SLIDE % or MIN CAPACITY% or MIN VFD %	Value: Indicates the minimum amp draw, slide %, digital scroll load%, or speed allowed (usually 40%). This is where the slide valve or VFD will be set when the compressor is turned on. This % is a function of actual amp draw relative to the FLA. 'Time (sec)' field: If used, this forces a time delay before unloading all running compressors before the next compressor is started. This time delay is specified in the 'Unload Compressor Before Starting Next' box in the 'Compressor Information' panel under the MAGNUM screen. Will Delay next compressor for this time after EVAP pump/valve is opened. Target: If this set point is setup as a target type the value in the night setback column will be added to the set point VALUE to allow safety unloading all the way down to this value. This replaces a hardcoded 20%. This is also utilized in conjunction with hotgas setpoints #4 and #5 on temperature.
32	MAX ADJUST %	Value of set point contains the maximum percentage change that can be made to the slide valve or VFD. 'Time (sec)' field: A zero indicates that the calculated FLA will be used; else the value in setpoint #31 will be used when starting the next compressor. This value is specified in the 'Wanted FLA starting next Compressor' box in the 'Cooling Info' panel under the MAG RTU screen.
33	MIN ADJUST %	Indicates the minimum percentage change that can be made to the slide valve or the VFD. For Fixed Step Compressors with adjustable speed AO's when returning to 100% after shutting down another compressor, this Setpoint will be the percent of adjustment along with Setpoint #56 "PULSE DELAY" which is the time frame between capacity adjustments.

#	Name	Description
34	SLIDE SENSITY	This controls the sensitivity of the adjustment made to the Wanted Percentage (adjustments are relative to the difference between the current control sensor and target). The larger the value the larger the adjustment (usually 1).
35	AMP DB HI	Used only with screw and centrifugal compressors. If the set point type is "humidity" then the upper dead band is value times the FLA for that circuit else the value is the upper dead band limit of the FLA. If the amps are within the dead band, the slide valve will not be moved. If controlled by Slide Position, instead of FLA, this Setpoint will not be used.
36	AMP DB LO	Used only with screw and centrifugal compressors. . If the set point type is "humidity" then the lower dead band is value times the FLA for that circuit else the value is the lower dead band limit of the FLA. If the amps are within the dead band, the slide valve will not be moved. If controlled by Slide Position, instead of FLA, this Setpoint will not be used.
37	LOAD PULSE	Length of time to engage the slide valve load solenoid in tenths of a second (usually between 1 and 9). 'Time (sec)' field: If non-zero, use this value as a multiplier to increase the load pulse when the compressor's amp draw is more than three times the value of Setpoint #36 "AMP DB LO". 'SEC to Ignore Safety' field: If zero, then use delay between pulses. If non-zero, then no delay between pulses when the compressor's amp draw is more than twice the value of Setpoint #36 "AMP DB LO" away from the wanted FLA.
38	UNLOAD PULSE	Length of time to engage the slide valve unload solenoid in tenths of a second (usually between 1 and 9). Optional: If compressor type is Hanbell 3 solenoid and Time (SEC) cell of Setpoint #38, is not zero DO NOT turn the unload solenoid ON (which is normal) when the compressor is in a fast unload state, pump down unloading state or for the first 15 minutes after the compressor is turned off.
39	LUBE OIL TMP	If a compressor is running this set point is used as a safety. If oil temperature is less than the value for the time specified then generate an alarm. The oil must reach this temperature before the system will move out of the LUBE state. If the oil temperature is below this value before the compressor begins its startup sequence, the circuit will be placed in the OFF-LO OIL TMP state. 'Time (sec)' field: If in LUBE state, the compressor type is centrifugal, and this field is equal to 0 then the calculated oil temperature shut down is the saturated suction temperature plus the value of this setpoint, else it is simply the value of this setpoint. This option is selected in in the 'Lube State Oil Setpoint' box in the "Cooling Info" panel under the MAG RTU screen.
40	LUBE OIL PSI	The oil must reach this pressure differential between low and high oil pressure before the circuit will move out of the LUBE state.
41	LUBE DELAY	This is the maximum time that a compressor can be in the LUBE state. When this time is exceeded, an alarm is generated and the compressor is locked out. Both the oil temperature and pressure must be satisfied before the LUBE state will be exited. Refer to the OIL PMP LUBING state.
42	HI WATER TMP	If active, the control sensor's value will be compared to the value of this Setpoint. If it exceeds this temperature for the time specified in the "Time (sec)' field' a HI WATER TMP alarm will be generated. No lockouts will occur. This alarm will repeat if the control value drops .5° below this Setpoint and then rises above it again.
43	CENT P-DWN FLA	Only used with variable compressors. If active, this will be the threshold for ending the pump down state, the FLA Setpoint for that compressor will be multiplied by this value, it will be treated as a percentage. If the Setpoint is inactive then the FLA Setpoint for that compressor will be used.

#	Name	Description
44	Only used for Cent. Compressors	Not used
45	CND STG1 ON (RO Type)	When the discharge pressure is above this value, turn on the first stage of the condenser fans. 'Time (sec)' field: (Applies to compressors with shared condensers) If non-zero, then the compressor in start-up state will not be in sole control of the condenser fans, it will control off of highest discharge pressure. If zero, then compressor in start-up will have sole condenser control for 5 minutes. This option is selected in the 'Newly started Comp Controls Common Fan Bank' box in the 'Condenser Information' panel under the MAGNUM screen.
	PID MOD Individual PID MOD Step Common	If active, the value is the multiplier for the Proportional(Kp) adjustment, <u>Setup as Setpoint Type</u>
46	CND STG1 OFF (RO Type)	If stage 1 of condenser capacity is on and the discharge pressure drops below this value, then turn this stage off.
	PID MOD Individual PID Step Common	If active, uses Multiplier for Ki adjustments (Integral Time Delay). <u>Setup as Time Field</u>
47	CND DIFF ON (RO Type)	Differential pressure added to Setpoint #45 to set the threshold at which each additional stage of condenser capacity will turn on.
	PID MOD Individual PID MOD Step Common	If active, use Multiplier for Kd adjustments, <u>Setup as Time Field</u> - <u>Time (sec) field is ROC window</u>
48	CND DIFF OFF (RO Type)	Differential pressure added to Setpoint #46 to set the threshold at which each additional stage of condenser capacity will turn off.
	CND ADJ DELAY (Modulating Type)	If active this is the time in seconds between condenser adjustments to the AO. If inactive, then 30 seconds will be used as the delay. If type is DELAY: (required for condenser relay delays). -MIN VFD Opening cell contains the time delay between turning on a relay and moving the AO to its minimum position (Setpoint #52). -MAX VFD Opening cell contains the time delay between turning off a relay and moving the AO to 100%.
	DUAL PSI DELTA (Dual V8)	Minimum difference in pressure before the second stage of condenser capacity can be started.
49	CND MIN RUN (RO Type)	Once a condenser stage has been turned on, it will remain on for at least the amount of minutes specified in this Setpoint. Time (SEC) column number is used to designate Cond Fan AO stage. Inactive with value of 0, min of 0 and max of 0, in all config files.
	DUAL TIME DELAY (Dual V8)	Time delay once the pressure difference in Setpoint #48 has been reached before the second condenser stage can be started.
	CND START % (Modulating Type)	If active, then starting value for condenser when called for.
50	CND TRGT (Modulating Type)	Target logic will try to maintain modulating the AO. SP must be set up as target type and use the Hi/Low zones for the target control zone. If target type in Heat Pump mode, setback is added to target.
	LO AMB SUMP OFF (RO Type)	If active and ambient temperature is less than the value of this Setpoint, then the sump pump relay will be locked off if it is the starting condenser Relay Output. When the ambient temperature rises above the value of this Setpoint plus two times the value in Setpoint #192 "FRZ TEMP DIFF" if active (hard coded 15°F if inactive), then the sump pump relay will be allowed on again.

#	Name	Description
51	CND ADJ DIV (Modulating Type)	Controls scaling of the amount the AO is adjusted (usually 1). The larger the number the smaller the AO adjustment as the adjustment will be divided by this value.
	CND VFD MIN	If there is a VFD associated with the condenser, this is the starting minimum speed. 'Time (sec)' field: This field contains the condenser stage that must be on before the VFD is modulated.
52	CND MIN % (Modulating Type)	Minimum AO % allowed. If compressor is off, then check the "Time (SEC)" field: If 0, then the AO % will be set to the value of this Setpoint. If 2 and the run/stop is set to run, then set the AO % to 100%, else set the AO % to 0%. This option is selected in the "Default Valve Opening % when Comp. is OFF" box in the condenser information section in the MAG HVAC screen.
53	CND ROC (Modulating Type)	Maximum negative rate of change allowed. If the rate of change is less than this Setpoint, then stop modulating the AO. The absolute value of this Setpoint also serves as the maximum positive rate of change allowed. If the rate of change is greater than the absolute value of this Setpoint, then stop modulating the AO.
54	CND MIN SPD (RO Type)	Minimum speed percentage for variable speed condenser control.
	CND ADJ MULT (Modulating Type)	Controls scaling of the amount the AO is adjusted. The larger the number the larger the AO adjustment as the adjustment will be multiplied by this value.
55	CND MAX SPD (RO Type)	Maximum speed percentage for variable speed condenser control.
	CND MIN ADJ (Modulating Type)	The value in this Setpoint is the minimum % the AO will be modulated when a change is made.
56	PULSE DELAY	Used with variable capacity screws. The number of seconds between load or unload pulses (Usually between 3 and 5. Allows load change to be checked before next pulse and eliminates oil foaming when unloading too fast). 'Time (sec)' field: If used, this is the fast unloading state time delay. This option is selected in in the 'Fast Unload Delay' box in the 'Compressor Information' panel under the MAG- NUM screen. For Fixed Step Compressors with adjustable speed AO's when returning to 100% after shutting down another compressor, this Setpoint will be the time frame between capacity adjustments along with Setpoint #33 "MIN ADJUST %" which is the percent of adjustment.
	CMP ADJ DELY	
57	LO AMB PROC	When this Setpoint is active and there is a process pump, the process pump will be turned on when the ambient temperature is less than the value of this Setpoint. The process pump will be turned off again when the ambient temperature is 5.0° Fahrenheit greater than the value of this Setpoint.
58	CFG TESTING	This must be setup as 'Not Used'. If active the system will not lockout when an I/O communications signal is lost. This Setpoint should NOT be active in a live unit.
59	ACYC OFF->ON	This is the anti-cycle time delay (in seconds) from when the compressor was turned off. This value is used in a calculation to determine how long a compressor should be in the anti-cycle state. Refer to the Standard Control Options in manual, Compressor Anti- Cycle Logic (OFF to ON).
60	MITSI P-DWN CUTIN	If the compressor is a Mitsubishi, is being unloaded, and the suction pressure is greater than this Setpoint, then the compressor will be forced to pump down. NOTE: this value is used whether the Setpoint is active or inactive.
61	PMP DWN OFF	This is the suction pressure value for turning off the compressor when in the PUMP DOWN or for opening the liquid line solenoid during the PRE-PUMP down state.

#	Name	Description
62	PMP DWN DELY	Maximum time delay (in seconds) that a compressor can remain in the PUMP DOWN or PRE-PUMP down states. The Time in sec field specifies the time the unit will remain in unloading before shutting off the LLS & EXV and pumping down.
63	ACYC ON->ON	This is the anti-cycle time delay (in seconds) from when the compressor was turned on. This value is used in a calculation to determine how long a compressor should be in the anti-cycle state. Refer to the Standard Control Options section 5.11, Compressor Anti-Cycle Logic (ON to ON).
64	COMP MIN RUN	This is the minimum run time (in minutes) for a compressor once it is turned on. This mini- mum run time can be overridden by a safety condition, however.
65	EXV ZONE1	Temperature differential used to build the EXV Zone 1 both plus and minus.
	SCExvTarget	SC SUPERHEAT TARGET - SC SUPERHEAT AVERAGE THIS # SECONDS - <u>Setup as Target</u>
66	EXV ZONE2	Temperature differential that is used to build the EXV Zone 2 both plus and minus. Temperatures above this zone are considered in zone 3.
	SCExvKIntegr	SC SUPERHEAT CONTROL ZONE - SC MPLY Ki) FOR VALVE ADJ WHEN IN FAST ZONE- <u>Setup as Target</u>
67		The EXV control logic will compare the value of this Setpoint to the temperature rate of change to determine the valve adjustment when the temperature is within the EXV control zone. 'Safety Down Time (MIN)' field: The minimum time delay between EXV adjustments when in the EXV control zone.
	SCEXvKProp	SC SUPERHEAT MULTIPLIER (Kp) -SC RATE OF CHG MULTIPLIER - <u>Setup as Target</u>
68	EXV ROC ZONE1	The EXV control logic will compare the value of this Setpoint to the temperature rate of change to determine the valve adjustment when the temperature is within zone 1. 'Safety Down Time (MIN)' field: This is the minimum time delay between EXV adjustments when in the EXV control zone 1. If this Setpoint is inactive then the ROC for this zone is 0 and the delay is 15 seconds.
	SCExvKDeriv	SC ADJUST LIMIT IN FAST ZONE (Kd) Velocity of Superheat - SC OUTSIDE FAST ZONE ADJ LIMIT
69	EXV ROC ZONE2	The EXV control logic will compare the value of this Setpoint to the temperature rate of change to determine the valve adjustment when the temperature is within zone 2. 'Safety Down Time (MIN)' field: This is the minimum time delay between EXV adjustments when in the EXV control zone 2. If this Setpoint is inactive then the ROC for this zone is 0 and the delay is 15 seconds.
	SCExvKAccel	<u>Setup as Target</u>
70	EXV ROC ZONE3	The EXV control logic will compare the value of this Setpoint to the temperature rate of change to determine the valve adjustment when the temperature is within zone 3. 'Safety Down Time (MIN)' field: This is the minimum time delay between EXV adjustments when in the EXV control zone 3. If this Setpoint is inactive then the ROC for this zone is 0 and the delay is 15 seconds.
	SCLowSprht	SC LOW SUPERHEAT SAFETY - SC LOW SH TIME TO SAFETY - <u>Setup as Alarm</u>
71	EXV TOO FAST	When the superheat is with the control zone, the EXV control logic will compare the value of this Setpoint to the temperature rate of change to determine the valve adjustment when the temperature is within the zone and rising too fast. 'Safety Down Time (MIN)' field: This is the minimum time delay between EXV adjustments if the rate of change is too fast when in EXV control zones 1 or 2. If this Setpoint is inactive then the ROC for this zone is 0 and the delay is 15 seconds.
	SCExvKiDelay	SC SECONDS DELAY BETWEEN ADJUSTMENTS (Ki) - <u>Setup as Setpoint</u>

#	Name	Description
72	EXV CHANGING	When the superheat is with the control zone, the EXV control logic will compare the value of this Setpoint to the temperature rate of change to determine the valve adjustment when the temperature is within the zone and rising.
	SCExvStartup	<u>Setup as Setpoint</u>
73	STARTER DLAY	This Setpoint controls the start of a compressor's second relay. If the 'Select Value: # decimals & print char' cell is set to 'HUMD or %' then logic is: If First Compressor Relay has been on longer than 2 seconds and the FLA% goes below the value of this setpoint or is still above the value but reaches the time value in the safety time field than turn on the second relay. (If the low zone field is zero use the hardcoded 2 seconds delay at start. If greater than zero use that value). Setpoint Information Screen, if the ' Select Value: # decimals & print char ' cell is set to 'Seconds' then the Setpoints value is a time delay between the first and second relay's start. Used for part wind (typical value of 1) and star delta (typical value of 5) starter. starts. Used for part wind (typical value of 1) and star delta (typical value of 5) starter.
74	OIL PUMP OFF	If oil pump is set up to cycle and discharge psi minus, etc.(specified in MCS-Config), this Setpoint is not used. If Discharge PSI minus Suction PSI is less than Setpoint #74 minus 10 PSI than <u>turn on</u> the oil pump RO. If Discharge PSI minus Suction PSI is greater than Setpoint #74, <u>turn off</u> the oil pump RO.
75	HI AMPS	This Setpoint is a percentage of the FLA; it is used to create the high amp draw limit. The value of this Setpoint is multiplied by the respective compressor's full load amps Setpoint (#171 through #190) to obtain its upper limit. If the compressor's amps exceed this value for the time specified in this Setpoint, then a safety trip occurs. Hi amp unloading logic. If amp reading exceeds half way point between FLA set point and Hi amp FLA %, compressor will unload and enter Hi amp unloading state. Compressor will remain in this state and unload until the amp reading is less than or equal to 100% of FLA set point.
76	LO AMPS	This Setpoint is a percentage of the FLA; it is used to create the low amp draw limit. The value of this Setpoint is multiplied by the respective compressor's full load amps Setpoint (#171 through #190) to obtain its lower limit. If the compressor's amps fall below this value for the time specified in this Setpoint, then a safety trip occurs.
77	LOW SUCTION	If active, the Magnum checks for low suction pressure for each running compressor. If suction pressure is less than this value for the specified period of time, a safety trip occurs. Refers to 'Suction Pressure' column in the Circuit SI screen.
78	LO SUCT UNLD	The purpose of this Setpoint is to take corrective action to prevent a low suction pressure safety trip. For fixed step compressors: If a compressor has more than one step, is fully loaded, and if the suction pressure is less than the value of Setpoint #77 "LOW SUCTION" plus the value of this Setpoint, then one step of capacity will be turned off. For variable step compressors: If a compressor has a suction pressure less than the value of Setpoint #77 "LOW SUCTION" plus the value of this Setpoint, then the compressor will be forced to unload. The circuit state will be changed to LO SUCT HOLD, and will remain in this state for a minimum of the time in Setpoint #101 "SAFETY HOLD DELAY". At that time, if the suction pressure has increased greater than the value of Setpoint #77 "LOW SUCTION" plus the value of Setpoint #79 "LOW SUCT RELD" the compressor will return to normal control. Time (SEC) column contains delay before Lo Suct PSI unloading. Used with unit that has EXV logic. This delay before unloading allows the "Low suction PSI opening" EXV control state to open the valve to increase pressure.
79	LOW SUCT RELD	Refer to Setpoint #78 description.

#	Name	Description
80	UNSAFE SUCT	If active, the Magnum checks for unsafely low suction pressure for each running compressor. If suction pressure is less than this value for the specified period of time a lockout occurs (can configured as a regular safety with automatic reset if 'Setpoint Type' is Setpoint instead of Lockout). NOTE: The time period specified should be very short (2-5 seconds). If this Setpoint trips, the compressor will be sent straight to the Lockout state. Refers to 'Suction Pressure' column in the Circuit SI screen.
81	HI DISC PSI	If active, the Magnum checks for high discharge pressure for each running compressor. If the discharge pressure sensor reads greater than this Setpoint for the specified period of time, a safety trip will occur. Refers to 'Discharge Pressure' column in the Circuit SI screen.
82	HI DISC UNLD	The purpose of this Setpoint is to take corrective action to prevent a high discharge pressure safety trip. For fixed step compressors: If a compressor has more than one step, is fully loaded, and if the discharge pressure is more than the value of Setpoint #81 "HI DISC PSI" minus the value of this Setpoint, then one step of capacity will be turned off. For variable step compressors: If a compressor has a discharge pressure more than the value of Setpoint #81 "HI DISC PSI" minus the value of this Setpoint, then the compressor will be forced to unload. The circuit state will be changed to HI DISC HOLD, and will remain in this state for a minimum of the time in Setpoint #101 "SAFETY HOLD DELAY". At that time, if the discharge pressure has decreased below than the value of Setpoint #81 "HI DISC PSI" minus the value of Setpoint #83 "HI DISC RELD" the compressor will return to normal control.
83	HI DISC RELD	Refer to Setpoint #82 description.
84	LO DISC SHEAT	If the calculated discharge superheat is less than this value for the specified period of time, a safety trip will occur. Also, there is an option in the Circuit Base screen to tie a Relay Output to this Setpoint that will activate whenever a low discharge superheat condition occurs. A Low Discharge Superheat condition can also put the circuit into a 'HI DISC UN- LOAD' state where the compressor will unload to try to raise the superheat. If economizer is being used, when the discharge superheat goes below the value for the safety time / 9 the economizer is turned off.
85	LO DISC PSI	If active, the Magnum checks for low discharge pressure. If the discharge sensor reading is less than this value for the specified period of time, a safety trip occurs.
86	HI RETURN TEMP	Only active in Mitsubishi compressors. If active the Magnum will check for high entering liquid temperature. If this temperature is greater than the value in this Setpoint, the circuit state will be HI WATER HOLD.
87	HI DISC TMP	If active, the Magnum checks for high discharge temperature for each compressor. If the discharge temperature sensor reading is greater than this Setpoint for the specified period of time, a safety trip will occur. Refers to 'Discharge Temperature' column in the Circuit SI screen.
88	DIS TMP UNLD	The purpose of this Setpoint is to take corrective action to prevent a high discharge temperature safety trip. For fixed step compressors: If a compressor has more than one step, is fully loaded, and if the discharge temperature is more than the value of Setpoint #87 "HI DISC TMP" minus the value of this Setpoint, then one step of capacity will be turned off. For variable step compressors: If a compressor has a discharge temperature more than the value of Setpoint #87 "HI DISC TMP" minus the value of this Setpoint, then the compressor will be forced to unload. The circuit state will be changed to HI DISC HOLD, and will remain in this state for a minimum of the time in Setpoint #101 "SAFETY HOLD DELAY". At that time, if the discharge temperature has decreased below than the value of Setpoint #87 "HI DISC TMP" minus the value of Setpoint #89 "HDISC T RELD" the compressor will return to normal control.
89	DIS TMP RELD	Refer to Setpoint #88 description.

#	Name	Description
90	COND FAULT	For Condensers with Fault Indicators: If Setpoint is active, a condenser fault occurs, and the Setpoint type is Alarm, then an alarm message will be generated. If the type is Lock-out, and a condenser fault occurs, then all of the compressors associated with this fault will be locked off. For Common VFD Fan Condensers with Bypass: Time in seconds before the bypass can be used when a fault has occurred.
91	LOW OIL DIF	If active, the Magnum checks for low differential oil pressure. If the calculated differential oil pressure is less than this value for the specified period of time, a safety trip occurs. Refers to 'Oil Pressure' column in the Circuit SI screen.
92	UNSAFE OIL	If active, the Magnum checks for unsafe differential oil pressure. If the calculated differential oil pressure is less than this value for the specified period of time, a lockout occurs. NOTE: The time period specified should be very short (2-5 seconds). If this Setpoint trips, the compressor will be sent straight to the Lockout state. Refers to 'Oil Pressure' column in the Circuit SI screen.
93	HI OIL SEAL	Only used with screw or centrifugal compressors. If the oil seal or oil cooler temperature exceeds the value of this Setpoint for the time specified, a safety trip occurs. Refers to 'Oil Seal Temp' column in Circuit SI screen.
94	HI OIL TEMP	If active, the Magnum checks for high oil temperature. The sensor can be either an analog or digital input. If the oil temperature sensor reading is ON (Digital) or exceeding the temperature value of this Setpoint (Analog) for the specified period of time, a safety trip occurs. Refers to 'Oil Temp' column in the Circuit SI screen.
95	MOTOR FAULT	If active, the Magnum checks for high motor temperature. The sensor can be either an analog or digital input. If the motor temperature sensor reading is ON (Digital) or exceeding the temperature value of this Setpoint (Analog) for the specified period of time, a safety trip occurs. Refers to 'Motor Temp' column in the Circuit SI screen.
96	NO CMP PROOF	If active, when the compressor is called to be on by the controller, the Magnum will check for a digital input to indicate that the compressor is indeed running. If the controller calls for a compressor to turn on and no proof is given in the specified period of time, a safety trip occurs. Refers to 'Comp Proof' column in the Circuit Base screen
97	DIRTY FILTER	Only used for screw compressors. If discharge pressure minus oil filter pressure is greater than this value for the time specified, a safety trip occurs.
98	LLS#2 ON	This Setpoint is used to control a second liquid line solenoid. When the actual circuit capacity is greater than this value (can either be number of steps for Fixed Step compressors, or percentage of full load amps for Variable Step compressors) for the number of seconds in the 'Time (sec)' field, the second liquid line solenoid will open. When the actual circuit capacity falls below this value minus the 'Lockout Delay Hrs.' Field, then the second liquid line will be turned off. 'Time (sec)' field: The delay in seconds before the solenoid will be turned on. If zero, then there will be no delay. 'Lockout Delay Hrs.' Field: Offset that will be subtracted from the value of this Setpoint. When the actual circuit capacity falls below this offset, the solenoid will be turned off. If zero, then an offset of 20% will be used.

#	Name	Description
99	LLS#3 ON (ECONOMIZER)	<p>This Setpoint is used to control a third liquid line solenoid. When the actual circuit capacity is greater than this value (can either be number of steps for Fixed Step compressors, or percentage of full load amps for Variable Step compressors) for the number of seconds in the 'Time (sec)' field, the third liquid line solenoid will open. When the actual circuit capacity falls below this value minus the 'Lockout Delay Hrs.' Field, then the third liquid line will be turned off.</p> <p>'Time (sec)' field: The delay in seconds before the solenoid will be turned on. If zero, then there will be no delay.</p> <p>'Lockout Delay Hrs.' Field: Offset that will be subtracted from the value of this Setpoint. When the actual circuit capacity falls below this offset, the solenoid will be turned off. If zero, then an offset of 20% will be used.</p> <p>If the LO DISC SHEAT Setpoint #84 is active and the discharge superheat goes below the value in this Setpoint for the safety time / 9, the economizer will be turned off.</p>
100	HIGH SUMP TEMP	If active, and sump temperature is above the value of this Setpoint for the time specified, a HIGH SUMP TEMP alarm is generated and the unit is locked out.
101	SAFETY HOLD DELAY	<p>Time in seconds that the circuit will remain in a hold state after the condition that caused it has returned to normal. The circuit can be holding for the following reasons:</p> <ul style="list-style-type: none"> ■ Low suction pressure ■ Low refrigerant temperature ■ High discharge pressure ■ High discharge temperature ■ High amperage
102	PUMP FREEZE PROTECTION	If active, and the leaving temperature sensor is below the value of this Setpoint, a pump will be forced on to protect against freezing. The leaving temperature must rise above this Setpoint plus Setpoint #192 "FRZ TMP DIFF" to turn the pump off again.
103	LEAD COMP	<p>If type is Setpoint: Enables the user to specify the lead compressor. The value of this Setpoint will indicate the lead compressor. If zero, then auto rotation is enabled.</p> <p>'Time (sec)' field: If non-zero, the compressor with the least amount of run time will become the lead upon rotation.</p> <p>If type is Target and the value is 0: Indicates that special rotation for dual barrel systems will be used. Refer to section on Custom Rotation.</p>
104	COMP ROTATION	Specifies the number of days between rotations (Setpoint #103 must be set to zero to enable auto rotation). If zero, then rotation will occur with every cycle.
105	PUMP FAILURE (NO FLOW)	<p>If active, flow is lost, and only one pump is present, then the system will be locked out. If the system has two pumps and flow is lost, then the backup pump will start and the lead pump will be locked out. If the second pump is running and flow is lost again then the entire system will be locked out. A lock out reset will be required to restart the system or to reactivate a locked out pump.</p> <p>If inactive, and the flow is lost, the system will move to the OFF- NO EVAP FLOW state. When flow is returned the system will automatically restart.</p> <p>If looking at individual pumps for each circuit in the Circuit base, make this Setpoint a "Lockout". If flow is not made within the value of this Setpoint the first time than, an alarm will be generated. The system counts through the value of this Setpoint a second time, if flow is made then the unit will run as normal. If flow is not made the second time, the pump and all associated compressors for that circuit will be locked out.</p> <p>If the setpoint lockout delay (hrs) is set to 0 then the circuit will LOCK OUT on the first NO FLOW proof.</p>
106	LEAD PUMP	Indicates which pump is the lead. If zero, then rotation of the pumps will occur whenever the lead pump is turned off. If no rotation has occurred during the current day, a forced rotation will occur at midnight, ensuring at least one rotation per day. If value is non-zero, then rotation of the pumps is inactive and the value will specify the lead pump. This Setpoint can be changed in a live unit and the appropriate action will be taken immediately.

#	Name	Description
107	EcoDelayMech	Seconds to delay after the economizer is fully loaded, valve opened to its maximum, and all associated fans are on before the mechanical cooling is enabled. If inactive, then the value of Setpoint #125 "Eco StageDly" will be used for this delay. 'Time (sec)' field: This value is used as a multiplier in the calculation that determines when it is too cold to use economizer cooling. If the control temperature drops below Setpoint #1 "CTL TARGET" minus ('Time (sec)' field of this Setpoint multiplied by the value of Set- point #3 "CTL ZONE -") then shut off all economizer cooling. If the value in this 'Time (sec)' field is zero, a hardcoded 3 will be used instead.
108	PUMP DELAY	Time in seconds to keep the chilled water pump running after the last compressor has been turned off to ensure the chiller barrel does not freeze.
109	HiRefLevel	This Setpoint has two functions. If active, the Magnum checks for high refrigeration level. If the refrigeration level sensor is above this value for the specified period of time, a safety trip occurs. If active, system has EXV valve control based on refrigerant level, and the refrigerant level is greater than this value, then the EXV valve adjustment will be set to the value in Setpoint #13 "EXV COURSE" * (-3). Refers to 'Refrig Level' column in the Circuit SI screen
110	RefLvlExvAdj (EXV Control: Refrigerant Level)	If Setpoint #84 "LO DiscSPRHT" is active and it has reached one third of its safety time, then Setpoint #9 "REF LVL TRG" will be set to the value of this Setpoint. The purpose is to decrease the EXV valve opening to avoid a low discharge superheat safety trip. This change will be updated in the Setpoint status value.
	DSprhtExvAdj (EXV Control: Dis- charge or Suction Superheat)	If Setpoint #84 "LO DiscSPRHT" is active and it has reached one third of its safety time, then Setpoint #9 "SUPERHT TRGT" will be increased by the value of this Setpoint. The purpose is to decrease the EXV valve opening to avoid a low discharge superheat safety trip.
111	FREEZE	If active, the Magnum will compare the leaving temperature to this Setpoint. If it is less than this value for the specified period of time, a safety trip occurs.
112	NO STOP	This Setpoint is used to ensure that a compressor is actually off when the controller calls for it to be off. This Setpoint contains a percentage of the FLA for Setpoints #171-189. If the compressor amperage is greater than this percentage of the FLA Setpoint for the specified period of time, signaling that the compressor is still running, then the entire system is locked out and a NO STOP alarm is generated. If a Control Power relay is specified, then it will be turned off when this safety trips.
113	OIL INJ TEMP DIFF	This is a temperature differential subtracted from Setpoint #8 to control the oil injection relay. When discharge temperature is above this differential, then oil injection is turned on. If inactive then value will be 5.6° F (2.8° C).
114	OIL TEMP DIFF	This is a temperature differential used in controlling the oil heater and second liquid line solenoid. If inactive then value will be set to 5° F.
115	EcoVFDfanDely	If active, and the fluid cooler has a VFD condenser fan, this Setpoint will be the time in seconds between adjustments to the VFD. If inactive, then the value of Setpoint #124 "EcoVlvAdjDly" will be used for this delay timer.
116	Defrost On Temp	Only used in Turbo Ice Machines. When control temperature falls below this value, then a defrost cycle begins. When the temperature rises .5° F above this value then the defrost cycle will be terminated.
117	Defrost On Delay	Only used in Turbo Ice Machines. Time in seconds of predefrost delay.
118	Defrost On Cycle	Only used in Turbo Ice Machines. Time in defrost cycle for each circuit.
119	EcoOffsetON	Temperature offset to determine when the economizer can be used. The ambient temperature must be less than Setpoint #1 "CTL TARGET" minus the value of this Setpoint for the economizer to begin.

#	Name	Description
120	Eco Stg Dely	Once the economizer valve has been opened to its maximum and all fans associated only with it have been turned on, the economizer function will wait this time in seconds before the first condenser fan is turned on or VFD is set to its minimum position. The minimum setting of the VFD is the value of Setpoint #54 "CND MIN SPD".
120	H-PMP SW TIME	Time delay for switching between heating and cooling modes for heat pumps.
121	Eco MIN VLV%	Minimum Economizer Analog Output valve percentage. This will be the value used when first starting the economizer function as well as the lowest level before turning off. This Setpoint must be active to indicate that the Economizer AO option is active.
122	Eco MAX VLV%	Maximum Economizer Analog Output valve percentage.
123	Eco MAX ADJ	Maximum adjustment to the Economizer Analog Output valve percentage with each calculation. Formula:[absolute value of(Target – current) * Multiplier Setpoint #126] / Divisor Setpoint #127
124	EcoVlvAdjDly	Delay between Economizer Analog Output valve adjustments.
125	Eco StageDly	Time delay between economizer reaching its maximum opening and turning on the associated condenser fans. If no condenser fans associated, then this Setpoint needs to be 0 and non-active.
126	Eco MULTI	Multiplier to scale adjustments to the Economizer Analog Output valve percentage. The difference between the control sensor and its target will be multiplied by this value.
127	Eco DIVIDE	Divisor to scale adjustments to the Economizer Analog Output valve percentage. The difference between the control sensor and its target will be divided by this value.
128	Lost Leg Alarm (Only HVAC)	If active, a check for a lost leg (lost current flow) on a part winding starter is added. A current sensor will be placed on only one of the legs; it must be set up to be multiplied by 2 in MCS-Config (select CT-### x2 as the sensor in the SI screen). If current flow to the leg with the sensor is lost, a low amp alarm will be generated. If the sensor is reading more than the wanted FLA times the value of this Setpoint for the specified period of time, then a high amp alarm is generated.
129	RH CUTIN (Only HVAC)	Used with the 'Hot Gas Reheat' option. If the reheat sensor temperature is less than this value, then the hot gas reheat function will be activated.
130	RH CUTOFF ADJ (Only HVAC)	The reheat cutout temperature is calculated by adding this value to Setpoint #129 "RH CUTIN"
131	Reh StrtDlay	The reheat state is STARTING. The compressor is running and the RH TEMP is less than Setpoint #129. It will remain in this state until the time is greater than Setpoint #131, and then will move to the ON state.
132	RH BLEED DLY (Only HVAC)	Delay in seconds that the hot gas reheat function will keep the bleed solenoid on before exiting reheat mode.
133	RH STAGE DLY (Only HVAC)	Delay in seconds until the hot gas reheat function starts when all criteria has been met.
134	BARREL HEATER	If ambient falls below this temperature, then the barrel heater will turn on.
135	REFRIG LEAK	Used to detect a digital signal from a refrigerant leak detector.
136	VI PULSE	Used with an adjustable VI, volume ratio. This is the pulse time expressed in tenths of a second to adjust the VI.
137	VI DEADBAND	Used with an adjustable VI, volume ratio. If the VI reading is greater than the VI wanted ratio plus the value of this Setpoint, then the increase RO is off and the decrease RO is pulsed. If the VI reading is less than the VI wanted ratio minus the value of this Setpoint, then the increase RO is pulsed and the decrease RO is off.
138	VI DELAY	This is the time delay between VI wanted ratio calculations.

#	Name	Description
139	OIL FLOAT	If active, the Magnum checks for an oil float digital input. It must be ON for the period of time specified in the Setpoint before this Setpoint will trip.
140	Not Used (Only HVAC)	
141	Not Used (Only HVAC)	
142	SERVICE MODE	If non-zero, then a compressor being disabled by the pump down switch will be continue to run until its suction pressure is zero. The compressor will be turned on to perform the pump down the number of times indicated in this Setpoint. This is in preparation for service to be performed on the compressor.
143	UNLOADED %	Used if a slide percentage sensor is present. When this sensor is reading less than the value of this Setpoint, then the slide is considered unloaded. Also used for a centrifugal vane closed. If the vane% sensor is reading less than the value of this Setpoint, then the vane is considered closed. Optional: If Setpoint is set up as a target, the value of this Setpoint equals the % at which the slide is considered closed. If the Time(SEC) field is set > 0 then slide control will be used instead of AMPS. High & low zone are used to develop the control zone based upon the capacity wanted %. Make Setpoint #35 "AMP DB HI" and Setpoint #36 "AMP DB LO" non-active.
144	OIL HEATER ON	The oil heater will be turned on if the oil temperature is less than the value of this Setpoint. It will be turned off if the oil temperature is greater than the value of this Setpoint plus 5.0° Fahrenheit. 'Time (sec)' field: If zero, then the calculated oil temp will be the saturated suction temperature plus the value of the Setpoint. Else it will be the value of this Setpoint.
145	OIL COOLER ON	The oil cooler will be turned on if the oil seal temperature is greater than the value of this Setpoint. It will be turned off if the oil seal temperature is less than the value of this Setpoint minus 5.0° Fahrenheit.
146	PROC TARG	Process pump target. The control value can be either temperature or pressure.
147	PROC ZONE	Process pump control zone. This value is added to Setpoint #146 "PROC TARG" to calculate the high value and subtracted to calculate the low value of the control zone. The process pump's VFD will be modulated to maintain inside this zone. The adjustment to the pump speed is calculated by subtracting the controlling SI from the value of Setpoint #146. This range has a minimum of 1% ADJ and a maximum of 15%.
148	PROC DELY	Process pump delay in seconds before next change. If calculated adjustment (Target minus controlling SI) is greater than the zone x2, or if the slope is greater than the ROC x2, decrement twice as fast.
149	PROC MAX ROC	Process pump rate of change limit. If the ROC exceeds this value, no change is required. The ROC window equals the value of Setpoint 148 to a maximum of 60 seconds.
150	PROC MIN SPD%	Minimum process pump speed if using the Modulating (AO) option. Number of Relay Outputs that will be staged if using the Staging (RO) option.
151	UNLOADED OFF	If active the system has to be fully unloaded and go below this value to shut the compressor off. If the Setpoint is setup as a target type then the night setback value is the value the temperature has to go above before allowing the compressor to start. While waiting the unit state will be (unit is off/Temp). 'Time (sec)' field: If non-zero, then the value of this Setpoint and the night setback value is used as a differential and not a set temperature. The value of this Setpoint is subtracted from Setpoint #1. The value of the night setback is added to Setpoint#1
152	HP OVERHEAT	This Setpoint is only used when the heat pump option has been selected in the 'Unit Type' box in the 'General Information' panel under the MAGNUM screen. It is used to protect against a heat pump with unloaders (or variable speed) from overheating. When this Set- point is active and the leaving temperature sensor is greater than this Setpoint minus 3.0° Fahrenheit, then the compressor will enter HIGH TEMP UNLOAD state. The temperature must drop to less than this Setpoint minus 4.5° Fahrenheit before the system will move to the holding state.

#	Name	Description
153	SftyUnld Del	The time delay in seconds between compressor capacity adjustments when safety unloading.
154	VFD Sfty Adj	The VFD percentage adjustment to be made after every amount of time in Setpoint #153 "SftyUnld Del" when safety unloading.
155	LO REF TMP	If active, the Magnum checks for low refrigerant temperature. If the refrigerant temperature is less than the value of this Setpoint for the specified period of time, a safety trip occurs.
156	LO REF UNLD	The purpose of this Setpoint is to take preventative action before a low refrigerant temperature safety trip. The compressor will unload when the refrigerant temperature is less than the value of the Setpoint #155 "LO REF TMP" plus this Setpoint. The compressor state will be changed to LO TMP UNLOAD. The compressor will remain in this state until the refrigerant temperature is above the value of Setpoint #155 "LO REF TMP" plus twice the value of this Setpoint. The compressor state change to LO TMP HOLD.
157	HP LoSuctAdj (Only HVAC)	This Setpoint is only used when the heat pump option has been selected in the 'Unit Type' box in the 'General Information' panel under the MAGNUM screen. When in heating mode, the low suction value Setpoint #77 "LOW SUCTION" is reduced by the value of this Setpoint.
	B-PUMP DELAY (Boiler/Pump Control)	The time delay expressed as seconds between making decisions as to pump settings.
158	DEF TRIG TMP (Only HVAC) (Mitsubishi Fast unload delay)	If a defrost option has been specified and either coil #1 or coil #2 temperature is less than or equal to this Setpoint a defrost cycle will be started if sufficient time has elapsed since the last defrost. If set point type is ALARM, an a defrost trigger alarm will be generated.
	B-STAGE DELY (Boiler/Pump Control)	The time delay expressed as seconds between making decisions as to boiler stage settings.
159	DEF TRIG DEL (Only HVAC) (Mitsubishi 40% unload delay)	Time in minutes between defrost cycles.
	B-VFD DELAY (Boiler/Pump Control)	The time delay expressed as seconds between making decisions as to pump VFD setting. 'Sec. to Ignore Safety' field: contains the minimum valve setting. For example if this cell contains 500, the valve will initially be set to 50.0% and it will never be less than this value. 'Window to extend Safety Time(sec)' field: contains the maximum valve setting. This will normally be 1000 for 100.0%.
160	DEF REV DEL (Only HVAC)	If a reversing valve is used, this is the delay in minutes the system must wait once the valve has been opened before the defrost cycle can continue.
	B-VFD TARGET (Boiler/Pump Control)	The target flow that is to be maintained. This can be a differential if both input and output pressures sensors are specified or the actual flow of the input if only sensor specified. 'Time(sec)' field: contains the delay in seconds before another pump can be turned on once the valve gets to 100.0% 'Sec. to Ignore Safety' field: contains high dead band for the control zone. This is added to the value of this set point. In this example the high dead band will be 63.0. 'Window to extend Safety Time(sec)' field: contains low dead band for the control zone. This is subtracted from the value of this set point. In this example the low dead band will be 57.5. 'Safety Time Extension' field: contains the maximum valve adjustment that can be made at one time. In this example the maximum adjustment to the valve will be 3.0%..
161	DEF TERM TMP (Only HVAC)	If both coil #1 and coil #2 temperature are greater than the value of this Setpoint, then the defrost cycle can be terminated.
	B-PUMP FLT (Boiler/ Pump Control)	The 'Value' is not used as this set point is set up to check the status of a digital input indicated in the Starting Pump Fault cell. 'Time(sec)' field: contains the delay before the system will place a pump in a failed state.

#	Name	Description
162	DEF TERM DEL (Only HVAC)	The length of time in minutes of the defrost cycle.
163	HP HEAT TARG (Only HVAC)	If active, then this value will become the target temperature during heating mode. Time (SEC): value added to the purge target to create upper dead band limit for exiting purge.
	B-HEAT TRGT (Boiler/Pump Control)	The heating target that is to be maintained.
164	HP CTL ZONE + (Only HVAC)	Added to Setpoint #163 "HP HEAT TARG" to create the upper limit of the control zone during heating mode.
	B-HEAT ZONE+ (Boiler/Pump Control)	The high dead band for the heating control zone. This value is added to the value of set point #163.
165	HP CTL ZONE – (Only HVAC)	Subtracted from Setpoint #163 "HP HEAT TARG" to create the lower limit of the control zone during heating mode.
	B-HEAT ZONE- (Boiler/Pump Control)	The low dead band for the heating control zone. This value is subtracted from the value of set point #163.
166	PHASE LOSS	If active, value, min, max and adjust value should all be 0. The time field is the time before trip and should be 2 seconds to trip after phaseloss input trips. The safety down time(min) value is when the control will come back to check the phaseloss input to see if it has reset. If the input has reset then the Magnum will do a lockout reset. The safety down time value is in minutes, so if 1, after a minute the logic will start checking the phaseloss input.
167	PURGE FLT ERROR	If active and purge float error occurs, a purge float alarm is generated. This Fault requires a lockout reset to resume purge operation.
168	PURGE COUNT	If the total number of purges that occurred during the last three purge cycles exceed this value, then reset all counters and generate a Maximum Purges Exceeded alarm. For the first thirty minutes of compressor run time – this alarm is by passed.
169	PURGE PSI ST	When the purge pressure sensor reading is equal or greater than this value, then a purge cycle will be initiated. The cycle will end when the purge pressure sensor reading is less than the value of this Setpoint minus Setpoint #193 "PSI DIFF", or 5 psi if inactive.
170	EXCESS PURGE	If the time in a purge cycle exceeds this Setpoint's value in seconds, then the cycle will be terminated and an Excessive Purge Time alarm will be generated. This fault requires a lockout reset to resume purge operation.
171	FLA COMP#1	Full Load Amps for compressor #1. This is the amps at design suction and discharge pressures referenced in the MCS-Config RO screen. This value is used to calculate the high and the low amperage safety limits. Refer to Setpoints #75 and #76. For screw compressors: The amp draw when the compressor is fully loaded. This value is used to calculate the Full Load Amps Percentage (FLA %), which is used to control loading and unloading the slide valve. If 1 is set in the Time (SEC) column activates "Screw gap logic".
172	FLA COMP#2	Full Load Amps for compressor #2. Refer to Setpoint #171.
173	FLA COMP#3	Full Load Amps for compressor #3. Refer to Setpoint #171.
174	FLA COMP#4	Full Load Amps for compressor #4. Refer to Setpoint #171.
175	FLA COMP#5	Full Load Amps for compressor #5. Refer to Setpoint #171.
176	FLA COMP#6	Full Load Amps for compressor #6. Refer to Setpoint #171.
177	FLA COMP#7	Full Load Amps for compressor #7. Refer to Setpoint #171.

#	Name	Description
178	FLA COMP#8	Full Load Amps for compressor #8. Refer to Setpoint #171.
179	FLA COMP#9	Full Load Amps for compressor #9. Refer to Setpoint #171.
180	FLA COMP#10	Full Load Amps for compressor #10. Refer to Setpoint #171.
181	FLA COMP#11	Full Load Amps for compressor #11. Refer to Setpoint #171.
182	FLA COMP#12	Full Load Amps for compressor #12. Refer to Setpoint #171.
183	FLA COMP#13	Full Load Amps for compressor #13. Refer to Setpoint #171.
184	FLA COMP#14	Full Load Amps for compressor #14. Refer to Setpoint #171.
185	FLA COMP#15	Full Load Amps for compressor #15. Refer to Setpoint #171.
186	FLA COMP#16	Full Load Amps for compressor #16. Refer to Setpoint #171.
187	FLA COMP#17	Full Load Amps for compressor #17. Refer to Setpoint #171.
188	FLA COMP#18	Full Load Amps for compressor #18. Refer to Setpoint #171.
189	FLA COMP#19	Full Load Amps for compressor #19. Refer to Setpoint #171.
	B-FLA PUMP (Boiler/ Pump Control)	The expended amp draw of the pump. If active this value is used to calculate the high and the low ampere safeties limits. Refer to set points 75 and 76.
190	FLA COMP#20	Full Load Amps for compressor #20. Refer to Setpoint #171.
	B-FLA BOILER (Boil- er/Pump Control)	The 'Value' is not used as this set point is set up to check the status of a digital input indicated in the Starting Boiler Fault cell. 'Time(sec)' field: contains the delay before the system will place a boiler stage in a failed state.
191	TEMP DIFF	This temperature differential is used to replace the hardcoded temperature differential values of several other Setpoints. If active, it is used with the following: <ul style="list-style-type: none"> ■ Discharge temperature ■ Low oil seal temperature ■ Low/high ambient cutoffs ■ Compressor discharge superheat If inactive, then hardcoded value of 5° F is used.
192	FRZ TEMP DIFF	If active, this value is added to Setpoint #102 "PUMP FREEZE PROTECTION" to determine if the leaving temperature is above the freeze protection zone.
193	CND HI/LO ZONE	The value in this Setpoint is the high and low zone for your target of Setpoint #50 "CND TRGT". If inactive then a default zone of 5 psi will be used, if metric .3 Bar.
194	CND 2ND ZONE	The value in this Setpoint is the 2nd high and low zone for your target of Setpoint #50 "CND TRGT". If inactive then a default zone of 20 psi will be used, if metric 1.4 Bar.
195	LOW VOLTAGE	If active and the voltage of any one of the voltage sensors is less than the value of this Setpoint for the time specified in the safety time cell, then a Low Voltage alarm will be generated and the unit will be locked out. Voltage sensors are specified in the General Information panel under the MAGNUM screen.

#	Name	Description
196	HI VOLTAGE	If active and the voltage of any one of the voltage sensors is greater than the value of this Setpoint for the time specified in the safety time cell, then a Hi Voltage alarm will be generated and the unit will be locked out. Voltage sensors are specified in the General Information panel under the MAGNUM screen.
197	LEAD Proc Pmp (Only HVAC)	Must be active and set to 0. At midnight set the running pumps VFD to the value and wait the safety time cell's value. Once the time has elapsed set the VFD to the MIN VFD CELL VALUE and turn the next pump on with its VFD set to the value in the MAX VFD CELL. Wait the safety time cell's value, then turn off the original running pump.
198	PROC PUMP FLT. (Only HVAC)	If process pump fault sensors are specified, the Magnum checks for process pump failure. The process pump fault sensor reading is ON (Digital) for the time specified in the safety time cell
199	MOP TARG PSI	If active, maximum operating pressure (MOP) control will be added to the EXV control logic. This value will be the MOP suction pressure target.
200	MOP PSI ZONE	Added to and subtracted from Setpoint #199 to develop the upper and lower limits of the MOP control zone.
201	MOP ADJ % TME	The adjustment value by which the EXV valve will close each time the MOP logic calls for it to maintain the suction pressure target. This adjustment will be made each time after the delay in the 'Time (sec)' field has expired. 'Time (sec)' field: The delay between MOP adjustments.
202	DELTA TEMP EVP (Only HVAC)	If active, the Magnum will check the temperature differential before additional capacity is enabled. If the difference between entering and leaving temperature is less than the value of this setpoint for the ½ amount of time in the 'Time (sec)' field, then additional capacity will be allowed else no additional steps will be allowed on. If the difference between entering and leaving temperature is greater than the value of this Setpoint for the amount of time in the 'Time (sec)' field, then a high delta evaporator temperature alarm will be generated.
203	HiSuctSheat	If active, the Magnum will check for high suction superheat. If the suction superheat is greater than the value of this setpoint for the specified period of time, an alarm will be generated and a safety trip occurs.
204	COND LOW AMB (Only HVAC)	Standard condenser logic dictates that a newly started compressor will use its own discharge pressure as the control for the first five minutes. If this Setpoint is active and the ambient temperature sensor is reading less than the value of this Setpoint, then this compressor's discharge pressure will remain in control for the additional time in seconds as specified in the 'Time (sec)' field.
205	MDP MIN OIL DIFF	If active the type must be Target. If active, MDP logic will be added to EXV control. If the oil differential pressure is less than the value of this Setpoint following compressor start up during the time specified in the Sec to Ignore Safety field, then the MDP function is active and will close the EXV valve to re-store the oil differential pressure. However, the EXV will not be allowed to go into the MDP logic if the suction pressure is less than Setpoint #77 "LOW SUCTION" plus the value of Setpoint #79 "LOW SUCT RELD". The MDP logic will be exited and go to EXV HOLDING when the suction pressure is less than the Setpoint #77 "LOW SUCTION" plus the value of Setpoint #78 "LOW SUCT UNLD". The "Time (sec)" field contains the offset value added to Setpoint #205 value field to Calculate the oil differential pressure for exiting the MDP control. Magnum software version 8.05S1 and later multiple this value by 10 to add a decimal, so if you enter a value of 5 in this field the offset is 5.0psi. Prior to 8.05S1 software version you need to enter the value with 1 assumed decimal place, for example if you wanted an offset of 5.0psi you need to enter 50 in this field. The 'Low Zone' field contains the percentage to close the EXV valve when in the "MDP CLOSE" state. The 'High Zone' cell contains the time (in minutes – not seconds) that the MDP will be active after a compressor is started.

#	Name	Description
206	COND HI AMB	If active, standard condenser control on compressor startup logic will be bypassed when there is a high ambient temperature. If the condenser type is common and the ambient temperature is above the value of this Setpoint, then the compressor with the highest discharge pressure will have control of the condenser.
207	UNBAL VOLTS	If active, the average of the voltage sensors is calculated. Each individual voltage sensor is compared to this average and if the difference is greater than the value of this setpoint, an alarm is generated and the unit is locked out. After the voltages have returned to normal an automatic lockout reset will occur after the delay in the Safety Down Time(MIN) field.
208	LOW SI OFF (Only HVAC)	If active, the Magnum checks for a Low SI Off sensor for each compressor. The sensor can be either an analog or digital input, and is specified in the Circuit SI screen. If the Low SI Off sensor reading is OFF (Digital) or falls below the value of this Setpoint (Analog) for the specified period of time, the circuit will be disabled. If a digital input, the circuit will be enabled once the sensor is ON. If an analog input, the circuit will be enabled once the sensor is greater than this value plus the value in the 'Time (sec)' field. 'Time (sec)' field: Differential value of this Setpoint which the analog input must be greater than to enable the compressor.
209	HI SI OFF (Only HVAC)	If active, the Magnum checks for a High SI Off sensor for each compressor. The sensor can be either an analog or digital input, and is specified in the Circuit SI screen. If the High SI Off sensor reading is ON (Digital) or rises above the value of this Setpoint (Analog) for the specified period of time, the circuit will be disabled. If a digital input, the circuit will be enabled once the sensor is OFF. If an analog input, the circuit will be enabled once the sensor is less than this value minus the value in the 'Time (sec)' field. 'Time (sec)' field: Differential value of this Setpoint which the analog input must be less than to enable the compressor.
210	ECO LL3 D-SHT (Only HVAC)	If active and the economizer liquid line solenoid is controlled on percentage (not last step), then a low discharge superheat test is added before checking whether the solenoid should be turned on or not. If discharge superheat is less than this value plus Setpoint #84 "LO DISC SHEAT", then the solenoid will be turned off.
211	NO OIL FLOW (Only HVAC)	If active and there is an Oil Flow sensor specified in the 'Oil Flow Switch' cell of the Circuit SI screen, then the Magnum will test for oil flow. If the No Oil Flow sensor reading is OFF (Digital) or falls below the value of this Setpoint (Analog) for the specified period of time, then a safety trip occurs.
212	COMP SPD FLT (Only HVAC)	If active and there is a Compressor Speed Fault sensor specified in the 'Compressor speed fault' cell of the Circuit Base screen, then the Magnum will test for Compressor Speed Fault whether the compressor is running or not. The fault sensor can be either an analog or digital input. If the fault sensor reading is ON (Digital) or falls below the value of this Setpoint (Analog) for the specified period of time, then a safety trip occurs.
213	PROC LOW FLOW	If active and using an in and out sensor in the process control, the differential needs to be less than this value for a safety trip. If pointing to one sensor for control, that sensor needs to be below this value to trip. The time before safety trip is set in the Time(SEC) field. The process logic supports 2 pumps which lead/lag on a safety trip.
214	TURBOCOR Staging Delay (Only HVAC)	If active, type should be Delay. If active and a TurboCor compressor: Value is the delay for unloading all compressors. Safety time is the time delay between compressor starts. Min VFD Opening is used to develop stage delay, Safety time minus the value of this cell.
215	TURBOCOR Ratio (Only HVAC)	If active, type should be Delay. If active and a TurboCor compressor: Value is the minimum ratio required before a compressor can be started. Safety time is the time delay between compressor starts. Min VFD Opening is used to develop stage delay, Safety time minus the value of this cell.

#	Name	Description
216	LIS MOTOR TEMP	If active, and motor temperature is greater than this value then Liquid injection solenoid (LIS) is ON. If it is less than this value minus the 'Time (sec)' field of this set point then the LIS is OFF. 'Time (sec)' field: Offset of motor temperature to turn LIS OFF.
217	LOW EXV TARGET (Only HVAC)	The minimum Refrigerant Level target. If active and the EXV is controlled by Refrigerant Level, then a new variable level target logic will be activated. As the unit capacity increases, the refrigerant level target will change according to a linear calculation between Setpoint #9 "LEVEL TARGET" (the maximum target level) and Setpoint #217 "LOW EXV TARGET" (the minimum target level). This relationship is explained in the following graph: <div style="text-align: center;"> <p>EXV Level Target (Example of a 3 step system)</p> <p>The graph shows a linear decrease in the EXV Level Target as the Total Cooling Capacity of the Unit increases. The target starts at 45% for a 25% capacity (Setpoint #9) and reaches 25% for a 300% capacity (Setpoint #217). The x-axis also includes intermediate values: 80%, 135%, 190%, and 245%. A legend indicates the red line represents the 'EXV Level Target'.</p> </div>
218	OilRecSpeed	HUMD or % - If setup as "Delay type" Fixed compressor cannot run without the vfd tandem. If not setup as a delay type the fixed compressor will be able to run without the vfd compressor being available. Value – Speed in % to move the compressor to during an oil balance/boost Time – Amount of time to wait in seconds after oil level is tripped before entering balance/boost
219	OilRecMaxBal	SECONDS - Alarm Type Value – Max time allowed in seconds to stay in balance mode before moving onto Boost mode
220	ToManyOilBa	MINUTES – Alarm Type Value – If an oil balance occurs twice within this time frame an alarm will be posted and the balance mode will be skipped and will be sent straight to a boost mode.
221	OilRecMaxBst	MINUTES – Alarm Type Value – Max time allowed in minutes to stay in the boost mode before locking out that circuit on an alarm.
222	ToManyOilBst	MINUTES – Alarm Type Value – If an oil boost occurs twice within this time frame an alarm will be posted and the circuit will be locked out.
223	OIL REC OIL CHARGE CYCLE	Time on for oil charge cycle.
224	OIL REC REPEAT CYCLE	Time delay before repeating cycles.
225	CLLC LEVEL TARGET	The 'Value' is the target that is to be maintained of the condenser liquid level. The 'Time (sec)' contains the dead band of the target. For example if the value is 60.0 (target) and the 'Time (sec)' field is 5 (dead band) the control zone for the condenser liquid level is between 55.0 and 65.0.

#	Name	Description
226	CLLC VALVE TARGET (Only HVAC)	The 'Value' is the target or minimum opening of the CLLC control valve. The 'Time (sec)' contains the normal delay between making valve adjustments. This time is in seconds. The 'Sec. to Ignore Safety' contains the delay between making valve adjustments when the CLLC is in a startup mode or the chilled water is not with in its control zone, this is an unstable condition. The 'Window to extend Safety Time(sec)' contains the maximum valve adjustment value. This value has an assumed decimal place; that is a value of 50 will allow a maximum adjustment of 5.0. The actual adjustment will be calculated based upon the valve setting and its desired position. This set point is only used if the AO TYPE of CLLC valve has been selected.
227	CLLC MAX ROC	Condenser Liquid Level Control max ROC both plus and minus ROC. If opening the CLLC valve and the slope is less than this value then the state will be holding else if will be opening. If closing the CLLC valve and the slope is greater than this value then the state will be holding else if will be closing.
228	Force On Oil Recovery (Only HVAC)	If active the type should be DELAY, this Set point force compressor ON for oil, if more than 1 compressor in a group is needed then the safety time is delay. The 'Value' is compressor current run time in minutes. The safety time is the delay between turning on multiple compressors. Time to bypass or extend safety time is not used. The max adj is time that a compressor is in ON OIL RECOVERY state. Extend safety test time is on time to force off ready compressor to on.
229	CHK VALVE FLT (Only TurboCor compressor type selection)	NOTE: Discharge Pressure Sensor needs to be installed between compressor and check valve. VALUE: If the psi differential goes above this value while the compressor is off safety trip the unit (all compressors). Time (SEC): The time to wait before the safety trip. SEC to Ignore Safety: The time the compressor has to be off before checking the psi differential.
230	MAX DIFF PSI ROC (Only HVAC)	If active, this Setpoint helps with Low Suction/Unsafe Suction trips in EXV Logic. Value field: Maximum Differential Pressure Rate of Change before forcing a change to the EXV position (Suggested value of 10 PSI). 'Time (sec)' field: Seconds between samples used for calculating the Rate of Change (Suggested value of 15 seconds). 'Safety Down Time(min)' field: Minimum delay between EXV adjustments (Suggested value of 10 seconds). 'Sec. to Ignore Safety' field: Delay after compressor start before adjusting the EXV based on the Maximum Differential Pressure Rate of Change (Suggested value of 300 seconds). 'Window to Extend Safety Time(sec)' field: Adjustment multiplier to the EXV (Suggested value of 1). 'Safety Time Extension (sec)' field: Adjustment divisor to the EXV (Suggested value of 20).
231	Not Used (Only HVAC)	
232	Not Used (Only HVAC)	
233	Not Used (Only HVAC)	
234	Not Used (Only HVAC)	

#	Name	Description
235	Low Ambient Off (Only HVAC)	If type of condenser is evaporative condenser and the setpoint is active and target type. This is used with a sump pump and condenser fans. If the ambient drops below the valve then disable the sump pump. When the ambient goes above the HIGH ZONE allow the sump pump as the first stage. If the ambient goes below the HIGH ZONE minus the NIGHT SETBACK but above the set point value plus the NIGHT SETBACK then the sump pump becomes the second stage.
236	Unit Status (Only HVAC)	If the number of available compressors is less than the value of this setpoint and the chilled water out temp is above the control zone and the chilled water rate of change is not dropping (greater than zero) and this condition has existed for the time period in the setpoint safety time then the control status relay will be turned off, else the control status relay will be turned on.
237	Low Suction Unloads (Only HVAC)	If active the number of low suction unloads will be tracked. If the number of unloads is greater than the value with in the time specified in the safety time cell then the circuit will be locked off.
238	Chiller Pump Rotation (Only HVAC)	If active, type must be DELAY type. The safety time is the delay between turning on chiller pumps.
239	Process Pump Rotation (Only HVAC)	Should be delay type. Rotates process pumps at midnight.
240	Split Scroll Staging (Only HVAC)	If active and compressor type is a scroll with split staging, PETRA special staging: Value contains the number of compressor steps available for staging. Safety Time is the delay between step adjustments.
241	Amp Imbalance	This test averages the 3 amp readings then finds the amp reading which is the furthest away from the average and checks to see if this amp reading deviation percentage is more than the unbalance percentage setpoint value.
242	Not Used (Only HVAC)	
243	Vestibule Cool Target (Only HVAC)	If active then set point must be TARGET type. If active and there is a cooling relay for the vestibule then that relay will be turned on if the vestibule temperature is above the control zone, the value of this set point plus the High Zone of this set point. It will remain on until the vestibule temperature drops below the value of this set point minus the Low Zone of this set point. If relay is needed on the vestibule fan relay will also be turned on.
244	Vestibule Heat Target (Only HVAC)	If active then set point must be TARGET type. If active and there is a heating relay for the vestibule then that relay will be turned on if the vestibule temperature is below the control zone, the value of this set point minus the Low Zone of this set point. It will remain on until the vestibule temperature rises above the value of this set point plus the High Zone of this set point. If relay is needed on the vestibule fan relay will also be turned on.
245	Low Sump Level (Only HVAC)	If active and the condenser is an evaporator cooled condenser with a sump level indicator then the sump liquid level is checked. if the indicator is on for the time in safety time the condenser is locked off, It will remain off until the indicator is no longer true. If the set point is an ALARM type a low sump level alarm will be generated when ever the condenser is locked off.
246	Sump Heat Target (Only HVAC)	If active, then set point must be TARGET type. If active and the condenser is an evaporator cooled condenser with both a heater relay and a sump temperature sensor specified then the sump temperature will controlled. If the sump temperature is less than the value of this set point the sump heater will be turned on. It will remain on until the sump temperature rises above the set point value plus the value of the High Zone.
247	Not Used (Only HVAC)	

#	Name	Description
248	Not Used (Only HVAC)	
249	Not Used (Only HVAC)	
250	Not Used (Only HVAC)	
251	Not Used (Only HVAC)	
252	Not Used (Only HVAC)	
253	Sub Cooler Target (Only HVAC)	<p>This set point must be a TARGET type and is required for sub cooler EXV control as it is used to develop the EXV sub cooler target.</p> <p>If the low discharge safety counter is high and set point #84 and #110 are active and there are both a discharge pressure and temperature sensor the target is the value of this set point plus the Night Set Back value.</p> <p>Else, the target is the value of this set point.</p>
254	Sub Cooler Fine Delay (Only HVAC)	<p>This set point is required for sub cooler EXV control.</p> <p>The value of this set point is the amount of adjustment to the EXV sub cooler and the safety time is the delay between adjustments.</p>
255	Sub Cooler MOP Delay (Only HVAC)	<p>If active, the set point must be a TARGET type.</p> <p>If active, Maximum Operating Pressure, MOP, is used when controlling the EXV. The MOP control is develop by add the High Zone and subtracting the Low Zone values from the value of this set point. If the sub cooler suction pressure is with in this zone the EXV state will be MOP holding.</p>

Revision/Disclaimer Page

Date	Author	Description of Changes
11-03-09	RCT	Magnum Manual Rev 1.25 was used as the base for this manual Renamed file to Magnum Version 8 Manual Rev 1.0 to avoid confusion with existing manuals Expanded all items regarding Magnum V8 software
04-09-10	RCT	Rev 1.1 Added pump rotation changes Added process-pump rotation changes Checked and updated all Setpoints including the use of the 'Time (sec)' field Added new Setpoint fields Replaced MCS Connect screens with new versions Corrected items from DB E-mail dated 4/5/10 Reviewed and added compressor types to RO sequence Added low temperature safety and unload section Added high suction superheat for flooded chiller Added section on EXV control and maximum operating pressure control to the EXV logic
05-03-10	RCT	Rev 1.2 Updated the BMS points section for information on all 20 compressors Updated OIL PUMP LUBE state Added section on compressor setup Added section on slide calculation Added section on FLA calculation Added BWW's comments Added Centrifugal Setpoints Added Centrifugal write up and external purge option Added SI16-AO4 and RO10 drawings
05-10-10	RCT	Rev 1.3 Added section on V8 enhancements Corrected BMS entries for circuits 9-20
09-02-10	RCT	Rev 1.4 Expanded section on V8 enhancements Updated Setpoints Updated new functions through 8.013-J Added release version to new functions Updated and expanded the User Defined section
09-13-10	BWW	Rev 1.5 Corrected page 10 statement about MCS-SI16-AO4 board "SI16-AO4; 16 Sensor Inputs, 1 through 12 are universal and 13 through 16 can be either digital or virtual inputs pulse 4 Analog Outputs per board with a maximum of 4 boards." This is not correct; all 16 inputs are universal
10-27-10	WLK	Rev 1.6 Updated EXV logic and Setpoints
05-09-11	WLK	Rev 2.2 General editing/restructuring of manual Updated Setpoints
09-21-11	WLK	Rev 2.3 Added sections about Condenser Liquid Level Control (CLLC), Boiler Control, Defrost Control, and Second Set of Evaporator Pumps/ Fans. Added TurboCor alarm section.
09-26-11	WLK	Rev 2.4 Updated Setpoint section. Added Setpoints #217 and #218.
	WLK	Rev 2.5 Added Transmit Software and Transmit/Receive Configuration to Authorization Function page.
12-09-11	BWW	Rev 2.5 Corrected section 7.60 MDP EXV Logic Corrected section 13.2 Magnum Setpoints--Setpoint #205 "MDP MIN OIL DIFF"
06-24-12	MAS	Rev 2.6 Updated section 13.2 Magnum Setpoints--Setpoint #99 "LLS#3 ON (ECONOMIZER)" Setpoint #84 "LO DISC SHEAT" Setpoint #4 "HGS TEMP ON" Setpoint #5 "HGS TEMP OFF" Setpoint #143 "UNLOADED %" Added section 7.7.6.4. Excess Purge Logic Updated Hardware

Date	Author	Description of Changes
11-26-12	MAS	REV 2.7 Updated section 13.2 Magnum Setpoints--Setpoint #33 "MIN ADJUST%" Setpoint #56 "PULSE DELAY" Setpoint #105 "PUMP FAILURE" Setpoint #147 "PROC ZONE" Setpoint #148 "PROC DELY" Setpoint #149 "PROC MAX ROC" Updated Micro Control System's Address
01-07-13	MAS	REV 2.8 Updated section 13.2 Magnum Setpoints--Setpoint #35 "AMP DB HI" Setpoint #36 "AMP DB LO" Setpoint #61 "PMP DWN OFF" Updated section 7.39.1. Economizer Set up Updated Authorization Function
02-13-13	MAS	REV 2.9 Updated section 13.2 Magnum Setpoints--Setpoint #45 "CND STG1 ON" Setpoint #46 "CND STG1 OFF" Setpoint #47 "CND DIFF ON" Setpoint #48 "CND ADJ DELAY" Setpoint #48 "CND DIFF OFF" Setpoint #48 "DUAL PSI DELTA" Setpoint #49 "CND START %" Setpoint #49 "CND MIN RUN" Setpoint #49 "DUAL TIME DELAY" Setpoint #50 "CND TRGT" Setpoint #50 "LO AMB SUMP OFF" Setpoint #51 "CND ADJ DIV" Setpoint #51 "CND VFD MIN" Setpoint #52 "CND MIN %" Setpoint #53 "CND ROC" Setpoint #54 "CND ADJ MULT" Setpoint #54 "CND MIN SPD" Setpoint #55 "CND MIN ADJ" Setpoint #55 "CND MAX SPD" Setpoint #90 "CND FAULT" Setpoint #130 "CmpSpdUnld%" Setpoint #131 "CmpSpdLoad%" Setpoint #193 "CND HI/LO ZONE" Setpoint #194 "CND 2 nd ZONE" Updated Section 7.73. "Condenser Control Logic"
04-04-13	MAS	REV 3.0 Updated section 7.73.3.9. Modulating Condenser Updated section 13.2 Magnum Setpoints--Setpoint #3 "CTL ZONE -" Setpoint #30 "MAX SLIDE %" Setpoint #31 "MIN SLIDE%" Setpoint #35 "AMP DB LO" Setpoint #36 "AMP DB HI" Setpoint #125 "Eco StageDly" Setpoint #143 "UNLOADED %" Updated 7.4.1. Screw Compressor with Slide Piston Updated 7.75. HVAC Defrost Cycle
10-18-13	MAS	REV 3.1 Updated section 13.2 Magnum Setpoints--Setpoint #38 "UNLOAD PULSE" Setpoint #167 "PURGE FLT ERROR" Setpoint #168 "PURGE COUNT" Setpoint #170 "EXCESS PURGE" Setpoint #229 "CHK VALVE FLT" Setpoint #230 "MAX DIFF PSI ROC" Added 7.10 Custom Rotation Added Setpoint #228 "FORCE ON OIL RECOVERY"
02-26-15	DEW	Change Front Cover
07-6/8-15	DEW	REV 3.2 - Move to Indesign
08-06-15	DEW	Edits to - Condenser Level Control
08-11-15	DEW	Remove two states added in EXV states Change name Evaporator Level Control
08-24-15	DEW	Change reference to V8 to just Magnum - clean up
10-29/30-15	DEW	Add changes from Bob, upgrade to V17

11-02-15	DEW	Add changes from Bob
11-10-15	DEW	Add new Setpoints from Bob
12-03-15	DEW	Add reference to Ice Mode
1-29-16	DEW	Update setpoints, remove Centrifugal references
2-12-16	DEW	Make changes to Condenser section, add new Boiler section
2-19-16	DEW	Make changes to setpoint 151, 241
4-13-16	DEW	Change to setpoint 105, changes to BMS Module
5-13-16	DEW	Replace missing section on Scroll Compressors
10-03-16	DEW	Update drawings
12-03-16	DEW	Made change to setpoint 236 as per Brian
12-20-16	DEW	Add Windows/Safety Ext. Time to ignore for setpoints
02-02-17	DEW	Add Modbus Fault Sensors and Chillers Rotation
03-06-17	DEW	Add MCS Adaptive Condenser Fan Logic
05-15-16	DEW	Make changes to BMS Circuit and Compressors states
06-26/28-17	DEW	Make corrections to setpoint #74 and #109/#110 - also setpoint #4, #31,#50
08-31-17	DEW	Make corrections to Adaptive Condenser add setpoint #48
10-09-17	DEW	12.28 added Low Water Temp addition - changed setpoint #25
10-09-17	DEW	10.5 added Unit is Holding - added to setpoint #1
05-30-18	DEW	Changes to setpoint 229 from Brian
06-04-18	DEW	Added info on Condenser Discharge Pressure Section
06-08-18	DEW	Add Unit Type info
07-23-18	DEW	Added section on Oil Recovery Logic
07-23-18	DEW	Added addition to setpoint 23 as per DC2
08-31-18	DEW	Revised setpoint 166 Added BMS alarms
11-29-18	DEW	Added Superheat updated from JGW
11-29-18 - 12-13-18	DEW	Revised setpoint 56 as per Danny C. Revised to specs sent from Brian 11-21-18
12-10-18	DEW	Add new compressor points to BMS section - need to add when BACnet and N2 points yet
11-8-11-19	DEW	Add section on PID - add photos etc for 12 volt, add heat recovery chapter 7
12-9-19	DEW	Add new Authorization for RS485 service
12-19-20	DEW	Change setpoint 1 - unoccupied not supported in HVAC
3-19-20	DEW	Add address setting for IO expansion boards, chapter 3, Shared VFD, chapter 9
3-19-20	DEW	Add 6Tandem EXV's, chapter 21
3-23-20	DEW	Add PID AO CONTROL
5-20-20	DEW	Added screen shot for Condenser Reset, moved Revision Pages to back of manual
6-16-2020	DEW	Modify Setpoint 73 and Part Wind and Star Delta Starters section
7-29-30-2020	DEW	Add PID Condenser control, change description setpoint 46, 47
12-01-2020	DEW	Re-do Chapter 17, add description for Voltage and Un-Balanced Voltage
1-21-2021	DEW	Change setpoints 218-222
2-2-2021	DEW	ADDED UNLOAD DELAY AND COAST



Providing HVAC/R Control Solutions Worldwide

5580 Enterprise Pkwy. Fort Myers, FL 33905

Office: (239) 694-0089

Fax: (239) 694-0031

www.mcsccontrols.com