

Keysight Technologies

Design and Test Solutions for Advanced Automotive

Accelerate Automotive Design and Test
with Flexible, High-Performance Platforms





Table of Contents

Introduction.....	3
Testing and Characterizing Automotive Serial Buses.....	4
Automotive Radar.....	7
EMI/EMC.....	12
Wireless Technologies to Connect Cars.....	13
Instrumentation for Testing Beyond the Bench.....	19
Wireless Power Transfer.....	20
Automotive Power Device Testing.....	22
Automotive Power Analysis & Testing.....	24
Advanced Multi-Channel Car Infotainment System Test.....	28
Automotive Functional Test.....	29
Automotive ECU Test.....	31
Automotive In-Circuit Test.....	33
Advanced Automotive Research at the Nanoscale.....	36
Accelerate Automotive Design and Test with Flexible, High-Performance Platforms.....	37
For Additional Information.....	37
Services and Support.....	38

Introduction

The intelligent and connected car is no longer a futuristic concept. With each new model launched, leading automobile manufacturers are pushing out increasingly sophisticated navigation, safety and infotainment features.

The excitement over autonomous driving is spurring safety developments, with needs for superb sensor systems that can over-ride bad driver decisions or actions. Other technologies, like vehicular biometry and new connected infotainment gadgets are rapidly changing the dashboards of future cars.

On a broader level, innovations like route tracking and driver health monitoring are set to trigger a need for connectivity to supporting infrastructures by government agencies. Imagine road gantries that monitor how frequently you use busy roads, or automatic carbon-emission report systems, leading to taxation systems based on how eco-friendly your car and your driving habits are.

These are exciting times for automotive electronics manufacturers, and one can see the parallel of Moore's Law moving onboard the vehicle - only this time, besides transistors, we are talking 5G technology, 802.11ac WiFi, BroadR-Reach, MOST150, CAN, LIN, FlexRay and more.

Applying advanced automotive technologies offers enormous benefits; however, it also triggers new design and test challenges for developers and manufacturers. Based on over 75 years' experience and technical knowledge of RF, millimeter wave, wireless, and high-speed digital design and test, Keysight Technologies, Inc. provides one of the broadest and most powerful range of automotive design and test solutions from early R&D to manufacturing stages, backed by our team of dedicated technology experts worldwide. Like you, we believe every drive should be maximized for safety, smoothness, and style for every driver and passenger.



Keysight is dedicated to provide innovations in automotive electronics test to help our customers produce better, energy-efficient and greener vehicles.

Testing and Characterizing Automotive Serial Buses

With significantly increasing electronic features and functions, today's automobiles include a variety of serial buses such as I²C, SPI, UART, CAN, CAN FD, CXPI, SENT, LIN, FlexRay, BroadR-Reach, and MOST. Automotive serial buses must be able to operate reliably in the harsh electrical environment of the automobile where random and infrequent transients occur. Keysight Automotive Serial Bus solutions solve challenges of designing and testing your automotive serial buses.

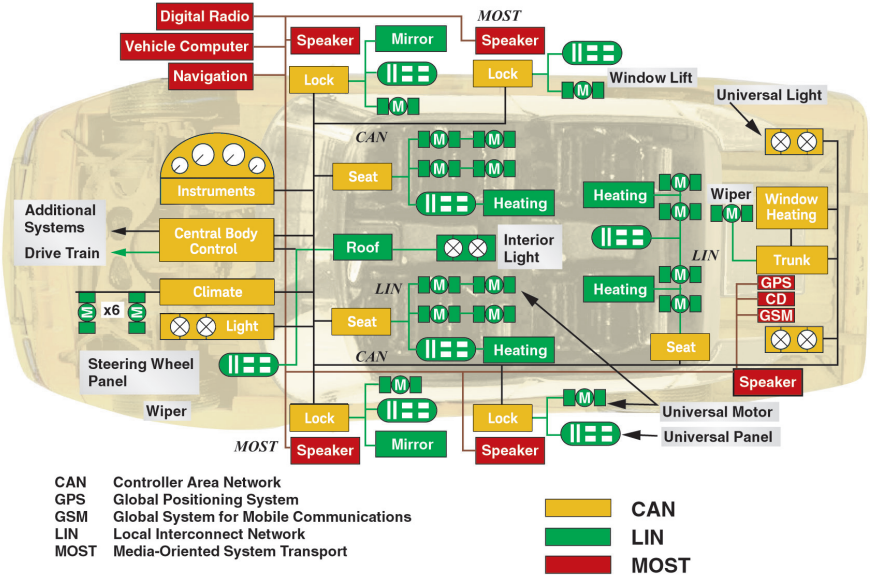

Physical layer testing

The primary measurement tools used to test and characterize the physical layer of these buses are oscilloscopes, such as Keysight's InfiniiVision X-Series and Infiniium Series oscilloscopes.

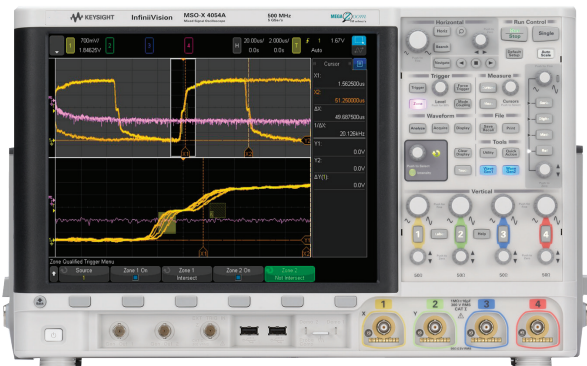

InfiniiVision 4000 X-Series oscilloscope

Serial protocol triggering and decoding

Using an oscilloscope with serial bus protocol triggering and decoding can significantly speed up the debug process by isolating specific messages of interest for analysis. Keysight's InfiniiVision and Infiniium Series oscilloscopes offer a broad range of protocol-specific options, including the ability to symbolically trigger on and decode

the differential CAN bus, which has been the automobile's "workhorse" serial bus for drive-train and body control for nearly 30 years. In addition, these scopes also support the CAN-FD, CXPI, LIN, FlexRay protocols which are also widely researched in today's automotive designs.

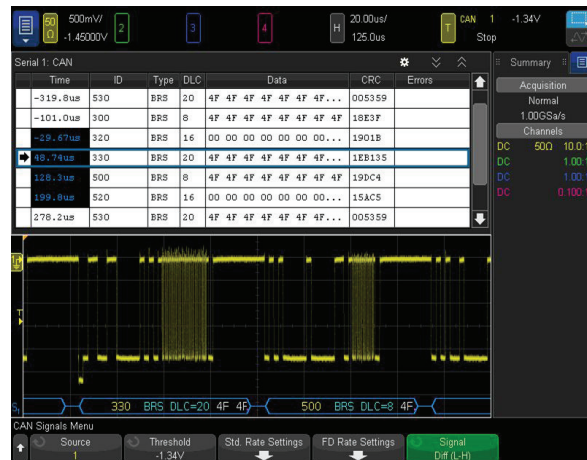

CAN-dbc symbolic trigger and decode

Testing and Characterizing Automotive Serial Buses

Automated compliance testing

Considering using high-speed serial buses such as MOST150 or BroadR-Reach/Ethernet? Each industry standards body specifies required tests for physical layer compliancy. For each standard, Keysight's Infiniium oscilloscopes offer fully automated applications that perform 100% testing of physical layer compliancy. The application produces a test report that details the results of each test as well as the overall results.

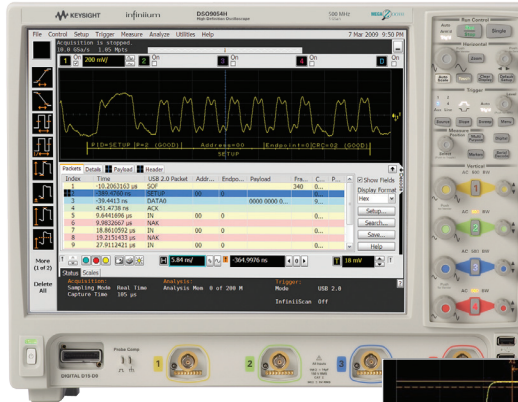

Infiniium oscilloscopes for BroadR-Reach and MOST

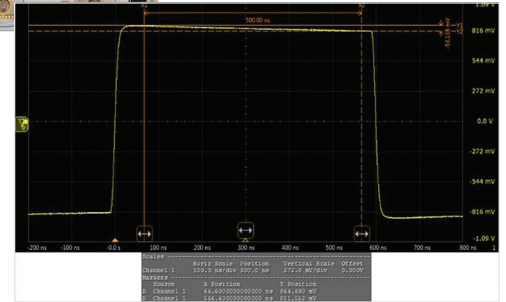

Compliance testing of MOST150 SP2 eye-diagram

Debugging, characterization, validation and reliability testing at temperature

Temperatures, both high and low, affect the performance and reliability of electronic components, assemblies and systems. The temperature extremes that automotive electronics are subject to are some of the most severe in the electronics industry. Measuring the performance of electronic components, assemblies and systems at these extremes with an oscilloscope requires specialized oscilloscope probes that have been designed to perform under these conditions.

Keysight offers a series of Extreme Temperature Probing solutions for oscilloscope measurements for both voltage and current at temperature ranges from -55 °C to +150 °C.

N7007A Single-ended passive 400 MHz 10 MΩ input R 2 m long cable -40 to +85 °C	N2797A Single-ended 1.5 GHz 1 MΩ input R -40 to +85 °C	InfiniiMax + N5450B extension cable + probe head 1.5 GHz - 16 GHz 50 kΩ input R -55 to +150 °C	N2820A/21A High sensitivity current probe Current 1.5 GΩ input R -55 to +150 °C	N7013A Extreme temp probing kit for differential probes Up to 70 MHz Compatible with N2818A/N2792A/N2790A/N2791A -40 to +85 °C

Extreme Temperature Probing solutions

Testing and Characterizing Automotive Serial Buses

Pulse function arbitrary generation

One of the key challenges to develop a serial bus receiver is how to build robustness against environmental electrical stress which can include electromagnetic radiation disturbing the communication signal, capacitive loading of cables, the frequency response of connector interfaces etc. The 81160A Pulse Function Arbitrary Noise Generator can simulate potential distortions and deformations in your lab to provide fast and cost-effective verification for your automotive serial buses.

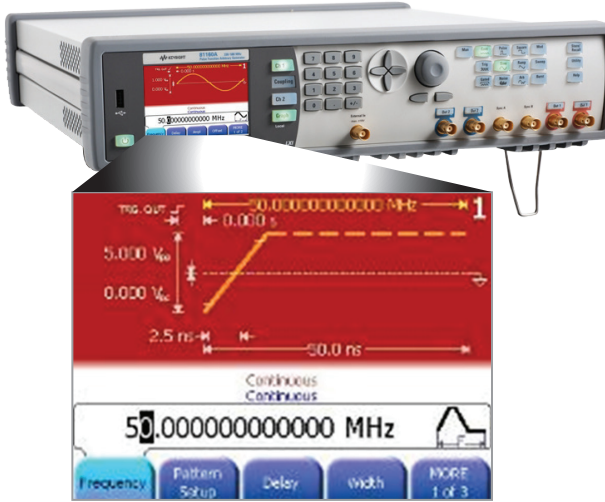

81160A pulse function arbitrary noise generator

The Keysight 81160A is a “4in1” instrument that can generate pulses, digital patterns, modulated function/arbitrary waveforms and truly random noise signals. With the internal channel addition, it even allows combining signals without external cabling. With two event interfaces (strobe and trigger) per channel, the user has full flexibility in automating the tests. In total, the instrument opens up a huge space of possible test scenarios in the automotive application field. The 81160A is compliant with MOST50 and MOST150, based on the MOST compliance requirements 2V1.

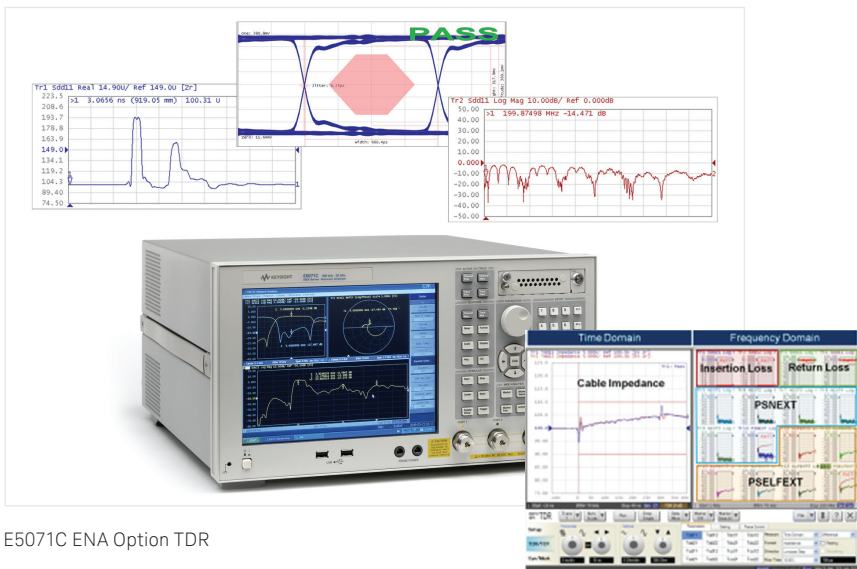

E5071C ENA Option TDR

Cable and connector testing

As data rates of automotive systems increase, signal integrity of interconnects drastically affects system performance. Fast and accurate analysis of interconnect performance in both time and frequency domains is critical to ensure reliable system performance. Because managing multiple test systems becomes

difficult, a single test system that can fully characterize differential high speed interconnects is a very powerful tool.

Keysight's E5071C ENA Option TDR provides a one-box solution for cable and connector testing, including impedance, S-parameters, and eye

diagrams. The ENA Option TDR provides the following three breakthroughs for signal integrity design and verification: simple and intuitive operation, fast and accurate measurements, and high ESD robustness.

Automotive Radar

Applying radar technologies to advanced automotive helps drivers to avoid potential risks from other vehicles, pedestrians and objects on roads and makes self-driving cars possible. The major applications of automotive radars are advanced emergency braking, blind spot monitoring, lane change assist, adaptive cruise control, parking assist, front and rear cross traffic alert, stop-and-go, and more. Keysight provides various automotive radar solutions from design simulation to signal generation and analysis tools.

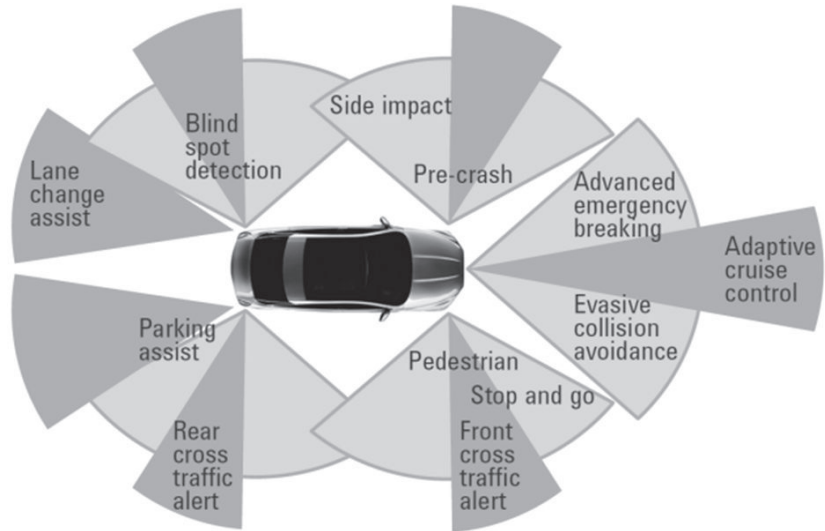

Wideband signal analysis solution

The UXA signal analyzer is extensively used in radar test for a wide range of measurements. Its world class dynamic range allows it to measure lower level emissions while in the presence of larger signals. Combined with a smart mixer, the UXA enables pain-free measurements up to 110 GHz, or up to THz frequencies using other mixers. The UXA has real-time capability with 510 MHz bandwidth when transient activity needs to be measured.

The M1971E smart mixer covers 55 GHz to 90 GHz. It is a great fit for automotive radar analysis with up to 1.5 GHz dual conversion path for widest dynamic range with swept measurement and up to 2.5 GHz AUX IF path for wideband I/Q analysis.

Controlling UXA signal analyzer's external mixing with M1971E smart mixer and connecting the AUX IF output port to Infiniium S-Series oscilloscope, 89600 VSA software can easily make vector and FMCW radar analysis of E-band automotive radar signals up to 2.5 GHz bandwidth.

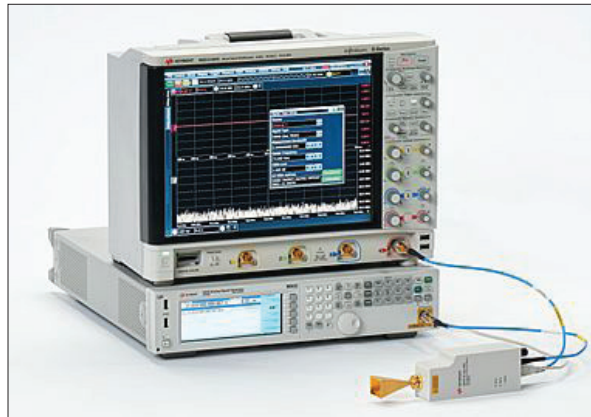

77/79 GHz automotive radar signal analysis reference solution

77/79 GHz automotive radar signal analysis reference solution

- The E-band Signal Analysis Reference Solution provides high performance signal analysis for the 55-90 GHz frequency bandwidth up to 2.5 GHz of instantaneous bandwidth.
- Automotive radar applications can benefit from this reference solution as it provides a lower price point for mmW measurements by utilizing standard benchtop equipment to create high performance measurement solutions.
- The N8838A External Mixer Assistant software controls the S-series Oscilloscope, MXG Signal Generator and M1971E Smart mixer. This enables the user to connect, control, and calibrate the system within one user interface, allowing the user to focus on making FMCW and radar measurements with the 89601B VSA software.

Automotive Radar

Microwave analog and vector signal generation

PSG Signal Generators and X-Series Microwave Signal Generators provide microwave frequency signals with basic to advanced functionality, each delivering benchmark performance in its class to automotive radar developers. PSG models offer metrology-grade performance to 67 GHz, with frequency extenders to 1.1 THz. Vector PSG models offer 80 MHz internal modulation bandwidth and 2 GHz bandwidth using an external modulation source, AM, FM, PM, pulse, ASK, FSK, MSK, PSK, QAM and custom I/Q modulations, dual internal function generators for sine, square, triangular, ramp and noise, as well as step, list, ramp sweep frequency, and power. Combined with the M8190A wideband arbitrary waveform generator, PSG can generate wide bandwidth signals up to 44 GHz frequency. Additional features of PSG include creating reference signals for radar, multi-tone, NPR, custom modulation, WLAN, GPS/GNSS, MATLAB, and more as well as multi-channel baseband generation, digital I/O, MIMO fading, and RF to RF fading with the N5106A PXB Baseband Generator and Channel Emulator.

The MXG is the pure and precise alternative to the PSG, with advantages in size and speed. It delivers the performance you need--spectral purity, output power, switching speed and more--to perform module- and system-level testing. The benefits of the MXG are generating the signals for radar receiver sensitivity test with best-in-class phase noise and

spurious performance, reducing test stand size with two rack-unit height, maximizing throughput with fast switching speed, creating variable RADAR PRI and pulse width with the integrated pulse train generator. Maximize resources with low cost of ownership, and minimizing downtime and expenses with self-maintenance strategy and low-cost repairs.

Keysight Signal Studio and embedded software is a suite of flexible, easy-to-use, signal creation software that will cut the time spent on signal simulation. And, with a demonstrated first-to-market track record, Keysight's signal creation software helps you stay at the forefront of product development as wireless systems continue to evolve.



N5183B MXG microwave signal generator

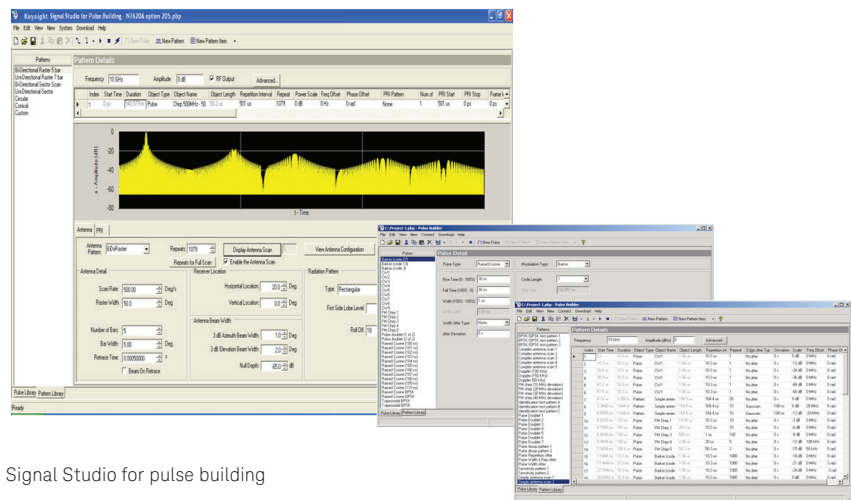

Signal Studio for pulse building

Automotive Radar

Radar component characterization and phase noise test

The N5251A Millimeter-Wave Network Analyzer is ideally designed to enable designers of automotive radar components to fully characterize their devices from 10 MHz to 110 GHz in a single measurement. The 4 port configuration, together with the true mode differential application, allows the users to make measurements on the components used in the radar systems. In addition, the fully integrated pulse capability of the system allows users to easily stimulate and measure the response of their device.

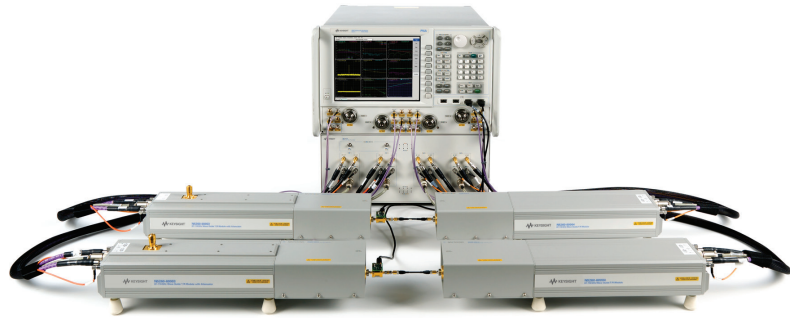

N5251A Millimeter-wave network analyzer

The E5052B Signal Source Analyzer, combined with the E5053A down converter and 11970 series harmonic mixers, is an ideal solution to test the phase noise of free-running VCOs at microwave and millimeter-wave frequencies accurately. Exceptional low phase noise sensitivity and drift signal tracking are achieved up to 110 GHz.



E5052B signal source analyzer with E5053A downconverter plus 11970 harmonic mixer

M8190A wide-band high performance AWG for flexible automotive radar test and research applications

The frequency band around 79 GHz is proven to be one of the “sweet spots” in terms of atmospheric attenuation. It is located in the middle of the two oxygen absorption peaks. With a modulation bandwidth of up to 4 GHz this band opens a wide area of applications. Today we will find long and short range automotive radars for all kinds of driver assistance systems. Keysight



M8190A Arbitrary Waveform Generator

Technologies offers the M8190A wide band Arbitrary Waveform Generator for signal generation and signal path emulation, and high performance Infiniium series oscilloscopes with Vector Signal Analysis software for the evaluation of captured signals. With Keysight’s M8190A High Performance AWG, the user has all the freedom in crafting the needed waveform. This will be the best choice for a test source for the envisioned application.

Key features of the M8190A Arbitrary Waveform Generator are precise signals with two DAC settings of 14-bit resolution up to 8 GSa/s and 12-bit resolution up to 12 GSa/s, high-speed arbitrary waveform generation with variable sample rate from 125 MSa/s to 12 GSa/s, spurious-free-dynamic range up to 90 dBc, 2 GSa waveform memory per channel, advanced sequencing, and 5 GHz analog bandwidth.

Automotive Radar

W1905 SystemVue (SV) Radar Model Library

Key features of SV for modeling and simulation of FMCW systems

- Different FMCW Signals
- Antenna and Array antenna model with beamforming
- RF-DSP multi-domain
- Custom DSP algorithm
- Environment scenarios: Moving Platforms, clutter, targets, clutter, interference
- Advanced Measurements
- Estimating range and velocity
- Support
 - Anti-Collision (AC) – Measures velocity to avoid accidents
 - Stop-and-Go – Measures distance to avoid collision
 - Blind spot detection (BSD) – Detects flow or speed of traffic
 - Lane change assist (LCA)
 - Pre-crash Safety (PCS)

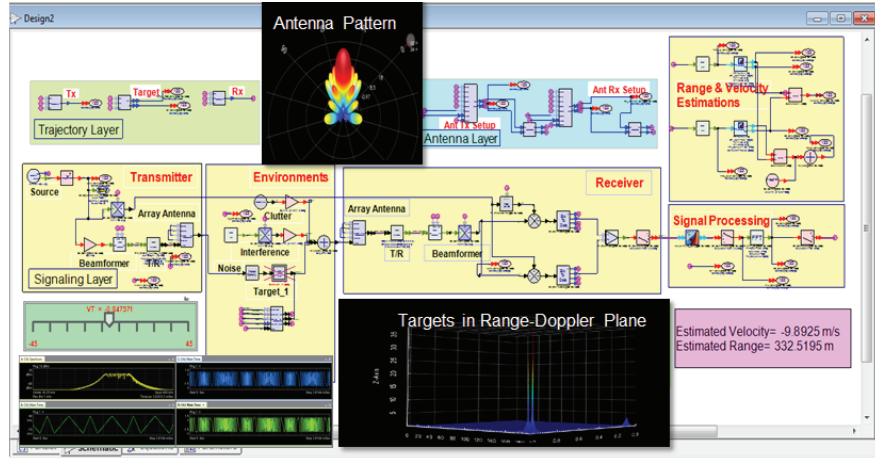
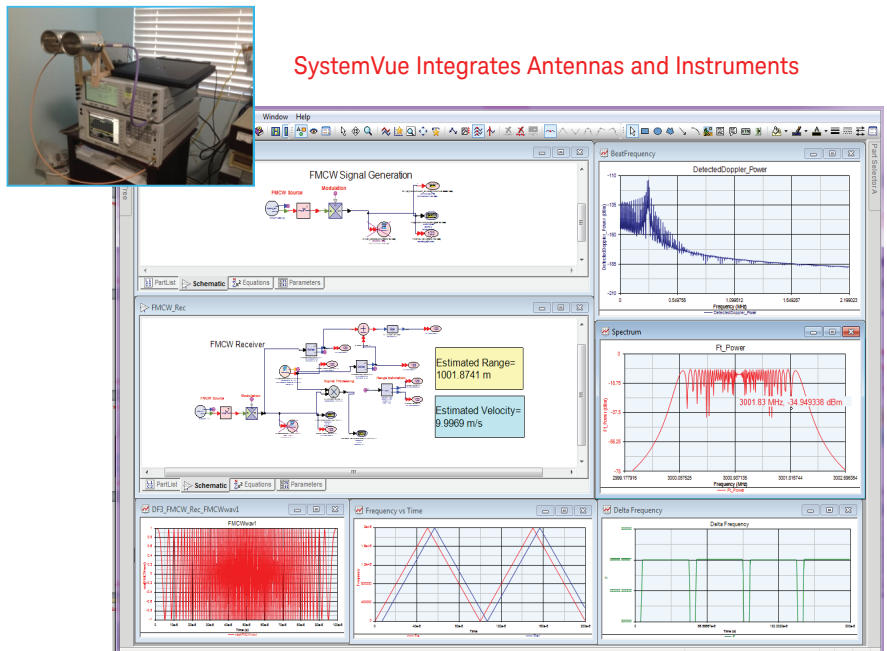

Figure 1. A typical example for modeling and simulation of a PCS system

Verification, test and implementation

- SV can link to AWG/ARBs to Emulate FMCW signal with environments
- Measured raw waveforms can be acquired back to SystemVue for further processing for advanced measurements
- Integrating SV with Instruments can form automated test system
- Using SV integrated solution the user can build his/her own FMCW system quickly for R&D purpose
- Custom automotive radar HW architectures can be inserted in the radar platform, including FM source, target, receiver, signal processing and measurements.
- Custom Algorithms also can be inserted to the Platform for verification, test and implementation.
- SV also helps FPGA implementation



SystemVue Integrates Antennas and Instruments

Figure 2. A typical example for building a custom FMCW radar using SV to integrate antennas and Keysight instruments

Automotive Radar

76 to 81 GHz automotive radar transceiver power test

Automotive radar applications in the 76 to 81 GHz range have been gaining momentum in the last few years. The radar operating in the E-band spectrum is designed and intended to support various objectives, including adaptive cruise control, blind spot detection, lane departure warning, pre-crash mitigation, and other road safety features. These automotive radar applications can be categorized into three types: short range radar (SRR), middle range radar (MRR), and long range radar (LRR). These radar transceiver modules are installed at various locations on the vehicle. Some transceivers are single-channel or single-port transceivers, while others have a multiple-channel design necessary for using MIMO transmission algorithms. Manufacturers of these transceiver ICs or subsystems are required to measure and validate the maximum radiated power when operating in transmission mode.

Designed with a WR-12 flange connector, the E8486A waveguide power sensor makes precise and direct waveguide measurements in the E-band frequency range and is compatible with most Keysight power meters. A wide dynamic range of -60 to +20 dBm and a SWR performance of 1.06 minimize measurement uncertainty caused by mismatch, providing high accuracy even with low power signals. With the E8486A, get the precision and accuracy you need for E-band applications in a single power sensor.

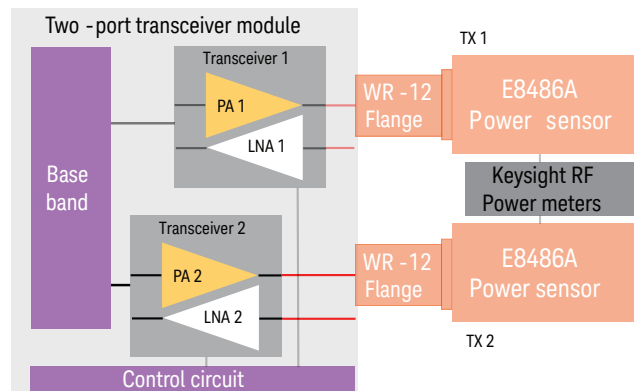

E8486A E-Band Waveguide Power Sensor and radar transceiver module test case

EMI/EMC

N9038A MXE EMI receiver

Keep your EMI test queue flowing with Keysight's compliance receivers and precompliance spectrum analyzers! Working with our Solutions Partners, Keysight provides complete solutions for automotive emissions and immunity testing.

Key features of Keysight N9038A MXE EMI receiver

- CISPR 16 and MIL STD compliant
- Fast time domain scanning
- Enhanced built-in EMC measurements
- Advanced diagnostic capability
- Real-time spectrum analysis (RTSA) for diagnosing high-speed transient signals

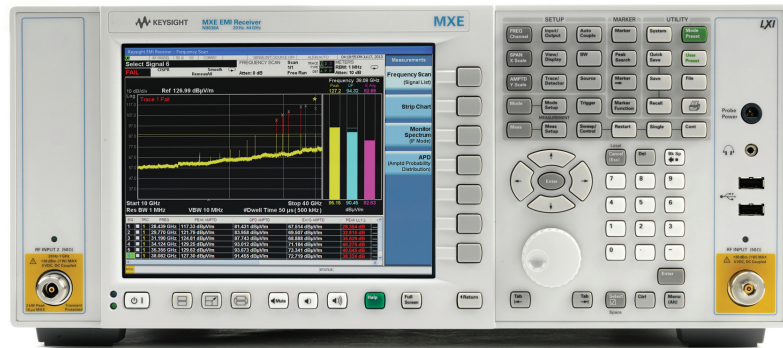

N9038A MXE EMI receiver

EMPro (Electro-Magnetic Professional)

EMPro offers 3-dimensional full-wave electro-magnetic simulators based on the frequency domain technology, FEM (Finite Element Method) and the time domain technology, FDTD (Finite Difference Time Domain). With these simulation technologies, any arbitrary 3D structures can be simulated, and emission level at any distance, for example, 3 and 10 meters, can be calculated and compared to EMI limits such as FCC or CISPR.

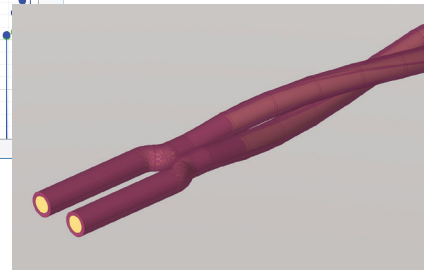
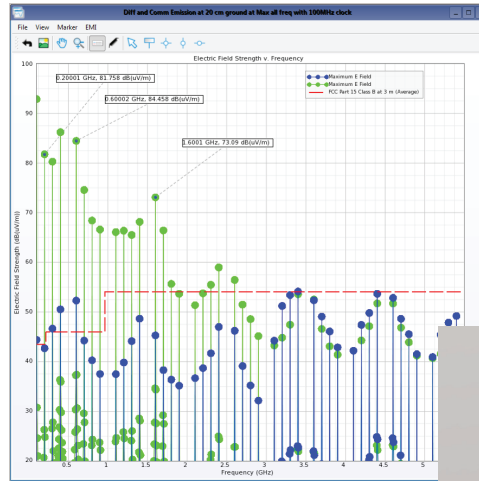

EMPro provides electromagnetic simulators that can predict radiated emission levels from electronic components and cabling

Wireless Technologies to Connect Cars

More and more advanced vehicles have wireless connections and these Connected Cars (Car-to-X) will improve safety, security, performance, reliability and infotainment. Automotive designers and developers need to verify various types of wireless technologies including 2G, 3G, 4G LTE and LTE-Advanced, and coming 5G, WLAN, Bluetooth, Near Field Communication (NFC), and more to guarantee the safety and the performance of the Connected Cars.

Design, test and deliver your next automotive breakthrough with the X-Series signal analyzers

Engineering is all about connecting ideas and solving problems. This experience drives the X-Series signal analyzers: they are the benchmark for accessible performance that puts you closer to the answer by easily linking cause and effect.

meet specific automotive wireless test needs including IEEE 802.11p, cellular technologies, Bluetooth and more. Industry-leading 89600 VSA software supports more than 75 signal standards and modulation types, helping accelerate your designs.

The X-Series signal analyzers offer analysis bandwidth up to 1 GHz (with UXA model), real-time spectrum analysis (RTSA) up to 510 MHz bandwidth (UXA and PXA), and a streamlined multi-touch user interface. The X-Series applications help automotive wireless developers easily

To ensure measurement integrity and repeatable results, we use the same proven algorithms in every X-Series signal analyzer. Across the full spectrum --from CXA to UXA --you'll find the tools you need to design, test and deliver your next breakthrough.

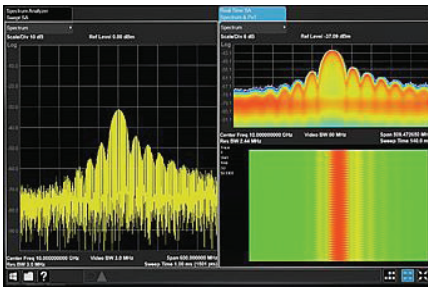

RTSA display with PXA/MXA helps visualize the multi-burst signals of WLAN and Bluetooth.



N9030B PXA performance signal analyzer with RTSA, ideal for your R&D environment



N9020B MXA Mid-range signal analyzer provides the best value for your design verification

Wireless Technologies to Connect Cars

WLAN 802.11p signal generation and analysis

Keysight offers accurate and flexible signal generation and signal analysis solutions for the 802.11p design and test lifecycle.

The signal generation solution comprises the N7617B Signal Studio for WLAN 802.11a/b/g/j/p/n/ac/ah software which enables creation of standard-compliant 802.11p waveforms that can be used for accurate receiver testing and evaluation of receiver performance, including under fading condition with vector signal generator (N5182B MXG or N5172B EXG X-Series signal generators, E8267D PSG, or M9381A PXIe VSG).

The signal analysis solution is made up of the 89601B vector signal analysis (VSA) software with WLAN Modulation Analysis for 802.11a/b/g/p/j (89601B VSA Option B7R) and the X-Series signal analyzers with N9077 WLAN 802.11a/b/g/j/p/n/ac/ah Measurement Application. Together, these signal generation and analysis solutions address and exceed the stringent requirements of 802.11p physical layer tests—from research, development, verification to manufacturing.

Path	Enabled	Fading Type	Spectral Shape	Delay Type	Delay	Loss	Vehicle Speed	Doppler Frequency	Center Freq. Offset	Phase Shift	Frequency Offset	Log Normal
1	<input checked="" type="checkbox"/>	Rayleigh	Classical SSB	Fixed	0.000 us	0.00 dB	0.00 km/h	0.000 Hz	0.000 Hz	0.00°	0.000 Hz	<input type="checkbox"/>
2	<input checked="" type="checkbox"/>	Rayleigh	Jakes Half Bathtub	Fixed	0.000 us	14.00 dB	90.81 km/h	492.000 Hz	Doppler Frequency	0.00°	0.000 Hz	<input type="checkbox"/>
3	<input checked="" type="checkbox"/>	Rayleigh	Jakes Half Bathtub	Fixed	0.000 us	17.00 dB	54.23 km/h	295.000 Hz	Doppler Frequency	0.00°	0.000 Hz	<input type="checkbox"/>
4	<input checked="" type="checkbox"/>	Rayleigh	Classical SSB	Fixed	0.000 us	0.00 dB	0.00 km/h	0.000 Hz	Doppler Frequency	0.00°	0.000 Hz	<input type="checkbox"/>
5	<input checked="" type="checkbox"/>	Rayleigh	Classical SSB	Fixed	0.000 us	0.00 dB	0.00 km/h	0.000 Hz	Doppler Frequency	0.00°	0.000 Hz	<input type="checkbox"/>
6	<input checked="" type="checkbox"/>	Rayleigh	Classical SSB	Fixed	0.000 us	0.00 dB	0.00 km/h	0.000 Hz	Doppler Frequency	0.00°	0.000 Hz	<input type="checkbox"/>
7	<input checked="" type="checkbox"/>	Rayleigh	Classical SSB	Fixed	0.000 us	0.00 dB	0.00 km/h	0.000 Hz	Doppler Frequency	0.00°	0.000 Hz	<input type="checkbox"/>
8	<input checked="" type="checkbox"/>	Rayleigh	Classical SSB	Fixed	0.000 us	0.00 dB	0.00 km/h	0.000 Hz	Doppler Frequency	0.00°	0.000 Hz	<input type="checkbox"/>
9	<input checked="" type="checkbox"/>	Rayleigh	Classical SSB	Fixed	0.000 us	0.00 dB	0.00 km/h	0.000 Hz	Doppler Frequency	0.00°	0.000 Hz	<input type="checkbox"/>
10	<input checked="" type="checkbox"/>	Rayleigh	Classical SSB	Fixed	0.000 us	0.00 dB	0.00 km/h	0.000 Hz	Doppler Frequency	0.00°	0.000 Hz	<input type="checkbox"/>

A screen shot of the 802.11p fading simulation with N7605B Signal Studio



SEM measurement on a 10-MHz FCC Class A, 802.11p transmitter with 0-dBm maximum output power by the Keysight N9077 WLAN measurement application

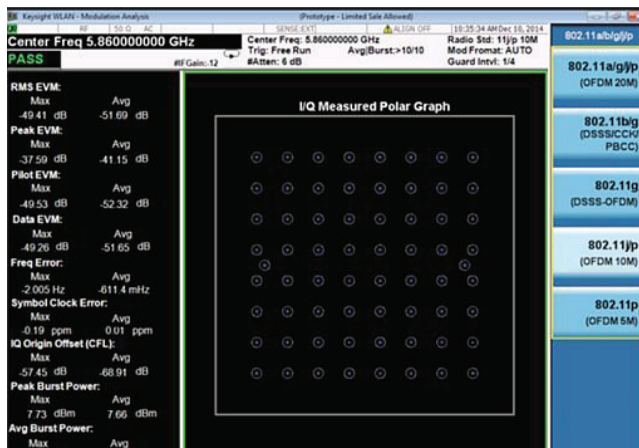

EVM measurement with Keysight N9077 WLAN measurement application

Wireless Technologies to Connect Cars

Cellular and wireless connectivity test sets

From development to high-volume production of wireless modules and devices equipped in advanced vehicles, Keysight one-box test solutions deliver fast measurement speeds, repeatable accuracy, and exceptional flexibility for testing today's and future wireless technologies in the automotive industry. That translates to lower costs and increased profit margins for your company. There's a Keysight solution for testing all major wireless technologies and wireless connectivity formats including: LTE-Advanced, LTE FDD/TDD, GSM/GPRS/EGPRS/EDGE, W-CDMA/HSPA/HSPA+/DC-HSDPA, cdma2000/1xEV-DO/eHRPD, TD-SCDMA/TD-HSDPA/TD-HSUPA, *Bluetooth* including EDR and Low Energy, ZigBee, WLAN, and WiMAX.

E6640A EXM wireless test set...

drives down the cost of capital equipment by optimizing multi-device and multi-format testing with up to four TRX modules per mainframe, each covering up to 6 GHz with 160 MHz bandwidth. Each TRX module can be configured with two full duplex and two half-duplex ports or four full-duplex ports, depending on your application requirements. The test set is customizable to connect up to 32 DUTs with multi-port adapter (MPA) technology. It's scalable to meet your production needs for today's and future wireless technologies including LTE-Advanced, LTE FDD, LTE TDD, HSPA+, W-CDMA, 1xEV-DO, cdma2000, GSM/EDGE-Evo, TD-SCDMA, 802.11ac, 802.11a/b/g/n/p, WLAN MIMO, *Bluetooth*, multi-satellite GNSS, and digital video in one-box.

E5515 8960 Series 10 wireless communication test set...

supports various 2G, 3G and 3.5G technologies in vehicles with industry-standard high-speed, accurate and reliable RF measurements and flexible network emulation focused on the needs of manufacturing and RF design, verification and integration. The latest release of firmware for the E5515 8960 Series 10 Wireless Communication Test Set now includes the detection and status of the eCall Flag (Manual or Automatic). This is an essential test which will ensure your eCall In-Vehicle System module sets and transmits the correct eCall Flag setting.



E6640A EXM wireless test set for wireless manufacturing

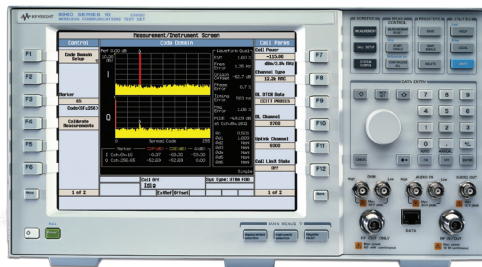

E5515 8960 Series 10 wireless communication test set

Wireless Technologies to Connect Cars

E7515A UXM wireless test set ...

is a highly-integrated signaling test set created for functional and RF design validation in next generation in-car wireless communication and beyond. It provides the integrated capabilities you need to test the latest designs, delivering LTE-Advanced category 6 now and handling more complex requirements later. You will be ready for 4G and beyond with UXM's multi-format capable platform that will handle the next advancements in antenna techniques, component carriers, and data rates. The extensible architecture includes high-speed interconnects, upgradable processors, expansion slots, and versatile display capabilities with 15-inch touch screen interface.

Near Field Communication (NFC)...

is a fusion technology that provides new valuable service to the users by integrating RFID technology with mobile communication devices, & wireless Internet infrastructure, and provides various benefits to various wireless connections in automotive industries.

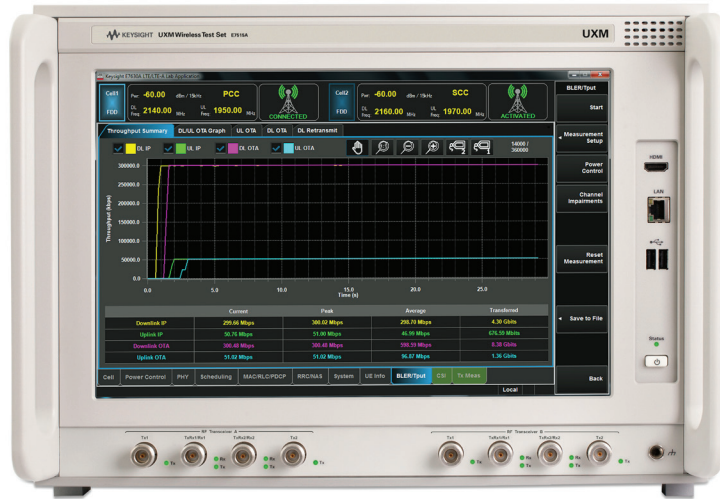

E7515A UXM wireless test set

T3111SNFC
Conformance
Test System

- NFC & RFID devices emulator
- Users can build their own test cases
- Automated test cases execution

- Validated tool for NFC forum certification program
- RF and protocol testing in one single instrument
- One box test solution; no need for external instrumentation
- Robots supported



T3121SNFC
R&D Test System

Wireless Technologies to Connect Cars

High efficiency, low cost RF testing solution for automotive TPMS, RKE/PKE applications

The key challenge we address with our low cost RF test solution is testing the RF transceivers used in tire-pressure monitoring system (TPMS), or the remote keyless entry (RKE) and passive keyless entry (PKE). Testing items include: center frequency, power and FSK deviation for the transmitters, and the sensitivity test for the receivers.

These RF devices adopt ASK/FSK modulation and work in ISM bands (such as 315 MHz, 433 MHz), and they enable low power, high performance RF communications between themselves and the ECUs of the vehicles, yet remain with long battery life.

Using an efficient and reliable testing solution helps you ramp up volume manufacturing and deliver products with proven quality, and helps you save time and money. Accelerate RF analysis, and yet hold your budget!

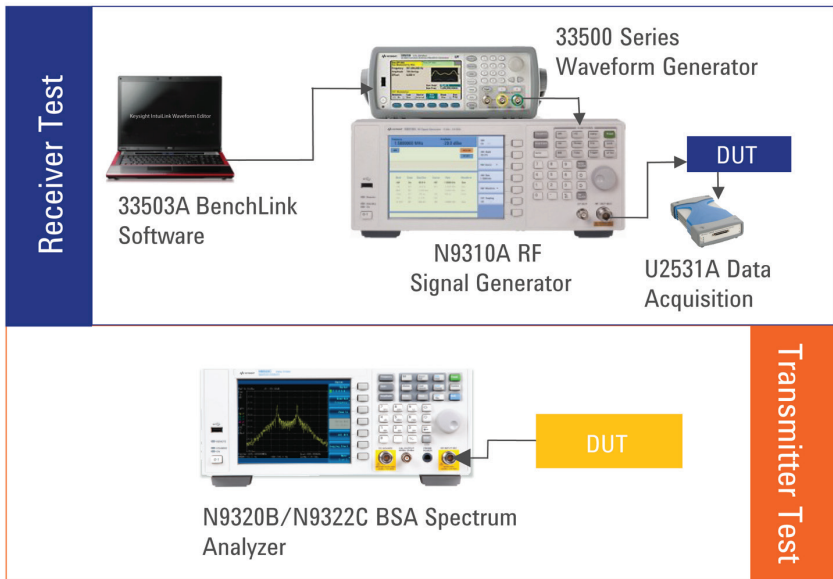

Equipment setups for receiver and transmitter tests

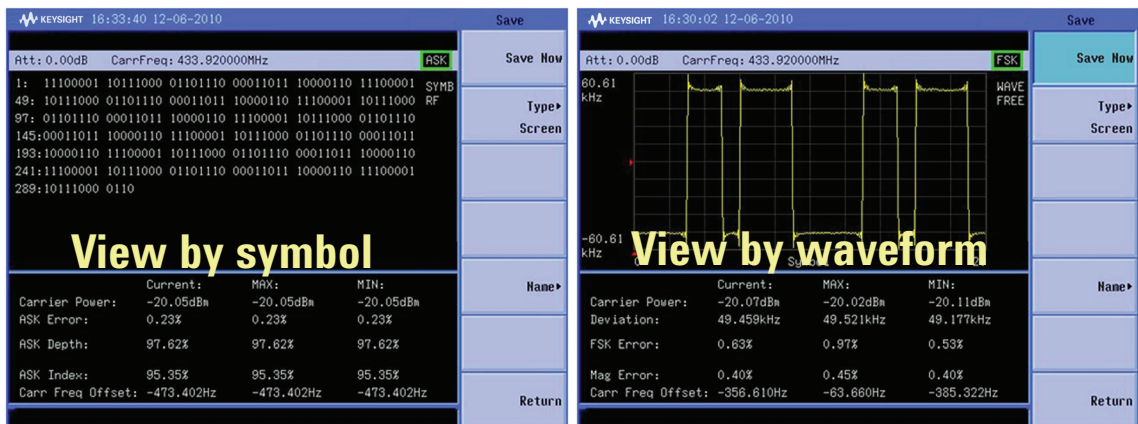

N9320B/N9322C spectrum analyzer provides one-button FSK signal analysis with symbol and waveform view maps

Wireless Technologies to Connect Cars

Navigation systems

Navigations systems are available in many automobiles to guide drivers to their destinations, and location information is also used in systems like eCall to alert emergency centers to the vehicle's location. The core of these systems are the navigation receivers that make use of signals from one or more global navigation satellite systems such as GPS, GLONASS, and Beidou. Verification of these receivers can be performed by using simulated satellite signals to test for time to first location fix, receiver sensitivity, and location accuracy.

For R&D and design verification, the N7609B Signal Studio for GNSS software can be used with the N5172B EXG or N5182B MXG signal generators to provide real-time simulation of multi-satellite signals from the GPS, SBAS/QZSS, GLONASS, Galileo, and Beidou systems. This solution provides up to 40 channels for any combination of GPS, SBAS/QZSS or GLONASS line-of-sight and multipath signals, with 16 additional channels to support Galileo. Real-time impairments such as multipath and pseudo-range errors can be added.

For manufacturing test, the N7609B also offers a basic mode option that generates arbitrary waveform files that simulate single or multi-satellite signals for short periods of time. These waveform files are compatible with many Keysight RF vector signal generators, including PXI modules and wireless test sets.

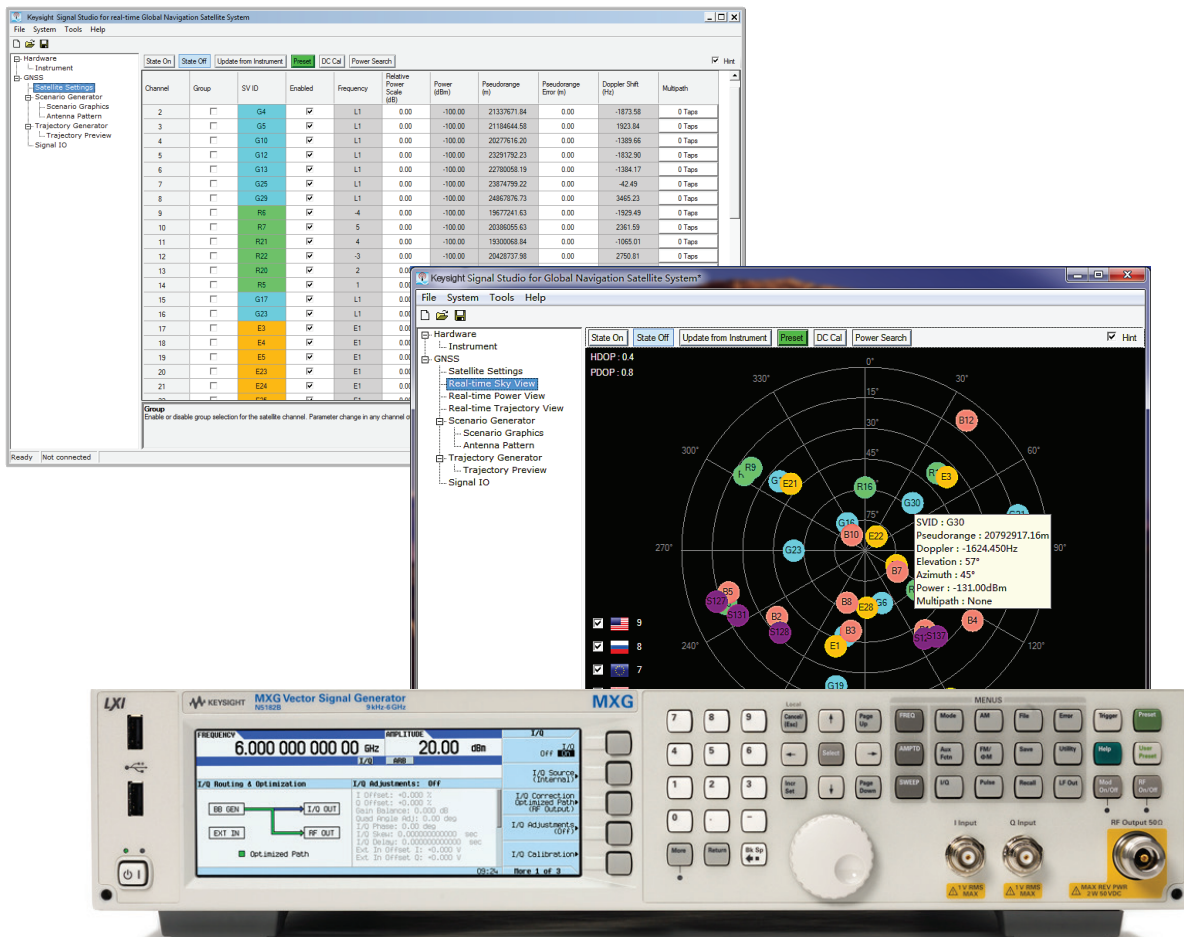

Real-time GNSS simulation using N7609B and MXG signal generator

Instrumentation for Testing Beyond the Bench

FieldFox and HSA RF & microwave handheld analyzers

Did you know Keysight offers more than just benchtop solutions? Keysight's handheld solutions complement the benchtops and can replace multiple benchtop instruments for simple and precise measurements and verifications. Weighing at 7 lb (3.2 kg), Keysight's FieldFox and HSA handheld RF & microwave analyzers make measurements in or around assembled vehicles easier and faster.

Wireless connectivity and in-vehicle networks

Whether it is vehicle infotainment or navigation and driving assistance or completely autonomous driving, connectivity and in-vehicle networks need to be at optimal performance. Rusty components and damaged or over-bent cables can cause degradation in car connectivity, FieldFox as a cable and antenna tester with return loss/VSWR, distance-to-fault (DTF) and time-domain reflectometry (TDR) enables you to measure and maintain the performance of RF cables, connectors and antennas built in the car.

With various wireless technologies used in connected cars, such as 3G, LTE, Bluetooth, Wi-Fi, and near-field communication, interference issues have become a major challenge for automotive manufacturers. FieldFox and HSA analyzers offer portable spectrum analysis, interference analysis and channel scanning to detect on-board interfering signals among the numerous electronic systems, identify the source and eliminate interference.

Vehicle performance optimization

N934xC HSAs with the ASK/FSK modulation feature allows vehicle manufacturers to validate and troubleshoot common vehicle optimization systems such as tire pressure monitoring systems (TPMS), and remote keyless and passive keyless entry (RKE and PKE) which operate in the ISM band and use FSK modulation to transmit signals. ASK/FSK modulation analysis shows the modulation metrics, including carrier power, carrier frequency offset, ASK modulation depth/index, and FSK deviation. The demodulated signal can be viewed in different format settings. Modulation metrics for reporting and set-up of parameters can be saved for future analysis.

Electromagnetic interference

N934xC HSAs provide EMI filters and quasi-peak detector for EMI pre-compliance test and for identifying any potential EMI risk in design. HSA meets CISPR Class A requirements and FieldFox meets CISPR Class B, making them ideal for diagnosing any EMI related issues.

And there's more...

FieldFox provides precision measurements up to 50 GHz as a cable and antenna tester, vector network analyzer, spectrum analyzer, power meter, independent signal generator, vector voltmeter, and variable DC source. The network analyzer function enables you to measure the isolation signals inside and outside the vehicle, and evaluate the return loss of antennas such as radio, cell band, GPS and tire pressure sensor antennas. In a rugged and convenient portable form factor, FieldFox and HSA offer budget flexibility where you can buy features you need today, and easily upgrade later.



FieldFox analyzers integrate RF and microwave testing capabilities of 10 instruments into a single, compact and lightweight instrument

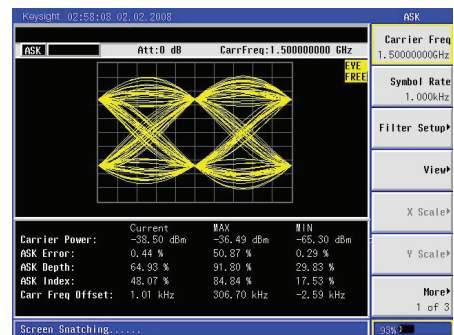

N934x HSA analyzers offer great value and ASK/FSK demodulation

Wireless Power Transfer

Wireless Power Transfer Efficiency Measurements

Wireless charging performance largely relies on power transfer efficiency between transmitter and receiver coils or resonators. Obtaining high power transfer efficiency between them is critical to ensure reliable wireless charging systems.

Keysight offers option 006 wireless power transfer analysis software in E5072A, E5061B, and E5063A ENA series network analyzers. It provides two operation modes with the following benefits:

- Real-time power transfer efficiency measurements between transmitter and receiver coils/resonators
- Arbitrary source voltage and load impedance setting
- Advanced 2D/3D simulation to visualize dependency of load impedance
- Network analysis data output for further circuit modeling and simulation in Keysight ADS simulator

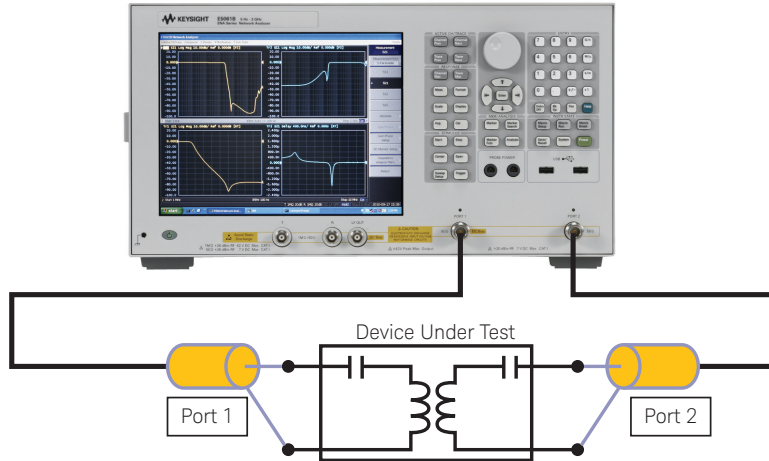

Measurement setup for wireless power transfer analysis with ENA series network analyzers

Mode-1: Real-time wireless power transfer analysis

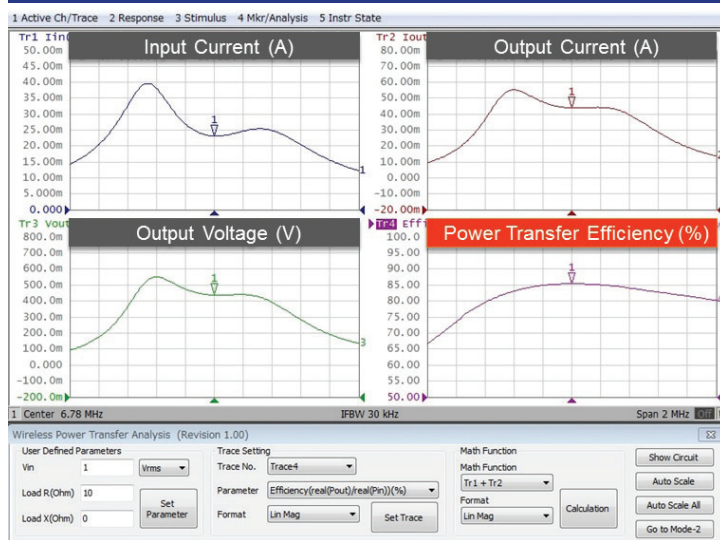

Mode-2: Advanced 2D/3D simulation

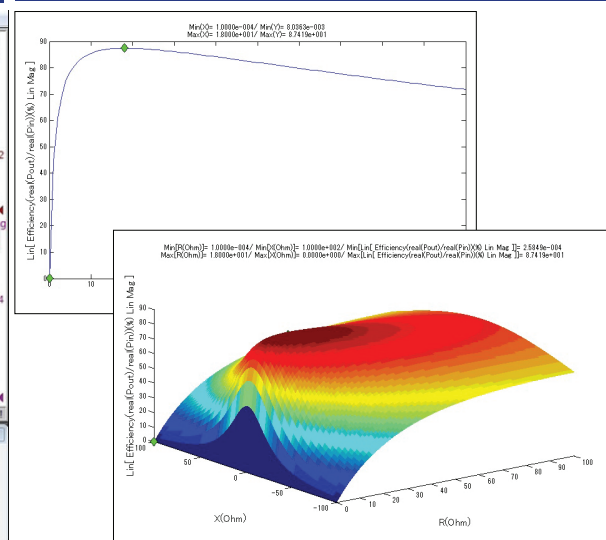

Option 006 wireless power transfer analysis available in E5072A/E5061B/E5063A ENA series network analyzers

Wireless Power Transfer

Characterizing components in wireless power transfer

Characterizing components in wireless power transfer systems is important to achieve reliable performance in wireless charging. Keysight E5072A, E5061B, E5063A ENA series network analyzers address various measurement requirements for characterization of components in wireless power transfer systems.

1. Configurable test set for high power measurements

Testing components in wireless power transfer systems at actual operating conditions often requires power output that exceeds the capability of a standard network analyzer. The E5072A offers configurable test set to boost output power with an external power amplifier.

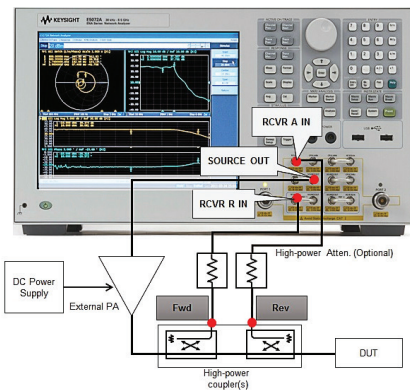

High-power measurement setup with E5072A ENA series network analyzer

2. Combination analyzers for component characterization

The E5061B option 3L5 LF-RF network analysis provides network analysis capability from 5 Hz, and option 005 adds impedance analysis function. It is a highly versatile solution for characterization of components in wireless power transfer systems.

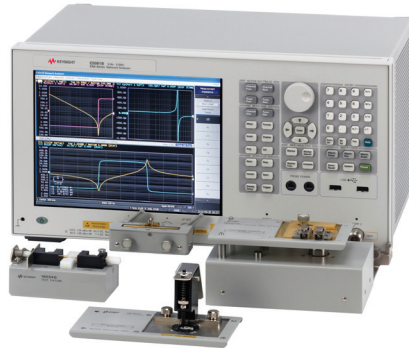

Combination analysis of network and impedance with E5061B ENA series network analyzer

3. Affordable solution for volume production

The E5063A is the best choice for Go/No Go tests at manufacturing for its affordable price. With frequency availability from 100 KHz up to 18 GHz and frequency upgrade path, it brings the best balance between cost and performance for volume measurements of components in wireless power transfer systems.

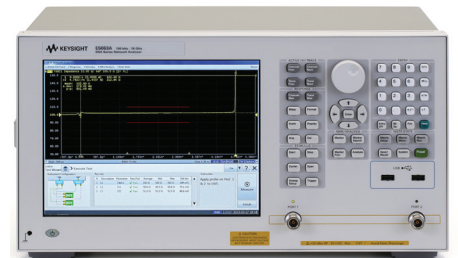

The best balance between cost and performance with E5063A ENA series network analyzer

Automotive Power Device Testing

Hybrid electric vehicle (HEV) and electric vehicle (EV) technologies can significantly improve automotive fuel efficiency. The core of these technologies is the electrified power train. Since electrical engineers working in the automotive industry have to develop highly efficient, safe and reliable electric circuits, the evaluation of final circuit characteristics is very important. This makes evaluating the efficiency of the entire circuit a necessary process.

To enable this, a detailed understanding of the power devices and components used in a circuit is mandatory. This is especially true for power devices used in the circuit (IGBTs, MOSFETs, etc.), since their performance often dictates the efficiency, safety and reliability of the entire circuit. Unfortunately, device manufacturer supplied datasheet information is often not sufficient to meet these needs. The datasheet conditions are often different from actual use conditions, and the supplied information often has large margins with no information on device variations. This makes it hard to design reliable and efficient circuits using only the information supplied by device and component manufactures.

Keysight offers unprecedented solutions for component level testing by B1505A and B1506A Power Device Analyzer family.

Power Devices Everywhere in the Car

Power Train System

- EV/HEV motor, Inverter
- Charger, Generator
- Transmission
- Fuel injection



Safety Control

- Auto cruse control
- Rader

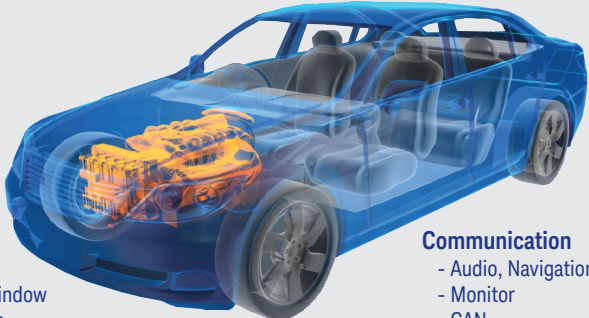

Vehicle Control

- ABS
- EPS
- Suspension
- Acceleration

Body control

- Air conditioner
- Power Door/Window
- Lighting system

Communication

- Audio, Navigation
- Monitor
- CAN



Keysight Power Device Analyzer family meets tough requirement for power device characterization needs, up to 10 kV, 1500 A wide voltage and current range, up to 3 kV capacitance measurement and gate charge measurement and temperature dependency measurement for key parameters from -50°C to +250°C.

Automotive Power Device Testing

B1506A power device analyzer for circuit design

The B1506A Power Device Analyzer for Circuit Design is a complete solution that can help automotive electronic circuit designers maximize the efficiency, safety and reliability of automotive electrical systems. It can evaluate all relevant device and component parameters under a wide range of operating conditions, including IV parameters such as breakdown voltage and on-resistance, as well as three-terminal FET capacitances, gate resistance, gate charge and power loss.

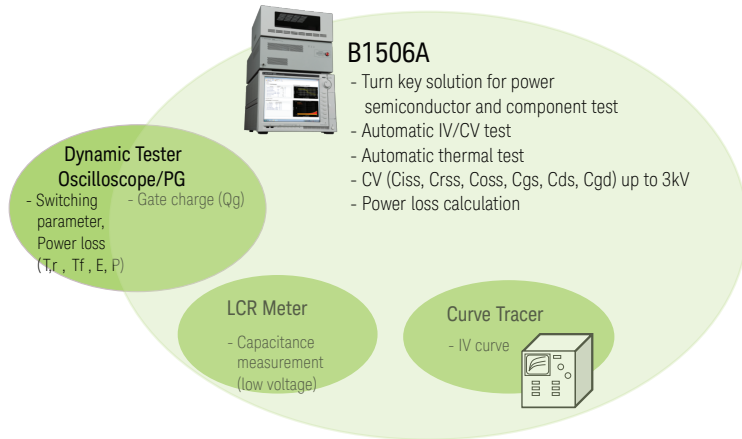

B1506A power device analyzer covers IV test of curve tracer, high voltage bias capacitance measurement and Gate charge (Qg) measurement that is usually characterized by dynamic tester.

B1505A power device analyzer/curve tracer

The B1505A is a more flexible alternative to the B1506A, offering wider current and voltage ranges, better low-current measurement accuracy, high voltage with medium current measurement (e.g. 500 mA at 1.2 kV) capability, a GaN current collapse testing option and the ability to measure more than three pins simultaneously. In addition, the B1505A can measure both on-wafer and packaged devices. Besides being widely used by power device manufacturers, the B1505A is valuable for automotive electronics engineers utilizing GaN power devices, measuring the sense emitter current of 4-terminal IGBTs, and characterizing HVICs for gate driver circuits.

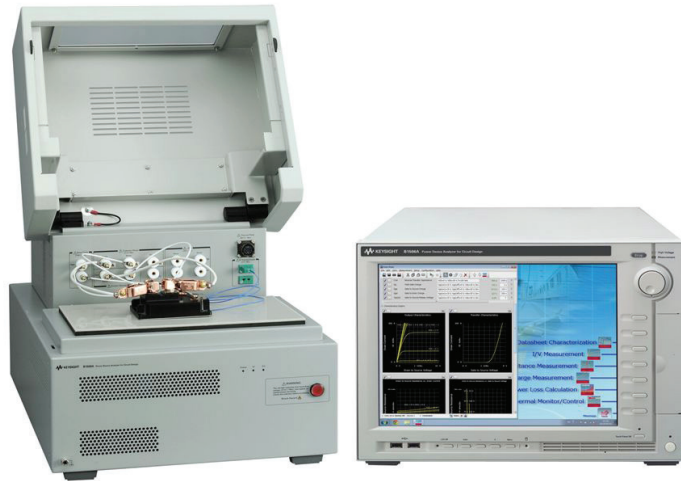

B1506A power device analyzer for circuit design

Automotive Power Analysis & Testing

Power analysis to optimize efficiency

IntegraVision AC/DC Power Analyzer

- PA2201A 2-channel, 1 phase
- PA2203A 4-channel, 3 phase

The IntegraVision Power Analyzer is designed for powertrain testing of EV/HEV/PHEVs. With touch-driven oscilloscope visualization, it provides accurate measurements (0.05% basic accuracy) for high efficiency measurements and supports capture and measurement of dynamic power waveforms. It is used for:

- Battery and battery management
- Drivetrain motor control systems
- Electric Motors
- DC: DC converters

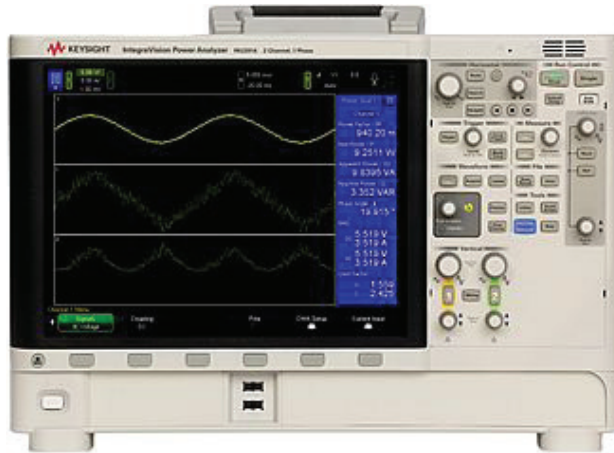

IntegraVision AC/DC Power Analyzer

Generate power transients for automotive electronics Immunity testing

DC power design test with N6705B DC power analyzer for 50 - 500 W

Motors and solenoids cause vehicle power system voltage transients and dropouts. Vehicle electronics require adequate power transient immunity, and their mission-critical nature requires thorough testing of ECUs, electro-mechanical components, infotainment, and telematics.

The N6705B DC Power Analyzer can run a variety of DC transient tests on your own bench. Easily create transient waveforms on 50 - 500 W DC power outputs with the built-in arbitrary generator through the intuitive front panel display.

The 14585A Control & Analysis Software quickly creates & modifies transient waveforms. Sequence built-in and custom waveform segments, repeat segments as desired, and quickly modify your waveforms as you cycle through design iterations.



PA2201A making an efficiency measurement on signal containing both AC and DC

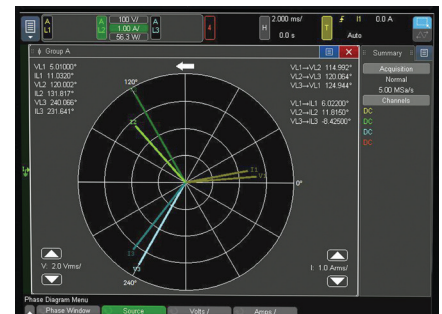

PA2203A measuring a three phase signal

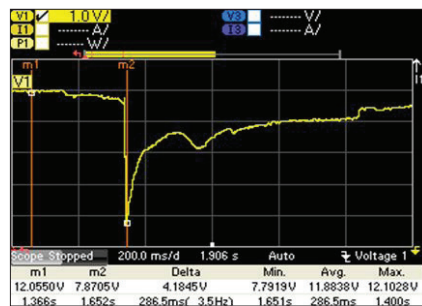

Power supply reset test waveform profile created with N6705B. Engine crank profile on DC power system in-vehicle captured with a digitizing oscilloscope and easily loaded into the N6705B DC Power Analyzer to define the transient output of the DC Supply.

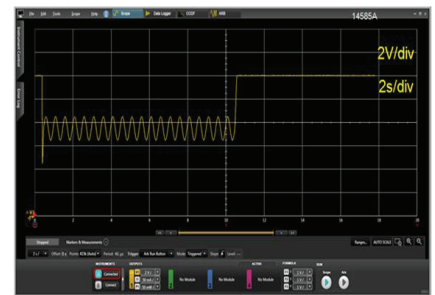

ISO 16750-2: 4.6.3 starting profile generated with N6705B & 14585A

Automotive Power Analysis & Testing

Advanced power system for 500 – 2000 W DC power and transient testing

The Advanced Power System family of high-performance DC supplies can provide stimulus up to 2000 W or up to 200 A for your most demanding higher-power testing applications. Extremely fast up- and down-programming speeds improve your production test productivity.

The APS allows you to generate transients simulate many engine cranking and other transients required by the ISO 16750-2, ISO 7637-2, LV-124, and LV-148 standards. You can define and easily modify arbitrary waveforms with the 14585A Control & Analysis Software. The combination of the APS and the 14585A is an easy-to-use, economical way to generate such transients with rise & fall times as low as 1 ms.

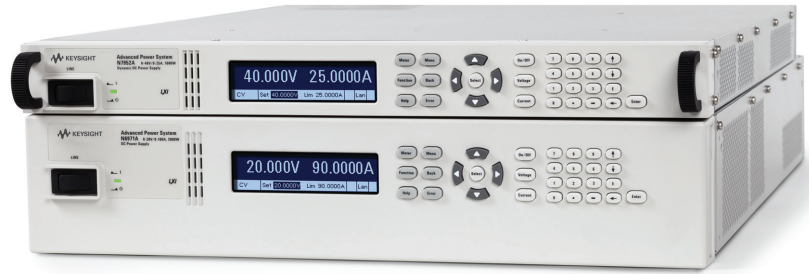

N6900/N7900 advanced power system

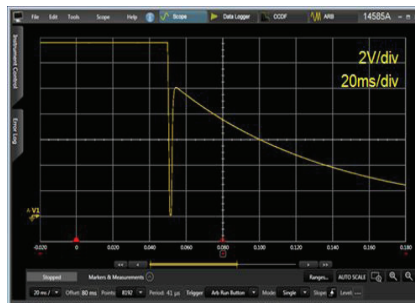

ISO 7637-2: 5.6.2 test pulse 2b motor transient generation with APS and 14585A

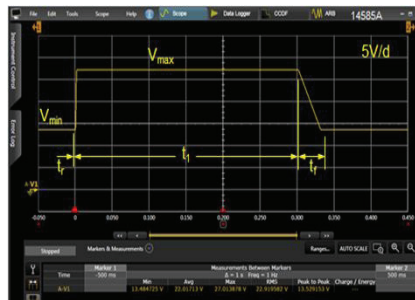

LV 124 / VW 80000 2013-06: E-05 alternator load dump with APS

Parameter	Value
DUT op. mode	ll.c
V_{min}	13.5V
V_{max}	27V (+4%, 0%)
t_r	<2 ms
t_f	300 ms
t_{tr}	<30 ms

Automotive Power Analysis & Testing

Testing electromechanical systems with regenerative energy or back EMFs

Electromechanical systems like power steering and clutch motors use servo motors that generate energy or back EMFs during normal operation. Testing these systems and motors creates challenges for safely absorbing this energy during functional testing. Servo motors can be tested on dynamometer stands where a second motor acts as the load or brake on the servo motor.

In the test system, an Advanced Power System DC Supply combined with a Power Dissipater acts as the vehicle battery, with the ability to both source power and sink regenerated energy. A second APS powers the load motor.

Combining APS Supply & Power Dissipater is superior to discrete power supplies with eLoads due to improved control of power sourcing/sinking and the ability to instantly absorb regenerated energy.

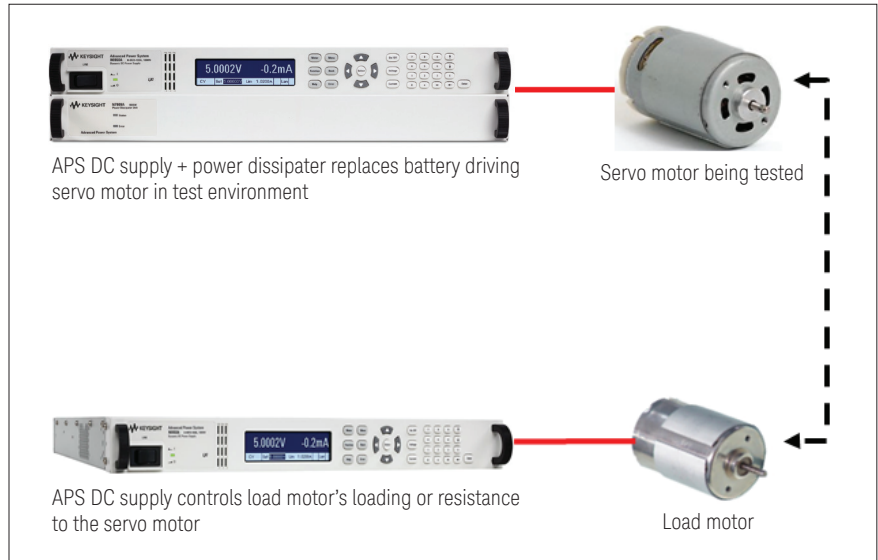

Servo Motor Test: power dissipater absorbs regenerated energy to prevent excessive back EMF

DC power EV traction motor testing

- Electric Vehicles (EVs) use batteries as their primary source of energy.
- Some large EVs use AC traction motors in their drivetrains.
- High power, high voltage DC power supplies are used to test the inverters and the combination of inverters + AC traction motors.
- An N8900 series 750V supply replaces the vehicle battery during the test.

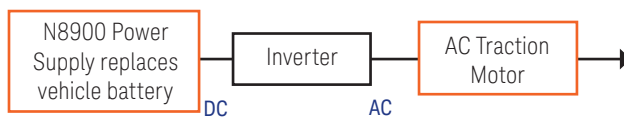

Keysight N8900 Series 5 - 15 kW DC power supplies scalable to 90 kW

Automotive Power Analysis & Testing

DC power for life & durability testing

ELife and durability testing is critical to vehicle system reliability. DC Power Supplies and Electronic Loads are fundamental to productive and meaningful life testing. Keysight's 50-60 kW DC power supplies provide reliable, stable power for your DUTs during life testing. Modular electronic loads allow you to mix and match loads to match the requirements of each DUT. Keysight eLoads quickly step through sequences of load settings and measure load voltages and currents.

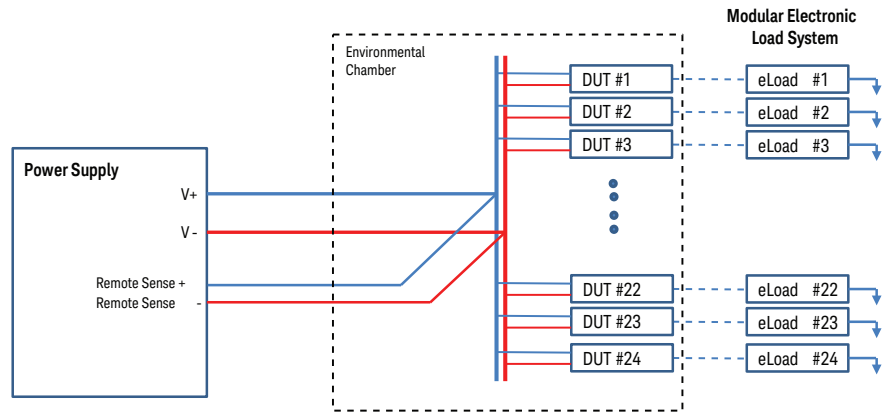

N8900 series autoranging DC Supplies provide 5 kW – 60 kW at up to 1500V and up to 510 A



N3300 series Loads can be configured with load modules ranging from 150 – 600 W

Advanced Multi-Channel Car Infotainment System Test

Today, the majority of automotive audio devices have more than two channels, from six channels (5.1) in surround sound applications to 16 or more channels. The conventional solution for testing multiple channels with a two channel audio analyzer requires add-on switchers which are slow and inaccurate. As only one or two channels are being observed at a time, designers and manufacturers are often blind to interactions between channels, and they may miss seeing output clipping in channels during full power output tests as well as phase and crosstalk interactions, particularly the complexity of all the output channels interacting with each other. Besides, current and future car radio infotainment systems consist of wireless connectivity, GPS, display, and more, and this will make manufacturers face various challenges to test all of these parameters while maintaining low manufacturing cost.

Make multi-functional and higher performance audio measurements with the U8903B audio analyzer. The next generation of the U8903A, the new U8903B comes with added POLQA capability in addition to two-channel wideband analog generator and analyzer functions. Test ultra-low distortion devices with a low residual distortion of <-110 dB, and accurately measure harmonics and noise over 1.5 MHz with the U8903B's wide measurement bandwidth. With the U8903B audio analyzer, you get an audio test solution that is configurable to meet your specific audio application needs. The key features of U8903B audio analyzer are analog audio test up to 1.5 MHz measurement bandwidth, 2 to 8 configurable analog channels, less than 110 dB residual distortion, speech quality test including POLQA (Perceptual Objective Listening Quality Analysis) and PESQ (Perceptual Evaluation of Speech Quality), automatic test sequence, USB control interface and recording/playback mode.



U8903B performance audio analyzer

Automotive Functional Test

Automotive functional test system with PXI solutions

Electronic control modules in a vehicle require adequate measurement accuracy, high power input and high power rating load simulation. Keysight's TS-8989 one box system solution targeted for automotive ECU test consists of high current switch/load, PXI controller & instrumentation, test executive software and development tools.

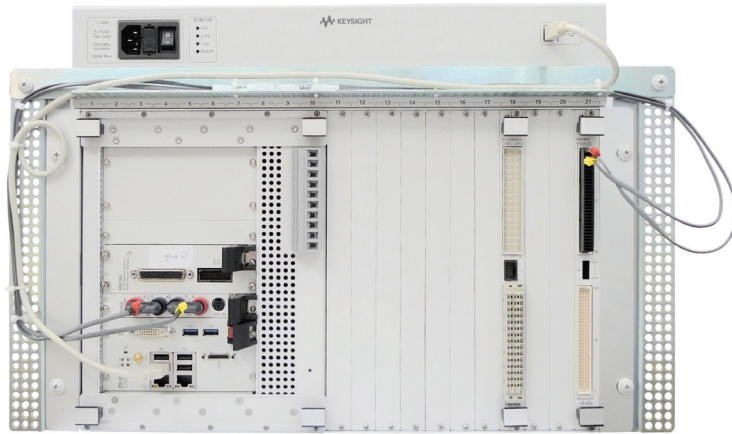

TS-8989 PXI functional test system

The system is capable of handling up to 104 test points and 40A current, providing a cost effective solution to low to medium pin automotive products.

TS-8989 simple Body Control Modules (BCM)...

The BCM is responsible for monitoring and controlling various electronic accessories in a vehicle's body. It controls the power windows, lamps, air conditioning, central locking, washer motor and many other functions. In order to emulate the specific body control, test engineers can choose the appropriate internal/external passive load devices from TS8989 family load cards. For example, a 10 A rating resistive load is needed to represent the effect of a power window motor. Following with voltage/current measurement of functionality check, the load is connected to a high speed, high accuracy PXI digital multi-meter (DMM) through switching matrix.

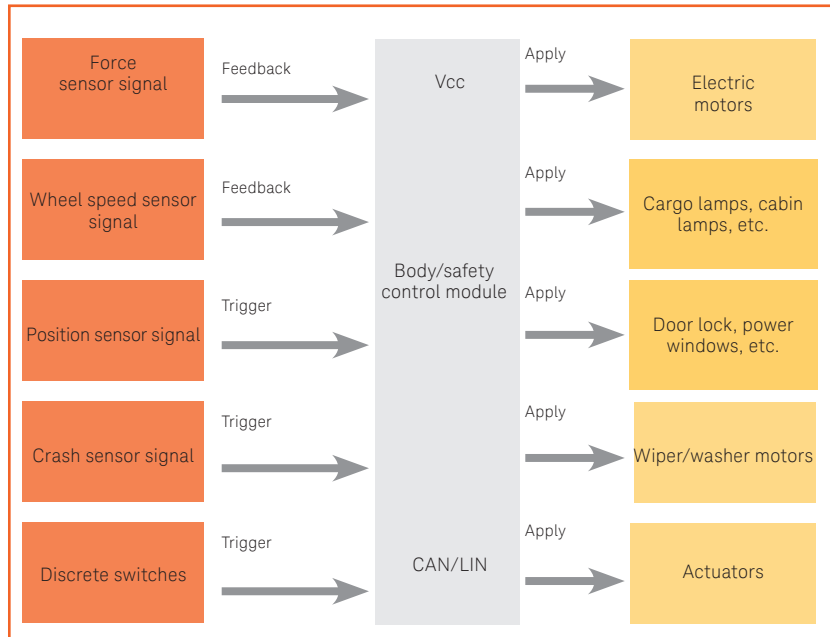

A typical simple 40-pins BCM test setup requires high current 30A load cards for power switching, 7.5A load card with fly back protection for load switching, 40x4 matrix for I/O

switching, and a high speed DMM for rapid mode changes between resistance, voltage and current measurements which TS-8989 provides all in a one box environment.

Automotive Functional Test

Automotive data acquisition and electronic functional test with the 34980A multifunction switch/measure system

The 34980A is an expandable and reconfigurable mainframe with a built-in DMM which offers a selection of 21 switch, measurement and control modules. Of its many uses, it is often found in automotive applications for data acquisition and production test in ATE/functional test systems.

For automotive engine test, the 34980A and multiplexer switch modules are used to accurately and quickly measure a large number of physical parameters, such as temperature, oil pressure, fuel flow, RPM and exhaust composition. The 34980A also provides engine control including engine shutdown in cases where critical limits are reached. Data acquired by the 34980A can be analyzed on standard computer systems.

Every Electronic Braking Control Unit (EBCU) module is electronically tested for possible brake failure during the production process. The 34980A provides the central switching of the test system. Matrix switch modules are used to connect stimulus signals from various instruments and loads to the EBCU module test points, and to measure results with the speed, flexibility and the performance required to handle these complicated tests.



Multi-function switch/measure unit

Automotive ECU Test

Automotive ECU test

Testing the automotive electronic control unit (ECU) is all about applying the right stimulus and measuring the precise output. Keysight has the right selection of PXI modules for up to 100V of input and up to 250V of measurement. This eliminates the needs of having external amplifying circuitry as signal conditioning for both the analog input and digital input to the ECU.



M91xxx Family of Automotive PXI Test Instruments

In addition, the most common challenging measurement for the engine control module is measuring the injector output which involves the flyback circuitry. As illustrated in the diagram below, the flyback voltage can shoot as high as ~200V. In manufacturing testing, it is important to capture both the voltages at all stages and the time taken for each voltage to happen.

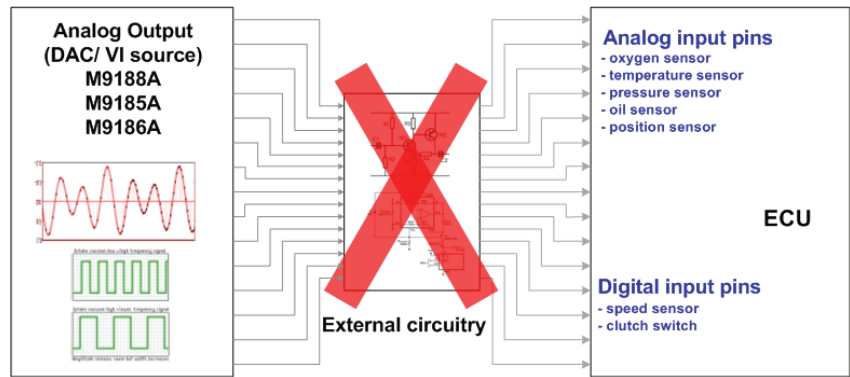

As such, Keysight’s PXI modules for Automotive Electronics Testing are the right solution, providing the right voltage levels without the need for external amplifying circuits.

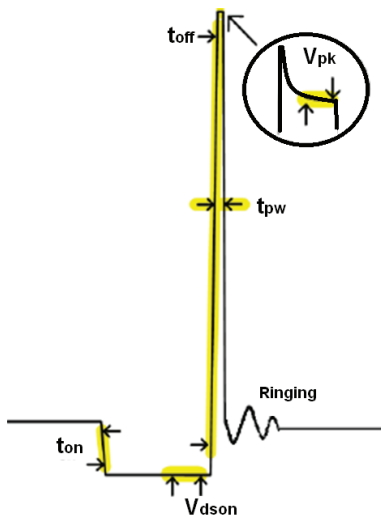

ECU output signals such as this spike can be captured by the M9217A digitizer and M9216A high voltage data acquisition module.

DAC/VI Source Modules	Features
M9216A PXI high voltage data acquisition module	Allows simultaneous measurement of eight to 32 channels of positive voltages ranging from 1 mV to 100 V
M9217A PXI digitizer	Single slot, two isolated input channels, supports up to ±256 V and sampling rate of 20 MSa/s and 16-bit resolution
M9188A PXI dynamic digital/analog converter	1-slot unipolar D/A converter; 16 channels that can supply typical waveforms at high voltages; four isolated banks with four channels per bank.
M9185A PXI isolated D/A converter	Fully independent, isolated D/A converter; supplies high voltage levels in parallel of up to eight or 16 channels; outputs up to ±16 V per channel
M9186A PXI isolated single-channel voltage/current source	Measures resultant current, or sources a current and measures the resultant voltage. Comprises “low” amplifier that provides voltages in the range of 16 volts at up to 200 ma, and “high” amplifier providing voltages in the range of 100 V at up to 20 mA.

Automotive ECU Test

CX3300A device current waveform analyzer

Automotive applications must meet legislations for emission, fuel/energy consumption, etc, and electronics control units (ECUs) will play increasingly important roles to achieve regulatory compliance.

To help automotive applications meet various regulatory guidelines, the ECU is designed for lower current operation under high voltage bias.

The CX3300 series of device current waveform analyzers can visualize wideband low-level current waveforms which were previously unmeasurable or undetectable, from 100 pA up to 10 A, with a maximum of 200 MHz bandwidth.

CX3300A reveals real ECU current waveforms you've never seen before

The ECU was originally used for controlling automotive functions like the internal combustion engine, E-motor, power steering actuator, etc. Nowadays though, the typical vehicle is seeing an increase in the number of high functionality ECUs used, for power train, suspension, body control and safety control, among other functions. The ECU also plays an important role for power control (DC-DC inverters) for EV/HEVs.

For developing and debugging the ECU, the engineer needs to check not only the voltage waveform but also the current waveform because the current waveform can reveal more information to help detect hidden signals with a wider dynamic range, surfacing problems previously undetected in the voltage waveform.

Many vehicular electronics components, including ECUs, work under battery operation, hence power consumption must be kept lower. Having precise current waveform measurement is a key factor for good low power consumption design. The CX3300A enables wide dynamic measurement range, ultra-low noise floor and a maximum of 1 GHz sampling rate, revealing real current waveforms previously not visible.

The "Anywhere" zoom function enables you to quickly expand any waveform segment and view the current in greater details along any specific timeframe.

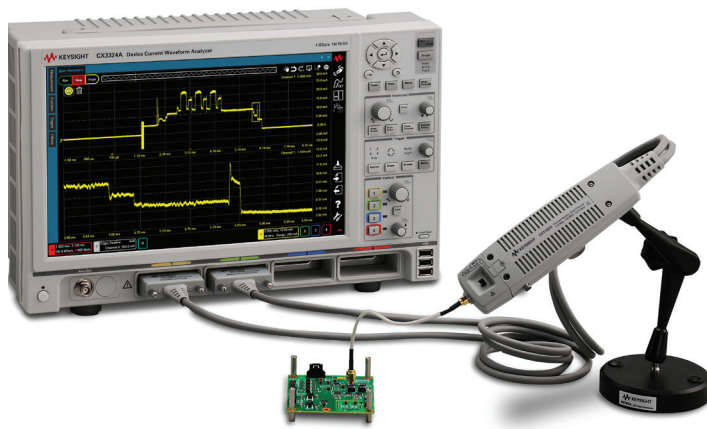

The CX3300A is designed to test today's high-functionality ECUs.

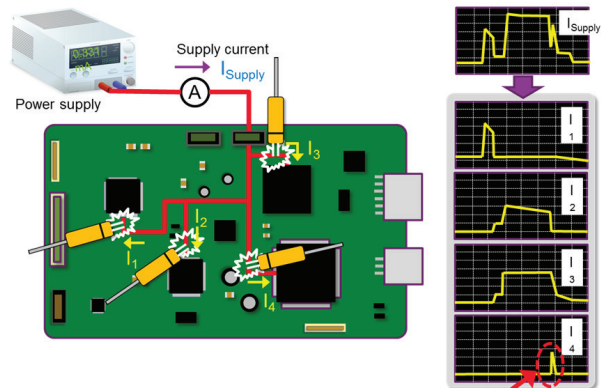

The CX3300A enables a wide dynamic measurement range, revealing real current waveforms previously not visible, to help detect functionality issues.

Automotive In-Circuit Test

Automotive fuse box testing

The i1000D In-circuit Test System now features new digital capabilities, including digital PCF/VCL library based testing, Boundary Scan and I²C/SPI serial programming on a simple, low-cost test fixture. This presents an excellent opportunity for customers who are looking for better test coverage without any increase in cost.

Fuse Box Testing in the i1000D is applicable to both High Voltage and High Current measurements. The test methodology is integrated into the standard window based programming sequence. It safeguards against fixture relays of up to 1A and is able to drive voltages of up to 150V during testing. All safeguards are built into the system, which can be controlled automatically by the programmers.

Keysight's latest Mini ICT now provides a flexible option for testing smaller ECU boards that may not need a full-sized ICT system.

It can be integrated into different applications to provide a combination of functional test and in-circuit test coverage, with device or pin-level defect information.

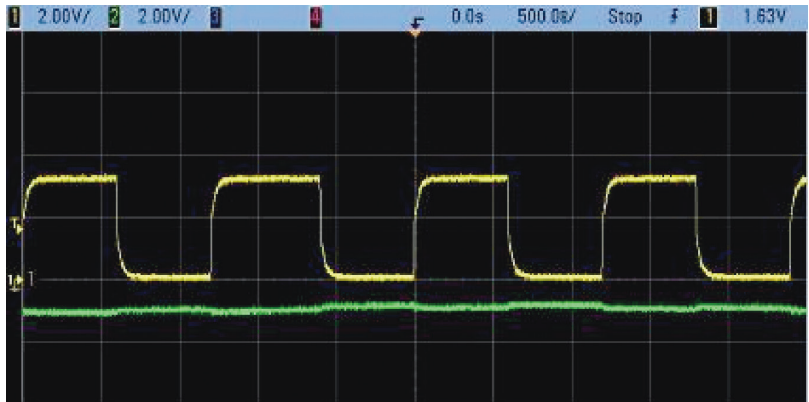

No cross talk on adjacent channels

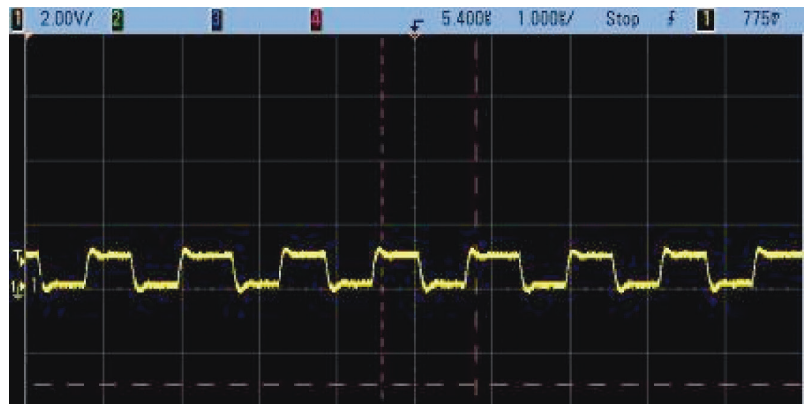

Low signal loss



i1000D small footprint Inline in-circuit test system



Keysight Mini ICT

Automotive In-Circuit Test

Fully automated manufacturing test with i3070 series 5i inline in-circuit test system

Keysight offers one of the broadest range of in-circuit test solutions for automotive electronics manufacturers. Automating ICT helps reduce the risks of ESD shocks to sensitive automotive PCBAs, and provides cost and space utilization efficiency.

Our fully-automated i3070 Series 5i inline ICT solutions help ensure the electrical process integrity of your ECU circuit boards. This award-winning solution is designed to ensure transportability, reliability and stability for all your tests as you replicate production tests across multiple facilities. Our innovative system design ensures easy maintenance and fixture change.

The latest i3070 Series 5i offers a lean option which is slimmer than ever, reducing floor space needs by 56% compared with the classic i3070 standalone solution.



Keysight i3070 E9988EL inline ICT

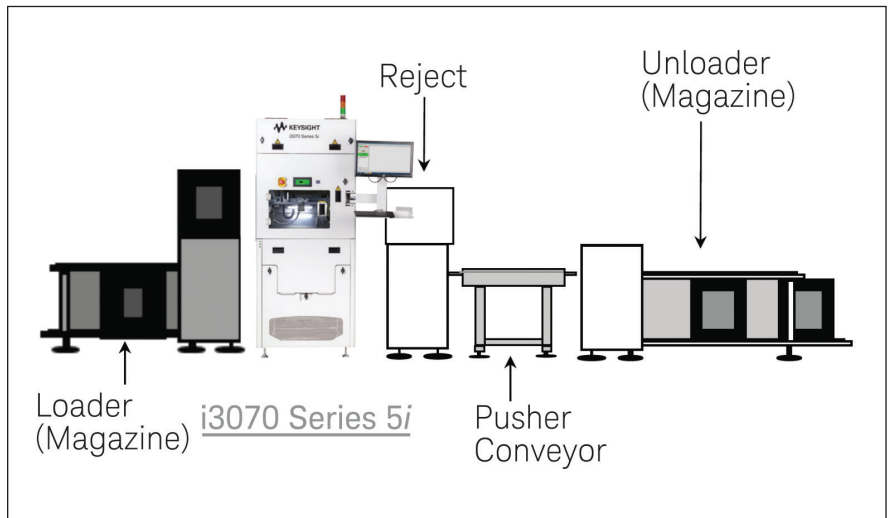

Island mode deployment example

Automotive In-Circuit Test

Addressing current and future boundary scan needs

Keysight x1149 Boundary Scan Analyzer is a printed circuit board tester in compliance with the IEEE 1149.1 Standard test access port (TAP) and boundary scan architecture. The Keysight x1149 offers an easy to use software interface for development, debug and production runtime.

The latest x1149 software enables design for test and test probe reduction, useful features for tests at the design and prototype stage.

During mass production stage, datalogging, baseline control and other features help you to ramp up test throughout and reduce debugging time.

The x1149 Boundary Scan Analyzer has a simple, easy and efficient GUI which provides flexible and convenient screen information management. It has a built-in CAD translation tool and uses the i3070 board file for test generation. The debugged test and library can be reused throughout the entire product life cycle. The advantages include adjustable TCK slew rate and voltage, which ensures test transportability, repeatability and

stability. Production-friendly pin-level failure reports save diagnostic time. Program CPLD/FPGA using STAPL, SVF, JAM and JBC.

In-System programming uses HEX, S-records and binary files.

The x1149 Scan Path linker lowers your cost of ownership by increasing interconnect nets coverage. It also comes with Keysight's Cover-Extended Technology that combines Boundary Scan with capacitive-coupled sensing technology, based on Vectorless Test Extended Performance (VTEP) technology.

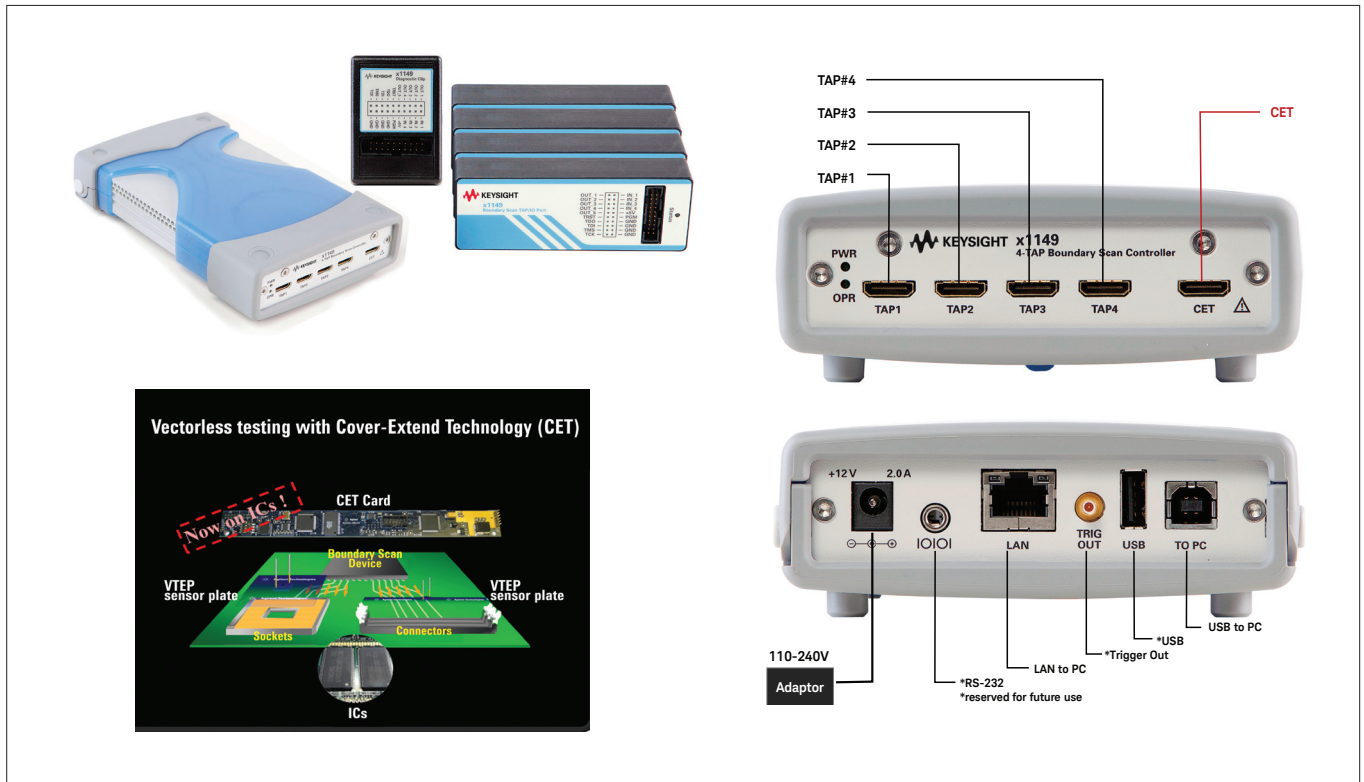

X1149 boundary scan analyzer and Cover-Extend Technology

Advanced Automotive Research at the Nanoscale

Atomic Force Microscopes (AFM), Nanoindentation and Field Emission Scanning Electron Microscopes (FE-SEM) help engineers perceive and understand physical processes occurring at the nanoscale that affect ultimate lifetime, reliability, and performance of automotive components.

Automotive Component	AFM Capability
Fuel cells and GaN devices	Electrical characterization
Lithium batteries' cathodes/anodes	Erosion/degradation studies
Batteries and other energy storage mechanisms	Ionic transport studies
Batteries and other energy storage mechanisms	Corrosion studies (i.e., electrochemistry)

Automotive Component	Nano Indenter Capability
Lithium batteries' cathodes/anodes	Mechanical reliability/degradation testing)
Metals and other materials	Wear and hardness testing
Paints and coatings	Scratch testing

Automotive Component	Compact, Low-voltage FE-SEM Capability
Fuel cells and lithium batteries	High-resolution imaging of membranes/ separators
Machined parts, platings, coatings	Morphology and composition characterization
Systems based on MEMS sensors (e.g., airbags)	Device performance and failure analysis

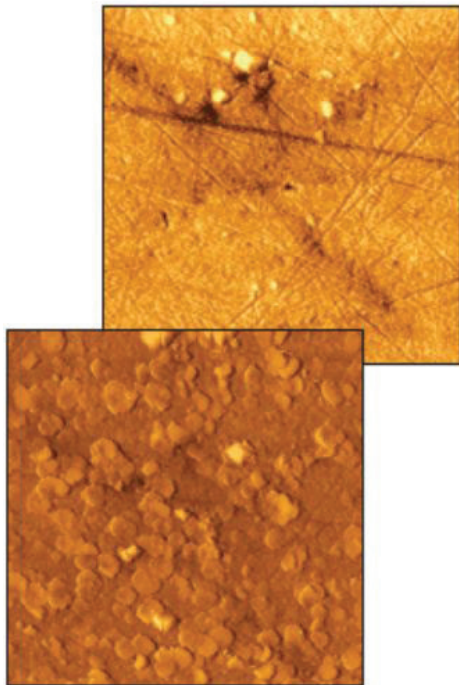

AFM corrosion study of a polished metal surface. Rest potential (top). After six cycles (bottom).

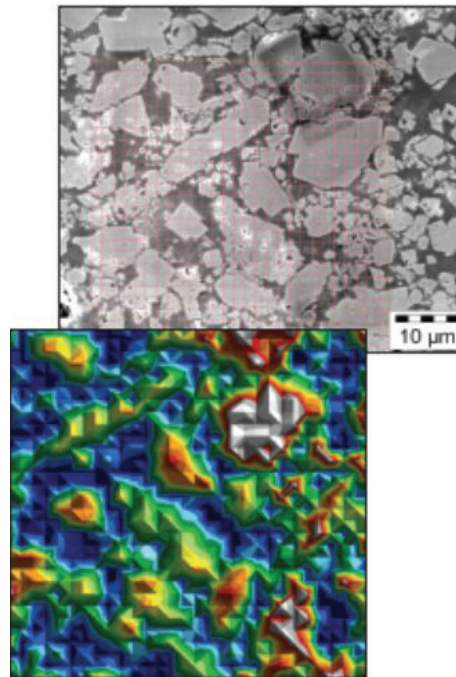

Express Test Nanoindentation Grid (top) and Express Test – Modulus [GPa].

Accelerate Automotive Design and Test with Flexible, High-Performance Platforms

Design and development

Keysight design and development tools help you verify your automotive devices even before having prototypes. We are determined never to let test equipment needs stand in your way of developing innovative products for evolving automotive device design and development.

Integration and interoperability

Keysight provides test equipment to help ensure your automotive devices will integrate and interoperate with other devices. Keysight also provides tools and services to streamline the way you prepare for certification, helping you evaluate module performance, characterize interoperability, and make sure your integration efforts result in certified products.

Design verification and conformance

Keysight offers pre-conformance and design-validation test systems built around our test tools. Keysight's test solutions let you check your new products against requirements so you can determine if your automotive products will be allowed to operate in the defined geographic regions.

Manufacturing

Keysight extends its expertise to offer stand-alone products and system solutions to help get your automotive device designs to market faster and more efficiently.

Service and maintenance

Keysight's tools allow you to do more in the field in less time and increase your ability to detect and eliminate interfering signals among automotive devices used today in cars around the world.

For Additional Information

www.keysight.com/find/SA
www.keysight.com/find/SG
www.keysight.com/find/SSA
www.keysight.com/find/Scope
www.keysight.com/find/NA
www.keysight.com/find/mmWave
www.keysight.com/find/FieldFox
www.keysight.com/find/HSA

www.keysight.com/find/Modular
www.keysight.com/find/EXM
www.keysight.com/find/EMI
www.keysight.com/find/Power
www.keysight.com/find/ICT
www.keysight.com/find/AudioAnalyzer
www.keysight.com/find/automotive

Services and Support

Secure communications and safety

As cars become increasingly high-tech, measurement quality becomes increasingly critical. Wireless and millimeter wave technologies may provide increased connectivity, security and safety, but only if they are based on accurate, repeatable measurements in R&D and manufacturing.

The ISO/TS 16949 standard, together with region, country or company-specific regulations, defines the quality management system, processes and guidelines for your entire supply chain. Keysight can partner with you to deliver the services and support solution you need to meet these external and internal requirements.

EMI/EMC

The CISPR 16 standard specifies test equipment must be calibrated by labs accredited to ISO 17025. And Keysight has a global network of service centers accredited to ISO 17025, spanning a wide range of electronic parameters and featuring industry-leading measurement uncertainties. Whether you are doing pre-qualification or qualification testing, you can trust your equipment will continue to meet its warranted specifications and comply with the CISPR standards.

In-circuit test

Keysight provides on-site and remote support for your 3070/i3070 Series in-circuit test systems. System Uptime Support helps you achieve the highest possible uptime. You get access to technical experts who provide remote assistance, as well as customer engineers who come to your site to perform repairs, upgrades and preventive maintenance. Keysight also offers Cooperative Support, where your technicians are trained to provide front-line support, then work with a team of remote and on-site Keysight engineers to expedite troubleshooting, diagnostics and repair of your mission-critical systems.

Solution partnership

Keysight offers a broad portfolio of services and support to address all of your test equipment needs:

- Start-up assistance and training helps you quickly and effectively use your new equipment
- Calibration and warranty assurance plans provide coverage for up to 5, 7 or 10 years
- Flexible service delivery, such as on-site mobile labs that reduce your calibration turnaround time from days to hours
- Premium used equipment includes the same high performance and 3-year standard warranty as new units
- Trade-in programs (available on both Keysight and non-Keysight models) offers you significant credits to upgrade to the latest Keysight technology

Having the right measurement solution is only the beginning. Design engineers count on repeatable results across work groups to avoid discrepancies that can impact development cycle time, time-to-market and budgets. Manufacturing strives to meet production goals, but inaccurate measurements can affect yield and product quality. Keysight calibration and repair services keep instruments operating to warranted specifications over their lifetime, ensuring accurate, repeatable measurements across R&D and manufacturing.



Evolving

Our unique combination of hardware, software, support, and people can help you reach your next breakthrough. **We are unlocking the future of technology.**

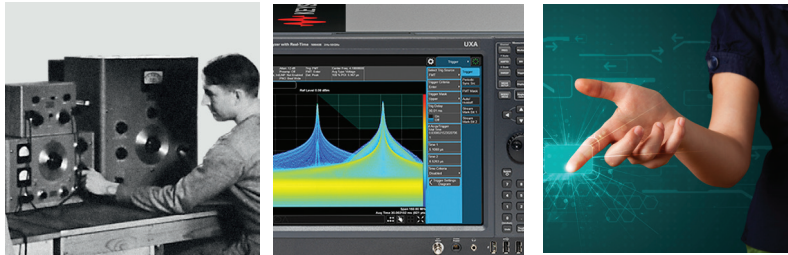

From Hewlett-Packard to Agilent to Keysight

myKeysight

myKeysight

www.keysight.com/find/mykeysight

A personalized view into the information most relevant to you.

Keysight Infoline

Keysight Infoline

www.keysight.com/find/Infoline

Keysight's insight to best in class information management. Free access to your Keysight equipment company reports and e-library.

KEYSIGHT SERVICES

Keysight Services

www.keysight.com/find/service

Our deep offering in design, test, and measurement services deploys an industry-leading array of people, processes, and tools. The result? We help you implement new technologies and engineer improved processes that lower costs.



Three-Year Warranty

www.keysight.com/find/ThreeYearWarranty

Keysight's committed to superior product quality and lower total cost of ownership. Keysight is the only test and measurement company with three-year warranty standard on all instruments, worldwide. And, we provide a one-year warranty on many accessories, calibration devices, systems and custom products.



Keysight Assurance Plans

www.keysight.com/find/AssurancePlans

Up to ten years of protection and no budgetary surprises to ensure your instruments are operating to specification, so you can rely on accurate measurements.

"WiMAX," "Fixed WiMAX," "Mobile WiMAX," "WiMAX Forum," the WiMAX Forum logo, "WiMAX Forum Certified," and the WiMAX Forum Certified logo are trademarks of the WiMAX Forum.

The word **Bluetooth** and it's logo are U.S. registered trademarks of **Bluetooth SIG**.

www.keysight.com/find/automotive

For more information on Keysight Technologies' products, applications or services, please contact your local Keysight office. The complete list is available at: www.keysight.com/find/contactus

Americas

Canada	(877) 894 4414
Brazil	55 11 3351 7010
Mexico	001 800 254 2440
United States	(800) 829 4444

Asia Pacific

Australia	1 800 629 485
China	800 810 0189
Hong Kong	800 938 693
India	1 800 11 2626
Japan	0120 (421) 345
Korea	080 769 0800
Malaysia	1 800 888 848
Singapore	1 800 375 8100
Taiwan	0800 047 866
Other AP Countries	(65) 6375 8100

Europe & Middle East

Austria	0800 001122
Belgium	0800 58580
Finland	0800 523252
France	0805 980333
Germany	0800 6270999
Ireland	1800 832700
Israel	1 809 343051
Italy	800 599100
Luxembourg	+32 800 58580
Netherlands	0800 0233200
Russia	8800 5009286
Spain	800 000154
Sweden	0200 882255
Switzerland	0800 805353
	Opt. 1 (DE)
	Opt. 2 (FR)
	Opt. 3 (IT)
United Kingdom	0800 0260637

For other unlisted countries:
www.keysight.com/find/contactus
(BP-06-08-16)



www.keysight.com/go/quality
Keysight Technologies, Inc.
DEKRA Certified ISO 9001:2015
Quality Management System