

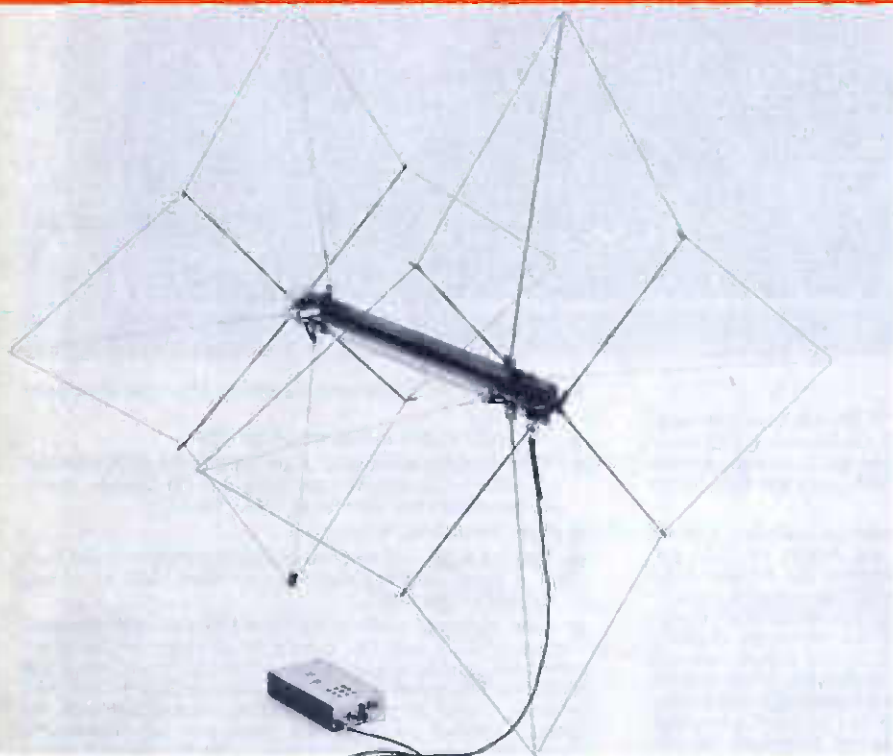

April 1976

radio communication

journal of the Radio Society of Great Britain



The aerial when fully extended.
It is shown connected to a pocket
transceiver

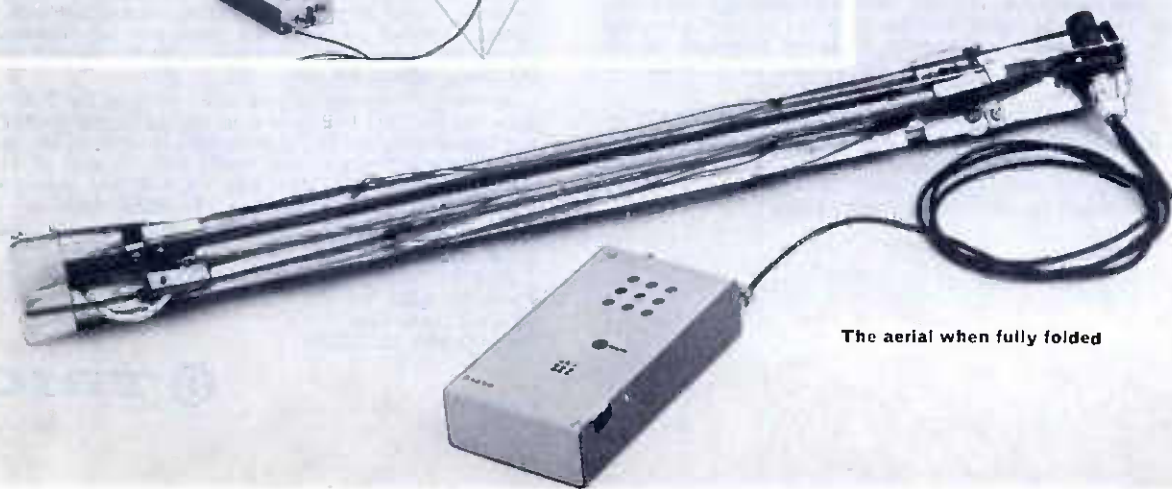

The aerial when fully folded

THE G8ENN INSTANT BEAM

by

D. A. Tong, G8ENN

p 270



TS-700G

In case you hadn't noticed, the TRIO TS-700 has a new look. Now updated and incorporating all the features which made it the most sought after transceiver on 2 metres, it now includes additional refinements which you, the keen radio amateurs, have requested.

The basic concept remains the same; a complete 2 metre station package operating from a.c. mains or 12V d.c. supplies, providing full VFO coverage of the 2 metre band with facilities for 22 crystal controlled channels for popular repeater and net frequency working. The same TRIO design standards such as the ultra linear PA operation resulting from the use of an inverter derived 20 volt supply, are still used. The same supply is also used to feed the driver and the audio stages of the receiver. TRIO's acknowledged leadership in the quality audio field has been put to good advantage in their amateur equipment. Everyone comments on the clean crisp audio quality of the TS-700G both on transmit and receive.

The main refinements can be summarized as follows:

- ★ New improved receiver front end system contributes to a new standard of sensitivity; $0.25\mu\text{V}$ for 10dB S + N/N ratio on SSB, 20dB quieting for $0.4\mu\text{V}$ on FM. This is the best receiver on the market today.

- ★ New FM IF strip with narrower filter for European market.
- ★ New centre zero tuning meter for FM.
- ★ New 100kHz calibrator with automatic disconnection of antenna to remove confusing outside signals. Automatic transmitter disable in CAL. mode.
- ★ New logarithmic S meter.
- ★ New repeater and reverse repeater operation at the turn of a panel switch. Operates on either VFO or crystal controlled channels.
- ★ New improved audio system for FM and AM transmit. The use of fully balanced mixing at all stages of frequency conversion guarantees a clean signal free from unwanted products. The power output of the transmitter is normally between 15 and 18 watts and this, in conjunction with the TRIO amplified ALC system, gives you an outstanding signal. Just listen to 2 metres and judge for yourself which rig always sounds the best.

If you are considering your once only rig for 2 metres, then the TS-700G has to be your logical choice. Backed by the largest company in Japan making amateur radio equipment, and the best service facilities in Europe at Lowe Electronics, the TS-700G SSB/FM/CW/AM transceiver has to be the all time best buy. TS-700G, £324 + VAT.

Sole Importers
LOWE ELECTRONICS
 Cavendish Road
 Matlock Derbyshire
 Tel: Matlock 2817/2430

 **TRIO**

EDITOR

A. W. Hutchinson

ASSISTANT EDITOR

R. J. Eckersley

EDITORIAL ASSISTANT

P. Linnett

DRAUGHTSMAN

D. E. Cole

EDITORIAL PANEL

J. P. Hawker, G3VA

G. R. Jessop, G6JP

R. F. Stevens, G2BVN

ADVERTISING REPRESENTATIVE

C. C. Lindsay



April 1976

Volume 52 No 4

CONTENTS

- 268 Current comment—*Data processor*
- 269 QTC
- 270 The G8ENN instant beam—D. A. Tong, PhD, BSc, G8ENN
- 272 New products—*Heathkit GD-1157, FT101 speech processing kit*
- 273 Equipment review—*The Scopex 4D-25 oscilloscope*
- 274 Technical topics—Pat Hawker, G3VA
- 278 Four-two-seventy—Martin Dann, G3NHE
- 279 Microwaves—Dain Evans, G3RPE
- 280 UHF repeater planning in the UK
- 282 The month on the air—John Allaway, G3FKM
- 284 Propagation predictions. HF propagation study
- 285 Council proceedings
- 286 Obituaries. Your opinion
- 287 Looking ahead
- 288 Contest news
- 290 Contests calendar. Mobile rallies calendar. Special event stations
- 291 Members' ads

RSGB NEWS BULLETIN SERVICE

The RSGB news bulletin, callsign GB2RS, is broadcast every Sunday morning on hf and vhf, giving almost complete coverage of the British Isles. Its main purpose is to provide an outlet for amateur radio news items and announcements which, by virtue of their topicality or urgency, cannot wait for the next issue of *Radio Communication*.

The bulletin is prepared early on Thursday morning, and news items, marked "GB2RS news" should reach RSGB HQ by first post that day (telephoned items can also be accepted until 10am). No guarantee can be given of inclusion in part or whole of any item submitted and, once broadcast, items are not usually repeated.

SCHEDULE

Time	MHz	Location and coverage (hf) or beam heading (vhf) of station
0930	3-6	G2MI, Bromley, Kent (SE England)
1000	3-6	G8ML, Cheltenham (SW England)
	144-5	GM3UAG, Ellon, Aberdeenshire (NNW)
	144-5	G8GGK, Croydon, Surrey (NE)
1015	3-6	G13GAL, Belfast (N Ireland)
	144-5	G13TLT, Bangor, Co Down (N)
1030	3-6	G2CVV, Derby (N Midlands)
	144-5	G4DCH, Burnham-on-Sea (NW)
	144-5	GM3UAG, Ellon, Aberdeenshire (SW)
	144-5	G3PWJ, Brierley Hill (NW)
1045	144-5	G8CDP, Middlesbrough (NW)
	144-5	G8GGK, Croydon, Surrey (SW)
	144-5	G8BHQ, Stockport (NNW)
1100	3-6	G5VO, Bridlington (NE England)
	144-5	G3PWJ, Brierley Hill (SW)
1115	3-6	G3LEQ, Knutsford (NW England)
1130	3-6	GM3EHI, Belshill, Lanarkshire (S Scotland)
1200	3-6	GM3HGA, Aberdeen (NE Scotland)

Radio Communication is published by The Radio Society of Great Britain as its official journal on the first Tuesday of each month and is sent free and post paid to all members of the Society



MEMBER OF THE ASSOCIATION OF BUREAUX OF CIRCULATION

© RADIO SOCIETY OF GREAT BRITAIN 1976

19,106 copies
per issue
average
circulation
in 1975

Contributions and all correspondence concerning the content of *Radio Communication* should be addressed to: The Editor, *Radio Communication*, 35 Doughty Street, London WC1N 2AE. Tel 01-837 8688. (Circulation queries should be addressed to: The Subscriptions Department, RSGB).

Closing date for contributions unless otherwise notified: 4th of month preceding month of publication.

Advertising, other than Members' Ads, should be sent to the above address marked for the attention of Mr C. C. Lindsay. Tel 01-838 5839.

LOWE ELECTRONICS



TRIO TR2200G

This little powerhouse is now the world's fastest selling two metre FM transceiver. Unbeatable at any price, it's combination of rugged reliability and high sensitivity give it universal appeal. Now that more and more repeaters are opening, the TR2200G allows the operator to work over long distances with ease—we can often work GB3P! from Matlock using the whip antenna on the TR2200G.

The rig comes complete with carrying case, shoulder strap, microphone, Nicad charger, two battery carriers and fitted with three channels (S20, S22 and R7 normally but alternatives supplied to your choice). Facilities for 12 channels and incorporating Trio's unique fork repeater access tone generator.



TR2200G Crystals
normally held in stock
£5.25 per Ch + 15p p & p

SO 145-00
S20 145-500
S21 145-525
S22 145-550
S23 145-575
S24 145-600
Tx Rx
R3 145-075/675
R4 145-100/700
R5 145-125/725
R6 145-150/750
R7 145-175/775
R8 145-200/800

RR3 145-675/675
RR4 145-700/1100
RR5 145-725/1125
RR6 145-750/1150
RR7 145-775/1175
RR8 145-800/200



If you hanker after mobile working from your car, the VB2200 amplifier is a marvellous addition. This superb amplifier comes complete with a carrying cradle for the TR2200G and boosts the power output from 1W to 10W. The amplifier is automatically switched by an RF VOX system and also supplies regulated D.C. for the TR2200G.
TR2200G, £88 + VAT

TR7200G

The TR7200G is the best selling 2 metre FM mobile transceiver in Europe. Some of the reasons why this is so may not be obvious from the basic specification. It's not just the high sensitivity (0.3µV 15dB quieting) or the superb finish, it's the full range of accessories and the finest service backup in the country. It's the little details like the LED under the channel number indicator that is RF powered and only lights when you have a receive crystal fitted. The "transmit" lamp gives the same function for the transmit crystals. This means that you no longer have to wonder which channels are operational when you are mobile. Did you know that by removing the rear panel accessory plug you can drop the receiver gain by 10dB to prevent the fellow next to you in the car park at the rally from blowing your head off!

Did you know that the TR7200G has a public address facility—useful if you're campaigning for the position of VHF manager!

Did you know that the swr protection system is not the "sudden death" variety but gradually reduces the Tx power with increasing SWR so that you are not put completely off the air when your mobile whip antenna gets wet. The same system protects the PA

and driver from over voltage damage when the rig is used in a vehicle having a high charge voltage from the alternator.

Only Trio equipment has the unique tuning fork controlled repeater access tone generator to ensure access first time, every time.

All these features and more, can only be provided in equipment made to professional standards by a professional company. The Trio Corporation is the largest electronics manufacturer in Japan offering a range of amateur equipment and you, the customer, benefit every time.

The TR7200G comes to you complete with mobile mounting bracket, stand off feet for fixed station use, microphone, microphone bracket, cable, spare fuse, manual, fitted five channels as follows:

145-50	Simplex	145-55	Simplex	145-15/75	Duplex
145-525	Simplex			145-175/775	Duplex

with most other IARU channels available ex stock.

TR7200G, £130 + VAT.

HEAD OFFICE

119 Cavendish Road, Matlock, Derbyshire. Tel. 2817 or 2430 9 a.m. to 9 p.m.

BRANCH OFFICES

39 Pound Street, Carshalton, Surrey. Tel. 01-669 6822

Soho House, 362-4 Soho Road, Handsworth, Birmingham. Tel. 021-554 0708

AGENTS

Alan GW3YSA, 35 Pen-Y-Waun, Elai Isaf, Nr. Pontypridd. Tel. Newton Llantwit 3809

EVENINGS AND WEEKENDS

John G3JYG, 16 Harvard Road, Ringmer, Lewes, Sussex. Tel. Ringmer 812071

Sim GM3SAN, 19 Ellismuir Road, Ballieston, Nr. Glasgow. Tel. 041-771 0364

OPENING HOURS: 9-5.30 TUESDAY TO SATURDAY INCLUSIVE

OPENING SOON, LOWE ELECTRONICS IN LEEDS. KEEP ALERT FOR DETAILS

LOWE ELECTRONICS

TOP SELLER FOR HF OPERATION



TRIO TS520

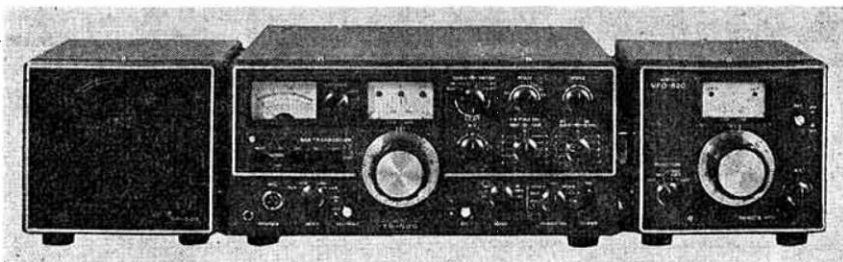

The TS520 is now the top selling transceiver in Europe. Why!

- 1 It's the best—no argument here since it only takes a quick listen to any amateur band to hear the evidence.
- 2 It's backed by the best service available anywhere. BeIcom choose Lowe Electronics, Trio choose Lowe Electronics—our customers are our best advertisement so ask around.
- 3 The TS520 has the only complete range of matching accessories—even a matching 2 metre transverter, the TV502. Designed and produced by a professional company to professional standards, this all solid state transverter gives instant 2 metre operation for the TS520 owner.
- 4 Price. At £318.00 plus VAT, the TS520 is selling at around the price that similar equipment sold at before the recent VAT increases.

And all the features that in other rigs cost extra, in the TS520 they all come as standard.

★ RIT ★ NOISE BLANKER ★ AMPLIFIED 2 SPEED AGC ★ 25kHz CALIBRATOR ★ BLOWER COOLED PA ★ FIXED CHANNEL OPERATION
★ 4 FUNCTION METERING ★ AMPLIFIED ALC ★ BUILT IN SPEECH COMPRESSOR ★ LED INDICATORS FOR FIX, VFO, RIT ★ LOW POWER TUNE UP FOR LONG PA LIFE ★ TRANSVERTER OUTPUTS ★ 12V DC/240V AC OPERATION ★ FULL RANGE OF MATCHING ACCESSORIES

TV502



★ PRICES Ex-VAT
TS520 £318; SPS20 £20; VFO520 £84; TV502 £100.

IC7300FB



Announcing a marvellous new rig for mobile or portable use on 2 metres. Just read the basic specification to realise that this has to be the rig for you.

TX

Power output of 40 watts eliminates the need for a linear. Low power consumption of only 1.2 Amps from a 12 volt source allows long operating periods for portable contest use.

All mode operation using a newly developed system of simultaneous SSB, AM and FM sets new signal standards and eliminates mode switching problems.

Ultimate deviation limiting at 100 per cent output power generates a superb punchy signal that will raise comment whenever heard.

RX

46dB quieting for an input signal of only 0.123 microvolts will now be the standard of comparison for other receivers. NEW IF system using overcoupled filters to give two channel monitoring at the same time. Single conversion to an IF of 600KHz produces automatic repeater shift using a single crystal for transmit and receive.

NEW Flexycryst (pat. app. for) device using a newly developed quartz/rubber mixture produces 1Mhz shift from one crystal—just think, only two crystals needed to cover the entire two metre band.

Before sending for further details, read the specification again and remember that figures on paper do not mean that the equipment described is actually any good.

CRYSTALS—Special April Offer

As well as reverse repeater crystals for most 2 metre equipment, we have limited stocks of the following: Reverse S20, reverse S22 and reverse SO. Send now to avoid disappointment.

SEND 25p IN STAMPS FOR FULL CATALOGUES, LISTS, BARGAINS, ETC.

LOWE ELECTRONICS



LA106

High power. High performance. Modest cost. A reasonably priced, compact, high performance linear for 2 metres. SSB/FM/CW operation. 10W of drive for around 180W input gives your signal the extra kick to get it out of the noise. Built in receive preamplifier with adjustable RF gain and helical filters for increased selectivity and reduced intermod from out of band signals. Built in regulated 13V 2.5A supply for Liner 2 or any similar driver.

The LA106 will match any rig such as the TS700, FT221, IC201 in any mode provided that the drive level is around the 10W level. Using a rugged valve in the PA allows you to get away with occasional misuse (just try a high power solid state amplifier into a mismatched load) and gives very low intermod products.



LINER 2 Mk. 2

Belcom have just introduced the latest model of the Liner 2 with many detail improvements, notably in the new receiver front end which results in much higher sensitivity, and transmitter modifications which improve the signal quality and lower the level of unwanted signals.

The Liner 2 is still the ideal way to get into real DX operation on 2 metres and continues the Belcom tradition of being one step ahead of the field in amateur radio developments.

Frequency coverage 144.1-144.34. 10W output. Complete with the usual Belcom comprehensive range of accessories including mobile mount etc.

Contact us soon for a demonstration.



LINER 430

Two steps ahead comes the Liner 430. Already being used by us to make mobile contacts with the U.S.A., the Liner 430 opens up a whole new dimension of long distance contacts via the OSCAR satellites.

Covering two 480 kHz bands in 20 kHz steps and using the exclusive Belcom Auto watch system which detects the presence of a signal anywhere within VFO range without tuning. No more missing signals, and worn out fingers from control twiddling.

10 watts output. Selectable USB/LSB/CW operation. Dual conversion using 50MHz and 7.8MHz IF's results in excellent image rejection and high sensitivity.

Truly a new dimension in amateur radio from the Liner 430.



FS1007P

The home station FM transceiver with everything. ★ Mains or 12 volt operation ★ 16 channel scanning ★ channel skipping facility ★ priority channel with front panel crystal sockets ★ manual or auto scan ★ switched high/low power ★ switched wide/narrow deviation ★ S meter ★ RF output meter ★ centre zero tuning meter ★ RX fine tuning control ★ built in SWR bridge ★ built in digital clock with alarm and auto switch on ★ built in loudspeaker ★ 10 watt TX ★ 0.3 microvolt sensitivity ★ superb styling and finish ★

All this and supplied fitted receive crystals for 145, 145.25, S20, S21, S22, 145.6, 145.8, R3, R4, R5, R6, R7 together with transmit crystals for 145, S20, R6 make the FS1007P the most incredible bargain on the FM market. Backed by the combined reputations of Belcom and Lowe Electronics.

508-514 ALUM ROCK ROAD
BIRMINGHAM 8

021-327 1497
6313



NEW GENERAL COVERAGE RECEIVER FRG-7

**HERE'S THE
LATEST FROM
YAESU MUSEN—
COMING SOON!**



AS WE GO TO PRESS WE ARE AWAITING DESPATCH OF THE FIRST CONSIGNMENT OF THIS BRAND NEW COMPETITIVELY PRICED GENERAL COVERAGE RECEIVER (500kHz TO 30MHz CONTINUOUS). THE PRICE, CONSTRUCTION AND SPECIFICATION MAKE THIS SET A WINNER, BUT PLEASE REMEMBER THAT SUPPLIES WILL BE VERY LIMITED AT FIRST—SO DON'T DELAY, RESERVE YOUR SET NOW—A COUPLE OF STAMPS BRINGS THE PRELIMINARY LEAFLET.

AMATEUR ELECTRONICS UK — YOUR FIRST CHOICE FOR YAESU MUSEN!

YAESU MUSEN MAIN CATALOGUE—DUE TO LIMITED SUPPLIES OUR CHARGE FOR THIS REMAINS AT 25 PENCE POST PAID BUT FOR THE BENEFIT OF THE SERIOUS ENQUIRER THIS NOW COMES TO YOU TOGETHER WITH OUR CREDIT VOUCHER VALUE £1 FOR USE AGAINST YOUR FUTURE YAESU PURCHASE.

CREDIT TERMS: New Low Deposit, Trade-ins Welcomed

NEW BRANCH AMATEUR ELECTRONICS UK—COASTAL, 316-318
NORTHDOWN ROAD, CLIFTONVILLE, KENT. THANET (0843) 22060.

PHONE KEN McINNES, G3FTE FOR COURTEOUS ATTENTION

AGENTS SCOTTISH—RON TURNER, GM8HXQ, WISHAW 72172
WALES & WEST—ROSS CLARE, GW3NWS, CAERLEON 422232

AMATEUR ELECTRONICS UK



Western

PLEASE NOTE! ★ **NEW EXTENDED SERVICE**
 ★ **NEW LOW PRICES**
 ★ **NEW HEAD OFFICE/FACILITY**

AVAILABLE FROM APRIL 5th AT

We are pleased to announce that we are adding a new factory and Head Office to our facilities, which are specifically designed to keep us ahead in the field of handling your requirements. We hope that you will avail yourself of these facilities which will include a centralised Servicing Department, which we believe to be the largest and best equipped in the country. Mail orders will be handled promptly, and we shall continue, of course, the excellent Securicor delivery/collection service, which we first used, which is now copied by so many of our competitors. To speed your request, please contact the following:

ALL MAIL ORDER, EXPORT, TELEPHONED ORDERS ON ACCESS/BARCLAYCARD, SALES ENQUIRIES, to:

The Sales Manager
George Cuppleditch (right)
 (G3NMM, VS6DS, VS1EF, MD4GC, ZC8JG).

Contact:
WESTERN ELECTRONICS PRESS

Manager
Terry Robinson (G8JTW) (right)
for all your printing needs

NOTE PAPER
 INVOICE SETS
 DUPLICATE BOOKS
 COLOUR BROCHURES
 QSL CARDS, ETC.

SOUTHAMPTON BRANCH
 1, West Park Road, Southampton.
 Tel. 0703 27464.

Manager
Sid Boakes (G3HXN) (right)

NEW HOURS OF OPENING
 Tue. to Fri. 9-5.30. Sat. 9-4.

NOTE: CLOSED FROM APRIL 19 TO 24 INC.

We are extending, for a trial period, our hours of opening on Saturday to give prospective customers time to reach us from further afield. We are only a few hundred yards from Southampton Central Station, which is 1 hr. 6 minutes from London!



SERVICE ENQUIRIES to:

Service Manager
Ian Partridge (right)
 (G3PRR, VS1KX)



ALL AT FAIRFIELD ESTATE, LOUTH, LINCS.

Tel. Louth (0507) 4955/6.

Managing Director
Hal Perkins, G3NMH, (right)



LEICESTER BRANCH at
May's Audio Centre
 27, Churchgate,
 Leicester.

Contact
Harry Harmsworth, G3ACQ
 Tel. (0533) 58662.

Open Mon-Sat. 9am-6pm. Closed Thurs.

WESTERN FOR TEST EQUIPMENT

GRID DIP METER, TE-15

*Operates as a Grid Dip Oscillator, Absorption Wave-meter and Oscillating Detector.

*Versatile Portable Applications

Specification: Freq. range: 440kHz-280MHz in 6 coils.

Coil	MHz	Coil	MHz
A	0-44-1-3	D	14-40
B	1-3-4-3	E	40-120
C	4-14	F	120-280



RF SIGNAL GENERATOR, TE-20D

*Factory calibrated and tested

*Dual output RF terminals

*Separate Variable Audio Output
 Specification: Freq. range: 120kHz-500MHz (7 bands). Freq. accuracy: $\pm 2\%$. Audio output: to 8 volt. internal modulation; 400Hz approx. Tube: 12BH7A, 6AR5. Power source: 105-125V, 220-240V, AC, 50/60 Hz. 12 watts
 Employs a Xtal socket and can be used as below: (a) Self-calibration, (b) Marker generator.

TEST EQUIPMENT PRICES (including P & P and VAT)

SE-250B Injector	£3.24
SE-350A Tracer	£17.28
SE-360 Tracer/Injector	£19.17
SE-6850 Generator	£45.44
TE-15 G.D.O.	£27.00
TE-20D R.F. Generator	£27.00
TE-22D A.F. Generator	£35.64
TE-40 A.C. Millivoltmeter	£37.00
TE-65 V.T.V.M.	£37.00
TE-68 Insult. Tester	£48.50
TO-3 Oscilloscope	£91.80

Electronics (UK) Ltd



IT'S "WESTERN" FOR YAESU
AND "WESTERN" FOR VALUE

NEW SPECIAL OFFER PRICES (EXC. VAT) — ACT QUICKLY

**NEW, EX-STOCK
FT-101EX
THE FAMOUS
FT-101E BUT LESS
EXTRAS
£299 + VAT**

★ FT/FP-200 ONLY £240	★ FT-201 ONLY £270	★ FT-101E ONLY £375
HF TRANSCEIVERS	HF RECEIVERS	HF LINEAR AMPLIFIERS
FT75B £160.00	FR-101S £240.00	FL2000B £215.00
FT75B AC PSU/Sprk £40.00	FR-101S Digital £315.00	FL2100B £215.00
DC75B DC PSU/spkr £40.00	FR-101D £315.00	VHF TRANSCEIVERS
FT-101E £375.00	FR-101D Digital £389.00	FT-221 £318.50
FT-101EE £350.00	FRG-7.0 5-30MHz £120.00	FT-224 £125.00
FT-101EX £299.00	(Available May)	SIG 80R £199.00
FT/FP200 £240.00	HF TRANSMITTER	TEST EQUIPMENT
FT-201 + DC psu £270.00	FL-101 + RF Processor £295.00	YP-150 £35.00
FT-401B £315.00	BARGAIN .. BARGAIN ..	SPEAKERS
FT/FP501 £415.00	FL101RF + FR101D £582.00	All types £15.00

BRITAIN'S BEST BUY!
for the serious FM Repeater operator—
the **STANDARD C828!**
There's no other choice!

BASE STATION — MOBILE — PORTABLE

- We're so fascinated by this little beauty that we think it makes everything else "obsolete" (or expensive). The Price! £168.75 inc. VAT.
- 10 watts (Hi), 1w. (Lo) output.
- 12 channels **SIMPLEX** or **REPEATER**, 10 Ch. fitted.
- Single crystal control means you only have to buy 1 **CRYSTAL PER CHANNEL**.
- Fitted S0, S20, 21, 22, 23 and R3, 4, 5, 6, and 7.
- LED (BUSY) indicates whether you have accessed the repeater or not.
- LED's to indicate **EXTERNAL VFO**, **TRANSMITTER ON REPEATER OPERATION**.
- **SPEAKER/MIC** gives **PRIVATE LISTENING** and has switch to override the channel selector enabling a changeover to be made to an external VFO (Type CV110).
- **TONEBURST** is built in (Automatic on "Repeater")
- **NEW LEATHER CARRYING CASE/ANTENNA TYPE FCB-01J** (available later) makes the C828 into a 12 Ch. 1/10w. portable unit.



SPECIAL OFFER! CDE ROTORS: AR30 £24, AR40 £29, CD-44 £59, HAM-2 £89, + VAT

BACK IN STOCK AGAIN

THE OSKER SWR200 POWER METER

Features: Switchable for 52 or 75 ohm systems. Each instrument is individually calibrated. Four ranges: 0-2, 0-20, 0-200 and 0-2kW, 3-200 MHz. Excellent Styling.

Price: £22.68 inc. VAT.



ANTENNAS

NEWTRONICS

- G6-144A 6dB 2m. Collinear £35.00
- CGT-144. 5-4dB. Mobile Collinear £25.00
- CG-144 as above less Mount £17.00

HUSTLER HF RANGE EX-STOCK J BEAM, MOSLEY, HY-GAIN AND BANTER.

PRICE LIST - Please send S.A.E. - CATALOGUES 50P

Western Electronics (UK) Ltd

HEAD OFFICE (All Mail/Enquiries)

**FAIRFIELD ESTATE
LOUTH, LINCS, LN11 0JH**
(Tel. Louth (0507) 4955 6).

Agents: LES LYSKE, G13DF, NEWTOWNARDS (0247) 812449
ALAN CAMERON G630GJ, ALLOA (02592) 4653
DAVID LACEY, G81YP (Evening) Norwich (0603) 868581

SHOWROOMS AT:
1, WEST PARK ROAD, SOUTHAMPTON, Tel. 27464.
Open Tue.-Fri. 9-5.30. Sat 9-4.
27, CHURCHGATE, LEICESTER, Tel. 58662.
Open Mon.-Sat. 9-6. Closed Thur.





YAESU MUSEN

FR-101 SOLID STATE RECEIVER



FR-101DD (D-DS-S)

The FR-101(D) is a wide coverage communications receiver (Mains and 12V) for amateur and SW. BC. use. Four switched crystal filters provide optimum bandwidths for A.M., SSB, FM, CW, and RTTY. The receiver accepts external VFO control from the FL-101 or the FT-101E transceiver. It is constructed using plug in boards, has an adjustable noise blanker, fixed channel crystal control operation is possible, LED's indicate VFO and clarifier (± 5 kHz) status and 100/25kHz switchable crystal calibrator is standard.

Deluxe and Standard versions with or without digital readout available.

COVERAGE (metres)

160, 80, 40, 20, 15, 10, 4, 2
60, 31, 25, 19, 16, 13, 11, CB
+4 Bands around 4, 5, 8, 25MHz
30+ 500kHz Segments

AGC Threshold $1\mu\text{V}$ Attack
3 or 4m. S. Release $\cdot 5$ or 2 Sec
AF Output 2W (10% D)

SENSITIVITY (@ 14MHz)

CW 0.2 μV 10dB N+S/W
SSB 0.3 μV 10dB N+S/N
AM 1 μV 10dB N+S/W
FM 1 μV 12dB SINAD

Stability 100Hz/30 mins
Linearity 1kHz. Backlash 50Hz
Image -60dB

SELECTIVITY (@ 6dB)

CW 600Hz (2.5:1)
SSB 2.4kHz (1.67:1)
AM 6kHz (2:1)
FM 20kHz (2.25:1)

12 FET 20 BIP 33 DID 4 IC's
6 Tubes. 5 BIP. 88 DID. 23 IC's
13"W x 6 (7")H x 1 1/2 (14") D

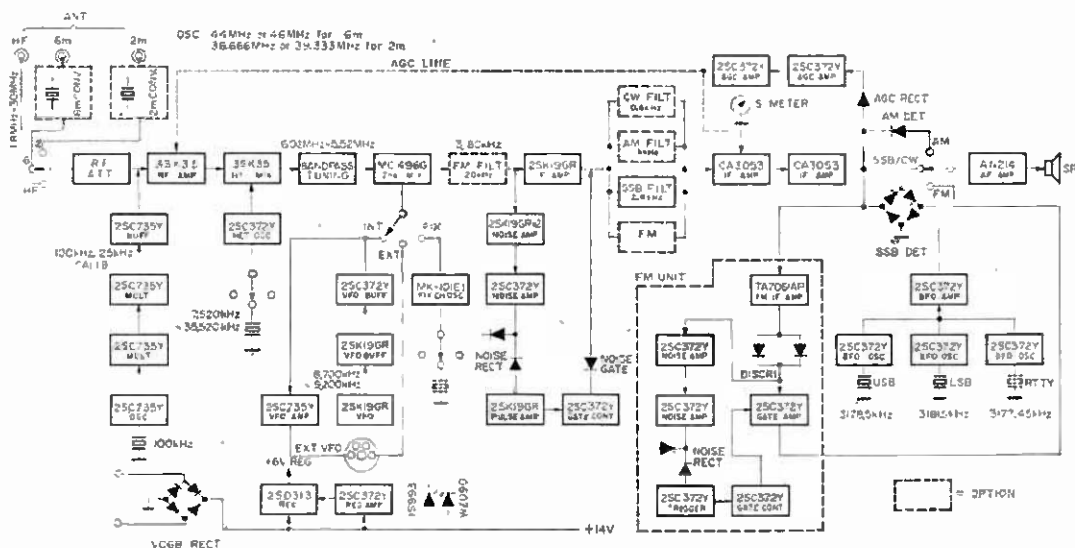

FR101 BLDCK DIAGRAM

70MHz CONV. FITTED

YAESU MUSEN



MOBILE/BASE TRANSCEIVER FT-101

The FT-101E is a complete station in a rugged 30lbs. package, constructed to high standards using serviceable plug in boards and a complement of 14FET's, 26 Bi-polars, 3 IC's, 38 Diodes and 3 valves.

The transceiver with the "built-ins" which are often not available elsewhere or come as costly extras:

AC and 12V DC power supplies, R.F. speech processor, adjustable noise blanker, fully adjustable VOX, crystal calibrator (100 or 25kHz), internal speaker, fan, Top Band, A.M., etc. and it comes supplied complete with hand microphone and full set of accessory plugs.



FT-101E (EE-EX)

SENSITIVITY 0.3 μ V 10dB N + S/N

SELECTIVITY 2.4kHz (1.67:1)

RESPONSE 0.35-2.7kHz

AUDIO 3W (10% D)

IMAGE -50dB

INTERMOD -30dB

SIDEBAND -50dB

CARRIER -50dB

A.G.C. 3 μ V, 8mS ATT. 1.8S REL

260W P.I.P. A3j 180W A1 80W A3

13"W x 6(7)"H x 11½(14)"D

DC 20A TX, 5A S.B., 0.5A RX

STABILITY 100Hz/30 mins

1.8 to 30MHz (10MHz RX)

LINEARITY 1kHz

BACKLASH 50Hz

SEMI BREAK-IN CW

ADJUSTABLE SIDETONE

RIT WITH SEPARATE SWITCH

LED'S INDICATE VFO & RIT

ADJUSTABLE CARRIER LEVEL

ERGONOMIC LEVER SWITCHES

LOW POWER OUTPUT SOCKET

HEATER SWITCH FOR PA

CW FILTER PROVISION

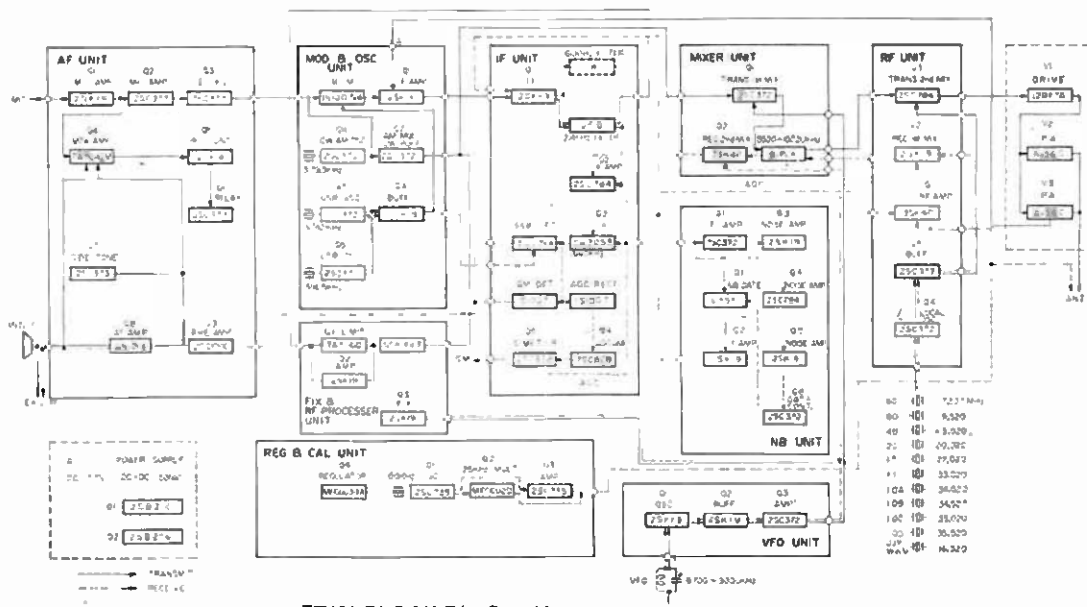



YAESU MUSEN

FT221 MULTI MODE TRANSCEIVER

100kHz calibrator (1MHz \div 10)

"S" meter/FM centre zero/PO
Clarifier IRT and IRT/ITT
600kHz up and down shifts
44 FIX channels (4 \times 11)
Fully adjustable squelch.
AM, FM, USB, LSB, CW.
Dual speed VFO drive
Readout Better than 1kHz.

2.4 and 12kHz bandwidths

PLL VFO

Clean Output

Mic supplied

Noise Blanker

AC or 12V DC

CW sidetone

Semi Break-in

Sensitive

ALC socket

RLY Socket

Plug in boards

11 $\frac{1}{2}$ " x 5" x 11 $\frac{1}{2}$ "

Rigid 22lbs.

Tone burst

Adjustable VOX

Mic Gain Control.



The FT221 design offers an unparalleled level of technical sophistication, whilst pertinaciously following the precepts of practicality, ergonomics, economy and reliability.

One look at the construction: plug in boards throughout (with presets positioned for easy access) one glance at the circuitry and you will be convinced that the FT221 may have rivals but no peers.

The final frequency is derived via a single signal frequency mix from 10.7MHz. The tunable component is produced by a 133MHz voltage controlled oscillator (VCO), phased locked to the sum of; the temperature compensated 8MHz VFO (or one of the 11 fix crystals) and the nonupled 14MHz band (or repeater shift) crystals. The DC control voltage from the VCO is applied to 8 varicap diodes in both the transmitter and the receiver effectively electrically ganging the RF tuned circuits to the VFO and Band crystals, thus both the transmitted and receiver are always fully on resonance even when using the repeater facility. This narrow band technique further improves the transmitter output spectrum and the receiver's immunity to overload, rendering continual tweaking of pre-selectors obsolete.

If for any reason, the VCO should not lock, an

indicator light flashes, the transmitter, and the receiver audio, being disabled.

The transmitter employs; a balanced FET mixer, RF derived ALC (which is fed to the two first mosfet TX I.F. amplifiers) preventing over driving and allowing operation at full rated output on low DC supply voltage and ends by using a BAM 20 (series modulated for true A.M.) to drive (a 40W P.E.P.) BAM 40 PA, rated by its manufacturer to withstand any VSWR irrespective of phase angle.

The sensitive receiver offers a remarkable immunity to overload, the mosfet RF stage is AGC controlled, the FET mixer feeds a transfilter then an I.F. amplifier. This band limited signal, of the correct level, is presented to the noise blanker gate (before any serious pulse stretching occurs) and hence to either the quality crystal filter on SSB, or the 455kHz mixer for FM.

Designed for the serious amateur, it also offers a unique double push tone burst, selcal socket, and linear amplifier provisions (relay make and break and ALC sockets) with the spectral purity that allows you to use one with a clear conscience.

"The rig here is a FT221 need one say more?"

YAESU MUSEN



TEST EQUIPMENT



YP150

POWER METER/DUMMY LOAD

The YP150 is a fan cooled 50 ohm dummy load, (using a large carbon resistor which maintains impedance (VSWR less than 1.2:1 at 145MHz) by the use of a "Tapering Trough") and a power meter, for use between 1-8 and 200MHz. Calibrated 6, 30 and 150W FSD on a large 3½" x 2" meter with a maximum error of 10% (FSD) size 6 (7") x 4½" x 11(12") weight 6lbs.

MONITOR SCOPE

The YO100. The Multi purpose monitor offers: through line display, 1-8 to 60MHz (145MHz at reduced ratings), of transmitted signals, of 10 to 500W, monitoring of the I.F. of a receiver (3-18MHz standard 445kHz and 9MHz options), trapezoidal exhibition, audio and RTTY portrayal. Built in 1-5 and 1-8kHz oscillators permit the measurement of power, in accord with statutory two tone P.E.P. measurement requisites.



YO100



YC355D

DIGITAL FREQUENCY METER

The YC355D counts from 5Hz to 35MHz. The D model's prescaler extends this range to over 200MHz. The ingenious design offers: a dual range system (providing eight digit readout but using only five cold cathode tubes) and operation from mains, or 12V. DC, at the flick of a switch. The accuracy offered is time base (1MHz crystal (±0.0005% at 25°C, ±0.0025%, 0 to 40°C)) + 1 count, input impedance is switchable 1 Mohm or 50 ohm (B.N.C. socket), construction is on double sided epoxy board. Size 8½" x 3" x 11" (12½") weight 7lbs.

DIGITAL DISPLAY

The YC601 digital display unit (for 101 and 401 series (3-18MHz I.F.)) indicates transmit and received frequencies to 100Hz on six bright green, 9 segment gas discharge tubes. Built in mains p.s.u. (consumes only 10W), gate time of 100mS., size 3" x 8½" x 9" (10½") and weight 5½lbs. Supplied complete with connecting cables, etc.



YC601



Yaesu Musen Authorised UK Distributors

(IN ALPHABETICAL ORDER)

AMATEUR ELECTRONICS UK



SOUTH MIDLANDS COMMUNICATIONS LTD.

Western Electronics (UK) Ltd





South Midlands

ESTABLISHED 1958—OVER 17

YAESU MUSEN MAIN UK DISTRIBUTOR 2-YEAR GUARANTEE

SMC's guarantee, confident in Yaesu quality, is, until further notice, extended to 2 years, covering both labour and free components (excluding valves, semi-conductors and carriage).

New General Coverage Receiver from YAESU—FRG-7

FULLY SOLID-STATE, WITH PHASE-LOCKED SPIN-TUNED SYNTHESIZER FOR NO-GAP 500kHz—30MHz COVERAGE FROM MAINS OR 12V DC—SAE FOR FURTHER DETAILS

AVAILABLE FROM SMC NEXT MONTH, PRICE AROUND £130 + VAT

FREE SECURICOR DELIVERY
(items over £55, over £5 post free)

FOR FURTHER INFORMATION
SEE YAESU OR SMC ADVERTS

CU AT BELLE VUE AND
THE VHF CONVENTION



FT221 ex stock



FT101E ex stock

THE LARGEST STOCKS OF YAESU AND BEST SERVICE IN THE UK

NEW LINEAR AMPLIFIERS FROM KLM

EX-STOCK (POST FREE) VAT 25%

Solid State Linears

SSB/CW/FM—12V DC—10W drive

PA 10—70 BL 70W output—£100.00

PA 10—140 BL 140W output—£140.00

SAE FOR FURTHER DETAILS OF RANGE



NEW 432MHZ TRANSVERTER

From Microwave Modules—28 or 50MHz I.F.

*Ideal for use with the FT620B

Tx. Balanced dual gate Mosfet mixer

5 linear stages, 6 watts output.

Rx. Cascode low noise R.F. Mosfet mixer.



MMT 432
Ex stock £71.20

NEW QUALITY COAX RELAYS Ex Stock

Type TTE Coaxial change over relays 12V DC 50 ohm (P/P 30p). VAT 8%

	Power	Crosstalk	0-2dB	1-5:1		
	500MHz	500MHz	Insertion	VSWR		
CX120	50W	35dB	5GHz	1-2GHz	Cable entry	£8.50
CX230	300W	40dB	1GHz	2-3GHz	BNC sockets	£14.00
CX600N	600W	40dB	1GHz	1-5GHz	N sockets	£16.75

MICROWAVE MODULES CONVERTERS (28MHz IF EX STOCK)

432MHz Transverter	..	£71.20	144MHz Mosfet Converter	..	£15.20
432MHz Converter	..	£18.10	144MHz Converter + LD	..	£16.30
70MHz Mosfet Converter	..	£15.20	144MHz Pre Amp 2 Outs	..	£9.00
70MHz Converter + LD	..	£16.30	1.296MHz Converter	..	£24.00

ALL EX STOCK P & P 30p. VAT 25%

LOW PRICE CRYSTAL FILTERS AND AT ONLY £3.50 PAIR (Singles £2 ea.) CRYSTALS P & P 20p VAT Rate 25%

NEW for '101 OWNERS 12kHz-FM Filter to give your optimum response on FM. EX STOCK IN TOTTON—£14.50 (post paid VAT 25%)

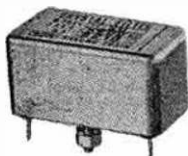

YF Filter
FT200 @ £2.20 each
10A, 10C

Individually supplied with \pm 8dB, (25dB), 50dB bandwidths, ripple factor and insertion loss.

YF107M600 600Hz 10-7MHz cw	..	£13.00
YF107M2-4 2-4Hz 10-7MHz ssb	..	£12.00
YF107M12 12kHz 10-7MHz Im/a.m.	..	£12.00
YF90M600 600Hz 9MHz cw	..	£13.00
YF90F2-4 2kHz 9MHz ssb	..	£11.00
YF90F12 12kHz 9MHz Im/a.m.	..	£13.00
Carrier crystal HC18/U (each)	..	£1.50

Spare Yaesu crystals available at £2.20-£3. 144MHz (common types) channel crystals to order at £3.50 pair, 8 weeks delivery.
Converter crystal £2
38-568 (2m), 42 (4m), 50-5 (70cm)
Pye Pocket Phones
433-2 £4.50 pair

FT2FB (14MHz Rx, 18MHz Tx)	
144 (-16R, -20, -30, -36, -40, -50R, -60, -70, -80)	
145 (-32, -84, -90)	
ALL Simplex, ALL Duplex and all Inverse Repeater (both T & R)	
TR2200 (44MHz Rx, 12MHz Tx)	
SIMPLEX	
S (0, 20, 21, 22, 23, 24)	
DUPLX	
R (3, 5, 6, 7)	

FT2F (52MHz Rx, 6MHz Tx)	
144 (-15, -25, -35, -45, -50R, -60R, -70)	
145 (-08, -09, -68, -90)	
ALL Simplex, ALL Duplex and all Inverse Repeater (both T & R)	
C148A & C228MB	
SIMPLEX	
S (20, 21, 22, 23, 24)	
DUPLX	
R (3, 5, 6, 7) (T only)	

Send large SAE for FREE Yaesu catalogue & 22-page Stock/Price/S.H. Lists



PLEASE NOTE—THESE PRICES DO NOT INCLUDE VAT (25% or 8%)

Terms: Cash with order, or credit card holders just phone in for, if possible, same day despatch. Immediate H.P. available for card owners for amounts up to £150.00. Holders of current U.K. cell phone (where references have been provided) can be speedily cleared, or normal H.P. at competitive rates is available.



Communications Ltd

YEARS OF PROFESSIONAL EXPERIENCE

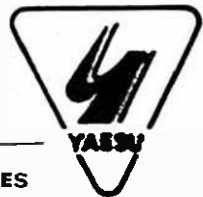

LIGHTNING ARRESTER — NEW — COAX SLIDE SWITCHES

Gas Discharge (90V Strike) DC-1GHz,
SO293 each end, VSWR 1:1.1, 50 ohms.
Max Loss 0.2dB, Surge 5 KA. AC 5A.
EX-STOCK, Post and packing 20p. VAT 8%
NSK7S Low Price £7.50



Up to: 1kW, 1-5GHz, 0-3dB loss, 1:2:1 VSWR,
50dB isolation, 50 ohm 'N' or 'PL' fittings.
EX-STOCK P & P 30p. VAT 8%
TWS 100NG 1 in 2 out Gold 'N' £1.25
TWS 150NG 1 in 5 out Gold 'N' £17.50

CDE ROTATORS

EX STOCK (IN TOTTON) FOR FAST DELIVERY (25% VAT, CABLE 8%).



CARRIAGE (B.R.S.) Free. Securicor delivery £1 extra
All rotators supplied complete with appropriate control box and instructions.

AR30 (list. centre and immediate right) .. £26.60
AR40 (list. centre and far right) .. £34.60
AR33 De-Luxe control AR40 .. £41.25
CD44 (C.B. III, left) medium duty .. £59.75
Ham 11 (C.B. III, left) heavy duty .. £105.50
2010/220 Stolle .. £37.50
Control cable 5 core 18p/yard, 8 core 27p/yard

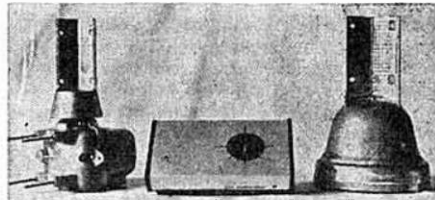

AEC METERS, Power, SWR and Field Strength

(p. & p. 40p. VAT 8%). Delivery from mid-April
SWR10 (T.L.H.), 50/75Ω, SWR (±10%), 1-5MHz up. .. £8.15
SWR20 (B.L.H.), 50Ω, SWR (±10%), 1-5MHz up, F.S., Power 10 and 100W FSD (±10%) .. £9.90
SWR40 (centre) 50/75Ω, SWR (±10%), 1-5MHz up, F.S. .. £7.80
SWR50A (T.R.H.) 50/75Ω, SWR (±5%) 3-5MHz up. Power to 1kW (±20%) .. £9.60
SWR50 (B.R.H.) as SWR50A (300μA) but 100μA meters .. £11.20

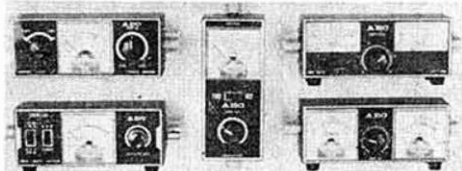

VERSATOWERST - ELETOWERS - HAMTOWERS - TELOMASTS - ALI MASTS

For further information on MASTS and TOWERS send a SAE to Totton

CUSHCRAFT VHF OMNIDIRECTIONAL (Car. 80p) VAT 25%

RINGO RANGER—ARX2—6dB gain over λλ ground plane. Uses 3 x λλ in phase and λλ stub, ultra low angle radiation, approx 10° high. (Illustrated right) LOW PRICE EX STOCK

ARX2 6dB Ringo Ranger ..	£18.50	ABW144 2m Big Wheel ..	£13.80
AR2 3dB Ringo Veri ..	£11.45	ABW125 ABW harness ..	£7.30
AR25 QRO AR2 ..	£13.50	ASQ1 2m Squalo ..	£11.75
CK1000 29MHz Ringo ..	£23.20	ASQ22 Stacked ASQ ..	£24.15

JAYBEAM 70 (4m), 144 (2m) 432 (70) (Car. about 80p) 25% VAT

D5/2m 5 over 5 slot feed ..	£9.00	D6/70 3 over 8 slot feed ..	£12.00
D6/2m 8 over 8 slot feed ..	£12.00	PBM18/70 18 ele Para. ..	£12.50
5KY/2m 5 element crossed ..	£9.40	MBM48/70 46 ele Multi ..	£13.90
8KY/2m 8 element crossed ..	£11.70	MBM83/70 88 ele Multi ..	£16.50
10XY/2m 10 element crossed ..	£16.15	12KY/70 12 ele crossed ..	£19.00
5Y/2m 5 element yagi ..	£4.90	4Y/4m 4 element yagi ..	£7.75
8Y/2m 8 element yagi ..	£6.40	PMH2/70 2 way harness ..	£3.75
10Y/2m 10 ele long yagi ..	£12.60	PMH2/4m 2 way harness ..	£6.00
14Y/2m 14 ele long yagi ..	£16.25	PMH2/Circ. phasing ..	£3.25
Q4/2m 4 element quad ..	£9.50	PMH2/2m 2 way harness ..	£4.50
Q6/2m 6 element quad ..	£12.80	2010 Rotator automatic ..	£37.50
PBM10/2m 10 ele Para ..	£14.95	RZ100 Rotator bearing ..	£9.17
PBM14/2m 14 ele Para ..	£19.20	JBL15/59 2" Joint sleeve ..	£2.50



HY GAIN HF RANGE (Car £1.00-£2.50) VAT 25%

18AVT/WB—10-80m—wide band, 50 ohm, 1kW. Sell supporting, 25', trapped λλ, roof or ground mounted, low radiation angle vertical.

BN86 1:1 Balun	£11.00	TH2MKIII 10-20m 2 element ..	£85.60
103BA 10m 3 ele	£39.80	TH3NJR 10-20m 3 elements ..	£87.60
153BA 15m 3 ele	£48.80	TH3MKIII 10-20m 3 element ..	£124.60
203BA 20m 4 ele	£84.00	TH5DXK 10-20m 6 ele total ..	£109.60
402BA 40m 2 ele	£133.00	HY QUAD 10-20m 2 element ..	£138.00
18V 10-80 Load Vert. ..	£22.00	DB1015A 10-15m 3 element ..	£90.00
12AVQ 10-20m Trap Vertical ..	£29.60	LA1 Lightning arrester gas ..	£18.50
14AVQ 10-40m Trap Vertical ..	£42.00	LA2 Lightning arrester spark ..	£3.00
18AVT/WB 10-80m Trap Vert. ..	£58.60	HY TOWER 10-80m Vertical ..	£149.00

GEM QUAD FIBREGLASS QUAD (Carriage £2.00) VAT 25%

GQ2E 2 element	£95.00	GQ4E 4 element	£198.00
GQ3E 3 element	£147.00	CKI1 1 ele. Conv	£55.00

G WHIP HF MOBILE (Carriage 75p) VAT 25%

Tribander 10-20m (+LF) ..	£19.53	LF40, 80 or 160	£4.51
Multi/mobile 10-20m (+MM) ..	£15.73	MM40, 80 or 160	£4.51
Flexiwhip 10m c/w base (+FF) ..	£10.45	FF15, 20, 40, 80 or 160 ..	£4.67
Basemount 1/2" hole mount ..	£1.81	Telescopic whip for coils ..	£1.22

MOSLEY TRI-BAND BEAMS (Carriage £2.50) VAT 25%

TA33 3 ele 200W R.M.S. ..	£58.00	TA32 2 ele. 300W A.M. ..	£40.00
MUSTANG 3 ele 2kW P.I.P. ..	£75.00	MUSTANG 2 ele. 1kW A.M. ..	£60.00

CABLES RF FEEDERS (Carriage extra) VAT 8%

RG8/U 50 ohm Heavy .. per yd. 39p	UR39 75 ohm Medium .. per yd. 23p
UR57 75 ohm Heavy .. per yd. 34p	T82B 75 ohm Distribution .. per yd. 26p
75 ohm Flat twin .. per yd. 6p	UR43 50 ohm Solid Cent. .. per yd. 14p
300 ohm Ribbon .. per yd. 6p	UR70 50 ohm Strand Cent. .. per yd. 14p

SOUTH MIDLANDS COMMUNICATIONS LTD

OSBORNE ROAD, TOTTON
SOUTHAMPTON SO4 4DN

S.M.C.
A MEMBER OF THE ARRA
Hours of business:
9-5.30 9-12.30 Saturday.

Cables: Aerial Southampton
Telex: Chamcom 47388
Tel: (04216) 4830 & 2785

AGENTS (evenings) (ALL QTHR)
Brian Kennedy G3ZUL, Droithwich (09057) 4510,
Peter Avill G3TPX, Darton (022 678) 2517, Ian
McKechnie G4BDDX, Bridge of Allan (076663)
323, Howarth Jones G3WTFP, Pontypridd (035 287) 848, Marvyn Anderson G13WVY,
N.I. Trandrage 840556.

PAUL
G3VJF

THANET

 **ICOM**® for **MOBILE**

REPEATERS! REPEATERS! REPEATERS!

After a lot of hard work by the RSGB Repeater Working Group and, of course, the individual repeater groups, no less than 38 proposals have been submitted to the Home Office in application for the issue of repeater licences, and some 20 more are in the pipeline awaiting a complete proposal. This total comprises 21 on 2 metres—of which 7 are operational and 2 very nearly so, 34 on 70cm., one on 4 Metres and one on 23 cms. Thus we can expect a considerable increase in the use of repeaters during the next year. Repeaters are a boon to VHF and UHF operation, giving a vastly increased range and usefulness to the equipment in your car—or, of course, your base station if you live in a hotel! There is probably one in your area. The RSGB will send you a newsheet IF YOU SEND THEM AN SAE.

 **ICOM**® **TRANSCIVERS FROM THANET**

are all designed to give you the optimum use of repeaters as well as the simplex channels recommended by the RSGB.

The **ICOM IC-22A** has crystals for ALL the proposed and existing 2m repeaters and you can buy the excellent **ICOM IC-30A** 70cm transceiver similarly crystallised for ALL the 70cm repeaters (as soon as we get crystals). Tone bursts are all automatic, operating on repeater channels only.

Contact us for further details about these excellent transceivers—and by the way it is well worth remembering that we can offer special discounts to clubs providing several sets are bought at the same time. Bring this up at your next club meeting!

WHAT ARE THE ADVANTAGES OF BUYING **ICOM**® FROM THANET

Well—Compare these points:

1. We check EVERY transceiver before it leaves us.
2. We try to keep adequate stocks for instant supply—not always possible but we try our best.
3. We give a free, automatic, crystal controlled tone burst with every IC-22A, IC-22S and IC-201. A tone burst is also fitted to the IC-30A.
4. We modify the IC-201 for reverse repeater use (see January Radcom).
5. We have over 1000 spare crystals in stock for ICOM equipment plus many other spare parts.
6. We offer a full ONE YEAR warranty on parts and labour (providing the set hasn't been tampered with without our permission), semi-conductors carry a 6-month warranty.
7. If your set goes wrong within 4 weeks we will pay for carriage both ways.
8. We have a comprehensive range of AGENTS who offer you the full THANET service—the above warranty terms apply equally.
9. We have also an authorised DEALER network. Where a set is purchased from a dealer it is he who is responsible for the warranty.
10. We despatch sets FREE by Securicor from HERNE BAY using their very reliable next day delivery service. Where an antenna is supplied with the set that will also travel free providing it is small enough for Securicor to accept. If we possibly can we will despatch on the SAME DAY as receiving your cheque (if you have a UK call sign) or your telephoned ACCESS or BARCLAYCARD number.

WE ARE ALWAYS HAPPY TO TALK TO YOU ON THE PHONE ABOUT ICOM EQUIPMENT AND TO SEND FURTHER DETAILS OR TECHNICAL SPECS. DON'T BE FRIGHTENED TO USE OUR ANSAFONE AFTER HOURS.

REMEMBER—YOUR THANET AGENTS ARE KEEN TO DEMONSTRATE ICOM EQUIPMENT TO YOU EVENINGS AND WEEKENDS. PLEASE PHONE THEM FIRST THOUGH.

NEWS FOR THE MIOLANOS. We now have an agent who is easy for you to get to. He is Tony Fernyhough at SUTTON COLDFIELD (very convenient for the Motorway and Birmingham, 1 mile from the A38, 1 mile from the A453 and 6 miles from Spaghetti Junction)

THUS WE NOW HAVE AGENTS IN:

WALES

Tony Bleckmore GW3FKO
2 Joseph Parry Close, Llandough,
Penarth, CARDIFF, Glamorgan
Tel: 0222 702882

NORTH

Peter Avill, G3TPX,
7 Moorland Crescent,
MAPPLEWELL, Barnsley, Yorks
Tel: DARTON (022678) 2517

MIOLANOS

Tony Fernyhough, G6AVH
30 Bedford Drive,
SUTTON COLDFIELD
West Midlands B75 6AU. 021-320 2305

LONDON

Terry Barnett, G8BAM
7 Cochrane Court,
Leyton Grange,
LONDON E10 Tel: 01-556 9366

SCOTLAND

Ian McKechnie GMS00X
41 Westerlea Drive,
BRIDGE OF ALLAN
Stirlingshire (077983) 3223

SOUTH-EAST

Crayford Electronics
32 Iron Mill Lane,
CRAYFORD, Kent.
Crayford (03225) 24625

ELECTRONICS

DAVE
G8ELP

THANET for  **ICOM**®

With the rapid increase in the number of repeaters available on 2m and 70cm, mobile operation on VHF and UHF is becoming more and more popular. Aerials are neat and efficient and the equipment is small and easy to use. The ICOM range offers you excellent value for money with no hidden extras and we offer the experience and service which is so important should you be unfortunate enough to need after sales service.

FOR 2 METRES



IC-22A

The 22 channel FM mobile rig with 10 channels fitted—these being the most useful 5 simplex channels and the 5 UK repeater channels. The simplex channels are 145.0, S20, S21, S22, and S23. If you buy from us during the next two months we will also offer you S24 at a ridiculous price—thus giving you a 22 channel rig WHICH IS HALF FULL OF CRYSTALS. This is worth thinking about when you consider that 11 pairs of crystals can cost you £61! There is an automatic CRYSTAL CONTROLLED tone burst fitted which operates on REPEATER CHANNELS ONLY. Ex stock at time of going to press. **£176.25 inc. VAT**



IC-225

An 80 Channel FM mobile rig with all 80 channels fitted. Uses an excellent phase lock loop system. Channels are at 25kHz spacing which fits in with the UK and continental channel systems giving all the UK simplex and repeater frequencies. A crystal controlled tone burst is introduced when working repeaters and reverse repeater facility is available on all channels by adding one extra 11-300MHz crystal. Ex-stock at time of going to press. **£250 inc. VAT**

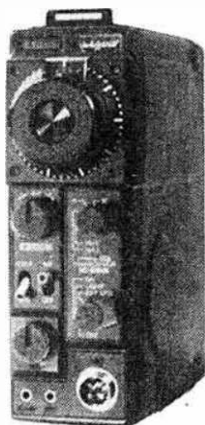

ICOM IC-202

A NEW MODEL FROM ICOM!

Hand held SSB portable with 3 watts p.e.p. output. Full VXO over the ranges 144.00-144.2 and 144.2 to 144.4. Two other ranges available with extra crystals. Internal batteries. RIT, True I.F., noise blanker. Add a linear if you want more power, but you'll be surprised what can be done with 3W p.e.p.!

IN STOCK £179 INC. VAT

TOUR BURST GENERATORS CTBI Crystal controlled. Requires 12V on transmit. Suitable for ICOM transceivers where they can be used to provide automatic tone selection on repeaters. **£8.00 inc VAT and P&P.**

IC-3PA The perfect companion to convert your ICOM mobile into a base station. Provides 13.8V at 3-5A. Well regulated, with automatic electronic overload protection which is much faster than a fuse! Extra forward spacing speaker and quick release mounting bracket to fit ICOM mobiles. **£46.87.**

REVCO mobile antennas. An excellent range of 1/2 antennas with a stainless steel whip and neat loading coil. The magnetic base is a beauty. All aerials are of the hinged mount type. 1/2 whip with loading coil and base **£7.00 + £1 carriage**, 1/2 whip with loading coil and magnetic base and 3-5 metres of cable **£15.00 + £1 carriage**, magnetic base alone with 3-5m cable **£8.00 + 75c carriage**



IC-301

See January RADCOM for a fair report on this excellent rig. FM/SSB/CW with Full VFO coverage. Very, very stable. Mains or 13.8V supply. A 2 metre luxury! Ex stock at the time of going to press. **£392.50 inc. VAT**

AND FOR 70 cms

 **ICOM**® **IC-30A**

IC-30A

An excellent 10W rig for the new repeaters on 70cm. Comes with 433.2 fitted. 5 Crystals for the new FM simplex and repeater channels are included in the price and will be supplied when available. **£250 inc. VAT**

ANTENNA SPECIALISTS!

2 metre and 70cm mobile aerials in stock. See page 301 for details.

 **ICOM**®

APPOINTED AGENT FOR ICOM AMATEUR RADIO EQUIPMENT IN THE UNITED KINGDOM

NOTE: ALL OUR ADVERTISED PRICES NOW INCLUDE VAT. CARRIAGE IS FREE EXCEPT WHERE STATED.

FREE SECURICOR DELIVERY ON ALL TRANSCEIVERS

THANET ELECTRONICS

34 Cliff Avenue, Herne Bay, Kent CT6 6LZ. Tel. (02273) 63846



CAMPIONE ELECTRONICA ELCA SAS

Via Matteo 8 CH 6911 Campione Tel.: 091 (Lugano) / 68 95 55 Telex: CH 73 639 ELCA

SOLE DISTRIBUTOR EUROPE OF **NEC** AMATEUR RADIO EQUIPMENT

presents : CQ-301 Lin. Ampl. and CQ-110 SSB-Transceiver

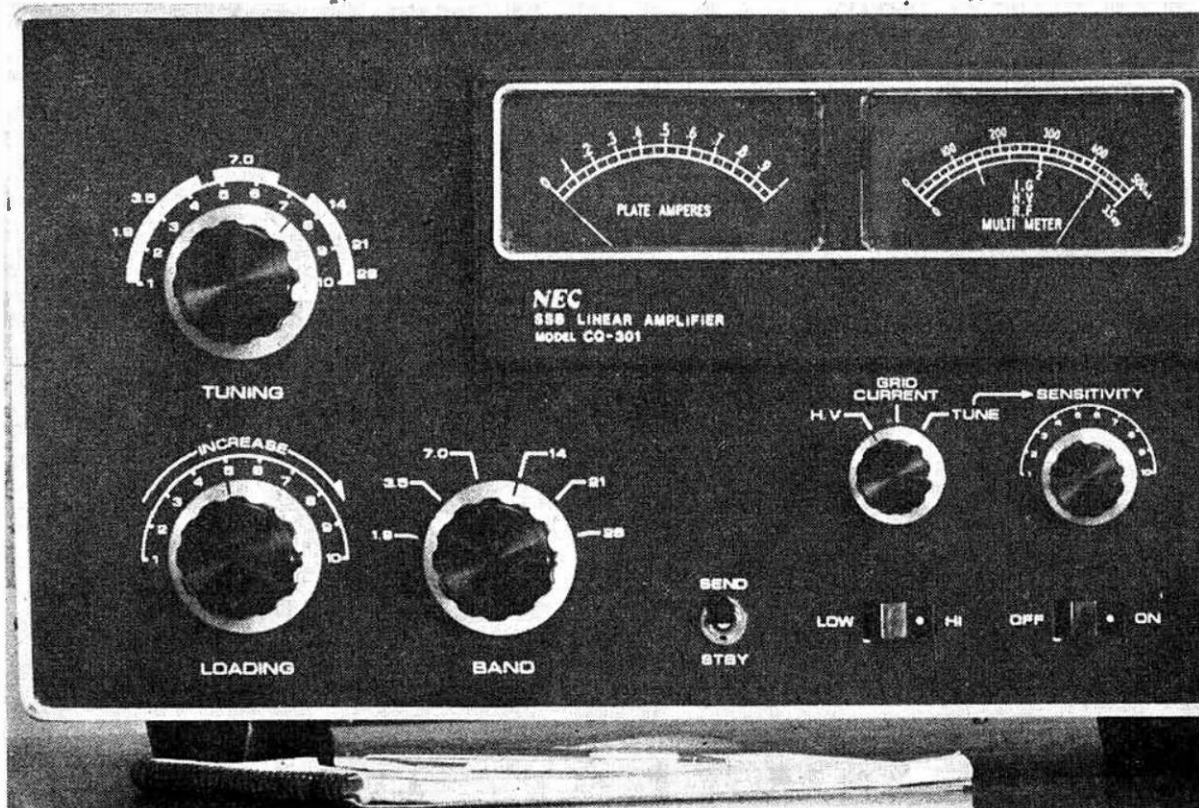

The CQ-110 (300W PEP) and the CQ-301 (3KW PEP) represent highest communication standards for radio amateurs today. The CQ-110 using the 7360 beam deflection tube as mixer guarantees highest cross modulation for your QSO. With the CQ-301 in combination, you have the most outstanding signal of any place in the world. Only a big company like NEC with their 85 years' experience in communication can give such features.

Sole Distributor for UK:

Waters & Stanton Electronics, Hockley Audio, 31 Spa Road, Hockley Essex. Tel. 03 704 6835

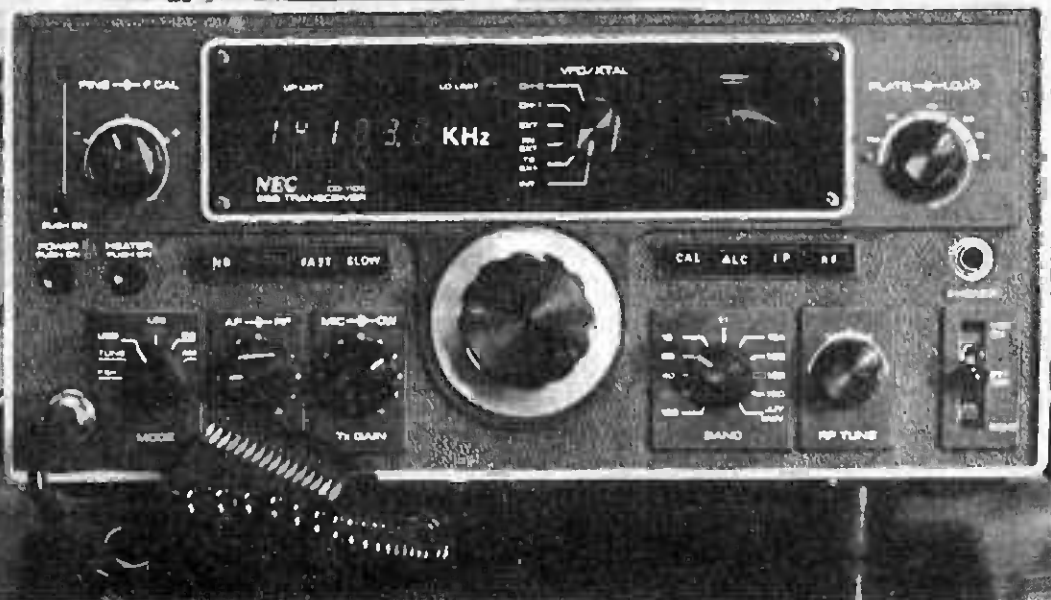

Still the best way to get from 160 to 10 meters:

Wide Frequency Range and Selectivity Flexibility

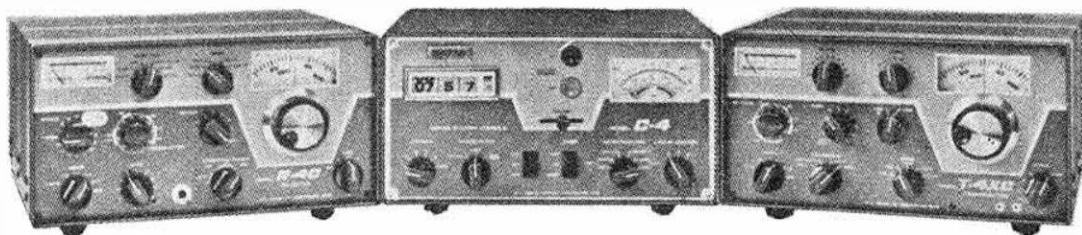

Drake C-Line

Both the R-4C and T-4XC cover extra 500kHz ranges throughout the HF spectrum. Additional crystals, which are front panel selectable, provide new bands as they are needed such as those discussed for 10, 18, and 24MHz.

The excellent performance of the system makes weak signal DXing on 160 meters a pleasure.

Both units employ the famous Drake PTO for super stability and 1kHz direct dial readout. Calibration remains the same when switching between modes.

With the proper use of the passband tuning, notch filter, and eight-pole crystal lattice filter (SSB supplied, five others for A.M., CW, and RTTY available as accessories), the R-4C gives outstanding results in severe QRM as compared to fixed selectivity systems.

Complete transceive capability using either PTO is provided, with spot signal for zero beating.

The C-4 integrates a myriad of functions together, including phone patch, rotor control, remote motor controlled antenna switch, master station control, wattmeter, and many others.

C-LINE ACCESSORIES

- Standard Crystals for T-4XC or R-4C
- Accessory I.F. Filters
- AC Power Supply
- Matching Speaker
- Antenna Matching Networks
- RF Wattmeters
- Station Console
- Desk Top or Hand Held Ceramic Microphones
- Noise Blanker

S.A.E. WITH ENQUIRIES PLEASE

RADIO SHACK LTD.

188 BROADHURST GARDENS, LONDON NW6 3AY

Just around the corner from West Hampstead Underground Station

Telephone: 01-624 7174. Cables: Radio Shack, London NW6

Telex 23718

Giro Account No.: 588 7151

Open Mon-Fri 9-5, Sat 9-1. Closed for lunch 1-2

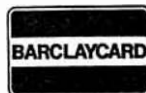



DRAKE

Radio Shack Ltd

DO YOU KNOW A SARGAIN WHEN YOU SEE ONE ?

MANY OF THE PRICES OF THE R. L. DRAKE COMPANY WERE INCREASED FROM FEBRUARY 1st.

RADIO SHACK LTD., the U.K. importers and distributors, INTEND TO SELL AT THE OLD PRICES FOR AS LONG AS POSSIBLE.

COMPARE THE PERFORMANCE AND COST OF DRAKE RECEIVERS, TRANSMITTERS AND TRANSCEIVERS, WITH OTHER EQUIPMENT ADVERTISESED IN THIS MAGAZINE. SEND US A S.A.E. AND WE'LL BE HAPPY TO SEND YOU DETAILS OF ITEMS IN WHICH YOU ARE INTERESTED. INCIDENTALLY, MOST ITEMS ARE EX STOCK.

PRICE INCLUDES 25% VAT

DRAKE RECEIVERS AND ACCESSORIES

R-4C Receiver—SSB, A.M., SW, RTTY ..	£398.00
FL250 Filter for R-4C (250kHz) ..	£38.75
FL500 Filter for R-4C (500kHz) ..	£38.75
FL1500 Filter for R-4C (1.5kHz) ..	£38.75
FL4000 Filter for R-4C (4.0kHz) ..	£38.75
FL6000 Filter for R-4C (6.0kHz) ..	£38.75
4-NB Noise Blanker for R-4C ..	£51.25
MS-4 Matching speaker for R-4C ..	£18.75
SPR-4 Receiver—General Purpose ..	£412.50
AL-4 Loop Antenna for SPR-4 ..	£18.75
5-NB Noise Blanker for SPR-4 ..	£50.50
SCC-4 100kHz Calibrator for SPR-4 ..	£15.50
TA-4 Transceiver adaptor for SPR-4, T-4XC ..	£28.00
DC Power Cord for SPR-4 ..	£4.50
Amateur Bands Crystal Kit for SPR-4 ..	£28.00
Time and freq. Crystal Kit for SPR-4 ..	£17.50
MARS Crystal Kit for SPR-4 ..	£17.50
Teletype Commercial Kit for SPR-4 ..	£15.00
Aeronautical Crystal Kit for SPR-4 ..	£28.25
Marino Crystal Kit for SPR-4 ..	£38.50
Tropical Bands Crystal Kit for SPR-4 ..	£11.75
RY-4 Teletype Adaptor for SPR-4 ..	£18.50
DSR-2 Digital Receiver ..	£1,450.00
SSR-1 Receiver—General coverage ..	£225.00

DRAKE TRANSCEIVER & ACCESSORIES

TR-4C SSB Transceiver ..	£410.00
34-PNB plug-in noise blanker ..	£50.50
AC-4 115/240v P.S.U. ..	£80.00
DC-4 12v P.S.U. ..	£82.50
MMK-3 mobile mounting kit ..	£5.00
RV-4C Remote V.F.O. ..	£80.00
FF-1 Crystal control ..	£34.50

DRAKE TRANSMITTER & ACCESSORIES

T-4XC SSB Transmitter ..	£395.00
L-4B Linear & power supply ..	£550.00
MN-4 Antenna match ..	£75.00
MN-2000 Antenna match ..	£180.00
W-4 RF wattmeter ..	£47.00
WV-4 RF wattmeter ..	£55.75
C-4 Station control ..	£272.50

ADDITIONAL ACCESSORIES

TV42LP L.P.F. 100w ..	£12.50
TV3300LP L.P.F. 2kw ..	£15.00
RP-500 Rx, protector ..	£34.50
7072 Hand mic. ..	£13.25
7075 Desk mic. ..	£26.25
Accessory crystals ..	£4.50
Fixed freq. x'tals ..	£8.00

HUSTLER MOBILE ANTENNAS

MO-1 foldover mast ..	£12.45
MO-2 foldover mast ..	£12.45
BM-1 Bumper mount ..	£9.30

C-32 Ball mount ..	£4.50
C-29 Stainless steel spring ..	£8.25
RM-10 10m Resonator ..	£8.45
RM-15 15m Resonator ..	£9.40
RM-20 20m Resonator ..	£9.95
RM-40 40m Resonator ..	£12.45
RM-80 80m Resonator ..	£13.45
SF-2 2m 1/2 whip ..	£10.00
DCL Diacone 80-500MHz ..	£18.75
CG-144 2m coilnear ..	£22.50
CGT-144 2m coilnear with mount ..	£35.00
RM-80S 80m Resonator ..	£22.50
4BTY 10-40m Vertical ..	£65.00
QD-1 Quick disconnect ..	£8.15
5105 top section of above ..	£5.00
G-144A 2m coilnear ..	£43.75
SARLOW-WADLEY XCR-30 ..	£160.00
TR-801 FM tuner kit ..	£25.00
N6S02 Philips main unit ..	£9.50

SHURE MICROPHONES

201 Ceramic ..	£8.75
202 noise-cancelling ..	£9.50
401A magnetic ..	£10.00
444 Desk model ..	£21.25
444T Desk model and preamp ..	£23.75

ROBOT SSTV

80A camera ..	£287.50
70B monitor ..	£398.75
Kit to convert 70A to 70B ..	£91.25
Model E macro lens ..	£48.50

VENUS SSTV

SS-2 monitor ..	£250.00
Camera ..	£312.50
P-1 polaroid adaptor ..	£21.25
V-1 viewing hood ..	£8.75

MICROWAVE MODULES

MMC144 converters (state IF) ..	£18.00
MMC144/28 LO ..	£19.00
2m Preamp ..	£11.30
MMC432/28 ..	£22.50
MMC70/28 ..	£19.00
MMV 1296 ..	£31.30
MMV432 ..	£21.00

YAESU MUSEN

FT-101E transceiver ..	£488.75
FV-101 remote VFO ..	£85.00
FT-401B transceiver ..	£412.50
FV-401B remote vfo ..	£85.00
FT-200B transceiver ..	£316.75
FT-201 transceiver ..	£408.00
FT-221 transceiver ..	£386.12
FR-101D Receiver ..	£437.50
FR-101D digital receiver ..	£531.25

FL-101 transmitter ..	£343.75
FL-2100B linear ..	£293.75
SP-101B spkr. console ..	£18.75
YC-355D dig. frag. meter ..	£145.00
YO-100 monitoroscope ..	£113.40
YP-150 dummy load/wattm. ..	£55.00
YC-601 dig. readout unit ..	£112.50

MISCELLANEOUS ITEMS

MFJ filters CWF-2BX ..	£18.87
Kokusai mech. filters MF45510CK ..	£19.25
Belling Lee H.P. filters ..	£3.75
SWR-10agl. meter ..	£7.50
SWR-50twin meter ..	£19.80

JAYBEAM ANTENNAS

4Y/4M ..	£9.80
5Y/2M ..	£8.13
8Y/2M ..	£8.00
10Y/2M ..	£15.75
10XV/2M ..	£29.19
PBM1/4/2M ..	£24.00
D3/2M ..	£11.25
D8/2M ..	£15.00
SVMK/2M ..	£8.13
XD/2M ..	£8.25
UGP/2M ..	£5.84
HM/2M ..	£5.13
SFM portable mast ..	£8.00
Q4/2M ..	£12.00
Q8/2M ..	£16.00
M5H48/70 ..	£17.40
P MH/2C ..	£4.07
P MH/2/2M ..	£5.83
P M70/4 ..	£9.75

HY-GAIN ANTENNAS

18HT 6-30m Vertical Tower ..	£186.25
12AVQ 10-30m Trapped Vertical ..	£37.00
14AVQ/WB 10-40m Trapped Vertical ..	£60.00
16AVT/WB 10-30m Trapped Vertical ..	£73.25
18V 10-30m Vertical ..	£27.50
12RMQ Roof mounting kit for 12AVQ ..	£15.00
14RMQ Roof mounting kit for 14AVQ/WB ..	£20.75
LC 80 Q 80m Loading coil for 14AVQ/WB ..	£15.00
TH6DX 6 element beam 10/15/20 ..	£187.00
TH3MK3 3 element beam 10/15/20 ..	£185.75
TH3JR 3 element beam 10/15/20 ..	£109.50
TH2MK3 2 element beam 10/15/20 ..	£107.00
HY-DUAD 2 element 3 band quad ..	£172.50
OB10-15A 10 and 15 metre beam ..	£112.50
2048A 4 element 20 metre beam ..	£148.75
2038A 3 element 20 metre beam ..	£117.50
1538A 3 element 15 metre beam ..	£82.00
1038A 3 element 10 metre beam ..	£49.50
4028A 2 element 40 metre beam ..	£168.25
499 Flush body mount ..	£7.75
417 De luxe spring ..	£6.00
492 Miniature spring ..	£3.25
415 Bumper mount ..	£7.50
511 Extra heavy duty spring ..	£8.00
LA-1 Lightning arrester ..	£23.25
LA-2 In-line lightning arrester ..	£3.75
BN-86 Ferrite balun ..	£13.75
TE 701 Antenna noise bridge 1-100MHz ..	£22.50
TE 7-02 Antenna noise bridge 1-300MHz ..	£30.00

CDR ROTATORS

AR-22L ..	£40.00
AR-30 ..	£33.25
AR-40 ..	£43.25
CD-44 ..	£27.20
HAM-2 ..	£131.88

DRAKE ★ SALES ★ SERVICE
SECURICOR ★ B.R.S. ★ ACCESS ★ BARCLAYCARD ★ HP

RADIO SHACK LTD.

188 BROADHURST GARDENS
LONDON, NW6 3AY

TELEX 23718
OPEN 5 DAYS 9-5. CLOSED 1-2pm
SATURDAY 9-1pm

Just round the corner from West Hampstead Underground Station
Telephone: 01-824 7174 Cables: Radio Shack, London, N.W.8
Giro Account No: 588 7151

COUNCIL

President

E. J. Allaway, MB, ChB, MRCS, LRCP
G3FKM

Immediate Past-President

C. H. Parsons, GW8NP

Honorary Treasurer and Executive Vice-President

J. Q. Brown, LLB, FCA, G3DVV

Telecommunications Liaison Officer

R. F. Stevens, G2BVN

Members

D. J. Andrews, G3MXJ
R. J. Baker, G3USB
P. Balestrini, TEng(CIE), MITE, MIAM,
G3BPT
D. Byrne, G3KPO
D. S. Evans, G3RPE
R. W. Fisher, G3PWJ
W. F. McGonigle, G3GXP
J. R. Potty, G4JW
D. M. Pratt, BTEch, MIEE, MIERE, G3KEP
W. A. Scarr, MA, FBIS, G2WS
A. W. Smith, GM3AEL
R. F. Stevens, G2BVN
G. M. C. Stone, G3FZL
C. J. Thomas, G3PSM
D. M. Thomas, GW3RWX

REGIONAL REPRESENTATIVES

Region 1—B. O'Brien, G2AMV
Region 2—R. C. Andraeng, G4CMT
Region 3—H. S. Pinchin, G3VPE
Region 4—T. Darn, G3GY
Region 5—P. F. Chilcott, G4BBA
Region 6—D. C. Andrews, G4CWB
Region 7—R. S. Hewes, G3TDR
Region 8—D. N. T. Williams, G3MDO
Region 9—H. W. Leonard, G4UZ
Region 10—R. G. Barrett, GW8HEZ
Region 11—P. H. Hudson, GW3IEQ
Region 12—F. Hall, GM8BZX
Region 13—Rev S. J. Smith, GM4DNM
Region 14—A. J. Mitchell, GM3UDL
Region 15—H. J. Campbell, G18FOK
Region 16—R. E. G. Kendall, G8BNE
Region 17—L. Hawkyard, G5HD
Region 18—P. J. Fay, G3AKG
Region 19—D. S. Smith, G4DAX
Region 20—G. Mather, G3GKA

HONORARY OFFICERS

Awards manager (hf)

C. R. Emary, G5GH

Awards manager (vhf)

Jack Hum, G5UM

Intruder Watch organizer

S. A. G. Cook, G5XB

QSL Bureau manager

A. O. Milne, G2MI

Slow morse practice transmissions organizer

M. A. C. MacBrayne, G3KGU

Taped lecture library curator

S. W. Coursey, G3JJC

Trophies manager

P. A. Miles, G3KDB

VHF manager

G. M. C. Stone, G3FZL

RADIO SOCIETY OF GREAT BRITAIN

35 Doughty Street, London WC1N 2AE

Telephone 01-837 8688

Founded 1913

Incorporated 1926

Member society, International

Amateur Radio Union

PATRON: HRH The Prince Philip, Duke of Edinburgh, KG

The national society representing all UK radio amateurs

Membership is open to all those with an active interest in radio experimentation and communication as a hobby.

Annual membership rates: UK—£8 (including VAT); Unlicensed members under 18 years of age, £3. Overseas—£7.50.

Applications for membership should be made to the general manager, from whom full details of Society services may also be obtained.

GENERAL MANAGER AND SECRETARY

G. R. Jessop, CEng, MIERE, G6JP

EDITOR

A. W. Hutchinson

CURRENT COMMENT

Data processor

The response to the Honorary Treasurer's comments about a data processor for the Society that appeared in this space last month is most encouraging. Many members offered advice and/or assistance, and it is obvious that a number of these appreciate that we are moving into a more modern method of handling our members' subscription records and sales records.

By the adoption of a data processor, the fundamental aim is to save money in the long term by replacing the present labour-intensive manual system of members' records and book sales procedures with a modern system of great flexibility and ready access.

A study, extending over the past eight months, has been carried out by Society personnel into the various systems and alternatives that had been offered. From these the IBM32 is clearly the most suitable machine at present available for our needs and the decision to order one has been made following the advice of data processing consultants who, incidentally, also happen to be members.

Once we have an adequate membership record and accounting system functioning (with a saving of staff), headquarters will be able to concentrate its efforts on the "Society" aspect of work.

In view of the interest in this matter the Honorary Treasurer will publish a more detailed report on the project in next month's *Radio Communication*.

G. R. JESSOP, G6JP
General manager

RSGB Radio Communication Exhibition

Alexandra Palace, London

30 July - 1 August 1976

The RSGB will be organizing and running this exhibition through its Mobile & Exhibition Committee, with Mr J. Hitchins, G8GBN, as exhibition manager.

Times of opening will be 1000-2000, 30, 31 July, and 1000-1600, 1 August.

There is easy access to the site, ample free parking and a frequent bus service between Alexandra Palace and the London Underground.

Several thousand square feet space have already been reserved. Further details will be sent on receipt of an sae at RSGB.

QTC

amateur radio news

GB2RS

The present frequency of 3.6MHz used for the Sunday news broadcasts lies in the segment of 3,580 to 3,620kHz, which by the IARU Region 1 band plan is the recommended segment for rtty. There have been reports of interference from ssb stations to rtty transmissions and with the start of the rtty news bulletin on 3,590kHz it is proposed to change the GB2RS frequency to 3,650kHz.

Monitoring of this frequency has not revealed any regular occupancy and the nearest scheduled transmission is the EI news bulletin on 3,630kHz. Members who consider that there are reasons why the change should *not* be made are asked to write to the general manager.

27MHz

Enquiries have been made to headquarters as to the views of the Society on the so-called citizens band activity in the segment between 27 and 28MHz. At the present time the opinion of the Council is that no support can be given to the establishment of a communications band in this part of the spectrum. In the UK all transmissions in this band comprise the use of tones, ie for paging and location and for model control. Reports of cb activities in the USA show gross violations of the regulations, leading in some cases to heavy fines and prison sentences. The Society has no desire to see the spread of these practices to the UK, particularly as in many cases press reports do not differentiate between the licensed radio amateur and the 27MHz users, most of whom are unlicensed.

Dollar parity

On 5 March the value of the pound sterling dropped to below USA \$2 for the first time. As this appears to be a permanent drop in the exchange rate the prices of all American books and magazine subscriptions will be increased in line with increased subscription rates as follows:

QST (includes ARRL membership)	£6.10
CQ	£6.10
73 Magazine	£5.80

Also from 7 April, would members ordering American books please add five per cent to the price of the book shown in the last "by post" price list.

Facts and figures

The Home Office advises that the following numbers of amateur licences were in force at 31 January 1976:

Class A	15,779	Class B/M	2,097
Class B	5,691	Class F/M	19
Class A/M	3,921	Television	304

The callsign record received from the Home Office dated 27 February 1976 gives the latest callsigns issued in the G4 and G8 series as G4ETZ and G8LFU respectively.

At the end of February 1976 RSGB membership totalled 19,721, made up of 16,596 UK corporate, 1,113 UK associate and 2,012 overseas members.

RSGB Region 11 ORM & Mobile Rally

Royal Lido, Bastion Road
Prestatyn, Clwyd
Saturday 15 May 1976

PROGRAMME

11am : event opens
12.30pm : official opening
2pm : business meeting commences

The RSGB Council will be represented by the President, Dr E. J. Allaway, G3FKM; the Immediate Past-President, Mr C. H. Parsons, GW8NP; and the Zone E manager, Mr D. M. Thomas, G W3RWX

Trade stands

Refreshments

Talk-in on 145 and 145.5MHz fm, 144.32MHz ssb, 3,760kHz, 1,980kHz and 432MHz

HRM publications

Will members please note that publications advertised in *Ham Radio Magazine* cannot be obtained through the UK subscription office, which deals only with matters connected with HRM subscriptions. Payment for publications can be made by means of a bank draft which can be obtained from a branch of any of the major banks. A small charge, usually about 25p, is made for this service.

IARU meeting

A conference of the Region 2 (N & S America) societies of the IARU will take place in Florida between 10 and 15 April 1976. Following this there will be a meeting on 16/17 April at which all regional associations of the IARU will be represented.

Regions 1 and 3 have already held meetings to determine future policies, particularly with regard to WARC 1979, and the Miami meeting will be a valuable opportunity to achieve worldwide agreement among national societies. It is anticipated that Region 1 will be represented by the chairman (PA0LOU) and secretary (G2BVN).

In connection with WARC 1979, both IARU HQ and Region 1 are circulating periodical WARC newsletters intended to inform all societies and others involved with frequency planning of the amateur service.

Stolen equipment

The following equipment has been stolen from Billesden, Leicestershire: ITT receiver 3LMUTA, transmitter 4LMWA, serial No 207; Pye transmitter T30AM/6392, receiver R7AM/33085; Pye transmitter T30AM/1291, receiver R7AM/1292, monitor receiver AM10FRX; Pye transmitter T30AM/3055, receiver R6AM/2234; Pye transmitter T470/1854, receiver R470/2214; Pye transmitter T470/1685, receiver R470/1870; terminating unit No 191. Any information concerning this equipment should be given to Uppingham Road Police Station, Leicester, or any police station.

Between 31 December and 2 January a Philips Westminster vhf transceiver, grey with a six-channel selector, was stolen in Farnborough, Hampshire. Any information concerning this equipment should be given to Farnborough Police Station, tel Farnborough 40661, or any police station.

The G8ENN instant beam

by D. A. TONG, PhD, BSc, G8ENN*

Introduction

This article describes the construction of a collapsible directional aerial which was intended primarily for use with the 144MHz transceivers described previously [1, 2]. Its gain compared with a $\lambda/4$ whip aerial is very roughly 6dB and is enough to give a useful increase in range. It has been in use by the author since 1971.

As indicated by the title, the emphasis is on portability, light weight and ease of use, otherwise the aerial would not be worth its carriage and the attractions of "foot-mobile" operating would be lost. In practice the aerial slips easily into a rucksack and allows full advantage to be taken of any lofty radio vantage point, without turning an outing into an exclusively "amateur radio" affair.

The aerial is based on the cubical quad in which the driven element is a loop with a circumference equal to one wavelength and the reflector is a similar slightly larger loop (Fig 1). Such an aerial is well suited to hand-held portable work since its radiation pattern is less affected by surrounding objects than the more usual Yagi array. Additional advantages over the Yagi in this application are that its width is only $\lambda/4$ rather than $\lambda/2$; it, and any bystanders, are much less vulnerable to accidental damage; it is easily held in one hand while in use. This leaves the other hand free to hold the radio.

As with the Yagi, one or more parasitic director elements can be added to the quad to give a corresponding increase in gain and directivity. The constructional method described below could easily be extended to provide a four-element beam but this was not done because the aerial would then become awkward to hold in one hand when deployed. The dimensions given in Fig 1 were taken from [3].

Basic design

Views of the aerial extended, half-folded, and completely folded are shown in the photographs. The main structural member is made from two pieces of aluminium angle glued together. Support rods are pivoted on to this "chassis" in such a way that they can fold down to occupy the volume defined by its cross-sectional area. This gives good protection to the rods when the aerial is folded.

In the deployed state the eight support rods are raised slightly past the perpendicular to the longitudinal axis of the chassis and provide anchoring points for the two flexible wire loops. A coil spring is attached near to the pivot of each rod so that when the rod makes an angle of less than about 45° to the chassis it is pulled down along the chassis, whereas

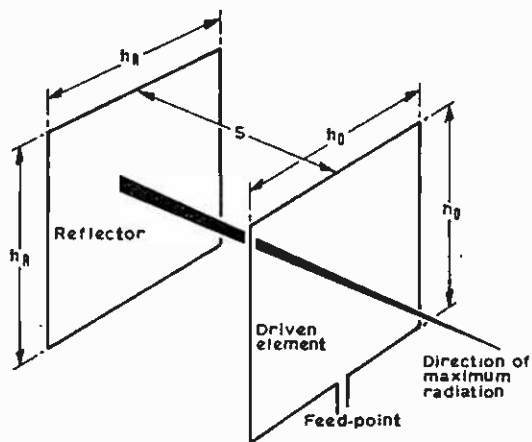

Fig 1. The basic configuration of the so-called cubical quad aerial. The driven element is a loop with a perimeter ($4h_d$) equal to one wavelength at the operating frequency and the reflector is similar except the perimeter ($4h_r$) is typically five per cent greater than that of the driven element. Dimensions used in the aerial described in this article were $4h_d = 80$ in and $4h_r = 84$ in. The separation between elements is typically $0.15 < s/\lambda < 0.2$ where λ is the operating wavelength. In this aerial the actual separation is about 18in (ie, 0.22λ). This is rather more than originally intended and results from the extra outward pull from the elastic. The difference in performance is very slight indeed.

when raised against the spring tension past the 45° point, the spring acts so as to pull the rod away from the chassis. Stops are used to define the rest positions of the rods when the aerial is deployed.

This mechanical bistable action makes a large contribution to the convenience of the complete aerial, but a further important improvement is obtained by stretching four pieces of elastic between the mid-points of opposite straight sections of the same loop. This is shown more clearly in the photographs. The elastic has three functions. First, it tensions the wire when the aerial is in use; second, it holds the wire in position close to the chassis when the aerial is folded and obviates tangling, and third, it forces the four supports of each loop to act in unison when the aerial is being erected or collapsed. Thus, to fold each loop it is necessary to move only

Note...The angled section of this hole is only used with the feeder support rod and allows the coaxial feeder to emerge

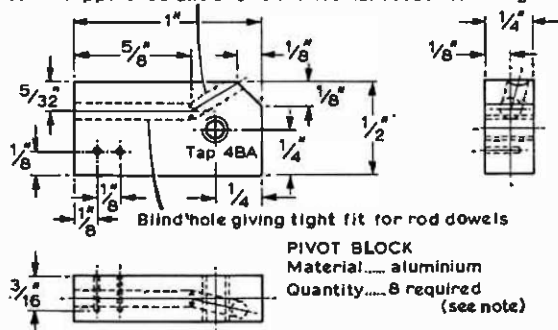

Fig 2. Details of the mounting blocks for the support rods

* 11 Moor Park Avenue, Leeds, Yorks LS6 4BT.

one rod past the perpendicular, after which the four rods snap down to the closed position together.

The driven element is actually fed at a corner rather than at the centre of a side as shown in Fig 1. This has no adverse effect on performance but makes the feed point coincide with a support rod and is therefore superior mechanically. That particular support rod is hollow and the feeder cable passes through the tube giving quite a neat appearance.

Constructional details

Details of the various component parts are shown in Figs 2 to 5. Aluminium is used where possible for the sake of lightness. The choice of material for the support rods is rather difficult since they must combine strength and rigidity with a certain amount of flexibility. Metal cannot be used for all the rods otherwise severe losses are introduced. Ideally glass-fibre reinforced plastic rods would be used as in fishing rods, but no source of suitable material could be located. Split-cane rods have good mechanical properties initially but tend to distort with age. Wooden dowel ($\frac{1}{8}$ in diameter) has proved to be adequate but a little fragile.

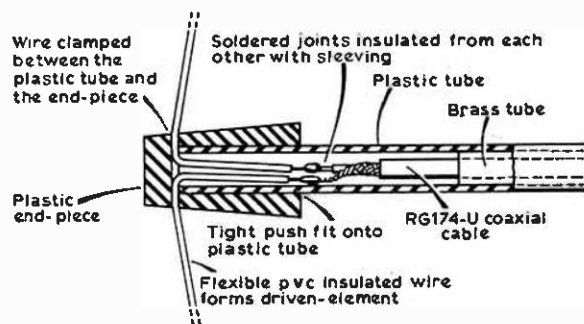
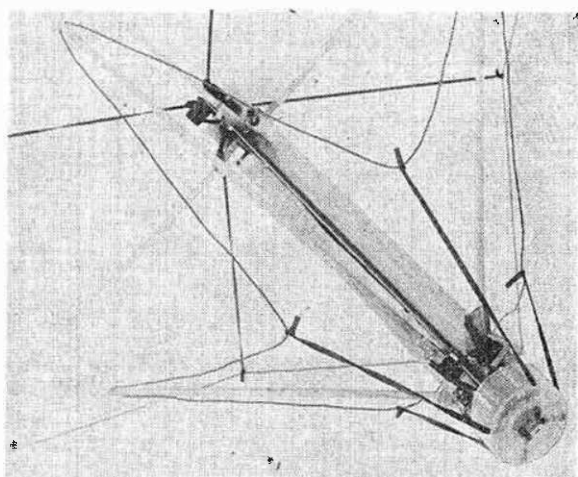

Fig 3. Details of the method of terminating the driven element and of joining it to the coaxial cable inside the support tube

Seven rods are push fitted into seven small aluminium blocks which form the pivots. Details of the blocks are given in Fig 2. The small hook is used to anchor the coil spring and is made from a piece of stiff wire from a straightened paper clip. The hook fits into two holes drilled into the block and is secured with Araldite or similar adhesive. It is strongly recommended that curing of the adhesive here and in the rest of the construction be carried out in a domestic oven at about 150°C. This ensures that the resin first becomes very fluid so that good wetting of the substrate occurs. Full strength is obtained after about 30min at this temperature. It is also very important that the metal to be glued is clean. A vigorous application of scouring powder such as Vim, followed by thorough rinsing, is effective.

Four of the seven wooden rods are used to support the reflector element and are 14in long. This allows a penetration of 0.5in into the aluminium blocks. The other three rods support the driven element and are 13½in long. The fourth support for this element derives its strength from a 12in length of $\frac{1}{8}$ in diameter thin-walled brass tubing of the type used by model builders, which is glued into its specially drilled aluminium block in such a way as to allow the feeder cable (miniature flexible coaxial cable type RG174-U, nominal outside diameter 0.1in) to pass down the tube and



The aerial shown half-collapsed, seen from the pivot area of the driven element

emerge from the block. A plastic tube ($\frac{1}{8}$ in outside diameter and 12½in long) is slid on to the brass tube and carries the anchoring device for the driven element. This "device" consists merely of a plastic cap from a tube of Evostik drilled out as shown in Fig 3 so as to be a tight push fit on to the plastic tube.

The chassis is made from two identical pieces of 16swg aluminium sheet drilled and bent as shown in Fig 4. The two pieces are glued together, being clamped during curing by two nuts and bolts. The eight aluminium blocks (without the wooden rods) are then fixed to the chassis with 4BA bolts using large washers between the bearing surfaces. After carefully adjusting each bolt to give the best compromise between rigidity and ease of pivoting, the bolts are secured by applying one drop of an adhesive such as "Cyanolit" to the tapped hole in the blocks.

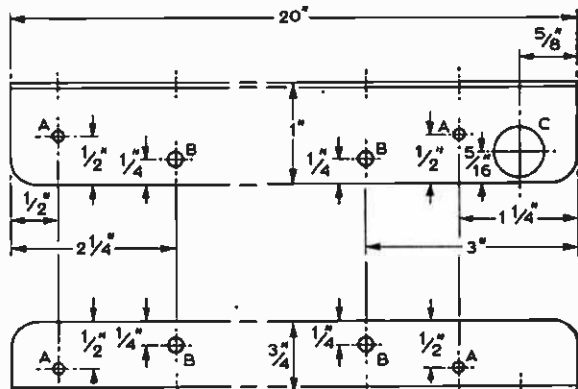

Holes 'A'... 8BA clearance 'B'... 4BA clear
'C'... 1/2" dia for coaxial socket on one piece only
CHASSIS PIECE Material... 16swg aluminium angle
Quantity... 2 required (one minus hole 'C')

Fig 4. Details of the two aluminium angle sections used to form the chassis of the aerial

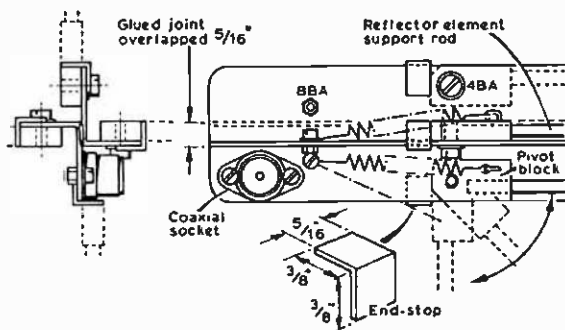

Fig 5. Details of the end-stops which define the angle made by the support rods relative to the chassis when the aerial is erected

The next step is to fix the end-stops (Fig 5) to each pivot in turn. They are positioned so as to allow the blocks to stand with the rod axis perpendicular to that of the chassis. Again Araldite is used, but time can be saved by giving only a 10min bake to each end-stop, ie just enough to hold it in position, with the full 30min bake applied when all eight stops have been fitted. After baking, the stops should be drilled and a 6BA bolt used to further secure each one. This ensures that if the adhesive bond fails, the aerial will still be usable.

The coil springs used in the prototype came from R. S. Components Ltd, but have since been dropped from their catalogue. Suitable springs can probably be obtained from other sources. The dimensions of those used were 1/4in by

1/4in and each had 63 turns. The springs are mounted by hooking one end on to the wire loops on the blocks and bolting the other end to the chassis with 8BA brass bolts. After mounting the springs the support rods can be fitted and the bistable action of each pivot checked.

The two wire loops are made from flexible stranded wire with pvc insulation, preferably in contrasting colours so that each loop is easily identifiable when the aerial is being opened. Suitable wire is R. S. Components type R. S. 7/0-2mm. Each loop is threaded through holes drilled 1/4in from the ends of the support rods, and after carefully arranging the wire so that each leg of the perimeter is of equal length, a drop of adhesive should be applied to each hole.

The final stage in construction is to fix the pieces of elastic. Material with a long "stretch" is required and the best has proved to be rubber used for model aircraft and with a cross-section 3mm by 1mm. The lengths of the four pieces (two to each loop) are a compromise between excessive distortion of the loops with bending of the support rods when the aerial is deployed, and tidy folding when closed. The arrangement is shown in the photographs; the centre points of each elastic strip should be anchored at the extremities of the chassis.

References

- [1]. "A hand-portable transceiver", D. A. Tong, *Wireless World* April 1972, 154-160.
- [2]. "A pocket-sized transceiver", D. A. Tong, *Wireless World* July 1974, 245-252, and August 1974, 293-298.
- [3] *VHF/UHF Manual*, G. R. Jessop, published by the RSGB. □

NEW PRODUCTS

Auto intrusion alarm

The Heathkit GD-1157 is a solid-state vehicle intrusion alarm operated by bonnet, boot and door switches and using the existing vehicle horn for an audible warning. The electronics of the unit are contained on one pcb to be mounted in an aluminium chassis and cabinet which will usually be accommodated in the boot of the vehicle. In order to overcome possible difficulties with cars not having an accessible horn relay, this item can be obtained as an optional extra. Very full instructions are given in the assembly manual regarding this section of the installation. The alarm may be wired to existing door switches, or the push-button switches provided with the kit may be used.

There are eight circuits in the alarm, viz: regulator, exit delay, latch, enter delay, delay bypass, duty cycle, timer and relay driver. The entire system can be disabled by a hidden switch while exit and entry delay times can be set so that the car may be left or entered without triggering the alarm. When set, the alarm sounds immediately a door or the boot is opened, for a period of 2min, then resets and repeats the 2min alarm cycle until reset or the cause of the alarm has been removed. There is a tamper-proof circuit which ensures that once the alarm has sounded the arm/disable switch no

longer functions and access to the concealed control unit is necessary. Any attempt to enter also cancels the delay and the alarm will sound immediately upon driver entry thus warning that an attempt has been made to interfere with the vehicle.

The alarm is available for 12V negative earth systems only and the set and armed current is 28mA. Installation demands a fair amount of mechanical work in mounting switches and car wiring but the very comprehensive assembly manual should remove any problems. Protection of this type is particularly suitable for cars containing valuable radio equipment which is vulnerable to theft or vandalism.

The Heathkit GD-1157 is available for £18.80 (inc VAT), with the horn relay (GDA-1157-2) costing an additional £2.80, from Heath (Gloucester) Ltd, Bristol Road, Gloucester, GL2 6EE, or by personal callers only from the London Heathkit centre at 233 Tottenham Court Road (tel 01-636 7349).

FT101 speech processing kit

Following the successful rf speech clipper produced by Holdings of Blackburn, a kit version is now available. The cost of the complete G3LLL kit is £29 but there are a number of options available for the purchase of individual parts. These are set out on a descriptive leaflet which may be obtained by sending an sae to the address below. The speech clipper was recently reviewed in *Amateur Radio (VK)* and attracted favourable comment. Further information may be obtained from Holdings, Mincing Lane, Darwen St, Blackburn (tel 59595). □

EQUIPMENT REVIEW

The Scopex 4D-25 oscilloscope

by R. O. PHILLIPS, G8CXJ*

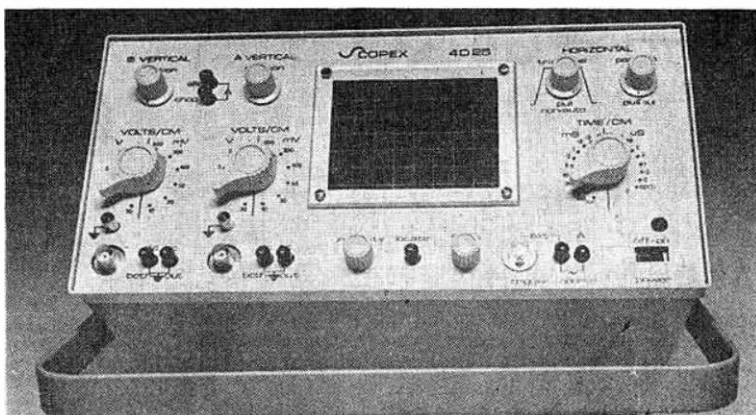

IN the July 1974 issue of *Radio Communication* the Scopex 4D-10 oscilloscope was reviewed, and this review looks at another scope from the same manufacturer which is capable of providing dual-trace operation up to 25MHz. The instrument was kindly loaned for review by the manufacturers, Scopex Ltd of Letchworth, and is obtainable from them at a price of £225 plus VAT. A probe kit which provides X10 and X1 options is available as an accessory and costs £10 plus VAT. The delivery time quoted by the company is approximately four weeks.

Comments

The front panel of the 4D-25 is similar in all respects to the 4D-10 except that the timebase has an extended range down to 0.2µs/cm, which can be increased to 40ns/cm using the X5 horizontal magnifier. The only other visual difference between the two models is that the 4D-25 is 3in deeper.

Specification

The following details are quoted by the manufacturer

Sensitivity	A and B Vertical 10mV/cm—50V/cm ± 3% (12 calibrated ranges)
Bandwidth (3dB)	dc coupled dc to 25MHz ac coupled 3Hz to 25MHz
Input impedance	1MΩ ± 2% and 27pF approx
Rise time	14ns
Sweep speeds	Horizontal 0.2µs/cm to 200ms/cm ± 3% (19 calibrated ranges)
External sensitivity	1V/cm (200mV/cm magnified)
External impedance	1MΩ ± 10% and 20pF approx
	Trigger circuit
Sources	External input; Channel A; Power line frequency
Sensitivity	Internal: 3mm minimum from 10Hz to 5MHz rising to 1.5cm at 25MHz External: 200mV p-p from 30Hz to 5MHz 300m Vp-p from 5MHz to 25MHz
Input impedance	1MΩ and 20pF approx
Power requirements	210–250V ac 35VA
Dimensions	Height 6in, width 12½in, depth 17½in
Weight	9kg
Available from	Scopex Instruments Ltd, Pixmore Industrial Estate, Pixmore Avenue, Letchworth, Herts SG6 1JJ.

* 170 Shirehall Road, Hawley, Dartford, Kent.

Separate controls are provided for selecting the appropriate sensitivity for the Y-input amplifiers: 12 calibrated positions are available ranging from 10mV/cm to 50V/cm.

One of the outstanding features of the 4D-10 model was the ease of achieving trace triggering. This is also the case with the 4D-25 which uses a tunnel diode in the trigger circuit to provide very stable triggering at the selected point on either the rising or falling part of the signal waveform.

A comment that was made in the previous review was that under strong lighting conditions it became difficult to see the trace. This is also true for the 4D-25 version which could benefit from a light hood.

The 4D-25 oscilloscope functions very well and where measurement of level and frequency are required up to 25MHz it offers quite good value for money. However, even with VAT at 8% the price may be rather more than many amateurs are prepared to pay. □

CLUB LIABILITY

It has always been thought that many clubs and societies do not have adequate insurance to protect them against claims arising from injury to or damage to the property of members of the public. The RSGB takes this opportunity of reminding members that the consequences of a serious claim can be disastrous for an unincorporated club holding no capital, and these consequences may result in individual members being faced with liabilities quite beyond their means.

There is of course no need for any member to be exposed to such serious liabilities as insurance is readily available at modest cost. During the next few days club secretaries should be receiving a letter from our insurers, the Sun Alliance & London Group, giving details of a simple insurance scheme which we hope many will consider to be of value.

It is recommended that immediate and careful attention be given to this important matter.

COMPETING IN GM

Aberdeen RS competition

The annual Aberdeen RS building competition will take place in the clubroom behind 91 Crown Street, Aberdeen, on 7 May. Prizes: £10, £5 and £2; rules as last year.

technical topics

Pat Hawker, G3VA

AMATEUR radio sometimes seems prone to undersell itself. For example S. M. Dyke, G3ROZ, ("Your opinion" February 1976) in his interesting if rather bitter comment on the buying of boxes suggested that amateurs did little to pioneer ssb since it was already well-established in commercial usage in the 'thirties. Well, yes and no. Surely what was then in common use, at least on hf in the larger point-to-point stations, was ssb with a low-level pilot carrier used to provide afc in the receiver. What amateurs showed (and one must admit the bandwagon started rolling in the USA, with no great early enthusiasm in the UK) was that hf operation on ssb was possible without receiver afc and thus with carriers suppressed to the maximum possible degree. It was the amateur experience that led to the wide-scale adoption of ssb for commercial hf transceivers, mobile communications and the like; just as at present amateurs appear to be leading the field in the use of ssb on vhf and microwaves. Whether all this constitutes a "decline of amateur radio" must be for others to judge, but we doubt whether any decline in home R&D (if in fact this has occurred) can be linked either to a particular mode or even to the availability of commercially made amateur rigs. R&D depends much more on an attitude of mind.

Using "all-wave" receivers

The recent mention of the development of new-style "all-wave" broadcast receivers that provide at least some of the facilities and performance of communications receivers (*TT* February) has prompted Alan Gordon, G3XOI, to draw attention to some of the sets already on the UK market. He reports that his eldest son recently wanted a general purpose receiver at a modest price, and a search led to the acquisition of a transistor receiver marketed by W. H. Smith's, described as the "Multiband receiver Model 56". This covers six bands: 150-350kHz (long wave); 540-1,500kHz (medium wave); 1.6-4.4MHz; 4-12MHz; 12-26MHz; and vhf fm 88-108MHz. After fitting an outboard bfo the set was found to resolve ssb signals quite satisfactorily on 1.8 and 3.5MHz (not yet tried for ssb on other bands as this requires an external aerial). G3XOI feels that at £16.75 such a receiver provides a good starter for any swl prepared to roll his own bfo, providing both broadcast reception and a general coverage receiver for hf (though he does not mention if the problem of "image" reception which mars so many receivers has been satisfactorily overcome or whether this will need an external tuned pre-amplifier).

When considering the question of ssb and cw reception on all those models that do not contain a bfo, it is well worth remembering that carrier reinsertion is possible at *signal frequency* as well as by the more usual i.f. bfo. This can be provided by a small external oscillator with good bandspread tuning, and does not require any modification or wired coupling to the broadcast receiver. In these days of good

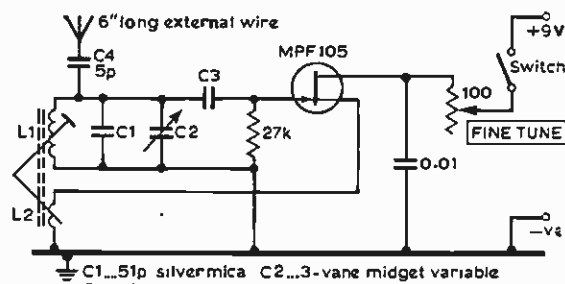

L1, 20 turns and L2, 8 turns wound on 1/4" dia slug-tuned former

Fig 1. Typical small external vfo arrangement used to provide carrier re-insertion at signal frequency to allow ssb reception on broadcast "all-wave" receivers or to improve ssb reception on communications receivers having too fast a tuning rate or lack of local oscillator stability. This design tunes 7MHz with a fine-tuning (clarifier) control provided by the variable resistor in the drain circuit. Harmonic injection allows the oscillator to be used also on 14 and 21 MHz. In practice any stable oscillator with easy tuning can be used for this application and should be adjusted to provide an rf input about 10 or more times the strength of the incoming signals, but not so great a signal that it swamps the receiver agc

fet oscillators it is not difficult to rig up a small tunable oscillator with its own 9V battery. It need only be placed within a few feet of the receiver; often the harmonics provide sufficient injection to eliminate the need for bandswitching. The main receiver is tuned to maximum "monkey-chatter" and then the speech resolved by carefully tuning the external oscillator. With this technique, the stability of the receiver's local oscillator is far less critical than when an i.f. bfo is used, since moderate drift will not affect reception unless the signal drifts right out of the passband. Carrier re-insertion at signal frequency was quite popular in the early days of amateur ssb though it is seldom mentioned today.

Almost any stable vfo-type oscillator is suitable: the one shown in Fig 1 stems from an article "Single sideband on the all-wave radio" by R. E. Baird, W7CSD, (*73 Magazine* April 1970) brought to my notice some time ago by Roy Stevens, G2BVN. The direct-conversion type of receiver has shown that sufficient stability for re-insertion at signal frequency is not too difficult. W7CSD reported that, using this approach, some of the better "all-wave" portable receivers gave results good enough for serious amateur reception. Once you get used to the two-knob tuning technique, signal-frequency injection can also provide excellent ssb reception on many of the older hf communications receivers where oscillator drift or insufficient bfo injection would otherwise mar results. Such receivers should be used with the bfo switched off.

It is usually much easier to build an external vfo with good stability and easy tuning than to improve the hf oscillator and tuning arrangements of the main receiver. You may be surprised at the results that are possible on receivers never intended for ssb.

Solid-state/valve interface 2

In *TT* (August 1975) details were given of a 2N2218 transistor interface stage used by Mike Small, G4DVI, between a SL611 ic amplifier and a grounded-grid 12BY7A driver stage. Fig 2 shows an alternative arrangement which Phil Horwood, G3FRB, reports to be capable of providing sufficient grid drive to be used directly with a power amplifier without an intermediate thermionic driver stage. The pnp

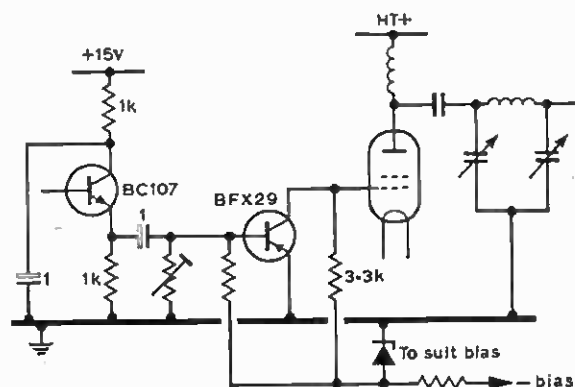

Fig 2. Method of directly driving a valve power amplifier from solid-state exciter without intermediate thermionic driver as suggested by G3FRB

transistor must be a high-voltage type chosen to suit the grid swing of the particular amplifier valve, but G3FRB says the BFX29 is suitable for use with an 807, 6146 or similar valve. The pre-set resistor is adjusted to provide the correct AB1 anode current for the output valve.

Wire-wrap tools

Tools that enable a home-constructor to achieve a "professional" finish always seem popular. In a recent *Electronic Design*, David L. Holmes describes two inexpensive manual wire-wrapping and unwrapping tools made from small-diameter nickel, aluminium or brass tubing available from hobby shops (outer diameter tubing of $\frac{1}{16}$, $\frac{3}{32}$, $\frac{1}{8}$, $\frac{5}{32}$ and $\frac{3}{16}$ in outer diameter, cut into 2in lengths is used; for the $\frac{1}{16}$ in and $\frac{3}{32}$ in tubing nickel is preferable as it is harder than brass or aluminium).

First epoxy the $\frac{1}{16}$ in tubing inside the $\frac{3}{32}$ in tubing to form two handles. Then, for the wrapping tool, form the stem by applying epoxy to a length of $\frac{1}{16}$ in tubing, insert it into the $\frac{3}{32}$ in tubing and carefully crimp one end of *only* the $\frac{3}{32}$ in tubing until there is a noticeable gap between the two tubes. Make the crimp roughly $\frac{1}{16}$ in long.

Select a drill bit about the size of the wire for which the tool is intended (an example is an 0.020in drill for 30 American wire gauge). Drill a hole through just the $\frac{3}{32}$ in tubing at right angles to the stem at the back of the crimp; then drill a hole through the gap towards the previously drilled hole (see Fig 3). With a file, shape the tubing at the drilled back of the crimp so that a wire inserted from the front slides easily out

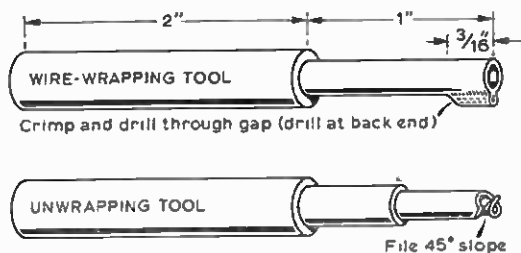

Fig 3. Wire wrapping and unwrapping tools to give a professional finish and made from short lengths of metal tubing. Described by David Holmes in *Electronic Design*

at the back. Finally epoxy lin of the stem inside the handle and allow sufficient time for curing before attempting to use.

The unwrapping tool is intended to remove right-handed wire wrapping. One end of a length of $\frac{1}{16}$ in tubing is filed to about a 45° slope. Then position the tube with the slope to your right and face it upwards. On the side of the tubing closest to you, at the mid-point of the slope, and perpendicular to it, file a notch halfway through the slope and form a counterclockwise groove that winds part way around the tubing. The groove depth should cut partially through the tubing at the start and taper off as it lengthens. Epoxy $\frac{1}{16}$ in of the square end of this $\frac{1}{16}$ in tubing into $\frac{3}{32}$ in and $\frac{1}{2}$ in of the $\frac{3}{32}$ in tubing into the handle, again allowing sufficient curing time before attempting to use.

David Holmes points out that with constant use the tools will wear but the faces can be reformed easily with about 5min work with a file.

"Melt Ohm" fuses and fire hazards

Protection of electronic equipment from fire risk is by no means simple and one still hears occasionally of equipment catching fire, even in the potentially dangerous situation of where it is not being operated. This can arise where components have overheated and then smouldered for some time before actually bursting into flame.

Electronics (22 January, 1976) reports that the Japanese firm Susumu have recently developed a new type of low-wattage, resistor fuse ("Melt Ohm") which fuses at 400°C instead of the more normal 2,000°C. It is claimed that this can be used to break circuits without risk of flaming or arcing. Resistance values are given as from 0.47Ω and 10kΩ, with wattage ratings down to 0.025W. The device will blow within 40-42s when three times the rated voltage is applied across it, or 5-6s at five times rated voltage. It operates without any rupturing of its outer coating so that it cannot, itself, produce risk of fire.

This type of component would thus seem to provide useful protection against equipment malfunctions that could cause fires, although it would still seem to leave a risk which can occasionally arise even when components are functioning normally, but overheating. This risk can of course be minimized by careful design and good quality components, including good ventilation. British domestic equipment manufacturers recommend customers not to obstruct the necessary all-round ventilation—a point to be considered when, for example, squeezing a transceiver into an enclosed space.

PSU for TR2200G etc

The current popularity of small hand-held and mobile equipments has resulted in a requirement for such ancillary items as mains power supplies and battery chargers.

Stephen Price, G4BWE, has sent along details of a simple power supply which allows him to use a Trio/Kenwood TR2200G transceiver from mains supplies and would also be suitable for many other units requiring 12V and which already have built-in voltage regulation.

In such units, which include the TR2200G, it is possible to dispense with zener reference diodes and such techniques as ic operational amplifiers or ic voltage regulation since the equipment can cope with moderate variations in supply voltage. He writes:

"In these circumstances an uncomplicated design has been

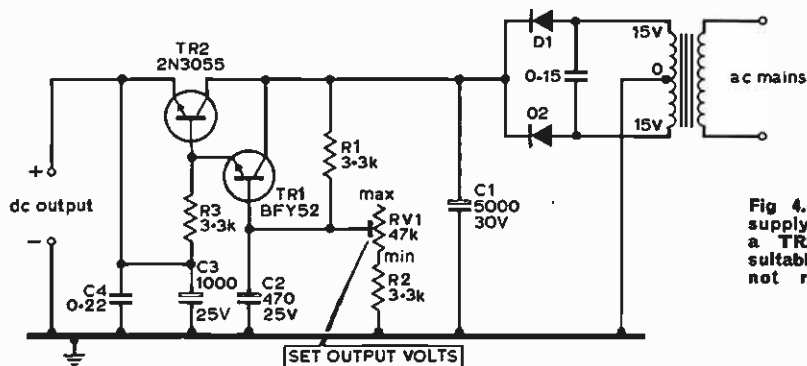

Fig 4. A 12V mains power supply as used by G4BWE with a TR2200G transceiver but suitable for other equipments not requiring full voltage regulation

evolved. The potential divider (see Fig 4) consisting of R1, R2 and RV1 determines the base voltage of TR1 and thus controls the emitter potential of TR2. The 470µF electrolytic (C2) ensures that the control voltage, and consequently the output, is free from ripple.

"RV1 is used to set the output voltage anywhere between 10 and 20V. This control should be positioned for minimum voltage before first connecting the TR2200G; the slider may then be slowly advanced, while keeping an eye on the 'battery check' meter.

"The TR2200G should draw just under 0.5A on transmit, so that for this equipment TR2 requires only a small heat-sink dissipation about 4W on transmit). However, if TR2 is mounted on a larger extruded heat-sink and TR1 is also provided with heat-sink cooling, then the supply should also be capable of providing the 3A or so needed to run a 10W transceiver.

"An alternative to the 15-0-15V transformer would be to use one with a single 15V winding in conjunction with a bridge rectifier."

VHF integrated power modules

Just over five years ago we noted (TT December 1970) that a new technique had been developed to simplify the design of vhf and uhf solid-state transmitters: the *broadband integrated power module*. The idea was to provide "packaged" power amplifiers consisting of several cascaded amplifier stages, correctly matched and forming the basis of a complete transmitter amplifier which might be expected to be less vulnerable to the various forms of parasitic oscillation and the other headaches that can still go with designing transistor transmitters. These modules seem to have been taken up for applications as airborne uhf transmitters and more recently for commercial mobiles. From an amateur viewpoint the only snag was that the cost was fairly high and many modules are designed for frequency ranges not quite covering the amateur bands.

John Wilson, G8KIS, has recently been testing a number of Mullard units and has found they do indeed cut out many of the headaches associated with pa design. He has found that the new Mullard 437BGY/A, for instance, although specified for 148 to 174MHz, will work very satisfactorily on 144MHz nbfn. The component is approximately 5 by 2 by 1cm and with a dc supply of 12V will deliver more than 18W rf output when driven by an input of about 200mW. In effect the device is a complete two-stage Class C power amplifier with input and output matching networks (to

50Ω) built in. Harmonic output is quoted as better than -25dB, though this means, as with virtually all transistor amplifiers, that a low-pass filter is needed. The only other requirements are a heat sink, pc board and decoupling. But, G8KIS comments, unless you cost your own time (or devices lost in the testing) the result is unlikely to be cheaper than building an equivalent transmitter using discrete devices.

He also notes that Mullard Ltd produce a similar unit covering 68 to 88MHz and have a longer-established range of units for 380 to 512MHz. So if you are in a hurry, do not have a ready-built pa available and want to avoid the problem of matching networks, these integrated modules can prove extremely useful.

Ni-cad constant-current charging

Last year (TT March 1975) some notes were included on the charging of ni-cad (nickel-cadmium) cells, along with the charger used by Ken Basterfield, G4BXP. Recently, Peter Martin, G4AZC, has described two adjustable arrangements which he has found useful in keeping in trim some surplus ni-cad cells which power his 144MHz hand-portable unit. He writes:

"These simple but reliable circuits may be of interest to others. The transistor can be any general-purpose type that is capable of carrying 50mA, for example the BC108 of Fig 5 or the pnp version BC308 as used in Fig 6. This series transistor is provided with a clip-type heat-sink.

"RV1 sets the charging current (at 45mA for AA/HP7 size ni-cads) and the light emitting diode acts as a reverse-polarity protection as well as indicating that charging is taking place. The two 1N4001 diodes act as a simple OR gate, allowing either batteries or mains-supply to power the equipment (via a simple regulator circuit to reduce the 20V

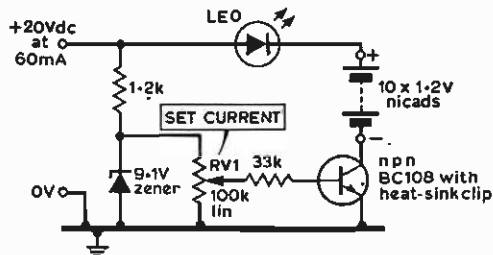

Fig 5. A simple ni-cad constant-current battery charger capable of charging 10 1.2V cells in series (G4AZC)

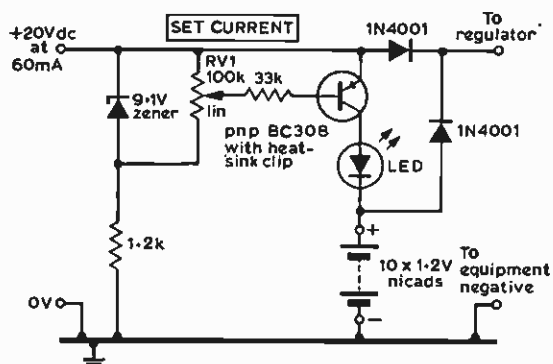

Fig.6. A re-arrangement of Fig 5 enabling the equipment to be used on mains while charging, with automatic switchover to batteries in the event of mains failure (G4AZC)

supply to 12V). In the event of mains failure the equipment automatically goes over to battery power, making the system ideal for such applications as Raynet.

"The components can be assembled on a small piece of Veroboard and mounted in a diecast box, enabling the handheld equipment to be placed on charge while still in operation."

Trimming aerials for resonance

Ted Cook, ZS6BT, was interested in the suggestion (*TT* January) that some of the older techniques used for matching transmitters to aerials possessed some useful virtues. He recalls a method commonly used in the 'thirties, in the "pre-gdo days", to adjust aerial systems—not just nostalgically but in the belief that the system can be updated and put to extremely good use. He writes:

"In my youth the method for finding aerial resonance was to disconnect the aerial from the feedline, insert an rf ammeter, then excite the aerial remotely from another temporary aerial some distance away, adjusting the transmitter and trimming the aerial while observing the rf meter through a pair of binoculars.

"Today we can still make use of this system but we no longer need to disconnect the feeders nor use binoculars; we can do the job from inside the shack by making use of the station's reflectometer.

"We still excite the aerial remotely but we reverse the reflectometer and connect the feedline to a matching dummy load (ie aerial to input of the reflectometer, dummy load to output). Then set the reflectometer to read a forward power of about 10W and vary the exciting frequency until the reflectometer peaks, indicating resonance.

"The explanation is that the aerial has now become the 'source of rf' and the power flowing down the feedline will deflect the reflectometer. But if we remember the rule that 'the coupling between transmitter and feedline cannot affect the match between aerial and feedline' but merely affects the amount of power transferred from the transmitter we find that we now have the power-transfer point at the aerial! The resistive feedline cannot affect the aerial and the aerial cannot react upon the resistive feedline. This means that a reflectometer peak indicates true aerial resonance.

"Imagine setting up and adjusting a tri-band trapped ground-plane by this method, adjusting for each band in

turn. But what about the radials? Of course we can plot the bandwidth of an aerial but what about the matching, especially of those radials?

"The answer is beautifully simple. If the radiation resistance does not match the (resistive) feedline we cannot transfer all the power induced. The reflectometer peak still indicates resonance, but the reading will be below maximum. So if we can find and hold the transmitter at the resonant frequency, we can then adjust the matching if this is a practical proposition. In the case of a ground-plane with radials we can alter radial length and compensate by re-resonating the aerial (as one possible approach). All the rest follows.

"An important warning, of course, is not to attempt to do these adjustments when the band is 'open' or is busy, or you will not be popular! Normally about 100W in the exciting aerial is needed to produce an induced power of about 10W.

"For an experiment, I took my multi-band double-zepp (open-wire feedline down to a Z-match aerial tuning unit) and excited it at 21MHz. Then I tuned it up for resonance and loading into the dummy. The transmitter was next tuned up on the dummy, and the double-zepp thereafter connected to the transmitter. It was so exact that I could not improve either resonance or loading.

"Adjusting a delta- or gamma-match by this technique is easy. It is an ideal way of ensuring that the aerial gets the maximum rf out of the transmitter, always provided that you are not using up lots of rf to heat up a ferrite balun."

A dual-band matching technique

W. A. Roberts, G2RO, has come across a simple but useful aerial matching technique which seems capable of a more general application than in the particular circumstances for which it was used. He has a buried 50Ω coaxial feeder which goes to the bottom of his garden and there connects directly to a grounded 7MHz aerial which is five quarter-waves long (about 165ft) and which has been carefully pruned to resonance so that it provides an excellent match to the feeder.

The availability of a long aerial which is high over most of its length seemed to invite its use on 1.8MHz but, being on this band a quarter-wave plus about one-sixteenth wave, it provides only a poor match to the feeder. However, it occurred to G2RO that if he used a series capacitor to "shorten" the electrical length of the wire to one quarter-wave on 1.8MHz, then the series capacitance likely to be needed would be of a value large enough to make its effect at 7MHz trivial. So it has proved.

The series capacitance turned out to be about 600pF. The match at 1.8MHz became virtually perfect while the difference in the already excellent match at 7MHz was barely discernible. The result is that G2RO now has a dual-band aerial consisting of a single grounded wire correctly and resonantly matched at both 7MHz and 1.8MHz from a single 50Ω feeder.

This dual-band principle, he feels, might be applied to any pair of frequencies separated by a ratio of four or more; examples would be 1.8/7, 3.5/14 and 7/28MHz bands. The same technique could also be equally well applied to centrefed aerials if the matching capacitor is repeated on each side of the feeder connection.

Feedback

John King, G4CFJ, apologises for an error in the item on an interference-free car regulator last month. The value of the resistor to the base of TR1 should be 220Ω, not 330Ω. □

4-2-70

Martin Dann, G3NHE*

International VHF Convention 1976

It looks as though the move to Brunel University will add new dimensions to this major vhf/uhf event, the facilities being considerably improved. For example, excellent seating facilities, with tables, are available in the large room containing the bar, a special licence for which is being obtained. The lectures will be held in three 180-seat theatres which will be linked by closed circuit tv for the opening address and the talk about the state of the art.

Details of the convention, together with application form for tickets, appeared as a supplement to last month's *Radio Communication*, but one or two additional points are worth mentioning. All convention tickets are numbered and during the dinner there will be a draw for prizes which, if previous years are anything to go by, are well worth winning. Also, there will be the customary bring-and-buy sale, and on the Sunday the Pye group will be providing a range of test equipment to test various transmitter and receiver parameters.

With the opportunity to meet old friends, make new ones, attend one of the three lecture streams on Saturday and Sunday, and, for those who wish, dine and dance the evening away in convivial company, this is the vhf occasion not to miss—see you there!

Four metres

When Whitehaven was in the county of Cumberland, G3BW would have been a rarity on 70MHz, but even with G3VVT (Kendal) and G3JYP (Appleby) already active from Cumbria, Bill's appearance is most welcome from this sparsely populated area. Located behind the Cumbrian hills, and with the Pennines forming a further barrier to the south-east, G3BW welcomes offers of skeds and attention by county seekers.

From one rare county to another—John Baker, GW3MHW, of Castle Cacreinon in Powys, regrets the apparent decline of activity on this band. He recalls that in 1964 (before which the 70MHz allocation was only 200kHz wide) it was difficult to find a crystal frequency to clear other band users, but feels that ± 20 kHz of the calling frequencies is now more than adequate, except during some contests. Located 1,200ft asl, GW3MHW is already active on cw and ssb, but proposes to increase his power, aerial gain and aerial height as soon as he can, and hopes to be active on ssb from his old site in Cardiganshire (now Dyfed).

Drew Givens, GM3YOR, also finds activity low on 70MHz in Kirkcaldy, although he lists seven other stations active from Fife, six from Perth, two from Aberdeen, one from Alloa and seven from Edinburgh and the Borders. On several occasions he has heard good signals from GB3SU on an otherwise empty band, and suggests that 70MHz operators south of the border may get a pleasant surprise by looking carefully to the north more often.

Peter Brooker, G3WXC (Coves, IoW) describes himself as

a relatively recent migrant to the "sanity of 4m" but, like the other 70MHz correspondents this month, is concerned by the lack of regular activity. Apart from a lively fm group in Bournemouth, operating on 70.26MHz, Peter hears little in his part of the country. He finds it strange that the few kilohertz of 1.8MHz still capable of carrying amateur traffic are filled with stations making inter-G contacts over a range of 100–150 miles, despite the heavy QRM, while the wide open spaces of the 70MHz band remain almost deserted. G3WXC, QTHR, will be happy to arrange skeds with anyone wanting to work the Isle of Wight on 70MHz, Tuesday or Wednesday evenings being preferred times.

Two metres

After several unsuccessful attempts to work SP by meteor-scatter, GW3NJW (Cardiff) finally made his first Polish QSO on 11 January, not by m-s, but during the auroral opening. During another m-s sked with GM4CXP, Clive was amazed to get a report of 3½min of tropo reception by the Scottish station. GW3NJW's site is so poor to the north that it is some six years since he worked his only GM via tropo, and that was a well-sited portable station, which shows what can be done, with patience, from the poorest of sites.

Both G2AYQ (St Agnes) and G4DMY (Camborne) mention the lively state of 144MHz activity in Cornwall, making it well worthwhile turning the beam in that direction. There are an estimated 40 amateurs on the band, at least 20 of whom use ssb, and G4DMY makes the further point that holidaymakers visiting the county with vhf gear should certainly consider using sideband.

GM3YOR finds activity very spasmodic on 144MHz, with little happening except during openings, auroras and contests. He gets the impression that there are a great many "licensed listeners" on the band who only appear for the exception rather than the norm.

Seventy centimetres

Anyone requiring Cumbria on 432MHz will find G3BW willing to oblige if possible, and he is always prepared to arrange a sked. Bill is active on the band every evening, having a nightly sked with G3AUS in Devon at 2215gmt, followed by a get-together with GD2HDZ and G3KMS (Bolton), all beams pointing south-east. G3BW wonders what has happened to all the activity on 432MHz, having been told of the days (before ssb, Multibeams and the like, and when a '3/20 tripler was the order of the day) when activity was at a level difficult to imagine now.

Moonbounce

Following the report of the G3VZI/WA6LET contact during the November 1975 e-m-e tests on 432MHz, we have now received news of results at the Californian end of the tests. G3VZI was, in fact, the only UK station contacted, but the Stanford Research Institute's team had a total of 91 two-way QSOs, 14 on ssb, during the 31 October and 23 November sessions: they worked 63 different stations in 20 states, 11 countries and 5 continents. In view of the possibility that future tests might include 144 and 1,296MHz, it is interesting to note the estimates made by WA6LET of the equipment capability required on the different bands. The necessary erp to be heard at the institute's 150ft dish is given as 10kW for 1,296 and 432MHz, and 20kW for 144MHz, while the necessary aerial gain minus noise figure to hear them is 20dB for 1,296, 10dB for 432 and 16dB for 144MHz.

* 49 Windermere Court, North Anston, Sheffield S31 7GJ.

DX news

There is no exceptional dx working to report at the time of writing, although there was a spell of reasonable tropo conditions towards the end of February. The south of the country seems to have been more favoured than the north, and the best dx heard of so far was a couple of HB9s who appeared on 2m ssb. G3DAO reports that DL, PA0 and F were audible in Selsey at good strength, and Peter's best dx was DF5FQ/P in QRA EL38a on 144MHz cw. This was on 25 February, but with G3DAO the lift started on the 23rd.

Mike Connah, G8IMF, also found conditions on 144MHz good on 25 February, working F1DBN (AK19c), PA0GNK (CL80j), ON1DG (BL79g), DJ7CL (EI13j), DB4FO (EK65g) and LX1SI (DJ22g). Mike also comments on the mini-auroral opening of 7 February, just 28 days after the good opening in January. He first heard Tone A signals at 1812gmt, and the event was still in progress when he had to go QRT at 1902. No ssb was heard, but Mike did manage to log cw from GM3UKG and GM3JFG, both on beam headings of 25°.

BR34348 of Chatham was listening during the late February opening and heard many Dutch, Belgian and French stations. Few of these, however, were as good dx as G3BW (Whitehaven) who was heard by Harold during the 432MHz Open Contest on 8 February, despite conditions which, he felt, were below average.

Amateur tv sound on 144MHz

The VHF Committee has agreed that, as such operation is usually localized, and on fm, a sound frequency in the upper part of the 144MHz band should be used: if, however, the sound mode is A3j then a frequency in the ssb segment should be selected.

Facsimile on 2m

What may well be the first two-way fax contact on 144MHz took place between G8LHB in Elm Park, Essex, and G3LRO in East Ham. The contact, which took place at 1840gmt on 17 February 1976 was also copied by another West Ham amateur, G3ZZ. Good signals were received in both directions on a frequency of 145.1MHz, but in future, to comply with the band plan, the fax calling channel will be 144.7MHz.

Filling the gaps

Jack Hum, G5UM, was pleased to see that his thoughts on the filling of the empty areas of 144MHz attracted some comment, but regretted that some had taken the suggestion as a resurrection of the old fm versus a.m. argument, which he had not intended. We often receive excellent reasoned arguments for one mode or another, and most of them are perfectly valid, but from different viewpoints such as efficiency, cheapness, convenience, simplicity, aural aesthetics etc. As G8ILJ points out in a balanced argument in favour of ssb, fm and a.m., our vhf/uhf bands are still amply wide enough to accommodate all modes.

Expedition news

Cornishmen G3CZZ and G4DMY will be making the short trip from Cornwall to the Isles of Scilly in April, and between the 10th and 17th will be active on 144MHz ssb. A two-day trip last year resulted in only 12 contacts, but better things are expected this year as a result of much improved equipment.

Finally copy for the June issue should reach G3NHE by 5 May. □

microwaves

Dain Evans, G3RPE*

Microwave data sheets

In order to speed the circulation of design information, the Microwave Sub-committee has arranged the distribution of data sheets which summarize current developments. Information sent in on a particular topic will be given on a single A4 sheet; there will consequently be little room for other than essential constructional details, but these will probably be sufficient for all but the least experienced amateur. In due course the data will be written up formally and these versions will also include additional information on reproducibility or improvements that has been fed back to the originators. This "pre-publication" of data seems to be a useful method for reducing the risks usually associated with the "one-off".

The data sheets already available are as follows:

- No 1. G8AGN 384/1152MHz tripler using a BXY35A varactor.
- No 2. G3WJG 70 or 500mW 384MHz crystal-controlled source.
- No 3. G8AGN 1152/3456MHz tripler using a BXY28E varactor.
- No 4. G3WJG 384/5760MHz varactor multiplier and waveguide filter.
- No 5. G8AGN 3456MHz interdigital filter.
- No 6. G3RPE summary of 10GHz information in *Radio Communication*.

The data sheets may be obtained by sending a large sae to Ann Hayter, G3JHM, QTHR.

From "DUBUS-INFO"

The number 3 1975 issue of *DUBUS-INFO* (obtainable from GW3NJW) contains a troughline 2.3GHz converter by DL7QY which is fitted with an integral BFR34 preamplifier; and also a varicap-tuned indicating absorption wavemeter due to DJ2HF and DC0DA which covers 70-1350MHz. The following issue contains details of PA0VV's version of the G3LQR 1,152/2,303MHz multiplier which is claimed to be significantly more efficient. Using the nomenclature of the June 1975 *Microwaves* note on this design, the modifications suggested are:

- (a) Change the length of the main trough to 59mm and increase L1 to 52mm and L3 to 22mm.
- (b) Connect the input directly to L1 at a point 13mm from its cold end.
- (c) Increase the coupling between L2 and L3 by reversing the tab.
- (d) Mount the output connector 9mm up from the cold end of the circuit.

By reducing the length of L3 to 13mm, this line will then tune 3.4GHz.

The fifth microwave round table

The report on this event has, unfortunately, had to be held over because of shortage of space—Ed □

*4 Upper Sales, Chaulden, Hemel Hempstead, Herts.

UHF repeater planning in the UK

BEFORE 1975 the number of repeater proposals received had been relatively small and the task of administration was divided between the VHF Manager, VHF Committee, Telecommunications Liaison Committee, Telecommunications Liaison Officer and RSGB HQ. However, during the first six months of 1975 the number of repeater enquiries increased to such an extent that it was decided to carry out the main administrative work and co-ordination from RSGB HQ.

As a first step to improving communication with the growing number of repeater groups, a meeting was held at Brunel University in October 1975 in order to set up the Repeater Working Group (RWG) as a sub-committee of the VHF Committee to which it delegated future repeater developments. A large number of groups attended this meeting and a report was published in the December 1975 issue of *Radio Communication*. The Home Office had agreed to answer written questions put by the repeater groups, and their replies were read at the meeting. Arising from the questions, the Home Office invited the Society to formulate an overall plan for a uhf repeater system, which would become the basis for negotiations between the Society and the Home Office for the licensing conditions of future 70cm repeaters.

At the first formal meeting of the RWG in November 1975, the task of preparing the 70cm plan commenced and subsequently hundreds of man-hours were spent on the plan both in full committee and by individual members of the group at smaller informal meetings. The overall plan was completed in time for the RWG meeting on 7 February 1976 at which the Society's general manager, G6JP, and the Telecommunications Liaison Officer, G2BVN, were briefed so that they could present it to the Home Office at a meeting held on 12 February.

The plan

At the first meeting of the RWG several alternative approaches were considered and after much discussion it was concluded that the following criteria should be used when formulating the plan (not necessarily in order of importance):

- (1) UK population distribution;
- (2) The location of affiliated societies and RSGB groups;
- (3) The location of electronics industries and institutions;
- (4) Location of repeaters already proposed;
- (5) Terrain;
- (6) Typical uhf repeater coverage.

In trying to determine the most likely areas where a repeater should be located, the group used these criteria for the following reasons; (1) Overall population distribution should indicate amateur population distribution; (2) affiliated societies would probably compose the core of potential repeater groups and hence be a guide to future repeater locations; (3) in areas where electronic research, development and manufacture are undertaken it could be expected that a viable repeater group had been or will be formed; (4) those repeater groups would have already produced acceptable proposals; (5) it is likely that two closely-spaced communities would not be served adequately by one uhf repeater because of intervening high ground; (6) as a result of the experimental data derived from the GB3PY experiment, tests at other sites, and data obtained from a professional report on uhf path losses, typical repeater performance was established.

Calculations showed that a 75 per cent coverage area of a 10W erp transmitter over average terrain to a mobile station does not normally exceed the equivalent of a 35km square. Thus it was decided to construct a 33km square grid covering the UK. The agreed criteria were applied in each square to determine the likely repeater requirement.

Location

The map shows the likely uhf repeater locations and, as it is in part a projection of the requirements for the foreseeable future, it was necessary to consider three time scales.

Phase 1—The 21 proposals submitted to the Home Office on 12 February 1976.

Phase 2—The repeaters likely to be proposed within the next two to three years (the most likely to be considered are those indicated).

Phase 3—Those repeaters likely to be proposed from three years hence, including possible special installations.

The actual repeater position within each grid square will be determined by terrain and other local conditions. Thus for grid squares with projected repeaters the actual position in the square shown on the map need not necessarily be correct.

Frequencies

Because two factors primarily determine the number of repeater channels; minimum geographical spacing consistent with an acceptable level of co-channel interference under normal propagation conditions, and minimum number of crystals required, five channels were considered to be the optimum.

A plan for 70cm which already existed was that recommended by IARU Region 1 at the 1975 Warsaw Conference, in which repeater inputs were from 433.00–433.225MHz, with output frequencies 1.6MHz high in frequency [1]. The group decided that this plan was not suitable because (a) the UK allocation 430–432MHz was not being fully utilized; (b) the plan may not be the optimum for compatibility with ATV operation; (c) it was thought desirable that it should be possible to monitor repeater output frequencies within the range normally covered by tunable receivers.

The RWG considered an alternative plan which would have used a national output band from 433.225 to 433.40MHz and two input bands, one for the restricted zone (see map) with inputs 1.6MHz high, and 2MHz low in all other areas. It was hoped that the restricted zone transmitting limitations would be lifted and the low frequency input channels would be adopted nationally. The Society contacted the Home Office to see if these transmitting restrictions could be lifted, but was advised that this would not be possible for many years. As an alternative the Society suggested the use of two spot frequencies within the restricted zone, but this was also ruled out.

The RWG was then faced with a very difficult decision; should there be a split input system for an indeterminate period of many years or should it propose a single national plan? It was decided that the latter was preferable, and other interested parties were then consulted. Almost all agreed that this was the best solution, and the proposal adopted is shown in the table.

Channel No.	Repeater output frequency (MHz)	Repeater input frequency (MHz)
RB2	433.05	434.65
RB4	433.10	434.70
RB6	433.15	434.75
RB10	433.25	434.85
RB14	433.35	434.95
Simplex channels		
SU8	433.20	Working channel
SU12	433.30	RTTY
SU16	433.40	Working channel
SU18	433.45	Working channel
SU20	433.50	Mobile calling channel

A 50kHz system has been recommended to ensure compatibility with existing equipment. It is envisaged that a 25kHz channel spacing system could be used at some time in the future.

The Home Office has already approved in principle the RWG plan, and following a further meeting it is anticipated that a block licence will be issued shortly.

70cm REPEATER BAND PLAN

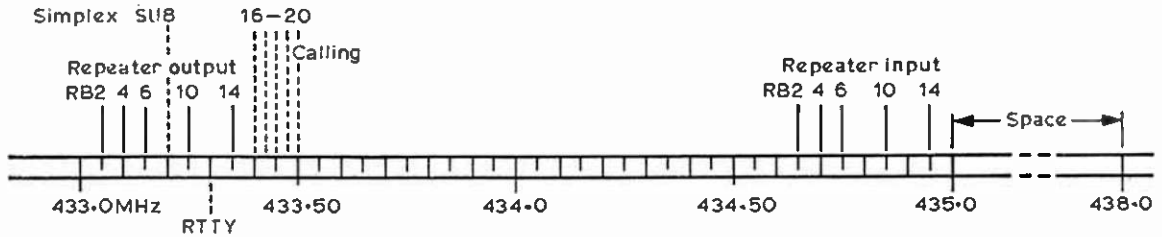

Summary of repeater locations April 1976

The last two letters of the repeater callsign are shown on the map together with the channel number.

PHASE 1

- GB3HU—Hull
- GB3MR—Manchester
- GB3LL—Llanddulas
- GB3ST—Stoke on Trent
- GB3CB—Birmingham
- GB3ME—Rugby
- GB3CI—Corby
- GB3BD—Bedford
- GB3PY—Cambridge
- GB3WS—Sudbury
- GB3IH—Ipswich
- GB3LT—Luton
- GB3LV—Cheshunt
- GB3ER—Danbury
- GB3HR—Bushy
- GB3LW—Central London
- GB3EK—Margate
- GB3NS—Banstead
- GB3PH—Portsmouth Hill
- GB3BR—Brighton
- GB3SD—Portland
- GB3SH—NW Kent (Final location as yet unknown.)

PHASE 2 (+ allocated channel)

- GB3ED—Edinburgh RB14
- GB3GL—Glasgow RB14
- GB3FC—Fylde Coast RB2
- GB3PF—Pendle Forest RB6
- GB3LI—Liverpool RB6
- GB3LE—Leicester RB10
- GB3KL—King's Lynn RB4
- GB3NR—Norwich RB2
- GB3YL—Yarmouth area RB14
- GB3NH—Northampton RB14
- GB3HP—Aylesbury RB2
- GB3BS—Bristol RB10
- GB3BN—Bracknell RB4
- GB3CH—Caradon Hill RB2

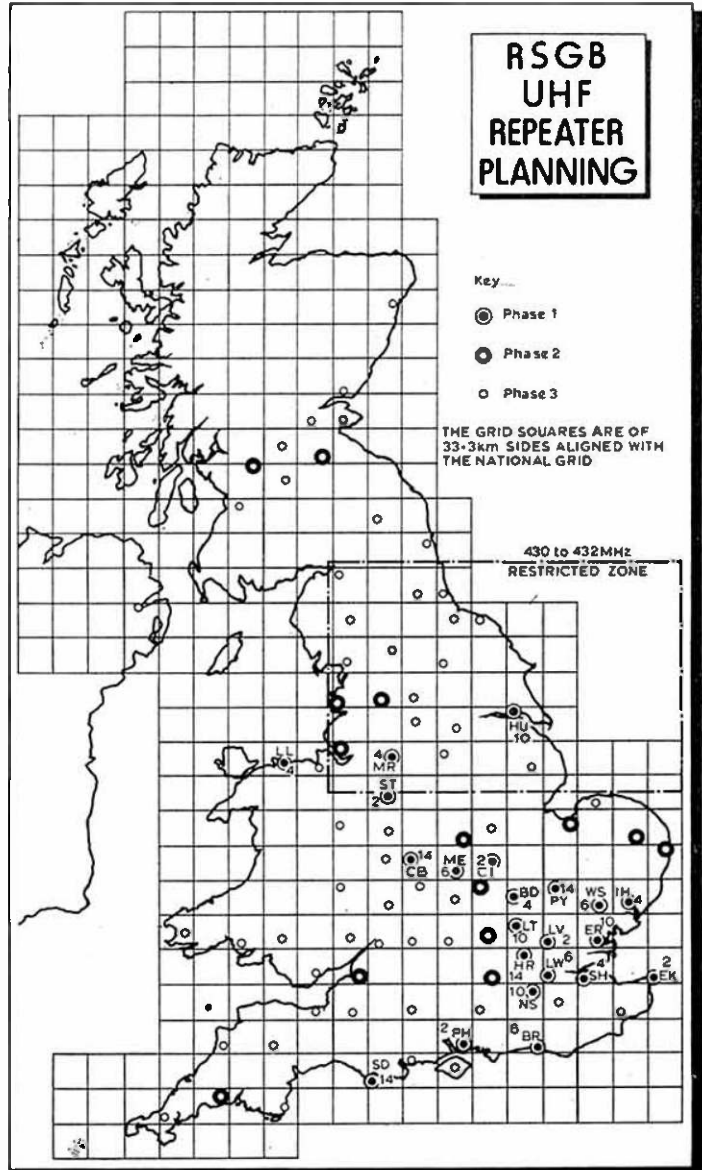

A copy of this map measuring 9in by 15½in is now available from RSGB HQ, price 29p incl p & p.

the month on the air

John Alloway, G3FKM*

IT is calculated that there are about 400,000 licensed amateur radio operators in the world at the present time, and that the total number will reach one million by 1981-2. The amateur radio service will be pressing for extra frequency space at WARC 1979 and it is most important that we are seen to be using what we already have to the fullest extent during the next three years. The current silence on 21 and 28MHz could very effectively be broken by their use for local contacts at times when no long-distance propagation exists.

10m activity day

A second 10m activity day has been arranged for 11 April 1976 (0001 to 2359). Any mode may be used and all amateurs are asked to take part. Listener reports will be appreciated, and in order to stimulate interest participants are asked to exchange reports and serial numbers (from 001). This is not a contest but an exercise to study propagation at the bottom stage of the present sunspot cycle, and also an attempt to increase the use of this band, bearing in mind that the WARC will be considering the level of amateur usage of all our bands in 1979. Please send reports and opinions of band conditions to the organizer—D. Whitaker, BR525429, c/o RSGB, "Hillcourt", 57 Green Lane, Harrogate, N Yorks.

Top band news

The latest letter from VK3CZ details European signals heard or worked during the four weeks ended 26 February. He only missed three mornings and his loggings were as follows: 30 January G3ZYY at 1919, 7 February DJ3CY at 1942, 8 February GD4BEG at 1947 followed by a contact with G4AEH and hearing PA0RYS. OK4NH/MM was heard on 12 February at 1943, OH2BM on 17 February at 2002, and G3ZYY on 21 February at 2004. DHJ was heard each day except 6 February. Arthur says that he will use 1,803.2kHz in future to avoid VK5KO who usually uses 1,802kHz, and whose sunrise is about 30min later.

9G1LZ reports hearing G3SZA, G3KMI, GD4BEG, other Gs, GWs, GMs, EI0CL, PAs, DLs, OKs, W6BYB/VE1 and W1,2,3,4 and 8 plus KV4FZ between 0100 and 0200 on 24 January. VK6HD heard DL0KS, DJ0YD and GM4AHY.

It is believed that ZL stations may now use 1,803 to 1,813kHz. ZL2BT reports that this is much better than the former segment around 1,875kHz.

DX news

Recent changes in former Portuguese colonies in Africa have meant sadness and suffering for the holders of a number of well-known call signs. It is believed that CR6LF lost his home and all his belongings (but not his log books for the period 1965-75) and is now in South-West Africa. He may be reached at the address given in *QTH Corner*. In Mozambique C9MIZ, C9MBU, C9MFO, C9MIC and C9MRV all

had their equipment confiscated by the police on 20 December.

VK6RU, who is QSL manager for both VK9XI and VK9XW, says that both stations are frequently to be found between 14,225 and 14,235kHz on Mondays from 1300 to 1500.

ZD7SD, Bill, and his wife Sybil, ZD7SS, are reported to be active on 3.5MHz ssb between 0500 and 0900, and on 7MHz from 0930 to 1200. ZD7SS is often to be found between 14,215 and 14,255kHz at weekends between 2000 and 2300.

As from 1 February the rule regarding submission of QSL cards for DXCC credit for those with at least 250 confirmed was changed, and they may now submit cards once a year regardless of number.

VE1BFV has been active on 14MHz ssb. He is located on Sable Is and says that he will be there for another five months. He works at the weather station and he has another amateur with him. At the time of writing they had an FT101 and long-wire aerial, but it was hoped that a linear and beam would be available soon. W3HNC has been quoted as QSL manager.

Guy, FR7ZL, says that he made 2,509 contacts from Glorioso during his 97-day stay. He expects to be going to Europa Is in June—this island counts as Juan de Nova. His stay should last until August.

The latest schedule of operation by LUIZA in the S Orkneys is as follows: 0100-14,060kHz, 0200-14,330kHz, and 0400-7,003kHz. Those who would like a contact with the S Shetlands might be interested to know that a new station—CE9AV—has been worked around 14,209kHz at 0030.

Recent discussion concerning the possible separate DXCC status of Walvis Bay was followed up by your scribe. In a letter to G3FKM, Garth Grobbelaar, ZS3AA, confirms that the area, although belonging to South Africa, is in fact administered by South-West Africa so cannot be counted separately from the latter.

The exhibition station from the Third Ghana International Trade Fair operated as planned using the call sign 9G1TF from 31 January to 15 February. Sixty-two countries were contacted, and visitors included Col I. K. Acheampong, the Head of State.

Expeditions

JA0CUV/1, JA2PJC and JA3KWJ started a Pacific expedition on 23 March. They were due to visit Nauru and the Gilbert Is, and then spend two weeks on Tuvalu (commencing 23 March), followed by three days each at Fiji, New Hebrides, Solomon Is, and Nauru again on their return journey to Japan. JA0CUV/1 and JA2PJC already hold the calls VR1AJ and VR1AK. Likely frequencies to be used are given as 1,803/1,826, 3,505, 7,005, 14,005/14,025, 21,005/21,025 and 28,005/28,025kHz for cw operation, and 3,775, 7,095/7,150, 14,195, 21,300 and 28,600kHz ssb. QSLs should be sent to JA0CUV/1 with IRCS and SAES (see *QTH Corner*).

Another Japanese activity—by the Kanagawa Sea Exploration Team, who will be visiting Parece Vela during April or May. They will have two licensed amateurs with them and it is possible that they will be active as JD1YAH/JD1E. Parece Vela was not given DXCC status when last considered a few years ago.

9L1JM will visit Turtle Is (off the coast of Sierra Leone) for one day—possibly on 10 or 11 April. He may use the call sign 9L3JM.

Bill Rindone, WB7ABK, was leaving on a major expedition in mid-March, going first to Tonga, and then through the

*10 Knightlow Road, Birmingham B17 8QB.

QTH Corner

A35AF via WA4NRE, R. Crawley, Box 1895, Knoxville, Tenn., 37901, USA.
CSAJ via DL7AH, Cronstettenstr 62, 6000 Frankfurt 1, W Germany.
CSAM Fr M. Cleary, Box 463, Banjul, Gambia.
ex-C0M1Z via REP Bureau Rua D. Pedro V 7-4, Lisbon 2, Portugal.
ex-CR6LF PO Box 21543, Windhoek, 9100 South-West Africa.
ex-CR6Z J. Fidalgo, Rua Marques de Pombal No 4, Tomar, Portugal.
JA0CUV/1 Teck Kumagai, Box 22, Mitaka, Tokyo 181, Japan.
K860V/K86 via K56FF, PO Box 1618, Pago Pago, American Samoa, 96799.
PJ8CO via W1VE, C. O'Rourke, Apple Lane, Roxbury, Ct, 06783, USA.
PJ0USA via K2FJ, E. Palmer, RFO 3-Williston Rd, E. Aurora, NY, 14052, USA.
PY0BXC J. Faria, Rua Cel Joaquim Calvacante 393, 5300 Oitinda, PE, Brazil.
PY0PO J. Alexandre F, Rua A. Novais 174, Gracos, 50000 Rocife, PE, Brazil.
VU7AN1 F. W. Burn, Chatham PO, Pl. Bialr, Andaman Is, via India.
7P8AG } via SM3CX5, J. Svansson, Berghemsv 11, 86021 Sundsbruk, Sweden.
7P8AH }

RSGB QSL Bureau, G2MI, Bromley, Kent, BR2 7NH.

Pacific to Asia and Africa. Most stops will be in rare countries, and he expects to activate a new one. Both cw and ssb will be used, and frequencies will be about 25kHz above the lower band edge on cw, and ssb just below 7,100, 14,200, 21,300 and 28,600kHz. Equipment includes a TS520 plus TA-33 beam and dipoles.

HC1XG hopes to be active from the Galapagos Is as HC8XG between 25 April and 9 May. He may use cw only, but may also be accompanied by one or other operators who will use ssb.

International Amateur Radio Hds

G3YBH (P. Storey, 29 Chalfont Rd, Liverpool 18) has recently been appointed British co-ordinator for this organization, which is similar to the "Ham-Hop Club". Interested readers are invited to write to Phil for details (see page 5). The club exists to help those going overseas to get into contact with amateurs in the areas they will visit, and to arrange sightseeing and/or accommodation. It covers 19 countries at the time of writing and more helpers in the UK would be very welcome.

Contests

Helvetia XXII Contest

1500 1 May to 1700 2 May.

1-8 to 28MHz, cw and phone—the same station may be worked on each band for QSO and multiplier credit, but only on one mode. Exchanges consist of RS/T followed by serial number (from 001), and Swiss stations indicate their canton with a two-letter suffix. Each contact counts three points and the multiplier is the sum of cantons worked on each band added together. Include a summary with log and also a signed declaration that the rules of the contest and local amateur radio have been observed. Post within 30 days to: USKA Traffic Mgr, Rene Oehninger, HB9AHA, im Moos, 5707 Seengen, Switzerland. This contest is an excellent way of making contacts to qualify for the beautiful "H-22" certificate.

WAB Contest (LF phone)

0900 to 2100 4 April.

1-8, 3-5 and 7MHz. Exchange RS/QSO number/WAB area/county/WAB book if any. Send logs to G4BFY, 10 Toll Bar Av, Bottesford, Nottingham, NG13 0BB.

The Bermuda Contest

0000 24 April to 0200 25 April (Phone).

Full rules were given on page 216 of March *Radio Communication*. Please note that it is not permitted to contact USA/Canadian stations transmitting outside the Region 1 section of the 7MHz band (above 7,100kHz) in the phone section of this contest.

The PACC Contest

1200 24 April to 1800 25 April.

1-8 to 28MHz. Please avoid lower 10kHz of cw bands, and upper 25kHz of phone bands in accordance with IARU recommendations. Single- and multi-operator sections. Exchange RS/T plus serial number (from 001). PA/PE/PI stations will also give a two-letter code which indicates their province. Each QSO counts three points and stations may be worked only once per band—either cw or phone. No cross-mode contacts are permitted. The multiplier is the total number of provinces contacted on each band added together (maximum 72). Logs should indicate date and time, station worked, number sent and received, if multiplier, points claimed. They should be posted before 30 June to: VERON Contest Manager, PA0DIN, PO Box 1166, Arnhem, The Netherlands. A signed declaration that the participant has observed the contest rules and also the amateur radio regulations in his country must be enclosed. Listeners may take part and should log PA/PE/PI stations only, noting the code group given by them and the call signs of the stations being worked. Each station counts one point, the multiplier being the same as in the transmitting section.

In the 1975 PACC Contest UK scores were as follows: GM3KLA (5,628 points), G3ESF (4,284), G3TXF (825), GW4DOO (540), G3MCA (510) and G4BBA (40).

Band reports

No reports of any signals being heard on 28MHz have been received this month; correspondents will no doubt hope that the forecast of the beginning of the next sunspot cycle later this year is correct.

Many thanks to the following for data used in preparing this section: Gs 2HKU, 3HB, 4RZ, 5JL, 6GH, 3KSH and 3UOL, BRSSs 17567, 31301 and 35608, and As 7056, 8312, 8428, 8713, 8783, 8946 and 8961.

Stations listed in italics were using ssb, the rest cw.

1-8MHz. 0100 W4BVV, PY1RO. 0400 K1PBW, AC2PV, A4EAS, 0500 W2HCW, W3WJD. 0600 EA8CR, W8HIO. 1900 VK3CZ, VK5KO. 3-5MHz. 0000 EA9FE, VU2GDG. 0100 FG7AR/FS7. 0200 A4XF. 0300 EP2SN, PZ9AB, VE1BFV (Sable Is), VP2s. 0400 VP1DW. 0600 HI, HR, XE. 0700 C6ABA, F77AW, VE2ASQ/TG9 (QSL to VE2KQ), ZL2-3-4, ZL3NR/C. 1700 HZ1SH, ZLs 2BT, 4KE, 3D2KG. 1800 DE8DK/YK, Z66JL. 1900 J01AKE, JH0BQL. 2000 JAs, ST2SA, 575CJ, 5X5HK, 9M8HG. 2100 FP8FU, ZB2A, ZSs, 5Z4LW, 9K2DR, 9X5PT. 2300 HZ1PT, YB0ABV, ZD7WT.

7MHz. 0700 VKs, ZLs. 0800 JAs, VKs, ZLs. 1600 9V1SR. 1800 457DA. 1900 FL8SD. 2000 9K2DR. 2100 A9XU, YB0ABV, 9L1BH. 2200 CE8AA, TU2EF, 8P6DW. 2300 FG7AM, JA6YG, KP4s, PY0PO, ZD7WT.

14MHz. 0000 KC4AAC. 0700 A9XT, J71s AH, AQ, ST2SA. 0800 AP2AC, JAs, SV1HA/P (Corfu), ZLs. 3D2KG, 5N2s. 0900 JAs, JH1KSB/JD1, WB9REK/KL7, KX6LX, P29KE, PY0PO, VR4DX, 9N1MM. 1000 DU1EJ, 3D2AJ (QSL to W6SC). 1200 J71AK, KC6AA, V56BL. 1300 VK9s, XI, XW, 9N1MM, 1400 9M8HB. 1500 YB8ACK. 1600 KL7IEH, VQ9P, 9M2s. 1700 FG7AR/FS7, 9L1BH. 1800 3B8DA. 1900 KH6CF, KL7PI, VP8NK, ZD7WT, 4K1A. 2000 KC4USG, VP1PTL. 2200 LU, VP2s. 2300 CEs, LUs, PYs, ZD7FT.

21MHz. 0900 5T5ZR, 9V1SH. 1200 VP8LP, ZD7WT, ZPs, ZSs. 1300 FR7BB. 1400 F6DKJ/FM7, F77AW, 3B8CV, 5U7BA, 5V7WT, 9L1BH. 1500 FB8ZG, K3HVG/HR6, ST2SA, ZD7FT. 1600 CE8CH, 9G1LZ. 1700 KC4AAC. 1900 CPs, D4s, DAs, VP2s.

Many thanks to all correspondents, and also to the following for items extracted from their publications: DX News Sheet (*Geoff Watts*), the 29 DX Club Newsletter (*VK6RV*), Long Skip (*VE1ALJ3*), the West Coast DX Bulletin (*WA6AUD*), DX'press (*PA0TO*), CQ Magazine (*WIWY*), and the Ex-G Radio Club Bulletin (*W3HQO*).

Please send all items for May issue to reach G3FKM no later than 5 April, and for June issue by 5 May. □

Propagation predictions

As sunspot activity is still low, the propagation predictions are much as they were last month. The change from winter to summer conditions, which occurs during April, will lead to a worsening of already poor conditions on 21 and 28MHz. 28MHz will be of no practical value to dx, but short-skip conditions will live up this band as well as 21MHz over distances of about 700-1,800km. Traffic with North America and Japan will be almost impossible. Traffic with Africa and South America will be possible only for very brief periods.

As the season advances, 14MHz will remain open noticeably longer than in previous months, while traffic with Australia will become more difficult during the afternoon. During June and July the favourable conditions for traffic with Australia are on 14MHz before noon. The times for traffic with Japan will change during the course of summer from mid-morning to afternoon, and in high summer there will also be a chance of contact during the early hours of the morning. Traffic with KH6 will be possible on days with average MFUs from about 1630 to 2100 gmt on the direct and from 0530 to 0700gmt via the indirect path. On the whole, chances for dx via the indirect path on 14MHz during April will be relatively poor.

Shorter nights and rising F2 night frequencies will lead to an improvement in traffic with North America on 7MHz during the second half of the night. Traffic with South America and South Africa will also improve as the month goes on. The F2 daytime frequencies are mostly well below 7MHz, causing interruption of local traffic by the dead zone.

On 3.5MHz, dx traffic will be possible if the whole of the path lies in darkness. This applies even more to this band than to 7MHz. The advancing summer and increased static will shorten the distances covered. Local traffic will seldom be interrupted by the dead zone.

14 MHz		APRIL 1976																				
USA-East W1-4	S																					
USA-West W6,7	S																					
Caribbean 6Y5,FM, TI	S																					
Brazil PY	S																					
South Africa ZS	S																					
SE Asia HS, 9M2	S																					
Australia VK	S																					
Japan JA	S																					

Time (GMT) 00 02 04 06 08 10 12 14 16 18 20 22 24

21 MHz		APRIL 1976																				
Caribbean 6Y5,FM, TI	S																					
Brazil PY	S																					
South Africa ZS	S																					
SE Asia HS, 9M2	S																					
Australia VK	S																					

Time (GMT) 00 02 04 06 08 10 12 14 16 18 20 22 24

S... Short path 1-5 days 6-20 days
 L... Long path Openings on more than 20 days in the month

HF propagation study

THE RSGB Propagation Studies Committee (formerly known as the Scientific Studies Committee) proposes to publish additional hf propagation predictions for the next 12 months, as part of its study programme. The predictions, supplied by Cable & Wireless Ltd, show the highest probable frequency (hpf) in megahertz times 10, at two-hourly intervals of gmt, for up to 50 different routes to/ from the UK. The predictions for Suva, Sydney and Wellington are shown for both the short (s) and long (l) routes.

Since the standard muf is based upon monthly median values of ionospheric characteristics, the probability of a sky-wave path for this frequency is assumed to be 50 per cent. The frequency that would have a 90 per cent probability of propagating (fot) and the frequency which has 10 per cent probability (highest probable frequency—hpf) is obtained by multiplying the median standard muf by an appropriate factor. In the prediction tables an hpf/muf factor of 1.27 has been used for all routes at all hours.

The reason for quoting hpf's in these predictions is to indicate at a

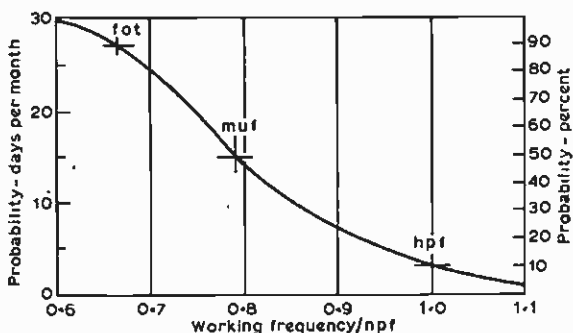

glance the highest frequencies on which operation is likely to be possible. This is to cater for the avid dxer and those wishing to make optimum use of the available hf spectrum, for example during contests. The communication probability on any band can be determined by finding the hpf from the tables, calculating the ratio of frequency band/hpf and applying this to the graph.

As an example of use of this month's tables, suppose it is desired to communicate with Nairobi on 28MHz. There would be little probability of doing so when the hpf is less than 28, so the best time is between 1400 and 1700. At 1600 the ratio 28/hpf is 0.94 giving, from the graph, a probability of five days; while on 21MHz, the ratio 21/hpf is 0.7 giving a probability of 25 days. On this basis it might seem that communication on 14MHz is a certainty; however, absorption and noise are inversely proportional to frequency so although the propagation probability is high the signal level will most likely be well below noise level. As a rule-of-thumb guide, the two amateur bands immediately below the predicted hpf will be the ones most likely to provide communications.

Reports of conditions would be welcome on as many of the routes as possible, in the form of an extract from the station log, giving date, frequency band, callsign, time worked/heard and whether short or long path (where appropriate). These will be evaluated in conjunction with the predictions, and, periodically, appropriate modifications will be made to the route hpf factor where necessary, thus improving the accuracy of the predictions. Reports should be sent to G4AQ, QTHR.

GMT	Predicted hpf's (MHz x 10) for April 1976																									
	00	02	04	06	08	10	12	14	16	18	20	22	24	00	02	04	06	08	10	12	14	16	18	20	22	24
Aden	120	120	144	201	235	246	258	272	275	188	135	117	120	110	119	108	68	208	246	244	275	291	322	249	149	110
Ascension	125	125	152	199	224	230	239	248	247	200	158	120	125	125	125	152	199	224	230	239	248	247	200	158	120	125
Barbados	115	102	97	87	115	192	215	215	233	230	235	194	115	115	94	92	82	101	159	197	199	214	205	208	174	115
Bermuda	112	97	92	96	120	154	211	211	227	221	225	165	112	111	114	102	112	121	228	229	247	263	263	257	171	111
Buenos Aires	108	122	106	181	230	253	260	265	291	270	195	128	108	115	125	158	199	221	220	227	237	220	138	122	186	115
Cape Town	116	115	129	178	209	213	218	232	232	224	213	124	116	105	115	105	122	196	241	237	260	275	288	251	186	105
Dakar	122	102	97	83	94	100	144	164	171	181	172	149	122	125	121	120	131	128	131	134	141	149	143	143	136	125
Denver	111	114	105	119	144	224	233	233	272	272	257	164	111	73	83	72	102	131	152	153	157	168	168	162	103	73
Fairbanks	98	84	135	174	191	195	196	178	139	129	135	105	98	98	84	135	174	191	195	196	178	139	129	135	105	98
Falklands	128	120	119	129	141	129	122	111	143	159	157	139	125	117	95	97	98	115	140	199	202	216	211	214	165	117
Gibraltar	110	117	107	158	221	253	257	254	298	338	194	114	110	98	112	96	114	174	210	210	223	232	238	227	150	88
Hongkong	115	106	98	100	130	112	219	226	241	238	247	182	115	124	105	100	100	93	81	114	158	172	176	168	147	124
Los Angeles	88	97	88	133	164	178	181	191	195	196	185	110	88	117	100	124	156	234	247	265	274	277	225	172	130	117
Malla	119	95	92	97	115	114	101	181	202	192	190	182	119	84	68	108	144	163	174	173	174	178	167	149	101	84
Mauritius	119	116	121	197	239	253	271	281	298	260	168	115	119	117	114	161	188	209	210	211	216	216	145	131	124	117
Mexico	119	110	97	86	98	145	191	183	200	199	197	153	119	98	92	145	162	180	161	176	158	121	122	122	111	98
Moscow	122	125	158	199	220	220	183	140	135	138	135	122	122	111	114	103	117	119	234	232	252	272	271	258	194	111
New Delhi	116	115	116	195	238	256	271	289	304	324	223	129	116	117	114	161	188	209	210	211	216	219	183	171	107	117
New York	124	122	122	141	162	173	174	149	125	130	149	129	124	103	119	108	153	150	121	120	121	128	121	215	138	103
Oaska	98	84	156	174	191	189	143	145	147	140	122	108	98	114	107	100	102	148	108	108	102	97	102	172	167	114
Perth	125	112	108	122	106	103	133	150	161	147	157	143	125	115	110	128	152	168	147	136	136	145	114	145	125	115
Rio de Janeiro	111	114	103	119	219	234	232	252	272	271	258	122	111	101	116	105	128	117	97	103	112	117	114	171	150	101
Sallebury	116	115	116	195	238	256	271	289	304	324	223	129	116	116	115	116	195	238	256	271	289	304	324	223	129	116
Singapore	117	114	161	188	209	210	211	216	219	183	171	107	117	125	112	108	122	106	103	133	150	161	147	157	143	125
Suva (s)	103	119	108	153	150	121	120	121	128	121	215	138	103	115	110	128	152	168	147	136	136	145	114	145	125	115
Suva (l)	98	84	156	174	191	189	143	145	147	140	122	108	98	114	107	100	102	148	108	108	102	97	102	172	167	114
Sydney (s)	125	112	108	122	106	103	133	150	161	147	157	143	125	115	110	128	152	168	147	136	136	145	114	145	125	115
Sydney (l)	115	110	128	152	168	147	136	136	145	114	145	125	115	101	116	105	128	117	97	103	112	117	114	171	150	101
Wellington (s)																										
Wellington (l)																										

council proceedings

A brief report of the Council meeting held on
23 January 1976

Present: Dr E. J. Allaway (President, in the Chair), Messrs D. J. Andrews, R. J. Baker, P. Balestrini, J. O. Brown, D. Byrne, D. S. Evans, R. W. Fisher, W. F. McGonigle, C. H. Parsons, D. M. Pratt, W. A. Scarr, R. F. Stevens, G. M. C. Stone, C. J. Thomas, D. M. Thomas (members of Council) G. R. Jessop (general manager), A. W. Hutchinson (editor), D. A. Evans (minutes secretary).

Apologies for absence were received from Mr A. W. Smith, GM3AEL. The President welcomed the new Council members to the meeting and reminded all present that Council meetings were of a confidential nature.

Election of Executive Vice-President

Mr Stevens said that just as in 1970 and 1973 when Dr John Saxton had been a prestige President it was desirable to have a similar President before 1979. Several members of Council had considered this and Lord Wallace of Coslany had been asked if he would be prepared to stand for nomination for President in 1977. Mr Stevens said this offer had been made on a very tentative basis and that Lord Wallace very promptly replied in the affirmative. In addition, Lord Wallace had intimated that he wished to become involved with the Society during 1976 so that experience could be gained prior to 1977. As Lord Wallace could not be appointed Executive Vice-President for 1976 Mr J. O. Brown agreed to assist the Society by accepting this office.

"Council proceedings"

Considerable discussion took place on expediting the publication of "Council proceedings". It was decided that for a trial period it would not await approval by Council but would be approved by the President and the general manager for publication in the earliest possible issue of *Radio Communication*.

Financial report

Mr Brown said it was too early to give complete results for the first six months of the financial year 1975-6. He summarized the position by saying that the deficiency was less than the amount budgeted, main points being that book sales and advertising revenue were more than budget, while subscription income was below budget.

Mr Brown read a letter from Halsey, Lightly & Hemsley (Solicitors) stating that Mrs Shirley-Price, widow of the late Mr D. R. Shirley-Price, G8SP, had left the sum of £4,292.50 to the Society. This legacy was largely the result of out-of-office activities by Mr A. Othen in connection with the disposal of deceased amateurs' equipment. In the case of Mr Shirley-Price, G8SP, his widow had obviously been grateful to Mr Othen for the work done, and had thus made the legacy to the Society.

Purchase of a data processor

Mr Brown said that this matter should be fully discussed and a decision made at this meeting; there being three main alternatives for the long-term future of the Society and its membership records:

- (1) The records could remain as at present with the necessity of employing more staff at higher inflating salaries. For book despatches extra ancillary equipment would have to be purchased to make the operation more efficient.
- (2) The Society could look at a computer bureau solution to membership records, but because of the lack of control and dubious staff savings he did not favour this approach.
- (3) Purchase a mini office processor such as the IBM32 to do both membership and book sales accounting, which could be paid for over a period of some years.

Mr Brown said he favoured the IBM32 processor and reported his conversations with other IBM32 users.

Mr Jessop presented a diagram showing present staff, and predicted staff if the IBM32 were purchased. He saw a saving of at least two or more staff if the IBM32 were integrated correctly into the Society's operations, and the saving of staff salaries would be substantial.

Mr Stevens asked if the Society could really afford the new

VHF/UHF Manual, the new *Radio Communication Handbook*, a processor and a deficit at the same time.

Mr Brown reported that with possible bank assistance the Society would certainly not run out of money.

Mr Jessop asked that revenue items and capital items should not be confused, but considered separately. Both books would earn the Society revenue in due course.

Mr Parsons said that the Society's problems had to be solved and these included the book sales as well as the membership records and that the IBM32 appeared to be the right solution.

Mr Jessop explained some of the problems with the subscription records and the Elliott system at present in use, which was laborious and time-consuming.

Mr Byrne said he did not see how the Society could proceed without a modern system and advocated the purchase of the IBM32 system.

In reply to a suggestion by Mr C. Thomas, that the ICL2903 machine was a cheaper alternative, it was stated this had been fully investigated but on several grounds it was unsuitable for the Society's use.

Dr Dain Evans asked if annual estimates of cost savings had been made.

Mr Jessop replied that between £5,000 and £7,000 should be saved annually and that these savings would result in considerably better membership services.

Mr Pratt asked about operation.

Mr Jessop said this would present no real problems and several members of the existing staff would be trained in specific routines.

Mr Baker said he was one hundred per cent behind the project but queried the cash flow position.

Mr Brown said that the bank would assist the Society if required and that for this reason it was important not to delay the project.

Mr D. Thomas thought the project was very well worth looking at and that he had explored a time-sharing system. Mr Jessop reported that the costs of this system had been received and examined at headquarters. The relative costs of the time-sharing and other systems had been compared but the former were not attractive.

Mr Andrews said he did not advocate a bureau or time sharing system because of the one major disadvantage, lack of rapid access to one's own data records. Mr Andrews suggested staff savings would be difficult with a bureau or time sharing system and said that an in-house processor offered a lot of savings.

Mr C. Thomas asked if other programs could go onto an in-house system. An answer in the affirmative was given.

Dr Dain Evans said that in his experience bureau data retrieval was very slow and if the information was incorrect the system became unworkable. The advantage of an in-house system was immediate data recovery and feedback.

Mr Stevens said that as it seemed the Society would require a data processor, and that as an order placed now could be cancelled within six months if it was finally decided not to proceed, there would be nothing to lose by placing an order and thus allow time for further consideration of the project. This course of action was adopted as a proposition, seconded by Mr Brown and accepted by Council.

Membership and representation

The following summary of membership increase during January-November 1975 was accepted:

	Jan	Feb	Mar	Apr	May	Jun	Jul	Aug	Sept	Oct	Nov
New members	135	186	183	230	121	248	140	73	218	357	302
Total losses	27	16	78	48	34	9	20	39	33	7	59
Nett increase	108	170	105	182	87	239	120	34	185	?	243
Total increase	108	278	383	565	652	891	1,011	1,045	1,230	1,587	1,930
Annual rate	1,296	1,668	1,532	1,695	1,565	1,782	1,733	1,560	1,640	1,904	2,105

It was resolved:

- (i) to accept reduced subscriptions from 23 members;
- (ii) to waive the subscriptions of five members;
- (iii) to grant affiliation to the University of Warwick Amateur Radio Society, and the Coulsdon Amateur Transmitting Society (previously Purley & District Radio Club).
- (iv) to approve the appointment of Mr D. H. Plumridge, GM3KMG, as area representative for the Mid-Lanark area of Region 14.

Mullard Award

The Mullard Company had agreed that this award should be continued, the value to be £50 per annum. The award to be presented annually to a member or group of members of the RSGB who, in the opinion of the RSGB Council, has made a significant contribution to, or new innovation which furthers the art of radio communication, Council accepted this award and the terms of reference.

Appointment of committees, honorary officers and representatives on outside bodies

The composition of committees for 1976 was considered and certain additions and amendments agreed. Two amendments to the list of honorary officers were agreed. It was agreed that the title of the Scientific Studies Committee be changed to Propagation Studies Committee.

Committee minutes and recommendations

Council accepted the minutes of the following committee meetings: Interference (24.10.75 and 11.12.75), Scientific Studies (11.11.75), VHF (13.11.75), Repeater Working Group (6.12.75), Finance & Staff (18.11.75 and 18.12.75), Education (22.11.75), Educational Visits Scheme (15.11.75), Membership & Representation (24.11.75), Mobile & Exhibition (25.11.75), Technical & Publications (9.12.75), Telecommunications Liaison (27.11.75).

Mr Stevens reported that the Telecommunications Liaison Committee had discussed the monitoring of the amateur bands in order to improve the image of amateur radio prior to 1979. It was proposed that a system patterned on the lines of the ARRL monitoring system should be instituted as a service to members which would ultimately be of benefit to everyone. It was agreed that the committee be asked to produce an outline of the proposed system.

Mr Andrews raised the subject of amendments to the rules for HF NFD to bring them more into line with present day conditions. After discussion, the new rules were accepted.

Repeaters

It was reported that an application from the Burnley Repeater Group, GB3RF, had been resubmitted to the Home Office on the grounds of terrain and that the HO had now decided that this repeater could go ahead in principle; and that the first Raynet exercise through a repeater had taken place and very good co-operation had been established.

obituaries

The Society records with regret the deaths of the following radio amateurs:

Mr D. Abbott, G6TA

Douglas Abbott died on 10 February aged 69. An active amateur from the early days, he constructed all his own equipment to professional standards. He was among the first to work 2m and ssb, and held many certificates for working dx, mostly on 14MHz, including the first CQ USA-WPX-76 awarded to a UK amateur.

Mr E. Eamer, G3XCM

Eric Eamer died on 18 February. He was a founder member of the Horsham ARC and was formerly a member of the Cray Valley RS.

Mr F. J. Finn, G6UF

Francis Finn died on 28 January aged 75. A keen dx operator, he had been licensed for over 50 years and was an active member of the Barnsley ARC.

Mr J. E. Jeckway, G3ODJ

John Jeckway, who died on 13 February aged 63, was first licensed as VS5CL in 1951. He was chairman of the Lymington & DAA and a member of RNARS, and until recently was active on the hf bands with ssb.

Mr J. B. McCall, G3GHO

"Mac" McCall died on 15 February aged 63. He was a well-known operator during the early days of 2m, and in recent years was active on 80m.

Mr C. K. W. Peakin, G8JFO

Bill Peakin died on 26 February aged 77. Although his interest in radio dated back to the early days, he was one of the oldest RAE entrants when he obtained his licence a few years ago. He was a member of the Yeovil ARC and was RSGB area representative for SE Somerset.

M A. Pettitimberty, F9HK

Auguste Pettitimberty, who died on 20 February aged 64, was first licensed as F2AT in 1927, and during the 'thirties operated from China as XU2AT. An excellent speaker of English, he was well

known on 80m. In 1972 he founded the Radio Club of Bondy near Paris and remained its president until his death.

Mr W. F. Swain, BRS31270

W. F. Swain, who died recently, was secretary of the St Lawrence Hospital, Bodmin, Amateur Radio Section, and a keen radio amateur.

Mr F. Tee, G3VLY

Fred Tee died on 28 February at the age of 76. He was a very active amateur on all bands and in local activities. He was a founder member of Fareham & D ARC and was its vice-president when he died, and he was a member of the Royal Naval ARS.

Mr J. H. Thomas, GW8444

Jack Thomas died on 23 February, aged 50. He was a keen swl and QSLd all over the world, as well as stimulating much local interest in radio construction and operation.

Mr S. Trengrove, G3OJN

Stan Trengrove died on 13 February. He was a regular member of the Cornish net on 80m.

your opinion

The Editor

Radio Communication

Sir—Like G6XM ("Your Opinion," February) I too feel constrained to top-up my life membership and have pleasure in sending a cheque for the same amount (£25) as he did.

Little did I think when in 1929 I commuted two weeks' take-home pay towards my life membership that what was then a considerable sum would become chicken-feed in the economic conditions that were to prevail 47 years later and which have wreaked such havoc on our Society's finances.

It is a sobering thought that if only 1,000 of the Society's 19,000+ members could each bring themselves to write out a cheque for £10 to donate to 35 Doughty Street this havoc would be largely remedied.

Just one further point: if other British magazines catering for the amateur radio interest could bring themselves to pay some heed to the RSGB and its good works, they would by persuading those outside to come in, strengthen the Society and its ability, adequately funded, to fight the battles of the future. Without this capability, the future of Britain's amateur radio movement is bleak—and so is that of the journals and the advertisers which cater for it.

Jack Hum, G5UM

The Editor

Radio Communication

Sir—With reference to the continuing debate on repeaters, the letter by G3IOR seems to us more of a personal attack on Mr Tye than any constructive criticism. Furthermore, he seems to be guilty of the same fault as that with which he accuses Mr Tye, i.e. that his opinion is that of the majority. The figure of "300 possible users" seems highly unlikely in the Norfolk area, especially as our recent inquiry of the Norfolk ARC elicited only lukewarm enthusiasm for the Bacton repeater.

As to "having difficulty with propagation well understood by the experienced radio amateur", we hardly think that, since Mr Tye can be heard working dx regularly on 2m, 70cm, 23cm and 13cm, such criticism seems distinctly silly.

In contrast, the comments of G13XZM seem on a more rational level. While appreciating the effort some amateurs have put into the Bacton repeater, and their corresponding feeling of being let down at the refusal, we (dare I say among others?) do not support it as we feel it is not truly amateur radio activity, although we can see it is very useful for emergency service, such as Raynet. We agree with G13XZM that an increasing number of appliance operators is not in the amateur spirit, and the growth of repeaters would greatly proliferate the large amount of commercial repeater equipment now available.

However, our main aim in this letter is to point out that enthusiasm in the Norfolk area for the Bacton repeater is not widespread, and look forward to other comments.

P. Le Fevre, G8AWZ; R. Chiddick, G8AUN;
S. Webb, G4BEW; R. Reed, G3ZIG;
C. Black, G8ECN.

The Editor
Radio Communication

Sir—The pen is only normally used at this QTH for filling in the log and claiming rate rebates, but I have now decided it has one more task.

There is little wonder that the column once known as "Letters to the Editor" has changed to "Your Opinion". I would imagine the editor wants to keep his title as remote as possible from some of the unconstructive feuds which have recently been witnessed in this column. The British amateurs who have recently been contributing to these running battles, pro or anti repeater, with long or short hair, should remember that *Radio Communication* has a world-wide circulation. I wonder what strange pictures the amateurs abroad are forming of these strange warlike "G" persons. A computer print-out from the Volcan-British dictionary could define "Radio Amateur, British, 1975" as "very exothermic life-form with decreasing mind-width".

Gentlemen, are there not sufficient facets on each of our numerous amateur allocations to occupy us in a civilized manner without any one individual claiming to operate Supermode on "the" band. I have held a Class B licence and now a Class A licence for some years. Until reading recent arguments I have enjoyed every minute of amateur radio, this enjoyment has been attained while being both a first- and second-class citizen (depending on how and which way round one interprets the artificial A-B barrier). I do hope that during this time I have not offended anyone sharing this excellent hobby by operating any band, at any time, on any mode, by natural or artificially assisted methods of propagation.

Consider the freshly-licensed amateur running 1W fm with one set of crystals on his local repeater frequency. Even if his 1W rig is ex-Tokyo and he has very little knowledge of how it works, then the personal enjoyment he is experiencing is probably greater than the personal enjoyment of the hardened pre-war licensee having his 7,400th consecutive early-morning sked with VK, or that which is experienced when one gets one's first eme contact on 1:3GHz. If our 1W fm operator was not attaining the enjoyment he requires from the hobby he would damn well change.

Can we then operate how and when we want within the limits of our licences, allowing others to do similarly, and refrain from criticizing those who do not think in the same way as we do. It would be very boring if we all thought alike.

Philosophy over, I must now prepare to read, hopefully, more constructive letters in future issues of *Radio Communication*, perhaps they will be more lighthearted and that we can carry on laughing at ourselves in our hobby. The day we stop laughing at ourselves will be a catastrophic day for amateur radio.

M. I. Sneap, G3ZYC
(Fellow of the Human Race)

The Editor
Radio Communication

Sir—May I draw your attention to the increasing intrusion of telephony, mostly a.m., into the portions of the bands reserved by general agreement for telegraphy only.

This is particularly prevalent on 80m. Recently I was in QSO on 3:576MHz, when a group of mainly a.m. stations settled on the frequency; these I can usually cope with, by using crystal and audio filters, but it seems they attract another group, who spend time and effort trying to jam the phone stations and make them move up into the phone section. This kind of QRM renders part of the band an absolute bedlam and reflects no credit on amateurs.

The disturbing thing is that the intruders are mostly old-timers, by their call signs, apparently members of the RSGB, the RAOTA, and their local clubs, judging by their conversation.

Are they not competent to carry on their group QSOs in the phone section in face of ssb competition (groups, as they seem unable to net) that they have to intrude on the cw section, or is it plain selfish disregard of the accepted norms? It seems to me that these "gentlemen" would have been the first to complain some years ago about this sort of thing; in some cases I have written personally to the persons concerned, who say their licenses permit operation from 3:5 to 3:8MHz, so what am I complaining about.

The RSGB supports the IARU band plan. The hf bands seem better regulated, by the general disapproval, plainly demonstrated, in many cases, of "hiddery"; but 80m seems to be the worst band in this respect. I think it is time something definite was done to restore some semblance of order to our bands, primarily by the RSGB, by exhortation, by public disapproval of offenders, by members similarly expressing their views direct and by post, but not by senseless QRM, and even more by the fuller use of A1.

J. Douglas, G2CAS/ON4ZD



G3UEU (foreground) and G4BLL/P on the summit of Pen-y-Ghent, 2,273ft asl, with sstv equipment on 2m consisting of a Linc 2, 8-el beam, 16ft portable mast, Venus monitor and Honda 300W generator. Video source was a pre-recorded tape recorded from a flying-spot scanner. Their best 2m dx to date has been two-way sstv with ON5QF. Schedules over the coming months would be welcomed

The Editor
Radio Communication

Sir—G3ROZ would appear to imply that he is ashamed of being associated with today's amateur radio movement ("Your Opinion" February). If this is the case then I sincerely hope for the sake of the future of amateur radio that G3ROZ is not "your average old G3 - -".

As a wet-behind-the-ears G4 + 3, I for one, and I hope there are many more who share the same sentiments, am proud to be part of the modern amateur radio scene even if I do operate "black boxes", albeit in my case satin chrome and grey. There is still room for development and home construction even in this scene, and I would refer, for instance, to my own particular interest in slow scan television (no doubt there will be some scathing comments lurking in the wings regarding this "modern" mode of transmission).

Please, please, do not print any more letters selling amateur radio down the drain, and I would venture to suggest that this is perhaps where any such letters ought to be re-directed in the future.

P. Burnett, G4BLL

Sirs—On 11 June 1975 you were kind enough to elect me as a corporate member of RSGB, waiving the annual subscription. This, because I am a blind person.

During a recent visit to St Dunstan's I was made aware of your financial position.

It is with pleasure that I enclose a cheque for £8 to cover the year 1975-6, and shall do this annually—the next subscription being due on 11 June this year.

Thank you for your kindness.

Duncan Sutherland, G4DJJ

Looking ahead

25 April—Northern Radio Societies Association Convention and Exhibition, Belle Vue, Manchester.

8-9 May—International VHF Convention, Brunel University, Uxbridge, Middlesex.

15 May—Region 11 ORM and mobile rally, Royal Lido, Prestatyn, Clwyd.

30 July-1 August—RSGB Radio Communication Exhibition, Alexandra Palace, London.

26 September—Welsh Amateur Radio Convention, Oakdale Community College, Blackwood, Gwent.

28-30 October—Amateur Radio Retailers Association Exhibition, Granby Halls, Leicester.

contest news

7MHz Contest results

There is no doubt that conditions were excellent during the cw weekend, reflected in the very big increase in logs received. Unfortunately things were not quite the same for the phone section, but judging from the comments all contestants enjoyed the contest and appreciated the rule changes. Once again aeriels seem to be the deciding factor, with more ambitious systems going higher each year. The winners in both sections were using 2-el Yagis between 90 and 120ft. Regrettably both stations lost their towers during the severe storms in January. The listings this year have been shown in three sections, British Isles, Europe, and rest of the world. The standard of log keeping generally was very high indeed, but please read the rules! Next year points will be deducted for log entries not including a multiplier check list and again stations not completing a declaration form will be used as check logs. Congratulations to the leaders in each section and we look forward to hearing you again next year.

Just a few comments from the logs... What a contest—don't change a thing... heard LNS giving serial number 600 but didn't believe it... Nice opening to USA... Don't change the rules... For me not an enjoyable contest—details please of aeriels used by leading stations which enabled them to give 589 to stations I couldn't hear!... Didn't start until after "Kojak" then spent evening

UK CW TRANSMITTING

Posn	Callign	Points	Posn	Callign	Points
1	G3LNS	23,575	21	G3XWZ	2,095
2	G4BUE	12,915	22	G3MWP	2,060
3	G3ORH	11,300	23	G3JZG	2,020
4	G8CJ	10,640	24	GMSYEH	1,855
5	G3VMW	9,385	25	G3ZZD	1,515
6	G3SXW	8,270	26	G8D1	1,465
7	G4BEG	8,145	27	G4DBW	1,325
8	G3SEF	7,090	28	G2AJB	1,275
9	G3TXF	5,910	29	G3UYM	1,180
10	G2QT	5,800	30	G8KU	1,160
11	G3HMA	5,620	31	G3YMW	1,050
12	G3JAS	4,305	32	G5ASY	965
13	G3YHC	4,220	33	G3SWX	865
14	G4OOD	3,615	34	G3WJS	705
15	G3CFS	3,295	35	G4ODL	625
16	G4OIX	3,290	36	G4DNV	450
17	G3UBH	2,675	37	G3JFY	365
18	G4BXT	2,605	38	G3JKY/A	310
19	G3VDL	2,240	39	GW3XNS	25
20	G3KSH	2,100			

UK CW RECEIVING

Posn	Station	Points	Posn	Station	Points
1	BR515822	4,535	3	A8277	1,195
2	A8312	1,900			

EUROPE CW TRANSMITTING

Posn	Callign	Points	Posn	Callign	Points	Posn	Callign	Points	Posn	Callign	Points					
1	SP8XA	790	25	PH1PT	500	49	HA3NU	385	73	OH8BN	235	97	OK1DAV	135		
2	UK2GAN	710	26	OZ4HW	495		DL1YA	385		YZ1NZW	235		DK6RY	135		
3	DL1BLJ	700	27	DL3ZR	485	51	OK1IAS	370	75	OK2PGU	230	99	UA4SM	130		
4	Y21SCO	700	28	OH4XG	480		OK2PCN	365		UBSLCN	225	100	UP2BF	125		
5	PA0TAU	685	29	UBSWAL	475	52	UP2BDF	365	76	UA1GW	225		UC2AW	120		
6	DJ8Z	680		OZ1W	475	54	DK8FO	350		OH2LU	225	101	OK2SPS	120		
7	UP2BAO	660	31	DK5MP	470	55	UY5CW	335	79	OZ2OI	215		UA3WAF	110		
8	OK2BLG	660		DK5SN	460	56	FGXJ	330		OH281	215		UP2BBF	110		
9	HA0KLE	640	32	DL2US	460	57	UA1AMM	305	81	HA3QV	195	103	OK1KZ	110		
10	UR2ROQ	630	34	OK1VP	455		SM0BDS	300	62	UB5FOV	195		UB5OCR	110		
11	DK9FE	615	35	OK1DKR	450	58	UP2OU	300	83	OH2DN	190	107	UA4HAG	100		
12	UA1ADG	610		OK1DAV	445		OK2SL5	300	64	UA3DOP	190	108	UB5QDU	90		
13	UB5ZAT	600	36	DF1SV	445	51	SM0GGM	295		DJ8QD	175	109	UK1NAA	85		
14	UB5FI	590	38	OK9EG	435	62	YZ1NFR	275	85	OK2YX	175	110	UC2WAS	75		
15	UA4HOV	570	39	UP2BAS	425	63	OK3YD	275	87	UA2FAT	170	111	SP8FNA	55		
16	F8PK	565		PA0DJN	425		UA6LHA	160		UA6LHA	160		Check logs received from:			
17	DK5SN	560		UA3OAO	420	65	OZ2NM	270		UQ2JG	160		SP9CAV	PA0HOP	OK3CFA	
18	OK4SY	555	41	UA4HDX	420		UP2GM	265	88	EA2JJ	160		OK2BSA	PA0OV8	UA3FCL	
19	OJ4AN	545		UK2GAT	420	66	UK50E	265		OH2SO	160		HB9CK	UA3VAQ	UA1SW	
20	UA5LAB	525	44	E18F	415		EA4BV	265		UP2BAZ	160		PA0HRM	UA4YAH	SP2GUB	
21	DJ8WD	520	45	UB5MET	410	89	UA3AFQ	260	93	UQ2GFA	155		SP4GHT	UK2GAM	G30YY	
22	DJ6OZ	515	46	OH8WL	405	70	UP2BCR	250		OH1VF	150		UK2FAA	UL7NAF	UK6LAZ	
23	HA1SB	505	47	PA0JR	400	71	OK1MSP	245	94	UA3IAK	150		UK5WAS	UK4YAN	UK3DCC	
24	UP2BAR	505	48	PA0V8	395	72	UB5UAE	240	96	OK2BEF	140		UK4HBB			

building tv filter!... Thoroughly enjoyable contest never heard QRM from dx like that before... I appreciate the sensible starting time... I didn't know that 40 was so good... my ageing 50 watter had to fight for them!... wait until I get my vertical back up next year!... Please keep this contest as it is... Not one of my better contests, 449 from a very strong HA0 was the last straw!

Finally, the adjudicators would like to thank contestants for all the comments and assure them that all are considered when compiling the rules for next year's test. HCT/IKM

REST OF WDRLD CW TRANSMITTING

Posn	Callign	Points	Posn	Callign	Points
1	K1RQE	3,520	16	UK9WBD	1,000
2	EP2TW	2,980	17	UA9CFV	960
3	UA9WS	2,560	18	WB4HYN/4	900
4	UV9AX	2,240	19	W3ARK	870
5	UK9SAY	1,880	20	W2JDC	850
6	PY7SR	1,860	21	XN1AW	830
7	W40MW	1,790	22	W8VSK	760
8	W8SZR/3	1,720	23	UJ6JAS	700
9	UW0WL	1,670	24	JA4FHE	650
10	XJ3EJK	1,400	25	UL7PQ	630
11	W44MIX	1,380	26	WA2JZX	580
12	W44FCT	1,350	27	WA3YIV	540
13	UK9HAC	1,210	28	UL7EAM	340
14	UA9FAJ	1,180	29	C9MIZ	140
15	UL7GBO	1,120	30	JA5GPR	70

REST OF WORLD CW RECEIVING

Posn	Station	Points
1	BERS-195	600
2	UA9-185-822	410

EUROPE CW RECEIVING

Posn	Station	Points	Posn	Station	Points
1	OK1-18558	735	5	HA7-008	435
2	DZ-OR-1815	645	6	UP2-038-453	210
3	OL-KLAUS	560	7	OK1-13188	205
4	IS0-87850	445			

UK SSB TRANSMITTING

Posn	Callign	Points	Posn	Callign	Points
1	G3WJN	4,285	10	G48YY	895
2	G3KMA	3,250		G4APL	895
3	G3TOE	2,055	12	G3JAS	970
4	G2QT	1,895	13	G4BYN	835
5	G4ALG	1,790	14	GW4CYD	750
6	G3TXF	1,340	15	G3SWX	725
7	G3KSH	1,315	16	G3EBH	625
8	GW4BLE	1,130	17	G3YIZ	615
9	G3VLX	1,120	18	G4BYA	285
			19	GW3XNS	230

UK SSB RECEIVING

Posn	Station	Points	Posn	Station	Points
1	BR530225	2,555	7	A8890	1,420
2	BR54032	2,425	8	A8949	1,410
3	BR526431	2,270	9	A8524	1,345
4	A8312	1,740	10	BR526249	1,215
5	BR515822	1,645	11	BR525429	1,125
6	BR528198	1,590	12	A8379	390

EUROPE SSB TRANSMITTING

Posn	Callign	Points	Posn	Callign	Points	Posn	Callign	Points	Posn	Callign	Points	Posn	Callign	Points
1	DLBJS	865	12	DF1KT/A	490	23	{3REH	310	33	P11ARS	210	43	{OK3YCA	80
2	DKSVO	785	13	DK1IU	480		{F3HL	310	34	OZBOI	190		{UB5GBD	80
3	DK3LM	770	14	I3BBZ	460	25	OKIOWA	305	35	UK3VAC	185	45	UB5JOL	60
4	DK8BI	620	15	YU3TJA	435	26	DL1QU	285	36	{SP3CQC	175	46	OK1JVT	25
5	UK4HBB	615	16	UP2PN	430	27	UP2OU	270		{OH7NW	175			
6	UP2ER	590	17	DK5AZ	415	28	DK5KJ	260	38	LASC	155			
7	DL8FE	571	18	UR2RJ	390	29	OZ8VO	250		{UK2GJB	145			
8	{DJ6OZ	530	19	UV3FD	375	30	{OK9FE	230	39	{UB3IAA	145			
	ONS5G	530	20	ON5WL	340		{UR2QA	230	41	UK1ZA A	135			
10	PA0TAU	605	21	DN4XG	320	32	DL1YA	215	42	OK1KZ	105			
11	DK5SG	500	22	PA0HTR	315									

Check logs received from:
 UK2GAB, UV3DN, GM4EHB,
 UA3TN, UA9ADF, G8KLO,
 G13285, REF27460, UA3TAQ.

Leading station details

EUROPE SSB RECEIVING

Posn	Station	Points	Posn	Station	Points
1	I2-14713	840	13	HE9-1LN	435
2	OZ-DR1815	785	14	OK-1-5635	400
3	I4-82155	665	15	UA9-101-045	365
4	I0-58479	605	16	I0-57699	338
5	I3-60767	585	17	I2-12496	300
6	I1-12387	675	18	UP2-038621	285
7	DL-ANTON	490	19	I5-50661	280
8	I0-58101	485	20	I2-58844	220
9	DL-JANKER	475	21	I2-59920	215
10	I4-20681	460	22	I5-57718	170
11	{I0-54651	450			
	{DL-F01-148965	450			

REST OF WORLD SSB TRANSMITTING

Posn	Callign	Points	Posn	Callign	Points
1	EP2TW	3,370	8	9Y4LA	720
2	UL7OAO	1,350	5	UA9WS	650
3	UA1CBO	800	8	UW9SG	260

REST OF WORLD SSB RECEIVING

Posn	Station	Points
1	UA9-166-622	800

G3WJN, RX: Drake 4C. Aerial: 2-el Yagi.

QSOs: 393

Bonus: SM, DL, ON, PA0, IOK, YU, SDF, OH, YL, IS0, CTI, HA, OZ, HB9, LX1, CTZ, EA, LA, OE, UP2, UL7, UJ8, UA, UB5, UQ2, UA9, URZ, 4X4, ED, VK8, HK, YV, 9Y4, VU, CO, PY, ZP, CE, ZL1, ZL2, ZL3, CP, 5L2, LU, VVK7.

G2KMA, RX: KW2000A. Aerial: Inverted-V al 50ft.

QSOs: 380.

Bonus: DL, SM, PA0, ON4, EA, F, DM, CTI, OZ, HB9, LX, LA, EI, OK, OE, SP1, YZ, O4, YO, SV, IS0, HA, UA, UP2, UB5, UQ2, URZ, UL7, UA9, UO6, 4XK, CT3, VK6, VK7, EP2, LU, HK.

EP2TW, RX: Drake 4B. Aerial: half-square at 40ft.

QSOs: 63

Bonus: G2, 3, 4, 8, G1, 3, 4, 5, GM3, 4, GW3, 4.

G3LNS, RX: Drake 4C. Aerial: 2-el Yagi.

QSOs: 715.

Bonus: YZ, DJ, UP, UB5, UQ2, UA, UAZ, UL7, DK, DH, UR, UA9, OZ, HA, F, DM, SP, PA0, JA, W1, W4, W8, VE1, EP, VK3, EA, LZ, W3, LA, W2, W9, VE2, CX, PY, VE3, W5, FY, W7, W0, W5, KP4, YV, 9Y4, ZL1, 2, 3, 4, CT1, EA8, VKZ, VK7, UC, SM, YO, ON4, H1, HB9, 1, E1.

G4BUE, RX: FR101 + 80Hz filter. Aerial: five switchable sloping dipoles at 60ft.

QSOs: 460.

Bonus: UA, YU, HA, OL, OH, UQ2, DM, UB5, OK, SP, UP2, E1, HB9, URZ, LZ, W1, CT1, W4, W3, VO1, W2, VE1, VE2, UAZ, SM, FY7, PY, VE3, W8, UA9, W0, W5, W7, EP, W6, VE4, UL7, VE7, VE5, ZL3, ZL4, F, DA0, YO, EA, OZ, ON.

January 1976 70MHz CW Contest results

As might have been expected, the weather could have been better, but nevertheless several portable stations braved the elements. Generally the timing and duration of the contest was about right, but there were several pleas for more 70MHz contests. There were suggestions of auroral conditions and unusual solar noise. Congratulations to the winner and runners-up.

G4BWW

Posn	Callign	Score	QSOs	QTH	Best dx	Km
1	GW3WRA/P	365	51	YL06	G3DAH	285
2	G3NHE	314	48	ZNS4	G3DAO	290
3	G3UKV/P	302	45	YM28	G3DAH	288
4	GW3XBYP	289	39	YM28	G2DAH	330
5	G3RJX	280	42	ZM31	GM3YOR/A	410
6	{G4DGA/A	242	48	ZL59	G3BW	448
	{G3VPK	242	40	AL14	G3AUS	330
8	G3SNN/P	228	38	YL39	G3JYP	330
9	{G3JYP	226	25	YO38	G4CWH/P	438
	{G3PFM/P	226	37	YK09	G3PWK	290
11	G3KMI/P	215	37	ZK04	GM3JNW	525
12	G4CWH/P	213	41	ZK10	G3JYP	425
13	G3ZMO	191	45	ZL08	G3JYP	321
14	G5DF	171	33	ZL45	G3JYP	375
15	G3LVP	163	37	AL33	GW3XBYP	275
16	G3DAO	155	36	ZK16	G3NHE	280
17	G4ALG/P	147	39	ZL35	G4AIR	200
18	G3FJE/A	132	30	ZM79	G3BW	304
19	G3TAL	129	25	ZK14	G3NHE	275
20	G5UM	119	26	ZM35	G3JYP	235
21	G4DKX	116	20	AM76	GW3WRA/P	284
22	G3NPI	110	32	ZL48	G3NHE	210
23	{G3SPG/A	105	33	ZL30	GW3XBYP	230
	{G3ZKE	105	30	ZL40	GW3XBYP	235
25	G3OZT	104	24	ZK13	G3UKV/P	215
26	G3TWG	102	33	ZL37	G4AIR	220
27	G3ROZ	93	31	ZL50	G5HD/P	260
28	G3WXC	81	19	ZK24	GW3XBYP	233
29	G5HD/P	70	10	YL72	G3VPK	315
30	{G3XDY	60	12	AM77	G3PFM/P	278
	{G2WS/P	60	12	YL57	G3VPK	243
32	GM3JNW	55	7	YP19	G3KMI/P	535
33	G3YOW	50	12	ZL70	G3NHE	264
34	G3PGN	40	14	AL22	G3PFM/P	260
35	GM3YOR/A	38	6	YQ64	G3RJX	420

1976 RSGB Direction Finding Contests

The full programme of eight qualifying events is published in "Contests calendar". No changes are being made in the rules, and the Final will be organized by the High Wycombe group. Details of the first three events are given below.

DF Qualifying Event Rugby

Date: 2 May 1976.

Map: OS Sheet 152 Northampton and Milton Keynes.

Assembly: 1300bst for start at 1320bst.

Location: Lay-by on A413 1/2 km SW of Akeley, NGR 702372.

Intending competitors requiring tea are asked to notify Mr D. Newman, Haynes House, 78 High Street, Whittlebury, Towcester, Northants, (tel 0327-857350) not later than 25 April.

DF Qualifying Event Dartford Heath

Date: 16 May 1976.

Map: OS Sheet 188 Maidstone and the Weald of Kent.

Assembly: 1300bst for start at 1320bst.

Location: Forecourt of the Hop Pocket public house, Paddock Wood, on B2160, NGR 669454.

Intending competitors requiring tea are asked to notify Mr F. G. Wells, 25 St David's Road, Hextable, Swanley, Kent, (tel 0322-62726) not later than 6 May.

DF Qualifying Event South Manchester

Date: 6 June 1976.

Map: OS Sheet 109 Manchester.

Assembly: 1300bst for start at 1320bst.

Location: Car park at Heaton Park on A665 about 100yd north of its junction with A6044, NGR 826033.

Intending competitors requiring tea are asked to notify Mr D. C. Holland, 32 Woodville Drive, Sale, Cheshire, (tel 061-973 1837) not later than 31 May.

National Field Day

Groups intending to compete in this year's NFD are reminded that properly completed application forms must be sent to G3NKS, QTHR, by 30 April.

144MHz Portable Contest rules

1600-1600gmt, 22-23 May

All entries and checklogs to: VHF Contests Committee, c/o G4CUT, 59 Harewood Road, Chelmsford, Essex CM1 3DH.

The following general rules, published in the January issue of *Radio Communication*, will apply: 1, 2, 3, 4d, 5a, 6a, 7a, 8a, 9a, 10a, 11-22.

144MHz Open CW Contest rules

0800-1600gmt, 23 May

All entries and checklogs to: VHF Contests Committee, c/o G3FZL, 11 Liphook Crescent, Forest Hill, London SE23 3BN.

The following general rules, published in the January issue of *Radio Communication*, will apply: 1, 2, 3, 4a, 5a, 6b, 7a, 8a, 9a, 10a, 11-22.

International Amateur Television Contest results

Of the 52 entrants in this contest, six held "G" calls and occupy the following positions in Section A of the contest: 16, G6AHT/T; 21, G6ALC/T and G6ALH/T; 22, G6GDR/T; 23, G6ALQ/T; 27, G6AFF/T. The next contest will take place on 11-12 September 1976.

IARU Region 1 co-ordinated vhf/uhf/shf contest dates and times

There is a standing agreement between IARU Region 1 member societies to organize or participate in vhf/uhf/shf contests on the first weekends of March, May, July, September, October and November. The dates in 1976 are:

6-7 March	1600-1600gmt	144MHz, 432MHz, 1.3GHz
1-2 May	1800-1800gmt	144MHz, 432MHz, 1.3GHz
3-4 July	1600-1600gmt	144MHz, 432MHz, 1.3GHz
4-5 September	1600-1600gmt	144MHz only
3-4 October	1600-1600gmt	432MHz and above
1-2 November	2000-0800gmt	144MHz, 432MHz, 1.3GHz

The contests in September and October are internationally judged by member societies in rotation. The RSGB VHF Contests Committee plans its own contests calendar to embrace these dates within the annual programme.

Contests calendar

11 April	3.5MHz LP
24-25 April	1.3GHz Open (Trophy) (Rules in March issue)
24-25 April	PACC
24-25 April	Bermuda Phone
1-2 May	432MHz Open & Listeners (Trophy) (Rules in March issue)
2 May	DF Qualifying Event Rugby (Rules in April issue)
8-9 May	Bermuda CW
16 May	DF Qualifying Event Dartford Heath (Rules in April issue)
22-23 May	144MHz Portable (Rules in April issue)
23 May	144MHz CW Open (Rules in April issue)
6 June	DF Qualifying Event South Manchester (Rules in April issue)
12-13 June	HF NFD (Rules in March issue)
19-20 June	Microwave
20 June	DF Qualifying Event Chelmsford
26-27 June	Summer 1.8MHz
3-4 July	VHF NFD & Listeners (Rules in March issue)
11 July	DF Qualifying Event Coventry
18 July	3.5MHz FD
18 July	DF Qualifying Event Oxford
25 July	144MHz QRP
1 August	DF Qualifying Event Salisbury
7-8 August	70MHz Portable & Listeners (Trophy)
22 August	DF Qualifying Event Slade
4-5 September	144MHz Open & Listeners (Trophy)
4-5 September	SSB FD
12 September	DF Final High Wycombe
2-3 October	UHF/SHF
9-10 October	21/28MHz
16-17 October	7MHz CW
24 October	70MHz Fixed
Oct-Nov	432MHz Cumulatives
6-7 November	144MHz CW
6-7 November	7MHz Phone
13-14 November	Second 1.8MHz
5 December	144MHz Fixed

Mobile rallies calendar

- 25 April—North Midlands Mobile Rally, Drayton Manor Park, Tamworth. Details from G8DEM, QTHR.
- 2 May—Spalding Tulip-time Rally, Glead Boys School, Halmer Gardens, Spalding. All the usual attractions. Talk-in on 2m. Details from G3VPR, QTHR.
- 2 May—Cardiff RSGB Group Mobile Picnic, Porthkerry Park, Barry. Commences 1pm. Details from GW3GHC.
- 23 May—Welsh Mobile Rally, Barry Rugby Football Ground, Barry, S Glamorgan. Trade stands, raffles, club bar. Talk-in on 2m-320, via GBSBC on R6 and ssb 144.3MHz.
- 23 May—Northern Mobile Rally, Victoria Park Hall, Keighley, W Yorkshire. Talk-in on top band 1.910MHz; 2m a.m. 145.000MHz; 2m fm 145.525MHz (S21); 2m ssb 144.250MHz; 70cm fm 433.200MHz; lectures on "Practical vhf aerials" by E. Ashby, G3HCW, and "FM repeaters" by the UK Northern FM Repeater Group. All the usual attractions. Rally opens 11.30a.m. Organized by the Otley RS. Details from G8BZY, QTHR.
- 30 May—Hull & D ARS Mobile Rally, College of Agriculture, Bishop Burton, near Beverley. Details from G3AGX, QTHR.
- 13 June—Elvaston Castle Rally, near Derby. Further details from P. Neal, G3WFL.
- 13 June—Goole & D ARS Rally, High School, Goole.
- 20 June—HMS Mercury Mobile Rally.
- 27 June—Longleat Mobile Rally, Longleat House, Longleat, nr Warminster, Wilts. Talk-in stations operational on 160, 80 and 2m, 1,820, 3,775, and 145.50kHz plus vfo (callsigns to be announced later). Rally opens 10am. Walking df hunt starting at 3pm on 160m, all members of the family can take part. All the usual attractions. No charge for entrance to the rally, but visitors must pay for entrance to Longleat Park. Car parking available. Overnight camping from 6pm, Saturday 26 June. Details from G3ULJ, QTHR.
- 4 July—Upton Mobile Rally. Exhibition space and further details from G3TQD, QTHR.
- 18 July—Cornish Radio Amateur Club Rally, Cornwall Technical College, Camborne (venue to be confirmed). Details from G3NKE, QTHR.
- 15 August—Derby & D ARS Rally, Rykneld Schools, Derby. Details from G3FGY, QTHR.
- 22 August—Preston & ARS Mobile Rally, Walton-le-Dale County Secondary School, Preston.
- 29 August—Torbay ARS Rally. Newton Abbot Rugby Ground. Details from G3GDW, QTHR.
- 26 Sept—Harlow & D ARS Rally. Venue as last year. Details from G3WUX, G8JXU, G3YDI, QTHR.

Special event stations

GB3RN, 16-25 April

The Royal Naval Amateur Radio Society will be active from HMS *Beifasi*, Pool of London, between 16 and 25 April. Operation will be on 1.8 to 28MHz and 144MHz.

GB3WI, 17-19 April

Operational during "Hobbies for all" exhibition organized by the Rolleston-on-Dove Women's Institute at the Forest of Needwood High School, Rolleston, Burton-on-Trent. Exhibits will include amateur radio, model railways, aircraft, boats, collections, handicrafts, photography and sports. Details from G4BPW, QTHR.

GB2SW, 1-9 May

This station will be set up in the market square during the annual Stow-on-the-Wold Horse Fair to mark the quinqucentenary of the granting of the fair's charter. It will be under the direction of G2AOK and other local amateurs. Operative from 9am to 7pm on 160-10m. Special QSL cards. Other entertainments will include an ox roast, a mediaeval market, exhibitions, carnivals and a fun fair. From 10 to 31, May the station will be located at 6 Church Street, home of G2AOK.

GB3MRC, 15 May

The Solway Radio Club will operate this station on the Maryport Rotary Club Field Day. It will be active on the 80, 20 and 2m bands. 2m Scottish contacts especially welcome.

members' ads

These subsidized flat-rate advertisements are accepted as a service to members of RSGB. They must be submitted on the Members' Ads order form printed in alternate issues of *Radio Communication*, or on a postcard similarly laid out. Each must be accompanied by a recent *Radio Communication* wrapper addressed to the advertiser, as proof of membership, and a remittance by postal order or cheque for 50p (stamps not accepted). They will not be acknowledged. Those not clearly worded or punctuated will be returned. No correspondence concerning this service can be entered into.

The closing date for each issue is the 1st of the preceding month, but no guarantee of inclusion in a specific issue can be given. Valid advertisements not published in the issue following receipt will be held over until the next issue.

Trade or business advertisements, even from members, will not be accepted for Members' Ads but should be submitted as classified or display advertisements in the usual way. Traders who are members must enclose a signed declaration that the items for sale or wanted are part of, or intended for, their own personal amateur station.

The RSGB reserves the right to refuse advertisements, and accepts no responsibility for errors or omissions or for the quality of goods offered for sale. Advertisements may be edited or abbreviated as necessary.

Post to: MEMBERS' ADS, "RADIO COMMUNICATION",
35 DOUGHTY STREET, LONDON WC1N 2AE.

FOR SALE

Hudson FM208 tx/rx working 2m, £22. Same with remote control box and mobile bracket, £28. Heathkit vvm, similar IM18, £20. All ono. G3GIC, QTHR. Tel 01-567 6389.

QQV06-40A h/b linear, rack mounting with blower and tuned lines, £18 ono. PSU, 12V 1p to drive above at up to 200W dc input, £15 ono. Mains psu, APT-506, 200-500V, regulated rack mounting with neg 50V o/p added, £10 ono. G8CHE, QTHR. Tel 01-953 2030 ext 3278, 9-5 only.

Heath SB230, latest silent 1kW linear, 10-80m, inspection/demonstration London, offers over £200. Brand new HZP 1 : 1 balun, £3. Shure 401A hand-held mic, £7. EHT transformer, 840V, rms, 500mA, £5. R. J. Toby. Tel 01-727 5641 ext 25 (daytime), 01-560 3046 (evenings).

Linear 2, 144-1-144-33, good cond, recently checked over by suppliers, £130. Cousins, G8FCU, Wylholme, Gorefield Road, Leverington, Wisbech, Cambs.

Trio 9R-59DS communications rx, manual, etc, £45. Also with tape recorder, £5. PR40 preselector for rx, £5. Prinztronic mini scientific calculator, trig ratios, memory logs, square roots, etc, £13.50. 1MHz xtal calibrator, £2.50. Tel 021 747 3998.

RTTY Creed 7E page printer, with 85R for spares, Marconi HU11 terminal unit and spare, also a few rolls of paper, £25 the lot, or why? Consider rx, vertical antenna, atu, etc. Buyer collects. Tel 0709-551626 (Yorkshire), weekends only.

9MHz xtal filters, XF9B, £23. QC1246AX, £20. Both with carrier xtal. PSU, 0-3kV, 300mA, plus 600V stab, 24V, dc bias, £25. 4m linear, pair QY3-125s and heater transformer, £15. QM70, 70cm converter, 28-30MHz, i.f., £12. QV06-40A, £3. Tel Chilbolton 244.

SB/M printing reperforator, £27. 8-track cartridge mechanism, £9.50. Stereo car cassette player, £12.50. Telefunken tape recorder, £36.50. G3TGF, QTHR.

Linear 2, immaculate cond, as new, with preamp, also Asahi diamond whip, complete, £135 ono. LO/Z Joymatch atu, as new, £8 ono. G4BOJ, 223 Upperthorpe, Sheffield 6. Tel 686263.

Storno Viscount xtals on S23, £32. AM10D tuneable rx, £30. Telford TC9 a.m./f.m. tuneable tx, £50. KW Vanguard with 160m, £20. Pye Vanguard L/B, £10. Pair Pye Compacts on 433-2 with charger, £90. All ono. G8HPE, QTHR. Tel Romford (Essex) 45733.

Trio QR666 rx, gen coverage, as new, in original packing, little used, £125. Davis, 34 Sims Lane, Quedgeley, Glos.

Heath RF1U, 100kHz to 100MHz, rf generator, vgc, £20. Joystick vfa, with 3A tuner, £10. APT 12V 5A stabilized psu, £5. Heath HD10 electronic key, £20. Murphy AP100335 m/hf rx, less case, £20. Shaw, 16 Deansfield, Four Spires, Cricklade, Wilts.

HW7 tx/rx, HWA71 psu, £50. Katsumi EK108A keyer, £25. Items absolute new cond and perfect. Jones, G3RCU, QTHR. Tel 093-67 4117.

2m a.m. tx, £10. Storno base station, 3ch, 2m, fm, £30. Would exchange for low band Vanguard with controls and xtals, or fb low band Cambridge with xtals. Bean, G3TJQ, QTHR. Tel 01-679 1089 (evenings).

Linear 2 with PA3 mics, mobile mount, etc, £125 ono. Pye Cambridge AM10B xtals for 145, £30. G3TIN, QTHR. Tel Bloxwich 403145.

Minimitter top 2-7 a.m./cw, 24W, 160-40, regular use, £15. Wanted: DX40U or similar tx for hf bands. GWSHJ, QTHR.

Xtal filter, monolithic type in HC-18U, 10-7MHz-15kHz bandwidth at -3dB and 50kHz at -20dB imp 3kΩ, £2. M. Nakane, 2-5-7 Teraya, Tsurumi-ku, Yokohama City, 230, Japan.

CD44 antenna rotator, less than year old and under dealers' warranty, £49. Cushcraft ARX2 2m antenna, omni-directional and very low angle radiation, virtually new, £14. G2KF, QTHR. Tel Par 2337.

TA33JR 3-el triband beam. Could deliver if not too far off beaten track. G3XHK, QTHR. Tel Bourton on Water 20606, ext 202 or 235.

HQ11 mini-beam, good cond, £35. Pair TT21, new, £5. Buyer collect. G3TFO, QTHR.

Facsimile Muirhead type 900 tx/rx, power unit, beautiful cond, £250. AR88D with matching spkr, 1000kHz marker unit, 12V power unit, spare valves, original handbook, realigned and in exc cond. Buyer collects, both or vno. James. Tel 0362-2437 (Norfolk).

Grundig Satellite amateur 210 rx, amateur bands 10-160m, mw, lw and vhf, ssb unit instruction manual and circuit diagrams, £95 ono. Tel 01-764 3288 after 6.30pm.

Dash Cambridge, tx as FM10, rx a.m./fm, xtal'd for S0, S20, S22, R6, 1,750Hz tone, £32. Pocketphones, 433-2, rechargeable. Tx/rx, mod for long life, PP3, £26. G3USE, QTHR. Tel Luton 20312.

Antenna, 10XY beam, 1/2 whip, Bantex with magnetic mount, both almost new, offers over £25. Dexteam DB3, 3-el beam, £15. 22 Manor Gardens, Buckden. Tel Huntingdon 810569.

Yaesu FR50B rx, mint, with box and manual, £70. Would consider exchange for TR2200G, KP202 or similar 2m tx/rx. W. J. Cowell, 35 Bare Avenue, Morecambe, Lancs. Tel 412831.

Drake 2B spkr-calibrator and multiplier, manual, exc cond, £85. Also Heathkit HW7, factory aligned, £35. Buyer inspects and collects. G3ZDR, QTHR. Tel Gravesend 63284 (evenings).

Eddystone 649 and Codar preselector, 1.8-30MHz, fitted slow ssb tuning, manual, £22. PCR3 + psu, 3 band mw + 2-23MHz, fitted bfo, rf, gain for ssb and cw circuits, good cond, £18. G3FWA, QTHR. Tel 0234 854687.

Mosley TA32Jr, 10-15-20m, new cond, £12. Three-band G4ZU Minibeam three-element array, £12. 1in longplay tape, 5in spool, 50p. 931A photomultipliers, 2 only, £3. G4DRH. Tel St Annes 722081 (Lancs).

Linear 2 with pre-amp, cw mod, and R115E psu, £120. 1C22A, 2 months old, with time out indicator, £135. Microwave Modules, 70cm converter, 18-20MHz i.f., £9. HRO with 6 coils and psu, £14. G4DSC, QTHR. Tel Ripon 2230.

BC221-T frequency meter, original calibration book, stabilized mains psu, original spares, valves, headphonses, canvas carrying bag, mint, £25. Cossor gauging oscillator. BBC radio bridge rx. Offers? Wanted: R1155 rx in good cond (unmodified) for ATC. G3JFC, QTHR. Tel Crayford 522489.

Heathkit dc psu HP13B, used one week only on bench, never mounted in vehicle, £50 ono. Pye Vanguard AM25T tx, converted 2m, £12. 2m 4 element Yagi J-Beam, £2. G4DMS, QTHR. Tel 0327 50632.

G3ZVC 9MHz tx/rx, built and working on usb, £50. FT-ZF, unmodified, with additional channels 145-50MHz and 145-80MHz, £100. R. T. Payne, GM4AWA, 65 Durlay Dene Crescent, Bridge of Earn, Perth PHZ 9RD. Tel Perth (0738) 21241 ext 238 (office).

Hewlett Packard HP45 advanced scientific calculator, includes 48 pre-programmed functions, 9 addressable memories, 15 digit readout, rechargeable internal ni-cad, mains adapter charger, £60. V. Yelland, 20 The Mile End, Walthamstow, London E17 5QE. Tel 01-553 3794.

RAE complete ICS course, all manuals, £20. Henderson, 53 Dumyat Drive, Falkirk, Scotland. Tel Falkirk 25559.

144MHz mostet converter, MMC144/28, £9. Dan Guile, 29 Lymington Close, London SW18 4QL.

Mosley TA32 Jr, high power version plus balun, three months old, unused. Also CDE AR40, unused, with control cable. Offers please. Medco 75Ω low pass filter, £4. G4DXG, QTHR, with sse or tel 01-679 3215 after 7pm.

Keyer ETM3, £30. 9D0 Heath, £15. AV07, £10. Stellaphone recorder, working, needs attention, £10. G3MEA. Tel 01-254 2747 evenings.

Swop approx £150 of SLR camera and lenses, f2, 1/1,000-1-2 secs, auto/man, Pentax body, for fm gear. For sale: 40 copies *Ham Radio*, first serious offer secures. 1MHz xtal, £1.25. G3AAJ, QTHR. Tel 01-989 6741.

Trlo 2200G, R6, R7, S20, S22, perfect cond, £75. *Wanted*: hf vertical 18AVT/14AVQ, why? Must be in good cond, could collect if necessary. GW4BCD, QTHR.

FT101 Mk2 80/160, £250. Europa SP640, fitted blower, £80. Linear FL2100, new, £200. Pye Pocketphones, conv 433-1MHz, 2 pair with batt, £20. Sony 405 camera, £30. With tripod, BC221 mains, charts, £18. Will deliver 50 miles. GM4DAE, QTHR. Tel 041-778 5040.

IC210, as new, £175. Belcom LA106 amplifier, £140. Belcom scanning rx, fitted 6ch, £60. ITT Startone, a.n., 12kHz, high band, £50. Digital multimeter, £25. *Wanted*: hf band tx/rx, IC22, or standard C828. G6JDS. Tel Terrington St John 401 daytime.

Cambridge pot volt box, advance of generator type H, Airme 10kV ionization tester, Bruel and Kjaer automatic vibration exciter, control type 1019, offers. G3FAU, QTHR.

9R59DE plus spkr, works well, i.f. output for scope, with h/b 2m converter i.f., 1-8-3-8MHz, sell together or split, £35. G4ARG, QTHR. Tel 686 1756.

Digital watch, Sinclair kit, unopened, £15 inc post. Ian Davey, New Street, Hinckley, Leics. Tel 0455 32173.

813s, £4. 832A, £2. 829, £2. 5763s, £1. For callers only—Bendix 2m pa PN-8-A, uses pair HK24Gs with spares, £10. Quad fm tuner with decoder, £15. Labgear psu, mod for LG300, £20. Rough but working, 1kW linear and psu, £30. G2PU, QTHR. Tel 0223 870454.

Multiscript 3, 21 range taut band meter, 0-1-500V dc, 10-500V ac, with integral 3-speed paper strip recorder, BC221 AH, acpu, original charts, mint. Startronic Starpack dual stap. Psu, 0-3V dc, 500mA, limiter. Offers? Byrne, Alverstone Manor Hotel, Shanklin, toW. Tel Shanklin 2586.

NCX5 with Mk 2 mod, plus ps, £150. Top band to 20m transverter, £20. Reliable performers both but must make way for modern equipment. G2DMR, QTHR. Tel Burgh Heath 58729 evenings.

Heathkit Mohican rx, Stellaphone ST459 spool recorder, Swan 350C Versatower, SP60, AR22, TA33 Jr, Sensible offers invited. G3MTX, QTHR. Tel 0424 210177.

FT200, FP200, perf order, recently realigned, SMC, full 10m, YD846 mic, £210. 7200G Autotone, complete, £105. Will haggle. G8HVV, QTHR. Tel 04447 2893.

Four 400A valves, £10 each. Three ht smoothing chokes, 50p each. Buyer collects. G3UXV, 189 Ongar Road, Brentwood, Essex. Tel 0277 221604.

2N3055 with sockets, 3 for £1. Transformer 425-0-425V, 120mA + 275-0-275V, 65mA + LTO, £4. Transformer 4kV, 10mA, £4. Sealed audio filters, cw/rty, £2.50 post paid. Sae details. 19 x 10in case, free caller. *Wanted*: A2293, E180F valves. G3SBA, QTHR. Tel 05827 4815.

Frequency meter TS174U, 20-250MHz, £30. Yaesu FL2100, new, unused, in box, £200. *Wanted*: Trlo TS200. Tel East Horsley (Surrey) 4805, weekdays 9-7.

2N6084 12V 2m power transistor, as used in *ARRL Handbook*, 10W in, for over 50W out, £9. *Wanted*: uhf base and chimney for 4CX250. Swap for above transistor or pay cash. G8HPE, QTHR. Tel Romford (Essex) 45733.

Trlo VB2200 2m pa, Jaybeam 8XY/2M, Stolle rotator, Mosley "Atlas" 4 band vert. Offers. *Wanted*: HA350, T388 companion tx or FR100 rx. Lockwood, G3XLL, QTHR. Tel 408685.

Pye Bantam, Ultra Cub or similar high band hand portable suitable for conversion to 145MHz. G8LAE, 10 St Andrews Close, Old Windsor, Berks SL4 2QU.

HQ1 minibeam, hybrid quad aerial for 20/15/10m, in working order although slightly damaged, easily repairable, £30. Bargain, no offers. Heathkit spectrum analyser, exc cond, hardly used, £65 ono. G3UCT, 91 Kings Ride, Camberley, Surrey. Tel Camberley (0276) 21702 evenings.

Europa 2m transverter, exc cond, with built-in relay, £75. 80m coil for G3FIF mobile aerial, £2. Antec 1th ground plane, £6. Astro compass in original box, £3. G3JURE, QTHR. Tel 089 426 5311 (day), 3044 (evening).

"**RSGB Bulletin**", 1947 to date. Any offers? G3WUZ, QTHR. Star ST700E ssb tx, 80-10m, 2X6146B, vgc. GC3XZC, QTHR. Tel Jersey (0534) 24973.

Yaesu FT200 tx/rx with psu spkr, mic and blower, exc cond, ready to go, £180. RadCom, complete years 1970, 71, 72, £2 per year. Spare valves HRO, MX, offers? Steve, G3ZZD. Tel Tunbridge Wells 34117.

XF9B filter with both carrier xtals, £17.50. 65-00, 65-50MHz HC6U xtals, £4. All post paid. G3TDJ. Tel Bude (0288) 3701.

Heathkit GR64 gen cov rx, 550kHz-30MHz, 4 bands, as new, £30. G8JBS, QTHR. Tel Locks Heath 3684.

SSB xtal filters, Cathodeon 1-4MHz usb, bandwidth 6dB 2-35kHz min, 60dB 4-1kHz max, terminating impedances 1k Ω /15pF, requires carrier xtals 1-400MHz usb, 1-403MHz lsb, unused, £5 each, post paid. Blowers, filters, servo motors, xmrs, etc. SAE list. G3YLO, QTHR. Tel Luton 25595.

Xtal calibrator outputs 1MHz, 100kHz, 10kHz to above 2m, built-in deac, £6. Xtals 10X 100kHz, 500kHz, HC6U 8-118MHz, 14-438MHz, HC25U 26-682MHz, 28-805MHz, 27-098MHz, 50p each. H/B 2m fet converter, 24-26MHz i.f., £5. 2200 xtals 144-72, 145-32, offers? G8DLT, QTHR.

TS510 with ac psu, £200. DX150B cc rx, mint, £60. Phones, £2 pair. MM 2m converter, 28MHz i.f., £12. TE20D signal generator, £15. SMC trap dipole, new, £15. Micronta testmeter, £2. Tel Fergus 0782 617106 evenings.

Swan Cygnet Z70B 5 band, exc cond, 13in x 11in x 5in, needs only mic and aerial, manual, 2 6LQ6s for above, new, £300. Owner returning ZL. G4EEG, QTHR. Tel Puriton 683136.

Microwave Modules 4m converter, 28MHz i.f., mint cond, £14. Pye base station, low band, £10. Trio 9R-59 gen cov rx, handbook, as new, £18. Class D wavemeter, £5. P. Moss, G3ZHU, QTHR. Tel Luton 33666 (office).

KEN KP202, 145, 145-5, 145-55, R5, R6, R7, helical ni-cads, case and charger, £100. PA3 pre-amp for liner 2, £4.50. SSM 2m to mw converter, 12V, £12. Heathkit VF-1U vfo, 160 to 10, £10. G3SZJ, QTHR. Tel Derby (0332) 56875.

Heathkit IO18U scope including demodulation probe, £33. Heathkit HA201 2m amplifier, £12. Telford TC7 with MM converters, 144/432MHz, £50. Microwave a.m. tx, with 6 xtals, mic, £23. Veractor tripler, 432MHz, £10 excluding carr. G8HPD, QTHR. Tel Wheat-hampstead 3307 after 8pm.

KW2000A tx/rx, ac psu, 6146BS, Shure mic, vgc, £165. DC psu, £27. HC6U xtals S20, S21, S22, R5, R6, R7, £1.50 each. *Wanted*: Hallcrafters FMP300, Galaxy 5, KW2000E. G4AFY, QTHR. Tel Kidderminster 63358.

FR50B, exc cond, with top band and xtal cal, also external spkr, £65. Pye Cambridge with mod to tune 28-30MHz for use with cov, £18. G. Webb, 91 Gallows Hill Lane, Abbots Langley, Watford, Herts. Tel Kings Langley 64172.

Mullard 1in vidicon camera tube, type XQ1043, brand new, with data. CRT VCR138A with screen, base. VHF rx, type 62H, with psu 234A, offers. *Wanted*: Circuit for Furzehill oscillator, type G425. Cooper, 53 Jepps Avenue, Barton, Preston. Tel 0772 862493.

High band Vanguard AM25T with all control equipment carrier and tx/rx xtals for 145-9MHz, £20 ono. Mustang 8 track cassette player, needs attention, first reasonable offer, G8HYSY, QTHR. 3ft diam met balloons, ideal for supporting vertical aerial, 65p each, post included. *Wanted*: Keying paddle. GW4AEC, QTHR. Tel Portmadoc 2295.

Westminster W15AM, fully converted a.m./fm tone burst, 6ch, R5, R6, R7, S0, S22, handbook, cradle, 1/s, £40 ono. Cambridge AM10D, fully converted as above but 4ch, £25 ono. G3VZV, QTHR. Tel Whipsnade 872848.

Television camera, Marconi Mk3, ex-broadcast type complete with lens, cable, ccu, psu, monitor and circuit, £50. Large quantity of spares inc lenses, zoom, amplifiers, spg, monitors. SAE for list. Summers, G8GQS, QTHR. Tel Gainsborough 2802 3940.

Avometer model 40 with book, PM spkrs 3in to 10in, amplifier 10W steel, table cabinet, meters, early valves, components, chokes, transformers, relays, books, service sheets, coils, wire, indicator lamps. *Wanted*: 12AVQ Hy-gain aerial. G3DFS, QTHR.

Microwave Modules converters 4m, 2m, £12 each. 70cm, £15. All 28MHz o/p. TW 4m tx, £10. Heathkit HW16 cw tx/rx, 60/40/15m, £40. G4BMM, QTHR. Tel Luton 35617.

Trio 9R59DS, all mods and spkr, £45. Codar PR30 preselector, £4. "Q" mult, £4. Cossor doublebeam scope, £15. HF trap vertical V3JR, £8. 0-15V p/s, £6. SAE for further list. Pryce, 2 Seven Sisters, Willingdon, Eastbourne.

TS700, owners 20 HC18U xtals, 8-325 to 8-800MHz in 25kHz steps, includes G83VHF, ssb calling, S20, S21, S22, S23, S24, RR5, RR6, RR7 only, £6. High quality miniature coax leads, including plugs, £2.50. 18 HC18U xtals, 67-8 to 76-3MHz in 500kHz steps, including 72-3MHz and 72-8MHz for 2m, £3. G8ENI, QTHR. Tel Cheslyn Hay 415374.

Yaesu FL200B tx, spare set valves, £120 ono. Carr by arrangement. G3WAO, 6 Hazeldown Avenue, Preston, Weymouth, Dorset. Tel 0305 833590.

Liner 2 with PA3 preamp, and R115 mains psu, as new, £130. Prefer buyer collect. Also G8AEV 2m converter, 2-4MHz, i.f., £8. G3KNB, QTHR. Tel Stafford 62105.

70cm J-Beam antennas, 18 element Parabeam PBM18/70, £12.50. 48 element Multibeam MBM48/70, £14. Both new, unused. G4AIJ, QTHR. Tel Ludlow 3197.

Revophone cats whisker crystal set by Cable Accessories, Tipton, Staffs, with modern phones, no profit purchase, receipt produced, £15. Buyer inspects. Roth, 49 Stanchester Way, Curry Rivel, Somerset. Tel Langport 250987.

Inoue 1C700 tx/rx, good cond, complete station with mic and key, Mosfet front-end and mixer, £122 ono. G3RGC, 6 Winchester Avenue, Grimsby. Tel 70098 after 6 pm.

Pye Westminster a.m. on 145.0 and 145.50, £65. Also Eddystone EC10 Mk1 plus converter for 2m, £70. Pye Cambridge 6ch a.m./fm, £35. G8KAS, QTHR. Tel Uckfield 2771 after 6pm.

FT200 + FP200 and home-made 160m transverter, full 28MHz, very good cond, boxed, £225. No offers please. G4DBX, 96 Coleridge Way, Crewe, Cheshire.

IC22A, little used, 2 months old, fitted 10ch, toneburst in original packing, £155. TE15 GDO 440kHz-280MHz, little used, £18. G3TSO, 11 The Oval, Henlow, Beds.

Heath SB303 rx, with SSM 2m converter and matching spkr, SB410 tx, SB620 spectrum analyzer with interconnecting cables and manuals, all excellent, £370. 10MHz scope, £20. Buyers collect. G8AWV, QTHR. Tel 01-794 9934 (home), Ashford (Middx) 51234 (work).

FT201, new, little used, £310. HW32A 20m tx/rx, with big ac psu, £60. Storno Viscount 2m fm mobile, £25. G3UGF, QTHR. Tel Bradford 814218 evenings.

FTDX401, £275. YO100 Monitorscope, £75. Tech TE15 grid dip meter, £12. 50Ω load, £5. Three band vertical, £10. All in mint cond, nearest offer on any item secures. G4DQH, QTHR. Tel Dronfield 413500 after 6pm.

FLDX500, 3.5-30MHz, immac cond, £135. Matching FRDX500, 1.8-30MHz, 2m-6m, £145. Buyer collect. G3YSJ, 27 Peters Close, Upton, Poole, Dorset. Tel Lytchett Minster 2371.

Vanguard a.m. 25B, control unit and cable, no xtals, £15. Heathkit grid dip oscillator, £6. Handbooks. G3TWP, QTHR. Tel Winchester 69835 evenings.

G3ZVC ssb tx/rx, with XF9B filter, built in diecast box, includes tx/rx switching, led indicators, "S"-meter, spkr and regulated psu, 12V supply, BNC connectors, all working, £60 or offer. R. Hall, G8KER, Croft House, Grove Road, Burbage, Leics LE10 2AD. Liner 2, manual, mounting, £125. Linear 40, Mk 2, unused, £30. G8AEV fm/a.m. tx with vfo unit, clean signal, £20. Heathkit Mohican rx, £25. Carr extra. G8JFE, QTHR. Tel Hawick 3441.

SB301 10-80m rx, exc cond, including handbook, £100. R1475 2-20MHz rx, vgc, including matching psu, Burns fm detector, handbook, £25. RTTY psu, rectifier type 66A, 80-0-80V, £5. G8I2D, QTHR. Tel 01-317 9735.

Pye fm 2m, 100W tx, xtals inc R7, tone generator, £29. Lowe Monitor rx, S0, S20, S2, R7, mains psu, £28. Repeater, CMOS tone generator, new, £3. 2m pre-amp fets, £3.50. Pye 2m rx strip, £4. G8FHN. Tel Medway 63365 (Kent).

KP202, case, ni-cads, charger, helical whip, tone burst, fitted 145.00, S20, S21, S22, R5, R6, (R7 extra), as new cond. Exchange for Trio 2200G, same cond. Reason, need both mobile and portable rig. P. I. Martin, 41 Ottoline Drive, Troon, Ayrshire KA10 7AN. Tel Troon 311245.

Hammarlund HQ-170A with auto transformer, 237 Rowley Lane, Lepton, Huddersfield. Tel Kirkburton 2744.

DX100U + SB10U (property late G3IUD), offers over £33. Buyer inspect/collect. Enquiries sae. Boxed, unused 6DE7 for Lafayette Starflight, 70p, plus 64p stamp. G6QI, QTHR. Tel Mullion 546.

Shack clearance, call at my QTH after 10am Saturday 10 and Sunday 11 April, bargains galore, everything must go, no reasonable offer refused, space urgently needed. G3YRB, QTHR.

Yaesu FR400SDX, 160-2m, as new, £175. G3ORC, QTHR. Tel Meopham 812289.

Complete station: Heathkit SB101 tx/rx with cw filter, SB600 and HP23A, £180. SB220 linear amplifier, £240. Technical Associates speech compressor, £20. D. Yeaman, 5 Chartwell Road, Bishopton, Renfrews, Tel Bishopton 2941.

46 element Jaybeam 70cm aerial, correctly dimensioned with connecting length of Aerialite 363 cable, £12.50. Latest 88 element Jaybeam with cable length, £14.50. G4AHH, QTHR. Tel Silverstone 857350.

SSB phasing tx, 20m and 80m, 120W, working, needs p/s, £15. Prefer buyer collect. Capacitors, new, 2pf to 1200pf ceramic, 47pf and 8,200pf mica, 200 mixed, 75p. Elliott, "Oatlands," Southend Road, Howe Green, Chelmsford CM2 7TD. Tel 71604.

KW Atlanta tx, £220. Codar AT5 plus 12V supply, £15. Creed 7B teleprinter, RSGB Teleprinter Handbook plus paper rolls and spares, as new, unused, £25. GM4BCK, QTHR.

KW2000E plus ac psu, £230. Do you own a Hammarlund HXL-1 linear amplifier? If you do please contact me as I have problems with mine. G3NFV, QTHR. Tel Lea 75204 evenings or weekends.

Property of late G3TNE, 30ft professional triangular lattice tower with ground post, first reasonable offer over £50 secures. Buyer collects. G3HVA, QTHR. Tel Tadley 4445.

Trio JR310 rx, fitted 10AZ filter, mint cond, approx 10 hrs use, complete with manual and original packing, £75. Buyer collects. Tel 021 458 3537 after 7pm.

Trio 9R59DS with spkr, stabiliser, xtal, calibrator, handbook, £40. G3NNG rx, completely built, Eddystone dial requires aligning, £20. 2m base station, 45W, tip phase mod, £18. Send sae for details and other items for sale. G8FXG, QTHR. Tel Didcot 813916 evenings. Liner 2, good cond, fitted preamp, £120 ono. G3JKS, 115 Marshaiswick Lane, St Albans. Tel St Albans 59318.

Yaesu FT401B tx/rx, 560W, new, boxed, £360. Hy-gain hi-tower 10-30, vertical, new, unused, £130. CD44, latest model, £55. Mini-beam HQ1, £50. Pye Cambridge 4m fm, less xtals, £25. Taylor, 5 Luther Road, Winton, Bournemouth. Tel Bournemouth 0202 50400. Sony CB801W walkie-talkies for 10m conversion, size 2in by 1in by 5in. Trio 7200G, VFO30, BPF2, plus components for adding 600kHz shift to vfo. Offers. G8FGD, QTHR. Tel 0272 582981.

RTTY Creed 7E/RP teleprinter, good order, £25. Delivery extra by arrangement. G3RDG, QTHR. Tel 01-455 8831.

Valves 723A/B, 4CX250B, QQV03/20A, 572B, 4X150A, 5763, EF50, 6146W, TT21, TD03/10E, several CRTs, all new, boxed and cheap. Wanted: vhf mobiles and hf ssb tx/rx. G3VJ/VQ9J, 13 Alberlus Gardens, Hayle, Cornwall. Tel 753606.

Transformers, 500W auto, £6. 650-0-850V, 200mA, £5. 813 heater, £3.50. 6.3 + 6.3, @8A, £3.50. Professional psu, 12V, @500mA, £6. Avometer model 8, £15. Hamgear 1.8-7MHz converter, £4. Transistorized 1W 2m fm tx + T/B osc and extras, £15. Lowe 2m fm rx, 6 xtals, new, £30. All items guaranteed working and good cond. c/o Butterfield, G3RBU, QTHR.

Honda E300E generator, only 40 hrs use, as new, list £148, £75. Xtals, nearly new, HC6U, 44633-3 (144.6 rx), 40-000 (for 2m conv), £1 each. 1 1/2 ceramic formers, 3in long, 25p each. Orchard, G3TTC, 5 Hurst Close, Chessington, Surrey.

SSB solid-state rx module, ex-commercial equipment, 1.6-4.0MHz band, SE1, 5.2MHz ssb/a.m. xtal filters, Plessey SL600 series, ICs, instruction manual, £20. Inclusive carr. G3JMJ, QTHR. Tel 073 271 3467.

Original vols 1 and 2 of Radio and TV Servicing, plus 10 books 1955/56, 56/57, 57/58, 58/59, 59/60, 60/61, 61/62. Also 1965/66, 66/67, 67/68, 12 for £12. Valves, as new, unused, 4 807, £8. HRO valves, 2 6C6, 2 6D6, 1 6B7, £4. Offers for new valves—2 GZ32, 2 EL34, 3 GZ34, 1 5U4G, 1 6V6GT, 4 EL34, 4 EF86, 1 5Z4. Fisher, G2FFN. Tel Billericay (02744) 52441.

RFL 100W 2m transistor linear, £55. Garex 2m deluxe rx, a.m., fm, ssb, cw, £45. Glass fibre dish, 4ft x 9in deep with 23, 13 and 9cm dipole feeds, £15. Stornophone 500, 160MHz, with ni-cads and charger, £35. G4CXJ, QTHR. Tel Witney 2573.

Cosor scope d/beam, spare tube, manual, £12. 2m, 5-el quad, £5. Wanted: Heathkit 610 monitorscope, Barwood, G4EGR, 41 Winefield Road, Knowle, Bristol 3. Tel 772804.

Heathkit IB1100 counter, plus prescaler suitable to 250MHz, ideal for 2m, built to manufacturer's spec, as new, £90 ono. G8HVQ, QTHR. Tel Marlinstown 345 evenings.

KW2000B with ac psu, recently aligned, two new pa valves, exc cond, going transistor h/b throughout station, £225 ono, carr included. Lewis, G4DQP, 32 Colne Road, Trawden, Colne, Lancs. Tel 02824 6622.

Trio 9R59DS, 19 months old, good cond, will accept £50 ono. Wanted: Trio JR310, must be good cond. Allen, 21 Woodlands Drive, Ruisnton, Taunton, Somerset TA3 5JU. Tel Henlade 442602.

AR88D, good cond, complete with English repair manual, £25. Carr extra or buyer collects. G3BJB, QTHR. Tel 0886 32107.

R216 rx, 19 to 157MHz, with psu and data, £25. B44 Mk II tx/rx, £5. All as new and working. Buyer collects after 1830. G3KTN, QTHR. FT2F, 12ch + 4, fm a.m., £120. S00, S08, S20, S21, S22, S23, S24, S32, R3, R4, R6, R7, + xtals for 144-40, 144-48, 144-60, 144-80. Buyer collect or pay carr. G3TFN, QTHR. Tel 061 761 2952.

WANTED

Pye 6 to 12V inverter, neg earth, or would consider anything similar. For sale: Liner 2, Galaxy 5, Mk 2 hf ssb/cw tx/rx, covers 80-10 400W p.e.p., includes dc psu. Hybrid, would make excellent mobile unit. G8GHZ, QTHR. Tel Northampton 61794.

FT75 or other hf tx/rx, reasonable cond. J. White, 11 Shrewsbury Road, London N11. Tel 01-368 0332 or 01-253 0661 ext 18 (office).

SSB tx/rx with 160m or suitable for conversion, any cond, will rebuild if necessary. HRO or similar class rx. A.M./cw tx. Class D w/meter xtal. Black box and cheap oscilloscope. All replies answered. G3IUV, QTHR.

Eddystone EA12 rx, good cond essential. G3WEX, QTHR. Tel Sutton Coldfield 021 354 4265.

Research student for interesting M.Phil project on communications receivers, start Autumn 1976 in Aberdeen. Grant available. Suit amateur who has or hopes to have good degree in electronics, physics or maths. GM3HAT, QTHR. Tel Aberdeen 36004.

Will pay top price for a new and guaranteed unused Eimac 4CX1000A tx valve. G2AMJ, QTHR. Tel Hull 653358 or 655584, giving asking price and full details.

New school club requires 18AVT/WB, Viceroy Mk III/IV and good GC rx at lowest possible prices. Can collect 50 miles Bristol. Offers to G3MFL, 13 Emborcourt Drive, Backwell, Bristol BS19 3HJ.

FT101, TS520 or similar wanted. G4BIK, QTHR. Tel 051 724 4229.

Manuals and circuits for Cossor scope type 1049, and telequipment type 4A. Also base connections for crt type 908A (MOV), service type CV1529. Roy Harcup, 19 Peel Green Road, Barton, Eccles, Manchester. Tel 051 789 5293.

Linear SB200, KW1000, FL2000 etc. Will exchange very good cond 2m 3 band hand portable, fm 145MHz fitted, for 2m or 4m transverter or above item with cash adjustment. G3VOF, QTHR. Tel Ingrebourne (04023) 73366.

Copy of "Amateur Radio", author H G Rayner. H. Stephens, 46 Burghold Road, Skegness, Lincs.

KW2000A mobile dc psu or similar, all replies answered. GI4DOM, 10 Gransha Parade, Glen Road, Belfast BT11 8AR.

FT101, Atlas 215 or similar mobile hf rig. Also 80m G whip, twin meter swr bridge, and Sinclair PZ6. For sale: Texas T1-2500 Data-math calculator, £16.50 ono. I. Jenson, 82 Valley Road, Sutton Coldfield, West Midlands B74 2JF.

Mountain rescue team requires hand portable RTs, E band a.m. 12½kHz or convertible. Reasonable price, cash available. Fowler, 42 Burnedge Lane, Grasscroft, Oldham. Tel Saddleworth 3316.

Personal portable dry cell operated cw QRP tx/rx for either 14 or 21MHz. H/B or modified commercial unit welcome. Rx must be specially good. G2RO, QTHR. Tel Torcross (Devon) 616.

B2 rx in working order, with or without psu. Any B2 spares such as plugs, coils, crystals etc. G3FQX, QTHR. Tel Winchester 63906.

Returning overseas soon, required urgently in good working cond. KW2000 A or B with psu. VQ9NLB, 47 Sprules Road, London SE4. Tel 01-732 0690.

B13 valve base and smoothing capacitor for 2,500Vp/s. G3HAS, QTHR.

SSB tx 160/10 or 80/10 kW Vespa, Viceroy, or similar, around £65. D. A. Davies, 51 Upper Howsell Road, Malvern, Worcestershire.

"Radio Communication Handbook" in good cond. J. Shepherd, 140 The Broadway, Herne Bay, Kent.

CRT type 26 for Cossor 339 scope, unused one preferred, would pay £5. G3FNJ, QTHR.

KW1000, SB200 or good h/b hf linear, no tv sweep tubes please.

Cawthorne, G3TXF, High Beams, London Road, Feering, Essex CO5 9ED. Tel Kelvedon (0376) 70157.

FT101, reasonable price. Faulty unit considered. 9 Brackenhill, Osbaldwick, York.

Old radios, pre-war components, early valves, sets, and wireless books, magazines, wanted by collector-enthusiast. Valve car radios, any cond considered for anything above. C. Sawyer, 210 Gordon Avenue, Camberley, Surrey. Tel Camberley (0276) 29460.

Am getting no output from my bfo No 8, mainly due to faulty output transformer. Seek replacement, can you help? Your price paid. G3DPS, RSARS, School of Signals, Blandford Camp, Dorset DT11 8RH.

Drake-line tx/rx, would prefer later models, why? For sale: R216 vhf rx, 19-157MHz, a.m./fm/cw, separate mains power supply to match rx, vgc, £100. Jesson, G4CNY, QTHR. Tel 0432 3237.

CRT type 4EPI or 910 for telequipment scope model 720, UHF base and chimney for 4CX250. G4EFA (ex G8GBX) QTHR. Tel 814085.

Tripod with pan and tilt head for Pye Lynx cctv camera, also telephone answering machine. G3SSZ, 1 Rayleigh Close, London N13. Tel 01-803 3111.

CT160 valve tester. AVO electronic testmeter, Eddystone 770R. G3VPI, QTHR. Tel 0473 79186.

Honda generator or similar. Will collect. Landor, 6 Queens Road, St Helier, Jersey, CI. Tel 0534 54186 evenings.

RX 3-ganged tuning capacitor, approx 20pF each section, SCR522, mod, and drive trans xtals, 1MHz 2MHz marker, also 464-8kHz, all HC6/U type. Haslam, G3XSI, QTHR.

Drake SPR4 rx, please state price and cond. For sale: Barlow Wadley XCR30, mk2, remarkable performer, price £95. Alis, 7 Hillside Avenue, Wembley, Middlesex.

Information, manual, circuit diagram on US Army rx BC-312-N, to buy or borrow, Mike Roberts, 118 Hobs Moat Road, Solihull, West Midlands B92 8PF.

PCR3 rx, any cond. R. Dickens, 32 Ingersoll Road, Shepherds Bush, London W12 7BD.

Navy B47 rx. Marconi TF2330 wave analyser. Bradley CT471 multimeter. R206 II adaptor. Marconi TF2701 LC&R bridge. Plessey TDMS70 Marconi TF2002 sig gen. Passfield, 30 Greenleaf Close, Tulse Hill, London SW2. Tel 01-674 5825.

Projection tv, Sony 2100 vtr, other video equipment. Why? Homer, 32 Iron Mill Lane, Crayford, Kent. Tel Crayford (0322) 524625.

To buy or borrow, service manual or circuit diagram for Cossor CC2/8MS, high band G8IVW, QTHR.

Hy-Gain 14AVQ/WB, details and price please. Tel Hunt, Standish 422789 (Wigan).

High band video head and/or rotary transformer for Ampex VR7003H video tape recorder. G8CMO, QTHR. Tel 0264 61345 (office).

AR8 S-meter. G3AUB, 8 Longden Lane, Macclesfield, Ches. Tel Macclesfield (0625) 25910.

CW tx/rx HW7 or cw tx for 80/20m or 20/15m, why? Would consider Codar AT5 with psu. For sale: R216 psu, working, £10 ono. Heathkit dc psu HP13, OK rx, needs attention for tx, £18 ono. Carr extra. McIlroy, Mill Street, Ballymena, N Ireland BT43 5AA. Tel Ballymena 3284.

Orake gear, T4X, R4A or early T4XB, R4B, alternatively early Heath SB line SB300/301 and SB400/401. Also Heath HM102 wattmeter. Coull, "Oomel", Eiham, Kent. Tel 0303 57271 (day), Eiham 244 (evenings and weekends).

Yagi 2 or 3 element TA33jr, TA32 etc. G4BHE, 4 Foxmoor Close, Oakley, Basingstoke, Hants. Tel Basingstoke 781468.

12AVQ or 14AVQ vertical. Thurgar, G4CSX, 10 Wickor Way, Emsworth, Hants. Tel Emsworth 3957.

SB200 or KW1000. HW32. Circuit for R1155. GW4DJW, QTHR. Tel 035 287 877.

Pair S.G. Brown Type A phones, good cond. Bovey, 1 Chapel Lane, Dartmouth, Devon TQ6 9BL.

S-meter for AR8D rx. G4EUL, 15 Sandleigh Road, Leigh-on-Sea, Essex SS9 1JT.

Hudson FM208, Storno CQM19, h/b or 2m. Can collect in UK. G3CHKV, QTHR. Tel 0481 41278, 6-7pm.

Transistor gdo. Modern wide-band oscilloscope. MW/jw/tm stereo hi-fi tuner unit. Letters only. G8FKF, Northview, Marsh Road, Stallingborough, nr Grimsby, South Humberside DN37 8AN.

C12 Army tx/rx, must be in working cond and have atu and connecting cables. Any ex-WD army, navy or air force radio equipment. Details and price please. Ian Greenshield, Monksilver, Limpley Stoke, Bath BA3 6HH. Tel Limpley Stoke 3215 evenings.

G2OAF Mk 2 rx, working or not. TF1449, leads and probes, in good cond. G3PJN, QTHR. Tel Chesterfield 6040 after 6pm.

Oishes 3ft to 6ft. Any waveguide WG14 components, especially VG switch. Varactor 8XY36. Anything for 24GHz. Diodes MBD102. G8ADP, QTHR.

FM 2m tx, any make considered, willing to pay up to £25. G8LKR, 13 Alexander Road, Stotfold, Hitchin, Herts.

Neon stabilizer for LO stage of R209 or details of suitable alternative. G. H. Hallam, 1 East Street, Helmshore, Rossendale, Lancs. Tel Rossendale 4303.

Kokusai mech filter MF455-15K for hard-up swl. Also Eddystone 898 dial unit, both good cond. P. Dale, 144 Northwood Way, Northwood Hills, Middx. Tel Northwood 21017.

MFJ SBF-2BX ssb filter, boxed in cabinet, your price paid. Bennett, 1 Whitehaven Road, Bramhall, Stockport, Cheshire SK7 1FL. Tel 061 439 1346.

HRO-5 with bandspread coils, 160-10m, must be vgc, no sprk/psu needed, handbook if available. Eddystone EA12 rx, would exchange for FTDX150. GM3HBT, QTHR. Tel Larkhall 883306 after 6pm.

Pocketfone tx and rx ni-cads. G8KUX, 28 Conqueror Road, St Leonard's, East Sussex. Tel Hastings (0424) 426737.

QRP rig, HW7 type, HRO spares and/or rx for rebuild el-bug or paddle. For sale: Sotatron 513 5in scope with manual, £25. Advance 150W voltstat audio oscillator with data. G3VXS, QTHR.

RULE BRITANNIA !! UK victorious In US FT. Club test of Jap, US and U Clippers. Wireless Institute of Australia reports on G3LL Clipper: "Receiver performed somewhat better than original—on transmit—most effective—average power increase—two 5 points—no loss quality". Buying FT.101 ? FT.101B or EE plus G3LL RF Clipper £472.50 cash, Clipper £45.00 or D.I.Y. from £28.00. Shure 444 £19.50, 401A £10.25, 201 £8.75. G-Whips, Lincor 2 £181.00 HQ1 Mini Beam £81.00. All Inc VAT and carriage. Details s.a.o. phone orders give Access number for quick despatch. Holdings 30/41 Mincing Lane, Blackburn Tel: 59995/6.

Complete the coupon and we'll send you our complete, new catalogue.



The new Heathkit catalogue is now out. Full as ever with exciting, new models. To make building a Heathkit even more interesting and satisfying.

And, naturally, being Heathkit, every kit is absolutely complete. Right down to the last nut and bolt. So you won't find yourself embarrassingly short of a vital component on a Saturday evening—when the shops are shut.

You'll also get a very easy to understand instruction manual that takes you step by step through the assembly.

Clip the coupon now (enclosing a 10p stamp for postage) and we'll send you your copy to browse through.

With the world's largest range of electronic kits to choose from, there really is something for everyone.

Including our full range of test equipment, amateur radio gear, hi-fi equipment and many general interest kits.

So, when you receive your catalogue you should have hours of pleasant reading.

And, if you happen to be in London or Gloucester, call in and see us. The London Heathkit Centre is at 233 Tottenham Court Road. The Gloucester showroom is next to our factory in Bristol Road.

At either one you'll be able to see for yourself the one thing the catalogue can't show you.

Namely, how well a completed Heathkit performs. Heath (Gloucester) Limited, Dept. RC-46, Bristol Road, Gloucester, GL2 6EE. Tel: Gloucester (0452) 29451.

Digital IC tester.

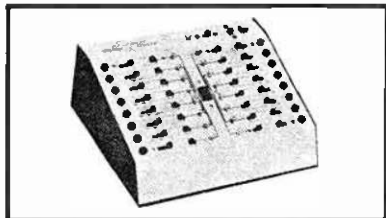

Heathkit Modulus. A new era in Hi-Fi.

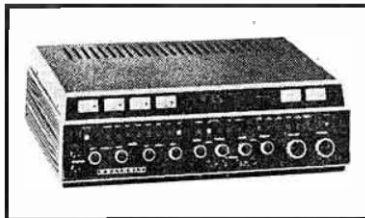

SSB Transceiver.

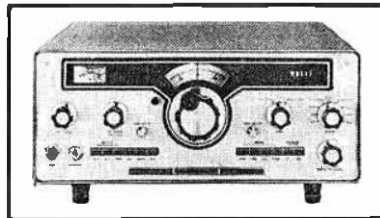

The new Heathkit catalogue. Out now. FREE.

To: Heath (Gloucester) Limited, Dept. RC-46, Gloucester, GL2 6EE.

Please send me my Heathkit catalogue. I enclose a 10p stamp for postage.

Name _____

Address _____

Postcode _____

HEATH
Schlumberger

EASY TERMS AVAILABLE
WITH HEATHKIT MONTHLY
BUDGET PLAN

STEPHENS-JAMES LTD

47 WARRINGTON ROAD, LEIGH, LANCS WN7 3EA
TEL 052-35 76790

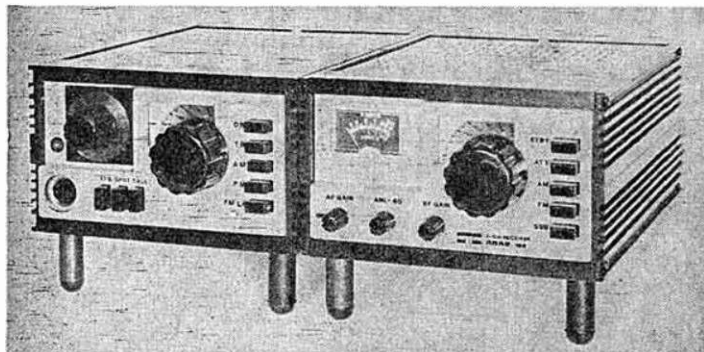

ARAC102 Solid State Two Band Rx 28-30MHz, 144-146MHz, am-fm-ssb. 12V dc built-in speaker £108
ATL222 Solid State Transmitter am-fm-cw, 8 watts, 144-146MHz + 12 crystal channels—tone burst complete with microphone £140
Full range of modules for Rx's, Tx's etc. Send large SAE for details.

ELECTRONIC DEVELOPMENTS. (Below) Four of our current range of models now in production. Designed and manufactured by us: Magnum 2 & 4 metre Transverters £110. Magnum 2m Linear Amplifier £105. VHF Absorption Wavemeter 65-230MHz £18. SWL Tuning unit Mk1. 50 switchable/tunable positions for frequency coverage 2-30MHz. Two inputs. Long wire or co-ax £15.50. OVERSEAS TRADE ENQUIRIES WELCOME.

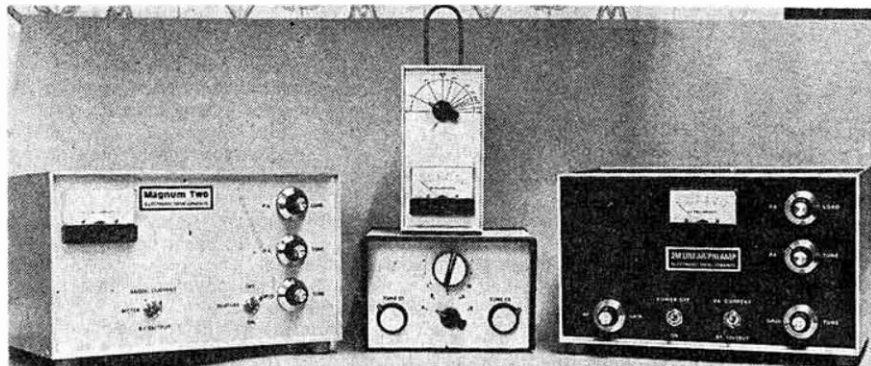

INSTANT HP AND CREDIT FACILITIES AVAILABLE. BARCLAYCARD AND ACCESS FACILITIES. FULL GUARANTEE ON ALLEQUIPMENT. PART EXCHANGES WELCOME. AFTER SALES SERVICE. SAE WITH ALL ENQUIRIES PLEASE. FREE DELIVERY SOME AREAS. SPOT CASH PAID FOR GOOD EQUIPMENT.
SHOP HOURS 9.30 TO 5.30 MONDAY TO SATURDAY. NO PARKING PROBLEMS.

Stockists for the current range of equipment by

★ YAESU ★ DRAKE ★ OECCA COMMUNICATIONS ★
HY-GAIN ★ JAYBEAM ★ OMEGA ★ G-WHIPS ★ ATLAS ★
SPACE MARK ★ C.O.R. ★ MICROWAVE MODULES ★
SHURE ★ AMTRON ★ BARLOW WAOLEY ★ EAGLE
★ BELCOM ★ UNIOEN ★ KATSUMI ★ TECHNICAL
ASSOCIATES ★ ICOM ★ S.T.E.

Send SAE for latest information. All prices include VAT.

ACCESSORIES

Emote 102L BX Rotator	★ ★ ★	£68.75	Post 85p
Single Meter SWR Bridge 50 ohms	★	£6.20	.. 30p
Twin Meter SWR Bridge 50 ohm	★ ★	£11.20	.. 40p
Osker SWR Meter	★ ★ ★ ★	£25.82	.. 50p
Omega Noise Bridge TE-701	★ ★	£22.50	.. 20p
Omega Noise Bridge TE-702	★ ★	£30.00	.. 20p
Planet Speech Processor	★ ★ ★	£35.00	.. 50p
Tech. Associates Audio Filter	★ ★	£32.50	.. 50p
Tech. Associates Speech Compressor	★	£29.12	.. 50p
Drake Low Pass Filter	★ ★ ★ ★	£15.00	.. 50p
Tech 15. G.D.O.	★ ★ ★ ★	£22.00	.. 40p
Morse Keys	★ ★ ★ ★	£7.50	.. 42p

Oplope "T" pieces 62p; 3" ceramic insulators 32p; PL259 48p;
SO248 42p; cable reducers 15p; 300 and 75 ohm twin feeder 8p
yard; UR41 18p yard; UR57 40p yard.

SECONDHAND EQUIPMENT

MAGNUM 4 metre Transverter	£60
SWAN 300 Transceiver	£300
DATONG Speech Clipper	£35
HEATHKIT HW32 with HB PSU	£75
NATIONAL NCX5 Transceiver	£185
ATLAS AC PSU	£75
SWAN 300B with dc psu	£300
M/MODULES Converter	£12

WINTER SALE! OF HONDA GENERATORS



FOR FULL DETAILS AND SALE PRICES WHICH INCLUDE FREE DELIVERY IN THE UNITED KINGDOM.

Call, write or phone Godalming 23279. (24-HOUR ANSWERING SERVICE). OPEN TUES-SAT. 10.30-1.30, 2.30-6.30.

**Ashley
Dukes**

FARNCOMBE ST.
FARNCOMBE
GODALMING
SURREY

FM CRYSTALS from stock

Hc25/U	145-0	145-2	S20	S21	S22	S23	S24	145-8
Tx	6-04167	6-05000	6-06250	6-06354	6-06458	6-06563	6-06667	6-07500
Tx	12-0833	12-1000	12-1250	12-1271	12-1292	12-1313	12-1333	12-1500
Tx	18-1250	18-1500	18-1875	18-1908	18-1936	18-1969	18-2000	18-2250
Rx	14-9222	14-9444	14-9778	14-9806	14-9833	14-9861	14-9889	15-0111
Rx	44-7867	44-8333	44-9333	44-9417	44-9500	44-9583	44-9667	45-0333
Rx	51-9000	51-9667	52-0667	52-0750	52-0833	52-0917	52-1000	52-1667

Repeater channels in same ranges: R2, R3, R4, R5, R6, R7, R8
Rx crystals for repeater inputs: R3, R4, R5, R6, R7, R8

Hc8/U

Tx ranges: 4, 8MHz Rx range: 10, 44/45MHz

Simplex channels: 145.0, S20, S21, S22

Repeaters: R3, R4, R5, R6, R7

40-5000 for Cambridge tuneable conversion (Rad, Comm. Dec. '74)

Inclusive price £2.50 each

Giro 35 563 4007

Prompt despatch by First Class post

SAE please for list

Phone 04-868 7597

HARTLEY CRYSTALS

Green Lane, Milford, Godalming, Surrey GU8 5BG

Two publications for the price of one!

30th ANNIVERSARY EDITION World Radio TV Handbook 1976

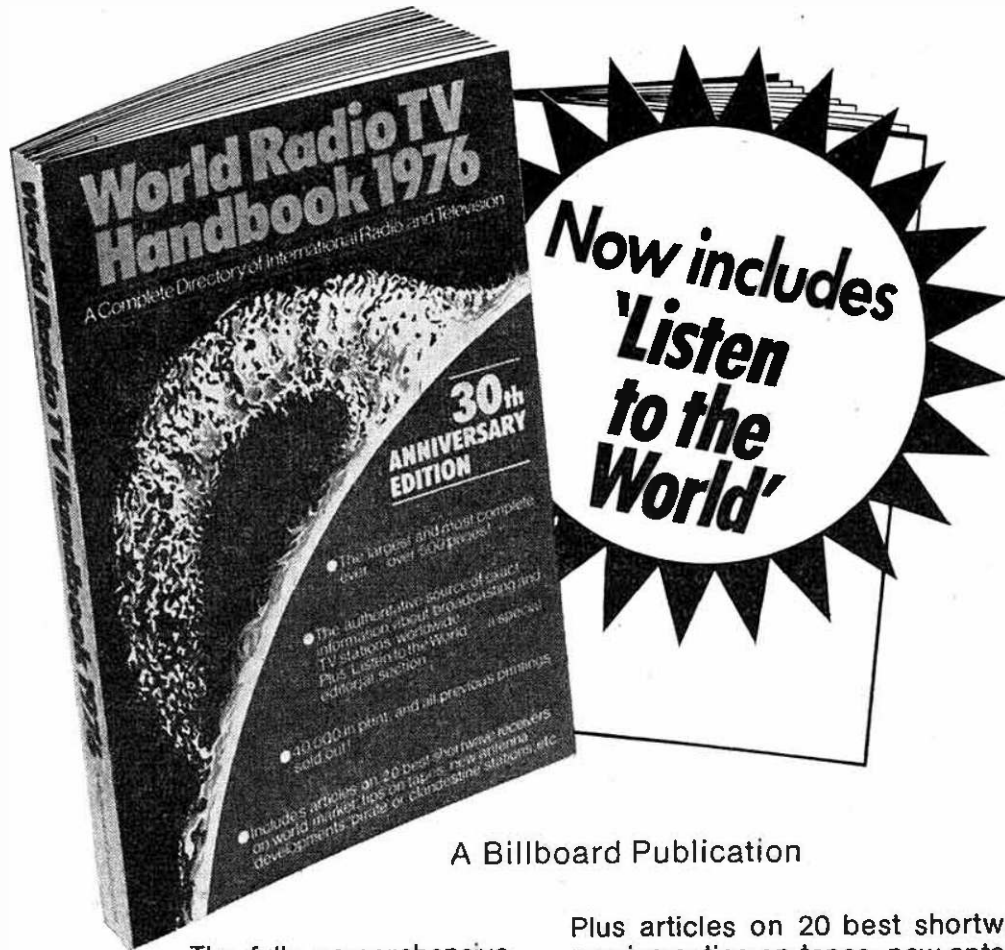

A Billboard Publication

The fully comprehensive guide to the technical world of TV and radio... plus 'Listen to the World'—the world's foremost guide to international medium and shortwave broadcasting. At 560 pages—it's the biggest and best ever! The professional and enthusiast's bible. Contains authoritative information about broadcasting and TV stations world-wide...bands, DX programmes, time charts, etc.

Plus articles on 20 best shortwave receivers; tips on tapes; new antenna developments; 'pirate' stations, etc.

OUT NOW! at £4.50

From your bookshop—or direct from:

The sole trade distributors:

ARGUS BOOKS Ltd.

Station Road, King's Langley, Herts.

Sales Dept: King's Langley 66694.

AMATEUR RADIO BULK BUYING GROUP

"PURRECTION"
FROM



NEW VHF and UHF PRESCALERS

The range is now extended to include 3 Prescaler Modules:
500MHz ÷ 100 Model FS5000. This top of the range model enables the range of most HF Digital Frequency Meters to be extended up to 500MHz. By dividing the input signal frequency by a factor of 100, the output is sufficiently low in frequency to drive standard TTL logic circuitry even when measuring frequencies in the 70cm band. PCB size is approx. 3½" x 2". Price: £30.50.

500MHz ÷ 10 Model FS500. Similar specification and size to model FS5000 but having a frequency division ratio of 10. Price: £27.00.
150MHz ÷ 10 Model FS150. VHF Prescaler for use up to 150MHz with switchable ÷ 1 preamp mode for use down to audio frequencies. Still the most popular Prescalers available at the new low price of £23.00.

Note: Catronics Prescaler will work into all the popular DFMs including those by Heathkit, RCS, Yaesu, etc. and the G3XGP design—in fact we haven't found one into which it won't work yet!

CRYSTAL CALIBRATOR

Catronics model M6 giving outputs at 1MHz, 200kHz, 100kHz, 50kHz and 25kHz at the flick of a switch, with harmonics audible up to 2m band. 6 volt supply. Complete PCB module, accurately set to frequency and switch assembly—£8.90. Also available—kits of parts for regulator for operation on 9 to 20 volt supplies, £1.60. Complete Boxed Unit with battery, £14.50 (+50p post).



HAVE YOU ordered your 1976 subscription yet? If not, send £3.30 now to receive 4 quarterly magazines chock-full of constructional articles.

VHF COMMUNICATIONS, the English language edition of the German publication UKW-BERICHTE, is a quarterly amateur radio magazine especially catering for vhf/uhf/shf technology. It is published in spring, summer, autumn and winter.

All special components required for the construction of the described equipment, such as printed circuit boards, coil formers, semiconductors and crystals, as well as complete kits, are available for despatch direct from Germany. Many of the printed circuit boards, in addition to a few selected kits, are stocked in the UK. A price list of kits and materials is available—send see for your copy.

All back issues are available, either post free from Germany (approx. 3 weeks) or can be despatched from UK stock (approx. 3 days) if UK postage is added.

Complete Volumes: 1970, 1971
(per year) 1972, 1973, 1974
1975

Individual back issues
Plastic Binder to hold 12 editions
(three volumes)

Vois 1970-72 with FREE BINDER
Vois. 1972-74 with FREE BINDER
Vois. 1970-75 with TWO BINDERS

Sent from Germany	For Delivery from UK add:
£2.50	30p per vol.
£2.90	30p per vol.
£3.30	30p
85p	10p each
£1.20	35p each
£8.00	70p
£8.40	70p
£16.55	£1.00

Administration address and Callers (by appointment) to:
39 POUND STREET, CARSHALTON, SURREY
Tel: 01-669 6701 (9 a.m. to 6 p.m., 1 p.m. Sat.)

All Mail Orders and enquiries to: Dept. 604
20 THORNTON CRESCENT, OLD COULSOON, SURREY

TYPE HG3F 144MHz MOBILE ANTENNA

Inexpensive half wave VHF whip antenna covering 144-146MHz with approx. 3dB of gain compared to a ¼ wave whip comprising stainless steel tapered whip section fed via bottom series coil. The whip may be angled from the base and also folded to avoid damage etc. Mounting by ¼" diameter hole. Price only £7.80 + 50p post, price inc. 25% VAT. High band 148-174MHz versions available for the commercial radiotelephone frequencies. Price £6.25 + 8% VAT + 50p post. 50ohm Co-ax cable to suit, 12p per metre.



REVCO

Available from

A. J. H. ELECTRONICS
59 WAVERLEY ROAD
THE KENT
WARKS RUGBY
PHONE 76473

SPRING SALE—orders received April only

2-metre Crystals	HC25/U—6, 8, 12 and 18MHz Tx, 11MHz Rx, £1.10 ea
Channels S0, S20-S23	HC6/U—4 and 8MHz Tx, 10 and 11MHz Rx, £1.10 ea
R4-R7 and 14S-8 only	HC8/U—36MHz Tx and 45MHz Rx to Pye specs., £1.90 ea.

Plus the following useful frequencies—100kHz and 1MHz—£3.75 each, 5 10 and 38-66637MHz—£1.10 each.

Building a clock? Buy the crystal now—2-097152 and 3-2768MHz—£2.00 each.

Please add V.A.T. Money will be refunded immediately if any items are not actually in stock when your order is received. Please note that "Radcom" must be mentioned in order to qualify for these prices, most of which are typical for larger quantities. Trade enquiries invited.

INTERFACE QUARTZ DEVICES Ltd

29 MARKET STREET, CREWKERNE, SOMERSET
Tel: (046031) 2578. Telex: 46263

WE'LL GIVE YOU CREDIT—FOR READING THIS!

**ICOM
NEC
TRIO
YAESU
JAYBEAM
STOLLE
SHURE**

The continuing spiral of retail prices means that the rig you are saving for now will cost you more in a few months' time. In fact it may be further off than you thought! The answer is to buy now on credit. We specialise in credit for the amateur and swl and if you have a UK callsign we can arrange immediate credit. The interest charges you pay are all but nullified by the present rate of inflation. Minimum deposits are down now to 20% and are shown below against each piece of equipment. Act now and beat inflation. Call in, write or telephone to arrange your credit transaction. Alternatively you can simply quote your Barclaycard or Access number for immediate despatch.

**HYGAIN
MINI-PRODUCTS
NIHON
MFJ
CDE
DRAKE
TECH ASSOC.**

DIAL: HOCKLEY (03 704) 6835 (2 LINES) FOR INSTANT DESPATCH



**ICOM
IC-21A
CASH £262.50
HP DEPOSIT
£52.50
IMMEDIATE DELIVERY**

This is the complete 2m fm base or mobile station rig. Small enough to fit into the car yet comprehensive enough to fulfil your complete base station requirements. Power output control from 0-5 to over 10 watts fully protected and built-in 240V AC power supply. This 24 channel rig boasts a host of features including IRT; S-metre; Centre zero metre; squelch, mic gain, swr meter switched deviation, xtal calibrator, 5 channels fitted.



ICOM 22A CASH £176.25 HP DEPOSIT £35.25

2 metre fm transceiver designed for mobile use. Features 22 channels, high and low power switching for 10 or 1 watt output. Xtals are supplied for no less than 5 simplex and 5 repeater channels (that's £50's worth), mobile mount, handbook, microphone, and the unique front panel tone-burst select switch. This is the complete mobile fm rig and most widely used in Europe. IMMEDIATE DELIVERY

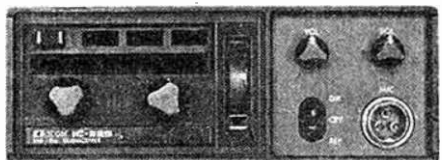

**ICOM
IC-225
CASH £287.50
HP DEPOSIT
£57.50
IMMEDIATE DELIVERY**

The most sophisticated 2 metre fm transceiver available for mobile use. Complete coverage of 2 metres in 80-25 kHz channels and automatic repeater shift (with reverse repeater shift optional). Not another 'xtal to supply! 10 watts output power, mobile mount, handbook, microphone, spare fuses and OC card, etc.—altogether the most compact all-channel 2 metre fm rig available!

**IN STOCK!
2M SSB/CW
PORTABLE
ICOM 202**

**CASH £179
HP
DEPOSIT
£36**

Just the thing for the coming summer months. 3W ssb and cw portable transceiver imported by us and complete with vfo control 144-144.4 plus IRT and noise blanker. This is going to be a winner.



**ICOM
IC-201
CASH £393.75
HP DEPOSIT
£78.75
IMMEDIATE DELIVERY**

The all-mode 2 metre transceiver. FM/LSB/CW, vfo or 'xtal, centre zero meter, 600kHz repeater repeater and reverse repeater shift, tone-burst, two-speed tuning, var/cw break-in, cw monitor, noise blanker, rf gain, mic gain, stable vfo, calibrator, squelch, swr meter, 12V DC or 240V AC. This compact rig is the ideal base station or mobile unit for the amateur who insists on the best —it's ICOM of course!

**NEC
CQ-110**

160-10m TRANSCIVER
The only 160m to 10m digital transceiver. 12V DC and 240V AC. 100Hz readout completely self-contained CW/SSB/A.M./FSK 300 watts. Send for colour catalogue.

**HQ-1
10-15-20M**

**MINI-BEAM IN STOCK
1KW RATING. 8FT TURNING RADIUS**
A real signal puncher for the small garden. Hundreds in use and it is now ready for despatch to solve your small qth problem.
IMMEDIATE DELIVERY £269.95

**G30JV
G3XTX**

WATERS & STANTON ELECTRONICS

**G30QT
G8LOG**

HEAD OFFICE: Hockley Audio, 31 Spa Road, Hockley, Essex. Tel. 03-704 6835

**EAST LONDON SALES: J. R. Electronics, 198 Collier Row Lane, Romford, Essex. Tel: Romford (0706) 68956
NORTHERN SALES OFFICE: Bredhurst Electronics, Willowbrook, School Lane, Bunbury, Tel: (Bunbury) 0829 260708
SCOTTISH AGENT: GM3GRX, 6 Drossie Road, Falkirk, FK15LU, Stirlingshire.**

Mondays to Saturday 9 a.m.—5.30 p.m. Early Closing Wednesday

SOLE DISTRIBUTORS FOR NEC IN UK INCLUDING IRELAND



GAREX (G3ZVI)

Printed circuit boards from Pye R/T equipment, with circuits. All transistor, all in good used condition.

- 10-7MHz I. F. board £2.20
- 455kHz block filters 25kHz chann. spacing, low impedance £2.10
- 25kHz chann. spacing, high impedance 90p
- 12kHz chann. spacing, price & details on application
- 455kHz A.M. I.F. board (ex AM25B) £1.25
- Squelch boards (ex Cambridge) AM 40p (ex AM25T) 50p
- (ex AM25B) Type A or B. 17p. 2 for 30p
- MIC. amplifier board ex AM25B 85p ex AM25T 95p
- Mod. output board ex AM25B or T 50p
- Rx Audio board ex AM25B 50p; ex AM10 £1.70; ex AM25T 50p
- 6kHz Audio block filter ex AM25B 30p. AGC Assembly ex AM25B 30p
- Mic preamp board, 2 transistor, emitter follower output 60p
- Modulation transformers with connection data
- p.p. NKT404/OC28/OC35 to OQV03—10 £1.45. Driver to suit 40p.

—20s, £1.45. Driver to suit, 40p.
 Audio Transformers 5A05 to 3Ω & 10Ω, pp NKT404 to 3Ω, small or large.
 Drivers to suit NKT404, small or large, 40p ea. any 2 for 70p, 3 for £1.00.
 Lt Choke 3A 0-1Ω, for psu or hash filter, 40p each, 3 for £1.00.

Camera video board (Lynx) new £4.40

Reed switch S.P.C.O. 35mm x 5mm dia. (75mm overleads) 10VA rating 40p

Reed relay coils to match above, 24V (2-5k res.) 25p

Palinton (min. Jones) connectors, chassis mtg. 18 way female 35p

ditto, 6 way (2 pins at rt. angles) male or female 20p ea. 5+ 17p

Toggle switches, SP biased off 20p each, 5+ 17p.

Crystals HC5U: 12-700MHz, 11-155MHz 60p

HC6U for 2m Tx 9 0856 (145-05), 9 0888 (145-10), 9 0719 (145-15) MHz £1.70

Valves (New or tested ex. equip) 8091, EC91, EL91, 6BH6, 6BJ6, 6CB6, £Z81, EY81 20p each, any 5+ 17p

Integrated circuits (new, full spec.)

783 voltage reg. TOS metal case, 2137V out of 150mA for 5/40V in 90p

SN7660 FM quadrature detector £1.25

CD4041 AE quad. 2-input NOR gate for tone-burst gen. 40p

NE555 Timer for tone-burst gen. or time-out indicator 75p

709 (Tos); 741 (OIL-6) 6p Amps 25p each

5+ 1C's (any mix) at 20% discount

Relays. Miniature 12V plastic cover 2PCO 40p; 4PCO 45p

25 AMP 5V single make 5V double make 12V d/make 12V a/make 45p

GPO type 2400, 12V coil, 4PCO or 2P make, 40p; any 5+ 25p.

Toroidal inverter transformers (with circuits)

Input 12V DC, output 390V 200mA (doubled) £2.50

Input 12V DC, output 160/280V 150mA (doubled) (Range) £2.10

HT choke suitable for 2-3kHz inverters 60p

Rectilinear pots multiturn, preset, p.c. mtg. (new)

10, 20, 25, 100, 250, 500, 2k, 2-5k, 25p each, any 5+ 25p

Air spaced Trimmers small 20p, 30p, large 10p, 25p; small 20p with

1/2" spindle, 20p each, any 5+ 17p.

Butterfly trimmers large 2 x 17-5p, 2 x 10p 60p

Beehive trimmers 2-2p 6p each, 5+ 5p.

Tetter trimmers 2-10pF, multiturn, OK for UHF. 70p

Tx Multiplier Transformer for AM10, AM25B, or T. High or Low Band 35p

Other Pye coils and transformers also available

10-7 IFT (valve type) 2 1/2" x 2" square double tuned 25p; 2 for 40p; 6 for £1.00

Mobile PSU 12V DC input (floating for + or - E) transistor inverter 170,

220 or 380V DC at 180mA, output, fully smoothed, chassis section, self-

contained, fully wired and tested, with circuit £5.75

As above, but partly assembled (as cut out), complete with all com-

ponents, circuit, finish-it-yourself 15p ea; 12 for £1.30; 50 for £4.50

Needs min. wire end, 6p each, 10 for 55p, 100 for £4.00.

Slide Switches (new) min. OPDT 15p, 5+ 12p; 2P3W, 22p, 5+ 16p.

Toggle Switches (new) min. DPDT, centre off, 65p, each, 5+ 55p.

Resistor kits 10512 1/2W 5% C-film, 10 each value 22Ω to 1M (570pce) £6.30

Diff. 1/2W, £5.30

PL259 UHF Plugs + reducer 60p each, 5+ 50p.

SO239 VHF Socket panel mtg. 45p each 5+ 35p

Numericators ZM1080 or equiv. 70p each, 5+ 63p.

Nicad Rechargeable cells U7 size, new, £1 each; 4+ 1 90p; 10+ 85p

Mainline transformers, multitap primaries

515-450-0-450-515V 240mA, 50V, 50mA, 5V 2A, 8-3V 4A (12 lb) £6.50

170-0-170V 90mA, 50V 50mA, 8-3V 3-3A, 5V 2A (5-5 lb) £2.50

345-0-345V 150 mA, 5V 2A £3.95

0-148-232V 160mA, 26-5V 1A, 13-9V 5A, 50V 50mA (10-5 lb) £3.95

Auto 0-100-110-150-200-230-240-250, 200VA £3.25

HT chokes, 5H 80mA, 4H 240mA, 1H 240mA, 1-25H 350mA, 1-8H 125mA

£1.25

High grade types: 9H 250mA, 8H 240mA, £2.70, 10H 20mA, 35H 25mA £1.55

Vibrators 4 pin non-sync. 5, 12 or 24V 60p

Where components are ex-equipment, they are in good condition, your satisfaction guaranteed. Wherever possible, full supporting data is given. Prices quoted are inclusive of UK post and packing & VAT.

Mail order only. Sole address for orders and enquiries

GAREX ELECTRONICS

7 NORVIC ROYE, MARSWORTH, TRING, HERTS HP23 4LS

S.a.e. with all enquiries please. Phone Cheddington (STO 0286) 668684
 8.30pm-9pm and weekends only.

C&C electronics

10 West Park London SE9 4RQ

Telephone 01-852 9397



CRYSTALS

During the forthcoming months we shall be exhibiting at many of the rallies, exhibitions and conventions throughout the UK, where you will find many of our products at reduced prices. It may well be worth a quick telephone call to see if we shall be at your local event.

NEW PRICES ON MADE TO ORDER CRYSTALS

We can now offer quality crystals over a complete range from 50kHz to 216MHz with extremely favourable discounts for large quantities of the same frequency specification. This includes fundamentals up to 25MHz and 3rd overtones from 10MHz. Please enquire for further details. Crystals in HC6/U, HC18/U and HC25/U 1.5-21MHz fundamental, 21-105MHz overtones. Delivery 2-4 weeks. Specification: 50ppm 0-60C or 30ppm at ambient. (State required tolerance end 1/P capacity on fundamentals). Prices 1.5-2.6MHz £3.25, 2.6-105MHz £2.46, 5% discount on five or more crystals. Please note crystals below 4MHz not available in HC18 or 25/U at the above prices.

STOCK CRYSTALS IN POPULAR FREQUENCIES

TRANSMIT CRYSTALS (MHz) in HC6/U Price £1.75

S80	S21	S22	S23	R3	R4	R6	R6	R7
145-500	145-828	145-550	145-575	145-075	148-100	145-125	148-150	148-175

4-0416	4-0423	4-0430	4-0437	4-0288	4-0305	4-0312	4-0319	4-0326
8-0633	8-0647	8-0651	8-0675	8-0597	8-0611	8-0625	8-0639	8-0652

RU1	SU20	SU22	GB3PY					
144-342	144-400	144-500	144-520		145-000	145-900	70-280	70-480
433-025	433-200	433-500	433-550	431-350				

8-0189	8-0222	8-0277	8-0287	7-9679	8-0555	8-1000	8-7825	8-6100
12-0284	12-0333	12-0416	12-0430	11-9819	4-0277	4-0500		
				13-5378	13-5488	13-9484		

RECEIVE CRYSTALS (MHz) in HC6/U Price £1.75.

44MHz range also in HC25/U. Price £2.10.

S80	S21	S22	S23	R3	R4	R5	R6	R7
145-500	145-525	145-550	145-575	145-075	148-700	145-725	145-750	145-775

10-3803	10-3621	10-3639	10-3657	10-3728	10-3746	10-3764	10-3782	10-3800
44-9333	44-9416	44-9500	44-9583	44-9916	45-0000	45-0083	45-0166	45-0250

RU1	SU20	SU22	GB3PY					
434-025	433-200	433-500	433-550	433-350	145-000	145-900	70-25	70-40

30-2803	30-1785	30-2000	30-2035	30-1892	10-3246	10-3817	29-7800	29-8800
	11-7361	11-7444	11-7468		44-7686	45-0333		

Crystals supplied in 3 weeks to any stated frequency for the following V.H.F. transceivers Heathkit, Icom, Ken, Standard, Trio and Yaesu. Price £2.10/crystal

10-2450MHz I.F. crystals in HC18/U 20ppm -20C to +70C. Price £2.00.

REPEATER 1/P CHANNEL CRYSTALS in HC6/U. Price £1.75

R3 44-7916MHz R4 44-8000MHz R5 44-8063MHz R6 44-8156MHz R7 44-8250MHz

CONVERTER CRYSTALS (MHz) in HC18/U. 38-65666, £1.75

70-0000 96-0000 101-0000 105-0666 116-0000 Price £2.55

PYE POCKETPHONE CRYSTALS in HC18/U. Price £4.00/pair

for 433-200MHz GB3PY 433-500 (SU20)

CRYSTAL SOCKETS HC6/U and HC25/U. Price 15p.

LOW FREQUENCY STANDARDS (8% VAT)

100kHz in HC13/U (Same base as HC6/U) price £2.35

1000kHz in HC6/U. Price £2.35

All prices include postage to UK and Irish addresses. Crystals supplied to any specification for industrial, mobile radio or marine use etc. State equipment specification when enquiring. Please send s.a.e. with all enquiries.

The above prices are ex VAT. Please add 25% unless otherwise stated.

Please note we are now authorised distributors for Antenna Specialist products. Prices available on request.

PNEUMATIC TELESCOPIC HILOMASTS

Extended by standard vehicle foot pump—easily retracted for severe weather conditions.

Elegant when extended. Unobtrusive when retracted.

Prices from £133. Write to

CLARBROOK ENGINEERING CO. LTD.

Jutsums Lane—Romford RM7 0ER. Tel: Romford 65173

the outclasser

ANTENNA SPECIALISTS

STOP PRESS!

HMR173
2m 11 ELE YAGI
13dB GAIN OVER
DIPOLE.
VER. OR HOR.
POLARISATION
USES GAMMA
MATCH FOR BEST
VSWR £24.00.

ASP 655
130-174MHz
3dB GAIN
DC GROUNDED
BASE STATION
ANT. COMPLETE
WITH MOUNTING
BRACKETS, £13.75



ASP201
1/2W Unity Gain
108-512MHz

ASP201 £2.80
ASP629 £6.59
ASP393 £15.20
ASP677 £12.87
ASPE667 £16.10
ASP749UK £24.50

With the exceptions of the ASP629 and ASP749UK, all the other antennas require a single hole of 0.375" for mounting.

ASPR332 Gutter Mount £7.00 Complete with 17' of cable and PL259 plug.

Boot Mount £3.20.

Magnetic Mount £7.85 Complete with 17' of cable.

We also stock various bases, whips, springs, transformers, splitters, etc.

Please add 75p. for p & p for each antenna and accessory.

VAT of 25% to be added to above prices. Please send SAE for further details.

(TRADE ENQUIRIES WELCOMED)



©

"Stripes of Quality"

YOUR RETAILERS ARE: London: Lee Electronics, 400 Edgware Road, London, W2. Tel: 01-723 5521
Kent: Thanet Electronics, 34 Cliff Avenue, Herne Bay. Tel: (02273) 63846
Cheshire: Bredhurst Electronics, Willowbrook, School Lane, Bunbury, Tarporley, Tel. Bunbury (0829) 260708.
Wales: J. J. Doyle, GW8JEV, 54 Brynecatwg, Cadoxton, Neath, Glam. Tel. Neath (0639) 2942.
AGENTS: Terry Barnett, G8BAM, 7 Cochrane Court, Leyton Grange, London, E.10. Tel: 01-558 9366
Peter Avill, G3TPX, 7 Moorland Crescent, Mapplewell, Barnsley, Yorks. Tel. Darton (022878) 2517
Ian McKechnie, GM8DOX, 41 Westerlea Drive, Bridge of Allan, Stirlingshire. Tel. Bridge of Allan (078683) 3223.

J. YU, 21 Langley Avenue, Surbiton, Surrey KT6 6QN

Also manufacturers of crystal controlled tone bursts.

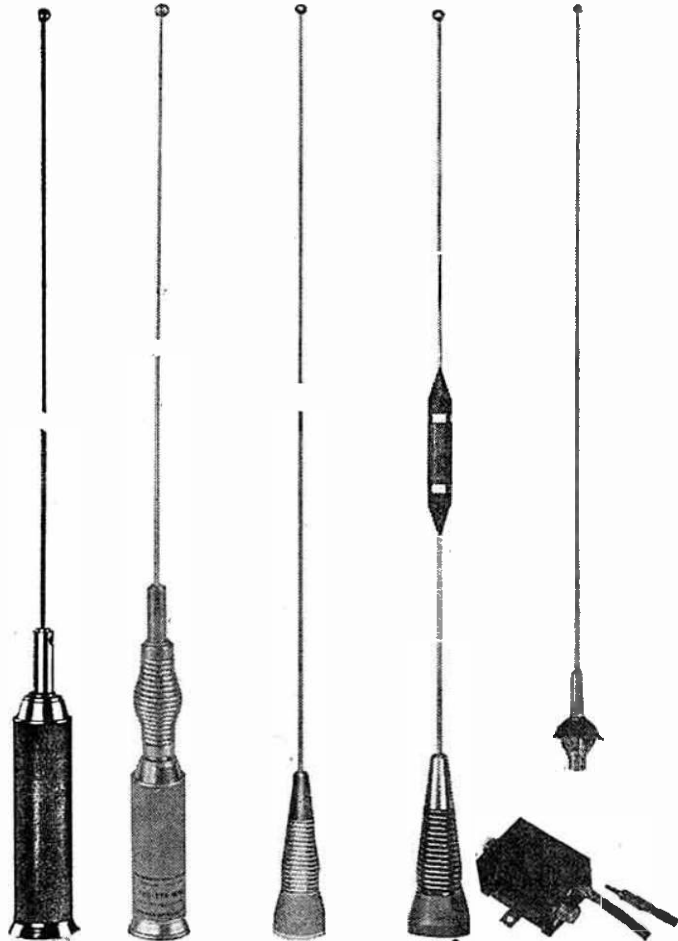

ASP629

1/2W 3dB Gain
130-174MHz,
DC Grounded

ASP393

ASP677

1/2W 3dB Gain
140-174MHz

ASPE667

5dB Gain
Collinear
425-440MHz
Complete with 17'
of RG58U and
PL259 plug

ASP749UK

1/2W Disguise Ant.
3dB Gain
144-174MHz.
Complete with
cables, plug, and
splitter for
car radio

BREDHURST ELECTRONICS



2 METRE TRANSCEIVERS

IC22A	Fitted with 10 crystals	£141
IC202	SSB Hand held 3W PEP	£143
IC225	80 channel PLL	£230
IC21A	22 channel 12/240V the ideal home station rig	£210
IC201	As reviewed in January <i>Radio Communication</i>	£315

All above include adjustable toneburst unit
Crystal controlled toneburst £10 extra
70cm mobile and base station transceivers also available.
SAE for full colour brochure

All above VAT extra at 25%. Carriage free.

NEW. We are now stocking antennas by
Antenna Specialists. See page 301 for full
details

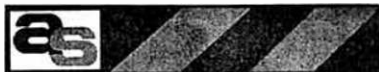

Willowbrook, School Lane, Bunbury, Tarporley,
Cheshire Tel: Bunbury (0829) 258708 G3OQT
CALLERS BY APPOINTMENT

REG. WARD & CO. LTD. G2BSW G8CA

K.W.		YAESU	
106 Mon. Scope	£85.00	FT101E Transceiver ..	£395.00
103 VSWR Meter and combined Power Meter..	£16.00	FR400 SDX Receiver ..	£210.00
107 Combined E-Z March, VSWR and RF Power Indicator, Dummy load and Antenna Switch for 4 outlets	£86.00	FT200B Transceiver and FP200 PSU	£255.00
Trap Dipole Co-axial Feeder	£28.00	201 Transceiver	£290.00
Trep Dipole with Balun ..	£29.00	FR101 S Receiver	£270.00
3-way Antenna Switches (for co-ax)	£8.00	FR101 S Receiver	£350.00
SHURE MICROPHONES		FT401B	£330.00
Model 444	£18.20	YO100 Monitor scope ..	£165.00
Model 201	£8.40		

EOYSTONE	
EC10 Mark 2 General Coverage receiver ..	£152.00
Model 1001 One only ..	P.O.A.

USED EQUIPMENT

TRIO J.R. 500S good condition	£55.00	TRIO J.R. 310 with manual	£80.00
		KW202RX. Excellent	£150.00

Valves for Yaesu, etc. 6BZ6, 6U8, 6KD8, 12AX7A, 12BY7A, 12AU7, 6J56C, 6146, 6HF6, 6LQ6, 6EAB, 6GK8, 6146B, 6KD6, RCA Valves for KW equipment etc.

Sentinel 2m Preamps and 2m converters/Europa transverters, J Beams and Stallo rotators, 140' 14g enamel ant. wire, Insulators, 82 & 75 ohm co-ax, and UHF plugs, sockets and reducers, G-Whip mobile antenna, Wightraps, Mast couplers, Hy-Gain verticals.

ANTRON KITS

TRADE INS WITH PLEASURE. OUR STOCK OF GOOD SECOND-HAND EQUIPMENT CHANGES DAILY—LET US KNOW YOUR REQUIREMENTS. Due to currency fluctuations price of imported equipment are liable to alteration. Add 25% VAT to all prices except used equipment.

HP TERMS AVAILABLE

CARRIAGE EXTRA ON ALL ITEMS

AXMINSTER, DEVON EX13 5DP Telephone 33163

ROBOT SSTV

Sole UK Concessionaires

AERO & GENERAL SUPPLIES

(Please note our new address)

Nanaimo House, 32 Rufford Avenue

Bramcote, Nottingham NG9 3JU

Tel. Nottingham 397588

PS: We have some bargains in Digital Clocks too. SAE for details please.

R.T. & I. offer the finest selection of first-class new and fully overhauled second-hand communications and electronics equipment in the U.K.

- Constantly changing stocks of a vast range of equipment
- Cash or Hire Purchase terms easily arranged.
- Part exchanges welcomed.
- We are 'spot cash' buyers for almost all electronic equipment.

Send S.A.E for our latest list of over 50 receivers and many other interesting items.

R.T. & I. ELECTRONICS LTD.

Ashville Old Hall, Ashville Road, London E.11 Tel: 01-539 4986

J & A TWEEDY (ELECTRONIC SUPPLIES) LIMITED

Roger, G3YBO—79 Chatsworth Road, Chesterfield, Derbyshire. Telephone Chesterfield 863755

Jack, G3ZY—The Ham Shack, Roughton Lane, Woodhall Spa, Lincs. Telephone Woodhall Spa 52793

Good clean used equipment available at our Chesterfield Branch.

Yaesu FT 201—Transceiver—80-10m	£285.00
Yaesu FT 101 Mk II Transceiver 160-10m	£275.00
Yaesu FT 401—Transceiver 80-10m	£225.00
Yaesu YO 100—Monitor Scope	£75.00
Yaesu FR 50—Receiver 80-10m	£75.00
Star SR 550—Receiver 160-10m	£45.00
Star SR 600—Receiver 80-10m	£85.00
Telford TC 9—2m Transmitter AM/FM	£60.00
KW E-Z Match ATU for 80-10m	£18.00
KW 77 160-10m Receiver	£75.00
2m Europa Transverter 2-10m	£87.00
4M Europa B Transverter 4-10m	£75.00
H/B 2m TX AM/FM Xtals complete	£20.00
SSM 2m Conv IP 28-30mc	£12.00
Eddystone 730/1 GC 800kc—30Mc	£95.00

Prices include VAT—Carriage at cost

ORAKE YAESU ICOM HY-GAIN JAYBEAM TAVASU

SOLID STATE MODULES

63 WOODHEAD ROAD, SOLID, LOCKWOOD,
HUDDERSFIELD, HD4 6ER

Telephone 0484-23991

You get the performance and reliability implicit in the
sale of 1000's of our Europas, Converters and Preamplifiers

EUROPA 'B'—THE WORLD'S BEST SELLING 2M TRANSVERTER



VHF TRANSVERTER. EUROPA B 2 METRE or 4 METRE or 6 METRE
In production now for over three years and in use all over the world and ideal for normal tropo or OSCAR work. The Europa B plugs into Yaesu/Sommerkamp equipment and you are on VHF. All other HF equipment can be used with our Europa power supply the CPS 10.

The EUROPA B gives you:

- ★ The confidence of our most efficient back up service in the 12 month warranty period and beyond.
- ★ Highest transmit power available 200W. Highest receive sensitivity available—2dB N.F.
- ★ Compact, attractive appearance will complement your station. Size: 9" x 4 1/2" front panel 4 1/2" deep.
- ★ Cleanest output spectrum available. All spurious outputs—80dB.
- ★ Price: £109.37 complete to plug in and from stock.

EUROPA COMPLETE POWER SUPPLY TYPE CPS 10

Supplies all voltages to Europa and contains a dummy load attenuator to make the Europa compatible with any HF equipment. Price £50.00—Ex stock.

VHF CONVERTERS 2 METRES, 4 METRES, 70cm, SATELLITE BAND AND MARINE BAND FROM STOCK. Other frequencies to Order.

SENTINEL DUAL GATE MOSFET CONVERTERS

- ★ N.F. 2dB. Gain—30dB.
- ★ No oscillator frequency multiplication to reduce spurious signals.
- ★ Very high tolerance crystals, sp.p.m. for calibration accuracy.
- ★ Strong signals and overvoltage and reverse polarity protection built in.
- ★ Standard I.F.s are: 2 metres: 28-30MHz, 2-4MHz, 4-6MHz, 4 metres: 28-28.7MHz.
- ★ Size only: 2 1/2" x 1 1/2" x 3" long except 2-4MHz and 4-6MHz which are double conversion and 4" long. Price only £18.75 and ex-stock.

SENTINEL 2 METRE CONVERTER KIT, 28-30MHz IF ONLY

A well proven kit supplied with printed circuit board drilled and with all coils mounted to make assembly easy. Price £12.74, ex-stock and IF it doesn't work send it back with £2.30 and we will fix it. YOU CAN'T GO WRONG!

SENTINEL X 2 METRE CONVERTER

A de luxe version of the Sentinel. Performance spec. is the same but it contains an external mains power supply and a front panel RF gain control.

- ★ Size: 5" x 1 1/2" front panel, 4" deep.
- ★ Stock 2 metre I.F.s: 28-30MHz, 2-4MHz, 4-6MHz. Price: £24.37—ex-stock.

SENTINEL MF Another Dual Gate MOSFET 2 metre converter which converts to medium wave in 2 switched bands. Price: £20.00 ex-stock.

2 METRE or 4 METRE PRE-AMPLIFIERS. These can be supplied for Satellite and Marine Band from stock. Other frequencies to order.
Two models to choose from:

SENTINEL LOW-NOISE FET PRE-AMPLIFIER

- ★ This pre-amplifier uses a selected low noise FET to provide the ultimate in sensitivity and selectivity.
- ★ Isolated supply lines, compatible with any equipment.
- ★ Low noise figure—1dB. High gain—30dB.
- ★ Size: 1 1/2" x 2 1/2" x 3". Price £9.98—ex-stock.

PA3 DUAL GATE MOSFET PRE-AMP

★ Small about 1 cubic inch, printed circuit pre-amp. Now incorporated in thousands of transceivers.

- ★ Low noise figure—2dB. Gain 18dB. Price £8.97 with fitting instructions.

70cm U.H.F. CONVERTERS AND PRE-AMPS

SM 70 70cm to 2 metre FET converter. This is a very high performance 70cm converter at a very attractive price. Size: 1 1/2" x 2 1/2" x 3". N.F. 3.5dB. Gain 30dB. Price: £18.75—ex-stock.

SM71 70cm (432MHz) PRE-AMPLIFIER

Selected FETs give a noise figure of—3.5dB and a gain of 18dB. Size: 2 1/2" x 1 1/2" x 4". This unit is also available on other frequencies, e.g. 400MHz region for satellite or radio astronomy use, for which it was originally developed. Price: £11.25—ex-stock.

NEW!

SSM Z MATCH 80-10 METRES

This unit has been produced to satisfy the constant demand for a compact matching unit to meet the critical load requirement of the modern P.A. Receivers are also becoming more sensitive to aerial matching and our Z match can of course be used to match the aerial to your receiver. The units have been tested at 2KW CW output power into a Bird Termination Wattmeter/Dummy load. The aerial connections can be used with balanced or unbalanced feeders and the connectors are screw terminals for wire aerials ANO SO239s (or co-ax fed aerials). Don't forget that multiband aerials respond as well to your harmonics as to the wanted signal. Our Z match will provide harmonic attenuation as a bonus. Price is only £29.50.

All prices include 25% VAT and delivery. 12 months guarantee on all units. We offer same day COD (£50 limit)
ACCESS, BARCLAYCARD, H.P. or C.W.O.

If you require more detailed information or help, we are a telephone call or a letter away, so do not hesitate to ask.
YOU CAN CALL IN ANYTIME TO INSPECT OR COLLECT EQUIPMENT: PAUL, G3MXG.

THE MERSEYSIDE ROCK SHOP

WHERE SERVICE STILL MEANS SOMETHING

VAT—PRICES EXCLUDE VAT WHICH SHOULD BE ADDED AT THE RATE OF 25% EXCEPT IN THE CASE OF TEST EQUIPMENT CRYSTALS 8%—OVERSEAS ORDERS (Inc. Air and Channel rates) NO VAT CHARGEABLE.

2M TX & RX CRYSTAL AVAILABILITY AND PRICE CHART

CRYSTAL FREQUENCY RANGE USE (TX or RX) and HOLDER	OUTPUT FREQUENCY													
	4MHz-TX-HC25/U	6MHz-TX-HC25/U	8MHz-TX-HC25/U	10MHz-RX-HC25/U	11MHz-RX-HC25/U	12MHz-TX-HC25/U	14MHz-RX-HC25/U	18MHz-TX-HC25/U	36MHz-TX-HC5 & 25/U	41MHz-RX-HC25/U	44MHz-RX-HC25/U	49MHz-TX-HC5 & 25/U	59MHz-RX-HC25/U	72MHz-TX-HC25/U
144-030	..	b	b	b	b	b	b	b	b	b	b	b	b	b
144-4/433-2	..	a	b	b	b	b	b	b	b	b	b	b	b	b
144-480	..	a	b	b	b	b	b	b	b	b	b	b	b	b
144-500	..	b	b	b	b	b	b	b	b	b	b	b	b	b
144-700	..	b	b	b	b	b	b	b	b	b	b	b	b	b
145-000/SO	..	a	a	a	a	a	a	a	a	a	a	a	a	a
145-050/R2T	..	a	a	a	a	a	a	a	a	a	a	a	a	a
145-075/R3T	..	a	a	a	a	a	a	a	a	a	a	a	a	a
145-100/R4T	..	a	a	a	a	a	a	a	a	a	a	a	a	a
145-125/R5T	..	a	a	a	a	a	a	a	a	a	a	a	a	a
145-150/R6T	..	a	a	a	a	a	a	a	a	a	a	a	a	a
145-175/RTT	..	a	a	a	a	a	a	a	a	a	a	a	a	a
145-200/R8T	..	a	a	a	a	a	a	a	a	a	a	a	a	a
145-300/S12	..	b	b	b	b	b	b	b	b	b	b	b	b	b
145-350/S14	..	b	b	b	b	b	b	b	b	b	b	b	b	b
145-400/S16	..	b	b	b	b	b	b	b	b	b	b	b	b	b
145-500/S20	..	a	a	a	a	a	a	a	a	a	a	a	a	a
145-525/S21	..	a	a	a	a	a	a	a	a	a	a	a	a	a
145-550/S22	..	a	a	a	a	a	a	a	a	a	a	a	a	a
145-575/S23	..	a	a	a	a	a	a	a	a	a	a	a	a	a
145-600/S24	..	a	a	a	a	a	a	a	a	a	a	a	a	a
145-650/R2R	..	b	b	b	b	b	b	b	b	b	b	b	b	b
145-675/R3R	..	b	b	b	b	b	b	b	b	b	b	b	b	b
145-700/R4R	..	b	b	b	b	b	b	b	b	b	b	b	b	b
145-725/R5R	..	b	b	b	b	b	b	b	b	b	b	b	b	b
145-750/R6R	..	b	b	b	b	b	b	b	b	b	b	b	b	b
145-775/R7R	..	b	b	b	b	b	b	b	b	b	b	b	b	b
145-800/R8R	..	a	a	a	a	a	a	a	a	a	a	a	a	c
145-950	..	a	b	a	a	b	b	b	b	b	b	b	b	b

PRICES: (a) £2.00, (b) and (c) £2.50 + VAT (25%).

AVAILABILITY: (a) and (c) stock items, normally available by return (we have over 3,000 items in stock). (b) Four weeks normally but it is quite possible we could be able to supply from stock.

N.B. Frequencies as listed above but in alternative holders are available as per code (b).

ORDERING. All we require to know is (1) Output frequency, (2) Crystal frequency range, (3) The holder, and (4) Either the load capacitance (pfs) or equipment. The exact crystal frequency is not essential, though it would be of assistance to quote it if known.

JAPANESE AND AMERICAN EQUIPMENTS

With the ever increasing popularity of Japanese equipments we have further expanded our range of stock crystals. We can now supply for YAESU (FT2F, FT2FT, FT2 Auto, FT224), most of the ICOM range and the TRIO-KENWOOD range. With other types due in during the coming months. We can also supply from stock crystals for the HEATHKIT HW202 and HW17A.

4m CRYSTALS FOR 70-76MHz—HC5/U

TX 8-7825MHz and RX 29-7800MHz at £2.00 each + VAT (25%)
 RX 6-7468MHz at £2.50 each + VAT (25%)

CRYSTALS FOR PROFESSIONAL USE

CRYSTALS TO COMMERCIAL SPECIFICATIONS

We can supply crystals to most commercial and MIL specifications, with an express service for that urgent order. Please send S.A.E. for details or telephone between 4.30-7pm and ask for Mr. Norcliffe.

70cm CRYSTALS FOR REVISED BRITISH BANO PLAN

We have in stock SU8 (433-2MHz) and RB10 (GB3PY-431.35/433.35) for use in all undermentioned equipments at £2.00 + VAT (25%) per crystal. PYE Pocketfone (PF1), UHF Cambridge (U10B), UHF Westminster (W15U), UHF Base Stn. (U450) and STORNO CQI and CQM 662. Other channels, e.g. SB20 (433-5) are available as per class (b) 2m Xials. 10-265MHz "ALTERNATIVE" IF CRYSTALS—£2.50 + VAT (25%) For use in PYE and other equipments with 10-7MHz and 455kHz IFs to get rid of the "birdy" just above 145.0MHz. In HC6/U, HC19/U and HC25/U. CRYSTAL SOCKETS—HC6/U, HC13/U and HC25/U (Low loss) 18p each plus 18p P. & P. per order (P. & P. free if ordered with crystals).

CONVERTER/TRANSVERTER CRYSTALS—HC18/U

New low price—all at £2.80 each. 38-6666MHz (144/28), 42MHz (70/28), 58MHz (144/28), 70MHz (144/4), 71MHz (144/2), 95MHz (432/52), 98MHz (1,296/432/144), 101MHz (432/28), 109-6666MHz (1,296/28) and 116MHz (144/28).

CRYSTALS SPECIALLY MANUFACTURED FOR AMATEUR USE TO CUSTOMERS REQUIREMENTS

In either code PE (±0.003% at ambient) or code IO (±0.005% 0 to 60°C) In HC6/U 1-5 to 2-6MHz, £3.25 + VAT (25%) and HC8/U 2.6-105MHz and HC18/U and HC25/U 4-105MHz £2.80 + VAT (25%). Delivery usually 4-5 weeks. Fundamentals (1-5-21MHz) will be supplied to 30pf circuit conditions, and overtones (21-105MHz) to series resonant conditions unless otherwise specified. For details of closer tolerance crystals please send S.A.E.

TEST EQUIPMENT FREQUENCY STANDARD CRYSTALS—8% VAT

100kHz in HC13/U, 1MHz and 5MHz in HC6/U and 10MHz and 10-7MHz in HC8/U and HC25/U all at £2.50 each plus 8% VAT.

BURNS ELECTRONICS

We are the Northern Appointed Agents for BURNS KITS etc. and can supply most of their products from stock.

MODULAR COMMUNICATIONS SYSTEMS

For the RTTY enthusiast we can recommend and supply the "MCS" range of products. This includes terminal units, AFS keys, magnet drivers for TTL interface, telegraph distortion measuring adaptor, RTTY audio processor, power units, etc.

For the CW man we have the "MCS" CW filter which gives three stages of active filtering. Please send S.A.E. for full details of the "MCS" range.

ANZAC MD-108 DOUBLE BALANCED MIXER

5-600MHz supplied with full details for only £4.80 plus 25% VAT.

TERMS: CASH WITH ORDER—MAIL ORDER ONLY—S.A.E. WITH ALL ENQUIRIES—PRICES INCLUDE P. & P. (BRITISH ISLES) EXCEPT WHERE STATED—OVERSEAS CHARGED AT COST.

P.M. ELECTRONIC SERVICES

7A ARROW PARK ROAD, UPTON, WIRRAL, MERSEYSIDE, L49 0UB

Tel: 051-677 8818, 4.30-7pm.

Cables: CRYSTAL, BIRKENHEAD

TMP ELECTRONIC SUPPLIES

YAESU—HY-GAIN—BELCOM—MFJ ETC

USED EQUIPMENT

FT200's. A few in stock £170-£200
 EDDYSTONE 888A £70
 HEATH Linear. SB-200 £155
 AR88 (buyer collects) £40

WANTED FOR CASH

PYE Cambridge's Hi-Band models. Trio receivers JR500, 9R59DS, JR310

SAE WITH ALL ENQUIRIES

3 Bryn Clyd, Leeswood, Mold, Clwyd, CH7 4RU

Tel: Pontybockln 846 (035 287)

RTTY AUDIO FREQUENCY SHIFT CONVERTOR CV-89A/URA-8A.

First quantity release of this most sought after Ritty Converter. Brief description uses 15 BG9 & BG7 Valves, with a 2" C.R. Tuning Tube. Housed in a gray alloy case size 17" x 5" x 15" deep. Input supply fully filtered for interference. Requires 105-125 Volts A.C. A two position Selectivity or Filter Switch that enables to set up for any Narrow Shift from 10-200 cycles or any Wide Shift from 200-1000 Cycles. The Mean or Centre Freq for the Narrow Shift is 1000 Cycles, for the Wide Shift is 2550 Cycles. Normal Audio Input from receiver is 600 ohms. The Converter will operate with an input of 60 Microwatts to 60 Milliwatts or about -14 to +18 OBM. Has Internal Tone OSC Freq 595-1785 CPS. Mark Space Switch Normal or Reverse. Supplied in good used condition. checked complete, but not tested electronically. £22.50. Carr. £2.50 onwards.

COMPARATORS CM-22A/URA-8A same colour and size, using 13 BG7 and BG9 Valves. Made for use with above for Dual Diversity Reception. 105-125V AC supply. Used good condition, checked complete but not tested electronically. £10.00. Carr. as above.

TELEPRINTER CREED 7B. New or rebuilt as new by Gov. in original Gov. Transit Case. Power 100-250V OC. Few only at £22.50 each. Carr. £3.50 or at cost.

Full details and circuits in Teleprinter Handbook (RSGB) If possible collect ex Warehouse by appointment, and save car. cost also delivery time. Terms cash with order. VAT at 8%. Phone: Morley (0532) 531179.

JOHNS RADIO, 424 BRADFORD ROAD, BATLEY, YORKS.

432MHz SSB TRANSVERTER MMT432

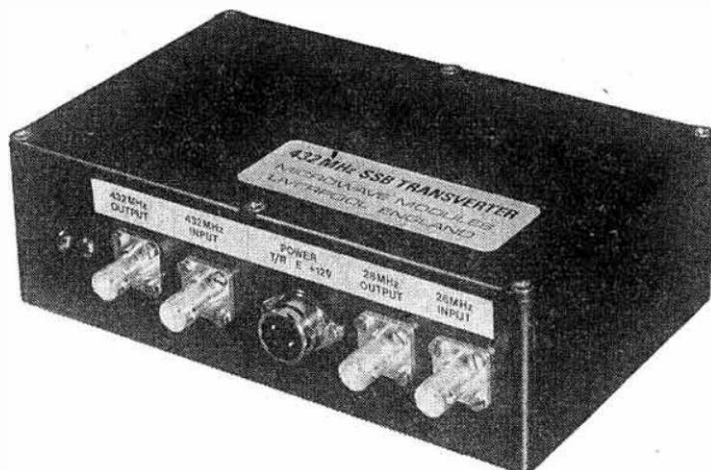

Over the past six months we have been manufacturing this transverter purely for the Export Market. Volume sales have proved the long term reliability of the unit, under a wide range of environmental conditions, and we are certain that worldwide the MMT432 transverter is without competition in this field. As a result of the export demand we have greatly increased the manufacturing rate for this unit, and we are now in a position to promote the sales of the unit in this country.

This 432MHz solid-state transverter, used in conjunction with any 28MHz SSB transceiver, gives a high-reliability transceive capability at 432MHz. This combination of a low-noise receive converter and a low-distortion transmit converter producing a spurious-free linear SSB signal makes the unit ideal for all communication at 432MHz, particularly where high stability and sensitivity are of importance.

In line with recent advances in UHF semiconductor technology we have incorporated gold metalised 1.5 dB noise figure devices in the receive converter, yielding a true overall system noise figure of better than 3 dB. The conservative 10 watts developed by the transmit section is switched by a PIN diode aerial change-over relay which has a through loss in the receive or transmit condition of less than 0.2 dB.

SPECIFICATION

DC power requirements
Current consumption
Power output
Drive requirements at 28MHz
Level of spurious output
Receive converter gain
Receive converter noise figure
Power socket
RF input/output sockets
Size
Weight

12 volts nominal (11-13 volts)
150 mA quiescent, 2.2 amps peak
10 watts RMS (continuous rating)
500 mW (or 1 mW in low input power position)
-65 dB relative to peak output power
30 dB typical
better than 3.0 dB
5 pin DIN (pins 1, 3 and 5) (plug supplied)
50 ohm BNC or 75 ohm Belling-Lee as required
187 x 120 x 53mm
800g

PRICE £89.00 INC. VAT

MICROWAVE MODULES LIMITED
BROOKFIELD DRIVE, AINTREE, LIVERPOOL
L9 7AN **TEL.: 051-523 4011**

J. BIRKETT

25 THE STRAIT LINCOLN, LN2 1JF
Tel: 20767. Member of ARRA
RADIO COMPONENT SUPPLIERS

VHF POWER TRANSISTORS TYPE 2N3375 £2

LOW POWER 2N3866 IN TO18 CAN
With Heat Sink 20p

50 Assorted Transistor Electrolytics
for 57p

741 8 Lead DIL OP-amps 5 for £1

NE555 I.C. Timer at 50p

Stripline transistor like BFR90 at £3

VHF FETS LIKE

2N3819

6 for £1

SMALL BALUM FERRITE

TRANSFORMERS

6 for 50p

SILICON DIODES

Type BYX95

1250 PIV 1amp at 12 for £1

BY103 1300 PIV 1amp at 15p

BY133 1200PIV 1amp at 12 for £1

VHF DUAL GATE

MOS FETS

LIKE 40673

33p each

4 for £1.10

Sub-miniature Ceramic Plate
Capacitors 100 assorted from 1-8pF
to .01uF 57p

Low Pass Filter Feed Thru's 1000 +
1000 20p dozen

Please add 15p post & packing on
orders under £1.50

SILICON SOLAR CELLS

3 to 5 Volt 15Ma

in Daylight

35p each

Branded BC109B 7 for 57p

X Band Gunn Diodes £1.85

X Band Detector Diodes like sim 2
at 15p or IN23 at 25p

20 assorted ITT 250M.W.

Zeners at 75p

20 assorted STC 750MA Diodes at 50p

20 Silicon Photo Transistors at £1

4 Amp Power Transistors

Type BD187 at 40p each

4 for £1.35

General Purpose Plastic Power
30 watt Transistors

NPN 22p, PNP 25p, 35p pair.

QM70 PRODUCTS

THIS MONTH WE FEATURE OUR

◀ SOLID STATE 2M LINEAR AMPLIFIER ▶

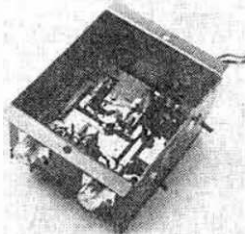

144PA50: All solid state 50 WATTS RMS OUTPUT linear amplifier (for 10 watts rms input), 12V operation and internal automatic RF sensing switch means that you only need to connect this unit in your 2m antenna line together with a source of 12V DC for 50 watts rms OUTPUT. Accepts ssb, fm, a.m. or cw with switchable hang time for ssb and cw operation. Supplied complete with DC power cord and fitted SO239 sockets... £55.00.

(Photos: R. Tuff, G4DCT)

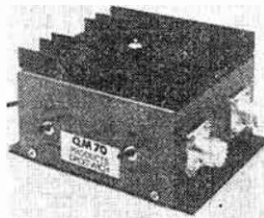

2FM70: This small unit obviates the need for the expense of a second transceiver or the complexity of numerous add on units with multiple connecting leads. By simply inserting the unit in the antenna lead of your 2m FM transceiver you are ready to transmit and receive on either 2m or 70cm AT THE FLICK OF A SWITCH. The 2FM70 has its own 70cm to 2m receive converter built in and all switching is carried out within the unit. Size 105mm x 40mm x 180mm. Weight 450 grams. Supplied complete with power cord and mobile mounting bracket. £58.00.

28/144 HIGH POWER TRANSVERTER: A 10m to 2m hybrid transverter offering up to 200W p.e.p. input. Excellent FET receive converter with two I.F. outputs fitted as standard. Master oscillator is doubly stabilised and the p.e. section is well ventilated. Takes all drive and switching from your 10m ssb transceiver. Built in antenna change over relay, metering and power on warning neon. Completes with harness and plugs for connection to your 10m ssb transceiver. For transceivers with 8-3V heater cells we fit the required transformer at no extra cost... £111.00.

All UHF units have BNC sockets, all VHF units have SO239 sockets. 12 months guarantee on all units. All prices include VAT and carriage to the UK mainland.

Send s.a.e for full detailed literature of all our products

QM70 PRODUCTS

VALE ROAD, STOURPORT, WORCS. DY13 8YJ

28/432/10W Output Transverter: This new version of our already highly successful transverter is now rated at 10 watts rms (real watts) output. Simply connect to your 10m ssb transceiver for ssb operation on 70cm, inbuilt receiver uses two high gain low noise RF stages and a MOSFET mixer for excellent gain and noise figures. Two I.F. outputs supplied as standard. The transmit chain also uses all solid state components giving a clean and linear output. We have been manufacturing 70cm ssb transverters for over 2 years—who else has this experience? Fitted with RF power output meter, LEDs for rx and tx states and an internal antenna change over relay. 12V negative earth operation... £98.00.

432 VLA: 432MHz valve linear amplifier. Fully compatible with our 28/432 transverter providing up to 50 watts rms output. Linear biased for ssb, fm a.m. cw or avar video... £42.00.

28/144 SOLID STATE TRANSVERTER—see our previous adverts

AGENTS

Lee Electronics, Crayford Electronics, D. P. Hobbs Ltd.
P. Avill G3TPX (qthr). Tel: 0228 78 2517. Evenings and
weekends. C. Goadby G8HVV (qthr). M. Anderson,
G3WWY (qthr), Tandraage 656.

NEW! Frequency-Agile Audio Filter, Model FL1

First-ever fully automatic notch filter plus fully variable band-pass filter with a.f.c.

IMPROVES ALL EXISTING RECEIVERS—CONNECTS BETWEEN RECEIVER & LOUDSPEAKER

Automatic Notch Mode

It sounds fantastic but it's true, with Model FL1 in circuit you can simply forget about heterodyne interference (audio whistles). In its automatic notch mode the filter will automatically locate and remove an interfering whistle in your receiver's audio output, usually in less than one second. No more fiddling with manual notch filters, the advanced Datong circuitry does it faster and better and automatically.

So far as we know this is the first-ever device with this capability, it has to be heard to be believed.

Variable Band-pass Mode

Nearly as spectacular and just as revolutionary, Model FL1 in its band-pass mode for the first time puts you in complete control of your receiver pass-band for CW and SSB. Compare these features with any other audio filter:

- ★ Flat-topped response for ease of tuning of CW, and for effective SSB filtering.
- ★ Continuously variable bandwidth (20Hz to 1000Hz) for perfect matching of selectivity to prevailing conditions or CW sending speed.
- ★ Continuously variable centre frequency (250 to 3000Hz) so you can put the pass-band precisely where you want it.
- ★ Switchable a.f.c. makes the 20Hz bandwidth as easy to use as if it were 100Hz.

Model FL1 looks just as good inside as it does outside. All components, including controls, connectors, and eight i.c.s plus six transistors, are directly mounted on two large glass-epoxy P.C.B.s. Power comes from either an Internal PP9 battery (not supplied) or an external supply between 8.5 and 16 volts DC. Price in the U.K.: only £47.50 plus 5% VAT (p.p. included). Full details on request.

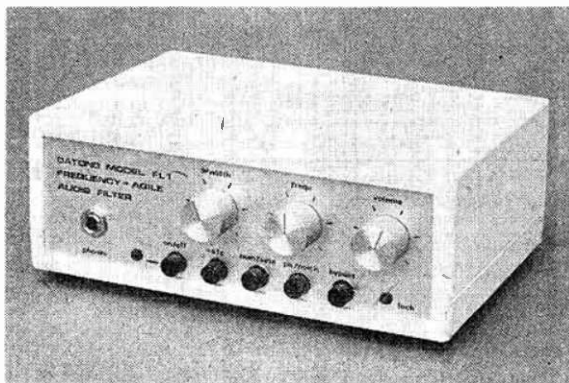

Our UNIVERSAL R.F. CLIPPER and R.F. CLIPPER MODULE are available from stock as usual. Please see previous ads. for details. Data available on request.

DATONG ELECTRONICS LTD.

11 MOOR PARK AVENUE • LEEDS LS6 4BT • TELEPHONE 0532-755579

AMATEUR RADIO - G3V FV

CHAS. H. YOUNG LTD., 170-172 Corporation Street, Birmingham B46UD. Tel. 021-2361635

Raymart Band Checker 1.8-145MHz £18.50 (75p)

Folded Aluminium Boxes with lids ideal for electronic projects:

RM7 6½" x 2½" x 1½" 45p	RM14 7" x 5" x 2½" 68p
RM8 4" x 4" x 1½" 45p	RM15 8" x 6" x 3" 95p
RM9 4" x 2½" x 1½" 41p	RM16 10" x 7" x 3" £1.06
RM10 5½" x 4" x 1½" 41p	RM17 10" x 4½" x 3" 83p
RM11 4" x 2½" x 2" 45p	RM18 12" x 5" x 3" £1.06
RM12 3" x 2" x 1" 38p	RM19 12" x 8" 3" £1.30
RM13 6" x 4" x 2" 58p	

All boxes p & p (50p)

Aluminium Panels 18 swg:

8" x 3" 8p, 6" x 6" 15p, 8" x 4" 20p, 6" x 4" 10p, 8" x 3" 10p, 12" x 12" 56p

All panels p & p (50p)

Paxolin Printed Circuit Board 10½" x 8½"

50p (50p)

Microwave Modules:

70MHz Converters 28-28.7MHz I.F.

136 28-30	£18.00
144 2-4	£18.00
144 4-6	£18.00
144 28-30	£18.00
144 28-30 with 116MHz. O/P	£18.20
432 28-30MHz I.F.	£22.00
432 144-146	£22.00
1296 28-30	£29.00
1296 144-146	£29.00

50p

432 .. Varactor Tripler

1296

144 .. Preamp (2 outputs)

Raymart 3" ribbed inductors

.. AT-Insulator

14 swg H/O Bare copper wire (approx 140ft)

NL2 Polythene Cord 200lb B. S. (approx 170 yds)

NL4 400lb B. S.

Henke of PVC aerial wire (150ft)

per yd, 5p (50p)
£1.00 (50p)

● **Midland Agents:**
for **EDDYSTONE, JOSTY KITS,**
J BEAM, ICOM
Multi-Storey Car Park at rear of Shop

NO C.O.D. PLEASE PRINT YOUR NAME AND ADDRESS: YOU MAY ORDER GOODS BY PHONE AND PAY BY ACCESS OR BARCLAY. Enquiries S.A.E. please. Prices include VAT and are subject to change without notice.

SERVICE

WE SPECIALISE IN THE SERVICE OF EDDYSTONE RECEIVERS AND CAN ACCEPT OTHER MAKES OF COMMERCIALY MADE COMMUNICATION EQUIPMENT

ICOM

IC22A £178.25 (£1.50)

IC225 £275.00 (£1.50)

IC201 £397.50 (£2.50)

IC3PA £46.87 (£1.50)

RECEIVERS

EC10 MH1 5-30MHz

£224.95 (£2.50)

EB37 1/w m/w-22MHz

£224.95 (£2.50)

JAYBEAM AERIALS

5Y/2M 5ele

£8.12

8Y/2M 8ele

£8.00

10Y/2M 10ele

£15.75

5XY/2M crossed 5ele

£11.75

8XY/2M crossed 8ele

£14.82

10XY/2M crossed 10ele

£20.18

Q4/2M 4ele quad

£12.00

Q5/2M 5ele quad

£16.00

UGP/2M ground plane

£5.93 (£1.95)

HO/2M halo head

£2.82 (0.75p)

HM/2M halo with 24" mast

£3.12 (0.75p)

£ whip

£9.56 (£1.50)

Bantex £ whip

£7.87 (£1.50)

Also range of 70cm Jaybeam aerials.

MANUALS TO COVER EDDYSTONE RECEIVERS... PLEASE INQUIRE

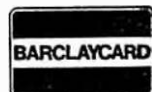

Get the Optimum from your Rig

— STOP MISTREATING IT!

Match your antenna system to the PA stage with a KW 107
— observe your TX 'Waveform' with a KW 108



KW 108 Monitorscope

- KW 108 MONITORSCOPE**
- Monitor your transmitted "Waveform" 10-160 metres.
 - Can be left permanently in antenna feed.
 - Two-tone generator incorporated to ensure optimum linearity for SSB.
 - Displays SSB, AM and CW "Waveform".
 - A further safeguard for your PA tubes.

KW 107 ANTENNA TUNING SYSTEM

The KW range of aerial matching units will ensure optimum power transfer from the PA stage to the antenna system.



KW 107 Antenna Tuning System
KW109 ANTENNA TUNING SYSTEM

- Longer life for your PA tubes.
- KW 107, suitable for most transceivers and transmitters (250 watsc rating).
- The KW 109 is for use with linear amplifiers.
- Antenna selection.
- RF power and SWR measurement.
- Dummy load incorporated.
- Observation of SWR with and without antenna tuner.
- Attractive "G" line case.

The antenna tuner in the above unit can be purchased separately if you already have the KW 101/103, dummy load and antenna switch. This unit is known as the KW E-Z match.

- Offers same facilities as KW 107 but with higher power rating for most linear amplifiers.

Other KW favourites:

- KW 2000E Transceiver 10-160;
 - KW 204 Transmitter;
 - KW 1000 Linear Amplifier;
 - KW 202 Receiver;
 - KW 160 ATU;
 - KW 103 SWR/RF Power meter;
 - KW Dummy Load;
 - KW Traps (the original and best);
 - KW Trap Dipoles;
 - KW Low Pass Filter;
 - KW Balun;
 - KW Antenna Switch.
- Stockists for Hy-Gain beams and verticals, CDR rotators, Shure microphones, etc.

Write or 'phone for catalogue to:



Communications Products
DECCA COMMUNICATIONS LTD

1 Heath Street, Dartford Kent

Tel: Dartford 25574/21919

Easy terms on Equipment available over 12, 18 or 24 months.

“With 40 years experience as an Amateur and Professional operator I can truthfully say that this is the only multi-band antenna I have found which gives the results which might be expected from verticals tailor made for each band” —G6SX

MINIMUM RF LOSS and VERY LOW ANGLE FIRE ensures **FURTHER MINIMUM SIGNAL LOSS** from Ionosphere and Earth Bounce, making **DX—COMMONPLACE**—with only **MILLIWATTS** of RF power, in spite of the present Sunspot minima. Send stamp for **PROOF!**

YOU just CANNOT AFFORD R.F. LOSSES — and S.W.L.'s, remember, the **SAME antenna*** is used for **RECEIVING the DX — YOU SURE CAN'T WORK 'EM — IF YOU CAN'T HEAR 'EM !!** — the **'JOYSTICK V.F.A.** — the **'QRP ANTENNA (230cm—7' 6")** that handles **ALL your R.F. — "FLEA POWER" or KILOWATT EFFICIENTLY !!!**

— AS SUPPLIED TO H.M. GOVT. COMMUNICATIONS H.Q. —

PRICES INCLUDE V.A.T. INSURANCE AND DELIVERY BY POST OR CARRIER

JOYSTICK V.F.A., £18.00; JOYMATCH A.T.U.'s:—111 (Med. wave - 30MHz), £18.00; 111A (1-6-30MHz), £18.00; 111B (L match, 1-6-30MHz), £18.20; LO-Z500 (1-6 thru 30MHz, 500w.), £23.35; BUDGET LINE: A.T.U. 1-6-30MHz, £8.90; A.T.U. Medium and SW bands, £8.90 (both in kit form, £7.40); Aerial Bandswitch (complete aerial system, medium and SW bands), £7.40; Artificial Earth, £7.40; OX CRYSTAL SET (Home and World-Wide reception) ready to use, £4.88; Comm. Headphones 8ohm, £4.90; Field Strength Meter, £2.11; Set valves 9R59DS, £6.21; Coaxial cable 50 or 75ohms, per 10metres, £1.55; SYSTEM "A": V.F.A. + 111B, £32.08; SYSTEM "X": VFA + either 111 or 111A, £34.47; SYSTEM "O": VFA + Aerial B'switch, £24.63; SYSTEM "J": VFA + LO-Z500 + F/S meter, £41.03.

PARTRIDGE SUPER PACKAGE

Send stamp for details and expert advice.

BOX 6



G3CED G3VFA

COMPLETE RADIO STATION FOR ANY LOCATION. Comprising: Trio OR666 Gen. Cov. RX, Headphones VFA., System "A" all connecting cables, del. (our risk) ASSEMBLED IN SECONOSI (Save £14.05)

£206.93

PHONE 0643 62535 (OR 62639 AFTER OFFICE HOURS)

JUST TELEPHONE YOUR CARO NUMBER

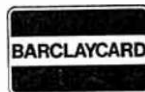

MOSLEY MAKES *impact*

MONOBANDERS

A310	3 Element 10 metres	£38.00
A315	3 Element 15 metres	£44.00

DUAL-BANDERS

Elan	3 Elements 10 and 15 metres	£48.00
Elan	2 Elements 10 and 15 metres	£35.00
TD-2	Trap Dipole 40 and 80 metres	£23.00

TRI-BANDERS

Mustang	3 Elements 10, 15 and 20 metres	£75.00
Mustang	2 Elements 10, 15 and 20 metres	£60.00
TA-33 Jr.	3 Elements 10, 15 and 20 metres	£58.00
TA-32 Jr.	2 Elements 10, 15 and 20 metres	£40.00
TA-31 Jr.	Rotary dipole 10, 15 and 20 metres	£25.00
V-3 Jr.	Trap Vertical 10, 15 and 20 metres	£19.00
EI-Toro	Vertical 20, 40 and 80 metres	£17.50

QUAD BANDERS

Atlas	Trap Vertical 10, 15, 20 and 40 metres	£33.00
-------	--	--------

SWL ANTENNAS

SWL 7	Dipole 11, 13, 16, 19, 25, 31 and 49 metres	£17.50
RD-5	Dipole 10, 15, 20, 40 and 80 metres	£17.50

TOWERS
ROTATORS
COAX
ROPES &
LINES

BASIC
PRICES
ADD VAT

**All antennas
available ex works**

Send for HANDBOOK
containing full details of
Antennas and other technical
information 33 pages 40p.
Refundable upon purchase of Antenna.

**40 Valley Road
New Costessey
Norwich, Norfolk NR5 OBD
ENGLAND**

**MOSLEY
Electronics Ltd**

COME TO THE NORTH'S PREMIER AMATEUR RADIO EVENT!

NORTHERN RADIO SOCIETIES ASSOCIATION ANNUAL

CONVENTION & EXHIBITION

BELLE VUE—MANCHESTER

SUNDAY 25th APRIL 1976—doors open at 11 am.

- ★ TRADE STANDS
- ★ INTER-CLUB QUIZ
- ★ CONSTRUCTION CONTEST
- ★ CLUB DISPLAY STANDS
- ★ GRAND RAFFLE
- ★ CLUB STAND TROPHY
- ★ RSGB BOOKSTALL
- ★ CW CHALLENGE
- ★ RTTY & OTHER DEMONSTRATIONS

THE FOLLOWING TRADERS HAVE BOOKED EXHIBITION SPACE:—

ABC Electronics Ltd
The Amateur Radio Shop
Axiol Products Ltd
J Birrell
Bredhurst Electronics
Doram Electronics Ltd
Electro Supplies
Isherwoods Electronics
Lowe Electronics
M & B Radio
Microwave Modules Ltd
P M Electronic Services
QM70 Products
RSGB Publications
Radiotronics
South Midlands Communications Ltd
Stamford Electronics
Stephens-James Ltd
Telford Communications
Thanet Electronics

- ★ REPEATER EXHIBITS
- ★ THE HOME OFFICE will provide a working exhibit enabling visitors to have their aerial filters checked and aligned. (Belling or BNC sockets only).
- ★ GB3NRS HF Bands station plus talk-in on 1.930 MHz (AM) 70.26MHz (AM & FM), 144.290MHz (SSB), 145.000MHz (AM) and 145.500MHz (FM). Distant talk-in via GB3MP repeater on Ch-R6.

Exhibition Hall entrance is at rear of Belle Vue, opposite main car park (off Hyde Rd, A57)



LEE ELECTRONICS LTD

01-723 5521 CLOSED THURSDAYS G8JVL
 400 EDGWARE ROAD, PADDINGTON, W.2
 LONDON'S LEADING STOCKISTS OF YAESU •
 ANTENNA SPECIALISTS • STANDARD • ICOM
 BANTEK • JAYBEAM • REYCO • QM70 • ETC.

SPECIAL EXCLUSIVE OFFER

Perspek Quat Covers designed and manufactured by us to keep your Yaesu equipment in mint condition. Suitable for Models FT101, 101B, FL101, FR101, FT201, FT101E, FL2100, FT277B, FT221, FT220 etc. Price £4.50 each inc. VAT. Carriage 45p. FT221, FT220, FT620 £3.95 inc. VAT. P & P 45p.

YAESU

	Carriage free
FT200B with p.e.u.	£255
200R Sigmaizer 2m	£195
FR101E Transceiver	£395
FR101S add receiver	£270
FT101 D digital rx	£250
FL101 transmitter	£275
FL2100B linear	£230
FT501 with p.e.u.	£425
FT224 2m transceiver	£130
FT201 transceiver	£310
FR101Q/L with B/C bands	£345
YC355D 200MHz	£135
FT221 AM/FM SSB Transceiver	£318
YC501 Digital Display	£95
FR101 DD Digital with B/C bands	£425

STANDARD RANGE

CT145A 2m 2W Transceiver	£90
C830 1W Marine Version	£98
C828 2m 10W Transceiver	£135
C430 70cm 10W Transceiver	£160

CLOSE FOR STOCK TAKING 14/4 TO 28/4 INCLUSIVE

* TRICITY FINANCE * BARCLAYCARD * ACCESS * FREE PARKING AT REAR OF SHOP

NB: ASP and Frequency Counters Subject to 8% VAT; Other Items 25% VAT.

J-BEAM

	Price p/p
4m 4 element	£7.75 (1.00)
5Y 2m 8 element Yagi	£4.90 (75p)
5Y 2m 8 element Yagi	£8.40 (75p)
10Y 2m 10 element Yagi	£12.60 (1.00)
PBM10 2m parabeam	£14.95 (1.00)
PBM 14.2m parabeam	£19.20 (1.00)
D5 2m 5 over 5	£9.00 (1.00)
D8 2m 8 over 8	£12.00 (1.00)
5XY 2m Crossed Yagi	£8.40 (1.00)
8XY 2m Crossed Yagi	£11.70 (1.00)
10XY 2m Crossed Yagi	£16.15 (1.00)
Q4 2m 4 element quad	£9.60 (1.00)
Q6 2m 6 element quad	£12.90 (1.00)
UGP 2m Ground plane	£4.75 (75p)
D8 70cm 8 over 8	£16.38 (1.00)
PBB18 70cm parabeam	£12.58 (1.00)
MBM48 70cm	£13.90 (1.25)
MBM88 70cm	£18.50 (1.50)
12XY 70cm	£18.00 (1.00)
PMH2C Phasing harness	£3.25
Rotators UR43/67 in stock.	

MOBILE AERIALS Price p/p

Jaybeam TAB 1/2 whip with cable	£7.65 (50p)
Bantex BSU 70cm 1/2 wave	£3.90 (45p)
Bantex BS 2m 1/2 wave with base	£6.20 (65p)
Bantex BS 2m with boot lip mount	£9.95 (65p)
Bantex magnetic mount	£7.65 (50p)
Bantex magnetic mount with 1/2 whip	£12.50 (85p)
Revco 1/2 wave with coil and base	£6.35 (65p)
Hustler 2m co-linear mobile	£25.00 (50p)

ASP ANTENNAS

ASP201	£2.80 (75p)
ASP629	£8.58 (75p)
ASP393	£15.20 (75p)
ASP677	£12.87 (75p)
ASP667 Co-linear 70cm	£16.10 (75p)
ASP655 Base antenna	£13.75 (75p)
ASP, R332 Gutter Mount	£7.00 (30p)
ASP Boot Mount	£3.20 (25p)

ICOM RANGE

	Carriage free
IC22A 2m transceiver, 22 channel with 10 static fitted	£140
IC225 2m 80 channel	£220
IC201 2m V.F.O. 10 watt 12V/230v	£315
All ICOM models available with Xtal tone burst (if required)	
XTB2 xtal Tburst	£9.95

MICROWAVE MODULES

	Price p/p
2m converter 2-4, 4-8, 28/30	£15.10 (15p)
4m converter 28-28-7	£15.10 (15p)
70cm converter 28/30	
144/146	£18.00 (15p)
1296MHz converter 28/30MHz	£23.90 (15p)
2m converter 28-30/116 0dc output	£15.90 (15p)
70cm SSB Transverter	£11.20
500MHz Frequency counter	£61.10
500MHz Prescaler	£25.00
1296MHz Varactor Tripler	£25.00 (15p)
432MHz Varactor Tripler	£17.50 (15p)

LINEAR AMPLIFIERS

OM70 2m 50W FM/SSB	£44
--------------------	-----

NEW! SAMSON ETM-3C C-MOS KEYS

1µA battery drain—Why switch off?

- Self-completing dots/dashes/spaces. ● Can be used either as normal electronic keyer or as an iambic-mode squeeze keyer. ● 8-50 wpm. ● Constant 3:1 dash-dot ratio. ● 6 C-MOS ICs and 4 transistors. ● Plug-in PCB. ● Long battery life—typically 1µA drain when idling—Built-in batteryholder for 4 × 1.5V batteries (but will work over 3-10V range). ● PCB has both a reed relay (250V, 0-5A, 25W max) and a switching transistor (300V, 30mA max)—either keying method can be used ● Has the well-known fully-adjustable Samson precision keying lever assembly. ● Operate/Tune button. ● Sidetone oscillator. ● Grey case 4" × 2" × 6". £49.95

BUILT FOR DEPENDABLE MARINE & COMMERCIAL SERVICE

JUNKER PRECISION HAND KEY. A superbly engineered straight key used for many years by professionals afloat and ashore. With this key you can't help but send good morse. Free-standing—no screwing down. Front and back contacts—fully-adjustable gaps/tension. Key-click filter. Hinged grey cover. £21.95.

BAUER KEYING PADDLE. Single-paddle unit on 1 1/2" × 2" base for home-built El-bugs. Adjustable gaps/tensions. £8.95
88MH TOROIDS. For CW, RTTY, SSTV and other filters. 78p. each.

All prices postpaid UK and include 25% VAT. Please send stamp with enquiries.

SPACEMARK LTD.

Thornfield House, Delamer Road, Altrincham, Cheshire.
 (Tel: 061-928 8458)

MODULAR ELECTRONICS G8CQS

Transverter 432-28-8, 28-30MHz i.f. 8W PEP output at 13-8V. £68 plus VAT. Transverter 432-50-8, As above with FT620 i.f. of 50-52MHz. £70 plus VAT. Converter 432-28. Stabilized Osc. N.F. Typ. 2-8dB. Gain 30dB. Price £19.50 plus VAT.

Preamp/PA 432-PA. A custom designed amp. all stripline ccts. BNC connectors. Box size 110 × 60 × 30mm. Price £13.00 plus VAT. 144MHz Preamp/PA. Two models. PA.1 for 50 ohm. PA. Lin. for the Liner 2 impedances. Gain Typ. 15dB N.F. 2-5dB. Size 1 1/2" square with 0-6" mounting depth. Fibreglass PCB. £4.00 plus VAT.

Linear 40 Mk2. Transistor Linear amp. Suitable for multi-mode operation. 144MHz 10W input and 40W out at 13-8V DC keying cct. Price £36 plus VAT. FM40. 144MHz 10W in for 40W out. RF keying. 13-8V supply. Price £34 plus VAT. FM15. 144MHz 1W in for 15W out. RF keying. for the 2200 or sim. £28 plus VAT. Note.—The above RF power amplifiers can be fitted with a MOSFET preamplifier in the receive path for an extra £4.00 plus VAT.

S.A.E. FOR FURTHER DETAILS ON ANY OF THE ABOVE UNITS.

TRANSISTORS AND COMPONENTS. Prices include VAT but not postage.

PT4531. 13-8V TD117 case. 432MHz 0-25W in for 2W out. £1.00 inc.

PT4236b. 13-8V TO117 case. 144MHz 1-2W in for 10W out. £3.50.

PT2125d. 13-8V TO117 case. 144MHz 1-5W in for 15W out. £3.00.

PT2125a. 13-8V TO117 case. 144MHz 2-7W in for 15W out. £4.00.

BLY38. 13-8V TO117 case. 432MHz 0-5W in for 3W out. £2.50.

61387. Studless stripline high gain 432MHz transistor, designed for 28V but will give 1W out with 13-8V peak greater than 10dB. £1.50.

2N5915. 13-8V RCA HF case. 432MHz 2-0W in for 8W out. £8.90.

BFR90. Mullard T pack low noise RF amplifier. £3.60. BFR91. £4.00.

TP398. TRW T pack low noise RF amplifier. 3dB NF at 500MHz. £2.10.

Mosfets. 40673, 60p. 40841, 60p. MEM615, 65p. 3N204, £1.20. BFS28, 80p.

Bipolar. 2N2369, 22p. BC107, 15p. PT4166a, 55p. PT2125a, 55p. BC207, 16p.

6SX28, 25p. BC153, 15p. BFY56a, 27p. BFX41, 25p. BF121, 40p (UHF amp). BFX89, 60p. BFW16, 70p. BF115, 30p. Film Trimmers. 1mm. 1 to 6p and 1-5 to 100p, 12p each.

Air spaced UHF trimmers. 1-5 to 6-5p Oxley type. 20p each.

Disc ceramics. 1000p pack of 10 for 15p. 200p for 10 for 15p.

Plate ceramics. NPO 12p and 33p, 3p each.

Filters 10-7 MHz STC. Miniature type. 15kHz bandwidth. New. £5.00.

CTC RF power transistors. Most types are stocked. SAE for quotation. Postage and packing. For small components under 8 oz. weight 0-25. Transverters and amplifiers 0-90 includes insurance.

WORKSHOP: 4c, Sudley Road, Bognor Regis, Sussex. Phone Bognor 20313.

Orders to: 1 CONISTON CLOSE, BOGNOR REGIS, WEST SUSSEX PO22 8ND. BARCLAYCARD & ACCESS

G. W. M. RADIO LTD.

ALL PRICES include VAT and Post/carriage. Discount for callers.

OSCILLOSCOPES CD1212 SOLATRON. 5' tube. TB 100 nanosec to 5 secs. Input 200 microvolts to 100 volts. Clean and good working order with 24 mc/s dual trace plug-in unit, £85. Wide Band 40 mc/s unit £21. 24 mc/s unit £28. Scopes, CT436, £65. Plug-ins sold separately. ALSO a few double beam CT436 (Solatron CD1014), £65.
NO. 19 HEADSETS new and boxed for 19 and 62 etc. £2. 12 volt 4 pin vibrators 3 for £1.

AS10 Tx units. 2-10Mc/s, £6. Small shaded pole motors, 115/240V, £1.25.

RADIO TELEPHONES. Cambridge boot mounting HI or LO band, with accessories but less input plug, £25. Westminster UHF W15U, £50. Murphy Rover hybrid Hiband, £15. Vanguard units only, no accessories, valve multi channel lo band, £10.50. From time to time we have licensable equipment, please phone for latest stock position.

WATCHES! Quality ex-Ministry. Lemanie "Nero" pocket 1/5th second split hand stop-watch, £15. Lemanie wrist, stainless steel 1/5th second chronograph, £16.75. Smiths GS (awake second hand), £9.50. Eterna, £9.50. Wrist watches have screw backs and are fully overhauled. Sent by Registered post.

CRYSTALS. 1000 kc/s HC8U, £2.50. SAE for list of other Rcal crystals stocked.
METERS. Two types in desk top cases, all £2.50. 50-0-50 Microamp, 1000 ohms. calibrated 5-0-5. 1mA, 100 ohms, calibrated 10-0-10. New condition. BC221 complete charts, no PSU, £15. Aerial insulators, 1 1/2" white egg type, 6 for 67p, Pyrex 2 1/2", 75p.
CRYSTAL OVENS, octal based for 2 HC8U crystals, 12V, 85p.

TRANSMITTER P.A. units STC T4188, tunes 2-8 to 18Mc/s manual or 28V motor drive. 13" x 8" x 8". Pair CV2519 (4 x 150) 28V blower cooled. Bases are NOT UHF type. Ideal basis for Linear Amplifier construction, £11.00.

PERMEABILITY TUNER UNITS. High quality 4 medium 1 long wave push button tuner with manual tuning. Circuit for Hi-Fi tuner, £1.75.

REED RELAYS, a reed normally open, 5V DC coil as used in recent keyer designs. 15p each post 10p for any number. Also reed inserts 1-85" overall (body length 1-1"), diameter 9-14", max ratings 250V DC and 500 mA. Gold clad normally open contacts, 85p per dozen, £4.12 per 100, £30.25 per 1,000.

All receivers and Test Equipment are in working order at time of despatch. Carriage charges are for England and Wales only.

Terms: Cash with order Early closing Wednesday

G. W. M. RADIO LTD. 40-42 PORTLAND ROAD, WORTHING, SUSSEX Telephone 34897

ambit INTERNATIONAL (G.P.D.)

AMBIT is the wireless component specialist source: COILS BY TOKO INC (Shell stock values)

455/470kHz IFTs 27p 10-7MHz IFTs 30p (inc. cap.)
MC6 coils for VHF TX exciters and converters 3 1/2 or 4 1/2 18p
7BA min RF chokes 10, 22, 47, 100, 470, 1000uH 15p each
10RA min RF chokes 5, 1 and 43MH ex stock 27p each
10PA tunable coils (10% of nom value) 23 or 36 mh 30p
FILTERS BY TOKO:

MFHT 455kHz mechanical filter with silicon transistor in/out impedances. Available with BW of 4 and 7kHz £1.65
CFT 455kHz ceramic filters with input/output matching transformers. 6 or 8kHz types 55p, (also 470kHz 6kHz BW)
CFU 470kHz ceramic filters, slightly higher Q than the CFT series. BW 6kHz 60p
CFS10-7 WBFM ceramic filter for 10-7MHz, also suitable for use as communications roofing filter 40p each.

Fuller information on all TOKO items is included in our data folder/catalogue 40p inc. pp. price lists free with an SAE.

Linear ICs for wireless (other types in free list—SAE please)

CA3089E	1.94	For PLL	For Audio	
CA3123E	1.40	NE560B	2.50	LM380N 1.00
TBA120	0.75	NE561B	2.50	LM381N 1.85
TBA651	1.81	NE562B	2.50	TBA810AS 1.30
MC1350	0.70	NE565A	2.50	MC3401 0.68
MC1310P	2.20	NE567V	2.50	8038CC Waveform generator 3.10
CA3090AQ	3.75	NE566V	2.55	

300pF SWING VARICAPS: MVAM 1.05, MVAMI 2.75, MVAM2 = 2 matched diodes, MVAM1 = 3 matched diodes.

37 HIGH STREET, BRENTWOOD, ESSEX. CM14 4RH
(tel. 216029—tix 995194) pp 20p CWO please. VAT extra

CRAYFORD ELECTRONICS

32 IRON MILL LANE, CRAYFORD, KENT, DA1 4RR

Tel: Crayford (0322) 524825 (6—8.30 p.m. & weekends)



COMPARE THESE PRICES!

14MHz	All 1 1/2 40Bd gain	
	A5-6 hinge whip	£5.05
	A6-9 screw whip	£5.05
	CPW58 window clip	£3.25
	GP258 base station ground plane	£8.08
432MHz	GP58A professional version	£12.84
	B2-6 boot mount	£8.21
	All Collinear 6dBd gain	
	A5-12 hinge whip	£7.84
	A6-13 screw whip	£7.64
70MHz	CPU587 window clip	£7.00
	GP527D ground plane	£11.84
	1 1/2	
	A5-2 hinge whip	£3.52
	CPW14H window clip	£7.36

You do not pay for fancy chrome parts on our aeriels, just rugged construction for long and efficient service. As a bonus you will note our aeriels all obtain higher gain than our competitors. This is due to the fact that before encapsulation in grey PVC the steel rods are heavily copper plated. The window clips need no hole, connection is made via a BNC socket on the inside of the window. These feature an integral 'C' type ground plane to ensure a good impedance match. The ground plane aeriels, which have a 2" mast fixing, utilize a similar 'C' plane (except on 432MHz) and either a BNC (standard) or N (professional) socket outlet. The boot mount is the one piece plastic moulding that has 4 metres of UR78 cable attached. Any base, rod, 'C' unit etc can be supplied separately, normally from stock, as can the smallest nut, bolt or other mechanical part. It should be noted that two basic types of fitting are used, the hinge, using an Allen screw enables the rod to swing from vertical to horizontal and the screw, which is a 2BA Stud enabling speedy removal. Any hinge rod will fit any hinge base and similarly for the screw types.

A comprehensive leaflet is available giving details of all permutations and including information on the range of flexible helical aeriels for hand portables. Please send a large SAE, Carriage BRS is £1.30 on long aeriels (2m 1 1/2 and 4m 1/2) or 45p on the rest. Prices do not include 25% VAT which should be added to the total.

ACCESS GIRO 33563 0001 BARCLAYCARD

G4DSG D. P. HOBBS LTD. G3HEO

The Component Specialists

Inoue IC22A Transceiver 10 Channel Version £141.00. With Tone Burst.
Inoue IC225, Transceiver 80 Channel for 2M. £195.00.
Inoue Main Power Unit for IC22A, £35.00.
"Trio" QR866 General Coverage Receiver £130.00.
"Liner 2" SSB, 2M Transceiver £145.00.
R.115E, Regulated Power Supply for Liner 2 £21.00.
QM70 Products 28/144MHz. Solid-State Transverter, 2 watts output. Linear and Clean £41.40.
28/432MHz 10 watt output Transverter £78.00.
28/144 High Power Transverter up to 200 watts P.E.P. Input 2 I.F. outputs £88.00.
144PA 50 All Solid State 50 watts RMS output 2M. Linear Amplifier will accept FM, SSB, A.M., CW. £44.00.
432.VLA Linear Amplifier providing up to 50 watts RMS output £33.60.
2 FM70, 70CMS or 2M at the flick of a switch £46.40.
MICROWAVE MODULES
144 Conv. £15.12 1.296MHz Conv. £23.82 50MHz Counter £61.11
70MHz Conv. £15.12 2M Pre-Amp £9.04 500MHz Prescaler £21.60
70cm Conv. £18.08
Special Offer, Push-to-Talk Hand Mic 50K £3.38.
Also in Stock, Jaybeam, Qenco, Bontex, DieCast and Alum. Boxes and thousands of Components.
All prices basic Plus VAT at 25% Part Exchange welcome, Access or Barclay.

11 King Street, Luton, Beds. 20907

Essex Telecomms

Distributors for GEC-Marconi mobile radio equipment. VHF AM and FM mobiles, hand portables and base stations, together with ASP base and mobile aeriels, no hole boot mounts, etc. In stock now, 145MHz collinear vertical base aeriels. 6dB over 1/2 wave. Band width ±1MHz 50 ohm feed impedance. £32.50 inc. VAT. Carriage £2.00 BRS.

ESSEX TELECOMMUNICATIONS LTD.

Claydons Lane, Rayleigh, Essex SS7 7UP.
Rayleigh (03742) 79674 or 79883

CLASSIFIED ADVERTISEMENTS

Private advertisements 14p per word, minimum £2.00.
Trade advertisements 22p per word, minimum £2.50.
Box number 60p extra to postage at minimum.
Semi-display (boxed) 1" single column £9.50.
1½" single column £13.75.

Please write clearly. No responsibility accepted for errors.
Latest date for acceptance—4th of preceding month.
All classified advertisements must be prepaid.

Copy and remittance to:
ADVERTISEMENT SECTION,
RADIO SOCIETY OF GREAT BRITAIN,
35 DOUGHTY STREET, LONDON WC1N 2AE.

FOR SALE

ATTENTION FT101, FT401 OWNERS 401/101 epicyclic drive £1.25 or two for £2.00. 401 160 metre conversion kits £12.50. FT101 radio frequency speech clipper (ask for review reprint) £45.00 or DIY from £28.00. FT101 modification data—large size. Holdings, 39/41 Mincing Lane, Blackburn, BB2 2AF. Tel. 59595/6.

ZNI CALLSIGNS for lapel badges, car/shack emblems and other engraving needs. SAE for details. G3ZNI—QTHR.

OSCAR PREDICTOR, shows equator crossing time and longitude for 7 successive orbits. Siff plastic for shack wall. 65p Inc. post and VAT; discount for quantities. Trisagion Ltd., Oall, Rannoch Station, Perth PH17 2QH.

VALVES. New, boxed, guaranteed. British 6146, £3.25. American 6146B (as 2001) £3.70 ea. Inclusive. A. E. White, G3HCU, QTHR. Tel: 0306 (Oorkin) 730215.

QUALITY OSL CARDS. See for samples by return post. Quick delivery. Compalith Printing Services, 115 Promenade, Cheltenham, Glos GL50 1NW.

HBCV TYPE AERIALS 2m and 70cm 4-5 dB gain £4.50 inclusive. See details: Amateur Aerial Products, 55 Vauxhall Street, Rainbow Hill, Worcester, WR3 8PA.

FT401B, TX/RX tested on dummy board only, mint, £320.00. Beam TH3JNR unused £75.00. G3ODT, 3 Lomeshaye Road, Nelson, Lancs.

ASSEMBLED AND TESTED UNBOXED MODULES. Repeater Access Qac 1750Hz £3.50. VFO to drive G3ZVC Transceiver Board £11.50. (0-15p variable capacitor NOT supplied). Variable bandwidth 3W AF Amplifier. Ideal for extra audio and CW for G3ZVC board £9.50. G3ZVC SSB Transceiver Board £78.00. All prices include VAT p. & p. 20p extra. SAE for more information to BRICOM, 25 Bydemill Gardens, Highworth, Swindon, SN6 7BS.

2 METRE VERTICAL DIPOLES combining optimum electrical/mechanical specifications. Ideal exposed sites. SAE G3IZZ. QTHR.

MISCELLANEOUS

PATENTS and TRADE MARKS—Booklet on request. Kings Patent Agency Ltd (B. T. King, J. B. King, Reg Pat Agents)—148A Queen Victoria Street, London EC4. Tel: 01-248 6161. Telex: 883605. Established 1886.

PRINTED CIRCUIT BOARD ASSEMBLY with hand soldering to the very highest professional standard. Small Company pleased to accept batches of any quantity. Ring Brookwood 6670.

ACCOMMODATION

MALE TO SHARE HOUSE, own room, mid-Essex. Tel: Blackmore 822910, G4AK—QTHR.

SEMICONDUCTORS

Semiconductors: 2N4427 85p, 2N3856 70p, 2N3375 £3.25, 2N5590 £5, 2N5591 £10, 2N3478 70p, 40673 60p, 40841 60p, MC1596G £2.50, MC1590G 50p, CA3011 65p, CA3014 60p, CA3089E £1.90.
Varactor type multiplier: 2W In at 2m, 1W out at 70cm £5, 2m 5 channel 12V A.M. receiver board (15 cm x 8 cm) £35, 2m 10 dB cable attenuator (25W dissipation) £5. All prices inclusive. **MAIL ORDER ONLY**

HELLER ELECTRONICS

49 Blossom Way, Hounslow, Middx, TW5 9HB

BEST VALUE FOR MONEY

TONE BURST, 1750Hz, Stable, reliable £4.50
FM DETECTOR, 400kHz-1.6MHz. State frequency required £5.10

9-15V. All inclusive P & P, etc. CWO. SAE enquiries.

LYE COMMUNICATIONS

238 Stamford Road, Brierley Hill, West Midlands DY5 2QE

MORE DX? RUN A KILOWATT!

Make 250W sound like a MIGHTY KILOWATT with a SPEECH COMPRESSOR. Switched compression "Hi-Fi" or "DX". Just connect between mic and TX. EASY TO MAKE. All parts including case, instructions, money back guarantee, ONLY £5.80, post free.

CAMBRIDGE KITS 45 OLD SCHOOL LANE, MILTON, CAMBRIDGE

C. G. JAMES ELECTRONICS G3VVB

Staines Road, Feltham, Middx.

Prototype and Production Metalwork. Specialists to the Electronics Industry. Panels, chassis and sheet metal details. Machining in all metals and plastics. Plant list on application.

Tel. 01-570 3127

OS Ref TQ 113748

BRAND NEW COAX OFFERS

UR67 50 ohm low loss @ 25p per m, post 31p per m.
UR43 50 ohm standard @ 8p per m, postage 2p per m.
UR70 75 ohm standard, same price.
UR95 50 ohm miniature Nylon Coax 4p per m, post 1p per m.
Twin Screened Mic @ 6p per m.
Multicore Screened 4 core @ 8p 8 core @ 10p 20 core @ 15p.
All plus post, about 2p per m, except 20 core, 5p.
SAE Samples and full lists.

W. H. Westlake, Clawton, Holsworthy, Devon.

PRINTED CIRCUITS and HARDWARE

Readily available supplies of Constructors' hardware, Aluminium sheet and sections. Printed circuit boards, top quality for individual or published designs. Prompt service. Send 15p for catalogue.

RAMAR CONSTRUCTOR SERVICES

Masons Road, Stratford on Avon, Warwicks. Tel. 4879

INDEX TO ADVERTISERS

Aero & General Supplies	302	Lee Electronics	310
AJH Electronics	Cover Iv & 298	Lowe Electronics	Cover II & 250/252
Amateur Electronics	263	Lye Communications	312
Amateur Radio Bulk Buying Group	298	Microwave Modules Ltd	305
Ambit International	311	Modular Electronics	310
Ashley Dukes	296	Mosley Electronics Ltd	309
B. Bamber	Cover III	Northern Radio Societies Assn.	309
Billboard Publications Ltd	297	Partridge Electronics	308
J. Birkett	306	PM Electronic Services	304
Bredhurst Electronics	302	OM70 Products	306
Cambridge Kits	312	Radio Shack Ltd	286/7
Campioni Electronics SAS	284/5	Ramar Constructor Services	312
C & C Electronics	300	RT & I Electronics	302
Claybrook Engineering Co Ltd	300	Solid State Modules	303
Crayford Electronics	311	South Midlands	
Datong Electronics	307	Communications Ltd	260/1
Essex Telecommunications Ltd	311	Spacemart Ltd	310
Garex Electronics	300	Stephens-James Ltd	296
GWM Radio Ltd	311	Thanet Electronics	262/3
Hartley Crystals	296	TMP Supplies	304
Heath (Gloucester) Ltd	295	J & A Tweedy	302
Heller Electronics	312	Reg Ward & Co Ltd	302
D. P. Hobbs Ltd	311	Waters & Stanton Electronics	299
Holdings Ltd	294	Western Electronics (UK) Ltd	254/5
Interface Quartz Devices	298	W. H. Westlake	312
C G James	312	Chas. H. Young Ltd	307
Johns Radio	304	Yaesu Musen	256/9
KW Communications Ltd	308	J. Yu	301

B. BAMBER ELECTRONICS

DEPT RC, 5 STATION RD, LITTLEPORT, CAMBS, CB6 1QE
 TEL: ELY (0353) 860185 (TUESDAY-SATURDAY)

TERMS OF BUSINESS: CASH WITH ORDER MINIMUM ORDER OF £1.00.
ALL PRICES NOW INCLUDE POST & PACKING (UK ONLY)
EXPORT ENQUIRIES WELCOME
CALLERS WELCOME SATURDAY ONLY 9.30-12.00, 1.30-5.00
 Please enclose stamped addressed envelope with ALL Enquiries
PLEASE ADD VAT AS SHOWN

ALL BELOW—ADD 8% VAT

BARGAIN OFFER
MIXED COMPONENT PACKS, containing resistors, capacitors, switches, pots, etc.. All new. (Random sample bag revealed approx. 700 items) £2.00 per pack, white stocks last.

TUNED COILS, 2 section coils, around 1MHz, with a black smart tuning knob, which moves an internal core to vary the inductance, many uses, easily re-wound, 3 for 50p.

MAINS TRANSFORMERS for Pye F60 base, TX, new, 315V at 135mA + 500 V at 240mA (tapped at 340V) + 50V at 50mA + 6.5V at 8.5A (with connection data) low only £8.00.

MAINS TRANSFORMERS

All 240V input voltage quoted approx. RMS. (Please quote Type no only when ordering)

TYPE 1414, 14V at 4A, £2.50.

TYPE 10/2 10-0V at 12A, £1.50.

TYPE 28/4 28V at 4A, 125V at 500mA, £4.00.

TYPE 72703 400V at 10mA, 200V at 5mA, 6.3V at 400mA, £1.25.

TYPE 125BS approx. 125V at 30mA. 65p.

SMALL MAINS SUPPRESSORS (small chokes, ideal for radio, Hi-Fi inputs, etc.) approx. 1/2in x 1/2in, 3 for 50p.

PERSEPEX TUNER PANELS (for FM Band 2 tuners) marked 88-108MHz and Channels 0-70, clear numbers, red/black out, smart modern appearance, size approx. 1/2in x 1/2in, 2 for 35p.

HIGH BAND TRANSMITTER SECTION (suitable for 2M operation) 10W out. Complete with valves (2 x 6BH6 + 2 x 6X4) and antenna change-over relay. Requires 8MHz xtal (not supplied) and HT 250V DC + 12V for Hirs. Complete with circuits (As removed from Pye Cambridge AM10). **SOLD OUT**

8-06041 (for 145.088) xtal (suitable for above) £1.75.

WE NOW STOCK WELLER SOLDERING EQUIPMENT, (including the Famous TCP1) & **SPIRALUX Tools** for the Electronics enthusiast. SAE for list.

19" RACK MOUNTING PCB FRAMES, 7" high, with runners to take modules 5 1/2" x 8 1/2" deep. Complete with power unit (approx. 12V at 1A) that can be varied by a few volts up or down. (Power Supply, tested OK.) With mains socket at rear of main unit, plus mains voltage selector panel. Few only £7.00 each.

MODULES FOR ABOVE. These are Video Distribution amps (5 way) Lots of useful transistors, electrolytics etc. 1/2in wide front panel, (Fits into above unit) with removable PCB. **SOLD OUT**

MINIATURE 2 PIN PLUGS & SOCKETS (Fit into 1/2" hole, pins enclosed, with covers for chassis mounting, or can be used for in-line connectors) Bargain pack of 3 plugs + 3 sockets + covers 50p.

HEAVY DUTY HEATSINK BLOCKS, Undrilled, base area 2 1/2" x 2", with 6 fins, total height 2 1/2" 50p each.

9V RELAYS, Continental type, 2 pole change over 35p

RUBBER MAGNETS 1/2" square, with mounting hole, 20 for 30p.

PYE CAMBRIDGE PC BOARDS (Removed from high band AM10)
 RF and MIXER BOARD £7.00.
 10-7MHz I.F. BOARD £1.50.
 10-7MHz OSCILLATOR MIXER BOARD (with 11-155 Xtal) £1.25.

455kHz I.F. BOARD £2.00.
 AM AUDIO BOARD £1.20.
 AM SQUELCH BOARD 50p.

6 CHANNEL LED EX SWITCHES, 12V, complete with all trimmers and coils, (removed from high band AM10) £4.00.

CAMBRIDGE Mod Transformer £1.00.
 Mod Driver Transformer 75p.
 12/24V Inverter Transformer £1.25
 Pack of PA COILS, mostly silver plated 50p.

ALL BELOW—ADD 8% VAT

IMHOFF CABINETS 21in wide by 12 1/2in high by 18in deep, to take 19in unit 10 1/2in high. Very smart, deep turquoise, with silver side louvers, few only brand new, £10.00 each.

AS ABOVE, but 23in high, to take 19in unit 21in high, few only, **SOLD OUT**

B9D VALVE HOLDERS, for PL509, etc., ceramic chassis mounting, 5 for 50p.

PROGRAMMERS (Magnetic devices) Contain 0 microswitches (suitable for mains operation) with 9 rotating cams, all individually adjustable, ideal for switching disco lights, displays, etc., or industrial machine programming. (Need slow motion motor to drive cams, not supplied) 9 switch version £1.50, or 15 switch version £2.00.

DIE CAST BOXES (approx. size in inches)

4.3 - 2.2 - 1.2	85p
4.8 - 2.3 - 1.5	75p
4.8 x 3.8 - 1	85p
4.8 x 3.8 - 2	£1.00
6.8 x 4.8 - 2	£1.45
4.8 x 3.8 x 3	£1.55
6.8 x 4.8 x 4	£2.25
8.0 x 5.8 x 2	£1.85
10.0 - 6.6 - 2	£2.25

VALVES

00V03/20A (ex equipment) £3.00.

00V03/10 (ex equipment) 75p or 2 for £1.20.

2C39A (ex equipment) £1.00 each.

DET-22 (ex equipment) 2 for £1.00.

1mA METERS 2in square, plastic fronts (these have a paper scale stuck over the original marked 0-1mA which is easily peeled off and an internal 18K resistor which is easily removed) £1.75 each or 2 for £3.00.
XTAL PACKS, 51MHz range (our selection) HC8U 10 for £1.00 SAE for our latest xtal list.
 R/S Midget 3 pole, 4 way, rotary switches, 40p each.

PLUGS & SOCKETS

BNC "T" PIECES 50ohm £1.00 each.
BNC SKTS (single hole mounting) ex-equipment, 3 for 50p.

BNC PLUGS (ex-equipment) 5 for £1.00.
N-TYPE PLUGS 50ohm 60p each, 3 for £1.50.

N-Type Skts. (4 hole chassis mounting, 50ohms, Small coil lead type) 50p each.

Greenpar (GE30015) Chassis Lead Terminations (These are the units which bolt on to the chassis, the lead is secured by screw cap, and the inner of the coil passes through the chassis), 30p each, 4 for £1.00.

PL259 Plugs (PTFE) Brand new, packed with reducers, 65p each or 5 for £3.00.

SO239 Sockets (PTFE) Brand new, (8 hole fixing type) 50p each or 5 for £2.25.

25-way ISEP Plugs and Sockets 40p set (1 plug + 1 skt) Plugs and sockets sold separately at 25p each.

Andrews 44AN Free Skite (N-type) for FH4/50B or FH4/50L cable £1.00 each.

Bulgin Round Free Skite, 3 pin, for mains input on test equipment, etc. 25p each.

SO239 Back to Back Sockets £1.25 each.

BNC Insulated Sockets (single hole type) 65p each.

Bulgin Flat 2 pin Flex Connectors. Non-reversible. 40p each.

TRANSISTORS

QC200 Transistors, 6 for 50p.

PNP Audio Type TO6 Transistors, 12 for 25p.

BYX1 Transistors, 4 for 60p.

BYX 38/300 Stud Rectifiers, 300V at 2.5A, 4 for 60p.

BCY7Z Transistors, 4 for 50p.

BSX20, 3 for 50p. (VHF osc/mlt.)

BC108 (metal can) 4 for 50p.

PBC 108 (plastic BC 108) 5 for 50p.

BF152 (UHF amp/mixer) 3 for 50p.

BA121 Varicap Diodes, 4 for 50p.

ALL BELOW—ADD 8% VAT

Miniature 50ohm coax, high quality, PTFE insulation and blue PTFE cover, solid silver plated inner, and silver plated braid, approx 3mm. overall diameter. (ideal for unit wiring of RF stages up to 23cms, etc.) 4 metres for 50p.

SPERRY 7-SEGMENT P.G.D. DISPLAYS, digit height 0.3in red, with decimal points, 150V to 200V (nominal 180V) operation. These are high-volt industrial type, and therefore brighter than normal displays. All brand new. AT THE BARGAIN PRICE OF 50p PER DIGIT. TYPE 332 (two digits in one mount) £1.00 each. TYPE 333 (three digits in one mount) £1.50 (Sorry no single digit available.)

MOBILE CONVERTERS, 24V DC, input 13.8V at approx. 3.4A DC output, fully stabilised, £3.50 each.

PKts. of 2BA NUTS (The self-locking ones with the nylon insert) 100 for 50p.

Coils on 1/2" dia. 1 1/2" long paroxin formers, 5 for 20p.

Valveholders, mixed bag of 10 for 50p.

Springs, 1" long x 1/4" dia. per pack, 25p.

LF chokes on 1/2" x 2" core, 5 for 20p.

2-6pF, 10mm circular ceramic trimmers (for VHF/UHF work), 3 pin mounting, 5 for 50p.

TO3 transistor Insulator sets, 10 for 50p.

PC Board Withdrawal Handles, mixed coils 3 for 50p.

Solder, 20SWG, 60/40 alloy, approx. 6yds 25p.

Multifid Tubular Ceramic Trimmers, 1-18p1, 6 for 50p.

ICs, some coded, 14DIL type, untested, mixed, 20 for 25p.

1 1/2" Polythene chassis mounting fuseholders, 6 for 30p.

LES Lamps, 24V 1-2W, 10p for 40p.

Multiturn Pots, 10 turn, 1/2" spindle (ex-equip) following values available, 2kohm, 5kohm, 40kohm. £1.00 each.

Lead suppressors (10kohm) for mobile plug loads, 4 for 50p.

ALL BELOW—ADD 25% VAT

TV plugs (metal type) 5 for 50p.

TV sockets (metal type) 4 for 50p.

TV line connectors (back-to-back skt) 4 for 50p.

3 pin DIN plugs, 4 for 50p.

Din 3 pin Line Sockets, 15p each.

Din 6 pin Right Angled Plugs, 20p each.

Din Sockets 5 pin, 270 deg, 4 for 50p.

Din Speaker Skts, 2 pin, 4 for 30p.

I.F. Cane 1/2in square, suitable for rewind, 6 for 30p.

Miniature earphones with min. Jack plug, 2 for 60p.

1 Meg. 1in pots, 1/2" plastic spindle, 2 for 50p.

50kohm 1in pots, 1/2" plastic spindle, 40p each.

Mixed electrolytics, large bag, £1.00.

TWIN IF CANS, approx 1" x 1/2" x 1" high, around 3-5 to 5MHz, 2 separate transformers in one can, internally screened, 5 for 50p.

HIGH QUALITY SPEAKERS, 8 1/2" x 6" elliptical 2" deep, 4 ohms, inverse magnet, rated up to 10W £1.50 each, or 2 for £2.75. (Quantity, discount available).

ELECTROLYTIC CAPACITORS

DuBilier Electrolytics, 60µF, 450V, 2 for 50p.

DuBilier Electrolytics, 100µF, 275V, 2 for 50p.

Plessey Electrolytics, 470µF, 63V, 3 for 50p.

TCC Electrolytics, 1000µF, 30V, 3 for 60p.

Plessey Electrolytics, 1000µF, 180V, 40p each, (3 for £1.00).

DuBilier Electrolytics, 5000mfd at 35V, 50p each.

DuBilier Electrolytics, 5000µF, 60p each.

DuBilier Electrolytics, 8000mfd at 70V, 65p each.

ITT Electrolytics, 6800mfd at 25V, high grade, screw terminals, with mounting clips, 50p each.

Plessey Electrolytics, 10,000mfd at 63V, 75p each.

Plessey Cathodray Capacitors, 0.04µF at 12.5KV DC, screw terminals, £1.50 each.

A LARGE RANGE OF CAPACITORS AVAILABLE AT BARGAIN PRICES, SAE FOR LIST.

A. J. H. ELECTRONICS

Proprietor: A. J. HIBBERD

(G8AQN)

Tel: RUGBY daytime 76473, evening 71066

Terms of Business Cash with order, Mail order only, or Callers by appointment.

S.A.E. with enquiries

Postage Charge 40p

Minimum order £1.00.

Official orders accepted on a strict monthly basis.

Prices now include VAT

FULL MONEY-BACK GUARANTEE ON ALL ITEMS

VHF-LOW POWER TRANSMITTER KIT, comprising of three ready built P. C. boards: 3 channel oscillator, phase modulator multiplier, & mic. amplifier approx 1 watt output @ 145MHz, the three boards will build up in a space 3" x 7 1/2" & requires 4MHz crystals & 12 volt supply, all boards are new and unused and supplied with circuit and alignment data. £16.00.

GARRARD ZERO/100 SB semi-automatic transcription record player deck with belt driven turntable & parallel tracking arm. Brand new in manufacturers sealed boxes £36.00 + £1.00 p/p.

We still have a few PYE sets left as last month's advert.

NIXIE TUBES similar to Mullard ZM1080, side viewing with wire ends character height 1/2" only amber ones left. Brand new 60p each, 10 for £4.50, 25 for £10.00, 100 for £26.00.

7 SEGMENT LED DISPLAYS forward voltage 1.7V @ 2-20mA, ideal for making digital voltmeters, frequency counters, clocks etc. types available:
FND357 (red) right hand decimal point 1" character, common cathode £1.85 each 6 for £8.50.
FND590 (red) right hand decimal point 1/2" character, common cathode £1.25 each 6 for £6.85.
FND567 (red) right hand decimal point 1/2" character, common anode, £1.25 each, 6 for £6.85.
 Application sheets available on the above LEDs free with order or 20p per copy. Refundable on order.

GARDNERS ISOLATION TRANSFORMERS 240V AC input, 12V AC, 40 watts output (3 1/2 amps) these are enclosed in metal case with mains lead and fused input, the output is via a Bulgin 3 pin socket and supplied with matching plug. Ideal for making a mains supply for your mobile rig. Brand new and boxed, £3.75 each.

MAINS TRANSFORMER 250V AC input/output tapped 0/19/25/30/40/50V @ 1 amp. £2.50 each, 2 for £4.00.

TRIMMER CAPACITORS
MULLARD semi-airspaced 1.4-5-5p1, 2-10p1, 2-22p1 all 8p each.

CERAMIC 10mm dia. x 6mm high. VHF/UHF type 2-5p1, 3-10p1, 4-20p1, and 10-40p1, all 6p each.

CERAMIC 6mm dia 7-35p1 8p each

CERAMIC miniature compression type 8mm x 13mm 10-40p1, 6p each.

OXLEY airspaced 10mm sq. 1-10p1 18p each, 10 for £1.40.

CERAMIC PLAQUETE CAPACITORS 50VW, wire ended sizes vary from 4mm-12mm sq. all values in pfa. 22, 33, 39, 47, 56, 68, 82, 100, 120, 150, 180, 220, 270, 330, 390, 470, 560, 680, 820, 1000, all 3p each 10 for 25p, 1-2k, 1-5k, 2-2k, 3-3k, 4-7k, 8-8k, (mfid) 0-01, 0-015, 0-022, 0-033, 0-047, 0-1, all 31p each, 10 for 32p.

ELECTROLYTICS (all axial leads unless stated) values in Mfd. 10/40V, 10/35V, 22/25V, 47/16V, 47/25V, 47/35V, 100/10V, 100/12V, 100/40V, 150/16V, 250/16V, 330/4V, 33/15V, 220/25V, 330/25V, 470/25V, 680/25V, 1000/10V, all @ 10p or 10 for 70p. 1000/40V 15p each 10 for £1.00. 4700/40V, 10,000/16V can types 35p each.

MULLARD 2500/40V, 4000/40V can type 40p each. 700mfid 200V ideal for putting in series for linear PSU etc. £1.85 per 10, post and packing 60p.

PRE SET SKELETON POTS, 1/2 watt 10mm sq. vertical mounting, values in ohms, 100, 220, 470, 680, 1k, 2.2k, 4.7k, 6.8k, 10k, 15k, 22k, 47k, 68k, 100k, 220k, 470k, 1m, all 4p each.

REED RELAYS 14 pin DIL. Made by ASTRALUX, typed 12fA-3, 5V 10 mA coil res. 500 ohms, contacts rated 10 watts, normally open 45p each or 10 for £3.00.

NI-CAD BATTERIES "AA" (U7) size 1.2V 450 ma/h brand new stock £1.90 each, 5 off 95p, 10 off 90p each.

SILVER ZINC rechargeable battery made for the ITT SF1 startone, 12V @ 150 ma/h new £2.00 each. Charger unit for this requires 28V OC 50ma. £1.75 each.

FIBREGLASS P.C. BOARD 1/16" thick one size only 8" x 5" 40p each.

MULLARD I.F. FILTERS LP1157/2 ± 7kHz @ 6dB 60p each with connecting data.

TOYOCON CRYSTAL FILTERS 10M-5B-1 ± 7kHz @ 6dB ± 12kHz @ 60dB. Supplied with input and output matching transformers for I.F. freq. of 10.7MHz brand new with data sheet £4.00.

COILS 5mm dia. 18mm high with 10mm sq. base as used in PYE Rx RF boards (these have coils wound on them which can be removed, complete with core 5p each).

SEMICONDUCTORS

Transistors
DIL108 plastic version of BC108 12p each, 10 for £1.00.
NKT233D, NKT214, NKT212, 2G339, BC172, BC172A, all 18p each.

2N3771, 2N3772, £1.00 each.
2N4381 P channel FET 15p.
2N3823 N channel FET 26p.

BL736 VHF power 13 watts RF output for 4 watts drive £2.50 with circuit.

51389 (2N5914) VHF power 2 watt output 470MHz, 5 watt output 145MHz, capstan type £2.00.

Diodes
HP5082-2800 hot carrier diodes UHF/VHF mixer etc. 60p each, 4 for £2.00.

BA111 varicap 23p.
BA220

1N4148 general purpose silicon 6p, 1N54A Germanium general purpose 6p, 15 for 60p.

U14882/2 general purpose silicon 3p.
1N4002 rectifier 100 pIV @ 1 amp. 6p, 4 for 21p.

1N4005 rectifier 800pIV @ 1 amp. 16p, 4 for 36p.
1N4007 rectifier 1000pIV @ 1 amp. 12p, 4 for 46p.

6V126 rectifier 400pIV @ 1 amp. 16p.

BZX44C series zener diodes available in the following voltages: 1/2 watt wire ended, 3-3V, 3-9V, 4-7V, 7-9V, 9-1V, 10V, 11V, 13V, 16V, 18V, 24V, all 18p each.

BZX99C7Vs 7-5V zener 400mW 18p each.

RF CHOKES 17 microhenry, 22 microhenry, 100 microhenry 12p each.

COLOUR TV CRYSTALS 4433-916kHz wire ended 35p each.

HCB/U CRYSTAL HOLOERS moulded polythene P.C. or chassis mounting 10p each, 12 for £1.00.

FT243 CRYSTAL HOLOERS chassis mounting 8p each.

MINIATURE OXLEY PTFE feed through insulators "drill 3/32" hole and push in" 50 for 75p.

ELECTRONIQUES LOW MOTION DIALS type "SMD2" 6-1 and 36-1 induction drive with clear moulded front size 6 1/2" x 4" supplied with two pointers and two scales. Ideal for VFOs etc. £4.70.

ERNEST TURNER EDGEWISE METERS 100 micro-amp FSO. Oisplay area 1 1/2" x 9/16" only 15/8" deep brand new boxed £2.00 each. OK for "5" meters etc.

UR37 CO-AX heavy duty 75 ohm approx. 7/16" dia. 25p per Mtr. + 60p per 25 Mtrs for postage.

FERRITE RINGS 9/16" dia. 7/16" int. dia. 3/16" thick 14p each.

FERRITE BEADS similar to FX1115 4 for 16p.

NEW ITEMS THIS MONTH

3 GANG TUNING CAPACITORS approx 25p1 per section size 3" x 1 1/2" x 1 1/2" wide spaced vanes OK for VHF use, air gap .050 new £1.00 each.

3 GANG TUNING CAPACITORS 500p1 per section size 3 1/2" x 1 1/2" x 1 1/2" new 75p each.

TETTER TRIMMERS Jackson type C16 Cat. no. 5640/PM, 2-10p1 size 1" sq. 1/8" high temp. coef. less than +100ppm/°C 40p each 10 for £3.50.

CAPACITOR RINGS to suit screen on 4CX250B etc. made by Johnson USA cat. no. 124-0113-001 all silver plated and boxed capacity approx. 1000p1 50p each

REELS of CABLE single strand 500yds twisted twin 22swg, PVC covered, single strand 24 swg 1,500 yds both types are pari used reels but contain a minimum of 75% of the above lengths, only £3.00 per reel.

LEADLESS DISC CERAMICS 100p1 20% 500vW 20 for 15p.

MINIATURE SEMI-AIRSPACED TRIMMERS, similar to Mullard 808 series, 2-25p1 10mm dia x 7mm high three pin fixing, PC mounting 6p each, 10 for 50p, 100 for £3.75, box of 900 for £27.00.

PLASTIC SEMI-AIRSPACE TRIMMERS 7mm dia, 1-10p1 similar to Mullard type 808 series 6p each or £5.00 per 100.

BF180 VHF/UHF transistors 20p each, 10 for £1.75.

BF166 VHF transistors (replacements for W15AM Westminster RF front end). 15p each, 10 for £1.25.

CATHOON CRYSTAL OVENS 6/12v. AC/OC type MCO-2M 80°C as used in March Issue of Radio Communication frequency counter, new unused with base to suit HC6/U crystals, only 45p each.

10.7 MHz RADIO TELEPHONE MARKER OSCILLATORS size 3 1/2" x 1 1/2" x 1 1/2" ready to use complete with internal battery brand new stock £10.00 each.

BC108 plastic version 16p each, 10 for 75p, or 100 for £6.00.

1N4001, 2/3/4/5 RECTIFIER DIODES (special offer) all new marked full manufacturers spec. 25 for 75p state which required.

CA3089E 16 pin DIL FM IF amp. ideal for 10.7 MHz FM IF amps in domestic Hi-Fi tuners and communication equipment, limiting sensitivity 12 microvolts @ -3db point, internal squeel circuit and audio pre-amp + AGC, AFC, and "S" meter outputs supplied complete with data sheet, brand new unused our price ONLY £1.90, data sheet separate 20p.

EMI CARTRIDGE TAPE PLAYERS complete with 15 + 15 RMS watt stereo amp. 8 ohm speaker imp. with inputs for magnetic and ceramic pick-up, tape recorder, microphone, tuner, freq. 25c/s-25KHz ± 1db at rated output. Six only available please 'phone to reserve, price ONLY £46.00 each.

59 Waverley Road, The Kent, Rugby, Warwickshire.