

THE RAGUN PRO



Professional-Grade Smart Percussive Therapy™ Device

Table of contents

EN	4-12
DE	13-21
FR	22-30
IT	31-38
ES	39-48
NL	49-57
PL	58-66
EL	67-75
NO	76-84
SR	85-93
SV	94-102
TR	103-111

Getting started

Step 1

Turn on and float

Firmly press and hold the centre button on the button pad, then float the Theragun PRO across areas in need. Use the plus (+) and minus (-) buttons on the button pad to adjust the speed. Apply light to moderate pressure as needed.

Step 2

Get the Theragun app

We'll guide you through a stress-free setup and show you how to get the most out of your Theragun PRO.

Step 3

Feel the difference.™ Every day.

Take a deep breath and treat yourself with guided treatment presets or freestyle mode. It's all designed for you.

The Theragun PRO

- A OLED screen
- B Button pad
- C Theragun Triangle™ multi-grip
- D Lithium-ion battery

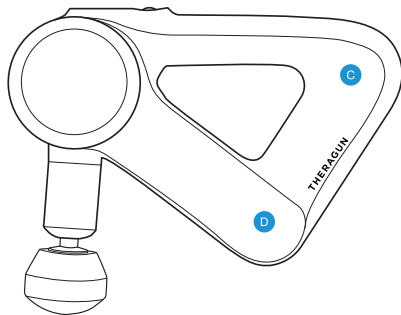
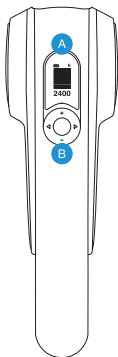

See Warnings insert for
important safety instructions

- E Battery release button
- F Rotating arm button
- G Rotating arm
- H Interchangeable attachments

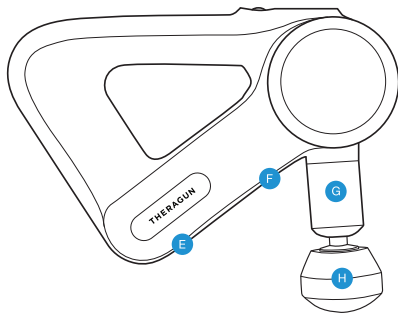

Using the Theragun PRO

1. Insert the lithium-ion battery fully before turning on the Theragun PRO.
2. To turn on the Theragun PRO, firmly press and hold the centre button on the button pad.
3. Press the plus (+) and minus (-) buttons on the button pad to increase or decrease speed.
4. Press the left (<) and right (>) arrows on the button pad to toggle between the Theragun PRO's pre-loaded treatment presets.
5. To turn off the Theragun PRO, firmly press and hold the centre button on the button pad until the device shuts down.

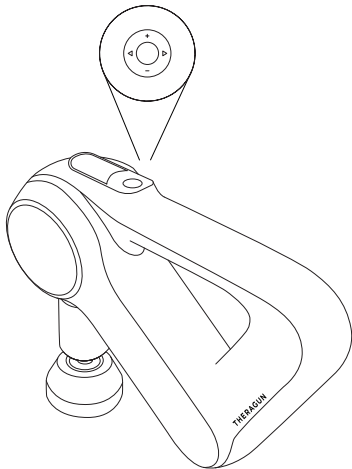

Connecting the attachments

Align the attachment with the tip of the rotating arm and push to connect. To remove, grip the attachment, placing 1 finger on each side of the plastic connector. Pull off the attachment.

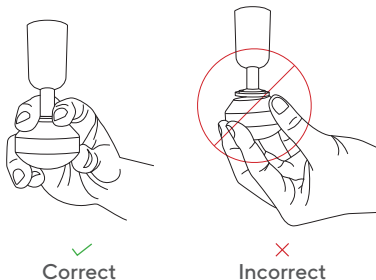

Using the rotating arm

Your Theragun PRO's rotating arm adjusts to 4 positions. To adjust the arm, push the rotating arm button on the underside of the Theragun PRO and move the arm to the desired position.

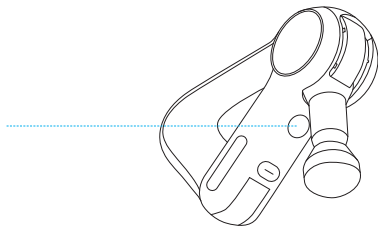

Lithium-ion battery

Align and insert the battery in the battery slot on the underside of the Theragun PRO with the flat side of the battery end facing the circular release button.

Battery life is displayed on the Theragun PRO's OLED screen when the device is turned on.

To remove the battery, press the circular release button above the battery slot and pull the battery out.

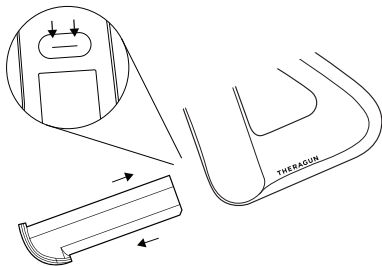

Charger

Plug the charging wire into the port on the charging dock. Insert the battery into the charging dock and press down until the light flashes. Charging is complete once the light stops flashing.

The Theragun PRO is wireless charging enabled. For more on wireless charging, visit [Theragun.com](https://www.theragun.com).

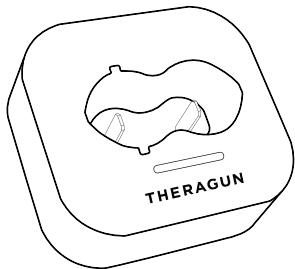

Smart Features

Your Theragun PRO is smart device enabled with Bluetooth connectivity, designed to pair seamlessly with the Theragun app. When you download the app, you'll be guided through a step-by-step setup and shown how to pair your device.

Once paired with your device, the app can remotely adjust speed, activate guided treatment presets, and make real-time recommendations based on your usage. Your Theragun PRO's OLED screen supports your app experience by displaying the current speed and force to help guide your treatment.

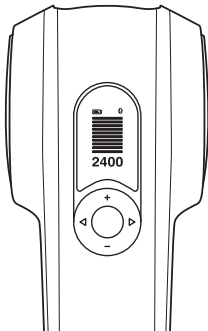

Scan the QR code
to get started.



Attachments

Your Theragun PRO comes with 6 different attachments designed for every muscle and need.

Dampener

For use on tender areas or near bones



Thumb

For lower back and trigger point therapy



Standard Ball

For overall, general use



Cone

For pinpoint muscle treatment



Wedge

For scraping, shoulder blades, or IT bands



Supersoft™

When you need a soft touch



Inbetriebnahme

Schritt 1

Einschalten und bewegen

Halten Sie den mittleren Knopf des Bedienfelds fest gedrückt und bewegen Sie die Theragun PRO über betroffene Stellen. Verwenden Sie die Schaltflächen plus (+) und minus (-) des Bedienfelds, um die Geschwindigkeit zu regulieren. Wenden Sie je nach Bedarf leichten bis moderaten Druck an.

Schritt 2

Laden Sie die Theragun-App herunter

Wir helfen Ihnen bei der einfachen Einrichtung und zeigen Ihnen, wie Sie das meiste aus Ihrer Theragun PRO herausholen.

Schritt 3

Feel the difference.™ Jeden Tag.

Atmen Sie tief durch und verwöhnen Sie sich mithilfe voreingestellter Behandlungsprogramme oder mithilfe des Freestyle-Modus. Sie haben die freie Wahl.

Die Theragun PRO

- A OLED-Display
- B Bedienfeld
- C Theragun Triangle™ Multigriff
- D Lithium-Ionen-Akku

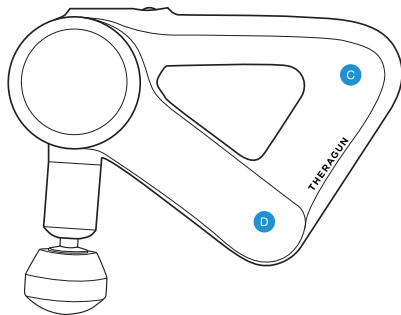
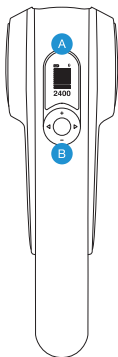

Bitte die beiliegenden wichtigen Warnhinweise zu Ihrer eigenen Sicherheit beachten

- E Entriegelungsknopf für Akku
- F Dreharmknopf
- G Dreharm
- H Austauschbare Aufsätze

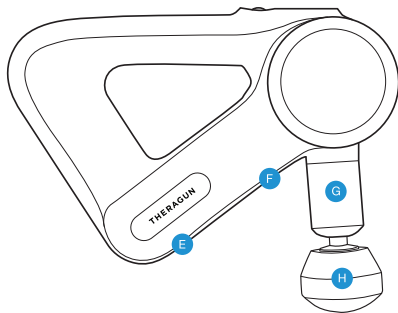

Verwendung der Theragun PRO

1. Legen Sie den Lithium-Ionen-Akku vollständig ein, bevor Sie die Theragun PRO einschalten.
2. Um die Theragun PRO einzuschalten, halten Sie den mittleren Knopf des Bedienfelds fest gedrückt.
3. Drücken Sie auf die Schaltflächen plus (+) und minus (-) auf dem Bedienfeld, um die Geschwindigkeit zu regulieren.
4. Drücken Sie auf den Pfeil nach links (<) oder nach rechts (>) auf dem Bedienfeld, um zwischen den voreingestellten Behandlungsprogrammen der Theragun PRO zu wechseln.
5. Um die Theragun PRO auszuschalten, halten Sie den mittleren Knopf des Bedienfelds fest gedrückt.

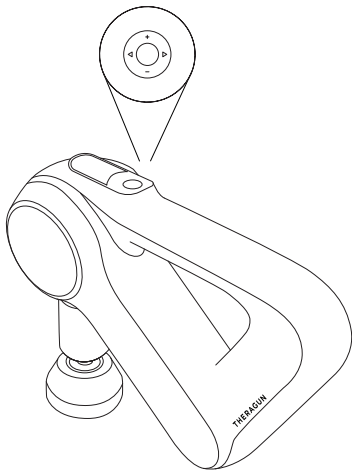

Einen Aufsatz anbringen

Richten Sie den Aufsatz an der Spitze des Dreharms aus und drücken Sie fest, um ihn aufzusetzen. Um den Aufsatz wieder zu entfernen, greifen Sie mit Daumen und Zeigefinger jeweils seitlich um den Kunststoffverbinder. Ziehen Sie den Aufsatz nun ab.

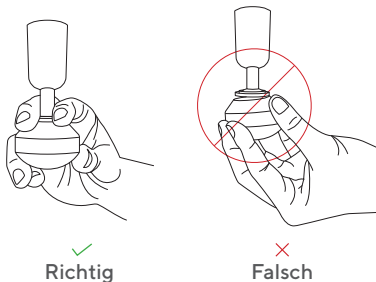

Den Dreharm verwenden

Der Dreharm der Theragun PRO verfügt über vier Positionen. Um den Arm zu verstellen, drücken Sie den Dreharmknopf an der Unterseite der Theragun PRO und bewegen Sie den Arm in die gewünschte Position.

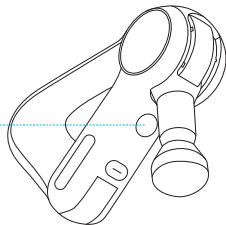

Lithium-Ionen-Akku

Schieben Sie den Akku in das dafür vorgesehene Fach an der Unterseite der Theragun PRO mit der flachen Akkuseite in Richtung des ovalen Entriegelungsknopfs.

Die Akkulaufzeit wird auf dem OLED-Display der Theragun PRO angezeigt, sobald das Gerät eingeschaltet ist.

Um den Akku zu entnehmen, drücken Sie auf den ovalen Entriegelungsknopf oberhalb des Akkufachs und nehmen Sie den Akku heraus.

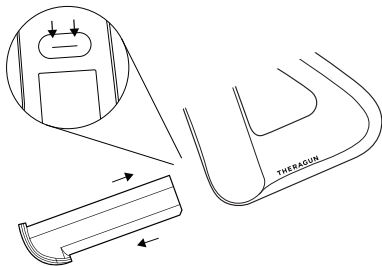

Ladegerät

Stecken Sie das Ladekabel in den Anschluss an der Ladestation. Stecken Sie den Akku in die Ladestation und drücken Sie ihn fest hinein, bis das Licht blinkt. Der Ladevorgang ist beendet, sobald das Licht aufhört zu blinken.

Die Theragun PRO kann kabellos aufgeladen werden. Weitere Informationen über kabelloses Aufladen finden Sie auf [Theragun.com](https://www.theragun.com).

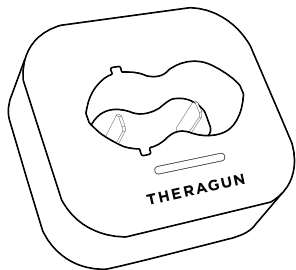

Smarte Funktionen

Ihre Theragun PRO ist ein smartes Gerät, das sich über Bluetooth mit der Theragun-App verbinden lässt. Laden Sie die App herunter und richten Sie sie Schritt für Schritt ein. Anschließend verbinden Sie Ihr Gerät.

Sobald das Gerät verbunden ist, kann die App per Fernschaltung die Geschwindigkeit regulieren, voreingestellte Behandlungsprogramme aktivieren und Empfehlungen in Echtzeit auf Basis Ihrer Nutzung erteilen. Das OLED-Display Ihrer Theragun PRO zeigt die aktuelle Geschwindigkeit und Intensität Ihrer Behandlung an.

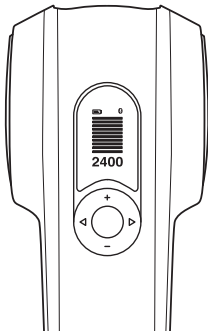

Scannen Sie den QR-Code
und legen Sie los.



Aufsätze

Im Lieferumfang Ihrer Theragun PRO sind sechs unterschiedliche Aufsätze für jeden Muskel und jeden Bedarf enthalten.

Dampener

Zur Verwendung an empfindlichen Stellen oder im Umfeld von Knochen



Thumb

Zur Behandlung des unteren Rückens und für Triggerpunkt-Therapie



Standard Ball

Zur allgemeinen Verwendung



Cone

Zur spezifischen Muskelbehandlung



Wedge

Zum Schaben, für Schulterblätter und IT-Bänder



Supersoft™

Für eine leichte Berührung



Commencer

Étape 1

Allumer l'appareil, puis le faire glisser sur votre corps

Appuyer fermement pendant plusieurs secondes sur le bouton central, puis faire glisser le Theragun PRO sur les zones à masser. Appuyer sur le bouton plus (+) et moins (-) pour régler la vitesse. Exercer une pression allant de légère à modérée selon les besoins.

Étape 2

Télécharger l'application Theragun

Nous vous guiderons tout au long de l'installation pour plus de commodité et vous montrerons comment profiter au mieux du Theragun PRO.

Étape 3

Feel the difference.™ Every Day. (Sentez la différence. Au quotidien.)

Inspirez profondément et offrez bien-être à votre corps grâce à des préréglages de massage guidé ou grâce au mode libre. Il a été conçu pour vous.

Le Theragun PRO

FR

- A Écran OLED
- B Bouton de réglage
- C Poignée à prise multiple Theragun Triangle™
- D Batterie lithium-ion

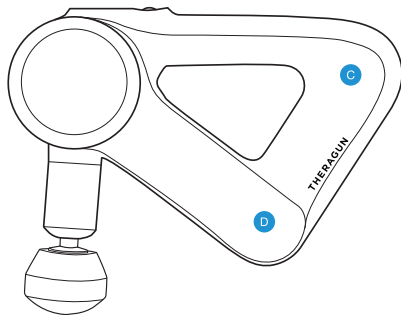
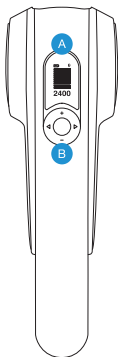

Voir la notice contenant
d'importantes précautions d'emploi

- E Bouton de détachement de la batterie
- F Bouton du bras rotatif
- G Bras rotatif
- H Embouts de thérapie

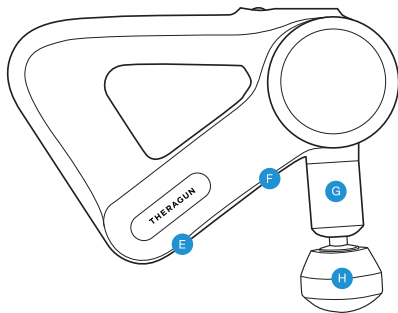

Utiliser le Theragun PRO

1. Insérer complètement la batterie lithium-ion avant d'allumer le Theragun PRO.
2. Pour allumer le Theragun PRO, appuyer fermement sur le bouton central pendant plusieurs secondes.
3. Appuyer sur le bouton plus **(+)** et moins **(-)** pour augmenter ou diminuer la vitesse.
4. Appuyer sur la flèche de gauche **(<)** et de droite **(>)** pour passer d'un préréglage de massage Theragun PRO à un autre.
5. Pour arrêter le Theragun PRO, appuyer fermement sur le bouton central pendant plusieurs secondes jusqu'à ce que le dispositif s'éteigne.

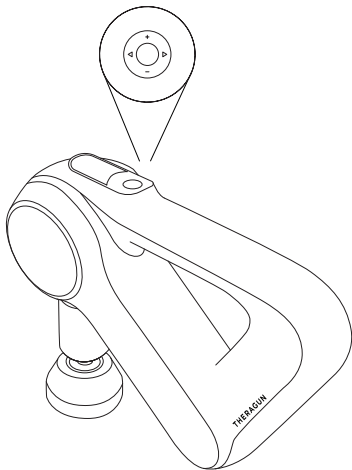

Changer les embouts de thérapie

Placez les embouts de thérapie au bout du bras de l'appareil et l'emboîter. Pour retirer les embouts de thérapie, placez votre main autour de ceux-ci et tirer pour les séparer de l'appareil.

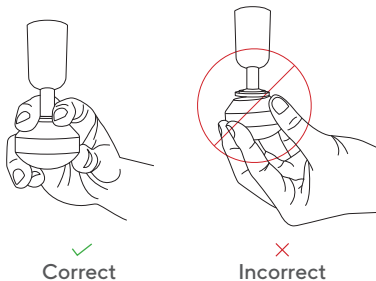

Utiliser le bras rotatif

Le bras rotatif de votre Theragun PRO dispose de 4 positions. Pour ajuster le bras, appuyer sur le bouton du bras rotatif, situé sous le Theragun PRO, puis le mettre dans la position souhaitée.

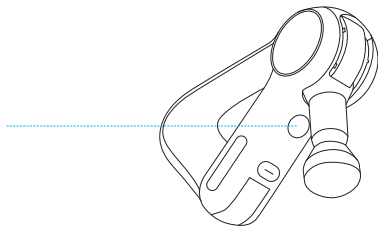

Batterie lithium-ion

Insérer la batterie dans le compartiment prévu cet effet, sous le Theragun PRO, en veillant à ce que l'extrémité plane de la batterie soit orientée vers le bouton de détachement.

L'autonomie de la batterie s'affiche sur l'écran OLED du Theragun PRO lorsque le dispositif est allumé.

Pour détacher la batterie, appuyer sur le bouton de détachement circulaire, situé au-dessus du compartiment de la batterie, puis la retirer.

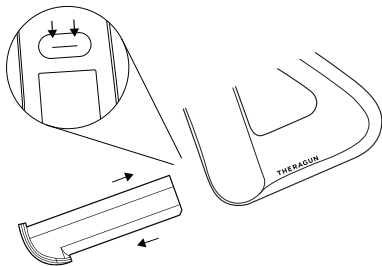

Chargeur

Brancher le câble au port de la station de recharge. Insérer la batterie dans la station de recharge, puis appuyer dessus jusqu'à ce qu'un voyant clignote. La batterie est complètement chargée lorsque le voyant cesse de clignoter.

Le Theragun PRO permet un chargement sans câble. Pour en savoir plus sur le chargement sans câble, veuillez visiter [Theragun.com](https://www.theragun.com).

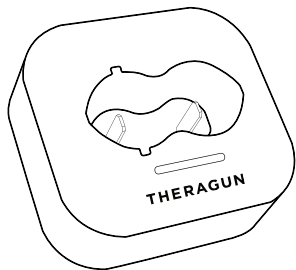

Fonctionnalités intelligentes

Votre Theragun PRO est un appareil intelligent grâce à sa connectivité Bluetooth, permettant de synchroniser l'appareil avec l'application Theragun. Une fois l'application téléchargée, vous pourrez procéder à l'installation guidée étape par étape, et synchroniser votre Theragun.

Une fois synchronisée à l'appareil, l'application permet de modifier à distance la vitesse de percussion, de mettre en route des préréglages de traitement, ainsi que vous prodiguer des conseils en temps réel sur comment améliorer votre utilisation. Pour vous guider lors de votre traitement, l'écran OLED du Theragun Pro permet d'afficher la fréquence de percussion et la pression appliquée.

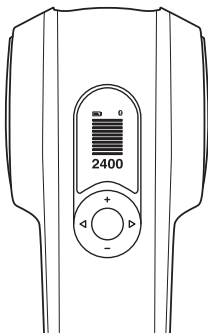

Scanner le QR code
pour démarrer.



Embouts de thérapie

Votre Theragun PRO est vendu avec 6 embouts de thérapie, conçus pour répondre à chacun de vos besoins, quelque soit le muscle que vous souhaitez traiter.

Dampener

Pour un traitement des zones sensibles ou à proximité des os



Thumb

Pour le traitement du bas du dos et du point de déclenchement



Standard Ball

Pour un traitement du corps dans sa globalité.



Cone

Pour un traitement musculaire précis



Wedge

Pour le raclage, les omoplates ou le tractus iliotibialis



Supersoft™

Pour un massage tout en douceur



Fasi preliminari

Fase 1

Accendi e via

Tieni premuto con forza il pulsante al centro del tastierino, quindi passa il Theragun PRO dove serve. Usa i pulsanti più **(+)** e meno **(-)** del tastierino per regolare la velocità. Applica una pressione da lieve a moderata, a seconda della necessità.

Fase 2

Scopri l'app Theragun

Ti guideremo in una procedura di configurazione lineare e ti mostreremo come ottenere il massimo dal tuo Theragun PRO.

Fase 3

Feel the difference.™ Ogni giorno.

Fa' un respiro profondo e rilassati con le preselezioni dei trattamenti guidati o con la modalità freestyle. Tutto è progettato intorno a te.

Theragun PRO

IT

- A Schermo OLED
- B Tastierino
- C Multi-grip Theragun Triangle™
- D Batteria agli ioni di litio

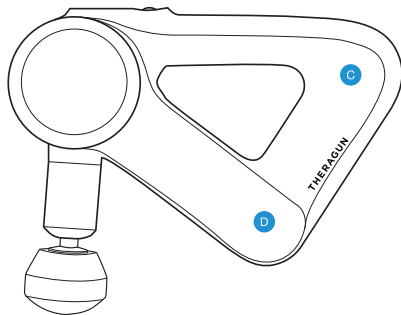
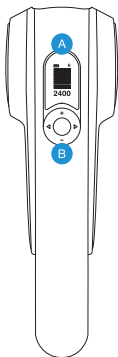

Consulta la scheda Avvertenze dove
troverai importanti istruzioni di sicurezza

IT

- E Pulsante di rilascio della batteria
- F Pulsante del braccio rotante
- G Braccio rotante
- H Attacchi intercambiabili

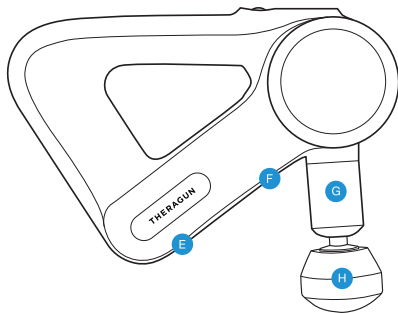

Utilizzo di Theragun PRO

1. Inserisci completamente la batteria agli ioni di litio prima di accendere Theragun PRO.
2. Per accendere Theragun PRO, tieni premuto con forza il pulsante al centro del tastierino.
3. Premi i pulsanti più **(+)** e meno **(-)** del tastierino per aumentare o diminuire la velocità.
4. Premi le frecce sinistra **(<)** e destra **(>)** del tastierino per alternare le preselezioni dei trattamenti precaricati di Theragun PRO.
5. Per spegnere Theragun PRO, tieni premuto con forza il pulsante al centro del tastierino fino allo spegnimento del dispositivo.

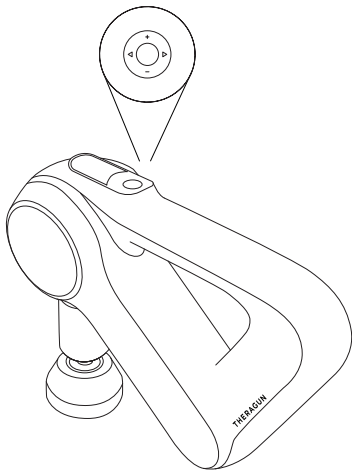

Collegamento degli attacchi

Allinea l'attacco alla punta del braccio rotante e premi per collegarli. Per rimuoverlo, afferra l'attacco posizionando un dito su ciascun lato del connettore in plastica. Sgancia l'attacco.

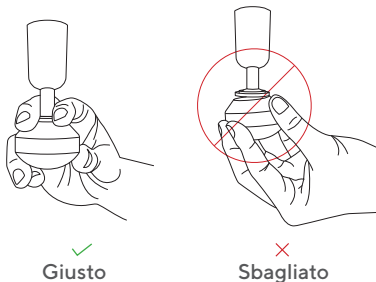

Utilizzo del braccio rotante

Il braccio rotante di Theragun PRO può essere regolato in 4 posizioni. Per regolare il braccio, premi il pulsante del braccio rotante sulla parte inferiore di Theragun PRO e spostalo nella posizione desiderata.

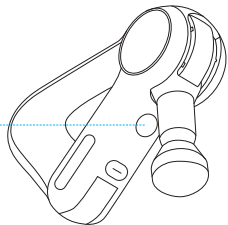

Batteria agli ioni di litio

Allinea e inserisci la batteria nell'alloggiamento posto sul lato inferiore di Theragun PRO con il lato piatto dell'estremità della batteria rivolto verso il pulsante circolare di rilascio.

Quando il dispositivo è acceso, il livello della batteria viene visualizzato sullo schermo OLED di Theragun PRO.

Per togliere la batteria, premi il pulsante circolare di rilascio sull'alloggiamento della batteria ed estrarla.

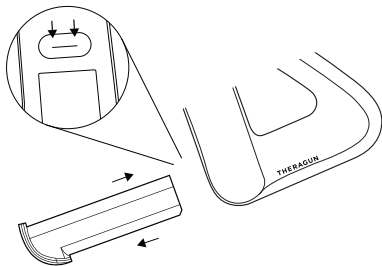

Caricatore

Inserisci il cavo di ricarica nell'entrata della base di ricarica. Inserisci la batteria nella base di ricarica e spingi verso il basso finché la luce non lampeggia. La carica è completa quando la luce smette di lampeggiare.

Theragun PRO è predisposto per essere ricaricato in modalità wireless. Per maggiori informazioni sulla ricarica wireless, visita il sito [Theragun.com](https://www.theragun.com).

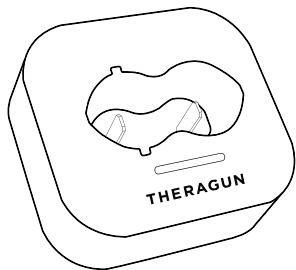

Funzionalità intelligenti

Il tuo Theragun PRO è un dispositivo intelligente dotato di connettività Bluetooth, progettato per accoppiarsi facilmente con la app Theragun. Quando scarichi la app, verrai guidato passo a passo in una procedura di configurazione e ti verrà illustrato come accoppiare il dispositivo.

Una volta accoppiata con il tuo dispositivo, la app può regolare da remoto la velocità, attivare le preselezioni dei trattamenti guidati e dare consigli in tempo reale in base all'utilizzo che ne fai. Lo schermo OLED del tuo Theragun PRO supporta l'esperienza della app visualizzando la velocità e la forza attuali per guidarti durante il trattamento.

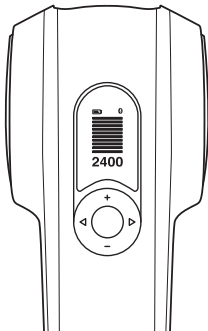

Effettua la scansione del codice QR per cominciare.



Attacchi

Theragun PRO è dotato di 6 diversi attacchi progettati per ogni muscolo e per ogni esigenza.

ES

Dampener

Per aree delicate o vicino alle ossa



Thumb

Terapia per trigger point e zona lombare



Standard Ball

Per un utilizzo generale e complessivo



Cone

Trattamento muscolare mirato



Wedge

Per raschiatura, scapole o benderelle ileotibiali



Supersoft™

Quando hai bisogno di un tocco morbido



Inicio

Paso 1

Encender y flotar

Mantén presionado firmemente el botón central de la Theragun PRO para encenderla y, a continuación, hazla flotar por las zonas del cuerpo que lo necesiten. Utiliza los botones Más (+) y Menos (-) para ajustar la velocidad. Aplica una presión ligera o más intensa sea necesario.

Paso 2

Obtener la Theragun App

Te guiaremos por un programa de uso sin complicaciones y te mostraremos cómo aprovechar al máximo tu Theragun PRO.

Paso 3

Feel the difference.™ Cada día.

Respira hondo y cuida tu cuerpo con tratamientos guiados o en modo libre. Todo está diseñado para ti.

La Theragun PRO

ES

- A Pantalla OLED
- B Botones de control
- C Empuñadura multiagarre Theragun Triangle™
- D Batería de ion de litio

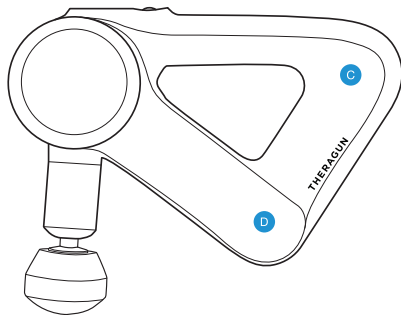
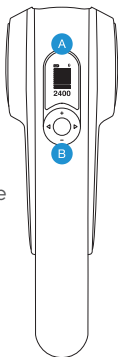

Consulta el folleto de advertencias para obtener instrucciones de seguridad importantes

ES

- E Botón de extracción de la batería
- F Botón del brazo articulable
- G Brazo articulable
- H Cabezales intercambiables

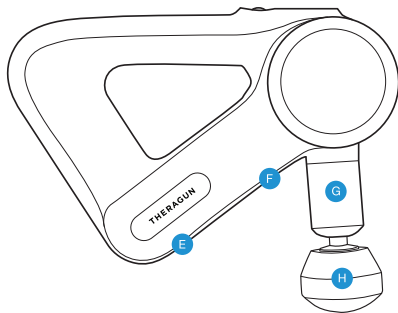

Uso del Theragun PRO

1. Inserte la batería de ion de litio totalmente antes de encender el Theragun PRO.
2. Para encender la Theragun PRO, mantén presionado firmemente el botón central.
3. Presiona los botones Más (+) y Menos (-) para aumentar o reducir la velocidad.
4. Presiona los botones Izquierda (<) y Derecha (>) para alternar entre los tratamientos guiados de la Theragun PRO.
5. Para apagar la Theragun, mantén pulsado firmemente el botón central hasta que el dispositivo se apague.

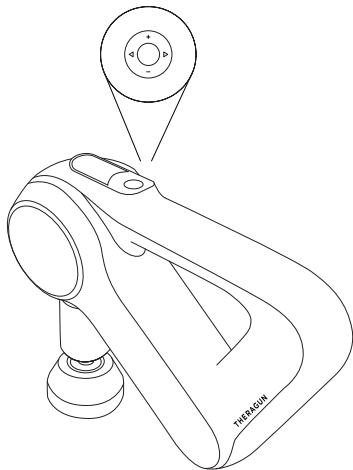

Conexión de los cabezales

Alinea el cabezal con la punta del brazo giratorio y empuje para conectarlo. Para quitarlo, agarra el cabezal, colocando un dedo a cada lado del conector de plástico. Extrae el cabezal.

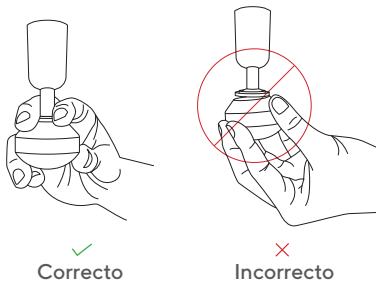

Uso del brazo articulable

El brazo articulable de la Theragun PRO tiene 4 posiciones. Para ajustar el brazo, presiona el botón de la brazo articulable situado en la parte inferior de la Theragun PRO y mueve el brazo a la posición deseada.

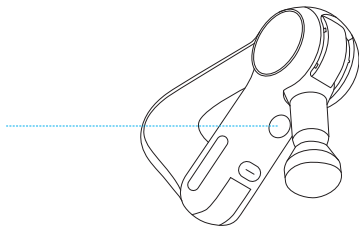

Batería de ion de litio

Alinea e inserta la batería en la correspondiente ranura situada en la parte inferior de la Theragun PRO con el lado plano de la batería apuntando hacia el botón ovalado de extracción.

El nivel de de batería se muestra en la pantalla OLED de la Theragun PRO cuando se enciende el dispositivo.

Para quitar la batería, presiona el botón de extracción ovalado situado encima de la ranura de la batería y extrae la batería.

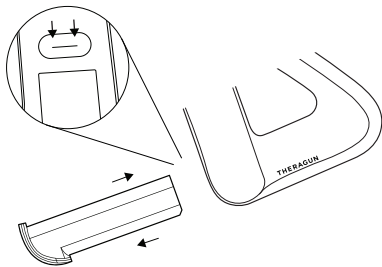

Cargador

ES

Enchufa el cable del cargador en el puerto de la base de carga. Inserta la batería en la base de carga y presiona hasta que parpadee la luz. La carga se habrá completado una vez que la luz deje de parpadear.

La Theragun PRO es compatible con la carga inalámbrica. Para obtener más información sobre carga inalámbrica, visite [Theragun.com](https://www.theragun.com).

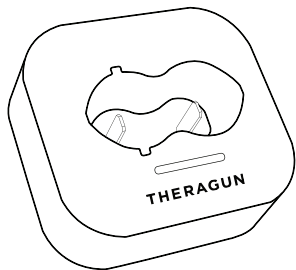

Funciones smart

La Theragun PRO es un dispositivo inteligente compatible con la conexión Bluetooth, diseñado para funcionar sin problemas con la Theragun App. Al descargar la aplicación, se te explicará cómo configurarla paso a paso y se te mostrará cómo emparejar el dispositivo.

Una vez el dispositivo está conectado, la aplicación puede controlar de forma remota la velocidad, activar tratamientos guiados y realizar recomendaciones en tiempo real según su uso. La pantalla OLED la Theragun PRO respalda su experiencia con la App mostrando la velocidad y fuerza actuales para ayudar a guiar tu tratamiento.

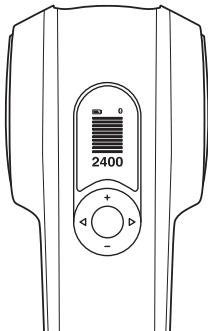

ES



Escanee el código QR
para empezar.



Cabezales

ES

La Theragun PRO incluye 6 cabezales diferentes diseñados para cada músculo y necesidad.

Dampener

Para uso en zonas sensibles o cerca de huesos



Thumb

Para el tratamiento de la zona lumbar y puntos concretos



Standard Ball

Para uso general



Cone

Para el tratamiento de músculos localizados



Wedge

Para uso transversal, omóplatos o bandas iliotibiales



Supersoft™

Cuando se necesita un toque suave



Aan de slag

Stap 1

Inschakelen en zweven

Houd de middelste knop op het toetsenblok stevig ingedrukt en beweeg de Theragun PRO vervolgens over probleemgebieden. Gebruik de knoppen plus **(+)** en min **(-)** op het toetsenblok om de snelheid aan te passen. Pas indien nodig lichte tot matige druk toe.

Stap 2

Download de Theragun-app

We leiden u door een stressvrije opstelling en laten u zien hoe u het meeste uit uw Theragun PRO kunt halen.

Stap 3

Feel the difference.™ Elke dag.

Adem diep in en trakteer uzelf op begeleide ingestelde behandelingen of gebruik de freestyle-modus. Het is allemaal voor u ontworpen.

De Theragun PRO

NL

- A OLED-scherm
- B Knoppenblok
- C Theragun Triangle™ multi-grip
- D Lithium-ion batterij

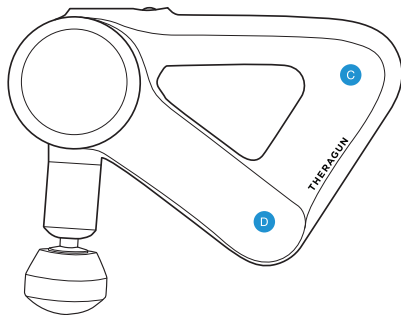
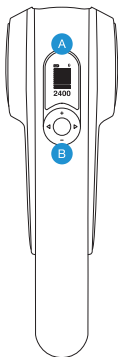

Zie de bijsluiter voor belangrijke
veiligheidsinstructies

NL

- E Ontgrendelknop van de batterij
- F Knop voor roterende arm
- G Roterende arm
- H Verwisselbare hulpstukken

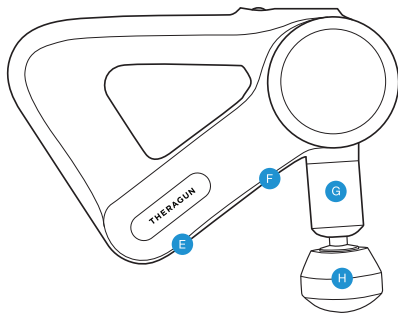

De Theragun PRO gebruiken

1. Plaats de lithium-ion batterij, voordat u de Theragun PRO inschakelt.
2. Om de Theragun PRO in te schakelen, houdt u de middelste knop op het toetsenblok stevig ingedrukt.
3. Druk op de knoppen plus **(+)** en min **(-)** op het toetsenblok om de snelheid te verhogen of te verlagen.
4. Druk op de pijlen links **(<)** en rechts **(>)** op het toetsenblok om te schakelen tussen de vooraf ingestelde behandelingen van de Theragun PRO.
5. Om de Theragun PRO uit te schakelen, houdt u de middelste knop op het toetsenblok stevig ingedrukt tot het apparaat uitschakelt.

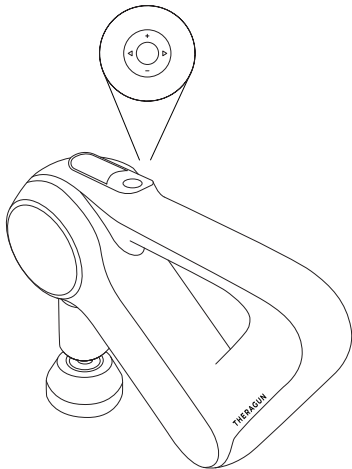

De hulpstukken aansluiten

Lijn het hulpstuk uit met de punt van de roterende arm en druk om het aan te sluiten. Om te verwijderen pakt u het hulpstuk vast en plaatst u één vinger aan elke kant van de plastic steun. Trek het hulpstuk eraf.

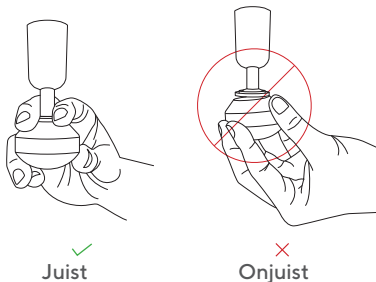

De roterende arm gebruiken

De roterende arm van uw Theragun PRO is in 4 posities verstelbaar. Om de arm af te stellen, drukt u op de knop van de roterende arm aan de onderkant van de Theragun PRO en verplaatst u de arm naar de gewenste positie.

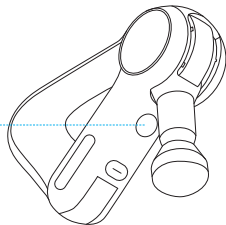

Lithium-ion batterij

Lijn de batterij uit en plaats deze in de batterijgleuf aan de onderkant van de Theragun PRO, met de platte kant van het batterijuiteinde in de richting van de ronde ontgrendelknop.

De levensduur van de batterij wordt weergegeven op het OLED-scherm van de Theragun PRO wanneer het apparaat is ingeschakeld.

Om de batterij te verwijderen, drukt u op de ronde ontgrendelknop boven de batterijgleuf en trekt u de batterij eruit.

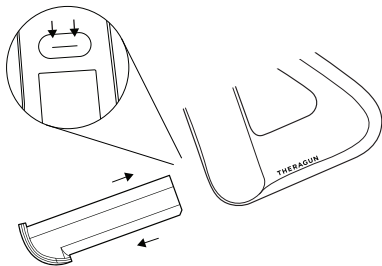

Oplader

Steek de laadkabel in de poort op het laadstation. Plaats de batterij in het laadstation en druk deze naar beneden totdat het lampje knippert. Het opladen is voltooid zodra het lampje niet meer knippert.

Voor de Theragun PRO is draadloos opladen ingeschakeld. Ga voor meer informatie over draadloos opladen naar [Theragun.com](https://www.theragun.com).

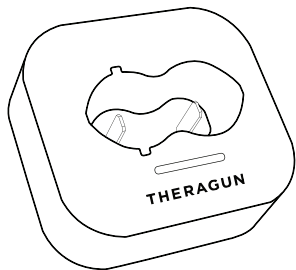

Slimme functies

Uw Theragun PRO is een slim apparaat uitgerust met Bluetooth-connectiviteit, ontworpen voor naadloze koppeling met de Theragun-app. Wanneer u de app downloadt, wordt u door een stapsgewijze installatie geleid en wordt getoond hoe u uw apparaat kunt koppelen.

Eenmaal gekoppeld aan uw apparaat, kan de app op afstand de snelheid aanpassen, begeleide ingestelde behandelingen activeren en realtime aanbevelingen geven op basis van uw gebruik. Het OLED-scherm van uw Theragun PRO ondersteunt uw app-ervaring door de huidige snelheid en kracht weer te geven om uw behandeling te begeleiden.

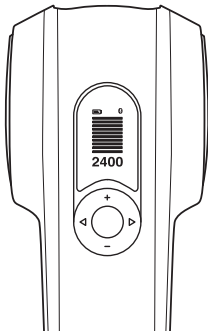

Scan de QR-code
om aan de slag te gaan.



Hulpstukken

Uw Theragun PRO wordt geleverd met 6 verschillende hulpstukken die zijn ontworpen voor elke spier en behoefte.

NL

Dampener

Voor gebruik op gevoelige plekken of in de buurt van botten



Thumb

Voor onderrug- en triggerpoint-therapie



Standard Ball

Voor totaal, algemeen gebruik



Cone

Voor lokale spierbehandeling



Wedge

Voor schrapen, schouderbladen of IT-banden



Supersoft™

Wanneer u een zachte aanraking nodig hebt



Pierwsze kroki

Krok 1

Włącz i przesuń po ciele

Mocno naciśnij i przytrzymaj przycisk główny na panelu przycisków, a następnie przesuń urządzenie Theragun PRO po obszarach wymagających masażu. Aby dostosować prędkość, użyj przycisków **(+)** oraz **(-)** na panelu przycisków. Dośnij średnio lub mocno, w zależności od potrzeb.

Krok 2

Pobierz aplikację Theragun

Przeprowadzimy cię przez łatwy proces konfiguracji i pokażemy, w jaki sposób w pełni wykorzystać możliwości urządzenia Theragun PRO.

Krok 3

Feel the difference.™ Każdego dnia.

Weź głęboki oddech i zadbaj o siebie za pomocą wstępnie skonfigurowanych zabiegów lub w trybie freestyle. Urządzenie zostało zaprojektowane pod kątem twoich potrzeb.

Urządzenie Theragun PRO

- A Ekran OLED
- B Panel przycisków
- C Uchwyt uniwersalny Theragun Triangle™
- D Akumulator litowo-jonowy

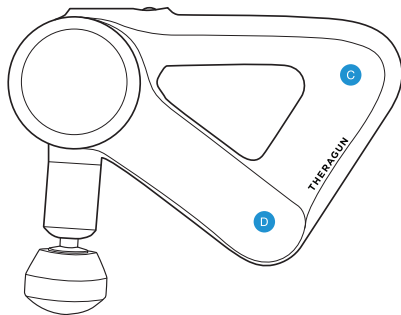
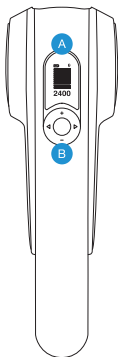

Zapoznaj się z ulotką Ostrzeżenia, która zawiera ważne informacje na temat bezpieczeństwa.

PL

- E Przycisk zwalniania akumulatora
- F Przycisk ramienia obrotowego
- G Ramię obrotowe
- H Wymienne nasadki

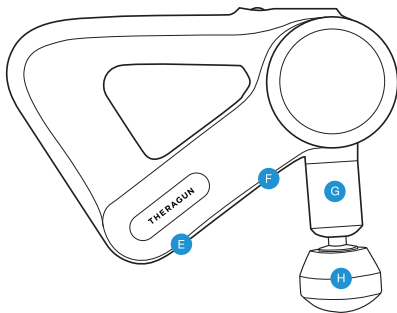

Sposób korzystania z urządzenia Theragun PRO

1. Przed włączeniem urządzenia Theragun PRO dokładnie włóż akumulator litowo-jonowy.
2. Aby włączyć masażer Theragun PRO, mocno naciśnij i przytrzymaj przycisk główny na panelu przycisków.
3. Aby zmniejszyć lub zwiększyć prędkość, użyj przycisków **(+)** oraz **(-)** na panelu przycisków.
4. Naciskaj strzałki w lewo **(<)** i w prawo **(>)** na panelu przycisków, aby przełączać pomiędzy wstępnie skonfigurowanymi zabiegami Theragun PRO.
5. Aby wyłączyć masażer Theragun PRO, mocno naciśnij i przytrzymaj przycisk główny na panelu przycisków i poczekaj, aż urządzenie się wyłączy.

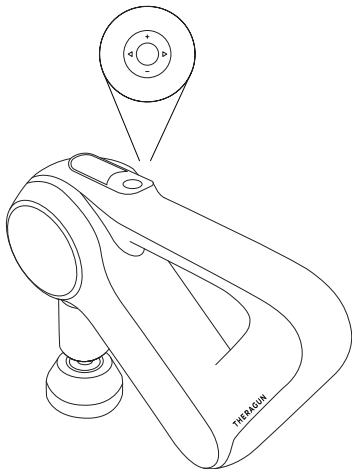

Podłączanie nasadek

Ustaw w jednej linii nasadkę oraz końcówkę ramienia obrotowego i popchnij ją, aby podłączyć. Aby zdjąć nasadkę, chwyć ją, umieszczając po jednym palcu z każdej strony łącznika z tworzywa sztucznego. Wyciągnij nasadkę.

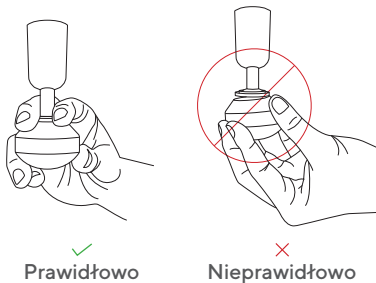

Korzystanie z ramienia obrotowego

Ramię obrotowe urządzenia Theragun PRO można ustawić w 4 pozycjach. Aby ustawić pozycję ramienia, naciśnij przycisk ramienia obrotowego znajdujący się na spodzie urządzenia Theragun PRO, i ustaw ramię w wybranej pozycji.

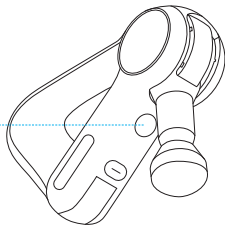

Akumulator litowo-jonowy

Ustaw akumulator na wysokości gniazda akumulatora, które znajduje się na spodzie urządzenia Theragun PRO, i włóż go płaską stroną akumulatora skierowaną w stronę okrągłego przycisku zwalniania.

Stan naładowania akumulatora jest widoczny na ekranie OLED urządzenia Theragun PRO, gdy jest ono włączone.

Aby wyjąć akumulator, naciśnij okrągły przycisk zwalniania znajdujący się powyżej gniazda akumulatora, a następnie wyciągnij akumulator.

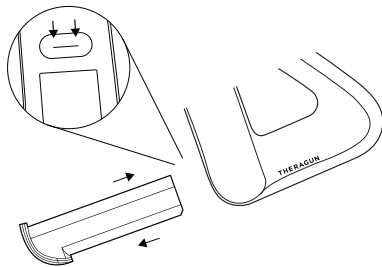

Ładowarka

Podłącz przewód ładowarki do portu stacji ładowania. Włóż akumulator do stacji ładowania i dociśnij w dół, aż dioda zacznie migać. Gdy dioda przestanie migać, akumulator jest naładowany.

Urządzenie Theragun PRO można ładować bezprzewodowo. Aby uzyskać więcej informacji na temat ładowania bezprzewodowego, odwiedź witrynę [Theragun.com](https://www.theragun.com).

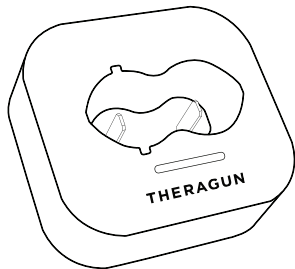

Inteligentne funkcje

Masażer Theragun PRO to inteligentne urządzenie zgodne z technologią Bluetooth, za pomocą której można je wygodnie sparować z aplikacją Theragun. Po pobraniu aplikacji uzyskasz instrukcje krok po kroku, dzięki którym skonfigurujesz i sparujesz swoje urządzenie.

Po sparowaniu urządzenia za pomocą aplikacji można zdalnie dostosować prędkość, włączyć wstępnie skonfigurowane zabiegi, a także uzyskiwać zalecenia w czasie rzeczywistym w oparciu o sposób korzystania z urządzenia. Ekran OLED urządzenia Theragun PRO w połączeniu z aplikacją umożliwia wyświetlanie aktualnej prędkości i siły, co ułatwia przeprowadzenie zabiegu.



Zeskanuj kod QR,
aby rozpocząć.

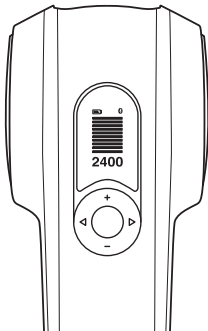

Nasadki

Do urządzenia Theragun PRO dołączono 6 różnych nasadek, dzięki czemu jest ono dostosowane do wszystkich mięśni i potrzeb.

PL

Dampener

Do zastosowania w delikatnych miejscach lub w pobliżu kości



Thumb

Do dolnego odcinka pleców i masażu punktów spustowych



Standard Ball

Do ogólnego zastosowania



Cone

Do masażu punktowego mięśni



Wedge

Do łopatek, pasma biodrowo-piszczelowego oraz zabiegu scraping



Supersoft™

Do delikatnego masażu



Ξεκινώντας

Βήμα 1

Ανοίξτε και κυλήστε

Πιέστε σταθερά και κρατήστε το κεντρικό κουμπί στο πληκτρολόγιο, μετά κυλήστε το Theragun PRO στις περιοχές που χρειάζεται. Χρησιμοποιήστε τα κουμπιά συν (+) και πλην (-) για να προσαρμόσετε την ταχύτητα. Εφαρμόστε ελαφριά έως μέτρια πίεση κατά περίπτωση.

Βήμα 2

Κατεβάστε την εφαρμογή Theragun

Θα σας καθοδηγήσουμε κατά την εγκατάσταση χωρίς πρόβλημα και θα σας δείξουμε πώς να αξιοποιήσετε καλύτερα το Theragun PRO.

Βήμα 3

Feel the difference.™ Κάθε μέρα.

Πάρτε βαθιά ανάσα και απολαύστε τα καθορισμένα προγράμματα θεραπείας ή την ελεύθερη λειτουργία. Έχουν σχεδιαστεί όλα για σας.

To Theragun PRO

EL

- A Οθόνη οργανικών φωτοδιόδων
- B Πληκτρολόγιο
- C Theragun Triangle™ με πολλαπλή λαβή
- D Μπαταρία ιόντων λιθίου

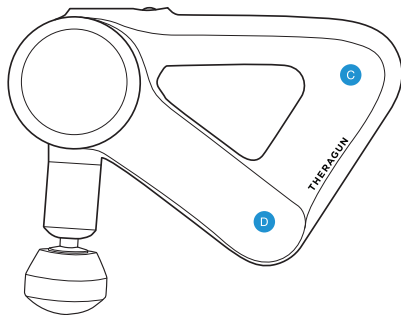
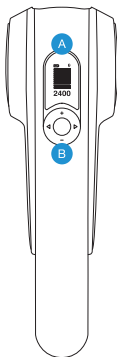

Δείτε τις Προειδοποιήσεις για σημαντικές οδηγίες ασφάλειας

- E Κουμπί αποσύνδεσης της μπαταρίας
- F Κουμπί περιστροφής βραχίονα
- G Βραχίονας περιστροφής
- H Εναλλάξιμα εξαρτήματα

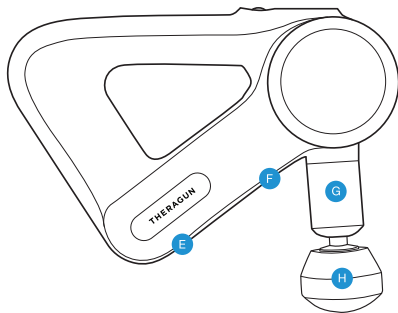

Χρήση του Theragun PRO

1. Τοποθετήστε πλήρως την μπαταρία ιόντων λιθίου πριν να ανοίξετε το Theragun PRO.
2. Για να ανοίξετε το Theragun PRO, πιέστε σταθερά και κρατήστε το κεντρικό κουμπί στο πληκτρολόγιο.
3. Πατήστε τα κουμπιά συν (+) και πλην (-) στο πληκτρολόγιο για να αυξήσετε ή να μειώσετε την ταχύτητα.
4. Πιέστε τα βέλη αριστερά (<) και δεξιά (>) στο πληκτρολόγιο για να μετακινηθείτε μεταξύ των προ-εγκατεστημένων προγραμμάτων θεραπείας του Theragun PRO.
5. Για να κλείσετε το Theragun PRO, πιέστε σταθερά και κρατήστε το κεντρικό κουμπί στο πληκτρολόγιο μέχρι να σβήσει η συσκευή.

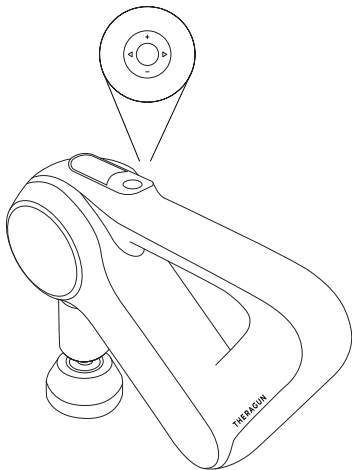

Σύνδεση των εξαρτημάτων

Ευθυγραμμίστε το εξάρτημα με την άκρη του βραχίονα περιστροφής και πιέστε για να συνδεθεί. Για να το αφαιρέσετε, κρατήστε το εξάρτημα βάζοντας 1 δάχτυλο σε κάθε πλευρά του πλαστικού συνδέσμου. Τραβήξτε και αφαιρέστε το εξάρτημα.

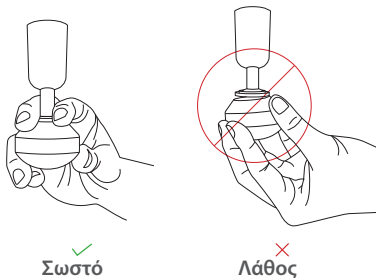

Χρήση του βραχίονα περιστροφής

Ο βραχίονας περιστροφής του Theragun PRO προσαρμόζεται σε 4 θέσεις. Για να προσαρμόσετε τον βραχίονα, πιέστε το κουμπί του βραχίονα περιστροφής στην κάτω πλευρά του Theragun PRO και μετακινήστε τον βραχίονα στην επιθυμητή θέση.

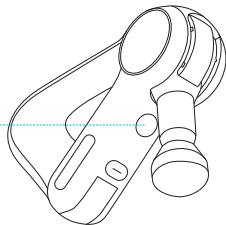

Μπαταρία ιόντων λιθίου

Ευθυγραμμίστε και τοποθετήστε την μπαταρία στην υποδοχή της μπαταρίας στην κάτω πλευρά του Theragun PRO με την επίπεδη πλευρά της μπαταρίας απέναντι από το κουμπί κυκλικής αποσύνδεσης.

Η διάρκεια ζωής της μπαταρίας εμφανίζεται στην οθόνη οργανικών φωτοδιόδων του Theragun PRO όταν η συσκευή είναι σε λειτουργία.

Για να αφαιρέσετε την μπαταρία, πιέστε το κουμπί κυκλικής αποσύνδεσης πάνω από την υποδοχή της μπαταρίας και τραβήξτε την μπαταρία.

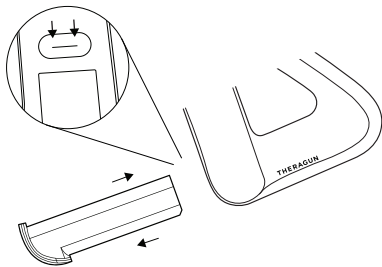

Φορτιστής

Συνδέστε το καλώδιο φόρτισης στη θύρα της βάσης φόρτισης. Τοποθετήστε την μπαταρία στη βάση φόρτισης και πιέστε μέχρι να ανάψει το φως. Η φόρτιση ολοκληρώνεται μόλις σταματήσει να αναβοσβήνει το φως.

Το Theragun PRO ενεργοποιείται με ασύρματη φόρτιση. Για περισσότερες πληροφορίες σχετικά με την ασύρματη φόρτιση, επισκεφθείτε το [Theragun.com](https://www.theragun.com).

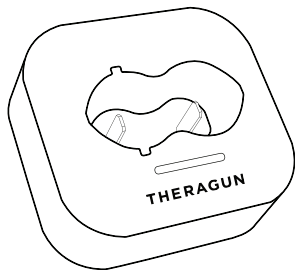

Έξυπνες λειτουργίες

Το Theragun PRO είναι μία έξυπνη συσκευή που ενεργοποιείται με συνδεσιμότητα Bluetooth, που σχεδιάστηκε για επικοινωνεί απρόσκοπτα με την εφαρμογή Theragun. Όταν κάνετε λήψη της εφαρμογής, θα σας δοθούν οδηγίες βήμα προς βήμα και θα δείτε πώς θα συνδέσετε τη συσκευή σας.

Μόλις συνδεθεί με τη συσκευή σας, η εφαρμογή μπορεί να προσαρμόσει την ταχύτητα από απόσταση, να ενεργοποιήσει τα προκαθορισμένα προγράμματα θεραπείας και να κάνει συστάσεις σε πραγματικό χρόνο με βάση τη χρήση σας. Η οθόνη οργανικών φωτοδιόδων του Theragun PRO υποστηρίζει την εμπειρία σας με την εφαρμογή εμφανίζοντας την τρέχουσα ταχύτητα και καθοδηγώντας τη θεραπεία σας.

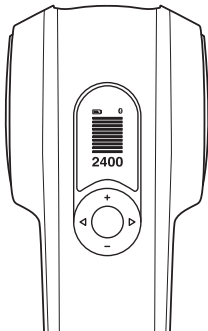

**Σαρώστε τον κωδικό QR
για να ξεκινήσετε.**



Εξαρτήματα

Το Theragun PRO διαθέτει 6 διαφορετικά εξαρτήματα που σχεδιάστηκαν για κάθε μυ και κάθε ανάγκη.

Dampener

Για χρήση σε ευαίσθητες περιοχές ή δίπλα σε οστά



Thumb

Για θεραπεία οσφυϊκής χώρας και σημείου ενεργοποίησης



Standard Ball

Για γενική χρήση



Cone

Για θεραπεία συγκεκριμένων μυών



Wedge

Για ζύσιμο, ωμοπλάτες ή λαγονοκνημιαίες ταινίες



Supersoft™

Όταν χρειάζεστε ένα απαλό άγγιγμα



Kom i gang

Trinn 1

Slå på og gli

Påfør trykk og hold senterknappen på tastepalten, så kan du bevege Theragun PRO over områder etter behov. Bruk pluss (+)- og minus(-)-knappene på tastepalten for å justere hastigheten. Påfør lett til moderat trykk etter behov.

Trinn 2

Skaff deg Theragun-appen

Vi veileder deg gjennom et stressfritt oppsett og viser deg hvordan du får mest mulig ut av din Theragun PRO.

Trinn 3

Feel the difference.™ Every day.

Pust dypt og unn deg selv forhåndsinnslite behandlingsalternativer eller freestylemodus. Alt er designet for deg.

Theragun PRO

- A OLED-skjerm
- B Tasteplate
- C Theragun Triangle™ multi-grep
- D Litiumbatteri

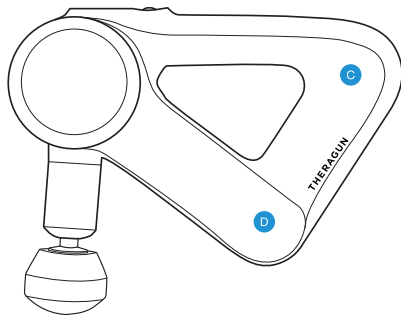
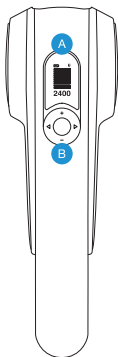

NO

Se advarsler-vedlegget for viktige sikkerhetsanvisninger

NO

- E Batteriutløser
- F Roterende arm-knapp
- G Roterende arm
- H Utskiftbare fester

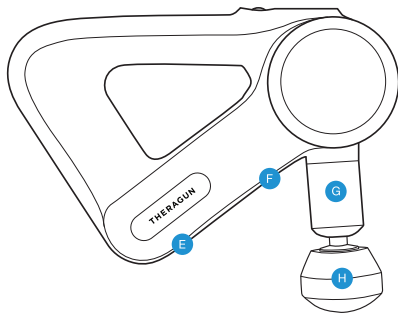

Bruk av Theragun PRO

1. Sett litiumbatteriet helt inn før du slår på Theragun PRO.
2. For å slå på Theragun PRO, trykk og hold senterknappen på tasteplaten.
3. Trykk på pluss (+)- og minus (-)-knappene på tasteplaten for å øke eller senke hastigheten.
4. Trykk på venstre (<)- og høyre (>)-pilene på tasteplaten for å bytte mellom forhåndsinnstilte behandlinger for Theragun PRO.
5. Hvis du vil slå av Theragun PRO, trykker du hardt på og holder nede senterknappen på tasteplaten til enheten slås av.

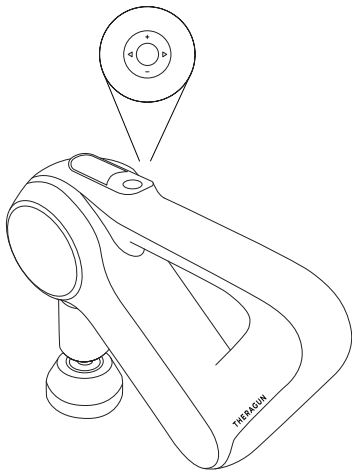

Koble til festene

Sammenfall festene med spissen på den roterende armen, og trykk for å koble til. For å fjerne, grip tak i festet, og plasser én finger på hver side av plasttilkoblingen. Trekk av festet.

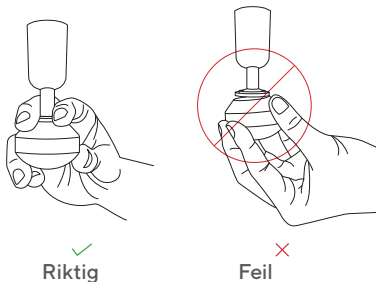

Bruk av roterende arm

Den roterende armen på Theragun PRO justerer seg til 4 posisjoner. For å justere armen, trykk på den roterende arm-knappen på undersiden av Theragun PRO og beveg armen til ønsket posisjon.

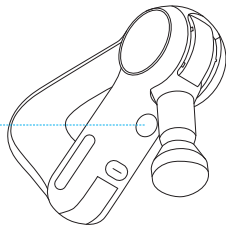

Litiumbatteri

Juster og sett inn batteriet i batterisporet på undersiden av Theragun PRO med den flate siden av batterienden vendt mot den sirkulære utløserknappen.

Batterilivet vises på Theragun PROs OLED-skjerm når enheten er skrudd på.

For å fjerne batteriet, trykk på den sirkulære utløserknappen over batterilommen og trekk batteriet ut.

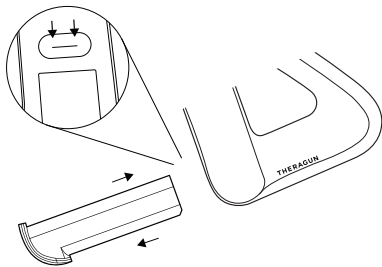

Lader

Sett ladeledningen inn i porten på ladestasjonen. Sett batteriet inn i ladestasjonen og trykk ned til lyset blinker. Ladingen er fullført når lyset slutter å blinke.

NO

Theragun PRO er aktivert for trådløs lading. For mer informasjon om trådløs lading, besøk [Theragun.com](https://www.theragun.com).

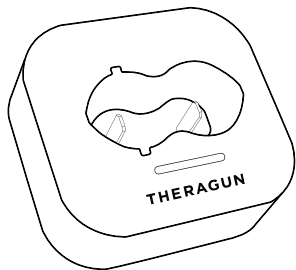

Smartfunksjoner

Din Theragun PRO er en smartenhet aktivert med Bluetooth-tilkobling, designet for sømløs sammenkobling med Theragun-appen. Når du laster ned appen, blir du veiledet gjennom et trinnvis oppsett som viser hvordan du parer enheten.

Når paret med enheten din kan appen fjernjustere hastighet, aktivere guidede behandlingsinnstillinger og foreta anbefalinger i sanntid etter bruk. OLED-skjermen på THERAGUN Pro støtter appens opplevelse ved å vise gjeldende hastighet og kraft for å hjelpe deg med behandlingen.

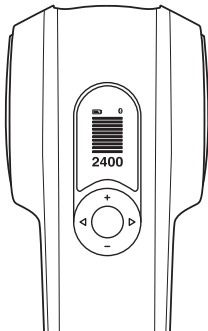

NO



Skann QR-koden
for å komme i gang.



Fester

Din Theragun PRO leveres med 6 forskjellige fester utformet for hver muskel og behov.

NO

Dampener

For bruk på ømme områder eller i nærheten av bein



Thumb

For behandling av lavere rygg- og triggerpunkter



Standard ball

For generell bruk



Cone

For å fastslå muskelbehandling



Wedge

For skraping, skulderblader, eller Iliotibialband (tractus iliotibialis)



Supersoft™

Når du trenger en myk berøring



POKRETANJE

1. korak

Uključite i pokrenite

Čvrsto pritisnite i držite centralni taster na tastaturi, potom pomerajte Theragun PRO preko željenih područja. Koristite plus (+) i minus (-) tastere na tastaturi da biste podesili brzinu. Po potrebi blago do umereno pritisnite.

2. korak

Instalirajte Theragun aplikaciju

Provešćemo vas kroz instalaciju bez stresa i pokazati vam kako da dobijete najbolje od svog Theragun PRO uređaja.

3. korak

Feel the difference.™ Svakog dana.

Duboko udahnite i tretirajte sebe unapred podešenim tretmanima ili tretmanima u slobodnom stilu. Sve je dizajnirano prema vama.

Theragun PRO

SR

- A OLED ekran
- B Tastatura
- C Theragun Triangle™ multi-grip drška
- D Litijum-jonska baterija

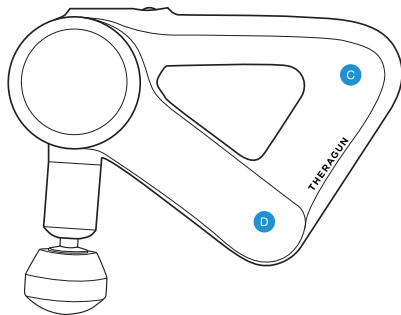
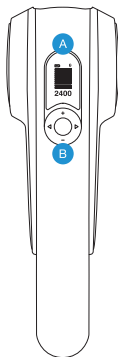

Za važna uputstva u vezi sa bezbednošću,
pogledajte Upozorenja

- E Taster za oslobađanje baterije
- F Taster rotirajuće osovine
- G Rotirajuća osovina
- H Zamenljivi dodaci

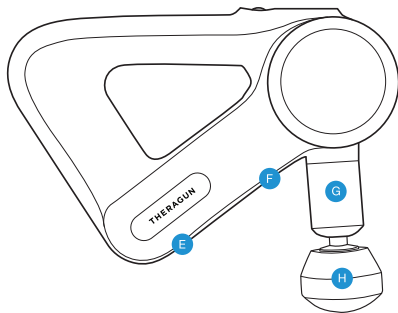

Korišćenje Theragun PRO uređaja

1. Ubacite litijum-jonsku bateriju do kraja pre uključivanja Theragun PRO uređaja.
2. Da biste uključili Theragun PRO, čvrsto pritisnite i držite centralni taster na tastaturi.
3. Pritiskajte plus (+) i minus (-) tastere na tastaturi da biste povećali ili smanjili brzinu.
4. Pritiskajte strelice na levo (<) i desno (>) na tastaturi da biste menjali unapred podešene tretmane na vašem Theragun PRO uređaju.
5. Da biste isključili Theragun PRO, čvrsto pritisnite i držite centralni taster na tastaturi dok se uređaj ne ugasi.

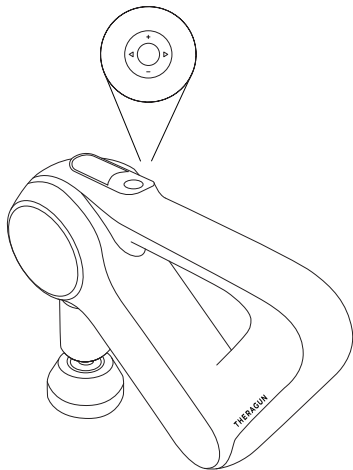

Povezivanje dodatka

Poravnajte dodatak s vrhom rotirajuće poluge i pritisnite da bi se zakačio. Da biste ga uklonili, uhvatite dodatak sa po jednim prstom sa svake strane plastičnog konektora. Povucite dodatak.

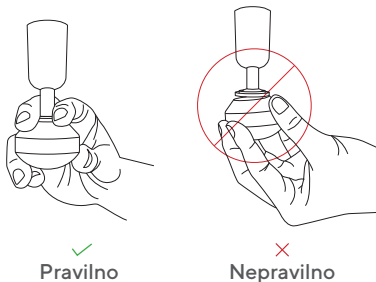

SR

Korišćenje rotirajuće poluge

Rotirajuća poluga vašeg Theragun PRO uređaja se podešava na četiri pozicije. Da biste podesili polugu, pritisnite taster rotirajuće poluge na donjoj strani Theragun PRO uređaja i pomerite polugu u željenu poziciju.

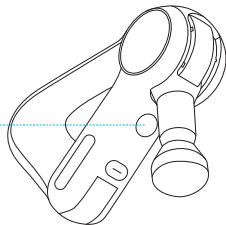

Litijum-jonska baterija

Poravnajte i ubacite bateriju u otvor za bateriju na donjoj strani Theragun PRO uređaja s ravnim krajem baterije ka cirkularnom oslobađajućem dugmetu.

Trajanje baterije se prikazuje na OLED ekranu Theragun PRO uređaja kada je on uključen.

Da biste uklonili bateriju, pritisnite cirkularno oslobađajuće dugme iznad otvora za bateriju i izvucite bateriju.

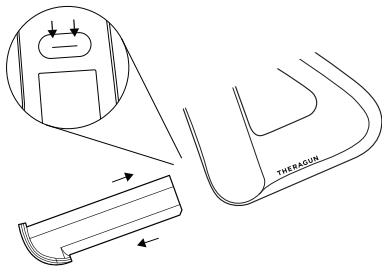

Punjač

Priključite provodnik za punjenje na ulaz na jedinici za punjenje. Ubacite bateriju u jedinicu za punjenje i pritisnite na dole dok svetlo zatreperi. Punjenje je gotovo kada svetlo prestane da treperi.

Theragun PRO se može puniti bežično. Za više informacija o bežičnom punjenju, posetite [Theragun.com](https://www.theragun.com).

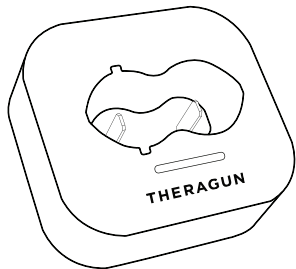

Pametne funkcije

Vaš Theragun PRO je pametni uređaj opremljen Bluetooth povezivanjem, dizajniran tako da se jednostavno povezuje s Theragun aplikacijom. Kada preuzmete aplikaciju, ona će vas voditi kroz podešavanje korak-po-korak i pokazati kako da uparite svoj uređaj.

Kada se upari s vašim uređajem, aplikacija može daljinski da podesi brzinu, aktivira unapred podešene tretmane i pruži preporuke u realnom vremenu koje se zasnivaju na vašem korišćenju uređaja. OLED ekran vašeg Theragun PRO uređaja podržava vašu aplikaciju tako što prikazuje trenutnu brzinu i snagu kako bi pomogao obavljanje vašeg tretmana.

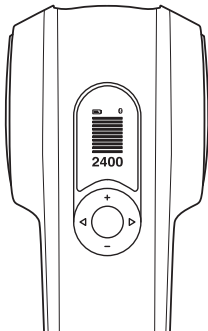

SR



Skenirajte QR kôd
da biste počeli.



Dodaci

Vaš Theragun PRO dolazi sa šest različitih dodataka dizajniranih za svaki mišić i potrebu.

Dampener

Za korišćenje na osetljivim područjima i blizu kostiju



Thumb

Za donji deo leđa i terapiju tačke-okidača



Standard Ball

Za sveobuhvatnu, opštu upotrebu



Cone

Za terapiju precizne tačke na mišiću



Wedge

Za trenje, lopatice ili iliotibijalne trake



Supersoft™

Kada vam treba nežan dodir



Kom igång

Steg 1

Slå på och låt den flyta

Tryck bestämt på och håll in mittknappen på knappsatsen och låt Theragun PRO flyta på områden efter behov. Använd plus- (+) och minus- (-) knapparna på knappsatsen för att justera hastigheten. Använd lätt till måttligt tryck efter behov.

SV

Steg 2

Hämta Theragun-appen

Vi vägleder dig genom inställningen utan stress och visar hur du får bäst utbyte av din Theragun PRO.

Steg 3

Feel the difference.™ Varje dag.

Ta ett djupt andetag och unna dig själv förinställda program eller ett freestyle-läge. Den är utformad för dig.

Theragun PRO

- A OLED-skärm
- B Knappsats
- C Theragun Triangle™ multigrepp
- D Litium-jon-batteri

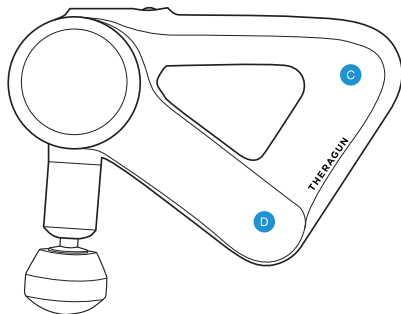
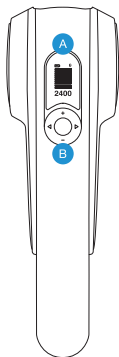

Se varningsinslag för viktiga
säkerhetsinstruktioner

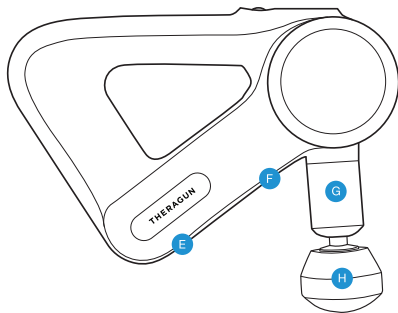

- SV
- E Batteriöppningsknapp
 - F Rotationsarmsknapp
 - G Rotationsarm
 - H Utbytbara tillbehör

Använda Theragun PRO

1. Sätt i litium-jon-batteriet helt innan du slår på Theragun PRO.
2. Slå på Theragun-PRO genom att trycka bestämt på och hålla in mittknappen på knappsatsen.
3. Tryck på plus- **(+)** och minus- **(-)** knapparna på knappsatsen för att öka och minska hastigheten.
4. Tryck på vänster- **(<)** och höger- **(>)** pilarna på knappsatsen för att växla mellan Theragun PRO:s behandlingsprogram.
5. Stäng av Theragun-PRO genom att trycka bestämt på och hålla in mittknappen på knappsatsen tills apparaten stängs av.

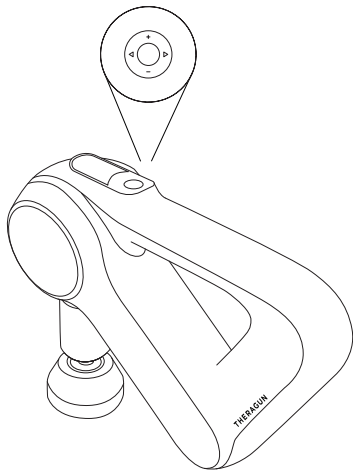

Montera tillbehör

Rikta in tillbehöret mot spetsen på rotationsarmen och tryck fast. Kläm med ett finger på var sida av plastkopplingen för att lossa tillbehöret. Dra bort tillbehöret.

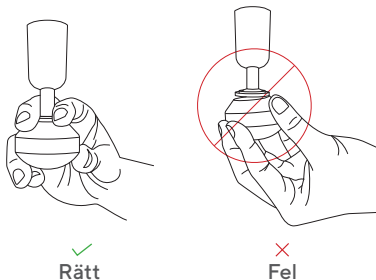

Använda rotationsarmen

Rotationsarmen på Theragun PRO kan ställas i 4 lägen. Justera armen genom att trycka på rotationsarmsknappen på undersidan av Theragun PRO och flytta armen till önskat läge.

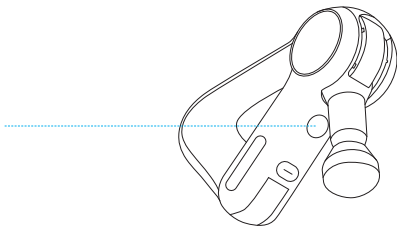

Litium-jon-batteri

Rikta in och sätt i batteriet i batterifacket på undersidan av Theragun PRO med batteriets platta ände vänd mot den runda lossningsknappen.

Batteriets laddning visas på Theragun PRO:s OLED-skärm när apparaten är påslagen.

Ta bort batteriet genom att trycka på den runda lossningsknappen ovanför batterifacket och dra ut batteriet.

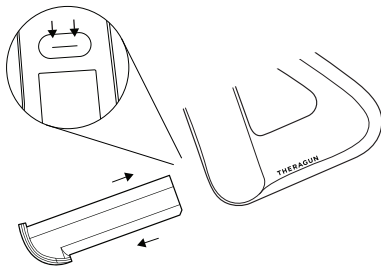

Laddare

Koppla i laddningskabeln i kontakten på laddningsstationen. Sätt i batteriet i laddningsstationen och tryck ned tills lampan blinkar. Laddningen är klar när lampan slutar blinka.

SV

Theragun PRO kan laddas trådlöst.
Se [Theragun.com](https://www.theragun.com) för mer information om trådlös laddning.

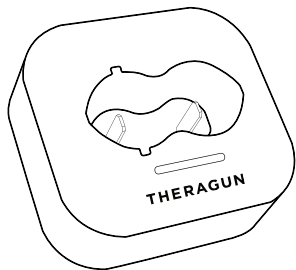

Smarta funktioner

Theragun PRO är en smart enhet utrustad med Bluetooth-funktion, avsedd för parkoppling med Theragun-appen. Efter nedladdning av appen får du anvisningar steg-för-steg för inställning och parkoppling av din apparat.

Efter parkoppling av apparaten kan appen användas för justering av hastighet, aktivering av behandlingsprogram och rekommendationer i realtid baserat på din användning. OLED-skärmen på Theragun PRO ger information om appen genom att visa aktuell hastighet och kraft så att du lättare kan reglera din användning.

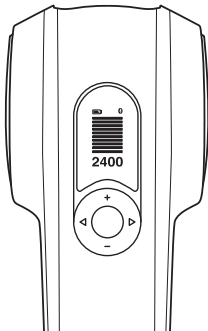

SV



Skanna QR-koden
för att komma igång.



Tillbehör

Din Theragun PRO levereras med 6 olika tillbehör utformade för varje muskel och behov.

Dampener

För ömma områden eller intill ben



Thumb

För behandling av rygglut och nervknutar



Standard Ball

För allmän användning



Cone

För punktbehandling av muskler



Wedge

För skrapning, skulderblad eller iliotibialband



Supersoft™

När du behöver mjuk beröring



Başlarken

1. Adım

Açma ve kaydırma

Kumanda pedi üzerinde ortadaki düğmeye sağlam bir şekilde basın ve basılı tutun, sonra Theragun PRO'yu ihtiyaç duyulan bölgeler üzerinde kaydırın. Hızı ayarlamak için kumanda pedi üzerindeki artı (+) ve eksi (-) düğmelerini kullanın. İhtiyaca göre hafif ila orta şiddette baskı uygulayın.

2. Adım

Theragun uygulamasını alın

Sorunsuz kurulum için sizi yönlendireceğiz ve Theragun PRO'dan en iyi şekilde nasıl yararlanacağınızı göstereceğiz.

3. Adım

Feel the difference.™ Every day.

Derin bir nefes alın ve kendinize yönlendirmeli işlem ön ayarlarını veya serbest modu uygulayın. Hepsisi sizin için tasarlandı.

Theragun PRO

TR

- A OLED ekran
- B Kumanda pedi
- C Theragun Triangle™ çoklu kavrama
- D Lityum iyon pil

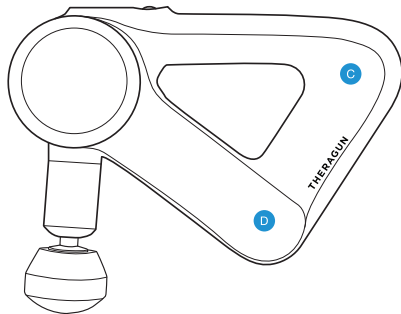
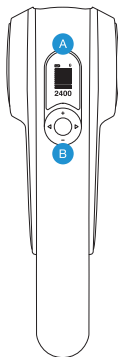

Önemli güvenlik talimatları için
Uyarılar ekine başvurun

- E Pil çıkarma düğmesi
- F Döner kol düğmesi
- G Döner kol
- H Değiştirilebilen ek parçalar

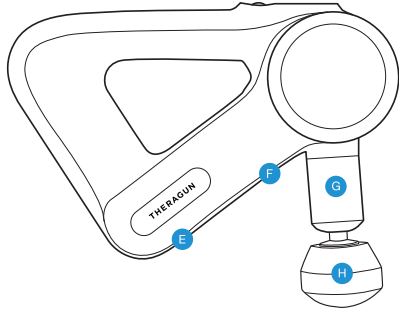

Theragun PRO kullanımı

1. Theragun PRO'yu açmadan önce lityum iyon pili tamamen yerleştirin.
2. Theragun PRO'yu açmak için kumanda pedinin ortasındaki düğmeye sağlam bir şekilde basın ve basılı tutun.
3. Hızı artırmak veya düşürmek için kumanda pedi üzerindeki artı (+) ve eksi (-) düğmelerine basın.
4. Theragun PRO'nun önceden yüklenen işlem ayarları arasında geçiş yapmak için sol (<) ve sağ (>) oklara basın.
5. Theragun PRO'yu kapatmak için, cihaz kapanana kadar, kumanda pedinin ortasındaki düğmeye sağlam bir şekilde basın ve basılı tutun.

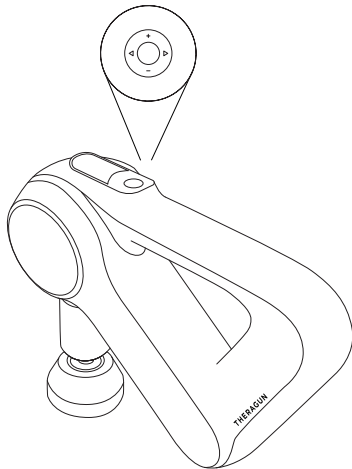

Ek parçaların bağlanması

Ek parçayı döner kolun ucuyla hizalayın ve bağlamak için itin. Çıkarmak için plastik konektörün her iki yanına 1 parmağınızı yerleştirerek ek parçayı tutun. Ek parçayı dışarı çekin.

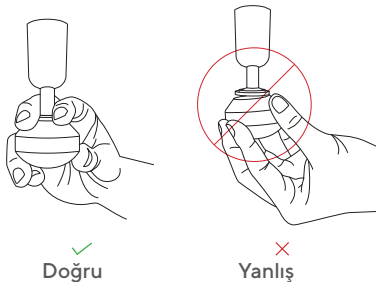

Döner kolun kullanılması

Theragun PRO'nuzun döner kolu 4 konuma ayarlanabilir. Kolu ayarlamak için, Theragun PRO'nun alt kısmındaki döner kol düğmesine basın ve kolu istenen konuma getirin.

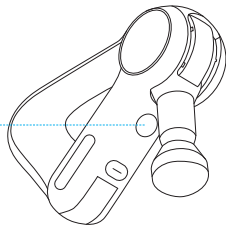

Lityum iyon pil

Pili hizalayın ve pil ucunun düz kenarı dairesel düğmeye bakacak şekilde Theragun PRO'nun alt tarafındaki pil yuvasına yerleştirin.

Cihaz açıldığından Theragun PRO'nun OLED ekranında pil ömrü görüntülenir.

Pili çıkarmak için, pil yuvasının üzerindeki dairesel düğmeye basın ve pili dışarı çekin.

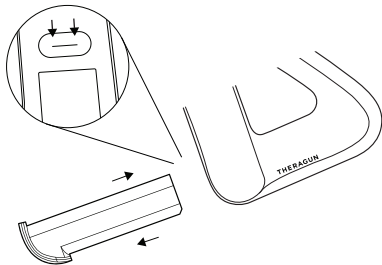

Şarj Cihazı

Şarj kablosunu şarj istasyonu üzerindeki porta takın. Pili şarj istasyonuna yerleştirin ve ışık yanınca kadar aşağı bastırın. Işığın yanıp sönmesi durduğunda şarj işlemi tamamlanır.

Theragun PRO kablolu şarj etkindir.
Kablolu şarj hakkında daha fazla bilgi için Theragun.com'u ziyaret edin.

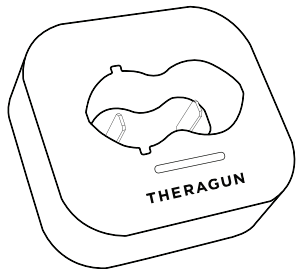

Akıllı Özellikler

Theragun PRO'nuz, Bluetooth bağlantısı olan, Theragun uygulamasıyla sorunsuz bir şekilde eşleşmek üzere tasarlanmış bir akıllı cihazdır. Uygulamayı indirdiğinizde, cihazınızın nasıl eşleştirileceği konusunda adım adım kurulumla yönlendirileceksiniz.

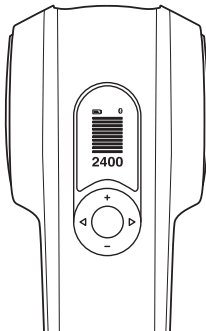

Cihazınızla eşleştiğinde, uygulama uzaktan hızı ayarlayabilir, yönlendirmeli işlem ön ayarlarını etkinleştirebilir ve kullanımınıza göre gerçek zamanlı önerilerde bulunabilir. Theragun PRO'nuzun OLED ekranı, işleminize yardımcı olmak için mevcut hızı ve kuvveti göstererek uygulama deneyiminizi destekler.



QR kodunu tarayarak
başlayın.



Ek parçalar

Theragun PRO'nuz, her kasa ve ihtiyaca göre tasarlanmış 6 farklı ek parçayla birlikte gelir.

Dampener

Kemiklere yakın hassas bölgelerde kullanım için



Thumb

Alt sırt ve işaret parmağı tedavisi için



Standard Ball

Genel kullanım için



Cone

İğne ucu kas tedavisi için



Wedge

Kazıma, kürek kemikleri ve IT bantları için



Supersoft™

Yumuşak bir dokunuşa ihtiyacınız olduğunda



THERAGUN

Born in Los Angeles, CA.
Designed for every*body*.



@Theragun