

# MC93XX

Mobile Computer

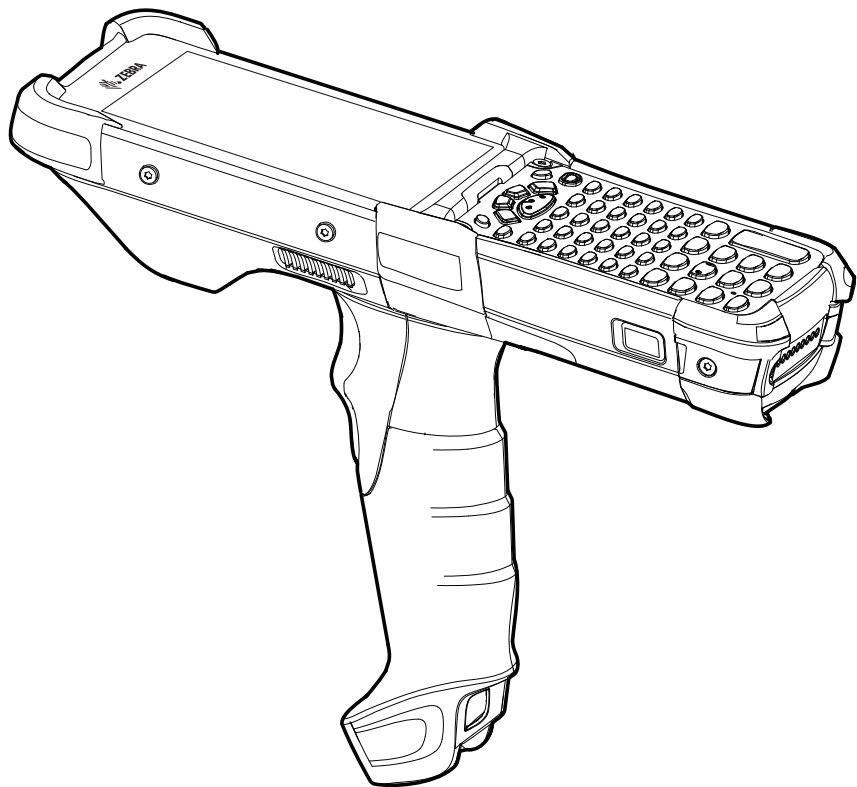

## Product Reference Guide for Android™ 10



**ZEBRA**

ZEBRA and the stylized Zebra head are trademarks of Zebra Technologies Corporation, registered in many jurisdictions worldwide. Google, Android, Google Play and other marks are trademarks of Google LLC. All other trademarks are the property of their respective owners.

© 2020 Zebra Technologies Corporation and/or its affiliates. All rights reserved.

For further information regarding legal and proprietary statements, go to:

COPYRIGHTS: [www.zebra.com/copyright](http://www.zebra.com/copyright)

WARRANTY: [www.zebra.com/warranty](http://www.zebra.com/warranty)

END USER LICENSE AGREEMENT: [www.zebra.com/eula](http://www.zebra.com/eula)

## Terms of Use

### Proprietary Statement

This manual contains proprietary information of Zebra Technologies Corporation and its subsidiaries (“Zebra Technologies”). It is intended solely for the information and use of parties operating and maintaining the equipment described herein. Such proprietary information may not be used, reproduced, or disclosed to any other parties for any other purpose without the express, written permission of Zebra Technologies.

### Product Improvements

Continuous improvement of products is a policy of Zebra Technologies. All specifications and designs are subject to change without notice.

### Liability Disclaimer

Zebra Technologies takes steps to ensure that its published Engineering specifications and manuals are correct; however, errors do occur. Zebra Technologies reserves the right to correct any such errors and disclaims liability resulting therefrom.

### Limitation of Liability

In no event shall Zebra Technologies or anyone else involved in the creation, production, or delivery of the accompanying product (including hardware and software) be liable for any damages whatsoever (including, without limitation, consequential damages including loss of business profits, business interruption, or loss of business information) arising out of the use of, the results of use of, or inability to use such product, even if Zebra Technologies has been advised of the possibility of such damages. Some jurisdictions do not allow the exclusion or limitation of incidental or consequential damages, so the above limitation or exclusion may not apply to you.

## Revision History

Changes to the original guide are listed below:

Change	Date	Description
-01 Rev A	10/2020	Initial release.

# Contents

<b>About This Guide</b> .....	<b>12</b>
Configurations .....	12
Notational Conventions .....	13
Icon Conventions .....	13
Service Information .....	13
Determining Software Versions.....	14
Determining the Serial Number.....	14
<b>Getting Started</b> .....	<b>16</b>
Unpacking .....	16
Device Features .....	17
Setting Up the Device .....	19
Installing a microSD Card .....	19
Installing the Battery .....	25
Charging the Battery.....	25
Charging Indicators .....	26
Backup Power .....	26
Zebra Visibility Services .....	26
Replacing the Battery.....	27
<b>Using the Device</b> .....	<b>29</b>
Home Screen .....	29
Setting Home Screen Rotation .....	30
Status Bar.....	30
Notification Icons.....	30
Status Icons .....	31
Managing Notifications .....	32
Opening the Quick Access Panel.....	33
Quick Access Panel Icons.....	33
Editing Icons on the Quick Settings Bar .....	34
Battery Management.....	34

Checking Battery Status .....	34
Monitoring Battery Usage .....	34
Low Battery Notification .....	35
Interactive Sensor Technology .....	35
Waking the Device .....	35
USB Communication .....	36
Transferring Files .....	36
Transferring Photos .....	36
Disconnect from the Host Computer .....	36
<b>Settings .....</b>	<b>37</b>
Accessing Settings .....	37
Display Settings .....	37
Setting the Screen Brightness Manually .....	37
Setting the Screen Brightness Automatically .....	37
Setting Night Light .....	37
Setting Screen Rotation .....	38
Setting Screen Timeout .....	38
Lock Screen Display .....	38
Setting Font Size .....	39
Touch Panel Mode .....	39
Setting the Date and Time .....	40
General Sound Setting .....	40
Sound Options .....	40
Setting Wake-Up Sources .....	41
Remapping a Button .....	41
Keyboards .....	42
Keyboard Configuration .....	42
Enabling Keyboards .....	42
Enabling Virtual Keyboards .....	42
Switching Between Keyboards .....	42
Using the Android and Gboard Keyboards .....	42
Edit Text .....	43
Entering Numbers, Symbols, and Special Characters .....	43
Using the Enterprise Keyboard .....	43
Numeric Tab .....	43
Alpha Tab .....	43
Additional Character Tab .....	43
Scan Tab .....	43
Language Usage .....	43
Changing the Language Setting .....	44
Adding Words to the Dictionary .....	44

Notifications.....	44
Setting App Notifications .....	44
Viewing Notification Settings for All Apps .....	45
Controlling Lock Screen Notifications .....	45
Blink Light.....	45
<b>Applications .....</b>	<b>46</b>
Accessing Apps.....	49
Switching Between Recent Apps.....	49
Battery Manager.....	49
Opening Battery Manager .....	49
Battery Manager Information Tab.....	49
Heater Control.....	51
Status .....	52
Advanced.....	52
Camera .....	53
Taking Photos.....	53
Taking a Panoramic Photo .....	54
Recording Videos .....	55
Photo Settings .....	56
Rear Camera Photo Settings .....	56
Front Camera Photo Settings.....	57
Video Settings .....	57
Rear Camera Video Settings .....	57
Front Camera Video Settings.....	58
DataWedge Demonstration.....	58
Scanner Selection .....	59
PTT Express Voice Client .....	60
PTT Express User Interface .....	60
PTT Audible Indicators .....	61
PTT Notification Icons .....	61
Enabling PTT Communication.....	61
Selecting a Talk Group .....	62
PTT Communication.....	62
Creating a Group Call .....	62
Responding with a Private Response .....	62
Disabling PTT Communication .....	63
RxLogger.....	64
RxLogger Configuration.....	64
Configuration File .....	64
Enabling Logging.....	64
Disabling Logging .....	64

## Contents

Extracting Log Files .....	64
Backing Up .....	64
RxLogger Utility .....	65
Initiating the Main Chat Head .....	65
Removing the Main Chat Head .....	65
Viewing Logs .....	65
Removing a Sub Chat Head Icon .....	65
Backing Up In Overlay View .....	65
Sound Recorder .....	65
<b>Data Capture .....</b>	<b>66</b>
Introduction .....	66
Integrated Imager .....	66
Operational Modes .....	66
Laser Scanner .....	67
RS507/RS507X Hands-Free Imager .....	67
RS5100 Ring Scanner .....	68
RS6000 Bluetooth Ring Scanner .....	68
DS3678 Digital Scanner .....	68
Scanning Considerations .....	69
Barcode Capture with Imager .....	69
Barcode Capture with Laser Scanner .....	70
Scanning with RS507/RS507X Hands-Free Imager .....	71
Scanning with RS6000 Bluetooth Ring Scanner .....	73
Scanning with the DS3608 USB Scanner or DS3678 Bluetooth Scanner .....	74
Pairing the RS507/RS507X/RS6000 Hands-Free Imager .....	75
Pairing Using Near Field Communication .....	75
Pairing in HID Mode Using Near Field Communication .....	76
Pairing Using Simple Serial Interface (SSI) .....	77
Pairing Using Bluetooth Human Interface Device .....	78
Pairing a Bluetooth Scanner .....	79
Pairing Using Bluetooth Human Interface Device .....	79
DataWedge .....	80
Enabling DataWedge .....	80
Disabling DataWedge .....	80
Supported Decoders .....	80
<b>Wireless .....</b>	<b>83</b>
Wireless Local Area Networks .....	83
Connecting to a Wi-Fi Network .....	84
Removing a Wi-Fi Network .....	84

WLAN Configuration .....	84
Configuring a Secure Wi-Fi Network .....	84
Manually Adding a Wi-Fi Network .....	85
Configuring for a Proxy Server .....	86
Configuring the Device to Use a Static IP Address .....	87
Wi-Fi Preferences .....	87
Additional Wi-Fi Settings .....	88
Wi-Fi Direct .....	88
Bluetooth .....	89
Adaptive Frequency Hopping .....	89
Security .....	90
Bluetooth Profiles .....	90
Bluetooth Power States .....	91
Bluetooth Radio Power .....	91
Enabling Bluetooth .....	91
Disabling Bluetooth .....	92
Discovering Bluetooth Device(s) .....	92
Changing the Bluetooth Name .....	92
Connecting to a Bluetooth Device .....	92
Selecting Profiles on the Bluetooth Device .....	92
Unpairing a Bluetooth Device .....	93
Cast .....	93
Near Field Communications .....	93
Reading NFC Cards .....	94
Sharing Information Using NFC .....	94
Enterprise NFC Settings .....	95
<b>Accessories .....</b>	<b>96</b>
Battery Charging .....	100
Main Battery Charging .....	100
Spare Battery Charging .....	100
Charging Indicators .....	100
Charging Temperature .....	101
1-Slot USB Charge Cradle with Spare Battery Charger .....	102
Setup .....	104
Charging the Device .....	105
4-Slot Charge Only ShareCradle .....	106
Setup .....	107
Charging the Devices .....	108
4-Slot Ethernet ShareCradle .....	109
Setup .....	110

Charging the Devices .....	111
Daisy-chaining Ethernet ShareCradles .....	111
Ethernet Settings.....	112
Configuring Ethernet Proxy Settings .....	113
Configuring Ethernet Static IP Address.....	113
Establishing Ethernet Connection .....	114
LED Indicators.....	115
4-Slot Spare Battery Charger .....	116
Setup .....	116
Charging the Spare Batteries.....	117
16-Slot Spare Battery Charger .....	118
Setup .....	118
Charging the Spare Batteries.....	119
USB Charge/Com Snap-on Cup .....	120
Connecting to the Device .....	121
Connecting the USB Charge/Com Snap-on Cup Cable to Host Computer .....	122
Charging the Device .....	123
Disconnecting the USB Charge/Com Snap-on Cup .....	124
MC93XX Charge Only Adapter .....	125
Charge Only Adapter Installation.....	126
Rubber Boot.....	129
Installing the Hand Strap.....	130
Un-powered Forklift Mount.....	131
4-Slot Charge Only ShareCradle Rack Installation .....	132
Rack Mount Installation.....	135
Wall Installation.....	138
Bottom Tray Assembly .....	138
Bracket Wall Mounting.....	138
<b>Application Deployment.....</b>	<b>140</b>
Security .....	140
Secure Certificates.....	140
Installing a Secure Certificate .....	140
Configuring Credential Storage Settings .....	141
Development Tools .....	141
Android Application Development .....	141
Development Workstation .....	141
Enabling Developer Options .....	141
EMDK for Android.....	142
StageNow .....	142
GMS Restricted.....	142
ADB USB Setup .....	142



Enabling USB Debugging .....	142
Application Installation .....	143
Installing Applications Using the USB Connection .....	143
Installing Applications Using the Android Debug Bridge .....	144
Installing Applications Using a microSD Card .....	144
Uninstalling an Application .....	145
Performing a System Update .....	145
Downloading the System Update Package .....	145
Performing a System Update Using microSD Card.....	146
Performing a System Update Using ADB .....	146
Verifying System Update Installation .....	147
Enterprise Reset .....	147
Performing an Enterprise Reset From Device Settings .....	147
Downloading the Enterprise Reset Package .....	147
Performing an Enterprise Reset Using microSD Card .....	147
Performing an Enterprise Reset Using ADB.....	148
Performing a Factory Reset .....	149
Downloading the Factory Reset Package .....	149
Performing a Factory Reset Using microSD Card.....	149
Performing a Factory Reset Using ADB .....	149
Storage.....	150
Random Access Memory .....	150
Viewing Memory.....	150
Internal Storage.....	151
Viewing Internal Storage .....	151
External Storage.....	151
Viewing External Storage.....	151
Formatting a microSD Card or USB Drive as Portable Storage.....	151
Formatting a microSD Card as Internal Memory.....	151
Enterprise Folder .....	152
Managing Apps .....	152
App Details .....	152
Managing Downloads.....	153
<b>Keypads.....</b>	<b>154</b>
Introduction .....	154

Removing and Replacing Keypads .....	154
58-Keys Alpha Numeric Function Keypad .....	159
53-Keys Standard Keypad .....	162
53-Keys IBM-5250 Emulator Keypad.....	165
53-Keys IBM-3270 Emulator Keypad.....	168
53-Keys VT Emulator Keypad.....	171
43-Keys Shifted Alpha Keypad .....	174
34-Keys Numeric Keypad .....	177
29-Keys Shifted Alpha Keypad .....	180
Keypad Special Functions.....	183
Special Characters.....	185
<b>Maintenance and Troubleshooting .....</b>	<b>187</b>
Maintaining the Device.....	187
Battery Safety Guidelines.....	187
Cleaning Instructions.....	188
Approved Cleanser Active Ingredients .....	188
Harmful Ingredients .....	188
Device Cleaning Instructions .....	189
Special Cleaning Notes .....	189
Cleaning Materials Required .....	189
Cleaning Frequency .....	189
Cleaning the Device.....	189
Housing .....	189
Display .....	189
Exit Window .....	190
Cleaning Battery Connectors.....	190
Cleaning Cradle Connectors .....	190
Troubleshooting the Device .....	190
1-Slot USB Charging Cradle Troubleshooting.....	193
4-Slot Charge Only Cradle Troubleshooting.....	194
4-Slot Ethernet Cradle Troubleshooting .....	195
4-Slot Spare Battery Charger Troubleshooting .....	196
16-Slot Spare Battery Charger Troubleshooting .....	196
<b>Specifications .....</b>	<b>198</b>
Technical Specifications.....	198
SE965 Decode Zone .....	198
SE4750-SR Decode Zone .....	199
SE4770-SR Decode Zones .....	200
SE4850-ER Decode Zone .....	200

I/O Connector Pin-Outs .....	202
MC93XX Accessory Specifications .....	203
1-Slot USB Charge Cradle with Spare Battery Charger Technical Specifications	203
4-Slot Charge Only ShareCradle Technical Specifications .....	203
4-Slot Ethernet ShareCradle Technical Specifications .....	204
4-Slot Spare Battery Charger Technical Specifications.....	204
16-Slot Spare Battery Charger Technical Specifications.....	205
USB Charge/Com Snap-on Cup Technical Specifications .....	206

# About This Guide

This guide provides information about setting up and using the MC93XX mobile computer. Some screens shown in this guide may differ from the actual screens shown on the device.

## Configurations

MC93XX used in this guide refers to all configurations, except where noted. MC93XX refers to the Trigger configuration.

This guide covers the following configurations:

**Table 1** Configurations

Configuration	Radios	Display	Memory	Data Capture Options	Operating System
MC93XX–G Base	WLAN: IEEE 802.11 a/b/g/n/ac/d/h/i/r/w WPAN: Bluetooth v5.0 Low Energy	4.3" WVGA (800 x 480) LCD	4 GB RAM/ 32 GB Flash	SE965 1D, SE4750-SR 2D, SE4850-ER 2D SE4750DPM SE4750DPW SE4770 2D	Android-based, Google™ Mobile Services (GMS) 10
Package 1 MC93XX–G Base + NFC (Tap to Pair) + Vibrator Motor	WLAN: IEEE 802.11 a/b/g/n/ac/d/h/i/r/w WPAN: Bluetooth v5.0 Low Energy	4.3" WVGA (800 x 480) LCD	4 GB RAM / 32 GB Flash	SE965 1D, SE4750-SR 2D, SE4850-ER 2D SE4750DPM SE4750DPW SE4770 2D	Android-based, Google™ Mobile Services (GMS) 10
Package 2 Package 1 + Front and Rear Facing Cameras	WLAN: IEEE 802.11 a/b/g/n/ac/d/h/i/r/w WPAN: Bluetooth v5.0 Low Energy	4.3" WVGA (800 x 480) LCD	4 GB RAM / 32 GB Flash	SE965 1D, SE4750-SR 2D, SE4850-ER 2D SE4770 2D	Android-based, Google™ Mobile Services (GMS) 10
MC93XX-G Freezer + NFC (Tap to Pair) + Vibrator Motor	WLAN: IEEE 802.11 a/b/g/n/ac/d/h/i/r/w WPAN: Bluetooth v5.0 Low Energy	4.3" WVGA (800 x 480) LCD. Optically Bonded to the Touch Panel.	4 GB RAM / 32 GB Flash	SE965 1D, SE4750-SR 2D, SE4850-ER 2D SE4770 2D	Android-based, Google™ Mobile Services (GMS) 10

## Notational Conventions

Notational conventions are used to highlight important information.

- **Bold** text is used to highlight the following:
  - Dialog box, window and screen names
  - Drop-down list and list box names
  - Check box and radio button names
  - Icons on a screen
  - Key names on a keypad
  - Button names on a screen.
- Bullets (•) indicate:
  - Action items
  - Lists of alternatives
  - Lists of required steps that are not necessarily sequential.
- Sequential lists (for example, those that describe step-by-step procedures) appear as numbered lists.

## Icon Conventions

The following icons are used throughout the document. The icons and their associated meanings are described below.



**NOTE:** The text here indicates information that is supplemental for the user to know and that is not required to complete a task.



**IMPORTANT:** The text here indicates information that is important for the user to know.



**CAUTION:** If the precaution is not heeded, the user could receive minor or moderate injury.



**WARNING:** If danger is not avoided, the user CAN be seriously injured or killed.



**DANGER:** If danger is not avoided, the user WILL be seriously injured or killed.

## Service Information

If you have a problem with your equipment, contact Customer Support for your region. Contact information is available at: [zebra.com/support](http://zebra.com/support).

When contacting support, please have the following information available:

- Serial number of the unit (found on manufacturing label)
- Model number or product name (found on manufacturing label)
- Software type and version number

Customer Support responds to calls by email or telephone within the time limits set forth in support agreements.

If the problem cannot be solved by Customer Support, the user may need to return the equipment for servicing and will be given specific directions. We are not responsible for any damages incurred during shipment if the approved shipping container is not used. Shipping the units improperly can possibly void the warranty. Remove the microSD card from the device before shipping for service.

If the device was purchased from a business partner, contact that business partner for support.

## Determining Software Versions

Before contacting Customer Support, determine the current software version on your device.

1. Swipe down from the Status bar with two fingers to open the Quick Access panel, and then touch .
2. Touch **About phone**.
3. Scroll to view the following information:
  - **Status**
  - **Battery information**
  - **SW components**
  - **Legal information**
  - **Model & hardware**
  - **Android version**
    - **Android security patch level**
    - **Build Fingerprint**

## Determining the Serial Number

Before contacting Customer Support, determine the serial number of your device.

Touch **About phone** > **Model & hardware** > **Serial number**.

If the manufacturing label is worn or missing, use an NFC enabled device to read the NFC tag under the battery compartment. You can download the NFC Reader application for free from the Google Play store.

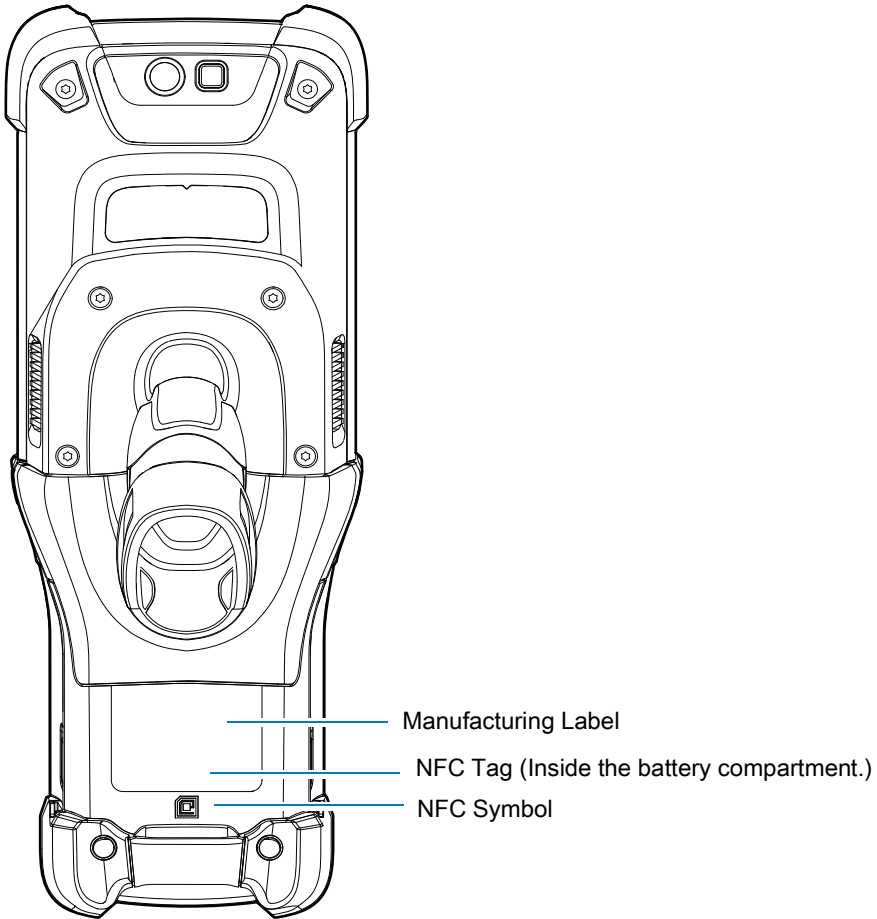

# Getting Started

This section provides information to get the device up and running for the first time.

## Unpacking

To unpack the device:

1. Carefully remove all protective material from the device and save the shipping container for later storage and shipping.
2. Verify the following items are in the box:
  - Mobile computer
  - Lithium-ion battery
  - Regulatory Guide.
3. Inspect the equipment for damage. If any equipment is missing or damaged, contact the Global Customer Support Center immediately.
4. Before using the device for the first time, remove the protective shipping film that covers the scan window, display, and camera window.



## Device Features

Figure 1 Device Front View

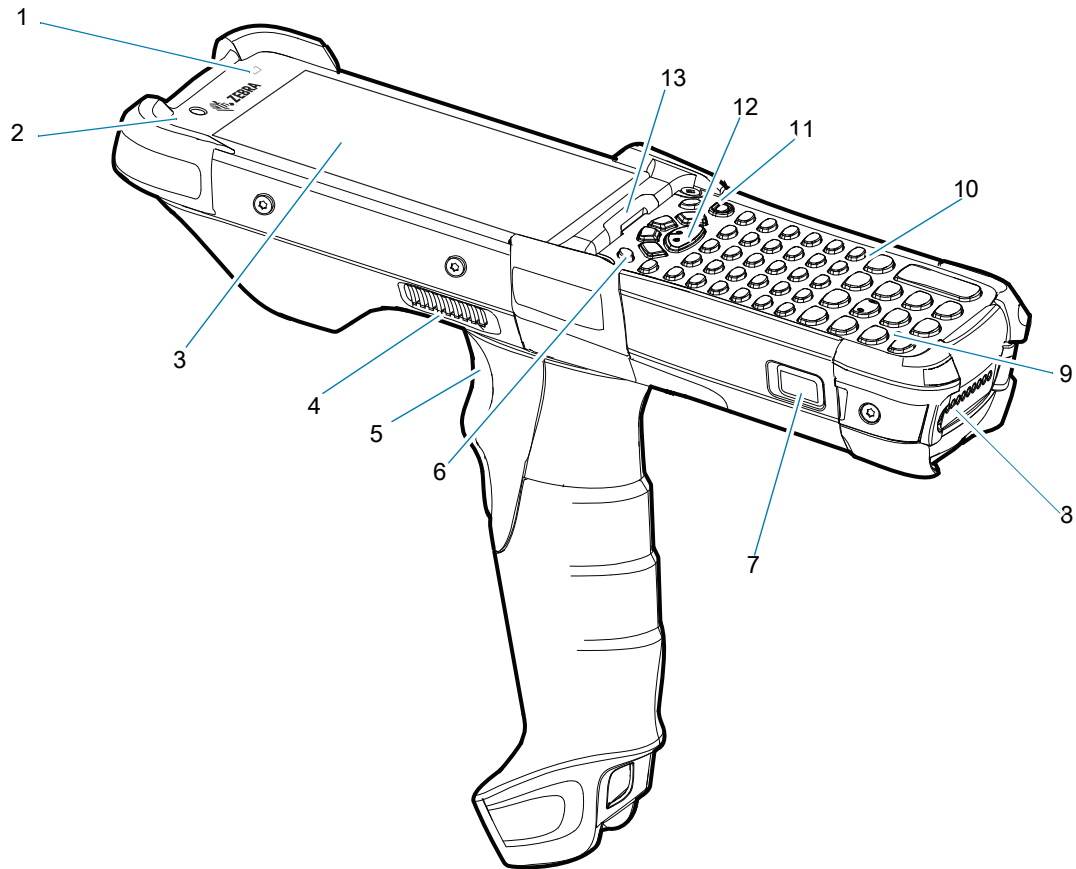

Number	Item	Function
1	Ambient light sensor	Controls display and keyboard backlight.
2	Front facing camera	Use to take photos and videos.  The front camera is available only on the premium configurations.
3	Display	Displays all information needed to operate the device.
4	Speaker side port	Provides audio output for video and music playback.
5	Trigger	Initiates data capture when a scan application is enabled.
6	P1 - Dedicated PTT key	Initiates push-to-talk communications (programmable).
7	Battery release latch	Releases the battery from the device.  To release the battery, simultaneously press the battery release latches on both the sides of the device.
8	Battery	Provides power for operating the device.
9	Microphone	Use for communications in Handset mode.
10	Keypad	Use to enter data and navigate on screen functions.

Number	Item	Function
11	Power button	Press and hold to turn on the device. Press to turn on or off the screen. Press and hold to select one of these options: <b>Power off</b> - Turn off the device. <b>Restart</b> - Restart the device when software stops responding.
12	Center scan button	Initiates data capture when a scan application is enabled.
13	Charger/Decode status LED	Indicates battery charging status while charging, app generated notifications, and data capture status.

**Figure 2** Device Rear View

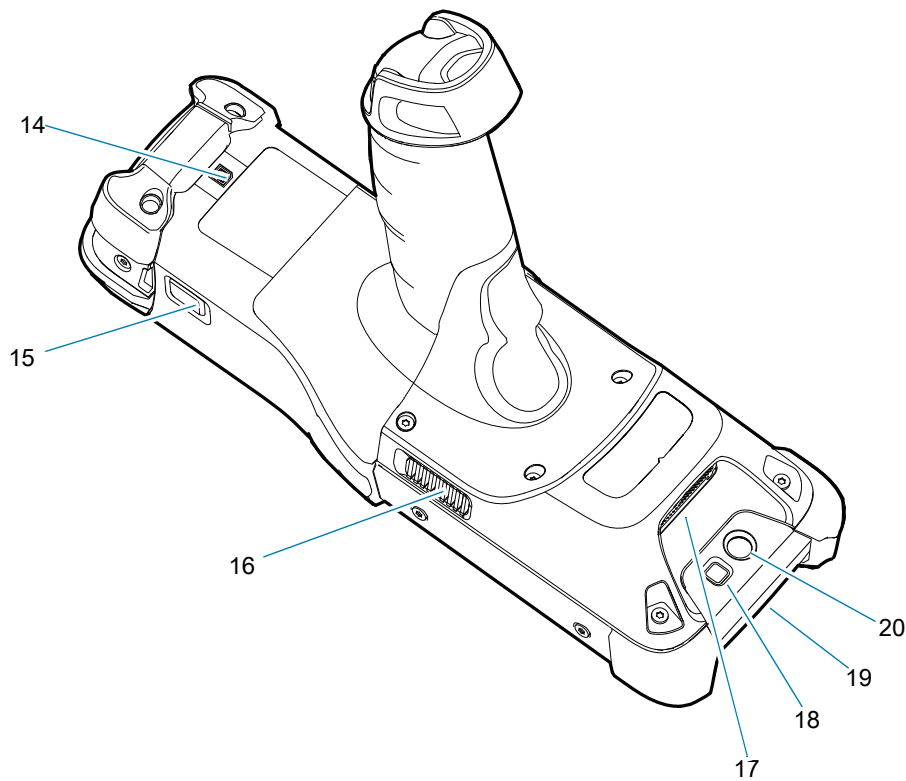

Number	Item	Function
14	Passive NFC tag (Inside the battery compartment.)	Provides secondary product label information (configuration, serial number and manufacture data code) in the event that the readable product label is worn or missing.
15	Battery release latch	Releases the battery from the device.
16	Side speaker port	Provides audio output for video and music playback.
17	Scanner exit window	Provides data capture using the scanner/imager.

Number	Item	Function
18	Camera flash	Provides illumination for the camera.  Camera is available only on some configurations.
19	NFC antenna	Provides communication with other NFC-enabled devices.  NFC antenna is available only on the premium configurations.
20	Rear camera	Takes photos and videos.  The rear camera is available only on the premium configurations.

## Setting Up the Device

To start using the device for the first time:

1. Install a microSD card (optional)
2. Install the battery
3. Charge the device
4. Power on the device.

## Installing a microSD Card

The microSD card slot provides secondary non-volatile storage. The slot is located under the keypad module. For more information, refer to the documentation provided with the card, and follow the manufacturer's recommendations for use. It is strongly recommended that prior to use, you must format the microSD card on the device.



**NOTE:** The following microSD cards were tested and are validated for use with the MC93XX:

- SanDisk 16GB (SDSDQ-016G-A11M)
- SanDisk 32GB (SDSDQ-032G-A11M)
- SanDisk 64GB (SDSDQUA-064G-U46A)
- SanDisk 128GB (SDSDQUI-128G-A46)
- SanDisk 200GB (SDSDQUAN-200G-A4A)



**CAUTION:** Follow proper electrostatic discharge (ESD) precautions to avoid damaging the microSD card. Proper ESD precautions include, but are not limited to, working on an ESD mat and ensuring that the operator is properly grounded.

1. Power off the device.
2. Remove the battery.

- Using a Torx T8 screwdriver with a large grip, remove the two keypad latch screws from inside the battery slot.

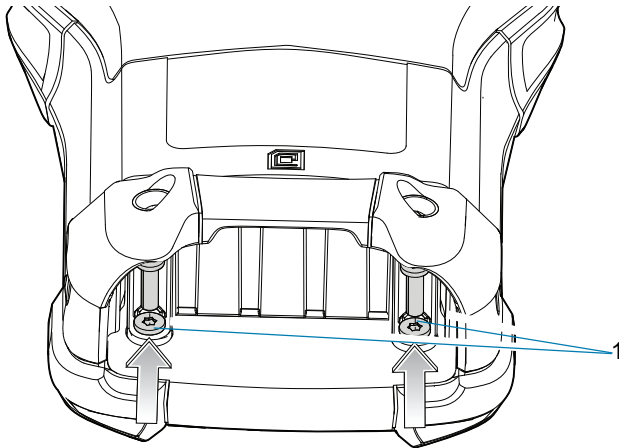

1	Keypad latch screws
---	---------------------

- Slide the keypad latches toward the bottom of the device.

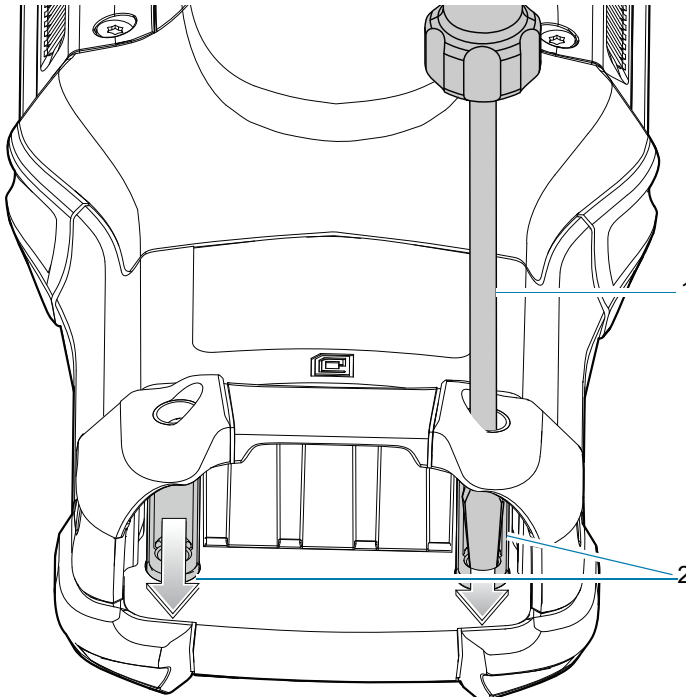

1	Screwdriver
	Keypad latches



**NOTE:** If the keypad latches are hard to move, use a screwdriver to gently slide them towards the bottom of the device.

- Turn the device over so that the keypad is visible.

- Using a Torx T8 screwdriver with a large grip, remove the two keypad assembly screws from the top of the keypad.

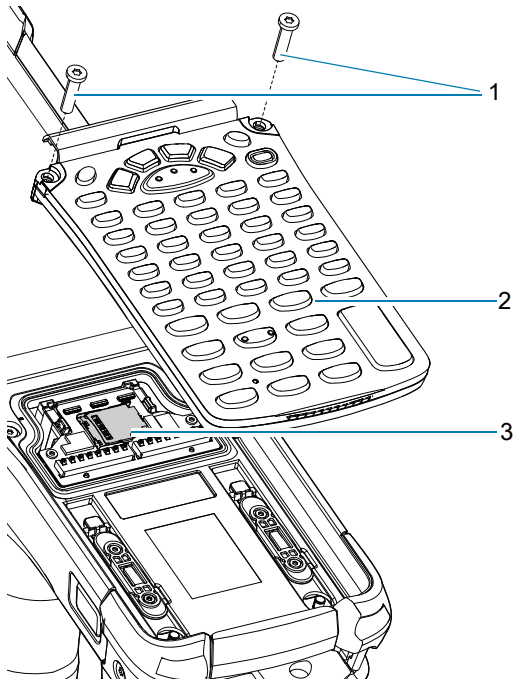

1	Keypad screws
2	Keypad
3	microSD card holder

- Lift the keypad from the device.
- Slide the microSD card holder to the Open position.

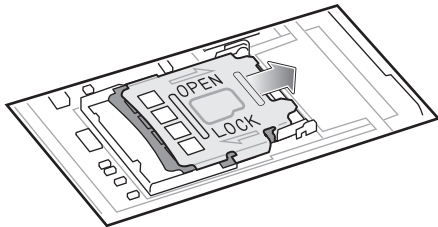

- Lift the microSD card holder.

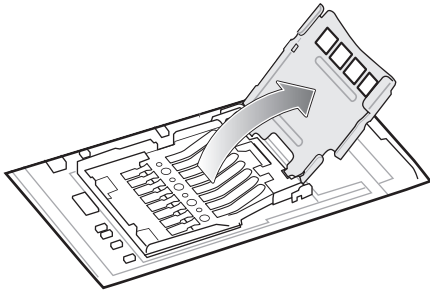

- 10.** Insert the microSD card into the card holder door ensuring that the card slides into the holding tabs on each side of the door.

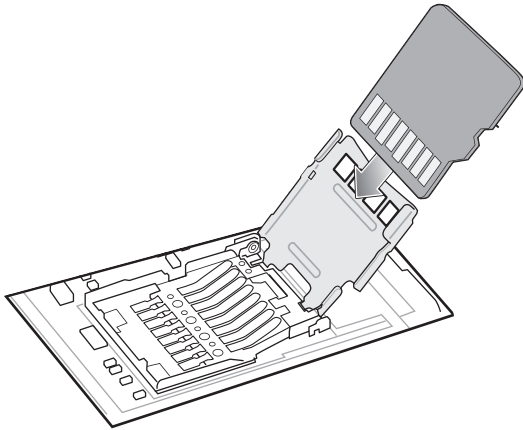

- 11.** Close the microSD card holder door and slide the door to the Lock position.

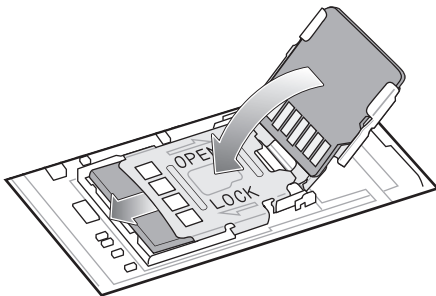

12. Align the keypad along the bottom ridge of the device, and then lay it flat.

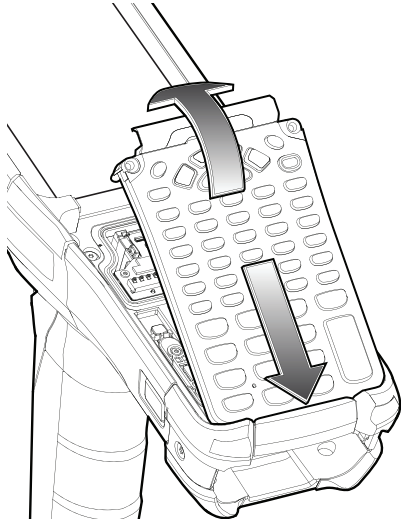

13. Using a Torx T8 screwdriver with a large grip and a long shaft, secure the keypad to the device using the two screws. Torque screws to 5.8 kgf-cm or 5.0 lbf-in.

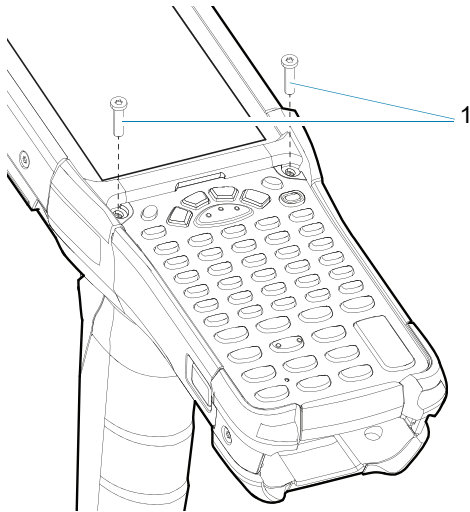

1	Keypad screws
---	---------------

14. Turn the device over so that the keypad latches are visible.

15. Slide both the keypad latches toward the top of the device.

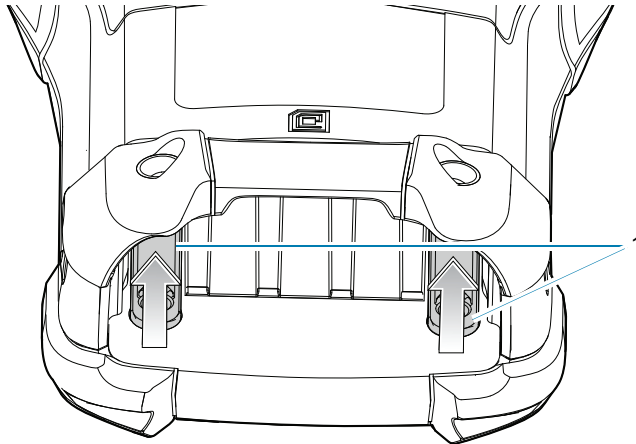

1	Keypad latches
---	----------------

16. Using a Torx T8 screwdriver, replace the two keypad latch screws inside the battery slot and torque to 5.8 kgf-cm or 5.0 lbf-in.

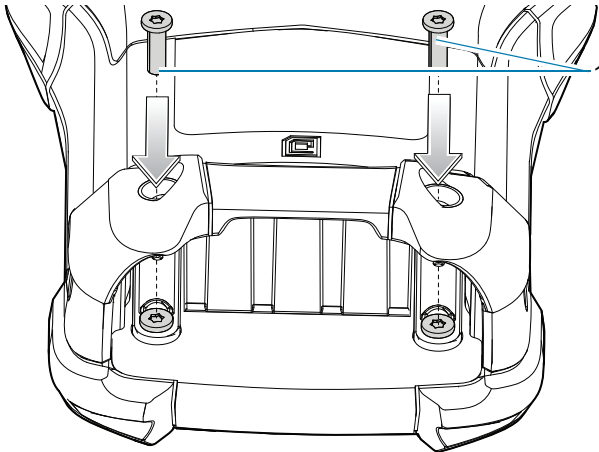

1	Keypad latch screws
---	---------------------

17. Insert the battery.

18. Press and hold the Power key to power on the device.



## Installing the Battery

1. Align the battery with the battery slot.

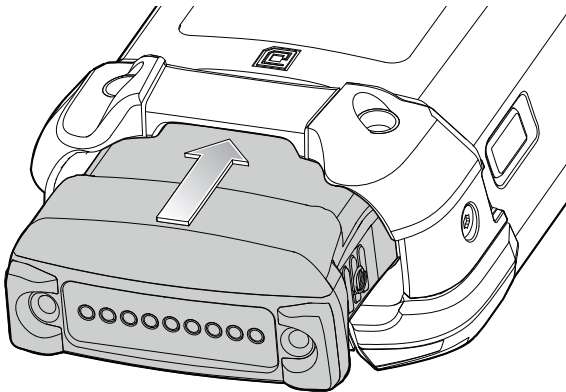

2. Push the battery into the battery slot.
3. Press battery firmly into the battery well.

Ensure that both the battery release buttons on the sides of the device return to the home position. An audible click sound indicates that both the battery release buttons on the sides of the device have returned to the home position locking the battery in place.

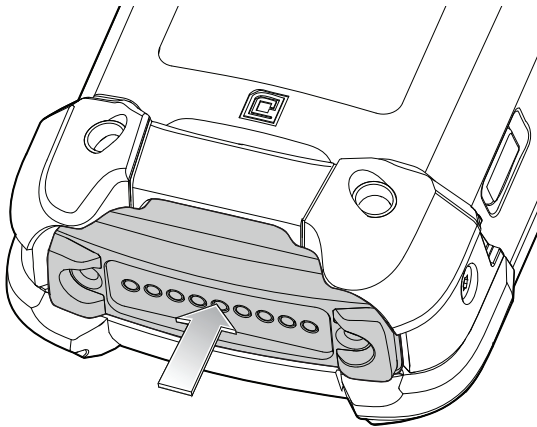

4. Press the Power button to turn on the device.

## Charging the Battery

To charge the main battery:

1. Ensure that the cradle is connected to power.
2. Slide the mobile computer into the slot in the cradle. The mobile computer Charge LED Indicator, indicates the mobile computer battery charging status.
3. Gently press down on the device to ensure proper contact.
4. When charging is complete, remove the mobile computer from the cradle slot.

Charge batteries in temperatures from 0°C to 40°C (32°F to 104°F). The device or cradle always performs battery charging in a safe and intelligent manner. At higher temperatures, for example at approximately +37°C (+98°F), the device or cradle may for small periods of time alternately enable and disable battery charging to keep the battery at acceptable temperatures. The device and cradle indicates when charging is disabled due to abnormal temperatures via its LED.

## Charging Indicators

The Charge LED Indicator indicates the charge status. See the table below for charging indications.

**Table 2** LED Charge Indicators

Status	Indications
Off	<ul style="list-style-type: none"> <li>The battery is not charging.</li> <li>The device is not inserted correctly in the cradle or connected to a power source.</li> <li>Cradle is not powered.</li> </ul>
Slow Blinking Amber Every 3 seconds	<ul style="list-style-type: none"> <li>Battery is charging, but the battery is fully depleted and does not yet have sufficient charge to power the device.</li> <li>After battery removal, indicates that the device is in hot swap mode with connectivity persistence.</li> </ul> <p>The SuperCap requires a minimum of 15 minutes to fully charge in order to provide adequate connectivity and memory session persistence.</p>
Solid Amber	<ul style="list-style-type: none"> <li>Battery is charging.</li> </ul>
Solid Green	<ul style="list-style-type: none"> <li>Battery charging is complete.</li> </ul>
Fast Blinking Red 2 blinks/second	<p>Charging error. For example:</p> <ul style="list-style-type: none"> <li>Temperature is too low or too high.</li> <li>Charging has gone on too long without completion (typically eight hours).</li> </ul>
Solid Red	<ul style="list-style-type: none"> <li>Battery is charging and battery is at the end of useful life.</li> <li>Charging complete and battery is at the end of useful life.</li> </ul>

## Backup Power

The device is equipped with a super-capacitor (supercap) to provide backup power to the device when the main battery is removed. The supercap will retain random access memory (RAM) data in memory for approximately five minutes after the main battery is removed during Hot Swap.



The supercap is automatically charged from the main battery and requires approximately fifteen minutes to fully charge.

## Zebra Visibility Services

The device captures and provides device analytics to a system administrator. The first time the device boots (or after a Factory reset), the **Zebra Services** agreement screen displays.

1. Leave **Device Data** enabled if you want the device to send analytics data. Zebra recommends keeping this option enabled.
2. Touch the **Device Data** switch to disable the device from sending analytics data.
3. Touch **OK** to confirm selection.

## Replacing the Battery

1. Push in the two primary Battery Release buttons.

The battery ejects slightly. With Hot Swap mode, when you remove the battery, the display turns off and the device enters a low power state. The device retains RAM data for approximately five minutes. Replace the battery within five minutes to preserve memory persistence.

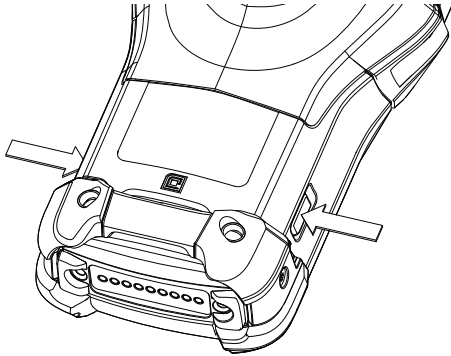

2. Push in the secondary battery release buttons on the sides of the battery.

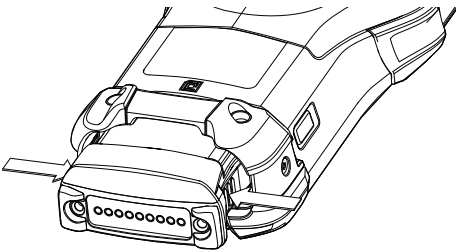

3. Remove the battery from the battery slot.

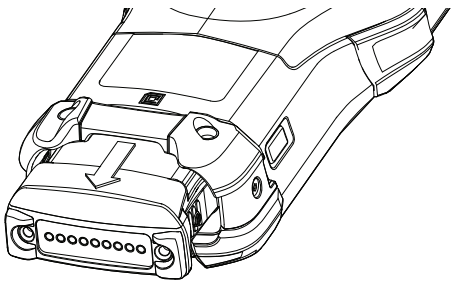

4. Align the battery with the battery slot.

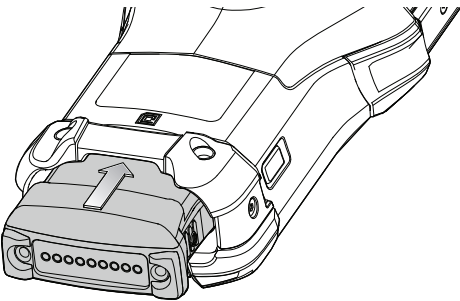

5. Push the battery into the battery slot.

6. Press battery firmly into the battery well.

Ensure that both the battery release buttons on the sides of the device return to the home position. You will hear an audible click sound indicating that both the battery release buttons on the sides of the device have returned to the home position locking the battery in place.

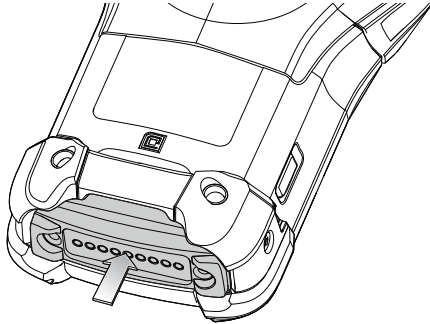

7. Press the Power button to turn on the device.

# Using the Device

## Home Screen

Turn on the device to display the Home screen. Depending on how your system administrator configured your device, your Home screen may appear differently than the graphics in this section.

After a suspend or screen time-out, the Home screen displays with the lock slider. Touch the screen and slide up to unlock.

The Home screen provides four additional screens to place widgets and shortcuts. Swipe the screen left or right to view the additional screens.

**Figure 3** Home Screen

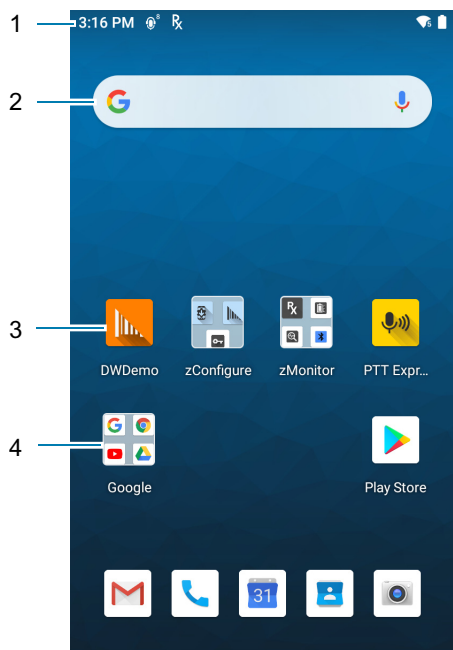

1	Status Bar	Displays the time, status icons (right side), and notification icons (left side). For more information see <a href="#">Notification Icons on page 30</a> and <a href="#">Managing Notifications on page 32</a> .
2	Widgets	Launches stand-alone apps that run on the Home screen.
3	Shortcut Icons	Opens apps installed on the device.
4	Folder	Contains apps.

## Setting Home Screen Rotation

By default, the Home screen rotation is disabled.

1. Touch and hold anywhere on the Home screen until the options appear.
2. Touch **Home settings**.
3. Touch the **Allow Home screen rotation** switch.
4. Touch the Home button.
5. Rotate the device.

## Status Bar

The Status bar displays the time, notification icons (left side), and status icons (right side).

If there are more notifications than can fit in the Status bar, a dot displays indicating that more notifications exist. Swipe down from the Status bar to open the Notification panel and view all notifications and status.

**Figure 4** Notification and Status Icons

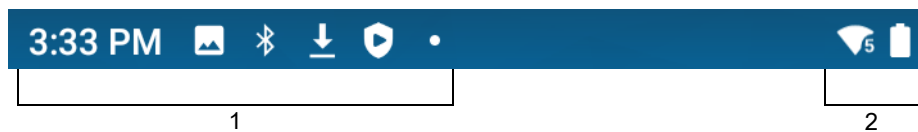

1	Notification Icons. See <a href="#">Notification Icons on page 30</a> .
2	Status Icons. See <a href="#">Status Icons on page 31</a> .







## Notification Icons

Notification icons indicate app events and messages.

**Table 3** Notification Icons

Icon	Description
	Main battery is low.
	More notifications are available for viewing.
	Data is syncing.
	Indicates an upcoming event. GMS devices only.
	Open Wi-Fi network is available.
	Audio is playing.
	Problem with sign-in or sync has occurred.
	Device is uploading data.
	Animated: the device is downloading data. Static: the download is complete.















**Table 3** Notification Icons (Continued)

Icon	Description
	Device is connected to or disconnected from a virtual private network (VPN).
	Preparing internal storage by checking it for errors.
	USB debugging is enabled on the device.
	Indicates the RxLogger app is running.
	Indicates the Bluetooth scanner is connected to the device.
	Indicates the ring scanner is connected to the device in HID mode.









## Status Icons

Status icons display system information for the device.

**Table 4** Status Icons

Icon	Description
	Alarm is active.
	Main battery is fully charged.
	Main battery is partially drained.
	Main battery charge is low.
	Main battery charge is very low.
	Main battery is charging.
	All sounds, except media and alarms, are muted. Vibrate mode is active.
	Do Not Disturb mode active.
	Airplane Mode is active. All radios are turned off.
	Bluetooth is on.
	The device is connected to a Bluetooth device.
	Connected to a Wi-Fi network. Indicates the Wi-Fi version number.
	Not connected to a Wi-Fi network or no Wi-Fi signal.
	Connected to an Ethernet network.
	Speakerphone enabled.

**Table 4** Status Icons (Continued)

Icon	Description
	Indicates that the Orange key is locked.
	Indicates that the Blue key is pressed.
	Indicates that the Blue key is locked.
	Indicates that the ALT key is pressed.
	Indicates that the CTRL key is pressed.
	Indicates that the Shift key is pressed.
	Indicates that the Shift key is locked.
	Indicates that the Large Key Indicator is selected.  To enable the large key indicator, go to <b>Settings &gt; Accessibility &gt; Display &gt; Large Key Indicator</b> .
	Indicates that the Blue Key and SHIFT key are pressed enabling CAPSLOCK.

## Managing Notifications

Notification icons report the arrival of new messages, calendar events, alarms, and ongoing events. When a notification occurs, an icon appears in the Status bar with a brief description. See [Notification Icons on page 30](#) for a list of possible notification icons and their description.

- To view a list of all notifications, open the Notification panel by dragging the Status bar down from the top of the screen.

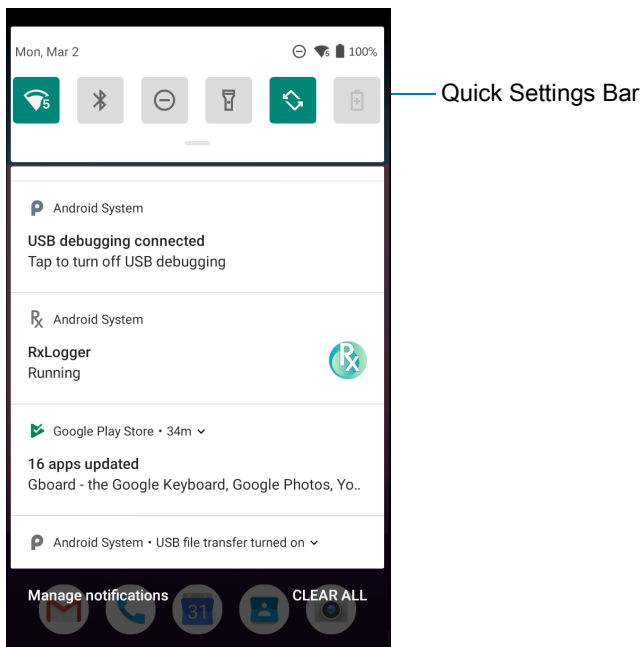



- To respond to a notification, open the Notification panel and then touch a notification. The Notification panel closes and the corresponding app opens.
- To manage recent or frequently used notifications, open the Notification panel and then touch **Manage notifications**. Touch the toggle switch next to an app to turn off all notifications, or touch an app for more notification options.
- To clear all notifications, open the Notification panel and then touch **CLEAR ALL**. All event-based notifications are removed. Ongoing notifications remain in the list.
- To close the Notification panel, swipe the Notification panel up.

## Opening the Quick Access Panel

Use the Quick Access panel to access frequently used settings (for example, Airplane mode). To get to the Quick Access Panel:

- If the device is locked, swipe down once.
- If the device is unlocked, swipe down once with two fingers, or twice with one finger.
- If the Notification panel is open, swipe down from the Quick Settings bar.

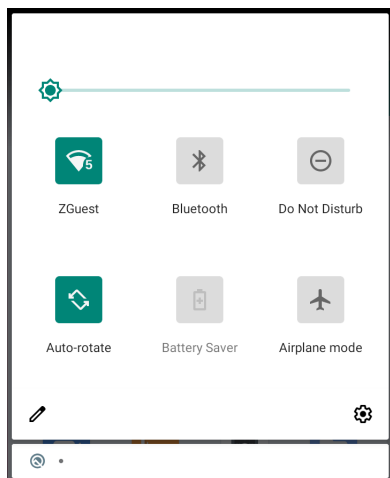

**NOTE:** Not all icons are pictured. Icons may vary.

### Quick Access Panel Icons

- Display brightness - Use the slider to decrease or increase the brightness of the screen.
- Wi-Fi network - Turn Wi-Fi on or off. To open Wi-Fi settings, touch the Wi-Fi network name.
- Bluetooth settings - Turn Bluetooth on or off. To open Bluetooth settings, touch **Bluetooth**.
- Do not disturb - Control how and when to receive notifications.
- Airplane mode - Turn Airplane mode on or off. When Airplane mode is on the device does not connect to Wi-Fi or Bluetooth.
- Auto-rotate - Lock the device's orientation in portrait or landscape mode or set to automatically rotate.
- Flashlight - Turn flashlight on or off. Turn camera flash on or off.

The thermal protection safety feature for the camera provides the following behavior if the temperature range is 40°C or above:

- If the flashlight is kept on for a certain period of time, it is automatically turned off and cannot be turned back on for a period of time until it has cooled off.
- During the cooling off period, the camera cannot be turned on. If you attempt to use the camera, a message displays indicating to try again after a period of time.
- Screen Cast - Share phone content on Chromecast or a television with Google Cast built-in. Touch cast screen to display a list of devices, then touch a device to begin casting.

## Editing Icons on the Quick Settings Bar

The first several setting tiles from the Quick Access panel become the Quick Settings bar.

Open the Quick Access panel and touch  to edit, add, or remove settings tiles.

## Battery Management

Observe the recommended battery optimization tips for your device.

- Set the screen to turn off after a short period of non-use.
- Reduce screen brightness.
- Turn off all wireless radios when not in use.
- Turn off automatic syncing for Email, Calendar, Contacts, and other apps.
- Minimize use of apps that keep the device from suspending, for example, music and video apps.



**NOTE:** Before checking the battery charge level, remove the device from any AC power source (cradle or cable).

## Checking Battery Status

- Open **Settings** and touch **About phone** > **Battery Information**.

Or, swipe up from the bottom of the screen and touch  to open the **Battery Manager** app. See [Battery Manager on page 49](#).

- **Battery present status** indicates if the battery is present.
- **Battery level** lists the battery charge (as a percentage of fully charged).
- Swipe down with two fingers from the status bar to open the quick access panel.
  - Battery percentage is displayed next to the battery icon.

## Monitoring Battery Usage

The **Battery** screen provides battery charge details and power management options to extend battery life.

1. Go to **Settings**.
2. Touch **Battery**.

Display battery information and power management options for a specific app.

1. Go to **Settings**.
2. Touch **Apps & notifications**.
3. Touch an app.

#### 4. Touch **Advanced** > **Battery**.

Different apps display different information. Some apps include buttons that open screens with settings to adjust power use. Use the **DISABLE** or **FORCE CLOSE** buttons to turn off apps that consume too much power.

### Low Battery Notification

When the battery charge level drops below 15% on the standard battery and 30% on the freezer battery, the device displays a notice to connect the device to power. The user should charge the battery using one of the charging accessories.

When the battery charge drops below 9% on the standard battery and 20% on the freezer battery, the device displays a notice to connect the device to power. The user must charge the battery using one of the charging accessories.

When the battery charge drops below 6% on the standard and freezer batteries, the device goes into a critical suspend mode to retain data, and the device turns off. The user must charge the battery using one of the charging accessories.

### Interactive Sensor Technology

The device contains sensors that monitor movement, orientation and ambient light.

- Gyroscope - Measures angular rotational velocity to detect rotation of the device.
- Accelerometer - Measures the linear acceleration of movement to detect the orientation of the device.
- Light Sensor - Detects ambient light and adjusts the screen brightness.

In order to take advantage of these sensors, applications use API commands. Refer to the Google Android Sensor APIs for more information. For information on the Zebra Android EMDK, go to: [techdocs.zebra.com](http://techdocs.zebra.com).

### Waking the Device

The device goes into Suspend mode when you press the Power button or after a period of inactivity (set in the Display settings window).

1. To wake the device from Suspend mode, press the Power button or the configured wake-up sources.

The Lock screen displays.

2. Swipe the screen up to unlock.
  - If the Pattern screen unlock feature is enabled, the Pattern screen appears instead of the Lock screen.
  - If the PIN or Password screen unlock feature is enabled, enter the PIN or password after unlocking the screen.



**NOTE:** If you enter the PIN, password, or pattern incorrectly five times, you must wait 30 seconds before trying again.

If you forget the PIN, password, or pattern contact your system administrator.

The device will wake on the detection of AC/DC power if it is either in suspend mode or powered off.

## USB Communication

Connect the device to a host computer to transfer files between the device and the host computer.

When connecting the device to a host computer, follow the host computer's instructions for connecting and disconnecting USB devices, to avoid damaging or corrupting files. For information on USB communication accessories available for this device, see [Accessories](#).

### Transferring Files

Use **Transfer files** to copy files between the device and the host computer.

1. Connect the device to a host computer using a USB accessory.
2. On the device, pull down the Notification panel and touch **Charging this device via USB**.  
By default, **No data transfer** is selected.
3. Touch **File Transfer**.
4. On the host computer, open a file explorer application.
5. Locate the **device** as a portable device.
6. Open the **Internal storage** folder.
7. Copy files to and from the device or delete files as required.

### Transferring Photos

Use **PTP** to copy photos from the device to the host computer.

1. Connect the device to a host computer using a USB accessory.
2. On the device, pull down the Notification panel and touch **Charging this device via USB**.
3. Touch **PTP**.
4. On the host computer, open a file explorer application.
5. Open the **Internal storage** folder.
6. Copy or delete photos as required.

### Disconnect from the Host Computer



Carefully follow the host computer's instructions to disconnect USB devices correctly to avoid losing information.



To disconnect the device from the host computer:

1. On the host computer, unmount the device.
2. Remove the device from the USB accessory.

# Settings

## Accessing Settings

There are multiple ways to access settings on a device.

- Swipe down with two fingers from the top of the Home screen to open the Quick Access panel and touch .
- Double-swipe down from the top of the Home screen to open the Quick Access panel and touch .
- Swipe up from the bottom of the Home screen to open APPS and touch  **Settings**.

## Display Settings

Use Display settings to change the screen brightness, enable night light, change the background image, enable screen rotation, control the keyboard backlight, set sleep time, and change font size.

### Setting the Screen Brightness Manually

Manually set the screen brightness using the touchscreen.

1. Swipe down with two fingers from the Status bar to open the Quick Access panel.
2. Slide the icon to adjust the screen brightness level.

To manually set the screen brightness using the keypad see Keypad Special Functions.

### Setting the Screen Brightness Automatically

Automatically adjust the screen brightness using the built-in light sensor.

1. Go to **Settings**.
2. Touch **Display**.
3. If disabled, touch **Adaptive brightness** to automatically adjust the brightness.  
By default, **Adaptive brightness** is enabled. Toggle the switch to disable.
4. Touch the Home button.

### Setting Night Light

The Night Light setting tints the screen amber, making the screen easier to look at in low light.

1. Go to **Settings**.

2. Touch **Display**.
3. Touch **Night Light**.
4. Touch **Schedule**.
5. Select one of the schedule values:
  - None (default)
  - Turns on at custom time
  - Turns on from sunset to sunrise.
6. By default, **Night Light** is disabled. Touch **TURN ON NOW** to enable.
7. Adjust the tint using the **Intensity** slider.
8. Touch the Home button.

## Setting Screen Rotation

By default, screen rotation is disabled.

1. Go to **Settings**.
2. Touch **Display > Advanced**.
3. Touch **Auto-rotate screen**.



**NOTE:** To change the Home screen rotation, see [Setting Home Screen Rotation on page 30](#).

4. Touch the Home button.

## Setting Screen Timeout

Set the screen sleep time.

1. Go to **Settings**.
2. Touch **Display > Screen timeout**.
3. Select one of the sleep values.
  - **15 seconds**
  - **30 seconds**
  - **1 minute**
  - **2 minutes**
  - **5 minutes**
  - **10 minutes**
  - **30 minutes** (default)
  - **Never**
4. Touch the Home button.

## Lock Screen Display

The lock screen display setting wakes the screen when notifications are received.

1. Go to **Settings**.
2. Touch **Display > Advanced**.
3. Touch **Lock screen display**.
4. In the **When to show** section, enable or disable an option using the switch.
5. Touch the Home button.

### Setting Font Size

Set the size of the font in system apps.

1. Go to **Settings**.
2. Touch **Display > Advanced**.
3. Touch **Font size**.
4. Select one of the font size values.
  - Small
  - Default
  - Large
  - Largest.
5. Touch the Home button.

### Touch Panel Mode

The device display is able to detect touches using a finger, a conductive-tip stylus, or gloved finger.



**NOTE:** A glove can be made of medical latex, leather, cotton, or wool. For optimal performance use a Zebra certified stylus.

1. Go to **Settings**.
2. Touch **Display > Advanced**.
3. Touch **Touch panel mode**.
4. Select:
  - **Glove and Finger (Screen Protector off)** to use a finger or a gloved finger on the screen without a screen protector.
  - **Stylus and Finger (Screen Protector off)** to use a finger or a stylus on the screen without a screen protector.
  - **Finger Only** to use a finger on the screen.
  - **Glove and Finger (Screen Protector on)** to use a finger or a gloved finger on the screen with a screen protector.
  - **Stylus and Finger (Screen Protector on)** to use a finger or a stylus on the screen with a screen protector.
  - **Finger and Stylus** to use a finger or a stylus on the screen.
  - **Finger and Glove** to use a finger or a gloved finger on the screen.
5. Touch the Home button.

## Setting the Date and Time

You are only required to set the time zone or set the date and time if the wireless LAN does not support Network Time Protocol (NTP).

1. Go to **Settings**.
2. Touch **System > Date & time**.
3. Touch **Update Interval**.
4. Select the interval time to synchronize your device time from the network.
5. Touch **Date**.
6. In the calendar, set today's date.
7. Touch **OK**.
8. Touch **Time**.
9. Touch the green circle, drag to the current hour and then release.
10. Touch the green circle, drag to the current minute and then release.
11. Touch **AM** or **PM**.
12. Touch **OK**.
13. Touch **Time zone**.
14. Select the current time zone from the list.
15. Touch **Use 24-hour format**.
16. Touch the Home button.

## General Sound Setting

Use the **Sound** settings to configure media and alarm volumes.

1. Go to **Settings**.
2. Touch **Sound**.
3. Touch an option to set sounds.



### Sound Options

- **Zebra volume controls**
  - **Ring volume** - Controls the ringtone volume.
  - **Media volume** - Controls the music, games, and media volume.
  - **Alarm volume** - Controls the alarm clock volume.
  - **Notifications volume** - Controls the notification volume.
  - **In call volume** - Controls the volume during a call.
  - **Scanner volume** - Controls the scanner volume.





**NOTE:** In the DataWedge Settings > Configure scanner settings > Scanner params menu, if Decode Audio Feedback is set to Optimized-beep, then the scanner volume slider has no effect, and the volume defaults to the highest volume. If you want to adjust the volume of the scanner beep, then you must select the Decode-short option under Decode Audio Feedback.

- **Volume presets**
  -  - Mutes the ring, notifications, and scanner so that the device does not make sounds or vibrate.
  -  - All sounds except media and alarms are silenced and vibrate mode is active.
  -  - Enables all sounds at the user defined levels.
- **Do Not Disturb** - Mutes some or all sounds and vibrations.
- **Shortcut to prevent ringing** - Select how the shortcut method prevents ringing.
- **Default notification sound** - Select a sound to play for all system notifications.
- **Default alarm sound** - Select a sound to play for alarms.
- **Other sounds and vibrations**
  - **Screen locking sounds** - Play a sound when locking and unlocking the screen (default – enabled).
  - **Charging sounds and vibration** - Plays a sound and vibrates when power is applied to the device (default - enabled).
  - **Touch sounds** - Play a sound when making screen selections (default – enabled).
  - **Touch vibration** - Vibrate the device when making screen selections (default – disabled).
- **Wireless Emergency alerts** - Touch to configure emergency broadcast settings and notifications.

## Setting Wake-Up Sources

By default the device wakes from suspend mode when the user presses the **Power** button. The device can be configured to wake when the user presses the **PTT** or **Scan** buttons on the left side of the device.

1. Go to **Settings**.
2. Touch **Wake-Up Sources**.
  - P1
  - SCAN
  - GRIP\_TRIGGER
3. Touch a checkbox. A check appears in the checkbox.
4. Touch the Home button.

## Remapping a Button

Buttons on the device can be programmed to perform different functions or as shortcuts to installed apps. For a list of key names and descriptions, refer to: [techdocs.zebra.com](http://techdocs.zebra.com).



**NOTE:** It is not recommended to remap the scan button.

1. Go to **Settings**.
2. Touch **Key Programmer**. A list of programmable buttons displays.

3. Select the button to remap.
4. Touch the **BUTTON REMAPPING** tab or the **SHORTCUT** tab that lists the available functions and applications.
5. Touch a function or application shortcut to map to the button.



**NOTE:** If you select an application shortcut, the application icon appears next to the button on the Key Programmer screen.

6. Touch the Home button.

## Keyboards

The device provides multiple keyboard options.

- Gboard - GMS devices only
- Physical Keyboard
- Enterprise Keyboard



**NOTE:** By default the Enterprise and Virtual Keyboards are disabled.

## Keyboard Configuration

### Enabling Keyboards



1. Go to **Settings**.
2. Touch **System > Languages & input > Virtual keyboard > Manage keyboards**.
3. Touch a keyboard to enable.

### Enabling Virtual Keyboards

To enable a virtual keyboard like Gboard or Enterprise keyboard:

1. Go to **Settings**.
2. Touch **System > Languages & input > KEYBOARDS > Physical keyboard**.
3. In the **KEYBOARD ASSISTANCE** area, enable **Show virtual keyboard**.

### Switching Between Keyboards

- To switch between keyboards, touch in a text box to display the current keyboard.
  - On the Gboard keyboard, touch and hold  (GMS devices only).
  - On the Enterprise keyboard, touch . Only available with Mobility DNA Enterprise License. Not pre-installed on the device. Contact Zebra Support for more information.

## Using the Android and Gboard Keyboards

Use the Android or Gboard keyboards to enter text in a text field.

To configure the keyboard settings, touch and hold , (comma) and then select **Android keyboard settings**.

## Edit Text

Edit entered text and use menu commands to cut, copy, and paste text within or across apps. Some apps do not support editing some or all of the text they display; others may offer their own way to select text.

## Entering Numbers, Symbols, and Special Characters

1. Enter numbers and symbols.
  - Touch and hold one of the top-row keys until a menu appears then select a number or special character.
  - Touch the Shift key once for a single capital letter. Touch the Shift key twice to lock in uppercase. Touch the Shift key a third time to unlock Capslock.
  - Touch **?123** to switch to the numbers and symbols keyboard.
  - Touch the **=\<** key on the numbers and symbols keyboard to view additional symbols.
2. Enter special characters.
  - Touch and hold a number or symbol key to open a menu of additional symbols. A larger version of the key displays briefly over the keyboard.

## Using the Enterprise Keyboard

The Enterprise Keyboard contains multiple keyboard types.

- Numeric
- Alpha
- Special characters
- Data capture.

### Numeric Tab

The numeric keyboard is labeled **123**. The keys displayed vary on the app being used. For example, an arrow displays in **Contacts**, however **Done** displays in **Email** account setup.

### Alpha Tab

The alpha keyboard is labeled using the language code. For English, the alpha keyboard is labeled **EN**.

### Additional Character Tab

The additional characters keyboard is labeled **#\*/**.

Touch  to enter emoji icons in a text message.

Touch **ABC** to return to the Symbols keyboard.

### Scan Tab

The Scan tab provides an easy data capture feature for scanning barcodes.

## Language Usage

Use the **Language & input** settings to change the device's language, including words added to the dictionary.

## Changing the Language Setting

1. Go to **Settings**.
2. Touch **System > Languages & input**.
3. Touch **Languages**. A list of available languages displays.
4. If the desired language is not listed, touch **Add a language** and select a language from the list.
5. Touch and hold  to the right of the desired language, then drag it to the top of the list.
6. The operating system text changes to the selected language.

## Adding Words to the Dictionary

1. Go to **Settings**.
2. Touch **System > Languages & input > Advanced > Personal dictionary**.
3. If prompted, select the language where this word or phrase is stored.
4. Touch **+** to add a new word or phrase to the dictionary.
5. Enter the word or phrase.
6. In the **Shortcut** text box, enter a shortcut for the word or phrase.
7. Touch the Home button.

## Notifications

### Setting App Notifications

To set notification settings for a specific app:

1. Go to **Settings**.
2. Touch **Apps & notifications > SEE ALL XX APPS**. The **App info** screen displays.
3. Select an app.
4. Touch **Notifications**.

Options vary depending on the app selected.

5. Select an available option:

**Show notifications** - Select to turn all notifications from this app on (default) or off.

Touch a notification category to display additional options.

- **Alerting** - Allow notifications from this app to make sound or vibrate the device.
  - **Pop on screen** - Allow notifications from this app to pop notifications on the screen.
- **Silent** - Do not allow notifications from this app to make sound or vibrate.
  - **Minimize** - In the Notification panel, collapse notifications to one line.
- **Advanced** - Touch for additional options.
  - **Sound** - Select a sound to play for notifications from this app.
  - **Vibrate** - Allow notifications from this app to vibrate the device.
  - **Blink light** - Allow notifications from this app the light the Notification LED blue.

- **Show notification dot** - Allow notifications from this app to add a notification dot to the app icon.
- **Override Do Not Disturb** - Allow these notifications to interrupt when Do Not Disturb is enabled.

### Advanced

- **Allow notification dot** - Do not allow this app to add a notification dot to the app icon.
- **Additional settings in the app** - Open the app settings.

## Viewing Notification Settings for All Apps

To view the notification settings for all apps:

1. Touch **Apps & Notifications**.
2. Scroll down to **Notifications** to view how many apps have notifications turned off.
3. To set or view notifications settings for a specific app, see [Setting App Notifications on page 44](#).

## Controlling Lock Screen Notifications

To control whether notifications can be seen when the device is locked:

1. Touch **Apps & notifications > Notifications**.
2. Touch **Notifications on lockscreen** and select one of the following:
  - **Show alerting and silent notifications** (default)
  - **Show alerting notifications only**
  - **Don't show notifications**.

## Blink Light

The Notification LED lights blue when an app, such as email and VoIP, generates a programmable notification or to indicate when the device is connected to a Bluetooth device. By default, LED notifications are enabled.

To change the notification setting:









1. Touch **Apps & notifications > Notifications > Advanced**.
2. Touch **Blink light** to toggle the notification on or off.

# Applications

The **APPS** screen displays icons for all installed apps. See [Application Deployment](#) for information on installing and uninstalling apps. For information on standard Android apps, go to the Google Play [Apps store](#).

The following table describes the apps installed on the device.













**Table 1** Apps

Icon	Description
	<b>Battery Manager</b> - Displays battery information, including charge level, status, health and wear level.
	<b>Bluetooth Pairing Utility</b> – Use to pair a Zebra Bluetooth scanner with the device by scanning a barcode.
	<b>Calculator</b> - Provides the basic and scientific arithmetic functions.
	<b>Calendar</b> - Use to manage events and appointments.
	<b>Camera</b> - Take photos or record videos. For more information, see <a href="#">Camera on page 53</a> .
	<b>Chrome</b> - Use to access the Internet or intranet.
	<b>Clock</b> - Use to schedule alarms for appointments or as a wake-up.
	<b>Contacts</b> - Use to manage contact information.
	<b>DataWedge</b> - Enables data capture using the imager. For more information, see <a href="#">DataWedge Demonstration on page 58</a> .

**Table 1** Apps (Continued)



Icon	Description
	<b>Diagnostic Tool</b> - Use to diagnose the device. For more information, see <a href="#">Diagnostic Tool on page 87</a> .
	<b>Drive</b> - Upload photos, videos, documents, and other files to personal storage site.
	<b>Duo</b> - A one-to-one video calling app (WWAN only).
	<b>DWDemo</b> - Provides a way to demonstrate the data capture features using the imager. For more information, see <a href="#">DataWedge Demonstration on page 58</a> .
	<b>Email</b> - Use to send and receive email.
	<b>Files</b> - Organize and manage files on the device.
	<b>Gmail</b> - Use to send and receive email using a Google email account.
	<b>Google</b> - Launches Google™ search app.
	<b>Hangouts</b> - Use to communicate with friends using text messages and photos.
	<b>Heater Control</b> - Use to check the status on the heater and sensors when using the device in cold environments. See <a href="#">Heater Control on page 51</a> .
	<b>Keep</b> - Use to create, edit, and share notes.
	<b>License Manager</b> - Use to manage software licenses on the device.
	<b>Maps</b> - Use to see your location on a map (with public transit, traffic, or satellite overlays). Search for any business or place of interest. Provides turn-by-turn navigation with voice guidance, traffic-avoidance, and alternate routes, for drivers, cyclists, walkers, and users of public transportation.
	<b>Photos</b> - Use to sync photos with Google account.

**Table 1** Apps (Continued)

Icon	Description
	<b>Play Movies &amp; TV</b> - View movies and video on your device.
	<b>Play Music</b> - Use to listen to music.
	<b>Play Store</b> - Download music, movies, books, and Android apps and games from the Google Play Store.
	<b>PTT Express</b> - Use to launch PTT Express client for VoIP communication.
	<b>RxLogger</b> - Use to diagnose device and app issues. For more information, see <a href="#">RxLogger on page 64</a> .
	<b>RxLogger Utility</b> - Use to view, backup, and archive RxLogger data.
	<b>Settings</b> - Use to configure the device.
	<b>Sound Recorder</b> - Use to record audio. For more information, see <a href="#">Sound Recorder on page 65</a> .
	<b>StageNow</b> - Allows the device to stage a device for initial use by initiating the deployment of settings, firmware, and software.
	<b>Velocity</b> - Opens the Ivanti (formerly Wavelink) terminal emulation app.
	<b>VoD</b> - The Video on Device basic app provides a how-to video for proper device cleaning. For Video on Device licensing information, go to <a href="http://learning.zebra.com">learning.zebra.com</a> .
	<b>Voice Search</b> - Use to perform searches by asking questions.



**Table 1** Apps (Continued)

Icon	Description
	<b>Worry Free Wifi Analyzer</b> - A diagnostic intelligent app. Use to diagnose surrounding area and display network stats, such as coverage hole detection, or AP in vicinity. Refer to the Worry Free Wi-Fi Analyzer Administrator Guide for Android.
	<b>YouTube</b> - Use to view videos on the YouTube™ web site.
	<b>Zebra Bluetooth Settings</b> - Use to configure Bluetooth logging.

## Accessing Apps

All apps installed on the device are accessed using the **APPS** window.

1. On the Home screen, swipe up from the bottom of the screen.
2. Slide the **APPS** window up or down to view more app icons.
3. Touch an icon to open the app.

## Switching Between Recent Apps

Use the Recent button to switch between recently used apps.

1. Touch Recent button.
  - A window appears on the screen with icons of recently used apps.
2. Slide the apps displayed up and down to view all recently used apps.
3. Swipe left or right to remove app from the list and force close the app.
4. Touch an icon to open an app or touch Back button to return to the current screen.

## Battery Manager

The **Battery Manager** provides detailed information about the battery and battery swap procedures on supported devices.



### Opening Battery Manager

To open the Battery Manager app, swipe up from the bottom of the Home screen, and then touch .

### Battery Manager Information Tab

The Battery Manager displays detailed information about battery charging, health, and status.

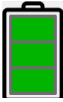
**Table 2** Battery Icon Description

Battery Icon	Description
	Battery charge level is between 85% and 100%.
	Battery charge level is between 19% and 84%.
	Battery charge level is between 0% and 18%.

- **Level** - The current battery charge level as a percentage. Displays -% when level is unknown.
- **Wear** - The health of the battery in graphical form. When the wear level exceeds 80%, the bar color changes to red.
- **Health** - The health of the battery. If a critical error occurs,  appears. Touch to view the error description.
  - **Decommission** - The battery is past its useful life and should be replaced. See system administrator.
  - **Good** - The battery is good.
  - **Charge error** - An error occurred while charging. See system administrator.
  - **Over Current** - An over-current condition occurred. See system administrator.
  - **Dead** - The battery has no charge. Replace the battery.
  - **Over Voltage** - An over-voltage condition occurred. See system administrator.
  - **Below Temperature** - The battery temperature is below the operating temperature. See system administrator.
  - **Failure Detected** - A failure has been detected in the battery. See system administrator.
  - **Unknown** - See system administrator.
- **Charge Status**
  - **Not charging** - The device is not charging.
  - **Charging-AC** - The device is connected to AC power and charging.
  - **Charging-USB** - The device is connected to a host computer with a USB cable and charging.
  - **Discharging** - The battery is discharging.
  - **Full** - That the battery is fully charged.
  - **Unknown** - The battery status is unknown.
- **Time until Full** - The amount of time until the battery is fully charged.
- **Time since charging** - The amount of time since the device began charging.
- **Time until empty** - The amount of time until the battery is empty.
- **Advanced info** - Touch to view additional battery information.
  - **Battery present status - Indicates that the battery is present.**

- **Battery level** - The battery charge level as a percentage of scale.
- **Battery scale** - The battery scale level used to determine battery level (100).
- **Battery voltage** - The current battery voltage in millivolts.
- **Battery temperature** - The current battery temperature in degrees Centigrade.
- **Battery technology** - The type of battery.
- **Battery current** - The average current into or out of the battery over the last second in mAh.
- **Battery manufacture date** - The date of manufacture.
- **Battery serial number** - The battery serial number. The number matches the serial number printed on the battery label.
- **Battery part number** - The battery part number.
- **Battery rated capacity** - Lists the rated capacity of the backup battery in mAh.
- **Battery decommission status** - Indicates if the battery is past its life span.
  - **Battery Good** - The battery is in good health.
  - **Decommissioned Battery** - The battery is past its useful life and should be replaced.
- **Base cumulative charge** - Cumulative charge using Zebra charging equipment only.
- **Battery present capacity** - Maximum amount of charge that could be pulled from the battery under the present discharge conditions if the battery were fully charged.
- **Battery health percentage** - With a range from **0** to **100**, this is the ratio of “present\_capacity” to “design\_capacity” at a discharge rate of “design\_capacity”.
- **% decommission threshold** - The default % decommission threshold for a gifted battery as 80%.
- **Battery present charge** - Amount of usable charge remaining in the battery at present under the current discharge conditions.
- **Battery total cumulative charge** - The total accumulated charge in all chargers.
- **Battery time since first use** - The time passed since the battery was placed in a Zebra terminal for the first time.
- **Battery error status** - The error status of the battery.
- **Battery usage number** - The health of the battery as a result of charging and discharging. A high number indicates low battery health.
- **Usage decommission threshold** - When the Battery usage number is greater than or equal to the Usage decommission threshold, the battery is past its useful life and should be replaced.
- **App version** - The application version number.

## Heater Control

The Heater Control application provides information about the sensors and heater applicable to the freezer device. To open the Heater Control, swipe up from the bottom of the Home screen and touch .



**IMPORTANT:** Heater Control app is only applicable to freezer configurations.

The scanner exit window heater ensures optimum scanner performance in freezer applications.

## Status

The Status tab displays the following details:

- **Temperature**
  - Display
  - MLB
  - Scanner
  - Vent
  - Scanner Window
  - Scanner Bay.
- **Humidity**
  - Scanner
  - Vent
- **Heater**
  - Scanner Window (default - enabled). This option should always be enabled for the heater to function properly. Disable this option only if you are performing debugging activities on the heater system.

## Advanced

The Advanced tab displays the following details:

- In the **Heater** area, tap to disable **Scanner Window Heater**. (default - enabled).
- In the **Advanced** area, tap to enable **Logging**. Logging allows you to log data for the heating system (heaters and sensors). The data resides in the `/sdcard/HeaterLogs` location in a .csv file on the device.
- Click **TEST HEATER** to perform a diagnostic test on the heating system.



**NOTE:** Heater tests must be performed in an ambient environment with temperature of less than +30° C. Once the tests are complete the results screen displays.

## Camera



**NOTE:** The device saves photos and videos on the microSD card, if installed and the storage path is changed manually. By default, or if a microSD card is not installed, the device saves photos and videos on the internal storage.

On SDM660 platform-based products, you can use the imager and camera simultaneously. By default, third-party camera applications are associated with the Datawedge Profile0 where scanning is enabled. In these applications the Scan button initiates the scan session. If you do not want scanning to be enabled in the application, you must associate a new Datawedge profile with the application and disable scanning.



**NOTE:** The native Google camera application is associated with a hidden DataWedge profile. The scanning functionality is temporarily disabled when the Google camera application is being used. If a third-party camera application is utilized the scanning functionality will not be disabled allowing the simultaneous use of the scanner and the camera. This will have a direct impact on the image quality. It is strongly recommended that you use the native Google camera application.

This section provides information for taking photos and recording videos using the integrated digital cameras.



## Taking Photos



**NOTE:** See [Photo Settings](#) for camera setting descriptions.

1. Swipe up from the bottom of the Home screen and touch **Camera**.





2. If necessary, touch the Camera Mode icon and touch .
  3. To switch between the rear camera and front camera (if available), touch .
  4. Frame the subject on the screen.
  5. To zoom in or out, press two fingers on the display and pinch or expand fingers. The zoom controls appear on the screen.
  6. Touch an area on the screen to focus. The focus circle appears. The two bars turn green when in focus.
  7. Touch .
- The camera takes a photo and a shutter sound plays.  
The photo momentarily displays as a thumbnail in the lower left corner.

## Taking a Panoramic Photo

Panorama mode creates a single wide image by panning slowly across a scene.

1. Swipe up from the bottom of the Home screen and touch **Camera**.





2. Touch the Camera Mode icon and touch .
3. Frame one side of the scene to capture.
4. Touch  and slowly pan across the area to capture. A small white square appears inside the button indicating the capture is in progress.  
If you are panning too quickly, the message **Too fast** appears.
5. Touch  to end the shot. The panorama appears immediately and a progress indicator displays while it saves the image.

## Recording Videos

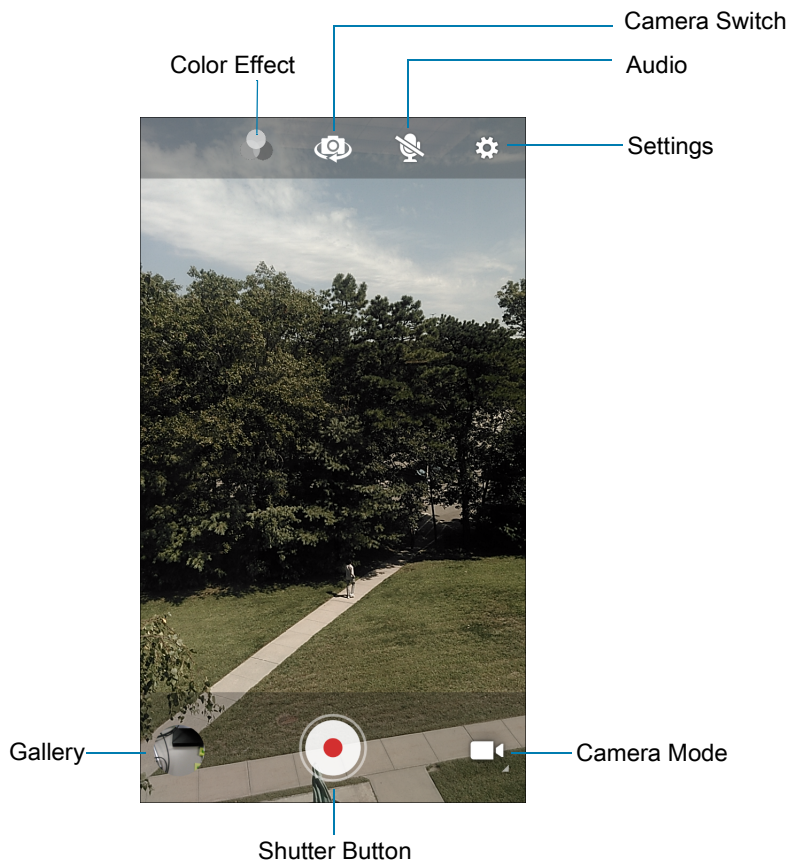
1. Swipe up from the bottom of the Home screen and touch **Camera**.
2. Touch the camera mode menu and touch .





3. To switch between the rear camera and front camera (if available), touch .
4. Point the camera and frame the scene.
5. To zoom in or out, press two fingers on the display and pinch or expand fingers. The zoom controls appear on the screen.
6. Touch  to start recording.  
The video time remaining appears in the top left of the screen.
7. Touch  to end the recording.  
The video momentarily displays as a thumbnail in the lower left corner.





## Photo Settings

In Photo mode, photo settings appear on screen. Touch  to display the photo settings options.

### Rear Camera Photo Settings

- **Flash** - Select whether the camera relies on its light meter to decide whether a flash is necessary, or to turn it on or off for all shots.
  -  **Off** - Disable flash.
  -  **Auto** - Adjust flash automatically depending upon light meter (default).
  -  **On** - Enable flash upon taking a photo.



- **Picture size** - The size (in pixels) of the photo to: **13M pixels** (default), **8M pixels**, **5M pixels**, **3M pixels**, **HD 1080**, **2M pixels**, **HD720**, **1M pixels**, **WVGA**, **VGA**, or **QVGA**.
- **Picture quality** - Set the picture quality setting to: **Low**, **Standard** (default) or **High**.
- **Countdown timer** - Select **Off** (default), **2 seconds**, **5 seconds** or **10 seconds**.
- **Storage** – Set the location to store the photo to: **Phone** or **SD Card**.
- **ISO** - Set camera sensitivity to light to: **Auto** (default), **ISO Auto (HJR)**, **ISO100**, **ISO200**, **ISO400**, **ISO800** or **ISO1600**.
- **Exposure** - Set the exposure settings to: **+2**, **+1**, **0**(default), **-1** or **-2**.
- **White balance** - Select how the camera adjusts colors in different kinds of light, to achieve the most natural-looking colors:
  -  **Incandescent** - Adjust the white balance for incandescent lighting.
  -  **Fluorescent** - Adjust the white balance for florescent lighting.
  -  **Auto** - Adjust the white balance automatically (default).
  -  **Daylight** - Adjust the white balance for daylight.
  -  **Cloudy** - Adjust the white balance for a cloudy environment.
- **Chroma Flash** - Sets the camera to take two pictures, one with flash and one without flash. The two images are combined to produce a final image with the sharpness and clarity and bright color tones from a picture with the flash, coupled with the natural colors of a picture without a flash. Options: **Off** (default) or **On**.
- **Redeye reduction** - Helps eliminate redeye effect. Options: **Disabled** (default), or **Enable**.
- **ZSL** - Set the camera to immediately take a picture when the button is pressed (default – enabled).
- **Anti Banding** - Allows the camera to avoid problems caused by artificial light sources that are not constant. These sources cycle (flicker) fast enough to go unnoticed to the human eye, appearing continuous. The camera's eye (its sensor) can still see this flicker. Options: **Auto** (default), **60 Hz**, **50 Hz**, or **Off**.

### Front Camera Photo Settings







- **Picture size** - Set the size (in pixels) of the photo to: **M pixels** (default), **HD720**, **1M pixels**, **WVGA**, **VGA**, or **QVGA**.
- **Picture quality** - Set the picture quality setting to: **Low**, **Standard** (default) or **High**.
- **Countdown timer** - Set to: **Off** (default), **2 seconds**, **5 seconds** or **10 seconds**.
- **Storage** – Set location to store the photo to: **Phone**.
- **Face Detection** - Select to turn face detection **Off** (default) or **On**.

### Video Settings





In Video mode, video settings appear on screen. Touch  to display the video settings options.

### Rear Camera Video Settings

- **Flash** - Select whether Rear-facing Camera relies on its light meter to decide whether a flash is necessary, or to turn it on or off for all shots.

-  **Off** - Disable flash (default).
-  **Torch** - Turn flash on continuously.
- **Video quality** - Set video quality to: **HD 1080p** (default), **HD 720p**, **SD 480p**, .
- **Video duration** - Set to: **30 seconds (MMS)**, or **30 minutes (default)**.
- **Storage** – Set the location to store the photo to: **Phone** (default) or **SD Card**.
- **White balance** - Select how the camera adjusts colors in different kinds of light, to achieve the most natural-looking colors.
  -  **Incandescent** - Adjust the white balance for incandescent lighting.
  -  **Fluorescent** - Adjust the white balance for florescent lighting.
  -  **Auto** - Adjust the white balance automatically (default).
  -  **Daylight** - Adjust the white balance for daylight.
  -  **Cloudy** - Adjust the white balance for a cloudy environment.
- **Image Stabilization** - Set to reduce blurry videos due to device movement. Options: **On** or **Off** (default).

### Front Camera Video Settings

- **Video quality** - Set video quality to: **HD1080** (default), **HD 720p** (default), **HD720**, or **SD 480p**, **VGA**, **CIF**, or **QVGA**.
- **Video duration** - Set to: **30 seconds (MMS)**, or **30 minutes** (default).
- **Storage** – Set the location to store the photo to: **Phone** (default) or **SD Card**.
- **White balance** - Select how the camera adjusts colors in different kinds of light, to achieve the most natural-looking colors.
  -  **Incandescent** - Adjust the white balance for incandescent lighting.
  -  **Fluorescent** - Adjust the white balance for florescent lighting.
  -  **Auto** - Adjust the white balance automatically (default).
  -  **Daylight** - Adjust the white balance for daylight.
  -  **Cloudy** - Adjust the white balance for a cloudy environment.
- **Image Stabilization** - Set to reduce blurry videos due to device movement. Options: **On** or **Off** (default).









## DataWedge Demonstration

Use **DataWedge Demonstration** to demonstrate data capture functionality. To configure DataWedge, refer to [techdocs.zebra.com/datawedge/](http://techdocs.zebra.com/datawedge/).



**NOTE:** DataWedge is enabled on the Home screen. To disable this feature, go to the DataWedge settings and disable the **Launcher** profile.

**Table 3** DataWedge Demonstration Icons

	Icon	Description
Illumination		Imager illumination is on. Touch to turn illumination off.
		Imager illumination is off. Touch to turn illumination on.
Data Capture		The data capture function is through the internal imager.
		A Bluetooth scanner is connected.
		A Bluetooth scanner is not connected.
		The data capture function is through the rear camera.
Scan Mode		Imager is in picklist mode. Touch to change to normal scan mode.
		Imager is in normal scan mode. Touch to change to picklist mode.
Menu		Opens a menu to view the application information or to set the application DataWedge profile.

## Scanner Selection

To select a scanner, touch  > **Settings** > **Scanner selection**.

See the Data Capture section for more information.

Press the programmable button or touch the yellow scan button to capture data. The data appears in the text field below the yellow button.

## PTT Express Voice Client



**NOTE:** Requires a PTT Express License. Not available in all countries.

PTT Express Voice Client enables Push-To-Talk (PTT) communication between disparate enterprise devices. Leveraging existing Wireless Local Area Network (WLAN) infrastructure, PTT Express delivers simple PTT communication without requiring a voice communication server.

- **Group Call:** Press and hold the PTT (Talk) button to start communicating with other voice client users.
- **Private Response:** Double-press the PTT button to respond to the originator of the last broadcast or to make a Private Response.

## PTT Express User Interface

**Figure 1** PTT Express Default User Interface

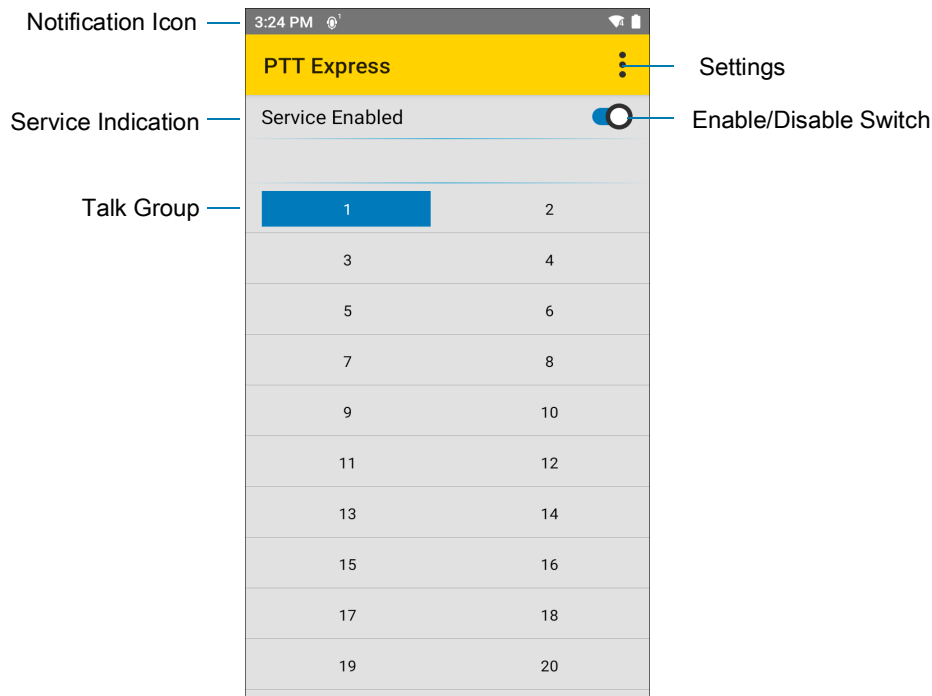

**Table 4** PTT Express Default User Interface Descriptions

Item	Description
Notification Icon	Indicates the current state of the PTT Express client.
Service Indication	Indicates the status of the PTT Express client. Options: <b>Service Enabled</b> , <b>Service Disabled</b> or <b>Service Unavailable</b> .
Talk Groups	Lists all 32 Talk Groups available for PTT communication.
Settings	Opens the PTT Express Settings screen.
Enable/Disable Switch	Turns the PTT service on and off.

## PTT Audible Indicators







The following tones provide helpful cues when using the voice client.

- **Talk Tone:** Double chirp. Plays when the Talk button is depressed. This is a prompt for you to start talking.
- **Access Tone:** Single beep. Plays when another user just finished a broadcast or response. You can now initiate a Group Broadcast or Private Response.
- **Busy Tone:** Continuous tone. Plays when the Talk button is depressed and another user is already communicating on the same talkgroup. Plays after the maximum allowed talk time is reached (60 seconds).
- **Network Tone:**
  - Three increasing pitch beeps. Plays when PTT Express acquires the WLAN connection and the service is enabled.
  - Three decreasing pitch beeps. Plays when PTT Express loses the WLAN connection or the service is disabled.

## PTT Notification Icons

Notification icons indicate the current state of the PTT Express Voice client.

**Table 5** PTT Express Icon Descriptions

Status Icon	Description
	The PTT Express Voice client is disabled.
	The PTT Express Voice client is enabled but not connected to a WLAN.
	The PTT Express Voice client is enabled, connected to a WLAN, and listening on the Talk Group indicated by the number next to the icon.
	The PTT Express Voice client is enabled, connected to a WLAN, and communicating on the Talk Group indicated by the number next to the icon.
	The PTT Express Voice client is enabled, connected to a WLAN, and in a private response.
	The PTT Express Voice client is enabled and muted.
	The PTT Express Voice client is enabled but it is not able to communicate due to a VoIP telephony call in progress.

## Enabling PTT Communication

1. Swipe up from the bottom of the Home screen and touch .
2. Slide the **Enable/Disable Switch** to the **ON** position. The button changes to **ON**.

## Selecting a Talk Group

One of 32 Talk Groups can be selected by PTT Express users. However, only one talk group may be enabled at a time on the device. Touch one of the 32 Talk Groups. The selected Talk Group is highlighted.

## PTT Communication



**NOTE:** This section describes the default PTT Express client configuration. Refer to the PTT Express V1.2 User Guide for detailed information on using the client.

**Figure 2** PTT Button

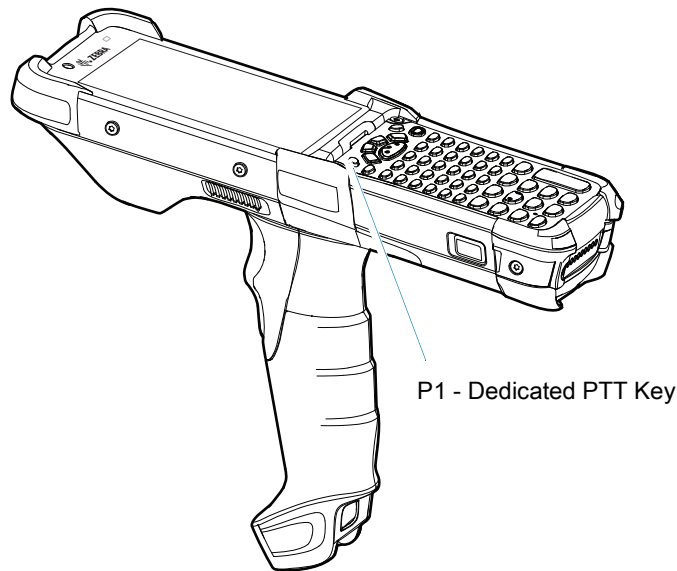

## Creating a Group Call

1. Press and hold the PTT button (or the Talk button on the headset) and listen for the talk tone.  
If you hear a busy tone, release the button and wait a moment before making another attempt. Ensure that PTT Express and the WLAN are enabled.
2. Start talking after hearing the talk tone.



**NOTE:** Holding the button for more than 60 seconds (default) drops the call, allowing others to make Group calls. Release the button when finished talking to allow others to make calls.

## Responding with a Private Response

The Private Response can only be initiated once a Group Call has been established. The initial Private Response is made to the originator of the Group Call.

1. Wait for an access tone.
2. Within 10 seconds, double-press the PTT button, and listen for the talk tone.
3. If you hear a busy tone, release the button and wait a moment before making another attempt. Ensure that PTT Express and the WLAN are enabled.
4. Start talking after the talk tone plays.
5. Release the button when finished talking.

### Disabling PTT Communication

1. Swipe up from the bottom of the Home screen and touch .
2. Slide the **Enable/Disable Switch** to the **OFF** position. The button changes to **OFF**.
3. Touch the Home button.

## RxLogger

RxLogger is a comprehensive diagnostic tool that provides application and system metrics, and diagnoses device and application issues. RxLogger logs the following information: CPU load, memory load, memory snapshots, battery consumption, power states, wireless logging, cellular logging, TCP dumps, Bluetooth logging, GPS logging, logcat, FTP push/pull, ANR dumps, etc. All generated logs and files are saved onto flash storage on the device (internal or external).

### RxLogger Configuration

RxLogger is built with an extensible plug-in architecture and comes packaged with a number of plug-ins already built-in. For information on configuring RxLogger, refer to [techdocs.zebra.com/rxlogger/](http://techdocs.zebra.com/rxlogger/).

To open the configuration screen, from the RxLogger home screen touch **Settings**.

### Configuration File

RxLogger configuration can be set using an XML file. The `config.xml` configuration file is located in the `RxLogger\config` folder. Copy the file from the device to a host computer using a USB connection. Edit the configuration file and then replace the XML file on the device. There is no need to stop and restart the RxLogger service since the file change is automatically detected.

### Enabling Logging

To enable logging:

1. Swipe the screen up and select .
2. Touch **Start**.
3. Touch the Home button.

### Disabling Logging

To disable logging:

1. Swipe the screen up and select .
2. Touch **Stop**.
3. Touch the Home button.

### Extracting Log Files

1. Connect the device to a host computer using an USB connection.
2. Using a file explorer, navigate to the `RxLogger` folder.
3. Copy the file from the device to the host computer.
4. Disconnect the device from the host computer.

### Backing Up

RxLogger Utility allows the user to make a zip file of the `RxLogger` folder in the device, which by default contains all the RxLogger logs stored in the device.



To save the backup data, touch  > **BackupNow**.

### RxLogger Utility

RxLogger Utility is a data monitoring application for viewing logs in the device while RxLogger is running. Logs and RxLogger Utility features are accessed using Main Chat Head.

#### Initiating the Main Chat Head

To initiate the Main Chat Head:

1. Open **RxLogger**.
2. Touch  > **Toggle Chat Head**. The Main Chat Head icon appears on the screen.
3. Touch and drag the Main Chat head icon to move it around the screen.

#### Removing the Main Chat Head

To remove the Main Chat Head icon:

1. Touch and drag the icon. A circle with an X appears.
2. Move the icon over the circle and then release.

#### Viewing Logs

To view logs:

1. Touch the Main Chat Head icon. The RxLogger Utility screen appears.
2. Touch a log to open it. The user can open many logs with each displaying a new sub Chat Head.
3. If necessary, scroll left or right to view additional Sub Chat Head icons.
4. Touch a Sub Chat Head to display the log contents.

#### Removing a Sub Chat Head Icon

To remove a sub chat Head icon, press and hold the icon until it disappears.

#### Backing Up In Overlay View

RxLogger Utility allows the user to make a zip file of the **RxLogger** folder in the device, which by default contains all the RxLogger logs stored in the device.

The Backup icon is always available in Overlay View.

1. Touch . The Backup dialog box appears.
2. Touch **Yes** to create the back up.

### Sound Recorder

Use **Sound Recorder** to record audio messages.

Recordings are saved on the microSD card (if installed) or the internal storage, and are available in the Play Music application (GMS devices).

# Data Capture

## Introduction

This chapter provides information for capturing barcode data using the internal camera and optional scan modules and Bluetooth scanner.

The device offers the following data capture options:

- Imager (SE4750-SR 2D, SE4850-ER 2D, SE4770 2D, SE4750DPM, and SE4750DPW).
- Laser Scanner (SE965 1D).
- Bluetooth (RS507/RS507X Hands-free imager, RS6000 Bluetooth Ring Scanner, and DS3678 Digital Barcode Scanner).



**NOTE:** DataWedge is installed and enabled on the device by default.

By default, the good decode beep is set to system volume (Notifications). The good decode beep can be set to another sound (Music and Media), and the volume can be independently controlled.

## Integrated Imager

The device with an integrated 2D imager has the following features:

- Omnidirectional reading of a variety of barcode symbologies, including the most popular linear, postal, PDF417, Digimarc, and 2D matrix code types.
- Advanced intuitive laser aiming cross-hair and dot aiming for easy point-and-shoot operation.

The imager uses imaging technology to take a picture of a barcode, and executes state-of-the-art software decoding algorithms to extract the barcode data from the image.

## Operational Modes

The device with an integrated imager supports two modes of operation, listed below. Activate each mode by pressing the Scan button.

- Decode mode - The device attempts to locate and decode enabled barcodes within its field of view. The imager remains in this mode as long as you hold the scan button, or until it decodes a barcode.



**NOTE:** To enable Pick List Mode, configure in DataWedge or set in an application using a API command.

- Pick List mode - Selectively decode a barcode when more than one barcode is in the device's field of view by moving the aiming crosshair or dot over the required barcode. Use this feature for pick lists containing multiple barcodes and manufacturing or transport labels containing more than one barcode type (either 1D or 2D).

## Laser Scanner

The device with a laser scanner has the following features:

- Reading of a variety of barcode symbologies, including the most popular linear, and 1D code types.
- Intuitive laser aiming for easy point-and-shoot operation.

## RS507/RS507X Hands-Free Imager

The RS507/RS507X Hands-free Imager is a wearable barcode scan solution for both 1D and 2D barcode symbologies.

**Figure 3** RS507/RS507X Hands-Free Imager

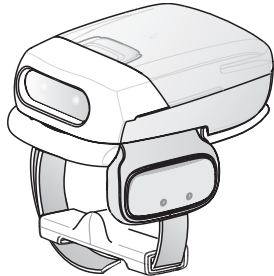

Refer to the RS507/RS507X Hands-free Imager Product Reference Guide for more information.

## RS5100 Ring Scanner

The RS5100 Ring Scanner is a wearable barcode scan solution for both 1D and 2D bar code symbologies.

**Figure 4** RS5100 Ring Scanner

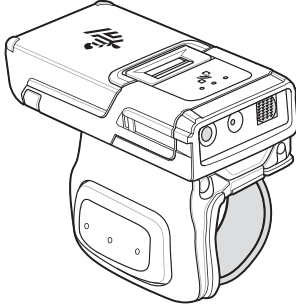

Refer to the RS5100 Ring Scanner Product Reference Guide for more information.

## RS6000 Bluetooth Ring Scanner

The RS6000 Bluetooth Ring Scanner is a wearable barcode scan solution for both 1D and 2D barcode symbologies.

**Figure 5** RS6000 Bluetooth Ring Scanner

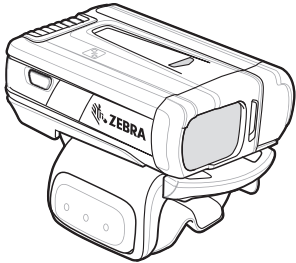

Refer to the RS6000 Bluetooth Ring Scanner Product Reference Guide for more information.

## DS3678 Digital Scanner

The cordless DS3678 combines superior 1D and 2D omnidirectional barcode scanning performance and advanced ergonomics in a lightweight design. See the DS36X8 Product Reference Guide for more information.

Figure 6 DS3678 Digital Scanner

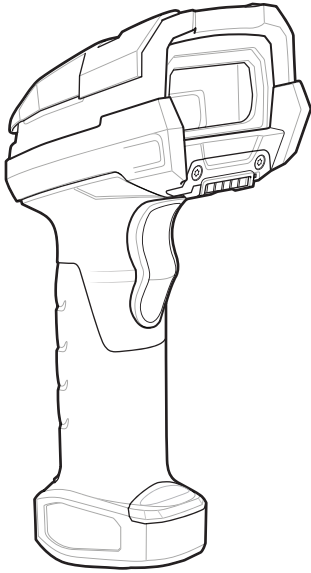

## Scanning Considerations

Typically, scanning is a simple matter of aim, scan, and decode, with a few quick trial efforts to master it. However, consider the following to optimize scanning performance:

- **Range:** Scanners decode best over a particular working range — minimum and maximum distances from the barcode. This range varies according to barcode density and scanning device optics. Scan within range for quick and constant decodes; scanning too close or too far away prevents decodes. Move the scanner closer and further away to find the right working range for the barcodes being scanned.
- **Angle:** Scanning angle is important for quick decodes. When the illumination/flash reflects directly back into the imager, the specular reflection can blind/saturate the imager. To avoid this, scan the barcode so that the beam does not bounce directly back. Do not scan at too sharp an angle; the scanner needs to collect scattered reflections from the scan to make a successful decode. Practice quickly shows what tolerances to work within.
- Hold the device farther away for larger symbols.
- Move the device closer for symbols with bars that are close together.



**NOTE:** Scanning procedures depend on the app and device configuration. An app may use different scanning procedures from the one listed above.

## Barcode Capture with Imager

To capture barcode data:

1. Ensure that an application is open on the device and a text field is in focus (text cursor in text field).
2. Point the top of the device at a barcode.

**Figure 7** Barcode Scanning – MC93XX

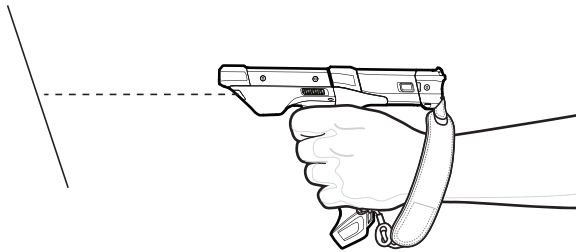

3. Press and hold the Scan button or Trigger.

The red laser aiming pattern turns on to assist in aiming.

4. Ensure the barcode is within the area formed by the cross-hairs in the aiming pattern. The aiming dot is used for increased visibility in bright lighting conditions.

The Scan LEDs light green and a beep sounds, by default, to indicate the barcode was decoded successfully. Note that when the device is in Pick List Mode, the device does not decode the barcode until the center of the crosshair touches the barcode.

**Figure 8** Aiming Pattern: Standard and Extended Range

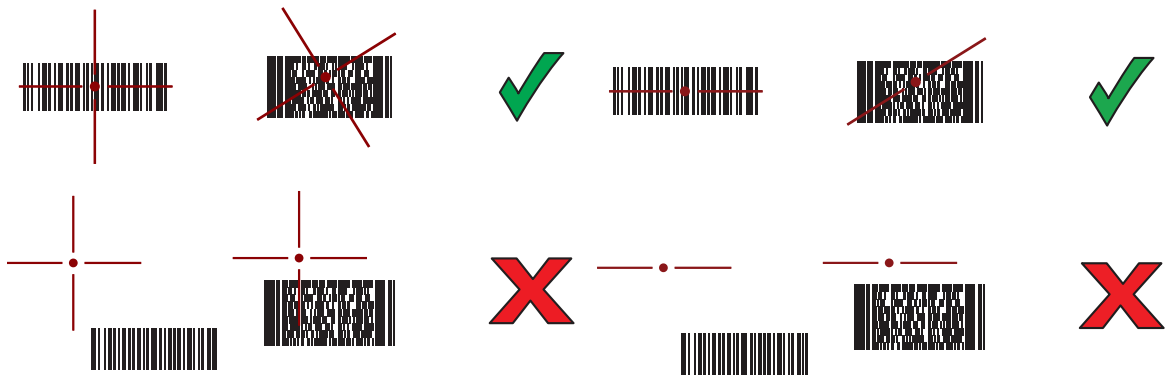

**Figure 9** Pick List Mode with Multiple Barcodes in Aiming Pattern: Standard and Extended Range



5. Release the scan button or Trigger.
6. The barcode content data appears in the text field.

## Barcode Capture with Laser Scanner

To capture barcode data:

1. Ensure that an application is open on the device and a text field is in focus (text cursor in text field).
2. Point the top of the device at a barcode.

3. Point the scan exit window at a barcode.

**Figure 10** Barcode Scanning – MC93XX

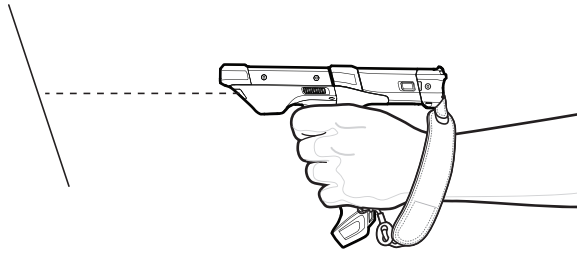

4. Press and hold the Scan button.

The red scan line turns on to assist in aiming. Ensure that the scan line crosses every bar and space of the barcode.

The Scan LEDs light green and a beep sounds, by default, to indicate the barcode was decoded successfully.

**Figure 11** Linear Scanner Aiming Pattern



5. Release the scan button.
6. The captured data appears in the text field.

## Scanning with RS507/RS507X Hands-Free Imager

To read a barcode, a scan-enabled app is required. The device contains the DataWedge app that allows you to enable the scanner to decode barcode data and display the barcode content.

To scan with the RS507/RS507X:

1. Pair the RS507/RS507X with the device. See [Pairing Bluetooth Scanners](#) or [Pairing Using Bluetooth Human Interface Device](#) for more information.
2. Ensure that an app is open on the device and a text field is in focus (text cursor in text field).
3. Point the RS507/RS507X at a barcode.

**Figure 12** Barcode Scanning with RS507/RS507X

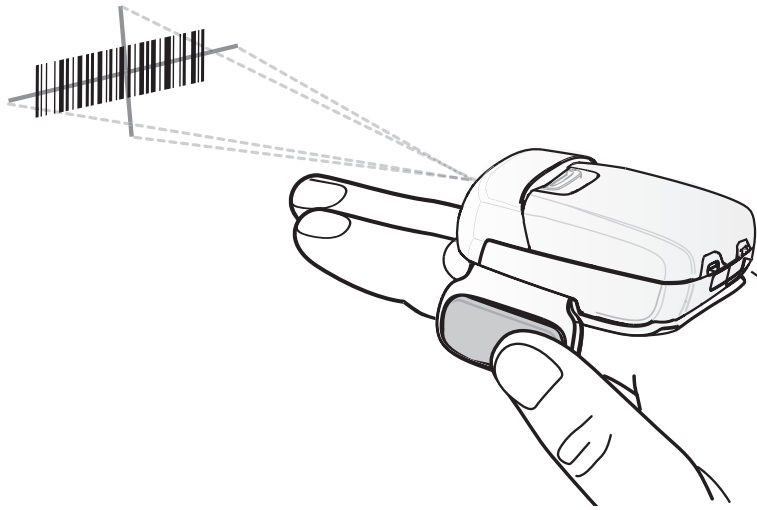

4. Press and hold the trigger.

The red laser aiming pattern turns on to assist in aiming. Ensure the barcode is within the area formed by the cross-hairs in the aiming pattern. The aiming dot increases visibility in bright lighting conditions.

The RS507/RS507X LEDs light green and a beep sounds to indicate the barcode was decoded successfully. When the RS507/RS507X is in Pick List mode, the RS507/RS507X does not decode the barcode until the center of the crosshair touches the barcode.

**Figure 13** RS507/RS507X Aiming Pattern



**Figure 14** RS507/RS507X Pick List Mode with Multiple Barcodes in Aiming Pattern



5. The captured data appears in the text field.



## Scanning with RS6000 Bluetooth Ring Scanner

To read a barcode, a scan-enabled app is required. Devices that contain the Zebra DataWedge app allows you to enable the scanner to decode barcode data and display the barcode content.

To scan with the RS6000:

1. Pair the RS6000 with the device. See Pairing Using Bluetooth Human Interface Device for more information.
2. Ensure that an app is open on the device and a text field is in focus (text cursor in text field).
3. Point the RS6000 at a barcode.

**Figure 15** Barcode Scanning with RS6000

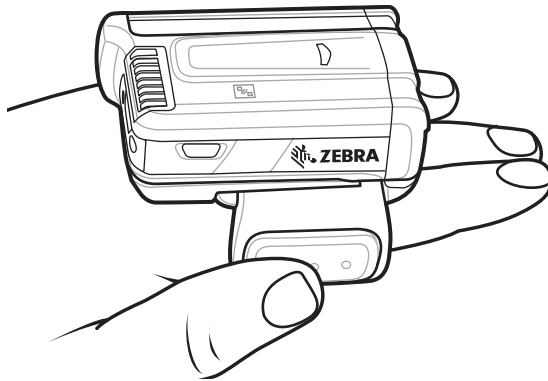

4. Press and hold the trigger.

The red laser aiming pattern turns on to assist in aiming. Ensure the barcode is within the area formed by the cross-hairs in the aiming pattern. The aiming dot increases visibility in bright lighting conditions.

The RS6000 LEDs light green and a beep sounds to indicate the barcode was decoded successfully. When the RS6000 is in Pick List mode, the RS6000 does not decode the barcode until the center of the crosshair touches the barcode.

**Figure 16** RS6000 Aiming Pattern

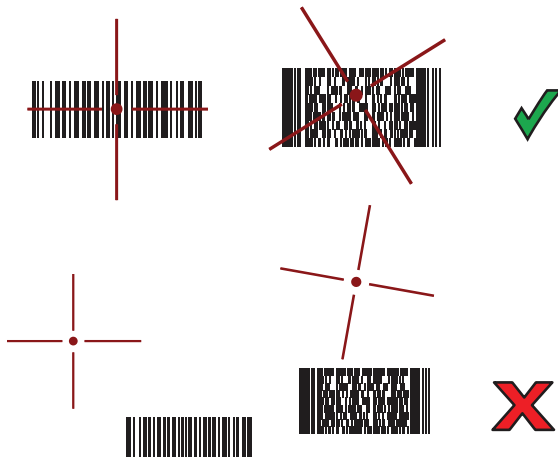

**Figure 17** RS6000 Pick List Mode with Multiple Barcodes in Aiming Pattern



5. The captured data appears in the text field.

## Scanning with the DS3608 USB Scanner or DS3678 Bluetooth Scanner

To scan with the DS3608 or DS3678:

1. Pair the scanner with the device. For more information, see [Connecting a USB Scanner for the DS3608](#) or [Pairing Bluetooth Scanners for the DS3678](#).
2. Ensure that an app is open on the device and a text field is in focus (text cursor in text field).
3. Point the scanner at a barcode.

**Figure 18** Barcode Scanning (DS3678 shown)

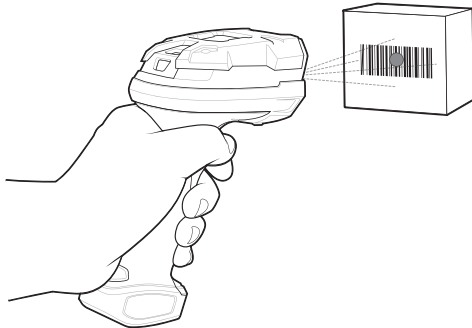

4. Press and hold the trigger.

Ensure the barcode is within the area formed by the aiming pattern. The aiming dot increases visibility in bright lighting conditions.

**Figure 19** DS3608/DS3678 Aiming Pattern

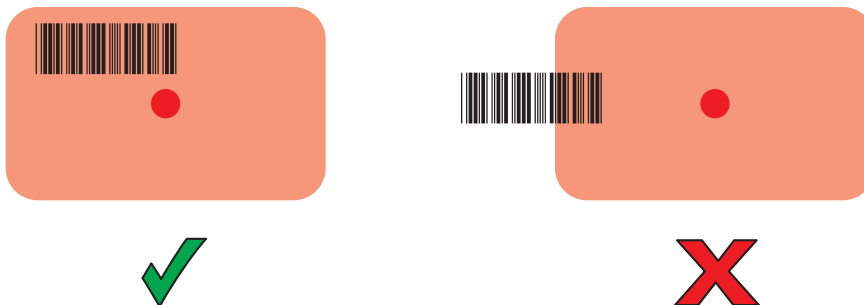

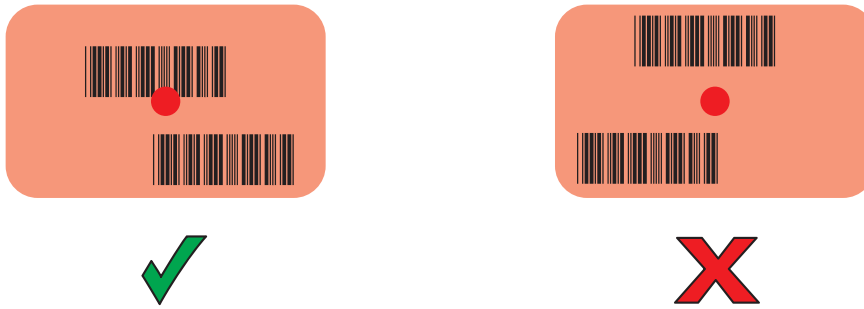
**Figure 20** DS3608/DS3678 Pick List Mode with Multiple Barcodes in Aiming Pattern

5. The captured data appears in the text field.

## Pairing the RS507/RS507X/RS6000 Hands-Free Imager

To connect the RS507/RS507X or RS6000 imager to the device, use one of the following methods:

- Near Field Communication (NFC) (RS6000 only)
- Simple Serial Interface (SSI)
- Bluetooth Human Interface Device (HID) Mode.

## Pairing Using Near Field Communication



**NOTE:** NFC is supported on the premium configurations of the device.

The MC93XX provides the ability to pair the RS6000 using NFC.

1. Ensure that NFC is enabled on the MC93XX.
2. Align the NFC icon on the RS6000 with the NFC icon on the back of the MC93XX.

The Status LED blinks blue indicating that the RS6000 is attempting to establish connection with the MC93XX. When connection is established, the Status LED turns off and the RS6000 emits a single string of low/high beeps.

A notification appears on the MC93XX screen.

The  icon appears in the Status bar.

**Figure 21** Align NFC Antennas

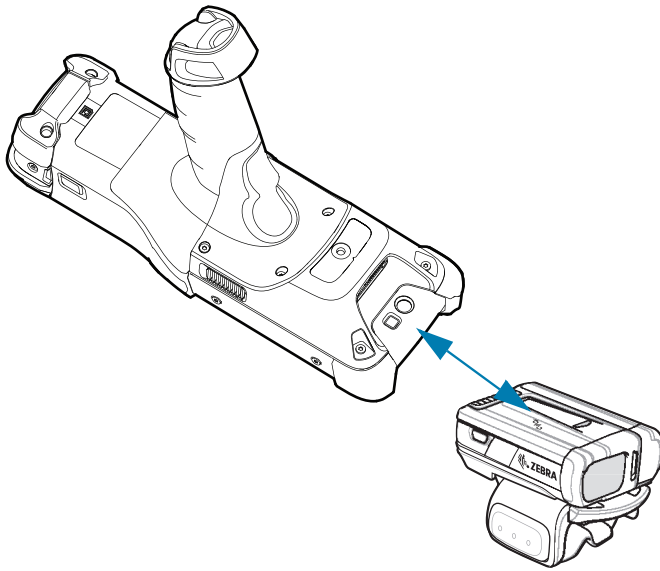

The MC93XX pairs with the RS6000 and  appears in the Status bar.



**NOTE:** Not all Zebra devices support NFC readers and the Tap-to-Pair feature.

## Pairing in HID Mode Using Near Field Communication

The MC93XX provides the ability to pair the RS6000 in HID Mode using NFC.



**NOTE:** NFC is supported on the premium and premium + configurations of the device and only with the RS6000.

1. Ensure that NFC is enabled on the MC93XX.
2. Ensure that Bluetooth is enabled on both devices.
3. Ensure that the Bluetooth device to discover is in discoverable mode.
4. Ensure that the two devices are within 10 meters (32.8 feet) of one another.
5. Place the RS6000 in Human Interface Device (HID) mode. If the RS6000 is already in HID mode, skip to step 6.
  - a. Remove the battery from the RS6000.
  - b. Press and hold the Restore key.
  - c. Install the battery onto the RS6000.
  - d. Keep holding the Restore key for about five seconds until a chirp is heard and the Scan LEDs flash green.
  - e. Scan the barcode below to place the RS6000 in HID mode.

**Figure 22** Bluetooth HID Barcode

6. Remove the battery from the RS6000.
7. Re-install the battery into the RS6000.
8. Align the NFC icon on the RS6000 with the NFC icon on the MC93XX.

The Status LED blinks blue indicating that the RS6000 is attempting to establish connection with the MC93XX. When connection is established, the Status LED turns off and the RS6000 emits a single string of low/high beeps.

A notification appears on the MC93XX screen.

The  icon appears in the Status bar.

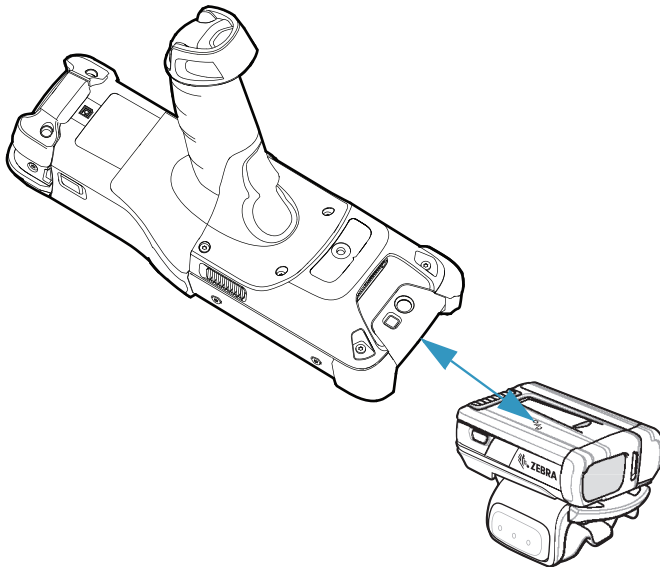
**Figure 23** Align NFC Antennas

The MC93XX pairs with the RS6000 and  appears in the Status bar.



**NOTE:** Not all Zebra devices support NFC readers and the Tap-to-Pair feature.

## Pairing Using Simple Serial Interface (SSI)

To pair the RS507/RS507X or RS6000 with the device using SSI.

1. Swipe up from the bottom of the Home screen and touch .

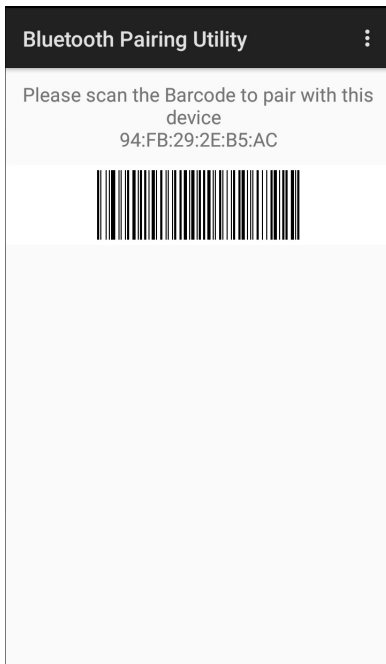
**Figure 24** Bluetooth Pairing Utility

2. Using the RS507/RS507X or RS6000, scan the barcode on the screen.

The RS507/RS507X or RS6000 emits a string of high/low/high/low beeps. The Scan LED flashes green indicating that the RS507/RS507X or RS6000 is attempting to establish connection with the device. When connection is established, the Scan LED turns off and the RS507/RS507X or RS6000 emits one string of low/high beeps.

A notification appears on the Notification panel and the  icon appears in the Status bar.

## Pairing Using Bluetooth Human Interface Device

To pair the RS507/RS507X or RS6000 with the device using Human Interface Device (HID):

1. Ensure that Bluetooth is enabled on both devices.
2. Ensure that the Bluetooth device to discover is in discoverable mode.
3. Ensure that the two devices are within 10 meters (32.8 feet) of one another.
4. Place the RS507/RS507X or RS6000 in HID mode. If the RS507/RS507X or RS6000 is already in HID mode, skip to step 5.
  - a. Remove the battery from the RS507/RS507X or RS6000.
  - b. Press and hold the Restore key.
  - c. Install the battery onto the RS507/RS507X or RS6000.
  - d. Keep holding the Restore key for about five seconds until a chirp is heard and the Scan LEDs flash green.
  - e. Scan the barcode below to place the RS507/RS507X or RS6000 in HID mode.

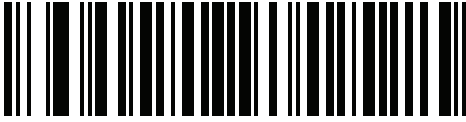
**Figure 25** RS507 Bluetooth HID Barcode**Figure 26** RS6000 Bluetooth HID Barcode

5. Remove the battery from the RS507/RS507X or RS6000.
6. Re-install the battery into the RS507/RS507X or RS6000.
7. Swipe down from the Status bar to open the Quick Access panel and then touch .
8. Touch **Bluetooth**.
9. Touch **Pair new device**. The device begins searching for discoverable Bluetooth devices in the area and displays them under **Available devices**.
10. Scroll through the list and select RS507/RS507X or RS6000.

The device connects to the RS507/RS507X or RS6000 and **Connected** appears below the device name. The Bluetooth device is added to the **Paired devices** list and a trusted (“paired”) connection is established.

A notification appears on Notification panel and the  icon appears in the Status bar.

## Pairing a Bluetooth Scanner

Connect the scanner to the device using one of the following methods:

- Simple Serial Interface (SSI) mode
- Bluetooth Human Interface Device (HID) mode.

## Pairing Using Bluetooth Human Interface Device

To pair the scanner with the device using HID:

1. Remove the battery from the scanner.
2. Replace the battery.
3. After the scanner reboots, scan the barcode below to place the scanner in HID mode.

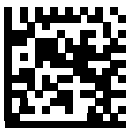
**Figure 27** Bluetooth HID Classic Barcode

4. On the device, swipe down from the Status bar to open the Quick Access panel and then touch .
5. Touch **Bluetooth**.

6. Touch **Pair new device**. The device begins searching for discoverable Bluetooth devices in the area and displays them under **Available devices**.
7. Scroll through the list and select XXXXX xxxxxx, where XXXXX is the scanner and xxxxxx is the serial number.

The device connects to the scanner, the scanner beeps once and **Connected** appears below the device name. The Bluetooth device is added to the **Paired devices** list and a trusted (“paired”) connection is established.

## DataWedge

DataWedge is a utility that adds advanced barcode scanning capability to any application without writing code. It runs in the background and handles the interface to built-in barcode scanners. The captured barcode data is converted to keystrokes and sent to the target application as if it was typed on the keypad. DataWedge allows any app on the device to get data from input sources such as a barcode scanner, MSR, RFID, voice, or serial port and manipulate the data based on options or rules.

Configure DataWedge to:

- Provide data capture services from any app.
- Use a particular scanner, reader or other peripheral device.
- Properly format and transmit data to a specific app.

To configure DataWedge refer to [techdocs.zebra.com/datawedge/](http://techdocs.zebra.com/datawedge/).

## Enabling DataWedge

1. Swipe up from the bottom of the Home screen and touch .
2. Touch **:** > **Settings**.
3. Touch the **DataWedge enabled** checkbox. A blue checkmark appears in the checkbox indicating that DataWedge is enabled.
4. Touch the Home button.

## Disabling DataWedge

1. Touch **:**.
2. Touch **Settings**.
3. Touch **DataWedge enabled**.

The blue check disappears from the checkbox indicating that DataWedge is disabled.

## Supported Decoders



**NOTE:** DataWedge supports the decoders listed below but not all are validated on this device.



**Table 6** Supported Decoders

Decoders	Camera	Internal Laser Scanner SE965	Internal Imager SE4750-SR & SE4850-ER	Internal Imager SE4770	RS5100	RS6000	RS507/RS507X	DS2278	DS3678	LI3678	DS8178
Australian Postal	O	--	O	O	O	O	O	O	O	--	O
Aztec	X	--	X	X	X	X	X	X	X	--	X
Canadian Postal	O	--	O	O	O	O	--	--	--	--	--
Chinese 2 of 5	O	O	O	O	O	O	O	O	O	O	O
Codabar	X	X	X	X	X	X	X	X	X	X	X
Code 11	O	O	O	O	O	O	O	O	O	O	O
Code 128	X	X	X	X	X	X	X	X	X	X	X
Code 39	X	X	X	X	X	X	X	X	X	X	X
Code 93	O	O	O	O	O	O	O	O	O	O	O
Composite AB	O	--	O	O	O	O	O	O	O	--	O
Composite C	O	--	O	O	O	O	O	O	O	--	O
Discrete 2 of 5	O	O	O	O	O	O	O	O	O	O	O
Datamatrix	X	--	X	X	X	X	X	X	X	--	X
Dutch Postal	O	--	O	O	O	O	O	O	O	--	O
DotCode	X	O	X	O	O	O	O	O	O	O	O
EAN13	X	X	X	X	X	X	X	X	X	X	X
EAN8	X	X	X	X	X	X	X	X	X	X	X
Grid Matrix	O	O	O	O	O	O	O	O	O	O	O
GS1 DataBar	X	X	X	X	X	X	X	X	X	X	X
GS1 DataBar Expanded	X	X	X	X	X	X	X	X	X	X	X
GS1 DataBar Limited	O	O	O	O	O	O	O	O	O	O	O
GS1 Datamatrix	O	--	O	O	O	O	--	O	O	--	O
GS1 QRCode	O	--	O	O	O	O	--	O	O	--	O
HAN XIN	O	--	O	O	O	O	--	--	O	O	--
Interleaved 2 of 5	O	O	O	O	O	O	O	O	O	O	O

**Table 6** Supported Decoders (Continued)

Decoders	Camera	Internal Laser Scanner SE965	Internal Imager SE4750-SR & SE4850-ER	Internal Imager SE4770	RS5100	RS6000	RS507/RS507X	DS2278	DS3678	LI3678	DS8178
Japanese Postal	O	--	O	O	O	O	O	O	O	--	O
Korean 3 of 5	O	O	O	O	O	O	O	O	O	O	O
MAIL MARK	X	--	X	X	X	X	--	X	X	--	X
Matrix 2 of 5	O	O	O	O	O	O	O	O	O	O	O
Maxicode	X	--	X	X	X	X	X	X	X	--	X
MicroPDF	O	--	O	O	O	O	O	O	O	--	O
MicroQR	O	--	O	O	O	O	O	O	O	--	O
MSI	O	O	O	O	O	O	O	O	O	O	O
PDF417	X	--	X	X	X	X	X	X	X	--	X
QR Code	X	--	X	X	X	X	X	X	X	--	X
Decoder Signature	O	--	O	O	O	O	O	O	--	--	--
TLC 39	O	O	O	O	O	O	O	O	O	O	O
Trioptic 39	O	O	O	O	O	O	O	O	O	O	O
UK Postal	O	--	O	O	O	O	O	O	O	--	O
UPCA	X	X	X	X	X	X	X	X	X	X	X
UPCE0	X	X	X	X	X	X	X	X	X	X	X
UPCE1	O	O	O	O	O	O	O	O	O	O	O
US4state	O	--	O	O	O	O	O	O	O	--	O
US4state FICS	O	--	O	O	O	O	O	O	O	--	O
US Planet	O	--	O	O	O	O	O	O	O	--	O
US Postnet	O	--	O	O	O	O	O	O	O	--	O

**Key**

X = Enabled

O = Disabled

-- = Not Supported

Touch the Back button to return to the previous screen.

# Wireless

This section provides information on the following wireless features:

- Wireless Local Area Network (WLAN)
- Bluetooth

## Wireless Local Area Networks

Wireless local area networks (WLANs) allow the device to communicate wirelessly inside a building. Before using the device on a WLAN, the facility must be set up with the required hardware to run the WLAN (sometimes known as infrastructure). The infrastructure and the device must both be properly configured to enable this communication.

Refer to the documentation provided with the infrastructure (access points (APs), access ports, switches, Radius servers, etc.) for instructions on how to set up the infrastructure.

Once the infrastructure is set up to enforce the chosen WLAN security scheme, use the **Wireless & networks** settings configure the device to match the security scheme.

The device supports the following WLAN security options:

- None
- Enhanced Open
- Wireless Equivalent Privacy (WEP)
- Wi-Fi Protected Access (WPA)/WPA2 Personal (PSK)
- WPA3-Personal
- WPA/WPA2/WPA3 Enterprise (EAP)
  - Protected Extensible Authentication Protocol (PEAP) - with MSCHAPV2 and GTC authentication.
  - Transport Layer Security (TLS)
  - Tunneled Transport Layer Security (TTLS) - with Password Authentication Protocol (PAP), MSCHAP and MSCHAPv2 authentication
  - Password (PWD)
  - Lightweight Extensible Authentication Protocol (LEAP).
- WPA3-Enterprise 192-bit

The **Status** bar displays icons that indicate Wi-Fi network availability and Wi-Fi status.



**NOTE:** To extend the life of the battery, turn off Wi-Fi when not in use.

## Connecting to a Wi-Fi Network

To connect to a Wi-Fi network:

1. Go to **Settings**.
2. Touch **Wi-Fi** to open the **Wi-Fi** screen. The device searches for WLANs in the area and lists them.
3. Scroll through the list and select the desired WLAN network.
4. For open networks, touch profile once or press and hold and then select **Connect** or for secure networks enter the required password or other credentials then touch **Connect**. See the system administrator for more information.

The device obtains a network address and other required information from the network using the dynamic host configuration protocol (DHCP) protocol. To configure the device with a fixed internet protocol (IP) address, see [Configuring the Device to Use a Static IP Address on page 87](#).

5. In the Wi-Fi setting field, **Connected** appears indicating that the device is connected to the WLAN.

## Removing a Wi-Fi Network

To remove a remembered or connected network:

1. Go to **Settings**.
2. Touch **Network & Internet > W-Fi**.
3. Scroll down to the bottom of the list and touch **Saved networks**.
4. Touch the name of the network.
5. Touch **FORGET**.
6. Touch the Home button.

## WLAN Configuration

This section provides information on configuring Wi-Fi settings.

### Configuring a Secure Wi-Fi Network

1. Go to **Settings**.
2. Touch **Network & Internet > Wi-Fi**.
3. Slide the switch to the **ON** position.
4. The device searches for WLANs in the area and lists them on the screen.
5. Scroll through the list and select the desired WLAN network.
6. Touch the desired network. If the network security is **Open**, the device automatically connects to the network. For all other network security a dialog box appears.
7. If the network security is WPA/WPA2-Personal, WPA3-Personal, or WEP, enter the required password and then touch **Connect**.
8. If the network security is WPA/WPA2/WPA3 Enterprise:

- Touch the **EAP method** drop-down list and select one of the following:
    - **PEAP**
    - **TLS**
    - **TTLS**
    - **PWD**
    - **LEAP**.
  - Touch the **Phase 2 authentication** drop-down list and select an authentication method.
  - If required, touch **CA certificate** and select a Certification Authority (CA) certificate. Note: Certificates are installed using the **Security** settings.
  - If required, touch **User certificate** and select a user certificate. Note: User certificates are installed using the Security settings.
  - If required, in the **Identity** text box, enter the username credentials.
  - If desired, in the **Anonymous identity** text box, enter an anonymous identity username.
  - If required, in the **Password** text box, enter the password for then given identity.
9. If the network security is **WPA3-Enterprise 192-bit**:
- Touch **CA certificate** and select a Certification Authority (CA) certificate. Note: Certificates are installed using the **Security** settings.
  - Touch **User certificate** and select a user certificate. Note: User certificates are installed using the **Security** settings.
  - In the **Identity** text box, enter the username credentials.



**NOTE:** By default, the network Proxy is set to **None** and the IP settings is set to **DHCP**. See Configuring for a Proxy Server for setting connection to a proxy server and see Configuring the Device to Use a Static IP Address for setting the device to use a static IP address.

10. Touch **Connect**.
11. Touch the Home button.

## Manually Adding a Wi-Fi Network

Manually add a Wi-Fi network if the network does not broadcast its name (SSID) or to add a Wi-Fi network when out of range.

1. Go to **Settings**.
2. Touch **Network & Internet > Wi-Fi**.
3. Slide the Wi-Fi switch to the **On** position.
4. Scroll to the bottom of the list and select **Add network**.
5. In the **Network name** text box, enter the name of the Wi-Fi network.
6. In the **Security** drop-down list, set the type of security to:
  - **None**
  - **Enhanced Open**
  - **WEP**
  - **WPA/WPA2-Personal**

- **WPA3-Personal**
  - **WPA/WPA2/WPA3-Enterprise**
  - **WPA3-Enterprise 192-bit**
7. If the network security is **None** , touch **Save**.
  8. If the network security is **WEP**, **WPA3-Personal**, or **WPA/WPA2-Personal**, enter the required password and then touch **Save**.
  9. If the network security is **WPA/WPA2/WPA3-Enterprise**:
    - Touch the **EAP method** drop-down list and select one of the following:
      - **PEAP**
      - **TLS**
      - **TTLS**
      - **PWD**
      - **LEAP**.
    - Touch the **Phase 2 authentication** drop-down list and select an authentication method.
    - If required, touch **CA certificate** and select a Certification Authority (CA) certificate. Note: Certificates are installed using the **Security** settings.
    - If required, touch **User certificate** and select a user certificate. Note: User certificates are installed using the **Security** settings.
    - If required, in the **Identity** text box, enter the username credentials.
    - If desired, in the **Anonymous identity** text box, enter an anonymous identity username.
    - If required, in the **Password** text box, enter the password for the given identity.
  10. If the network security is **WPA3-Enterprise 192-bit**:
    - Touch **CA certificate** and select a Certification Authority (CA) certificate. Note: Certificates are installed using the **Security** settings.
    - Touch **User certificate** and select a user certificate. Note: User certificates are installed using the **Security** settings.
    - In the **Identity** text box, enter the username credentials.
-  **NOTE:** By default, the network Proxy is set to **None** and the IP settings is set to **DHCP**. See [Configuring for a Proxy Server on page 86](#) for setting connection to a proxy server and see [Configuring the Device to Use a Static IP Address on page 87](#) for setting the device to use a static IP address.
11. Touch **Save**. To connect to the saved network, touch and hold on the saved network and select **Connect to network**.
  12. Touch the Home button.

## Configuring for a Proxy Server

A proxy server is a server that acts as an intermediary for requests from clients seeking resources from other servers. A client connects to the proxy server and requests some service, such as a file, connection, web page, or other resource, available from a different server. The proxy server evaluates the request according to its filtering rules. For example, it may filter traffic by IP address or protocol. If the request is validated by the filter, the proxy provides the resource by connecting to the relevant server and requesting the service on behalf of the client.

It is important for enterprise customers to be able to set up secure computing environments within their companies, making proxy configuration essential. Proxy configuration acts as a security barrier ensuring that the proxy server monitors all traffic between the Internet and the intranet. This is normally an integral part of security enforcement in corporate firewalls within intranets.

1. Go to **Settings**.
2. Touch **Network & Internet > Wi-Fi**.
3. Slide the Wi-Fi switch to the **On** position.
4. In the network dialog box, select and touch a network.
5. Touch **Advanced options**.
6. Touch **Proxy** and select **Manual**.
7. In the **Proxy hostname** text box, enter the address of the proxy server.
8. In the **Proxy port** text box, enter the port number for the proxy server.
9. In the **Bypass proxy for** text box, enter addresses for web sites that are not required to go through the proxy server. Use a comma “,” between addresses. Do not use spaces or carriage returns between addresses.
10. Touch **Connect**.
11. Touch the Home button.

## Configuring the Device to Use a Static IP Address

By default, the device is configured to use Dynamic Host Configuration Protocol (DHCP) to assign an Internet protocol (IP) address when connecting to a wireless network.

1. Go to **Settings**.
2. Touch **Network & Internet > Wi-Fi**.
3. Slide the Wi-Fi switch to the **On** position.
4. In the network dialog box, select and touch a network.
5. Touch **Advanced options**.
6. Touch **IP settings** and select **Static**.
7. In the **IP address** text box, enter an IP address for the device.
8. If required, in the **Gateway** text box, enter a gateway address for the device.
9. If required, in the **Network prefix length** text box, enter the prefix length.
10. If required, in the **DNS 1** text box, enter a Domain Name System (DNS) address.
11. If required, in the **DNS 2** text box, enter a DNS address.
12. Touch **Connect**.
13. Touch the Home button.

## Wi-Fi Preferences

Use the **Wi-Fi preferences** to configure advanced Wi-Fi settings. From the Wi-Fi screen scroll down to the bottom of the screen and touch **Wi-Fi preferences**.

- **Turn on Wi-Fi automatically** - When enabled, Wi-Fi automatically turns back on when near high quality saved networks.

- **Open network notification** - When enabled, notifies the user when an open network is available.
- **Advanced** - Touch to expand options.
  - **Additional settings** - See Additional Settings.
  - **Install Certificates** – Touch to install certificates.
  - **Network rating provider** - Disabled (AOSP devices). To help determine what constitutes a good Wi-Fi network, Android supports external Network rating providers that provide information about the quality of open Wi-Fi networks. Select one of the providers listed or **None**. If none are available or selected, the Connect to open networks feature is disabled.
  - **MAC address** - Displays the Media Access Control (MAC) address of the device when connecting to Wi-Fi networks.
  - **IP address** - Displays the IP address of the device when connecting to Wi-Fi networks.

## Additional Wi-Fi Settings



**NOTE:** Additional Wi-Fi settings are for the device, not for a specific wireless network.

Use the **Additional Settings** to configure additional Wi-Fi settings. To view the additional Wi-Fi settings, scroll to the bottom of the **Wi-Fi** screen and touch **Wi-Fi Preferences > Advanced > Additional settings**.

- **Regulatory**
  - **Country Selection** - Displays the acquired country code if 802.11d is enabled, else it displays the currently selected country code.
  - **Region code** - Displays the current region code.
- **Band and Channel Selection**
  - **Wi-Fi frequency band** - Set the frequency band to: **Auto** (default), **5 GHz only** or **2.4 GHz only**.
  - **Available channels (2.4 GHz)** - Touch to display the **Available channels** menu. Select specific channels and touch **OK**.
  - **Available channels (5 GHz)** - Touch to display the **Available channels** menu. Select specific channels and touch **OK**.
- **Logging**
  - **Advanced Logging** – Touch to enable advanced logging or change the log directory.
  - **Wireless logs** - Use to capture Wi-Fi log files.
    - **Fusion Logger** - Touch to open the **Fusion Logger** application. This application maintains a history of high level WLAN events which helps to understand the status of connectivity.
    - **Fusion Status** - Touch to display live status of WLAN state. Also provides information about the device and connected profile.
- **About**
  - **Version** - Displays the current Fusion information.

## Wi-Fi Direct

Wi-Fi Direct devices can connect to each other without having to go through an access point. Wi-Fi Direct devices establish their own ad-hoc network when required, letting you see which devices are available and choose which one you want to connect to.



1. Go to **Settings**.
  2. Touch **Wi-Fi > Wi-Fi preferences > Advanced > Wi-Fi Direct**. The device begins searching for another Wi-Fi Direct device.
  3. Under **Peer devices**, touch the other device name.
  4. On the other device, select **Accept**.
- Connected** appears on the device. On both devices, in their respective Wi-Fi Direct screens, the other device name appears in the list.

## Bluetooth

Bluetooth devices can communicate without wires, using frequency-hopping spread spectrum (FHSS) radio frequency (RF) to transmit and receive data in the 2.4 GHz Industry Scientific and Medical (ISM) band (802.15.1). Bluetooth wireless technology is specifically designed for short-range (10 m (32.8 ft)) communication and low power consumption.

Devices with Bluetooth capabilities can exchange information (for example, files, appointments, and tasks) with other Bluetooth enabled devices such as printers, access points, and other mobile devices.

The device supports Bluetooth Low Energy. Bluetooth Low Energy is targeted at applications in the healthcare, fitness, security, and home entertainment industries. It provides reduced power consumption and cost while maintaining standard Bluetooth range.

## Adaptive Frequency Hopping

Adaptive Frequency Hopping (AFH) is a method of avoiding fixed frequency interferers, and can be used with Bluetooth voice. All devices in the piconet (Bluetooth network) must be AFH-capable in order for AFH to work. There is no AFH when connecting and discovering devices. Avoid making Bluetooth connections and discoveries during critical 802.11b communications. AFH for Bluetooth consists of four main sections:

- Channel Classification - A method of detecting an interference on a channel-by-channel basis, or pre-defined channel mask.
- Link Management - Coordinates and distributes the AFH information to the rest of the Bluetooth network.
- Hop Sequence Modification - Avoids interference by selectively reducing the number of hopping channels.
- Channel Maintenance - A method for periodically re-evaluating the channels.

When AFH is enabled, the Bluetooth radio “hops around” (instead of through) the 802.11b high-rate channels. AFH coexistence allows enterprise devices to operate in any infrastructure.

The Bluetooth radio in this device operates as a Class 2 device power class. The maximum output power is 2.5 mW and the expected range is 10 m (32.8 ft). A definition of ranges based on power class is difficult to obtain due to power and device differences, and whether in open space or closed office space.



**NOTE:** It is not recommended to perform Bluetooth wireless technology inquiry when high rate 802.11b operation is required.

## Security

The current Bluetooth specification defines security at the link level. Application-level security is not specified. This allows application developers to define security mechanisms tailored to their specific need. Link-level security occurs between devices, not users, while application-level security can be implemented on a per-user basis. The Bluetooth specification defines security algorithms and procedures required to authenticate devices, and if needed, encrypt the data flowing on the link between the devices. Device authentication is a mandatory feature of Bluetooth while link encryption is optional.

Pairing of Bluetooth devices is accomplished by creating an initialization key used to authenticate the devices and create a link key for them. Entering a common personal identification number (PIN) in the devices being paired generates the initialization key. The PIN is never sent over the air. By default, the Bluetooth stack responds with no key when a key is requested (it is up to user to respond to the key request event). Authentication of Bluetooth devices is based-upon a challenge-response transaction. Bluetooth allows for a PIN or passkey used to create other 128-bit keys used for security and encryption. The encryption key is derived from the link key used to authenticate the pairing devices. Also worthy of note is the limited range and fast frequency hopping of the Bluetooth radios that makes long-distance eavesdropping difficult.

Recommendations are:

- Perform pairing in a secure environment
- Keep PIN codes private and do not store the PIN codes in the device
- Implement application-level security.

## Bluetooth Profiles

The device supports the Bluetooth services listed.

**Table 7** Bluetooth Profiles

Profile	Description
Service Discovery Protocol (SDP)	Handles the search for known and specific services as well as general services.
Serial Port Profile (SPP)	Allows use of RFCOMM protocol to emulate serial cable connection between two Bluetooth peer devices. For example, connecting the device to a printer.
Object Push Profile (OPP)	Allows the device to push and pull objects to and from a push server.
Advanced Audio Distribution Profile (A2DP)	Allows the device to stream stereo-quality audio to a wireless headset or wireless stereo speakers.
Audio/Video Remote Control Profile (AVRCP)	Allows the device to control A/V equipment to which a user has access. It may be used in concert with A2DP.
Personal Area Network (PAN)	Allows the use of Bluetooth Network Encapsulation Protocol to provide L3 networking capabilities over a Bluetooth link. Only PANU role is supported.
Human Interface Device Profile (HID)	Allows Bluetooth keyboards, pointing devices, gaming devices and remote monitoring devices to connect to the device.
Headset Profile (HSP)	Allows a hands-free device, such as a Bluetooth headset, to place and receive calls on the device.

**Table 7** Bluetooth Profiles (Continued)

Profile	Description
Hands-Free Profile (HFP)	Allows car hands-free kits to communicate with the device in the car.
Phone Book Access Profile (PBAP)	Allows exchange of Phone Book Objects between a car kit and a mobile device to allow the car kit to display the name of the incoming caller; allow the car kit to download the phone book so you can initiate a call from the car display.
Out of Band (OOB)	Allows exchange of information used in the pairing process. Pairing is completed using the Bluetooth radio, but requires information from the OOB mechanism. Using OOB with NFC enables pairing when devices simply get close, rather than requiring a lengthy discovery process.
Symbol Serial Interface (SSI)	Allows for communication with Bluetooth Imager.
Generic Attribute Profile (GATT)	Provides profile discovery and description services for Bluetooth Low Energy protocol. It defines how attributes are grouped together into sets to form services.
Dial Up Networking (DUN)	Provides a standard to access the Internet and other dial-up services over Bluetooth.
Generic Access Profile (GAP)	Use for device discovery and authentication.
Object EXchange (OBEX)	Facilitates the exchange of binary objects between devices.

## Bluetooth Power States

The Bluetooth radio is off by default.

- Suspend - When the device goes into suspend mode, the Bluetooth radio stays on.
- Airplane Mode - When the device is placed in Airplane Mode, the Bluetooth radio turns off. When Airplane mode is disabled, the Bluetooth radio returns to the prior state. When in Airplane Mode, the Bluetooth radio can be turned back on if desired.

## Bluetooth Radio Power

Turn off the Bluetooth radio to save power or if entering an area with radio restrictions (for example, an airplane). When the radio is off, other Bluetooth devices cannot see or connect to the device. Turn on the Bluetooth radio to exchange information with other Bluetooth devices (within range). Communicate only with Bluetooth radios in close proximity.



**NOTE:** To achieve the best battery life, turn off radios when not in use.

### Enabling Bluetooth

1. Swipe down from the Status bar to open the Notification panel.
2. Touch  to turn Bluetooth on.
3. Touch the Home button.

## Disabling Bluetooth

1. Swipe down from the Status bar to open the Notification panel.
2. Touch  to turn Bluetooth off.
3. Touch the Home button.

## Discovering Bluetooth Device(s)

The device can receive information from discovered devices without pairing. However, once paired, the device and a paired device exchange information automatically when the Bluetooth radio is on.

1. Ensure that Bluetooth is enabled on both devices.
2. Ensure that the Bluetooth device to discover is in discoverable mode.
3. Ensure that the two devices are within 10 meters (32.8 feet) of one another.
4. Swipe down from the Status bar to open the Quick Access panel.
5. Touch and hold **Bluetooth**.
6. Touch **Pair new device**. The device begins searching for discoverable Bluetooth devices in the area and displays them under **Available devices**.
7. Scroll through the list and select a device. The Bluetooth pairing request dialog box appears.
8. Touch **Pair** on both devices.
9. The Bluetooth device is added to the **Paired devices** list and a trusted (“paired”) connection is established.

## Changing the Bluetooth Name

By default, the device has a generic Bluetooth name that is visible to other devices when connected.

1. Go to **Settings**.
2. Touch **Connected devices > Connection preferences > Bluetooth**.
3. If Bluetooth is not on, move the switch to turn Bluetooth on.
4. Touch **Device name**.
5. Enter a name and touch **RENAME**.
6. Touch the Home button.

## Connecting to a Bluetooth Device

Once paired, connect to a Bluetooth device.

1. Go to **Settings**.
2. Touch **Connected devices > Connection preferences > Bluetooth**.
3. In the list, touch the unconnected Bluetooth device.

When connected, **Connected** appears below the device name.

## Selecting Profiles on the Bluetooth Device

Some Bluetooth devices have multiple profiles.

1. Go to **Settings**.
2. Touch **Connected devices > Connection preferences > Bluetooth**.
3. In the **Paired Devices** list, touch  next to the device name.
4. Turn on or off a profile to allow the device to use that profile.
5. Touch the Home button.

## Unpairing a Bluetooth Device

Unpairing a Bluetooth device erases all pairing information.

1. Go to **Settings**.
2. Touch **Connected devices > Connection preferences > Bluetooth**.
3. In the **Paired Devices** list, touch  next to the device name.
4. Touch **FORGET**.
5. Touch the Home button.

## Cast

Use **Cast** to mirror the device screen on a Miracast enabled wireless display.

1. Go to **Settings**.
2. Touch **Connected devices > Connection preferences > Cast**.
3. Touch  > **Enable wireless display**.  
The device searches for nearby Miracast devices and lists them.
4. Touch a device to begin casting.
5. Touch the Home button.

## Near Field Communications

NFC/HF RFID is a short-range wireless connectivity technology standard that enables secure transaction between a reader and a contactless smartcard. The technology is based on ISO/IEC 14443 type A and B (proximity), ISO/IEC 15693 (vicinity), and FeliCa standards, using the HF 13.56 MHz unlicensed band.

The device supports the following operating modes:

- Reader mode
- Peer-to-Peer communication
- Card Emulation mode.

Using NFC, the device can:

- Read contactless cards such as contactless tickets, ID cards and ePassport.
- Read and write information to contactless cards such as SmartPosters and tickets, as well as devices with NFC interface such as vending machines.
- Read information from supported medical sensors.

- Pair with supported Bluetooth devices such as printers (ex. ZQ5x, ZD5x), ring scanners (ex. RS6000), and headsets (ex. HS3100).
- Exchange data with another NFC device.
- Emulate contactless card such as ticket, or SmartPoster.

The device NFC antenna is positioned to read NFC cards from the top of the device while the device is being held.

### Reading NFC Cards

Read contactless cards using NFC.

**Figure 28** Reading Cards



1. Launch an NFC enabled application.
2. Hold device as shown.
3. Move the device close to the NFC card until it detects the card.
4. Hold the card steadily until the transaction is complete (usually indicated by the application).

### Sharing Information Using NFC

You can beam content like a web page, contact cards, pictures, YouTube links or location information from your screen to another device by bringing the devices together back to back.

Make sure both devices are unlocked, support NFC, and have both NFC and Android Beam turned on.

1. Open a screen that contains a web page, video, photo or contact.

2. Move the back of the device toward the back of the other device.
3. Align the NFC logo on the device with the NFC antenna on the other device.
4. Move the front of the device toward the front of the other device.

When the devices connect, a sound emits, the image on the screen reduces in size, the message **Touch to beam** displays.

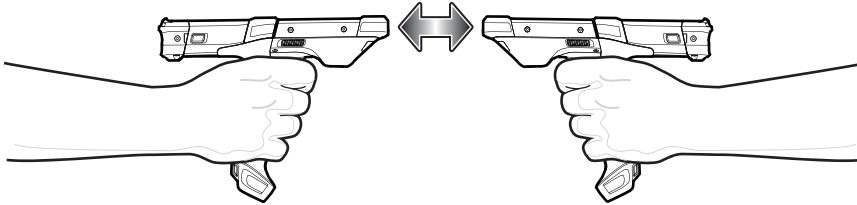

5. Touch anywhere on the screen.  
The transfer begins.

## Enterprise NFC Settings

Improve NFC performance or increase battery life by selecting which NFC features to use on the device.

- **Card Detection Mode** - Select a card detection mode.
  - **Low** - Increases battery life by lowering the NFC detection speed.
  - **Hybrid** - Provides a balance between NFC detection speed and battery life (default).
  - **Standard** - Provides the best NFC detection speed, but reduces battery life.
- **Supported Card Technology** - Select an option to detect only one NFC tag type, increasing battery life, but reducing detection speed.
  - **All (Default)** - Detects all NFC tag types. This provides the best detection speed, but reduces battery life.
  - **ISO 14443 Type A/B**
  - **FeliCa**
  - **ISO15693**
- **Other NFC settings available with Zebra administrator tools (CSP)** - Allows configuration of additional Enterprise NFC Settings through staging tools and Mobile Device Management (MDM) solutions with an MX version that supports the Enterprise NFC Settings Configuration Service Provider (CSP). For more information on using the Enterprise NFC Settings CSP, refer to: [techdocs.zebra.com](https://techdocs.zebra.com).

# Accessories

This section provides information for using the accessories for the device. The table below lists the accessories available for the device.

**Table 8** MC93XX Accessories

Accessory	Part Number	Description
<b>Cradles</b>		
1-Slot USB Charge Cradle with Spare Battery Charger	CRD-MC93-2SUCHG-01	Charges the MC93XX main battery and a spare battery, and synchronizes the MC93XX with a host computer through a USB connection. Requires power supply (PWR-BGA12V50W0WW), DC line cord (CBL-DC-388A1-01) and a country specific grounded AC line cord.
4-Slot Charge Only ShareCradle	CRD-MC93-4SCHG-01	Charges up to four MC93XXs. Requires power supply (PWR-BGA12V108W0WW), DC line cord (CBL-DC-381A1-01) and a country specific grounded AC line cord.
4-Slot Ethernet ShareCradle	CRD-MC93-4SETH-01	Charges up to four MC93XXs through the main battery and synchronizes the devices with a host computer through an Ethernet connection. Requires power supply (PWR-BGA12V108W0WW), DC line cord (CBL-DC-381A1-01) and a country specific grounded AC line cord.
<b>Chargers</b>		
4-Slot Spare Battery Charger	SAC-MC93-4SCHG-01	Charges up to four MC93XX spare batteries. Requires power supply (PWR-BGA12V50W0WW), DC line cord (CBL-DC-388A1-01) and a country specific grounded AC line cord.
16-Slot Spare Battery Charger	SAC-MC93-16SCHG-01	Charges up to 16 MC93XX spare batteries. Requires power supply (PWR-BGA12V108W0WW), DC line cord (CBL-DC-381A1-01) and a country specific grounded AC line cord.



**Table 8** MC93XX Accessories (Continued)

Accessory	Part Number	Description
Power Supply	PWR-BGA12V50W0WW	Provides 12 VDC, 4.16A power to the 1-Slot USB Charge Cradle and the 4-Slot Spare Battery Charger. Requires a DC line cord (CBL-DC-388A1-01) and a country specific grounded AC line cord.
Power Supply	PWR-BGA12V108W0WW	Provides 12 VDC, 9A power to the 4-Slot Charge Cradle with 4-Slot Battery Charger, and 16-Slot Battery Charger. Requires a DC line cord (CBL-DC-381A1-01) and a country specific grounded AC line cord.
Power Supply	PWR-WUA5V12W0US	Provides 5 VDC, 2.5A power to the USB Charge Cable. Includes plug adapter for use in the United States.
Power Supply	PWR-WUA5V12W0GB	Provides 5 VDC, 2.5A power to the USB Charge Cable. Includes plug adapter for use in the European Union.
Power Supply	PWR-WUA5V12W0EU	Provides 5 VDC, 2.5A power to the USB Charge Cable. Includes plug adapter for use in the United Kingdom.
Power Supply	PWR-WUA5V12W0AU	Provides 5 VDC, 2.5A power to the USB Charge Cable. Includes plug adapter for use in Australia.
Power Supply	PWR-WUA5V12W0CN	Provides 5 VDC, 2.5A power to the USB Charge Cable. Includes plug adapter for use in China.
Power Supply	PWR-WUA5V12W0IN	Provides 5 VDC, 2.5A power to the USB Charge Cable. Includes plug adapter for use in India.
US AC Line Cord	23844-00-00R	Provides power to 3-wire power supplies PWR-BGA12V50W0WW and PWR-BGA12V108W0WW.
DC Line Cord	CBL-DC-381A1-01	Provides power from the power supply (PWR-BGA12V108W0WW) to the 4-Slot Charge Only Cradle, 4-Slot Ethernet Cradle, and 16-Slot Battery Charger.
DC Line Cord	CBL-DC-388A1-01	Provides power from the power supply (PWR-BGA12V150W0WW) to the 1-Slot USB Charge Cradle and 4-Slot Battery Charger.

**Table 8** MC93XX Accessories (Continued)

Accessory	Part Number	Description
<b>Cables</b>		
<p>USB Charge/Com Snap-On Cup</p> <p>A separate USB cable and power supply is required to support fast charging. USB (Type-C) Cable is required to allow communication from the snap-on to the PC/laptop.</p>	CBL-MC93-USBCHG-01	Provides power and/or communication over USB to the device. Requires wall adapter/power supply PWR-WUA5V12W0xx.
1-Slot Cradle USB Cable	CBL-TC2X-USBC-01	Provides USB communication through the 1-Slot USB cradle to the host computer.
<b>Miscellaneous</b>		
Cradle Adapter	ADP-MC93-CRDCUP-01	MC93XX Charge Only Adapter for backwards compatibility with MC9XX cradles. Works with MC9XX 1-Slot USB Cradle, and 4-Slot Charge Only Cradle.
7000mAh PowerPrecision+ standard battery	BTRY-MC93-STN-01	Replacement standard battery.
	BTRY-MC93-STN-10	Replacement standard battery (10-pack).
	BTRY-MC93-STN-IN	Replacement standard battery (India).
5000mAh PowerPrecision+ freezer battery	BTRY-MC93-FRZ-01	Replacement freezer battery.
	BTRY-MC93-FRZ-10	Replacement freezer battery (10-pack).
7000mAh PowerPrecision+ non-incendive battery	BTRY-MC93-NI-01	Replacement non-incendive battery.
	BTRY-MC93-NI-10	Replacement non-incendive battery (10-pack).
MC93XX Hand Strap	SG-MC93-HDSTPG-01	Replacement hand strap for the MC93XX Hand strap loop holds an optional stylus (SG-TC7X-STYLUS-03).
MC93 Soft Holster for Gun	SG-MC9X-SHLSTG-01	Provides a soft, clip on holster and a shoulder strap for the MC93XX.
MC93 Rubber Boot for Gun	SG-MC93-RBTG-01	Provides additional protection for wear and tear of the MC93XX.
Screen Protector	MISC-MC93-SCRN-01	Provides additional protection for display (5-pack).
Stylus and Tether	SG-TC7X-STYLUS-03	Conductive carbon-filled stylus for capacitive touch panel; includes coiled tether (3-pack).
Un-powered Forklift Mount	MNT-MC93-FLCH-01	<p>Un-powered forklift mount. Allows installing the device on a roll bar or square surface of a forklift. Includes:</p> <p>Forklift holder (MNT-MC93-FLCH-01), RAM double socket arm for 1" ball (MNT-RAM-B201U), and RAM forklift clamp 2.5" max width square rail base with 1" ball (MNT-RAM-B247U25).</p>

**Table 8** MC93XX Accessories (Continued)

Accessory	Part Number	Description
34-key Numeric Keypad	KYPD-MC9334FNR-01	34-key Numeric Keypad
43-key Shifted Alpha Keypad	KYPD-MC9343FN-01	43-key Shifted Alpha Keypad
53-key 3270 Emulator Keypad	KYPD-MC93533270-01	53-key 3270 Emulator Keypad
53-key Keypad (Alpha-Numeric)	KYPD-MC93535250-01	53-key Keypad (Alpha-Numeric)
53-key 5250 Emulator Keypad	KYPD-MC9353ANR-01	53-key 5250 Emulator Keypad
53-key VT Emulator Keypad	KYPD-MC9353VT-01	53-key VT Emulator Keypad
58-Keys OmniiXT15f Keypad	KYPD-MC9358ANR-01	58-Keys OmniiXT15f Keypad
29-Keys Shifted Alpha Keypad	KYPD-MC9329NMR-01	29-Keys Shifted Alpha Keypad
34-key Numeric Keypad (10 Pack)	KYPD-MC9334FNR-10	34-key Numeric Keypad (10 Pack)  The 10 pack order includes a keypad installation tool.
43-key Shifted Alpha Keypad (10 Pack)	KYPD-MC9343FN-10	43-key Shifted Alpha Keypad (10 Pack)  The 10 pack order includes a keypad installation tool.
53-key 5250 Emulator Keypad (10 Pack)	KYPD-MC93535250-10	53-key 5250 Emulator Keypad (10 Pack)  The 10 pack order includes a keypad installation tool.
53-key VT Emulator Keypad (10 Pack)	KYPD-MC9353VT-10	53-key VT Emulator Keypad (10 Pack)  The 10 pack order includes a keypad installation tool.
53-key Keypad (Alpha-Numeric) (10 Pack)	KYPD-MC9353ANR-10	53-key Keypad (Alpha-Numeric) (10 Pack)  The 10 pack order includes a keypad installation tool.
58-Keys OmniiXT15f Keypad	KYPD-MC9358ANR-10	58-Keys OmniiXT15f Keypad (10 Pack)  The 10 pack order includes a keypad installation tool.
29-Keys Shifted Alpha Keypad	KYPD-MC9329NMR-10	29-Keys Shifted Alpha Keypad (10 Pack)  The 10 pack order includes a keypad installation tool.

## Battery Charging

### Main Battery Charging

To charge the main battery:

1. Ensure that the cradle is connected to power.
2. Slide the mobile computer into the slot in the cradle. The mobile computer Charge LED Indicator, indicates the mobile computer battery charging status.
3. Gently press down on the device to ensure proper contact.
4. When charging is complete, remove the mobile computer from the cradle slot.

### Spare Battery Charging

To charge the spare battery:

1. Connect the charger to a power source.
2. Insert the battery into a spare battery charging slot and gently press down on the battery to ensure proper contact. The spare battery charging LEDs on the front of the cradle indicates the spare battery charging status.
3. When charging is complete, remove the battery from the charging slot.

### Charging Indicators

The Charge LED Indicator indicates the charge status.

**Table 9** LED Charge Indicators

Status	Indications
Off	<ul style="list-style-type: none"> <li>• The battery is not charging.</li> <li>• The device is not inserted correctly in the cradle or connected to a power source.</li> <li>• Cradle is not powered.</li> </ul>
Slow Blinking Amber Every 3 seconds	<ul style="list-style-type: none"> <li>• Battery is charging, but the battery is fully depleted and does not yet have sufficient charge to power the device.</li> <li>• After battery removal, indicates that the device is in hot swap mode with connectivity persistence.</li> </ul> <p>The SuperCap requires a minimum of 15 minutes to fully charge in order to provide adequate connectivity and memory session persistence.</p>
Solid Amber	<ul style="list-style-type: none"> <li>• Battery is charging.</li> </ul>

**Table 9** LED Charge Indicators (Continued)

Status	Indications
Solid Green	<ul style="list-style-type: none"> <li>Battery charging is complete.</li> </ul>
Fast Blinking Red 2 blinks/second	Charging error. For example: <ul style="list-style-type: none"> <li>Temperature is too low or too high.</li> <li>Charging has gone on too long without completion (typically eight hours).</li> </ul>
Solid Red	<ul style="list-style-type: none"> <li>Battery is charging and battery is at the end of useful life.</li> <li>Charging complete and battery is at the end of useful life.</li> </ul>

## Charging Temperature

Charge batteries in temperatures from 0°C to 40°C (32°F to 104°F). The device or cradle always performs battery charging in a safe and intelligent manner. At higher temperatures, for example at approximately +37°C (+98°F), the device or cradle may for small periods of time alternately enable and disable battery charging to keep the battery at acceptable temperatures. The device and cradle indicates when charging is disabled due to abnormal temperatures via its LED.

## 1-Slot USB Charge Cradle with Spare Battery Charger



**CAUTION:** Ensure that you follow the guidelines for battery safety described in [Battery Safety Guidelines on page 185](#).

The 1-Slot USB Charge Cradle with spare battery:

- Provides 9 VDC power to operate the mobile computer and charge the battery.
- Provides 4.2 VDC power to charge the spare battery.
- Provides a USB port for data communication between the mobile computer and a host computer or other USB devices, for example, a printer.
- Synchronizes information between the mobile computer and a host computer. With customized or third party software, it can also synchronize the mobile computer with corporate databases.
- Compatible with the following batteries:
  - 7000mAh PowerPrecision+ standard battery
  - 5000mAh PowerPrecision+ freezer battery
  - 7000mAh PowerPrecision+ non-incendive battery.

**Figure 29** 1-Slot USB Charge Cradle with Spare Battery Charger

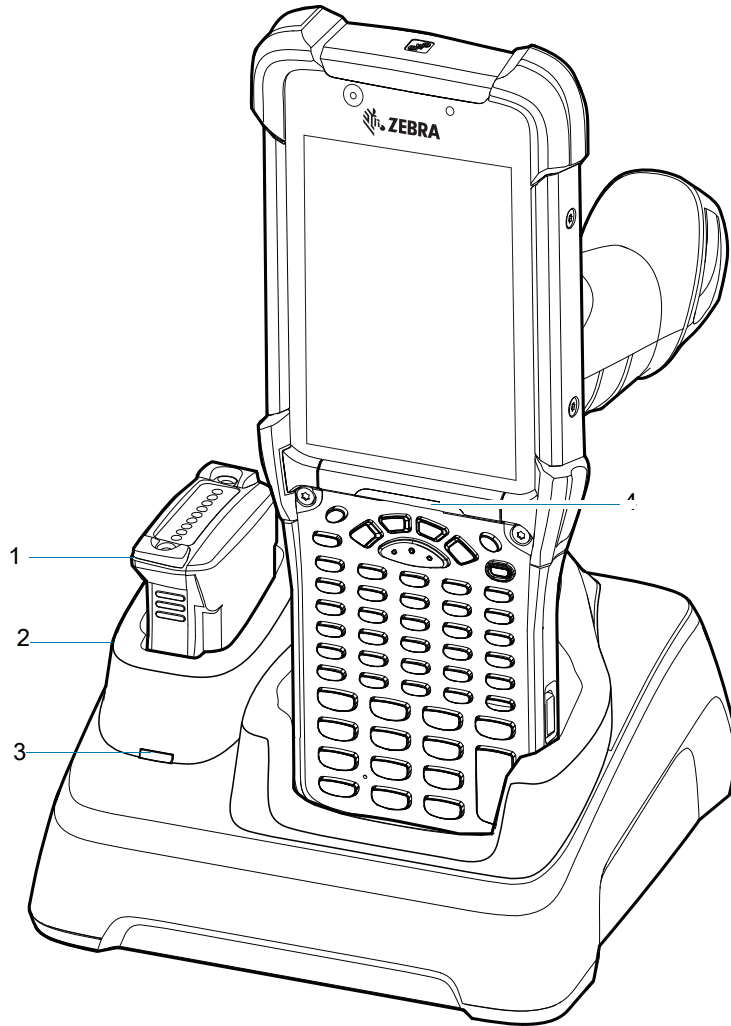

1	Spare battery
2	Spare battery charging well
3	Spare battery charging LED
4	Indicator LED bar

## Setup

**Figure 30** 1-Slot USB Charge Cradle with Spare Battery Charger Setup

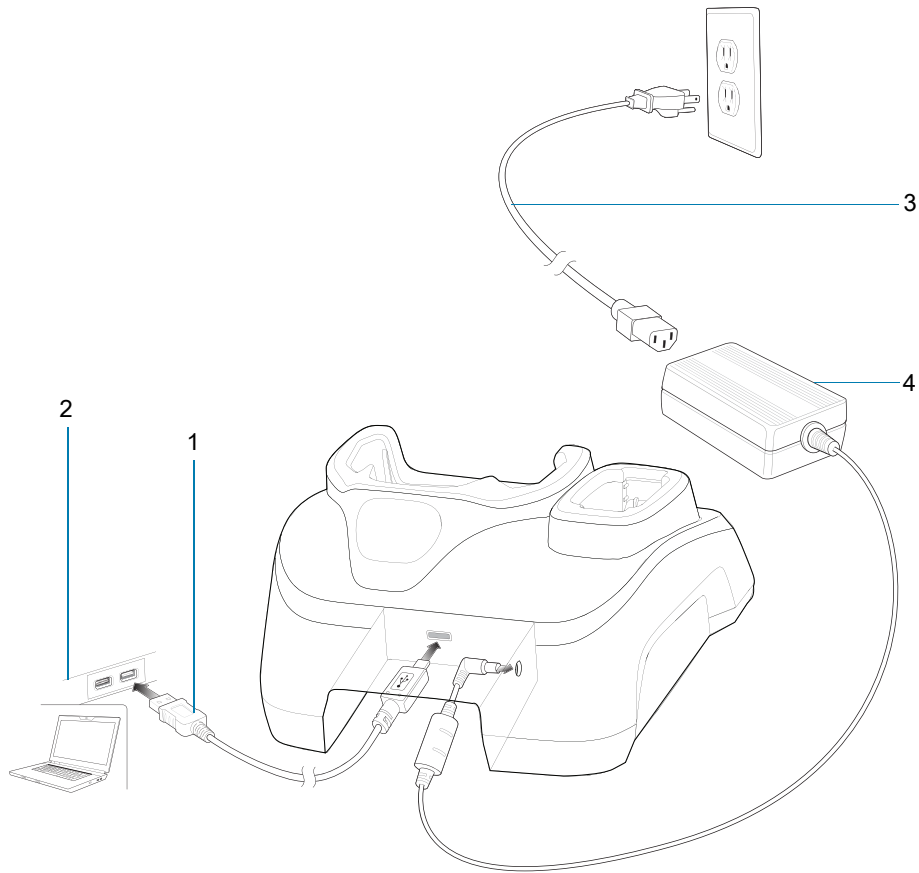

1	USB Cable
2	Host computer
3	AC Line Cord
4	Power Supply



## Charging the Device



**CAUTION:** Ensure that you follow the guidelines for battery safety described in [Battery Safety Guidelines on page 185](#).

1. Connect the cradle to a power source.

**Figure 31** 1-Slot USB Charge Cradle with Spare Battery Charger

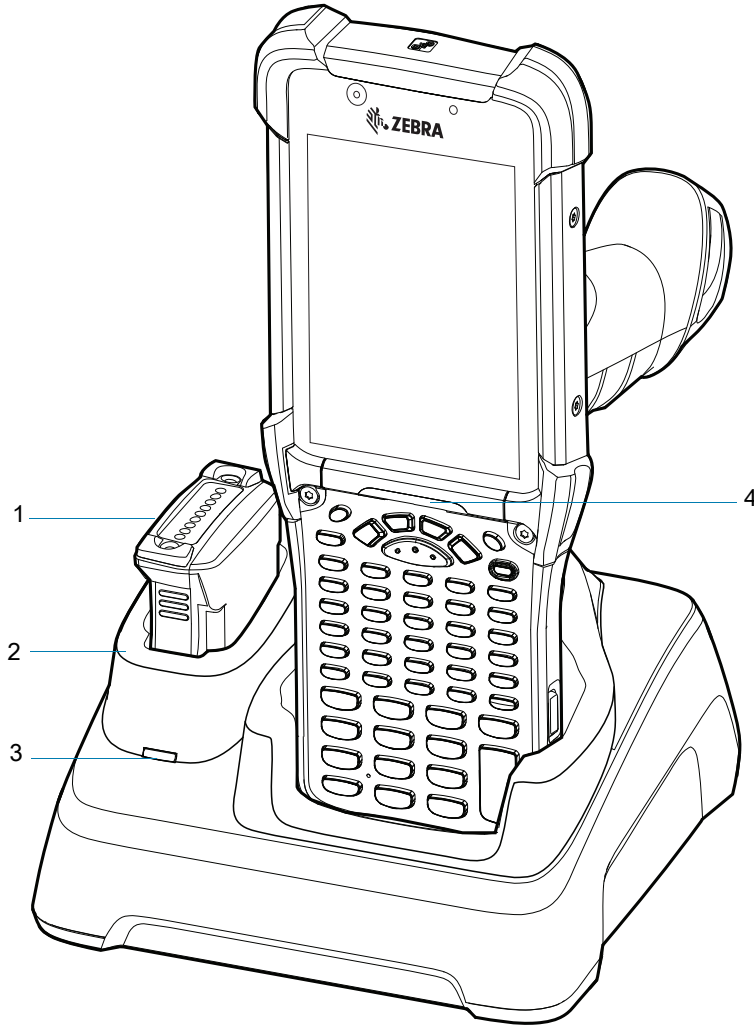

1	Spare battery
2	Spare battery charging well
3	Spare battery charging LED
4	Indicator LED bar

2. Slide the device into the slot in the cradle. The device Charge LED Indicator, indicates the battery charging status.
3. Gently press down on the device to ensure proper contact.
4. When charging is complete, remove the devices from the cradle slot.

The 1-Slot USB charge cradle charges the MC93XX's main battery and a spare battery simultaneously.

## 4-Slot Charge Only ShareCradle

The 4-Slot Charge Only ShareCradle:

- Provides 9 VDC power to operating the mobile computer and charge the battery.
- Simultaneously charges up to four mobile computers.
- Compatible with devices using the following batteries:
  - 7000mAh PowerPrecision+ standard battery
  - 5000mAh PowerPrecision+ freezer battery
  - 7000mAh PowerPrecision+ non-incendive battery.

**Figure 32** 4-Slot Charge Only ShareCradle

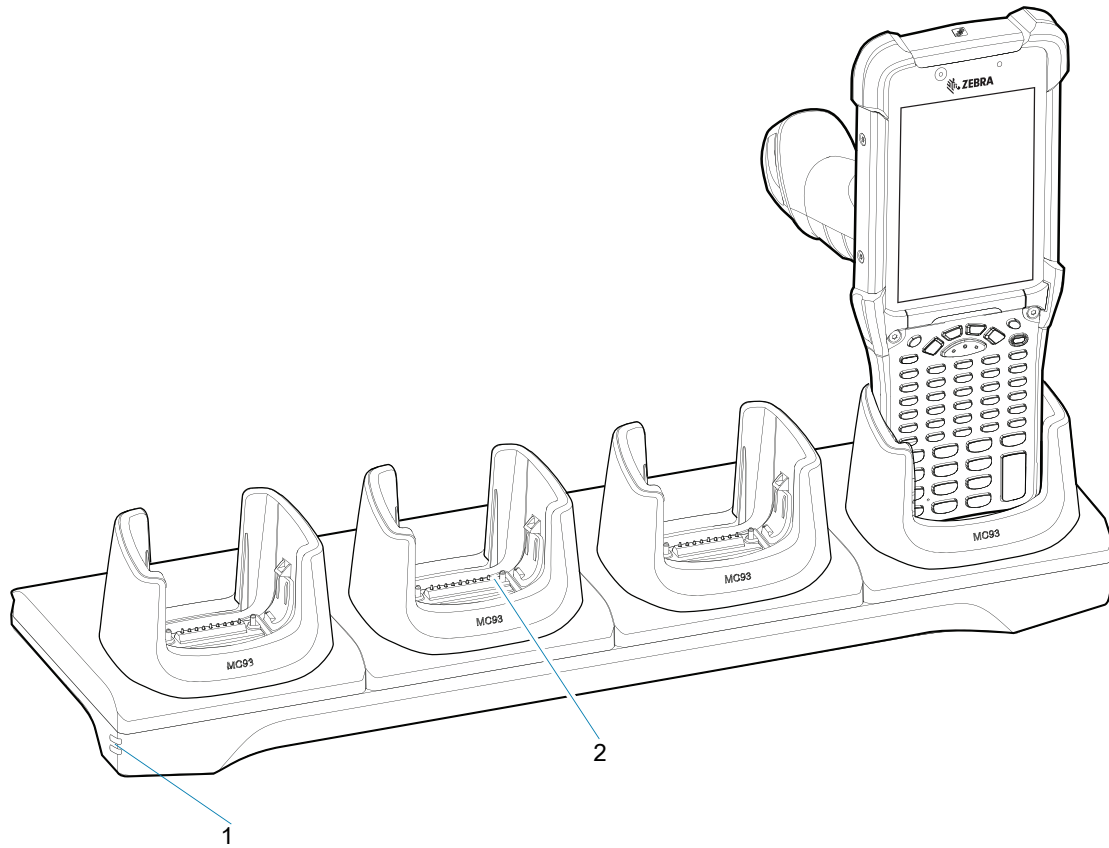

1	Power LED
2	Charging slot

## Setup

**Figure 33** 4-Slot Charge Only ShareCradle Setup

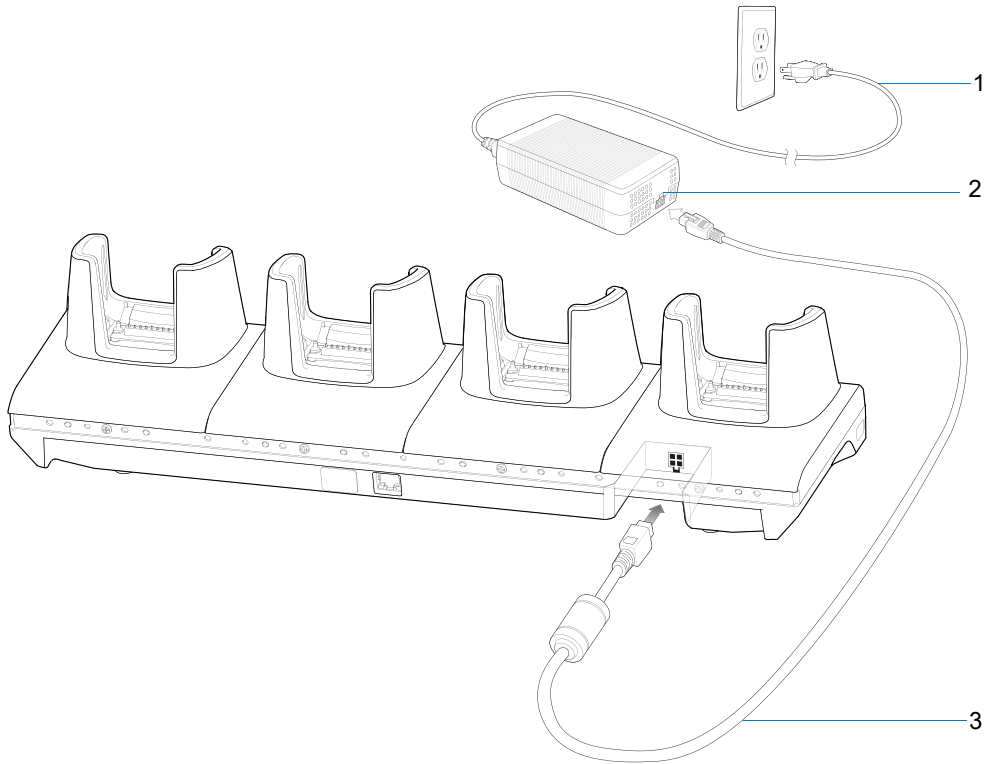

1	AC line cord
2	Power supply
3	DC line cord

## Charging the Devices

1. Connect the cradle to a power source.
2. Slide the devices into the slot in the cradle. The devices Charge LED Indicator, indicates the battery charging status.

**Figure 34** 4-Slot Charge Only ShareCradle

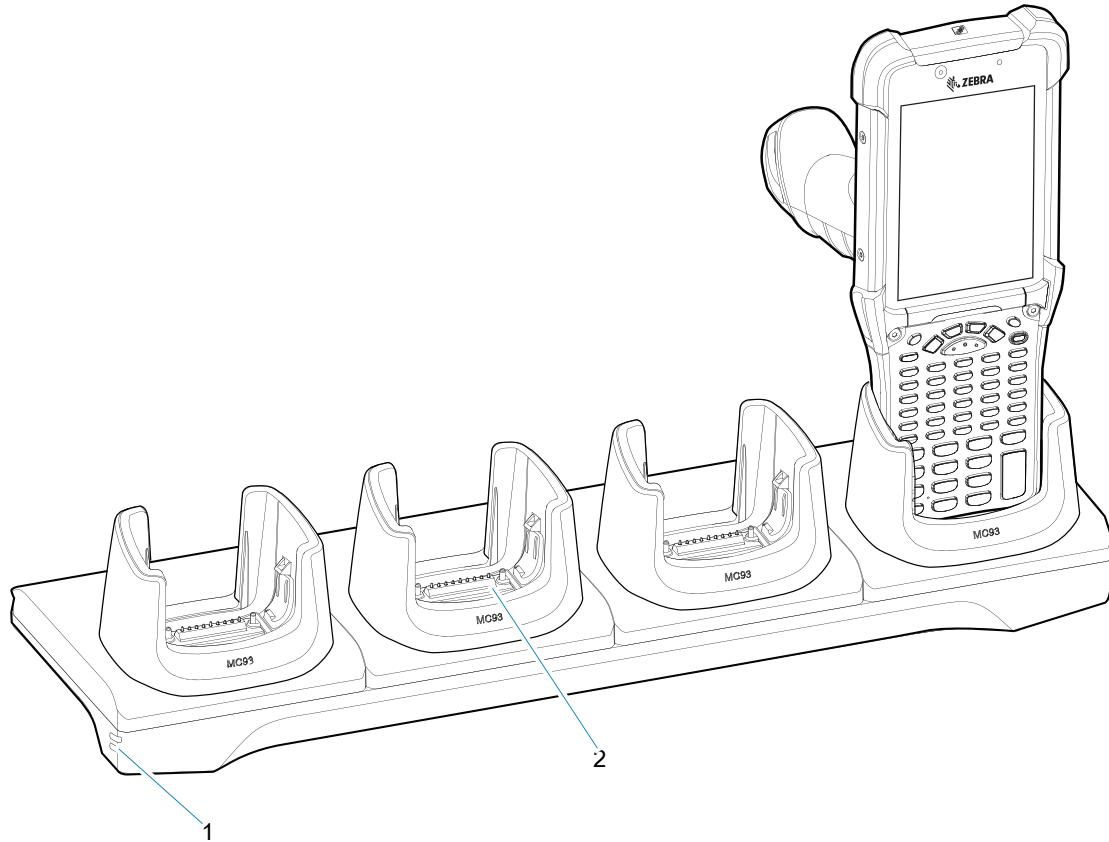

1	Power LED
2	Charging slot

3. Gently press down on the device to ensure proper contact.
4. When charging is complete, remove the devices from the cradle slot.

## 4-Slot Ethernet ShareCradle

The 4-Slot Ethernet ShareCradle:

- Provides 9 VDC power to operating the mobile computer and charge the battery.
- Simultaneously charges up to four mobile computers.
- Compatible with devices using the following batteries:
  - 7000mAh PowerPrecision+ standard battery
  - 5000mAh PowerPrecision+ freezer battery
  - 7000mAh PowerPrecision+ non-incendive battery.

**Figure 35** 4-Slot Ethernet ShareCradle

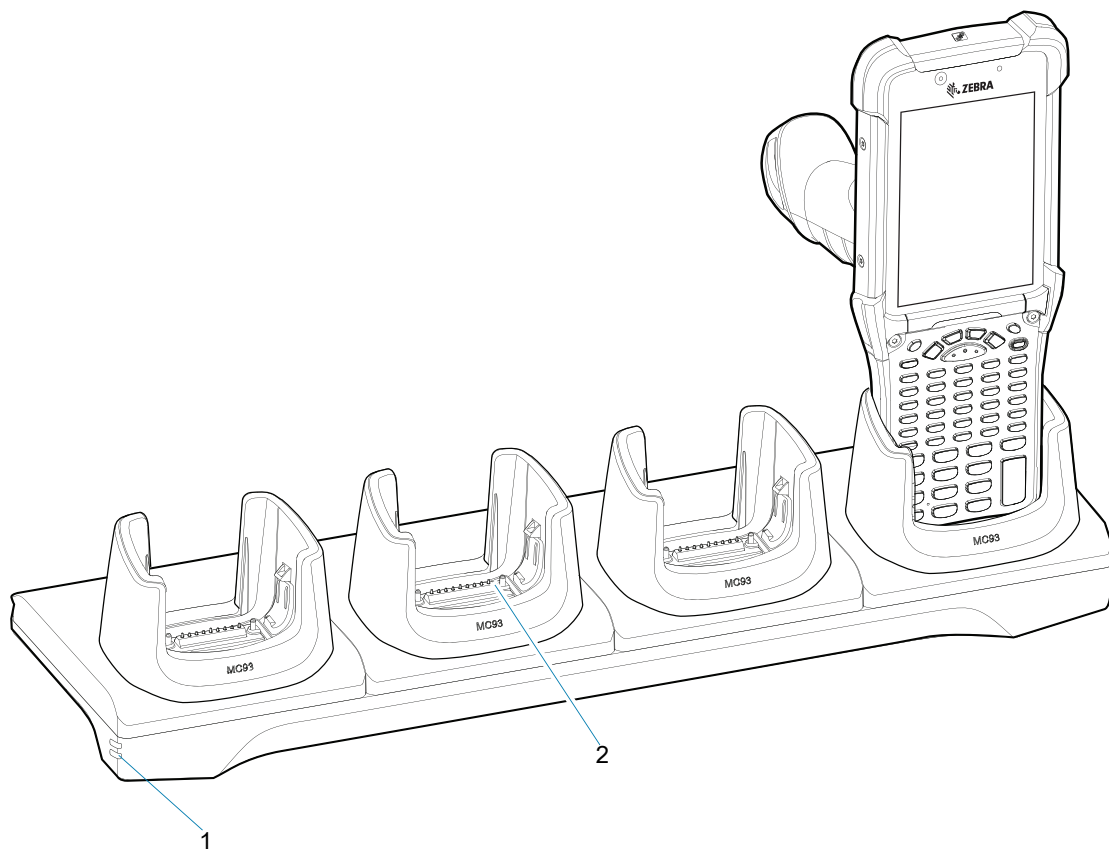

1	Power LED
2	Charging slot

## Setup

Figure 36 4-Slot Ethernet ShareCradle Setup

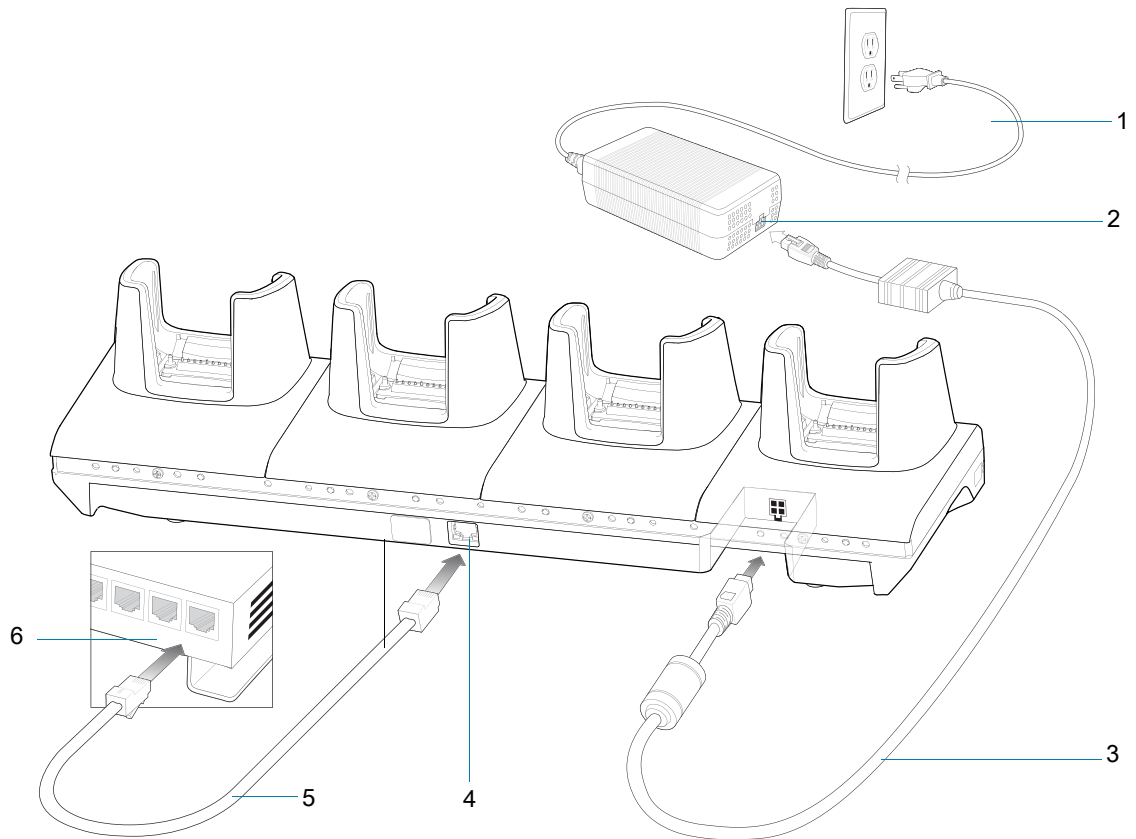

1	AC line cord
2	Power supply
3	DC line cord
4	Primary port
5	Ethernet cable
6	Router

## Charging the Devices

1. Connect the cradle to a power source.
2. Slide the devices into the slot in the cradle. The devices Charge LED Indicator, indicates the battery charging status.

**Figure 37** 4-Slot Ethernet ShareCradle

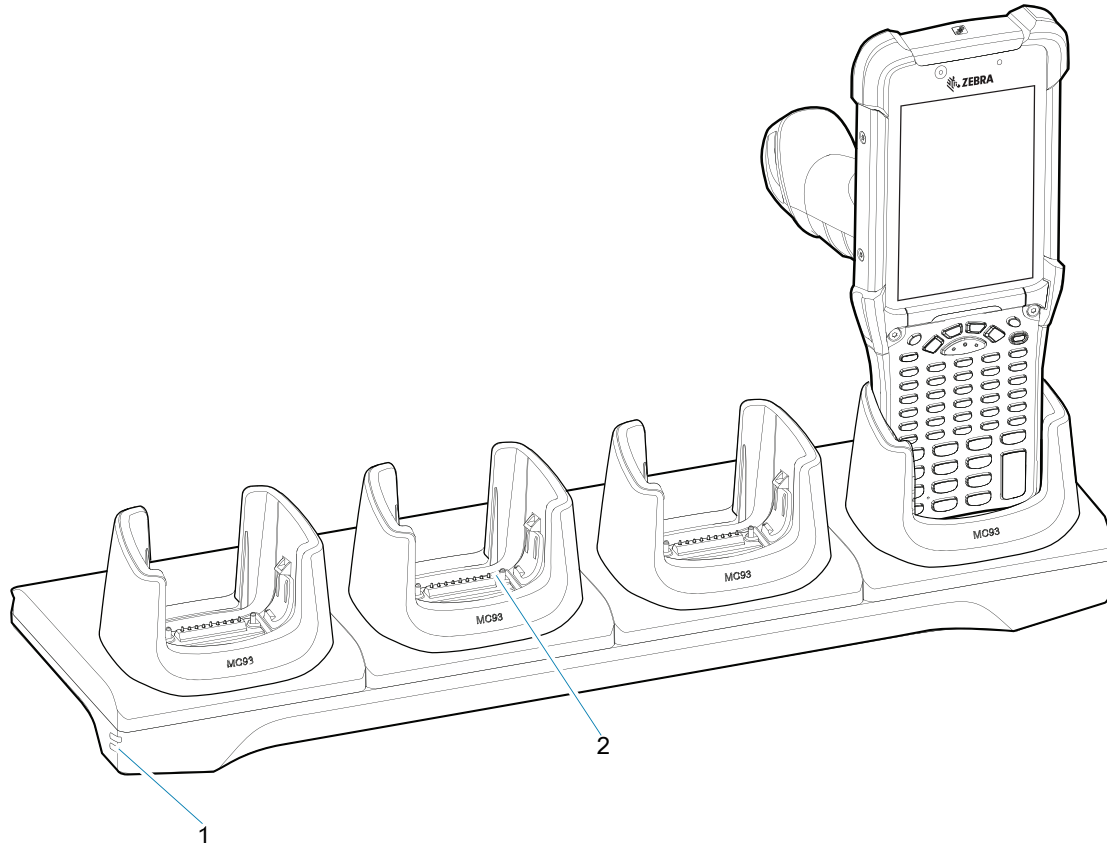

1	Power LED
2	Charging slot

3. Gently press down on the device to ensure proper contact.
4. When charging is complete, remove the devices from the cradle slot.

## Daisy-chaining Ethernet ShareCradles

Daisy-chain up to ten 4-Slot Ethernet ShareCradles to connect several cradles to an Ethernet network. Use either a straight or crossover cable. Daisy-chaining should not be attempted when the main Ethernet connection to the first cradle is 10 Mbps as throughput issues will almost certainly result.

To daisy-chain 4-Slot Ethernet ShareCradles:

1. Connect power to each 4-Slot Ethernet ShareCradle.
2. Connect an Ethernet cable to one of the ports on the switch and the other end to the Primary Port of the first cradle.

3. Connect an Ethernet cable to the Secondary port of the first cradle.
4. Connect the other end of the Ethernet cable to the Primary port of the next 4-Slot Ethernet ShareCradle.

**Figure 38** Daisy-chaining 4-Slot Ethernet ShareCradles

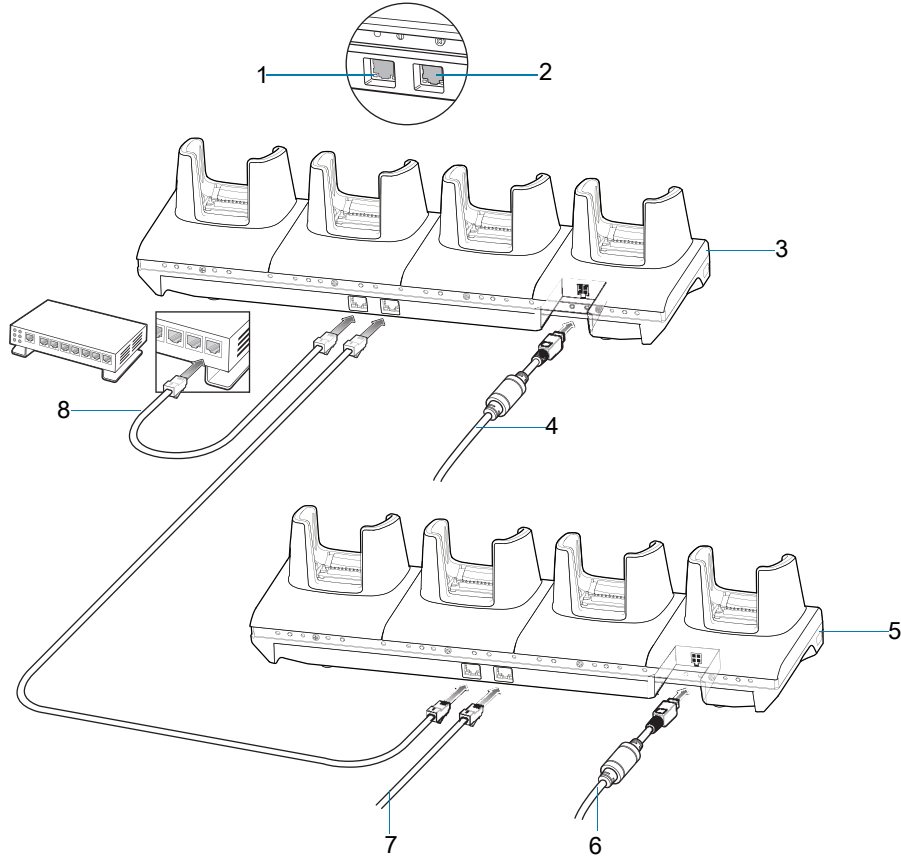

1	Primary port
2	Secondary port
3	First cradle
4	To power supply
5	Second cradle
6	To power supply
7	Ethernet cable to next cradle
8	To Ethernet switch

5. Connect additional cradles as described in step 3 and 4.

## Ethernet Settings

The following settings can be configured when using Ethernet communication:

- Proxy Settings
- Static IP.



## Configuring Ethernet Proxy Settings

The MC93XX includes Ethernet cradle drivers. After inserting the device, configure the Ethernet connection:

1. Swipe down from the status bar to open the quick access panel and then touch .
2. Touch **Network & Internet > Ethernet**.
3. Slide the switch to the **ON** position.
4. Place the device into the Ethernet cradle slot.
5. Touch and hold **eth0** until the menu appears.
6. Touch **Modify Proxy**.
7. Touch the **Proxy** drop-down list and select **Manual**.

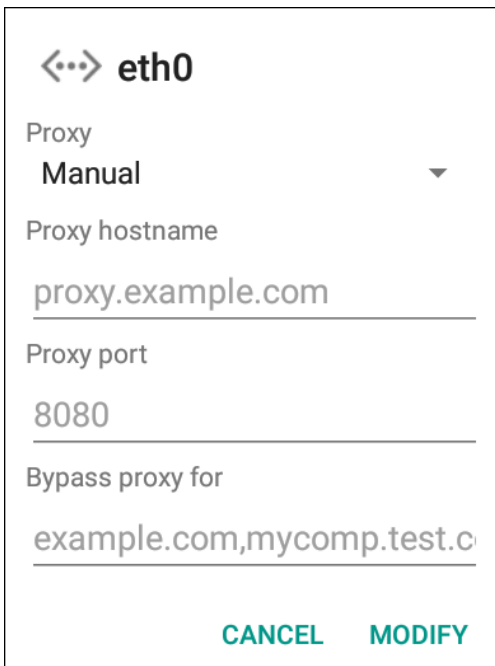

 **eth0**

Proxy  
Manual ▼

Proxy hostname  
proxy.example.com

Proxy port  
8080

Bypass proxy for  
example.com,mycomp.test.c

CANCEL MODIFY

8. In the **Proxy hostname** field, enter the proxy server address.
9. In the **Proxy port** field, enter the proxy server port number.



**NOTE:** When entering proxy addresses in the Bypass proxy for field, do not use spaces or carriage returns between addresses.

10. In the **Bypass proxy for** text box, enter addresses for web sites that do not require to go through the proxy server. Use the separator comma “,” between addresses.
11. Touch **MODIFY**.
12. Touch the Home button.

## Configuring Ethernet Static IP Address

The MC93XX includes Ethernet cradle drivers. After inserting the device, configure the Ethernet connection:

1. Swipe down from the status bar to open the quick access panel and then touch .
2. Touch **Network & Internet > Ethernet**.

3. Slide the switch to the **ON** position.
4. Place the device into the Ethernet cradle slot.
5. Touch **eth0**.
6. Touch **Disconnect**.
7. Touch **eth0**.
8. Touch the IP settings drop-down list and select **Static**.

**<··> eth0**

Proxy  
**None** ▼

IP settings  
**Static** ▼

IP address  
192.168.1.128

---

Gateway  
192.168.1.1

---

Netmask  
255.255.255.0

---

DNS 1  
8.8.8.8

---

DNS 2  
4.4.4.4

---

CANCEL    CONNECT

9. In the **IP** address field, enter the proxy server address.
10. If required, in the **Gateway** field, enter a gateway address for the device.
11. If required, in the **Netmask** field, enter the network mask address
12. If required, in the **DNS** address fields, enter a Domain Name System (DNS) addresses.
13. Touch **CONNECT**.
14. Touch the Home button.

### Establishing Ethernet Connection

1. Double-swipe down from the top of the Home screen to open the Quick Access panel and touch .
2. Touch **Network & Internet > Ethernet**.
3. Slide the Ethernet switch to the **ON** position.

4. Place the device into the Ethernet cradle slot.
5. Touch **eth0** to view Ethernet connection details.

## LED Indicators

There are two green LEDs on the side of the cradle. These green LEDs light and blink to indicate the data transfer rate.

**Table 10** LED Data Rate Indicators

Data Rate	1000 LED	100/10 LED
1 Gbps	On/Blink	Off
100 Mbps	Off	On/Blink
10 Mbps	Off	On/Blink

## 4-Slot Spare Battery Charger



**CAUTION:** Ensure that you follow the guidelines for battery safety described in [Battery Safety Guidelines](#) on page 185.

The 4-Slot Spare Battery Charger:

- Charges up to 4 spare batteries.
- Provides 4.2 VDC power to charge the spare battery.

### Setup

**Figure 39** 4-Slot Spare Battery Charger Setup

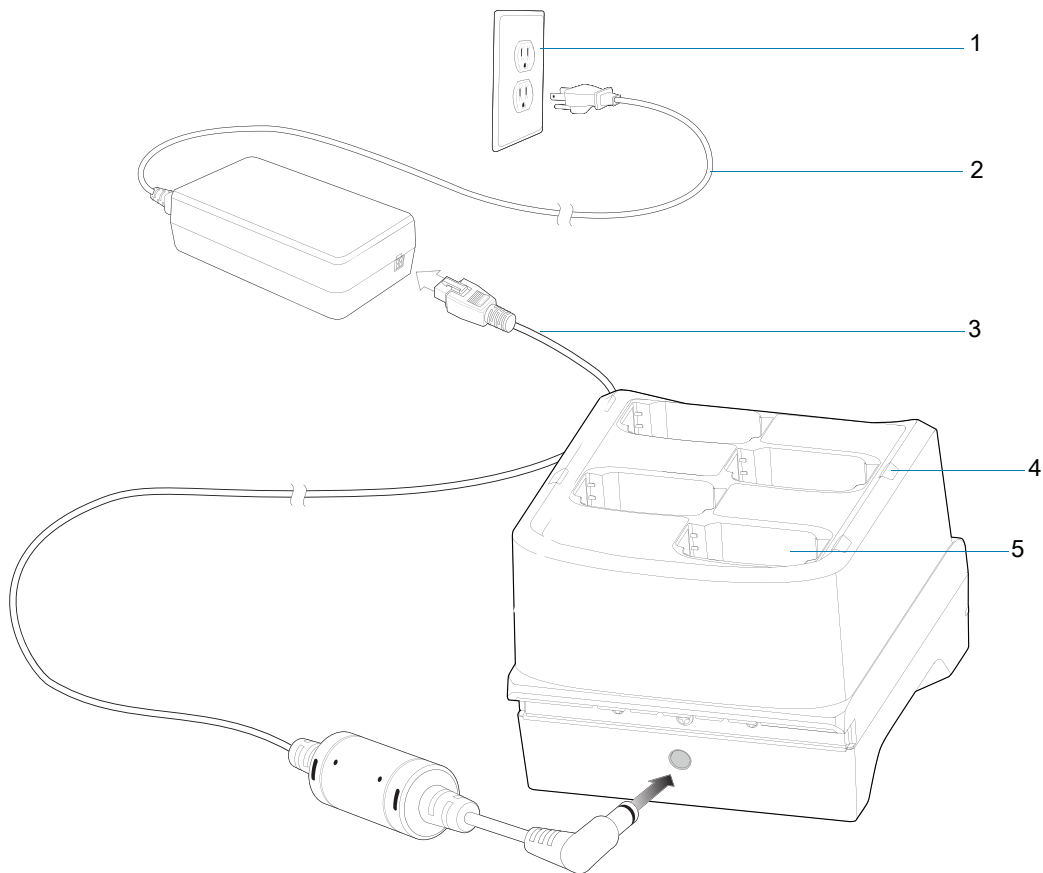

1	Power supply
2	AC line cord
3	DC line cord
4	Spare battery charging LED
5	Charging slot

## Charging the Spare Batteries

1. Connect the charger to a power source.

**Figure 40** 4-Slot Spare Battery Charger

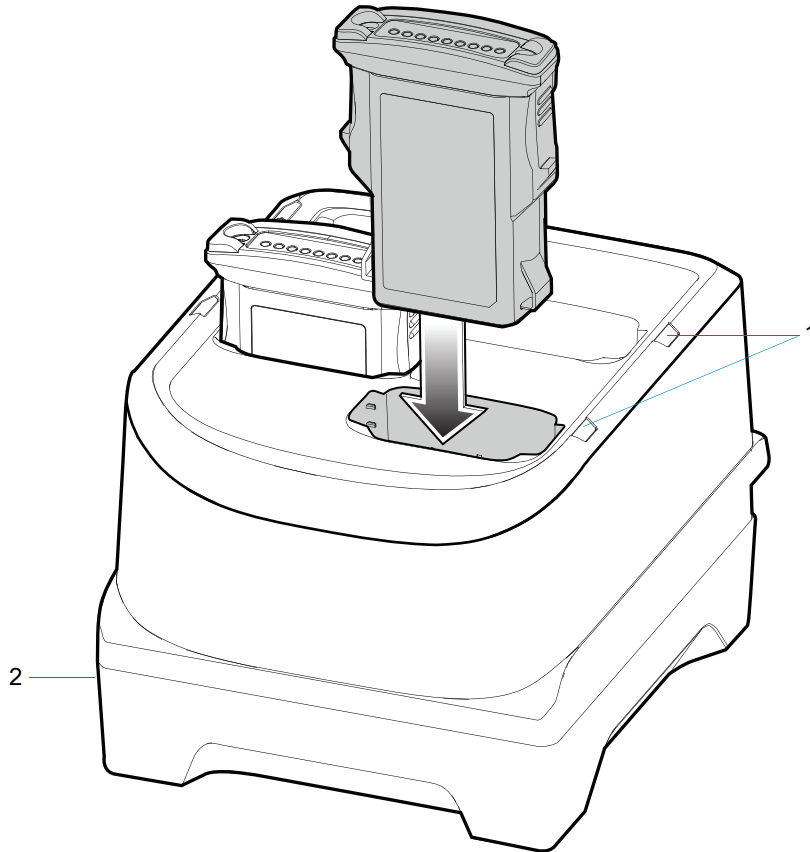

1	Spare battery charging LEDs
2	Power LED

2. Insert the battery into a spare battery charging slot and gently press down on the battery to ensure proper contact.

## 16-Slot Spare Battery Charger



**CAUTION:** Ensure that you follow the guidelines for battery safety described in [Battery Safety Guidelines](#) on page 185.

The 16-Slot Spare Battery Charger:

- Charges up to 16 spare batteries.
- Provides 4.2 VDC power to charge the spare battery.

### Setup

**Figure 41** 16-Slot Spare Battery Charger Setup

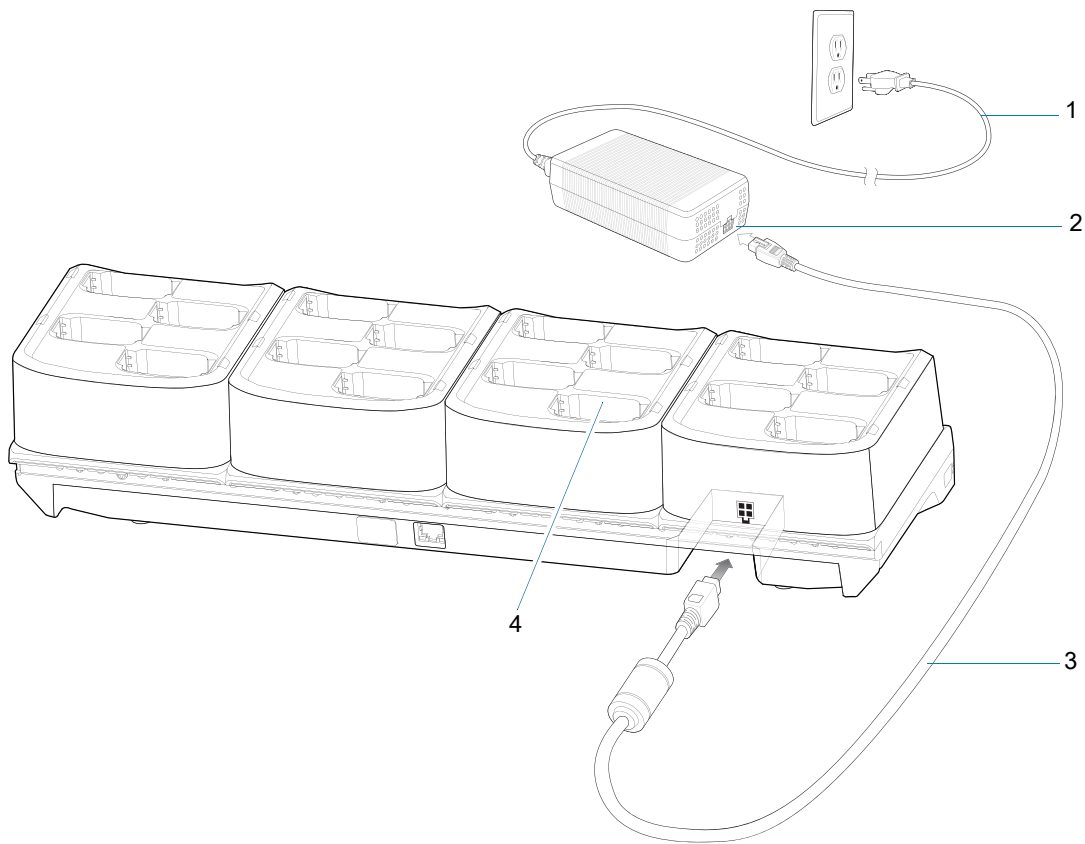

1	AC line cord
2	Power supply
3	DC line cord
4	Charging slot

## Charging the Spare Batteries



**CAUTION:** Ensure that you follow the guidelines for battery safety described in [Battery Safety Guidelines](#) on page 185.

1. Connect the charger to a power source.

**Figure 42** 16-Slot Spare Battery Charger

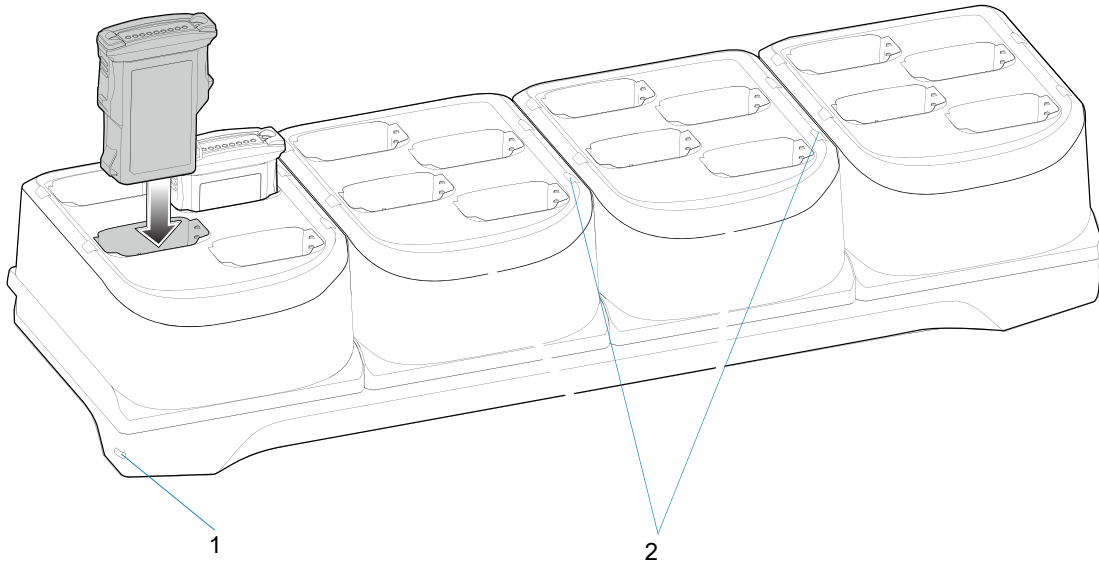

1	Power LED
2	Spare battery charging LED

2. Insert the battery into a spare battery charging slot and gently press down on the battery to ensure proper contact.

## USB Charge/Com Snap-on Cup

The USB Charge/Com Snap-on Cup:

- Provides 5 VDC power to operate the device and to charge the battery.
- Provides power and/or communication with the host computer over USB to the device.

**Figure 43** USB Charge/Com Snap-on Cup



1	Pigtail with USB socket
2	USB charge/com snap-on cup



## Connecting to the Device



**NOTE:** To function properly, remove the lower part of the rubber boot or the entire rubber boot before placing the device in a charging cradle.

Insert the device straight onto the USB Charge/Com Snap-on Cup until the device touches the bottom of the cable cup.

**Figure 44** Connecting the USB Charge/Com Snap-on Cup

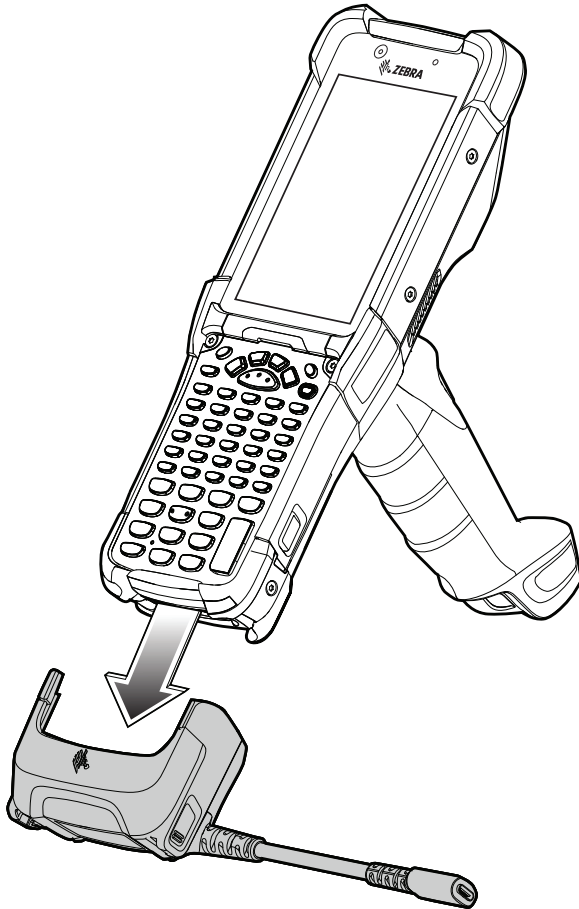

## Connecting the USB Charge/Com Snap-on Cup Cable to Host Computer

To connect the USB Charge/Com Snap-on Cup cable to a host computer:

1. Connect the USB Charge/Com Snap-on Cup to the device.
2. Connect the USB connector to a host computer.

**Figure 45** Connecting USB Charge/Com Snap-on Cup to Host Computer

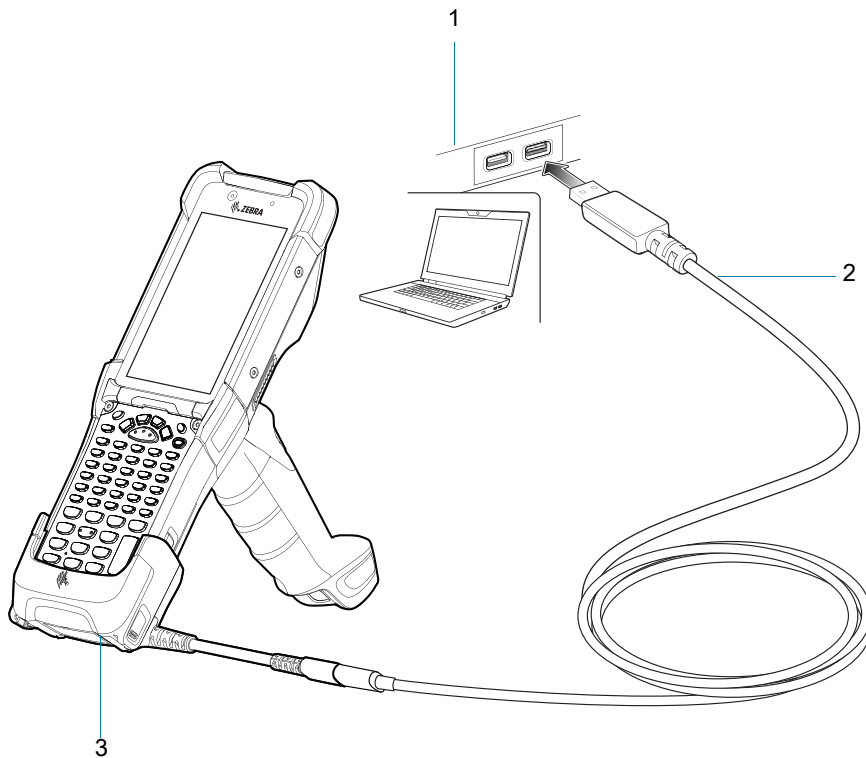

1	Host computer
2	USB cable
3	USB charge/com snap-on cup

## Charging the Device

To charge the device using the USB Charge/Com Snap-on Cup:

1. Connect the USB Charge/Com Snap-on Cup to the device.
2. Connect the USB connector of the power supply.
3. Plug the power supply into a power outlet.

**Figure 46** Charging the Device using the USB Charge Cable

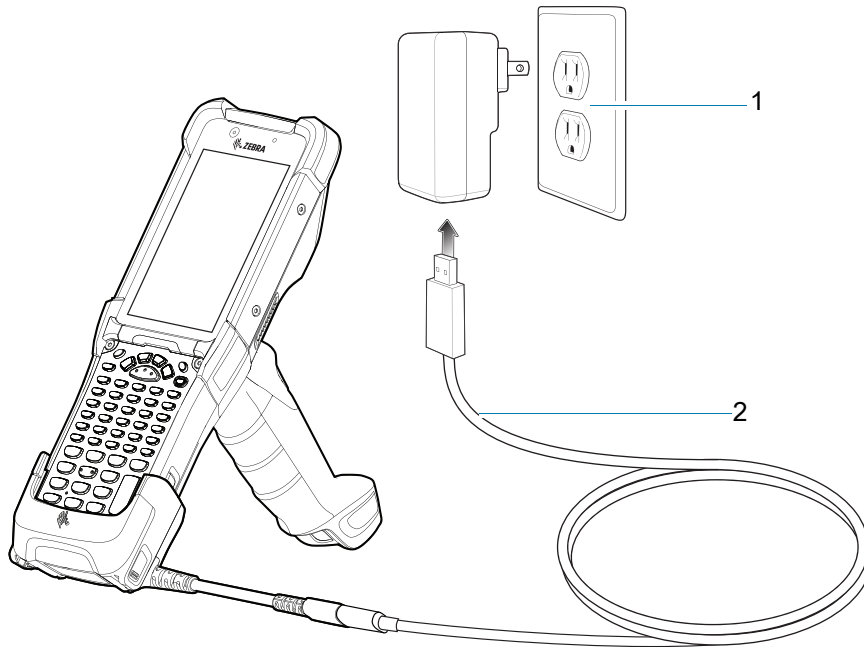

1	Power supply
2	USB cable

## Disconnecting the USB Charge/Com Snap-on Cup

To disconnect the USB Charge/Com Snap-on Cup from the device:

1. Depress the two latches on either side of the cup.
2. Pull the cup off the bottom of the device.

**Figure 47** Disconnecting the USB Charge/Com Snap-on Cup

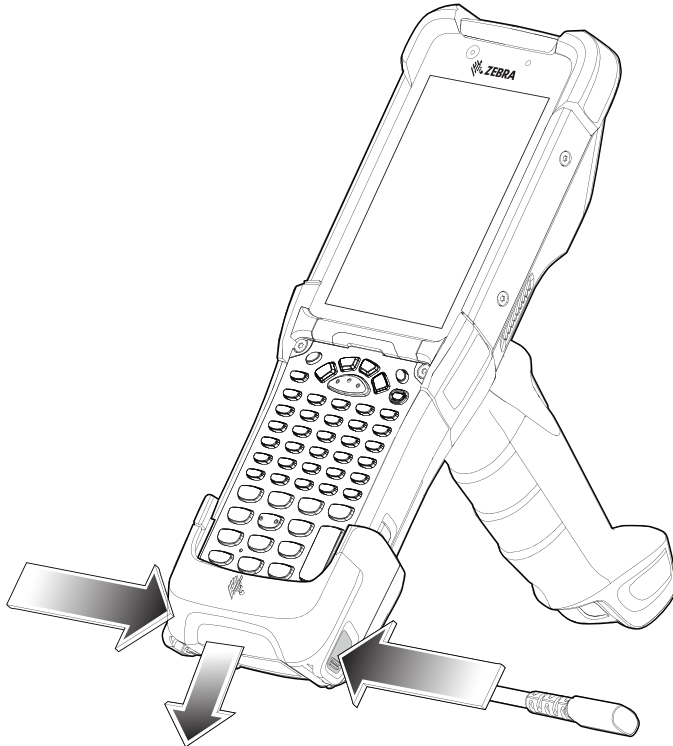

## MC93XX Charge Only Adapter

Use the Charge Only Adapter for backwards compatibility with the MC9XXX cradles and the MC93XX mobile computer.

- Charge Only Adapter supports terminal charging only for the MC9XXX 1-Slot Cradle and 4-Slot Cradle.
- Charge Only Adapter provides charge only and no communication when used with the MC9XXX cradles.

**Figure 48** MC9X 1-Slot Cradle Charge Only Adapter

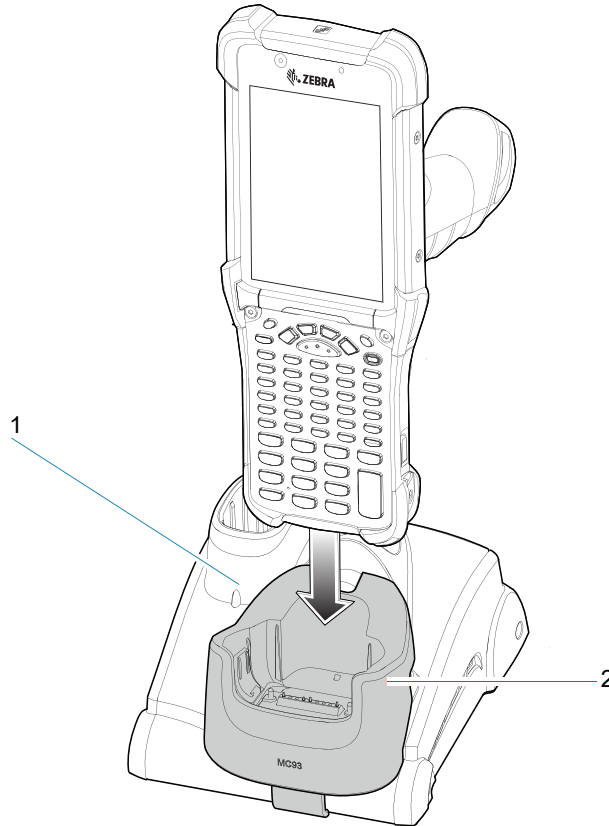

1	Charge only adapter
2	MC92 1-Slot cradle

**Figure 49** MC9X 4-Slot Cradle Charge Only Adapter

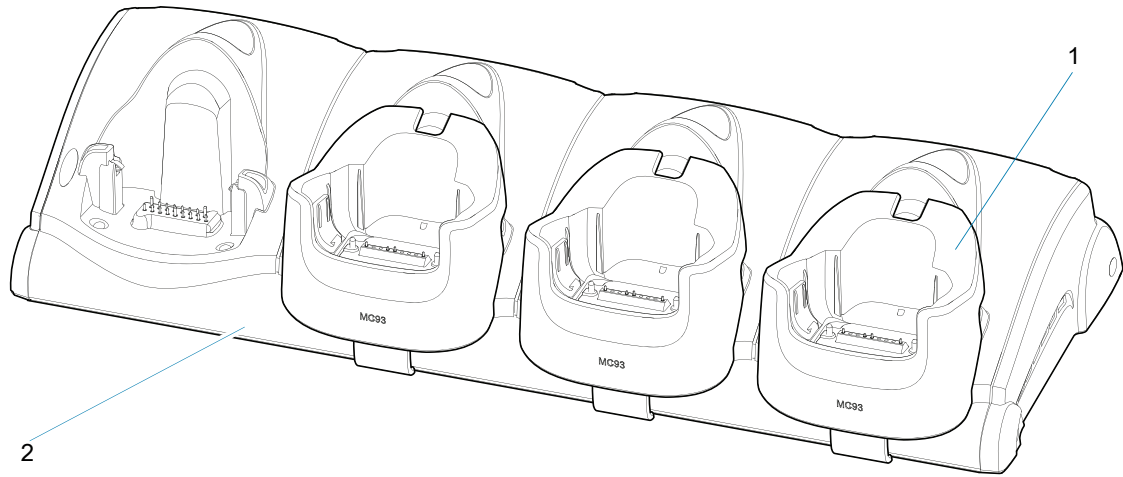

1	Charge only adapter
2	MC92 4-Slot cradle

## Charge Only Adapter Installation

To install the Charge Only Adapter:

1. Clean the MC9XXX cradle and contacts surface as specified with an alcohol wipe, using a back and forth motion with your finger.  
For more information about cleaning, refer to the MC93XX Mobile Computer User Guide.

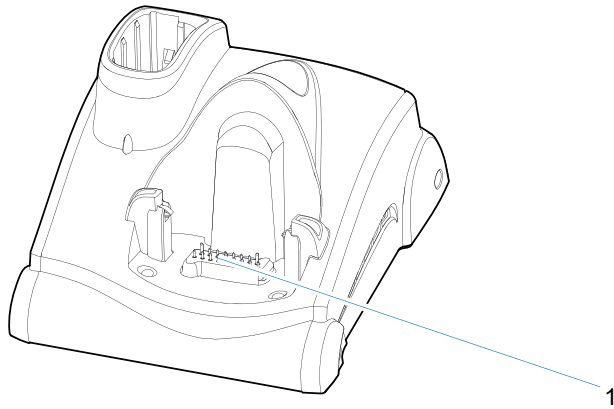

1	Clean cradle contacts and surface
---	-----------------------------------

2. Peel and remove the adhesive from the back of the adapter.

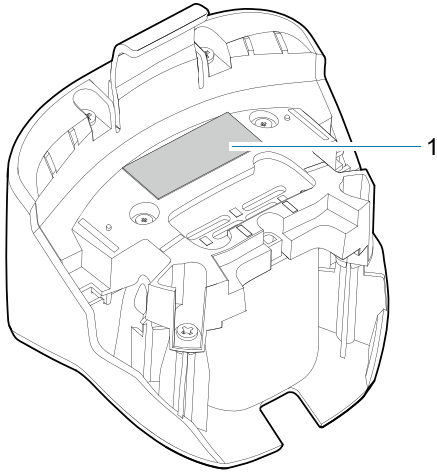

1	Peel and remove adhesive liner
---	--------------------------------

3. Insert the adapter into the MC9XXX cradle and adhere to the bottom of the cradle.

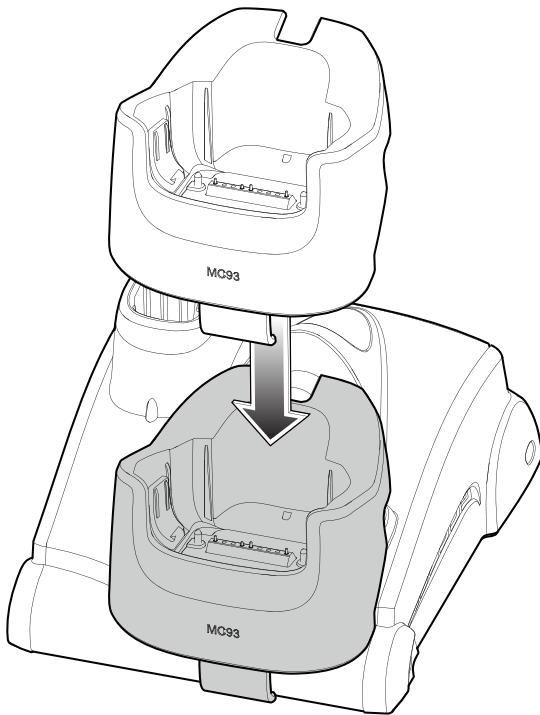

4. Insert the device into the cradle.

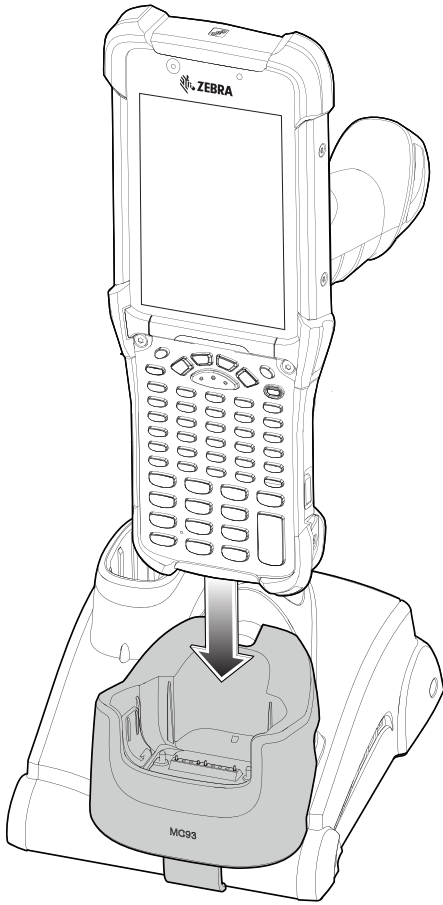



## Rubber Boot

To attach the rubber boot:

1. If using the rubber boot with a device with the SE965 laser scanner, retain the shim (default assembly).  
If using the rubber boot with a device with either the SE4750SR or the SE4850ER imager, you must snap-off the shim by pushing it through.

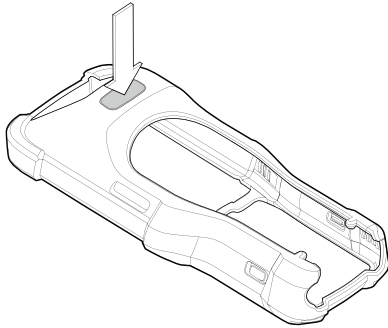

2. Slide the top of the device into the top of the rubber boot.

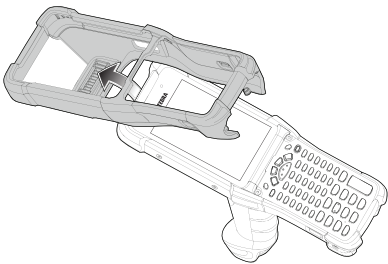

3. Grasp the bottom of the rubber boot and place over the bottom of the device.

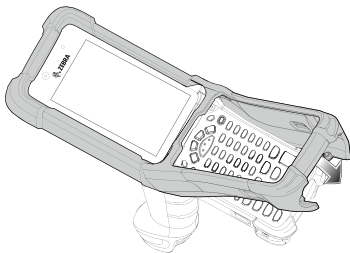

4. Turn the device over and ensure that the two alignment tabs completely fit into the two alignment slots on the device.

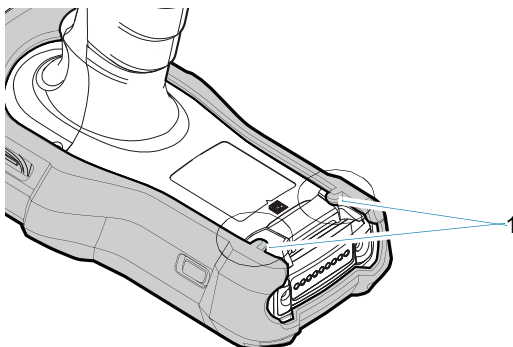

1	Tabs
---	------



**NOTE:** To charge the device in a cradle, completely remove the rubber boot.

## Installing the Hand Strap

To install the hand strap:

1. Thread and pull-through the short section through the opening near the base of the trigger handle.

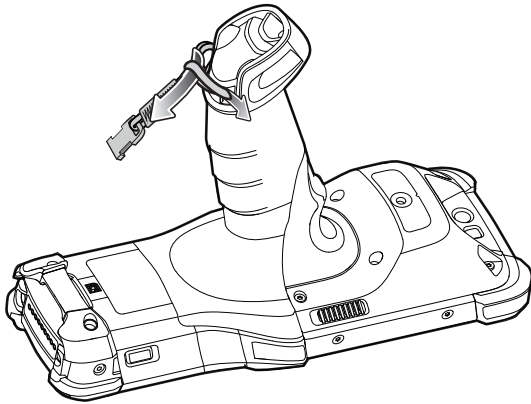

2. Thread and pull-through the longer section through the opening near the battery.

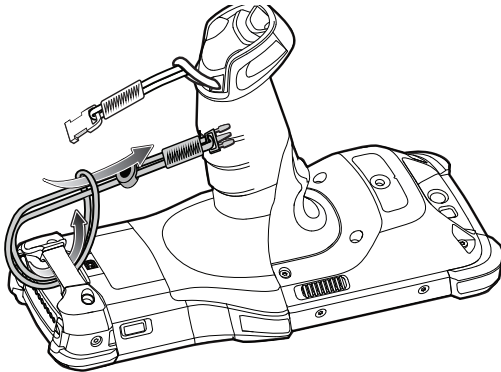

3. Attach the two plastic ends together.

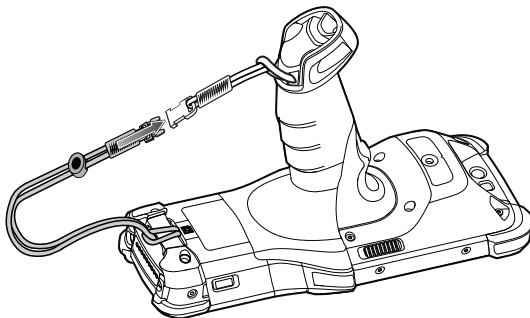

## Un-powered Forklift Mount

The Un-powered Forklift Mount on a forklift allows you to place the device in a holder. The forklift mount does not provide charging or communication to the device. Install the Forklift Mount on a square surface or roll bar of a forklift. The mount supports portrait (vertical) orientation only.

To install the MC93XX in an un-powered forklift mount holder:

1. Secure the RAM Clamp Base to the forklift mounting surface using two screws and nuts.
2. Attach the RAM Socket Arm to the RAM Clamp Base and the Forklift Mount Holder.
3. Turn the Socket Arm hand-screw clockwise until tight.

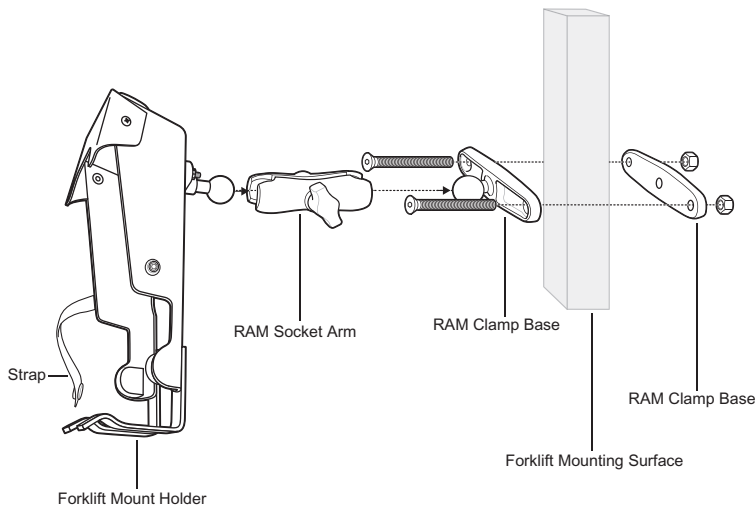

4. Insert the device into the Forklift Mount Holder at a 45° angle in one of two ways (shown below).
5. Rotate and snap the device into place.
6. If required, secure the device with the rubber strap, and snap it into place.

**Figure 50** Insert Device into Forklift Mount Holder, Rotate and Snap (Option 1)

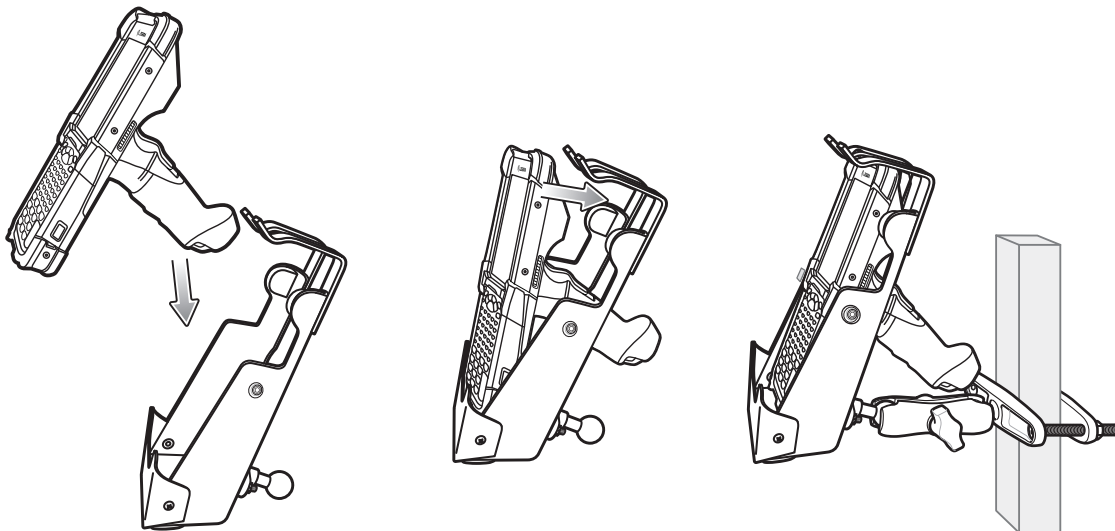

**Figure 51** Insert Device into Forklift Mount Holder, Rotate and Snap (Option 2)

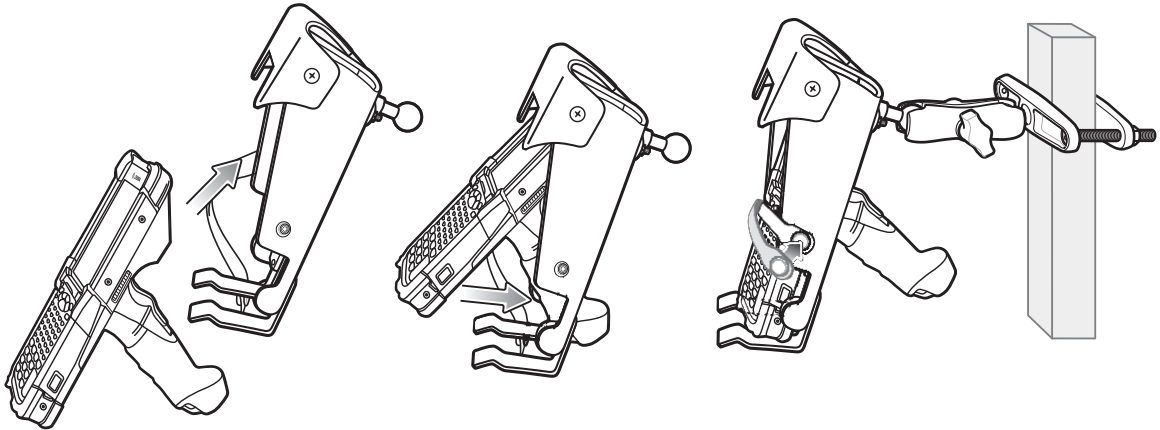

**NOTE:** Use strap in this orientation for added retention of the device.

## 4-Slot Charge Only ShareCradle Rack Installation

Use the Rack/Wall Mount Bracket to mount a 4-slot charge only sharecradle on a rack. When installing on a rack, first assemble the bracket and cradles/chargers and then install the assembly on the rack.

1. Place the power supply in bottom tray.
2. Connect AC line cord to power supply.
3. Connect DC line cord to power supply.
4. Secure power supply and cables to bottom tray with tie wraps.



**NOTE:** Ensure tie wrap buckle is on side of power supply. Tie wrap buckle on top of power supply interferes with top tray.

5. Route cables through cable slots.

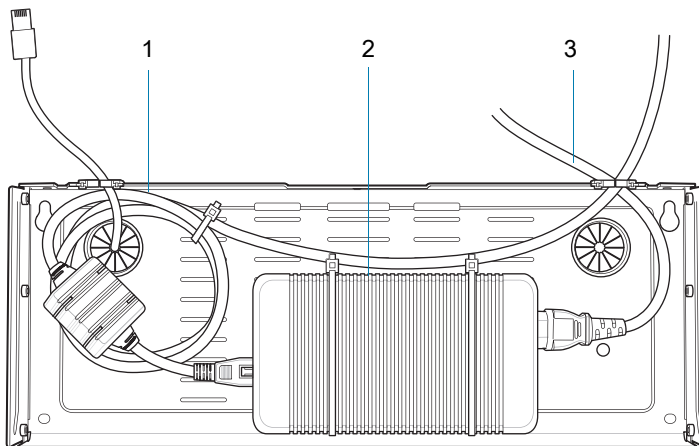

1	DC line cord
2	Power supply
3	AC line cord

6. Secure four M2.5 studs to top tray as shown.

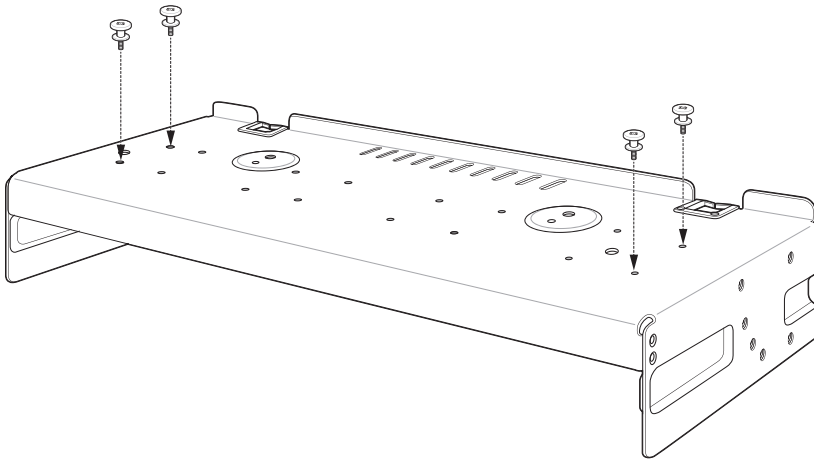

7. Align and install 4-Slot cradle onto studs of top tray.

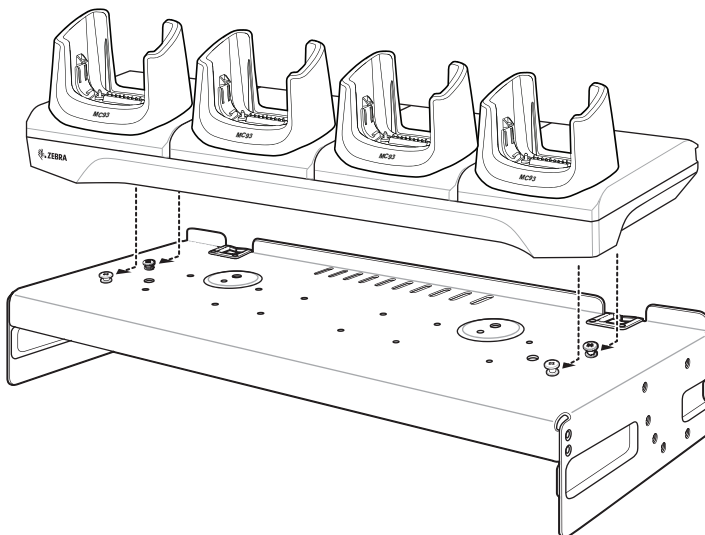

8. Secure cradle to top tray with two M2.5 safety screws.

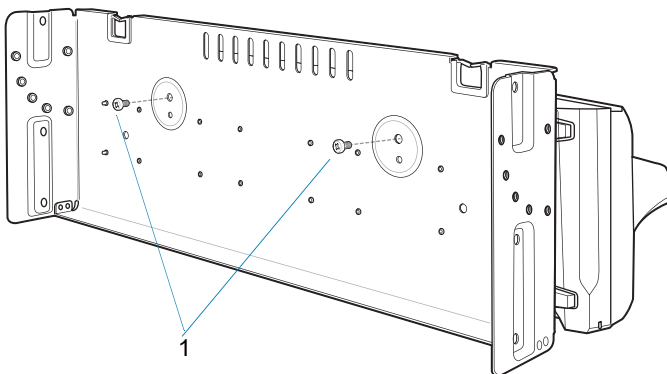

1	Safety screws (2)
---	-------------------

9. Slide top tray onto bottom tray.

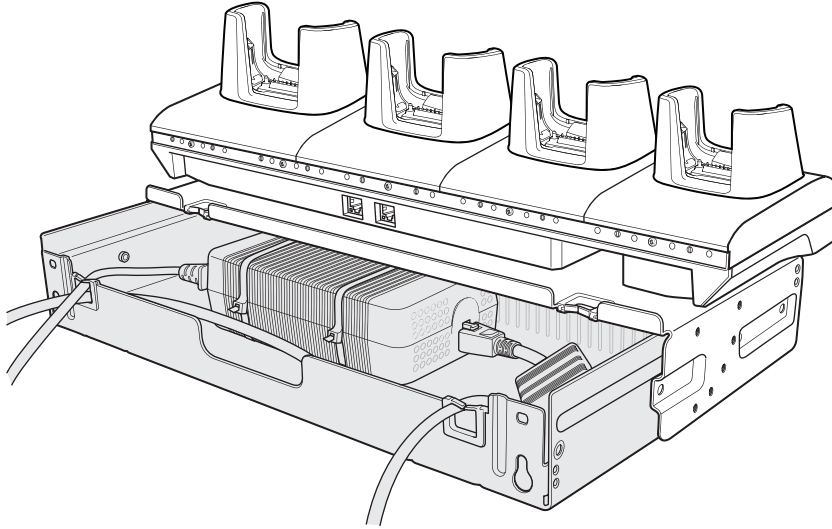

10. Connect cables to cradle.

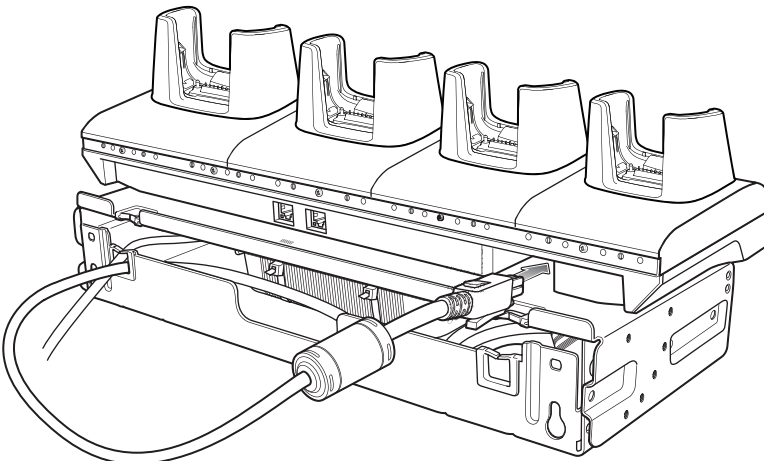

11. Secure top tray to bottom tray with 4 M5 screws (two on each side).

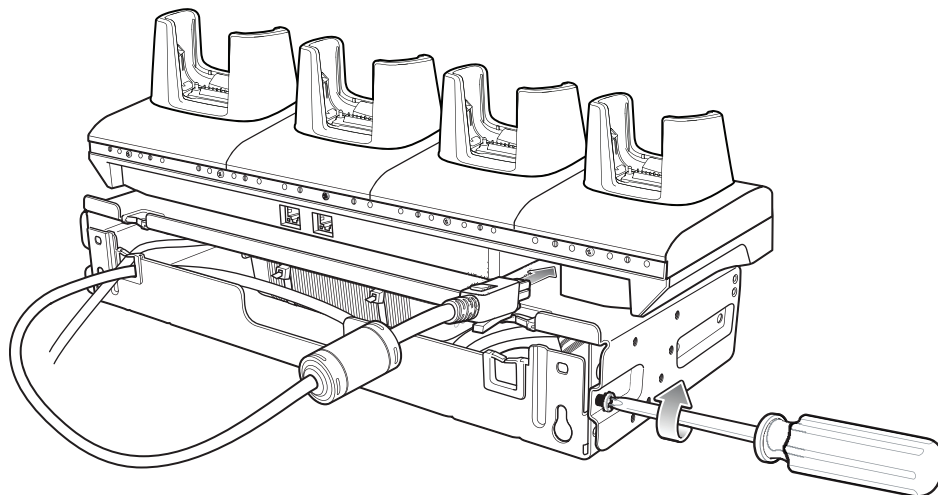

See [Rack Mount Installation on page 135](#) for installing the bracket assembly onto a rack.

## Rack Mount Installation



**NOTE:** Use screws provided with rack system. Refer to the rack user documentation for instructions.

1. Secure mounting brackets to both sides of top tray with four M5 screws (two on each side). For 4-Slot cradles, position the flange for horizontal installation. For 4-Slot Battery Chargers, position the flange for 25° installation.

**Figure 52** Flange Horizontal Position (4-Slot Cradles)

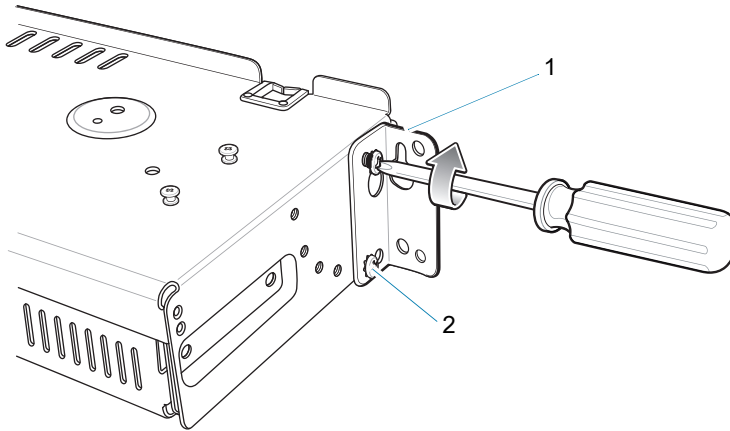

1	Flange
2	Fifth screw hole

**Figure 53** Flange 25° Position (4-Slot Battery Chargers)

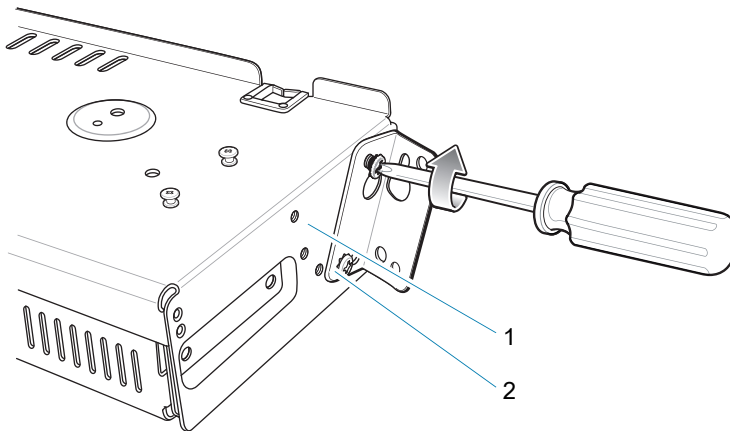

1	Top screw hole
2	Flange



**CAUTION:** Install mounting bracket with 4-Slot cradle at a maximum height of four feet from ground. Install mounting bracket with 4-Slot Battery Charger at a maximum height of three feet from ground.



**NOTE:** Distance between two horizontal mounted brackets should be at least 14" apart (from top of one flange to the top of the next flange).

Distance between a horizontal mounted bracket and a 25° mounted bracket should be at least 16.25" apart (from top of one flange to the top of the next flange).

There should be enough clearance (2.75") between the top of the device and the bottom of the mounting bracket above.

2. Install two rack system screws for top of mounting brackets. The screw heads should protrude half way from the rail.

**Figure 54** Install Rack System Screws

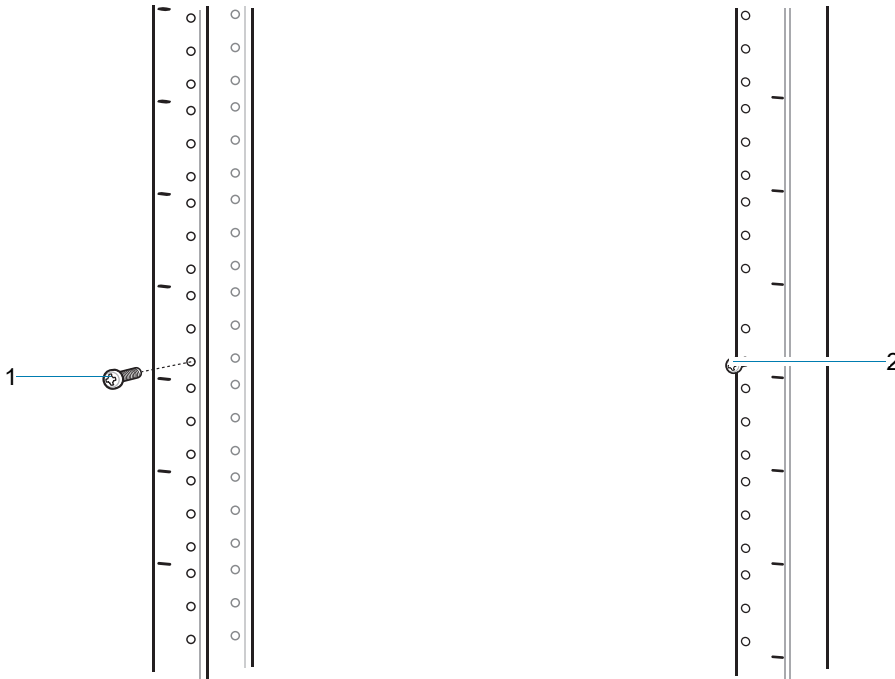

1	Rack screw
2	Rack screw

3. Align the mounting bracket's top mounting key holes with the screws.
4. Place the brackets on the screws.



**Figure 55** Secure Bracket to Rack (Horizontal Position Shown)

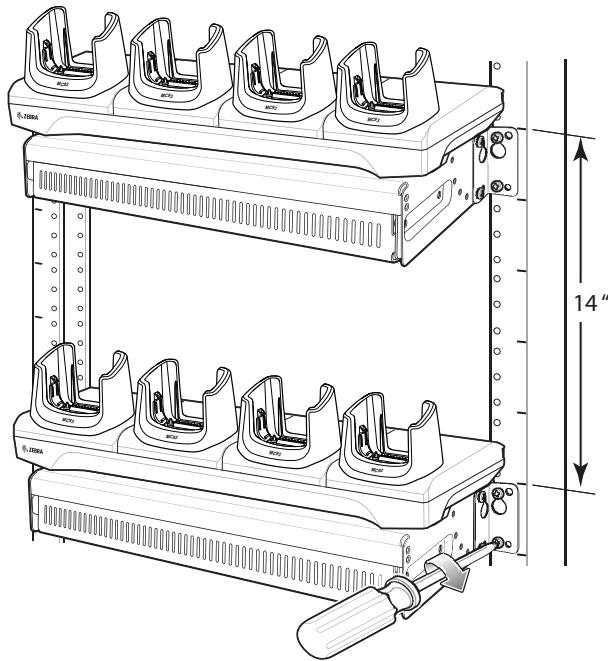

5. Secure the top screws.
6. Install bottom screws and tighten screws.
7. Route cables and connect to power source.



**CAUTION:** Installer should ensure that all building codes are followed when connecting the power supplies to an AC power source.

While installing the brackets, power supplies and cables:

- Use tie wraps to secure cables to the bracket and rails.
- Coil cables wherever possible.
- Route power cables along the rails.

Route inter-cradle cables to the side rails and then from the rails to the bracket.

## Wall Installation

Use the Rack/Wall Mount Bracket to mount four 4-Slot Battery Chargers or a cradle on a wall. When installing on a wall, first assemble the bottom tray, install the bottom tray on the wall and then assemble the top tray.

Use mounting hardware (screws and/or anchors) appropriate for the type of wall mounting the bracket onto. The Mount Bracket mounting slots dimensions are 5 mm (0.2 in.). Fasteners must be able to hold a minimum of 20 Kg (44 lbs.)

For proper installation consult a professional installer. Failure to install the bracket properly can possibly result in damage to the hardware.



**CAUTION:** Install mounting bracket with 4-Slot cradle at a maximum height of four feet from ground. Install mounting bracket with 4-Slot Battery Charger at a maximum height of three feet from ground.

## Bottom Tray Assembly

See steps 1 through 5 in [4-Slot Charge Only ShareCradle Rack Installation on page 132](#) for instructions.

## Bracket Wall Mounting

1. Drill holes and install anchors according to the template supplied with the bracket.
2. Install two screws for bottom of bracket. The screw heads should protrude 2.5 mm (0.01") from the wall.

**Figure 56** Horizontal Mounting Template

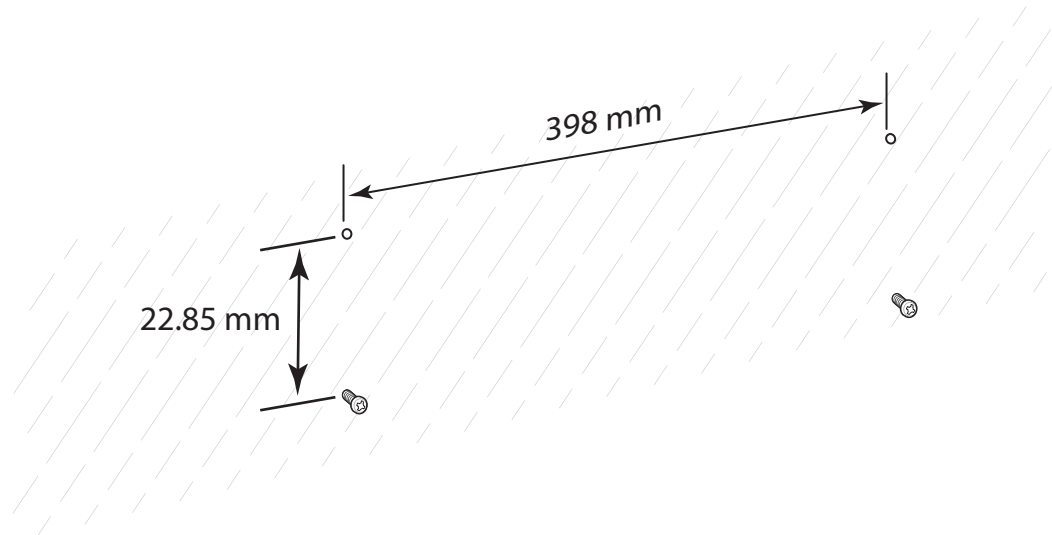

3. Align the mounting bracket's bottom mounting key holes with the screws.

4. Hang the bracket on the screws.

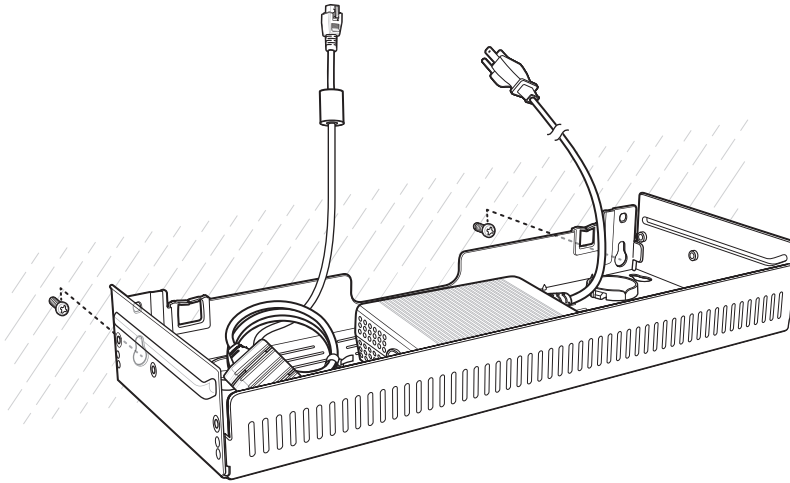

5. Install two top screws.
6. Tighten all screws.

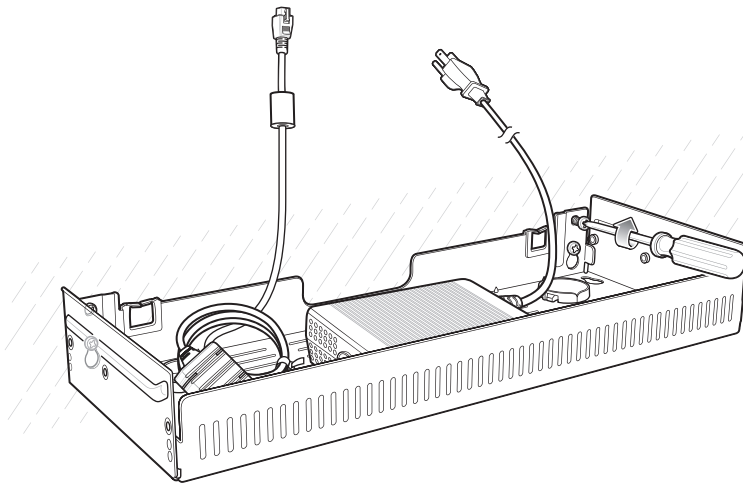

7. Assemble the four 4-Slot Battery Chargers or cradle onto the bracket. See steps 7 through 11 in [4-Slot Charge Only ShareCradle Rack Installation on page 132](#).
8. Route cables and connect to power source.



**CAUTION:** Installer should ensure that all building codes are followed when connecting the power supplies to an AC power source.

While installing the brackets, power supplies and cables:

- Use tie wraps to secure cables to the bracket and rails.
- Coil cables wherever possible.
- Route power cables along the rails.
- Route inter-cradle cables to the side rails and then from the rails to the bracket.

# Application Deployment

## Security

The device implements a set of security policies that determine whether an application is allowed to run and, if allowed, with what level of trust. To develop an application, you must know the security configuration of the device, and how to sign an application with the appropriate certificate to allow the application to run (and to run with the needed level of trust).



**NOTE:** Ensure the date is set correctly before installing certificates or when accessing secure web sites.

## Secure Certificates

If the VPN or Wi-Fi networks rely on secure certificates, obtain the certificates and store them in the device's secure credential storage, before configuring access to the VPN or Wi-Fi networks.

If downloading the certificates from a web site, set a password for the credential storage. The device supports X.509 certificates saved in PKCS#12 key store files with a .p12 extension (if key store has a .pfx or other extension, change to .p12).

The device also installs any accompanying private key or certificate authority certificates contained in the key store.

## Installing a Secure Certificate

To install a secure certificate:

1. Copy the certificate from the host computer to the root of the device's internal memory. See [USB Communication on page 36](#) for information about connecting the device to a host computer and copying files.
2. Go to **Settings**.
3. Touch **Security > Advanced > Encryption & credentials**.
4. Touch **Install from storage**.
5. Navigate to the location of the certificate file.
6. Touch the filename of the certificate to install.
7. If prompted, enter the password for credential storage. If a password has not been set for the credential storage, enter a password for it twice and then touch **OK**.
8. If prompted, enter the certificate's password and touch **OK**.

9. Enter a name for the certificate and in the Credential use drop-down, select **VPN and apps** or **Wi-Fi**.
10. Touch **OK**.

The certificate can now be used when connecting to a secure network. For security, the certificate is deleted from the internal memory.

### Configuring Credential Storage Settings

1. Go to **Settings**.
2. Touch **Security > Advanced > Encryption & credentials**.
  - **Trusted credentials** - Touch to display the trusted system and user credentials.
  - **User credentials** - Touch to display user credentials.
  - **Install from storage** - Touch to install a secure certificate from the internal storage.
  - **Clear credentials** - Deletes all secure certificates and related credentials.

## Development Tools

Development tools for Android include Android Studio, EMDK for Android, and StageNow.

### Android Application Development

#### Development Workstation

Android development tools are available at [developer.android.com](http://developer.android.com).

To start developing applications for the device, download Android Studio. Development can take place on a Microsoft® Windows®, Mac® OS X®, or Linux® operating system.

Applications are written in Java or Kotlin, but compiled and executed in the Dalvik virtual machine. Once the Java code is compiled cleanly, the developer tools make sure the application is packaged properly, including the AndroidManifest.xml file.

Android Studio contains a full featured IDE as well as SDK components required to develop Android applications.

#### Enabling Developer Options

The **Developer options** screen sets development related settings. By default, the Developer Options are hidden.

1. Go to **Settings**.
2. Touch **About phone**.
3. Scroll down to **Build number**.
4. Tap **Build number** seven times. The message **You are now a developer!** appears.
5. Touch the Back button.
6. Touch **System > Advanced > Developer options**.
7. Slide the **USB debugging** switch to the **ON** position.

### EMDK for Android

EMDK for Android provides developers with tools to create business applications for enterprise mobile devices. It is designed for use with Google's Android Studio and includes Android class libraries such as Barcode, sample applications with source code, and the associated documentation.

EMDK for Android allows applications to take full advantage of the capabilities that Zebra devices have to offer. It embeds Profile Manager technology within Android Studio IDE, providing a GUI-based development tool designed specifically for Zebra devices. This allows fewer lines of code, resulting in reduced development time, effort, and errors.

For more information go to: [techdocs.zebra.com](http://techdocs.zebra.com).

### StageNow

StageNow is Zebra's next-generation Android Staging Solution built on the MX platform. It allows quick and easy creation of device profiles, and can deploy to devices simply by scanning a barcode, reading a tag, or playing an audio file.

The StageNow Staging Solution includes the following components:

- The StageNow Workstation tool installs on the staging workstation (host computer) and lets the administrator easily create staging profiles for configuring device components, and perform other staging actions such as checking the condition of a target device to determine suitability for software upgrades or other activities. The StageNow Workstation stores profiles and other created content for later use.
- The StageNow Client resides on the device and provides a user interface for the staging operator to initiate staging. The operator uses one or more of the desired staging methods (print and scan a barcode, read an NFC tag or play an audio file) to deliver staging material to the device.

For more information go to: [techdocs.zebra.com](http://techdocs.zebra.com).

### GMS Restricted

GMS Restricted mode deactivates Google Mobile Services (GMS). All GMS apps are removed from the device and communication with Google (analytics data collection and location services) is disabled. It also provides enhanced security and privacy.

Use StageNow to disable or enable GMS Restricted mode. After a device is in GMS Restricted mode, enable and disable individual GMS apps and services using StageNow. To ensure GMS Restricted mode persists after an Enterprise Reset, use the Persist Manager option in StageNow. For more information on StageNow, refer to [techdocs.zebra.com](http://techdocs.zebra.com).

### ADB USB Setup

To use the ADB, install the USB driver. This assumes that the development SDK has been installed on the host computer. Go to [developer.android.com/sdk/index.html](http://developer.android.com/sdk/index.html) for details on setting up the development SDK.

ADB driver for Windows and Linux are available on the Zebra Support Central web site at [www.zebra.com/support](http://www.zebra.com/support). Download the ADB and USB Driver Setup package. Follow the instructions with the package to install the ADB and USB drivers for Windows and Linux.

### Enabling USB Debugging

By default, USB debugging is disabled.

1. Go to **Settings**.
2. Touch **About phone**.
3. Scroll down to **Build number**.
4. Tap **Build number** seven times. The message **You are now a developer!** appears.
5. Touch the Back button.
6. Touch **System > Advanced > Developer options**.
7. Slide the **USB debugging** switch to the **ON** position.
8. Touch **OK**.
9. Connect the device to the host computer using the Rugged Charge/USB Cable.  
The **Allow USB debugging?** dialog box appears on the device.
10. On the device, touch **OK**.
11. On the host computer, navigate to the **platform-tools** folder.
12. Type **adb devices**.  
The following displays:  
**List of devices attached**  
XXXXXXXXXXXXXXXXX device (where XXXXXXXXXXXXXXXXXXXX is the device number).



**NOTE:** If device number does not appear, ensure that ADB drivers are installed properly.

13. Touch the Home button.

## Application Installation

After an application is developed, install the application onto the device using one of the following methods:

- USB connection, see [Installing Applications Using the USB Connection on page 143](#).
- Android Debug Bridge, see [Installing Applications Using the Android Debug Bridge on page 144](#).
- microSD Card, see [Installing Applications Using a microSD Card on page 144](#).
- Mobile device management (MDM) platforms that have application provisioning. Refer to the MDM software documentation for details.

### Installing Applications Using the USB Connection

1. Connect the device to a host computer using the Rugged Charge/USB cable.
2. Pull down the Notification panel and touch **Charging this device via USB**.
3. Touch **File Transfer**.
4. On the host computer, open a file manager application.
5. On the host computer, copy the application .apk file from the host computer to the device.



**CAUTION:** Carefully follow the host computer's instructions to unmount the microSD card and disconnect USB devices correctly to avoid losing information.

6. Disconnect the device from the host computer.
7. Swipe the screen up and select  to view files on the Internal Storage.
8. Locate the application .apk file.
9. Touch the application file.
10. Touch **Continue** to install the app or **Cancel** to stop the installation.
11. To confirm installation and accept what the application affects, touch **Install** otherwise touch **Cancel**.
12. Touch **Open** to open the application or **Done** to exit the installation process. The application appears in the App list.

### Installing Applications Using the Android Debug Bridge

Use ADB commands to install application onto the device.

1. Ensure that the ADB drivers are installed on the host computer. See [ADB USB Setup on page 142](#).
2. Connect the device to a host computer using USB. See [USB Communication on page 36](#).
3. Go to **Settings**.
4. Touch **System > Advanced > Developer options**.
5. Slide the switch to the **ON** position.
6. Touch **USB Debugging**. A check appears in the check box. The **Allow USB debugging?** dialog box appears.
7. Touch **OK**.
8. On the host computer, open a command prompt window and use the adb command:  

```
adb install <application>
```

where: <application> = the path and filename of the apk file.
9. Disconnect the device from the host computer. See [USB Communication on page 36](#).

### Installing Applications Using a microSD Card





When connecting the device to a host computer and mounting its microSD card, follow the host computer's instructions for connecting and disconnecting USB devices, to avoid damaging or corrupting files.

It is strongly recommended that prior to use, you must format the microSD card on the device.

1. Copy the apk file to the root of the microSD card.
  - Copy the apk file to a microSD card using a host computer (see [USB Communication](#) for more information), and then installing the microSD card into the device (see [Replacing the microSD Card](#) for more information).
  - Connect the device with a microSD card already installed to the host computer, and copy apk file to the microSD card. See [USB Communication](#) for more information. Disconnect the device from the host computer.
2. Connect the device to a host computer using USB. See [USB Communication](#).
3. Copy the application APK file from the host computer to the microSD card.



4. Remove the microSD card from the host computer.
5. Press and hold the Power button on the device until the menu appears.
6. Touch **Power off**.
7. Remove the battery from the device.
8. Remove the keypad.
9. Slide the microSD card holder to the Open position.
10. Lift the microSD card holder.
11. Insert the microSD card into the card holder door ensuring that the card slides into the holding tabs on each side of the door.
12. Close the microSD card holder door and slide the door to the Lock position.
13. Replace the keypad.
14. Insert the battery.
15. Press and hold the Power button to turn on the device.
16. Swipe the screen up and select  to view files on the microSD card.
17. Touch  > **SD card**.
18. Locate the application .apk file.
19. Touch the application file.
20. Touch **Continue** to install the app or **Cancel** to stop the installation.
21. To confirm installation and accept what the application affects, touch **Install** otherwise touch **Cancel**.
22. Touch **Open** to open the application or **Done** to exit the installation process. The application appears in the App list.

### Uninstalling an Application

1. Go to **Settings**.
2. Touch **Apps & notifications**.
3. Touch **See all apps** to view all apps in the list.
4. Scroll through the list to the app.
5. Touch the app. The **App info** screen appears.
6. Touch **Uninstall**.
7. Touch **OK** to confirm.

### Performing a System Update

System Update packages can contain either partial or complete updates for the operating system. Zebra distributes the System Update packages on the Zebra Support & Downloads web site. Perform a system update using either a microSD card or using ADB.

### Downloading the System Update Package

1. Go to the Zebra Support & Downloads web site, [www.zebra.com/support](http://www.zebra.com/support).

2. Download the appropriate System Update package to a host computer.

## Performing a System Update Using microSD Card

It is strongly recommended that prior to use, you must format the microSD card on the device.

1. Copy the System Update zip file to the root of the microSD card.
  - Copy the zip file to a microSD card using a host computer (see USB Communication for more information), and then installing the microSD card into the device (see Replacing the microSD Card for more information).
  - Connect the device with a microSD card already installed to the host computer, and copy zip file to the microSD card. See USB Communication for more information. Disconnect the device from the host computer.
2. Press and hold the Power button until the menu appears.
3. Touch **Restart**.
4. Press and hold the Trigger button until the device vibrates. The System Recovery screen appears.
5. Press the Up and Down buttons to navigate to **Apply upgrade from SD card**.
6. Press the Enter button.
7. Use the Up and Down buttons to navigate to **Full OTA Package** or **Diff OTA Package**.
8. Press the Enter button.
9. Use the Up and Down buttons to navigate to the System Update file.
10. Press the Power button. The System Update installs and then the device returns to the Recovery screen.
11. Press the Power button to reboot the device.

## Performing a System Update Using ADB

1. Go to **Settings**.
2. Touch **System > Advanced > Developer options**.
3. Slide the switch to the **ON** position.
4. Touch **USB Debugging**. A check appears in the check box. The **Allow USB debugging?** dialog box appears.
5. Touch **OK**.
6. On the host computer, open a command prompt window and use the adb command:

```
adb devices
```

The following displays:

```
List of devices attached
```

```
XXXXXXXXXXXXXXXX device (where XXXXXXXXXXXXXXXXXXXX is the device number).
```



**NOTE:** If device number does not appear, ensure that ADB drivers are installed properly.

7. Type:

```
adb reboot recovery
```

8. Press Enter. The System Recovery screen appears on the device.
9. Press the Volume Up and Volume Down buttons to navigate to **Apply upgrade from ADB**.
10. Press the Power button.
11. Use the Volume Up and Volume Down buttons to navigate to **Full OTA Package** or **Diff OTA Package**.
12. Press the Power button.
13. On the host computer command prompt window type:  
`adb sideload <file>`  
where: <file> = the path and filename of the zip file.
14. Press Enter. The System Update installs (progress appears as percentage in the Command Prompt window) and then the System Recovery screen appears on the device.
15. Press the Power button to reboot the device.

### Verifying System Update Installation

1. Go to **Settings**.
2. Touch **About phone**.
3. Scroll down to **Build number**.
4. Ensure that the build number matches the new system update package file number.

### Enterprise Reset

An Enterprise Reset erases all user data in the `/data` partition, including data in the primary storage locations (`/sdcard` and emulated storage).

Before performing an Enterprise Reset, provision all necessary configuration files and restore after the reset.

Perform Enterprise Reset using device settings, or ADB.

### Performing an Enterprise Reset From Device Settings

1. Go to **Settings**.
2. Touch **System > Reset options > Erase all data (enterprise reset)**.
3. Touch **Erase all data** twice to confirm the Enterprise Reset.

### Downloading the Enterprise Reset Package

1. Go to the Zebra Support & Downloads web site, [www.zebra.com/support](http://www.zebra.com/support).
2. Download the Enterprise Reset file to a host computer.

### Performing an Enterprise Reset Using microSD Card

It is strongly recommended that prior to use, you must format the microSD card on the device.

1. Copy the Enterprise Reset zip file to the root of the microSD card.

- Copy the zip file to a microSD card using a host computer (see USB Communication for more information) and then installing the microSD card into the device (see Replacing the microSD Card for more information).
  - Connect the device with a microSD card already installed to the host computer and copy zip file to the microSD card. See USB Communication for more information. Disconnect the device from the host computer.
2. Press and hold the Power button until the menu appears.
  3. Touch **Restart**.
  4. Press and hold the Trigger button until the device vibrates. The System Recovery screen appears.
  5. Press the Up and Down buttons to navigate to **Apply upgrade from SD card**.
  6. Press the Enter button.
  7. Use the Up and Down buttons to navigate to **Full OTA Package**.
  8. Press the Enter button.
  9. Use the Up and Down buttons to navigate to the Enterprise Reset file.
  10. Press the Power button. The Enterprise Reset occurs and then the device returns to the Recovery screen.
  11. Press the Power button to reboot the device.

### Performing an Enterprise Reset Using ADB

1. Go to **Settings**.
2. Touch **System > Advanced > Developer options**.
3. Slide the switch to the **ON** position.
4. Touch **USB Debugging**. A check appears in the check box. The **Allow USB debugging?** dialog box appears.
5. Touch **OK**.
6. On the host computer, open a command prompt window and type:

**adb devices**.

The following displays:

**List of devices attached**

XXXXXXXXXXXXXXXXX device (where XXXXXXXXXXXXXXXXXXXX is the device number).



**NOTE:** If device number does not appear, ensure that ADB drivers are installed properly.

7. Type:  
**adb reboot recovery**
8. Press Enter. The System Recovery screen appears on the device.
9. On the host computer command prompt window type:  
**adb sideload <file>**  
where: <file> = the path and filename of the zip file.

10. Press Enter. The Enterprise Reset package installs and then the System Recovery screen appears on the device.

## Performing a Factory Reset

A Factory Reset erases all data in the `/data` and `/enterprise` partitions in internal storage and clears all device settings. A Factory Reset returns the device to the last installed operating system image. To revert to a previous operating system version, re-install that operating system image. See [Performing a System Update](#) for more information.

### Downloading the Factory Reset Package

To download the Factory Reset package:

1. Go to the Zebra Support & Downloads web site, [www.zebra.com/support](http://www.zebra.com/support).
2. Download the appropriate Factory Reset file to a host computer.

### Performing a Factory Reset Using microSD Card

1. Copy the Factory Reset zip file to the root of the microSD card.
  - Copy the zip file to a microSD card using a host computer (see USB Communication for more information) and then installing the microSD card into the device (see Replacing the microSD Card for more information).
  - Connect the device with a microSD card already installed to the host computer and copy zip file to the microSD card. See USB Communication for more information. Disconnect the device from the host computer.
2. Press and hold the Power button until the menu appears.
3. Touch **Restart**.
4. Press and hold the Trigger button until the device vibrates. The System Recovery screen appears.
5. Press the Up and Down buttons to navigate to **Apply upgrade from SD card**.
6. Press the Enter button.
7. Use the Up and Down buttons to navigate to **Full OTA Package**.
8. Press the Enter button.
9. Use the Up and Down buttons to navigate to the Factory Reset file.
10. Press the Power button. The Factory Reset occurs and then the device returns to the Recovery screen.
11. Press the Power button to reboot the device.

### Performing a Factory Reset Using ADB

To perform an Factory Reset using ADB:

1. Go to **Settings**.
2. Touch **System > Advanced > Developer options**.
3. Slide the switch to the **ON** position.
4. Touch **USB Debugging**. A check appears in the check box. The **Allow USB debugging?** dialog box appears.

5. Touch **OK**.
6. On the host computer, open a command prompt window and type:

**adb devices.**

The following displays:

**List of devices attached**

XXXXXXXXXXXXXXXXX device (where XXXXXXXXXXXXXXXXXXXX is the device number).



**NOTE:** If device number does not appear, ensure that ADB drivers are installed properly.

7. Type:  
**adb reboot recovery**
8. Press Enter. The System Recovery screen appears on the device.
9. On the host computer command prompt window type:  
**adb sideload <file>**  
where: <file> = the path and filename of the zip file.
10. Press Enter. The Factory Reset package installs and then the System Recovery screen appears on the device.

## Storage

The device contains the following types of file storage:

- Random Access Memory (RAM)
- Internal storage
- Enterprise folder.

## Random Access Memory

Executing programs use RAM to store data. Data stored in RAM is lost upon a reset. The operating system manages how applications use RAM. It only allows applications and component processes and services to use RAM when required. It may cache recently used processes in RAM, so they restart more quickly when opened again, but it will erase the cache if it needs the RAM for new activities.

The screen displays the amount of used and free RAM.

- **Performance** - Indicates memory performance.
- **Total memory** - Indicates the total amount of RAM available.
- **Average used (%)** - Indicates the average amount of memory (as a percentage) used during the period of time selected (default - 3 hours).
- **Free** - Indicates the total amount of unused RAM.
- **Memory used by apps** - Touch to view RAM usage by individual apps.

## Viewing Memory

1. Go to **Settings**.
2. Touch **System > Advanced > Developer options > Memory**.

## Internal Storage

The device has internal storage. The internal storage content can be viewed and files copied to and from when the device is connected to a host computer. Some applications are designed to be stored on the internal storage rather than in internal memory.

### Viewing Internal Storage

1. Go to **Settings**.
2. Touch **Storage**.

## External Storage

The device can have a removable microSD card. The microSD card content can be viewed and files copied to and from when the device is connected to a host computer.

### Viewing External Storage

1. Go to **Settings**.
2. Touch **Storage**.

Portable storage displays the total amount of space on the installed and the amount used.

To unmount the microSD card, touch .

Touch **SD card** to view the contents of the card.

### Formatting a microSD Card or USB Drive as Portable Storage

1. Touch **SD card** or **USB drive**.
2. Touch  > **Storage settings**.
3. Touch **Format**.
4. Touch **ERASE & FORMAT**.
5. Touch **DONE**.

### Formatting a microSD Card as Internal Memory

You can format a microSD card as internal memory to increase the actual amount of the device's internal memory. Once formatted, the microSD card can only be read by this device.

1. Touch **SD card**.
2. Touch  > **Storage settings**.
3. Touch **Format as internal**.
4. Touch **ERASE & FORMAT**.
5. Touch **DONE**.

## Enterprise Folder

The Enterprise folder (within internal flash) is a super-persistent storage that is persistent after a reset and an Enterprise Reset. The Enterprise folder is erased during a Factory Reset. The Enterprise folder is used for deployment and device-unique data. The Enterprise folder is approximately 128 MB (formatted). Applications can persist data after an Enterprise Reset by saving data to the enterprise/user folder. The folder is ext4 formatted and is only accessible from a host computer using ADB or from an MDM.

## Managing Apps

Apps use two kinds of memory: storage memory and RAM. Apps use storage memory for themselves and any files, settings, and other data they use. They also use RAM when they are running.

1. Go to **Settings**.
2. Touch **Apps & notifications**.
3. Touch **See all XX apps** to view all apps on the device.
4. Touch **⋮ > Show system** to include system processes in the list.
5. Touch an app, process, or service in the list to open a screen with details about it and, depending on the item, to change its settings, permissions, notifications and to force stop or uninstall it.

## App Details



Apps have different kinds of information and controls.

- **Force stop** - Stop an app.
- **Disable** - Disable an app.
- **Uninstall** - Remove the app and all of its data and settings from the device. See [Uninstalling an Application on page 145](#) for information about uninstalling apps.
- **Notifications** - Set the app notification settings.
- **Permissions** - Lists the areas on the device that the app has access to.
- **Storage & cache** - Lists how much information is stored, and includes buttons for clearing it.
- **Mobile data & Wi-Fi** - Provides information about data consumed by an app.
- **Advanced**
  - **Screen time** - Displays the amount of time the app has displayed on the screen.
  - **Battery** - Lists the amount of computing power used by the app.
  - **Open by default** - If you have configured an app to launch certain file types by default, you can clear that setting here.
  - **Display over other apps** - allows an app to display on top of other apps.
  - **App details** - Provides a link to additional app details on the Play store.
  - **Additional settings in the app** - Opens settings in the app.
  - **Modify system settings** - Allows an app to modify the system settings.



## Managing Downloads

Files and apps downloaded using the Browser or Email are stored on the Internal storage in the Download directory. Use the Downloads app to view, open, or delete downloaded items.

1. Swipe the screen up and touch .
2. Touch  > **Downloads**.
3. Touch and hold an item, select items to delete and touch . The item is deleted from the device.

# Keypads

## Introduction

The device has the following interchangeable modular keypads:

- 58-key Alpha Numeric Function keypad
- 53-key Standard keypad
- 53-key IBM-5250 Emulator keypad
- 53-key IBM-3270 Emulator keypad
- 53-key VT Emulator keypad
- 43-key Shifted Alpha keypad
- 34-key Numeric keypad
- 29-key Shifted Alpha keypad.

To support specialized applications, you can change the modular keypads in the field when required.

## Removing and Replacing Keypads

1. Power off the device.
2. Remove the battery.
3. Using a Torx T8 screwdriver with a large grip, remove the two keypad latch screws from inside the battery slot.

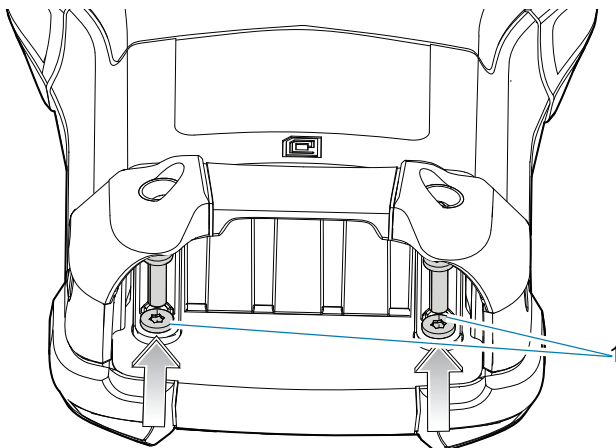

## Keypads

1	Keypad latch screws
---	---------------------

4. Slide the keypad latches toward the bottom of the device.

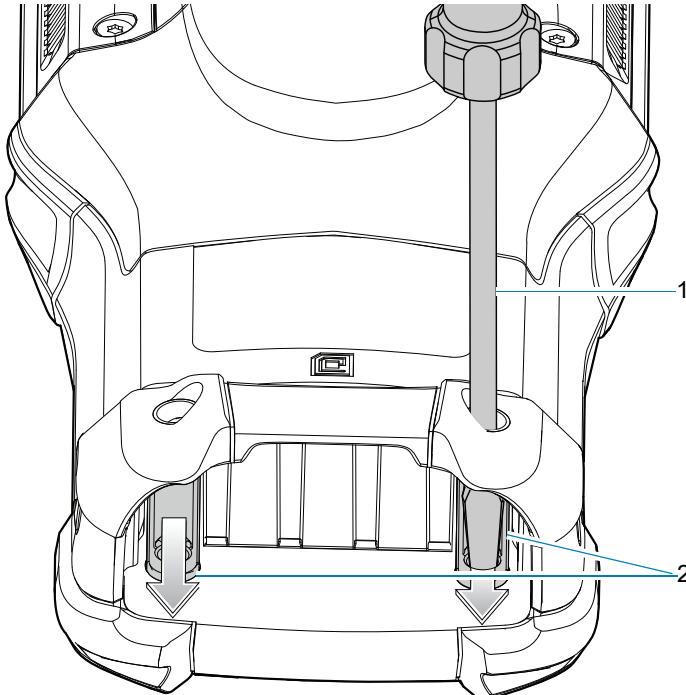

1	Screwdriver
2	Keypad latches



**NOTE:** If the keypad latches are hard to move, use a screwdriver to gently slide them towards the bottom of the device.

5. Turn the device over so that the keypad is visible.

- Using a Torx T8 screwdriver with a large grip, remove the two keypad assembly screws from the top of the keypad.

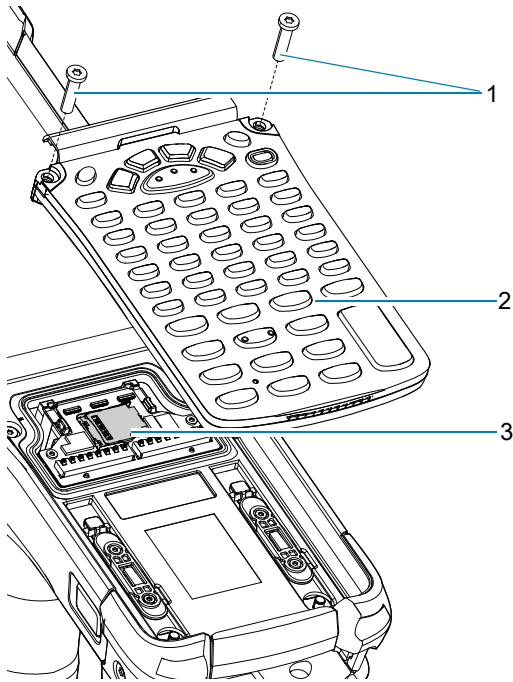

1	Keypad screws
2	Keypad
3	microSD card holder

- Lift the keypad from the device.
- Align the keypad along the bottom ridge of the device, and then lay it flat.

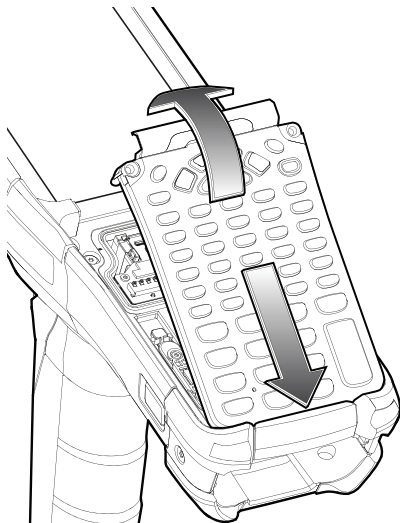

## Keypads

- Using a Torx T8 screwdriver with a large grip and a long shaft, secure the keypad to the device using the two screws. Torque screws to 5.8 kgf-cm or 5.0 lbf-in.

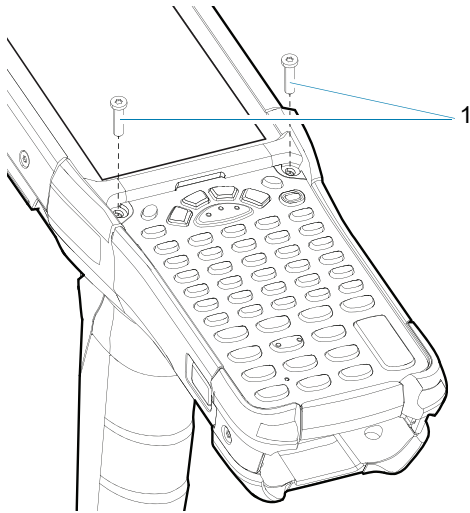

1	Keypad screws
---	---------------

- Turn the device over so that the keypad latches are visible.
- Slide both the keypad latches toward the top of the device.

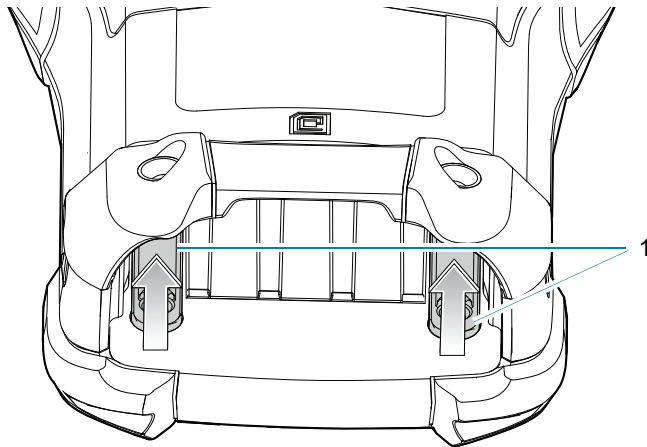

1	Keypad latches
---	----------------

## Keypads

12. Using a Torx T8 screwdriver, replace the two keypad latch screws inside the battery slot and torque to 5.8 kgf-cm or 5.0 lbf-in.

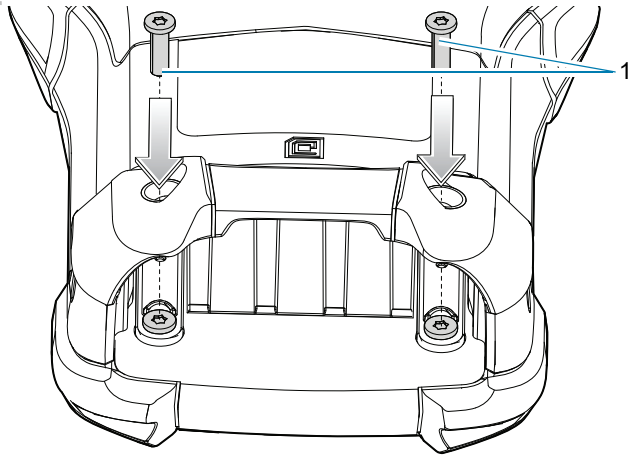

1	Keypad latch screws
---	---------------------

13. Insert the battery.
14. Press and hold the Power key to power on the device.



## 58-Keys Alpha Numeric Function Keypad

The 58-key keypad contains a Power button, application keys, scroll keys and function keys. The keypad is color-coded to indicate the alternate function key (blue) values. Note that keypad functions can be changed by an application so the device's keypad may not function exactly as described. See the Key Descriptions table for key and button details, and the Keypad Special Functions table for the keypad's various functions.

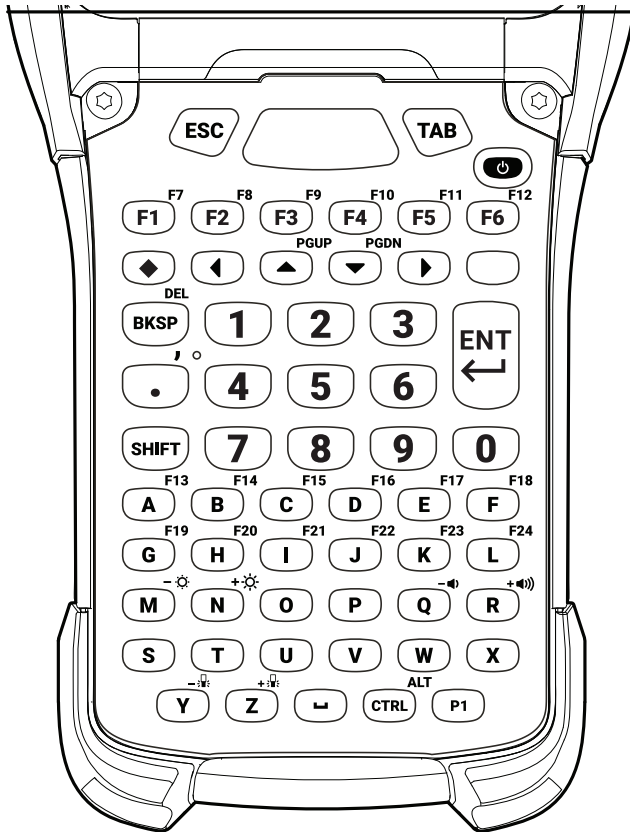















**Figure 57** 58-Keys Alpha Numeric Function Keypad



**Table 11** 58-Key Alpha Numeric Function Keypad Key Descriptions







Key	Description
Power (Red) 	Turns the device on and off.  Performs a warm boot and a hard reset. See Resetting the Device for more information.
P1 	User programmable key. By default, P1 is the dedicated PTT key.
Scan (Yellow) 	Activates the scanner/imager in a scan enabled application.

**Table 11** 58-Key Alpha Numeric Function Keypad Key Descriptions (Continued)

Key	Description
ESC 	Exits the current operation.
TAB 	Tab function.
Up and Down 	Moves up and down from one item to another.
Left and Right 	Moves left and right from one item to another.
Alpha 	Use the alpha keys for alphabetic characters.
BKSP 	Backspace function.
SPACE 	Space function.
Numeric/Application 	The numeric keys generate keycodes 0 to 9.
Function (blue) 	<p>Press and release the blue function key to activate the keypad alternate functions (shown on the keypad in Blue). Press the Blue function key once to put the keyboard into one-shot mode. The  icon appears on the Status bar. Press the Blue function key again the keypad is locked in function mode, and the  icon appears in the Status bar. Press and release the Blue function key a third time to return to the default keypad functions, and the  icon clears.</p> <p>Press the blue function key and SHIFT to activate CAPSLOCK mode, the  icon appears.</p>
Control 	<p>Press and release the CTRL key to activate the keypad alternate CTRL functions. The  icon appears in the status bar.</p> <p>Press the Blue key followed by the CTRL key to activate the keypad alternate ALT functions. The  icon appears in the status bar.</p>



**Table 11** 58-Key Alpha Numeric Function Keypad Key Descriptions (Continued)

Key	Description																		
Shift 	<p>Press and release the SHIFT key to activate the keypad alternate SHIFT functions. The  icon appears in the status bar. After pressing another key, the keypad returns to the non-shift state.</p> <p>Press and release the SHIFT key twice to enable the Shift Lock state. The  icon appears in the status bar. Press and release the SHIFT key again to disable the Shift Lock state.</p>																		
Period/Decimal Point 	<p>Produces a period for alpha entries and a decimal point for numeric entries.</p>																		
Diamond 	<p>Provides a 3x3 matrix on the screen with nine additional symbols. With a single tap you can select via touch input or the keyboard, 1-9 numerical keys. Double tapping the Diamond key locks the 3x3 grid, and you can select multiple keys. Pressing the Diamond key a third time closes the 3x3 matrix. You can modify the symbols in the 3x3 matrix using the StageNow utility in the KeyMappingMgr settings.</p> <div style="text-align: center; border: 1px solid gray; padding: 5px; margin: 10px 0;"> <table style="border-collapse: collapse; width: 100%;"> <tr> <td style="border: 1px solid gray; padding: 2px 5px; text-align: center;">1</td> <td style="border: 1px solid gray; padding: 2px 5px; text-align: center;">2</td> <td style="border: 1px solid gray; padding: 2px 5px; text-align: center;">3</td> </tr> <tr> <td style="border: 1px solid gray; padding: 2px 5px; text-align: center;"> </td> <td style="border: 1px solid gray; padding: 2px 5px; text-align: center;">[</td> <td style="border: 1px solid gray; padding: 2px 5px; text-align: center;">]</td> </tr> <tr> <td style="border: 1px solid gray; padding: 2px 5px; text-align: center;">4</td> <td style="border: 1px solid gray; padding: 2px 5px; text-align: center;">5</td> <td style="border: 1px solid gray; padding: 2px 5px; text-align: center;">6</td> </tr> <tr> <td style="border: 1px solid gray; padding: 2px 5px; text-align: center;">£</td> <td style="border: 1px solid gray; padding: 2px 5px; text-align: center;">:</td> <td style="border: 1px solid gray; padding: 2px 5px; text-align: center;">€</td> </tr> <tr> <td style="border: 1px solid gray; padding: 2px 5px; text-align: center;">7</td> <td style="border: 1px solid gray; padding: 2px 5px; text-align: center;">8</td> <td style="border: 1px solid gray; padding: 2px 5px; text-align: center;">9</td> </tr> <tr> <td style="border: 1px solid gray; padding: 2px 5px; text-align: center;">~</td> <td style="border: 1px solid gray; padding: 2px 5px; text-align: center;">@</td> <td style="border: 1px solid gray; padding: 2px 5px; text-align: center;">-</td> </tr> </table> </div> <p>This is the default symbol layout for this keyboard.</p>	1	2	3		[	]	4	5	6	£	:	€	7	8	9	~	@	-
1	2	3																	
	[	]																	
4	5	6																	
£	:	€																	
7	8	9																	
~	@	-																	
Enter 	<p>Executes a selected item or function.</p>																		



## 53-Keys Standard Keypad

The 53-key keypad contains a Power button, application keys, scroll keys and function keys. The keypad is color-coded to indicate the alternate function key (blue) values. Note that keypad functions can be changed by an application so the device's keypad may not function exactly as described. See the Key Descriptions table for key and button details, and the Keypad Special Functions table for the keypad's various functions.

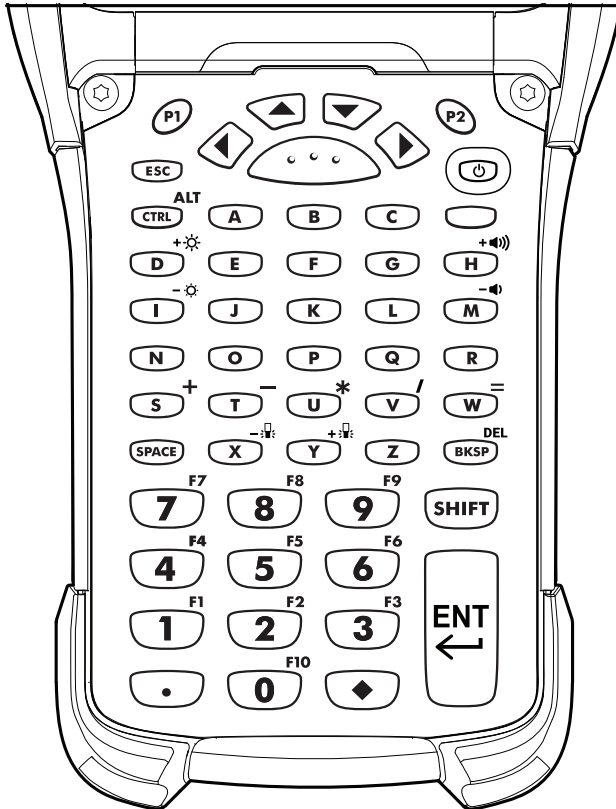















**Figure 58** 53-Keys Standard Keypad





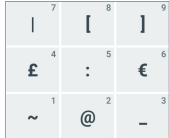

**Table 12** 53-Key Standard Keypad Key Descriptions

Key	Description
Power (Red) 	Turns the device on and off.  Performs a warm boot and a hard reset. See Resetting the Device for more information.
P1 / P2 	User programmable keys: <ul style="list-style-type: none"> <li>• By default, P1 is the dedicated PTT key.</li> <li>• By default, P2 acts like another Scan key.</li> </ul>
Scan (Yellow) 	Activates the scanner/imager in a scan enabled application.

**Table 12** 53-Key Standard Keypad Key Descriptions (Continued)

Key	Description
Up and Down 	Moves up and down from one item to another.
Left and Right 	Moves left and right from one item to another.
ESC 	Exits the current operation.
Alpha 	Use the alpha keys for alphabetic characters.
SPACE/BKSP 	Space and backspace functions.
Numeric/Application 	The numeric keys generate keycodes 0 to 9.
Function (blue) 	<p>Press and release the blue function key to activate the keypad alternate functions (shown on the keypad in Blue). Press the Blue function key once to put the keyboard into one-shot mode. The  icon appears on the Status bar. Press the Blue function key again the keypad is locked in function mode, and the  icon appears in the Status bar. Press and release the Blue function key a third time to return to the default keypad functions, and the  icon clears.</p> <p>Press the blue function key and SHIFT to activate CAPSLOCK mode, the  icon appears.</p>
Control ALT 	<p>Press and release the CTRL key to activate the keypad alternate CTRL functions. The  icon appears in the status bar.</p> <p>Press the Blue key followed by the CTRL key to activate the keypad alternate ALT functions. The  icon appears in the status bar.</p>
Shift 	<p>Press and release the SHIFT key to activate the keypad alternate SHIFT functions. The  icon appears in the status bar. After pressing another key, the keypad returns to the non-shift state.</p> <p>Press and release the SHIFT key twice to enable the Shift Lock state. The  icon appears in the status bar. Press and release the SHIFT key again to disable the Shift Lock state.</p>

**Table 12** 53-Key Standard Keypad Key Descriptions (Continued)

Key	Description
Period/Decimal Point 	Produces a period for alpha entries and a decimal point for numeric entries.
Diamond 	Provides a 3x3 matrix on the screen with nine additional symbols. With a single tap you can select via touch input or the keyboard, 1-9 numerical keys. Double tapping the Diamond key locks the 3x3 grid, and you can select multiple keys. Pressing the Diamond key a third time closes the 3x3 matrix. You can modify the symbols in the 3x3 matrix using the StageNow utility in the KeyMappingMgr settings.   <p>This is the default symbol layout for this keyboard.</p>
Enter 	Executes a selected item or function.

## 53-Keys IBM-5250 Emulator Keypad

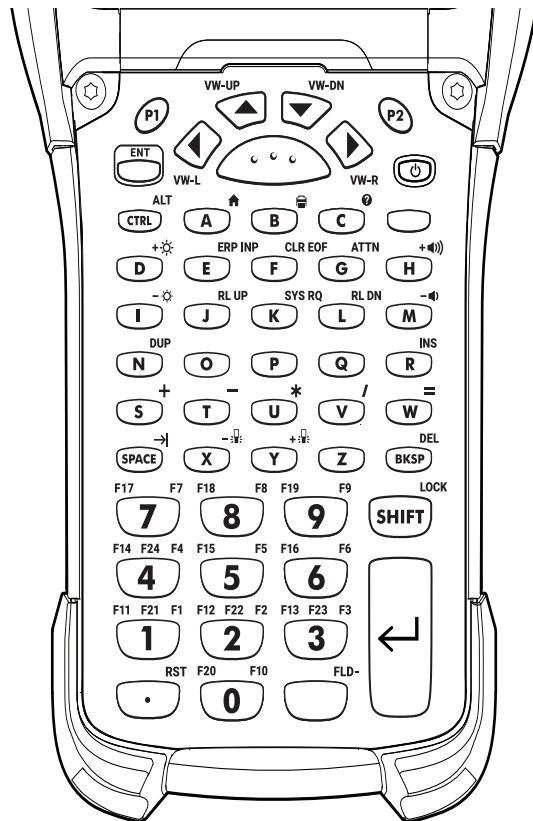

The IBM-5250 emulator keypad contains a Power button, application keys, scroll keys and a function key. The keypad is color-coded to indicate the alternate function key (blue) values. Note that keypad functions can be changed by an application so the device's keypad may not function exactly as described. See the Key Descriptions table for key and button details, and the Keypad Special Functions table for the keypad's various functions.

**Figure 59** 53-Keys IBM-5250 Emulator Keypad



















**NOTE:** The IBM-5250 emulator configuration is only used when the device is running the 5250 emulation software.



**Table 13** IBM-5250 Emulator Descriptions

Key	Description
Power (red) 	Turns the device on and off. Performs a warm boot and a hard reset. See Resetting the Device for more information.
P1/P2 	User programmable keys: <ul style="list-style-type: none"> <li>• By default, P1 is the dedicated PTT key.</li> <li>• By default, P2 acts like another Scan key.</li> </ul>
Scan (yellow) 	Activates the scanner/imager in a scan enabled application.

**Table 13** IBM-5250 Emulator Descriptions (Continued)

Key	Description
Up and Down <b>VW-UP</b> <b>VW-DN</b> 	Moves up and down from one item to another.
Left and Right  <b>VW-L</b> <b>VW-R</b>	Moves left and right from one item to another.
ENT 	The enter key.
Alpha 	Use the alpha keys for alphabetic characters.
SPACE/BKSP 	Space and backspace functions.
Application <b>F11</b> <b>F1</b> <b>F12</b> <b>F2</b> <b>F13</b> <b>F3</b> 	The numeric keys generate keycodes 0 to 9.
Function (blue) 	<p>Press and release the blue function key to activate the keypad alternate functions (shown on the keypad in Blue). Press the Blue function key once to put the keyboard into one-shot mode. The  icon appears on the Status bar. Press the Blue function key again the keypad is locked in function mode, and the  icon appears in the Status bar. Press and release the Blue function key a third time to return to the default keypad functions, and the  icon clears.</p> <p>Press the blue function key and SHIFT to activate CAPSLOCK mode, the  icon appears.</p>
Control <b>ALT</b> 	<p>Press and release the CTRL key to activate the keypad alternate CTRL functions. The  icon appears in the status bars.</p> <p>Press the Blue key followed by the CTRL key to activate the keypad alternate ALT functions. The  icon appears in the status bar.</p>
Shift <b>LOCK</b> 	<p>Press and release the SHIFT key to activate the keypad alternate SHIFT functions. The  icon appears in the status bar. After pressing another key, the keypad returns to the non-shift state.</p> <p>Press and release the SHIFT key twice to enable the Shift Lock state. The  icon appears in the status bar. Press and release the SHIFT key again to disable the Shift Lock state.</p>

**Table 13** IBM-5250 Emulator Descriptions (Continued)

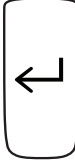
Key	Description																		
<p>Period/Decimal Point</p> 	<p>Produces a period for alpha entries and a decimal point for numeric entries.</p>																		
<p>Diamond</p> 	<p>Provides a 3x3 matrix on the screen with nine additional symbols. With a single tap you can select via touch input or the keyboard, 1-9 numerical keys. Double tapping the Diamond key locks the 3x3 grid, and you can select multiple keys. Pressing the Diamond key a third time closes the 3x3 matrix. You can modify the symbols in the 3x3 matrix using the StageNow utility in the KeyMappingMgr settings.</p> <div style="border: 1px solid gray; padding: 5px; margin: 10px 0;"> <table style="border-collapse: collapse; text-align: center; width: 100%;"> <tr> <td style="border: 1px solid gray; width: 33px; height: 33px;"> </td> <td style="border: 1px solid gray; width: 33px; height: 33px;">[</td> <td style="border: 1px solid gray; width: 33px; height: 33px;">]</td> </tr> <tr> <td style="font-size: 8px;">7</td> <td style="font-size: 8px;">8</td> <td style="font-size: 8px;">9</td> </tr> <tr> <td style="border: 1px solid gray; width: 33px; height: 33px;">£</td> <td style="border: 1px solid gray; width: 33px; height: 33px;">:</td> <td style="border: 1px solid gray; width: 33px; height: 33px;">€</td> </tr> <tr> <td style="font-size: 8px;">4</td> <td style="font-size: 8px;">5</td> <td style="font-size: 8px;">6</td> </tr> <tr> <td style="border: 1px solid gray; width: 33px; height: 33px;">~</td> <td style="border: 1px solid gray; width: 33px; height: 33px;">@</td> <td style="border: 1px solid gray; width: 33px; height: 33px;">-</td> </tr> <tr> <td style="font-size: 8px;">1</td> <td style="font-size: 8px;">2</td> <td style="font-size: 8px;">3</td> </tr> </table> </div> <p>This is the default symbol layout for this keyboard.</p>		[	]	7	8	9	£	:	€	4	5	6	~	@	-	1	2	3
	[	]																	
7	8	9																	
£	:	€																	
4	5	6																	
~	@	-																	
1	2	3																	
<p>FIELD_EXIT</p> 	<p>Executes a selected item or function.</p>																		

## 53-Keys IBM-3270 Emulator Keypad

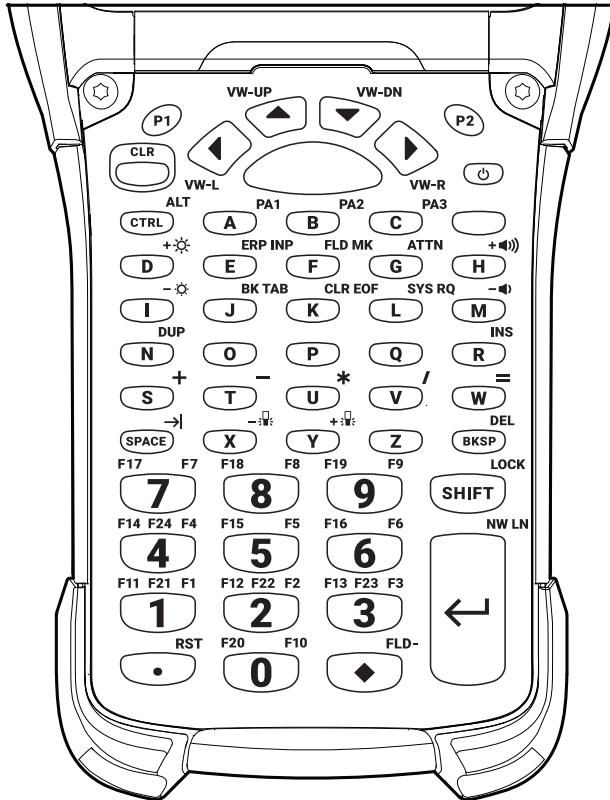

The IBM-3270 emulator keypad contains a Power button, application keys, scroll keys and a function key. The keypad is color-coded to indicate the alternate function key (blue, green, orange) values. Note that keypad functions can be changed by an application so the device's keypad may not function exactly as described. See the Key Descriptions table for key and button details.

**Figure 60** 53-Keys IBM-3270 Emulator Keypad



















**NOTE:** The IBM-3270 emulator configuration is only used when the device is running the 3270 emulation software.

**Table 14** IBM-3270 Emulator Descriptions



Key	Description
Power (red) 	Turns the device on and off. Performs a warm boot and a hard reset. See Resetting the Device for more information.
P1/P2 	User programmable keys: <ul style="list-style-type: none"> <li>• By default, P1 is the dedicated PTT key.</li> <li>• By default, P2 acts like another Scan key.</li> </ul>
Scan (yellow) 	Activates the scanner/imager in a scan enabled application.



**Table 14** IBM-3270 Emulator Descriptions (Continued)

Key	Description
Up and Down <b>VW-UP</b> <b>VW-DN</b> 	Moves up and down from one item to another.
Left and Right  <b>VW-L</b> <b>VW-R</b>	Moves left and right from one item to another.
CLR 	The clear key.
Alpha <b>PA1</b> <b>PA2</b> <b>PA3</b> 	Use the alpha keys for alphabetic characters.
SPACE/BKSP 	Space and backspace functions.
Application <b>F11 F21 F1</b> <b>F12 F22 F2</b> <b>F13 F23 F3</b> 	The numeric keys generate keycodes 0 to 9.
Function (Blue) 	<p>Press and release the Blue function key to activate the keypad alternate functions (shown on the keypad in Blue). Press the Blue function key once to put the keyboard into one-shot mode. The  icon appears on the Status bar. Press the Blue function key again the keypad is locked in function mode, and the  icon appears in the Status bar. Press and release the Blue function key a third time to return to the default keypad functions, and the  icon clears.</p> <p>Press the blue function key and SHIFT to activate CAPSLOCK mode, the  icon appears.</p>
Control 	<p>Press and release the CTRL key to activate the keypad alternate CTRL functions (shown on the keypad in Green). The  icon appears in the status bars.</p> <p>Press the Blue key followed by the CTRL key to activate the keypad alternate ALT functions. The  icon appears in the status bar.</p>
Shift 	<p>Press and release the SHIFT key to activate the keypad alternate SHIFT functions (shown on the keypad in Orange). The  icon appears in the status bar. After pressing another key, the keypad returns to the non-shift state.</p> <p>Press and release the SHIFT key twice to enable the Shift Lock state. The  icon appears in the status bar. Press and release the SHIFT key again to disable the Shift Lock state.</p>

**Table 14** IBM-3270 Emulator Descriptions (Continued)

Key	Description									
<p style="text-align: center;">Period/Decimal Point <b>RST</b></p> 	<p>Produces a period for alpha entries and a decimal point for numeric entries.</p>									
<p style="text-align: center;">Diamond <b>FLD</b></p> 	<p>Provides a 3x3 matrix on the screen with nine additional symbols. With a single tap you can select via touch input or the keyboard, 1-9 numerical keys. Double tapping the Diamond key locks the 3x3 grid, and you can select multiple keys. Pressing the Diamond key a third time closes the 3x3 matrix. You can modify the symbols in the 3x3 matrix using the StageNow utility in the KeyMappingMgr settings.</p> <div style="text-align: center; border: 1px solid gray; padding: 5px; width: fit-content; margin: 10px auto;"> <table border="1" style="border-collapse: collapse; text-align: center;"> <tr> <td style="padding: 2px 5px;"> </td> <td style="padding: 2px 5px;">[</td> <td style="padding: 2px 5px;">]</td> </tr> <tr> <td style="padding: 2px 5px;">£</td> <td style="padding: 2px 5px;">:</td> <td style="padding: 2px 5px;">€</td> </tr> <tr> <td style="padding: 2px 5px;">~</td> <td style="padding: 2px 5px;">@</td> <td style="padding: 2px 5px;">-</td> </tr> </table> </div> <p>This is the default symbol for this keyboard.</p>		[	]	£	:	€	~	@	-
	[	]								
£	:	€								
~	@	-								
<p style="text-align: center;">ENTER <b>NW LN</b></p> 	<p>Executes a selected item or function.</p>									

## 53-Keys VT Emulator Keypad

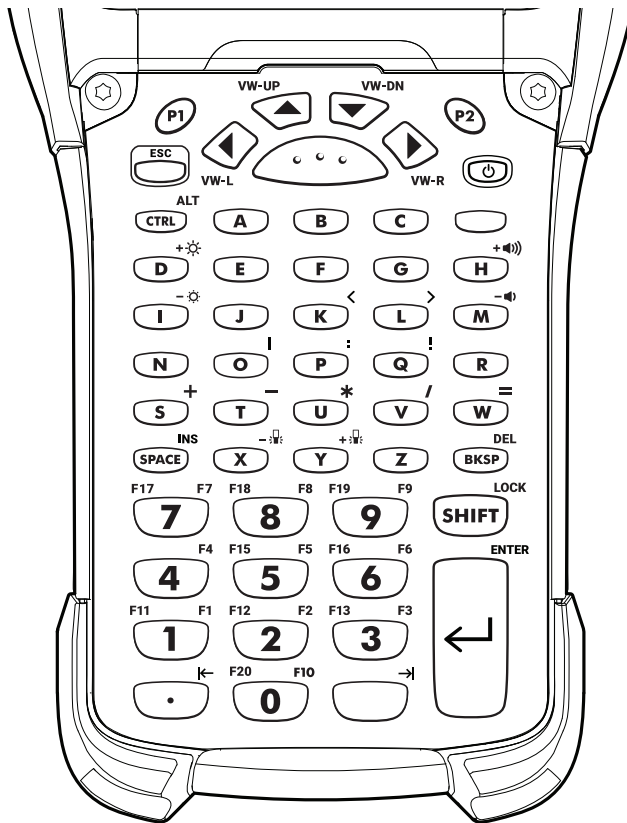

The VT emulator keypad contains a Power button, application keys, scroll keys and a function key. The keypad is color-coded to indicate the alternate function key (blue) values. Note that keypad functions can be changed by an application so the device's keypad may not function exactly as described. See the Key Descriptions table for key and button details, and the Keypad Special Functions table for the keypad's various functions.

**Figure 61** 53-Keys VT Emulator Keypad



















**NOTE:** The VT emulator configuration is only used when the device is running the VT emulation software.



**Table 15** VT Emulator Descriptions

Key	Description
Power (red) 	Turns the device on and off.  Performs a warm boot and a hard reset. See Resetting the Device for more information.
P1/P2 	User programmable keys: <ul style="list-style-type: none"> <li>• By default, P1 is the dedicated PTT key.</li> <li>• By default, P2 acts like another Scan key.</li> </ul>
Scan (yellow) 	Activates the scanner/imager in a scan enabled application.

**Table 15** VT Emulator Descriptions (Continued)

Key	Description
Up and Down <b>VW-UP</b> <b>VW-DN</b> 	Moves up and down from one item to another.
Left and Right  <b>VW-L</b> <b>VW-R</b>	Moves left and right from one item to another.
ESC 	Exits the current operation.
Alpha 	Use the alpha keys for alphabetic characters.
SPACE/BKSP 	Space and backspace functions.
Application F11 F1 F12 F2 F13 F3 	The numeric keys generate keycodes 0 to 9. These keys can also be assigned to an application.
Function (blue) 	<p>Press and release the blue function key to activate the keypad alternate functions (shown on the keypad in Blue). Press the Blue function key once to put the keyboard into one-shot mode. The  icon appears on the Status bar. Press the Blue function key again the keypad is locked in function mode, and the  icon appears in the Status bar. Press and release the Blue function key a third time to return to the default keypad functions, and the  icon clears.</p> <p>Press the blue function key and SHIFT to activate CAPSLOCK mode, the  icon appears.</p>
Control ALT 	<p>Press and release the CTRL key to activate the keypad alternate CTRL functions. The  icon appears in the status bar.</p> <p>Press the Blue key followed by the CTRL key to activate the keypad alternate ALT functions. The  icon appears in the status bar.</p>
Shift LOCK 	<p>Press and release the SHIFT key to activate the keypad alternate SHIFT functions. The  icon appears in the status bar. After pressing another key, the keypad returns to the non-shift state.</p> <p>Press and release the SHIFT key twice to enable the Shift Lock state. The  icon appears in the status bar. Press and release the SHIFT key again to disable the Shift Lock state.</p>

**Table 15** VT Emulator Descriptions (Continued)

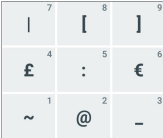
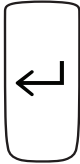
Key	Description
<p>Period/Decimal Point</p> 	<p>Produces a period for alpha entries and decimal point for numeric entries.</p>
<p>Diamond</p> 	<p>Provides a 3x3 matrix on the screen with nine additional symbols. With a single tap you can select via touch input or the keyboard, 1-9 numerical keys. Double tapping the Diamond key locks the 3x3 grid, and you can select multiple keys. Pressing the Diamond key a third time closes the 3x3 matrix. You can modify the symbols in the 3x3 matrix using the StageNow utility in the KeyMappingMgr settings.</p> <div style="text-align: center; margin: 10px 0;">  </div> <p>This is the default symbol layout for this keyboard.</p>
<p>Enter</p> 	<p>Executes a selected item or function.</p>



## 43-Keys Shifted Alpha Keypad

The 43-key keypad contains a **Power** button, application keys, scroll keys and a function key. The keypad is color-coded to indicate the alternate function key (blue) values and the alternate ALPHA key (orange) values. Note that keypad functions can be changed by an application so the MC93XX's keypad may not function exactly as described. See the Key Descriptions table for key and button details, and the Keypad Special Functions table for the keypad's various functions.

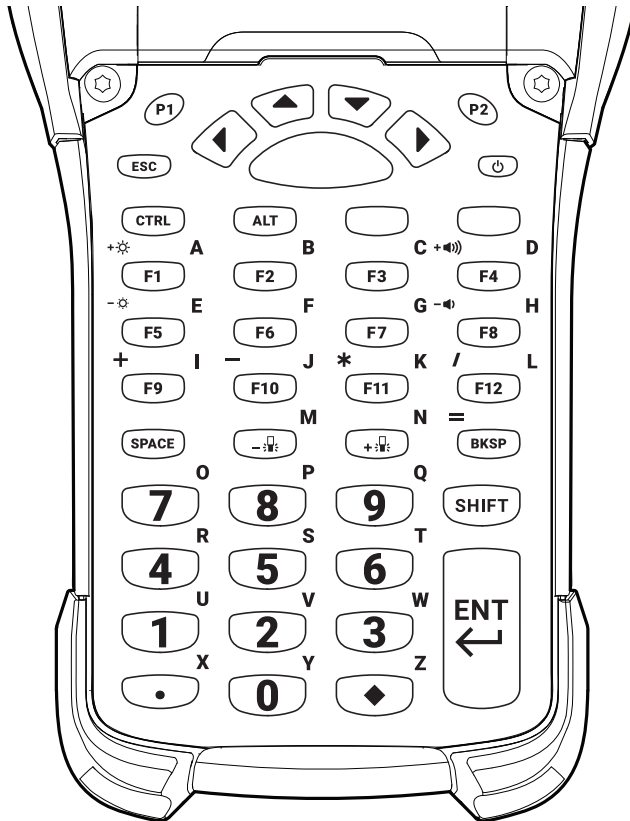















**Figure 62** 43-Keys Shifted Alpha Keypad









**Table 16** 43 Shifted Alpha Descriptions

Key	Description
Power (red) 	Turns the device on and off. Performs a warm boot and a hard reset. See Resetting the Device for more information.
P1/P2 	User programmable keys: <ul style="list-style-type: none"> <li>• By default, P1 is the dedicated PTT key.</li> <li>• By default, P2 acts like another Scan key.</li> </ul>
Scan (yellow) 	Activates the scanner/imager in a scan enabled application.

**Table 16** 43 Shifted Alpha Descriptions (Continued)

Key	Description
Up and Down 	Moves up and down from one item to another.
Left and Right 	Moves left and right from one item to another.
ESC 	Exits the current operation.
CTRL 	Press and release the CTRL key to activate the keypad alternate CTRL functions. The <b>C</b> icon appears in the status bars.
ALT 	Press the Blue key followed by the CTRL key to activate the keypad alternate ALT functions. The <b>A</b> icon appears in the status bar.
SPACE/BKSP 	Space and backspace functions.
Application 	The numeric keys generate keycodes 0 to 9.
Function (Blue) 	<p>Press and release the blue function key to activate the keypad alternate functions (shown on the keypad in Blue). Press the Blue function key once to put the keyboard into one-shot mode. The  icon appears on the Status bar. Press the Blue function key again the keypad is locked in function mode, and the  icon appears in the Status bar. Press and release the Blue function key a third time to return to the default keypad functions, and the  icon clears.</p> <p>Press the blue function key and SHIFT to activate CAPSLOCK mode, the  icon appears.</p>
Function (Orange) 	<p>Press and release the blue function key to activate the alpha key functions (shown on the keypad in Orange).</p> <p>Press and release the Orange function key to activate the keypad alternate functions (shown on the keypad in Orange). Press the Orange function key once to put the keyboard into one-shot mode. The  icon appears on the Status bar. Press the Orange function key again the keypad is locked in function mode, and the  icon appears in the Status bar. Press and release the Orange function key a third time to return to the default keypad functions, and the  icon clears.</p>

**Table 16** 43 Shifted Alpha Descriptions (Continued)

Key	Description																		
	<p>Press and release the SHIFT key to activate the keypad alternate SHIFT functions. The  icon appears in the status bar. After pressing another key, the keypad returns to the non-shift state.</p> <p>Press and release the SHIFT key twice to enable the Shift Lock state. The  icon appears in the status bar. Press and release the SHIFT key again to disable the Shift Lock state.</p>																		
	<p>Produces a period for alpha entries and a decimal point for numeric entries.</p>																		
	<p>Provides a 3x3 matrix on the screen with nine additional symbols. With a single tap you can select via touch input or the keyboard, 1-9 numerical keys. Double tapping the Diamond key locks the 3x3 grid, and you can select multiple keys. Pressing the Diamond key a third time closes the 3x3 matrix. You can modify the symbols in the 3x3 matrix using the StageNow utility in the KeyMappingMgr settings.</p> <div style="text-align: center; border: 1px solid gray; padding: 5px; margin: 10px 0;"> <table border="1" style="border-collapse: collapse; text-align: center;"> <tr> <td style="font-size: 8px;">7</td> <td style="font-size: 8px;">8</td> <td style="font-size: 8px;">9</td> </tr> <tr> <td> </td> <td>[</td> <td>]</td> </tr> <tr> <td style="font-size: 8px;">4</td> <td style="font-size: 8px;">5</td> <td style="font-size: 8px;">6</td> </tr> <tr> <td>£</td> <td>:</td> <td>€</td> </tr> <tr> <td style="font-size: 8px;">1</td> <td style="font-size: 8px;">2</td> <td style="font-size: 8px;">3</td> </tr> <tr> <td>~</td> <td>@</td> <td>-</td> </tr> </table> </div> <p>This is the default symbol layout for this keyboard.</p>	7	8	9		[	]	4	5	6	£	:	€	1	2	3	~	@	-
7	8	9																	
	[	]																	
4	5	6																	
£	:	€																	
1	2	3																	
~	@	-																	
	<p>Executes a selected item or function.</p>																		









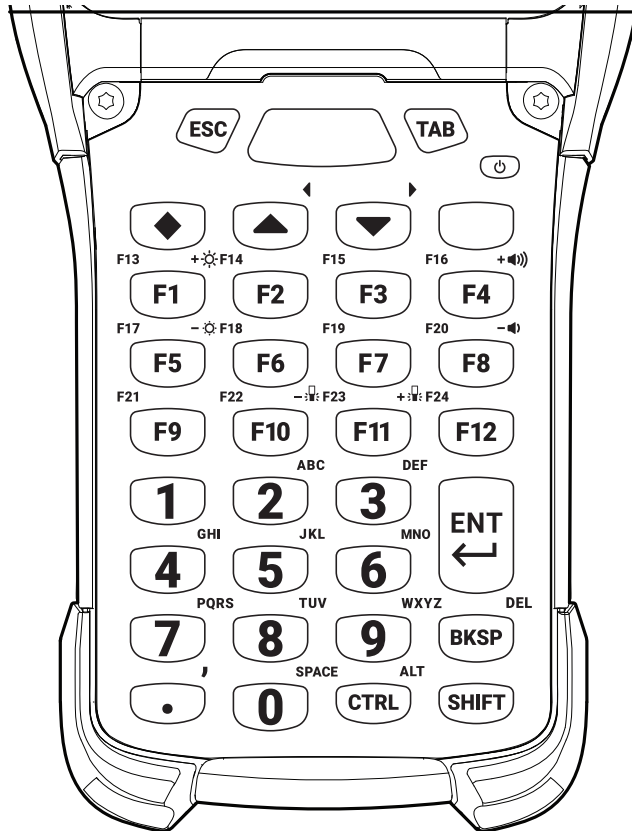

## 34-Keys Numeric Keypad

The 34-key keypad contains a **Power** button, application keys, scroll keys and a function key. The keypad is color-coded to indicate the alternate function key (blue) values and the alternate Shift key values. Note that keypad functions can be changed by an application so the MC93XX's keypad may not function exactly as described. See the Key Descriptions table for key and button details.













**Figure 63** 34-Keys Numeric Keypad



**Table 17** 34-Keys Descriptions

Key	Description												
Power (red) 	Turns the device on and off.  Performs a warm boot and a hard reset. See Resetting the Device for more information.												
Diamond 	Provides a 3x3 matrix on the screen with nine additional symbols. With a single tap you can select via touch input or the keyboard, 1-9 numerical keys. Double tapping the Diamond key locks the 3x3 grid, and you can select multiple keys. Pressing the Diamond key a third time closes the 3x3 matrix. You can modify the symbols in the 3x3 matrix using the StageNow utility in the KeyMappingMgr settings.  <table border="1" data-bbox="617 672 902 909"> <tr> <td>1</td> <td>2</td> <td>3</td> </tr> <tr> <td> </td> <td>[</td> <td>]</td> </tr> <tr> <td>£</td> <td>:</td> <td>€</td> </tr> <tr> <td>~</td> <td>@</td> <td>-</td> </tr> </table> This is the default symbol layout for this keyboard.	1	2	3		[	]	£	:	€	~	@	-
1	2	3											
	[	]											
£	:	€											
~	@	-											
ESC 	Exits the current operation.												
TAB 	Tab function.												
Scan (yellow) 	Activates the scanner/imager in a scan enabled application.												
Up and Down 	Moves up and down from one item to another.												
BKSP 	Space and backspace functions.												
Application 	The numeric keys generate keycodes 0 to 9.												

**Table 17** 34-Keys Descriptions (Continued)

Key	Description
Function (blue) 	<p>Press and release the blue function key to activate the keypad alternate functions (shown on the keypad in Blue). Press the Blue function key once to put the keyboard into one-shot mode. The  icon appears on the Status bar. Press the Blue function key again the keypad is locked in function mode, and the  icon appears in the Status bar. Press and release the Blue function key a third time to return to the default keypad functions, and the  icon clears.</p> <p>Press the Blue key followed by the CTRL key to activate the keypad alternate ALT functions. The  icon appears in the status bar.</p> <p>Press the blue function key and SHIFT to activate CAPSLOCK mode, the  icon appears.</p>
CTRL 	<p>Press and release the CTRL key to activate the keypad alternate CTRL functions. The  icon appears in the status bars.</p>
Shift 	<p>Press and release the SHIFT key to activate the keypad alternate SHIFT functions. The  icon appears in the status bar. After pressing another key, the keypad returns to the non-shift state.</p> <p>Press and release the SHIFT key twice to enable the Shift Lock state. The  icon appears in the status bar. Press and release the SHIFT key again to disable the Shift Lock state.</p>
Period/Decimal Point 	<p>Produces a period for alpha entries and a decimal point for numeric entries.</p>
ENT 	<p>Executes a selected item or function.</p>



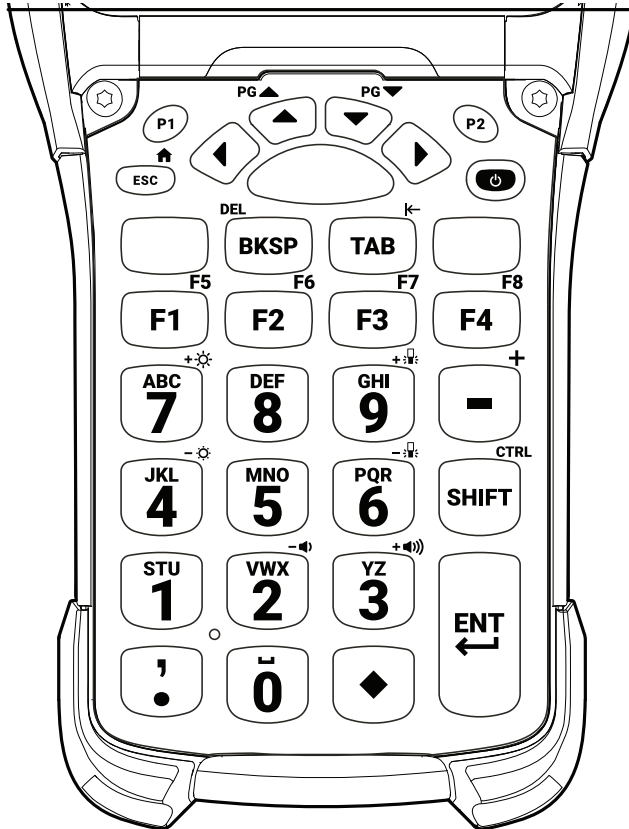

## 29-Keys Shifted Alpha Keypad

The 29-key keypad contains a **Power** button, application keys, scroll keys and a function key. Note that keypad functions can be changed by an application so the MC93XX's keypad may not function exactly as described. See the Key Descriptions table for key and button details, and the Keypad Special Functions table for the keypad's various functions.



















**Figure 64** 29-Keys Keypad



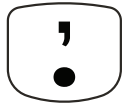
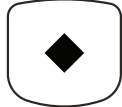

**Table 18** 29-Keys Descriptions

Key	Description
Power (red) 	Turns the device on and off. Performs a warm boot and a hard reset. See Resetting the Device for more information.
P1/P2 	User programmable keys: <ul style="list-style-type: none"> <li>• By default, P1 is the dedicated PTT key.</li> <li>• By default, P2 acts like another Scan key.</li> </ul>
Scan (yellow) 	Activates the scanner/imager in a scan enabled application.
Up and Down 	Moves up and down from one item to another.

**Table 18** 29-Keys Descriptions (Continued)

Key	Description
Left and Right 	Moves left and right from one item to another.
ESC 	Exits the current operation.
Shift 	<p>Press and release the SHIFT key to activate the keypad alternate SHIFT functions. The  icon appears in the status bar. After pressing another key, the keypad returns to the non-shift state.</p> <p>Press and release the SHIFT key twice to enable the Shift Lock state. The  icon appears in the status bar. Press and release the SHIFT key again to disable the Shift Lock state.</p>
BKSP 	Backspace function.
TAB 	Tab function.
Application 	The numeric keys generate keycodes 0 to 9.
Application 	The application keys.
Function (Blue) 	<p>Press and release the blue function key to activate the keypad alternate functions (shown on the keypad in Blue). Press the Blue function key once to put the keyboard into one-shot mode. The  icon appears on the Status bar. Press the Blue function key again the keypad is locked in function mode, and the  icon appears in the Status bar. Press and release the Blue function key a third time to return to the default keypad functions, and the  icon clears.</p> <p>Press the blue function key and SHIFT to activate CAPSLOCK mode, the  icon appears.</p>
Function (Orange) 	<p>Press and release the blue function key to activate the alpha key functions (shown on the keypad in Orange).</p> <p>Press and release the Orange function key to activate the keypad alternate functions (shown on the keypad in Orange). Press the Orange function key once to put the keyboard into one-shot mode. The  icon appears on the Status bar. Press the Orange function key again the keypad is locked in function mode, and the  icon appears in the Status bar. Press and release the Orange function key a third time to return to the default keypad functions, and the  icon clears.</p>









**Table 18** 29-Keys Descriptions (Continued)

Key	Description									
Period/Decimal Point 	Produces a period for alpha entries and a decimal point for numeric entries.									
Diamond 	Provides a 3x3 matrix on the screen with nine additional symbols. With a single tap you can select via touch input or the keyboard, 1-9 numerical keys. Double tapping the Diamond key locks the 3x3 grid, and you can select multiple keys. Pressing the Diamond key a third time closes the 3x3 matrix. You can modify the symbols in the 3x3 matrix using the StageNow utility in the KeyMappingMgr settings. <div style="text-align: center; margin: 10px 0;"> <table border="1" style="border-collapse: collapse; font-family: monospace;"> <tr> <td style="padding: 2px 5px;">!</td> <td style="padding: 2px 5px;">[</td> <td style="padding: 2px 5px;">]</td> </tr> <tr> <td style="padding: 2px 5px;">#</td> <td style="padding: 2px 5px;">;</td> <td style="padding: 2px 5px;">:</td> </tr> <tr> <td style="padding: 2px 5px;">*</td> <td style="padding: 2px 5px;">/</td> <td style="padding: 2px 5px;">+</td> </tr> </table> </div> This is the default symbol layout for this keyboard.	!	[	]	#	;	:	*	/	+
!	[	]								
#	;	:								
*	/	+								
Enter 	Executes a selected item or function.									

## Keypad Special Functions

The keypad special functions are color coded on the keypads. For example, on the 53-key keypad, the display backlight icon is blue indicating that the blue function key must be selected first to access the display backlight.

**Table 19** Keypad Special Functions

Icon	Special Function	58 Key (Omni XT15f)	53 Key (Standard, 5250, 3270, VT)	43 Key	34 Key (Omni XT15f)	29 Key
	Decreases the keyboard backlight intensity.	Blue key+Y	Blue key + X	Keylight+Down	Blue key+F10	Blue key+7
	Increases the keypad backlight intensity.	Blue key+Z	Blue key + Y	Keylight+Up	Blue key+F11	Blue key+9
	Increases display backlight intensity.	Blue key+N	Blue key + D	Blue key+F1	Blue key+F1	Blue key+7
	Decreases display backlight intensity.	Blue key+M	Blue key + I	Blue key+F5	Blue key+F5	Blue key+4
	Increases overall system volume.	Blue key+R	Blue key + H	Blue key+F4	Blue key+F4	Blue key+3
	Decreases overall system volume.	Blue key+Q	Blue key + M	Blue key+F8	Blue key+F8	Blue key+2
<b>ALT</b>	Enables Alt keypad functions.  Only applicable if the Large Key Indicator is enabled.	Blue key+CTRL	Blue key + CTRL	ALT	Blue key+CTRL	
	Caps Lock	Blue key+SHIFT	BLUE + SHIFT	Blue key+SHIFT	Blue key SHIFT	
	Sends TAB character (forward tab).	TAB	Blue key + Space	Blue key+SPACE	TAB	TAB



**NOTE:** Use of display and keypad backlighting can significantly reduce battery life.



## Special Characters

The keypads can be selected as necessary to support specialized applications. The keypads contain a **Power** button, application keys, scroll keys and function keys. The keypad is color-coded to indicate the alternate function key (blue/orange) values. The following table details special character generation. Characters can also be generated using the keyboard input panel.



**NOTE:** Shift-1 through Shift-0 only applies to the Standard 53-key keyboard. On the 5250, 3270, and VT 53-key keyboards the Shift + <num> combinations generate F11-F20 keys.

**Table 20** Special Character Generation Map

Special Character	58 Key (Omni XT15f)	53 Key (Standard, 5250, 3270, VT)	43 Key	34 Key (Omni XT15f)	29 Key
[ (open square bracket)	Diamond+2	Blue Key+E	Diamond+8	Diamond+2	Diamond+8
] (close square bracket)	Diamond+3	Blue Key+F	Diamond+9	Diamond+3	Diamond+9
/ (forward slash)	Not Applicable	Blue Key+V	Blue Key+F12	Not Applicable	Blue Key+8
\ (backslash)	Not Applicable	Blue Key+G	Not Applicable	Not Applicable	Not Applicable
= (equal sign)	Not Applicable	Blue Key+W	Blue Key+Bksp	Not Applicable	Blue Key+5
; (semi-colon)	Not Applicable	Blue Key+R	Not Applicable	Not Applicable	Diamond+5
` (apostrophe)	Not Applicable	Blue Key+J	Not Applicable	Not Applicable	Not Applicable
, (comma)	Shift+. (Dot)	Blue Key+A	Not Applicable	Blue Key+. (Dot)	Not Applicable
. (period)	Dot	Blue Key+B	Not Applicable	Dot	Not Applicable
! (exclamation sign)	Shift+1	Shift+1	Shift+1	Shift+1	Shift+1
@ (at sign)	Shift+2	Shift+2	Shift+2	Shift+2	Shift+2
# (pound sign)	Shift+3	Shift+3	Shift+3	Shift+3	Shift+3
\$ (dollar sign)	Shift+4	Shift+4	Shift+4	Shift+4	Shift+4
% (percent sign)	Shift+5	Shift+5	Shift+5	Shift+5	Shift+5
^ (carat)	Shift+6	Shift+6	Shift+6	Shift+6	Shift+6
& (ampersand)	Shift+7	Shift+7	Shift+7	Shift+7	Shift+7
* (asterisk)	Shift+8	Blue Key+U Shift+8	Blue Key+F11, Shift+8	Shift+8	Shift+8
( (open parenthesis)	Shift+9	Shift+9	Shift+9	Shift+9	Shift+9

## Keypads

**Table 20** Special Character Generation Map (Continued)

Special Character	58 Key (Omni XT15f)	53 Key (Standard, 5250, 3270, VT)	43 Key	34 Key (Omni XT15f)	29 Key
) (close parenthesis)	Shift+0	Shift+0	Shift+0	Shift+0	Shift+0
' (single quote)	Not Applicable	Blue Key+C	Not Applicable	Not Applicable	Not Applicable
" (double quote)	Not Applicable	Shift+Blue Key+C	Not Applicable	Not Applicable	Not Applicable
+ (plus sign)	Not Applicable	Blue Key+S	Blue Key+F9	Not Applicable	Orange Key+ - (Minus)
- (dash)	Not Applicable	Blue Key+N, Blue Key+T	Blue Key+F10	Not Applicable	Minus key
: (colon)	Diamond+5	Shift+Blue Key+R	Diamond+5	Diamond+5	Diamond+6
< (less than sign)	Shift+Blue Key+. (Dot)	Shift+Blue Key+A	Not Applicable	Shift + Blue Key+. (Dot)	Shift+ Orange Key+ . (Dot)
> (greater than sign)	Shift+. (Dot)	Shift+Blue Key+B	Shift+. (Dot)	Shift+. (Dot)	Shift+. (Dot)
? (question mark)	Not Applicable	Shift+Blue Key+V	Shift+Blue Key+F12	Not Applicable	Shift +Blue Key+8
_ (underscore)	Diamond+9	Shift+Blue Key+N	Diamond+3	Diamond+9	Shift + - (Minus)
{ (open curly bracket)	Not Applicable	Shift+Blue Key+E	Not Applicable	Not Applicable	Not Applicable
} (close curly bracket)	Not Applicable	Shift+Blue Key+F	Not Applicable	Not Applicable	Not Applicable
~ (tilde)	Diamond+7	Shift+Blue Key+J	Diamond+1	Diamond+7	Not Applicable
(pipe)	Diamond+1	Shift+Blue Key+G	Diamond+7	Diamond+1	Not Applicable

# Maintenance and Troubleshooting

## Maintaining the Device

For trouble-free service, observe the following tips when using the device:

- To avoid scratching the screen, use a Zebra approved capacitive compatible stylus intended for use with a touch-sensitive screen. Never use an actual pen or pencil or other sharp object on the surface of the device screen.
- The touch-sensitive screen of the device is glass. Do not drop the device or subject it to strong impact.
- Protect the device from temperature extremes. Do not leave it on the dashboard of a car on a hot day, and keep it away from heat sources.
- Do not store the device in any location that is dusty, damp, or wet.
- Use a soft lens cloth to clean the device. If the surface of the device screen becomes soiled, clean it with a soft cloth moistened with an approved cleanser. For a list of approved cleansers, see Approved Cleanser Active Ingredients.
- Periodically replace the rechargeable battery to ensure maximum battery life and product performance. Battery life depends on individual usage patterns.

## Battery Safety Guidelines

- The area in which the units are charged should be clear of debris and combustible materials or chemicals. Particular care should be taken where the device is charged in a non commercial environment.
- Follow battery usage, storage, and charging guidelines found in this guide.
- Improper battery use may result in a fire, explosion, or other hazard.
- To charge the mobile device battery, the ambient battery and charger temperatures must be between +32°F and +104°F (0°C and +40°C).
- Do not use incompatible batteries and chargers, including non-Zebra batteries and chargers. Use of an incompatible battery or charger may present a risk of fire, explosion, leakage, or other hazard. If you have any questions about the compatibility of a battery or a charger, contact the Global Customer Support Center.
- For devices that utilize a USB port as a charging source, the device shall only be connected to products that bear the USB-IF logo or have completed the USB-IF compliance program.
- Do not disassemble or open, crush, bend or deform, puncture, or shred the battery.
- Severe impact from dropping any battery-operated device on a hard surface could cause the battery to overheat.
- Do not short circuit a battery or allow metallic or conductive objects to contact the battery terminals.

- Do not modify or remanufacture, attempt to insert foreign objects into the battery, immerse or expose to water or other liquids, or expose to fire, explosion, or other hazard.
- Do not leave or store the equipment in or near areas that might get very hot, such as in a parked vehicle or near a radiator or other heat source. Do not place battery into a microwave oven or dryer.
- Battery usage by children should be supervised.
- Please follow local regulations to properly dispose of used rechargeable batteries.
- Do not dispose of batteries in fire.
- In the event of a battery leak, do not allow the liquid to come in contact with the skin or eyes. If contact has been made, wash the affected area with water for 15 minutes, and seek medical advice.
- If you suspect damage to your equipment or battery, contact Customer Support to arrange for inspection.

## Cleaning Instructions



**CAUTION:** Always wear eye protection.

Read warning label on alcohol product before using.

If you have to use any other solution for medical reasons please contact the Global Customer Support Center for more information.



**WARNING:** Avoid exposing this product to contact with hot oil or other flammable liquids. If such exposure occurs, unplug the device and clean the product immediately in accordance with these guidelines.

## Approved Cleanser Active Ingredients

100% of the active ingredients in any cleaner must consist of one or some combination of the following: isopropyl alcohol, bleach/sodium hypochlorite<sup>1</sup> (see important note below), or mild dish soap.



**IMPORTANT:** Use pre-moistened wipes and do not allow liquid cleaner to pool.

<sup>1</sup>When using sodium hypochlorite (bleach) based products, always follow the manufacturer's recommended instructions: use gloves during application and remove the residue afterwards with a damp alcohol cloth or a cotton swab to avoid prolonged skin contact while handling the device.

Due to the powerful oxidizing nature of sodium hypochlorite, the metal surfaces on the device are prone to oxidation (corrosion) when exposed to this chemical in the liquid form (including wipes). In the event that these type of disinfectants come in contact with metal on the device, prompt removal with an alcohol-dampened cloth or cotton swab after the cleaning step is critical.

## Harmful Ingredients

The following chemicals are known to damage the plastics on the device and should not come in contact with the device: acetone; ketones; ethers; aromatic and chlorinated hydrocarbons; aqueous or alcoholic alkaline solutions; ethanolamine; toluene; trichloroethylene; benzene; carbolic acid and TB-lysoform.

Many vinyl gloves contain phthalate additives, which are often not recommended for medical use and are known to be harmful to the housing of the device.

### Device Cleaning Instructions

Do not apply liquid directly to the device. Dampen a soft cloth or use pre-moistened wipes. Do not wrap the device in the cloth or wipe, instead gently wipe the unit. Be careful not to let liquid pool around the display window or other places. Before use, allow the unit to air dry.



**NOTE:** For thorough cleaning, it is recommended to first remove all accessory attachments, such as hand straps or cradle cups, from the mobile device and to clean them separately.

### Special Cleaning Notes

Do not handle the device while wearing vinyl gloves containing phthalates. Remove vinyl gloves and wash hands to eliminate any residue left from the gloves.

If products containing any of the harmful ingredients listed above are used prior to handling the device, such as a hand sanitizer that contains ethanalamine, hands must be completely dry before handling the device to prevent damage to the device.



**IMPORTANT:** If the battery connectors are exposed to cleaning agents, thoroughly wipe off as much of the chemical as possible and clean with an alcohol wipe. It is also recommended to install the battery in the terminal prior to cleaning and disinfecting the device to help minimize buildup on the connectors.

When using cleaning/disinfectant agents on the device, it is important to follow the directions prescribed by the cleaning/disinfectant agent manufacturer.

### Cleaning Materials Required

- Alcohol wipes
- Lens tissue
- Cotton-tipped applicators
- Isopropyl alcohol
- Can of compressed air with a tube.

### Cleaning Frequency

The cleaning frequency is at the customer's discretion due to the varied environments in which the mobile devices are used and may be cleaned as frequently as required. When dirt is visible, it is recommended to clean the mobile device to avoid build up of particles which make the device more difficult to clean later on.

## Cleaning the Device

### Housing

Thoroughly wipe the housing, including all buttons and triggers, using an approved alcohol wipe.

### Display

The display can be wiped down with an approved alcohol wipe, but care should be taken not to allow any pooling of liquid around the edges of the display. Immediately dry the display with a soft, non-abrasive cloth to prevent streaking.

### Exit Window

Wipe the exit window periodically with a lens tissue or other material suitable for cleaning optical material such as eyeglasses.

### Cleaning Battery Connectors

1. Remove the main battery from the mobile computer.
2. Dip the cotton portion of the cotton-tipped applicator in isopropyl alcohol.
3. To remove any grease or dirt, rub the cotton portion of the cotton-tipped applicator back-and-forth across the connectors on the battery and terminal sides. Do not leave any cotton residue on the connectors.
4. Repeat at least three times.
5. Use a dry cotton-tipped applicator and repeat steps 3 and 4. Do not leave any cotton residue on the connectors.
6. Inspect the area for any grease or dirt and repeat the cleaning process if necessary.



**CAUTION:** After cleaning the battery connectors with bleach-based chemicals, follow the Battery Connector Cleaning instructions to remove bleach from the connectors.

### Cleaning Cradle Connectors

1. Remove the DC power cable from the cradle.
2. Dip the cotton portion of the cotton-tipped applicator in isopropyl alcohol.
3. Rub the cotton portion of the cotton-tipped applicator along the pins of the connector. Slowly move the applicator back-and-forth from one side of the connector to the other. Do not leave any cotton residue on the connector.
4. All sides of the connector should also be rubbed with the cotton-tipped applicator.
5. Remove any lint left by the cotton-tipped applicator.
6. If grease and other dirt can be found on other areas of the cradle, use a lint-free cloth and alcohol to remove.
7. Allow at least 10 to 30 minutes (depending on ambient temperature and humidity) for the alcohol to air dry before applying power to cradle.

If the temperature is low and humidity is high, longer drying time is required. Warm temperature and low humidity requires less drying time.



**CAUTION:** After cleaning the cradle connectors with bleach-based chemicals, follow the Cleaning Cradle Connectors instructions to remove bleach from the connectors.

## Troubleshooting the Device

The following tables provides typical problems that might arise and the solution for correcting the problem.

**Table 21** Troubleshooting the MC93XX

Problem	Cause	Solution
When pressing the power button the device does not turn on.	Battery not charged.	Charge or replace the battery in the device.
	Battery not installed properly.	Install the battery properly.
	System crash.	Perform a reset.
When pressing the power button the device does not turn on but LED bar blinks.	Battery charge is at a level where data is maintained but battery should be re-charged.	Charge or replace the battery in the device.
Battery did not charge.	Battery failed.	Replace battery. If the device still does not operate, perform a reset.
	Device removed from cradle while battery was charging.	Insert device in cradle. The 7,000 mAh battery fully charges in less than five hours at room temperature.
	Extreme battery temperature.	Battery does not charge if ambient temperature is below 0°C (32°F) or above 40°C (104°F).
Cannot see characters on display.	Device not powered on.	Press the Power button.
During data communication with a host computer, no data transmitted, or transmitted data was incomplete.	Device removed from cradle or disconnected from host computer during communication.	Replace the device in the cradle, or reattach the communication cable and re-transmit.
	Incorrect cable configuration.	See the system administrator.
	Communication software was incorrectly installed or configured.	Perform setup.
During data communication over Wi-Fi, no data transmitted, or transmitted data was incomplete.	Wi-Fi radio is not on.	Turn on the Wi-Fi radio.
	You moved out of range of an access point.	Move closer to an access point.
During data communication over Bluetooth, no data transmitted, or transmitted data was incomplete.	Bluetooth radio is not on.	Turn on the Bluetooth radio.
	You moved out of range of another Bluetooth device.	Move within 10 meters (32.8 feet) of the other device.
No sound.	Volume setting is low or turned off.	Adjust the volume.

**Table 21** Troubleshooting the MC93XX (Continued)

Problem	Cause	Solution
Device shuts off.	Device is inactive.	The display turns off after a period of inactivity. Set this period to 15 seconds, 30 seconds, 1, 2, 5, 10 or 30 minutes.
	Battery is depleted.	Replace the battery.
Tapping the window buttons or icons does not activate the corresponding feature.	The device is not responding.	Reset the device.
A message appears stating that the device memory is full.	Too many files stored on the device.	Delete unused memos and records. If necessary, save these records on the host computer (or use an SD card for additional memory).
	Too many applications installed on the device.	Remove user-installed applications on the device to recover memory. Select <b>⚙ &gt; Storage &gt; FREE UP SPACE &gt; REVIEW RECENT ITEMS</b> . Select the unused program(s) and tap <b>FREE UP</b> .
The device does not decode with reading bar code.	Scanning application is not loaded.	Load a scanning application on the device or enable DataWedge. See the system administrator.
	Unreadable bar code.	Ensure the symbol is not defaced.
	Distance between exit window and bar code is incorrect.	Place the device within proper scanning range.
	Device is not programmed for the bar code.	Program the device to accept the type of bar code being scanned. Refer to the EMDK or DataWedge application.
	Device is not programmed to generate a beep.	If the device does not beep on a good decode, set the application to generate a beep on good decode.
	Battery is low.	If the scanner stops emitting a laser beam upon a trigger press, check the battery level. When the battery is low, the scanner shuts off before the device low battery condition notification. Note: If the scanner is still not reading symbols, contact the distributor or the Global Customer Support Center.
Device cannot find any Bluetooth devices nearby.	Too far from other Bluetooth devices.	Move closer to the other Bluetooth device(s), within a range of 10 meters (32.8 feet).
	The Bluetooth device(s) nearby are not turned on.	Turn on the Bluetooth device(s) to find.
	The Bluetooth device(s) are not in discoverable mode.	Set the Bluetooth device(s) to discoverable mode. If needed, refer to the device's user documentation for help.
Cannot unlock device.	User enters incorrect password.	If you enter an incorrect password eight times, you are requested to enter a code before trying again. If you forgot the password, contact your system administrator.



**Table 21** Troubleshooting the MC93XX (Continued)

Problem	Cause	Solution
Battery pack communication error.	The battery is not inserted properly.	Remove and reinsert the battery into the device.
	The battery is properly inserted, however, when the terminal is in an active vibration environment or has fallen from a high vantage point (more than 8 ft), it might interrupt battery communication.	Remove and reinsert the battery into the device.
	The battery communication pin is damaged.	Remove the battery and insert a new battery into the device.

## 1-Slot USB Charging Cradle Troubleshooting

**Table 22** Troubleshooting the 1-Slot USB Charging Cradle

Symptom	Possible Cause	Action
LEDs do not light when device or spare battery is inserted.	Cradle is not receiving power.	Ensure the power cable is connected securely to both the cradle and to AC power.
	Device is not seated firmly in the cradle.	Remove and re-insert the device into the cradle, ensuring it is firmly seated.
	Spare battery is not seated firmly in the cradle.	Remove and re-insert the spare battery into the charging slot, ensuring it is firmly seated.
Device battery is not charging.	Device was removed from cradle or cradle was unplugged from AC power too soon.	Ensure cradle is receiving power. Ensure device is seated correctly. Confirm main battery is charging. The battery charges from fully depleted to 90% in approximately 2.5 hours, and from fully depleted to 100% in approximately three hours.
	Battery is faulty.	Verify that other batteries charge properly. If so, replace the faulty battery.
	The device is not fully seated in the cradle.	Remove and re-insert the device into the cradle, ensuring it is firmly seated.
	Extreme battery temperature.	Battery does not charge if ambient temperature is below 5°C (40°F) or above 40°C (104°F).

**Table 22** Troubleshooting the 1-Slot USB Charging Cradle (Continued)

Symptom	Possible Cause	Action
Spare battery is not charging.	Battery not fully seated in charging slot.	Remove and re-insert the spare battery in the cradle, ensuring it is firmly seated. The battery charges from fully depleted to 90% in approximately 2.5 hours, and from fully depleted to 100% in approximately three hours.
	Battery inserted incorrectly.	Re-insert the battery so the charging contacts on the battery align with the contacts on the cradle.
	Battery is faulty.	Verify that other batteries charge properly. If so, replace the faulty battery.

## 4-Slot Charge Only Cradle Troubleshooting

**Table 23** Troubleshooting the 4-Slot Charge Only Cradle

Problem	Cause	Solution
Battery is not charging.	Device removed from the cradle too soon.	Replace the device in the cradle. The battery charges from fully depleted to 90% in approximately 2.5 hours, and from fully depleted to 100% in approximately three hours.
	Battery is faulty.	Verify that other batteries charge properly. If so, replace the faulty battery.
	Device is not inserted correctly in the cradle.	Remove the device and reinsert it correctly. Verify charging is active. Touch  > <b>System</b> > <b>About phone</b> > <b>Status</b> to view battery status.
	Ambient temperature of the cradle is too warm.	Move the cradle to an area where the ambient temperature is between 5°C (40°F) or above 40°C (104°F).

**Table 23** Troubleshooting the 4-Slot Charge Only Cradle

Problem	Cause	Solution
Spare Battery not charging.	Charger is not receiving power.	Ensure the power cable is connected securely to both the charger and to AC power.
	Spare battery is not correctly seated.	Remove and re-insert the battery into the battery adapter, ensuring it is correctly seated.
	Battery adapter is not seated properly.	Remove and re-insert the battery adapter into the charger, ensuring it is correctly seated.
	Battery was removed from the charger or charger was unplugged from AC power too soon.	Ensure charger is receiving power. Ensure the spare battery is seated correctly. The battery charges from fully depleted to 90% in approximately 2.5 hours, and from fully depleted to 100% in approximately three hours.
	Battery is faulty.	Verify that other batteries charge properly. If so, replace the faulty battery.

### 4-Slot Ethernet Cradle Troubleshooting

**Table 24** Troubleshooting the 4-Slot Ethernet Cradle

Problem	Cause	Solution
During communication, no data transmits, or transmitted data was incomplete.	Device removed from cradle during communications.	Replace device in cradle and retransmit.
	Incorrect cable configuration.	Ensure that the correct cable configuration.
	Device has no active connection.	An icon is visible in the status bar if a connection is currently active.
Battery is not charging.	Device removed from the cradle too soon.	Replace the device in the cradle. The battery charges from fully depleted to 90% in approximately 2.5 hours, and from fully depleted to 100% in approximately three hours.
	Battery is faulty.	Verify that other batteries charge properly. If so, replace the faulty battery.
	Device is not inserted correctly in the cradle.	Remove the device and reinsert it correctly. Verify charging is active. Touch <b>⚙</b> > <b>System</b> > <b>About phone</b> > <b>Status</b> to view battery status.
	Ambient temperature of the cradle is too warm.	Move the cradle to an area where the ambient temperature is between 5°C (+40°F) and +40°C (+104°F).

## 4-Slot Spare Battery Charger Troubleshooting

**Table 25** Troubleshooting the 4-Slot Battery Charger

Problem	Cause	Solution
Spare Battery Charging LED does not light when spare battery is inserted.	Spare battery is not correctly seated.	Remove and re-insert the spare battery into the charging slot, ensuring it is correctly seated.
Spare Battery not charging.	Charger is not receiving power.	Ensure the power cable is connected securely to both the charger and to AC power.
	Spare battery is not correctly seated.	Remove and re-insert the battery into the battery adapter, ensuring it is correctly seated.
	Battery adapter is not seated properly.	Remove and re-insert the battery adapter into the charger, ensuring it is correctly seated.
	Battery was removed from the charger or charger was unplugged from AC power too soon.	Ensure charger is receiving power. Ensure the spare battery is seated correctly. The battery charges from fully depleted to 90% in approximately 2.5 hours, and from fully depleted to 100% in approximately three hours.
	Battery is faulty.	Verify that other batteries charge properly. If so, replace the faulty battery.

## 16-Slot Spare Battery Charger Troubleshooting

**Table 26** Troubleshooting the 16-Slot Battery Charger

Problem	Cause	Solution
Spare Battery Charging LED does not light when spare battery is inserted.	Spare battery is not correctly seated.	Remove and re-insert the spare battery into the charging slot, ensuring it is correctly seated.

**Table 26** Troubleshooting the 16-Slot Battery Charger (Continued)

Problem	Cause	Solution
Spare Battery not charging.	Charger is not receiving power.	Ensure the power cable is connected securely to both the charger and to AC power.
	Spare battery is not correctly seated.	Remove and re-insert the battery into the battery adapter, ensuring it is correctly seated.
	Battery adapter is not seated properly.	Remove and re-insert the battery adapter into the charger, ensuring it is correctly seated.
	Battery was removed from the charger or charger was unplugged from AC power too soon.	Ensure charger is receiving power. Ensure the spare battery is seated correctly. The battery charges from fully depleted to 90% in approximately 2.5 hours, and from fully depleted to 100% in approximately three hours.
	Battery is faulty.	Verify that other batteries charge properly. If so, replace the faulty battery.

# Specifications

## Technical Specifications

For device technical specifications, go to [www.zebra.com](http://www.zebra.com).

### SE965 Decode Zone

The table below lists the typical distances for selected barcode densities. The minimum element width (or “symbol density”) is the width in mils of the narrowest element (bar or space) in the symbol.

**Table 27** SE965 Decode Distances

Symbol Density/ Barcode Type	Barcode Content/ Contrast <sup>Note 1</sup>	Typical Working Ranges	
		Near	Far
5.0 mil Code 128	1234 80% MRD	1.2 in 3.05 cm	7.7 in 19.56 cm
5.0 mil Code 39	ABCDEFGH 80% MRD	1.2 in 3.05 cm	12.5 in 31.75 cm
7.5 mil Code 39	ABCDEF 80% MRD	1.1 in 2.79 cm	18.5 in 46.99 cm
10 mil Code 128	1234 80% MRD	1.2 in 3.05 cm Note 3	19.0 in 48.26 cm
13 mil 100% UPC	012345678905 80% MRD	1.6 in 4.06 cm	27.0 in 68.58 cm
15 mil Code 128	1234 80% MRD	1.0 in 2.54 cm Note 3	29.5 in 74.93 cm
20 mil Code 39	123 80% MRD	1.4 in 3.56 cm Note 3	52.0 in 132.08 cm

**Table 27** SE965 Decode Distances (Continued)

Symbol Density/ Barcode Type	Barcode Content/ Contrast <sup>Note 1</sup>	Typical Working Ranges	
		Near	Far
55 mil Code 39	CD 80% MRD	31.4 in 8.64 cm Note 3	100.0 in 254.0 cm
100 mil Code 39	123456 80% MRD	2.0 ft 60.96 cm Note 3	17 ft 518.16 cm

1. Contrast is measured as Mean Reflective Difference (MRD) at 650 nm.

2. Working range specifications at temperature = 23°C, pitch=18°, roll=0°, skew=0°, photographic quality, ambient light ~150 ft-c, humidity 45-70% RH.

3. Dependent upon width of barcode.

4. Distances measured from front edge of scan engine chassis.

## SE4750-SR Decode Zone

The table below lists the typical distances for selected barcode densities. The minimum element width (or “symbol density”) is the width in mils of the narrowest element (bar or space) in the symbol.

**Table 28** SE4750-SR Decode Distances

Symbol Density/ Barcode Type	Typical Working Ranges	
	Near	Far
3.0 mil Code 39	3.7 in 9.3 cm	5.4 in 13.71 cm
5.0 mil Code 128	3.2 in 8.12 cm	7.6 in 19.30 cm
5.0 mil PDF417	4.0 in 10.16 cm	7.0 in 17.78 cm
6.67 mil PDF417	2.9 in 7.36 cm	9.0 in 22.86 cm
10. mil Data Matrix	3.0 in 7.62 cm	9.4 in 23.87 cm
100% UPCA	1.8 in 4.57 cm Note 2	20.0 in 50.8 cm
15 mil Code 128	2.4 in 6.10 cm	22.0 in 55.88 cm
20 mil Code 39	1.6 in 4.06 cm	30.0 in 76.2 cm

## SE4770-SR Decode Zones

The table below lists the typical distances for selected bar code densities.

**Table 29** SE4770-SR Decode Distances

Symbology	Typical Working Range	
	Near	Far
3 mil Code 39	2.8 in. 7.11 cm	5.8 in. 14.73 cm
5 mil Code 128	2.3 in. 5.84 cm	9.8 in. 24.89 cm
5 mil PDF417	3.0 in. 7.62 cm	7.9 in. 20.06 cm
6.67 mil PDF 417	2.2 in. 5.58 cm	10.1 in. 25.65 cm
10 mil DataMatrix	2.4 in. 6.09 cm	11.0 in. 27.94 cm
100% UPCA	1.6 in. 4.06 cm	24.9 in. 63.24 cm
15 mil Code 128	2.4 in. 6.09* cm	27.8 in. 70.61 cm
20 mil Code 39	1.6 in. 4.06 cm	36.1 in. 91.69 cm
20 mil QR	1.1 in. 2.79 cm	17.5 in. 44.45 cm
* Limited by width of bar code in field of view. See SE4770 Integration Guide for details.  Photographic quality bar code at 18° tilt pitch angle under 30 fcd ambient illumination. Distances measured from front edge of scan engine chassis.		

## SE4850-ER Decode Zone

The table below lists the typical distances for selected barcode densities. The minimum element width (or “symbol density”) is the width in mils of the narrowest element (bar or space) in the symbol.

**Table 30** SE4850-ER Decode Distances

Symbol Density/ Barcode Type	Typical Working Ranges @20 Ft-Cd Minimum	
	Near	Far
10 mil Code 39	5.0 in. * 12.7 cm *	62.0 in. 157.48 cm
13 100% UPC	7.0 in. 17.78 cm	77.0 in. 195.58 cm
15 mil Code 128	10.0 in. * 25.4 cm *	86.0 in. 218.44 cm



## Specifications

**Table 30** SE4850-ER Decode Distances (Continued)

Symbol Density/ Barcode Type	Typical Working Ranges @20 Ft-Cd Minimum	
	Near	Far
20 mil Code 39	8.0 in. * 20.32 cm *	137.0 in. 347.98 cm
40 mil Code 39	9.0 in. * 22.86 cm *	298.0 in. ** 756.92 cm **
55 mil Code 39	11.0* in. * 27.94* cm *	378.0 in. ** 960.12 cm **
100 mil Code 39 (paper)	21.0* in. * 53.34* cm *	600.0 in. ** 1524 cm **
100 mil Code 39 (reflective)	42.0 in. * 106.68 cm *	600.0 in. 1524.0 cm
DataMatrix 10	6.0 in. 15.24 cm	38.0 in. 96.52 cm
DataMatrix 55	7.0 in. 17.78 cm	200.0 in. 508.0 cm
DataMatrix 300 (reflective)	23.0 in. 58.42 cm	516.0 in. 1310.64 cm
15 mil Code 128 (4 in. wide)	8.0 in. * 20.32 cm *	86.0 in. 218.44 cm
* Limited by width of bar code in field of view.		
** Range is reduced under low ambient light level.		

## I/O Connector Pin-Outs

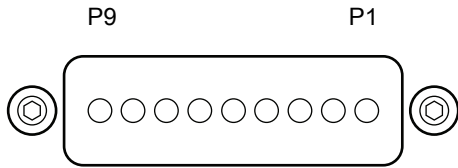

**Table 31** I/O Connector Pin-Outs

Pin	Signal	Description
1	Ground	Ground pin connected to the Cradle or USB Charge Cable ground.
2	USB D-	USB OTG data signal negative.
3	USB D+	USB OTG data signal positive.
4	USB PWR	Power supply from USB Charging Cable.
5	Batt_Det_C	Connected with 1k $\Omega$ resistor to Ground in the battery pack.
6	Cradle_PWR	DC Power supply from the Cradle.
7	USB_CC2	Used by USB_CC2 following USB type-C specification for USB 2.0.
8	USB_CC1	Used by USB_CC1 following USB type-C specification for USB 2.0.
9	GND	Ground pin connected to the Cradle or USB Charge Cable ground.

## MC93XX Accessory Specifications

### 1-Slot USB Charge Cradle with Spare Battery Charger Technical Specifications

**Table 32** 1-Slot USB Charge Cradle with Spare Battery Charger Technical Specifications

Item	Description
Dimensions	Height: 87.9 mm (3.46 in) Width: 152.4 mm (6.00 in) Depth: 159.4 mm (6.28 in)
Weight	522 g (18.41 oz)
Input Voltage	12 VDC
Power Consumption	28 watts
Operating Temperature	0°C to 40°C (32°F to 104°F)
Storage Temperature	-40°C to 70°C (-40°F to 158°F)
Charging Temperature	0°C to 40°C (32°F to 104°F)
Humidity	5% to 95% non-condensing
Drop	75 cm (30 in.) to concrete; 2 drops/side for a total of 12 drops at room temperature (23°C).
Electrostatic Discharge (ESD)	+/- 15 kV air +/- 8 kV contact +/- 8 kV indirect discharge

### 4-Slot Charge Only ShareCradle Technical Specifications

**Table 33** 4-Slot Charge Only ShareCradle Technical Specifications

Item	Description
Dimensions	Height: 116.5 mm (4.59 in) Width: 152.4 mm (6.00 in) Depth: 132.7 mm (5.22 in)
Weight	1879 g (66.28 oz)
Input Voltage	12 VDC
Power Consumption	63 watts
Operating Temperature	0°C to 40°C (32°F to 104°F)
Storage Temperature	-40°C to 70°C (-40°F to 158°F)
Charging Temperature	0°C to 40°C (32°F to 104°F)

## Specifications

**Table 33** 4-Slot Charge Only ShareCradle Technical Specifications (Continued)

Item	Description
Humidity	5% to 95% non-condensing
Drop	75 cm (30 in.) to concrete; 2 drops/side for a total of 12 drops at room temperature (23°C).
Electrostatic Discharge (ESD)	+/- 15 kV air +/- 8 kV contact +/- 8 kV indirect discharge

### 4-Slot Ethernet ShareCradle Technical Specifications

**Table 34** 4-Slot Ethernet ShareCradle Technical Specifications

Item	Description
Dimensions	Height: 116.5 mm (4.59 in.) Width: 489.0 mm (19.25 in.) Depth: 132.7 mm (5.22 in.)
Weight	2070 g (37.67 oz)
Input Voltage	12 VDC
Power Consumption	80 watts
Operating Temperature	0°C to 40°C (32°F to 104°F)
Storage Temperature	-40°C to 70°C (-40°F to 158°F)
Charging Temperature	0°C to 40°C (32°F to 104°F)
Humidity	5% to 95% non-condensing
Drop	75 cm (30 in.) to concrete; 2 drops/side for a total of 12 drops at room temperature (23°C).
Electrostatic Discharge (ESD)	+/- 15 kV air +/- 8 kV contact +/- 8 kV indirect discharge

### 4-Slot Spare Battery Charger Technical Specifications

**Table 35** 4-Slot Spare Battery Charger Technical Specifications

Item	Description
Dimensions	Height: 104.4 mm (4.11 in.) Width: 121.9 mm (4.80 in.) Depth: 142.4 mm (5.61 in.)
Weight	619.3 g (21.85 oz)
Input Voltage	12 VDC
Power Consumption	30 watts

## Specifications

**Table 35** 4-Slot Spare Battery Charger Technical Specifications (Continued)

Item	Description
Operating Temperature	0°C to 40°C (32°F to 104°F)
Storage Temperature	-40°C to 70°C (-40°F to 158°F)
Charging Temperature	0°C to 40°C (32°F to 104°F)
Humidity	5% to 95% non-condensing
Drop	75 cm (30 in.) to concrete; 2 drops/side for a total of 12 drops at room temperature (23°C).
Electrostatic Discharge (ESD)	+/- 15 kV air +/- 8 kV contact +/- 8 kV indirect discharge

## 16-Slot Spare Battery Charger Technical Specifications

**Table 36** 16-Slot Spare Battery Charger Technical Specifications

Item	Description
Dimensions	Height: 104.9 mm (4.13 in.) Width: 489.0 mm (19.25 in.) Depth: 142.4 mm (5.61 in.)
Weight	2480 g (87.48 oz)
Input Voltage	12 VDC
Power Consumption	106 watts
Operating Temperature	0°C to 40°C (32°F to 104°F)
Storage Temperature	-40°C to 70°C (-40°F to 158°F)
Charging Temperature	0°C to 40°C (32°F to 104°F)
Humidity	5% to 95% non-condensing
Drop	75 cm (30 in.) to concrete; 2 drops/side for a total of 12 drops at room temperature (23°C).
Electrostatic Discharge (ESD)	+/- 15 kV air +/- 8 kV contact +/- 8 kV indirect discharge

## USB Charge/Com Snap-on Cup Technical Specifications

**Table 37** USB Charge Cable Technical Specifications

Item	Description
Dimensions	Height: 55.8 mm (2.19 in.) Width (with cable): 199.5 mm (7.85 in.) Depth 52.8mm (2.07 in.)
Weight	76.1 g (2.68 oz)
Input Voltage	5 VDC
Power Consumption	12 watts
Operating Temperature	0°C to 50°C (32°F to 104°F)
Storage Temperature	-40°C to 70°C (-40°F to 158°F)
Charging Temperature	0°C to 40°C (32°F to 104°F)
Humidity	5% to 95% non-condensing
Drop	75 cm (30 in.) to concrete; 2 drops/side for a total of 12 drops at room temperature (23°C).
Electrostatic Discharge (ESD)	+/- 15 kV air +/- 8 kV contact +/- 8 kV indirect discharge

