

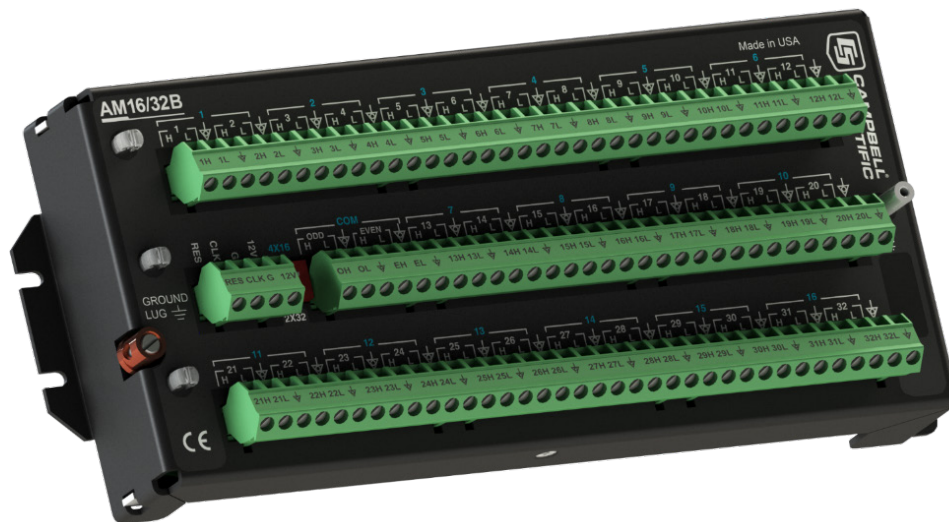

# AM16/32B

## Relay Multiplexer





# Guarantee

---

This equipment is guaranteed against defects in materials and workmanship. We will repair or replace products which prove to be defective during the guarantee period as detailed on your invoice, provided they are returned to us prepaid. The guarantee will not apply to:

- Equipment which has been modified or altered in any way without the written permission of Campbell Scientific
- Batteries
- Any product which has been subjected to misuse, neglect, acts of God or damage in transit.

Campbell Scientific will return guaranteed equipment by surface carrier prepaid. Campbell Scientific will not reimburse the claimant for costs incurred in removing and/or reinstalling equipment. This guarantee and the Company's obligation thereunder is in lieu of all other guarantees, expressed or implied, including those of suitability and fitness for a particular purpose. Campbell Scientific is not liable for consequential damage.

Please inform us before returning equipment and obtain a Repair Reference Number whether the repair is under guarantee or not. Please state the faults as clearly as possible, and if the product is out of the guarantee period it should be accompanied by a purchase order. Quotations for repairs can be given on request. It is the policy of Campbell Scientific to protect the health of its employees and provide a safe working environment, in support of this policy a "Declaration of Hazardous Material and Decontamination" form will be issued for completion.

When returning equipment, the Repair Reference Number must be clearly marked on the outside of the package. Complete the "Declaration of Hazardous Material and Decontamination" form and ensure a completed copy is returned with your goods. Please note your Repair may not be processed if you do not include a copy of this form and Campbell Scientific Ltd reserves the right to return goods at the customers' expense.

Note that goods sent air freight are subject to Customs clearance fees which Campbell Scientific will charge to customers. In many cases, these charges are greater than the cost of the repair.



Campbell Scientific Ltd,  
80 Hathern Road,  
Shepshed, Loughborough, LE12 9GX, UK  
Tel: +44 (0) 1509 601141  
Fax: +44 (0) 1509 270924  
Email: [support@campbellsci.co.uk](mailto:support@campbellsci.co.uk)  
[www.campbellsci.co.uk](http://www.campbellsci.co.uk)



# About this manual

---

Please note that this manual was originally produced by Campbell Scientific Inc. primarily for the North American market. Some spellings, weights and measures may reflect this origin.

Some useful conversion factors:

<b>Area:</b> 1 in <sup>2</sup> (square inch) = 645 mm <sup>2</sup>	<b>Mass:</b> 1 oz. (ounce) = 28.35 g 1 lb (pound weight) = 0.454 kg
<b>Length:</b> 1 in. (inch) = 25.4 mm 1 ft (foot) = 304.8 mm 1 yard = 0.914 m 1 mile = 1.609 km	<b>Pressure:</b> 1 psi (lb/in <sup>2</sup> ) = 68.95 mb
	<b>Volume:</b> 1 UK pint = 568.3 ml 1 UK gallon = 4.546 litres 1 US gallon = 3.785 litres

In addition, while most of the information in the manual is correct for all countries, certain information is specific to the North American market and so may not be applicable to European users.

Differences include the U.S standard external power supply details where some information (for example the AC transformer input voltage) will not be applicable for British/European use. *Please note, however, that when a power supply adapter is ordered it will be suitable for use in your country.*

Reference to some radio transmitters, digital cell phones and aerials may also not be applicable according to your locality.

Some brackets, shields and enclosure options, including wiring, are not sold as standard items in the European market; in some cases alternatives are offered. Details of the alternatives will be covered in separate manuals.

Part numbers prefixed with a “#” symbol are special order parts for use with non-EU variants or for special installations. Please quote the full part number with the # when ordering.

## Recycling information



At the end of this product's life it should not be put in commercial or domestic refuse but sent for recycling. Any batteries contained within the product or used during the products life should be removed from the product and also be sent to an appropriate recycling facility.

Campbell Scientific Ltd can advise on the recycling of the equipment and in some cases arrange collection and the correct disposal of it, although charges may apply for some items or territories.

For further advice or support, please contact Campbell Scientific Ltd, or your local agent.



Campbell Scientific Ltd, 80 Hathern Road, Shepshed, Loughborough, LE12 9GX,  
UK Tel: +44 (0) 1509 601141 Fax: +44 (0) 1509 270924  
Email: [support@campbellsci.co.uk](mailto:support@campbellsci.co.uk)  
[www.campbellsci.co.uk](http://www.campbellsci.co.uk)



# Safety

---

**DANGER** — MANY HAZARDS ARE ASSOCIATED WITH INSTALLING, USING, MAINTAINING, AND WORKING ON OR AROUND **TRIPODS, TOWERS, AND ANY ATTACHMENTS TO TRIPODS AND TOWERS SUCH AS SENSORS, CROSSARMS, ENCLOSURES, ANTENNAS, ETC.** FAILURE TO PROPERLY AND COMPLETELY ASSEMBLE, INSTALL, OPERATE, USE, AND MAINTAIN TRIPODS, TOWERS, AND ATTACHMENTS, AND FAILURE TO HEED WARNINGS, INCREASES THE RISK OF DEATH, ACCIDENT, SERIOUS INJURY, PROPERTY DAMAGE, AND PRODUCT FAILURE. TAKE ALL REASONABLE PRECAUTIONS TO AVOID THESE HAZARDS. CHECK WITH YOUR ORGANIZATION'S SAFETY COORDINATOR (OR POLICY) FOR PROCEDURES AND REQUIRED PROTECTIVE EQUIPMENT PRIOR TO PERFORMING ANY WORK.

Use tripods, towers, and attachments to tripods and towers only for purposes for which they are designed. Do not exceed design limits. Be familiar and comply with all instructions provided in product manuals. Manuals are available at [www.campbellsci.eu](http://www.campbellsci.eu) or by telephoning +44(0) 1509 828 888 (UK). You are responsible for conformance with governing codes and regulations, including safety regulations, and the integrity and location of structures or land to which towers, tripods, and any attachments are attached. Installation sites should be evaluated and approved by a qualified engineer. If questions or concerns arise regarding installation, use, or maintenance of tripods, towers, attachments, or electrical connections, consult with a licensed and qualified engineer or electrician.

## General

- Prior to performing site or installation work, obtain required approvals and permits. Comply with all governing structure-height regulations, such as those of the FAA in the USA.
- Use only qualified personnel for installation, use, and maintenance of tripods and towers, and any attachments to tripods and towers. The use of licensed and qualified contractors is highly recommended.
- Read all applicable instructions carefully and understand procedures thoroughly before beginning work.
- Wear a **hardhat** and **eye protection**, and take **other appropriate safety precautions** while working on or around tripods and towers.
- **Do not climb** tripods or towers at any time, and prohibit climbing by other persons. Take reasonable precautions to secure tripod and tower sites from trespassers.
- Use only manufacturer recommended parts, materials, and tools.

## Utility and Electrical

- **You can be killed** or sustain serious bodily injury if the tripod, tower, or attachments you are installing, constructing, using, or maintaining, or a tool, stake, or anchor, come in **contact with overhead or underground utility lines.**
- Maintain a distance of at least one-and-one-half times structure height, or 20 feet, or the distance required by applicable law, **whichever is greater**, between overhead utility lines and the structure (tripod, tower, attachments, or tools).
- Prior to performing site or installation work, inform all utility companies and have all underground utilities marked.
- Comply with all electrical codes. Electrical equipment and related grounding devices should be installed by a licensed and qualified electrician.

## Elevated Work and Weather

- Exercise extreme caution when performing elevated work.
- Use appropriate equipment and safety practices.
- During installation and maintenance, keep tower and tripod sites clear of un-trained or non-essential personnel. Take precautions to prevent elevated tools and objects from dropping.
- Do not perform any work in inclement weather, including wind, rain, snow, lightning, etc.

## Maintenance

- Periodically (at least yearly) check for wear and damage, including corrosion, stress cracks, frayed cables, loose cable clamps, cable tightness, etc. and take necessary corrective actions.
- Periodically (at least yearly) check electrical ground connections.

WHILE EVERY ATTEMPT IS MADE TO EMBODY THE HIGHEST DEGREE OF SAFETY IN ALL CAMPBELL SCIENTIFIC PRODUCTS, THE CUSTOMER ASSUMES ALL RISK FROM ANY INJURY RESULTING FROM IMPROPER INSTALLATION, USE, OR MAINTENANCE OF TRIPODS, TOWERS, OR ATTACHMENTS TO TRIPODS AND TOWERS SUCH AS SENSORS, CROSSARMS, ENCLOSURES, ANTENNAS, ETC.





# Table of contents

---

1. Introduction .....	1
1.1 Typical applications .....	1
1.2 Compatibility.....	1
2. Precautions.....	2
3. Initial inspection.....	2
4. QuickStart.....	3
5. Overview.....	9
6. AM16/32B specifications .....	10
7. Installation .....	12
7.1 Wiring to data logger .....	13
7.1.1 Control terminals.....	13
7.1.2 COM terminals.....	13
7.1.3 Measurement terminals .....	14
7.2 Grounding .....	14
7.3 Power supply .....	14
7.4 Installation in enclosure.....	15
8. Operation .....	15
8.1 Programming.....	16
8.1.1 <i>Short Cut</i> programs.....	16
8.1.2 Using CRBasic MuxSelect() instruction .....	18
8.1.3 General programming considerations.....	18
8.1.4 Mixed sensor types.....	19
8.2 General measurement considerations.....	19
8.2.1 Long cable lengths .....	19
8.2.2 Completion resistors .....	19
8.2.3 Contact degradation .....	19
Appendix A. Importing <i>Short Cut</i> code into <i>CRBasic Editor</i> .....	20
Appendix B. Example measurements and programs .....	21
B.1 Single-ended voltage measurement.....	21
B.2 Differential voltage measurement .....	23
B.3 Half-bridge measurement.....	24
B.4 Full-bridge measurement .....	25
B.5 CS616 measurement.....	26

<b>Appendix C. Thermocouple measurement</b> .....	<b>28</b>
C.1 Measurement considerations .....	28
C.1.1 Reference junction .....	28
C.1.2 Data logger reference.....	28
C.1.3 AM16/32B reference.....	30
C.1.4 Thermal gradients.....	30

**List of Figures**

FIGURE 5-1. AM16/32B Relay Multiplexer.....	10
FIGURE 7-1. Example of AM16/32B-to-data-logger signal connection (4x16 mode) .....	14
FIGURE B-1. Typical single-ended voltage measurement connection .....	22
FIGURE B-2. Typical differential voltage measurement connection.....	23
FIGURE B-3. Typical half-bridge measurement connection .....	24
FIGURE B-4. Full-bridge measurement .....	26
FIGURE C-1. Differential thermocouple measurement with reference junction at the data logger.	29
FIGURE C-2. Differential thermocouple measurement with reference junction at the AM16/32B (using 107-L thermistor) .....	29
FIGURE C-3. AM16/32B aluminium cover plate.....	30

**List of Tables**

Table 7-1. Control terminal function and data logger connection <sup>1</sup> .....	13
Table B-1. Wiring for single-ended voltage measurements CRBasic example .....	22
Table B-2. Wiring for differential voltage measurements CRBasic example .....	23
Table B-3. Wiring for Campbell Scientific 107 temperature sensors CRBasic example.....	25
Table B-4. Wiring for Load Cells CRBasic Example .....	26
Table B-5. Wiring for CS616 Sensor CRBasic Example .....	27

# 1. Introduction

---

The primary function of the AM16/32B multiplexer (also known as a mux) is to increase the number of sensors that can be measured by CR6, CR3000, CR1000X, CR800-series, CR300-series, and CR1000 data loggers. The AM16/32B is positioned between the sensors and the data logger. Mechanical relays in the AM16/32B connect each of the sensor channels in turn to a common output destined for the data logger. The user program advances the multiplexer through the sensor channels, making measurements and storing data.

A slide switch located on the AM16/32B top panel selects one of two modes of operation. In 2x32 mode, the multiplexer adds 32 terminal pairs. In 4x16 mode, it adds 16 terminal groups with four terminals each. The data logger program is written according to the selected mode and the sensors to be measured.

The maximum number of sensors multiplexed by an AM16/32B depends primarily on the type(s) of sensors to be measured.

## NOTE:

This manual provides information for CRBasic data loggers and AM16/32Bs with serial numbers greater than 5056.

For Edlog and other retired data logger support, or for specifications for AM16/32Bs with serial numbers less than 5056, see an older version of this manual at [www.campbellsci.com/old-manuals](http://www.campbellsci.com/old-manuals).

## 1.1 Typical applications

The AM16/32B is intended for use in applications where more terminals are needed than the data logger has available. Most commonly, the AM16/32B is used to multiplex analogue sensor signals, although it can also be used to multiplex switched excitations, continuous analogue outputs, or even certain pulse counting measurements (those that require only intermittent sampling). It is also possible to multiplex sensors of different, but compatible, types (see [Mixed sensor types](#) (p. 19)).

## 1.2 Compatibility

The AM16/32B is compatible with Campbell Scientific CR6, CR3000, CR1000X, CR800-series, CR300-series, and CR1000 data loggers.

The AM16/32B is compatible with a wide variety of commercially available sensors. As long as relay contact current maximums are not exceeded (see [Precautions](#) (p. 2)), and no more than four

lines are switched at a time, system compatibility for a specific sensor is determined by sensor-data logger compatibility.

**NOTE:**

The AM16/32B is also compatible with the CDM-A108 and CDM-A116 24-bit analogue input modules by using the CRBasic `CDM_MuxSelect()` instruction. Refer to the *CRBasic Help* for information on using the AM16/32B with these modules. The CDM-A100 Series manual includes a sample program for the CDM-A108 and the AM16/32B.

## 2. Precautions

---

The AM16/32B is not designed to multiplex power. Its intended function is to switch low-level analogue signals. Switched currents in excess of 30 mA will degrade the relay contacts involved, rendering that channel unsuitable for further low-level analogue measurement. Customers who need to switch power are directed to Campbell Scientific SDM-CD16AC, A6REL-12, or A21REL-12 relays.

Changing the setting of the mode switch from 4x16 to 2x32 connects **COM ODD H** to **COM EVEN H** and also **COM ODD L** to **COM EVEN L**. After wiring the AM16/32B, exercise due care to avoid inadvertently putting excess voltage on a line or short-circuiting a power supply, which might damage connected devices such as data logger, wiring panel, sensor, or multiplexer, and which would not be covered under warranty.

## 3. Initial inspection

---

- The AM16/32B ships with:
  - 4 grommets
  - 4 screws
- Upon receipt of the AM16/32B, inspect the packaging and contents for damage. File damage claims with the shipping company.
- Immediately check package contents. Thoroughly check all packaging material for product that may be concealed. Check model number, part numbers, and product descriptions against the shipping documents. Model or part numbers are found on each product. On cables, the number is often found at the end of the cable that connects to the measurement device. Ensure that the expected lengths of cables were received. Contact Campbell Scientific immediately if there are any discrepancies.

# 4. QuickStart

*Short Cut* is an easy way to program the data logger to make measurements through an AM16/32B multiplexer. *Short Cut* is included in installations of *LoggerNet*, *PC400*, *PC200W*, and *RTDAQ*. It is also available as a download on [www.campbellsci.eu](http://www.campbellsci.eu). *Short Cut* supports the CR6, CR3000, CR1000X, CR800-series, and CR1000 data loggers when creating a program to take measurements through an AM16/32B. *Short Cut* does not include support for programming the CR300-series to use the AM16/32B. To use the AM16/32B with the CR300 series, the program must be created in the *CRBasic Editor*. See [Single-ended voltage measurement](#) (p. 21) and [Differential voltage measurement](#) (p. 23) for CR300-series programming examples.

This section will demonstrate programming a data logger to measure 6 Campbell Scientific 107 temperature sensors as an example for creating a program using a multiplexer. With minor changes, these steps also apply to other measurements and data loggers.

Open *Short Cut*. From the *LoggerNet* toolbar, click **Program** > *Short Cut*. In *PC200W* and *PC400*, click on the *Short Cut* icon.



Select **Create New Program**.



**NOTE:** The first time *Short Cut* is run, a prompt will appear asking for a choice of first notch frequency. Select **60 Hz Noise Rejection** for the United States and areas using 60 Hz AC voltage. Select **50 Hz Noise Rejection** for most of Europe and areas that operate at 50 Hz.

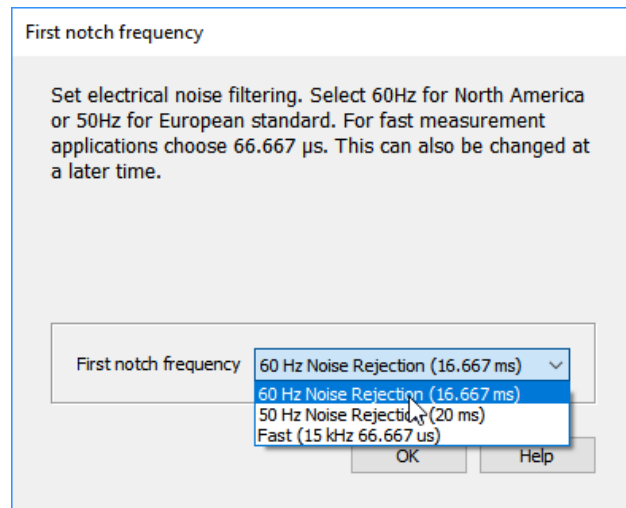

A second prompt lists sensor support options. **Campbell Scientific, Inc. (US)** is the best option outside Europe.

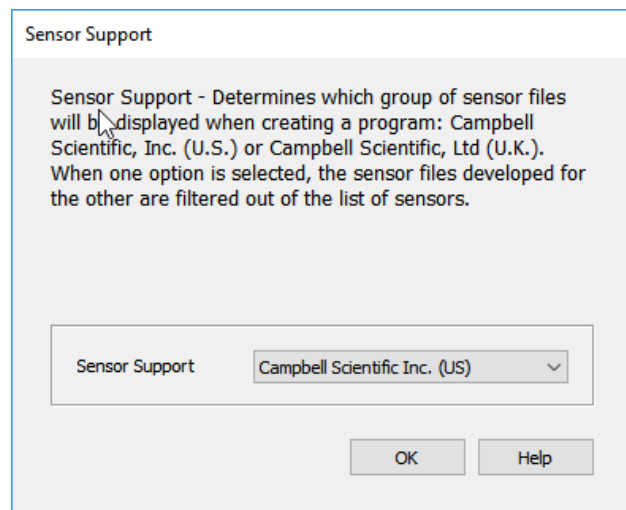

To change the first notch frequency or sensor support option for future programs, use the **Program** menu.

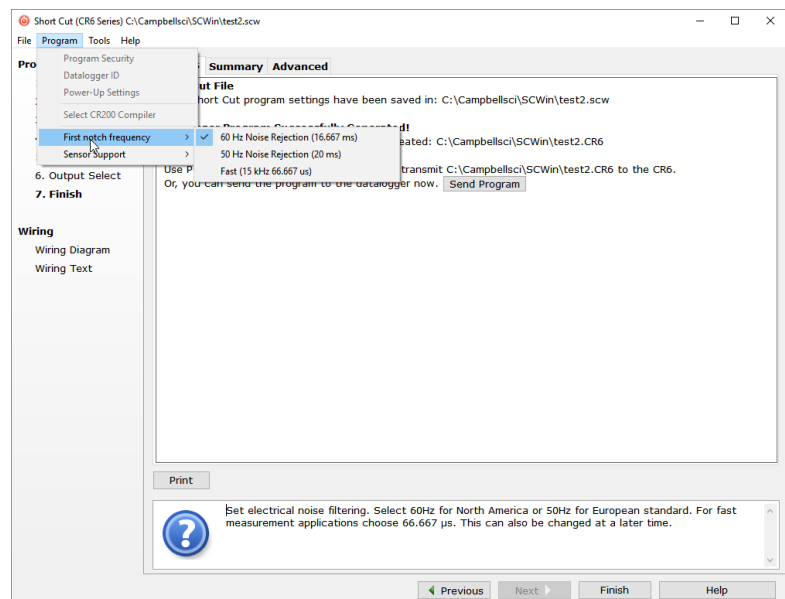

Select the data logger model in the **Datalogger Model** drop-down list. This tutorial uses the CR6-series data logger.

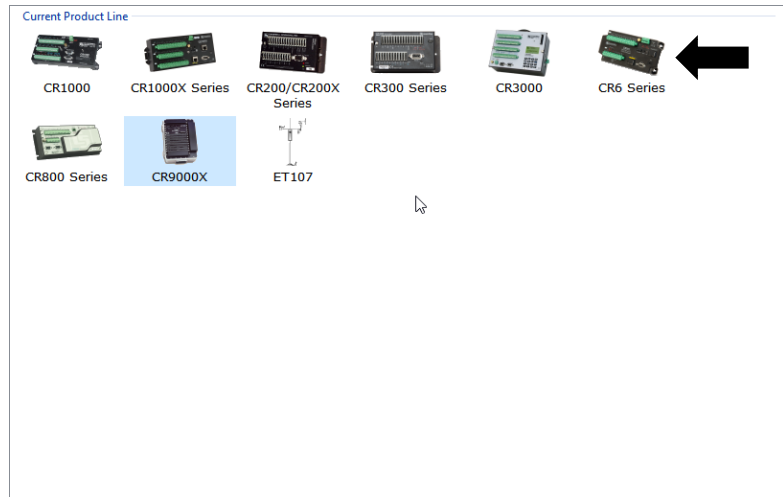

The **Progress Bar** is used to track the progress of the program being created. It is also used to jump directly to any step in the programming process.

**Progress**

1. New/Open
2. Datalogger
3. **Sensors**
4. Output Setup
5. Adv. Outputs
6. Output Select
7. Finish

**Wiring**

- Wiring Diagram
- Wiring Text

The next window displays **Available Sensors and Devices**. Expand a folder by clicking on the ► symbol. Expand the **Devices** folder, then double-click on the **AM16/32** to add it to the **Selected** panel.

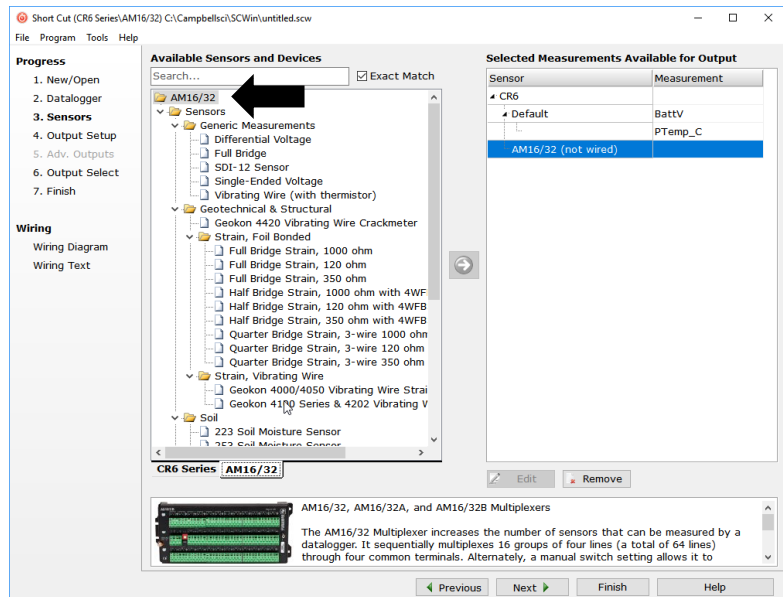

When the AM16/32 multiplexer is added as a device, a new **AM16/32** tab will appear at the bottom of the **Available Sensors and Devices** pane. With the **AM16/32** tab selected, select the **Sensors** > **Temperature** subfolder. Double-click on **107 Temperature Probe (4-wire)**.

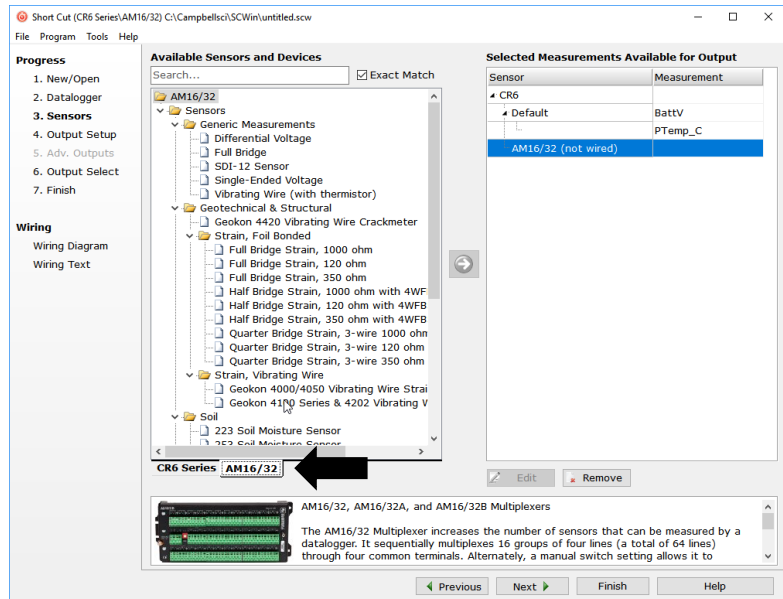

In the resulting window, enter the number of 107 temperature probes to measure on this AM16/32B multiplexer. For this tutorial, enter **6** as the number of 107 (4-wire) sensors to add. Click **OK** in the dialog window to accept the default name of **T107\_C** and the default units of **Deg C**.

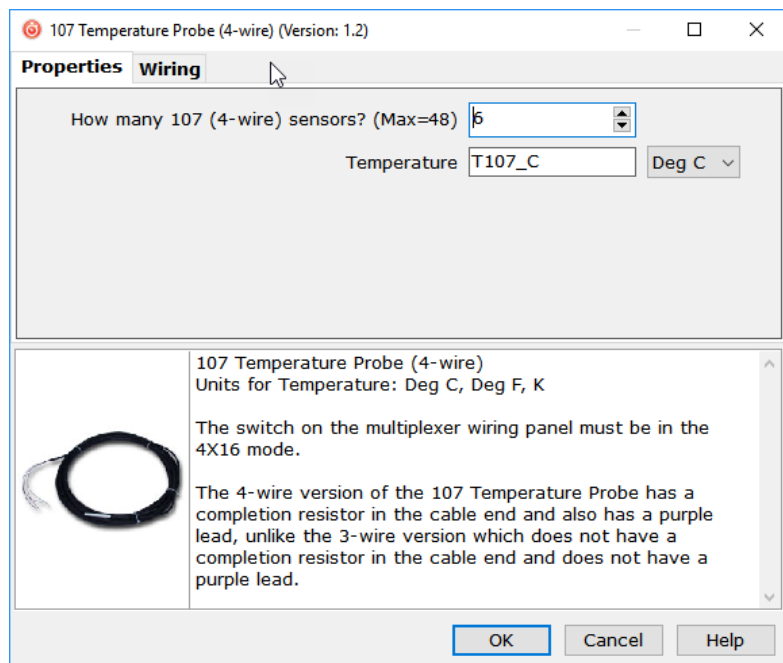



In the **Scan Interval** box, enter how frequently the data logger should make measurements. When measuring with an AM16/32B multiplexer, an interval of 30 seconds or longer is recommended. Enter **30** and select **Seconds**.

Click **Next**.

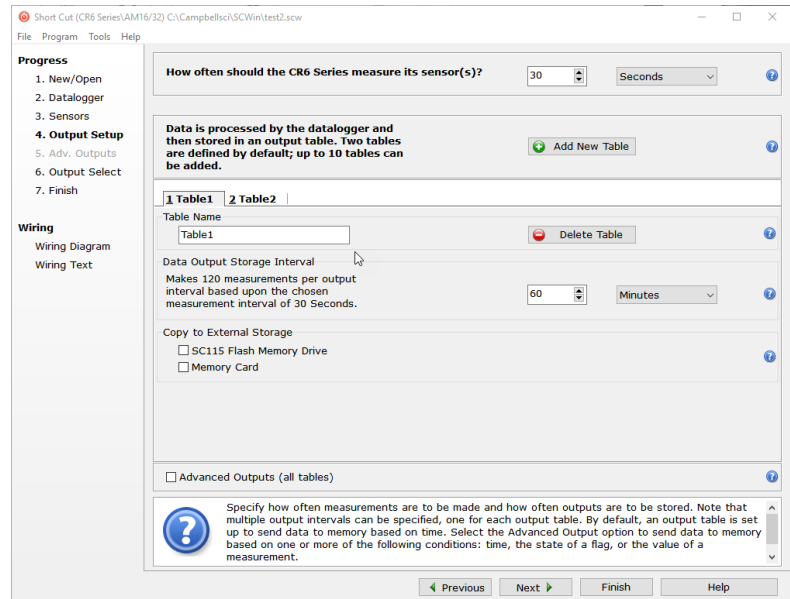

After adding the measurements, click **Wiring Diagram** to see how the sensors are wired to the AM16/32B and how the AM16/32B is wired to the data logger. The data logger tab (**CR6 Series** in this example) shows the connection between the AM16/32B and the data logger, and the **AM16/32** tab shows the sensor connection to the AM16/32B.

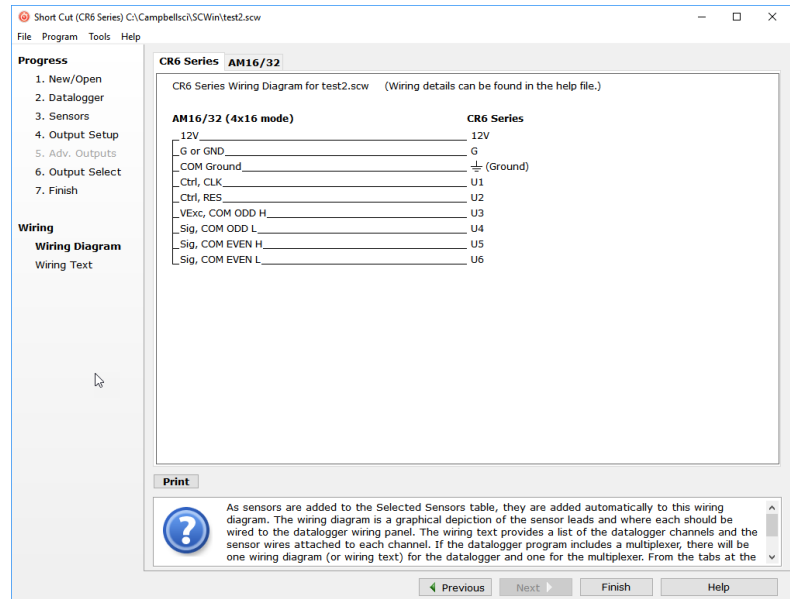

With power disconnected, wire the sensors and devices as shown in the wiring diagrams. Insert the wires, taking care to tighten the terminals on the conductors themselves, not the insulation.

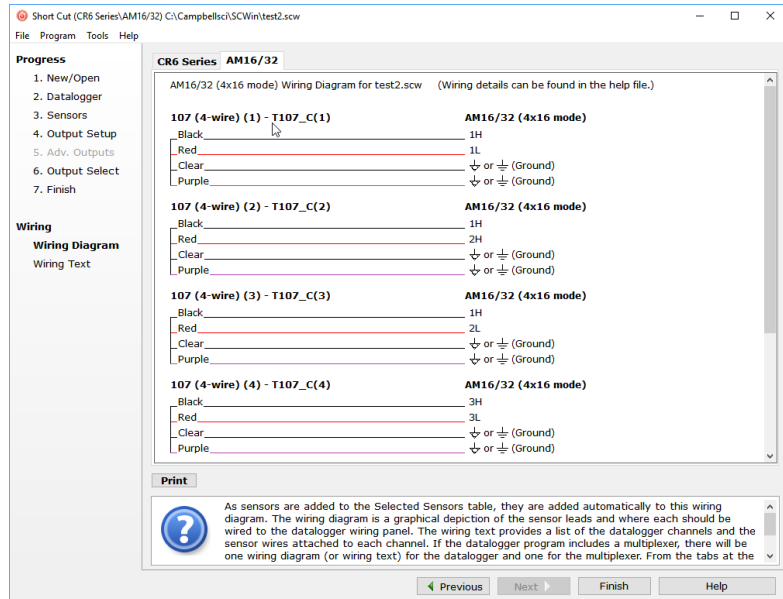

Click on **Sensors** in the **Progress** list to return to the sensor-selection screen.

Select any other sensors being installed in the **Sensors** section. Add sensors to the data logger by selecting the data logger tab (**CR6** in this example). Add sensors to the multiplexer by selecting the **AM16/32** tab.

Finish the remaining *Short Cut* steps to complete the program. The remaining steps are outlined in *Short Cut Help*, which is accessed by clicking on **Help** > **Short Cut Help** > **Contents** > **Programming Steps**.

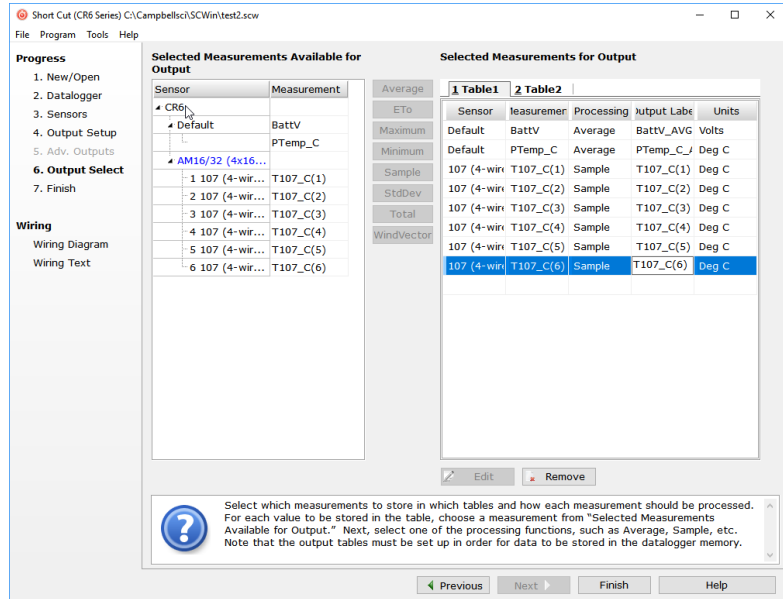

If *LoggerNet*, *PC200W*, *PC400*, or *RTDAQ* is running on the computer and the computer-to-data-logger connection is active, click **Finish** in *Short Cut*, and a prompt will appear to send the program just created to the data logger.

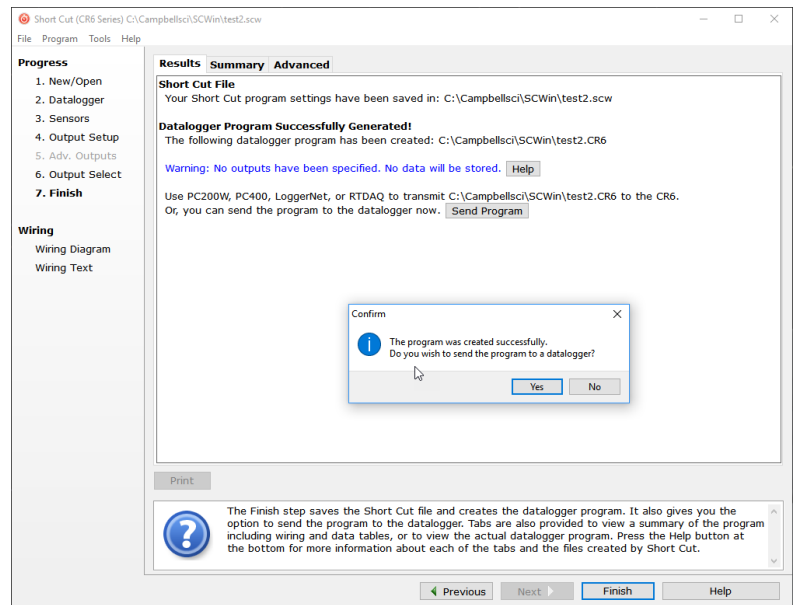
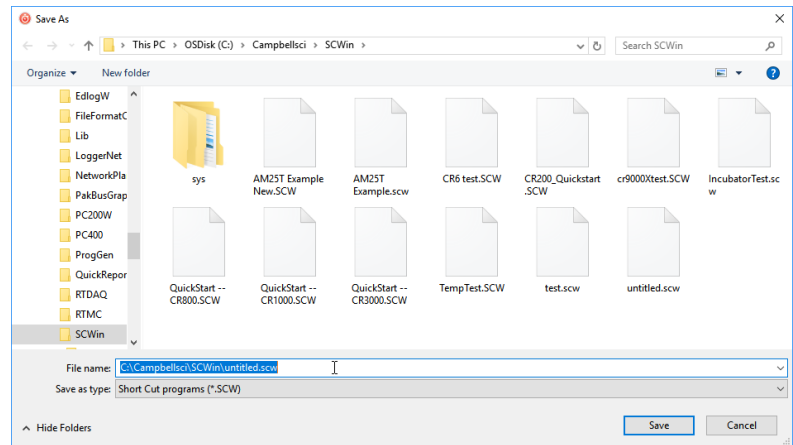

After powering on and sending the program to the data logger, check the output of sensors in the data logger support software data display to make sure the measurements are within the expected range.

## 5. Overview

Under data logger control, the AM16/32B sequentially connects terminal pairs or groups to data logger terminals. This effectively expands the number of terminals available on a data logger.

FIGURE 5-1 shows the wiring panel of the AM16/32B multiplexer. The group of four terminals located near the mode switch are dedicated to the connection of data logger power and control lines. **COM ODD** and **EVEN** terminals on the other side of the mode switch carry multiplexed signals destined for data logger terminals. The remaining terminals on the AM16/32B are for sensor and sensor-shield connection. All of the inputs of the AM16/32B are protected against

surges with transient suppression. Data-logger-to-AM16/32B cabling requires a minimum of six and as many as nine individually insulated wires with shields.

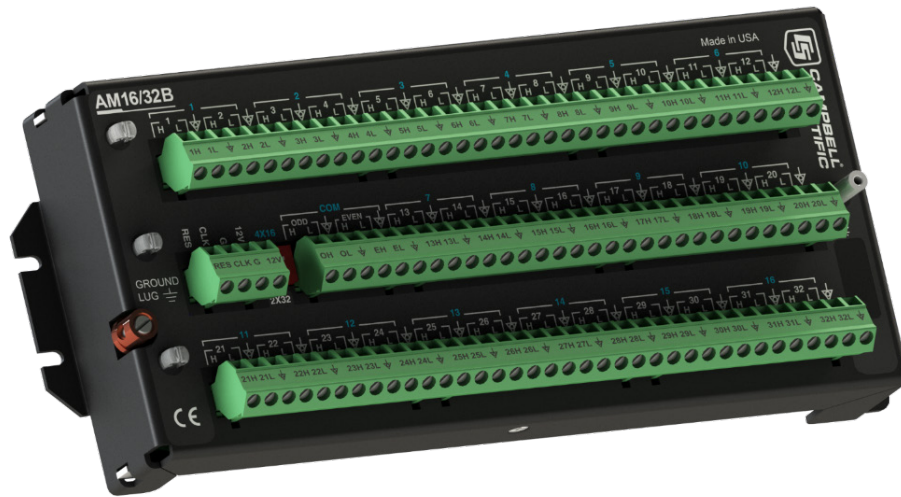

FIGURE 5-1. AM16/32B Relay Multiplexer

## 6. AM16/32B specifications

Power <sup>1, 2</sup> :	Unregulated 9.6 to 16 VDC
Current drain	
Quiescent:	< 210 $\mu$ A
Active:	6 mA typical in 2x32 mode 11 mA typical in 4x16 mode
Reset (RES) <sup>1</sup> :	A continuous signal between 3.3 VDC and 8 VDC holds the AM16/32B in an active state (where a clock pulse can trigger a channel advance). A signal voltage < 0.9 VDC deactivates the AM16/32B (clock pulse will not trigger a channel advance; AM16/32B is also reset).
Clock (CLK) <sup>1</sup> :	On the transition from <1.5 V to >3.3 V, a channel advance is actuated on the leading edge of the clock signal; clock pulse should be a minimum of 1 ms wide; maximum voltage is 8 VDC.

## Operational temperature

Standard: -25 to 50 °C

Extended: -55 to 85 °C

Operational humidity: 0 to 95%, non-condensing

## Dimensions

Length: 23.9 cm (9.4 in)

Width: 10.2 cm (4.0 in)

Depth: 4.6 cm (1.8 in)

Weight: 680 g (1.5 lb) (approx.)

Mounting tab hole spacing: 1 x 3 x 9 in. Up to 1/8 in or 3 mm diameter screws

Expandability<sup>3</sup> (nominal):  
4 AM16/32Bs per CR6  
4 AM16/32Bs per CR3000  
4 AM16/32Bs per CR1000X  
2 AM16/32Bs per CR800/CR850  
1 AM16/32B per CR300  
4 AM16/32Bs per CR1000

Maximum cable length: Depends on sensor and scan rate. In general, longer cable lengths necessitate longer measurement delays. Refer to data logger and sensor manuals for details.

Maximum switching current<sup>4</sup>: 500 mA

## Contact specifications

Initial contact resistance: <0.1  $\Omega$  max.

Initial contact bounce: <1 ms

Contact material: Silver Palladium

Wiper to N.O. contact capacitance: 0.5 pF

Typical low-current (<30 mA) life:  $5 \times 10^7$  operations

Maximum contact voltage rating: 70 V

## Relay Switching

Thermal emf: 0.3  $\mu$ V typical; 0.5  $\mu$ V maximum

Operate time: <10 ms over temperature and supply ranges  
Break-before-make guaranteed by design.  
Relays disengage from previous selected channel before engaging next channel.

## ESD

Air discharge: complies with IEC61000-4-2, test level 4 ( $\pm$ 15 kV)

Contact discharge: complies with IEC61000-4-2, test level 4 ( $\pm$ 8 kV)

Surge: Complies with IEC61000-4-5, test level 3 ( $\pm$ 2 kV, 2 ohms coupling impedance)

Compliance: View EU Declaration of Conformity at [www.campbellsci.eu/am16-32b](http://www.campbellsci.eu/am16-32b)

<sup>1</sup> The **Reset**, **Clock**, and **+12V** terminals are protected by 18-volt TVS diodes.

<sup>2</sup> For power specifications on serial numbers less than 5056, refer to an older version of this manual at [www.campbellsci.com/old-manuals](http://www.campbellsci.com/old-manuals).

<sup>3</sup> Assumes sequential activation of multiplexers and that each data logger channel is uniquely dedicated. If the application requires additional multiplexing capability, please consult Campbell Scientific for application assistance.

<sup>4</sup> Switching currents greater than 30 mA (occasional 50 mA current is acceptable) will degrade the contact surfaces of the mechanical relays and increase their resistance. This will adversely affect the suitability of these relays to multiplex low voltage signals. Although a relay used in this manner no longer qualifies for low voltage measurement, it continues to be useful for switching currents in excess of 30 mA.

# 7. Installation

---

If using *Short Cut* to program the data logger, skip Section 7.1, *Wiring to Data Logger*. *Short Cut* creates the wiring diagram. See [QuickStart](#) (p. 3) for a *Short Cut* tutorial.

# 7.1 Wiring to data logger

Removable terminal strips allow wiring to remain intact while the multiplexer is used elsewhere. The green terminal strips are easily removed; no tools are required. Replacement terminal strips may be purchased from Campbell Scientific.

## 7.1.1 Control terminals

Table 7-1 shows control connections to Campbell Scientific data loggers.

Table 7-1. Control terminal function and data logger connection		
Control terminal	Function	Data logger connection terminal
12V	Power	12V
G	Power ground	G (power ground)
CLK	Clock	C (control port), U (universal) terminal configured for control
RES	Reset	C, U terminal configured for control

## 7.1.2 COM terminals

The four terminals dedicated to multiplexer-data-logger connection are located under the blue **COM** label next to the mode switch. The terminals are labelled: **ODD H/L** and **EVEN H/L**. In 4x16 mode, the AM16/32B maintains the four **COM** terminals electrically isolated from one another. In 2x32 mode, the AM16/32B maintains an internal connection between **ODD H** and **EVEN H** and between **ODD L** and **EVEN L**. How the **COM** terminals connect to data logger terminals determines the function of the measurement terminals. For proper function, these terminals must be wired according to the measurement instructions in the CRBasic program. See [Operation](#) (p. 15) for details and [Example measurements and programs](#) (p. 21) for examples.

Common  $\nabla$  terminals are provided next to the **COM ODD** and **COM EVEN** terminals. They connect internally to the other thirty-two  $\nabla$  terminals on the AM16/32B and are connected at all times (not switched). Their function is to provide a path to ground for sensor cable shields. A **COM** $\nabla$  terminal should be wired to data logger ground ( $\oplus$ ) as shown in [FIGURE 7-1](#).

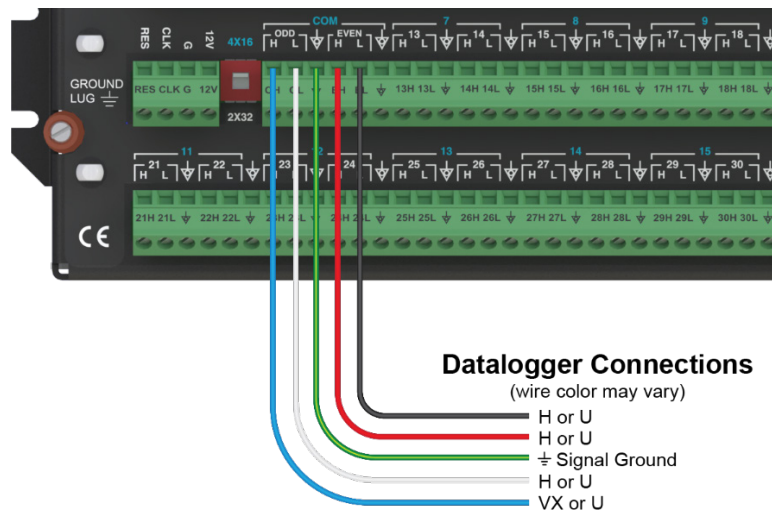

FIGURE 7-1. Example of AM16/32B-to-data-logger signal connection (4x16 mode)

## 7.1.3 Measurement terminals

Wire sensors and transducers according to the **COM** terminal connections and the measurement instructions in the CRBasic program. See [Operation](#) (p. 15) for details and [Example measurements and programs](#) (p. 21) for examples.

## 7.2 Grounding

Connect the AM16/32B ground lug to earth ground via an 8 AWG wire. Keep this connection as short as possible. The ground lug provides a path to dissipate surges that might propagate on a sensor shield line. A 35 V varistor is connected internally between the shield ground and the ground lug to provide surge suppression.

The AM16/32B **GND** terminal is connected to data logger power ground. The AM16/32B **GND** terminal is also connected to the cable shield and, via that, to data logger power ground (see [Table 7-1](#)). If a separate power supply is used, connect the AM16/32B ground to the power supply ground. Connect an AM16/32B **COM** terminal to a data logger signal ground ( $\perp$ ) via the cable that connects the **COM** terminals (see [FIGURE 7-1](#)). The data logger must connect to earth ground by one of the methods described in the installation and maintenance section of the data logger manual.

## 7.3 Power supply

The AM16/32B requires a continuous power supply for operation. The positive side of the power supply is connected to **12V**, and the negative side is connected to **G**. Connect the **G** wire first for safety.



The average power required to operate an AM16/32B depends on the percentage of time it is active. At a minimum, the power supply must be able to sustain the system between site visits anticipating the worst environmental extremes. Refer to the application note [Power Supplies](#) and the video [Power Budgeting](#), both available at [www.campbellsci.eu](http://www.campbellsci.eu), for more help in selecting a power supply.

## 7.4 Installation in enclosure

Protect the AM16/32B from moisture. Moisture in the electronics will seriously damage the AM16/32B. In most cases, protection from water is easily accomplished by placing the AM16/32B in a weathertight enclosure with desiccant and elevating the enclosure above the ground. Desiccant in enclosures should be changed periodically. Use a humidity indicator card inside the enclosure to determine when the desiccant needs to be replaced.

Mount the AM16/32B to an enclosure backplate by inserting the included screws through the mounting holes in the AM16/32B and into the included grommets.

# 8. Operation

---

The reset (**RES**) line is used to switch on the AM16/32B by applying 3.3 to 8 VDC. When this line drops lower than 0.9 VDC, the multiplexer enters a low-power, low current-drain state. In the low-power state, the common (**COM**) terminals are electrically disconnected from all the sensor input channels. Always connect **RES** to a data logger terminal configured for control.

The **MuxSelect()** instruction is used to turn on the AM16/32B and advance to the channel specified in the instruction. When the instruction is first given, the **COM** terminals are switched to connect with the first set of measurement terminals according to the mode switch, either **4x16** or **2x32**. Measurement instructions run within a **SubScan()/NextSubScan** construct.

**PulsePort()** at the end of the SubScan switches (or clocks) to the next set of measurement terminals by sending a pulse on **CLK**. The voltage level must fall below 1.5 VDC and then rise above 3.3 VDC to clock the multiplexer.

Once the measurements are complete, **PortSet()** returns the AM16/32B to a low-power state. Example programs using the **MuxSelect()** instruction are found in [Example measurements and programs](#) (p. 21).

Another method of operation uses the **PortSet()** instruction in place of **MuxSelect()**. Typically, this is seen when creating the program in *Short Cut* or migrating a program from the older AM16/32 or AM16/32A multiplexers. The program created in [QuickStart](#) (p. 3) uses the **PortSet()** instruction.

The terminals for sensor attachment are divided into 16 groups (mode switch set to **4x16**) or into 32 groups (mode switch set to **2x32**). The groups consist of four or two Simultaneously Enabled

Terminals (SETs). With the mode switch set to **4x16**, the blue channel numbers apply. The SETs are numbered starting at 1 (1H, 1L, 2H, 2L) and continuing until SET 16 (31H, 31L, 32H, 32L).

In **4x16** mode, the odd-numbered terminals (example: 5H, 5L) are relay-switched to the **COM ODD** terminals while the even terminals (6H, 6L) are switched to the **COM EVEN** terminals. When activated by the **RES** line, as the AM16/32B receives clock pulses from the data logger, each SET of four in turn is switched into contact with the four **COM** terminals. For example, when the first clock pulse is received from the data logger, SET 1, consisting of 1H, 1L, 2H, and 2L, is connected to **COM ODD H**, **ODD L**, **EVEN H**, and **EVEN L** terminals respectively. When the second clock pulse is received, the first SET is switched out (SET 1 sensor inputs become open circuits), and SET 2 (3H, 3L, 4H, 4L) are connected to the four **COM** terminals. A given SET will typically be connected to the common terminals for 10 ms.

With the mode switch set to **2x32**, the white channel numbers apply. The SETs are labelled beginning with 1H, 1L and ending with 32H, 32L. In **2x32** mode when the AM16/32B selects a given channel, the **H** terminal is relay-connected to both **COM H** terminals, and the **L** sensor terminal is connected to both **COM L** terminals.

## 8.1 Programming

### 8.1.1 *Short Cut* programs

In most cases, *Short Cut* is the best way to create or begin data logger programs for the AM16/32B multiplexer. See [QuickStart](#) (p. 3) for a *Short Cut* tutorial. The details that follow pertain to CRBasic programs generated by *Short Cut*.

#### NOTE:

To accommodate the AM16/32 and AM16/32A, *Short Cut* adds a delay of 150 ms after enabling the multiplexer. This delay is not required for the AM16/32B and may be deleted to increase the speed of the program.

When programming with *Short Cut*, three instructions operate the multiplexer: 1) the **PortSet()** instruction enables or disables the multiplexer, 2) the **SubScan()/NextSubScan** instruction begins/ends the measurement loop, and 3) the **PulsePort()** instruction clocks through the measurement channels. The CRBasic program must also specifically increment an index variable and use that variable to determine where each measurement is stored. The generalized programming sequence follows:

```

'Turn AM16/32B Multiplexer on
PortSet(C2,1)
'Delay command inserted by Short Cut.
'Not required by AM16/32B and may be removed to increase program speed.
Delay(0,150,mSec)
'Reset counter
LCount=1
'Begin measurement loop
SubScan(0,uSec,5) 'measures 5 sets
'Switch to next AM16/32B Multiplexer channel
PulsePort(C1,10000)
'Make measurements
'Increment counter according to measurement mode
LCount=LCount+1
NextSubScan
'Turn AM16/32 Multiplexer off
PortSet(C2,0)

```

The `SubScan()` instruction is used to create a measurement loop for the multiplexer. The third parameter in the `SubScan()` instruction, **Count**, is the number of sets on the multiplexer that will be used. For example, if the instruction is `SubScan(0,  $\mu$ Sec, 7)` and the multiplexer is in 2x32 mode, the first seven terminal pairs (numbers in white) on the multiplexer will be used. When in 4x16 mode, this instruction will use the first seven groups of four (numbers in blue) on the multiplexer.

It may be desirable to use the repetition parameter, **Reps**, of the measurement instructions between `SubScan()` and `NextSubScan`. The repetitions parameter is the number of sensors per instruction that will be measured. See the examples below:

### Example 1

```

'Example 1
LCount = 1
SubScan (0,uSec,7)
PulsePort (C1,10000)
VoltDiff (Dest(LCount),1,mV5000,1,True ,0,60,1.0,0)
LCount = LCount + 1
NextSubScan

```

In this example, one measurement is made per `VoltDiff()` instruction because the instruction has a repetition parameter of 1 (the second parameter in the `VoltDiff()` instruction). With the multiplexer in 2x32 mode, differential voltage measurements will be made on the first seven 2x32 terminal pairs because the **Count** parameter of the `SubScan()` instruction is 7.

## Example 2

```
'Example 2
LCount = 1
SubScan (0,uSec,7)
  PulsePort (C1,10000)
  VoltDiff (Dest(LCount),2,mV5000,1,True ,0,60,1.0,0)
  LCount = LCount + 2
NextSubScan
```

With the multiplexer in 4x16 mode, differential voltage measurements will be made on the first seven 4x16 terminal groups because the **Count** parameter of the **SubScan()** instruction is 7. Two differential sensors are measured per terminal group because the **VoltDiff()** instruction has a repetition parameter of 2. Thus, a total of 14 differential voltage measurements will be made (2 measurement per subscan × 7 subscans = 14).

## 8.1.2 Using CRBasic MuxSelect() instruction

The CRBasic **MuxSelect()** instruction is used to enable the multiplexer and select a specific channel to begin measurements. This can simplify the data logger program by making one set of measurements at a time. Use the **PulsePort()** instruction to advance the multiplexer and the **PortSet()** instruction to disable it. The generalized programming sequence follows:

```
'Turn AM16/32B Multiplexer on, C1-CLK, C2-RES
'Advance to first measurement channel in SET 1
MuxSelect (C1, C2 ,20,1,1)
'Make SET 1 measurements
  '<insert measurement instruction(s)>
'Advance to first measurement channel in SET 2
PulsePort (C1 ,10000) 'move to Set 2
'Make SET 2 measurements
  '<insert measurement instruction(s)>
'Advance to first measurement channel in SET 3
PulsePort (C1 ,10000) 'move to Set 3
'Make SET 3 measurements
  '<insert measurement instruction(s)>
'Turn AM16/32 Multiplexer off
PortSet(C2,0)
```

For measurement and program examples, see [Example measurements and programs](#) (p. 21).

## 8.1.3 General programming considerations

Excitation voltage, integration time, and delay time associated with measuring the signal, and the speed at which the channels are advanced, can be varied within the data logger program. In general, longer delay times are necessary when sensors and data logger are separated by longer cable lengths. Consult the data logger or sensor manual for additional information on these topics.

## 8.1.4 Mixed sensor types

In applications where sensor types are mixed, experienced programmers can create multiple configurations, though it is preferred to use multiple multiplexers for these situations. When programming for mixed sensors on a single AM16/32B, it is especially important to verify that each measurement is reasonable. Consult Campbell Scientific for application assistance when it is necessary to multiplex markedly different sensor types in an application.

# 8.2 General measurement considerations

## 8.2.1 Long cable lengths

Longer sensor-to-AM16/32B cables result in greater induced and capacitively coupled voltages (cross talk) between cable wires. It may also be necessary to program a delay within the measurement instruction to allow time for wire capacitances to discharge after advancing a channel, before the measurement is made. This can be done by increasing the **DeLay** parameter in the **PuLsePort()** instruction or by adding a **DeLay()** instruction after the **PuLsePort()** instruction. A delay of 20 ms or more is recommended.

## 8.2.2 Completion resistors

In some applications, it is advantageous to place completion resistors at the AM16/32B terminal strips. Certain sensors specific to the use of multiplexers are available from Campbell Scientific. Examples include soil moisture probes and thermistor probes.

## 8.2.3 Contact degradation

Once excitation in excess of 30 mA has been multiplexed, that channel relay contacts are unsuitable for further low voltage measurement. To prevent undue degradation, it is advisable to reserve certain channels for sensor excitation and use other channels for sensor signals.

Refer to [Precautions](#) (p. 2) for more information on contact degradation.



# Appendix A. Importing *Short Cut* code into *CRBasic Editor*

---

*Short Cut* creates a .DEF file that contains wiring information and a program file that can be imported into the *CRBasic Editor*. By default, these files reside in the C:\campbellsci\SCWin folder.

Import *Short Cut* program file and wiring information into *CRBasic Editor*.

1. Create the *Short Cut* program. After saving the *Short Cut* program, click the **Advanced** tab then the **CRBasic Editor** button. A program file with a generic name will open in CRBasic. Provide a meaningful name and save the CRBasic program. This program can now be edited for additional refinement.

## NOTE:

Once the file is edited with *CRBasic Editor*, *Short Cut* can no longer be used to edit the program it created.

2. To add the *Short Cut* wiring information into the new CRBasic program, open the .DEF file located in the C:\campbellsci\SCWin folder, and copy the wiring information, which is at the beginning of the .DEF file.
3. Go into the CRBasic program and paste the wiring information into it.
4. In the CRBasic program, highlight the wiring information, right-click, and select **Comment Block**. This adds an apostrophe (') to the beginning of each of the highlighted lines, which instructs the data logger compiler to ignore those lines when compiling. The **Comment Block** feature is demonstrated at about 5:10 in the [CRBasic | Features](#) video .





# Appendix B. Example measurements and programs

---

This section covers sensor-to-AM16/32B connections and AM16/32B-to-data logger connections. The following are examples only and should not be construed as the only way to make a particular measurement. See the measurement section of the data logger manual for more information on basic bridge measurements. The figures in this section do not show the wire connections between the data logger and AM16/32B control terminals. Only the path for each sensor through the AM16/32B to the data logger is shown. Control wiring is shown in the table giving the wiring for each example.

The programs use the `MuxSelect()` instruction to select the specified starting channel and turn the multiplexer on (High). Programs created with *Short Cut* will use the `PortSet()` instruction to turn the multiplexer on (High). While `PortSet()` is backward compatible with the older AM16/32 and AM16/32A, these older versions also require a 150 ms `Delay()` instruction immediately after the `PortSet()` instruction. Using `MuxSelect()` with the AM16/32B does not require the delay, allowing for faster operation. In all cases, `PortSet()` is used at the end of each scan to turn the multiplexer off (Low).

The example programs are downloadable from the Campbell Scientific website: [www.campbellsci.eu/downloads/am16-32b-example-programs](http://www.campbellsci.eu/downloads/am16-32b-example-programs). A single Zip archive contains all the example programs referenced in this manual.

Use the *CRBasic Editor* to view and edit the example programs.

## B.1 Single-ended voltage measurement

FIGURE B-1 shows a typical connection for single-ended voltage measurements. Using this method, a data logger can make up to 48 single-ended voltage measurements through a multiplexer. See *AM16-32B Example B-1 CR300 single-ended measurements.CR300, AM16-32B Example B-2 CR1000X single-ended measurements.CR1X*, and [Table B-1](#) for the programs and wiring diagram, or use *Short Cut* to create the program. With minor adjustments, the CR1000X program can be used with the CR6, CR3000, CR800 series, or CR1000. In either case, the AM16/32B must be in 4x16 mode. View the program in the *CRBasic Editor*.

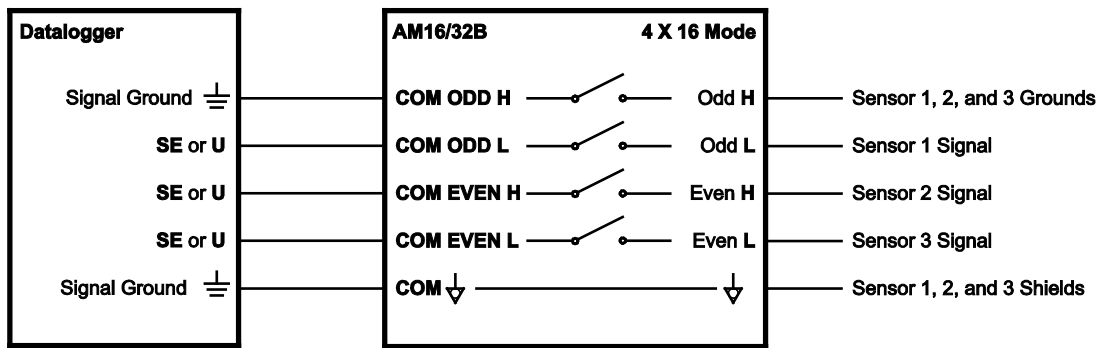

FIGURE B-1. Typical single-ended voltage measurement connection

Table B-1. Wiring for single-ended voltage measurements CRBasic example				
CR1000X	CR300	AM16/32B in 4X16 mode		Sensors
		Control and COM terminals	Measurement terminals	
⏏ (Signal Ground)	⏏ (Signal Ground)	COM ODD H	Odd-numbered H terminal	Sensor 1, 2, and 3 grounds
1H	1H	COM ODD L	Odd-numbered L terminal	Sensor 1 signal
1L	1L	COM EVEN H	Even-numbered H terminal	Sensor 2 signal
2H	2H	COM EVEN L	Even-numbered L terminal	Sensor 3 signal
⏏	⏏	COM ⏏	⏏	Sensor 1, 2, and 3 shields
12V	SW12V	12V		
G	G	G		
C1	C1	CLK		
C2	C2	RES		

## B.2 Differential voltage measurement

FIGURE B-2 shows a typical connection for differential voltage measurements. Using this method, a data logger can make up to 32 differential voltage measurements through a multiplexer. See *AM16-32B Example B-3 CR300 differential measurements.CR300*, *AM16-32B Example B-4 CR1000X differential measurements.CR1X*, and [Table B-2](#) for the programs and wiring diagram, or use *Short Cut* to create the program. With minor adjustments, the CR1000X program can be used with the CR6, CR3000, CR800 series, or CR1000. In either case, the AM16/32B must be in 2x32 mode. View the program in the *CRBasic Editor*.

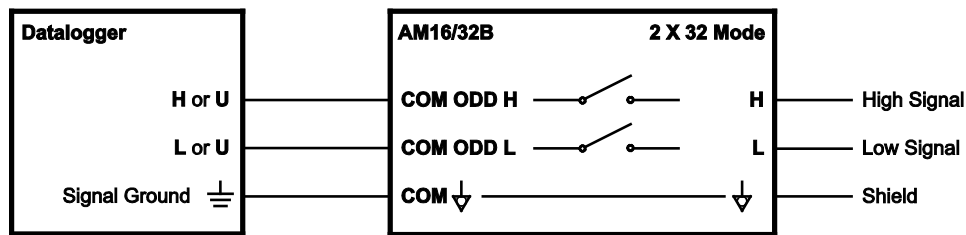

FIGURE B-2. Typical differential voltage measurement connection

These programs use arrays for multipliers and offsets. This allows individual adjustment of the multiplier and offset for each sensor. For example, in this program the third multiplier,  $\mathcal{B}$ , and the third offset,  $\mathcal{G}$ , would be applied to the third measurement,  $\text{Di ffV}(3)$ .

Table B-2. Wiring for differential voltage measurements CRBasic example				
CR1000X	CR300	AM16/32B in 2X32 mode		Sensors
		Control and COM terminals	Measurement terminals	
1H	1H	COM ODD H	H	High signal
1L	1L	COM ODD L	L	Low signal
⏏ (Signal Ground)	⏏ (Signal Ground)	COM ⏏	⏏	Shield
12V	SW12V	12V		
G	G	G		
C1	C1	CLK		
C2	C2	RES		

## B.3 Half-bridge measurement

FIGURE B-3 shows a typical connection for half-bridge measurements, such as 107 temperature sensors. Using this method, a data logger can make up to 48 half-bridge measurements through a multiplexer. See *AM16-32B Example B-5 CR6 107 temperature probe measurements.CR6* and [Table B-3](#) for the program and wiring diagram, or use *Short Cut* to create the program. With minor adjustments, the CR6 program can be used with the CR3000, CR1000X, CR800 series, CR300 series, or CR1000. This program measures 48 Campbell Scientific 107 temperature sensors through an AM16/32B. The AM16/32B must be in 4x16 mode.

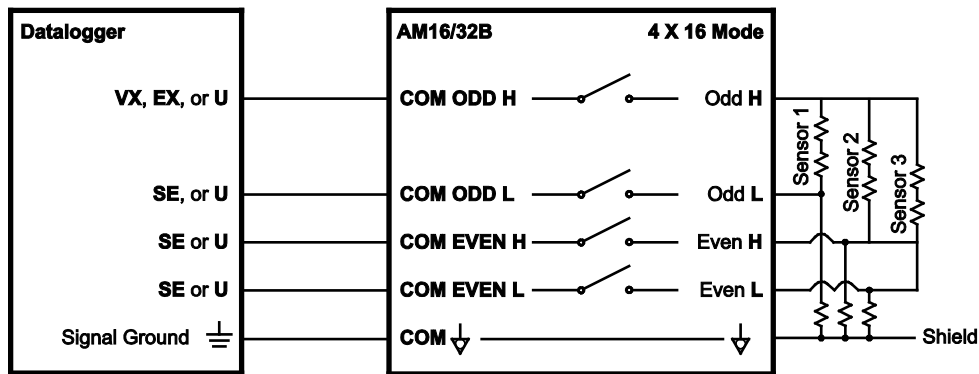

FIGURE B-3. Typical half-bridge measurement connection

Table B-3. Wiring for Campbell Scientific 107 temperature sensors CRBasic example

CR6	AM16/32B in 4X16 mode		Sensors
	Control and COM terminals	Measurement terminals	
U3	COM ODD H	Odd-numbered H terminal	Sensor 1, 2, and 3 excitation (black wire)
U4	COM ODD L	Odd-numbered L terminal	Sensor 1 signal (red wire)
U5	COM EVEN H	Even-numbered H terminal	Sensor 2 signal (red wire)
U6	COM EVEN L	Even-numbered L terminal	Sensor 3 signal (red wire)
⏏ (Signal Ground)	COM ⏏	⏏	Sensor 1, 2, and 3 grounds and shields (purple and clear wires)
12V	12V		
G	G		
U1	CLK		
U2	RES		

## B.4 Full-bridge measurement

Up to sixteen full-bridge measurements may be multiplexed through the AM16/32B. A problem with making full-bridge measurements with this configuration is that the resistance of the wire and multiplexer relays can cause a voltage drop, reducing the excitation at the bridge. The following section describes a configuration that compensates for this by measuring the excitation at the bridge. See *AM16-32B Example B-6 CR1000X load cell measurements.CR1X* and [Table B-4](#) for the program and wiring diagram, or use *Short Cut* to create the program. With minor adjustments, the CR1000X program can be used with the CR6, CR3000, CR800 series, CR300 series, or CR1000. This program measures 16 load cell sensors through an AM16/32B. The AM16/32B must be in 4x16 mode.

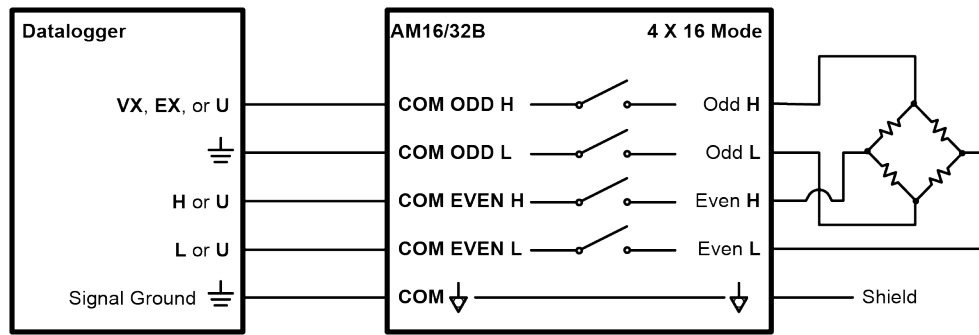

FIGURE B-4. Full-bridge measurement

Table B-4. Wiring for Load Cells CRBasic Example			
CR1000X	AM16/32B in 4X16 mode		Sensors
	Control and COM terminals	Measurement terminals	
VX1	COM ODD H	Odd-numbered H	Excitation
⏏ (Signal Ground)	COM ODD L	Odd-numbered L	Ground
1H	COM EVEN H	Even-numbered H	High
1L	COM EVEN L	Even-numbered L	Low
⏏	COM ⏏	⏏	Shield
12V	12V		
G	G		
C1	CLK		
C2	RES		

## B.5 CS616 measurement

Example *AM16-32B Example B-7 CR1000X CS616 measurements*. *CR1X* is a CR1000X program measuring 48 Campbell Scientific CS616 water content reflectometers through an AM16/32B. With minor adjustments, this program can be used with the CR6, CR3000, CR800-series, or CR1000. The AM16/32B must be in 4x16 mode. See *AM16-32B Example B-7 CR1000X CS616 measurements*. *CR1X* and [Table B-5](#) for the program and wiring diagram, or use *Short Cut* to create the program.

Table B-5. Wiring for CS616 Sensor CRBasic Example

CR1000X	AM16/32B in 4X16 mode		Sensors <sup>1</sup>
	Control and COM terminals	Measurement terminals	
C2	COM ODD H	Odd-numbered H	Sensor 1, 2, and 3 Orange
1H	COM ODD L	Odd-numbered L	Sensor 1 Green
1L	COM EVEN H	Even-numbered H	Sensor 2 Green
2H	COM EVEN L	Even-numbered L	Sensor 3 Green
⏏ (Signal Ground)	COM ⏏	⏏	Black
12V	12V		
G	G		
C1	CLK		
C3	RES		

<sup>1</sup>The red wire for each CS616 connects to the 12V terminal of the data logger. The clear wire for each CS616 connects to the G terminal of the data logger. User-supplied terminal blocks may be required.





# Appendix C. Thermocouple measurement

---

If the AM16/32B will be used in thermocouple measurements, the practices outlined below should be followed to make the best possible measurement. The data logger manuals contain thorough discussions of thermocouple measurement and error analysis. These topics will not be covered here.

## NOTE:

The AM16/32B is not recommended for making highly accurate thermocouple measurements. Instead, Campbell Scientific recommends the AM25T, which uses an onboard PRT as a reference junction.

## C.1 Measurement considerations

### C.1.1 Reference junction

As shown in [FIGURE C-1](#) and [FIGURE C-2](#), two reference junction configurations are possible: 1) reference located at the data logger or 2) reference at the AM16/32B.

### C.1.2 Data logger reference

If the reference junction is at the data logger, matching thermocouple wire should be run between the **COM** terminals of the multiplexer and the differential input channel on the data logger (observe TC wire polarity).

The CR6, CR3000, CR1000X, CR800 series, CR300 series, and CR1000 have built-in temperature references.

## NOTE:

The measurement from the CR6 and CR300 [PanelTemp\(\)](#) instruction does not accurately reflect the temperature of the wiring panel, since it measures the temperature of the main processing board. Therefore, if the processor or charge (CHG) input are active, the PanelTemp measurement will be warmer than ambient. This should be taken into consideration if this measurement is used as a reference temperature for thermocouples.

When the reference junction is located at the data logger, the signal wires between the data logger and the AM16/32B must be of the same wire type as the thermocouple (FIGURE C-1). The “polarity” of the thermocouple wires must be maintained on each side of the multiplexer (for example, if constantan wire is input to an L terminal, then a constantan wire should run between the multiplexer **COM ODD L** terminal and the data logger measurement terminal). FIGURE C-1 and FIGURE C-2 depict type T thermocouple applications, but other thermocouple types (for example, E, J, and K) may also be measured and linearized by the data loggers.

It is not recommended to make measurements of any other sensor type through the AM16/32B if thermocouples are measured with respect to the data logger reference (the signal wires between the data logger and AM16/32B are made of thermocouple wire). Two problems would arise due to the properties of thermocouple wire.

First, an extraneous thermocouple voltage would be added to the non-thermocouple signal at the junction of dissimilar metals (for example, the multiplexer **COM** terminals). The magnitude of this signal would vary with the temperature difference between the data logger and the AM16/32B.

Second, some thermocouple wires have a greater resistance than copper, which adds resistance to the non-thermocouple sensor circuit. For example, constantan is approximately 26 times more resistive than copper.

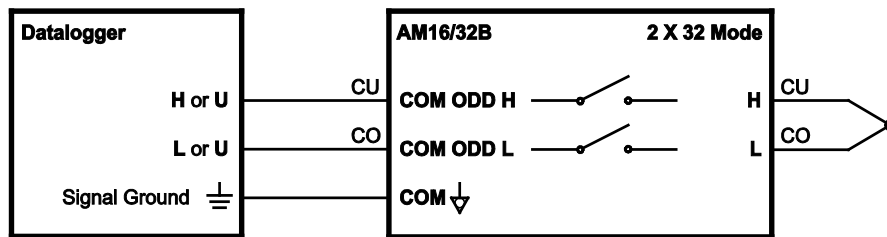

FIGURE C-1. Differential thermocouple measurement with reference junction at the data logger

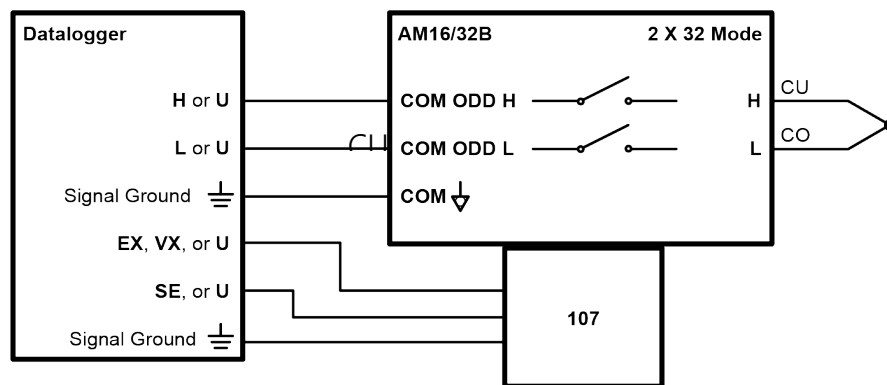

FIGURE C-2. Differential thermocouple measurement with reference junction at the AM16/32B (using 107-L thermistor)

### C.1.3 AM16/32B reference

An external reference, usually a thermistor, can be located at the AM16/32B, as shown in [FIGURE C-2](#). This approach requires an additional single-ended data logger input to measure the reference. Position the reference next to the **COM** terminals and, when practical, measure the thermocouples on SETs that are in close proximity to the **COM** terminals in order to minimize thermal gradients.

### C.1.4 Thermal gradients

Thermal gradients between the AM16/32B measurement terminals and **COM** terminals can cause errors in thermocouple readings. For example, with type T thermocouples, a one-degree gradient between the input terminals and the **COM** terminals will result in an approximate one-degree measurement error. Installing the aluminium cover plate ([FIGURE C-3](#)) helps to minimize gradients. For best results, the AM16/32B should be shielded and insulated from all radiant- and conducted-thermal sources. When an enclosure is used, gradients resulting from heat conducted along the thermocouple wire can be minimized by coiling some wire inside the enclosure. This technique allows heat to largely dissipate before it reaches the terminals. If the AM16/32B is housed in a field enclosure, the enclosure should be shielded from solar radiation.



*FIGURE C-3. AM16/32B aluminium cover plate*



## Global Sales & Support Network

A worldwide network to help meet your needs



### Campbell Scientific regional offices

#### Australia

*Location:* Garbutt, QLD Australia  
*Phone:* 61.7.4401.7700  
*Email:* [info@campbellsci.com.au](mailto:info@campbellsci.com.au)  
*Website:* [www.campbellsci.com.au](http://www.campbellsci.com.au)

#### Brazil

*Location:* São Paulo, SP Brazil  
*Phone:* 11.3732.3399  
*Email:* [vendas@campbellsci.com.br](mailto:vendas@campbellsci.com.br)  
*Website:* [www.campbellsci.com.br](http://www.campbellsci.com.br)

#### Canada

*Location:* Edmonton, AB Canada  
*Phone:* 780.454.2505  
*Email:* [dataloggers@campbellsci.ca](mailto:dataloggers@campbellsci.ca)  
*Website:* [www.campbellsci.ca](http://www.campbellsci.ca)

#### China

*Location:* Beijing, P. R. China  
*Phone:* 86.10.6561.0080  
*Email:* [info@campbellsci.com.cn](mailto:info@campbellsci.com.cn)  
*Website:* [www.campbellsci.com.cn](http://www.campbellsci.com.cn)

#### Costa Rica

*Location:* San Pedro, Costa Rica  
*Phone:* 506.2280.1564  
*Email:* [info@campbellsci.cc](mailto:info@campbellsci.cc)  
*Website:* [www.campbellsci.cc](http://www.campbellsci.cc)

#### France

*Location:* Vincennes, France  
*Phone:* 0033.0.1.56.45.15.20  
*Email:* [info@campbellsci.fr](mailto:info@campbellsci.fr)  
*Website:* [www.campbellsci.fr](http://www.campbellsci.fr)

#### Germany

*Location:* Bremen, Germany  
*Phone:* 49.0.421.460974.0  
*Email:* [info@campbellsci.de](mailto:info@campbellsci.de)  
*Website:* [www.campbellsci.de](http://www.campbellsci.de)

#### India

*Location:* New Delhi, DL India  
*Phone:* 91.11.46500481.482  
*Email:* [info@campbellsci.in](mailto:info@campbellsci.in)  
*Website:* [www.campbellsci.in](http://www.campbellsci.in)

#### South Africa

*Location:* Stellenbosch, South Africa  
*Phone:* 27.21.8809960  
*Email:* [sales@campbellsci.co.za](mailto:sales@campbellsci.co.za)  
*Website:* [www.campbellsci.co.za](http://www.campbellsci.co.za)

#### Spain

*Location:* Barcelona, Spain  
*Phone:* 34.93.2323938  
*Email:* [info@campbellsci.es](mailto:info@campbellsci.es)  
*Website:* [www.campbellsci.es](http://www.campbellsci.es)

#### Thailand

*Location:* Bangkok, Thailand  
*Phone:* 66.2.719.3399  
*Email:* [info@campbellsci.asia](mailto:info@campbellsci.asia)  
*Website:* [www.campbellsci.asia](http://www.campbellsci.asia)

#### UK

*Location:* Shepshed, Loughborough, UK  
*Phone:* 44.0.1509.601141  
*Email:* [sales@campbellsci.co.uk](mailto:sales@campbellsci.co.uk)  
*Website:* [www.campbellsci.co.uk](http://www.campbellsci.co.uk)

#### USA

*Location:* Logan, UT USA  
*Phone:* 435.227.9120  
*Email:* [info@campbellsci.com](mailto:info@campbellsci.com)  
*Website:* [www.campbellsci.com](http://www.campbellsci.com)