



**HUGHES**

HughesNet<sup>®</sup> 

# **HX90 Satellite Router Installation Guide**

1039456-0001  
Revision A  
April 11, 2012

---

11717 Exploration Lane, Germantown, MD 20876  
Phone (301) 428-5500 Fax (301) 428-1868/2830

### **Copyright © 2012 Hughes Network Systems, LLC**

All rights reserved. This publication and its contents are proprietary to Hughes Network Systems, LLC. No part of this publication may be reproduced in any form or by any means without the written permission of Hughes Network Systems, LLC, 11717 Exploration Lane, Germantown, Maryland 20876.

Hughes Network Systems, LLC has made every effort to ensure the correctness and completeness of the material in this document. Hughes Network Systems, LLC shall not be liable for errors contained herein. The information in this document is subject to change without notice. Hughes Network Systems, LLC makes no warranty of any kind with regard to this material, including, but not limited to, the implied warranties of merchantability and fitness for a particular purpose.

### **Trademarks**

Hughes, Hughes Network Systems, and HughesNet are trademarks of Hughes Network Systems, LLC. All other trademarks are the property of their respective owners.

# Contents

---

<b>Understanding safety alert messages</b> . . . . .	7
Messages concerning personal injury . . . . .	7
Messages concerning property damage . . . . .	7
Safety symbols . . . . .	8
Additional symbols . . . . .	8
<b>Chapter 1</b>	
<b>Satellite router overview</b> . . . . .	9
Scope of this installation guide . . . . .	10
Satellite router specifications . . . . .	10
LAN port configuration . . . . .	10
<b>Chapter 2</b>	
<b>Preparing for installation</b> . . . . .	11
Installation summary . . . . .	11
Installation checklist . . . . .	13
Items required for installation . . . . .	14
Conducting a site survey . . . . .	15
Power supply information . . . . .	15
Computer and networking requirements . . . . .	17
Computer requirements . . . . .	17
Networking and Internet browser requirements . . . . .	18
Related components . . . . .	18
Antenna . . . . .	18
IFL cables . . . . .	19
Hub or similar network device . . . . .	20
Instructions for related components . . . . .	20
<b>Chapter 3</b>	
<b>Installing the satellite router</b> . . . . .	21
Prerequisites for installing the router . . . . .	21
Selecting the router installation location . . . . .	21
Ventilation and heat sources . . . . .	22
Router operating position . . . . .	22
Connecting the transmit and receive cables . . . . .	23
Connecting the installer laptop to the router . . . . .	24
Connecting the power supply . . . . .	24
Connecting an AC/DC power supply . . . . .	25
Connecting and assembling a DC/DC power supply . . . . .	26
Powering up the router . . . . .	27

AC/DC power supply . . . . .	27
DC/DC power supply . . . . .	27
LEDS on power-up . . . . .	28
<b>Chapter 4</b>	
<b>Commissioning the satellite router . . . . .</b>	<b>29</b>
Satellite-based commissioning . . . . .	29
Obtaining an IP address from the satellite router . . . . .	30
Verifying the Ethernet connection . . . . .	30
Uploading the sbc.cfg file to the satellite router . . . . .	32
Entering commissioning parameters . . . . .	34
Receive antenna pointing — Ka-band . . . . .	45
Receive antenna pointing — Ku-band . . . . .	49
Transmit antenna pointing — Ku-band . . . . .	50
Registering the satellite router . . . . .	52
Manual commissioning . . . . .	57
Entering parameters—manual commissioning . . . . .	58
Manually accessing the antenna pointing screens . . . . .	59
Software download-manual commissioning . . . . .	60
<b>Chapter 5</b>	
<b>Completing the installation . . . . .</b>	<b>61</b>
Confirming that the satellite router’s files are up to date . . . . .	61
Connecting the satellite router to the customer’s computer . . . . .	63
Printing the System Information page . . . . .	63
Creating a shortcut to the System Control Center . . . . .	64
Installation complete . . . . .	64
<b>Chapter 6</b>	
<b>System control center . . . . .</b>	<b>67</b>
Accessing the System Control Center . . . . .	67
System Control Center home page . . . . .	67
Text links . . . . .	68
Common features on System Control Center screens . . . . .	70
Button links . . . . .	70
Links in the left panel . . . . .	73
Small icon on System Control Center screens (Advanced Pages) . . . . .	73
Status and information screens . . . . .	74
Features a customer may not see . . . . .	75
System Status page . . . . .	75
Reception Information page . . . . .	77
Examining receive status . . . . .	78
Transmission Information page . . . . .	79
Examining transmit status . . . . .	80
System Information page . . . . .	82

Help page . . . . .	83
System Control Center tools for troubleshooting . . . . .	84
<b>Chapter 7</b>	
<b>LEDs . . . . .</b>	<b>85</b>
Front panel LEDs . . . . .	85
LAN port LEDs . . . . .	87
Using LEDs for troubleshooting . . . . .	87
<b>Chapter 8</b>	
<b>Troubleshooting . . . . .</b>	<b>89</b>
Important troubleshooting information . . . . .	89
Troubleshooting reference diagram . . . . .	90
Troubleshooting common problems . . . . .	91
Cannot access the Internet . . . . .	91
Confirming that the satellite router is commissioned . . . . .	91
Confirming the receive signal . . . . .	93
Confirming the transmit signal . . . . .	93
Confirming that TCP Acceleration is operational . . . . .	94
Confirming that Web Acceleration is operational . . . . .	95
Confirming NOC connectivity . . . . .	97
Confirming NOC connectivity (Static IP Address) . . . . .	98
Confirming Internet connectivity . . . . .	99
Checking the DNS setting . . . . .	99
Checking for viruses and firewall issues . . . . .	100
Cannot access the System Control Center . . . . .	100
Satellite router connected directly to a computer . . . . .	100
Satellite router connected to an Ethernet device . . . . .	100
Using the front panel LEDs for troubleshooting . . . . .	101
Power LED off and one or more LEDs flashing . . . . .	102
All LEDs flashing . . . . .	102
All LEDs off . . . . .	102
Checking the Power LED . . . . .	103
Checking the LAN LED . . . . .	103
Problem with a connected device . . . . .	104
Transmit LED is off . . . . .	105
Receive LED is off . . . . .	105
System LED is off . . . . .	106
Using the LAN port LEDs for troubleshooting . . . . .	106
Orange LED and the front panel LAN LED are both off . . . . .	107
Orange LED is on but the front panel LAN LED is not . . . . .	107
Troubleshooting other problems . . . . .	107
Slow speed or intermittent operation . . . . .	107
Viewing problem-related statistics . . . . .	108
Checking for possible AC outlet problems . . . . .	109

<b>Appendix A</b>	
<b>LNB selection reference</b> . . . . .	<b>111</b>
<b>Appendix B</b>	
<b>Updating the router software</b> . . . . .	<b>113</b>
Extracting files . . . . .	113
Update instructions . . . . .	113
<b>Appendix C</b>	
<b>Standards compliance</b> . . . . .	<b>115</b>
Safety — Operating conditions for Canada . . . . .	115
Repairs in Canada . . . . .	115
Electromagnetic interference (EMI) . . . . .	116
FCC Part 15 . . . . .	116
Canada Class B warning . . . . .	117
R&TTE (EU) . . . . .	117
Electromagnetic compatibility (EMC) . . . . .	117
R&TTE (EU) . . . . .	117
IPoS . . . . .	117
<b>Acronyms and abbreviations</b> . . . . .	<b>119</b>
<b>Index</b> . . . . .	<b>121</b>

# Understanding safety alert messages

---

Safety alert messages call attention to potential safety hazards and tell you how to avoid them. These messages are identified by the signal words DANGER, WARNING, CAUTION, or NOTICE, as illustrated below. To avoid possible property damage, personal injury, or in some cases possible death, read and comply with all safety alert messages.

## Messages concerning personal injury

The signal words DANGER, WARNING, and CAUTION indicate hazards that could result in personal injury or in some cases death, as explained below. Each of these signal words indicates the severity of the potential hazard.

 **DANGER**

DANGER indicates a potentially hazardous situation which, if not avoided, *will* result in death or serious injury.

---

 **WARNING**

WARNING indicates a potentially hazardous situation which, if not avoided, *could* result in death or serious injury.

---

 **CAUTION**

CAUTION indicates a potentially hazardous situation which, if not avoided, could result in *minor or moderate* injury.

---

## Messages concerning property damage

 **NOTICE**

NOTICE is used for advisory messages concerning possible property damage, product damage or malfunction, data loss, or other unwanted results—but *not* personal injury.

---

## Safety symbols

The generic safety alert symbol  calls attention to a potential personal injury hazard. It appears next to the DANGER, WARNING, and CAUTION signal words as part of the signal word label. Other symbols may appear next to DANGER, WARNING, or CAUTION to indicate a specific type of hazard (for example, fire or electric shock). If other hazard symbols are used in this document they are identified in this section.

### *Additional symbols*

This document uses the following hazard symbols:



Indicates a safety message that concerns a potential electric shock hazard.



Indicates a safety alert message that concerns a potentially hazardous situation in which you could be exposed to radio frequency (RF) energy.



# Satellite router overview

---

The HX90 satellite router connects to a satellite network to provide Internet or intranet service or both to a host—typically a computer—or to multiple hosts on a wired (Ethernet) or wireless LAN. The router has two Ethernet LAN ports so it can be connected to one or two LAN subnets. The HX90 satellite router is designed to meet the needs of enterprise business customers, small business users, and consumers.

The HX90 is an IP router, and so it eliminates the need for an external router. The HX90 can be used in either a Ka-band or Ku-band bent-pipe satellite network. This installation guide includes instructions for both Ka-band and Ku-band installations.

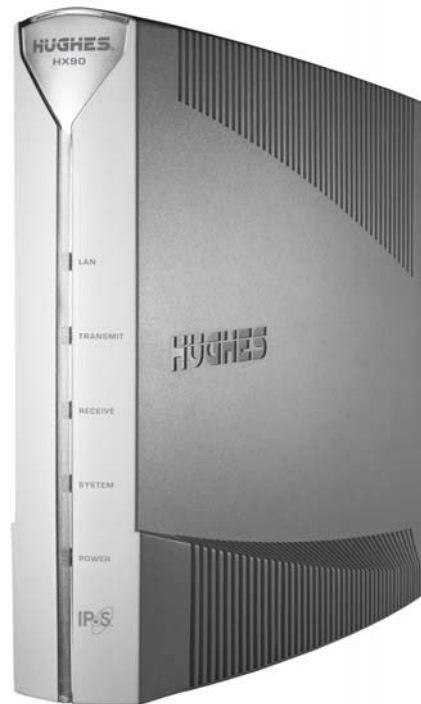

Figure 1: HX90 satellite router

## Terminology

In this installation guide:

- *Satellite router* and *router* both refer to the HX90 satellite router.
- *Installer Support* refers to organizations that provide assistance to professional installers of Hughes satellite equipment. If you do not know who provides your support, contact your program manager.

## Scope of this installation guide

This installation guide explains how to install, commission, activate, and troubleshoot the HX90 satellite router. It also contains certain reference information concerning operation of the satellite router, such as troubleshooting information.

### Audience

This guide is intended to be used by professional installers. It may also be useful for:

- Trainers who train installers
- Call center operators who respond to customers' calls

## Satellite router specifications

Table 1: Specifications for the HX90 satellite router

Weight	1.6 lb (0.73 kg)
Height	8.0 inches (20.3 cm)
Width	1.6 inches (4.1 cm); 2.4 inches (6.1 cm) at base
Depth	9.0 inches (22.9 cm)
Operating temperature range	32 °F to 122 °F (0 °C to 50 °C) Above 5,000 ft (1,524 m) altitude, the maximum temperature is reduced by 1 °C per 1,000 ft (305 m).
Operating humidity range	5% to 90% non-condensing
Altitude	Up to 15,000 ft (4,572 m)
Cooling method	Convection
Protocol support	TCP/IP (Transmission Control Protocol / Internet Protocol) protocol suite
Supported frequency ranges	Ka-band or Ku-band
Network interface ports	Two RJ-45 Ethernet LAN ports supporting 10BaseT or 100BaseT operation
Power supplies and power requirements	See <i>Power supply information</i> on page 15.

## LAN port configuration

The satellite router's two LAN ports support the following configurations:

- Dual port, single subnet – Only one LAN port is configured with an IP address at the NOC, which means the router supports one subnet. This is the default configuration.
- Dual port, independent subnet – Each LAN port is configured with a separate IP address at the NOC, which means the router supports independent subnets.

# Preparing for installation

This section describes preparations for installing the satellite router and includes information you should know before you begin. Review this information before you install the satellite router, antenna assembly, antenna mount, or IFL cables. Refer also to *Installation summary* on page 11.

To install the satellite router, you need the Installation Reference Sheet and installation specification. These two documents contain parameters you need to install the router and other installation information. The *Installation Reference Sheet* is specific to a single installation site. The *installation specification* is customer-specific; it applies to all terminal installations for a specific customer. From your installation support web site, print the Installation Reference Sheet for your installation site and the applicable installation specification. (To find the correct installation specification, search for the customer’s name in the title.)

## Installation summary

This guide explains how to install the HX90 satellite router. It includes *limited* information about other satellite terminal components. The *satellite router* is the small indoor unit. The *satellite terminal* includes the satellite router and the antenna, radio assembly, and IFL cables, as shown in Figure 2.

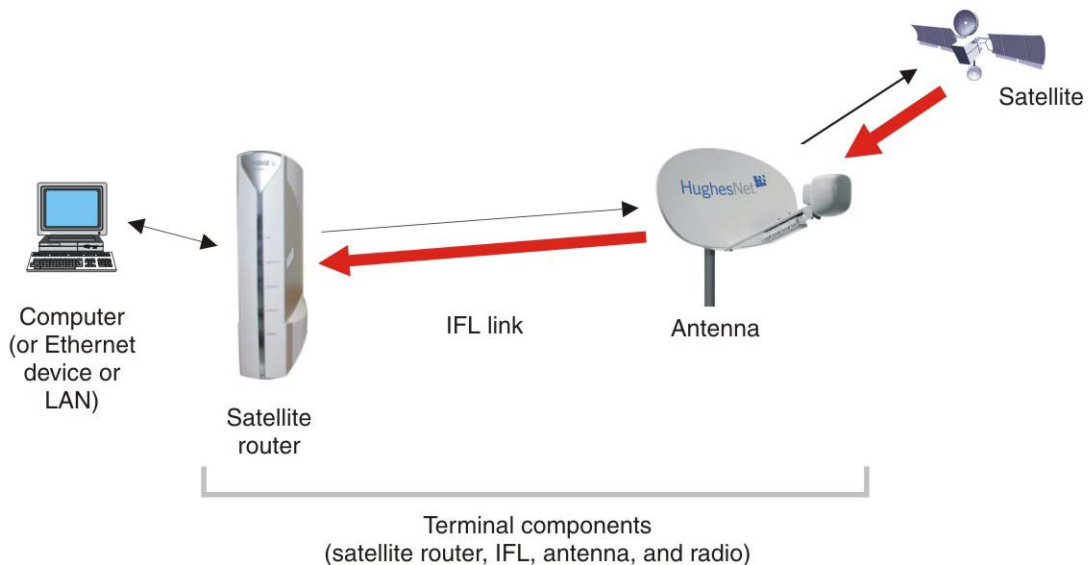

Figure 2: Satellite router and related terminal components

This summary focuses on installation of the satellite router, but also includes some information on related tasks such as antenna installation and pointing. The tasks listed below are the main installation tasks, *but these are not all* of the installation tasks.

Complete all steps in the order they are presented in this installation guide unless you have a specific reason for doing them in a different order. In any case, make sure all steps are completed. You must install the antenna before the satellite router can be commissioned. Then you point the antenna as part of the router commissioning procedure.

Details for the satellite router installation tasks are included in later chapters in this guide.

### **Preparing for the installation**

- Make sure you have all items required for installation, including the Installation Reference Sheet and installation specification, all equipment to be installed, and required tools for the outdoor equipment.
- *Consumer installations only:* Make sure the customer's computer meets the requirements listed in *Computer and networking requirements* on page 17.
- Conduct a site survey.
- Assemble and install the antenna and radio as instructed in the antenna installation guide.

### **Installing the satellite router**

- Connect the transmit and receive cables.
- Connect the router to the installer laptop.
- Connect the power supply.
- Power up the router and observe the LEDs to verify normal operation.

### **Commissioning the router and pointing the antenna**

- Upload the `sbc.cfg` file (if you are instructed to upload it).
- Enter the antenna location and satellite and radio parameters.
- Point the antenna.
- Register the satellite router.

### **Completing the installation**

- Confirm that all files are current.
- Connect the router to the customer's computer.

## Installation checklist

To help ensure a successful installation, **pay careful attention to the items listed in the checklist below as you install the satellite router, antenna, and IFL cables.**

### IFL cables

For specific cable information see Table 3 on page 20.

- Use only Hughes-approved cables.
- Do not exceed maximum length for the ODU type (1 W or 2 W), cable type, and cable part number.
- Do not exceed the cable bend radius.
- Properly terminate cables.

### Connectors and connections

- Use only connector types approved for cable type used. Check all connections for tightness.

*Outdoors:*

- Make sure F connectors connected to the radio assembly are tightened to 20 inch-lb torque.
- Carefully follow waterproofing procedures, using dielectric grease and Hughes-approved weatherproof tape.

### Power source

#### ***Check AC power outlet for correct wiring***

- Before connecting the router power supply to the AC power source (using a surge protector), use an AC outlet tester to verify that the outlet is wired correctly. Wiring problems may include:
  - Hot and neutral wires reversed
  - Neutral and ground wires reversed
  - Open ground (incomplete connection)
  - Open neutral

If the outlet is wired improperly, notify the customer you are not permitted to connect the system to a faulty outlet. Do not proceed with installation until a properly wired outlet is provided.

### **Check neutral-ground (N-G) voltage**

- With a digital multimeter set to AC voltage, measure the voltage between neutral and ground at the AC power outlet. If the N-G voltage measures 2 VAC or greater, please advise the customer to have an electrician evaluate the electrical power outlet. N-G voltages may have a negative impact on the performance of electronic equipment.

### **Grounding (router, antenna, radio, and IFL)**

- Adhere to Hughes grounding requirements.
- Use only approved ground wires, ground blocks, lugs, and clamps.

For detailed information refer to the appropriate FSB, as listed in Table 3 on page 20.

## **Items required for installation**

To install the HX90 satellite router, you need:

- HX90 satellite router
- Power supply (provided in the shipping carton)
- Surge protector (recommended), provided by the customer
- Cat-5 Ethernet cable
- `sbc.cfg` file (if you are instructed to upload it)
- Installation Reference Sheet and installation specification (provided to the installer)

### **Notes**

**sbc.cfg file** — If needed, you can download the most current `sbc.cfg` file from your installation support web site.

**SAN and PIN or site ID** — Identification numbers are required to register the satellite router. Customers who purchased their system from a Hughes retail channel in the United States or Canada receive an order confirmation e-mail containing their site account number (SAN) and personal identification number (PIN). For enterprise customers or customers outside the United States and Canada, you need a site ID to register the router.

**DC/DC power supply** — If the site has a DC power source, it requires a DC/DC power supply. See Table 2 on page 17. The installer must provide the wire required to assemble the DC input power cable.

## Additional equipment

- Antenna
- Hughes antenna pointing tool (DAPT for Ka-band, DAPT or OPI for Ku-band)
- IFL cables, cable connectors, and ground blocks

For more information on these items, see *Related components* on page 18.

No tools are required to install the router. For tools needed to install the antenna mount and antenna and point the antenna, see:

- **Antenna Site Preparation and Mount Installation Guide** (1035678-0001)
- The installation guide for the antenna model you are installing

## Conducting a site survey

Survey the customer site to confirm that the location meets the requirements for installation of the satellite router. For complete site survey information, including site requirements, see the **Antenna Site Preparation and Mount Installation Guide** (1035678-0001).

The key site survey tasks related to installation of the satellite router are:

1. Make sure there is an unobstructed line of sight to the satellite specified on the Installation Reference Sheet.
2. Review the Installation Reference Sheet for site-specific instructions and the installation specification for customer-specific instructions.

## Power supply information

See also *Connecting the power supply* on page 24.

The power supply is included in the satellite router shipping carton.

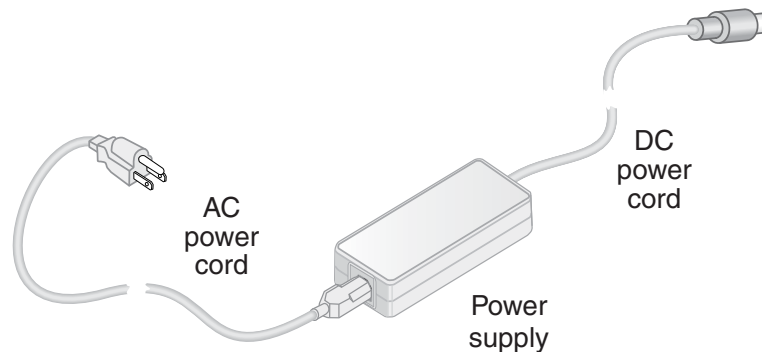

Figure 3: AC power supply for the HX90 satellite router

Before proceeding, make sure you have the correct power supply. Check the part number on the power supply and refer to Figure 3.

### NOTICE

- Always use the power supply provided with the satellite router. The router's performance may suffer if the wrong power supply is used.
- Connect the AC/DC power supply to a three-wire, grounded outlet with an input of 110/240 VAC. A suitable surge protector is recommended to protect the satellite router from possible damage due to power surges.
- Always connect the DC power cord to the HX90 rear panel before applying power to the power supply. If you apply power to the power supply and then connect the DC power cord, the satellite router may not perform properly and could be damaged.
- Observe the power standards and requirements of the country where it is installed.

---

### CAUTION



If there is any reason to remove power from the satellite router, always unplug the AC power cord from the power source (power outlet, power strip, or surge protector). Do not remove the DC power cord from the router's rear panel. Doing so could result in an electrical shock or damage the router.

When you re-apply power to the router, plug the AC power cord into the power source.

---



**Table 2: Power supply specifications for the HX90 satellite router**

Power supply type	Electrical requirements
AC/DC (64 W)	Input line voltage: 90 to 264 VAC, 2 A maximum Input line frequency: 50 to 60 Hz AC Rated power consumption: 64 W
AC/DC (80 W)	Input line voltage: 90 to 264 VAC, 2 A maximum Input line frequency: 50 to 60 Hz AC Rated power consumption: 80 W
DC/DC (65 W)	Input line voltage: 12 to 24 VDC, 10 A maximum Rated power consumption: 65 W

All listed power supplies may be used with a 1 W or 2 W Ka-band or Ku-band radio. All have a detachable power cord.

## Computer and networking requirements

This section lists the requirements for the computer or other device, network, and browser to be used with the satellite router.

### *Computer requirements*

The HX90 satellite router can be used with any device that supports IP and has a 10/100 BaseT Ethernet LAN port. Typically, the router is connected to a customer's computer. However, the HX90 is self-hosted; it does not require a computer for any of its functions.

Requirements for the computer to be used with the satellite router are the same for the laptop computer you use to install the router and the customer's computer that will be connected to the router. In either case, the computer should meet the minimum requirements specified by the computer operating system manufacturer and the following networking and browser requirements.

Make sure the installer laptop is configured to support DHCP.

**Note:** The satellite router can be used with a Mac computer that meets these requirements, but Mac computers are not supported as a tool for installing the satellite router.

## ***Networking and Internet browser requirements***

- Ethernet port
- Ethernet NIC installed on at least one computer, 10/100 BaseT
- Ethernet cable (provided for consumer installations)
- A web browser such as Internet Explorer with proxy settings disabled

**Connecting a network** — If the customer wants to connect a network to the satellite router, this requires an Ethernet hub or other such device. The customer must supply and configure the hub and cables. Required IP address information is obtained during commissioning.

**Static IP address** — The computer can be configured to use a static IP address if the HughesNet service plan provides for one or more static IP addresses. If the computer is configured to use a *specific* static IP address, disable DHCP.



Do not connect the power supply to the satellite router, or connect the power supply to a power source until you are instructed to do so.

---

## **Related components**

The satellite router is the indoor component of the satellite terminal. The terminal also includes the (outdoor) antenna and IFL cables. This section presents information on the outdoor components and other related equipment. For additional information, see the applicable documents listed in Table 3 on page 20.

### ***Antenna***

You must assemble and install the antenna before you install the satellite router. You *point* the antenna as part of the router commissioning process.



Only a trained professional installer should install the outdoor antenna assembly. In the United States, the Federal Communications Commission (FCC) requires professional installation and service of the antenna assembly because it transmits radio frequency (RF) energy.

---

The HX90 satellite router can be used with a 0.74 m, 0.98 m, 1.2 m, or 1.8 m two-way satellite antenna. The antenna assembly is shipped in a separate box.

The main source of information on the antenna is the antenna installation guide. Each antenna model has its own installation guide. If you do not have the antenna installation guide, find the required antenna model on the Installation Reference

Sheet or installation specification; then locate the installation guide for that model on your installation support web site.

### NOTICE

When you install the antenna assembly, read and follow all safety alerts and instructions in the antenna installation guide and in the **Antenna Site Preparation and Mount Installation Guide** (1035678-0001).

---

## IFL cables

Before you can install the satellite router, you must route the coaxial IFL cables between the indoor satellite router location and the antenna. Then you connect the router and the antenna by connecting the IFL cable to both components.

The routing path of the IFL cables between the router and the antenna depends on the building configuration. Guidelines for installing IFL cables are included in the **Antenna Site Preparation and Mount Installation Guide** (1035678-0001).

### Requirements for cables, connectors, and ground blocks

You must use approved cable types and connectors to connect the router to the outdoor satellite antenna. For grounding, you must use approved ground blocks and grounding connectors. For detailed specifications and information on these components, see the documents listed in Table 3 on page 20.

The coaxial IFL cables and the ground block to which they are connected must meet the grounding requirements specified in the following warning:



You must comply with applicable local codes and the grounding requirements in Field Service Bulletin (FSB), **HNS Broadband Requirements for RG-6 and RG-11 IFL Cable Connectors, Ground Blocks, and Ground Block Location** (FSB\_050518\_01). Improper grounding can result in electric shock injury, property damage, and/or poor router performance.

---

### Labeling the IFL cables

Label the receive and transmit IFL cables at the outdoor point-of-entry and at the indoor location where the satellite router is installed as follows:

- Wrap a piece of *red* electrical tape around the receive cable, and mark SAT IN on the tape.
- Wrap a piece of *blue* electrical tape around the transmit cable, and mark SAT OUT on the tape.

## ***Hub or similar network device***

If the satellite router is to be connected to a network, an Ethernet hub, router, wireless base station, or other similar device is required. The customer must supply and configure the network device, including required cables, according to the device manufacturer's documentation. Required IP address information is obtained during router commissioning.

## ***Instructions for related components***

This installation guide covers only installation of the satellite router. For installation instructions for other components, see Table 3 on page 20. You can view or download these documents at <https://dwayinstalls.hns.com/> (click **Installer Login Click Here!!**) or your installation support web site. If you cannot log in, contact Installer Support, or contact your program manager for access to these documents.

**Table 3: Related installation documents**

<b>Component or topic</b>	<b>Where to find instructions</b>
Safety (all components) Site survey Site preparation Antenna mounts IFL	<b><i>Antenna Site Preparation and Mount Installation Guide</i></b> (1035678-0001).
IFL cables (specifications, approved types, maximum lengths)	For Ku-band installations: Field Service Bulletin (FSB), <b><i>IFL Cable, Approved List (with lengths) for DW7x00, DW60xx, and DW40xx Domestic Installations</i></b> (FSB_060316_01). (IFL cable specifications in this FSB apply to HX90 Ka-band and Ku-band installations.)
IFL cable connectors Grounding Ground blocks	Field Service Bulletin (FSB), <b><i>HNS Broadband Requirements for RG-6 and RG-11 IFL Cable Connectors, Ground Blocks, and Ground Block Location</i></b> (FSB_050518_01).
Antenna, antenna pointing Radio assembly	See the antenna installation guide for the specific antenna model you are installing. For Ka-band antennas, see also the <b><i>Ka-Band Antenna Pointing Guide for Bent-Pipe Satellite Networks</i></b> (1038764-0001). Antenna pointing for Ku-band antennas is covered in the antenna installation guide.

For enterprise installations, also see and adhere to the customer-specific installation specification.

# Installing the satellite router

---

Installation of the HX90 satellite router consists of physical installation, followed by commissioning and registration. These processes prepare the router for operation on the satellite network. Installation tasks include:

- Physical installation and power-up
- Entering parameters required for commissioning
- Commissioning, including antenna pointing

The installation software is factory pre-installed in the satellite router. If necessary, this software is automatically updated as part of the installation process. You access the installation software through a browser on your installer computer to perform tasks such as entering required parameters.

## Prerequisites for installing the router

The following are required before you can install, commission, and register the satellite router:

- The antenna and radio assembly must be installed, as instructed in the antenna installation guide. (However, you point the antenna as part of the router commissioning process, which is explained later in this installation guide.)
- The IFL cables must be installed and connected to the satellite router and to the radio assembly (LNB and transmitter).

See also *Items required for installation* on page 14 and *Related components* on page 18.

## Selecting the router installation location

Select a location for the satellite router that will accommodate all required cable connections, including connection to the power source.

## ***Ventilation and heat sources***

Make sure the installation location meets the following requirements concerning ventilation and heat sources.

### **NOTICE**

- Do not block any of the router's ventilation openings.
  - Leave 6 inches of space around the top and sides of the router to ensure adequate ventilation and prevent overheating.
  - Do not place the router near a heat source such as direct sunlight, a radiator, heat register or vent, oven, stove, amplifier, or other apparatus that produces heat.
- 

## **Router operating position**

### **NOTICE**

Install and operate the HX90 router only in the upright vertical position as shown in Figure 4. Any other position could result in insufficient ventilation, overheating, and malfunction.

---

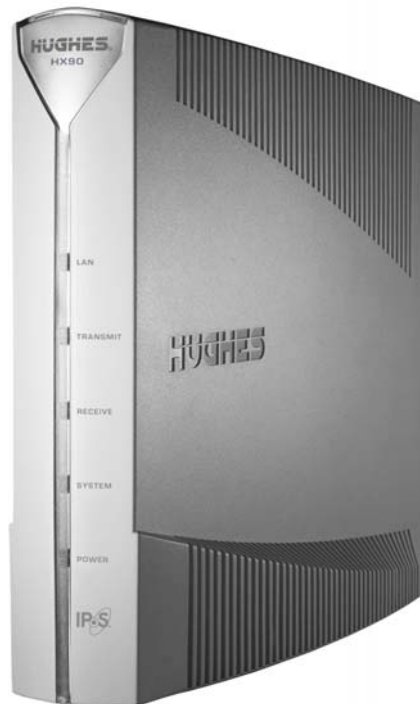

Figure 4: HX90 in vertical position

## Connecting the transmit and receive cables

Connect the transmit and receive IFL cables to the satellite router.

1. Connect the transmit and receive cables to the connectors on the rear panel of the router as shown in Figure 5.

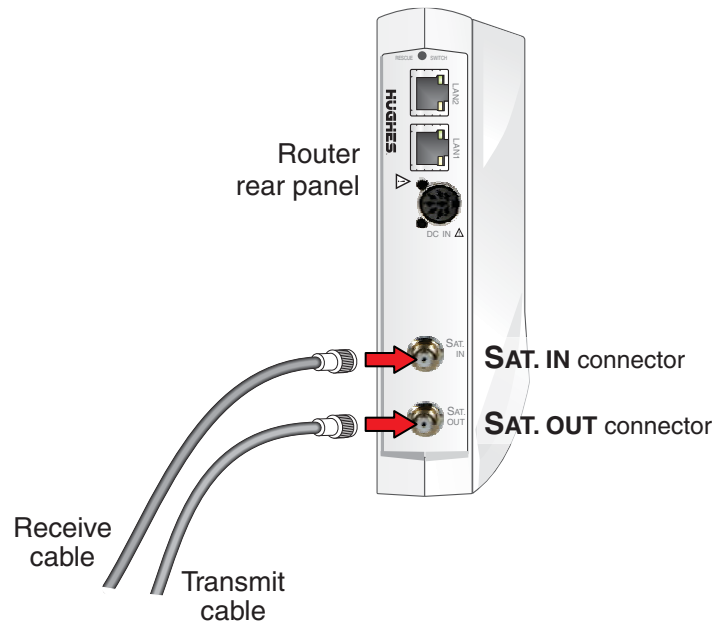

Figure 5: Connecting the transmit and receive cables to the router

### NOTICE

The transmit and receive cable connectors must be securely tightened.

- Make sure each connector is properly aligned (not cross-threaded).
- The connector should be finger tight with no play.

---

**Note:** The satellite router may operate correctly when first installed even if the transmit and receive cable connectors are not adequately tightened. However, problems could develop later. Therefore, successful router operation is not an indication that the cables are adequately tightened.

2. Make sure neither the satellite router nor the customer's computer are connected to an Ethernet router or switch.

**Note:** Do not connect any device to the satellite router at this time except the installer laptop computer. Ethernet devices may only be connected to the router after it is installed and commissioned.

## Connecting the installer laptop to the router

For this task you need an Ethernet cable.

To access the satellite router so you can perform the required installation procedures, you connect your installer laptop computer to the router. After the router is installed and registered with the satellite network, you connect the router to the customer's computer or other device. During router installation the installer laptop computer must be directly connected to the router without any intervening connection.

Connect the installer laptop to the router:

1. Use an Ethernet cable to connect your laptop computer directly to either of the router's two LAN ports, as shown in Figure 6.  
*Do not* connect the installer laptop to the router through an Ethernet router or switch.

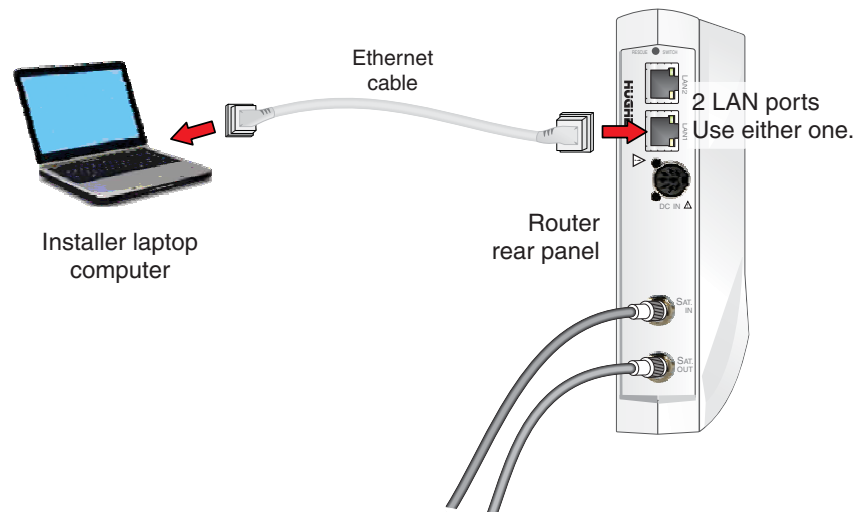

Figure 6: Connecting the installer laptop

2. Make sure that neither the satellite router nor the customer's computer are connected to an Ethernet router or switch.
3. If you are running firewall software on the laptop computer, disable it until you complete installation of the router.

The LAN LED on the front of the router should now be on.

## Connecting the power supply

Follow the instructions in *Connecting an AC/DC power supply* on page 25 or *Connecting and assembling a DC/DC power supply* on page 26.



## Connecting an AC/DC power supply

### NOTICE

The following apply to the AC/DC power supplies:

- The input must be 120-240 VAC.
  - A suitable surge protector is recommended to protect the router from possible damage due to power surges.
- 

The customer provides the surge protector. If a surge protector or power strip is not present, use a wall outlet or other power source.

In some countries, the router may use a replacement AC power cord. Different countries have different standards and requirements that must be observed.

Before connecting the router power supply to the AC power source (using a surge protector), use an AC outlet tester to verify that the power outlet is wired correctly. Wiring problems may include:

- Hot and neutral wires reversed
- Neutral and ground wires reversed
- Open ground (incomplete connection)
- Open neutral

If the outlet is wired improperly, notify the customer that you are not permitted to connect the system to a faulty outlet. Do not proceed with the installation until a properly wired outlet is provided.

Connect the power supply as follows:

1. Check *Power supply information* on page 15 to make sure you have the correct power supply.
2. Connect the DC power cord to the DC IN port on the router, as shown in Figure 7 on page 26.

### NOTICE

If you apply power to the power supply and then connect the DC power cord, the satellite router may not perform properly and could be damaged.

---

3. Connect the AC power cord to the power supply.

Do not connect the AC power cord to the surge protector at this time. Wait until you are ready to observe the router's LEDs upon power-up, as explained in *Powering up the router* on page 27 and *LEDS on power-up* on page 28.

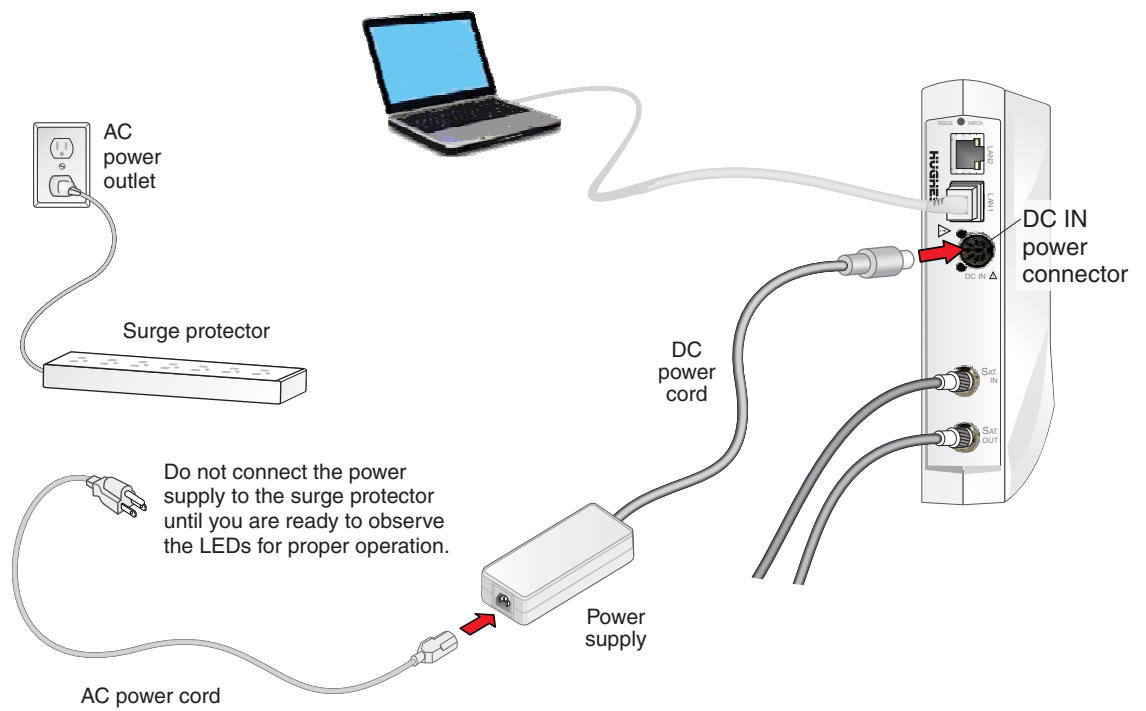

Figure 7: Connecting an AC power supply

### ***Connecting and assembling a DC/DC power supply***

Figure 8 shows the DC/DC power supply used with the HX90 router.

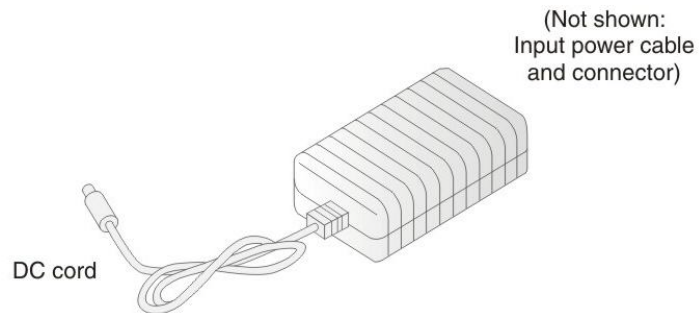

Figure 8: DC/DC power supply

Connect and assemble the DC/DC power supply as follows:

1. Connect the DC power cord to the DC IN port on the router.

**Note:** The input cable kit is included in the power supply kit. The cable kit contains an input power connector, connector pins, and a wiring diagram; it does not include wire.

2. Assemble the input power cable according to the wiring diagram included in the cable kit.
3. Connect the input power cable to the DC power source, but do not connect the input power connector to the power supply at this time.

Do not connect the input power connector to the power supply until you are ready to observe the router's LEDs upon power-up, as explained in *LEDS on power-up* on page 28.

## Powering up the router

Check *Power supply information* on page 15 to make sure you have the correct power supply. Follow these instructions to power up the router for the first time.

### *AC/DC power supply*

Prerequisites:

- The power outlet has been tested, as described in *Connecting an AC/DC power supply* on page 25.
  - According to previous instructions, the DC power cord is connected to the router's rear panel, and the AC power cord is connected to the power supply.
1. Connect the AC power cord into the surge protector or wall outlet.
  2. Observe the LEDs for proper operation. See *LEDS on power-up* on page 28.

### *DC/DC power supply*

Prerequisites: The DC power cord is connected to the router's rear panel, and the input power cable is assembled and connected to the DC power source.

1. Connect the input cable connector to the power supply.
2. Observe the LEDs for proper operation. See *LEDS on power-up* on page 28.

## LEDS on power-up

As the router powers up, observe the front panel LEDs to make sure the router is working properly. When power is applied to the router or after a router reset, the LEDs light up in the following order, indicating normal power-up:

1. All LEDs light up for ½ sec while the router performs a self-test.
2. The Power LED lights up and remains on, indicating the router is powered up.
3. The Power LED and System LED light up for about 5 to 10 sec while the router loads and prepares applications.
4. If the router LAN port is connected to a network device, the LAN LED lights up within 30 sec, indicating that LAN connectivity is detected.
5. The Power LED blinks, indicating that the router is not commissioned.

If the LEDs do not function as described, make sure you have the correct power supply. Refer to Figure 2 on page 17.

# Commissioning the satellite router

---

Commissioning refers to a series of procedures to make the newly installed satellite router ready for network operation and register the router with the service provider's network.

## Commissioning methods

Two methods are available for commissioning the HX90 satellite router:

- *Satellite-based commissioning* on page 29
- *Manual commissioning* on page 57

Satellite-based commissioning is the preferred commissioning method. Use the manual commissioning method only if satellite-based commissioning is not available *and* if you are instructed to do so by the service provider.

## Satellite-based commissioning

Satellite-based commissioning (SBC) is the preferred commissioning method. Using SBC, you use a web-based interface on the satellite router to:

- Obtain an IP address from the router
- Verify the Ethernet connection (ping test)
- Upload the `sbc.cfg` file to the router
- Enter commissioning parameters
- Point the antenna
- Register the router

The satellite router contains an SBC configuration file (`sbc.cfg`) that contains satellite information for SBC and the auto-commissioning server (ACS) used during commissioning. Occasionally, new satellites are activated to support broadband service. As a result, you may be required to upload an `sbc.cfg` file to the router prior to installation or manually enter satellite parameters during router installation.

If a new `sbc.cfg` file is available you are instructed to download the `sbc.cfg` file from an installation support web site. You must save the `sbc.cfg` file to the installer laptop computer prior to commissioning so you can upload it to the router.

If a new satellite is activated but a new `sbc.cfg` file is not available, the new satellite parameters are distributed to you in a technical update email or in an installation specification. In this case you must manually enter the new satellite parameters.

**Note:** If the service provider has provided you with an `sbc.cfg` file, you must complete the procedures in *Uploading the sbc.cfg file to the satellite router* on page 32 to upload the file to the router.

If you need troubleshooting information concerning satellite-based commissioning, see the satellite router's online Help. Access this information through the System Control Center [Help](#) link (**Help > Frequently Asked Questions**).

### ***Obtaining an IP address from the satellite router***

1. Make sure the installer laptop is configured to support DHCP.
2. Verify that the installer laptop is connected to the router with an Ethernet cable.
3. Open a command prompt or window on the installer laptop.
4. Type **ipconfig/release**.
5. Press **Enter**.
6. Type **ipconfig/renew**.
7. Press **Enter**.

To view all IP configuration commands, open a command prompt window, type **ipconfig/help**, and press **Enter**.

If the router does not assign IP address 192.168.0.2 to the installer laptop, restart the installer laptop to obtain the IP address.

### ***Verifying the Ethernet connection***

Execute a ping test to verify that the Ethernet connection between the satellite router and the installer laptop is active:

1. Open a command prompt or window on the installer laptop.
2. Type **ping 192.168.0.1**.
3. Press **Enter**.

If the ping is successful, the ping results show that all sent packets were received.

```
C:\Users>ping 192.168.0.1
Pinging 192.168.0.1 with 32 bytes of data:
Reply from 192.168.0.1: bytes=32 time=1ms TTL=64
Reply from 192.168.0.1: bytes=32 time=1ms TTL=64
Reply from 192.168.0.1: bytes=32 time=1ms TTL=64
Reply from 192.168.0.1: bytes=32 time=1ms TTL=64

Ping statistics for 192.168.0.1:
    Packets: Sent = 4, Received = 4, Lost = 0 (0% loss),
    Approximate round trip times in milli-seconds:
        Minimum = 1ms, Maximum = 1ms, Average = 1ms

C:\Users>_
```

Figure 9: Successful ping test

If the ping fails, the ping results show that packets were lost, and time-out messages may also appear.

```
C:\Users>ping 192.168.0.1
Pinging 192.168.0.1 with 32 bytes of data:
Request timed out.
Request timed out.
Request timed out.
Request timed out.

Ping statistics for 192.168.0.1:
    Packets: Sent = 4, Received = 0, Lost = 4 (100% loss)
C:\Users>_
```

Figure 10: Failed ping test

4. If the ping test fails, make sure:
  - The laptop's network interface card (NIC) is properly installed.
  - The laptop is configured to support DHCP.
5. If the NIC is installed properly and the laptop is configured to support DHCP, make sure all cable connections are secure (properly aligned-not cross threaded; finger tight with no play).
6. If the connections are secure:
  - a. Unplug the router from the power source.
  - b. Shut down and power off the computer.
  - c. Plug the router back in.
  - d. Turn the computer back on.



Do not power cycle the satellite router by unplugging the power cord from the router's rear panel. Doing so could result in static electricity discharge that could shock you and/or damage the router.

---

7. Make sure an Ethernet router or switch is not connected to the satellite router and to the customer's computer.
8. Try the ping test again.
9. If the ping test is unsuccessful, call Installer Support for assistance.

## Uploading the `sbc.cfg` file to the satellite router

The `sbc.cfg` file contains satellite information for SBC and the auto-commissioning server (ACS) to be used for the commissioning process. Once you have obtained the `sbc.cfg` file, save it on the installer laptop computer making sure to note the location where the file is saved.

If you do not need to upload an `sbc.cfg` file, go to *Entering the antenna location* on page 34 to upload the `sbc.cfg` file:

1. Open a browser on the installer laptop.
2. Type `http://192.168.0.1/fs/registration/setup.html` in the address bar.
3. Press **Enter**.

The Satellite Setup menu appears.

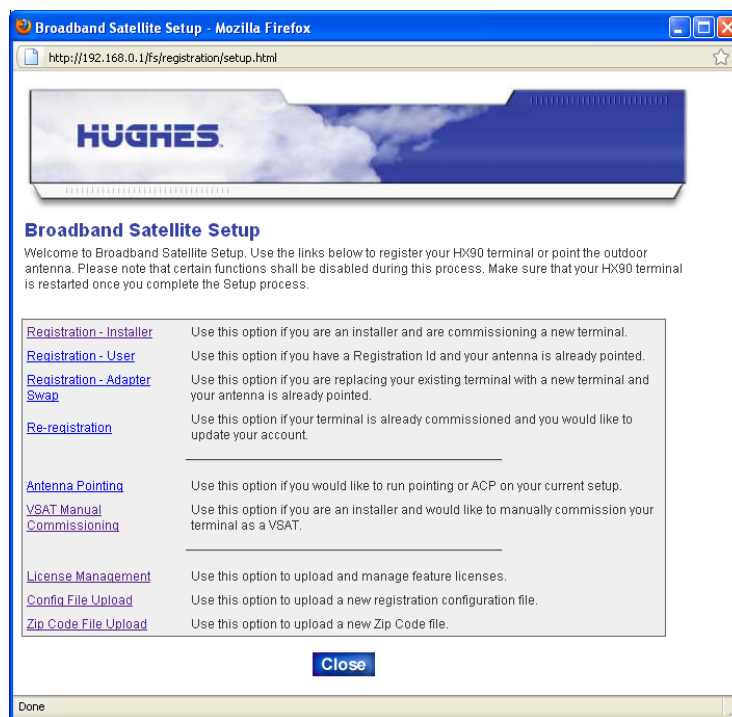

Figure 11: Satellite Setup menu

4. Click [Config File Upload](#).

**Note:** Do not click [Zip Code File Upload](#)—this button is used to update the ZIP code table in the router.



**Note:** The following apply to the screen illustrations in this installation guide:

- Most screen illustrations show only the relevant part of the screen and do not include features such as browser menus, toolbars, and window borders.
- The screen illustrations are *examples*. Values shown in these illustrations may not apply to the satellite router you are installing. Do not use values shown to install or configure the router unless the instructions say to do so.
- On some screens and in some messages you may see the word *terminal* or the abbreviation *VSAT*. Both refer to the HX90 satellite router.
- *Screen* and *page* are both used to refer to a set of information from your computer or satellite router that is displayed on your computer monitor.

The Configuration File Upload screen appears.

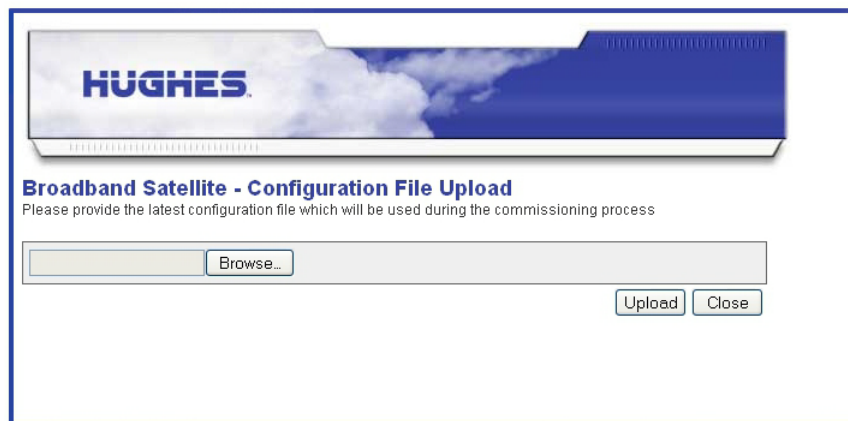

Figure 12: Configuration File Upload screen

5. Click **Browse** on the Configuration File Upload screen.
6. Navigate to the location on the installer laptop where you saved the `sbc.cfg` file.
7. Select the `sbc.cfg` file and click **Open**.
8. Click **Upload**, and wait for the upload to complete.
9. Wait to see the message shown in Figure 13, which indicates that the configuration has been transferred to the router.

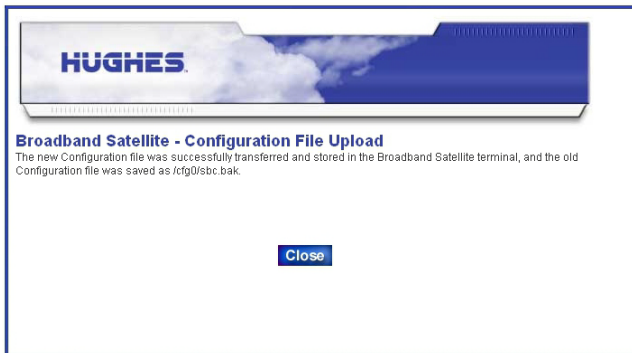

Figure 13: Confirming the sbc.cfg file upload

- After the upload completes, click **Close** on the Configuration File Upload screen to return to the Satellite Setup menu.

### *Entering commissioning parameters*

To commission the satellite router you enter parameters for the antenna location, satellite, and radio. In some circumstances you may have to enter the antenna location and/or satellite parameters manually, as explained in the sections that follow.

#### **Entering the antenna location**

Begin commissioning by entering the antenna location:

1. Open a browser on the installer laptop.
2. Type **http://192.168.0.1/fs/registration/setup.html** in the address bar.
3. Press **Enter**.  
The Satellite Setup menu appears.

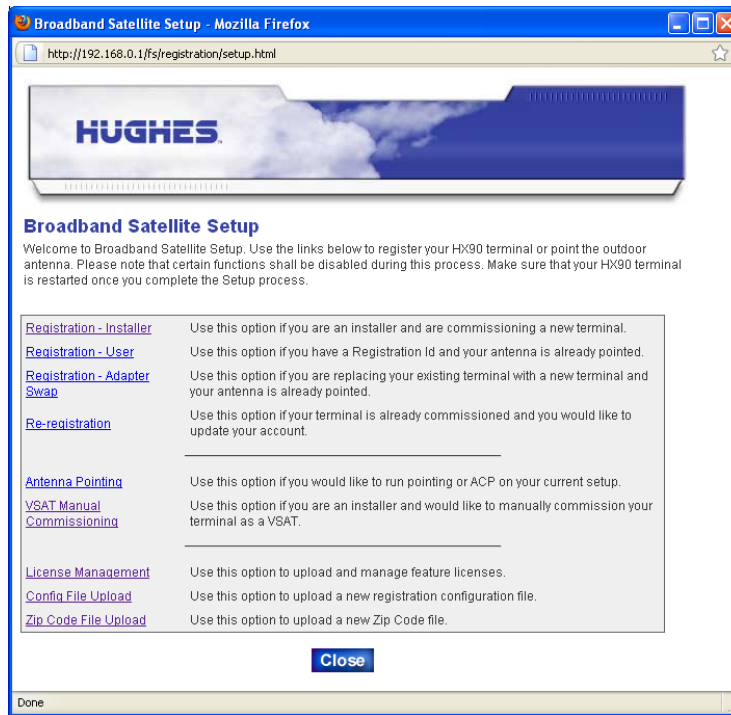

Figure 14: Satellite Setup menu

4. Click **Registration - Installer**.
5. *If you are installing the satellite router outside of the United States or Canada, go to Entering the antenna location (manual entry) on page 37. Follow the steps there to manually enter the antenna location.*  
*If you are installing the router in the United States or Canada, continue to the next step.*
6. On the Antenna Location screen, enter the ZIP code of the installation location, and click **Next**.

**HUGHES**

**Broadband Satellite - Antenna Location**  
 Enter the zip code of your antenna installation location, or check the "Enter location manually" box to enter the location manually. Click **Next** to continue.

My antenna is installed in the following zipcode:

Enter location manually

**Back** **Next** **Exit**

Figure 15: Antenna Location screen

After you enter the ZIP code and click **Next**, the Verification of Antenna Location screen appears.

**HUGHES**

**Broadband Satellite - Verification of Antenna Location**  
 Verify the Antenna Location listed below then click **Next** to continue. If the location information is incorrect, click **Back** to change the zipcode.

Zipcode:	20876	Germantown, MD
Latitude:	39.1	N
Longitude:	77.2	W

**Back** **Next** **Exit**

Figure 16: Verification of Antenna Location screen

7. Verify that the displayed information is correct and click **Next**.

## Entering the antenna location (manual entry)

This is an *alternate* method for entering the antenna location. Use it only if you need to manually enter the antenna location. Use this method for router installations outside the United States or Canada.

Skip this section if you have entered a ZIP code for the antenna location.

1. On the Antenna Location screen (Figure 15 on page 36), click the *Enter Location Manually* checkbox.

The Manual Entry of Antenna Location screen appears.

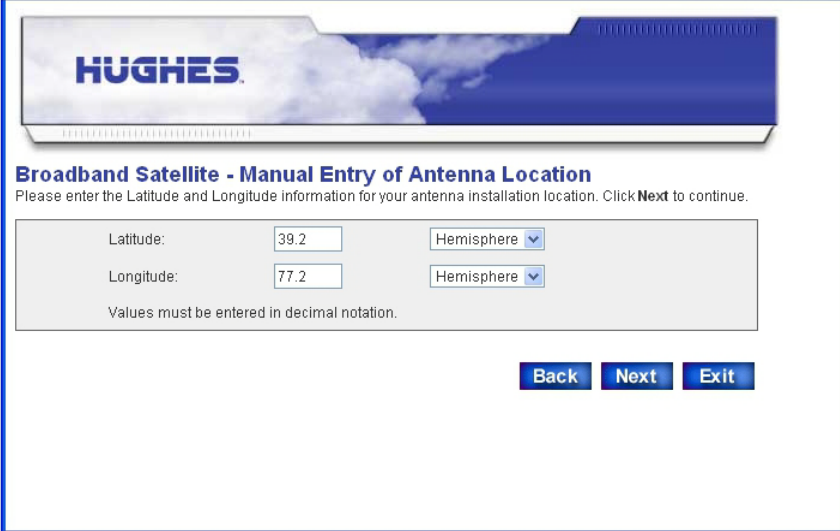

Figure 17: Manual Entry of Antenna Location screen

2. Enter the latitude and longitude for your location.  
Enter latitude and longitude in degrees, to the nearest tenth of a degree.
3. Be sure to select from the drop-down list boxes (Latitude: North or South, Longitude: East or West).
4. Click **Next**.

**Note:** There is no verification screen when you manually enter the antenna location.

## Entering satellite parameters

1. On the Satellite Parameters screen, click the *Satellite Transponders* drop-down list.

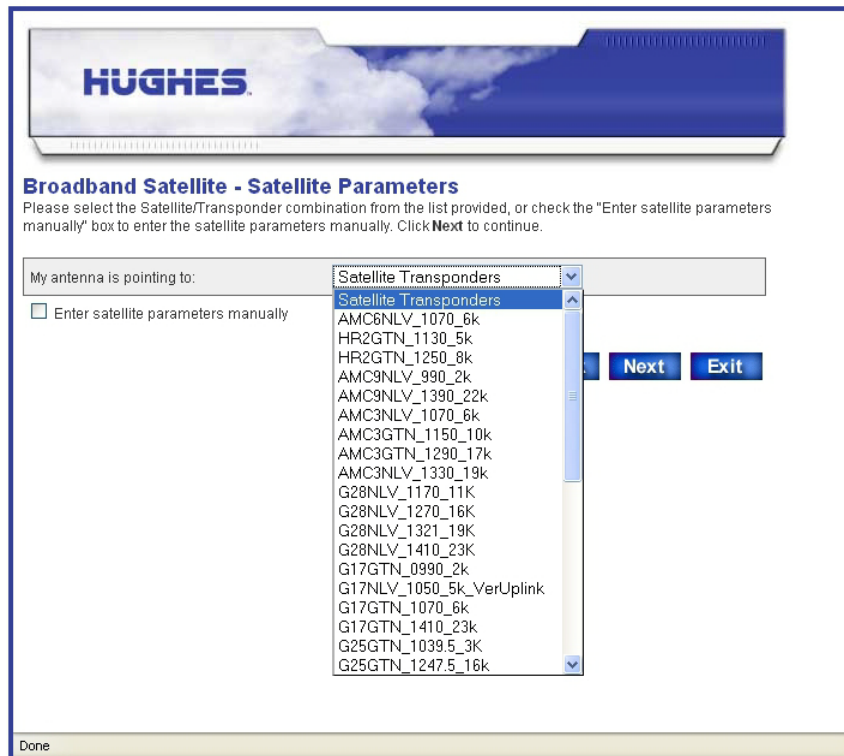

Figure 18: Satellite Parameters screen

- From the list, select the satellite transponder listed on the Installation Reference Sheet or installation specification; then click **Next**.

**Note:** If your satellite transponder is not listed in the drop-down list, you must use the manual entry method. See *Entering the antenna location (manual entry)* on page 37.

**Note:** The list of satellite transponders may be updated at any time, so you may see different transponders than those shown in Figure 18.

The Verification of Satellite Parameters screen appears.

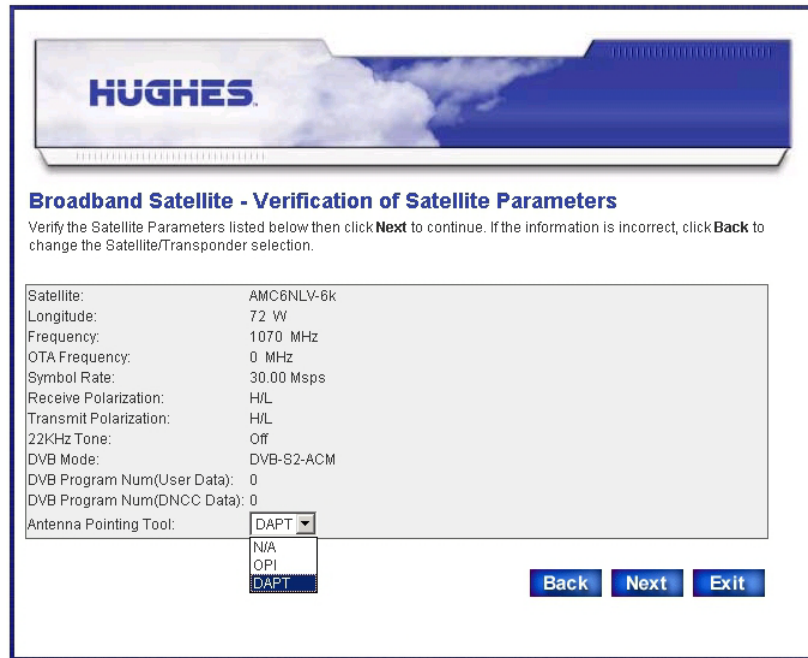

Figure 19: Verifying the satellite parameters screen

3. Verify that the displayed information is correct and click **Next**.  
If the parameters are not correct for the installation, click **Back** to change the satellite transponder selection.
4. If you plan to use an antenna pointing tool, select **DAPT**, **OPI**, or **N/A** (for none) from the *Antenna Pointing Tool* drop-down list.  
For Ka-band select **DAPT**; for Ku-band a **DAPT** or **OPI** may be used.
5. Click **Next**.

### Entering satellite parameters (manual entry)

This is an alternate method for entering the satellite parameters. You must use this method if the satellite and transponder for your installation are not listed in the drop-down list in Figure 18 on page 38 *and* you were not provided with an `sbccfg` file.

***Skip this section if you selected a satellite and transponder on the Satellite Parameters screen.***

The satellite parameters are provided to you in a technical update email or in an installation specification.

To enter the parameters:

1. On the Satellite Parameters screen, select the *Enter satellite parameters manually* checkbox shown in Figure 18 on page 38.

2. Click **Next**.

**HUGHES**

### Broadband Satellite - Satellite Parameters

Please select the Satellite/Transponder combination from the list provided, or check the "Enter satellite parameters manually" box to enter the satellite parameters manually. Click **Next** to continue.

My antenna is pointing to:

Enter satellite parameters manually

**Back** **Next** **Exit**

Done

Figure 20: Satellite Parameters screen

The Manual Entry of Satellite Parameters screen appears.

**HUGHES**

### Broadband Satellite - Manual Entry of Satellite Parameters

Please enter the Satellite Parameters below then click **Next** to continue.

Longitude (Degrees): <input type="text" value="105"/> <input type="text" value="West"/>	22KHz Tone: <input type="text" value="Off"/>
Frequency: <input type="text" value="1245.0"/> MHz	DVB Mode: <input type="text" value="DVB-S2-ACM"/>
OTA Frequency: <input type="text" value="0.0"/> MHz	DVB Program Num(User Data): <input type="text" value="20500"/>
Symbol Rate: <input type="text" value="25.00"/> Msps	DVB Program Num(DNCC Data): <input type="text" value="40000"/>
Receive Polarization: <input type="text" value="H/L"/>	Antenna Pointing Tool: <input type="text" value="DAPT"/>
Transmit Polarization: <input type="text" value="V/R"/>	

**Back** **Next** **Exit**

Figure 21: Manual Entry of Satellite Parameters screen

3. Enter or select the parameters.



4. If you plan to use an antenna pointing tool, select **DAPT**, **OPI**, or **N/A** (for none) from the *Antenna Pointing Tool* drop-down list.  
For Ka-band select **DAPT**; for Ku-band a **DAPT** or **OPI** may be used.
5. Click **Next**.

**Note:** There is no verification screen when you manually enter the satellite parameters.

### Entering radio parameters

1. On the Receive LNB Selection screen, select the installed LNB from the Receive LNB drop-down list (Figure 22 on page 42).  
The list of LNBs you see depends on the how the router is configured, based on its `sbc.cfg` file.  
Select the LNB option that matches the part number or other identifier on the installed LNB. If you cannot find the LNB part number or identifier, refer to the LNB illustrations in LNB selection reference on page 109 for guidance. If you are not sure which LNB option to select, contact Installer Support.

#### **NOTICE**

Make sure you select the correct LNB. If you select the wrong LNB, the satellite router will not work.

---



(On either list, available LNB selections may vary.)

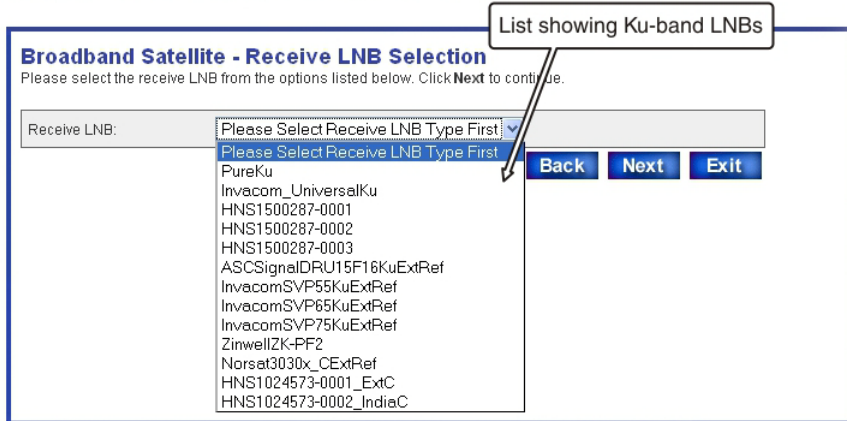

Figure 22: Receive LNB Selection screen—two variations

2. Click **Next**.  
The Verification of Receive LNB Parameters screen appears, showing information for the selected LNB.

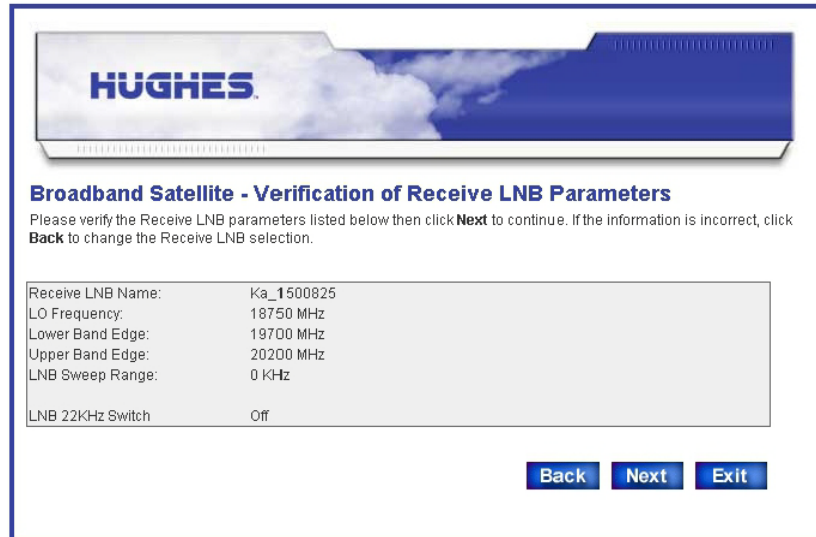

Figure 23: Verification of Receive LNB Parameters screen

3. Verify that the displayed information is correct and click **Next**.  
The Transmit Radio Parameters screen appears.

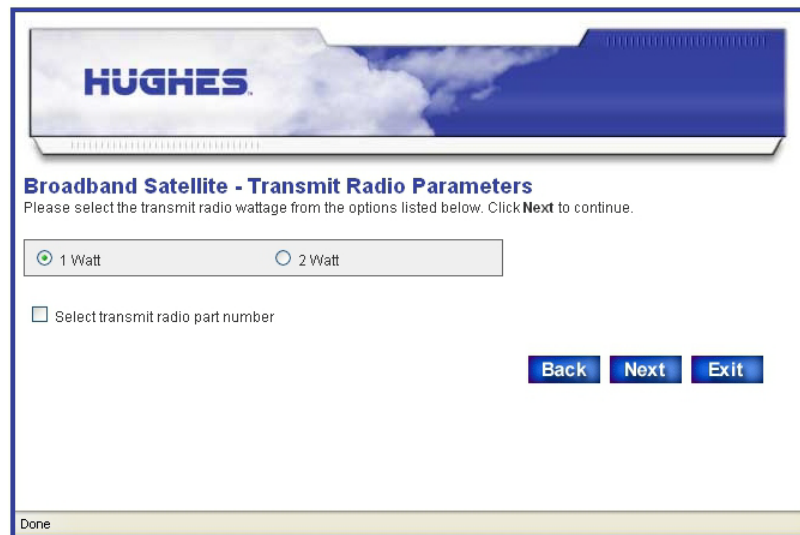

Figure 24: Transmit Radio Parameters screen

4. On the Transmit Radio Parameters screen, use the checkbox to select the radio part number if you know it—otherwise, select the transmit radio type (1 Watt or 2 Watt).

The radio part number should be on the Installation Reference Sheet or installation specification.

If you know the radio part number:

- a. Click the *Select transmit radio part number* checkbox.
- b. Click the drop-down list and select the transmit radio part number.

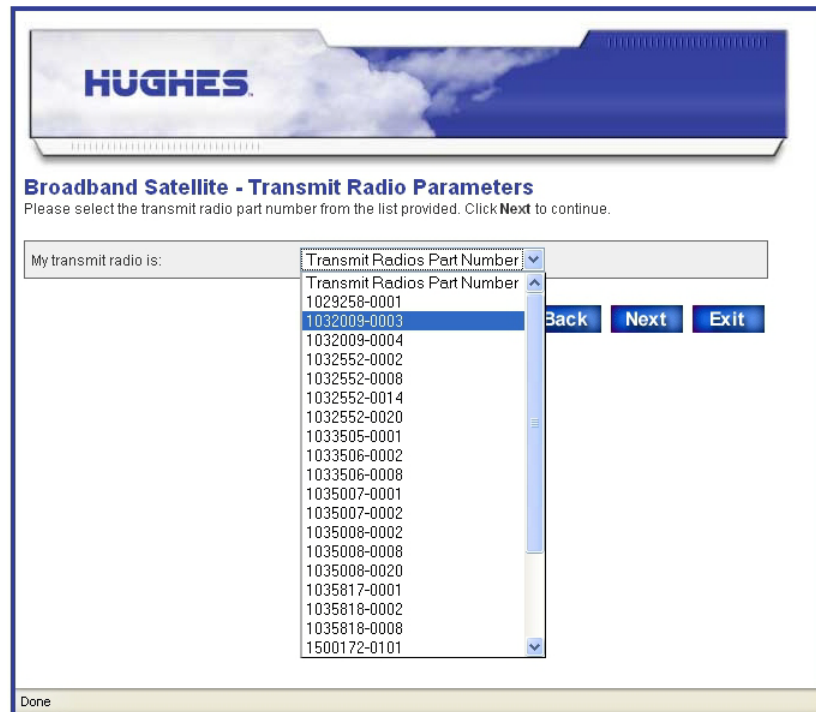

Figure 25: Selecting the transmit radio by part number

5. Click **Next**.  
The Verification of Transmit Radio Parameters screen appears.

**Note:** The verification screen appears only if you selected the transmit radio by its part number.

**Note:** The list of transmit radio part numbers may be updated at any time, so you may see different part numbers than those shown in Figure 25 on page 44.

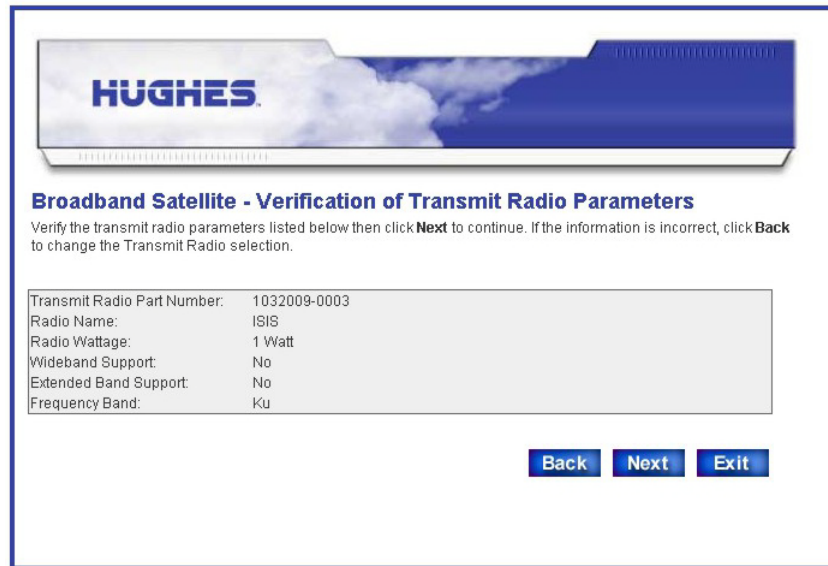

Figure 26: Verification of Transmit Radio Parameters screen

6. Verify that the displayed information is correct and click **Next**.  
The Receive Antenna Pointing screen opens.

### ***Receive antenna pointing — Ka-band***

**Note:** This section applies to Ka-band installations only. For Ku-band, skip this section; go to *Receive antenna pointing — Ku-band* on page 49.

To receive-point the antenna, you go the antenna location and point the antenna at its assigned satellite using a squinter and DAPT (both are pointing tools) and then validate pointing on the installer laptop as explained in this section.

The squinter blocks half the feed horn so you can measure Es/No at two azimuth positions and at two elevation positions. When the antenna is pointed correctly, the two azimuth Es/No values match, and the two elevation Es/No values match.

The DAPT displays SQF and Es/No values in real time and guides you through the pointing validation process. The DAPT values are replicated on the DAPT Antenna Pointing Status window (Figure 28 on page 46), also in real time.

To receive-point the antenna, use the screens illustrated in this section, and you must also follow the procedure for squinter pointing that is documented in the ***Ka-Band Antenna Pointing Guide for Bent-Pipe Satellite Networks*** (1038764-0001).

To receive-point the antenna:

1. On the Receive Antenna Pointing screen, click **Display Signal Strength** (Figure 27) to open the DAPT Antenna Pointing Status window.

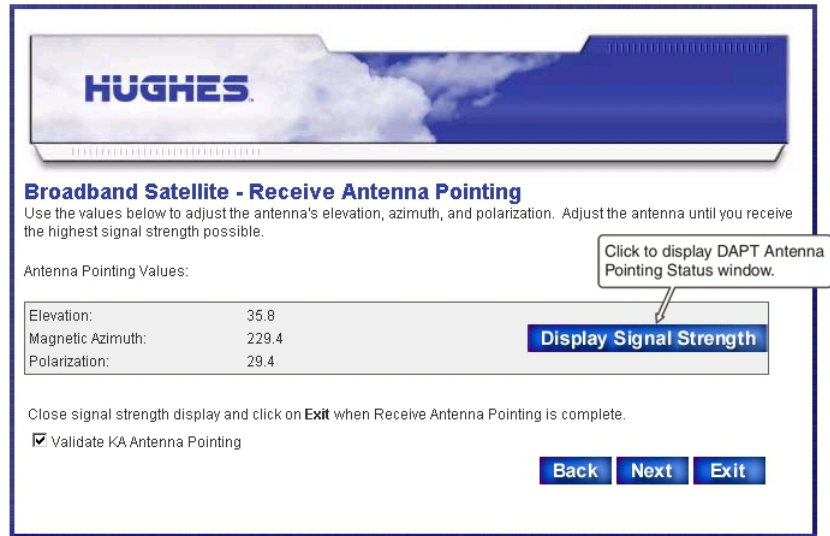

Figure 27: Receive Antenna Pointing screen

Keep the Receive Antenna Pointing screen open until antenna pointing is complete.

The *Validate KA Antenna Pointing* checkbox is checked by default. If you uncheck it (not recommended), pointing will not be validated.

If the radio assembly is Ka-band and the text next to this checkbox reads *Perform ACP*, you probably selected the wrong LNB. In this case go back to the Receive LNB Selection screen and select the correct LNB.

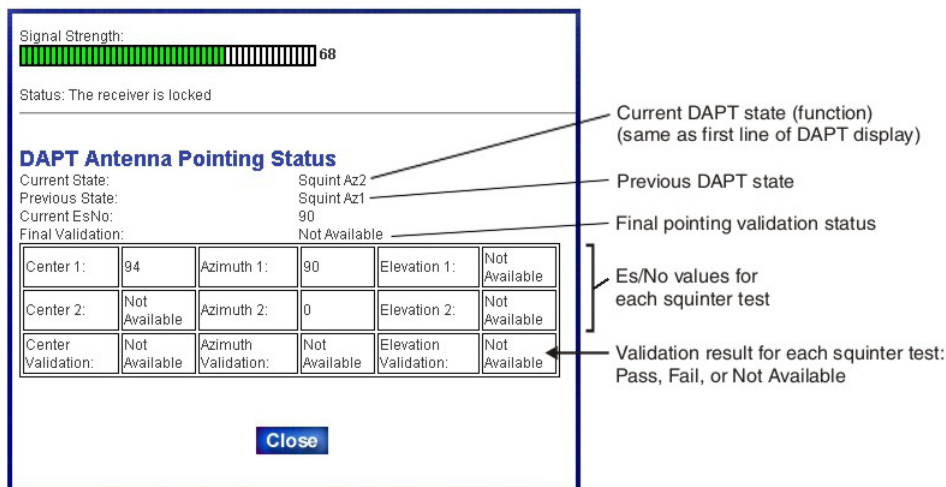

Figure 28: DAPT Antenna Pointing Status window

**Note:** The DAPT Antenna Pointing Status window displays the DAPT test values as each pointing test is completed. If you click **Close** before antenna pointing is done, the values will be lost. Then you would have to click **Display Signal Strength** again on the Receive Antenna Pointing screen to reopen the DAPT Antenna Pointing Status window and begin pointing again.

2. Take the DAPT, squinter, and jumper cable to the antenna location. Refer to the pointing guide for other equipment you may need.
3. Point the antenna as explained in ***Ka-Band Antenna Pointing Guide for Bent-Pipe Satellite Networks*** (1038764-0001).

**Important:** Squinter pointing is a multi-step process. Read and follow the pointing guide carefully. Make pointing adjustments to the antenna as instructed in the antenna installation guide.

To complete squinter pointing, you must obtain a Pass value for:

- Center validation
- Azimuth validation
- Elevation validation

For each validation test you can see the Es/No values and Pass/Fail result on the DAPT Antenna Pointing Status window.

4. Perform the pointing validation steps described in the ***Ka-Band Antenna Pointing Guide for Bent-Pipe Satellite Networks*** (1038764-0001). Pointing is validated when *all four* validation fields show *Pass*, as shown in Figure 30 on page 48.

Validation is also indicated in the DAPT Antenna Pointing Status window, as shown in Figure 29.

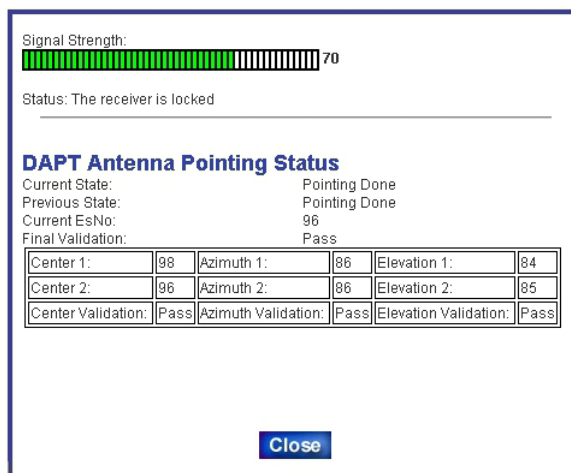

Figure 29: DAPT Antenna Pointing Status window — final validation passed

When antenna pointing (including validation) is complete, the DAPT displays a *Pointing Done* message, and the DAPT status window shows *Current State: Pointing Done*.

5. When pointing is complete, click **Close**.

- Click **Next** on the Receive Antenna Pointing screen.  
The KA Antenna Pointing Validation screen opens, showing a summary of the squinter pointing results.

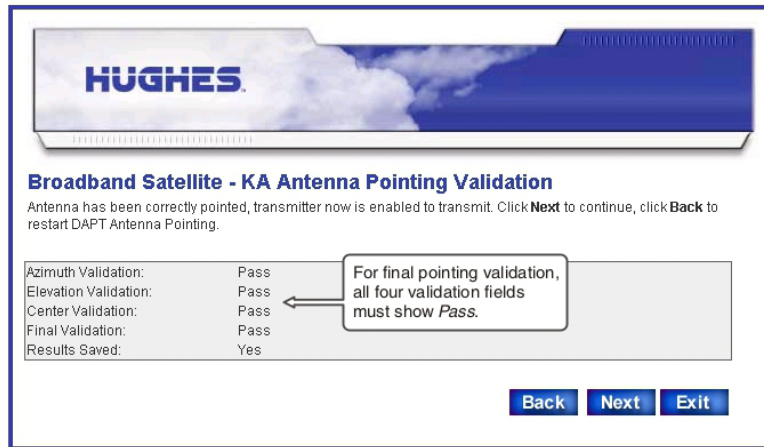

Figure 30: KA Antenna Pointing Validation screen — final validation passed

**Note:** If you open the pointing validation screen before antenna pointing is complete, a message appears (instead of the text shown in the screen illustration above) asking you to wait until pointing is complete. The message advises that if you exit antenna pointing without passing final validation, the **transmitter will be disabled**.

**Note:** The *Results Saved* field indicates whether you saved the pointing values or not when the DAPT prompted *Store Results?* near the end of the squinter pointing process.

- This step depends on the validation test results:
  - If any validation test fails, click **Back** to restart DAPT antenna pointing; then re-test until all tests pass.
  - If you are using satellite-based commissioning and all four validation tests pass, click **Next** to continue.

**Note:** The **Next** button shown in Figure 30 is present only if final validation is successful. If any test failed, only the **Back** and **Exit** buttons are present.

- If you are following the instructions for Ka-band manual commissioning and all four validation tests *pass*, this is the last step; click **Exit**.

When all four validation tests have passed, Ka-band pointing is complete and validated.



## Receive antenna pointing — Ku-band

**Note:** *This section applies to Ku-band installations only.* For Ka-band, skip this section; go to *Registering the satellite router* on page 52.

Follow these steps to receive-point the antenna using the displayed signal strength, as shown in Figure 31. Adjust the antenna to point it as instructed in the antenna installation guide.

1. Click **Display Signal Strength** on the Receive Antenna Pointing screen to open the Signal Quality window.

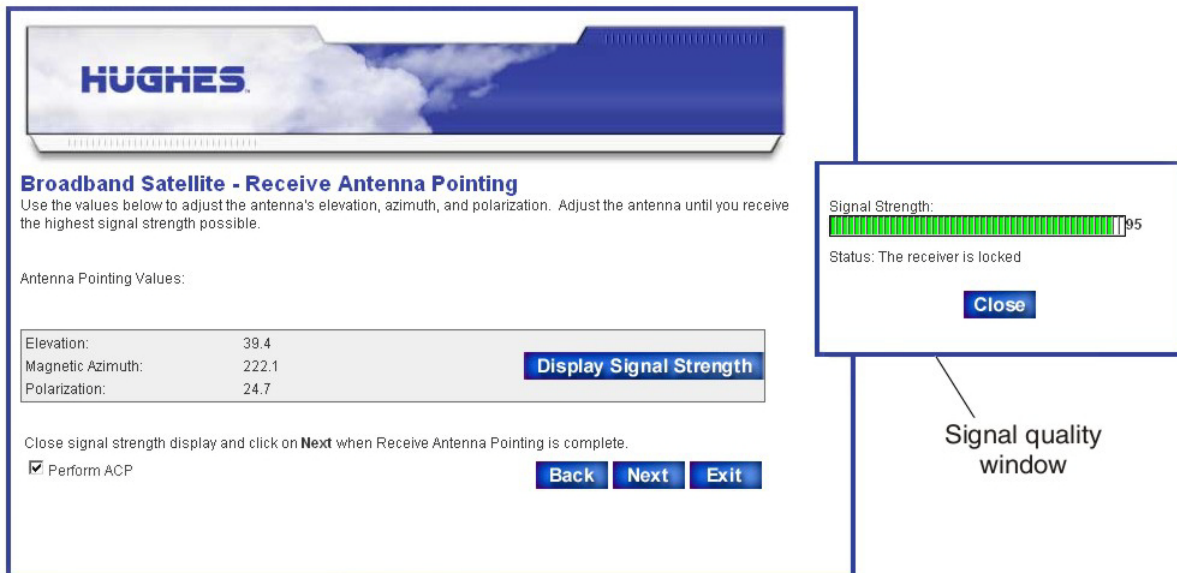

Figure 31: Receive Pointing screen with signal quality window

**Note:** The Signal Quality window is small and may not appear on top. If it is not on top, minimize other windows until you can see it.

If the radio assembly is Ku-band and the text next to this checkbox reads *Validate KA Antenna Pointing*, you probably selected the wrong LNB. In this case go back to the Receive LNB Selection screen and select the correct LNB.

2. Use the Signal Quality indication to peak receive pointing as instructed in the antenna installation guide.

**Note:** You must peak the signal even if the antenna is locked to it. When the signal is locked, a check mark appears in the *Perform ACP* checkbox on the Receive Antenna pointing screen.

3. After you have peaked the signal, click **Close** to close the Signal Quality window.

## Transmit antenna pointing — Ku-band

**Note:** This section applies to Ku-band installations only.

1. On the Receive Antenna Pointing screen, select the *Perform ACP* checkbox if your service provider offers automatic cross-polarization (ACP).

**Note:** The *Perform ACP* checkbox is automatically checked if ACP is enabled at the NOC. If it is not automatically checked, likely reasons are that the NOC does not support ACP, ACP is not enabled at the NOC, or there is a problem with the ACP server.

**Note:** The ACP test is required for Ku-band customers in the United States and Canada; for customers outside the United States and Canada, it is optional.

2. Click **Next**.
3. On the Transmit Antenna Pointing screen, click **Manual** to initiate the manual cross-polarization test.

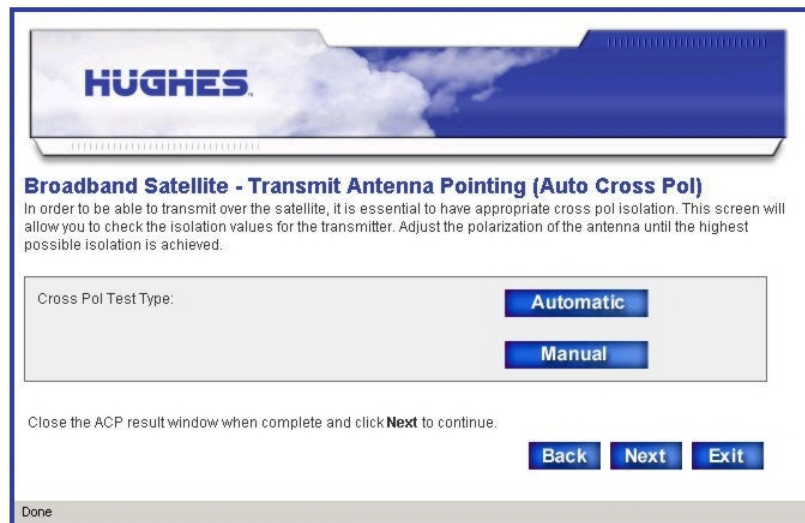

Figure 32: Initiating a manual cross-polarization test

Be ready to adjust the antenna. For antenna adjustment instructions, see the antenna installation guide.

**Note:** The manual cross-polarization test times out 3 to 5 minutes after you click the **Manual** button. Therefore you must complete any antenna adjustments required to achieve maximum transmit isolation within this time.

4. In the Warning dialog that warns that the transmitter is actively powered on during the manual cross-polarization test, click **Continue**.



Figure 33: Manual cross-polarization warning message

The Cross Pol Test window displays the test status, isolation value, and pass/fail result.

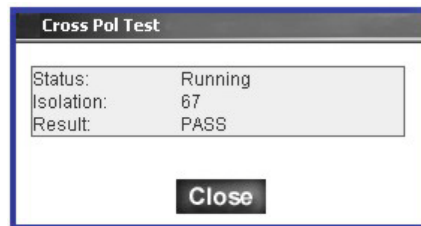

Figure 34: Manual cross-polarization test results

5. Adjust the antenna during the manual cross-polarization test to achieve maximum transmit isolation.
6. Lock down the antenna adjustment when the router consistently passes the manual cross-polarization test.
7. Click **Close** to close the Cross Pol Test window.
8. On the Transmit Antenna Pointing screen, click **Automatic** to initiate the ACP test.
9. If the router fails ACP, re-peak the transmit isolation in manual cross-polarization test mode.
10. If the router passes ACP, click **Close** to close the Cross Pol Test window. *Ku-band pointing is now complete.*
11. What you do now depends on whether you are using satellite-based or manual commissioning:
  - If you are using satellite-based commissioning, click **Next** on the Transmit Antenna Pointing screen to continue.
  - If you are following the instructions for Ku-band manual commissioning, click **Exit**; then go to *Software download-manual commissioning* on page 60.

## Registering the satellite router

To register the satellite router with the service provider's network, you select and access a registration server.

To register the satellite router:

1. Click **Next** on the Transmit Antenna Pointing screen.
2. On the Registration Server Selection screen, select a registration server from the drop-down list.
  - For U.S. and Canadian consumer installations, select *SAN\_and\_PIN\_Registration*.
  - For enterprise installations and installations outside of the United States and Canada, select *SiteID\_Registration*.

If you are unsure which server to select, refer to the Installation Reference Sheet or installation specification.

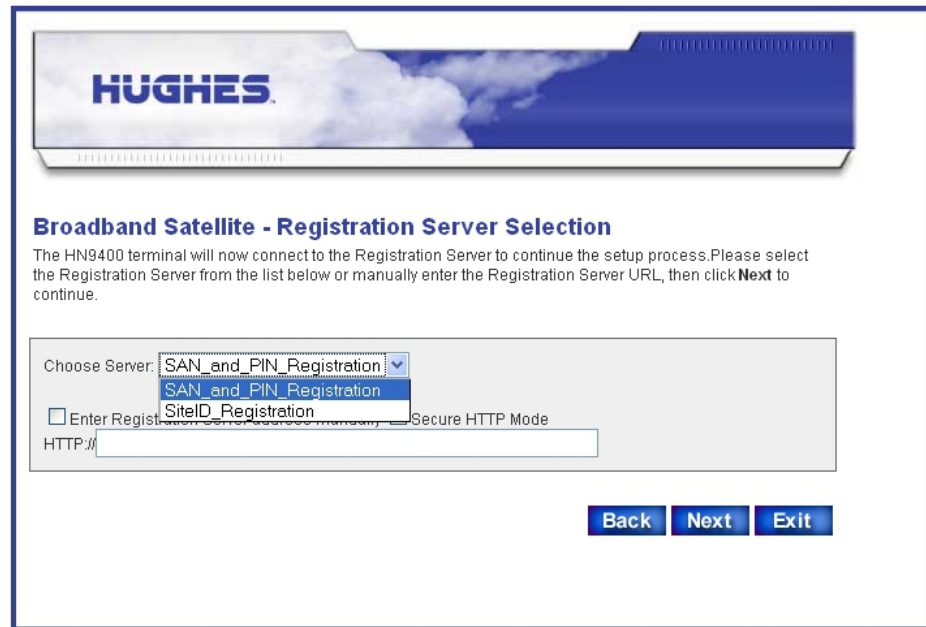

Figure 35: Selecting the registration server

If necessary, you can *manually* enter the registration server's address as follows:

- a. Select the *Enter Registration Server Address Manually* checkbox.
- b. Enter the registration server's address in the HTTP:// field.
- c. Select the *Secure HTTP Mode* checkbox to enable a secure connection to the registration server.

3. Click **Next**.  
The Registration in Progress screen appears, displaying registration status information.

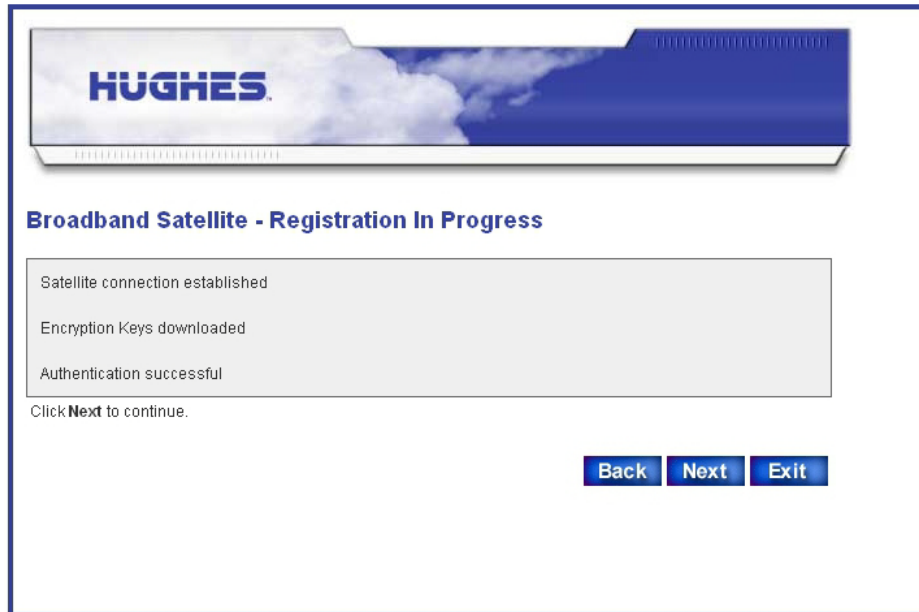

Figure 36: Registration in Progress screen

4. Click **Next** on the Registration in Progress screen when prompted to do so.
5. Click **OK** on the redirect notification message window (shown here) to access the registration server.

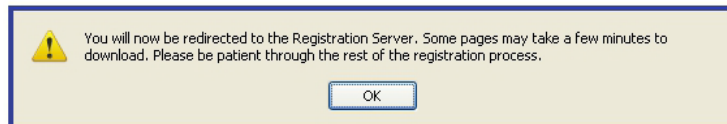

Figure 37: Redirect notification message

6. If you see a *Security Alert* message concerning the site security certificate, click **Yes** to accept the security certificate.

**Note:** As you progress through the registration screens, you may see numerous *Security Alert* screens with messages about Internet site security certificates. Click **Yes** to accept the certificate and continue. You may see several of these security screens in a row.

7. Depending on your country location and type of installation, go to *Registering in the United States or Canada (consumer installations)* on page 54 or *Registering outside the United States and Canada, and enterprise installations* on page 55.

## Registering in the United States or Canada (consumer installations)

*This section applies only to consumer installations in the United States or Canada.*

1. Read the INSTALLER NOTICE! carefully.
2. Ask the customer to scroll down to review and accept the subscriber agreement. If the customer does not accept the agreement, you cannot continue with the installation. Do not click the **Accept** button yourself.

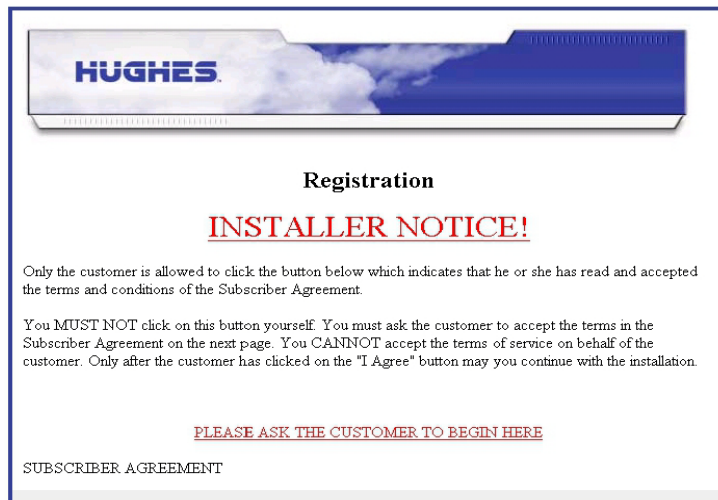

Figure 38: Installer notice and subscriber agreement screen

3. On the registration screen shown in Figure 39 on page 54, ask the customer to enter their site account number (SAN) and PIN; then click **Continue**.

The screenshot shows a web page with the Hughes logo at the top. Below the logo, the word "Registration" is centered. On the left side, there is a "VeriSign Secure Site" logo with a "Click to verify" button. Below the logo, it says "Your information is protected using industry standard SSL technology." In the center, there is a "Site Account Information" section with two input fields: "Site Account Number (SAN):" with the value "TAH10000440" and "PIN:" with the value "1000". Below these fields is a "Continue" button. At the bottom of the page, it says "Please wait ...".

Figure 39: Entering SAN and PIN

4. Follow the steps in *Completing registration* on page 55.

## Registering outside the United States and Canada, and enterprise installations

*This section applies only to enterprise installations and all installations outside the United States and Canada.*

1. Enter the customer's site ID on the registration screen (Figure 40) and click **Continue**.

Site Account Information	
Site Account Number (SAN):	TAH10000440
PIN:	1000

Figure 40: Entering a site ID

2. Follow the steps in *Completing registration* on page 55.

### Completing registration

*These instructions apply to all router installations.*

Follow these instructions to complete router registration:

1. On the Registration Welcome screen, click **Continue**.

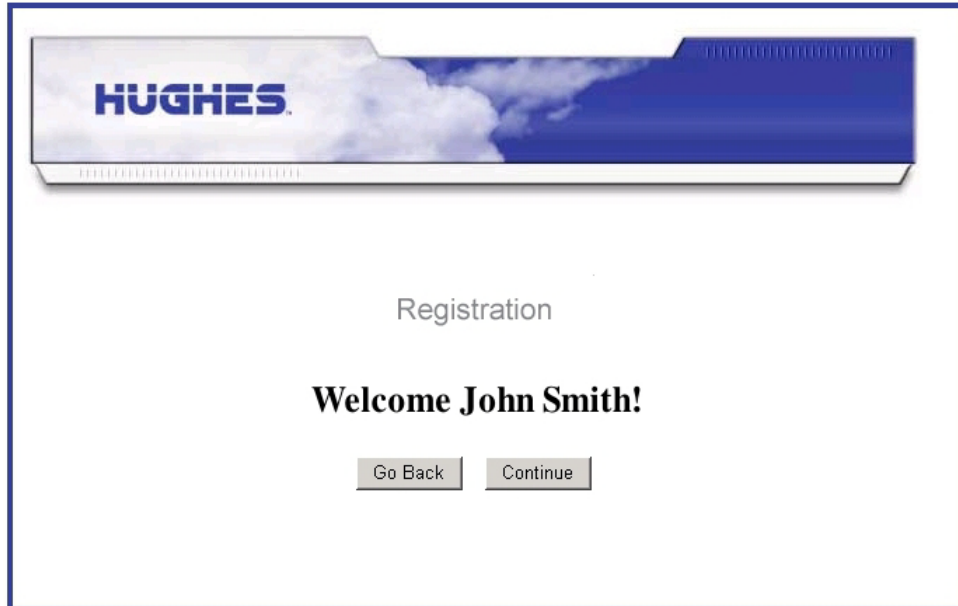

Figure 41: Registration Welcome screen

The Registration screen appears.



Figure 42: Registration screen with router identification information



This screen shows the Site ID, the router's IP address (Terminal IP Address), and the router's subnet mask (Terminal Subnet Mask).

2. If a printer is available, click **Print this Page** to print the Registration screen.
3. Give the printout to the customer.  
The customer will need this information if they ever need to contact their service provider for assistance. If no printer is available, advise the customer to record this information and make sure they know where it is recorded. Make sure the customer knows where this information is recorded.
4. Click **Continue** to download configuration parameters to the router.  
A second Registration in Progress screen appears briefly (not shown here) while the configuration parameters are downloaded. Then the Registration Complete screen appears.
5. Click **Restart** on the Registration Complete screen.

This restarts the satellite router.

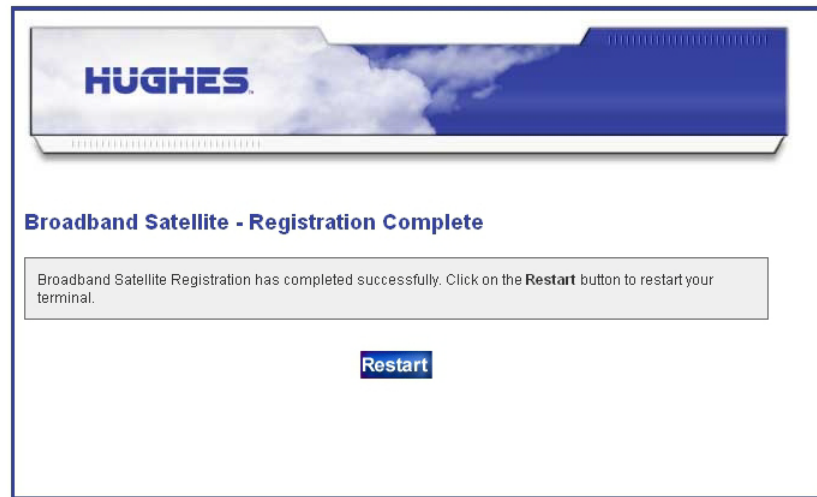

Figure 43: Registration complete – restarting the router

The Terminal Reset screen appears. (It is not shown here.)

6. Click **Close** on the Terminal Reset screen.

The router is now commissioned.

## Manual commissioning

If satellite-based commissioning is not available, you must commission the router manually. However, do not use the manual commissioning method unless you are instructed to do so by the service provider.

Manual commissioning requires coordination between you and the Network Operations Center (NOC). A technician enters parameters at the NOC, and you enter the same parameters at the installation site. The NOC also downloads encryption

keys and certain parameters to the router. Manual commissioning process consists of:

- Entering manual commissioning parameters
- Antenna pointing

For both tasks you use the satellite router's web-based interface.

**Note:** The satellite router's serial number must be loaded at the NOC by a NOC representative to complete the manual commissioning process.

### *Entering parameters—manual commissioning*

Follow these steps to enter the manual commissioning parameters:

1. Open a web browser on the installer laptop.
2. Type **http://192.168.0.1/fs/registration/setup.html** in the browser address bar and press **Enter**.

The Satellite Setup menu appears.

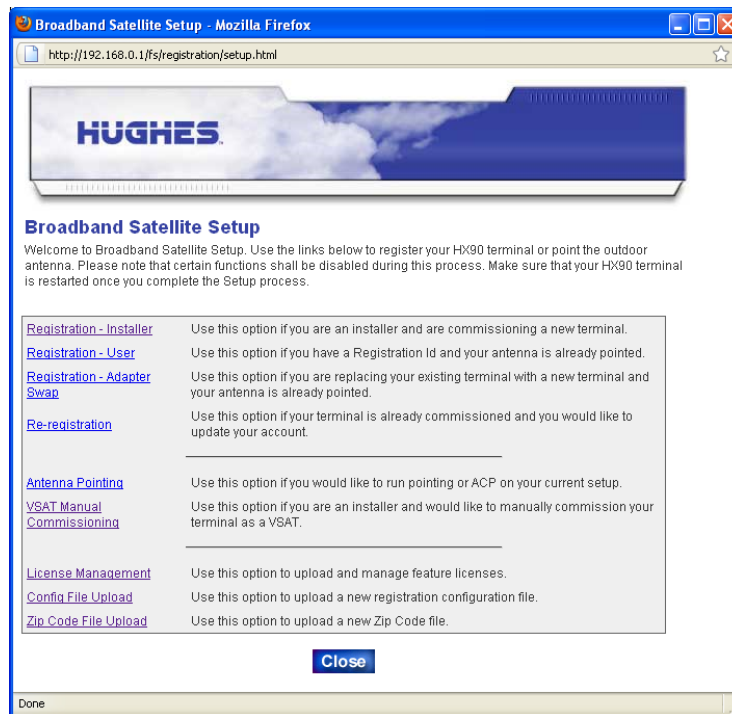

Figure 44: Satellite Setup menu

3. Click **VSAT Manual Commissioning** to access the Manual Commissioning page.

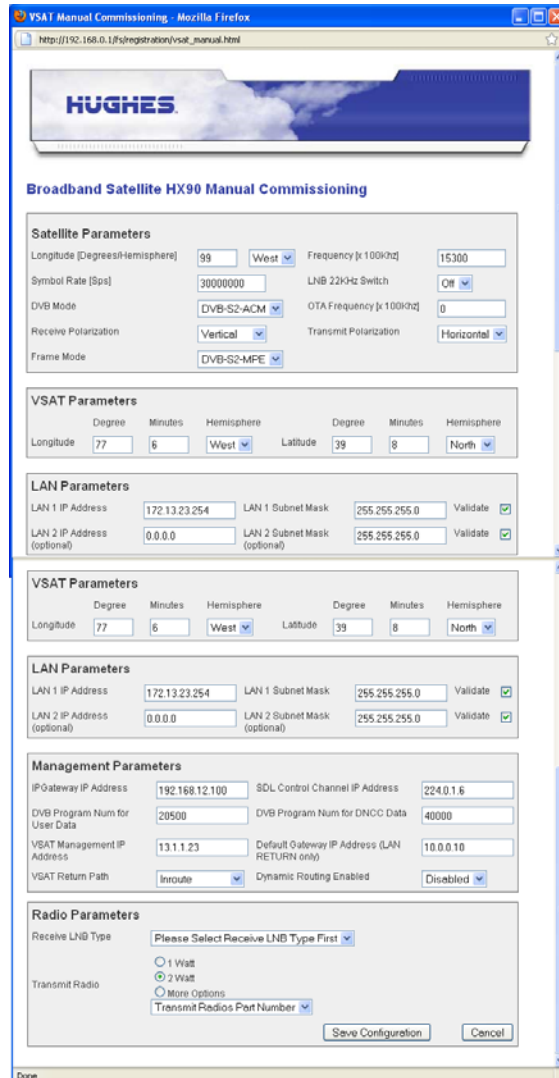

Figure 45: Manual Commissioning page

4. Enter or select parameters on the Manual Commissioning page. The parameters may be provided to you in the Installation Reference Sheet, installation specification, or in another form of communication from your installation point-of-contact.
5. When you are finished, click **Save Configuration**. The router saves the parameters and reboots.

## Manually accessing the antenna pointing screens

To manually access the antenna pointing screens.

1. Open a web browser on the installer laptop.
2. Type **http://192.168.0.1/fs/registration/setup.html** in the browser address bar and press **Enter**. The Satellite Setup menu opens (Figure 44 on page 58).
3. Click **Antenna Pointing**. The Antenna Pointing screen appears as shown in Figure 46 on page 60.
4. Select the antenna pointing tool you will use—DAPT, OPI, or N/A (none).
5. Click **Next**.

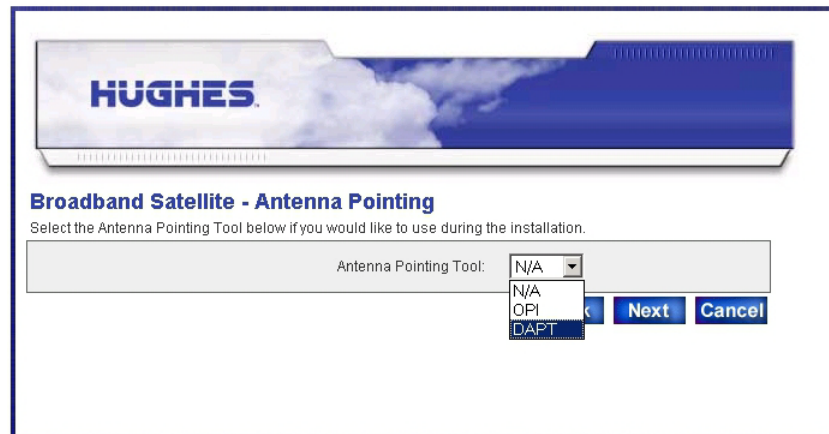

Figure 46: Antenna pointing screen

6. To continue manual commissioning, follow the steps in:
  - *Receive antenna pointing — Ka-band* on page 45
  - *Receive antenna pointing — Ku-band* on page 49
  - *Transmit antenna pointing — Ku-band* on page 50

### ***Software download-manual commissioning***

Prerequisite: Antenna pointing must be completed and validated.

1. Wait for the router's operational software to download.  
This may take about 15 minutes.
2. To confirm that the download is complete, follow the steps in *Confirming that the satellite router's files are up to date* on page 61.

The router is now commissioned.

# Completing the installation

This chapter describes the tasks you perform after commissioning to complete the satellite router installation.

## Confirming that the satellite router's files are up to date

Use the System Control Center to confirm that the satellite router is operating with the most current version of software.

1. Open a web browser such as Internet Explorer.
2. In the browser's address bar, type **www.systemcontrolcenter.com** or **192.168.0.1**.
3. Press **Enter**.  
The System Control Center home page appears in the browser window.
4. Click the **System Status** link.  
The System Status page appears.

HughesNet

System Status OK Reception Info Transmission Info System Info

What do these controls mean?

Home  
Problem Troubleshooting  
Detailed Problem Statistics  
Connectivity Test  
Help

**SYSTEM STATUS**

Signal Strength	85
<i>Note: Signal Strength is not an indicator of browsing speed. Precipitation can affect Signal Strength. If you do not see a red flag next to any of the status messages on this page, you should be able to browse the Internet successfully.</i>	
Receive Status	Receiver operational. (RxCode 5)
Transmit Status	Transmitter ready. (TxCode 8)
Software Download Status	All files are up-to-date.
Service Status	Commissioned [Keys updated]
TCP Acceleration Status	Operational
Web Acceleration Status	Operational; Upstream Addr: 66.82.9.81
Diagnostics Code	0000-0000-0000-0005(Hourly) 0000-0000-0000-0005(Recent)
Fair Access Policy Threshold Exceeded	NO

Figure 47: System Status page

5. Check the Software Download Status.  
If it reads `All files are up-to-date`, the router has been commissioned.
6. Wait 15 minutes after completing registration for all files to be downloaded from the NOC to the router.
7. If `All files are up-to-date` does not appear after 15 minutes, restart the router:
  - a. Go to the System Control Center home page.
  - b. In the Help section, click **Restart HX90**.
8. If you do not see the `All files are up-to-date` message, power cycle the satellite router:
  - a. Unplug the power cord from the power source.
  - b. *If the router is connected to a DC power source*, unplug the DC input cable from the router's power supply.
  - c. Wait 5 sec.
  - d. Plug the power cord back into the power source.
  - e. *If the power source is DC*, plug the input cable back into the power supply.



Do not power cycle the satellite router by unplugging the power cord from the router's rear panel. Doing so could result in static electricity discharge that could shock you and/or damage the router.

---

## Connecting the satellite router to the customer's computer

Use an Ethernet cable to connect the router to the customer's computer as shown in Figure 48. You can connect to either of the two LAN ports on the rear panel of the satellite router. Verify that the customer can browse the Internet.

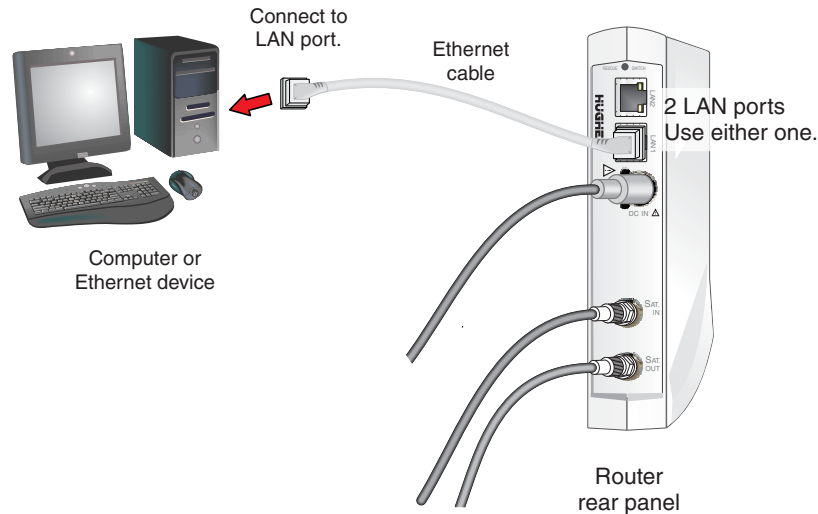

Figure 48: Connecting the HX90 to the customer's computer

You (the installer) are required to stay at the installation site until the customer can connect to the Internet so you can offer assistance if necessary.

After you have installed and registered the satellite router, verify that the customer can browse the Internet. If the customer cannot browse the Internet:

1. Configure the installer laptop so its network properties match those of the customer's computer.
2. Connect the installer laptop to the satellite router with an Ethernet cable.
3. Open a web browser on the installer laptop.
4. Try to access the router's System Control Center by typing in the browser's address bar:  
**www.systemcontrolcenter.com** or **192.168.0.1**.
5. Press **Enter**.
6. If the router is functioning, the System Control Center appears.
7. Type **www.hughes.com** or some other known site in the browser address bar and press **Enter**.  
If the site appears, the router is functioning. The customer should refer to the contact information (click **Contact Information**) on the System Control Center Help page for technical assistance.

## Printing the System Information page

*This section applies to consumer installations only.*

Help the customer print a copy of the System Control Center's System Information page, which contains important information about the status of the satellite router. Explain to the user that they will need the information on this page if they ever need technical assistance at a time when they cannot access the System Information page.

1. Show the customer how to open the System Control Center home page.  
If you need instructions, see *Accessing the System Control Center* on page 67.
2. Tell the customer to click the [System Info](#) link to open the System Information Page.
3. Tell the customer to click the [Print this page](#) link near the center of the screen.

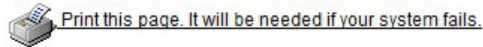

The page should print. Tell the customer to keep it in a safe place.

**Note:** If for any reason you cannot print the page, you can capture the screen image by pressing **Alt+PrintScreen**. Paste the captured image into a word processing document or image editor program and then save the image in a file.

## Creating a shortcut to the System Control Center

*Consumer installations only:* Create a shortcut to the System Control Center home page on the customer's Windows desktop.

1. Open the System Control Center home page in a web browser.

**Note:** The method described here works for Internet Explorer. For other browsers see the browser's instructions for creating a shortcut to a URL.

2. Drag the icon that appears in front of the address displayed in the browser to the computer desktop.

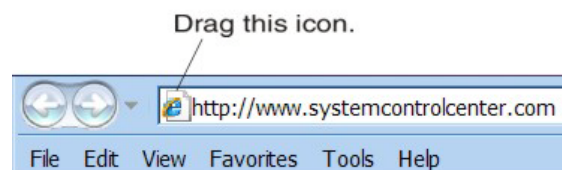

Figure 49: Icon used to create shortcut

## Installation complete

If you have successfully followed all previous instructions, at this point the satellite router is installed, commissioned, and activated. **The remaining information in this installation guide is provided for reference or troubleshooting purposes. You may or may not need it.**



Once the satellite router installation is complete, the customer can connect an Ethernet hub, router, or switch to the HX90 router to support multiple computers on a LAN, using the address information shown in on the System Information page (Figure 64 on page 82).



# System control center

---

The System Control Center is a set of screens and links you can use to monitor your broadband service and troubleshoot the satellite router in the event of a problem. The System Control Center provides access to system status, configuration information, and online documentation through a web browser on a computer connected to the satellite router. Use the System Control Center to find system information for configuring networks or to check system performance if the satellite router does not seem to be functioning properly.

## Accessing the System Control Center

**Prerequisites:** To access the System Control Center, a computer with a web browser installed must be connected to one of the satellite router's LAN ports. (Because the System Control Center web site is hosted on the router, the computer does not have to be connected to the Internet.)

To open the System Control Center, double-click the System Control Center shortcut on your computer desktop, or follow these steps:

1. Open a web browser such as Internet Explorer.
2. In the browser address bar, type **www.systemcontrolcenter.com** or **192.168.0.1** and press **Enter**.

**Note:** To use 192.168.0.1, DHCP must be enabled on the computer.

The System Control Center home page appears as shown in Figure 50 on page 68.

If you are unable to access the System Control Center, refer to *Cannot access the System Control Center* on page 100.

## System Control Center home page

The System Control Center home page contains numerous links to satellite router features and important information regarding operation of the satellite router.

The button links at the top of the page appear on all System Control Center screens and are explained in *Button links* on page 70.

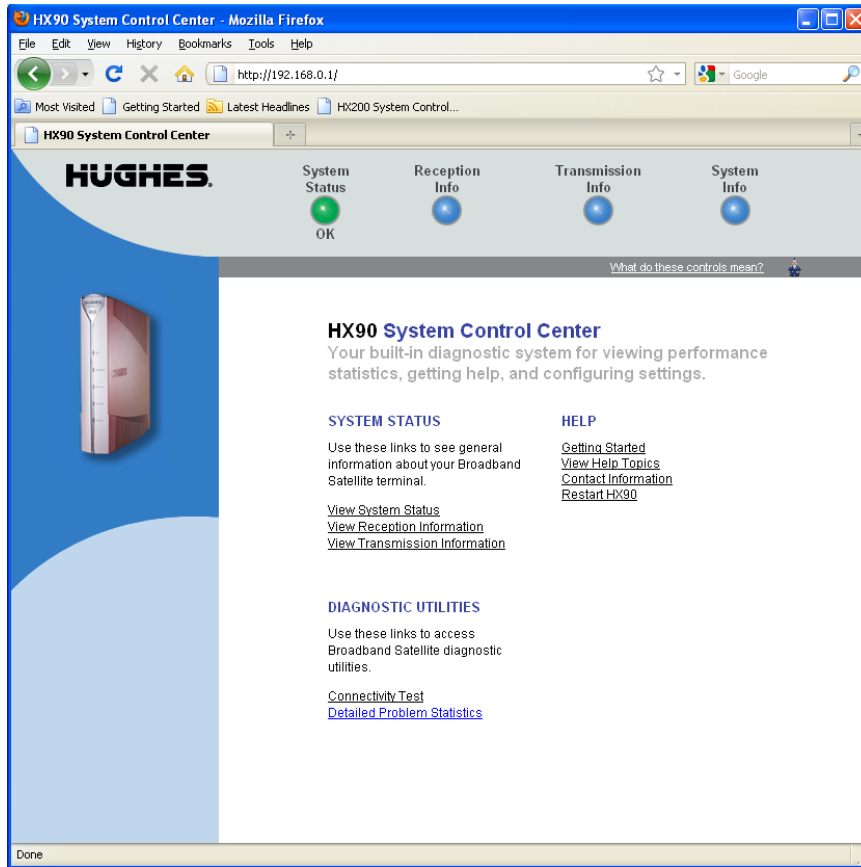

Figure 50: System Control Center home page

## Text links

The System Control Center home page includes the following text links:

### System Status links

- [View System Status](#) — Opens the System Status page, which displays general system status information such as signal strength and administrative status.
- [View Reception Information](#) — Opens the Reception Information page, which displays information on data received by the satellite router.
- [View Transmission Information](#) — Opens the Transmission Information page, which displays information on data transmitted by the satellite router.

**Note:** These links take you to the same destinations as the button links at the top of each System Control Center page.

## Diagnostic utilities links

[Connectivity Test](#) – Opens the Connectivity Test page, which you can use to test the connection between the satellite router and the NOC. See Confirming NOC connectivity on page 93.

[Detailed Problem Statistics](#) – Opens a screen you can use to view statistics concerning router operation.

## Help links

[Getting Started](#) – Through this link you can find general operating instructions for the HX90 router, recommended settings for your browser and TCP/IP, answers to frequently asked questions, and troubleshooting information.

[View Help Topics](#) – Opens the Help page, which includes a variety of topics such as recommended browser and TCP/IP settings.

[Contact information](#) – Opens to a page that provides contact information for assistance and additional information.

[Restart HX90](#) – Restarts the satellite router.

## myHughesNet

**Note:** [myHughesNet](#) links may or may not be present on the satellite router depending on the country where the router is used and the customer's service plan.

[Go to myHughesNet](#) provides access to the HughesNet Web Portal, which contains a variety of useful tools, resources, and information. Access to the HughesNet portal is determined by the service plan purchased by the customer.

## Common features on System Control Center screens

Certain features are common to some or all of the System Control Center screens, as shown in Figure 51. These features are explained in the following sections.

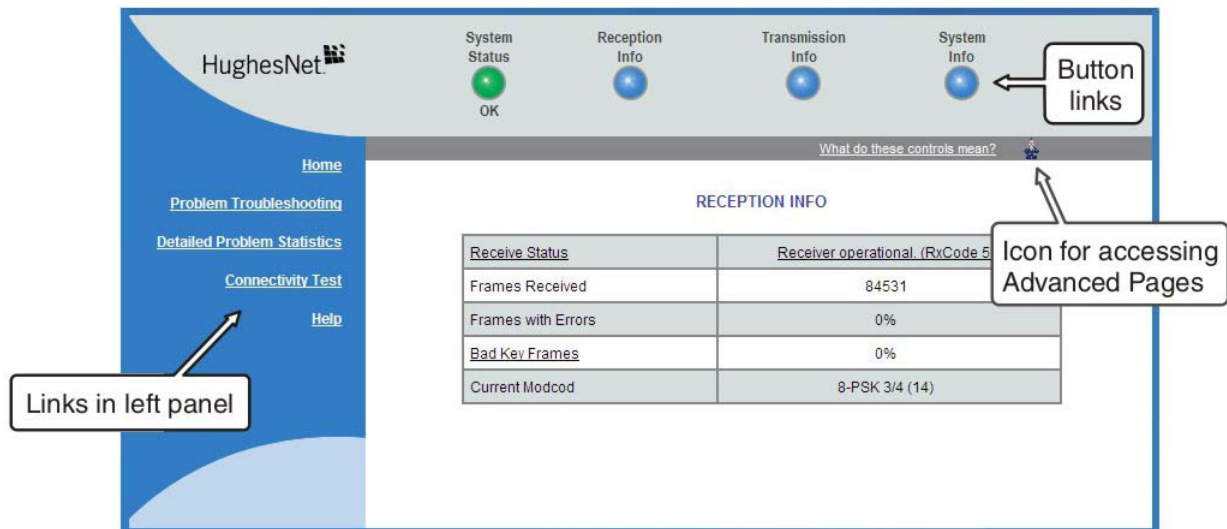

Figure 51: Common features on System Control Center screens

### ***Button links***

At the top of each System Control Center page are four round buttons with labels above them as shown in Figure 52 on page 71. Each button is a link to the System Control Center page identified by the label—for example, the **System Status** button is a link to the System Status page. Click the button to go to the page identified by the

label. The System Status button link is also a status indicator, as explained in Table 5 on page 72. The other three button links are links only; they are not indicators.

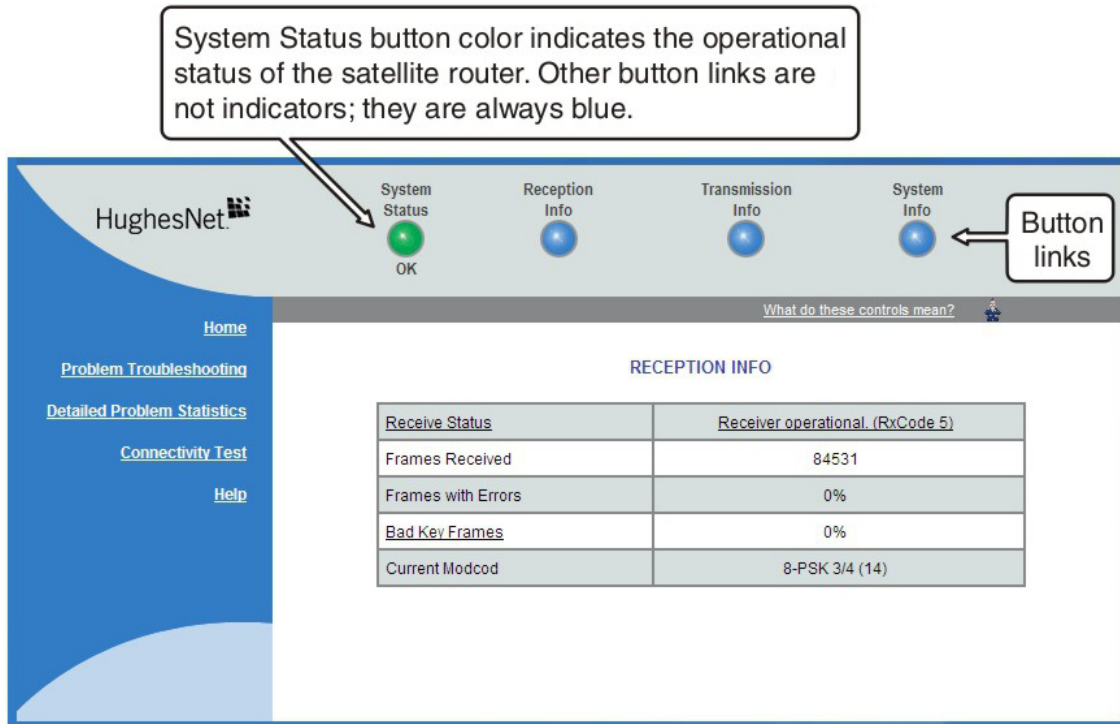

Figure 52: System Control Center button links

The destination page for each button link is identified below:

**Table 4: Button links on System Control Center screens**





Button	Destination	Description of destination page
System Status	System Status page	Displays general status information such as signal strength and commissioning status. For more information see <i>System Status page</i> on page 75.
Reception Info	Reception Information page	Displays statistics about received data. For more information see <i>Reception Information page</i> on page 77.
Transmission Info	Transmission Information page	Displays statistics about transmitted data. For more information see <i>Transmission Information page</i> on page 79.
System Info	System Information page	Displays system information such as the satellite router's serial number and software version. For more information see <i>System Information page</i> on page 82.



### System Status button

The System Status button (only) is a status indicator as well as a link. It changes color to indicate the satellite router's current status, as explained in Table 5 on page 72. To

see more detailed status information, click the *System Status* button to open the System Status page.

**Table 5: System Status button colors**

Button color	Meaning
 Green	The satellite router is operating normally. (OK appears beneath the System Status button.)
 Red	A problem has been detected.
 Yellow	Performance is temporarily impaired because: <ul style="list-style-type: none"> <li>• There may be a problem with Web Acceleration.</li> <li>• The router may be temporarily using a backup configuration.</li> <li>• There may be virus activity.</li> </ul>
 Orange	Degraded — The router is fully operational, but performance is temporarily impaired because: <ul style="list-style-type: none"> <li>• The daily download allowance has been exceeded. This allowance does not apply if the subscriber's service plan has no download limit.</li> <li>• Not all IPSec sessions are functioning. As a result, data will not flow between some destinations.</li> </ul>

If the System Status button is red  or yellow , look for a red flag next to any value or values on the System Control Center information pages (those with tables listing parameters and values). The red flag indicates a problem related to the parameter listed next to the flagged value. If the parameter name is underlined, click the parameter name to see a message that may include helpful information, depending on what the problem is.

### *IPSec icon*

An icon that looks like a small lock next to the System Status button means IPSec is enabled. This icon is shown in Figure 53.

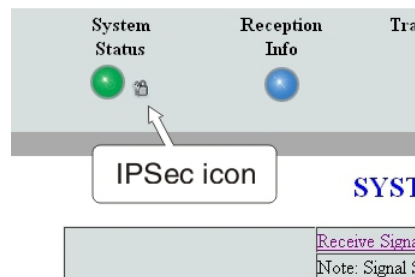

Figure 53: IPSec icon



IPSec (Internet Protocol Security) is a set of network protocols and services that provide security to IP networks by authenticating and encrypting each IP packet of a data stream. IPSec-protected packets travel through a virtual tunnel or path between two points. An IPSec tunnel is *up* when it has been established between two peers and is capable of carrying traffic. If it cannot carry traffic it is *down*.

When IPSec is enabled (IPSec icon present), the router attempts to establish all configured tunnels. The status of all configured tunnels at any given time (if IPSec is enabled) is one of the following:

- All tunnels are established (green System Status button).
- Some tunnels are established (orange System Status button).
- No tunnels are established (red System Status button).

### ***Links in the left panel***

The following links appear in the left panel of each System Control Center page (except the home page):

**Note:** Some of these links may not appear because they are not enabled by the NOC.

- [Home](#) — Opens the System Control Center home page.
- [Detailed Problem Statistics](#) — Opens a screen you can use to view statistics concerning router operation. See *Viewing problem-related statistics* on page 108.
- [Connectivity Test](#) — Opens the Connectivity Test page, which allows you to test the connection between the router and the satellite. See *Confirming NOC connectivity* on page 97.
- [Help](#) — Opens the Help page. Refer to the Help page, which includes a variety of topics such as getting started and recommended browser settings.

### ***Small icon on System Control Center screens (Advanced Pages)***

The icon indicated by the arrow in the following illustration opens the Advanced Pages. This icon appears on all System Control Center pages. For more information on the Advanced Pages, see Chapter 9 – *Advanced Pages* on page 111.

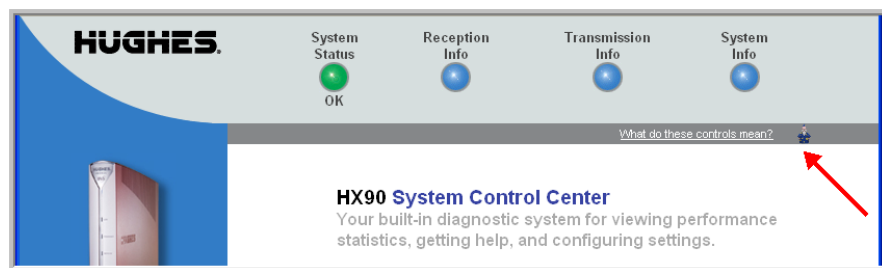

Figure 54: Icon for accessing the Advanced Pages

## Status and information screens

Several of the System Control Center screens list status and operational parameters and their current values in a tabular format. For example, the following illustration shows the Reception Information page. The left column lists the parameters, and the right column shows the current value of the parameter listed in the left column. Parameters are listed in this format on these screens:

- System Status page
- Reception Information page
- Transmission Information page

On any of these screens, if a parameter name or the current value of a parameter is underlined, you can click the name or value to see an explanation of it.

Parameters	Current value
<u>Receive Status</u>	<u>Receiver operational. (RxCode 5)</u>
Frames Received	84531
Frames with Errors	0%
<u>Bad Key Frames</u>	0%
Current Modcod	8-PSK 3/4 (14)

Figure 55: Format of status and information screens

The parameters listed on each screen are explained in this guide in the section for each screen:



- *System Status page* on page 75
- *Reception Information page* on page 77
- *Transmission Information page* on page 79
- *System Information page* on page 82

### Red flag indicator

On the status and information screens, a red flag next to a value indicates a problem related to the parameter listed in the same row where the flagged value appears. The

flagged value appears in the right column; the parameter appears in the left column. The value indicates the current state of the parameter.

**SYSTEM STATUS**

Signal Strength	21 
<i>Note: Signal Strength is not an indicator of browsing speed. Precipitation can affect Signal Strength. If you do not see a red flag next to any of the status messages on this page, you should be able to browse the Internet successfully.</i>	
<a href="#">Receive Status</a>	<a href="#">Receiver not locked to a signal. Receive cable fault suspected. (RxCode 6)</a> 
<a href="#">Transmit Status</a>	<a href="#">Transmitter unavailable due to receive signal problems. (TxCode 6)</a> 
<a href="#">Software Download Status</a>	Waiting for first h
Service Status	Commissioned [Keys updated]
TCP Acceleration Status	Disabled
Web Acceleration Status	Inactive

Click the flagged parameter value to see more information.

Figure 56: Red flag problem indicator

If you see a red flag, you can click the underlined parameter value in the right column to see additional information about the problem.

## Features a customer may not see

A customer may see descriptions of certain features in the satellite router user guide that do not appear on their System Control Center screens. This is because some features may be enabled or disabled by the NOC depending on the customer's service plan or customer-specific requirements. If a feature is not enabled the screen or screens for that feature or links to it do not appear. Features that may be enabled or disabled by the NOC are:

- Web Acceleration
- Problem Troubleshooting
- Detailed Problem Statistics
- Port Forwarding
- Download Allowance Status
- Browsing Optimization Utility

## System Status page

The System Status page displays important information about the satellite router's operational status.

Available system status values may vary, depending on how the satellite router is configured. Therefore, some options shown in Figure 57 may not appear on your System Status screen.

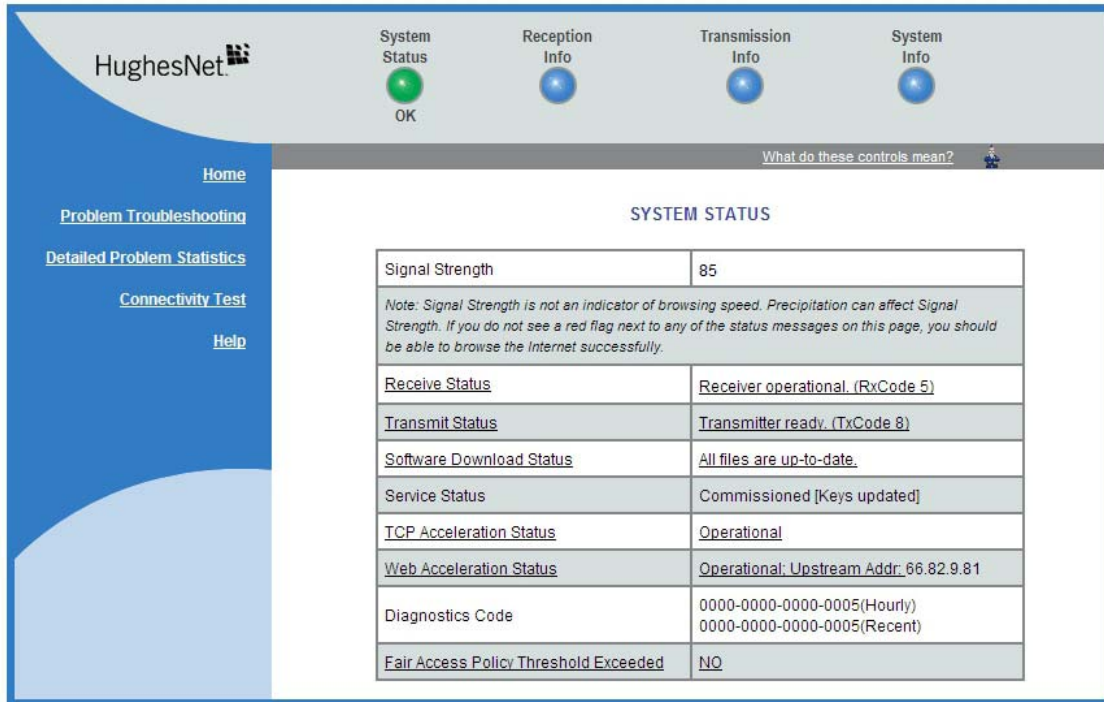

Figure 57: System Status page

The parameters listed on the System Status page are explained in the following table.

**Table 6: System Status page parameters**

Parameter	Explanation
Signal Strength	Receive signal strength. A value of 30 or less indicates a weak signal.
Receive Status	Indicates if the receive data path is operational or other status. Click the displayed RxCode for explanation of the displayed code.
Transmit Status	Indicates if the transmit data path is operational or other status. Click the displayed TxCode for corresponding Help information.
Software Download Status	Indicates if the satellite router’s software and configuration are up to date.
Service Status	Indicates if the router has been commissioned (registered with the system). You can determine if the router has ever been de-commissioned by clicking the <a href="#">Service History link</a> .

**Table 6: System Status page parameters (Continued)**

Parameter	Explanation
TCP Acceleration Status	Indicates if TCP Acceleration is operational or other status. TCP acceleration improves the router's performance.
Web Acceleration Status	Indicates if Web Acceleration is operational or other status. Web acceleration improves web browsing performance. This field is present only if the NOC operator has enabled Web Acceleration on the satellite router.
Diagnostics Code	If you need technical assistance, this code may be useful to Installer Support.
Fair Access Policy Threshold Exceeded	Indicates if a subscriber has exceeded the limit for downloads established by the subscriber's service plan. Subscribers who exceed the download limit temporarily experience reduced download speeds.

## Reception Information page

The Reception Information page shown in Figure 58 displays information about data received by the satellite router.

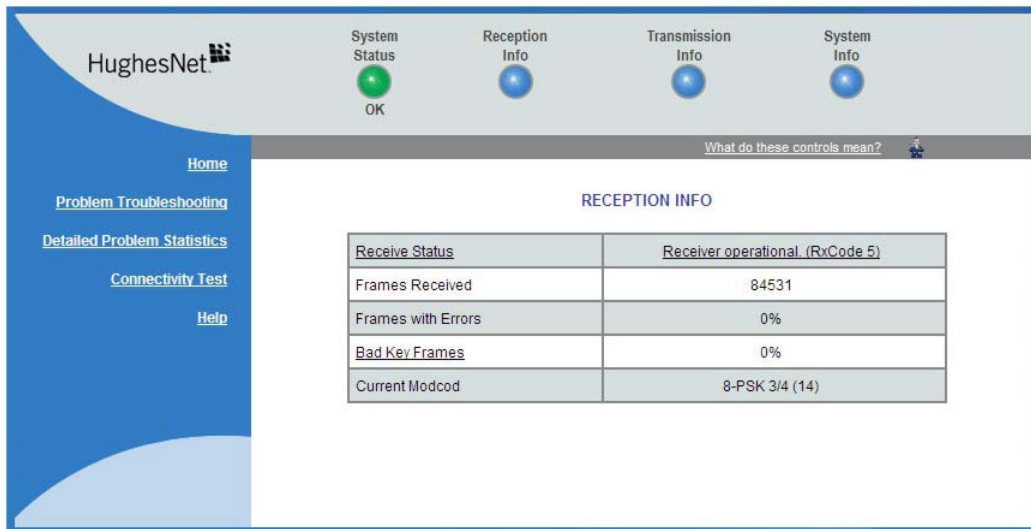

Figure 58: Reception Information page

The parameters listed on the Reception Information page are explained in the following table.

**Table 7: Reception Information page parameters**

Parameter	Explanation
Receive Status	Indicates if the receive data path is operational or other status. Click the displayed RxCode for explanation of the displayed code.
Frames Received	Number of data messages received by the satellite router.
Frames with Errors	Percentage of received frames determined to be corrupted. Any number greater than zero indicates a problem except when adverse weather conditions are present. Frames may be corrupted in adverse weather conditions or if there is a problem with the receive cable or antenna assembly.
Bad Key Frames	Percentage of received frames that could not be decrypted successfully. All data received over the satellite is encrypted. Any number greater than zero indicates a problem except when adverse weather conditions are present. Bad key frames may indicate that the router is not commissioned.
Current Modcod	Level of encoding the router can accept based on the current signal quality. Lower Modcod numbers are used if signal impairments such as rain are present. Adaptive coding and modulation (Modcod) is a Hughes-developed technique that maximizes over-the-air bandwidth utilization.

### Examining receive status

You can check the Receive Status parameter to find out if the receive data path is operational or if there is a problem. Normal receive status is indicated by the message `Receiver operational (RxCode 5)`.

The following two illustrations show how you can view a list of all RxCodes or see an explanation of the currently displayed RxCode. Each RxCode—except RxCode 5—indicates a specific problem in the receive path.

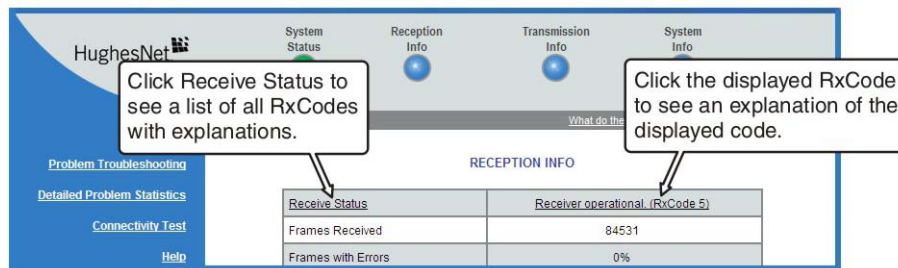

Figure 59: Finding additional Receive Status information

The next illustration shows the list of all RxCodes. Click the explanation (link) next to the RxCode to see more information.

[Help](#) | [Frequently Asked Questions](#) | [What are the meanings of the Receive Status messages?](#)

Click on an item below to get more information about the Receive Status message.

**RxCode Receive Status**

- 1 [The receiver is in pointing mode.](#)
- 2 [The receiver is in factory or NOC mode.](#)
- 3 [The receiver is not locked.](#)
- 4 [The receiver is locked to the wrong network.](#)
- 5 [The receiver is operational.](#)
- 6 [The receiver is not detecting any signal.](#)
- 7 [The receiver is locked to an unknown network.](#)
- 8 [The receiver cable and transmit cable are switched.](#)
- 9 [The receiver cable is shorted.](#)

Click any underlined link to see more information.

Figure 60: List of all RxCodes

## Transmission Information page

The Transmission Information page shown in Figure 61 displays information about data transmissions from the satellite router.

The screenshot shows the HughesNet interface. At the top, there are four status indicators: System Status (OK), Reception Info, Transmission Info, and System Info. The main content area is titled "TRANSMISSION INFO" and contains a table with the following data:

Transmit Status	Transmitter ready (TxCode 8)
Number of Successful Transmissions	4652
Number of Failed Transmissions	0
Number of Packets Submitted for Transmission	727

Figure 61: Transmission Information page

The parameters listed on the Transmission Information page are explained in the following table.

**Table 8: Transmission Information page parameters**

Parameter	Explanation
Transmit Status	Indicates if the transmit data path is operational. Click the displayed TxCode for explanation of the displayed code.
Number of Successful Transmissions	Number of frames transmitted to the satellite.
Number of Failed Transmissions	Number of frames that could not be sent. A continuously increasing value indicates a transmission problem. If a low value is displayed and does not increase, and the system is functioning, there is no reason for concern.
Number of Packets Submitted for Transmission	Total number of data packets queued for transmission to the satellite since the router was last restarted.

### *Examining transmit status*

You can check the Transmit Status parameter to find out if the transmission data path is operational or if there is a problem. Normal transmit status is indicated by the message `Transmitter ready (TxCode 8)`.

The following two illustrations show how you can view a list of all TxCodes or see an explanation of the currently displayed TxCode. Each TxCode—except TxCode 8—indicates a specific problem in the transmission path.

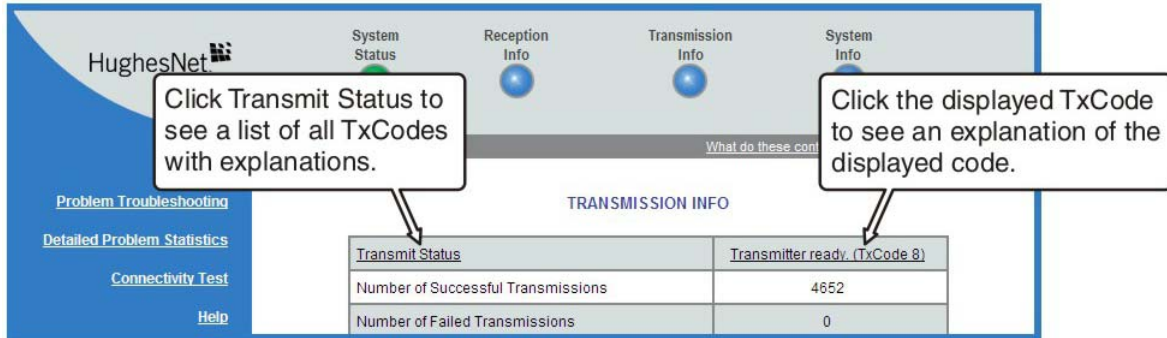

Figure 62: Finding additional Transmit Status information



The next illustration shows the list of all TxCodes. Click the explanation (link) next to the TxCode to see more information.

[Help](#) | [Frequently Asked Questions](#) | [What are the meanings of the Transmit Status messages?](#)

Click on an item below to get more information about the Transmit Status message.

**TxCode Transmit Status**

- 1 [The transmitter has been disabled by the Network Operations Center](#)
- 2 [The transmitter has been placed in test mode by the Network Operations Center](#)
- 3 [The transmitter is locking to the receive carrier](#)
- 5 [The transmitter is not locked to network timing](#)
- 6 [The transmitter is not available because the receiver is not detecting a signal or is not locked to the correct network](#)
- 7 [The transmitter is not available because the receiver is not tuned for normal operation](#)
- 8 [Transmitter available for Normal Operation](#)
- 9 [The satellite transmitter is adjusting for optimal network timing](#)
- 10 [The transmitter is unable to communicate with the Network Operations Center](#)

Click any underlined link to see more information.

Figure 63: List of TXCodes (not all codes are shown)

## System Information page

The System Information page shown in Figure 64 provides system information for the satellite router such as Site ID and the release number of the router's operational software.

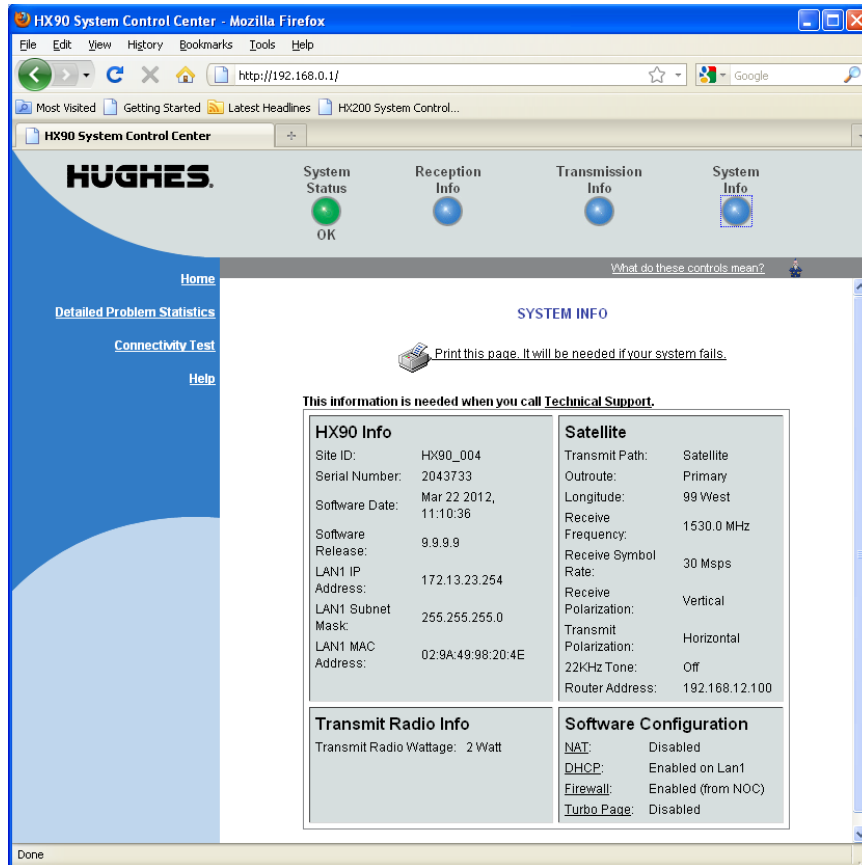

Figure 64: System Information page

The parameters listed in the **HX90 Info** section of the System Information page are explained in the following table. Other sections of the screen (*Transmit Radio Info* and *Satellite*) provide additional information about the router installation and the router software (Software Configuration).

Table 9: System Information page parameters — HX90 Info section

Parameter	Explanation
Site ID	Identifies the site where the router is installed.
Serial number	The router's serial number. The serial number may be required for troubleshooting.
Zipcode	ZIP code of the router site.
Software Date	Software build date.

**Table 9: System Information page parameters — HX90 Info section (Continued)**

Parameter	Explanation
Software Release	Version of the router's software. This is typically the factory-installed software version. However, if the NOC downloads a newer version of Gateway software to the router, the newer version number is displayed.
LAN1 IP Address	The satellite router address. The default router address is 192.168.0.1. A different router address can be configured.
LAN1 Subnet Mask	Range of addresses available to the satellite router.
LAN1 MAC Address	MAC address for the satellite router.
LAN2 IP Address	Address available for a second LAN connection.
LAN2 Subnet Mask	Subnet mask (range of available addresses) available for a second LAN connection.
LAN2 MAC Address	MAC address a second LAN connection.
NAT IP Address	The Internet routable public IP address assigned to the router. NAT translates this address to local private addresses in the range 192.168.0.x that can be used by the devices on your local network (where x = 0-9).
NAT Subnet mask	The NAT subnet mask (range of available addresses) assigned to the router is always 255.255.255.255.

## Help page

The System Control Center Help page (Figure 65 on page 84) contains information to help the user get started in using the satellite router, find contact information for assistance, and other helpful information.

To display the Help page:

- Click [View Help Topics](#) on the System Control Center home page.

or

- Click [Help](#) in the left panel of any System Control Center page.

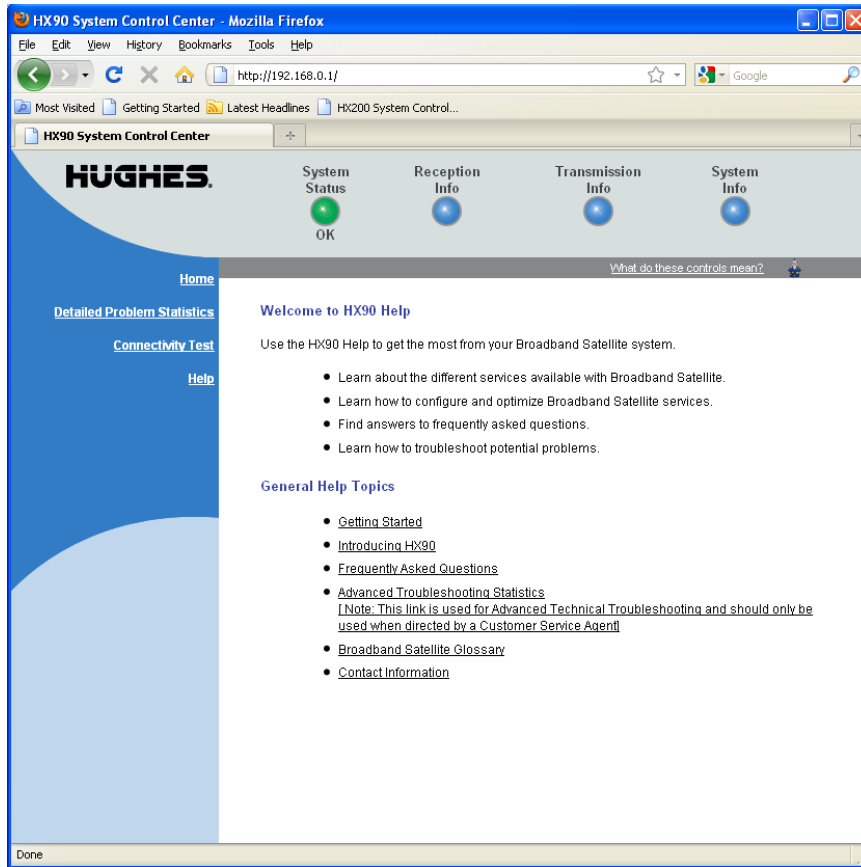

Figure 65: Help page

## System Control Center tools for troubleshooting

The System Control Center includes screens that are useful for troubleshooting. For details see:

- *Troubleshooting common problems* on page 91
- *Confirming NOC connectivity* on page 97
- *Viewing problem-related statistics* on page 108

The satellite router has five LEDs on the front panel and small LEDs on the LAN ports on the back of the router. The LEDs provide information about the satellite router's operating status.

### Front panel LEDs

The satellite router has five LEDs on the front panel, as shown in Figure 66. By their appearance—on, off, blinking, or flashing—the LEDs indicate the router's operating status. All are blue when lit. The front panel LEDs are all blue when lit.

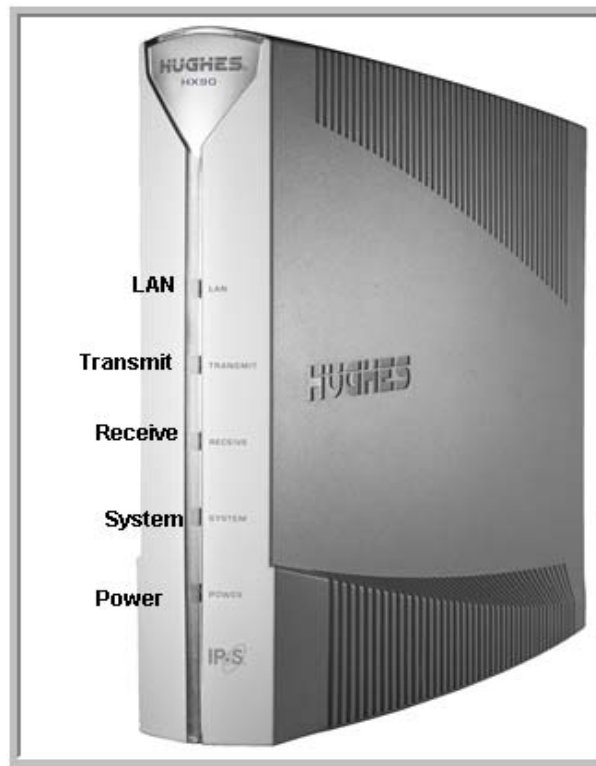

Figure 66: Front panel LEDs on the HX90 router

Table 10 explains what the router status is when the LEDs are on, off, or blinking. *On* means the LED is continuously lit. *Blinking* means the LED is usually on, but intermittently turns off briefly. *Flashing* means the LED alternates between on and off for periods of ½ sec to 1 sec.

**Table 10: Front panel LED indications**

LED	Appearance	Satellite router status
LAN	On	Satellite router is connected to a computer network card or Ethernet device
	<b>Blinking</b>	Transmitting and/or receiving data
	Off	No device is connected to the LAN port or the device connected to the LAN port is not working properly
Transmit	On	OK - Transmit path is operational
	<b>Blinking, mostly on</b>	Transmitting data
	Blinking, mostly off	Ranging (The router is measuring the distance to the satellite to calibrate transmit timing and transmit power.)
	Off*	Condition preventing transmission
Receive	On	OK - Receive path is operational
	<b>Blinking</b>	Receiving data
	Off*	Condition preventing receipt of data
System	<b>On</b>	Connection established with the NOC
	Blinking*	Virus protection blocking data
	Off*	Condition preventing full operation
Power	<b>On</b>	Power is on and the router is functioning normally
	Flashing	Operating with fallback.bin (backup) version of software
	Blinking	Router is not commissioned or has lost its configuration data
	Off*	No power

**Bold type** indicates LED appearance during normal operation when the satellite router is transmitting or receiving data.

\*Indicates an operational problem.

If it appears the LEDs are not functioning properly, make sure you have the correct power supply. Refer to Table 2 on page 17 for detailed power supply information.

## LAN port LEDs

Green and orange LEDs on each of the two LAN (Ethernet) ports on the router's rear panel indicate link status and speed, as explained in Figure 67.

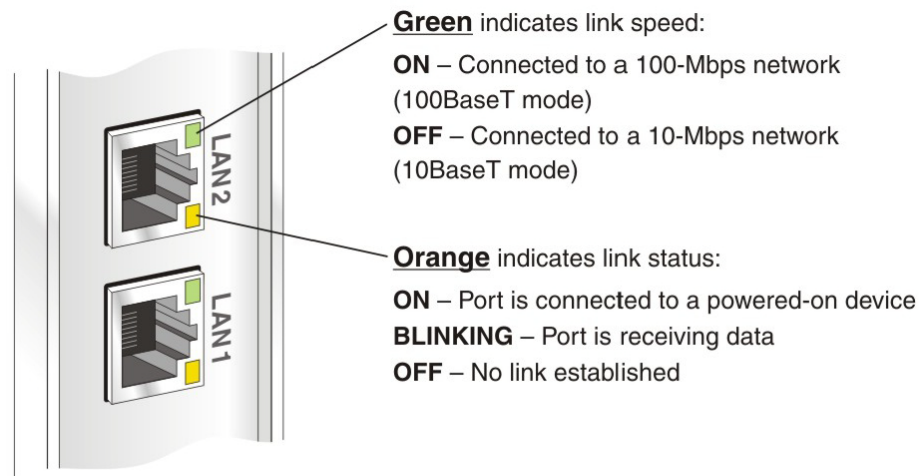

Figure 67: LAN port LEDs

## Using LEDs for troubleshooting

For information on using the satellite router's LEDs for troubleshooting, see:

- *Using the front panel LEDs for troubleshooting* on page 101
- *Using the LAN port LEDs for troubleshooting* on page 106





## Chapter 8

# Troubleshooting

---

This chapter provides troubleshooting procedures. Most section headings describe a problem you could encounter (such as **System LED is off**) or they describe troubleshooting procedures for correcting a problem (such as **Confirming Internet connectivity**). To correct a problem, find the description that matches your problem, then find the troubleshooting procedure or procedures for your problem.

If you cannot correct the problem, contact Hughes Installer Support.

Other sections in this guide that contain troubleshooting information are listed below:

- For explanation of **red flags** on System Control Center screens, see *Red flag indicator* on page 74.
- The **Advanced Pages** contain diagnostic and other information that may help in troubleshooting. See Chapter 9 – *Advanced Pages* on page 111.

In addition, the HX90 satellite router provides its own online Help, which includes substantial troubleshooting information (including troubleshooting commissioning problems). Access this information through the System Control Center [Help](#) link (**Help > Frequently Asked Questions**).

Another valuable source of troubleshooting information is the HughesNet Knowledge Base, available online at <http://kb.hughesnet.com>.

## Important troubleshooting information

### NOTICE

Do **not** use the recessed rescue switch on the router's rear panel unless you are a qualified technician. Pressing this switch could cause the router to become inoperable.

---

### NOTICE

This installation guide contains some procedures that instruct you to restart the router using the Restart function in the System Control Center. When so instructed, do not power cycle the router. Doing so will destroy data that may be useful for troubleshooting.

---

**CAUTION**



When this installation guide instructs you to power cycle the router, you should remove and then re-apply power. If the satellite router uses an AC/DC power supply, disconnect the AC power cord from the power source (power strip, wall outlet, or surge protector). If the satellite router uses a DC/DC power supply, disconnect the DC input cable connector from the router's power supply. In either case (AC/DC or DC/DC), *do not unplug the power cord from the satellite router's rear panel*. Doing so could result in static electricity discharge that could shock you and/or damage the router.

---

## Troubleshooting reference diagram

If you need to use any of the troubleshooting procedures provided in this chapter, you may find it useful to refer to Figure 68. This diagram shows all power and cable connections for a properly installed HX90 satellite router.

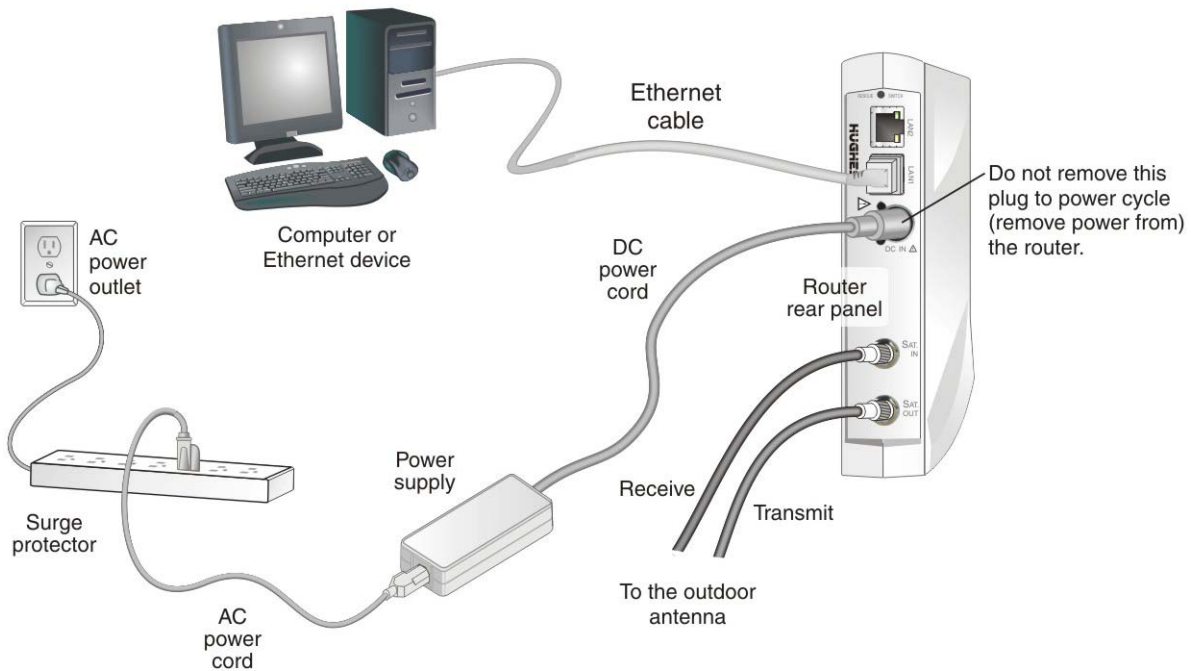

This diagram shows an AC/DC power supply. If a DC/DC power supply is used, the configuration is similar but does not include a surge protector.

Figure 68: Troubleshooting reference diagram

## Troubleshooting common problems

### *Cannot access the Internet*

If you can access the System Control Center but you cannot access the Internet, you may be able to resolve the problem by performing some or all of the following troubleshooting procedures:

- *Confirming that the satellite router is commissioned* on page 91
- *Confirming the receive signal* on page 93
- *Confirming the transmit signal* on page 93
- *Confirming that TCP Acceleration is operational* on page 94
- *Confirming that Web Acceleration is operational* on page 95
- *Confirming NOC connectivity* on page 97
- *Confirming Internet connectivity* on page 99
- *Checking for viruses and firewall issues* on page 100

Try each procedure in the order they are presented. After each procedure, try to access the Internet. If you cannot access the Internet, continue to the next procedure.

If you have tried all of these procedures and cannot access the Internet, try them all again. If you still cannot access the Internet, contact Hughes Installer Support.

For most of these troubleshooting procedures you use the router's System Control Center. To access the System Control Center on a computer connected to the router:

1. Open a web browser such as Internet Explorer.
2. In the browser's address bar, type **www.systemcontrolcenter.com** or **192.168.0.1**.
3. Press **Enter**.

The System Control Center home page opens.

### *Confirming that the satellite router is commissioned*

To confirm that the router is commissioned:

1. At the System Control Center, click the **System Info** link.  
The System Information page appears.

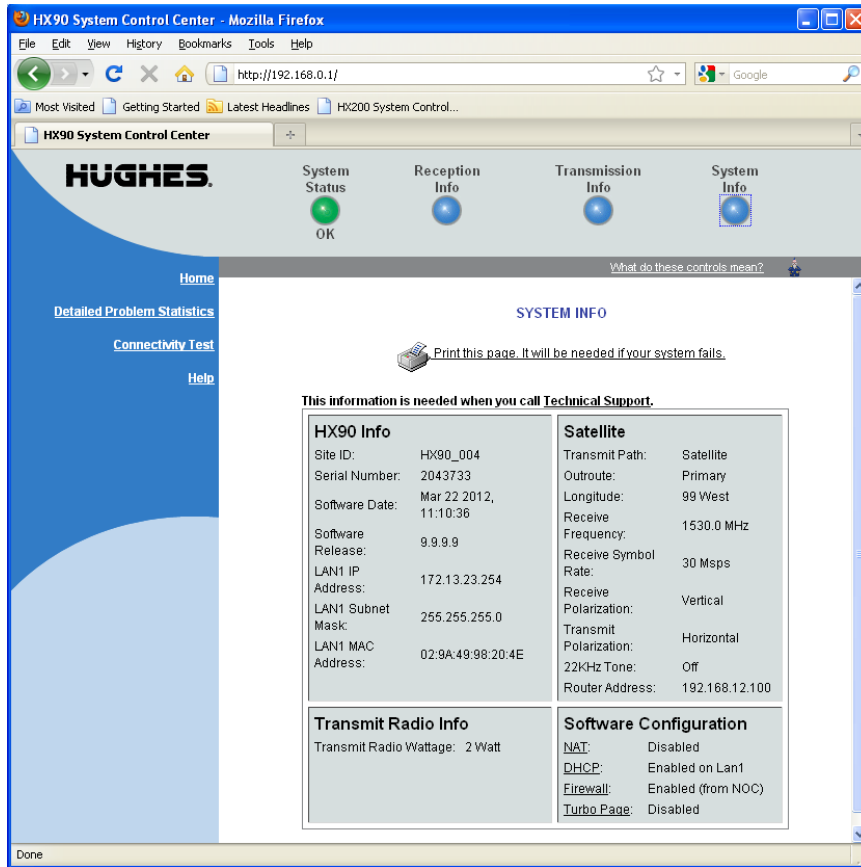

Figure 69: System Info page

**Note:** The System Info page for your installation may show different fields and values.

2. In the HX90 section, check the *Site ID* line.  
If the numeric site ID appears, the satellite router is commissioned. Proceed to *Confirming the receive signal* on page 93.  
If *Not\_Commissioned* appears, the router is not commissioned. Contact Installer Support.

## Confirming the receive signal

To confirm that the router is properly receiving satellite signals:

1. At the System Control Center, click the [Reception Info](#) link.  
The Reception Information page appears.
2. In the Receive Status field, check the RxCode.  
If the RxCode is Receiver operational (RxCode 5) the router is receiving signals properly; proceed to *Confirming the transmit signal* on page 93.  
If any other RxCode appears, the router is not receiving signals properly. Click the **RxCode**, and follow the troubleshooting procedure that appears. Click the **RxCode** for explanation of the problem and/or troubleshooting information.

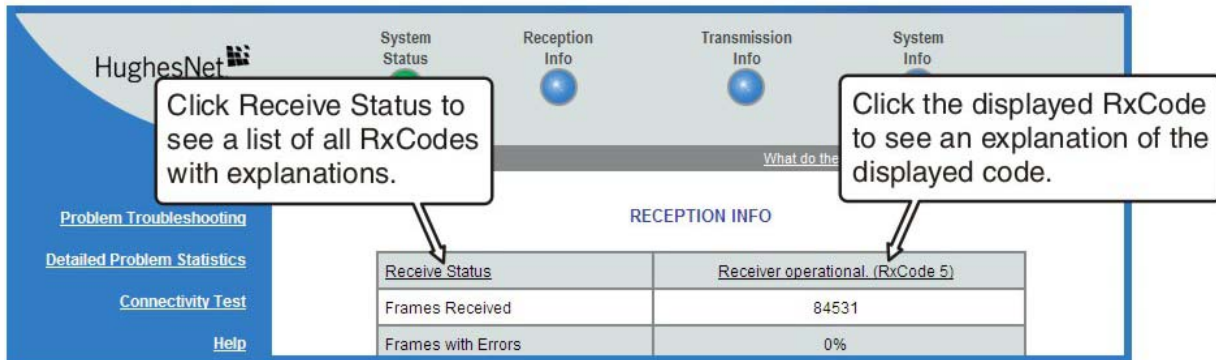

Figure 70: Reception Info page

**Note:** The RxCode shown is an example.

## Confirming the transmit signal

To confirm that the router is properly transmitting signals to the satellite:

1. At the System Control Center, click the [Transmission Info](#) link.  
The Transmission Information page appears.
2. In the Transmit Status field, check the TxCode.  
If the TxCode is Transmitter Ready (RxCode 8) the router is transmitting signals properly; proceed to *Confirming that TCP Acceleration is operational* on page 94.

If any other TxCode appears, the router is not transmitting signals properly. Click the TxCode for explanation of the problem and/or troubleshooting information.

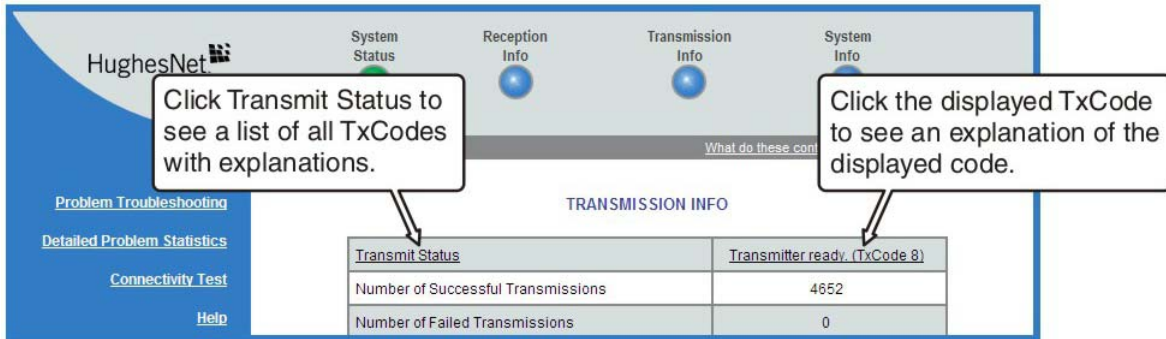

Figure 71: Transmission Info page

**Note:** The TxCode shown is an example.

### ***Confirming that TCP Acceleration is operational***

TCP Acceleration is a proprietary Hughes protocol that optimizes performance for TCP/IP-based applications, including faster downloads over satellite.

To determine if TCP acceleration is operational:

1. At the System Control Center, click the [System Status](#) link. The System Status page appears.

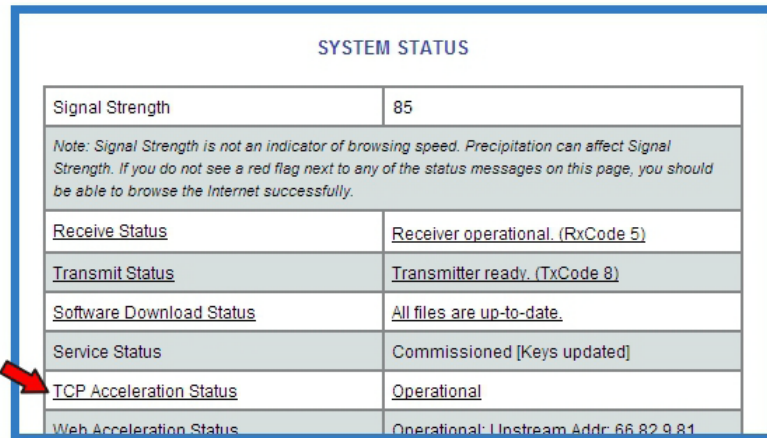

Figure 72: Confirming that TCP Acceleration is operational

2. Check the *TCP Acceleration Status* field. If the TCP Acceleration Status is Operational, TCP Acceleration is enabled and working properly. Proceed to *Confirming that Web Acceleration is operational* on page 95.

3. If the TCP Acceleration Status is Disabled, restart the router:
  - a. Go to the System Control Center home page.
  - b. In the Help section, click [Restart HX90](#).
4. If TCP Acceleration is still disabled, power cycle the router:
  - a. Unplug the power cord from the power source.
  - b. *If the router is connected to a DC power source*, unplug the DC input cable from the satellite router's power supply.
  - c. Wait 10 sec.
  - d. Plug the power cord back into the power source.
  - e. *If the power source is DC*, plug the input cable back into the power supply.



Do not power cycle the satellite router by unplugging the power cord from the router's rear panel. Doing so could result in static electricity discharge that could shock you and/or damage the router.

---

5. If TCP Acceleration is still disabled, power cycle the Ethernet device according to the device documentation.
6. If TCP Acceleration is still disabled, restart the computer.
7. Check the *TCP Acceleration Status* field again.

If TCP Acceleration is enabled but you still cannot access the Internet, go to *Confirming that Web Acceleration is operational* on page 95.

If TCP Acceleration is still **disabled**, contact Installer Support for assistance.

**Note:** TCP Acceleration Status may also be *Not Operational* (problem with the receive or transmit link) or *Impaired*. Impaired status may result from a number of factors; in many cases it clears within a minute or two.

### ***Confirming that Web Acceleration is operational***

**Note:** This section applies only if the NOC operator has enabled Web Acceleration on the satellite router.

Web Acceleration is a Hughes feature that enhances browsing performance on non-secure web sites. Follow these steps to confirm that Web Acceleration is operating properly:

1. From any System Control Center page, observe the System Status button indicator.
  - If the indicator button is green, Web Acceleration is functioning normally.
  - If the indicator button is yellow, Web Acceleration may not be operational. Continue to the next step.
2. Click the [System Status](#) link to access the System Status page.

3. Observe the message in the *Web Acceleration Status* field.  
If the Web Acceleration Status is Operational, Web Acceleration is enabled.  
Proceed to *Confirming NOC connectivity* on page 97.

**Note:** Web Acceleration Status may be Operational or Inactive during normal operation. Connecting does not indicate a problem unless it persists for more than a few seconds.

4. If the Web Acceleration Status is Not operational, Web Acceleration Status is disabled. Follow these steps:
  - a. Make sure the router is transmitting and receiving. See *Confirming the receive signal* on page 93 and *Confirming the transmit signal* on page 93. If necessary, troubleshoot as stated in these sections.
  - b. Wait 2 hr.
5. If Web acceleration is still disabled, restart the router:
  - a. Go to the System Control Center home page.
  - b. In the Help section, click [Restart HX90](#).
6. If Web acceleration is still disabled, power cycle the router:
  - a. Unplug the power cord from the power source.
  - b. *If the router is connected to a DC power source*, unplug the DC input cable from the satellite router's power supply.
  - c. Wait 10 sec.
  - d. Plug the power cord back into the power source.
  - e. **If the power source is DC**, plug the input cable back into the power supply.



Do not power cycle the satellite router by unplugging the power cord from the router's rear panel. Doing so could result in static electricity discharge that could shock you and/or damage the router.

---

7. Check the *Web Acceleration Status* field again.  
If Web Acceleration is still not operational, contact your service provider for assistance.



## Confirming NOC connectivity

Use the *Connectivity Test* page to check connectivity to the Hughes Network Operations Center (NOC). You may want to open a second web browser to access the Help page while you execute a connectivity test.

1. Click [Connectivity Test](#) on the System Control Center page to access the Connectivity Test page.

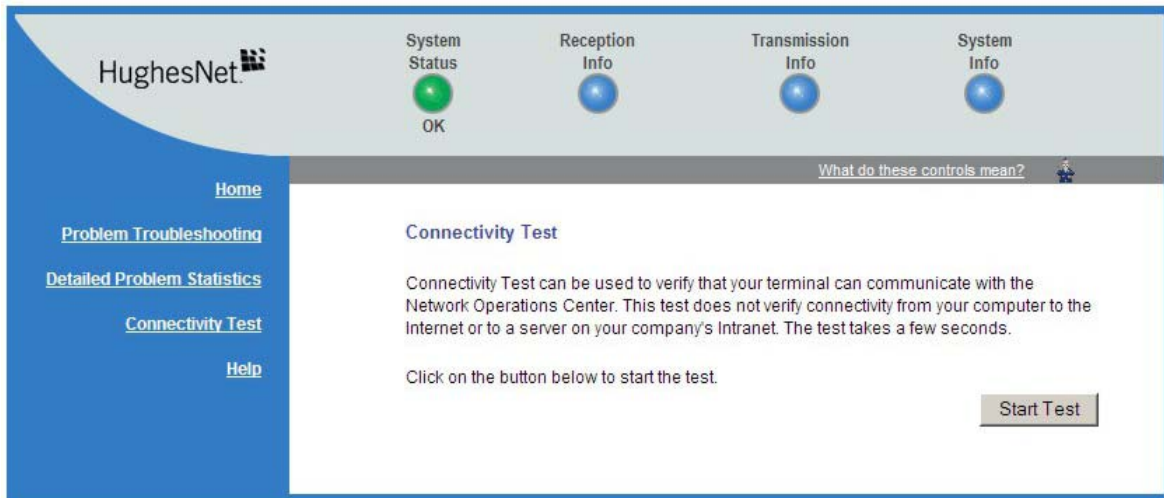

Figure 73: Connectivity test — initial page

2. Click **Start Test**. The Connectivity Test results page appears.

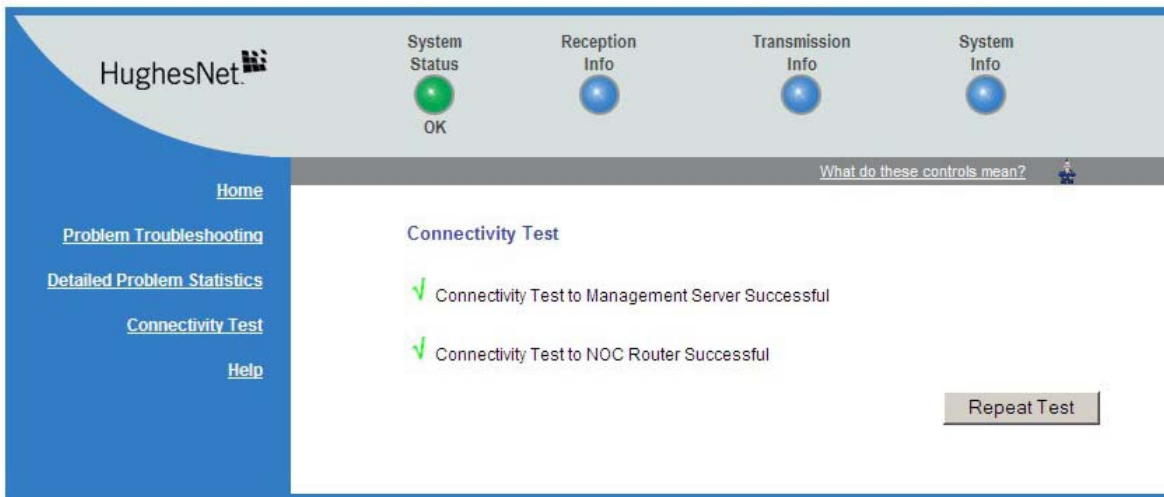

Figure 74: Connectivity Test — results page

3. If the connectivity test succeeds but you still cannot access the Internet, follow these steps to ping the router address from your computer.  
For more information on the ping test, see *Verifying the Ethernet connection* on page 30.
  - a. At the System Control Center, click the [System Info](#) link.  
The System Information page appears.
  - b. Record the router address listed in the *HX90 Info* section.
  - c. On the Windows desktop, go to **Start > Run**.  
The **Run** box appears.
  - d. In the *Open* field, type command.
  - e. Click **OK**.  
The Command window appears.
  - f. At the prompt, type ping followed by a space and the router address.  
For example, if the router address is 172.19.19.1, type  
**ping 172.19.19.1**.
  - g. Press **Enter**.  
If pinging the router address succeeds but you still cannot access the Internet, skip to *Confirming Internet connectivity* on page 99.

### ***Confirming NOC connectivity (Static IP Address)***

*This section applies only if the router is using a static IP address.*

If pinging the router address fails, and DHCP is disabled on the router, the default gateway address is probably not set correctly in the computer's operating system settings. The default gateway address should be the router IP address as displayed on the System Information page *HX90 Info* section, in the LAN1 IP Address field.

1. Check the default gateway address in the computer operating system's network properties settings; make sure it is the same as the satellite router's IP address (LAN1 IP Address).
2. Ping the router address from your computer.  
For information on the ping test, see *Verifying the Ethernet connection* on page 30.
3. If the ping test fails, restart the satellite router:
  - a. Go to the *System Control Center* home page.
  - b. In the Help section, click [Restart HX90](#).
4. If restart does not correct the problem, power cycle the satellite router:
  - a. Unplug the power cord from the power source.
  - b. *If the router is connected to a DC power source*, unplug the DC input cable from the router's power supply.
  - c. Wait 10 sec.

- d. Plug the power cord back into the power source.
- e. *If the power source is DC*, plug the input cable back into the power supply.



Do not power cycle the satellite router by unplugging the power cord from the router's rear panel. Doing so could result in static electricity discharge that could shock you and/or damage the router.

---

5. If you still cannot access the Internet, contact your service provider.

### ***Confirming Internet connectivity***

To troubleshoot Internet connectivity issues for customers whose service providers offer Internet connectivity:

If you lose access to the Internet, this could be a result of a temporary Internet problem or a problem with the site you are trying to access. If you lose Internet connectivity, try these troubleshooting steps:

1. Open a command prompt on a computer connected to the router.
2. Ping the HughesNet web server:
  - a. Type **ping www.hughesnet.com** (or other server address provided by the customer).
  - b. Press **Enter**.

If the ping test succeeds, there may be a temporary problem with the web site you originally tried to access. Wait a while and then try to access the web site again. If the ping test fails, continue with these steps.

3. Ping the test server:
  - a. Type **ping 198.77.116.39**.
  - b. Press **Enter**.

If the ping test is successful but you still cannot browse the Internet, complete the procedures in *Checking the DNS setting* on page 99.

If the ping test fails, contact Installer Support for assistance.

### ***Checking the DNS setting***

If you can ping the test server but cannot browse the Internet, follow these steps to check the DNS settings on your computer. The steps may vary slightly based on your computer's operating system.

1. On the Windows task bar, click **Start > Run**.
2. In the Run window, type **command**.
3. Click **OK**.
4. Type **ipconfig /all** and press **Enter**.
5. Locate the DNS addresses in the *DNS Servers* field.
6. For customers who have their own NOC, verify that the customer-specific DNS address appears in the *DNS Servers* field.
7. Close the *Command* window.

If the DNS address is correct, wait a while and try to access a web site again. There may be a temporary Internet connection outage. If you are still cannot access a web site after waiting, complete the procedures in *Checking for viruses and firewall issues*. If the DNS address is not correct, contact Installer Support for assistance.

### ***Checking for viruses and firewall issues***

If you have confirmed all connections but still cannot access the Internet, check the computer (and all other computers on the same network) for viruses. If you find a virus, delete or disable it, then try to browse the Internet again.

If you are using a firewall, refer to the firewall documentation and make sure none of its settings are blocking access to either the Internet or the Hughes servers. Make sure you are using the latest version of any anti-virus and/or firewall software.

## **Cannot access the System Control Center**

If you cannot access the System Control Center, follow the troubleshooting procedure that corresponds to your hardware configuration:

- Satellite router connected directly to a computer
- Satellite router connected to an Ethernet device

### ***Satellite router connected directly to a computer***

Follow the steps below if the router is connected directly to a computer.

1. On the computer desktop, double-click the **System Control Center** shortcut icon.
2. If the System Control Center does not appear, open a web browser.
3. Type **www.systemcontrolcenter.com** in the browser's address bar.
4. Press **Enter**.
5. If the System Control Center does not appear, type **192.168.0.1** in the browser's address bar.
6. Press **Enter**.
7. If the System Control Center does not appear, check the LAN cable connections at the satellite router and at the computer. Check the physical connections and look for LED activity on both LAN ports.

If there is no LED activity, there could be a problem with the connection or NIC.

If the System Control Center does not appear, repeat these steps. If it still does not appear, contact Installer Support.

### ***Satellite router connected to an Ethernet device***

If the satellite router is connected to an Ethernet device such as a router or a wireless base station, follow these steps:

1. Disconnect the Ethernet cable from the device.
2. Using an Ethernet cable you know is good, connect the satellite router LAN port directly to the Ethernet port on the computer.

This temporarily bypasses the Ethernet device as a way to help determine where and what the problem is.

3. Power cycle the satellite router:
  - a. Unplug the power cord from the power source.
  - b. *If the router is connected to a DC power source, unplug the DC input cable from the satellite router's power supply.*
  - c. Wait 10 sec.
  - d. Plug the power cord back into the power source.
  - e. *If the power source is DC, plug the input cable back into the power supply.*



Do not power cycle the satellite router by unplugging the power cord from the router's rear panel. Doing so could result in static electricity discharge that could shock you and/or damage the router.

---

4. Attempt to access the System Control Center by completing the steps in *Satellite router connected directly to a computer* on page 100.
5. If you cannot access the System Control Center, restart the computer.
6. Try again to access the System Control Center.

If you still **cannot** access the System Control Center, contact your service provider.

If you can now access the System Control Center, your Ethernet device may not be properly configured. Refer to the documentation for your Ethernet device to configure it properly. Be sure to re-connect the satellite router to the Ethernet device before attempting to access the System Control Center.

## Using the front panel LEDs for troubleshooting

This section explains how to use the satellite router's front panel LEDs to recognize and troubleshoot problems.

Before proceeding, make sure the transmit and receive cables are securely tightened.

### NOTICE

- Make sure each connector is properly aligned (not cross-threaded).
  - Finger tight with no connector play is adequate.
- 

**Note:** The router may operate correctly when first installed even if the transmit and receive cable connectors are not adequately tightened. However, problems could develop later. Therefore, correct operation of the satellite router's is not an indication that the cables are adequately tightened.

## ***Power LED off and one or more LEDs flashing***

If after power-up or a reset the Power LED is off and one or more of the other LEDs is flashing, the router could have a fatal error and may have to be replaced. If all LEDs are flashing, go to *All LEDs flashing* on page 102.

**Note:** If the Power LED is flashing but no other LED is flashing, this does not indicate a problem.

1. If the Power LED is off and one or more of the other LEDs is flashing, try power cycling the router:
  - a. Unplug the power cord from the power source.
  - b. *If the router is connected to a DC power source*, unplug the DC input cable from the satellite router's power supply.
  - c. Wait 10 sec.
  - d. Plug the power cord back into the power source.
  - e. *If the power source is DC*, plug the input cable back into the power supply.



To remove power from the satellite router, always unplug the AC power cord from the power source (power outlet, power strip, or surge protector). Do not remove the DC power cord from the router's rear panel. Doing so could result in an electrical shock or damage to the router.

---

The router may recover.

2. If the fatal error indication continues, the router must be replaced. Contact Installer Support.

## ***All LEDs flashing***

If all LEDs are flashing simultaneously, this indicates that the satellite router's firmware is corrupted. A router in this state cannot be recovered. Contact Installer Support for assistance.

## ***All LEDs off***

If all LEDs on the front panel are off:

1. Make sure all power connections are secure.
2. If the AC power cord is connected to a power strip or surge protector, make sure the power strip or surge protector is turned on.
3. If the power connections are secure, power cycle the satellite router:
  - a. Unplug the power cord from the power source.
  - b. *If the router is connected to a DC power source*, unplug the DC input cable from the satellite router's power supply.
  - c. Wait 10 sec.

- d. Plug the power cord back into the power source.
- e. *If the power source is DC*, plug the input cable back into the power supply.



Do not power cycle the satellite router by unplugging the power cord from the router's rear panel. Doing so could result in static electricity discharge that could shock you and/or damage the router.

---

4. Test the power outlet to make sure there is not a problem with the power source.
5. If the LEDs do not turn on, contact Installer Support.

### ***Checking the Power LED***

If the Power LED is off, check the power supply connections. (The router does not have an off/on switch.) If the Power LED is on, proceed to *Checking the LAN LED* on page 103.

### ***Checking the LAN LED***

If the front panel LAN LED is off:

1. Disconnect and reconnect the Ethernet cable from the router and from the computer. Make sure the cable is securely connected to the router LAN port and to the computer's LAN port.
2. If the LAN LED is still off, power cycle the satellite router:
  - a. Unplug the power cord from the power source.
  - b. *If the router is connected to a DC power source*, unplug the DC input cable from the satellite router's power supply.
  - c. Wait 10 sec.
  - d. Plug the power cord back into the power source.
  - e. *If the power source is DC*, plug the input cable back into the power supply.



Do not power cycle the satellite router by unplugging the power cord from the router's rear panel. Doing so could result in static electricity discharge that could shock you and/or damage the router.

---

3. If the LAN LED is still off, check the LAN port LEDs on the back panel.
  - If the orange LED is on and the front panel LAN LED is not, contact Installer Support for assistance.
  - If both the orange LED and the front panel LAN LED are off, check all network equipment that connects the computer with the router, including the computer's Ethernet card, Ethernet cable(s) and any switch or hub. Replace one or more of the items to try to isolate the problem.

4. If the front panel LAN LED is still off, check the Windows Device Manager to see if the computer's NIC or network adapter is installed correctly.
  - a. In Windows XP, for example, click **Start > Settings > Control Panel > System > Hardware > Device Manager**.  
A screen appears listing all the devices installed on the computer.
  - b. Look for **Network adapters**.  
If the NIC is not properly installed, a red X appears next to its listing.
  - c. If a red X is present, troubleshoot the NIC installation using the manufacturer's instructions and Windows documentation.
5. If the LAN LED is still off, follow this step *only if the satellite router is connected to a hub, router, or other network device (that is, not connected directly to the computer)*. Connect the computer directly to the satellite router (to bypass the network device) as follows:
  - a. Disconnect the Ethernet cable from the device.
  - b. Using an Ethernet cable you know is good, connect the satellite router LAN port directly to the Ethernet port on the computer.  
This temporarily bypasses the Ethernet device as a way to help determine where and what the problem is.
  - c. Check the router's LAN LED.
6. If the LAN LED is on, but was off before you made this direct connection, there is probably a problem with your network device or the connections to it. Check those connections. If the LAN LED is still off after checking the connections, contact the manufacturer of the network device for assistance.
7. If you have not found any problem so far, but the LAN LED is still off, power cycle the router again.
8. If the LAN LED is still off, power cycle the Ethernet device according to the device documentation.
9. If the LAN LED is still off, restart the computer.
10. If the LAN LED is still off, try connecting the satellite router to another computer.

If the front panel LAN LED is now on, there may be a problem with the customer's computer that was connected to the satellite router.

If the LAN LED is still **off**, contact Installer Support.

## Problem with a connected device

If a device *other than a computer* is connected to the satellite router, the System Control Center is probably never accessible. However, you can troubleshoot based on the following LED conditions. For details, go to the listed page.

- *Transmit LED is off* on page 105
- *Receive LED is off* on page 105
- *System LED is off* on page 106



## ***Transmit LED is off***

If the satellite router is not operating normally and the Transmit LED is off, follow these steps:

1. Check all cable connections, from the satellite router to the outdoor satellite antenna, and tighten any connections that seem loose.

Make sure cable connections to the router are secure (properly aligned—not cross threaded; finger tight with no play).

**Note:** The router may operate correctly when first installed even if the transmit and receive cable connectors are not adequately tightened. However, problems could develop later. Therefore, correct operation of the satellite router is not an indication that the cables are adequately tightened.

2. If the LED is still **off**, check the cable for breaks.
3. If the problem persists, contact Installer Support.

## ***Receive LED is off***

If the satellite router is not operating normally and the Receive LED is off, follow these steps:

1. Check all cable connections, from the satellite router to the outdoor satellite antenna, and tighten any connections that seem loose.

Make sure cable connections to the router are secure (properly aligned-not cross threaded; finger tight with no play).

**Note:** The router may operate correctly when first installed even if the transmit and receive cable connectors are not adequately tightened. However, problems could develop later. Therefore, correct operation of the satellite router is not an indication that the cables are adequately tightened.

2. If the LED is still off, restart the router:
  - a. Go to the System Control Center home page.
  - b. In the Help section, click [Restart HX90](#).
3. If the LED is still off, power cycle the satellite router:
  - a. Unplug the power cord from the power source.
  - b. *If the router is connected to a DC power source*, unplug the DC input cable from the router's power supply.
  - c. Wait 10 sec.

- d. Plug the power cord back into the power source.
- e. *If the power source is DC*, plug the input cable back into the power supply.



Do not power cycle the satellite router by unplugging the power cord from the router's rear panel. Doing so could result in static electricity discharge that could shock you and/or damage the router.

---

4. If the problem persists, contact Installer Support.

### ***System LED is off***

If the System LED is off, but the Transmit and Receive LEDs are on, there may be a problem at the NOC. Take the following steps.

1. Wait 15 minutes.  
If there is a problem at the NOC, it may soon be corrected and the System LED comes on. You can then resume normal operation.
2. If the LED does not turn on after 15 minutes, power cycle the satellite router:
  - a. Unplug the power cord from the power source.
  - b. *If the router is connected to a DC power source*, unplug the DC input cable from the router's power supply.
  - c. Wait 10 sec.
  - d. Plug the power cord back into the power source.
  - e. *If the power source is DC*, plug the input cable back into the power supply.



Do not power cycle the satellite router by unplugging the power cord from the router's rear panel. Doing so could result in static electricity discharge that could shock you and/or damage the router.

---

3. If the problem persists, contact Installer Support.

## **Using the LAN port LEDs for troubleshooting**

Each LAN port on the router's rear panel has two small LEDs (green and orange) as illustrated in Figure 67 on page 87. This section explains how to use the LAN port LEDs to troubleshoot a LAN port problem.

## ***Orange LED and the front panel LAN LED are both off***

If both the orange LED and the front panel LAN LED are off:

1. Check all network equipment that connects the satellite router with the computer, including the computer's network card, network cable(s), and switch or hub if used.
2. If possible, replace any of these items one at a time to try to isolate the problem.
3. If the equipment seems to be OK, power cycle the satellite router:
  - a. Unplug the power cord from the power source.
  - b. *If the router is connected to a DC power source*, unplug the DC input cable from the satellite router's power supply.
  - c. Wait 10 sec.
  - d. Plug the power cord back into the power source.
  - e. *If the power source is DC*, plug the input cable back into the power supply.



To remove power from the satellite router, always unplug the AC power cord from the power source (power outlet, power strip, or surge protector). Do not remove the DC power cord from the router's rear panel. Doing so could result in an electrical shock or damage to the router.

---

## ***Orange LED is on but the front panel LAN LED is not***

If the orange LAN port LED is on but the front panel LAN LED is not, contact your service provider for assistance.

## **Troubleshooting other problems**

This section provides troubleshooting help for possible problems that are not included in the preceding troubleshooting sections.

### ***Slow speed or intermittent operation***

If you notice that the router's transmission speed is slow or that operation is intermittent, make sure the transmit and receive cable connectors are finger tight. (Make sure connectors are properly aligned—not cross threaded, and finger tight with no play.)

## Viewing problem-related statistics

**Note:** *The Detailed Problem Statistics page and link are present on your HX90 only if they have been enabled by the NOC.*

You can use the Detailed Problem Statistics page to view selected operational statistics recorded over a recent specific hourly time frame.

To view statistics:

1. Click **Detailed Problem Statistics** on the System Control Center home page—or in the left panel of other System Control Center pages.  
The Detailed Problem Statistics page appears.

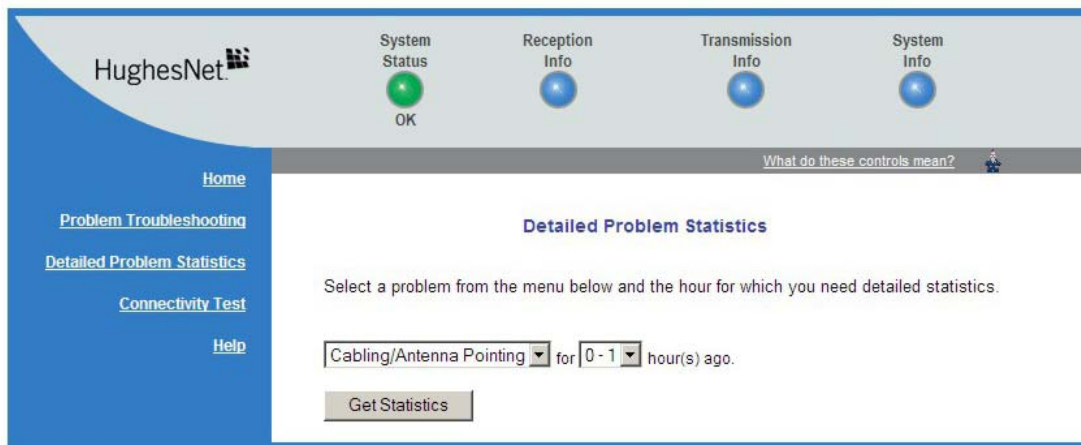

Figure 75: Detailed Problem Statistics

- From the drop-down list above the *Get Statistics* button, select a category of statistics (for example, TCP Acceleration).

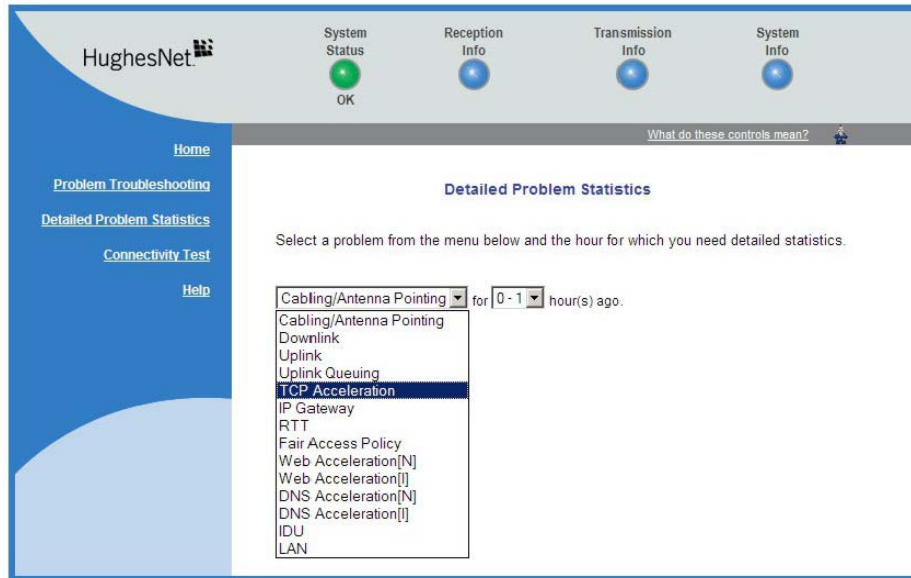

Figure 76: Selecting a category of statistics

- Select a time period (for example, 0 - 1 hour ago).
- Click **Get Statistics**.  
The System Control Center displays the statistics you requested.

**Note:** Most of the displayed statistical information is very technical and requires interpretation by a trained technician.

## Checking for possible AC outlet problems

If you are troubleshooting a problem and you have tried other steps but they have not solved the problem, there could be a problem with the AC power outlet. Check the outlet wiring, and measure the voltage between neutral and ground at the AC outlet, as explained in *Power source* on page 13.



# LNB selection reference

This appendix applies to the commissioning task of entering the radio parameters (*Entering radio parameters* on page 41). As part of this task you select the LNB for your installation from a drop-down list.

If you are not sure which LNB to select on the Receive LNB Selection screen (Figure 22 on page 42), the illustrations in this appendix may help you identify the installed LNB and therefore which option you should select from the drop-down list. The list of LNBs you see depends on the how the router is configured.

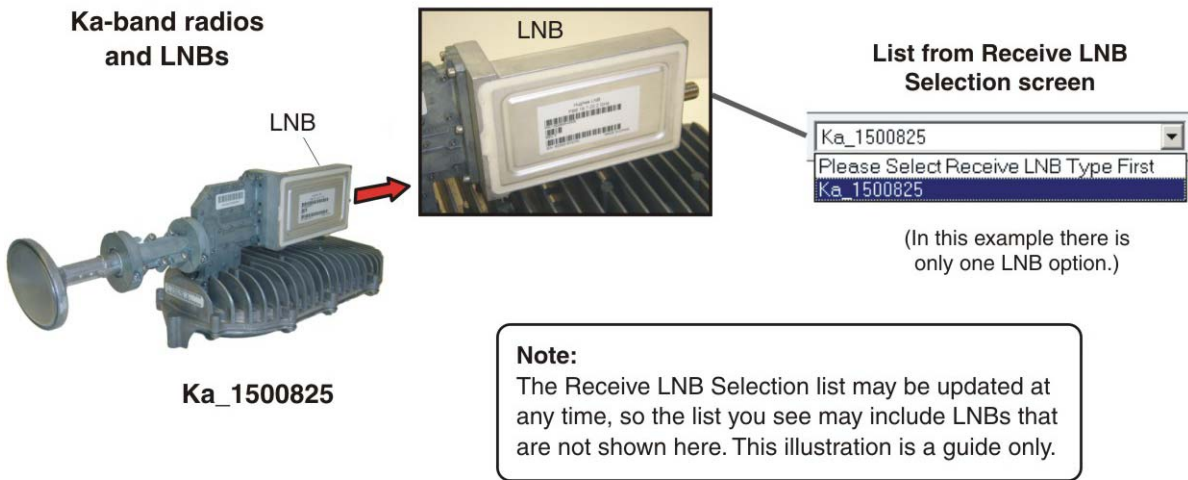

Figure 77: Selection aid for Ka-band LNBs

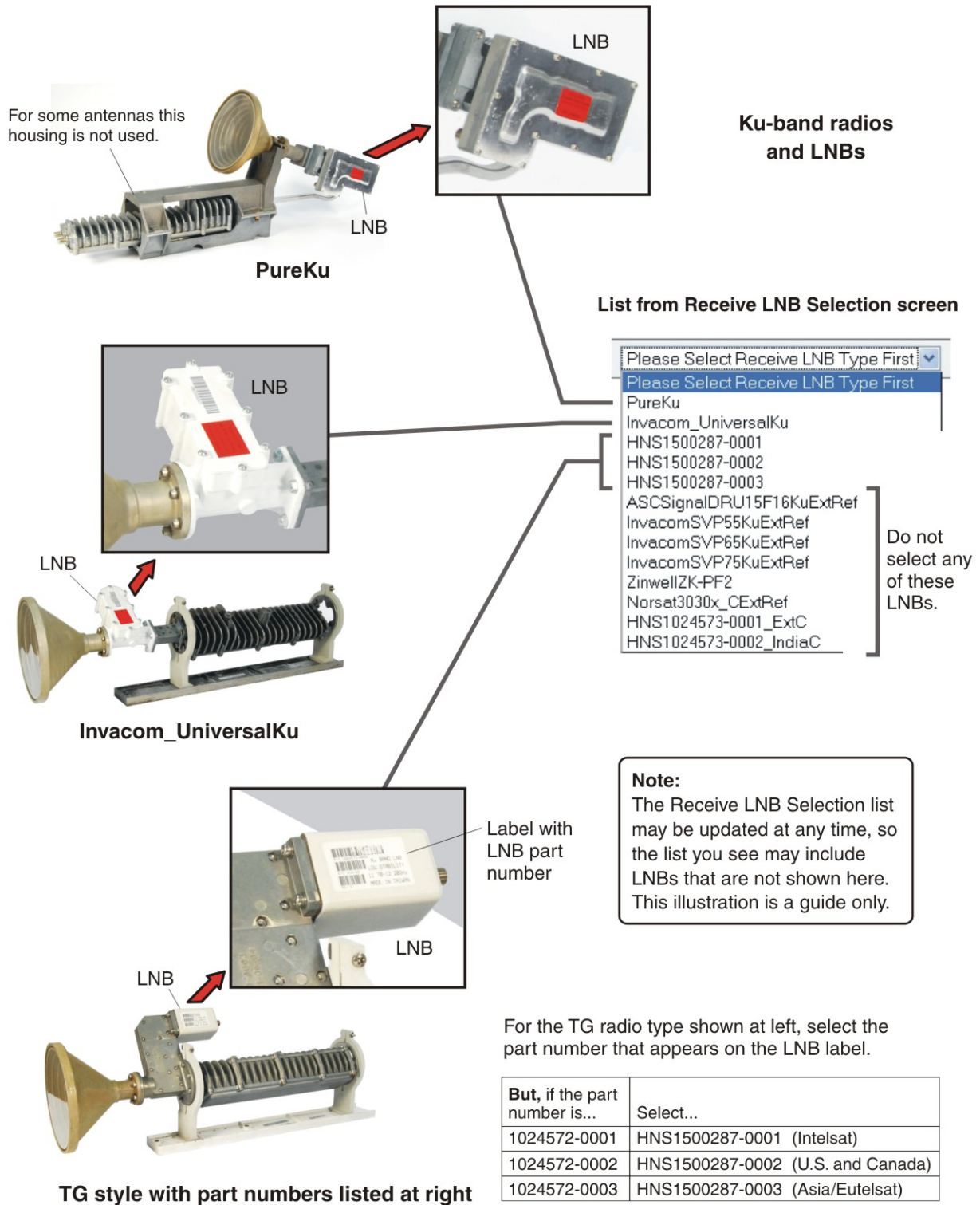

Figure 78: Selection aid for Ku-band LNBs



# Updating the router software

---

The Fallback Updater utility updates the router's `fallback.bin` file with the current software release. Update the `fallback.bin` file only if you are instructed to do so by Hughes.

The Fallback Updater is typically distributed to installers, when it is needed, as a `.ZIP` file in an email message and may also be available for download from your installation support web site. If you need the web site address, contact Installer Support.

## Extracting files

These are general instructions for extracting the Fallback Updater files.

1. Create a folder for the Fallback Updater on your installer laptop.
2. Copy the `.ZIP` file to the folder you created.  
This file contains the Updater utility and all supporting files.
3. Extract the files from the `.ZIP` file to the same folder or to another folder.

It is recommended that you extract the files to a folder that will contain only the extracted files.

## Update instructions

The files extracted with the Fallback Updater include instructions for using the Fallback Updater. To ensure success, follow the provided instructions exactly.

The instructions may include troubleshooting information.



If troubleshooting instructions tell you to power cycle the router, do not power cycle the satellite router by unplugging the power cord from the router's rear panel. Doing so could result in static electricity discharge that could shock you and/or damage the router.

---



## Appendix C

# Standards compliance

The HX90 satellite router has been certified to comply with the standards listed in Table 11. Additional information follows the table.

**Table 11: HX90 standards compliance**

Category	Standard
Safety	UL60950-1 for the USA
	CAN/CSA-C22.2 No. 60950-1 for Canada
	EN60950-1 for the EU
Electromagnetic Interference (EMI)	FCC Part 15 for the USA
	ICES-003 for Canada
Electromagnetic Compatibility (EMC)	EN 301 489-1 and EN 301 489-12 for the EU
Telecommunications	TIA IPoS

## Safety — Operating conditions for Canada

In addition to the warnings and safety guidelines listed in this document, the following operating conditions apply to the HX90 when used in Canada:

The Canadian Department of Communications label identifies certified equipment. This certification means that the equipment meets certain telecommunications network protective operational and safety requirements. The Department does not guarantee that the equipment will operate to the user's satisfaction.

Before installing the equipment, users should make sure they are permitted to connect to the facilities of the local telecommunications company. The equipment must also be installed using an acceptable method of connection. In some cases, the company's inside wiring associated with a single line individual service may be extended by means of a certified connector assembly (telephone extension cord). The customer should be aware that compliance with the above conditions may not prevent degradation of service in some situations.

### *Repairs in Canada*

Repairs to certified equipment should be made by an authorized Canadian maintenance facility designated by the supplier. Any repairs or alterations made by the user to this equipment, or equipment malfunctions, may give the telecommunications company cause to request the user to disconnect the equipment.

Users should ensure for their own protection that the electrical ground connections of the power utility, telephone lines, and internal metallic water pipe system, if present, are connected together. This precaution may be particularly important in rural areas.



Users should not attempt to make electrical ground connections themselves, but should contact the appropriate electrical inspection authority, or electrician, as appropriate.

---

## Electromagnetic interference (EMI)

This product conforms to EMI standards of the U.S. FCC, Canadian CSA, and European Union (EU), as detailed in the following sections. The installation and maintenance procedures in the installation guide must be followed to ensure compliance with these regulations.

### NOTICE

This is a class B product. In a domestic environment, this product may cause radio interference, in which case the user may be required to take adequate measures.

---

### ***FCC Part 15***

This section applies to the HX90 satellite router.

Standards to which conformity is declared: FCC Part 15

The router complies with Part 15 of the FCC Rules. Operation is subject to the following two conditions: (1) This device may not cause harmful interference, and (2) this device must accept any interference received, including interference that may cause undesired operation.

Responsible party's name: Hughes Network System, LLC

Address: 11717 Exploration Lane, Germantown, MD 20876

Telephone: 1 (866) 347-3292

Trade name: HUGHES

Type of equipment: Two-way Hughes system

Model number: HX90 (1502573-xxxx)

### ***Canada Class B warning***

The two-way Hughes system (HX90) complies with the Canadian ICES-003, Class B standard.

Cet appareil numérique de la classe B est conforme à la norme NMB-003 du Canada.

### ***R&TTE (EU)***

This product is within the scope of the EU Radio Equipment and Telecommunications Terminal Equipment (R&TTE) Directive.

## **Electromagnetic compatibility (EMC)**

This product conforms to the EMC standards of the European Union (EU). The installation and maintenance procedures in the installation guide must be followed to ensure compliance with these regulations.

### **NOTICE**

This is a class B product. In a domestic environment, this product may cause radio interference, in which case the user may be required to take adequate measures.

---

### ***R&TTE (EU)***

This product is within the scope of the EU Radio Equipment and Telecommunications Terminal Equipment (R&TTE) Directive.

## **IPoS**

The Hughes HX90 system is compliant with IPoS, ratified by the Telecommunications Industry Association (TIA-1008), first published in October 2003 and issued as Revision A in May 2006.



Figure 79: IPoS symbol



# Acronyms and abbreviations

---

## **A**

---

AC – Alternating current  
ACP – Automatic cross-polarization  
ACS – Auto-commissioning server

## **C**

---

CAN – Canada  
CSA – Canadian Standards Association

## **D**

---

DAPT – DiSeqC antenna pointing tool  
DC – Direct current ,  
DHCP – Dynamic Host Configuration Protocol  
DNS – Domain Name System

## **E**

---

EMC – Electromagnetic Compatibility  
EMI – Electromagnetic Interference  
Es/No – Energy per symbol per noise power spectral density  
EU – European Union

## **F**

---

FCC – Federal Communications Commission  
FSB – Field service bulletin

## **H**

---

HTTP – HyperText Transfer Protocol

## **I**

---

ICES – Interference-Causing Equipment Standard

ID – Identifier  
IDU – indoor unit  
IFL – Inter-facility link  
IP – Internet Protocol  
IPoS – Internet Protocol over Satellite  
IPSec – Internet Protocol Security

## **L**

---

LAN – Local area network  
LED – Light emitting diode  
LNB – Low-noise block

## **N**

---

NAT – Network address translation  
NIC – Network interface card  
NOC – Network Operations Center  
NSP – Network service provider

## **O**

---

ODU – Outdoor unit (antenna and radio assembly)  
  
OPI – Outdoor pointing interface

## **P**

---

PIN – Personal identification number

## **R**

---

R&TTE – Radio equipment and Telecommunications Terminal Equipment  
RF – Radio frequency

## **S**

---

SAN – Site account number

SAT IN – Satellite in

SAT OUT – Satellite out

SBC – Satellite-based commissioning

SQF – Signal quality factor

## **T**

---

TCP – Transmission Control Protocol

TCP/IP – Transmission Control Protocol/Internet Protocol

TIA – Telecommunications Industry Association

## **U**

---

UL – Underwriters Laboratory

URL – Uniform resource locator

## **V**

---

VAC – Volts, alternating current

VDC – Volts, direct current

VSAT – Very small aperture terminal

## **Z**

---

ZIP – Zone improvement plan (U.S. Postal Service)



## **A**

---

AC/DC power supply 25  
Address for opening the System Control Center 67  
Address, See IP address 10  
Advanced Pages  
    accessing 73  
Antenna 11  
    documentation 20  
    installing 12  
    location, entering 34  
    pointing 19  
Audience for this guide 10

## **B**

---

Browser requirements 17  
Button links on System Control Center pages 70

## **C**

---

Cable connectors, tightness 23  
Cables, approved types 19  
Canada Class B warning 117  
Canadian safety standards 115  
Checklist for installation 13  
Class B warning (Canada) 117  
Color of System Status button 71  
Commissioning 29  
    entering commissioning parameters 34  
    manual commissioning 57  
    methods 29  
    registering the satellite router 52  
    satellite-based commissioning 29  
Completing installation 61  
Compliance with standards 115  
Computer requirements 17  
Confirming 61  
    files are up to date 61  
    Internet connectivity 99  
    NOC connectivity 98  
    receive signal 93  
    router is commissioned 91

TCP Acceleration 94  
    transmit signal 93  
    Web Acceleration 95  
Connecting 23  
    IFL cables 23  
    installer laptop to satellite router 24  
    satellite router to the customer's computer 63  
    transmit and receive cables 23

## **D**

---

DAPT pointing tool 15  
DC/DC power supply 26  
Detailed Problem Statistics page 108  
DNS setting 99  
Download limit 77

## **E**

---

EMC standards 117  
EMI standards 116  
Environment 10  
Ethernet connection, verifying 30

## **F**

---

Fair Access Policy 77  
    *See also* Download limit  
Fallback Updater 113  
FCC Part 15 116  
Firewall 100  
Front panel LEDs 85

## **G**

---

Grounding requirements, outdoor equipment 19

## **H**

---

Heat sources 22  
Help page (System Control Center) 83  
Hub 20

## **I**

---

- Icon for accessing Advanced Pages 73
- IFL cable connectors 19
- IFL cables
  - connecting to router 23
  - grounding 19
  - requirements 19
  - specifications 20
- Installation checklist 13
- Installation Reference Sheet, defined 11
- Installation specification, defined 11
- Installation summary 11
- Installer laptop computer 24
  - connecting to the satellite router 24
  - requirements 17
- Installing 11
  - completing 61
  - items required for installation 14
  - preparing 12
  - prerequisites 21
  - satellite router 21
    - summary 11
    - tasks 21
- IP address 30
  - obtaining router IP address 30
- IPoS 117
- IPSec 72

## **L**

---

- Labeling IFL cables 19
- LAN ports 10
  - configuration 10
- Lan ports
  - LEDs 87
- Latitude and longitude 37
- LEDs
  - front panel 85
  - LAN ports 87
  - on power-up 28
  - purpose 85
  - using for troubleshooting 87
- Links (System Control Center) 68
- LNB, selection 41
- Location for satellite router 21

## **M**

---

- Manual commissioning 57

## **N**

---

- Networking requirements 18
- N-G voltage 14
  - measuring 14
- N-G voltage, measuring 109

## **O**

---

- Obtaining router IP address 30
- Opening the System Control Center 67
- OPI pointing tool 39

## **P**

---

- Parameters on System Control Center screens 74
- Position for operating router 22
- Power cycling 90
- Power outlet 13
  - requirements 16
  - testing 13
- Power supply 15
  - AC/DC 24
  - DC/DC 26
- Powering down the satellite router 16
- Powering up the satellite router 27
- Preparing for installation 11
- Prerequisites for installation 21

## **R**

---

- Radio parameters 41
- Receive antenna pointing 45
  - ka-band 45
  - Ku-band 49
- Receive cable, connecting 23
- Receive status 78
- Reception Information page 77
- Red flag indicators 74
- Registering the satellite router 52
- Related components and documentation 20
- Related installation documentation 20
- Repairs in Canada 115
- Rescue switch 89
- Restart router 69

RxCodes 78

## **S**

---

Safety standards, Canadian 115  
Safety symbols 8  
Satellite parameters 37  
Satellite router overview 9  
Satellite transponders 37  
Satellite-based commissioning 29  
sbc.cfg file 32  
Scope of this guide 10  
Shortcut to the System Control Center 64  
Site survey 15  
Slow speed 107  
Specifications 10  
Standards compliance 115  
Statistics, viewing 108  
System Control Center 67  
    opening 67  
    Reception Information page 77  
    System Information page 82  
    System Status button colors 71  
    System Status page 75  
    Transmission Information page 79  
System Information page 82  
System Status button colors 72  
System Status page 75

## **T**

---

Tests and Testing, See Troubleshooting 89  
Transmission Information page 79  
Transmit antenna pointing (Ku-band) 50  
Transmit cable,connecting 23  
Transmit radio parameters 44  
Transmit Status 80  
Troubleshooting 89  
    cannot access System Control Center 100  
    cannot access the Internet 91  
    problem with a connected device 104  
    reference diagram 90  
    using front panel LEDs 101  
    using LAN port LEDs 106  
TXCodes 80

## **U**

---

Updating router software (fallback.bin file) 113  
Uploading the sbc.cfg file 32

## **V**

---

Ventilation 22  
Viruses 100

