

BUBBLE SCIENCE

A hand is shown from the bottom right, holding a single, clear bubble. The background is a vibrant blue, filled with numerous other bubbles of various sizes, some in sharp focus and others blurred, creating a sense of depth and movement. The overall aesthetic is clean and scientific.

THAMES & KOSMOS

WARNING — Science Education Set. This set contains chemicals and/or parts that may be harmful if misused. Read cautions on individual containers and in manual carefully. Not to be used by children except under adult supervision.

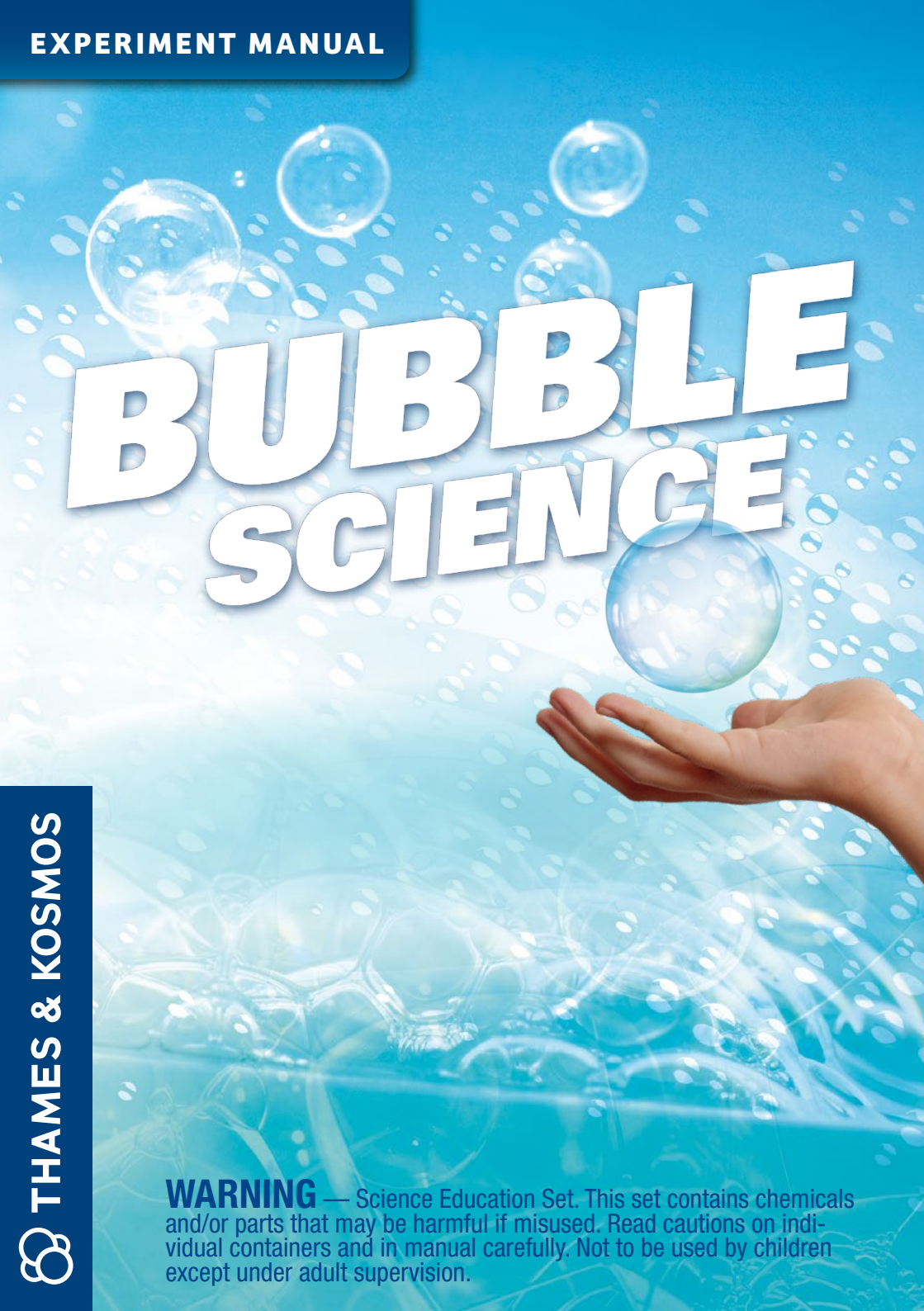

What's in your experiment kit



Checklist: Find – Inspect – Check off

✓	No.	Description	Qty.	Item No.
<input type="checkbox"/>	1	PUSTEFIX concentrate	250 ml	none
<input type="checkbox"/>	2	Connector ball	8	000 401
<input type="checkbox"/>	3	Connector rod, long	2	700 230
<input type="checkbox"/>	4	Connector rod, short	12	700 231
<input type="checkbox"/>	5	Large bubble-blowing ring	1	000 404
<input type="checkbox"/>	6	Plastic tray with sockets	1	000 405
<input type="checkbox"/>	7	Toy car	1	000 406
<input type="checkbox"/>	8	Measuring cup (5 to 30 ml)	2	061 150
<input type="checkbox"/>	9	Plastic funnel	1	000 410
<input type="checkbox"/>	10	Cardboard, red	1	000 411
<input type="checkbox"/>	11	Cardboard, green	1	000 412
<input type="checkbox"/>	12	Drinking straw	3	000 414

Before doing anything else, please check all the parts against the list to make sure that nothing is missing. If you are missing any parts, please contact Thames & Kosmos customer service.

Additional things you will need:

empty jelly jars or preserving jars with lids, liquid soap or soap shavings, dishwashing liquid, distilled water, glycerin, sugar, pennies, paper clips, candle, matches, baking sheet, ruler, cotton thread, sewing needle, bucket or shallow bowl, 1 meter of flexible wire

Any materials not contained in the kit are marked in *italic script* in the “You will need” boxes.

Preparation, Tips, and Tricks Pages 3 to 7

The right recipe for a perfect soap bubble solution



Experiments with Water and Soap • Pages 8 to 12

Investigate the difference
between soap and
dishwashing liquid



Fascinating Giant Bubbles Pages 19 to 25



Rainbow Colors: Shimmering Soap Bubbles Pages 26 to 29

How many colors does a
soap bubble have?



Geometric Shapes Made of Soap Film • Pages 30 to 43

Conjure up cubes,
prisms, and octahedra
made of soap bubbles



Soap Fun with Friends Pages 44 to 48

Handball, tennis, and car
racing with soap bubbles



Astonishing Bubble-Blowing Experiments • Pages 13 to 18

Learn your first bubble-
blowing tricks



CHECK IT OUT

You will find supplemental
information on pages 6, 7,
12, 18, 25, 29, 42, and 43.

WARNING!

CAUTION! Some parts of this kit have pointed or sharp corners or edges due to their function. Do not injure yourself!

Not appropriate for children under 3 years of age, due to risk of swallowing small parts and liquids.

The following applies to the soap mixture: Do not swallow! Keep away from young children! Do not put in eyes or on mucous membranes!

Before starting, check the contents against the list to make sure all the right parts are in the kit.

Save the packaging and instructions, as they contain important information.

Rules for safe experimentation

- Carefully prepare your workplace for the experiments. Make sure you have enough space, and get everything ready before you need it.
- Carry out the experiments calmly and carefully, and follow the instructions precisely.
- Read the instructions before use, follow them, and keep them on hand for reference.
- Keep young children and pets away from the experiment area.
- Store the experiment kit out of the reach of young children.

SAFETY INFORMATION

Dear Parents!

This experiment kit will help your child discover how to turn the right mixture of soap and water into a lot more than just little round soap bubbles. He or she will learn, for example, how to make hand-blown bubbles, how to produce square bubbles, and how to conjure up gigantic monster bubbles by using the soap bubble frame. Please stand by your child's side and be ready to offer help whenever necessary. With a little practice and patience, your child will soon be able to amaze friends and family members with astonishing soap bubble tricks!

We wish you and your child a lot of fun and interesting experimentation.



A child in a blue shirt is blowing bubbles in a park. The bubbles are large and colorful, reflecting the sunlight. The background is a soft-focus green lawn and trees.

Preparation, Tips, and Tricks

For your soap bubble experiments to come off right, it's important to use the right kind of soapy water. You can buy ready-made soap bubble solutions in toy stores or mix them up yourself out of various ingredients. In this chapter, you will learn how to make the right kind of soap solution, how to conjure up soap bubbles with many different bubble wand devices, and lots of other tips and tricks.

The right soap solution

YOU WILL NEED

- PUSTEFIX concentrate
- measuring cup
- water
- small bowl

HERE'S HOW

1. Dilute the concentrate with water at a ratio of 1:5 – in other words, add five units of water to one unit of concentrate.
2. Stir everything well and let the mixture stand until the foam on the surface has dissolved.



1



2

Soap bubble recipe

For some of the experiments, such as the one in which you will be blowing giant bubbles (see page 23), you will need a larger quantity of soap solution.

Recipe suggestion 1, for quick success

YOU WILL NEED

- bucket or washbowl
- 1 liter (distilled) water (4 cups)
- 2-3 tablespoons dishwashing liquid
- 1 teaspoon glycerin (from the drug store)

HERE'S HOW

Mix the (distilled) water with the dishwashing liquid and glycerin.

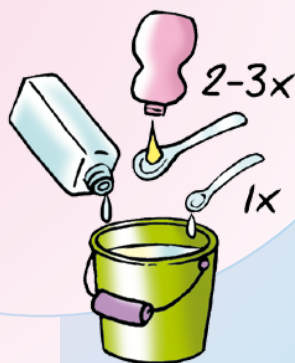

Recipe suggestion 2, for giant bubbles

YOU WILL NEED

- 500 g sugar (2 and 1/2 cups)
- 7 liters water (2 gallons)
- 750 ml dishwashing liquid (3 cups)
- 60 ml glycerin (4 tablespoons)
- 10-liter bucket (3-gallon)

HERE'S HOW

1. Dissolve 500 g sugar in 1 liter of warm water.
2. Mix 750 ml dishwashing liquid with 1 liter water.
3. Stir the sugar solution and neutral soap solution together with 60 ml glycerin and another 5 liters of water, and let the mixture stand for a few hours. If you let the mixture stand for one or two days, the experiment will work even better.



The Right Water

Normal tap water often contains calcium, which makes it “hard.” Since calcium binds to the soap, it makes sense to work with distilled water. The “softer” the water is, the more durable the soap bubbles will be. **Glycerin liquid, which contains alcohol, acts like sugar** in helping to make the soap solution stickier and the soap bubble skin thicker. This way, the soap bubbles will last longer!



THE BEST RECIPE?



There isn't a single “ultimate” soap bubble recipe, because a soap solution will behave differently depending on climate and season. All soap bubble artists have experimented with different ingredients and tested different liquid soaps. Over time, each one has invented his or her “own” soap solution. Sooner or later, you too will probably find your own personal super-best soap mixture!



Five tips for bubble blowers

1

Soap bubbles love rainy days! Why? The bubbles are especially successful and long-lasting if the humidity is high. Hot, dry summer days will cause bubbles to pop quickly, because the water on the bubble's skin evaporates fast.



2 Wind is the soap bubble researcher's archenemy. So for your experiments, look for a place that is sheltered from the wind.



3 The best known tool for blowing bubbles is a drinking straw. Use this trick for preparing the end you blow into: Make two cuts, about 1 cm deep, into one end of the straw, and bend back the four resulting flaps.



4 Soap bubbles are light as air and quite beautiful — but they are also sticky! The best thing is to take your experiment kit outside and let the bubbles rise up into the sky. If you work inside, you should first cover a wide area of the room with newspapers.



5 You will find a few time-tested tips in the experiment kit. With a little imagination, though, you can invent and try out your own bubble-blowing tools. Poke around in the kitchen and the basement. How about a wire clothes hanger as a bubble wand? Or a toilet paper roll as a blow-tube?





Experiments with Water and Soap

The Sumerians were already making soap 4,000 years ago. But it wasn't until 100 years ago that a lot of people learned how fresh and clean they could feel after a shower or a bath. Today, we use a lot of different cleaning agents on a daily basis. But is there any difference between, say, soap and dishwashing liquid? You'll find out in the following experiments!

Doing the soap test

YOU WILL NEED

- 2 empty jelly jars with lids
- 1 teaspoon of liquid soap or soap shavings
- 1 teaspoon of dishwashing liquid

HERE'S HOW

1. Fill both jelly jars with water and set them in the fridge for about an hour.
2. Take both jars out of the fridge and add a teaspoon of soap to one and a teaspoon of dishwashing liquid to the other. Screw the lids tightly onto both jars.
3. Now shake both jars thoroughly. As you do this, check their contents every one or two minutes. In which jar does the soap dissolve quicker? In which jar do you get more soap bubbles?

→ WHAT'S HAPPENING?

Dishwashing liquid is a chemical that reacts just like soap to water and oil — only a little more strongly!

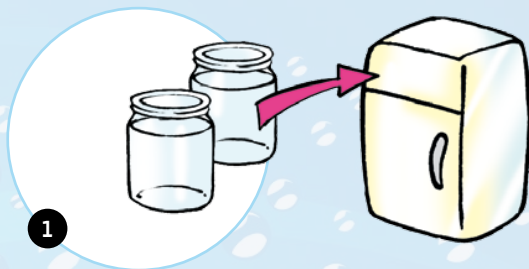

A skin made of water

Have you ever done a belly flop into a swimming pool? If your entire body smacks flat against the water's surface, it can hurt quite a bit. The reason has to do with the so-called surface tension of water.

YOU WILL NEED

- 1 bowl of water
- 1 paper clip
- 1 sheet of (blotting) paper
- dishwashing liquid or soap

HERE'S HOW

1. Fill a shallow bowl with water. Lay a sheet of paper (ideally, blotting paper) flat against the water's surface. Now carefully place the paper clip on the paper.

What do you think will happen? Will the paper clip sink or float?

2. Now add a dash of dishwashing liquid or a little soap to the bowl of water.

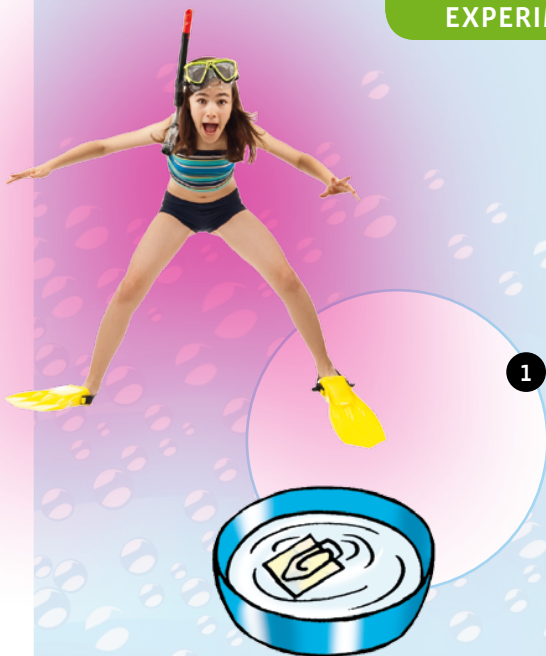

→ WHAT'S HAPPENING?

The surface tension of the water holds the paper clip up even after the paper has become water-logged and sunk. But the soap reduces the water's surface tension and destroys its skin. The paper clip can no longer be held up, and it sinks.

A trick with pennies

Soap reduces the surface tension of water. You can use this effect of soap on water to perform a trick that will astonish your friends. To be sure it comes off, you should practice the trick a few times before presenting it.

YOU WILL NEED

- measuring cup
- a few pennies
- 1 teaspoon of dishwashing liquid

HERE'S HOW

1. Fill the measuring cup to the brim with water. Place the pennies next to it. But before your presentation, secretly rub one of the pennies with soap or dishwashing liquid. Now tell a friend that you know that exactly three pennies will fit into the measuring cup before it overflows.
2. Carefully slip the first penny into the measuring cup, then the second and the third.

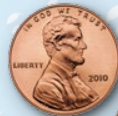

→ WHAT'S HAPPENING?

Even though the water level rises, the cup doesn't overflow. The water's surface tension holds it to the upper edge of the cup. Even the second and third pennies fail to break the water's skin. But as soon as you drop in the one that was rubbed with soap, the cup overflows.



LOVE-HATE RELATIONSHIP BETWEEN WATER AND SOAP MOLECULES

Any soap solution consists of molecules of the water and molecules of the added soap. In water, the soap molecules decompose into electrically positively-charged particles (the little hats), which spread out inside the liquid, and negative particles (green men), which pack themselves into an extremely thin layer on both surfaces.

These negative particles consist of hydrophilic ("water-loving") "heads," which they stick into the internal liquid layer of the water molecules, and hydrophobic ("water-hating") "feet," which stick outward. The water-rejecting ends even stick out into the air. This thin layer of negative particles on the bubble skin reduces the water's surface tension, and also prevents the water molecules on the inside from evaporating.



WATER STRIDER

Did you know that there are animals that can walk on water? The surface tension of water creates a razor-thin surface on which some animals spend their whole lives. The water strider is one of them. This creature lives on the border between air and water. Like an ice skater, it glides over the water's surface with its legs making little indentations in the water's skin.



The skin of a soap bubble

You can't make lasting bubbles out of pure water. If you blow through a straw into a glass of water, it will certainly bubble quite a bit, but all the little bubbles will immediately disappear again. Not until you add some soap will the liquid form nice, pretty round bubbles that last. The soap reduces the surface tension of the water and makes the water's skin soft and flexible. The skin of a soap bubble is super-thin — usually less than a thousandth of a millimeter.

A young girl with dark hair is blowing a large, colorful soap bubble. The bubble is iridescent, showing vibrant rainbow colors. The background is dark, making the bubble stand out. The girl's face is partially visible on the right side of the frame, looking towards the camera.

Astonishing Bubble-Blowing Experiments

Blowing a small soap bubble inside of a large one is a feat that almost any soap-bubble artist can perform. Still, it's not as easy as it looks. With a little practice, though, you will definitely be able to do it. In this chapter, you will also learn that soap bubbles can blow back at you, and that a lot of soap-bubble artists simply use their hands to conjure up soap bubbles.

The bubble in the bubble

YOU WILL NEED

- funnel
- drinking straw
- soap solution (diluted concentrate)

HERE'S HOW

1. Dip the rim of the funnel into the soap solution and blow the biggest bubble you can, but don't release it from the funnel. Hold your finger over the funnel opening.
2. Coat the entire straw with soap solution, and then carefully insert it into the bubble.
3. Carefully blow a small bubble into the big one. Hold the straw in the bubble at a downward slant, so the smaller bubble is easier to release and so it doesn't join together with the big one to form a single bubble. After a while, you can try blowing several bubbles inside a giant one.

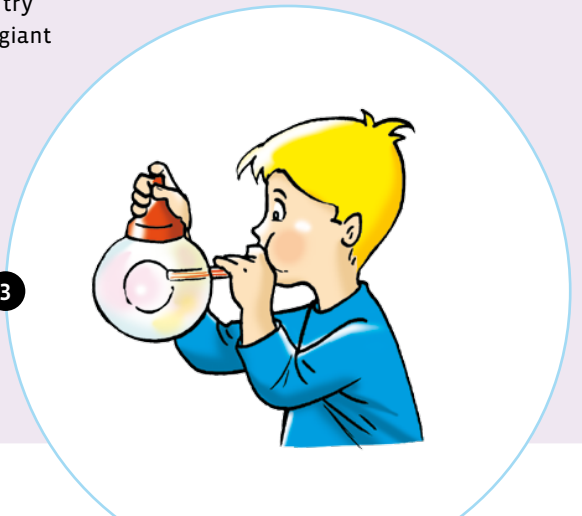

A soap bubble blows back

YOU WILL NEED

- funnel
- soap solution (diluted concentrate)
- 1 candle
- dish or saucer
- a few matches

HERE'S HOW

Soap bubbles can blow back too! This experiment will demonstrate the power of a soap bubble's lungs.

1. Set the candle on a plate on the table and light it. Dip the funnel into the soap solution and blow a large bubble without releasing it from the funnel.
2. Hold your finger over the funnel opening, and hold the opening about 1.5 cm away from the candle flame.

→ WHAT'S HAPPENING?

When you remove your finger from the opening, the soap bubble starts to blow. You can gauge the strength of the stream of air coming from the bubble by watching the flickering of the candle flame. The bubble gets smaller and smaller, and eventually disappears inside the funnel.

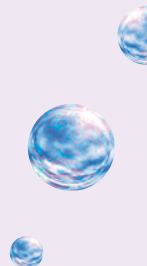
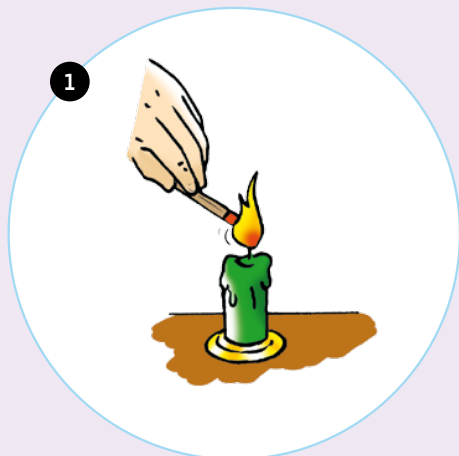

Blowing bubbles with your hands

YOU WILL NEED

- *your hands*
- *1 bucket with soap solution (diluted concentrate or recipe suggestion 1 or 2, see page 5)*

HERE'S HOW

1. Place your thumbs and index fingers together so their tips are touching.
2. Dunk your hands deep into a bucket of soap solution. Make sure that both hands get completely coated all the way around. When you pull your hands back out, there should be a film of soap between your fingers.
3. Blow softly against the soap skin — you will get a large soap bubble. If you want to release the bubble from your hands and let it float freely in the air, slowly narrow the opening of the blow-hole between your fingers. In this way, you will seal the bubble and it will fly away.
4. You can also blow soap bubbles with just one hand. Dip your hand in the soap solution until a film of soap has formed in the “O.” Then, blow softly.

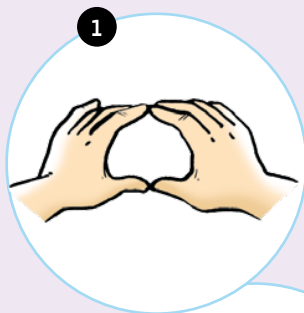

Test your lungs

YOU WILL NEED

- drinking straw
- soap solution (diluted concentrate)
- *baking pan*
- *ruler*

HERE'S HOW

1. Fill a baking pan with about 2 to 3 mm of soap solution and wet the ruler in the solution.
2. Take a deep breath and blow through the straw to make a half-bubble in the pan. Empty all the air out of your lungs into it.
3. Now you can measure the air volume by pushing the damp ruler through the half-bubble of soap and measuring the diameter from one edge of the bubble to the other.

→ WHAT'S HAPPENING?

You blow a portion of the air in your lungs into every soap bubble you make. The soap bubbles gently rise up into the air as soon as you release them from the straw. The reason for this is the warmth of the air that comes straight from your body.

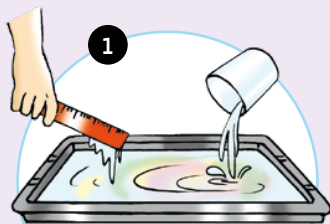

In the table, you can check how much air the bubble contains. Compare your lung volume with that of your friends. Who can blow the biggest soap bubble dome?



<i>Diameter</i>	<i>Lung volume</i>
<i>5 cm</i>	<i>about 0.03 liters</i>
<i>10 cm</i>	<i>about 0.3 liters</i>
<i>12 cm</i>	<i>about 0.5 liters</i>
<i>15 cm</i>	<i>about 0.9 liters</i>
<i>18 cm</i>	<i>about 1.5 liters</i>
<i>20 cm</i>	<i>about 2.0 liters</i>

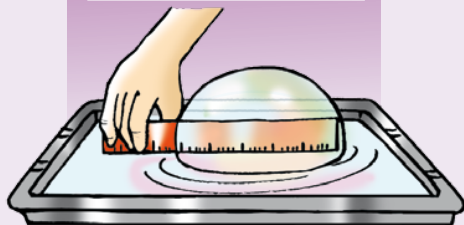



Photo: Udo Weger



The Wonderful World of Soap Bubbles

Blowing bubbles is an age-old game. Over 5,000 years ago, the ancient Sumerians discovered soap. Since then, soap bubbles have enchanted people the world over. Soap production has improved over the centuries, with special ingredients in the soap solution allowing bubbles to be especially colorful and long-lasting.

Performing artists and clowns are particularly entranced by soap bubbles. With an inventive spirit and lots of practice, they have come up with a constant stream of feats and tricks to enchant the public: soap bubbles that dance through the air to music, long chains of bubbles, and gigantic bubbles big enough to contain a person or even a car. Some clowns and magicians have become quite famous on account of their bubble-blowing.





Fascinating GIANT BUBBLES

You can use the soap bubble frame, which was invented by an American soap bubble expert, to make giant soap bubbles and perform a lot of other exciting experiments. You will find a few experiment suggestions in this chapter. The big ring is also a crucial piece of equipment for any soap bubble artist. Soap bubble experts the world over have worked with it. The ring can be used for a lot of different tricks. It is especially good for conjuring up monster bubbles. Try it yourself!

The soap bubble frame (part 1)

YOU WILL NEED

- 2 drinking straws
- *cotton thread (about 60 to 80 cm length)*
- *sewing needle*
- *shallow bowl*
- *soap solution (diluted concentrate or recipe suggestion 1 or 2, see page 5)*

HERE'S HOW

1. Use a sewing needle to run the cotton thread through both straws, and tie the ends to get four equal sides: two straw sides and two thread sides.
2. Fill a shallow bowl with soap solution.
3. Hold the soap bubble frame by the straw sides like they are two handles, and dip the entire frame into the soap solution. Be sure that your hands get wet, too. When you pull out the frame, your hands should be about 5 cm apart.
4. Outside the bucket, stretch the frame by pulling your hands slowly apart. You will see a film of soap stretching between the four sides of the frame.
5. If you move the frame through the air with an even motion, you will get a large soapy tube. To close the tube into a bubble, simply move the two straw handles together.

With a little practice and the right weather conditions, you can get really gigantic bubbles using this method!

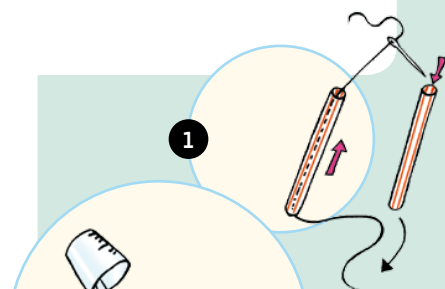

The soap bubble frame (part 2)

YOU WILL NEED

- soap bubble frame from Experiment 10
- soap solution (diluted concentrate)
- drinking straw

HERE'S HOW: MINI-BUBBLES

1. This time, hold the frame by the thread sides instead of the straws, and dip it into the soap solution. Pull on the thread so a narrow film of soap forms between the straws.
2. Guide the soap film back and forth in front of your mouth like a harmonica, blowing steadily into it.

HERE'S HOW: BLOWING WITH THE FRAME

1. Form a film of soap inside the frame.
2. Hold the frame about 3 to 5 cm away from your mouth and blow softly into the center of the soap skin.



→ **WHAT'S HAPPENING?**

You get a lot of little bubbles!

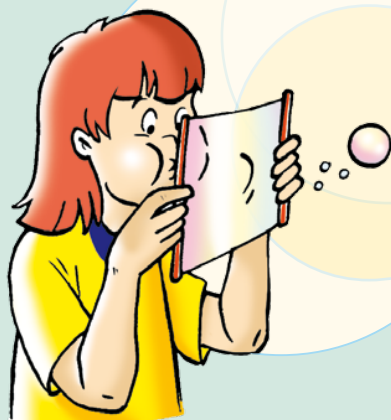

→ **WHAT'S HAPPENING?**

The soap film bulges out and gradually forms a bubble.

The soap bubble frame (part 2)

HERE'S HOW: CAPTURING A BUBBLE

1. Blow a medium-sized bubble with the frame, exactly as described in the Experiment 10.
2. Then try enclosing this bubble inside of a giant one. Pull the frame through the air so you catch the medium-sized bubble in the soapy tube.

Did it work?



HERE'S HOW: THE SOAP BUBBLE TRAMPOLINE

1. Dip the frame in the soap solution, pull it out, and hold it in front of your body like a tray.
2. Ask a friend to blow a bubble into the air with the straw.



→ WHAT'S HAPPENING?

With a little practice, you can get the soap bubble to bounce on the film of soap without bursting, just like on a trampoline.

The big ring

YOU WILL NEED

- large ring
- black plastic tray
- soap solution (larger quantity of diluted concentrate or *recipe suggestion 2, see page 5*)

HERE'S HOW

1. Fill the black plastic tray from the kit with soap solution.
2. Completely submerge the ring in the soap solution and carefully pull it out again. There will be a skin of soap shimmering in the ring. Just as you did with the soap bubble frame, pull the ring through the air.

Have fun with your monster bubbles!

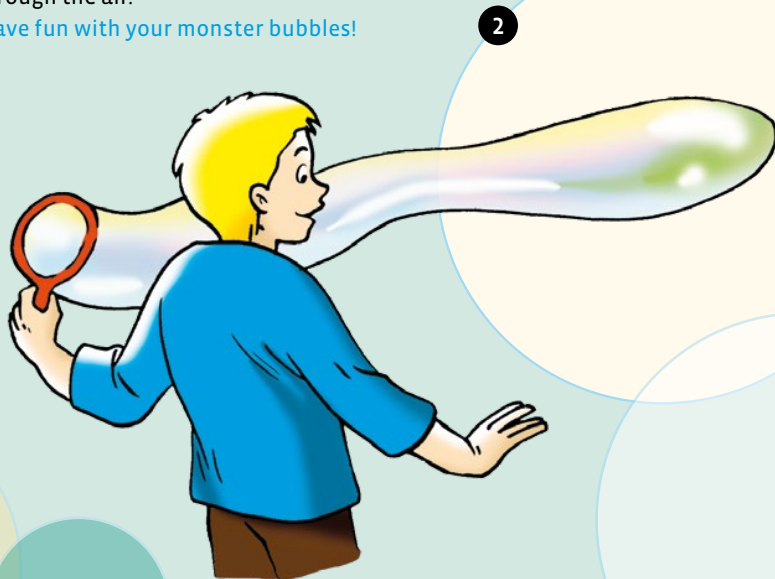
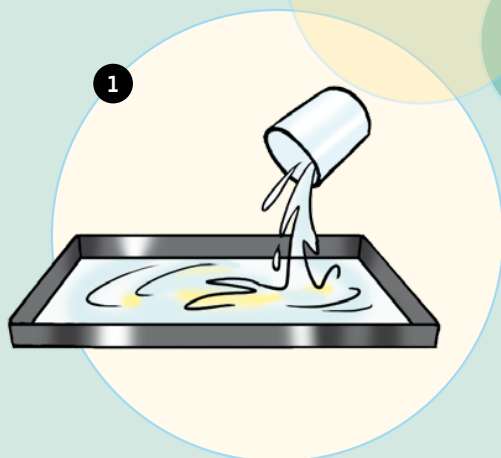

Shapes made of wire

YOU WILL NEED

- about 1 meter of bendable wire (such as green garden wire)
- soap solution (diluted concentrate or recipe suggestion 1 or 2, see page 5)

HERE'S HOW

1. Bend the wire into any shape that you like. Just be sure that the shape contains an enclosed area. You can wind the wire's end a few times around the handle to keep it in place.

2. Dip your shape into the soap solution and blow.

What do soap bubbles look like when they are blown through a square or heart-shaped loop of wire?

→ WHAT'S HAPPENING?

Regardless what shape your wire has, the soap bubbles are always round! That has to do with the fact that the elastic film of soap seeks to form the most stable geometric shape — a sphere. But there's a trick for making square bubbles. You will find this surprising technique on page 38!

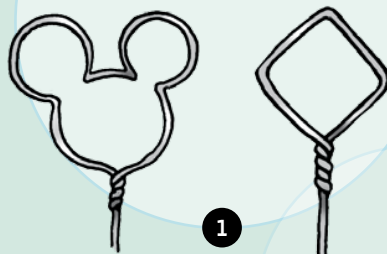

2





Who was Rolf Hein?

In 1948, a German chemist by the name of Rolf Hein invented a new cleaning product. Unfortunately, the product didn't work for washing clothes! On the other hand, it made great bubbles — beautiful, long-lasting ones. Rolf Hein could see right away that it would make a wonderful toy. So the soap bubble solution was quickly packed into aluminum tubes along with a bubble-blowing wand made of spring wire, and everything was sealed up tight with a cork. The great bubble-blowing craze had begun! And because so many people had so much fun with this toy, it continued to spread across the whole world. Today, a mind-boggling 5 million tubes, or 500,000 liters, of Pustefix soap bubble solution are produced every year.

World's largest free floating soap bubble

According to Guinness World Records, the largest free floating soap bubble had a volume of 13.67 cubic meters (483 cubic feet) and was made using a giant wand. It was produced by Jarom Watts at The Lincoln Center in Spokane, Washington, on February 21, 2009.



MARK TWAIN ON BLOWING BUBBLES:

“A soap-bubble is the most beautiful thing, and the most exquisite, in nature... I wonder how much it would take to buy a soap-bubble, if there was only one in the world?”

From *A Tramp Abroad* by Mark Twain, author of *Tom Sawyer* and *The Adventures of Huckleberry Finn*

Soap bubbles are transparent, yet they shimmer with all the colors of the rainbow — regardless of whether they are large or small. Try and find out how many different colors you can see. Then, on page 29, you will learn why it is that soap bubbles shimmer with so many different colors.



Rainbow Colors: Shimmering Soap Bubbles

Observing colors

YOU WILL NEED

- measuring cup
- drinking straw
- soap solution (diluted concentrate)
- black plastic tray

HERE'S HOW

1. Completely wet the small measuring cup inside and out with soap solution.
2. Wet the straw as well, and use it to carefully place a soap bubble on the rim of the cup. Then, position the black plastic tray behind the cup with the bubble.

1



2



→ WHAT'S HAPPENING?

The soap bubble shines with a lot of different colors. The shimmering multi-colored spectrum on the bubble's skin is one of the special attractions of soap bubbles.

Color contrasts

YOU WILL NEED

- large ring
- soap solution (concentrate)
- red, green, and *white* contrast paper
- black plastic tray
- *shallow soup bowl*

HERE'S HOW

1. In a bright room, set the black plastic tray upright on a table by leaning it against the wall or other object. Lay a white sheet of paper directly in front of it. The paper has to be well illuminated. If the regular light is not bright enough, use a desk lamp.
2. Pour the soap solution into the plate, and dip the ring into it to get a film of soap stretched across it. Let the excess soap drip off.
3. Hold the ring in front of the plastic tray, and tilt it forward a little so it reflects the light of the paper.
4. Now switch out the white paper for the red sheet, and repeat the experiment. Next, you can test the play of colors with the green paper.

What colors do you see in each case?



→ WHAT'S HAPPENING?

By using contrasting colors, you can get interesting differences in the colors you perceive. It's especially striking when you lay the red and green sheets next to each other and look at the different reflections of the two colors in the soap film at the same time.

“Beheaded” soap bubble egg



When soap bubbles burst, it looks like they just suddenly explode into the air. On closer investigation, though, it turns out that there’s advance notice of the end of a soap bubble, because soap bubbles actually explode in stages — turning from a round sphere to a half-sphere, and finally ending up as a drop of soap solution.

Due to the force of gravity, the film of soap gradually falls, with the layer of soap in the upper part of the bubble becoming thinner and thinner. As that happens, the upper portion suddenly appears transparent. The soap bubble acts like a breakfast egg in an egg cup. That’s the first step of the bursting process: Just before the bubble bursts, its top portion turns transparent. Then, for just a fraction of a second, the soap bubble looks like a soft-boiled egg with its top sliced off.

CHECK IT OUT



Colorful soap bubbles

Red, green, yellow, blue, orange — how do all these colors get onto the soap bubble? The colors come from white light, which is composed of a combination of all colors. Light moves in waves, with each wave having a different length. When light waves strike a film of soap, most of the light passes through the film. A small portion, though, is thrown back (reflected), just like off a mirror. In the process, the light waves on the front wall of the soap film and the ones on the back wall become layered on top of each other. The phenomenon is known as interference. Interference is what causes the alternating pattern of different colors on the soap bubble.

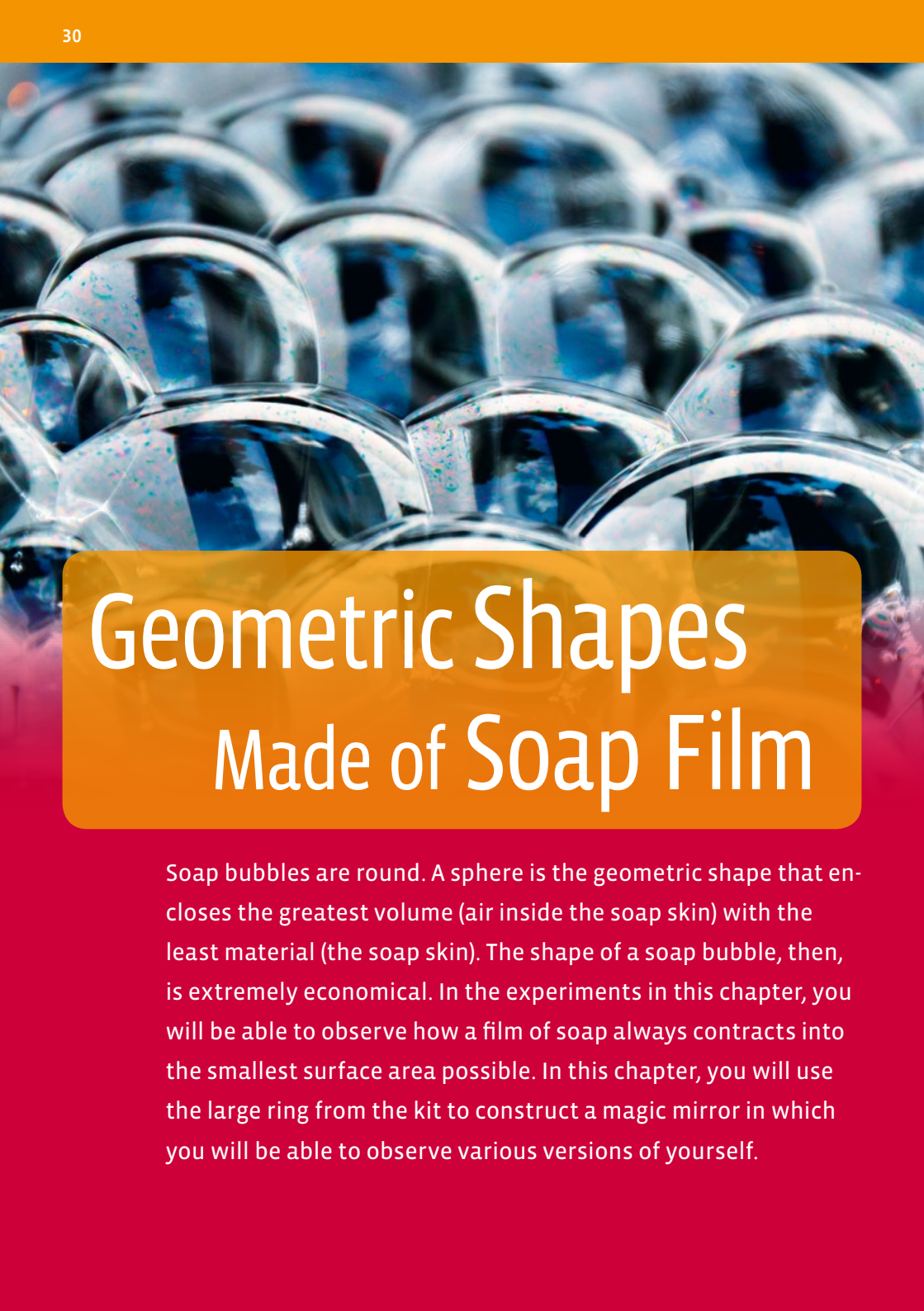

Geometric Shapes Made of Soap Film

Soap bubbles are round. A sphere is the geometric shape that encloses the greatest volume (air inside the soap skin) with the least material (the soap skin). The shape of a soap bubble, then, is extremely economical. In the experiments in this chapter, you will be able to observe how a film of soap always contracts into the smallest surface area possible. In this chapter, you will use the large ring from the kit to construct a magic mirror in which you will be able to observe various versions of yourself.

The inner circle

YOU WILL NEED

- large ring
- soap solution (diluted concentrate)
- *black cotton string*

HERE'S HOW

1. Tie the cotton string into a loop. Dip the loop in the soap solution until it's nice and saturated. Next, dip your ring into the solution and wait for a continuous film of soap to form inside it.
2. Next, carefully lay the loop of string on the film of soap inside the ring.
3. Now use a dry finger or straw to poke a hole in the loop.

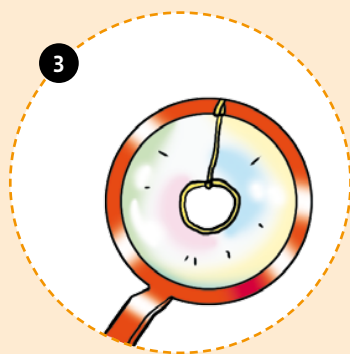
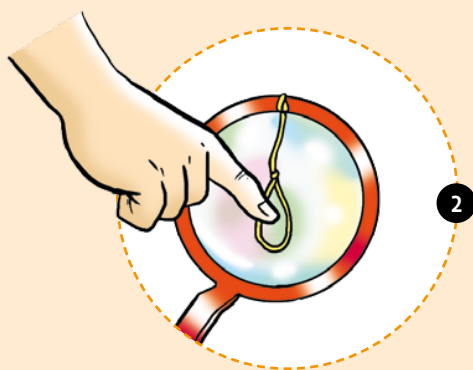
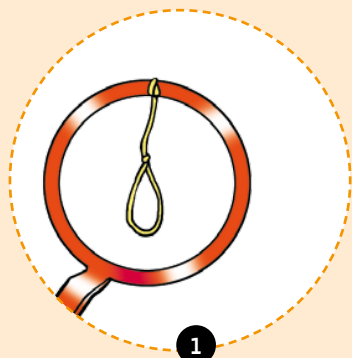

→ WHAT'S HAPPENING?

As soon as the film of soap inside the loop bursts, the loop adjusts itself into an exact circle. The string encloses the greatest possible volume within itself. If you move the ring back and forth a little, the loop will wander around in the soap film inside the ring.

Ring around the rosie

YOU WILL NEED

- large ring
- soap solution (diluted concentrate)
- *black cotton string*

HERE'S HOW

1. Tie the string in the ring as shown in Image 1.
2. Dip the ring into the soap solution.
3. Then, pierce the “flower petals” with your finger.

What happens?

→ WHAT'S HAPPENING?

When you pierce the individual flower petals with your dry finger, you see a flower inside the ring.

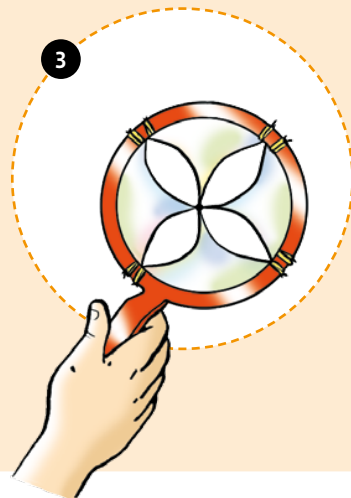
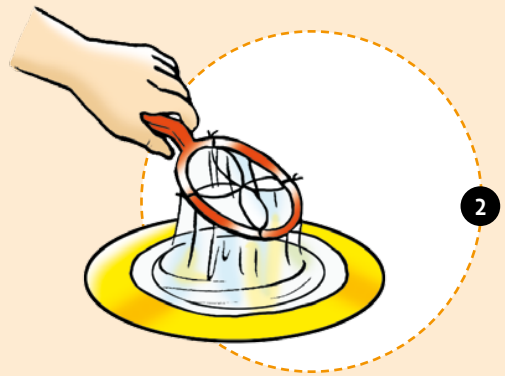
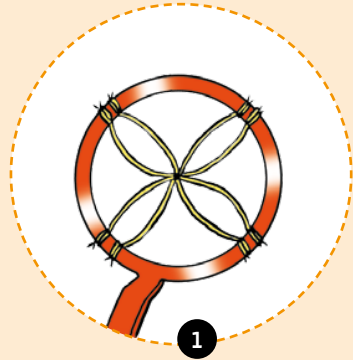

Linked soap bubbles

YOU WILL NEED

- black plastic tray
- soap solution (diluted concentrate)
- straw and/or funnel

HERE'S HOW

1. Turn the black plastic tray so the side with the smooth bottom is up, and pour 3 to 4 mm of soap solution into it.
2. Blow with the straw or funnel to make a soap bubble dome. Now, with the moist straw, penetrate the dome and blow a smaller dome inside it.
3. How many domes can you create inside one another?

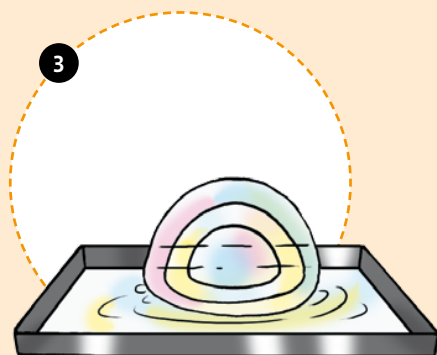
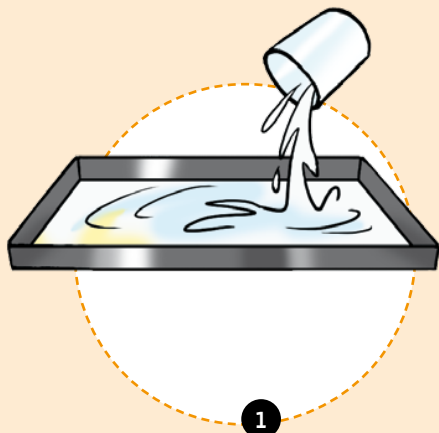

→ WHAT'S HAPPENING?

As soon as a soap bubble lands on a soapy surface, it turns into a dome in the blink of an eye. This is the most economical option for enveloping a given quantity of air.

The magic mirror

For this experiment, you'll have to be very quick or work together with a friend, because the bubbles burst quickly. Only once the entire ring is filled with soap bubbles will the magic mirror be relatively stable.

YOU WILL NEED

- large ring
- soap solution (diluted concentrate)
- drinking straw

HERE'S HOW

1. Dip the large ring into the soap solution to create a film of soap inside it. Dip the end of your straw into the soap, and blow a series of bubbles onto the film. The individual bubbles will settle against one another in a honeycomb pattern.
2. Gently move the ring up and down and observe the movement of the soap honeycomb.

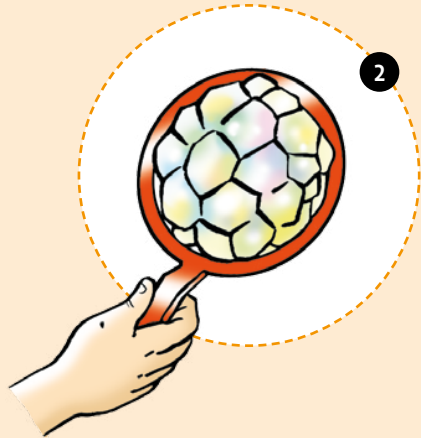

→ WHAT'S HAPPENING?

Soap bubbles carry a mirror image of their surroundings with them as they move through the air. If you look at a soap bubble, your mirror image will appear normal on the forward-bulging front side. On the rear side, your mirror image will be turned upside-down. The effect is fantastic, and well worth the effort.

Soap bubbles in six-sided shapes

If you sit in the bathtub taking a bubble bath, you have plenty of time to observe the soap suds. All the little bubbles in the foam collect in a certain way — namely, in six-sided shapes, or hexagons. Try investigating the way that soap bubbles attach to one another.



YOU WILL NEED

- soap solution (diluted concentrate)
- drinking straw
- black plastic tray

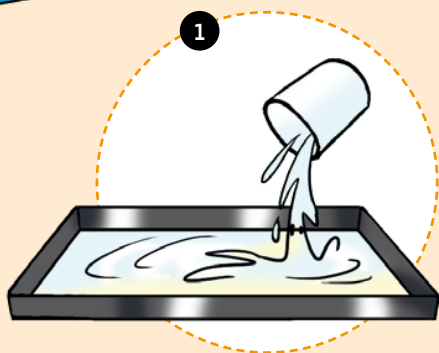

HERE'S HOW

1. Fill the black plastic tray with the diluted concentrate until the bottom is well covered.
2. Now, use the straw to blow lots of little bubbles in the tray.

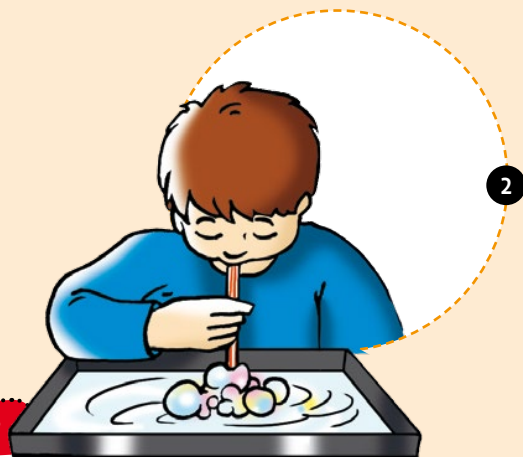

→ WHAT'S HAPPENING?

As soon as two bubbles bump together, they attach to each other by a single wall of soap. If several come together, the connecting walls always form in the same way and at the same angles.



Natural phenomena quiz

When hexagons collect together, there are practically no spaces between them. This “principle of economy” doesn’t just apply to soap bubbles, though. The same structure can also be found in other natural phenomena.

HERE'S HOW

Take a careful look at the hexagons on these two pages. Can you guess what it is you’re looking at? You will find the answers below — but don’t peek! First try to guess, and then check whether you got it right.

1

EXPERIMENT 21

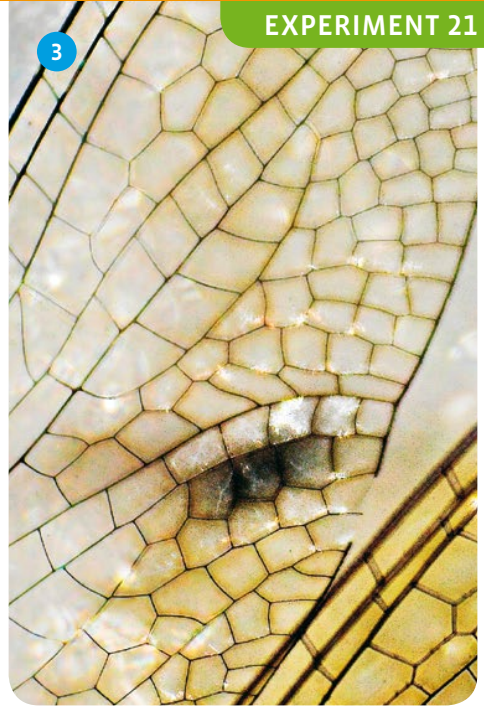

Square soap bubbles

Hard to believe, but they really do exist! With the help of a cube-shaped geometric figure, there's a little trick you can use to make a square soap bubble.

YOU WILL NEED

- 8 balls and 12 rods
- 1 longer rod
- drinking straw
- *soap solution (recipe suggestion 1, see page 5)*
- *bucket*

HERE'S HOW

1. First, to make a cube, assemble a square out of four balls and four rods. The square marks scratched into the ball should be pointing toward the center, and the two marker lines should be pointing up.
2. Insert four more rods into the upper holes and connect them to the four remaining balls and rods to form a cube. Then mount the longer rod to one corner of the cube to serve as a handle.
3. Grab the cube by the handle and dip it into the bucket of soap solution.
4. When you pull the cube back out of the bucket, you will see a square expanse of soap film. Carefully blow with the straw into the center of the cube. The square film will inflate into a cube-shaped soap bubble!
5. You can use the straw to change the cube model over and over again. Blow into the different soap skins, set small bubbles on the soap walls, or pop one or another of the soap walls with a dry finger.

How does your geometric shape change?
What new shapes do you get?

→ WHAT'S HAPPENING?

Surprisingly enough, the soap skins don't stretch over the six sides of the cube, but instead form inside the model.

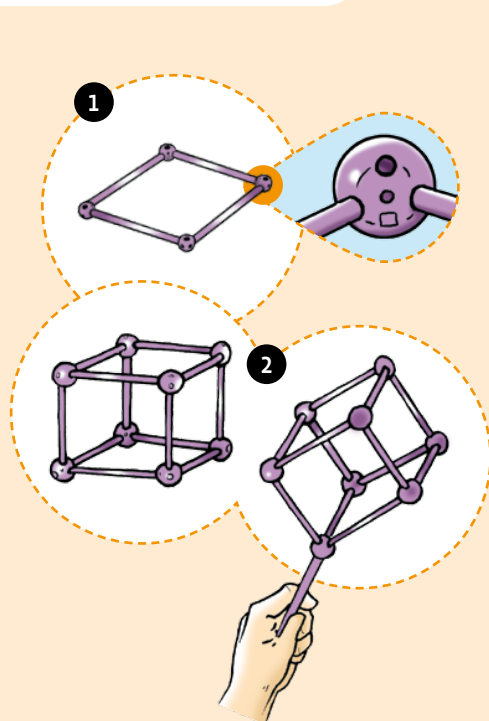

Tetrahedra, prisms, and octahedra

YOU WILL NEED

- 4 balls and 6 rods for the tetrahedron
- 6 balls and 8 rods for the prism
- 6 balls and 12 rods for the octahedron
- soap solution (recipe suggestion 1, see page 5)
- bucket

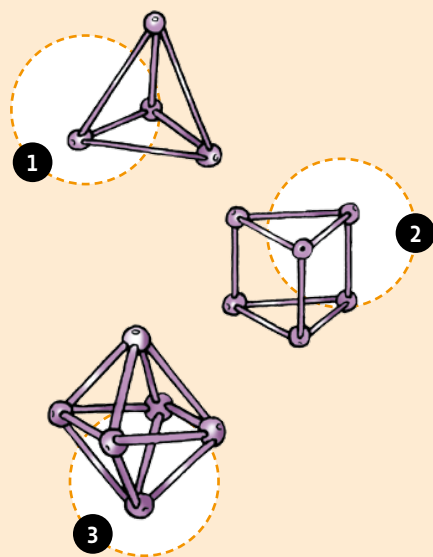

→ WHAT'S HAPPENING?

In each shape, a different geometric structure appears due to the play of forces of the soap skins — and yet, they always form according to the principle of economy.

HERE'S HOW

1. For the **tetrahedron**, first assemble an equilateral triangle out of three balls and three rods. The triangle markers scratched into the balls should be pointing inward. Now insert three rods around the triangle marker of the fourth ball and stick them into the balls of the equilateral triangle.
2. For the **prism**, assemble a triangle out of three balls and three rods. The square markers should be pointing outward and the two marker lines should be pointing up. Now insert three rods into the upper holes. Add three more balls and three rods to complete the prism.
3. For the **octahedron**, take the first ball in your hand and insert four rods into the four holes all around the square. Now insert another ball onto each of the free rod ends, making sure that all the squares are on the inside. If you connect the four balls with four rods, you get a pyramid. If you then assemble another ball-and-rod arrangement just like the first, you can mount this second model onto the pyramid and derive the complex geometric figure known as an octahedron (eight-sided figure).
4. Dip each model into the bucket of soap solution. You'll be surprised where the films of soap appear!

The soap bubble bridge

You can use soap skin models to simulate bridge structures, for example. The flexible soap film is an ideal model for the exact curve that every bridge has to allow for. Build your own soap bubble bridge and observe the perfect form of the soap skin model.

YOU WILL NEED

- 2 small measuring cups
- soap solution (diluted concentrate)
- drinking straw

HERE'S HOW

1. Dip both measuring cups into the soap solution and wet your hands in it as well. Now use the straw to make a soap bubble on the rim of each of the cups. Set the two cups right next to each other.

Do the two soap bubbles join together?

2. You can easily pass the moist straw between the two bubbles, so it gently touches both of them.

3. You can change the shape of the resulting bubble bridge by moving the cups closer together or farther apart. You will always get the most stable shape, and a perfect curve. If you pull the cups really far apart, the two bubbles will separate again.

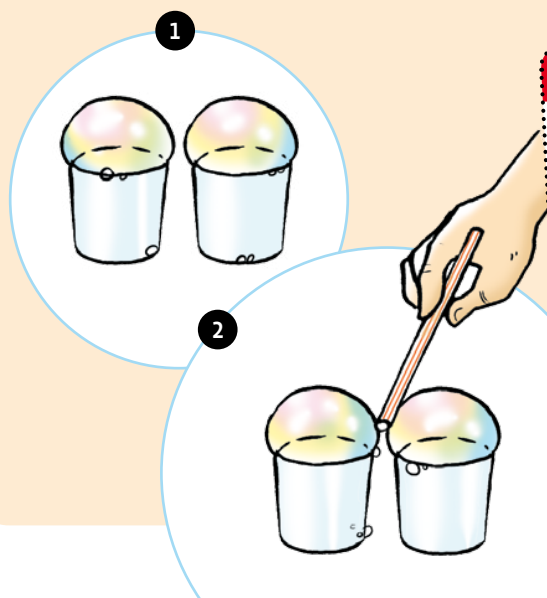

→ WHAT'S HAPPENING?

The two soap bubbles join together. What you get is either one big bubble, or two bubbles connected by a shared wall. The kind of connection you get depends on how vigorously you moved the straw back and forth.

Saving the life of a soap bubble

One of the greatest problems with experimenting with soap bubbles is that they are so short-lived. But soap bubble experts know a few tricks for prolonging the life of a soap bubble.

YOU WILL NEED

- *preserving jars*
- *measuring cups*
- *drinking straw*
- *soap solution (diluted concentrate)*

HERE'S HOW

1. Thoroughly wet a preserving jar and measuring cup with soap solution and set the small measuring cup inside the preserving jar. From above, use the straw to blow a soap bubble on the rim of the cup.
2. Carefully close the jar with the lid. This way, you can save a soap bubble for several hours, or maybe even several days, since it will be protected from dust particles.
3. Mix various soap solutions (with various washing liquids, with and without glycerin) and blow a bubble from each mixture in a preserving jar. Label the jars so you don't forget the soap solution composition of each jar's bubble.
4. Now you can study the life span of each of the bubbles. This way, you can quickly discover the mixture of water and soap that works the best.



Why are soap bubbles round?

Soap bubbles form according to a regularity known to scientists as the principle of “minimal surfaces.” In conformance with a natural law, the skin of the soap bubble always attempts to enclose the air in the smallest possible surface. The geometric shape that encloses the greatest possible volume of air in the smallest possible surface is the sphere. That’s the reason soap bubbles are round. Small soap bubbles are perfect spheres, while larger ones wobble through the air like an underinflated soccer ball. In their case, the internal pressure of the bubble is too weak to shape the soap skin into a proper sphere.



A roof made of soap skin



Films of soap always seek to form the smallest and most stable shape. This property of soap bubbles comes in handy for architects in their work. At the German Institute for Light Surface Structures, soap bubble models are an everyday thing. Famous architects experiment with boards, rods, and string to figure out the ideal surfaces for roof structures. Frei Otto was one of the first architects to recognize the special properties of soap suds, and to use them for architectural construction. Among other things, he drew up the famous roof of the Munich Olympics stadium as a soap film model before his design was implemented in full scale.

CHECK IT OUT



The oldest soap bubble in the world

Soap bubble artists have always tried to find ways to make their bubbles last a long time, mixing various (secret) ingredients into the soap solution to lengthen the bubbles' lives. A lot of people have tried to create a soap bubble that will never burst. There are a few reports about the longest-lived soap bubble ever. What's certain is that it survived for over a year! The legend has it that the bubble was saved in a pickle jar, where it was protected from dust and wind. Supposedly, this ancient soap bubble only burst because one day a careless cleaning woman bumped against the pickle jar while doing her chores. Too bad — who knows how long it might otherwise have lived?

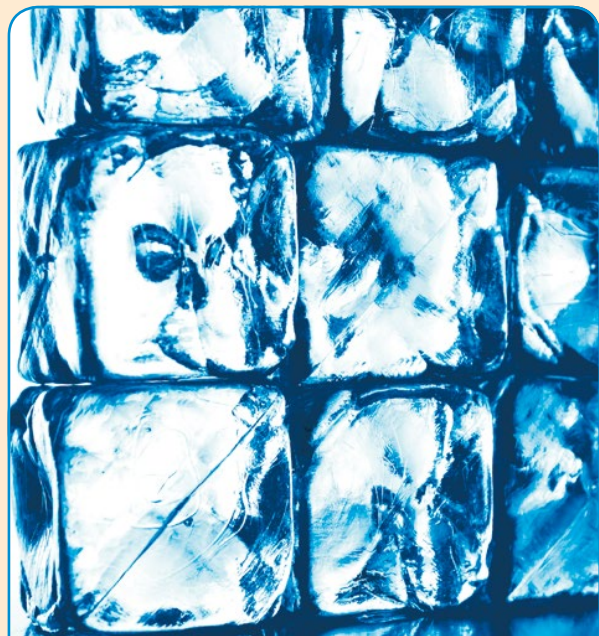

Deep-frozen soap bubbles

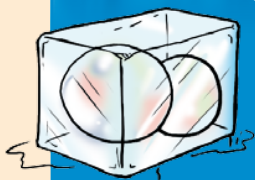

There once was a professor who was absolutely crazy about soap bubbles, and he wanted to do whatever he could to make his beloved bubbles live longer. For years, he considered one technique after another for preventing the bubbles from bursting. Finally, he performed this experiment along with some students from his university: They blew a few soap bubbles, and then carefully froze them in a freezer. And it actually worked! In their frozen state, the bubbles were best protected from evaporation, and thus from bursting as well. Their airy lightness and shimmering colors, however, were lost in the freezing process.



Good Clean Fun with Friends

Now you will be able to take everything you have learned about soap bubbles and use it in fun games that you can play with your friends. Challenge your friends to a singles or doubles match, for example. You will soon find out who has the best talent for this special type of "soap bubble" tennis. But even if you don't have a tennis racket, you can still play ball with the delicate soap bubbles. Woolen or cotton fabrics spread out on the playing surface can help keep the bubbles from bursting. Or how about a fun target game with a toy car you shoot into a soap bubble dome?



Fun target game

YOU WILL NEED

- large baking sheet or some other large, smooth surface
- drinking straw
- small model car
- soap solution (recipe suggestion 2, see page 5)



HERE'S HOW

1. Fill the baking sheet with 2 to 3 mm of soap solution. One of the players should now use the straw to blow a soap bubble dome in the center of the sheet. Then the player should wet the car with soap solution and try to flick it across the soapy sheet directly into the center of the dome.
2. If he or she succeeds in getting the car into the dome without bursting the bubble, he or she gets a point. But if the car speeds through the bubble or past it, it's the next player's turn.

Who is the most skilled at flicking the car right into the center of the bubble in the fewest number of tries?

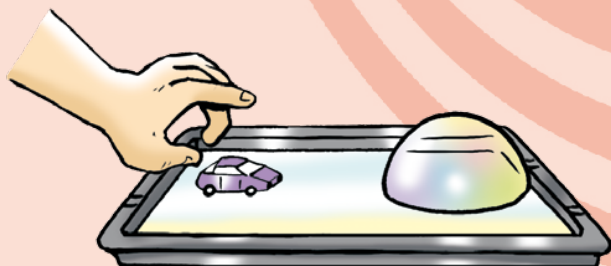

Tennis match

YOU WILL NEED

- large ring or a ring made out of wire
- soap solution (recipe suggestion 2, see page 5)
- drinking straw

HERE'S HOW

1. Each player gets his or her own tennis racket, meaning a ring with a diameter of about 15 to 20 cm. The contestants in the first match dip their rackets into the soap solution to form a film of soap in the ring.
2. Now the referee brings the first soap bubble ball into play – by blowing a soap bubble into the air with the straw.
3. The first player carefully moves his or her racket under the bubble and makes the bubble bounce softly off it back up into the air.
4. Now it's the second player's turn.

How many times can you hit a soap bubble back and forth?

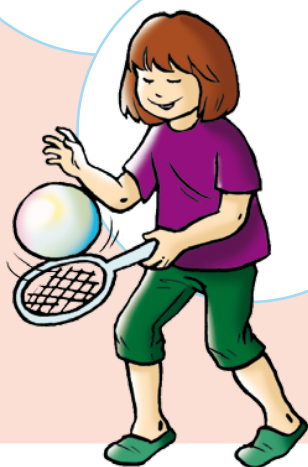
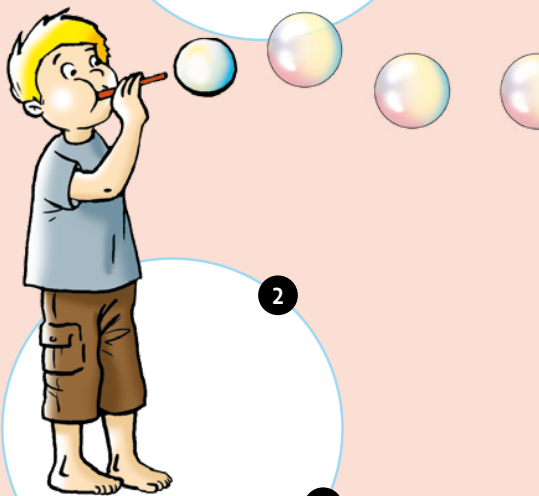
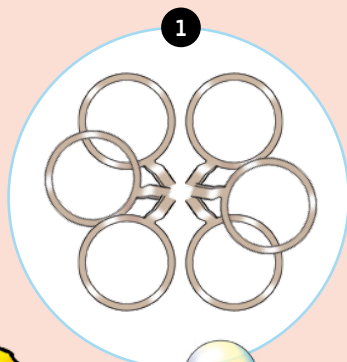

Ball game

YOU WILL NEED

- woolen winter gloves for each player
- soap solution (recipe suggestion 2, see page 5)
- drinking straw

HERE'S HOW

1. All the players arrange themselves in a tight circle, and each of them puts on one of the woolen gloves.
2. Now the first bubble is blown with the straw and sent into the air. The first player catches the bubble softly in his or her gloved hand, and throws it back up into the air.
3. Then, the next player in the circle has to catch the bubble. The one who makes the bubble burst gets a negative point, and the game restarts with a new soap bubble.

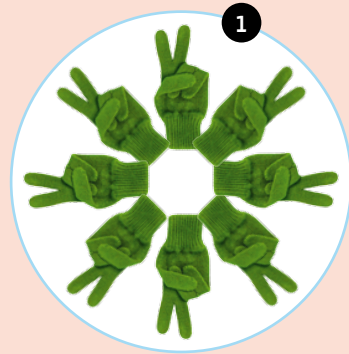

The great big soap bubble carpet

YOU WILL NEED

- *bucket of soap solution*
(*recipe suggestion 2, see page 5*)
- *cotton thread or string*
(*about 1.5 meters in length*)

For this game, you will need at least four players for the soap bubble carpet to be really big. It should be played outside, since a lot of soap solution will dribble down. Most important is that the playing area should be sheltered from the wind.

HERE'S HOW

1. Tie the cotton string into a loop. All the players should hold the string in both hands so it forms a circle. Now, you all dip the entire string deep into the soap solution.
2. When you pull the saturated string back out of the bucket, you will first want to hold your hands close together, or the film of soap will break right away. Only when you are all standing up straight should you carefully pull the string apart to make the soap carpet spread out. Then, you will be holding a big film of soap between your hands like a giant mirror.

Do you have any other ideas?

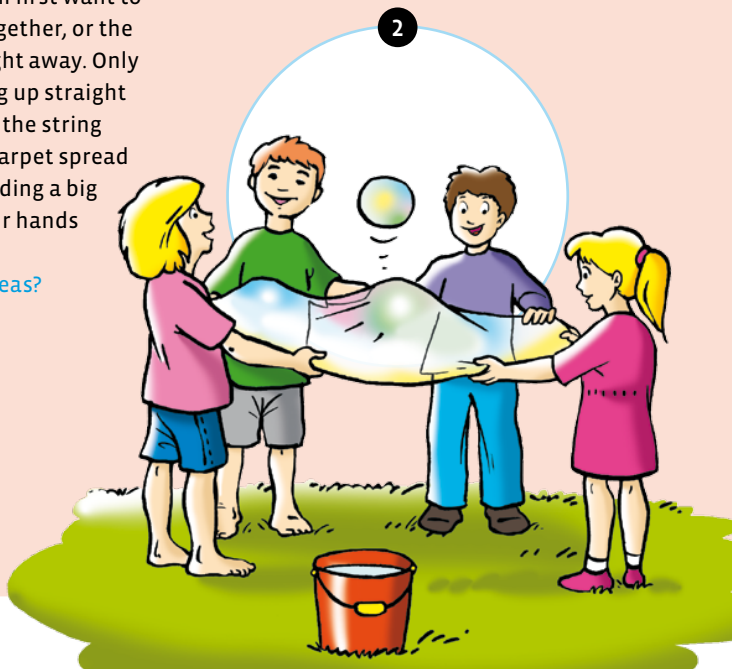



Kosmos Quality and Safety

More than one hundred years of expertise in publishing science experiment kits stand behind every product that bears the Kosmos name. Kosmos experiment kits are designed by an experienced team of specialists and tested with the utmost care during development and production. With regard to product safety, these experiment kits follow European and US safety standards, as well as our own refined proprietary safety guidelines. By working closely with our manufacturing partners and safety testing labs, we are able to control all stages of production. While the majority of our products are made in Germany, all of our products, regardless of origin, follow the same rigid quality standards.

1st Edition 2011

© 2011 Franckh-Kosmos Verlags-GmbH & Co. KG, Pfisterstrasse 5 - 7, 70184 Stuttgart, Germany

This work, including all its parts, is copyright protected. Any use outside the specific limits of the copyright law is prohibited and punishable by law without the consent of the publisher. This applies specifically to reproductions, translations, microfilming, and storage and processing in electronic systems and networks. We do not guarantee that all material in this work is free from other copyright or other protection.

Concept: Cordula Gerndt

Revision: Uta Koßmagk, Wiesbaden

Project management: Dr. Mark Bachofer, Ita Meister

Product development: Elena Ryvkin

Design and layout: Atelier Bea Klenk, Klenk/Riedinger

Illustrations: Michael Schlegel, Würzburg, p. 1 middle right, 14, 15, 16, 42 bottom right; all others Andrea Mangold, München
Photos: ag visuell, p. 1 middle left, 8; Alexandr Anastasin, p. 37 top left; Arthémus, p. 12 middle left; by-studio, p. 9 bottom left; c, p. 7 bottom left; Jacek Chabraszewski, p. 10; DeVice, p. 7 middle right; Markus Eckardt, p. 1 top left, 3; Maria Eleftheria, p. 27; Oliver Erdmann, p. 43 bottom right; fotojagodka, p. 36 top; Fotolina, p. 7 top right; Frog 974, p. 9 bottom right; helix, p. 26; Thomas Graf, p. 43 top left; igor_gubarev, p. 8; image-team, p. 45; Katja Jentschura, p. 1 bottom left, 13; Stefan Körber, p. 30, 37 bottom right; Djordje Korovljevic, p. 36; Lasse Kristensen, p. 7 bottom middle; Linleo, p. 1 top left, 7 top left; Nat Ulrich, p. 6; NilsZ, p. 47; Andreas Osipitschuk, p. 43 bottom right; Paylessimages, p. 4, 7; Piju, p. 6 bottom left; Yvonne Pranci, p. 44; Mauro Rodrigues, p. 37 bottom left; RRF, p. 6 bottom left; Naty Strawberry, p. 12 right; Taffi, p. 11; twixx, p. 12 middle right; yamix, p. 42 bottom left (all previous www.fotolia.com); Arad Mojtahedi, S42 top right; Radox, p. 42 top middle (both Wikipedia); Kazbeki, Wikipedia, CC-BY-SA-3.0, p. 18 middle top; Roland Berger, p. 1 top right, 19; Alexander Klink, p. 25 left; Mila Zinkova, p. 29 (all Wikipedia, CC-BY-3.0); brokenchopstick, CC-BY-2.0 US, www.flickr.com, p. 26; Anonymer Maler (1854), p. 18 bottom; C. J. Chaplin, p. 18 middle bottom; Michael Flaig, Stuttgart, U2; Oliver Klases, Stuttgart, p. 1 bottom left, 13; Bernward Krämer, p. 25 right; Photocase.com, p. 37 top right; PixelQuelle.de, p. 12 left; Udo Weger, www.pic.ch, p. 18 top

Package design and layout: Atelier Bea Klenk, Klenk/Riedinger

with use of photos from: ag visuell, Crashoran, Anna Khomulo, Paylessimages (all www.fotolia.com) and Oliver Klases, Stuttgart as well as a graphic by Claus Rayhle, Stuttgart.

Flap quiz photos: Daniel Fleck, DramaSan, Oliver Erdmann, Robert Kneschke, picsfive, Piju (all www.fotolia.com);

Radox (Wikipedia) and illustrations by Michael Schlegel, Würzburg and Andrea Mangold, München.

The publisher has made every effort to identify the owners of the rights to all photos used. If there is any instance in which the owners of the rights to any pictures have not been acknowledged, they are asked to inform the publisher about their copyright ownership so that they may receive the customary image fee.

1st English Edition © 2012 Thames & Kosmos, LLC, Providence, RI, USA

® Thames & Kosmos is a registered trademark of Thames & Kosmos, LLC.

Text: Ted McGuire; Additional Graphics and Layout: Dan Freitas

Distributed in North America by Thames & Kosmos, LLC, Providence, RI 02903

Phone: 800-587-2872; Email: support@thamesandkosmos.com

Printed in Germany / Imprimé en Allemagne

