



The Ultimate in Fall Protection

## Instructions for the following series products:

Pour-in-Place Securaspan® HLL

Model Numbers: 7400220, 7400230,  
7400240, 7400250, 7400260.

### **USER INSTRUCTION MANUAL FOR SECURASPAN® HORIZONTAL LIFELINE SYSTEMS FOR POUR-IN-PLACE CONCRETE CONSTRUCTION**

*This manual is intended to meet the Manufacturer's Instructions requirement of applicable standards defined in Section 1.2 and should be used as part of an employee training program as required by the identified agencies.*

**WARNING:** *This product is part of a fall protection system. These instructions must be provided to the users of this equipment. Users must read and understand these instructions or have the instructions explained to them before using this equipment. Users must read and follow the manufacturer's instructions for each component or part of the complete system. Manufacturer's instructions must be followed for proper use and maintenance of this product. Alterations or misuse of this product, or failure to follow instructions may result in serious injury or death.*

**IMPORTANT:** *If any questions arise on the use, care, application, or suitability for use of this safety equipment, contact DBI-SALA immediately.*

**IMPORTANT:** *Before using this equipment, record the product identification information found on the product information labels on the Inspection and Maintenance Log at the back of this manual.*

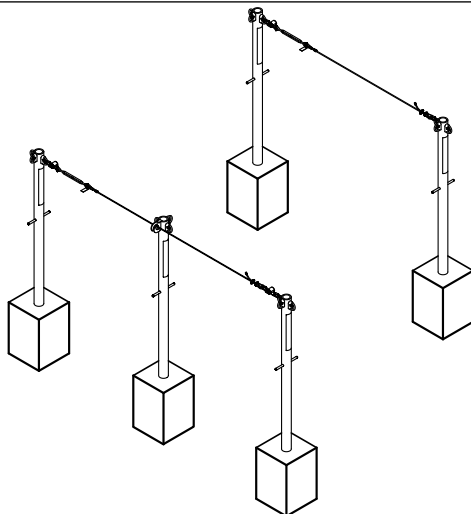

**Figure 1 - SecuraSpan® Single Span Horizontal Lifeline**

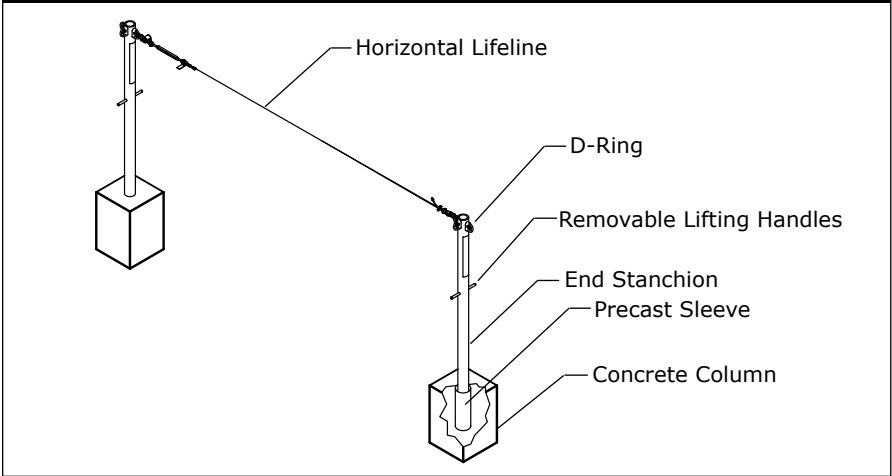

**Figure 2 - SecuraSpan® Single Span Horizontal Lifeline**

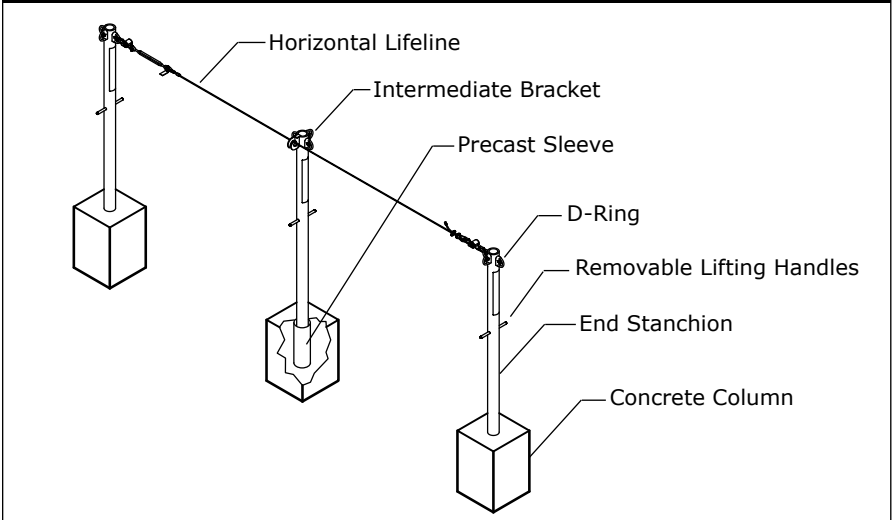

## **1.0 APPLICATION**

**1.1 PURPOSE:** SecuraSpan® Horizontal Lifeline systems (HLL) are designed to be used as an anchoring means for up to six users, with no more than two users per span (see section 3.2 C). The SecuraSpan system may be used in many situations where a combination of horizontal mobility and fall protection is needed. Figures 1 and 2 show two configurations of the SecuraSpan HLL systems.

**1.2 LIMITATIONS:** The following limits apply to the installation and use of the SecuraSpan Horizontal Lifeline System. Other limitations may apply.

**IMPORTANT:** OSHA regulations state that horizontal lifelines shall be installed and used under the supervision of a qualified person (see below for definition) as part of a complete personal fall arrest system that maintains a safety factor of at least two.

**QUALIFIED PERSON:** An individual with a recognized degree or professional certificate, and extensive knowledge and experience in the subject field, who is capable of design, analysis, evaluation, and specification in the subject work, project, or product. Refer to OSHA 1910.66, 1926.32, and 1926.502.

- A. HORIZONTAL LIFELINE SPAN:** The maximum horizontal lifeline span length is 60 ft. (18.3 m). The system length can be extended by using multiple spans (see Figure 2). The span length must be reduced when clearance is limited. See section 3.0 for clearance information.
- B. ANCHORAGES:** SecuraSpan Horizontal Lifeline (HLL) systems must only be installed to anchorages capable of meeting the strength requirements specified in Section 2.4.
- C. SYSTEM CAPACITY:** The capacity of single span systems is two persons. The capacity of multiple span systems is two persons secured on each span with a maximum of six people installed on the system. The maximum weight of each person, including tools and clothing, is 310 lbs (141 kg).
- D. CONNECTING SUBSYSTEM:** Each person's connecting subsystem (energy absorbing lanyard or SRL) must limit fall arrest forces to 900 lbs. (4 kN) or less. Or, alternatively, 900 lbs (4kN) average arresting force in accordance with ANSI Z359.13 or Z359.14. See section 2.1.
- E. FREE FALL:** Rig and use the personal fall arrest system such that the maximum potential free fall does not exceed government regulatory and subsystem manufacturer's requirements. See section 3.0 and subsystem manufacturer's instructions for more information.

- F. SWING FALLS:** See Figure 3. Swing falls occur when the anchorage point is not in line vertically with the worker. The force of striking an object in a swing fall may cause serious injury or death. Minimize swing falls by working as directly in line with the anchorage point as possible. Do not permit a swing fall if injury could occur. Swing

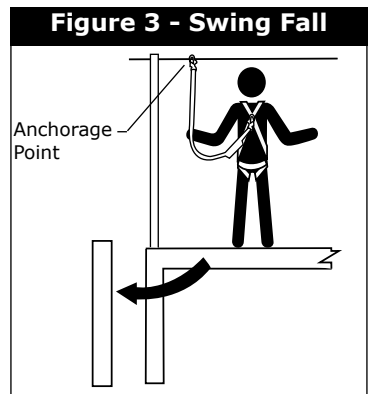

falls will significantly increase the clearance required when a self retracting lifeline or other variable length connecting subsystem is used. If a swing fall situation exists in your application, contact DBI-SALA before proceeding.

**G. FALL CLEARANCE:** There must be sufficient clearance below the worker to arrest a fall before striking the lower level or obstruction. See section 3.0 for clearance information.

**H. BODY SUPPORT:** The SecuraSpan HLL must only be used with personal fall arrest systems incorporating a full body harness.

**I. PHYSICAL AND ENVIRONMENTAL HAZARDS:** Use of this equipment in areas with physical or environmental hazards may require additional precautions to reduce the possibility of injury to the user or damage to the equipment. Hazards may include, but are not limited to: heat, chemicals, corrosive environments, high voltage power lines, gases, moving machinery, and sharp edges. Contact DBI-SALA if you have questions about using this equipment where physical or environmental hazards exist.

**J. TRAINING:** This equipment must be installed and used by persons trained in the correct application and use of this equipment. See section 4.0.

**1.3 APPLICABLE STANDARDS:** Refer to national consensus standards including ANSI Z359.1, as well as local, state and federal (OSHA1910.66, 1926.502, and CSA in Canada) requirements for more information on personal fall arrest systems and associated components.

## **2.0 SYSTEM REQUIREMENTS**

**2.1 COMPATIBILITY OF COMPONENTS AND SUBSYSTEMS:** The SecuraSpan® HLL system is designed for use with DBI-SALA approved components or subsystems. Use of this system with non-approved components may result in incompatibility between equipment and could affect the reliability and safety of the complete system. PFAS components used with the SecuraSpan HLL system must meet applicable OSHA, state, federal and ANSI requirements. A full body harness must be worn by the worker(s) when connected to the system. In addition, the connecting subsystem between the worker's harness and the HLL must be capable of limiting fall arrest forces to a maximum of 900 lbs (4 kN). Or, alternatively, 900 lbs (4kN) average arresting force in accordance with ANSI Z359.13 or Z359.14.

**IMPORTANT:** *The SecuraSpan HLL system is approved for use with SALA Talon, SALA 11-ft. Web or Cable UltraLok, and Protecta Rebel SRLs only. Clearance values (see section 3.2) may not be accurate if used with other SRL models.*

**2.2 COMPATIBILITY OF CONNECTORS:** Connectors are considered to be compatible with connecting elements when they have been designed to work together in such a way that their sizes and shapes do not cause their gate mechanisms to inadvertently open regardless of how they become oriented. Contact DBI-SALA if you have any questions about compatibility.

Connectors (hooks, carabiners, and D-rings) must be capable of supporting at least 5,000 lbs. (22.2 kN). Connectors must be compatible with the anchorage or other system components. Do not use equipment that is not compatible. Non-compatible connectors may unintentionally disengage. See Figure 4. Connectors must be compatible in size, shape, and strength. Self-locking snap hooks and carabiners are required by ANSI Z359.1, OSHA and CSA Z259.12.

**Figure 4 - Unintentional Disengagement (Roll-out)**

If the connecting element that a snap hook (shown) or carabiner attaches to is undersized or irregular in shape, a situation could occur where the connecting element applies a force to the gate of the snap hook or carabiner. This force may cause the gate (of either a self-locking or a non-locking snap hook) to open, allowing the snap hook or carabiner to disengage from the connecting point.

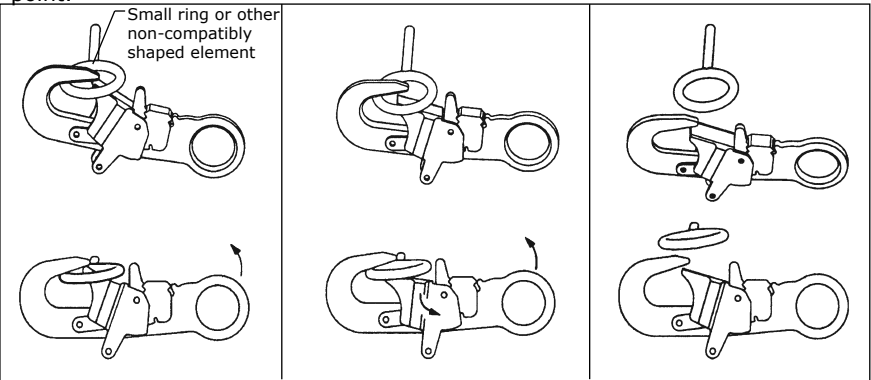

1. Force is applied to the snap hook.
2. The gate presses against the connecting ring.
3. The gate opens allowing the snap hook to slip off.

**2.3 MAKING CONNECTIONS:** Only use self-locking snap hooks and carabiners with this equipment. Only use connectors that are suitable to each application. Ensure all connections are compatible in size, shape and strength. Do not use equipment that is not compatible. Ensure all connectors are fully closed and locked.

DBI-SALA connectors (snap hooks and carabiners) are designed to be used only as specified in each product's user's instructions. See Figure 5 for inappropriate connections. DBI-SALA snap hooks and carabiners should not be connected:

**Figure 5 - Inappropriate Connections**

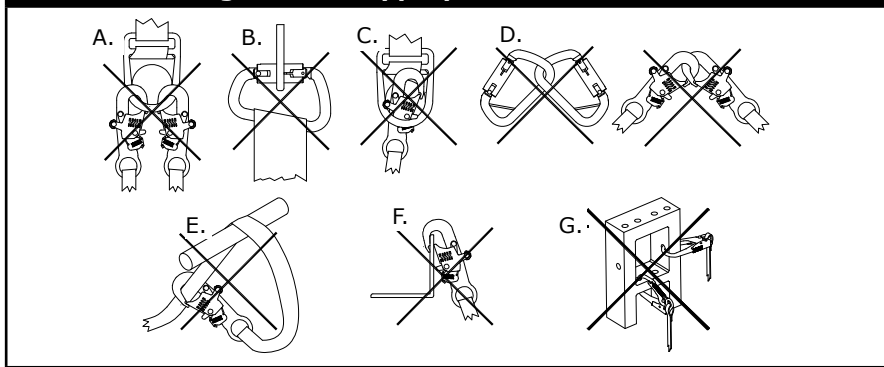

- A. To a D-ring to which another connector is attached.
- B. In a manner that would result in a load on the gate.

**CAUTION:** Large throat snap hooks should not be connected to standard size D-rings or similar objects which will result in a load on the gate if the hook or D-ring twists or rotates.

- C. In a false engagement, where features that protrude from the snap hook or carabiner catch on the anchor, and without visual confirmation seems to be fully engaged to the anchor point.
- D. To each other.
- E. Directly to webbing or rope lanyard or tie-back (unless the manufacturer's instructions for both the lanyard and connector specifically allows such a connection).
- F. To any object which is shaped or dimensioned such that the snap hook or carabiner will not close and lock, or that roll-out could occur.
- G. In a manner that does not allow the connector to align properly while under load.

**2.4 COLUMN LOAD REQUIREMENTS:** The column on which the SecuraSpan HLL system is installed must support the loads applied by the system during a fall arrest. The stanchion attachment points may be subjected to both horizontal and vertical forces. The column on which the horizontal lifeline stanchions are installed must be sufficiently secured to provide the load capacities specified in Figure 6 and 7.

The minimum column size is 16 inches square. Columns smaller than 16 inches square do not have the strength to resist the loads applied by the SecuraSpan system. Rebar ties must be provided within 3 inches of the top of the column. (See Figure 8.)

### 3.0 INSTALLATION AND USE

**WARNING:** Do not alter or intentionally misuse this equipment. Consult DBI-SALA when using this equipment in combination with components or subsystems other than those described in this manual. Some subsystem and component combinations may interfere with the operation of this equipment. Use caution when using this equipment around moving machinery, electrical hazards, chemical hazards, and sharp edges.

**WARNING:** Consult your doctor if there is any reason to doubt your fitness to safely absorb the shock from a fall arrest. Age and fitness seriously affect a worker's ability to withstand arrest forces. Pregnant women or minors must not use DBI-SALA SecuraSpan® HLL systems.

**3.1 BEFORE EACH USE** inspect this equipment according to section 5. Do not use this equipment if inspection reveals an unsafe or defective condition. Plan your use of the fall protection system prior to exposing workers to dangerous situations. Consider all factors affecting your safety before using this system.

**Figure 6 - Column Load Requirements**

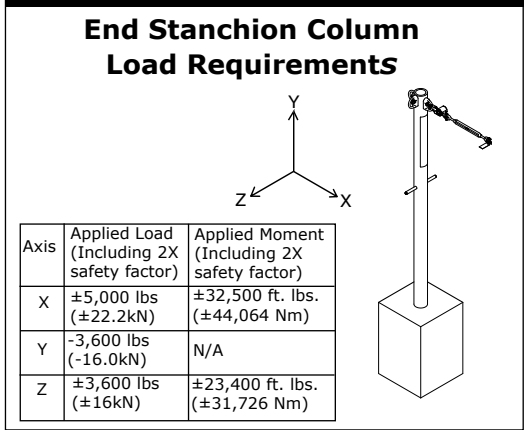

**Figure 7 - Column Load Requirements**

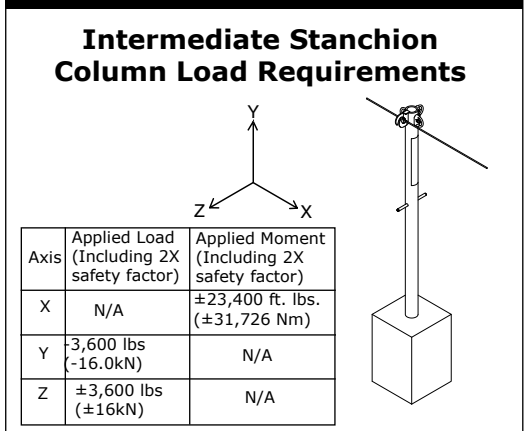

**Figure 8 - Rebar Ties**

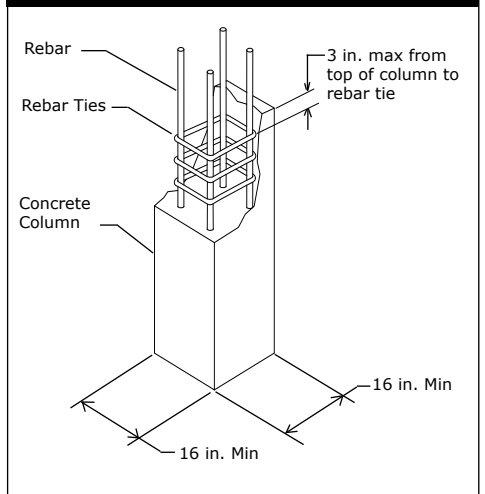

- A. Read and understand all manufacturer's instructions for each component of the personal fall arrest system. All DBI-SALA harnesses and connecting subsystems are supplied with separate user instructions. Keep all instructions for future reference.
- B. Review sections 1.0 and 2.0 to ensure system limitations and other requirements have been met. Review applicable information regarding system clearance criteria, and ensure changes have not been made to the system installation (i.e. length), or occurred at the job site, that could affect the required fall clearance. Do not use the system if changes are required.

**3.2 SYSTEM INSTALLATION:** Figure 1 shows a typical single span SecuraSpan HLL system installation. Figure 2 shows a typical multiple span system installation. SecuraSpan HLL systems must be installed to meet the clearance requirements specified in Figures 9 and 11.

- A. **INSTALLATION OF PRECAST STEEL SLEEVES:** Sleeves cast into the concrete columns serve as the connection for the SecuraSpan pour-in-place stanchion. (See Figures 1 and 2.) Cast the steel sleeve into freshly poured concrete. Locate the sleeve in the center of the column and confirm that is plumb.

**IMPORTANT:** *The installer must prevent concrete and other materials from entering the sleeve from the bottom or top before the concrete cures. Seal both open ends of the sleeve with tape before casting the sleeve in freshly poured concrete. The tape can be removed from the top of the sleeve after the concrete is fully cured.*

**WARNING:** *The sleeve must be cast to a minimum depth of 12 inches. Make sure the sleeve does not float upwards in the concrete column before the concrete has set. A cast socket of less than 12 inches will not safely support fall arrest loads.*

- B. **SYSTEM HEIGHT:** The stanchions must be located at a height such that the lifeline is at or above the elevation of the harness attachment point. Generally for decking operations, the lifeline elevation is sufficient provided the decking is laid at the same elevation as the tops of the columns.
- C. **SYSTEM DIRECTION:** The SecuraSpan Horizontal Lifeline must be installed straight and horizontal, without turns or bends. Up to three horizontal lifelines may be connected to the same stanchion (see Figure 9). If three lifelines are attached to a single stanchion, a maximum of two users per lifeline may attach to the lifelines rather than two users per span.



**D. EVALUATION OF STRUCTURE STRENGTH AND HORIZONTAL**

**LIFELINE SPANS:** The location of the stanchions must be determined, and the strengths of the columns must be evaluated according to section 2.4.

**E. EVALUATION OF HORIZONTAL LIFELINE SPANS FOR CLEARANCE:**

The elevation and length of the system span(s) must be determined. This information is used to evaluate the horizontal lifeline system clearance. Refer to Figures 10 and 11 for minimum clearance requirements. Do not begin installation unless clearances have been reviewed and determined to be in compliance with Figures 10 or 11.

**Figure 9 - Lifeline Directions**

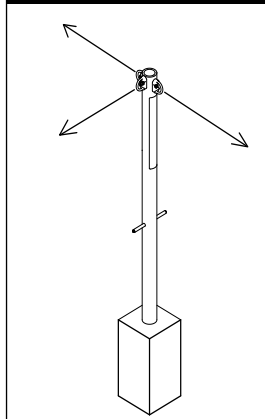
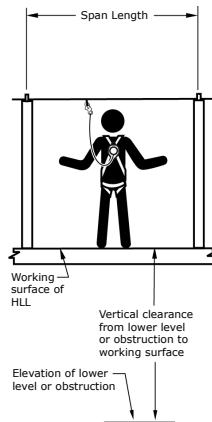

**Figure 10 - Fall Clearance for Self Retracting Lifelines**

**WARNING:** Clearance chart only applies to workers located directly adjacent to the HLL with their SRL connected to the HLL immediately next to them. Working away from the point where the SRL connects to the HLL will increase fall clearance.

**WARNING:** The SecuraSpan HLL system is approved for use with SALA Talon, SALA 11-ft. Web or Cable UltraLok, and Protecta Rebel SRLs only. Clearance values (see section 3.2) may not be accurate if used with other SRL models.

| Clearance Chart                    |                      |
|------------------------------------|----------------------|
| DBI-SALA Self Retracting Lifelines |                      |
| Span<br>ft. (m)                    | Clearance<br>ft. (m) |
| 0-10 (0-3)                         | 6'-1" (2.1)          |
| 10-20 (3-6.1)                      | 8'-0" (2.4)          |
| 20-30 (6.1-9.0)                    | 9'-1" (2.8)          |
| 30-40 (9.0-12.3)                   | 10'-2" (3.1)         |
| 40-50 (12.3-15.4)                  | 11'-4" (3.5)         |
| 50-60 (15.4-18.5)                  | 12'-5" (3.8)         |



**F. STANCHION INSTALLATION:**

**SECURING THE STANCHION TO THE COLUMN:** Once the concrete has cured to a minimum compressive strength of 2000 psi the stanchions can be installed in the steel sleeves. Remove tape or other material used to prevent concrete from entering the top of the sleeves prior to curing of the concrete. Verify that each sleeve is plumb. The interior of each sleeve must be at least 12 inches in depth and clear of obstructions so that stanchions can be fully inserted. Insert each stanchion. Removable handles are provided to assist in lifting the stanchion during installation into the sleeve.

**WARNING:** Do not install the stanchions until the concrete has cured to a compressive strength of at least 2000 psi.

## Figure 11 - Fall Clearance for DBI-Sala Energy Absorbing Lanyards

Required Clearance from nearest lower level or obstruction to HLL system height:

1. Select the row that corresponds to your system's span length in the SPAN LENGTH column of the clearance table
2. Find the column that represents the length of lanyard you are using.
3. The required clearance is found where the SPAN LENGTH row and the lanyard length column intersect.

Use this distance to determine if adequate clearance exists in the event of a fall. If there is inadequate clearance, do not use the system, or reduce the span or lanyard length and reevaluate the required clearance.

Example: Span length is 42 ft and lanyard length is 5 ft.  
The required clearance is 21 ft 6 in.

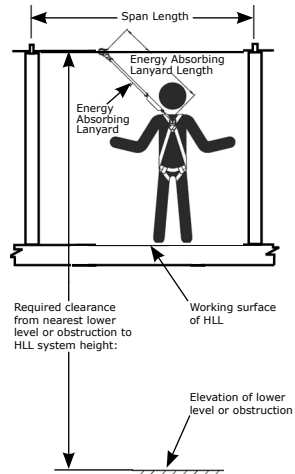

| Clearance Chart  |                       |   |             |             |             |
|--|-----------------------|---|-------------|-------------|-------------|
| DBI-SALA Energy Absorbing Lanyards                           |                       |   |             |             |             |
| Span Length<br>Dimensions in Feet<br>(meters in parenthesis) |                       | Length of Energy Absorbing Lanyard<br>Dimensions in Ft.-In. (meters in parenthesis) |             |             |             |
| Greater than   | Less than or equal to | 3-0 (.9)  | 4-0 (1.2)   | 5-0 (1.5)   | 6-0 (1.8)   |
| 0 (0)  | 10 (3.1)              | 14-11 (4.6)   | 15-11 (4.9) | 16-11 (5.2) | 17-11 (5.5) |
| 10 (3.1)   | 15 (4.6)              | 15-7 (4.8)  | 16-7 (5.1)  | 17-7 (5.4)  | 18-7 (5.7)  |
| 15 (4.6)   | 20 (6.1)              | 16-2 (4.9)  | 17-2 (5.2)  | 18-2 (5.5)  | 19-2 (5.8)  |
| 20 (6.1)   | 25 (7.8)              | 16-11 (5.2)   | 17-11 (5.5) | 18-11 (5.8) | 19-11 (6.1) |
| 25 (7.8)   | 30 (9.1)              | 17-6 (5.3)  | 18-6 (5.6)  | 19-6 (5.9)  | 20-6 (6.3)  |
| 30 (9.1)   | 35 (10.7)             | 18-2 (5.5)  | 19-2 (5.8)  | 20-2 (6.2)  | 21-2 (6.5)  |
| 35 (10.7)  | 40 (12.2)             | 18-10 (5.7)   | 19-10 (6.1) | 20-10 (6.4) | 21-10 (6.7) |
| 40 (12.2)  | 45 (13.7)             | 19-6 (5.9)  | 20-6 (6.3)  | 21-6 (6.6)  | 22-6 (6.9)  |
| 45 (13.7)  | 50 (15.2)             | 20-1 (6.1)  | 21-1 (6.4)  | 22-1 (6.7)  | 23-1 (7.0)  |
| 50 (15.2)  | 55 (16.8)             | 20-10 (6.4)   | 21-10 (6.7) | 22-10 (7.0) | 23-10 (7.3) |
| 55 (16.8)  | 60 (18.3)             | 21-5 (6.5)  | 22-5 (6.8)  | 23-5 (7.1)  | 24-5 (7.4)  |
| 60 (18.3)  | 65 (19.8)             | 22-1 (6.7)  | 23-1 (7.0)  | 24-1 (7.3)  | 25-1 (7.7)  |
| 65 (19.8)  | 70 (21.3)             | 22-8 (6.9)  | 23-8 (7.2)  | 24-8 (7.5)  | 25-8 (7.8)  |
| 70 (21.3)  | 75 (22.9)             | 23-5 (7.1)  | 24-5 (7.4)  | 25-5 (7.8)  | 26-5 (8.1)  |
| 75 (22.9)  | 80 (24.4)             | 24-0 (7.3)  | 25-0 (7.6)  | 26-0 (7.9)  | 27-0 (8.2)  |
| 80 (24.4)  | 85 (25.9)             | 24-8 (7.5)  | 25-8 (7.8)  | 26-8 (8.1)  | 27-8 (8.4)  |
| 85 (25.9)  | 90 (27.4)             | 25-4 (7.7)  | 26-4 (8.0)  | 27-4 (8.3)  | 28-4 (8.6)  |
| 90 (27.4)  | 95 (29.0)             | 26-0 (7.9)  | 27-0 (8.2)  | 28-0 (8.5)  | 29-0 (8.7)  |
| 95 (29.0)  | 100 (30.5)            | 26-7 (8.1)  | 27-7 (8.4)  | 28-7 (8.7)  | 29-7 (9.0)  |

## G. INSTALLING OPTIONAL INTERMEDIATE BRACKETS:

Any stanchion may be converted to an intermediate stanchion by installing an Intermediate Bracket Kit (7400200). Install the intermediate bracket using the ½ in.-bolt and locknut provided with the bracket as shown in Figure 12. Ensure the intermediate brackets are oriented as shown, with the tab located over the top of the stanchion to contain the wire rope assembly.

**H. HLL ASSEMBLY INSTALLATION:** Figures 13 and 14 identify the components and locations of a single span and multiple span Pour-in-place Securaspan Horizontal lifelines.

**CAUTION:** Multiple span SecuraSpan HLL systems require the use of a Zorbit™ energy absorber at both end terminations. Failure to do so could result in failure of the system and serious injury or death to the user.



**CAUTION:** Do not rigidly mount Zorbit to structure or stanchion. May cause failure due to bending. Mount so Zorbit can pivot and move freely as shown in Figures 13 and 14.

- Step 1.** Connect the carabiner on the turnbuckle end of the HLL assembly to the D-ring of the first stanchion.
- Step 2.** Extend the turnbuckle so that ½ inch (13 mm) of threads remain exposed in the turnbuckle body slots.
- Step 3.** When present, route the wire rope through any intermediate brackets.
- Step 4 .** Connect the carabiner on the thimble clamp end of the HLL assembly to the D-ring of the last stanchion. Loosen the cable clips at the end of the cable assembly and pull the wire rope tight to remove slack. Secure the cable clip 1 1/2 inches (28 mm) from the thimble clamp as shown in Figures 12 and 13. At least 8 inches (20.3 cm) of wire rope must extend out from the free cable clip. Torque cable clips to 45 ft-lbs (61 Nm) and thimble clamp nuts to 40 ft-lbs (54 Nm).
- Step 5.** To pre-load the system, tighten the wire rope by rotating the turnbuckle body. The unrestrained jaw of the turnbuckle must be prevented from turning to prevent twisting of the wire rope. Tension the wire rope until the sag on the system at mid-span is 6 in. (15.25 cm) or less, with no weight on the wire rope. The turnbuckle will not over tension the wire rope.

**Figure 12 - Assembly**

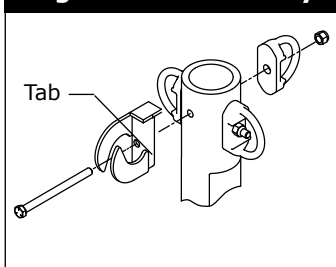

**Step 6.** After pre-loading the system, re-torque all cable clips to values specified previously.

**Figure 13 - Single Span HLL Installation**

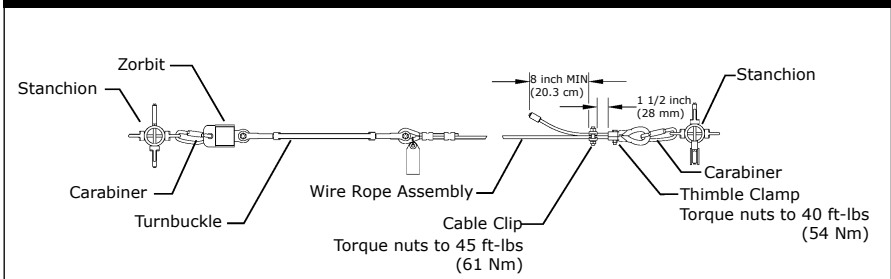

**Figure 14 - Multiple Span HLL Installation**

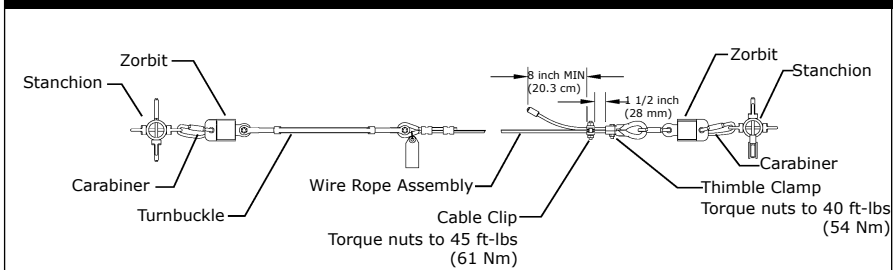

### 3.3 OPERATION:

#### A. PERSONAL FALL ARREST SYSTEM COMPONENTS:

Inspect and don the full body harness according to manufacturer's instructions. Attach the connecting subsystem (energy absorbing lanyard or SRL) to the dorsal connection on the harness.

**WARNING:** Risk of swing falls is greater when using an SRL. Swing falls significantly increase the clearance required to arrest a fall and may result in serious injury or death. To avoid swing fall hazards, do not work beyond the stanchions on either side of the span or at excessive distances to either side of the HLL system. Do not climb above the HLL system.

**B. CONNECTING TO THE HLL SYSTEM:** Approach the work area using the appropriate access equipment. Connect the personal fall arrest system (the free snap hook on the energy absorbing lanyard or carabiner attached to the SRL) to the horizontal lifeline. Connectors must meet all compatibility and strength requirements.

**C. HAZARDOUS SITUATIONS:** Do not take unnecessary risks, such as jumping or reaching too far from the edge of the working surface. Do not allow the connecting subsystem to pass under arms or between feet. To avoid inadequate fall clearance, do not climb above the horizontal lifeline. To avoid

swing fall hazards, do not work too far from either side of the system.

**D. TWO PERSONS CONNECTED WITHIN A SINGLE SPAN:**

When a person falls while connected to the horizontal lifeline, the wire rope will deflect within the span to which the worker is connected. If two persons are connected to the system within the same span, and one person falls, the second person may be pulled off the working surface due to deflection of the HLL. The potential for the second person falling increases as the HLL span length increases.

**E. FREE FALL:** The personal fall arrest system must be rigged to limit free falls to 6 feet or less when using an energy absorbing lanyard according to OSHA requirements.

**F. SHARP EDGES:** Avoid working where the connecting subsystem or other system components will be in contact with, or abrade against, unprotected sharp edges. If working around sharp edges is unavoidable, a protective cover must be used to prevent cutting of the personal fall arrest system (PFAS) components.

**G. IN THE EVENT OF A FALL:** The responsible party must have a rescue plan and the ability to implement a rescue. Tolerable suspension time in a full body harness is limited, so a prompt rescue is critical.

**IMPORTANT:** Use care when handling an expended Zorbit energy absorber. The tearing of the energy absorber material produces extremely sharp edges.

**H. RESCUE:** With the number of potential scenarios for a worker requiring rescue, an on-site rescue team is beneficial. The rescue team is given the tools, both in equipment and techniques, so it can perform a successful rescue. Training should be provided on a periodic basis to ensure rescuers' proficiency.

**3.4 SYSTEM REMOVAL:** When no longer required, the system should be removed from the job site. To slacken the wire rope, loosen the turnbuckle until tension is removed from the wire rope. Remove the carabiners that connect the wire rope to the end stanchions. Ensure there are no knots or kinks in the wire rope before storage.

## **4.0 TRAINING**

**4.1** It is the responsibility of the user to assure they are familiar with these instructions, and are trained in the correct care and use of this equipment. The user must also be aware of the operating characteristics, application limits, and consequences of improper use of this equipment.

## 5.0 INSPECTION

**5.1 INSPECTION FREQUENCY:** The Horizontal Lifeline System shall be inspected by the user before each use; and additionally, by a Competent Person<sup>1</sup> other than the user after installation and at intervals of no more than one year<sup>2</sup>. Results of the Competent Person Inspection should be recorded in the "*Inspection and Maintenance Log*" at the back of this manual.

### 5.2 INSPECTION STEPS:

- Step 1.** Inspect the stanchions for damage. Make sure the stanchion tubes are not bent. Look for any cracks or deformities in the tube. Inspect all hardware (D-rings, bolts, nuts, etc.) for any cracks, deformities or corrosion. Make sure all hardware is present and secure.
- Step 2.** Inspect the turnbuckle for damage. Ensure sufficient threads are engaged into the turnbuckle body. Look for any cracks or deformities in the metal. Inspect metal components for rust or corrosion that may affect their strength or operation.
- Step 3.** Inspect the wire rope for rust, corrosion, broken wires, or other obvious faults. Inspect the wire rope for proper tension. Inspect all hardware (fasteners, carabiners, wire rope cable clips, etc.) securing the HLL assembly to ensure they are present and properly installed.
- Step 4.** Inspect the Zorbit™ Energy Absorber for extension or deformities. There should be no tearing of the metal between holes in the Zorbit coiled section. Increase inspection frequency if the Zorbit is exposed to prolonged vibration. Extended Zorbit Energy Absorbers must be removed from service and destroyed, or marked for training only. Inspect securing hardware for strength and function.
- Step 5.** Inspect system labels. The labels must be present and fully legible. See section 8.0. Replace labels if missing or illegible.

**IMPORTANT:** *If this equipment is subjected to the forces of a fall arrest, it must be removed from service and destroyed, or returned to DBI-SALA for inspection or repair.*

- 5.3** If inspection reveals an unsafe or defective condition, remove unit from service and destroy, or contact DBI-SALA for possible repair.
- 5.4 USER EQUIPMENT:** Inspect harnesses, energy absorbing lanyards and SRLs used with the HLL system according to manufacturer's instructions.

---

**1** **Competent Person:** *One who is capable of identifying existing and predictable hazards in the surroundings or working conditions which are unsanitary, hazardous, or dangerous to employees, and who has authorization to take prompt corrective measures to eliminate them.*

**2** **Inspection Frequency:** *Extreme working conditions (harsh environments, prolonged use, etc.) may require increasing the frequency of Competent Person Inspections.*

## **6.0 MAINTENANCE, SERVICING, STORAGE**

**6.1** The SecuraSpan® HLL components require no scheduled maintenance, other than repair or replacement of items found defective during inspection. See section 5.0. If components become heavily soiled with grease, paint, or other substances, clean with appropriate cleaning solutions. Do not use caustic chemicals that could damage system components. Store HLL components in a clean, dry, cool enclosure.

**6.2 USER EQUIPMENT:** Maintain, service, and store user subsystem equipment (harnesses, lanyards, SRLs, etc.) according to manufacturer's instructions.

## **7.0 SPECIFICATIONS**

### **7.1 COMPONENTS:**

- **STANCHION:** Aluminum tube with zinc plated alloy steel D-rings and fasteners.
- **ZORBIT™ ENERGY ABSORBER:** Stainless steel.
- **WIRE ROPE:** 3/8-inch (10 mm) diameter, 7x19 galvanized wire rope. Minimum tensile strength 14,400 lbs (64 kN).
- **CABLE ASSEMBLY COMPONENTS:** Turnbuckle, thimbles, and cable clips are galvanized steel.
- **MOUNTING HARDWARE AND CARABINERS:** Zinc plated steel.

### **7.2 ZORBIT ENERGY ABSORBER PERFORMANCE:**

**Peak Dynamic Pullout Load:** 2,500 lbs. (11 kN).

**Average Dynamic Pullout Load:** 2,000 lbs. (8.9 kN)

**Maximum Pullout:** 48.5 inches (1.25 m)

**Minimum Tensile Strength:** 5,000 lbs. (22.2 kN)

U.S. Patent No 6,279,680







# INSPECTION AND MAINTENANCE LOG

**SERIAL NUMBER:**

**MODEL NUMBER:**

**DATE PURCHASED:**

**DATE OF FIRST USE:**

**INSPECTION DATE**

**INSPECTION ITEMS NOTED**

**CORRECTIVE ACTION**

**MAINTENANCE PERFORMED**

Approved By:

Approved By:

Approved By:

Approved By:

Approved By:

Approved By:

Approved By:

Approved By:

Approved By:

Approved By:

Approved By:

Approved By:

Approved By:

Approved By:

Approved By:

Approved By:

Approved By:

Approved By:

Approved By:

# INSPECTION AND MAINTENANCE LOG

**SERIAL NUMBER:**

**MODEL NUMBER:**

**DATE PURCHASED:**

**DATE OF FIRST USE:**

**INSPECTION DATE**

**INSPECTION ITEMS NOTED**

**CORRECTIVE ACTION**

**MAINTENANCE PERFORMED**

Approved By:

Approved By:

Approved By:

Approved By:

Approved By:

Approved By:

Approved By:

Approved By:

Approved By:

Approved By:

Approved By:

Approved By:

Approved By:

Approved By:

Approved By:

Approved By:

Approved By:

Approved By:

Approved By:

## LIMITED LIFETIME WARRANTY

**Warranty to End User:** D B Industries, LLC dba CAPITAL SAFETY USA ("CAPITAL SAFETY") warrants to the original end user ("End User") that its products are free from defects in materials and workmanship under normal use and service. This warranty extends for the lifetime of the product from the date the product is purchased by the End User, in new and unused condition, from a CAPITAL SAFETY authorized distributor. CAPITAL SAFETY'S entire liability to End User and End User's exclusive remedy under this warranty is limited to the repair or replacement in kind of any defective product within its lifetime (as CAPITAL SAFETY in its sole discretion determines and deems appropriate). No oral or written information or advice given by CAPITAL SAFETY, its distributors, directors, officers, agents or employees shall create any different or additional warranties or in any way increase the scope of this warranty. CAPITAL SAFETY will not accept liability for defects that are the result of product abuse, misuse, alteration or modification, or for defects that are due to a failure to install, maintain, or use the product in accordance with the manufacturer's instructions.

CAPITAL SAFETY'S WARRANTY APPLIES ONLY TO THE END USER. THIS WARRANTY IS THE ONLY WARRANTY APPLICABLE TO OUR PRODUCTS AND IS IN LIEU OF ALL OTHER WARRANTIES AND LIABILITIES, EXPRESSED OR IMPLIED. CAPITAL SAFETY EXPRESSLY EXCLUDES AND DISCLAIMS ANY IMPLIED WARRANTIES OF MERCHANTABILITY OR FITNESS FOR A PARTICULAR PURPOSE, AND SHALL NOT BE LIABLE FOR INCIDENTAL, PUNITIVE OR CONSEQUENTIAL DAMAGES OF ANY NATURE, INCLUDING WITHOUT LIMITATION, LOST PROFITS, REVENUES, OR PRODUCTIVITY, OR FOR BODILY INJURY OR DEATH OR LOSS OR DAMAGE TO PROPERTY, UNDER ANY THEORY OF LIABILITY, INCLUDING WITHOUT LIMITATION, CONTRACT, WARRANTY, STRICT LIABILITY, TORT (INCLUDING NEGLIGENCE) OR OTHER LEGAL OR EQUITABLE THEORY.

capital  
S A F E T Y

Global Leader in Fall Protection

### USA

3833 SALA Way  
Red Wing, MN 55066-5005  
Toll Free: 800.328.6146  
Phone: 651.388.8282  
Fax: 651.388.5065  
solutions@capitalsafety.com

### Brazil

Rua Anne Frank, 2621  
Boqueirão Curitiba PR  
81650-020  
Brazil  
Phone: 0800-942-2300  
brasil@capitalsafety.com

### Mexico

Calle Norte 35, 895-E  
Col. Industrial Vallejo  
C.P. 02300 Azcapotzalco  
Mexico D.F.  
Phone: (55) 57194820  
mexico@capitalsafety.com

### Colombia

Compañía Latinoamericana de Seguridad S.A.S.  
Carrera 106 #15-25 Interior 105 Manzana 15  
Zona Franca - Bogotá, Colombia  
Phone: 57 1 6014777  
servicioalcliente@capitalsafety.com

### Canada

260 Export Boulevard  
Mississauga, ON L5S 1Y9  
Phone: 905.795.9333  
Toll-Free: 800.387.7484  
Fax: 888.387.7484  
info.ca@capitalsafety.com

### EMEA (Europe, Middle East, Africa)

*EMEA Headquarters:*  
5a Merse Road  
North Moons Moat  
Redditch, Worcestershire  
B98 9HL UK  
Phone: + 44 (0)1527 548 000  
Fax: + 44 (0)1527 591 000  
csgne@capitalsafety.com

### France:

Le Broc Center  
Z.I. 1re Avenue - BP15  
06511 Carros Le Broc Cedex  
France  
Phone: + 33 04 97 10 00 10  
Fax: + 33 04 93 08 79 70  
information@capitalsafety.com

### Australia & New Zealand

95 Derby Street  
Silverwater  
Sydney NSW 2128  
Australia  
Phone: +(61) 2 8753 7600  
Toll-Free : 1800 245 002 (AUS)  
Toll-Free : 0800 212 505 (NZ)  
Fax: +(61) 2 8753 7603  
sales@capitalsafety.com.au

### Asia

*Singapore:*  
69, Ubi Road 1, #05-20  
Oxley Bizhub  
Singapore 408731  
Phone: +65 - 65587758  
Fax: +65 - 65587058  
inquiry@capitalsafety.com

### Shanghai:

Rm 1406, China Venturetech Plaza  
819 Nan Jing Xi Rd,  
Shanghai 200041, P R China  
Phone: +86 21 62539050  
Fax: +86 21 62539060  
inquiry@capitalsafety.cn

[www.capitalsafety.com](http://www.capitalsafety.com)

