

# Electrical equipment floor space

David Bredhold, MS,  
Application Engineer,  
Louisville, KY

Charles J.  
Nochumson, PE,  
National Application  
Engineer,  
Phoenix, AZ

## Abstract

Adequate space is a concern for electrical installations for several reasons including:

- Worker safety
- Working room
- Adequate clearances for personnel working on energized equipment to escape should a problem occur

The National Electrical Code® (NEC) addresses the minimum requirements to meet these needs.

On the other hand, building owners are looking for ways to minimize the size of electrical equipment in order to accommodate more building space for productive uses, thus minimizing costs. In addition, the smaller the equipment, the easier it is to move it into the required location. Factory installation and connection of components can lead to smaller overall lineups, typically resulting in reduced installation costs. This paper will review some of the NEC requirements regarding required electrical space and discuss new product concepts serving to reduce equipment size, resulting in reduced space requirements, reduced installation time, and reduced installation costs.

## Introduction

When designing a power distribution system, floor space is always a concern. In new buildings, space costs money. The first question from the Architect to the Electrical Engineer on new projects is almost always, "How much space is required for the electrical equipment?" In existing facilities, just finding enough space to get the job done can be a challenge. In many facilities, such as college dorms, hospitals, and office buildings, the amount of electrical loads continues to grow, but the size of the electrical rooms or closets stays the same.

Engineers are often looking for innovative ways to provide the appropriate power distribution equipment while NEC's requirement for safe working space in front, beside, and sometimes behind the electrical equipment. Fortunately, manufacturers are addressing this issue in several different ways including smaller components, front-access-only equipment, and pre-wired electrical assemblies.

1. **Smaller components**—Breakers and other electrical components continue to grow smaller. Circuit breaker manufacturers continue to advance the science of extinguishing an arc and continue to develop new, stronger materials to withstand the violent internal explosions caused when the breaker interrupts a high-current fault. With these new advancements, circuit breakers continue to get smaller. Smaller electrical components mean smaller assemblies, requiring less floor space.
2. **Front-access-only equipment**—By developing equipment that can be totally installed and maintained from the front, rear access and rear-access space are no longer required.
3. **Prewired electrical assemblies**—Electrical space requirements for equipment assembled in a factory to Underwriters Laboratories (UL) standards are often different than the requirements faced by the electrician during field installation. For instance, stacking two 42-circuit panelboards, one above the other, is not practical or permitted in the "field" but is permitted in a factory built switchboard meeting UL standards provided the appropriate barriers are in place. Prewired assemblies are becoming much more common in electrical construction, especially where space is a concern.

The remainder of this paper will further discuss these concepts in relation to NEC requirements.

# EAT•N

Powering Business Worldwide

## Space and NEC worker safety requirements

### Working space

Tasks such as troubleshooting and testing may require work in areas where live parts are exposed. Adequate clearance must be available around equipment in the vicinity of live parts to afford an opportunity to gain adequate clearance to avoid harm from the live parts. A few key NEC articles that address this issue are:

**Article 110.26**—Requires that sufficient access and working space shall be provided and maintained around all electrical equipment to permit ready and safe operation and maintenance of such equipment.

**Table 110.26(A)**—Defines requirements for minimum depths for working space in low-voltage (0–600 V) installations.

**Table 110.34 (A)**—Defines requirements for depths of working space for installations of 601 V and above.

**Article 110.26(A)(2)**—Specifies that the width of the working space in front of the electrical equipment shall be the width of the equipment or 30 inches (762 mm), whichever is greater. The goal is to prevent a worker from being unduly crowded when testing or maintaining equipment. The width of the working space is a factor regarding worker safety. When the possibility exists to encounter live components, a worker must have adequate room to avoid contacting grounded components or incurring injury when retreating.

### Working room

Though not working on or near live parts, workers still require room to maneuver comfortably around electrical equipment. The NEC provides for this situation in **Article 110.26(A)(1)(a)**, titled *Dead-Front Assemblies*, that states “Working space shall not be required in the back or sides of assemblies, such as dead-front switchboards or motor control centers, **where all connections and all renewable or adjustable parts, such as fuses or switches, are accessible from locations other than the back or sides**.” It further states, “Where access is required to work on non-electrical parts on the back of enclosed equipment, a minimum horizontal working space of 30 in (762 mm) shall be provided.”

The object of this NEC article is to allow workers the “elbow room” needed to maneuver. Workers need to be able to pull cable, repair assemblies, and replace components without injuring themselves.

### Space-saving examples

The above-referenced NEC space requirements must be complied with in all situations. However, from an owner’s perspective, space costs money. Space not occupied by electrical equipment can be used for other equipment, reserved for future use, or utilized for production or for income generation. Though electrical equipment must occupy space, all who are responsible for its design, purchase, and installation want it to occupy no more space than necessary.

### Pre-wired assembly example

**Figure 1** depicts a conventional electrical room layout where spacing is consistent with basic NEC clearance requirements.

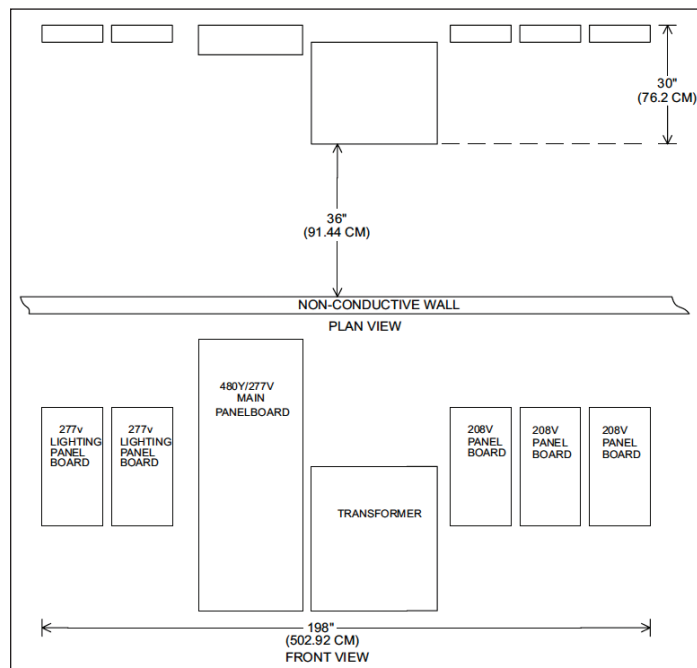

**Figure 1. Conventional panelboard/transformer room layout**

Floor space dedicated for this conventional layout employing panelboards and a transformer shown is 90.75 ft<sup>2</sup> (8.43 m<sup>2</sup>). Components are mounted individually on the wall. The cost incurred and time expended installing conduit and pulling cable to field-connect these components is a significant portion of the equipment installation costs. Note that the working space is taken into account for this layout because the transformer protrudes from the wall. Working space must be allowed in front of the transformer; in practice, additional space may be required by some building codes for passage between the transformer and the wall.

**Figure 2** illustrates the concept of mounting and cable-connecting the various panelboards and dry-type transformers of **Figure 1** in a factory, incorporating them into a single Integrated Facilities Switchboard (IFS) that requires access from the front only.

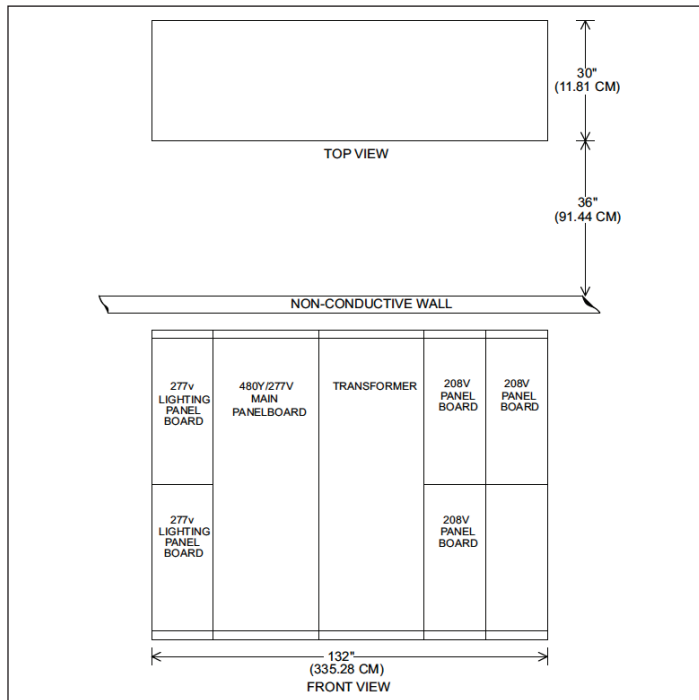
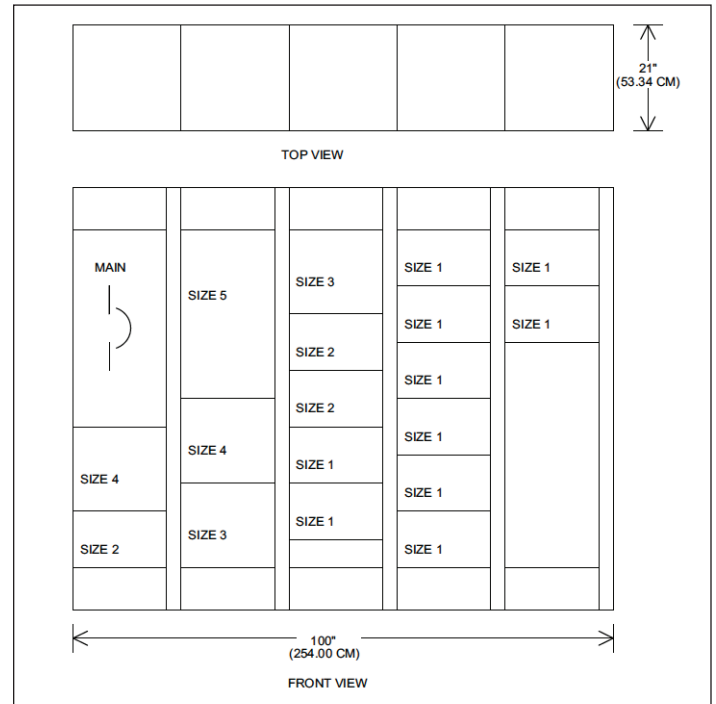

**Figure 2. Integrated Facilities Switchboard (IFS)**

This IFS assembly can incorporate normal main switchboard structures along with structures that incorporate multiple panelboards per structure (usually two), as well as dry-type transformers. This relatively new type of switchboard is UL-labeled and typically will incorporate a combination of 480/277 V or 208/120 V panelboards, along with a 480 V to 208Y/120 V dry-type step-down transformer. As can be seen from **Figure 2**, the IFS assembly provides significant space savings when compared to the conventional installation shown in **Figure 1**. In this example, the IFS structure occupies only 60.5 ft<sup>2</sup> (5.63 m<sup>2</sup>) resulting in an equipment floor space savings of 30.25 ft<sup>2</sup> (2.81 m<sup>2</sup>). Note that the working space is shown in front to properly compare the space requirements to the installation in **Figure 1**. Field installation time and cost are also significantly reduced.

**Smaller components example**

The concept of incorporating physically smaller, protective components in an assembly to minimize the size of the overall assembly is another space-savings method. To illustrate this approach, **Figure 3** shows a conventional motor control center (MCC) that is completely front accessible, thus no NEC requirement for rear working space clearance. This conventional MCC utilizes electromechanical starters with adjustable (heater-type) overload relays.



**Figure 3. Conventional motor control center (MCC)**

The MCC illustrated in **Figure 3** houses the following components:

- 1—1200 A main circuit breaker
- 10—Size 1 starters with motor circuit protector
- 3—Size 2 starters with motor circuit protector
- 2—Size 3 starters with motor circuit protector
- 2—Size 4 starters with motor circuit protector
- 1—Size 5 starter with motor circuit protector

The equipment floor space required is approximately 14.58 ft<sup>2</sup> (1.36 m<sup>2</sup>).

**Figure 4** illustrates an MCC that is termed an Intelligent Technologies MCC (IT MCC).

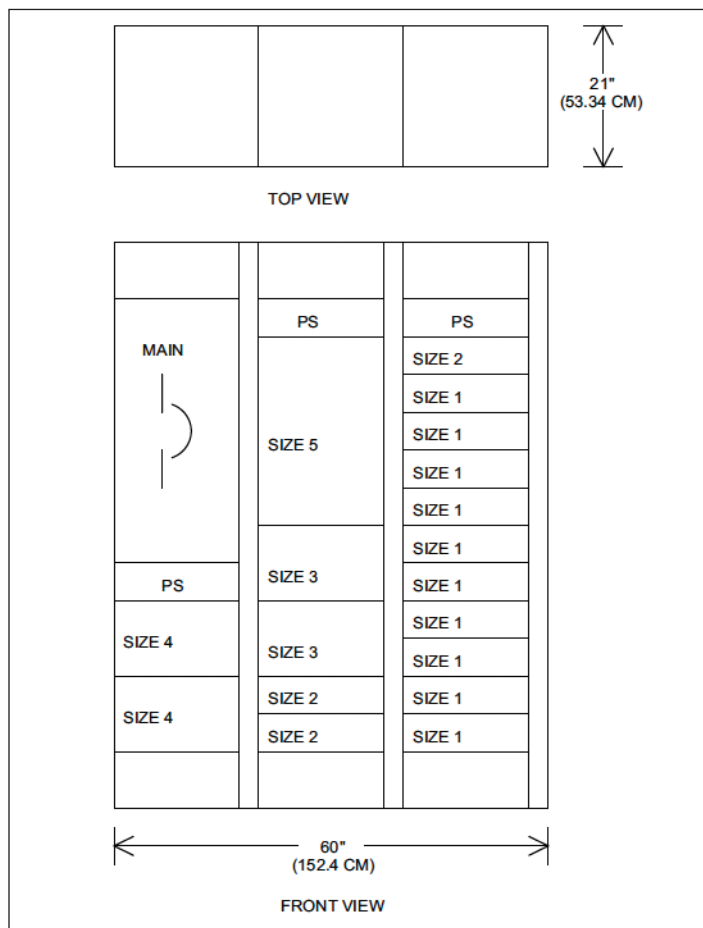

**Figure 4. Advanced design IT MCC (IT MCC)**

While containing the same number of combination starters as the MCC in **Figure 3**, the IT MCC requires only three structures where the conventional MCC requires five structures. The IT MCC employs newly designed, smaller combination starter units that utilize advanced technology to accomplish the size-reduction in unit buckets and, in turn, in overall MCC construction. This advanced technology includes the following features:

- The circuit breakers, while smaller than previous designs, are fully rated, molded case, overcurrent protective devices. The breakers are built and tested to the UL 489 standard.
- The starters are NEMA-rated starters, tested to NEMA standards. Size-reduction is provided through technological advances from advanced molding techniques and optimized power contact size, while retaining the electrical and mechanical life dictated by NEMA standards. A feature helping to reduce starter size is the use of 24 Vdc coils, supplied by power supplies (shown as PS in the **Figure 4**).
- The overload relays are microprocessor-based, solid-state overload relays that offer a significant size-reduction, contributing to the overall reduction in starter size.

The actual equipment floor space occupied by this advanced design is 8.75 ft<sup>2</sup> (0.81 m<sup>2</sup>), resulting in a savings of 5.83 ft<sup>2</sup> (0.54 m<sup>2</sup>) of floor space over a conventional design. Additionally, approximately 10 ft<sup>2</sup> (0.903 m<sup>2</sup>) of working space in front of the equipment will be saved over that required for the conventional MCC.

Similar to the previous IFS panelboard/dry-type example, and in addition to the equipment floor space savings, the reduced space for NEC required code clearances needs to be taken into account along with the reduced cost of equipment handling and installation.

## Medium-voltage examples

### Medium-voltage vacuum breaker switchgear

These concepts of utilizing front-accessible-only equipment, equipment utilizing more factory assembly, and smaller components to reduce equipment floor space with associated reduced NEC floor space requirements also apply to equipment rated over 600 V. An illustration of medium-voltage space reduction is shown in **Figure 5** and **Figure 6**.

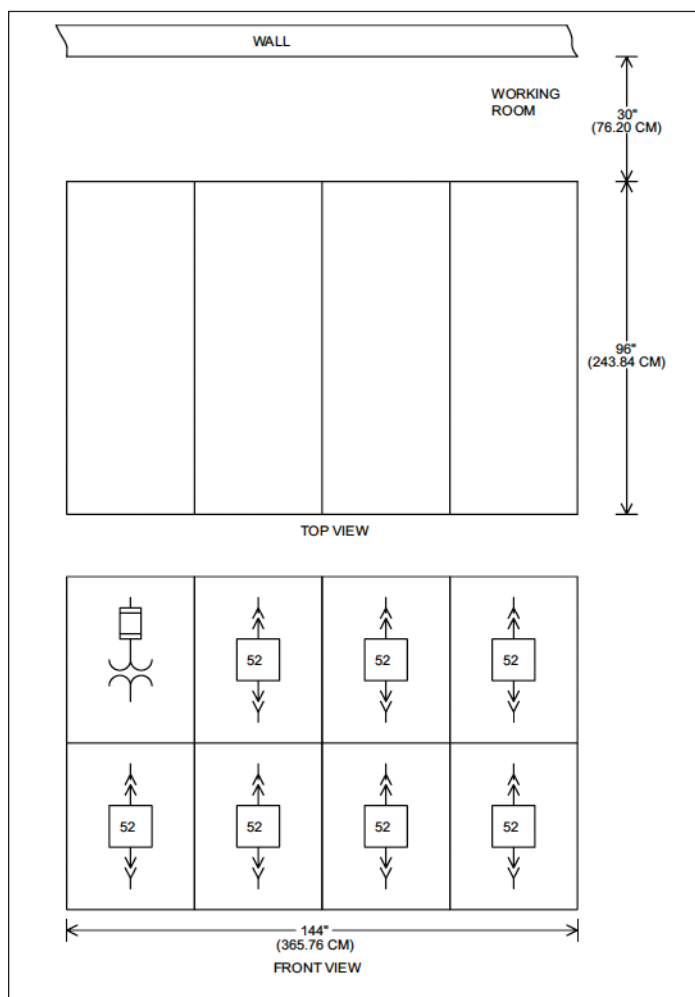

**Figure 5. Standard metal-clad switchgear**

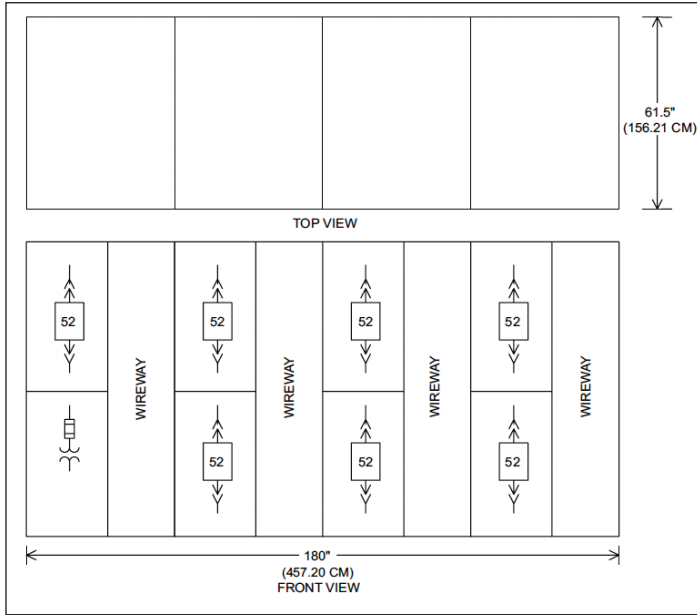

**Figure 6. New metal-enclosed vacuum breaker switchgear**

A conventional lineup of medium-voltage, metal-clad vacuum breaker equipment is shown in **Figure 5**. The depth of the front working room is dependent on the voltage to ground as required by the NEC. Standard metal-clad switchgear applied on a grounded system of 13.2 kV phase-to-phase requires 5 ft (1.52 m) front clearance for Condition 2 (exposed live parts on one side of the working space and grounded parts on the other side). In addition, the NEC requires rear access of 30 inches (762 mm) for making de-energized cable connections where there are no other energized parts. Most power system designers however, would show a minimum of 3 ft (0.91 m) rear access to provide for more space to pull cables. For front space, they would normally require an approximately 8.5 ft (2.59 m) aisle for original installation and also for future removal of the structures should the system need to be upgraded or in the event it is damaged. The working room required for the equipment itself is 96 ft<sup>2</sup> (8.92 m<sup>2</sup>).

**Figure 6** illustrates a relatively new development utilizing front accessible, full metal-clad vacuum breaker cubicles built into metal-enclosed vacuum breaker switchgear. Cable termination is accomplished in side access cable pull structures and cable pulling is done in the front of the equipment. Because of the use of new technology (vacuum breakers built into a molded resin material), the width of the breaker structures has been reduced from 36 inches (91.44 cm) wide to 26 inches (66.04 cm) wide. Though the overall width of the equipment may increase depending on the number of breakers, auxiliary instrumentation, and single-line configuration, significant savings will typically result due to:

- Elimination of the need for rear clearance
- Reduced equipment depth required for metal-enclosed versus metal-clad bus construction
- Reduced depth front aisles required in front of the equipment for installation and removal of structures

The actual equipment space required for the line-up shown in **Figure 6** is 76.875 ft<sup>2</sup> (7.14 m<sup>2</sup>) of floor space versus the previous 96 ft<sup>2</sup> (8.92 m<sup>2</sup>). However, significantly more space savings will result from not requiring working room behind the gear and an adequate 5.5 ft (1.68 m) aisle in lieu of 8.5 ft (2.59 m) aisle in front of the equipment.

**Medium-voltage secondary unit substations**

The last concept to be discussed has to do with secondary unit substations (SUS) that typically represent a considerable amount of floor space utilized on a project. This concept combines the medium-voltage primary breaker into the low-voltage, metal-enclosed power circuit breaker (American National Standards Institute [ANSI] C37) switchgear equipment. Previously, fused load interrupter switches were typically utilized for the primary protection of unit substations. This was due to their lower cost and reduced space requirements vs. vacuum circuit breakers.

With the advent of new vacuum circuit breakers built into molded resin housings and incorporating built-in microprocessor relay units, they can now be supplied as manual breakers in 600 A frames resulting in reduced costs and smaller footprints. These breakers can provide customized transformer protection including ground fault protection, differential protection, etc. **Figure 7** depicts a conventional SUS consisting of primary fused switch, transformer, and secondary low-voltage switchgear. The required floor space is approximately 119 ft<sup>2</sup> (11.06 m<sup>2</sup>). The primary switch is typically cable-connected to the transformer and the transformer is connected to the low-voltage switchgear by means of buswork with flexible braided connectors.

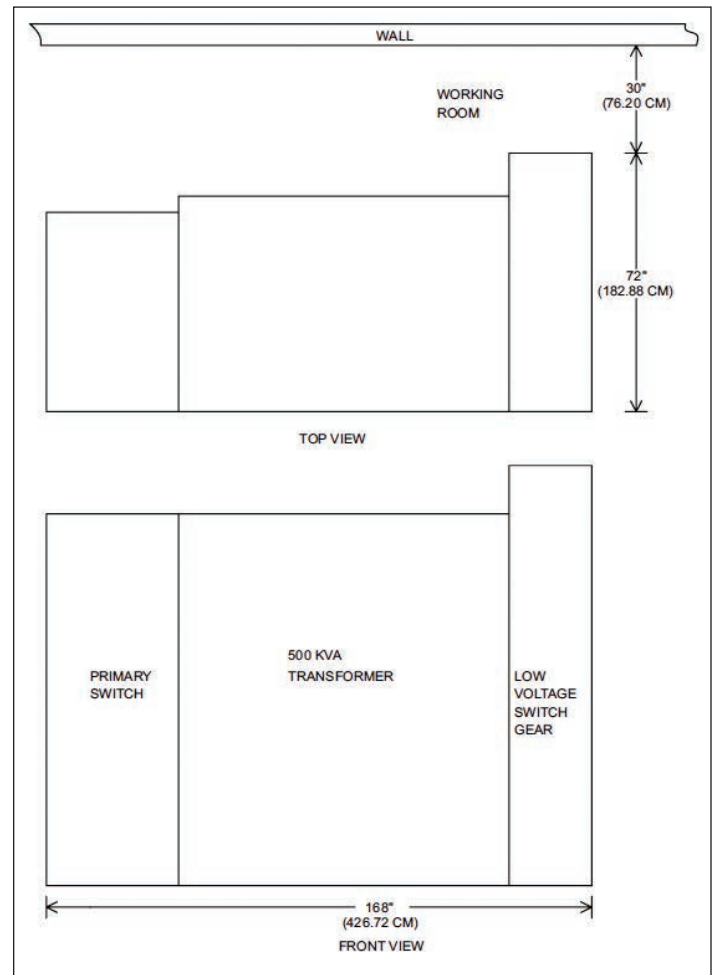

**Figure 7. Conventional SUS**

**Figure 8** illustrates a newly developed Integrated Unit Substation (IUS) concept that incorporates a medium-voltage vacuum breaker located in a drawout cell, isolated by barriers, that is then incorporated into the low-voltage, metal-enclosed ANSI switchgear.

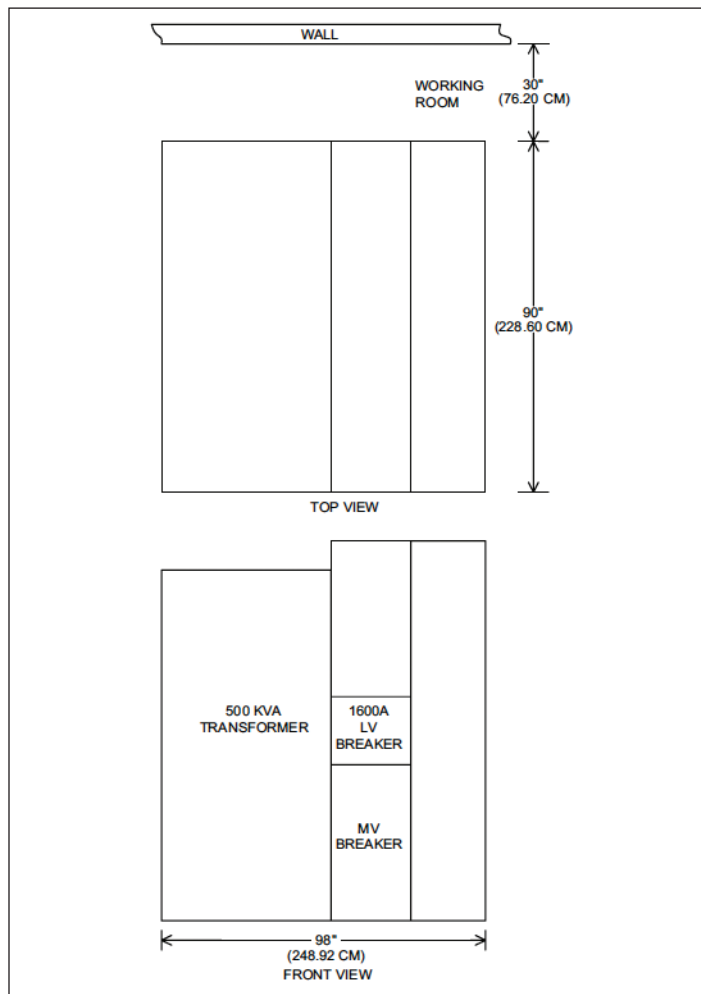

**Figure 8. Integrated unit substation (IUS)**

The structure shown to the right of the transformer in **Figure 8** includes both the primary and secondary transformer main breakers, resulting in a compact space-saving design. The low-voltage feeder breakers would be located to the right of the main structure as required. Not only is the primary switch space saved, but the transformer is then rotated 90 degrees, resulting in a smaller transformer footprint. Other than the medium-voltage transformer primary breaker being located below the secondary main breaker, the rest of the low-voltage switchgear would not change.

## Floor space economics

### Retail space

The average cost nationally to construct retail space in 2006 was \$105.80 per ft<sup>2</sup> (Retail Update, 2006). The IFS in **Figure 2** is typically employed for construction of electrical systems for national, chain type retail establishments. Space-savings realized through use of the IFS is 30.25 ft<sup>2</sup> (2.81 m<sup>2</sup>). Therefore, cost savings for the equipment alone for this floor space amounts to \$3,200.00.

A business may wish to put the space saved to a productive use instead of forgoing its construction. A report from US Business Reporter states that revenue realized from retail space varies from \$235.00 per ft<sup>2</sup> for Kmart to \$422.00 per ft<sup>2</sup> for Walmart. Using the figure for Walmart, annual sales of \$12,765.00 would accrue from the 30.25 ft<sup>2</sup> (2.81 m<sup>2</sup>) of space saved using an IFS. A realization of 20% profit annually, or \$2,553.00, would result. This is in addition to the initial overall combination of equipment and installation savings. The simple payback for the space is approximately 1.25 years.

### Industrial space

Data from R.S. Means (2006) indicates that the cost per square foot to build a three-story factory in St. Louis was \$102.30 in 2006. Using the medium-voltage distribution system shown in **Figure 6** instead of the system shown in **Figure 5**, one realizes a saving of 76.875 ft<sup>2</sup> (7.14 m<sup>2</sup>) of just equipment floor space without considering the additional savings from reduced working space requirements mandated by the NEC. Construction costs for the space would be \$7,864.00. If production yields \$200 per ft<sup>2</sup>, annual revenue would amount to \$15,375.00. A realization of 20% profit annually, or \$3,075.00, results. Simple payback for the space is approximately 2.56 years.

## Conclusion

Worker safety is of utmost importance in the minds of all when planning facilities. The NEC requires adequate space for workers to move about equipment. Equipment occupying less floor space also requires less space to be dedicated to worker safety, allowing the space to be used for productive purposes. When considering equipment purchases, in addition to giving consideration to other factors, attention should be paid to the equipment and Code clearance space required. The space-saving ideas presented can result in real economic first cost installation savings and additional useable space that could result in long-term savings.

## References

National Fire Protection Association, NFPA 70, National Electrical Code, Quincy, MA, 2008.

Alcantara, J.L. (2006), *Retail Update*. From [http://www.ewweb.com/mag/electric\\_retail\\_update\\_2/](http://www.ewweb.com/mag/electric_retail_update_2/), Retrieved November 11, 2007.

US Business Reporter (n.d.). *Understanding Retail Data*. From <http://www.activemedia-guide.com/retailstats.htm>, Retrieved November 11, 2007.

Haughey, J. (2006), R.S. *Means cost comparisons: Light industrial buildings*. From <http://www.bdcnetwork.com/article/CA6372672.html>, Retrieved November 11, 2007.

**Eaton**  
1000 Eaton Boulevard  
Cleveland, OH 44122  
United States  
Eaton.com

© 2018 Eaton  
All Rights Reserved  
Printed in USA  
Publication No. AP083007EN / Z21152  
June 2018



Eaton is a registered trademark.

All other trademarks are property  
of their respective owners.