

T10J

10-Channel Digital Proportional R/C System

S.BUS 2™



INSTRUCTION MANUAL

Futaba®

Digital Proportional R/C System

1M23N29216



10 CHANNEL COMPUTER SYSTEM
T10J MANUAL

TABLE OF CONTENTS

Introduction.....	6
● Support and Service	6
● Application, Export, and Modification....	7
● Definitions of Symbols.....	9
● Safety Precautions (do not operate without reading).....	9
<hr/>	
Before use.....	12
● Features of 10J	12
● Contents and technical specifications	13
● System compatibility	13
● Accessories.....	14
● Transmitter controls.....	15
Battery.....	17
Switch	18
To turn on the 10J	18
Receiver and servo connections	19
Charging the batteries	22
Stick adjustment.....	23
Adjusting display contrast.....	24
Connector/Plug.....	24
Transmitter displays & buttons	25
Warning & error displays.....	26
Link procedure	27
● Receiver nomenclature.....	28
● R3008SB CH mode	29
● Receiver's antenna installation.....	30
● Mounting the servo.....	31
● Range check the radio	32
● S.BUS/S.BUS2 Installation	33
● S.BUS Wiring example.....	34
● S.BUS2 System.....	35
● S.BUS/S.BUS2 Device setting	36
● Telemetry System.....	37

INTRODUCTION

BEFORE USE

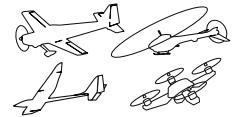

COMMON



AIRPLANE



HELICOPTER



GLIDER



MULTICOPTER



TX SETTING

Common function	38
●Model select.....	40
Model select	41
Model copy.....	41
Date reset.....	41
RX type.....	42
Link	42
●Model name.....	43
Model name	43
User name	44
●Fail safe.....	45
●Servo reverse	47
●Timer.....	48
●Servo monitor.....	49
●End point	50
●Trim.....	51
●Sub trim	52
●Program mixing	53
●AUX channel	56
●Parameter	58
Date reset.....	60
Model type	61
Swash type (for heli).....	61
Wing type (for glider)	61
ATL Trim	61
LCD contrast	62
Back light	62
Light time.....	62
Light adjustment.....	62
Home display	62
Battery alarm voltage	62
Battery alarm voltage vibration	63
Buzzer tone	63
Jog key navigation.....	63
Jog light.....	63
Jog light time	64
Telemetry mode	64
Telemetry unit.....	64
Speech language	64
Speech volume	64

Stick position alarm	65
●Telemetry	66
Telemetry:Rx-batt	66
Telemetry:Ext-volt	70
Telemetry:temp.....	75
Telemetry:rpm.....	76
Telemetry:altitude	77
Telemetry:vario	78
Telemetry:distance	79
Telemetry:speed.....	81
Telemetry:battery.....	82
●Sensor slot.....	83
Sensor:register.....	84
Sensor:sens slot.....	85
Sensor:initialize	86
Sensor:all clear	87
Sensor:manually assigning a sensor	88
●S.BUS servo link	89
●Model transfer.....	92
●Trainer	93

Airplane function	95
●Aileron Differential.....	97
●Aileron→Rudder	98
●V-Tail.....	99
●Gyro sensor	100
●Elevon	101
●Ailvator	102
●Throttle→Needle Mixing	103
●Dual rate / EXPO.....	104
●Flaperon.....	106
●Air brake	108
●Flap→Elevator mixing.....	110
●Elevator→Flap mixing.....	111
●Flap trim.....	112
●Throttle cut.....	113
●Idle down	115
●Snap roll.....	116

●Throttle curve	117
●PIT-curve	118
●Throttle delay	119

Helicopter function120

●Condition	122
●Swash AFR	123
●Swash mixing	124
●Swash ring	126
●Trim offset	127
●Delay	128
●Throttle cut.....	129
●Gyro sensor	131
●Dual rate / EXPO	132
●Throttle curve	134
●Pitch curve.....	136
●Revolution mixing (PIT to RUD)	138
●Throttle hold	140
●Governor mixing.....	141
●Hovering throttle	143
●Hovering pitch	144
●HI/LO-pitch trim	145
●Swash→Throttle mixing	146
●Throttle→Needle mixing.....	147

Glider function148

●Aileron Differential.....	150
●Aileron→Rudder	151
●V-tail.....	152
●Gyro sensor	153
●Dual rate / EXPO	154
●Motor switch	156
●Condition	157
●Rudder→Aileron mixing	158
●Camber flap mixing.....	159

●Camber mixing	160
●Butterfly mixing	161
●Camber→Elevator mixing.....	162
●Elevator→Camber mixing.....	163
●Aileron→Camber mixing.....	165
●Aileron→Brake flap	166
●Trim mix	167

Multicopter function168

●Gyro sensor	170
●Dual rate / EXPO	171
●Center alarm	173

TX setting.....174

●Stick-mode.....	174
●Stick-adjustment.....	174
●Throttle stick reverse.....	175
●Language	175

INTRODUCTION

Thank you for purchasing a Futaba® T-FHSS Air-2.4GHz 10J series digital proportional R/C system. This system is extremely versatile and may be used by beginners and pros alike. In order for you to make the best use of your system and to fly safely, please read this manual carefully. If you have any difficulties while using your system, please consult the manual, our online Frequently Asked Questions (on the web pages referenced below), your hobby dealer, or the Futaba Service Center.

Introduction

Due to unforeseen changes in production procedures, the information contained in this manual is subject to change without notice.

Support and Service: It is recommended to have your Futaba equipment serviced annually during your hobby's "off season" to ensure safe operation.

IN NORTH AMERICA

Please feel free to contact the Futaba Service Center for assistance in operation, use and programming. Please be sure to regularly visit the 10J Frequently Asked Questions web site at www.futabausa.com. This page includes extensive programming, use, set up and safety information on the 10J radio system and is updated regularly. Any technical updates and US manual corrections will be available on this web page. If you do not find the answers to your questions there, please see the end of our F.A.Q. area for information on contacting us via email for the most rapid and convenient response.

Don't have Internet access? Internet access is available at no charge at most public libraries, schools, and other public resources. We find internet support to be a fabulous reference for many modelers as items can be printed and saved for future reference, and can be accessed at any hour of the day, night, weekend or holiday. If you do not wish to access the internet for information, however, don't worry. Our support teams are available Monday through Friday 8-5 Central time to assist you.

FOR SERVICE:

Futaba Service Center
FUTABA Corporation of America
2681 Wall Triana Hwy
Huntsville, AL 35824, U.S.A.
Phone: 1-256-461-9399
FAX: 1-256-461-1059
www.futabausa.com

OUTSIDE NORTH AMERICA

Please contact your Futaba importer in your region of the world to assist you with any questions, problems or service needs.

Please recognize that all information in this manual, and all support availability, is based upon the systems sold in North America only. Products purchased elsewhere may vary. Always contact your region's support center for assistance.

Application, Export, and Modification

1. This product may be used for model airplane or surface (boat, car, robot) use. It is not intended for use in any application other than the control of models for hobby and recreational purposes. The product is subject to regulations of the Ministry of Radio/Telecommunications and is restricted under Japanese law to such purposes.

2. Exportation precautions:

(a) When this product is exported from the country of manufacture, its use is to be approved by the laws governing the country of destination which govern devices that emit radio frequencies. If this product is then re-exported to other countries, it may be subject to restrictions on such export. Prior approval of the appropriate government authorities may be required. If you have purchased this product from an exporter outside your country, and not the authorized Futaba distributor in your country, please contact the seller immediately to determine if such export regulations have been met.

(b) Use of this product with other than models may be restricted by Export and Trade Control Regulations, and an application for export approval must be submitted. This equipment must not be utilized to operate equipment other than radio controlled models.

3. Modification, adjustment, and replacement of parts: Futaba is not responsible for unauthorized modification, adjustment, and replacement of parts on this product. Any such changes may void the warranty.

Compliance Information Statement

This device complies with part 15 of the FCC Rules. Operation is subject to the following two conditions:

(1) This device may not cause harmful interference, and (2) This device must accept any interference received, including interference that may cause undesired operation.

RF Radiation Exposure Statement

This equipment complies with FCC radiation exposure limits set forth for an uncontrolled environment.

This transmitter must not be co-located or operating in conjunction with any other antenna or transmitter.

The responsible party for the compliance of this device is:

FUTABA Corporation of America

2681 Wall Triana Hwy Huntsville, AL 35824, U.S.A.

Phone: 1-256-461-9399 or E-mail: service@futabaUSA.com



The RBRC. SEAL on the nickel-cadmium battery contained in Futaba products indicates that Futaba Corporation is voluntarily participating in an industry-wide program to collect and recycle these batteries at the end of their useful lives, when taken out of service within the United States. The RBRC. program provides a convenient alternative to placing used nickel-cadmium batteries into the trash or municipal waste system, which is illegal in some areas.

(for USA)

You may contact your local recycling center for information on where to return the spent battery. Please call 1-800-8BATTERY for information on NiCd battery recycling in your area. Futaba Corporation involvement in this program is part of its commitment to protecting our environment and conserving natural resources.

*RBRC is a trademark of the Rechargeable Battery Recycling Corporation.

Federal Communications Commission Interference Statement (for U.S.A.)

This equipment has been tested and found to comply with the limits for a Class B digital device, pursuant to Part 15 of the FCC Rules. These limits are designed to provide reasonable protection against harmful interference in a residential installation.

This equipment generates, uses and can radiate radio frequency energy and, if not installed and used in accordance with the instructions, may cause harmful interference to radio communications. However, there is no guarantee that interference will not occur in a particular installation. If this equipment does cause harmful interference to radio or television reception, which can be determined by turning the equipment off and on, the user is encouraged to try to correct the interference by one or more of the following measures:

- Reorient or relocate the receiving antenna.
- Increase the separation between the equipment and receiver.
- Connect the equipment into an outlet on a circuit different from that to which the receiver is connected.
- Consult the dealer or an experienced radio/TV technician for help.

CAUTION:

To assure continued FCC compliance:

Any changes or modifications not expressly approved by the grantee of this device could void the user's authority to operate the equipment.

WARNING:

This product contains a chemical known to cause cancer and birth defects (or other reproductive harm).

Compliance Information Statement (for EU)

Declaration of Conformity

Hereby, Futaba Corporation declares that the radio equipment type T10J is in compliance with Directive 2014/53/EU.

The full text of the EU declaration of conformity is available at the following internet address:

<http://www.rc.futaba.co.jp/english/index.html>

Where to Fly

We recommend that you fly at a recognized model airplane flying field. You can find model clubs and fields by asking your nearest hobby dealer, or, in the US, by contacting the Academy of Model Aeronautics.

The national Academy of Model Aeronautics (AMA) has more than 2,500 chartered clubs across the country. Through any one of them, instructor training programs and insured newcomer training are available. Contact the AMA at the address or toll-free phone number below.

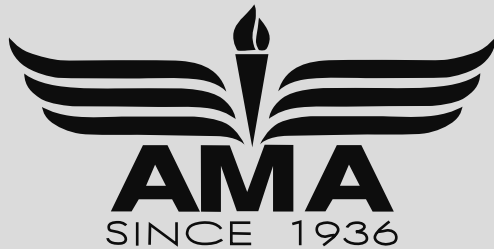
**Academy of Model Aeronautics**

5161 East Memorial Drive

Muncie, IN 47302

Tele. (800) 435-9262

Fax (765) 289-4248

or via the Internet at <http://www.modelaircraft.org>

Always pay particular attention to the flying field's rules, as well as the presence and location of spectators, the wind direction, and any obstacles on the field. Be very careful flying in areas near power lines, tall buildings, or communication facilities as there may be radio interference in their vicinity.

Precautions

Application, Export, and Modification Precautions.

1. This product is only designed for use with radio control models. Use of the product described in this instruction manual is limited to radio control models.
2. Export precautions:
 - a) When this product is exported, it cannot be used where prohibited by the laws governing radio waves of the destination country.
 - b) Use of this product with other than models may be restricted by Export and Trade Control Regulations.
3. Modification, adjustment, and parts replacement

Futaba is not responsible for unauthorized modification, adjustment, or replacement of parts on this product.

 - No part of this manual may be reproduced in any form without prior permission.
 - The contents of this manual are subject to change without prior notice.
 - The contents of this manual should be complete, but if there are any unclear or missing parts please contact a Futaba Service Center.
 - Futaba is not responsible for the use of this product by the customer.
 - Company and product names in this manual are trademarks or registered trademarks of the respective company.

For safe use

Please observe the following precautions to ensure safe use of this product at all times.

Meaning of Special Markings:

The parts of this manual indicated by the following marks require special attention from the standpoint of safety.

- ⚠ **DANGER** - Procedures which may lead to dangerous conditions and cause death/serious injury if not carried out properly.
- ⚠ **WARNING** - Procedures which may lead to a dangerous condition or cause death or serious injury to the user if not carried out properly, or procedures where the probability of superficial injury or physical damage is high.
- ⚠ **CAUTION** - Procedures where the possibility of serious injury to the user is small, but there is a danger of injury, or physical damage, if not carried out properly.

⊘ = Prohibited ⓘ = Mandatory

WARNING: Always keep electrical components away from small children.

Flying Precautions

⚠ WARNING

⊘ **Never grasp the built-in transmitter antenna while flying.**

■ The transmitter output may drop drastically.

ⓘ **Always make sure that all transmitter stick movements operate all functions properly in the model prior to flight. Also, make sure that all switches, etc. function properly as well. If there are any difficulties, do not use the system until all inputs are functioning properly.**

⊘ **Never fly in power down (range check) mode.**

■ In the dedicated range test power down mode, the transmitter output range is reduced and may cause a crash.

⊘ **While operating, never touch the transmitter with, or bring the transmitter near, another transmitter, a cellphone, or other wireless devices.**

■ Doing so may cause erroneous operation.

⊘ **Never fly on a rainy day, when the wind is strong or at night.**

■ Water could lead to failure or improper functionality and poor control of the aircraft which could lead to a crash.

⊘ **Never turn the power switch off during flight or while the engine or motor is running.**

■ Operation will become impossible and the aircraft will crash. Even if the power switch is turned on, operation will not begin until transmitter and receiver internal processing is complete.

⊘ **Do not start the engine or motor while wearing the neck strap.**

■ The neck strap may become entangled with the rotating propeller, rotor, etc. and cause serious injury.

⊘ **Do not fly when you are physically impaired as it could pose a safety hazard to yourself or others.**

⊘ Do not fly at the following places:

- Near another radio control flying field.
- Near or above people.
- Near homes, schools, hospitals or other places where people congregate.
- Near high voltage lines, high structures, or communication facilities.

⊘ When setting the transmitter on the ground during flight preparations, do not stand it upright.

- The transmitter may tip over, the sticks may move and the propeller or rotor may rotate unexpectedly and cause injury.

⊘ Do not touch the engine, motor, or FET amp during and immediately after use.

- These items may become hot during use.

⚠ For safety, fly so that the aircraft is visible at all times.

- Flying behind buildings or other large structures will not only cause you to lose sight of the aircraft, but also degrade the RF link performance and cause loss of control.

⚠ From the standpoint of safety, always set the fail safe function.

- In particular, normally set the throttle channel to idle.

⚠ Always check the remaining capacity of the transmitter and receiver batteries before each flying session prior to flight.

- Low battery capacity will cause loss of control and a crash.

⚠ Always check operation of each control surface and perform a range test before each flying session. Also, when using the trainer function, check the operation of both the teacher and student transmitter.

- Even one incorrect transmitter setting or aircraft abnormality can cause a crash.

⚠ Before turning on the transmitter:

1. Always move the transmitter throttle stick position to the minimum (idle) position.
2. Turn on the transmitter first and then the receiver.

⚠ When turning off the transmitter's power switch. After the engine or motor has stopped (state in which it will not rotate again):

1. Turn off the receiver power switch.
2. Then turn off the transmitter power switch.

- If the power switch is turned on/off in the opposite order, the propeller may rotate unexpectedly and cause a serious injury.

- Also always observe the above order when setting the fail safe function.

- Maximum low throttle: Direction in which the engine or motor runs at the slowest speed or stops.

⚠ When adjusting the transmitter, stop the engine except when necessary. In the case of a motor, disconnect the wiring and don't allow it to continue operation. When doing so, please exercise extreme caution. Ensure that the aircraft is secured and that it will not come into contact with anything or anyone. Ensure that the motor will not rotate prior to making any adjustments.

- Unexpected high speed rotation of the engine may cause a serious injury.

Battery and Charger Handling Precautions

⚠ DANGER

⊘ Do not recharge a battery that is damaged, deteriorated, leaking electrolyte, or wet.

⊘ Do not use the charger in applications other than as intended.

⊘ Do not allow the charger or battery to become wet.

- Do not use the charger, when it or your hands, are wet. Do not use the charger in humid places.

⊘ Do not short circuit the battery.

⊘ Do not solder, repair, deform, modify, or disassemble the battery and/or battery charger.

⊘ Do not drop the battery into a fire or bring it near a fire.

⊘ Do not charge and store the battery in direct sunlight or other hot places.

⊘ Do not charge the battery if it is covered with any object as it may become very hot.

⊘ Do not use the battery in a combustible environment.

- The combustibles may ignite and cause an explosion or fire.

⚠ Always charge the battery before each flying session.

- If the battery goes dead during flight, the aircraft will crash.

⚠ Always use the charger with the specified power supply voltage.

- Use the special charger by connecting it to a proper power outlet.

⚠ If the battery liquid should get in your eyes, do not rub your eyes, but immediately wash them with tap water or other clean water and get treated by a doctor.

- The liquid can cause blindness.

⚠ WARNING

⊘ Do not touch the charger and battery for any length of time during charging.

■ Doing so may result in burns.

⊘ Do not use a charger or battery that has been damaged.

⊘ If any abnormalities such as smoke or discoloration are noted with either the charger or the battery, remove the battery from the charger and disconnect the power cord plug and do not use the charger.

■ Continued use may cause fire, combustion, generation of heat, or rupture.

⊘ Do not subject the batteries to impact.

■ Doing so may cause fire, combustion, generation of heat, rupture, or liquid leakage.

⚠ CAUTION

⊘ Do not place heavy objects on top of the battery or charger. Also, do not place the battery or charger in any location where it may fall.

■ Doing so may cause damage or injury.

⊘ Do not store or use the battery and charger where it is dusty or humid.

■ Insert the power cord plug into the receptacle only after eliminating the dust.

⚠ If the battery leaks liquid or generates an abnormal odor, immediately move it to a safe place for disposal.

■ Not doing so may cause combustion.

⚠ If the battery liquid gets on your skin or clothing, immediately flush the area with tap water or other clean water.

■ Consult a doctor. The liquid can cause skin damage.

⚠ After the specified charging time has elapsed, end charging and disconnect the charger from the receptacle.

⚠ When recycling or disposing of the battery, isolate the terminals by covering them with insulation tape.

■ Short circuit of the terminals may cause combustion, generation of heat or rupture.

⊘ Do not charge the battery in extreme temperatures.

■ Doing so will degrade the battery performance. An ambient temperature of 10 °C to 30 °C (50 °F to 86 °F) is ideal for charging.

⚠ Unplug the charger when not in use.

⊘ Do not bend or pull the cord unreasonably and do not place heavy objects on the cord.

■ The power cord may be damaged and cause combustion, generation of heat, or electric shock.

Storage and Disposal Precautions

⚠ CAUTION

⊘ Do not store wireless devices in the following places:

- Where it is extremely hot (40°C [104F] or higher) or cold (-10°C [14F] or lower)
- Where the equipment will be exposed to direct sunlight
- Where the humidity is high
- Where vibration is prevalent
- Where it is very dusty
- Where the device may be exposed to steam and heat

⚠ When the device will not be used for a long time, remove the battery from the transmitter and aircraft and store them in a dry place where the temperature is between 0 and 30°C [32F and 86F].

■ When left 'as is', batteries may deteriorate, leak, or be otherwise damaged.

Other Precautions

⚠ CAUTION

⊘ Do not directly expose plastic parts to fuel, oil, exhaust gas, etc.

■ If left in such an environment, the plastic may be damaged.
■ Since the metal parts of the case may corrode, always keep them clean.

⚠ Join the Academy of Model Aeronautics.

■ The Academy of Model Aeronautics (AMA) provides guidelines and liability protection should the need arise.

⚠ Always use genuine Futaba products such as transmitter, receiver, servo, FET amplifier, battery, etc.

■ Futaba is not responsible for damage sustained by combination with parts other than Futaba Genuine Parts. Use the parts specified in the instruction manual and catalog.

BEFORE USE

FEATURES

- **T-FHSS Air-2.4G multi-function 10-channel transmitter**

The Futaba 2.4GHz T-FHSS Air system is employed.

- **Telemetry system**

A T-FHSS Air bidirectional communication system is used. The voltage of the battery mounted in the fuselage can be displayed at the transmitter during flight. Altitude, speed, temperature and other fuselage data can be displayed at the transmitter by installing various optional telemetry sensors in the fuselage.

- **Speech function**

Telemetry data can be listened to by plugging commercial earphones into the transmitter.

- **Built-in diversity antenna**

Diversity antenna built into the transmitter provides a simple appearance and improves handling ease.

- **S.BUS/S.BUS2 servo setting function**

S.BUS/S.BUS2 servo channel and various functions can be set by connecting the servo to the transmitter.

- **Power-saving type transmitter**

Four AA alkaline batteries can be used. The optional HT5F1800B (NiMH 6.0V, 1800mA) or FT2F2100BV2 (lithium-ferrite 6.6V, 2100mA) battery can also be used.

- **Vibration**

A function that notifies the operator of various alarms by vibrating the transmitter can be selected.

- **Unique model memory system**

The transmitter body contains a 30 model memory.

- **Mixing type selection**

Fixed wing, helicopter, and glider mixing type can be selected to match the fuselage. In addition, 8 swash plate types can also be selected for helicopters. Multi-copter selection is also possible.

- **Digital trim**

Rapid trimming during flight is possible. The sound changes at the center of trim. The step size can be arbitrarily changed. The trim position is displayed on the LCD.

- **Lever head length adjustment and new lever head shape**

The lever head length can be adjusted. A new lever head shape that reduces slip during operation has been adopted.

- **Switch/VR position change and AUX channel function change**

Mixing and other switches and knobs can be selected. Since the function of the AUX channels (5ch ~ 10ch) can also be changed, original mixing, in addition to existing mixing, can be created by using the programmable mixing function.

- **Model data transfer function**

Model data can be wirelessly transferred between 10J or 8J transmitters.

R3008SB receiver

- **T-FHSS Air system S.BUS compatible**

S.BUS output and conventional channel output are provided. S.BUS and conventional system sharing is possible.

●EXT battery terminal

The voltage can be displayed at the transmitter by branch connecting the drive battery, etc. installed in the fuselage with the CA-RVIN-700 cable sold separately.

●Battery fail safe function

If the receiver battery voltage drops below the set value when the fail safe mode was selected, the battery fail safe function moves the servo to a preset position.

CONTENTS AND TECHNICAL SPECIFICATIONS

(Specifications and ratings are subject to change without notice.)

Your 10J includes the following components:

- T10J transmitter for airplanes or helicopters
- R3008SB Receiver
- Switch harness
- Neck strap

*The set contents depend on the type of set.

Transmitter T10J

(2-stick, 10-channel, T-FHSS Air-2.4G system)
Transmitting frequency: 2.4GHz band
System: T-FHSS Air, S-FHSS, switchable
Power supply: 6.0V Dry battery

Frequency band 2.4GHz
RF power output 100mw EIRP

Receiver R3008SB

(T-FHSS Air-2.4G system, dual antenna diversity, S.BUS system)
Power requirement: 4.8V~7.4V battery or regulated output from ESC, etc. (*1)
Size: 0.98 x 1.86 x 0.56 in. (24.9 x 47.3 x 14.3 mm)
Weight: 0.36 oz. (10.1g)
Battery F/S Voltage: It sets up with a transmitter
(*1) When using ESC's make sure that the regulated output capacity meets your usage application.

Frequency band 2.4GHz
RF power output 37.8mw EIRP

SYSTEM COMPATIBILITY

The **10J** is a **2.4GHz T-FHSS Air system**. The transmitter can also be switched to **S-FHSS**. (However, the telemetry system cannot be used with S-FHSS.) The usable receivers are shown below.

Communications System	Usable Receivers
T-FHSS Air (Default)	R3001SB, R3004SB, R3006SB, R3008SB
S-FHSS (Change is possible)	R2001SB, R2008SB, R2006GS, R2106GF

NOTE :

*The Futaba **T-FHSS Air** system cannot be used with Futaba **S-FHSS/FASST/FASSTest** systems. Use it with a **T-FHSS Air** system transmitter and receiver. The **T10J** is a **T-FHSS Air system**, but can also be used with an **S-FHSS** receiver by switching to **S-FHSS**. However, in this case the telemetry system cannot be used.

*The **T-FHSS Air system** and **T-FHSS** surface system are different. The **T10J** cannot be used with the **R334SB, R334SB-E** or **T-FHSS** surface system receivers.

The following additional accessories are available from your dealer. Refer to a Futaba catalog for more information:

- HT5F1800B Transmitter battery pack - the (1800mAh) transmitter NiMH battery pack may be easily exchanged with a fresh one to provide enough capacity for extended flying sessions.
- FT2F2100B Transmitter LiFe battery pack can also be used. However, charge with the charger only for LiFe.
- Trainer cord - the optional training cord may be used to help a beginning pilot learn to fly easily by placing the instructor on a separate transmitter. Note that the T10J transmitter may be connected to another T10J system, as well as to any other models of Futaba transmitters. The T10J transmitter uses one of the three cord plug types according to the transmitter connected. (Refer to the description at the TRAINER function instructions). The part number of this cord is: FUTM4405.
- Servos - there are various kinds of servos. Please choose the Futaba servos best suited for the model and purpose you are using them for. If you utilize a S.BUS system, you should choose a S.BUS servo.
- Telemetry sensor - please purchase an optional sensor, in order to utilize bidirectional communication system and to acquire the information from a model high up in the sky.
[Temperature sensor : SBS-01T] [Altitude sensor : SBS-01A] [RPM sensor magnet type : SBS-01RM]
[RPM sensor optical type : SBS-01RO] [GPS sensor : SBS-01G] [Voltage sensor : SBS-01V]
- Neckstrap - a neckstrap can be connected to your T10J system to make it easier to handle and improve your flying precision since your hands won't need to support the transmitter's weight.
- Y-harnesses, servo extensions, hub,etc - Genuine Futaba extensions and Y-harnesses, including a heavy-duty version with heavier wire, are available to aid in your larger model and other installations.
- Gyros - a variety of genuine Futaba gyros is available for your aircraft or helicopter needs.
- Governor - for helicopter use. Automatically adjusts throttle servo position to maintain a constant head speed regardless of blade pitch, load, weather, etc.
- Receivers - various models of Futaba receivers may be purchased for use in other models. (Receivers for T-FHSS Air, S-FHSS types are available.)

TRANSMITTER CONTROLS - AIRPLANE

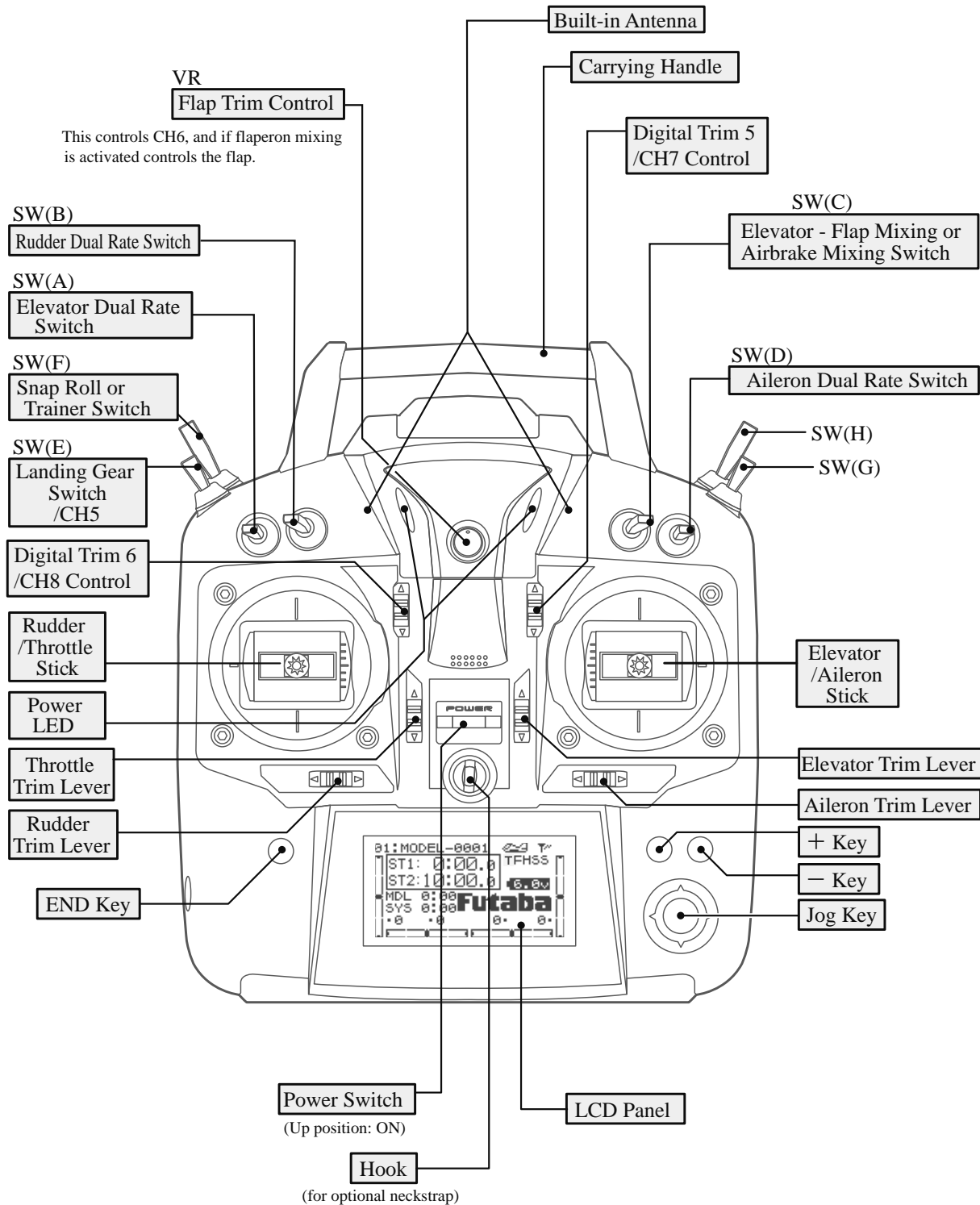

Before use

This figure shows the default switch assignments for a 10JA Mode 2 (for USA) system as supplied by the factory. You can change many of the switch positions or functions by selecting a new position within the setting menu for the function you wish to move.

TRANSMITTER CONTROLS - HELI

Before use

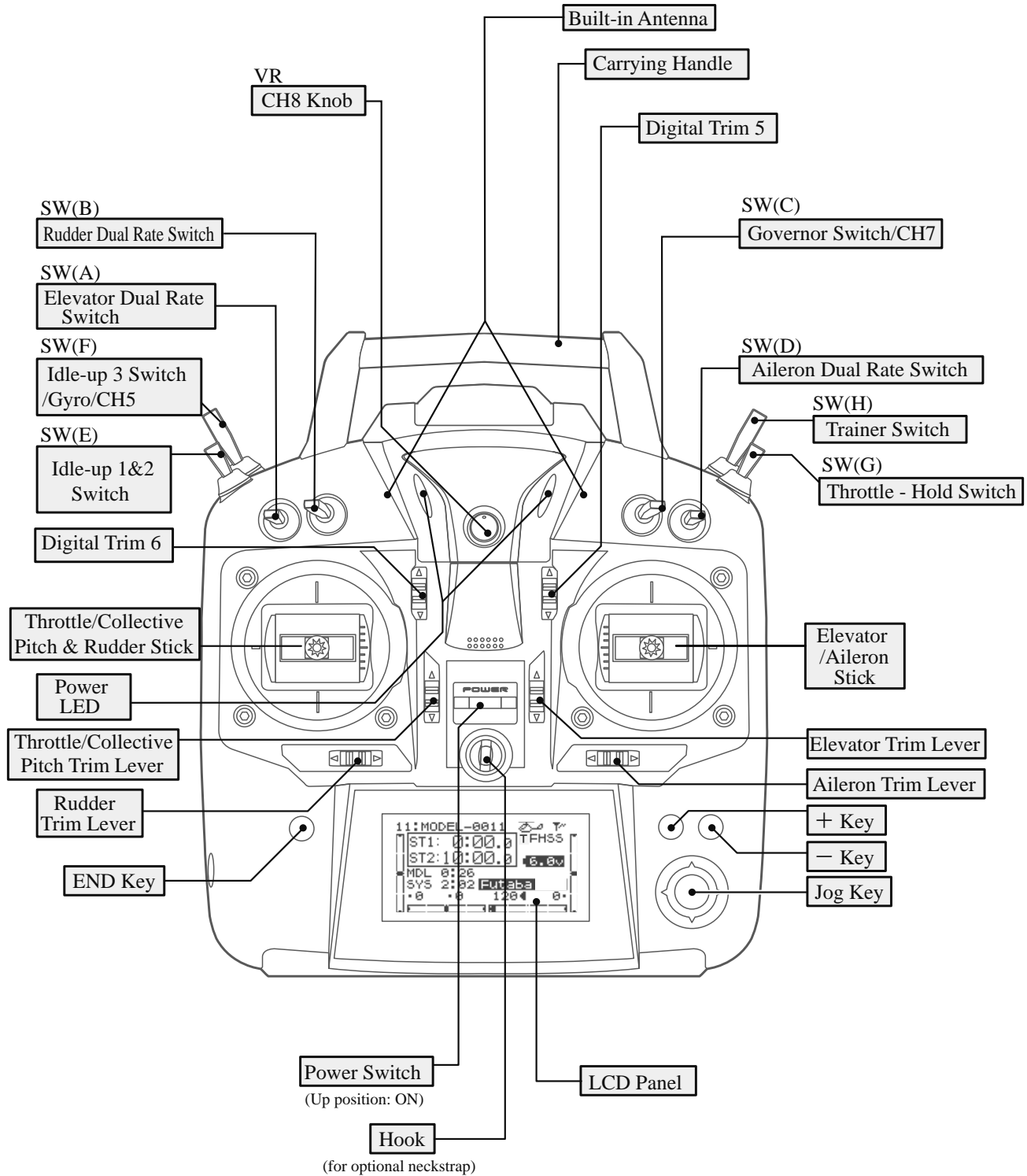

This figure shows the default switch assignments for a 10JH Mode 2 system as supplied by the factory. You can change many of the switch positions or functions by selecting a new position within the setting menu for the function you wish to move.

INSTALLATION AND REMOVAL OF THE TRANSMITTER BATTERY

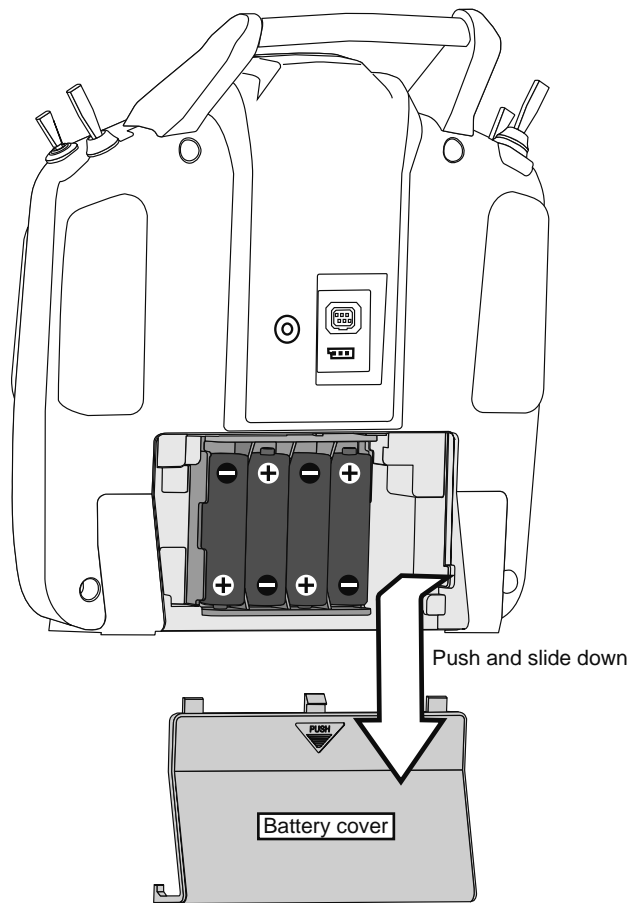

The T10J transmitter is designed to work with either four (4) AA alkaline dry cell batteries, or HT5F1800B/FT2F2100B battery pack, both available separately. The transmitter batteries used are a matter of personal preference. AA Alkaline batteries are available at any local hobby shop, grocery store, etc. A battery pack will need to be purchased from a hobby shop.

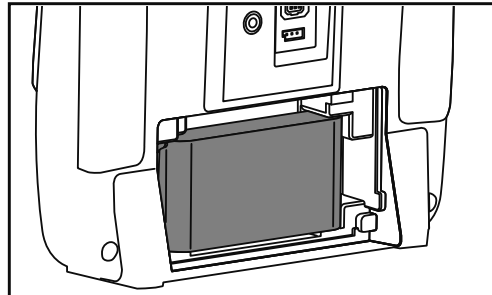

Remove the battery BOX if you choose to use the optional HT5F1800B/FT2F2100B battery pack, which can be recharged from the transmitter.

And "BATT TYPE" in a PARAMETER is changed into "HT5F1800B : 5.0V FT2F2100B : 5.8V".

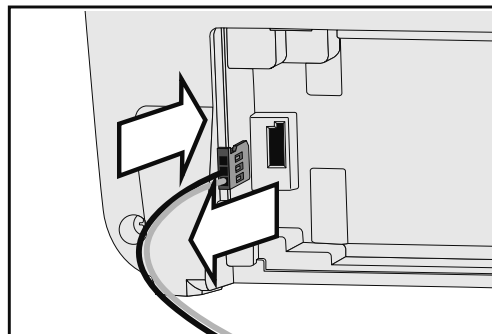

NOTE: If you need to remove or replace the transmitter battery, do not pull strongly on the battery wires to remove it. Insert the connector straight as shown.

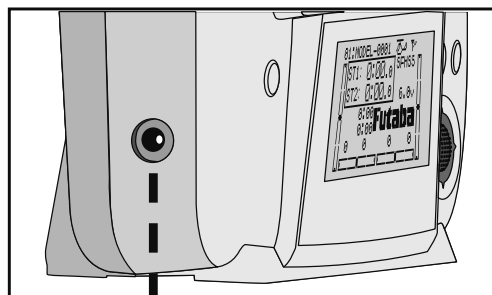

NOTE: This plug is for charging HT5F1800B. The other battery cannot be charged. FT2F2100B is removed from a transmitter, and charges with an exclusive charger(LBC-4E5).

Before use

⚠ WARNING

- ❗ Be careful not to drop the battery.
- ⊘ Never disconnect the battery connector from the T10J transmitter after turning off the power until the screen is completely blank and the transmitter has shut down completely.
 - * Internal devices such as memories may be damaged.
 - * If there is any problem, the message "Backup Error" will be shown the next time when you turn on the power of the transmitter. Do not use the transmitter as it is. Send it to the Futaba Service Center.
- ⊘ Do not connect any other chargers except the special charger to this charging connector.
- ❗ The voltage drop characteristics of a rechargeable battery and dry cell battery are different. Change the battery alarm voltage to 5.0V for the HT5F1800B and to 5.8V for the FT2F2100B.

SWITCH ASSIGNMENT TABLE

- The factory default functions activated by the switches and VR for an 10JA Mode 2 for USA transmitter are shown below.
- Most 10J functions may be reassigned to non-default positions quickly and easily.
- Basic control assignments of channels 5-10 are quickly adjustable in AUX-CH.
- Note that most functions need to be activated in the programming to operate.
- 10JH, 10JA and 10JA Mode 2 for USA transmitter functions are similar but reverse certain switch commands. Always check that you have the desired switch assignment for each function during set up.

10JA , 10JH, the TOP RIGHT SWITCHES are spring-loaded and 2-position

Switch / VR	ACRO	HELI	MULTICOPTER	Glider A-1	Glider A-2	Glider AF1	Glider AF2	Glider AF4
Switch A	Elevator D/R / CH9	Elevator D/R / CH9	Elevator D/R / CH9	Elevator D/R / CH9	Elevator D/R / CH9	Elevator D/R / CH9	Elevator D/R / CH9	Elevator D/R
Switch B	Rudder D/R	Rudder D/R	Rudder D/R	Rudder D/R	Rudder D/R	Rudder D/R	Rudder D/R	Rudder D/R
Switch C	(UP) ELE → FLP (Center/Down) Idle down (Down) Air brake	Governor / 7CH	6CH					
Switch D	Aileron D/R / CH10	Aileron D/R / CH10	Aileron D/R / CH10	Aileron D/R	Aileron D/R	Aileron D/R	Aileron D/R	Aileron D/R
Switch E		Idle up1,2	5CH					
Switch F		Idle up3 / Gyro / 5CH						
Switch G	Gear / 5CH	Throttle hold		6CH	6CH	6CH		
Switch H	Snap roll / Trainer	Throttle cut / Trainer	Trainer	Trainer	Trainer	Trainer	Trainer	Trainer
VR	Flap / 6CH	Hovering pitch / CH8	7CH	10CH	10CH	10CH	10CH	10CH
DT5	7CH			5CH	5CH	Flap(5CH)	Flap(5/6CH)	Flap(5/6CH)
DT6	8CH		8CH	8CH	8CH	8CH	8CH	Flap(8/9CH)

10JA Mode 2 transmitters for USA, the TOP LEFT SWITCHES are spring-loaded and 2-position

Switch / VR	ACRO	HELI	MULTICOPTER	Glider A-1	Glider A-2	Glider AF1	Glider AF2	Glider AF4
Switch A	Elevator D/R / CH9	Elevator D/R / CH9	Elevator D/R / CH9	Elevator D/R / CH9	Elevator D/R / CH9	Elevator D/R / CH9	Elevator D/R / CH9	Elevator D/R
Switch B	Rudder D/R	Rudder D/R	Rudder D/R	Rudder D/R	Rudder D/R	Rudder D/R	Rudder D/R	Rudder D/R
Switch C	(UP) ELE → FLP (Center/Down) Idle down (Down) Air brake	Governor / 7CH	6CH					
Switch D	Aileron D/R / CH10	Aileron D/R / CH10	Aileron D/R / CH10	Aileron D/R	Aileron D/R	Aileron D/R	Aileron D/R	Aileron D/R
Switch E	Gear / 5CH	Throttle hold	5CH					
Switch F	Snap roll / Trainer	Trainer	Trainer	Trainer	Trainer	Trainer	Trainer	Trainer
Switch G		Idle up1,2		6CH	6CH	6CH		
Switch H		Throttle cut / Idle up3 / Gyro / 5CH						
VR	Flap / 6CH	Hovering pitch / CH8	7CH	10CH	10CH	10CH	10CH	10CH
DT5	7CH			5CH	5CH	Flap(5CH)	Flap(5/6CH)	Flap(5/6CH)
DT6	8CH		8CH	8CH	8CH	8CH	8CH	Flap(8/9CH)

*On the 10JA Mode 2 for USA transmitters, the TOP LEFT **SWITCHES** are spring-loaded and 2-position; on the 10JA Mode 1, 10JH, those switches are on the right side. For consistency, the switch position's designation remains the same (upper left is F, etc), but the functions are moved to match the switch type.

TO TURN ON THE 10J SYSTEM

First make sure the throttle stick is in the low throttle position.

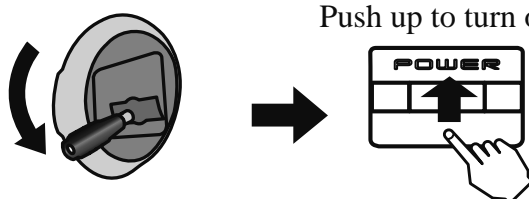

*If the throttle stick is not in the low position, you'll have an alarm until the stick is in the low position. (In the case of Multicopter mode, throttle position alarm does not occur.)

RECEIVER AND SERVO CONNECTIONS

*When using 8 or more channels, use an S.BUS function or use a second R3008SB and link both to your transmitter.

Aircraft

Receiver Output and Channel	Aircraft (ACRO)
1	Ailerons/Aileron-1 ¹ /combined Flap-2 & Aileron-1 ² /combined Aileron-1 & Elevator-2 ⁵
2	Elevator/combined Aileron-2 & Elevator-1 ⁵
3	Throttle
4	Rudder
5	Landing gear/Aileron-2 ^{1,3} /combined Flap-1 and Aileron-2 ^{2,3}
6	Flap(s)/combined Flap-1 and Aileron-2 ²
7	Aileron-2 ¹
8	Elevator-2 ⁴ /Mixture control
9	AU9
10	AU0

¹ Aileron Differential mode (**AILE-DIFF**).

² Flaperon mode.

³ Using Second Aileron option, second Aileron servo output is sent to channels 5 and 6. (**AILE-2**)

⁴ **AILEVATOR** (dual elevator) mode.

⁵ **ELEVON** mode.

(Tail Type)

(NORMAL)

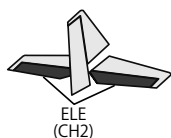

(V-TAIL)

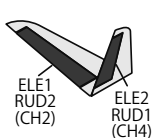

(AILEVATOR)

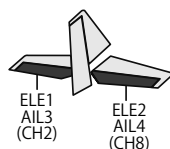

(ELEVON)

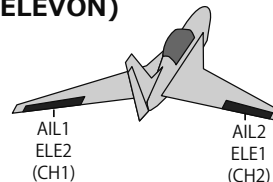

(Wing Type)

(FLAPERON)

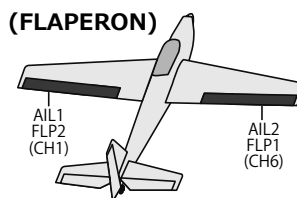

(FLAP)

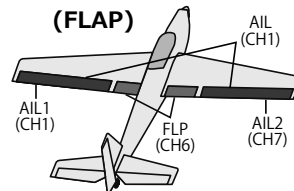

Multicopter

Receiver Output and Channel	Multicopter (MULTICOPT)
1	Aileron (Multicopter Controller)
2	Elevator (Multicopter Controller)
3	Throttle (Multicopter Controller)
4	Rudder (Multicopter Controller)
5	Mode (Multicopter Controller)
6	AU6 *When using a "GYRO SENS" function, 6CH is used for Mode (Multicopter Controller).
7	AU7
8	AU8
9	AU9
10	AU0

*Use the controller of multicopter corresponding to Futaba.

Before use

RECEIVER AND SERVO CONNECTIONS

*When using 8 or more channels, use an S.BUS function or use a second R3008SB and link both to your transmitter.

Before use

Receiver Output and Channel	Helicopter (HELI)
1	Aileron (cyclic roll)
2	Elevator (cyclic pitch)
3	Throttle
4	Rudder
5	Gyro
6	Pitch (collective pitch)
7	AU7/Governor
8	AU8/ELE2/Mixture control
9	AU9
10	AU0

(Swash Type)

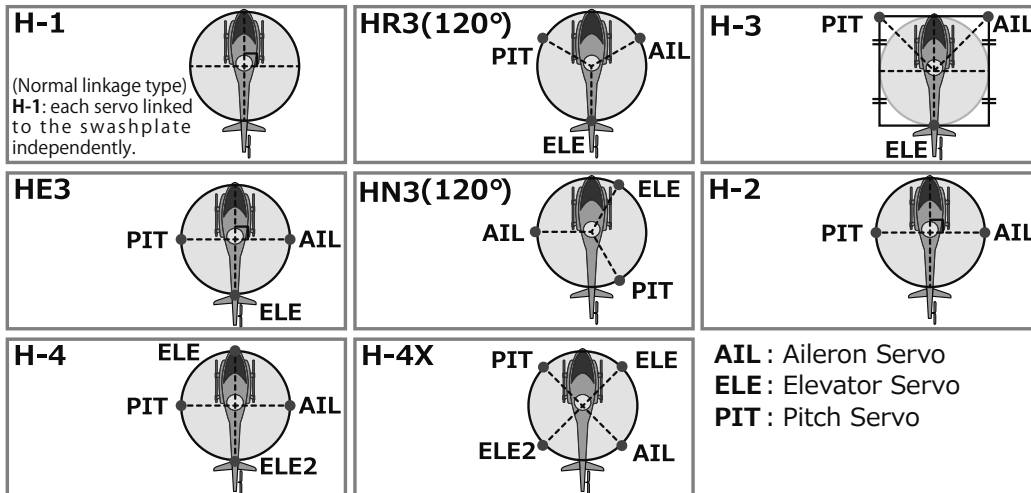

RECEIVER AND SERVO CONNECTIONS

*When using 8 or more channels, use an S.BUS function or use a second R3008SB and link both to your transmitter.

Glider

CH	1AIL(A-1) 1 Aileron	2AIL(A-2) 2 Aileron	2A+1F(AF1) 2 Aileron 1 Flap	2A+2F(AF2) 2 Aileron 2 Flap	2A+4F(AF4) 2 Aileron 4 Flap
1	Aileron	Aileron	Aileron	Aileron	Aileron
2	Elevator	Elevator	Elevator	Elevator	Elevator
3	Motor	Motor	Motor	Motor	Motor
4	Rudder	Rudder	Rudder	Rudder	Rudder
5	AU5	AU5	Flap	Flap	Flap
6	AU6	AU6	AU6	Flap2	Flap2
7	AU7	Aileron2	Aileron2	Aileron2	Aileron2
8	AU8	AU8	AU8	AU8	Flap3
9	AU9	AU9	AU9	AU9	Flap4
10	AU0	AU0 ¹	AU0 ¹	AU0 ¹	AU0 ¹

Before use

(Wing type)

¹When Camber Mix is being used, it operates together with AU0.

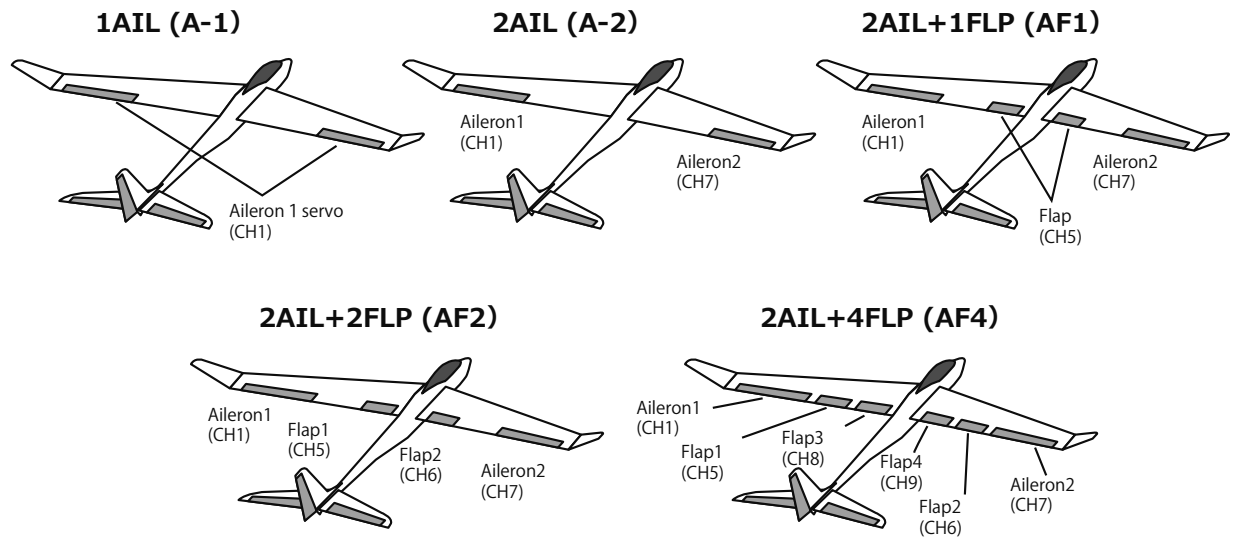

(Tail type)

(Normal)

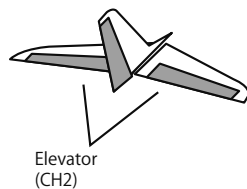

(Vtail)

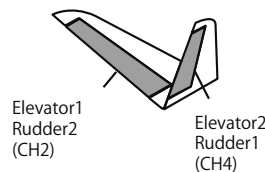

CHARGING THE BATTERIES (When the rechargeable battery option is used)

Charging Your System's Batteries

1. Connect the transmitter charging jack and batteries to the transmitter and receiver connectors of the charger.
2. Plug the charger into a wall socket.
3. Check that the charger LED lights.

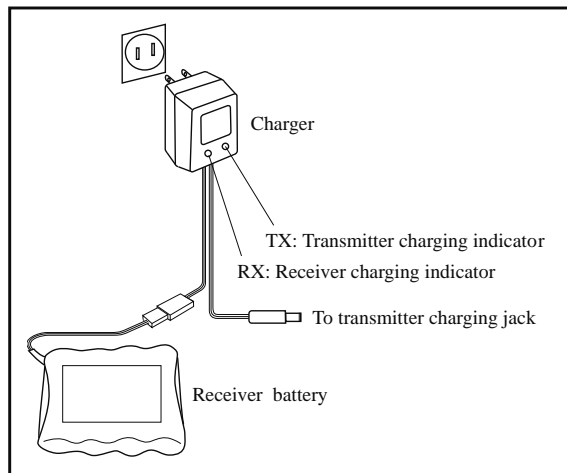

Before use

According to the description of the battery to be used and its exclusive charger, please use it after carrying out full charge.

We recommend charging the batteries with the charger supplied with your system. Note that the use of a fast charger may damage the batteries by overheating and dramatically reduce their lifetime.

When HT5F1800B is chosen, HBC-3A (4) is recommended.

When charging FT2F2100B, please make sure to remove the battery from the system to charge it. Charger for this battery is recommended to use LBC-4E5.

Battery Care and Precautions

Below you will find some general rules and guidelines which should be adhered to when charging transmitter and/or receiver battery packs. These are included to serve only as general guidelines, and are not intended to replace or supersede the information provided by the battery and/or charger manufacturer. For complete information, please refer to the instructions that are included with the battery pack(s) and/or chargers that accompany the products purchased.

- Do not allow children to charge battery packs without adult supervision.
- Do not charge battery packs that have been damaged in any way. We strongly suggest frequent inspection of the battery packs to ensure that no damage has occurred.
- Do not allow batteries to overheat! If overheated, disconnect the battery from the charger immediately and allow to cool.
- Do not mix cells- all cells should be of the same material, configuration, etc.
- Do not deep cycle NiMH batteries as permanent damage could result.
- Never charge batteries on a surface that may become hot, or may be impacted by the heat.
- Immediately end the charging procedure if either the batteries or charger itself become overly hot.
- NiMH cells do not exhibit the “memory effect” like NiCd cells, so little cycling is needed. Store NiMH packs with some voltage remaining on the cells (refer to battery supplier).
- NiMH cells have a self-discharge rate of approximately 20-25% (compared to 15% for NiCd batteries). It is important to recharge NiMH batteries immediately prior to use.
- Never connect the battery in reverse. Reverse connection will cause the battery to overheat or will damage the inside of the charger.
- Do not add an additional charge after charging.
- Never charge with a current exceeding the nominal capacity (1C) of the rechargeable battery.
- If a battery is charged with a current exceeding 1C, the battery will overheat and deteriorate.
- Do not connect two battery packs or more to one output terminal.
- Avoid extremely cold and hot places and the direct sunlight when you charge batteries.
- It is recommended to perform charging within the 10 ~ 30°C (50-86°F) range. Otherwise, it may cause abnormal charging and overheat.

ADJUSTING THE LENGTH OF THE CONTROL STICKS

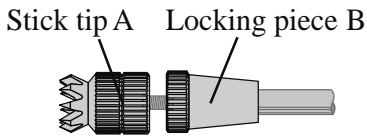

You may change the length of the control sticks to make your transmitter more comfortable to hold and operate. To lengthen or shorten your transmitter's sticks, first unlock the stick tip by holding locking piece B and turning stick tip A counterclockwise. Next, move the locking piece B up or down (to lengthen or shorten). When the length feels comfortable, lock the position by turning locking piece B counterclockwise.

STICK LEVER TENSION ADJUSTMENT

You may adjust the tension of your sticks to provide the feel that you prefer for flying. To adjust your springs, you'll have to remove the rear case of the transmitter. First, remove the battery cover on the rear of the transmitter. Next, unplug the battery wire, and remove the battery from the transmitter. Next, using a screwdriver, remove the four screws that hold the transmitter's rear cover in position, and put them in a safe place. Gently ease off the transmitter's rear cover. Now you'll see the view shown in the figure above.

Using a small Phillips screwdriver, rotate the adjusting screw for each stick for the desired spring tension. The tension increases when the adjusting screw is turned clockwise. When you are satisfied with the spring tensions, reattach the transmitter's rear cover. When the cover is properly in place, reinstall and tighten the four screws. Reinstall the battery and cover.

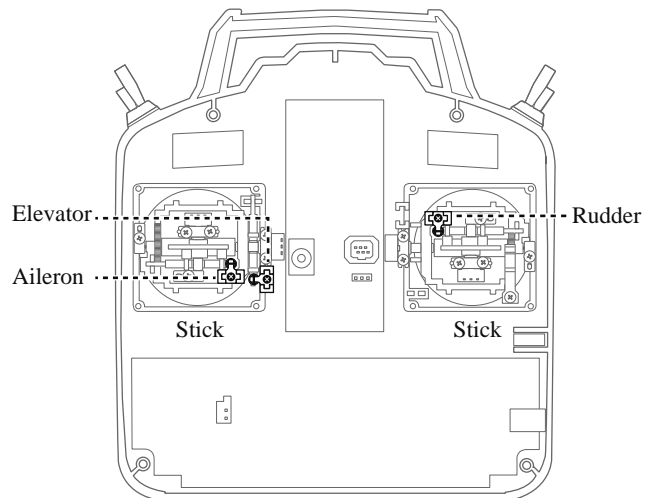
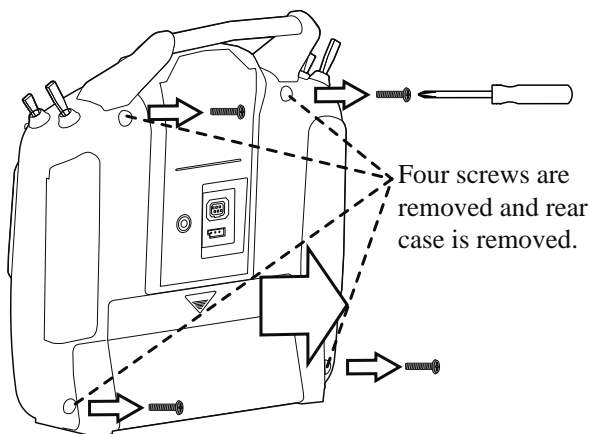

Mode 2 transmitter with rear case removed.

+ screw is clockwise.

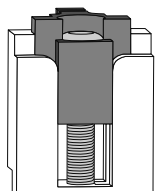

Stick tension maximum

+ screw is counter-clockwise.

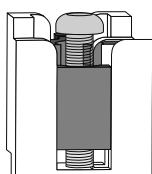

Stick tension minimum

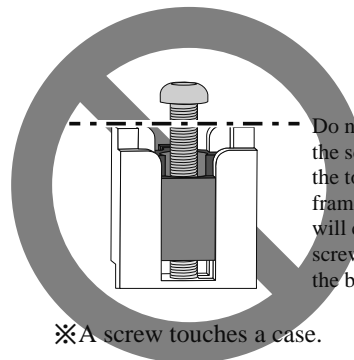

✘ A screw touches a case.

Before use

ADJUSTING DISPLAY CONTRAST

To adjust the display contrast, from the home menu press and hold the **END BUTTON**.
Push the **+ KEY** while still holding the **END BUTTON**:

- + **KEY** to brighten
- **KEY** to darken the display

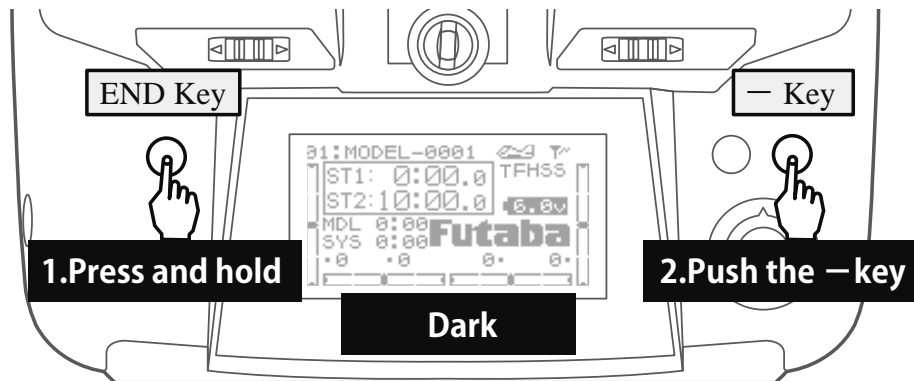
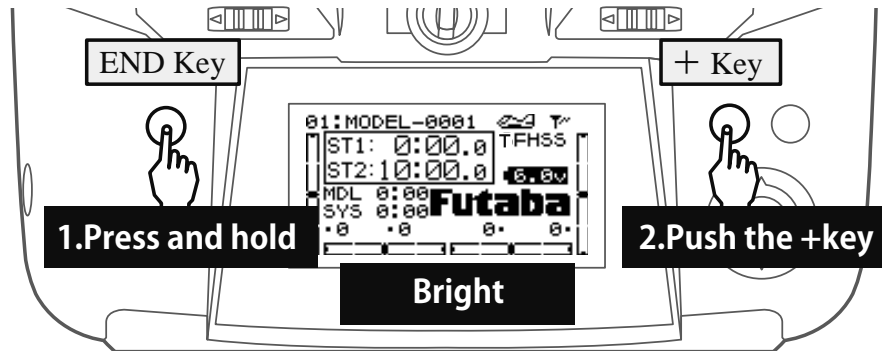

Before use

CONNECTOR / PLUG

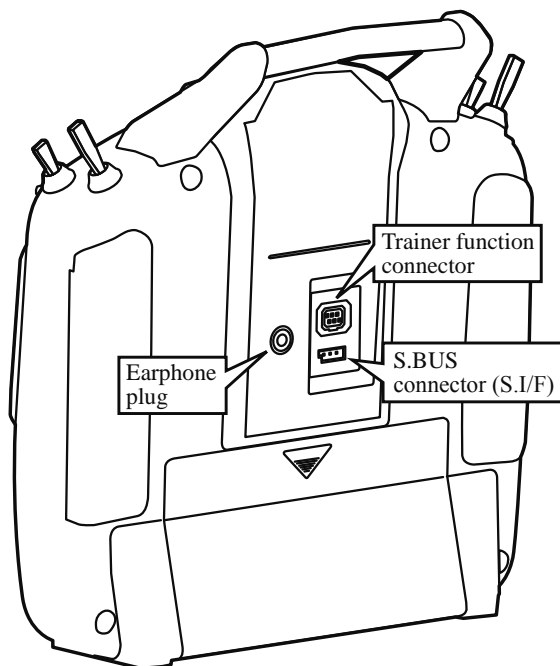

Trainer function connector

When you use the trainer function, connect the optional trainer cable between the transmitters for teacher and student.

*You can set the trainer function on the Trainer Function screen.

S.BUS connector (S.I/F)

When setting an S.BUS servo and telemetry sensor, connect them both here.

(Supply power by 3-way hub or 2-way cord.)

Earphone plug

The telemetry data can be listened to by plugging in commercial 3.5mm earphones. (See the telemetry item for the detailed setting.)

TRANSMITTER DISPLAYS & BUTTONS

When you first turn on your transmitter, a confirmation double beep sounds, and the screen shown below appears. Before flying, or even starting the engine, be sure that the model type and name appearing on the display matches the model that you are about to fly! If you are in the wrong model memory, servos may be reversed, and travels and trims will be wrong, potentially leading to a crash.

Edit buttons and Start-up Screen (appears when system is first turned on):

Total timer display <TIMER>
Shows the cumulated ON time. (hours:minutes)

Up/down timer display <ST1.ST2>
(minutes:seconds)

Model timer display <MDL>
Shows the cumulated ON time for each model.(hours:minutes)

System timer display <SYS>
Shows the cumulated ON time.(hours:minutes)

Resetting timers:
Select the desired timer with JOG KEY. The timer display flashes. To reset the timer, press JOG KEY.

Press and hold + KEY for one second to open programming menus.

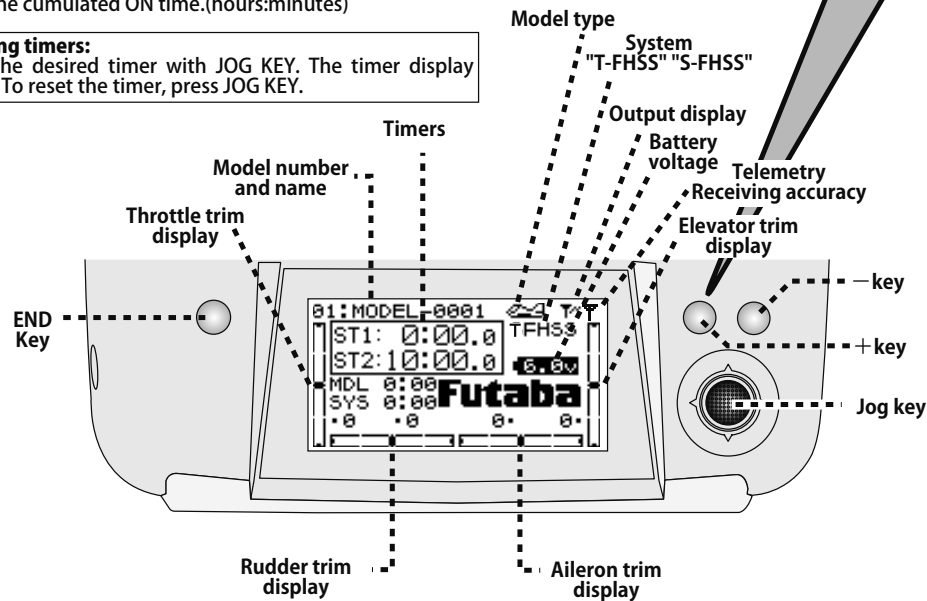

Before use

JOG KEY:

Control **JOG KEY** to scroll up/scroll down/scroll left/scroll right and select the option to edit within a function. When the menu has multiple pages, move the **JOG KEY** horizontally (left or right).

Press **JOG KEY** to select the actual function you wish to edit from the menu.

Press **JOG KEY** and hold one second to confirm major decisions, such as the decision to: select a different model from memory, copy one model memory over another, trim reset, store channel position in FailSafe, change model type, reset entire model, condition of a helicopter setup is changed. An on screen inquiry will ask if you are sure.

Press **JOG KEY** again to accept the change.

+ KEY:

Press and hold + **KEY** for one second to open programming menus. It is used for changing a setup, or a numerical increase. Changing the menu pages can also be performed.

- KEY:

It is used for change of a setup, or reduction of a number. Change of the page of a menu can also be performed.

END BUTTON:

Press END BUTTON to return to previous screen, close functions back to menus, and close menus to start-up screen.

WARNING & ERROR DISPLAYS

An alarm or error indication may appear on the display of your transmitter for a number of reasons, including when the transmitter power switch is turned on, when the battery voltage is low, and several others. Each display has a unique sound associated with it, as described below.

LOW BATTERY ERROR: Warning sound: Continuous beep until transmitter is powered off.

The **LOW BATTERY** warning is displayed when the transmitter battery voltage drops below 4.1V.

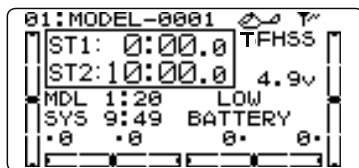

Land your model as soon as possible before loss of control due to a dead battery.

Before use

MIXING ALERT WARNING: Warning sound: Several beeps repeated until problem resolved or overridden.

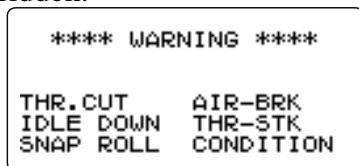

The **MIXING ALERT** warning is displayed to alert you whenever you turn on the transmitter with any of the mixing switches active. This warning will disappear when the offending switch or control is deactivated. Switches for which warnings will be issued at power-up are listed below. Throttle cut, idle-down, snap roll, airbrake, throttle-stick and condition, motor SW. If turning a switch OFF does not stop the mixing warning: The functions described previously probably use the same switch and the OFF direction setting is reversed. In short, one of the mixings described above is not in the OFF state. In this case, reset the warning display by pressing both **+ / - KEY** at the same time. Next, change one of the switch settings of the duplicated mixings.

*If "ESC mode" is chosen by "THR.CUT", a THR CUT will not start warning.

BACKUP ERROR: Warning sound: Several beeps (repeated continuously)

The **BACKUP ERROR** warning occurs when the transmitter memory is lost for any reason. If this occurs, all of the data will be reset when the power is turned on again.

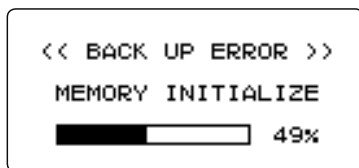

Do not fly when this message is displayed: all programming has been erased and is not available. Return your transmitter to Futaba for service.

A setup of warning of each sensor can be performed in **TELEMETRY**.

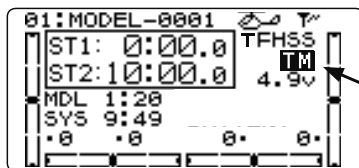

"TM" mark is shown about warning of TELEMETRY.

LINK PROCEDURE (T10J/R3008SB)

Each transmitter has an individually assigned, unique ID code. In order to start operation, the receiver must be linked with the ID code of the transmitter with which it is being paired. Once the link is made, the ID code is stored in the receiver and no further linking is necessary unless the receiver is to be used with another transmitter. When you purchase additional R3008SB receivers, this procedure is necessary; otherwise the receiver will not work.

Link procedure

1. Place the transmitter and the receiver close to each other within 20 inches (half meter).



2. Turn on the transmitter.
3. Select [MDL-SEL] and access the setup screen shown below by press the **jog** key .
4. Use the **jog** key to select (NO LINK) or the **ID number** next to LINK in the [MDL-SEL] menu.

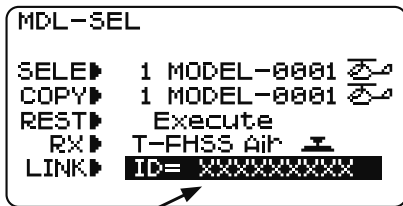

5. Hold down the **jog** key to enter the link mode.
6. A chime from the transmitter notifies the operator that the transmitter has entered the link mode.

"Beep beep beep"

(Enters the link mode for 20 seconds)

In "Link" Mode



7. Immediately **turn on the receiver** power.
The receiver will enter the linking state (**LED blinks red**) about 3 seconds after the receiver power is turned on.

8. If the receiver ID is displayed in the transmitter and the LED changed from red blinking to a **steady green light**, linking is complete. (The receiver linking wait state ends in about 3 seconds.)
9. Check system operation. If the transmitter and receiver are not linked, try linking again.

*If there are many T-FHSS Air systems turned on in close proximity, your receiver might have difficulty establishing a link to your transmitter. This is a rare occurrence. However, should another T-FHSS Air transmitter/receiver be linking at the same time, your receiver could link to the wrong transmitter. This is very dangerous if you do not notice this situation. In order to avoid the problem, we strongly recommend you to double check whether your receiver is really under control by your transmitter.

*When the linked transmitter power is turned on, communications begins.

*When using 2 receivers, perform the linking operation the same as the 1st receiver. (However, when 2 receivers are used, the telemetry system cannot be used.)

*Link is required when a new model is made from a model selection.

Before use

⚠ WARNING

- ❗ After the linking is done, please cycle receiver power and check that the receiver to be linked is really under the control of the transmitter.
- ⊘ Don't perform the linking procedure with motor's main wire connected or with the engine operating as it may result in serious injury.

RECEIVER NOMENCLATURE

Before using the receiver, be sure to read the precautions listed in the following pages.

Receiver R3008SB

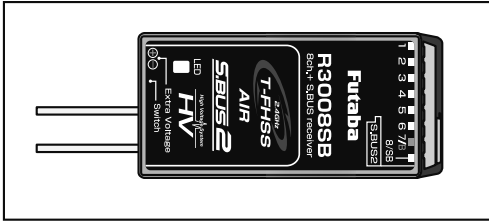

Connector

"1 through 6": outputs for the channels 1 through 6

"7/B": outputs of 7 channels and power.

(7/B)

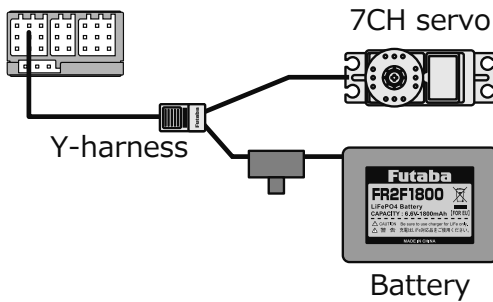

"8/SB": outputs of 8 channels or S.BUS port.

[S.BUS Servo S.BUS Gyro] →

*When using 8/SB as S.BUS, you have to set CH MODE of the following page to mode B or mode D.

"S.BUS2": outputs of S.BUS2 port. ←

[S.BUS2 Servo S.BUS2 Gyro Telemetry Sensor] ←

*When using 8 or more channels, use an S.BUS function or use a second R3008SB and link both to your transmitter.

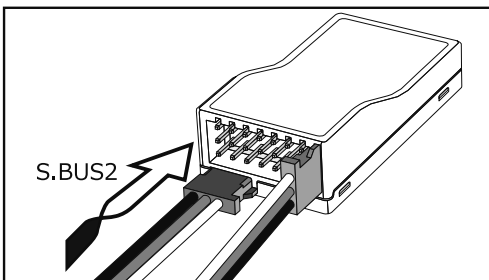

Connector insertion

Firmly insert the connector in the direction shown in the figure. Insert the S.BUS2 by turning it 90 degrees.

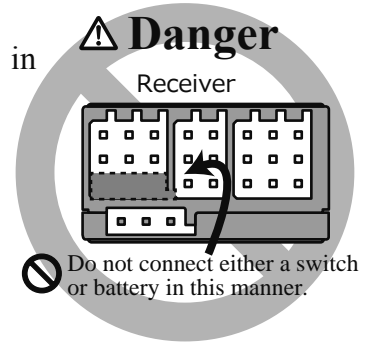

Danger

Don't connect a connector, as shown in a before figure.

*It will short-circuit, if connected in this way. A short circuit across the battery terminals may cause abnormal heating, fire and burns.

Don't connect servo for conventional system to S.BUS/S.BUS2 port.

*Digital servo for conventional system → It does not operate.
*Analog servo → It may cause abnormal heat, fire and burning.

Warning

S.BUS2 connectors

Don't connect an S.BUS servo / gyro to S.BUS2 connector.

LED Monitor

This monitor is used to check the CH mode of the receiver.

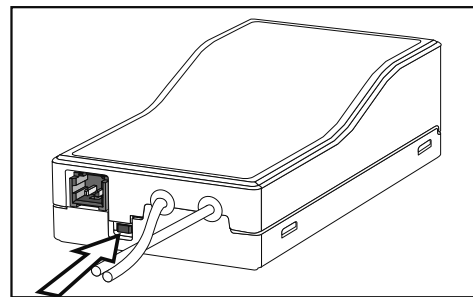

Mode Switch

Use the small plastic screw driver that was included with your receiver.

Switch is also used for the CH mode selection.

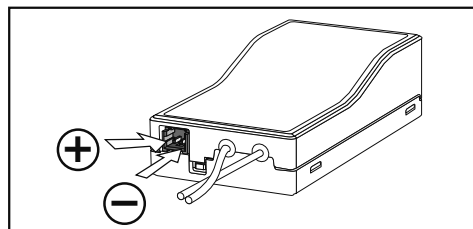

Extra Voltage Connector

Before use

Extra Voltage Connector

Use this connector when using a voltage telemetry device to send the battery voltage (DC0 ~ 70V) from the receiver to the transmitter.

You will need to purchase the optional External Voltage input cable (CA-RVIN-700) FUTM5551.

You can then make a cable with an extra connector to the External voltage connector.

Danger

Don't touch wiring.

* There is a danger of receiving an electric shock.

Don't short-circuit the battery terminals.

* A short circuit across the battery terminals may cause abnormal heating, fire and burns.

Please double check your polarity (+ and -) when hooking up your connectors.

* If + and - of wiring are mistaken, it will damage, ignite and explode.

Don't connect to Extra Voltage before turning on a receiver power supply.

R3008SB CH MODE

The R3008SB receiver is a very versatile unit. It has 8 PWM outputs, S.BUS and S.BUS2 outputs. Additionally the PWM outputs can be changed from channels 1-8 to channels 9-10. If you only desire to use it as an 7 channel receiver (without S.BUS), it can be used without any setting changes.

How to change the R3008SB Channel mode

The R3008SB is capable of changing its channel allocations as described in the table below.

1. Turn on the receiver. (At this moment, the transmitter should be off.) Then, LED blinks RED in about 3 seconds. Next, wait until it becomes solid RED.
2. Press and hold the Mode Switch more than 5 seconds.
3. Release the button when the LED blinks RED and GREEN simultaneously.
4. The receiver is now in the "Operation CH Set" mode. At this moment, the LED indicates current set status through flashing a pattern that corresponds to the CH mode.
 - *Cannot exit this CH setting mode before the operation mode is fixed.
 - *See the below table that shows correspondence between "CH mode" and way of flashing LED.
 - *Default CH mode is "Mode B".
5. By pressing the Mode Switch, the operation CH is switched sequentially as "Mode C" "Mode D" "Mode E" "Mode A"....
6. The operation mode will be set by pressing the Mode Switch more than 2 seconds at the desired CH mode.
7. Release the button when the LED blinks RED and GREEN simultaneously. Then, the operation CH is fixed.
8. After confirming the operation CH mode is changed, turn off and back on the receiver power.

*The "Operation CH Set" mode cannot be changed during the receiver communicates to the transmitter.

Before use

R3008SB CH Mode table

Output connector	Channel				
	<i>Mode A</i> 1 ~ 8CH	<i>Mode B</i> 1 ~ 7CH	<i>Mode C</i> 9 ~ 10CH	<i>Mode D</i> 9 ~ 10CH	<i>Mode E</i> 8 ~ 10CH
1	1	1	9	9	8
2	2	2	10	10	9
3	3	3	11	11	10
4	4	4	12	12	11
5	5	5	DG1	DG1	12
6	6	6	DG2	DG2	DG1
7/B	7	7	—	—	DG2
8/SB	8	S.BUS	—	S.BUS	S.BUS
Red LED blink	1 time	2 times	3 times	4 times	5 times

Default CH mode

RECEIVER'S ANTENNA INSTALLATION

The R3008SB has two antennas. In order to maximize signal reception and promote safe modeling Futaba has adopted a diversity antenna system. This allows the receiver to obtain RF signals on both antennas and fly problem-free.

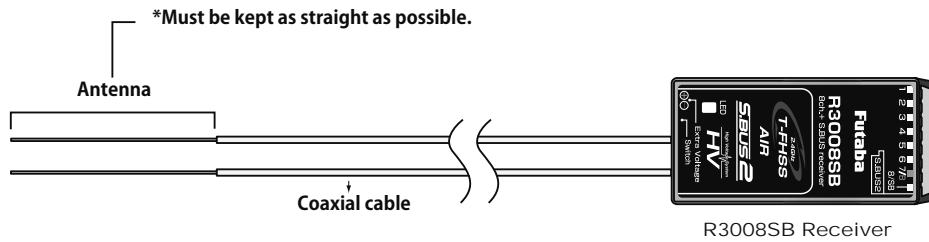

R3008SB Receiver

To obtain the best results of the diversity function, please refer to the following instructions:

1. The two antennas must be kept as straight as possible. Otherwise it will reduce the effective range.
2. The two antennas should be placed at 90 degrees to each other.

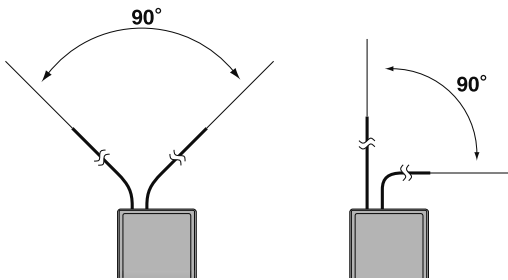

This is not a critical figure, but the most important thing is to keep the antennas away from each other as much as possible.

Larger models can have large metal objects that can attenuate the RF signal. In this case the antennas should be placed at both sides of the model. Then the best RF signal condition is obtained at any flying attitude.

3. The antennas must be kept away from conductive materials, such as metal, carbon and fuel tank by at least a half inch. The coaxial part of the antennas does not need to follow these guidelines, but do not bend it in a tight radius.
4. Keep the antennas away from the motor, ESC, and other noise sources as much as possible.

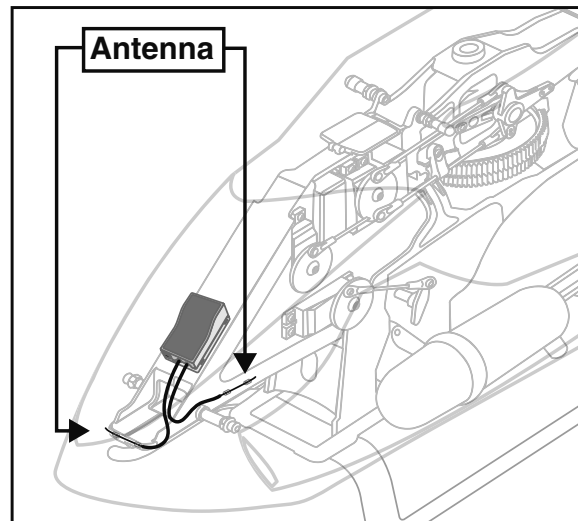
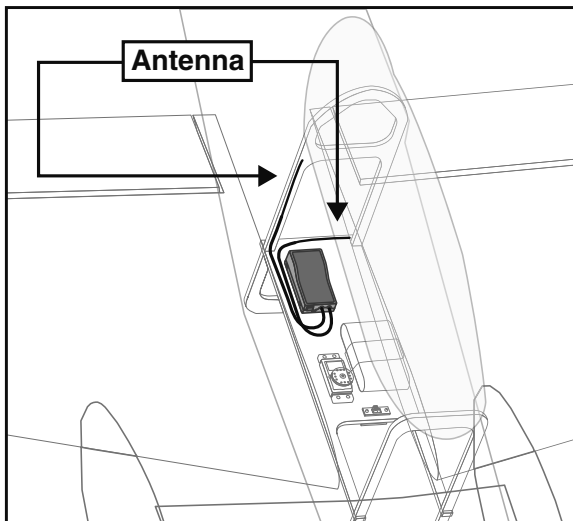

- *The two antennas should be placed at 90 degrees to each other.
- *The Illustration demonstrates how the antenna should be placed.

*Receiver Vibration and Waterproofing: The receiver contains precision electronic parts. Be sure to avoid vibration, shock, and temperature extremes. For protection, wrap the receiver in foam rubber or other vibration-absorbing materials. It is also a good idea to waterproof the receiver by placing it in a plastic bag and securing the open end of the bag with a rubber band before wrapping it with foam rubber. If you accidentally get moisture or fuel inside the receiver, you may experience intermittent operation or a crash. If in doubt, return the receiver to our service center for service.

MOUNTING THE SERVO

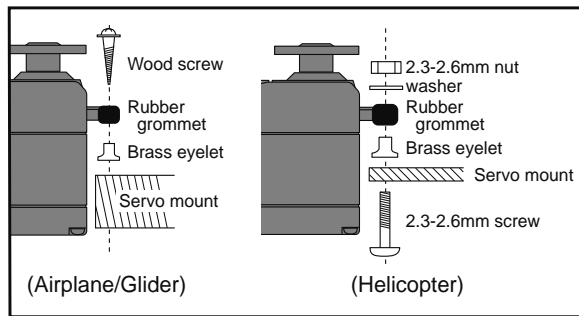

Servo lead wires

To prevent the servo lead cable from being broken by vibration during flight, provide a little slack in the cable and fasten it at suitable points. Periodically check the cable during daily maintenance.

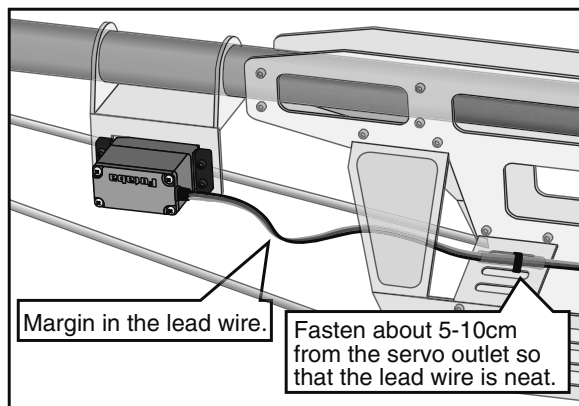

MOUNTING THE POWER SWITCH

When mounting a power switch to an airframe, make a rectangular hole that is a little larger than the total stroke of the switch so that you can turn the switch ON/OFF without binding.

Avoid mounting the switch where it can be covered by engine oil and dust. In general, it is recommended to mount the power switch on the side of the fuselage that is opposite the muffler.

SAFETY PRECAUTIONS when you install receiver and servos

⚠ Warning

Connecting connectors

- ❗ Be sure to insert the connector until it stops at the deepest point.

How to protect the receiver from vibration and water

- ❗ Wrap the receiver with something soft such as foam rubber to avoid vibration. If there is a chance of getting wet, put the receiver in a waterproof bag or balloon to avoid water.

Receiver's antenna

- ⊘ Never cut the receiver's antenna. Do not bind the receiver's antenna with the cables for servos.

- ❗ Locate the receiver's antenna as far as possible from metals or carbon fiber components such as frames, cables, etc.

*Cutting or binding the receiver's antenna will reduce the radio reception sensitivity and range, and may cause a crash.

Servo throw

- ❗ Adjust your system so that pushrods will not bind or sag when operating the servos to the full extent.

*If excessive force is continuously applied to a servo, the servo could be damaged due to force on the gear train and/or power consumption causing rapid battery drain.

Mounting servos

- ❗ Use a vibration-proof rubber (such as rubber grommet) under a servo when mounting the servo on a servo mount. And be sure that the servo cases do not touch directly to the metal parts such as servo mount.

*If the servo case contacts the airframe directly, vibration will travel to and possibly damage the servo.

Before use

RANGE CHECK THE RADIO

A range check must be performed before the first flight of a new model. It is not necessary to do a range check before every flight (but is not a bad idea to perform a range check before the first flight of each day). A range check is the final opportunity to reveal any radio malfunctions, and to be certain the system has adequate operational range.

We have installed a special “Power Down Mode” in the T10J in order to perform an operational ground range check. During this mode, the RF power is reduced in order to test the operational range of the T10J.

To activate the Power Down Mode and Perform A Range Check:

1) To activate the “Power Down Mode” please hold down the **JOG KEY** and then turn the transmitter switch on. A power mode screen is displayed. Press the **JOG KEY** to select the Power Down function. When this mode is active the red LED on the lighting from of the transmitter will provide users with an audible and visual indication that the transmitter is in the “Power Down Mode”. Audibly, the transmitter will beep one time every three seconds. Visually, the LCD screen will display “POWER DOWN MODE”. The words “POWER DOWN MODE” will blink as an additional reminder that the transmitter is in the “Power Down Mode”.

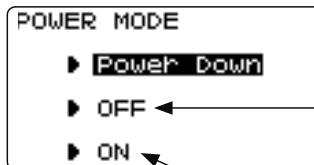

Select the "**OFF**" and press the **Jog key**. A screen opens without outputting power. The receiver does not operate.

Select the "**ON**" and press the **Jog key**. Power is usually outputted from power mode.

2) With the “Power Down Mode” activated, walk away from the model while simultaneously operating the controls. Have an assistant stand by the model and signal what the controls are doing to confirm that they operate correctly. You should be able to walk approximately 30-50 paces from the model without losing control.

3) If everything operates correctly, return to the model. Push **END KEY** and complete power down mode. Set the transmitter in a safe yet accessible location so it will be within reach after starting the engine. Be certain the throttle stick is all the way down, and then start the engine. Perform another range check with your assistant holding the model and the engine running at various speeds.

If the servos jitter or move inadvertently, there may be a problem. Do NOT fly the aircraft! Look for loose servo connections or binding pushrods. Also be certain that the battery has been fully charged.

4) NEVER start flying when the “Power Down Mode” is active.

Servo test operation at the time of Power Down Mode:

During Power Down mode, you can use automatic servo testing to check the range of a specified servo (it moves to right and left slowly).

1) A "SERVO" is chosen from a menu.

2) **JOG KEY** is moved to a side and 2 pages is called. Next, **JOG KEY** is moved down and CH is displayed.

3) CH of the servo which wants to operate is chosen. Then, the + **KEY** is pressed and it is made ACT.

The servo selected during Power Down Mode operates alone, allowing you to check its operation.

It is during Power Down Mode starting, and if "SERVO TEST" is turned ON, it will move.

*In the Power Down Mode, the throttle servo does not operate.

*Helicopter mode, condition is fixed to NOR.

DANGER

 NEVER start flying when the “Power Down Mode” is active. *Control is impossible and your model crashes.

S.BUS/S.BUS2 INSTALLATION

This set uses the S.BUS/S.BUS2 system. The wiring is as simplified and clean mounting as possible, even with models that use a large number of servos. In addition, the wings can be quickly installed to the fuselage without any extraneous wiring by the use of only one simple wire, even when there are a large number of servos used.

- When using S.BUS/S.BUS2, special settings and mixes in your transmitter may be unnecessary.
- The S.BUS/S.BUS2 servos memorize the number of channels themselves. (Settable with the T10J)
- The S.BUS/S.BUS2 system and conventional system (receiver conventional CH used) can be mixed.

S.BUS Glider usage example

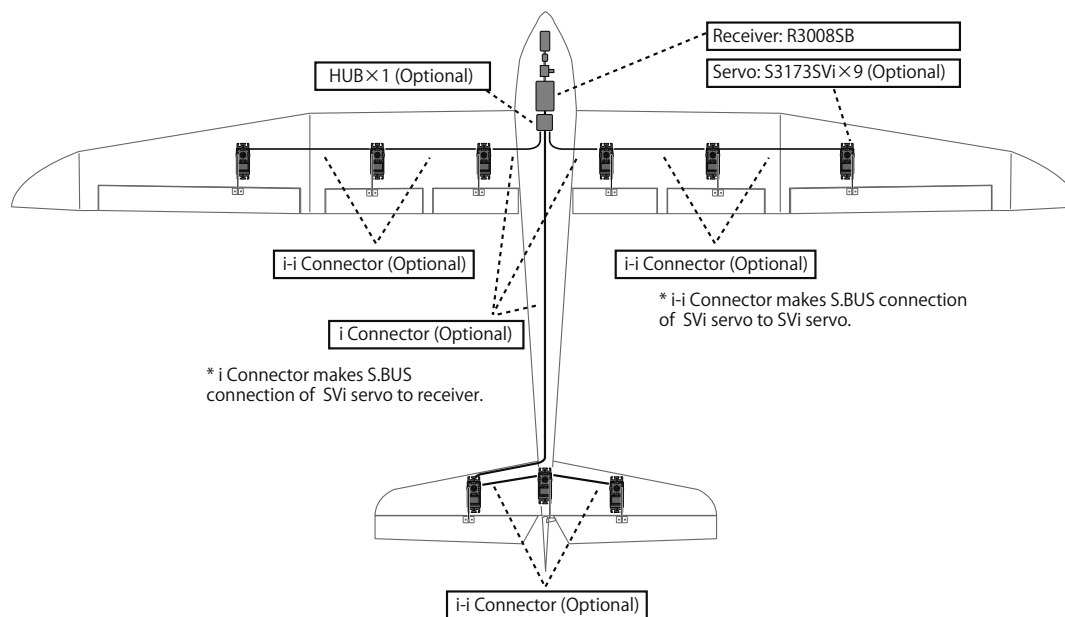

S.BUS Aerobatic plane usage example

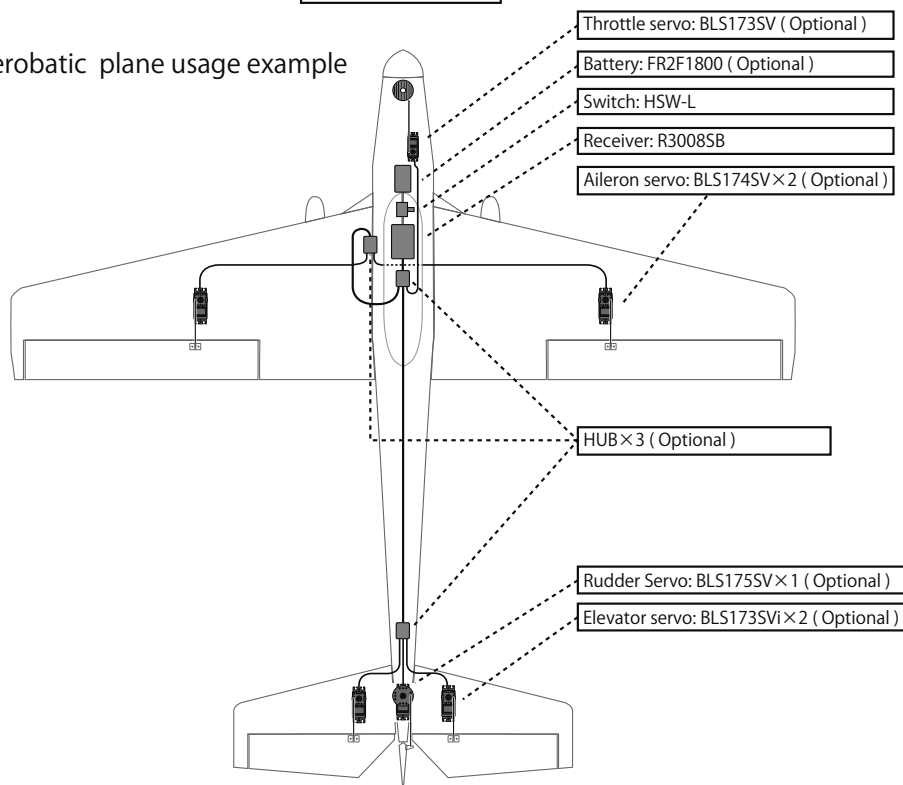

Before use

S.BUS WIRING EXAMPLE

Before use

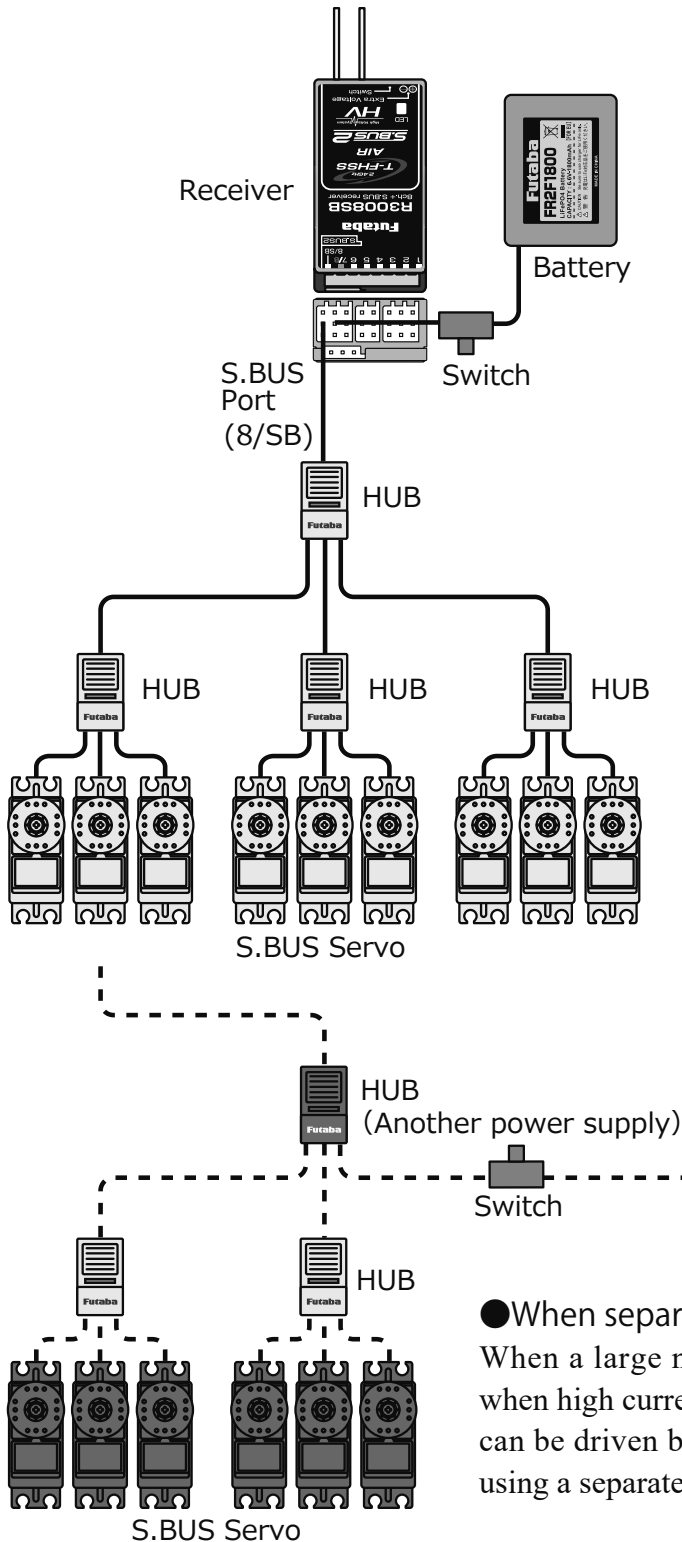

● S.BUS Servo

Since the channel number is memorized by the S.BUS itself, any connector can be used.

Optional Parts

● 4-Terminal box



Four connectors can be inserted

Optional Parts

● 6-Terminal box (TB16PP)

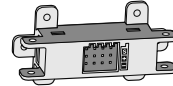

Six connectors can be inserted

⚠ Warning

Power supply

❗ Please make sure that you use a battery that can deliver enough capacity for the number and kind of servos used. Alkaline batteries cannot be used.

● When separate power supply used

When a large number of servos are used or when high current servos are used, the servos can be driven by a separate power supply by using a separate Power Supply 3-way Hub.

Optional Parts

Orange



HUB

Three connectors can be inserted.

Optional Parts

Green



HUB

Used when using a separate power supply battery.

S.BUS2 SYSTEM

When using the S.BUS2 port, an impressive array of telemetry sensors may be utilized.

S.BUS2 TABLE

Receiver port	S.BUS Servo S.BUS Gyro	S.BUS2 Servo S.BUS2 Gyro	Telemetry sensor
S.BUS	○	○	×
S.BUS2	×	○	○

(※) Don't connect S.BUS Servo, S.BUS Gyro to S.BUS2 connector.

S.BUS servos and gyros and S.BUS2 servos and gyros must be used in the correct receiver ports. Please refer to the instruction manual to make sure you connect to the correct one.

Before use

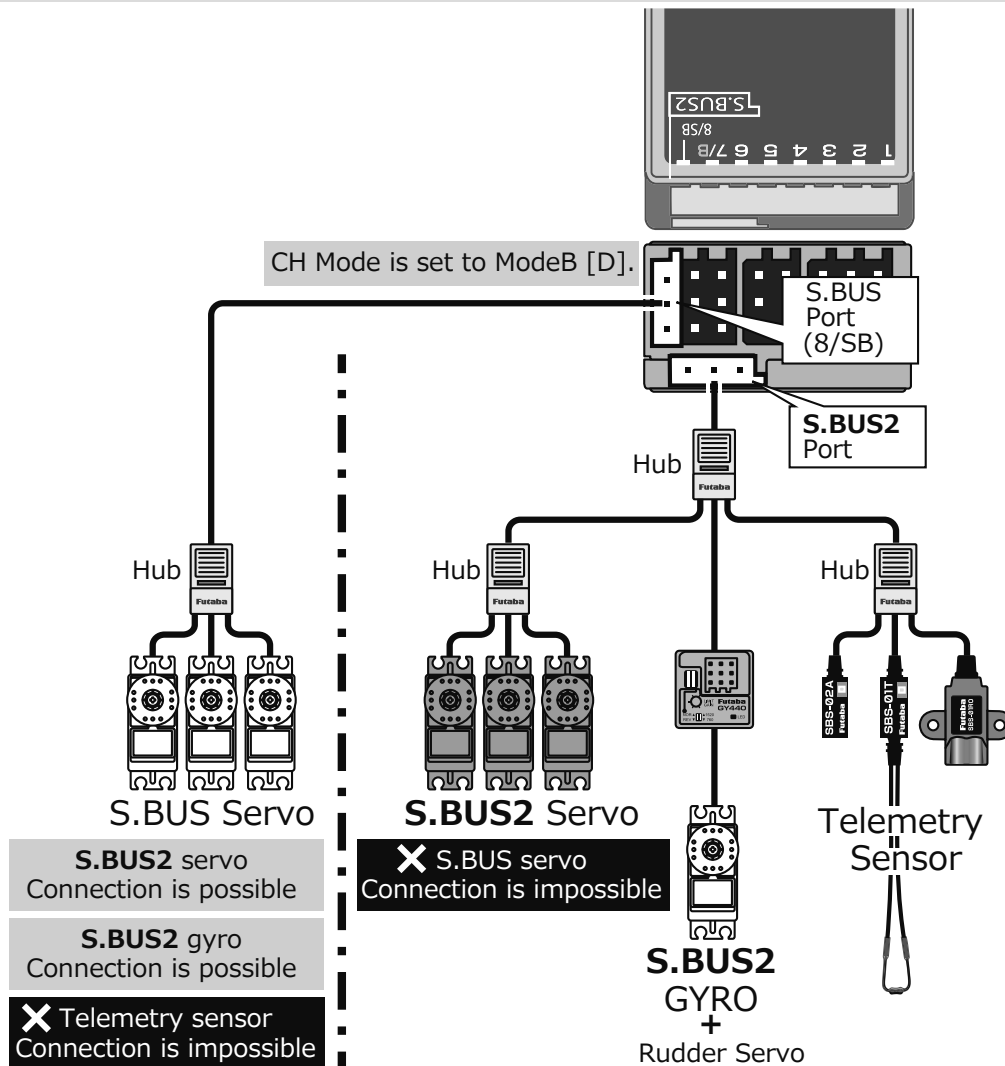

S.BUS/S.BUS2 DEVICE SETTING

S.BUS/S.BUS2 servos or a telemetry sensor can be connected directly to the T10J. Channel setting and other data can be entered for the S.BUS/S.BUS2 servos or sensors.

Back of T10J

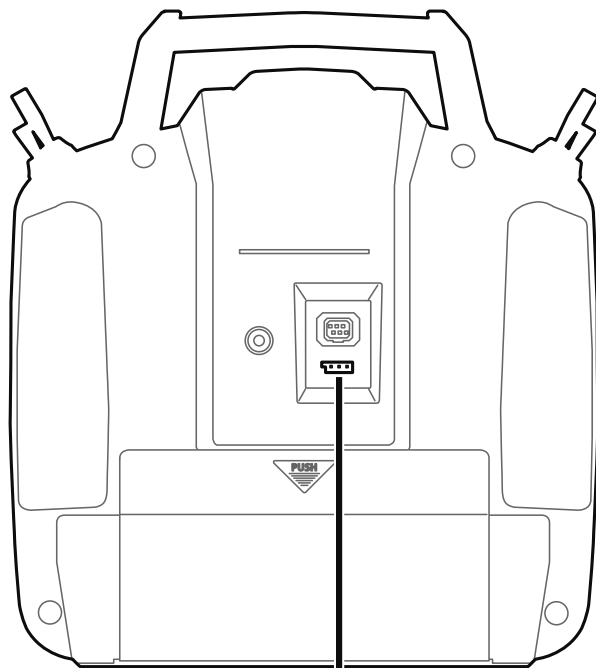

Before use

3-way hub
or Y-harnesses



S.BUS/S.BUS2
device
(S.BUS/S.BUS2
Servo)
(Telemetry sensor)



Receivers
Battery

1. Turn on the transmitter power.
2. Call the setup screen.
Servo: → S.BUS LINK → MODE IN
Sensor: → SENSOR → REGISTER
3. Connect the S.BUS device and battery you want to set with a 3-way hub or Y-harnesses as shown in the figure.
4. Perform setting in accordance with each screen.
5. This sets the channel and other data for each S.BUS servo, or telemetry device to be used with the S.BUS device or receiver.

TELEMETRY SYSTEM

The R3008SB receiver features bi-directional communication with a T-FHSS Air Futaba transmitter using the S.BUS2 port. Using the S.BUS2 port an impressive array of telemetry sensors may be utilized. It also includes both standard PWM output ports and S.BUS output ports.

- *Telemetry is available only in the T-FHSS Air mode.
- *The telemetry function requires the corresponding receiver (R3008SB).
- *The T10J will enter and keep the ID number of the R3008SB that it is linked to.
- *When you use two or more R3008SB, set telemetry mode to INH.

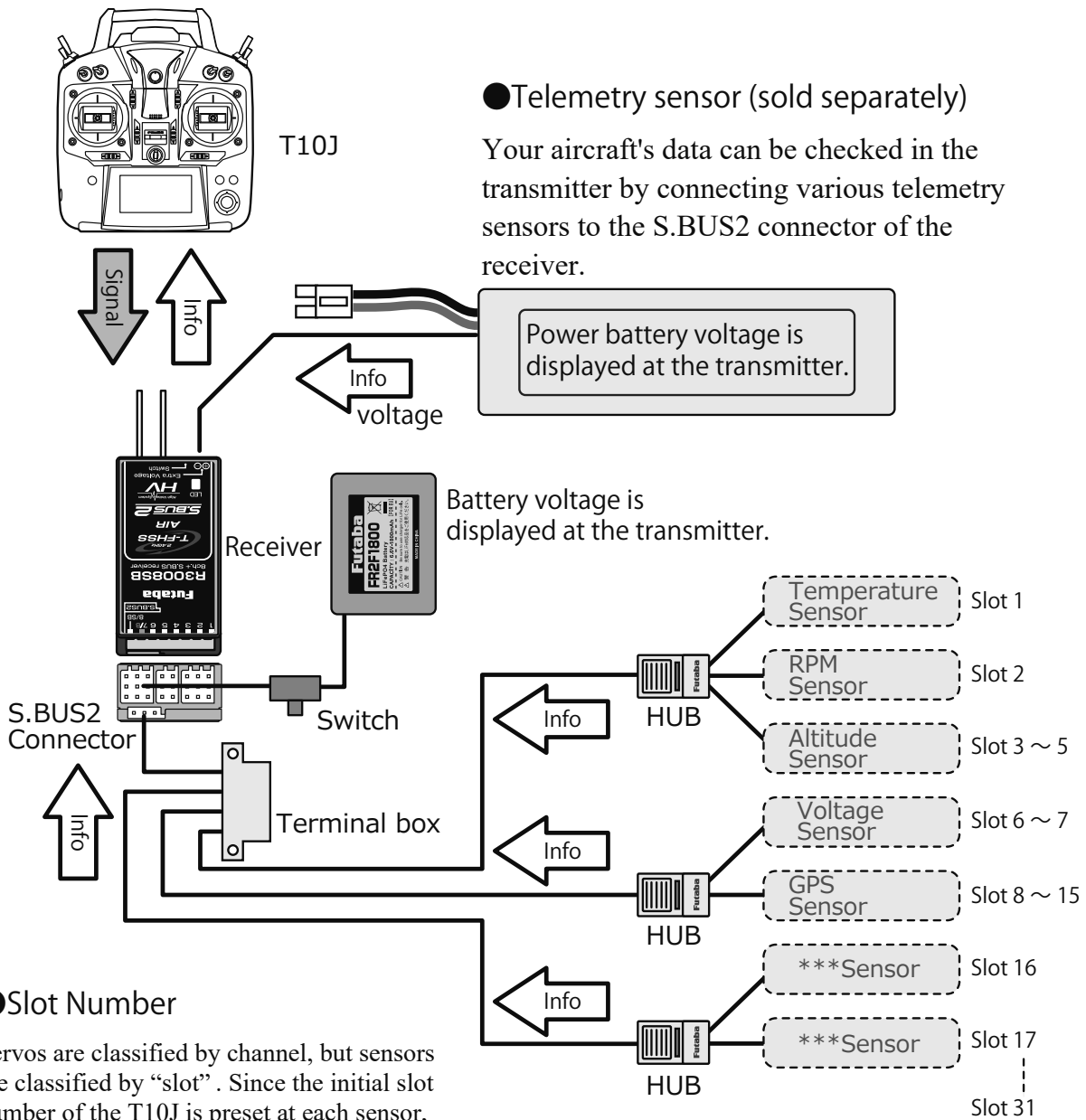

Before use

Common function



The setting screens are called from the following menu. All the functions common to airplane, helicopter, glider, and multi-copter model types are shown here.

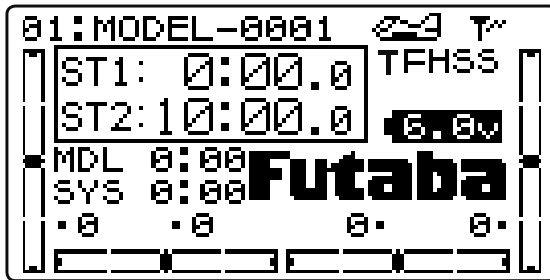
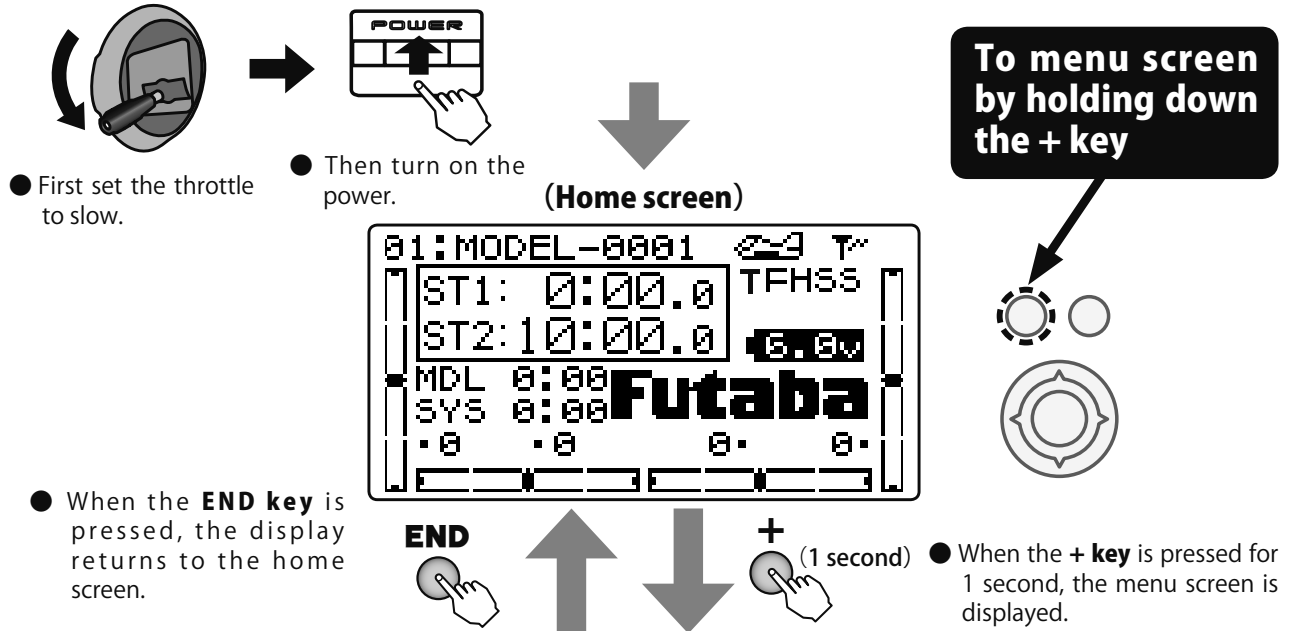

Common function

MENU

MENU 1/3

MENU	1 2 3
▶MDL-SEL	▶END POINT
▶MDL-NAME	▶TRIM
▶FAIL SAFE	▶SUB TRIM
▶REVERSE	▶P.MIX1-6
▶TIMER	▶AUX-CHAN
▶SERVO	▶PARAMETER

MENU 2/3

MENU	1 2 3
▶TELEMETRY	▶AIL→RUD
▶SENSOR	▶V-TAIL
▶SBUS LINK	▶GYRO SENS
▶MDL-TRANS	▶ELEVON
▶TRAINER	▶AILVATOR
▶AIL-DIFF	▶THR→NEEDL

MENU 3/3

MENU	1 2 3
▶D/R,EXPO	▶THR.CUT
▶FLAPERON	▶IDLE DOWN
▶AIR-BRK	▶SNAP ROLL
▶FLAP→ELE	▶THR-CURVE
▶ELE→FLAP	▶PIT-CURVE
▶FLAP TRIM	▶THR DELAY

(Selection)

- Move the cursor (highlighted) up and down and to the left and right with the **Jog** key and select the function. The cursor can be moved over several pages.

(Calling the setting screen)

- Press the **Jog** key to open the setting screen.

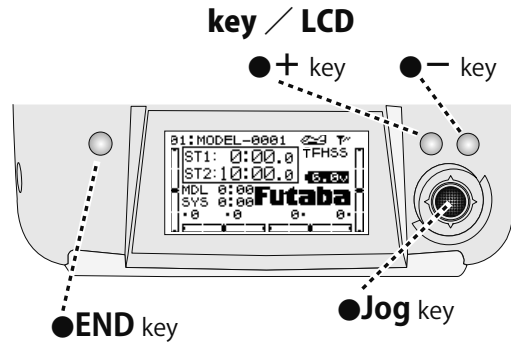

■ Function

MENU1/3	
MDL-SEL	(P.40)
Model select / Model Copy / Data reset / RX / Link	
MDL-NAME	(P.43)
Model name / User name	
FAIL SAFE	(P.45)
Fail safe	
REVERSE	(P.47)
Servo reverse	
TIMER	(P.48)
Timer	
SERVO	(P.49)
Servo monitor / Servo test	
END POINT	(P.50)
End point	
TRIM	(P.51)
Trim reset / Trim step	
SUB TRIM	(P.52)
Sub trim	
P.MIX1-6	(P.53)
Program mixing 1 ~ 6	
AUX-CHAN	(P.56)
AUX channel	
PARAMETER	(P.58)
Data reset / Model type / ATL-trim / LCD contrast / Back light : mode, time, adjustment / Home display / Battery alarm / Battery vibration / Buzzer tone / Jog navi / Jog light / Jog time / Telemetry : mode, unit / Speech : language, volume / Stick position alarm	

MENU2/3	
TELEMETRY	(P.66)
Telemetry Display / Alarm setup	
SENSOR	(P.83)
Telemetry sensor	
SBUS LINK	(P.89)
S.BUS servo set up	
MDL-TRANS	(P.92)
Data transfer of another 10J or 8J	
TRAINER	(P.93)
Trainer	



MDL-SEL

Model select (select / copy / reset / RX type / link)

(Common)

Function

This function is used when calling and copying model data stored in the transmitter. The selected model data can also be reset. System changes

(T-FHSS Air, S-FHSS) matched to the receiver type and linking with the receiver are also done here.

Model select (SELECT)

The model data of up to 30 models can be stored in the transmitter. This function is used when calling saved model data.

Model copy (COPY)

This is the model data copy function. It is convenient when you want to store model data as backup or build a number of models with the same data settings.

- The data of the model memory currently in use can be copied to another model memory.

Data reset (RESET)

The model data currently in use can be reset to its initial value. However, it does not Reset other than the following of a **parameter**.

[The function reset in a parameter : **ATL trim, TELEMETRY mode, STK POSI ALRM**]

Receiver selection (RX)

The R3008SB supplied with the transmitter, employs the T-FHSS Air system. When you want to use an S-FHSS receiver, switch to S-FHSS here. However, the telemetry function cannot be used with the S-FHSS system.

Link (LINK)

When linking with the receiver, the transmitter is set to the link mode here. The ID number of the currently linked receiver is displayed.

Method

Calling the setting screen

① Call the menu screen from the home screen by pressing the **+** key for 1 second.



② Select "MDL-SEL" from the menu with the **Jog** key.

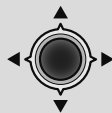

③ Open the setting screen by pressing the **Jog** key.

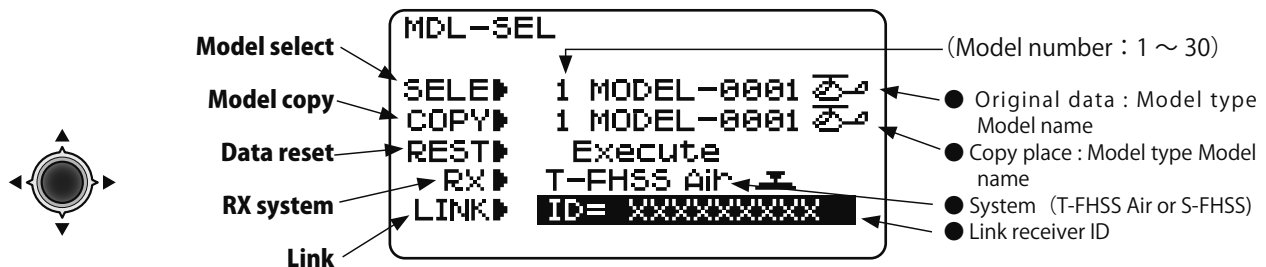

- Select the setting item with the **Jog** key.

Common function



Model select

- ① Select the **SELECT** item and then select the model number by pressing the **+ key** or **- key**.

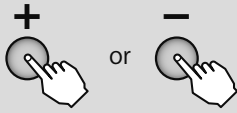

Selection range : 1 ~ 30

- ② Press the **Jog key** for 1 second.



- Confirmation message "sure?" blinks.

- ③ Select the model by pressing the **Jog key**.



- A confirmation "beep beep" sounds to show that selection is complete.

For safety, a double setting system is used. When a change is cancelled after the confirmation message is displayed, the change is not made when moved to another setting item by Jog key.

Model copy

- ① Select the **COPY** item and the select the model number of the copy destination by pressing the **+ key** or **- key**.

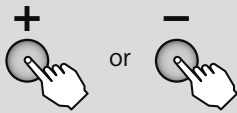

Selection range : 1 ~ 30

- ② Press the **Jog key** for 1 second.



- Confirmation message "sure?" blinks.

- ③ Copy the model by pressing the **Jog key**.



- A confirmation "beep" sounds and "**Complete**" is displayed on the screen to show that copying is complete.

For safety, a double setting system is used. When a change is cancelled after the confirmation message is displayed, the change is not made when moved to another setting item by Jog key.

Date reset

- ① Select the **REST** item and then press the **Jog key** for 1 second.



- Confirmation message "sure?" blinks.

- ② Date reset by pressing the **Jog key**.



- A confirmation "beep" sounds and "**Complete**" is displayed on the screen is complete.

For safety, a double setting system is used. When a change is cancelled after the confirmation message is displayed, the change is not made when moved to another setting item by Jog key.

⚠ CAUTION

Only the throttle channel (CH3) initial setting is REV (reverse). Thoroughly check the Hi and Low directions of the engine or motor used and be careful that they do not suddenly run at full speed. Even after data reset, CH3 is reversed.



RX type

- ① Select the RX item and then select **T-FHSS Air** or **S-FHSS** by pressing the **+** key or **-** key.

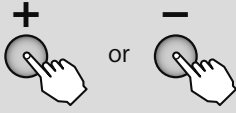

**Selection range : T-FHSS Air,
S-FHSS**

- Confirmation message "sure?" blinks.

- ② RX type change by pressing the **Jog key**.



- A confirmation "beep" sounds is complete.

For safety, a double setting system is used. When a change is cancelled after the confirmation message is displayed, the change is not made when moved to another setting item by Jog key.

Link

- ① Select the LINK item and then press the **Jog key** for 1 second.



- **T-FHSS Air** only. **S-FHSS** does not enter the link mode. Use the receiver link button to link the receiver.

- ② Enters the link mode for about 20 seconds. During this time, bring the receiver near the transmitter and turn on the receiver power. When linking, the receiver ID is displayed.

- In the link mode, a confirmation "beep beep beep" sounds and the time remaining is displayed on the screen. When 20 seconds have elapsed, a continuous beep sounds and the link mode is exited.

For safety, linking must not be performed while the drive motor or engine is running. When linking is complete, turn the power off and on and check operation.

***Link is required when a new model is made from a model selection.**



MDL-NAME Model name / User name

(Common)

Function

A model name is inputted into each model in T10J.

User name is inputted into T10J.

Model name setting (MDL NAME)

This function assigns a name to the model data. The model name is displayed on the top row of the home screen. This serves to prevent model memory mistakes if the current aircraft name or other name is entered.

- Up to 10 characters can be set.

User name setting (USR NAME)

The user name displayed on the home screen can be set. (When a user name is not set, the Futaba logo is displayed) When the home screen display is changed to USR-NAME by PARAMETER, the set user name is displayed on the home screen.

- Up to 10 characters can be set.

Method

Calling the setting screen

- ① Call the menu screen from the home screen by pressing the **+ key** for 1 second.

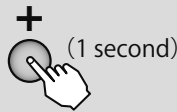

- ② Select **"MDL-NAME"** from the menu with the **Jog key**.

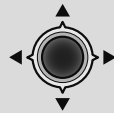

- ③ Open the setting screen by pressing the **Jog key**.



Model name

User name

(Reset)

(Candidate characters)

- Characters that can be entered ;
Numeric/upper case alphabet/
lower case alphabet

Model name

- ① Move the cursor to the model name digit you want to change by pressing the **+ key** or **- key**.

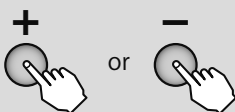

- ② Move the cursor to the candidate character you want to change with the **Jog key**.



- ③ Change the character by pressing the **Jog key**.



Set the model name by repeating steps ① to ③ above.

Reset method : When the cursor is moved to any digit of the model name by + key or - key and the Jog key is pressed in the state in which the cursor was moved to RESET by Jog key, the model name returns to its initial setting.

Common function



User name

① Move the cursor to the user name digit you want to change by pressing the **+ key** or **- key**.

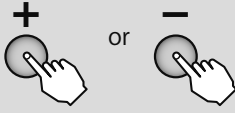

② Move the cursor to the candidate character you want to change with the **Jog key**.

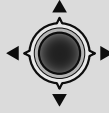

③ Change the character by pressing the **Jog key**.



Set the user name by repeating steps ① to ③ above.

Reset method: When the cursor is moved to any digit of the user name by + key or - key and the Jog key is pressed in the state in which the cursor was moved to RESET by Jog key, the user name returns to its initial setting (Futaba logo).

Displaying the user name on the home screen

The set user name can be displayed on the home screen. (When a user name is not set, the Futaba logo is displayed.) When the home screen display is changed to USR-NAME by PARAMETER, the set user name is displayed.

Common function

Calling the setting screen

① Call the menu screen from the home screen by pressing the **+ key** for 1 second.

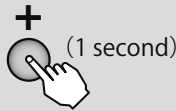

② Select **"PARAMETER"** from the menu with the **Jog key**.

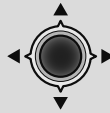

③ Open the setting screen by pressing the **Jog key**.



Parameter

① Select **"HOME-DSP"** from the parameter 2 page with the **Jog key**.

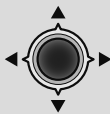

② Select **"USR-NAME"** by pressing the **+ key** or **- key**.



③ **End** setting by pressing the **END key**.

END





FAIL SAFE Fail safe

(Common)

Function

When normal radiowaves cannot be received due to noise and interference, the NOR mode, which holds the servo of each channel in its position immediately before reception was lost, or F/S (Fail Safe) mode, which moves the servo of each channel to a preset position, can be selected. When T-FHSS Air is selected, the battery fail safe voltage can be set.

- When the throttle channel was reversed by servo reverse function, the F/S data is also reversed. (Throttle channel only) If the receiver battery voltage drops below the set value when the fail safe mode was selected, the battery fail safe function moves the servo to a preset position.
- The S-FHSS fail safe voltage is 3.8V.
- Only the throttle channel battery fail safe function can be turned on and off.

- When this function was performed reset the battery fail safe function by the following method and immediately land.

Reset method : The battery fail safe function can be temporarily disabled by moving the throttle stick to the slowest side. However, after 30 seconds the battery fail safe function will return to the battery fail safe state.

⚠ WARNING

For safety, always set the fail safe functions.

- Remember to set the throttle channel fail safe function so that the servo moves to the maximum slow side for airplanes and to the slow side from the hovering position for helicopters. Crashing of the model at full high when normal radio waves cannot be received due to interference, etc., is very dangerous.
- If the battery fail safe is reset by the throttle stick, it may be mistaken for an engine malfunction and will be reset at throttle slow and the model will continue to fly. If you have any doubts, immediately land.

Method

Calling the setting screen

① Call the menu screen from the home screen by pressing the **+ key** for 1 second.

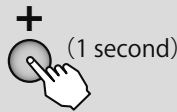

② Select **"Fail safe"** from the menu with the **Jog key**.

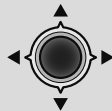

③ Open the setting screen by pressing the **Jog key**.

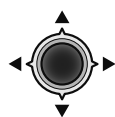

- Select the setting item with the **Jog key**.

	Mode select	F/S Position	
FAIL SAFE	MODE.	1 2 3	TFHSS
			B-F/S
1: AIL	NOR	---	---
2: ELE	NOR	---	---
3: THR	F/S	20%	ACT
4: RUD	NOR	---	---
5: GER	NOR	---	---

Common function

Fail safe

Mode selection

① Select the mode by pressing the **+ key** or **- key** at the MODE item of each channel.

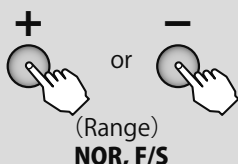

(When F/S mode was selected)

F/S position

② In the mode selected state, set the F/S position by holding the stick of that channel in the position you want to set and press the **Jog key** for 1 second.

- A confirmation beeping sounds to show that the servo position was set.

When using the B-F/S mode

① Select ACT by pressing the **+ key** or **- key** at the B-F/S item.





Battery fail safe voltage setting

① Select **BATTERY F/S VOLTAGE** on page 3 of the fail safe screen with the **Jog key**.

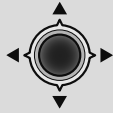

② Set the voltage by pressing the **+** key or **-** key.



(Set up range)

3.8V 4.0V 4.2V 4.4V 4.6V 4.8V
5.0V 5.3V 5.6V 5.9V 6.2V 6.5V
6.8V 7.1V 7.4V

③ End setting by pressing the **END key**.

END





REVERSE Servo reverse

(Common)

Function

Servo reversing (REVERSE): changes the direction an individual servo responds to a CONTROL STICK motion.

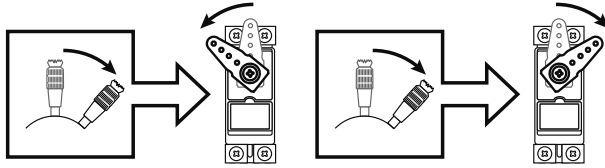

For CCPM helicopters, be sure to read the section on SWASH AFR before reversing any servos.

With the exception of CCPM helicopters, always complete your servo reversing prior to any other programming.

When using ACRO functions that control multiple servos, such as FLAPERON or V-TAIL, it may be confusing to determine whether the servo needs to be reversed or a setting in the function needs to be reversed. Refer to the instructions for each specialized function for further details.

CAUTION

- ❗ Only the throttle channel (CH3) initial setting is REV (reverse). Thoroughly check the Hi and Low directions of the engine or motor used and be careful that they do not suddenly run at full speed.
- ❗ Since the direction of the ailerons of an airplane can be easily mistaken, be very careful.

Method

Calling the setting screen

① Call the menu screen from the home screen by pressing the **+** key for 1 second.

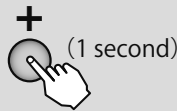

② Select **"REVERSE"** from the menu with the **Jog** key.

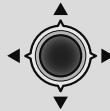

③ Open the setting screen by pressing the **Jog** key.



To prevent erroneous setting, after the servo reverse screen was called as described above, the channel will not be selected if the Jog key is not pressed at the left and right.

Channel select →

- Select the channel with the **Jog** key.

REVERSE

A	E	T	R	G	F	A	A	A	A
I	L	H	U	E	L	U	U	U	U
L	E	R	D	R	P	7	8	9	8
REV	□	□	■	□	□	□	□	□	□
NOR	■	■	□	■	■	■	■	■	■
	1	2	3	4	5	6	7	8	9 10

- The currently selected channel is highlighted.
- Display Reverse/Normal
REV : Reverse
NOR : Normal
(Channel number)

Servo Reverse

① Channel is Select by **Jog** key.



Selection range : 1 ~ 10ch

② NOR or REV is chosen by **Jog** key.



- The confirmation message **"sure?"** blinks on the screen. (Not displayed if the same as before.)

③ Reverse the servo by pressing the **Jog** key.



- A confirmation beeping sounds and the direction of operation is reversed.

For safety, a double setting system is used. When a change is cancelled after the confirmation message is displayed, the change is not made when moved to another setting item by Jog key.

Common function



TIMER

Timer

(Common)

Function

The timer is convenient during a competition to set the specified amount of time or the flying time on a full tank of fuel.

- Two timer systems can be set. Timer 1 <TMR1> and Timer 2 <TMR2>
- The timers can be set for each model. Since the timers can be set to match the model, they do not have to be reset each time the model is changed
- The type of timer can be selected from among up (UP), down (DOWN), and down stop (DN-STP). The up timer is counted up from 0 and the elapsed time is displayed on the screen. The down timer is counted down from the set time and the remaining time is displayed on the screen. The down stop timer stops the count at 0. Each timer can be set up to 99 minutes 59 seconds.

- Switches A to H, throttle stick (ST-THR), or power switch (PWR-SW) can be selected as the start/stop switch (ON-SW). The ON/OFF direction can also be set. However, when the power switch was selected, the timer starts when the power switch is turned on.
- When the timer you want to reset is selected with the Jog key and the Jog key is pressed for 1 second at the home screen, the timer is reset. Switches A to H can be selected as the reset switch (RS-SW). The ON/OFF direction can also be set.
- The up/down timer audible alarm indicates the time by a beep every second, continuous beeping at 2 second intervals from 20 seconds before the set time, and a continuous beeping at a 1 second interval from 10 seconds before the set time.

Method

Common function

Calling the setting screen

- 1 Call the menu screen from the home screen by pressing the **+** key for 1 second.

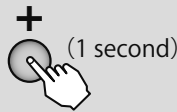

- 2 Select **"TIMER"** from the menu with the **Jog** key.

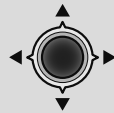

- 3 Open the setting screen by pressing the **Jog** key.



- Select the item with the **Jog** key.

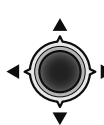

- Time set up
- Mode selection
- ON Switch selection
- Switch direction
- Reset Switch selection
- Switch direction

	TIMER <TMR1>	<TMR2>
TIME	0:00.0	10:00.0
MODE	UP	DOWN
ON-SW	SWA	SWA
Switch direction	NULL	NULL
RS-SW	SWA	SWA
Switch direction	NULL	NULL

(Timer1) (Timer2)

- When the throttle switch is selected at switch selection, hold the throttle stick in the position you want to set the ON/OFF point at ON direction setting and set the ON/OFF position by pressing the Jog key for 1 second. The timer is turned ON at points higher than this position. The ON direction can be switched by pressing the **+** key or **-** key.

Timer <TMR1> <TMR2>

Mode selection

- 1 Select timer mode from the **"MODE"** with the **+** or **-** key.

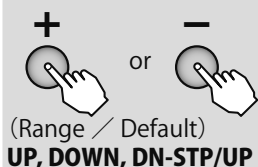

Timer time setting

- 2 Set the time by pressing the **+** key or **-** key at each TIME (minutes):(second) item.

(Range / Default)
0 ~ 99 minutes 59 seconds/10 minutes 00 second

Switch selection and ON direction setting

- 3 Select the switch by pressing the **+** key or **-** key at the ON-SW or RS-SW item and set the ON direction by pressing the **+** key or **-** key at the ON direction setting item.

(Switch setting range/Default)
ON-SW: SwA ~ H, ST-THR, PWR-SW/SwA
RS-SW: SwA ~ H/SwA
(Switch ON direction/Default)
3P SW: NULL (normally off), UP, UP&DWN, UP&CNT, CENTER, CNT&DN, DOWN/NULL
2P SW: NULL, UP, DOWN/NULL



SERVO

Servo monitor / Servo test

(Common)

Function

The servo display/servo test function displays the CH1 to CH10 servo output bar graph and tests servo operation.

- The servo display function can be used for a simple operation check of such functions as the mixing function.
- When the servo test function is turned on, the servo moves to the left and right at the set period. A

variable speed LNR (linear) mode or fixed speed JMP (jump) mode can be selected. This can be used to check the servo, etc. Operation ON/OFF can also be selected for each channel.

CAUTION

⊘ Using the servo test will move the servos to their full throw. Do not use this with linkages installed. Using it may damage the servo and linkage.

Method

Calling the setting screen

① Call the menu screen from the home screen by pressing the **+** key for 1 second.

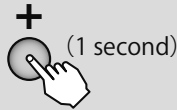

② Select **"SERVO"** from the menu with the **Jog** key.

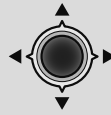

③ Open the setting screen by pressing the **Jog** key.



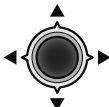

- Select the setting item with the **Jog** key.

(Servo Monitor)

SERVO 1 2 TEST

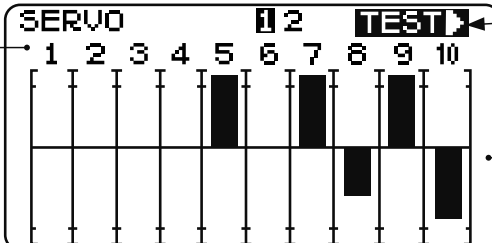

(Servo Test)

SERVO 1 2 GRPH

TEST OFF TYPE LNR

CYCL 10

SPD 7

(■ACT □INH)

CH 1 2 3 4 5 6 7 8-10

■ □ □ □ □ □ □ □

Switching to the servo test screen

- Switch the screen by selecting TEST and operating the jog key to the left and right.
- The servo operating position of each channel is displayed on a bar graph.

Screen change

- Where "GRPH" is chosen, a **Jog** key is pressed in right or left.

Type Select

Cycle Select

Speed setting

- Operation of a servo test

Common function

Servo test

Type/cycle/speed setting

① Select the setting item (TYPE, CYCL, SPD) with the Jog key and set the item by pressing the **+** key or **-** key.

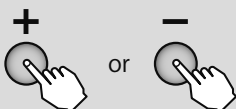

(Range / Default)
 TYPE : LNR, JMP / LNR
 CYCL : 1 ~ 100 / 10 (full speed at 1)
 SPD : 1 ~ 100 / 7 (full speed at 100)

Channel selection

② Select the channel you want to test with the **Jog** key and select ACT/INH by pressing the **+** key or **-** key.

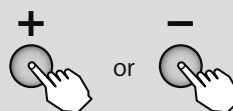

Selection range : ACT, INH
 Default : INH (only CH1 is ACT)

Servo test start/stop

③ Select the **"TEST"** item with the **Jog** key and start/stop the servo test by pressing the **+** key or **-** key.

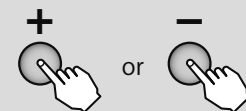

Selection range : ON, OFF
 Default : OFF



END POINT End point

(Common)

Function

The End Point function adjusts the left and right servo throws, generates differential throws, and will correct improper linkage settings.

- The servo travel can be adjusted individually at the left and right sides.

Servo throw

At 100% setting the servo throw of each channel is about 40° for channels 1 to 4 and about 55° for channels 5 to 10. However, the maximum servo travel for channels 5 to 10 is about 110%.

*When channels 5 to 8 were mixed by flaperon, differential or aileron, the throw becomes the same (about 40°) as channels 1 to 4.

Method

Calling the setting screen

- ① Call the menu screen from the home screen by pressing the **+ key** for 1 second.

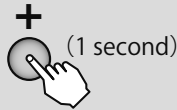

- ② Select **"END POINT"** from the menu with the **Jog key**.

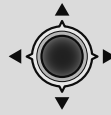

- ③ Open the setting screen by pressing the **Jog key**.



Common function

- Select the channel with the **Jog key**.

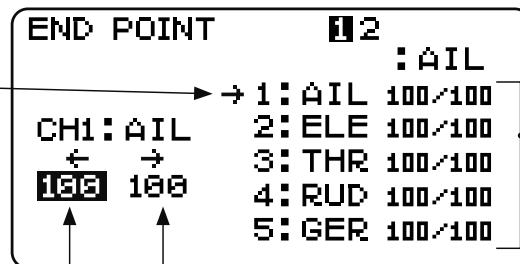

- The setting rate of each channel

(Left / Down) rate display (Right / Up) rate display

< ChannelDisplay >

ACROBATIC		HELICOPTER		GLIDER (AF4)		MULTICOPTER	
1: AIL (Aileron)	6: FLP (Flap)	1: AIL (Aileron)	6: PIT (PITCH)	1: AIL (Aileron)	6: FL2 (Flap2)	1: AIL (Aileron)	6: AU6
2: ELE (Elevator)	7: AU7	2: ELE (Elevator)	7: AU7	2: ELE (Elevator)	7: AL2 (Aileron2)	2: ELE (Elevator)	7: AU7
3: THR (Throttle)	8: AU8	3: THR (Throttle)	8: AU8	3: MOT (Motor)	8: FL3 (Flap3)	3: THR (Throttle)	8: AU8
4: RUD (Rudder)	9: AU9	4: RUD (Rudder)	9: AU9	4: RUD (Rudder)	9: FL4 (Flap4)	4: RUD (Rudder)	9: AU9
5: GER (Gear)	10: AU0	5: GYR (GYRO)	10: AU0	5: FLP (Flap)	10: AU0	5: MOD	10: AU0

End point

- ① A channel is chosen by **Jog key**.



Selection range : 1 ~ 10ch

- ② Operate the stick or knob of the selected channel fully to the left (down) or right (up) and adjust the rate by pressing the **+ key** or **- key**.

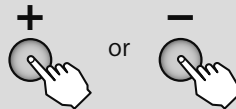

Range :
0 ~ 140%
Default : 100%

- When you want to return the set value to the initial value, press the **+ key** and **- key** simultaneously.

Adjust the rate of each direction of the stick and VR by repeating step ①.



TRIM

Trim reset / Trim step

(Common)

Function

Trim Reset

This function returns the trim of the model memory in use to the center (initial state).

However, at this time, sub trim and trim step amount are not reset.

Trim Step

The amount of trim change per step can be changed between 1 and 40 according to the aircraft capacity and trim application.

Set it to match the application. With ordinary aircraft, a setting of about 2 to 10 should be fine. (Initial value: 4)

Method

Calling the setting screen

① Call the menu screen from the home screen by pressing the **+** key for 1 second.

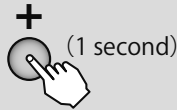

② Select **"TRIM"** from the menu with the **Jog** key.

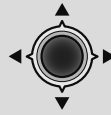

③ Open the setting screen by pressing the **Jog** key.



Trim Reset

Trim step

TRIM	RESET	Execute	
STEP	AIL	4 (→)	0)
	ELE	4 (+)	0)
	THR	4 (+)	0)
	RUD	4 (→)	0)
	DT5	4 (+)	0)
	DT6	4 (+)	0)

(Trim step rate)

● Select the item with the **Jog** key.

● The numbers in () indicate the current trim position. (The trim operating range is 120 ~ 100[DT5,DT6])

Common function

Trim reset

① Select the **RESET** item and press the **Jog** key for 1 second.



● A "beep" sounds to indicate that resetting is complete. At this time, the trim position number returns to 0.

● For example, when the step size is the initial value (4), trim movement from center to end is 30 steps. If the step size is made 40, the trim moves 3 steps.

Trim step

① Select the trim you want to set from the **STEP** item and set the step size by pressing the **+** key or **-** key.

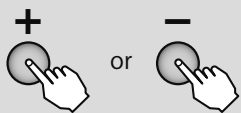

Range : 1 ~ 40

Default : 4

● When you want to return the set value to the initial value, press the **+** key and **-** key simultaneously.



SUB TRIM Sub trim

(Common)

Function

The Sub-Trim function is used to set the servo neutral position, and may be used to make fine adjustments to the control surface after linkages and pushrods are hooked up. When you begin to set up a model, be sure that the digital trims are set to their center position.

Setting precautions

If sub trim is too large, the servo operating range may be exceeded at maximum control surface angle and generate a dead band in which the servo does not operate. First connect the linkage so that the amount of sub trim used is held to a minimum.

Method

Calling the setting screen

① Call the menu screen from the home screen by pressing the **+ key** for 1 second.



② Select **"SUB TRIM"** from the menu with the **Jog key**.

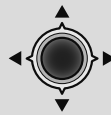

③ Open the setting screen by pressing the **Jog key**.



Common function

● Select the channel with the **Jog key**.

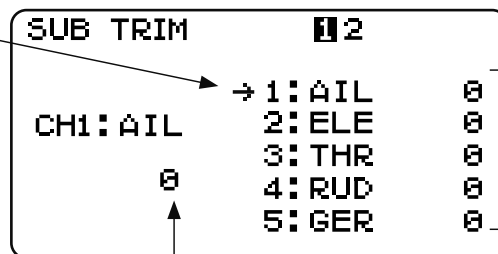

● SUB trim rate of each channel.

SUB trim rate of the selected channel.

< ChannelDisplay >

ACROBATIC		HELICOPTER		GLIDER (AF4)		MULTICOPTER	
1: AIL (Aileron)	6: FLP (Flap)	1: AIL (Aileron)	6: PIT (PITCH)	1: AIL (Aileron)	6: FL2 (Flap2)	1: AIL (Aileron)	6: AU6
2: ELE (Elevator)	7: AU7	2: ELE (Elevator)	7: AU7	2: ELE (Elevator)	7: AL2 (Aileron2)	2: ELE (Elevator)	7: AU7
3: THR (Throttle)	8: AU8	3: THR (Throttle)	8: AU8	3: MOT (Motor)	8: FL3 (Flap3)	3: THR (Throttle)	8: AU8
4: RUD (Rudder)	9: AU9	4: RUD (Rudder)	9: AU9	4: RUD (Rudder)	9: FL4 (Flap4)	4: RUD (Rudder)	9: AU9
5: GER (Gear)	10: AU0	5: GYR (GYRO)	10: AU0	5: FLP (Flap)	10: AU0	5: MOD	10: AU0

Sub trim

① A channel is chosen by **Jog key**.



Selection range :
(page 1) 1 ~ 5ch
(page 2) 6 ~ 10ch

② Select the SUB trim you want to set from channel item and set the rate by pressing the **+ key** or **- key**.

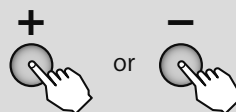

Range :
-120 ~ +120%
Default : 0%

● When you want to return the set value to the initial value, press the **+ key** and **- key** simultaneously.



Function

Mixing that can independently customize 6 functions can be used. Programmable mixing is used to remove bad tendencies of the aircraft and make operation pleasant. In addition to mixing between arbitrary channels, this function includes

linking (linking with another mix), trim addition, offset, and switch setting functions.

P.MIX 1 ~ 4 (normal type)

The following functions can be set for programmable mixing 1 to 4:

[Mixing Channel]

- Use this function by changing the channel because the master channel and slave channels initial setting is a temporary combination.
- When OFS was selected as the master channel, the mixing rate setting applies to slave only. When a mixing rate is set, slave servo operation is offset by that amount.
- A knob (VR) or digital trim (DT5, DT6), as well as a channel, can be selected as the master channel.

[Trim selection]

- Whether or not mixing includes master channel trim operation can be selected.

[Mixing reference point change]

- The master channel mixing reference point can be shifted.

[Switch selection]

- The programmable mixing ON/OFF switch can be selected. The switches that can be selected are switches A to H and the throttle stick.
- The switch operating direction can be set. When a 2 position switch was selected, up /down can be set, and when a 3 position switch was selected, up/up and down /up / and center/center/center and down /down can be selected. When the throttle stick was selected, the ON/OFF position and operation direction can be set. When "NULL" is selected, mixing is always ON.

P. MIX 5 ~ 6 (curve type)

Programmable mix 5 to 6 allows setting of the mixing rate by 5 point curve.

OFS and knob/digital trim use and trim selection by normal type master channel setting described above are impossible, but switch selection is possible.



Common function

Method

Calling the setting screen

① Call the menu screen from the home screen by pressing the **+ key** for 1 second.

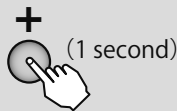

② Select **"P.MIX1-6"** from the menu with the **Jog key**.

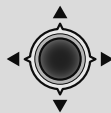

③ Open the setting screen by pressing the **Jog key**.





P.MIX Selection

■ Calling the setting screen

- ① Use the **Jog key** to select the P.MIX number you want to use.
- ② Call the setting screen by pressing the **Jog key**.

- P.MIX1 ~ 4 (normal type)
- P.MIX5 ~ 6 (curve type)



(P.MIX 1-6)

P.MIX1-6

```

NOR: 1 MAIL→RUD
      2 INH
      3 RUD→ELE
      4 INH
CRV: 5 RUD→AIL
      6 RUD→ELE
  
```

to P.MIX1 ~ 4
set up screen

to P.MIX5 ~ 6
set up screen

(P.MIX1 ~ 4 set up screen)

Mixing rate adjustment

P.MIX1

RATE+▶ 0% MIX▶ INH

→▶ 0%

OFFST▶ 0% TRM▶ OFF

(0%)

MASTR▶ AIL SW▶ SWB

SLAVE▶ RUD POSI▶ NULL

Function activation

- When INH is selected, the function cannot be used. When ON or OFF is selected, the function is activated. ON and OFF changes are linked to the switch.

Trim ON/OFF

Switch selection

Switch direction

(Master CH Current position)

- Select the item with the **Jog key**.

P.MIX1 ~ 4

■ Function activation

- ① Select the MIX item and select ON or OFF by pressing the **+ key** or **- key**.

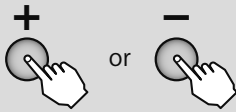

- When you do not want to use the function select INH.

■ Master/slave channel selection

- ② Select the MASTR channel you want to use by pressing the **+ key** or **- key**.
- ③ Select the Slave channel you want to use by pressing the **+ key** or **- key**.

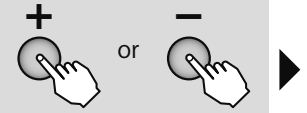

- A knob VR or digital trim DT5/DT6, as well as channels 1 to 10, can be specified as the master channel. In addition, when OFS was selected as the master channel, slave servo operation is offset.

■ Mixing rate adjustment

- ④ Select the RATE item and adjust the mixing rate by pressing the **+ key** or **- key** for each direction of the stick, etc. selected at the master channel.

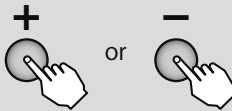

Range : -100 ~ +100%
Default : 0%

- When you want to return the set value to the initial value, press the **+ key** and **- key** simultaneously.

(Changing the ON/OFF Switch)

■ ON/OFF Switch selection

- ① Select the "SW" item and then select the switch by pressing the **+ key** or **- key**.

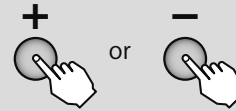

Selection range : SwA ~ SwH, THR

■ Switch ON direction setting

- ② Select the "POSI" item and select the switch ON direction by pressing the **+ key** or **- key**.

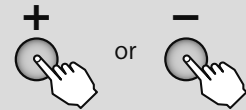

- 2P SW : **NULL (always ON), UP, DOWN**
- 3P SW : **NULL (always ON), UP, UP&D, UP&C, CNTR, C&DN, DOWN**
- THR stick: Hold the stick at the ON/OFF point and set the ON/OFF position by pressing the **Jog key** for 1 second. (If the **Jog key** is pressed for 1 second when the position was set, it returns to the NULL state.) The switch ON direction can also be selected by pressing the **+ key** or **- key**.



(Changing the mixing reference point)

■ **Mixing reference point setting**

- ① Select the "OFFST" item and hold the master side stick or knob in the position you want to set and set the new reference point by pressing the **Jog key**.



Range : -100 ~ +100%
(THR only 0 ~ 100%)

Default : 0%

(Including trim operation)

■ **Trim ON/OFF setting**

- ① Select the "TRM" item and select ON or OFF by pressing the **+ key** or **- key**.

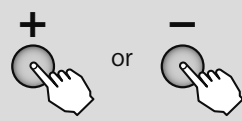

Range : OFF、ON

Default : OFF

- When you do not want to include trim in mixing select OFF.

⚠ **CAUTION**

- ① At the end of setting, check that the mixing function is performed normally.

(P.MIX5 ~ 6 set up screen)

- Select the item with the **Jog key**.



5Point curve setting

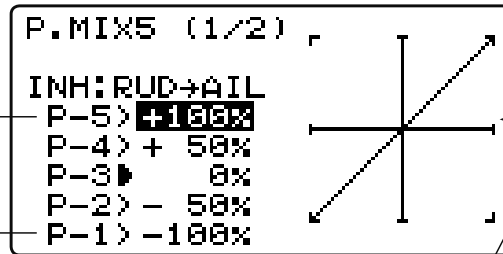

- The set curve is displayed on a graph.

Function activation
Master CH select
Slave CH select

Switch selection
Switch ON direction

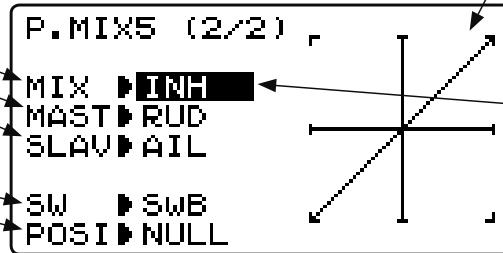

- When INH is selected, the function cannot be used. When ON or OFF is selected, the function is activated. ON and OFF changes are linked to the switch.

Common function

P.MIX5 ~ 6

Refer to the P.MIX1 ~ 4 setting method described previously for settings other than the 5 point curve setting described below.

■ **5point curve setting**

- ① Select the setting item (P-1 ~ P-5) of each point with the **Jog key** and set the amount of movement of each point by pressing the **+ key** or **- key**.

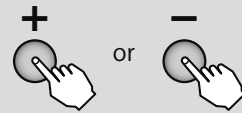

Range : -100 ~ +100%

Default : 0%

⚠ **CAUTION**

- ① At the end of setting, check that the mixing function is performed normally.



AUX-CHAN AUX Channel (Common)

Function

Auxiliary channel function (AUX-CH): defines the relationship between the transmitter controls and the receiver output for channels 5-10.

△ Remember that if you assign primary control of a channel to a switch which you later use for other functions (like dual/triple rates or airbrakes), every time you use that other function you will also be moving the auxiliary channel.

Method

Calling the setting screen

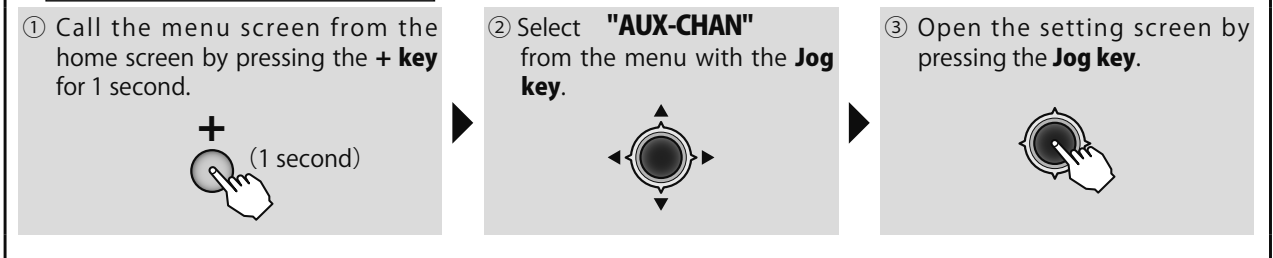

Common function

```

AUX-CHAN
CH5 ▶ SWG
CH6 ▶ VR
CH7 ▶ DT5
CH8 ▶ DT6
CH9 ▶ SwA
CH10▶ SwD
    
```

< AUX Channel Default >

ACROBATIC		HELICOPTER		GLIDER		MULTICOPTER	
CH5	SwG (SwitchG)	CH5	SwF (SwitchF)	CH5	DT5 (Trim5)	CH5	SwE (SwitchE)
CH6	VR (Volume)	CH6	--- (PITCH)	CH6	SwG (SwitchG)	CH6	SwC (SwitchC)
CH7	DT5 (Trim5)	CH7	SwC (SwitchC)	CH7	SwD (SwitchD)	CH7	VR (Volume)
CH8	DT6 (Trim6)	CH8	VR (Volume)	CH8	DT6 (Trim6)	CH8	DT6 (Trim6)
CH9	SwA (SwitchA)	CH9	SwA (SwitchA)	CH9	SwA (SwitchA)	CH9	SwA (SwitchA)
CH10	SwD (SwitchD)	CH10	SwD (SwitchD)	CH10	VR (Volume)	CH10	SwD (SwitchD)

AUX Channel

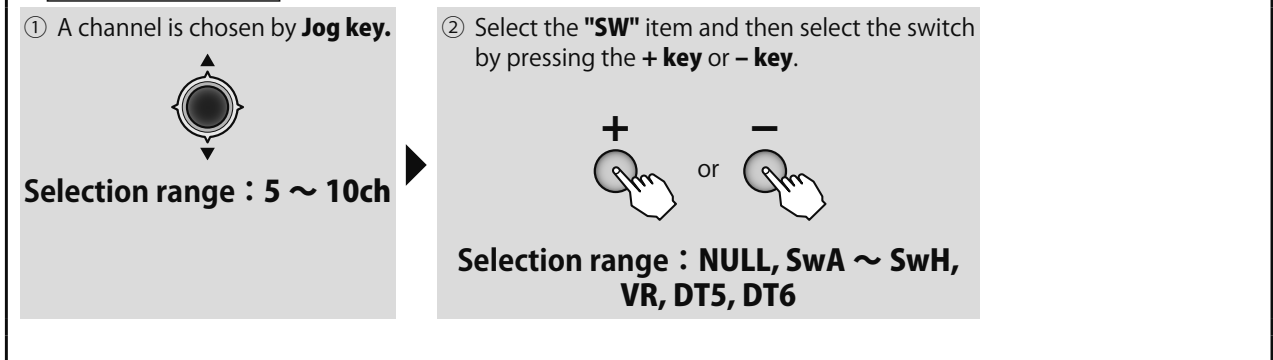



⚠ WARNING

The priority of AUX

Don't assign two or more functions to one channel.

Priority may be given to a higher rank function and a low rank function may be canceled.

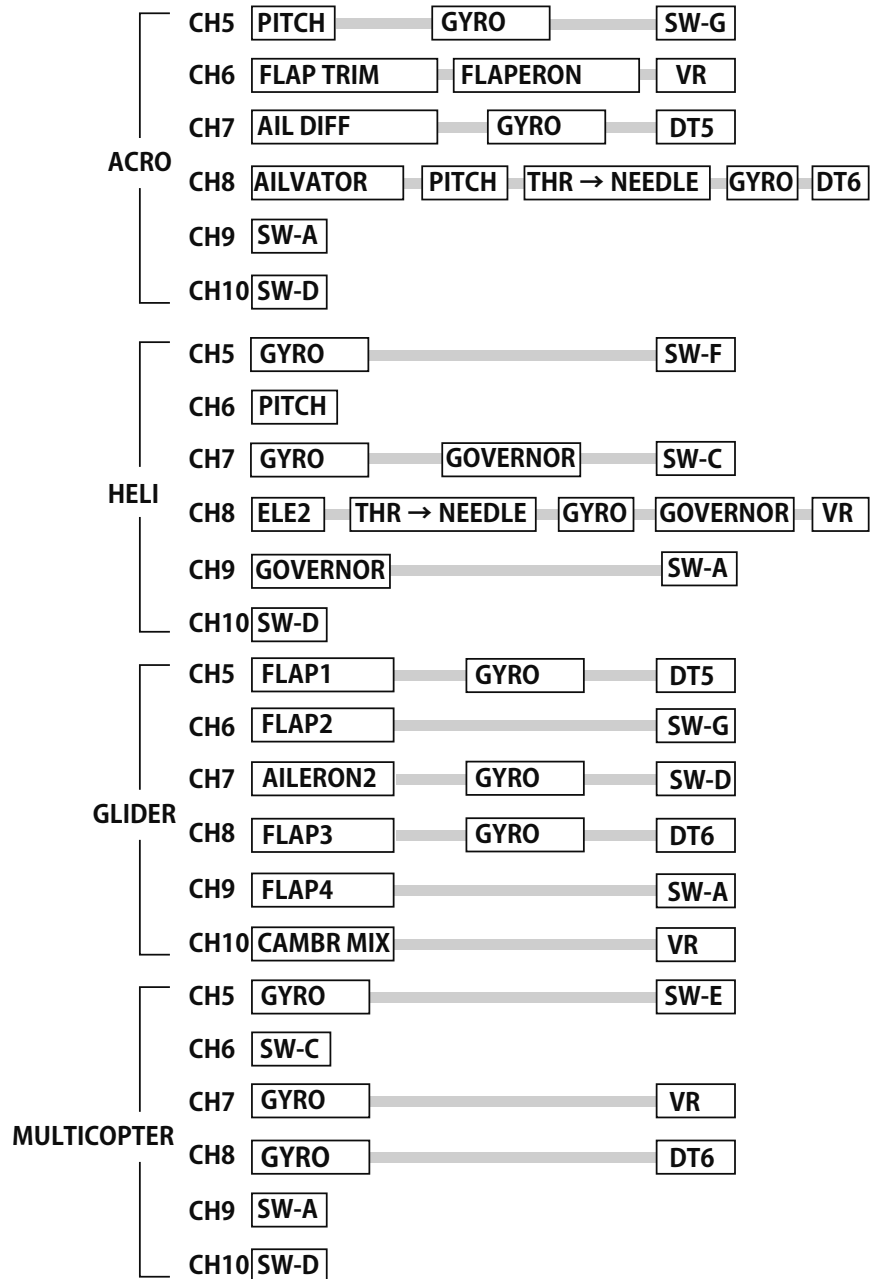

Common function



PARAMETER Parameter function

(Common)

Function

PARAMETER submenu: sets those parameters you would likely set once, and then not disturb again.

Once you have selected the correct model you wish to work with, the next step is setting up the proper parameters for this specific model:

Data reset (RESET)

The present model data is reset. Data Reset does NOT reset, ATL Trim, TELEMETRY mode, or STK POSI Alarm.

Model type (TYPE) SWASH : Only helicopter WING : Only glider

MODEL TYPE: sets the type of programming used for this model.

The T10J has 30 model memories, which can each support:

- One powered aircraft (ACRO) memory type (with multiple wing and tail configurations. See twin aileron servos, twin elevator servos, ELEVON, and V-TAIL for further information.)
- Eight helicopter swashplate types, including CCPM. See Helicopter MODEL TYPE for details.
- If you use CGY750, the swash type should choose H-1. (Swash type is chosen by setup in CGY750.)
- Five glider wing types. See glider WING TYPE for details.
- Multicopter type.

Before doing anything else to set up your aircraft, first you must decide which MODEL TYPE best fits this particular aircraft. (Each model memory may be set to a different model type.) If your transmitter is a T10JA, the default is ACRO. If it is a T10JH, the default is HELI(H1).

ATL Trim (ATL)

Adjustable travel limit (ATL): makes the channel 3 TRIM LEVER (THROTTLE TRIM) effective only at low throttle, disabling the trim at high throttle. This prevents pushrod jamming due to idling trim changes. This function defaults to ON. If you are not using channel 3 for throttle, you may want trim operation the same as on all other channels. To do so, set ATL to OFF. If you need the ATL to be effective at the top of the stick instead of the bottom, reverse the THR-REV setting. Note that this affects all models in the radio, not just the model you are currently editing.

LCD contrast (CONTRAST)

Contrast adjustment LCD screen.

- You adjust to legible contrast. set up range -10 ~ +10

Back light (BACK-LIT)

Back light mode of a LCD screen can be chosen.

- ALWAYS / KEY-ON (Shines for a definite period of time after key operation.) / OFF

Light time (LIT-TIME)

Sets the length of time the backlight will stay on.

- Set up range 1 ~ 30

Light adjustment (LIT-ADJS)

Light volume adjustment of a back light.

- Set up range 1 ~ 30

Home display (HOME-DSP)

Item selection displayed on a home screen

- Futaba logo (Default), **USR-NAME**, **RX BATT**, **DT5/DT6**, **THR/PIT** (Case of helicopter, the position of a throttle and pitch.)



Battery alarm (BATT-ALM)

Select the battery alarm voltage according to the battery to be used.

- 4 dry cell batteries ⇒ 4.2V DRY4
- HT5F1800B (NiMH battery) ⇒ 5.0V NiMH5
- FT2F2100B (Lithium ferrite battery) ⇒ 5.8V LiFe2

Battery alarm vibration (BATT VIB)

Battery alarm is told with vibration.

Buzzer tone (BUZ-TONE)

The tone of buzzer sound when a key is pressed.

- Set up range : OFF,1(low) ~ 100(high)

Jog key navigation (Jog-NAVI)

Blink at the time of Jog key operation, Display of the operation direction.

Jog light (Jog-LIT)

ON/OFF of a Jog key light.

Jog light time (Jog-TIME)

Time setting in which a Jog key light shines.

- Set up range : 1 ~ 30(s)

Telemetry mode setting (TELEMETRY MODE)

Sets whether or not telemetry is activated. When using 2 receivers with 1 transmitter, select INH.

- Range : ACT / INH

Telemetry display units setting (TELEMETRY UNIT)

Sets whether the telemetry display is in meters or yards/pounds.

- Range : METER / YARD (°C / °F)

Speech language setting (SPEECH LANGUAGE)

Sets the speech language when listening to telemetry information through earphones.

- Range : Japanese (JPN), English (English)

Speech volume setting (SPEECH VOLUME)

Sets the volume when listening to telemetry information through earphones.

- Range : LOW / HIGH

Stick position alarm setting (STK POSI ALRM)

Can be set so that an audible alarm sounds once when the throttle stick reaches the set position.



Method

Calling the setting screen

① Call the menu screen from the home screen by pressing the **+** key for 1 second.



② Select **"PARAMETER"** from the menu with the **Jog** key.

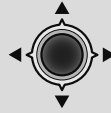

③ Open the setting screen by pressing the **Jog** key.

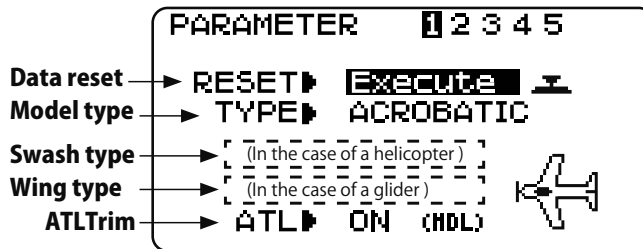

----- page 1

● Next page 2 ~ 5



LCD contrast (CONTRAST)

Back light (BACK-LIT)

Light time (LIT-TIME)

----- page 2

Light adjustment (LIT-ADJS)

Home display (HOME-DSP)

Battery alarm (BATT ALM)

Battery alarm vibration (BATT VIB)

Buzzer tone (BUZ-TONE)

----- page 3

Jog key navigation (JOG-NAVI)

Jog light (JOG-LIT)

Jog light time (JOG-TIME)

(TELEMETRY MODE)

(TELEMETRY UNIT)

(SPEECH LANGUAGE)

(SPEECH VOLUME)

----- page 4

Stick position alarm (STK POSI ALRM)

----- page 5

Date reset

① Call the **"RESET"** from the PARAMETER by Press the **Jog** key for 1 second.



● Confirmation message **"sure?"** blinks.

② Date reset by pressing the **Jog** key.



● A confirmation "beep" sounds and **"Complete"** is displayed on the screen is complete.

For safety, a double setting system is used. You need to confirm your setting changes by pressing the jog key. When "Complete" can be seen, it is the completion of reset.

CAUTION Only the throttle channel (CH3) initial setting is REV (reverse). Thoroughly check the Hi and Low directions of the engine or motor used and be careful that they do not suddenly run at full speed. Even after data reset, CH3 is reversed.



Model type

- ① Select the **"TYPE"** item and then select the model type by pressing the **+ key** or **- key**.

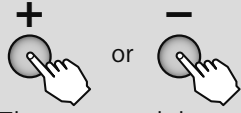

- The new model type is displayed on the screen.

- ② Press the **Jog key** for 1 second.



- Confirmation message **"sure?"** blinks.

- ③ Model type change by pressing the **Jog key**.



- A confirmation "beep" sounds is complete.

For safety, a double setting system is used. You need to confirm your setting changes by pressing the jog key. If you fail to press the jog key and see "Complete" on your screen, your changed are not saved.

Selection range :
ACROBATIC,
HELICOPTER, GLIDER, MULTI
COPT

Swash type (for Heli)

- ① Select the **"SWASH"** item and then select the swash type by pressing the **+ key** or **- key**.

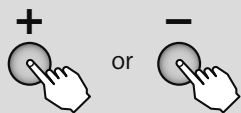

- ② Press the **Jog key** for 1 second.



- Confirmation message **"sure?"** blinks.

- ③ Swash type change by pressing the **Jog key**.



- A confirmation "beep" sounds is complete.

For safety, a double setting system is used. You need to confirm your setting changes by pressing the jog key. If you fail to press the jog key and see "Complete" on your screen, your changed are not saved.

Selection range : **H-1, HR3,**
H-3, HE3, HN3, H-2, H-4, H4X

Wing type (for Glider)

- ① Select the **"WING"** item and then select the swash type by pressing the **+ key** or **- key**.

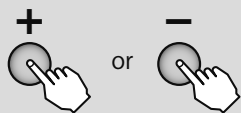

- ② Press the **Jog key** for 1 second.



- Confirmation message **"sure?"** blinks.

- ③ Swash type change by pressing the **Jog key**.



- A confirmation "beep" sounds is complete.

For safety, a double setting system is used. When a change is cancelled after the confirmation message is displayed, the change is not made when moved to another setting item by Jog key.

Selection range : **1AIL, 2AIL,**
2A+1F, 2A+2F, 2A+4F

ATL Trim ON/OFF

- ① Select the **"ATL"** item and change the mode by pressing the **+ key** or **- key**.

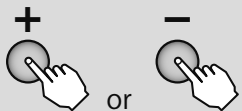

Selection range : **ON, OFF**

Default : **OFF**

Common function



LCD contrast

- ① Select the "**CONTRAST**" item and change numerical value (contrast) by pressing the **+ key** or **- key**.

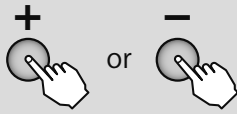

Selection range : **-10 ~ +10**

Default : **0**

Back-light / Light-time / Light-adjustment

■ Back-light mode

Select the "**BACK-LIT**" item and change the mode by pressing the **+ key** or **- key**.

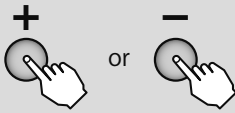

- "**ALWAYS**" : always ON
- "**OFF**" : always OFF
- "**KEY-ON**" : It light on after Key operation.

Selection range :
ALWAYS, OFF, KEY-ON

Default : **ALWAYS**

■ Light-time

Select the "**LIT-TIME**" item and change numerical value (time) by pressing the **+ key** or **- key**.

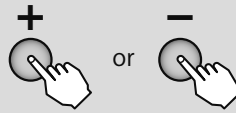

- It is only a case in "**KEY-ON**" mode here.

Selection range : **1 ~ 30(s)**
Default : **10(s)**

- When you want to return the set value to the initial value, press the **+ key** and **- key** simultaneously.

■ Light-adjustment

Select the "**LIT-ADJ**" item and change numerical value (brightness) by pressing the **+ key** or **- key**.

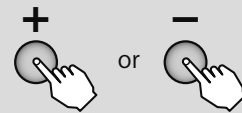

- It is the brightest at 30.

Selection range : **1 ~ 30**
Default : **15**

- When you want to return the set value to the initial value, press the **+ key** and **- key** simultaneously.

Home display

- ① Select the "**HOME-DSP**" item and change the mode by pressing the **+ key** or **- key**.



- "**Futaba**" : Display about a Futaba logo.
- "**USR-NAME**" : Display about a user name.
- "**DT5/DT6**" : Display about the position of DT5 and DT6
- "**RX BATT**" : Display about the receiver battery voltage
- "**THR/PIT**" : Display about the position of pitch and throttle.

Selection range :
**Futaba, USR-NAME,DT5/
DT6, RX BATT, THR/PIT(*)**

Default : **Futaba**

*Only Heli mode can be chosen about **THR/PIT**.

Battery alarm voltage

- ① Select the "**BATT ALM**" item and change the numerical value (voltage) by pressing the **+ key** or **- key**.

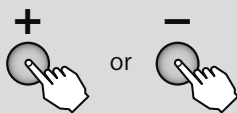

- AA alkaline batteries ⇒ 4.2V DRY4
- Futaba HT5F1800B ⇒ 5.0V NiMH5
- Futaba FT2F2100B ⇒ 5.8V LiFe2

*The voltage drop of a rechargeable battery and a dry cell battery is different. When using a rechargeable battery, always change the voltage.

Selection range :
**4.2V 4.6V 5.0V 5.4V 5.8V
6.2V 6.6V 7.0V 7.4V**

*The flight should be stopped and charged before 0.2 V before the alarm is activated.



Battery alarm voltage vibration

- ① Select the **"BATT VIB"** item and change the ON or OFF by pressing the **+ key** or **- key**.

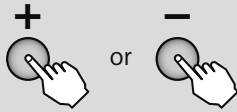

- ON ⇒ The battery alarm of a transmitter is told with vibration.

Selection range :
ON, OFF

Buzzer tone

- ① Select the **"BUZ-TONE"** item and change the numerical value (tone) by pressing the **+ key** or **- key**. The higher the numerical value the higher the tone.

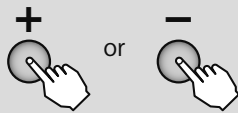

- When you want to return the set value to the initial value, press the **+ key** and **- key** simultaneously.

Selection range :
OFF, 1 ~ 100

Jog key navigation

- ① Select the **"Jog-NAVI"** item and change the mode by pressing the **+ key** or **- key**.

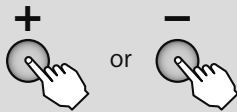

Selection range :
ON,OFF

When **NAVI** selected
flashes when the **Jog key** was pressed.

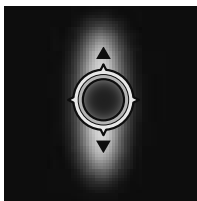

When a function that only operates in the vertical direction is selected, the LED blinks vertically.

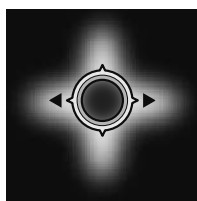

When a function that operates in the vertical and horizontal directions is selected, the LED blinks vertically and horizontally.

Jog light

- ① Select the **"Jog-LIT"** item and change the mode by pressing the **+ key** or **- key**.

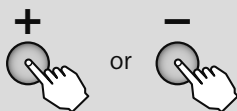

- **"ALWAYS"** : The light is always switched on.
- **"KEY-ON"** : KEY operation → Light on.
- **"OFF"** : Always off.

Selection range :
ALWAYS, KEY-ON, OFF

Default : KEY-ON



Jog light time

- ① Select the "**Jog-TIME**" item and change numerical value (time) by pressing the **+ key** or **- key**.

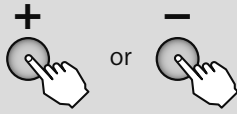

- Jog-Lit sets the lighting time when KEY-ON was set.

Selection range :

1 ~ 30

Default : 10

- When you want to return the set value to the initial value, press the **+ key** and **- key** simultaneously.

Telemetry mode

- ① Select the "**TELEMETRY-MODE**" item and change the mode by pressing the **+ key** or **- key**.

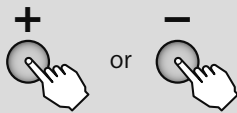

Selection range :

ACT, INH

Telemetry unit

- ① Select the "**TELEMETRY-UNIT**" item and change the mode by pressing the **+ key** or **- key**.

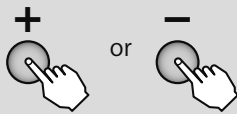

Selection range :

METER, YARD

Speech language

- ① Select the "**SPEECH-LANGUAGE**" item and change the language by pressing the **+ key** or **- key**.

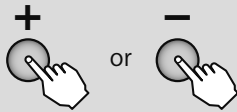

Selection range :
Japanese, English

Speech volume

- ① Select the "**SPEECH-VOLUME**" item and change the volume by pressing the **+ key** or **- key**.

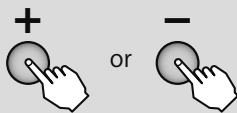

Selection range :
HIGH, LOW



Stick position alarm

An alarm (single beep) can be sounded at the specified throttle stick position.

- Alarm function ON/OFF can be set by switch.

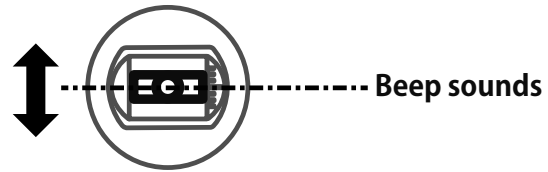

Select "Parameter"

Press the Jog key to the side and select page 5.

- Select the item with the Jog key.

(STK POSI ALRM)

	PARAMETER	1	2	3	4	5
	STK POSI ALRM (MDL)					
INH ↔ ON/OFF	MODE ▶	ON				
Switch selction	SW ▶	SWA				
Switch direction	POSI ▶	DOWN				
Stick position	STICK ▶	50%	(50%)		

When the THR stick is set to the specified position.

- **Parameter** setting is not reset. However, STK POSI ALRM, Telemetry mode and the ATL trim on which (MDL) was displayed are resettable.

- When INH is selected, the function cannot be used. When ON or OFF is selected, the function is activated. ON and OFF changes are linked to the switch.

- The number in parenthesis is the current throttle stick position.

① Stick position is chosen by Jog key.



	PARAMETER	1	2	3	4	5
	STK POSI ALRM (MDL)					
	MODE ▶	ON				
	SW ▶	SWA				
	POSI ▶	DOWN				
	STICK ▶	45%	(45%)		

② Set the throttle stick to the position at which you want to generate the alarm.

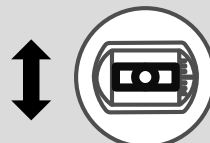

THR Stick

③ When the Jog key is held down the alarm sounds at that position.



Memorize the position at which the beep is to sound.

Common function



TELEMETRY Telemetry

(Common)

Function

This screen displays and sets the various information from the receiver. An alarm and vibration can be generated depending on the information. For example, a drop in the voltage of the receiver battery housed in the aircraft can be reported by an alarm.

- This function can only be used in the T-FHSS Air mode. The S-FHSS system cannot use telemetry.
- Telemetry sensors sold separately can be mounted in the aircraft to display a variety of information. (Receiver voltage does not require a sensor.)
- The telemetry function cannot be used if the telemetry mode of the parameters is not ACT.
- When 2 receivers are used with 1 transmitter, the telemetry function cannot be used.

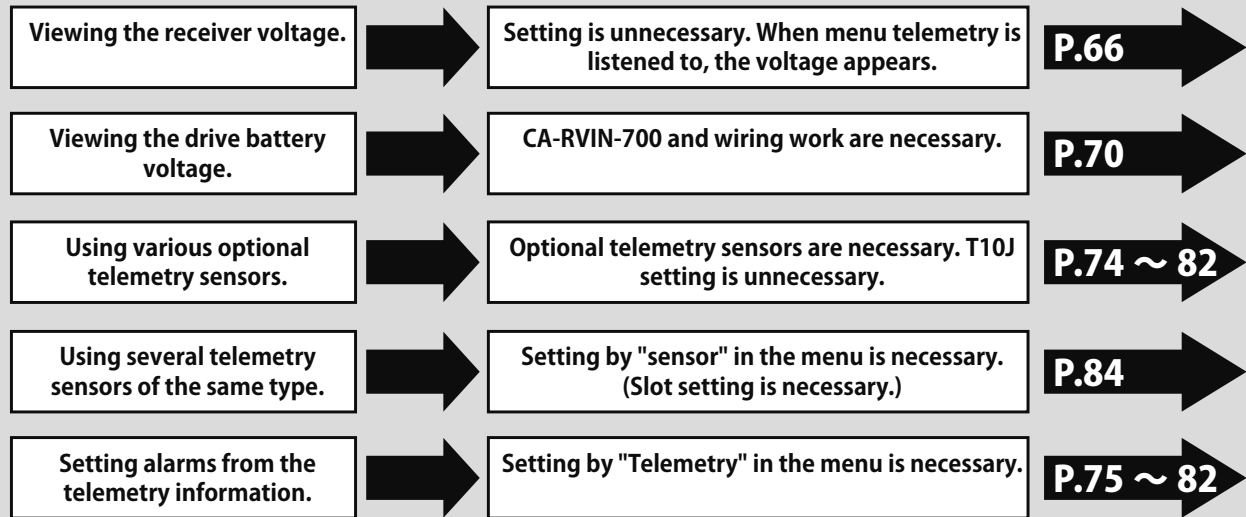

Common function

RX-BATT

● Viewing the receiver voltage.

In the initial state, the receiver voltage is displayed at the transmitter.

Display

Calling the setting screen

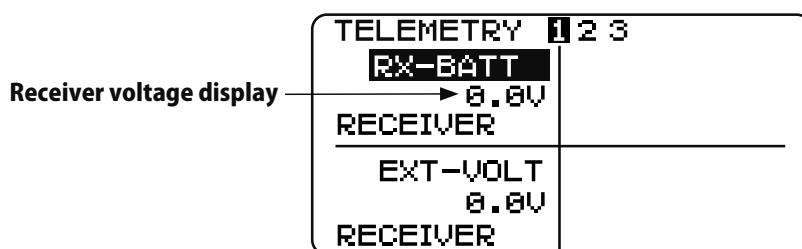
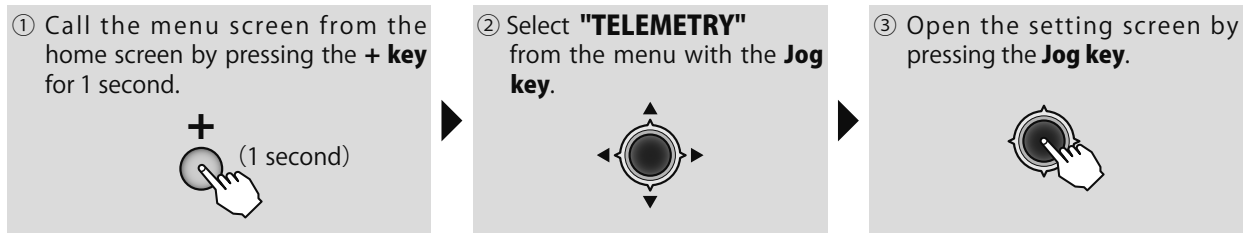

● How to display receiver voltage on a home screen.

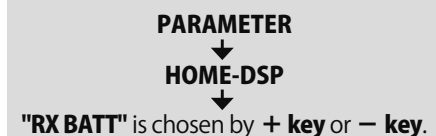



● Viewing the receiver voltage maximum and minimum values.

In the initial state, the receiver voltage maximum and minimum values are displayed in the transmitter. (Value until reset)

Display

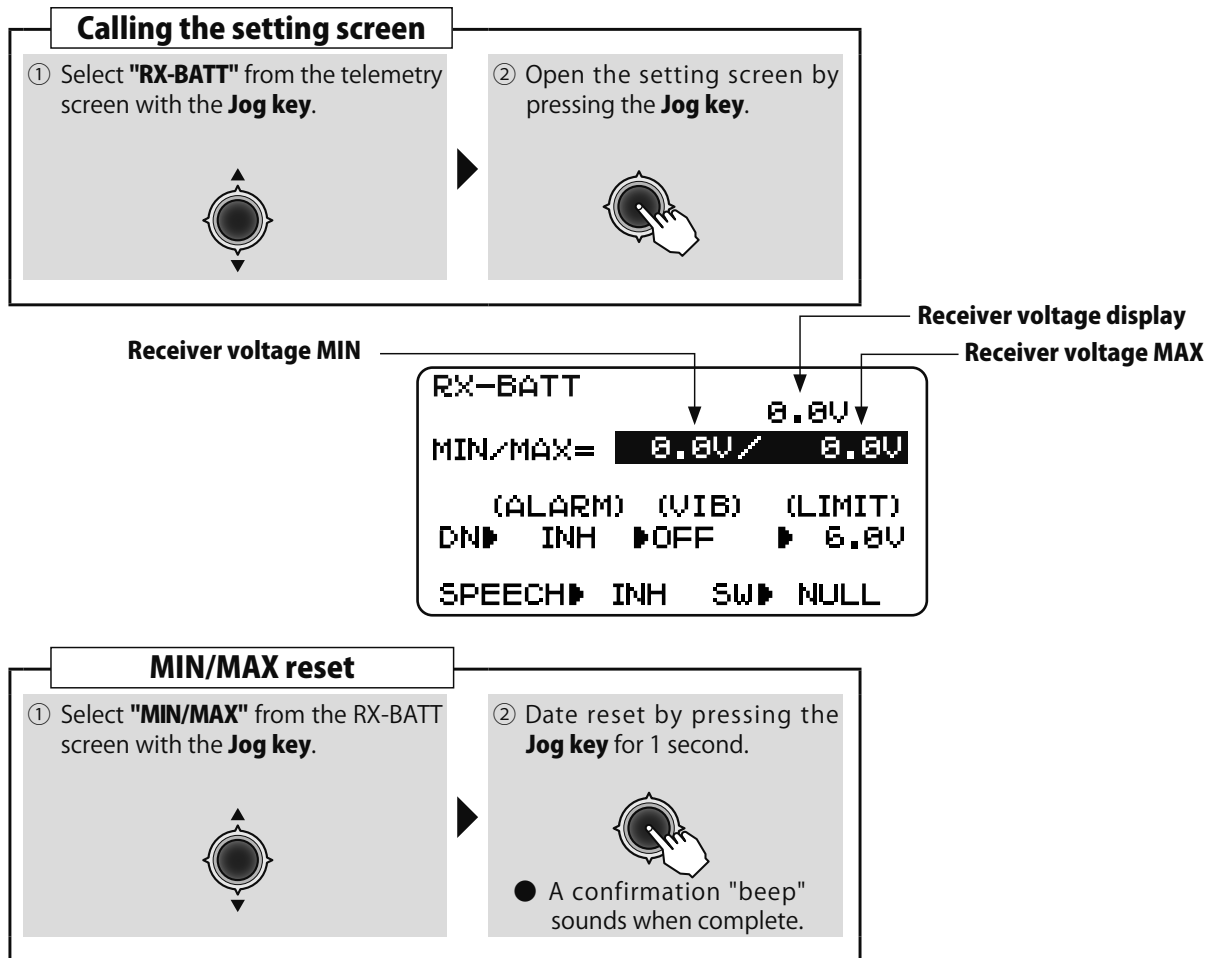

Common function

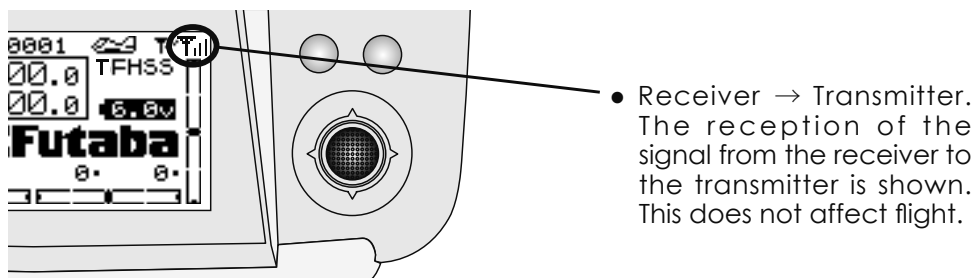

⚠ WARNING

- ⊘ Do not stare at or set the transmitter setting screen while flying.
 - Losing sight of the aircraft during flight is very dangerous.
 - When you want to check the information during flight, call the telemetry screen before flight and have the screen checked by someone other than the operator.



● Setting receiver voltage alarm.

Use this setting to sound an alarm when the receiver battery voltage drops dangerously low. VIB (vibration) that vibrates the transmitter at the same time can also be set.

Method

Calling the setting screen

① Select "RX-BATT" from the telemetry screen with the **Jog key**.



② Open the setting screen by pressing the **Jog key**.



DN (down) shows that an alarm is generated when the voltage drops below the set voltage.

```

RX-BATT                               6.8V
MIN/MAX= 6.8V / 6.8V
(ALARM) (VIB) (LIMIT)
DN▶ INH ▶OFF ▶ 6.8V
SPEECH▶ INH SW▶ NULL
  
```

Alarm set

① In the RX-BATT screen state, select **(ALARM)** from the menu with the **Jog key**.

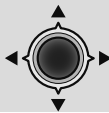

② Select the **"ACT"** by pressing the **+ key** or **- key**.

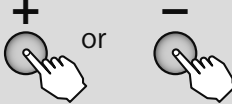

Vibration set

① In the RX-BATT screen state, select **(VIB)** from the menu with the **Jog key**.

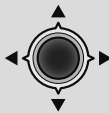

② Select the **"TYP1 ~ TYP3"** by pressing the **+ key** or **- key**.

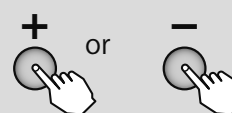

"VIB" types

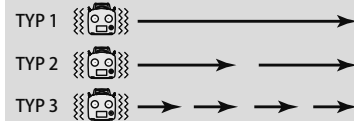

Alarm voltage set

① In the RX-BATT screen state, select **(LIMIT)** 0.0V from the menu with the **Jog key**.

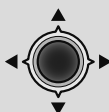

② Select the voltage by pressing the **+ key** or **- key**.

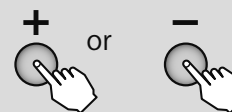

Selection range :
3.5V ~ 8.4V

● When you want to set 5.0V, press the **+ key** and **- key** simultaneously.



● Listening to the receiver voltage by speech.

The receiver voltage can be heard verbally from the transmitter with a commercial earphone (3.5 φ plug). The speech function can be turned on and off with the specified switch.

Method

Calling the setting screen

① Select "RX-BATT" from the telemetry screen with the **Jog key**.



② Open the setting screen by pressing the **Jog key**.

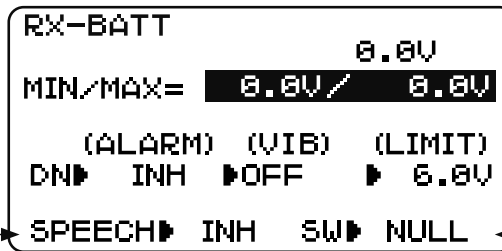

Speech
ACT / INH

Selects the switch
that turns the speech
function on and off.

Speech

① In the RX-BATT screen state, select **(SPEECH)** from the menu with the **Jog key**.

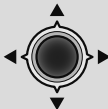

② Select the "ACT" by pressing the **+ key** or **- key**.

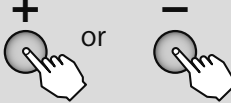

Switch

① In the RX-BATT screen state, select **(SW)** from the menu with the **Jog key**.

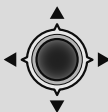

In "NULL", a speech always turns on.

② Select the switch by pressing the **+ key** or **- key**.

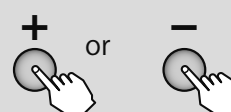

Selection range :
NULL, SWA ~ SWH

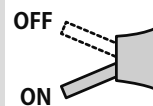

2 Position

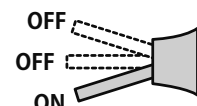

3 Position

Common function



EXT-VOLT

When connected as shown in the figure, the voltage of the drive battery in the aircraft and another power supply battery can be displayed at the T10J.

- CA-RVIN-700 (external voltage input connector sold separately) is necessary.
- Soldered wiring work is necessary.

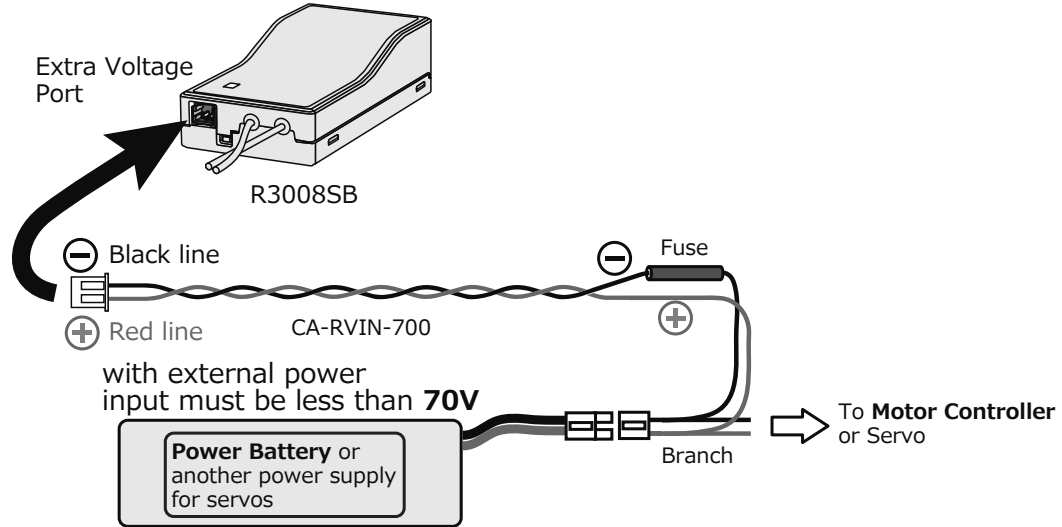

● EXT-Voltage display

When connected as shown in the figure, the drive battery voltage is displayed at the transmitter.

Display

Calling the setting screen

① Call the menu screen from the home screen by pressing the **+** key for 1 second.

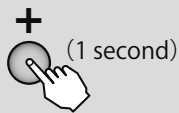

② Select **"TELEMETRY"** from the menu with the **Jog** key.

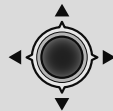

③ Open the setting screen by pressing the **Jog** key.

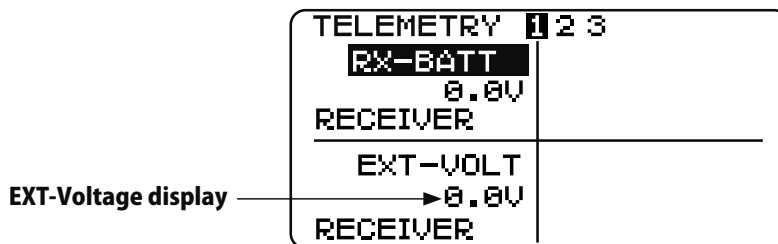



● EXT-Voltage MIN/MAX

In the initial state, the EXT-voltage maximum and minimum values are displayed at the transmitter.
(Value until reset)

Calling the setting screen

① Select "**EXT-VOLT**" from the telemetry screen with the **Jog** key.



② Open the setting screen by pressing the **Jog** key.



EXT-Voltage MIN

EXT-Voltage display

EXT-Voltage MAX

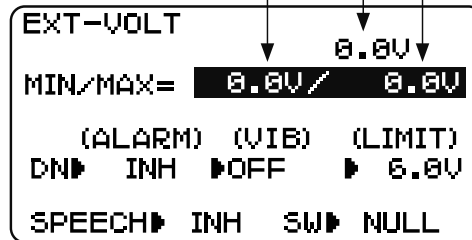

MIN/MAX reset

① In the EXT-VOLT screen state, select **(MIN/MAX)** from the menu with the **Jog** key.



② Date reset by pressing the **Jog** key for 1 second.



- A confirmation "beep" sounds is complete.



● EXT-Voltage alarm set up

This setting will sound an alarm when the EXT-voltage drops dangerously low. VIB (vibration) that vibrates the transmitter at the same time can also be set.

Method

Calling the setting screen

① Select "EXT-VOLT" from the telemetry screen with the **Jog** key.



② Open the setting screen by pressing the **Jog** key.



DN (down) shows that an alarm is generated when the voltage drops below the set voltage.

```

EXT-VOLT                               8.8V
MIN/MAX= 8.8V / 8.8V
(ALARM) (VIB) (LIMIT)
DN▶ INH ▶OFF ▶ 6.8V
SPEECH▶ INH SW▶ NULL
    
```

Alarm set

① In the EXT-VOLT screen state, select (ALARM) from the menu with the **Jog** key.

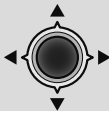

② Select the "ACT" by pressing the **+** key or **-** key.

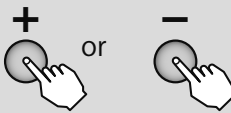

Vibration set

① In the EXT-VOLT screen state, select (VIB) from the menu with the **Jog** key.

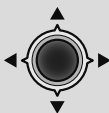

② Select the "TYP1 ~ TYP3" by pressing the **+** key or **-** key.

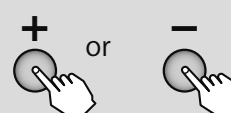

"VIB" types

If the following types are selected, the transmitter will vibrate during the warning.

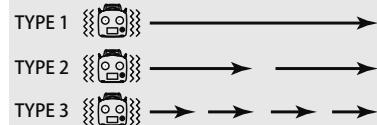

Alarm voltage set

① In the EXT-VOLT screen state, select (LIMIT) from the menu with the **Jog** key.

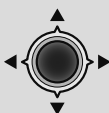

② Select the voltage by pressing the **+** key or **-** key.

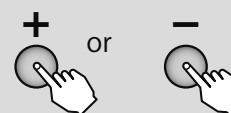

Selection range :
0.0V ~ 70.0V

● When you want to set 5.0V, press the **+** key and **-** key simultaneously.



● Listening to the EXT-voltage by speech.

The EXT- voltage can be heard verbally from the transmitter with a commercial earphone (3.5mm plug). The speech function can be turned on and off with the specified switch.

Method

Calling the setting screen

- ① Select "EXT-VOLT" from the telemetry screen with the **Jog key**.



- ② Open the setting screen by pressing the **Jog key**.

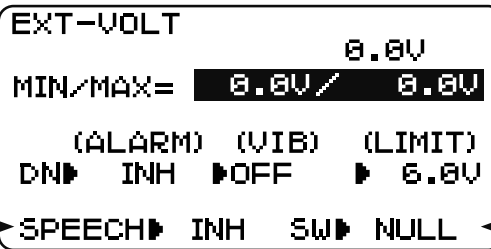

Speech
ACT / INH

Speech ON/OFF Switch
selection

Speech

- ① In the EXT-VOLT screen state, select **(SPEECH)** from the menu with the **Jog key**.

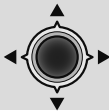

- ② Select the "ACT" by pressing the **+ key** or **- key**.

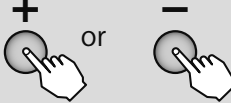

Switch set

- ① In the EXT-VOLT screen state, select **(SW)** from the menu with the **Jog key**.



In "NULL", a speech always turns on.

- ② Select the switch by pressing the **+ key** or **- key**.

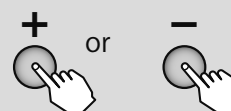

Selection range :
NULL, SWA ~ SWH

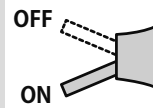

2 Position

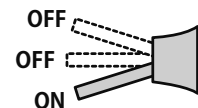

3 Position

Common function



Various telemetry sensors (optional) information display and alarm setting

Various telemetry sensors (sold separately) are connectable to the S.BUS2 port of the R3008SB through a 3-way hub and relay terminals. The information of sensors connected at initialization can be viewed as long as 2 or more of the same kind of sensor are not used (for example, 2 temperature sensors).

- Sensors that can be used with the T10J: Futaba SBS-01T, SBS-01RM, SBS-01RO, SBS-01A, SBS-01V, SBS-01G
 - Robbe sensors that can be used with the T10J: Robbe TEMP125, GPS-1675, VARIO-1712, VARIO-1672, CURR-1678
- *Futaba does not sell Robbe sensor.

Sensor Connection

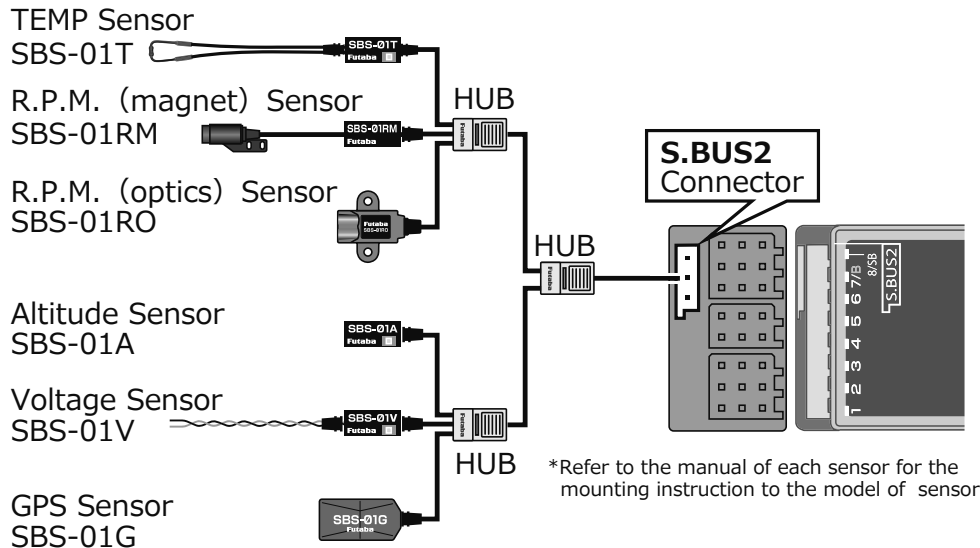

Method

Sensor information can be viewed by calling telemetry from the menu and calling the connected sensor display page. The detailed setting screen of that sensor can be called by selecting and pressing the sensor you want to select with the Jog key.

- Refer to the receiver battery (RX-BATT) item for a description of key operation.

- ① Select "TELEMETRY" from the menu with the **Jog** key.

TELEMETRY	1 2 3
RX-BATT	02 TEMP
0.0V	-----
RECEIVER	SBS-01T
EXT-VOLT	05 R.P.M
0.0V	0rpm
RECEIVER	SBS-01RM/O

- ② The sensor item of your choice is chosen by **Jog** key, and **Jog** key is pressed.

TELEMETRY	1 2 3
RX-BATT	02 TEMP
0.0V	-----
RECEIVER	SBS-01T
EXT-VOLT	05 R.P.M
0.0V	0rpm
RECEIVER	SBS-01RM/O



Sensor set up



TEMP : Display of SBS-01T(Optional), and alarm setup

*A temperature sensor must be installed in the aircraft.

TEMP is a screen which displays/sets up the temperature information from an optional temperature sensor.

The temperature of the model (engine, motor, battery etc.) which is flying can be displayed.

If it becomes higher or lower than the setting an alarm and/or vibration will alert you.

● Conversion of a display unit is performed by "TELEMETRY UNIT" of "PARAMETER".

- Select [TEMP] in the TELEMETRY screen and access the setup screen shown below by press the Jog key.

- "UP" will show that an alarm will start when the temperature rises above the set value.
- "DN" will show that an alarm will start when the temperature drops below the set value.

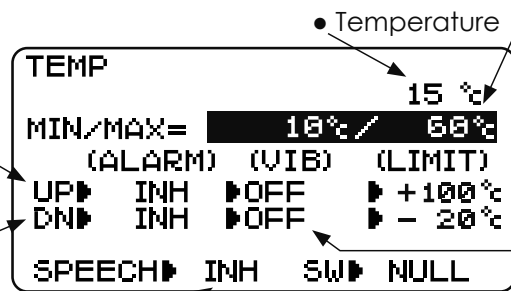

- You can hear the temperature through an earphone or headset, by activating the Speech function.

- The maximum and the minimum when powering ON are shown.
- Maximum and minimum date reset by pressing the **Jog key** for 1 second.

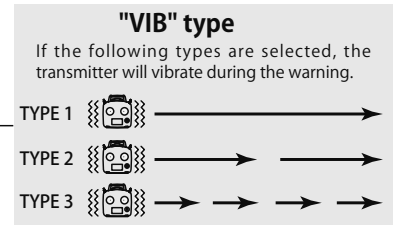

- Switch selection

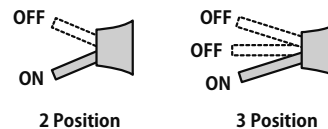

Common function

Alert set : Hot warning

1. Move the cursor to the UP:(ALERT) item.
2. Select the ACT mode by press the +-key.
3. Move the cursor to the UP:(LIMIT)[value]item.
4. Adjust the rate by press the +-key.
Initial value: +100°C
Adjustment range: -20°C ~200°C
(UP:(LIMIT) ≥ DN:(LIMIT))

*When the + - key simultaneous press, the rate is reset to the initial value.

(To terminate the input and return to the original state, touch the END key.)

Alert set : Low-temperature warning

1. Move the cursor to the DN:(ALERT) item.
2. Select the ACT mode by press the +-key.
3. Move the cursor to the DN:(LIMIT)[value]item.
4. Adjust the rate by press the +-key.
Initial value: 0°C
Adjustment range: -20°C ~200°C
(UP:(LIMIT) ≥ DN:(LIMIT))

*When the + - key simultaneous press, the rate is reset to the initial value.

(To terminate the input and return to the original state, touch the END key.)



R.P.M : Display of SBS-01RM/RO(Optional), and alarm setup

*A RPM sensor must be installed in the aircraft.

RPM is a screen which displays / sets up the RPM information from an optional RPM sensor.

The RPM of the model (engine, motor, etc.) which is flying can be shown.

If it becomes higher or lower than the setting an alarm and/or vibration will alert you.

- Select [RPM] in the TELEMETRY screen and access the setup screen shown below by press the Jog key.

- UP: Indicates that the alarm will start when the RPM rises above the set value.
- DN: Indicates that the alarm will start when the RPM falls below the set value.

- You can hear the RPM data through an earphone or headset, by Activating the Speech function.

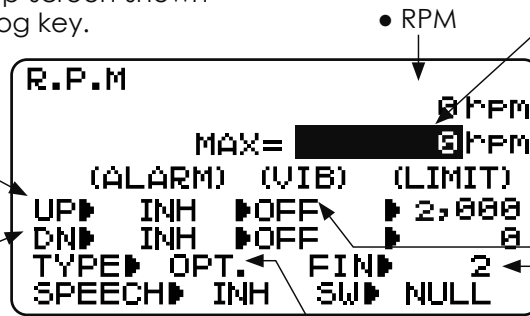

- "MAG.(MAGNETIC)" or "OPT.(OPTICAL)" is set according to the sensor you use.

SBS-01RM : MAGNETIC
SBS-01RO : OPTICAL

- Switch selection

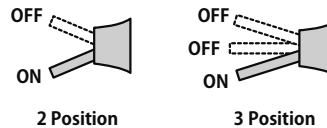

- The maximum when powering ON are shown.
- Maximum date reset by pressing the **Jog** key for 1 second.

"VIB" type

If the following types are selected, the transmitter will vibrate during the warning.

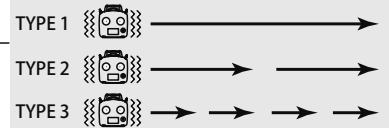

- In "OPTICAL", the number of blades("FIN" of the propeller (r o t o r) your model is entered.
- In "MAGNETIC", the gear ratio of your engine (motor) you are using is entered.

Common function

Alert set : Over rotations

1. Move the cursor to the UP:ALERT item.
2. Select the ACT mode by press the +-key.
3. Move the cursor to the UP:(LIMIT) [value]item.
4. Adjust the rate by press the +-key.
Initial value: 2000rpm
Adjustment range: 0rpm~390,000rpm
(UP:(LIMIT) ≥ DN:(LIMIT))

*When the + - key simultaneous press, the rate is reset to the initial value.

(To terminate the input and return to the original state, touch the END key.)

Alert set : Under rotations

1. Move the cursor to the DN:ALERT item.
2. Select the ACT mode by press the +-key.
3. Move the cursor to the DN:(LIMIT) [value]item.
4. Adjust the rate by press the +-key.
Initial value: 0rpm
Adjustment range: 0rpm~390,000rpm
(UP:(LIMIT) ≥ DN:(LIMIT))

*When the + - key simultaneous press, the rate is reset to the initial value.

(To terminate the input and return to the original state, touch the END key.)



ALTITUDE : Display of SBS-01A / SBS-01G(Optional), and alarm setup

*An altitude sensor or GPS sensor must be installed in the aircraft.

ALTITUDE is a screen which displays / sets up the altitude information from an optional altitude sensor or GPS sensor. The altitude of the model which is flying can be known. If it becomes higher (low) than preset altitude, you can be told by alarm. To show warning by vibration can also be chosen. Data when a power supply is turned on shall be 0 m, and it displays the altitude which changed from there. Even if the altitude of an airfield is high,

that shall be 0 m and the altitude difference from an airfield is displayed. This sensor calculates the altitude from atmospheric pressure. Atmospheric pressure will get lower as you go up in altitude, using this the sensor will estimate the altitude. Please understand that an exact advanced display cannot be performed if atmospheric pressure changes in a weather situation.

● Conversion of a display unit is performed by "TELEMETRY UNIT" of "PARAMETER".

● Select [ALTITUDE] in the TELEMETRY screen and access the setup screen shown below by press the Jog key.

● The maximum and the minimum when powering ON are shown.

● Maximum and minimum date reset by pressing the Jog key for 1 second.

● "UP" indicates the alarm will start when the altitude reaches above your set value.

● "DN" indicates the alarm will start when the altitude reaches below your set value.

● You can hear the Altitude data through an earphone or headset, by Activating the Speech function.

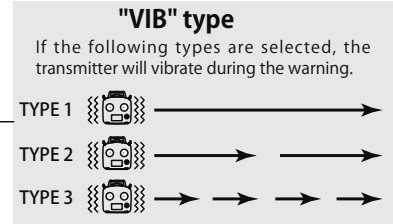
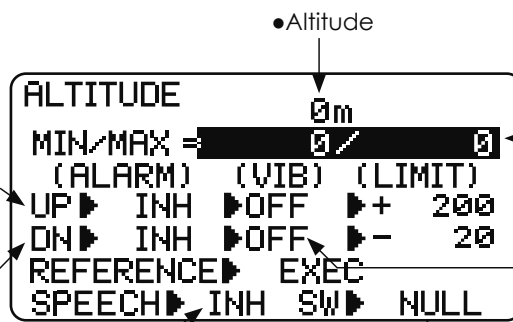

● Switch selection

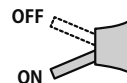

2 Position



3 Position

Common function

First, the set of a reference is required.

1. The model and transmitter to which the altitude sensor was connected are turned on.
2. Move the cursor to the [REFERENCE] of "EXEC" item.
3. Press the Jog key (1s or more press).

*Atmospheric pressure is changed according to the weather also at the same airfield. You should preset before a flight.

Alert set : High side

1. Move the cursor to the UP:(ALERT) item.
2. Select the ACT mode by press the +-key.
3. Move the cursor to the UP:(LIMIT)[value] item.
4. Adjust the rate by press the +-key.
Initial value: +200(m)
Adjustment range: -500~+5000(m)
(UP:(LIMIT) ≥ DN:(LIMIT))

*When the + - key simultaneous press, the rate is reset to the initial value.

(To terminate the input and return to the original state, touch the END key.)

Alert set : Low side

1. Move the cursor to the DN:(ALERT) item.
2. Select the ACT mode by press the +-key.
3. Move the cursor to the UP:(LIMIT)[value] item.
4. Adjust the rate by press the +-key.
Initial value: -50(m)
Adjustment range: -500~+5000(m)
(UP:(LIMIT) ≥ DN:(LIMIT))

*When the + - key simultaneous press, the rate is reset to the initial value.

(To terminate the input and return to the original state, touch the END key.)



VARIO : Display of SBS-01A / SBS-01G(Optional), and alarm setup

*An altitude sensor or GPS sensor must be installed in the aircraft.

VARIO is a screen which displays / sets up the variometer information from an optional altitude sensor or GPS sensor.

The variometer of the model which is flying can be known.

If it becomes higher or lower than the setting an alarm and/or vibration will alert you.

● Conversion of a display unit is performed by "TELEMETRY UNIT" of "PARAMETER".

● Select [VARIO] in the TELEMETRY screen and access the setup screen shown below by press the Jog key.

● The maximum and the minimum when powering ON are shown.
● Maximum and minimum date reset by pressing the **Jog key** for 1 second.

● "UP" indicates the alarm will start when the vario reaches above your set value.

● "DN" indicates the alarm will start when the vario reaches below your set value.

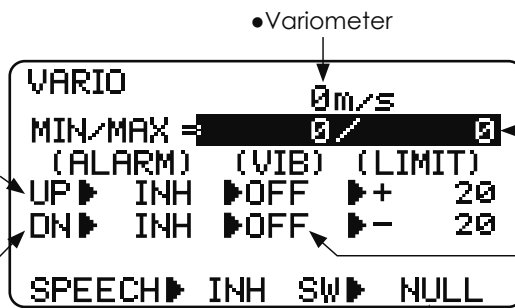

● You can hear the Vario data through an earphone or headset, by Activating the Speech function.

● Switch selection

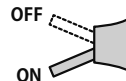

2 Position



3 Position

"VIB" type

If the following types are selected, the transmitter will vibrate during the warning.

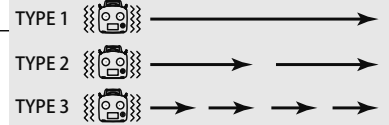

Common function

Alert set : Rise side

1. Move the cursor to the UP:(ALERT) item.
2. Select the ACT mode by press the +-key.
3. Move the cursor to the UP:(LIMIT)[value]item.
4. Adjust the rate by press the +-key.
Initial value: +50(m/s)
Adjustment range: -150~+150(m/s)
(UP:(LIMIT) ≥ DN:(LIMIT))

*When the + - key simultaneous press, the rate is reset to the initial value.

(To terminate the input and return to the original state, touch the END key.)

Alert set : Low side

1. Move the cursor to the DN:(ALERT) item.
2. Select the ACT mode by press the +-key.
3. Move the cursor to the DN:(LIMIT)[value]item.
4. Adjust the rate by press the +-key.
Initial value: -50(m/s)
Adjustment range: -150~+150(m/s)
(UP:(LIMIT) ≥ DN:(LIMIT))

*When the + - key simultaneous press, the rate is reset to the initial value.

(To terminate the input and return to the original state, touch the END key.)



DISTANCE : Display of SBS-01G(Optional), and alarm setup

*An GPS sensor must be installed in the aircraft.

The Distance screen displays and sets altitude data from an SBS-01G GPS Sensor (sold separately), and allows the distance to the airborne aircraft to be read by the transmitter. When the aircraft flies inside or outside the set distance an alarm and vibration alerts the pilot.

*Positioning time of GPS

A short time is required until the positioning of the GPS is established. In the meantime, don't move the model during this process. Wait until the GPS sensor's LED turns solid green. If it is blinking green it is still acquiring the satellites signals.

● Conversion of a display unit is performed by "TELEMETRY UNIT" of "PARAMETER".

- This indicates the receiving accuracy from a GPS satellite. When three bars are displayed, the GPS is ready for use. Pushing [REFERENCE] sets the current aircraft position as the starting point.
- Select [DISTANCE] in the TELEMETRY screen and access the setup screen shown below by press the Jog key.
- Current distance
- This indicates Maximum Distance the aircraft flew to.
- Maximum date reset by pressing the Jog key for 1 second.

DISTANCE 12 G.1

MAX = 0m

(ALARM) (VIB) (LIMIT)

UP ▶ INH ▶ OFF ▶ 200m

DN ▶ INH ▶ OFF ▶ 0m

REFERENCE ▶ EXEC

SPEECH ▶ INH SW ▶ NULL

- The UP: an alarm is generated when the set value is exceeded.
- The DN: an alarm is generated when the distance drops below the set value.
- You can hear the Distance data through an earphone or headset, by Activating the Speech function.

"VIB" type

If the following types are selected, the transmitter will vibrate during the warning.

TYPE 1 → → →

TYPE 2 → → →

TYPE 3 → → →

● Switch selection

2 Position

3 Position

Common function

Setting the reference position

1. Turn on the transmitter and the model with the GPS sensor installed in it.
2. Wait for the GPS accuracy indicator to display three bars.
3. Move the cursor to REFERENCE [EXEC] and press the Jog key(1s or more press). The models current position is now stored and the distance is set to 0 m.

*Now, the position of the present model was set to 0 m.

Setting a "too far" alert distance

1. Move the cursor to the UP:(ALERT) item.
2. Select the ACT mode by press the +-key.
3. Move the cursor to the UP:(LIMIT)[value]item.
4. Adjust the rate by press the +-key.
Initial value: 200(m)
Adjustment range: 0~5000(m)
(UP:(LIMIT) ≥ DN:(LIMIT))

*When the + - key simultaneous press, the rate is reset to the initial value.

(To terminate the input and return to the original state, touch the END key.)

Setting a "too close" alert distance.

1. Move the cursor to the DN:(ALERT) item.
2. Select the ACT mode by press the +-key.
3. Move the cursor to the UP:(LIMIT)[value]item.
4. Adjust the rate by press the +-key.
Initial value: 0(m)
Adjustment range: 0~5000(m)
(UP:(LIMIT) ≥ DN:(LIMIT))

*When the + - key simultaneous press, the rate is reset to the initial value.

(To terminate the input and return to the original state, touch the END key.)



● 2nd page of [DISTANCE]

- Select [DISTANCE] in the TELEMETRY screen and access the setup screen shown below by press the Jog key.

- Jog key press a side made 2 page.

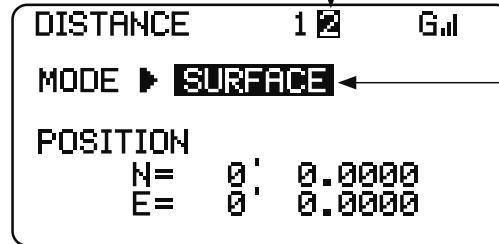

- Current position display.
N: North latitude, E: East longitude
S: South latitude, W: West longitude

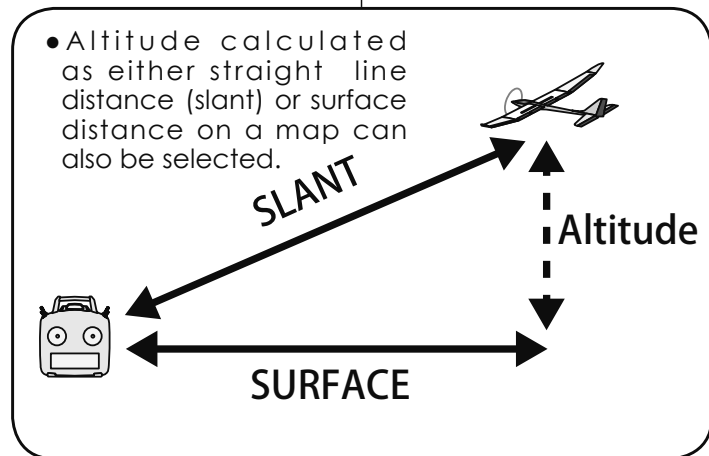

Two distance calculation methods are available Surface (straight line distance), and Slant may be selected.

1. Select page 2 by Jog key press side from the "DISTANCE" screen.
2. Select <SLANT> <SURFACE> next to "MODE" press the +/- key.



SPEED : Display of SBS-01G(Optional), and alarm setup

*An GPS sensor must be installed in the aircraft.

The speed screen displays and sets the speed data from an SBS-01G (GPS sensor) sold separately.

The speed of the aircraft during flight can be displayed.

After flight, the maximum speed during flight can be viewed. Because this speed is based on position data from a GPS satellite, the ground speed is displayed instead of air speed. Consequently, with a head wind, the displayed speed decreases

and with a tail wind, the displayed speed increases.

- Conversion of a display unit is performed by "TELEMETRY UNIT" of "PARAMETER".

*Positioning time of GPS

A short time is required until the positioning of the GPS is established. In the meantime, don't move the model during this process. Wait until the GPS sensor's LED turns solid green. If it is blinking green it is still acquiring the satellites signals.

- This indicates the receiving accuracy from a GPS satellite. When three bars are displayed, the GPS is ready for use. Speed is not displayed when receiving accuracy is bad.
- Select [SPEED] in the TELEMETRY screen and access the setup screen shown below by press the Jog key.
- The UP: that an alarm is generated when the set value is exceeded.
- The DN: that an alarm is generated when the speed drops below the set value.
- You can hear the Speed data through an earphone or headset, by Activating the Speech function.

SPEED Gnd

0 km/h

MAX = 0 km/h

(ALARM) (VIB) (LIMIT)

UP ▶ INH ▶ OFF ▶ 200

DN ▶ INH ▶ OFF ▶ 0

SPEECH ▶ INH SW ▶ NULL

- Current speed
- This indicates Maximum speed the aircraft flew to.
- Maximum date reset by pressing the Jog key for 1 second.

"VIB" type

If the following types are selected, the transmitter will vibrate during the warning.

TYPE 1 →

TYPE 2 → →

TYPE 3 → → →

- Switch selection

OFF

ON

2 Position

OFF

OFF

ON

3 Position

Common function

Alert setting when speed increases

1. Move the cursor to the UP:(ALERT) item.
2. Select the ACT mode by press the +key.
3. Move the cursor to the UP:(LIMIT)[value]item .
4. Adjust the rate by press the +key.
Initial value: 200(km/h)
Adjustment range: 0~500(km/h)
(UP:(LIMIT) ≥ DN:(LIMIT))

*When the + - key simultaneous press, the rate is reset to the initial value.

(To terminate the input and return to the original state, touch the END key.)

Alert setting when speed decreases

1. Move the cursor to the DN:(ALERT) item.
2. Select the ACT mode by press the +key.
3. Move the cursor to the UP:(LIMIT)[value]item .
4. Adjust the rate by press the +key.
Initial value: 0(km/h)
Adjustment range: 0~500(km/h)
(UP:(LIMIT) ≥ DN:(LIMIT))

*When the + - key simultaneous press, the rate is reset to the initial value.

*This alarm is started once a model becomes more than setting speed.

(To terminate the input and return to the original state, touch the END key.)

*Speed alarm precaution

Since the GPS speed sensor displays the ground speed, it cannot be used as a stall alarm. For example, an aircraft that stalls at 50km/h will stall if the tailwind is 5km/h or greater even though 55km/h is displayed by ground speed. In addition, with an aircraft that will disintegrate in midflight at 400km/h at an over-speed alarm, when the headwind reaches 30km/h the airplane will disintegrate in midair due to over speeding even at a ground speed of 370km/h.



BATTERY / EXT-VOLT: Display of SBS-01V(Optional), and alarm setup

*SBS-01V must be installed in the aircraft.

In this screen, the battery voltage is displayed. In order to use this function, it is necessary to connect of R3008SB ⇔ SBS-01V ⇔ Battery

SBS-01V measures two batteries. The drive battery connected to two lines is displayed on EXT-VOLT. The battery for receivers connected to 3P lines is displayed here.

- Select [BATTERY] in the TELEMETRY screen and access the setup screen shown below by press the Jog key.
- The maximum and the minimum when powering ON are shown.
- Maximum and minimum date reset by pressing the **Jog key** for 1 second.

• "DN" will show that an alarm will start when the EXT-VOLT drops below the set value.

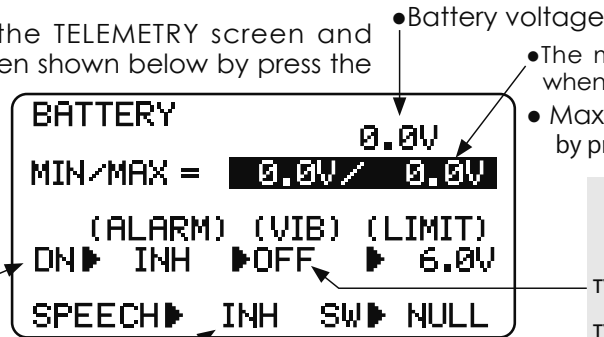

• You can hear the Battery data through an earphone or headset, by Activating the Speech function.

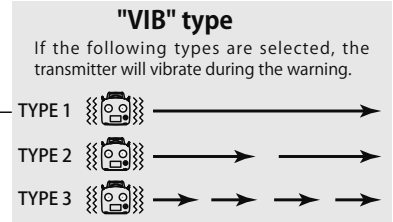
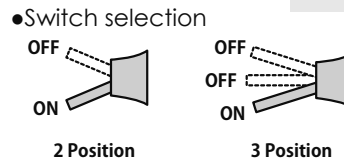

Common function

- Select [EXT-VOLT] in the TELEMETRY screen and access the setup screen shown below by press the Jog key.
- The maximum and the minimum when powering ON are shown.
- Maximum and minimum date reset by pressing the **Jog key** for 1 second.

• "DN" will show that an alarm will start when the EXT-VOLT drops below the set value.

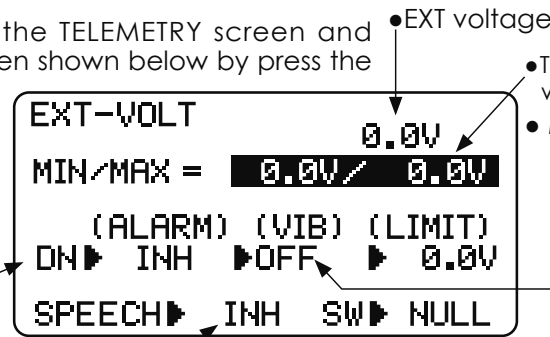

• You can hear the Extra Voltage data through an earphone or headset, by Activating the Speech function.

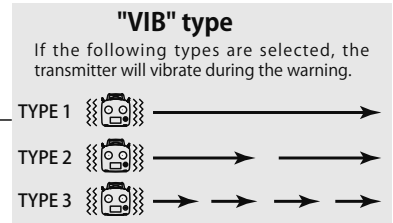
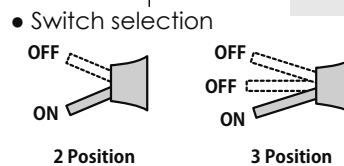

Alert set : Low-temperature warning

1. Move the cursor to the DN:(ALERT) item.
2. Select the ACT mode by press the +key.
3. Move the cursor to the DN:(LIMIT)[value]item.
4. Adjust the rate by press the +key.
Initial value: 5.0V
Adjustment range: 3.5~8.4V(BATTERY)
Adjustment range: 0~70V(EXT-VOLT)

*When the + - key simultaneous press, the rate is reset to the initial value.

(To terminate the input and return to the original state, touch the END key.)



SENSOR

Sensor Slot

(Common)

Function

This screen registers the telemetry sensors used with the transmitter. When only one of a certain type of sensor is used, this setting is unnecessary and the sensor can be used by simply connecting it

to the S.BUS2 port of the transmitter.

When using 2 or more of the same kind of sensor, they must be registered here.

[What is a slot?]

Servos are classified by CH, but **sensors** are classified in units called "**slot**". There are **slots** from **No. 1** to **No. 31**.

Altitude sensors, GPS sensors and other data sensor units may use **multiple slots**.

Using a sensor which uses two or more slots, the required number of slots is automatically assigned by setting up a **start slot**.

When 2 or more of the same kind of sensor are used, the sensors themselves must allocate unused slots and memorize that slot.

- The "**SENSOR**" of a menu is chosen, and **Jog key** press.

- **Jog key** presses side and makes it 2 pages.

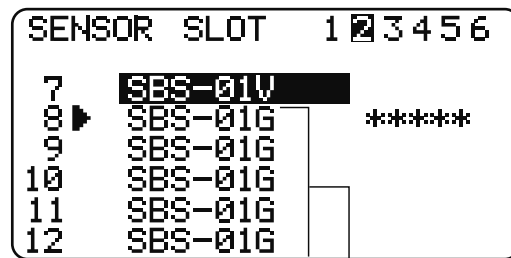
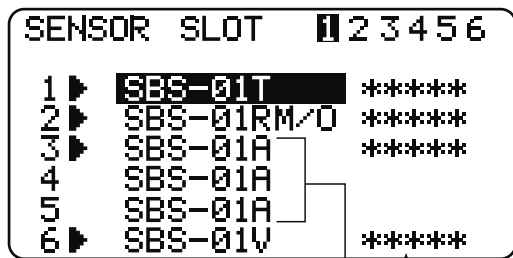

● Slot number

● 8 slots SBS-01G is used.

● 3 slots SBS-01A is used.

● SensorID : When multiple sensors of the same type are not used, ID is unnecessary.

Common function

< Assignable slot >

*Altimeter, GPS, and other sensors that display a large amount of data require multiple slots.

*Depending on the type of sensor, the slot numbers that can be allocated may be limited.

Sensor	The required number of slots	The number which can be used as a start slot	Selling area
TEMP(SBS-01T)	1 slot	1 ~ 31	Global
RPM(SBS01RM,SBS-01RO)	1 slot	1 ~ 31	
Voltage(SBS-01V)	2 slot	1,2,3,4,5,6,8,9,10,11,12,13,14,16,17,18,19,20,21,22,24,25,26,27,28,29,30	
Altitude(SBS-01A)	3 slot	1,2,3,4,5,8,9,10,11,12,13,16,17,18,19,20,21,24,25,26,27,28,29	
GPS(SBS-01G)	8 slot	8,16,24	
TEMP125-F1713	1 slot	1 ~ 31	Europe
VARIO-F1712	2 slot	1,2,3,4,5,6,8,9,10,11,12,13,14,16,17,18,19,20,21,22,24,25,26,27,28,29,30	
VARIO-F1672	2 slot	1,2,3,4,5,6,8,9,10,11,12,13,14,16,17,18,19,20,21,22,24,25,26,27,28,29,30	
CURR-F1678	3 slot	1,2,3,4,5,8,9,10,11,12,13,16,17,18,19,20,21,24,25,26,27,28,29	
GPS-F1675	8 slot	8,16,24	



● REGISTER (When using multiple telemetry sensors of the same type.)

This function registers an additional sensor. Connect the sensor as shown in the figure and register it by the following procedure. The sensor ID is registered in the transmitter.

Sensor connect

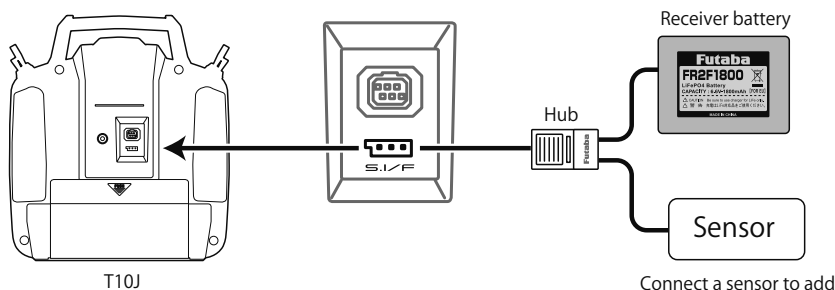

Method

Calling the setting screen

- 1 Call the menu screen from the home screen by pressing the **+** key for 1 second.



- 2 Select **"SENSOR"** from the menu with the **Jog** key.

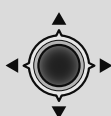

- 3 Open the setting screen by pressing the **Jog** key.



- 4 **Jog** key presses side and makes it 6pages.

SENSOR SLOT 1 2 3 4 5 6

```

1 ▶ SBS-01T *****
2 ▶ SBS-01RM/O *****
3 ▶ SBS-01A *****
4 ▶ SBS-01A
5 ▶ SBS-01A
6 ▶ SBS-01V *****
    
```

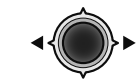

Left 1-time
press
or
Right 10-
time press

SENSOR SLOT 1 2 3 4 5 6

```

31 INHIBIT
▶ REGISTER
▶ SENS SLOT
▶ INITIALIZE
▶ ALL CLEAR
    
```

Common function

Sensor register

- 1 **"REGISTER"** in SENSOR SLOT page 6 is chosen by **Jog** key.



- 2 Press the **Jog** key for 1 second.



- Confirmation message **"sure?"** blinks.

- 3 Press the **Jog** key.



- A confirmation **"beep"** sounds when complete.

- **"COMU-ERROR"** : When the number of slots needed in registration is insufficient, an error is displayed and registration cannot be performed.



● SENS SLOT

This procedure changes the slot number of one registered sensor.

Sensor connection

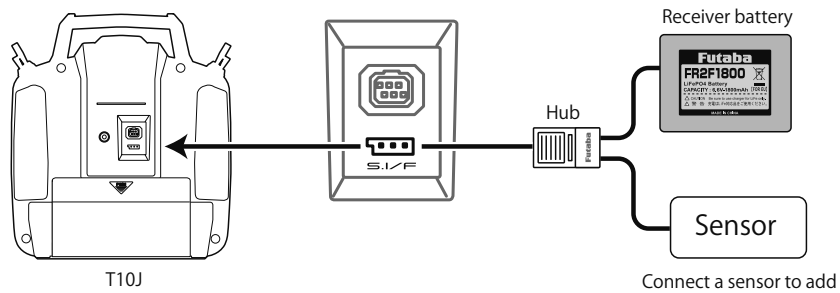

Calling the setting screen

① "SENS SLOT" in SENSOR SLOT page
6 is chosen by **Jog key**.



② **Jog key** press.



● **READ** is chosen and **Jog key** is pressed → "sure?"
→ **Jog key** is pressed.

SENSOR SLOT SETTING

READ

START SLOT = ** → 1

SLOT LENGTH = **

TYPE = ----

ID = *****

● **Number** is chosen, Input a number by the **+** key or **-** key.

*Referred to

< Assignable slot >

● **"COMU-ERROR"** when reading goes wrong.

● Once the sensor is read correctly, the Sensor ID will be displayed



● INITIALIZE

This function returns the slot setting and alarm setting of each sensor to their initial value (shipped state). Various sensors can be used one by one.

*The slot number memorized at each sensor cannot be initialized.

Calling the setting screen

① Call the menu screen from the home screen by pressing the **+** key for 1 second.



② Select **"SENSOR"** from the menu with the **Jog** key.

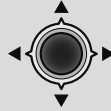

③ Open the setting screen by pressing the **Jog** key.



④ **Jog** key presses side and makes it 6 pages

SENSOR	SLOT	1	2	3	4	5	6
1	▶	SBS-01T	*****				
2	▶	SBS-01RM/O	*****				
3	▶	SBS-01A	*****				
4	▶	SBS-01A					
5	▶	SBS-01A					
6	▶	SBS-01V	*****				



SENSOR	SLOT	1	2	3	4	5	6
31	▶	INHIBIT					
	▶	REGISTER					
	▶	SENS SLOT					
	▶	INITIALIZE					
	▶	ALL CLEAR					

Common function

Initialize

① **"INITIALIZE"** in SENSOR SLOT page 6 is chosen by **Jog** key.



② Press the **Jog** key for 1 second.



● Confirmation message **"sure?"** blinks.

③ Press the **Jog** key.



● The initialization is done when **"Complete"** is shown.



● ALL CLEAR

This function sets all the slots to INH. Sensors cannot be used even if connected to the receiver. All the alarm settings of each sensor are also cleared.

*The slot number memorized at each sensor is not initialized.

Calling the setting screen

① Call the menu screen from the home screen by pressing the **+** key for 1 second.

 (1 second)

② Select **"SENSOR"** from the menu with the **Jog key**.

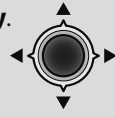

③ Open the setting screen by pressing the **Jog key**.



▶ ④ **Jog key** presses side and makes it 6 pages

SENSOR	SLOT	1	2	3	4	5	6
1 ▶	SBS-01T	*****					
2 ▶	SBS-01RM/O	*****					
3 ▶	SBS-01A	*****					
4 ▶	SBS-01A						
5 ▶	SBS-01A						
6 ▶	SBS-01V	*****					



Left 1-time
press
or
Right 10-
time press

SENSOR	SLOT	1	2	3	4	5	6
31	INHIBIT						
▶	REGISTER						
▶	SENS SLOT						
▶	INITIALIZE						
▶	ALL CLEAR						

Common function

All clear

① **"ALL CLEAR"** in SENSOR SLOT page 6 is chosen by **Jog key**.



② Press the **Jog key** for 1 second.



- Confirmation message **"sure?"** blinks.

③ Press the **Jog key**.



- The clearing is done when **"Complete"** is shown.

87



● Manually assigning a sensor slot number

A slot number can be assigned without connecting the sensor to the transmitter. In a manual set, it is required to store a start slot number in a sensor.

Calling the setting screen

- ① Call the menu screen from the home screen by pressing the **+ key** for 1 second.



- ② Select **"SENSOR"** from the menu with the **Jog key**.

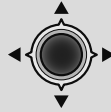

- ③ Open the setting screen by pressing the **Jog key**.



- ④ **Jog key** is pressed in a side and it searches for an empty slot. (INHIBIT).

SENSOR SLOT 1 2 3 4 5 6

1	SBS-01T	*****
2	SBS-01RM/O	*****
3	SBS-01A	*****
4	SBS-01A	
5	SBS-01A	
6	SBS-01V	*****



SENSOR SLOT 1 2 3 4 5 6

13	SBS-01G	
14	SBS-01G	
15	SBS-01G	
16	INHIBIT	
17	INHIBIT	
18	INHIBIT	

Common function

Assignment of slot

- ① When an INHIBIT slot is selected and the **Jog key** is pressed, a list of sensors that can be assigned to that slot is displayed.



*Refer to the <Assignable slots> table.

- ② Select the sensor you want to assign and press the **Jog key**.



- ③ Press the **END key**.

END





SBUS LINK S.BUS servo link

(Common)

Function

An S.BUS servo can memorize the channel and various settings you input. Servo setting can be performed on the T10J screen by wiring the servo as shown in the figure.

* With some S.BUS(2) servos, there are some functions with cannot be used. If a function cannot be used, the display screen will change. (Only the function which can be used by a servo is displayed.)

* After reading completion, with connection of the above figure, if a stick is moved, the test of operation of the servo can be operated and carried out.

Method

Calling the setting screen

① Call the menu screen from the home screen by pressing the **+** key for 1 second.

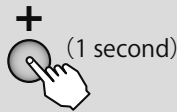

② Select **"SBUS LINK"** from the menu with the **Jog** key.

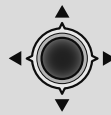

③ Open the setting screen by pressing the **Jog** key.



S.BUS SX

MODE IN

PLEASE DO NOT YET
CONNECT A SERVO

④ Press the **Jog** key for 1 second.



(1 second)

S.BUS SX

(NO LINK)

READ

⑤ Connect a S.BUS servo to set up.

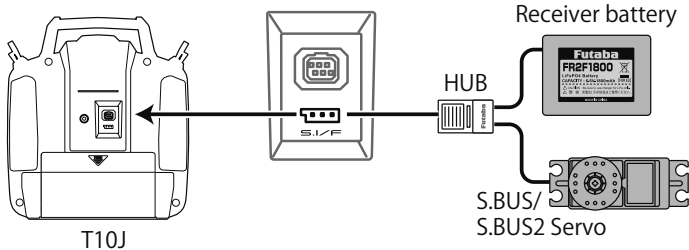

CAUTION

- Don't connect a servo until "MODE IN".
- Otherwise, a servo will vibrate and break down.

S.BUS Servo setting

⑤ **"READ"** is chosen by **Jog** key, Press the **Jog** key for 1 second.



⑥ READ is completed and the item in which data of S.BUS servo and a setup are possible is displayed.

* **"COMU-ERROR"** :
It is failure of READ. Check a servo and connection.

⑦ S.BUS servo is set up.
⑧ **"WRITE"** is chosen and **Jog** key is pressed for 1 second.



The writing is done when **"Complete"** is shown.

Next page S.BUS servo function

Common function



S.BUS Servo Description of function of each parameter

*There are a function which can be used according to the kind of servo, and an impossible function.

```

S.BUS SX      1 2
ID= 017-00016
READ WRITE RESET

CHAN▶ 1  DEAD▶ 0.36
                    REVE▶ NORM
NEUT▶ 0.00
EPA▶ 100.0(L/R) 100.0

```

```

S.BUS SX      1 2
ID= 017-00016
READ WRITE RESET

STRE▶ 2.0  SPED▶ INH
BOST▶ 5%  STAR▶ 3.0
DAMP▶ 80  SMOT▶ ON
BSTM▶ OFF

```

ID = [ID]

Displays the ID of the servo whose parameters are to be read. It cannot be changed.

CHAN ▶ [Channel]

Channel of the S.BUS system assigned to the servo. Always assign a channel before use.

NEUT ▶ [Neutral Offset]

The neutral position can be changed. When the neutral offset is large value, the servo's range of travel is restricted on one side.

EPA ▶ [Travel Adjust]

The left and right travels centered about the neutral position can be set independently.

DEAD ▶ [Dead band]

The dead band angle at stopping can be specified.

[Relationship between dead band set value and servo operation]

Small → Dead band angle is small and the servo is immediately operated by a small signal change.

Large → Dead band angle is large and the servo does not operate at small signal changes.

(Note) If the dead band angle is too small, the servo will operate continuously and the current consumption will increase and the life of the servo will be shortened.

REVE ▶ [Reverse]

The direction in which the servo rotates can be changed.

STRE ▶ [Stretcher]

The servo hold characteristic can be set. The torque which attempts to return the servo to the target position when the current servo position has deviated from the target position can be adjusted.

This is used when stopping hunting, etc., but the holding characteristic changes as shown below.

[Relationship between stretcher and servo operation]

Small → Servo holding force becomes weaker.

Large → Servo holding force becomes stronger.

(Note) When this parameter is large, the current consumption increases.



BOST ▶ 3% ~ 45% [Boost]

The minimum current applied to the internal motor when starting the servo can be set. Since a small travel does not start the motor, it essentially feels like the dead band was expanded. The motor can be immediately started by adjusting the minimum current which can start the motor.

[Relationship between boost set value and servo operation]

Small → Motor reacts to a minute current and operation becomes smooth.

Large → Initial response improves and output torque increases. However, if the torque is too large, operation will become rough.

DAMP ▶ [Damper]

The characteristic when the servo is stopped can be set.

When smaller than the standard value, the characteristic becomes an overshoot characteristic. If the value is larger than the standard value, the brake is applied before the stop position.

Especially, when a large load is applied, overshoot, etc. are suppressed by inertia and hunting may occur, depending on the conditions. If hunting (phenomena which cause the servo to oscillate) occurs even though the Dead Band, Stretcher, Boost and other parameters are suitable, adjust this parameter to a value larger than the initial value.

[Relationship between damper set value and servo operation]

Small → When you want to overshoot. Set so that hunting does not occur.

Large → When you want to operate so that braking is not applied. However, it will feel like the servo response has worsened.

(Note) If used in the hunting state, not only will the current consumption increase, but the life of the servo will also be shortened.

BSTM ▶ ON/OFF [Boost ON/OFF]

OFF : It is the boost ON at the time of low-speed operation.(In the case of usual)

ON : It is always the boost ON.(When quick operation is hope)

SPED ▶ [Speed Control]

Speeds can be matched by specifying the operating speed. The speed of multiple servos can be matched without being affected by motor fluctuations. This is effective for load torques below the maximum torque.

However, note that the maximum speed will not be exceed what the servo is capable of even if the servos operating voltage is increased.

STAR ▶ [Soft Start]

Restricts operation in the specified direction the instant the power is turned on. By using this setting, the first initial movement when the power is turned on slowly moves the servo to the specified position.

SMOT ▶ [Smoother]

This function changes smoothness of the servo operation relative to stick movement changes. Smooth setting is used for normal flight. Select the "OFF" mode when quick operation is necessary such as 3D.



MDL-TRANS Model transfer

(Common)

Function

Transmission of model data is possible with T10J transmitters. Data transfer is performed by the radio. The MDL-TRANS function works with the current model you are using in the transmitter. As for the receiving transmitter, any data on the current model that is receiving the information will be over-written.

*T10J does not carry out normal operation during data transfer.

CAUTION

- Always check servo direction prior to every flight as an additional precaution to confirm proper model date, hook ups, and radio function.

NOTE: MDL-TRANS between two T10J radios should be performed within a 2-meter range.

Method

Calling the setting screen

- Call the menu screen from the home screen by pressing the **+** key for 1 second.

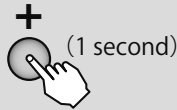

- Select **"MDL-TRANS"** from the menu with the **Jog** key.

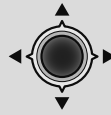

- Open the setting screen by pressing the **Jog** key.



Common function



Execution of transmission/
reception

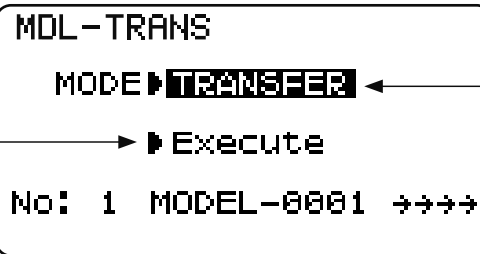

MODE :
TRANSFER (T10J of data origin) /
RECEIVE (T10J which receives data)

Model transfer

- MDL-TRANS between two T10J radios should be performed within 2-meter range.

- In each T10J, the **+** or **-** key is pressed and it is made **"TRANSFER"** and **"RECEIVE"**.

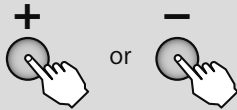

- "TRANSFER"** : T10J of data origin
- "RECEIVE"** : T10J which receives data

Selection range : **TRANSFER, RECEIVE**

- Select **"Execute"** with the **Jog** key.

Perform the following work from
[1]RECEIVE T10J to [2]TRANSFER
T10J in order.

- Hold down the **Jog** key the **RECEIVE** T10J.
- Hold down the **Jog** key the **TRANSFER** T10J.



- "Complete"** is displayed and the mode transfer is finished.

From T8J to T10J, data transfer is possible. In that case, TYPE of T10J on the **"RECEIVER"** side is changed into **"T8J"** by **+** **-** key. However, data cannot be sent to T8J from T10J.

If data is not being transmitted, the receiving transmitter returns to normal operation 10 seconds after execution. At this time, **"Failure"** (not transmitting) is displayed.



Function

Since the channel and operation mode used in training can be selected, the training difficulty can be set to match the student's level.

The trainer function can be used by connecting the instructor's transmitter to the student's transmitter using a special trainer cord (sold separately). Student operation is possible by instructor switch operation. If the student enters a dangerous situation, control can be immediately switched to the instructor.

- Four operation modes can be selected at each channel.
- The trainer switch is set to switch H.

When the trainer function is used, the snap roll function is automatically deactivated.

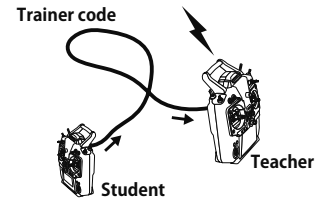

⚠ CAUTION

Use the trainer function under the following conditions:

- When the instructor uses a T10J transmitter, set the student's transmitter modulation to PPM (for conventional frequency transmitter). (When the student uses a T10J transmitter, the modulation mode does not have to be changed. A PPM signal is always output from the trainer jack.)
- Before flight always confirm that all the instructor and student channels operate normally as set.
- Always insert the trainer cord as far as it will go and take measures so that the cord will not work loose during use.
- Always remove the high frequency module of the student's transmitter. (For module type)
- Never turn on the student's transmitter power switch.

Trainer function operation modes

- FNC mode: The channel set to this mode can be controlled by the student using the mixing set at the instructor's transmitter. ***Student settings are returned to their initial value in advance. Next, reverse function makes all channels normal.**
- MIX mode: The channel set to this mode is controlled by mixing the instructor and student signals. Correction rudder is applied by the instructor. When this mode is selected, the student's rate is reduced to prevent servo overthrow. The student's rate can also be set. ***Student settings are returned to their initial value in advance. Next, reverse function makes all channels normal.**
- NOR mode: The channel set to this mode is controlled by signals from the student's transmitter. (The instructor and student settings must be the same.)
- OFF mode: The channel set to this mode cannot be controlled by the student. It can only be controlled by the instructor.

However, channels not provided at the student's transmitter are controlled by the instructor regardless of the above settings.

When other models are selected, the trainer function is deactivated, but the channel settings remain.

Example of use

- When the FUNC mode is set at the stick channel, helicopter stick operation training is possible even with a 4EX transmitter (4 channels for aircraft).
- Control by the instructor is possible by setting only the training channel matched to the student's level to the NORM mode and setting the other channels to the OFF mode.

◆ Trainer Cords

Instructor	Student	Trainer Cords
10J	10C, 9C, 7C, 6EX, 4EX	T12FG (FUTM4405)
	18MZ, 14MZ, 14SG, FX-22, 12Z, 12FG, 8FG, 10J , 8J, 6J	T12FG (FUTM4405) and 9C (FUTM4415) Trainer Cords
18MZ, 14MZ, 14SG, FX-22, 12Z, 12FG, 8FG, 10C, 9C, 7C, 8J, 6J, 4EX	10J	



Common function



Method

Calling the setting screen

① Call the menu screen from the home screen by pressing the **+ key** for 1 second.



② Select **"TRAINER"** from the menu with the **Jog key**.

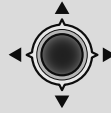

③ Open the setting screen by pressing the **Jog key**.



(Trainer function)

● Select the item with the **Jog key**.



Function activation

Channel Select

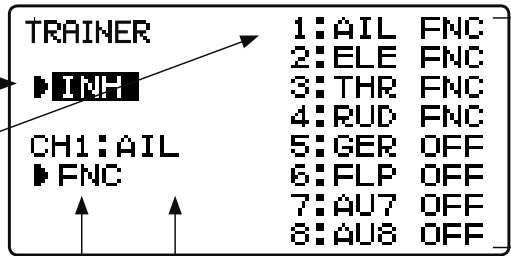

● Channel setting mode display

Select CH mode Display Rate by student (at MIX mode)

< ChannelDisplay >

ACROBATIC		HELICOPTER		GLIDER (AF2)		MULTICOPTER	
1: AIL (Aileron)	6: FLP (Flap)	1: AIL (Aileron)	6: PIT (PITCH)	1: AIL (Aileron)	6: FL2 (Flap2)	1: AIL (Aileron)	6: AU6
2: ELE (Elevator)	7: AU7	2: ELE (Elevator)	7: AU7	2: ELE (Elevator)	7: AI2 (Aileron2)	2: ELE (Elevator)	7: AU7
3: THR (Throttle)	8: AU8	3: THR (Throttle)	8: AU8	3: MOT (Motor)	8: AU8	3: THR (Throttle)	8: AU8
4: RUD (Rudder)		4: RUD (Rudder)		4: RUD (Rudder)		4: RUD (Rudder)	
5: GER (Gear)		5: GYR (GYRO)		5: FLP (Flap)		5: MOD (Mode)	

*CH9 and CH10 cannot use a trainer function.

Trainer function

Function activation

① Select the **"OFF"** by pressing the **+ key** or **- key**.

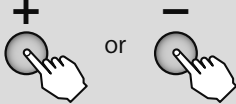

● When you do not want to use the function select INH.

Mode setting

② The mode of the channel of hope is chosen by pressing the **+ key** or **- key**.

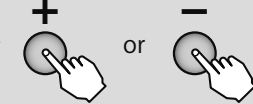

Selection range : OFF, NOR, FNC, MIX, Default : OFF

(When MIX mode Select)

Student rate setting

③ **Jog key** is pressed in a side and a channel is chosen, rate setting by pressing the **+ key** or **- key**.

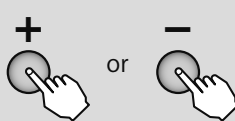

Range : 0 ~ 100%

Default : 30%



Airplane Function

The setting screen of each function is called from the following menu. The function when the model type was set to airplane (ACROBATIC) is displayed here.

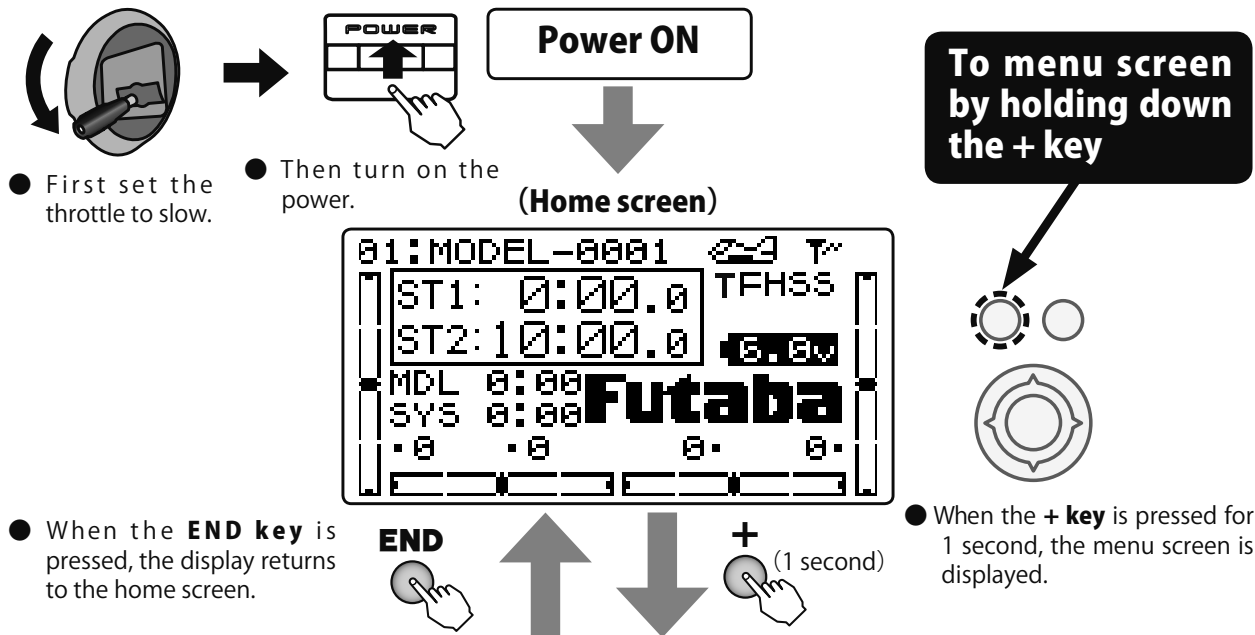

MENU

MENU 1/3

MENU 2/3

MENU 3/3

MENU 1 2 3	
▶MDL-SEL	▶END POINT
▶MDL-NAME	▶TRIM
▶FAIL SAFE	▶SUB TRIM
▶REVERSE	▶P.MIX1-6
▶TIMER	▶AUX-CHAN
▶SERVO	▶PARAMETER

MENU 1 2 3	
▶TELEMETRY	▶AIL→RUD
▶SENSOR	▶V-TAIL
▶SBUS LINK	▶GYRO SENS
▶MDL-TRANS	▶ELEVON
▶TRAINER	▶AILVATOR
▶AIL-DIFF	▶THR→NEEDL

MENU 1 2 3	
▶D/R EXPO	▶THR.CUT
▶FLAPERON	▶IDLE DOWN
▶AIR-BRK	▶SNAP ROLL
▶FLAP→ELE	▶THR-CURVE
▶ELE→FLAP	▶PIT-CURVE
▶FLAP TRIM	▶THR DELAY

(Selection)

● Move the cursor (highlighted) up and down and to the left and right with the **Jog key** and select the function. The cursor can be moved over several pages.

(Calling the setting screen)

● Press the **Jog key** to open the setting screen.

Airplane

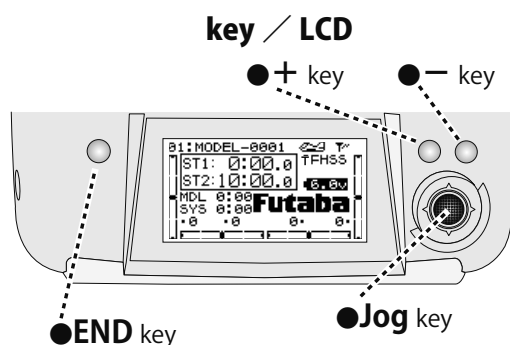

Refer to "**Common Functions**" previously described for a description of this function.

■ **Function**

Airplane

MENU1/3	
MDL-SEL (P.40)	Model select / Model Copy / Data reset / RX / Link
MDL-NAME (P.43)	Model name / User name
FAIL SAFE (P.45)	Fail safe
REVERSE (P.47)	Servo reverse
TIMER (P.48)	Timer
SERVO (P.49)	Servo monitor / Servo test
END POINT (P.50)	End point
TRIM (P.51)	Trim reset / Trim step
SUB TRIM (P.52)	Sub trim
P.MIX1-6 (P.53)	Program mixing 1 ~ 6
AUX-CHAN (P.56)	AUX channel
PARAMETER (P.58)	Data reset / Model type / ATL-trim / LCD contrast / Back light : mode, time, adjustment / Home display / Battery alarm / Battery vibration / Buzzer tone / Jog navi / Jog light / Jog time / Telemetry : mode, unit / Speech : language, volume / Stick position alarm

MENU2/3	
TELEMETRY (P.66)	Telemetry Display / Alarm setup
SENSOR (P.83)	Telemetry sensor
SBUS LINK (P.89)	S.BUS servo set up
MDL-TRANS (P.92)	Data transfer of another 10J or 8J
TRAINER (P.93)	Trainer
AIL-DIFF (P.97)	Aileron Differential
AIL → RUD (P.98)	Aileron → Rudder
V-TAIL (P.99)	V-Tail
GYRO SENS (P.100)	Gyro mixing
ELEVON (P.101)	Elevon
AILVATOR (P.102)	Ailvator
THR → NEEDL (P.103)	Throttle → Needle Mixing

MENU3/3	
D/R, EXPO (P.104)	Dual rate / EXPO
FLAPERON (P.106)	Flaperon
AIR-BRK (P.108)	Air brake
FLAP → ELE (P.110)	Flap → Elevator mixing
ELE → FLAP (P.111)	Elevator → Flap mixing
FLAP TRIM (P.112)	Flap trim
THR.CUT (P.113)	Throttle cut
IDLE DOWN (P.115)	Idle down
SNAP ROLL (P.116)	Snap roll
THR-CURVE (P.117)	Throttle curve
PIT-CURVE (P.118)	PIT-curve
THR DELAY (P.119)	Throttle delay



AIL-DIFF

Aileron differential

(ACROBATIC)

Function

The left and right aileron differential can be adjusted independently. This function is restricted to 2 servo aileron.

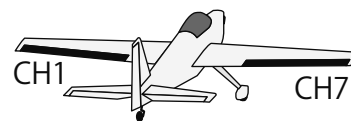

NOTE : Aileron Differential cannot be used simultaneously with Flaperon or Elevon. If another function is already active, "Others WING mix "ON" is displayed on the screen. After setting the active function to "INH" , set the Aileron Differential function to "ACT" .

Method

Calling the setting screen

① Call the menu screen from the home screen by pressing the **+** key for 1 second.

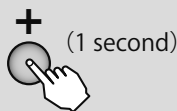

② Select **"AIL-DIFF"** from the menu with the **Jog key**.



③ Open the setting screen by pressing the **Jog key**.



● When INH is selected, the function cannot be used. To use the function, select ACT.

(Aileron)
L : Aileron stick Left side rate
R : Aileron stick Right side rate

● Select the setting item with the **Jog key**.

Aileron Differential

■ Activating the function

① Select the **"MIX"** item and then select the **"ACT"** by pressing the **+** key or **- key**.

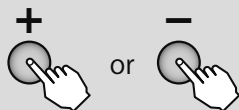

● When you do not use a function, set to the "INH" side.

■ Aileron rate

② Select the **"RATE-AIL1"** item and move the aileron stick to the left and right and adjust the travel of each servo by pressing the **+** key or **- key**.

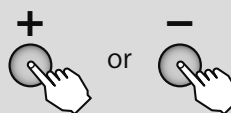

Range : -120 ~ +120%
Default : +100%

● When you want to return to the initial value, press the **+** key and **- key** simultaneously. However, when the polarity is changed only the number returns to the initial value.

(Adjust the **"RATE-AIL2"** item in the same way as ②.)



AIL → RUD

Aileron → Rudder mixing

(ACROBATIC)

Function

Use this mix when you want to mix the rudders with aileron operation. This allows the aircraft to bank at a steep angle.

- When the linkage direction is reversed by the linkage, adjustments can be made by changing the rate polarity.

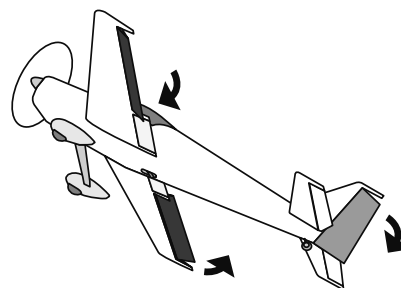

Method

Calling the setting screen

- ① Call the menu screen from the home screen by pressing the **+** key for 1 second.



- ② Select **"AIL → RUD"** from the menu with the **Jog key**.



- ③ Open the setting screen by pressing the **Jog key**.



Activating the function

Mixing rate

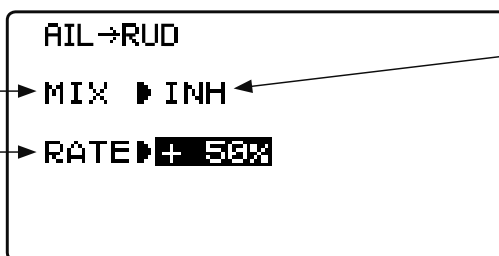

- When not using this function, select INH.

- Select the setting item with the **Jog key**.

Aileron → Rudder Mixing

■ Activating the function

- ① Select the **"MIX"** item and then select the **"ON"** by pressing the **+** key or **-** key.

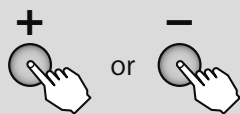

- When you do not use a function, set to the **"INH"** side.

■ Mixing rate

- ② Select the **"RATE"** item and then adjust the mixing rate by pressing the **+** key or **-** key.

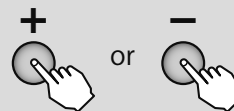

Range : **-100 ~ +100%**

Default : **+50%**

- When you want to return the set value to the initial value, press the **+** key and **-** key simultaneously. However, polarity does not return.

Airplane



V-TAIL

V-Tail

(ACROBATIC)

Function

This mixing is used with V tail aircraft that combine the elevator and rudder functions.

NOTE : V Tail cannot be used simultaneously with Elevon or Ailevator. When another function is already activated, "Other WING mix "ON" " is displayed on the screen. Set the V tail function to ACT after setting the active function to INH.

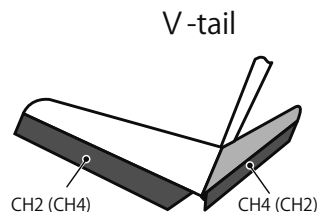

	CH2 Servo	CH4 Servo
Elevator	ELE1	ELE2
Rudder	RUD2	RUD1

Method

Calling the setting screen

① Call the menu screen from the home screen by pressing the **+** key for 1 second.

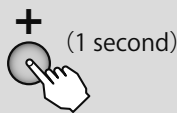

② Select "V-TAIL" from the menu with the **Jog** key.



③ Open the setting screen by pressing the **Jog** key.



Activating the function → V-TAIL MIX INH

ELE1 rate → RATE-ELE1 + 50%

ELE2 rate → ELE2 - 50%

RUD2 rate → RUD2 + 50%

RUD1 rate → RUD1 + 50%

● When INH is selected, the function cannot be used. To use the function, select ACT.

(Rate adjustment)

● Select the setting item with the **Jog** key.

V-TAIL

■ Activating the function

① Select the "MIX" item and then select the "ACT" by pressing the **+** key or **-** key.

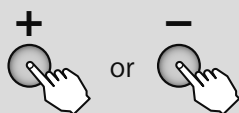

● When you do not use a function, set to the "INH" side.

■ Rate adjustment

② Select the "RATE" item and then adjust the mixing rate by pressing the **+** key or **-** key.

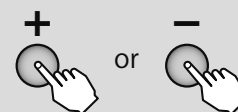

Range : -100 ~ +100%
Default : +50%
(only ELE2 : -50%)

● When you want to return the set value to the initial value, press the **+** key and **-** key simultaneously. However, polarity does not return.

NOTE : We recommend that setting be performed while moving the stick and checking the amount of movement. If the amount of movement is too large, elevator and rudder operation will be compounded and the servo travel range will be exceeded and a dead band in which the servo will not operate may be created.



GYRO SENS Gyro sensor (ACROBATIC)

Function

This function is dedicated mixing for switching the gyro sensitivity and gyro mode (AVCS/NORMAL) of Futaba airplane use gyros. Up to 3 axes can be set.

- The sensitivity switch can be selected and the sensitivity of each direction of the switch can be set. (Switches A to H) If the airplane stalls during

flight, the gyro will lose control of the plane's attitude. From the standpoint of safety, we recommend that the OFF (0%) position also be set using a 3 position switch.

- CH5, CH5/CH7, CH5/CH8 or CH5/CH7/CH8 combinations can be selected as the sensitivity setting channel.

Method

Calling the setting screen

① Call the menu screen from the home screen by pressing the **+** key for 1 second.



② Select **"GYRO SENS"** from the menu with the **Jog key**.



③ Open the setting screen by pressing the **Jog key**.



Activating the function

Gain Channel selection

Switch direction

Gyrotype, Gain rate

GYRO SENS

MIX ▸ INH SW ▸ SwA

CH ▸ CH5/CH7/CH8

▸ UP (UP)

type	rate
CH5 ▸ STD	▸ 50.0%
CH7 ▸ STD	▸ 50.0%
CH8 ▸ STD	▸ 50.0%

- When not using this function, select INH.
- Sensitivity switch selection
- (Current switch operating direction)
- Switches to the sensitivity setting screen of each switch direction when the **Jog key** is pressed.

- Select the setting item with the **Jog key**.

- When using a Futaba GYA gyro, select gyro type GY. This switches the gyro sensitivity setting item to mode and sensitivity direct reading display.

GYRO SENS

■ Activating the function

① Select the **"MIX"** item and then select the **"ON"** by pressing the **+** key or **- key**.

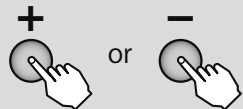

- When you do not use a function, set to the "INH" side.

■ Sensitivity switch selection

② Select the **"SW"** item and then select the switch by pressing the **+** key or **- key**.

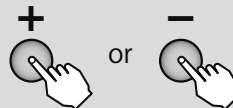

Range : SwA ~ SwH Default : SwA

■ Sensitivity setting channel selection

③ Select the **"CH"** item and then select the sensitivity setting channel by pressing the **+** key or **- key**.

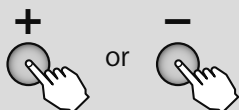

Range : CH5, CH5/CH7, CH5/CH8, CH5/CH7/CH8

Default : CH5

■ Gyro type and sensitivity setting

④ Press the **Jog key** and select the sensitivity setting screen you want to set and then set "type" (gyro type) and "rate" (gyro sensitivity) of each channel by pressing the **+** key or **- key**.

("type") Range : STD, GY Default : STD

("rate") Range : 0 ~ 100%(STD), NOR100 ~ 0 ~ AVC100%(GY) Default : 50%(STD), 0%(GY)

- When you want to return the set value to the initial value, press the **+** key and **- key** simultaneously.



ELEVON

Elevon

(ACROBATIC)

Function

This mixing is used with delta wing, tailless, and disk shaped airplanes that combine the aileron and elevator functions.

Connect the CH1 servo to the left aileron and the CH2 servo to the right aileron.

- The aileron and elevator travel can be adjusted individually.

NOTE : Elevon cannot be used simultaneously with V-tail or Ailevator functions. You may use Flaperon or Differential when this function is active. If another function is already active, "Other WING mix "ON" is displayed on the screen. After setting the active function to "INH" , set the elevon function to "ACT" .

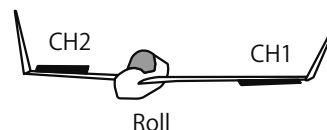
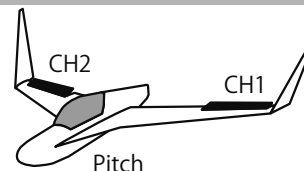

	CH1 servo	CH2 servo
Roll	AIL1	AIL2
Pitch	ELE2	ELE1

Method

Calling the setting screen

- 1 Call the menu screen from the home screen by pressing the **+** key for 1 second.

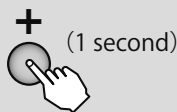

- 2 Select "ELEVON" from the menu with the **Jog key**.



- 3 Open the setting screen by pressing the **Jog key**.



Activating the function

Aileron1 (CH1) rate → RATE-AIL1

Aileron2 (CH2) rate → AIL2

Elevator2 (CH1) rate → ELE2

Elevator1 (CH2) rate → ELE1

ELEVON
MIX ▶ INH

(L) (R)

RATE-AIL1 ▶ +100% +100%

AIL2 ▶ +100% +100%

ELE2 ▶ +100%

ELE1 ▶ -100%

- When INH is selected, the function cannot be used. To use the function, select ACT.
- (Aileron rate)
- L : Aileron stick Left side rate
- R : Aileron stick Right side rate
- (Elevator rate)

- Select the setting item with the **Jog key**.

ELEVON

■ Activating the function

- 1 Select the "MIX" item and then select the "ACT" by pressing the **+** key or **-** key.

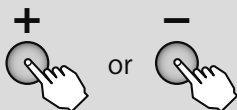

- When you do not use a function, set to the "INH" side.

■ Rate set

- 2 Select the "RATE" item and then adjust the mixing rate by pressing the **+** key or **-** key.

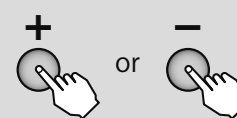

Range : -120 ~ +120%

Default : +100%

(only ELE1 : -100%)

- When you want to return the set value to the initial value, press the **+** key and **-** key simultaneously. However, polarity does not return.

NOTE : We recommend that setting be performed while moving the stick and checking the amount of movement. If the amount of movement is too large, elevator and aileron operation will be compounded and the servo travel range will be exceeded and a dead band in which the servo will not operate may be created.

Airplane



AILVATOR Ailvator

(ACROBATIC)

Function

Ailvator mixes both Ailerons and Elevators together. Or the function can be used separate from your ailerons when you have two Elevator servos. Since there are aircraft like jet fighters that use the elevators as ailerons, using this function can give you a sense of reality. Aileron operation can also be used with 2 elevator servo specifications. The servos connect to the receiver CH2 and CH8 output.

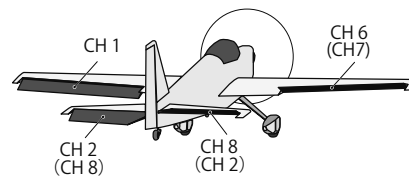

	CH2 servo	CH8 servo
Roll	AIL3	AIL4
Pitch	ELE1	ELE2

- Elevator and aileron travel can be adjusted individually.
- Confirm the direction of operation, because it is different depending on the linkage.

NOTE : Ailvator cannot be used simultaneously with V-tail or Elevon functions. When "Other WING mix "ON" "is displayed on the screen, set the ailvator function to ACT after setting the active function to INH.

Method

Calling the setting screen

① Call the menu screen from the home screen by pressing the **+** key for 1 second.



② Select "AILVATOR" from the menu with the **Jog key**.

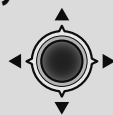

③ Open the setting screen by pressing the **Jog key**.



Airplane

- Select the setting item with the **Jog key**.



Activating the function

AIL3 Rate set

AIL4 Rate set

ELE2 Rate set

ELE1 Rate set

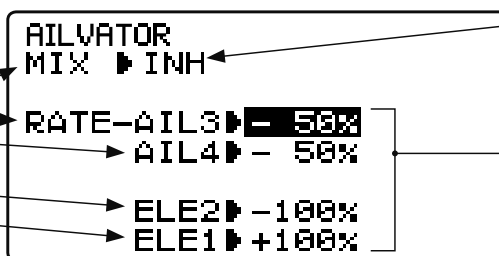

- When INH is selected, the function cannot be used. To use the function, select ACT.

(Rate)

AILVATOR

■ Activating the function

① Select the "MIX" item and then select the "ACT" by pressing the **+** key or **-** key.

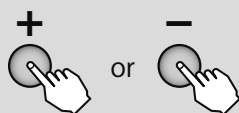

- When you do not use a function, set to the "INH" side.

■ Rate set

② Select the "RATE" item and then adjust the mixing rate by pressing the **+** key or **-** key.

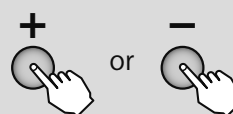

Range : -100 ~ +100%
 Default : -50% (AIL3, AIL4),
 -100% (ELE2), +100% (ELE1)

- When you want to return the set value to the initial value, press the **+** key and **-** key simultaneously. However, polarity does not return.

NOTE : We recommend that setting be performed while moving the stick and checking the amount of movement. If the amount of movement is too large, elevator and aileron operation will be compounded and the servo travel range will be exceeded and a dead band in which the servo will not operate may be created.

- When used as 2 elevator servos specifications without aileron operation, set the AIL3 and AIL4 travel to 0%.



THR → NEEDL

Throttle → Needle mixing

(ACROBATIC)

Function

This function is used when the engine is equipped with a mixture control system (needle control and other mixture adjustments to the engine).

The throttle control servo connects to receiver CH8.

- The mixture can be set by 5 point curve in relation to the throttle stick.

- An acceleration function which accelerates the engine to the optimal mixture when the throttle is opened can be set.

NOTE : This cannot be used if Ailevator function is active as they cannot be used simultaneously. "AILVATOR mix "ON" "is displayed on the screen. Set the THR → NEEDL function to ACT after setting the active function to INH.

Method

Calling the setting screen

- ① Call the menu screen from the home screen by pressing the **+** key for 1 second.



- ② Select "THR → NEEDL" from the menu with the **Jog** key.



- ③ Open the setting screen by pressing the **Jog** key.



- Select the setting item with the **Jog** key.



Activating the function

5 Point curve set
(Cursor moves with a THR stick)

Acceleration rate

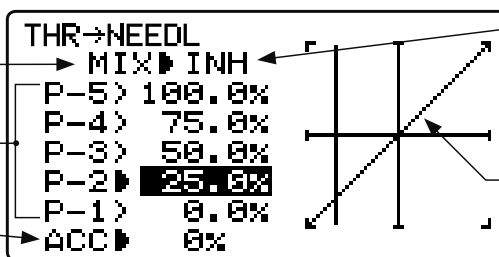

- When not using this function, select INH.

- The set-up curve is shown

Throttle curve

■ Activating the function

- ① Select the "MIX" item and then select the "ON" by pressing the **+** key or **-** key.

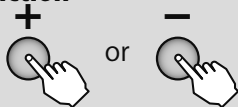

- When you do not use a function, set to the "INH" side.

■ 5 point curve setting

- ② Select the setting item (P-1 ~ P-5) and then set the travel of each point by pressing the **+** key or **-** key.

Range : 0 ~ 100%

Default : P-1:0%, P-2:25%, P-3:50%, P-4:75%, P-5:100%

■ Acceleration rate

- ③ Select the "ACC" item and adjust the acceleration amount by pressing the **+** key or **-** key.

Range : 0 ~ 100%, Default : 0%

- When you want to return the set value to the initial value, press the **+** key and **-** key simultaneously.

NOTE : When using the acceleration function, since the needle stroke is large, adjust your settings so there is no binding of your linkage.

- An acceleration function helps the engine compensate for sudden, large amounts of throttle input by making the mixture suddenly richer, then easing it back to the proper adjustment for that throttle setting. This function requires some adjustment to best fit your engine and your flying style. Adjust engine' s response until no hesitation occurs on rapid throttle input.

- Superfluous operation of a needle servo becomes large as it approaches to 100%. Moreover, time to usually return to a position becomes late.

Airplane



Function

D/R

The aileron, elevator and rudder channel control surface angle can be switched in 2 steps

- The control surface angle is adjusted by each direction of the switch. The left and right (up and down) direction of each switch can be set individually.

EXP

This function makes operation more pleasant by changing the operating curve so that servo movement is sluggish or sensitive relative to stick operation near the aileron, elevator, throttle, and rudder neutral position. Adjustments can be made in 2 steps according to the control surface angle.

- The "-" side makes servo movement sluggish and the "+" side makes servo movement sensitive near the neutral position. Exponential is applied to entire throttle servo travel. When the "+" side is increased, the slow side becomes sluggish and the high side becomes sensitive.
- Setting corresponding to each rate of dual rate (D/R) is possible. (Except throttle) The direction of each switch and the left and right (up and down) direction of each channel can be set individually.

Switch selection (SW)

Switches A to H can be selected as the aileron channel, elevator channel, and rudder channel dual rate (exponential) switch.

- Default : Aileron : SwitchD / Elevator : SwitchA / Rudder : SwitchB

Method

Airplane

Calling the setting screen

- 1 Call the menu screen from the home screen by pressing the **+** key for 1 second.



- 2 Select "D/R, EXPO" from the menu with the **Jog** key.



- 3 Open the setting screen by pressing the **Jog** key.

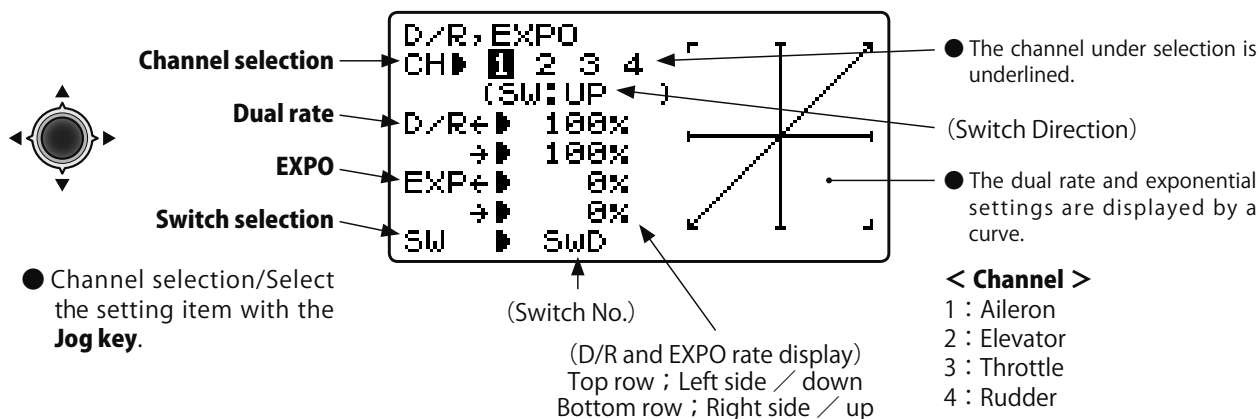



D/R

① A channel is chosen by **Jog key**.



Range : **1, 2, 4**

② Adjust the rate by moving the cursor to D/R with the **Jog key**, switching the dual rate switch to the direction you want to set, moving the stick to the left (down) or right (up) side and pressing the **+ key** or **- key**.



Range :
0 ~ 140%
Default : **100%**

- When you want to return the set value to the initial value, press the **+ key** and **- key** simultaneously.

Adjust the rate of each direction of the dual rate switch and stick by repeating step

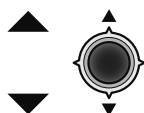

- Moving to another setting item of the same channel is possible by **Jog key**.

EXPO

① Select the "**EXP**" item and then select the channel with the **Jog key**.



Range : **1 ~ 4**

② Adjust the rate by moving the cursor to EXP with the **Jog key**, switching the dual rate switch to the direction you want to set, moving the stick to the left (down) or right (up) side and pressing the **+ key** or **- key**.



Range :
-100 ~ +100%
Default : **0%**

- When you want to return the set value to the initial value, press the **+ key** and **- key** simultaneously.

Adjust the rate of each direction of the dual rate switch and stick by repeating step

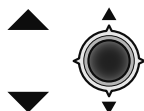

- Moving to another setting item of the same channel is possible by **Jog key**.

Switch Change

① Select the "**SW**" item and then select the channel with the **Jog key**.



Range : **1, 2, 4**

② A switch is chosen by **+ key** or **-key**.

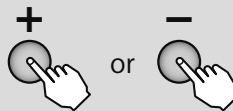

Range : **SwA ~ SwH**



FLAPERON Flaperon

(ACROBATIC)

Function

This mixing function mixes two ailerons and also gives the ailerons a flap function. Aileron and left and right aileron control surfaces can be raised at the same time. If this function is used together with air brake function, the aircraft speed can be dropped when landing and is effective in narrow places. Connect the left aileron servo to CH1 (AIL) and the right aileron servo to CH6 (FLP).

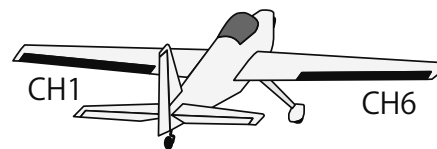

- The up and down angle of the left and right aileron control surfaces can be adjusted individually.
- The left and right flap travel can also be adjusted individually.

	CH6 servo	CH1 servo
Aileron Operation	Right Aileron	Left Aileron
Flap Operation	Flap1	Flap2

NOTE : Only the Flaperon, AileronDifferential, or Elevon functions can be used. They cannot be turned on simultaneously. When another function is already activated, "Other WING mix "ON" "is displayed on the screen. Set the Flaperon function to ACT after setting the active function to INH.

Method

Calling the setting screen

① Call the menu screen from the home screen by pressing the **+** key for 1 second.



② Select **"FLAPERON"** from the menu with the **Jog key**.



③ Open the setting screen by pressing the **Jog key**.



Airplane

Activating the function

```

FLAPERON
MIX ▶ INH
          (L)  (R)
RATE-AIL1 ▶ +100% +100%
Aileron2 (CH6) rate ▶ AIL2 ▶ +100% +100%
Flap2 (CH1) rate ▶ FLP2 ▶ +100%
Flap1 (CH6) rate ▶ FLP1 ▶ -100%
```

- When INH is selected, the function cannot be used. To use the function, select ACT.
- (Aileron rate)
L : Aileron stick Left side rate
R : Aileron stick Right side rate
- (Flap rate)

- Select the setting item with the **Jog key**.



Flaperon

■ Activating the function

- ① Select the "MIX" item and then select the "ACT" by pressing the **+** key or **-** key.

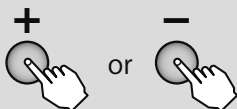

- When you do not use a function, set to the "INH" side.

■ Aileron rate

- ② Select "RATE-AIL1" and operate the aileron stick to the left and right and adjust the travel of each servo by pressing the **+** key or **-** key.

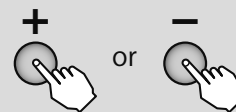

Range : **-120 ~ +120%**

Default : **100%**

- When you want to return the set value to the initial value, press the **+** key and **-** key simultaneously. However, when the polarity is changed, only the number is returned to the initial value.
(The "RATE-AIL 2" item is adjusted in the same way as ②.)

(When flap trim is used, make the settings shown below.)

- However, set the basic travel with the Flap function in advance. (Default : 0%)

■ Flap rate

- ③ Select the "RATE-FLP2" item and adjust the Flap2 travel by pressing the **+** key or **-** key.

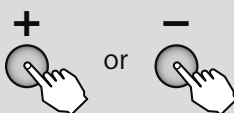

Range : **-120 ~ +120%**

Default : **+100%**

- When you want to return the set value to the initial value, press the **+** key and **-** key simultaneously. However, polarity does not return.

(The "RATE-FLP1" item is adjusted in the same way as ③. However, the "RATE-FLP1" side initial value is -100%.)

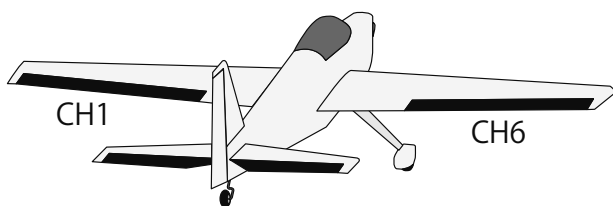

Flaperon ACT

When flaperon is active, the ailerons can be controlled by the servos connected to CH1 and CH6. The servo travel can be adjusted by the left and right end points.

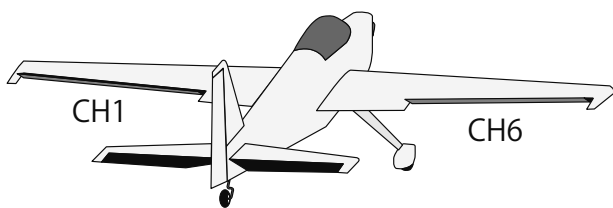

+ Air brake ACT

The left and right ailerons can be raised (brake operation) and lowered (flap operation) at the same time by setting SW-C to its lowest position.



AIR-BRK

Air brake

(ACROBATIC)

Function

This function is used when the air brake is necessary during landing and is turned on and off by switch C (initial setting).

- Normally when the ailerons are used as a brake, they are raised (UP side)
- When the operation mode is "OFST" (offset), the air brake is controlled by switch operation. When the operation mode is "LINR" (linear), the air brake is operated linearly at switch ON and from the control stick set position.

- If the "LINR" mode was selected, the throttle stick controls CH3 and the air brake operation, but it can be separated from CH3 operation. CH 3 control can be switched from stick to stick or to VR knob. However, when other than stick was selected, the throttle trim and function reverse functions cannot be used.
- When used in the "LINR" mode, adjust the travel with the throttle stick at the maximum slow side (braking amount maximum).

● Adjustment item for every wing type

Display	(Normal)	Flaperon	Aileron Differential
AIL1(1CH)	----	Aileron1	Aileron1
ELEV(2CH)	Elevator	Elevator	Elevator
FLAP(6CH)	Flap	Aileron2	Flap
AIL2(7CH)	----	----	Aileron2

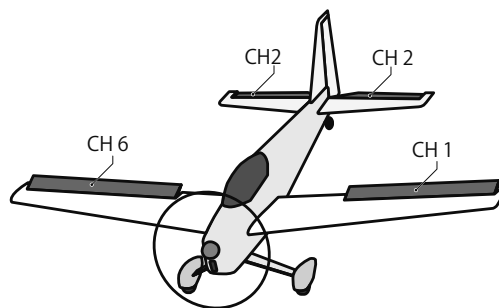

Method

Airplane

Calling the setting screen

① Call the menu screen from the home screen by pressing the **+** key for 1 second.

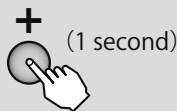

② Select **"AIR-BRK"** from the menu with the **Jog key**.



③ Open the setting screen by pressing the **Jog key**.





Activating the function

AIR-BRK

-rate-	CH3	----
AIL1	MIX	INH
ELEV	SW	SWC
FLAP		DOWN
AIL2	MOD	OFST
-delay-		----
ELEV		

3CH Control set

- When not using this Function select INH. The display of On/Off is shown when active and assigned to a switch.

Switch selection

Switch direction

Mode

- Select the setting item with the **Jog key**.
- When the "LINR" operation mode was selected, the current throttle stick position is displayed at the operation reference point and in the bottom row parentheses.



Air brake

■ Activating the function

- ① Select the "MIX" item and then select the "ON" or "OFF" by pressing the **+ key** or **- key**.

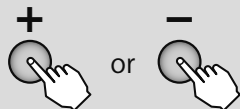

- When you do not use a function, set to the "INH" side.

■ Rate set

- ② Select the "rate" item and adjust the servo travel by pressing the **+ key** or **- key**.

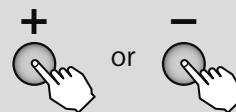

Range : **-100 ~ +100%**
Default : **+50% (ELEV only -10%)**

- When you want to return the set value to the initial value, press the **+ key** and **- key** simultaneously. However, polarity does not return.

■ Delay Rate set

- ③ Select the "delay" item and adjust the elevator operation delay by pressing the **+ key** or **- key**.

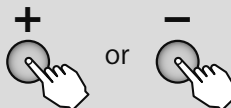

- The amount of delay is large at 100%.

Range : **0 ~ 100%**, Default : **0%**

- When you want to return the set value to the initial value, press the **+ key** and **- key** simultaneously.

(In the case of change of a switch)

■ Switch selection

- ① Select the "SW" item and then select the switch by pressing the **+ key** or **- key**.

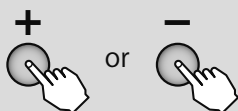

Range : **SwA ~ SwH**
Default : **SwC**

■ Switch direction

- ② Select the ON direction by pressing the **+ key** or **- key** at the ON direction selection item.

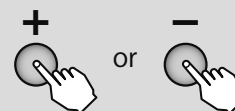

Range :

- 2P SW : **NULL, UP, DOWN**
- 3P SW : **NULL, UP, UP&D, UP&C, CNTR, C&DN, DOWN**

(In the case of change of a mode)

■ Mode

- ① Select the "MOD" item and select the operation mode by pressing the **+ key** or the **- key**.

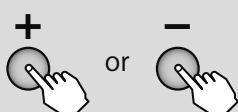

Range : **OFST, LINR**
Default : **OFST**

■ Operation reference point setting ("LINR" mode only)

- ② Select the operation reference point setting item newly displayed at the bottom row of "MOD" and hold the throttle stick at the air brake start point and set the reference point by pressing the **Jog key** for 1 second.



Range : **0 ~ 100%**

(When 3CH control is changed at the time of "LINR")

■ "LINR" mode 3CH control

- ① Select the "CH3" item and select control by pressing the **+key** or **-key**.

Range : **THR, SwA ~ SwH, VR, DT5, DT6**
Default : **THR**



Function

This mixing is used to compensate for pitch changes (elevator direction) at flap operation.

- When the mixing direction is reversed by the linkage adjustment is possible by changing the rate polarity.
- The mixing reference point can be shifted. (OFFSET)

Method

Calling the setting screen

① Call the menu screen from the home screen by pressing the **+** key for 1 second.



② Select **"FLAP → ELE"** from the menu with the **Jog key**.



③ Open the setting screen by pressing the **Jog key**.



FLAP → ELE

- MIX ▶ INH
- Mixing rate ▶ RATE ▶ 0%
- Mixing offset rate ▶ OFFSET ▶ 0% (- 96%)

● When not using this function, select INH.

(Present flap operating position)

- Select the setting item with the **Jog key**.

Flap → ElevatorMixing

■ Activating the function

① Select the **"MIX"** item and then select the **"ON"** by pressing the **+** key or **-** key.

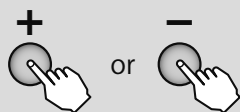

- When you do not use a function, set to the **"INH"** side.

■ Mixing rate

② Select the **"RATE"** item and then adjust the mixing rate by pressing the **+** key or **-** key.

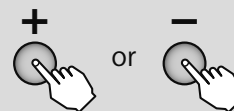

Range : **-100 ~ +100%**
Default : **0%**

- When you want to return the set value to the initial value, press the **+** key and **-** key simultaneously.

(When changing the mixing reference point)

■ Mixing reference point offset setting

① Select the **"OFFSET"** item and turn the Flap knob to the point you want to make the mixing reference point and set the reference point by pressing the **Jog key** for 1 second.



Range : **-100 ~ +100%** Default : **0%**



ELE → FLAP Elevator → Flap mixing (ACROBATIC)

Function

This mixing is used when you want to apply mixing from elevators to flaps. Usually, mixing is such that the flaps are lowered by raising the elevators. When used with Fun Fly and other aircraft, small loops are possible.

- The up side and down side rates can be adjusted.

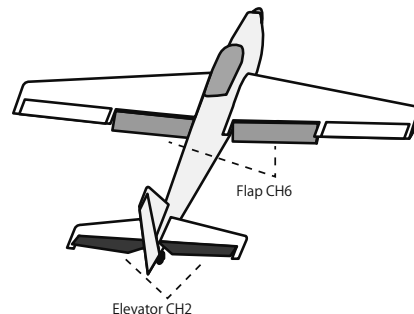

Method

Calling the setting screen

① Call the menu screen from the home screen by pressing the **+** key for 1 second.



② Select "ELE → FLAP" from the menu with the **Jog** key.



③ Open the setting screen by pressing the **Jog** key.





Activating the function

Mixing rate

Switch selection

Switch direction

ELE → FLAP

→ MIX ▸ INH

RATE ↑ ▸ + 50%

RATE ↓ ▸ + 50%

→ SW ▸ SWC

→ POSI ▸ UP

- When not using this Function select INH. The display of On/Off is shown when active and assigned to a switch.
- This cursor position operates and chooses an elevator stick.
- Sets the ON/OFF direction of the selected switch.
- 2P SW : NULL, UP, DOWN
- 3P SW : NULL, UP, UP&D, UP&C, CNTR, C&DN, DOWN

Elevator → FlapMixing

■ Activating the function

① Select the "MIX" item and then select the **ON** or **OFF** by pressing the **+** key or **-** key.

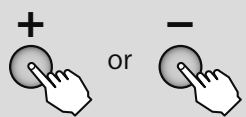

- When you do not use a function, set to the "INH" side.

■ Switch selection

② Select the "SW" item and then select the switch by pressing the **+** key or **-** key.

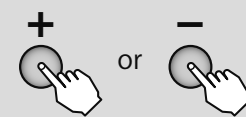

Range : SwA ~ SwH, Default : SwC

■ Switch direction

③ Select the "POSI" by pressing the **+** key or **-** key at the **ON** direction selection item.

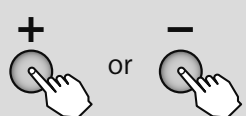

Range :

- 2P SW : NULL, UP, DOWN
- 3P SW : NULL, UP, UP&D, UP&C, CNTR, C&DN, DOWN

■ Mixing rate

④ Select the "RATE" item and then adjust the mixing rate by pressing the **+** key or **-** key.

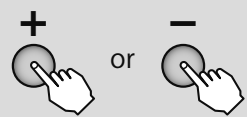

Range : -100 ~ +100% Default : +50%

- When you want to return the set value to the initial value, press the **+** key and **-** key simultaneously. However, polarity does not return.
- RATE ↑ / ↓ cursor position operates and chooses an elevator stick.



FLAP TRIM Flap trim (ACROBATIC)

Function

This function trims the CH6 VR knob.

- The trim travel can be adjusted.

*When the flaperon function is activated ("ACT"), this function is turned on automatically. It can be turned on and off independently.

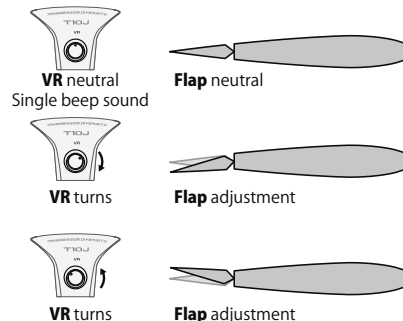

Method

Calling the setting screen

- ① Call the menu screen from the home screen by pressing the **+** key for 1 second.
- ② Select **"FLAP TRIM"** from the menu with the **Jog** key.
- ③ Open the setting screen by pressing the **Jog** key.

Airplane

FLAP TRIM

MIX ▸ INH

Flap trim rate → RATE ▸ 0%

- When INH is selected, the function cannot be used. To use the function, select ACT.

- Select the setting item with the **Jog** key.

Flap Trim

■ **Activating the function**

① Select the **"MIX"** item and then select the **"ACT"** by pressing the **+** key or **-** key.

- When you do not use a function, set to the "INH" side.

■ **Flap rate**

② Select the **"RATE"** item and then adjust the flap rate by pressing the **+** key or **-** key.

Range : -100 ~ +100%
Default : 0%

- When you want to return the set value to the initial value, press the **+** key and **-** key simultaneously.



THR.CUT Throttle cut

(ACROBATIC)

Function

This function cuts (stops) the engine or motor by stick operation. At throttle operation, the rate is adjusted to the position which completely cuts the throttle servo or ESC when the throttle is operated. When Thr.Cut is active, the throttle position is held regardless of the throttle stick position.

- NOR/ESC operation mode switching. For motor aircraft, select ESC. For motor aircraft, the throttle position when the function is reset can be set so

the motor will not unexpectedly run at high speed when the throttle cut function is reset. When the throttle stick is higher than the set throttle position, the throttle cut function is not reset even if the switch is set to OFF. Set to a safe throttle position (slow side).

- Function operation can be selected from among switches A ~ H.
- Set the throttle cut function for safety also.

Method

Calling the setting screen

- 1 Call the menu screen from the home screen by pressing the **+** key for 1 second.



- 2 Select **"THR.CUT"** from the menu with the **Jog key**.



- 3 Open the setting screen by pressing the **Jog key**.



- **Activating the function**
- **Cut Position rate**
- **Throttle Position**
- **Switch selection**
- **Switch direction**

```

THR.CUT
MODE ▶ NOR
MIX ▶ INH
RATE ▶ ████ 8%
THR ▶ 15% ( 15%)
SW ▶ SWA
POSI ▶ NULL
  
```

- Select the setting item with the **Jog key**.

- Sets the ON/OFF direction of the selected switch.
 - 2P SW : NULL, UP, DOWN
 - 3P SW : NULL, UP, UP&D, UP&C, CNTR, C&DN, DOWN

- When not using this Function select INH. The display of On/Off is shown when active and assigned to a switch.

- Adjusts the rate to the position that completely cuts the throttle servo or ESC.

- The "THR" item can be set when the operation mode is "ESC". The number in parentheses is the current throttle stick position.

Airplane



Throttle Cut

■ Mode

- ① Select the "MODE" item and then select the mode by pressing the **+ key** or **- key**.

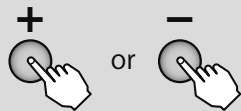

Range : **NOR, ESC**
Default : **NOR**

- "NOR" : Engine plane
- "ESC" : Electric motor plane

■ Activating the function

- ② Select the "MIX" item and then select the off by pressing the **+ key** or **- key**.

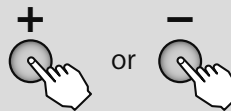

- When you do not use a function, set to the "INH" side.

■ Switch selection

- ③ Select the "SW" item and then select the switch by pressing the **+ key** or **- key**.

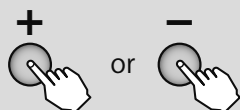

Range : **SwA ~ SwH**
Default : **SwA**

■ Switch direction

- ④ Select the "POSI" by pressing the **+ key** or **- key** at the ON direction selection item.

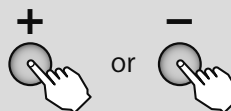

Range :

- 2P SW : **NULL, UP, DOWN**
- 3P SW : **NULL, UP, UP&D, UP&C, CNTR, C&DN, DOWN**

■ Cut Position rate

- ⑤ Select the "RATE" item and then select the cht position by pressing the **+ key** or **- key** (motor stop).

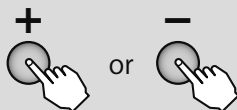

- It adjusts to the position where an engine is cut.

Range : **-30 ~ 0 ~ +30%**
Default : **0%**

- When you want to return the set value to the initial value, press the **+ key** and **- key** simultaneously.

(In the case of ESC)

■ Function release Throttle Position

- ⑥ Select the "THR" item and then select the release position by THR stick is lowered and **Jog key** is pressed for 1 second.



- Set to a safe low throttle position.

Range : **0 ~ 100%**
Default : **15%**



IDLE DOWN Idle down

(ACROBATIC)

Function

This function is linked to the air brake switch and gear switch and lowers the engine idle. It is used when engine idle is set high to prevent the engine from stalling during flight and you want to lower engine idle when landing.

- The amount engine idle is lowered can be set.
- At idling down operation, the stop lever adjusts the idle down amount.
- Function operation can be selected from among switches A ~ H. The switch direction can also be selected.

Method

Calling the setting screen

① Call the menu screen from the home screen by pressing the **+** key for 1 second.



② Select **"IDLE DOWN"** from the menu with the **Jog key**.



③ Open the setting screen by pressing the **Jog key**.





Activating the function

Idle down rate

Switch selection

Switch direction

IDLE DOWN

MIX ▶ INH

RATE ▶ 3%

SW ▶ SwC

POSI ▶ C&DN

- When not using this Function select INH. The display of On/Off is shown when active and assigned to a switch.
- Sets the ON/OFF direction of the selected switch.
- 2P SW : **NULL, UP, DOWN**
- 3P SW : **NULL, UP, UP&D, UP&C, CNTR, C&DN, DOWN**

Idle down

■ Activating the function

① Select the **"MIX"** item and then select the on or off by pressing the **+** key or **-** key.

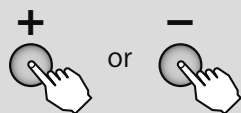

- When you do not use a function, set to the "INH" side.

■ Switch selection

② Select the **"SW"** item and then select the switch by pressing the **+** key or **-** key.

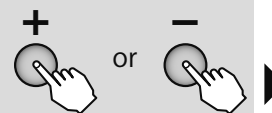

Range : **SwA ~ SwH**, Default : **SwC**

■ Switch direction

③ Select the **"POSI"** by pressing the **+** key or **-** key at the ON direction selection item.

Range :

- 2P SW : **NULL, UP, DOWN**
- 3P SW : **NULL, UP, UP&D, UP&C, CNTR, C&DN, DOWN**

■ Idle down rate

④ Select the **"RATE"** item and then adjust the idle down rate by pressing the **+** key or **-** key.

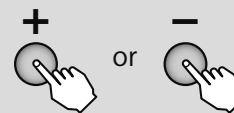

Range : **0 ~ 40%**
Default : **0%**

- When you want to return the set value to the initial value, press the **+** key and **-** key simultaneously.

- The idle down amount is usually 10% ~ 20%. Hold down the aircraft and set the throttle switch to the maximum slow position while the engine is running and adjust the idle drop amount while turning the switch on and off.



SNAP ROLL Snap roll

(ACROBATIC)

Function

This function performs snap roll by switch (SwH).

- The roll direction is selected from among 4 directions (R/U, L/U, R/D, L/D) by 2 switches.
- As a safety measure, a safety mode can be set so that operation is not performed even if a switch is mistakenly turned on when retracting the landing gear.

(Direction Switch)

	SW1	SW2
1: R/U		
2: L/U		
3: R/D		
4: L/D		

NOTE : The trainer function cannot be turned on simultaneously with this function. If the trainer function is active, "trainer "ACT"" is displayed on the screen. After setting the trainer function to "INH" , turn on this function.

Method

Calling the setting screen

① Call the menu screen from the home screen by pressing the **+** key for 1 second.



② Select **"SNAP ROLL"** from the menu with the **Jog key**.



③ Open the setting screen by pressing the **Jog key**.



Activating the function

● Select the setting item with the **Jog key**.

SNAP ROLL (1:R/U)

-Rate- MIX ▶ INH

AIL ▶ +100% SAFE-

ELE ▶ +100% MODE ▶ FREE

RUD ▶ +100% DIRC-

SW1 ▶ NULL

SW2 ▶ NULL

(Snap roll direction)

● When INH is selected, the function cannot be used. To use the function, select OFF(ON).

Safe mode set

Direction Switch selection

Snap roll

Activating the function

① Select the **"MIX"** item and then select the **"OFF"** by pressing the **+** key or **-** key.

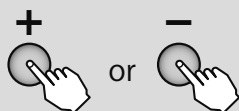

- When you do not use a function, set to the "INH" side.

Direction switch selection

② Select the **"DIRC-SW1"** and **"DIRC-SW2"** item and select each switch by pressing the **+** key or **-** key.

Range :
NULL, SwA ~ SwH
Default : **NULL**

Servo Rate set

③ Switch the DIRC-SW1 or DIRC-SW2 in the direction you are wanting to adjust by pressing the **+** key or **-** key at the "AIL" , "ELE" , and "RUD" items.

Range : **-120 ~ +120%**

- Set the R/U, L/U, R/D, and L/D directions.

Safe mode set

④ Select the **"SAFE-MODE"** item and then select the mode by pressing the **+** key or **-** key.

Range :
FREE, CH5+, CH5-
Default : **FREE**

- When a 3 position switch was selected at "DIRC-SW1" setting, 1:R/U, 2:L/U, 3:R/D switching is possible with 1 switch. At this time, "DIRC-SW2" cannot be selected.

Safe mode setting can set the direction of the landing gear switch.

- When "CH5-" was selected, the safety device sets the landing gear switch to the rear position and the snap switch is not effective even if operated. When the landing gear switch is in the forward position, operation is possible. When "CH5+" was selected, the safety device operates and the snap switch is ineffective even if operated. When the landing gear switch is in the rear position, operation is possible.
- When "FREE" was selected: The safety device does not operate regardless of the switch direction.



THR-CURVE Throttle curve (Airplane)

(ACROBATIC)

Function

This function sets a 5 point throttle curve so that the engine/motor speed relative to movement of the throttle stick is the optimum value for flight.

- A curve can be set for each switch position.

However, this function cannot be used when the throttle EXP function was set. When this function is set, the throttle EXP function cannot be used.

Method

Calling the setting screen

- 1 Call the menu screen from the home screen by pressing the **+** key for 1 second.



- 2 Select **"THR-CURVE"** from the menu with the **Jog key**.



- 3 Open the setting screen by pressing the **Jog key**.



Activating the function

Switch selection

5 point curve set

- Select the setting item with the **Jog key**.

THR-CURVE

► MIX ► INH

SW ► SwE (DN)

P-5 > 100.0%

P-4 > 75.0%

P-3 > 50.0%

P-2 > 25.0%

P-1 > 0.0%

- When not using this function, select INH.
- The set-up curve is shown
- (Present switch position)

Throttle curve

■ Activating the function

- 1 Select the **"MIX"** item and then select the **"ON"** by pressing the **+** key or **- key**.

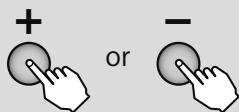

- When you do not use a function, set to the "INH" side.

■ Switch selection

- 2 Select the **"SW"** item and then select the switch by pressing the **+** key or **- key**.

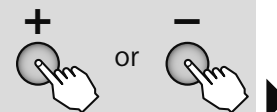

Range : SwA ~ SwH, Default : SwE

■ 5 point curve set

- 3 By **Jog key**, either of **P-1** to **P-5** is chosen. The **+** key or **- key** is pressed and a rate is set up.

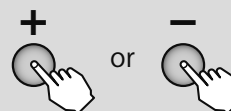

Range : 0 ~ 100%

Default : P-1:0%, P-2:25%, P-3:50%, P-4:75%, P-5:100%

Airplane



PIT-CURVE Pitch curve (Airplane)

(ACROBATIC)

Function

This function is a function for the variable pitch propellers of an airplane.

The curve of five points can be set up.

- PIT-curve function cannot be used when an AILVATOR function is ACT.
- CH of a pitch can be set to 8CH or 5CH.

Method

Calling the setting screen

① Call the menu screen from the home screen by pressing the **+** key for 1 second.



② Select **"PIT-CURVE"** from the menu with the **Jog key**.



③ Open the setting screen by pressing the **Jog key**.



Airplane

Activating the function →

Switch selection →

5 point curve set →

PIT-CURVE

MIX ▸ INH CH ▸ 8

SW ▸ SwE (DN)

P-5 ▸ +100%

P-4 ▸ + 50%

P-3 ▸ 0%

P-2 ▸ - 50%

P-1 ▸ -100%

● When not using this function, select INH.

Channel selection

● The set-up curve is shown (Present switch position)

PIT-curve

■ Activating the function

① Select the **"MIX"** item and then select the **"ON"** by pressing the **+** key or **- key**.

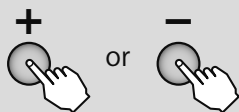

- When you do not use a function, set to the "INH" side.

■ Switch selection

② Select the **"SW"** item and then select the switch by pressing the **+** key or **- key**.

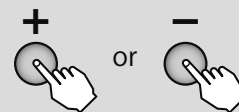

Range : SwA ~ SwH, Default : SwE

■ 5 point curve set

③ By **Jog key**, either of P-1 to P-5 is chosen. The **+** key or **- key** is pressed and a rate is set up.

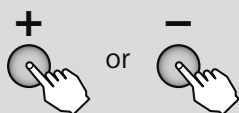

Range : -100 ~ +100%

Default : P-1:-100%, P-2:-50%, P-3:0%, P-4:+50%, P-5:+100%

(When a channel is changed)

■ Channel selection

① Select the **"CH"** item and then select the channel by pressing the **+** key or **- key**.

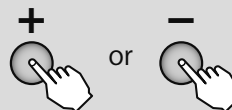

Range : 8CH, 5CH

Default : 8CH



Function

When this function is used, the throttle servo operating speed can be slowed down.

(Perfect for turbojet engine throttle control, etc.)

- The amount of delay can be set.

Method

Calling the setting screen

① Call the menu screen from the home screen by pressing the **+** key for 1 second.



② Select **"THR DELAY"** from the menu with the **Jog key**.



③ Open the setting screen by pressing the **Jog key**.

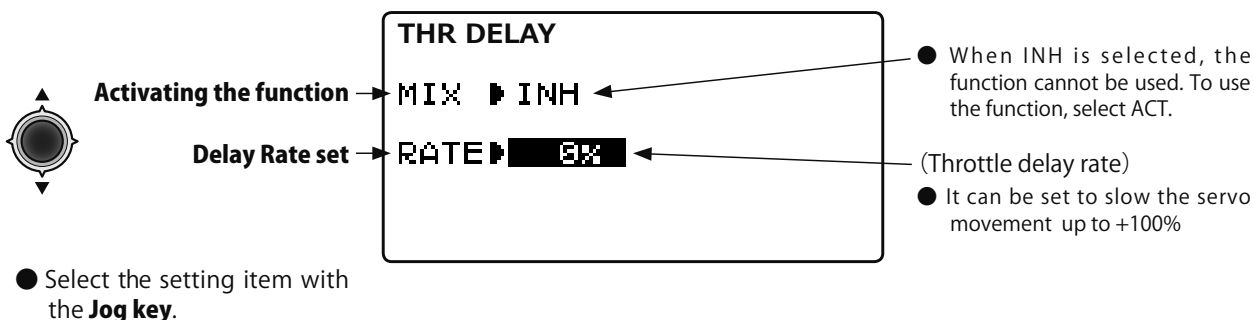

Airplane

THR DELAY

Activating the function

① Select the **"MIX"** item and then select the **"ACT"** by pressing the **+** key or **-** key.

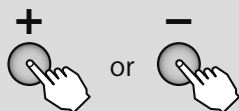

- When you do not use a function, set to the "INH" side.

Delay Rate set

② Select the **"RATE"** item and then adjust the rate by pressing the **+** key or **-** key.

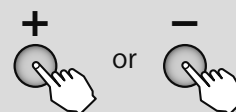

Range : **0 ~ 100%**
Default : **0%**

- When you want to return the set value to the initial value, press the **+** key and **-** key simultaneously.

HELICOPTER Function



The setting screen of each function is called from the following menu. The function when the model type was set to helicopter is displayed here.

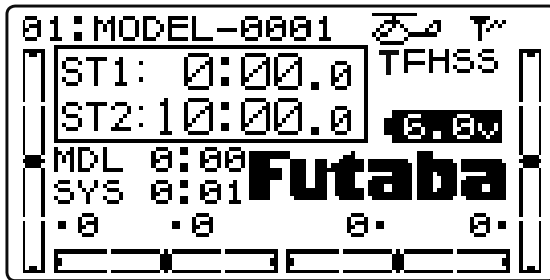
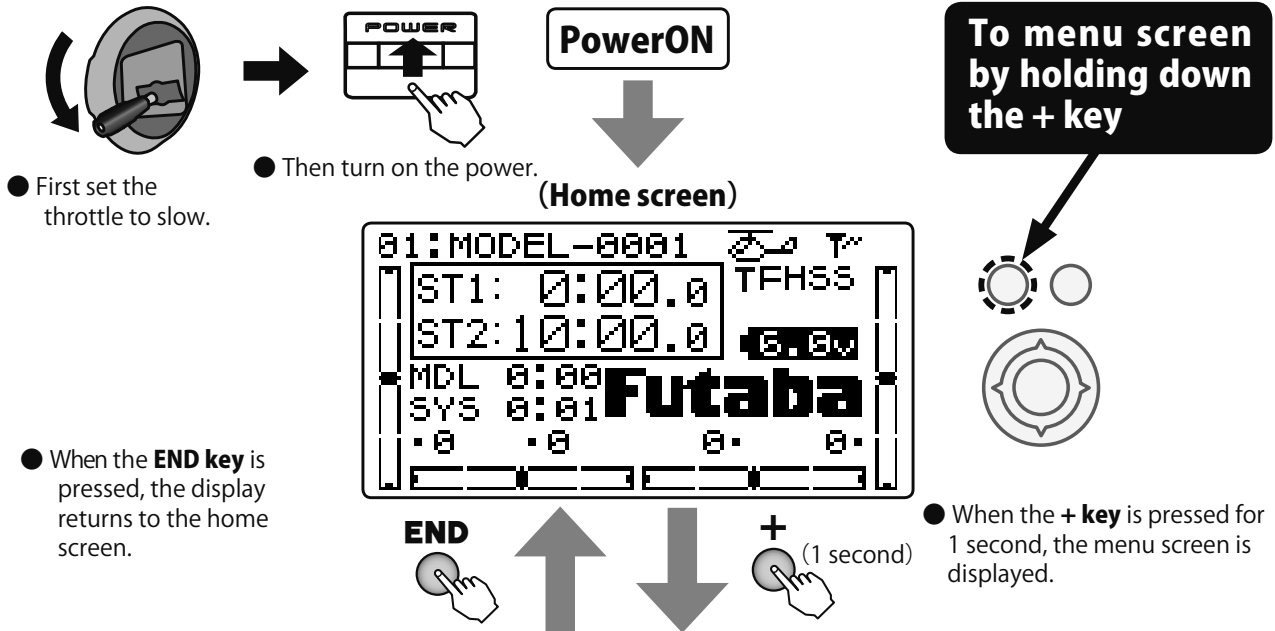

MENU

MENU
1/3

MENU	1	2	3
▶ MDL-SEL	▶ END POINT		
▶ MDL-NAME	▶ TRIM		
▶ FAIL SAFE	▶ SUB TRIM		
▶ REVERSE	▶ P.MIX1-6		
▶ TIMER	▶ AUX-CHAN		
▶ SERVO	▶ PARAMETER		

MENU
2/3

MENU	1	2	3
▶ TELEMETRY	▶ SWASH AFR		
▶ SENSOR	▶ SWH.MIX		
▶ SBUS LINK	▶ SWH.RING		
▶ MDL-TRANS	▶ OFFSET		
▶ TRAINER	▶ DELAY		
▶ CONDITION	▶ THR.CUT		

MENU
3/3

MENU	1	2	3
▶ GYRO SENS	▶ GOVERNOR		
▶ D/R,EXPO	▶ HOV-THR		
▶ THR-CURVE	▶ HOV-PIT		
▶ PIT-CURVE	▶ HI / LO-PIT		
▶ REVO.MIX	▶ THR-MIX		
▶ THR HOLD	▶ THR→NEEDL		

(Selection)

● Move the cursor (highlighted) up and down and to the left and right with the Jog key and select the function. The cursor can be moved over several pages.

(Calling the setting screen)

● Press the Jog key to open the setting screen.

Helicopter



(Condition switching at each setting screen)



- Press the jog button for 1 second.
When setting conditions with the following function, each setting can be made by switching the condition by pressing the **Jog key** for 1 second. Throttle curve, Pitch curve, Pitch → Rudder, Gyro sens, HI/LO-Pitch, OFFSET, Throttle MIX, THR → Needle, Swash MIX

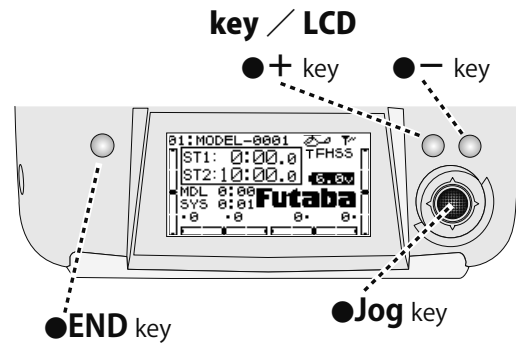

Refer to "**Common Functions**" previously described for a description of this function.

■ **Function**

MENU1/3	
MDL-SEL (P.40)	Model select / Model Copy / Data reset / RX / Link
MDL-NAME (P.43)	Model name / User name
FAIL SAFE (P.45)	Fail safe
REVERSE (P.47)	Servo reverse
TIMER (P.48)	Timer
SERVO (P.49)	Servo monitor / Servo test
END POINT (P.50)	End point
TRIM (P.51)	Trim reset / Trim step
SUB TRIM (P.52)	Sub trim
P.MIX1-6 (P.53)	Program mixing 1 ~ 6
AUX-CHAN (P.56)	AUX channel
PARAMETER (P.58)	Data reset / Model type / ATL-trim / LCD contrast / Back light : mode, time, adjustment / Home display / Battery alarm / Battery vibration / Buzzer tone / Jog navi / Jog light / Jog time / Telemetry : mode, unit / Speech : language, volume / Stick position alarm

MENU2/3	
TELEMETRY (P.66)	Telemetry Display / Alarm setup
SENSOR (P.83)	Telemetry sensor
SBUS LINK (P.89)	S.BUS servo set up
MDL-TRANS (P.92)	Data transfer of another 10J or 8J
TRAINER (P.93)	Trainer
CONDITION (Idle-up • Throttlehold) (P.122)	Condition
SWASH AFR (H-1 removes) (P.123)	Swash AFR
SWH.MIX (P.124)	Swash MIXing
SWH.RING (P.126)	Swash RING
OFFSET (P.127)	Trim offset
DELAY (P.128)	Delay
THR.CHT (P.129)	Throttle cut

MENU3/3	
GYRO SENS (P.131)	Gyro mixing
D/R, EXPO (P.132)	Dual rate / EXPO
THR-CURVE (P.134)	Throttle curve
PIT-CURVE (P.136)	Pitch curve
REVO.MIX (P.138)	Revolution mixing (PIT to RUD)
THR HOLD (P.140)	Throttlehold
GOVERNOR (P.141)	Governor mixing
HOV-THR (P.143)	Hovering Throttle
HOV-PIT (P.144)	Hovering Pitch
HI/LO-PIT (P.145)	HI/LO-pitch trim
THR-MIX (P.146)	Swash → Throttle mixing
THR-NEEDL (P.147)	Throttle → Needle mixing

Helicopter



CONDITION Condition select (Idle-up • Throttlehold) (HELICOPTER)

Function

The condition switches (idle up 1/2/3 and throttle hold switch) are not operative at initial setting. Switch setting is performed in advance with the condition select function.

- Initially set to idle up 1: SwE (center), idle up 2: SwE (forward), idle up 3: SwF (forward), throttle hold: SwG (forward).

Method

Calling the setting screen

① Call the menu screen from the home screen by pressing the **+** key for 1 second.



② Select **"CONDITION"** from the menu with the **Jog key**.



③ Open the setting screen by pressing the **Jog key**.

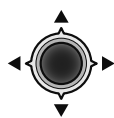

Idle-up setting
Throttlehold setting

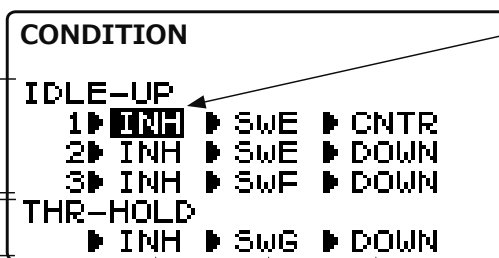

- When not using this Function select INH. The display of On/Off is shown when active and assigned to a switch.

- Select the setting item with the **Jog key**.

(Activating the function) (Switch selection) (Switch direction)

Helicopter

Condition select

Activating the function

① Select the **"INH"** item of the condition you want to use and set it to **"ON"** or **"OFF"** by pressing the **+** key or **-** key.

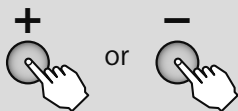

- Set conditions you do not want to use to **"INH"**.

(In the case of change of a switch)

Switch selection

② A cursor is moved to **"Switch selection"** and a switch is changed by **+** key or **-** key.

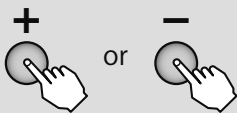

Range : SwA ~ SwH
Default : SwE (IDLE-UP1/2)、
SwF (IDLE-UP3)、SwG (THR-HOLD)

Switch direction

③ A cursor is moved to **"Switch direction"** and a switch direction is changed by **+** key or **-** key.

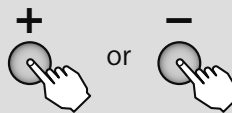

Range :
● 2P SW : NULL, UP, DOWN
● 3P SW : NULL, UP, UP&D, UP&C, CNTR, C&DN, DOWN



SWASH AFR

Swash AFR

(HELICOPTER)

Function

(When swash type is H-1, this setting screen is not displayed.)

This is the adjustable function rate (AFR) function when HR3, H-3, HE3, HN3, H-2, H-4, or H4X is selected as the swash type. The ailerons, elevators, and pitch steering angle and direction can be adjusted.

Method

Calling the setting screen

① Call the menu screen from the home screen by pressing the **+** key for 1 second.



② Select **"SWASH AFR"** from the menu with the **Jog key**.



③ Open the setting screen by pressing the **Jog key**.



● Select the setting item with the **Jog key**.

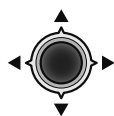

Rete

SWASH AFR

RATE-AIL ▶ + 50%
ELE ▶ + 50%
PIT ▶ + 50%

● Depending on the swash type the screen display is different.

● When the polarity is changed, the direction of operation is reversed.

NOTE : If the steering angle is too large, linkage binding may occur .

Swash AFR

■ Travel adjustment of each function

① Select each function item of **"RATE"** and set the rate by pressing the **+** key or **-** key.

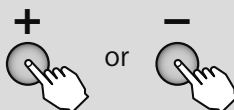

Range : **-100 ~ +100%**
Default : **+50%**

● When you want to return the set value to the initial value, press the **+** key and **-** key simultaneously. However, polarity does not return.



SWH.MIX

Swash mixing

(HELICOPTER)

Function

This mixing is used to correct the bad tendencies of the swash plate in the aileron direction and elevator direction relative to aileron, elevator, and pitch operations. It adjusts the rate of the direction that requires correction so that the servo operates

smoothly in the proper direction relative to each operation.

- The correction amount of each condition can be set.
- The left and right (up and down) correction amount can be set for each condition.

Example of use: Using to correct bad roll tendencies

- ① AIL → ELE is set to ON.
- ② ACTION/ON is common to all conditions. The rate of unused conditions is set to 0%.
- ③ When the nose drops at right roll and the right side rate is adjusted in the "+" direction, the elevators move to the up side when the right aileron is deflected. Left roll can be adjusted by left side rate. However, since the left and right ailerons polarity and elevators operating direction relationship is reversed; check the correction direction by swash plate operation.

Method

Calling the setting screen

- ① Call the menu screen from the home screen by pressing the **+** key for 1 second.

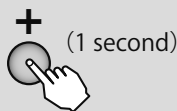

- ② Select **"SWH.MIX"** from the menu with the **Jog** key.



- ③ Open the setting screen by pressing the **Jog** key.



- Select the setting item with the **Jog** key.

Condition
 Mixing master direction
 Mixing rate

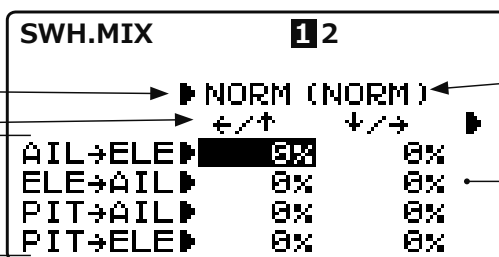

(Present condition)

(Rate)

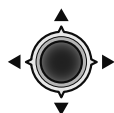

Helicopter

Activating the function

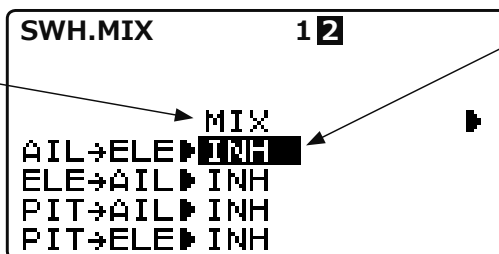

- When not using this function, select INH.



Swash mixing

■ Activating the function

- ① Select the "MIX" item and then select the "ON" by pressing the **+ key** or **- key**.

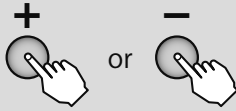

- When you are not using a function, set this to INH.

■ Setup of rate

- ② Select the "RATE" item and then adjust the mixing rate by pressing the **+ key** or **- key**.

Range : **-100 ~ +100%**

Default : **0%**

- When you want to return the set value to the initial value, press the **+ key** and **- key** simultaneously.

- ON/OFF of a function, Setup of rate, and a trim, **Jog key** is pushed and setting condition can be chosen.

Range :
NORM, IDL1, IDL2, IDL3, HOLD





SWH.RING Swash ring

(HELICOPTER)

Function

This swash mixing function limits swash travel to prevent damage to the switch linkage due to simultaneous aileron and elevator operation. It is effective in 3D aerobatics with a large steering angle.

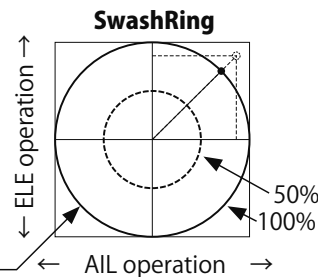

- Aileron and elevator stick operation is limited to within the circle (swash mixing) in the figure shown at the right. (When rate is 100%)

Method

Calling the setting screen

① Call the menu screen from the home screen by pressing the **+** key for 1 second.



② Select "SWH.RING" from the menu with the **Jog key**.



③ Open the setting screen by pressing the **Jog key**.



SWH.RING

MIX ▶ INH

Swash Ring rate ▶ RATE ▶ 100%

AIL = 0%

ELE = 0%

- When not using this function, select INH.
- Displays the actual aileron and elevator combined travel when the stick is manipulated.
- Select the setting item with the **Jog key**.
- Adjusts the operable range (swash mixing) of the aileron and elevator sticks.

Helicopter

Swash Ring

■ Activating the function

① Select the "MIX" item and then select the "ON" by pressing the **+** key or **-** key.

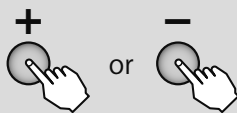

- When you do not use a function, set to the "INH" side.

■ Setup of rate

② Select the "RATE" item and then adjust the mixing rate by pressing the **+** key or **-** key.

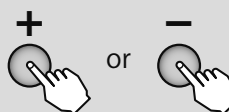

Range : 50 ~ 200%
Default : 100%

- When you want to return the set value to the initial value, press the **+** key and **-** key simultaneously.

NOTE : Adjust the swash mixing rate to the largest swash inclination at which the linkage rod does not interfere.



OFFSET

Trim offset

(HELICOPTER)

Function

If this trim offset function is used, independent trim adjustments can be made during hovering and in the air. This function can offset the ailerons, elevators, and rudder neutral position by linking to the set switch or condition. A habit that tends to appear from the standpoint of helicopter characteristics when flying at high speed is possible. This function can correct this habit.

- For a clockwise rotation rotor, since the helicopter tilts to the right during flight, use the offset function to set the swash plate so that the helicopter tilts to the left. Since the direction of the elevators is

different depending on adjustment of the aircraft, decide the setting direction after flight. When the gyro is used in the AVCS mode at the rudder, etc., the offset rate is made 0% (initial setting) to make corrections at the gyro side.

- When the switch was selected 1 offset system can be set for a 2 position switch and 2 offset systems can be set for a 3 position switch. Linking to conditions (IDL1 ~ 3, HOLD) is also possible.
- When the offset function is on, data adjustment is possible even by digital trim. The trim adjusted rate is input in the air. (When the offset function is ON, the initial screen trim display is linked.)

Method

Calling the setting screen

- 1 Call the menu screen from the home screen by pressing the **+** key for 1 second.



- 2 Select **"OFFSET"** from the menu with the **Jog key**.



- 3 Open the setting screen by pressing the **Jog key**.



- Select the setting item with the **Jog key**.

Activating the function

Switch direction,

Selection of condition

Offset rate

Switch selection

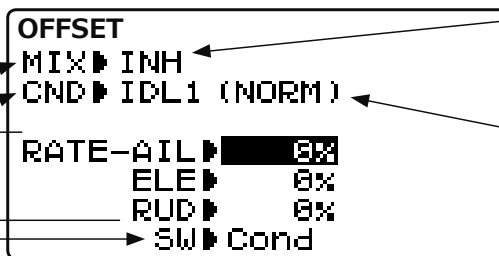

- When not using this Function select INH. The display of On/Off is shown when active and assigned to a switch.

(Present condition)

- When "Cond" is chosen, if Jog key is pushed for 1 second, it will change to each condition setting screen.



Trim offset

Activating the function

- 1 Select the **"MIX"** item and then select the **"ON"** or **"OFF"** by pressing the **+** key or **-** key.

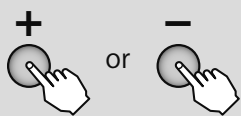

- When you do not use a function, set to the "INH" side.

Switch selection

- 2 Select the **"SW"** item and then select the switch by pressing the **+** key or **-** key.

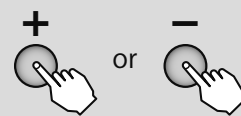

Range : **Cond, SwA ~ SwH**

Switch direction and condition selection

- 3 Select the switch direction and condition you want to set at the switch direction and condition items.

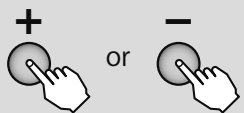

Offset rate

- 4 Select the **"RATE"** item and then adjust the offset rate by pressing the **+** key or **-** key.

Range : **-120 ~ +120%**

Default : **0%**

- When you want to return the set value to the initial value, press the **+** key and **-** key simultaneously.



DELAY

Delay

(HELICOPTER)

Function

This function prevents sudden offset changes when the offset, pitch→rudder mixing and condition select (Idle-up • Throttle-hold) functions are turned on and off.

- Delay can be set at the ailerons, elevators, rudder, throttle, and pitch.
- The set delay is common to the offset, pitch→rudder mixing, and condition select functions.
- The delay rate is reflected in common. In other words, it can't be established different rate by the respective functions.

Method

Calling the setting screen

① Call the menu screen from the home screen by pressing the **+** key for 1 second.

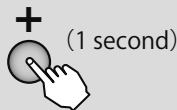

② Select **"DELAY"** from the menu with the **Jog key**.

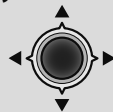

③ Open the setting screen by pressing the **Jog key**.



- Select the setting item with the **Jog key**.

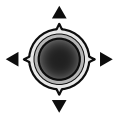

Delay rate

DELAY

RATE-AIL	▶	0% (OFF)
ELE	▶	0% (OFF)
RUD	▶	0% (OFF)
THR	▶	0% (OFF)
PIT	▶	0% (OFF)

- Linked to the offset, revolution mixing, and throttle hold functions and turned "ON".

- The delay is maximum at 100%.

Servo Speed Normal

0%

100% More slowly

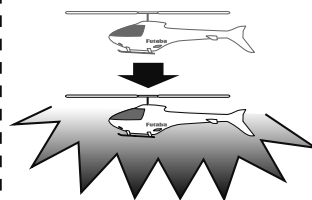

ON
Function ON

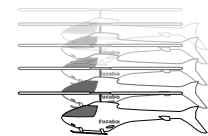

Delay rate

Delay rate setup

① Select the **"RATE"** item and then adjust the delay rate by pressing the **+** key or **-** key.

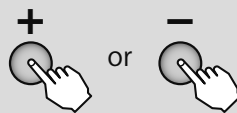

Range : 0 ~ 100%

Default : 0%

- When you want to return the set value to the initial value, press the **+** key and **-** key simultaneously.



THR.CUT Throttle cut (HELICOPTER)

Function

This function cuts (stops) the engine or motor by stick operation. At throttle operation, the rate is adjusted to the position which completely cuts the throttle servo or ESC when the throttle is operated. At function operation, this position is held regardless of the throttle stick position.

the motor will not unexpectedly run at high speed when the throttle cut function is reset. When the throttle stick is higher than the set throttle position, the throttle cut function is not reset even if the switch is set to OFF. Set to a safe throttle position (slow side).

- NOR/ESC operation mode switching. For motor aircraft, select ESC. For motor aircraft, the throttle position when the function is reset can be set so

- Function operation can be selected from among switches A ~ H.
- Set the throttle cut function for safety also.

Method

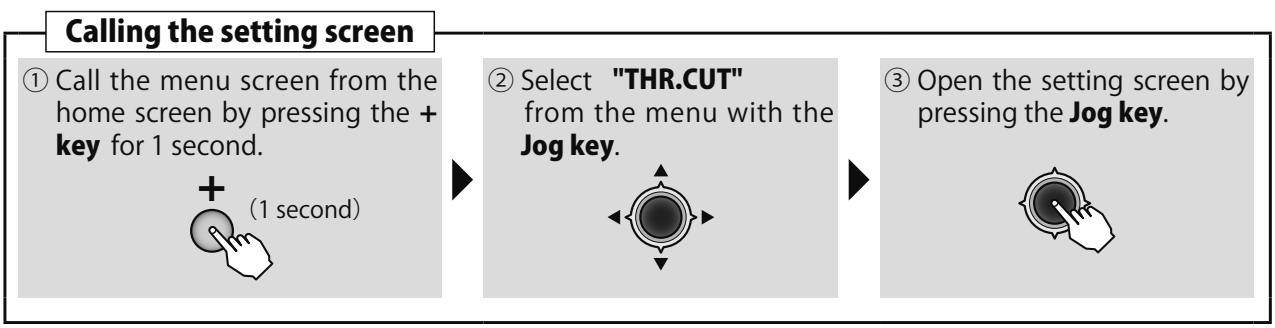

Mode

Activating the function

Cut Position rate

Throttle Position

Switch selection

Switch direction

THR.CUT

MODE ▶ NOR

MIX ▶ INH

RATE ▶ 0%

THR ▶ 15% (15%)

SW ▶ SWA

POSI ▶ NULL

- When not using this Function select INH. The display of On/Off is shown when active and assigned to a switch.
- Adjusts the rate to the position that completely cuts the throttle servo or ESC.
- The "THR" item can be set when the operation mode is "ESC". The number in parentheses is the current throttle stick position.

- Select the setting item with the **Jog key**.
- Sets the ON/OFF direction of the selected switch.
 - 2P SW : NULL, UP, DOWN
 - 3P SW : NULL, UP, UP&D, UP&C, CNTR, C&DN, DOWN

Helicopter



Throttle Cut

■ Mode

- ① Select the "MODE" item and then select the mode by pressing the **+ key** or **- key**.

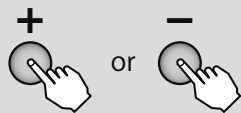

Range : **NOR, ESC**
Default : **NOR**

- "NOR" : Engine plane
- "ESC" : Electric motor plane

■ Activating the function

- ② Select the "MIX" item and then select the off by pressing the **+ key** or **- key**.

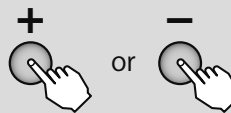

- When you do not use a function, set to the "INH" side.

■ Switch selection

- ③ Select the "SW" item and then select the switch by pressing the **+ key** or **- key**.

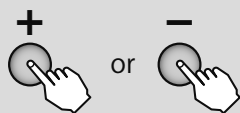

Range : **SwA ~ SwH**
Default : **SwA**

■ Switch direction

- ④ Select the "POSI" by pressing the **+ key** or **- key** at the ON direction selection item.

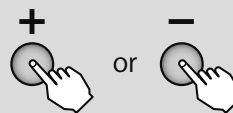

- Range :
- 2P SW : **NULL, UP, DOWN**
 - 3P SW : **NULL, UP, UP&D, UP&C, CNTR, C&DN, DOWN**

■ Cut Position rate

- ⑤ Select the "RATE" item and then select the cht position by pressing the **+ key** or **- key** (motor stop).

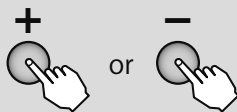

- It adjusts to the position where an engine is cut.

Range : **-30 ~ 0 ~ +30%**
Default : **0%**

- When you want to return the set value to the initial value, press the **+ key** and **- key** simultaneously.

(In the case of ESC)

■ Function release Throttle Position

- ⑥ Select the "THR" item and then select the release position by THR stick is lowered and **Jog key** is pressed for 1 second.



- Set to a safe low throttle position.

Range : **0 ~ 100%**
Default : **15%**



GYRO SENS Gyro mixing (HELICOPTER)

(For helicopters Gyro mixing)

Function

This mixing adjusts the gyro sensitivity from the transmitter. The AVCS gyro (GY mode) or normal gyro (STD mode) can be selected. Up to 3 axes can be set.

- The sensitivity can be linked to the condition (Cond) or an arbitrary switch and set.

- When the GY mode was selected, "AVC" or "NOR" is displayed at the sensitivity setting value.
- The sensitivity setting channel can be selected from the RUD (CH5), RUD/AIL(CH5/CH7), RUD/ELE (CH5/CH8) or RUD/AIL/ELE (CH5/CH7/CH8) combinations.

Method

Calling the setting screen

① Call the menu screen from the home screen by pressing the **+** key for 1 second.

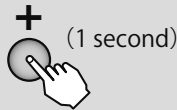

② Select **"GYRO SENS"** from the menu with the **Jog key**.

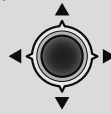

③ Open the setting screen by pressing the **Jog key**.



Activating the function

Gain channel selection

Switch direction

GYRO SENS

MIX ▶ INH SW ▶ Cond

CH ▶ RUD/AIL/ELE (CH5/7/8)

▶ NORM (NORM)

type	rate
RUD ▶ STD	▶ 50.0%
AIL ▶ STD	▶ 50.0%
ELE ▶ STD	▶ 50.0%

• When not using this function, select INH.

Gain switch direction
(Present switch position)

• Switches to the sensitivity setting screen of each switch direction when the **Jog key** is pressed.

● Select the setting item with the **Jog key**.

(Gyro type) (Gyro Gain set)

● When a Futaba GY gyro is used, gyro type "GY" is selected. This switches the gyro sensitivity setting item to the mode and sensitivity direct reading display.

Gyro setup

■ Activating the function

① Select the **"MIX"** item and then select the **"ON"** by pressing the **+** key or **- key**.

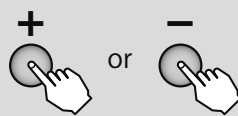

- When you do not use a function, set to the "INH" side.

■ Gain switch selection

② Select the **"SW"** item and then select the switch by pressing the **+** key or **- key**.

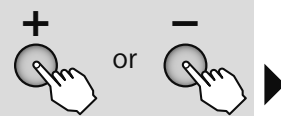

Range : **Cond, SwA ~ SwH**

■ Gain channel selection

③ Select the **"CH"** item and then select the sensitivity setting channel by pressing the **+** key or **- key**.

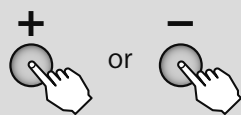

Range : **RUD, RUD/AIL, RUD/ELE, RUD/AIL/ELE**
Default : **RUD**

■ Gyro type and sensitivity setting

④ Press the **Jog key** and select the sensitivity setting screen you want to set and then set **"type"** (gyro type) and **"rate"** (gyro sensitivity) of each channel by pressing the **+** key or **- key**.

("type") Range : **STD, GY** Default : **STD**

("rate") Range : **0 ~ 100% (STD) , NOR100 ~ 0 ~ AVC100% (GY)** Default : **50% (STD) , 0% (GY)**

- When you want to return the set value to the initial value, press the **+** key and **- key** simultaneously.

Helicopter



Function

D/R

The aileron, elevator and rudder channel control surface angle can be switched in 2 steps

- The control surface angle is adjusted by each direction of the switch or condition. The left and right (up and down) direction of each switch can be set individually.

EXP

This function makes operation more pleasant by changing the operating curve so that servo movement is sluggish or sensitive relative to stick operation near the aileron, elevator, throttle, and rudder neutral position. Adjustments can be made in 2 steps according to the control surface angle.

- The "-" side makes servo movement sluggish and the "+" side makes servo movement sensitive near the neutral position. Exponential is applied to entire throttle servo travel. When the "+" side is increased, the slow side becomes sluggish and the high side becomes sensitive.
- Setting corresponding to each rate of dual rate (D/R) is possible. (Except throttle) The direction of each switch and the left and right (up and down) direction of each channel can be set individually.

Switch selection (SW)

Switches A to H can be selected as the aileron channel, elevator channel, and rudder channel dual rate (exponential) switch.

- Select : Switch ~ SwitchH / condition : Cond
- Default : Aileron : SwitchD / Elevator : SwitchA / Rudder : SwitchB

Method

Calling the setting screen

① Call the menu screen from the home screen by pressing the + key for 1 second.

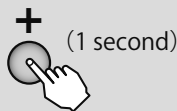

② Select "D/R,EXPO" from the menu with the Jog key.



③ Open the setting screen by pressing the Jog key.



Helicopter

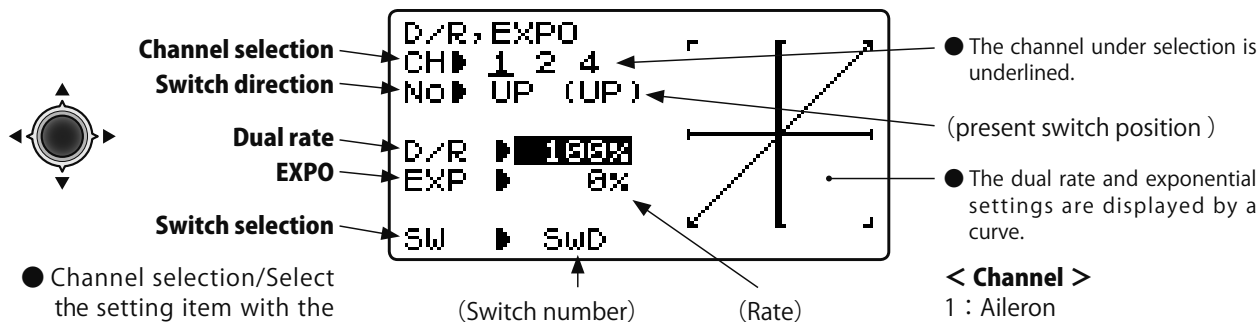

- Channel selection/Select the setting item with the **Jog key**.
- **Jog key** is pushed for 1 second, a condition screen will change.



Dual rate

■ Channel selection

① A channel is chosen by **Jog key**.



Range : **1, 2, 4**

■ Switch direction

② Select the "No" item and then select the switch direction or condition by pressing the **+ key** or **- key**.

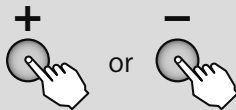

■ D/R Setup of rate

③ Select each function item of "D/R" and set the rate by pressing the **+ key** or **- key**.

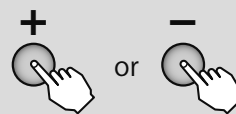

Range : **0 ~ 140%** Default : **100%**

● When you want to return the set value to the initial value, press the **+ key** and **- key** simultaneously.

Adjust the rate of each direction of the dual rate switch and stick by repeating step

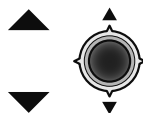

● Moving to another setting item of the same channel is possible by **Jog key**.

EXPO

■ Channel selection

① A channel is chosen by **Jog key**.



Range : **1, 2, 4**

■ Switch direction

② Select the "No" item and then select the switch direction or condition by pressing the **+ key** or **- key**.

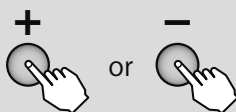

■ EXP Setup of rate

③ Select the "EXP" item and then adjust the rate by pressing the **+ key** or **- key**.

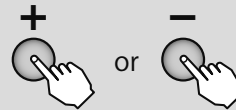

Range : **-100 ~ +100%** Default : **0%**

● When you want to return the set value to the initial value, press the **+ key** and **- key** simultaneously.

Adjust the rate of each direction of the dual rate switch and stick by repeating step

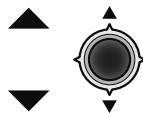

● Moving to another setting item of the same channel is possible by **Jog key**.

Switch Change

■ Channel selection

① Select the "SW" item and then select the channel with the **Jog key**.



Range : **1, 2, 4**

■ Switch selection

② A switch or Cond is chosen by **+ key** or **- key**.



Range : **SwA ~ SwH, Cond**

● When "Cond" is chosen, a setup is possible for every condition.



THR-CURVE

Throttle curve (For helicopters)

(HELICOPTER)

Function

The throttle curve function sets a 5 point curve in relation to the throttle stick movement and adjusts each point over the 0 ~ 100% range so that the engine speed is optimum for flight.

- Normal (NOR), idle up 1 (IDL1), idle up 2 (IDL2), and idle up 3 (IDL3) throttle curves can be set.
- The normal (NOR), idle up 1 (IDL1), idle up 2 (IDL2), and idle up 3 (IDL3) switch can be pre-set at the condition selection screen.

(Normal throttle curve adjustment method)

The normal throttle curve creates a basic throttle curve centered near hovering. This curve is adjusted together with the normal pitch curve so that engine speed is constant and up/down control is easiest. The normal throttle function is always on.

(Idle up 1/2/3 throttle curve adjustment method)

The idle up curves are set so that the engine maintains a constant speed even when the pitch is reduced during flight. Curves matched to the purpose such as loop, roll and 3D are created and idle up curves 1/2/3 are by aerobatics.

⚠ CAUTIONS

! [Operation precautions] When starting the engine, always set idle up sticks 1/2/3 to OFF and start the engine at idling.

Method

Calling the setting screen

① Call the menu screen from the home screen by pressing the **+** key for 1 second.



② Select **"THR-CURVE"** from the menu with the **Jog** key.



③ Open the setting screen by pressing the **Jog** key.



Helicopter

Activating the function →

Setting condition →

5point curve rate →

● Select the setting item with the **Jog** key.

THR-CURVE

→ MIX ▸ ---

CND ▸ NOR (NOR)

P-5 >	100.0%	
P-4 >	75.0%	
P-3 >	50.0%	
P-2 >	25.0%	
P-1 >	0.0%	

(Rate)

(Present condition)

● When not using this Function select INH. The display of On/Off is shown when active and assigned to a switch. A display when normal is "----" (alwaysON).

● The THR-CURVE settings are displayed by a curve.



Throttle curve

■ Activating the throttle curves (ID1/2/3)

- ① Select the "MIX" item and set to "ON" or "OFF" by pressing the + key or - key.

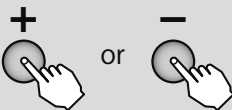

- For the normal condition, "---" is displayed. (Always ON)
- When you do not want to use an idle up curve, set to "INH".

Range : **NOR, ID1, ID2, ID3**

■ 5 point curve setting

- ② Select the setting item of each point (P-1 ~ P-5) with the **Jog key** and set the travel of each point by pressing the + key or - key.

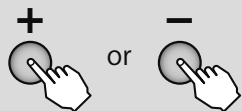

Range : **0 ~ 100%**

Default :

P-5: 100%

P-4: 75%

P-3: 50%

P-2: 25%

P-1: 0%

- When you want to return the set value to the initial value, press the + key and - key simultaneously.

■ Curve copying method

- ① Select the "CND" item and switch to the curve copy mode by pressing the **Jog key**.



- ② Press the + key or - key and select the copy destination condition.

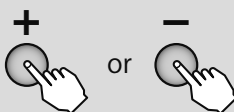

- ③ Copy the condition by pressing the **Jog key** for 1 second.

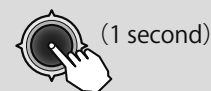

● Throttle curve setting examples

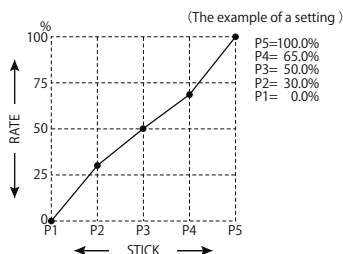

(Normal)

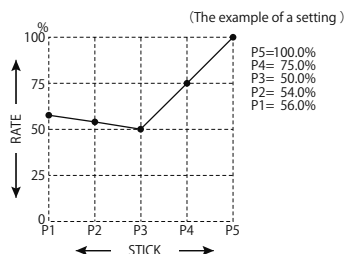

(Idle-up1)

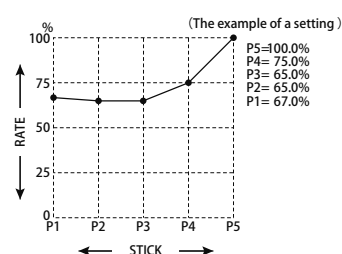

(Idle-up2)

NOTE : Set the actual value of the throttle curve according to the fuselage specifications.

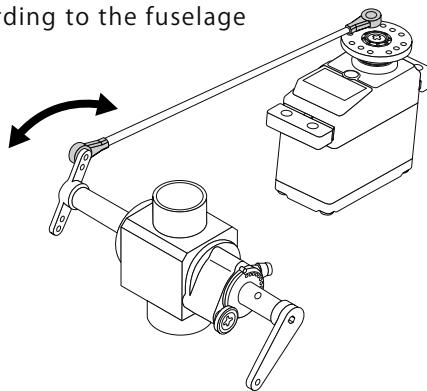



PIT-CURVE Pitch curve (For helicopters)

(HELICOPTER)

Function

The pitch curve function allows setting by a 5 point curve in relation to throttle stick movement and adjustment of each point over the -100% ~ +100% range so that the pitch enters the optimum flight state.

- Normal (NOR), idle up 1 (IDL1), idle up 2 (IDL2), idle up 3 (IDL3), and hold (HLD) pitch curves can be set.
- The normal (NOR), idle up 1 (IDL1), idle up 2 (IDL2), idle up 3 (IDL3), and hold (HLD) switches can be pre-set at the conditions selection screen.

NOTE : When the hold switch is on, the hold function has priority even though an idle up switch is in any position.

(Normal curve adjustment method)

The normal pitch curve creates a basic pitch curve centered near hovering. This curve is adjusted together with the throttle pitch curve so that engine speed is constant and up/down control is easiest.

(Idle up 1/2/3 curve adjustment method)

The high side pitch curve sets the maximum pitch that does not apply a load to the engine. The low side pitch curve is created to match the purpose such as loop, roll, and 3D. The idle up 1/2/3 curves are used by aerobatics.

(Throttle hold curve adjustment method)

The throttle hold curve is used when performing auto rotation dives. Set the intermediate pitch to match the stick work at pitch up.

Method

Helicopter

Calling the setting screen

① Call the menu screen from the home screen by pressing the **+** key for 1 second.



② Select **"PIT-CURVE"** from the menu with the **Jog** key.



③ Open the setting screen by pressing the **Jog** key.



Activating the function →

Condition →

5point curve rate →

- Select the setting item with the **Jog** key.

PIT-CURVE

MIX ▸ ----

CNC ▸ NOR (NOR)

P-5 ▸ +100%

P-4 ▸ + 50%

P-3 ▸ 0%

P-2 ▸ - 50%

P-1 ▸ -100%

- When not using this Function select INH. The display of On/Off is shown when active and assigned to a switch. When normal, "----" (always ON) is displayed.
- The PIT-CURVE settings are displayed by a curve.

(Rate) (Present condition)



Pitch curve

■ Activating the pitch curves (ID1/2/3, HLD)

- ① Select the "MIX" item and then select the "ON" or "OFF" by pressing the **+ key** or **- key**.

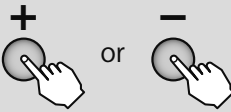

- For the normal condition, "---" is displayed. (Always ON)
- When you do not want to use an idle up, hold curve, set to "INH".

Range : **NOR, ID1, ID2, ID3, HLD**

■ 5 point curve setting

- ② Select the setting item of each point (P-1 ~ P-5) with the **Jog key** and set the travel of each point by pressing the **+ key** or **- key**.

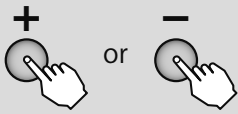

Range : **-100 ~ +100%**

Default :

P-5: +100%

P-4: +50%

P-3: 0%

P-2: -50%

P-1: -100%

- When you want to return the set value to the initial value, press the **+ key** and **- key** simultaneously.

■ Curve copying method

- ① Select the "CND" item and switch to the curve copy mode by pressing the **Jog key**.



- ② Press the **+ key** or **- key** and select the copy destination condition.

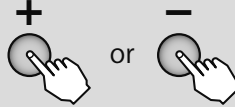

- ③ Copy the condition by pressing the **Jog key** for 1 second.



● Pitch curve setting examples

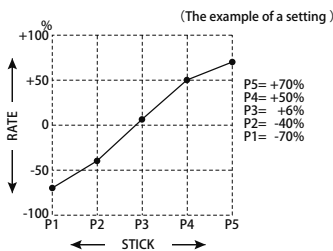

(Normal)

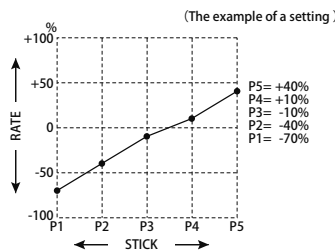

(Idle-up1)

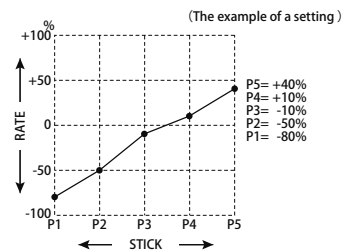

(Idle-up2)

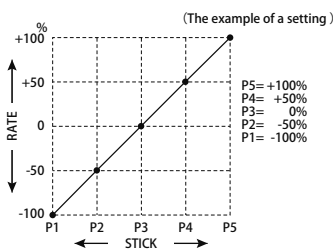

(Hold)

NOTE : Set the actual value of the pitch curve according to the fuselage specifications.

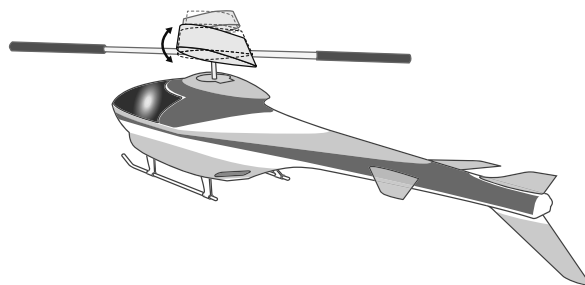



Function

The pitch→rudder mixing function controls the pitch of the tail rotor to suppress the reaction torque (force that attempts to swing the helicopter in the direction opposite the direction of rotation of the main rotor) generated by the main rotor pitch and speed. It is adjusted so that the pitch of the tail rotor is also changed when the main rotor pitch changes and reaction torque appears and so that the nose does not swing to the left and right. However, when the AVCS mode is used with a GY Series gyro, pitch→rudder mixing is unnecessary.

- The normal (NOR) idle up 1/2 (IDL1,2), and idle up 3 (IDL3) rates can be set.
 - The high side and low side rates can be adjusted.
 - For a clockwise rotation rotor, the operating direction is set so that the rudder is mixed in the right direction when the pitch becomes plus. For a counterclockwise rotation rotor, the setting is opposite. The operating direction setting reverses the rate polarity.
CW rotation: Low side (LOW) -10%, high side (HIGH) +10%
CCW rotation: Low side (LOW) +10%, high side (HIGH) -10%
- *The above values are the initial values. Replace them with the actual setting values.

Adjustment procedure

First, trim at hovering and then adjust the neutral position.

(Normal pitch → rudder mixing)

● **Throttle low side (slow while hovering) adjustment**

Repeatedly hover from take off and land from hovering at a constant rate matched to your own rhythm, and adjust pitch → rudder mixing so that the nose does not deflect when the throttle is raised and lowered.

If the nose points to the left when landing from hovering or points to the right when taking off, when hovering stabilizes and the stick moves to the neutral position, low side mixing rate is probably too large and when the nose points in the opposite direction, low side rate is probably too small. However, when landing, the direction of the nose may not stabilize depending on the state on the ground. The direction of the nose may also become unstable when rotation of the rotor does not rise.

● **Throttle high (up to climbing from hovering and diving hovering) adjustment**

Repeat up to climbing from hovering and diving hovering matched to your own rhythm and adjust pitch → rudder mixing so that the nose does not deflect to the left and right when the throttle is raised and lowered. If the nose points to the right when climbing from hovering, the high side mixing rate is too large and if the nose points to the left, the mixing rate is too small. Repeat climbing and diving and make adjustment while taking the balance.

(idle-up1/2,3Pitch → Rudder mixing)

This mixing sets the mixing rate so that the rudder direction is straight forward at high speed flight.

Helicopter

Method

Calling the setting screen

① Call the menu screen from the home screen by pressing the **+** key for 1 second.



② Select **"REVO.MIX"** from the menu with the **Jog key**.



③ Open the setting screen by pressing the **Jog key**.





REVO.MIX

- MIX ▸ INH
- CND ▸ NORM (NOR)
- HIGH ▸ + 10%
- LOW ▸ - 10%

● When not using this function, select INH.

(present switch position)

● Select the setting item with the **Jog** key.

(Rate)

Labels for the REVO.MIX screen:

- Activating the function
- Selection of condition
- High side Setup of rate
- Low side Setup of rate

Pitch → Ruddermixing

■ Activating the function

① Select the "MIX" item and then select the "ON" by pressing the **+** key or **-** key.

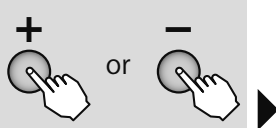

● When you do not use a function, set to the "INH" side.

■ Selection of condition

② Select the "CND" item and selection of condition by pressing the **+** key or **-** key.

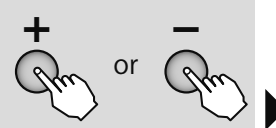

Range : **NORM, IDL1/2, IDL3**

■ Setup of rate

③ Select each function item of "HI" or "LO" and set the rate by pressing the **+** key or **-** key.

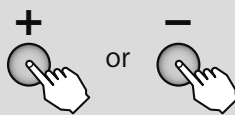

Range : **-100 ~ +100%**

Default(NORM) : **-20%(LOW), +20%(HIGH)**

Default(IDL1/2/3) : **0%(LOW), 0%(HIGH)**

● When you want to return the set value to the initial value, press the **+** key and **-** key simultaneously.

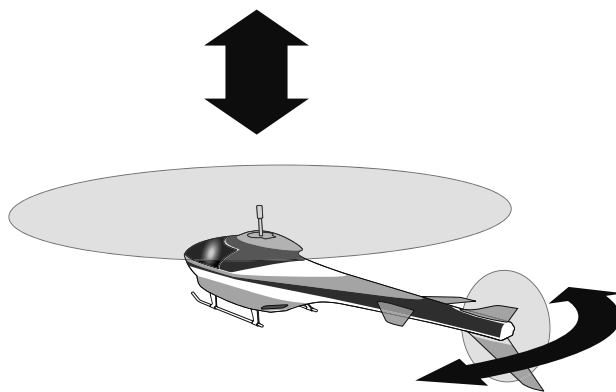



THR HOLD Throttle hold

(HELICOPTER)

Function

The throttle hold function fixes or stops the engine throttle position by hold switch operation during an auto rotation dive. Operation can be set within the -50% ~ +50% range based on the

throttle trim position.

The switch is changed at the conditions selection screen. (Initial setting: SwG)

CAUTIONS

[NOTE] Priority is given to throttlehold over idle-up.

Method

Calling the setting screen

① Call the menu screen from the home screen by pressing the **+** key for 1 second.



② Select **"THR HOLD"** from the menu with the **Jog key**.

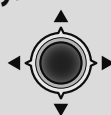

③ Open the setting screen by pressing the **Jog key**.



THR HOLD

Activating the function → MIX ▶ INH

hold throttle position → RATE ▶ **5%**

● Select the setting item with the **Jog key**.

● When not using this Function select INH. The display of On/Off is shown when active and assigned to a switch.

Throttle hold

Activating the function

① Select the **"MIX"** item and then select the **"ON"** or **"OFF"** by pressing the **+** key or **-** key.

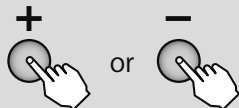

● When you do not use a function, set to the "INH" side.

Hold throttle position

② Select the **"RATE"** item and then adjust the rate by pressing the **+** key or **-** key.

Range : **-50 ~ +50%**
Default : **0%**

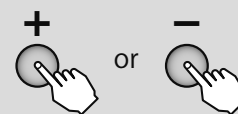

● When you want to return the set value to the initial value, press the **+** key and **-** key simultaneously.

● Function ACT ↔ INH is linked to condition THR-HOLD, and can be set at any screen.

[Hold position adjustment method]

- When you want to lower the engine idling, set to the "+" direction and adjust so that the carburetor is full open.
- When maintaining idling, set the throttle stick to the slow position and turn the hold switch on and off and set to the number at which the servo does not operate.

NOTE : When connecting the throttle linkage, lower the digital trim to the slowest and adjust so that the carburetor is full open.

Helicopter



GOVERNOR

Governor mixing

(HELICOPTER)

Function

When a governor (CGY750/GY701/GV-1, etc.) is used, the speed can be adjusted from the transmitter. CH7 or CH8 or CH9 can be selected as the speed setting control channel.

When using a separate ON/OFF switch (cut switch), ON/OFF control uses CH8. In this case, CH7 or CH9 controls speed setting.

Setting examples :

● Example of setting that switches the speed and ON/OFF by 3 position switch

Governor speed (setting example)	3position		Adjustment from transmitter
	Switch direction	Setup of rate	
R.P.M 1 : OFF	UP	0%	0% (Governor R.P.M "off")
R.P.M 2 : 1400	CNTR	50%	"50%"
R.P.M 3 : 1700	DOWN	100%	"100%"
*For example, speed 3 sets the maximum speed to be used and is lowered and adjusted at the transmitter.	*For the time being use the initial rate setting.		*Since speed adjustment from the transmitter is rate setting, checking the actual speed at the governor display and remembering its relationship is convenient.

● Switching the speed for each condition

The speed for each condition can be set by selecting "Cond" by switch. Since speed adjustment from the transmitter is rate setting, for the actual speed check the governor display.

● Controlling governor ON/OFF by separate switch

When a separate switch is used to turn the governor on and off, switch setting is performed by "OFF-CNTRL" item.

*Speed and ON/OFF switch settings are different depending on the governor. Perform these settings in accordance with the instruction manual of the governor used.

*At throttle hold, always confirm that the governor is OFF. Conversely, when raising the speed value, reverse the polarity of "CH8".

Method

Calling the setting screen

① Call the menu screen from the home screen by pressing the **+** key for 1 second.



② Select **"GOVERNOR"** from the menu with the **Jog** key.



③ Open the setting screen by pressing the **Jog** key.



GOVERNOR

MIX ▶ INH OFF-CTRL

MODE ▶ Cond ▶ CH8

→ NORM ▶ 0.0% SW ▶ SWB

IDL1 ▶ 50.0% POS ▶ DOWN

IDL2 ▶ 100.0%

IDL3 ▶ 100.0%

HOLD ▶ OFF

Activating the function →

Switch selection →

Setup of rate →

● Select the setting item with the **Jog** key.

● The above screen shows the case when the speed is set for each condition.

● When "INH", the function cannot be used. When you want to use CH7 as the speed setting channel, select "CH7" and when you want to use CH8(9), select "CH8(9)".



Governor mixing

■ Activating the function (R.P.M CH selection)

- ① Select the "MIX" item and then select the "CH7""CH8" or "CH9" by pressing the **+ key** or **- key**.

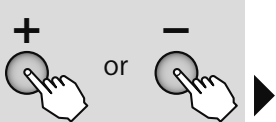

- When you do not use a function, set to the "INH" side.

■ Switch selection

- ② Select the "MODE" item and then select the switch by pressing the **+ key** or **- key**.

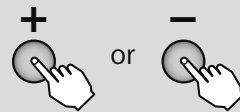

Range : **Cond, SwA ~ SwH**

■ R.P.M setting

- ③ Select the "RATE" item and then adjust the rate by pressing the **+ key** or **- key**.

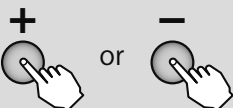

Range : **0.0 ~ 100.0%**

Default :
(**Cond**)

**NORM=0.0%, IDL1=50.0%, IDL2=100.0%,
IDL3=100.0%, HOLD=0.0%**

(2P Switch selection)

UP=0.0%, DOWN=100.0%

(3P Switch selection)

UP=0.0%, CNTR=50.0%, DOWN=100.0%

(When using an ON/OFF switch)

*Select the OFF-CTRL item and then adjust the rate by pressing the **+ key** or **- key**.

■ ON/OFF Switch selection

- ① Select the "SW" item and then select the switch by pressing the **+ key** or **- key**.

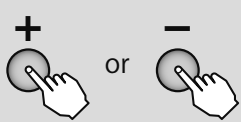

Range : **SwA ~ SwH**

Default : **SwA**

■ Switch direction

- ② Select the "POSI" by pressing the **+ key** or **- key** at the ON direction selection item.



- 2P SW : **UP, DOWN**
- 3P SW : **UP, UP&D, UP&C, CNTR, C&DN, DOWN**

(When number of rotations goes up at the time of Throttlehold)

*If the speed is increased at throttle hold, the governor and transmitter operating directions will not coincide. In this case, match the operating directions by reversing the polarity of "CH8".

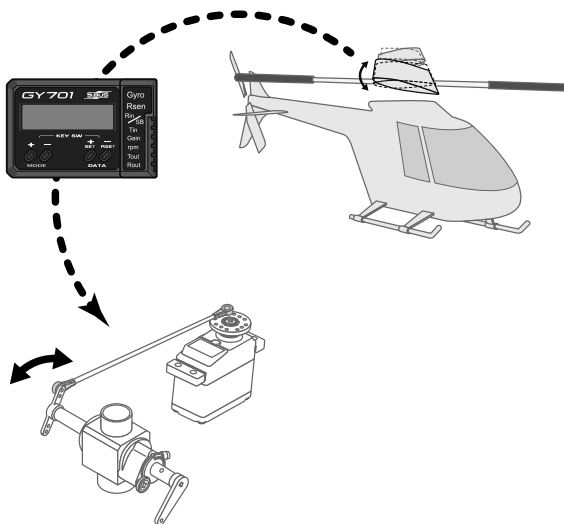

What is a governor ?

A governor is made up of a set of sensors which read the RPM of the helicopter's head, and a control unit that automatically adjusts the throttle setting to maintain a constant head speed regardless of changes in pitch of blades, weather conditions, etc. Governors are extremely popular in competition helicopters due to the consistency provided.

How does it help in helicopter setup? The governor eliminates the need to spend large amounts of time setting up throttle curves, as it automatically adjusts the engine's RPM to maintain the desired head speed.



HOV-THR Hovering throttle

(HELICOPTER)

Function

The hovering throttle function trims the throttle near the hovering point.

When the hovering throttle knob is turned clockwise, the speed increases and when it is turned counterclockwise, the speed decreases. Rotor speed changes due to changes in the temperature,

humidity, and other flying conditions can be trimmed. Adjust for the most stable rotor speed. More precise trimming is possible by using this function together with the hovering pitch function.

- The operation condition can be selected from only normal or normal/idle up 1.

Method

Calling the setting screen

- ① Call the menu screen from the home screen by pressing the **+** key for 1 second.



- ② Select **"HOV-THR"** from the menu with the **Jog key**.

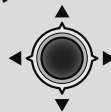

- ③ Open the setting screen by pressing the **Jog key**.



Activating the function

Trim memory setting

VR setting

Selection of condition

HOV-THR

MIX ▶ INH OFFSET

RATE ▶ 0% (0%)

VR ▶ +DT6

MODE ▶ NORM

- When "INH", the function cannot be used. To use the function, switch to "ON".
- (Compensation amount at trim memory)
- (Actual compensation amount including the hovering throttle knob)
- The knob operating direction is different depending on the polarity.

- Select the setting item with the **Jog key**.
- NORM : Only the normal condition operates
- NORM/IDL1 : It operates by normal condition and idle-up1.

Hovering Throttle

■ Activating the function

- ① Select the **"MIX"** item and then select the **"ON"** by pressing the **+** key or **-** key.

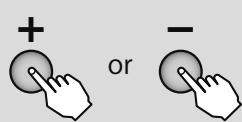

- When you do not use a function, set to the "INH" side.

■ Selection of condition

- ② Select the **"MODE"** item and then select condition by pressing the **+** key or **-** key.

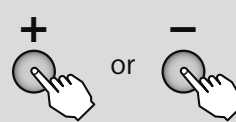

Range : **NORM, NORM/IDL1**
Default : **NORM**

■ VR setting

- ③ Select the **"VR"** item and then select the **"VR"** or **"DT"** by pressing the **+** key or **-** key.

Range : NULL (OFF), +VR, -VR, +DT5, -DT5, +DT6, -DT6
Default : **+DT6**

(Memorizing the hovering throttle adjustment position)

■ Memory setting

- ④ Select the **"RATE"** item and memorize the current trim position by pressing the **Jog** key.



- When the knob is returned to the center after memorization, the trim position returns to its previous position.

[NOTE] If memorization is repeated at the same position, the value is cumulated.

Helicopter



HOV-PIT

Hovering pitch

(HELICOPTER)

Function

The hovering pitch function trims the pitch near the hovering point.

When the hovering pitch knob is turned clockwise, the pitch gets stronger and when it is turned counterclockwise, the pitch gets weaker. Rotor speed changes due to changes in temperature, humidity, and other flying conditions can be trimmed. Adjust for the most stable rotor rotation.

More precise trimming is possible by using this function together with the hovering throttle function.

- The operating condition can be selected from normal only and normal/idle up 1.
- The trim position can be memorized. If it is memorized before the model memory is changed, the original trim state can be retrieved by merely setting the knob to the center when the trim position is recalled.

Method

Calling the setting screen

① Call the menu screen from the home screen by pressing the **+** key for 1 second.

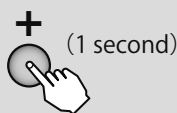

② Select "HOV-PIT" from the menu with the **Jog** key.

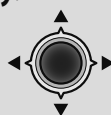

③ Open the setting screen by pressing the **Jog** key.



Activating the function

Trim memory setting

VR setting

Selection of condition

HOV-PIT

MIX ▶ INH OFFSET

RATE ▶ ████████ (%) (0%)

VR ▶ -VR

MODE ▶ NORM

- When "INH", the function cannot be used. To use the function, switch to "ON".
- (Compensation amount at trim memory)
- (Actual compensation amount including the hovering pitch knob)
- The knob operating direction is different depending on the polarity

- Select the setting item with the **Jog** key.
- NORM : Only the normal condition operates
- NORM/IDL1 : It operates by normal condition and idle-up1.

Helicopter

Hovering Pitch

■ Activating the function

① Select the "MIX" item and then select the "ON" by pressing the **+** key or **-** key.

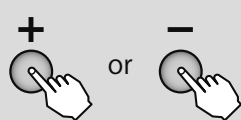

- When you do not use a function, set to the "INH" side.

■ Selection of condition

② Select the "MODE" item and then select condition by pressing the **+** key or **-** key.

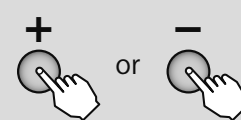

Range : **NORM, NORM/IDL1**
Default : **NORM**

■ VR setting

③ Select the "VR" item and then select the "VR" or "DT" by pressing the **+** key or **-** key.

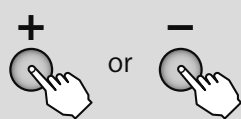

Range : NULL (OFF), +VR, -VR, +DT5, -DT5, +DT6, -DT6
Default : **-VR**

(Memorizing the hovering pitch adjustment position)

■ Memory setting

④ Select the "RATE" item and memorize the current trim position by pressing the **Jog** key.

- When the knob is returned to the center after memorization, the trim position returns to its previous position.

[NOTE] If memorization is repeated at the same position, the value is cumulated.



HI/LO-PIT

HI/LO-pitch trim

(HELICOPTER)

Function

The high/low pitch trim function adjusts the pitch servo high side and low side to the optimum pitch individually for each flight condition (normal, idle up 1/2/3, hold).

- The high pitch and low pitch trim levers and operating direction can be selected. The trim levers operate in common for each condition and a use/do not use trim lever can be selected for each function.

Method

Calling the setting screen

① Call the menu screen from the home screen by pressing the **+** key for 1 second.



② Select **"HI/LO-PIT"** from the menu with the **Jog key**.



③ Open the setting screen by pressing the **Jog key**.

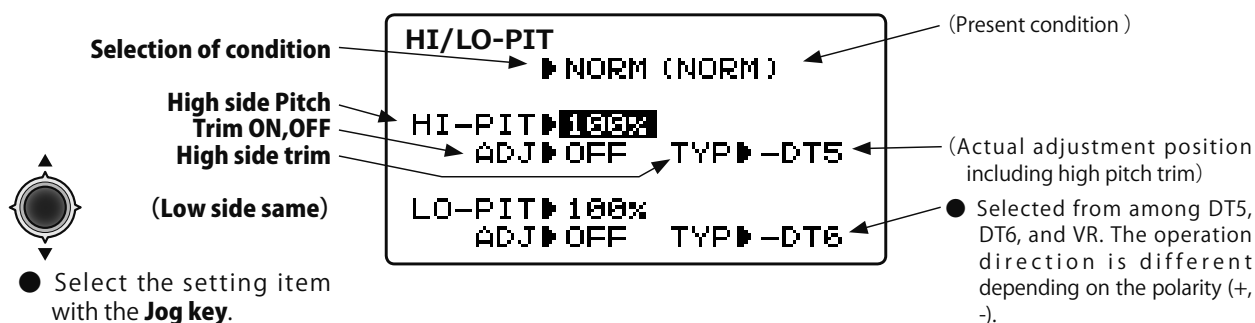

- Select the setting item with the **Jog key**.

- Selected from among DT5, DT6, and VR. The operation direction is different depending on the polarity (+, -).

HI/LO-pitch trim

■ Selection of condition

① Select the setting condition selection item and select the condition by pressing the **+** key or **-** key.

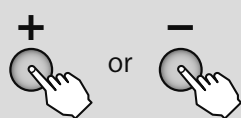

■ DT, VR adjustment ON, OFF selection

② Select ON, OFF by pressing the **+** key or **-** key at the high side "ADJ" item.

■ TYP selection

③ Select trim or VR by pressing the **+** key or **-** key at the "TYP" item.

Range : **+DT5, -DT5, +DT6, -DT6, +VR, -VR**

- The high side or low side pitch can be adjusted with the selected digital trim or VR.

■ Adjustment by Key operation

④ Select each function item of "HI-PIT" or "LO-PIT" and set the pitch rate by pressing the **+** key or **-** key.

Range : **60 ~ 100%**
Default : **100%**



THR-MIX

Throttle mixing

(HELICOPTER)

Function

This mixing compensates for slowing of the helicopter when the ailerons, elevators, and rudder are operated.

- The compensation amount can be set for each condition.

- The correction amount limits the throttle hold point 5 (or highest point) operation.

Method

Calling the setting screen

① Call the menu screen from the home screen by pressing the **+** key for 1 second.



② Select "THR-MIX" from the menu with the **Jog key**.



③ Open the setting screen by pressing the **Jog key**.

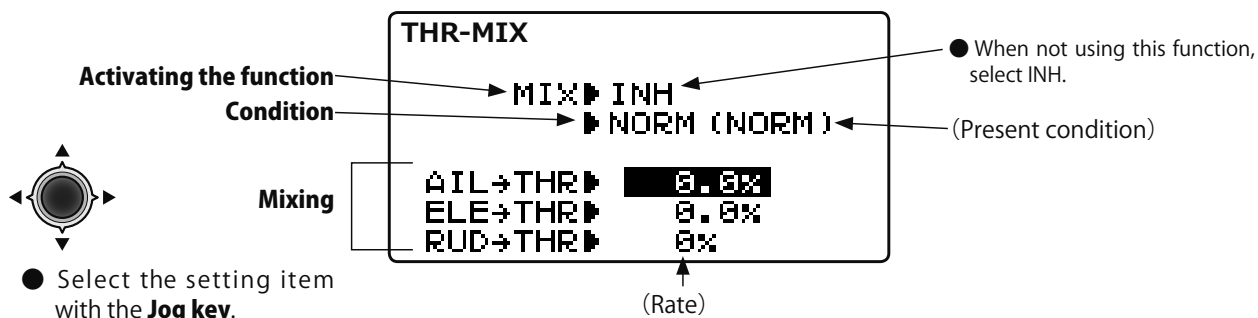

Helicopter

Throttle mixing

Activating the function

① Select the "MIX" item and then select the "ON" by pressing the **+** key or **-** key.

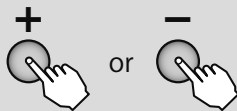

- When you do not use a function, set to the "INH" side.

Setup of rate

② Select each function item of "MIX" and set the rate by pressing the **+** key or **-** key.

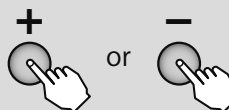

Range : 0 ~ 100%
(RUD → THR : -100 ~ +100%)
Default : 0%

- When you want to return the set value to the initial value, press the **+** key and **-** key simultaneously.

• The setting condition can be selected by pressing the **Jog key** at rate adjustment.

Range : **NORM, IDL1, IDL2, IDL3**





THR → NEEDL Throttle → Needle mixing (For helicopters) (HELICOPTER)

Function

This mixing sets the mixture by a 5 point curve in relation to throttle stick movement when the engine is equipped with a mixture control system (needle control or other mixture adjustment). Normal condition (NOR) idle up use (ID2) and idle up 3 (ID3) can be set independently. The needle servo connects to CH8 of the transmitter.

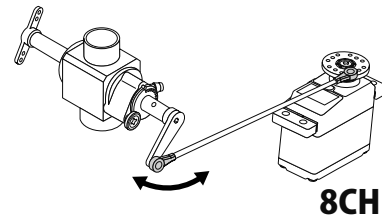

Method

Calling the setting screen

① Call the menu screen from the home screen by pressing the **+** key for 1 second.



② Select "THR → NEEDL" from the menu with the **Jog** key.

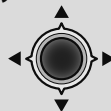

③ Open the setting screen by pressing the **Jog** key.



Activating the function

Condition

5 point curve set

THR → NEEDL	MIX ▶ INH
CND ▶ NOR (NOR)	
P-5 >	100.0%
P-4 >	75.0%
P-3 >	50.0%
P-2 >	25.0%
P-1 ▶	0.0%

- When not using this function, select INH.
- (Present condition)
- The CURVE settings are displayed by a curve.

● Select the setting item with the **Jog** key.

Throttle → Needle mixing

■ Activating the function

① Select the "MIX" item and then select the "ON" by pressing the **+** key or **-** key.

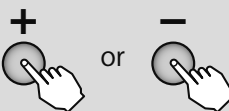

● When you do not use a function, set to the "INH" side.

● When such, setting condition can be chosen by pressing **Jog** key.

Range : NOR, I12, ID3



■ 5 point curve setting

② Select the setting item of each point (P-1 ~ P-5) with the **Jog** key and set the travel of each point by pressing the **+** key or **-** key.

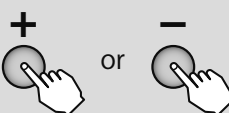

Range : 0.0 ~ 100.0%

Default :
P-5: 100.0%
P-4: 75.0%
P-3: 50.0%
P-2: 25.0%
P-1: 0.0%

● When you want to return the set value to the initial value, press the **+** key and **-** key simultaneously.

■ Curve copying method

① Select the "CND" item and switch to the curve copy mode by pressing the **Jog** key.



② Press the **+** key or **-** key and select the copy destination condition.



③ Copy the condition by pressing the **Jog** key for 1 second.



Helicopter

Glider function



The setting screen of each function is called from the following menu. The function when the model type was set to glider (2AIL+4FLP) is displayed here.

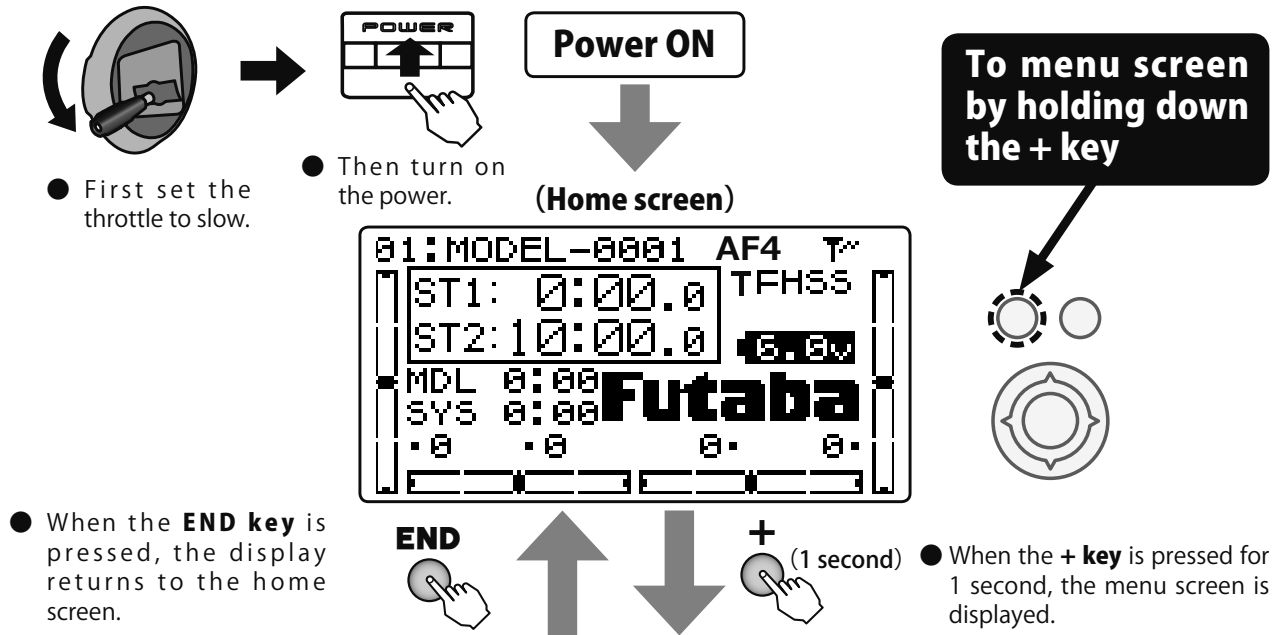

MENU

MENU
1/3

MENU	AF4	1 2 3
▶ MDL-SEL		▶ END POINT
▶ MDL-NAME		▶ TRIM
▶ FAIL SAFE		▶ SUB TRIM
▶ REVERSE		▶ P.MIX1-6
▶ TIMER		▶ AUX-CHAN
▶ SERVO		▶ PARAMETER

MENU
2/3

MENU	AF4	1 2 3
▶ TELEMETRY		▶ AIL→RUD
▶ SENSOR		▶ V-TAIL
▶ SBUS LINK		▶ GYRO SENS
▶ MDL-TRANS		
▶ TRAINER		
▶ AIL-DIFF		

MENU
3/3

MENU	AF4	1 2 3
▶ D/R,EXPO		▶ BUTTERFLY
▶ MOTOR		▶ CAMBR→ELE
▶ CONDITION		▶ ELE→CAMBR
▶ RUD→AIL		▶ AIL→CAMBR
▶ CAMBR FLP		▶ AIL→BRKFL
▶ CAMBR MIX		▶ TRIM MIX

(Selection)

● Move the cursor (highlighted) up and down and to the left and right with the **Jog key** and select the function. The cursor can be moved over several pages.

(Calling the setting screen)

● Press the **Jog key** to open the setting screen.

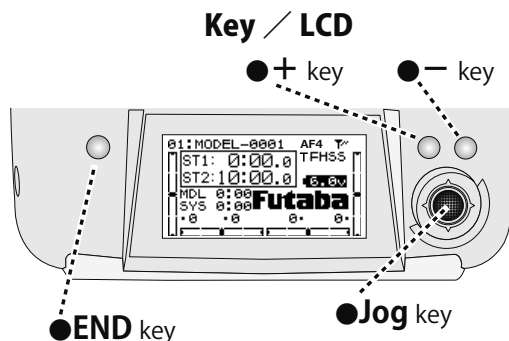

■ The menu item is an example of WING type 2 ailerons + 4 flaps. The menu items can be changed according to the WING type. For example, if WING type is 1AIL, since the item blinks, reference only the item of the WING type used.

Relevant WING type display → **WING TYPE** 1AIL 2AIL 2AIL+1F 2AIL+2F 2AIL+4F

Refer to "Common Functions" previously described for a description of this function.

■ **Function**

MENU1/3	
MDL-SEL (P.40)	Model select / Model Copy / Data reset / RX / Link
MDL-NAME (P.43)	Model name / User name
FAIL SAFE (P.45)	Fail safe
REVERSE (P.47)	Servo reverse
TIMER (P.48)	Timer
SERVO (P.49)	Servo monitor / Servo test
END POINT (P.50)	End point
TRIM (P.51)	Trim reset / Trim step
SUB TRIM (P.52)	Sub trim
P.MIX1-6 (P.53)	Program mixing 1 ~ 6
AUX-CHAN (P.56)	AUX channel
PARAMETER (P.58)	Data reset / Model type / ATL-trim / LCD contrast / Back light : mode, time, adjustment / Home display / Battery alarm / Battery vibration / Buzzer tone / Jog navi / Jog light / Jog time / Telemetry : mode, unit / Speech : language, volume / Stick position alarm

MENU2/3	
TELEMETRY (P.66)	Telemetry Display / Alarm setup
SENSOR (P.83)	Telemetry sensor
SBUS LINK (P.89)	S.BUS servo set up
MDL-TRANS (P.92)	Data transfer of another 10J or 8J
TRAINER (P.93)	Trainer
AIL-DIFF (P.150)	Aileron Differential
AIL → RUD (P.151)	Aileron → Rudder
V-TAIL (P.152)	V-Tail
GYRO SENS (P.153)	Gyro mixing

MENU 3/3	
D/R, EXPO (P.154)	Dual rate / EXPO
MOTOR SW (P.156)	Motor switch
CONDITION (P.157)	Condition
RUD → AIL (P.158)	Rudder → Aileron mixing
CAMBR FLP (P.159)	Camber flap mixing
CAMBR MIX (P.160)	Camber mixing
BUTTERFLY (P.161)	Butterfly mixing
CAMBR → ELE (P.162)	Camber → Elevator mixing
ELE → CAMBR (P.163)	Elevator → Camber mixing
AIL → CAMBR (P.165)	Aileron → Camber mixing
AIL → BRKFL (P.166)	Aileron → Brake flap
TRIM MIX (P.167)	Trim MIX



AIL-DIFF

Aileron differential

(GLIDER)

WING TYPE

2AIL

2AIL+1F

2AIL+2F

2AIL+4F

Function

Two servos can be used for ailerons and a differential can be applied to left and right aileron operation.

Connect the left aileron to CH1 (AIL) and the right aileron to CH7.

- The up and down angle of the left and right aileron control surface can be adjusted individually.

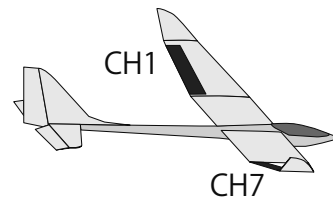

Method

Calling the setting screen

- ① Call the menu screen from the home screen by pressing the **+** key for 1 second.



- ② Select "AIL-DIFF" from the menu with the **Jog** key.



- ③ Open the setting screen by pressing the **Jog** key.

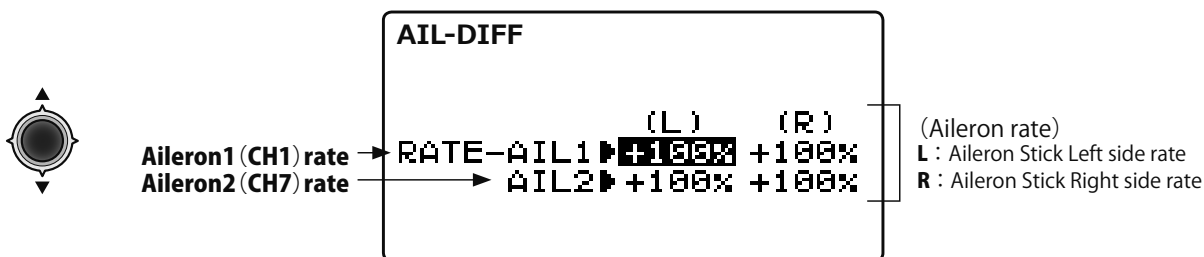

- Select the setting item with the **Jog** key.

Aileron Differential

■ Aileron control surface angle adjustment

- ① Select the "RATE-AIL1" item and then move the aileron stick to the left and right and adjust the travel of each by pressing the **+** key or **-** key.

Range : -120 ~ +120%
Default : +100%

- When you want to return the set value to the initial value, press the **+** key and **-** key simultaneously. However, polarity does not return.

(Adjust the **RATE-AIL2** item the same as ①.)



AIL → RUD Aileron → Rudder

(GLIDER)

WING TYPE 1AIL 2AIL 2AIL+1F 2AIL+2F 2AIL+4F

Function

Use this mix when you want to mix the rudder with aileron operation. This allows the aircraft to bank at a steep angle.

- When the mixing direction is reversed by the linkage, adjustments can be made by changing the rate polarity.

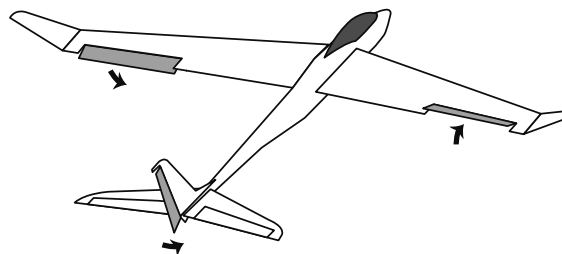

Method

Calling the setting screen

- 1 Call the menu screen from the home screen by pressing the **+** key for 1 second.



- 2 Select "AIL → RUD" from the menu with the **Jog key**.

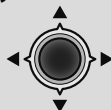

- 3 Open the setting screen by pressing the **Jog key**.



AIL → RUD

Activating the function → MIX ▶ **INH**

Rate adjustment → RATE ▶ **0% (NORM)**

SW ▶ SWA

POSI ▶ DOWN

- When not using this function, select INH.
- When condition was used, the display can be switched and each connection can be set by switching the condition switch.
- The ON/OFF switch can be changed. (Selected with the **Jog key** and changed with the **+**key)
- Sets the ON/OFF direction of the selected switch.

3 Position Switch

NULL UP UP&DWN UP&CNT CENTER CNT&DN DOWN

2 Position Switch

NULL UP DOWN

Aileron → Rudder

■ Activating the function

- 1 Select the "MIX" item and then select the "ON" by pressing the **+** key or **-** key.

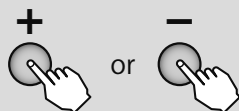

- When you do not use a function, set to the "INH" side.

■ Mixing rate

- 2 Select the "RATE" item and then adjust the mixing rate by pressing the **+** key or **-** key.

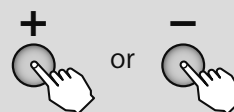

Range : -100 ~ +100%
Default : 0%

- When you want to return the set value to the initial value, press the **+** key and **-** key simultaneously. However, polarity does not return.



V-TAIL

V-Tail

(GLIDER)

WING TYPE 1AIL 2AIL 2AIL+1F 2AIL+2F 2AIL+4F

Function

This mixing is used with V tail aircraft that combine the elevator and rudder functions.

V-tail

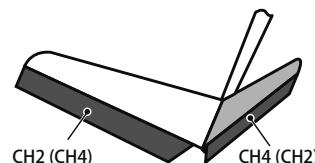

	CH2 Servo	CH4 Servo
Elevator	ELE1	ELE2
Rudder	RUD2	RUD1

Method

Calling the setting screen

① Call the menu screen from the home screen by pressing the **+** key for 1 second.



② Select "V-TAIL" from the menu with the **Jog** key.



③ Open the setting screen by pressing the **Jog** key.



Activating the function

V-TAIL
MIX ▶ INH

ELE1 rate → RATE-ELE1 ▶ + 50%
ELE2 rate → ELE2 ▶ - 50%

RUD2 rate → RUD2 ▶ + 50%
RUD1 rate → RUD1 ▶ + 50%

● When INH is selected, the function cannot be used. To use the function, select ACT.

(Rate adjustment)

● Select the setting item with the **Jog** key.

V-TAIL

■ Activating the function

① Select the "MIX" item and then select the "ACT" by pressing the **+** key or **-** key.

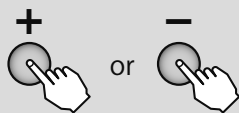

● When you do not use a function, set to the "INH" side.

■ Rate adjustment

② Select the "RATE" item and then adjust the mixing rate by pressing the **+** key or **-** key.

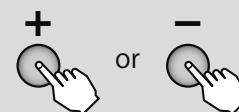

Range : -100 ~ +100%
Default : +50%
(only ELE2 : -50%)

● When you want to return the set value to the initial value, press the **+** key and **-** key simultaneously. However, polarity does not return.

NOTE : We recommend that setting be performed while moving the stick and checking the amount of movement. If the amount of movement is too large, elevator and rudder operation will be compounded and the servo travel range will be exceeded and a dead band in which the servo will not operate may be created.



GYRO SENS Gyro sensor

(GLIDER)

WING TYPE **1TAIL**

Function

This function is dedicated mixing for switching the gyro sensitivity and gyro mode (AVCS/NORMAL) of Futaba airplane use gyros. Up to 3 axes can be set.

- The sensitivity switch can be selected and the sensitivity of each direction of the switch can be set. (Switches A to H) If the airplane stalls during

flight, the gyro will lose control of the plane's attitude. From the standpoint of safety, we recommend that the OFF (0%) position also be set using a 3 position switch.

- CH5, CH5/CH7, CH5/CH8 or CH5/CH7/CH8 combinations can be selected as the sensitivity setting channel.

Method

Calling the setting screen

- 1 Call the menu screen from the home screen by pressing the **+** key for 1 second.



- 2 Select **"GYRO SENS"** from the menu with the **Jog key**.



- 3 Open the setting screen by pressing the **Jog key**.



Activating the function

Gain Channel selection

Switch direction

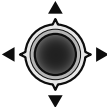

Gyrotype, Gain rate

- Select the setting item with the **Jog key**.

GYRO SENS

MIX ▶ INH ← SW ▶ SwA ←

CH ▶ CH5/CH7/CH8 ←

▶ UP (UP) ←

	type	rate
CH5 ▶	STD	▶ 50.0%
CH7 ▶	STD	▶ 50.0%
CH8 ▶	STD	▶ 50.0%

(Gyro type) (Gyro Gain)

- When not using this function, select INH.
- Sensitivity switch selection
- (Current switch operating direction)
- Switches to the sensitivity setting screen of each switch direction when the **Jog key** is pressed.



- When using a Futaba GYA gyro, select gyro type GY. This switches the gyro sensitivity setting item to mode and sensitivity direct reading display.

GYRO SENS

■ Activating the function

- 1 Select the **"MIX"** item and then select the **"ON"** by pressing the **+** key or **-** key.

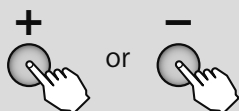

- When you do not use a function, set to the "INH" side.

■ Sensitivity switch selection

- 2 Select the **"SW"** item and then select the switch by pressing the **+** key or **-** key.

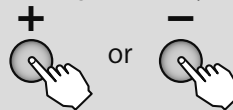

Range : SwA ~ SwH, Default : SwA

■ Sensitivity setting channel selection

- 3 Select the **"CH"** item and then select the sensitivity setting channel by pressing the **+** key or **-** key.

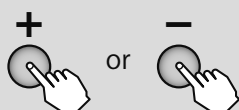

Range : CH5, CH5/CH7, CH5/CH8, CH5/CH7/CH8

Default : CH5

■ Gyro type and sensitivity setting

- 4 Press the **Jog key** and select the sensitivity setting screen you want to set and then set "type" (gyro type) and "rate" (gyro sensitivity) of each channel by pressing the **+** key or **-** key.

("type") Range : STD,GY Default : STD

("rate") Range : 0 ~ 100%(STD) , NOR100 ~ 0 ~ AVC100%(GY) Default : 50%(STD) , 0%(GY)

- When you want to return the set value to the initial value, press the **+** key and **-** key simultaneously.

Glider



D/R, EXPO

Dual rate / EXPO

(GLIDER)

WING TYPE

1AIL

2AIL

2AIL+1F

2AIL+2F

2AIL+4F

Function

D/R

The aileron, elevator and rudder channel control surface angle can be switched in 2 steps

- The control surface angle is adjusted by each direction of the switch. The left and right (up and down) direction of each switch can be set individually.

EXP

This function makes operation more pleasant by changing the operating curve so that servo movement is sluggish or sensitive relative to stick operation near the aileron, elevator, throttle, and rudder neutral position. Adjustments can be made in 2 steps according to the control surface angle.

- The "-" side makes servo movement sluggish and the "+" side makes servo movement sensitive near the neutral position. Exponential is applied to entire throttle servo travel. When the "+" side is increased, the slow side becomes sluggish and the high side becomes sensitive.
- Setting corresponding to each rate of dual rate (D/R) is possible. (Except throttle) The direction of each switch and the left and right (up and down) direction of each channel can be set individually.

Switch selection (SW)

Switches A to H can be selected as the aileron channel, elevator channel, and rudder channel dual rate (exponential) switch.

- Default : Aileron : SwitchD / Elevator : SwitchA / Rudder : SwitchB

Method

Calling the setting screen

- 1 Call the menu screen from the home screen by pressing the **+** key for 1 second.

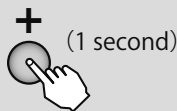

- 2 Select **"D/R, EXPO"** from the menu with the **Jog** key.



- 3 Open the setting screen by pressing the **Jog** key.



Glider

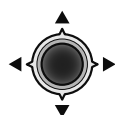

Channel selection

Dual rate

EXPO

Switch selection

D/R, EXPO

CH ▶ 1 2 3 4

(SW: UP ◀)

D/R ◀▶ 100%

▶▶ 100%

EXP ◀▶ 0%

▶▶ 0%

SW ▶ SWD

- Channel selection/Select the setting item with the **Jog** key.

(Switch number)

(D/R and EXPO rate display)
Top row ; Left side / down
Bottom row ; Right side / up

- The channel under selection is underlined.

(Switch Direction)

- The dual rate and exponential settings are displayed by a curve.

< Channel >

- 1 : Aileron
- 2 : Elevator
- 3 : Throttle
- 4 : Rudder



D/R

① A channel is chosen by **Jog key**.



Range : **1, 2, 4**

② Adjust the rate by moving the cursor to D/R with the **Jog key**, switching the dual rate switch to the direction you want to set, moving the stick to the left (down) or right (up) side and pressing the **+ key** or **- key**.



Range :
0 ~ 140%
Default : **100%**

- When you want to return the set value to the initial value, press the **+ key** and **- key** simultaneously.

Adjust the rate of each direction of the dual rate switch and stick by repeating step

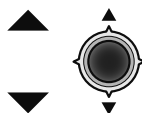

- Moving to another setting item of the same channel is possible by **Jog key**.

EXPO

① Select the "EXP" item and then select the channel with the **Jog key**.



Range : **1 ~ 4**

② Adjust the rate by moving the cursor to EXP with the **Jog key**, switching the dual rate switch to the direction you want to set, moving the stick to the left (down) or right (up) side and pressing the **+ key** or **- key**.



Range :
-100 ~ +100%
Default : **0%**

- When you want to return the set value to the initial value, press the **+ key** and **- key** simultaneously.

Adjust the rate of each direction of the dual rate switch and stick by repeating step

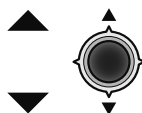

- Moving to another setting item of the same channel is possible by **Jog key**.

Switch Change

① Select the "SW" item and then select the channel with the **Jog key**.



Range : **1, 2, 4**

② A switch is chosen by **+ key** or **- key**.

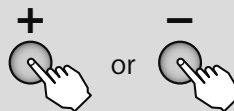

Range : **SwA ~ SwH**



MOTOR SW Motor switch

(GLIDER)

WING TYPE 1AIL 2AIL 2AIL+1F 2AIL+2F 2AIL+4F

Function

This function sets the operating motor when the EP glider with motor is started by switch. The operating speed can individually set in 2 ranges of high from slow and slow from high. **If you do motor control with a throttle stick, you should set this function to INH.**

- For safety, the ON/OFF switch of the aircraft itself can be set.
- If a transmitter power supply is switched on while the motor SW has been ON, the warning will operate. Be sure to switch on a power supply with the motor-start switch OFF.

Method

Calling the setting screen

- ① Call the menu screen from the home screen by pressing the **+** key for 1 second.
- ② Select **"MOTOR SW"** from the menu with the **Jog key**.
- ③ Open the setting screen by pressing the **Jog key**.

MOTOR SW

MODE ▶ OFF (0%)

SAFE SW ▶ SWA ▶ DOWN

STRT SW ▶ SWD ▶ DOWN (ON)

POSI ▶ 0% ▶ 100%

SPEED ▶ OFF ▶ OFF

- Present motor control position
- If this safety switch is not ON, the motor will not start even if the starter switch is turned on. In "NULL", a safe function does not work.
- Start SW
- A setup of the motor control position (3CH end point) of High-side and Low-side

● Select the setting item with the **Jog key**.

Motor

- Decelerating speed setting
- Accelerating speed setting

- ① **Activating the function**
Select the **"MODE"** item and then select the **"OFF"** by pressing the **+** key or **-** key.
● When you do not use a function, set to the "INH" side.
- ② **Switch selection**
Change the switch by pressing the **+** key or **-** key at the switch selection item.
Range : SwA ~ SwH
- ③ **Switch direction**
Select the **"DOWN"** item and then select the position by pressing the **+** key or **-** key.
● 2P SW : UP, DOWN
● 3P SW : UP, UP&D, UP&C, CNTR, C&DN, DOWN
- ④ **Speed setting**
Select **"SPEED"** next to (OFF) and (ON) by **Jog key**.
Range : OFF,1 ~ 10(more slowly)
● (ON) is the acceleration speed setting.
● (OFF) is the deceleration speed setting.

⚠ DANGER

- ! Always remove the propeller from the motor during setting and at operation checks.
 - There is the danger of the propeller spinning unexpectedly and causing a serious injury.

Glider



CONDITION Condition

(GLIDER)

WING TYPE 1AIL 2AIL 2AIL+1F 2AIL+2F 2AIL+4F

Function

The condition function lets you change multiple settings by one switch operation. Different settings can be made immediately by switching 2 conditions.

- The functions that can be changed by condition are:
 - Aileron→Rudder • Rudder→Aileron
 - Camber FLP • Camber MIX • Butterfly
 - Camber→ELE • ELE→Camber • AIL→Camber
 - AIL→BRKFL • Trim mix

Method

Calling the setting screen

① Call the menu screen from the home screen by pressing the **+** key for 1 second.



② Select "CONDITION" from the menu with the **Jog** key.



③ Open the setting screen by pressing the **Jog** key.

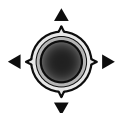

Condition1

Condition2

- Select the setting item with the **Jog** key.

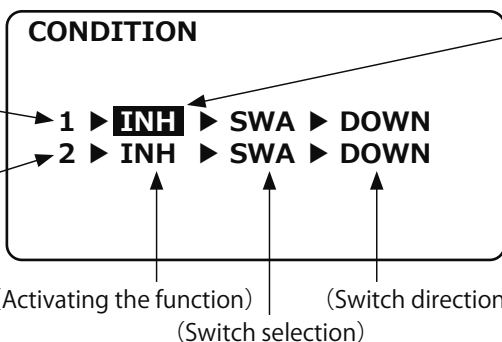

- When not using this Function select INH. The display of On/Off is shown when active and assigned to a switch.

- Priority is given to the condition 2 when the condition 1 and 2 is turned on simultaneously.

CONDITION

■ Activating the function

① Select the "INH" item of the condition you want to use and then set that condition to "ON" or "OFF" by pressing the **+** key or **-** key.

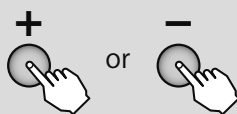

- Set conditions you do not want to use to "INH".

(Changing the switch)

■ Switch selection

② Change the switch by pressing the **+** key or **-** key at the switch selection item.

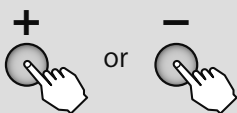

Range : SwA ~ SwH

Default : SwA

■ Switch direction

③ Select the ON direction by pressing the **+** key or **-** key at the ON direction selection item.

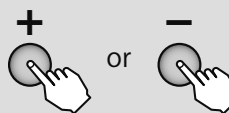

Range :

- 2P SW : NULL, UP, DOWN
- 3P SW : NULL, UP, UP&D, UP&C, CNTR, C&DN, DOWN



RUD → AIL Rudder → Aileron

(GLIDER)

WING TYPE 1AIL 2AIL 2AIL+1F 2AIL+2F 2AIL+4F

Function

This function is used when you want to mix the ailerons with rudder input. It is used when rudder is applied during roll maneuvers such as, knife edge flight. It can be used to turn or bank scale models, large models, etc. like a full-size aircraft.

- When the mixing direction is reversed by the linkage, adjustments can be made by changing the rate polarity.

Method

Calling the setting screen

① Call the menu screen from the home screen by pressing the **+** key for 1 second.

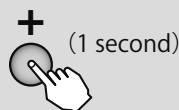

② Select **"RUD → AIL"** from the menu with the **Jog key**.



③ Open the setting screen by pressing the **Jog key**.



▲ **Activating the function**

● Select the setting item with the **Jog key**.

RUD → AIL

MIX ▶ **INH**

Mixing rate

RATE ▶ **0% (NORM)**

SW ▶ **SWA**

POSI ▶ **DOWN**

● When not using this function, select INH.

● When condition was used, the display can be switched and each connection can be set by switching the condition switch.

● The ON/OFF switch can be changed. (Selected by **Jog key** and changed by **+** key.)

● Sets the ON/OFF direction of the selected switch.

3 Position Switch

NULL UP UP&DWN UP&CNT CENTER CNT&DN DOWN

2 Position Switch

NULL UP DOWN

RUD → AIL

■ Activating the function

① Select the **"MIX"** item and then select the **"ON"** by pressing the **+** key or **-** key.

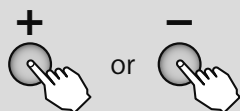

- When you do not use a function, set to the "INH" side.

■ Mixing rate

② Select the **"RATE"** item and then adjust the mixing rate by pressing the **+** key or **-** key.

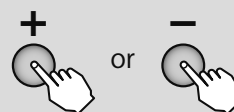

Range : **-100 ~ +100%**
Default : **0%**

- When you want to return the set value to the initial value, press the **+** key and **-** key simultaneously. However, polarity does not return.

Glider



CAMBR FLP Camber flap

(GLIDER)

WING TYPE

2AIL+1F

2AIL+2F

2AIL+4F

Function

The up/down travel of each flap (camber flaps: FLP1/2, brake flaps: FLP3/4) can be adjusted independently for each servo according to the wing type. The camber flaps operates by DT5 and the brake flaps operates by DT6.

- The axis of each flap can be shifted
- The control switch can be changed by AUX channel

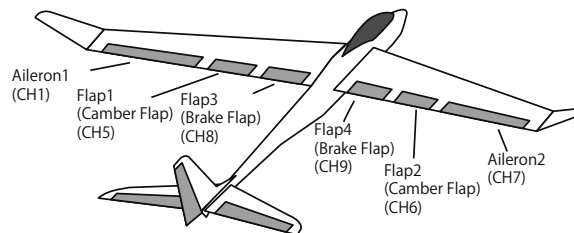

Method

Calling the setting screen

① Call the menu screen from the home screen by pressing the **+** key for 1 second.

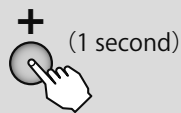

② Select "CAMBR FLP" from the menu with the **Jog key**.



③ Open the setting screen by pressing the **Jog key**.



DT5 and DT6 set the amount of movement when the flap is operated.

- Flap1
- Flap2
- Flap3
- Flap4

CAMBR FLP		CAMBER FLAP		1 2
	(RT1)	(RT2)	(OFS)	
F1	+100	+100	0	
F2	+100	+100	0	
F3	+100	+100	0	
F4	+100	+100	0	

- Up side rate
- Down side rate
- Offset rate

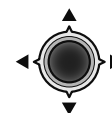

- Select the setting item with the **Jog key**.

+



-



- The number is changed by **+** key or **-** key.

Camber FLP 2 page

[Brakeflap → Camberflap]

(Currently selected condition)

CAMBR FLP (NORM)		1 2		
BRAKE FLAP → CAMBER		(RT1)	(RT2)	(OFS)
FL		+100	+100	0
MIX	INH			
SW	SWA			DOWN

- Selection of whether or not mixing from brake FLP to camber FLP is performed

- Brake FLP to camber FLP mixing switch selection

- Brake FLP to camber FLP mixing rate and offset (axis shift)

- Brake FLP to camber FLP mixing switch operation direction

Glider



CAMBR MIX Camber mixing

(GLIDER)

WING TYPE

2AIL

2AIL+1F

2AIL+2F

2AIL+4F

Function

This function adjusts the rate of camber operation for the wing camber (ailerons, camber flaps, brake flaps) in the negative and positive directions. The aileron, flap, and elevator rates can also be adjusted independently and attitude changes caused by camber operation can be

corrected.

*Initial setting assigns camber operation to side lever DT6.

- Operation can be turned on and off by switch
- VR can be changed by AUX channel 10

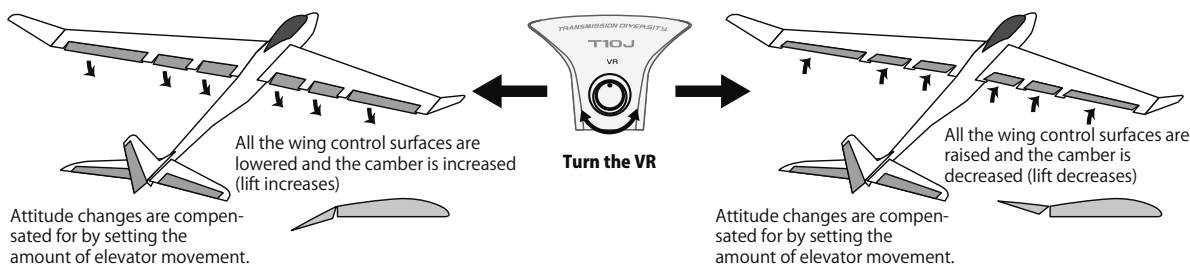

Method

Calling the setting screen

- 1 Call the menu screen from the home screen by pressing the **+** key for 1 second.



- 2 Select **"CAMBR MIX"** from the menu with the **Jog** key.



- 3 Open the setting screen by pressing the **Jog** key.



Sets the amount of movement when the VR was turned.

- Aileron1
- Aileron2
- Camber MIX ACT/INH
- Can be set to operate from a switch. When NULL, it is operated by a VR.

(Currently selected condition)

CAMBR MIX (NORM)		1	2
	(RATE1)	(RATE2)	
AIL1	0	0	
AIL2	0	0	
MIX	INH		
SW	SwA	DOWN	

• Select the setting item with the **Jog** key.

• The number is changed by **+** key or **-** key.

(RATE1): The amount of operations when VR is turned to the right.

(RATE2): The amount of operations when VR is turned to the left.

Sets the amount of movement when the VR is turned.

[Camber FLP 2 page]

(Currently selected condition)

CAMBR MIX (NORM)		1	2
	(RATE1)	(RATE2)	
FLP1	0	0	
FLP2	0	0	
FLP3	0	0	
FLP4	0	0	
ELE	0	0	

• Amount of compensation of the elevator when the camber changed.



BUTTERFLY Butterfly mixing

(GLIDER)

WING TYPE

2AIL

2AIL+1F

2AIL+2F

2AIL+4F

Function

This function is utilized to quickly slow the aircraft and reduce altitude by simultaneously raising the left and right ailerons and lowering the flaps (camber flap, brake flap).

Butterfly (Crow) produces an extremely efficient landing configuration by accomplishing the following:

1. Slow the aircraft's velocity.
2. Provide washout at the wing tips to reduce the tendency to tip stall.
3. Create more lift toward the center of the wing allowing it to fly at a slower speed
 - Mixing during flight can be turned ON/OFF by setting a switch.
 - The point at which the butterfly operation reference point can be offset.
 - The differential rate can be adjusted.

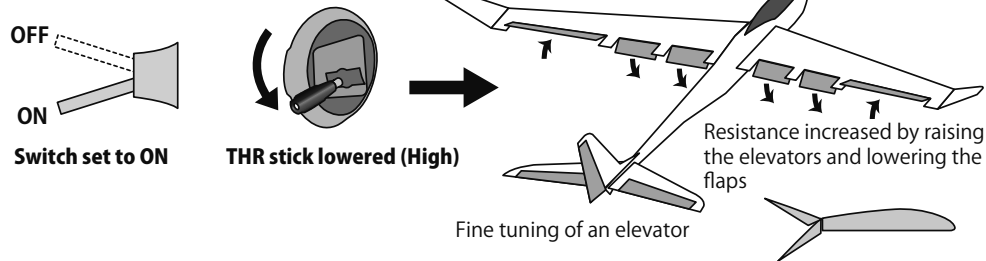

Method

Calling the setting screen

- ① Call the menu screen from the home screen by pressing the **+** key for 1 second.



- ② Select **"BUTTERFLY"** from the menu with the **Jog** key.

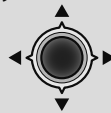

- ③ Open the setting screen by pressing the **Jog** key.



Amount of movement setting

(Currently selected condition)

- Aileron1
- Aileron2
- Amount of elevator compensation
- Butterfly : ACT/INH
- Can be either set to a switch or when NULL is controlled by the THR stick.

BUTTERFLY		(NORM)	
AIL1	▶ 0	FLP1	▶ 0
AIL2	▶ 0	FLP2	▶ 0
ELE	▶ 0	FLP3	▶ 0
		FLP4	▶ 0
MIX	▶ INH	<div style="border: 1px dashed black; padding: 2px;"> DOWN (60%) </div>	
SW	▶ SwA		
OFST	▶ 60%		

● Current THR stick position
0% : Low 100% : High

- Select the setting item with the **Jog** key.
- The number is changed by **+** key or **-** key.

- Offset setting –Select "OFST" XX%.



OFST ▶ 100%

At THR stick **high** press the **Jog** key for 1 second

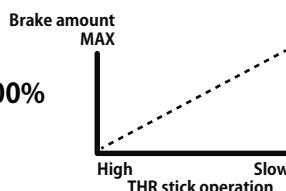

OFST ▶ 60%

At THR stick **60%** press the **Jog** key for 1 second

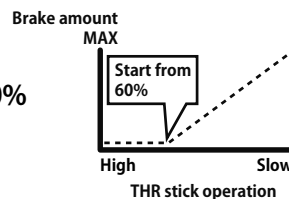

- When MIX is set to ACT, the amount of MIX(s) according to stick operation is displayed.
- When offset is set below a center, the mixing of THR stick operates by the high side.



CAMBR → ELE Camber → Elevator mixing

(GLIDER)

WING TYPE

2AIL+1F

2AIL+2F

2AIL+4F

Function

When the camber/speed flaps are utilized, the aircraft might experience, a change in pitch. This mix compensates for such changes by incorporating elevator input.

- The elevator servos up/down rates can be adjusted separately. If the mixing direction is reversed, change the mixing rate polarity (+ or -).
- Mixing during flight can be turned ON/OFF by setting a switch. (Always ON at SW [NULL] setting)

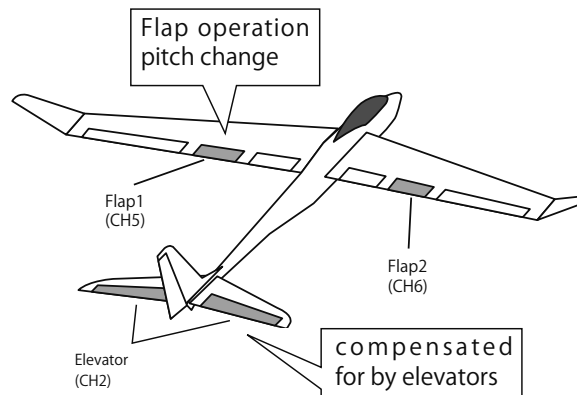

Method

Calling the setting screen

- 1 Call the menu screen from the home screen by pressing the **+** key for 1 second.



- 2 Select **"CAMBR → ELE"** from the menu with the **Jog key**.



- 3 Open the setting screen by pressing the **Jog key**.



CAMBR → ELE (NORM)

ELE ▶ (RATE1) 0 ▶ (RATE2) 0

MIX ▶ INH

SW ▶ SwA ▶ DOWN

- When not using this function, select INH.
- When condition is used, the display can be switched and each connection can be set by switching the condition switch.

3 Position Switch

NULL UP UP&DWN UP&CNT CENTER CNT&DN DOWN

2 Position Switch

NULL UP DOWN

- The ON/OFF switch can be changed. (Selected with the **Jog key** and changed with the **+** key)
- Sets the ON/OFF direction of the selected switch.
- (RATE1) and (RATE2) show the direction of camber of operation.

Camber → ELE mixing

Activating the function

- 1 Select the **"MIX"** item and then select the **"ON"** by pressing the **+** key or **-** key.

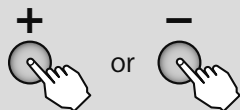

- When you do not use a function, set to the "INH" side.

Mixing rate

- 2 Select the **"RATE"** item and then adjust the mixing rate by pressing the **+** key or **-** key.

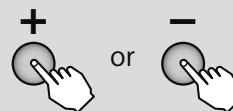

Range : -120 ~ +120%
Default : 0%

- When you want to return the set value to the initial value, press the **+** key and **-** key simultaneously.



ELE → CAMBR

Elevator → Camber mixing

(GLIDER)

Function

This function is used when you want to mix the camber flaps with elevator operation. When used, the flaps are lowered by up elevator, and lift is increased.

WING TYPE

2AIL

2AIL+1F

2AIL+2F

2AIL+4F

- In-flight mixing can be turned ON/OFF by assigning this to a switch. (Always ON at SW [NULL] setting)
- The mixing rate can be adjusted.
- Setting so that the flaps are not operated near the center of the elevators is possible. (RANGE)

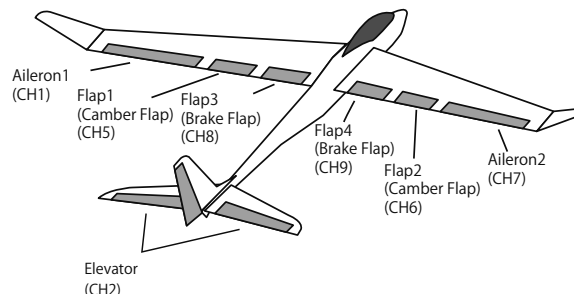
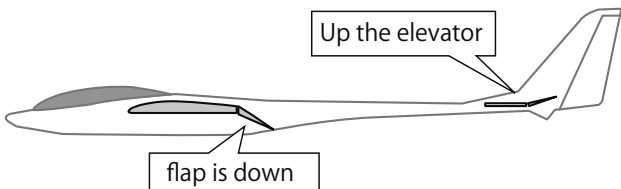

Method

Calling the setting screen

- 1 Call the menu screen from the home screen by pressing the **+** key for 1 second.

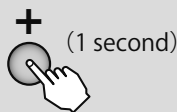

- 2 Select "ELE → CAMBR" from the menu with the **Jog** key.



- 3 Open the setting screen by pressing the **Jog** key.



(Currently selected condition)

ELE→CAMBR (NORM) 1 2	
(RATE1)	(RATE2)
AIL1 ▶ 0 ▶	0
AIL2 ▶ 0 ▶	0
MIX ▶ INH	
SW ▶ SwA ▶	DOWN
RANGE ▶ 0% (0%)

● Described on the next page. ● Current position of the elevator stick

Mixing rate

- Aileron1
- Aileron2
- Camber MIX ACT/INH
- Can be either set to a switch or when NULL is always active.

● Select the setting item with the **Jog** key.

● The number is changed by **+** key or **-** key.

[ELE → Camber 2 page]

(Currently selected condition)

ELE→CAMBR (NORM) 1 2	
(RATE1)	(RATE2)
FLP1 ▶ 0 ▶	0
FLP2 ▶ 0 ▶	0
FLP3 ▶ 0 ▶	0
FLP4 ▶ 0 ▶	0

● (RATE1) and (RATE2) show the direction of elevator of operation.



(ELE → Camber)

ELE→CAMBR (NORM) F1 2		
	(RATE1)	(RATE2)
AIL1 ▶	0 ▶	0
AIL2 ▶	0 ▶	0
MIX ▶	INH	
SW ▶	SwA ▶	DOWN
RANGE ▶	0%	(0%)

● When MIX is set to ACT, the amount of MIX(s) according to stick operation is displayed.

● Setting that inhibits camber mixing near the elevator center position. Setting so that camber mixing is performed only when the elevators were operated greatly is possible.

RANGE setting

■ Setting state

- ① Select the "0%" item next to RANGE with the **Jog** key.



■ To setting value

- ② Move the elevator stick to the position you want operation to begin.



Can be either up or down. When set to down, the up side is also set by the same amount.

■ Set value memorization

- ③ Press the **Jog** key for 1 second.



Hold the stick in position.



ELE→CAMBR (NORM) F1 2		
	(RATE1)	(RATE2)
AIL1 ▶	0 ▶	0
AIL2 ▶	0 ▶	0
MIX ▶	INH	
SW ▶	SwA ▶	DOWN
RANGE ▶	30%	(30%)

When elevator operation exceeds the range, the stick position is displayed and mixing is performed.

● When a RANGE number is selected and the **Jog** key is pressed for 1 second, RANGE is reset to 0% and normal mixing is performed.



AIL → CAMBR Aileron → Camber mixing

(GLIDER)

Function

WING TYPE

2AIL+2F 2AIL+4F

This mixing links the camber flaps with aileron operation (stick). It is used when you want to increase roll axis maneuverability.

- When the mixing direction is reversed by the linkage, adjustments can be made by changing the rate polarity.

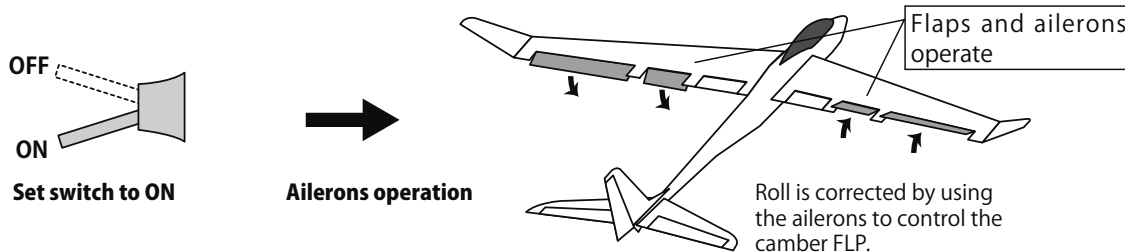

Method

Calling the setting screen

- 1 Call the menu screen from the home screen by pressing the **+** key for 1 second.



- 2 Select "AIL → CAMBR" from the menu with the **Jog key**.

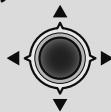

- 3 Open the setting screen by pressing the **Jog key**.



AIL→CAMBR (NORM)

Mixing rate

Activating the function

● When not using this function, select INH.

● When condition was used, the display can be switched and each connection can be set by switching the condition switch.

● The ON/OFF switch can be changed. (Selected with the **Jog key** and changed with the +key)

● Sets the ON/OFF direction of the selected switch.

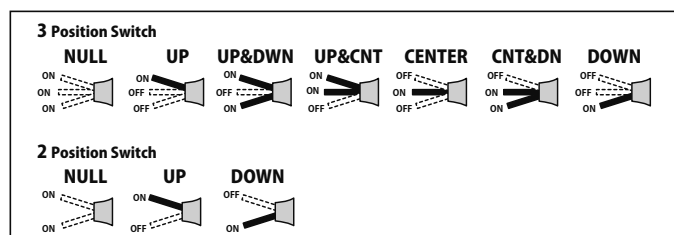

AIL → Camber mixing

Activating the function

- 1 Select the "MIX" item and then select the "ON" by pressing the **+** key or **-** key.

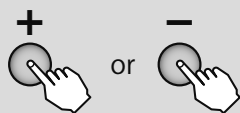

- When you do not use a function, set to the "INH" side.

Mixing rate

- 2 Select the "RATE" item and then adjust the mixing rate by pressing the **+** key or **-** key.

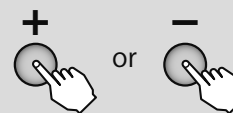

Range : -120 ~ +120%
Default : 0%

- When you want to return the set value to the initial value, press the **+** key and **-** key simultaneously.



AIL → BRKFL Aileron → Brake flap mixing

(GLIDER)

Function

This mixing links the brake flaps with aileron operation (stick). It is used when you want to increase roll axis maneuverability.

WING TYPE

2AIL+4F

- When the mixing direction is reversed by the linkage, adjustments can be made by changing the rate polarity.

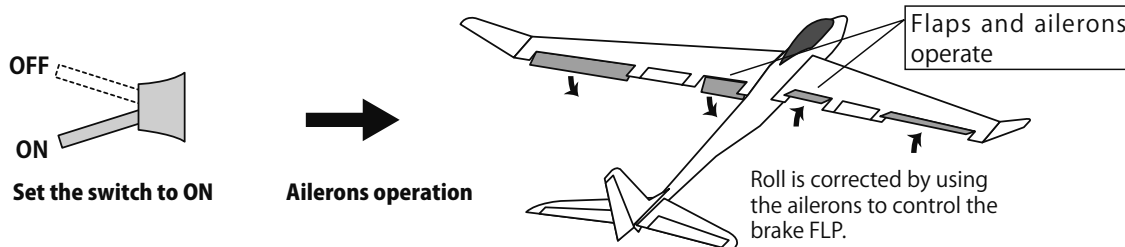

Method

Calling the setting screen

- 1 Call the menu screen from the home screen by pressing the **+** key for 1 second.

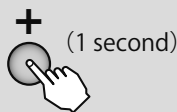

- 2 Select "AIL → BRKFL" from the menu with the **Jog** key.



- 3 Open the setting screen by pressing the **Jog** key.

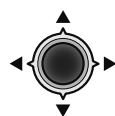

Mixing rate

Activating the function

- Select the setting item with the **Jog** key.

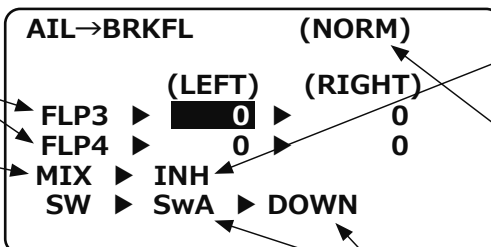

- When not using this function, select INH.

- When condition was used, the display can be switched and each connection can be set by switching the condition switch.

3 Position Switch

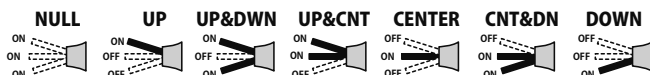

2 Position Switch

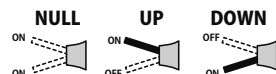

- The ON/OFF switch can be changed. (Selected with the **Jog** key and changed with the +key)

- Sets the ON/OFF direction of the selected switch.

AIL → BRKFL mixing

Activating the function

- 1 Select the "MIX" item and then select the "ON" by pressing the **+** key or **-** key.

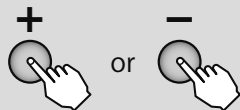

- When you do not use a function, set to the "INH" side.

Mixing rate

- 2 Select the "RATE" item and then adjust the mixing rate by pressing the **+** key or **-** key.

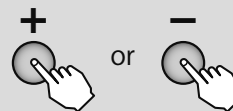

Range : -120 ~ +120%
Default : 0%

- When you want to return the set value to the initial value, press the **+** key and **-** key simultaneously.



TRIM MIX

Trim mix

(GLIDER)

WING TYPE

2AIL

2AIL+1F

2AIL+2F

2AIL+4F

Function

This function shifts the ailerons, elevators, and each flap trim to the preset position by means of a switch.

•The servo speed at which trim is to the set position can be set.

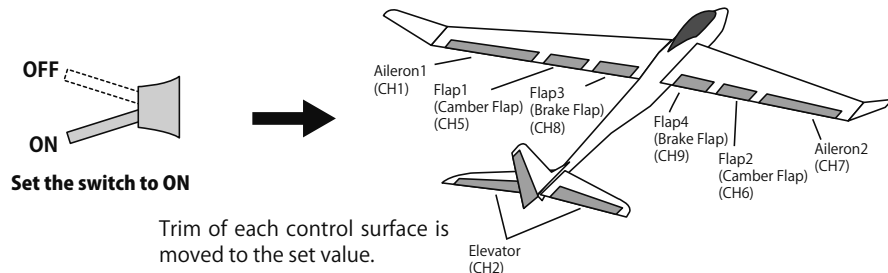

Method

Calling the setting screen

① Call the menu screen from the home screen by pressing the **+** key for 1 second.

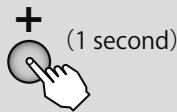

② Select "TRIM MIX" from the menu with the **Jog key**.

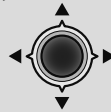

③ Open the setting screen by pressing the **Jog key**.



- Select the setting item with the **Jog key**.
- The number is changed by **+** key or **-** key.

Activating the function

- When not using this function, select INH.

[TRIM MIX page1]

TRIM MIX (NORM) 1 2					
AIL1	▶	0	FLP1	▶	0
AIL2	▶	0	FLP2	▶	0
ELE	▶	0	FLP3	▶	0
			FLP4	▶	0

● When condition is used, the display can be switched and each connection can be set by switching the condition switch.

● Sets the trim neutral position of each control surface.
Range : -100 ~ +100
Returned to 0 by pressing the **+** key and **-** key simultaneously.

[TRIM MIX page2]

TRIM MIX 1 2			
MIX	▶	INH	
SW	▶	SwA	◀ DOWN
DELAY		AIL	▶ OFF
		FLP	▶ OFF
		ELE	▶ OFF

● The ON/OFF switch can be changed. (Selected with the **Jog key** and changed with the +key)

● Sets the ON/OFF direction of the selected switch.

● Servo speed at which the trim position is to the set position. Sudden attitude changes are prevented by turning the switch on. (Selected by **Jog key** and changed by **+** key and **-** key.)

Range : **OFF**(fast shift), 1 ~ 10 (slow shift)
Returned to OFF by pressing the **Jog key** for a long time.

*This is not the servo speed when the stick was operated.

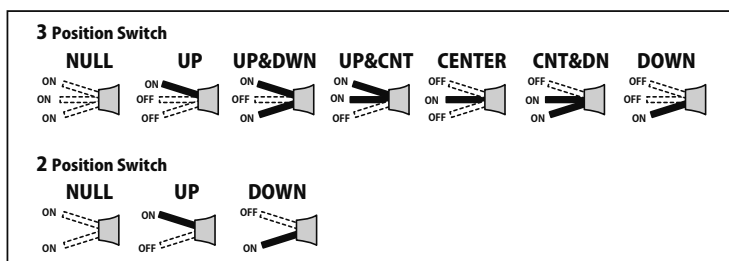

Multicopter Function



The setting screen of each function is called from the following menu. The function when the model type was set to multicopter (MULTI COPT) is displayed here.

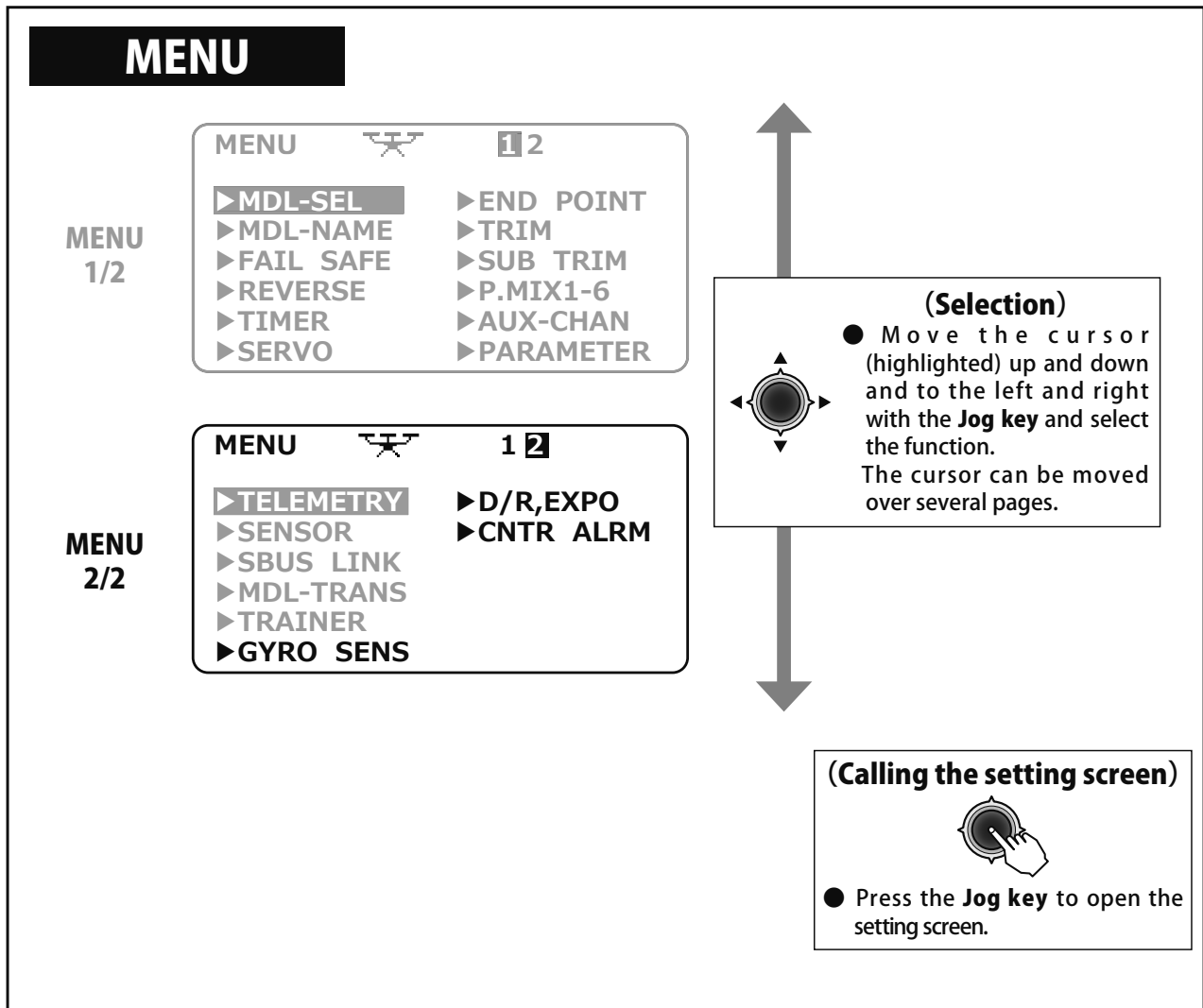
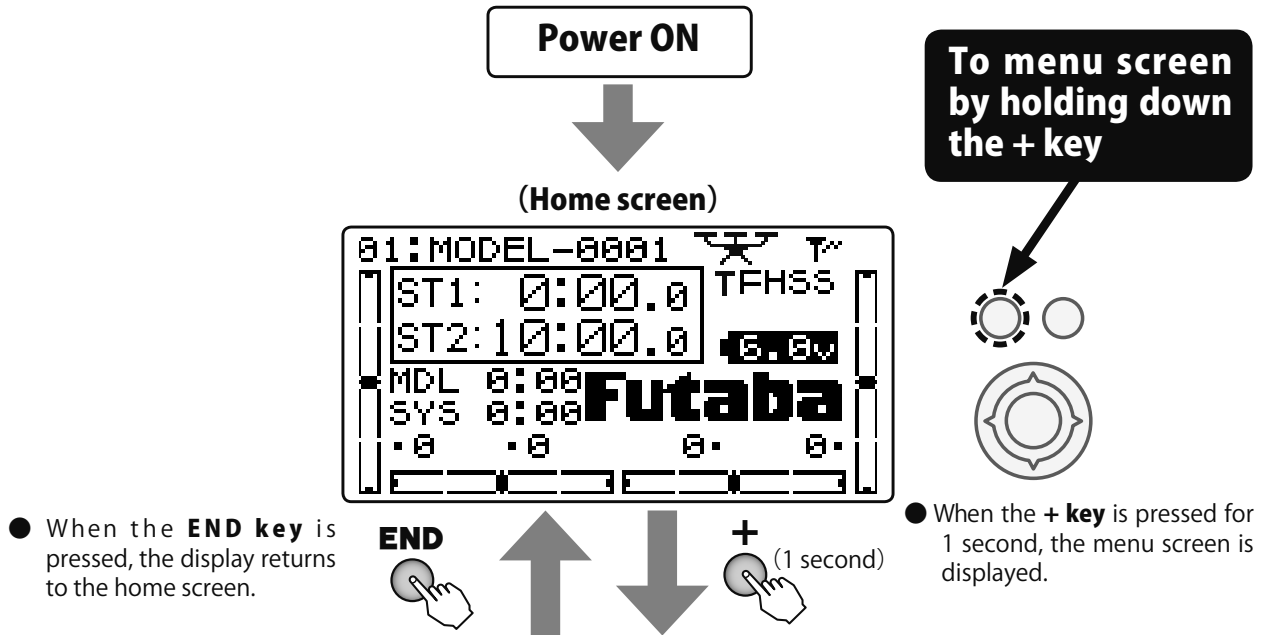

Multicopter

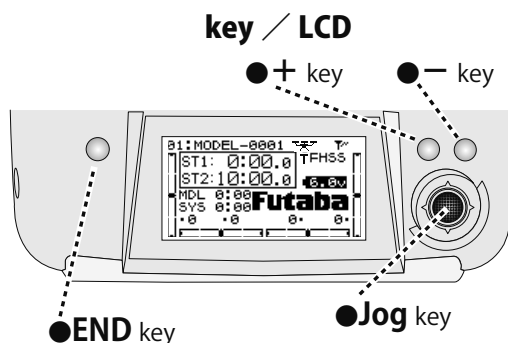

Refer to "**Common Functions**" previously described for a description of this function.

■ **Function**

MENU1/3	
MDL-SEL (P.40)	Model select / Model Copy / Data reset / RX / Link
MDL-NAME (P.43)	Model name / User name
FAIL SAFE (P.45)	Fail safe
REVERSE (P.47)	Servo reverse
TIMER (P.48)	Timer
SERVO (P.49)	Servo monitor / Servo test
END POINT (P.50)	End point
TRIM (P.51)	Trim reset / Trim step
SUB TRIM (P.52)	Sub trim
P.MIX1-6 (P.53)	Program mixing 1 ~ 6
AUX-CHAN (P.56)	AUX channel
PARAMETER (P.58)	Data reset / Model type / ATL-trim / LCD contrast / Back light : mode, time, adjustment / Home display / Battery alarm / Battery vibration / Buzzer tone / Jog navi / Jog light / Jog time / Telemetry : mode, unit / Speech : language, volume / Stick position alarm

MENU2/3	
TELEMETRY (P.66)	Telemetry Display / Alarm setup
SENSOR (P.83)	Telemetry sensor
SBUS LINK (P.89)	S.BUS servo set up
MDL-TRANS (P.92)	Data transfer of another T10J
TRAINER (P.93)	Trainer
GYRO SENS (P.170)	Gyro mixing
D/R, EXPO (P.171)	Dual rate / EXPO
CNTR ALRM (P.173)	Center alarm





GYRO SENS Gyro sensor

(MULTICOPT)

Function

This function is dedicated mixing for switching the gyro sensitivity and gyro mode (AVCS/NORMAL) of Futaba gyros. Up to 3 axes can be set. The attitude control of multicopter uses the system of multicopter attachment.

This "GYROSENS" will be used for accessories, such as camera control.

- The sensitivity switch can be selected and the sensitivity of each direction of the switch can be set. (Switches A to H)
- CH5, CH5/CH7, CH5/CH8 or CH5/CH7/CH8 combinations can be selected as the sensitivity setting channel.

*When this function is used, it becomes impossible for CH5 to use it for multi copter controller. Use CH6 for multi copter controller and use SwC.

Method

Calling the setting screen

① Call the menu screen from the home screen by pressing the **+** key for 1 second.



② Select "GYRO SENS" from the menu with the **Jog key**.



③ Open the setting screen by pressing the **Jog key**.



Gyrotype, Gain rate

- Select the setting item with the **Jog key**.

GYRO SENS

MIX ▶ INH ← SW ▶ SwA ←

CH ▶ CH5/CH7/CH8 ←

UP (UP) ←

	type	rate
CH5 ▶	STD	▶ 50.0%
CH7 ▶	STD	▶ 50.0%
CH8 ▶	STD	▶ 50.0%

(Gyro type) (Gyro Gain)

- When not using this function, select INH.
- Gain switch selection
- (Current switch operating direction)
- Switches to the sensitivity setting screen of each switch direction when the **Jog key** is pressed.

● When using a Futaba GYA gyro, select gyro type GY. This switches the gyro sensitivity setting item to mode and sensitivity direct reading display.

GYRO SENS

■ Activating the function

① Select the "MIX" item and then select the "ON" by pressing the **+** key or **-** key.

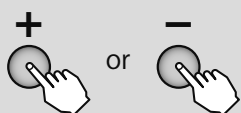

- When you do not use a function, set to the "INH" side.

■ Sensitivity switch selection

② Select the "SW" item and then select the switch by pressing the **+** key or **-** key.

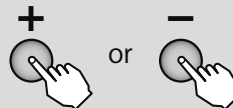

Range : SwA ~ SwH, Default : SwA

■ Sensitivity setting channel selection

③ Select the "CH" item and then select the sensitivity setting channel by pressing the **+** key or **-** key.

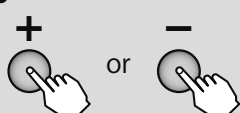

Range : CH5, CH5/CH7, CH5/CH8, CH5/CH7/CH8

Default : CH5

■ Gyro type and sensitivity setting

④ Press the **Jog key** and select the sensitivity setting screen you want to set and then set "type" (gyro type) and "rate" (gyro sensitivity) of each channel by pressing the **+** key or **-** key.

("type") Range : STD,GY Default : STD

("rate") Range : 0 ~ 100%(STD) , NOR100 ~ 0 ~ AVC100%(GY) Default : 50%(STD) , 0%(GY)

- When you want to return the set value to the initial value, press the **+** key and **-** key simultaneously.



Function

D/R

The aileron, elevator and rudder channel control surface angle can be switched in 2 steps

- The control surface angle is adjusted by each direction of the switch. The left and right (up and down) direction of each switch can be set individually.

EXP

This function makes operation more pleasant by changing the operating curve so that servo movement is sluggish or sensitive relative to stick operation near the aileron, elevator, throttle, and rudder neutral position. Adjustments can be made in 2 steps according to the control surface angle.

- The "-" side makes servo movement sluggish and the "+" side makes servo movement sensitive near the neutral position. Exponential is applied to entire throttle servo travel. When the "+" side is increased, the slow side becomes sluggish and the high side becomes sensitive.
- Setting corresponding to each rate of dual rate (D/R) is possible. (Except throttle) The direction of each switch and the left and right (up and down) direction of each channel can be set individually.

Switch selection (SW)

Switches A to H can be selected as the aileron channel, elevator channel, and rudder channel dual rate (exponential) switch.

- Default : Aileron : SwitchD / Elevator : SwitchA / Rudder : SwitchB

Method

Calling the setting screen

① Call the menu screen from the home screen by pressing the **+** key for 1 second.



② Select "D/R,EXPO" from the menu with the **Jog** key.



③ Open the setting screen by pressing the **Jog** key.

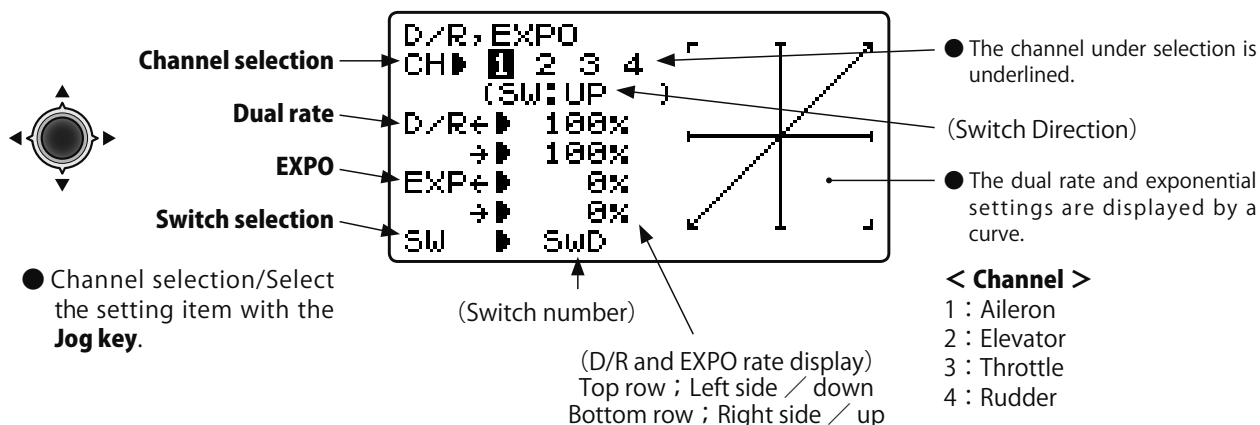



D/R

① A channel is chosen by **Jog key**.



Range : 1, 2, 4

② Adjust the rate by moving the cursor to D/R with the **Jog key**, switching the dual rate switch to the direction you want to set, moving the stick to the left (down) or right (up) side and pressing the **+ key** or **- key**.



Range :
0 ~ 140%
Default : **100%**

- When you want to return the set value to the initial value, press the **+ key** and **- key** simultaneously.

Adjust the rate of each direction of the dual rate switch and stick by repeating step

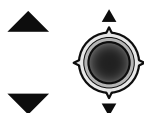

- Moving to another setting item of the same channel is possible by **Jog key**.

EXPO

① Select the "EXP" item and then select the channel with the **Jog key**.



Range : 1 ~ 4

② Adjust the rate by moving the cursor to EXP with the **Jog key**, switching the dual rate switch to the direction you want to set, moving the stick to the left (down) or right (up) side and pressing the **+ key** or **- key**.



Range :
-100 ~ +100%
Default : **0%**

- When you want to return the set value to the initial value, press the **+ key** and **- key** simultaneously.

Adjust the rate of each direction of the dual rate switch and stick by repeating step

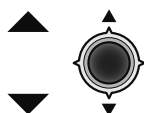

- Moving to another setting item of the same channel is possible by **Jog key**.

Switch Change

① Select the "SW" item and then select the channel with the **Jog key**.



Range : 1, 2, 4

② A switch is chosen by **+ key** or **-key**.

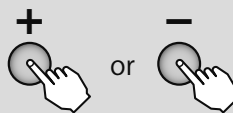

Range : SwA ~ SwH



CNTR ALRM Center alarm

(MULTICOPT)

Function

- An alarm (single beep) can be sounded at the specified throttle stick position.
- Alarm function ON/OFF can be set by switch.

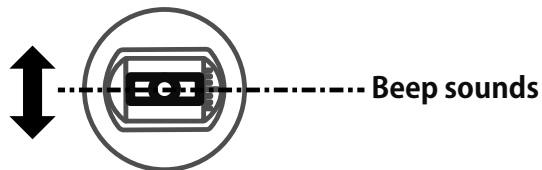

When the THR stick is set to the specified position.

Method

Calling the setting screen

① Call the menu screen from the home screen by pressing the **+** key for 1 second.



② Select "CNTR ALRM" from the menu with the **Jog key**.



③ Open the setting screen by pressing the **Jog key**.



- Select the item with the **Jog key**.

- INH ⇔ ON/OFF
- Switch selction
- Switch direction
- Stick position
- Low position alarm

CNTR ALRM

STK POSI ALRM

MODE ▶ **ON**

SW ▶ SwA

POSI ▶ DOWN

STICK ▶ 50% (50%)

LoALM ▶ OFF

- When INH is selected, the function cannot be used. When ON or OFF is selected, the function is activated. ON and OFF changes are linked to the switch.
- The number in parenthesis is the current throttle stick position.

- ON** ; If the throttle stick is not in the low position, you'll have an alarm until the stick is in the low position.
- OFF** ; Low position alarm does not occur.

Position setting

① Stick position is chosen by **Jog key**.



CNTR ALRM

STK POSI ALRM

MODE ▶ ON

SW ▶ SwA

POSI ▶ DOWN

STICK ▶ **45%** (45%)

LoALM ▶ OFF

② Set the throttle stick to the position at which you want to generate the alarm.

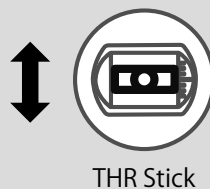

③ When the **Jog key** is held down the alarm sounds at that position.



Memorize the position at which the beep is to sound.

Multicopter

TX SETTING

The settings here are special settings that are unnecessary during normal use. The stick mode can be changed and stick adjustment (calibration), throttle lever reverse, and language can be set.

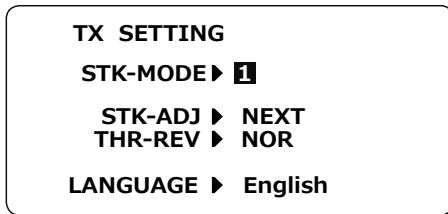

Turn on the power switch with the + key and – key pressed in the power off state. The screen shown at the left appears. To return to the home screen, turn off the power and then turn the power back on without pressing the keys.

■ STK-MODE

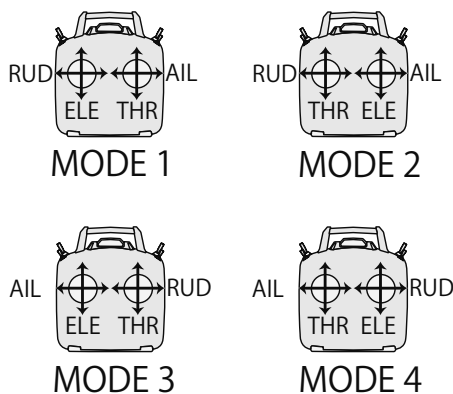

This is the MODE1 ~ MODE4 setting. The initial state is MODE2. To change the mode the stick ratchet must be changed. Request that this be done by Futaba Service. (Charged modification)

■ STK-ADJ

This function is normally not used. If stick deviation should occur, make this adjustment. Do not use it in the normal state.

Calling the setting screen

- ① Turn off the power and then turn the power back on while pressing the **+** key and **–** key simultaneously.

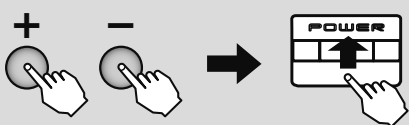

- ② Select **STK-ADJ** → **NEXT** in the menu with the **Jog** key.

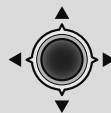

- ③ Enter the setting screen by pressing the **Jog** key.



Stick adjustment

- ① Select the stick you want to adjust with 1 ~ 4 with the **+** key.

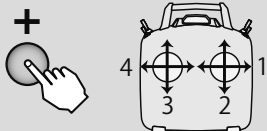

- ② Press the **Jog** key down and select **NEUT** ■.

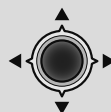

- ③ Set the stick to the **neutral** position and press the **Jog** key.



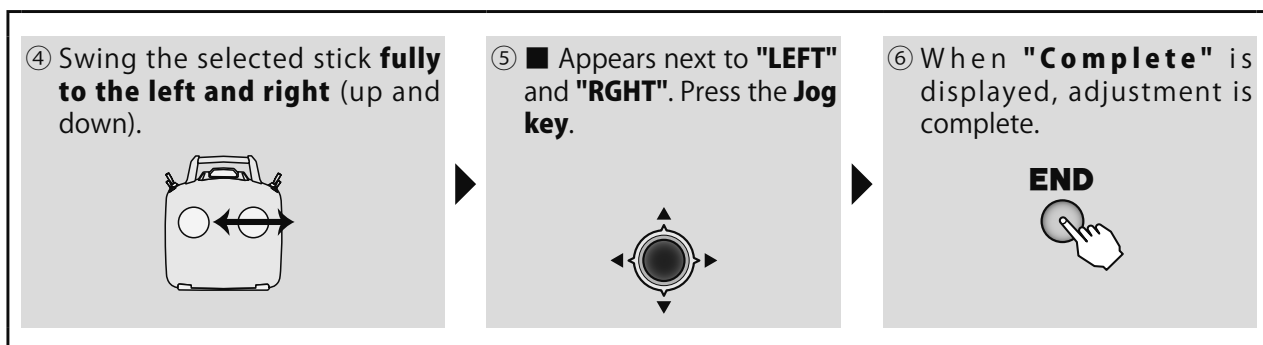

THR-REV

This function is not used. When you want to use full throttle with the throttle stick down and slow with the throttle stick up, select REV. When the stick is up, trim is effective and when the stick is down, trim is not effective.

*Throttle servo operation reversed by the linkage is usually performed by reverse in the normal menu. When throttle servo operation is reversed with the THR-REV function, trim becomes ineffective at slow.

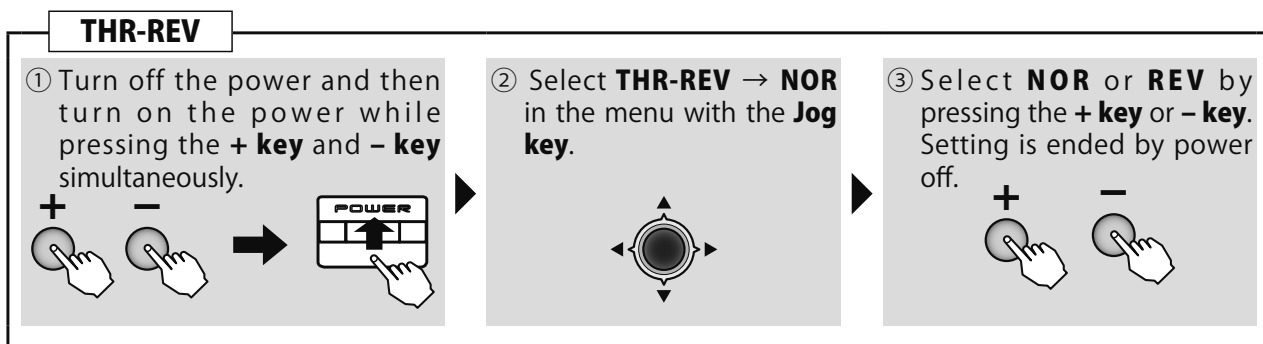

LANGUAGE

The language displayed at proportional can be changed. The initial setting is English, but can be selected from among 7 languages.



Return from the transmitter setting screen to the normal menu by turning on the power without pressing a key.

FUTABA CORPORATION

oak kandakajicho 8F 3-4 Kandakajicho, Chiyoda-ku, Tokyo 101-0045, Japan

TEL: +81-3-4316-4820, FAX: +81-3-4316-4823

©FUTABA CORPORATION 2018, 5 (5)