

# RCA

# Power Transistors

Selection Guide / Data / Application Notes



SSD-204C  
1975 DATABOOK Series

**RCA** Solid  
State

## **A New Approach To Data Service . . .**

### **1975 RCA Solid State DATABOOKS**

Seven textbook-size volumes covering all current commercial RCA solid-state devices (through January 1, 1975)

Linear Integrated Circuits and DMOS Devices (Data only) . . . . .	SSD-201C
Linear Integrated Circuits and DMOS Devices (Application Notes only) . . . . .	SSD-202C
COS/MOS Digital Integrated Circuits . . . . .	SSD-203C
Power Transistors . . . . .	SSD-204C
RF/Microwave Devices . . . . .	SSD-205C
Thyristors, Rectifiers, and Diacs . . . . .	SSD-206C
High-Reliability Devices . . . . .	SSD-207C

Announcement Newsletter: "What's New in Solid State"  
Available FREE to all DATABOOK users.

"Bingo-type Response-Card Service" included with News-  
letter Available FREE to all DATABOOK users.

Update Mailing Service available by subscription.

Indexed Binder available for Update Filing.

**NOTE:** See pages 3 and 4 for additional information on this total data service. To qualify for Newsletter mailing, use the form on page 4 (unless you received your DATABOOK directly from RCA). You must qualify annually since a new mailing list is started for each edition of the DATABOOKS.

# **RCA**

# **Power Transistors**

---

---

This DATABOOK contains complete data and related application notes on power transistors presently available from RCA Solid State Division as standard products. For ease of type selection, product matrix charts are given on pages 11-25. Data sheets are then included in type-number sequence, followed by dimensional outlines and suggested mounting hardware for all types, by application notes in numerical order, and finally by a comprehensive subject index.

To simplify data reference, data sheets are arranged as nearly as possible in numerical-alphabetical-numerical sequence of type numbers. Because some data sheets include more than one type number, however, some types may be out of sequence. If you don't find the type you're looking for where you expect it to be, please consult the Index to Devices on pages 6-9.

Trade Mark(s) Registered®  
Marca(s) Registrada(s)

Copyright 1974 by RCA Corporation  
(All rights reserved under Pan-American Copyright Convention)

Printed in USA/11-74

Information furnished by RCA is believed to be accurate and reliable. However, no responsibility is assumed by RCA for its use; nor for any infringements of patents or other rights of third parties which may result from its use. No license is granted by implication or otherwise under any patent or patent rights of RCA.

RCA Solid State | Box 3200 | Somerville, N.J., U.S.A. 08876  
RCA Limited | Sunbury-on-Thames | Middlesex TW16 7HW, England  
RCA s.a. | 4400 Herstal | Liege, Belgium

# RCA Solid State Total Data Service System

The RCA Solid State DATABOOKS are supplemented throughout the year by a comprehensive data service system that keeps you aware of all new device announcements and lets you obtain as much or as little product information as you need — when you need it.

New solid-state devices and related publications announced during the year are described in a newsletter entitled "What's New in Solid State". If you obtained your DATABOOK(s) directly from RCA, your name is already on the mailing list for this newsletter. If you obtained your book(s) from a source other than RCA and wish to receive the newsletter, please fill out the form on page 4, detach it, and mail it to RCA.

Each newsletter issue contains a "bingo"-type fast-response form for your use in requesting information on new devices of interest to you. If you wish to receive all new product information published throughout the year, without having to use the newsletter response form, you may subscribe to a mailing service which will bring you all new data sheets and application notes in a package every other month. You can also obtain a binder for easy filing of all your supplementary material. Provisions for obtaining information on the update mailing service and the binder are included in the order form on page 4.

Because we are interested in your reaction to this approach to data service, we invite you to add your comments to the form when you return it, or to send your remarks to one of the addresses listed at the top of the form. We solicit your constructive criticism to help us improve our service to you.

# Order Form for "What's New in Solid State" and for further information on Update Mailings and Binders

Please fill out just one copy of this form, and mail it to:

(a) from U.S.A. and Canada:

RCA Solid State Division  
Box 3200  
Somerville, N. J., U.S.A. 08876

(b) from Latin America and Far East:

RCA Solid State  
International Sales  
Somerville, N. J., U.S.A. 08876

(c) from United Kingdom, Europe, Middle East, and Africa:

RCA Limited  
Sunbury-on-Thames  
Middlesex TW16 7HW, England

RCA s.a.  
or 4400 Herstal  
Liege, Belgium

Please add my name to the mailing list for "What's New in Solid State"

Please send me details on obtaining update mailings for my DATABOOKS  
and a binder for filing of supplementary material.

Name    
(Last) (Initials)

Company

Address   
(Number) (Street, RFD, P.O. Box)

Home     
Business     
(City) (State or Prov.)

(Country) (Zip or Pstl. Zone)

**Function: (Check One)**

- A  Executive/Administration
- B  Purchasing/Procurement
- C  Research/Development
- D  Design Engineer
- E  Application/Components Engineer
- F  Production/Manufacturing
- G  Documentation/Library
- H  Reliability/QA
- I  Education/Training
- J  Program/Project Management
- K  Marketing

**Activity: (Check One)**

- A  Broadcast
- B  Communication
- C  Instrumentation/Control
- D  Computer/Data Processing
- E  Computer, Peripheral
- F  Automotive
- G  Industrial
- H  Medical
- I  Research
- J  Transportation
- K  Consumer, Electronic
- L  Consumer, Appliance
- M  Space
- N  Ordnance
- O  Avionics
- P  Electronic Warfare

**Product Interest:  
(Indicate order of interest if  
more than one is marked)**

- A  Linear IC's
- B  Digital IC's, COS/MOS
- C  Digital IC's, Bipolar
- D  Thyristors/Rectifiers
- E  Liquid Crystals
- F  Semiconductor Diodes
- G  RF Power Semiconductors
- H  MOSFETS
- I  Power Transistors
- J  Power Hybrid Circuits

# Table of Contents

	Page
Index to Devices .....	6
Index to Application Notes .....	10
Type Selection Charts:	
Monolithic Darlington Types .....	11
Hometaxial-Base Types .....	12
Epitaxial-Base Types .....	16
High-Voltage Types .....	19
High-Speed Switching Types .....	22
Types for Audio-Frequency Linear Amplifiers .....	24
Technical Data:	
Power Transistors .....	27
Power-Transistor Chips .....	697
Power Hybrid Circuits .....	703
Dimensional Outlines .....	718
Suggested Mounting Hardware .....	726
Application Notes .....	729
Subject Index .....	868

# Index to Power Transistors and Power Hybrid Circuits

Type No.	Page No.	Collector-to-Base Voltage (Max.) — V	Power Dissipation (Max.) — W	DC Current Transfer Ratio	Data Sheet File No.	Type No.	Page No.	Collector-to-Base Voltage (Max.) — V	Power Dissipation (Max.) — W	DC Current Transfer Ratio	Data Sheet File No.
2N697	28	60	2	40-120	16	2N5189	192	60	5	30 min.	296
2N699	30	120	2	40-120	22	2N5202	155	120	35	10-100	766
2N918	33	30	0.3	20 min.	83	2N5239	196	300	100	20-80	321
2N1479	37	60	5	20-60	135	2N5240	196	375	100	20-80	321
2N1480	37	100	5	20 min.	135	2N5262	202	75	5	35 min.	313
2N1481	37	60	5	35-100	135	2N5293	207	80	36	30-120	322
2N1482	37	100	5	35-100	135	2N5294	207	80	36	30-120	322
2N1483	40	60	25	20-60	137	2N5295	207	60	36	30-120	322
2N1484	40	100	25	20-60	137	2N5296	207	60	36	30-120	322
2N1485	40	60	25	35-100	137	2N5297	207	80	36	20-80	322
2N1486	40	100	25	35-100	137	2N5298	207	80	36	20-80	322
2N1487	44	60	75	15-45	139	2N5320	214	100	10	30-130	325
2N1488	44	100	75	15-45	139	2N5321	214	75	10	40-250	325
2N1489	44	60	75	25-75	139	2N5322	214	-100	10	30-130	325
2N1490	44	100	75	25-75	139	2N5323	214	-75	10	40-250	325
2N1613	48	75	3	20 min.	106	2N5415	220	-200	10	30-150	336
2N1711	53	75	3	35 min.	26	2N5416	220	-350	10	30-120	336
2N1893	57	120	3	40-120	34	2N5490	225	60	50	20-100	353
2N2015	63	100	150	15-50	12	2N5491	225	60	50	20-100	353
2N2016	63	130	150	15-50	12	2N5492	225	75	50	20-100	353
2N2102	48	120	5	20 min.	106	2N5493	225	75	50	20-100	353
2N2270	66	60	5	50-200	24	2N5494	225	60	50	20-100	353
2N2405	57	120	5	60-200	34	2N5495	225	60	50	20-100	353
2N2857	70	30	0.3	30-150	61	2N5496	225	90	50	20-100	353
2N2895	74	120	1.8	40-120	143	2N5497	225	90	50	20-100	353
2N2896	74	140	1.8	60-200	143	2N5575	231	70	300	10-40	359
2N2897	74	60	1.8	50-200	143	2N5578	231	90	300	10-40	359
2N3053	80	60	5	50-250	432	2N5671	237	120	140	20-100	383
2N3054	85	90	25	25-150	527	2N5672	237	150	140	20-100	383
2N3055	92	100	115	20-70	524	2N5781	242	-80	10	20-100	413
2N3263	99	150	20	25-75	54	2N5782	242	-65	10	20-100	413
2N3264	99	120	30	20-80	54	2N5783	242	-45	10	20-100	413
2N3265	99	150	24	25-75	54	2N5784	242	80	10	20-100	413
2N3266	99	120	28	20-80	54	2N5785	242	65	10	20-100	413
2N3439	104	450	10	40-160	64	2N5786	242	45	10	20-100	413
2N3440	104	300	10	40-160	64	2N5804	253	300	110	10-100	407
2N3441	109	160	25	25-100	529	2N5805	253	375	110	10-100	407
2N3442	116	160	117	20-70	528	2N5838	258	275	100	8-40	410
2N3478	124	30	0.2	25-150	77	2N5839	258	300	100	10-50	410
2N3583	128	250	2.5	40 min.	138	2N5840	258	375	100	10-50	410
2N3584	128	375	2.5	25-100	138	2N5954	264	-85	40	20-100	675
2N3585	128	500	2.5	25-100	138	2N5955	264	-70	40	20-100	675
2N3600	33	30	0.3	20-150	83	2N5956	264	-50	40	20-100	675
2N3771	135	50	150	15-60	525	2N6032	271	120	140	10-50	462
2N3772	135	100	150	15-60	525	2N6033	271	150	140	10-50	462
2N3773	143	160	150	15-60	526	2N6055	277	60	100	100-18000	563
2N3839	151	30	0.3	30-150	229	2N6056	277	80	100	100-18000	563
2N3878	155	120	35	50-200	766	2N6077	281	300	45	12-70	492
2N3879	155	120	35	20-80	766	2N6078	281	275	45	12-70	492
2N4036	162	-90	7	20-200	216	2N6079	281	375	45	12-50	492
2N4037	162	-60	7	50-250	216	2N6098	287	70	75	20-80	485
2N4063	104	450	-	40-160	64	2N6099	287	70	75	20-80	485
2N4064	104	300	10	40-160	64	2N6100	287	80	75	20-80	485
2N4240	128	500	2.5	30-150	138	2N6101	287	80	75	20-80	485
2N4314	162	-90	7	50-250	216	2N6102	287	45	75	15-60	485
2N4347	116	140	100	15-60	528	2N6103	287	45	75	15-60	485
2N4348	143	140	120	15-60	526	2N6106	293	-80	40	30-150	676
2N5034	168	55	83	20-80	244	2N6107	293	-80	40	30-150	676
2N5035	168	55	83	20-80	244	2N6108	293	-60	40	30-150	676
2N5036	168	70	83	20-80	244	2N6109	293	-60	40	30-150	676
2N5037	168	70	83	20-80	244	2N6110	293	-40	40	30-150	676
2N5038	174	150	140	50-200	698	2N6111	293	-40	40	30-150	676
2N5039	174	120	140	30-150	698	2N6175	304	300	20	30-190	508
2N5109	181	40	3.5	40-120	281	2N6176	304	350	20	30-150	508
2N5179	187	20	0.3	25-250	288	2N6177	304	450	20	30-150	508



# Index to Power Transistors and Power Hybrid Circuits (Cont'd)

Type No.	Page No.	Collector-to-Base Voltage (Max.) - V	Power Dissipation (Max.) - W	DC Current Transfer Ratio	Data Sheet File No.	Type No.	Page No.	Collector-to-Base Voltage (Max.) - V	Power Dissipation (Max.) - W	DC Current Transfer Ratio	Data Sheet File No.
2N6178	310	100	25	30-130	562	-2N6500	155	120	35	15-60	766
2N6179	310	75	25	40-250	562	2N6510	385	250#	125	10 min.	848
2N6180	310	-100	25	30-130	562	2N6511	385	300#	125	10 min.	848
2N6181	310	-75	25	40-250	562	2N6512	385	350#	125	10 min.	848
2N6211	318	-275	35	30-175	507	2N6513	385	400#	125	10 min.	848
2N6212	318	-350	35	30-175	507	2N6514	385	350#	125	10 min.	848
2N6213	318	-400	35	30-150	507	40250	391	50	29	25-100	112
2N6214	318	-450	20	10-100	507	40250V1	391	50	5.8	25-100	112
2N6246	323	-70	125	20-100	677	40251	391	50	11.7	25-100	112
2N6247	323	-90	125	20-100	677	40309	395	18*	5	70-350	78
2N6248	323	-110	125	20-100	677	40310	395	35*	29	20-120	78
2N6249	332	300	175	20-100	523	40311	395	30*	5	70-350	78
2N6250	332	375	175	20-100	523	40312	395	60#	29	20-120	78
2N6251	332	450	175	20-100	523	40313	395	300#	35	40-250	78
2N6253	92	55	115	20-70	524	40314	395	40*	5	70-350	78
2N6254	92	100	150	20-70	524	40315	395	35*	5	70-350	78
2N6257	135	50	150	15-75	525	40316	395	40#	29	20-120	78
2N6258	135	100	250	20-60	525	40317	395	40*	5	40-200	78
2N6259	143	170	250	15-60	526	40318	395	300#	35	50 min.	78
2N6260	85	50	29	20-100	527	40319	395	-40*	5	35-200	78
2N6261	85	90	50	25-100	527	40320	395	40*	5	40-200	78
2N6262	116	170	150	20-70	528	40321	395	300#	5	25-200	78
2N6263	109	140	20	20-100	529	40322	395	300#	35	75 min.	78
2N6264	109	170	50	20-60	529	40323	395	10*	5	70-350	78
2N6288	293	40	40	30-150	676	40324	395	35*	29	20-120	78
2N6289	293	40	40	30-150	676	40325	395	35*	117	12-60	78
2N6290	293	60	40	30-150	676	40326	395	40*	5	40-200	78
2N6291	293	60	40	30-150	676	40327	395	300#	5	40-250	78
2N6292	293	80	40	30-150	676	40328	395	300#	35	40 min.	78
2N6293	293	80	40	30-150	676	40346	402	175#	10	25 min.	211
2N6354	339	150	140	20-150	582	40346V1	402	175#	10	25 min.	211
2N6371	345	50	117	15-60	607	40346V2	402	175#	4	25 min.	211
2N6372	264	50	40	20-100	675	40347	405	60	8.75	25-100	88
2N6373	264	70	40	20-100	675	40347V1	405	60	4.4	25-100	88
2N6374	264	90	40	20-100	675	40347V2	405	60	11.7	25-100	88
2N6383	350	40	100	1000-20000	609	40348	405	90	8.75	30-125	88
2N6384	350	60	100	1000-20000	609	40348V1	405	90	4.4	30-125	88
2N6385	350	80	100	1000-20000	609	40348V2	405	90	11.7	30-125	88
2N6386	356	40	40	1000-20000	610	40349	405	160	8.75	30-125	88
2N6387	356	60	40	1000-20000	610	40349V1	405	160	4.4	30-125	88
2N6388	356	80	40	1000-20000	610	40349V2	405	160	11.7	30-125	88
2N6389	362	20	0.2	25-250	617	40360	395	70*	5	40-200	78
2N6467	264	-110	40	15-150	675	40361	395	70#	5	70-350	78
2N6468	264	-130	40	15-150	675	40362	395	-70#	5	35-200	78
2N6469	323	-50	125	20-150	677	40363	395	70#	115	20-70	78
2N6470	323	50	125	20-150	677	40364	395	60#	35	35-175	78
2N6471	323	70	125	20-150	677	40366	411	120	5	40-120	215
2N6472	323	90	125	20-150	677	40367	411	100	5	35-100	215
2N6473	293	110	40	15-150	676	40368	411	100	25	35-100	215
2N6474	293	130	40	15-150	676	40369	411	100	75	25-75	215
2N6475	293	-110	40	15-150	676	40372	85	90	25	25-150	527
2N6476	293	-130	40	15-150	676	40373	109	160	25	25-100	529
2N6477	366	140	20	25-100	680	40374	128	250	5.8	40 min.	138
2N6478	366	160	25	25-100	680	40375	155	120	5.8	50-200	766
2N6479	372	100	50	20-300	702	40385	411	450	5	40-160	215
2N6480	372	100	50	20-300	702	40389	80	60	3.5	50-250	432
2N6481	372	100	67	20-300	702	40390	104	300	3.5	40-160	64
2N6482	372	100	67	20-300	702	40391	162	-60	3.5	50-250	216
2N6486	379	50	75	20-150	678	40392	80	60	7	50-250	432
2N6487	379	70	75	20-150	678	40394	162	-60	7	50-250	216
2N6488	379	90	75	20-150	678	40406	416	-50*	1	30-200	219
2N6489	379	-50	75	20-150	678	40407	416	50*	1	40-200	219
2N6490	379	-70	75	20-150	678	40408	416	90*	1	40-200	219
2N6491	379	-90	75	20-150	678	40409	416	90#	3	50-250	219
2N6496	174	150	140	12-100	698	40410	416	-90#	3	50-250	219

# Index to Power Transistors and Power Hybrid Circuits (Cont'd)

Type No.	Page No.	Collector-to-Base Voltage (Max.) - V	Power Dissipation (Max.) - W	DC Current Transfer Ratio	Data Sheet File No.	Type No.	Page No.	Collector-to-Base Voltage (Max.) - V	Power Dissipation (Max.) - W	DC Current Transfer Ratio	Data Sheet File No.
40411	416	90#	150	35-100	219	CH4037	698	-40*	-	35 min.	632
40412	402	250#	10	40 min.	211	CH5320	698	80*	-	30 min.	632
40412V1	402	250#	4	40 min.	211	CH5321	698	55*	-	30 min.	632
40412V2	402	250#	10	40 min.	211	CH5322	698	-80*	-	30 min.	632
40537	422	-55#	5	50-300	302	CH5323	698	-55*	-	30 min.	632
40538	422	-55#	5	15-90	302	CH5262	698	35*	-	30 min.	632
40539	425	55#	5	15-90	303	CH6479	698	60*	-	40 min.	632
40542	428	50#	83	20-70	304	HC2000H	704	75#	35	7A*	566
40543	428	60#	83	20-70	304	HC2500	709	75#	≤100	7A*	681
40544	425	50#	7	35-200	303	RCA1A01	479	70*	5	40-200	651
40594	432	95#	10	70-350	358	RCA1A02	479	-50*	7	30-200	651
40595	432	-95#	10	70-350	358	RCA1A03	479	95	10	70-300	651
40608	435	40	3.5	35-120	356	RCA1A04	479	-95	10	70-300	651
40611	432	25*	5	70-500	358	RCA1A05	479	-75	5	50-250	651
40613	432	25*	36	30-120	358	RCA1A06	479	75	5	50-250	651
40616	432	32*	5	70-500	358	RCA1A07	479	50	5	50-250	651
40618	432	30*	36	30-120	358	RCA1A08	479	-50	7	70-250	651
40621	432	32*	36	25-100	358	RCA1A09	479	175*	10	20-100	651
40622	432	40*	36	25-100	358	RCA1A10	479	-175*	10	40-250	651
40624	432	45*	50	20-100	358	RCA1A11	479	175*	10	40-250	651
40625	432	45*	3.5	100-300	358	RCA1A15	479	100*	10	20-100	651
40627	432	55*	50	20-100	358	RCA1A16	479	-100*	10	40-250	651
40628	432	55*	3.5	100-300	358	RCA1A17	479	90*	5	40-200	651
40629	432	35#	36	20-70	358	RCA1A18	479	10*	7	40-250	651
40630	432	40#	36	20-70	358	RCA1A19	479	-10*	7	40-250	651
40631	432	45#	36	20-70	358	RCA1B01	489	95	115	20-70	647
40632	432	60#	50	20-70	358	RCA1B04	493	225	150	15-75	649
40634	432	-75#	5	50-250	358	RCA1B05	498	275	150	15-75	650
40635	432	75#	5	50-250	358	RCA1B06	503	120	150	10-50	648
40636	432	95#	115	20-70	358	RCA1B07	507	80	100	1000-15000	791
40829	264	-90	40	20-100	675	RCA1B08	507	-80	100	1000-15000	791
40830	264	-70	40	20-100	675	RCA1C03	512	120	40	50-250	652
40831	264	-50	40	20-100	675	RCA1C04	512	-120	40	50-250	652
40850	439	450	35	25 min.	498	RCA1C05	515	60	40	20-120	644
40851	439	450	45	12 min.	498	RCA1C06	515	-60	40	20-120	644
40852	439	450	100	12 min.	498	RCA1C07	519	75	75	20-120	646
40853	439	450	100	10 min.	498	RCA1C08	519	-75	75	20-120	646
40854	439	450	110	10 min.	498	RCA1C09	523	75	75	20-120	645
40885	304	300	20	30-190	508	RCA1C10	527	40	40	50-250	642
40886	304	350	20	30-150	508	RCA1C11	527	-40	40	50-250	642
40887	304	450	20	30-150	508	RCA1C12	512	140	40	40-250	652
40894	443	20	0.3	50-250	548	RCA1C13	512	-140	40	40-250	652
40895	443	20	0.3	40-250	548	RCA1C14	532	60	50	20-70	643
40896	443	20	0.3	27-250	548	RCA1E02	536	200	35	30-150	653
40897	443	20	0.3	70-250	548	RCA1E03	536	-200	35	30-150	653
40910	85	50	29	20-100	527	RCA29	538	40	30	15-75	583
40911	85	90	50	25-100	527	RCA29A	538	60	30	15-75	583
40912	109	140	20	20-100	529	RCA29B	538	80	30	15-75	583
40913	109	170	50	20-60	529	RCA29C	538	100	30	15-75	583
40915	448	35	0.2	20 min.	574	RCA29/SDH	542	40	36	40 min.	792
41500	452	35	40	25 min.	772	RCA29A/SDH	542	60	36	40 min.	792
41501	456	-35	40	25 min.	770	RCA29B/SDH	542	80	36	40 min.	792
41502	459	30*	3	30 min.	773	RCA29C/SDH	542	100	50	40 min.	792
41503	462	-30*	1	20 min.	774	RCA30	548	-40	30	15-75	584
41504	465	35#	36	25 min.	775	RCA30A	548	-60	30	15-75	584
41505	468	200*	20	20 min.	771	RCA30B	548	-80	30	15-75	584
41506	471	200	100	8 min.	776	RCA30C	548	-100	30	15-75	584
43104	475	180	150	15-60	622	RCA31	552	40	40	10-50	585
CH2102	698	60*	-	50 min.	632	RCA31A	552	60	40	10-50	585
CH2270	698	45*	-	50 min.	632	RCA31B	552	80	40	10-50	585
CH2405	698	90*	-	50 min.	632	RCA31C	552	100	40	10-50	585
CH3053	698	30*	-	50 min.	632	RCA31/SDH	556	40	36	25 min.	793
CH3439	698	325*	-	30 min.	632	RCA31A/SDH	556	60	36	25 min.	793
CH3440	698	250*	-	30 min.	632	RCA31B/SDH	556	80	36	25 min.	793
CH4036	698	-65*	-	35 min.	632	RCA31C/SDH	556	100	50	25 min.	793

# Index to Power Transistors and Power Hybrid Circuits (Cont'd)

Type No.	Page No.	Collector-to-Base Voltage (Max.) - V	Power Dissipation (Max.) - W	DC Current Transfer Ratio	Data Sheet File No.	Type No.	Page No.	Collector-to-Base Voltage (Max.) - V	Power Dissipation (Max.) - W	DC Current Transfer Ratio	Data Sheet File No.
RCA32	562	-40	40	10-50	586	RCP111D	639	350	6.25	50-300	822
RCA32A	562	-40	40	10-50	586	RCP113A	639	200	6.25	30-150	822
RCA32B	562	-80	40	10-50	586	RCP113B	639	250	6.25	30-150	822
RCA32C	562	-100	40	10-50	586	RCP113C	639	300	6.25	30-150	822
RCA41	566	40	65	15-75	587	RCP113D	639	350	6.25	30-150	822
RCA41A	566	60	65	15-75	587	RCP115	639	100	6.25	50 min.	822
RCA41B	566	80	65	15-75	587	RCP115B	639	250	6.25	50 min.	822
RCA41C	566	100	65	15-75	587	RCP117	639	100	6.25	20 min.	822
RCA41/SDH	570	40	75	30 min.	794	RCP117B	639	250	6.25	20 min.	822
RCA41A/SDH	570	60	75	30 min.	794	RCP700A	649	-55	10	50-250	821
RCA41B/SDH	570	80	75	30 min.	794	RCP700B	649	-85	10	50-250	821
RCA42	574	-40	65	15-75	588	RCP700C	649	-105	10	50-250	821
RCA42A	574	-60	65	15-75	588	RCP700D	649	-125	10	50-250	821
RCA42B	574	-80	65	15-75	588	RCP701A	659	55	10	50-250	820
RCA42C	574	-100	65	15-75	588	RCP701B	659	85	10	50-250	820
RCA120	578	60	60	1000 min.	840	RCP701C	659	105	10	50-250	820
RCA121	578	80	60	1000 min.	840	RCP701D	659	125	10	50-250	820
RCA122	578	100	60	1000 min.	840	RCP702A	649	-55	10	30-150	821
RCA125	583	-60	6	1000 min.	841	RCP702B	649	-85	10	30-150	821
RCA126	583	-80	6	1000 min.	841	RCP702C	649	-105	10	30-150	821
RCA410	587	200	125	30-90	509	RCP702D	649	-125	10	30-150	821
RCA411	592	300	125	30-90	510	RCP703A	659	55	10	30-150	820
RCA413	597	400	125	20-80	511	RCP703B	659	85	10	30-150	820
RCA423	602	400	125	30-90	512	RCP703C	659	105	10	30-150	820
RCA431	607	400	125	15-35	513	RCP703D	659	125	10	30-150	820
RCA1000	612	60	90	750 min.	594	RCP704	649	-45	10	50 min.	821
RCA1001	612	80	90	750 min.	594	RCP704B	649	-85	10	50 min.	821
RCA3054	615	90	36	25-100	618	RCP705	659	45	10	50 min.	820
RCA3055	615	100	75	20-70	618	RCP705B	659	85	10	50 min.	820
RCA3441	622	140	36	20-150	666	RCP706	649	-45	10	20 min.	821
RCA6263	622	160	36	20-150	666	RCP706B	649	-85	10	20 min.	821
RCA8203	627	-40	60	1000-20,000	835	RCP707	659	45	10	20 min.	820
RCA8203A	627	-60	60	1000-20,000	835	RCP707B	659	85	10	20 min.	820
RCA8203B	627	-80	60	1000-20,000	835	RCS242	669	50	115	20 min.	778
RCA8350	633	-40	70	1000-20,000	861	RCS559	673	-275	35	10-100	782
RCA8350A	633	-60	70	1000-20,000	861	RCS560	673	-250	35	7.5 min.	782
RCA8350B	633	-80	70	1000-20,000	861	RCS564	678	300	175	5 min.	779
RCP111A	639	200	6.25	50-300	822	RCS880	685	-150*	0.75	20-150	777
RCP111B	639	250	6.25	50-300	822	RCS881	689	-250	0.75	20 min.	780
RCP111C	639	300	6.25	50-300	822	RCS882	693	-350	7.5	20 min.	781

- \* = V<sub>CEO</sub>
- # = V<sub>CER</sub>
- = Supply Voltage
- ▲ = Output Current

# Application Notes for Power Transistors

No.	Title	Page
1CE-402	"Operating Considerations for RCA Solid State Devices"	.730
AN-3065	"Silicon Transistors for High-Voltage Applications"	.735
AN-3565	"A 100-Watt, 18 kHz Inverter Using RCA-2N5202 Silicon Power Transistors"	.745
AN-4124	"Handling and Mounting of RCA Molded-Plastic Transistors and Thyristors"	.748
AN-4509	"Compact 5-Volt Power Supplies Using High-Voltage Power Transistors"	.756
AN-4558	"A 60-Watt, 20-Volt Regulated Power Supply Using a Single Pass Transistor"	.764
AN-4573	"Testing for Forward-Bias Second Breakdown in Power Transistors"	.776
AN-4612	"Thermal-Cycling Rating System for Silicon Power Transistors"	.782
AN-4673	"A 750-Watt Three-Phase Frequency Converter"	.785
AN-4783	"Thermal-Cycling Ratings of Power Transistors"	.790
AN-6145	"Test Set for Nondestructive Safe-Area Measurements"	.797
AN-6163	"Measurement of Power-Transistor Thermal-Cycling Capability"	.805
AN-6195	"A Switching Regulator Using RCA P-N-P Power Darlingtons Transistors"	.815
AN-6215	"Interpretation of Voltage Ratings for Transistors"	.823
AN-6249	"Real-Time Controls of Silicon Power-Transistor Reliability"	.829
AN-6272	"Characteristics of RCA Monolithic Power Darlingtons"	.834
AN-6281	"Accurate Measurement of Sustaining Voltage of Power Transistors — A Pulsed-Breakdown Test Set"	.840
AN-6297	"Biasing Circuit for the Output Stage of a Power Transistor — The $V_{BE}$ Multiplier"	.846
AN-6320	"Radiation Hardness Capability of RCA Silicon Power Transistors"	.848
AN-6330	"A Safe-Area Rating System for Power Inverters Handling Capacitive and Inductive Loads"	.856

# MONOLITHIC DARLINGTON TYPES

$I_C$  to 10 A . . .  $P_T$  to 100 W . . .  $h_{FE}$  to 1000 min.

$I_C = -10$ A max. $P_T = 60$ W max. VERSAWATT (TO-220)	$I_C = 8$ A max. $P_T = 90$ W max. (TO-3)	$I_C = 8$ A max. $P_T = 60$ W max. VERSAWATT (TO-220)	$I_C = 10$ A max. $P_T = 100$ W max. (TO-3)	$I_C = 10$ A max. $P_T = 60$ W max. VERSAWATT (TO-220)	$I_C = 10$ A max. $P_T = 70$ W max. (TO-3)
130 x 130 <sup>▲</sup>	136 x 136	136 x 136	136 x 136	136 x 136	136 x 136
Family Designation					
RCA8203 [P-N-P]	2N6385 [N-P-N]	TA8904 [N-P-N]	2N6385 [N-P-N]	2N6388 [N-P-N]	RCA8350 [P-N-P]
<p><b>RCA8203</b> <math>V_{CEP(sus)} = -40</math> V <math>h_{FE} = 1000-20,000</math> @ -3 A <math>f_T = 20</math> MHz min. <math>I_C = -8</math> A</p> <p style="text-align: right;">File No. 835</p>	<p><b>RCA1000</b> <math>V_{CEO(sus)} = 60</math> V <math>h_{FE} = 1000</math> min. @ 3 A <math>t_{on} = 1 \mu s</math> typ. <math>t_f = 3 \mu s</math> typ. <math>t_s = 1 \mu s</math> typ.</p> <p style="text-align: right;">File No. 594</p>	<p><b>RCA122</b> <math>V_{CER(sus)} = 100</math> V <math>h_{FE} = 1000</math> min. @ 3 A <math>f_T = 20</math> MHz min.</p> <p style="text-align: right;">File No. 840</p>	<p><b>2N6383</b> <math>V_{CEO(sus)} = 40</math> V <math>h_{FE} = 1000</math> min. @ 5 A <math>t_{on} = 1 \mu s</math> typ. <math>t_f = 3 \mu s</math> typ. <math>t_s = 1 \mu s</math> typ. <math>I_C = 10</math> A CT</p> <p style="text-align: right;">File No. 609</p>	<p><b>2N6386</b> <math>V_{CEO(sus)} = 40</math> V <math>h_{FE} = 1000</math> min. @ 3 A <math>t_{on} = 1 \mu s</math> typ. <math>t_f = 3 \mu s</math> typ. <math>t_s = 1 \mu s</math> typ. <math>I_C = 10</math> A, <math>P_T = 40</math> W CT</p> <p style="text-align: right;">File No. 610</p>	<p><b>RCA8350</b> <math>V_{CER(sus)} = -40</math> V <math>h_{FE} = 1000-20,000</math> @ -5 A <math>f_T = 20</math> MHz min.</p> <p style="text-align: right;">File No. 861</p>
<p><b>RCA125</b> <math>V_{CEO} = -60</math> V <math>h_{FE} = 1000</math> min. @ -3 A <math>f_T = 20</math> MHz min. <math>I_C = -8</math> A</p> <p style="text-align: right;">File No. 841</p>	<p><b>RCA1001</b> <math>V_{CEO(sus)} = 80</math> V <math>h_{FE} = 1000</math> min. @ 3 A <math>t_{on} = 1 \mu s</math> typ. <math>t_f = 3 \mu s</math> typ. <math>t_s = 1 \mu s</math> typ.</p> <p style="text-align: right;">File No. 594</p>		<p><b>2N6055</b> <math>V_{CEO(sus)} = 60</math> V <math>h_{FE} = 750</math> min. @ 4 A <math>t_{on} = 1 \mu s</math> typ. <math>t_f = 3 \mu s</math> typ. <math>t_s = 1 \mu s</math> typ. <math>I_C = 8</math> A</p> <p style="text-align: right;">File No. 563</p>	<p><b>RCA120</b> <math>V_{CER(sus)} = 60</math> V <math>h_{FE} = 1000</math> min. @ 3 A <math>f_T = 20</math> MHz min. <math>I_C = 8</math> A <math>P_T = 60</math> W</p> <p style="text-align: right;">File No. 840</p>	<p><b>RCA8350A</b> <math>V_{CER(sus)} = -60</math> V <math>h_{FE} = 1000-20,000</math> @ -5 A <math>f_T = 20</math> MHz min.</p> <p style="text-align: right;">File No. 861</p>
<p><b>RCA8203A</b> <math>V_{CER(sus)} = -60</math> V <math>h_{FE} = 1000-20,000</math> @ -5 A <math>f_T = 20</math> MHz min. <math>I_C = -10</math> A</p> <p style="text-align: right;">File No. 835</p>			<p><b>2N6384</b> <math>V_{CEO(sus)} = 60</math> V <math>h_{FE} = 1000</math> min. @ 5 A <math>t_{on} = 1 \mu s</math> typ. <math>t_f = 3 \mu s</math> typ. <math>t_s = 1 \mu s</math> typ. <math>I_C = 10</math> A CT</p> <p style="text-align: right;">File No. 609</p>	<p><b>2N6387</b> <math>V_{CEO(sus)} = 60</math> V <math>h_{FE} = 1000</math> min. @ 5 A <math>t_{on} = 1 \mu s</math> typ. <math>t_f = 3 \mu s</math> typ. <math>t_s = 1 \mu s</math> typ. <math>I_C = 10</math> A, <math>P_T = 40</math> W CT</p> <p style="text-align: right;">File No. 610</p>	<p><b>RCA8350B</b> <math>V_{CER(sus)} = -80</math> V <math>h_{FE} = 1000-20,000</math> @ -5 A <math>f_T = 20</math> MHz min.</p> <p style="text-align: right;">File No. 861</p>
<p><b>RCA126</b> <math>V_{CEO} = -80</math> V <math>h_{FE} = 1000</math> min. @ -3 A <math>f_T = 20</math> MHz min. <math>I_C = -8</math> A</p> <p style="text-align: right;">File No. 841</p>			<p><b>2N6056</b> <math>V_{CEO(sus)} = 80</math> V <math>h_{FE} = 750</math> min. @ 4 A <math>t_{on} = 1 \mu s</math> typ. <math>t_f = 3 \mu s</math> typ. <math>t_s = 1 \mu s</math> typ. <math>I_C = 8</math> A</p> <p style="text-align: right;">File No. 563</p>	<p><b>RCA121</b> <math>V_{CER(sus)} = 80</math> V <math>h_{FE} = 1000</math> min. @ 3 A <math>f_T = 20</math> MHz min. <math>I_C = 8</math> A <math>P_T = 60</math> W</p> <p style="text-align: right;">File No. 840</p>	
<p><b>RCA8203B</b> <math>V_{CER(sus)} = -80</math> V <math>h_{FE} = 1000-20,000</math> @ -5 A <math>f_T = 20</math> MHz min. <math>I_C = -10</math> A</p> <p style="text-align: right;">File No. 835</p>			<p><b>2N6385</b> <math>V_{CEO(sus)} = 80</math> V <math>h_{FE} = 1000</math> min. @ 5 A <math>t_{on} = 1 \mu s</math> typ. <math>t_f = 3 \mu s</math> typ. <math>t_s = 1 \mu s</math> typ. <math>I_C = 10</math> A CT</p> <p style="text-align: right;">File No. 609</p>	<p><b>2N6388</b> <math>V_{CEO(sus)} = 80</math> V <math>h_{FE} = 1000</math> min. @ 5 A <math>t_{on} = 1 \mu s</math> typ. <math>t_f = 3 \mu s</math> typ. <math>t_s = 1 \mu s</math> typ. <math>I_C = 10</math> A, <math>P_T = 40</math> W CT</p> <p style="text-align: right;">File No. 610</p>	

▲ Pellet size—values shown are edge dimensions in thousands-of-an-inch (mils).

CT—Complementary Type available

# HOMETAXIAL-BASE N-P-N POWER TYPES

$I_C$  to 80 A . . .  $P_T$  to 300 W . . .  $V_{CE}$  to 170 V

$I_C = 1.5$ A max. $P_T = 5$ W max. (TO-39)*	$I_C = 1.5$ A max. $P_T = 8.75$ W max. (TO-39)*	$I_C = 1.5$ A max. $P_T = 8.75$ W max. (TO-39)*	$I_C = 3.5$ A max. $P_T = 10$ W max. (TO-39)*	$I_C = 4$ A max. $P_T = 50$ W max. (TO-66)**	$I_C = 4$ A max. $P_T = 36$ W max. VERSAWATT (TO-220)
90 x 90 $\Delta$	90 x 90	90 x 90	90 x 90	130 x 130	130 x 130
Family Designation					
2N1482	2N1482	40349	2N5786	2N3054	2N5298
<b>2N1479<math>\bullet</math></b> $V_{CEV} = 60$ V $h_{FE} = 20-60$ @ 200 mA  File No. 135	<b>40347</b> $V_{CEV(sus)} = 60$ V $h_{FE} = 25-125$ @ 450 mA $f_T = 1.5$ MHz typ.	<b>40349</b> $V_{CEV(sus)} = 160$ V $h_{FE} = 30-125$ @ 150 mA $f_T = 1.5$ MHz typ.	<b>2N5786<math>\bullet</math></b> $V_{CEV(sus)} = 45$ V $h_{FE} = 20-100$ @ 1.6 A $f_T = 1$ MHz min.  CT File No. 413	<b>40250</b> $V_{CEV(sus)} = 50$ V $h_{FE} = 25-100$ @ 1.5 A $f_T = 1.2$ MHz typ. $P_T = 29$ W  CT File No. 112	<b>41504</b> $V_{CEV(sus)} = 35$ V $h_{FE} = 25$ min. @ 1 A $f_T = 0.8$ MHz min.
<b>2N1481<math>\bullet</math></b> $V_{CEV} = 60$ V $h_{FE} = 35-100$ @ 200 mA  File No. 135	<b>40348</b> $V_{CEV(sus)} = 90$ V $h_{FE} = 30-125$ @ 300 mA $f_T = 1.5$ MHz typ.		<b>2N5785<math>\bullet</math></b> $V_{CEV(sus)} = 65$ V $h_{FE} = 20-100$ @ 1.2 A $f_T = 1$ MHz. min.  CT File No. 413	<b>2N6260</b> $V_{CEV(sus)} = 50$ V $h_{FE} = 20-100$ @ 1.5 A $f_T = 0.8$ MHz min. $P_T = 29$ W	<b>2N5295</b> <b>2N5296</b> $V_{CEV(sus)} = 50$ V $h_{FE} = 30-120$ @ 1 A $f_T = 0.8$ MHz min.  CT File No. 322
<b>2N1480<math>\bullet</math></b> $V_{CEV} = 100$ V $h_{FE} = 20$ min. @ 200 mA  File No. 135			<b>2N5784<math>\bullet</math></b> $V_{CEV(sus)} = 80$ V $h_{FE} = 20-100$ @ 1 A $f_T = 1$ MHz min.  CT File No. 413	<b>2N3054</b> $V_{CEV(sus)} = 60$ V $h_{FE} = 25-150$ @ 0.5 A $f_T = 0.8$ MHz min. $P_T = 25$ W  CT File No. 527	<b>2N5297</b> <b>2N5298</b> $V_{CEV(sus)} = 70$ V $h_{FE} = 20-80$ @ 1.5 A $f_T = 0.8$ MHz min.  CT File No. 322
<b>2N1482<math>\bullet</math></b> $V_{CEV} = 100$ V $h_{FE} = 35-100$ @ 200 mA  File No. 135	$\Delta$ Pellet size—values shown are edge dimensions in thousands-of-an-inch (mils)  *Available with a. flange for easy heat sinking $R_{\theta JC} = 15^\circ$ C/W b. free-air radiator $R_{\theta JA} = 40-50^\circ$ C/W  **Available with free-air radiator $R_{\theta JA} = 30^\circ$ C/W  $\bullet$ These transistors are also available in TO-5 packages in U.S.A., Canada, Latin America, and Far East  CT—Complementary Type available			<b>2N6261</b> $V_{CEV(sus)} = 85$ V $h_{FE} = 25-100$ @ 1.5 A $f_T = 0.8$ MHz min. $P_T = 50$ W  File No. 527	<b>2N5293</b> <b>2N5294</b> $V_{CEV(sus)} = 70$ V $h_{FE} = 30-120$ @ 0.5 A $f_T = 0.8$ MHz min.  CT File No. 322

# HOMETAXIAL-BASE N-P-N POWER TYPES

$I_C$  to 80 A . . .  $P_T$  to 300 W . . .  $V_{CE}$  to 170 V

$I_C = 3$ A max. $P_T = 25$ W max. (TO-8)	$I_C = 3$ A max. $P_T = 50$ W max. (TO-66)**	$I_C = 3$ A max. $P_T = 36$ W max. VERSAWATT (TO-220)	$I_C = 4$ A max. $P_T = 50$ W max. VERSAWATT (TO-220)	$I_C = 4$ A max. $P_T = 50$ W max. VERSAWATT (TO-220)	$I_C = 7$ A max. $P_T = 50$ W max. VERSAWATT (TO-220)
130 x 130 <sup>A</sup>	130 x 130	130 x 130	130 x 130	130 x 130	150 x 150
Family Designation					
2N1486	2N3441	2N6478	2N6478	2N6478	2N5496
<b>2N1483</b> $V_{CEV} = 60$ V $h_{FE} = 20-60$ @ 750 mA  File No. 137	<b>2N6263</b> $V_{CEr(sus)} = 130$ V $h_{FE} = 20-100$ @ 0.5 A $f_T = 1.2$ MHz typ. $P_T = 20$ W  File No. 529	<b>2N6477</b> $V_{CEr(sus)} = 130$ V $h_{FE} = 25-100$ @ 1 A $f_T = 0.8$ MHz min.  File No. 680	<b>RCA29/SDH</b> $V_{CEO} = 40$ V $h_{FE} = 40$ min. @ 0.2 A $f_T = 0.8$ MHz min. $I_C = 4$ A $P_T = 36$ W  File No. 792	<b>RCA31/SDH</b> $V_{CEO} = 40$ V $h_{FE} = 25$ min. @ 1 A $f_T = 0.8$ MHz min. $I_C = 4$ A $P_T = 36$ W  File No. 793	<b>2N5491</b> <b>2N5490</b> $V_{CEr(sus)} = 50$ V $h_{FE} = 20-100$ @ 2 A $f_T = 0.8$ MHz min.  CT File No. 353
<b>2N1485</b> $V_{CEV} = 60$ V $h_{FE} = 20-100$ @ 750 mA  File No. 137	<b>2N3441</b> $V_{CEr(sus)} = 150$ V $h_{FE} = 25-100$ @ 0.5 A $f_T = 1.2$ MHz typ. $P_T = 25$ W  CT File No. 529	<b>2N6478</b> $V_{CEr(sus)} = 150$ V $h_{FE} = 25-100$ @ 1 A $f_T = 0.8$ MHz min.  File No. 680	<b>RCA29A/SDH</b> $V_{CEO} = 60$ V $h_{FE} = 40$ min. @ 0.2 A $f_T = 0.8$ MHz min. $I_C = 4$ A $P_T = 36$ W  File No. 792	<b>RCA31A/SDH</b> $V_{CEO} = 60$ V $h_{FE} = 25$ min. @ 1 A $f_T = 0.8$ MHz min. $I_C = 4$ A $P_T = 36$ W  File No. 793	<b>2N5495</b> <b>2N5494</b> $V_{CEr(sus)} = 50$ V $h_{FE} = 20-100$ @ 3 A $f_T = 0.8$ MHz min.  CT File No. 353
<b>2N1484</b> $V_{CEV} = 100$ V $h_{FE} = 20-60$ @ 750 mA  File No. 137	<b>2N6264</b> $V_{CEr(sus)} = 170$ V $h_{FE} = 20-60$ @ 1 A $f_T = 1.2$ MHz typ. $P_T = 50$ W  File No. 529		<b>RCA29B/SDH</b> $V_{CEO} = 80$ V $h_{FE} = 40$ min. @ 0.2 A $f_T = 0.8$ MHz min. $I_C = 4$ A $P_T = 36$ W  File No. 792	<b>RCA31B/SDH</b> $V_{CEO} = 80$ V $h_{FE} = 25$ min. @ 1 A $f_T = 0.8$ MHz min. $I_C = 4$ A $P_T = 36$ W  File No. 793	<b>2N5493</b> <b>2N5492</b> $V_{CEr(sus)} = 65$ V $h_{FE} = 20-100$ @ 2.5 A $f_T = 0.8$ MHz min.  CT File No. 353
<b>2N1486</b> $V_{CEV} = 100$ V $h_{FE} = 35-100$ @ 750 mA  File No. 137			<b>RCA29C/SDH</b> $V_{CEO} = 100$ V $h_{FE} = 40$ min. @ 0.2 A $f_T = 0.8$ MHz min. $I_C = 2.5$ A $P_T = 50$ W  File No. 792	<b>RCA31C/SDH</b> $V_{CEO} = 100$ V $h_{FE} = 25$ min. @ 1 A $f_T = 0.8$ MHz min. $I_C = 2.5$ A $P_T = 50$ W  File No. 793	<b>2N5497</b> <b>2N5496</b> $V_{CEr(sus)} = 80$ V $h_{FE} = 20-100$ @ 3.5 A $f_T = 0.8$ MHz min.  CT File No. 353

▲ Pellet size—values shown are edge dimensions in thousands-of-an-inch (mils)

\*\*Available with free-air radiator  $R_{\theta JA} = 30^\circ \text{C/W}$

CT — Complementary Type available

# HOMETAXIAL-BASE N-P-N POWER TYPES

$I_C$  to 80 A . . .  $P_T$  to 300 W . . .  $V_{CE}$  to 170 V

$I_C = 6$ A max. $P_T = 75$ W max. (TO-3)	$I_C = 8$ A max. $P_T = 83$ W VERSAWATT (TO-220)	$I_C = 10$ A max. $P_T = 150$ W (TO-36)	$I_C = 15$ A max. $P_T = 150$ W max. (TO-3)	$I_C = 16$ A max. $P_T = 75$ W max. VERSAWATT (TO-220)
180 x 180A	180 x 180	180 x 180	180 x 180	180 x 180
Family Designation				
2N1490	2N5037	2N2016	2N3055	2N6103
<b>2N1487</b> $V_{CEV} = 60$ V $h_{FE} = 15-45$ @ 1.5 A  File No. 139	<b>2N5034</b> $V_{CER(sus)} = 45$ V $h_{FE} = 20-80$ @ 4 A $f_T = 800$ kHz min. $I_C = 6$ A  File No. 244	<b>2N2015</b> $V_{CEO(sus)} = 50$ V $h_{FE} = 15-50$ @ 5 A  File No. 12	<b>RCS242</b> $V_{CER(sus)} = 50$ V $h_{FE} = 20$ min. @ 3 A $f_T = 0.8$ MHz min. $P_T = 115$ W  File No. 778	<b>RCA41/SDH</b> $V_{CEO} = 40$ V $h_{FE} = 30$ min. @ 0.3 A $f_T = 0.8$ MHz min. $I_C = 16$ A  File No. 794
<b>2N1489</b> $V_{CEV} = 60$ V $h_{FE} = 25-75$ @ 1.5 A  File No. 139	<b>2N5035</b> $V_{CER(sus)} = 45$ V $h_{FE} = 20-80$ @ 4 A $f_T = 800$ kHz min. $I_C = 6$ A  File No. 244	<b>2N2016</b> $V_{CEO(sus)} = 65$ V $h_{FE} = 15-50$ @ 5 A  File No. 12	<b>2N6371</b> $V_{CEV(sus)} = 50$ V $h_{FE} = 15-60$ @ 8 A $f_T = 1$ MHz typ. $P_T = 117$ W  CT File No. 607	<b>RCA41A/SDH</b> $V_{CEO} = 60$ V $h_{FE} = 30$ min. @ 0.3 A $f_T = 0.8$ MHz min. $I_C = 10$ A  File No. 794
<b>2N1488</b> $V_{CEV} = 100$ V $h_{FE} = 15-45$ @ 1.5 A  File No. 139	<b>2N5036</b> $V_{CER(sus)} = 60$ V $h_{FE} = 20-80$ @ 5 A $f_T = 800$ kHz min. $I_C = 8$ A  File No. 244		<b>2N6253</b> $V_{CER(sus)} = 55$ V $h_{FE} = 20-70$ @ 3 A $f_T = 0.8$ MHz min. $P_T = 115$ W  File No. 524	<b>RCA41B/SDH</b> $V_{CEO} = 80$ V $h_{FE} = 30$ min. @ 0.3 A $f_T = 0.8$ MHz min. $I_C = 10$ A  File No. 794
<b>2N1490</b> $V_{CEV} = 100$ V $h_{FE} = 25-75$ @ 1.5 A  File No. 139	<b>2N5037</b> $V_{CER(sus)} = 60$ V $h_{FE} = 20-80$ @ 5 A $f_T = 800$ kHz min. $I_C = 8$ A  File No. 244		<b>2N3055</b> $V_{CER(sus)} = 70$ V $h_{FE} = 20-70$ @ 4 A $f_T = 0.8$ MHz min. $P_T = 115$ W  CT File No. 524	
			<b>2N6254</b> $V_{CER(sus)} = 85$ V $h_{FE} = 20-70$ @ 5 A $f_T = 0.8$ MHz min $P_T = 150$ W  File No. 524	

▲ Pellet size—values shown are edge dimensions in thousands-of-an-inch (mils)

CT—Complementary Type available



# HOMETAXIAL-BASE N-P-N POWER TYPES

$I_C$  to 80 A . . .  $P_T$  to 300 W . . .  $V_{CE}$  to 170 V

$I_C = 16$ A max. $P_T = 75$ W max. VERSAWATT (TO-220)	$I_C = 10$ A max. $P_T = 150$ W max. (TO-3)	$I_C = 30$ A max. $P_T = 250$ W max. (TO-3)	$I_C = 16$ A max. $P_T = 250$ W max. (TO-3)	$I_C = 80$ A max. $P_T = 300$ W max. (Modified TO-3)
<b>180 x 180▲</b>	<b>180 x 180</b>	<b>250 x 250</b>	<b>250 x 250</b>	<b>380 x 380</b>
Family Designation				
<b>2N6103</b>	<b>2N3442</b>	<b>2N3771</b>	<b>2N3773</b>	<b>2N5578</b>
<b>2N6102</b> <b>2N6103</b> $V_{CEr(sus)} = 45$ V $h_{FE} = 15-60$ @ 8 A $f_T = 0.8$ MHz min. $I_C = 16$ A max.  File No. 485	<b>2N4347</b> $V_{CEV(sus)} = 140$ V $h_{FE} = 15-60$ @ 2 A $f_T = 0.8$ MHz typ. $P_T = 100$ W  CT File No. 528	<b>2N6257</b> $V_{CEr(sus)} = 45$ V $h_{FE} = 15-75$ @ 8 A $f_T = 0.6$ MHz min. $P_T = 150$ W $I_C = 20$ A  File No. 525	<b>2N4348</b> $V_{CEV(sus)} = 140$ V $h_{FE} = 15-60$ @ 8 A $f_T = 0.7$ MHz typ. $P_T = 120$ W $I_C = 10$ A  File No. 526	<b>2N5575</b> $V_{CEQ(sus)} = 50$ V $h_{FE} = 10-40$ @ 60 A $f_T = 0.4$ MHz min.  File No. 359
<b>2N6098</b> <b>2N6099</b> $V_{CEr(sus)} = 65$ V $h_{FE} = 20-80$ @ 4 A $f_T = 0.8$ MHz min. $I_C = 10$ A max.  File No. 485	<b>2N3442</b> $V_{CEV(sus)} = 160$ V $h_{FE} = 20-70$ @ 3 A $f_T = 0.8$ MHz typ. $P_T = 117$ W  File No. 528	<b>2N3771</b> $V_{CEr(sus)} = 45$ V $h_{FE} = 15-60$ @ 15 A $f_T = 0.8$ MHz min. $P_T = 150$ W $I_C = 30$ A  File No. 525	<b>2N3773</b> $V_{CEV(sus)} = 160$ V $h_{FE} = 15-60$ @ 8 A $f_T = 0.7$ MHz typ. $P_T = 150$ W $I_C = 16$ A  File No. 526	<b>2N5578</b> $V_{CEO(sus)} = 70$ V $h_{FE} = 10-40$ @ 40 A $f_T = 0.4$ MHz min.  File No. 359
<b>2N6100</b> <b>2N6101</b> $V_{CEr(sus)} = 75$ V $h_{FE} = 20-80$ @ 5 A $f_T = 0.8$ MHz min. $I_C = 10$ A max.  File No. 485	<b>2N6262</b> $V_{CEV(sus)} = 170$ V $h_{FE} = 20-70$ @ 3 A $f_T = 0.8$ MHz min. $P_T = 150$ W  File No. 528	<b>2N3772</b> $V_{CEr(sus)} = 70$ V $h_{FE} = 15-60$ @ 10 A $f_T = 0.8$ MHz min. $P_T = 150$ W  CT File No. 525	<b>2N6259</b> $V_{CEr(sus)} = 160$ V $h_{FE} = 15-60$ @ 8 A $f_T = 0.6$ MHz typ. $P_T = 250$ W $I_C = 16$ A  File No. 526	
		<b>2N6258</b> $V_{CEr(sus)} = 85$ V $h_{FE} = 20-60$ @ 15 A $f_T = 0.6$ MHz min. $P_T = 250$ W $I_C = 30$ A  File No. 525	<b>43104</b> $V_{CEX} = 160$ V $h_{FE} = 15-60$ @ 8 A $f_T = 0.7$ MHz typ. $I_C = 4$ A $P_T = 150$ W  File No. 622	

▲ Pellet size—values shown are edge dimensions in thousands-of-an-inch (mils)

CT—Complementary Type available

# EPITAXIAL-BASE N-P-N and P-N-P TYPES

$I_C$  to 15 A . . .  $P_T$  to 200 W . . .  $V_{CE}$  to 125 V

$I_C = -2$ A max. $P_T = 10$ W max. RCP Plastic	$I_C = 2$ A max. $P_T = 10$ W max. RCP Plastic	$I_C = -2$ A max. $P_T = 10$ W max. RCP Plastic	$I_C = 2$ A max. $P_T = 10$ W max. RCP Plastic	$I_C = -2$ A max. $P_T = 10$ W max. RCP Plastic	$I_C = 2$ A max. $P_T = 10$ W max. RCP Plastic
42 x 42A	42 x 42	42 x 42	42 x 42	42 x 42	42 x 42
Family Designation					
RCP700 [P-N-P]	RCP701 [N-P-N]	RCP700 [P-N-P]	RCP701 [N-P-N]	RCP700 [P-N-P]	RCP701 [N-P-N]
<b>RCP706</b> $V_{CE0(sus)} = -30$ V $h_{FE} = 20$ min. @ -500 mA $f_T = 50$ MHz min.  CT File No. 821	<b>RCP707</b> $V_{CE0(sus)} = 30$ V $h_{FE} = 20$ min. @ 500 mA $f_T = 50$ MHz min.  CT File No. 820	<b>RCP702A</b> $V_{CE0(sus)} = -40$ V $h_{FE} = 30-150$ @ -500 mA $f_T = 50$ MHz min.  CT File No. 821	<b>RCP703A</b> $V_{CE0(sus)} = 40$ V $h_{FE} = 30-150$ @ 500 mA $f_T = 50$ MHz min.  CT File No. 820	<b>RCP700A</b> $V_{CE0(sus)} = -40$ V $h_{FE} = 50-250$ @ -500 mA $f_T = 50$ MHz min.  CT File No. 821	<b>RCP701A</b> $V_{CE0(sus)} = 40$ V $h_{FE} = 50-250$ @ 500 mA $f_T = 50$ MHz min.  CT File No. 820
<b>RCP704</b> $V_{CE0(sus)} = -30$ V $h_{FE} = 50$ min. @ -500 mA $f_T = 50$ MHz min.  CT File No. 821	<b>RCP705</b> $V_{CE0(sus)} = 30$ V $h_{FE} = 50$ min. @ 500 mA $f_T = 50$ MHz min.  CT File No. 820	<b>RCP702B</b> $V_{CE0(sus)} = -60$ V $h_{FE} = 30-150$ @ -500 mA $f_T = 50$ MHz min.  CT File No. 821	<b>RCP703B</b> $V_{CE0(sus)} = 60$ V $h_{FE} = 30-150$ @ 500 mA $f_T = 50$ MHz min.  CT File No. 820	<b>RCP700B</b> $V_{CE0(sus)} = -60$ V $h_{FE} = 50-250$ @ -500 mA $f_T = 50$ MHz min.  CT File No. 821	<b>RCP701B</b> $V_{CE0(sus)} = 60$ V $h_{FE} = 50-250$ @ 500 mA $f_T = 50$ MHz min.  CT File No. 820
<b>RCP706B</b> $V_{CE0(sus)} = -60$ V $h_{FE} = 20$ min. @ -500 mA $f_T = 50$ MHz min.  CT File No. 821	<b>RCP707B</b> $V_{CE0(sus)} = 60$ V $h_{FE} = 20$ min. @ 500 mA $f_T = 50$ MHz min.  CT File No. 820	<b>RCP702C</b> $V_{CE0(sus)} = -80$ V $h_{FE} = 30-150$ @ -500 mA $f_T = 50$ MHz min.  CT File No. 821	<b>RCP703C</b> $V_{CE0(sus)} = 80$ V $h_{FE} = 30-150$ @ 500 mA $f_T = 50$ MHz min.  CT File No. 820	<b>RCP700C</b> $V_{CE0(sus)} = -80$ V $h_{FE} = 50-250$ @ -500 mA $f_T = 50$ MHz min.  CT File No. 821	<b>RCP701C</b> $V_{CE0(sus)} = 80$ V $h_{FE} = 50-250$ @ 500 mA $f_T = 50$ MHz min.  CT File No. 820
<b>RCP704B</b> $V_{CE0(sus)} = -60$ V $h_{FE} = 50$ min. @ -500 mA $f_T = 50$ MHz min.  CT File No. 821	<b>RCP705B</b> $V_{CE0(sus)} = 60$ V $h_{FE} = 50$ min. @ 500 mA $f_T = 50$ MHz min.  CT File No. 820	<b>RCP704D</b> $V_{CE0(sus)} = -100$ V $h_{FE} = 30-150$ @ -500 mA $f_T = 50$ MHz min.  CT File No. 821	<b>RCP703D</b> $V_{CE0(sus)} = 100$ V $h_{FE} = 30-150$ @ 500 mA $f_T = 50$ MHz min.  CT File No. 820	<b>RCP700D</b> $V_{CE0(sus)} = -100$ V $h_{FE} = 50-250$ @ -500 mA $f_T = 50$ MHz min.  CT File No. 821	<b>RCP701D</b> $V_{CE0(sus)} = 100$ V $h_{FE} = 50-250$ @ 500 mA $f_T = 50$ MHz min.  CT File No. 820

▲ Pellet size—values shown are edge dimensions in thousands-of-an-inch (mils).

CT—Complementary Type available

# EPITAXIAL-BASE N-P-N and P-N-P POWER TYPES

$I_C$  to 15 A ...  $P_T$  to 200 W ...  $V_{CE}$  to 125 V

$I_C = -3.5$ max. $P_T = 10$ W max. (TO-39)*	$I_C = 6$ A max. $P_T = 40$ W max. (TO-66)**	$I_C = -6$ A max. $P_T = 40$ W max. (TO-66)**	$I_C = 7$ A max. $P_T = 40$ W max. VERSAWATT (TO-220)	$I_C = 7$ A max. $P_T = 40$ W max. VERSAWATT (TO-220)
90 x 90▲	90 x 90	90 x 90	90 x 90	90 x 90
Family Designation				
2N5783 [P-N-P]	2N6372 [N-P-N]	2N5954 [P-N-P]	2N6292 [N-P-N]	2N6292 [N-P-N]
<p><b>2N5783●</b>  <math>V_{CER(sus)} = -45</math> V  <math>h_{FE} = 20-100</math>                      @ -1.6 A  <math>f_T = 8</math> MHz min.</p> <p style="text-align: center;">CT File No. 413</p>	<p><b>2N6374</b>  <math>V_{CER(sus)} = 45</math> V  <math>h_{FE} = 20-100</math>                      @ 3 A  <math>f_T = 4</math> MHz min.</p> <p style="text-align: center;">CT File No. 675</p>	<p><b>2N5956</b>  <math>V_{CER(sus)} = -45</math> V  <math>h_{FE} = 20-100</math>                      @ -3 A  <math>f_T = 5</math> MHz min.</p> <p style="text-align: center;">CT File No. 675</p>	<p><b>2N6288</b>  <b>2N6289</b>  <math>V_{CER(sus)} = 40</math> V  <math>h_{FE} = 30-150</math>                      @ 3 A  <math>f_T = 4</math> MHz min.</p> <p style="text-align: center;">CT File No. 676</p>	<p><b>41500</b>  <math>V_{CEX} = 35</math> V  <math>h_{FE} = 25</math> min.                      @ 1 A  <math>f_T = 4</math> MHz min.</p> <p style="text-align: center;">CT File No. 772</p>
<p><b>2N5782●</b>  <math>V_{CER(sus)} = -65</math> V  <math>h_{FE} = 20-100</math>                      @ -1.2 A  <math>f_T = 8</math> MHz min.</p> <p style="text-align: center;">CT File No. 413</p>	<p><b>2N6373</b>  <math>V_{CER(sus)} = 65</math> V  <math>h_{FE} = 20-100</math>                      @ 2.5 A  <math>f_T = 4</math> MHz min.</p> <p style="text-align: center;">CT File No. 675</p>	<p><b>2N5955</b>  <math>V_{CER(sus)} = -65</math> V  <math>h_{FE} = 20-100</math>                      @ -2.5 A  <math>f_T = 5</math> MHz min.</p> <p style="text-align: center;">CT File No. 675</p>	<p><b>2N6290</b>  <b>2N6291</b>  <math>V_{CER(sus)} = 60</math> V  <math>h_{FE} = 30-150</math>                      @ 2.5 A  <math>f_T = 4</math> MHz min.</p> <p style="text-align: center;">CT File No. 676</p>	
<p><b>2N5781●</b>  <math>V_{CER(sus)} = -80</math> V  <math>h_{FE} = 20-100</math>                      @ -1 A  <math>f_T = 8</math> MHz min.</p> <p style="text-align: center;">CT File No. 413</p>	<p><b>2N6372</b>  <math>V_{CER(sus)} = 85</math> V  <math>h_{FE} = 20-100</math>                      @ 2 A  <math>f_T = 4</math> MHz min.</p> <p style="text-align: center;">CT File No. 675</p>	<p><b>2N5954</b>  <math>V_{CER(sus)} = -85</math> V  <math>h_{FE} = 20-100</math>                      @ -2 A  <math>f_T = 5</math> MHz min.</p> <p style="text-align: center;">CT File No. 675</p>	<p><b>2N6292</b>  <b>2N6293</b>  <math>V_{CER(sus)} = 80</math> V  <math>h_{FE} = 30-150</math>                      @ 2 A  <math>f_T = 4</math> MHz min.</p> <p style="text-align: center;">CT File No. 676</p>	
		<p><b>2N6467</b>  <math>V_{CER(sus)} = -105</math> V  <math>h_{FE} = 20-100</math>                      @ -1 A  <math>f_T = 5</math> MHz min.</p> <p style="text-align: center;">File No. 675</p>	<p><b>2N6473</b>  <math>V_{CER(sus)} = 110</math> V  <math>h_{FE} = 30-150</math>                      @ 1.5 A  <math>f_T = 5</math> MHz typ.</p> <p style="text-align: center;">CT File No. 676</p>	
		<p><b>2N6468</b>  <math>V_{CER(sus)} = -125</math> V  <math>h_{FE} = 20-100</math>                      @ -1 A  <math>f_T = 5</math> MHz min.</p> <p style="text-align: center;">File No. 675</p>	<p><b>2N6474</b>  <math>V_{CER(sus)} = 130</math> V  <math>h_{FE} = 30-150</math>                      @ 1 A  <math>f_T = 5</math> MHz typ.</p> <p style="text-align: center;">CT File No. 676</p>	

▲ Pellet size—values shown are edge dimensions in thousands-of-an-inch (mils).

\* Available with

a. flange for easy heat sinking  $R_{\theta JC} = 15^\circ$  C/W

b. free-air radiator  $R_{\theta JA} = 40-50^\circ$  C/W

\*\* Available with free-air radiator  $R_{\theta JA} = 30^\circ$  C/W

● These transistors are also available in TO-5 packages in U.S.A., Canada, Latin America, and Far East.

CT—Complementary Type available

# EPITAXIAL-BASE N-P-N and P-N-P POWER TYPES

$I_C$  to 15 A ...  $P_T$  to 200 W ...  $V_{CE}$  to 125 V

$I_C = -7$ A max. $P_T = 40$ W max. VERSAWATT (TO-220)	$I_C = -7$ A max. $P_T = 40$ W max. VERSAWATT (TO-220)	$I_C = 15$ A max. $P_T = 125$ W max. (TO-3)	$I_C = -15$ A max. $P_T = 125$ W max. (TO-3)	$I_C = 15$ A max. $P_T = 75$ W max. VERSAWATT (TO-220)	$I_C = -15$ A max. $P_T = 75$ W max. VERSAWATT (TO-220)
90 x 90A	90 x 90	150 x 150	150 x 150	150 x 150	150 x 150
Family Designation					
2N6107 [P-N-P]	2N6107 [P-N-P]	2N6472 [N-P-N]	2N6248 [P-N-P]	2N6488 [N-P-N]	2N6491 [P-N-P]
<p style="text-align: center;"><b>41501</b></p> <p><math>V_{CEr}</math> (sus) = -35 V <math>h_{FE} = 25</math> min. @ -1 A</p> <p style="text-align: center;">CT File No. 770</p>	<p style="text-align: center;"><b>2N6110</b> <b>2N6111</b></p> <p><math>V_{CEr}</math> (sus) = -40 V <math>h_{FE} = 30-150</math> @ -3 A <math>f_T = 10</math> MHz min.</p> <p style="text-align: center;">CT File No. 676</p>	<p style="text-align: center;"><b>2N6470</b></p> <p><math>V_{CEr}</math> (sus) = 45 V <math>h_{FE} = 20-100</math> @ 5 A <math>f_T = 5</math> MHz typ.</p> <p style="text-align: center;">CT File No. 677</p>	<p style="text-align: center;"><b>2N6469</b></p> <p><math>V_{CEr}</math> (sus) = -45 V <math>h_{FE} = 20-100</math> @ -5 A <math>f_T = 6</math> MHz min.</p> <p style="text-align: center;">CT File No. 677</p>	<p style="text-align: center;"><b>2N6486</b></p> <p><math>V_{CEr}</math> (sus) = 50 V <math>h_{FE} = 30-150</math> @ 6 A <math>f_T = 5</math> MHz typ.</p> <p style="text-align: center;">CT File No. 678</p>	<p style="text-align: center;"><b>2N6489</b></p> <p><math>V_{CEr}</math> (sus) = -50 V <math>h_{FE} = 30-150</math> @ -6 A <math>f_T = 5</math> MHz typ.</p> <p style="text-align: center;">CT File No. 678</p>
	<p style="text-align: center;"><b>2N6108</b> <b>2N6109</b></p> <p><math>V_{CEr}</math> (sus) = -60 V <math>h_{FE} = 30-150</math> @ -2.5 A <math>f_T = 10</math> MHz min.</p> <p style="text-align: center;">CT File No. 676</p>	<p style="text-align: center;"><b>2N6471</b></p> <p><math>V_{CEr}</math> (sus) = 65 V <math>h_{FE} = 20-100</math> @ 7 A <math>f_T = 5</math> MHz typ.</p> <p style="text-align: center;">CT File No. 677</p>	<p style="text-align: center;"><b>2N6246</b></p> <p><math>V_{CEr}</math> (sus) = -65 V <math>h_{FE} = 20-100</math> @ -7 A <math>f_T = 6</math> MHz min.</p> <p style="text-align: center;">CT File No. 677</p>	<p style="text-align: center;"><b>2N6487</b></p> <p><math>V_{CEr}</math> (sus) = 70 V <math>h_{FE} = 30-150</math> @ 5 A <math>f_T = 5</math> MHz typ.</p> <p style="text-align: center;">CT File No. 678</p>	<p style="text-align: center;"><b>2N6490</b></p> <p><math>V_{CEr}</math> (sus) = -70 V <math>h_{FE} = 30-150</math> @ -5 A <math>f_T = 5</math> MHz typ.</p> <p style="text-align: center;">CT File No. 678</p>
	<p style="text-align: center;"><b>2N6106</b> <b>2N6107</b></p> <p><math>V_{CEr}</math> (sus) = -80 V <math>h_{FE} = 30-150</math> @ -2 A <math>f_T = 10</math> MHz min.</p> <p style="text-align: center;">CT File No. 676</p>	<p style="text-align: center;"><b>2N6472</b></p> <p><math>V_{CEr}</math> (sus) = 85 V <math>h_{FE} = 20-100</math> @ 6 A <math>f_T = 5</math> MHz typ.</p> <p style="text-align: center;">CT File No. 677</p>	<p style="text-align: center;"><b>2N6247</b></p> <p><math>V_{CEr}</math> (sus) = -85 V <math>h_{FE} = 20-100</math> @ -6 A <math>f_T = 6</math> MHz min.</p> <p style="text-align: center;">CT File No. 677</p>	<p style="text-align: center;"><b>2N6488</b></p> <p><math>V_{CEr}</math> (sus) = 90 V <math>h_{FE} = 30-150</math> @ 4 A <math>f_T = 5</math> MHz typ.</p> <p style="text-align: center;">CT File No. 678</p>	<p style="text-align: center;"><b>2N6491</b></p> <p><math>V_{CEr}</math> (sus) = -90 V <math>h_{FE} = 30-150</math> @ -4 A <math>f_T = 5</math> MHz typ.</p> <p style="text-align: center;">CT File No. 678</p>
	<p style="text-align: center;"><b>2N6475</b></p> <p><math>V_{CEr}</math> (sus) = -110 V <math>h_{FE} = 30-150</math> @ -1.5 A <math>f_T = 5</math> MHz typ.</p> <p style="text-align: center;">CT File No. 676</p>		<p style="text-align: center;"><b>2N6248</b></p> <p><math>V_{CEr}</math> (sus) = -105 V <math>h_{FE} = 20-100</math> @ -5 A <math>f_T = 6</math> MHz min.</p> <p style="text-align: center;">File No. 677</p>		
	<p style="text-align: center;"><b>2N6476</b></p> <p><math>V_{CEr}</math> (sus) = -130 V <math>h_{FE} = 30-150</math> @ -1 A <math>f_T = 5</math> MHz typ.</p> <p style="text-align: center;">CT File No. 676</p>				

▲ Pellet size—values shown are edge dimensions in thousands-of-an-inch (mils).

CT—Complementary Type available

# HIGH-VOLTAGE N-P-N and P-N-P POWER TYPES

$I_C$  to 30 A . . .  $f_T$  to 20 MHz . . .  $P_T$  to 175 W

$I_C = 150$ mA max. $P_T = 6.25$ W max. RCP Plastic	$I_C = 150$ mA max. $P_T = 6.25$ W max. RCP Plastic	$I_C = 150$ mA max. $P_T = 6.25$ W max. RCP Plastic	$I_C = 1$ A max. $P_T = 20$ W max. (Plastic TO-5)	$I_C = 1$ A max. $P_T = 10$ W max. (TO-39)*
<b>32 x 32▲</b>	<b>32 x 32</b>	<b>32 x 32</b>	<b>32 x 32</b>	<b>42 x 42</b>
Family Designation				
RCP111 [N-P-N]	RCP111 [N-P-N]	RCP111 [N-P-N]	2N6177 [N-P-N]	2N3439 [N-P-N]
<b>RCP117</b> $V_{CE0(sus)} = 100$ V $h_{FE} = 20$ min. @ 25 mA $f_T = 80$ MHz typ.  File No. 822	<b>RCP113A</b> $V_{CE0(sus)} = 200$ V $h_{FE} = 30-150$ @ 25 mA $f_T = 80$ MHz typ.	<b>RCP111A</b> $V_{CE0(sus)} = 200$ V $h_{FE} = 50-300$ @ 25 mA $f_T = 80$ MHz typ.	<b>41505</b> $V_{CE0(sus)} = 200$ V $h_{FE} = 20$ min. @ 50 mA	<b>2N3440<sup>●</sup></b> $V_{CEr(sus)} = 40-160$ @ 20 mA $f_T = 15$ MHz min.
<b>RCP115</b> $V_{CE0(sus)} = 100$ V $h_{FE} = 50$ min. @ 25 mA $f_T = 80$ MHz typ.  File No. 822	<b>RCP113B</b> $V_{CE0(sus)} = 250$ V $h_{FE} = 30-150$ @ 25 mA $f_T = 80$ MHz typ.	<b>RCP111B</b> $V_{CE0(sus)} = 250$ V $h_{FE} = 50-300$ @ 25 mA $f_T = 80$ MHz typ.	<b>2N6175</b> <b>40885■</b> "Plastic 2N3440" $V_{CEr(sus)} = 300$ V $h_{FE} = 30-190$ @ 20 mA $f_T = 20$ MHz min. CT File No. 508	<b>2N3439<sup>●</sup></b> $V_{CEr(sus)} = 40-160$ @ 20 mA $f_T = 15$ MHz min.  File No. 64
<b>RCP117B</b> $V_{CE0(sus)} = 250$ V $h_{FE} = 20$ min. @ 25 mA $f_T = 80$ MHz typ.  File No. 822	<b>RCP113C</b> $V_{CE0(sus)} = 300$ V $h_{FE} = 30-150$ @ 25 mA $f_T = 80$ MHz typ.	<b>RCP111C</b> $V_{CE0(sus)} = 300$ V $h_{FE} = 50-300$ @ 25 mA $f_T = 80$ MHz typ.	<b>2N6176</b> <b>40886■</b> $V_{CEr(sus)} = 350$ V $h_{FE} = 30-150$ @ 20 mA $f_T = 20$ MHz min. CT File No. 508	
<b>RCP115B</b> $V_{CE0(sus)} = 250$ V $h_{FE} = 50$ min. @ 25 mA $f_T = 80$ MHz typ.  File No. 822	<b>RCP113D</b> $V_{CE0(sus)} = 350$ V $h_{FE} = 30-150$ @ 25 mA $f_T = 80$ MHz typ.	<b>RCP111D</b> $V_{CE0(sus)} = 350$ V $h_{FE} = 50-300$ @ 25 mA $f_T = 80$ MHz typ.	<b>2N6177</b> <b>40887■</b> "Plastic 2N3439" $V_{CEr(sus)} = 400$ V $h_{FE} = 30-150$ @ 50 mA $f_T = 20$ MHz min. CT File No. 508	

▲ Pellet size—values shown are edge dimensions in thousands-of-an-inch (mils).

- \* Available with
  - a. flange for easy heat sinking  $R_{\theta JC} = 15^\circ$  C/W
  - b. free-air radiator  $R_{\theta JA} = 45^\circ$  C/W
- Type with a factory-attached heat clip

● These transistors are also available in TO-5 packages in U.S.A., Canada, Latin America, and Far East

CT—Complementary Type available

# HIGH-VOLTAGE N-P-N and P-N-P POWER TYPES

$I_C$  to 30 A . . .  $f_T$  to 20 MHz . . .  $P_T$  to 175 W

$I_C = -1$ A max. $P_T = 10$ W max. (TO-39)*	$I_C = 5$ A max. $P_T = 35$ W max. (TO-66)**	$I_C = -5$ A max. $P_T = 35$ W max. (TO-66)**	$I_C = -2$ A max. $P_T = 20$ W max. (TO-66)**	$I_C = 10$ A peak $P_T = 45$ W max. (TO-66)**
42 x 42▲	103 x 103	124 x 124	124 x 124	130 x 130
Family Designation				
2N5415 [P-N-P]	2N3585 [N-P-N]	2N6213 [P-N-P]	2N6213 [P-N-P]	2N6079 [N-P-N]
<b>RCS880</b> $V_{CE0(sus)} = -150$ V $h_{FE} = 20-150$ @ -50 mA $P_T = 7.5$ W  File No. 777	<b>2N3583</b> $V_{CE(sus)} = 250$ V $h_{FE} = 40$ min. @ 100 mA $h_{FE} = 10$ min. @ 1 A $f_T = 15$ MHz min.  File No. 138	<b>2N6211</b> $V_{CE(sus)} = -250$ V $h_{FE} = 10-100$ @ -1 A $f_T = 20$ MHz min.  CT File No. 507	<b>RCS560</b> $V_{CE(sus)} = -225$ V $h_{FE} = 7.5$ min. @ -0.75 A $f_T = 20$ MHz min.  File No. 782	<b>2N6078</b> $V_{CE(sus)} = 275$ V $h_{FE} = 12-70$ @ 1.2 A $t_r = 0.3$ $\mu$ s typ. $t_f = 0.3$ $\mu$ s typ.  File No. 492
<b>2N5415</b> $V_{CE0(sus)} = -200$ V $h_{FE} = 30-150$ @ -50 mA $f_T = 15$ MHz min. $R_T = 10$ W  CT File No. 336	<b>2N3584</b> $V_{CE(sus)} = 300$ V $h_{FE} = 40$ min. @ 100 mA $h_{FE} = 25-100$ @ 1 A $f_T = 15$ MHz min.  CT File No. 138	<b>2N6212</b> $V_{CE(sus)} = -325$ V $h_{FE} = 10-100$ @ -1 A $f_T = 20$ MHz min.  CT File No. 507	<b>RCS559</b> $V_{CE(sus)} = -250$ V $h_{FE} = 10-100$ @ -0.75 A $f_T = 20$ MHz min.  File No. 782	<b>2N6077</b> $V_{CE(sus)} = 300$ V $h_{FE} = 12-70$ @ 1.2 A $t_r = 0.3$ $\mu$ s typ. $t_f = 0.3$ $\mu$ s typ.  CT File No. 492
<b>RCS881</b> $V_{CE(sus)} = -250$ V $h_{FE} = 20$ min. @ -35 mA $f_T = 15$ MHz min. $P_T = 7.5$ W  File No. 780	<b>2N3585</b> $V_{CE(sus)} = 400$ V $h_{FE} = 40$ min. @ 100 mA $h_{FE} = 25-100$ @ 1 A $f_T = 15$ MHz min.  CT File No. 138	<b>2N6213</b> $V_{CE(sus)} = -375$ V $h_{FE} = 10-100$ @ -1 A $f_T = 20$ MHz min.  File No. 507		<b>2N6079</b> $V_{CE(sus)} = 375$ V $h_{FE} = 12-50$ @ 1.2 A $t_r = 0.3$ $\mu$ s typ. $t_f = 0.3$ $\mu$ s typ.  File No. 492
<b>RCS882</b> $V_{CE(sus)} = -350$ V $h_{FE} = 20$ min. @ -35 mA $f_T = 15$ MHz min. $P_T = 7.5$ W  File No. 781	<b>2N4240</b> $V_{CE(sus)} = 400$ V $h_{FE} = 40$ min. @ 100 mA $h_{FE} = 30-150$ @ 750 mA $f_T = 15$ MHz min.  File No. 138	<b>2N6214</b> $V_{CE(sus)} = -425$ V $h_{FE} = 10-100$ @ -1 A $f_T = 20$ MHz min.  File No. 507		<b>40851</b> $V_{CE(sus)} = 375$ V $h_{FE} = 12$ min. @ 1.2 A $t_r = 0.3$ $\mu$ s typ. $t_f = 0.3$ $\mu$ s typ.  File No. 498
<b>2N5416</b> $V_{CE(sus)} = -350$ V $h_{FE} = 30-120$ @ -50 mA $f_T = 15$ MHz min. $P_T = 10$ W  CT File No. 336	<b>40850</b> $V_{CE(sus)} = 400$ V $h_{FE} = 25$ min. @ 750 mA $f_T = 15$ MHz min.  File No. 498	<p>▲ Pellet size—values shown are edge dimensions in thousands-of-an-inch (mils).</p> <p>* Available with a. flange for easy heat sinking <math>R_{\theta JC} = 15^\circ</math> C/W b. free-air radiator <math>R_{\theta JA} = 45^\circ</math> C/W</p> <p>** Available with free-air radiator <math>R_{\theta JA} = 30^\circ</math> C/W</p> <p>CT—Complementary Type available</p>		

# HIGH-VOLTAGE N-P-N and P-N-P POWER TYPES

$I_C$  to 30 A . . .  $f_T$  to 20 MHz . . .  $P_T$  to 175 W

$I_C = 10$ A peak $P_T = 125$ W max. (TO-3)	$I_C = 5$ A max. $P_T = 100$ W max. (TO-3)		$I_C = 7$ A max. $P_T = 125$ W max. (TO-3)	$I_C = 15$ A peak $P_T = 110$ W max. (TO-3)	$I_C = 30$ A peak $P_T = 175$ W max. (TO-3)
	Switching	Linear			Switching
130 x 130▲	130 x 130	130 x 130	180 x 180	210 x 210	260 x 260
Family Designation					
2N5840 [N-P-N]	2N5840 [N-P-N]	2N5240 [N-P-N]	2N6510 [N-P-N]	2N5804 [N-P-N]	2N6252 [N-P-N]
<b>RCA 410#</b> $V_{CE0(sus)} = 200$ V $h_{FE} = 30-90$ @ 1 A $t_r = 0.35$ $\mu$ s typ. $t_f = 0.15$ $\mu$ s typ.  File No. 509	<b>41506</b> $V_{CE0(sus)} = 200$ V $h_{FE} = 8$ min. @ 2 A	<b>2N5239</b> $V_{CE0(sus)} = 250$ V $h_{FE} = 20$ min. @ 2 A $h_{FE} = 20-80$ @ 0.4 A $f_T = 5$ MHz min.	<b>2N6510</b> $V_{CE0(sus)} = 250$ V $h_{FE} = 10$ min. @ 3 A $f_T = 3$ MHz min.	<b>2N5804</b> $V_{CE0(sus)} = 300$ V $h_{FE} = 25-250$ @ 0.5 A $h_{FE} = 10-100$ @ 5 A $t_r = 0.4$ $\mu$ s typ. $t_f = 1.2$ $\mu$ s typ. File No. 407	<b>2N6249</b> $V_{CE0(sus)} = 225$ V $h_{FE} = 10-50$ @ 10 A $t_r = 0.8$ $\mu$ s typ. $t_f = 0.5$ $\mu$ s typ.  File No. 523
<b>RCA 411#</b> $V_{CE0(sus)} = 300$ V $h_{FE} = 30-90$ @ 1 A $t_r = 0.35$ $\mu$ s typ. $t_f = 0.15$ $\mu$ s typ.  File No. 510	<b>2N5838</b> $V_{CE0(sus)} = 275$ V $h_{FE} = 20$ min. @ 0.5 A $h_{FE} = 8-40$ @ 3 A $t_r = 0.8$ $\mu$ s typ. $t_f = 0.4$ $\mu$ s typ. File No. 410	<b>2N5240</b> $V_{CE0(sus)} = 350$ V $h_{FE} = 20$ min. @ 2 A $h_{FE} = 20-80$ @ 0.4 A $f_T = 5$ MHz min.	<b>2N6511</b> $V_{CE0(sus)} = 300$ V $h_{FE} = 10$ min. @ 4 A $f_T = 3$ MHz min.	<b>2N5805</b> $V_{CE0(sus)} = 375$ V $h_{FE} = 25-250$ @ 0.5 A $h_{FE} = 10-100$ @ 5 A $t_r = 0.4$ $\mu$ s typ. $t_f = 1.2$ $\mu$ s typ. File No. 407	<b>RCS564</b> $V_{CE0(sus)} = 225$ V $h_{FE} = 5$ min. @ 10 A $t_r = 0.8$ $\mu$ s typ. $t_f = 1$ $\mu$ s typ.  File No. 782
<b>RCA 413#</b> $V_{CE0(sus)} = 325$ V $h_{FE} = 20-80$ @ 0.5 A $t_r = 0.35$ $\mu$ s typ. $t_f = 0.15$ $\mu$ s typ.  File No. 511	<b>2N5839</b> $V_{CE0(sus)} = 300$ V $h_{FE} = 20$ min. @ 0.5 A $h_{FE} = 10-50$ @ 2 A $t_r = 0.6$ $\mu$ s typ. $t_f = 0.35$ $\mu$ s typ. File No. 410		<b>2N6512</b> $V_{CE0(sus)} = 350$ V $h_{FE} = 10$ min. @ 4 A $f_T = 3$ MHz min.	<b>40853</b> $V_{CE0(sus)} = 375$ V $h_{FE} = 10$ min. @ 5 A $t_r = 0.4$ $\mu$ s typ. $t_f = 1.2$ $\mu$ s typ.	<b>2N6250</b> $V_{CE0(sus)} = 300$ V $h_{FE} = 8-50$ @ 10 A $t_r = 0.8$ $\mu$ s typ. $t_f = 0.5$ $\mu$ s typ.  File No. 523
<b>RCA 423#</b> $V_{CE0(sus)} = 325$ V $h_{FE} = 30-90$ @ 1 A $t_r = 0.35$ $\mu$ s typ. $t_f = 0.15$ $\mu$ s typ.  File No. 512	<b>2N5840</b> $V_{CE0(sus)} = 325$ V $h_{FE} = 20$ min. @ 0.5 A $h_{FE} = 10-50$ @ 2 A $t_r = 0.6$ $\mu$ s typ. $t_f = 0.35$ $\mu$ s typ. File No. 410		<b>2N6514</b> $V_{CE0(sus)} = 350$ V $h_{FE} = 10$ min. @ 5 A $f_T =$ MHz min.		<b>2N6251</b> $V_{CE0(sus)} = 375$ V $h_{FE} = 6-50$ @ 10 A $t_r = 0.8$ $\mu$ s typ. $t_f = 0.5$ $\mu$ s typ.  File No. 523
<b>RCA 431#</b> $V_{CE0(sus)} = 325$ V $h_{FE} = 15-35$ @ 2.5 A $t_r = 0.35$ $\mu$ s typ. $t_f = 0.15$ $\mu$ s typ.  File No. 513	<b>40852</b> $V_{CE0(sus)} = 375$ V $h_{FE} = 12$ min. @ 1.2 A $t_r = 0.5$ $\mu$ s typ. $t_f = 0.35$ $\mu$ s typ.		<b>2N6513</b> $V_{CE0(sus)} = 400$ V $h_{FE} = 10$ min. @ 4 A $f_T = 3$ MHz min.		<b>40854</b> $V_{CE0(sus)} = 325$ V $h_{FE} = 8$ min. @ 10 A $t_r = 0.8$ $\mu$ s typ. $t_f = 0.5$ $\mu$ s typ.  File No. 498

▲ Pellet size—values shown are edge dimensions in thousands-of-an-inch (mils).

# For new equipment design only—not recommended for retrofit.

# HIGH-SPEED SWITCHING N-P-N and P-N-P POWER TYPES

$f_T$  to 250 MHz ...  $I_C$  to 60 A ...  $P_T$  to 140 W

$I_C = 1$ A max. $P_T = 5$ W max. (TO-39)*	$I_C = -1$ A max. $P_T = 7$ W max. (TO-39)*	$I_C = 2$ A max. $P_T = 5$ W max. (Lo Profile TO-39)	$I_C = 2$ A max. $P_T = 10$ W max. (TO-39)*	$I_C = -2$ A max. $P_T = 10$ W max. (TO-39)*	$I_C = 2$ A max. $P_T = 25$ W max. (Plastic TO-5)
30 x 30A	30 x 30	32 x 32	42 x 42	42 x 42	42 x 42
Family Designation					
2N2102 [N-P-N]	2N4036 [P-N-P]	2N5262 [N-P-N]	2N5320 [N-P-N]	2N5322 [P-N-P]	2N6179 [N-P-N]
<p style="text-align: center;"><b>41502</b></p> <p><math>V_{CE0}(sus) = 30</math> V <math>h_{FE} = 20</math> min. @ 150 mA <math>P_T = 3</math> W</p> <p style="text-align: center;">CT File No. 773</p>	<p style="text-align: center;"><b>41503</b></p> <p><math>V_{CE0}(sus) = -30</math> V <math>h_{FE} = 20</math> min. @ -150 mA</p> <p style="text-align: center;">CT File No. 774</p>	<p style="text-align: center;"><b>2N5189</b></p> <p><math>V_{CE0}(sus) = 35</math> V <math>h_{FE} = 15</math> min. @ 1 A <math>f_T = 250</math> MHz min. <math>t_{on} = 40</math> ns max. <math>t_{off} = 70</math> ns max.</p> <p style="text-align: center;">File No. 296</p>	<p style="text-align: center;"><b>2N5321*</b></p> <p><math>V_{CE0}(sus) = 65</math> V <math>h_{FE} = 40-250</math> @ 500 mA <math>f_T = 50</math> MHz min. <math>t_{on} = 80</math> ns max. <math>t_{off} = 800</math> ns max.</p> <p style="text-align: center;">CT File No. 325</p>	<p style="text-align: center;"><b>2N5323*</b></p> <p><math>V_{CE0}(sus) = -65</math> V <math>h_{FE} = 40-250</math> @ -500 mA <math>f_T = 50</math> MHz min.</p> <p style="text-align: center;">CT File No. 325</p>	<p style="text-align: center;"><b>2N6179</b></p> <p>"Plastic 2N5320" <math>V_{CE0}(sus) = 65</math> V <math>h_{FE} = 40-250</math> @ 500 mA <math>f_T = 50</math> MHz min. <math>t_{on} = 80</math> ns max. <math>t_{off} = 800</math> ns max.</p> <p style="text-align: center;">CT File No. 562</p>
<p style="text-align: center;"><b>2N3053*</b></p> <p><math>V_{CE0}(sus) = 50</math> V <math>h_{FE} = 50-250</math> @ 150 mA <math>f_T = 100</math> MHz min. <math>P_T = 5</math> W</p> <p style="text-align: center;">CT File No. 432</p>	<p style="text-align: center;"><b>2N4037*</b></p> <p><math>V_{CE0}(sus) = -60</math> V <math>h_{FE} = 50-250</math> @ -150 mA <math>f_T = 60</math> MHz min.</p> <p style="text-align: center;">CT File No. 216</p>	<p style="text-align: center;"><b>2N5262</b></p> <p><math>V_{CE0}(sus) = 50</math> V <math>h_{FE} = 25</math> min. @ 1 A <math>f_T = 250</math> MHz min. <math>t_{on} = 30</math> ns max. <math>t_{off} = 60</math> ns max.</p> <p style="text-align: center;">File No. 313</p>	<p style="text-align: center;"><b>2N5320*</b></p> <p><math>V_{CE0}(sus) = 90</math> V <math>h_{FE} = 30-130</math> @ 500 mA <math>f_T = 50</math> MHz min. <math>t_{on} = 80</math> ns max. <math>t_{off} = 800</math> ns max.</p> <p style="text-align: center;">CT File No. 325</p>	<p style="text-align: center;"><b>2N5322*</b></p> <p><math>V_{CE0}(sus) = -90</math> V <math>h_{FE} = 30-130</math> @ -500 mA <math>h_{FE} = 10</math> min. @ -1 A <math>f_T = 50</math> MHz min.</p> <p style="text-align: center;">CT File No. 325</p>	<p style="text-align: center;"><b>2N6178</b></p> <p>"Plastic 2N5320" <math>V_{CE0}(sus) = 90</math> V <math>h_{FE} = 30-130</math> @ 500 mA <math>f_T = 50</math> MHz min. <math>t_{on} = 80</math> ns max. <math>t_{off} = 800</math> ns max.</p> <p style="text-align: center;">CT File No. 562</p>
<p style="text-align: center;"><b>2N2102*</b></p> <p><math>V_{CE0}(sus) = 80</math> V <math>h_{FE} = 40-120</math> @ 150 mA <math>f_T = 120</math> MHz min. <math>P_T = 5</math> W</p> <p style="text-align: center;">CT File No. 106</p>	<p style="text-align: center;"><b>2N4036*</b></p> <p><math>V_{CE0}(sus) = -85</math> V <math>h_{FE} = 40-140</math> @ -150 mA <math>f_T = 60</math> MHz min.</p> <p style="text-align: center;">CT File No. 216</p>	<p>▲ Pellet size—values shown are edge dimensions in thousands-of-an-inch (mils).</p> <p>*Available with a. flange for easy heat sinking <math>R_{\theta JC} = 15^\circ</math> C/W b. free-air radiator <math>R_{\theta JA} = 50^\circ</math> C/W</p> <p>● These transistors are also available in TO-5 packages in U.S.A., Canada, Latin America, and Far East</p> <p>CT—Complementary Type available</p>			
	<p style="text-align: center;"><b>2N4314*</b></p> <p><math>V_{CE0}(sus) = -85</math> V <math>h_{FE} = 50-250</math> @ -150 mA <math>f_T = 60</math> MHz min.</p> <p style="text-align: center;">File No. 216</p>				



# HIGH-SPEED SWITCHING N-P-N and P-N-P POWER TYPES

$f_T$  to 250 MHz ...  $I_C$  to 60 A ...  $P_T$  to 140 W

$I_C = -2$ A max. $P_T = 25$ W max. (Plastic TO-5)	$I_C = 7$ A max. $P_T = 35$ W max. (TO-66)**	$I_C = 15$ A max. $P_T = 85$ W max. (Radial)	$I_C = 20$ A max. $P_T = 140$ W max. (TO-3)	$I_C = 25$ A max. $P_T = 125$ W max. (TO-63)	$I_C = 30$ A max. $P_T = 140$ W max. (TO-3)	$I_C = 60$ A max. $P_T = 140$ W max. (Modified TO-3)
42 x 42A	103 x 103	155 x 155	146 x 183	215 x 222	220 x 220	220 x 220 [2 CHIPS]
Family Designation						
2N6181 [P-N-P]	2N3879 [N-P-N]	2N6480 [N-P-N]	2N5038 [N-P-N]	2N3263 [N-P-N]	2N5671 [N-P-N]	2N6033 [N-P-N]
<b>2N6181</b> "Plastic 2N5323" $V_{CEr(sus)} = -65$ V $h_{FE} = 40-250$ @ -500 mA $f_T = 50$ MHz min.  CT File No. 562	<b>2N3878†</b> $V_{CEr(sus)} = 60$ V $h_{FE} = 20$ min. @ 4 A $h_{FE} = 50-200$ @ 0.5 A $f_T = 60$ MHz min. $t_r = 400$ ns max. $t_f = 400$ ns max. $I_C = 7$ A File No. 766	<b>2N6479</b> (Isolated Collector)  <b>2N6481</b> (Non-Isolated Coll.) $V_{CEr(sus)} = 80$ V $h_{FE} = 20$ min. @ 12 A $f_T = 100$ MHz typ. Radiation Hard File No. 702	<b>2N5039</b> $V_{CEr(sus)} = 95$ V $h_{FE} = 20$ min. @ 10 A $h_{FE} = 30-150$ @ 2 A $f_T = 60$ MHz min. $t_{on} = 0.5$ $\mu$ s max. $t_{off} = 2$ $\mu$ s max. File No. 698	<b>2N3266</b> <b>2N3264#</b> $V_{CEr(sus)} = 80$ V $h_{FE} = 20-80$ @ 15 A $f_T = 20$ MHz min. $t_{on} = 0.5$ $\mu$ s max. $t_{off} = 2$ $\mu$ s max. File No. 54	<b>2N5671</b> $V_{CEr(sus)} = 110$ V $h_{FE} = 20$ min. @ 20 A $h_{FE} = 20-100$ @ 15 A $f_T = 50$ MHz min. $t_{on} = 0.5$ $\mu$ s max. $t_{off} = 2$ $\mu$ s max. File No. 383	<b>2N6032</b> $V_{CEr(sus)} = 110$ V $h_{FE} = 10-50$ @ 50 A $f_T = 50$ MHz min. $t_r = 1$ $\mu$ s max. $t_f = 0.5$ $\mu$ s max. File No. 462
<b>2N6180</b> "Plastic 2N5322" $V_{CEr(sus)} = -90$ V $h_{FE} = 30-130$ @ -500 mA $h_{FE} = 10$ min. @ -1 A $f_T = 50$ MHz min.  CT File No. 562	<b>2N3879</b> $V_{CEr(sus)} = 90$ V $h_{FE} = 40$ min. @ 0.4 A $h_{FE} = 20-80$ @ 4 A $f_T = 60$ MHz min. $t_r = 400$ ns max. $t_f = 400$ ns max. $I_C = 7$ A File No. 766	<b>2N6480</b> (Isolated Collector)  <b>2N6482</b> (Non-Isolated Coll.) $V_{CEr(sus)} = 80$ V $h_{FE} = 20$ min. @ 12 A $f_T = 100$ MHz typ. Radiation Hard File No. 702	<b>2N5038</b> $V_{CEr(sus)} = 110$ V $h_{FE} = 20$ min. @ 12 A $h_{FE} = 50-200$ @ 2 A $f_T = 60$ MHz min. $t_{on} = 0.5$ $\mu$ s max. $t_{off} = 2$ $\mu$ s max. File No. 698	<b>2N3265</b> <b>2N3263#</b> $V_{CEr(sus)} = 110$ V $h_{FE} = 25-75$ @ 15 A $f_T = 20$ MHz min. $t_{on} = 0.5$ $\mu$ s max. $t_{off} = 2$ $\mu$ s max. File No. 54	<b>2N5672</b> $V_{CEr(sus)} = 140$ V $h_{FE} = 20$ min. @ 20 A $h_{FE} = 20-100$ @ 15 A $f_T = 50$ MHz min. $t_{on} = 0.5$ $\mu$ s max. $t_{off} = 2$ $\mu$ s max. File No. 383	<b>2N6033</b> $V_{CEr(sus)} = 140$ V $h_{FE} = 10-50$ @ 40 A $f_T = 50$ MHz min. $t_r = 1$ $\mu$ s max. $t_f = 0.5$ $\mu$ s max. File No. 462
	<b>2N5202</b> $V_{CEr(sus)} = 75$ V $h_{FE} = 10-100$ @ 4 A $f_T = 60$ MHz min. $t_r = 400$ ns max. $t_f = 400$ ns max. $I_C = 4$ A File No. 766		<b>2N6496</b> $V_{CEr(sus)} = 130$ V $h_{FE} = 12-100$ @ 8 A $f_T = 60$ MHz min. $t_r = 0.5$ $\mu$ s max. $t_s = 1.5$ $\mu$ s max. $t_f = 0.5$ $\mu$ s max. File No. 698			
	<b>2N6500</b> $V_{CEr(sus)} = 110$ V $h_{FE} = 15-60$ @ 3 A $f_T = 60$ MHz min. $t_r = 400$ ns max. $t_f = 500$ ns max. $I_C = 4$ A File No. 766		<b>2N6354</b> $V_{CEr(sus)} = 130$ V $h_{FE} = 20-150$ @ 5 A $h_{FE} = 10-100$ @ 10 A $f_T = 80$ MHz min. $t_r = 0.3$ $\mu$ s max. $t_f = 0.2$ $\mu$ s max. $I_C = 12$ A peak File No. 582			

▲ Pellet size—values shown are edge dimensions in thousands-of-an-inch (mil).

\*\* Available with free-air radiator  $R_{\theta JA} = 30^\circ$  C/W  
 † Also available with heat radiator (40375).

■ Flat radial lead version

CT—Complementary Type available

# TYPES FOR AUDIO-FREQUENCY LINEAR AMPLIFIERS

Power Output (8 $\Omega$ Imped.)	Bull. File No.	Circuit No.	Output Transistors		Class B Driver Transistors		$V_{BE}$ Mult. (Bias)
			N-P-N	P-N-P	N-P-N	P-N-P	
12 W	642	A012B (True-Comp.)	RCA1C10 (2N6292)	RCA1C11 (2N6107)	—	—	—
	642	A012D (IC Driving True Comp.)	RCA1C10 (2N6292)	RCA1C11 (2N6107)	—	—	—
25 W	643	A025C (Quasi-Comp.)	RCA1C14 [2] (2N5496)	—	RCA1A06 (2N2102)	RCA1A05 (2N4036)	—
	644	A025B (Full-Comp.)	RCA1C05 (2N6292)	RCA1C06 (2N6107)	RCA1A06 (2N2102)	RCA1A05 (2N4036)	—
40 W	645	A040C (Quasi-Comp.)	RCA1C09 [2] (2N6103)	—	RCA1A06 (2N2102)	RCA1A05 (2N4036)	—
	646	A040B (Full-Comp.)	RCA1C07 (2N6488)	RCA1C08 (2N6491)	RCA1A06 (2N2102)	RCA1A05 (2N4036)	—
	791	A040D (Full-Comp. Darlington Output)	RCA1B07 (2N6385)	RCA1B08 (TA8925)	—	—	RCA1A18 (2N2102)
70 W	647	A070A (Quasi-Comp. Hom. Output)	RCA1B01 [2] (2N3055)	—	RCA1A03 (2N5322)	RCA1A04 (2N5322)	—
	648	A070C (Quasi-Comp.)	RCA1B06 [2] (2N5840)	—	RCA1C03 (2N6474)	RCA1A04 (2N6476)	RCA1A18 (2N2102)
120 W	649	A120C (Quasi-Comp. Parallel Output)	RCA1B04 [4] (2N5240)	—	RCA1C12 (2N6474)	RCA1C13 (2N6476)	RCA1A18 (2N2102)
200 W	650	A200C (Quasi-Comp. Parallel Output)	RCA1B05 [6] (2N5240)	—	RCA1B05 [2] (2N5240)	—	RCA1A18 (2N2102)

Numbers in brackets indicate number of devices used in the stage.  
Type numbers in parentheses indicate the transistor-family designation.

### Typical Power Output for 4 $\Omega$ and 16 $\Omega$ Load for AF Linear Amplifiers

Amplifier Circuit No.	A012B		A012D		A025A		A025B		A040A		A040B		A040D		A070A		A070C		A120C		A200C	
Impedance — $\Omega$ (Load)	4	16	4	16	4	16	4	16	4	16	4	16	4	8	4	16	4	16	4	16	4	16
Typical Power Output — W	12*	6.5	9*	6.5	45	16	45	16	55	25	75	25	40	30	100	40	100	50	180	80	300	130

\*Power output limited by driver-circuit capability.

# TYPES FOR AUDIO-FREQUENCY LINEAR AMPLIFIERS

Class B Pre-Driver Transistors		Protection Circuit		Class A Pre-Driver Transistors		Input Devices
N-P-N	P-N-P	N-P-N	P-N-P	N-P-N	P-N-P	
—	—	—	—	—	RCA1A08 (2N4036)	RCA1A07 [2] (2N2102)
—	—	—	—	—	—	CA3094AT
—	—	RCA1A18 (2N2102)	RCA1A19 (2N4036)	RCA1A01 (2N2102)	—	RCA1A02 [2] (2N4036)
—	—	RCA1A18 (2N2102)	RCA1A19 (2N4036)	RCA1A01 (2N2102)	—	RCA1A02 [2] (2N4036)
—	—	RCA1A18 (2N2102)	RCA1A19 (2N4036)	RCA1A01 (2N2102)	—	RCA1A02 [2] (2N4036)
—	—	RCA1A18 (2N2102)	RCA1A19 (2N4036)	RCA1A01 (2N2102)	—	RCA1A02 [2] (2N4036)
—	—	RCA1A18 (2N2102)	RCA1A19 (2N4036)	RCA1A15 [2] (2N3440)	RCA1A16 [2] (2N5416)	RCA1A17 [2] (2N2102)
—	—	RCA1A18 (2N2102)	RCA1A19 (2N4036)	RCA1A17 (2N2102)	—	RCA1A02 [2] (2N4036)
—	—	RCA1A18 (2N2102)	RCA1A19 (2N4036)	RCA1A15■ [2] (2N3439)	RCA1A16 [2] (2N5415)	RCA1A17 [2] (2N2102)
—	—	RCA1A18 (2N2102)	RCA1A19 (2N4036)	RCA1A09■ [2] (2N3439)	RCA1A10 [2] (2N5415)	RCA1A11 [2] (2N3439)
RCA1E02 (1N3585)	RCA1E03 (2N6211)	RCA1A18 (2N2102)	RCA1A19 (2N4036)	RCA1A09■ [2] (2N3439)	RCA1A10 [2] (2N5415)	RCA1A11 [2] (2N3439)

■ Current Source

Other applications for the types above. . .

Audio Power Amplifiers—Linear Modulators—Servo Amplifiers—Operational Amplifiers

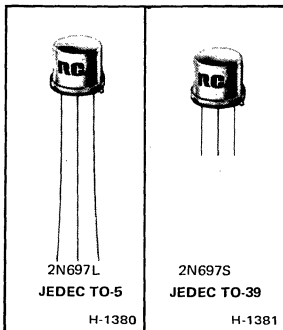


# Technical Data



# Power Transistors

## 2N697



### Silicon N-P-N Planar Transistor

For High-Speed Switching Service in Electronic Data-Processing Systems

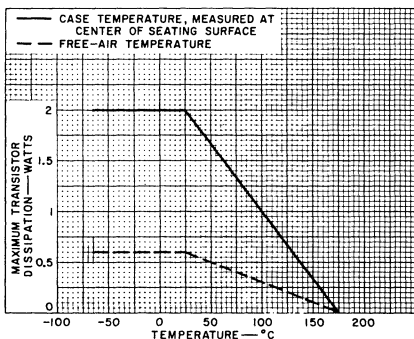
**Features:**

- Characteristics stabilized by prolonged baking at 300°C
- Typical pulse beta = 75
- Low saturation voltages

These devices are available with either 1½-inch leads (TO-5 package) or ½-inch leads (TO-39 package). The longer-lead versions are specified by suffix "L" after the type number; the shorter-lead versions are specified by suffix "S" after the type number.

RCA-2N697 is a silicon n-p-n transistor designed for use in high-speed-switching applications in military and industrial data-processing equipment.

This transistor is especially designed and processed to assure stability of characteristics and reliable performance under conditions of severe thermal and mechanical stress, and other environmental hazards.



92CS-1116IRI

Fig. 1 - Current derating chart.

**MAXIMUM RATINGS, Absolute-Maximum Values:**

COLLECTOR-TO-BASE VOLTAGE .....	V <sub>CBO</sub>	60	V
COLLECTOR-TO-EMITTER VOLTAGE:			
With external base-to-emitter resistance (R <sub>BE</sub> ) ≤ 10 Ω .....	V <sub>CER</sub>	50	V
EMITTER-TO-BASE VOLTAGE .....	V <sub>EBO</sub>	5	V
COLLECTOR CURRENT .....	I <sub>C</sub>	0.5	A
TRANSISTOR DISSIPATION:	P <sub>T</sub>		
At case temperatures up to 25°C .....		2	W
At case temperatures above 25°C .....	See Fig. 1		
At free-air temperatures up to 25°C .....		0.6	W
At free-air temperatures above 25°C .....	See Fig. 1		
TEMPERATURE RANGE:			
Storage and Operating (Junction) .....		-65 to +175	°C
LEAD TEMPERATURE (During soldering):			
At distance ≥ 1/16 in. (1.58 mm) from seating plane for 10 s max. ....		255	°C

ELECTRICAL CHARACTERISTICS, At Ambient Temperature ( $T_A$ ) = 25°C, Unless Otherwise Specified

CHARACTERISTIC	SYMBOL	TEST CONDITIONS						LIMITS			UNITS
		VOLTAGE V dc		CURRENT mA dc			Min.	Typ.	Max.		
		$V_{CB}$	$V_{CE}$	$I_C$	$I_E$	$I_B$					
Collector-Cutoff Current: With Emitter Open At $T_A = 150^\circ\text{C}$	$I_{CBO}$	30			0		—	0.01	1	$\mu\text{A}$	
		30			0		—	1	100		
DC Forward-Current Transfer Ratio	$h_{FE}$		10	150 <sup>b</sup>			40	75	120		
Collector-to-Base Breakdown Voltage	$V_{(BR)CBO}$			0.1	0		60	75	—	V	
Emitter-to-Base Breakdown Voltage	$V_{(BR)EBO}$			0	0.1		5	7.5	—	V	
Collector-to-Emitter Voltage: With External Base-to- Emitter Resistance ( $R_{BE}$ ) = 10 $\Omega$	$V_{CER}$			100 <sup>a</sup>			50	60	—	V	
Collector-to-Emitter Saturation Voltage	$V_{CE(sat)}$			150 <sup>b</sup>		15	—	0.8	1.5	V	
Base-to-Emitter Saturation Voltage	$V_{BE(sat)}$			150 <sup>b</sup>		15	—	1	1.3	V	
Small-Signal Forward- Current Transfer Ratio: $f = 20$ MHz	$h_{fe}$		10	50			5	10	—		
Output Capacitance	$C_{ob}$	10			0		—	20	35	pF	
Gain-Bandwidth Product <sup>c</sup>	$f_T$						—	100	—	MHz	

<sup>a</sup>Pulsed to prevent excessive heating of collector junction.

<sup>b</sup>Pulsed: Pulse duration  $\leq 12\text{ms}$ ; duty factor  $\leq 2\%$ .

<sup>c</sup>Frequency at which  $h_{fe} = 1$ .

## TERMINAL CONNECTIONS

Lead 1 — Emitter

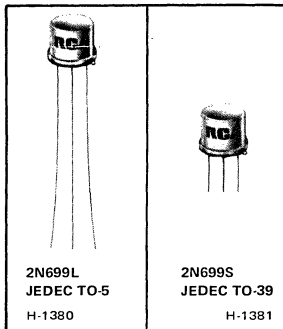
Lead 2 — Base

Lead 3 — Collector, Case



# Power Transistors

## 2N699



### Silicon N-P-N Planar Transistor

General-Purpose Type for Small-Signal, Medium-Power Applications

**Features:**

- Minimum gain-bandwidth product = 50 MHz
- High breakdown voltage
- Planar construction for low-noise and low-leakage characteristics
- Low output capacitance

These devices are available with either 1½-inch leads (TO-5 package) or ½-inch leads (TO-39 package). The longer-lead versions are specified by suffix "L" after the type number; the shorter-lead versions are specified by suffix "S" after the type number.

RCA-2N699 is a silicon n-p-n planar transistor intended for a wide variety of small-signal and medium-power applications in military and industrial equipment. The 2N699 features a minimum gain-bandwidth product of 50 MHz making it well

suited for vhf and video applications. The junction design of the 2N699 makes possible higher breakdown-voltage ratings, lower saturation voltages, higher sustaining voltages, and lower output capacitance.

**MAXIMUM RATINGS, Absolute-Maximum Values:**

COLLECTOR-TO-BASE VOLTAGE . . . . .	$V_{CBO}$	120	V
COLLECTOR-TO-EMITTER VOLTAGE: With external base-to-emitter resistance ( $R_{BE}$ ) $\leq 10 \Omega$ . . . . .	$V_{CER}$	80	V
EMITTER-TO-BASE VOLTAGE . . . . .	$V_{EBO}$	5	V
COLLECTOR CURRENT . . . . .	$I_C$	1	A
TRANSISTOR DISSIPATION: At case temperatures up to 25°C . . . . .	$P_T$	2	W
At case temperatures above 25°C . . . . .		See Fig.1	
At free-air temperatures up to 25°C . . . . .		0.6	W
At free-air temperatures above 25°C . . . . .		See Fig.1	
TEMPERATURE RANGE: Storage . . . . .		-65 to +200	°C
Operating (Junction) . . . . .		175	°C
LEAD TEMPERATURE (During soldering): At distance $\geq 1/16$ in. (1.58 mm) from seating plane for 10 s max. . . . .		230	°C

**TERMINAL CONNECTIONS**

- Lead 1 – Emitter
- Lead 2 – Base
- Lead 3 – Collector, Case



ELECTRICAL CHARACTERISTICS, At Case Temperature ( $T_C$ ) = 25°C

CHARACTERISTIC	SYMBOL	TEST CONDITIONS						LIMITS		UNITS
		DC VOLTAGE V			DC CURRENT mA			Min.	Max.	
		V <sub>CB</sub>	V <sub>CE</sub>	V <sub>EB</sub>	I <sub>C</sub>	I <sub>E</sub>	I <sub>B</sub>			
Collector-Cutoff Current	I <sub>CBO</sub>	60				0		—	0.05	μA
Emitter-Cutoff Current	I <sub>EBO</sub>			5	0			—	0.05	μA
Collector-to-Base Breakdown Voltage	V <sub>(BR)CBO</sub>				0.1	0		120	—	V
DC Forward-Current Transfer Ratio	h <sub>FE</sub>		10		150 <sup>a</sup>			40	120	
Collector-to-Emitter Sustaining Voltage: External Base-to-Emitter Resistance (R <sub>BE</sub> ) = 10 Ω	V <sub>CER(sus)</sub>				100 <sup>a</sup>			80	—	V
Collector-to-Emitter Saturation Voltage	V <sub>CE(sat)</sub>				150		15	—	2	V
Base-to-Emitter Saturation Voltage	V <sub>BE(sat)</sub>				150		15	—	1.3	V
Small-Signal Forward-Current Transfer Ratio: f = 1 kHz f = 1 kHz f = 20 MHz	h <sub>fe</sub>		5 10 10		1 5 50			35 45 5	100 — —	
Output Capacitance	C <sub>ob</sub>	10				0		—	15	pF
Input Resistance: f = 1 kHz	h <sub>ib</sub>	5 10			1 5			20 —	30 10	Ω
Voltage-Feedback Ratio: f = 1 kHz	h <sub>rb</sub>	5 10			1 5			— —	2.5x10 <sup>-4</sup> 3x10 <sup>-4</sup>	
Output Conductance: f = 1 kHz	h <sub>ob</sub>	5 10			1 5			0.1 0.1	0.5 1	μmho
Thermal Resistance: Junction-to-Case	R <sub>θJC</sub>							—	75	°C/W
Junction-to-Ambient	R <sub>θJA</sub>							—	250	°C/W

<sup>a</sup>Pulsed: Pulse duration = 300 μs; duty factor ≤ 2%.

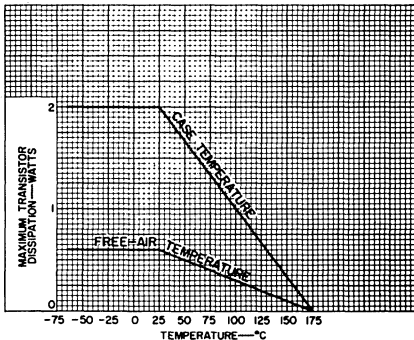


Fig. 1 - Current derating curves.

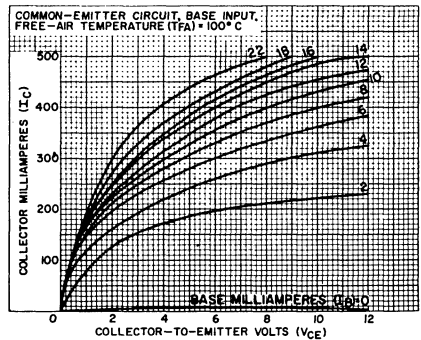


Fig. 2 - Typical output characteristics at  $T_A = 100^\circ\text{C}$ .

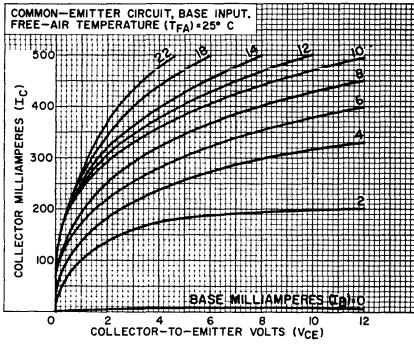


Fig. 3 - Typical output characteristics at  $T_A = 25^\circ\text{C}$ .

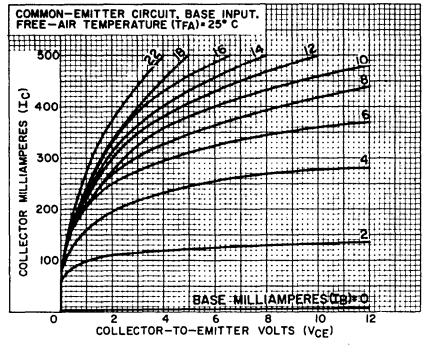


Fig. 4 - Typical output characteristics at  $T_A = -55^\circ\text{C}$ .

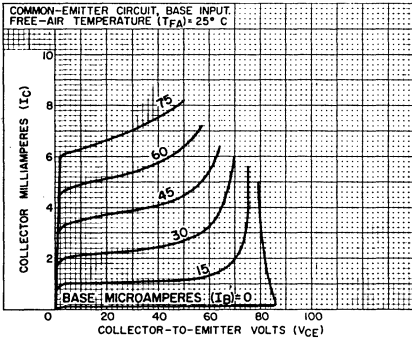


Fig. 5 - Typical output characteristics at  $T_A = 25^\circ\text{C}$ .

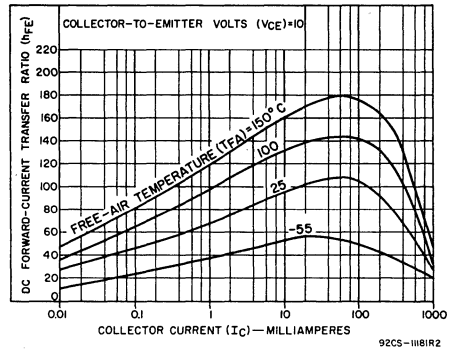


Fig. 6 - Typical dc beta characteristics.

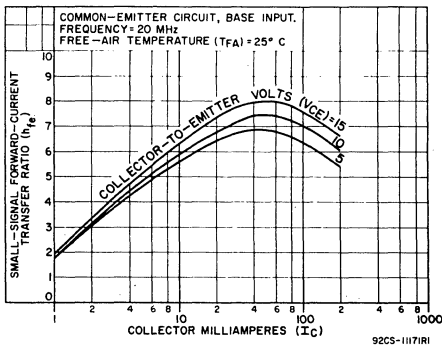


Fig. 7 - Typical small-signal, forward-current transfer ratio characteristics.

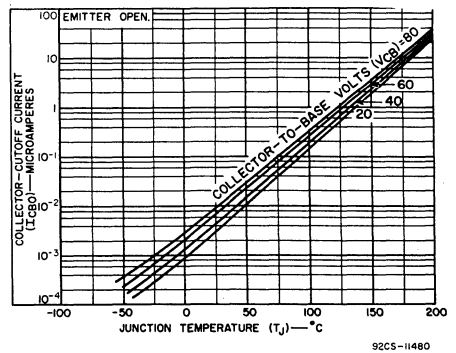


Fig. 8 - Typical collector-cutoff current characteristics.



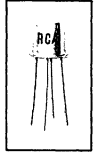
# RF Power Transistors

2N918  
2N3600

RCA-2N918 and RCA-2N3600 are double-diffused epitaxial planar transistors of the silicon n-p-n type. They are extremely useful in low-noise-amplifier, oscillator, and converter applications at VHF frequencies.

These devices utilize a hermetically sealed four-lead JEDEC TO-72 package. All active elements of the transistor are insulated from the case, which may be grounded by means of the fourth lead in applications requiring minimum feedback capacitance, shielding of the device, or both.

## SILICON N-P-N EPITAXIAL PLANAR TRANSISTORS



JEDEC TO-72

For VHF Applications  
In Military, Communications,  
and Industrial Equipment

**MAXIMUM RATINGS, Absolute-Maximum Values:**

2N918 2N3600

COLLECTOR-TO-BASE VOLTAGE, $V_{CB0}$ . . . . .	30	30 max.	V
COLLECTOR-TO-EMITTER VOLTAGE, $V_{CE0}$ . . . . .	15	15 max.	V
EMITTER-TO-BASE VOLTAGE, $V_{EB0}$ . . . . .	3	3 max.	V
COLLECTOR CURRENT, $I_C$ . . . . .	50	* max.	mA
TRANSISTOR DISSIPATION, $P_T$ :			
For operation with heat sink:			
At case temperatures**	{ up to 25°C . . . . .	300	300 max. mW
	{ above 25°C . . . . .	Derate at 1.71 mW/°C	
For operation at ambient temperatures:			
At ambient temperatures	{ up to 25°C . . . . .	200	200 max. mW
	{ above 25°C . . . . .	Derate at 1.14 mW/°C	
TEMPERATURE RANGE:			
Storage and Operating (Junction) . . . . .	-65 to +200		°C
LEAD TEMPERATURE (During Soldering):			
At distances $\geq$ 1/16 inch from seating surface for 60 seconds max. . . . .	300	300 max.	°C

\* Limited by transistor dissipation.  
\*\* Measured at center of seating surface.

**FEATURES**

- high gain-bandwidth product
  - hermetically sealed four-lead package
  - low leakage current
  - high 200-MHz power gain
- 2N3600
- low noise figure  
NF = 4.5 dB max. at 200 MHz
  - low collector-to-base time constant  
 $r_b' C_c = 15$  ps max.
  - high power gain as neutralized amplifier  
 $G_{pe} = 17$  dB min. at 200 MHz

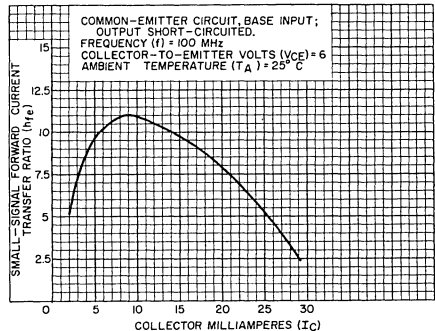
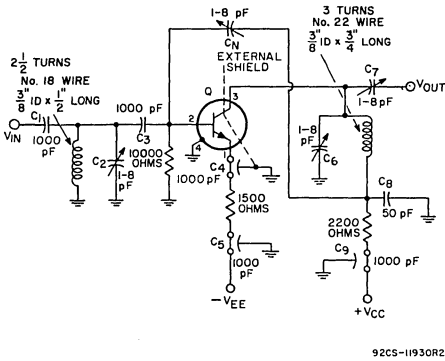


Fig. 1 - Small-signal beta characteristic for types 2N918 and 2N3600.

## ELECTRICAL CHARACTERISTICS

Characteristics	Symbols	TEST CONDITIONS							LIMITS						Units		
		Ambient Temperature	Frequency	DC Collector-to-Base Voltage	DC Collector-to-Emitter Voltage	DC Emitter Current	DC Collector Current	DC Base Current	Type 2N918			Type 2N3600					
				V <sub>CB</sub>	V <sub>CE</sub>	I <sub>E</sub>	I <sub>C</sub>	I <sub>B</sub>	Min.	Typ.	Max.	Min.	Typ.	Max.			
		T <sub>A</sub>	f	V	V	mA	mA	mA									
Collector-Cutoff Current	I <sub>CBO</sub>	25 150		15 15		0 0					-	-	0.01 1	-	-	0.01 1	μA μA
Collector-to-Base Breakdown Voltage	BV <sub>CB0</sub>	25				0	0.001			30	-	-	30	-	-		V
Collector-to-Emitter Sustaining Voltage	BV <sub>CE0(sus)</sub>	25						3	0	15	-	-	15	-	-		V
Emitter-to-Base Breakdown Voltage	BV <sub>EB0</sub>	25				0.01		0		3	-	-	3	-	-		V
Collector-to-Emitter Saturation Voltage	V <sub>CE(sat)</sub>	25						10	1	-	-	0.4	-	-	0.4		V
Base-to-Emitter Saturation Voltage	V <sub>BE(sat)</sub>	25						10	1	-	-	1	-	-	1		V
Static Forward Current-Transfer Ratio	h <sub>FE</sub>	25			1			3		20	-	-	20	-	150		
Small-Signal Forward Current-Transfer Ratio <sup>a</sup>	h <sub>fe</sub>	25	100 100 1 kHz		10 6 6			4 5 2		6	-	-	-	-	8.5 40	-	15 200
Common-Base Output Capacitance <sup>b</sup>	C <sub>ob</sub>	25	0.1 to 1	10 0		0 0				-	-	1.7 3	-	-	-		pF pF
Collector-to-Base Feedback Capacitance <sup>b</sup>	C <sub>cb</sub>	25	0.1 to 1	10		0				-	-	-	-	-	1		pF
Common-Base Input Capacitance <sup>c</sup> (V <sub>EB</sub> = 0.5V)	C <sub>ib</sub>	25	0.1 to 1					0		-	-	2	-	1.4	-		pF
Collector-to-Base Time Constant <sup>a</sup>	t <sub>b</sub> 'C <sub>c</sub>	25	40 31.9	6 6				2 5		-	15	-	-	4	-	15	ps ps
Small-Signal Power Gain in Neutralized Common-Emitter Amplifier Circuit <sup>a</sup> (See Fig.2 & Fig.3)	G <sub>pe</sub>	25	200		12 6			6 5		15	21	-	-	17	-	24	dB dB
Small-Signal Power Gain in Unneutralized Common-Emitter Amplifier Circuit <sup>a</sup> (See Fig.4)	G <sub>pe</sub>	25	200		10			5		-	13	-	-	-	-		dB
Power Output in Common-Emitter Oscillator Circuit <sup>a</sup> (See Fig.5)	P <sub>o</sub>	25	≥ 500	10		12				30	-	-	20	-	-		mW
Nose Figure <sup>a</sup> (See Fig.2)	NF	25	200		6			1.5		-	-	-	-	-	-	4.5	dB
Noise Figure <sup>a,d</sup>	NF	25	60		6			1		-	-	6	-	-	3	dB	

<sup>a</sup> Lead No.4 (case) grounded.<sup>b</sup> Three-terminal measurement of the collector-to-base capacitance with the case and emitter leads connected to the guard terminal.<sup>c</sup> Lead No.4 (case) floating.<sup>d</sup> Generator Resistance (R<sub>g</sub>) = 400 ohms.

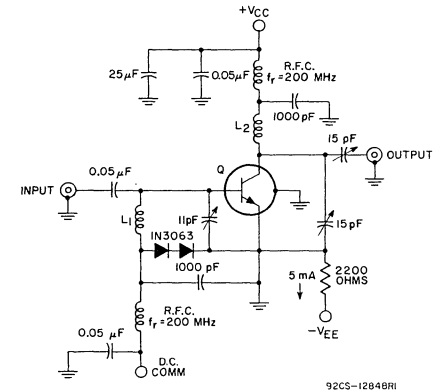


92CS-11930R2

NOTE: (Neutralization Procedure): (a) Connect a 50- $\Omega$  rf voltmeter to the output of a 200-MHz signal generator ( $R_g = 50 \Omega$ ), and adjust the generator output to 5 mV. (b) Connect the generator to the input and the rf voltmeter to the output of the amplifier, as shown above. (c) Apply  $V_{EE}$  and  $V_{CC}$ , and adjust the generator output to provide an amplifier output of 5 mV. (d) Tune  $C_2$ ,  $C_6$ , and  $C_7$  for maximum amplifier output, readjusting the generator output, as required, to maintain an output of 5 mV from the amplifier. (e) Interchange the connections to the signal generator and the rf voltmeter. (f) With sufficient signal applied to the output terminals of the amplifier, adjust CN for a minimum indication at the amplifier input. (g) Repeat steps (a), (b), (c), and (d) to determine if retuning is necessary.

Q = Type 2N3600

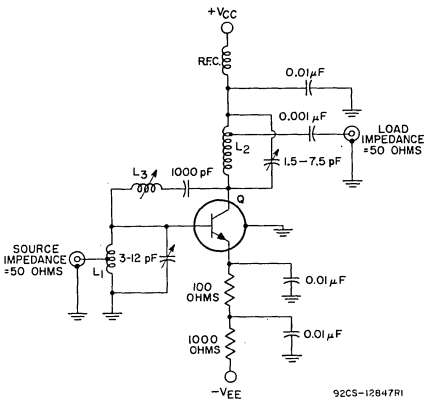
Fig. 2 - Neutralized amplifier circuit used to measure power gain and noise figure at 200 MHz for type 2N3600.



92CS-12848R1

$L_1$  - 1 loop #12 AWG wire;  $I_D = 13/16"$   
 $L_2$  - 1/2 loop #12 AWG wire;  $I_D = 1-3/16"$   
 Q = 2N918

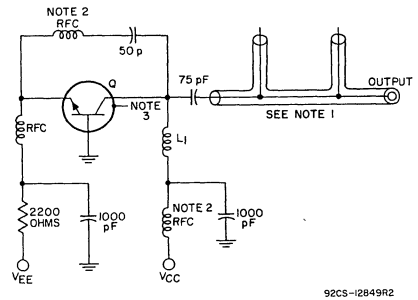
Fig. 4 - Circuit used to measure 200-MHz unneutralized power gain for type 2N918.



92CS-12847R1

$L_1$  - 3.5 turns No.16 tinned copper wire; 5/16" dia.; 7/16" long; turns ratio  $\approx 4:2$   
 $L_2$  - 8 turns No.16 tinned copper wire; 1/8" dia.; 7/8" long; turns ratio  $\approx 8:1$   
 $L_3$  - MILLER #4303 (0.4 - 0.65  $\mu$ H) or equivalent  
 Q = Type 2N918

Fig. 3 - Neutralized amplifier circuit used to measure power gain at 200 MHz for type 2N918.



92CS-12849R2

Note 1 - Coaxial-Line output network consisting of:  
 2 General Radio Type 874 TEE or equivalent  
 1 General Radio Type 874-D20 Adjustable Stub or equivalent  
 1 General Radio Type 874-LA Adjustable Line or equivalent  
 1 General Radio Type 874-WN3 Short-circuit termination or equivalent  
 Note 2 - RFC = 0.2  $\mu$ H Ohmite #2-460 or equivalent  
 Note 3 - Lead Number 4 (case) floating  
 $L_1$  - 2 turns #16AWG wire, 3/8 inch OD, 1-1/4 inch long  
 Q = 2N918 or 2N3600

Fig. 5 - Circuit used to measure 500-MHz oscillator power output for types 2N918 and 2N3600.

**TWO-PORT ADMITTANCE ( $y$ ) PARAMETERS AS FUNCTIONS OF COLLECTOR CURRENT ( $I_C$ ) FOR RCA TYPES 2N918 AND 2N3600**

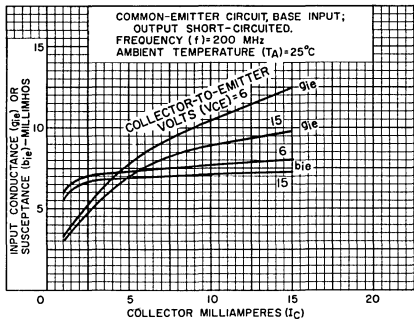


Fig. 6 - Input admittance ( $y_{ie}$ ).

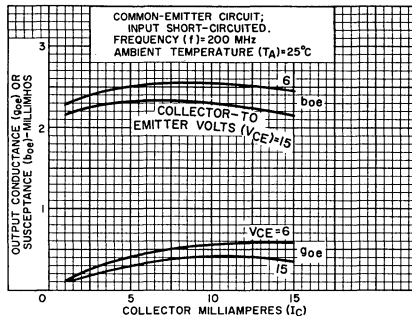


Fig. 7 - Output admittance ( $y_{oe}$ ).

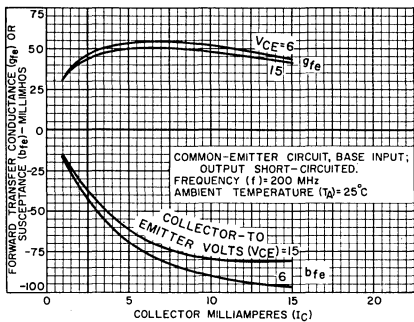


Fig. 8 - Forward transadmittance ( $y_{fe}$ ).

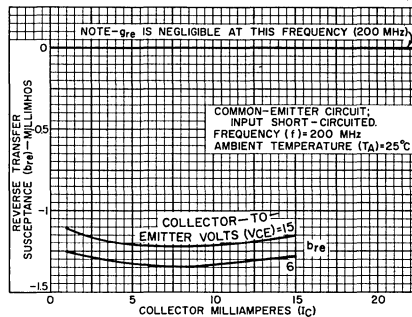


Fig. 9 - Reverse transadmittance ( $y_{re}$ ).

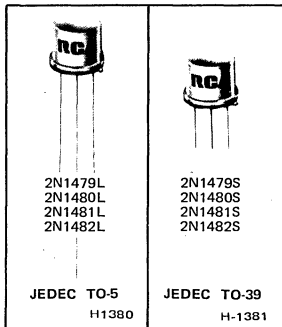
**TERMINAL CONNECTIONS**

- LEAD 1 - EMITTER
- LEAD 2 - BASE
- LEAD 3 - COLLECTOR
- LEAD 4 - CONNECTED TO CASE

**RCA**  
Solid State  
Division

## Power Transistors

2N1479 2N1480  
2N1481 2N1482



## Silicon N-P-N Power Transistors

General-Purpose Types for  
Medium-Power Applications

### Features:

- High-temperature characterization
- High dc beta at 200 mA
- Full switching-time characterization at 200 mA

These devices are available with either 1/2-inch leads (TO-5 package) or 1/4-inch leads (TO-39 package). The longer-lead versions are specified by suffix "L" after the type number; the shorter-lead versions are specified by suffix "S" after the type number.

RCA-2N1479-2N1482 are diffused-junction silicon n-p-n power transistors. These transistors are intended for a wide variety of applications in industrial and military equipment.

They are particularly useful in power-switching circuits such as in dc-to-dc converters, inverters, choppers, solenoid and relay controls; in oscillator, regulator, and pulse-amplifier

circuits; and as class A and class B push-pull audio and servo amplifiers.

These transistors feature high beta at high current, and excellent high-temperature performance. They employ the JEDEC TO-39 or TO-5 hermetic package.

### Maximum Ratings, Absolute-Maximum Values:

*COLLECTOR-TO-BASE VOLTAGE .....	$V_{CBO}$	60	100	V
*COLLECTOR-TO-EMITTER VOLTAGE:				
With base open, sustaining .....	$V_{CEO(sus)}$	40	55	V
With emitter-to-base reverse biased				
( $V_{EB} = 1.5$ volts) .....	$V_{CEX}$	60	100	V
*EMITTER-TO-BASE VOLTAGE .....	$V_{EB}$	12	12	V
*COLLECTOR CURRENT .....	$I_C$	1.5	1.5	A
*EMITTER CURRENT .....	$I_E$	-1.75	-1.75	A
*BASE CURRENT .....	$I_B$	1	1	A
*TRANSISTOR DISSIPATION:	$P_T$			
(See Rating Chart Fig. 1):				
At case temperature of 25° C .....		5	5	W
At case temperature of 100° C .....		2.86	2.86	W
TEMPERATURE RANGE:				
Operating and Storage .....		-65 to +200		°C

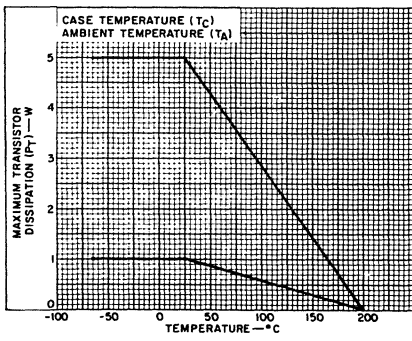
\*In accordance with JEDEC registration data

ELECTRICAL CHARACTERISTICS, At Case Temperature ( $T_C$ ) = 25°C unless otherwise specified

CHARACTERISTIC	SYMBOL	TEST CONDITIONS						LIMITS								UNITS
		VOLTAGE V dc			CURRENT mA dc			2N1479		2N1480		2N1481		2N1482		
		V <sub>CB</sub>	V <sub>CE</sub>	V <sub>EB</sub>	I <sub>C</sub>	I <sub>B</sub>	I <sub>E</sub>	Min.	Max.	Min.	Max.	Min.	Max.	Min.	Max.	
Collector Cutoff Current: $T_C = 150^\circ\text{C}$	I <sub>CBO</sub>	30					0		10				10		10	μA
		30					0		500		500		500		500	
Emitter Cutoff Current	I <sub>EBO</sub>			12	0				10		10		10		10	μA
Collector-To-Emitter Voltage: With base-emitter junction reverse-biased	V <sub>CEX</sub>			1.5	0.25			60		100		60		100		V
With base open, sustaining	V <sub>CEO(sus)</sub>				50	0		40		55		40		55		V
Base-To-Emitter Voltage	V <sub>BE</sub>		4		200				3		3		3		3	V
DC Current Transfer Ratio	h <sub>FE</sub>		4		200			20	60	20	60	35	100	35	100	
Small-Signal Current Transfer Ratio	h <sub>fe</sub>		4		5			50 Typ.		50 Typ.		50 Typ.		50 Typ.		
DC Collector-To-Emitter Saturation Resistance	r <sub>CE(sat)</sub>				200 200	20 10			7		7		7		7	Ω
Collector-To-Base Capacitance	C <sub>ob</sub>	40						150 Typ.		150 Typ.		150 Typ.		150 Typ.		pF
Thermal Time Constant	τ <sub>1</sub>							10 Typ.		10 Typ.		10 Typ.		10 Typ.		ms
Alpha-Cutoff Frequency	f <sub>αb</sub>	28			5			1.5 Typ.		1.5 Typ.		1.5 Typ.		1.5 Typ.		MHz
Switching Time:																
Delay Time	t <sub>d</sub> <sup>*</sup>							0.2 Typ.		0.2 Typ.		0.2 Typ.		0.2 Typ.		μs
Rise Time	t <sub>r</sub> <sup>*</sup>							1 Typ.		1 Typ.		1 Typ.		1 Typ.		
Storage Time	t <sub>s</sub> <sup>*</sup>							0.6 Typ.		0.6 Typ.		0.6 Typ.		0.6 Typ.		
Fall Time	t <sub>f</sub> <sup>*</sup>							1 Typ.		1 Typ.		1 Typ.		1 Typ.		
Thermal Resistance:																
Junction-to-case	R <sub>θJC</sub>							35		35		35		35		°C/W
Junction-to-free air	R <sub>θJFA</sub>							200		200		200		200		

\*In accordance with JEDEC registration data

\*I<sub>C</sub> = 200 mA, I<sub>B1</sub> = 20 mA, I<sub>B2</sub> = -8.5 mA; see Figs. 6 and 7.



92CS-10446 R4

Fig. 1 - Derating chart for all types.

TERMINAL CONNECTIONS

- Lead 1 - Emitter
- Lead 2 - Base
- Case, Lead 3 - Collector



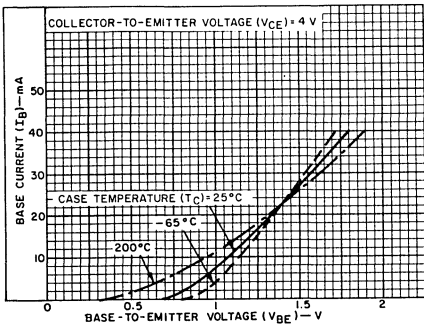


Fig. 2 — Typical input characteristics for all types.

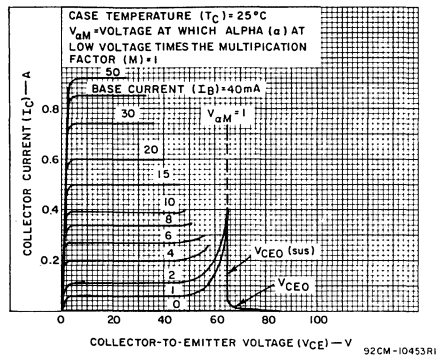


Fig. 3 — Typical output characteristics for all types.

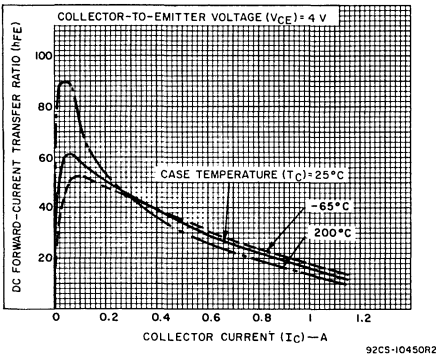


Fig. 4 — Typical dc beta characteristics for all types.

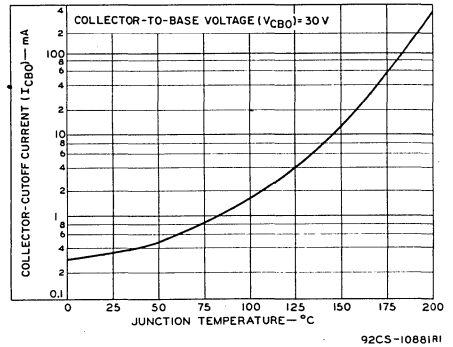


Fig. 5 — Typical leakage characteristics for all types.

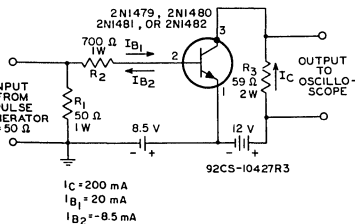


Fig. 6 — Test circuit for measurement of saturated switching times.

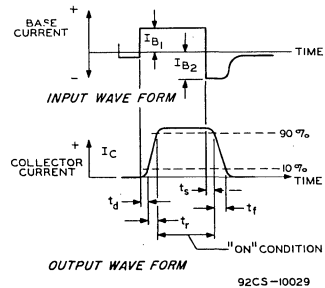


Fig. 7 — Oscilloscope display for measurement of switching times (test circuit in Fig. 6).



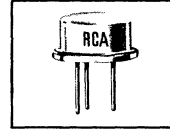
## Power Transistors

**2N1483 2N1484**  
**2N1485 2N1486**

RCA-2N1483-2N1486 are diffused-junction power transistors of the silicon n-p-n type. These transistors are intended for a wide variety of applications in industrial and military equipment. They are particularly useful in power-switching circuits such as in dc-to-dc converters, inverters, choppers, solenoid and relay controls; in oscillator, regulator, and pulse amplifier circuits; and as class-A and class-B push-pull audio and servo amplifiers.

These transistors feature high beta at high current, and excellent high temperature performance.

### Intermediate-Power Types



JEDEC-TO-8

- Maximum dissipation rating of 25 watts at a case temperature of 25°C
- 2N1485 and 2N1486 have a maximum saturation resistance of 1 ohm

#### Maximum Ratings, *Absolute-Maximum Values:*

	2N1483	2N1484		
	2N1485	2N1486		
COLLECTOR-TO-BASE VOLTAGE . . . . .	60	100	max.	volts
COLLECTOR-TO-EMITTER VOLTAGE:				
With base open (sustaining voltage) . . . . .	40	55	max.	volts
With emitter-to-base reverse				
biased ( $V_{EB} = 1.5$ volts) . . . . .	60	100	max.	volts
EMITTER-TO-BASE VOLTAGE . . . . .	12	12	max.	volts
COLLECTOR CURRENT . . . . .	3	3	max.	amp
EMITTER CURRENT . . . . .	-3.5	-3.5	max.	amp
BASE CURRENT . . . . .	1.5	1.5	max.	amp
TRANSISTOR DISSIPATION:				
(See Rating Chart Fig. 3):				
At case temperature of 25°C . . . . .	25	25	max.	watts
At case temperature of 100°C . . . . .	14.1	14.1	max.	watts
TEMPERATURE RANGE:				
Operating and Storage . . . . .	-65 to +200			°C

ELECTRICAL CHARACTERISTICS, At Case Temperature ( $T_C$ ) = 25°C unless otherwise specified

CHARACTERISTIC	SYMBOL	TEST CONDITIONS				LIMITS				UNITS
		VOLTAGE V dc		CURRENT mA dc		2N1483		2N1484		
		$V_{CB}$	$V_{CE}$	$I_C$	$I_B$	Min.	Max.	Min.	Max.	
Collector Cutoff Current: With emitter open	$I_{CBO}$	30				-	15	-	15	$\mu A$
At $T_C = 150^\circ C$		30				-	750	-	750	
Emitter Cutoff Current $V_{EB} = 12 V$	$I_{EBO}$			0		-	15	-	15	$\mu A$
DC Forward-Current Transfer Ratio	$h_{FE}$		4	750 <sup>a</sup>		20	60	20	60	
Collector-to-Emitter Sustaining Voltage: With base open	$V_{CEO(sus)}$			100 <sup>a</sup>	0	40	-	55	-	V
With base-emitter junction reverse-biased ( $V_{BE} = -1.5 V$ )	$V_{CEX}$			0.25		60	-	100	-	
Base-to-Emitter Voltage	$V_{BE}$		4	750 <sup>a</sup>		-	3.5	-	3.5	V
Collector-to-Emitter Saturation Resistance	$r_{CE(sat)}$			750	75	-	2.67	-	2.67	$\Omega$
Collector-to-Base Capacitance	$C_{ob}$	40				175 (typ.)		175 (typ.)		pF
Thermal Time Constant	$\tau_1$					10 (typ.)		10 (typ.)		ms
Alpha Cutoff Frequency	$f_{ab}$	28		5		1.25 (typ.)		1.25 (typ.)		MHz
Saturated Switching Time										$\mu s$
Delay time	$t_d$					0.2 (typ.)		0.2 (typ.)		
Rise time	$t_r$					1 (typ.)		1 (typ.)		
Storage time	$t_s$					0.8 (typ.)		0.8 (typ.)		
Fall time	$t_f$					1.1 (typ.)		1.1 (typ.)		
Thermal Resistance: Junction-to-case	$R_{\theta JC}$					-	7	-	7	$^\circ C/W$
Junction-to-ambient	$R_{\theta JA}$					-	100	-	100	

<sup>a</sup>Pulsed, pulse duration = 300  $\mu s$ , duty factor = 1.8%.

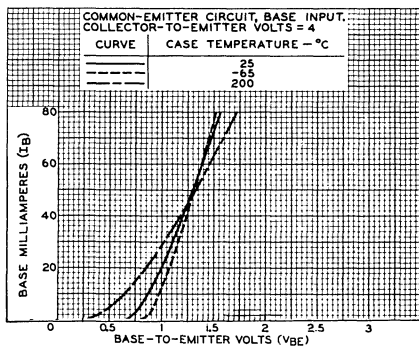


Fig. 1—Typical input characteristics for all types.

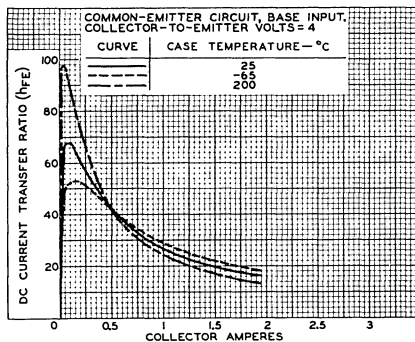
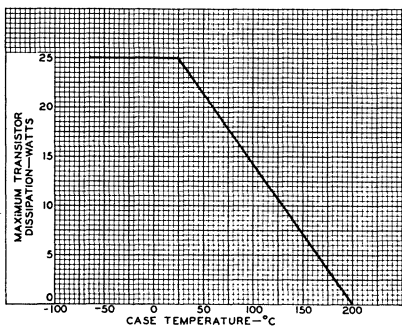


Fig. 2—Typical operation characteristics for all types.

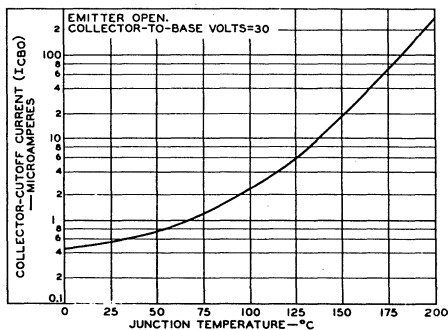
ELECTRICAL CHARACTERISTICS, At Case Temperature ( $T_C$ ) = 25°C unless otherwise specified

CHARACTERISTIC	SYMBOL	TEST CONDITIONS				LIMITS				UNITS
		VOLTAGE V dc		CURRENT mA dc		2N1485		2N1486		
		V <sub>CB</sub>	V <sub>CE</sub>	I <sub>C</sub>	I <sub>B</sub>	Min.	Max.	Min.	Max.	
Collector Cutoff Current: With emitter open At $T_C = 150^\circ\text{C}$	I <sub>CBO</sub>	30				—	15	—	15	μA
		30				—	750	—	750	
Emitter Cutoff Current V <sub>EB</sub> = 12 V	I <sub>EBO</sub>			0		—	15	—	15	μA
DC Forward-Current Transfer Ratio	h <sub>FE</sub>		4	750 <sup>a</sup>		35	100	35	100	
Collector-to-Emitter Sustaining Voltage: With base open	V <sub>CEO(sus)</sub>			100 <sup>a</sup>	0	40	—	55	—	V
With base-emitter junction reverse-biased (V <sub>BE</sub> = -1.5 V)	V <sub>CEX</sub>			0.25		60	—	100	—	
Base-to-Emitter Voltage	V <sub>BE</sub>		4	750 <sup>a</sup>		—	2.5	—	2.5	V
Collector-to-Emitter Saturation Resistance	r <sub>CE(sat)</sub>			750	40	—	1	—	1	Ω
Collector-to-Base Capacitance	C <sub>ob</sub>	40				175 (typ.)		175 (typ.)		pF
Thermal Time Constant	τ <sub>1</sub>					10 (typ.)		10 (typ.)		ms
Alpha Cutoff Frequency	f <sub>ab</sub>	28		5		1.25 (typ.)		1.25 (typ.)		MHz
Saturated Switching Time										
Delay time	t <sub>d</sub>					0.2 (typ.)		0.2 (typ.)		μs
Rise time	t <sub>r</sub>					1 (typ.)		1 (typ.)		
Storage time	t <sub>s</sub>					0.8 (typ.)		0.8 (typ.)		
Fall time	t <sub>f</sub>					1.1 (typ.)		1.1 (typ.)		
Thermal Resistance: Junction-to-case	R <sub>θJC</sub>					—	7	—	7	°C/W
Junction-to-ambient	R <sub>θJA</sub>					—	100	—	100	

<sup>a</sup> Pulsed, pulse duration = 300 μs, duty factor = 1.8%.



92CS-10442R2



92CS-10862

Fig. 3—Rating chart for all types.

Fig. 4—Typical operation characteristics for all types.

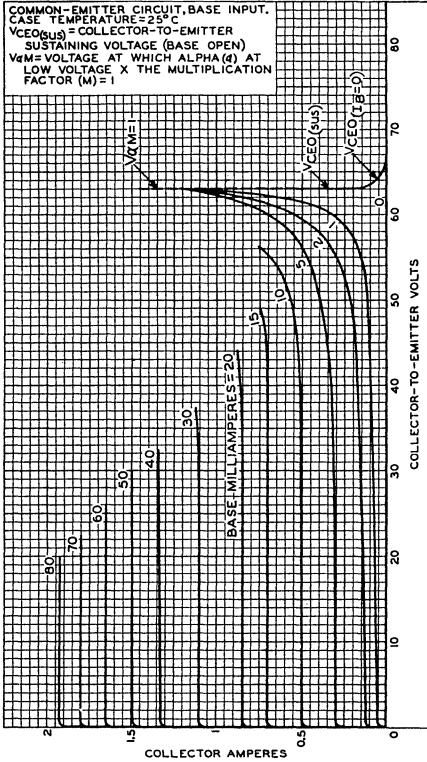
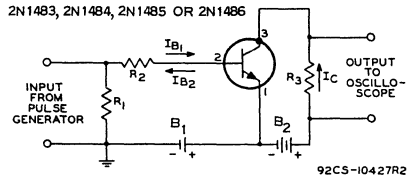
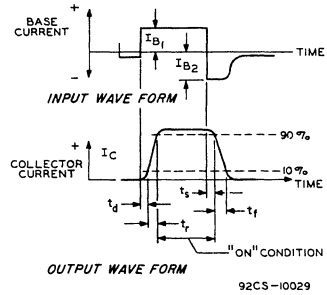


Fig. 5—Typical collector characteristics for all types.



- B<sub>1</sub> = 8.5 volts
- B<sub>2</sub> = 12 volts
- R<sub>1</sub> = 50 ohms, 1 watt
- R<sub>2</sub> = 220 ohms, 1 watt
- R<sub>3</sub> = 15.9 ohms, 2 watts



Typical Operation of the 2N1483 - 2N1486

At Case Temperature (T<sub>C</sub>) = 25°C:

DC Supply Voltage (B <sub>2</sub> )	12	V
DC Base Bias Voltage (B <sub>1</sub> )	-8.5	V
Generator Resistance	50	Ω
"On" DC Collector Current	750	mA
"Turn-On" Base Current (I <sub>B1</sub> )	65	mA
"Turn-Off" Base Current (I <sub>B2</sub> )	-35	mA

Fig. 6—Typical power-switching circuit.

TERMINAL CONNECTIONS

- Lead 1 - Emitter
- Lead 2 - Base
- Case, Lead 3 - Collector



## Power Transistors

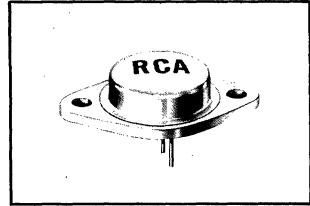
2N1487 2N1488  
2N1489 2N1490

RCA-2N1487-2N1490 are diffused-junction power transistors of the silicon n-p-n type. These transistors are intended for a wide variety of applications in industrial and military equipment. They are particularly useful in power-switching circuits such as in dc-to-dc converters, inverters, choppers, solenoid and relay controls; in oscillator, regulator, and pulse-amplifier circuits; and as class-A and class-B push-pull audio and servo amplifiers.

These transistors feature high power-dissipation ratings, high beta at high current, and excellent high temperature performance.

- Maximum dissipation rating of 75 watts at a mounting flange temperature of 25°C
- 2N1489 and 2N1490 have a maximum saturation resistance of 0.67 ohm

### High-Power Types



JEDEC TO-3

#### Maximum Ratings, *Absolute-Maximum Values:*

	2N1487 2N1489	2N1488 2N1490		
COLLECTOR-TO-BASE VOLTAGE . . . . .	60	100	max.	volts
COLLECTOR-TO-EMITTER VOLTAGE:				
With base open (sustaining voltage) . . . . .	40	55	max.	volts
With emitter-to-base reverse biased ( $V_{EB} = 1.5$ volts) . . . . .	60	100	max.	volts
EMITTER-TO-BASE VOLTAGE . . . . .	10	10	max.	volts
COLLECTOR CURRENT . . . . .	6	6	max.	amp
EMITTER CURRENT . . . . .	-8	-8	max.	amp
BASE CURRENT . . . . .	3	3	max.	amp
TRANSISTOR DISSIPATION: (See Rating Chart Fig. 1):				
At mounting-flange temperature of 25°C . . . . .	75	75	max.	watts
At mounting-flange temperature of 100°C . . . . .	43	43	max.	watts
TEMPERATURE RANGE:				
Operating and Storage . . . . .	-65 to +200			°C

ELECTRICAL CHARACTERISTICS

Mounting-flange temperature = 25°C unless otherwise specified.

Characteristic	Symbol	TEST CONDITIONS					LIMITS								Units	
		DC Collector Voltage (volts)		DC Emitter Voltage (volts)		DC Collector Current (ma)	DC Base Current (ma)	Type 2N1487		Type 2N1488		Type 2N1489		Type 2N1490		
		V <sub>CB</sub>	V <sub>CE</sub>	V <sub>EB</sub>	I <sub>C</sub>	I <sub>B</sub>	Min.	Max.	Min.	Max.	Min.	Max.	Min.	Max.		
Collector-Cutoff Current: With I <sub>E</sub> = 0 and at mounting flange temperature of; 25°C 150°C	I <sub>CBO</sub>	30						25	25	25	25	25	25	μa		
Emitter-Cutoff Current	I <sub>EBO</sub>			10	0			25	25	25	25	25	25	μa		
Collector-To-Emitter Voltage: (Emitter-to-base reverse bias) (Base open sustaining voltage)	V <sub>CEX</sub> V <sub>CEO</sub> (sus)			1.5	0.5		60	100	60	100	60	100	60	100	volts	
DC Current Transfer Ratio	h <sub>FE</sub>		4		1.5amps		15	45	15	45	25	75	25	75		
DC Collector-To-Emitter Saturation Resistance	r <sub>CE(sat)</sub>				1.5amps 1.5amps	300 100		2		2			0.67	0.67	ohms ohm	
Base-To-Emitter Voltage	V <sub>BE</sub>		4		1.5amps			3.5	3.5	2.5	2.5	2.5	2.5	volts		
Thermal Resistance: Junction-to-mounting flange	R <sub>θJC</sub>							2.33	2.33	2.33	2.33	2.33	2.33	°C/w		

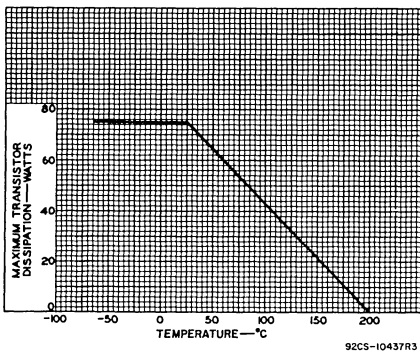


Fig. 1 - Rating Chart for Types 2N1487, 2N1488, 2N1489, and 2N1490.

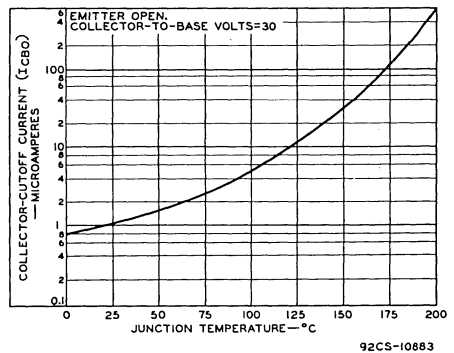


Fig. 2 - Typical Operation Characteristics for Types 2N1487, 2N1488, 2N1489, and 2N1490.

Typical Operation of the 2N1487, 2N1488, 2N1489, and 2N1490 in the Power-Switching Circuit of Fig. 3:

DC Supply Voltage ( $B_2$ )	12	volts
DC Base Bias Voltage ( $B_1$ )	-8.5	volts
Generator Resistance	50	ohms
"On" DC Collector Current	1.5	amp
"Turn-On" Base Current ( $I_{B1}$ )	300	ma
"Turn-Off" Base Current ( $I_{B2}$ )	-150	ma
Switching Time:		
Delay Time ( $t_d$ )	0.2	$\mu$ sec
Rise Time ( $t_r$ )	1.0	$\mu$ sec
Storage Time ( $t_s$ )	1.0	$\mu$ sec
Fall Time ( $t_f$ )	1.2	$\mu$ sec

Typical Characteristics of the 2N1487, 2N1488, 2N1489, and 2N1490 at a Mounting-Flange Temperature of 25°C:

Collector-to-base capacitance: $C_{ob}$ ( $V_{CB} = 40$ volts)	200	$\mu$ mf
Thermal Time Constant, $\tau_1$	12	msec
Alpha-Cutoff Frequency $f_{ab}$ ( $V_{CB} = 12$ volts, $I_C = 100$ ma)	1	Mc

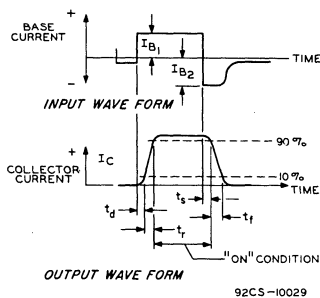
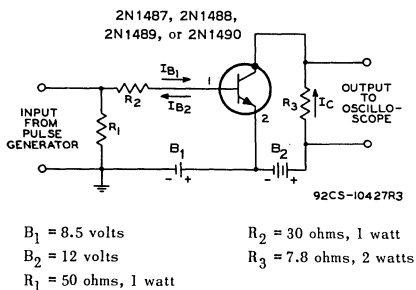


Fig. 3 - Typical Power-Switching Circuit.



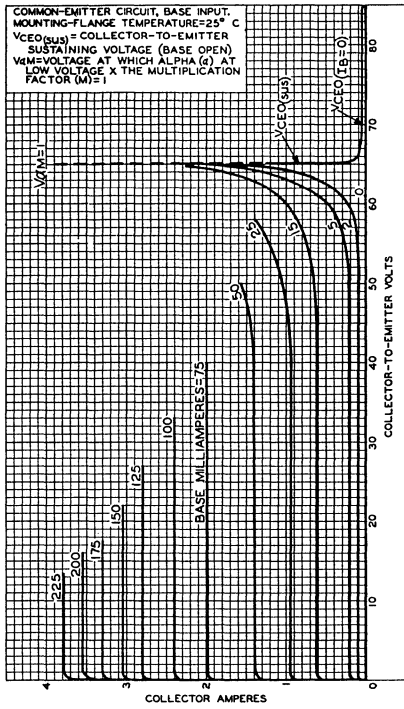


Fig. 4 - Typical Collector Characteristics for Types 2N1487, 2N1488, 2N1489, and 2N1490.

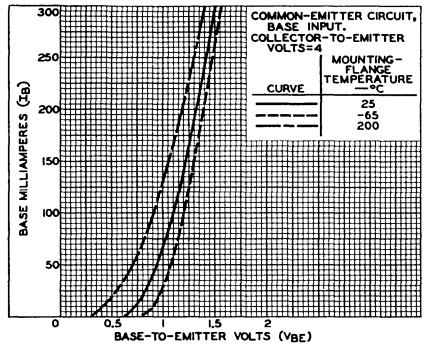


Fig. 5 - Typical Input Characteristics for Types 2N1487, 2N1488, 2N1489, and 2N1490.

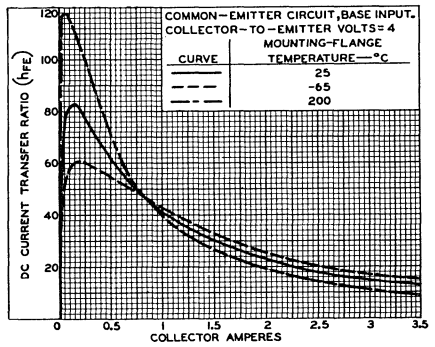


Fig. 6 - Typical Operation Characteristics for Types 2N1487, 2N1488, 2N1489, and 2N1490.

**TERMINAL CONNECTIONS**

- Pin 1 - Base
- Pin 2 - Emitter
- Case - Collector
- Mounting Flange - Collector

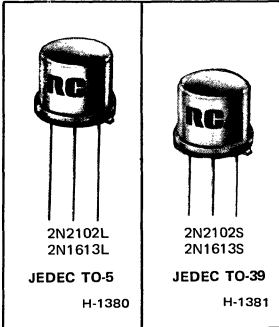


# Power Transistors

**2N2102**  
**2N1613**

## Medium-Power Silicon N-P-N Planar Transistors

For Small-Signal Applications  
In Industrial and Commercial Equipment



**Features:**

- For operation at junction temperature up to 200°C
- Planar construction for low noise and low leakage
- Low output capacitance

These devices are available with either 1/2-inch leads (TO-5 package) or 1/4-inch leads (TO-39 package). The longer-lead versions are specified by suffix "L" after the type number; the shorter-lead versions are specified by suffix "S" after the type number.

RCA-2N2102 and 2N1613 are silicon n-p-n planar transistors intended for a wide variety of small-signal and medium-power applications in military and industrial equipment. They feature exceptionally low noise, low leakage, high switching speed, and high pulsed beta.

RCA-2N2102 is a direct replacement for the 2N1613. In addition, because of its junction design, the 2N2102 has higher breakdown-voltage ratings, higher dissipation ratings, lower saturation voltages, higher sustaining voltages, and lower output capacitance.

**RCA-2N2102 Features:**

- Gain bandwidth product ( $f_T$ ) = 120 MHz (typ.); useful in applications from dc to 20 MHz
- High breakdown voltage:  
 $V_{(BR)CBO} = 120$  V min. at  $I_C = 0.1$  mA
- Low saturation voltages:  
 $V_{CE(sat)} = 0.5$  V max. at  $I_C = 150$  mA  
 $V_{BE(sat)} = 1.1$  V max. at  $I_C = 150$  mA
- Beta ( $h_{FE}$ ) controlled over 5 decades of  $I_C$

MAXIMUM RATINGS, <i>Absolute-Maximum Values:</i>	2N2102	2N1613	
*COLLECTOR-TO-BASE VOLTAGE .....	120	75	V
*COLLECTOR-TO-EMITTER SUSTAINING VOLTAGE:			
With external base-to-emitter resistance			
( $R_{BE}) = 10 \Omega$ .....	80	50	V
With base open .....	65		V
*EMITTER-TO-BASE VOLTAGE .....	7	7	V
COLLECTOR CURRENT .....	$I_C$	1	A
*TRANSISTOR DISSIPATION:			
At case temperatures up to 25°C .....	5	3	W
At free-air temperatures up to 25°C .....	1	0.8	W
At temperatures above 25°C .....	See Figs. 1 and 2		
*TEMPERATURE RANGE:			
Storage and operating (Junction) .....	— -65 to + 200 —		°C
*LEAD TEMPERATURE (During soldering):			
At distance $\geq 1/16$ in. (1.58 mm) from seating plane for 10 s max. ....	— 300 —		°C

\*In accordance with JEDEC registration data format

ELECTRICAL CHARACTERISTICS, At Case Temperature ( $T_C$ ) = 25°C unless otherwise specified

CHARACTERISTIC	SYMBOL	TEST CONDITIONS				LIMITS				UNITS
		VOLTAGE V dc		CURRENT mA dc		2N2102		2N1613		
		V <sub>CB</sub>	V <sub>CE</sub>	I <sub>C</sub>	I <sub>B</sub>	Min.	Max.	Min.	Max.	
* Collector Cutoff Current: With emitter open At $T_C = 150^\circ\text{C}$	I <sub>CBO</sub>	60				—	0.002	—	0.01	μA
		60				—	2	—	10	
* Emitter Cutoff Current: V <sub>EB</sub> = 5 V	I <sub>EBO</sub>			0		—	0.002	—	0.01	μA
* DC Forward-Current Transfer Ratio  At $T_C = -55^\circ\text{C}$	h <sub>FE</sub>		10	0.01		10	—	—	—	
			10	0.1		20	—	20	—	
			10	10 <sup>a</sup>		35	—	35	—	
			10	150 <sup>a</sup>		40	120	40	120	
			10	500 <sup>a</sup>		25	—	20	—	
		10	10 <sup>a</sup>		20	—	20	—		
* Collector-to-Emitter Reachthrough Voltage: V <sub>EB</sub> = 1.5 V, I <sub>E</sub> = 0	V <sub>RT</sub>					120	—	—	—	V
* Collector-to-Base Breakdown Voltage: With emitter open	V <sub>(BR)CBO</sub>			0.1		120	—	75	—	V
* Emitter-to-Base Breakdown Voltage: I <sub>E</sub> = 0.1 mA	V <sub>(BR)EBO</sub>			0		7	—	7	—	V
* Collector-to-Emitter Sustaining Voltage: With base open	V <sub>CEO(sus)</sub>			100 <sup>a</sup>	0	65	—	—	—	V
With external base-to-emitter resistance (R <sub>BE</sub> ) = 10 Ω	V <sub>CER(sus)</sub>			100 <sup>a</sup>		80	—	50	—	V
* Base-to-Emitter Saturation Voltage	V <sub>BE(sat)</sub>			150 <sup>a</sup>	15	—	1.1	—	1.3	V
* Collector-to-Emitter Saturation Voltage	V <sub>CE(sat)</sub>			150 <sup>a</sup>	15	—	0.5	—	1.5	V
* Common-Emitter, Small-Signal, Forward-Current Transfer Ratio (f = 1 kHz)	h <sub>fe</sub>		5 10	1 5		30 35	100 150	30 35	100 150	
Magnitude of Common-Emitter, Small-Signal, Forward-Current Transfer Ratio (f = 20 MHz)	h <sub>fe</sub>		10	50		3	—	3	—	
* Input Resistance: f = 1 kHz	h <sub>ib</sub>	5 10		1 5		24 4	34 8	24 4	34 8	Ω
* Small-Signal Reverse Voltage Transfer (Feedback) Ratio: f = 1 kHz	h <sub>rb</sub>	5 10 10		1 1 5		— — —	3 × 10 <sup>-4</sup> — 3 × 10 <sup>-4</sup>	— — —	3 × 10 <sup>-4</sup> 3 × 10 <sup>-4</sup> —	
* Output Conductance: f = 1 kHz	h <sub>ob</sub>	5 10		1 5		0.01 0.01	0.5 1	0.05 0.05	0.5 0.5	μmho
* Output Capacitance: I <sub>E</sub> = 0	C <sub>ob</sub>	10				—	15	—	25	pF
* Input Capacitance: V <sub>EB</sub> = 0.5 V	C <sub>ib</sub>			0		—	80	—	80	pF

ELECTRICAL CHARACTERISTICS, At Case Temperature ( $T_C$ ) = 25°C

CHARACTERISTIC	SYMBOL	TEST CONDITIONS				LIMITS				UNITS
		VOLTAGE V dc		CURRENT mA dc		2N2102		2N1613		
		V <sub>CE</sub>	V <sub>BE</sub>	I <sub>C</sub>	I <sub>B</sub>	Min.	Max.	Min.	Max.	
* Noise Figure: Circuit Bandwidth (BW) = 1 Hz Reference signal freq. = 1 kHz Generator resistance (R <sub>G</sub> ) = 510 Ω (2N1613); (Z <sub>G</sub> ) = 1000 Ω (2N2102)	NF	10		0.3		—	6	—	12	dB
* Saturated Switching Time (See Fig.14)	t <sub>d</sub> +t <sub>r</sub> +t <sub>f</sub>					—	30	—	30	ns
Thermal Resistance:										
Junction-to-case	R <sub>θJC</sub>					—	35	—	58.3	°C/W
Junction-to-ambient	R <sub>θJA</sub>					—	175	—	219	

\* In accordance with JEDEC registration data format.

a Pulsed, pulse duration = 300 μs, duty factor = 1.8% (2N2102) ≤ 2% (2N1613).

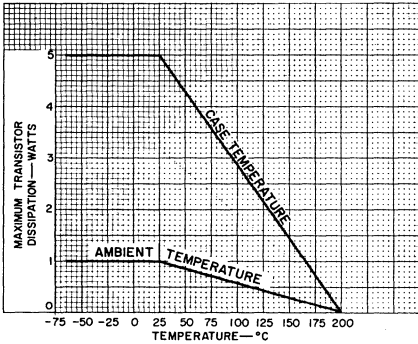


Fig.1 – Rating chart for 2N2102.

92CS-11172R2

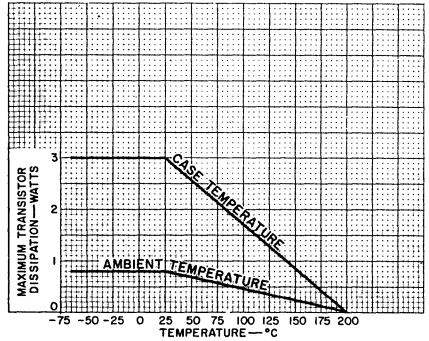


Fig.2 – Rating chart for 2N1613.

92CS-11173R2

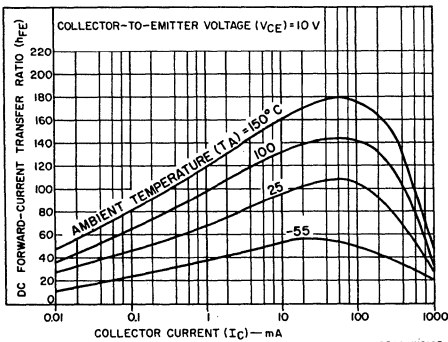


Fig.3 – Typical dc beta characteristics for both types.

92CS-11181R3

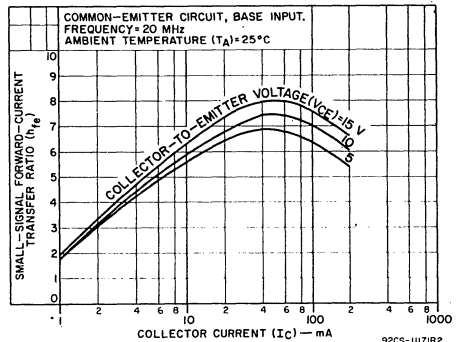


Fig.4 – Typical small-signal beta characteristics for both types.

92CS-11171R2

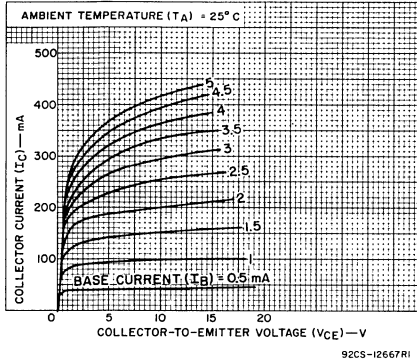


Fig.5 — Typical output characteristics for both types.

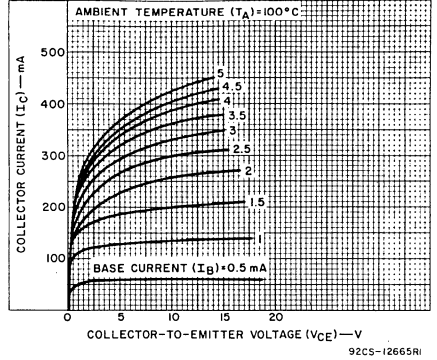


Fig.6 — Typical output characteristics for both types.

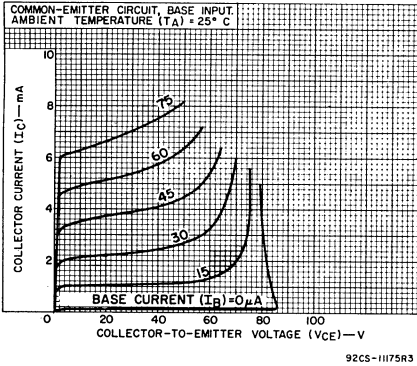


Fig.7 — Typical output characteristics for both types.

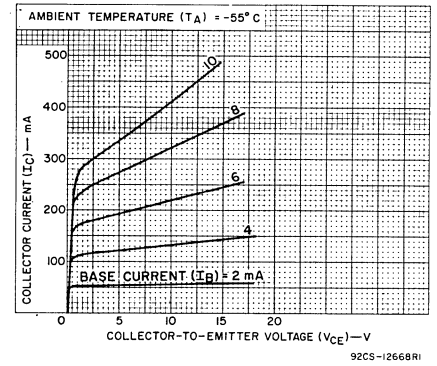


Fig.8 — Typical output characteristics for both types.

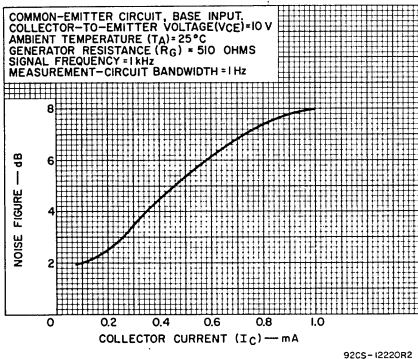


Fig.9 — Typical noise figure characteristics for both types.

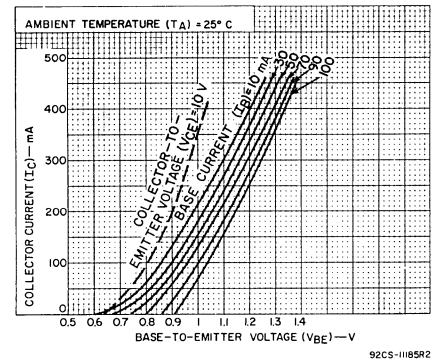


Fig.10 — Typical transfer characteristics for both types.

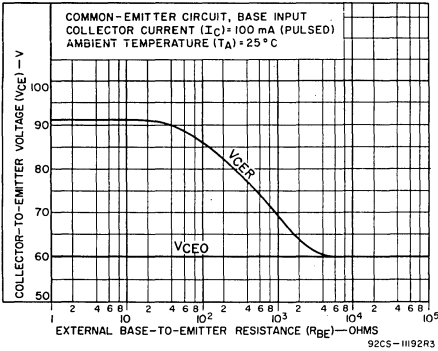


Fig. 11 — Typical sustaining voltage vs. base-to-emitter resistance for 2N1613.

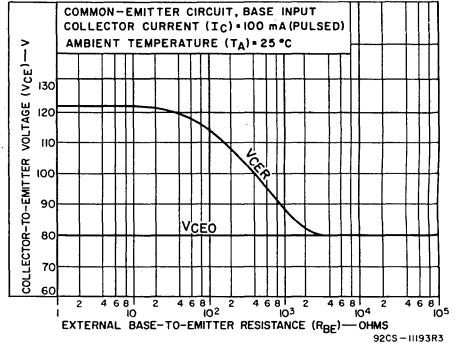


Fig. 12 — Typical sustaining voltage vs. base-to-emitter resistance for 2N2102.

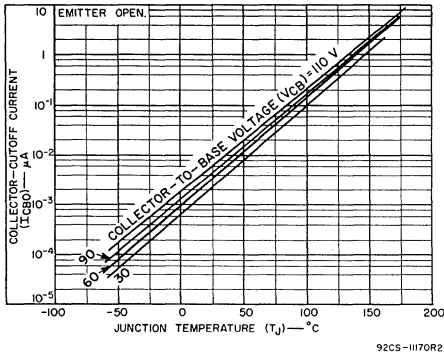


Fig. 13 — Typical leakage characteristics for both types.

**TERMINAL CONNECTIONS**

- Lead 1 — Emitter
- Lead 2 — Base
- Case, Lead 3 — Collector

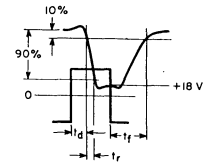
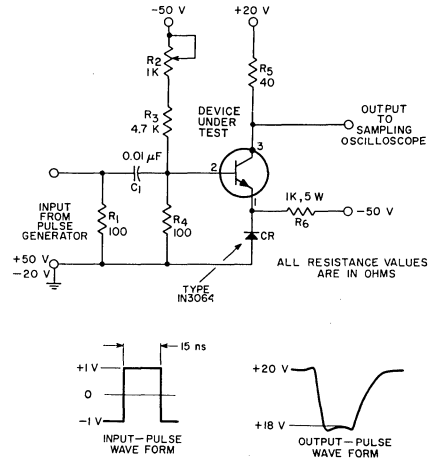
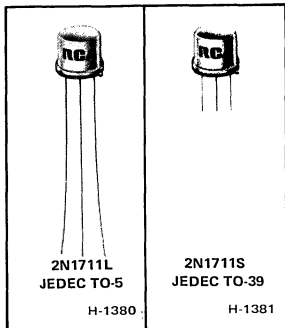


Fig. 14 — Circuit for measurement of switching time, and associated waveforms.



# Power Transistors

## 2N1711



### Silicon N-P-N Planar Transistors

General-Purpose Type for Small-Signal, Medium-Power Applications

**Features:**

- Minimum gain-bandwidth product = 70 MHz; useful in applications from dc to 25 MHz
- Operation at high junction temperatures
- Planar construction for low-noise and low-leakage characteristics
- Low output capacitance

These devices are available with either 1/2-inch leads (TO-5 package) or 1/8-inch leads (TO-39 package). The longer-lead versions are specified by suffix "L" after the type number; the shorter-lead versions are specified by suffix "S" after the type number.

RCA-2N1711 is a silicon n-p-n planar transistor intended for a wide variety of small-signal and medium-power applications in military and industrial equipment. It features exceptionally

low noise and leakage characteristics, high pulse beta ( $h_{FE}$ ), high breakdown-voltage ratings, low saturation voltages, high sustaining voltages, and low output capacitance.

**MAXIMUM RATINGS, Absolute-Maximum Values:**

COLLECTOR-TO-BASE VOLTAGE .....	$V_{CBO}$	75	V
COLLECTOR-TO-EMITTER VOLTAGE:			
With external base-to-emitter resistance ( $R_{BE}$ ) $\leq 10 \Omega$ .....	$V_{CER}$	50	V
EMITTER-TO-BASE VOLTAGE .....	$V_{EB0}$	7	V
COLLECTOR CURRENT .....	$I_C$	1	A
TRANSISTOR DISSIPATION:	$P_T$		
At case temperatures up to 25°C .....		3	W
At case temperatures above 25°C .....		See Fig. 1	
At free-air temperatures up to 25°C .....		0.8	W
At free-air temperatures above 25°C .....		See Fig. 1	
TEMPERATURE RANGE:			
Storage and Operating (Junction) .....		-65 to +200	°C
LEAD TEMPERATURE (During soldering):			
At distance $\geq 1/16$ in. (1.58 mm) from seating plane for 10 s max. ....		230	°C

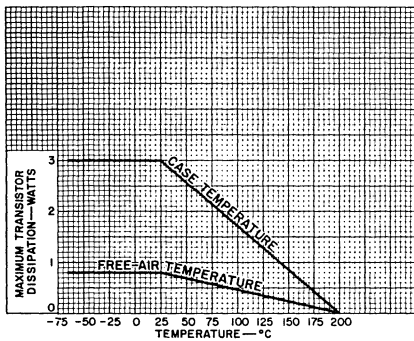
## ELECTRICAL CHARACTERISTICS

Characteristic	Symbol	TEST CONDITIONS									LIMITS		Units
		Case Temperature °C	Frequency kHz	DC Collector-to-Base Voltage V	DC Collector-to-Emitter Voltage V	DC Emitter-to-Base Voltage V	DC Collector Current mA	DC Emitter Current mA	DC Base Current mA	Min.	Max.		
				$V_{CB}$	$V_{CE}$	$V_{EB}$	$I_C$	$I_E$	$I_B$				
Collector-Cutoff Current	$I_{CBO}$	25 150		60 60				0 0			-	0.01 10	$\mu A$
Emitter-Cutoff Current	$I_{EBO}$	25				5	0				-	0.005	$\mu A$
DC-Pulse Forward-Current Transfer Ratio <sup>a</sup>	$h_{FE}$	25 25 25			10 10 10			10 150 500			75 100 40	- 300 -	
DC Forward-Current Transfer Ratio	$h_{FE}$	25 25 -55			10 10 10			0.01 0.1 10			20 35 35	- - -	
Collector-to-Base Breakdown Voltage	$V_{(BR)CBO}$	25						0.1	0		75	-	V
Emitter-to-Base Breakdown Voltage	$V_{(BR)EBO}$	25						0	0.1		7	-	V
Collector-to-Emitter Reach-Through Voltage	$V_{RT}$	25				1.5 <sup>b</sup>		0.1			75	-	V
Collector-to-Emitter Sustaining Voltage with External Base-to-Emitter Resistance = 10 ohms	$V_{CER(sus)}$	25						100 (pulsed)			50	-	V
Collector-to-Emitter Saturation Voltage	$V_{CE(sat)}$	25						150		15	-	1.5	V
Base-to-Emitter Saturation Voltage	$V_{BE(sat)}$	25						150		15	-	1.3	V
Small-Signal Forward-Current Transfer Ratio	$h_{fe}$	25 25 25	1 1 20 MHz		5 10 10			1 5 50			50 70 5	200 300 -	
Noise Figure: Generator resistance ( $R_G$ ) = 510 ohms, circuit bandwidth (BW) = 1 cycle	NF	25	1	10				0.3			-	8	dB
Output Capacitance	$C_{ob}$	25		10					0		-	15	pF
Input Capacitance	$C_{ib}$	25					0.5	0			-	80	pF
Input Resistance	$h_{ib}$	25 25	1 1	5 10				1 5			24 4	34 8	$\Omega$
Voltage-Feedback Ratio	$h_{rb}$	25 25	1 1	5 10				1 5			-	$5 \times 10^{-4}$ $5 \times 10^{-4}$	
Output Conductance	$h_{ob}$	25 25	1 1	5 10				1 5			0.1 0.1	0.5 1	$\mu mho$
Thermal Resistance: Junction-to-case	$R_{\theta JC}$	-									-	58.3	$^{\circ}C/W$
Junction-to-free air	$R_{\theta JA}$	-									-	219	

<sup>a</sup> Pulse duration = 300  $\mu s$ ; duty factor  $\leq 2\%$ .

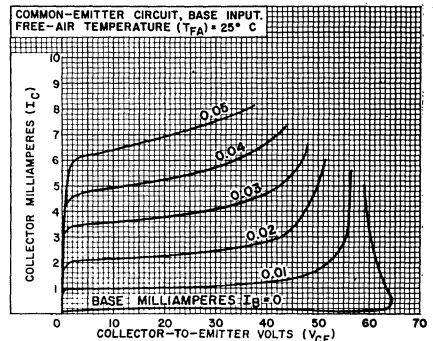
<sup>b</sup>  $V_{EBF}$  = Emitter-to-base floating potential.





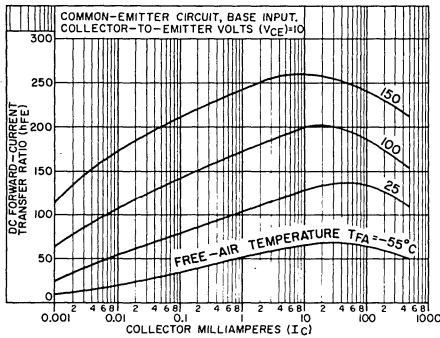
92CS-11173RI

Fig. 1 - Current derating curves.



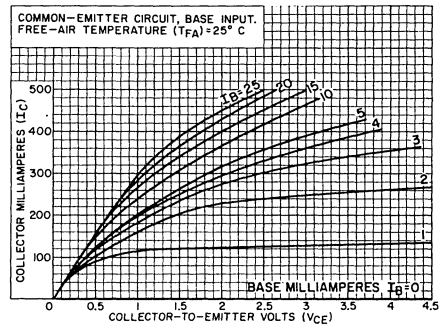
92CS-11630

Fig. 2 - Typical output characteristics.



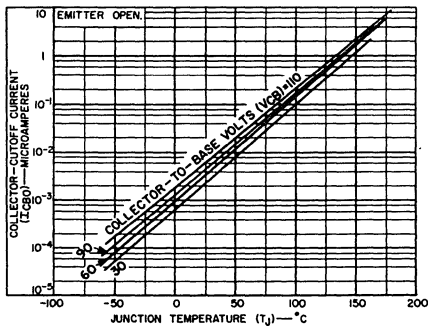
92CS-11629

Fig. 3 - Typical dc beta characteristics.



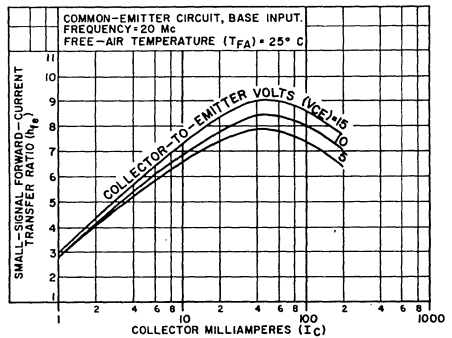
92CS-11631

Fig. 4 - Typical output characteristics.



92CS-11170RI

Fig. 5 - Typical collector-cutoff-current characteristics.



92CS-11628

Fig. 6 - Typical small-signal beta characteristics.

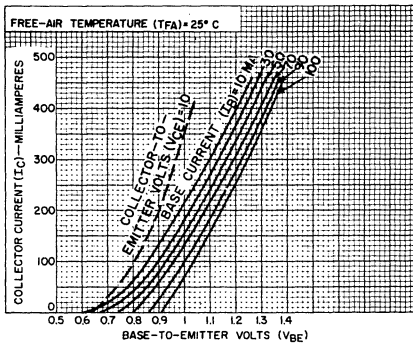


Fig. 7— Typical transfer characteristics.

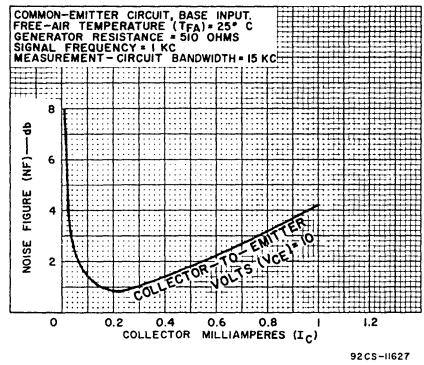


Fig. 8— Typical audio-frequency noise-figure characteristic.

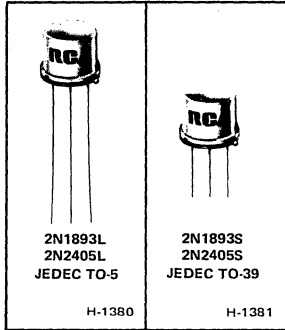
#### TERMINAL CONNECTIONS

- Lead 1 — Emitter
- Lead 2 — Base
- Lead 3 — Collector, Case



# Power Transistors

**2N1893**  
**2N2405**



## Medium-Power Silicon N-P-N Planar Transistors

For Small-Signal Applications  
In Industrial and Commercial Equipment

**Features:**

- For operation at junction temperature up to 200°C
- Planar construction for low noise and low leakage
- Low output capacitance

These devices are available with either 1½-inch leads (TO-5 package) or ½-inch leads (TO-39 package). The longer-lead versions are specified by suffix "L" after the type number; the shorter-lead versions are specified by suffix "S" after the type number.

RCA-2N2405<sup>▲</sup> and 2N1893 are silicon n-p-n planar transistors intended for a variety of small-signal and medium-power applications. They feature exceptionally high collector-to-emitter sustaining voltage, low leakage characteristics, high switching speeds, and high pulse beta ( $h_{FE}$ ).

RCA-2N2405 is a direct replacement for type 2N1893 for most applications. In addition, the 2N2405 has higher voltage ratings, lower saturation voltages, and higher sustaining voltages than the 2N1893.

<sup>▲</sup> Formerly Dev. Type TA2235A.

**RCA-2N2405 Features:**

- Minimum gain-bandwidth product ( $f_T$ ) of 120 MHz; useful in applications from dc to 50 MHz
- High sustaining voltage:  
 $V_{CEO}(sus) = 90$  V min.
- Low saturation voltages:  
 $V_{CE}(sat) = 0.5$  V max. at  $I_C = 150$  mA  
 $V_{BE}(sat) = 1.1$  V max. at  $I_C = 150$  mA

**MAXIMUM RATINGS, Absolute-Maximum Values:**

	2N2405	2N1893		
*COLLECTOR-TO-BASE VOLTAGE . . . . .	$V_{CBO}$	120	120	V
COLLECTOR-TO-EMITTER SUSTAINING VOLTAGE:				
With external base-to-emitter resistance ( $R_{BE}$ ) $\leq 10 \Omega$ . . . . .	$V_{CER}(sus)$	140	100	V
With base-emitter junction reverse-biased . . . . .	$V_{CEX}(sus)$	120 <sup>●</sup>	120	V
* With base open . . . . .	$V_{CEO}(sus)$	90	80	V
*EMITTER-TO-BASE VOLTAGE . . . . .	$V_{EBO}$	7	7	V
*COLLECTOR CURRENT . . . . .	$I_C$	1	0.5	A
*TRANSISTOR DISSIPATION:	$P_T$			
At case temperatures up to 25°C . . . . .		5	3	W
At free-air temperatures up to 25°C . . . . .		1	0.8	W
At temperatures above 25°C . . . . .		See Figs. 1 and 2		
*TEMPERATURE RANGE:				
Storage and operating (Junction) . . . . .		← -65 to +200 →		°C
*LEAD TEMPERATURE (During soldering):				
At distance from seating plane for 10 s max.				
$\geq 1/16$ in. (1.58 mm) for 2N1893 and				
$\geq 1/32$ in. (0.8 mm) for 2N2405 . . . . .		← 255 →		°C

\* In accordance with JEDEC registration data format (JS-9 RDF-2)

●  $R_{BE} = 500 \Omega$  (2N2405)

ELECTRICAL CHARACTERISTICS, Case Temperature ( $T_C$ ) = 25°C Unless Otherwise Specified

CHARACTERISTIC	SYMBOL	TEST CONDITIONS						LIMITS				UNITS
		DC Collector Voltage (V)		DC Emitter Voltage (V)	DC Current (mA)			Type 2N2405		Type 2N1893		
		$V_{CB}$	$V_{CE}$	$V_{EB}$	$I_C$	$I_E$	$I_B$	Min.	Max.	Min.	Max.	
* Collector-Cutoff Current: $T_C = 150^\circ\text{C}$	$I_{CBO}$	90 90				0 0	- -	0.01 10	- -	0.01 15	$\mu\text{A}$	
* Emitter-Cutoff Current	$I_{EBO}$			5	0		-	0.01	-	0.01	$\mu\text{A}$	
* Collector-to-Emitter Sustaining Voltage: With base open	$V_{CE0(sus)}$				100° 30°	0 0	90 90	- -	- 80	- -	V	
* With external base-to-emitter resistance ( $R_{BE}$ ) = 10 $\Omega$ ( $R_{BE}$ ) = 500 $\Omega$	$V_{CEr(sus)}$				100° 100°		140 120	- -	100 -	- -	V	
* Collector-to-Base Breakdown Voltage	$V_{(BR)CBO}$				0.1	0	120	-	120	-	V	
* Emitter-to-Base Breakdown Voltage	$V_{(BR)EBO}$				0	0.1	7	-	7	-	V	
* Collector-to-Emitter Saturation Voltage	$V_{CE(sat)}$				150° 50°	15 5	- -	0.5 0.2	- -	5 1.2	V	
* Base-to-Emitter Saturation Voltage	$V_{BE(sat)}$				150° 50°	15 5	- -	1.1 0.9	- -	1.3 0.9	V	
* DC Forward-Current Transfer Ratio	$h_{FE}$	10 10 10			150° 10° 0.1		60 35 -	200 -	40 35 20	120 -		
* $T_C = -55^\circ\text{C}$	$h_{FE}$	10 10			10 10		20 -	- -	- 20	- -		
* Small-Signal Forward-Current Transfer Ratio: $f = 1$ kHz 1 kHz 1 kHz 20 MHz 20 MHz	$h_{fe}$	5 5 10 10 10			1 5 5 50 50		- 50 -	- 275 -	30 -	100 -		
* Input Resistance (at $f = 1$ kHz)	$h_{ib}$	5 10			1 5		24 4	34 8	20 4	30 8	$\Omega$	
* Voltage-Feedback Ratio (at $f = 1$ kHz)	$h_{rb}$	5 10			1 5		- -	$3 \times 10^{-4}$ $3 \times 10^{-4}$	- -	$1.25 \times 10^{-4}$ $1.5 \times 10^{-4}$		
* Output Conductance (at $f = 1$ kHz)	$h_{ob}$	5 10			1 5		- -	0.5 0.5	- -	0.5 0.5	$\mu\text{mho}$	
* Output Capacitance	$C_{obo}$	10				0	-	15	-	15	pF	
* Input Capacitance	$C_{ibo}$			0.5	0		-	80	-	85	pF	
* Noise Figure (Wide-Band) Generator resistance ( $R_G$ ) = 500 $\Omega$ Circuit Bandwidth (BW) = 15 kHz Reference signal frequency = 1 kHz	NF	10			0.3		-	6	-	-	dB	
* Thermal Resistance: Junction-to-case Junction-to-ambient	$\theta_{J-C}$ $\theta_{J-A}$							- 35 175	- -	58.3 219	$^\circ\text{C/W}$	

• Pulsed. Pulse duration = 300  $\mu\text{sec}$  max.; duty factor  $\leq 2\%$ .

\* In accordance with JEDEC registration data format (JS-9 RDF-2).

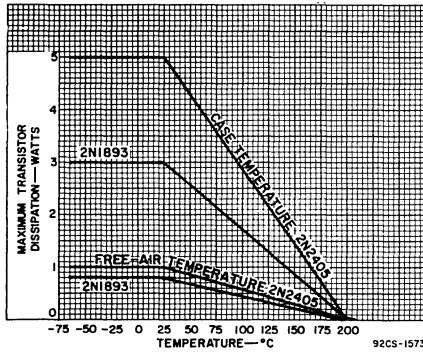


Fig.1 - Dissipation derating curves for types 2N2405 and 2N1893.

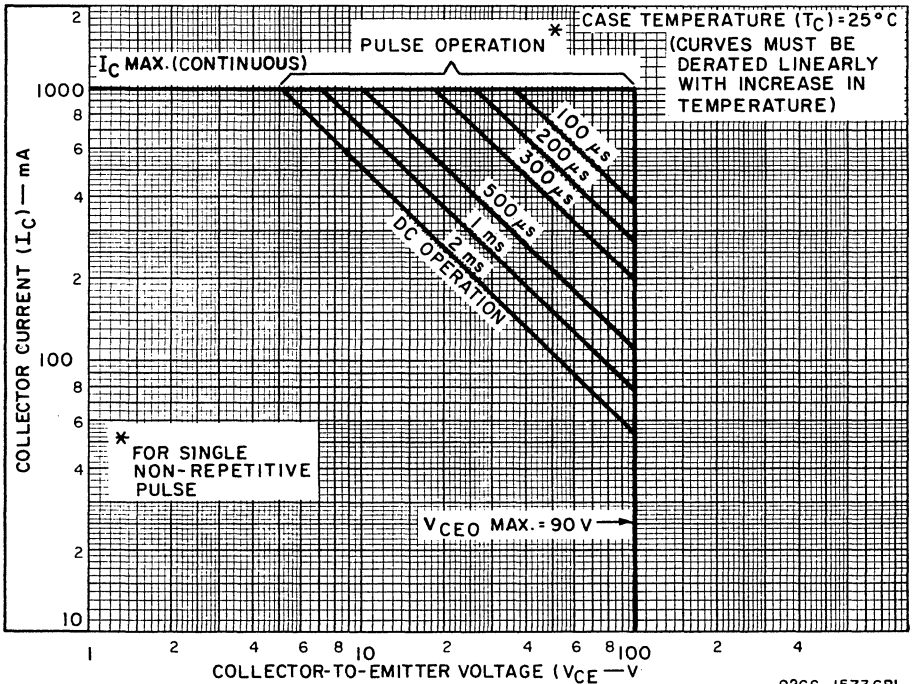


Fig.2 - Maximum operating areas for type 2N2405.

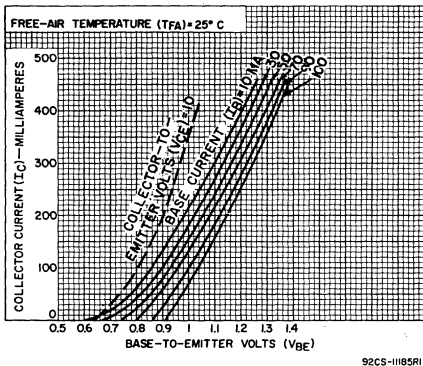


Fig. 3 - Typical transfer characteristics for types 2N2405 and 2N1893.

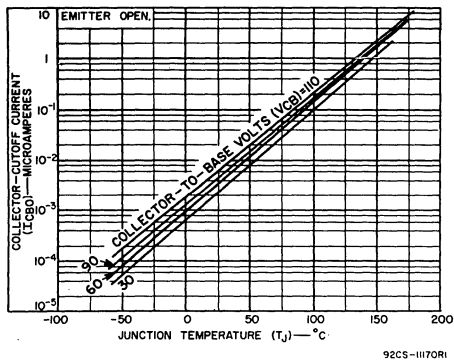


Fig. 4 - Typical cutoff characteristics for types 2N2405 and 2N1893.

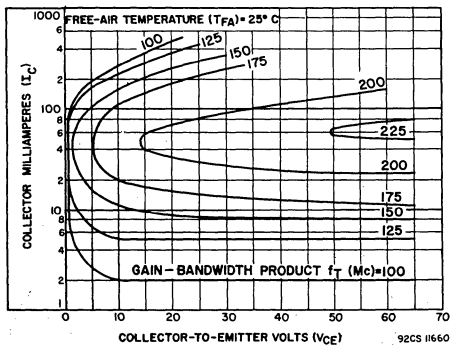


Fig. 5 - Typical gain bandwidth product characteristics for types 2N2405 and 2N1893.

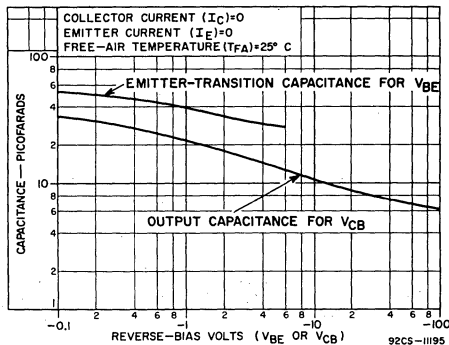


Fig. 6 - Typical capacitance characteristics for types 2N2405 and 2N1893.

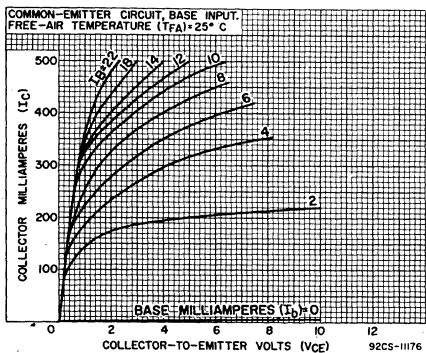


Fig. 7 - Typical collector characteristics at 25°C for type 2N2405.

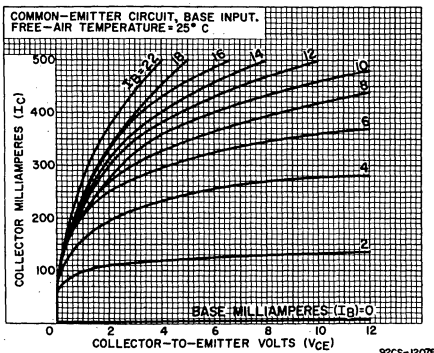
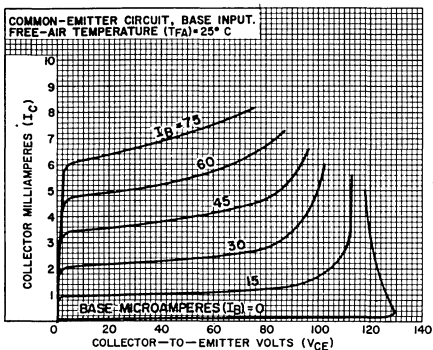
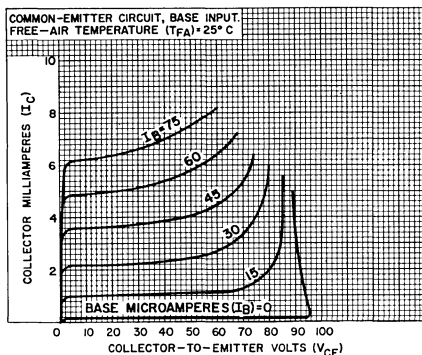


Fig. 8 - Typical collector characteristics at 25°C for type 2N1893.



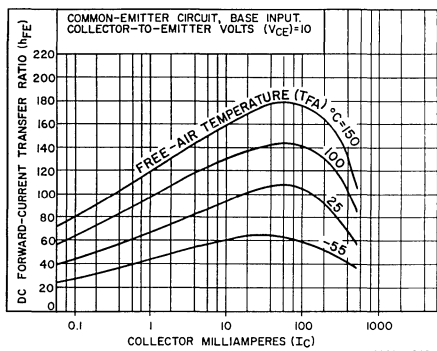
92CS 11647

Fig.9 - Typical collector characteristics at 25°C for type 2N2405.



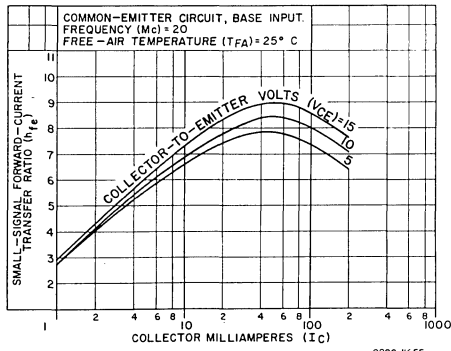
92CS 11653

Fig.10 - Typical collector characteristics at 25°C for type 2N1893.



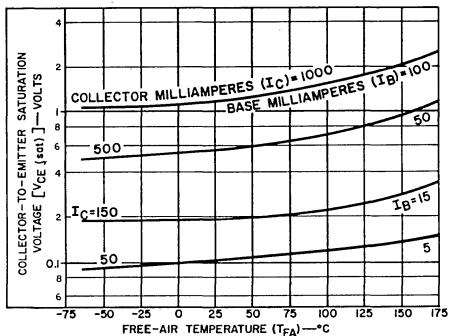
92CS-11648

Fig.11 - Typical dc-beta characteristics for types 2N2405 and 2N1893.



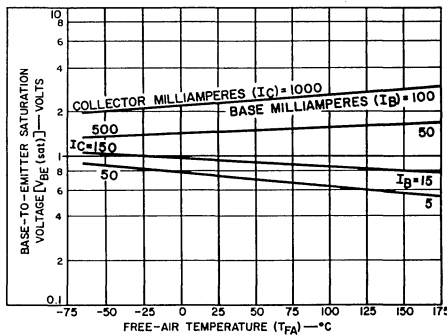
92CS 11655

Fig.12 - Typical small-signal beta characteristics for types 2N2405 and 2N1893.



92CS 11652

Fig.13 - Typical saturation characteristics for types 2N2405 and 2N1893.



92CS 11651

Fig.14 - Typical saturation characteristics for types 2N2405 and 2N1893.

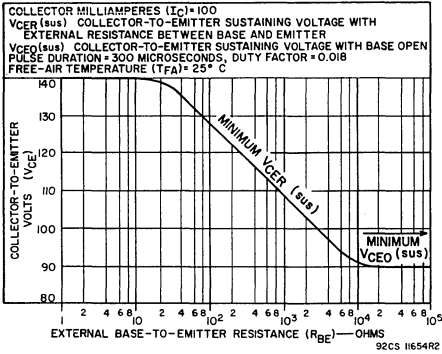


Fig.15 - Sustaining voltage characteristic for type 2N2405.

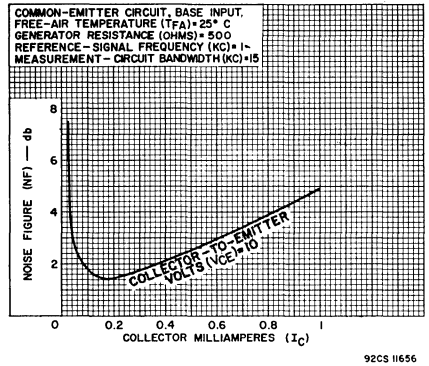


Fig.16 - Typical wide-band noise characteristic for type 2N2405.

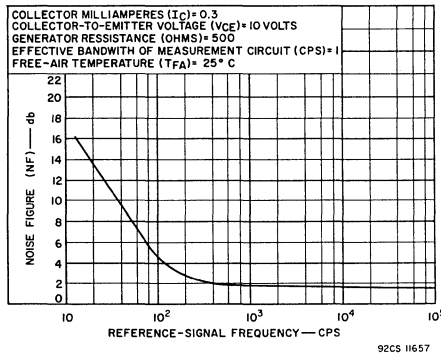


Fig.17 - Typical narrow-band noise characteristic for type 2N2405.

TERMINAL CONNECTIONS

- Lead 1 - Emitter
- Lead 2 - Base
- Lead 3 - Collector, Case





# Power Transistors

## 2N2015 2N2016

RCA 2N2015 and 2N2016 are diffused-junction power transistors of the silicon n-p-n type having very high power-dissipation capabilities (150 watts). The 2N2015 and 2N2016 are particularly useful in power-switching circuits such as those employed in dc-to-dc converters, inverters, choppers, and relay-control equipment. They are also extremely useful in oscillator, regulator, and pulse-amplifier circuits, and as class A and class B push-pull amplifiers for af and servo applications.

**Maximum Ratings, Absolute-Maximum Values:**

	2N2015	2N2016		
COLLECTOR-TO-BASE VOLTAGE.	100	130	max.	volts
COLLECTOR-TO-EMITTER VOLTAGE:				
With base open				
(Sustaining voltage)	50	65	max.	volts
EMITTER-TO-BASE VOLTAGE.	10	10	max.	volts
COLLECTOR CURRENT.	10	10	max.	amp
EMITTER CURRENT.	-13	-13	max.	amp
BASE CURRENT.	6	6	max.	amp
TRANSISTOR DISSIPATION:*				
At case temperatures				
up to 25° C.	150	150	max.	watts
At other case				
temperatures	See Fig.1			
TEMPERATURE RANGE:				
Operating and Storage.	-65 to +200			°C
LEAD TEMPERATURE,				
1/16" ± 1/32" from case,				
for immersion in molten				
solder for 10 sec. max.	235	235	max.	°C

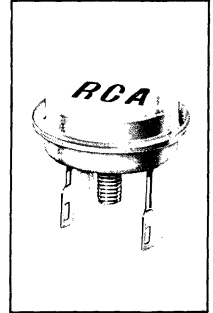
**Typical Characteristics of 2N2015 and 2N2016 at a Case Temperature<sup>c</sup> of 25° C:**

Collector-to-Base Capacitance, C <sub>ob</sub> :	
(V <sub>CB</sub> = 40 volts)	400 μf
Thermal Time Constant, T <sub>1</sub> .	30 msec
Forward Current-Transfer-Ratio	
Cutoff Frequency, f <sub>αc</sub> .	25 Kc

**TERMINAL CONNECTIONS**

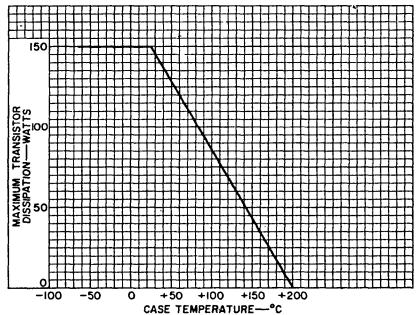
- Lead 1 - Emitter
- Lead 2 - Collector, Case
- Lead 3 - Base

### High-Power Types for Military and Industrial Applications



JEDEC TO-36

- for operation at high junction temperatures - up to 200° C
- very high dissipation rating - 150 watts
- very low thermal resistance, junction - to - case - 1.17° C/Watt
- very low saturation resistance - 0.25 ohm max. at I<sub>C</sub> = 5 amp, I<sub>B</sub> = 0.5 amp
- JEDEC TO-36 single-ended stud-type package with cold-weld hermetic seals



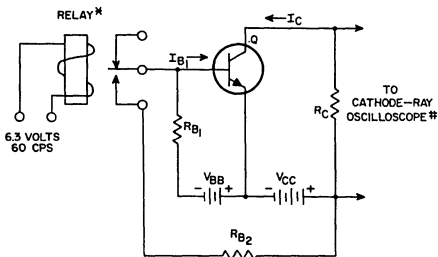
92CS-11089

Fig. 1 - Rating Chart for Types 2N2015 and 2N2016.

**ELECTRICAL CHARACTERISTICS**

Case temperature = 25° C unless otherwise specified.

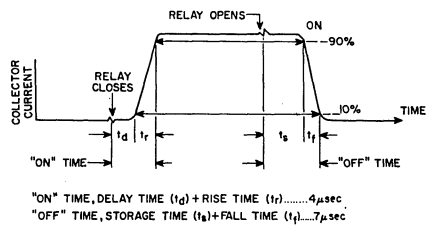
Characteristic	Symbol	TEST CONDITIONS					LIMITS				Units
		DC Collector-to-Base Voltage	DC Collector-to-Emitter Voltage	DC Emitter-to-Base Voltage	DC Collector Current	DC Base Current	Type 2N2015		Type 2N2016		
		$V_{CB}$	$V_{CE}$	$V_{EB}$	$I_C$	$I_B$	Min.	Max.	Min.	Max.	
Collector-Cutoff Current ( $I_{E=0}$ ) at case temperature of: 25° C 150° C	$I_{CBO}$	30 30					-	50	-	50	$\mu A$ mA
Emitter-Cutoff Current	$I_{EBO}$			10			-	50	-	50	$\mu A$
DC Forward-Current Transfer Ratio	$h_{FE}$		4 4		5 10		15 7.5	50	15 7.5	50	
Collector-to-Emitter Saturation Resistance	$R_s$				5	0.5	-	0.25	-	0.25	ohm
Base-to-Emitter Voltage	$V_{BE}$		4		5		-	2.2	-	2.2	volts
Collector-to-Emitter Voltage: Sustaining voltage with base open	$V_{CE0}$ (sus)				0.2	0	-	50	-	65	volts
With reverse bias between emitter and base	$V_{CEX}$			1.5	2 mA		-	100	-	130	volts
Thermal Resistance Junction-to-case	$R_T$						-	1.17	-	1.17	°C/W



\*C.R. CLARE TYPE HGP-1028 OR EQUIVALENT

# TEKTRONIX TYPE 545 OR EQUIVALENT

- Collector Supply Voltage ( $V_{CC}$ ) . . . . . 24 volts
- DC Base Bias Voltage ( $V_{BB}$ ) . . . . . 6 volts
- \*On\* DC Collector Current . . . . . 10 amperes
- \*Turn-On\* Base Current ( $I_{B1}$ ) . . . . . 2 amperes



\*On\* TIME, DELAY TIME ( $t_d$ ) + RISE TIME ( $t_r$ ) . . . . . 4  $\mu$ sec  
 \*Off\* TIME, STORAGE TIME ( $t_s$ ) + FALL TIME ( $t_f$ ) . . . . . 7  $\mu$ sec

- Base Resistance ( $R_{B1}$ ) . . . . . 10 ohms
- Base Resistance ( $R_{B2}$ ) . . . . . 10 ohms
- Collector Resistance ( $R_C$ ) . . . . . 2 ohms
- Switching Time:  
 \*On\* Time  
 [Delay time ( $t_d$ ) + Rise time ( $t_r$ )] . . . . . 4  $\mu$ sec  
 \*Off\* Time  
 [Storage time ( $t_s$ ) + Fall time ( $t_f$ )] . . . . . 7  $\mu$ sec

Fig. 2—Pulse-Response Test Circuit for Types 2N2015 and 2N2016.

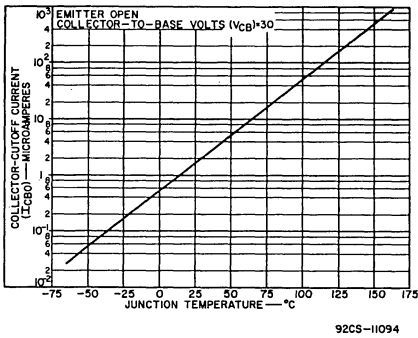


Fig. 3 - Typical Operation Characteristic for Types 2N2015 and 2N2016.

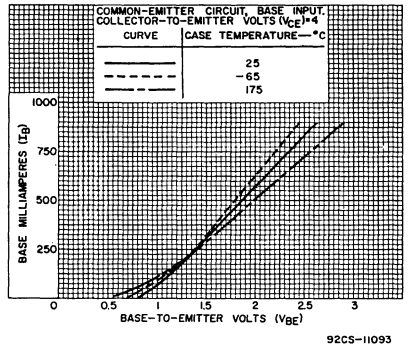


Fig. 5 - Typical Input Characteristics for Types 2N2015 and 2N2016.

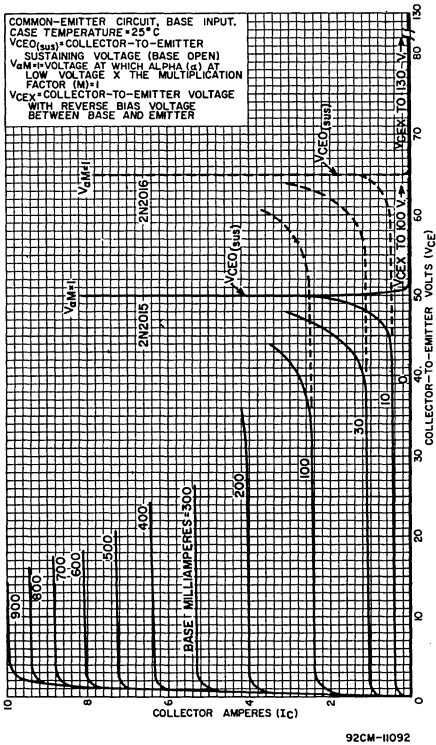


Fig. 4 - Typical Collector Characteristics for Types 2N2015 and 2N2016.

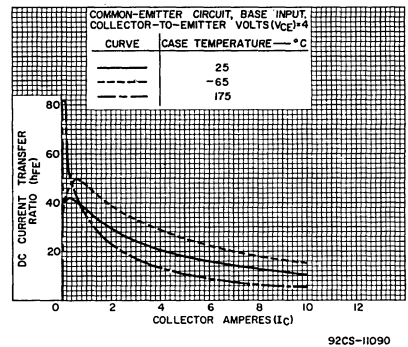


Fig. 6 - Typical Operation Characteristics for Types 2N2015 and 2N2016.

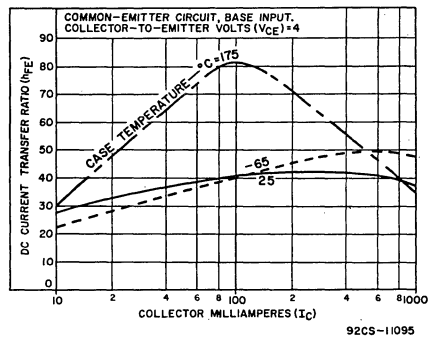
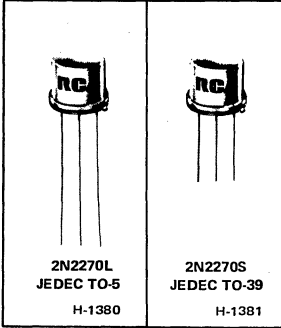


Fig. 7 - Typical Operation Characteristics for Types 2N2015 and 2N2016.



# Power Transistors

## 2N2270



### Silicon N-P-N Planar Transistor

General-Purpose Type for Small-Signal,  
Medium-Power Applications

*Features:*

- Minimum gain-bandwidth product = 100 MHz; useful in applications from dc to 20 MHz
- Operation at high junction temperatures
- Planar construction for low-noise and low-leakage characteristics
- Very low output capacitance

These devices are available with either 1½-inch leads (TO-5 package) or ½-inch leads (TO-39 package). The longer-lead versions are specified by suffix "L" after the type number; the shorter-lead versions are specified by suffix "S" after the type number.

RCA-2N2270 is a silicon n-p-n planar transistor intended for a wide variety of small-signal and medium-power applications in military and industrial equipment. It features exceptionally

low noise and leakage characteristics, and very low output capacitance.

**MAXIMUM RATINGS, Absolute-Maximum Values:**

* COLLECTOR-TO-BASE VOLTAGE .....	$V_{CB0}$	60	V
COLLECTOR-TO-EMITTER VOLTAGE:			
With external base-to-emitter resistance ( $R_{BE}$ ) $\leq 10 \Omega$ .....	$V_{CER}$	60	V
With base open .....	$V_{CEO}$	45	V
* EMITTER-TO-BASE VOLTAGE .....	$V_{EBO}$	7	V
* COLLECTOR CURRENT .....	$I_C$	1	A
* TRANSISTOR DISSIPATION:	$P_T$		
At case temperatures up to 25°C .....		5	W
At case temperatures above 25°C .....		See Fig. 1	
At free-air temperatures up to 25°C .....		1	W
At free-air temperatures above 25°C .....		See Fig. 1	
* TEMPERATURE RANGE:			
Storage and operating (Junction) .....		-65 to +200	°C
* LEAD TEMPERATURE (During soldering):			
At distance $\geq 1/16$ in. (1.58 mm) from seating plane for 10 s max		230	°C

\* In accordance with JEDEC registration data format (JS-6 RDF-1)

ELECTRICAL CHARACTERISTICS, At Case Temperature ( $T_C$ ) = 25°C unless otherwise specified

CHARACTERISTIC	SYMBOL	VOLTAGE V			CURRENT mA			LIMITS		UNITS
		$V_{CB}$	$V_{CE}$	$V_{EB}$	$I_C$	$I_E$	$I_B$	MIN.	MAX.	
* Collector Cutoff Current: With emitter open At $T_C = 150^\circ\text{C}$	$I_{CBO}$	60			0			—	0.05	$\mu\text{A}$
		60			0			—	50	
* Emitter Cutoff Current	$I_{EBO}$			5	0			—	0.1	$\mu\text{A}$
* Collector-to-Base Breakdown Voltage	$V_{(BR)CBO}$				0.05 $\mu\text{A}$	0		60	—	V
* Emitter-to-Base Breakdown Voltage	$V_{(BR)EBO}$				0	0.1		7	—	V
* Collector-to-Emitter Sustaining Voltage: With external base-to- emitter resistance ( $R_{BE}$ ) = 10 $\Omega$	$V_{CER(sus)}$				100 <sup>a</sup>			60	—	V
With base open	$V_{CEO(sus)}$				100 <sup>a</sup>	0		45	—	
* Collector-to-Emitter Saturation Voltage	$V_{CE(sat)}$				150 <sup>a</sup>		15	—	0.9	V
* Base-to-Emitter Saturation Voltage	$V_{BE(sat)}$				150 <sup>a</sup>		15	—	1.2	V
* DC Forward Current Transfer Ratio	$h_{FE}$		10 10		150 <sup>a</sup> 1			50 30	200 —	
* Small-Signal Forward Current Transfer Ratio: f = 1 kHz f = 20 MHz	$h_{fe}$		10 10		5 50			50 5	275 —	
* Gain-Bandwidth Product	$f_T$		10		50			100	—	MHz
* Noise Figure: Generator resistance ( $R_G$ ) = 1 k $\Omega$ Circuit bandwidth (BW) = 1 Hz f = 1 kHz	NF		10 ( $V_{cc}$ )		0.3			—	10	dB
* Output Capacitance	$C_{ob}$	10			0			—	15	pF
* Input Capacitance	$C_{ib}$			0.5	0			—	80	pF
* Saturated Switching Time (See Fig. 8)	$t_d+t_r+t_s+t_f$							—	30	ns
* Thermal Resistance: Junction-to-case	$R_{\theta JC}$							—	35	$^\circ\text{C/W}$
Junction-to-free air	$R_{\theta FA}$							—	175	

\* In accordance with JEDEC registration data format (JS-6 RDF-1)

<sup>a</sup> Pulsed: Pulse duration = 300  $\mu\text{s}$ ; duty factor = 1.8%

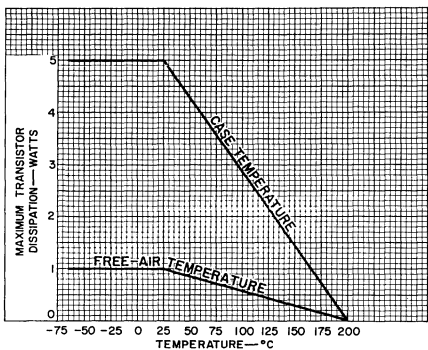


Fig. 1 - Rating chart.

92CS-11172R1

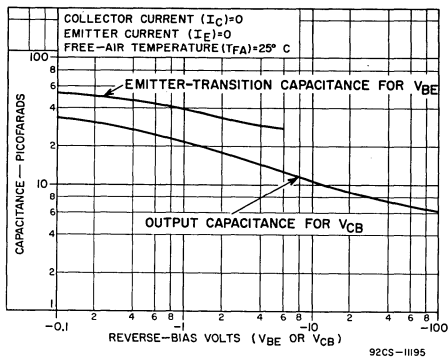


Fig. 2 - Typical emitter-transition-capacitance and output-capacitance characteristics.

92CS-11195

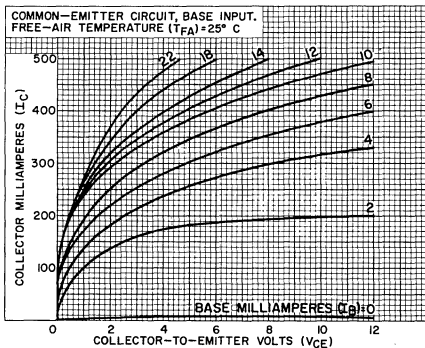


Fig. 3 - Typical collector characteristics.

92CS-11189

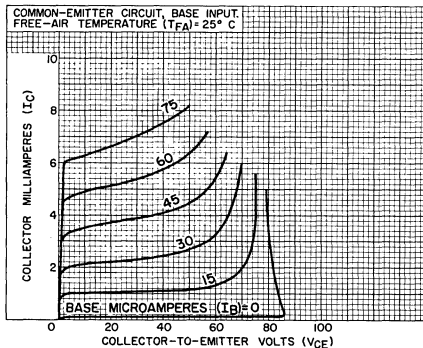


Fig. 4 - Typical collector characteristics.

92CS-11175R1

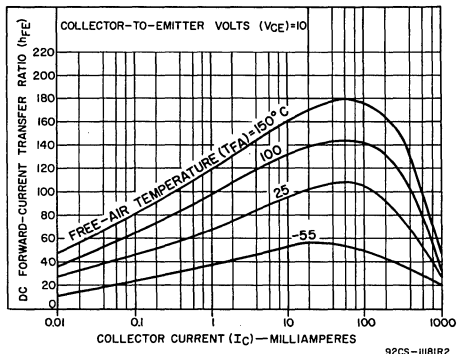


Fig. 5 - Typical dc forward-current transfer ratio characteristics.

92CS-11181R2

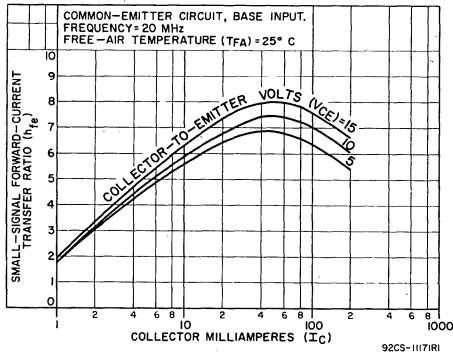


Fig. 6 - Typical small-signal forward-current transfer ratio characteristics.

92CS-11171R1

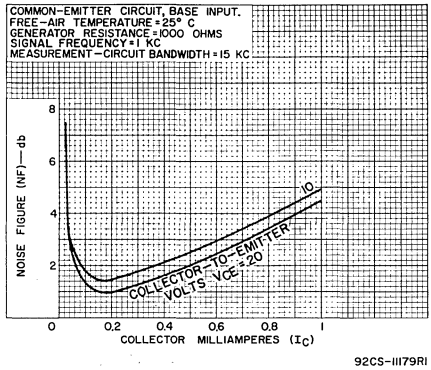
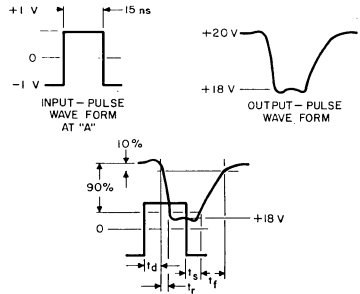
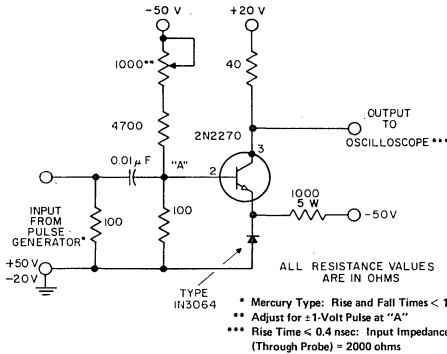


Fig. 7 - Typical of noise-figure characteristics.



92CS-20295

Fig. 8 - Test circuit for measurement of saturated switching time and associated waveforms.

**TERMINAL CONNECTIONS**

- Lead 1 - Emitter
- Lead 2 - Base
- Lead 3 - Collector, Case

**RCA**  
Solid State  
Division

# RF Power Transistors

## 2N2857

RCA-2N2857 is a double-diffused epitaxial planar transistor of the silicon n-p-n type. It is extremely useful in low-noise-amplifier, oscillator, and converter applications at frequencies up to 500 MHz in the common-emitter configuration, and up to 1200 MHz in the common-base configuration.

The 2N2857 utilizes a hermetically sealed four-lead JEDEC TO-72 package. All active elements of the transistor are insulated from the case, which may be grounded by means of the fourth lead in applications requiring shielding of the device.

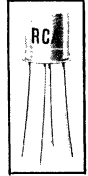
### Maximum Ratings, Absolute-Maximum Values:

COLLECTOR-TO-BASE VOLTAGE, $V_{CB0}$ . . . . .	30 max.	V
COLLECTOR-TO-EMITTER VOLTAGE, $V_{CE0}$ . . . . .	15 max.	V
EMITTER-TO-BASE VOLTAGE, $V_{EB0}$ . . . . .	2.5 max.	V
COLLECTOR CURRENT, $I_C$ . . . . .	40 max.	mA
TRANSISTOR DISSIPATION, Pt:		
At case temp (up to 25°C) . . . . .	300 max.	mW
temperatures* (above 25°C) . . . . .	Derate at 1.72	mW/°C
At ambient (up to 25°C) . . . . .	200 max.	mW
temperatures (above 25°C) . . . . .	Derate at 1.14	mW/°C
TEMPERATURE RANGE:		
Storage and Operating (Junction) . . . . .	-65 to +200	°C
LEAD TEMPERATURE (during soldering):		
At distances $\geq 1/32$ inch from seating surface for 10 seconds max . . . . .	265 max.	°C

\* Measured at center of seating surface.

# SILICON N-P-N EPITAXIAL PLANAR TRANSISTOR

For UHF Applications  
in Industrial and Military Equipment



JEDEC  
TO-72

### FEATURES

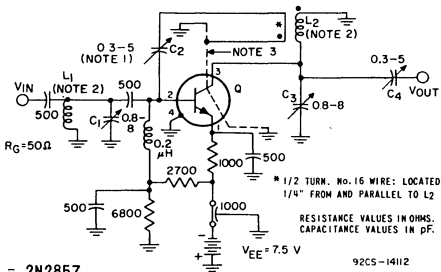
- high gain-bandwidth product— $f_T = 1000$  MHz min.
- high converter (450-to-30 MHz) gain— $G_c = 15$  dB typ. for circuit bandwidth of approximately 2 MHz
- high power gain as neutralized amplifier— $G_{pe} = 12.5$  dB min. at 450 MHz for circuit bandwidth of 20 MHz
- high power output as uhf oscillator— $P_o = \begin{cases} 30 \text{ mW min., } 40 \text{ mW typ. at } 500 \text{ MHz} \\ 20 \text{ mW typ., at } 1 \text{ GHz} \end{cases}$
- low device noise figure— $NF = \begin{cases} 4.5 \text{ dB max. as } 450 \text{ MHz amplifier} \\ 7.5 \text{ dB typ. as } 450\text{-to-}30 \text{ MHz converter} \end{cases}$
- low collector-to-base time constant— $r_b' C_c = 7$  ps typ.
- low collector-to-base feedback capacitance— $C_{cb} = 0.6$  pF typ.

(D) INTERCHANGE THE CONNECTIONS TO THE SIGNAL GENERATOR AND THE RF-VOLTMETER. (E) WITH SUFFICIENT SIGNAL APPLIED TO THE OUTPUT TERMINALS OF THE AMPLIFIER, ADJUST  $C_2$  FOR A MINIMUM INDICATION AT THE INPUT. (F) REPEAT STEPS (A), (B), AND (C) TO DETERMINE IF RETUNING IS NECESSARY.

NOTE 2:  $L_1$  &  $L_2$  — SILVER-PLATED BRASS ROD, 1-1/2" LONG x 1/4" DIA. INSTALL AT LEAST 1/2" FROM NEAREST VERTICAL CHASSIS SURFACE.

NOTE 3: EXTERNAL INTERLEAD SHIELD TO ISOLATE THE COLLECTOR LEAD FROM THE EMITTER AND BASE LEADS.

Fig. 1—Neutralized amplifier circuit used to measure 450 MHz power gain and noise figure for type 2N2857.



Q = 2N2857

NOTE 1: (NEUTRALIZATION PROCEDURE): (A) CONNECT A 450-MHz SIGNAL GENERATOR (WITH  $R_G = 50 \Omega$ ) TO THE INPUT TERMINALS OF THE AMPLIFIER. (B) CONNECT A 50- $\Omega$  RF VOLTMETER ACROSS THE OUTPUT TERMINALS OF THE AMPLIFIER. (C) APPLY  $V_{EE}$ , AND WITH THE SIGNAL GENERATOR ADJUSTED FOR 5 mV OUTPUT FROM THE AMPLIFIER, TUNE  $C_1$ ,  $C_3$ , AND  $C_4$  FOR MAXIMUM OUTPUT.



ELECTRICAL CHARACTERISTICS, At an Ambient Temperature,  $T_A = 25^\circ C$ , Unless Otherwise Specified

Characteristic	Symbol	Frequency $f$	TEST CONDITIONS						LIMITS			Units		
			DC Collector-to-Base Voltage $V_{CB}$	DC Collector-to-Emitter Voltage $V_{CE}$	DC Emitter-to-Base Voltage $V_{EB}$	DC Emitter Current $I_E$	DC Base Current $I_B$	DC Collector Current $I_C$	Type 2N2857					
			MHz	V	V	V	mA	mA	mA	Min.	Typ.		Max.	
Collector-Cutoff Current	$I_{CBO}$	$T_A = 25^\circ C$ $T_A = 150^\circ C$	15 15				0 0				- -	- -	10 1.0	nA $\mu A$
Collector-to-Base Breakdown Voltage	$BV_{CBO}$					0		0.001		30	-	-	-	V
Collector-to-Emitter Breakdown Voltage	$BV_{CEO}$							0		15	-	-	-	V
Emitter-to-Base Breakdown Voltage	$BV_{EBO}$					-0.01		0		2.5	-	-	-	V
Static Forward-Current Transfer Ratio	$h_{FE}$			1				3		30	-	150		
Small-Signal Forward-Current Transfer Ratio	$h_{fe}$	$0.001^c$ $100^c$		6 6				2 5		50 10	- -	220 19		
Collector-to-Base Feedback Capacitance	$C_{cb}$	0.1 to 1 <sup>b</sup>	10			0				-	0.6	1.0		pF
Input Capacitance	$C_{ib}$	0.1 to 1 <sup>d</sup>			0.5			0		-	1.4	-		pF
Collector-to-Base Time Constant	$r_b' C_c$	31.9 <sup>c</sup>	6			-2				4	7	15		ps
Small-Signal, Common-Emitter Power Gain in Neutralized Amplifier Circuit (See Fig. 1)	$G_{pe}$	450 <sup>c</sup>		6				1.5		12.5	-	19		dB
Power Output as Oscillator (See Fig. 2)	$P_o$	$\geq 500^a$	10			-12				30	-	-		mW
UHF Device Noise Figure	NF	450C, d, f		6				1.5		-	3.8	4.5		dB
UHF Measured Noise Figure	NF	450C, d		6				1.5		-	-	5.0		dB
VHF Device Noise Figure	NF	60B, d		6				1		-	2.2	-		dB

a Fourth lead (case) not connected

b Three-terminal measurement: Lead No. 1 (Emitter) and lead No. 4 (Case) connected to guard terminal.

c Fourth lead (case) grounded.

d Generator resistance,  $R_g = 50$  ohms.

e Generator resistance,  $R_g = 400$  ohms.

f Device noise figure is approximately 0.5 dB lower than the measured noise figure. The difference is due to the insertion loss at the input of the test circuit (0.25 dB) and the contribution of the following stages in the test setup (0.25 dB).

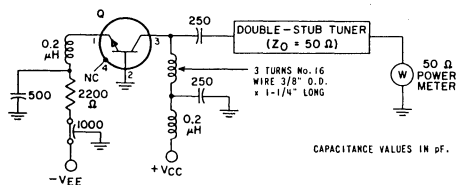


Fig. 2 - Oscillator circuit used to measure 500-MHz power output for type 2N2857.

92CS-14111

Q = 2N2857

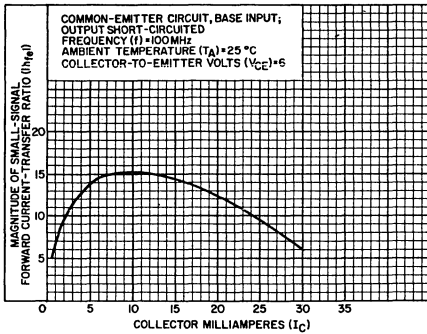


Fig. 3 - Small-signal beta characteristic for type 2N2857.

92CS-14169

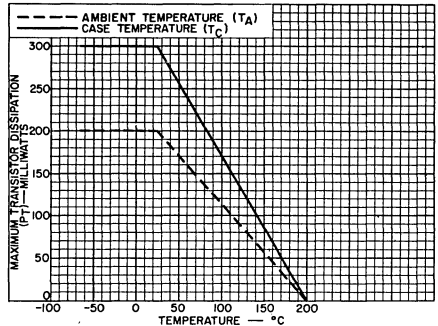


Fig. 4 - Rating chart for type 2N2857.

92CS-12489R

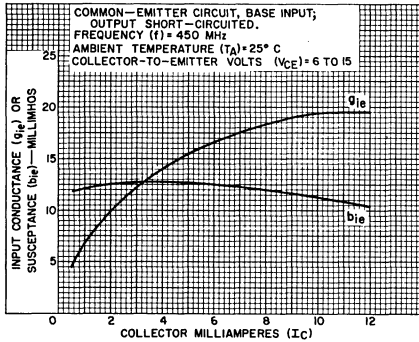


Fig. 5 - Input admittance ( $y_{ie}$ ).

92CS-12150R1

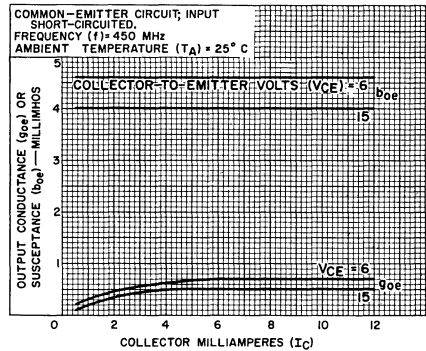


Fig. 6 - Output admittance ( $y_{oe}$ ).

92CS-12148R1

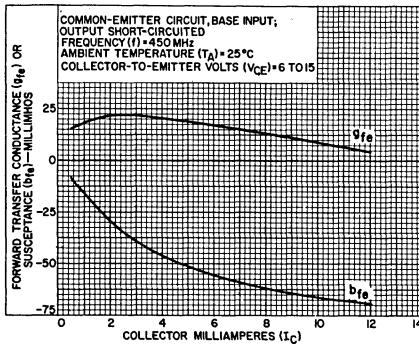


Fig. 7 - Forward transadmittance ( $y_{fe}$ ).

92CS-12149R1

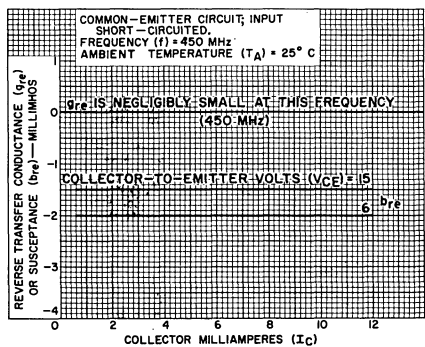


Fig. 8 - Reverse transadmittance ( $y_{re}$ ).

92CS-12154R2

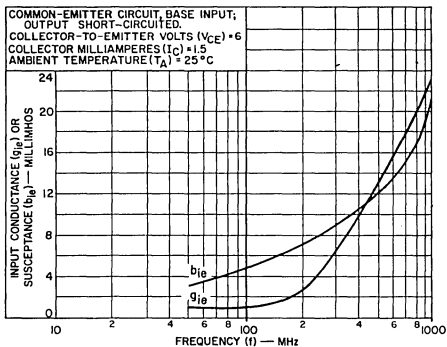


Fig. 9 - Input admittance ( $y_{ie}$ ).

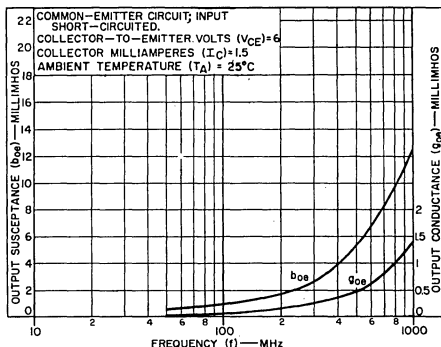


Fig. 10 - Output admittance ( $y_{oe}$ ).

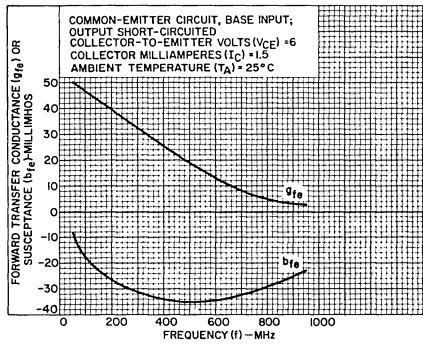


Fig. 11 - Forward transadmittance ( $y_{fe}$ ).

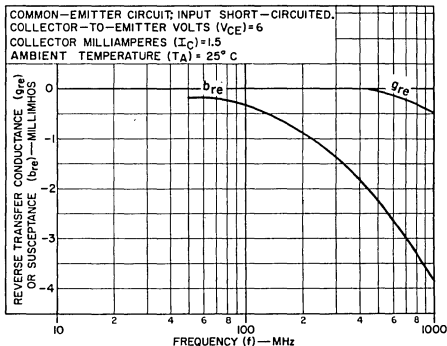


Fig. 12 - Reverse transadmittance ( $y_{re}$ ).

**TERMINAL CONNECTIONS**

- Lead 1 - Emitter
- Lead 2 - Base
- Lead 3 - Collector
- Lead 4 - Connected to case

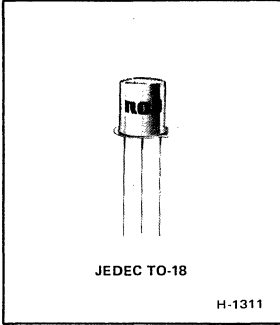


# Power Transistors

## 2N2895

## 2N2896

## 2N2897



### Silicon N-P-N Planar Transistors

General-Purpose Types for Small-Signal, and Low-to-Medium-Power Applications

*Features:*

- High minimum gain-bandwidth products useful in applications from dc to 40 MHz
- Operation at high junction temperatures
- Planar construction for low-noise and low-leakage characteristics
- Very low output capacitance
- High switching-speed capabilities (non-sat)

RCA 2N2895, 2N2896, and 2N2897 are silicon n-p-n planar transistors intended for a wide variety of small-signal and low-to-medium-power applications in military and industrial equipment.

These transistors are TO-18 versions of RCA's versatile 2N2102 family of n-p-n silicon transistors for small-signal and medium-

power military and industrial applications.

These transistors feature extremely low leakage characteristics, high pulse dc beta, high small-signal beta, very low output capacitance, and large gain-bandwidth products. Type 2N2895 also has an exceptionally low noise figure of 8 dB max.

**MAXIMUM RATINGS, Absolute-Maximum Values:**

		2N2895	2N2896	2N2897	
COLLECTOR-TO-BASE VOLTAGE	$V_{CBO}$	120	140	60	V
COLLECTOR-TO-EMITTER VOLTAGE:					
With external base-to-emitter resistance ( $R_{BE}$ ) $\leq 10 \Omega$	$V_{CER}$	80	140	60	V
With base open	$V_{CEO}$	65	90	45	V
EMITTER-TO-BASE VOLTAGE	$V_{EBO}$	7	7	7	V
COLLECTOR CURRENT	$I_C$	1	1	1	A
TRANSISTOR DISSIPATION:	$P_T$				
At case temperatures up to 25°C		1.8	1.8	1.8	W
At case temperatures above 25°C			See Fig. 1		
At free-air temperatures up to 25°C		0.5	0.5	0.5	W
At free-air temperatures above 25°C			See Fig. 1		
TEMPERATURE RANGE:					
Storage and operating (junction)			-65 to +200		°C
LEAD TEMPERATURE (During soldering):					
At distance $\geq 1/32$ in. (0.8 mm) from seating plane for 10 s max.			255		°C

ELECTRICAL CHARACTERISTICS, At Case Temperature ( $T_C$ ) = 25°C unless otherwise specified

CHARACTERISTIC	SYMBOL	TEST CONDITIONS				LIMITS						UNITS
		VOLTAGE V dc		CURRENT mA dc		2N2895		2N2896		2N2897		
		$V_{CB}$	$V_{CE}$	$I_C$	$I_B$	Min.	Max.	Min.	Max.	Min.	Max.	
Collector Cutoff Current: With emitter open	$I_{CBO}$	90				—	—	—	0.01	—	—	$\mu A$
At $T_C = 150^\circ C$		60				—	0.002	—	—	—	0.05	
Emitter Cutoff Current ( $V_{EB} = 5 V$ )	$I_{EBO}$			0		—	0.002	—	0.01	—	0.05	$\mu A$
DC Forward-Current Transfer Ratio	$h_{FE}$		10	150 <sup>a</sup>		40	120	60	200	50	200	
			10	500 <sup>a</sup>		25	—	—	—	—	—	
			10	0.1		20	—	—	—	—	—	
			10	1		—	—	35	—	35	—	
At $T_C = -55^\circ C$			10	10		20	—	20	—	—	—	
Collector-to-Base Breakdown Voltage: With emitter open	$V_{(BR)CBO}$			0.1		120	—	140	—	60	—	V
Emitter-to-Base Breakdown Voltage ( $I_E = 0.1 mA$ )	$V_{(BR)EBO}$			0		7	—	7	—	7	—	V
Collector-to-Emitter Sustaining Voltage: With base open	$V_{CEO(sus)}$			100 <sup>a</sup>	0	65	—	90	—	45	—	V
With external base-to-emitter resistance ( $R_{BE} = 10 \Omega$ )	$V_{CER(sus)}$			100 <sup>a</sup>		80	—	140	—	60	—	
Collector-to-Emitter Saturation Voltage	$V_{CE(sat)}$			150 <sup>a</sup>	15	—	0.6	—	0.6	—	1	V
Base-to-Emitter Saturation Voltage	$V_{BE(sat)}$			150 <sup>a</sup>	15	—	1.2	—	1.2	—	1.3	V
Common-Emitter, Small- Signal, Forward-Current Transfer Ratio: $f = 1 kHz$ $= 20 MHz$	$h_{fe}$		5 10	5 50		50 6	200 —	50 6	275 —	50 5	275 —	
Noise Figure: Generator resistance = 510 $\Omega$ , circuit bandwidth = 1 cps, $f = 1 kHz$	NF		10	0.3		—	8	—	—	—	—	dB
Output Capacitance: ( $I_E = 0, f = 140 kHz$ )	$C_{ob}$	10				—	15	—	15	—	15	pF
Input Capacitance: ( $V_{EB} = 0.5 V, f = 140 kHz$ )	$C_{ib}$			0		—	80	—	80	—	80	pF
Thermal Resistance: Junction-to-case	$R_{\theta JC}$					—	97	—	97	—	97	$^{\circ}C/W$
Junction-to-free air	$R_{\theta JFA}$					—	350	—	350	—	350	

<sup>a</sup> Pulsed, pulse duration = 300  $\mu s$ , duty factor = 1.8%.

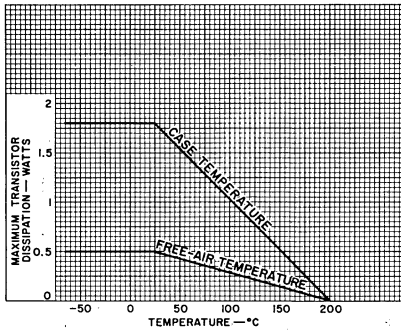


Fig. 1-Rating chart for 2N2895, 2N2896, and 2N2897.

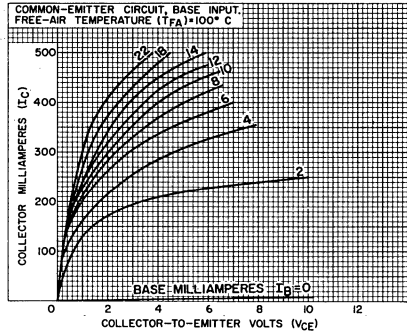


Fig. 2-Typical collector characteristics at 100°C for 2N2895.

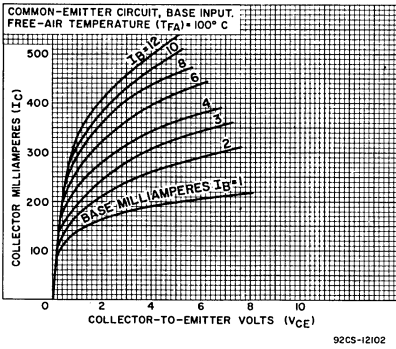


Fig. 3-Typical collector characteristics at 100°C for 2N2896 and 2N2897.

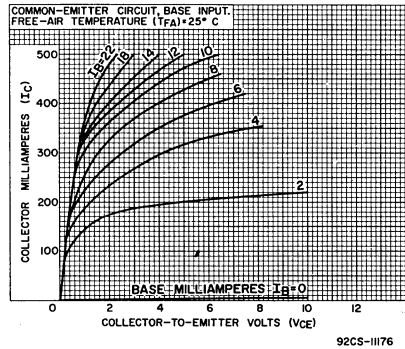


Fig. 4-Typical collector characteristics at 25°C for 2N2895.

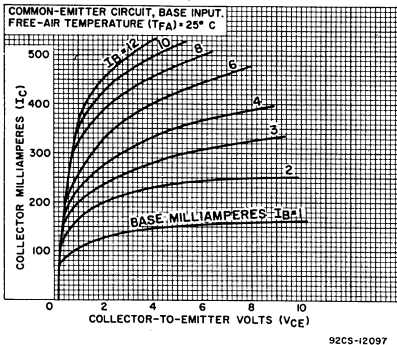


Fig. 5-Typical collector characteristics at 25°C for 2N2896 and 2N2897.

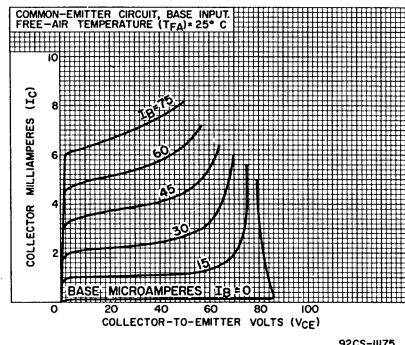


Fig. 6-Typical collector characteristics at 25°C for 2N2895.

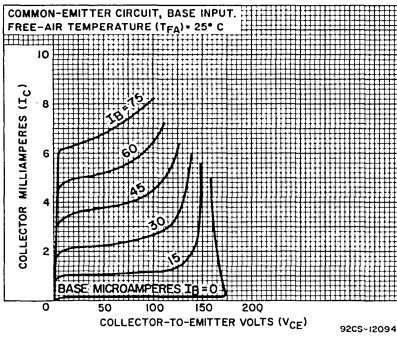


Fig. 7—Typical collector characteristics at 25°C for 2N2895.

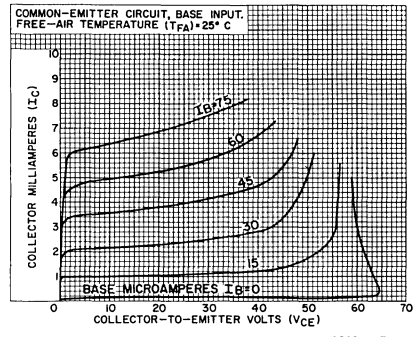


Fig. 8—Typical collector characteristics at 25°C for 2N2897.

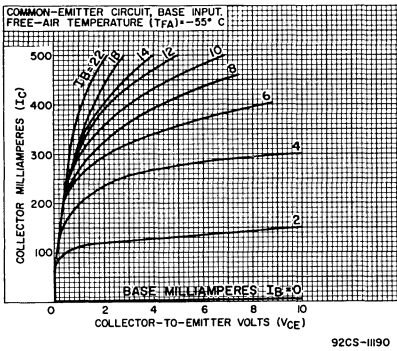


Fig. 9—Typical collector characteristics at -55°C for 2N2895.

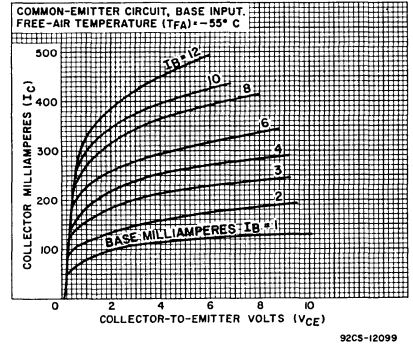


Fig. 10—Typical collector characteristics at -55°C for 2N2896 and 2N2897.

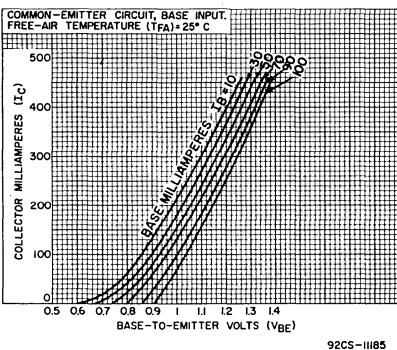


Fig. 11—Typical transfer characteristics for 2N2895 and 2N2896.

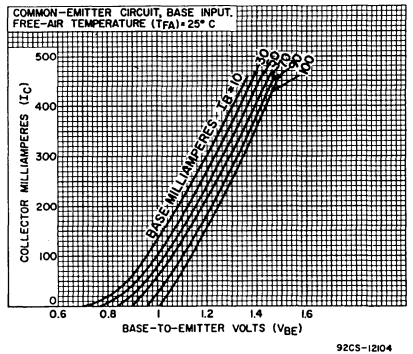


Fig. 12—Typical transfer characteristics for 2N2897.

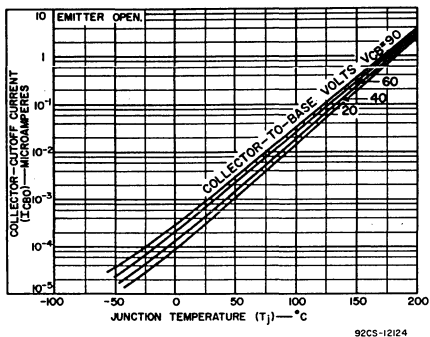


Fig. 13—Typical collector-cutoff-current characteristics for 2N2895 and 2N2896.

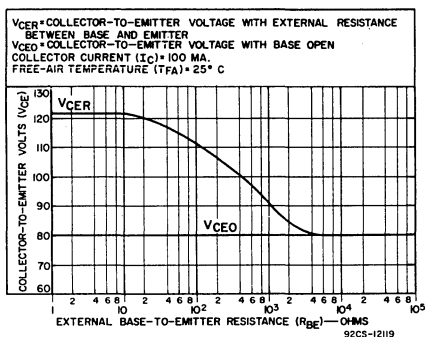


Fig. 14—Typical collector-to-emitter-voltage characteristic for 2N2895.

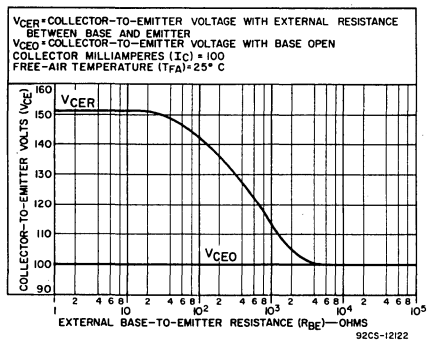


Fig. 15—Typical collector-to-emitter-voltage characteristic for 2N2896.

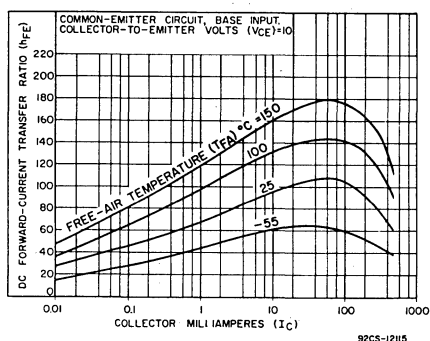


Fig. 16—Typical dc beta characteristics for 2N2895.

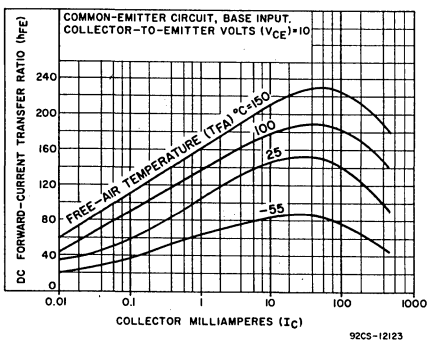


Fig. 17—Typical dc beta characteristics for 2N2896 and 2N2897.

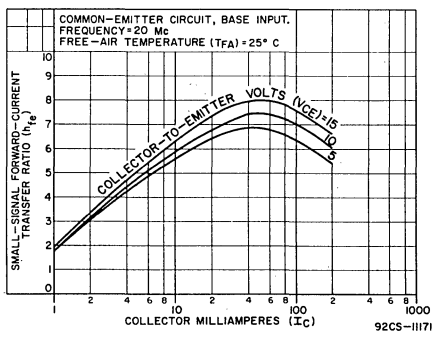


Fig. 18—Typical small-signal beta characteristics for all types.



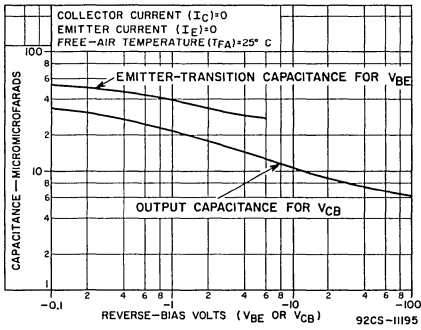


Fig. 19—Typical emitter-transition capacitance and output-capacitance characteristics for all types.

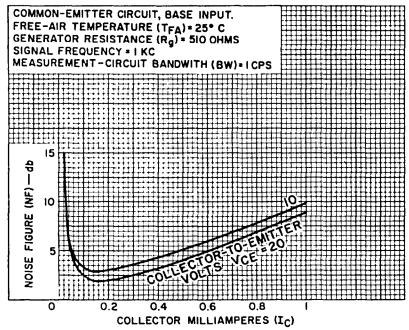


Fig. 20—Typical of noise-figure characteristics for 2N2895.

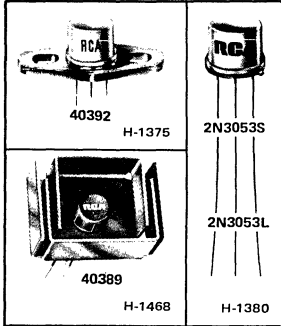
**TERMINAL CONNECTIONS**

- Lead 1 - Emitter
- Lead 2 - Base
- Lead 3 - Collector
- Lead 4 - Connected to case



# Power Transistors

## 2N3053 40389 40392



### General-Purpose, Medium-Power Silicon N-P-N Planar Transistors

For Small-Signal Applications  
In Industrial and Commercial Equipment

**Features:**

- Maximum safe-area-of-operation curve
- Forward- and reverse-bias operation without second breakdown
- Low leakage current

These devices are available with either 1½-inch leads (TO-5 package) or ½-inch leads (TO-39 package). The longer-lead versions are specified by suffix "L" after the type number; the shorter-lead versions are specified by suffix "S" after the type number.

RCA-2N3053 is a silicon n-p-n planar transistor useful up to 20 MHz in small-signal, medium-power applications. Type 40389 is a 2N3053 with a factory-attached diamond-shaped mounting flange.

**Applications:**

- Audio amplifiers
- Controlled amplifiers
- Power supplies
- Power oscillators

**MAXIMUM RATINGS, Absolute-Maximum Values:**

	2N3053	40389 40392	
COLLECTOR-TO-BASE VOLTAGE . . . . .	60	60	V <sub>CBO</sub> V
COLLECTOR-TO-EMITTER SUSTAINING VOLTAGE: With external base-to-emitter resistance (RBE) = 10 Ω . . . . .	50	50	V <sub>CER(sus)</sub> V
With base open . . . . .	40	40	V <sub>CEO(sus)</sub> V
With base-emitter-junction reverse-biased . . . . .	60	60	V <sub>CEV(sus)</sub> V
EMITTER-TO-BASE VOLTAGE . . . . .	5	5	V <sub>EBO</sub> V
COLLECTOR CURRENT . . . . .	0.7	0.7	I <sub>C</sub> A
TRANSISTOR DISSIPATION: At case temperatures up to 25°C . . . . .	5	7	P <sub>T</sub> W
At free-air temperatures up to 25°C . . . . .	1	3.5	W
At temperatures above 25°C . . . . .	See Figs.1, 2, and 3		
TEMPERATURE RANGE: Storage and operating (Junction) . . . . .	← -65 to +200 →		°C
LEAD TEMPERATURE (During soldering): At distance ≥ 1/32 in. (0.8 mm) from seating plane for 10 s max. . . . .	← 235 →		°C

ELECTRICAL CHARACTERISTICS, At Case Temperature ( $T_C$ ) = 25°C

Characteristics	Symbol	TEST CONDITIONS							LIMITS		Units
		DC Collector Voltage V		DC Emitter or Base Voltage V		DC Current mA			Types 2N3053 40389 40392		
		$V_{CB}$	$V_{CE}$	$V_{EB}$	$V_{BE}$	$I_C$	$I_E$	$I_B$	Min.	Max.	
Collector-Cutoff Current	$I_{CBO}$	30					0		—	0.25	$\mu A$
Emitter-Cutoff Current	$I_{EBO}$			4		0			—	0.25	$\mu A$
DC Forward-Current Transfer Ratio	$h_{FE}$		10			150 <sup>a</sup>			50	250	
Collector-to-Base Breakdown Voltage	$BV_{CBO}$					0.1	0		60	—	V
Emitter-to-Base Breakdown Voltage	$BV_{EBO}$					0	0.1		5	—	V
Collector-to-Emitter Sustaining Voltage: With base open	$V_{CEO(sus)}$					100 <sup>a</sup>		0	40	—	V
With external base-to-emitter resistance ( $R_{BE}$ ) = 10 $\Omega$	$V_{CER(sus)}$					100 <sup>a</sup>			50	—	V
Base-to-Emitter Saturation Voltage	$V_{BE(sat)}$					150		15	—	1.7	V
Collector-to-Emitter Saturation Voltage	$V_{CE(sat)}$					150		15	—	1.4	V
Small-Signal, Forward Current Transfer Ratio (At 20 MHz)	$h_{fe}$		10			50			5	—	
Output Capacitance	$C_{ob}$	10					0		—	15	pF
Input Capacitance	$C_{ib}$			0.5		0			—	80	pF
Thermal Resistance:											
Junction-to-Case	$\theta_{J-C}$								35(max.) 2N3053		°C/W
									25(max.) 40392		°C/W
Junction-to-Free Air	$\theta_{J-FA}$								175(max.) 2N3053		°C/W
									50(max.) 40389		°C/W

<sup>a</sup>Pulsed; pulse duration = 300 $\mu s$ , duty factor = 1.8%.

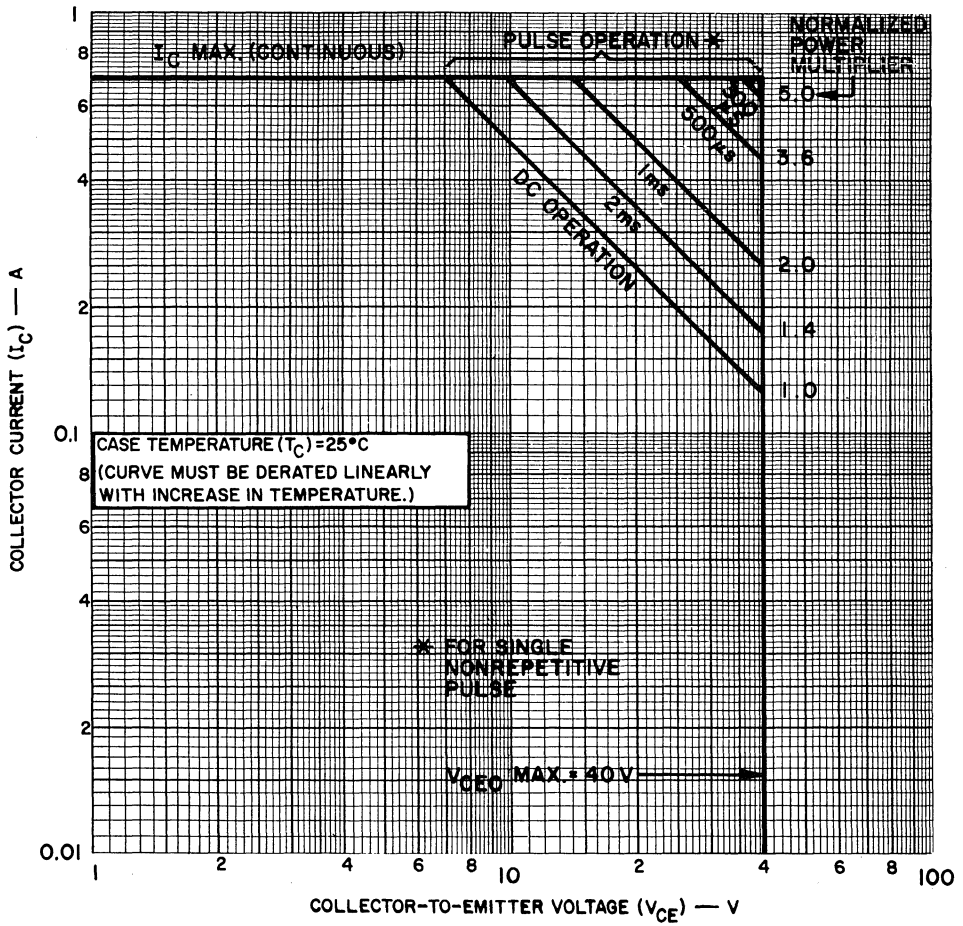
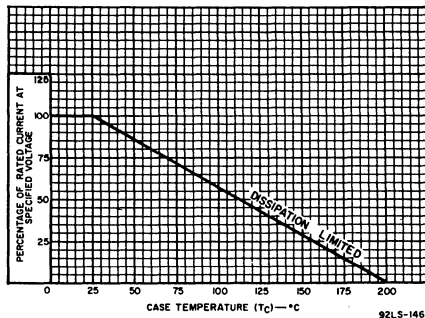


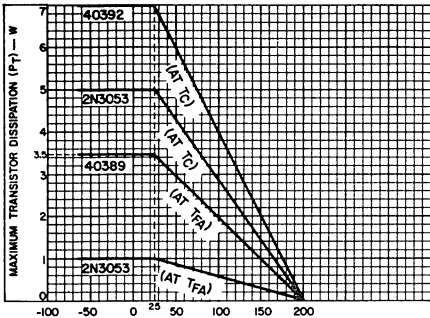
Fig.1 — Maximum operating areas for type 2N3053.

92SS-3362

Fig.2 — Derating curve for type 2N3053.

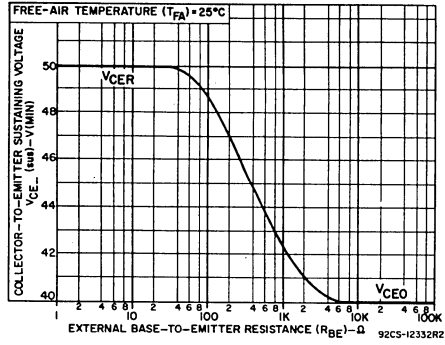


92LS-1469



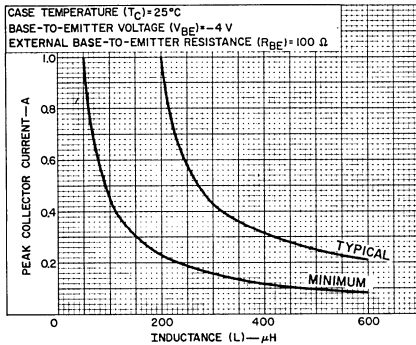
9255-3002

Fig. 3 - Dissipation derating curves for all types.



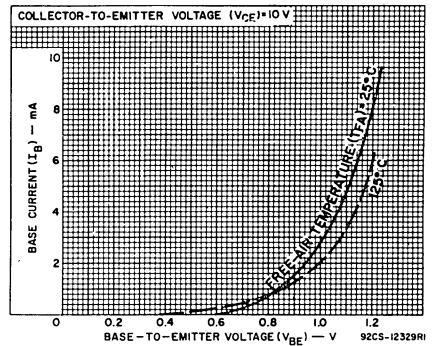
92CS-12332R2

Fig. 4 - Sustaining voltage vs. base-to-emitter resistance for all types.



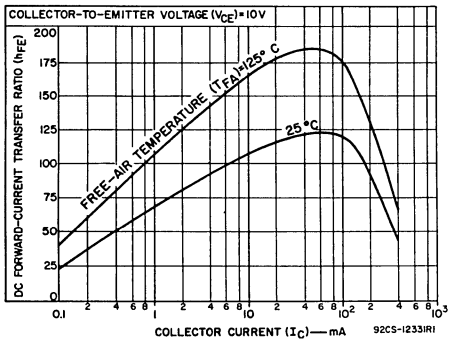
9255-3365

Fig. 5 - Reverse-bias, second-breakdown characteristics for all types.



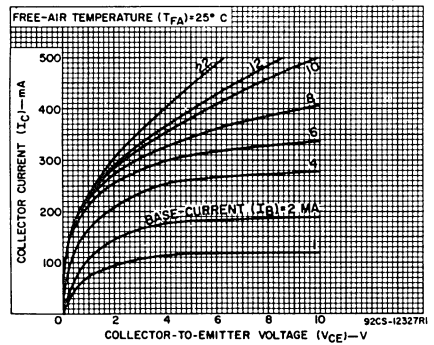
92CS-12332R1

Fig. 6 - Typical dc-beta characteristics for all types.



92CS-12331R1

Fig. 7 - Typical input characteristics for all types.



92CS-12327R1

Fig. 8 - Typical output characteristics for all types.

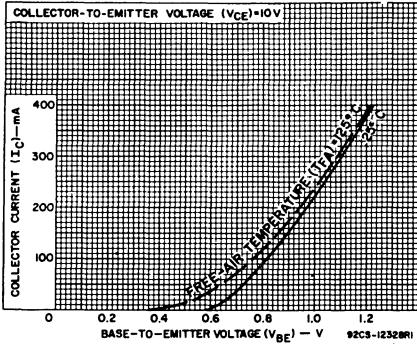


Fig. 9 - Typical transfer characteristics for all types.

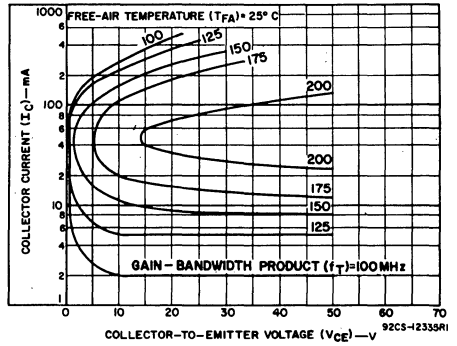


Fig. 10 - Typical variation of gain-bandwidth product with  $I_C$  and  $V_{CE}$  for all types.

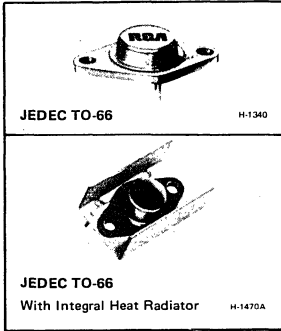
**TERMINAL CONNECTIONS**

- Lead 1 — Emitter
- Lead 2 — Base
- Lead 3 — Collector



# Power Transistors

2N3054 2N6260 2N6261  
40372 40910 40911



## Hometaxial II<sup>®</sup> Medium-Power Silicon N-P-N Transistors

Rugged Devices for Intermediate-Power Applications in Industrial and Commercial Equipment

**Features:**

- $f_T = 800$  kHz at 0.2 A (2N3054, 40372)
- Maximum safe-area-of-operation curves for dc and pulse operation
- $V_{CEV(sus)} = 90$  V min (2N3054, 2N6261)
- Low saturation voltage:  $V_{CE(sat)} = 1.0$  V at  $I_C = 0.5$  A (2N3054)

RCA 2N3054, 2N6260, and 2N6061 are hometaxial-base<sup>®</sup> silicon n-p-n transistors intended for a wide variety of medium- to high-power applications.

Types 40372, 40910, and 40911 are the 2N3054, 2N6260, and 2N6061 with factory-attached heat radiators intended for printed-circuit-board applications.

• "Hometaxial" was coined by RCA from "homogeneous" and "axial" to describe a single-diffused transistor with a base region of homogeneous-resistivity in the axial direction (emitter-to-collector).

**Applications:**

- Power switching circuits
- Series- and shunt-regulator driver and output stages
- High-fidelity amplifiers
- Solenoid drivers

"Hometaxial II" is a term used to describe RCA's expanded line of transistors produced by the hometaxial process.

**MAXIMUM RATINGS, Absolute-Maximum Values:**

	2N6260 40910	2N3054 40372	2N6261 40911	
*COLLECTOR-TO-BASE VOLTAGE .....	$V_{CBO}$	50	90	90 V
COLLECTOR-TO-EMITTER VOLTAGE:				
* With base open .....	$V_{CEO}$	40	55	80 V
* With external base-to-emitter resistance ( $R_{BE}$ ) = 100 $\Omega$ .....	$V_{CER(sus)}$	45	60	85 V
With base reverse-biased ( $V_{BE} = -1.5$ V) .....	$V_{CEV(sus)}$	50	90	90 V
*EMITTER-TO-BASE VOLTAGE .....	$V_{EBO}$	5	7	7 V
*CONTINUOUS COLLECTOR CURRENT .....	$I_C$	3	4	4 A
*CONTINUOUS BASE CURRENT .....	$I_B$	2	2	2 A
TRANSISTOR DISSIPATION:	$P_T$			
* At case temperature up to 25 $^{\circ}$ C .....		29	25	50 W
At ambient temperatures up to 25 $^{\circ}$ C .....		(2N6260) 5.8 (40910)	(2N3054) 5.8 (40372)	(2N6261) 5.8 (40911)
* At temperatures above 25 $^{\circ}$ C .....		See Figs. 4 & 11    See Figs. 4 & 9    See Figs. 1 & 7		
*TEMPERATURE RANGE:				
Storage & Operating (Junction) .....		↔ -65 to 200 ↔		$^{\circ}$ C
*PIN TEMPERATURE (During Soldering):				
At distance $\geq 1/32$ in. (0.8 mm) from seating plane for 10 s max. ....		↔ 235 ↔		$^{\circ}$ C

\*In accordance with JEDEC registration data format JS-9 RDF-10 (2N3054), JS-6 RDF-2 (2N6260, 2N6261)

ELECTRICAL CHARACTERISTICS, At Case Temperature ( $T_C$ ) = 25°C unless otherwise specified

CHARACTERISTIC	SYMBOL	TEST CONDITIONS				LIMITS						UNITS	
		VOLTAGE V dc		CURRENT A dc		2N6260 40910		2N3054 40372		2N6261 40911			
		$V_{CE}$	$V_{BE}$	$I_C$	$I_B$	Min.	Max.	Min.	Max.	Min.	Max.		
* Collector-Cutoff Current: With base open	$I_{CEO}$	30 60			0 0	— —	1 —	— —	0.5 —	— —	— 0.5	mA	
With base-emitter junction reverse-biased	$I_{CEX}$	40 80 90	-1.5 -1.5 -1.5			— — —	5 — —	— — —	— — 1.0	— — —	— — 0.5	mA	
At $T_C = 150^\circ\text{C}$	$I_{CEX}$	40 80 90	-1.5 -1.5 -1.5			— — —	25 — —	— — —	— — 6.0	— — —	— — 1.0	mA	
* Emitter-Cutoff Current	$I_{EBO}$		-5 -7		0 0	— —	5 —	— —	— 1.0	— —	— 0.2	mA	
Collector-to-Emitter Sustaining Voltage: With base open	$V_{CEO(sus)}$				0.1 <sup>a</sup>	0	40	—	55	—	80	V	
With external base-to- emitter resistance ( $R_{BE}$ ) = 100Ω	$V_{CER(sus)}$				0.1 <sup>a</sup>	45	—	60	—	85	—	V	
* DC Forward-Current Transfer Ratio	$h_{FE}$	2 2 4 4 4			4 <sup>a</sup> 1.5 <sup>a</sup> 3 <sup>a</sup> 0.5 <sup>a</sup> 1.5 <sup>a</sup>	— — — — 20	— — — — 100	— — — 5 25	— — — 150 —	— — — — —	5 25 — — —	— 100 — — —	
* Collector-to-Emitter Saturation Voltage	$V_{CE(sat)}$				0.5 <sup>a</sup> 1.5 <sup>a</sup> 3 <sup>a</sup>	0.05 <sup>a</sup> 0.15 <sup>a</sup> 1 <sup>a</sup>	— — —	— 1.5 —	— — 6.0	— — —	— — —	1.5 0.5 —	V
* Base-to-Emitter Voltage	$V_{BE}$	2 4 4			1.5 1.5 0.5	— — —	— 2.2 —	— — —	— — 1.7	— — —	— — —	1.5 — —	V
* Common-Emitter, Small-Signal, Short-Circuit, Forward Current Transfer Ratio Cutoff Frequency	$f_{hfe}$	4			0.1	0.03	—	0.03	—	0.03	—	—	MHz
* Magnitude of Common- Emitter, Small-Signal, Short-Circuit Forward Current Transfer Ratio ( $f = 0.4$ MHz)	$ h_{fe} $	4			0.1	2	—	—	—	—	2	—	
* Common-Emitter, Small-Signal, Short- Circuit Forward Current Transfer Ratio ( $f = 1$ kHz)	$h_{fe}$	4			0.1	25	—	25	—	25	—	—	
Forward-Bias Second Breakdown Collector Current ( $t = 1$ s)	$I_{S/b}$	40 80 55				0.725 — —	— — —	— — 0.455	— — —	— — —	— 0.625 —	— — —	A
Thermal Resistance: Junction-to-Case	$R_{\theta JC}$					6 (max.) 2N6260		7 (max.) 2N3054		3.5 (max.) 2N6261			°C/W
Junction-to-Ambient	$R_{\theta JA}$					30 (max.) 40910		30 (max.) 40372		30 (max.) 40911			

<sup>a</sup>Pulsed; Pulse duration  $t_p = 300 \mu\text{s}$ , duty factor = 1.8%.<sup>\*</sup>In accordance with JEDEC registration data format JS- 9 RDF-10 (2N3054) JS-6 RDF-2 (2N6260-61)



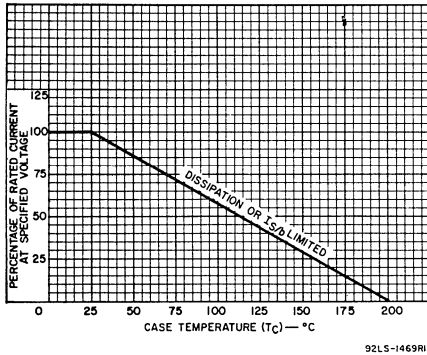
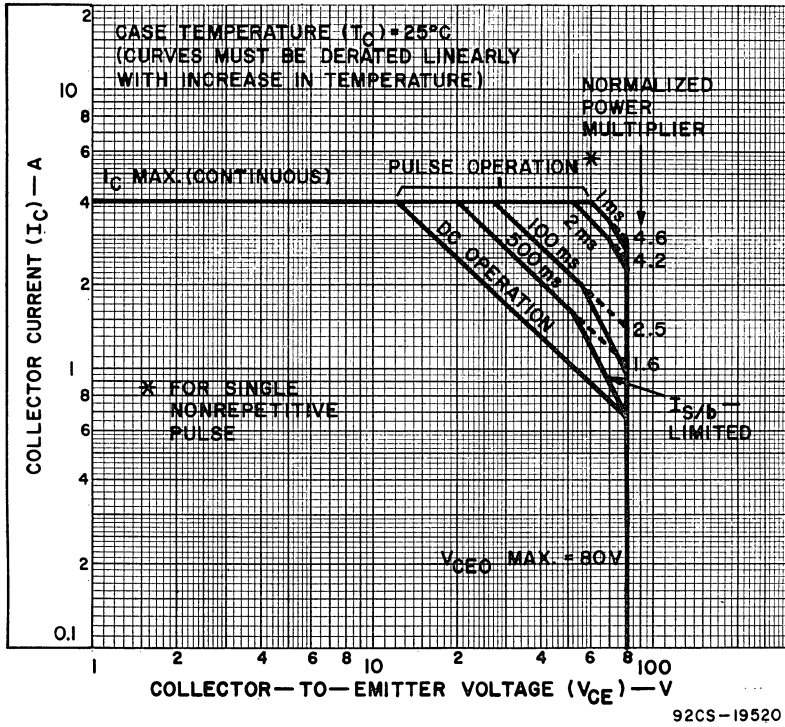


Fig.2—Current derating curve for all types.

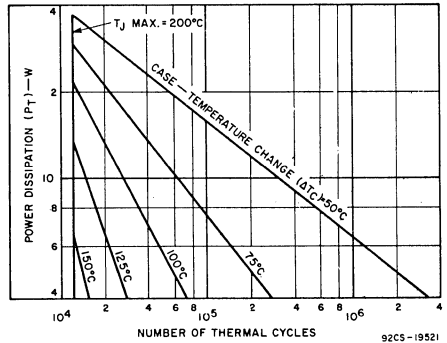


Fig.3—Thermal-cycle rating chart for type 2N6261.

TERMINAL CONNECTIONS  
FOR 2N3054, 2N6260, & 2N6261

Pin 1 - Base  
Pin 2 - Emitter  
Case, Mounting Flange - Collector

TERMINAL CONNECTIONS  
FOR 40372, 40910 & 40911

Pin 1 - Base  
Pin 2 - Emitter  
Heat Radiator-Collector

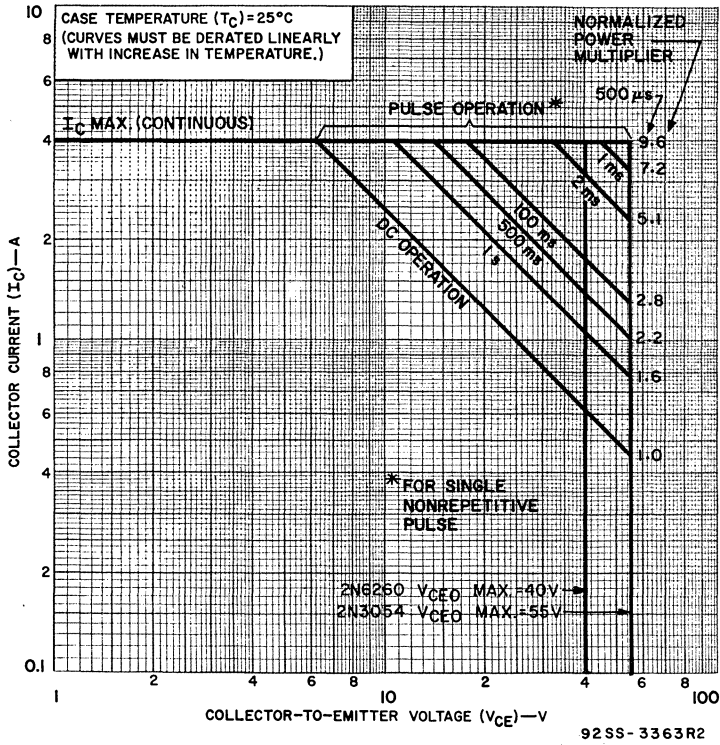


Fig.4—Maximum operating areas for types 2N3054 and 2N6260.

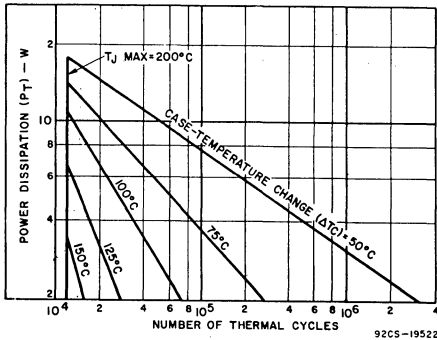


Fig.5—Thermal-cycle rating chart for type 2N3054.

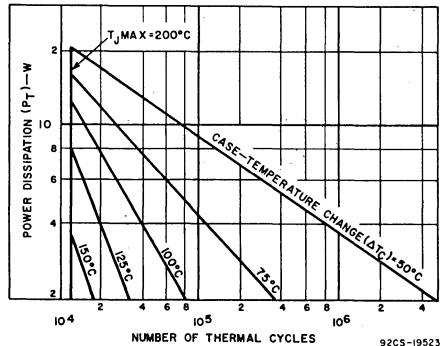


Fig.6—Thermal-cycle rating chart for type 2N6260.

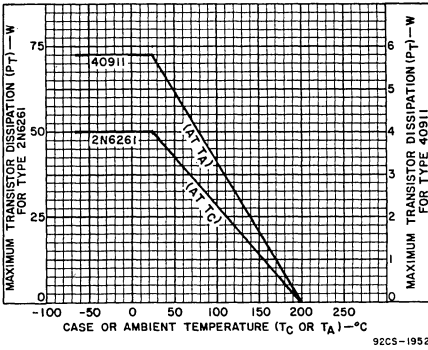


Fig. 7—Dissipation derating curve for types 2N6261 and 40911.

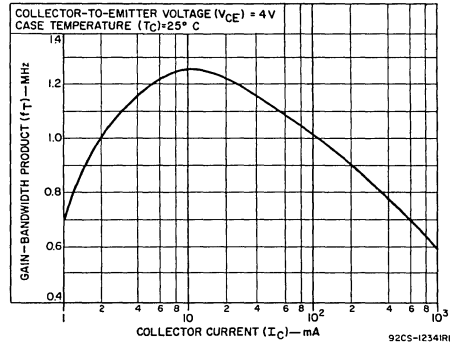


Fig. 8—Typical gain-bandwidth-product for all types.

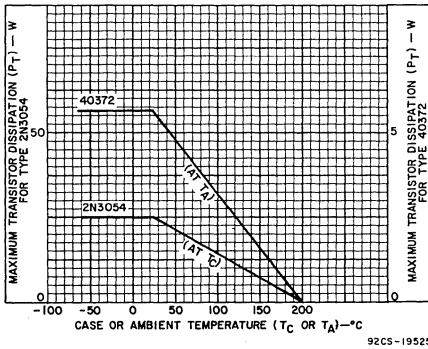


Fig. 9—Dissipation derating curve for types 2N3054 and 40372

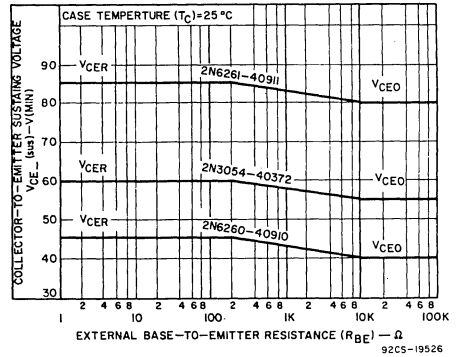


Fig. 10—Sustaining voltage vs. base-to-emitter resistance for all types.

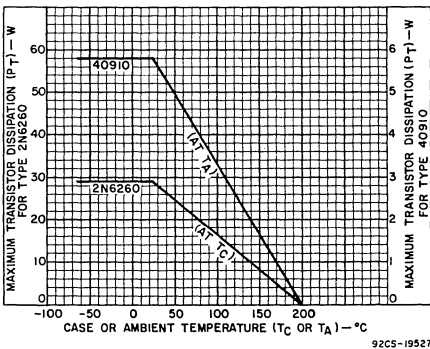


Fig. 11—Dissipation derating curve for types 2N6260 and 40910.

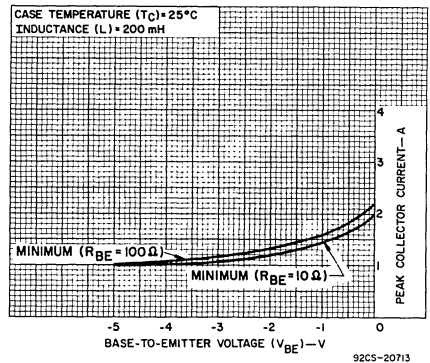


Fig. 12—Reverse-bias second-breakdown characteristics for all types.

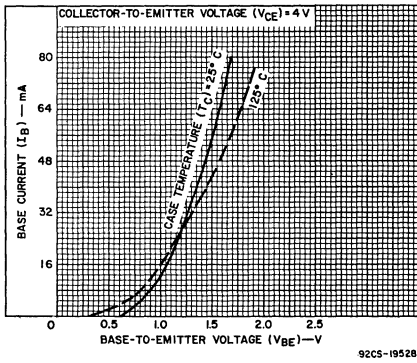


Fig.13—Typical input characteristics for types 2N6261 and 40911.

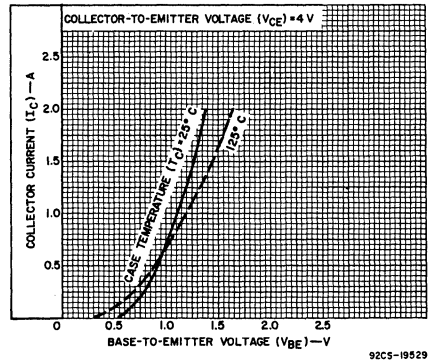


Fig.14—Typical transfer characteristics for types 2N6261 and 40911.

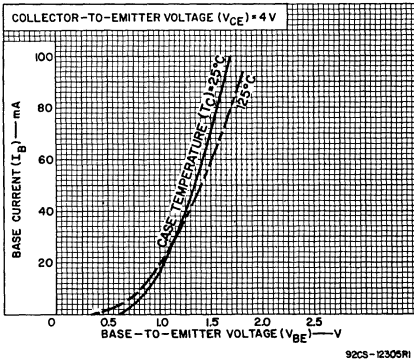


Fig.15—Typical input characteristics for types 2N3054 and 40372.

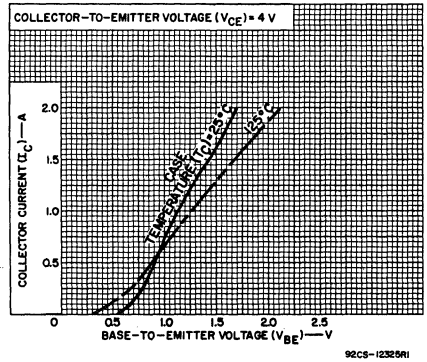


Fig.16—Typical transfer characteristics for types 2N3054 and 40372.

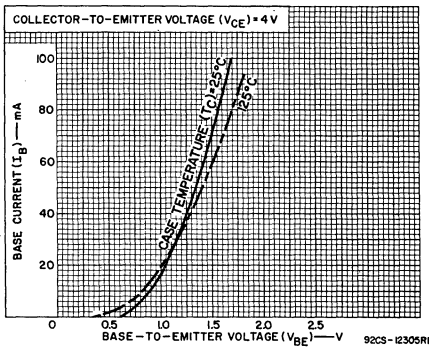


Fig.17—Typical input characteristics for types 2N6260 and 40910.

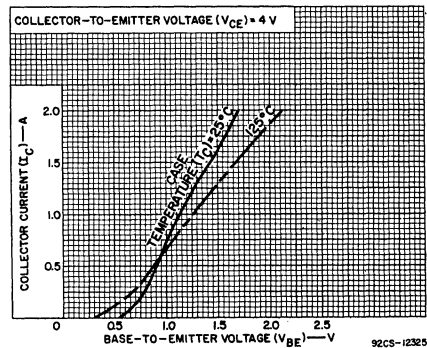


Fig.18—Typical transfer characteristics for types 2N6260 and 40910.

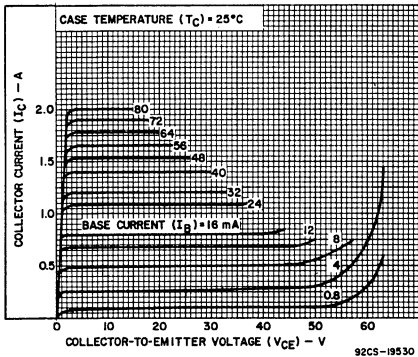


Fig. 19—Typical output characteristics for types 2N6261 and 40911.

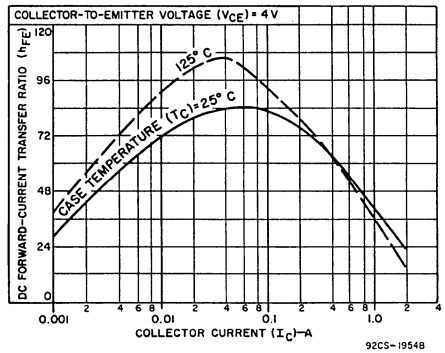


Fig. 20—Typical dc beta characteristics for types 2N6261 and 40911.

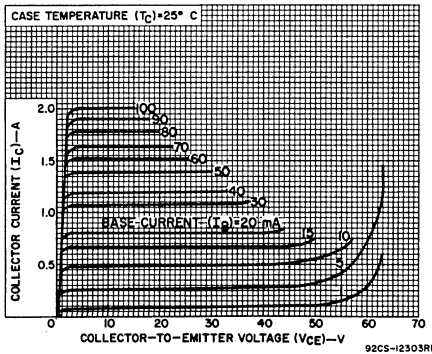


Fig. 21—Typical output characteristics for types 2N3054 and 40372.

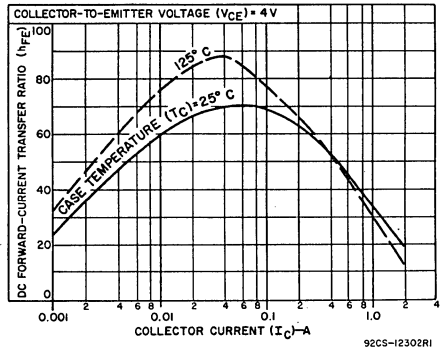


Fig. 22—Typical dc beta characteristics for types 2N3054 and 40372.

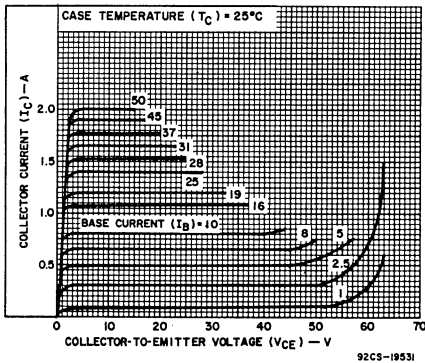


Fig. 23—Typical output characteristics for types 2N6260 and 40910.

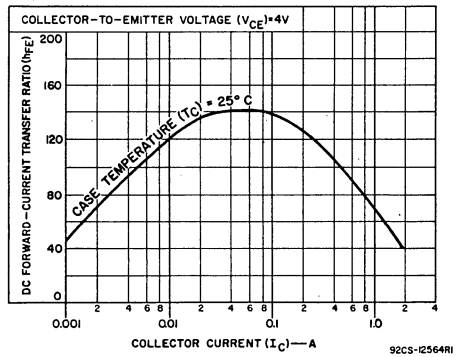
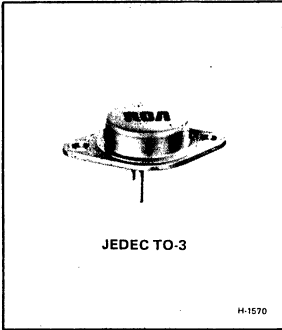


Fig. 24—Typical dc beta characteristics for types 2N6260 and 40910.



# Power Transistors

**2N3055**  
**2N6253**  
**2N6254**



## Hometaxial II<sup>®</sup> High-Power Silicon N-P-N Transistors

Rugged, Broadly Applicable Devices  
For Industrial and Commercial Use

**Features:**

- 2N6254: premium type from 2N3055 family
- Maximum safe-area-of-operation curves
- Low saturation voltages
- High dissipation ratings
- Thermal-cycle rating curves

**Applications:**

- Series and shunt regulators
- High-fidelity amplifiers
- Power-switching circuits
- Solenoid drivers

RCA 2N3055, 2N6253 and 2N6254 are silicon n-p-n transistors intended for a wide variety of high-power applications. The hometaxial<sup>®</sup>-base construction of these devices renders them highly resistant to second breakdown over a wide range of operating conditions.

- "Hometaxial" was coined by RCA from "homogeneous" and "axial" to describe a single-diffused transistor with a base region of homogeneous-resistivity silicon in the axial direction (emitter-to-collector).
- "Hometaxial II" is a term used to describe RCA's expanded line of transistors produced by the hometaxial process.

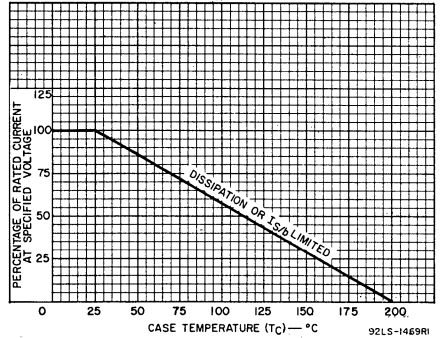


Fig. 1—Current derating curve.

**MAXIMUM RATINGS, Absolute-Maximum Values:**

- \*COLLECTOR-TO-BASE VOLTAGE . . . . .
- \*COLLECTOR-TO-EMITTER SUSTAINING VOLTAGE:
- With external base-to-emitter resistance ( $R_{BE}$ ) = 100Ω . . . . .
- With base open . . . . .
- With base reverse-biased  $V_{BE} = -1.5$  V . . . . .
- \*EMITTER-TO-BASE VOLTAGE . . . . .
- \*CONTINUOUS COLLECTOR CURRENT . . . . .
- \*CONTINUOUS BASE CURRENT . . . . .
- \*TRANSISTOR DISSIPATION . . . . .
- At case temperatures up to 25°C . . . . .
- At case temperatures above 25°C . . . . .
- \*TEMPERATURE RANGE:
- Storage and Operating (Junction) . . . . .
- \*PIN TEMPERATURE (During Soldering):
- At distances  $\geq 1/32$  in. (0.8 mm) from seating plane for 10 s max. . . . .

	2N6253	2N3055	2N6254	
$V_{CBO}$	55	100	100	V
$V_{CER}(sus)$	55	70	85	V
$V_{CEO}(sus)$	45	60	80	V
$V_{CEV}(sus)$	55	90	90	V
$V_{EBO}$	5	7	7	V
$I_C$	15	15	15	A
$I_B$	7	7	7	A
$P_T$				W
	115	115	150	
	← See Fig. 1 →			
	← -65 to +200 →			°C
	← 235 →			°C

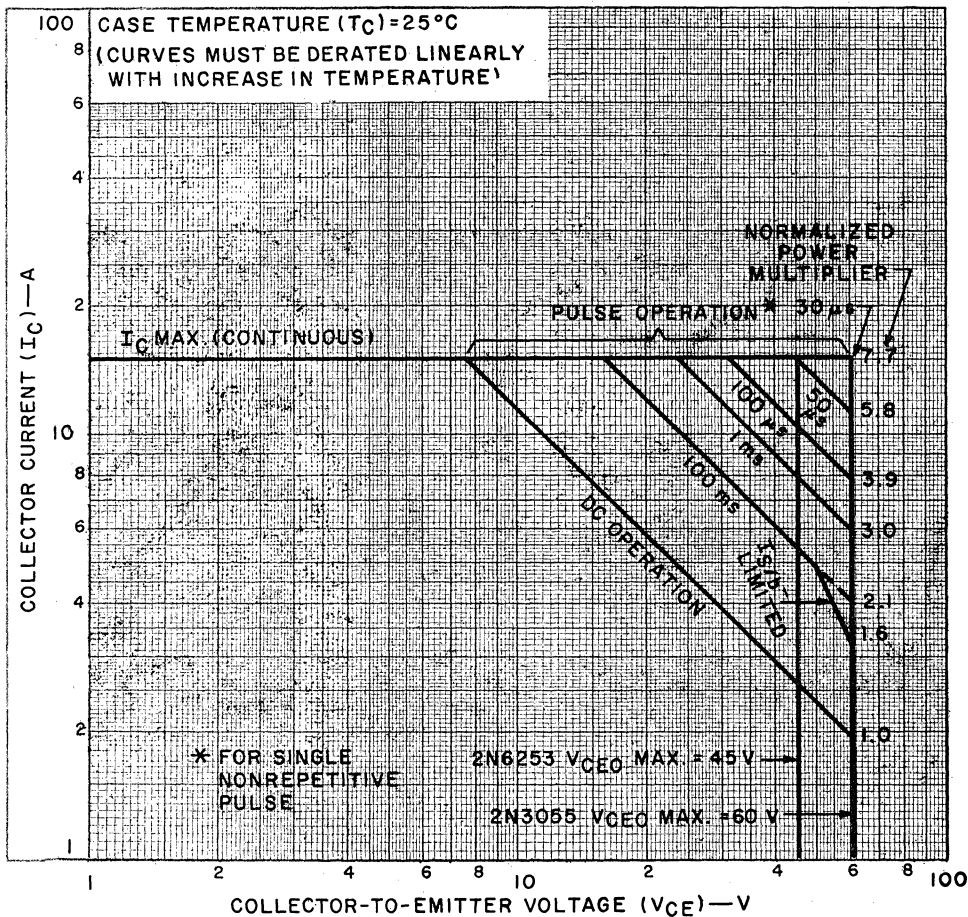
\*In accordance with JEDEC registration data formats (2N3055:JS-9 RDF-10/2N6253-4: JS-6 RDF-2).

ELECTRICAL CHARACTERISTICS, At Case Temperature ( $T_C$ ) = 25°C Unless Otherwise Specified.

CHARACTERISTIC	SYMBOL	TEST CONDITIONS				LIMITS						UNITS
		VOLTAGE V <sub>dc</sub>		CUR- RENT A dc		2N6253		2N3055		2N6254		
		V <sub>CE</sub>	V <sub>BE</sub>	I <sub>C</sub>	I <sub>B</sub>	MIN.	MAX.	MIN.	MAX.	MIN.	MAX.	
* Collector-Cutoff Current: With base open	I <sub>CEO</sub>	25			0	—	1.5	—	—	—	—	mA
		30			0	—	—	—	0.7	—	—	
		60			0	—	—	—	—	—	1	
With base-emitter junction reverse-biased	I <sub>CEX</sub>	55	-1.5			—	2	—	—	—	—	mA
		100	-1.5			—	—	—	5	—	0.5	
At T <sub>C</sub> = 150°C	I <sub>CEX</sub>	50	-1.5			—	10	—	—	—	—	mA
		100	-1.5			—	—	—	30	—	5	
* Emitter-Cutoff Current	I <sub>EBO</sub>					—	10	—	—	—	—	mA
						—	—	—	5	—	0.5	
Collector-to-Emitter Sustaining Voltage: With base open	V <sub>CEO(sus)</sub>			0.2 <sup>a</sup>	0	45	—	60	—	80	—	V
With external base-to- emitter resistance (R <sub>BE</sub> ) = 100Ω	V <sub>CER(sus)</sub>			0.2 <sup>a</sup>		55	—	70	—	85	—	
With base-emitter junction reverse-biased	V <sub>CEV(sus)</sub>		-1.5	0.1 <sup>a</sup>		55	—	90	—	90	—	
* DC Forward Current Transfer Ratio	h <sub>FE</sub>	4		15 <sup>a</sup>		3	—	—	—	5	—	—
		4		10 <sup>a</sup>		—	—	5	—	—	—	
		2		5 <sup>a</sup>		—	—	—	—	20	70	
		4		4 <sup>a</sup>		—	—	20	70	—	—	
		4		3 <sup>a</sup>		20	150	—	—	—	—	
* Base-to-Emitter Voltage	V <sub>BE</sub>	4		3 <sup>a</sup>		—	1.7	—	—	—	—	V
		4		4 <sup>a</sup>		—	—	—	1.8	—	—	
		2		5 <sup>a</sup>		—	—	—	—	—	1.5	
* Collector-to-Emitter Saturation Voltage	V <sub>CE(sat)</sub>			3 <sup>a</sup>	0.3 <sup>a</sup>	—	1	—	—	—	—	V
				4 <sup>a</sup>	0.4 <sup>a</sup>	—	—	—	1.1	—	—	
				5 <sup>a</sup>	0.5 <sup>a</sup>	—	—	—	—	—	0.5	
				10 <sup>a</sup>	3.3 <sup>a</sup>	—	—	—	8	—	—	
				15 <sup>a</sup>	3 <sup>a</sup>	—	—	—	—	—	4	
				15 <sup>a</sup>	5 <sup>a</sup>	—	4	—	—	—	—	
* Common-Emitter, Small- Signal, Short-Circuit Forward Current Transfer Ratio (f = 1 kHz)	h <sub>fe</sub>	4		1		10	—	15	120	10	—	
* Magnitude of Common- Emitter, Small-Signal, Short-Circuit, Forward Current Transfer Ratio (f = 0.4 MHz)	h <sub>fe</sub>	4		1		2	—	—	—	2	—	
Gain-Bandwidth Product	f <sub>T</sub>			1		—	—	800	—	—	—	kHz
* Common-Emitter, Short- Circuit, Small-Signal, Forward Current Transfer Ratio Cutoff Frequency	f <sub>hfe</sub>	4		1		10	—	10	—	10	—	kHz
Forward-Bias Second Break- down Collector Current	I <sub>S/b</sub>	80				—	—	—	—	1.87	—	A
		60				—	—	1.95	—	—	—	
		45				2.55	—	—	—	—	—	
Thermal Resistance: Junction-to-Case	R <sub>θJC</sub>					—	1.5	—	1.5	—	1.17	°C/W

<sup>a</sup> Pulsed: Pulse duration = 300 μs, duty factor = 1.8%.

\* In accordance with JEDEC registration data formats JS-9 RDF-10 (2N3055) and JS-6 RDF-2 (2N6253-4).



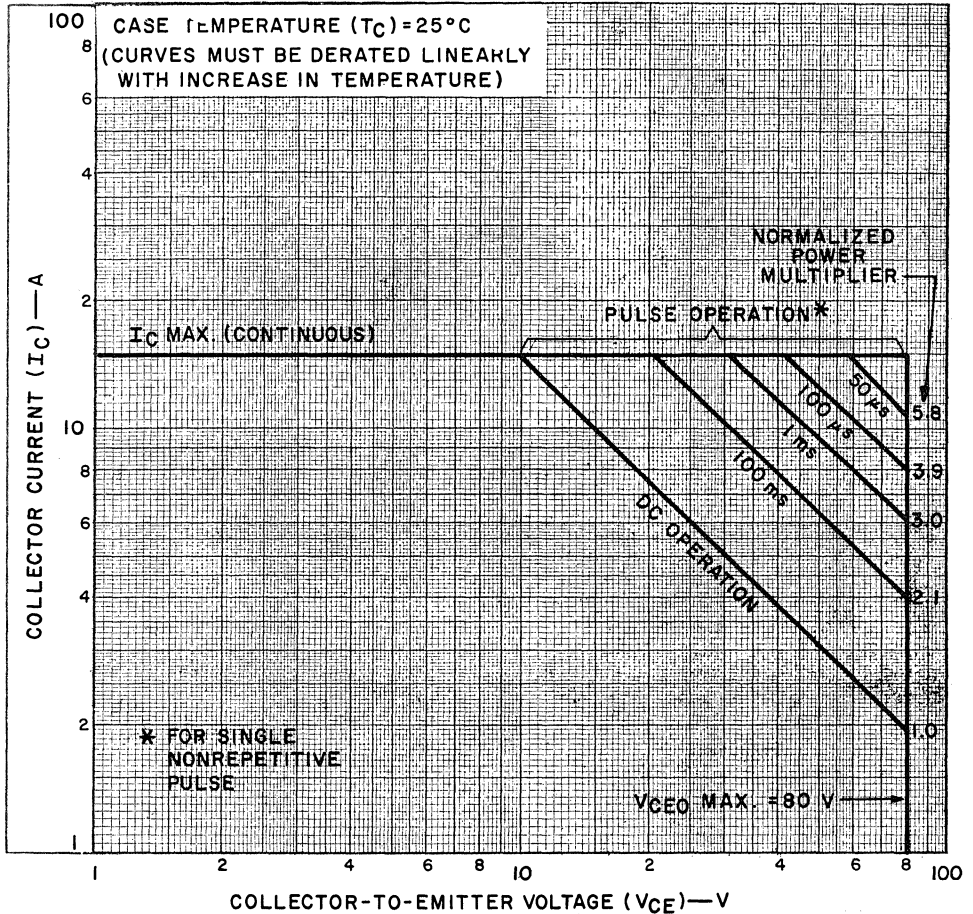
92SS-3364RI

Fig.2—Maximum operating areas for types 2N6253 and 2N3055.

TERMINAL CONNECTIONS

- Pin 1 — Base
- Pin 2 — Emitter
- Case — Collector
- Mounting Flange — Collector





92CS-19435

Fig.3—Maximum operating areas for 2N6254.

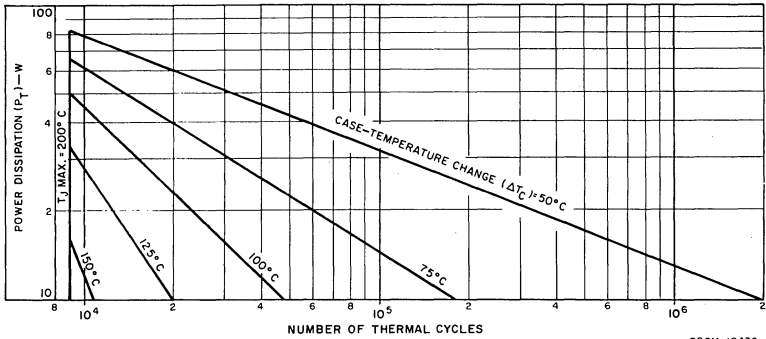


Fig.4—Thermal-cycle rating chart for types 2N3055 and 2N6253.

92CM-19436

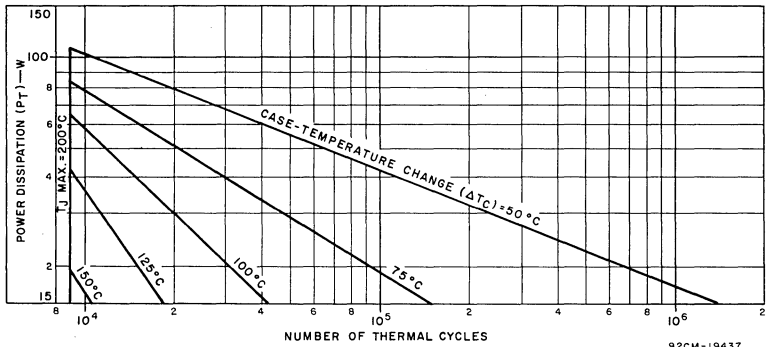


Fig.5—Thermal-cycle rating chart for type 2N6254.

92CM-19437

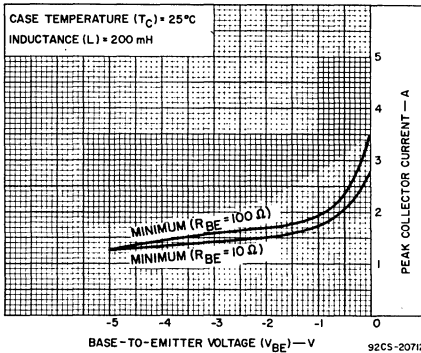


Fig.6—Reverse-bias, second-breakdown characteristics for all types.

92CS-20712

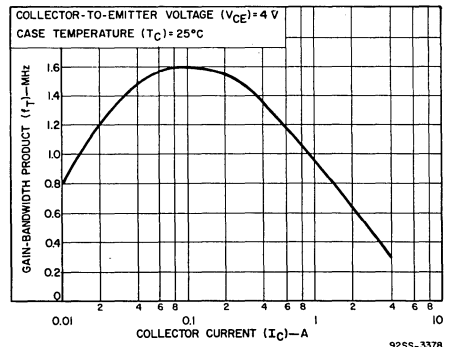


Fig.7—Typical gain-bandwidth product for all types.

92SS-3378

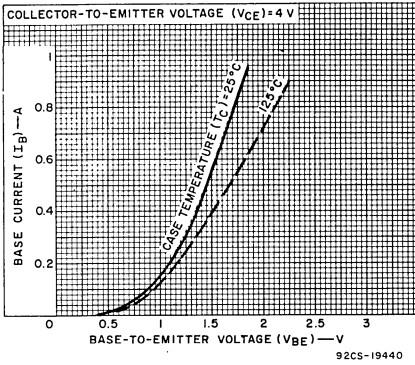


Fig.8—Typical input characteristics for type 2N6254.

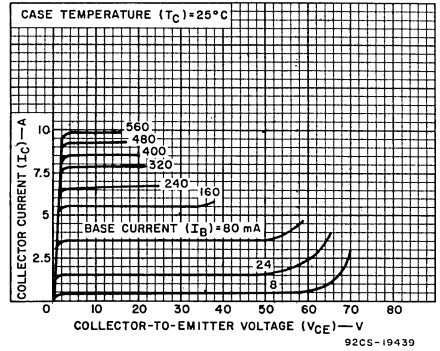


Fig.9—Typical output characteristics for type 2N6254.

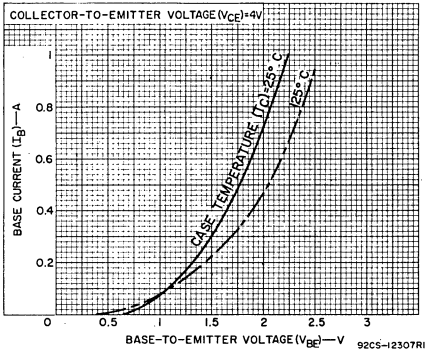


Fig.10—Typical input characteristics for type 2N3055.

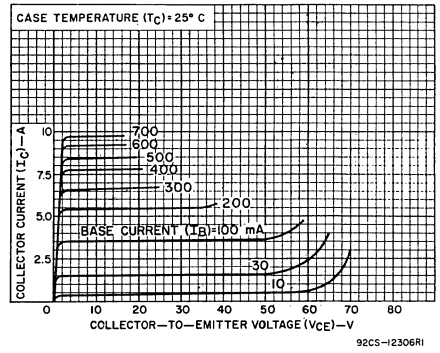


Fig.11—Typical output characteristics for type 2N3055.

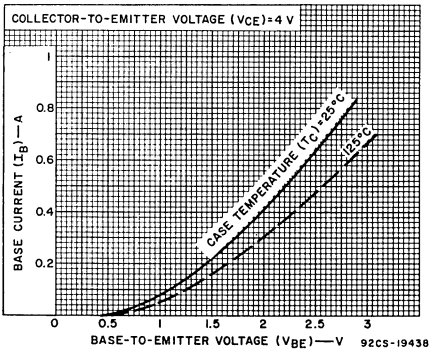


Fig.12—Typical input characteristics for type 2N6253.

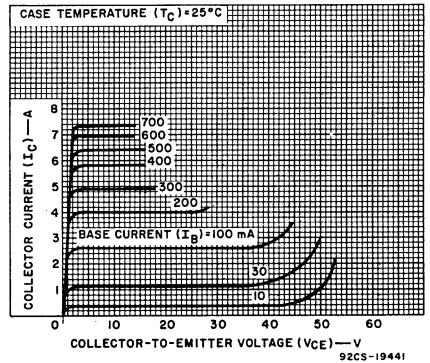


Fig.13—Typical output characteristics for type 2N6253.

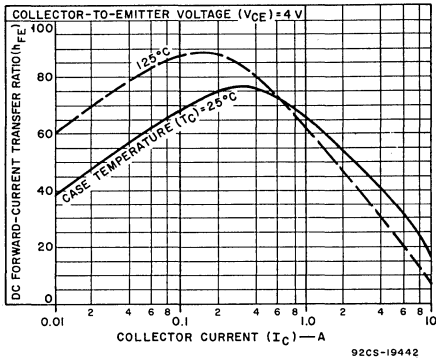


Fig.14—Typical dc-beta characteristics for type 2N6254.

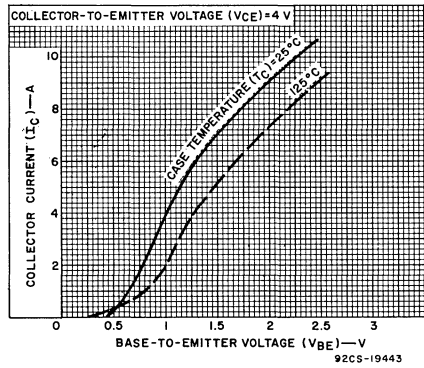


Fig.15—Typical transfer characteristics for type 2N6254.

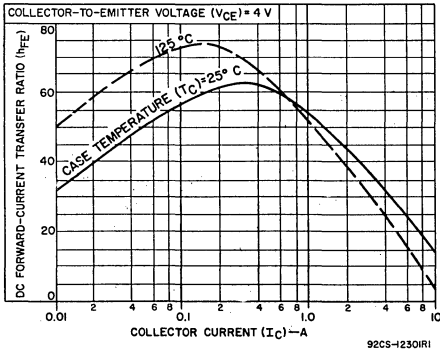


Fig.16—Typical dc-beta characteristics for type 2N3055.

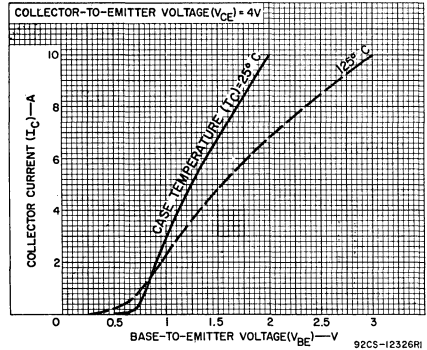


Fig.17—Typical transfer characteristics for types 2N6253 and 2N3055.

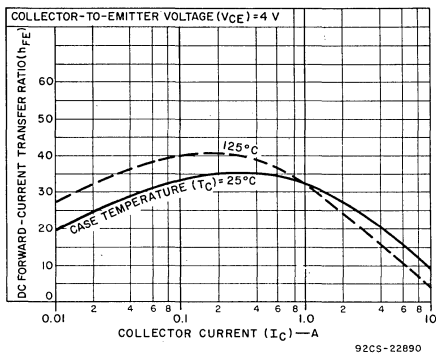


Fig.18—Typical dc-beta characteristics for type 2N6253.

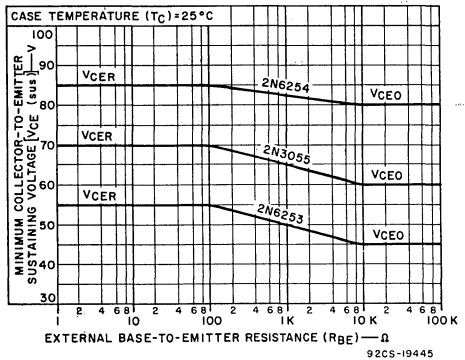
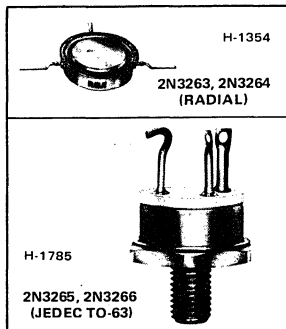


Fig.19—Sustaining voltage vs. base-to-emitter resistance for all types.

**RCA**  
Solid State  
Division

## Power Transistors

2N3263 2N3264  
2N3265 2N3266



## High-Power, High-Speed, High-Current Silicon N-P-N Power Transistors

Epitaxial Types for Aerospace, Military, and Industrial Applications

### Features:

- Low saturation voltages —
  - 2N3263 and 2N3265
    - $V_{CE(sat)} = 0.75 \text{ V (max.) at } I_C = 15 \text{ A}$
    - $V_{BE(sat)} = 1.60 \text{ V (max.) at } I_C = 15 \text{ A}$
  - 2N3264 and 2N3266
    - $V_{CE(sat)} = 1.20 \text{ V (max.) at } I_C = 15 \text{ A}$
    - $V_{BE(sat)} = 1.80 \text{ V (max.) at } I_C = 15 \text{ A}$
- High reliability and uniformity of characteristics
- High power dissipation
- Fast rise time at high collector current —
  - 0.2  $\mu\text{s}$  at 10 A (typical)

RCA-2N3263, 2N3264, 2N3265, and 2N3266<sup>•</sup> are n-p-n epitaxial silicon power transistors designed for high-reliability aerospace, military, and industrial equipment. Their high current-handling capability and fast switching speed make them desirable in applications where high circuit efficiency is required.

The 2N3263 and 2N3264 are sealed in flat 3/4-inch-diameter packages with radial leads. Types 2N3265 and 2N3266 utilize the JEDEC TO-63 package.

Typical high-speed switching applications for these transistors include switching-control amplifiers, power gates, switching regulators, dc-dc converters, and dc-ac inverters. Other recommended applications include dc-rf amplifiers and power oscillators.

<sup>•</sup> Formerly RCA Dev. Nos. TA2492, TA2493, TA2494, and TA2495, respectively.

### MAXIMUM RATINGS, Absolute-Maximum Values:

		2N3264 2N3266	2N3263 2N3265	
* COLLECTOR-TO-BASE VOLTAGE	$V_{CBO}$	120	150	V
COLLECTOR-TO-EMITTER SUSTAINING VOLTAGE:				
With 1.5 volts ( $V_{BE}$ ) of reverse bias	$V_{CEX(sus)}$	120	150	V
With external base-to-emitter resistance ( $R_{BE}$ ) $\leq 50 \Omega$	$V_{CER(sus)}$	80	110	V
* With base open	$V_{CEO(sus)}$	60	90	V
* EMITTER-TO-BASE VOLTAGE	$V_{EBO}$	7	7	V
* COLLECTOR CURRENT	$I_C$	25	25	A
* BASE CURRENT	$I_B$	10	10	A
* TRANSISTOR DISSIPATION	$P_T$	See Figs. 1 & 2		
* TEMPERATURE RANGE:				
Storage and operating (Junction)		— —65 to +200 — —		$^{\circ}\text{C}$
LEAD TEMPERATURE (During soldering):				
At distance $\geq 1/32$ in. (0.8 mm) from seating plane for 10 s max.		— —230 — —		$^{\circ}\text{C}$

\* In accordance with JEDEC registration data format.

ELECTRICAL CHARACTERISTICS, At Case Temperature ( $T_C$ ) = 25°C unless otherwise specified

CHARACTERISTIC	SYMBOL	TEST CONDITIONS						LIMITS				UNITS	
		VOLTAGE V dc			CURRENT A dc			2N3264 2N3266		2N3263 2N3265			
		V <sub>CB</sub>	V <sub>CE</sub>	V <sub>EB</sub>	I <sub>E</sub>	I <sub>B</sub>	I <sub>C</sub>	MIN.	MAX.	MIN.	MAX.		
Collector Cutoff Current: With emitter open	I <sub>CBO</sub>	60			0			—	10	—	—	mA	
At $T_C = 125^\circ\text{C}$		80			0			—	—	—	4		
With base reverse-biased	I <sub>CEX</sub>		120	1.5				—	20	—	—		
				150	1.5				—	—	—		20
Emitter Cutoff Current: At $T_C = 125^\circ\text{C}$	I <sub>EBO</sub>			7			0	—	15	—	5	mA	
					7			0	—	15	—		5
Emitter-to-Base Voltage	V <sub>EBO</sub>				0.02		0	7	—	7	—	V	
Collector-to-Emitter Sustaining Voltage: With base open	V <sub>CEO(sus)</sub> <sup>•</sup>					0	0.2	60	—	90	—	V	
With external base-to-emitter resistance ( $R_{BE} \leq 50 \Omega$ )	V <sub>CER(sus)</sub> <sup>•</sup>					0	0.2	80	—	110	—		
Collector-to-Emitter Saturation Voltage	V <sub>CE(sat)</sub> <sup>•</sup>				2	20	—	1.6	—	1	—	V	
					1.2	15	—	1.2	—	0.75	—		
Base-to-Emitter Saturation Voltage	V <sub>BE(sat)</sub> <sup>•</sup>				2	20	—	2.2	—	1.8	—	V	
					1.2	15	—	1.8	—	1.6	—		
DC Forward Current Transfer Ratio	h <sub>FE</sub> <sup>•</sup>		3			5	35	80	40	—	—	mA	
			3			15	20	80	25	75	—		
			2			15	—	—	20	55	—		
Second-Breakdown Collector Current: (See Fig. 7) DC forward-biased	I <sub>S/b</sub> <sup>▲</sup>	50						700	—	—	—	mA	
Pulsed, forward-biased, $t_p = 250 \mu\text{s}$		75						—	—	350	—		
Second-Breakdown Energy With base reverse-biased, and $R_{BE} = 20 \Omega$ , $L = 40 \mu\text{H}$	ES/b <sup>**</sup>			6			10	2	—	2	—	mJ	
Saturated Switching Time: (See Figs. 3 & 4) Turn-on ( $t_d + t_r$ )	t <sub>ON</sub>	V <sub>CC</sub> = 30				1.2 <sup>♠</sup>	15	—	0.5	—	0.5	μs	
Storage	t <sub>s</sub>					1.2 <sup>♠</sup>	15	—	1.5	—	1.5		
Fall	t <sub>f</sub>					1.2 <sup>♠</sup>	15	—	0.5	—	0.5		
Gain-Bandwidth Product (f = 1 MHz)	f <sub>T</sub>		10				3	20	—	20	—	MHz	
Collector-to-Base Feedback Capacitance (f = 1 MHz)	C <sub>ob</sub>		10		0			—	500	—	500	pF	
Thermal Resistance (Junction-to-Case)	R <sub>θJC</sub>		10					2N3263 2N3264	—	2N3265 2N3266	—	1	°C/W

<sup>•</sup> In accordance with JEDEC registration data format.

<sup>•</sup> Pulsed; pulse duration  $\leq 350 \mu\text{s}$ , duty factor  $\leq 2\%$ . CAUTION: The sustaining voltages V<sub>CEO(sus)</sub> and V<sub>CER(sus)</sub> MUST NOT be measured on a curve tracer. These sustaining voltages should be measured by means of the test circuit shown in Fig. 5.

<sup>▲</sup> I<sub>S/b</sub> is defined as the current at which second breakdown occurs at a specified collector voltage.

<sup>\*\*</sup> ES/b is defined as the energy at which second breakdown occurs under specified reverse bias conditions.  $ES/b = 1/2 LI^2$ , where L is a series load or leakage inductance and I is the collector current.

<sup>♠</sup> I<sub>B1</sub> = I<sub>B2</sub>.

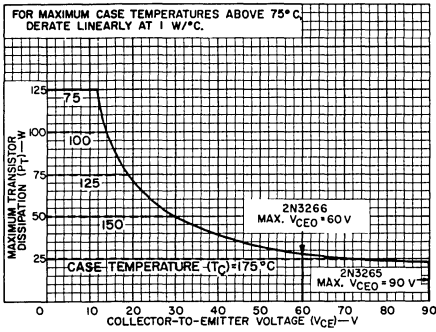


Fig.1—Rating chart for 2N3265 and 2N3266.

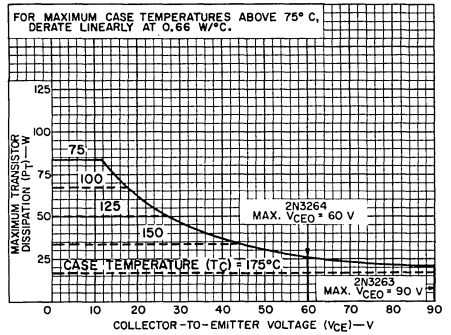


Fig.2—Rating chart for 2N3263 and 2N3264.

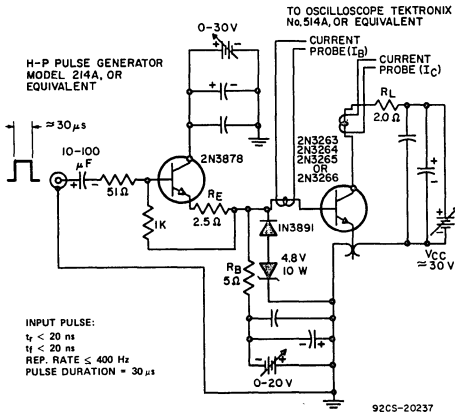


Fig.3—Circuit used to measure saturated switching times.

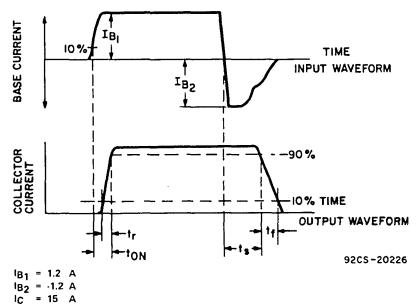


Fig.4—Phase relationship between input and output currents showing reference points for specification of switching times. (Test circuit shown in Fig. 3.)

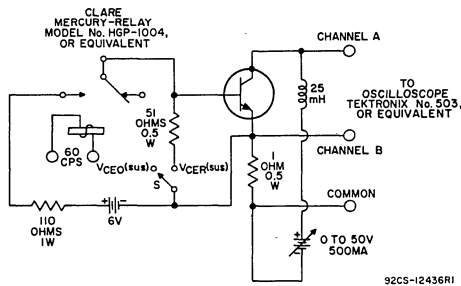
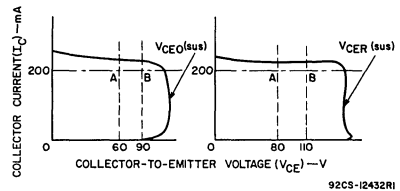


Fig.5—Circuit used to measure sustaining voltages  $V_{CE0}(sus)$  and  $V_{CER}(sus)$ .



The sustaining voltages  $V_{CE0}(sus)$  and  $V_{CER}(sus)$  are acceptable when the traces fall to the right of point "A" for types 2N3264 and 2N3266. The traces must fall to the right of point "B" for types 2N3263 and 2N3265.

Fig.6—Oscilloscope display for  $V_{CE0}(sus)$  and  $V_{CER}(sus)$  measurement. (Test circuit shown in Fig. 5.)

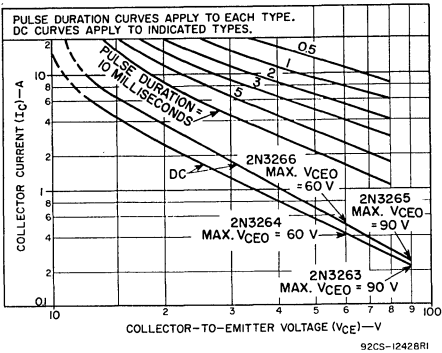


Fig. 7—Safe-operating region as a function of pulse width.

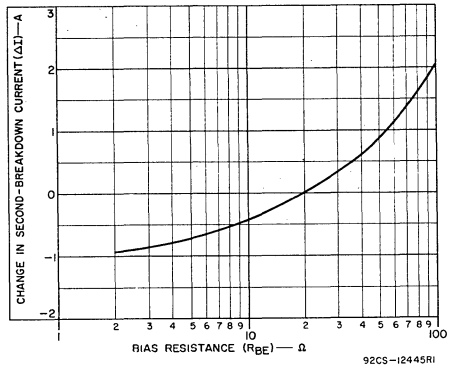


Fig. 8—Typical change in  $E_{sb}$  as a function of base-to-emitter resistance.

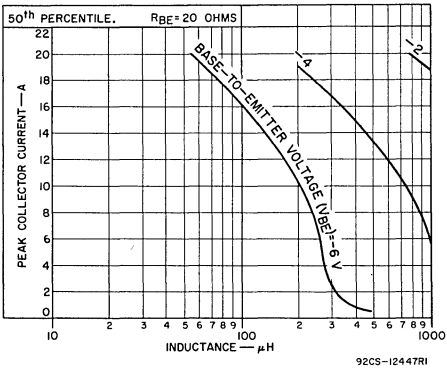


Fig. 9—Collector current as a function of inductance (10th percentile).

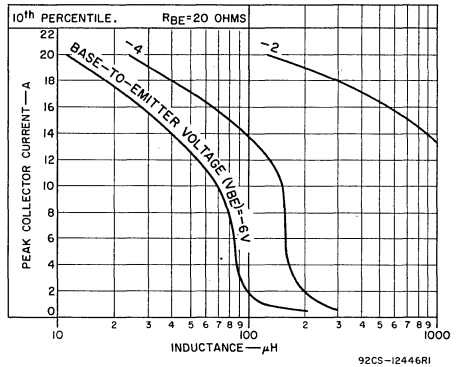


Fig. 10—Collector current as a function of inductance (50th percentile).

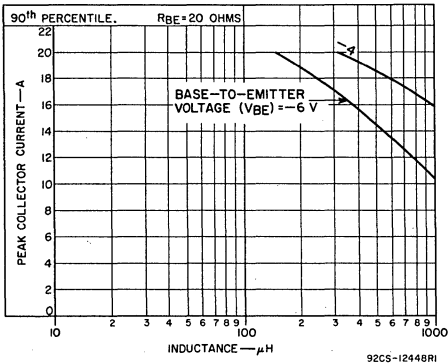


Fig. 11—Collector current as a function of inductance (90th percentile).

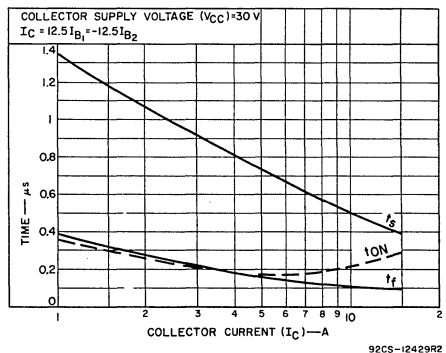


Fig. 12—Typical saturated-switching characteristics.



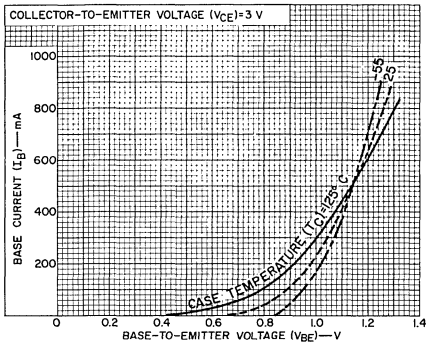


Fig. 13—Typical input characteristics.

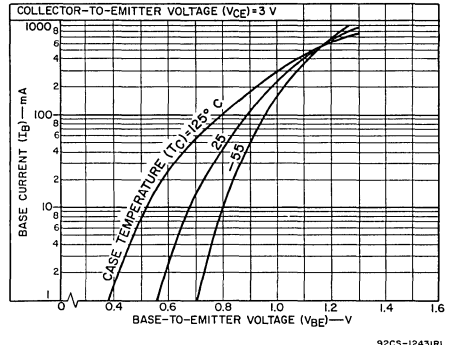


Fig. 14—Typical input characteristics.

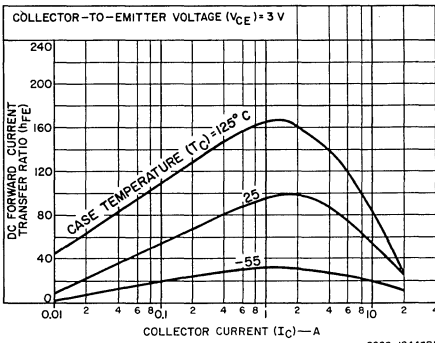


Fig. 15—Typical dc beta characteristics (median values).

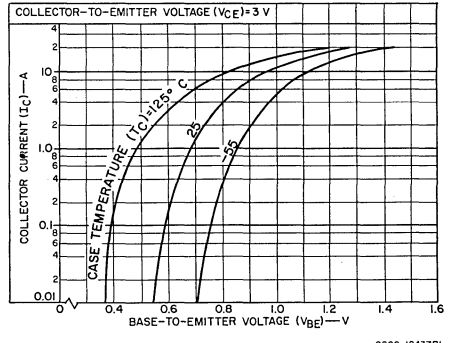


Fig. 16—Typical transfer characteristics.

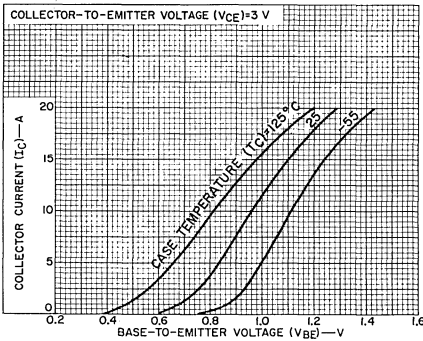


Fig. 17—Typical transfer characteristics.

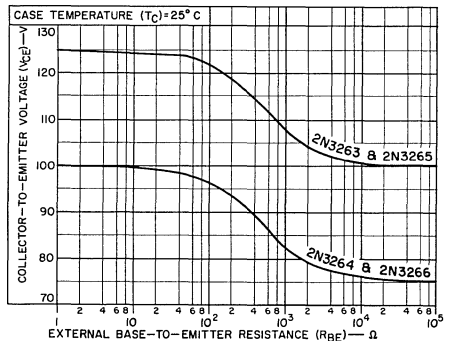


Fig. 18—Typical sustaining voltage vs. base-to-emitter resistance.

**TERMINAL CONNECTIONS**

2N3263, 2N3264

Lead 1 — Base

Case, Lead 2 — Collector

Lead 3 — Emitter

**TERMINAL CONNECTIONS**

2N3265, 2N3266

Pin 1 — Emitter

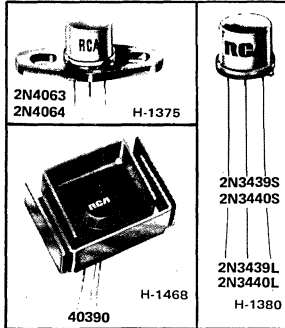
Pin 2 — Base

Case, Pin 3 — Collector



# Power Transistors

2N4063  
2N4064  
2N3439  
2N3440  
2N4063  
2N4064  
40390



## High-Voltage Silicon N-P-N Transistors

For High-Speed Switching and Linear-Amplifier Applications

### Features

- High voltage ratings:
  - $V_{CB0} = 450 \text{ V max. (2N3439, 2N4063)}$
  - $= 300 \text{ V max. (2N3440, 2N4064)}$
  - $V_{CE0(sus)} = 350 \text{ V max. (2N3439, 2N4063)}$
  - $= 250 \text{ V max. (2N3440, 2N4064)}$
- Maximum-area-of-operation curves
- Low saturation voltages

These devices are available with either 1½-inch leads (TO-5 package) or ½-inch leads (TO-39 package). The longer-lead versions are specified by suffix "L" after the type number; the shorter-lead versions are specified by suffix "S" after the type number.

RCA-2N3439\*, 2N3440\*\*, 2N4063, 2N4064, and 40390 are epitaxial-base silicon n-p-n transistors with high breakdown voltages, high-frequency response, and fast switching speeds. These transistors are intended for industrial, commercial, and military equipment. Typical applications include high-voltage differential and operational amplifiers, high-voltage inverters, and high-voltage, low-current switching and series regulators.

The 2N3439 and the 2N3440 differ primarily in their voltage ratings; the 2N4063 and 2N4064 have the same voltage ratings as the 2N3439 and 2N3440 respectively, but employ a flange package. Type 40390 is a 2N3440 with a factory-attached heat radiator; it is intended for printed-circuit-board applications.

\* Formerly RCA Dev. No. TA2458.  
\*\* Formerly RCA Dev. No. TA2470.

### Absolute-Maximum Values:

	2N3439 2N4063	2N3440 2N4064 40390	
COLLECTOR-TO-BASE VOLTAGE . . . . .	$V_{CB0}$ 450	300	V
COLLECTOR-TO-EMITTER SUSTAINING VOLTAGE . . . . .	$V_{CE0(sus)}$ 350	250	V
EMITTER-TO-BASE VOLTAGE . . . . .	$V_{EB0}$ 7	7	V
COLLECTOR CURRENT . . . . .	$I_C$ 1	1	A
BASE CURRENT . . . . .	$I_B$ 0.5	0.5	A
TRANSISTOR DISSIPATION . . . . .	$P_T$		
At case temperatures up to 25° C . . . . .	10	10(2N3440)	W
At free-air temperatures up to 25° C . . . . .	—	10(2N4064)	W
At free-air temperatures up to 50° C . . . . .	—	3.5(40390)	W
At free-air temperatures above 25° C or 50° C . . . . .	1(2N3439)	1(2N3440)	W
For pulse operation . . . . .	See Fig. 2.	See Fig. 9.	
TEMPERATURE RANGE:			
Storage & Operating (Junction) . . . . .	← -65 to 200 →		°C
LEAD TEMPERATURE (During soldering):			
At distance ≥ 1/32 in. from seating plane for 10 s max. . . . .	← 255 →		°C

ELECTRICAL CHARACTERISTICS, At Case Temperature ( $T_C$ ) = 25°C

Characteristic	Symbol	TEST CONDITIONS						LIMITS				Units	
		DC Collector Volts		DC Emitter or Base Volts		DC Current (milliamperes)		Types 2N3439 2N4063		Types 2N3440 2N4064 40390			
		$V_{CB}$	$V_{CE}$	$V_{EB}$	$V_{BE}$	$I_C$	$I_E$	$I_B$	Min.	Max.	Min.		Max.
Collector-Cutoff Current	$I_{CEO}$		300 200					0 0	- -	20 -	- -	- 50	$\mu A$ $\mu A$
	$I_{CEV}$		450 300		-1.5 -1.5				- -	500 -	- -	- 500	$\mu A$ $\mu A$
Emitter-Cutoff Current	$I_{EBO}$			6		0			-	20	-	20	$\mu A$
DC Forward-Current Transfer Ratio	$h_{FE}$		10 10			20 2			40 30	160 -	40 -	160 -	
Collector-to-Emitter Sustaining Voltage: (See Figs. 3 & 4.) With base open	$V_{CEO(sus)}$					50	0	350 <sup>a</sup>	-	250 <sup>a</sup>	-	-	V
Base-to-Emitter Saturation Voltage	$V_{BE(sat)}$					50	4	-	1.3	-	1.3	-	V
Collector-to-Emitter Saturation Voltage	$V_{CE(sat)}$					50	4	-	0.5	-	0.5	-	V
Small-Signal, Forward-Current Transfer Ratio (at 5 MHz)	$h_{fe}$		10			10			3	-	3	-	
Output Capacitance (at 1 MHz)	$C_{ob}$	10					0		-	10	-	10	pF
Second-Breakdown Collector Current: With base forward biased	$I_{S/b}$		200						50	-	50	-	mA
Thermal Resistance: Junction-to-Case	$\theta_{J-C}$								-	17.5	-	17.5	°C/W

<sup>a</sup>CAUTION: The sustaining voltage  $V_{CEO(sus)}$  MUST NOT be measured on a curve tracer. The sustaining voltage should be measured by means of the test circuit shown in Fig. 3.

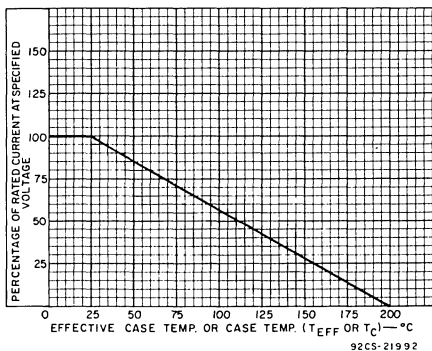


Fig. 1 - Current derating curve for all types.

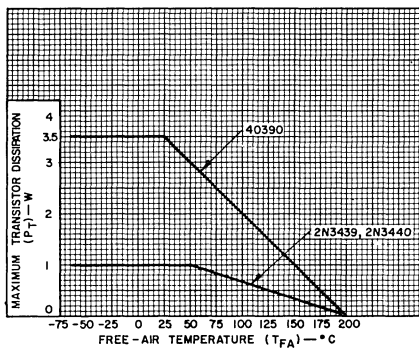


Fig. 2 - Dissipation derating curve for 2N3439, 2N3440, and 40390.

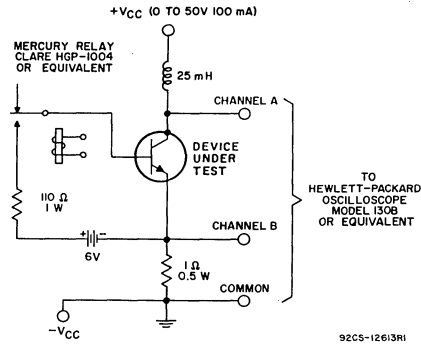
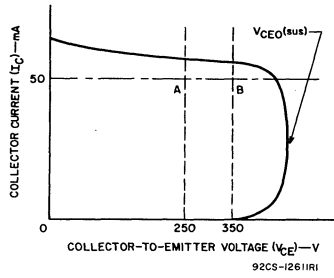


Fig. 3 - Circuit used to measure sustaining voltage,  $V_{CE0(sus)}$ , for all types.



The sustaining voltage  $V_{CE0(sus)}$  is acceptable when the trace falls to the right and above point "A" for types 2N3440, 2N4064 and 40390. The trace must fall to the right and above point "B" for types 2N3439 and 2N4063.

Fig. 4 - Oscilloscope display for measurement of sustaining voltages (test circuit shown in Fig. 3).

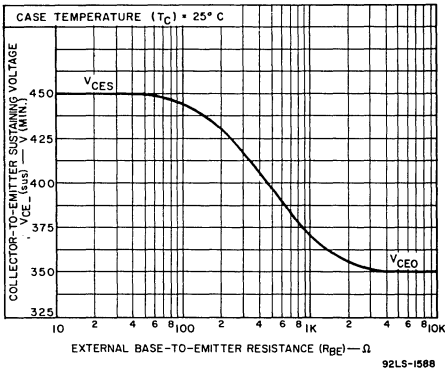


Fig. 5 - Sustaining voltage vs. base-to-emitter resistance for 2N3439 and 2N4063.

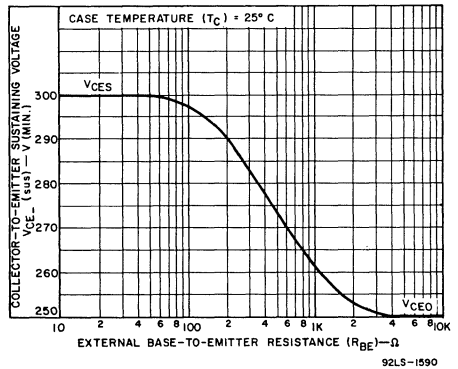


Fig. 6 - Sustaining voltage vs. base-to-emitter resistance for 2N3440, 2N4064, and 40390.

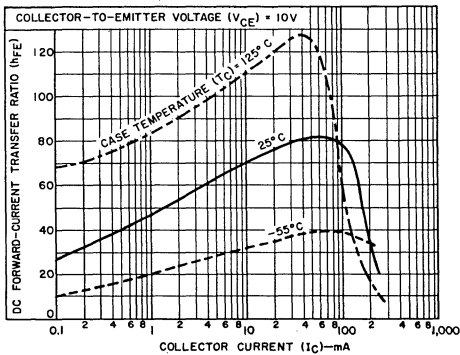


Fig. 7 - Typical dc-beta characteristics for all types.

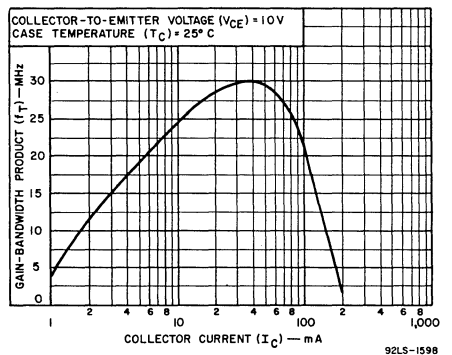
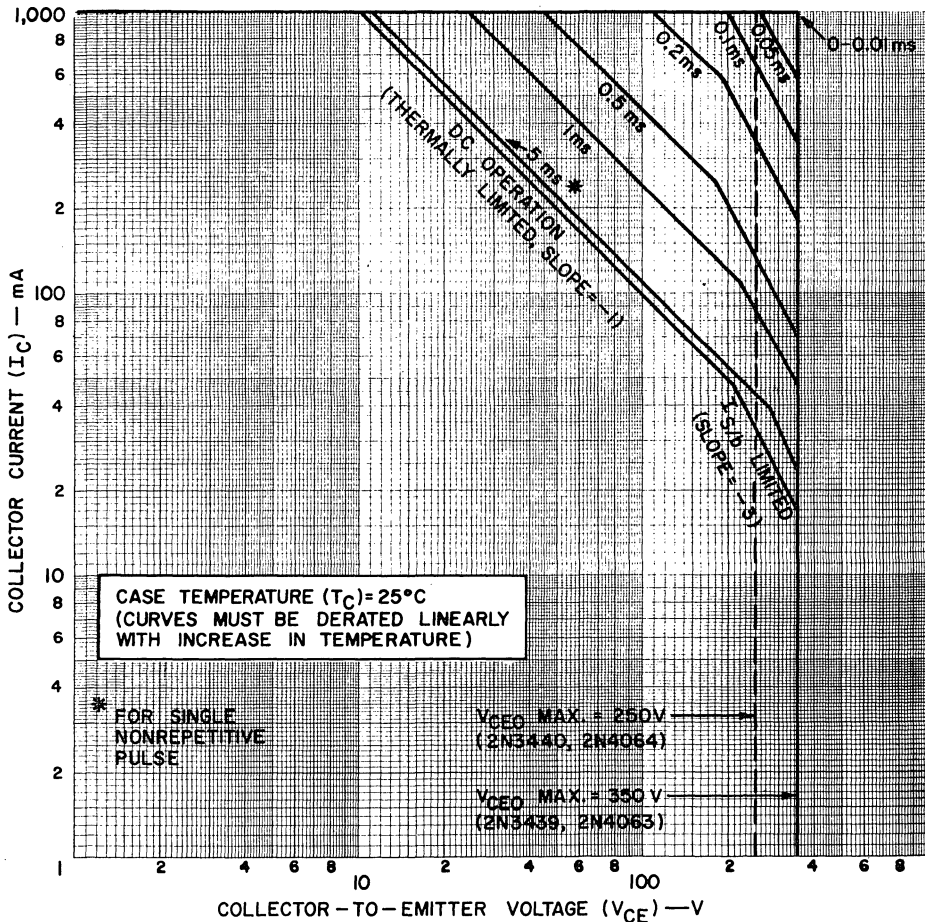


Fig. 8 - Typical gain-bandwidth product for all types.



92LM-1596

Fig. 9 — Maximum operating areas for 2N3439, 2N3440, 2N4063 and 2N4064.

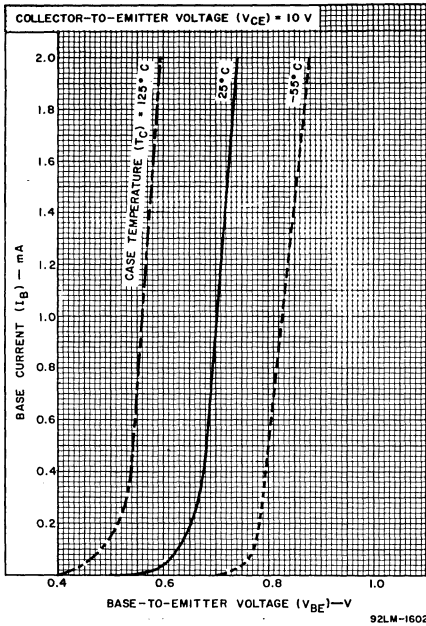


Fig. 10 — Typical input characteristics for all types.

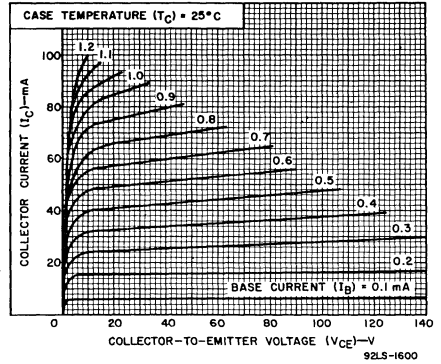


Fig. 11 — Typical output characteristics for all types.

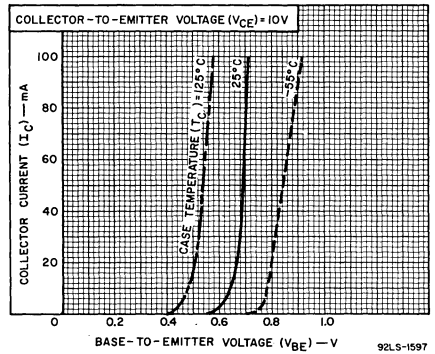


Fig. 12 — Typical transfer characteristics for all types.

**TERMINAL CONNECTIONS**  
2N4063, 2N4064

- Lead 1 — Emitter
- Lead 2 — Base
- Flange, Lead 3 — Collector

**TERMINAL CONNECTIONS**  
2N3439, 2N3440

- Lead 1 — Emitter
- Lead 2 — Base
- Case, Lead 3 — Collector

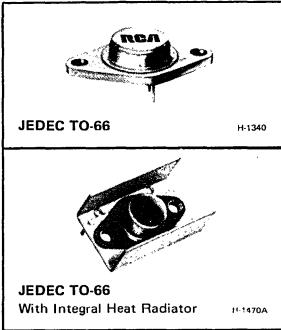
**TERMINAL CONNECTIONS**  
40390

- Lead 1 — Emitter
- Lead 2 — Base
- Heat-Radiator, Lead 3 — Collector



# Power Transistors

2N3441 2N6263 2N6264  
40373 40912 40913



## Hometaxial II<sup>®</sup> Medium-Power Silicon N-P-N Transistors

Rugged Devices for Intermediate Power Applications in Industrial and Commercial Equipment

**Features:**

- 2N6264: premium type from 2N3441 family
- Maximum safe-area-of-operation curves for dc and pulse operation
- High voltage ratings
- Low saturation voltages
- Thermal-cycling rating curves

**Applications:**

- Series and shunt regulators
- High-fidelity amplifiers
- Power switching circuits
- Solenoid drivers

RCA 2N3441, 2N6263, and 2N6264 are hometaxial-base silicon n-p-n transistors intended for a wide variety of medium- to-high power, high-voltage applications.

“Hometaxial” was coined by RCA from “homogenous” and “axial” to describe a single-diffused transistor with a base region of homogeneous-resistivity in the axial direction (emitter-to-collector).

Types 40373, 40912, and 40913 are the 2N3441, 2N6263, and 2N6264 with factory-attached heat-radiators intended for printed-circuit-board applications.

“Hometaxial II” is a term used to describe RCA’s expanded line of transistors produced by the hometaxial process.

**MAXIMUM RATINGS, Absolute-Maximum Values:**

	2N6263 40912	2N3441 40373	2N6264 40913		
*COLLECTOR-TO-BASE VOLTAGE	V <sub>CBO</sub>	140	160	170	V
COLLECTOR-TO-EMITTER SUSTAINING VOLTAGE:					
* With base open	V <sub>CEO(sus)</sub>	120	140	150	V
With external base-to-emitter resistance (R <sub>BE</sub> ) = 100Ω	V <sub>CER(sus)</sub>	130	150	160	V
With base reverse-biased (V <sub>BE</sub> = -1.5 V)	V <sub>CEV(sus)</sub>	140	160	170	V
*EMITTER-TO-BASE VOLTAGE	V <sub>EBO</sub>	7	7	7	V
*CONTINUOUS COLLECTOR CURRENT	I <sub>C</sub>	3	3	3	A
PEAK COLLECTOR CURRENT		4	4	4	A
*CONTINUOUS BASE CURRENT	I <sub>B</sub>	2	2	2	A
TRANSISTOR DISSIPATION:	P <sub>T</sub>				
* At case temperature up to 25°C		20	25	50	W
At ambient temperatures up to 25°C		(2N6263) 5.8 (40912)	(2N3441) 5.8 (40373)	(2N6264) 5.8 (40913)	W
* At temperatures above 25°C					
*TEMPERATURE RANGE:					
Storage & Operating (Junction)		-65 to 200			°C
*PIN TEMPERATURE (During Soldering):					
At distances ≥ 1/32 in. (0.8 mm) from seating plane for 10 s max.		235			°C

See Figs. 4 & 7 See Figs. 4 & 7 See Figs. 1 & 7

\*In accordance with JEDEC registration data format JS-6 RDF-2

ELECTRICAL CHARACTERISTICS, At Case Temperature ( $T_C$ ) = 25°C, Unless Otherwise Specified

CHARACTERISTIC	SYMBOL	TEST CONDITIONS				LIMITS						UNITS	
		VOLTAGE V dc		CURRENT A dc		2N6263 40912		2N3441 40373		2N6264 40913			
		V <sub>CE</sub>	V <sub>BE</sub>	I <sub>C</sub>	I <sub>B</sub>	Min.	Max.	Min.	Max.	Min.	Max.		
Collector-Cutoff Current:													
With base open	I <sub>CEO</sub>	100 130 140			0 0 0	— — —	5 — —	— — —	— — 100	— — —	— — —	1 — —	mA
Collector-Cutoff Current:													
With base-emitter junction reversed biased	I <sub>CEX</sub>	120 140 140 150	-1.5 -1.5 -1.5 -1.5			— — — —	2* — — —	— — 1 —	— — — —	— — — —	— — — —	— — — 0.05*	mA
	I <sub>CEX</sub> (T <sub>C</sub> = 150°C)	120 140 140 150	-1.5 -1.5 -1.5 -1.5			— — — —	10* — — —	— — 6* 5	— — — —	— — — —	— — — —	— — — 1*	
Emitter-Cutoff Current	I <sub>EBO</sub>		-5 -7			— —	2 —	— —	— 1	— —	— 0.2	— —	mA
Collector-to-Emitter Sustaining Voltage: <sup>a</sup>	V <sub>CEO(sus)</sub>												
With base open				0.1 <sup>b</sup>	0	120	—	140	—	150	—	—	
With external base-to-emitter resistance (R <sub>BE</sub> ) = 100 Ω	V <sub>CER(sus)</sub>			0.1		130	—	150	—	160	—	—	V
With base-emitter junction reversed biased	V <sub>CEV(sus)</sub>		-1.5	0.1		140	—	160	—	170	—	—	
DC Forward-Current Transfer Ratio	h <sub>FE</sub>	2 2 4 4		1 <sup>b</sup> 3 <sup>b</sup> 0.5 <sup>b</sup> 2.7 <sup>b</sup>		— 3 20	— — 100	— — 25	— — 100	20 5 —	60 — —	—	
Collector-to-Emitter Saturating Voltage	V <sub>CE(sat)</sub>			0.5 <sup>b</sup> 1 <sup>b</sup> 2.7 <sup>b</sup>	0.05 0.1 0.9	— — —	1.2* — —	— — —	— — 6*	— — —	— — —	0.5* — —	V
Base-to-Emitter Voltage	V <sub>BE</sub>	2 4 4		1 <sup>b</sup> 0.5 <sup>b</sup> 2.7 <sup>b</sup>		— — —	— 2* —	— — —	— 1.7 6*	— — —	— — —	1.5* — —	V
Magnitude of Common-Emitter, Small-Signal, Short-Circuit Forward Current Transfer Ratio (f = 0.4 MHz)	h <sub>fe</sub>	4 4		0.2 0.5		8 —	— —	— 5	— —	2 —	— —	— —	
Gain-Bandwidth Product	f <sub>T</sub>	4		0.2		800	—	800	—	800	—	—	kHz
Common-Emitter, Small-Signal, Short-Circuit Forward Current Transfer Ratio (f = 1 kHz)	h <sub>fe</sub>	4 4		0.1 0.5		25 —	— —	— 15	— 75	25 —	— —	— —	
Forward-Bias Second Breakdown Collector Current, Pulse Duration (non-repetitive) = 1 s	I <sub>S/b</sub>	120 120 120				0.167 — —	— — —	— — 0.21	— — —	— — —	— 0.417 —	— — —	A
Thermal Resistance:													
Junction-to-Case	R <sub>θJC</sub>					8.75 (max.) 2N6263		7 (max.) 2N3441		3.5 (max.) 2N6264			°C/W
Junction-to-Ambient	R <sub>θJA</sub>					30 (max.) 40912		30 (max.) 40373		30 (max.) 40913			

<sup>a</sup>In accordance with JEDEC registration data format (JS-6 RDF-2).

<sup>b</sup>CAUTION: The sustaining voltage V<sub>CEO(sus)</sub>, V<sub>CER(sus)</sub>, and V<sub>CEV(sus)</sub> MUST NOT be measured on a curve tracer.

These sustaining voltages should be measured by means of the test circuit shown in Fig. 11.

<sup>b</sup>Pulsed, pulse duration = 300 μs; duty factor ≤ 2 %.



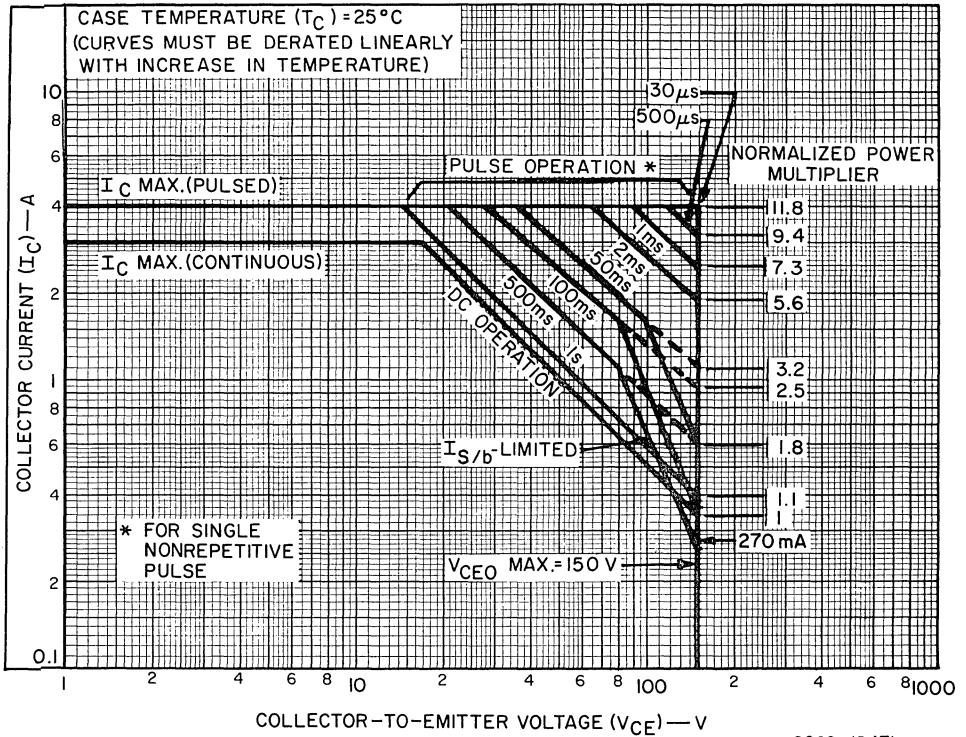


Fig. 1 - Maximum operating areas for type 2N6264.

92CS-19471

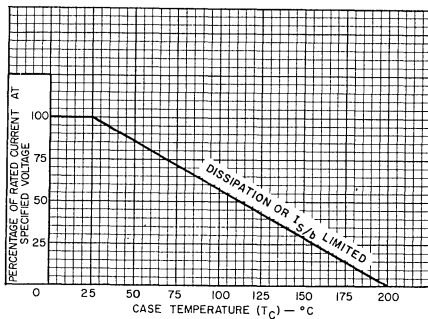


Fig. 2 - Current derating curve for all types.

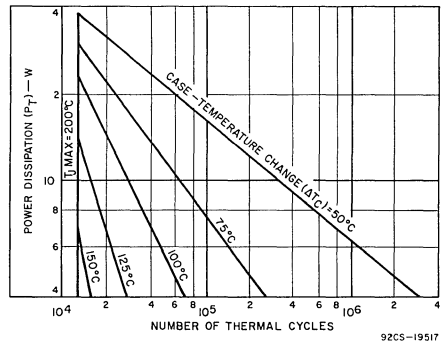


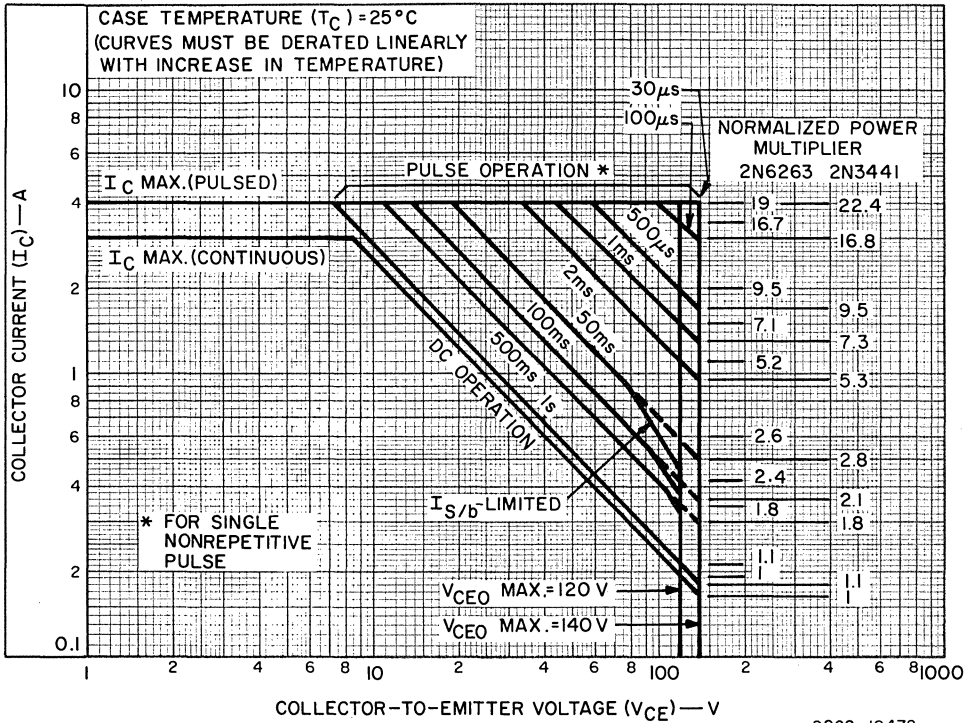
Fig. 3 - Thermal-cycle rating chart for type 2N6264.

**TERMINAL CONNECTIONS  
FOR 2N3441, 2N6263 & 2N6264**

Pin 1 - Base  
Pin 2 - Emitter  
Case, Mounting Flange - Collector

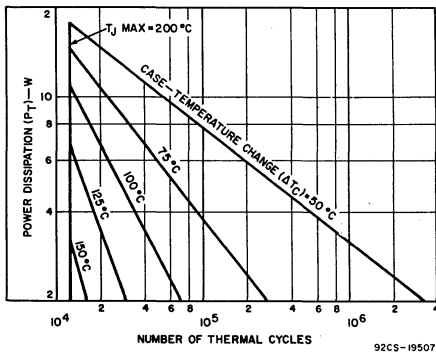
**TERMINAL CONNECTIONS  
FOR 40373, 40912, & 40913**

Pin 1 - Base  
Pin 2 - Emitter  
Heat-Radiator - Collector



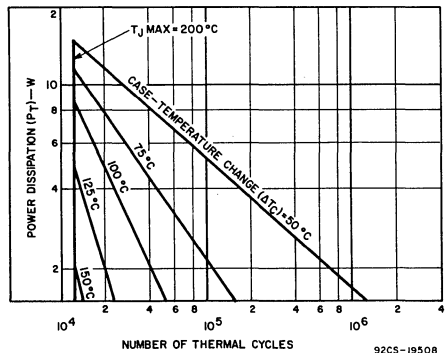
92CS-19472

Fig.4—Maximum operating areas for type 2N6263 and 2N3441.



92CS-19507

Fig.5—Thermal-cycle rating chart for type 2N3441.



92CS-19508

Fig.6—Thermal-cycle rating chart for type 2N6263.

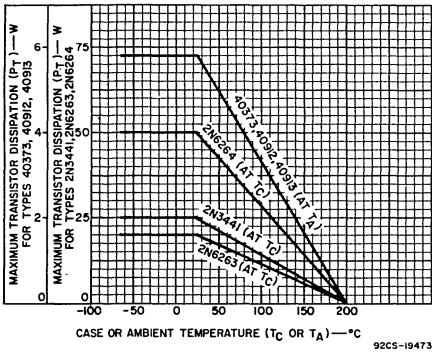


Fig. 7—Dissipation derating curves for all types.

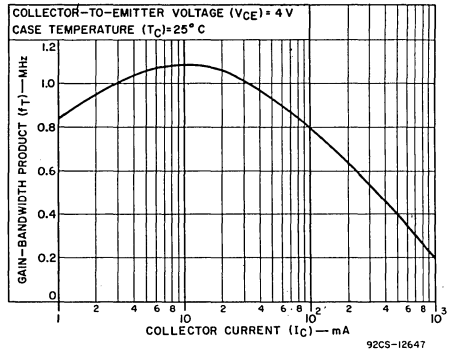


Fig. 8—Typical gain-bandwidth product for all types.

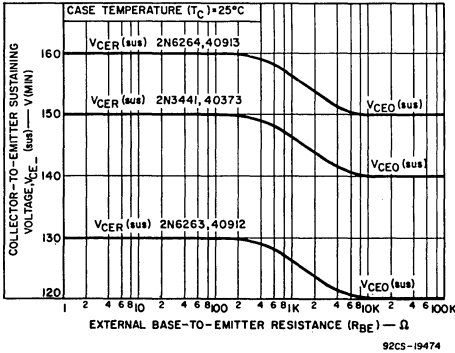


Fig. 9—Sustaining voltage vs. base-to-emitter resistance for all types.

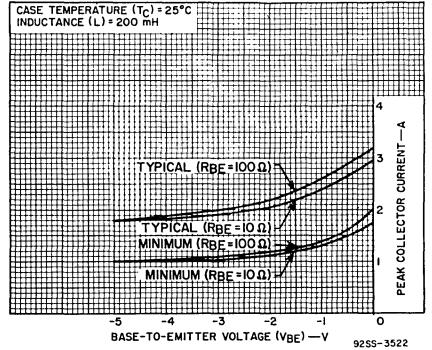


Fig. 10—Reverse-bias second-breakdown characteristics for all types.

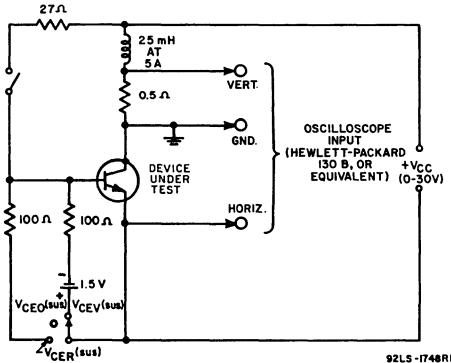
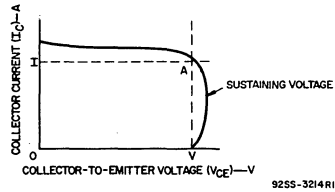


Fig. 11—Circuit used to measure sustaining voltages,  $V_{CE0(sus)}$ ,  $V_{CER(sus)}$ , and  $V_{CEV(sus)}$  for all types.



Note: The sustaining voltage,  $V_{CE0(sus)}$ ,  $V_{CER(sus)}$ , or  $V_{CEV(sus)}$  is acceptable when the trace falls to the right and above point "A" for all types. (For values of current and voltage, see *Electrical Characteristics*)

Fig. 12—Oscilloscope display for measurement of sustaining voltages (test circuit shown in Fig. 11).

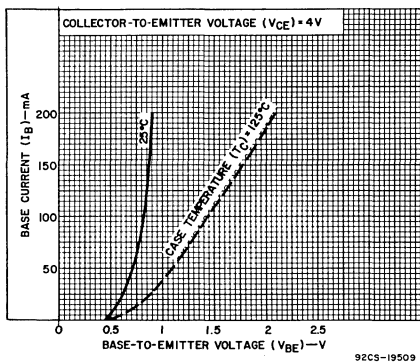


Fig. 13—Typical input characteristics for types 2N6264 and 40913.

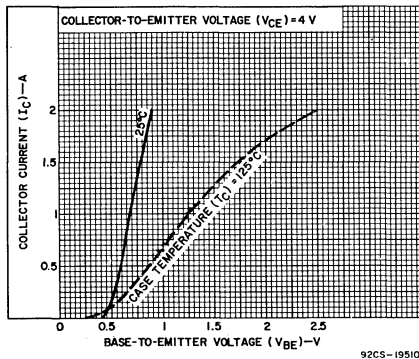


Fig. 14—Typical transfer characteristics for types 2N6264 and 40913.

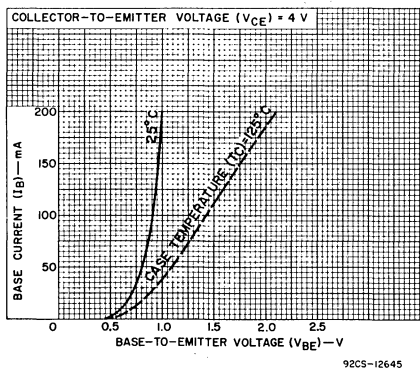


Fig. 15—Typical input characteristics for types 2N3441 and 40373.

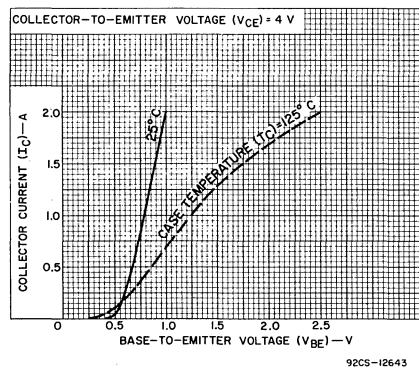


Fig. 16—Typical transfer characteristics for types 2N3441 and 40373.

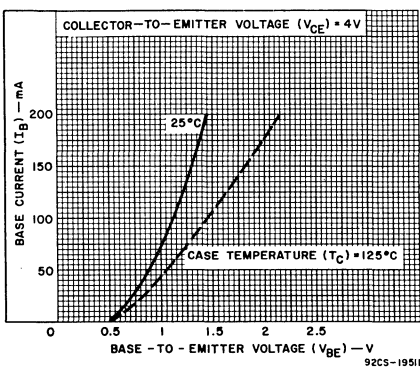


Fig. 17—Typical input characteristics for types 2N6263 and 40912.

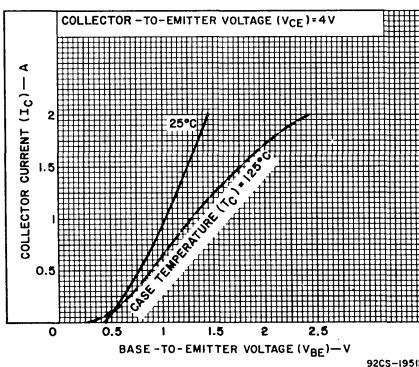


Fig. 18—Typical transfer characteristics for types 2N6263 and 40912.

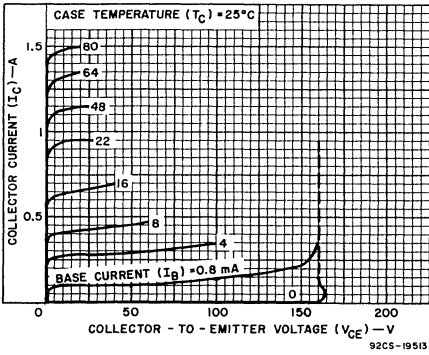


Fig. 19—Typical output characteristics for types 2N6264 and 40913.

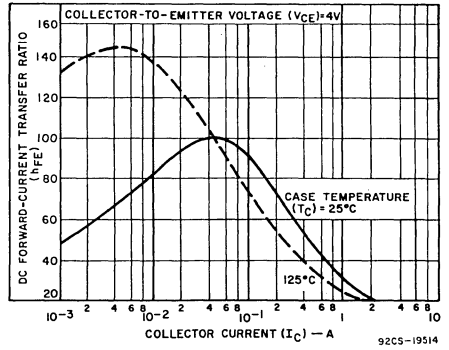


Fig. 20—Typical dc-beta characteristics for types 2N6264 and 40913.

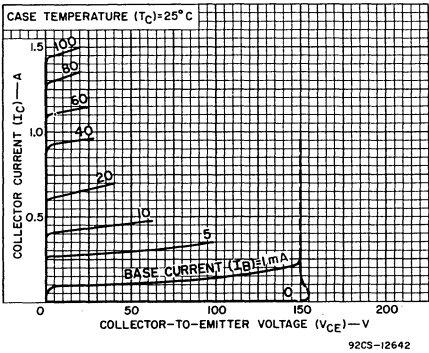


Fig. 21—Typical output characteristics for types 2N3441 and 40373.

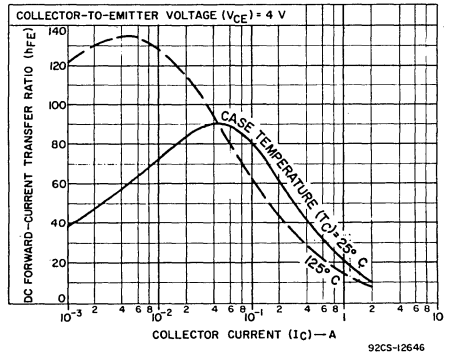


Fig. 22—Typical dc-beta characteristics for types 2N3441 and 40373.

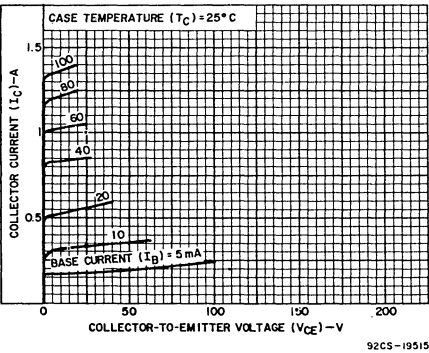


Fig. 23—Typical output characteristics for types 2N6263 and 40912.

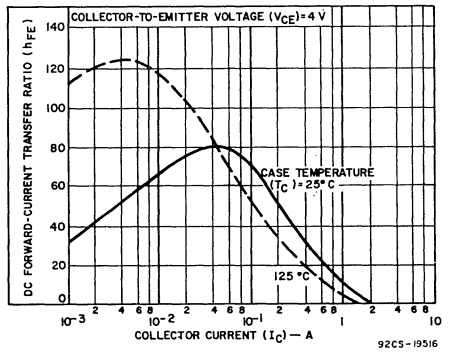
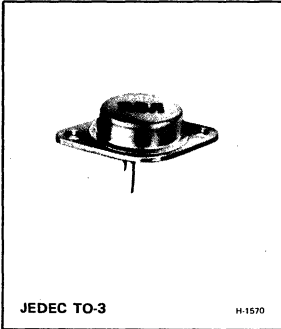


Fig. 24—Typical dc-beta characteristics for types 2N6263 and 40912.

**RCA**  
Solid State  
Division

**Power Transistors**  
**2N3442**  
**2N4347**  
**2N6262**



**Hometaxial II<sup>®</sup> High-Voltage  
Silicon N-P-N Transistors**

Rugged High-Power Devices for Applications in  
Industrial and Commercial Equipment

*Features:*

- Low saturation voltages
- Thermal-cycle rating charts
- High dissipation capability — 100 W (2N4347)  
— 117 W (2N3442)  
— 150 W (2N6262)
- Maximum area-of-operation curves  
for dc and pulse operation.

RCA 2N3442, 2N4347, and 2N6262 are hometaxial-base<sup>®</sup>, silicon n-p-n transistors intended for a wide variety of high-power, high-voltage applications. Typical applications for these transistors include power-switching circuits, audio amplifiers, series- and shunt-regulator driver and output stages, dc-to-dc converters, inverters, and solenoid (hammer)/ relay driver service.

These devices employ the popular JEDEC TO-3 package; they differ in maximum ratings for voltage, current, and power.

*Applications:*

- Series and shunt regulators
- High-fidelity amplifiers
- Power-switching circuits

● "Hometaxial" was coined by RCA from "homogeneous" and "axial" to describe a single-diffused transistor with a base region of homogeneous-resistivity silicon in the axial direction (emitter-to-collector). "Hometaxial II" is a term used to describe RCA's expanded line of transistors produced by the hometaxial process.

**MAXIMUM RATINGS, Absolute-Maximum Values:**

	2N4347	2N3442	2N6262		
*COLLECTOR-TO-BASE VOLTAGE .....	V <sub>CB0</sub>	140	160	170	V
COLLECTOR-TO-EMITTER VOLTAGE:					
* With base open .....	V <sub>CEO</sub>	120	140	150	V
With reverse bias (V <sub>BE</sub> ) of -1.5 V .....	V <sub>CEX</sub>	140*	160	170	V
*EMITTER-TO-BASE VOLTAGE .....	V <sub>EBO</sub>	7	7	7	V
*COLLECTOR CURRENT:	I <sub>C</sub>				
Continuous .....		5	10	10	A
Peak .....		10*	15	15	A
*BASE CURRENT:	I <sub>B</sub>				
Continuous .....		3	7	7	A
Peak .....		8*	—	—	A
*TRANSISTOR DISSIPATION:	P <sub>T</sub>				
At case temperature up to 25°C .....		100	117	150	W
At case temperatures above 25°C .....		← See Figs. 1, 4, 7, & 22 →			
*TEMPERATURE RANGE:					
Storage & Operating (Junction) .....		← -65 to +200 →			°C
*PIN TEMPERATURE (During Soldering):					
At distances ≥ 1/32 in. (0.8 mm) from case for 10 s max. ....		235	235	235	°C

\*In accordance with JEDEC registration data format (JS-6, RDF-2).

ELECTRICAL CHARACTERISTICS, At Case Temperature ( $T_C$ ) = 25°C unless otherwise specified

CHARACTERISTIC	SYMBOL	TEST CONDITIONS				LIMITS						UNITS	
		VOLTAGE		CURRENT		2N4347		2N3442		2N6262			
		V <sub>dc</sub>		A <sub>dc</sub>		Min.	Max.	Min.	Max.	Min.	Max.		
Collector Cutoff Current: With emitter open (V <sub>CB</sub> = 140 V)	I <sub>CBO</sub>					—	—	—	1*	—	1	mA	
* With base-emitter junction reverse-biased	I <sub>CEX</sub>	120 140 150	-1.5 -1.5 -1.5			— — —	2 — —	— — —	— 5 —	— — —	— — 0.1	mA	
* With base-emitter junction reverse-biased and T <sub>C</sub> = 150°C	I <sub>CEX</sub>	125 140 150	-1.5 -1.5 -1.5			— — —	10 — —	— — —	— 30 —	— — —	— — 2	mA	
* With base open	I <sub>CEO</sub>	100 110 140				— — —	200 — —	— — —	— — 200	— — —	— 1 —	mA	
* Emitter Cutoff Current	I <sub>EBO</sub>		-7	0		—	5	—	5	—	0.2	mA	
* DC Forward Current Transfer Ratio	h <sub>FE</sub>	2 4 4 4 4		3 <sup>a</sup> 10 <sup>a</sup> 2 <sup>a</sup> 3 <sup>a</sup> 5 <sup>a</sup> 10 <sup>a</sup>		— — 15 — 10 —	— — 60 — — —	— — — 20 — 7.5	— — — 70 — —	— — — — — —	20 5 — — — —	70 — — — — —	V
Collector-to-Emitter Sustaining Voltage: With base-emitter junction reverse- biased	V <sub>CEV(sus)</sub>		-1.5 -1.5	0.1 0.2		140 —	— —	160 —	— —	— 170	— —	— —	V
With external base-to-emitter resistance (R <sub>BE</sub> ) = 100Ω	V <sub>CER(sus)</sub>			0.1 0.2		130 —	— —	— 150	— —	— 160	— —	— —	V
* With base open	V <sub>CEO(sus)</sub>			0.2 <sup>a</sup> 0.2 <sup>a</sup>	0 0	120 —	— —	140 —	— —	— 150	— —	— —	V
* Base-to-Emitter Voltage	V <sub>BE</sub>	2 4 4 4 4		3 <sup>a</sup> 3 <sup>a</sup> 2 <sup>a</sup> 5 <sup>a</sup> 10 <sup>a</sup>		— — — 2 — —	— — — — —	1.7 — — — —	— — — — 5.7	— — — — —	— — — — —	1 — — — —	V
* Collector-to-Emitter Saturation Voltage	V <sub>CE(sat)</sub>			2 <sup>a</sup> 3 <sup>a</sup> 5 <sup>a</sup> 10 <sup>a</sup>	0.2 0.3 0.63 2	— — — —	1 — 2 —	— — — —	— 1 — 5	— — — —	— 0.5 — —	— — — —	V
Power Rating Test	PRT	67 78 100		1.5 1.5 1.5		1 — —	— — —	— 1 —	— — —	— — 1	— — —	— — —	s
* Magnitude of Common- Emitter, Small-Signal, Short-Circuit, Forward Current Transfer Ratio: f = 50 kHz	h <sub>fe</sub>	4		0.5		40	—	—	—	—	—	—	
f = 40 kHz	h <sub>fe</sub>	4 4		1 2		— —	— —	— 2	— —	2 —	— —	— —	
* Common-Emitter, Small- Signal, Short-Circuit, Forward Current Trans- fer Ratio (f = 1 kHz)	h <sub>fe</sub>	4 4 4		0.5 1 2		40 — —	— — —	— — 12	— — 72	— 10 —	— — —	— — —	
Thermal Resistance: Junction-to-Case	R <sub>θJC</sub>					—	1.75	—	1.5	—	1.17	°C/W	

\* In accordance with JEDEC registration data format JS-6 RDF-2

<sup>a</sup> Pulse test; pulse duration = 300 μs, rep. rate = 60 Hz

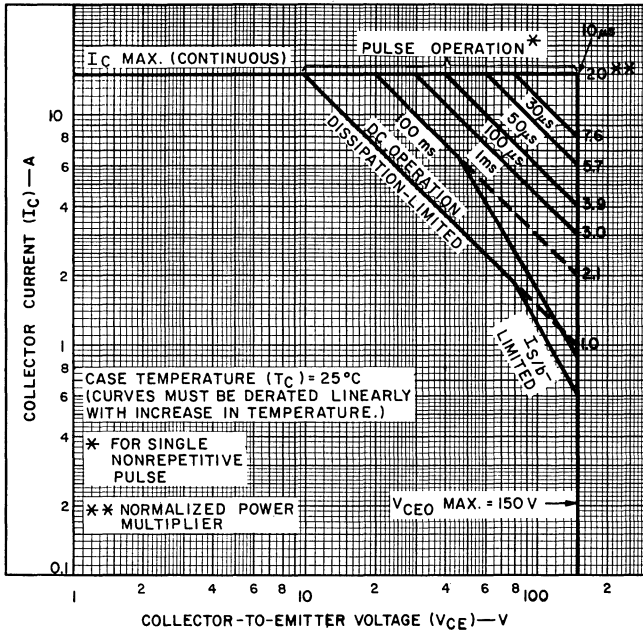


Fig.1—Maximum operating areas for type 2N6262.

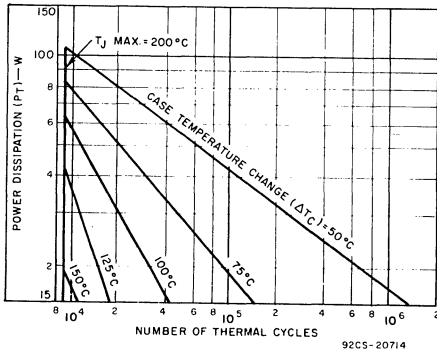


Fig.2—Thermal-cycle rating chart for type 2N6262.

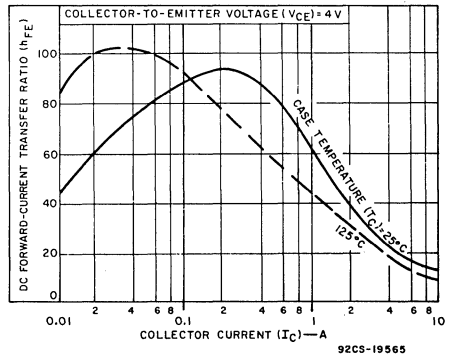


Fig.3—Typical dc beta characteristics for type 2N6262.



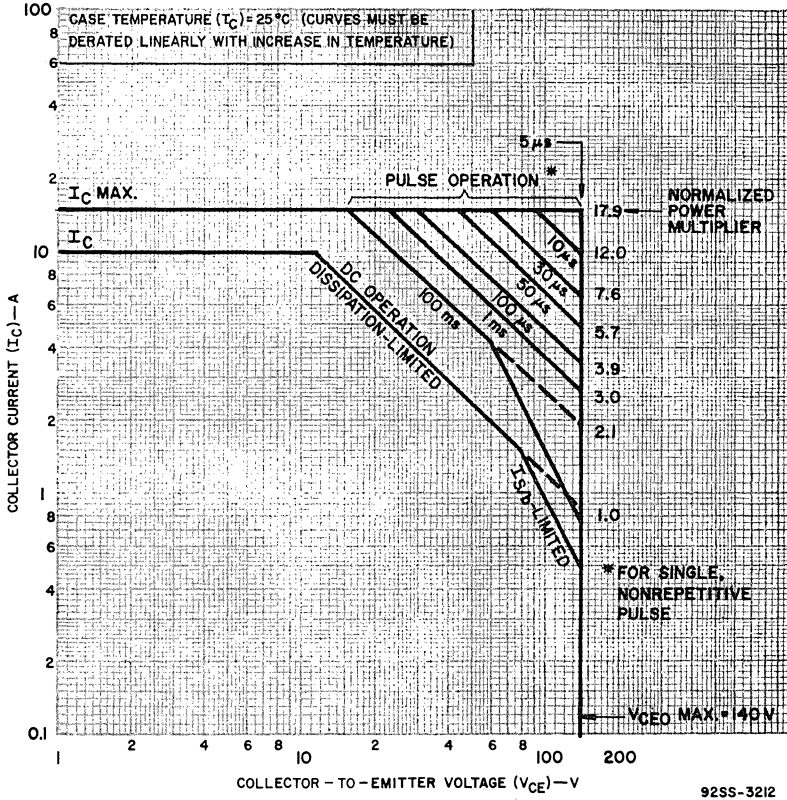


Fig.4—Maximum operating areas for type 2N3442.

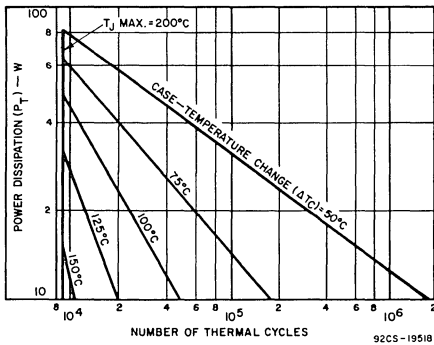


Fig.5—Thermal-cycle rating chart for type 2N3442.

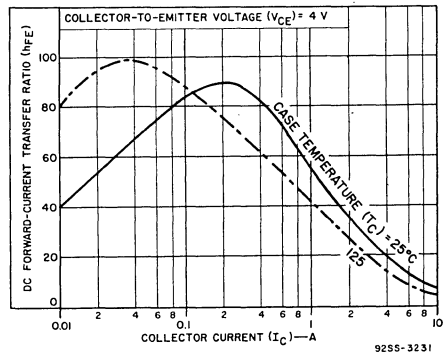


Fig.6—Typical dc beta characteristics for type 2N3442.

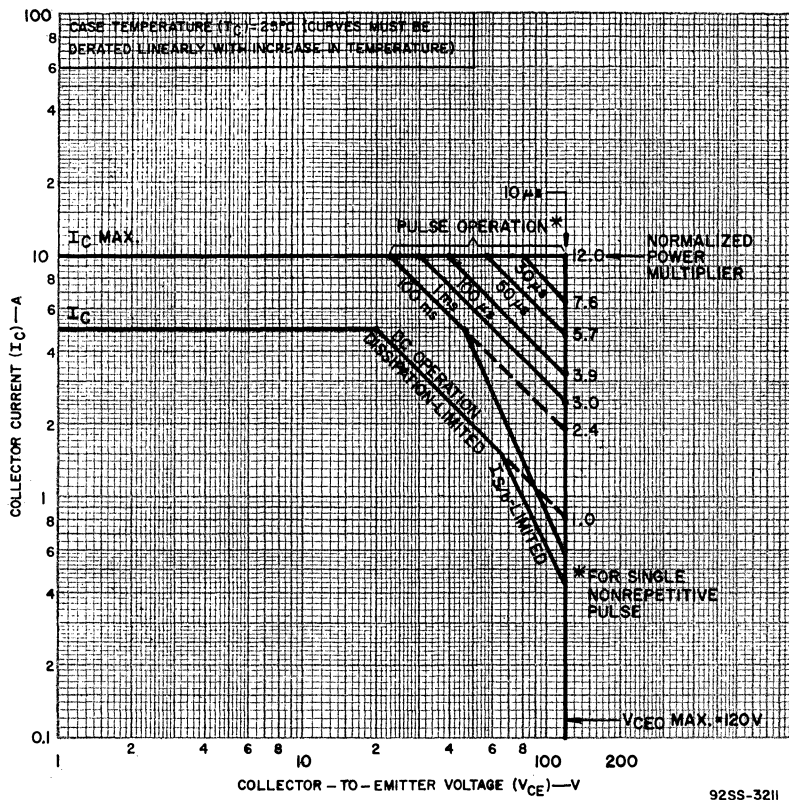


Fig. 7— Maximum operating areas for type 2N4347.

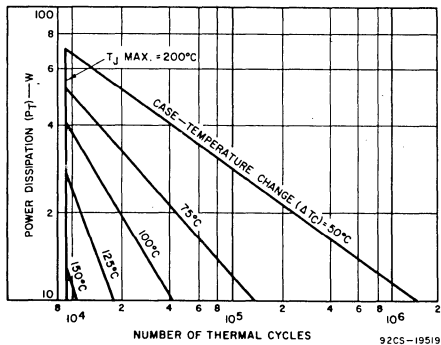


Fig. 8— Thermal-cycle rating chart for type 2N4347.

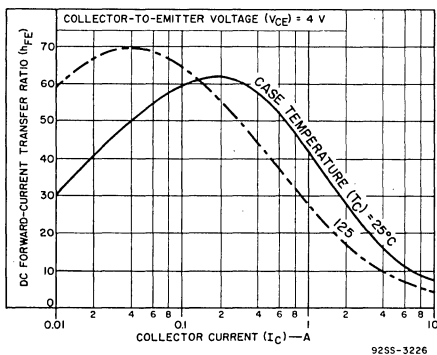


Fig. 9— Typical dc beta characteristics for type 2N4347.

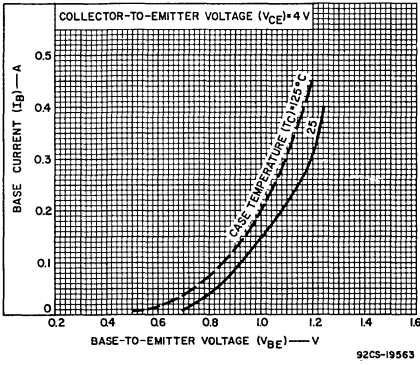


Fig. 10—Typical input characteristics for type 2N6262.

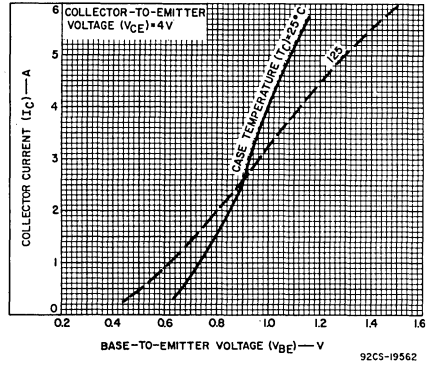


Fig. 11—Typical transfer characteristics for type 2N6262.

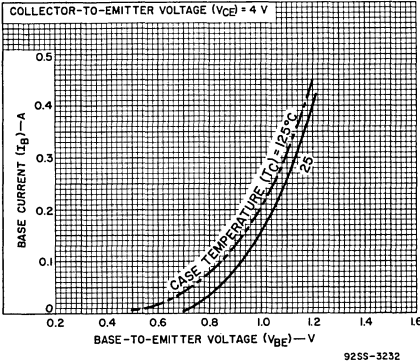


Fig. 12—Typical input characteristics for type 2N3442.

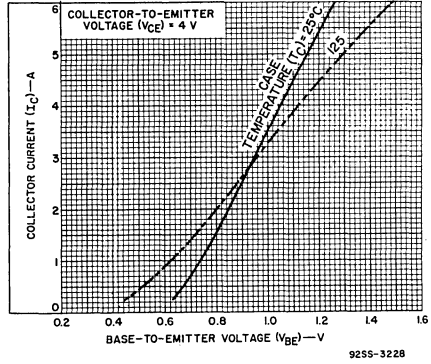


Fig. 13—Typical transfer characteristics for types 2N3442 and 2N4347.

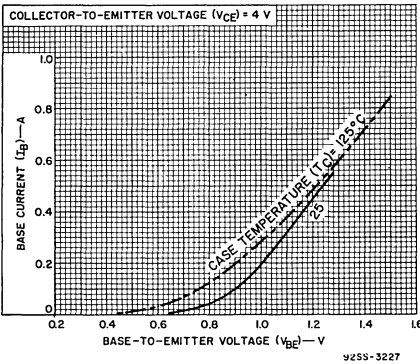


Fig. 14—Typical input characteristics for type 2N4347.

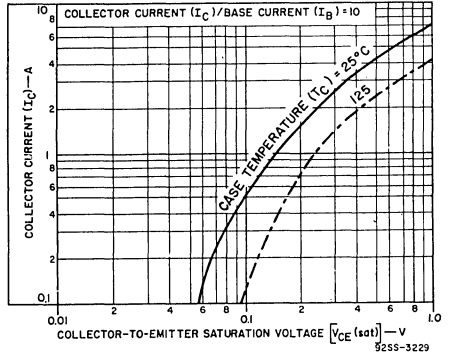


Fig. 15—Typical saturation-voltage characteristics for all types.

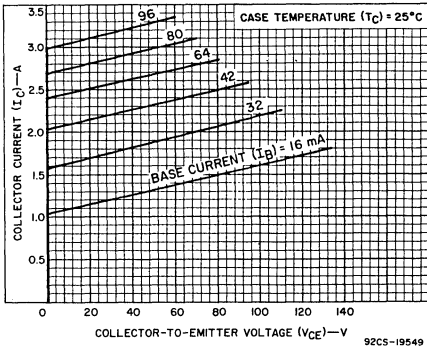


Fig.16—Typical large-signal output characteristics for type 2N6262.

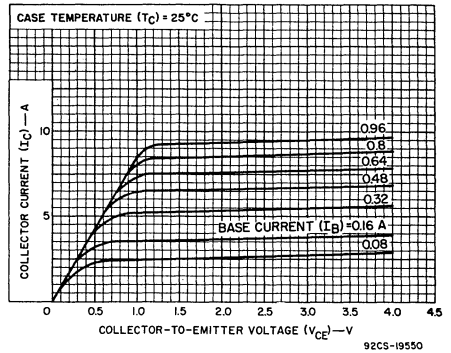


Fig.17—Typical small-signal output characteristics for type 2N6262.

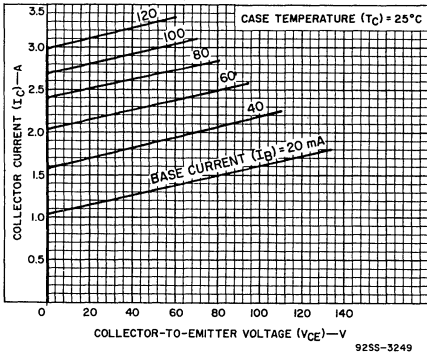


Fig.18—Typical large-signal output characteristics for type 2N3442.

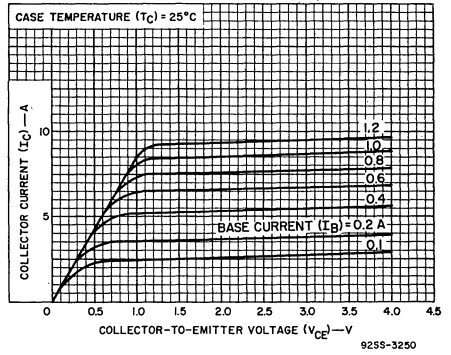


Fig.19—Typical small-signal output characteristics for type 2N3442.

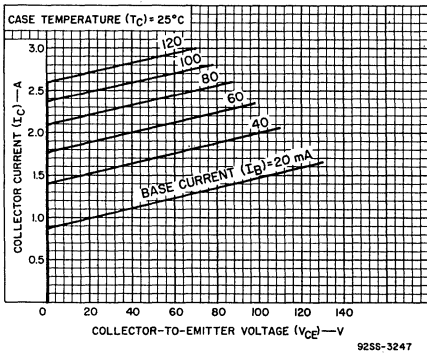


Fig.20—Typical large-signal output characteristics for type 2N4347.

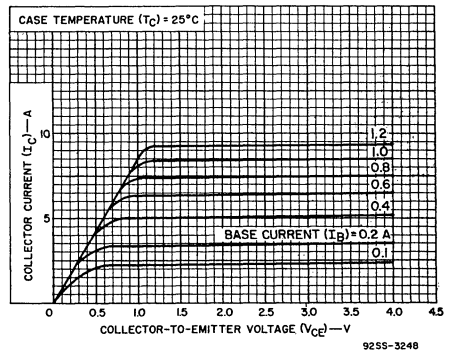


Fig.21—Typical small-signal output characteristics for type 2N4347.

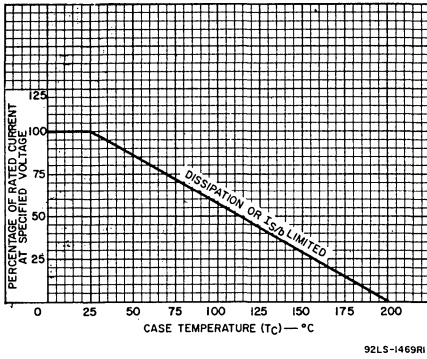


Fig. 22—Current derating curve for all types.

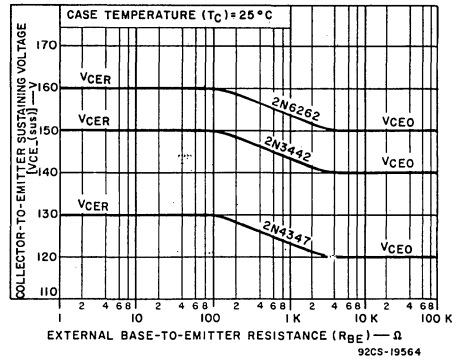


Fig. 23—Sustaining voltage vs. base-to-emitter resistance for all types.

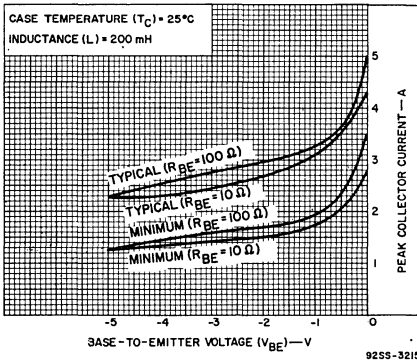


Fig. 24—Reverse-bias, second-breakdown characteristics for all types.

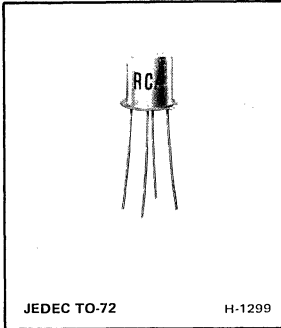
TERMINAL CONNECTIONS

- Pin 1 - Base
- Pin 2 - Emitter
- Case - Collector
- Mounting Flange - Collector

**RCA**  
Solid State  
Division

# RF Power Transistors

## 2N3478



### SILICON N-P-N EPITAXIAL PLANAR TRANSISTOR

For VHF/UHF Applications  
in Industrial and Commercial Equipment

*Features:*

- high gain-bandwidth product –  $f_T = 900\text{ MHz typ.}$
- low noise figure  
 $NF = 5\text{ dB typ. at } 470\text{ MHz}$   
 $4.5\text{ dB max. at } 200\text{ MHz}$   
 $2.5\text{ dB typ. at } 60\text{ MHz}$
- high unneutralized power gain  
 $G_{pe} = 11.5\text{ dB min. at } 200\text{ MHz}$
- hermetically sealed four-lead package
- all active elements insulated from case
- low collector-to-base feedback capacitance,  $C_{cb} 0.7\text{ pF max.}$

RCA-2N3478 is an epitaxial planar transistor of the silicon n-p-n type with characteristics which make it extremely useful as a general purpose rf amplifier at frequencies up to 470MHz. These characteristics include an exceptionally low noise figure at high frequencies, low leakage current, and a high gain-bandwidth product.

The 2N3478 utilizes a hermetically sealed four-lead package in which active elements of the transistor are insulated from the case. The case may be grounded by means of a fourth lead in applications requiring minimum feedback capacitance, shielding of the device, or both.

#### TERMINAL CONNECTIONS

- Lead 1 – Emitter
- Lead 2 – Base
- Lead 3 – Collector
- Lead 4 – Connected to case

#### Maximum Ratings, Absolute-Maximum Values:

Collector-to-Base Voltage, $V_{CBO}$ .....	30 max.	V
Collector-to-Emitter Voltage, $V_{CEO}$ .....	15 max.	V
Emitter-to-Base Voltage, $V_{EBO}$ .....	2 max.	V
Collector Current, $I_C$ .....	limited by dissipation	
Transistor Dissipation, $P_T$ :		
at ambient } up to $25^\circ\text{C}$ .....	200 max.	mW
temperatures } above $25^\circ\text{C}$ .....		See Fig. 1
Temperature Range:		
Storage and Operating (Junction) .....	-65 to 200	$^\circ\text{C}$
Lead Temperature (During Soldering):		
At distances not closer than $1/32''$ to seating surface for 10 seconds max. ....	265 max.	$^\circ\text{C}$

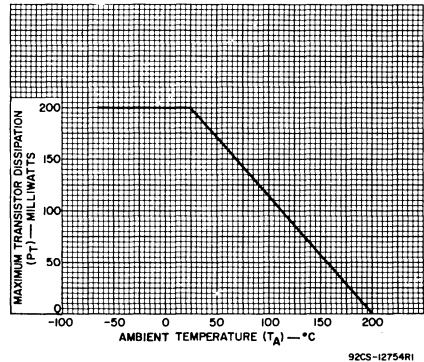


Fig. 1 - Rating chart for type 2N3478

ELECTRICAL CHARACTERISTICS, At an Ambient Temperature, ( $T_A$ ) of 25° C

Characteristics	Symbols	TEST CONDITIONS			LIMITS			Units
		Frequency f	DC Collector- to-Emitter Voltage V <sub>CE</sub>	DC Collector Current I <sub>C</sub>	Type 2N3478			
					Min.	Typ.	Max.	
		MHz	V	mA				
Collector-Cutoff Current ( $V_{CB} = 1\text{ V}, I_E = 0$ )	$I_{CBO}$				-	-	0.02	$\mu\text{A}$
Collector-to-Base Breakdown Voltage ( $I_E = 0$ )	$BV_{CBO}$			0.001	30	-	-	V
Collector-to-Emitter Breakdown Voltage	$BV_{CEO}$			0.001	15	-	-	V
Emitter-to-Base Breakdown Voltage ( $I_E = -0.001\text{ mA}$ )	$BV_{EBO}$			0	2	-	-	V
Static Forward-Current Transfer Ratio	$h_{FE}$		8	2	25	-	150	
Magnitude of Small-Signal Forward-Current Transfer Ratio	$h_{fe}^a$	100	8	2	7.5	9	16	
Collector-to-Base Feedback Capacitance ( $V_{CB} = 10\text{ V}, I_E = 0$ )	$C_{cb}^b$	0.1 to 1			-	-	0.7	pF
Small-Signal, Common-Emitter Power Gain in Unneutralized Amplifier Circuit (See Fig.4)	$G_{pe}^a$	200	8	2	11.5	-	17	dB
Small-Signal, Common-Emitter Power Gain in Neutralized Amplifier Circuit	$G_{pe}^a, c$	470	6	1.5	-	12	-	dB
UHF Noise Figure	$NF^a, c$	470	6	1.5	-	5	-	dB
VHF Noise Figure (See Fig.4)	$NF^a$ $NF^a, d$	200 60	8 8	2 1	- -	- 2.5	4.5 -	dB dB

<sup>a</sup> Fourth lead (case) grounded.

<sup>b</sup>  $C_{cb}$  is a three terminal measurement of the collector-to-base capacitance with the emitter and case connected to the guard terminal.

<sup>c</sup> Source Resistance,  $R_s = 50\text{ ohms}$ .

<sup>d</sup> Source Resistance,  $R_s = 400\text{ ohms}$ .

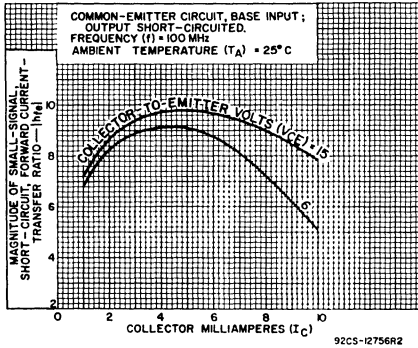


Fig. 2—Typical small-signal beta characteristics for type 2N3478

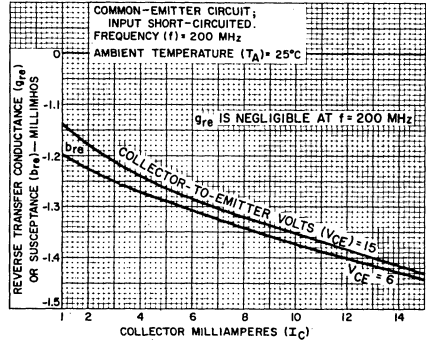
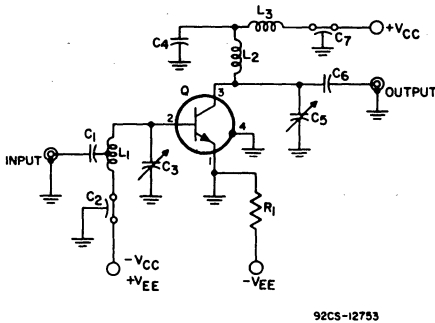


Fig. 3—Reverse transmittance ( $y_{re}$ )



$$C_1, C_4 = 510 \text{ pF}$$

$$C_2, C_7 = 2300 \text{ pF}$$

$$C_3, C_5 = 2\text{-}25 \text{ pF}$$

$$C_6 = 10 \text{ pF}$$

$$R_1 = 2000 \text{ ohms}$$

$$Q = 2N3478$$

$$L_1 = \frac{1}{2} \text{ Turn \# 14 Formvar} \bullet \text{ center tapped}$$

$$\text{Length}_1, l_1 = 2 \text{ inches}$$

$$L_2 = \frac{1}{2} \text{ Turn \# 14 Formvar} \bullet$$

$$\text{Length}_2, l_2 = 1 \frac{1}{2} \text{ inches}$$

$$L_3 = 1 \mu\text{H RRF choke}$$

$$\text{Source (Generator) Resistance}$$

$$R_g = 50 \text{ ohms}$$

$$\text{Load Resistance } R_L = 50 \text{ ohms}$$

• Trademark, Shawindian Products Corporation.

Fig. 4—200 MHz power gain and noise figure test circuit for type 2N3478



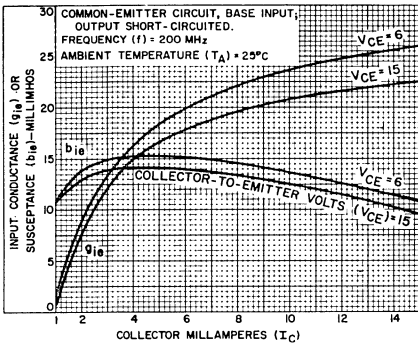


Fig. 5—Input admittance ( $y_{ie}$ )

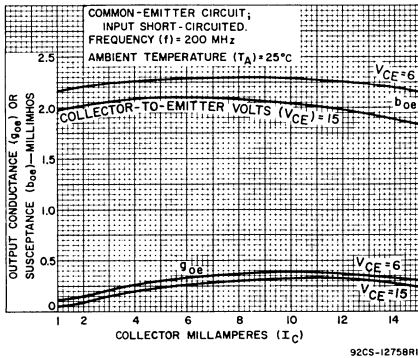


Fig. 6—Output admittance ( $y_{oe}$ )

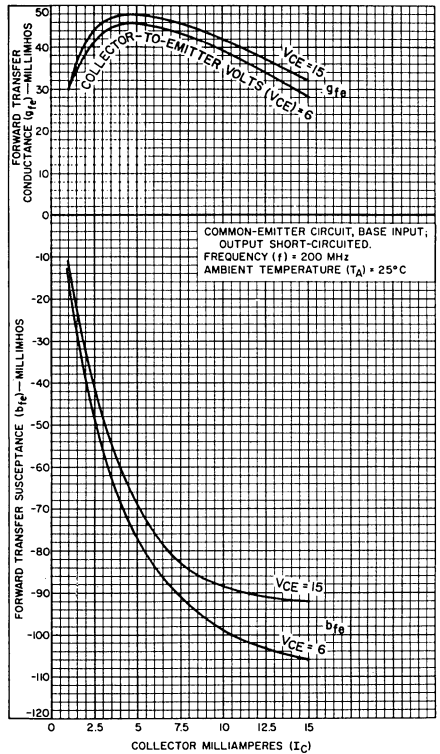
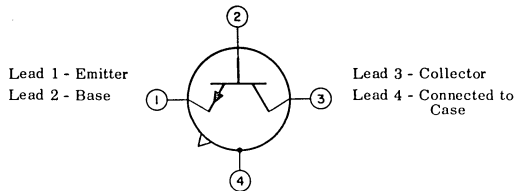


Fig. 7—Forward transmittance ( $y_{fe}$ )

TERMINAL DIAGRAM

Bottom View

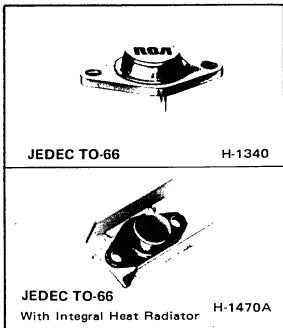




# Power Transistors

## 2N3583-2N3585

## 2N4240, 40374



### High-Voltage Silicon N-P-N Transistors

For High-Speed Switching and Linear-Amplifier Applications

#### Features

- 100-percent tested to assure freedom from second breakdown in both forward- and reverse-bias conditions when operated within specified limits
- JEDEC TO-66 package for 2N3583, 2N3584, 2N3585, and 2N4240
- JEDEC TO-66 package with heat radiator for 40374
- Economy types for ac/dc circuits
- Fast turn-on time at high collector current

RCA-2N3583,\* 2N3584,\* 2N3585,\* 2N4240,\* and 40374 are silicon n-p-n transistors with high breakdown voltages and fast switching speeds.

Type 40374 is a 2N3583 with a factory-attached heat radiator to increase the free-air dissipation rating. This device is intended for those applications which require a power transistor for mounting on a printed-circuit board. Tabs are provided on the underside of the radiator for mounting purposes and making electrical connection to the collector.

Typical applications for these transistors include high-voltage operational amplifiers, high-voltage switches, switching regulators, converters, inverters, deflection- and hi-fi amplifiers.

These transistors are also intended for a wide variety of applications in ac/dc commercial equipment.

Heat-radiator versions of types 2N3584, 2N3585, and 2N4240 can also be supplied on special order.

\*Formerly Dev. Nos. TA2510, TA2511, TA2512, and TA2871, respectively.

#### MAXIMUM RATINGS, Absolute-maximum values:

	2N3583	2N3584	2N3585 2N4240	40374	
*COLLECTOR-TO-BASE VOLTAGE	250	375	500	250	V
*COLLECTOR-TO-EMITTER VOLTAGE, sustaining	175	250	300	175	V
*EMITTER-TO-BASE VOLTAGE	6	6	6	6	V
*CONTINUOUS COLLECTOR CURRENT	1	2	2	2	A
*PEAK COLLECTOR CURRENT	5	5	5	5	A
*CONTINUOUS BASE CURRENT	1	1	1	1	A
*TRANSISTOR DISSIPATION					PT
At case temperature (T <sub>C</sub> ) = 25°C	35	35	35	35	W
At case temperatures above 25°C	Derate linearly at 0.2 W/°C				
For other conditions	See Figs. 7, 8, 9, 21, 22, & 23				
*TEMPERATURE RANGE:	← -65 to 200 →				°C
Storage & Operating (Junction)					
*PIN TEMPERATURE:					°C
1/16 in. (1.58 mm) from seating plane for 10 s max.	235	235	235	235	

\*In accordance with JEDEC registration data format JS-6 RDF-2 (2N3583), JS-6 RDF-1 (2N3584, 2N3585, 2N4240)

ELECTRICAL CHARACTERISTICS at Case Temperature ( $T_C$ ) = 25°C Unless Otherwise Specified

CHARACTERISTIC	SYMBOL	TEST CONDITIONS						LIMITS								UNITS
		VOLTAGE V dc		CURRENT mA dc				2N3583 40374		2N3584		2N3585		2N4240		
		V <sub>CE</sub>	V <sub>BE</sub>	I <sub>C</sub>	I <sub>E</sub>	I <sub>B</sub>	MIN.	MAX.	MIN.	MAX.	MIN.	MAX.	MIN.	MAX.		
Collector-Cutoff Current	I <sub>CEO</sub>	150				0	—	10	—	5	—	5	—	5	mA	
Collector-Cutoff Current	I <sub>CEX</sub>	225	-1.5				—	1.0	—	—	—	—	—	—	mA	
		340	-1.5				—	—	—	1.0	—	—	—	—	mA	
		450	-1.5				—	—	—	—	1.0	—	—	2.0	mA	
At T <sub>C</sub> = 150°C	I <sub>CEX</sub>	225	-1.5				—	3	—	—	—	—	—	—	mA	
		300	-1.5				—	—	—	3	—	3	—	5.0	mA	
Emitter-Cutoff Current	I <sub>EBO</sub>		-6	0			—	5.0	—	0.5	—	0.5	—	0.5	mA	
DC Forward-Current Transfer Ratio	h <sub>FE</sub>	2		750 <sup>a</sup>			—	—	—	—	—	—	10	100		
		2		1 A <sup>a</sup>			—	—	8	80	8	80	—	—		
		10		100 <sup>a</sup>			40	—	40	—	40	—	40	—		
		10		750 <sup>a</sup>			40	200	—	—	—	—	—	—		
		10		1 A <sup>a</sup>			—	—	—	—	—	—	30	150		
		10		1 A			10	—	25	100	25	100	—	—		
Collector-to-Emitter Sustaining Voltage: (See Figs. 1, 2, & 12) With base open	V <sub>CEO(sus)</sub>			200	0	175 <sup>a</sup>	—	250 <sup>a</sup>	—	300 <sup>a</sup>	—	300 <sup>a</sup>	—	—	V	
				200		250 <sup>a</sup>	—	300 <sup>a</sup>	—	400 <sup>a</sup>	—	400 <sup>a</sup>	—	—		
With external base-to-emitter resistance (R <sub>BE</sub> ) = 50Ω	V <sub>CER(sus)</sub>			200		250 <sup>a</sup>	—	300 <sup>a</sup>	—	400 <sup>a</sup>	—	400 <sup>a</sup>	—	—		
Base-to-Emitter Saturation Voltage	V <sub>BE(sat)</sub>			750 <sup>a</sup> 1 A <sup>a</sup>	75 100	— —	— 1.4	— —	— 1.4	— —	— 1.4	— —	— —	1.8	V	
Collector-to-Emitter Saturation Voltage	V <sub>CE(sat)</sub>			750 <sup>a</sup> 1 A <sup>a</sup>	75 125	— —	— 5	— —	— 0.75	— —	— 0.75	— —	— —	1.0	V	
Small-Signal Forward Current Transfer Ratio f = 5 MHz	h <sub>fe</sub>	10		200		3	—	3	—	3	—	3	—			
		30		100		25	350	—	—	—	—	—	—			
f = 1 kHz																
Magnitude of Common-Emitter, Small-Signal, Short-Circuit, Forward Current Transfer Ratio f = 5 MHz	h <sub>fe</sub>	10		200		2	—	2	—	2	—	3	—			
Output Capacitance: V <sub>CB</sub> = 10 V, f = 1 MHz	C <sub>obo</sub>			0		—	120	—	120	—	120	—	120	pF		
Second-Breakdown Collector Current with base forward-biased** (See Figs. 22 & 23)	I <sub>S/b</sub>	100				350	—	350	—	350	—	350	—	mA		
Second-Breakdown Energy with base reverse-biased R <sub>BE</sub> = 20Ω, L = 100 μH	E <sub>S/b</sub> <sup>†</sup>		---			50	—	200	—	200	—	50	—	μJ		
Saturated Switching Time (V <sub>CC</sub> = 200 V): Rise Time (See Figs. 13, 16, 17, & 18)	t <sub>r</sub>			1 A	100	—	—	—	3	—	3	—	—	—		
				750	75	—	—	—	—	—	—	—	—	0.5		
Storage Time (See Figs. 14, 16, 17, & 18)	t <sub>s</sub>			1 A	100	—	—	—	4	—	4	—	—	μs		
				750	75	—	—	—	—	—	—	—	—	6		
Fall Time (See Figs. 15, 16, 17, & 18)	t <sub>f</sub>			750	75	—	—	—	—	—	—	—	—	3		
				1 A	100	—	—	—	3	—	3	—	—	—		

ELECTRICAL CHARACTERISTICS at Case Temperature ( $T_C$ ) = 25°C Unless Otherwise Specified (Con't.)

CHARACTERISTIC	SYMBOL	TEST CONDITIONS					LIMITS								UNITS
		VOLTAGE V dc		CURRENT mA dc			2N3583 40374		2N3584		2N3585		2N4240		
		V <sub>CE</sub>	V <sub>BE</sub>	I <sub>C</sub>	I <sub>E</sub>	I <sub>B</sub>	MIN.	MAX.	MIN.	MAX.	MIN.	MAX.	MIN.	MAX.	
Thermal Resistance: Junction-to-Case	R <sub>θJC</sub>						5 (Max.) 2N3583	—	5	—	5	—	5	°C/W	
Junction-to-Ambient	R <sub>θJA</sub>						70 (Max.) 2N3583	—	70	—	70	—	70		
							30 (Max.) 40374	—	—	—	—	—	—		

\*In accordance with JEDEC registration data format JS-6 RDF-2 (2N3583), JS-6 RDF-1 (2N3584, 2N3585, 2N4240)

• CAUTION: The sustaining voltages V<sub>CEO</sub>(sus) and V<sub>CER</sub>(sus) MUST NOT be measured on a curve tracer. These sustaining voltages should be measured by means of the test circuit shown in Fig. 1.

\*\* Specified value of I<sub>S/B</sub> for given value of V<sub>CE</sub> as base voltage is increased from zero in a positive direction.

†ES<sub>/B</sub> is defined as the energy at which second breakdown occurs under specified reverse bias conditions. ES<sub>/B</sub> = 1/2 LI<sup>2</sup>, where L is a series load or leakage inductance and I is the peak collector current from Figs. 3, 4, and 5.

‡ Pulsed, pulse duration = 300 μs; duty factor ≤ 2%.

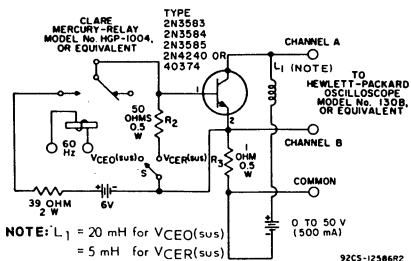


Fig. 1—Circuit used to measure sustaining voltages V<sub>CEO</sub>(sus) and V<sub>CER</sub>(sus) for all types.

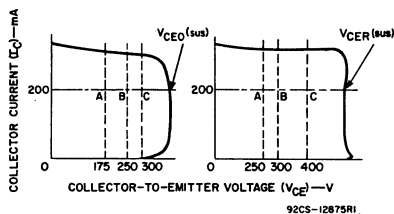


Fig. 2—Oscilloscope display for measurement of sustaining voltages (test circuit shown in Fig. 1).

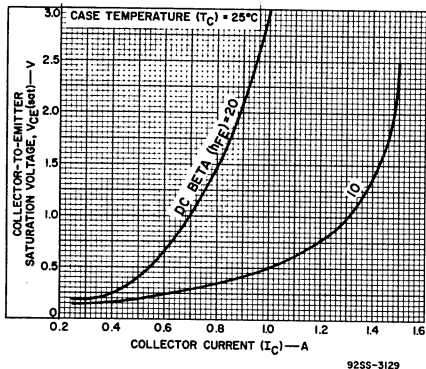


Fig. 3—Typical collector-to-emitter saturation voltage vs. current for types 2N3584 and 2N3585.

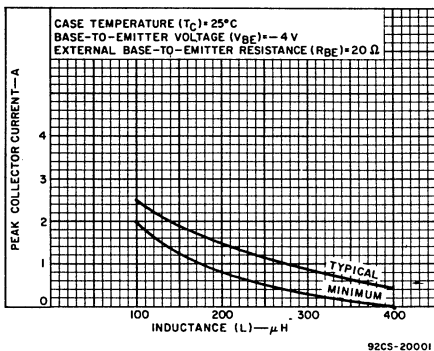


Fig. 4—Reverse-bias second breakdown characteristics for types 2N3584 and 2N3585.

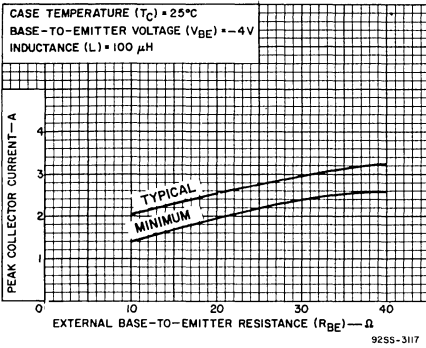


Fig. 5—Reverse-bias second breakdown characteristics for types 2N3584 and 2N3585.

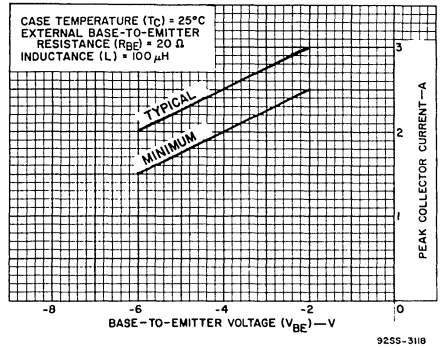


Fig. 6—Reverse-bias second breakdown characteristics for types 2N3583 and 2N3585.

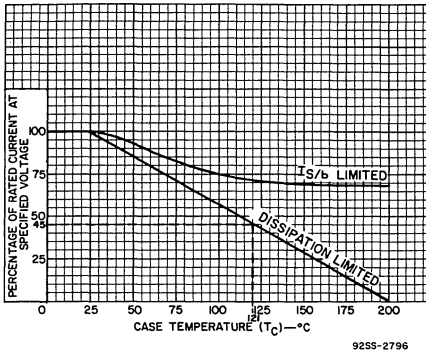


Fig. 7—Dissipation derating curves for all types.

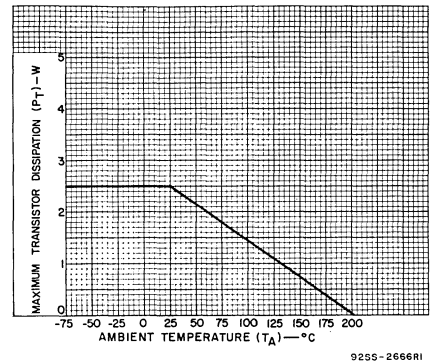


Fig. 8—Dissipation derating curve for types 2N3583, 2N3584, 2N3585, and 2N4240.

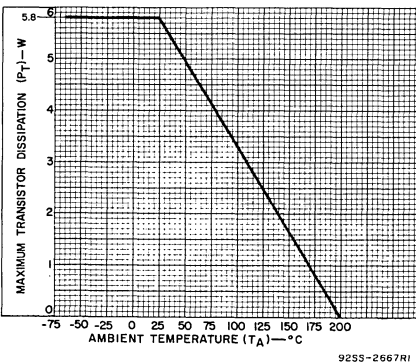


Fig. 9—Dissipation derating curve for type 40374.

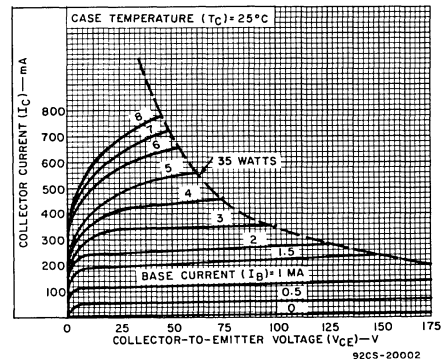


Fig. 10—Typical output characteristics for types 2N3583 and 40374.

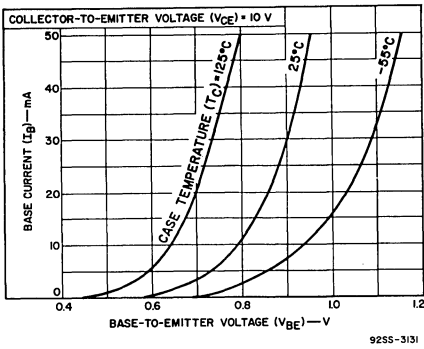


Fig. 11—Typical input characteristics for all types.

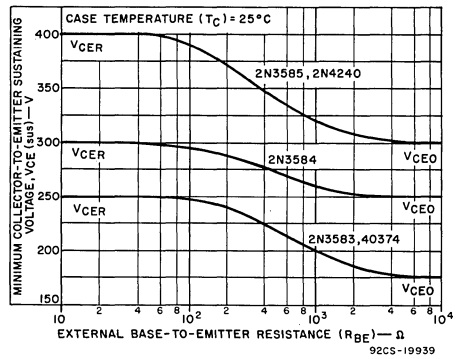


Fig. 12—Sustaining voltage vs. base-to-emitter resistance for all types.

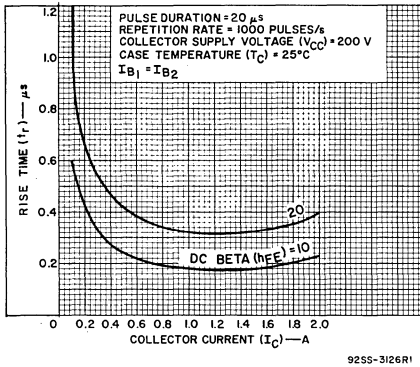


Fig. 13—Typical rise time vs. collector current for types 2N3584 and 2N3585.

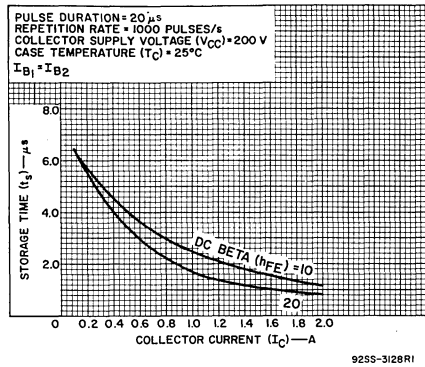


Fig. 14—Typical storage time vs. collector current for types 2N3584 and 2N3585.

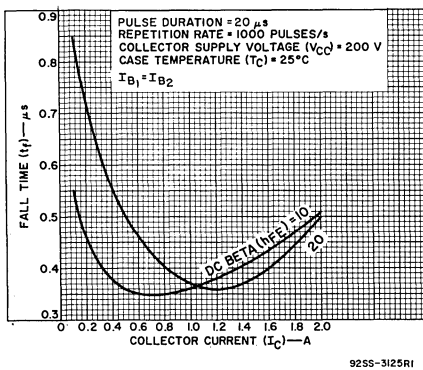


Fig. 15—Typical fall time vs. collector current for types 2N3584 and 2N3585.

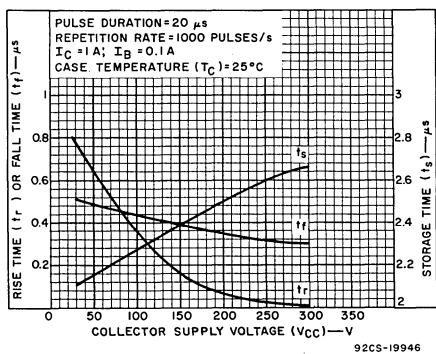
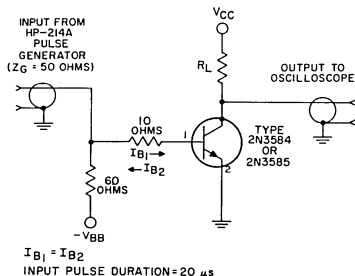
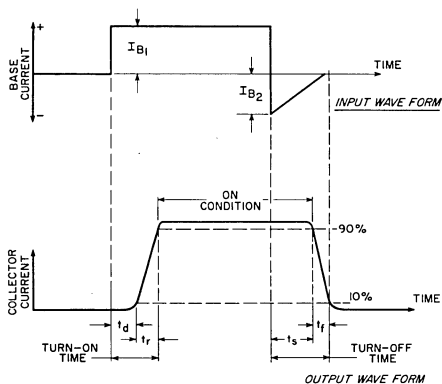


Fig. 16—Typical rise time, fall time, and storage time vs. collector supply voltage for types 2N3584 and 2N3585.



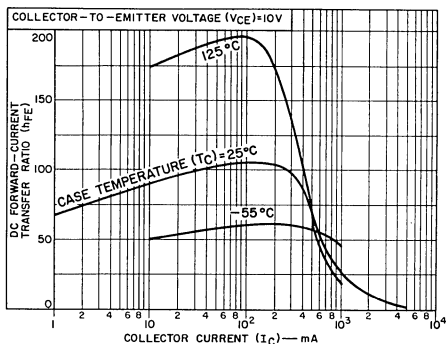
92CS-12585R1

Fig.17—Circuit used to measure switching time for types 2N3584 and 2N3585.



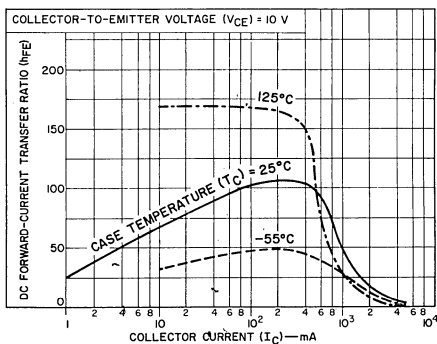
92CS-12874

Fig.18—Phase relationship between input and output currents, showing reference points for specification of switching times (test circuit shown in Fig.17).



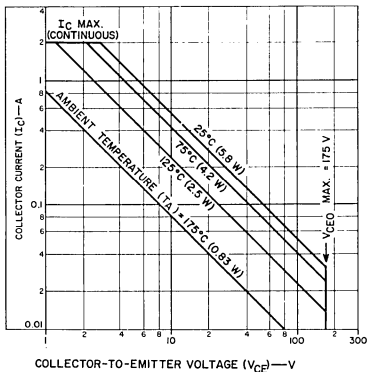
9255-3120

Fig.19—Typical dc beta vs. collector current for types 2N3583, 2N4240, and 40374.



9255-3130

Fig.20—Typical dc beta vs. collector current for types 2N3584 and 2N3585.



9255-3115R1

Fig.21—Maximum operating areas for type 40374.

**TERMINAL CONNECTIONS FOR TYPES 2N3583, 2N3584, 2N3585, AND 2N4240**

- Pin 1 - Base
- Pin 2 - Emitter
- Case, Mounting Flangé - Collector

**TERMINAL CONNECTIONS FOR TYPE 40374**

- Pin 1 - Base
- Pin 2 - Emitter
- Heat-Radiator - Collector

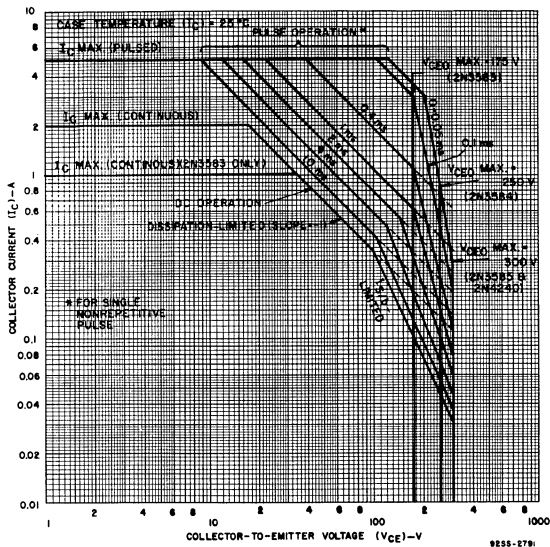


Fig. 22—Maximum operating areas for types 2N3583, 2N3584, 2N3585, and 2N4240 (dc conditions).

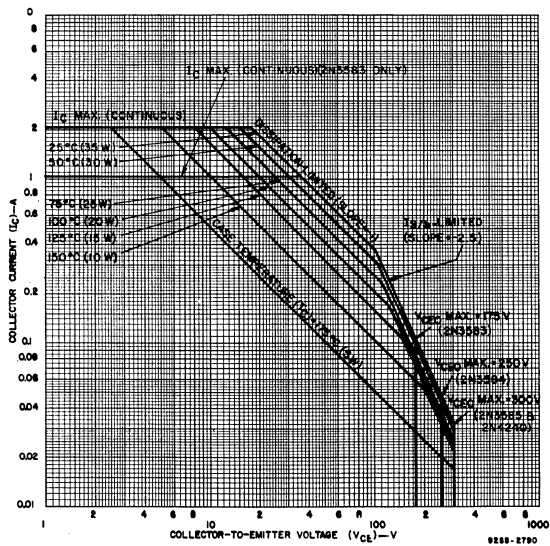


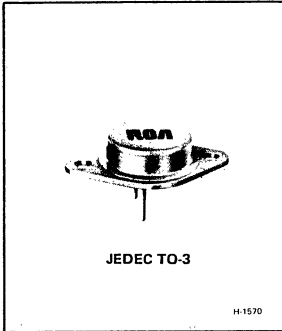
Fig. 23—Maximum operating areas for types 2N3583, 2N3584, 2N3585, and 2N4240 (pulse conditions).





# Power Transistors

**2N3771 2N6257**  
**2N3772 2N6258**



## Hometaxial II<sup>®</sup> High-Power High-Current Transistors

Rugged Silicon N-P-N Devices for Applications in Industrial and Commercial Equipment

*Features:*

- High dissipation capability
- $V_{CEX(sus)}$  at 3 A = 50 V min. (2N3771, 2N6257); = 90 V min. (2N3772, 2N6258)
- 15-A specification for:  $h_{FE}$ ,  $V_{BE}$ , &  $V_{CE(sat)}$  (2N3771, 2N6257)
- 10-A specification for:  $h_{FE}$ ,  $V_{BE}$ , &  $V_{CE(sat)}$  (2N3772, 2N6258)
- Low saturation voltage with high beta

RCA-2N3771, 2N3772, 2N6257, and 2N6258 are hometaxial-base<sup>®</sup>, silicon n-p-n transistors intended for a wide variety of high-power, high-current applications. Typical applications for these transistors include power-switching circuits, audio amplifiers, series- and shunt-regulator driver and output stages, dc-to-dc converters, inverters, and solenoid (hammer)/relay driver service.

All devices employ the popular JEDEC TO-3 package; they differ in maximum ratings for voltage, current, and power.

• "Hometaxial" was coined by RCA from "homogeneous" and "axial" to describe a single-diffused transistor with a base region of homogeneous-resistivity silicon in the axial direction (emitter-to-collector). "Hometaxial II" is a term used to describe RCA's expanded line of transistors produced by the hometaxial process.

**MAXIMUM RATINGS, Absolute-Maximum Values:**

	2N3771	2N3772	2N6257	2N6258	
*COLLECTOR-TO-BASE VOLTAGE	50	100	50	100	V
*COLLECTOR-TO-EMITTER VOLTAGE:					
With -1.5 V ( $V_{BE}$ ) & $R_{BE} = 100 \Omega$	$V_{CEX}$ 50	80	50	90	V
With base open	$V_{CEO}$ 40	60	40	80	V
*EMITTER-TO-BASE VOLTAGE	$V_{EBO}$ 5	7	5	7	V
*CONTINUOUS COLLECTOR CURRENT	$I_C$ 30	20	20	30	A
*PEAK COLLECTOR CURRENT	30	30	30	30	A
*CONTINUOUS BASE CURRENT	$I_B$ 7.5	5	5	7.5	A
*PEAK BASE CURRENT	15	15	15	15	A
*TRANSISTOR DISSIPATION:	$P_T$				
At case temperatures up to 25°C	150	150	150	250	W
At case temperatures above 25°C	← See Figs. 1, 6, & 7 →				
*TEMPERATURE RANGE:					
Storage & Operating (Junction)	← -65 to 200 →				°C
*PIN TEMPERATURE (During soldering):					
At distance $\geq 1/32$ in. (0.8 mm) from seating plane for 10 s max.	← 230 →				°C

\*In accordance with JEDEC registration data format JS-6 RDF-2.

ELECTRICAL CHARACTERISTICS, At Case Temperature ( $T_C$ ) = 25°C Unless Otherwise Specified

CHARACTERISTIC	SYMBOL	TEST CONDITIONS						LIMITS								UNITS	
		VOLTAGE V dc			CURRENT A dc			2N3771		2N3772		2N6257		2N6258			
		V <sub>CB</sub>	V <sub>CE</sub>	V <sub>BE</sub>	I <sub>C</sub>	I <sub>B</sub>	Min.	Max.	Min.	Max.	Min.	Max.	Min.	Max.			
Collector Cutoff Current: With emitter open	I <sub>CB0</sub>	50 100							2*			4			1	mA	
With base-emitter junction reverse-biased	I <sub>CEX</sub>		45 50 100	-1.5 -1.5 -1.5					2			4			1	mA	
With base-emitter junction reverse-biased, T <sub>C</sub> = 150°C	I <sub>CEX</sub>		30 45 100	-1.5 -1.5 -1.5					10		10		20		10	mA	
With base open	I <sub>CEO</sub>		25 30 50 60			0 0 0 0			10			10			2	mA	
Emitter Cutoff Current	I <sub>EBO</sub>			-5 -7	0 0				5			10			2	mA	
DC Forward Current Transfer Ratio	h <sub>FE</sub>		4 4 4 4 4		30 <sup>a</sup> 20 <sup>a</sup> 15 <sup>a</sup> 10 <sup>a</sup> 8 <sup>a</sup>			5		5	5			20	60		
Collector-to-Emitter Sustaining Voltage With base-emitter junction reverse-biased (R <sub>BE</sub> = 100Ω)	V <sub>CEX(sus)</sub>			-1.5	0.2			50		80		50		90		V	
With external base-to-emitter resistance (R <sub>BE</sub> = 100Ω)	V <sub>CER(sus)</sub>				0.2			45		70		45		85		V	
With base open	V <sub>CEO(sus)</sub>				0.2	0		40		60		40		80		V	
Base-to-Emitter Voltage	V <sub>BE</sub>		4 4 4 4		30 <sup>a</sup> 15 <sup>a</sup> 10 <sup>a</sup> 8 <sup>a</sup>				2.7							3.5	V
Collector-to-Emitter Saturation Voltage	V <sub>CE(sat)</sub>				30 <sup>a</sup> 20 <sup>a</sup> 15 <sup>a</sup> 10 <sup>a</sup> 8 <sup>a</sup>	6 4 1.5 1 0.8			4		4		4			3	V
Second-Breakdown Collector Current With base forward-biased and 1-5 nonrepetitive pulse	I <sub>S/b</sub> <sup>b</sup>		80 60 40								2.5					3.1	A
Second-Breakdown Energy With base reverse-biased and L = 40 mH, R <sub>BE</sub> = 100 Ω	E <sub>S/b</sub> <sup>c</sup>			-1.5	5			500		500		500		500			mJ
Magnitude of Common-Emitter, Small-Signal, Short-Circuit, Forward Current Transfer Ratio (f = 0.05 MHz)	h <sub>fe</sub>		4		1			4*	16 (Typ.)	4*	16 (Typ.)	4*	16 (Typ.)	4*	16 (Typ.)		
Common-Emitter, Small-Signal, Short-Circuit, Forward Current Transfer Ratio (f = 1 kHz)	h <sub>fe</sub>		4		1			40		40		40		40			
Thermal Resistances: Junction-to-case	R <sub>θJC</sub>								1.17		1.17		1.17		0.7	°C/W	

\* In accordance with JEDEC registration data format JS-6 RDF-2.

<sup>a</sup> Pulsed; pulse duration = 300 μs, rep. rate = 60 Hz, duty factor ≤ 2%.<sup>b</sup> I<sub>S/b</sub> is defined as the current at which second breakdown occurs at a specified collector voltage with the emitter-base junction forward biased for transistor operation in the active region.<sup>c</sup> E<sub>S/b</sub> is defined as the energy at which second breakdown occurs under specified reverse-bias conditions. E<sub>S/b</sub> = ½Li<sup>2</sup>, where L is a series load or leakage inductance and I is the peak collector current.

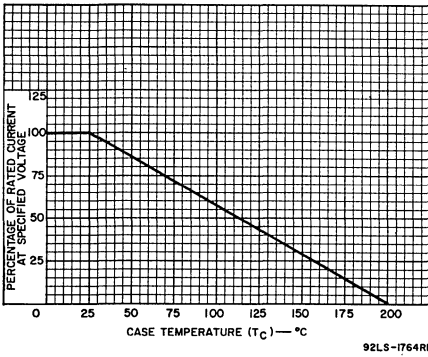


Fig. 1—Derating curve for all types.

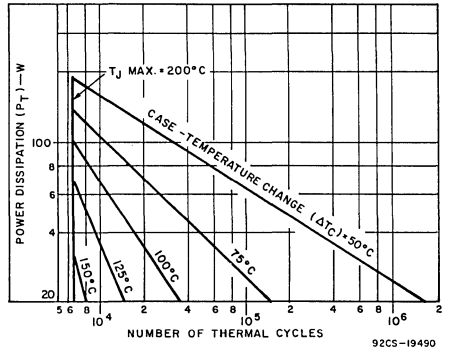


Fig. 2—Thermal-cycle rating chart for type 2N6258.

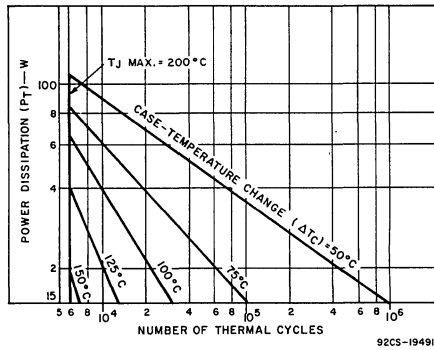


Fig. 3—Thermal-cycle rating chart for types 2N3771, 2N3772, and 2N6257.

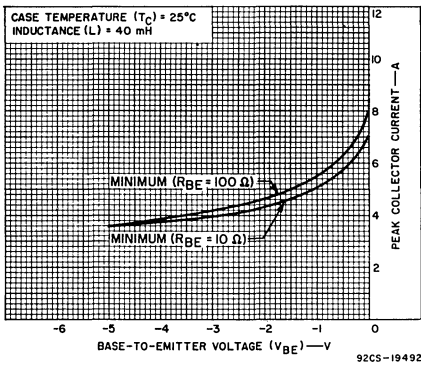


Fig. 4—Reverse-bias second-breakdown characteristics for all types.

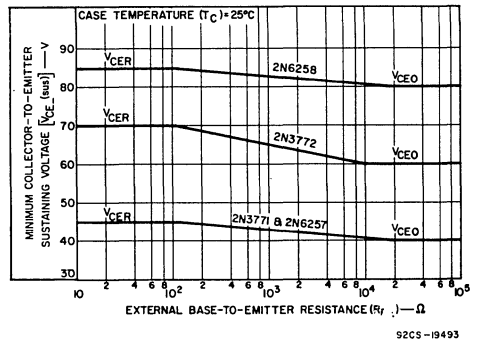
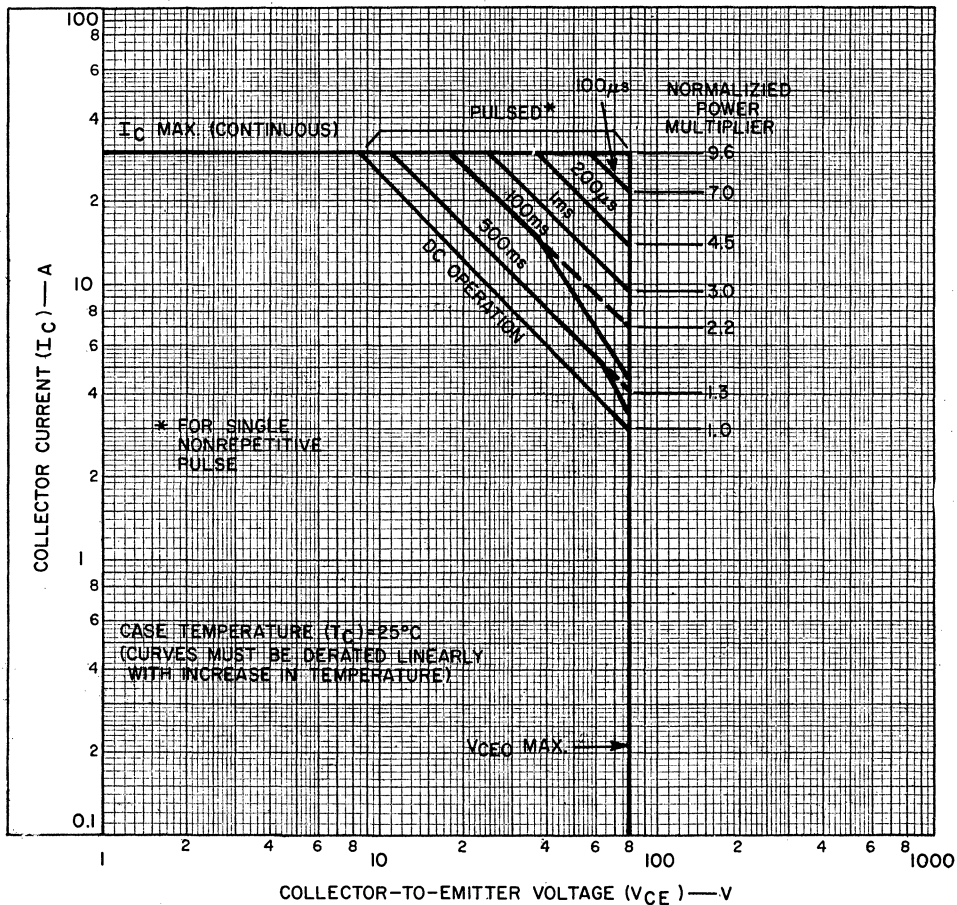


Fig. 5—Sustaining voltage vs. base-to-emitter resistance for all types.



92CS-19494

Fig.6—Maximum operating areas for types 2N6258.

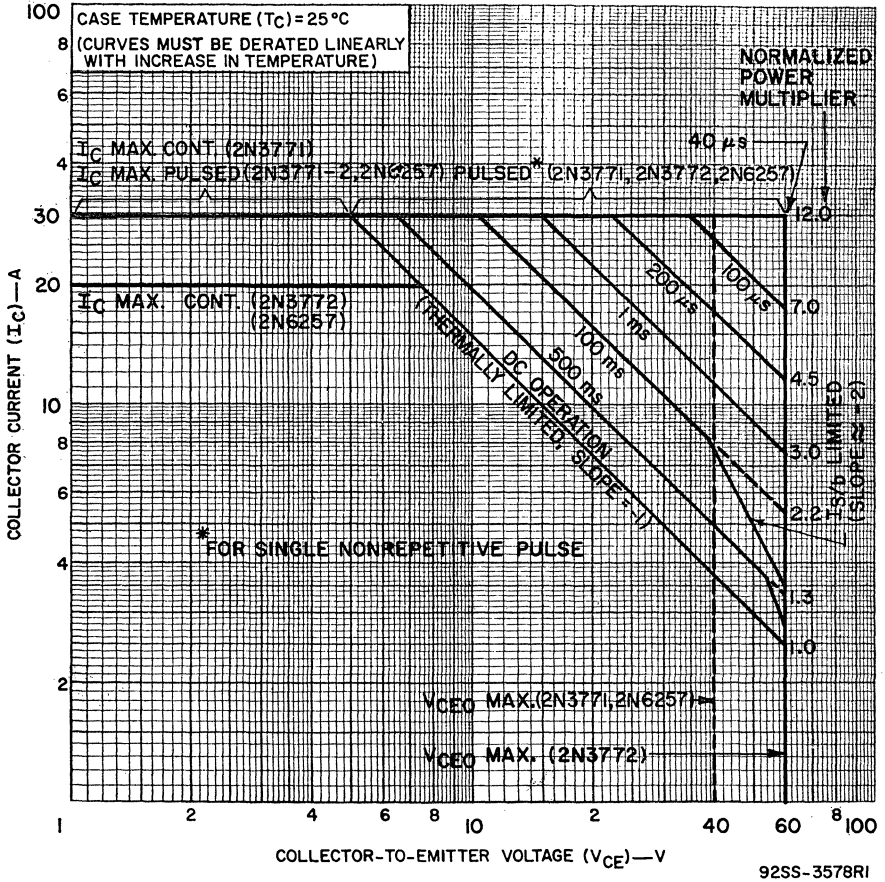


Fig.7—Maximum operating areas for types 2N3771, 2N3772, and 2N6257.

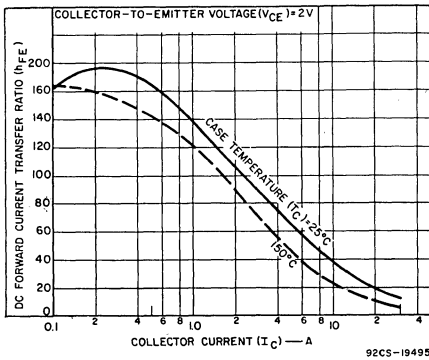


Fig.8—Typical dc beta characteristics for type 2N6258.

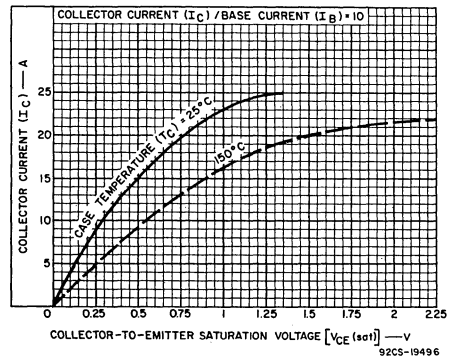


Fig.9—Typical saturation-voltage characteristics for type 2N6258.

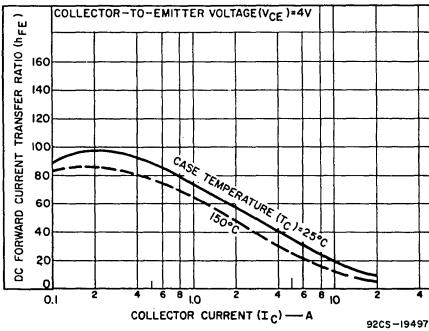


Fig.10—Typical dc beta characteristics for type 2N3772 and 2N6257.

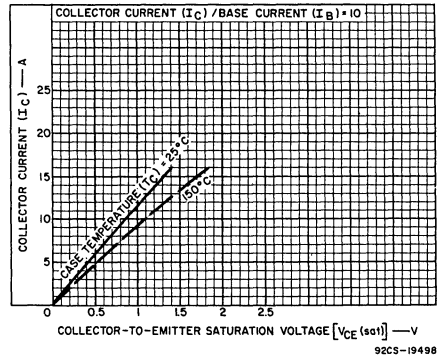


Fig.11—Typical saturation-voltage characteristics for types 2N3772 and 2N6257.

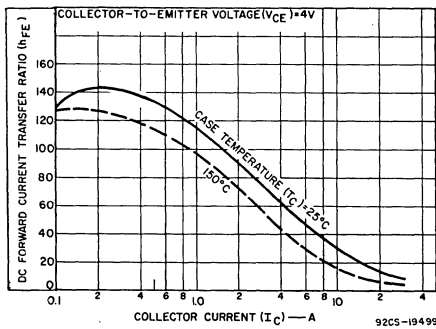


Fig.12—Typical dc beta characteristics for type 2N3771.

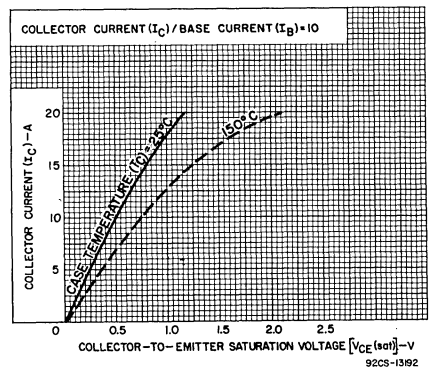


Fig.13—Typical saturation-voltage characteristics for type 2N3771.

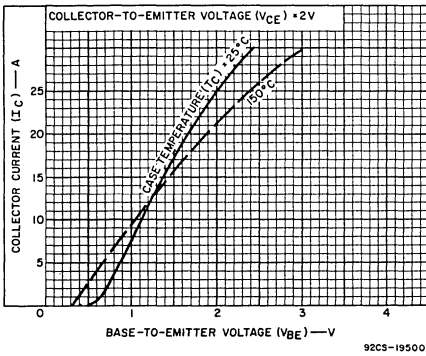


Fig.14—Typical transfer characteristics for type 2N6258.

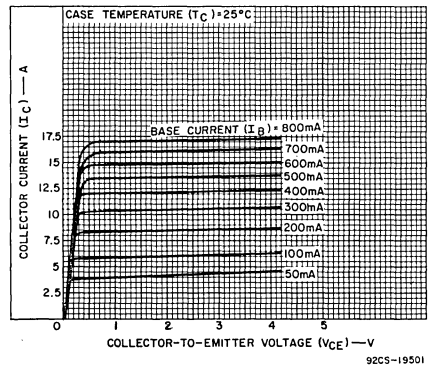


Fig.15—Typical output characteristics for type 2N6258.

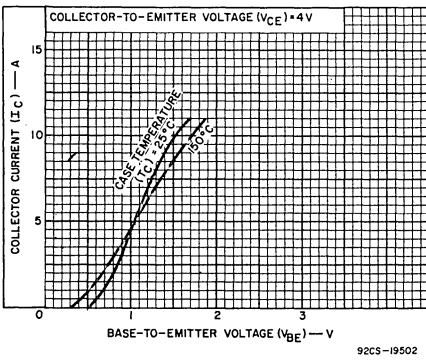


Fig.16—Typical transfer characteristics for types 2N3772 and 2N6257.

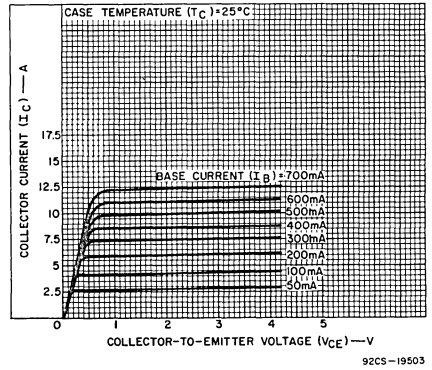


Fig.17—Typical output characteristics for types 2N3772 and 2N6257.

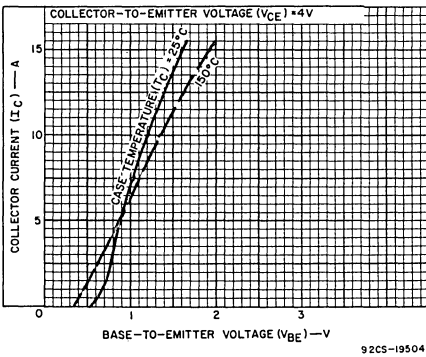


Fig.18—Typical transfer characteristics for type 2N3771.

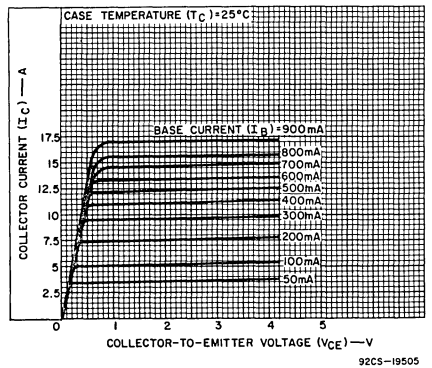


Fig.19—Typical output characteristics for type 2N3771.

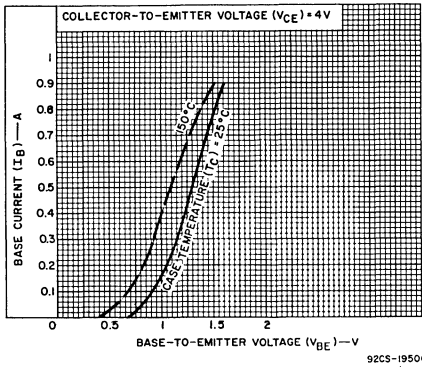


Fig.20—Typical input characteristics for type 2N6258.

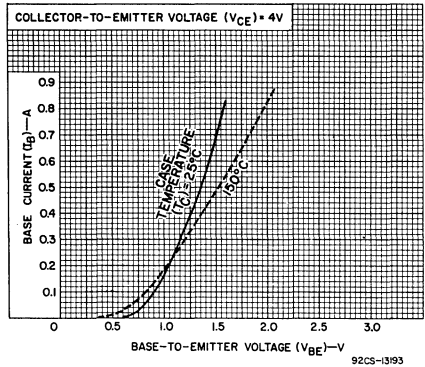


Fig.21—Typical input characteristics for types 2N3771 and 2N6257.

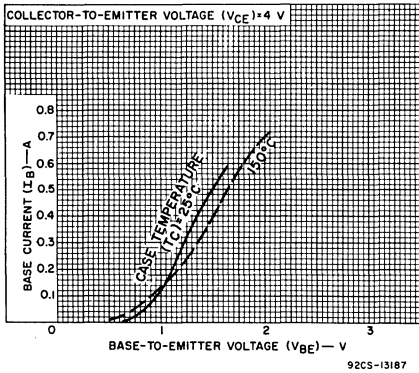


Fig.22—Typical input characteristics for type 2N3772.

**TERMINAL CONNECTIONS**

- Pin 1 — Base
- Pin 2 — Emitter
- Case — Collector
- Mounting Flange — Collector



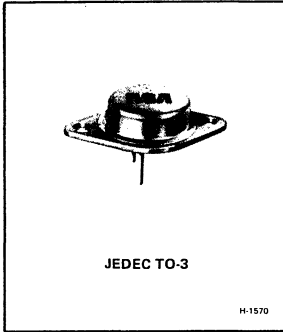


# Power Transistors

## 2N3773

## 2N4348

## 2N6259



## Hometaxial II<sup>®</sup> High-Current Silicon N-P-N Transistors

Rugged High-Voltage Devices for Applications in Industrial and Commercial Equipment

**Features:**

- High dissipation capability –  
120 W (2N4348), 150 W (2N3773), 250 W (2N6259)
- 5-A specification for  $h_{FE}$ ,  $V_{BE}$ , &  $V_{CE(sat)}$  (2N4348)
- 8-A specification for  $h_{FE}$ ,  $V_{BE}$ , &  $V_{CE(sat)}$  (2N3773, 2N6259)
- $V_{CEX}$  –  
140 V min (2N4348), 160 V min (2N3773), 170 V min (2N6259)
- Low saturation voltage with high beta

RCA-2N3773, 2N4348, and 2N6259 are hometaxial-base<sup>®</sup> silicon n-p-n transistors intended for a wide variety of high-voltage high-current applications. Typical applications for these transistors include power-switching circuits, audio amplifiers, series- and shunt-regulator driver and output stages, dc-to-dc converters, inverters, and solenoid (hammer)/relay driver service.

These devices employ the popular JEDEC TO-3 package; they differ in maximum ratings for voltage, current, and power.

<sup>®</sup> "Hometaxial" was coined by RCA from "homogeneous" and "axial" to describe a single-diffused transistor with a base region of homogeneous-resistivity silicon in the axial direction (emitter-to-collector). "Hometaxial II" is a term used to describe RCA's expanded line of transistors produced by the hometaxial process.

**MAXIMUM RATINGS, Absolute-Maximum Values:**

		2N4348	2N3773	2N6259	
*COLLECTOR-TO-BASE VOLTAGE	$V_{CBO}$	140	160	170	V
COLLECTOR-TO-EMITTER VOLTAGE:					
With base open	$V_{CEO}$	120	140	150	V
With reverse bias ( $V_{BE}$ ) of -1.5 V	$V_{CEX}$	140	160	170	V
*EMITTER-TO-BASE VOLTAGE	$V_{EBO}$	7	7	7	V
*COLLECTOR CURRENT:	$I_C$				
Continuous		10	16	16	A
Peak		30	30	30	A
*BASE CURRENT:	$I_B$				
Continuous		4	4	4	A
Peak		15	15	15	A
*TRANSISTOR DISSIPATION:	$P_T$				
At case temperatures up to 25°C		120	150	250	W
At case temperatures above 25°C		← See Figs. 1, 4, 7, & 22 →			
*TEMPERATURE RANGE:					
Storage & Operating (Junction)		← -65 to +200 →			°C
*PIN TEMPERATURE (During Soldering):					
At distances $\geq 1/32$ in. (0.8 mm) from case for 10 s max.		← 230 →			°C

<sup>®</sup> In accordance with JEDEC registration data format (JS-6, RDF-2).

ELECTRICAL CHARACTERISTICS, At Case Temperature ( $T_C$ ) = 25°C Unless Otherwise Specified

CHARACTERISTIC	SYMBOL	TEST CONDITIONS				LIMITS						UNITS
		VOLTAGE V dc		CURRENT A dc		2N4348		2N3773		2N6259		
		V <sub>CE</sub>	V <sub>BE</sub>	I <sub>C</sub>	I <sub>B</sub>	Min.	Max.	Min.	Max.	Min.	Max.	
Collector-Cutoff Current: With emitter open, V <sub>CB</sub> = 140 V	I <sub>CBO</sub>					—	—	—	2	—	—	mA
With base-emitter junction reverse-biased	I <sub>CEX</sub>	120	—1.5			—	2	—	—	—	—	mA
		140	—1.5			—	—	—	2	—	—	
		150	—1.5			—	—	—	—	—	0.2	
With base-emitter junction reverse-biased and T <sub>C</sub> = 150°C	I <sub>CEX</sub>	120	—1.5			—	10	—	—	—	—	mA
		140	—1.5			—	—	—	10	—	—	
		150	—1.5			—	—	—	—	—	4	
With base open	I <sub>CEO</sub>	100				—	200	—	—	—	—	mA
		120				—	—	—	10	—	2	
Emitter-Cutoff Current	I <sub>EBO</sub>		—7	0		—	5	—	5	—	2	mA
DC Forward Current Transfer Ratio	h <sub>FE</sub>	4		5 <sup>a</sup>		15	60	—	—	—	—	
		4		8 <sup>a</sup>		—	—	15	60	—	—	
		2		8 <sup>a</sup>		—	—	—	—	15	60	
		4		10 <sup>a</sup>		10	—	—	—	—	—	
		4		16 <sup>a</sup>		—	—	5	—	10	—	
Collector-to-Emitter Sustaining Voltage: With base-emitter junction reverse-biased (R <sub>BE</sub> = 100Ω)	V <sub>CEX(sus)</sub>		—1.5	0.1		140	—	160	—	170	—	V
With external base-to-emitter resistance (R <sub>BE</sub> ) = 100Ω	V <sub>CEr(sus)</sub>			0.2 <sup>a</sup>		140	—	150	—	160	—	V
With base open	V <sub>CEO(sus)</sub>			0.2 <sup>a</sup>	0	120	—	140	—	150	—	V
Base-to-Emitter Voltage	V <sub>BE</sub>	4		5 <sup>a</sup>		—	2	—	—	—	—	
		4		8 <sup>a</sup>		—	—	—	2.2	—	—	
		2		8 <sup>a</sup>		—	—	—	—	—	2	
		4		10 <sup>a</sup>		—	3	—	—	—	—	
Collector-to-Emitter Saturation Voltage	V <sub>CE(sat)</sub>			5 <sup>a</sup>	0.5	—	1	—	—	—	—	
				8 <sup>a</sup>	0.8	—	—	—	1.4	—	1	
				10 <sup>a</sup>	1.25	—	2	—	—	—	—	
				16 <sup>a</sup>	3.2	—	—	—	4	—	2.5	
Second-Breakdown Collector Current With base forward-biased and 1-s nonrepetitive pulse	I <sub>S/b</sub> <sup>b</sup>	80				1.5	—	—	—	—	—	A
		100				—	—	1.5	—	2.5	—	
Second-Breakdown Energy With base reverse-biased and L = 40 mH, R <sub>BE</sub> = 100Ω	ES <sub>b</sub> <sup>c</sup>		—1.5	2.5		0.125	—	0.125	—	0.125	—	J
Magnitude of Common-Emitter, Small-Signal, Short-Circuit, Forward Current Transfer Ratio (f = 50 kHz)	h <sub>fe</sub>	4		1		4	—	4	—	4	—	
Common-Emitter, Small- Signal, Short-Circuit, Forward Current Transfer Ratio (f = 1 kHz)	h <sub>fe</sub>	4		1		40	—	40	—	40	—	
Thermal Resistance Junction-to-Case	R <sub>θJC</sub>					—	1.46	—	1.17	—	0.7	°C/W

<sup>a</sup> In accordance with JEDEC registration data format JS-6 RDF-2.

<sup>b</sup> Pulsed; pulse duration = 300μs, rep. rate = 60 Hz.

<sup>c</sup> I<sub>S/b</sub> is defined as the current at which second breakdown occurs at a specified collector voltage with the emitter-base junction forward-biased for transistor operation in the active region.

<sup>c</sup> ES<sub>b</sub> is defined as the energy at which second breakdown occurs under specified reverse-bias conditions. ES<sub>b</sub> = 1/2LI<sup>2</sup> where L is a series load or leakage inductance and I is the peak collector current.

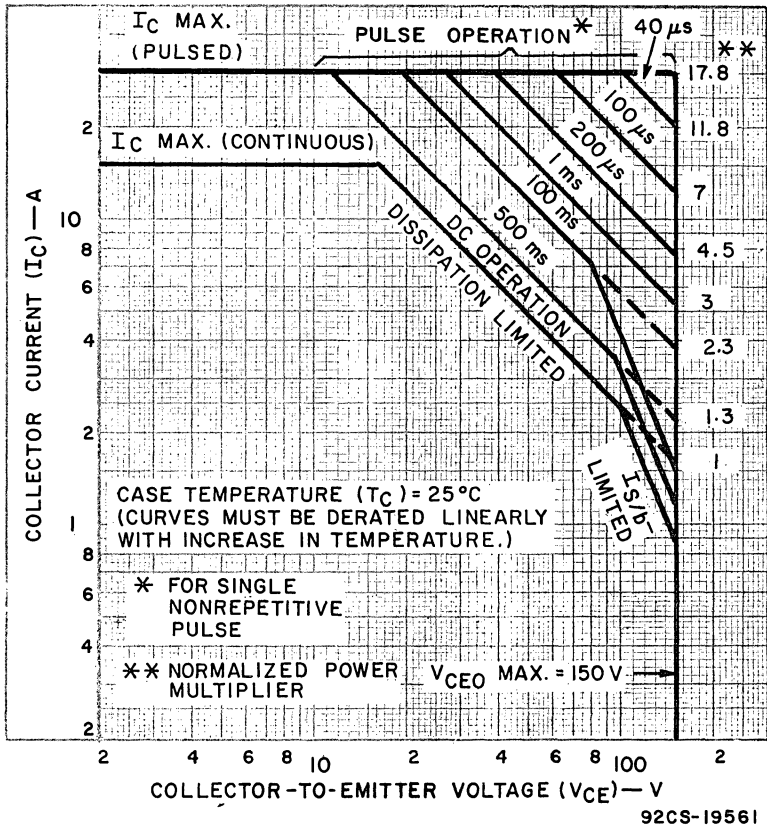


Fig. 1—Maximum operating areas for type 2N6259.

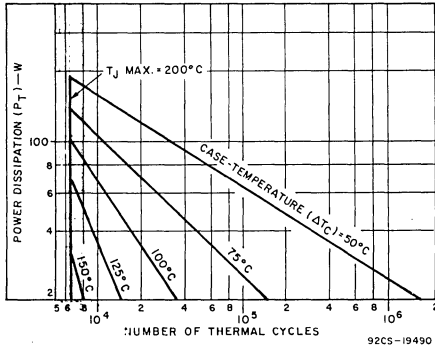


Fig. 2—Thermal-cycle rating chart for type 2N6259.

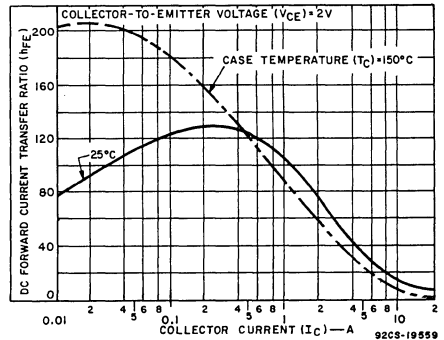


Fig. 3—Typical dc beta characteristics for type 2N6259.

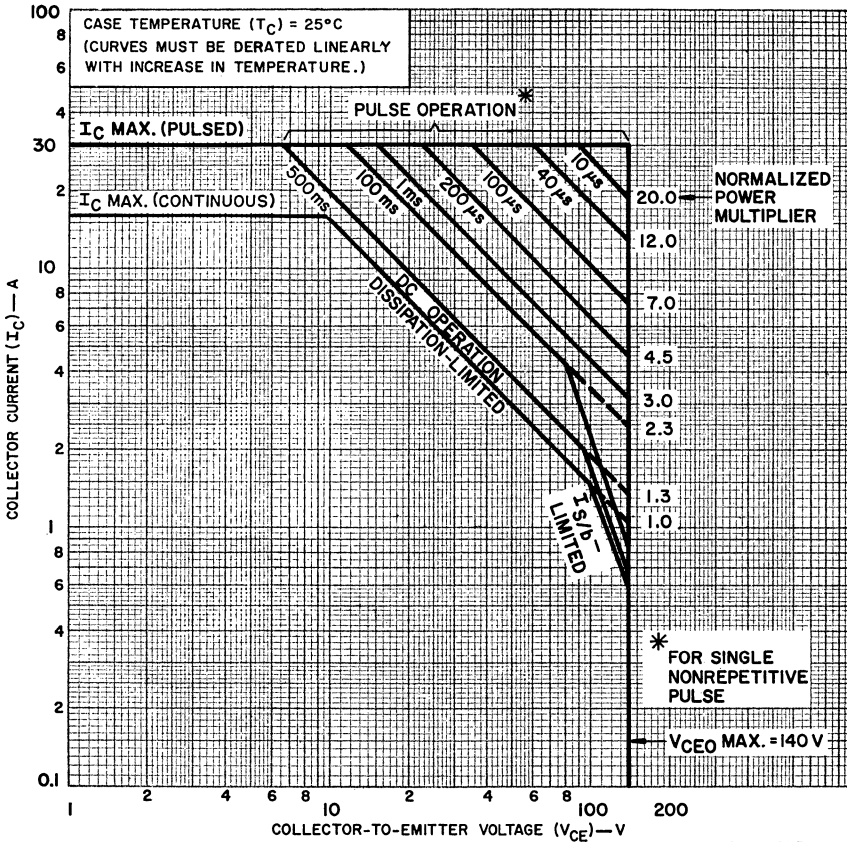


Fig.4—Maximum operating areas for type 2N3773.

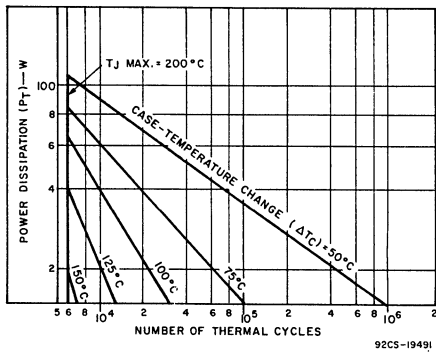


Fig.5—Thermal-cycle rating chart for type 2N3773.

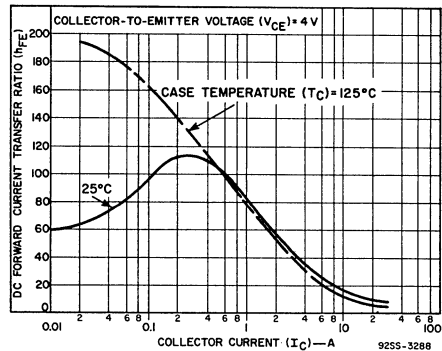


Fig.6—Typical dc beta characteristics for type 2N3773.

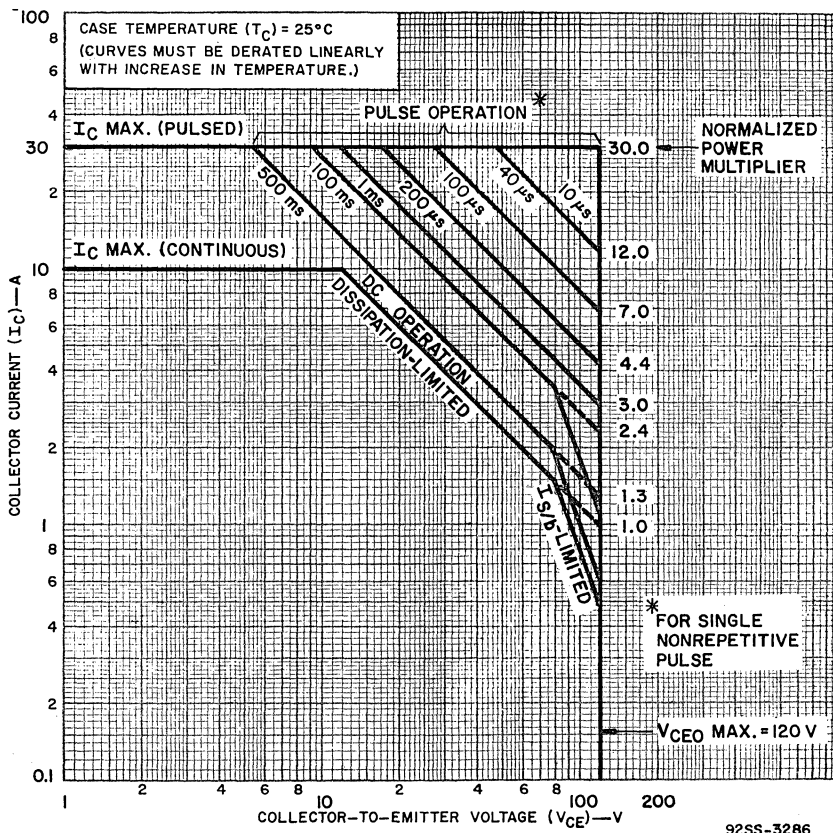


Fig.7—Maximum operating areas for type 2N4348.

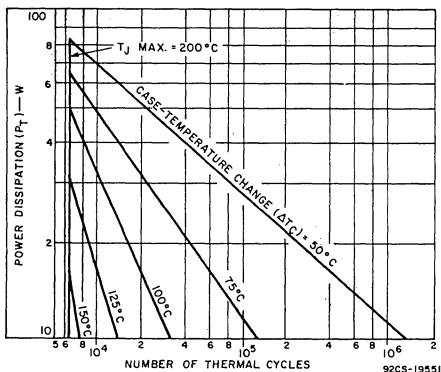


Fig.8—Thermal-cycle rating chart for type 2N4348.

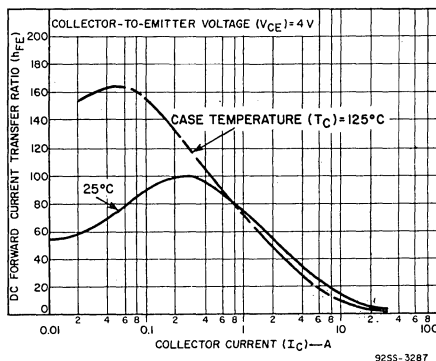


Fig.9—Typical dc beta characteristics for type 2N4348.

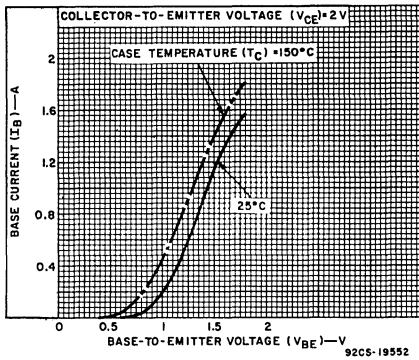


Fig.10—Typical input characteristics for type 2N6259.

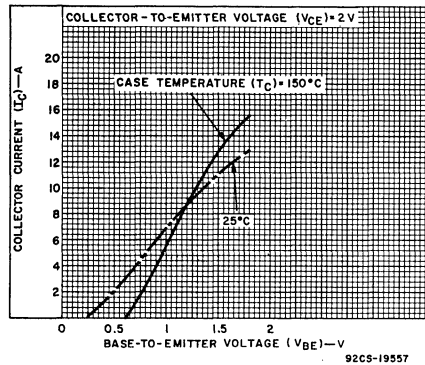


Fig.11—Typical transfer characteristics for type 2N6259.

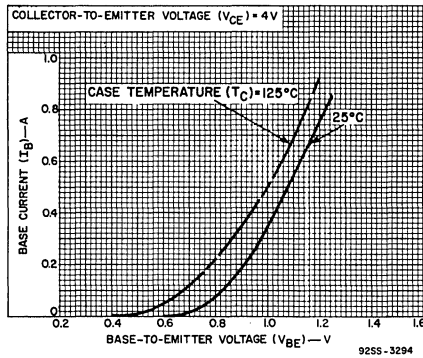


Fig.12—Typical input characteristics for type 2N3773.

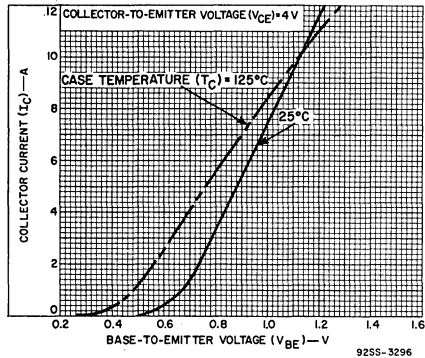


Fig.13—Typical transfer characteristics for type 2N3773.

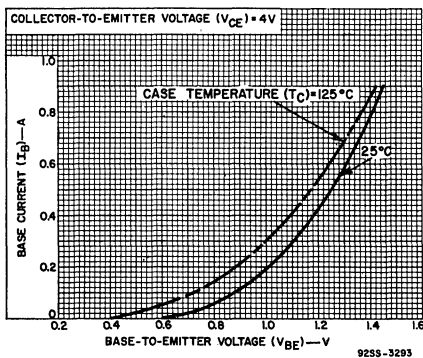


Fig.14—Typical input characteristics for type 2N4348.

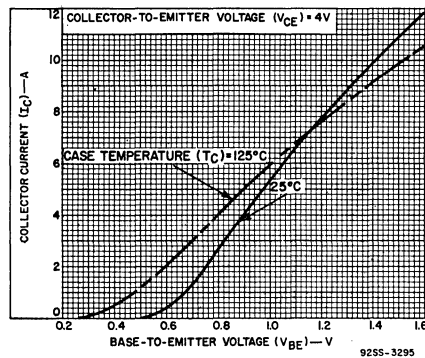


Fig.15—Typical transfer characteristics for type 2N4348.

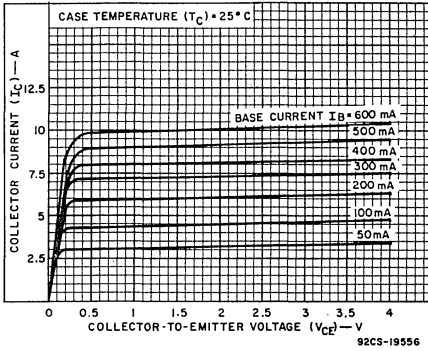


Fig.16—Typical output characteristics for type 2N6259.

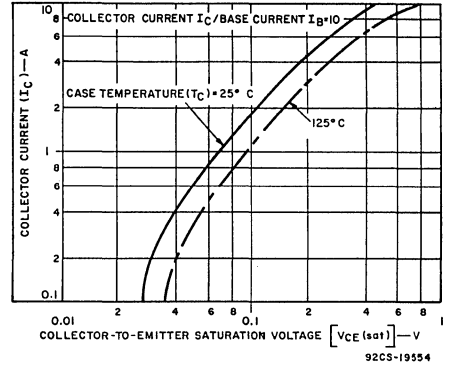


Fig.17—Typical saturation-voltage characteristics for type 2N6259.

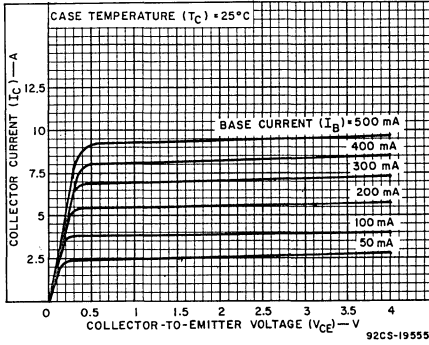


Fig.18—Typical output characteristics for type 2N3773.

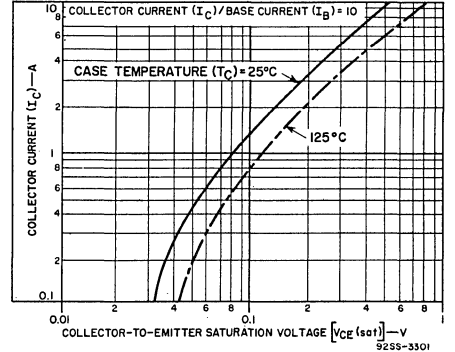


Fig.19—Typical saturation-voltage characteristics for type 2N3773.

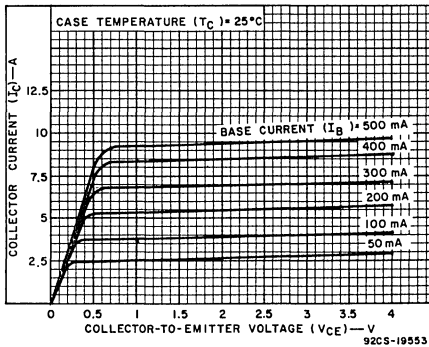


Fig.20—Typical output characteristics for type 2N4348.

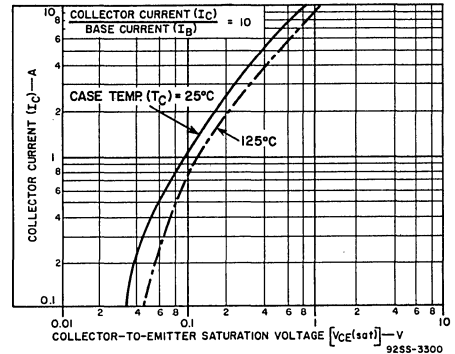


Fig.21—Typical saturation-voltage characteristics for type 2N4348.

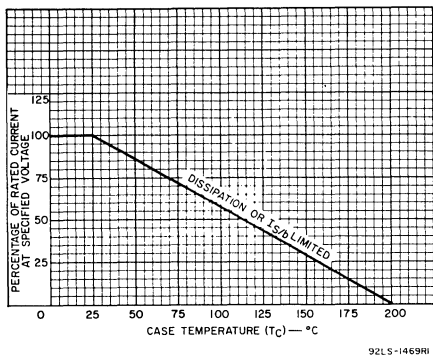


Fig. 22—Dissipation derating curve for all types.

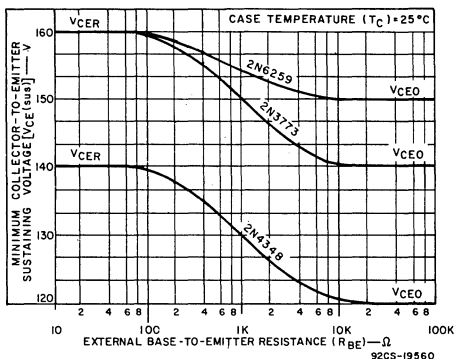


Fig. 23—Sustaining voltage vs. base-to-emitter resistance for all types.

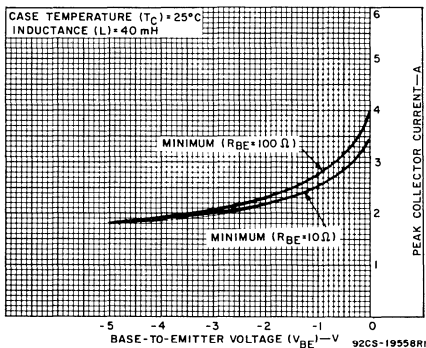


Fig. 24—Reverse-bias, second-breakdown characteristics for all types.

**TERMINAL CONNECTIONS**

- Pin 1 — Base
- Pin 2 — Emitter
- Case — Collector
- Mounting Flange — Collector





## RF Power Transistors

2N3839

RCA-2N3839\* is a double-diffused epitaxial planar transistor of the silicon n-p-n type. It is extremely useful in low-noise-amplifier, oscillator, and converter applications at frequencies up to 500 MHz in the common-emitter configuration, and up to 1200 MHz, in the common-base configuration.

The 2N3839 is mechanically and electrically like the 2N2857, but has a substantially lower noise figure.

The 2N3839 utilizes a hermetically sealed four-lead JEDEC TO-72 package. All active elements of the transistor are insulated from the case, which may be grounded by means of the fourth lead in applications requiring shielding of the device.

**Maximum Ratings, Absolute-Maximum Values:**

COLLECTOR-TO-BASE VOLTAGE,  $V_{CBO}$  . . . . . 30 max. V  
COLLECTOR-TO-EMITTER

VOLTAGE,  $V_{CEO}$  . . . . . 15 max. V

EMITTER-TO-BASE VOLTAGE,  $V_{EBO}$  . . . . . 2.5 max. V

COLLECTOR CURRENT,  $I_C$  . . . . . 40 max. mA

TRANSISTOR DISSIPATION,  $P_T$ :

For operation with heat sink:

At case  $\left\{ \begin{array}{l} \text{up to } 25^\circ\text{C} \dots\dots\dots 300 \text{ max. mW} \\ \text{temperatures** above } 25^\circ\text{C} \dots\dots \text{Derate at } 1.72 \text{ mW}/^\circ\text{C} \end{array} \right.$

For operation at ambient temperatures:

At ambient  $\left\{ \begin{array}{l} \text{up to } 25^\circ\text{C} \dots\dots\dots 200 \text{ max. mW} \\ \text{temperatures } \left\{ \begin{array}{l} \text{above } 25^\circ\text{C} \dots\dots \text{Derate at } 1.14 \text{ mW}/^\circ\text{C} \end{array} \right. \end{array} \right.$

TEMPERATURE RANGE:

Storage and Operating (Junction) . . . . .  $-65$  to  $+200$   $^\circ\text{C}$

LEAD TEMPERATURE (During Soldering):

At distances  $\geq 1/32$  inch from seating surface for 10 seconds max. . . . . 265 max.  $^\circ\text{C}$

\* Formerly Dev. No. TA-2363

\*\* Measured at center of seating surface.

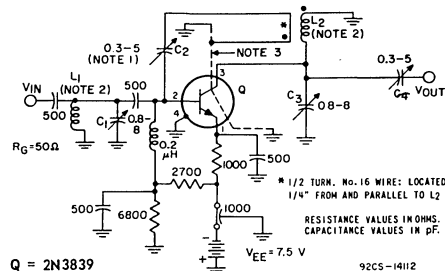
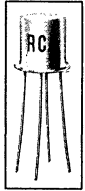


Fig. 1 - Neutralized amplifier circuit used to measure 450-MHz power gain and noise figure for type 2N3839.

## SILICON N-P-N EPITAXIAL PLANAR TRANSISTOR

For Low-Noise UHF Applications  
in Industrial and Military Equipment



JEDEC  
TO-72

**FEATURES**

- very low device noise figure —  
 $NF = 3.4$  dB max. as 450-MHz amplifier
- high gain-bandwidth product —  
 $f_T = 1000$  MHz min.
- high converter (450-to-30 MHz) gain —  
 $G_c = 15$  dB typ. for circuit bandwidth of approximately 2 MHz
- high power gain as neutralized amplifier —  
 $G_{pe} = 12.5$  dB min. at 450 MHz for circuit bandwidth of 20 MHz
- high power output as UHF oscillator —  
 $P_o = 30$  mW min., 40 mW typ. at 500 MHz  
 $= 20$  mW typ. at 1 GHz
- low collector-to-base time constant —  
 $r_b, C_c = 7$  ps typ.
- low collector-to-base feedback capacitance —  
 $C_{cb} = 0.6$  pF typ.

NOTE 1: (NEUTRALIZATION PROCEDURE): (A) CONNECT A 450-MHz SIGNAL GENERATOR (WITH  $R_g = 50$  OHMS) TO THE INPUT TERMINALS OF THE AMPLIFIER. (B) CONNECT A 50-OHM RF VOLTMETER ACROSS THE OUTPUT TERMINALS OF THE AMPLIFIER. (C) APPLY  $V_{EE}$ , AND WITH THE SIGNAL GENERATOR ADJUSTED FOR 5 mV OUTPUT FROM THE AMPLIFIER, TUNE  $C_1$ ,  $C_3$ , AND  $C_4$  FOR MAXIMUM OUTPUT. (D) INTERCHANGE THE CONNECTIONS TO THE SIGNAL GENERATOR AND THE RF VOLTMETER. (E) WITH SUFFICIENT SIGNAL APPLIED TO THE OUTPUT TERMINALS OF THE AMPLIFIER, ADJUST  $C_2$  FOR A MINIMUM INDICATION AT THE INPUT. (F) REPEAT STEPS (A), (B), AND (C) TO DETERMINE IF RETUNING IS NECESSARY.

NOTE 2:  $L_1$  &  $L_2$ —SILVER-PLATED BRASS ROD, 1-1/2" LONG x 1/4" DIA. INSTALL AT LEAST 1/2" FROM NEAREST VERTICAL CHASSIS SURFACE.

NOTE 3: EXTERNAL INTERLEAD SHIELD TO ISOLATE THE COLLECTOR LEAD FROM THE EMITTER AND BASE LEADS.

**ELECTRICAL CHARACTERISTICS, At an Ambient Temperature,  $T_A$ , of 25°C, Unless Otherwise Specified**

CHARACTERISTICS	SYMBOL	TEST CONDITIONS							LIMITS			UNITS	
		FREQUENCY	DC COLLECTOR-TO-BASE VOLTAGE	DC COLLECTOR-TO-EMITTER VOLTAGE	DC EMITTER-TO-BASE VOLTAGE	DC EMITTER CURRENT	DC BASE CURRENT	DC COLLECTOR CURRENT	TYPE 2N3839				
		f	$V_{CB}$	$V_{CE}$	$V_{EB}$	$I_E$	$I_B$	$I_C$	Min.	Typ.	Max.		
	MHz	V	V	V	mA	mA	mA						
Collector-Cutoff Current $T_A = 25^\circ\text{C}$ $T_A = 150^\circ\text{C}$	$I_{CBO}$		15 15			0 0				-	-	10 1.0	nA $\mu\text{A}$
Collector-to-Base Breakdown Voltage	$BV_{CBO}$					0		0.001	30	-	-		V
Collector-to-Emitter Breakdown Voltage	$BV_{CEO}$							0	3	15	-	-	V
Emitter-to-Base Breakdown Voltage	$BV_{EBO}$					0.01		0	2.5	-	-		V
Static Forward Current-Transfer Ratio	$h_{FE}$			1				3	30	-	150		
Small-Signal Forward Current-Transfer Ratio	$h_{fe}$	0.001 <sup>c</sup> 100 <sup>c</sup>		6 6				2 5	50 10	-	220 20		
Collector-to-Base Feedback Capacitance	$C_{cb}$	0.1 to 1.0 <sup>b</sup>	10			0			-	0.6	1.0		pF
Input Capacitance	$C_{ib}$	0.1 to 1.0			0.5			0	-	1.4	-		pF
Collector-to-Base Time Constant	$t_b, C_c$	31.9 <sup>c</sup>	6			-2			1	7	15		ps
Small-Signal, Common-Emitter Power Gain in Neutralized Amplifier Circuit (See Fig. 1)	$G_{pe}$	450 <sup>c</sup>		6				1.5	12.5	-	19		dB
Power Output as Oscillator (See Fig. 2)	$P_o$	$\geq 50^\circ$	10			-12			30	-	-		mW
UHF Measured Noise Figure (See Fig. 1)	NF	450 <sup>c,d</sup>		6				1.5	-	-	3.9		dB
UHF Device Noise Figure	NF	450 <sup>c,d,f</sup>		6				1.5	-	-	3.4		dB
VHF Measured Noise Figure	NF	60 <sup>c,e</sup>		6				1	-	2	-		dB

<sup>a</sup> Lead No. 4 (case) not connected.

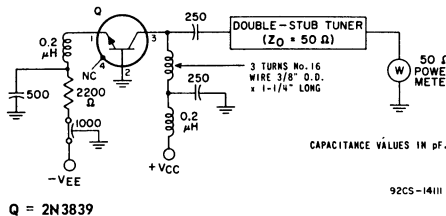
<sup>b</sup> 3-terminal measurement with emitter and case connected to guard terminal.

<sup>c</sup> Lead No. 4 (case) grounded.

<sup>d</sup> Generator resistance,  $R_g = 50$  ohms.

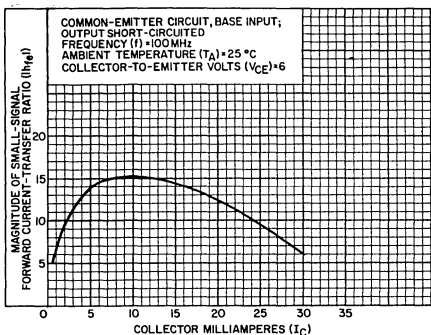
<sup>e</sup> Generator resistance,  $R_g = 400$  ohms.

<sup>f</sup> Device noise figure is approximately 0.5 dB lower than the measured noise figure. The difference is due to the insertion loss at the input of the test circuit (0.25 dB) and the contribution of the following stages in the test setup (0.25 dB).



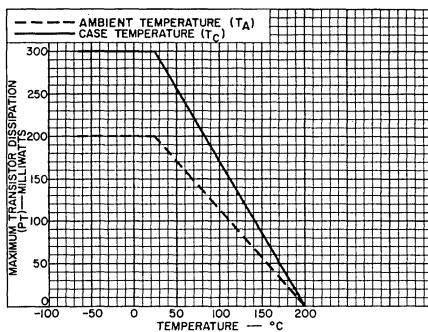
**Fig. 2 - Oscillator circuit used to measure 500-MHz power output for type 2N3839.**

Q = 2N3839



92CS-14169

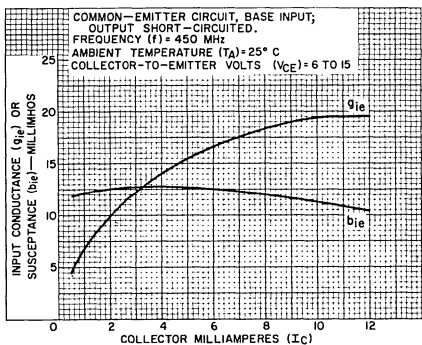
Fig. 3 - Small-Signal Beta Characteristic for Type 2N3839.



92CS-12483RI

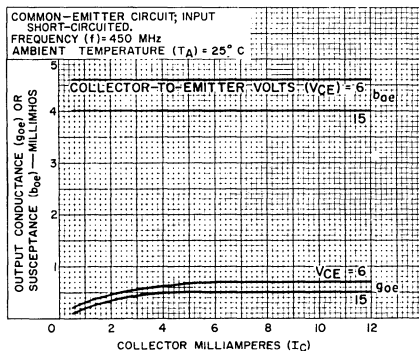
Fig. 4 - Rating Chart for Type 2N3839.

TWO-PORT ADMITTANCE (y) PARAMETERS AS FUNCTIONS OF COLLECTOR CURRENT (IC)



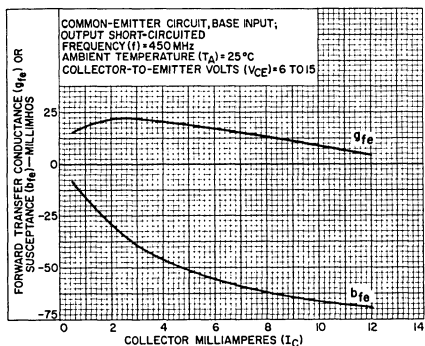
92CS-12150RI

Fig. 5 - Input Admittance ( $y_{ie}$ ).



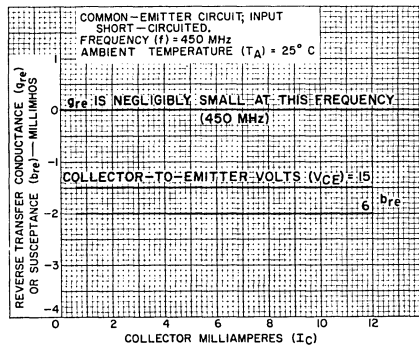
92CS-12148RI

Fig. 6 - Output Admittance ( $y_{oe}$ ).



92CS-12149RI

Fig. 7 - Forward Transadmittance ( $y_{fe}$ ).



92CS-12154RI

Fig. 8 - Reverse Transadmittance ( $y_{re}$ ).

TWO-PORT ADMITTANCE ( $y$ ) PARAMETERS AS FUNCTIONS OF FREQUENCY ( $f$ )

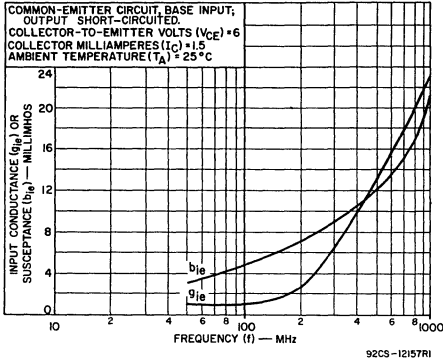


Fig.9 - Input Admittance ( $y_{ie}$ ).

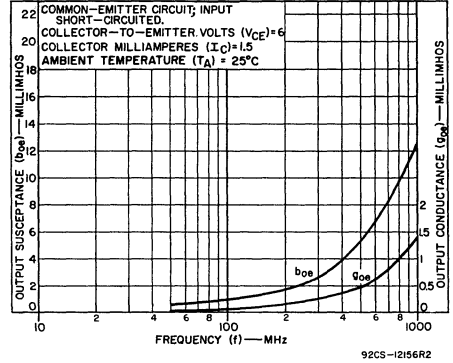


Fig.10 - Output Admittance

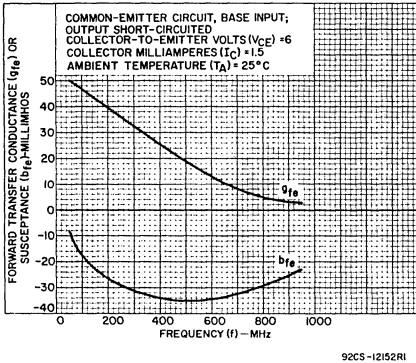


Fig.11 - Forward Transadmittance ( $y_{fe}$ ).

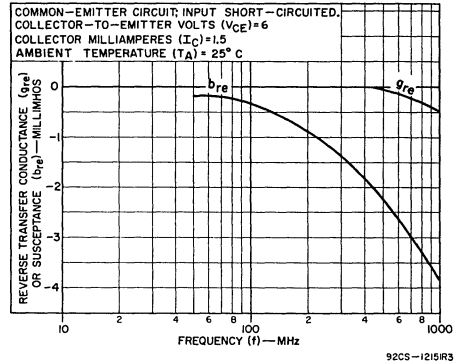


Fig.12 - Reverse Transadmittance ( $y_{re}$ ).

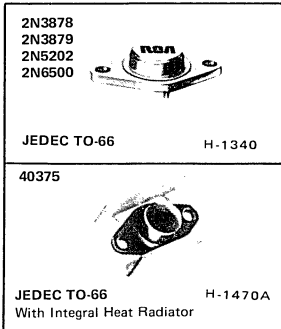
TERMINAL CONNECTIONS

- LEAD 1 - EMITTER
- LEAD 2 - BASE
- LEAD 3 - COLLECTOR
- LEAD 4 - CONNECTED TO CASE



# Power Transistors

**2N3878 2N5202**  
**2N3879 2N6500**  
**40375**



## High-Speed, Epitaxial-Collector Silicon N-P-N Transistors

For High-Speed Switching and Linear-Amplifier Applications

**Features:**

- ▣ Maximum-area-of-operation curves for dc and pulse operation
- ▣ Rated for safe operation in both forward- and reverse-bias conditions
- ▣ High sustaining voltage
- ▣ Total saturated transition time less than 1  $\mu$ s for 2N3879, 2N5202, and 2N6500

RCA-2N3878, 2N3879, 2N5202, and 2N6500<sup>o</sup> are epitaxial silicon n-p-n transistors. The 2N3878 is an amplifier type intended for audio-, ultrasonic-, and radio-frequency circuits. Types 2N3879, 2N5202, and 2N6500 are switching transistors intended for use in high-current, high-speed switching circuits. Type 40375 is a 2N3878 with a factory-attached heat radiator; it is intended for printed circuit-board applications.

Typical applications for these transistors include: low-distortion power amplifiers, oscillators, switching regulators, series regulators, converters, and inverters.

<sup>o</sup> Formerly RCA Dev. Type Nos. TA2509, TA2509A, TA7285, and TA8932, respectively.

**MAXIMUM RATINGS, Absolute-Maximum Values:**

		2N3878 40375	2N3879	2N5202	2N6500	
*COLLECTOR-TO-BASE VOLTAGE . . . . .	V <sub>CB0</sub>	120	120	100	120	V
COLLECTOR-TO-EMITTER SUSTAINING VOLTAGE: With external base-to-emitter resistance (R <sub>BE</sub> ) = 50 $\Omega$ .	V <sub>CEr(sus)</sub>	65	90	75*	110*	V
With base open. . . . .	V <sub>CEO(sus)</sub>	50*	75*	50	90*	V
*EMITTER-TO-BASE VOLTAGE . . . . .	V <sub>EBO</sub>	7	7	6	7	V
*CONTINUOUS COLLECTOR CURRENT . . . . .	I <sub>C</sub>	4	7	4	4	A
PEAK COLLECTOR CURRENT . . . . .	I <sub>CM</sub>	10	10	5	5	A
*CONTINUOUS BASE CURRENT . . . . .	I <sub>B</sub>	4	5	2	3	A
*TRANSISTOR DISSIPATION . . . . .	P <sub>T</sub>					
At case temperature (T <sub>C</sub> ) = 25°C . . . . .		35 (2N3878)	35	35	35	W
At case temperatures above 25°C . . . . .		Derate linearly at 0.2 W/°C				
At ambient temperature (T <sub>A</sub> ) = 25°C . . . . .		5.8 (40375)	—	—	—	W
For other conditions . . . . .		See Figs. 5, 6, 7, and 8				
*TEMPERATURE RANGE: Storage & operating (Junction) . . . . .			-65 to 200			°C
*PIN TEMPERATURE: 1/32 in. (0.8 mm) from seating plane for 10 s max. . . . .		235	235	235	235	°C

\* In accordance with JEDEC registration data format JS-6 RDF-2 (2N3878); JS-6 RDF-1 (2N3879, 2N5202, 2N6500).

ELECTRICAL CHARACTERISTICS, At Case Temperature ( $T_C$ ) = 25°C unless otherwise specified:

CHARACTERISTIC	SYMBOL	TEST CONDITIONS				LIMITS								UNITS
		VOLTAGE V dc		CURRENT A dc		2N3878 40375		2N3879		2N5202		2N6500		
		V <sub>CE</sub>	V <sub>BE</sub>	I <sub>C</sub>	I <sub>B</sub>	Min.	Max.	Min.	Max.	Min.	Max.	Min.	Max.	
* Collector Cutoff Current: With base-emitter junction reverse-biased	I <sub>CEV</sub>	100	-1.5			-	-	-	-	-	10	-	-	
		110	0			-	-	-	-	-	-	-	5	
* With base-emitter junction reverse-biased and $T_C = 150^\circ\text{C}$	I <sub>CEV</sub>	120	-1.5			-	25	-	25	-	-	-	-	
		100	-1.5			-	4	-	4	-	10	-	-	
With base open	I <sub>CEO</sub>	110	0			-	-	-	-	-	-	-	10	
		40			0	-	5*	-	5	-	-	-	-	
70	I <sub>CEO</sub>	70			0	-	-	-	-	-	-	-	5	
					0	-	-	-	-	-	-	-	-	
* Emitter Cutoff Current	I <sub>EBO</sub>		-6			-	-	-	-	-	10	-	-	
	I <sub>EBO</sub>		-7			-	10	-	10	-	-	-	25	
Collector-to-Emitter Sustaining Voltage (see Figs.3 and 4): With base open	V <sub>CEO(sus)</sub>			0.2	0	50 <sup>a</sup>	-	75 <sup>a</sup>	-	50 <sup>a</sup>	-	90 <sup>a</sup>	-	
With external base-to-emitter resistance (R <sub>BE</sub> ) = 50 Ω	V <sub>CER(sus)</sub>			0.2	0	65 <sup>a</sup>	-	90 <sup>a</sup>	-	75 <sup>a</sup>	-	110 <sup>a</sup>	-	
DC Forward-Current Transfer Ratio	h <sub>FE</sub>	1.2		4 <sup>b</sup>		-	-	-	-	10*	100*	-	-	
		2		0.5 <sup>b</sup>		40*	200*	-	-	-	-	-	-	
		2		3 <sup>b</sup>		-	-	-	-	-	-	-	15*	
		2		4 <sup>b</sup>		8*	-	12*	100*	-	-	-	60*	
		5		4 <sup>b</sup>		20*	-	20	80	-	-	-	-	
5		0.5 <sup>b</sup>		50*	200*	40	-	-	-	-	-	-		
* Collector-to-Emitter Saturation Voltage	V <sub>CE(sat)</sub>			3 <sup>b</sup>	0.3	-	-	-	-	-	-	-	1.5	
	V <sub>CE(sat)</sub>			4 <sup>b</sup>	0.4	-	2	-	1.2	-	1.2	-	-	
* Base-to-Emitter Voltage	V <sub>BE</sub>	2		4 <sup>b</sup>	-	-	2.5	-	-	-	-	-	-	
* Base-to-Emitter Saturation Voltage	V <sub>BE(sat)</sub>			3 <sup>b</sup>	0.3	-	-	-	-	-	-	-	2.5	
	V <sub>BE(sat)</sub>			4 <sup>b</sup>	0.4	-	-	-	2	-	2	-	-	
Collector-to-Base Output Capacitance : (f = 1 MHz, V <sub>CB</sub> = 10 V)	C <sub>ob</sub>					-	175*	-	175	-	175	-	175	
Second Breakdown Collector Current: With base forward-biased and 1- $\mu$ s nonrepetitive pulse	I <sub>S/b</sub>	40				750	-	500	-	400	-	400	-	
Second-Breakdown Energy: With base reverse-biased and R <sub>BE</sub> = 50 Ω, V <sub>BB</sub> = -4 V At L = 50 μH At L = 125 μH	E <sub>S/b</sub> <sup>c</sup>					-	-	-	-	0.4	-	-	-	
	E <sub>S/b</sub> <sup>c</sup>					1	-	1	-	-	-	0.5	-	
* Magnitude of Common Emitter, Small-Signal, Short-Circuit, Forward-Current Transfer Ratio:(f = 10 MHz)	h <sub>fe</sub>	10		0.5		4	-	4	-	6	-	6	-	
* Common-Emitter, Small-Signal, Short-Circuit, Forward-Current Transfer Ratio:(f = 1 kHz)	h <sub>fe</sub>	30		0.1		40	-	-	-	-	-	-	-	
Thermal Resistance: Junction-to-case	R <sub>θJC</sub>					2N3878	-	5	-	5	-	5	-	
	R <sub>θJC</sub>					40375	-	30	-	-	-	-	-	
Junction-to-ambient	R <sub>θJA</sub>												°C/W	

\* In accordance with JEDEC registration data format JS-6 RDF-2 (2N3878); JS-6 RDF-1 (2N3879, 2N5202, 2N6500).

<sup>a</sup> CAUTION: Sustaining voltages V<sub>CEO(sus)</sub> and V<sub>CER(sus)</sub> MUST NOT be measured on a curve tracer.

<sup>b</sup> Pulsed, pulse duration = 300 μs, duty factor ≤ 2%.

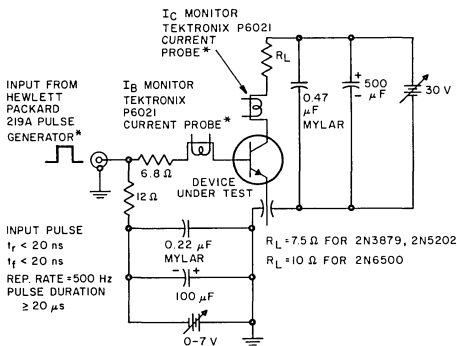
<sup>c</sup> E<sub>S/b</sub> is defined as the energy at which second breakdown occurs under specified reverse-bias conditions. E<sub>S/b</sub> = 1/2LI<sup>2</sup> where L is a series load or leakage inductance and I is the peak collector current.

TRANSITION AND STORAGE-TIME CHARACTERISTICS FOR SWITCHING TYPES, At Case Temperature ( $T_C$ ) = 25°C:

CHARACTERISTIC	SYMBOL	TEST CONDITIONS			LIMITS					UNITS	
		VOLTAGE V dc	CURRENT A dc		2N3879		2N5202		2N6500		
		V <sub>CC</sub>	I <sub>C</sub>	I <sub>B</sub>	Min.	Max.	Min.	Max.	Min.		Max.
Saturated Switching Time (see Figs. 1, 2, 18, 20, and 22.) Delay time	$t_d$	30	3	0.3 <sup>a</sup>	—	—	—	—	—	40	ns
		30	4	0.4 <sup>a</sup>	—	40	—	—	—	—	
		30	4	0.8 <sup>a</sup>	—	—	—	40	—	—	
Rise time	$t_r$	30	3	0.3 <sup>a</sup>	—	—	—	—	—	400	
		30	4	0.4 <sup>a</sup>	—	400	—	—	—	—	
		30	4	0.8 <sup>a</sup>	—	—	—	400	—	—	
Storage time	$t_s$	30	3	0.3 <sup>a</sup>	—	—	—	—	—	1000	
		30	4	0.4 <sup>a</sup>	—	800	—	—	—	—	
		30	4	0.8 <sup>a</sup>	—	—	—	1200	—	—	
Fall time	$t_f$	30	3	0.3 <sup>a</sup>	—	—	—	—	—	500	
		30	4	0.4 <sup>a</sup>	—	400	—	—	—	—	
		30	4	0.8 <sup>a</sup>	—	—	—	400	—	—	

\* In accordance with JEDEC registration data format (JS-6, RDF-1)

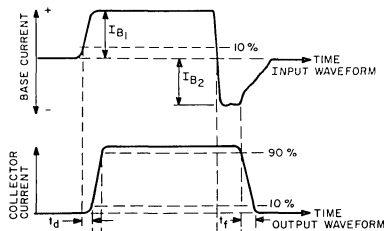
<sup>a</sup> I<sub>B1</sub> = I<sub>B2</sub>



\*OR EQUIVALENT

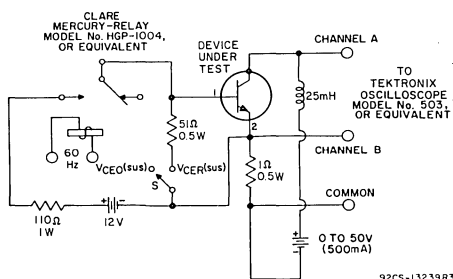
92CS-23754

Fig. 1 — Circuit used to measure switching times for 2N3879, 2N5202, and 2N6500.



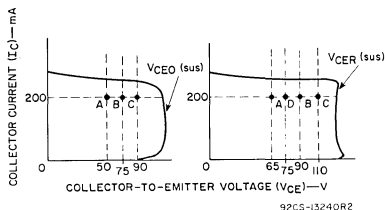
92CS-23760

Fig. 2 — Oscilloscope display for measurement of switching times. (Circuit shown in Fig. 1).



92CS-13259R3

Fig. 3 — Circuit used to measure sustaining voltages, V<sub>CE0</sub>(sus) and V<sub>CEr</sub>(sus) for all types.



92CS-13240R2

The sustaining voltages V<sub>CE0</sub>(sus) and V<sub>CEr</sub>(sus) are acceptable when the traces fall to the right and above point "A" for types 2N3878, 40375, and 2N5202; point "B" for type 2N3879; and point "C" for type 2N6500. The sustaining voltage V<sub>CEr</sub>(sus) is acceptable when the trace falls to the right and above point "D" for type 2N5202.

Fig. 4 — Oscilloscope display for measurement of sustaining voltages. (Circuit shown in Fig. 3.)

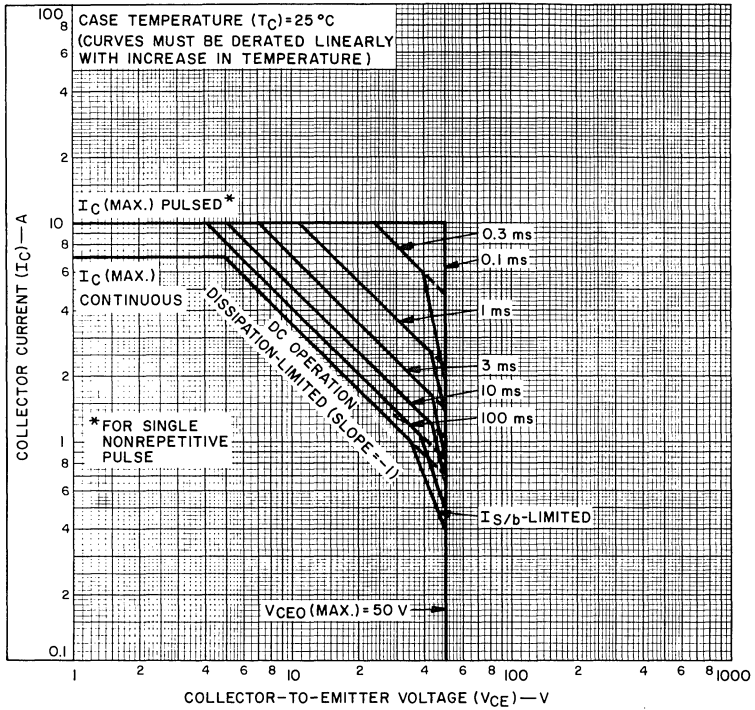
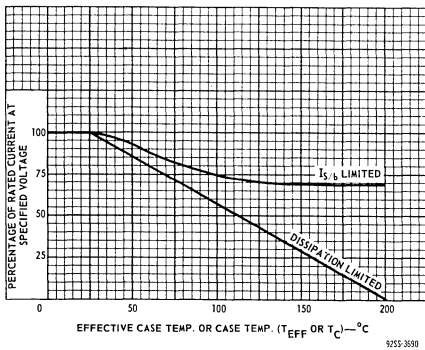


Fig. 5 - Maximum operating areas for 2N3878.

92CS-23755



Note: Use ambient temperature for derating 40375.

Fig. 6 - Dissipation derating for all types.

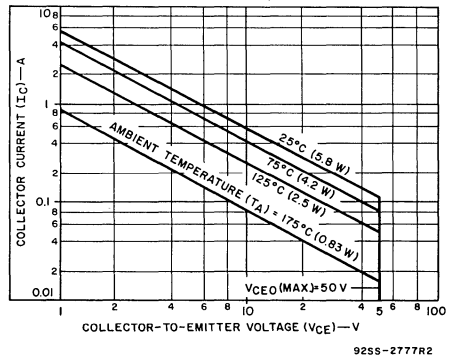


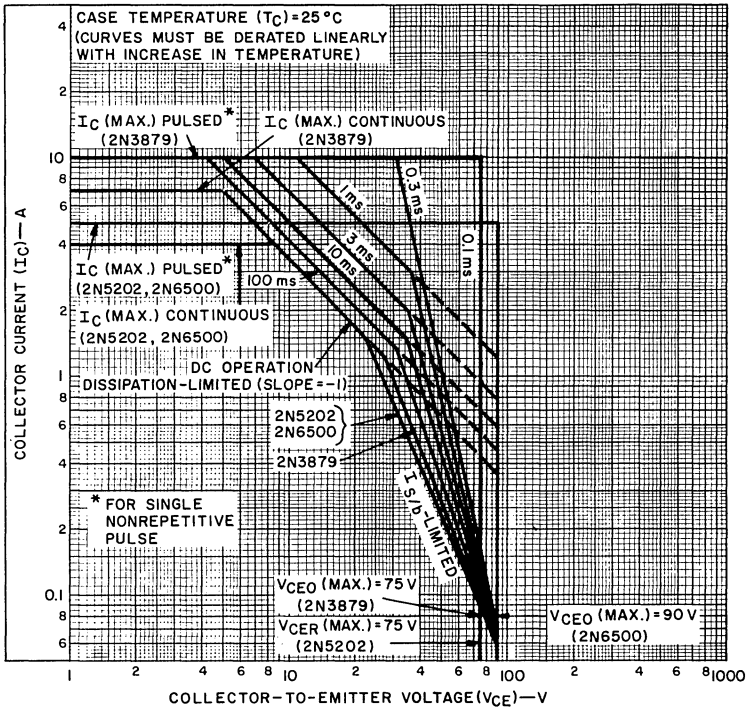
Fig. 7 - Maximum operating areas for 40375.

92SS-2777R2

TERMINAL CONNECTIONS

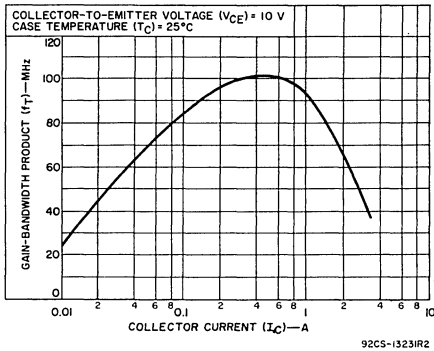
- Pin 1 - Base
- Pin 2 - Emitter
- Heat Radiator - Collector (40375)
- Case, Mounting Flange - Collector (2N3878, 2N3879, 2N5202, 2N6500)





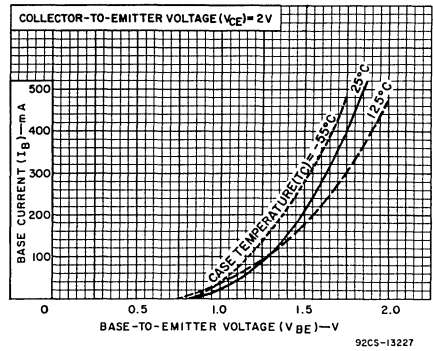
92CS-23756

Fig. 8 — Maximum operating areas for 2N3879, 2N5202, and 2N6500.



92CS-13231R2

Fig. 9 — Typical gain-bandwidth product for all types.



92CS-13227

Fig. 10 — Typical input characteristics for all types.

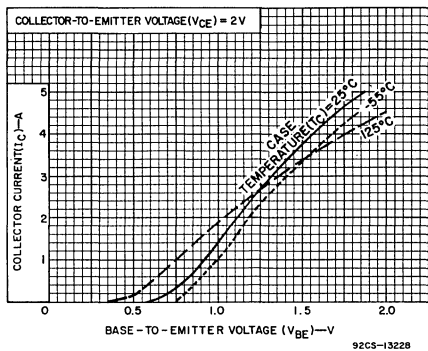


Fig. 11 - Typical transfer characteristics for all types.

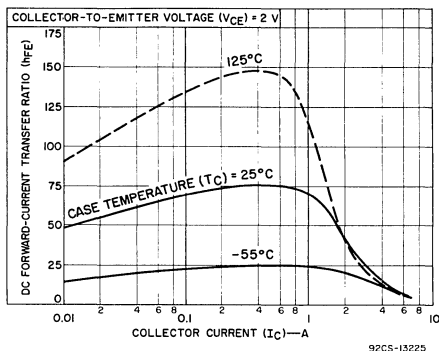


Fig. 12 - Typical dc beta characteristics for 2N3878, 2N3879, and 40375.

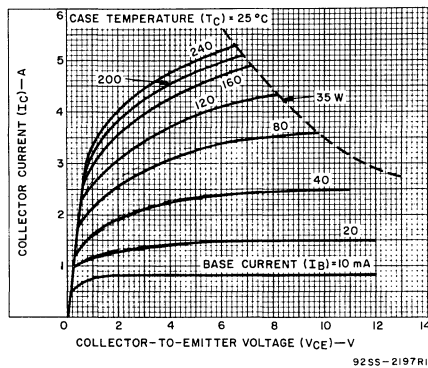


Fig. 13 - Typical output characteristics for 2N3878, 2N3879, 2N5202, and 40375.

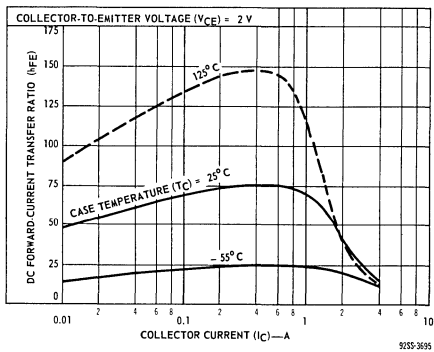


Fig. 14 - Typical dc beta characteristics for 2N5202.

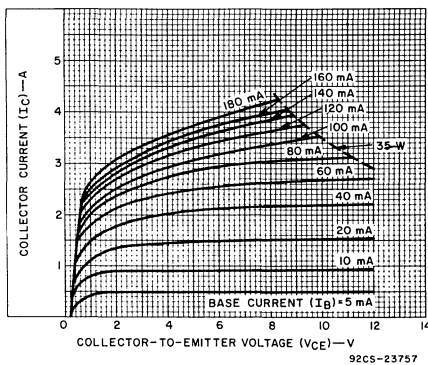


Fig. 15 - Typical output characteristics for 2N6500.

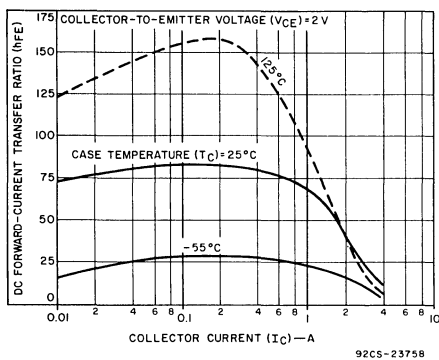


Fig. 16 - Typical dc beta characteristics for 2N6500.

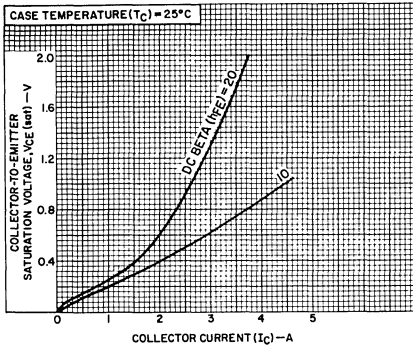


Fig.17 - Typical saturation-voltage characteristics for 2N3878, and 2N3879.

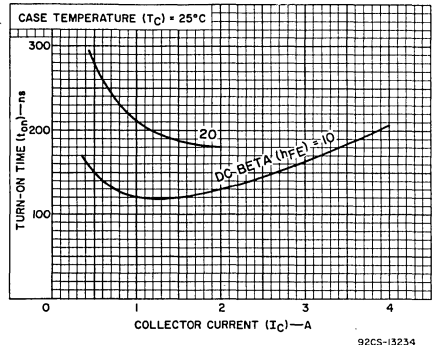


Fig.18 - Typical turn-on time for 2N3879, 2N5202, and 2N6500.

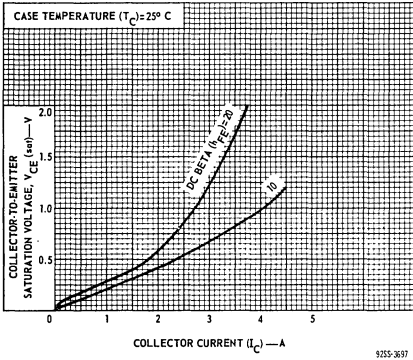


Fig.19 - Typical saturation-voltage characteristics for 2N5202.

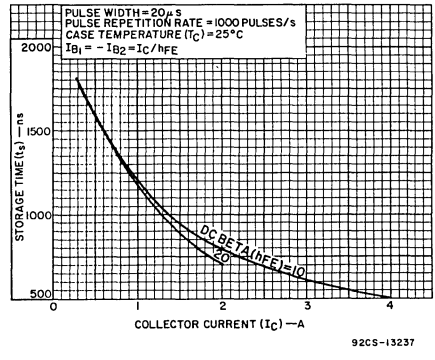


Fig.20 - Typical storage time for 2N3879, 2N5202, and 2N6500.

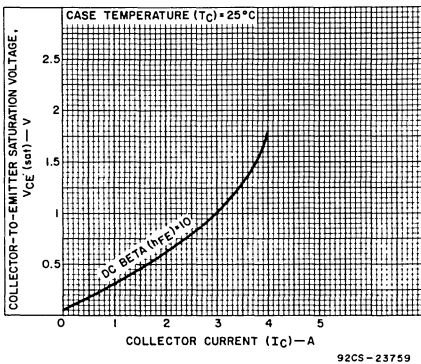


Fig.21 - Typical saturation-voltage characteristics for 2N6500.

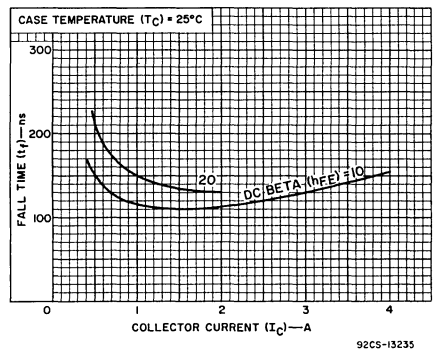


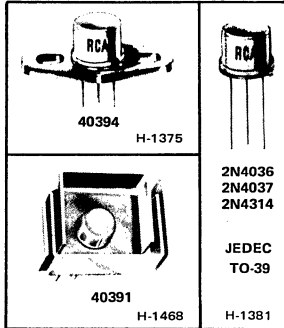
Fig.22 - Typical fall time for 2N3879, 2N5202, and 2N6500.



# Power Transistors

## 2N4036 2N4037 2N4314

### 40391 40394



## Medium-Power Silicon P-N-P Planar Transistors

General-Purpose Types for Industrial and Commercial Applications

**Features:**

- **2N4036** } are p-n-p complements of { **2N2102<sup>▲▲</sup>**
- **2N4037** } { **2N3053**
- Gain-bandwidth product ( $f_T$ ) = 60 MHz min
- High breakdown voltages
- Maximum-area-of-operation curves
- Planar construction provides low noise and low leakage
- Low saturation voltages
- High pulsed beta at high collector current
- Fast switching (2N4036)

These devices are available with either 1½-inch leads (TO-5 package) or ½-inch leads (TO-39 package). The longer-lead versions are specified by suffix "L" after the type number; the shorter-lead versions are specified by suffix "S" after the type number.

The 2N4036, 2N4037, 2N4314<sup>▲</sup>, 40391, and 40394 are double-diffused, epitaxial-planar, silicon p-n-p transistors; they differ in breakdown-voltage ratings, leakage-current, and saturation characteristics. The 40391 is a 2N4037 with a factory-attached heat radiator, intended for printed-circuit-board applications. Type 40394 is a 2N4037 with a factory-attached diamond-shaped mounting flange.

These transistors are intended for a wide variety of small-signal medium-power applications. With a minimum gain-

bandwidth product ( $f_T$ ) of 60 MHz, these devices provide useful gain at high frequencies. In addition, the 2N4036 is useful in high-speed saturated switching applications.

<sup>▲</sup> Formerly Dev. Nos. TA2651, TA2670, and TA2670A, respectively.

<sup>▲▲</sup> 2N2102 is a linear-beta type; the 2N3053 is a general-purpose type. For technical bulletins for these types, write to RCA Solid State Division, Box 3200, Somerville, N. J. 08876.

**MAXIMUM RATINGS, Absolute Maximum Values:**

	2N4036	2N4037 40391, 40394	2N4314	
* COLLECTOR-TO-BASE VOLTAGE	$V_{CBO}$ - 90	- 60	- 90	V
COLLECTOR-TO-EMITTER SUSTAINING VOLTAGE:				
With 1.5 volts ( $V_{BE}$ ) of reverse bias	$V_{CEV(sus)}$ - 85	- 60	- 85	V
With external base-to-emitter resistance ( $R_{BE}$ ) $\leq 200 \Omega$	$V_{CER(sus)}$ - 85	- 60	- 85	V
* With base open	$V_{CEO(sus)}$ - 65	- 40	- 65	V
* EMITTER-TO-BASE VOLTAGE	$V_{EBO}$ - 7	- 7	- 7	V
* COLLECTOR CURRENT	$I_C$ - 1.0	- 1.0	- 1.0	A
* BASE CURRENT	$I_B$ - 0.5	- 0.5	- 0.5	A
* TRANSISTOR DISSIPATION:	$P_T$			
At case temperatures up to 25°C	7	7(2N4037)	7	W
At free-air temperatures up to 25°C	-	7(40394)	-	W
At temperatures above 25°C	1	3.5(40391)	1	W
For pulsed operation	-	1(2N4037, 40394)	-	W
* TEMPERATURE RANGE:		See Figs. 6 and 7		
Storage & Operating (Junction)		See Fig. 1		°C
* LEAD TEMPERATURE (During soldering):				
At distance $\geq 1/16$ in. (1.58 mm) from seating plane for 10 s max.		230		°C

\* In accordance with JEDEC registration data format (JS-6 RDF-1 2N4036; JS-9 RDF-2 2N4037, 2N4314).

**ELECTRICAL CHARACTERISTICS, at Case Temperature ( $T_C$ ) = 25°C unless otherwise specified**

CHARACTERISTIC	SYMBOL	TEST CONDITIONS				LIMITS						UNITS	
		VOLTAGE V dc			CUR- RENT mA dc	2N4036		2N4037 40391 40394		2N4314			
		$V_{CB}$	$V_{CE}$	$V_{BE}$		Min.	Max.	Min.	Max.	Min.	Max.		
Collector Cutoff Current:	$I_{CBO}$	$-90$				-	-0.1*	-	-	-	-	m A	
With emitter open		$-60$				-	-0.02	-	-0.25*	-	-0.25*	$\mu$ A	
With base open			$-30$			-	-0.5*	-	-5*	-	-5*	$\mu$ A	
With base-emitter junction reverse biased	$I_{CEX}$		$-85$	1.5		-	-100*	-	-	-	-	m A	
$T_C = 150^\circ\text{C}$			$-30$	1.5		-	-0.1*	-	-	-	-	m A	
Emitter Cutoff Current	$I_{EBO}$			7 5	0 0	-	-0.1* 0	-	-	-	-1*	m A $\mu$ A	
Collector-to-Base Breakdown Voltage ( $I_E = 0$ )	$V_{(BR)CBO}$					-0.1	-90	-	-60*	-	-90*	V	
Emitter-to-Base Breakdown Voltage ( $I_E = -0.1\text{mA}$ )	$V_{(BR)EBO}$					0	-7	-	-7	-	-7	V	
Collector-to-Emitter Sustaining Voltage: (See Figs. 2 and 3) With base-emitter junction reverse biased	$V_{CEV(sus)}$			1.5	-100	-85 <sup>a</sup>	-	-60 <sup>a</sup>	-	-85 <sup>a</sup>	-	V	
With external base-to-emitter resistance ( $R_{BE} \leq 200 \Omega$ )	$V_{CER(sus)}$				-100	-85 <sup>a</sup>	-	-60 <sup>a</sup>	-	-85 <sup>a</sup>	-	V	
With base open	$V_{CEO(sus)}$				-100	-65 <sup>a</sup>	-	-40 <sup>a</sup>	-	-65 <sup>a</sup>	-	V	
Collector-to-Emitter Voltage ( $I_B = -15 \text{ mA}$ )	$V_{CE(sat)}$				-150	-	-0.65	-	-1.4	-	-1.4	V	
Base-to-Emitter Voltage	$V_{BE}$		$-10$		-150	-	-1.1	-	-1.5*	-	-1.5*	V	
Base-to-Emitter Voltage ( $I_B = -15 \text{ mA}$ )	$V_{BE(sat)}$				-150	-	-1.4	-	-	-	-	V	
DC Forward-Current Transfer Ratio	$h_{FE}$		$-2$ $-10$ $-10$ $-10$		$-150$ $-0.1$ $-1.0$ $-150^b$ $-500^b$	20 20	200 -	- -	- 15	- 50	250 50	250 250	- -
Common-Emitter, Small-Signal, Short-Circuit, Forward-Current Transfer Ratio (at $f = 20 \text{ MHz}$ )	$h_{fe}$		$-10$		$-50$	3.0	-	3.0	-	3.0	-	-	
Magnitude of Common-Emitter, Small-Signal, Short-Circuit, Forward-Current Transfer Ratio (at $f = 20 \text{ MHz}$ )	$ h_{fe} $		$-10$		$-50$	3.0	-	3.0	10	3.0	10	-	
Collector-Base Capacitance (at $f = 1 \text{ MHz}, I_E = 0$ )	$C_{cb}$		$-10$			-	30	-	30*	-	30*	pF	
Input Capacitance	$C_{ib}$			0.5	0	-	90	-	90	-	90	pF	
Sat. Switching Time: $\tau$ (See Figs. 10 and 11) Rise time Storage time Fall time Turn-on time Turn-off time	$t_r$ $t_s$ $t_f$ $t_{on}$ $t_{off}$		$-30$ $-30$ $-30$ $-30$ $-30$		$-150$ $-150$ $-150$ $-150$ $-150$	-	70 600 100 110 700	- - - - -	- - - - -	- - - - -	- - - - -	- - - - -	ns
Thermal Resistance:													
Junction-to-Case	$R_{\theta JC}$					-	25*	25 (max.) 2N4037 & 40394	-	-	25	-	$^\circ\text{C/W}$
Junction-to-Ambient	$R_{\theta JA}$					-	165	165 (max.) 2N4037 & 40394 50 (max.) 40391	-	-	165	-	$^\circ\text{C/W}$ $^\circ\text{C/W}$

<sup>a</sup> CAUTION: The sustaining voltages  $V_{CEO(sus)}$ ,  $V_{CER(sus)}$ , and  $V_{CEV(sus)}$  MUST NOT be measured on a curve tracer.

These sustaining voltages should be measured by means of the test circuit shown in Fig. 2.

<sup>b</sup> Pulsed; pulse duration  $\leq 300 \mu\text{s}$ , duty factor  $< 2\%$ .

\* In accordance with JEDEC registration data format (US 6 R D F 1 2N4036; JS 9 R D F 2 2N4037, 2N4314).

<sup>c</sup>  $I_{CB1} = I_{B2} = 15 \text{ mA}$

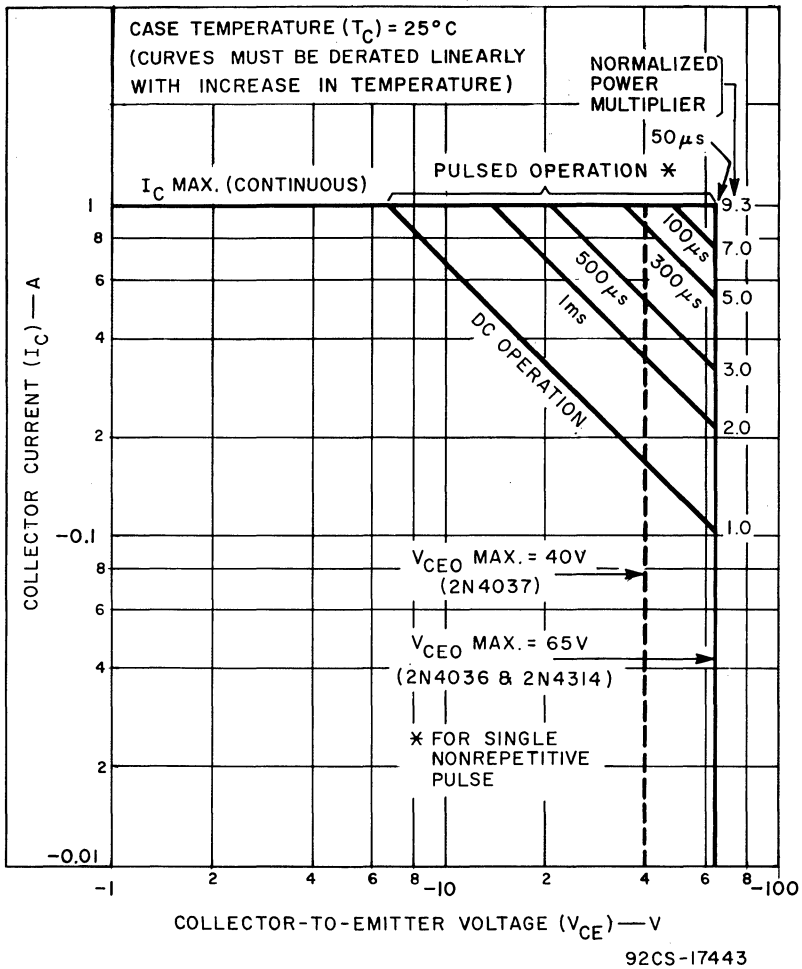


Fig. 1 — Maximum operating areas for types 2N4036, 2N4037, and 2N4314.

**TERMINAL CONNECTIONS  
FOR 40394**

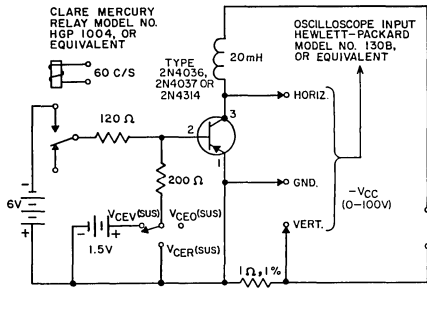
Lead 1 — Emitter  
Lead 2 — Base  
Flange, Lead 3 — Collector

**TERMINAL CONNECTIONS  
FOR 2N4036, 2N4037, 2N4314**

Lead 1 — Emitter  
Lead 2 — Base  
Case, Lead 3 — Collector

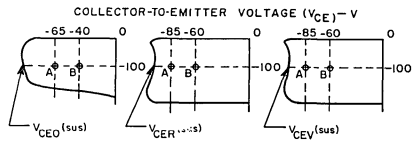
**TERMINAL CONNECTIONS  
FOR 40391**

Lead 1 — Emitter  
Lead 2 — Base  
Heat-Radiator, Lead 3 — Collector



92LS-1255RI

Fig.2 - Circuit used to measure sustaining voltages  $V_{CE0(sus)}$ ,  $V_{CER(sus)}$ , and  $V_{CEV(sus)}$  for all types.

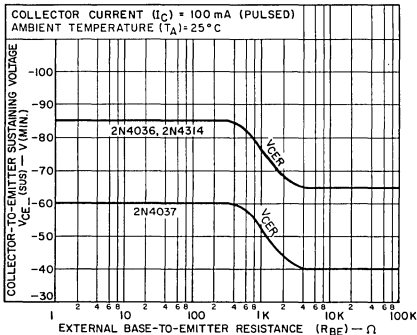


COLLECTOR CURRENT ( $I_C$ ) - mA

92LS-1263

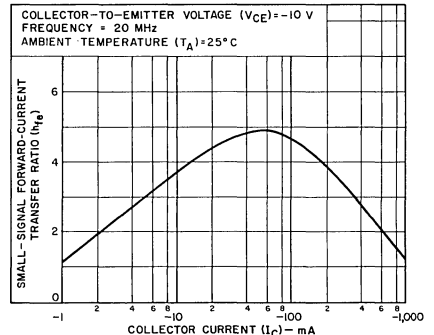
NOTE: The sustaining voltages  $V_{CE0(sus)}$ ,  $V_{CER(sus)}$ , and  $V_{CEV(sus)}$  are acceptable when the traces fall to the left and below point "A" for type 2N4036 and 2N4314, and point "B" for type 2N4037.

Fig.3 - Oscilloscope display for measurement of sustaining voltages (test circuit shown in Fig.2).



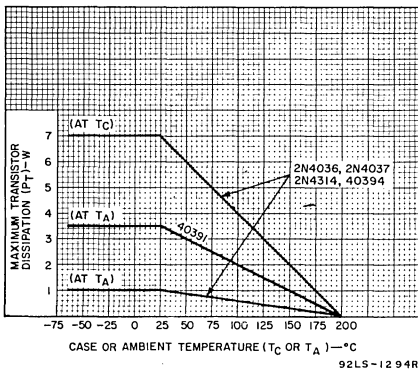
92LS-1256R2

Fig.4 - Sustaining voltage vs. base-to-emitter resistance for all types.



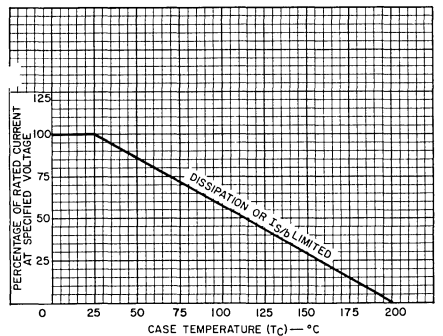
92LS-1257RI

Fig.5 - Typical small-signal beta characteristic for all types.



92LS-12 94R2

Fig.6 - Dissipation derating curve for all types.



92LS-1469RI

Fig.7 - Dissipation derating curve for types 2N4036, 2N4037, and 2N4314.

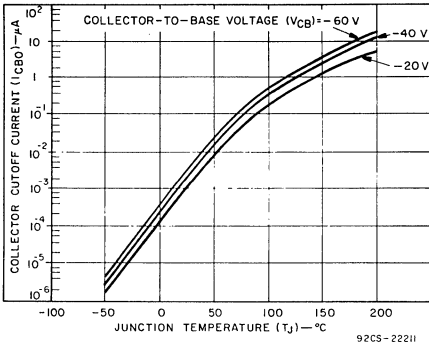


Fig. 8 - Typical collector-cutoff current vs. junction temperature for type 2N4036.

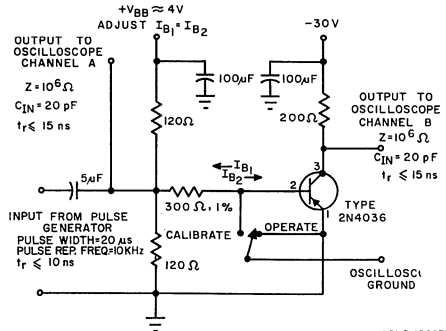


Fig. 9 - Circuit used to measure switching times for type 2N4036.

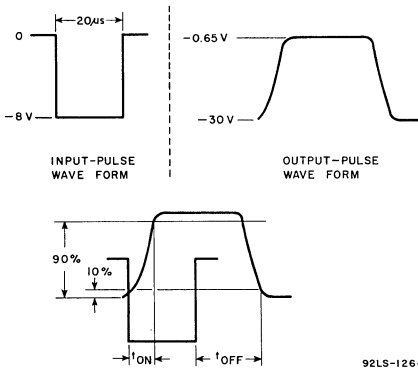


Fig. 10 - Oscilloscope display for measurement of switching times test circuit shown in Fig. 9.

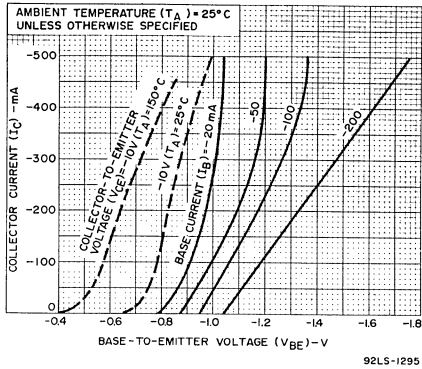


Fig. 11 - Typical transfer characteristics for types 2N4037 and 2N4314.

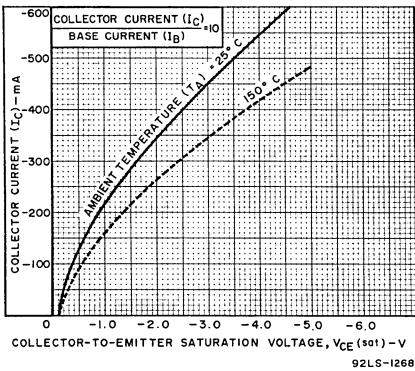


Fig. 12 - Typical saturation-voltage characteristics for type 2N4036.

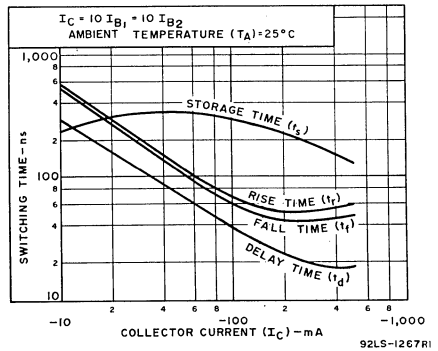


Fig. 13 - Typical saturated switching times for type 2N4036.



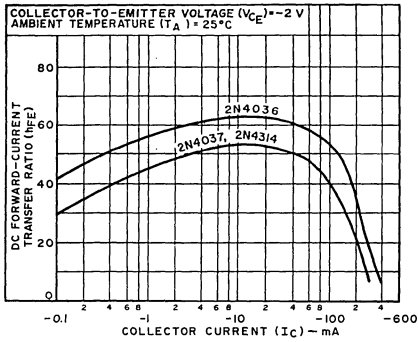


Fig.14 - Typical dc beta characteristics for all types.

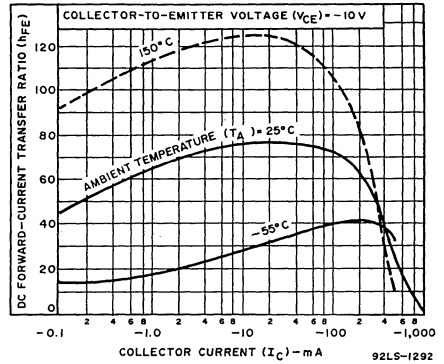


Fig.15 - Typical dc beta characteristics for types 2N4037 and 2N4314.

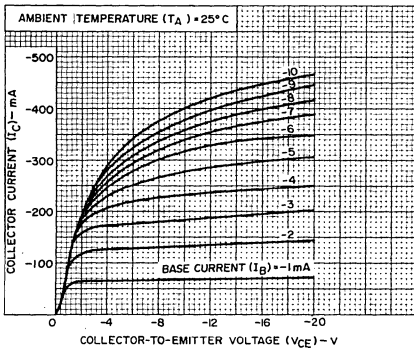


Fig.16 - Typical output characteristics for types 2N4037 and 2N4314.

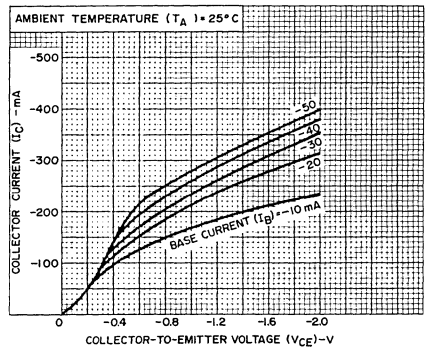


Fig.17 - Typical output characteristics for types 2N4037 and 2N4314.

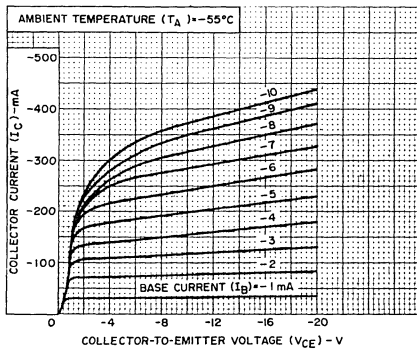


Fig.18 - Typical output characteristics for types 2N4037 and 2N4314.

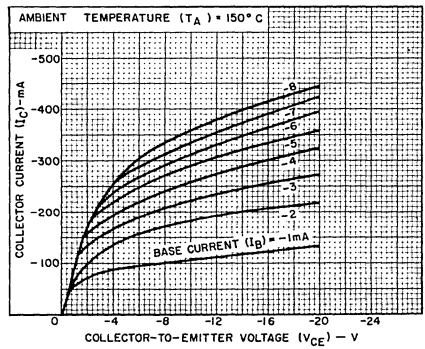
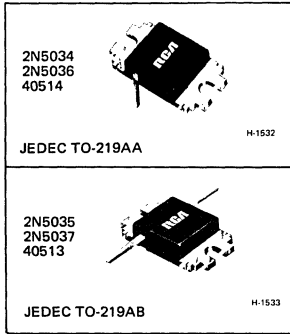


Fig.19 - Typical output characteristics for types 2N4037 and 2N4314.



# Power Transistors

2N5034 2N5035  
 2N5036 2N5037  
 40514 40513



## Molded Silicone-Plastic Hometaxial-Base Transistors

Silicon N-P-N Types for Industrial and Commercial Applications

**Features:**

- Low thermal resistance:  $\theta_{J-C} = 1.5^{\circ}\text{C/W max.}$
- Low saturation voltage
- High second breakdown ratings for both forward- and reverse-bias operation
- High peak collector current ratings
- Maximum-area-of-operation curves for DC and pulse operation

RCA-2N5034, 2N5035, 2N5036, 2N5037\*, 40513, and 40514 are hometaxial\*\*-base silicon n-p-n power transistors employing two versions of a unique plastic package. This new plastic package is available with two different lead configurations: a "vertical-lead" version which will fit a TO-3 socket; a "horizontal-lead" type for mounting on a printed-circuit board.

Types 2N5034, 2N5036, and 40514 are the "TO-3" versions. The 2N5034, 2N5036, and 40514 differ in breakdown-voltage, collector-current ratings, and leakage-current limits. These devices may be plugged into a TO-3 socket and secured by means of an over-clamp whose mounting holes are identical to those in a TO-3 socket.

Types 2N5035, 2N5037, and 40513 are electrically identical to the 2N5034, 2N5036, and 40514, respectively, but employ the horizontal-lead package.

These plastic transistors are intended for a wide variety of high-power switching and amplifier applications such as series and shunt regulator driver and output stages and for high-fidelity amplifiers.

\*Formerly Dev. Type Nos. TA7201, TA7202, TA7199, and TA7200 respectively.

\*\*"Hometaxial" was coined by RCA from "homogeneous" and "axial" to describe a single-diffused transistor with a base region of homogeneous-resistivity silicon in the axial direction (emitter-to-collector).

MAXIMUM RATINGS, Absolute-Maximum Values:	40514 40513	2N5034 2N5035	2N5036 2N5037	
* COLLECTOR-TO-BASE VOLTAGE .....	-	55	70	V
COLLECTOR-TO-EMITTER SUSTAINING VOLTAGE:				
With -1.5 volts ( $V_{BE}$ ) of reverse bias .....	-	55	70	V
* With external base-to-emitter resistance ( $R_{BE}$ ) = 100 $\Omega$ .....	45	45	60	V
With base open .....	-	40	50	V
* EMITTER-TO-BASE VOLTAGE .....	5	5	5	V
* CONTINUOUS COLLECTOR CURRENT .....	6	6	8	A
* PEAK COLLECTOR CURRENT .....	12	12	12	A
* CONTINUOUS BASE CURRENT .....	6	6	6	A
* TRANSISTOR DISSIPATION: .....				P <sub>T</sub>
At case temperatures up to 25°C .....	83	83	83	W
At temperatures above 25°C .....		See Fig. 1		
* TEMPERATURE RANGE:				
Storage & Operating (Junction) .....		-65 to 150		°C
* LEAD TEMPERATURE (During Soldering)				
2N5034, 2N5036, & 40514: At distance $\geq$ 1/16 in. (1.58mm) from seating plane for 10s max. ....		235		°C
2N5035, 2N5037, & 40513: At distances $\geq$ 1/8 in. (3.18mm) from case for 10s max. ....		235		°C

\* Types 2N5034-2N5037, inclusive, in accordance with JEDEC registration data format JS-6 RDF-2.

**ELECTRICAL CHARACTERISTICS** Case Temperature ( $T_C$ ) = 25°C Unless Otherwise Specified

Characteristic	Symbol	TEST CONDITIONS						LIMITS						Units
		DC Collector Voltage (V)		DC Emitter or Base Voltage (V)		DC Current (A)		Types 40514 40513		Types 2N5034 2N5035		Types 2N5036 2N5037		
		VCE	VEB	VBE	IC	IB	Min.	Max.	Min.	Max.	Min.	Max.		
Collector-Cutoff Current With external base-to-emitter resistance ( $R_{BE}$ ) = 100 Ω	$I_{CER}$	20					–	2.5	–	–	–	–	–	mA
		35					–	–	–	1.0	–	–		
		50					–	–	–	–	–	1.0		
* With base-emitter junction reverse biased	$I_{CEV}$ ( $T_C = 150^\circ C$ )	20					–	5.0	–	–	–	–	mA	
		35					–	–	–	5.0	–	–		
		50					–	–	–	–	–	5.0		
* With base open	$I_{CEO}$	30				0	–	–	–	2	–	–	mA	
		40				0	–	–	–	–	–	2		
* Emitter-Cutoff Current	$I_{EBO}$		5		0		–	5.0	–	5.0	–	5.0	mA	
* DC Forward-Current Transfer Ratio	$h_{FE}$	4			3 <sup>a</sup>		25	100	–	–	–	–		
		4			4 <sup>a</sup>		–	–	20	80	–	–		
		4			5 <sup>a</sup>		–	–	–	–	20	80		
		4			6 <sup>a</sup>		–	–	5	–	–	–		
		4			8 <sup>a</sup>		–	–	–	–	5	–		
Collector-to-Emitter Sustaining Voltage With base open	$V_{CEO(sus)}$				0.2 <sup>a</sup>	0	–	–	40	–	50	–	V	
With base-emitter junction reverse biased	$V_{CEV(sus)}$			–1.5	0.1 <sup>a</sup>		–	–	55	–	70	–	V	
With external base-to-emitter resistance ( $R_{BE}$ ) = 100 Ω	$V_{CER(sus)}$				0.2 <sup>a</sup>		45	–	45	–	60	–	V	
* Base-to-Emitter Voltage	$V_{BE}$	4			3 <sup>a</sup>		–	1.7	–	–	–	–	V	
		4			4 <sup>a</sup>		–	–	–	1.7	–	–		
		4			5 <sup>a</sup>		–	–	–	–	–	1.7		
* Collector-to-Emitter Saturation Voltage	$V_{CE(sat)}$				3 <sup>a</sup>	0.3	–	1.0	–	–	–	–	V	
					4 <sup>a</sup>	0.4	–	–	–	1.0	–	–		
					5 <sup>a</sup>	0.5	–	–	–	–	–	1.0		
* Common-Emitter, Small-Signal, Short-Circuit Forward-Current Transfer Ratio (f = 1 kHz)	$h_{fe}$	4			0.5		15	–	15	–	15	–		
* Magnitude of Common-Emitter, Small-Signal, Short-Circuit, Forward-Current Transfer Ratio (f = 100 kHz)	$ h_{fe} $	4			0.5		8	28	8	28	8	28		
Thermal Resistance (Junction-to-Case)	$\theta_{J-C}$						–	1.5	–	1.5	–	1.5	°C/W	

<sup>a</sup> Pulsed; pulse duration = 300 μs, duty factor = 1.8%.

\* Types 2N5034-2N5037, inclusive, in accordance with JEDEC registration data format JS-6 RDF-2.

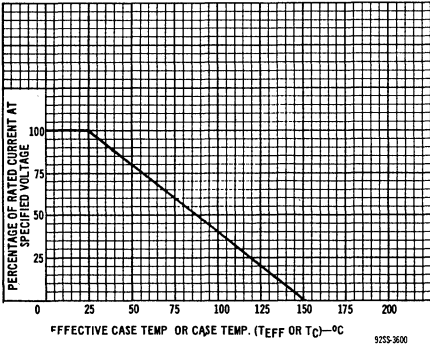


Fig. 1—Dissipation derating curve for all types.

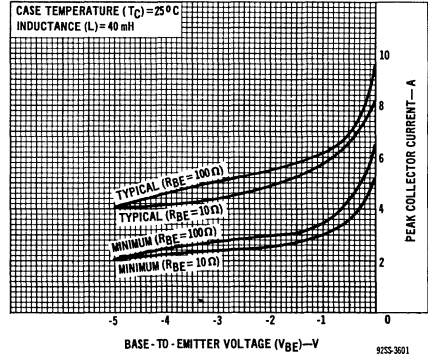


Fig. 2—Reverse-bias, second breakdown characteristics for all types.

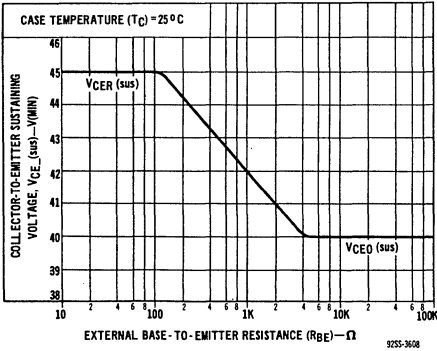


Fig. 3—Sustaining voltage vs. base-to-emitter resistance for types 2N5034 & 2N5035.

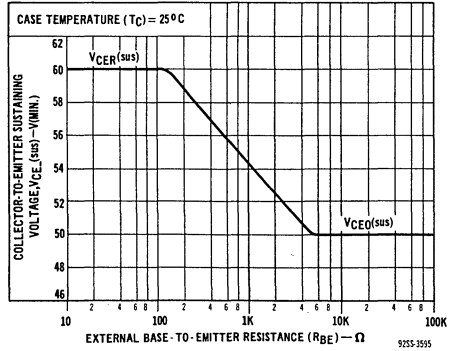


Fig. 4—Sustaining voltage vs. base-to-emitter resistance for types 2N5036 & 2N5037.

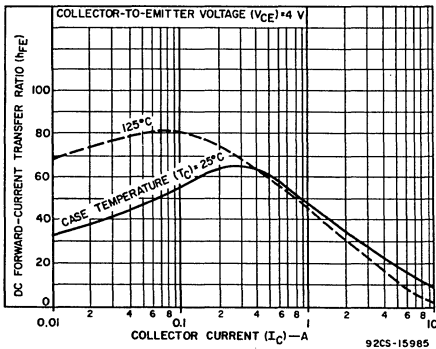


Fig. 5—Typical dc beta characteristics for types 2N5034, 2N5035, 40513, & 40514.

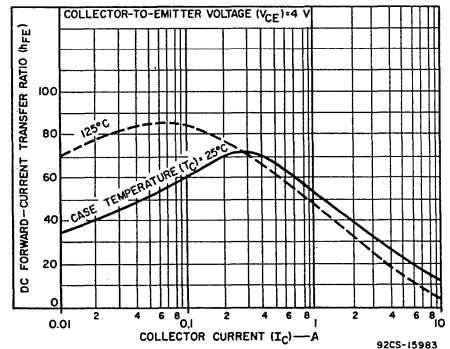


Fig. 6—Typical dc beta characteristics for types 2N5036 & 2N5037.

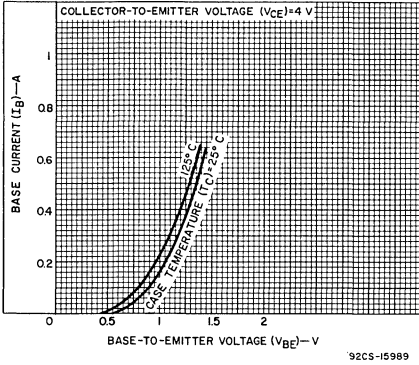


Fig. 7—Typical input characteristics for types 2N5034, 2N5035, 40513, & 40514.

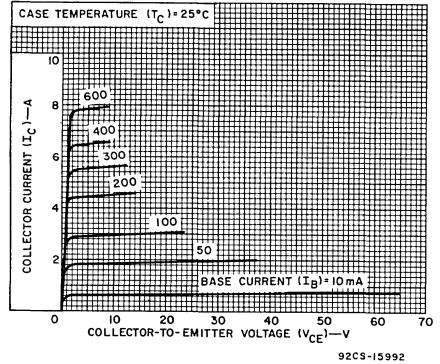


Fig. 8—Typical output characteristics for types 2N5034, 2N5035, 40513, & 40514.

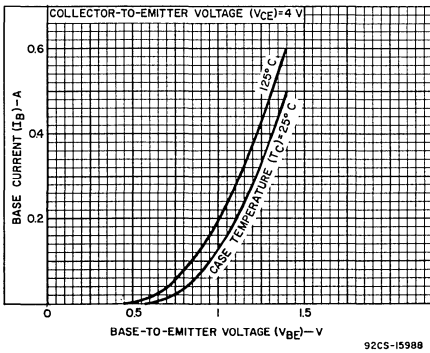


Fig. 9—Typical input characteristics for types 2N5036 & 2N5037.

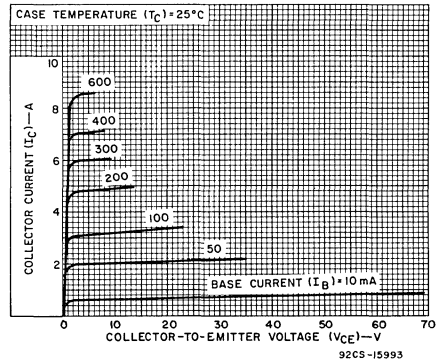


Fig. 10—Typical output characteristics for types 2N5036 & 2N5037.

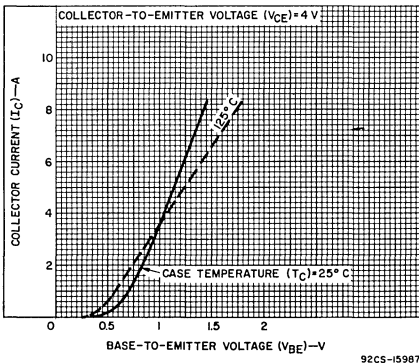


Fig. 11—Typical transfer characteristics for all types.

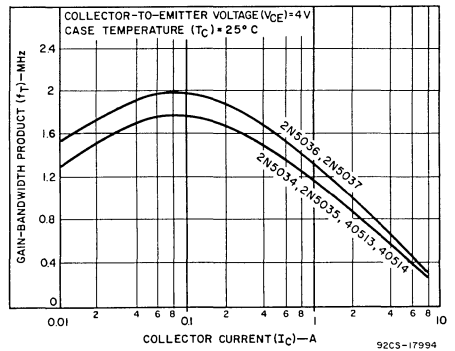


Fig. 12—Typical gain-bandwidth product for all types.

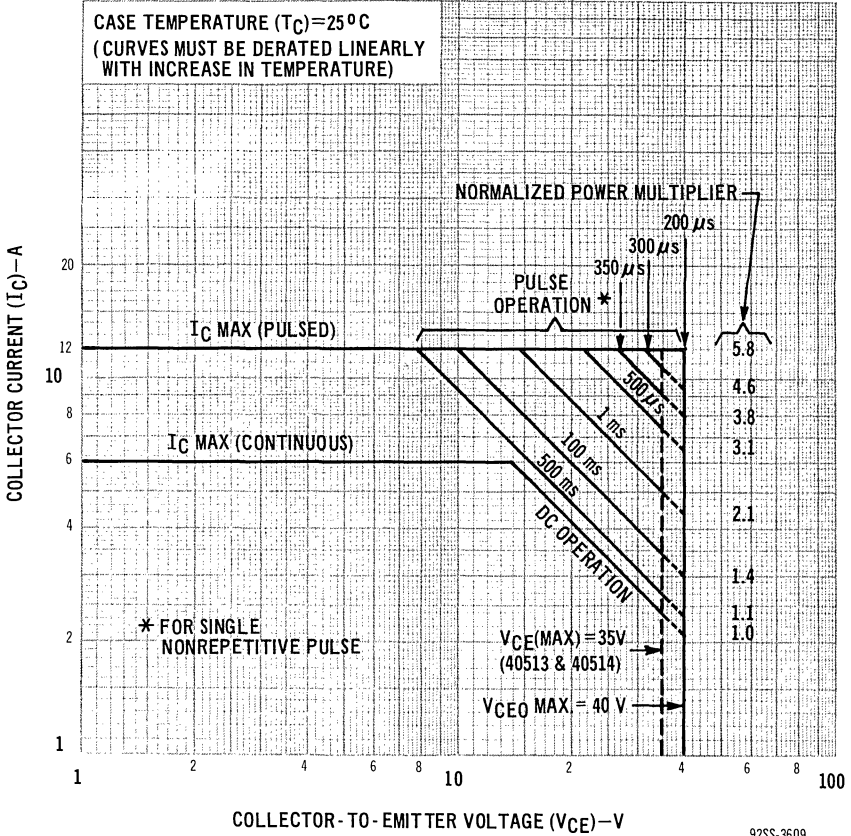


Fig. 13—Maximum operating areas for types 2N5034, 2N5035, 40513, & 40514.

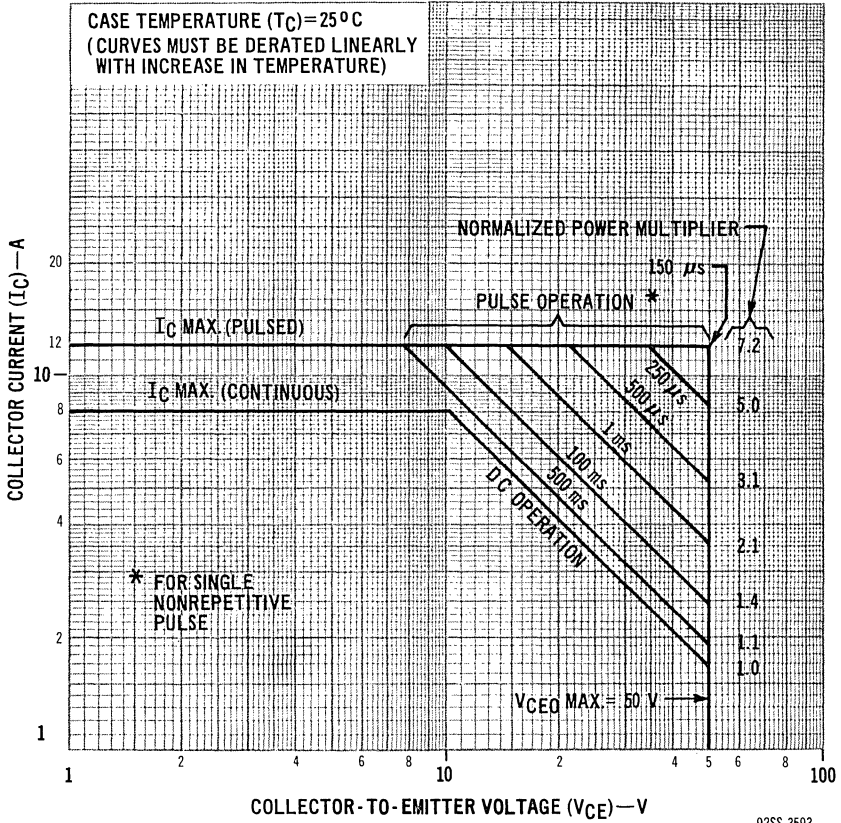


Fig. 14—Maximum operating areas for types 2N5036 & 2N5037.

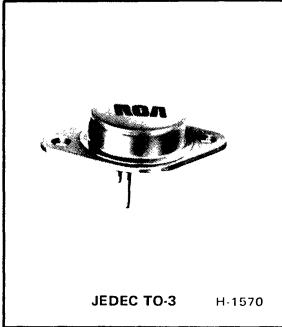
TERMINAL CONNECTIONS FOR ALL TYPES

- Lead No. 1 — Base
- Lead No. 2 — Emitter
- Mounting Flange — Collector



# Power Transistors

**2N5038**  
**2N5039**  
**2N6496**



## High-Current, High-Power, High-Speed Silicon N-P-N Power Transistors

Devices for Switching and Amplifier Circuits in Industrial and Commercial Applications

*Features:*

- Maximum operating area curves for dc and pulse operation
- $I_{S/B}$  limit line beginning at 28 V
- High collector current ratings
- High-dissipation capability

RCA-2N5038, 2N5039, and 2N6496 are epitaxial silicon n-p-n power transistors. They differ in breakdown-voltage ratings, leakage-current, and dc-beta values.

The high current-handling capability of these transistors in conjunction with fast switching speeds make these devices especially suited for switching-control amplifiers, power gates, switching regulators, converters, and inverters. Other recommended applications include dc-rf amplifiers and power oscil-

lators. These transistors are supplied in the JEDEC TO-3 package.

<b>Switching Time:</b> $t_r = 0.5 \mu s$ max. $t_s = 1.5 \mu s$ max. $t_f = 0.5 \mu s$ max.	$\left. \begin{array}{l} \\ \\ \end{array} \right\}$	Measured at:
		12 A (2N5038)
		10 A (2N5039)
		8 A (2N6496)

**MAXIMUM RATINGS, Absolute-Maximum Values:**

	2N5038	2N5039	2N6496	
*COLLECTOR-TO-BASE VOLTAGE .....	$V_{CBO}$ 150	120	150	V
COLLECTOR-TO-EMITTER SUSTAINING VOLTAGE: With - 1.5 volts ( $V_{BE}$ ) of reverse bias and external base-to-emitter resistance ( $R_{BE}$ ) = 100 $\Omega$ .....	$V_{CEX(sus)}$ 150	120	—	V
With $R_{BE} \leq 50 \Omega$ .....	$V_{CER(sus)}$ 110	95	130	V
With base open .....	$V_{CEO(sus)}$ 90	75	110	V
*EMITTER-TO-BASE VOLTAGE .....	$V_{EBO}$ 7	7	7	V
*CONTINUOUS COLLECTOR CURRENT .....	$I_C$ 20	20	15	A
*PEAK COLLECTOR CURRENT .....	30	30	—	A
*CONTINUOUS BASE CURRENT .....	$I_B$ 5	5	5	A
*TRANSISTOR DISSIPATION: At case temperatures up to 25°C and $V_{CE}$ up to 28 V .....	$P_T$ 140	140	140	W
At case temperature of 100°C and $V_{CB}$ of 20 V .....	80	80	80	W
At case temperatures up to 25°C and $V_{CE}$ above 28 V .....	← See Fig. 1. →			
At case temperatures above 25°C and $V_{CE}$ above 28 V .....	← See Figs. 1 & 2. →			
*TEMPERATURE RANGE: Storage & Operating (Junction) .....	← -65 to 200 →			°C
PIN TEMPERATURE (During Soldering) At distances $\geq 1/32$ in. (0.8 mm) from seating plane for 10 s max. ...	← 230 →			°C

\*In accordance with JEDEC registration data format (J5-6, RDF-1)



ELECTRICAL CHARACTERISTICS, At Case Temperature ( $T_C$ ) = 25°C Unless Otherwise Specified

CHARACTERISTIC	SYMBOL	TEST CONDITIONS				LIMITS						UNITS
		VOLTAGE V dc		CURRENT A dc		2N5038		2N5039		2N6496		
		$V_{CE}$	$V_{BE}$	$I_C$	$I_B$	Min.	Max.	Min.	Max.	Min.	Max.	
Collector Cutoff Current: With base open	$I_{CEO}$	55 70			0 0	-	- 20	-	20	-	-	mA
With base-emitter junction reverse-biased	$I_{CEV}$	110 140 130	-1.5 -1.5 0			-	- 50	-	50	-	- 20	
At $T_C = 150^\circ\text{C}$		85 100 130	-1.5 -1.5 0			-	- 10	-	10	-	- 25	
Emitter Cutoff Current	$I_{EBO}$		-5 -7	0 n		-	5 50	-	15 50	-	- 50	mA
DC Forward-Current Transfer Ratio	$h_{FE}$	5 5 5 2		2 <sup>a</sup> 10 <sup>a</sup> 12 <sup>a</sup> 8 <sup>a</sup>		50 - 20	250 - 100	30 20	250 100	- - - 12	- - - 100	
Magnitude of Small-Signal Forward-Current Transfer Ratio: $f = 5$ MHz	$ h_{fe} $	10		2		12	-	12	-	12	-	
Collector-to-Emitter Sustaining Voltage: With base open	$V_{CEO(sus)}$			0.2	0	90 <sup>b</sup>	-	75 <sup>b</sup>	-	100 <sup>b</sup>	-	V
With base-emitter junction reverse biased and external base-to-emitter resistance ( $R_{BE}$ ) = 100 $\Omega$	$V_{CEX(sus)}$		-1.5	0.2	0	150 <sup>b</sup>	-	120 <sup>b</sup>	-			
With $R_{BE} \leq 50 \Omega$	$V_{CER(sus)}$			0.2	0	110 <sup>b</sup>	-	95 <sup>b</sup>	-	130 <sup>b</sup>	-	
Emitter-to-Base Voltage: $I_E = 0.05$ A	$V_{EBO}$				0	7	-	7	-	7	-	V
Base-to-Emitter	$V_{BE}$	5 5 2		10 <sup>a</sup> 12 <sup>a</sup> 8 <sup>a</sup>		- - -	- 1.8	- -	1.8 -	- -	- 1.6	V
Collector-to-Emitter Saturation Voltage	$V_{CE(sat)}$			10 <sup>a</sup> 12 <sup>a</sup> 20 <sup>a</sup> 8 <sup>a</sup>	1.0 1.2 5 0.8	- - - -	- 1.0 2.5	- -	1.0 2.5	- -	- 1.0	V
Base-to-Emitter Saturation Voltage	$V_{BE(sat)}$			20 <sup>a</sup> 8 <sup>a</sup>	5 0.8	- -	3.3 -	- -	3.3 -	- -	- 2.0	V
Output Capacitance: $V_{CB} = 10$ V	$C_{ob}$					-	400	-	400	-	400	pF
Forward-Bias Second- Breakdown Collector Current: $t = 1s$ , nonrepetitive	$I_{S/b}$	28 45				5.0 0.9	- -	5.0 0.9	- -	5.0 0.9	- -	A
Second-Breakdown Energy: With base reverse biased, $R_B = 20 \Omega$ , $L = 180 \mu H$	$E_{S/b}$		-4 -4	12 8		13 -	- -	13 -	- -	- 5.7	- -	mJ
Saturated Switching Time ( $V_{CC} = 30$ V, $I_{B1} = I_{B2}$ ): Rise Time (See Figs.24, 26, and 27)	$t_r$			10 12 8	1.0 1.2 0.8	- - -	- 0.5	- -	0.5 -	- -	- 0.5	$\mu s$
Storage Time (See Figs.25, 26, and 27)	$t_s$			10 12 8	1.0 1.2 0.8	- - -	- 1.5	- -	1.5 -	- -	- 1.5	
Fall Time (See Figs. 24, 26, and 27)	$t_f$			10 12 8	1.0 1.2 0.8	- - -	- 0.5	- -	0.5 -	- -	- 0.5	
Thermal Resistance: Junction-to-Case	$R_{\theta JC}$	10		10		-	1.25	-	1.25	-	1.25	$^\circ\text{C/W}$

\* In accordance with JEDEC registration data format (JS-6, RDF-1). **b** CAUTION: The sustaining voltages  $V_{CEO(sus)}$ ,  $V_{CER(sus)}$ , and  $V_{CEX(sus)}$  MUST NOT be measured on a curve tracer. These sustaining voltages should be measured by means of the test circuit shown in Fig. 22.

**a** Pulsed; pulse duration  $\leq 350 \mu s$ , duty factor = 2%.

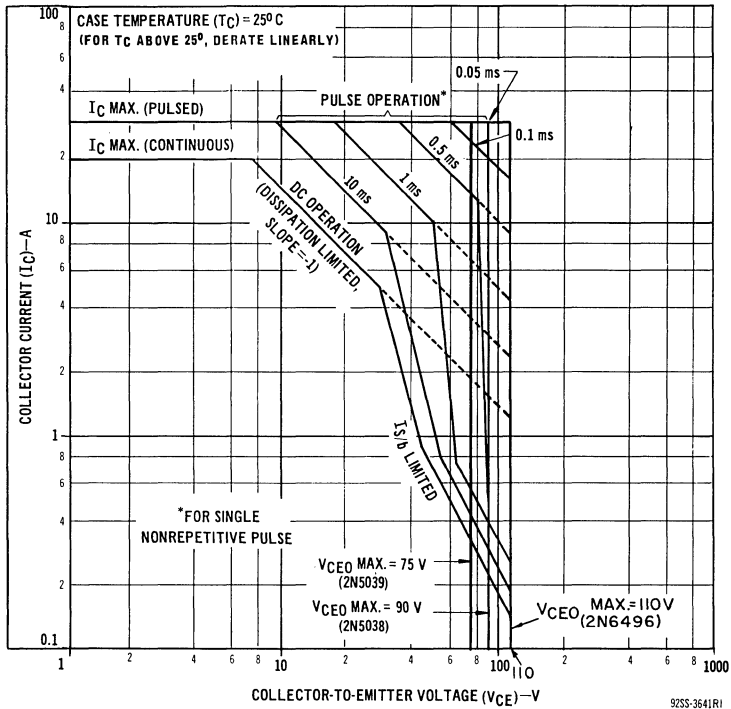


Fig. 1 — Maximum operating areas for all types.

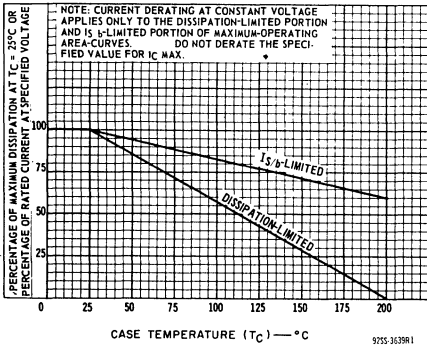


Fig. 2 — Dissipation derating curves for all types.

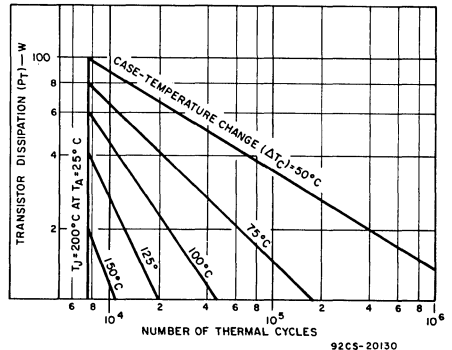


Fig. 3 — Thermal-cycling rating chart for all types.

TERMINAL CONNECTIONS

- Pin 1 — Base
- Pin 2 — Emitter
- Case — Collector
- Mounting Flange — Collector

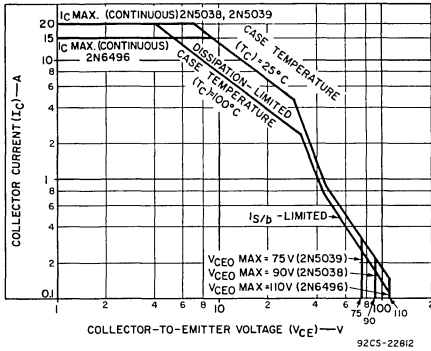


Fig. 4 - Maximum operating areas for all types.

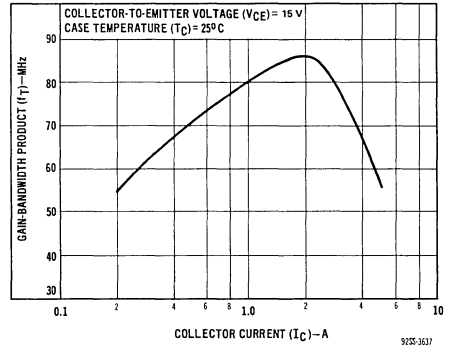


Fig. 5 - Typical gain-bandwidth product for all types.

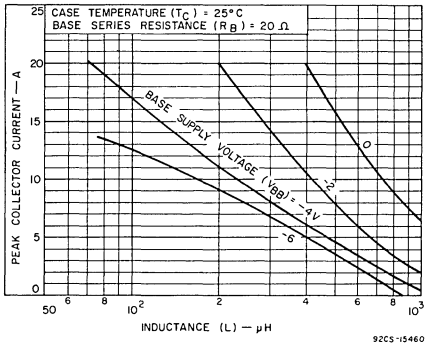


Fig. 6 - Maximum reverse-bias, second-breakdown characteristics for 2N5038 and 2N5039.

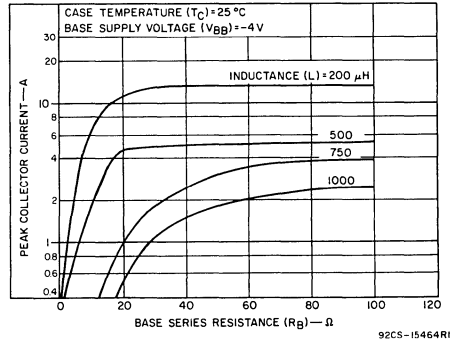


Fig. 7 - Maximum reverse-bias, second-breakdown characteristics for 2N5038 and 2N5039.

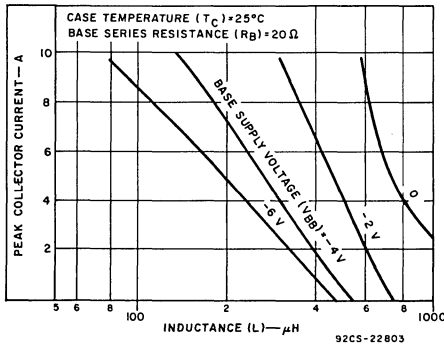


Fig. 8 - Maximum reverse-bias, second-breakdown characteristics for 2N6496.

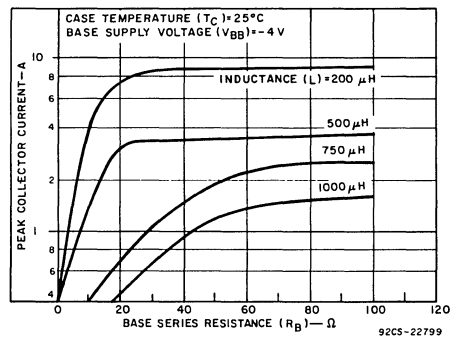


Fig. 9 - Maximum reverse-bias, second-breakdown characteristics for 2N6496.

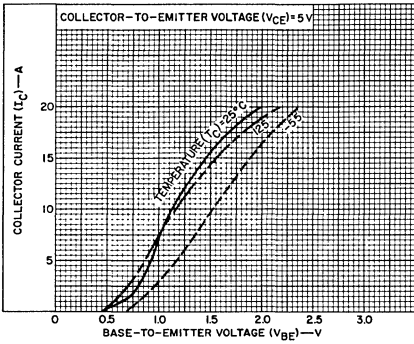


Fig. 10 - Typical transfer characteristics for 2N5038.

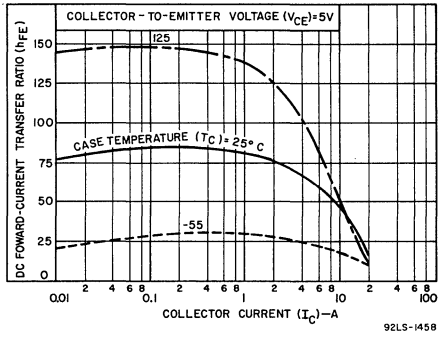


Fig. 11 - Typical dc beta characteristics for 2N5038.

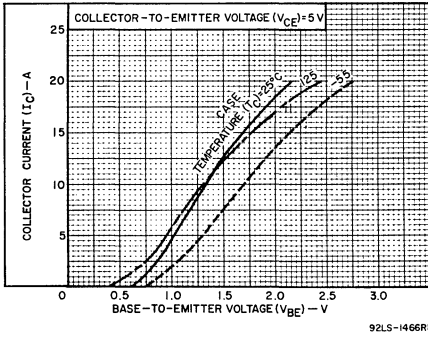


Fig. 12 - Typical transfer characteristics for 2N5039.

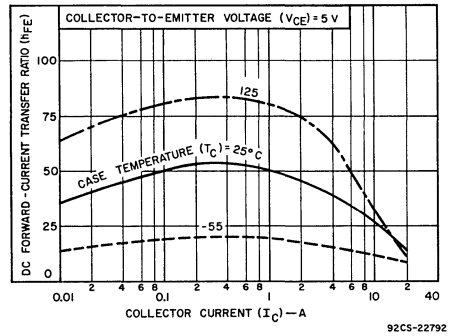


Fig. 13 - Typical dc beta characteristics for 2N5039.

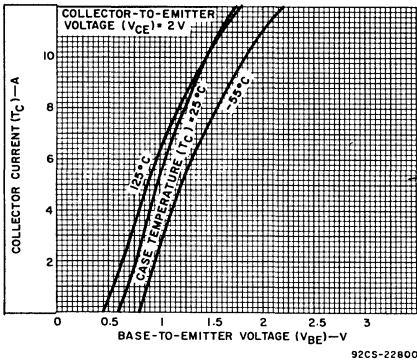


Fig. 14 - Typical transfer characteristics for 2N6496.

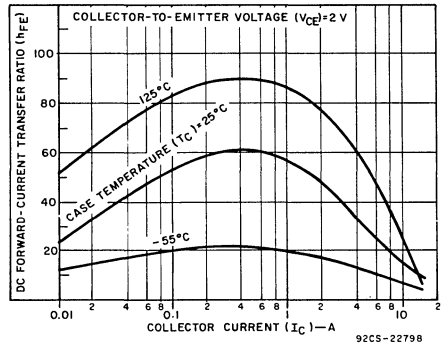


Fig. 15 - Typical dc beta characteristics for 2N6496.

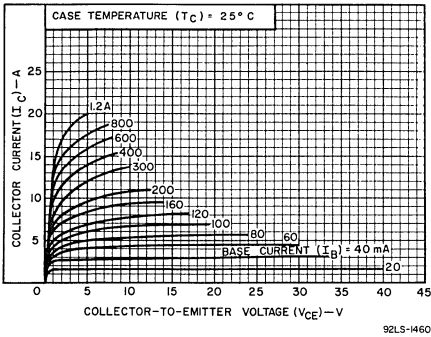


Fig. 16 – Typical output characteristics for 2N5038.

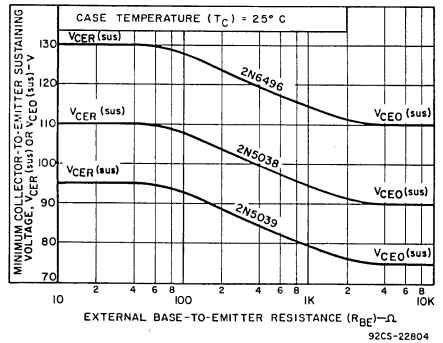


Fig. 17 – Collector-to-emitter sustaining voltage characteristic for all types.

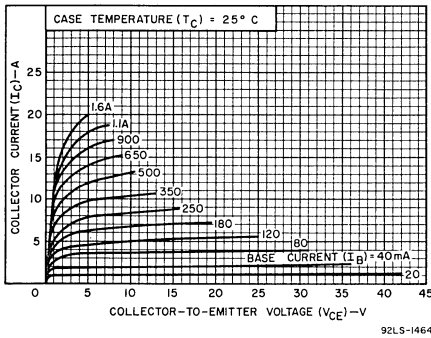


Fig. 18 – Typical output characteristics for 2N5039.

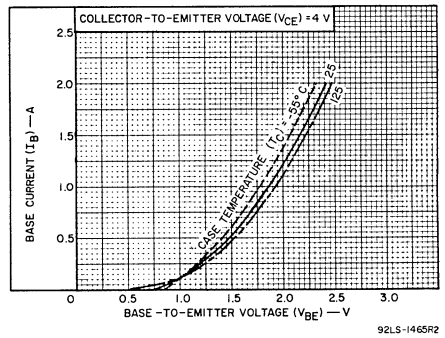


Fig. 19 – Typical input characteristics for 2N5038 and 2N5039.

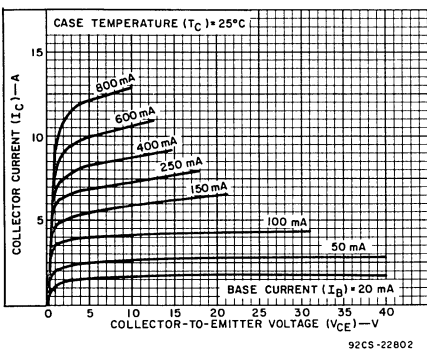


Fig. 20 – Typical output characteristics for 2N6496.

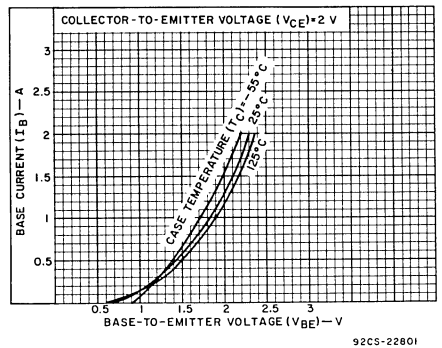
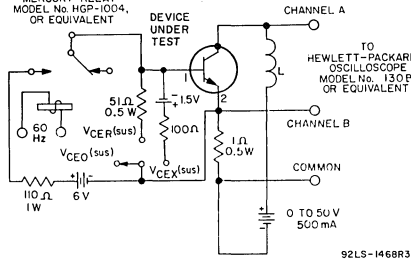
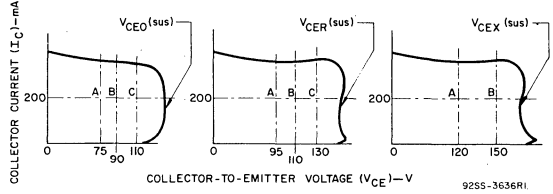


Fig. 21 – Typical input characteristics for 2N6496.



L = 15mH for V<sub>CE0(sus)</sub> and V<sub>CER(sus)</sub> measurements  
L = 2mH for V<sub>CEx(sus)</sub> measurements

Fig. 22 — Circuit used to measure sustaining voltages V<sub>CE0(sus)</sub>, V<sub>CER(sus)</sub>, and V<sub>CEx(sus)</sub>.



The sustaining voltages (V<sub>CE0(sus)</sub>, V<sub>CER(sus)</sub>, and V<sub>CEx(sus)</sub>) are acceptable when the traces fall to the right of point "A" for type 2N5039, point "B" for type 2N5038 and point "C" for type 2N6496. (NOTE: 2N6496 is not tested for V<sub>CEx(sus)</sub>.)

Fig. 23 — Oscilloscope display for measurement of sustaining voltages (Test circuit shown in Fig. 22).

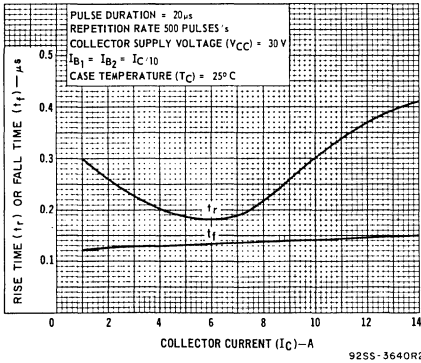


Fig. 24 — Typical rise-time and fall-time characteristics for all types.

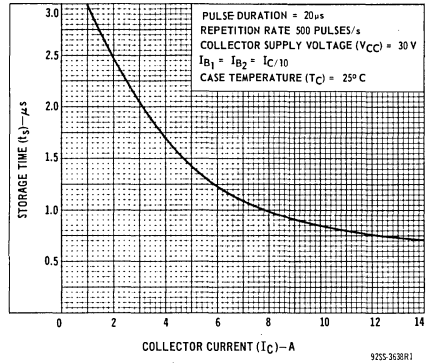


Fig. 25 — Typical storage time characteristic for all types.

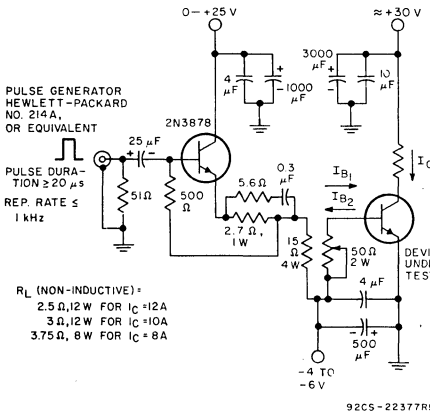


Fig. 26 — Circuit used to measure switching times for all types.

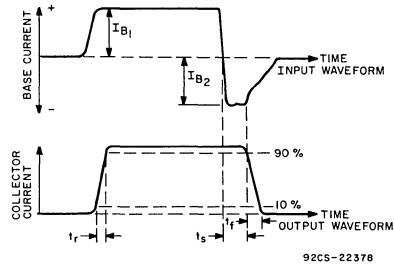
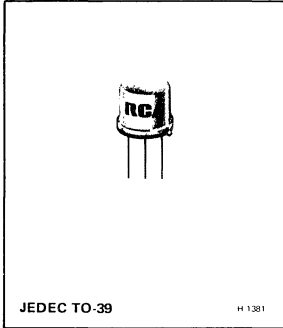


Fig. 27 — Phase relationship between input and output currents showing reference points for specification of switching times. (Test circuit shown in Fig. 26).



### Silicon N-P-N Overlay Transistor

High Gain for Line Amplifiers in CATV and MATV Equipment

*Features:*

- High gain-bandwidth product
- Large dynamic range
- Low distortion
- Low noise

RCA-2N5109\* is an epitaxial silicon n-p-n planar transistor employing "overlay" emitter electrode construction. It is especially designed to provide large dynamic range, low distortion, and low noise as a wideband amplifier into the vhf range.

A high gain-bandwidth product over a wide range of collector current makes the 2N5109 ideally suited for such applications as CATV and MATV line amplifiers and low-noise linear amplifiers.

\*Formerly RCA Dev. No. TA2800.

**MAXIMUM RATINGS, Absolute-Maximum Values:**

* COLLECTOR-TO-BASE VOLTAGE	$V_{CB0}$	40	V
COLLECTOR-TO-EMITTER VOLTAGE:			
* With base open	$V_{CE0}$	20	V
With external base-to-emitter resistance (RBE) = 10 $\Omega$	$V_{CER}$	40	V
* EMITTER-TO-BASE VOLTAGE	$V_{EBO}$	3	V
* CONTINUOUS COLLECTOR CURRENT	$I_C$	0.4	A
* CONTINUOUS BASE CURRENT	$I_B$	0.4	A
* TRANSISTOR DISSIPATION:	$P_T$		
At case temperature up to 75°C		2.5	W
At case temperature above 75°C		See Fig. 10	
* TEMPERATURE RANGE:			
Storage and operating (Junction)		-65 to +200	°C
* LEAD TEMPERATURE (During Soldering):			
At distances $\geq$ 1/32 in. (0.8 mm) from the seating plane for 10 s max		230	°C

\* In accordance with JEDEC registration data

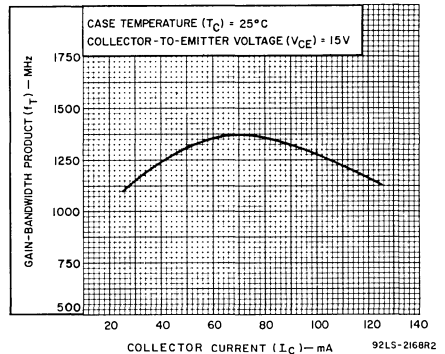


Fig. 1—Gain-bandwidth vs. collector current for type 2N5109.

ELECTRICAL CHARACTERISTICS, At Case Temperature ( $T_C$ ) = 25°C Unless Otherwise Specified

CHARACTERISTIC	SYMBOL	TEST CONDITIONS					LIMITS		UNITS
		DC COLLECTOR OR BASE VOLTAGE - V			DC CURRENT (mA)				
		V <sub>CB</sub>	V <sub>BE</sub>	V <sub>CE</sub>	I <sub>E</sub>	I <sub>C</sub>	MIN.	MAX.	
Collector-Cutoff Current: With base open	I <sub>CEO</sub>			15			-	20	μA
* With base-emitter junction reverse-biased T <sub>C</sub> = 150°C	I <sub>CEV</sub>		-1.5	35			-	5	mA
			-1.5	15			-	5	
* Emitter-Cutoff Current	I <sub>EBO</sub>		-3				-	0.1	mA
Collector-to-Base Breakdown Voltage	V <sub>(BR)CBO</sub>				0	0.1	40	-	V
* Collector-to-Emitter Sustaining Voltage: With external base-to-emitter resistance (R <sub>BE</sub> ) = 10 Ω	V <sub>CER(sus)</sub> <sup>a</sup>					5	40	-	V
With base open	V <sub>CEO(sus)</sub>					5	20	-	V
Emitter-to-Base Breakdown Voltage	V <sub>(BR)EBO</sub>				0.1	0	3	-	V
Collector-to-Emitter Saturation Voltage (I <sub>B</sub> = 10 mA)	V <sub>CE(sat)</sub>					100	-	0.5	V
* Collector-to-Base Capacitance (f = 1 MHz)	C <sub>cb</sub>	15			0		-	3.5	pF
* DC Forward-Current Transfer Ratio	h <sub>FE</sub>			15 5		50 360	40 5	120 -	
Small-Signal Common-Emitter Forward Current Transfer Ratio (f = 200 MHz)	h <sub>fe</sub>			15 15 15		25 50 100	4.8 6 4.8	- - -	
* Magnitude of Common-Emitter Small-Signal Forward Current Transfer Ratio (f = 200 MHz)	h <sub>fe</sub>			15		50	6	-	
* Available Amplifier Signal Input Power (See Fig. 9) (P <sub>out</sub> = 1.26 mW, Source Impedance = 50 Ω, f = 200MHz)	P <sub>i</sub>	15 (V <sub>CC</sub> )				50	-	0.1	mW
* Voltage Gain, Wideband, 50 to 216 MHz (See Fig. 8.)	G <sub>VE</sub>			15		50	11		dB
Cross Modulation @ 54 dBmV <sup>b</sup> Output (See Fig. 14.)	CM			15		50	-57 (typ.)		dB
Power Gain, Narrowband (f = 200 MHz, P <sub>IN</sub> = -10 dBm)	G <sub>PE</sub>			15		10	11		dB
Noise Figure (f = 200 MHz) (See Fig. 9.)	NF			15		10	3 (typ.)		dB
Thermal Resistance (Junction-to-Case)	R <sub>θJC</sub>						-	50	°C/W

<sup>a</sup> Pulsed through a 25 mH inductor; duty factor = 50%<sup>b</sup> 0 dBmV = 1 millivolt

\* In accordance with JEDEC registration data



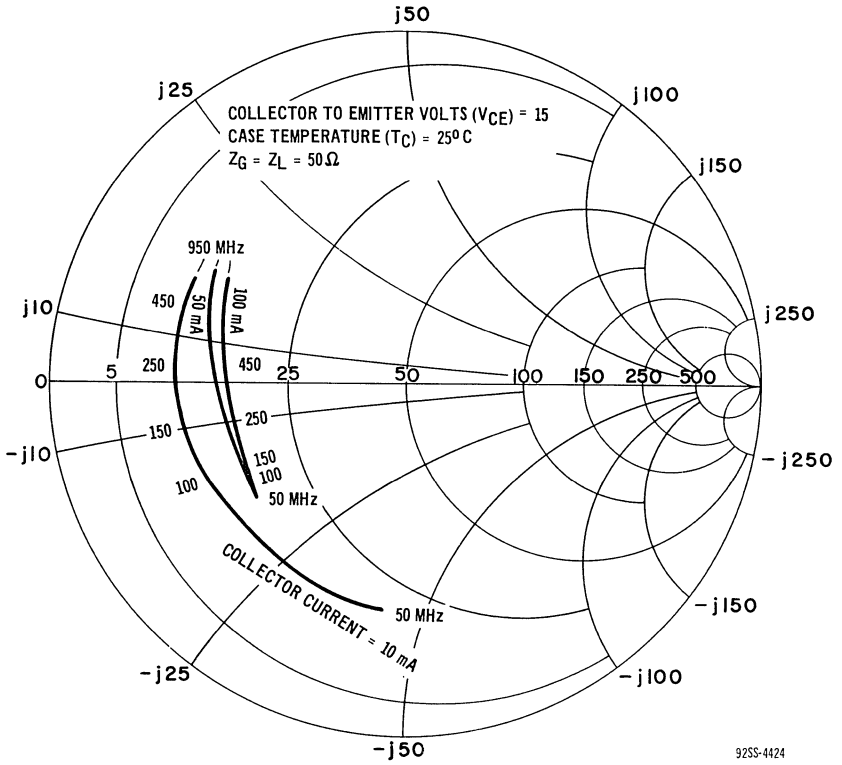


Fig.2—Input reflection coefficient ( $S_{11e}$ ) vs. frequency for type 2N5109.

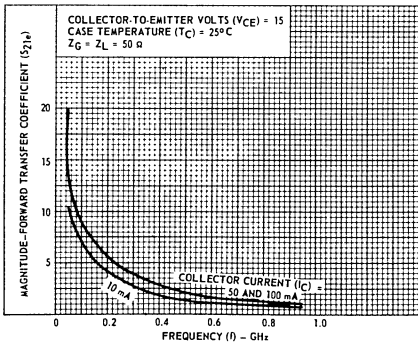


Fig.3—Magnitude of common-emitter forward transfer coefficient ( $S_{21e}$ ) vs. frequency for type 2N5109.

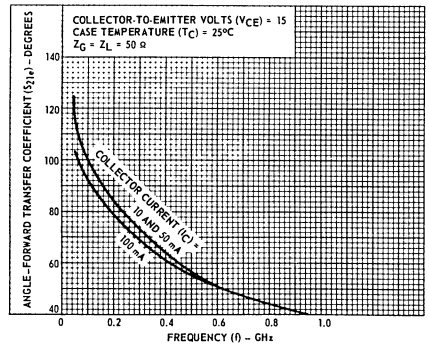


Fig.4—Angle of common-emitter forward transfer coefficient ( $S_{21e}$ ) vs. frequency for type 2N5109.

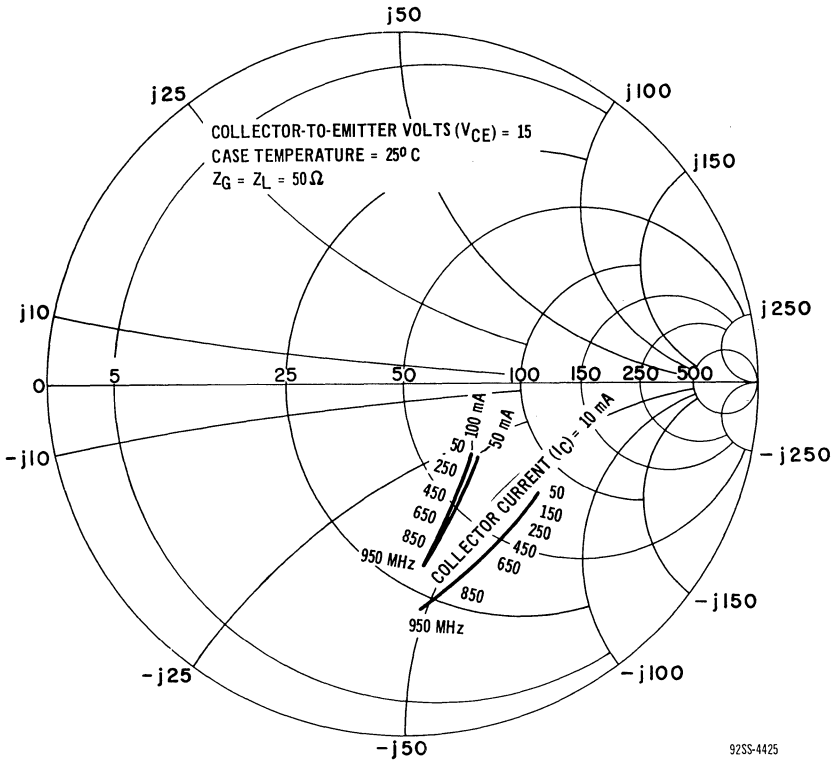


Fig.5—Output reflection coefficient ( $S_{22e}$ ) vs. frequency for type 2N5109.

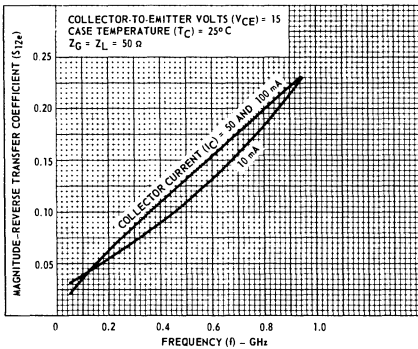


Fig.6—Magnitude of common-emitter, reverse transfer coefficient ( $S_{12e}$ ) for type 2N5109.

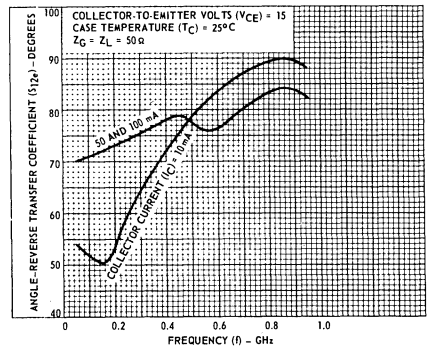
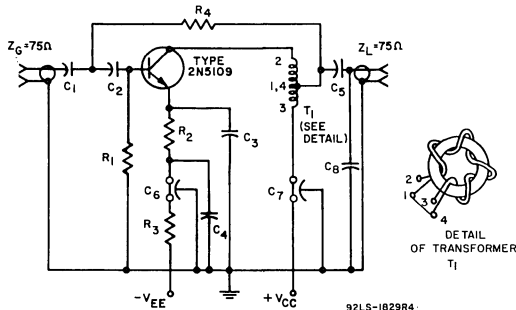
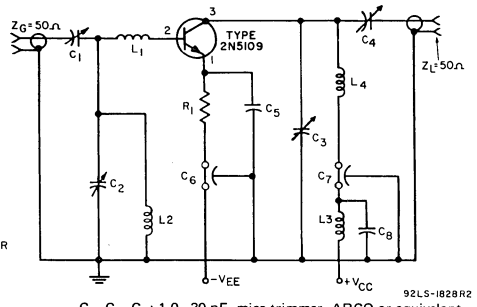


Fig.7—Angle of common-emitter reverse transfer coefficient ( $S_{12e}$ ) vs. frequency for type 2N5109.



- 92LS-1829R4
- C<sub>1</sub>, C<sub>2</sub>, C<sub>3</sub>, C<sub>5</sub>: 0.002 μF
  - C<sub>4</sub>: 0.03 μF
  - C<sub>6</sub>, C<sub>7</sub>: 1500 pF
  - C<sub>8</sub>: 18 pF
  - R<sub>1</sub>: 4.7 kΩ, 1/4 W
  - R<sub>2</sub>: 6.8 Ω, 1/2 W
  - R<sub>3</sub>: 330 Ω, 1 W
  - R<sub>4</sub>: 200 Ω, 1/4 W
  - T<sub>1</sub>: 4 turns No. 30 wire bifilar wound on "Indiana General" core No. CF-102-Q1, or equivalent.

Fig. 8—RF amplifier for voltage-gain testing of type 2N5109.



- 92LS-1828R2
- C<sub>1</sub>, C<sub>2</sub>, C<sub>3</sub>: 1.0–30 pF, mica trimmer, ARCO or equivalent
  - C<sub>4</sub>: 1.0–20 pF disc ceramic
  - C<sub>5</sub>: 10,000 pF disc ceramic
  - C<sub>6</sub>, C<sub>7</sub>: 1,000 pF disc ceramic
  - C<sub>8</sub>: 0.01 μF disc ceramic
  - L<sub>1</sub>: 4-1/2 turns, No. 22 wire, 3/16 in. (4.76 mm) I.D.
  - L<sub>2</sub>, L<sub>3</sub>: 0.82 μH RFC
  - L<sub>4</sub>: 3-1/2 turns, No. 22 wire, 3/16 in. (4.76 mm) I.D.
  - R<sub>1</sub>: 240 Ω, 2 W, carbon

Fig. 9—200-MHz amplifier for power-gain and noise-figure testing of type 2N5109.

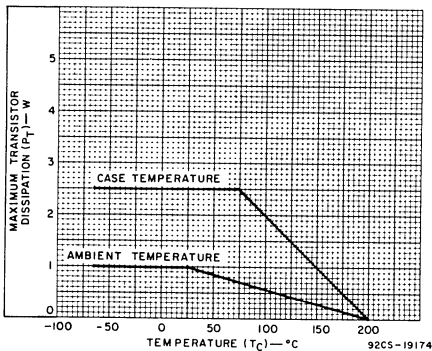


Fig. 10—Dissipation derating curve for type 2N5109.

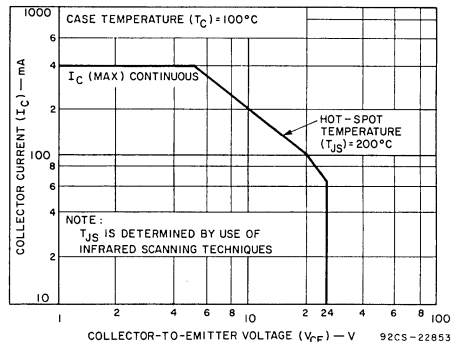


Fig. 11—Maximum operating area for type 2N5109.

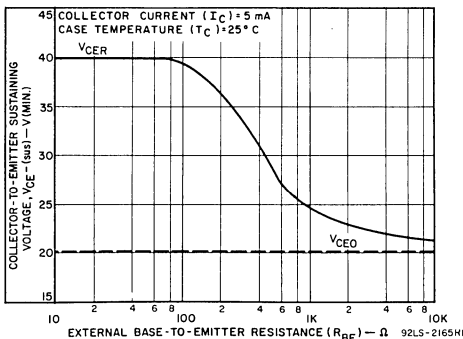


Fig. 12—Sustaining voltage vs. base-to-emitter resistance for type 2N5109.

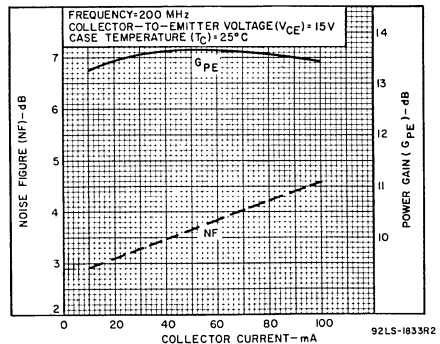
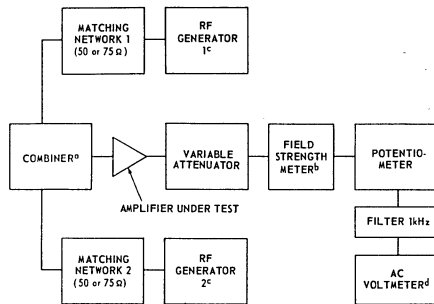


Fig. 13—Power gain and noise figure vs. collector current for type 2N5109.



a Provides 20 db isolation between generators

b 50–220 MHz with detector output

c Hewlett–Packard HP 608 D or equivalent

d Ballantine 861 or equivalent

93.5-1229R2

Fig. 14—Test set-up for measuring cross modulation in type 2N5109.

#### CROSS-MODULATION TEST PROCEDURE:

1. Set up equipment as shown in Fig. 14.
2. Set generator 1 to 150 MHz modulated 30% by 1,000 Hertz, and tune field strength meter to 150 MHz.
3. Adjust output level of generator 1 to give rated output from the amplifier under test.
4. Adjust potentiometer and AC voltmeter for a convenient level. This level then corresponds to 100% cross modulation.
5. Remove modulation. Readjust output level of generator 1 if necessary, to obtain the AC voltmeter "100% level". Do not readjust generator 1 during the following steps.
6. Set generator 2 to 210 MHz modulated 30% by 1,000 Hertz and tune field strength meter to 210 MHz.
7. Adjust output level of generator 2 to give rated output of the amplifier; i.e., the AC voltmeter indicates the "100% level".
8. Tune field strength meter to 150 MHz CW and read the AC voltmeter (a change of the AC voltmeter scale may be necessary).
9. Calculate percentage of cross modulation by comparing the reading of step 8 to the "100% level".

#### TERMINAL CONNECTIONS

Lead No.1 – Emitter  
 Lead No.2 – Base  
 Lead No.3 – Collector  
 Case – Collector



# RF Power Transistors

## 2N5179

RCA-2N5179\* is a double-diffused epitaxial planar transistor of the silicon n-p-n type. It is extremely useful in low-noise tuned-amplifier and converter applications at UHF frequencies, and as an oscillator up to 500 MHz.

The 2N5179 utilizes a hermetically sealed four-lead JEDEC TO-72 package. All active elements of the transistor are insulated from the case, which may be grounded by means of the fourth lead in applications requiring minimum feedback capacitance, shielding of the device, or both.

\* Formerly Dev. No. TA7319.

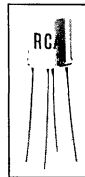
### Maximum Ratings, Absolute-Maximum Values:

COLLECTOR-TO-BASE VOLTAGE, $V_{CB0}$ .....	20 max.	V
COLLECTOR-TO-EMITTER VOLTAGE, $V_{CE0}$ .....	12 max.	V
EMITTER-TO-BASE VOLTAGE, $V_{EB0}$ .....	2.5 max.	V
COLLECTOR CURRENT, $I_C$ .....	50 max.	mA
TRANSISTOR DISSIPATION, $P_T$ :		
For operation with heat sink:		
At case temperatures** { up to 25°C .....	300 max.	mW
{ above 25°C .....	Derate at 1.71mW/°C	
For operation at ambient temperatures:		
At ambient temperatures { up to 25°C .....	200 max.	mW
{ above 25°C .....	Derate at 1.14mW/°C	
TEMPERATURE RANGE:		
Storage and Operating (Junction) .....	-65 to +200	°C
LEAD TEMPERATURE (During Soldering):		
At distances $\geq 1/32$ " from seating surface for 10 seconds max. ....	265 max.	°C

\*\* Measured at center of seating surface.

## SILICON N-P-N EPITAXIAL PLANAR TRANSISTOR

For UHF Applications in Military, Communications, and Industrial Equipment



JEDEC TO-72

- high gain-bandwidth product — 1000MHz min.
- hermetically sealed TO-72 four-lead metal package
- low leakage current
- high power gain as neutralized amplifier —  $G_{pie} = 15dB$  min. at 200MHz
- high power output as UHF oscillator — 20mW typ. at 500MHz
- low noise figure — NF = 4.5dB max. at 200MHz
- low collector-to-base time constant —  $r_{b'}C_c = 14ps$  max.
- high reliability — production lots of RCA-2N5179 are subjected to and meet the minimum mechanical, environmental, and life-test requirements of the basic MILITARY specification MIL-S-19500. See page 5 for a description of the Group A and Group B Tests.

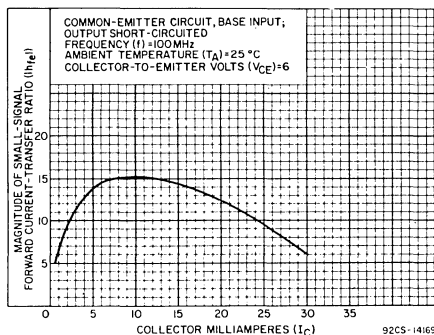
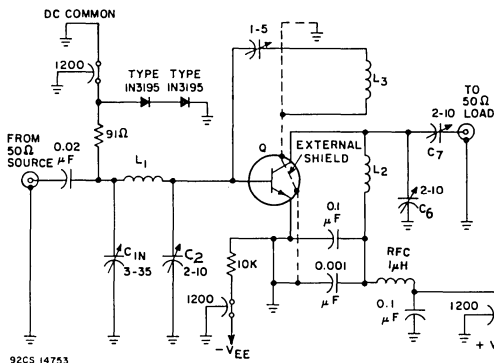


Fig. 1 — Small-Signal Beta Characteristic for Type 2N5179

ELECTRICAL CHARACTERISTICS, At Ambient Temperature ( $T_A$ ) = 25°C Unless Otherwise Specified

Characteristics	Symbols	TEST CONDITIONS						LIMITS			Units
		Frequency f	DC Collector- to-Base Voltage $V_{CB}$	DC Collector- to-Emitter Voltage $V_{CE}$	DC Emitter Current $I_E$	DC Collector Current $I_C$	DC Base Current $I_B$	Type 2N5179			
								Min.	Typ.	Max.	
Collector-Cutoff Current At $T_A = 150^\circ\text{C}$	$I_{CBO}$		15		0			-	-	0.02	$\mu\text{A}$
		15		0			-	-	1		
Collector-to-Base Breakdown Voltage	$V_{(BR)CBO}$				0	0.001		20	-	-	V
Collector-to-Emitter Sustaining Voltage	$V_{CEO(sus)}$					3	0	12	-	-	V
Emitter-to-Base Breakdown Voltage	$V_{(BR)EBO}$				-0.01	0		2.5	-	-	V
Collector-to-Emitter Saturation Voltage	$V_{CE(sat)}$					10	1	-	-	0.4	V
Base-to-Emitter Saturation Voltage	$V_{BE(sat)}$					10	1	-	-	1	V
Static Forward Current- Transfer Ratio	$h_{FE}$			1		3		25	70	250	
Magnitude of Small-Signal Forward Current-Transfer Ratio <sup>a</sup>	$ h_{fe} $	100 1 kHz		6 6		5 2		9 25	14 90	20 300	
Collector-to-Base Feedback Capacitance <sup>b</sup>	$C_{cb}$	0.1 to 1	10		0			-	0.7	1	pF
Common-Base Input Capacitance <sup>c</sup> ( $V_{EB} = 0.5\text{V}$ )	$C_{ib}$	0.1 to 1				0		-	-	2	pF
Collector-to-Base Time Constant <sup>a</sup>	$r_b C_c$	31.9	6			2		3	7	14	ps
Small-Signal Power Gain in Neutralized Common- Emitter Amplifier Circuit <sup>a</sup> (See Fig. 2)	$G_{pe}$	200		12		5		15	21	-	dB
Power Output in Common- Emitter Oscillator Cir- cuit (See Fig. 3)	$P_o$	>500	10		-12			20	-	-	mW
Noise Figure <sup>a</sup>	NF	200		6		1.5		-	3	4.5	dB

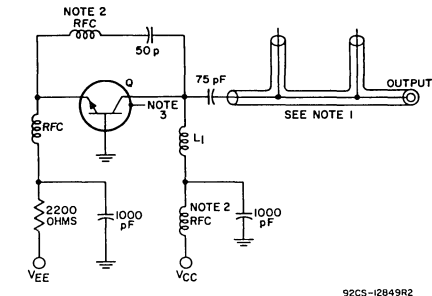
<sup>a</sup> Lead No.4(case) grounded;  $R_g = 125\Omega$ <sup>b</sup> Three-terminal measurement of the collector-to-base capacitance with the case and emitter leads connected to the guard terminal.<sup>c</sup> Lead No. 4 (case) floating.



NOTE: (Neutralization Procedure): (a) Connect a 50-Ω rf voltmeter to the output of a 200-MHz signal generator ( $R_g = 50\Omega$ ), and adjust the generator output to 5mV. (b) Connect the generator to the input and the rf voltmeter to the output of the amplifier, as shown above. (c) Apply  $V_{EE}$  and  $V_{CC}$ , and adjust the generator output to provide an amplifier output of 5mV. (d) Tune  $C_2$ ,  $C_6$ , and  $C_7$  for maximum amplifier output, readjusting the generator output, as required, to maintain an output of 5mV from the amplifier. (e) Interchange the connections to the signal generator and the rf voltmeter. (f) With sufficient signal applied to the output terminals of the amplifier, adjust  $C_4$  for a minimum indication at the amplifier input. (g) Repeat steps (a), (b), (c), and (d) to determine if retuning is necessary.

Q = Type 2N5179

Fig. 2 — Neutralized Amplifier Circuit Used to Measure Power Gain and Noise Figure at 200MHz for Type 2N5179



Note 1 — Coaxial-Line output network consisting of:

- 2 General Radio Type 874 TEE or equivalent
- 1 General Radio Type 874-D20 Adjustable Stub or equivalent
- 1 General Radio Type 874-LA Adjustable Line or equivalent
- 1 General Radio Type 874-WN3 Short-circuit termination or equivalent

Note 2 — RFC = 0.2μH Ohmite #2-460 or equivalent

Note 3 — Lead Number 4 (case) floating

L1 — 2 turns #16AWG wire, 3/8 inch OD, 1 1/4 inch long

Q = 2N5179

Fig. 3 — Circuit Used to Measure 500MHz Oscillator Power Output for Type 2N5179

TWO-PORT ADMITTANCE ( $y$ ) PARAMETERS AS FUNCTIONS OF COLLECTOR CURRENT ( $I_C$ ) FOR RCA TYPE 2N5179

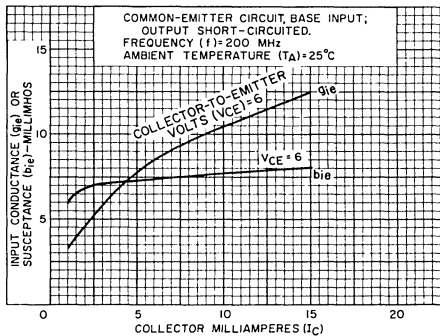


Fig. 4 — Input Admittance ( $y_{ie}$ )

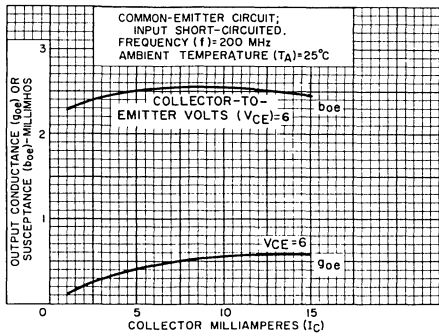


Fig. 5 — Output Admittance ( $y_{oe}$ )

TWO-PORT ADMITTANCE (y) PARAMETERS AS FUNCTIONS OF COLLECTOR CURRENT (I<sub>C</sub>) FOR RCA TYPE 2N5179

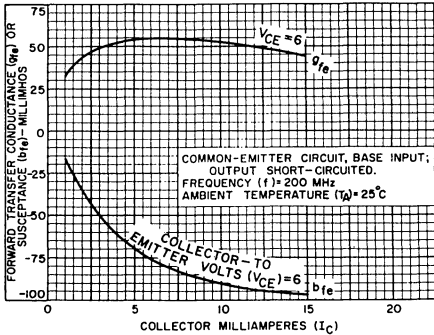


Fig. 6 - Forward Transadmittance (y<sub>fe</sub>)

92CS-14735

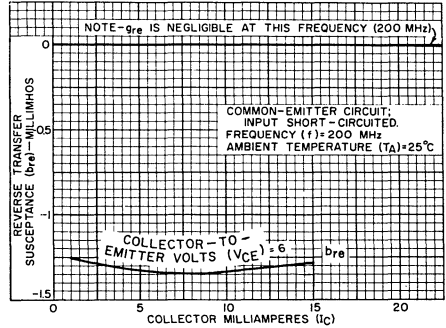


Fig. 7 - Reverse Transadmittance (y<sub>re</sub>)

92CS-14734

TWO-PORT ADMITTANCE (y) PARAMETERS AS FUNCTIONS OF FREQUENCY (f) FOR RCA TYPE 2N5179

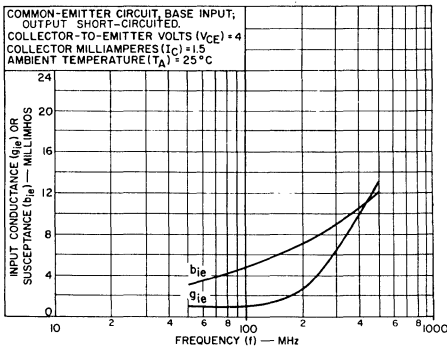


Fig. 8 - Input Admittance (y<sub>ie</sub>)

92CS-14731

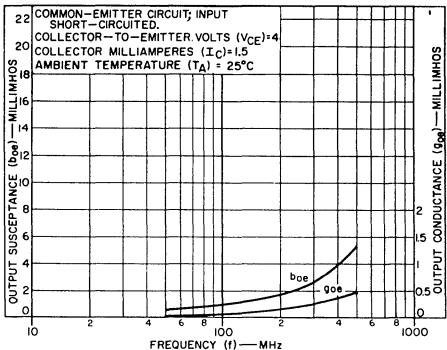


Fig. 9 - Output Admittance (y<sub>oe</sub>)

92CS-14730

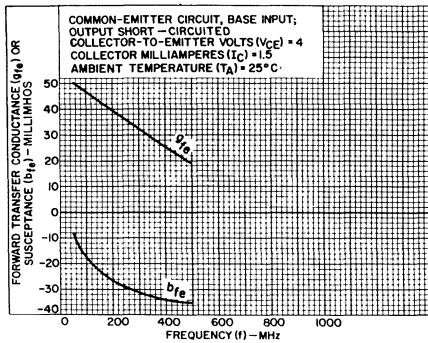


Fig. 10 - Forward Transadmittance (y<sub>fe</sub>)

92CS-14728

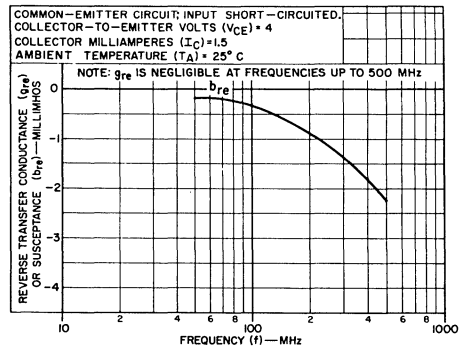
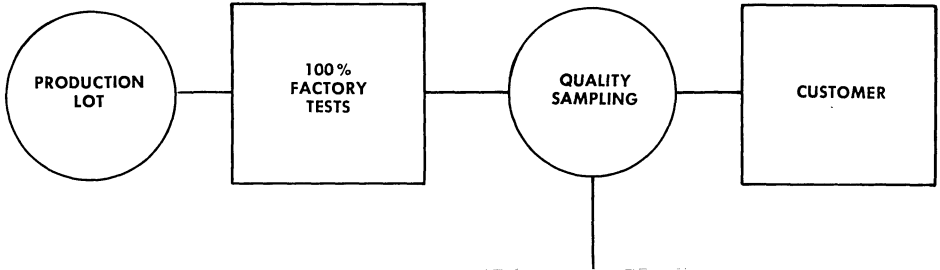


Fig. 11 - Reverse Transadmittance (y<sub>re</sub>)

92CS-14729



**GROUP A AND GROUP B QUALITY SAMPLING TESTS**



<u>ITEM</u>	<u>TEST DESCRIPTION</u>	<u>LTPD</u>
<b><u>GROUP A TESTS</u></b>		
Subgroup 1.	Visual and Mechanical Examination .....	5%
Subgroup 2.	Electrical .....	10%
<b><u>GROUP B TESTS</u></b>		
Subgroup 1.	Physical Dimensions .....	20%
Subgroup 2.	Solderability, Temperature Cycling, Thermal Shock, Moisture Resistance .....	20%
Subgroup 3.	Shock, Vibration Fatigue, Vibration Variable Frequency, Constant Acceleration .....	20%
Subgroup 4.	Terminal Strength .....	20%
Subgroup 5.	Salt Atmosphere .....	20%
Subgroup 6.	High-Temperature Life, Non-Operating ( $T_A = 200^\circ\text{C}$ ) .....	$\lambda = 10\%$
Subgroup 7.	Steady-State-Operation Life ( $P_D = 300\text{mW}$ , $T_A = 25^\circ\text{C}$ ) .....	$\lambda = 10\%$

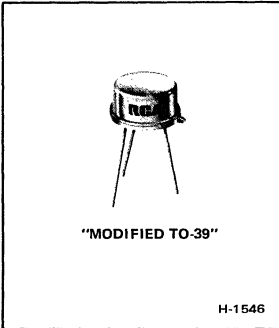
**TERMINAL CONNECTIONS**

- LEAD 1 – EMITTER
- LEAD 2 – BASE
- LEAD 3 – COLLECTOR
- LEAD 4 – CONNECTED TO CASE



# Power Transistors

## 2N5189



### High-Voltage Silicon N-P-N Switching Transistor

For Core-Driver and Line-Driver Service in Data-Processing Equipment and Other Critical Industrial and Military Applications

**Features:**

- Excellent power handling capability
- High switching speeds at high currents
- High breakdown-voltage capabilities
- High reliability

**TERMINAL CONNECTIONS**

- LEAD 1 — EMITTER
- LEAD 2 — BASE
- LEAD 3 — COLLECTOR, CASE

RCA-2N5189<sup>●</sup> is a double-diffused epitaxial planar transistor of the silicon n-p-n type featuring high breakdown voltages, low saturation voltages, and high switching speeds over a wide range of collector current.

It is especially useful in switching applications of high-performance computers and in other critical industrial applications where high-voltage and high-current-handling capabilities and

short "turn-off" and "turn-on" times are important design features. These features also make the 2N5189 particularly useful in class C circuits for mobile and portable equipment.

The 2N5189 is hermetically sealed in a metal package like the JEDEC TO-39 but with a reduced height (0.180 in. max., 0.160 in. min.) and 0.5 in. min. leads.

<sup>●</sup>Formerly RCA Dev. No. TA7322.

**MAXIMUM RATINGS, Absolute Maximum Values:**

*COLLECTOR-TO-BASE VOLTAGE .....	V <sub>CBO</sub>	60	V
COLLECTOR-TO-EMITTER VOLTAGE:			
* With base shorted to emitter .....	V <sub>CES</sub>	55	V
* With base open .....	V <sub>CEO</sub>	35	V
*EMITTER-TO-BASE VOLTAGE .....	V <sub>EBO</sub>	5	V
*CONTINUOUS COLLECTOR CURRENT .....	I <sub>C</sub>	2	A
TRANSISTOR DISSIPATION:	P <sub>T</sub>		
At case temperatures up to 25°C .....		5	W
At case temperatures above 25°C, derate linearly .....		28.5	mW/°C
* At ambient temperatures up to 25°C .....		0.8	W
* At ambient temperatures above 25°C, derate linearly .....		4.57	mW/°C
*TEMPERATURE RANGE:			
Storage and operating (Junction) .....		-65 to +200	°C
*LEAD TEMPERATURE (During soldering):			
At distances ≥ 1/32 in. (0.8 mm) from seating plane for 10 s max. ....		265	°C

\* In accordance with JEDEC registration data format JS-8/RDF-7.

ELECTRICAL CHARACTERISTICS, At Ambient Temperature ( $T_A$ ) = 25°C

CHARACTERISTIC	SYMBOL	TEST CONDITIONS				LIMITS		UNITS
		VOLTAGE V <sub>dc</sub>		CURRENT A <sub>dc</sub>		2N5189		
		V <sub>CB</sub>	V <sub>CE</sub>	I <sub>C</sub>	I <sub>B</sub>	MIN.	MAX.	
* Collector Cutoff Current: With emitter open	I <sub>CBO</sub>	60				—	100	μA
With emitter-base junction shorted	I <sub>CES</sub>		55			—	100	
* Emitter Cutoff Current (V <sub>EB</sub> =5V)	I <sub>EBO</sub>			0		—	10	μA
* Collector-to-Emitter Breakdown Voltage	V <sub>(BR)CEO</sub>			0.01		35	—	V
* Collector-to-Emitter Saturation Voltage	V <sub>CE(sat)</sub>			1 <sup>a</sup>	0.1	—	1	V
* Base-to-Emitter Saturation Voltage	V <sub>BE(sat)</sub>			1 <sup>a</sup>	0.1	—	1.5	V
* DC Forward Current Transfer Ratio	h <sub>FE</sub>		1 1 1	0.1 <sup>a</sup> 0.5 <sup>a</sup> 1 <sup>b</sup>		30 35 15	— — —	
Common-Emitter, Small-Signal, Short-Circuit, Forward Current Transfer Ratio (f = 100 MHz)	h <sub>fe</sub>		10	0.05		2.5	—	
Common-Base, Open-Circuit Output Capacitance (f = 1 MHz)	C <sub>ob</sub>	10				—	15	pF
* Switching Time (I <sub>B1</sub> =0.1 A): Turn-on (t <sub>d</sub> + t <sub>r</sub> )	t <sub>ON</sub>			I <sub>C</sub>	I <sub>B2</sub>			ns
Turn-off (t <sub>s</sub> + t <sub>f</sub> )	t <sub>OFF</sub>			1	—	—	40	
				1	-0.1	—	70	

\*In accordance with JEDEC registration data format JS-8/RDF-7.

<sup>a</sup>Pulsed: Pulse duration = 300 μs; duty factor ≤ 2%.

<sup>b</sup>Pulsed: Pulse duration ≤ 400 μs; duty factor ≤ 0.03.

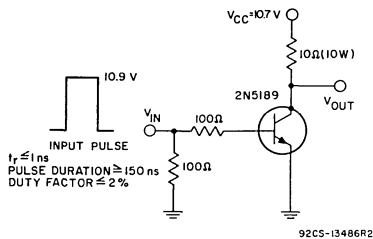


Fig. 1—Circuit used to measure turn-on time.

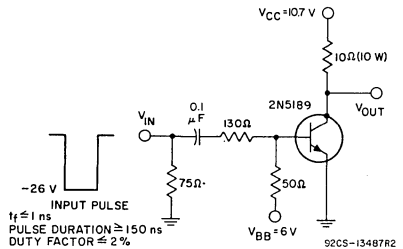


Fig. 2—Circuit used to measure turn-off time.

TYPICAL CHARACTERISTICS

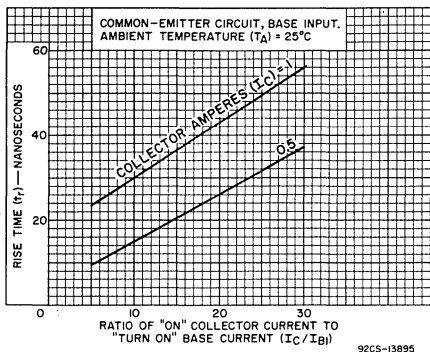


Fig. 3 — Rise Time vs  $I_C/I_{B1}$

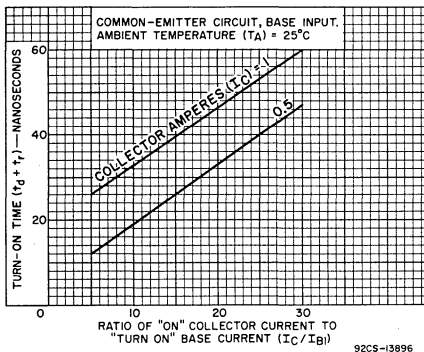


Fig. 4 — Turn-On Time vs  $I_C/I_{B1}$

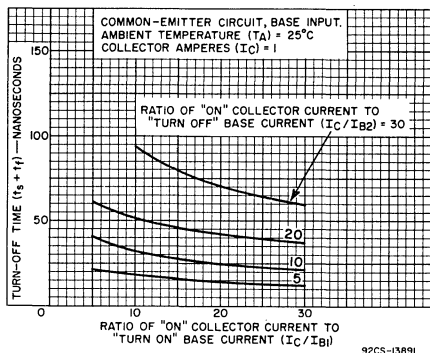


Fig. 5 — Turn-Off Time vs  $I_C/I_{B1}$

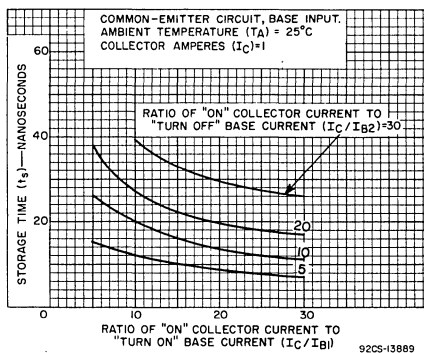


Fig. 6 — Storage Time vs  $I_C/I_{B1}$

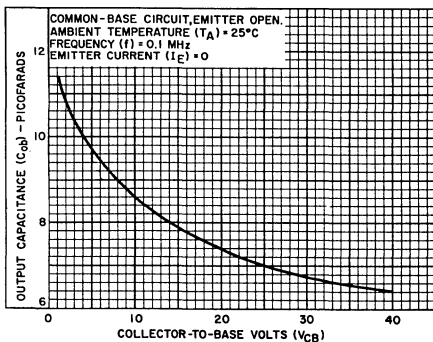


Fig. 7 — Output Capacitance vs Collector-to-Base Voltage

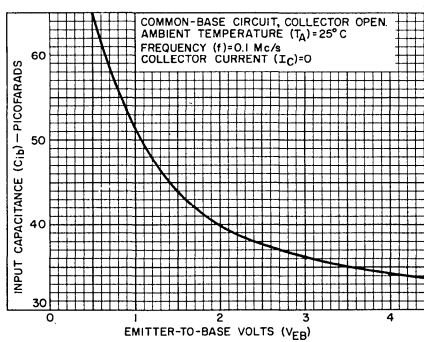


Fig. 8 — Input Capacitance vs Emitter-to-Base Voltage

TYPICAL CHARACTERISTICS

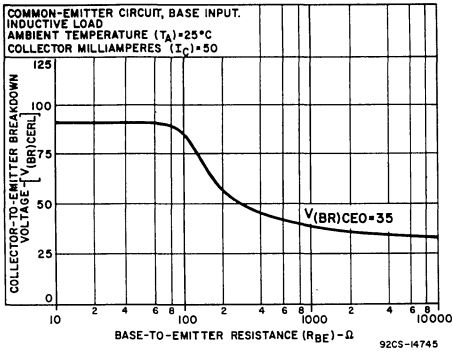


Fig. 9 - Collector-Cutoff Current vs Ambient Temperature

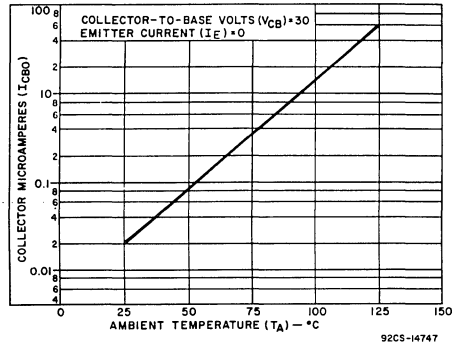


Fig. 10 - Collector-to-Emitter Breakdown Voltage vs Base-to-Emitter Resistance

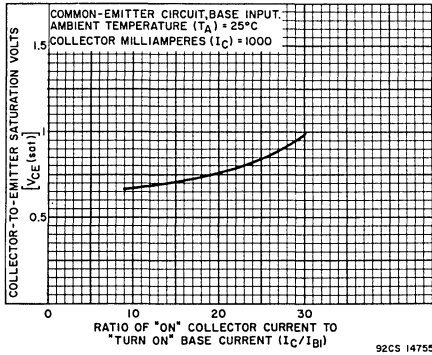


Fig. 11 - Collector-to-Emitter Saturation Voltage vs  $I_C/I_{B1}$

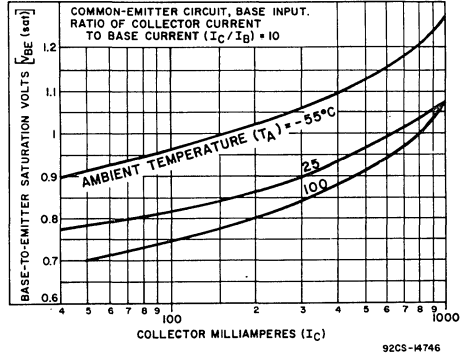


Fig. 12 - Base-to-Emitter Saturation Voltage vs  $I_C$

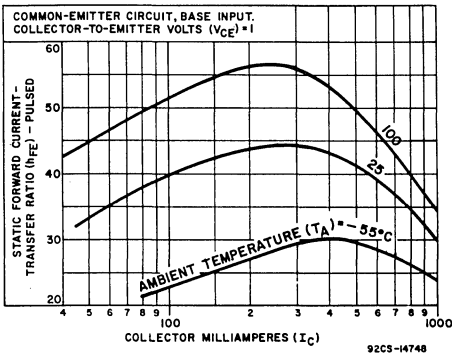


Fig. 13 - Static Forward Current-Transfer Ratio (Pulsed) vs  $I_C$

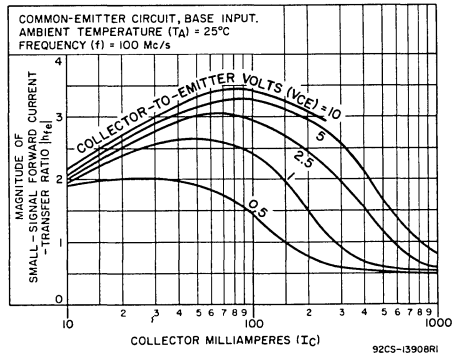


Fig. 14 - Small-Signal Forward Current-Transfer Ratio vs  $I_C$



# Power Transistors

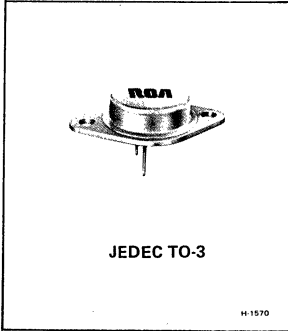
**2N5239**  
**2N5240**

## Silicon N-P-N Power Transistors

High-Voltage, High-Power Types for Applications in Industrial and Commercial Service

*Features:*

- High voltage ratings:  $V_{CER(sus)} = 350\text{ V}$ ,  $R_{BE} \leq 50\ \Omega$  (2N5240)  
 $= 250\text{ V}$ ,  $R_{BE} \leq 50\ \Omega$  (2N5239)
- High power dissipation rating:  $P_T = 100\text{ W}$  at  $V_{CE} = 150\text{ V}$ ,  $T_C = 25^\circ\text{C}$
- For switching applications where circuit values and operating conditions require a transistor with a high second breakdown rating ( $I_{S/b}$ ) (limit line begins at 150 V)
- Maximum area-of-operation curves for dc and pulse operation



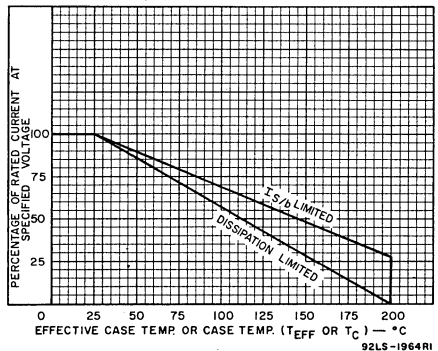
RCA-2N5239 and 2N5240\* are multiple epitaxial silicon n-p-n power transistors employing a new overlay construction with several emitter sites. Both devices employ the popular JEDEC TO-3 package; they differ in breakdown-voltage and leakage-current values.

The high breakdown voltage ratings and exceptional second-breakdown capabilities of these transistors make them especially suitable for use in series regulators, power amplifiers, inverters, deflection circuits, switching regulators, and high-voltage bridge amplifiers.

**MAXIMUM RATINGS, Absolute-Maximum Values:**

	2N5239	2N5240	
*COLLECTOR-TO-BASE VOLTAGE, $V_{CBO}$ .....	300	375	V
COLLECTOR-TO-EMITTER SUSTAINING VOLTAGE:			
* With base open, $V_{CEO(sus)}$ .....	225	300	V
With external base-to-emitter resistance ( $R_{BE}) \leq 50\ \Omega$ , $V_{CER(sus)}$ .....	250	350	V
*EMITTER-TO-BASE VOLTAGE, $V_{EBO}$	6	6	V
*COLLECTOR CURRENT, $I_C$ .....	5	5	A
*BASE CURRENT, $I_B$ .....	-2	-2	A
*TRANSISTOR DISSIPATION, $P_T$ :			
At case temperatures up to $25^\circ\text{C}$ and $V_{CE}$ up to 150 V.....	100	100	W
At case temperatures up to $25^\circ\text{C}$ and $V_{CE}$ above 150 V.....	See Fig 2.		
At case temperatures above $25^\circ\text{C}$ and $V_{CE}$ above 150 V.....	See Figs. 1 & 2		
*TEMPERATURE RANGE:			
Storage & Operating (Junction).....	-65	+200	$^\circ\text{C}$
*PIN TEMPERATURE (During Soldering)			
At distances $\geq 1/32$ in. from seating plane for 10 s max.....	230		$^\circ\text{C}$

\*RCA Dev. Nos. TA2765 and TA2765A, respectively.



**Fig. 1 - Dissipation derating curves for types 2N5239 & 2N5240**

\*In accordance with JEDEC registration data format (JS-6,RDF-2)

ELECTRICAL CHARACTERISTICS, Case Temperature ( $T_C$ ) = 25°C Unless Otherwise Specified

Characteristic	Symbol	TEST CONDITIONS				LIMITS				Units
		DC Collector Voltage (V)		DC Current (A)		Type 2N5239		Type 2N5240		
		V <sub>CE</sub>	V <sub>BE</sub>	I <sub>C</sub>	I <sub>B</sub>	Min.	Max.	Min.	Max.	
* Collector-Cutoff Current	I <sub>CEO</sub>	200	—	—	0	—	5.0	—	2.0	mA
	I <sub>CEV</sub>	300	-1.5	—	—	—	4.0	—	—	mA
	I <sub>CEV</sub>	375	-1.5	—	—	—	—	—	2.0	mA
	I <sub>CEV</sub> (T <sub>C</sub> =150°C)	300	-1.5	—	—	—	5.0	—	3.0	mA
* Emitter-Cutoff Current	I <sub>EBO</sub>	—	-5.0	0	—	—	5.0	—	1.0	mA
* Collector-to-Emitter Sustaining Voltage: (See Figs. 3 & 4) With base open	V <sub>CEO(sus)</sub>	—	—	0.2	0	225 <sup>b</sup>	—	300 <sup>b</sup>	—	V
	With external base-to-emitter resistance (R <sub>BE</sub> ) ≤ 50 Ω	V <sub>CER(sus)</sub>	—	—	0.2	0	250 <sup>b</sup>	—	350 <sup>b</sup>	—
* Emitter-to-Base Voltage	V <sub>EBO</sub>	—	—	—	0.02	6	—	6	—	V
* Base-to-Emitter Voltage	V <sub>BE</sub>	10	—	2.0 <sup>a</sup>	—	—	3.0	—	3.0	V
* Collector-to-Emitter Saturation Voltage	V <sub>CE(sat)</sub>	—	—	2.0 <sup>a</sup>	0.25	—	2.5	—	2.5	V
		—	—	4.5 <sup>a</sup>	1.125	—	5	—	5	
* DC Forward-Current Transfer Ratio	h <sub>FE</sub>	10	—	0.4 <sup>a</sup>	—	20	80	20	80	
		10	—	2.0 <sup>a</sup>	—	20	80	20	80	
		10	—	4.5 <sup>a</sup>	—	5	—	5	—	
* Output Capacitance (At 1 MHz) (V <sub>CB</sub> = 10V, I <sub>E</sub> = 0)	C <sub>ob</sub>	—	—	—	—	—	150	—	150	pF
* Second-Breakdown <sup>c</sup> Collector Current <sup>d</sup> (With base forward biased)	I <sub>S/b</sub> <sup>c</sup>	150	—	—	—	0.67	—	0.67	—	A
* Second-Breakdown Energy (With base reverse biased) R <sub>BE</sub> = 50 Ω, L = 0.2 mH	E <sub>S/b</sub> <sup>e</sup>	—	-4.0	4.0	—	1.6	—	1.6	—	mJ
* Gain-Bandwidth Product	f <sub>T</sub>	10	—	0.2	—	5.0	—	5.0	—	MHz
* Magnitude of Common-Emitter, Small-Signal, Short-Circuit, Forward Current Transfer Ratio (at 1 MHz)	h <sub>fe</sub>	10	—	0.2	—	5.0	—	5.0	—	
* Common-Emitter, Small-Signal Short-Circuit, Forward-Current Transfer Ratio (at 1 kHz)	h <sub>fe</sub>	10	—	4.0	—	20	—	20	—	
* Thermal Resistance (Junction-to-Case)	θ <sub>J-C</sub>	—	—	—	—	—	1.75	—	1.75	°C/W

<sup>a</sup> Pulsed; pulse duration ≤ 350 μs, duty factor = 2%.

<sup>b</sup> CAUTION: The sustaining voltages V<sub>CEO(sus)</sub> and V<sub>CER(sus)</sub> MUST NOT be measured on a curve tracer. These sustaining voltages should be measured by means of the test circuit shown in Fig. 3.

<sup>c</sup> I<sub>S/b</sub> is defined as the current at which second breakdown occurs at a specified collector voltage with the emitter-base junction forward biased for transistor operation in the active region.

<sup>d</sup> Pulsed; 1-s, non-repetitive pulse.

<sup>e</sup> E<sub>S/b</sub> is defined as the energy at which second breakdown occurs under specified reverse bias conditions. E<sub>S/b</sub> = 1/2LI<sup>2</sup>, where L is a series load or leakage inductance and I is the peak collector current.

\*In accordance with JEDEC registration data format (JS-6, RDF-2)

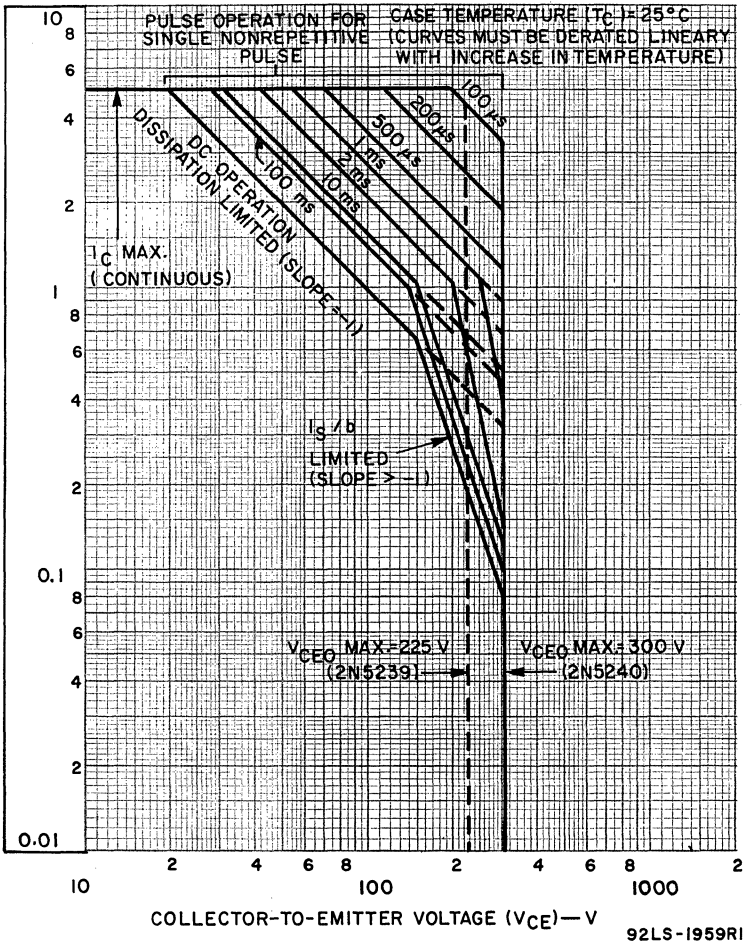


Fig. 2 - Maximum operating area for types 2N5239 & 2N5240



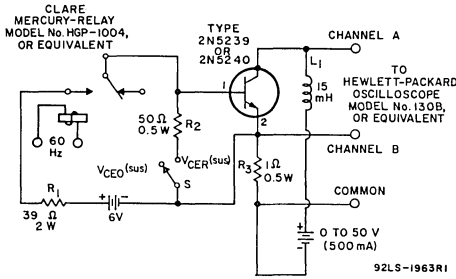
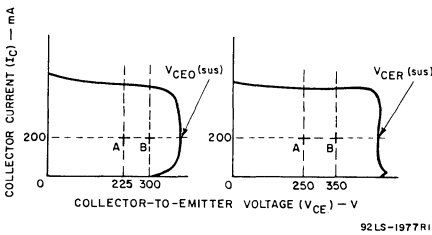


Fig. 3 - Circuit used to measure sustaining voltages  $V_{CE0(sus)}$  and  $V_{CEr(sus)}$  for types 2N5239 & 2N5240



Note: The sustaining voltages  $V_{CE0(sus)}$  and  $V_{CEr(sus)}$  are acceptable when the traces fall to the right and above points "A" and "B" for types 2N5239 and 2N5240

Fig. 4 - Oscilloscope display for measurement of sustaining voltages. (Test circuit shown in Fig. 3.)

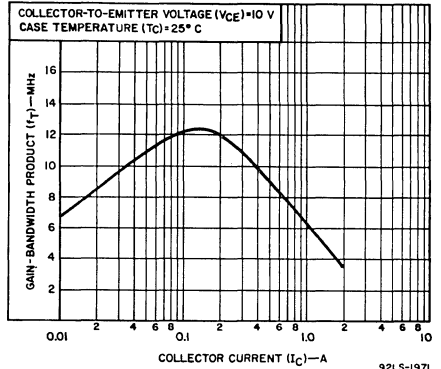


Fig. 6 - Typical gain-bandwidth product for types 2N5239 & 2N5240

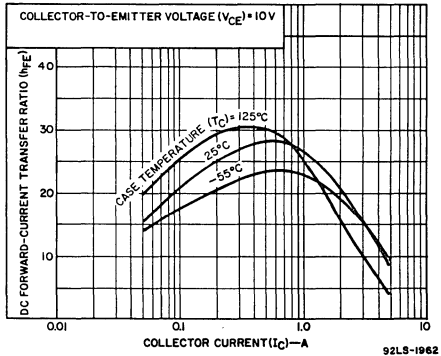


Fig. 7 - Typical DC beta for types 2N5239 & 2N5240

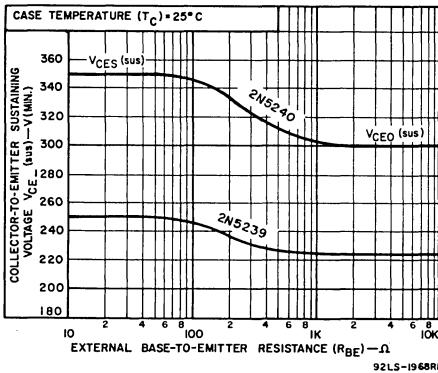


Fig. 5 - Sustaining voltage vs. base-to-emitter resistance for types 2N5239 & 2N5240

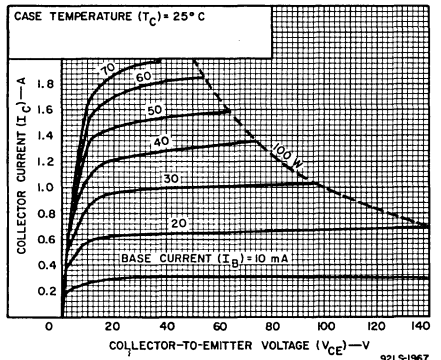


Fig. 8 - Typical output characteristics for types 2N5239 & 2N5240

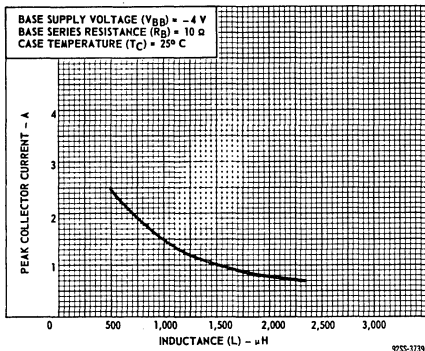


Fig. 9 - Typical reverse-bias, second breakdown characteristic for types 2N5239 & 2N5240

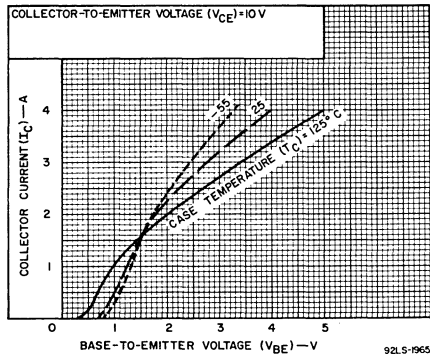


Fig. 12 - Typical transfer characteristics for types 2N5239 & 2N5240

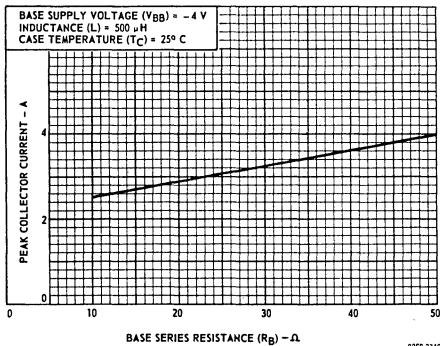


Fig. 10 - Typical reverse-bias, second breakdown characteristic for types 2N5239 & 2N5240

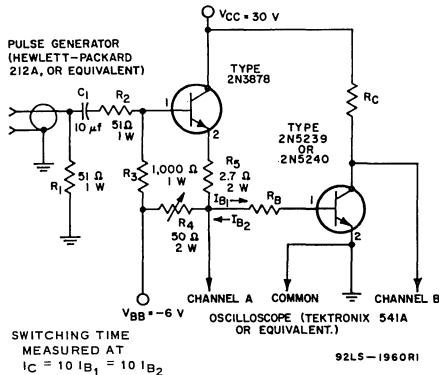


Fig. 13 - Circuit used to measure switching times for types 2N5239 & 2N5240

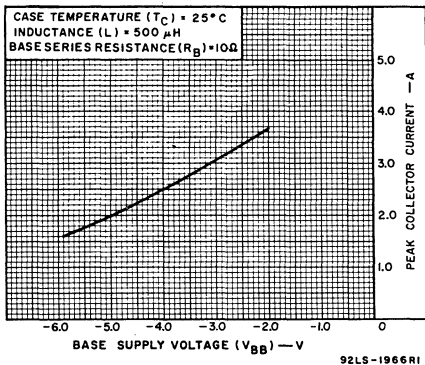


Fig. 11 - Typical reverse-bias, second breakdown characteristic for types 2N5239 & 2N5240

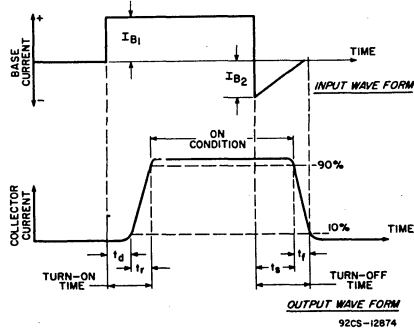


Fig. 14 - Oscilloscope display of switching times. (Test circuit shown in Fig. 13.)

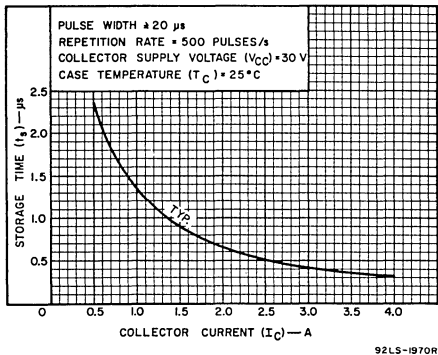


Fig. 15-Saturated switching time (storage) vs. collector current for types 2N5239 & 2N5240

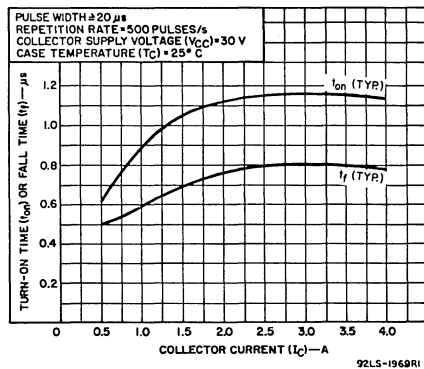


Fig. 16-Saturated switching times (turn-on and fall) vs. collector current for types 2N5239 & 2N5240

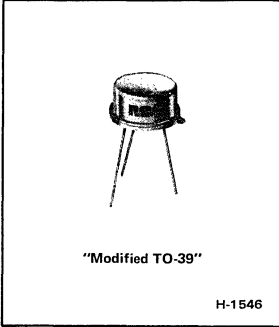
TERMINAL CONNECTIONS

- Pin 1 - Base
- Pin 2 - Emitter
- Case, Flange - Collector



# Power Transistors

## 2N5262



### Silicon N-P-N High-Speed Switching Transistor

For Memory-Driver Service in Data-Processing Equipment and Other Critical Industrial Applications

*Features:*

- Fast switching at 1A:  
 $t_{on} = 30 \text{ ns max.}$   
 $t_{off} = 60 \text{ ns max.}$
- High voltage ratings
- High power-dissipation ratings
- High dc beta at 1A — 25 min.
- Low saturation voltage at 1 A:  
 $0.5 \text{ V typ.}$
- Maximum-area-of-operation curves for dc and pulse operation
- Hermetic "low-profile TO-39" package
- Meets MIL-S-19500 specifications

RCA-2N5262<sup>®</sup> is a silicon n-p-n, epitaxial planar transistor with characteristics which make it exceptionally desirable for high-speed, high-voltage, high-current switching applications. In addition, the 2N5262 features very short turn-on and turn-off times and low saturation voltages. It is also controlled for freedom from second breakdown under both forward-bias and reverse-bias conditions, when operated within specified maximum ratings.

specification MIL-S-19500, and is hermetically sealed in a metal "low-profile JEDEC TO-39" package.

RCA-2N5262 is primarily intended for use as a driver for "2-1/2D" coincident-current and word-organized magnetic-memory systems, and in the other critical industrial applications requiring switching of large currents through inductive loads.

The 2N5262 meets the requirements of the basic military

● Formerly RCA Dev. No. TA7238.

**Maximum Ratings, Absolute-Maximum Values**

* COLLECTOR-TO-BASE VOLTAGE . . . . .	$V_{CBO}$	75	V
* COLLECTOR-TO-EMITTER VOLTAGE:			
With base open . . . . .	$V_{CEO}$	50	V
With emitter-base shorted . . . . .	$V_{CES}$	60	V
* EMITTER-TO-BASE VOLTAGE . . . . .	$V_{EBO}$	5	V
COLLECTOR CURRENT:			
* Continuous . . . . .		2	A
Instantaneous (See Fig.4) . . . . .		3	A
* TRANSISTOR DISSIPATION:	$P_T$		
At case temperatures up to 25°C . . . . .		4	W
At case temperatures above 25°C . . . . .		Derate linearly 22.8 mW/°C	
At ambient temperatures up to 25°C . . . . .		0.8	W
At ambient temperatures above 25°C . . . . .		Derate linearly 4.57 mW/°C	
* TEMPERATURE RANGE:			
Storage and operating (Junction) . . . . .		-65 to 200	°C
* LEAD TEMPERATURE (During soldering):			
At distance $\geq 1/32$ in. (0.8 mm) from seating plane for 10 s max . . . . .		265	°C

\* In accordance with JEDEC registration data format JS-8/RDF-7.

ELECTRICAL CHARACTERISTICS, At Ambient Temperature ( $T_A$ ) = 25°C

CHARACTERISTIC	SYMBOL	TEST CONDITIONS					LIMITS		UNITS
		VOLTAGE V dc		CURRENT A dc			2N5262		
		V <sub>CE</sub>	V <sub>CB</sub>	I <sub>C</sub>	I <sub>E</sub>	I <sub>B</sub>	MIN.	MAX.	
* Collector Cutoff Current: With emitter-to-base junction shorted	I <sub>CES</sub>	60					—	10	μA
With emitter open	I <sub>CBO</sub>		75				—	100	
* Emitter-to-Base Cutoff Current (V <sub>EB</sub> = 5V)	I <sub>EBO</sub>						—	100	μA
* Collector-to-Emitter Breakdown Voltage	V <sub>(BR)CEO</sub>			0.01			50	—	V
* Collector-to-Emitter Saturation Voltage	V <sub>CE(sat)</sub>			1 <sup>a</sup>		0.1	—	0.8	V
* Base-to-Emitter Saturation Voltage	V <sub>BE(sat)</sub>			1 <sup>a</sup>		0.1	—	1.4	V
* DC Forward Current Transfer Ratio	h <sub>FE</sub>	1 1 1		0.1 <sup>a</sup> 0.5 <sup>a</sup> 1 <sup>b</sup>			35 40 25	— — —	
Common-Emitter, Small-Signal, Short-Circuit, Forward Current Transfer Ratio (f = 100 MHz)	h <sub>fe</sub>	10		0.05			2.5	—	
Common-Base, Open-Circuit Output Capacitance (f = 1 MHz)	C <sub>ob</sub>		10		0		—	15	pF
* Switching Time: Turn-on (t <sub>d</sub> + t <sub>r</sub> )	t <sub>ON</sub>			I <sub>C</sub>	I <sub>B1</sub>	I <sub>B2</sub>			ns
Turn-off (t <sub>s</sub> + t <sub>f</sub> )		t <sub>OFF</sub>		1	0.1	—	—	30	
				1	0.1	—0.1	—	60	

\* In accordance with JEDEC registration data format JS-8/RDF-7.

<sup>a</sup> Pulsed: Pulse duration = 300 μs; duty factor ≤ 2%.

<sup>b</sup> Pulsed: Pulse duration ≤ 400 μs, duty factor ≤ 0.03.

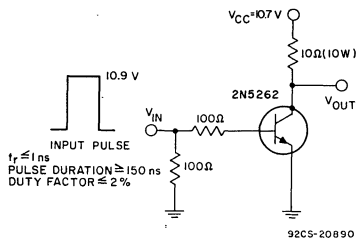


Fig.1—Circuit used to measure turn-on time.

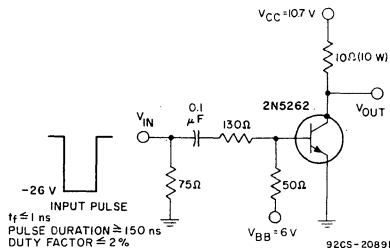


Fig.2—Circuit used to measure turn-off time.

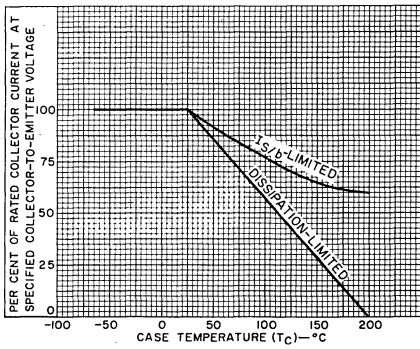


Fig. 3 - Derating curves.

92CS-14868R1

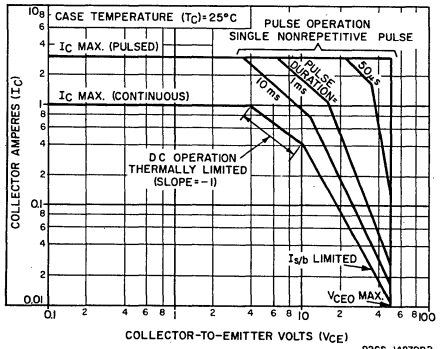


Fig. 4 - Safe area of operation.

92CS-14870R2

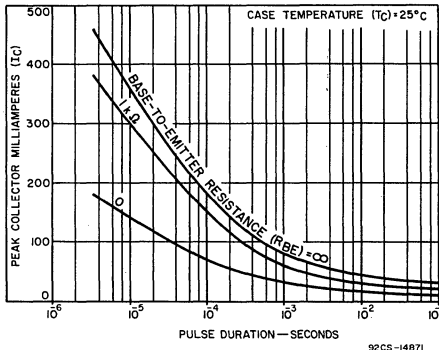


Fig. 5 - Typical second-breakdown characteristics.

92CS-14871

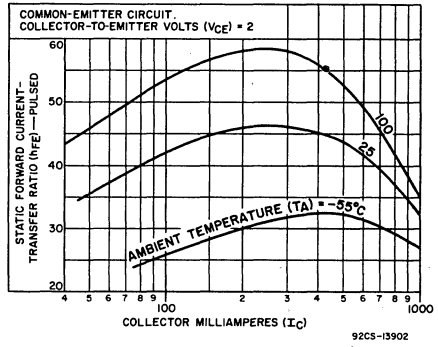


Fig. 6 - Typical dc beta characteristics.

92CS-13902

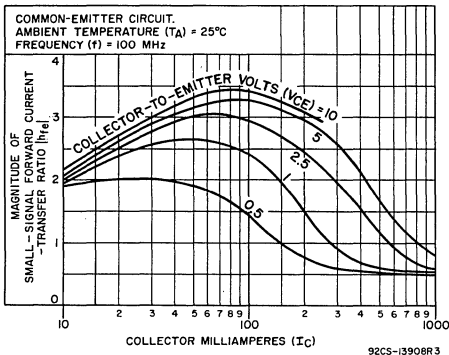


Fig. 7 - Typical small-signal beta characteristics.

92CS-13908R3

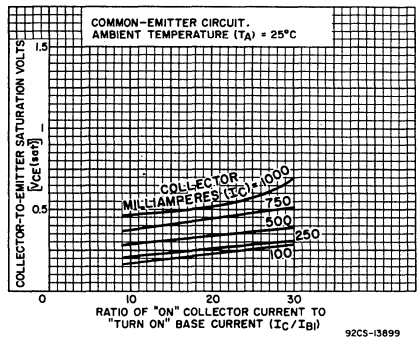


Fig. 8 - Typical saturation-voltage characteristics.

92CS-13899

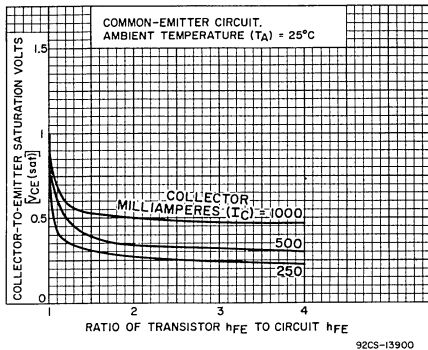


Fig. 9—Typical characteristics of saturation voltage vs. ratio of transistor beta to circuit beta.

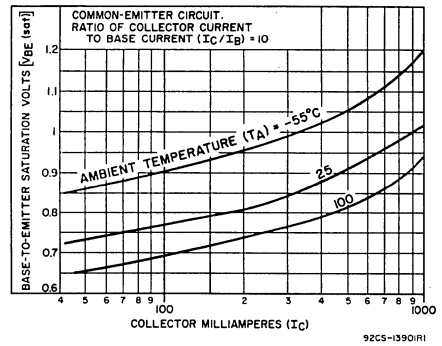


Fig. 10—Typical base-to-emitter saturation voltage vs. collector current.

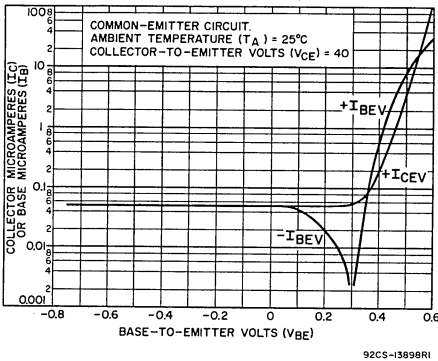


Fig. 11—Typical transfer characteristics.

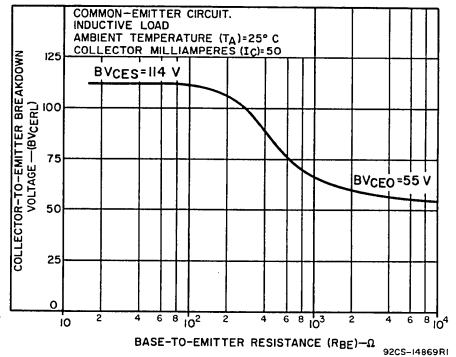


Fig. 12—Typical collector-to-emitter breakdown voltage vs. resistance.

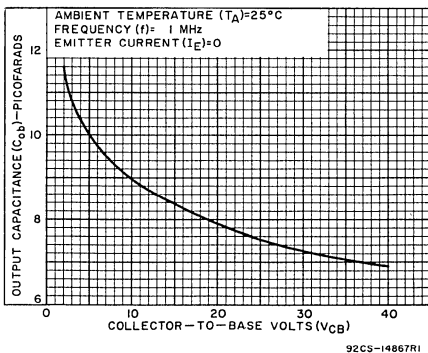


Fig. 13—Typical output capacitance vs. collector-to-base voltage.

**TERMINAL CONNECTIONS**

- LEAD 1 — EMITTER
- LEAD 2 — BASE
- LEAD 3 — COLLECTOR, CASE

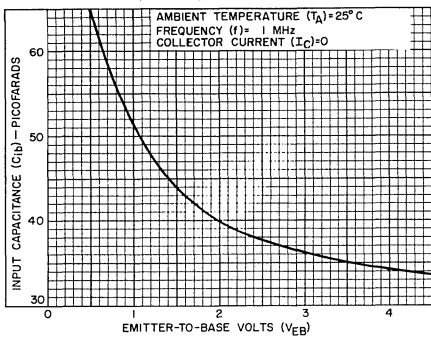


Fig. 14—Typical input capacitance vs. emitter-to-base voltage.

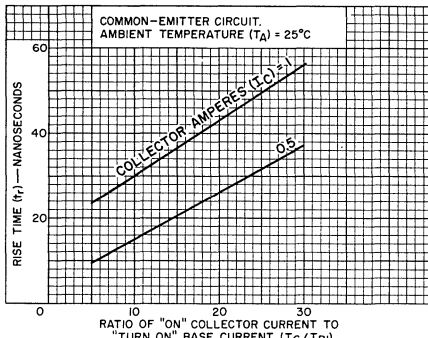


Fig. 15—Typical rise-time characteristics.

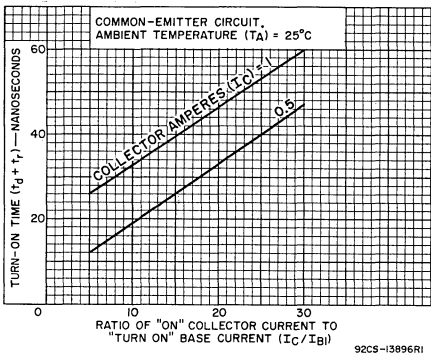


Fig. 16—Typical turn-on time characteristics.

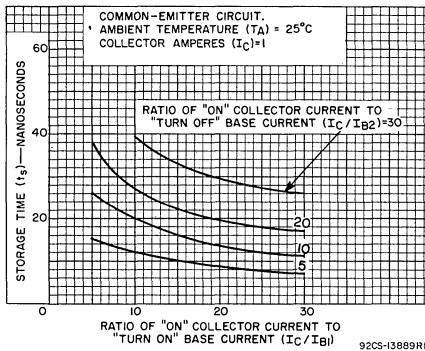


Fig. 17—Typical storage time characteristics.

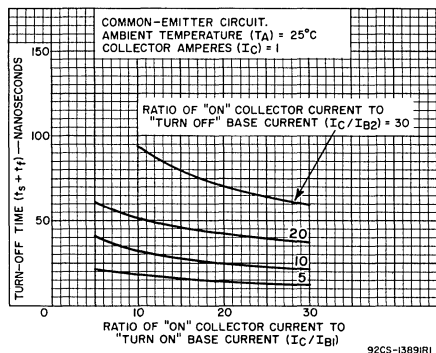


Fig. 18—Typical turn-off time characteristics.

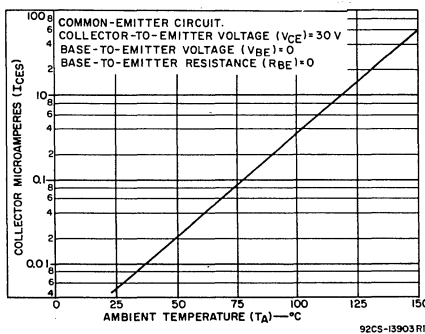


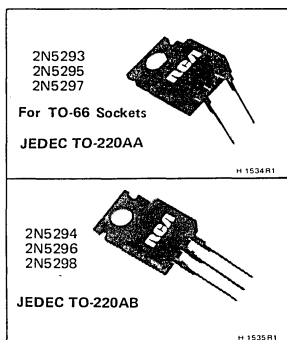
Fig. 19—Typical collector cutoff current as a function of temperature.





# Power Transistors

2N5293 2N5294  
 2N5295 2N5296  
 2N5297 2N5298



## Hometaxial-Base, Silicon N-P-N VERSAWATT Transistors

General-Purpose Types for Medium-Power Switching and Amplifier Applications in Military, Industrial, and Commercial Equipment

### FEATURES

- Low saturation voltage—
  - $V_{CE(sat)} = 1 \text{ V max. at } I_C = 0.5 \text{ A (2N5293, 2N5294)}$
  - $= 1 \text{ V max. at } I_C = 1 \text{ A (2N5295, 2N5296)}$
  - $= 1 \text{ V max. at } I_C = 1.5 \text{ A (2N5297, 2N5298)}$
- VERSAWATT package (molded-silicone plastic)
- Maximum safe-area-of-operation curves specified for DC and pulse service

RCA-2N5293, 2N5294, 2N5295, 2N5296, 2N5297 and 2N5298\* are hometaxial-base silicon n-p-n transistors. They are intended for a wide variety of medium-power switching and amplifier applications such as series and shunt regulators, and in driver and output stages of high-fidelity amplifiers. Types 2N5293, 2N5295, and 2N5297 have formed emitter and base leads for easy insertion into TO-66 sockets. Types 2N5294, 2N5296, and 2N5298 are electrically identical to the 2N5293, 2N5295, and 2N5297, respectively, but have straight leads.

These new plastic power transistors differ in voltage ratings and in the currents at which the parameters are controlled.

\* Formerly RCA Dev. Type Nos. TA7155, TA2911, TA7156, TA7137, TA7362, and TA7363, respectively.

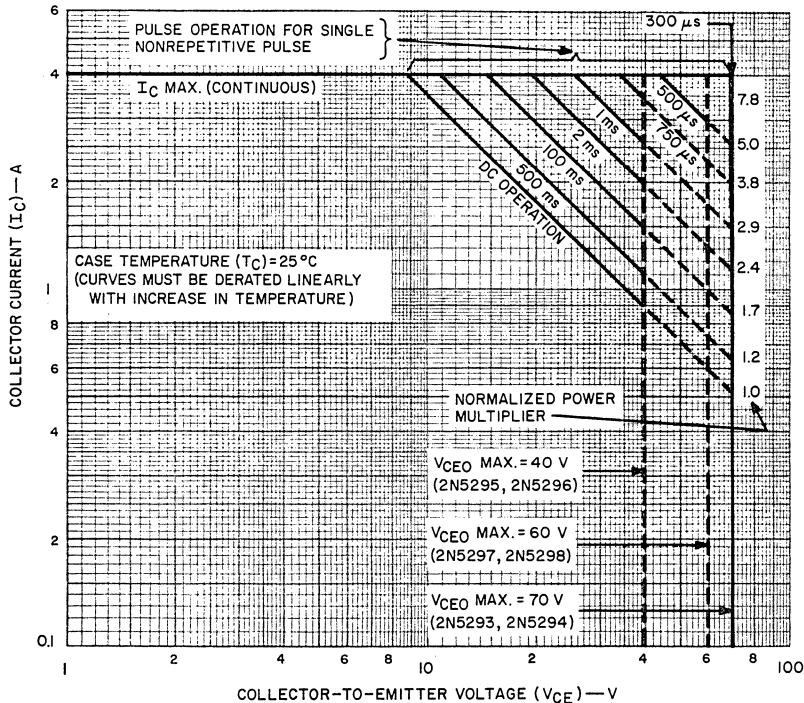
### MAXIMUM RATINGS, Absolute-Maximum Values:

	2N5293 2N5294	2N5295 2N5296	2N5297 2N5298		
COLLECTOR-TO-BASE VOLTAGE . . . . .	$V_{CBO}$	80	60	80	V
COLLECTOR-TO-EMITTER SUSTAINING VOLTAGE:					
With -1.5 volts ( $V_{BE}$ ) of reverse bias . . . . .	$V_{CEV(sus)}$	80	60	80	V
With external base-to-emitter resistance ( $R_{BE}$ ) = 100 $\Omega$ . . . . .	$V_{CER(sus)}$	75	50	70	V
With base open . . . . .	$V_{CEO(sus)}$	70	40	60	V
EMITTER-TO-BASE VOLTAGE . . . . .	$V_{EBO}$	7	5	5	V
COLLECTOR CURRENT . . . . .	$I_C$	4	4	4	A
BASE CURRENT . . . . .	$I_B$	2	2	2	A
TRANSISTOR DISSIPATION:	$P_T$				
At case temperatures up to 25°C . . . . .		36	36	36	W
At case temperatures above 25°C . . . . .			Derate linearly at 0.288 W/°C or see Fig. 1 & 2.		
At ambient temperatures up to 25°C . . . . .		1.8	1.8	1.8	W
At ambient temperatures above 25°C . . . . .			Derate linearly at 0.0144 W/°C		
TEMPERATURE RANGE:					
Storage & Operating (Junction) . . . . .		-65 to +150		°C	
LEAD TEMPERATURE (During Soldering):					
At distance $\geq$ 1/8 in. (3.17 mm) from case for 10 s max. . . . .		235		°C	

ELECTRICAL CHARACTERISTICS, At Case Temperature ( $T_C$ ) = 25°C, Unless Otherwise Specified.

Characteristic	Symbol	TEST CONDITIONS				LIMITS						Units	
		DC Voltage (V)		DC Current (A)		2N5293 2N5294		2N5295 2N5296		2N5297 2N5298			
		$V_{CE}$	$V_{BE}$	$I_C$	$I_B$	Min.	Max.	Min.	Max.	Min.	Max.		
Collector-Cutoff Current With base-emitter junction reverse biased	$I_{CEV}$	65 35	-1.5 -1.5			- -	0.5 -	- -	- 2	- -	0.5 -	mA	
	$I_{CEV}$ ( $T_C = 150^\circ\text{C}$ )	65 35	-1.5 -1.5			- -	3 -	- -	- 5	- -	3 -	mA	
Collector-Cutoff Current With external base-to-emitter resistance ( $R_{BE}$ ) = 100 $\Omega$	$I_{CER}$	50				-	0.5	-	-	-	0.5	mA	
	$I_{CER}$ ( $T_C = 150^\circ\text{C}$ )	50				-	2	-	-	-	2	mA	
Emitter-Cutoff Current	$I_{EBO}$		-7 -5			-	1	-	-	1	1	mA	
DC Forward-Current Transfer Ratio	$h_{FE}^c$	4		0.5		30	120	-	-	-	-		
		4		1		-	-	30	120	-	-		
		4		1.5		-	-	-	-	20	80		
Collector-to-Emitter Sustaining Voltage With base open	$V_{CEO(sus)}^c$			0.1	0	70	-	-	-	-	-	V	
				0.1	0	-	-	40	-	-	-		
				0.1	0	-	-	-	-	60	-		
With external base-to-emitter resistance ( $R_{BE}$ ) = 100 $\Omega$	$V_{CER(sus)}^c$			0.1		75	-	-	-	-	-	V	
				0.1		-	-	50	-	-	-		
				0.1		-	-	-	-	70	-		
With base-emitter junction reverse biased	$V_{CEV(sus)}^c$		-1.5	0.1		80	-	-	-	-	-	V	
			-1.5	0.1		-	-	60	-	-	-		
			-1.5	0.1		-	-	-	-	80	-		
Base-to-Emitter Voltage	$V_{BE}^c$	4		0.5		-	1.1	-	-	-	-	V	
		4		1		-	-	-	1.3	-	-		
		4		1.5		-	-	-	-	-	1.5		
Collector-to-Emitter Saturation Voltage	$V_{CE(sat)}^c$			0.5	0.05	-	1	-	-	-	-	V	
				1	0.1	-	-	-	1	-	-		
				1.5	0.15	-	-	-	-	-	1		
Gain-Bandwidth Product	$f_T$	4		0.2		0.8	-	0.8	-	0.8	-	MHz	
Sat. Switching Time Turn-On (See Figs. 22 - 24)	$t_{on}$	$V_{CC} = 30$		0.5	0.05 <sup>a</sup>	-	5	-	-	-	-	-	$\mu\text{s}$
				1	0.1 <sup>a</sup>	-	-	-	5	-	-	-	
				1.5	0.15 <sup>a</sup>	-	-	-	-	-	-	5	
Turn-Off (See Figs. 22 - 24)	$t_{off}$	$V_{CC} = 30$		0.5	-0.05 <sup>a</sup>	-	15	-	-	-	-	-	$\mu\text{s}$
				1	-0.1 <sup>b</sup>	-	-	-	15	-	-	-	
				1.5	-0.15 <sup>b</sup>	-	-	-	-	-	-	15	
Thermal Resistance; Junction-to-Case Junction-to-Ambient	$\theta_{J-C}$ $\theta_{J-A}$					-	3.5	-	3.5	-	3.5	$^\circ\text{C/W}$	
						-	70	-	70	-	70	$^\circ\text{C/W}$	

<sup>a</sup>  $I_{B1}$  value (turn-on base current).<sup>b</sup>  $I_{B2}$  value (turn-off base current).<sup>c</sup> Pulsed, pulse duration = 300  $\mu\text{s}$ ,  
duty factor = .018.



92CS-17160R1

Fig.1—Maximum operating areas for all types.

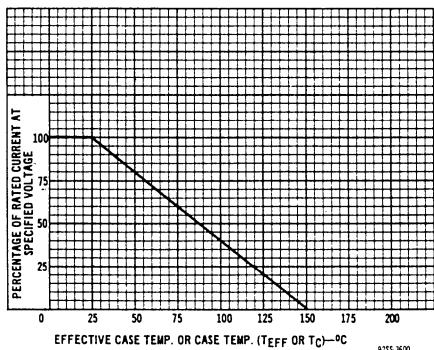


Fig.2—Derating curve for all types.

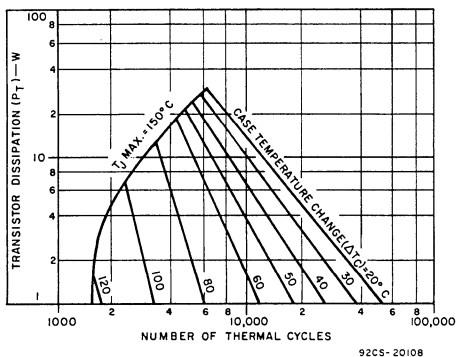


Fig.3—Thermal-cycling rating chart for all types.

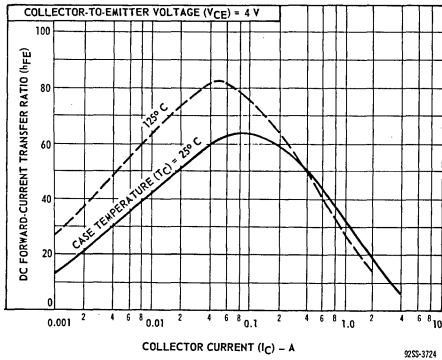


Fig.4 – Typical DC beta for types 2N5293 & 2N5294.

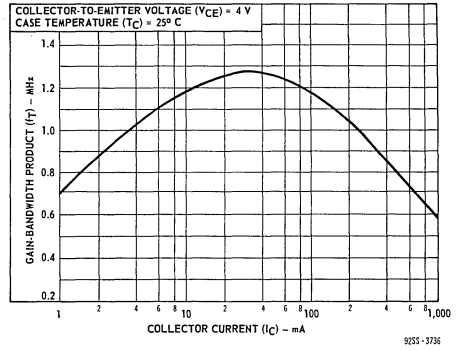


Fig.5 – Typical gain-bandwidth product for types 2N5293 & 2N5294.

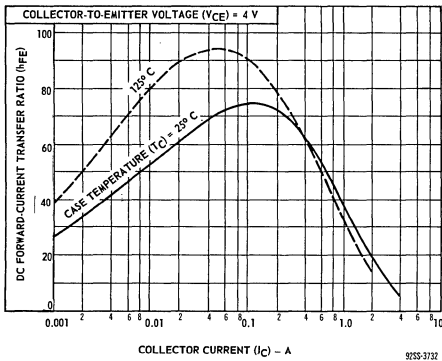


Fig.6 – Typical DC beta for types 2N5295 & 2N5296.

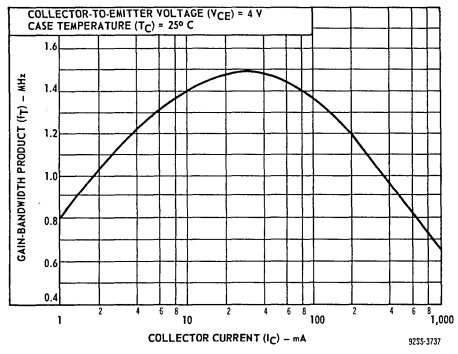


Fig.7 – Typical gain-bandwidth product for types 2N5295 & 2N5296.

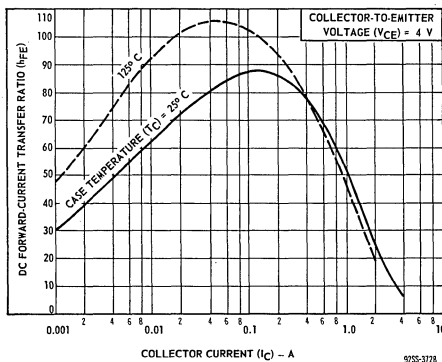


Fig.8 – Typical DC beta for types 2N5297 & 2N5298.

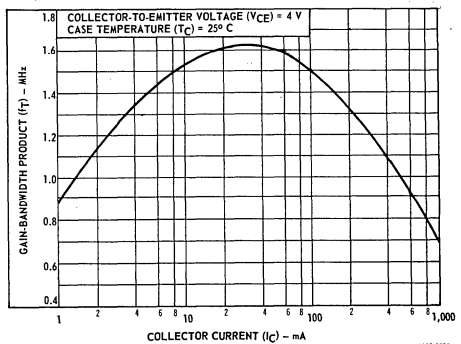


Fig.9 – Typical gain-bandwidth product for types 2N5297 & 2N5298.

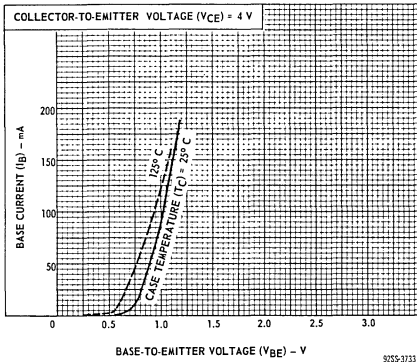


Fig. 10—Typical input characteristics for types 2N5293 & 2N5294.

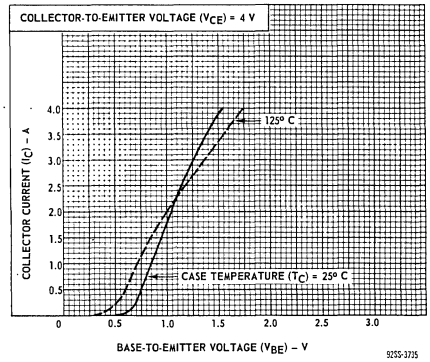


Fig. 11—Typical transfer characteristics for types 2N5293 & 2N5294.

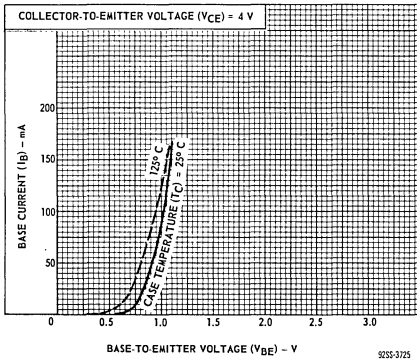


Fig. 12—Typical input characteristics for types 2N5295 & 2N5296.

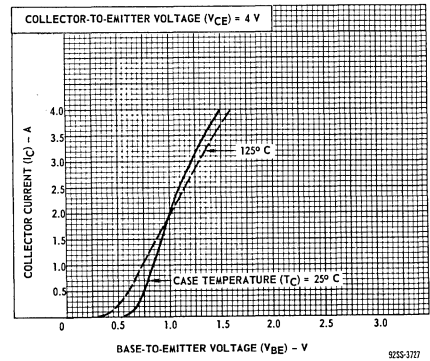


Fig. 13—Typical transfer characteristics for types 2N5295 & 2N5296.

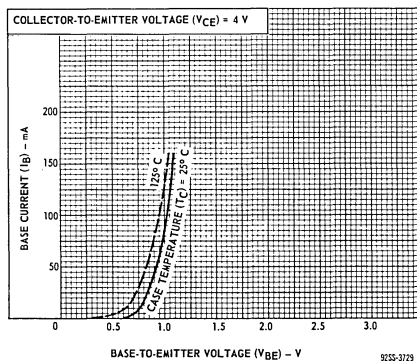


Fig. 14—Typical input characteristics for types 2N5297 & 2N5298.

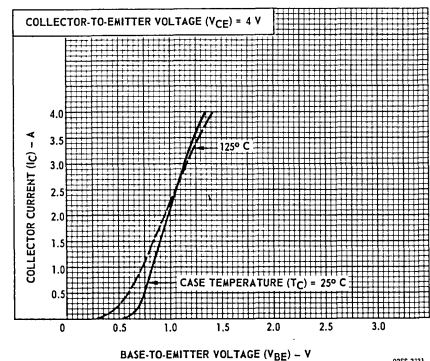


Fig. 15—Typical transfer characteristics for types 2N5297 & 2N5298.

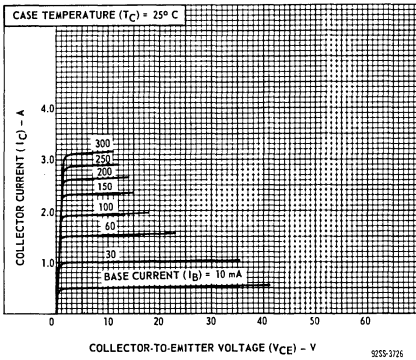


Fig.16—Typical output characteristics for types 2N5293 & 2N5294.

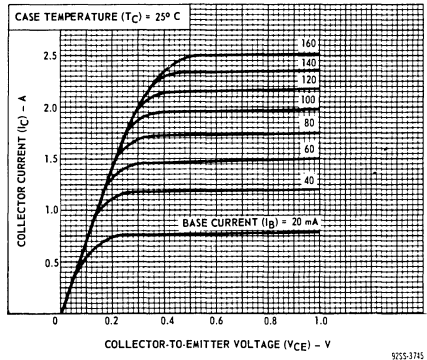


Fig.17—Typical output characteristics for types 2N5295 & 2N5296.

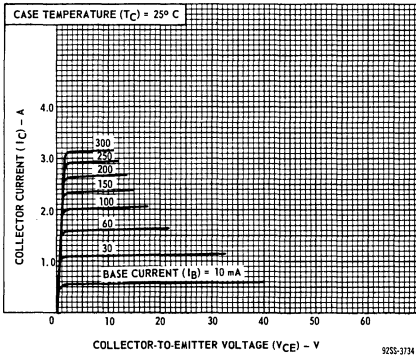


Fig.18—Typical output characteristics for types 2N5295 & 2N5296.

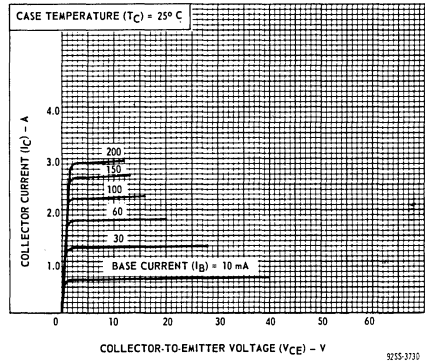


Fig.19—Typical output characteristics for types 2N5297 & 2N5298.

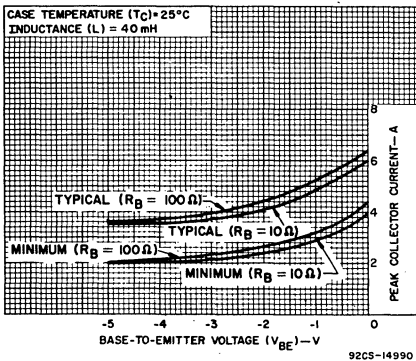


Fig.20—Reverse-bias, second-breakdown characteristics for all types.

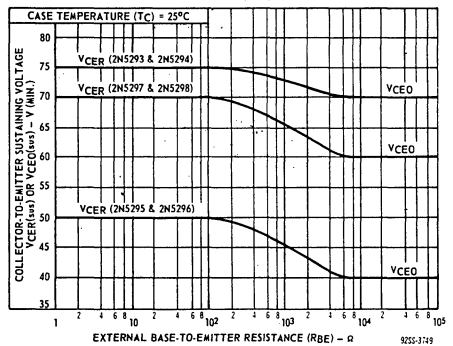


Fig.21—Sustaining voltage vs. base-to-emitter resistance for all types.

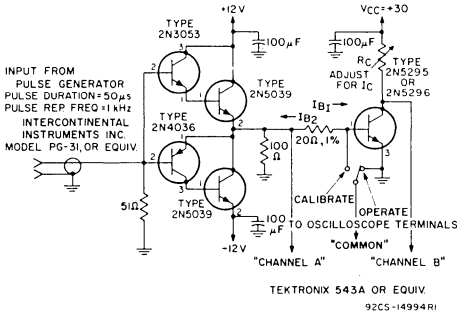


Fig.22—Circuit used to measure switching times for types 2N5295 & 2N5296.

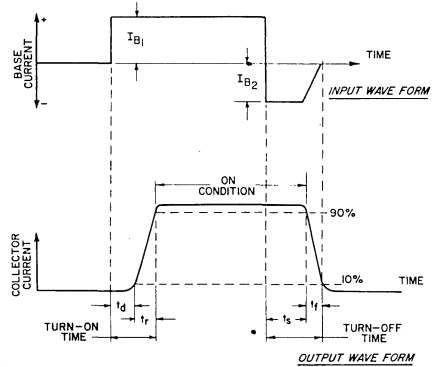


Fig.23—Phase relationship between input and output currents showing reference points for specification of switching times. (Test circuit shown in Fig.22.)

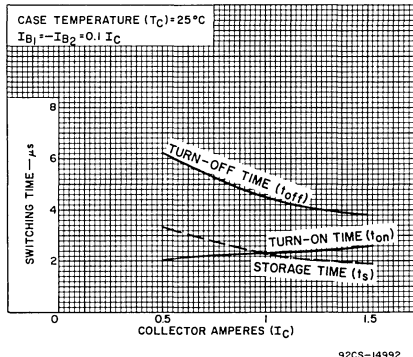


Fig.24—Typical saturated switching characteristics for types 2N5295 & 2N5296.

**TERMINAL CONNECTIONS FOR TYPES 2N5293, 2N5295, AND 2N5297**

- Lead No.1 - Base
- Lead No.3 - Emitter
- Mounting Flange - Collector
- - Do not use stub as tie point.

**TERMINAL CONNECTIONS FOR TYPES 2N5294, 2N5296, AND 2N5298**

- Lead No.1 - Base
- Lead No.2 - Collector
- Lead No.3 - Emitter
- Mounting Flange - Collector



# Power Transistors

**2N5320 2N5321**  
**2N5322 2N5323**

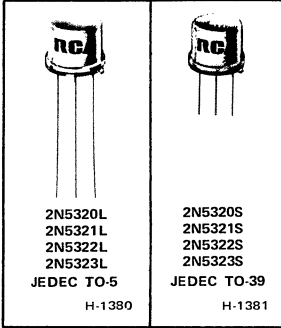
## Complementary N-P-N & P-N-P Silicon Power Transistors

General-Purpose Types for Small-Signal, Medium-Power Applications

*Features:*

- 2N5322 } P-N-P { 2N5320
- 2N5323 } Complements of: { 2N5321
- Maximum safe-area-of-operation curves
- Planar construction for low-noise and low-leakage characteristics
- Low saturation voltage
- High beta at high collector current

These devices are available with either 1½-inch leads (TO-5 package) or ½-inch leads (TO-39 package). The longer-lead versions are specified by suffix "L" after the type number; the shorter-lead versions are specified by suffix "S" after the type number.



RCA-2N5320, 2N5321, 2N5322 and 2N5323 are double-diffused epitaxial-planar silicon power transistors intended for small-signal medium-power applications. The 2N5320 and 2N5321 n-p-n types are actually high-current, high-dissipation versions of the 2N2102 with all of the salient features of that device. The 2N5322 and 2N5323, p-n-p complements of the 2N5320 and 2N5321, are actually high-current, high-power versions of the 2N4036 with all of its additional outstanding features. (Technical data on the 2N2102 and 2N4036 are shown in RCA Data Bulletin File Nos. 106 and 216, respectively).

### TERMINAL CONNECTIONS

- Lead 1 — Emitter
- Lead 2 — Base
- Lead 3 — Collector, Case

**MAXIMUM RATINGS, Absolute-Maximum Values:**

	2N5321	2N5323	2N5320	2N5322	
• COLLECTOR-TO-BASE VOLTAGE . . . . . $V_{CBO}$	75	-75	100	-100	V
COLLECTOR-TO-EMITTER SUSTAINING VOLTAGE:					
With 1.5 volts ( $V_{BE}$ ) of reverse bias. . . . . $V_{CEV(sus)}$	75	-75	100	-100	V
With external base-to-emitter resistance					
( $R_{BE}$ ) = 100 $\Omega$ . . . . . $V_{CER(sus)}$	65	-65	90	-90	V
With base open . . . . . $V_{CEO(sus)}$	50	-50	75	-75	V
• EMITTER-TO-BASE VOLTAGE . . . . . $V_{EBO}$	5	-5	7	-7	V
• COLLECTOR CURRENT . . . . . $I_C$	2	-2	2	-2	A
• BASE CURRENT . . . . . $I_B$	1	-1	1	-1	A
• TRANSISTOR DISSIPATION: . . . . . $P_T$	10	10	10	10	W
At case temperatures up to 25° C. . . . .					
At case temperatures above 25° C. . . . .					See Figs. 3 & 6 Derate linearly at 0.057 W/°C
• TEMPERATURE RANGE:					
Storage and operating (Junction) . . . . .	← -65 to + 200 →				°C
• LEAD TEMPERATURE (During soldering):					
At distance $\geq$ 1/32 in. (0.8 mm) from					
seating plane for 10 s max . . . . .	← 230 →				°C

\* In accordance with JEDEC registration data format (JS-6 RDF-1)



ELECTRICAL CHARACTERISTICS, Case Temperature ( $T_C$ ) = 25°C, unless otherwise specified

CHARACTERISTIC	Symbol	TEST CONDITIONS						LIMITS								Units	
		DC Voltage V			DC Current mA			Type 2N5320		Type 2N5321		Type 2N5322		Type 2N5323			
		V <sub>CB</sub>	V <sub>CE</sub>	V <sub>BE</sub>	I <sub>C</sub>	I <sub>B</sub>	Min.	Max.	Min.	Max.	Min.	Max.	Min.	Max.			
Collector-Cutoff Current: With base open ( $I_E = 0$ )	I <sub>CBO</sub>	80 60 -80 -60					-	0.5	-	-	-	-	-	-	-	-	μA
* With base-emitter junction reverse biased  $T_C = 150^\circ\text{C}$	I <sub>CEX</sub>		100 75 -100 -75	-1.5 -1.5 1.5 1.5			-	0.1	-	0.1	-	-	-	-	-	-	mA
			70 45 -70 -45	-1.5 -1.5 1.5 1.5			-	5	-	5	-	-	-5	-	-	-	mA
* Emitter-Cutoff Current	I <sub>EBO</sub>			-7 -5 7 5	0 0 0 0		-	0.1	-	-	0.1	-	-	-0.1	-	-	mA
				-5 -4 5 4	0 0 0 0		-	0.1	-	0.5	-	-	-	-0.1	-	-	μA
Collector-to-Emitter Breakdown Voltage: With base-emitter junction reverse biased	V <sub>(BR)CEV</sub>			-1.5 1.5	0.1 -0.1		100	-	75	-	-	-	-	-	-	-	V
Collector-to-Emitter Sustaining Voltage: With external base-to- emitter resistance (R <sub>BE</sub> ) = 100 Ω	V <sub>CE(sus)</sub> <sup>a</sup>				100 -100		90	-	65	-	-	-	-	-90	-	-65	V
* With base open	V <sub>CE0(sus)</sub> <sup>a</sup>				100 -100	0 0	75	-	50	-	-	-	-	-75	-	-50	V
* Collector-to-Emitter Saturation Voltage	V <sub>CE(sat)</sub>				50 -50	50 -50	-	0.5	-	0.8	-	-	-	-0.7	-	-	V
* Base-to-Emitter Voltage	V <sub>BE</sub>		4 -4		500 -500		-	1.1	-	1.4	-	-	-	-1.1	-	-1.4	V
* DC Forward Current Transfer Ratio	h <sub>FE</sub> <sup>b</sup> See NOTE		4 -4 2 -2		500 -500 1000 -1000		30 10	130	40	250	-	-	30	130	40	250	
Gain-Bandwidth Product	f <sub>T</sub>		4 -4		50 -50		50	-	50	-	-	50	-	50	-	-	MHz
* Magnitude of common-emitter, small-signal, short circuit, forward current transfer ratio (f = 10 MHz)	h <sub>fe</sub>		4 -4		50 -50		5	-	5	-	-	5	-	5	-	-	

ELECTRICAL CHARACTERISTICS, (Cont'd)

CHARACTERISTIC	Symbol	TEST CONDITIONS						LIMITS						Units		
		DC Voltage V			DC Current mA			Type 2N5320		Type 2N5321		Type 2N5322			Type 2N5323	
		V <sub>CB</sub>	V <sub>CE</sub>	V <sub>BE</sub>	I <sub>C</sub>	I <sub>B</sub>	Min.	Max.	Min.	Max.	Min.	Max.	Min.		Max.	
Second Breakdown Collector Current <sup>c,e</sup> (With base forward biased)	$I_{S-b}^d$		50 -35				200 -	- -	200 -	- -	- -285	- -	- -285	- -	mA	
* Sat. Switching Time: (See Fig. 11.)																
Turn-on Time	$t_{on}$		30 -30		500 -500	50 -50	- -	80 -	- -	80 -	- -	- 1000	- -	- 100	ns	
Turn-off Time	$t_{off}$		30 -30		500 -500	50 -50	- -	800 -	- -	800 -	- -	- 1000	- -	- 1000	ns	
Thermal Resistance:																
* Junction-to-Case	$\theta_{J-C}$						-	17.5	-	17.5	-	17.5	-	17.5	°C/W	
Junction-to-Ambient	$\theta_{J-A}$						-	150	-	150	-	150	-	150	°C/W	

<sup>a</sup> CAUTION: The sustaining voltages V<sub>CEO(sus)</sub> and V<sub>CEr(sus)</sub> MUST NOT be measured on a curve tracer.

<sup>b</sup> Pulsed; pulse duration ≤ 300 μs, duty factor ≤ 0.02.

<sup>c</sup> Safe operating regions for forward-bias operation are shown on pages 4 & 5.

<sup>d</sup> I<sub>S/b</sub> is defined as the current at which second breakdown occurs at a specified collector voltage with the emitter-base junction forward biased for transistor operation in the active region.

<sup>e</sup> Pulsed; 0.4s non-repetitive pulse.

\* In accordance with JEDEC registration data format (JS-6 RDF-1)

NOTE: RCA 2N5320, 2N5321, 2N5322, and 2N5323 can be shipped with color dots on the device case to indicate the following ranges of beta values within the beta limits specified for each device.

Color Code	Beta Range	Color Code	Beta Range
Brown	25-38	Green	73-110
Red	33-50	Blue	95-145
Orange	43-65	Violet	125-190
Yellow	56-85	White	165-250

Specific beta distributions or beta matching are available as custom types only on special order. For further details, contact your local RCA Sales office.

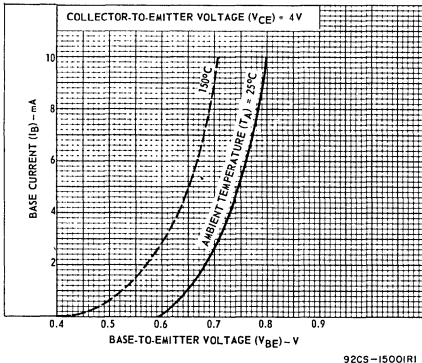


Fig. 1 - Typical input characteristics for types 2N5320 and 2N5321.

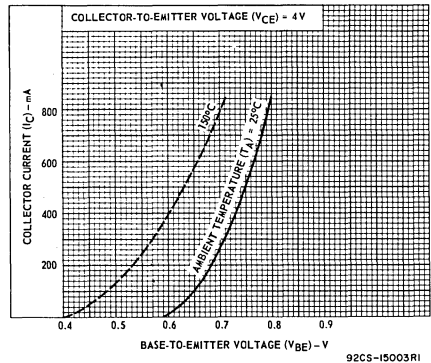
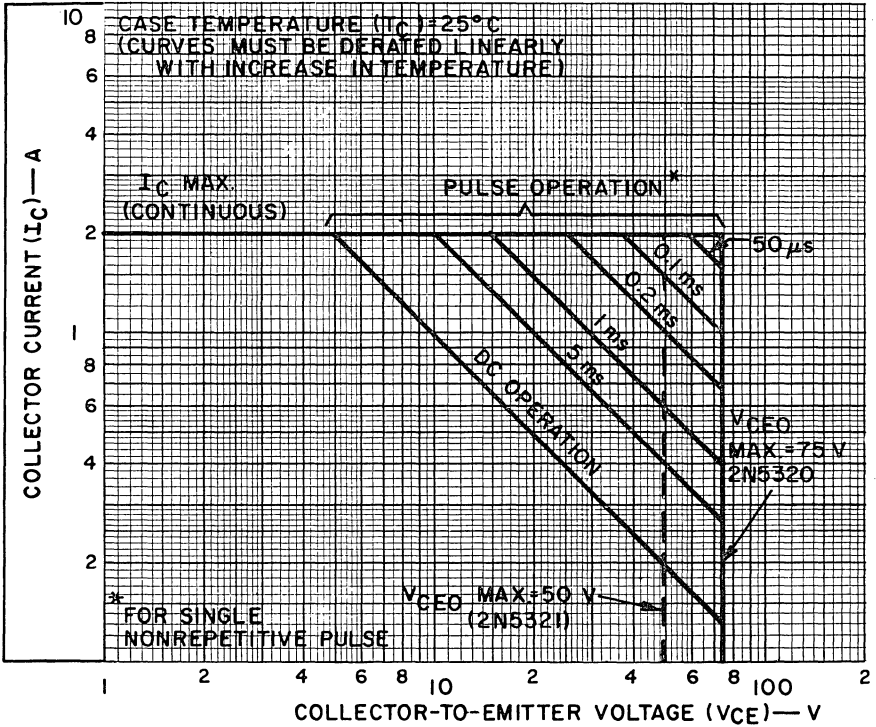


Fig. 2 - Typical transfer characteristics for types 2N5320 and 2N5321.



92CS-17546

Fig. 3 - Maximum operating areas for types 2N5320 and 2N5321.

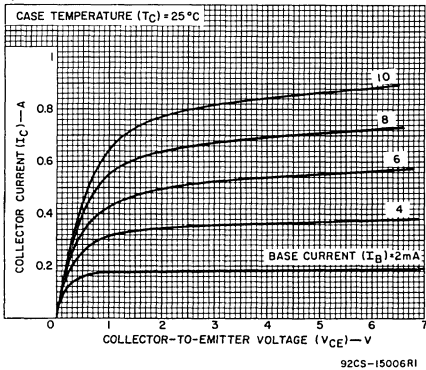


Fig. 4 - Typical output characteristics for types 2N5320 and 2N5321.

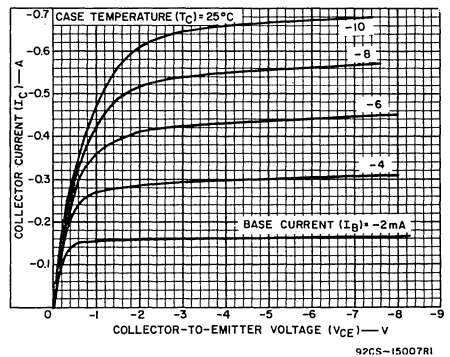


Fig. 5 - Typical output characteristics for types 2N5322 and 2N5323.

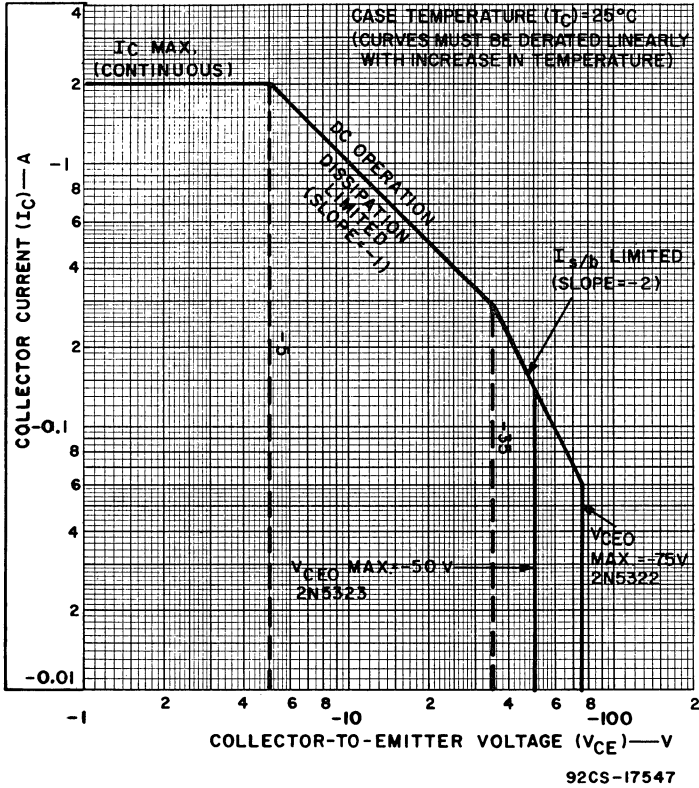


Fig. 6 - Maximum operating areas for types 2N5322 and 2N5323.

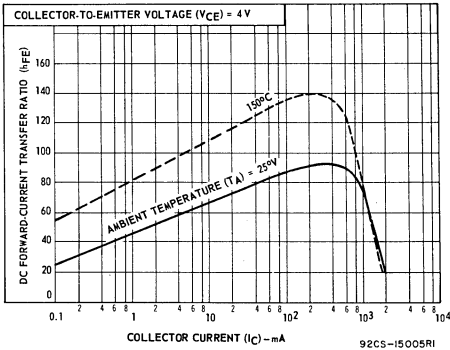


Fig. 7 - Typical static beta characteristics for types 2N5320 and 2N5321.

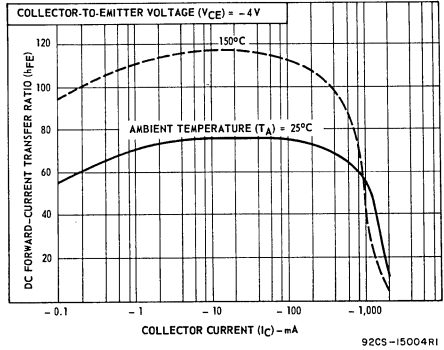


Fig. 8 - Typical static beta characteristics for types 2N5322 and 2N5323.

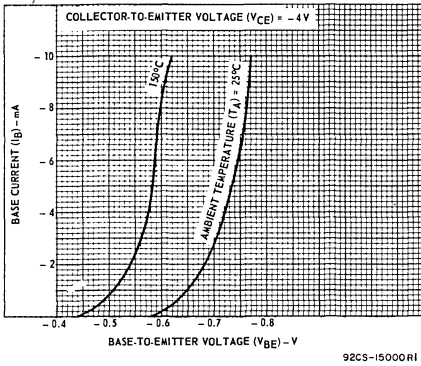


Fig. 9 - Typical input characteristics for types 2N5322 and 2N5323.

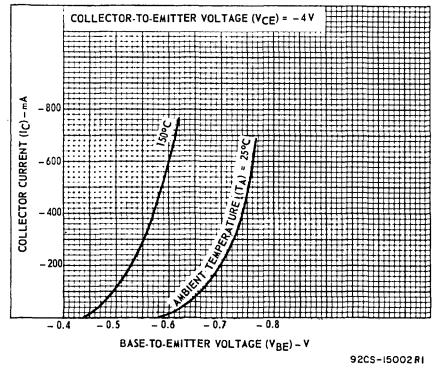
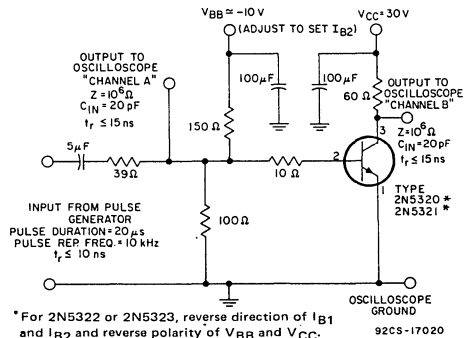


Fig. 10 - Typical transfer characteristics for types 2N5322 and 2N5323.



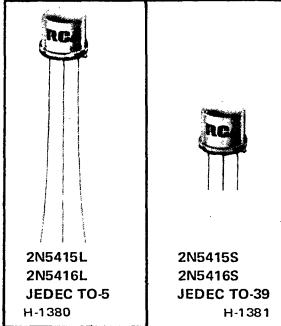
\* For 2N5322 or 2N5323, reverse direction of  $I_{B1}$  and  $I_{B2}$  and reverse polarity of  $V_{BB}$  and  $V_{CC}$ .

Fig. 11 - Circuit used to measure switching times for all types.

**RCA**  
Solid State  
Division

## Power Transistors

### 2N5415 2N5416



## Silicon P-N-P High-Voltage Transistors

For High-Speed Switching and Linear-Amplifier  
Applications in Military, Industrial and Commercial Equipment

#### Features:

- 2N5415: p-n-p complement of 2N3440<sup>◆</sup>
- 2N5416: p-n-p complement of 2N3439<sup>◆</sup>
- Maximum safe-area-of-operation curves
- High voltage ratings:  
 $V_{CBO} = -350$  V max. (2N5416)  
 $V_{CEO}(\text{sus}) = -300$  V max. (2N5416)  
 $-200$  V max. (2N5415)

These devices are available with either 1/2-inch leads (TO-5 package) or 3/8-inch leads (TO-39 package). The longer-lead versions are specified by suffix "L" after the type number; the shorter-lead versions are specified by suffix "S" after the type number.

RCA-2N5415 and 2N5416<sup>◆</sup> are silicon p-n-p transistors with high breakdown voltages, high frequency response, and fast switching speeds.

These transistors differ primarily in their voltage ratings. Typical applications include high-voltage differential and operational amplifiers; high-voltage inverters; and high-voltage, low-current switching and series regulators.

<sup>◆</sup> Formerly RCA Dev. Types TA2819 and TA2819A, respectively.

<sup>◆</sup> Data on types 2N3439 and 2N3440 are given in RCA data bulletin File No. 64.

#### TERMINAL CONNECTIONS

Lead 1 — Emitter  
Lead 2 — Base  
Lead 3 — Collector, Case

#### MAXIMUM RATINGS, Absolute-Maximum Values:

		2N5415	2N5416	
*COLLECTOR-TO-BASE VOLTAGE .....	$V_{CBO}$	-200	-350	V
COLLECTOR-TO-EMITTER SUSTAINING VOLTAGE: With external base-to-emitter resistance ( $R_{BE}$ ) = 50 $\Omega$ .....	$V_{CER}(\text{sus})$	-	-350	V
* With base open .....	$V_{CEO}(\text{sus})$	-200	-300	V
*EMITTER-TO-BASE VOLTAGE .....	$V_{EBO}$	-4	-6	V
*COLLECTOR CURRENT .....	$I_C$	-1	-1	A
*BASE CURRENT .....	$I_B$	-0.5	-0.5	A
*TRANSISTOR DISSIPATION:	$P_T$			
At case temperatures up to 25°C .....		10	10	W
At case temperatures above 25°C .....		See Figs. 1 and 2		
At ambient temperatures up to 50°C .....		1	1	W
At ambient temperatures above 50°C .....	Derate linearly at	6.7	6.7	mW/°C
*TEMPERATURE RANGE: Storage and Operating (Junction) .....		-65 to +200		°C
*LEAD TEMPERATURE (During soldering): At distance $\geq$ 1/32 in. (0.8 mm) from seating plane for 10 s max. ....		255		°C

<sup>◆</sup> In accordance with JEDEC registration data format (JS-9 RDF-8)

ELECTRICAL CHARACTERISTICS, Case Temperature ( $T_C$ ) = 25°C

CHARACTERISTIC	SYMBOL	TEST CONDITIONS				LIMITS				UNITS	
		VOLTAGE V dc			CURRENT mA dc		2N5415		2N5416		
		V <sub>CB</sub>	V <sub>CE</sub>	V <sub>BE</sub>	I <sub>C</sub>	I <sub>B</sub>	Min.	Max.	Min.		Max.
Collector-Cutoff Current: With base open	I <sub>CEO</sub>		-250 -150			0 0	- -	- -50	- -	-50 -	μA
With emitter open	I <sub>CBO</sub>	-280 -175					- -	- -50	- -	-50 -	μA
With base-emitter junction reverse-biased	I <sub>CEV</sub>		-300 -200	1.5 1.5			- -	- -50	- -	-50 -	μA
Emitter-Cutoff Current	I <sub>EBO</sub>			6 4	0 0		- -	- -20	- -	-20 -	μA
DC Forward-Current Transfer Ratio	h <sub>FE</sub>		-10 -10		-50 -50		- 30	- 150	30 -	120 -	
Collector-to-Emitter Sustaining Voltage: With base open (See Figs. 4 and 5)	V <sub>CEO(sus)</sub>				-50	0	-200 <sup>a</sup>	-	-300 <sup>a</sup>	-	V
With external base-to-emitter resistance (R <sub>BE</sub> )=50 Ω	V <sub>CER(sus)</sub>				-50		-	-	-350 <sup>a</sup>	-	V
Base-to-Emitter Saturation Voltage	V <sub>BE</sub>		-10		-50		-	-1.5	-	-1.5	V
Collector-to-Emitter Saturation Voltage	V <sub>CE(sat)</sub>				-50	-5	-	-2.5	-	-2	V
Common-Emitter, Small-Signal, Short-Circuit, Forward-Current Transfer Ratio (at 1 kHz)	h <sub>fe</sub>		-10		-5		25	-	25	-	
Magnitude of Common-Emitter, Small-Signal, Short-Circuit Forward-Current Transfer Ratio (at 5 MHz)	h <sub>fe</sub>		-10		-10		3	-	3	-	
Real Part of Common-Emitter Small-Signal, Short-Circuit Impedance (at 1 MHz)	Re(h <sub>ie</sub> )		-10		-5		-	300	-	300	Ω
Common-Base, Short-Circuit, Input Capacitance (at 1 MHz)	C <sub>ib</sub>			5	0		-	75	-	75	pF
Output Capacitance (at 1 MHz)	C <sub>ob</sub>	-10					-	15	-	15	pF
Forward-Bias, Second-Breakdown Collector Current: (0.4-s, non-repetitive pulse)	I <sub>S/b</sub> <sup>b</sup>		-100				-100	-	-100	-	mA
Thermal Resistance: Junction-to-Case	R <sub>θJC</sub>						-	17.5	-	17.5	°C/W

<sup>a</sup>CAUTION: The sustaining voltages V<sub>CEO(sus)</sub> and V<sub>CER(sus)</sub> MUST NOT be measured on a curve tracer. The sustaining voltage should be measured by means of the test circuit shown in Fig. 4.

<sup>b</sup>I<sub>S/b</sub> is defined as the current at which second breakdown occurs at a specified collector voltage.

<sup>c</sup>In accordance with JEDEC registration data format (JS-9 RDF-8).

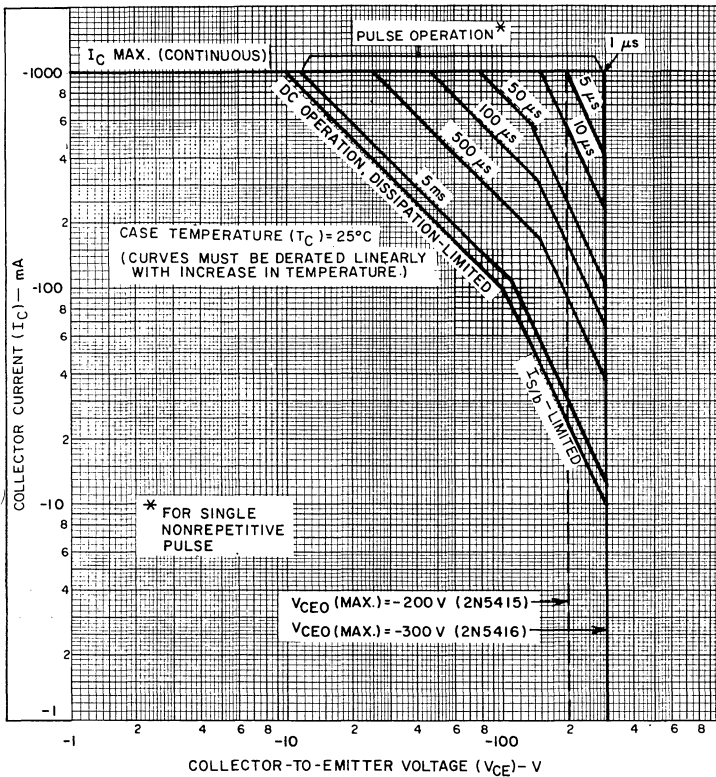


Fig. 1 - Maximum safe operating areas.

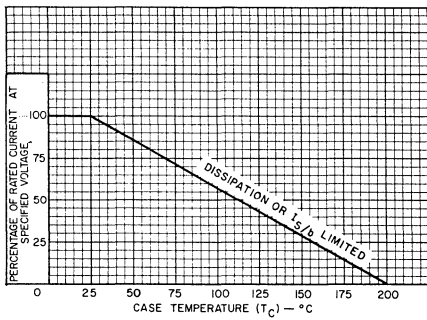


Fig. 2 - Dissipation derating curve.

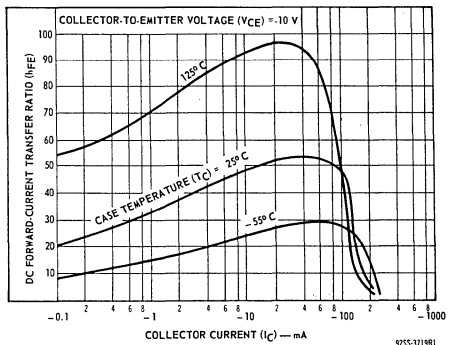


Fig. 3 - Typical dc beta characteristics for both types.



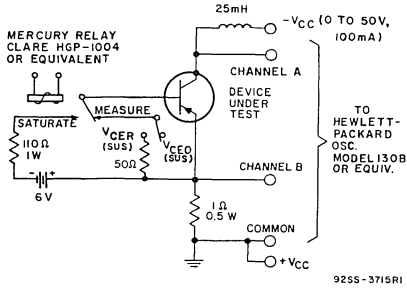
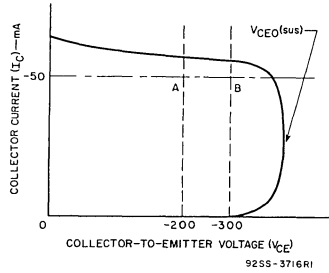


Fig. 4 - Circuit used to measure sustaining voltages,  $V_{CE0(sus)}$  and  $V_{CER(sus)}$  for both types.



The sustaining voltage  $V_{CE0(sus)}$  is acceptable when the trace falls to the right and above point "A" for type 2N5415. The trace must fall to the right and above point "B" for type 2N5416.

Fig. 5 - Oscilloscope display for measurement of sustaining voltages (test circuit shown in Fig. 4).

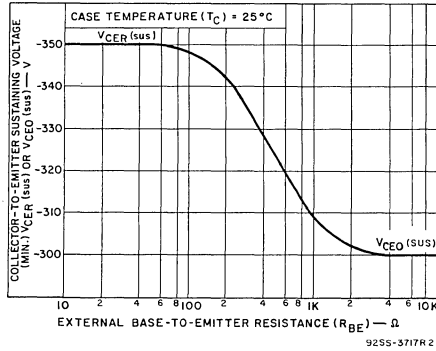


Fig. 6 - Sustaining voltage vs. base-to-emitter resistance for type 2N5416.

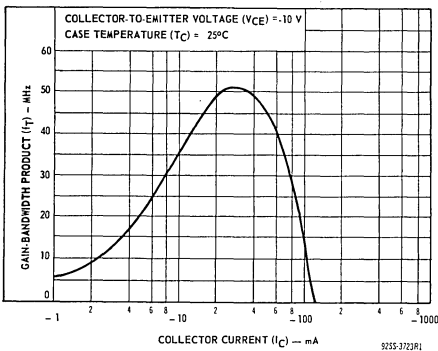


Fig. 7 - Typical gain-bandwidth product for both types.

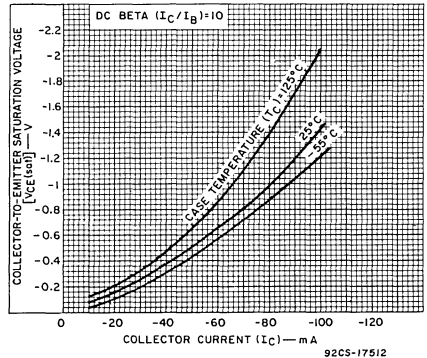


Fig. 8 - Typical collector-to-emitter saturation voltage for both types.

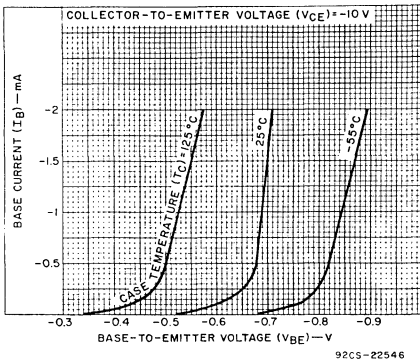


Fig. 9 — Typical input characteristics for both types.

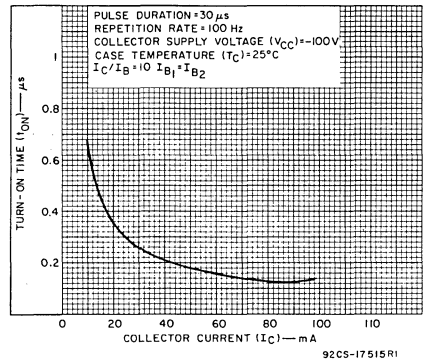


Fig. 10 — Typical turn-on time characteristic for both types.

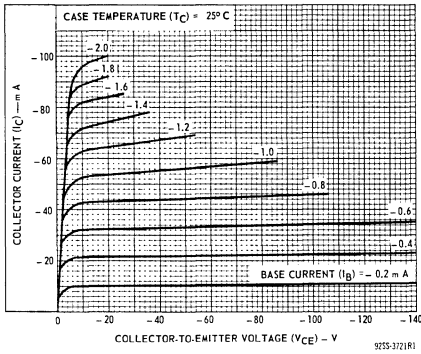


Fig. 11 — Typical output characteristics for both types.

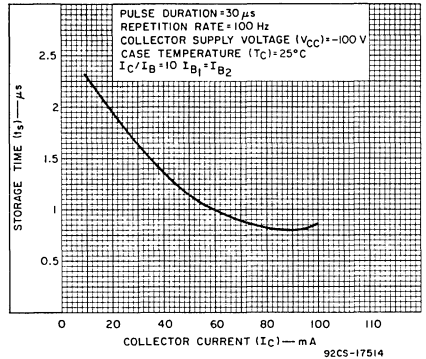


Fig. 12 — Typical storage-time characteristic for both types.

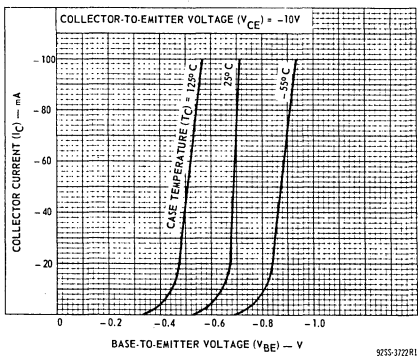


Fig. 13 — Typical transfer characteristics for both types.

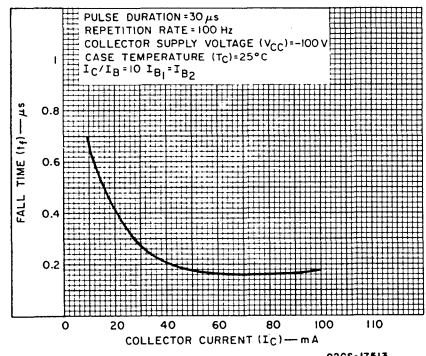
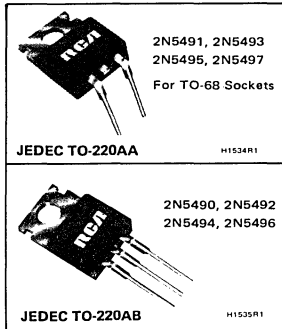


Fig. 14 — Typical fall-time characteristic for both types.



# Power Transistors

2N5490 2N5491  
 2N5492 2N5493  
 2N5494 2N5495  
 2N5496 2N5497



## Hometaxial-Base, Silicon N-P-N VERSAWATT Transistors

General-Purpose Types for Medium-Power Switching and Amplifier Applications in Military, Industrial, and Commercial Equipment

### FEATURES

- Low saturation voltage—
  - $V_{CE(sat)} = 1 \text{ V max. at } I_C = 2 \text{ A (2N5490, 2N5491)}$
  - $= 1 \text{ V max. at } I_C = 2.5 \text{ A (2N5492, 2N5493)}$
  - $= 1 \text{ V max. at } I_C = 3 \text{ A (2N5494, 2N5495)}$
  - $= 1 \text{ V max. at } I_C = 3.5 \text{ A (2N5496, 2N5497)}$
- VERSAWATT package (molded silicone plastic)
- Maximum safe-area-of-operation curves specified for DC and pulse operation

RCA-2N5490, 2N5491, 2N5492, 2N5493, 2N5494, 2N5495, 2N5496 and 2N5497\* are hometaxial-base silicon n-p-n transistors. They are intended for a wide variety of medium-power switching and amplifier applications, such as series and shunt regulators and driver and output stages of high-fidelity amplifiers.

Types 2N5491, 2N5493, 2N5495, and 2N5497 have formed emitter and base leads for insertion into TO-66 sockets. Types 2N5490, 2N5492, 2N5494, and 2N5496 are electrically identical to the 2N5491, 2N5493, 2N5495, and 2N5497 but have straight leads.

These new plastic power transistors differ in voltage ratings and in the currents at which the parameters are controlled.

\* Formerly RCA Dev. Nos. TA7317, TA7318, TA7315, TA7316, TA7313, TA7314, TA7311, TA7312, respectively.

### OPTIONAL LEAD CONFIGURATION

An additional lead forming for printed-circuit-board mounting is also available.

Please submit requirements to your RCA Technical Sales Representative, or write to RCA Low-Frequency Power Marketing, Somerville, N. J. 08876.

### Maximum Ratings, Absolute-Maximum Values:

		2N5490	2N5491	2N5492	2N5493	2N5494	2N5495	2N5496	2N5497
COLLECTOR-TO-BASE VOLTAGE . . . . .	$V_{CBO}$	60	75	90	V				
COLLECTOR-TO-EMITTER SUSTAINING VOLTAGE:									
With -1.5 volts ( $V_{BE}$ ) of reverse bias . . . . .	$V_{CEV(sus)}$	60	75	90	V				
With external base-to-emitter resistance ( $R_{BE}$ ) = 100 $\Omega$ . . . . .	$V_{CER(sus)}$	50	65	80	V				
With base open . . . . .	$V_{CEO(sus)}$	40	55	70	V				
EMITTER-TO-BASE VOLTAGE . . . . .	$V_{EBO}$	5	5	5	V				
COLLECTOR CURRENT . . . . .	$I_C$	7	7	7	A				
BASE CURRENT . . . . .	$I_B$	3	3	3	A				
TRANSISTOR DISSIPATION: . . . . .	$P_T$								
At case temperatures up to 25 $^{\circ}\text{C}$ . . . . .		50	50	50	W				
At ambient temperatures up to 25 $^{\circ}\text{C}$ . . . . .		1.8	1.8	1.8	W				
At case temperatures above 25 $^{\circ}\text{C}$ . . . . .		Derate linearly at 0.4 W/ $^{\circ}\text{C}$ or see Figs. 2 & 3.							
At ambient temperatures above 25 $^{\circ}\text{C}$ . . . . .		Derate linearly at 0.0144 W/ $^{\circ}\text{C}$							
TEMPERATURE RANGE:									
Storage & Operating (Junction) . . . . .		← -65 to 150 →			$^{\circ}\text{C}$				
LEAD TEMPERATURE (During Soldering):									
At distance $\geq 1/8$ in. (3.17 mm) from case for 10 s max . . . . .		← 235 →			$^{\circ}\text{C}$				

ELECTRICAL CHARACTERISTICS, Case Temperature ( $T_C$ ) = 25°C Unless Otherwise Specified

Characteristic	Symbol	TEST CONDITIONS				LIMITS								Units
		DC Voltage (V)		DC Current (A)		Types 2N5496 2N5497		Types 2N5494 2N5495		Types 2N5492 2N5493		Types 2N5490 2N5491		
		$V_{CE}$	$V_{BE}$	$I_C$	$I_B$	Min.	Max.	Min.	Max.	Min.	Max.	Min.	Max.	
Collector-Cutoff Current With base-emitter junction reverse biased	$I_{CEV}$	85 55 70	-1.5 -1.5 -1.5			-	1	-	-	-	-	-	-	mA
	$I_{CEV}$ ( $T_C = 150^\circ C$ )	85 55 70	-1.5 -1.5 -1.5			-	5	-	-	-	-	5	-	mA
Collector-Cutoff Current With external base-to-emitter resistance ( $R_{BE}$ ) = 100 $\Omega$	$I_{CER}$	70 40 55				-	0.5	-	-	-	-	-	2	mA
	$I_{CER}$ ( $T_C = 150^\circ C$ )	70 40 55				-	3.5	-	3.5	-	-	3.5	5	mA
Emitter-Cutoff Current	$I_{EBO}$		-5			-	1	-	1	-	1	-	1	mA
DC Forward-Current Transfer Ratio	$h_{FE}^c$	4		3.5		20	100	-	-	-	-	-	-	
		4		3		-	-	20	100	-	-	-	-	
		4		2.5		-	-	-	-	20	100	-	-	-
		4		2		-	-	-	-	-	-	20	100	-
Collector-to-Emitter Sustaining Voltage: With base open	$V_{CEO(sus)}^c$			0.1	0	70	-	40	-	55	-	40	-	V
With external base-to-emitter resistance ( $R_{BE}$ ) = 100 $\Omega$	$V_{CER(sus)}^c$			0.1		80	-	50	-	65	-	50	-	V
With base-emitter junction reverse biased	$V_{CEV(sus)}^c$		-1.5	0.1		90	-	60	-	75	-	60	-	V
Base-to-Emitter Voltage	$V_{BE}^c$	4		3.5		-	1.7	-	-	-	-	-	-	V
		4		3		-	-	-	1.5	-	-	-	-	V
		4		2.5		-	-	-	-	-	1.3	-	-	V
		4		2		-	-	-	-	-	-	-	1.1	V
Collector-to-Emitter Saturation Voltage	$V_{CE(sat)}^c$			3.5 3 2.5 2	0.35 0.3 0.25 0.2	-	1	-	-	1	-	-	-	V
Gain-Bandwidth Product	$f_T$	4		0.5		0.8	-	0.8	-	0.8	-	0.8	-	MHz
Sat. Switching Time: Turn-On (See Figs.15 and 17)	$t_{on}$	$V_{CC} = 30$		3.5 3 2.5 2	0.35 <sup>a</sup> 0.3 <sup>a</sup> 0.25 <sup>a</sup> 0.2	-	5	-	-	-	-	-	-	$\mu S$
				3.5 3 2.5 2	0.35 <sup>b</sup> 0.3 <sup>b</sup> 0.25 <sup>b</sup> 0.2	-	15	-	-	-	-	-	-	$\mu S$
Turn-Off (See Figs.15 and 17)	$t_{off}$	$V_{CC} = 30$		3.5 3 2.5 2	0.35 <sup>b</sup> 0.3 <sup>b</sup> 0.25 <sup>b</sup> 0.2	-	-	-	15	-	-	15	-	$\mu S$

ELECTRICAL CHARACTERISTICS, Case Temperature ( $T_C$ ) = 25°C Unless Otherwise Specified (Cont'd.)

Characteristic	Symbol	TEST CONDITIONS				LIMITS								Units
		DC Voltage (V)		DC Current (A)		Types 2N5496 2N5497		Types 2N5494 2N5495		Types 2N5492 2N5493		Types 2N5490 2N5491		
		$V_{CE}$	$V_{BE}$	$I_C$	$I_B$	Min.	Max.	Min.	Max.	Min.	Max.	Min.	Max.	
Thermal Resistance: Junction-to-Case	$\theta_{J-C}$					-	2.5	-	2.5	-	2.5	-	2.5	°C/W
Junction-to-Ambient	$\theta_{J-A}$					-	70	-	70	-	70	-	70	°C/W

<sup>a</sup>  $I_{B1}$  value (turn-on base current).

<sup>b</sup>  $I_{B2}$  value (turn-off base current).

<sup>c</sup> Pulsed, pulse duration = 300  $\mu$ s, duty factor = .018.

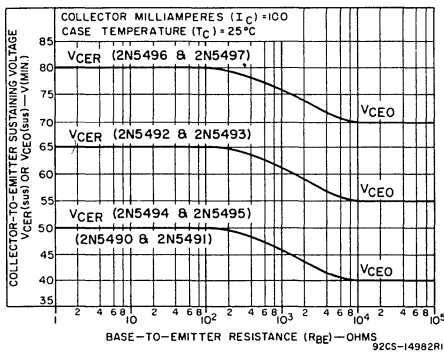


Fig. 1 - Collector-to-emitter sustaining voltage characteristics for types 2N5490 through 2N5497 inclusive.

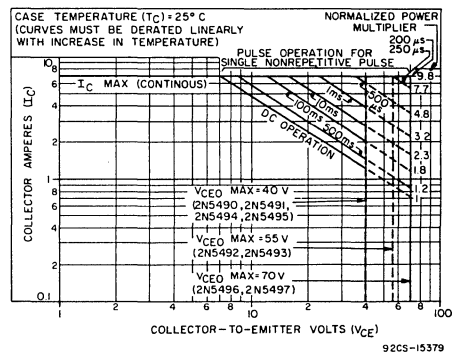


Fig. 2 - Maximum operating areas for types 2N5490 through 2N5497 inclusive.

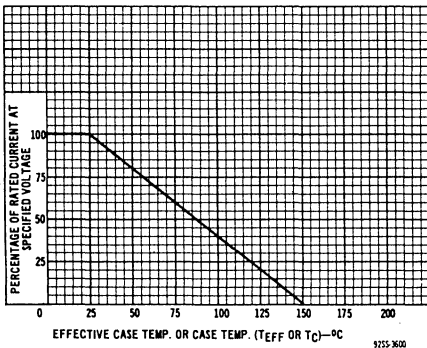


Fig. 3 - Derating curve for types 2N5490 through 2N5497 inclusive.

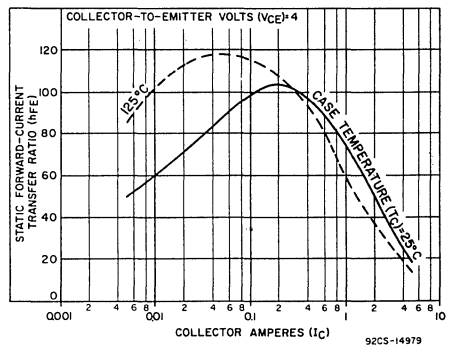


Fig. 4 - Typical static beta characteristics for types 2N5496 and 2N5497.

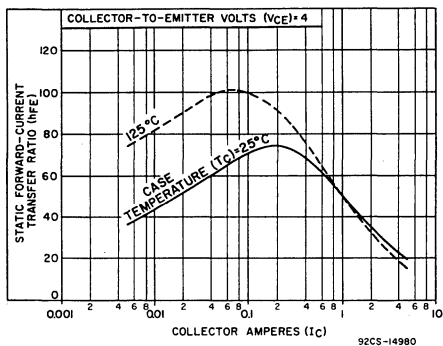


Fig.5 - Typical static beta characteristics for types 2N5494 and 2N5495.

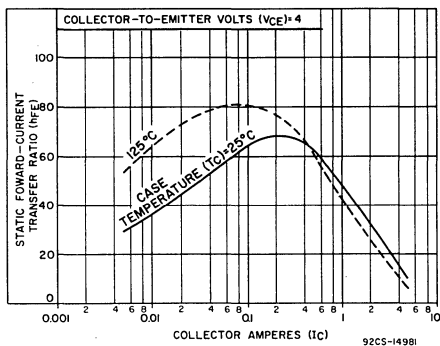


Fig.6 - Typical static beta characteristics for types 2N5490 through 2N5493 inclusive.

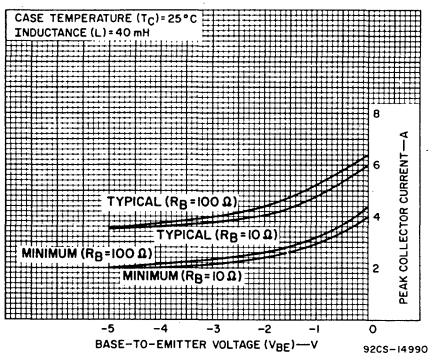


Fig.7 - Reverse bias, second-breakdown characteristics for types 2N5490 through 2N5497 inclusive.

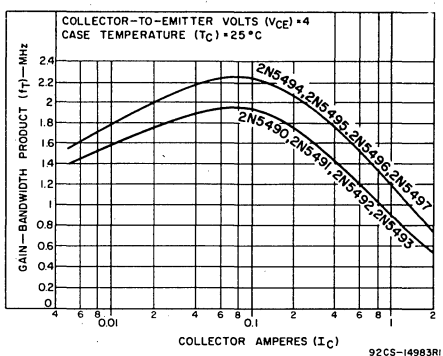


Fig.8 - Typical gain-bandwidth product for types 2N5490 through 2N5497 inclusive.

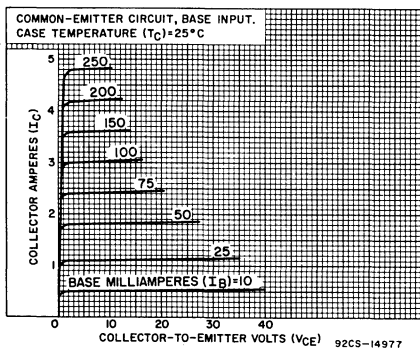


Fig.9 - Typical output characteristics for types 2N5494 through 2N5497 inclusive.

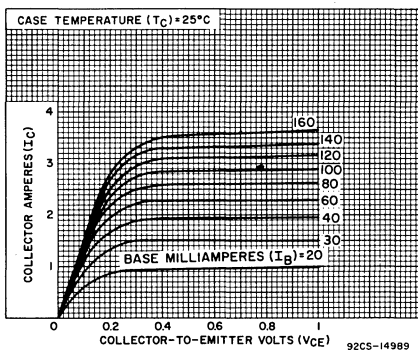


Fig.10 - Typical output characteristics for types 2N5494 and 2N5495.

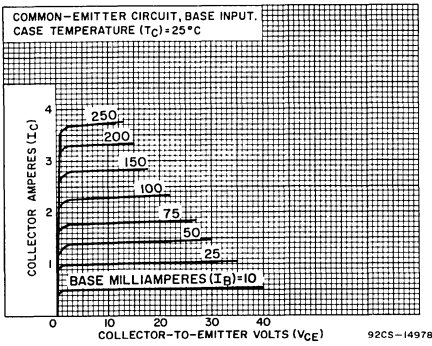


Fig. 11 - Typical output characteristics for types 2N5490 through 2N5493 inclusive.

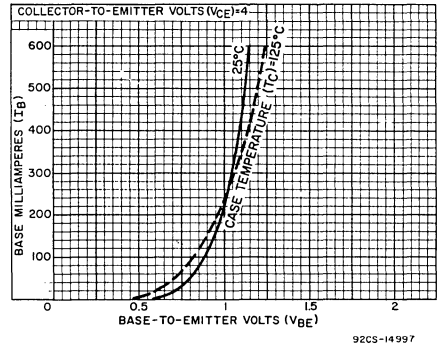


Fig. 12 - Typical input characteristics for types 2N5494 through 2N5497 inclusive.

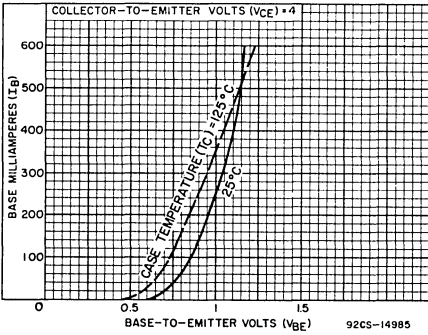


Fig. 13 - Typical input characteristics for types 2N5490 through 2N5493 inclusive.

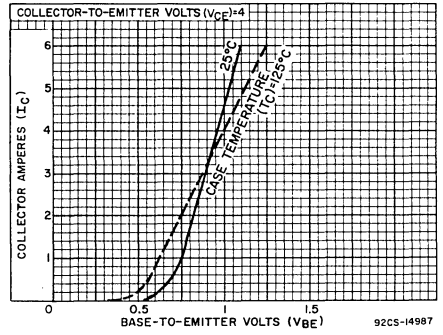


Fig. 14 - Typical transfer characteristics for types 2N5494 through 2N5497 inclusive.

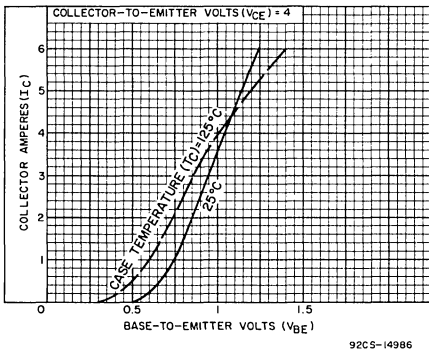


Fig. 15 - Typical transfer characteristics for types 2N5490 through 2N5493 inclusive.

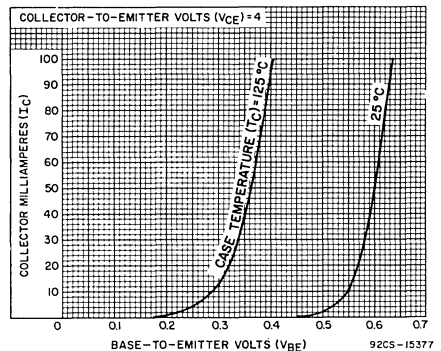


Fig. 16 - Typical transfer characteristics for types 2N5490 through 2N5497 inclusive.

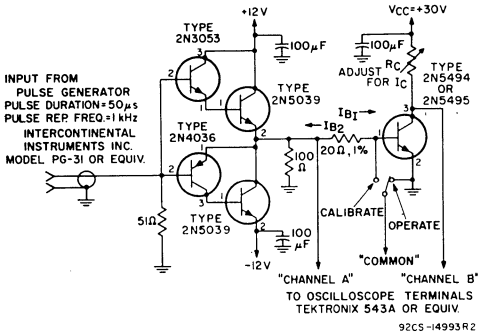


Fig.17 - Circuit used to measure switching times for types 2N5494 and 2N5495.

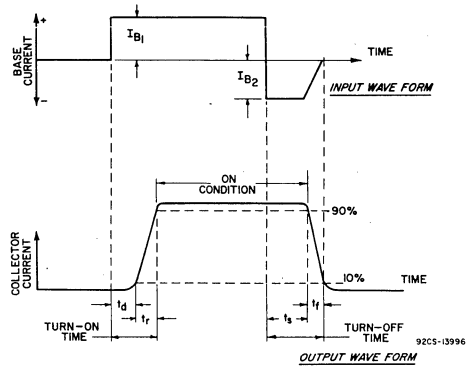


Fig.18 - Oscilloscope display for measurement of switching times (test circuit shown in Fig.17).

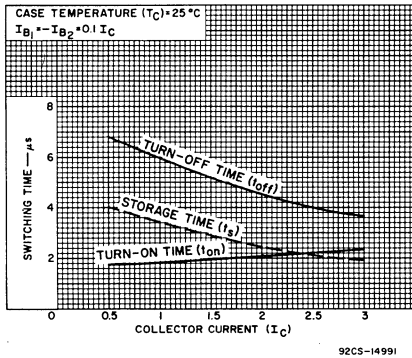


Fig.19 - Typical saturated switching characteristics for types 2N5494 and 2N5495.

**TERMINAL CONNECTIONS  
FOR TYPES 2N5490, 2N5492,  
2N5494, & 2N5496**

- Terminal No. 1-Base
- Terminal No. 3-Emitter
- Terminal No. 4-Collector

**TERMINAL CONNECTIONS  
FOR TYPES 2N5491, 2N5493,  
2N5495, & 2N5497**

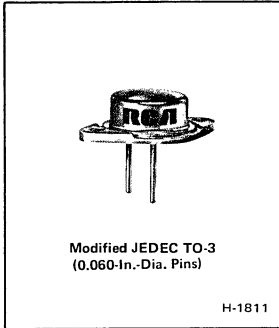
- Terminal No. 1-Base
- Terminal No. 2-Collector
- Terminal No. 3-Emitter
- Terminal No. 4-Collector





# Power Transistors

## 2N5575 2N5578



### High-Current, High-Power, Hometaxial-Base Silicon N-P-N Transistors

For Linear and Switching Applications in Military, Commercial, and Industrial Equipment

**Features:**

- Maximum safe-area-of operation curves
- $I_{S/B}$ -limit line beginning at 25 V
- High-current capability
- Low saturation voltage at high beta
- High-dissipation capability
- Low thermal resistance

RCA-2N5575 and 2N5578<sup>o</sup> are high-current, high-power, hometaxial-base silicon n-p-n transistors. They differ in maximum voltage and current ratings.

These power transistors are intended for a wide variety of high-current, high-power linear and switching applications such as low- to medium-frequency amplifiers, switching and

linear regulators, power-switching circuits, series- or shunt-regulator driver and output stages, dc-to-dc converters, inverters, control circuits, and solenoid (hammer)/relay drivers.

The high-current capability (100-A peak) makes these types particularly suitable for circuit designs that now require several low-current types connected in parallel.

<sup>o</sup> Formerly RCA Dev. Nos. TA7016 and TA7017, respectively.

**MAXIMUM RATINGS, Absolute-Maximum Values:**

		2N5575	2N5578	
*COLLECTOR-TO-BASE VOLTAGE	$V_{CB0}$	70	90	V
*COLLECTOR-TO-EMITTER VOLTAGE:				
With base open, sustaining	$V_{CEO(sus)}$	50	70	V
With external base-to-emitter resistance ( $R_{BE}$ ) = 10 $\Omega$ & $V_{BE}$ = -1.5 V	$V_{CEX}$	70	90	V
*EMITTER-TO-BASE VOLTAGE	$V_{EBO}$	8	8	V
*COLLECTOR CURRENT (Continuous)	$I_C$	80	60	A
*COLLECTOR CURRENT (Peak)		100	80	A
*BASE CURRENT (Continuous)	$I_B$	20	15	A
*TRANSISTOR DISSIPATION:	$P_T$			
At case temperatures up to 25°C and $V_{CE}$ up to 25 V		300	300	W
At case temperatures of 100°C and $V_{CB}$ of 25 V		150	150	W
At case temperatures up to 25°C and $V_{CE}$ above 25 V				See Fig. 1
At case temperatures above 25°C and $V_{CE}$ above 25 V				See Figs. 1 & 2
*TEMPERATURE RANGE:				
Operating (Junction)		-65 to 175		°C
Storage		-65 to 200		°C
*PIN TEMPERATURE (During Soldering):				
At distance $\geq$ 1/32 in. (0.8 mm) from case for 10 s max.		230		°C

\* In accordance with JEDEC registration data format JS-6 RDF-1.

ELECTRICAL CHARACTERISTICS, At Case Temperature ( $T_C$ ) = 25°C Unless Otherwise Specified

CHARACTERISTIC	SYMBOL	TEST CONDITIONS				LIMITS				UNITS
		Voltage V dc		Current A dc		2N5575		2N5578		
		V <sub>CE</sub>	V <sub>BE</sub>	I <sub>C</sub>	I <sub>B</sub>	Min.	Max.	Min.	Max.	
* Collector Cutoff Current: With base-emitter junction reverse-biased	I <sub>CEV</sub>	60 80	-1.5 -1.5			- -	10 -	- -	- 10	mA
With external base-emitter resistance (R <sub>BE</sub> )=10 Ω	I <sub>CER</sub>	50 70				- -	10 -	- -	- 10	mA
* With base-emitter junction reverse-biased	I <sub>CEV</sub> (T <sub>C</sub> =150°C)	60 80	-1.5 -1.5			- -	20 -	- -	- 20	mA
* Emitter Cutoff Current	I <sub>EBO</sub>		-8			-	10	-	10	mA
* Collector-to-Emitter Breakdown Voltage	V <sub>(BR)CEO</sub>			0.2	0	50	-	70	-	
* DC Forward Current Transfer Ratio	h <sub>FE</sub> <sup>a</sup>	3 4		40 <sup>a</sup> 60 <sup>a</sup>		- 10	- 40	10 -	40 -	
Collector-to-Emitter Sustaining Voltage: (See Figs. 5 and 6) With base open	V <sub>CEO(sus)</sub>			0.2		50 <sup>b</sup>	-	70 <sup>b</sup>	-	V
With base-emitter junction reverse-biased, R <sub>BE</sub> =10 Ω	V <sub>CEx(sus)</sub>		-1.5	0.2		70 <sup>b</sup>	-	90 <sup>b</sup>	-	V
Base-to-Emitter Voltage	V <sub>BE</sub> <sup>a</sup>	4 4		40 <sup>a</sup> 60 <sup>a</sup>		- -	- 3	- -	2.5 -	V
* Collector-to-Emitter Saturation Voltage	V <sub>CE(sat)</sub> <sup>a</sup>			40 <sup>a</sup> 60 <sup>a</sup>	4 6	- -	- 2	- -	1.5 -	V
* Base-to-Emitter Saturation Voltage	V <sub>BE(sat)</sub> <sup>a</sup>			40 <sup>a</sup> 60 <sup>a</sup>	4 6	- -	- 3	- -	2.5 -	V
Output Capacitance: (V <sub>CB</sub> = 10 V)	C <sub>ob</sub>					-	2000	-	2000	pF
Input Capacitance	C <sub>ib</sub>		-0.5	0		-	4000	-	4000	pF
* Magnitude of Common- Emitter, Small-Signal, Short-Circuit Forward Current Transfer Ratio (f=0.2 MHz)	h <sub>fe</sub>	4		10		2	-	2		
* Saturated Switching Time (V <sub>CC</sub> = 30 V):				40	4	-	-	-	10	μs
Turn-on time	t <sub>ON</sub>			60	6	-	15	-	-	
Turn-off time	t <sub>OFF</sub>			40 60	4 6	- -	- 15	- -	10 -	
Forward-Bias Second-Breakdown Collector Current (t = 1 s)	I <sub>S/b</sub>	25				12	-	12	-	A

<sup>a</sup>Pulsed; pulse duration ≤ 350 μs, duty factor=0.02.

<sup>b</sup>CAUTION: The sustaining voltages V<sub>CEO(sus)</sub> and V<sub>CEx(sus)</sub> MUST NOT be measured on a curve tracer. These sustaining voltages should be measured by means of the test circuit shown in Fig. 5.

\*In accordance with JEDEC registration data format JS-6 RDF-1.

ELECTRICAL CHARACTERISTICS, At Case Temperature ( $T_C$ ) = 25°C Unless Otherwise Specified (Cont'd.)

CHARACTERISTIC	SYMBOL	TEST CONDITIONS				LIMITS				UNITS
		Voltage V dc		Current A dc		2N5575		2N5578		
		$V_{CE}$	$V_{BE}$	$I_C$	$I_B$	Min.	Max.	Min.	Max.	
Second Breakdown Energy (With base reverse-biased, $R_{BE}=10 \Omega$ , $L=33$ mH)	$E_{S/b}$		-1.5	7		0.8	-	0.8	-	J
Thermal Resistance: (Junction-to-Case)	$R_{\theta JC}$					-	0.5	-	0.5	°C/W

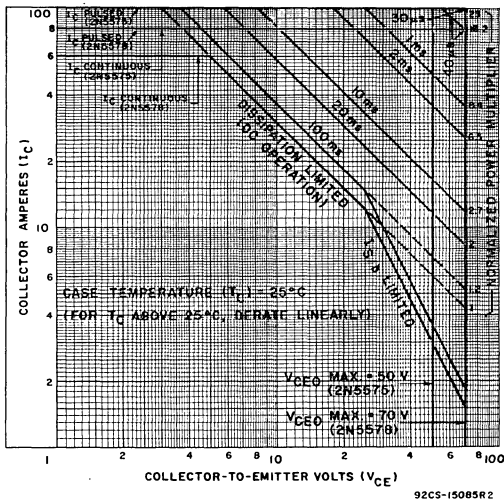


Fig. 1—Maximum operating areas for both types.

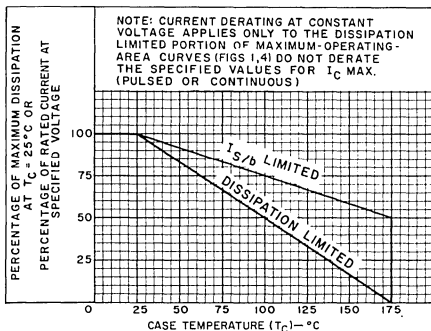


Fig. 2—Dissipation derating curves for both types.

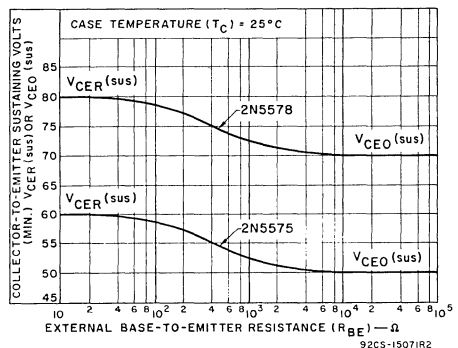


Fig. 3—Collector-to-emitter sustaining voltage characteristics for both types.

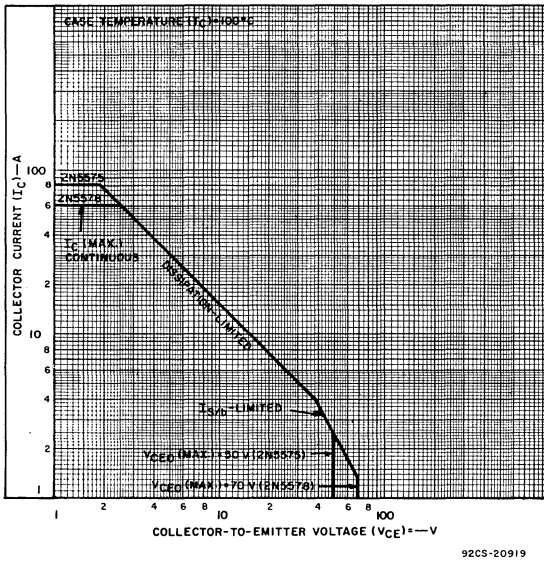


Fig. 4—Maximum operating areas for both types.

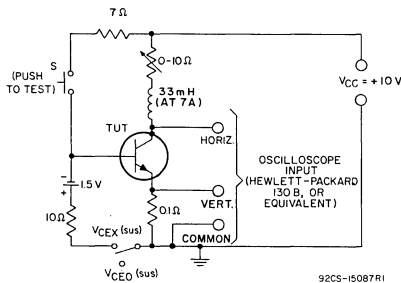
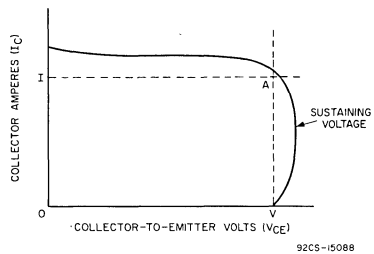


Fig. 5—Circuit used to measure sustaining voltages  $V_{CE0}(sus)$  and  $V_{CEX}(sus)$  for both types.



NOTE:  
The sustaining Voltage  $V_{CE0}(sus)$  or  $V_{CEX}(sus)$  is acceptable when the trace falls to the right and above point "A". (For values of current and voltage, see *Electrical Characteristics*.)

Fig. 6—Oscilloscope display for measurement of sustaining voltages (test circuit shown in Fig. 5).

**TERMINAL CONNECTIONS**

- Pin 1 — Base
- Pin 2 — Emitter
- Case — Collector
- Mounting Flange — Collector

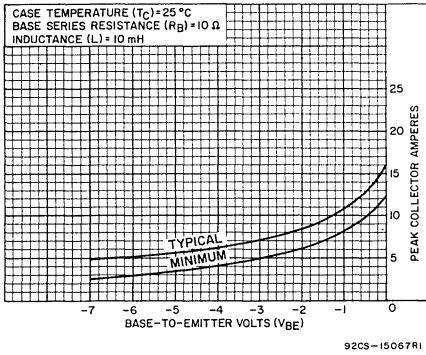


Fig. 7—Reverse-bias second-breakdown characteristics for both types.

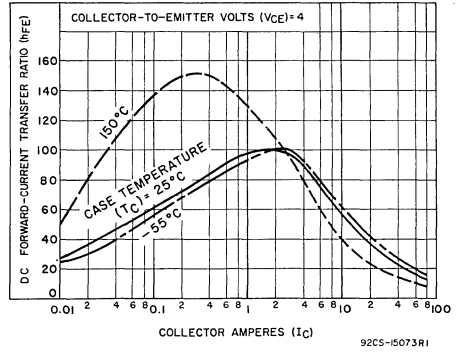


Fig. 8—Typical dc beta characteristics for type 2N5575.

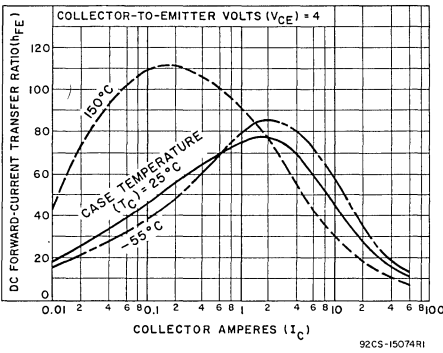


Fig. 9—Typical dc beta characteristics for type 2N5578.

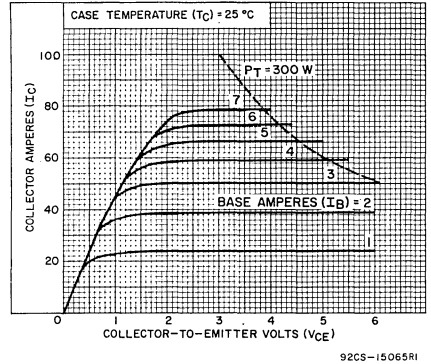


Fig. 10—Typical output characteristics for type 2N5575.

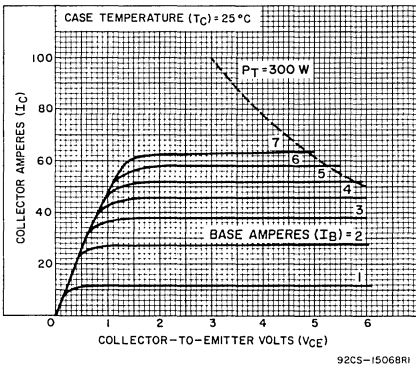


Fig. 11—Typical output characteristics for type 2N5578.

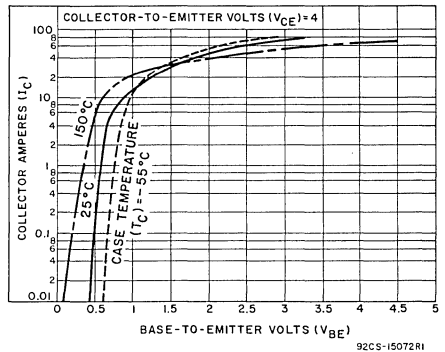


Fig. 12—Typical transfer characteristics for type 2N5575.

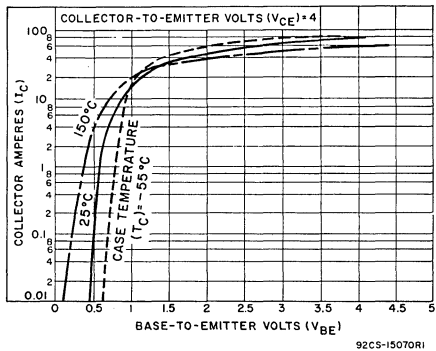


Fig. 13—Typical transfer characteristics for type 2N5578.

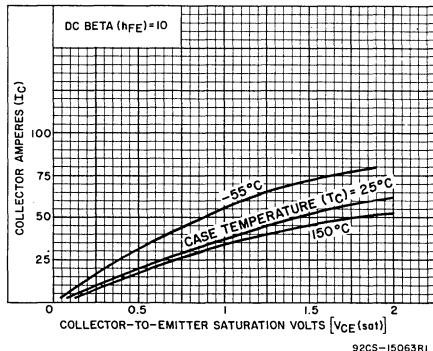


Fig. 14—Typical saturation voltage characteristics for type 2N5575.

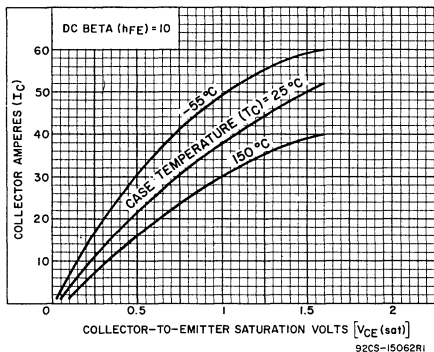


Fig. 15—Typical saturation voltage characteristics for type 2N5578.

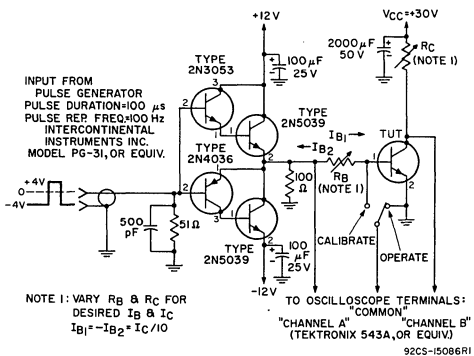


Fig. 16—Circuit used to measure switching times for both types.

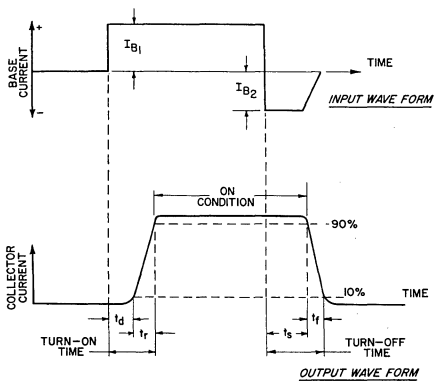


Fig. 17—Oscilloscope display for measurement of switching times (test circuit shown in Fig. 16).

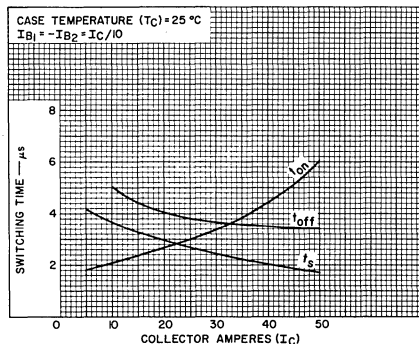


Fig. 18—Typical saturated switching characteristics for both types.



# Power Transistors

2N5671  
2N5672

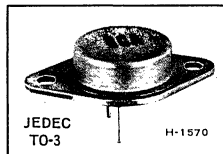
RCA Types 2N5671 and 2N5672<sup>▲</sup> are epitaxial silicon n-p-n transistors having high current and high power handling capability and fast switching speed. The 2N5672 is similar to the 2N5671 except that it has higher voltage ratings and lower leakage currents. These devices are especially suitable for switching-control amplifiers, power gates, switching regulators, power-switching circuits, converters, inverters, control circuits. Other recommended applications included DC-RF amplifiers and power oscillators.

<sup>▲</sup>Formerly Dev. Types TA7323 and TA7323A, respectively

## SILICON N-P-N POWER TRANSISTORS

High-Current, High-Speed  
High-Power Types

For Switching and  
Amplifier Applications in Military, Industrial,  
and Commercial Equipment



### MAXIMUM RATINGS, Absolute-Maximum Values:

*COLLECTOR-TO-BASE VOLTAGE, $V_{CBO}$ .....	2N5671	2N5672
	120	150

### COLLECTOR-TO-EMITTER SUSTAINING VOLTAGE:

With base open, $V_{CEO(sus)}$ .....	90	120	V
With external base-to-emitter resistance ( $R_{BE}$ ) $\leq 50 \Omega$ , $V_{CER(sus)}$ .....	110	140	V
With external base-to-emitter resistance ( $R_{BE}$ ) $\leq 50 \Omega$ & $V_{BE} = -1.5$ , $V_{CEX(sus)}$ .....	120	150	V
*EMITTER-TO-BASE VOLTAGE, $V_{EBO}$ .....	7	7	V
*COLLECTOR CURRENT, $I_C$ .....	30	30	A
*BASE CURRENT, $I_B$ .....	10	10	A
*TRANSISTOR DISSIPATION, $P_T$ :			

At case temperatures up to 25° C and $V_{CE}$ up to 24 V .....	140	140	W
At case temperatures up to 25° C and $V_{CE}$ above 24 V .....	See Fig. 2.		
At case temperatures above 25° C and $V_{CE}$ above 24 V .....	See Figs. 1&2.		

*TEMPERATURE RANGE:			
Storage & Operating (Junction) .....	-65 to +200		°C
*PIN TEMPERATURE (During Soldering)			
At distances $\geq 1/32$ in. from seating plane for 10 s max .....	230		°C

\*In accordance with JEDEC registration data format (JS-6, RFD-1)

### Features

- Maximum Safe-Area-of-Operation Curves . . .  $I_{S/b}$  limit line beginning at 24 V
- Fast Turn-On Time . . .  $t_{on} = 0.5\mu s$  max. at  $I_C = 15 A$
- High-Current Capability . . .  $h_{FE}$ ,  $V_{CE(sat)}$ ,  $V_{BE(sat)}$ , &  $V_{BE}$  measured at  $I_C = 15 A$
- Low  $V_{CE(sat)} = 0.75 V$  max.
- High  $P_T = 140 W$  max. at  $T_C = 25^\circ C$

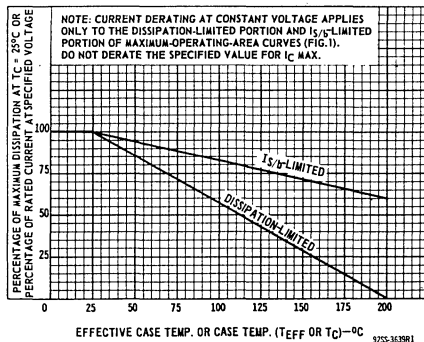


Fig. 1 - Dissipation derating curves for types 2N5671 & 2N5672

ELECTRICAL CHARACTERISTICS, Case Temperature ( $T_C$ ) = 25°C Unless Otherwise Specified

CHARACTERISTIC	SYMBOL	TEST CONDITIONS						LIMITS				UNITS
		DC Voltage (V)			DC Current (A)			Type 2N5671		Type 2N5672		
		$V_{CB}$	$V_{CE}$	$V_{BE}$	$I_C$	$I_B$	Min.	Max.	Min.	Max.		
* * Collector-Cutoff Current	$I_{CEO}$ $I_{CEV}$ $I_{CEV}$ ( $T_C=150^\circ\text{C}$ )	-	80 110 135 100	- -1.5 -1.5 -1.5	-	0 - - -	-	10 12 - 15	-	10 - 10 10	mA mA mA mA	
* Emitter-Cutoff Current	$I_{EBO}$	-	-	-7	0	-	-	10	-	10	mA	
Collector-to-Emitter Sustaining Voltage: (See Figs. 3, 4, & 5) With base open	$V_{CEO(sus)}$	-	-	-	0.2	0	90°	-	120°	-	V	
With external base-to-emitter resistance ( $R_{BE} \leq 50\ \Omega$ )	$V_{CER(sus)}$	-	-	-	0.2	0	110°	-	140°	-	V	
With base-emitter junction reverse biased & $R_{BE} \leq 50\ \Omega$	$V_{CEX(sus)}$	-	-	-1.5	0.2	-	120°	-	150°	-	V	
* Base-to-Emitter Saturation Voltage	$V_{BE(sat)}$	-	-	-	15	1.2	-	1.5	-	1.5	V	
Base-to-Emitter Voltage	$V_{BE}$	-	5	-	15	-	-	1.6	-	1.6	V	
* Collector-to-Emitter Saturation Voltage	$V_{CE(sat)}$	-	-	-	15	1.2	-	0.75	-	0.75	V	
* DC Forward-Current Transfer Ratio	$h_{FE}$	-	2 5	- -	15 20	- -	20 20	100 -	20 20	100 -		
Second-Breakdown Collector Current <sup>c</sup> With base forward biased	$I_{S/b}^b$	-	24 45	- -	- -	- -	5.8 <sup>c</sup> 0.9 <sup>c</sup>	- -	5.8 <sup>c</sup> 0.9 <sup>c</sup>	- -	A A	
Second-Breakdown Energy With base reverse biased $R_{BE} = 20\ \Omega$ , $L = 180\ \mu\text{H}$	$E_{S/b}^d$	-	-	-4	15	-	20	-	20	-	mJ	
Gain-Bandwidth Product	$f_T$	-	10	-	2	-	50	-	50	-	MHz	
Output Capacitance (At 1 MHz, $I_E = 0$ )	$C_{ob}$	10	-	-	-	-	-	900	-	900	pF	
* Saturated Switching Turn-On Time (Delay Time + Rise Time)	$t_{on}$	$V_{CC} = 30\ \text{V}$	-	-	15	$I_{B1} =$ $I_{B2} =$ 1.2	-	0.5	-	0.5	$\mu\text{s}$	
* Saturated Switching Storage Time	$t_s$	$V_{CC} = 30\ \text{V}$	-	-	15	$I_{B1} =$ $I_{B2} =$ 1.2	-	1.5	-	1.5	$\mu\text{s}$	



ELECTRICAL CHARACTERISTICS, Case Temperature ( $T_C$ ) = 25°C Unless Otherwise Specified (Cont'd.)

CHARACTERISTIC	SYMBOL	TEST CONDITIONS					LIMITS				UNITS
		DC Voltage (V)			DC Current (A)		Type 2N5671		Type 2N5672		
		$V_{CB}$	$V_{CE}$	$V_{BE}$	$I_C$	$I_B$	Min.	Max.	Min.	Max.	
* Saturated Switching Fall Time	$t_f$	$V_{CC}=30\text{ V}$	-	-	15	$I_{B1}=I_{B2}=1.2$	-	0.5	-	0.5	$\mu\text{s}$
Thermal Resistance (Junction-to-Case)	$\theta_{J-C}$	-	40	-	0.5	-	-	1.25	-	1.25	$^{\circ}\text{C/W}$

<sup>a</sup>Pulsed; pulse duration  $\leq 350 \mu\text{s}$ , duty factor=0.02.

<sup>b</sup>CAUTION: The sustaining voltages  $V_{CE0}(\text{sus})$  and  $V_{CEX}(\text{sus})$  MUST NOT be measured on a curve tracer.

These sustaining voltages should be measured by means of the test circuit shown in Fig. 5.

<sup>c</sup> $I_S/b$  is defined as the current at which second breakdown occurs at a specified collector voltage with the emitter-base junction forward-biased for transistor operation in the active region.

<sup>d</sup>Pulsed; 1-s, non-repetitive pulse.

<sup>e</sup> $E_{S/b}$  is defined as the energy at which second breakdown occurs under specified reverse-bias conditions.  $E_{S/b}=1/2LI^2$

where L is a series load or leakage inductance and I is the peak collector current.

\*In accordance with JEDEC registration data format JS-6 RDF-1.

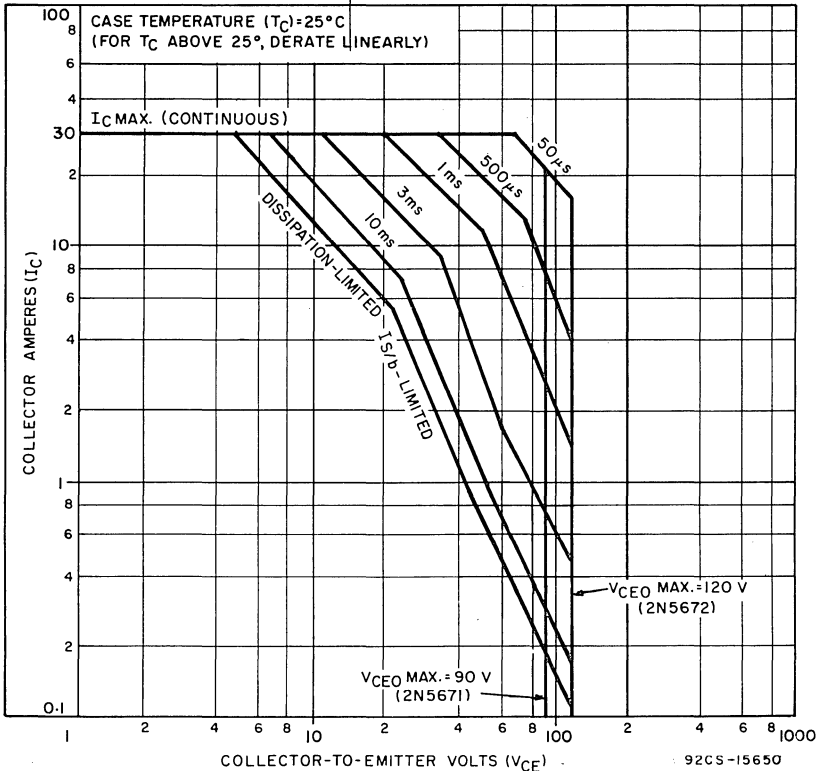


Fig.2 - Maximum operating areas for types 2N5671 & 2N5672

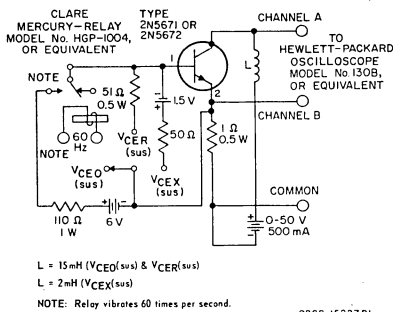
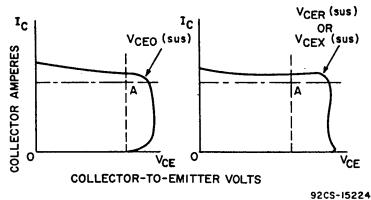


Fig. 3 - Circuit used to measure sustaining voltages  $V_{CE0}(sus)$ ,  $V_{CER}(sus)$ , &  $V_{CEx}(sus)$  for types 2N5671 & 2N5672



NOTE: The sustaining Voltages  $V_{CE0}(sus)$ ,  $V_{CER}(sus)$ , or  $V_{CEx}(sus)$  are acceptable when the trace falls to the right and above point "A". (For values of current and voltage, see Electrical Characteristics.)

Fig. 4 - Oscilloscope display for measurement of sustaining voltages for types 2N5671 & 2N5672 (Test circuit shown in Fig. 3.)

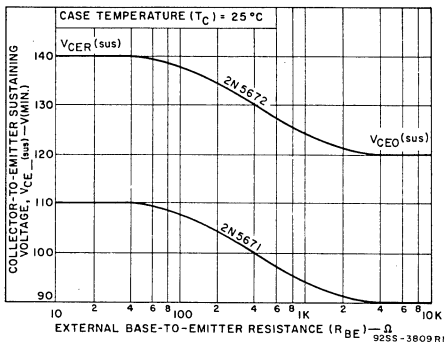


Fig. 5 - Collector-to-emitter sustaining voltage characteristics for types 2N5671 & 2N5672

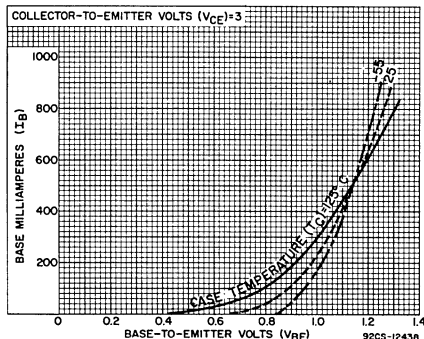


Fig. 6 - Typical input characteristics for types 2N5671 & 2N5672

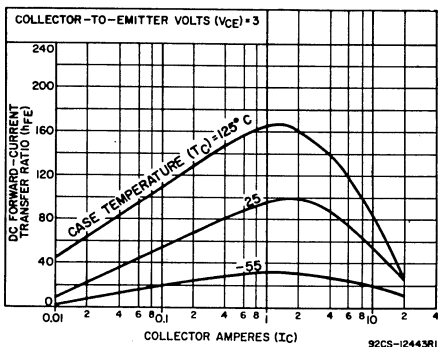


Fig. 7 - Typical DC beta characteristics for types 2N5671 & 2N5672

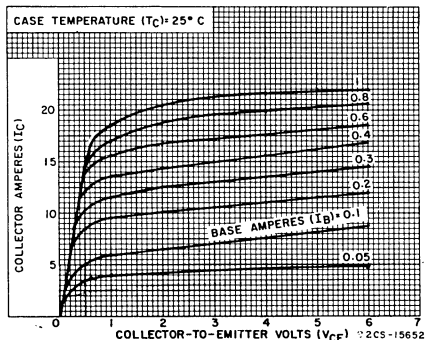


Fig. 8 - Typical output characteristics for types 2N5671 & 2N5672

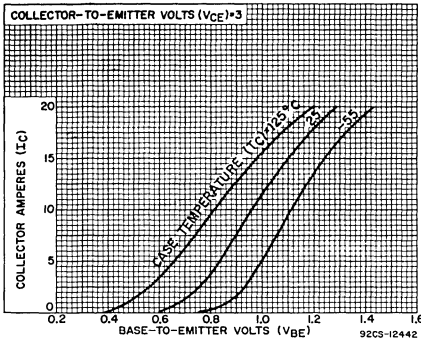


Fig. 9 Typical transfer characteristics for types 2N5671 & 2N5672

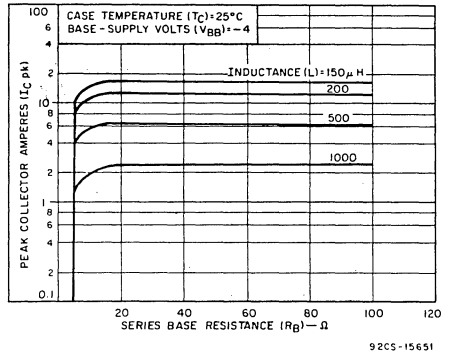


Fig. 10 - Maximum reverse-bias, second-breakdown characteristics for types 2N5671 & 2N5672

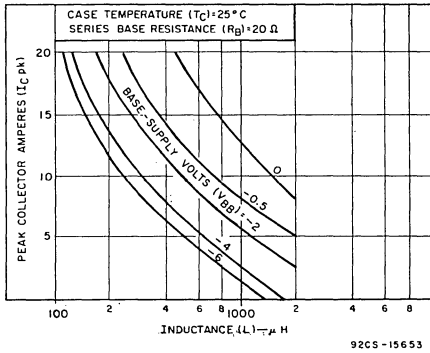


Fig. 11 - Maximum reverse-bias, second-breakdown characteristics for types 2N5671 & 2N5672

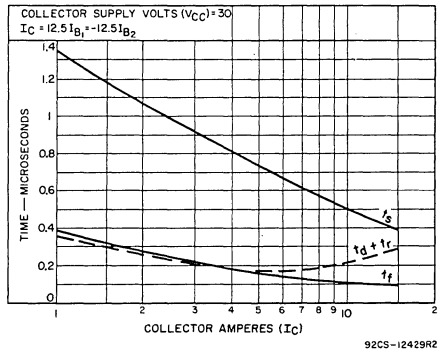


Fig. 12 - Typical saturated switching characteristics for types 2N5671 & 2N5672

TERMINAL CONNECTIONS

- Pin 1 - Base
- Pin 2 - Emitter
- Case - Collector
- Mounting Flange - Collector



# Power Transistors

2N5781 2N5782 2N5783  
2N5784 2N5785 2N5786

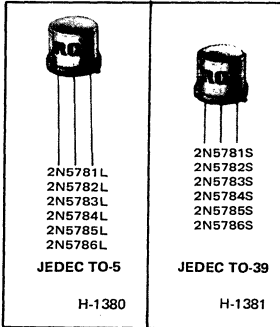
## Silicon N-P-N and P-N-P Epitaxial-Base Complementary-Symmetry Transistors

General-Purpose Types for Switching and Linear-Amplifier Applications

### Features:

- Low saturation voltages
- Maximum safe-area-of-operation curves
- Hermetically sealed package
- High gain at high current
- High breakdown voltages

These devices are available with either 1½-inch leads (TO-5 package) or ½-inch leads (TO-39 package). The longer-lead versions are specified by suffix "L" after the type number; the shorter-lead versions are specified by suffix "S" after the type number.



RCA-2N5781, 2N5782, and 2N5783 are epitaxial-base silicon p-n-p transistors - complements of the homotaxial-base silicon n-p-n types 2N5784, 2N5785, and 2N5786,\* respectively.

The three types in each family differ primarily in voltage ratings and saturation characteristics.

These transistors are intended for medium-power switching and complementary-symmetry audio amplifier applications.

- \* Formerly RCA Dev. Types TA7270, TA7271, TA7272, TA7289, TA7290, and TA7291 respectively.

### MAXIMUM RATINGS, Absolute-Maximum Values:

		P-N-P N-P-N	2N5781* 2N5784	2N5782* 2N5785	2N5783* 2N5786	
*COLLECTOR-TO-BASE VOLTAGE	$V_{CBO}$		80	65	45	V
COLLECTOR-TO-EMITTER SUSTAINING VOLTAGE:						
* With external base-to-emitter resistance ( $R_{BE}$ ) = 100 $\Omega$	$V_{CER}^{(sus)}$		80	65	45	V
With base open	$V_{CEO}^{(sus)}$		65	50	40	V
*EMITTER-TO-BASE VOLTAGE	$V_{EBO}$		5	5	3.5	V
*CONTINUOUS COLLECTOR CURRENT	$I_C$		3.5	3.5	3.5	A
*CONTINUOUS BASE CURRENT	$I_B$		1	1	1	A
*TRANSISTOR DISSIPATION:	$P_T$					
At case temperatures up to 25°C			10	10	10	W
At ambient temperatures up to 25°C			1	1	1	W
At case temperatures above 25°C	Derate linearly		0.057 W/°C, or see Fig. 7.			
At ambient temperatures above 25°C	Derate linearly		0.0057			W/°C
*TEMPERATURE RANGE:			-65 to +200			°C
Storage and operating (Junction)						
*LEAD TEMPERATURE (During soldering):			230			°C
At distance $\geq$ 1/32 in. (0.8 mm) from seating plane for 10 s max.						

\*In accordance with JEDEC registration data format: JS-6 RDF-2.

♦ For p-n-p devices, voltage and current values are negative.

ELECTRICAL CHARACTERISTICS, At Case Temperature ( $T_C$ ) = 25°C unless otherwise specified

CHARACTERISTIC	SYMBOL	TEST CONDITIONS <sup>♦</sup>				LIMITS				UNITS
		VOLTAGE V dc		CURRENT A dc		2N5781 p-n-p		2N5784 n-p-n		
		V <sub>CE</sub>	V <sub>BE</sub>	I <sub>C</sub>	I <sub>B</sub>	Min.	Max.	Min.	Max.	
Collector Cutoff Current: With external base-to-emitter resistance ( $R_{BE}$ ) = 100 $\Omega$	I <sub>CER</sub>	65				—	-10	—	10	$\mu$ A
At $T_C$ = 150°C		65				—	-1	—	1	mA
* With base-emitter junction reverse- biased and external base-to-emitter resistance ( $R_{BE}$ ) = 100 $\Omega$	I <sub>CEX</sub>	-75	1.5			—	-10	—	—	$\mu$ A
		75	-1.5			—	—	—	10	
* At $T_C$ = 150°C		-75	1.5			—	-1	—	—	mA
		75	-1.5			—	—	—	1	
* With base open	I <sub>CEO</sub>	50			0	—	-100	—	100	$\mu$ A
* Emitter Cutoff Current	I <sub>EBO</sub>		-5	0		—	-10	—	10	$\mu$ A
* DC Forward-Current Transfer Ratio	h <sub>FE</sub>	2		1 <sup>a</sup>		20	100	20	100	
		2		3.2 <sup>a</sup>		4	—	4	—	
* Collector-to-Emitter Sustaining Voltage (see Figs. 2 and 3): With base open	V <sub>CEO(sus)</sub>			0.1 <sup>a</sup>	0	-65 <sup>b</sup>	—	65 <sup>b</sup>	—	V
With external base-to-emitter resistance ( $R_{BE}$ ) = 100 $\Omega$	V <sub>CER(sus)</sub>			0.1 <sup>a</sup>		-80 <sup>b</sup>	—	80 <sup>b</sup>	—	
* Base-to-Emitter Voltage	V <sub>BE</sub>	2		1 <sup>a</sup>		—	-1.5	—	1.5	V
* Collector-to-Emitter Saturation Voltage (measured 0.25 in (6.35 mm) from case) <sup>c</sup>	V <sub>CE(sat)</sub>			1 <sup>a</sup>	0.1	—	-0.5	—	0.5	V
* Magnitude of Common-Emitter, Small-Signal, Short-Circuit, Forward-Current Transfer Ratio <sup>d</sup>	h <sub>fe</sub>									
f = 4 MHz							2	15	—	—
f = 200 kHz								5	20	
* Common-Emitter, Small-Signal, Short-Circuit, Forward-Current Transfer Ratio (f = 1 kHz)	h <sub>fe</sub>	2		0.1		25	—	25	—	
Saturated Switching Time (V <sub>CC</sub> = 30 V, I <sub>B1</sub> = I <sub>B2</sub> ): Turn-on (t <sub>d</sub> + t <sub>r</sub> )	t <sub>ON</sub>			-1	-0.1	—	0.5	—	—	$\mu$ s
				1	0.1	—	—	—	5	
Turn-off (t <sub>s</sub> + t <sub>f</sub> )	t <sub>OFF</sub>			-1	-0.1	—	2.5	—	—	
				1	0.1	—	—	—	15	
Thermal Resistance: Junction-to-case	R <sub><math>\theta</math>JC</sub>					—	17.5	—	17.5	°C/W
Junction-to-ambient	R <sub><math>\theta</math>JA</sub>					—	175	—	175	

\* In accordance with JEDEC registration data format JS-6 RDF-2.

<sup>a</sup> Pulsed, pulse duration = 300  $\mu$ s, duty factor = 1.8%

<sup>b</sup> CAUTION: Sustaining voltages V<sub>CEO(sus)</sub>, and V<sub>CER(sus)</sub>  
MUST NOT be measured on a curve tracer.

<sup>♦</sup> For p-n-p devices, voltage and current values are negative.

<sup>c</sup> Lead resistance is critical in this test.

<sup>d</sup> Measured at a frequency where |h<sub>fe</sub>| is decreasing at approximately 6 dB per octave.

ELECTRICAL CHARACTERISTICS, At Case Temperature ( $T_C$ ) = 25°C unless otherwise specified

CHARACTERISTIC	SYMBOL	TEST CONDITIONS <sup>♦</sup>				LIMITS				UNITS
		VOLTAGE V dc		CURRENT A dc		2N5782 p-n-p		2N5785 n-p-n		
		V <sub>CE</sub>	V <sub>BE</sub>	I <sub>C</sub>	I <sub>B</sub>	Min.	Max.	Min.	Max.	
Collector Cutoff Current: With external base-to-emitter resistance ( $R_{BE}$ ) = 100 $\Omega$	I <sub>CER</sub>	50				-	-10	-	10	$\mu$ A
At $T_C$ = 150°C		50				-	-1	-	1	mA
* With base-emitter junction reverse- biased and external base-to-emitter resistance ( $R_{BE}$ ) = 100 $\Omega$	I <sub>CEX</sub>	-60	1.5			-	-10	-	-	$\mu$ A
		60	-1.5			-	-	-	10	
* At $T_C$ = 150°C		-60	1.5			-	-1	-	-	mA
		60	-1.5			-	-	-	1	
* With base open	I <sub>CEO</sub>	35			0	-	-100	-	100	$\mu$ A
* Emitter Cutoff Current	I <sub>EBO</sub>		-5	0		-	-10	-	10	$\mu$ A
* DC Forward-Current Transfer Ratio	h <sub>FE</sub>	2		1.2 <sup>a</sup>		20	100	20	100	
		2		3.2 <sup>a</sup>		4	-	4	-	
* Collector-to-Emitter Sustaining Voltage (see Figs. 2 and 3): With base open	V <sub>CEO(sus)</sub>			0.1 <sup>a</sup>	0	-50 <sup>b</sup>	-	50 <sup>b</sup>	-	V
With external base-to-emitter resistance ( $R_{BE}$ ) = 100 $\Omega$	V <sub>CER(sus)</sub>			0.1 <sup>a</sup>		-65 <sup>b</sup>	-	65 <sup>b</sup>	-	
* Base-to-Emitter Voltage	V <sub>BE</sub>	2		1.2 <sup>a</sup>		-	-1.5	-	1.5	V
* Collector-to-Emitter Saturation Voltage (measured 0.25 in (6.35 mm) from case) <sup>c</sup>	V <sub>CE(sat)</sub>			-1.2 <sup>a</sup>	0.12	-	-0.75	-	0.75	V
				3.2 <sup>a</sup>	0.8 <sup>b</sup>	-	-2	-	2	
* Magnitude of Common-Emitter, Small-Signal, Short-Circuit, Forward-Current Transfer Ratio <sup>d</sup>	h <sub>fe</sub>									
f = 4 MHz		-2		-0.1		2	15	-	-	
f = 200 kHz		2		0.1		-	-	5	20	
* Common-Emitter, Small-Signal, Short-Circuit, Forward-Current Transfer Ratio (f = 1 kHz)	h <sub>fe</sub>	2		0.1		25	-	25	-	
Saturated Switching Time (V <sub>CC</sub> = 30 V, I <sub>B1</sub> = I <sub>B2</sub> ):	t <sub>ON</sub>									$\mu$ s
Turn-on (t <sub>d</sub> + t <sub>r</sub> )				-1	-0.1	-	0.5	-	-	
Turn-off (t <sub>s</sub> + t <sub>f</sub> )	t <sub>OFF</sub>			-1	-0.1	-	2.5	-	-	
				1	0.1	-	-	-	15	
Thermal Resistance: Junction-to-case	R <sub><math>\theta</math>JC</sub>						17.5	-	17.5	$^{\circ}$ C/W
Junction-to-ambient	R <sub><math>\theta</math>JA</sub>						-	175	-	175

\* In accordance with JEDEC registration data format JS-6 RDF-2.

<sup>a</sup> Pulsed, pulse duration = 300  $\mu$ s, duty factor = 1.8%.

<sup>b</sup> CAUTION: Sustaining voltages V<sub>CEO(sus)</sub>, and V<sub>CER(sus)</sub> MUST NOT be measured on a curve tracer.

<sup>♦</sup> For p-n-p devices, voltage and current values are negative.

<sup>c</sup> Lead resistance is critical in this test.

<sup>d</sup> Measured at a frequency where |h<sub>fe</sub>| is decreasing at approximately 6 dB per octave.

**ELECTRICAL CHARACTERISTICS, At Case Temperature ( $T_C$ ) = 25°C unless otherwise specified**

CHARACTERISTIC	SYMBOL	TEST CONDITIONS <sup>♦</sup>				LIMITS				UNITS
		VOLTAGE		CURRENT		2N5783		2N5786		
		V dc	A dc	p-n-p	n-p-n	Min.	Max.	Min.	Max.	
		V <sub>CE</sub>	V <sub>BE</sub>	I <sub>C</sub>	I <sub>B</sub>					
Collector Cutoff Current: With external base-to-emitter resistance (R <sub>BE</sub> ) = 100 Ω	I <sub>CER</sub>	40				-	-10	-	10	μA
At T <sub>C</sub> = 150°C		40.				-	-1	-	1	mA
* With base-emitter junction reverse- biased and external base-to-emitter resistance (R <sub>BE</sub> ) = 100 Ω	I <sub>CEX</sub>	-45	1.5			-	-10	-	-	μA
At T <sub>C</sub> = 150°C		45	-1.5			-	-	-	10	μA
* With base open	I <sub>CEO</sub>	-45	1.5			-	-1	-	-	mA
		45	-1.5			-	-	-	1	mA
* With base open	I <sub>CEO</sub>	25			0	-	-100	-	100	μA
* Emitter Cutoff Current	I <sub>EBO</sub>		-3.5	0		-	-10	-	10	μA
* DC Forward-Current Transfer Ratio	h <sub>FE</sub>	2		1.6 <sup>a</sup>		20	100	20	100	
		2		3.2 <sup>a</sup>		4	-	4	-	
* Collector-to-Emitter Sustaining Voltage (see Figs. 2 and 3): With base open	V <sub>CEO(sus)</sub>			0.1 <sup>a</sup>	0	-40 <sup>b</sup>	-	40 <sup>b</sup>	-	V
With external base-to-emitter resistance (R <sub>BE</sub> ) = 100 Ω	V <sub>CER(sus)</sub>			0.1 <sup>a</sup>		-45 <sup>b</sup>	-	45 <sup>b</sup>	-	V
* Base-to-Emitter Voltage	V <sub>BE</sub>	2		1.6 <sup>a</sup>		-	-1.5	-	1.5	V
* Collector-to-Emitter Saturation Voltage (measured 0.25 in (6.35 mm) from case) <sup>c</sup>	V <sub>CE(sat)</sub>			1.6 <sup>a</sup>	0.16	-	-1	-	1	V
				3.2 <sup>a</sup>	0.8	-	-2	-	2	V
* Magnitude of Common-Emitter, Small-Signal, Short-Circuit, Forward-Current Transfer Ratio <sup>d</sup>	h <sub>fe</sub>									
f = 4 MHz		-2		-0.1		2	15	-	-	
f = 200 kHz	2		0.1		-	-	5	20		
* Common-Emitter, Small-Signal, Short-Circuit, Forward-Current Transfer Ratio (f = 1 kHz)	h <sub>fe</sub>	2		0.1		25	-	25	-	
Saturated Switching Time (V <sub>CC</sub> = 30 V, I <sub>B1</sub> = I <sub>B2</sub> ): Turn-on (t <sub>d</sub> + t <sub>r</sub> )	t <sub>ON</sub>			-1	-0.1	-	0.5	-	-	μs
Turn-off (t <sub>s</sub> + t <sub>f</sub> )	t <sub>OFF</sub>			-1	-0.1	-	2.5	-	-	
Thermal Resistance : Junction-to-case	R <sub>θJC</sub>						17.5	-	17.5	°C/W
Junction-to-ambient	R <sub>θJA</sub>						175	-	175	°C/W

\* In accordance with JEDEC registration data format JS-6 RDF-2.

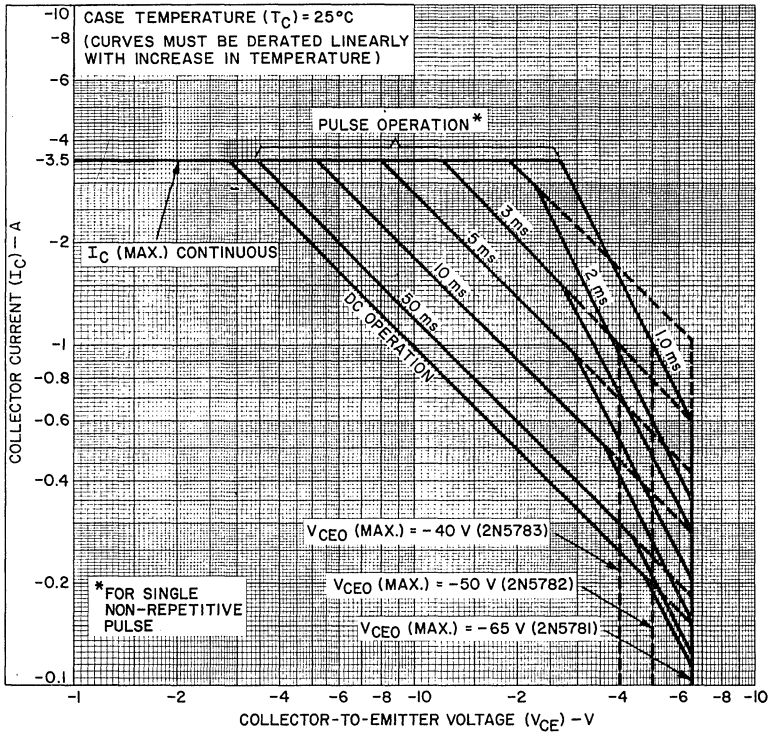
<sup>a</sup> Pulsed, pulse duration = 300 μs, duty factor = 1.8%.

<sup>b</sup> CAUTION: Sustaining voltages V<sub>CEO(sus)</sub>, and V<sub>CER(sus)</sub> MUST NOT be measured on a curve tracer.

♦ For p-n-p devices, voltage and current values are negative.

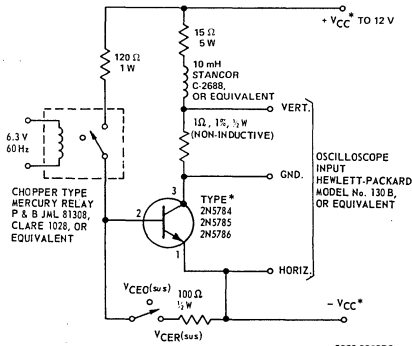
<sup>c</sup> Lead resistance is critical in this test.

<sup>d</sup> Measured at a frequency where |h<sub>fe</sub>| is decreasing at approximately 6 dB per octave.



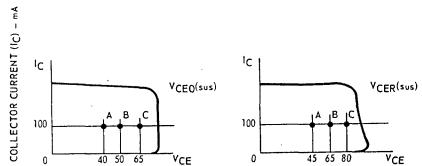
92CS-23943

Fig. 1 - Maximum operating areas for types 2N5781, 2N5782, and 2N5783.



\* FOR P-N-P TYPES 2N5781, 2N5782, & 2N5783, REVERSE POLARITY OF  $V_{CC}$ .

Fig. 2 - Circuit used to measure sustaining voltages  $V_{CEO}(sus)$  and  $V_{CEA}(sus)$ .

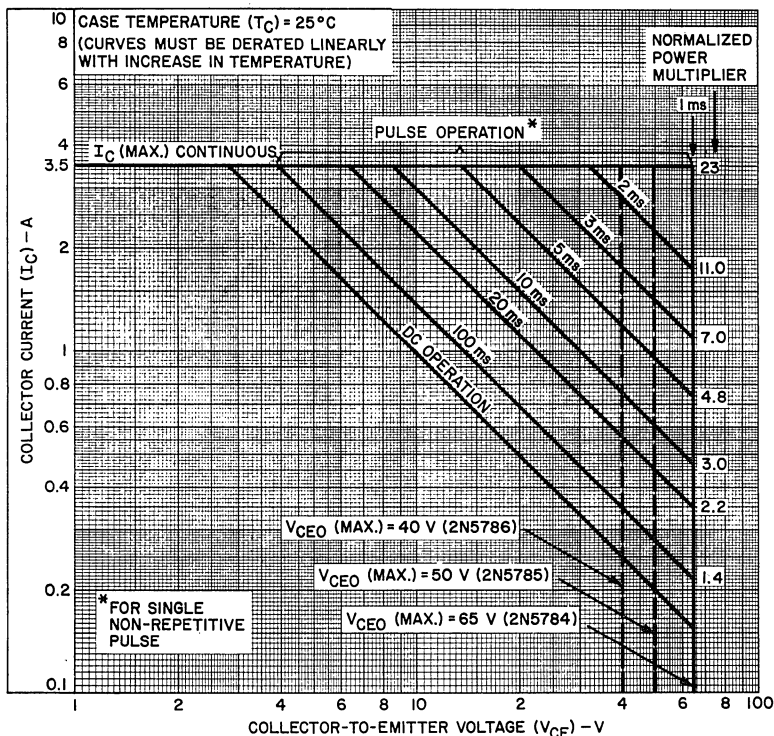


\* FOR TYPES 2N5781, 2N5782, AND 2N5783, THE VALUES FOR  $I_C$  AND  $V_{CE}$  ARE NEGATIVE.

The sustaining voltages  $V_{CEO}(sus)$  and  $V_{CEA}(sus)$  are acceptable when the trace fails to the right and above point "A" (2N5783 & 2N5786), "B" (2N5782 & 2N5785), or "C" (2N5781 & 2N5784).

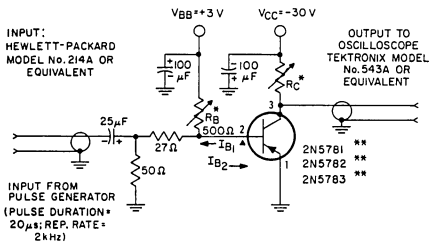
Fig. 3 - Oscilloscope display for measurement of sustaining voltages. (Test circuit shown in Fig. 2).





92CS-23944

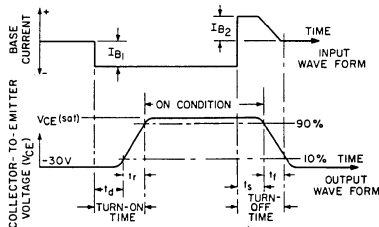
Fig. 4 - Maximum operating areas for types 2N5784, 2N5785, and 2N5786.



\*ADJUST  $R_B$  FOR  $I_{B2}$  AND  $R_C$  FOR  $I_C$   
 $I_{B1}$  AND  $I_{B2}$  MEASURED WITH TEKTRONIX CURRENT PROBE P6019 AND TYPE 134 AMPLIFIER, OR EQUIVALENT  
 \*\*For N-P-N types 2N5784, 2N5785, & 2N5786, reverse direction of  $I_{B1}$  and  $I_{B2}$  and reverse polarity of  $V_{BB}$  and  $V_{CC}$ .

92CS-15618R1

Fig. 5 - Circuit used to measure saturated switching times.



92CS-15619

Fig. 6 - Oscilloscope display for measurement of switching times. (Test circuit shown in Fig. 5).

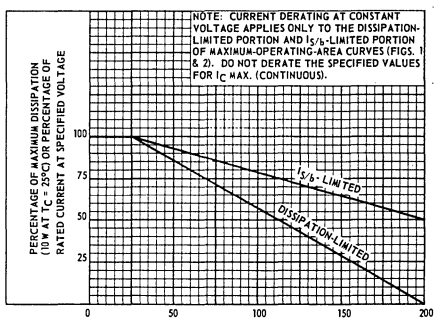


Fig. 7 - Dissipation derating curve for all types.

TERMINAL CONNECTIONS

- Lead 1 - Emitter
- Lead 2 - Base
- Lead 3 - Collector
- Case - Collector

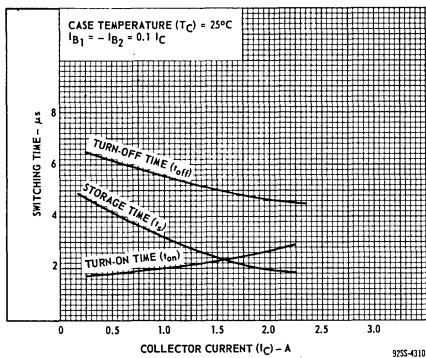


Fig. 8 - Typical saturated switching characteristics for types 2N5784, 2N5785, & 2N5786.

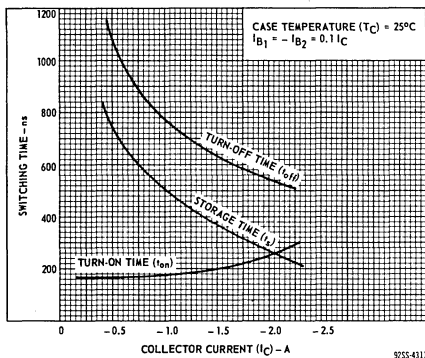


Fig. 9 - Typical saturated switching characteristics for types 2N5781, 2N5782, & 2N5783.

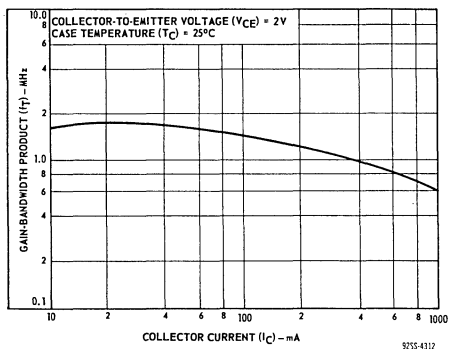


Fig. 10 - Typical gain-bandwidth product for types 2N5784, 2N5785, & 2N5786.

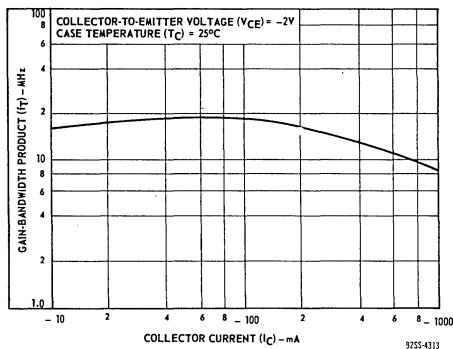


Fig. 11 - Typical gain-bandwidth product for types 2N5781, 2N5782, & 2N5783.

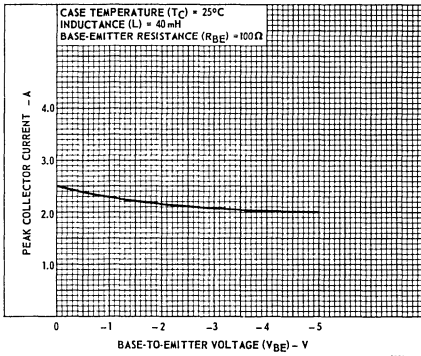


Fig. 12-Reverse-bias second-breakdown characteristics for types 2N5784, 2N5785, & 2N5786.

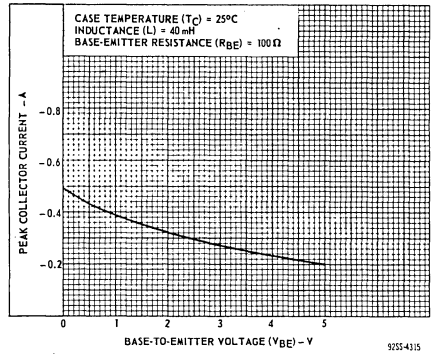


Fig. 13-Reverse-bias second-breakdown characteristics for types 2N5781, 2N5782, & 2N5783.

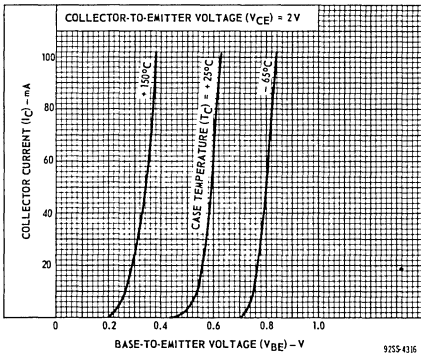


Fig. 14-Typical transfer characteristics for types 2N5784, 2N5785, & 2N5786.

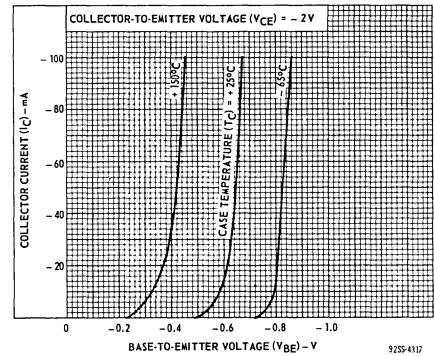


Fig. 15-Typical transfer characteristics for types 2N5781, 2N5782, & 2N5783.

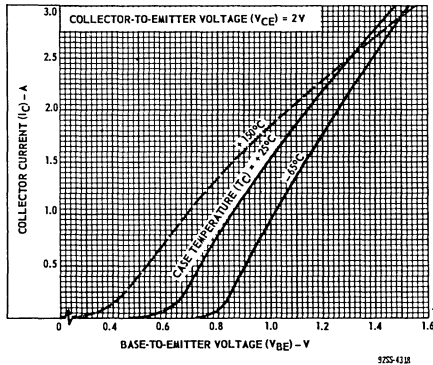


Fig. 16-Typical transfer characteristics for types 2N5784, 2N5785, & 2N5786.

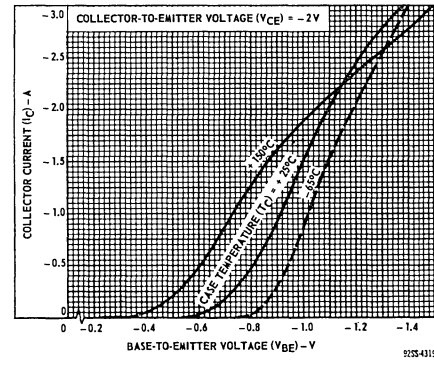


Fig. 17-Typical transfer characteristics for types 2N5781, 2N5782, & 2N5783.

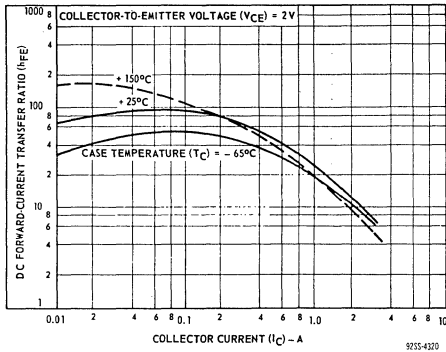


Fig. 18 - Typical DC-beta characteristics for type 2N5784.

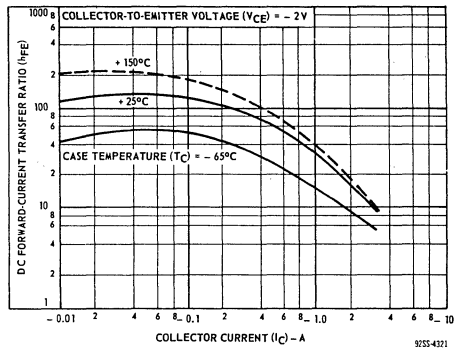


Fig. 19 - Typical DC-beta characteristics for type 2N5781.

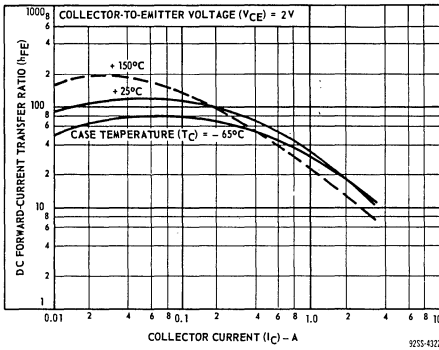


Fig. 20 - Typical DC-beta characteristics for type 2N5785.

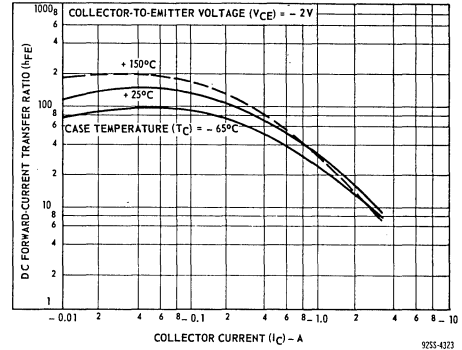


Fig. 21 - Typical DC-beta characteristics for type 2N5782.

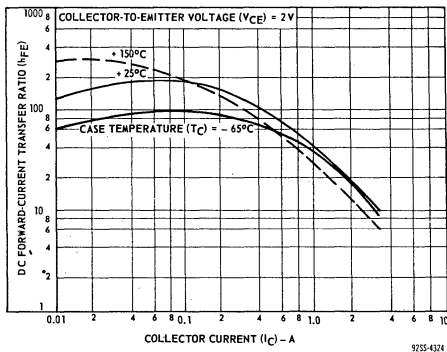


Fig. 22 - Typical DC-beta characteristics for type 2N5786.

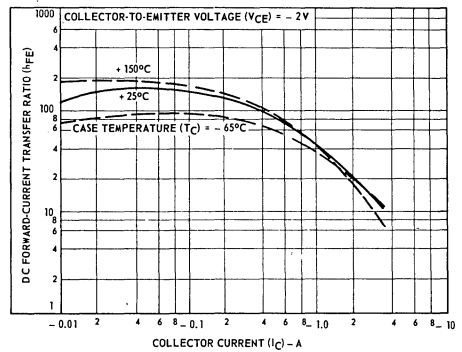
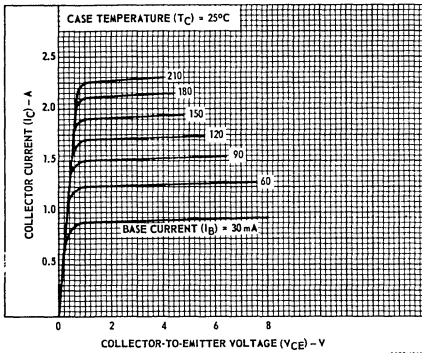
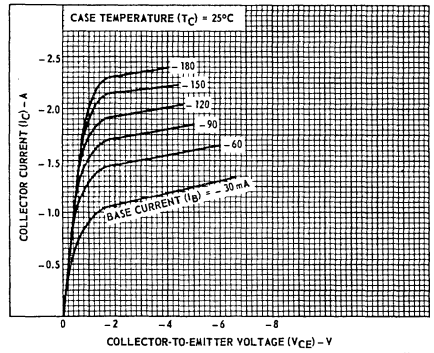


Fig. 23 - Typical DC-beta characteristics for type 2N5783.



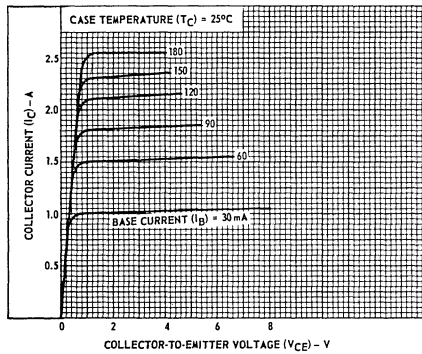
9255-4326

Fig. 24 - Typical output characteristics for type 2N5784.



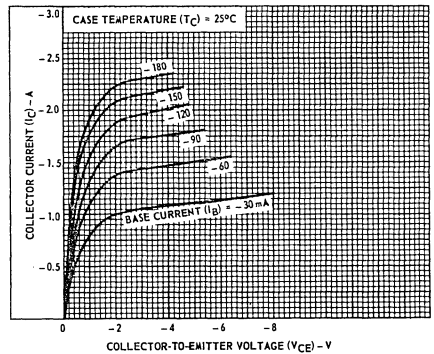
9255-4327

Fig. 25 - Typical output characteristics for type 2N5781.



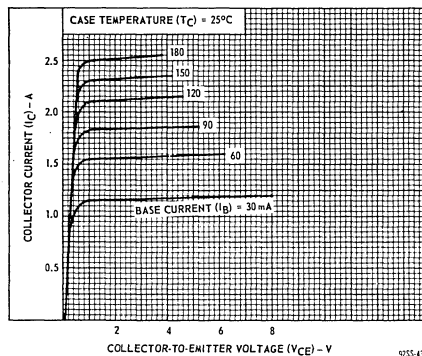
9255-4328

Fig. 26 - Typical output characteristics for type 2N5785.



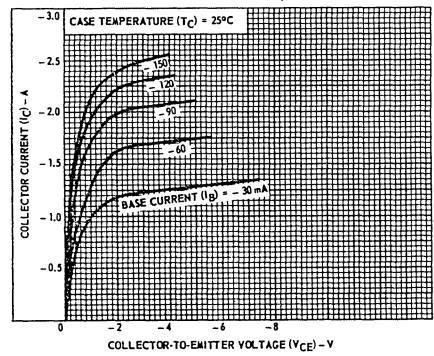
9255-4329

Fig. 27 - Typical output characteristics for type 2N5782.



9255-4330

Fig. 28 - Typical output characteristics for type 2N5786.



9255-4331

Fig. 29 - Typical output characteristics for type 2N5783.

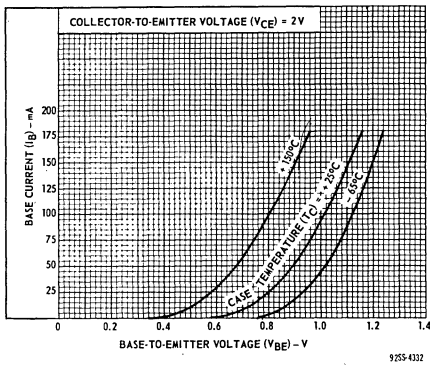


Fig. 30 - Typical input characteristics for type 2N5784.

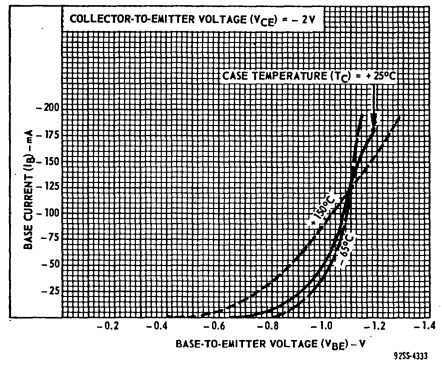


Fig. 31 - Typical input characteristics for type 2N5781.

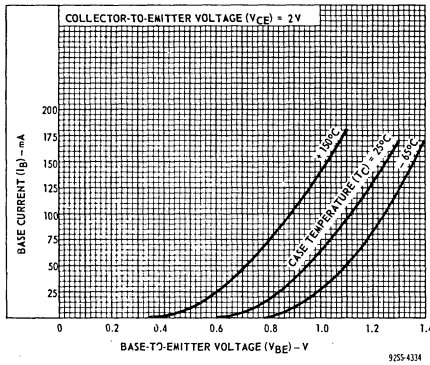


Fig. 32 - Typical input characteristics for type 2N5785.

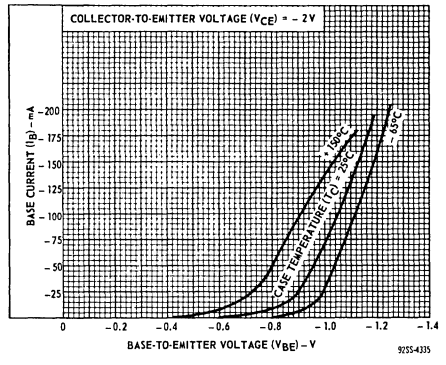


Fig. 33 - Typical input characteristics for type 2N5782.

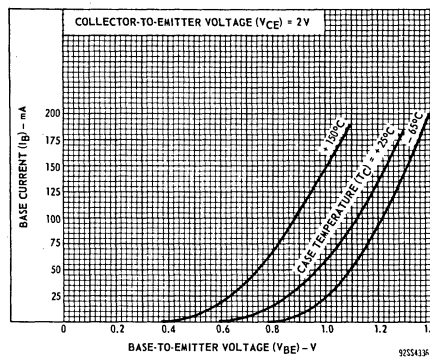


Fig. 34 - Typical input characteristics for type 2N5786.

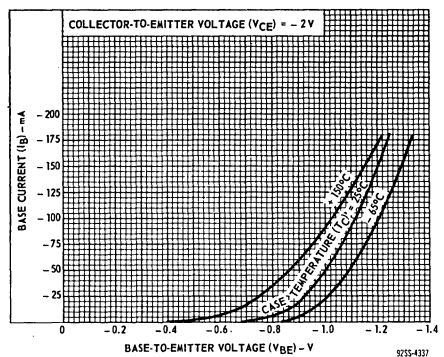
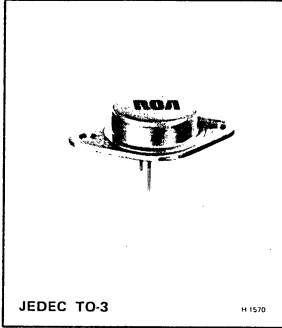


Fig. 35 - Typical input characteristics for type 2N5783.



# Power Transistors

2N5804  
2N5805



## High-Voltage, High-Power Silicon N-P-N Power Transistors

For Switching and Amplifier Applications

*Features:*

- Power dissipation ( $P_T$ ) = 110 W at 50 V
- High-voltage ratings:  
 $V_{CEO(sus)} = 300$  V max. (2N5805)  
 $= 225$  V max. (2N5804)
- Maximum-operating-area curves, for selection of maximum operating conditions for operation free from second breakdown.

RCA types 2N5804 and 2N5805\*\* are silicon n-p-n transistors with high breakdown-voltage ratings and fast switching speeds. Both devices employ the popular TO-3 package; they differ in breakdown-voltage ratings and leakage-current values. These transistors are especially suitable for power-switching circuits, switching regulators, converters, inverters, and power amplifiers.

\*\*Formerly RCA Dev. Nos. TA7130 and TA7130A, respectively.

**TERMINAL CONNECTIONS**

- Pin 1 — Base
- Pin 2 — Emitter
- Case — Collector
- Mounting Flange — Collector

**MAXIMUM RATINGS, Absolute-Maximum Values:**

	2N5804	2N5805	
*COLLECTOR-TO-BASE VOLTAGE	$V_{CBO}$ 300	375	V
COLLECTOR-TO-EMITTER SUSTAINING VOLTAGE:			
* With 1.5 volts ( $V_{BE}$ ) of reverse bias, and external base-to-emitter resistance ( $R_{BE}$ ) = 50 $\Omega$	$V_{CEX(sus)}$ 300	375	V
With base open	$V_{CEO(sus)}$ 225	300	V
*EMITTER-TO-BASE VOLTAGE	$V_{EBO}$ 6	6	V
*CONTINUOUS COLLECTOR CURRENT	$I_C$ 5	5	A
PEAK COLLECTOR CURRENT	$I_{CM}$ 15	15	A
*CONTINUOUS BASE CURRENT	$I_B$ 2	2	A
*TRANSISTOR DISSIPATION:	$P_T$		
At case temperatures up to 25° C and $V_{CE}$ up to 50 V	110	110	W
At case temperatures up to 25° C and $V_{CE}$ above 50 V		See Fig. 1	
At case temperatures above 25° C and $V_{CE}$ above 50 V		See Figs. 1 & 3	
*TEMPERATURE RANGE:			
Storage & Operating (Junction)	— -65 to +200 —		°C
*PIN TEMPERATURE (During Soldering):			
At distances $\geq$ 1/32 in. (0.8 mm) from seating plane for 10 s max	— +230 —		°C

\*In accordance with JEDEC registration data format (JS-6 RDF-1)

ELECTRICAL CHARACTERISTICS, At Case Temperature ( $T_C$ ) = 25°C Unless Otherwise Specified

CHARACTERISTIC	SYMBOL	TEST CONDITIONS				LIMITS				UNITS
		VOLTAGE V dc		CURRENT A dc		2N5804		2N5805		
		V <sub>CE</sub>	V <sub>BE</sub>	I <sub>C</sub>	I <sub>B</sub>	MIN.	MAX.	MIN.	MAX.	
Collector-Cutoff Current: With base open	I <sub>CEO</sub>	150			0	—	15	—	5	mA
With base-emitter junction reverse biased	I <sub>CEV</sub>	270	-1.5			—	5	—	—	mA
At T <sub>C</sub> = 100°C		340	-1.5			—	—	—	5	mA
	I <sub>CEV</sub>	270	-1.5			—	15	—	—	mA
		340	-1.5			—	—	—	15	mA
Emitter-Cutoff Current	I <sub>EBO</sub>		-6 -5	0 0		— —	30 5	— —	30 5	mA
DC Forward-Current Transfer Ratio	h <sub>FE</sub>	10 4		0.5 <sup>a</sup> 5 <sup>a</sup>		25 10	250 100	25 10	250 100	
Collector-to-Emitter Sustaining Voltage: (See Fig. 5, 6, and 7) With base open	V <sub>CEO(sus)</sub>			0.2	0	225 <sup>b</sup>	—	300 <sup>b</sup>	—	V
With external base-to- emitter resistance (R <sub>BE</sub> ) = 50 Ω	V <sub>CEX(sus)</sub>		-1.5	0.2 <sup>c</sup>	0	300 <sup>b</sup>	—	375 <sup>b</sup>	—	V
Emitter-to-Base Voltage	V <sub>EBO</sub>				0.03	6	—	6	—	V
Base-to-Emitter Saturation Voltage	V <sub>BE(sat)</sub>			5 <sup>a</sup>	0.5	—	2	—	2	V
Collector-to-Emitter Saturation Voltage	V <sub>CE(sat)</sub>			5 <sup>a</sup>	0.5	—	2	—	2	V
Output Capacitance V <sub>CB</sub> = 10 V, f = 1 MHz	C <sub>obo</sub>					—	450	—	450	pF
Forward-Bias, Second-Breakdown Collector Current: t = 1 s, nonrepetitive	I <sub>S/b</sub>	50				2.2	—	2.2	—	A
Second-Breakdown Energy With base reverse biased R <sub>B</sub> = 20 Ω, L = 50 μH	E <sub>S/b</sub>		-4	5		0.62	—	0.62	—	mJ
Magnitude of Common-Emitter, Small-Signal, Short-Circuit, Forward-Current Transfer Ratio f = 5 MHz	h <sub>fe</sub>	10		1		3	—	3	—	
Saturated Switching Time (V <sub>CC</sub> = 200 V): Turn-On (Delay Time + Rise Time)	t <sub>ON</sub>			5	0.5	—	0.5	—	0.5	μs
Storage (See Figs. 12, 13 and 14)	t <sub>s</sub>			5	0.5	—	3.5	—	3.5	μs
Fall (See Figs. 12, 13 and 16)	t <sub>f</sub>			5	0.5	—	2.0	—	2.0	μs
Thermal Resistance: (Junction-to-Case)	R <sub>θJC</sub>	10		5		—	1.6	—	1.6	°C/W

<sup>a</sup>Pulsed; pulse duration < 350 μs, duty factor = 2%

<sup>b</sup>CAUTION: The sustaining voltages V<sub>CEO(sus)</sub> and V<sub>CEX(sus)</sub> MUST NOT be measured on a curve tracer. These sustaining voltages should be measured by means of the test circuit shown in Fig. 6.

<sup>c</sup>Pulsed: pulse duration = 8.33 ms; duty factor = 50%

<sup>\*</sup>In accordance with JEDEC registration data format (JS-6 RDF-1).

<sup>\*\*</sup>Specified in JEDEC registration data as a derating factor of 0.625 W/°C.



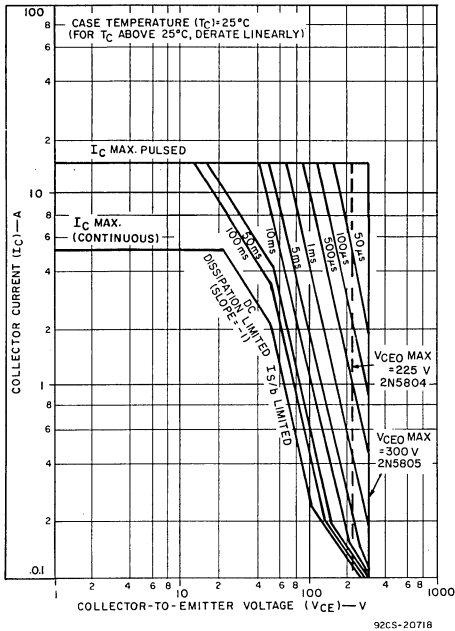


Fig. 1—Maximum operating areas for both types.

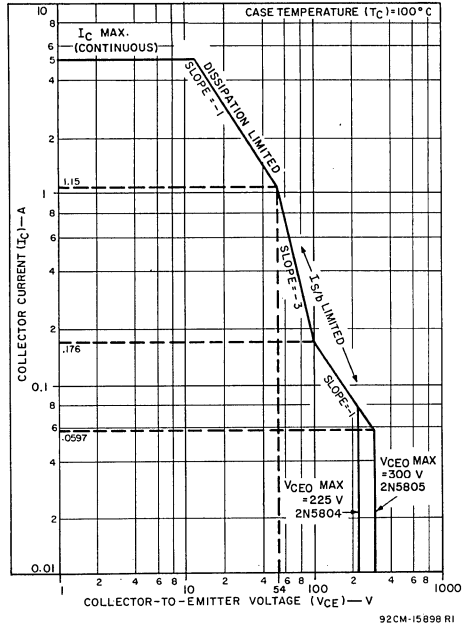


Fig. 2—Maximum operating areas for both types.

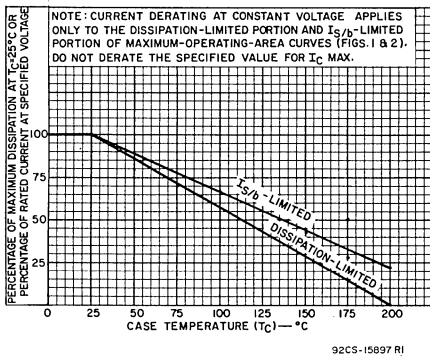


Fig. 3—Derating curves for both types.

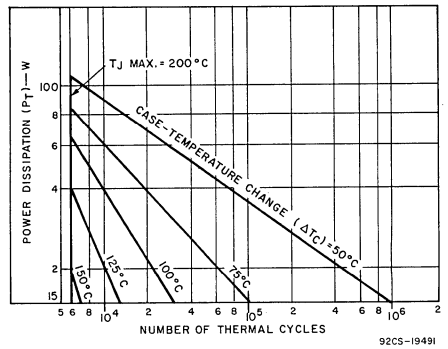


Fig. 4—Thermal-cycling rating chart.

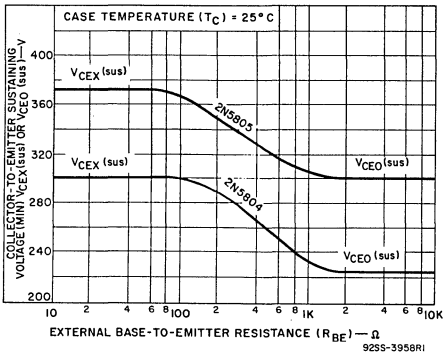


Fig. 5—Collector-to-emitter sustaining voltage characteristics.

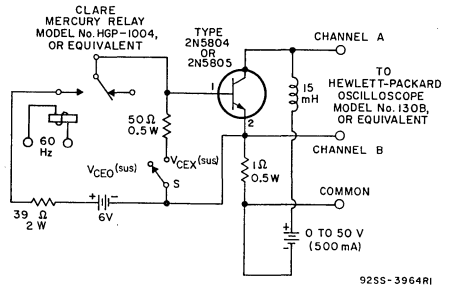


Fig. 6—Circuit used to measure sustaining voltages  $V_{CEO(sus)}$  and  $V_{CEX(sus)}$ .

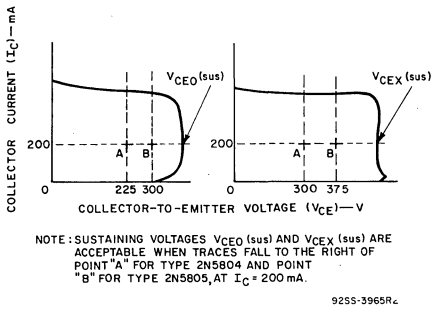


Fig. 7—Oscilloscope display for measurement of sustaining voltages (test circuit shown in Fig. 6).

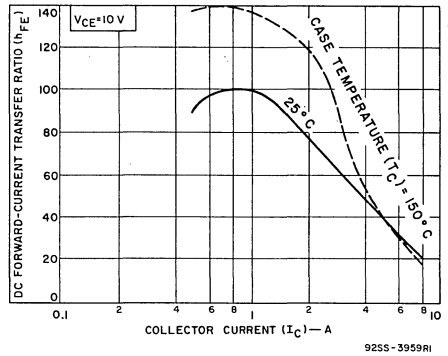


Fig. 8—Typical dc beta characteristics.

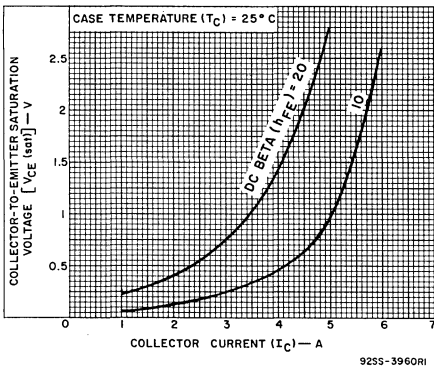


Fig. 9—Typical saturation-voltage characteristics.

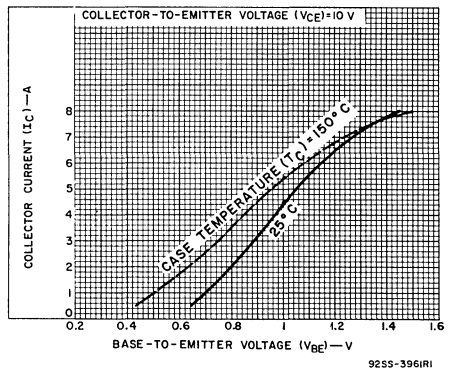


Fig. 10—Typical transfer characteristics.

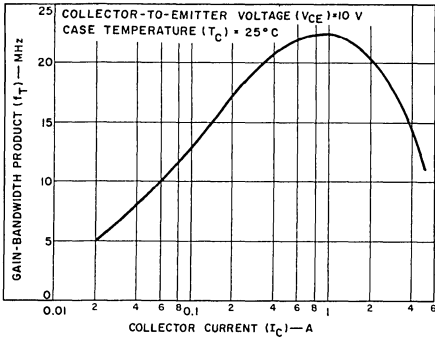


Fig. 11—Typical gain-bandwidth product.

92SS-3962R1

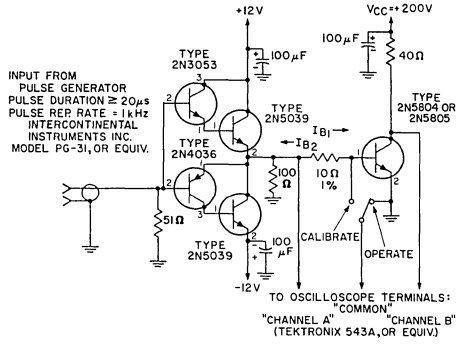


Fig. 12—Circuit used to measure switching times.

92SS-3966R1

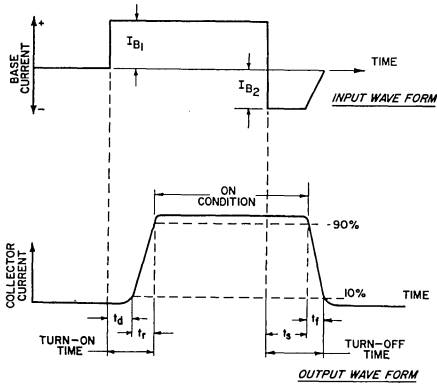


Fig. 13—Phase relationship between input and output currents showing reference points for specification of switching times (test circuit shown in Fig. 12).

92CS-13996R1

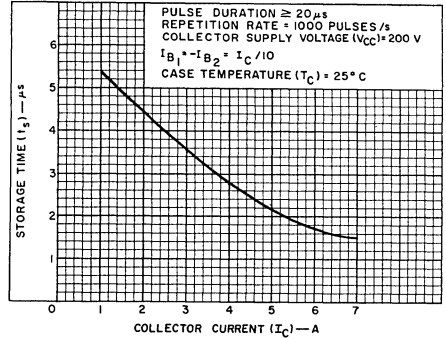


Fig. 14—Typical storage-time characteristic.

92SS-3963R1

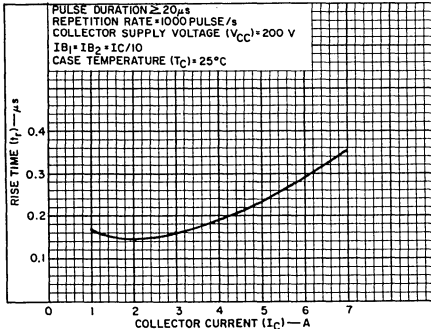


Fig. 15—Typical rise-time characteristic.

92CS-15895

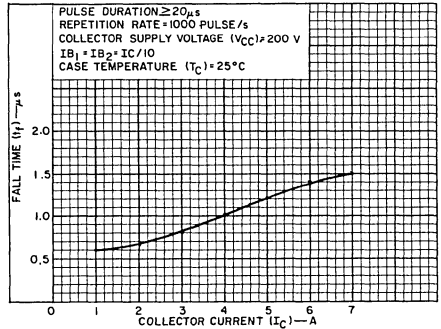


Fig. 16—Typical fall-time characteristic.

92CS-15896



# Power Transistors

2N5838  
2N5839  
2N5840

RCA 2N5838, 2N5839 and 2N5840\*\* are epitaxial silicon n-p-n power transistors utilizing a multiple-emitter-site structure. These devices employ the popular JEDEC TO-3 package; they differ mainly in voltage, current-gain, and  $V_{CE(sat)}$  ratings.

Featuring high breakdown voltage ratings and low-saturation voltage values, the 2N5838, 2N5839 and 2N5840 are especially suitable for use in inverters, deflection circuits, switching regulators, high-voltage bridge amplifiers, ignition circuits, and other high-voltage switching applications.

\*\* Formerly RCA Dev. types TA7513, TA7530, and TA7420 respectively.

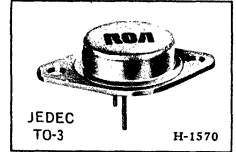
**MAXIMUM RATINGS, Absolute-Maximum Values:**

	2N5838	2N5839	2N5840	
*COLLECTOR-TO-BASE VOLTAGE, $V_{CBO}$ . . . . .	275	300	375	V
COLLECTOR-TO-EMITTER SUSTAINING VOLTAGE:				
With base open, $V_{CEO(sus)}$	250	275	350	V
With reverse bias ( $V_{BE}$ ) of -1.5 V, $V_{CEV(sus)}$ ▲ . . . . .	275	300	375	V
With external base-to-emitter resistance ( $R_{BE}) \leq 50 \Omega$ , $V_{CER(sus)}$ . . . . .	275	300	375	V
*EMITTER-TO-BASE VOLTAGE, $V_{EBO}$ . . . . .	6	6	6	V
*COLLECTOR CURRENT, $I_C$				
Continuous . . . . .	3	3	3	A
Peak . . . . .	5	5	5	A
*CONTINUOUS BASE CURRENT, $I_B$ . . . . .	1.5	1.5	1.5	A
*TRANSISTOR DISSIPATION, $P_T$ :				
At case temperature up to 25°C and $V_{CE}$ up to 40 V . . . . .	100	100	100	W
At case temperatures up to 25°C and $V_{CE}$ above 40 V . . . . .	See Fig. 2.			
At case temperatures above 25°C and $V_{CE}$ above 40 V . . . . .	See Figs. 1 & 2.			
*TEMPERATURE RANGE:				
Storage & Operating (Junction)	-65		+200	°C
*PIN TEMPERATURE (During Soldering):				
At distances $\geq 1/32$ in. (0.8 mm) from case for 10 s max . . . . .	230			°C

▲ In accordance with JEDEC registration data format (JS-6, RDF-1).  
Shown as  $V_{CEX(sus)}$  in JEDEC Registration Data.

# SILICON N-P-N POWER TRANSISTORS

High-Voltage  
High-Power Types  
For Switching and  
Linear Applications in Military, Industrial, and Commercial Equipment



**Features:**

- Maximum safe-area-of-operation curves
  - Low saturation voltages
  - High voltage ratings
- $V_{CER(sus)} = 375 \text{ V (2N5840)}$   
 $300 \text{ V (2N5839)}$   
 $275 \text{ V (2N5838)}$
- High dissipation rating
- $P_T = 100 \text{ W}$

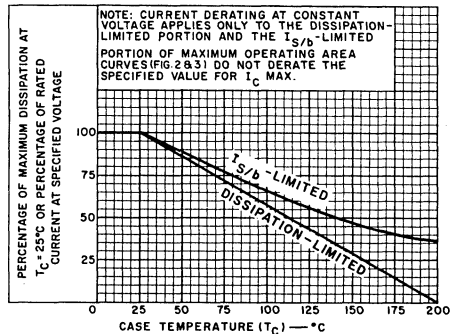


Fig. 1 - Derating curves for all types.

9255-4072 RI

ELECTRICAL CHARACTERISTICS, Case Temperature ( $T_C$ ) = 25°C

CHARACTERISTIC	SYMBOL	TEST CONDITIONS				LIMITS						UNITS	
		VOLTAGE V dc		CURRENT A dc		2N5838		2N5839		2N5840			
		V <sub>CE</sub>	V <sub>BE</sub>	I <sub>C</sub>	I <sub>B</sub>	Min.	Max.	Min.	Max.	Min.	Max.		
Collector-Cutoff Current: With base open	I <sub>CEO</sub>	200 250				-	2	-	-	-	-	mA	
With base-emitter junction reverse biased	I <sub>CEV</sub>	265 290 360	-1.5 -1.5 -1.5			-	5	-	2	-	-	2	mA
With base-emitter junction reverse biased, $T_C = 100^\circ\text{C}$	I <sub>CEV</sub> T <sub>C</sub> 100 °C	265 290 360	-1.5 -1.5 -1.5			-	8	-	5	-	-	5	mA
Emitter-Cutoff Current	I <sub>EBO</sub>		-6			-	1	-	1	-	-	1	mA
Collector-to-Emitter Sustaining Voltage: (See Figs. 4, 5, & 6) With base open	V <sub>CEO(sus)</sub> <sup>a</sup>			0.2 <sup>a</sup>		250 <sup>b</sup>	-	275 <sup>b</sup>	-	350 <sup>b</sup>	-	-	V
With base-emitter junction reverse biased	V <sub>CEX(sus)</sub> <sup>a</sup>		-1.5	0.1 <sup>a</sup>		275 <sup>b</sup>	-	300 <sup>b</sup>	-	375 <sup>b</sup>	-	-	V
With external base-to-emitter resistance (R <sub>BE</sub> ) = 50 Ω	V <sub>CER(sus)</sub> <sup>a</sup>			0.2 <sup>a</sup>		275 <sup>b</sup>	-	300 <sup>b</sup>	-	375 <sup>b</sup>	-	-	V
Emitter-to-Base Voltage I <sub>E</sub> = 0.02 A	V <sub>EBO</sub>					6	-	6	-	6	-	-	V
DC Forward-Current Transfer Ratio	h <sub>FE</sub>	5 3 2		0.5 <sup>a</sup> 2 <sup>a</sup> 3 <sup>a</sup>		20 - 8	- - 40	20 10 -	- 50 -	20 10 -	- 50 -	-	V
Base-to-Emitter Saturation Voltage	V <sub>BE(sat)</sub>			2 <sup>a</sup> 3 <sup>a</sup>	0.2 0.375	- -	- 2	- -	2 -	- -	- -	2 -	V
Collector-to-Emitter Saturation Voltage	V <sub>CE(sat)</sub>			2 <sup>a</sup> 3 <sup>a</sup>	0.2 0.375	- -	- 1	- -	1.5 -	- -	- -	1.5 -	V
Output Capacitance: V <sub>CB</sub> = 10 V, f = 1 MHz	C <sub>obo</sub>					-	150	-	150	-	-	150	pF
Magnitude of Common- Emitter, Small-Signal, Short- Circuit, Forward-Current Transfer Ratio (f = 1 MHz)	h <sub>fe</sub>	10		0.2		5	-	5	-	5	-	-	V
Forward-Bias, Second-Breakdown Collector Current: t = 1 s, nonrepetitive	I <sub>S</sub> <sup>b,c</sup>	40				2.5	-	2.5	-	2.5	-	-	A
Second Breakdown <sup>c</sup> Energy (With base reverse biased) R <sub>B</sub> = 50 Ω, L = 100 μH	E <sub>S</sub> <sup>b,d</sup>		-4			0.45	-	0.45	-	0.45	-	-	mJ
Thermal Resistance † (Junction-to-Case)	R <sub>θJC</sub>	10		5		1.75	-	1.75	-	1.75	-	-	°C/W

\* In accordance with JEDEC registration data format (JS-6 RDF-1)

<sup>a</sup> Pulsed; pulse duration = 350 μs, Duty factor ≤ 2%.

<sup>b</sup> CAUTION: This sustaining voltages V<sub>CEO(sus)</sub>, V<sub>CEX(sus)</sub> and V<sub>CER(sus)</sub>, MUST NOT be measured on a curve tracer. These sustaining voltages should be measured by means of the test circuit shown in Fig. 4.

<sup>c</sup> I<sub>S</sub>, I<sub>B</sub> is defined as the current at which second breakdown occurs at a specified collector voltage with the emitter-base junction forward biased for transistor operation in the active region.

<sup>d</sup> E<sub>S</sub>/b is defined as the energy at which second breakdown occurs under specified reverse bias conditions. E<sub>S</sub>/b = 1/2 L*i*<sup>2</sup> where L is a series load or leakage inductance, and *i* is the peak collector current.

<sup>e</sup> |I<sub>B1</sub> = I<sub>B2</sub> = value shown.

SWITCHING-TIME CHARACTERISTICS, At Case Temperature ( $T_C$ ) = 25°C

CHARACTERISTIC	SYMBOL	TEST CONDITIONS			LIMITS						UNITS	
		VOLTAGE V dc		CURRENT A dc	2N5838		2N5839		2N5840			
		$V_{CC}$	$I_C$	$I_B^{\bullet}$	Max.	Typ.	Max.	Typ.	Max.	Typ.		
Switching Times:												
Delay (See Figs. 11, 15, & 16)	$t_d$	200	2 3	0.2 0.375	- -	- 0.06	- -	0.07	- -	- -	0.07	$\mu s$
Rise (See Figs. 12, 15, & 16)	$t_r$	200	2 3	0.2 0.375	- 1.5	- 0.8	1.5	0.6	1.75	0.6		
Storage (See Figs. 13, 15, & 16)	$t_s$	200	2 3	0.2 0.375	- 3.0	- 1.0	3.75	1.75	3.0	1.75		
Fall (See Figs. 14, 15, & 16)	$t_f$	200	2 3	0.2 0.375	- 1.5	- 0.4	1.5	0.35	1.5	0.35		

\* In accordance with JEDEC registration data format (JS-6 RDF-1).

•  $I_{B1} = I_{B2} =$  value shown.

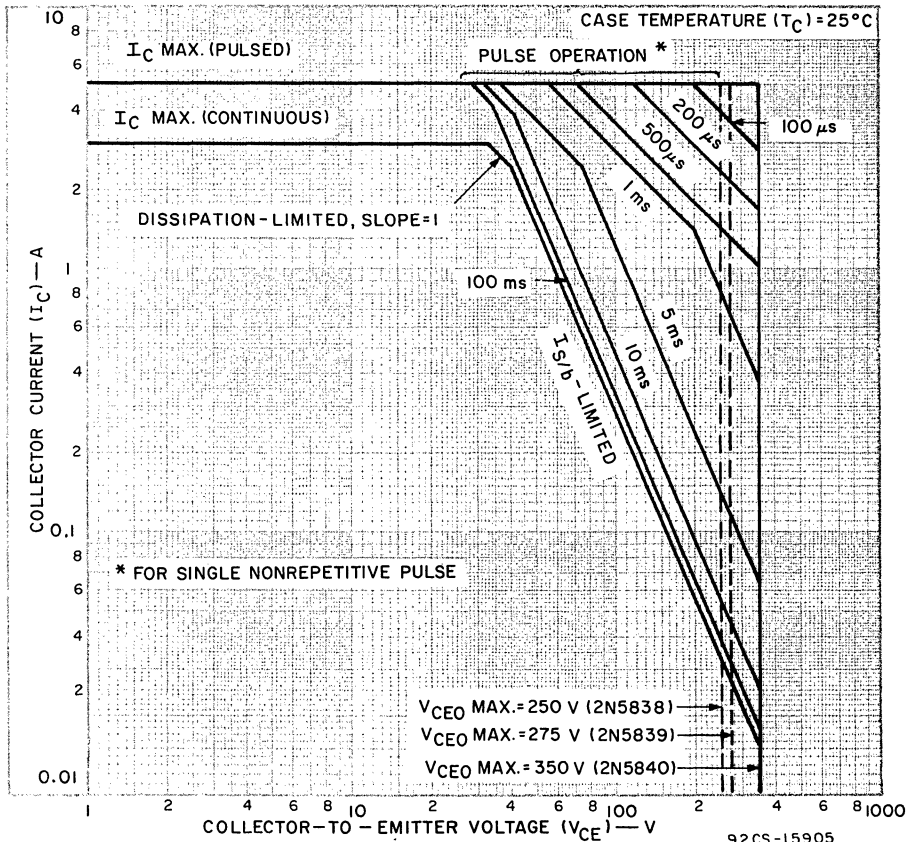


Fig. 2 - Maximum operating areas for all types.

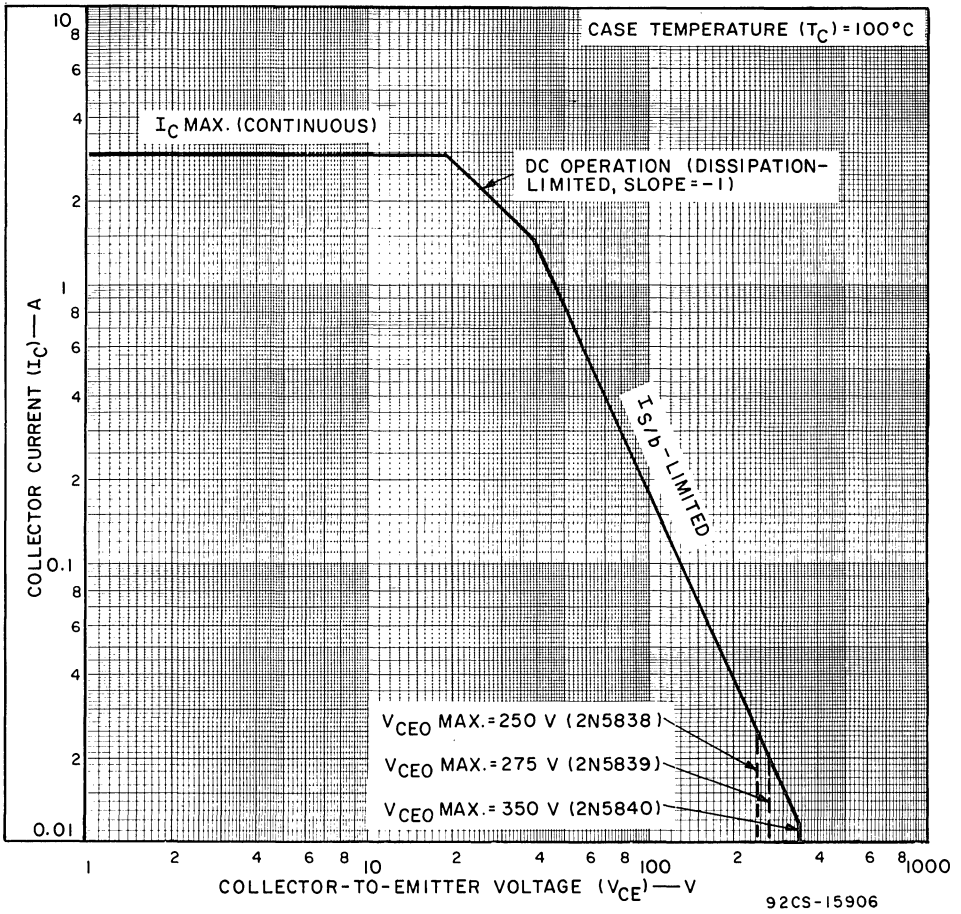
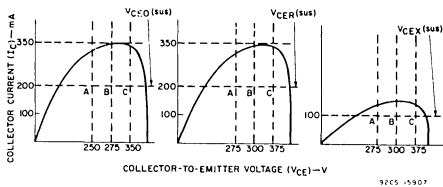


Fig. 3 - Maximum operating areas for all types.



The sustaining voltages  $V_{CE0}(sus)$ ,  $V_{CER}(sus)$ , and  $V_{CEX}(sus)$  are acceptable when the traces fall to the right and above point "A" for type 2N5838, point "B" for type 2N5839, and point "C" for type 2N5840.

Fig. 4 - Oscilloscope display for measurement of sustaining voltages (test circuit shown in Fig. 5).

TERMINAL CONNECTIONS

- Pin 1 - Base
- Pin 2 - Emitter
- Mounting Flange, Case - Collector

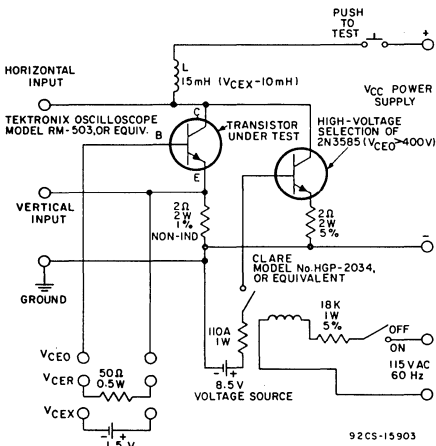


Fig. 5 - Circuit used to measure sustaining voltages  $V_{CEO}(sus)$ ,  $V_{CER}(sus)$ , and  $V_{CEx}(sus)$  for all types.

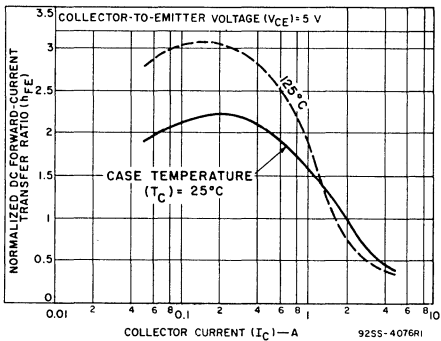


Fig. 7 - Typical normalized dc beta characteristics for all types.

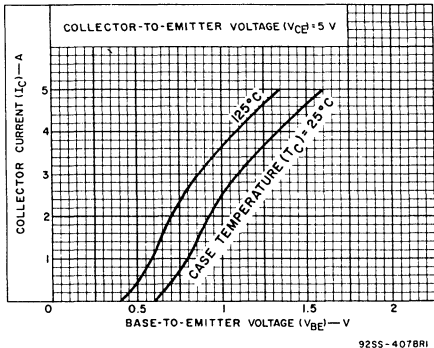


Fig. 9 - Typical transfer characteristics for all types.

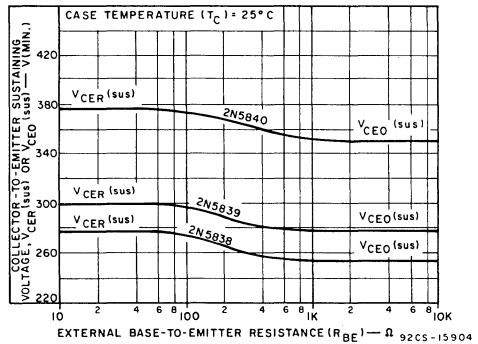


Fig. 6 - Collector-to-emitter sustaining voltage characteristics for all types.

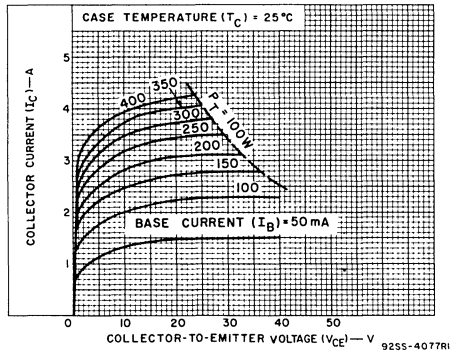


Fig. 8 - Typical output characteristics for all types.

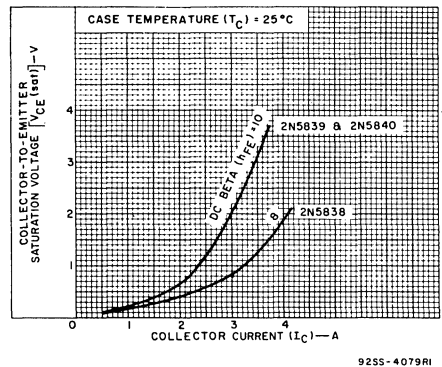


Fig. 10 - Typical saturation voltage characteristics for all types.



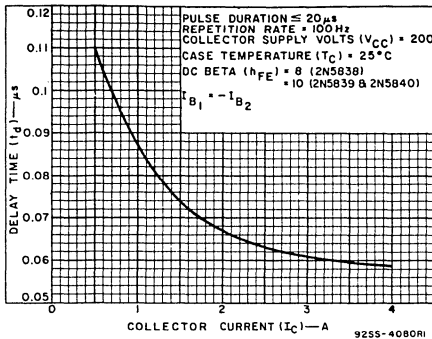


Fig. 11 - Typical delay-time characteristic for all types.

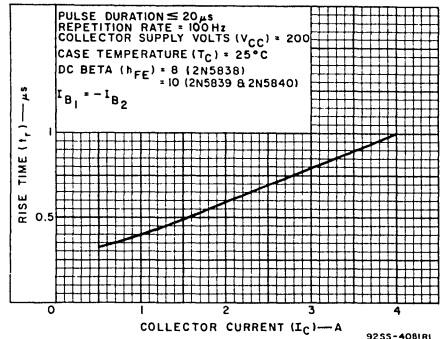


Fig. 12 - Typical rise-time characteristic for all types.

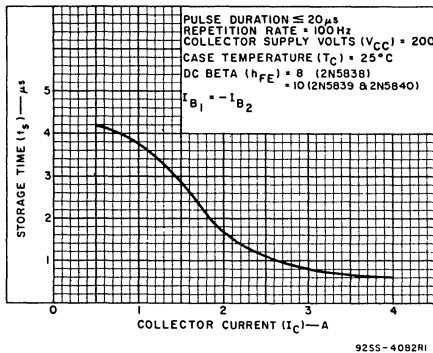


Fig. 13 - Typical storage-time characteristic for all types.

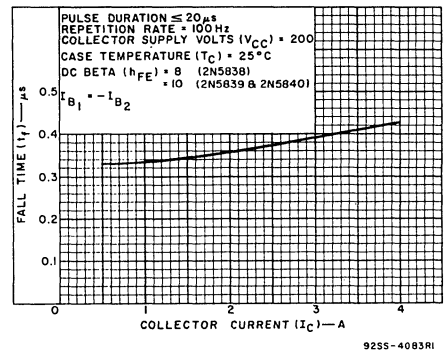
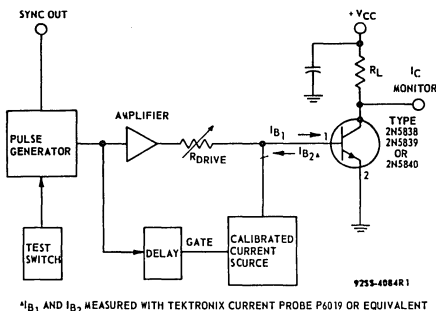


Fig. 14 - Typical fall-time characteristic for all types.



\*I<sub>B1</sub> and I<sub>B2</sub> MEASURED WITH TEKTRONIX CURRENT PROBE P6019 OR EQUIVALENT

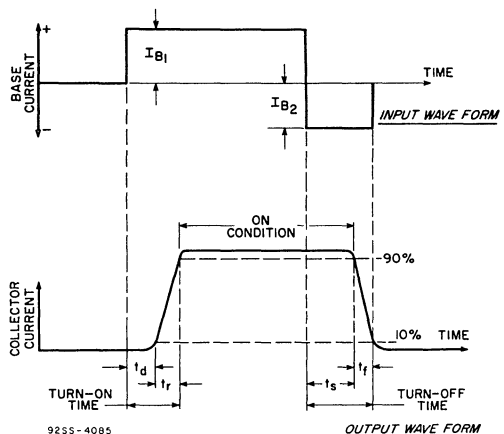


Fig. 16 - Phase relationship between input and output currents showing reference points for specification of switching times. (Test circuit shown in Fig. 15).

Fig. 15 - Circuit used to measure switching times for all types.



# Power Transistors

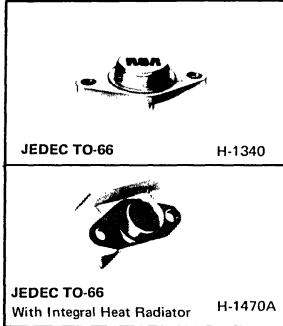
2N5954	2N6372	2N6467	40829
2N5955	2N6373	2N6468	40830
2N5956	2N6374		40831

## Silicon N-P-N and P-N-P Medium-Power Transistors

General-Purpose Types for Switching Applications in Military, Industrial, and Commercial Equipment

### Features

- 2N5954, 2N5955, 2N5956 complements to 2N6372, 2N6373, 2N6374
- Low saturation voltages
- Maximum-safe-area-of-operation curves
- Thermal-cycle ratings
- Hermetically-sealed JEDEC TO-66 package
- High gain at high current



RCA-2N5954, 2N5955, 2N5956, 2N6467, and 2N6468<sup>▲</sup> are multiple-epitaxial p-n-p transistors. RCA-2N6372, 2N6373, and 2N6374<sup>◆</sup> are multiple-epitaxial n-p-n transistors. They are complements to 2N5954, 2N5955, and 2N5956. These devices differ in voltage ratings and in the currents at which the parameters are controlled. All are supplied in the JEDEC TO-66 package.

Types 2N5954, 2N5955, and 2N5956 are available with factory-attached heat radiators as RCA types 40829, 40830.

and 40831, respectively. The other devices may be obtained with heat radiators on special order. Radiator versions are intended for printed-circuit-board applications, and differ electrically from their basic counterparts only in device dissipation (5.8 W up to 25°C ambient) and thermal resistance (30°C/W max. at T<sub>A</sub> = 25°C).

<sup>▲</sup> Formerly RCA Dev. Nos. TA7264, TA7265, TA7266, TA8710, and TA8709, respectively.

<sup>◆</sup> Formerly RCA Dev. Nos. TA8352, TA8353, and TA8354, respectively.

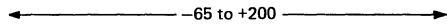
### MAXIMUM RATINGS, Absolute-Maximum Values:

	N-P-N	2N6374	2N6373	2N6372		
	P-N-P	2N5956 <sup>◆</sup> 40831 <sup>◆</sup>	2N5955 <sup>◆</sup> 40830 <sup>◆</sup>	2N5954 <sup>◆</sup> 40829 <sup>◆</sup>	2N6467 <sup>◆</sup>	2N6468 <sup>◆</sup>
*COLLECTOR-TO-BASE VOLTAGE . . . . . V <sub>CBO</sub>		50	70	90	110	130
COLLECTOR-TO-EMITTER VOLTAGE:						
* With 1.5 volts (V <sub>BE</sub> ) of reverse bias, and external base-to-emitter resistance (R <sub>BE</sub> ) = 100 Ω . . . . . V <sub>CEX</sub>		50	70	90	110	130
With external base-to-emitter resistance (R <sub>BE</sub> ) = 100 Ω . . . . . V <sub>CER</sub>		45	65	85	105	125
With base open . . . . . V <sub>CEO</sub>		40	60	80	100	120
*EMITTER-TO-BASE VOLTAGE . . . . . V <sub>EBO</sub>		5	5	5	5	5
*CONTINUOUS COLLECTOR CURRENT . . . . . I <sub>C</sub>		6	6	6	4	4
*CONTINUOUS BASE CURRENT . . . . . I <sub>B</sub>		2	2	2	2	2
TRANSISTOR DISSIPATION:						
At case temperatures up to 25°C . . . . .		40	40	40	40	40
		(2N6374)	(2N6373)	(2N6372)	(2N6467)	(2N6468)
		(2N5956)	(2N5955)	(2N5954)		
At ambient temperatures up to 25°C . . . . .		5.8	5.8	5.8	—	—
		(40831)	(40830)	(40829)		
At case temperatures above 25°C . . . . .						

See Figs. 1, 2, and 3.

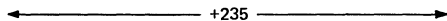
### \*TEMPERATURE RANGE:

Storage and Operating (Junction) . . . . .



### \*PIN TEMPERATURE (During Soldering):

At distances ≥ 1/32 in. (0.8 mm) from seating plane for 10 s max. . . . .



\* In accordance with JEDEC registration data format JS-6-RDF-2 (all types except 40829, 40830, and 40831)

◆ For p-n-p devices, voltage and current values are negative.

**ELECTRICAL CHARACTERISTICS, At Case Temperature ( $T_C$ ) = 25°C unless otherwise specified**

CHARACTERISTIC	SYMBOL	TEST CONDITIONS <sup>♦</sup>				LIMITS						UNITS	
		VOLTAGE V dc		CURRENT A dc		2N6374 2N5956 <sup>♦</sup> 40831 <sup>♦</sup>		2N6373 2N5955 <sup>♦</sup> 40830 <sup>♦</sup>		2N6372 2N5954 <sup>♦</sup> 40829 <sup>♦</sup>			
		V <sub>CE</sub>	V <sub>BE</sub>	I <sub>C</sub>	I <sub>B</sub>	Min.	Max.	Min.	Max.	Min.	Max.		
* Collector Cutoff Current: With external base-to-emitter resistance ( $R_{BE}$ ) = 100 $\Omega$	I <sub>CER</sub>	35 55 75				— — —	100 — —	— — —	100 — —	— — 100	— — —	$\mu$ A	
* With base-emitter junction reverse-biased, ( $R_{BE}$ ) = 100 $\Omega$	I <sub>CEX</sub>	45 65 85	-1.5 -1.5 -1.5			— — —	100 — —	— — —	— 100 —	— — 100	— — —	$\mu$ A	
* With base-emitter junction reverse-biased, ( $R_{BE}$ ) = 100 $\Omega$ , and $T_C$ = 150°C		45 65 85	-1.5 -1.5 -1.5			— — —	2 — —	— — —	— 2 —	— — —	— — 2	— — —	mA
* With base open	I <sub>CEO</sub>	25 45 65				— — —	1 — —	— — —	— 1 —	— — —	— — 1	mA	
* Emitter Cutoff Current	I <sub>EBO</sub>		-5			—	0.1	—	0.1	—	0.1	mA	
* DC Forward-Current Transfer Ratio	h <sub>FE</sub>	4 4 4 4		3 <sup>a</sup> 2.5 <sup>a</sup> 2 <sup>a</sup> 6 <sup>a</sup>		20 — — 5	100 — — —	— — — 5	— 20 — —	100 — — —	— — 20 5	100 — — —	
* Collector-to-Emitter Sustaining Voltage: With base open	V <sub>CEO(sus)</sub>			0.1 <sup>a</sup>		40 <sup>b</sup>	—	60 <sup>b</sup>	—	80 <sup>b</sup>	—		
With external base-to- emitter resistance ( $R_{BE}$ ) = 100 $\Omega$	V <sub>CER(sus)</sub>			0.1 <sup>a</sup>		45 <sup>b</sup>	—	65 <sup>b</sup>	—	85 <sup>b</sup>	—	V	
With base-emitter junction reverse-biased, ( $R_{BE}$ ) = 100 $\Omega$	V <sub>CEX(sus)</sub>		-1.5	0.1 <sup>a</sup>		50 <sup>b</sup>	—	70 <sup>b</sup>	—	90 <sup>b</sup>	—		
* Base-to-Emitter Voltage: All types All types All types 2N6372-2N6374	V <sub>BE</sub>	4 4 4 4		3 <sup>a</sup> 2.5 <sup>a</sup> 2 <sup>a</sup> 6 <sup>a</sup>		— — — —	2 — — 3	— — — —	— 2 — 3	— — — —	— — 2 3	— — — —	V
* Collector-to-Emitter Saturation Voltage	V <sub>CE(sat)</sub>			3 <sup>a</sup> 2.5 <sup>a</sup> 2 <sup>a</sup>	0.3 0.25 0.2	— — —	1 — —	— — —	— 1 —	— — —	— — 1	V	
* Magnitude of Forward- Current Transfer Ratio (f = 1 MHz): 2N6372-2N6374 2N5954-56, 40829-31	h <sub>fe</sub>	4 —4		1 -1		4 5	— —	4 5	— —	4 5	— —		
* Forward-Current Transfer Ratio (f = 1 kHz)	h <sub>fe</sub>	4		0.5		25	—	25	—	25	—		
Thermal Resistance: Junction-to-case, 2N5954-56, 2N6372-74	R <sub><math>\theta</math>JC</sub>					—	4.3	—	4.3	—	4.3	$^{\circ}$ C/W	
Junction-to-Ambient 40829-40831	R <sub><math>\theta</math>JA</sub>					—	30	—	30	—	30		

\* In accordance with JEDEC registration data format JS-6 RDF-2.

<sup>a</sup> Pulsed, pulse duration = 300  $\mu$ s, duty factor = 1.8%.

<sup>♦</sup> For p-n-p devices, voltage and current values are negative.

<sup>b</sup> CAUTION: Sustaining voltages V<sub>CEO(sus)</sub>, V<sub>CER(sus)</sub>, and V<sub>CEX(sus)</sub> MUST NOT be measured on a curve tracer. (See Figs. 19 & 20).

**ELECTRICAL CHARACTERISTICS, At Case Temperature ( $T_C$ ) = 25°C unless otherwise specified**

CHARACTERISTIC	SYMBOL	TEST CONDITIONS				LIMITS				UNITS
		VOLTAGE V dc		CURRENT A dc		2N6467		2N6468		
		$V_{CE}$	$V_{BE}$	$I_C$	$I_B$	Min.	Max.	Min.	Max.	
* Collector Cutoff Current: With external base-to-emitter resistance ( $R_{BE}$ ) = 100 $\Omega$	$I_{CER}$	-95 -100				-	-100	-	-	$\mu A$
* With base-emitter junction reverse-biased and external base- to-emitter resistance ( $R_{BE}$ ) = 100 $\Omega$	$I_{CEX}$	-100 -120	1.5 1.5			-	-100	-	-	$\mu A$
* With base-emitter junction reverse-biased, $R_{BE}$ = 100 $\Omega$ , and $T_C$ = 150°C		-100 -120	1.5 1.5			-	-2	-	-2	mA
* With base open	$I_{CEO}$	-50 -60				-	-1	-	-1	mA
* Emitter Cutoff Current	$I_{EBO}$		5			-	-0.1	-	-0.1	mA
* DC Forward-Current Transfer Ratio	$h_{FE}$	-4 -4		-1.5 <sup>a</sup> -4 <sup>a</sup>		15 5	150 -	15 5	150 -	
* Collector-to-Emitter Sustaining Voltage: With base open	$V_{CEO(sus)}$			-0.1 <sup>a</sup>		-100 <sup>b</sup>	-	-120 <sup>b</sup>	-	V
With external base-to-emitter resistance ( $R_{BE}$ ) = 100 $\Omega$	$V_{CER(sus)}$			-0.1 <sup>a</sup>		-105 <sup>b</sup>	-	-125 <sup>b</sup>	-	
With base-emitter junction reverse-biased and external base-to-emitter resistance ( $R_{BE}$ ) = 100 $\Omega$	$V_{CEX(sus)}$		1.5	-0.1 <sup>a</sup>		-110 <sup>b</sup>	-	-130 <sup>b</sup>	-	
* Base-to-Emitter Voltage	$V_{BE}$	-4 -4		-1.5 <sup>a</sup> -4 <sup>a</sup>		-	-2 -3.5	-	-2 -3.5	V
* Collector-to-Emitter Saturation Voltage	$V_{CE(sat)}$			-1.5 <sup>a</sup> -4 <sup>a</sup>	-0.15 -0.8	-	-1.2 -4	-	-1.2 -4	V
* Magnitude of Common Emitter, Small-Signal Short-Circuit, Forward-Current Transfer Ratio (f = 1 MHz)	$ h_{fe} $	-4		-1		5	-	5	-	
* Common-Emitter, Small- Signal, Short-Circuit, Forward- Current Transfer Ratio (f = 1 kHz)	$h_{fe}$	-4		-0.5		25	-	25	-	
Thermal Resistance: Junction-to-case	$R_{\theta JC}$					-	4.3	-	4.3	°C/W

<sup>a</sup> Pulsed, pulse duration = 300  $\mu s$ , duty factor = 1.8%.

<sup>b</sup> CAUTION: Sustaining voltages  $V_{CEO(sus)}$ ,  $V_{CER(sus)}$ , and  $V_{CEX(sus)}$  MUST NOT be measured on a curve tracer. (See Figs. 19 and 20).

\* In accordance with JEDEC registration data format JS-6 RDF-2.

**TERMINAL CONNECTIONS  
ALL JEDEC DEVICES**

Pin 1 – Base  
Pin 2 – Emitter  
Case, Mounting Flange – Collector

**TERMINAL CONNECTIONS  
40829, 40830, 40831**

Pin 1 – Base  
Pin 2 – Emitter  
Heat Radiator – Collector

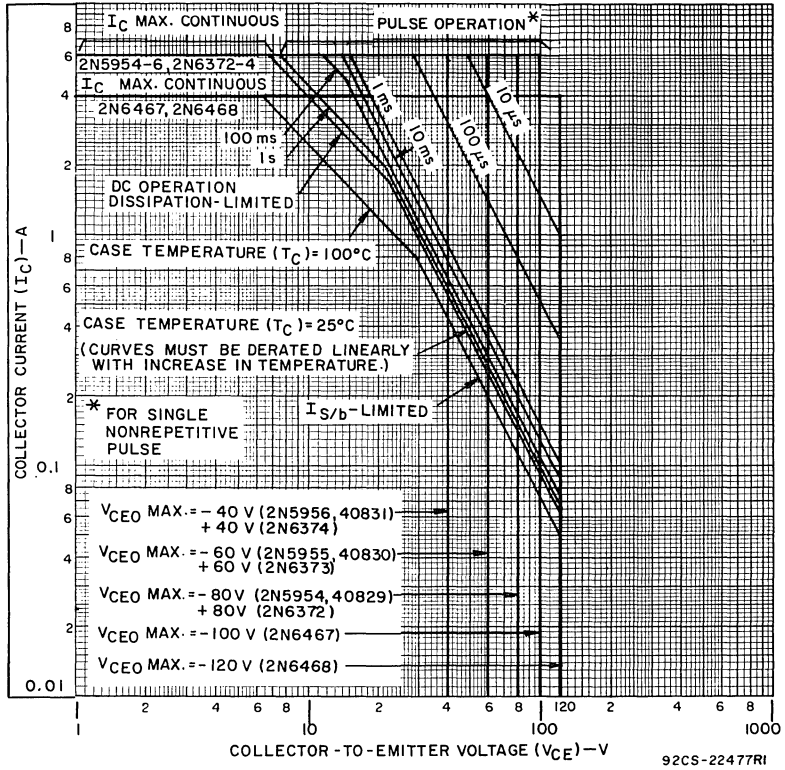


Fig. 1 — Maximum operating areas for all types.

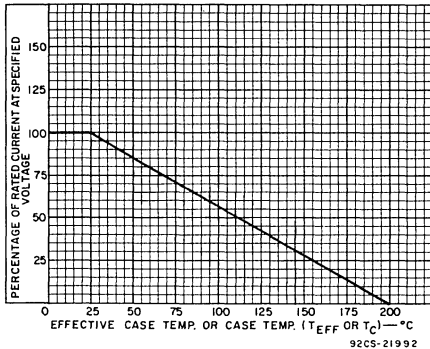


Fig. 2 — Current derating curve for all types.

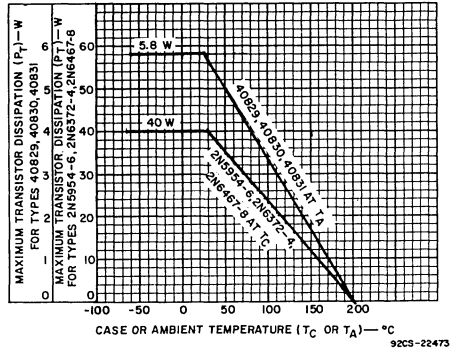


Fig. 3 — Dissipation derating curve for all types.

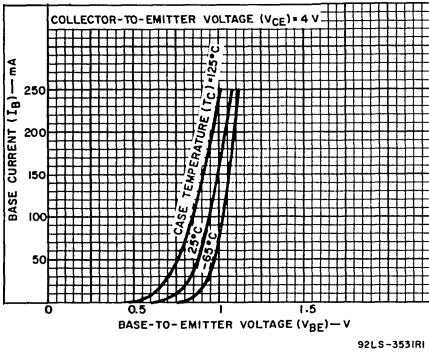


Fig. 4 — Typical input characteristics for all types. ♦

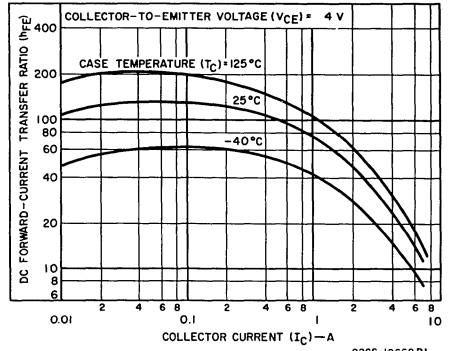


Fig. 5 — Typical dc beta characteristics for 2N6372, 2N6373, and 2N6374.

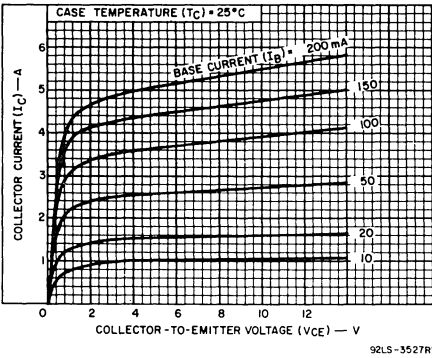


Fig. 6 — Typical output characteristics for all types. ♦

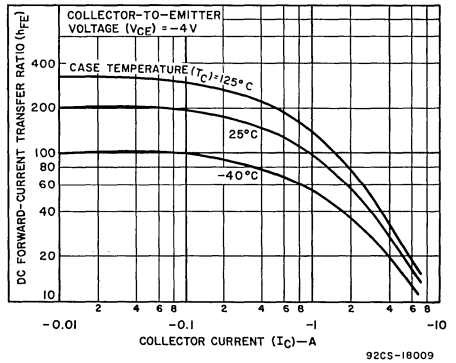


Fig. 7 — Typical dc beta characteristics for 2N5954 — 2N5956 and 40829 — 40831.

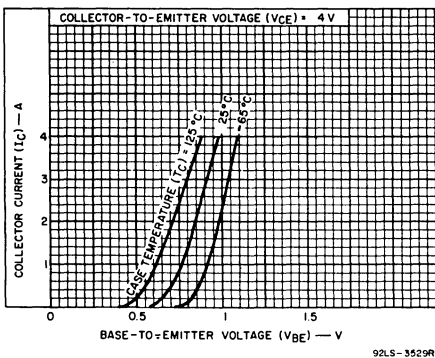


Fig. 8 — Typical transfer characteristics for all types. ♦

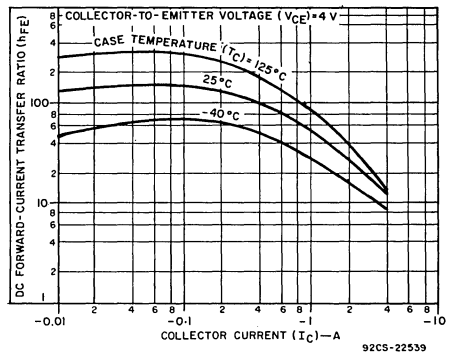


Fig. 9 — Typical dc beta characteristics for 2N6467 and 2N6468.

♦ For p-n-p devices, voltage and current values are negative.

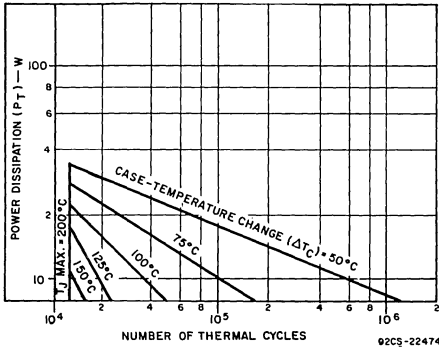


Fig. 10 - Thermal-cycling rating chart for all types.

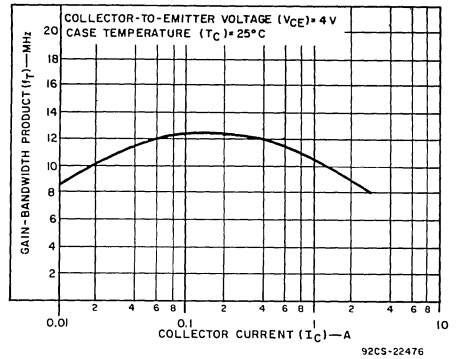


Fig. 11 - Typical gain-bandwidth product for all types.

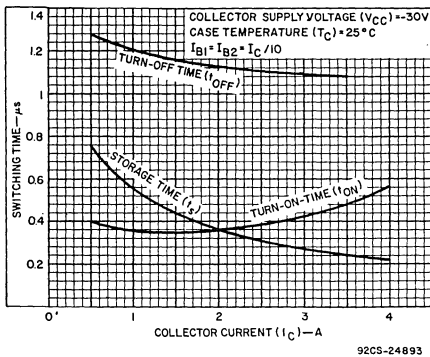


Fig. 12 - Typical saturated switching characteristics for 2N6372 - 2N6374.

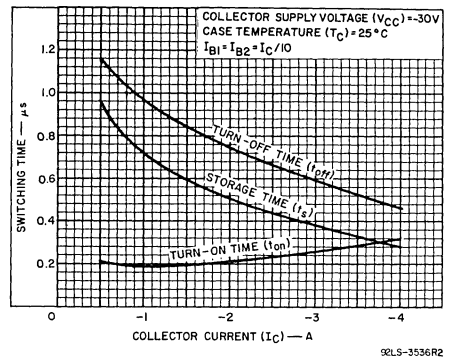


Fig. 13 - Typical saturated switching characteristics for 2N5954 - 2N5956, 2N6467 - 2N6468, and 40829 - 40831.

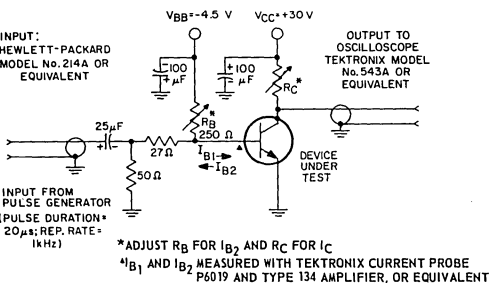


Fig. 14 - Circuit used to measure saturated switching times for n-p-n types.

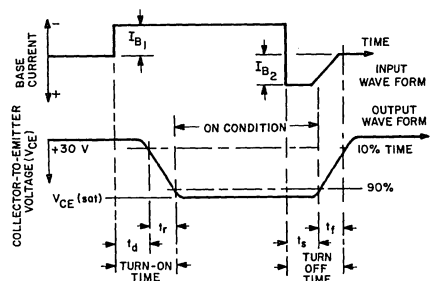


Fig. 15 - Oscilloscope display for measurement of switching times for n-p-n types.

♦ For p-n-p devices, voltage and current values are negative.

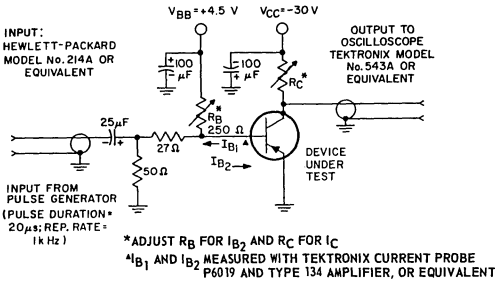


Fig. 16 - Circuit used to measure saturated switching times for p-n-p types.

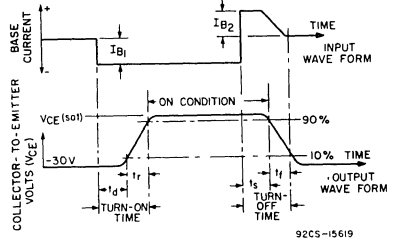


Fig. 17 - Oscilloscope display for measurement of switching times for p-n-p types.

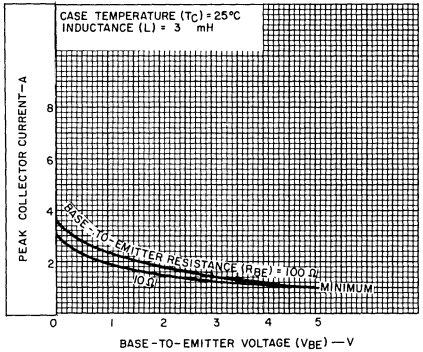
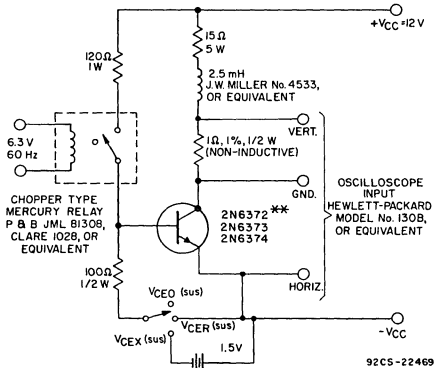
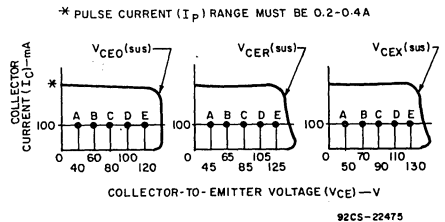


Fig. 18 - Minimum reverse-bias second-breakdown characteristic for all types.



\*\* FOR P-N-P TYPES 2N5954, 2N5955, 2N5956, 2N6467, AND 2N6468, 40829, 40830, AND 40831, REVERSE POLARITY OF VCC AND BATTERY.

Fig. 19 - Circuit used to measure sustaining voltages  $V_{CE0}(sus)$ ,  $V_{CEr}(sus)$ , and  $V_{CEX}(sus)$ .



The sustaining voltages,  $V_{CE0}(sus)$ ,  $V_{CEr}(sus)$ , and  $V_{CEX}(sus)$ , are acceptable when the traces fall to the right of point "A" for types 2N5956, 40831, and 2N6374; point "B" for types 2N5955, 40830, and 2N6373; point "C" for types 2N5954, 40829, and 2N6372; point "D" for type 2N6467, and point "E" for type 2N6468.

Fig. 20 - Oscilloscope display for measurement for sustaining voltages (test circuit shown in Fig. 19).

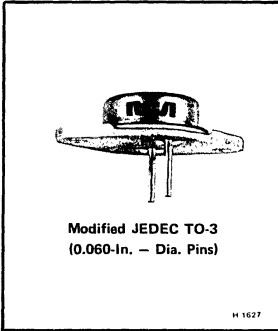
For p-n-p devices, voltage and current values are negative.





# Power Transistors

**2N6032**  
**2N6033**



## High-Current, High-Speed, High-Power Transistors

Silicon N-P-N Types

For Switching and Amplifier Applications in Military, Industrial, and Commercial Equipment

**Features:**

- Low  $V_{CE}(sat) = 1.0\text{ V max. at } 40\text{ A, } 1.3\text{ V max. at } 50\text{ A}$
- Maximum Safe-Area-of-Operation Curve...  $I_S/I_B$  limit line beginning at 24 V
- Fast Storage Time...  $t_s = 1.5\text{ }\mu\text{s max at } I_C = 40\text{ A (2N6033) } 50\text{ A (2N6032)}$
- High-Current Capability...  $V_{CE}(sat)$  &  $V_{BE}$  measured at  $I_C = 40\text{ A (2N6033) } = 50\text{ A (2N6032)}$
- High  $P_T$  (140 W max. at  $T_C = 25^\circ\text{C}$ )

RCA Types 2N6032 and 2N6033\* are epitaxial silicon n-p-n transistors having high-current and high-power handling capability and fast switching speed. The 2N6033 is similar to

the 2N6032; they differ in maximum values for continuous collector current and sustaining voltage.

\*Formerly RCA Dev. Types TA7337 and TA7337A, respectively.

**MAXIMUM RATINGS, Absolute Maximum Values:**

2N6032    2N6033

* COLLECTOR-TO-BASE VOLTAGE . . . . .	$V_{CBO}$	120	150	V
COLLECTOR-TO-EMITTER SUSTAINING VOLTAGE:				
With base open . . . . .	$V_{CEO}(sus)$	90	120	V
With external base-to-emitter resistance ( $R_{BE}) \leq 50\ \Omega$ . . . . .	$V_{CER}(sus)$	110	140	V
* With external base-to-emitter resistance ( $R_{BE}) \leq 50\ \Omega$ & $V_{BE} = -1.5\text{ V}$ . . . . .	$V_{CEX}(sus)$	120	150	V
* EMITTER-TO-BASE VOLTAGE . . . . .	$V_{EBO}$	7	7	V
* CONTINUOUS COLLECTOR CURRENT	$I_C$	50	40	A
* BASE CURRENT . . . . .	$I_B$	10	10	A
* EMITTER CURRENT . . . . .	$I_E$	50	40	A
* TRANSISTOR DISSIPATION:	$P_T$			
At case temperatures up to 25°C and $V_{CE}$ up to 24 V . . . . .		140	140	W
At case temperatures up to 25°C and $V_{CE}$ above 24 V . . . . .		See Fig. 2.		
At case temperatures above 25°C and $V_{CE}$ above 24 V . . . . .		See Figs. 2 and 3		
* TEMPERATURE RANGE:				
Storage & Operating (Junction) . . . . .		-65 to +200		°C
* PIN TEMPERATURE (During Soldering):				
At distances $\geq 1/32\text{ in. (0.8 mm)}$ from seating plane for 10 s max . . . . .		230		°C

**Applications:**

- Switching-control amplifiers
- Power gates
- Switching regulators
- Power-switching circuits
- Power oscillators
- DC-RF amplifiers
- Converters
- Inverters
- Control circuits

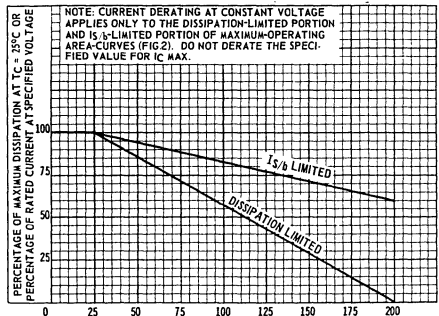


Fig. 1 — Derating curves for both types.

\*In accordance with JEDEC registration data format JS-6 RDF-1.

ELECTRICAL CHARACTERISTICS, Case Temperature ( $T_C$ ) = 25°C Unless Otherwise Specified

CHARACTERISTIC	SYMBOL	TEST CONDITIONS				LIMITS				UNITS
		VOLTAGE		CURRENT		2N6032		2N6033		
		V dc		A dc		Min.	Max.	Min.	Max.	
Collector-Cutoff Current: With base open	$I_{CEO}$	80	–	–	0	–	10	–	10	mA
* With base-emitter junction reverse biased $T_C = 150^\circ\text{C}$	$I_{CEV}$	110	-1.5	–	–	–	12	–	–	mA
		135	-1.5	–	–	–	–	–	10	mA
		100	-1.5	–	–	–	15	–	10	mA
* Emitter-Cutoff Current	$I_{EBO}$	–	–	0	–	–	10	–	10	mA
Collector-to-Emitter Sustaining Voltage: (See Figs. 12 & 13) With base open	$V_{CEO(sus)}$	–	–	0.2 <sup>b</sup>	0	90 <sup>a</sup>	–	120 <sup>a</sup>	–	V
With external base to emitter resistance ( $R_{BE}$ ) $\leq 50 \Omega$	$V_{CER(sus)}$	–	–	0.2 <sup>b</sup>	0	110 <sup>a</sup>	–	140 <sup>a</sup>	–	
With base-emitter junction reverse biased & $R_{BE} \leq 50 \Omega$	$V_{CEX(sus)}$	–	-1.5	0.2 <sup>b</sup>	0	120 <sup>a</sup>	–	150 <sup>a</sup>	–	
* Base-to-Emitter Saturation Voltage	$V_{BE(sat)}$	–	–	50 <sup>b</sup> 40 <sup>b</sup>	5 4	– –	2 –	– –	– 2	V
Base-to-Emitter Voltage	$V_{BE}$	2 2	– –	50 <sup>b</sup> 40 <sup>b</sup>	– –	– –	2 –	– –	– 2	V
* Collector-to-Emitter Saturation Voltage	$V_{CE(sat)}$	–	–	50 <sup>b</sup> 40 <sup>b</sup>	5 4	– –	1.3 –	– –	– 1	V
* DC Forward-Current Transfer Ratio	$h_{FE}$	2.6 2	– –	50 <sup>b</sup> 40 <sup>b</sup>	– –	10 –	50 –	– 10	– 50	
Second-Breakdown Collector Current With base forward biased, $t = 1$ s nonrepetitive	$I_{S/b}$	24 40	– –	– –	– –	5.8 <sup>c</sup> 0.9 <sup>c</sup>	– –	5.8 <sup>c</sup> 0.9 <sup>c</sup>	– –	A
Second-Breakdown Energy With base reverse biased ( $L = 310 \mu\text{H}$ , $R_{BE} = 5 \Omega$ )	$E_{S/b}$	–	-4	20	–	62	–	62	–	mJ
* Magnitude of common-emitter small-signal, short-circuit, forward-current transfer ratio $f = 5$ MHz	$ h_{fe} $	10	–	2	–	10	–	10	–	
* Gain-Bandwidth Product $f = 5$ MHz	$f_T$	10	–	2	–	50	–	50	–	MHz
Output Capacitance: $V_{CB} = 10$ V, $f = 1$ MHz	$C_{obo}$	–	–	–	–	–	800	–	800	pF
Thermal Resistance (Junction-to-Case)	$R_{\theta JC}$	20	–	2.5	–	–	1.25	–	1.25	°C/W

<sup>a</sup>In accordance with JEDEC registration format JS-6 RDF-1.

<sup>a</sup> CAUTION: The sustaining voltages  $V_{CEO(sus)}$ ,  $V_{CER(sus)}$ , and  $V_{CEX(sus)}$  MUST NOT be measured on a curve tracer. These sustaining voltages should be measured by means of the test circuit shown in Fig. 12.

<sup>b</sup> Pulsed: Pulse duration 300  $\mu\text{s}$ ; duty factor  $\leq 2\%$ .

SWITCHING TIME CHARACTERISTICS, Case Temperature ( $T_C$ ) = 25°C

CHARACTERISTIC	SYMBOL	TEST CONDITIONS				LIMITS				UNITS	
		VOLTAGE		CURRENT		2N6032		2N6033			
		V <sub>dc</sub>	A <sub>dc</sub>	V <sub>CE</sub>	V <sub>BE</sub>	I <sub>C</sub>	I <sub>B</sub>	Min.	Max.		Min.
Saturated Switching Time: (V <sub>CC</sub> =30 V, I <sub>B1</sub> = I <sub>B2</sub> ):											
Rise Time	t <sub>r</sub>	—	—	50	5	—	1	—	—	—	μs
Storage Time	t <sub>s</sub>	—	—	50	5	—	1.5	—	—	—	μs
Fall Time	t <sub>f</sub>	—	—	50	5	—	0.5	—	—	—	μs

\*In accordance with JEDEC registration format JS-6 RDF-1.

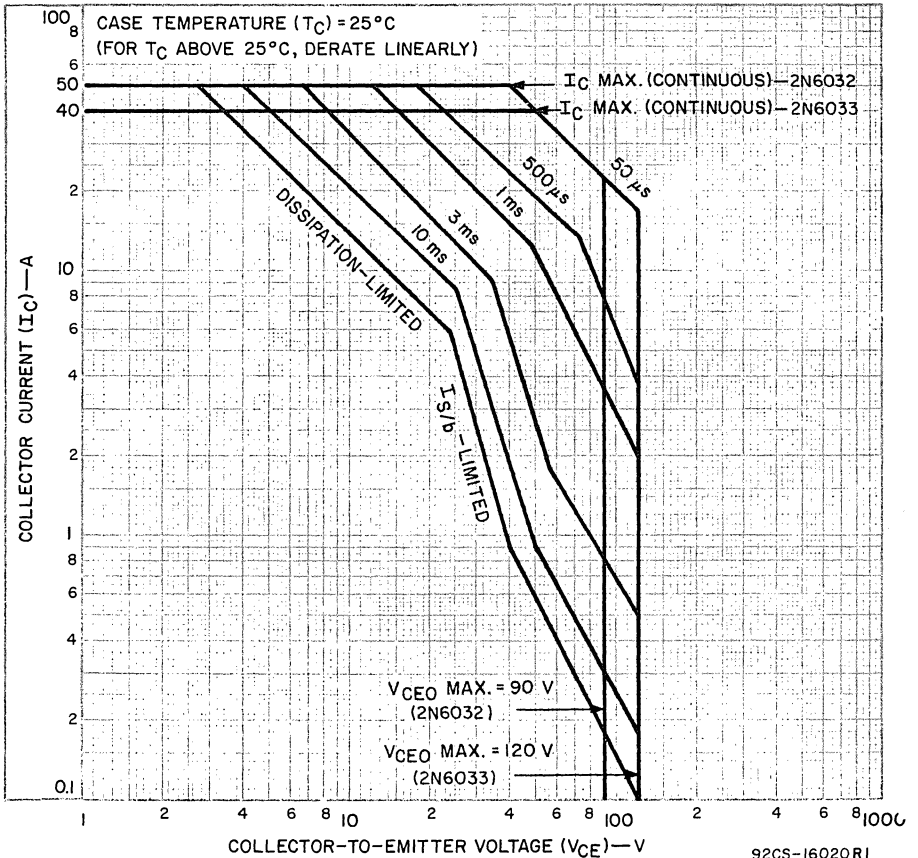


Fig. 2 — Maximum operating areas for both types.

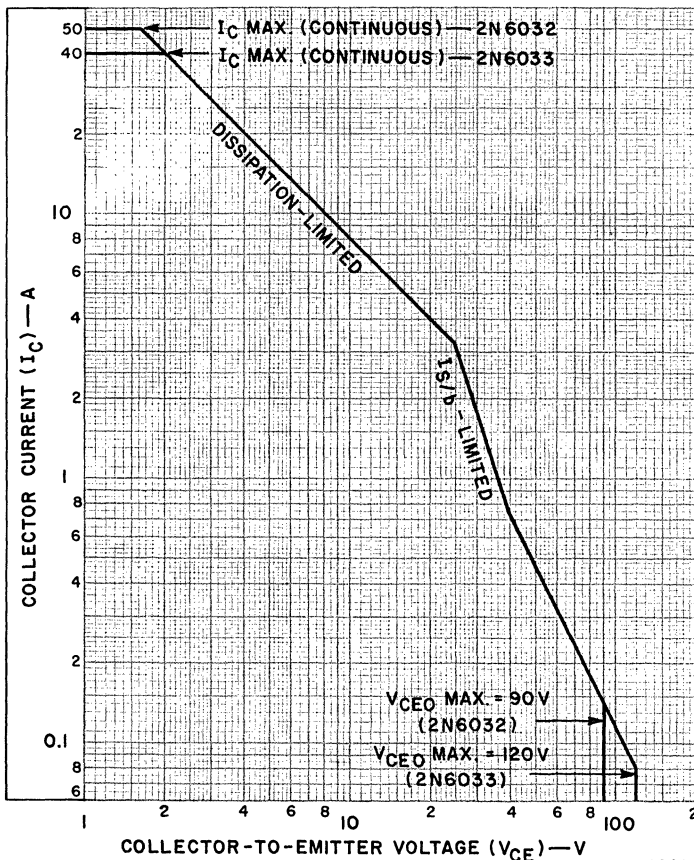


Fig. 3 — Maximum operating areas for both types at case temperature ( $T_C$ ) = 100°C. 92CS-17445

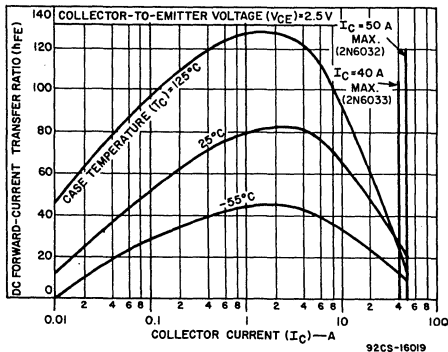


Fig. 4 — Typical dc-beta characteristic for both types.

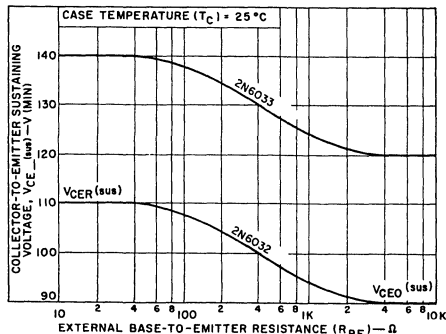


Fig. 5 — Collector-to-emitter sustaining voltage characteristics for both types.

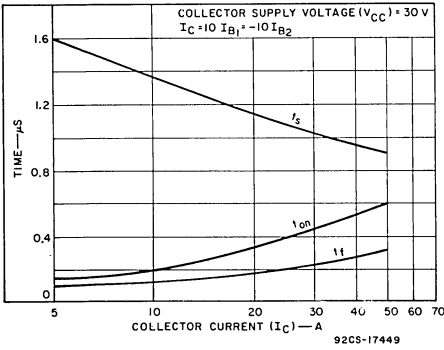


Fig. 6 - Typical saturated switching characteristics for both types.

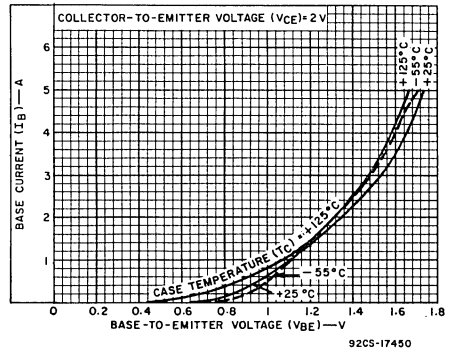


Fig. 7 - Typical input characteristics for both types.

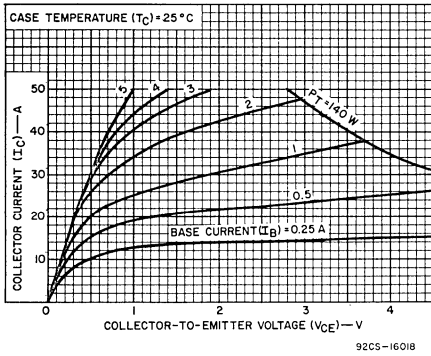


Fig. 8 - Typical collector characteristics for both types.

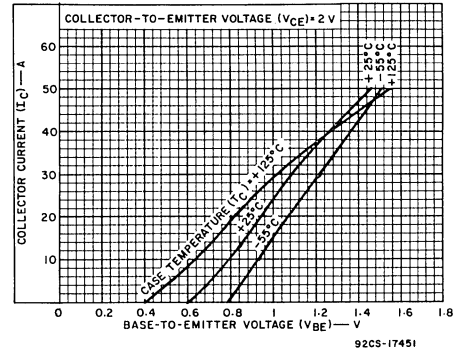


Fig. 9 - Typical transfer characteristics for both types.

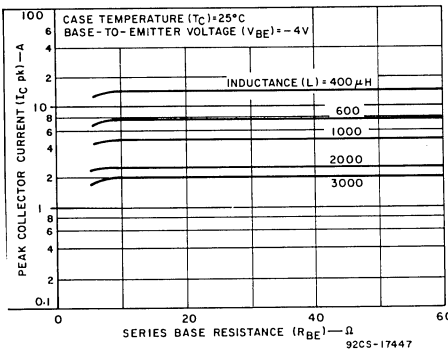


Fig. 10 - Maximum reverse-bias second-breakdown characteristics for both types.

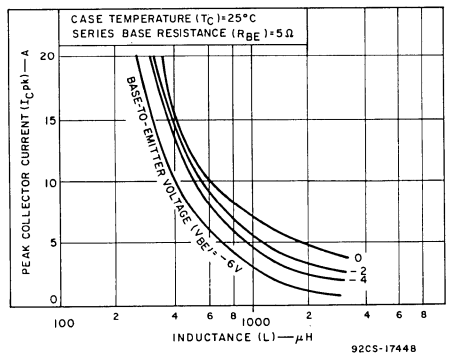
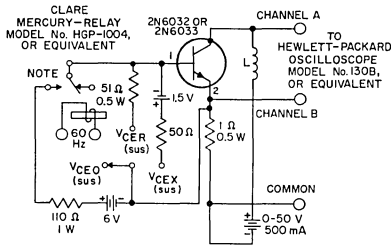


Fig. 11 - Maximum reverse-bias second-breakdown characteristics for both types.

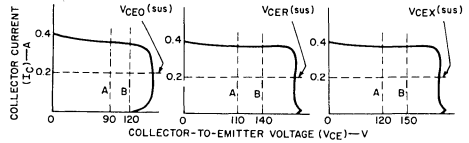


$L = 15 \text{ mH} [V_{CE0}(\text{sus}) \text{ \& } V_{CEr}(\text{sus})]$   
 $L = 2 \text{ mH} [V_{CEX}(\text{sus})]$

NOTE: Relay vibrates 60 times per second.

92SS-3955RI

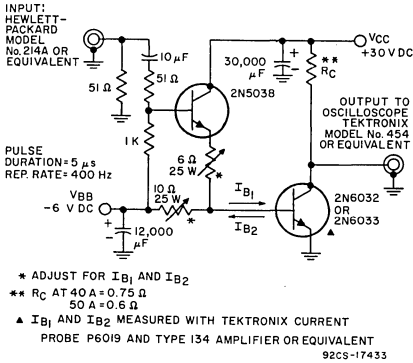
Fig. 12 — Circuit used to measure sustaining voltages  $V_{CE0}(\text{sus})$ ,  $V_{CEr}(\text{sus})$ , &  $V_{CEX}(\text{sus})$  for both types.



92CS-1602Z

NOTE: The sustaining voltages  $V_{CE0}(\text{sus})$ ,  $V_{CEr}(\text{sus})$ , or  $V_{CEX}(\text{sus})$  are acceptable when the trace falls to the right and above point "A" for type 2N6032 or point "B" for type 2N6033.

Fig. 13 — Oscilloscope display for measurement of sustaining voltages for both types. (Test circuit shown in Fig. 5).



\* ADJUST FOR  $I_{B1}$  AND  $I_{B2}$

\*\*  $R_C$  AT  $40 \text{ A} = 0.75 \Omega$   
 $50 \text{ A} = 0.6 \Omega$

▲  $I_{B1}$  AND  $I_{B2}$  MEASURED WITH TEKTRONIX CURRENT PROBE P6019 AND TYPE 134 AMPLIFIER OR EQUIVALENT

92CS-1743Z

Fig. 14 — Switching-time test set.

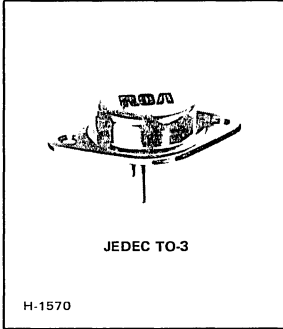
**TERMINAL CONNECTIONS**

- Pin 1 — Base
- Pin 2 — Emitter
- Case — Collector
- Mounting Flange — Collector



# Power Transistors

**2N6055**  
**2N6056**



## 8-Ampere Silicon N-P-N Darlington Power Transistors

60- and 80-Volt, 100-Watt Types  
With Gain of 750 at 4 Amperes

**Features:**

- Operation from IC without predriver
- Low leakage at high temperature
- High reverse-second-breakdown capability

**Applications:**

- Power switching
- Hammer drivers
- Audio amplifiers
- Series and shunt regulators

RCA-2N6055 and 2N6056 are monolithic n-p-n silicon Darlington transistors designed for low- and medium-frequency power applications. The double epitaxial construction of these devices provides good forward and reverse second-breakdown capability. Their high gain makes it possible for them to be driven directly from integrated circuits.

**TERMINAL CONNECTIONS**

- Pin 1 — Base
- Pin 2 — Emitter
- Case — Collector
- Mounting Flange — Collector

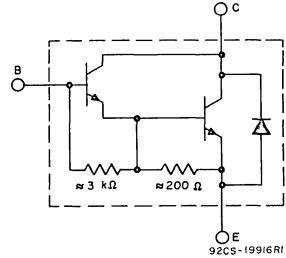


Fig. 1— Schematic diagram of 2N6055 and 2N6056 Darlington power transistors.

**MAXIMUM RATINGS, Absolute-Maximum Values:**

	2N6055	2N6056		
* COLLECTOR-TO-BASE VOLTAGE	V <sub>CBO</sub>	60	80	V
COLLECTOR-TO-EMITTER VOLTAGE:				
With base reverse-biased, V <sub>BE</sub> = -1.5 V, sustaining	V <sub>CEV</sub> (sus)	60	80	V
With external base-to-emitter resistance (R <sub>BE</sub> ) = 100Ω, sustaining	V <sub>CER</sub> (sus)	60	80	V
* With base open	V <sub>CEO</sub>	60	80	V
* EMITTER-TO-BASE VOLTAGE	V <sub>EB0</sub>	5	5	V
COLLECTOR CURRENT:	I <sub>C</sub>			
* Continuous		8	8	A
Peak		16	16	A
* CONTINUOUS BASE CURRENT	I <sub>B</sub>	120	120	mA
* TRANSISTOR DISSIPATION:	P <sub>T</sub>			
At case temperatures up to 25°C		100	100	W
At case temperatures above 25°C		See Figs. 2 and 3		
* TEMPERATURE RANGE:				
Storage & Operating (Junction)		-65 to +200		°C
* PIN TEMPERATURE (During Soldering):				
At distances ≥ 1/16 in. (1.58 mm) from seating plane for 10 s max		235		°C

\* In accordance with JEDEC registration data format JS-6 RDF-2

ELECTRICAL CHARACTERISTICS, at Case Temperature ( $T_C$ ) = 25°C unless otherwise specified

CHARACTERISTIC	SYMBOL	TEST CONDITIONS				LIMITS				UNITS
		DC VOLTAGE (V)		DC CURRENT (A)		2N6055		2N6056		
		$V_{CE}$	$V_{BE}$	$I_C$	$I_B$	MIN.	MAX.	MIN.	MAX.	
Collector Cutoff Current: With base open	$I_{CEO}$	30			0	—	0.5	—	—	mA
		40			0	—	—	—	0.5	
	$I_{CEX}$	60	-1.5			—	0.5	—	—	
		80	-1.5			—	—	—	0.5	
At $T_C = 150^\circ\text{C}$	$I_{CEX}$	60	-1.5			—	5	—	—	
		80	-1.5			—	—	—	5	
Emitter Cutoff Current	$I_{EBO}$		-5	0		—	2	—	2	mA
DC Forward Current	$h_{FE}$	3		8 <sup>a</sup>		100	—	100	—	
Transfer Ratio		3		4 <sup>a</sup>		750	18,000	750	18,000	
Collector-to-Emitter Sustaining Voltage: With base open	$V_{CEO(sus)}$				0.1 <sup>a</sup>	60 <sup>a</sup>	—	80 <sup>a</sup>	—	V
					0.1 <sup>a</sup>	60 <sup>a</sup>	—	80 <sup>a</sup>	—	
					0.1 <sup>a</sup>	60 <sup>a</sup>	—	80 <sup>a</sup>	—	
With external base-to-emitter resistance ( $R_{BE}$ ) = 100Ω	$V_{CER(sus)}$				0.1 <sup>a</sup>	60 <sup>a</sup>	—	80 <sup>a</sup>	—	V
With base-emitter junction reverse-biased	$V_{CEX(sus)}$		-1.5	0.1 <sup>a</sup>		60 <sup>a</sup>	—	80 <sup>a</sup>	—	V
Collector-to-Emitter Saturation Voltage	$V_{CE(sat)}$			4 <sup>a</sup>	0.016	—	2	—	2	V
				8 <sup>a</sup>	0.08	—	3	—	3	V
Base-to-Emitter Voltage	$V_{BE}$	3		4 <sup>a</sup>		—	2.8	—	2.8	V
At saturation	$V_{BE(sat)}$			8 <sup>a</sup>	0.08	—	4	—	4	V
Magnitude of Common-Emitter, Small-Signal Short-Circuit, Forward Current Transfer Ratio; $f = 1$ MHz	$ h_{fe} $	3		3		4	—	4	—	
Common-Base Output Capacitance; $f = 0.1$ MHz, $V_{CB} = 10$ V	$C_{obo}$					—	200	—	200	pF
Common-Emitter, Small-Signal, Short-Circuit Forward Current Transfer Ratio; $f = 1$ kHz	$h_{fe}$	3		3		300	—	300	—	—
Second Breakdown Energy: With base reverse-biased and $L = 12$ mH, $R_{BE} = 100\Omega$	$E_{S/bb}$		-1.5	5		150	—	150	—	mJ
Forward-Bias Second Breakdown Collector Current (1- $\mu$ s non-repetitive pulse)	$I_{S/b}$	33.3				3	—	3	—	A
		40				—	—	2	—	A
Thermal Resistance: Junction-to-Case	$R_{\theta JC}$					—	1.75	—	1.75	°C/W

<sup>a</sup> In accordance with JEDEC registration data format JS-6 RDF-2.

<sup>a</sup> Pulsed: Pulse duration = 300  $\mu$ s, duty factor = 2%.

<sup>b</sup>  $E_{S/b}$  is defined as the energy at which second breakdown occurs under specified reverse bias conditions.  $E_{S/b} = \frac{1}{2}LI^2$ , where L is a series load or leakage inductance and I is the peak collector current.



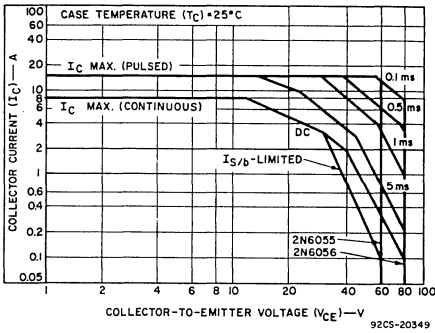


Fig. 2— Maximum operating areas for types 2N6055 and 2N6056.

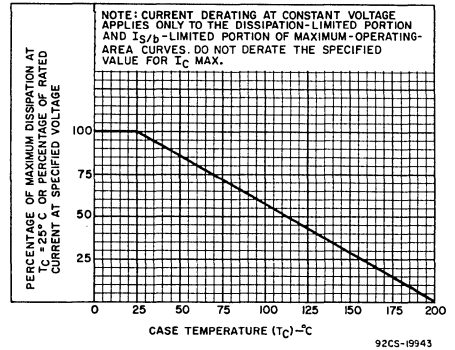


Fig. 3— Derating curve for both types.

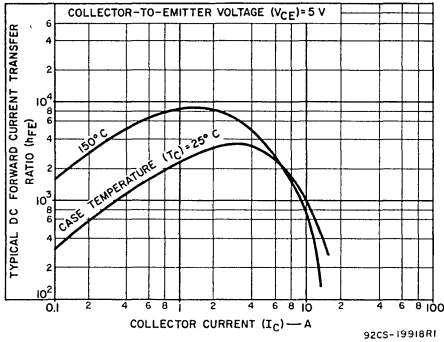


Fig. 4— Typical dc beta characteristics for both types.

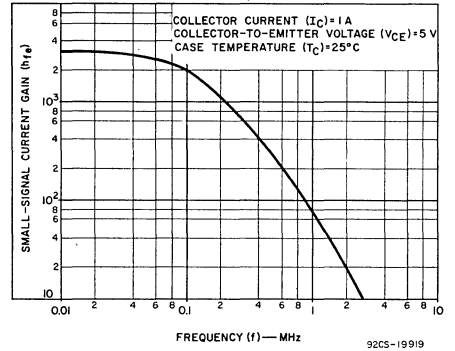


Fig. 5— Typical small-signal gain for both types.

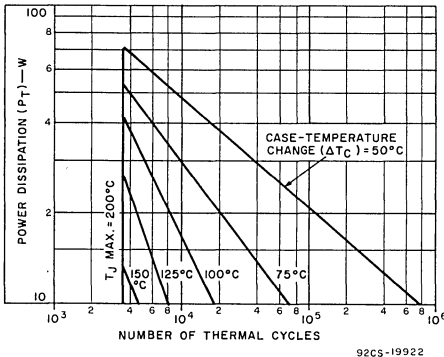


Fig. 6— Thermal-cycling rating chart for both types.

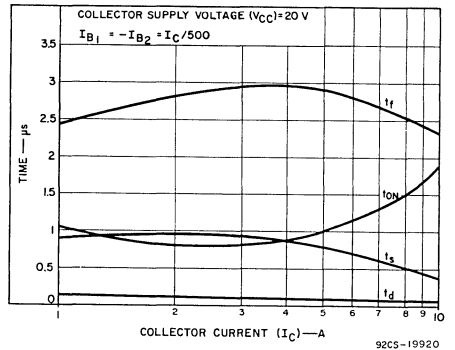


Fig. 7— Typical saturated switching-time characteristics for both types.

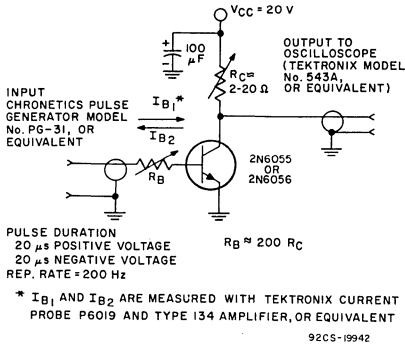
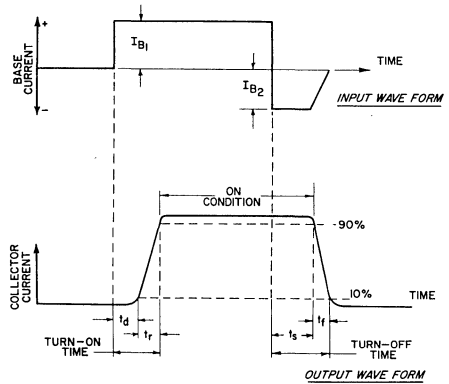
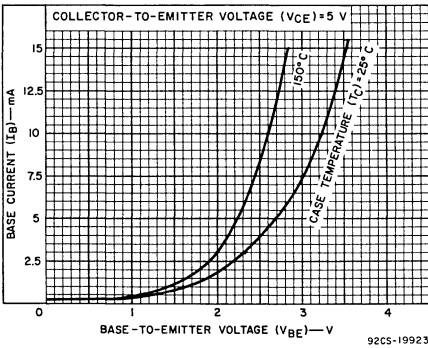


Fig. 8—Circuit used to measure saturated switching times.



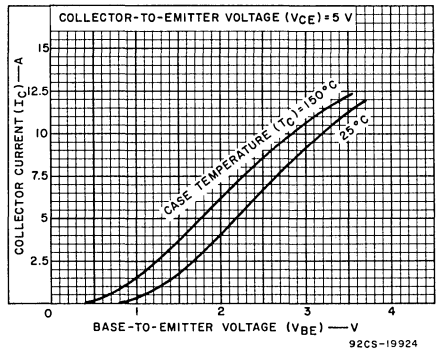
92CS-13996R1

Fig. 9—Phase relationship between input current and output current showing reference points for specification of switching times (test circuit shown in Fig. 8).



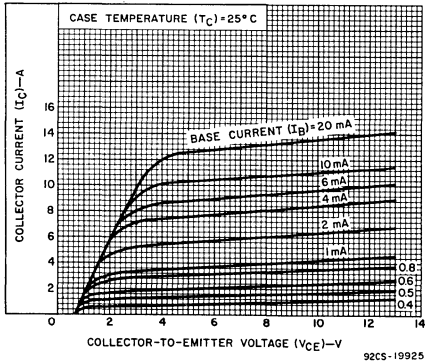
92CS-19923

Fig. 10—Typical input characteristics for both types.



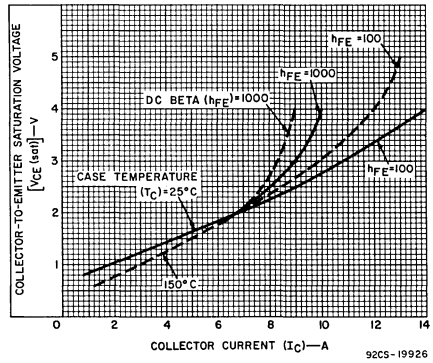
92CS-19924

Fig. 11—Typical transfer characteristics for both types.



92CS-19925

Fig. 12—Typical output characteristics for both types.



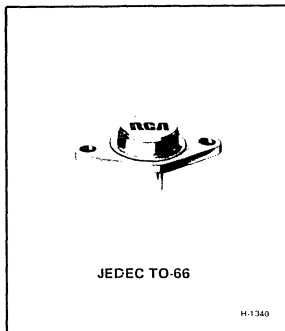
92CS-19926

Fig. 13—Typical saturation-voltage characteristics for both types.



# Power Transistors

**2N6077**  
**2N6078**  
**2N6079**



## High-Voltage, High-Power Silicon N-P-N Transistors

For Switching and Linear Applications

### Features

- Maximum safe-area-of-operation curves
- Low saturation voltages
- High voltage ratings :
  - VCER(sus) = 300 V (2N6077)
  - 275 V (2N6078)
  - 375 V (2N6079)
- High dissipation rating : PT = 45 W

### TERMINAL CONNECTIONS

- 1 Pin 1 — Base
- Pin 2 — Emitter
- Mounting Flange, Case-Collector

RCA-2N6077, 2N6078, and 2N6079 are multiple epitaxial silicon n-p-n power transistors utilizing a multiple-emitter-site structure. Multiple-epitaxial construction maximizes the volt-ampere characteristic of the device and provides fast switching speeds. Multiple-emitter-site design ensures uniform current flow throughout the structure, which produces a high  $I_S/B$  and a large safe-operation area.

These devices use the popular JEDEC TO-66 package; they differ mainly in voltage ratings, leakage-current limits, and  $V_{CE(sat)}$  ratings.

The 2N6077 is characterized for switching applications with load lines in the active region. These applications include sweep circuits and all circuits using the transistor as an active voltage clamp.

Type 2N6078 is characterized for switching applications with the load line extending into the reverse-bias region. Its voltage ratings make this device useful for switching regulators operating directly from a rectified 110-V or 220-V power line. The unit is rated to take surge currents up to 5 A and maintain saturation.

The 2N6079 is characterized for use in inverters operating directly from a rectified 110-V power line. The leakage current is specified at 450 volts; therefore the device can also be used in a series bridge configuration on a 220-V line. The V<sub>EBO</sub> rating of 9 volts eases requirements on the drive transformer in inverter applications. Storage time, an important factor in the frequency stability of an inverter, is specified in Fig. 12, which shows variation in storage time with variation in load current from zero to maximum (4 A).

### MAXIMUM RATINGS, Absolute-Maximum Values:

	2N6077	2N6078	2N6079	
*COLLECTOR-TO-BASE VOLTAGE	300	275	375	V
COLLECTOR-TO-EMITTER SUSTAINING VOLTAGE:				
With base open	V <sub>CEO</sub> (sus)	275	250	350
With reverse bias ( $V_{BE}$ ) of -1.5 V	V <sub>CEX</sub> (sus)	300	275	375
With external base-to-emitter resistance ( $R_{BE}$ ) $\leq 50 \Omega$	V <sub>CER</sub> (sus)	300	275	375
*EMITTER-TO-BASE VOLTAGE	V <sub>EBO</sub>	6	6	9
*COLLECTOR CURRENT:	I <sub>C</sub>			
Continuous		7	7	7
Peak		10	10	10
*CONTINUOUS BASE CURRENT	I <sub>B</sub>	4	4	4
*TRANSISTOR DISSIPATION:	P <sub>T</sub>			
At case temperatures up to 25°C and V <sub>CE</sub> up to 40 V		45	45	45
At case temperatures up to 25°C and V <sub>CE</sub> above 40 V				
At case temperatures above 25°C and V <sub>CE</sub> above 40 V				
*TEMPERATURE RANGE:				
Storage & Operating (Junction)			-65 to +200	°C
*PIN TEMPERATURE (During Soldering):				
At distances $\geq 1/32$ in. (0.8 mm) from case for 10 s max.			230	°C

See Fig. 1  
See Figs. 1, 2, and 4

\* In accordance with JEDEC registration data format (JS-6, RDF-1).

ELECTRICAL CHARACTERISTICS, At Case Temperature ( $T_C$ ) = 25°C unless otherwise specified

CHARACTERISTIC	SYMBOL	TEST CONDITIONS				LIMITS						UNITS					
		VOLTAGE V dc		CURRENT A dc		2N6077			2N6078				2N6079				
		V <sub>CE</sub>	V <sub>BE</sub>	I <sub>C</sub>	I <sub>B</sub>	Min.	Typ.	Max.	Min.	Typ.	Max.		Min.	Typ.	Max.		
Collector-Cutoff Current: With base open	I <sub>CEO</sub>	250		0		—	—	2	—	—	—	—	—	—	—	—	mA
* With base-emitter junction reverse biased	I <sub>CEV</sub>	250	-1.5			—	—	5	—	—	0.05	—	—	—	—	—	mA
* With base-emitter junction reverse biased, T <sub>C</sub> = 125°C		450	-1.5			—	—	8	—	—	0.2	—	—	—	—	—	mA
* Emitter-Cutoff Current	I <sub>EBO</sub>		-6 -9	0 0		—	—	1	—	—	1	—	—	—	—	—	mA
* Collector-to-Emitter Sustaining Voltage With base open	V <sub>CEO(sus)</sub>			0.2 <sup>a</sup>		275 <sup>b</sup>	—	—	250 <sup>b</sup>	—	—	350 <sup>b</sup>	—	—	—	—	V
With external base-to- emitter resistance: R <sub>BE</sub> = 50 Ω	V <sub>CER(sus)</sub>			0.2 <sup>a</sup>		300 <sup>b</sup>	—	—	275 <sup>b</sup>	—	—	375 <sup>b</sup>	—	—	—	—	V
* Emitter-to-Base Voltage: I <sub>E</sub> = 1 mA	V <sub>EBO</sub>			0		6	—	—	6	—	—	9	—	—	—	—	V
* DC Forward-Current Transfer Ratio	h <sub>FE</sub>	1		1.2 <sup>a</sup>		12	28	70	12	28	70	12	28	50	—	—	
* Base-to-Emitter Saturation Voltage	V <sub>BE(sat)</sub>			1.2 <sup>a</sup> 3 <sup>a</sup> 4 <sup>a</sup> 5 <sup>a</sup>	0.2 0.6 0.8 1	— — — —	1.0 1.2 — —	1.6 1.9 — —	— — — —	1.0 1.6 — —	1.6 — — —	— — — —	1.0 — 1.3 —	1.6 — 2 —	— — — —	—	V
* Collector-to-Emitter Saturation Voltage	V <sub>CE(sat)</sub>			1.2 <sup>a</sup> 3 <sup>a</sup> 4 <sup>a</sup> 5 <sup>a</sup>	0.2 0.6 0.8 1	— — — —	0.15 0.25 — —	0.5 1 — —	— — — —	0.15 — — —	0.5 — — —	— — — —	0.15 — 0.5 —	0.5 — 3 —	— — — —	—	V
Output Capacitance: V <sub>CB</sub> = 10 V, f = 1 MHz	C <sub>obo</sub>					—	—	150	—	—	150	—	—	150	—	—	pF
* Magnitude of Common Emitter, Small-Signal, Short-Circuit, Forward Current Transfer Ratio: f = 1 MHz	h <sub>fe</sub>	10		0.2		1	7	—	1	7	—	1	7	—	—	—	
Second Breakdown Collector Current (With base forward biased) Pulse duration (non- repetitive) = 1 s	I <sub>S/b</sub>	50				0.9	—	—	0.9	—	—	0.9	—	—	—	—	A
Second Breakdown Energy (With base reverse biased); R <sub>B</sub> = 50 Ω, L = 100 μH	E <sub>S/b</sub>		-4	3		0.45	—	—	0.45	—	—	0.45	—	—	—	—	mJ
Switching Times <sup>c</sup> (V <sub>CC</sub> = 250 V, I <sub>B1</sub> = I <sub>B2</sub> ):																	
Delay Time	t <sub>d</sub>			1.2	0.2	—	0.02	—	—	0.02	—	—	0.02	—	—	—	
* Rise Time	t <sub>r</sub>			1.2	0.2	—	0.3	0.75	—	0.3	0.75	—	0.3	0.75	—	—	μs
* Storage Time	t <sub>s</sub>			1.2	0.2	—	2.8	5	—	2.8	5	—	2.8	5	—	—	μs
* Fall Time	t <sub>f</sub>			1.2	0.2	—	0.3	0.75	—	0.3	0.75	—	0.3	0.75	—	—	μs
Thermal Resistance: Junction-to-Case	R <sub>θJC</sub>	20		2.25		—	—	3.9	—	—	3.9	—	—	3.9	—	—	°C/W

\* In accordance with JEDEC registration data format (JS-6 RDF-1).

<sup>a</sup> Pulsed; pulse duration ≤ 350 μs, Duty factor = 2%.

<sup>b</sup> CAUTION: The sustaining voltages V<sub>CEO(sus)</sub>, and V<sub>CER(sus)</sub>, MUST NOT be measured on a curve tracer. These sustaining voltages should be measured by means of the test circuit shown in Fig. 15.

<sup>c</sup> See Figs. 10-14, 17 and 18.

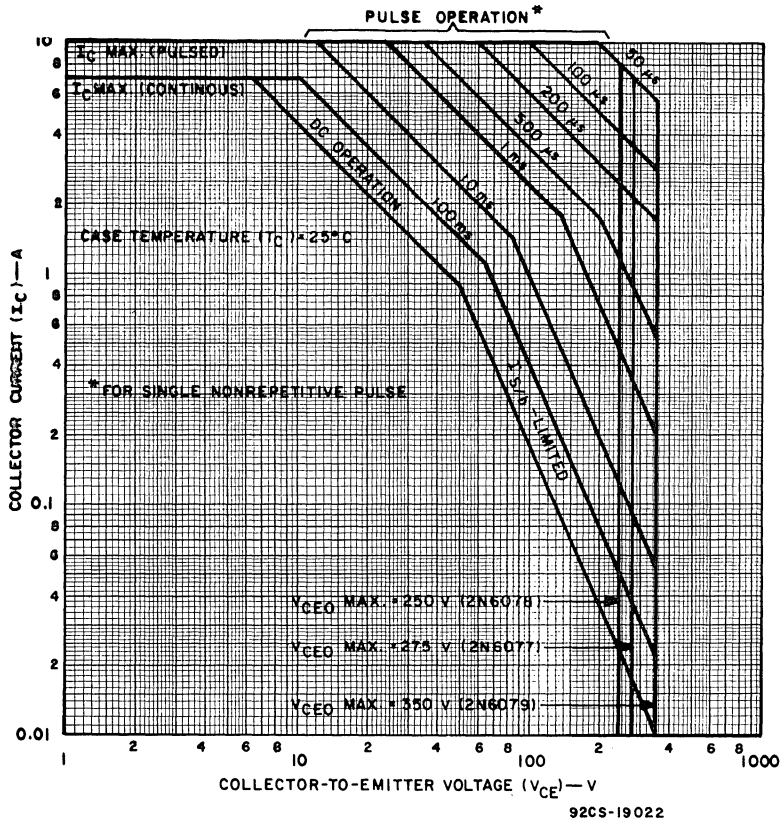


Fig. 1—Maximum operating areas for all types.

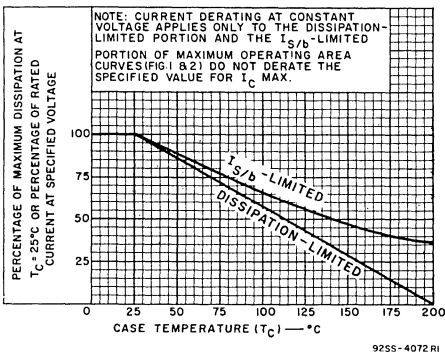


Fig. 2—Derating curve for all types.

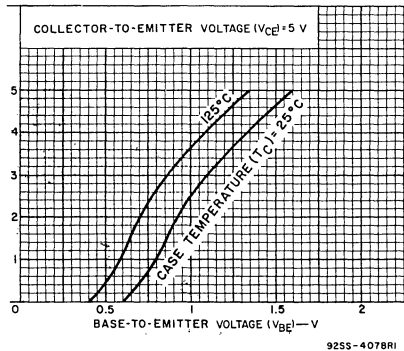


Fig. 3—Typical transfer characteristics for all types.

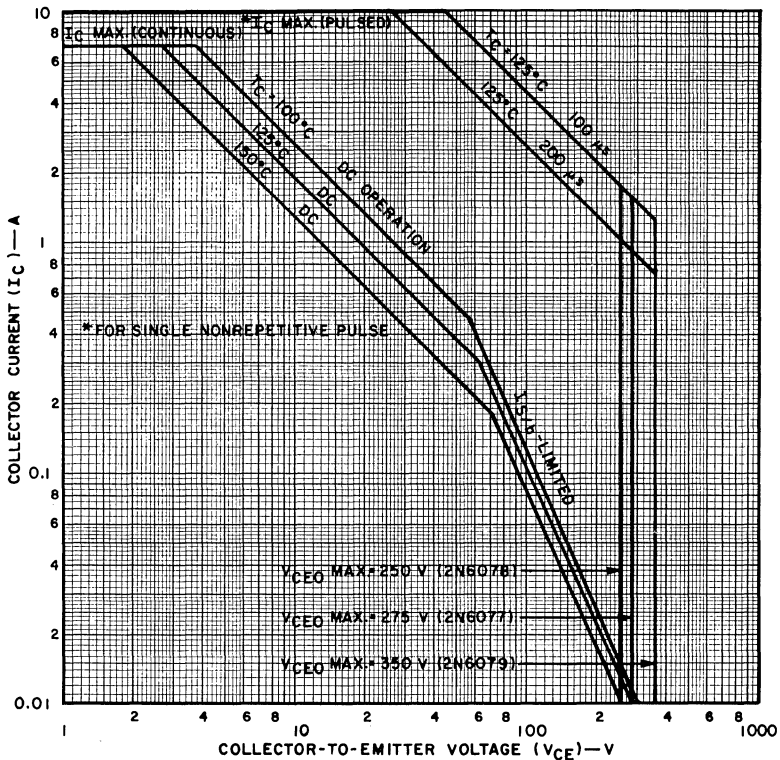


Fig.4—Maximum operating areas for all types.

92CS-19023

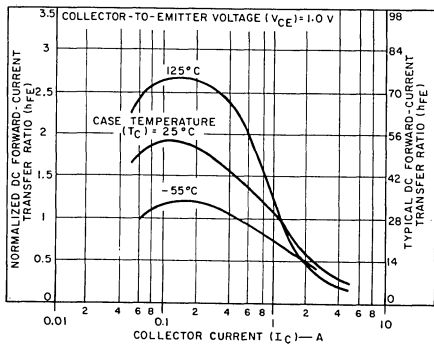


Fig.5—Typical normalized dc beta characteristics for all types.

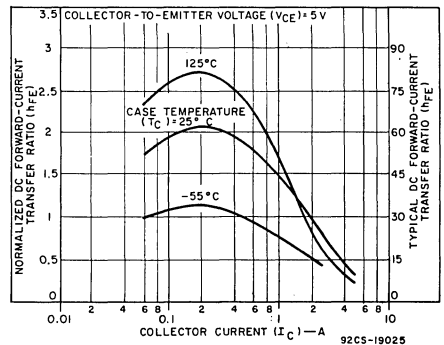


Fig.6—Typical normalized dc beta characteristics for all types.

Note (Figs. 5 & 6): To estimate min., max.  $h_{FE}$  at any current and temperature, read normalized dc forward-current transfer ratio and multiply by min., max. specifications given in Electrical Characteristics Chart.

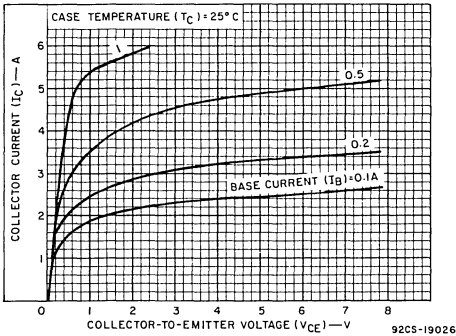


Fig. 7—Typical output characteristics for all types.

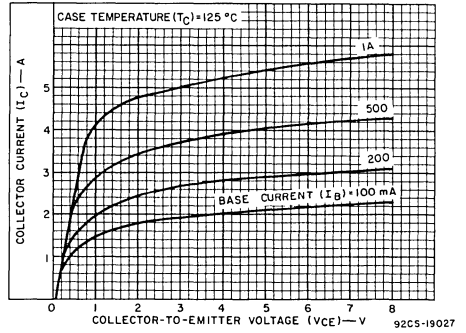


Fig. 8—Typical output characteristics for all types.

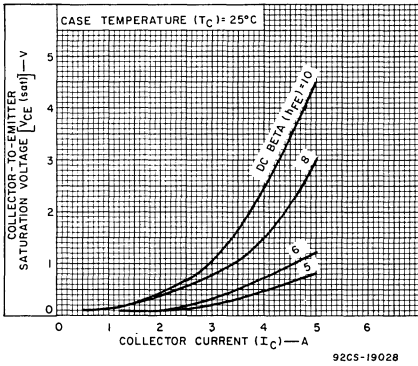


Fig. 9—Typical saturation voltage characteristics for all types.

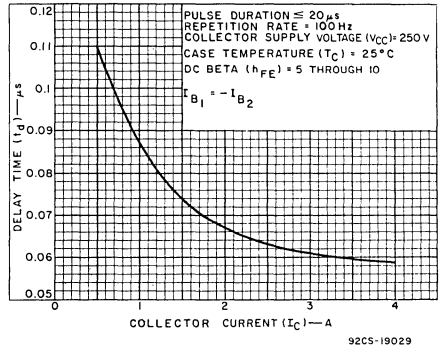


Fig. 10—Typical delay-time characteristic for all types.

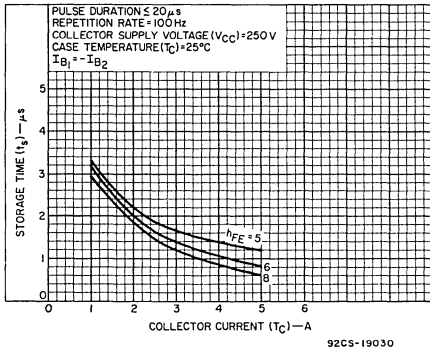


Fig. 11—Typical storage-time characteristic for all types (with constant forced gain).

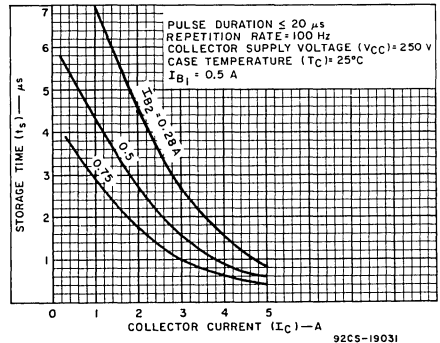


Fig. 12—Typical storage-time characteristic for all types (with constant-base drives).

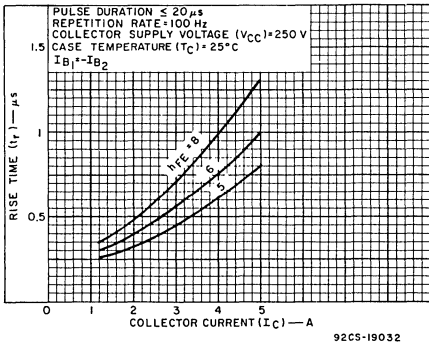


Fig. 13—Typical rise-time characteristic for all types.

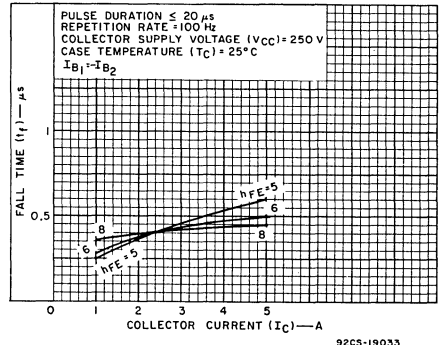


Fig. 14—Typical fall-time characteristic for all types.

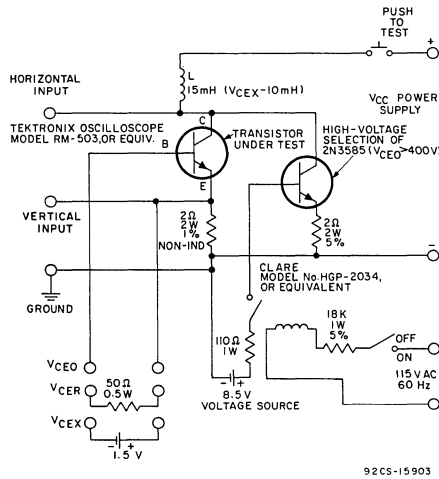
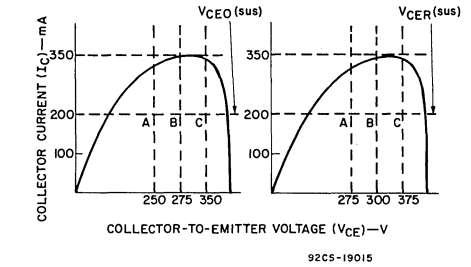


Fig. 15—Circuit used to measure sustaining voltages  $V_{CE0}(sus)$ ,  $V_{CEr}(sus)$  for all types.



The sustaining voltages  $V_{CE0}(sus)$  and  $V_{CEr}(sus)$  are acceptable when the traces fall to the right and above point "A" for type 2N6078 point "B" for type 2N6077 and point "C" for type 2N6079.

Fig. 16—Oscilloscope display for measurement of sustaining voltages (test circuit shown in Fig. 15).

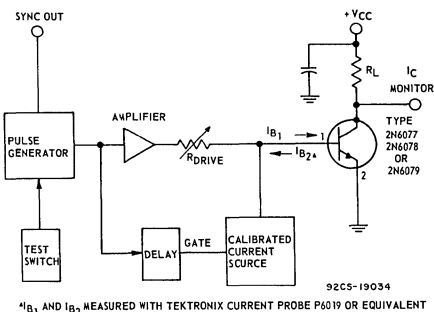


Fig. 17—Circuit used to measure switching times for all types.

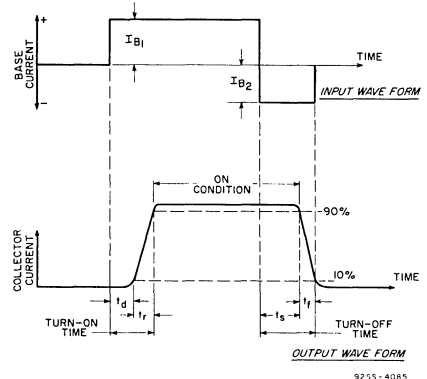


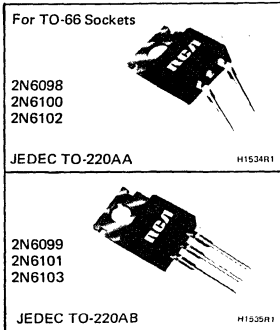
Fig. 18—Phase relationship between input and output currents showing reference points for specification of switching times. (Test circuit shown in Fig. 17).





# Power Transistors

2N6098 2N6099  
2N6100 2N6101  
2N6102 2N6103



## High-Current, Silicon N-P-N VERSAWATT Transistors

Designed for Medium-Power Linear and Switching Service in Consumer, Automotive, and Industrial Applications

### Features:

- Low saturation voltage —  
 $V_{CE(sat)} = 1\text{ V max. at } I_C = 4\text{ A (2N6098, 2N6099)}$   
 $= 1\text{ V max. at } I_C = 5\text{ A (2N6100, 2N6101)}$   
 $= 1\text{ V max. at } I_C = 8\text{ A (2N6102, 2N6103)}$
- VERSAWATT package (molded-silicone plastic)
- Maximum safe-area-of-operation curves
- Thermal-cycle rating curve

These RCA types are homotaxial-base silicon n-p-n transistors. Types 2N6098, 2N6100, and 2N6102 have formed emitter and base leads for easy insertion into TO-66 sockets. Types 2N6099, 2N6101, and 2N6103 are electrically identical to the 2N6098, 2N6100, and 2N6102, respectively.

These new VERSAWATT-package transistors differ in voltage ratings and in the currents at which the parameters are controlled. They are intended for a wide variety of medium-power switching and linear applications, such as series and shunt regulators, solenoid drivers, motor-speed

controls, inverters, and driver and output stages of high-fidelity amplifiers.

\*Formerly RCA Dev. Nos. TA7381-86, inclusive.

### OPTIONAL LEAD CONFIGURATION

An additional lead forming for printed-circuit board mounting is also available. Please submit requirements to your RCA Technical Sales Representative, or write to RCA Linear Power Marketing, Somerville, N.J. 08876.

### Maximum Ratings, Absolute-Maximum Values:

- \*COLLECTOR-TO-BASE VOLTAGE .....
- COLLECTOR-TO-EMITTER SUSTAINING VOLTAGE:
  - With external base-to-emitter resistance ( $R_{BE}$ ) = 100 $\Omega$  .....
  - \* With base open .....
- \*EMITTER-TO-BASE VOLTAGE .....
- \*COLLECTOR CURRENT (Continuous) .....
- \*BASE CURRENT .....
- TRANSISTOR DISSIPATION:
  - \* At case temperatures up to 25°C .....
  - At ambient temperatures up to 25°C .....
  - \* At case temperatures above 25°C, derate linearly .....
  - At ambient temperatures above 25°C, derate linearly .....
- \*TEMPERATURE RANGE:
  - Storage & Operating (Junction) .....
- \*LEAD TEMPERATURE (During Soldering):
  - At distance  $\geq 1/8$  in. (3.17 mm) from case of 10 s max .....

	2N6102	2N6098	2N6100	
	2N6103	2N6099	2N6101	
$V_{CBO}$	45	70	80	V
$V_{CER(sus)}$	45	65	75	V
$V_{CEO(sus)}$	40	60	70	V
$V_{EBO}$	5	8	8	V
$I_C$	16	10	10	A
$I_B$	4	4	4	A
$P_T$	75	75	75	W
	1.8	1.8	1.8	W
	← 0.6 →			W/°C
	← 0.0144 →			W/°C
	← -65 to 150 →			°C
	← 235 →			°C

\*In accordance with JEDEC registration data format JS-6 RDF-2.

ELECTRICAL CHARACTERISTICS, Case Temperature ( $T_C$ ) = 25°C Unless Otherwise Specified

Characteristic	Symbol	TEST CONDITIONS						LIMITS						Units
		DC Collector Voltage (V)		DC Emitter Voltage (V)		DC Current (A)		2N6102 2N6103		2N6098 2N6099		2N6100 2N6101		
		$V_{CE}$	$V_{EB}$	$I_C$	$I_B$	Min.	Max.	Min.	Max.	Min.	Max.			
* Collector-Cutoff Current With base-emitter junction reverse biased	$I_{CEX}$	40	1.5			-	2	-	-	-	-	-	mA	
		65	1.5			-	-	-	2	-	-			
		75	1.5			-	-	-	-	-	2			
	With base open	$I_{CEO}$	30			0	-	2	-	-	-	-		mA
			50			0	-	-	-	2	-	-		
			60			0	-	-	-	-	-	2		
* Emitter-Cutoff Current	$I_{EBO}$		5			-	1	-	-	-	-	mA		
			8			-	-	-	1	-	1			
* Collector-to-Emitter Sustaining Voltage: With external base-to-emitter resistance ( $R_{BE}$ ) = 100Ω <sup>a</sup>	$V_{CEr(sus)}$			0.2		45	-	65	-	75	-	V		
		With base open <sup>a</sup>	$V_{CEO(sus)}$		0.2	0	40	-	60	-	70		-	
* DC Forward-Current Transfer Ratio <sup>a</sup>	$h_{FE}$	4		4		-	-	20	80	-	-			
		4		5		-	-	-	-	20	80			
		4		8		15	60	-	-	-	-			
		4		10		-	-	5	-	5	-			
		4		16		5	-	-	-	-	-			
* Base-to-Emitter Voltage <sup>a</sup>	$V_{BE}$	4		4		-	-	-	1.7	-	-	V		
		4		5		-	-	-	-	-	1.7			
		4		8		-	1.7	-	-	-	-			
* Collector-to-Emitter Saturation Voltage <sup>a</sup>	$V_{CE(sat)}$			10	2	-	-	-	2.5	-	2.5	V		
				16	3.2	-	2.5	-	-	-	-			
* Common-Emitter, small-signal short-circuit, forward current transfer ratio	$h_{fe}$	4	f=1kHz	0.5		15	-	15	-	15	-			
* Magnitude of common-emitter, small-signal, short circuit, forward current transfer ratio	$ h_{fe} $	4	f=0.1MHz	0.5		8	28	8	28	8	28			
Thermal Resistance: Junction-to-Case- Junction-to-Ambient	$\theta_{J-C}$ $\theta_{J-A}$						1.67		1.67		1.67	°C/W		
							70		70		70			

<sup>a</sup>In accordance with JEDEC registration data format (JS-6, RDF-2)

<sup>a</sup>Pulsed, pulse duration = 300 μs, duty factor = 0.018

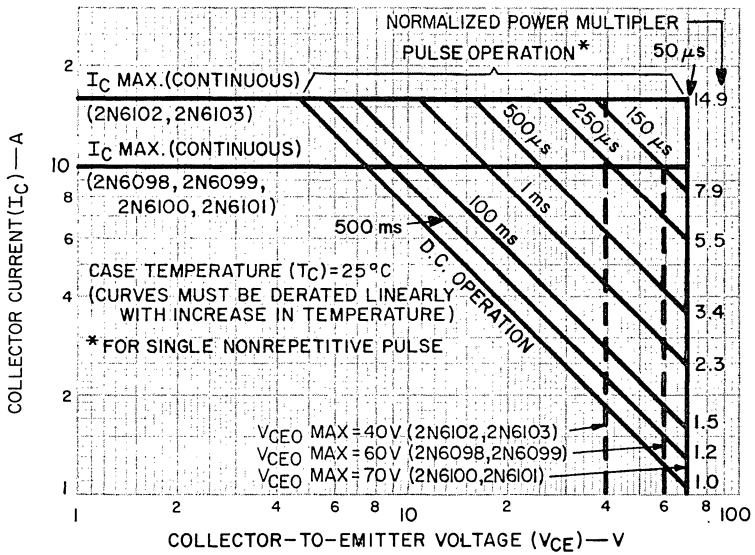


Fig. 1—Maximum safe operating areas for all types. 92CS-17954

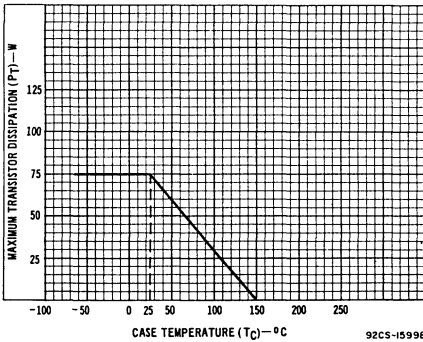


Fig. 2—Derating curve for all types. 92CS-15998

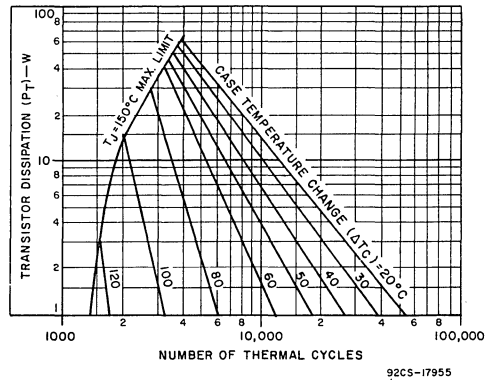


Fig. 3—Thermal-cycling rating for all types. 92CS-17955

**TERMINAL CONNECTIONS FOR  
TYPES 2N6098, 2N6100, 2N6102**

- Terminal No. 1—Base
- Terminal No. 3—Emitter
- Terminal No. 4—Collector

**TERMINAL CONNECTIONS FOR  
TYPES 2N6099, 2N6101, 2N6103**

- Terminal No. 1—Base
- Terminal No. 2—Collector
- Terminal No. 3—Emitter
- Terminal No. 4—Collector

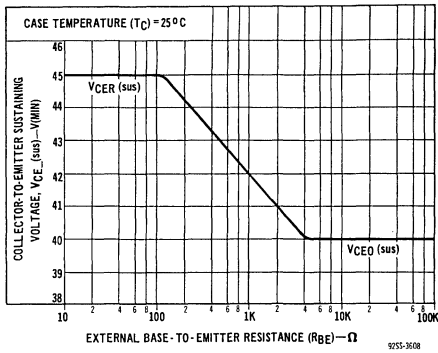


Fig.4—Sustaining voltage vs. base-to-emitter resistance for types 2N6102 and 2N6103.

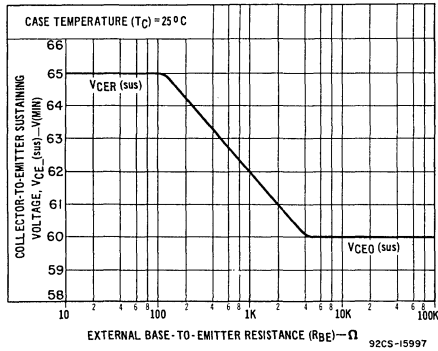


Fig.6—Sustaining voltage vs. base-to-emitter resistance for types 2N6098 and 2N6099.

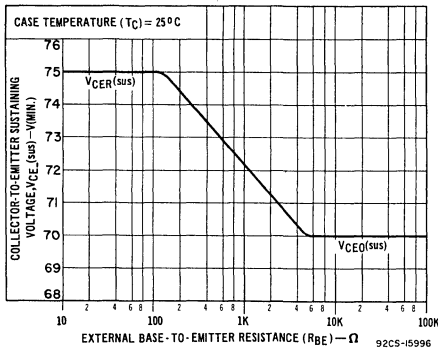


Fig.8—Sustaining voltage vs. base-to-emitter resistance for types 2N6100 and 2N6101.

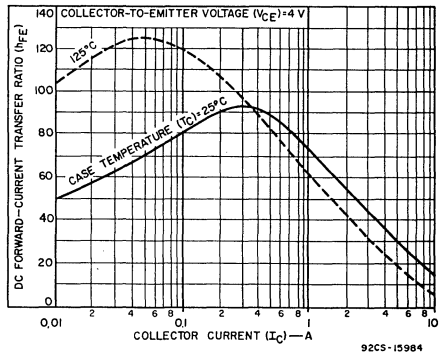


Fig.5—Typical dc beta characteristics for types 2N6102 and 2N6103.

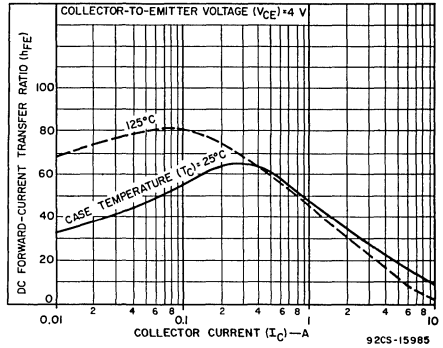


Fig.7—Typical dc beta characteristics for types 2N6098 and 2N6099.

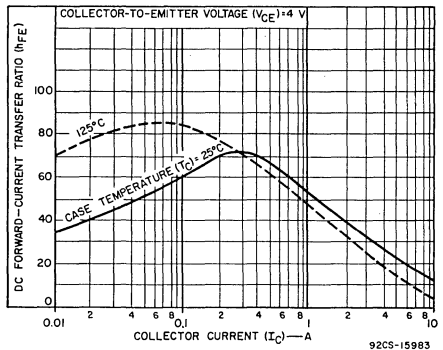


Fig.9—Typical dc beta characteristics for types 2N6100 and 6101.

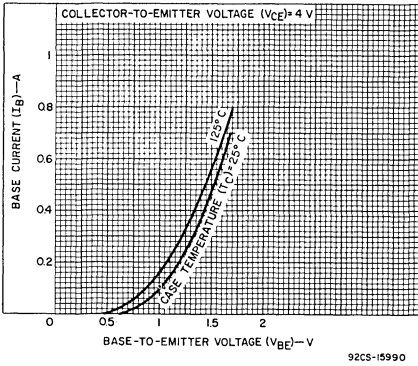


Fig. 10—Typical input characteristics for types 2N6102 and 2N6103.

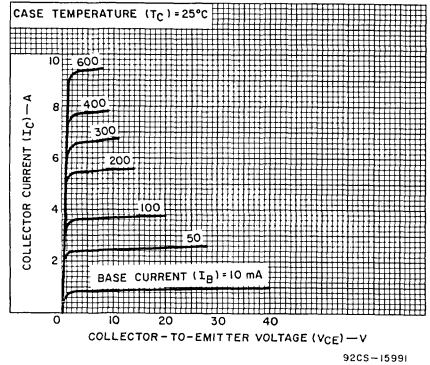


Fig. 11—Typical output characteristics for types 2N6102 and 2N6103.

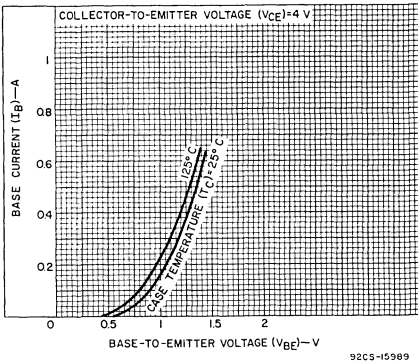


Fig. 12—Typical input characteristics for types 2N6098 and 2N6099.

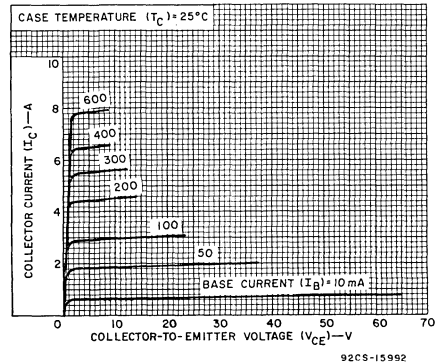


Fig. 13—Typical output characteristics for types 2N6098 and 2N6099.

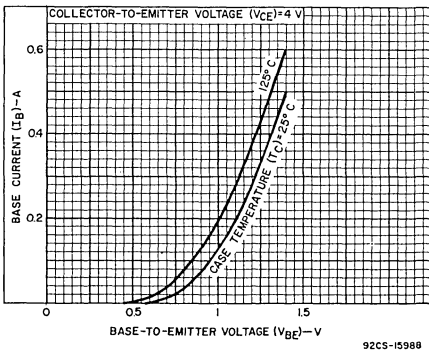


Fig. 14—Typical input characteristics for types 2N6100 and 2N6101.

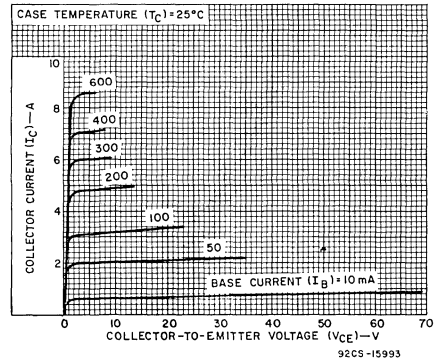


Fig. 15—Typical output characteristics for types 2N6100 and 2N6101.

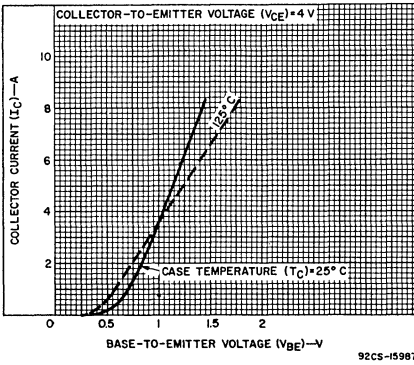


Fig. 16—Typical transfer characteristics for all types.

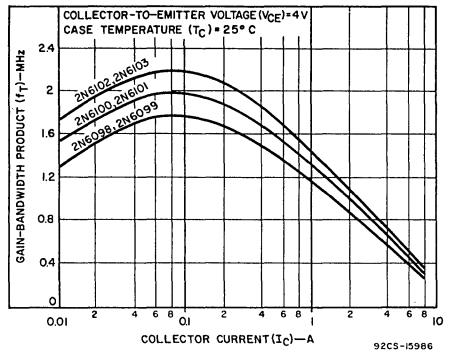


Fig. 17—Typical gain-bandwidth product for all types.

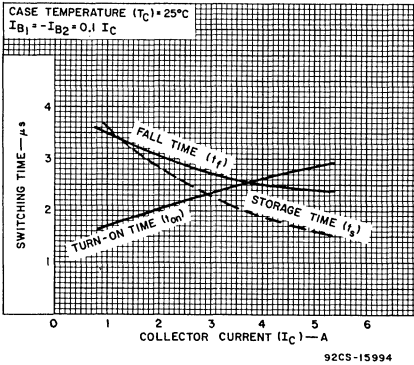


Fig. 18—Typical saturated switching characteristics for all types.

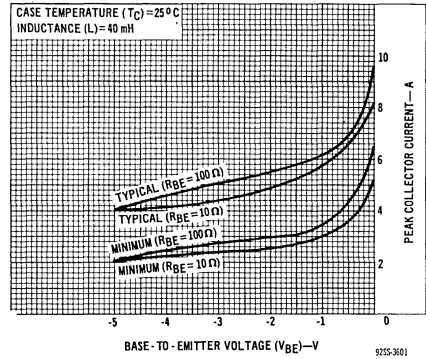
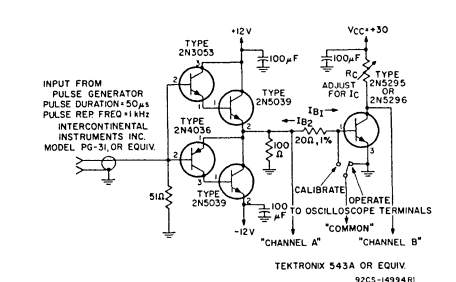


Fig. 19—Reverse-bias, second-breakdown characteristics for all types.



NOTE: Collector-terminal connection for transistor under test is mounting-flange (2N6098, 2N6100, 2N6102), lead No. 3 (2N6099, 2N6101, 2N6103).

Fig. 20—Circuit used to measure switching times for all types.

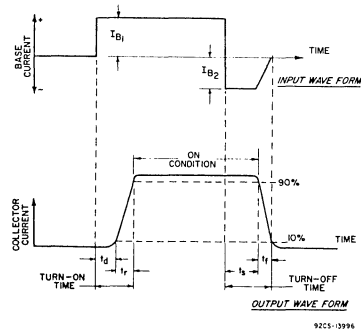
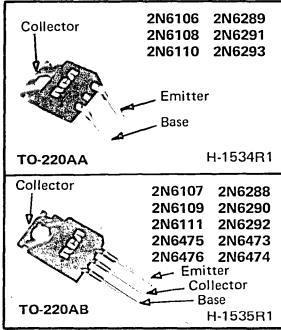


Fig. 21—Phase relationship between input current and output current showing reference points for specification of switching times. (Test circuit shown in Fig. 20).



# Power Transistors

## 2N6106-2N6111, 2N6288-2N6293, 2N6473-2N6476



### Epitaxial-Base, Silicon N-P-N and P-N-P VERSAWATT Transistors

General-Purpose Medium-Power Types for Switching and Amplifier Applications

**Features**

- Low saturation voltages
- Thermal-cycling ratings
- VERSAWATT package (molded silicone plastic)
- Maximum safe-area-of-operation curves specified for dc operation
- Complementary n-p-n and p-n-p types

RCA-2N6106-2N6111, 2N6288-2N6293, and 2N6473-2N6476 are epitaxial-base silicon transistors supplied in a VERSAWATT package. The 2N6288-2N6293, 2N6473, and 2N6474<sup>o</sup> are n-p-n complements of p-n-p types 2N6106-2N6111, 2N6475, and 2N6476<sup>o</sup>, respectively. All these transistors are intended for a wide variety of medium-power switching and amplifier applications, such as series and shunt regulators and driver and output stages of high-fidelity amplifiers.

The 2N6289, 2N6291, and 2N6293 n-p-n types and 2N6106, 2N6108, and 2N6110 p-n-p devices fit into TO-66 sockets. The remaining types are supplied in the JEDEC TO-220AB straight-lead version of the VERSAWATT package. All of these devices are also available on special order in a variety of lead-form configurations. Detailed information on these and other VERSAWATT outlines is contained in "RCA's Lineup of Power Transistors" (PSP-704).

<sup>o</sup> Formerly RCA Dev. Nos. TA7784, TA8323, TA7783, TA8232, TA7782, TA8231, TA8444, and TA8723, respectively.

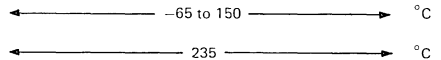
<sup>□</sup> Formerly RCA Dev. Nos. TA8210, TA7741, TA8211, TA7742, TA8212, TA7743, TA8445, and TA8722, respectively.

**MAXIMUM RATINGS, Absolute-Maximum Values:**

- \*COLLECTOR-TO-BASE VOLTAGE
- \*COLLECTOR-TO-EMITTER VOLTAGE:
  - With external base-supply resistance ( $R_{BB}$ ) = 100 $\Omega$ , and base supply voltage ( $V_{BB}$ ) = 0
  - With base open
- \*EMITTER-TO-BASE VOLTAGE
- \*COLLECTOR CURRENT (Continuous)
  - At case temperature  $\leq 106^\circ\text{C}$
- \*BASE CURRENT (Continuous)
  - At case temperature  $\leq 130^\circ\text{C}$
- TRANSISTOR DISSIPATION:
  - At case temperatures up to 25 $^\circ\text{C}$
  - \* At case temperatures up to 100 $^\circ\text{C}$
  - At ambient temperatures up to 25 $^\circ\text{C}$
  - At case temperatures above 25 $^\circ\text{C}$
  - \* At case temperatures above 100 $^\circ\text{C}$
  - At ambient temperatures above 25 $^\circ\text{C}$
- \*TEMPERATURE RANGE:
  - Storage and Operating (Junction)
- \*LEAD TEMPERATURE (During Soldering):
  - At distance  $\geq 1/8$  in. (3.17 mm) from case for 10 s max.

	2N6288	2N6290	2N6292		
N-P-N	2N6289	2N6291	2N6293	2N6473	2N6474
P-N-P	2N6110 $\diamond$	2N6108 $\diamond$	2N6106 $\diamond$	2N6475 $\diamond$	2N6476 $\diamond$
	2N6111 $\diamond$	2N6109 $\diamond$	2N6107 $\diamond$		
$V_{CBO}$	40	60	80	110	130
$V_{CEX}$	40	60	80	110	130
$V_{CEO}$	30	50	70	100	120
$V_{EBO}$	5	5	5	5	5
$I_C$	7	7	7	4	4
$I_B$	3	3	3	2	2
$P_T$	40	40	40	40	40
	16	16	16	16	16
	1.8	1.8	1.8	1.8	1.8

Derate linearly at 0.32 W/ $^\circ\text{C}$ , or see Fig. 2.  
 Derate linearly at 0.32 W/ $^\circ\text{C}$   
 Derate linearly at 0.0144 W/ $^\circ\text{C}$



\* In accordance with JEDEC registration data format (JS-6, RDF-2).

$\diamond$  For p-n-p devices, voltage and current values are negative.

ELECTRICAL CHARACTERISTICS, At Case Temperature ( $T_C$ ) = 25°C Unless Otherwise Specified

CHARACTERISTIC	SYMBOL	TEST CONDITIONS <sup>♠</sup>				LIMITS				UNITS
		VOLTAGE V dc		CURRENT A dc		2N6292 2N6293 2N6106 <sup>♣</sup> 2N6107 <sup>♣</sup>		2N6290 2N6291 2N6108 <sup>♣</sup> 2N6109 <sup>♣</sup>		
		V <sub>CE</sub>	V <sub>BE</sub>	I <sub>C</sub>	I <sub>B</sub>	MIN.	MAX.	MIN.	MAX.	
Collector-Cutoff Current: With external base-to-emitter resistance ( $R_{BE}$ ) = 100 $\Omega$	I <sub>CER</sub>	75				—	0.1	—	—	mA
With ( $R_{BE}$ ) = 100 $\Omega$ and $T_C$ = 150°C		55				—	—	0.1	—	
With base-emitter junction reverse-biased	I <sub>CEX</sub>	75	-1.5			—	0.1	—	—	mA
With base-emitter junction reverse-biased and $T_C$ = 150°C		56	-1.5			—	—	—	0.1	
With base open	I <sub>CEO</sub>	40			0	—	—	—	1	mA
		60			0	—	1	—	—	
Emitter-Cutoff Current	I <sub>EBO</sub>		-5	0		—	1	—	1	mA
Collector-to-Emitter Sustaining Voltage: With base open	V <sub>CE0(sus)</sub>			0.1 <sup>a</sup>	0	70	—	50	—	
With external base-to-emitter resistance ( $R_{BE}$ ) = 100 $\Omega$	V <sub>CER(sus)</sub>			0.1		80	—	60	—	
DC Forward-Current Transfer Ratio	h <sub>FE</sub>	4		2 <sup>a</sup>		30	150	—	—	
		4		2.5 <sup>a</sup>		—	—	30	150	
		4		7 <sup>a</sup>		2.3	—	2.3	—	
Base-to-Emitter Voltage: 2N6292, 2N6293 2N6290, 2N6291 All Types	V <sub>BE</sub>	4		2 <sup>a</sup>		—	1.5	—	—	V
		4		2.5 <sup>a</sup>		—	—	—	1.5	
		4		7 <sup>a</sup>		—	3	—	3	
Collector-to-Emitter Saturation Voltage	V <sub>CE(sat)</sub>			2 <sup>a</sup> 2.5 <sup>a</sup> 7 <sup>a</sup>	0.2 0.25 3 <sup>a</sup>	— — —	1 — 3.5	— — —	— 1 3.5	V
Common-Emitter, Small-Signal, Forward Current Transfer Ratio: f = 50 kHz	h <sub>fe</sub>	4		0.5		20	—	20	—	
Gain-Bandwidth Product: 2N6290-2N6293 2N6106-2N6109	f <sub>T</sub>	4 -4		0.5 -0.5		4 10	— —	4 10	— —	
Magnitude of Common- Emitter, Small-Signal, Forward-Current Transfer Ratio: f = 1 MHz	h <sub>fe</sub>	4		0.5		4	—	4	—	
2N6290-2N6293 2N6106-2N6109		-4		-0.5		10	—	10	—	
Collector-to-Base Capacitance: f = 1 MHz, V <sub>CB</sub> = 10 V	C <sub>obo</sub>			0		—	250	—	250	pF
Thermal Resistance: Junction-to-Case	R <sub><math>\theta</math>JC</sub>					—	3.125	—	3.125	
Junction-to-Ambient	R <sub><math>\theta</math>JA</sub>					—	70	—	70	

<sup>♠</sup>Pulsed: Pulse duration = 300  $\mu$ s, duty factor = 0.018.

<sup>♣</sup>For p-n-p devices, voltage and current values are negative.

<sup>a</sup>In accordance with JEDEC registration data format (JS-6 RDF-2).

CAUTION: The sustaining voltage V<sub>CER(sus)</sub> MUST NOT be measured on a curve tracer.



ELECTRICAL CHARACTERISTICS, At Case Temperature ( $T_C$ ) = 25°C Unless Otherwise Specified

CHARACTERISTIC	SYMBOL	TEST CONDITIONS*				LIMITS				UNITS
		VOLTAGE V dc		CURRENT A dc		2N6288 2N6289		2N6110 <sup>†</sup> 2N6111 <sup>†</sup>		
		V <sub>CE</sub>	V <sub>BE</sub>	I <sub>C</sub>	I <sub>B</sub>	MIN.	MAX.	MIN.	MAX.	
Collector-Cutoff Current: With external base-to-emitter resistance ( $R_{BE}$ ) = 100 $\Omega$	I <sub>CEX</sub>	35				-	0.1	-	-0.1	mA
With ( $R_{BE}$ ) = 100 $\Omega$ and $T_C$ = 150°C		30				-	2	-	-2	
* With base-emitter junction reverse-biased	I <sub>CEX</sub>	37.5	-1.5			-	0.1	-	-0.1	mA
* With base-emitter junction reverse-biased and $T_C$ = 150°C		30	-1.5			-	2	-	-2	
* With base open	I <sub>CEO</sub>	20			0	-	1	-	-1	mA
* Emitter-Cutoff Current	I <sub>EBO</sub>		5	0		-	1	-	-1	mA
Collector-to-Emitter Sustaining Voltage: With base open	V <sub>CEO(sus)</sub>			0.1 <sup>a</sup>	0	30	-	-30	-	V
With external base-to emitter resistance ( $R_{BE}$ ) = 100 $\Omega$	V <sub>CER(sus)</sub>			0.1		40	-	-40	-	V
* DC Forward Current Transfer Ratio	h <sub>FE</sub>	4		3 <sup>a</sup>		30	150	30	150	
		4		7 <sup>a</sup>		2.3	-	2.3	-	
* Base-to-Emitter Voltage: 2N6288, 2N6289 All Types	V <sub>BE</sub>	4		3 <sup>a</sup>		-	1.5	-	-	V
		4		7 <sup>a</sup>		-	3	-	3	
* Collector-to-Emitter Saturation Voltage	V <sub>CE(sat)</sub>			3 <sup>a</sup> 7 <sup>a</sup>	0.3 3	- -	1 3.5	- -	-1 -3.5	V
* Common-Emitter, Small- Signal, Forward-Current Transfer Ratio: f = 50 kHz	h <sub>fe</sub>	4		0.5		20	-	20	-	
Gain-Bandwidth Product: 2N6288-2N6289 2N6110-2N6111	f <sub>T</sub>	4		0.5		4	-	-	-	MHz
		-4		-0.5		-	-	10	-	
* Magnitude of Common- Emitter, Small-Signal, Forward- Current Transfer Ratio: f = 1 MHz	h <sub>fe</sub>	4		0.5		4	-	-	-	
2N6288-2N6289 2N6110-2N6111		-4		-0.5		-	-	10	-	
* Collector-to-Base Capacitance: f = 1 MHz, V <sub>CB</sub> = 10 V	C <sub>obo</sub>			0		-	250	-	250	pF
Thermal Resistance: Junction-to-Case	R <sub><math>\theta</math>JC</sub>					-	3.125	-	3.125	°C/W
Junction-to-Ambient	R <sub><math>\theta</math>JA</sub>					-	70	-	70	

<sup>a</sup>Pulsed: Pulse duration = 300  $\mu$ s, duty factor = 0.018.

<sup>†</sup>For p-n-p devices, voltage and current values are negative.

\* In accordance with JEDEC registration data format (JS-6 RDF-2).

CAUTION: The sustaining voltage V<sub>CER(sus)</sub> MUST NOT be measured on a curve tracer.

ELECTRICAL CHARACTERISTICS, At Case Temperature ( $T_C$ ) = 25°C Unless Otherwise Specified

CHARACTERISTIC	SYMBOL	TEST CONDITIONS <sup>♦</sup>				LIMITS				UNITS
		VOLTAGE V dc		CURRENT A dc		2N6474 2N6476 <sup>♦</sup>		2N6473 2N6475 <sup>♦</sup>		
		V <sub>CE</sub>	V <sub>BE</sub>	I <sub>C</sub>	I <sub>B</sub>	MIN.	MAX.	MIN.	MAX.	
Collector-Cutoff Current: With external base-to-emitter resistance ( $R_{BE}$ ) = 100 $\Omega$	I <sub>CER</sub>	120				–	0.1	–	–	mA
100					–	–	–	0.1		
With ( $R_{BE}$ ) = 100 $\Omega$ and $T_C$ = 100°C	I <sub>CER</sub>	120				–	2	–	–	mA
100					–	–	–	2		
* With base-emitter junction reverse-biased	I <sub>CEX</sub>	120	–1.5			–	0.1	–	–	mA
100		–1.5			–	–	–	0.1		
* With base-emitter junction reverse-biased and $T_C$ = 100°C	I <sub>CEX</sub>	120	–1.5			–	2	–	–	mA
100		–1.5			–	–	–	2		
* With base open	I <sub>CEO</sub>	60			0	–	1	–	–	mA
50					0	–	–	–	1	
* Emitter-Cutoff Current	I <sub>EBO</sub>		–5	0		–	1	–	1	mA
Collector-to-Emitter Sustaining Voltage: With base open	V <sub>CEO(sus)</sub>			0.1 <sup>a</sup>	0	120	–	100	–	V
* With external base-to emitter resistance ( $R_{BE}$ ) = 100 $\Omega$	V <sub>CER(sus)</sub>			0.1		130	–	110	–	V
* DC Forward-Current Transfer Ratio	h <sub>FE</sub>	4		1.5 <sup>a</sup>		15	150	15	150	
2.5				4 <sup>a</sup>		2	–	2	–	
* Base-to-Emitter Voltage	V <sub>BE</sub>	4		1.5 <sup>a</sup>		–	2	–	2	V
2.5				4 <sup>a</sup>		–	3.5	–	3.5	
* Collector-to-Emitter Saturation Voltage	V <sub>CE(sat)</sub>			1.5 <sup>a</sup>	0.15	–	1.2	–	1.2	V
				4 <sup>a</sup>	2	–	2.5	–	2.5	
* Common-Emitter, Small- Signal, Forward-Current Transfer Ratio: f = 50 kHz	h <sub>fe</sub>	4		0.5		20	–	20	–	
Gain-Bandwidth Product: 2N6473, 2N6474 2N6475, 2N6476	f <sub>T</sub>	4		0.5		4	–	4	–	MHz
–4				–0.5		10	–	10	–	
* Magnitude of Common- Emitter, Small-Signal, Forward-Current Transfer Ratio: f = 1 MHz 2N6473, 2N6474 2N6475, 2N6476	h <sub>fe</sub>	4		0.5		4	–	4	–	
–4				–0.5		10	–	10	–	
* Collector-to-Base Capacitance: f = 1 MHz, V <sub>CB</sub> = 10 V	C <sub>obo</sub>			0		–	250	–	250	pF
Thermal Resistance: Junction-to-Case	R <sub><math>\theta</math>JC</sub>					–	3.125	–	3.125	°C/W
Junction-to-Ambient	R <sub><math>\theta</math>JA</sub>					–	70	–	70	

<sup>a</sup>Pulsed: Pulse duration = 300  $\mu$ s, duty factor = 0.018.

<sup>♦</sup>For p-n-p devices, voltage and current values are negative.

\*In accordance with JEDEC registration data format (JS-6 RDF-2).

CAUTION: The sustaining voltage V<sub>CER(sus)</sub> MUST NOT be measured on a curve tracer.

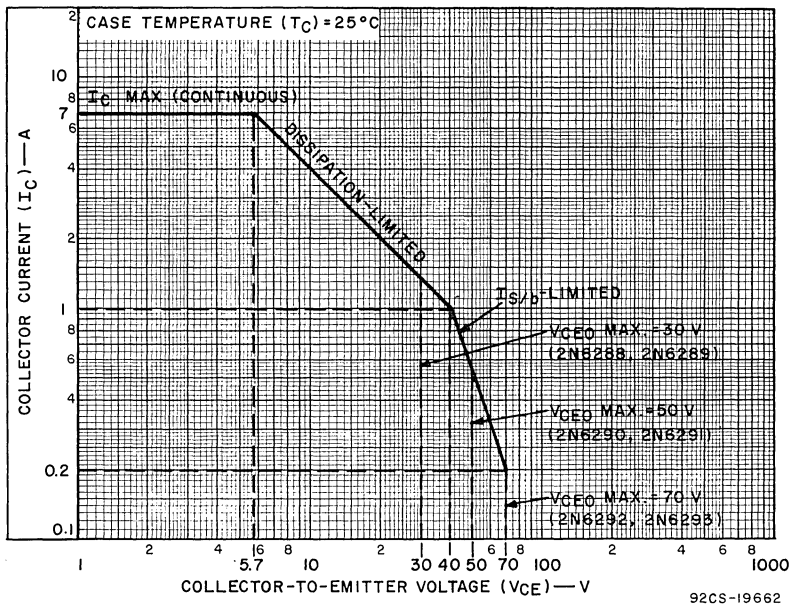


Fig. 1 - Maximum operating areas for 2N6288 - 2N6293.

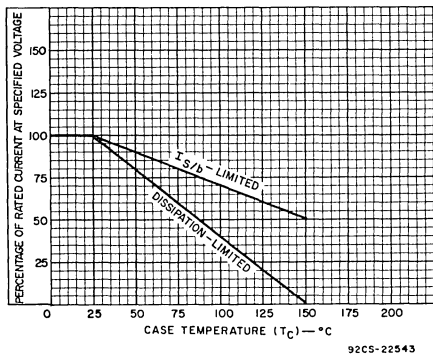


Fig. 2 - Current derating curves for all types.

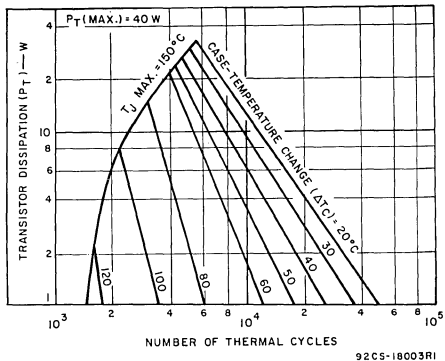


Fig. 3 - Thermal-cycling ratings for all types.

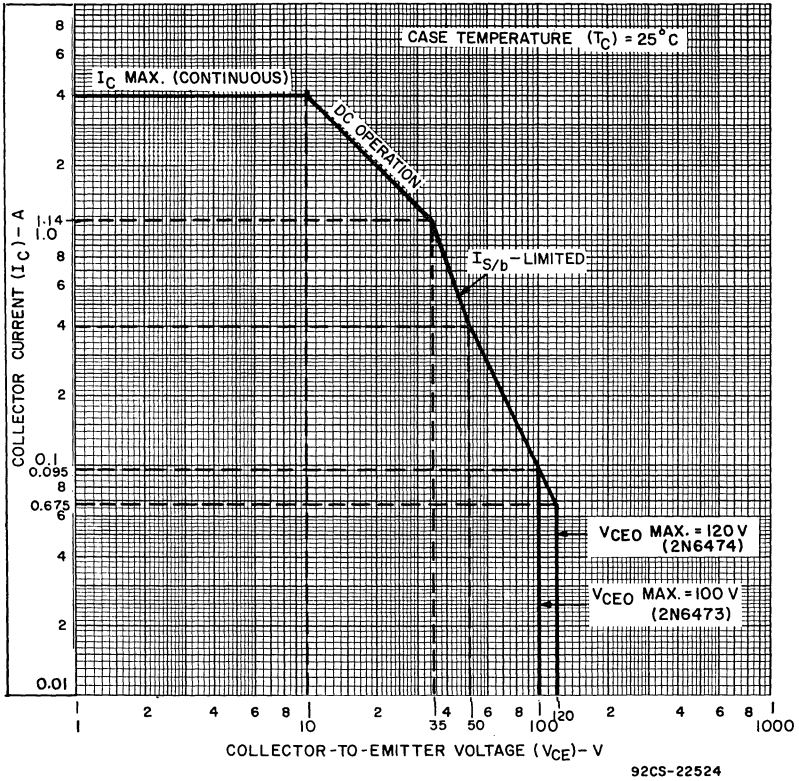


Fig. 4 - Maximum operating areas for 2N6473 and 2N6474.

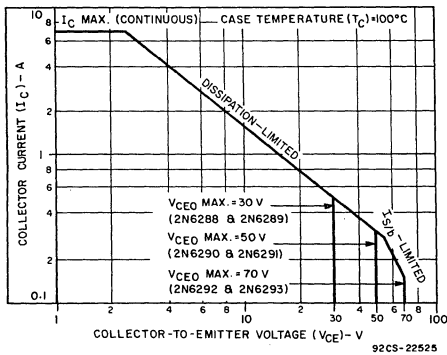


Fig. 5 - Maximum operating areas for 2N6288 - 2N6293.

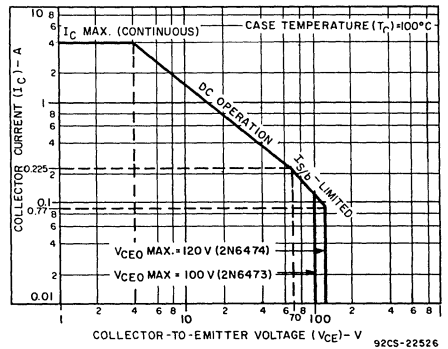


Fig. 6 - Maximum operating areas for 2N6473 - 2N6474.

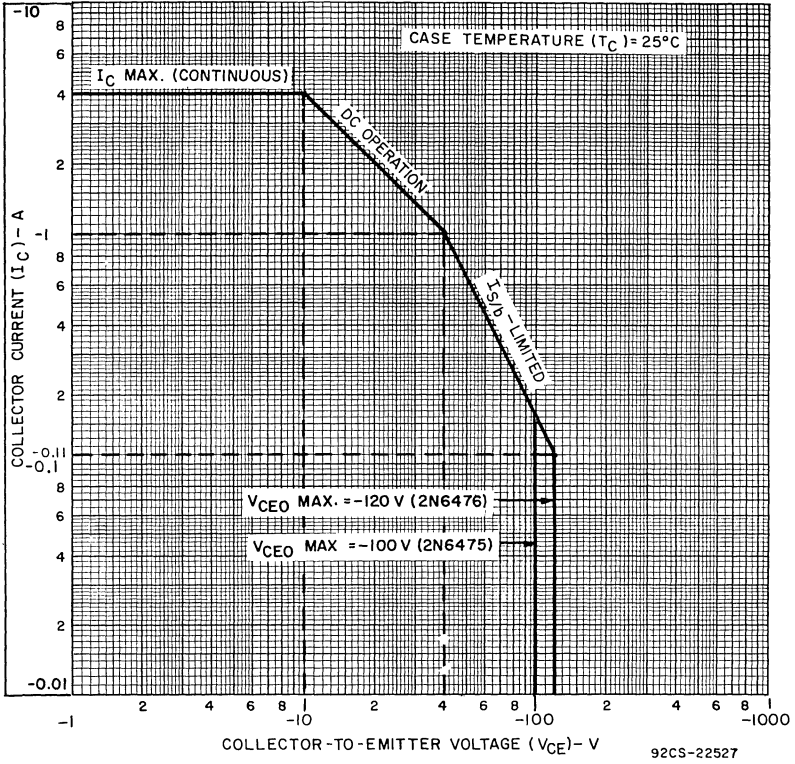


Fig. 7 - Maximum operating areas for 2N6475 - 2N6476.

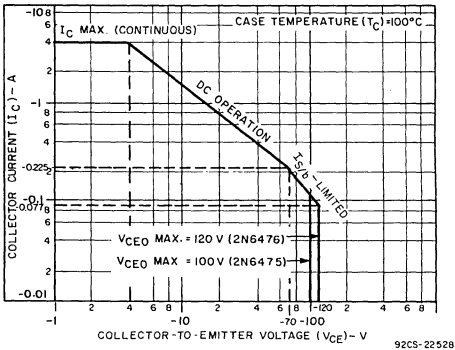


Fig. 8 - Maximum operating areas for 2N6475 and 2N6476.

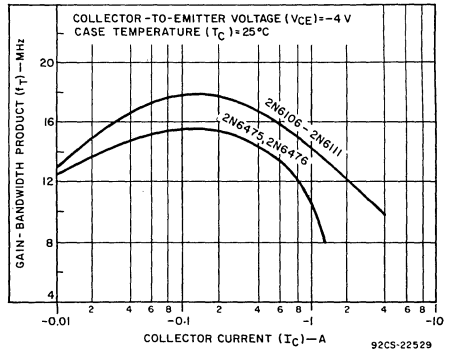
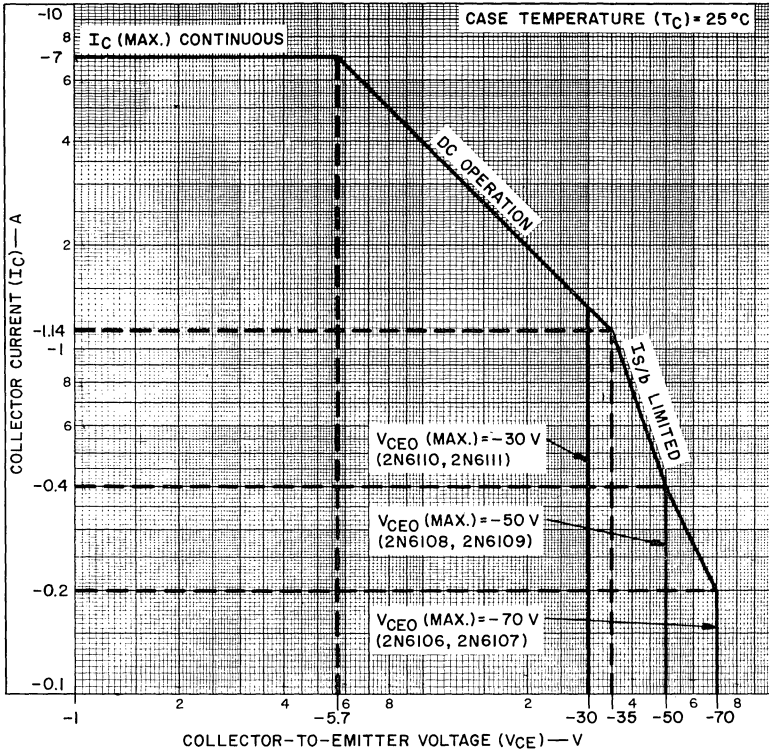


Fig. 9 - Typical gain-bandwidth product for 2N6106 - 2N6111, 2N6475, and 2N6476.



92CS-18001

Fig. 10 - Maximum operating areas for 2N6106 - 2N6111.

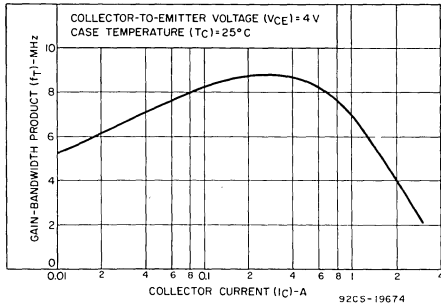


Fig. 11 - Typical gain-bandwidth product for 2N6288 - 2N6293.

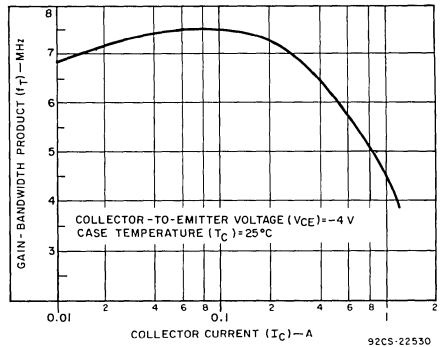


Fig. 12 - Typical gain-bandwidth product for 2N6473 and 2N6474.

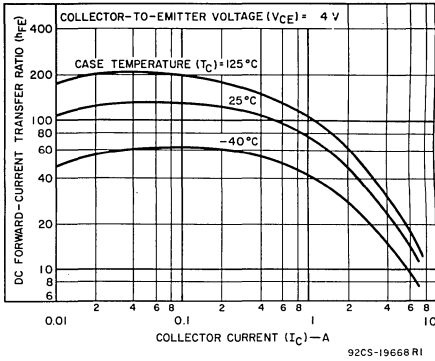


Fig. 13 — Typical dc beta characteristics for 2N6288 — 2N6293.

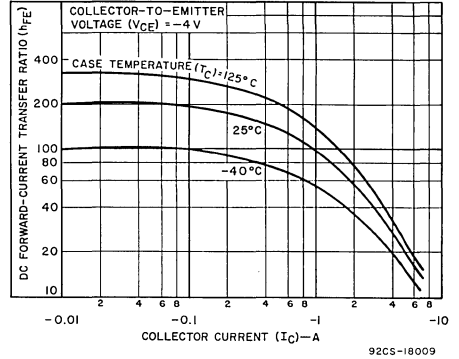


Fig. 14 — Typical dc beta characteristics for 2N6106 — 2N6111.

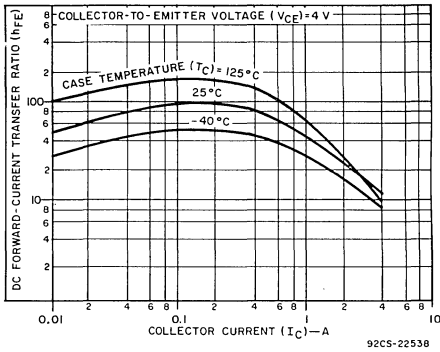


Fig. 15 — Typical dc beta characteristics for 2N6473 and 2N6474.

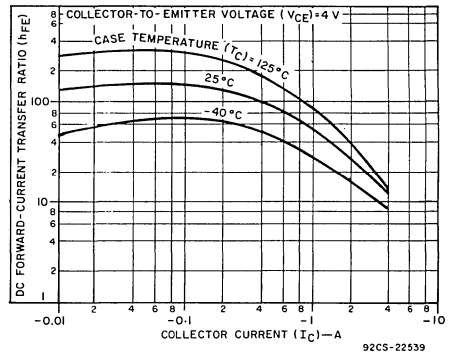


Fig. 16 — Typical dc beta characteristics for 2N6475 and 2N6476.

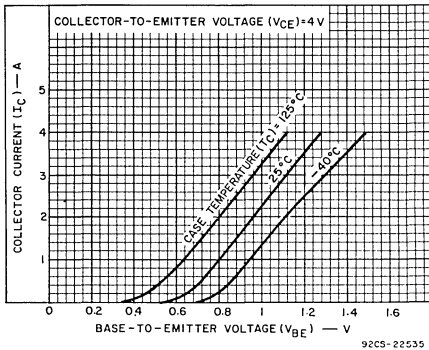


Fig. 17 — Typical transfer characteristics for 2N6288 — 2N6293.

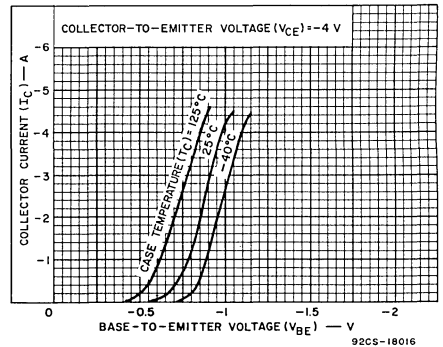


Fig. 18 — Typical transfer characteristics for 2N6106 — 2N6111.

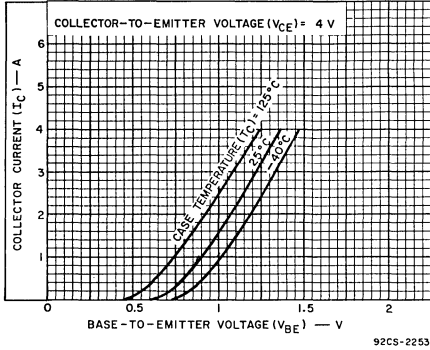


Fig. 19 — Typical transfer characteristics for 2N6473 and 2N6474.

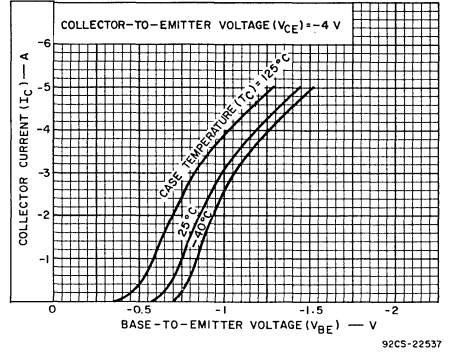


Fig. 20 — Typical transfer characteristics for 2N6475 and 2N6476.

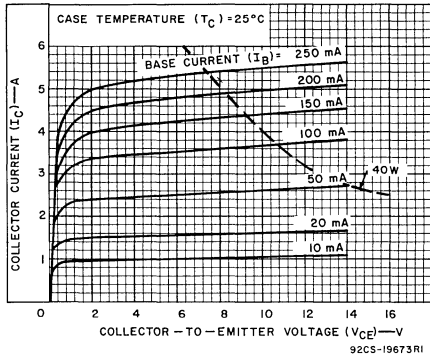


Fig. 21 — Typical output characteristics for 2N6288 - 2N6293.

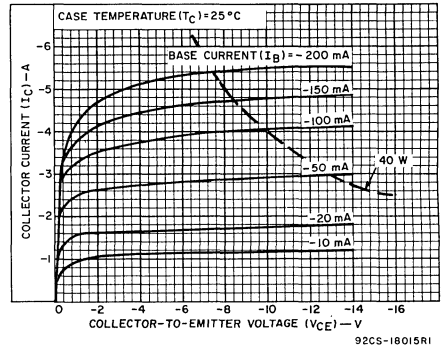


Fig. 22 — Typical output characteristics for 2N6106 - 2N6111.

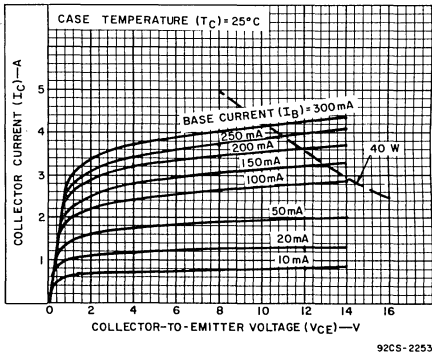


Fig. 23 — Typical output characteristics for 2N6473 and 2N6474.

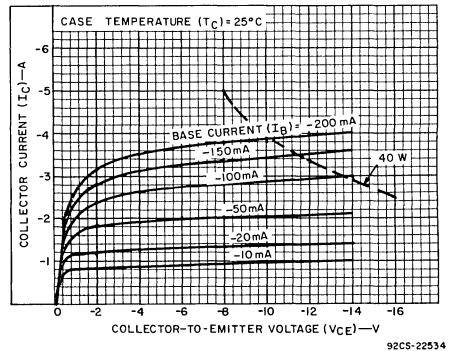


Fig. 24 — Typical output characteristics for 2N6475 and 2N6476.



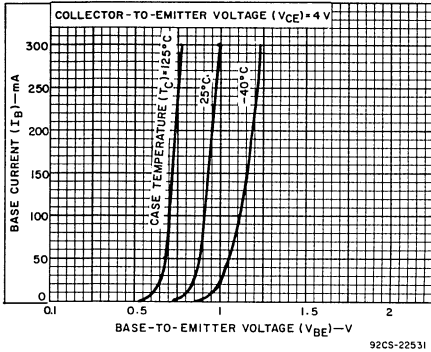


Fig. 25 - Typical input characteristics for 2N6288 - 2N6293.

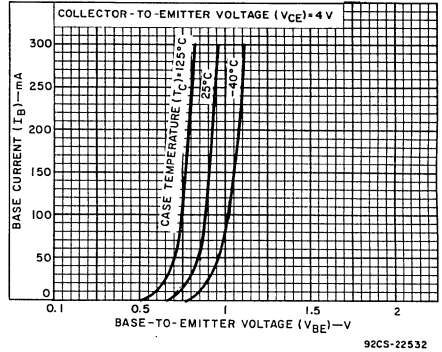


Fig. 26 - Typical input characteristics for 2N6473 and 2N6474.

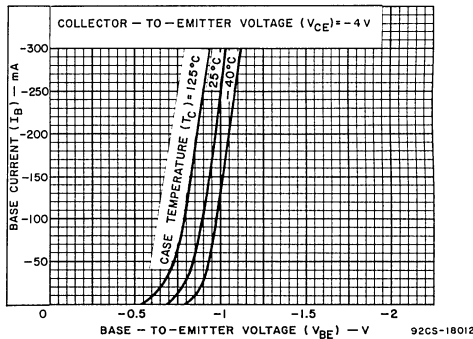


Fig. 27 - Typical input characteristics for 2N6106 - 2N6111, 2N6475, and 2N6476.

**TERMINAL CONNECTIONS  
JEDEC TO-220AA**

- Lead No.1 - Base
- Stub - Do not use stub as tie point.
- Lead No.3 - Emitter
- Mounting Flange - Collector

**TERMINAL CONNECTIONS  
JEDEC TO-220AB**

- Lead No.1 - Base
- Lead No.2 - Collector
- Lead No.3 - Emitter
- Mounting Flange - Collector

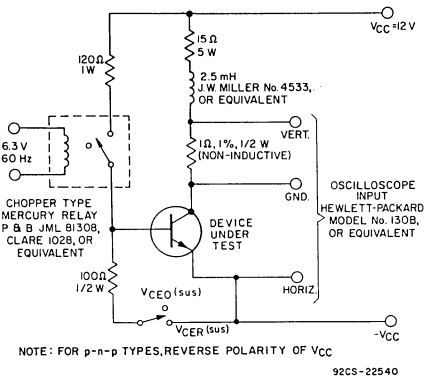
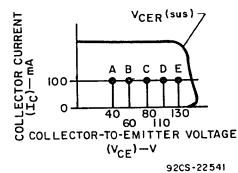


Fig. 28 - Circuit used to measure sustaining voltage  $V_{CER}(sus)$  for all types.



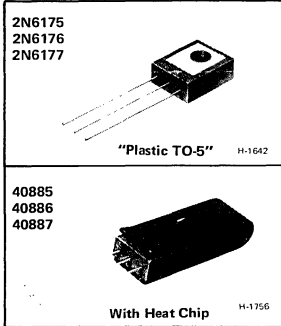
Note: Curve will be inverted and polarity reversed for p-n-p types. The sustaining voltage,  $V_{CER}(sus)$ , is acceptable when the traces fall to the right and above the designated points:  
Point A: 2N6110, 2N6111, 2N6288, 2N6289  
Point B: 2N6108, 2N6109, 2N6290, 2N6291  
Point C: 2N6106, 2N6107, 2N6292, 2N6293  
Point D: 2N6475, 2N6473  
Point E: 2N6476, 2N6474

Fig. 29 - Oscilloscope display for measurement of sustaining voltage (test circuit shown in Fig. 28).



# Power Transistors

2N6175 40885  
 2N6176 40886  
 2N6177 40887



## High-Voltage, Medium-Power Silicon N-P-N Transistors

For High-Speed Switching and Linear-Amplifier Applications

### Features

- Thermal fatigue ratings
- High frequency response:  $f_T = 20$  MHz
- Maximum area-of-operation curves for DC and pulse operation
- Designed to assure freedom from second breakdown in class A, B, and C operation at maximum ratings

RCA types 2N6175, 2N6176, and 2N6177\* are silicon n-p-n transistors with high breakdown voltages, high frequency response, and fast switching speeds. Types 40885, 40886, and 40887 are electrically identical to the 2N6175—2N6177, respectively, but are supplied with factory-attached heat clips.

Typical applications for these devices include TV video output, RGB output, chroma output, TV blanking, solenoid drivers, off-line inverters, regulators, audio output, and electrostatic deflection in display circuits.

- High voltage ratings:  
 $V_{CEO(sus)} = 350$  V max. (2N6177, 40887)  
 $= 300$  V max. (2N6176, 40886)  
 $= 250$  V max. (2N6175, 40885)
- Low saturation voltage:  
 $V_{CE(sat)} = 0.5$  V max.

### TERMINAL CONNECTIONS

Lead 1 — Emitter  
 Lead 2 — Base  
 Lead 3 — Collector

\*Formerly Dev. Nos. TA7739, TA7740 and TA7134, respectively.

### MAXIMUM RATINGS, Absolute-Maximum Values:

*COLLECTOR-TO-BASE VOLTAGE	$V_{CB0}$
*COLLECTOR-TO-EMITTER SUSTAINING VOLTAGE	$V_{CE0(sus)}$
*EMITTER-TO-BASE VOLTAGE	$V_{EB0}$
*COLLECTOR CURRENT	$I_C$
*BASE CURRENT	$I_B$
*TRANSISTOR DISSIPATION	$P_T$
At case temperatures up to 25°C	
At case temperatures above 25°C	
At ambient temperatures up to 25°C	
At ambient temperatures above 25°C	
For pulse operation	
*TEMPERATURE RANGE:	
Storage & Operating (Junction)	
*LEAD TEMPERATURE (During soldering):	
At distance $\geq 1/16$ in. (1.59 mm) from case for 10 s max.	

2N6175	2N6176	2N6177	
40885	40886	40887	
300	350	450	V
250	300	350	V
6	6	6	V
1.0	1.0	1.0	A
0.5	0.5	0.5	A
20	20	20	W
(2N6175, 2N6176, 2N6177)			
See Fig. 14			
0.8	0.8	0.8	W
(2N6175, 2N6176, 2N6177)			
1.4	1.4	1.4	W
(40885, 40886, 40887)			
See Fig. 15			
See Figs. 1, 4, and 7			
← 65 to 135 →			°C
← 230 →			°C

\*Types 2N6175, 2N6176, and 2N6177 in accordance with JEDEC registration data format JS-9 RDF-8.

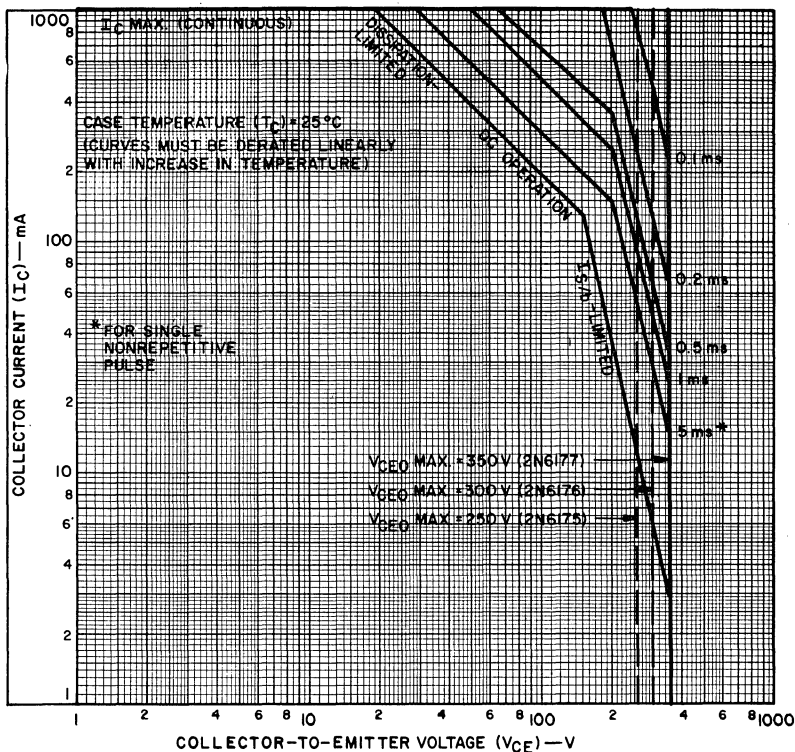
ELECTRICAL CHARACTERISTICS, At Case Temperature ( $T_C$ ) = 25°C

CHARACTERISTIC	SYMBOL	TEST CONDITIONS					LIMITS					UNITS
		VOLTAGE V dc		CUR- RENT mA dc		2N6175 40885		2N6176 40886		2N6177 40887		
		V <sub>CB</sub>	V <sub>CE</sub>	I <sub>C</sub>	I <sub>B</sub>	MIN.	MAX.	MIN.	MAX.	MIN.	MAX.	
Collector-Cutoff Current: With base open	I <sub>CEO</sub>		300 200		0 0	-	-	-	-	-	20	μA
* With emitter open	I <sub>CBO</sub>	360 280 240				-	-	-	50	-	20	
With base-emitter junction reverse- biased, V <sub>BE</sub> = -1.5 V	I <sub>CEV</sub>		450 300			-	-	-	500	-	500	
* Emitter-Cutoff Current. V <sub>BE</sub> = -6 V	I <sub>EBO</sub>			0		-	20	-	20	-	20	μA
DC Forward-Current Transfer Ratio	h <sub>FE</sub>		10 10 10 10	50 <sup>a</sup> 20 <sup>a</sup> 5 <sup>a</sup> 1 <sup>a</sup>		30*	190	30*	150	30*	150	
Collector-to-Emitter Sustaining Voltage: With base open	V <sub>CEO(sus)</sub>			50 <sup>a</sup>	0	250 <sup>b</sup>	-	300 <sup>b</sup>	-	350 <sup>b</sup>	-	V
Base-to-Emitter Saturation Voltage	V <sub>BE(sat)</sub>			50 <sup>a</sup>	4	-	1.3	-	1.3	-	1.3	V
Collector-to-Emitter Saturation Voltage	V <sub>CE(sat)</sub>			50 <sup>a</sup>	4	-	0.5	-	0.5	-	0.5	V
* Collector-to-Base Breakdown Voltage	V <sub>(BR)CBO</sub>			1 <sup>a</sup>		300		350		450		V
* Low-Frequency, Common- Emitter, Small-Signal, Short-Circuit, Forward- Current Transfer Ratio f = 1 kHz	h <sub>fe</sub>		10	5		25	-	25	-	25	-	
* Magnitude of Common- Emitter, Small-Signal, Short-Circuit, Forward- Current Transfer Ratio f = 3 MHz	h <sub>fe</sub>		20	20		7	-	7	-	7	-	
* Real Part of Common- Emitter, Small-Signal, Short-Circuit Input Impedance: f = 1 MHz	Re(h <sub>ie</sub> )		20 10	20 5		-	300	-	300	-	300	Ω
* Output Capacitance: f = 1 MHz	C <sub>cb</sub>	20				-	8	-	8	-	8	pF
Second-Breakdown Collector Current: With base forward biased, t = 0.4 s nonrepetitive	I <sub>S/b</sub> <sup>b</sup>		150			133	-	133	-	133	-	mA
Thermal Resistance: Junction-to-Case	R <sub>θJC</sub>					-	5.5 (2N6175)	-	5.5 (2N6176)	-	5.5 (2N6177)	
Junction-to-Ambient	R <sub>θJA</sub>					-	138 (2N6175) 78.6 (40885)	-	138 (2N6176) 78.6 (40886)	-	138 (2N6177) 78.6 (40887)	°C/W

\* Types 2N6175, 2N6176, and 2N6177 in accordance with JEDEC registration data format JS-9 RDF-8.

<sup>a</sup> Pulsed Pulse duration = 300 μs; duty factor ≤ 2%.

<sup>b</sup> CAUTION: The sustaining voltage V<sub>CEO(sus)</sub> MUST NOT be measured on a curve tracer. The sustaining voltage should be measured by means of the test circuit shown in Fig. 10



92SS-4405RI

Fig. 1—Maximum safe-operation-areas for types 2N6175, 2N6176, and 2N6177.

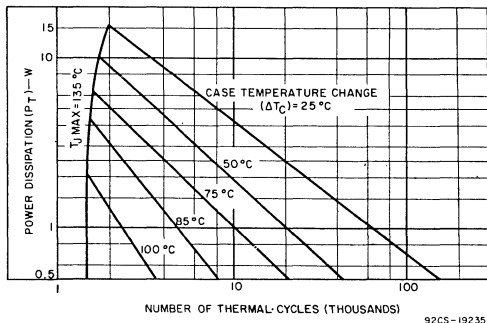


Fig. 2—Thermal-cycling rating chart.

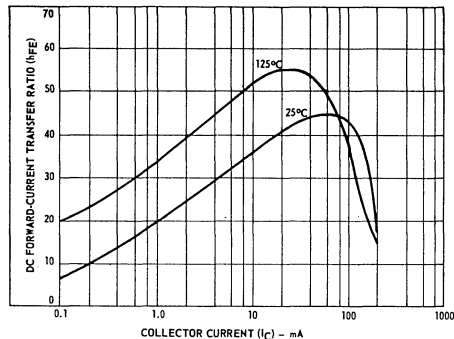


Fig. 3—Typical DC-beta characteristics for all types.

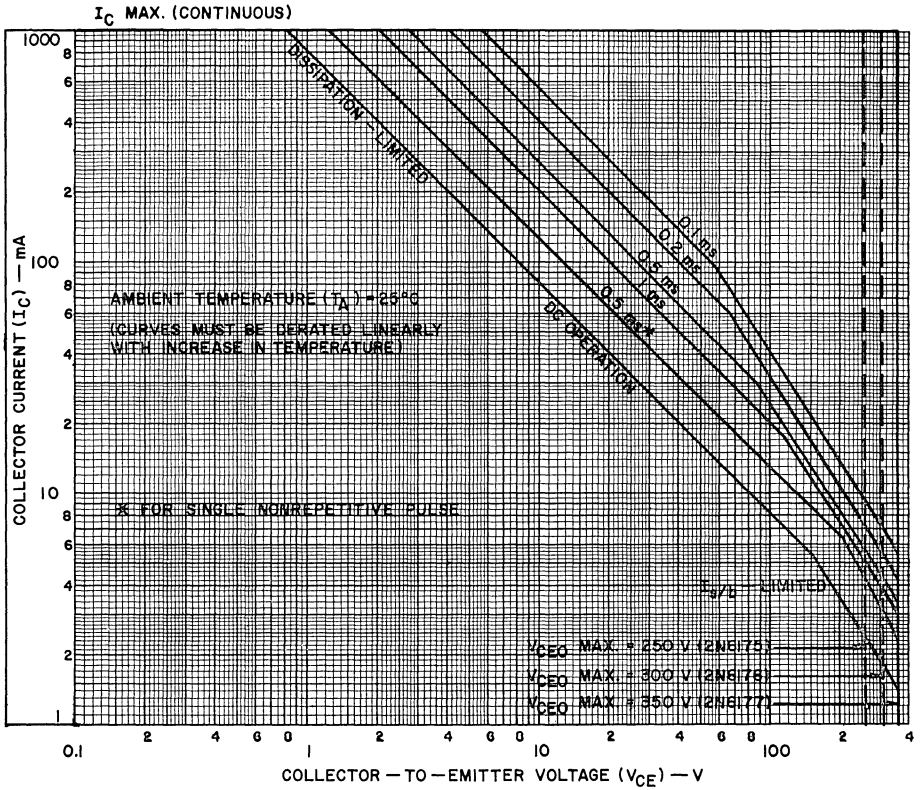


Fig. 4—Maximum safe area-of-operation at ambient temperature for types 2N6175, 2N6176, and 2N6177.

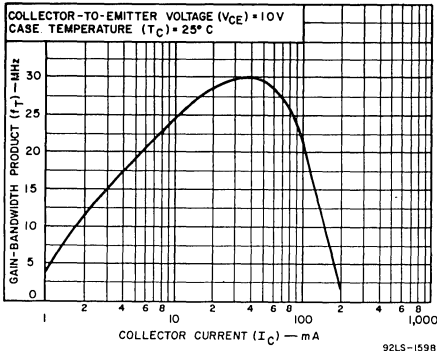


Fig. 5—Typical gain-bandwidth product for all types.

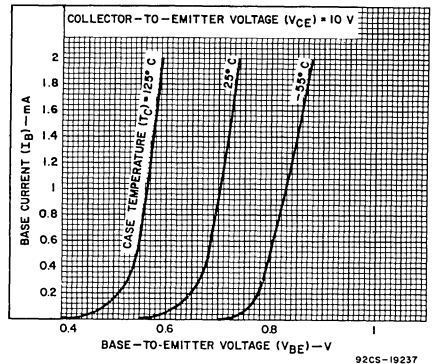
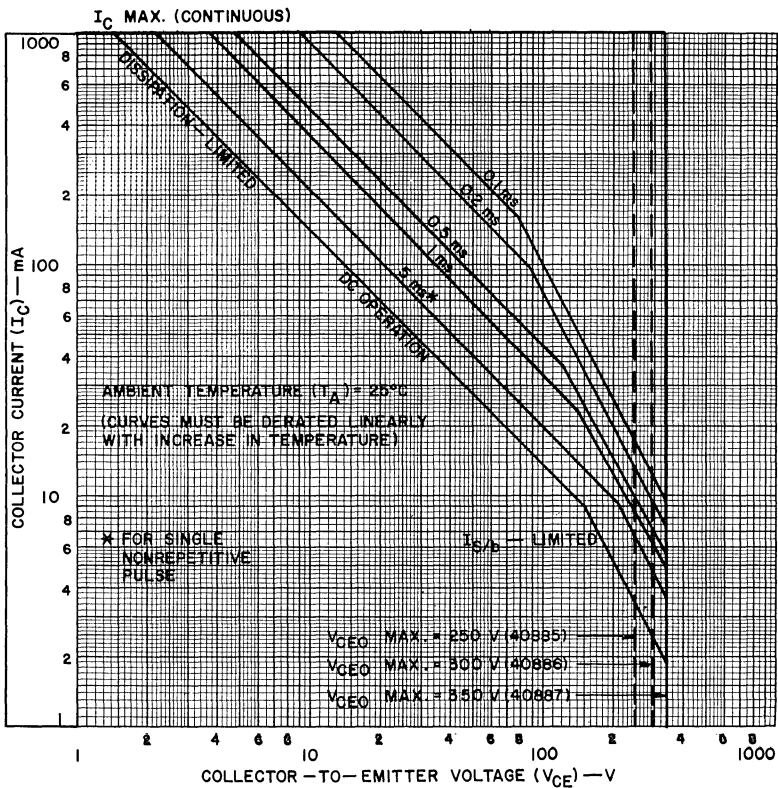


Fig. 6—Typical input characteristics for all types.



92CS-19236

Fig. 7—Maximum safe area-of-operation for types 40885, 40886, and 40887.

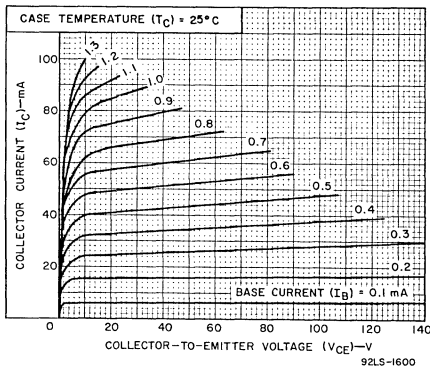


Fig. 8—Typical output characteristics for all types.

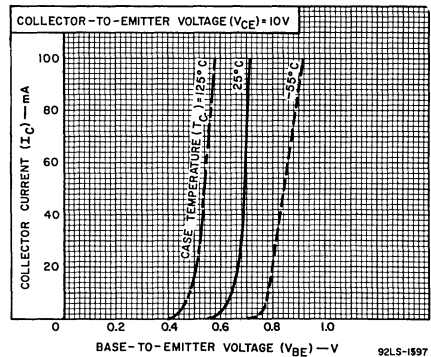


Fig. 9—Typical transfer characteristics for all types.

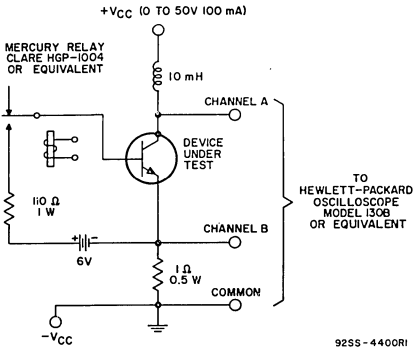
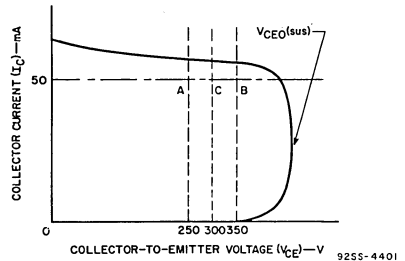


Fig. 10—Circuit used to measure sustaining voltage,  $V_{CE0}(sus)$ .



The sustaining voltage  $V_{CE0}(sus)$  is acceptable when the trace falls to the right and above point "A" for type 2N6175 or 40885. The trace must fall to the right and above point "B" for type 2N6177 or 40887 and above and to the right of point "C" for type 2N6176 or 40886.

Fig. 11—Oscilloscope display for measurement of sustaining voltages (test circuit shown in Fig. 9).

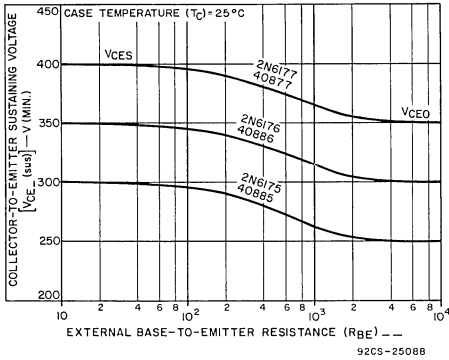


Fig. 12—Sustaining voltage vs. base-to-emitter resistance for all types.

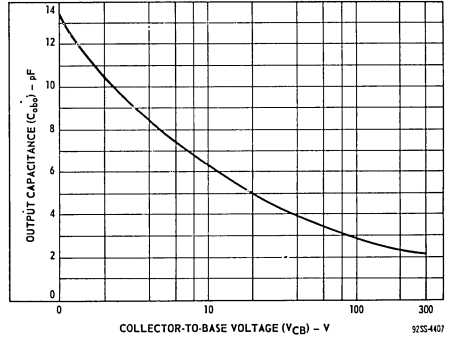


Fig. 13—Typical output capacitance vs collector-to-base voltage for all types.

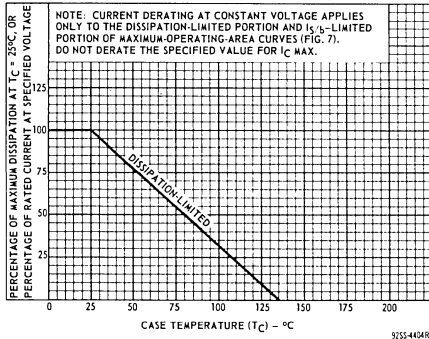


Fig. 14—Dissipation derating curve for all types.

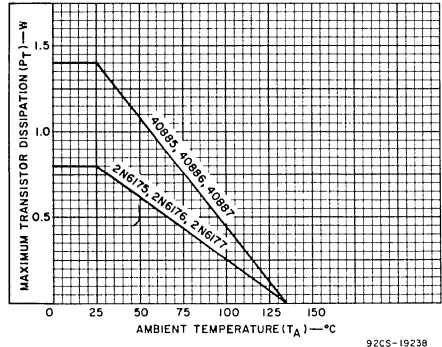


Fig. 15—Dissipation derating curves for all types.

**RCA**  
Solid State  
Division

## Power Transistors

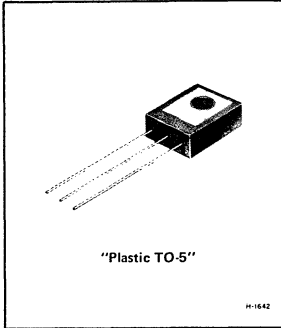
2N6178 2N6180  
2N6179 2N6181

### Silicon N-P-N & P-N-P Power Transistors

"Plastic TO-5" General-Purpose Types for  
Large-Signal, Medium-Power Applications

#### Features:

- Maximum area-of-operation curves
- Planar construction for low-noise and low-leakage characteristics
- Low saturation voltage (2N6178, 2N6180)
- High beta (2N6179, 2N6181)
- Fast switching (2N6178, 2N6179)
- "Plastic TO-5" package with insulated mounting hole



RCA types 2N6178, 2N6179, 2N6180, and 2N6181\* are silicon power transistors intended for large-signal, medium-power applications in industrial and commercial equipment.

The 2N6178 and 2N6179 are triple-diffused silicon n-p-n planar types. These types have features similar to the popular 2N2102 plus higher collector-current ratings and dissipation capability.

Types 2N6180 and 2N6181 (p-n-p complements of the 2N6178 and 2N6179, respectively) are double-diffused, epitaxial-planar devices. These types have features similar to the 2N4036 plus higher collector-current ratings and dissipation capability.

#### TERMINAL CONNECTIONS

Lead 1 — Emitter

Lead 2 — Base

Lead 3 — Collector

Rectangular Metal Slug-Collector

In addition, these types utilize the new RCA-developed "Plastic TO-5" package. This plastic package has an insulated mounting hole for ease of mounting and heat sinking for optimum thermal contact.

\* Formerly RCA Dev. Nos. TA7554-TA7557, respectively.

#### MAXIMUM RATINGS, Absolute-Maximum Values:

	2N6179	2N6181	2N6178	2N6180	
*COLLECTOR-TO-BASE VOLTAGE . . . . .	75	-75	100	-100	V
*COLLECTOR-TO-EMITTER VOLTAGE:					
With 1.5 volts ( $V_{BE}$ ) of reverse bias . . . . .	75	-75	100	-100	V
With external base-to-emitter resistance					
( $R_{BE}$ ) = 100 $\Omega$ , sustaining . . . . .	65	-65	90	-90	V
With base open, sustaining . . . . .	50	-50	75	-75	V
*EMITTER-TO-BASE VOLTAGE . . . . .	5	-5	7	-7	V
*CONTINUOUS COLLECTOR CURRENT . . . . .	2	-2	2	-2	A
*CONTINUOUS BASE CURRENT . . . . .	1	-1	1	-1	A
*TRANSISTOR DISSIPATION:					
At case temperatures up to 25°C . . . . .	25	25	25	25	W
At case temperatures above 25°C . . . . .		See Figs. 1, 2, & 3			
At case temperatures up to 100°C . . . . .	10	10	10	10	W
At case temperatures above 100°C . . . . .		See Figs. 3, 4, & 5			
*TEMPERATURE RANGE:					
Storage and operating (Junction) . . . . .	←----- -65 to 150 -----→				°C
*LEAD TEMPERATURE (During soldering):					
At distance $\geq 1/32$ in (0.8 mm) from					
seating plane for 10 s max . . . . .	←----- 230 -----→				°C

\*In accordance with JEDEC registration data format JS-6/RDF-1.



ELECTRICAL CHARACTERISTICS, at case temperature ( $T_C$ ) = 25°C, unless otherwise specified.

CHARACTERISTIC	SYMBOL	TEST CONDITIONS					LIMITS								UNITS		
		DC Voltage (V)			DC Current (mA)		Type 2N6178		Type 2N6179		Type 2N6180		Type 2N6181				
		V <sub>CB</sub>	V <sub>CE</sub>	V <sub>BE</sub>	I <sub>C</sub>	I <sub>B</sub>	Min.	Max.	Min.	Max.	Min.	Max.	Min.	Max.			
Collector-Cutoff Current With emitter open	I <sub>CBO</sub>	80 60 -80 -60					-	0.5	-	-	-	-	-	-	-	-	μA
With base open	I <sub>CEO</sub>		60 45 -60 -45				0 0 0 0	-	1	-	-	-	-	-	-	-	mA
With base reverse-biased	I <sub>CEV</sub>		100 75 -100 -75	-1.5 -1.5 1.5 1.5			-	0.1	-	-	0.1	-	-	-	-	-	mA
With base reverse-biased and T <sub>C</sub> = 100°C			70 45 -70 -45	-1.5 -1.5 1.5 1.5			-	0.5	-	-	0.5	-	-	-0.5	-	-	-0.5
Emitter-Cutoff Current	I <sub>EBO</sub>		-7 -5 7 5		0 0 0 0		-	0.1	-	-	0.1	-	-	-	-	-	mA
Emitter-to-Base Breakdown Voltage (I <sub>E</sub> = 0.1 mA)	V <sub>(BR)EBO</sub>				0 0		7	-	5	-	-	-	-	-	-	-5	V
Collector-to-Emitter Breakdown Voltage: With base-emitter junction reverse-biased	V <sub>(BR)ICEV</sub>			-1.5 1.5	0.1 -0.1		100	-	75	-	-	-	-100	-	-	-75	V
With base open	V <sub>(BR)ICEO</sub>				100 -100	0 0	75	-	50	-	-	-	-75	-	-	-50	V
Collector-to-Emitter Sustaining Voltage: With external base-to- emitter resistance (R <sub>BE</sub> ) = 100 Ω	V <sub>CE(sus)</sub> <sup>a</sup>				100 -100		90	-	65	-	-	-	-90	-	-	-65	V
With base open	V <sub>CEO(sus)</sub> <sup>a</sup>				100 -100	0 0	75	-	50	-	-	-	-75	-	-	-50	V
Collector-to-Emitter Saturation Voltage	V <sub>CE(sat)</sub>				500 -500	50 -50	-	0.5	-	0.8	-	-	-	-0.7	-	-1.2	V
Base-to-Emitter Saturation Voltage	V <sub>BE(sat)</sub>				500 -500	50 -50	-	1.2	-	1.5	-	-	-	-1.2	-	-1.5	V
Output Capacitance (At 1 MHz)	C <sub>obo</sub>	10 -10					12	20	12	20	-	-	25	40	25	40	pF
DC Forward-Current Transfer Ratio	h <sub>FE</sub>		4 -4 2 -2 2 -2		50 -50 500 <sup>b</sup> -500 <sup>b</sup> 1000 <sup>b</sup> -1000 <sup>b</sup>		30	130	40	250	-	-	30	130	40	250	
Second-Breakdown Collector Current c, d (With base forward-biased)	I <sub>S/b</sub>		V <sub>CC</sub> = 50 -50				200	-	200	-	-	-	-150	-	-	-150	mA
Gain-Bandwidth Product	f <sub>T</sub>		4 -4		50 -50		50	-	50	-	-	50	-	50	-	-	MHz
Magnitude of Common Emitter, Small-Signal, Short- Circuit Forward-Current Transfer Ratio (f = 10 MHz)	h <sub>fe</sub>		4 -4		50 -50		5	-	5	-	-	5	-	5	-	-	

Chart continued on page 3.

CHARACTERISTIC	SYMBOL	TEST CONDITIONS						LIMITS								UNITS
		DC Voltage (V)			DC Current (mA)			Type 2N6178		Type 2N6179		Type 2N6180		Type 2N6181		
		V <sub>CB</sub>	V <sub>CE</sub>	V <sub>BE</sub>	I <sub>C</sub>	I <sub>B</sub>	Min.	Max.	Min.	Max.	Min.	Max.	Min.	Max.		
Saturated Switching Time: (See Fig. 30 & 31) Turn-on Time	t <sub>on</sub>	V <sub>CC</sub> <sup>c</sup> 30 -30			500 -500	50 -50	-	80	-	80	-	-	100	-	100	ns
Turn-off Time	t <sub>off</sub>	V <sub>CC</sub> <sup>c</sup> 30 -30			500 -500	50 -50	-	800	-	800	-	1000	-	1000	ns	
Thermal Resistance: Junction-to-Case	R <sub>θJC</sub>						-	5	-	5	-	5	-	5	°C/W	
Junction-to-Ambient	R <sub>θJA</sub>						-	156	-	156	-	156	-	156	°C/W	

<sup>c</sup> In accordance with JEDEC registration data format JS-6/RDF-1.

<sup>c</sup> Safe operating regions for forward-bias operation are shown on Figs. 1, 2, 4, and 5.

<sup>a</sup> CAUTION: The sustaining voltages V<sub>CEO</sub>(sus) and V<sub>CER</sub>(SUS) MUST NOT be measured on a curve tracer.

<sup>d</sup> Pulsed: 0.4s, non-repetitive pulse.

<sup>b</sup> Pulsed; pulse duration ≤ 300 μs, duty factor ≤ 0.02.

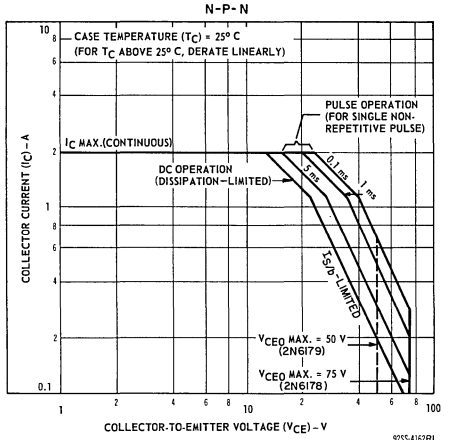


Fig.1—Maximum operating areas for 2N6178 and 2N6179 at T<sub>C</sub>=25°C.

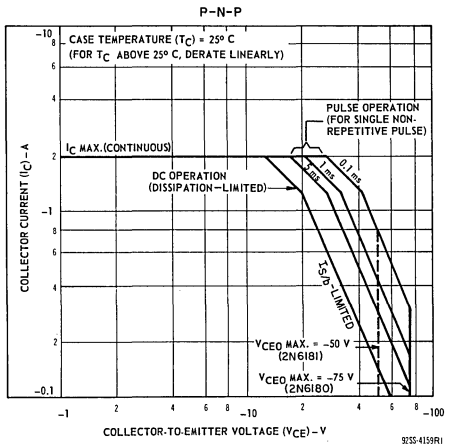


Fig.2—Maximum operating areas for 2N6180 and 2N6181 at T<sub>C</sub>=25°C.

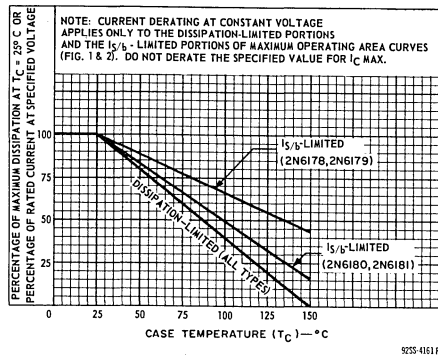


Fig.3—Derating curves for all types.

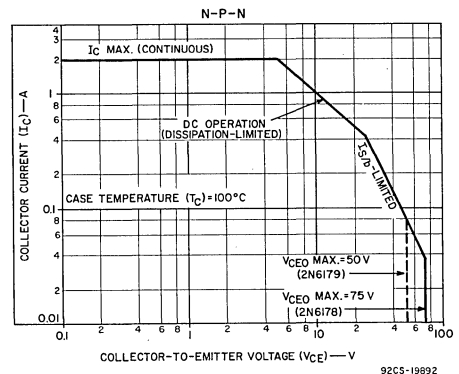


Fig.4—Maximum operating areas for 2N6178 and 2N6179 at T<sub>C</sub>=100°C.

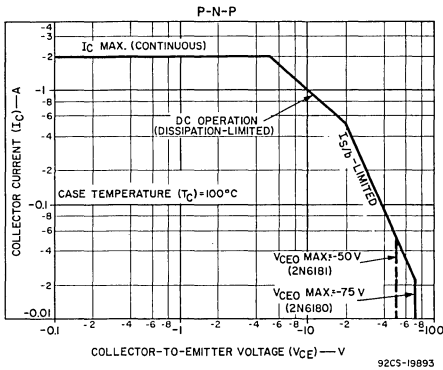


Fig. 5—Maximum operating areas for 2N6180 and 2N6181 at  $T_C=100^\circ\text{C}$ .

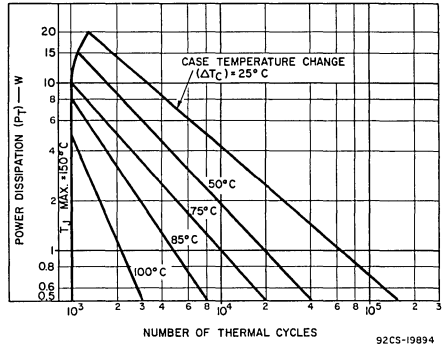


Fig. 6—Thermal-cycling rating chart for all types.

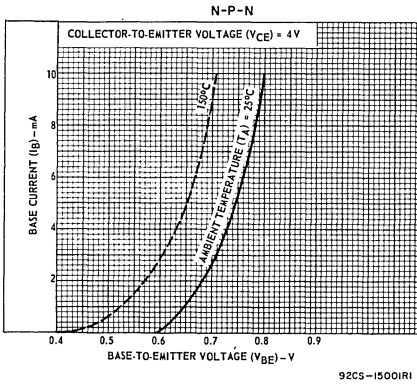


Fig. 7—Typical input characteristics for 2N6178 and 2N6179.

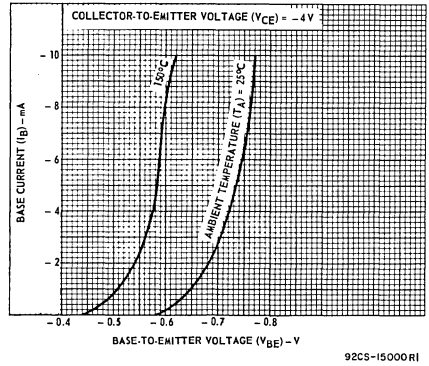


Fig. 8—Typical input characteristics for 2N6180 and 2N6181.

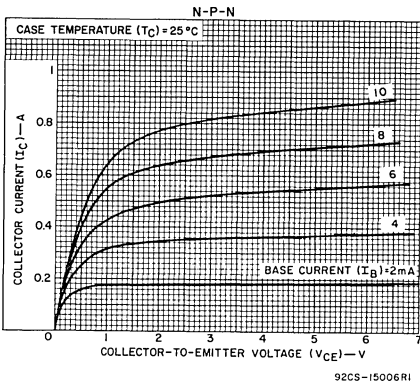


Fig. 9—Typical output characteristics for 2N6178 and 2N6179.

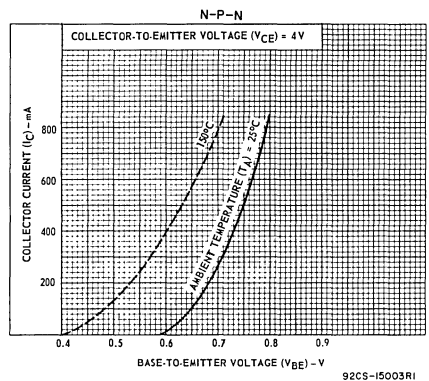


Fig. 10—Typical transfer characteristics for 2N6178 and 2N6179.

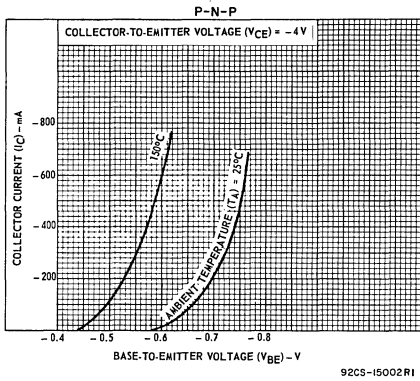


Fig. 11—Typical transfer characteristics for 2N6180 and 2N6181.

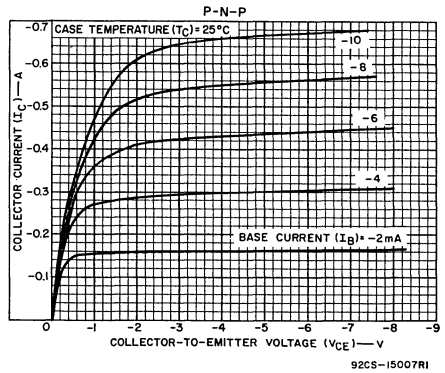


Fig. 12—Typical output characteristics for 2N6180 and 2N6181.

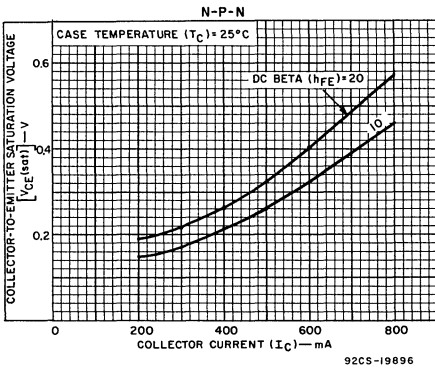


Fig. 13—Typical saturation-voltage characteristics for 2N6178 and 2N6179.

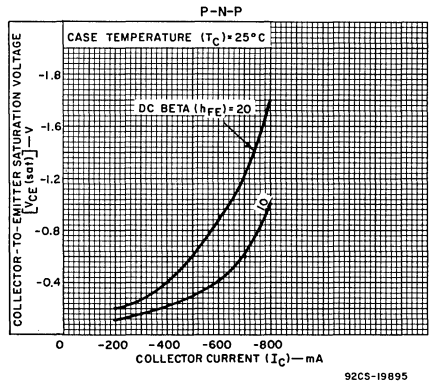
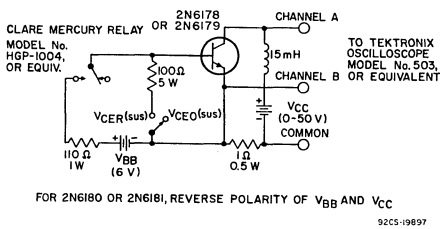


Fig. 14—Typical saturation-voltage characteristics for 2N6180 and 2N6181.



FOR 2N6180 OR 2N6181, REVERSE POLARITY OF  $V_{BB}$  AND  $V_{CC}$

92CS-19897

Fig. 15—Circuit used to measure sustaining voltages  $V_{CE0(sus)}$  and  $V_{CER(sus)}$ .

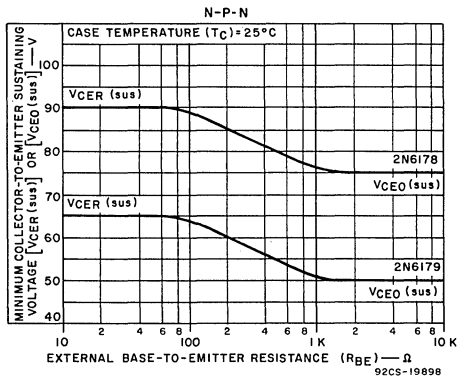


Fig. 16—Collector-to-emitter sustaining voltage characteristics for 2N6178 and 2N6179.

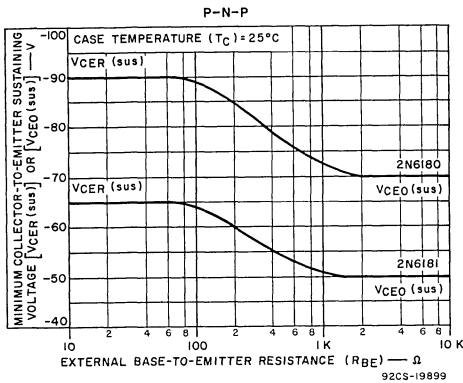
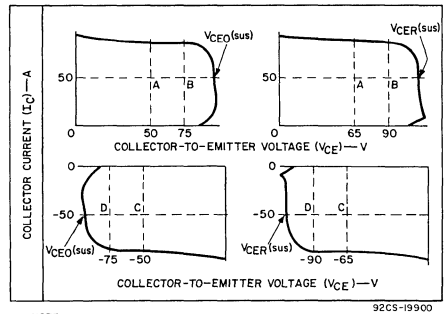


Fig. 17—Collector-to-emitter sustaining voltage characteristics for 2N6180 and 2N6181.



NOTE: SUSTAINING VOLTAGES  $V_{CE0(sus)}$  and  $V_{CEr(sus)}$  ARE ACCEPTABLE WHEN TRACES FALL TO THE RIGHT AND ABOVE POINTS "A" FOR TYPE 2N6179 POINTS "B" FOR TYPE 2N6178, TO THE LEFT AND BELOW POINTS "C" FOR TYPE 2N6181, AND POINTS "D" FOR TYPE 2N6180.

Fig. 18—Oscilloscope display for measurement of sustaining voltages (test circuit shown in Fig. 15).

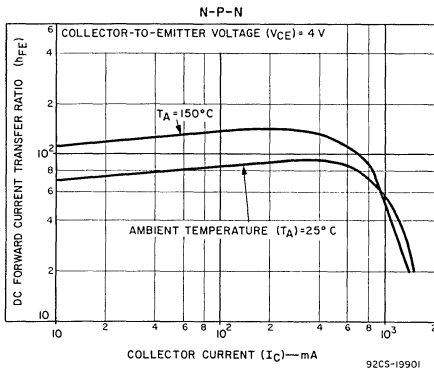


Fig. 19—Typical dc beta characteristics for 2N6178 and 2N6179.

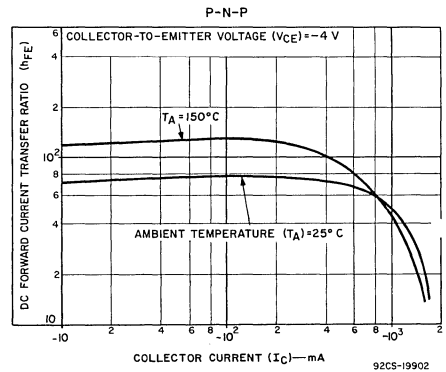


Fig. 20—Typical dc beta characteristics for 2N6180 and 2N6181.

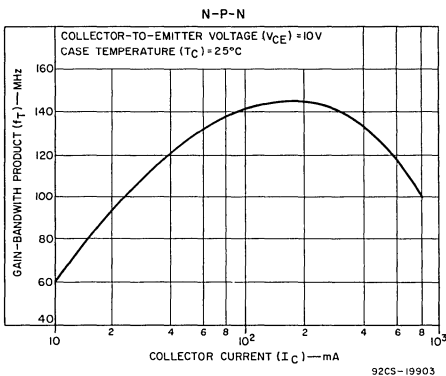


Fig. 21—Typical gain-bandwidth product for 2N6178 and 2N6179.

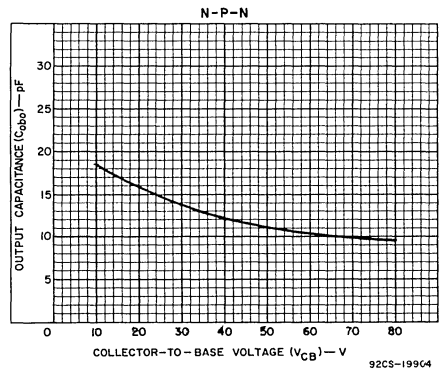


Fig. 22—Typical output capacitance vs. collector-to-base voltage for 2N6178 and 2N6179.

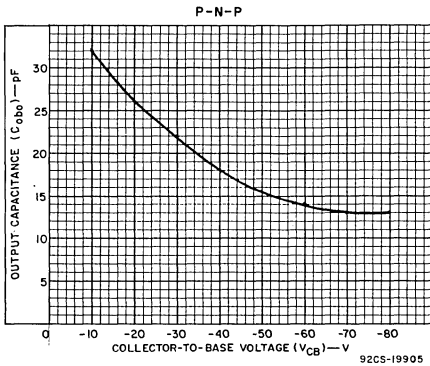


Fig. 23—Typical output capacitance vs. collector-to-base voltage for 2N6180 and 2N6181.

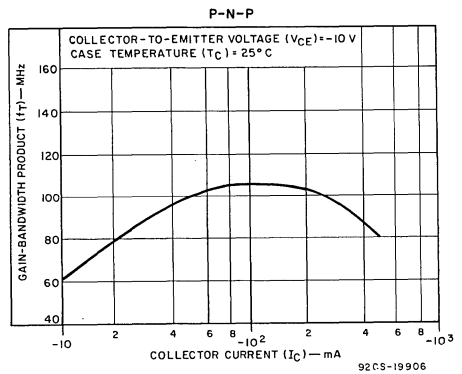


Fig. 24—Typical gain-bandwidth product for 2N6180 and 2N6181.

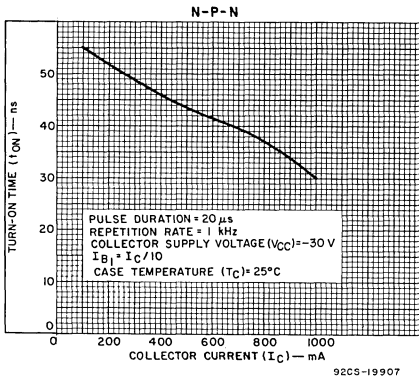


Fig. 25—Typical turn-on time for 2N6178 and 2N6179.

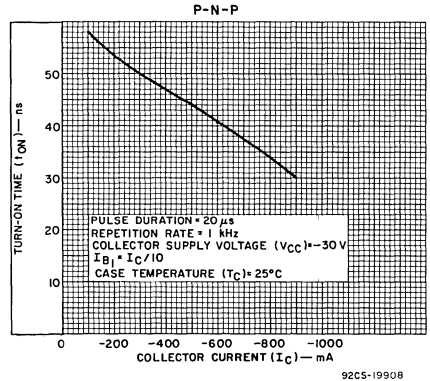


Fig. 26—Typical turn-on time for 2N6180 and 2N6181.

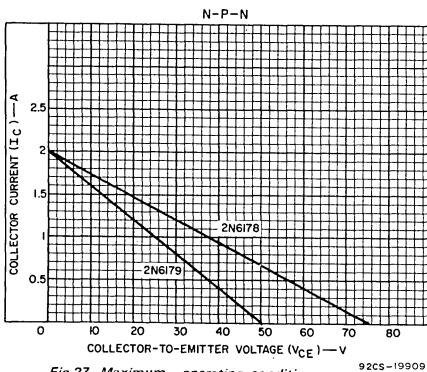


Fig. 27—Maximum operating conditions, resistive-load switching between saturation and cutoff for 2N6178 and 2N6179.

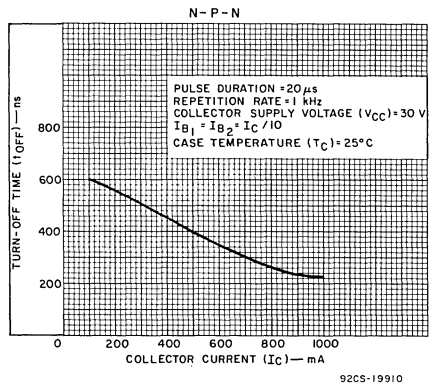


Fig. 28—Typical turn-off time for 2N6178 and 2N6179.

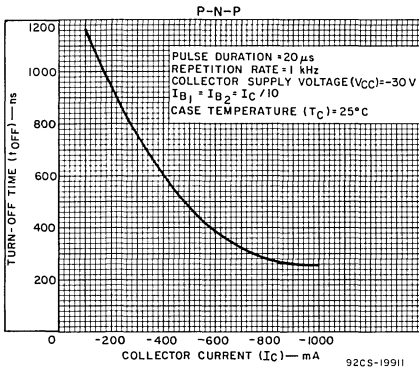


Fig.29—Typical turn-off time for 2N6180 and 2N6181.

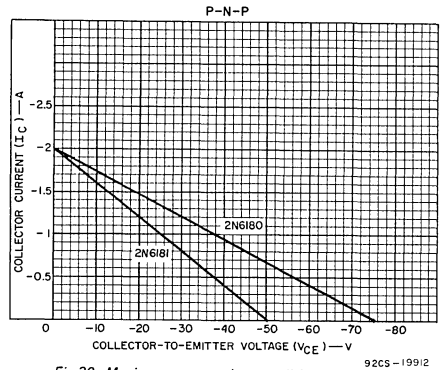


Fig.30—Maximum operating conditions, resistive-load switching between saturation and cutoff for 2N6180 and 2N6181.

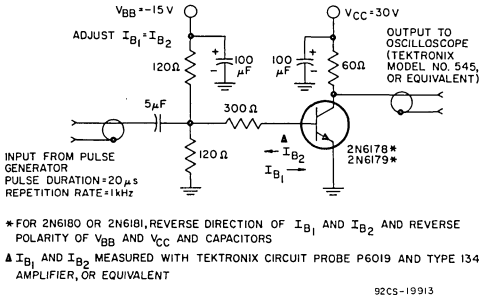


Fig.31—Circuit used to measure switching times for all types.

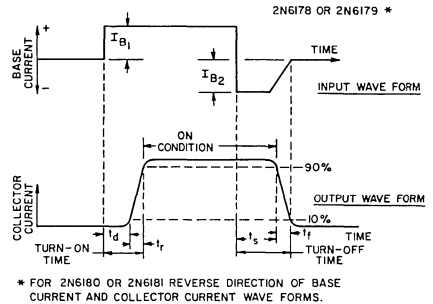


Fig.32—Phase relationship between input current and output voltage showing reference points for specification of switching times (test circuit shown in Fig.31).



# Power Transistors

## 2N6211, 2N6212 2N6213, 2N6214



### High-Voltage Medium-Power Silicon P-N-P Transistors

For Switching and Amplifier Applications  
In Military, Industrial, and Commercial Equipment

**Features:**

- High voltage ratings:
  - $V_{CEO(sus)}$  = -400 V max. (2N6214)
  - = -350 V max. (2N6213)
  - = -300 V max. (2N6212)
  - = -225 V max. (2N6211)
- Large safe-operating area
- Complements to 2N3585 transistor family
- Thermal-cycling rating

**Applications:**

- Power-Switching Circuits
- Switching Regulators
- Converters
- Inverters
- High-Fidelity Amplifiers

RCA types 2N6211, 2N6212, 2N6213, and 2N6214<sup>●</sup> are epitaxial silicon p-n-p transistors with high breakdown-voltage ratings and fast switching speeds. They are supplied in the popular JEDEC TO-66 package; they differ in breakdown-voltage ratings and leakage-current values.

<sup>●</sup> Formerly RCA Dev. Nos. TA7719, TA7410, TA8330, and TA8331, respectively.

**MAXIMUM RATINGS, Absolute-Maximum Values:**

		2N6211	2N6212	2N6213	2N6214	
*COLLECTOR-TO-BASE VOLTAGE	$V_{CBO}$	-275	-350	-400	-450	V
COLLECTOR-TO-EMITTER SUSTAINING VOLTAGE:						
With base open	$V_{CEO(sus)}$	-225	-300	-350	-400	V
With external base-to-emitter resistance ( $R_{BE}$ ) = 50 $\Omega$	$V_{CER(sus)}$	-250	-325	-375	-425	V
* With base-emitter junction reverse-biased ( $V_{BE}$ = 1.5 V)	$V_{CEX(sus)}$	-275	-350	-400	-450	V
*EMITTER-TO-BASE VOLTAGE	$V_{EBO}$	-6	-6	-6	-6	V
*COLLECTOR CURRENT (Continuous)	$I_C$	-2	-2	-2	-2	A
*BASE CURRENT (Continuous)	$I_B$	-1	-1	-1	-1	A
TRANSISTOR DISSIPATION: $P_T$						
* At case temperatures up to 100°C and $V_{CE}$ up to 50 V		20	20	20	20	W
At case temperatures up to 25°C and $V_{CE}$ up to 40 V		35	35	35	35	W
At case temperatures up to 25°C and $V_{CE}$ above 40 V		See Fig. 1				
At case temperatures above 25°C and $V_{CE}$ above 40 V		See Figs. 1 & 6.				
*TEMPERATURE RANGE:						
Storage & Operating (Junction)		←————— -65 to 200 —————→				°C
*LEAD TEMPERATURE (During Soldering):						
At distance $\geq$ 1/32 in. (0.8 mm) from case for 10s max.		←————— 230 —————→				°C

\*In accordance with JEDEC registration data format (JS-6 RDF-1)



ELECTRICAL CHARACTERISTICS, At Case Temperature ( $T_C$ ) = 25°C Unless Otherwise Specified

CHARACTERISTIC	SYMBOL	TEST CONDITIONS				LIMITS								UNITS
		Voltage V dc		Current A dc		2N6211		2N6212		2N6213		2N6214		
		$V_{CE}$	$V_{BE}$	I <sub>C</sub>	I <sub>B</sub>	Min.	Max.	Min.	Max.	Min.	Max.	Min.	Max.	
Collector-Cutoff Current: With base open	I <sub>CEO</sub>	-150			0	-	-5	-	-5	-	-5	-	-5	mA
With base-emitter junction reverse-biased	I <sub>CEV</sub>	-250	1.5			-	-0.5	-	-	-	-	-	-	
		-315	1.5			-	-	-	-0.5	-	-	-	-	
		-360	1.5			-	-	-	-	-	-0.5	-	-	
With base-emitter junction reverse biased and $T_C = 100^\circ\text{C}$		-410	1.5			-	-	-	-	-	-	-	-1	
		-250	1.5			-	-5	-	-5	-	-	-	-	
		-315	1.5			-	-	-	-	-	-	-5	-	
		-360	1.5			-	-	-	-	-	-	-	-	
		-410	1.5			-	-	-	-	-	-	-	-10	
Emitter-Cutoff Current	I <sub>EBO</sub>		6	0		-	-1	-	-0.5	-	-0.5	-	-0.5	mA
DC Forward-Current Transfer Ratio	h <sub>FE</sub>	-2.8		-1 <sup>a</sup>		10	100	-	-	-	-	-	-	
		-3.2		-1 <sup>a</sup>		-	-	10	100	-	-	-	-	
		-4		-1 <sup>a</sup>		-	-	-	-	10	100	-	-	
		-5		-1 <sup>a</sup>		-	-	-	-	-	10	100		
Collector-to-Emitter Sustaining Voltage: With base open	V <sub>CEO(sus)</sub>			-0.2 <sup>a</sup>	0	-225	-	-300	-	-350	-	-400	-	V
With external base-to-emitter resistance (R <sub>BE</sub> ) = 50 Ω	V <sub>CEB(sus)</sub>			-0.2 <sup>a</sup>		-250	-	-325	-	-375	-	-425	-	
With base-emitter junction reverse-biased and external base-to-emitter resistance (R <sub>BE</sub> ) = 50 Ω	V <sub>CEX(sus)</sub>		1.5	-0.2 <sup>a</sup>		-275	-	-350	-	-400	-	-450	-	
Emitter-to-Base Voltage	V <sub>EBO</sub>				0.5 mA 1 mA	-	-	-6	-	-6	-	-6	-	V
Emitter-to-Base Saturation Voltage	V <sub>BE(sat)</sub>			-1 <sup>a</sup>	-0.125	-	-1.4	-	-1.4	-	-1.4	-	-1.4	V
Collector-to-Emitter Saturation Voltage	V <sub>CE(sat)</sub>			-1 <sup>a</sup>	-0.125	-	-1.4	-	-1.6	-	-2	-	-2.5	V
Output Capacitance (f = 1 MHz)	C <sub>obo</sub>	-10 (V <sub>CB</sub> )				-	220	-	220	-	220	-	220	pF
Second-Breakdown Collector Current (Base forward-biased)	I <sub>S/b</sub>	-40				-0.875	-	-0.875	-	-0.875	-	-0.875	-	A
Magnitude of Common-Emitter, Small-Signal, Short-Circuit, Forward-Current Transfer Ratio (f = 5 MHz)	h <sub>fe</sub>	-10		-0.2		4	-	4	-	4	-	4	-	
Saturated Switching Times:														
Rise time	t <sub>r</sub>	V <sub>CC</sub> = -200 V		-1	I <sub>B1</sub> & I <sub>B2</sub> -0.125	-	0.6	-	0.6	-	0.6	-	0.6	μs
Storage time	t <sub>s</sub>	V <sub>CC</sub> = -200 V		-1	I <sub>B1</sub> & I <sub>B2</sub> -0.125	-	2.5	-	2.5	-	2.5	-	2.5	
Fall time	t <sub>f</sub>	V <sub>CC</sub> = -200 V		-1	I <sub>B1</sub> & I <sub>B2</sub> -0.125	-	0.6	-	0.6	-	0.6	-	0.6	
Thermal Resistance (Junction-to-case)	R <sub>θJC</sub>	-10		-1		-	5	-	5	-	5	-	5	°C/W

<sup>a</sup> In accordance with JEDEC registration data format JS-6 RDF-1.<sup>b</sup> Pulsed, pulse duration = 300 μs; duty factor ≤ 2%.

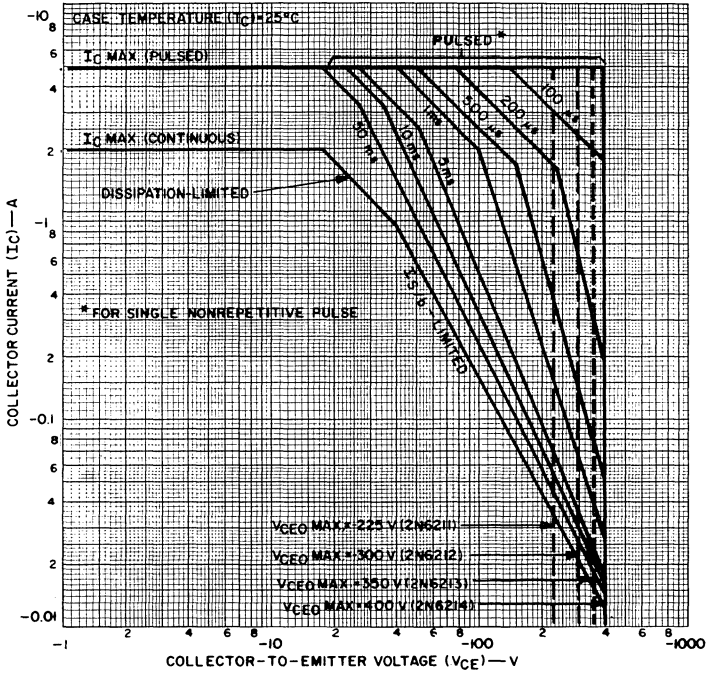


Fig. 1—Maximum operating areas for all types.

92CS-19220R1

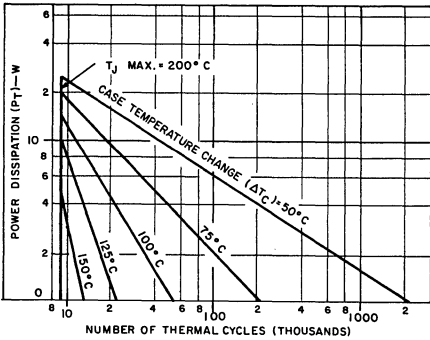


Fig. 2—Thermal-cycling rating chart for all types.

**TERMINAL CONNECTIONS**

- Pin 1 — Base
- Pin 2 — Emitter
- Case — Collector
- Mounting Flange — Collector

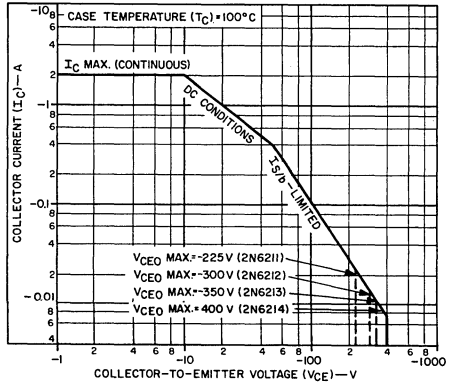


Fig. 3—Maximum operating areas for all types.

92CS-19218R1

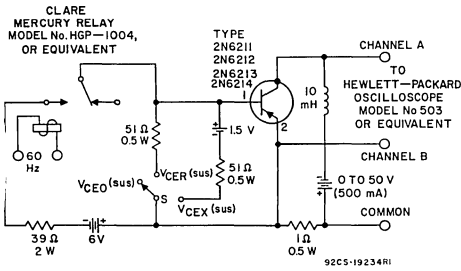


Fig. 4—Circuit used to measure sustaining voltages  $V_{CE0}(sus)$ ,  $V_{CER}(sus)$  and  $V_{CEX}(sus)$  for all types.

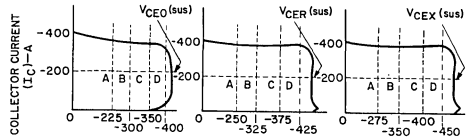


Fig. 5—Oscilloscope display for measurement of sustaining voltages (test circuit shown in Fig. 4).

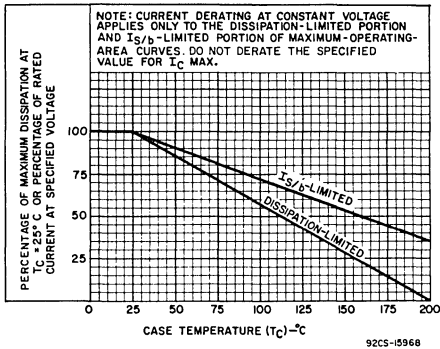


Fig. 6—Derating curves for all types.

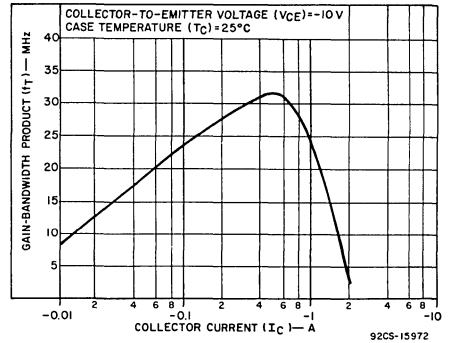


Fig. 7—Typical gain-bandwidth product for all types.

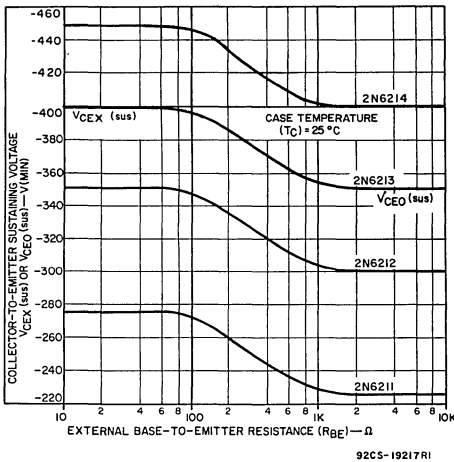


Fig. 8—Collector-to-emitter sustaining voltage characteristics for all types.

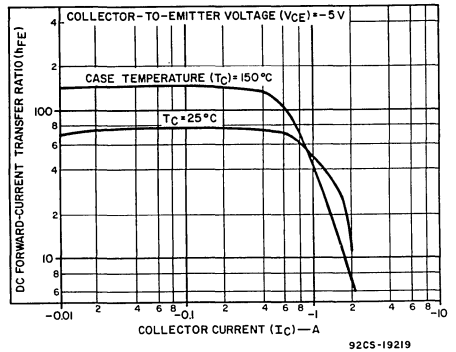


Fig. 9—Typical dc beta characteristic for all types.

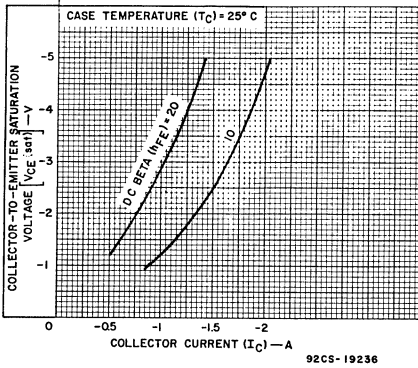


Fig. 10—Typical saturation-voltage characteristics for all types.

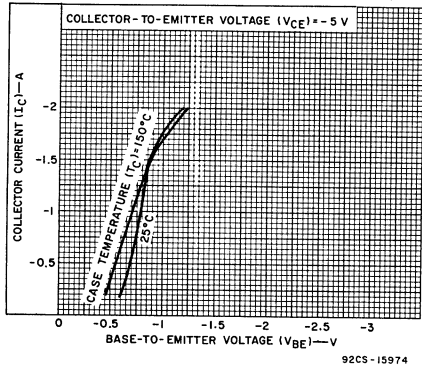


Fig. 11—Typical transfer characteristics for all types.

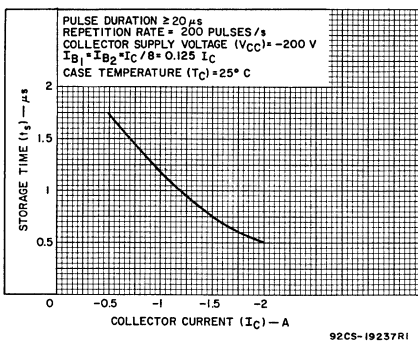


Fig. 12—Typical storage-time characteristic for all types.

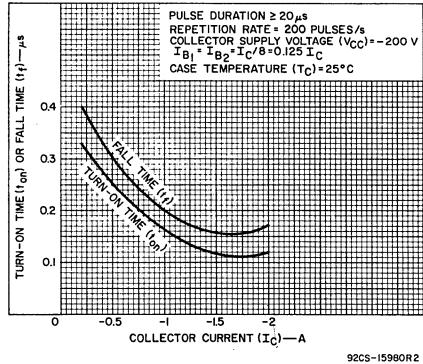


Fig. 13—Typical turn-on time and fall-time characteristics for all types.

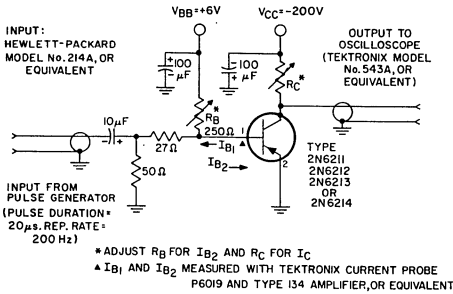


Fig. 14—Circuit used to measure saturated switching times for all types.

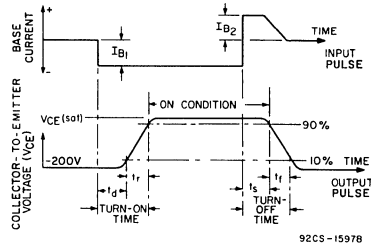
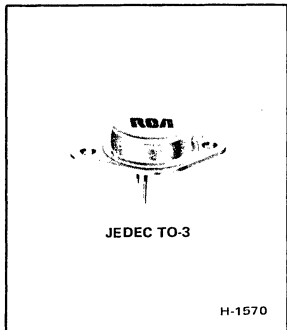


Fig. 15—Phase relationship between input current and output voltage showing reference points for specification of switching times. (Test circuit shown in Fig. 14).



# Power Transistors

**2N6246 2N6247 2N6248**  
**2N6469 2N6470 2N6471 2N6472**



## Silicon N-P-N and P-N-P Epitaxial-Base High-Power Transistors

General-Purpose Types for Switching and Linear-Amplifier Applications

**Features:**

- High dissipation capability: 125 W at 25°C
- Low saturation voltages
- Maximum safe-area-of-operation curves
- Hermetically sealed JEDEC TO-3 package
- High gain at high current
- Thermal-cycling rating curve

RCA-2N6246, 2N6247, 2N6248, and 2N6469▲ are epitaxial-base silicon p-n-p transistors featuring high gain at high current. RCA-2N6470, 2N6471, and 2N6472◆ are epitaxial-base silicon n-p-n transistors. They may be used as complements to the 2N6469, 2N6246, and 2N6247, respectively. All of these devices have a dissipation capability of 125 watts at case temperatures up to 25°C. They differ in voltage ratings

and in the currents at which the parameters are controlled. All are supplied in the JEDEC TO-3 package.

- ▲ Formerly RCA Dev. Nos. TA7281, TA7280, TA7279, and TA8724, respectively.
- ◆ Formerly RCA Dev. Nos. TA8726, TA8443, and TA8442, respectively.

**Maximum Ratings, Absolute-Maximum Values:**

	N-P-N	2N6470	2N6471	2N6472		
	P-N-P	2N6469◆	2N6246◆	2N6247◆	2N6248◆	
*COLLECTOR-TO-BASE VOLTAGE . . . . .	V <sub>CB0</sub>	50	70	90	110	V
COLLECTOR-TO-EMITTER VOLTAGE:						
* With external base-to-emitter resistance (R <sub>BE</sub> ) = 100 Ω . . . . .	V <sub>CER</sub>	50	70	90	110	V
With base open . . . . .	V <sub>CEO</sub>	40	60	80	100	V
*EMITTER-TO-BASE VOLTAGE . . . . .	V <sub>EBO</sub>	5	5	5	5	V
*CONTINUOUS COLLECTOR CURRENT . . . . .	I <sub>C</sub>	15	15	15	10	A
*CONTINUOUS BASE CURRENT . . . . .	I <sub>B</sub>	5	5	5	5	A
*TRANSISTOR DISSIPATION: . . . . .	P <sub>T</sub>					
At case temperatures up to 25°C . . . . .		125	125	125	125	W
At case temperatures above 25°C . . . . .		← See Fig. 3 →				
*TEMPERATURE RANGE:						
Storage & Operating (Junction) . . . . .		← -65 to +200 →				°C
*PIN TEMPERATURE (During Soldering):						
At distances ≥ 1/32" (0.8 mm) from seating plane for 10 s max. . . . .		← +235 →				°C

\* In accordance with JEDEC registration data format (JS-6 RDF-2).  
 ◆ For p-n-p devices, voltage and current values are negative.

ELECTRICAL CHARACTERISTICS FOR P-N-P TYPES, At case temperature ( $T_C$ ) = 25° C unless otherwise specified

CHARACTERISTIC	SYMBOL	TEST CONDITIONS					LIMITS						UNITS		
		V dc		A dc			2N6469		2N6246		2N6247			2N6248	
		$V_{CE}$	$I_C$	$I_B$	Min.	Max.	Min.	Max.	Min.	Max.	Min.	Max.			
Collector-Cutoff Current: With external base-emitter resistance ( $R_{BE}$ ) = 100Ω	$I_{CER}$	-35 -55 -75 -95			-	-200	-	-	-	-	-	-	-	-	μA
$V_{BE} = 1.5$ V	$I_{CEX}$	-45 -65 -85 -100			-	-200	-	-	-200	-	-	-	-	-	μA
		-45 -55 -70 -90			-	-5	-	-	-5	-	-	-	-	-	mA
At $T_C = 150^\circ\text{C}$ $V_{BE} = 1.5$ V					-	-	-	-	-	-	-	-	-		
With base open	$I_{CEO}$	-20 -30 -40 -50		0 0 0 0	-	-1	-	-	-1	-	-	-	-	-	mA
Emitter-Cutoff Current, $V_{BE} = 5$ V	$I_{EBO}$			0	-	-5	-	-	-5	-	-	-1	-	-	mA
DC Forward-Current Transfer Ratio	$h_{FE}$	-4 -4 -4 -4 -4	-5 <sup>a</sup> -7 <sup>a</sup> -6 <sup>a</sup> -10 <sup>a</sup> -15 <sup>a</sup>		20	150	-	-	20	100	-	-	20	100	
					-	-	-	-	-	-	-	20	100		
					-	-	-	-	-	-	-	-	5	-	
					5	-	5	-	5	-	5	-	-	-	
Collector-to-Emitter Sustaining Voltage With base open	$V_{CEO(sus)}$		-0.2	0	-40 <sup>b</sup>	-	-60 <sup>b</sup>	-	-80 <sup>b</sup>	-	-	-100 <sup>b</sup>	-	V	
With external base-emitter resistance ( $R_{BE}$ ) = 100Ω	$V_{CER(sus)}$		-0.2		-45 <sup>b</sup>	-	-65 <sup>b</sup>	-	-85 <sup>b</sup>	-	-	-105 <sup>b</sup>	-	V	
Base-to-Emitter Voltage	$V_{BE}$	-4 -4 -4 -4	15 <sup>a</sup> 7 <sup>a</sup> 6 <sup>a</sup> 5 <sup>a</sup>		-	-3.5	-	-	-2	-	-	-1.8	-	-	V
					-	-	-	-	-	-	-	-	-	-	
					-	-	-	-	-	-	-	-	-	-	
					-	-	-	-	-	-	-	-	-	-1.8	
Collector-to-Emitter Saturation Voltage	$V_{CE(sat)}$	-5 <sup>a</sup> -7 <sup>a</sup> -6 <sup>a</sup> -15 <sup>a</sup> -15 <sup>a</sup> -10 <sup>a</sup>	-0.5 -0.7 -0.6 -5 -3 -4 -2		-	-1.3	-	-	-1.3	-	-	-	-	-	-1.3
					-	-	-	-	-	-	-	-	-	-	
					-	-	-	-	-	-	-	-	-	-	
					-	-	-	-	-	-	-	-	-	-	
					-	-	-	-	-	-	-	-	-	-	
					-	-	-	-	-	-	-	-	-	-	
Magnitude of Common-Emitter Small-Signal Short-Circuit Forward-Current Transfer Ratio ( $f = 2$ MHz)	$ h_{fe} $	-4	-1		5	-	5	-	5	-	5	-	5	-	
Common-Emitter, Small-Signal, Short-Circuit, Forward-Current Transfer Ratio ( $f = 1$ kHz)	$h_{fe}$	-4	-1		25	-	25	-	25	-	25	-	25	-	
Thermal Resistance (Junction-to-case)	$R_{\theta JC}$				-	1.4	-	1.4	-	1.4	-	1.4	-	1.4	°C/W

\* In accordance with JEDEC registration data format (JS-6 RDF-2).

<sup>a</sup> Pulsed; pulse duration = 300 μs, duty factor = 1.8%.

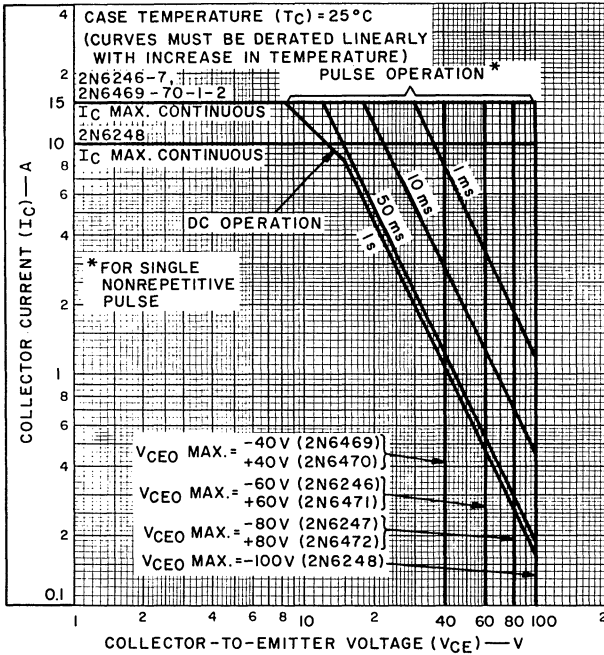
<sup>b</sup> CAUTION: Sustaining voltages  $V_{CEO(sus)}$ ,  $V_{CER(sus)}$ , and  $V_{CEX(sus)}$  MUST NOT be measured on a curve tracer. (See Fig. 2.2)

ELECTRICAL CHARACTERISTICS FOR N-P-N TYPES, At case temperature ( $T_C$ ) = 25° C unless otherwise specified

CHARACTERISTIC	SYMBOL	TEST CONDITIONS			LIMITS						UNITS
		V dc	A dc		2N6470		2N6471		2N6472		
		V <sub>CE</sub>	I <sub>C</sub>	I <sub>B</sub>	Min.	Max.	Min.	Max.	Min.	Max.	
Collector-Cutoff Current: With external base-emitter resistance ( $R_{BE}$ ) = 100Ω	I <sub>CER</sub>	35 55 75			- - ..	500	- - -	500	- - -	- - 500	μA
* V <sub>BE</sub> = -1.5 V	I <sub>CEx</sub>	45 65 85			- - -	500	- - -	500	- - -	- - 500	μA
* At T <sub>C</sub> = 150° C		40 60 80			- - -	5	- - -	5	- - -	- - 5	mA
* V <sub>BE</sub> = -1.5 V											
* With base open	I <sub>CEO</sub>	20 30 40		0 0 0	- - -	1	- - -	1	- - -	- - 1	mA
* Emitter-Cutoff Current; V <sub>BE</sub> = -5 V	I <sub>EBO</sub>		0		-	1	-	1	-	1	mA
* DC Forward Current Transfer Ratio	h <sub>FE</sub>	4 4	5 <sup>a</sup> 15 <sup>a</sup>		20 5	150 ..	20 5	150 ..	20 5	150 ..	
* Collector-to-Emitter Sustaining Voltage With base open	V <sub>CEO(sus)</sub>		0.2	0	40 <sup>b</sup>		60 <sup>b</sup>	-	80 <sup>b</sup>	-	V
* With external base-emitter resistance ( $R_{BE}$ ) = 100Ω	V <sub>CER(sus)</sub>		0.2		45 <sup>b</sup>		65 <sup>b</sup>	-	85 <sup>b</sup>	-	V
* Base-to-Emitter Voltage	V <sub>BE</sub>	4 4	5 <sup>a</sup> 15 <sup>a</sup>		- -	1.3 3.5	- -	1.3 3.5	- -	1.3 3.5	V
* Collector-to-Emitter Saturation Voltage	V <sub>CE(sat)</sub>		5 <sup>a</sup> 15 <sup>a</sup>	0.5 5	- -	1.3 3.5	- -	1.3 3.5	- -	1.3 3.5	V
* Magnitude of Common-Emitter Small-Signal Short-Circuit Forward-Current Transfer Ratio: (f = 1 MHz)	h <sub>fe</sub>	4	1		5		5	-	5	-	
* Common-Emitter, Small-Signal, Short-Circuit, Forward-Current Transfer Ratio (f = 1 kHz)	h <sub>fe</sub>	4	1		25		25	-	25	-	
* Thermal Resistance: (Junction-to-case)	R <sub>θJC</sub>				-	1.4	-	1.4	-	1.4	°C/W

\* In accordance with JEDEC registration data format (JS-6 RDF-2).

<sup>b</sup> CAUTION: Sustaining voltages V<sub>CEO(sus)</sub>, V<sub>CER(sus)</sub>, and V<sub>CEx(sus)</sub>  
MUST NOT be measured on a curve tracer. (See Fig. 22.)<sup>a</sup> Pulsed; pulse duration = 300 μs, duty factor = 1.8%.



92CS-22379

Fig.1 — Maximum operating areas for all types.

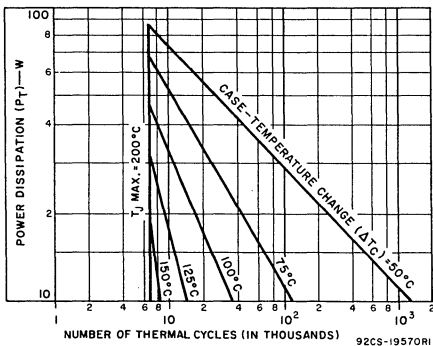


Fig.2 — Thermal-cycling rating chart for all types.

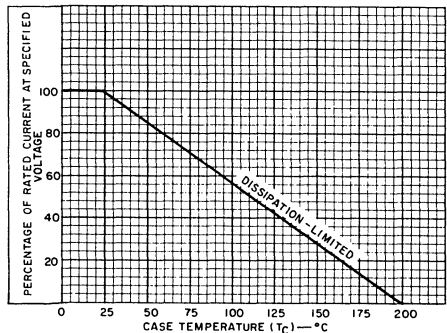


Fig.3 — Current derating for all types.



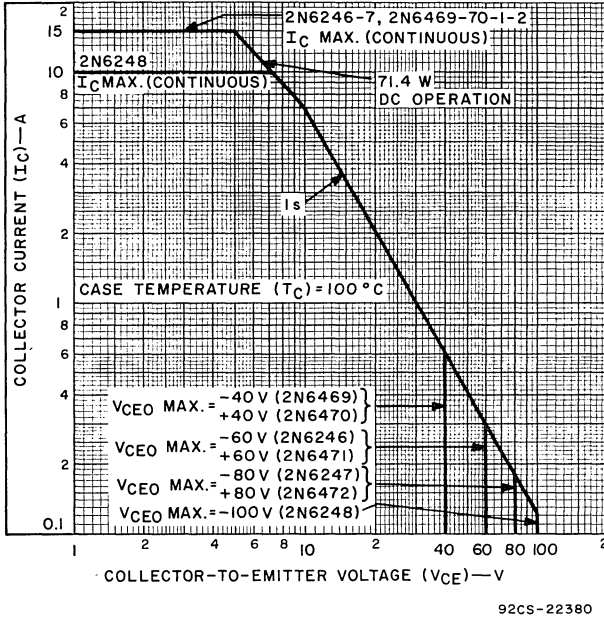


Fig.4 — Maximum operating areas for all types.

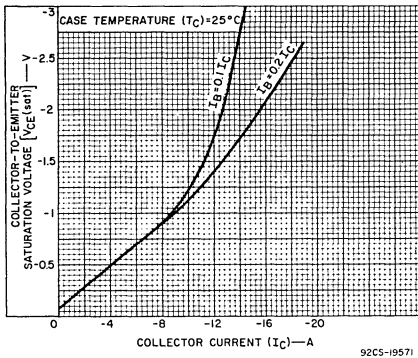


Fig.5 — Typical collector-to-emitter saturation-voltage characteristics for 2N6246, 2N6247, 2N6248, and 2N6469.

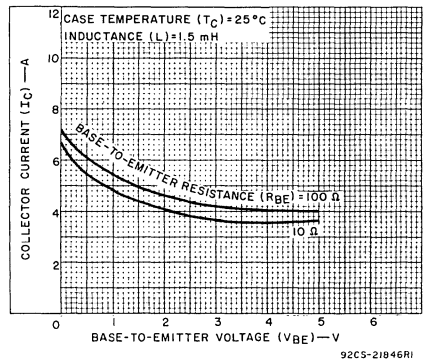


Fig.6 — Minimum reverse-bias second-breakdown characteristics for all types. (Values for p-n-p types are negative).

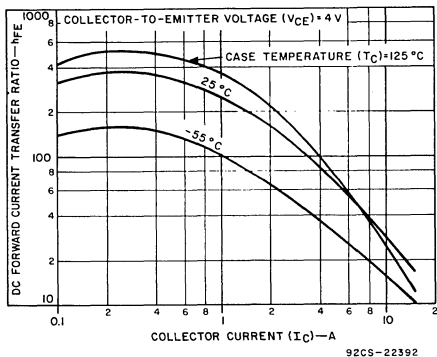


Fig. 7 - Typical dc beta characteristics for 2N6470, 2N6471, and 2N6472.

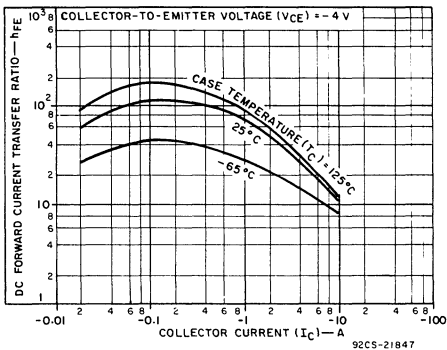


Fig. 8 - Typical dc beta characteristics for 2N6248.

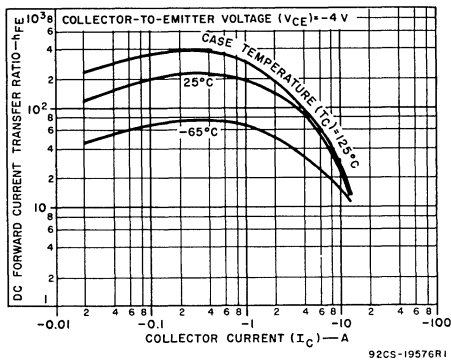


Fig. 9 - Typical dc beta characteristics for 2N6246, 2N6247, and 2N6469.

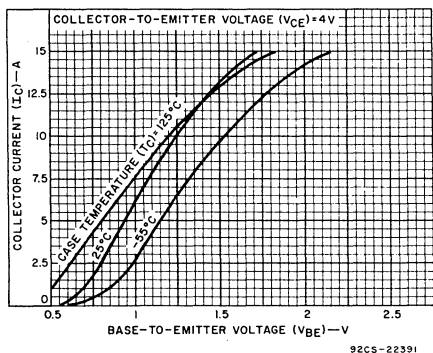


Fig. 10 - Typical transfer characteristics for 2N6470, 2N6471, and 2N6472.

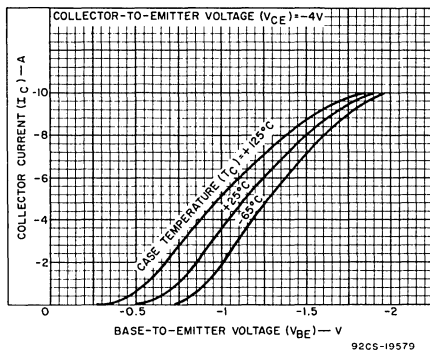


Fig. 11 - Typical transfer characteristics for 2N6246, 2N6247, 2N6248, and 2N6469.

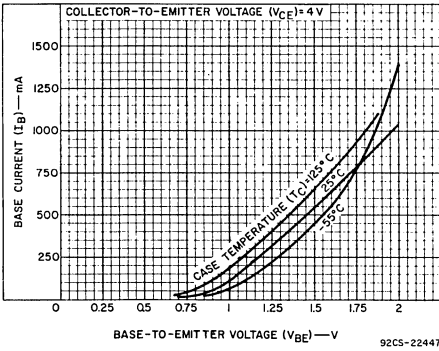


Fig. 12 - Typical input characteristics for 2N6470, 2N6471, and 2N6472.

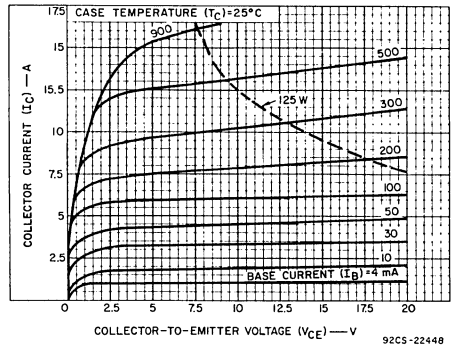


Fig. 13 - Typical output characteristics for 2N6470, 2N6471, and 2N6472.

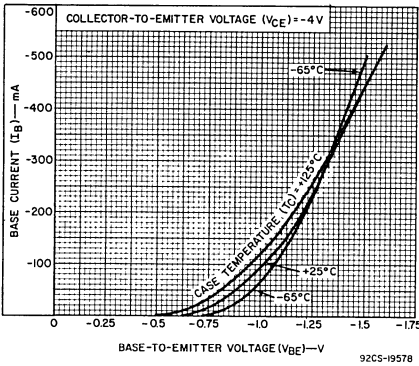


Fig. 14 - Typical input characteristics for 2N6248.

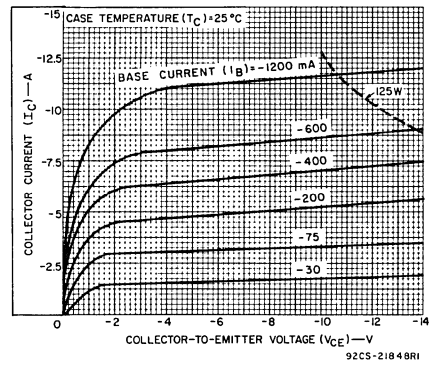


Fig. 15 - Typical output characteristics for 2N6248.

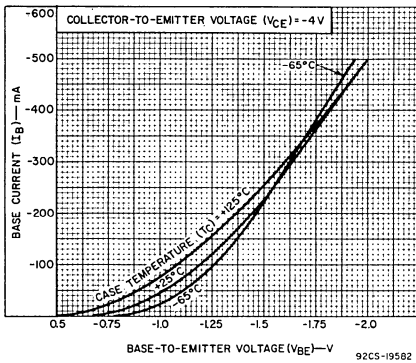


Fig. 16 - Typical input characteristics for 2N6246, 2N6247, and 2N6469.

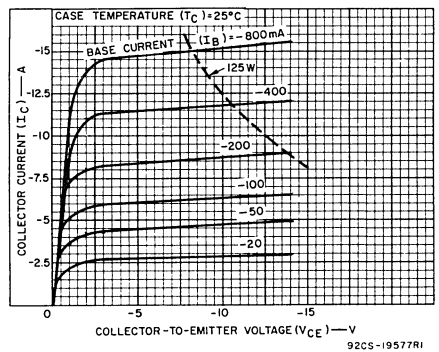


Fig. 17 - Typical output characteristics for 2N6246, 2N6247, and 2N6469.

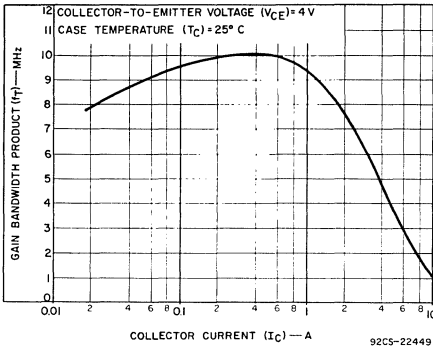


Fig.18 - Typical gain-bandwidth product vs. collector current for 2N6470, 2N6471, and 2N6472.

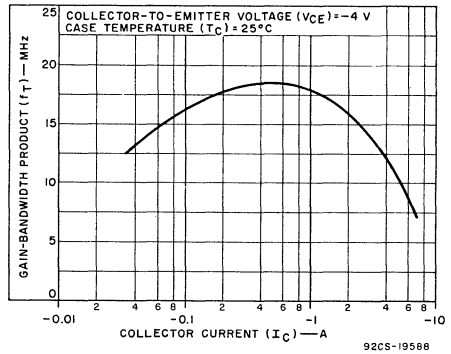


Fig.19 - Typical gain-bandwidth product vs. collector current for 2N6246, 2N6247, 2N6248, and 2N6469.

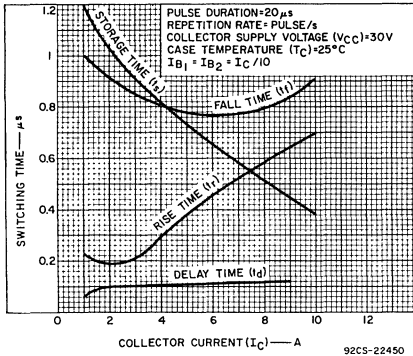


Fig.20 - Typical saturated switching characteristics for 2N6470, 2N6471, and 2N6472.

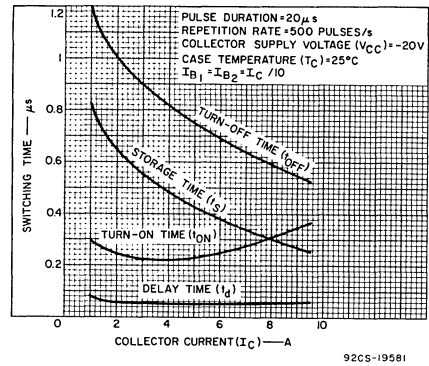
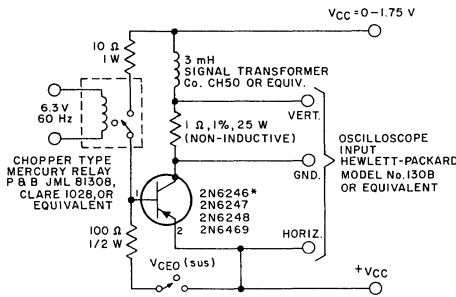


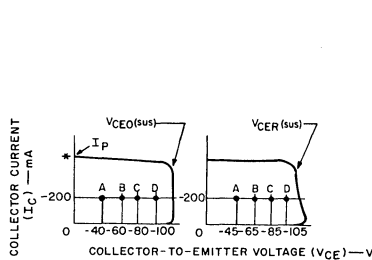
Fig.21 - Typical saturated switching characteristics for 2N6246, 2N6247, 2N6248, and 2N6469.



\* For N-P-N types 2N6470, 2N6471, and 2N6472, reverse polarity of  $V_{CC}$ .

92CS-24700

Fig.22 - Circuit used to measure sustaining voltages  $V_{CE0}(sus)$ ,  $V_{CEr}(sus)$ , and  $V_{CEX}(sus)$  for all types.



\* PULSE CURRENT ( $I_p$ ) RANGE = 0.6 - 0.8 A

THE SUSTAINING VOLTAGES  $V_{CE0}(sus)$  AND  $V_{CEr}(sus)$  ARE ACCEPTABLE WHEN THE TRACES FALL TO THE RIGHT AND ABOVE POINT "A" FOR TYPES 2N6469 AND 2N6470; POINT "B" FOR 2N6246 AND 2N6471; POINT "C" FOR 2N6247 AND 2N6472; AND POINT "D" FOR 2N6248. VALUES FOR N-P-N TYPES ARE POSITIVE.

92CS-24702

Fig.23 - Oscilloscope display for measurement of sustaining voltages (test circuit shown in Fig.22.)

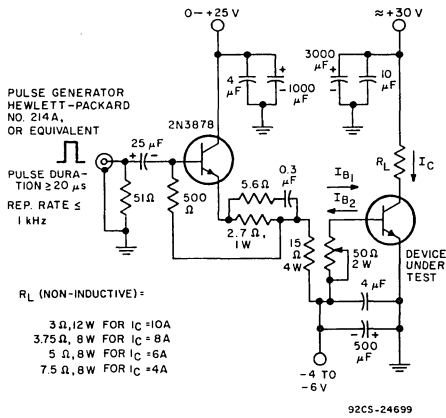


Fig.24 — Circuit used to measure switching times for 2N6470, 2N6471, and 2N6472.

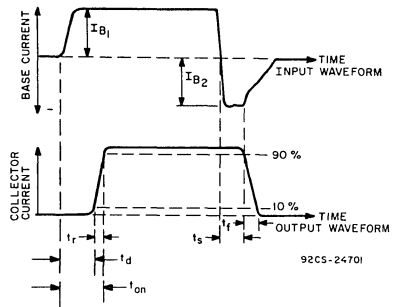


Fig.25 — Phase relationship between input and output currents showing reference points for specification of switching times. (Test circuit shown in Fig.24.)

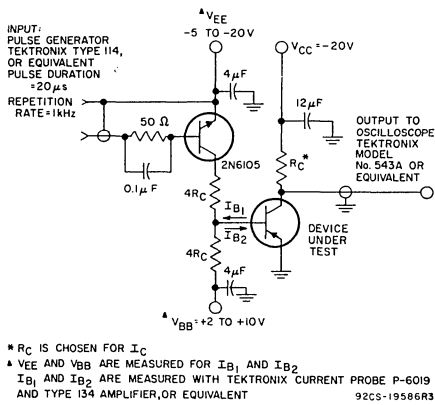


Fig.26 — Circuit used to measure switching times for 2N6246, 2N6247, 2N6248, and 2N6469.

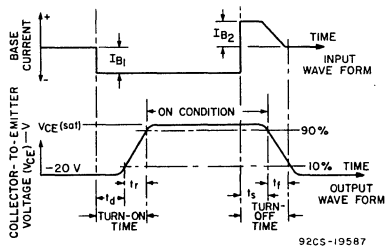


Fig.27 — Oscilloscope display for measurement of switching times.

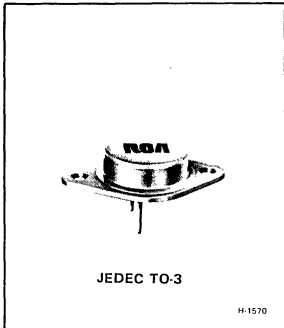
### TERMINAL CONNECTIONS

- Pin 1 — Base
- Pin 2 — Emitter
- Case — Collector
- Mounting Flange — Collector



# Power Transistors

2N6249  
2N6250  
2N6251



## 450-V, 30-A, 175-W Silicon N-P-N Switching Transistors

For Switching Applications in  
Industrial and Commercial Equipment

**Features:**

- High voltage ratings:  
 $V_{CBO} = 450\text{ V (2N6251)}$   
 $375\text{ V (2N6250)}$   
 $300\text{ V (2N6249)}$
- High dissipation rating:  $P_T = 175\text{ W}$
- Low saturation voltages
- Maximum safe-area-of-operation curves

RCA-2N6249, 2N6250, and 2N6251\* are multiple epitaxial silicon n-p-n power transistors utilizing a multiple-emitter-site structure. Multiple-epitaxial construction maximizes the volt-ampere characteristic of the device and provides fast switching speeds. Multiple-emitter-site design assures uniform current flow throughout the structure, which produces a high  $I_S/b$  and a large safe-operation area.

These devices use the popular JEDEC TO-3 package; they differ mainly in voltage ratings, leakage-current limits, and  $V_{CE(sat)}$  ratings.

The exceptional second-breakdown capabilities and high voltage-breakdown ratings make these transistors especially

suitable for off-line inverters, switching regulators, motor controls, and deflection circuit applications.

The high gain and high  $E_S/b$  energy-handling capability of the 2N6249 make it an excellent choice for motor-control applications in which large winding inductances are encountered and high surge currents are required to start the motor.

The high breakdown voltages, low saturation voltages, and fast-switching capability of the 2N6250 and 2N6251 make them especially suitable for inverter circuits operating directly off the rectified 115-V power line or in a bridge configuration operating from the rectified 220-V line.

\* Formerly RCA Dev. Nos. TA7005, TA7006, and TA7007.

**MAXIMUM RATINGS, Absolute-Maximum Values:**

		2N6249	2N6250	2N6251	
*COLLECTOR-TO-BASE VOLTAGE	$V_{CBO}$	300	375	450	V
COLLECTOR-TO-EMITTER SUSTAINING VOLTAGE:					
With base open	$V_{CEO(sus)}$	200	275	350	V
* With reverse bias ( $V_{BE} = 0\text{ V}$ (with base-emitter shorted))	$V_{CEX(sus)}$	225	300	375	V
With external base-to-emitter resistance ( $R_{BE} \leq 50\ \Omega$ )	$V_{CER(sus)}$	225	300	375	V
*EMITTER-TO-BASE VOLTAGE	$V_{EBO}$	6	6	6	V
COLLECTOR CURRENT:					
* Continuous	$I_C$	10	10	10	A
Peak		30	30	30	A
*CONTINUOUS BASE CURRENT	$I_B$	10	10	10	A
TRANSISTOR DISSIPATION:					
At case temperatures up to 25°C and $V_{CE}$ up to 30 V	$P_T$	175	175	175	W
At case temperatures up to 25°C and $V_{CE}$ above 30 V		← See Fig. 1 →			
* At case temperatures above 25°C and $V_{CE}$ above 30 V		← See Figs. 1, 2, & 4 →			
*TEMPERATURE RANGE:					
Storage & Operating (Junction)		← -65 to +200 →			°C
*PIN TEMPERATURE (During Soldering):					
At distances $\geq 1/32$ in. (0.8 mm) from case for 10 s max.		← 230 →			°C

\* In accordance with JEDEC registration data format (JS-6, RDF-1).

ELECTRICAL CHARACTERISTICS, At Case Temperature ( $T_C$ ) = 25°C Unless Otherwise Specified.

CHARACTERISTIC	SYMBOL	TEST CONDITIONS				LIMITS									UNITS			
		DC VOLTAGE (V)		DC CURRENT (A)		TYPE 2N6249			TYPE 2N6250			TYPE 2N6251						
		V <sub>CE</sub>	V <sub>BE</sub>	I <sub>C</sub>	I <sub>B</sub>	Min.	Typ.	Max.	Min.	Typ.	Max.	Min.	Typ.	Max.				
Collector-Cutoff Current: With base open	I <sub>CEO</sub>	150 225 300			0 0 0	-	-	5	-	-	5	-	-	-	-	-	-	-
With base-emitter junction reverse-biased	I <sub>CEV</sub>	225 300 375	-1.5 -1.5 -1.5			-	-	5	-	-	5	-	-	-	-	-	-	5
With base-emitter junction reverse-biased	I <sub>CEV</sub> T <sub>C</sub> = 125°C	225 300 375	-1.5 -1.5 -1.5			-	-	10	-	-	10	-	-	-	-	-	-	10
Emitter-Cutoff Current	I <sub>EBO</sub>		-6			-	-	1	-	-	1	-	-	-	-	-	-	1
Collector-to-Emitter Sustaining Voltage (see Figs. 15 & 16) With base open	V <sub>CEO(sus)</sub>			0.2		200 <sup>b</sup>	-	-	275 <sup>b</sup>	-	-	350 <sup>b</sup>	-	-	-	-	-	-
With external base-to-emitter resistance (R <sub>BE</sub> ) = 50 Ω	V <sub>CER(sus)</sub>			0.2		225 <sup>b</sup>	-	-	300 <sup>b</sup>	-	-	375 <sup>b</sup>	-	-	-	-	-	-
Emitter-to-Base Voltage (I <sub>E</sub> = 1 mA)	V <sub>EBO</sub>					6	-	-	6	-	-	6	-	-	-	-	-	6
DC Forward-Current Transfer Ratio	h <sub>FE</sub>	3 3 3		10 <sup>a</sup> 10 <sup>a</sup> 10 <sup>a</sup>		10	-	50	-	-	8	-	50	-	-	-	-	6
Base-to-Emitter Saturation Voltage	V <sub>BE(sat)</sub>			10 <sup>a</sup> 10 <sup>a</sup> 10 <sup>a</sup>	1 1.25 1.67	-	-	2.25	-	-	-	-	2.25	-	-	-	-	2.25
Collector-to-Emitter Saturation Voltage	V <sub>CE(sat)</sub>			10 <sup>a</sup> 10 <sup>a</sup> 10 <sup>a</sup>	1 1.25 1.67	-	-	1.5	-	-	-	-	1.5	-	-	-	-	1.5
Magnitude of Common Emitter, Small-Signal, Short-Circuit, Forward Current Transfer Ratio (f = 1 MHz)	h <sub>fe</sub>	10		1		2.5	8	-	2.5	8	-	2.5	8	-	2.5	8	-	-
Second Breakdown Collector Current (With base forward- biased) Pulse duration (non-repetitive) = 1 s	I <sub>S/b</sub>	30				5.8	-	-	5.8	-	-	5.8	-	-	-	-	-	-
Second Breakdown Energy (With base reverse-biased) R <sub>B</sub> = 50 Ω, L = 50 μH	E <sub>S/b</sub>		-4	10		2.5	-	-	2.5	-	-	2.5	-	-	-	-	-	-
Switching Times (V <sub>CC</sub> = 200 V, I <sub>B1</sub> = I <sub>B2</sub> ): Rise (See Figs. 13, 17, & 18)	t <sub>r</sub>			10 10 10	1 1.25 1.67	-	0.8	2	-	-	0.8	2	-	-	-	-	-	-
Storage (See Figs. 11, 12, 17, & 18)	t <sub>s</sub>			10 10 10	1 1.25 1.67	-	1.8	3.5	-	-	1.8	3.5	-	-	-	-	1.8	3.5
Fall (See Figs. 14, 17, & 18)	t <sub>f</sub>			10 10 10	1 1.25 1.67	-	0.5	1	-	-	0.5	1	-	-	-	-	0.5	1
Thermal Resistance: Junction-to-Case	R <sub>θJC</sub>	10		5		-	-	1	-	-	1	-	-	-	-	-	-	1

\* In accordance with JEDEC registration data format (JS-6 RDF-1).

<sup>a</sup> Pulsed; pulse duration ≤ 350 μs, duty factor = 2%.

<sup>b</sup> CAUTION: The sustaining voltages V<sub>CEO(sus)</sub> and V<sub>CER(sus)</sub> MUST NOT be measured on a curve tracer. These sustaining voltages should be measured by means of the test circuit shown in Fig. 15.

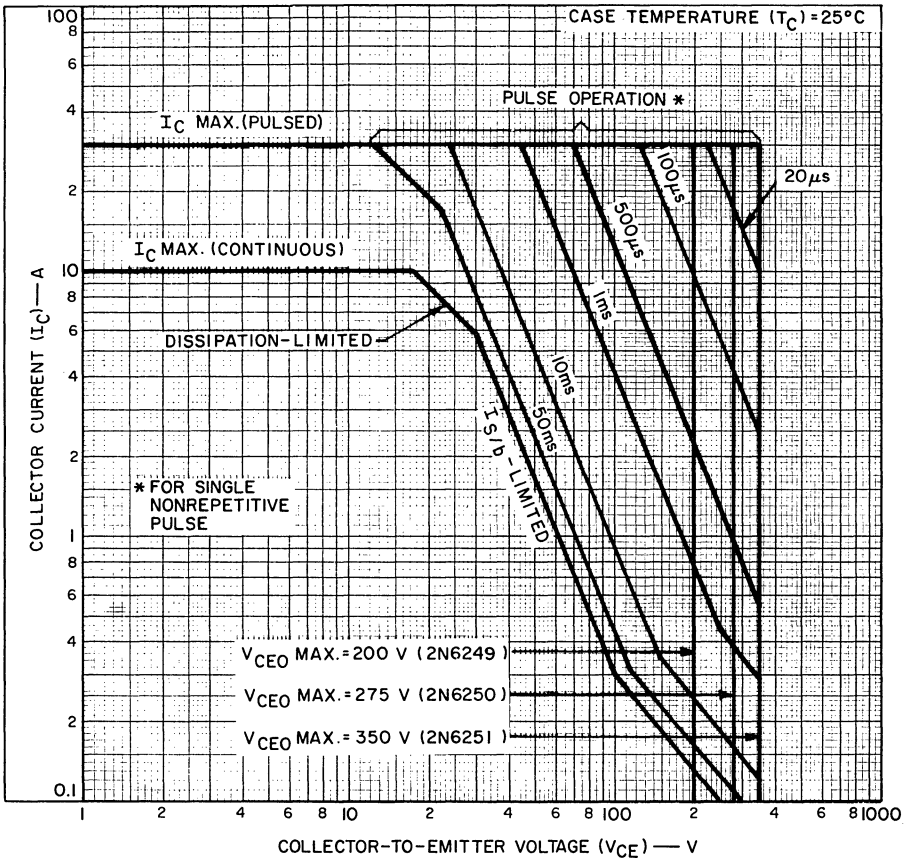


Fig. 1—Maximum operating areas for all types.

92CS-19468

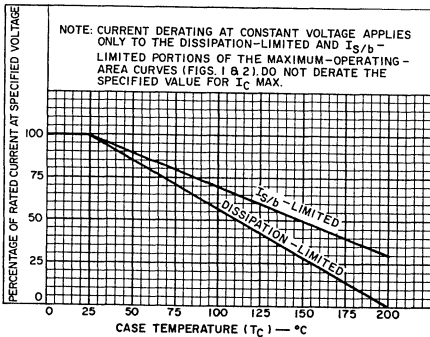


Fig. 2—Dissipation derating and  $I_S/B$  derating for all types.

92CS-19475

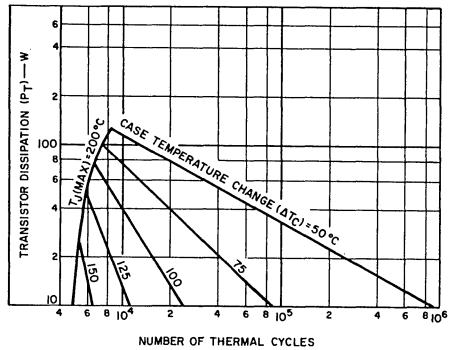


Fig. 3—Thermal-cycle rating chart for all types.

92CS-19476



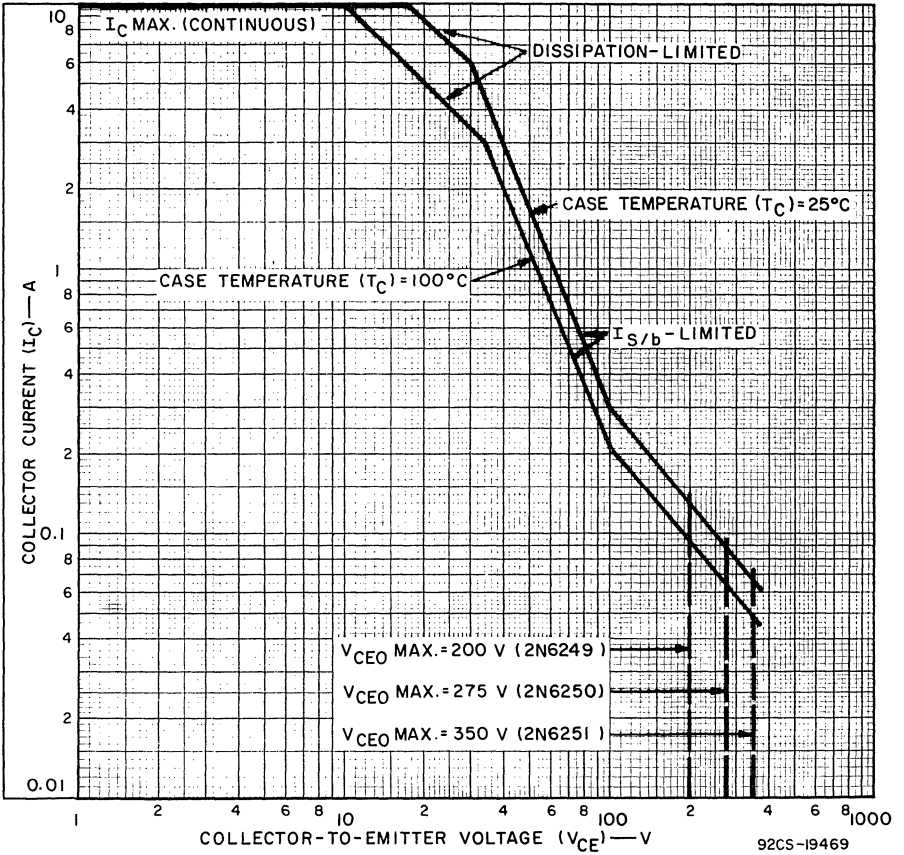


Fig. 4 -Maximum operating areas for all types.

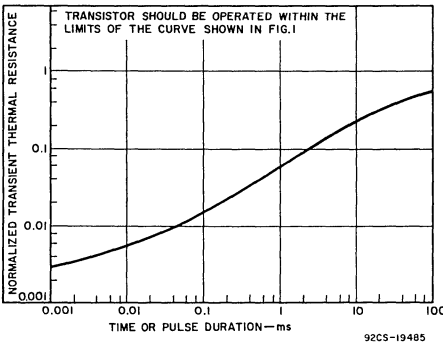


Fig. 5—Typical thermal response characteristic for all types.

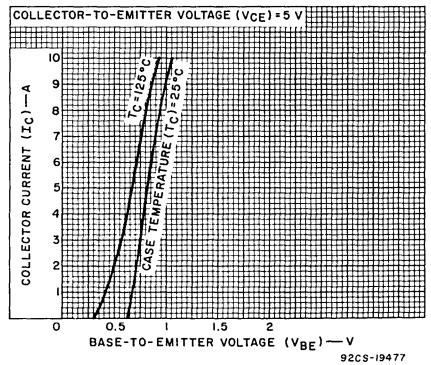


Fig. 6—Typical transfer characteristics for all types.

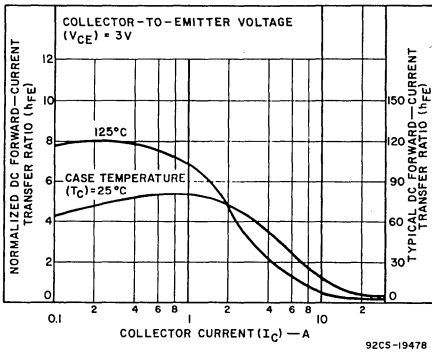


Fig. 7—Typical normalized dc beta characteristics for all types.

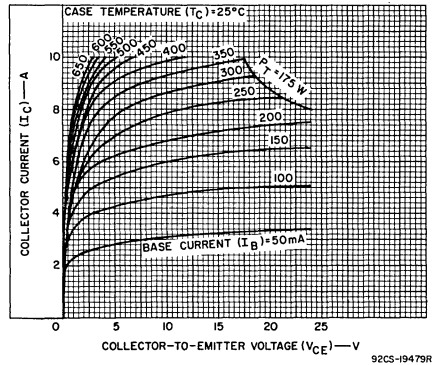


Fig. 8—Typical output characteristics for all types.

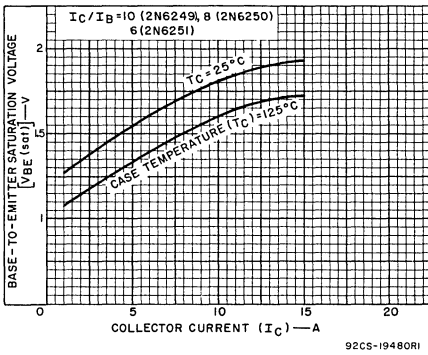


Fig. 9—Typical base-to-emitter saturation voltage characteristics for all types.

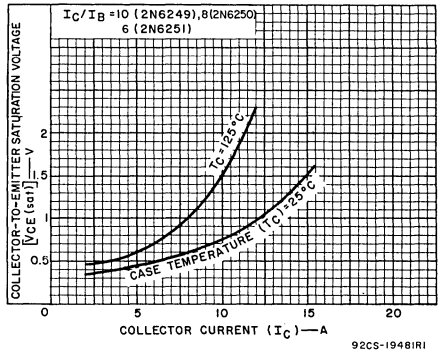


Fig. 10—Typical collector-to-emitter saturation voltage characteristics for all types.

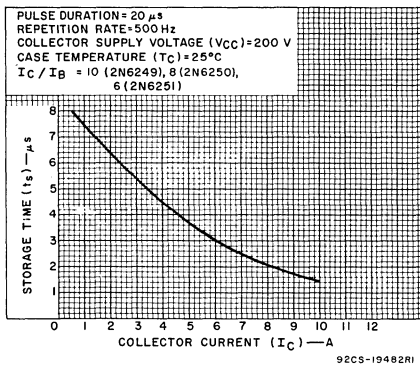


Fig. 11—Typical storage-time characteristics for all types (with constant forced gain).

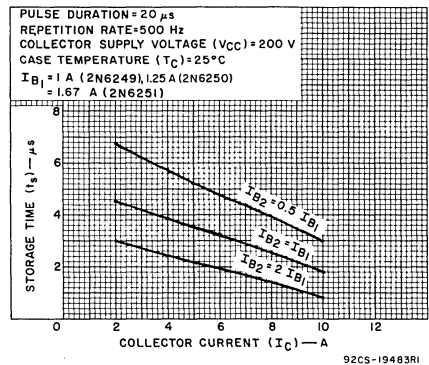


Fig. 12—Typical storage-time characteristics for all types (with constant base drive).

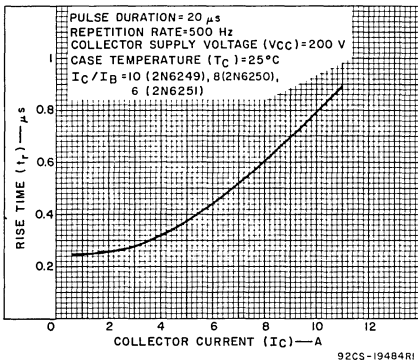


Fig.13—Typical rise-time characteristic for all types.

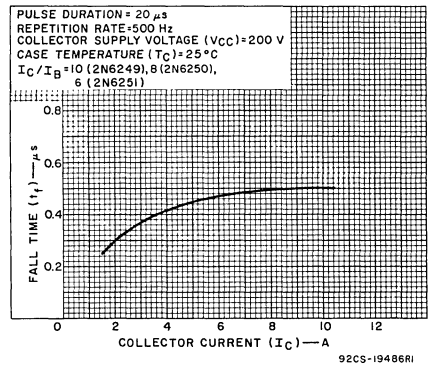


Fig.14—Typical fall-time characteristic for all types.

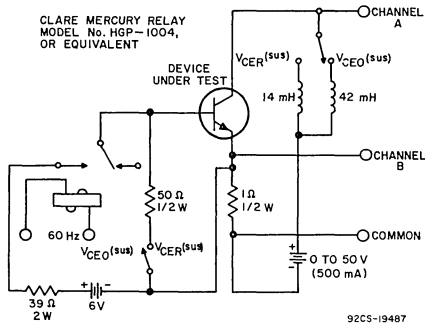
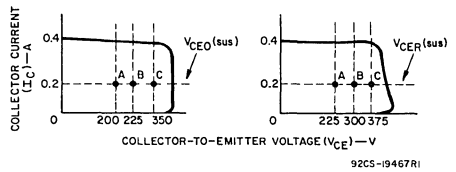


Fig.15—Circuit used to measure sustaining voltages  $V_{CE0}(sus)$  and  $V_{CEr}(sus)$  for all types.



The sustaining voltages  $V_{CE0}(sus)$  and  $V_{CEr}(sus)$  are acceptable when the traces fall to the right of point "A" for type 2N6249, point "B" for type 2N6250, and point "C" for type 2N6251 ( $I_C = 0.2$  A).

Fig.16—Oscilloscope display for measurement of sustaining voltages. (Test circuit shown in Fig. 15).

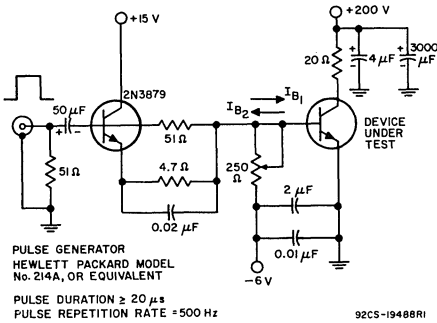


Fig. 17—Circuit used to measure switching times for all types.

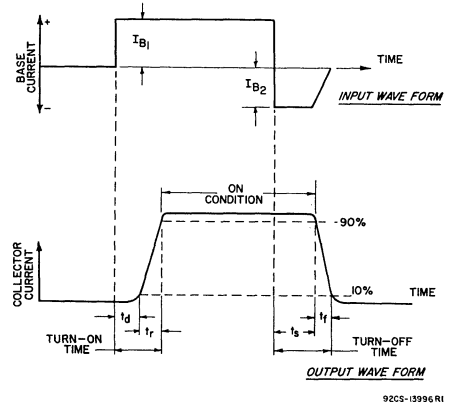


Fig. 18—Phase relationship between input and output currents showing reference points for specification of switching times (Test circuit shown in Fig. 17).

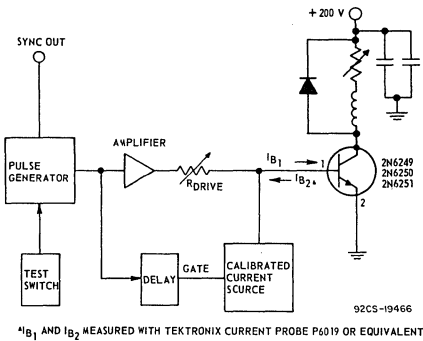


Fig. 19—Circuit used to measure inductive-load switching times for all types.

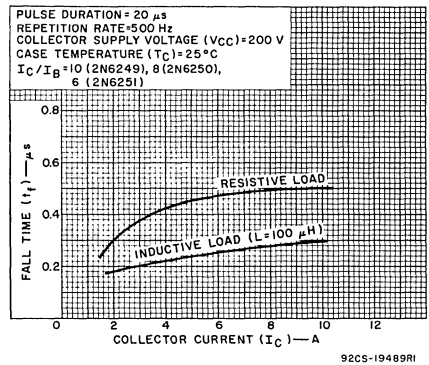


Fig. 20—Typical inductive- and resistive-load fall-time characteristics for all types.

**TERMINAL CONNECTIONS**

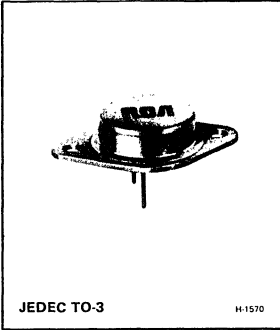
- Pin 1 — Base
- Pin 2 — Emitter
- Case — Collector

Mounting Flange — Collector



# Power Transistors

## 2N6354



### 120-V, 10-A, 140-W Silicon N-P-N Transistor

For Switching Applications in  
Military and Industrial Equipment

*Features:*

- High  $V_{CE(sus)}$ : 120 V
- Maximum safe-area-of operation curves
- Low saturation voltage:  $V_{CE(sat)} \leq 0.5$  V
- Fast switching speeds at  $I_C = 5$  A:
  - $t_r \leq 0.3 \mu s$
  - $t_s \leq 1 \mu s$
  - $t_f \leq 0.2 \mu s$
- High dissipation rating:  $P_T = 80$  W at  $100^\circ C$   
= 140 W at  $25^\circ C$

RCA type 2N6354<sup>®</sup> is an epitaxial silicon n-p-n power transistor with a multiple-emitter-site structure. The device is supplied in the JEDEC TO-3 package.

Typical high-speed switching applications for the 2N6354 include switching-control amplifiers operated from a 48-V (nominal) power supply, power gates, switching regulators, dc-dc converters, and power oscillators.

<sup>®</sup> Formerly RCA Dev. No. TA7534.

**MAXIMUM RATINGS, Absolute-Maximum Values:**

*COLLECTOR-TO-BASE VOLTAGE .....	$V_{CB0}$	150	V
COLLECTOR-TO-EMITTER VOLTAGE:			
With base open, sustaining .....	$V_{CE0(sus)}$	120	V
* With external base-to-emitter resistance ( $R_{BE}$ ) = $500\Omega$ .....	$V_{CEX}$	130	V
*EMITTER-TO-BASE VOLTAGE .....	$V_{EBO}$	6.5	V
*COLLECTOR CURRENT (Continuous) .....	$I_C$	10	A
COLLECTOR CURRENT (Peak) .....		12	A
*BASE CURRENT (Continuous) .....	$I_B$	5	A
*TRANSISTOR DISSIPATION: .....	$P_T$		
At case temperatures up to $25^\circ C$ and $V_{CE}$ up to 25 V .....		140	W
At case temperature of $100^\circ C$ and $V_{CB}$ of 20 V .....		80	W
At case temperatures up to $25^\circ C$ and $V_{CE}$ above 25 V .....			See Figs. 1 & 2
At case temperatures above $25^\circ C$ and $V_{CE}$ above 25 V .....			See Figs. 1, 2, & 4
*TEMPERATURE RANGE:			
Storage & Operating (Junction) .....		-65 to 200	$^\circ C$
*PIN TEMPERATURE (During Soldering):			
At distance $\geq 1/32$ in. (0.8 mm) from case for 10 s max. ....		230	$^\circ C$

\*In accordance with JEDEC registration data format JS-6 RDF-1.

ELECTRICAL CHARACTERISTICS, At Case Temperature ( $T_C$ ) = 25°C unless otherwise specified.

CHARACTERISTIC	SYMBOL	TEST CONDITIONS						LIMITS		UNITS
		DC VOLTAGE (V)				DC CURRENT (A)		2N6354		
		V <sub>CE</sub>	V <sub>CB</sub>	V <sub>EB</sub>	V <sub>BE</sub>	I <sub>C</sub>	I <sub>B</sub>	MIN.	MAX.	
Collector-Cutoff Current With emitter open	I <sub>CBO</sub>		150					—	5	mA
With base open	I <sub>CEO</sub>	100				0	—	20		
With base-emitter junction reverse-biased	I <sub>CEV</sub>	140			0		—	10		
At $T_C = 125^\circ\text{C}$	I <sub>CEV</sub>	140			0		—	20		
Emitter-Cutoff Current	I <sub>EBO</sub>			6.5		0		—	5	mA
Emitter-to-Base Voltage	V <sub>EBO</sub>						0.005	6.5	—	V
Collector-to-Emitter Voltage: At breakdown, with base open	V <sub>(BR)CEO</sub>					0.2	0	120 <sup>b</sup>	—	V
With external base-to emitter resistance (R <sub>BE</sub> ) ≤ 100 Ω	V <sub>CER(sus)</sub> <sup>f</sup>					0.2	0	130 <sup>b</sup>	—	
Saturation Voltage: Collector-to-Emitter	V <sub>CE(sat)</sub>					5 <sup>a</sup> 10 <sup>a</sup>	0.5 1.0	— —	0.5 1	V
Base-to-Emitter	V <sub>BE(sat)</sub>					5 <sup>a</sup> 10 <sup>a</sup>	0.5 1.0	— —	1.3 2	
DC Forward Current Transfer Ratio	h <sub>FE</sub>	2 2				5 <sup>a</sup> 10 <sup>a</sup>		20 10	150 100	
Forward-Bias Second- Breakdown Collector Current <sup>d</sup>	I <sub>S/b</sub> <sup>c</sup>	25 45						5.5 0.5	— —	A
Second-Breakdown Energy (With base reverse biased, R <sub>BE</sub> =51 Ω, L = 25 μH)	E <sub>S/b</sub> <sup>g</sup>			1		5		0.3	—	mJ
Magnitude of Common Emitter, Small-Signal, Short-Circuit Forward Current Transfer Ratio (f = 10 MHz)	h <sub>fe</sub>	10				1		8	—	
Saturated Switching Time: (See Figs. 11 & 12)	t <sub>r</sub>					5 10	0.5 <sup>e</sup> 1 <sup>e</sup>	— —	0.3 1	μs
Rise Time	t <sub>s1</sub>					5 10	0.5 <sup>e</sup> 1 <sup>e</sup>	— —	1 0.6	
Storage Time	t <sub>s2</sub>					0.5	0.5 <sup>e</sup>	—	2	
Storage Time (No Load)	t <sub>f</sub>					5 10	0.5 <sup>e</sup> 1 <sup>e</sup>	— —	0.2 0.2	
Fall Time	t <sub>f</sub>					5 10	0.5 <sup>e</sup> 1 <sup>e</sup>	— —	0.2 0.2	
Output Capacitance (f = 1 MHz)	C <sub>obo</sub>		10					—	300	pF
Thermal Resistance: Junction-to-Case	R <sub>θJC</sub>	20				1		—	1.25	°C/W

<sup>a</sup>In accordance with JEDEC registration data format JS-6 RDF-1.

<sup>b</sup>Pulsed; pulse duration ≤ 350 μs, duty factor = 2%.

<sup>c</sup>CAUTION: The collector-to-emitter voltages, V<sub>(BR)CEO</sub> and V<sub>CER(sus)</sub>, MUST NOT be measured on a curve tracer. These voltages should be measured by means of the test circuit shown in Fig. 5.

<sup>d</sup>I<sub>S/b</sub> is defined as the current at which second breakdown occurs at a specified collector voltage with the emitter-base junction forward-biased for transistor operation in the active region.

<sup>e</sup>Pulsed; 1-s non-repetitive pulse.

<sup>f</sup>I<sub>B1</sub> = I<sub>B2</sub> = value shown.

<sup>g</sup>L = 15 mH

<sup>h</sup>E<sub>S/b</sub> is defined as the energy at which second breakdown occurs under specified reverse bias conditions. E<sub>S/b</sub> = ½LI<sup>2</sup> where L is a series load or leakage inductance and I is the peak collector current.

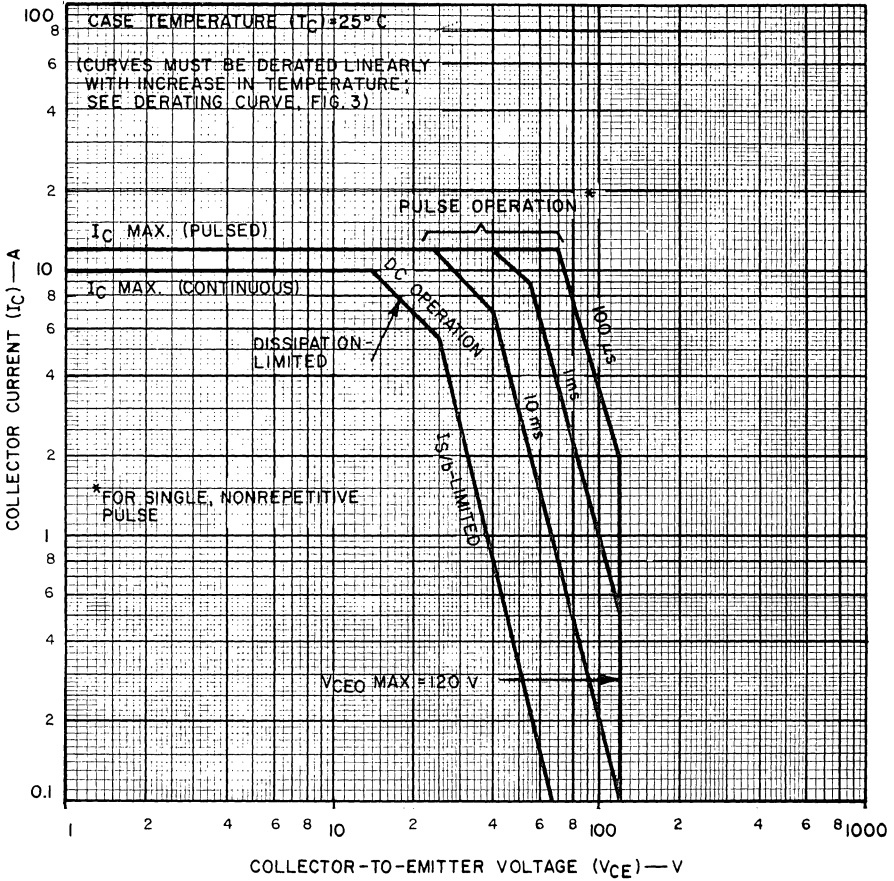


Fig. 1—Maximum operating areas.

92CS-20135

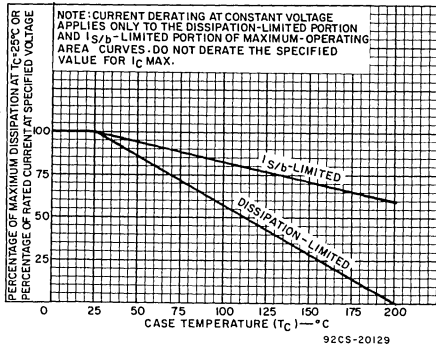


Fig. 2—Derating curves.

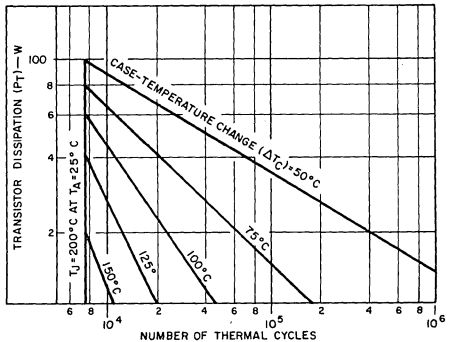


Fig. 3—Thermal-cycling rating chart.

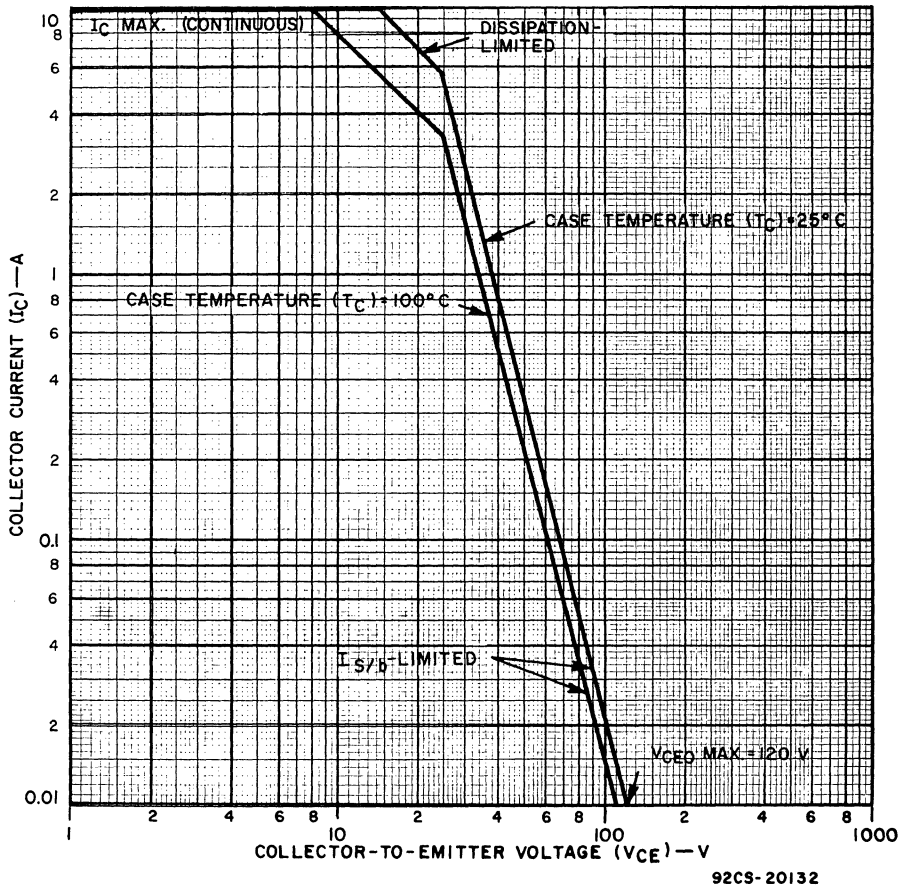


Fig.4—Maximum operating areas.

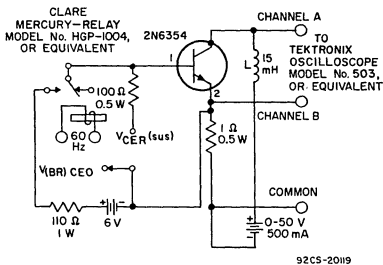
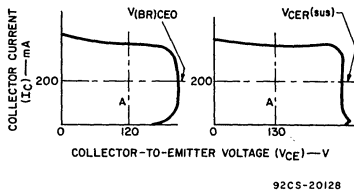


Fig.5—Circuit used to measure voltages  $V_{(BR)CEO}$  and  $V_{CE(sus)}$ .



NOTE: The voltages,  $V_{(BR)CEO}$  and  $V_{CE(sus)}$  are acceptable when the trace falls to the right of and above point "A".

Fig.6—Oscilloscope display for  $V_{(BR)CEO}$  and  $V_{CE(sus)}$  measurement (test circuit shown in Fig.5).



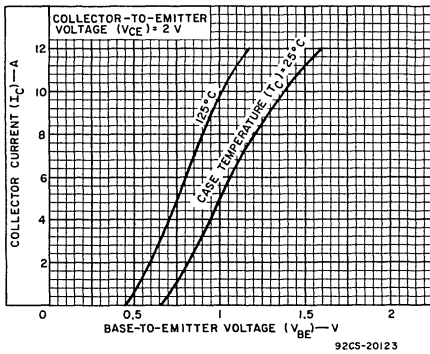


Fig. 7—Typical transfer characteristics.

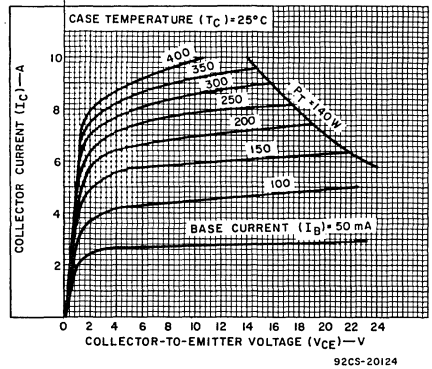


Fig. 8—Typical output characteristics.

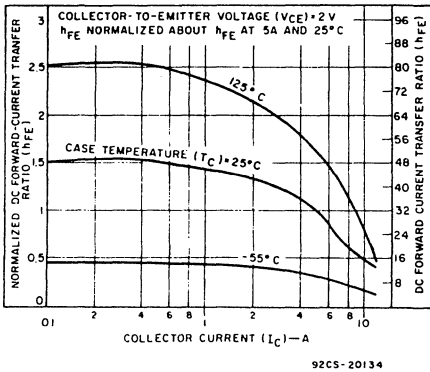


Fig. 9—Typical normalized dc beta characteristics.

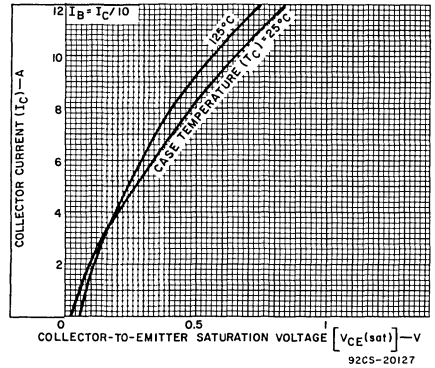


Fig. 10—Typical saturation voltage characteristics.

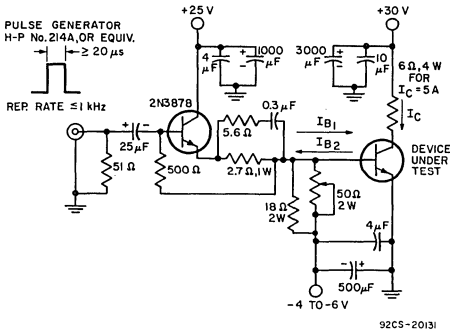


Fig. 11—Circuit used to measure switching times.

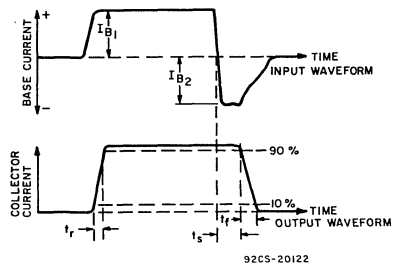


Fig. 12—Phase relationship between input and output currents showing reference points for specification of switching times (test circuit shown in Fig. 11).

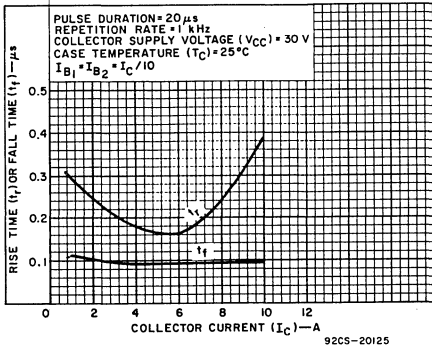


Fig. 13—Typical rise- and fall-time characteristics.

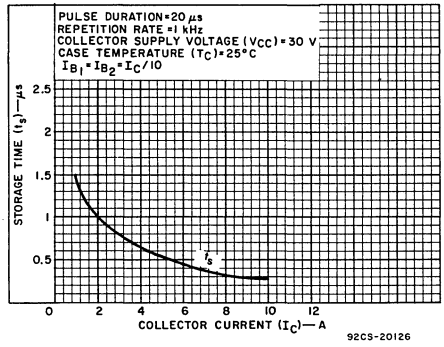


Fig. 14—Typical storage-time characteristics.

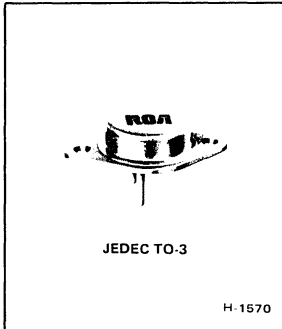
**TERMINAL CONNECTIONS**

- Pin 1 — Base
- Pin 2 — Emitter
- Mounting Flange, Case — Collector



# Power Transistors

## 2N6371



### Hometaxial II\* High-Power Silicon N-P-N Transistors

Rugged General-Purpose Device  
For Industrial and Commercial Uses

**Features:**

- Maximum-safe-area-of-operation curves
- Low saturation voltage
- High dissipation rating
- Thermal-cycle rating curve

**Applications:**

- Series and shunt regulators
- High-fidelity amplifiers
- Power-switching circuits
- Solenoid drivers
- 12-V audio and inverter circuits

The RCA-2N6371<sup>▲</sup> is a hometaxial-base<sup>®</sup> diffused-junction silicon n-p-n transistor intended for a wide variety of intermediate-power and high-power applications. It is especially suited for use in audio and inverter circuits at 12 volts.

- ▲ RCA-2N6371 is the direct replacement for RCA-40251.
- "Hometaxial" was coined by RCA from "homogeneous" and "axial" to describe a single-diffused transistor with a base region of homogeneous-resistivity silicon in the axial direction (emitter-to-collector). "Hometaxial II" is a term used to describe RCA's expanded line of transistors produced by the hometaxial process.

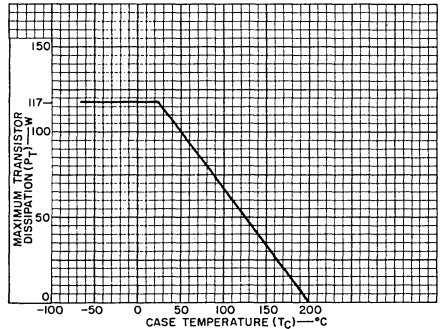


Fig. 1—Dissipation derating curve.

**MAXIMUM RATINGS, Absolute-Maximum Values:**

*COLLECTOR-TO-BASE VOLTAGE .....	V <sub>CBO</sub>	50	V
*COLLECTOR-TO-EMITTER SUSTAINING VOLTAGE:			
• With external base-to-emitter resistance R <sub>BE</sub> = 100 Ω .....	V <sub>CE(sus)</sub>	45	V
• With base open .....	V <sub>CE0(sus)</sub>	40	V
• With base reverse bias V <sub>BE</sub> = -1.5 V .....	V <sub>CEX(sus)</sub>	50	V
*EMITTER-TO-BASE VOLTAGE .....	V <sub>EBO</sub>	5	V
*CONTINUOUS COLLECTOR CURRENT .....	I <sub>C</sub>	16	A
*CONTINUOUS BASE CURRENT .....	I <sub>B</sub>	7	A
*TRANSISTOR DISSIPATION:	P <sub>T</sub>		
At case temperatures up to 25°C .....		117	W
At case temperatures above 25°C .....		See Fig. 1	
*TEMPERATURE RANGE:			
Storage and Operating (Junction) .....		-65 to +200	°C
*PIN TEMPERATURE (During Soldering):			
At distances ≥ 1/32 in. (0.8 mm) from seating plane for 10 s max. ....		235	°C

\*In accordance with JEDEC registration data format JS-6 RDF-2.

ELECTRICAL CHARACTERISTICS, At Case Temperature ( $T_C$ ) = 25°C Unless Otherwise Specified.

CHARACTERISTIC	SYMBOL	TEST CONDITIONS				LIMITS		UNITS
		VOLTAGE V <sub>dc</sub>		CURRENT A <sub>dc</sub>				
		V <sub>CE</sub>	V <sub>BE</sub>	I <sub>C</sub>	I <sub>B</sub>	MIN.	MAX.	
* Collector Cutoff Current: With base open	I <sub>CEO</sub>	25			0	—	1.5	mA
With base-emitter junction reverse-biased	I <sub>CEV</sub>	45	-1.5			—	2	
At T <sub>C</sub> = 150°C		40	-1.5			—	10	
* Emitter Cutoff Current	I <sub>EBO</sub>		-5	0		—	10	mA
* Collector-to-Emitter Sustaining Voltage: With base open	V <sub>CEO(sus)</sub>			0.2	0	40	—	V
* With external base-to- emitter resistance (R <sub>BE</sub> ) = 100 Ω	V <sub>CER(sus)</sub>			0.2		45	—	
With base-emitter junction reverse-biased	V <sub>CEx(sus)</sub>		-1.5	0.1		50	—	
* DC Forward Current Transfer Ratio	h <sub>FE</sub>	4		8 <sup>a</sup>		15	60	
		4		16 <sup>a</sup>		4	—	
* Base-to-Emitter Voltage	V <sub>BE</sub>	4		16 <sup>a</sup>		—	4	V
* Collector-to-Emitter Saturation Voltage	V <sub>CE(sat)</sub>			16 <sup>a</sup>	4	—	4	V
				8 <sup>a</sup>	0.8	—	1.5	
* Common-Emitter, Small- Signal, Short-Circuit Forward Current Transfer Ratio (f = 1 kHz)	h <sub>fe</sub>	4		1		10	—	
* Magnitude of Common- Emitter, Small-Signal, Short-Circuit, Forward Current Transfer Ratio: (f = 0.4 MHz)	h <sub>fe</sub>	4		1		2	—	
Gain-Bandwidth Product	f <sub>T</sub>			1		800	—	kHz
Forward-Bias Second Break- down Collector Current	I <sub>S/b</sub>	40				2.9	—	A
Thermal Resistance: Junction-to-Case	R <sub>θJC</sub>					—	1.5	°C/W

<sup>a</sup> Pulsed: Pulse duration = 300 μs, duty factor = 2%.

\* In accordance with JEDEC registration data format JS-6 RDF-2.

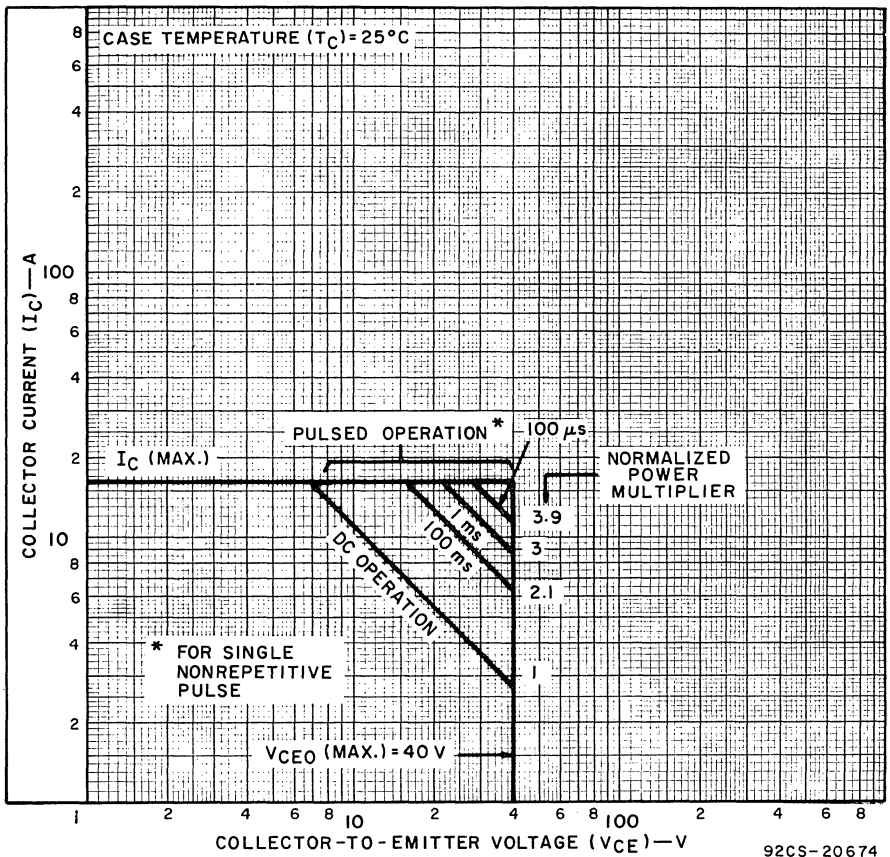


Fig. 2—Maximum safe area of operation at case temperature of 25°C.

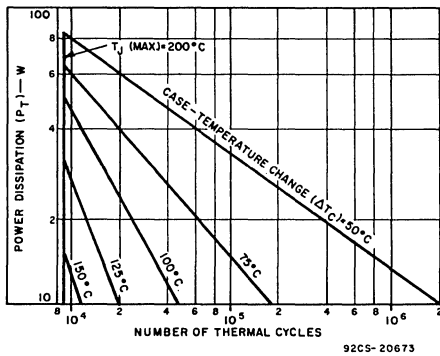


Fig. 3—Thermal-cycle rating chart.

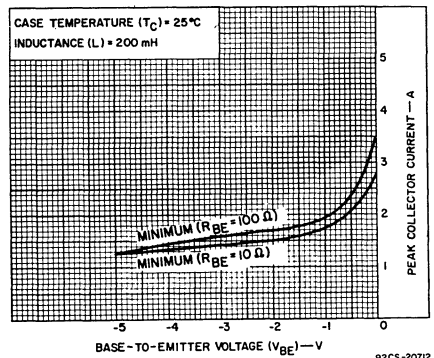


Fig. 4—Reverse-bias second-breakdown characteristics.

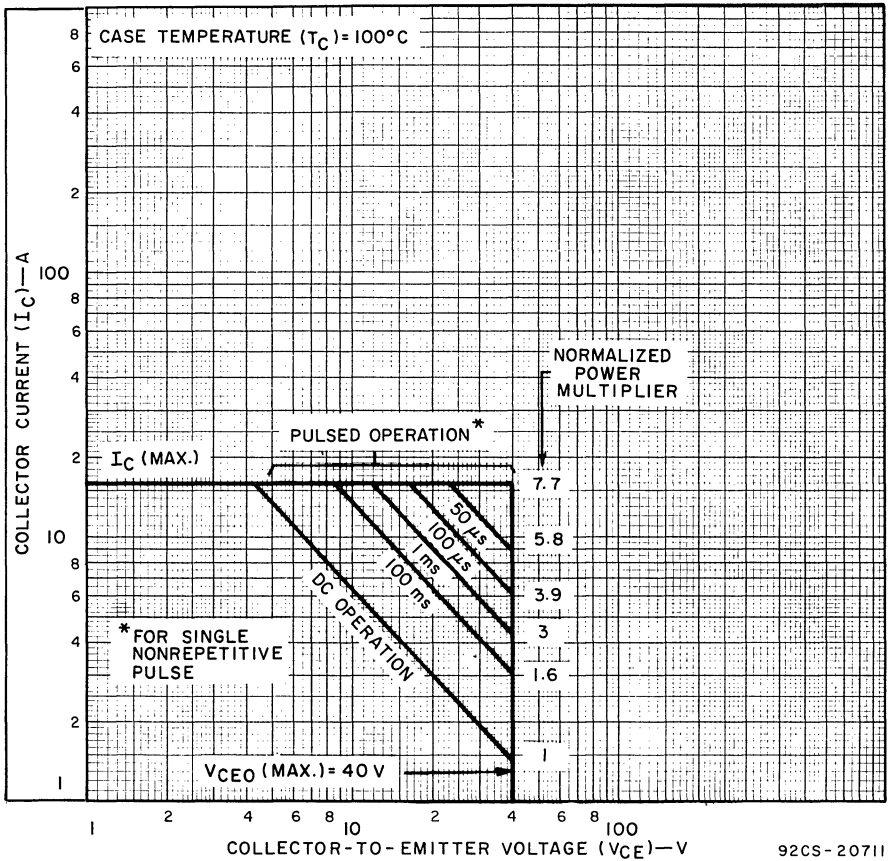


Fig. 5—Maximum safe area of operation at case temperature of 100°C.

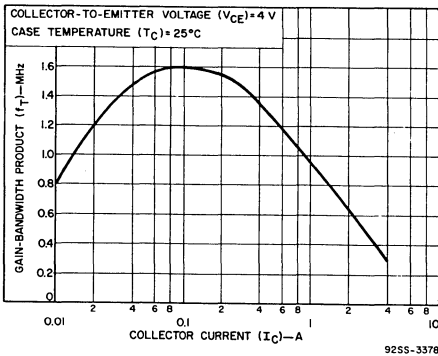


Fig. 6—Typical gain-bandwidth product.

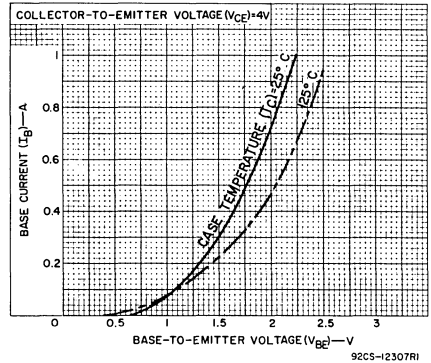


Fig. 7—Typical input characteristics.

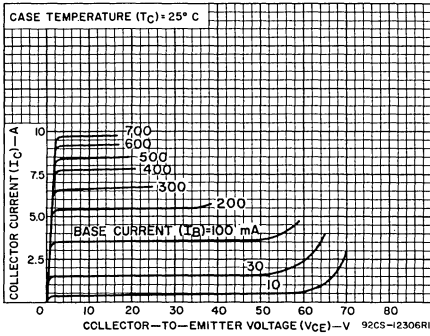


Fig. 8—Typical output characteristics.

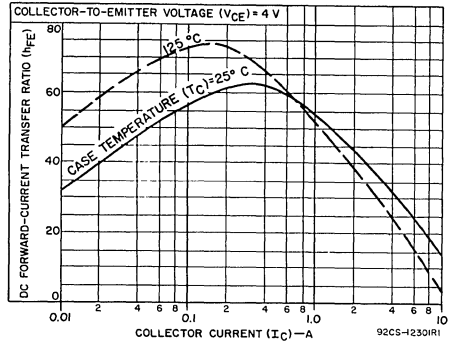


Fig. 9—Typical dc beta characteristics.

**TERMINAL CONNECTIONS**  
 Pin 1 — Base  
 Pin 2 — Emitter  
 Case — Collector  
 Mounting Flange — Collector

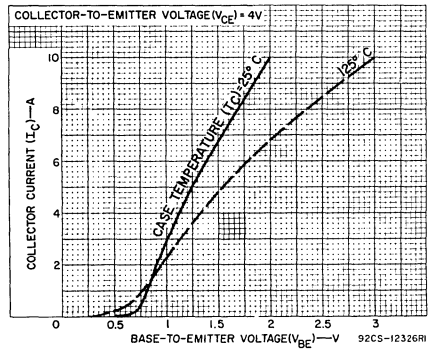
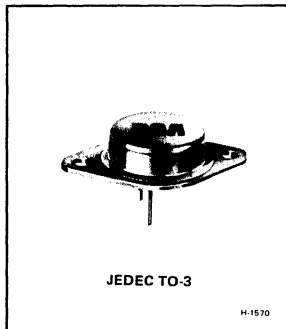


Fig. 10—Typical transfer characteristics.



# Power Transistors

## 2N6383 2N6384 2N6385



### 10-Ampere, N-P-N Darlington Power Transistors

40-60-80 Volts, 100 Watts  
Gain of 1000 at 5 A

**Features:**

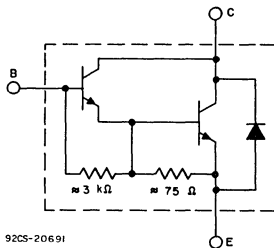
- Operates from IC without predriver
- Low leakage at high temperature
- High reverse second-breakdown capability

**Applications:**

- Power switching
- Audio amplifiers
- Hammer drivers
- Series and shunt regulators

The 2N6383, 2N6384, and 2N6385<sup>●</sup> are monolithic n-p-n silicon Darlington transistors designed for low- and medium-frequency power applications. The double epitaxial construction of these devices provides good forward and reverse second-breakdown capability; their high gain makes it possible for them to be driven directly from integrated circuits.

<sup>●</sup>Formerly RCA Dev. Nos. TA8349, TA8486, and TA8348.



9205-20691

Fig. 1—Schematic diagram for all types.

**MAXIMUM RATINGS, Absolute-Maximum Values:**

		2N6385	2N6384	2N6383	
* COLLECTOR-TO-BASE VOLTAGE	V <sub>CBO</sub>	80	60	40	V
COLLECTOR-TO-EMITTER VOLTAGE:					
With external base-to-emitter resistance (R <sub>BE</sub> ) = 100Ω, sustaining	V <sub>CE(R sus)</sub>	80	60	40	V
With base open, sustaining	V <sub>CEO(sus)</sub>	80	60	40	V
* With base reverse-biased V <sub>BE</sub> = -1.5 V, R <sub>BB</sub> = 100Ω	V <sub>CEX</sub>	80	60	40	V
* EMITTER-TO-BASE VOLTAGE	V <sub>EB0</sub>	5	5	5	V
COLLECTOR CURRENT:	I <sub>C</sub>				
Continuous		10	10	10	A
Peak		15	15	15	A
* CONTINUOUS BASE CURRENT	I <sub>B</sub>	0.25	0.25	0.25	A
* TRANSISTOR DISSIPATION:	P <sub>T</sub>				
At case temperatures up to 25°C		100	100	100	W
At case temperatures above 25°C		← See Fig. 3 →			
* TEMPERATURE RANGE:					
Storage and Operating (Junction)		← -65 to +200 →			°C
* PIN TEMPERATURE (During Soldering):					
At distances ≥ 1/32 in. 0.8 mm from seating plane for 10 s max.		← 235 →			°C

\*In accordance with JEDEC registration data format JS-6 RDF-2.



ELECTRICAL CHARACTERISTICS, At Case Temperature ( $T_C$ ) = 25°C Unless Otherwise Specified

CHARACTERISTIC	SYMBOL	TEST CONDITIONS				LIMITS						UNITS
		VOLTAGE V <sub>dc</sub>		CURRENT A <sub>dc</sub>		2N6385		2N6384		2N6383		
		V <sub>CE</sub>	V <sub>BE</sub>	I <sub>C</sub>	I <sub>B</sub>	MIN.	MAX.	MIN.	MAX.	MIN.	MAX.	
Collector-Cutoff Current: With base open	I <sub>CEO</sub>	80		0		-	1	-	-	-	-	mA
		60		0		-	-	-	1	-	-	
		40		0		-	-	-	-	-	1	
With base open and T <sub>C</sub> = 150°C	I <sub>CEO</sub>	80		0		-	10	-	-	-	-	mA
		60		0		-	-	-	10	-	-	
		40		0		-	-	-	-	-	10	
With base reverse-biased	I <sub>CEV</sub>	80	-1.5			-	0.3	-	-	-	-	mA
		60	-1.5			-	-	-	0.3	-	-	
		40	-1.5			-	-	-	-	-	0.3	
With base reverse-biased and T <sub>C</sub> = 150°C	I <sub>CEV</sub>	80	-1.5			-	3	-	-	-	-	mA
		60	-1.5			-	-	-	3	-	-	
		40	-1.5			-	-	-	-	-	3	
Emitter-Cutoff Current	I <sub>EBO</sub>		-5	0		-	5	-	5	-	5	mA
Collector-to-Emitter Sustaining Voltage: With base open	V <sub>CEO(sus)</sub>			0.2 <sup>a</sup>	0	80	-	60	-	40	-	V
				0.2 <sup>a</sup>		80	-	60	-	40	-	
				0.2 <sup>a</sup>		80	-	60	-	40	-	
With external base-to-emitter resistance (R <sub>BE</sub> ) = 100Ω	V <sub>CER(sus)</sub>			0.2 <sup>a</sup>		80	-	60	-	40	-	V
With base-emitter junction reverse-biased	V <sub>CEV(sus)</sub>		-1.5	0.2 <sup>a</sup>		80	-	60	-	40	-	
DC Forward Current Transfer Ratio	h <sub>FE</sub>	3		5 <sup>a</sup>		1000	20,000	1000	20,000	1000	20,000	
		3		10 <sup>a</sup>		100	-	100	-	100	-	
Base-to-Emitter Voltage	V <sub>BE</sub>	3		5 <sup>a</sup>		-	2.8	-	2.8	-	2.8	V
		3		10 <sup>a</sup>		-	4.5	-	4.5	-	4.5	
Collector-to-Emitter Saturation Voltage	V <sub>CE(sat)</sub>			5 <sup>a</sup>	0.01 <sup>a</sup>	-	2	-	2	-	2	V
				10 <sup>a</sup>	0.1 <sup>a</sup>	-	3	-	3	-	3	
Parallel Diode Forward Voltage Drop	V <sub>F</sub>			-10		-	4	-	4	-	4	V
Common-Emitter, Small-Signal, Short-Circuit Forward Current Transfer Ratio (f = 1 kHz)	h <sub>fe</sub>	5		1		1000	-	1000	-	1000	-	
Magnitude of Common-Emitter, Small-Signal, Short-Circuit, Forward Current Transfer Ratio (f = 1.0 MHz)	h <sub>fe</sub>	5		1		20	-	20	-	20	-	
Common Base Output Capacitance (V <sub>CB</sub> = 10 V, f = 1 MHz)	C <sub>ob</sub>					-	200	-	200	-	200	pF
Second Breakdown Energy With base reverse-biased and L = 12 mH, R <sub>BE</sub> = 100Ω	E <sub>S/bb</sub>		-1.5	4.5		120	-	120	-	120	-	mJ
Forward-Bias Second Breakdown Collector Current (1-s non-repetitive pulse)	I <sub>S/b</sub>	75				0.22	-	-	-	-	-	A
		55				-	-	-	0.62	-	-	
		35				-	-	-	-	-	2.85	
Thermal Resistance Junction-to-Case	R <sub>θJC</sub>					-	1.75	-	1.75	-	1.75	°C/W

<sup>a</sup> Pulsed: Pulse duration = 300 μs, duty factor = 1.8%.

<sup>b</sup> E<sub>S/bb</sub> is defined as the energy at which second breakdown occurs under specified reverse bias conditions.

E<sub>S/b</sub> = ½LI<sup>2</sup> where L is a series load or leakage inductance, and I is the peak collector current.

\* In accordance with JEDEC registration data format JS-6 RDF-2.

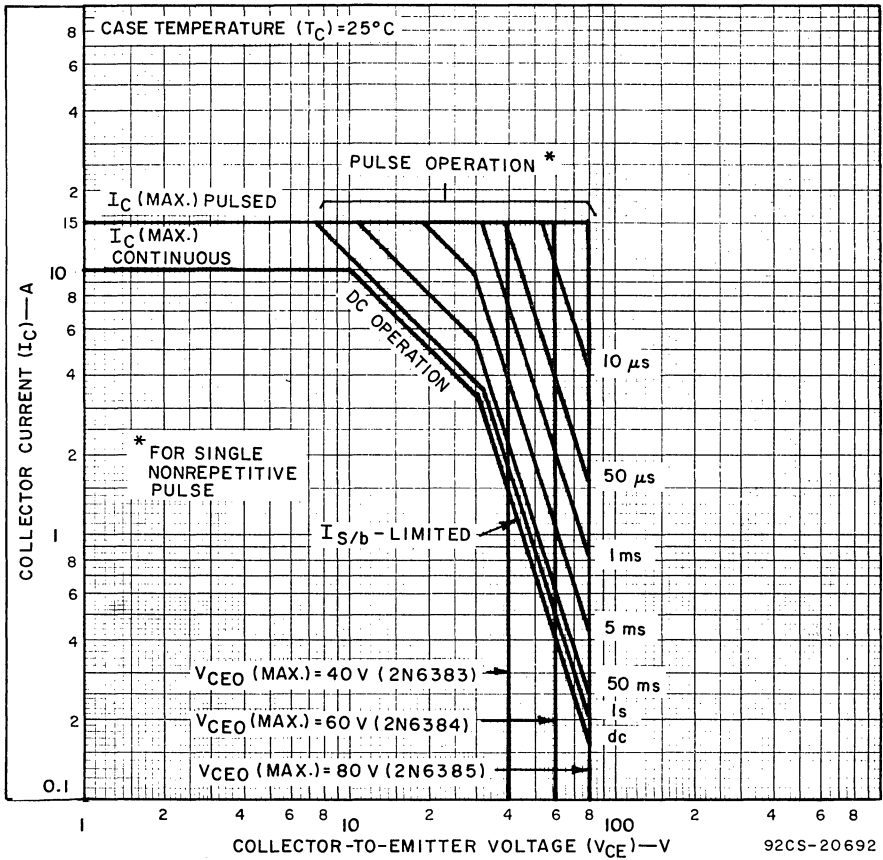


Fig. 2—Maximum operating area for all types.

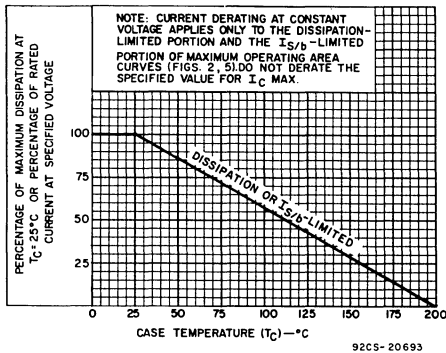


Fig. 3—Derating curves for all types.

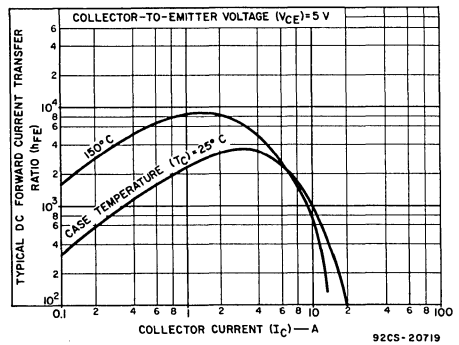


Fig. 4—Typical dc-beta characteristics for all types.

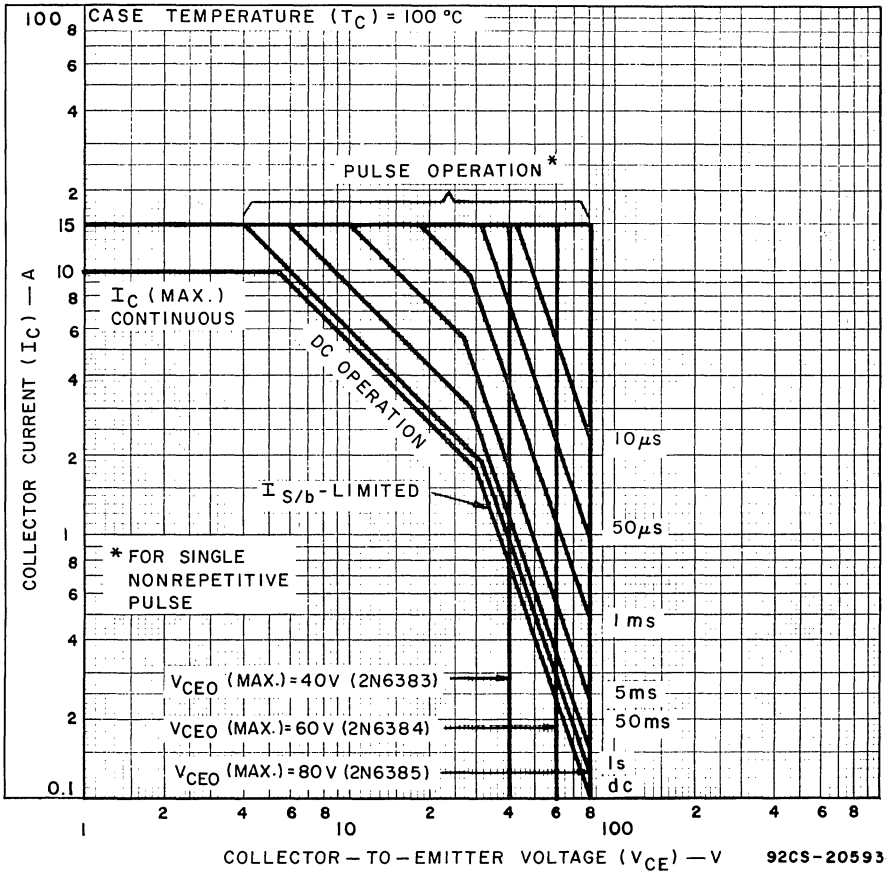


Fig. 5—Maximum operating area for all types

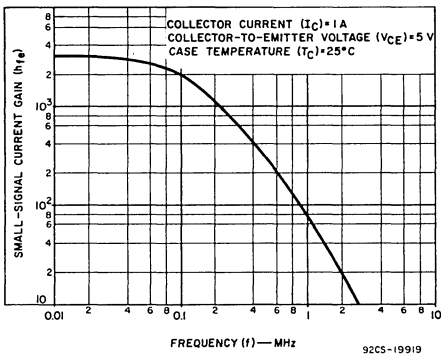


Fig. 6—Typical small-signal gain for all types.

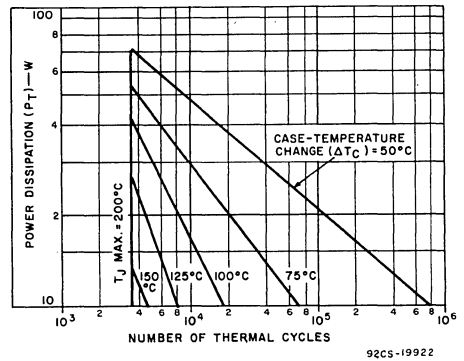


Fig. 7—Thermal-cycling rating chart for all types.

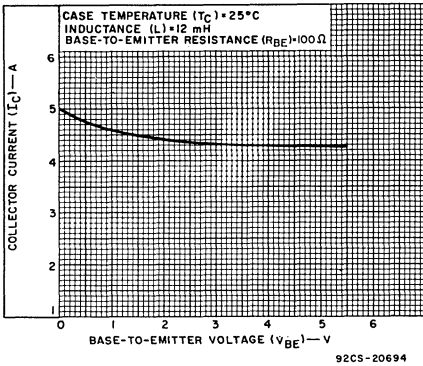


Fig. 8—Minimum values of reverse-bias second breakdown characteristic ( $E_{S/B}$ ) for all types.

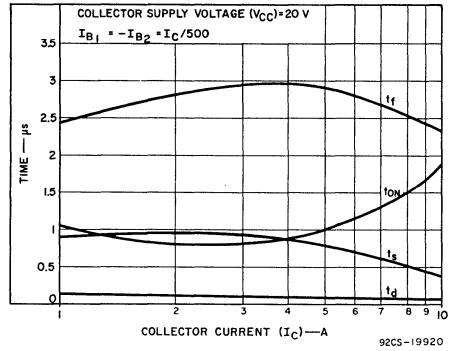


Fig. 9—Typical saturated switching-time characteristics for all types.

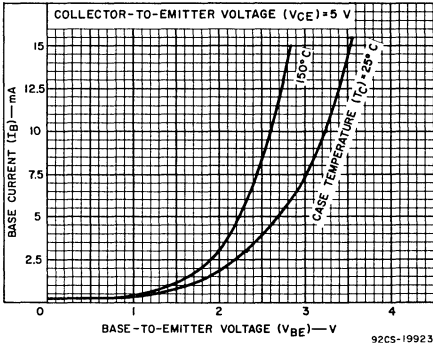


Fig. 10—Typical input characteristics for all types.

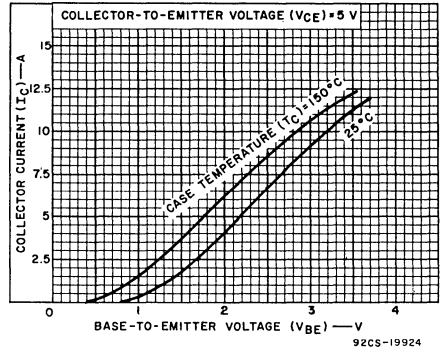


Fig. 11—Typical transfer characteristics for all types.

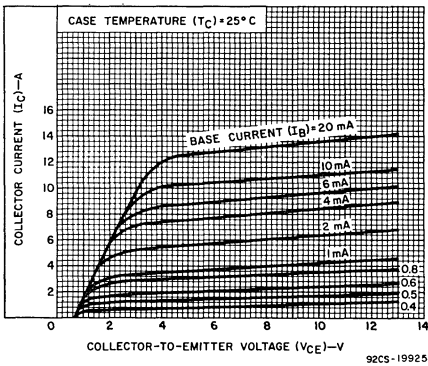


Fig. 12—Typical output characteristics for all types.

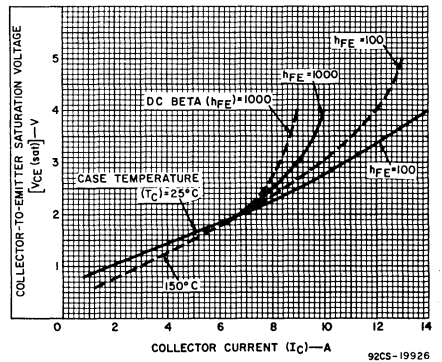


Fig. 13—Typical saturation characteristics for all types.

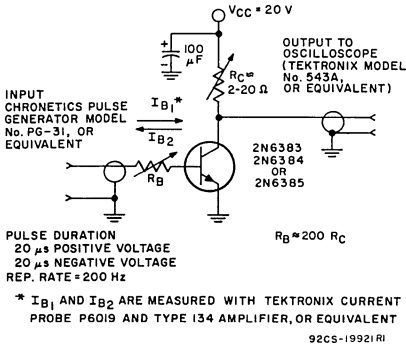


Fig. 14—Circuit used to measure saturated switching times.

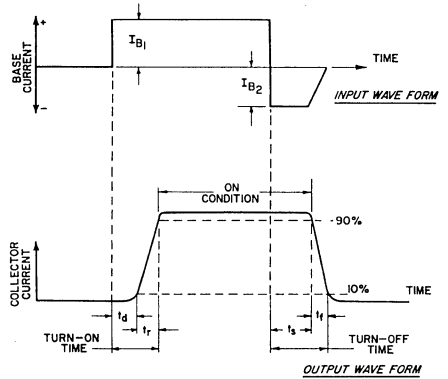


Fig. 15—Phase relationship between input current and output current showing reference points for specification of switching times (test circuit shown in Fig. 14).

### TERMINAL CONNECTIONS

- Pin 1 - Base
- Pin 2 - Emitter
- Case - Collector
- Mounting Flange - Collector



# Power Transistors

## 2N6386 2N6387 2N6388

### 10-Ampere, N-P-N Darlington Power Transistors

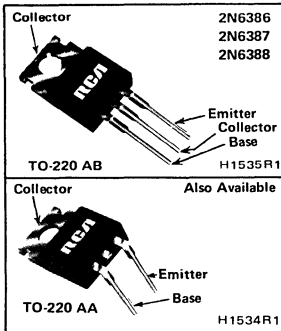
40-60-80 Volts, 40 Watts  
 Gain of 1000 at 5 A (2N6387, 2N6388)  
 Gain of 1000 at 3 A (2N6386)

**Features:**

- Operates from IC without predriver
- Low leakage at high temperature
- High reverse second-breakdown capability

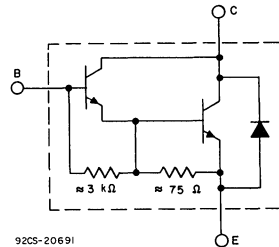
**Applications:**

- Power switching
- Audio amplifiers
- Hammer drivers
- Series and shunt regulators



The 2N6386, 2N6387, and 2N6388<sup>•</sup> are monolithic n-p-n silicon Darlington transistors designed for low- and medium-frequency power applications. The double epitaxial construction of these devices provides good forward and reverse second-breakdown capability; their high gain makes it possible for them to be driven directly from integrated circuits.

<sup>•</sup> Formerly RCA Dev. Nos. TA8202, TA8485, and TA8201, respectively.



92CS-2069I

Fig. 1—Schematic diagram for all types.

**MAXIMUM RATINGS, Absolute-Maximum Values:**

	2N6388	2N6387	2N6386		
* COLLECTOR-TO-BASE VOLTAGE	80	60	40	V	
COLLECTOR-TO-EMITTER VOLTAGE:					
With external base-to-emitter resistance ( $R_{BE}$ ) = 100 $\Omega$ , sustaining	$V_{CER(sus)}$	80	60	40	V
With base open, sustaining	$V_{CEO(sus)}$	80	60	40	V
* With base reverse-biased $V_{BE} = -1.5$ V	$V_{CEX}$	80	60	40	V
* EMITTER-TO-BASE VOLTAGE	$V_{EBO}$	5	5	5	V
COLLECTOR CURRENT:	$I_C$				
* Continuous	10	10	8	A	
Peak	15	15	15	A	
* CONTINUOUS BASE CURRENT	$I_B$	0.25	0.25	0.25	A
* TRANSISTOR DISSIPATION:	$P_T$				
At case temperatures up to 25°C	40	40	40	W	
At case temperatures above 25°C	← See Fig. 3 →				
TEMPERATURE RANGE:					
Storage and Operating (Junction)	← -65 to +150 →			°C	
* LEAD TEMPERATURE (During Soldering):					
At distances $\geq 1/8$ in.(3.17 mm) from case for 10 s max.	← 235 →			°C	

\*In accordance with JEDEC registration data format JS-6 RDF-2.

ELECTRICAL CHARACTERISTICS, At Case Temperature ( $T_C$ ) = 25°C Unless Otherwise Specified

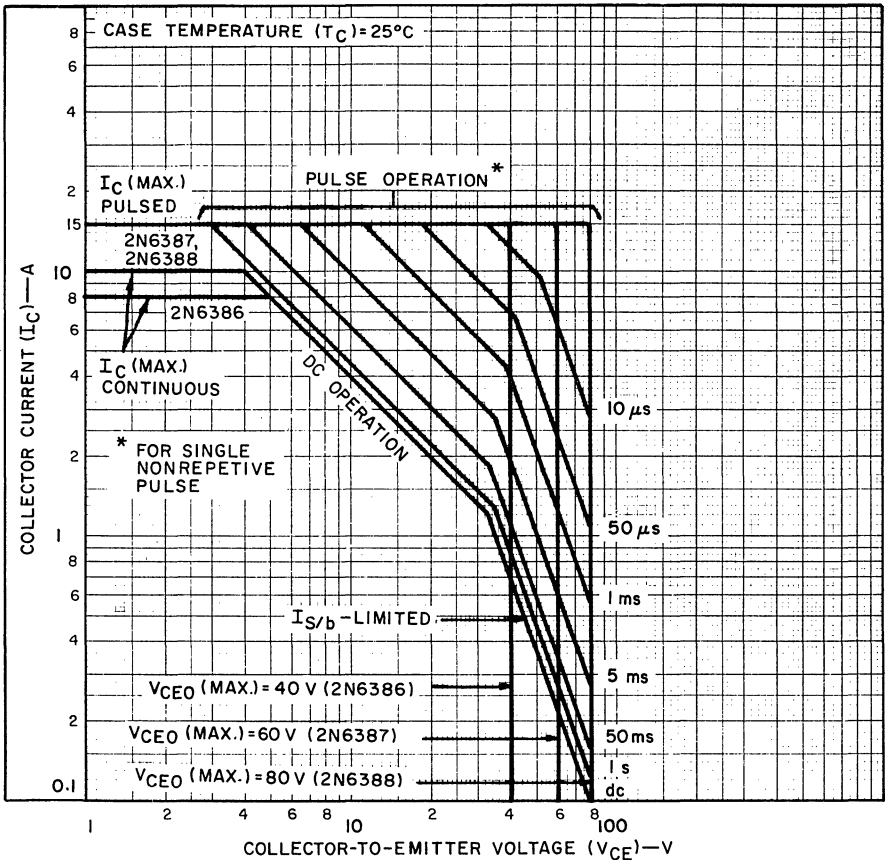
CHARACTERISTIC	SYMBOL	TEST CONDITIONS				LIMITS						UNITS
		VOLTAGE V dc		CURRENT A dc		2N6388		2N6387		2N6386		
		V <sub>CE</sub>	V <sub>BE</sub>	I <sub>C</sub>	I <sub>B</sub>	MIN.	MAX.	MIN.	MAX.	MIN.	MAX.	
* Collector-Cutoff Current: With base open	I <sub>CEO</sub>	80			0	-	1	-	-	-	-	mA
		60			0	-	-	-	1	-	-	
		40			0	-	-	-	-	-	1	
With base open and T <sub>C</sub> = 150°C		80			0	-	10	-	-	-		
		60			0	-	-	-	10	-		
		40			0	-	-	-	-	10		
* With base reverse-biased	I <sub>CEV</sub>	80	-1.5			-	0.3	-	-	-	-	mA
		60	-1.5			-	-	-	0.3	-	-	
		40	-1.5			-	-	-	-	-	0.3	
With base reverse- biased and T <sub>C</sub> = 150°C		80	-1.5			-	3	-	-	-		
		60	-1.5			-	-	-	3	-		
		40	-1.5			-	-	-	-	3		
* Emitter-Cutoff Current	I <sub>EBO</sub>		-5	0		-	5	-	5	-	5	mA
* Collector-to-Emitter Sustaining Voltage: With base open	V <sub>CEO(sus)</sub>			0.2 <sup>a</sup>	0	80	-	60	-	40	-	V
With external base-to- emitter resistance (R <sub>BE</sub> ) = 100Ω	V <sub>CER(sus)</sub>			0.2 <sup>a</sup>		80		60		40		
With base-emitter junction reverse-biased	V <sub>CEV(sus)</sub>		1.5	0.2 <sup>a</sup>		80		60		40		
* DC Forward Current Transfer Ratio	h <sub>FE</sub>	3		3 <sup>a</sup> 5 <sup>a</sup> 8 <sup>a</sup> 10 <sup>a</sup>		-	-	-	-	1000	20,000	V
		3				1000	20,000	1000	20,000	100	-	
		3				100	-	100	-	-	-	
* Base-to-Emitter Voltage	V <sub>BE</sub>	3		3 <sup>a</sup> 5 <sup>a</sup> 8 <sup>a</sup> 10 <sup>a</sup>		-	-	-	-	-	2.8	V
		3				-	2.8	-	2.8	-	4.5	
		3				-	4.5	-	4.5	-	-	
* Collector-to-Emitter Saturation Voltage	V <sub>CE(sat)</sub>			3 <sup>a</sup> 5 <sup>a</sup> 8 <sup>a</sup> 10 <sup>a</sup>	0.006 <sup>a</sup> 0.01 <sup>a</sup> 0.08 <sup>a</sup> 0.1 <sup>a</sup>	-	-	-	-	-	2	V
						-	2	-	2	-	3	
						-	3	-	3	-	-	
* Parallel Diode Forward Voltage Drop	V <sub>F</sub>			-8 -10		-	4	-	4	-	4	V
* Common-Emitter, Small- Signal, Short-Circuit Forward Current Transfer Ratio (f = 1 kHz)	h <sub>FE</sub>	5		1		1000		1000		1000		
* Magnitude of Common- Emitter, Small-Signal, Short-Circuit, Forward Current Transfer Ratio (f = 1.0 MHz)	h <sub>FE</sub>	5		1		20		20		20		
* Common Base Output Capacitance (V <sub>CB</sub> = 10 V, f = 1 MHz)	C <sub>Ob</sub>					-	200	-	200	-	200	pF
Second Breakdown Energy With base reverse-biased and L = 12 mH, R <sub>BE</sub> = 100Ω	E <sub>S/bb</sub>		-1.5	4.5		120		120		120		mJ
Forward-Bias Second Break- down Collector Current (0.5-s non-repetitive pulse)	I <sub>S/b</sub>	35				1.2		1.2		1.2		A
Thermal Resistance Junction-to-Case	R <sub>θJC</sub>					-	3.12	-	3.12	-	3.12	°C/W

<sup>a</sup> Pulsed: Pulse duration = 300 μs, duty factor = 1.8%.

<sup>b</sup> E<sub>S/b</sub> is defined as the energy at which second breakdown occurs under specified reverse bias conditions.

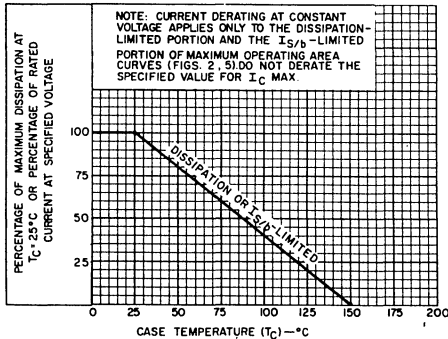
E<sub>S/b</sub> = ½LI<sup>2</sup> where L is a series load or leakage inductance, and I is the peak collector current.

\* In accordance with JEDEC registration data format JS-6 RDF-2.



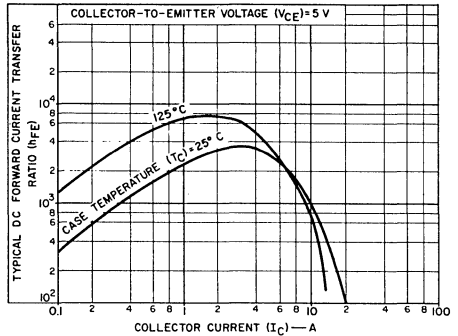
92CS-20695

Fig. 2—Maximum operating area for all types.



92CS-20696

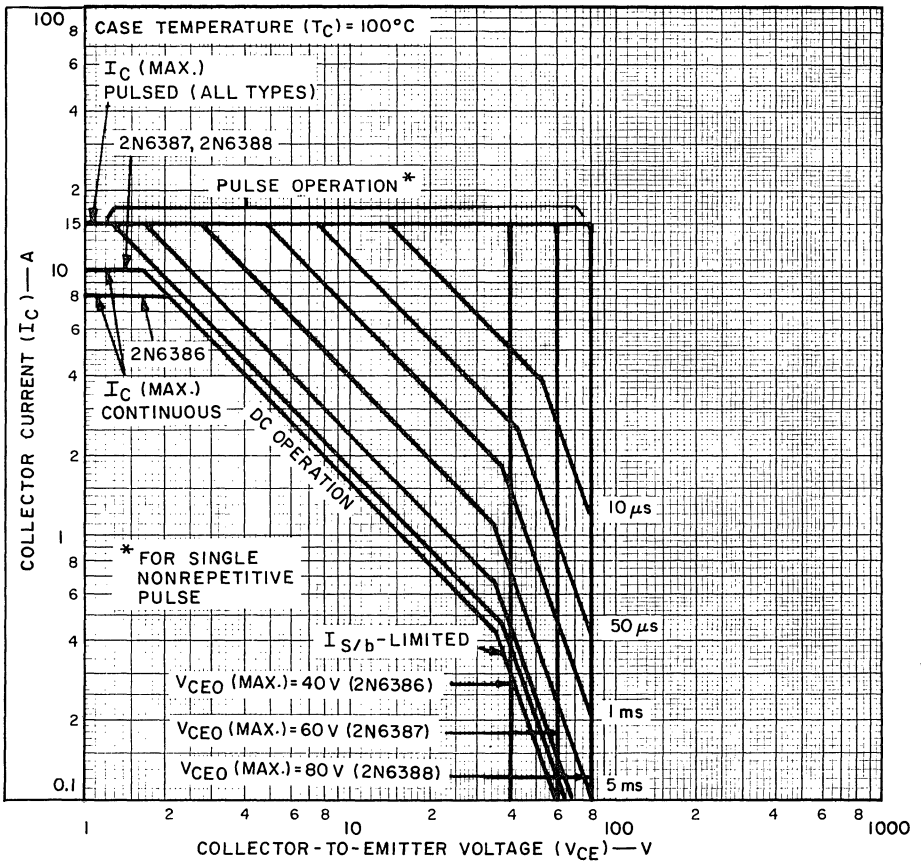
Fig. 3—Derating curves for all types.



92CS-20697

Fig. 4—Typical dc-beta characteristics for all types.





92CS-20634

Fig. 5—Maximum operating area for all types.

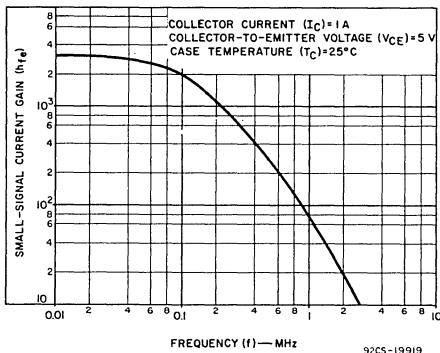


Fig. 6—Typical small-signal gain for all types.

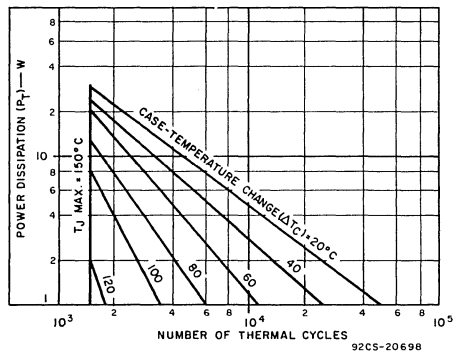


Fig. 7—Thermal-cycling rating chart for all types.

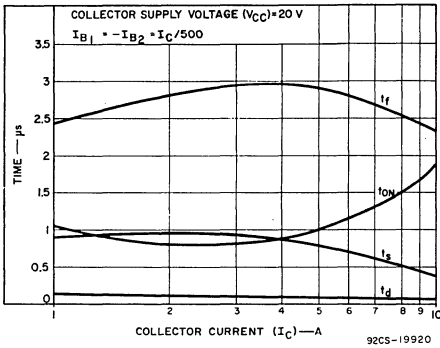


Fig. 8—Typical saturated switching-time characteristics for all types.

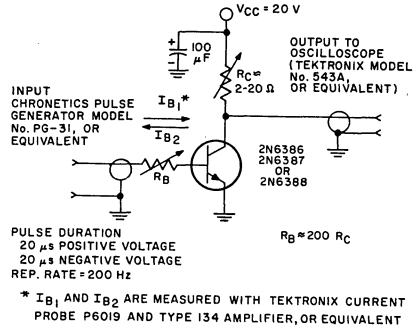


Fig. 9—Circuit used to measure saturated switching times.

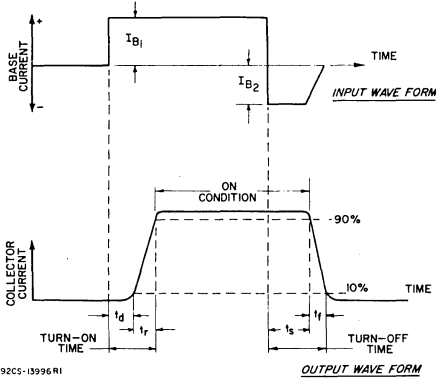


Fig. 10—Phase relationship between input current and output current showing reference points for specification of switching times (test circuit shown in Fig. 9).

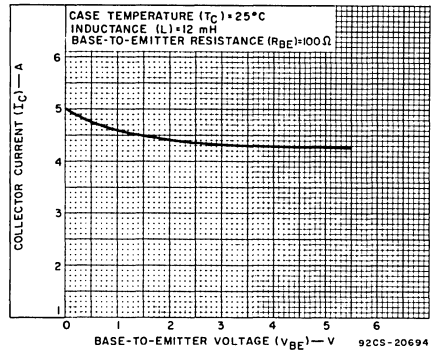


Fig. 11—Minimum values of reverse-bias second breakdown characteristic ( $E_S/b$ ) for all types.

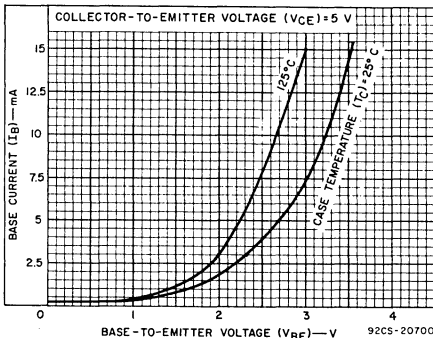


Fig. 12—Typical input characteristics for all types.

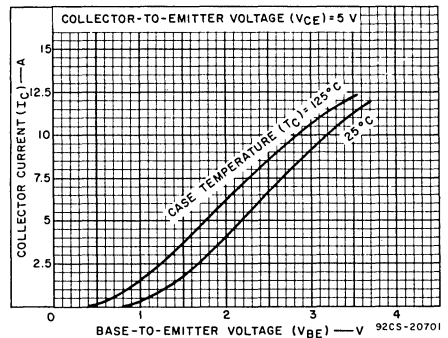


Fig. 13—Typical transfer characteristics for all types.

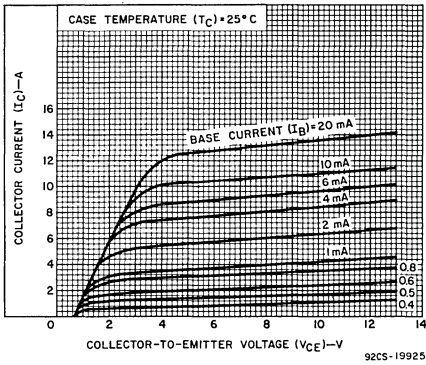


Fig. 14—Typical output characteristics for all types.

**TERMINAL CONNECTIONS**

- Lead No. 1 — Base
- Stub — Do not use stub as tie point.
- Lead No. 3 — Emitter
- Mounting Flange — Collector

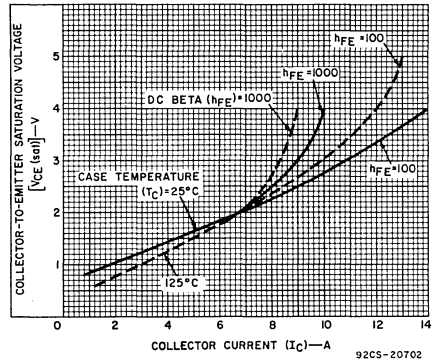


Fig. 15—Typical saturation characteristics for all types.

**TERMINAL CONNECTIONS**

- Lead No. 1 — Base
- Lead No. 2 — Collector
- Lead No. 3 — Emitter
- Mounting Flange — Collector



# RF Transistors

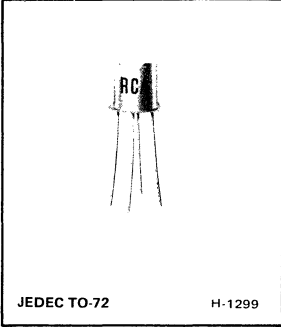
## 2N6389

### UHF/MATV Low-Noise Silicon N-P-N Transistor

For High-Gain Small-Signal Applications in UHF TV RF Amplifiers and UHF MATV Amplifiers

*Features:*

- Low noise figure:
  - NF = 3 dB (typ.) at 450 MHz, 1.5 mA
  - = 4 dB (typ.) at 890 MHz, 1.5 mA
  - = 6 dB (typ.) at 890 MHz, 10 mA
- High gain (tuned, unneutralized):
  - $G_{PE} = 15$  dB (min.) at 890 MHz



- High gain-bandwidth product
- Large dynamic range
- Low distortion
- Low collector-base capacitance

RCA 2N6389<sup>●</sup> is an epitaxial silicon n-p-n planar transistor intended for low-power, small-signal applications where both low noise and high gain are desirable. It utilizes a hermetically sealed four-lead JEDEC TO-72 package. All of the elements of the transistor are insulated from the case, which may be grounded by means of the fourth lead.

●Formerly RCA No. 40989.

**MAXIMUM RATINGS, Absolute-Maximum Values:**

*COLLECTOR-TO-BASE VOLTAGE .....	V <sub>CBO</sub>	20	V
*COLLECTOR-TO-EMITTER VOLTAGE .....	V <sub>CEO</sub>	12	V
*EMITTER-TO-BASE VOLTAGE .....	V <sub>EBO</sub>	2.5	V
*COLLECTOR CURRENT (Continuous) .....	I <sub>C</sub>	40	mA
*TRANSISTOR DISSIPATION:	P <sub>T</sub>		
At ambient temperatures up to 25°C .....		200	mW
At ambient temperatures above 25°C .....			Derate linearly at 1.14 mW/°C
*TEMPERATURE RANGE:			
Storage and Operating (Junction) .....			-65 to +200° C
*LEAD TEMPERATURE (During soldering):			
At distances ≥ 1/16 in. (1.59 mm) from seating plane for 60 s max. ....			300° C

\*In accordance with JEDEC registration data format JS-9 RDF-1.

**ELECTRICAL CHARACTERISTICS, At Ambient Temperature ( $T_A$ ) = 25°C**

CHARACTERISTIC	SYMBOL	TEST CONDITIONS					LIMITS		UNITS
		VOLTAGE V dc		CURRENT mA dc			MIN.	MAX.	
		$V_{CB}$	$V_{CE}$	$I_E$	$I_B$	$I_C$			

**STATIC**

* Collector Cutoff Current	$I_{CBO}$	15		0			—	20	nA
* Emitter Cutoff Current	$I_{EBO}$	$(V_{EB})_1$				0	—	1	$\mu A$
* Collector-to-Base Breakdown Voltage	$V_{(BR)CBO}$			0		0.001	20	—	V
* Collector-to-Emitter Breakdown Voltage	$V_{(BR)CEO}$				0	3	12	—	V
* Emitter-to-Base Breakdown Voltage	$V_{(BR)EBO}$			0.01		0	2.5	—	V
* DC Forward Current Transfer Ratio	$h_{FE}$		1			3	25	250	
Thermal Resistance: (Junction-to-Case)	$R_{\theta JC}$						—	880	$^{\circ}C/W$

**DYNAMIC**

Device Noise Figure: f = 890 MHz = 890 MHz = 450 MHz	NF	10 10 10				1.5 10 1.5	— — —	4(typ.) 6(typ.) 3(typ.)	dB
Small-Signal Common-Base Power Gain (f = 890 MHz)	$G_{PB}$	10				10	15	—	dB
* Small-Signal, Short Circuit Forward Current Transfer Ratio (f = 1 kHz)	$h_{fe}$		1			3	25	250	
* Magnitude of Small-Signal Short Circuit Forward Current Transfer Ratio (f = 200 MHz)	$ h_{fe} $		10			1.5	5	15	
* Collector-to-Base Time Constant (f = 31.9 MHz)	$r_b' C_c$	10		1.5			1	15	ps
* Collector-to-Base Capacitance (f = 1 MHz)	$C_{cb}$	10		0			0.4	0.55	pF

\* In accordance with JEDEC registration data format JS-9 RDF-1.

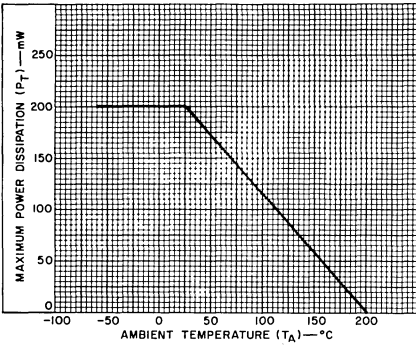


Fig. 1 - Power dissipation vs. ambient temperature.

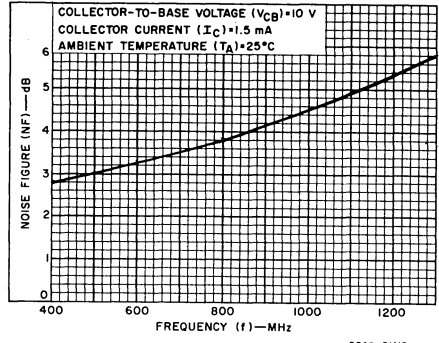


Fig. 2 - Typical common-base noise figure vs. frequency.

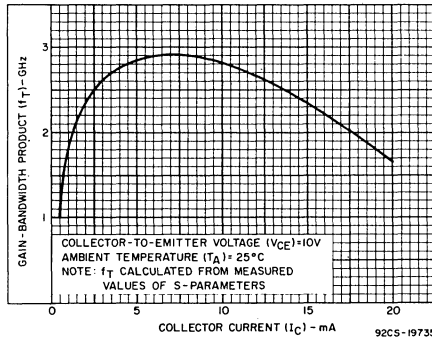
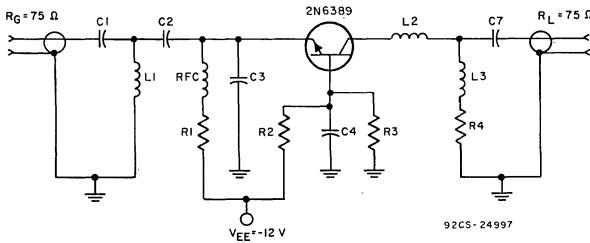


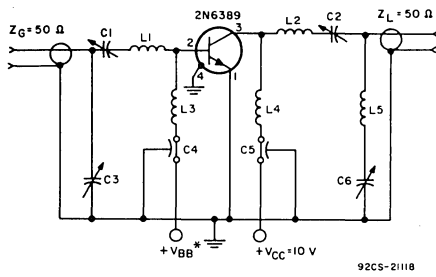
Fig. 3 - Gain-bandwidth product vs. collector current.



- C<sub>1</sub>, C<sub>7</sub>: 3.3 pF disc ceramic
- C<sub>2</sub>: 2.7 pF disc ceramic
- C<sub>3</sub>: 1 pF disc ceramic
- C<sub>4</sub>: 25 pF, ATC-100 or equivalent

- L<sub>1</sub>, L<sub>2</sub>: 2 turns, No. 18 wire, 0.125 in. (3.175 mm) ID
- RFC: 8 turns No. 28 wire, 0.062 in. (1.57 mm) ID
- R<sub>1</sub>: 270 Ω
- R<sub>2</sub>: 2.2 kΩ
- R<sub>3</sub>: 4.7 kΩ
- R<sub>4</sub>: 4.7 kΩ

Fig. 4 - 890-MHz common-base test circuit for gain and noise figure.



- C<sub>1</sub>: 1.0–30 pF
  - C<sub>2</sub>, C<sub>3</sub>: 1.0–20 pF
  - C<sub>4</sub>, C<sub>5</sub>: 0.04 μF
  - C<sub>6</sub>: 1–10 pF
  - L<sub>1</sub>: 2 turns No. 18 wire, 3/16 in. (0.188 mm) ID, 0.10 in. (2.54 mm) long
  - L<sub>2</sub>: 3 turns No. 18 wire, 3/16 in. (0.188 mm) ID, 0.15 in. (3.81 mm) long
  - L<sub>3</sub>-L<sub>4</sub>: 0.22-μH rf choke
  - L<sub>5</sub>: 3 turns No. 18 wire, 3/16 in. (0.188 mm) ID, 0.15 in. (3.81 mm) long
  - R<sub>1</sub>: 200Ω, 1/4 W
- \* V<sub>(BB)</sub> adjusted for I<sub>C</sub> = 1.5 mA

Fig. 5—Circuit diagram of 450-MHz amplifier used for measurement of noise figure.

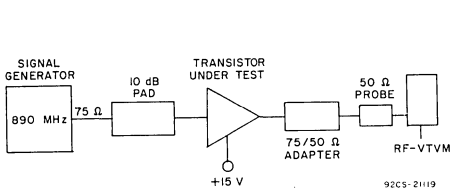


Fig. 6—Block diagram of test setup for measurement of gain.

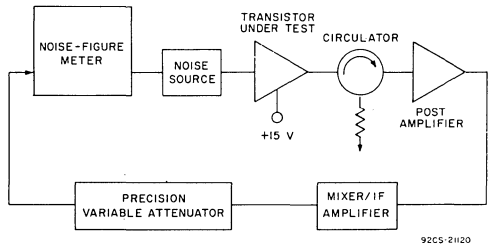


Fig. 7—Block diagram of noise-figure test set.

**TERMINAL CONNECTIONS**

- Lead 1 – Emitter
- Lead 2 – Base
- Lead 3 – Collector
- Lead 4 – Connected to case

**RCA**  
Solid State  
Division

## Power Transistors

**2N6477**  
**2N6478**

### Hometaxial-Base, Medium-Power Silicon N-P-N Transistors

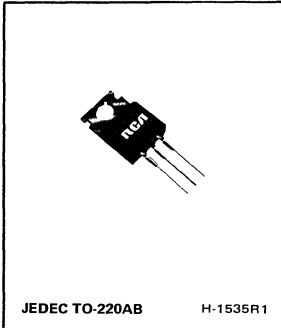
Rugged Devices for Intermediate Power Applications  
in Industrial and Commercial Equipment

#### Features:

- Maximum safe-area-of-operation curves for dc and pulse operation
- High voltage ratings
- Low saturation voltages
- Thermal-cycling rating curves

#### Applications:

- Series and shunt regulators
- High-fidelity amplifiers
- Power switching circuits
- Solenoid drivers
- Vertical output stages in color and B/W TV



RCA 2N6477 and 2N6478<sup>▲</sup> are hometaxial-base silicon n-p-n transistors intended for a wide variety of medium-to-high power, high-voltage applications. These devices, which are voltage extensions of the 2N5298 family, are especially useful in vertical output stages in color and black-and-white TV. The units differ in voltage ratings and in the currents at which parameters are controlled.

The 2N6477 and 2N6478 are supplied in the JEDEC TO-220AB

straight-lead version of the package. They are also available on special order in a variety of lead-form configurations. Two popular variations have leads formed to fit TO-66 sockets (specify formed lead No. 6201) or printed-circuit boards (specify formed lead No. 6207). Detailed information on these and other VERSAWATT outlines is contained in "RCA's Line-up of Power Transistors" (PSP-704).

<sup>▲</sup> Formerly RCA Dev. Nos. TA8405 and TA8343.

#### MAXIMUM RATINGS, *Absolute-Maximum Values:*

	2N6477	2N6478		
*COLLECTOR-TO-BASE VOLTAGE .....	V <sub>CBO</sub>	140	160	V
COLLECTOR-TO-EMITTER SUSTAINING VOLTAGE:				
With base open .....	V <sub>CEO(sus)</sub>	120	140	V
With external base-to-emitter resistance (R <sub>BE</sub> ) = 100 Ω .....	V <sub>CER(sus)</sub>	130	150	V
* With base reverse-biased (V <sub>BE</sub> = -1.5 V) .....	V <sub>CEV(sus)</sub>	140	160	V
*EMITTER-TO-BASE VOLTAGE .....	V <sub>EBO</sub>	5	5	V
*CONTINUOUS COLLECTOR CURRENT .....	I <sub>C</sub>	2.5	2.5	A
PEAK COLLECTOR CURRENT .....		4	4	A
*CONTINUOUS BASE CURRENT .....	I <sub>B</sub>	1	1	A
TRANSISTOR DISSIPATION:	P <sub>T</sub>			
* At case temperature up to 25°C .....		50	50	W
* At case temperatures above 25°C .....		See Fig. 2		
At ambient temperatures up to 25°C .....		1.8	1.8	W
At ambient temperatures above 25°C .....		Derate linearly at 0.0144		W/°C
*TEMPERATURE RANGE:				
Storage and Operating (Junction) .....		-65 to 150		°C
*PIN TEMPERATURE (During Soldering):				
At distances ≥ 1/32 in. (0.8 mm) from seating plane for 10 s max. ....		235		°C

\* In accordance with JEDEC registration data format JS-6 RDF-2.



ELECTRICAL CHARACTERISTICS, At Case Temperature ( $T_C$ ) = 25°C unless otherwise specified

CHARACTERISTIC	SYMBOL	TEST CONDITIONS				LIMITS				UNITS
		VOLTAGE V dc		CURRENT A dc		2N6477		2N6478		
		$V_{CE}$	$V_{BE}$	$I_C$	$I_B$	MIN.	MAX.	MIN.	MAX.	
* Collector-Cutoff Current: With base open	$I_{CEO}$	80 100			0 0	— —	2 —	— —	— 2	mA
With base-emitter junction reverse-biased	$I_{CEV}$	130 150	-1.5 -1.5			— —	2 —	— 2		
At $T_C = 150^\circ\text{C}$	$I_{CEV}$	120 140	-1.5 -1.5			— —	10 —	— 10		
* Emitter-Cutoff Current	$I_{EBO}$		-5	0		—	2	—	2	mA
* Collector-to-Emitter Sustaining Voltage: With base open	$V_{CEO(sus)}$			0.1 <sup>a</sup>	0	120	—	140	—	V
With external base-to-emitter resistance ( $R_{BE}$ ) = 100 $\Omega$	$V_{CER(sus)}$			0.1 <sup>a</sup>		130	—	150	—	
With base-emitter junction reverse-biased	$V_{CEV(sus)}$		-1.5	0.1 <sup>a</sup>		140	—	160	—	
* DC Forward-Current Transfer Ratio	$h_{FE}$	4 4		1 <sup>a</sup> 2.5 <sup>a</sup>		25 5	150 —	25 5	150 —	
* Collector-to-Emitter Saturation Voltage	$V_{CE(sat)}$			1 <sup>a</sup> 2.5 <sup>a</sup>	0.1 0.5	— —	1 2	— —	1 2	V
* Base-to-Emitter Voltage	$V_{BE}$	4 4		1 <sup>a</sup> 2.5 <sup>a</sup>		— —	1.8 3	— —	1.8 3	V
* Magnitude of Common-Emitter, Small-Signal, Short-Circuit Forward-Current Transfer Ratio: f = 40 kHz	$ h_{fe} $	4		0.5		5	—	5	—	
Gain-Bandwidth Product	$f_T$	4		0.5		200	—	200	—	kHz
* Common-Emitter, Small-Signal, Short-Circuit Forward-Current Transfer Ratio: f = 1 kHz	$h_{fe}$	4		0.1		25	—	25	—	
Thermal Resistance: Junction-to-Case	$R_{\theta JC}$					—	2.5	—	2.5	°C/W
Junction-to-Ambient	$R_{\theta JA}$					—	70	—	70	

\* In accordance with JEDEC registration data format (JS-6 RDF-2).

<sup>a</sup> Pulsed: Pulse duration = 300  $\mu\text{s}$ , duty factor = 1.8%.CAUTION: The sustaining voltage  $V_{CEO(sus)}$ ,  $V_{CER(sus)}$ , and  $V_{CEV(sus)}$  MUST NOT be measured on a curve tracer.

These sustaining voltages should be measured by means of the test circuit shown in Fig. 10.

## TERMINAL CONNECTIONS

## JEDEC TO-220AB

- Terminal No. 1 – Base
- Terminal No. 2 – Collector
- Terminal No. 3 – Emitter
- Terminal No. 4 – Collector

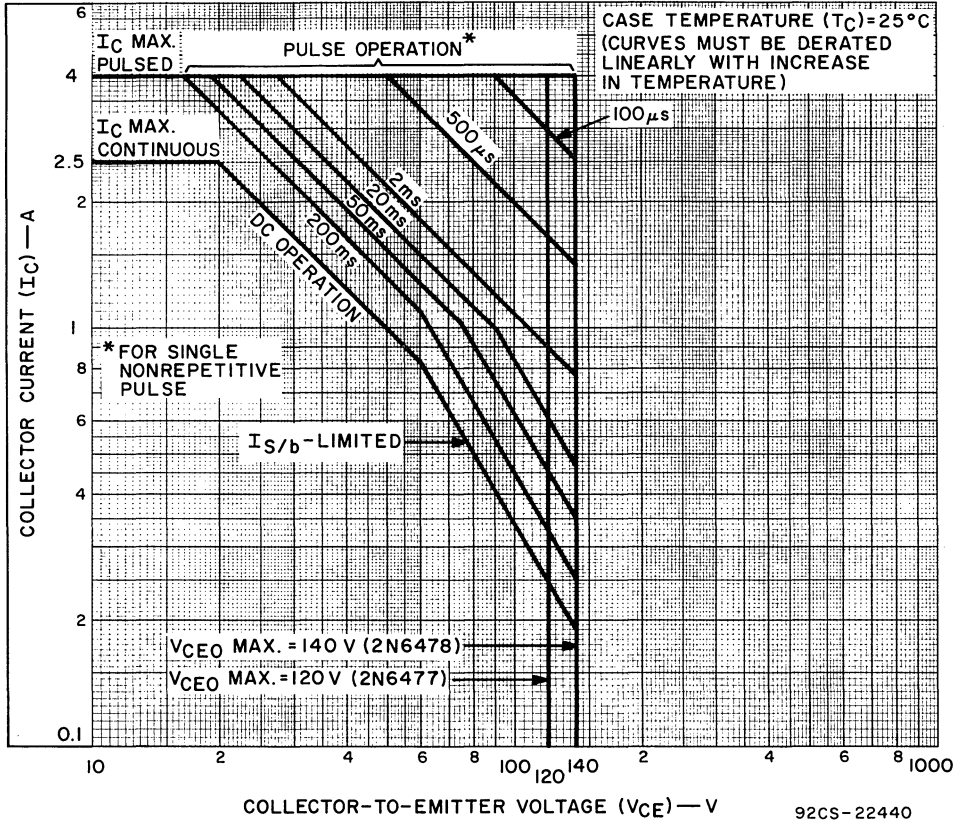


Fig.1 — Maximum operating areas for both types.

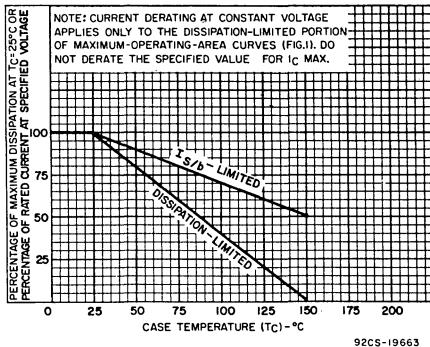


Fig.2 — Current derating curve for both types.

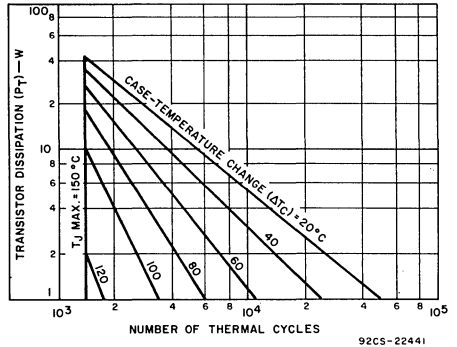


Fig.3 — Thermal-cycling rating chart for both types.

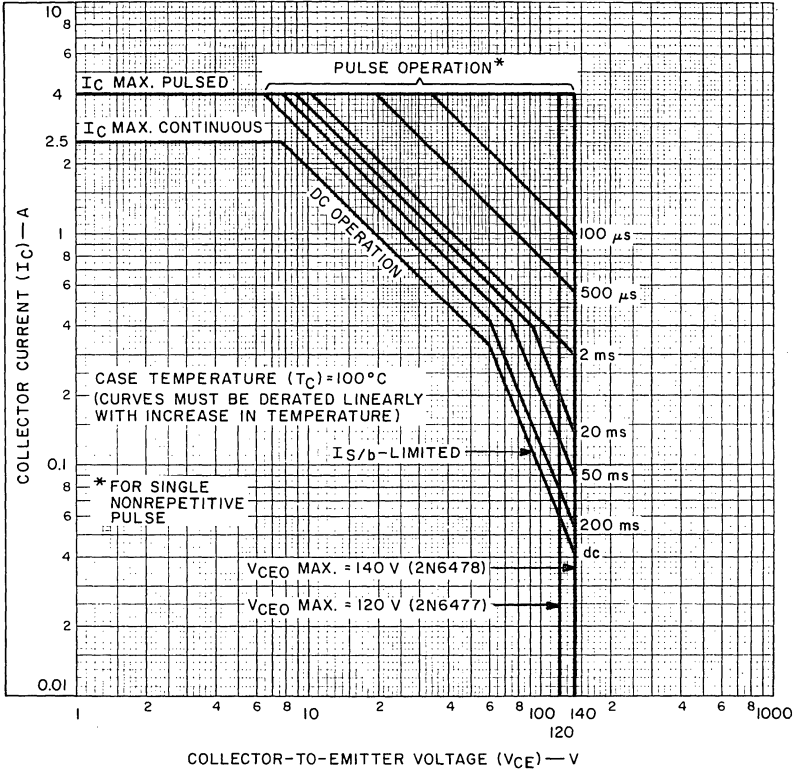


Fig. 4 — Maximum operating areas for both types.

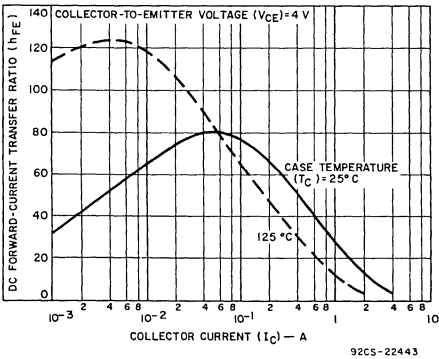


Fig. 5 — Typical dc beta characteristics for 2N6477.

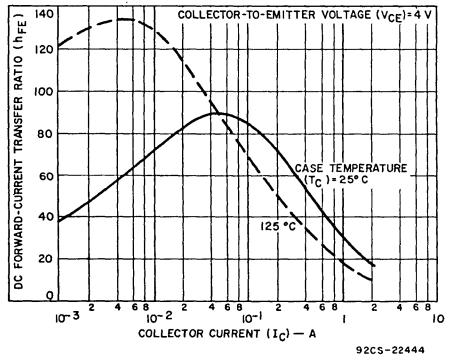


Fig. 6 — Typical dc beta characteristics for 2N6478.

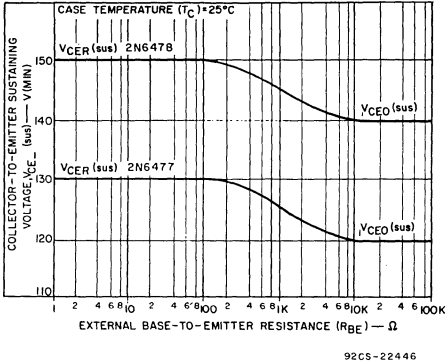


Fig.7 — Sustaining voltage vs. base-to-emitter resistance for both types.

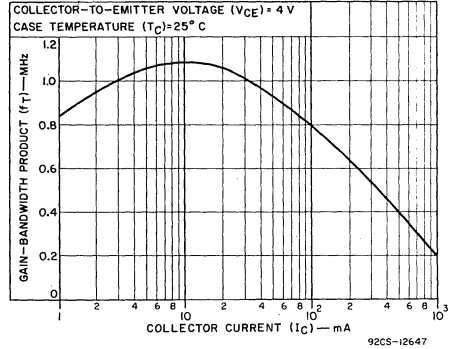


Fig.8 — Typical gain-bandwidth product for both types.

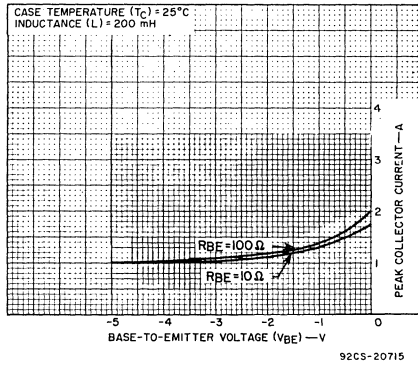


Fig.9 — Minimum reverse-bias second-breakdown characteristics for both types.

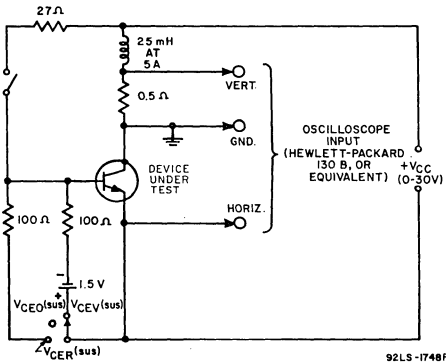
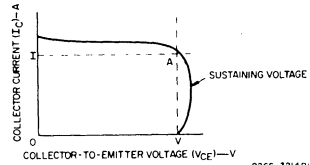


Fig.10 — Circuit used to measure sustaining voltages,  $V_{CEO(sus)}$ ,  $V_{CER(sus)}$ , and  $V_{CEV(sus)}$  for both types.



Note:  
The sustaining voltage,  $V_{CEO(sus)}$ ,  $V_{CER(sus)}$ , or  $V_{CEV(sus)}$  is acceptable when the trace falls to the right and above point "A" for all types. (For values of current and voltage, see *Electrical Characteristics*)

Fig.11 — Oscilloscope display for measurement of sustaining voltages (test circuit shown in Fig. 10).

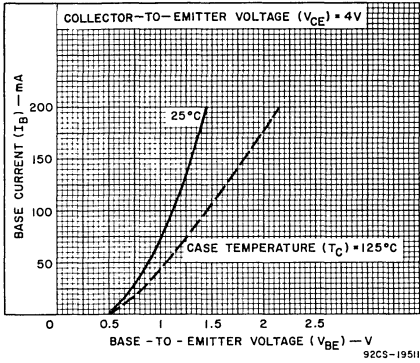


Fig. 12 — Typical input characteristics for 2N6477.

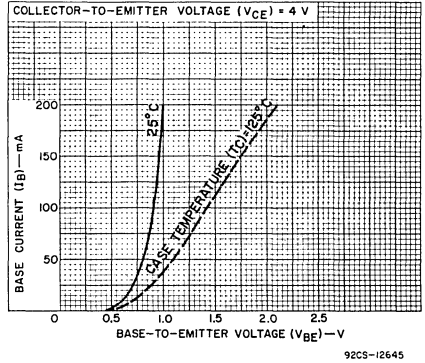


Fig. 13 — Typical input characteristics for 2N6478.

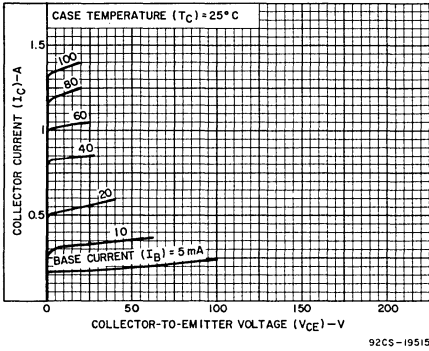


Fig. 14 — Typical output characteristics for 2N6477.

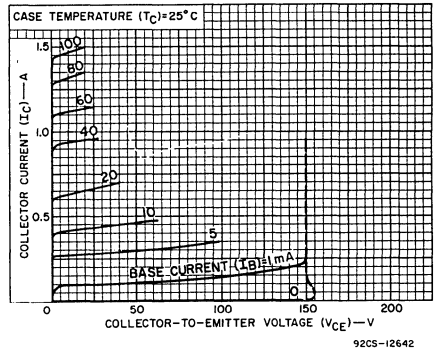


Fig. 15 — Typical output characteristics for 2N6478.

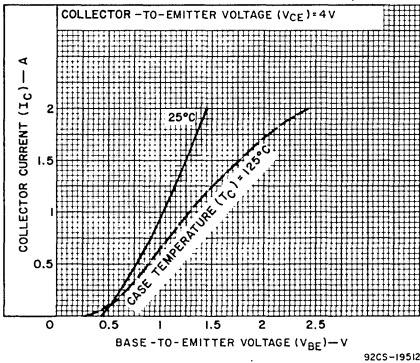


Fig. 16 — Typical transfer characteristics for 2N6477.

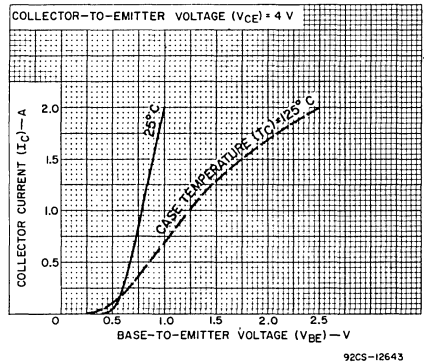
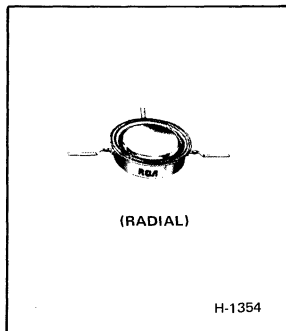


Fig. 17 — Typical transfer characteristics for 2N6478.



# Power Transistors

**2N6479 2N6481  
2N6480 2N6482**



## Radiation-Hardened Silicon N-P-N Power Transistors

Epitaxial-Planar Types for Aerospace and Military Applications

Rated for Operation in Radiation Environments  
with Cumulative Neutron Fluence Levels to  $1 \times 10^{14}$  Neutrons/cm<sup>2</sup>  
and Gamma Intensity to  $1 \times 10^8$  Rad(Si)/s

RCA types 2N6479, 2N6480, 2N6481, and 2N6482\* are epitaxial silicon n-p-n planar power-switching transistors. They are designed for aerospace applications in which they might be subjected to extreme neutron and gamma-ray exposure.

The 2N6479, 2N6480, 2N6481, and 2N6482 are intended for use in 5-to-10 ampere high-frequency power inverter service.

Types 2N6479 and 2N6481 differ from types 2N6480 and 2N6482, respectively, in voltage and power ratings. In types 2N6479 and 2N6480, the collector is isolated from the case.

\* Formerly RCA Dev. Nos. TA8007, TA8007B, TA8100, and TA8100B, respectively.

**MAXIMUM RATINGS, Absolute-Maximum Values:**

	2N6479	2N6480	2N6481	2N6482	
* COLLECTOR-TO-BASE VOLTAGE . . . . .	V <sub>CB0</sub>	100	100	100	100 V
COLLECTOR-TO-EMITTER SUSTAINING VOLTAGE:					
* With external base-to-emitter resistance (R <sub>BE</sub> ) ≤ 100 Ω . . . . .	V <sub>CER(sus)</sub>	80	100	80	100 V
* With base open . . . . .	V <sub>CEO(sus)</sub>	60	80	60	80 V
* EMITTER-TO-BASE VOLTAGE . . . . .	V <sub>EBO</sub>	6	6	6	6 V
* CONTINUOUS COLLECTOR CURRENT . . . . .	I <sub>C</sub>	12	12	12	12 A
* PEAK COLLECTOR CURRENT . . . . .		25	25	25	25 A
* CONTINUOUS BASE CURRENT . . . . .	I <sub>B</sub>	5	5	5	5 A
* TRANSISTOR DISSIPATION:	P <sub>T</sub>				
At case temperatures up to 25°C . . . . .		87	87	117	117 W
At case temperatures above 25°C . . . . .		See Figs. 1,2, and 4			
* TEMPERATURE RANGE:					
Storage and Operating (Junction) . . . . .		-65 to +200			°C
* TERMINAL TEMPERATURE (During Soldering):					
At distance ≥ 1/32 in. (0.8 mm) from seating plane for 10 s max. . . . .		230			°C

\* In accordance with JEDEC registration data format JS-6 RDF-1.

ELECTRICAL CHARACTERISTICS, At Case Temperature ( $T_C$ ) = 25°C

## PRE-RADIATION

CHARACTERISTIC	SYMBOL	TEST CONDITIONS				LIMITS				UNITS
		VOLTAGE V dc		CURRENT A dc		2N6479 2N6481		2N6480 2N6482		
		V <sub>CE</sub>	V <sub>EB</sub>	I <sub>B</sub>	I <sub>C</sub>	MIN.	MAX.	MIN.	MAX.	
Collector Cutoff Current: With emitter open, V <sub>CB</sub> = 100 V	I <sub>CB0</sub>						1	—	1	mA
With base shorted	I <sub>CES</sub>	60				—	200	—	200	μA
With base-emitter junction reverse-biased	I <sub>CEV</sub>	100	0			—	1	—	1	mA
At T <sub>C</sub> = 100°C		60	0			—	1	—	1	
Emitter Cutoff Current	I <sub>EBO</sub>		6			—	2	—	2	mA
Emitter-to-Base Voltage: I <sub>E</sub> = 2 mA	V <sub>EBO</sub>					6	—	6	—	V
Collector-to-Emitter Sustaining Voltage: With base open	V <sub>CEO(sus)</sub>				0.2 <sup>a</sup>	60 <sup>b</sup>	—	80 <sup>b</sup>	—	V
With external base-to- emitter resistance (R <sub>BE</sub> ) = 100 Ω	V <sub>CER(sus)</sub>				0.2	80 <sup>b</sup>	—	100 <sup>b</sup>	—	
Collector-to-Emitter Saturation Voltage	V <sub>CE(sat)</sub>			1.2	12 <sup>a</sup>	—	0.75	—	0.75	V
Base-to-Emitter Saturation Voltage	V <sub>BE(sat)</sub>			1.2	12 <sup>a</sup>	—	1.5	—	1.5	V
DC Forward Current Transfer Ratio	h <sub>FE</sub>	2			12 <sup>a</sup>	20	300	20	300	
Second Breakdown Collector Current: With base forward- biased, t = 1 s	I <sub>S/b</sub>	12				7.3	—	7.3	—	A
Second Breakdown Energy : With base reverse- biased, R <sub>BE</sub> = 100 Ω, L = 100 μH	E <sub>S/b</sub> **				5	1.25	—	1.25	—	mJ
Saturated Switching Time (V <sub>CC</sub> = 30 V, I <sub>B1</sub> = I <sub>B2</sub> ):										ns
Rise	t <sub>r</sub>			1.2	12	—	400	—	400	
Storage	t <sub>s</sub>			1.2	12	—	800	—	800	
Fall	t <sub>f</sub>			1.2	12	—	200	—	200	
Magnitude of Common Emitter Small-Signal Short Circuit Forward Current Transfer Ratio: f = 10 MHz	h <sub>fe</sub>	5			1	10	—	10	—	
Collector-to-Base Feedback Capacitance: V <sub>CB</sub> = 10 V, f = 1 MHz	C <sub>ob</sub>					—	400	—	400	pF
Thermal Resistance: Junction-to-Case	R <sub>θJC</sub>	10			5	—	2	—	1.5	°C/W

\* In accordance with JEDEC registration data format JS-6 RDF-1.

<sup>a</sup> Pulsed; pulse duration ≤ 350 μs, duty factor ≤ 2%.<sup>b</sup> CAUTION: The sustaining voltages V<sub>CEO(sus)</sub> and V<sub>CER(sus)</sub> MUST NOT be measured on a curve tracer. These sustaining voltages should be measured by means of the test circuit shown in Fig.13.

## POST-NEUTRON-RADIATION ELECTRICAL CHARACTERISTICS

AFTER EXPOSURE TO  $5 \times 10^{13}$  NEUTRONS/cm<sup>2</sup> (1 MeV equiv.), At Case Temperature ( $T_C$ ) = 25°C

CHARACTERISTIC	SYMBOL	TEST CONDITIONS				LIMITS		UNITS
		VOLTAGE V dc		CURRENT A dc		For all Types		
		V <sub>CE</sub>	V <sub>BE</sub>	I <sub>C</sub>	I <sub>B</sub>	MIN.	MAX.	
* Collector Cutoff Current: With base-emitter junction reverse-biased	I <sub>CEV</sub>	100	0			—	1.2	mA
* Emitter Cutoff Current	I <sub>EBO</sub>		-5			—	2.2	mA
* Collector-to-Emitter Sustaining Voltage: With base open	V <sub>CEO(sus)</sub>			0.2 0.2	0.05 0.05	80 <sup>b</sup> 60 <sup>c</sup>	— —	V
* Collector-to-Emitter Saturation Voltage	V <sub>CE(sat)</sub>			7 <sup>a</sup>	1.4	—	1.5	V
* Base-to-Emitter Saturation Voltage	V <sub>BE(sat)</sub>			7 <sup>a</sup>	1.4	—	1.5	V
* DC Forward Current Transfer Ratio	h <sub>FE</sub>	5		7 <sup>a</sup>		12	—	
Magnitude of Common Emitter, Small-Signal Short Circuit Forward Current Transfer Ratio: Ratio (f = 10 MHz)	h <sub>fe</sub>	5		1		10	—	
* Damage Constant	K <sup>▲</sup>					—	9 x 10 <sup>-16</sup>	

\* In accordance with JEDEC registration data format JS-6 RDF-1.

a Pulsed: pulse duration  $\leq 350 \mu\text{s}$ , duty factor  $\leq 2\%$ .

b For types 2N6480, 2N6482.

c For types 2N6479, 2N6481.

$$^{\Delta}\text{Damage constant } K = \frac{1}{\phi} \frac{1}{h_{FE2} - h_{FE1}}$$

Where  $h_{FE1}$  = Beta prior to exposure

$h_{FE2}$  = Beta after exposure

$\phi$  = Neutron fluence (1 MeV equiv.)

Knowing  $K$ ,  $h_{FE2}$  may be calculated for other fluences using the relationship:

$$h_{FE2} = \frac{1}{K\phi + \frac{1}{h_{FE1}}}$$

TYPICAL CHARACTERISTIC DURING GAMMA EXPOSURE FOR DOSE RATES OF LESS THAN  $1 \times 10^8$  RAD(Si)/sec

CHARACTERISTIC	SYMBOL	TEST CONDITIONS		LIMITS	UNITS
		VOLTAGE - V dc		For all Types	
		V <sub>CB</sub>	V <sub>BE</sub>	TYPICAL	
Collector-to-Base Charge Generation Constant	(C)	20	0	5 x 10 <sup>-8</sup>	$\frac{\text{Coulomb}}{\text{Rad}}$

The charge generated in the depletion region of a transistor is proportional to the volume of the depletion region, the total dose, and the energy of the gamma radiation.

The primary base-collector photo current [ $I_{pp(\text{base})}$ ] = (C) $\dot{\gamma}$ , where  $\dot{\gamma}$  is the gamma dose rate in Rad(Si)/s.



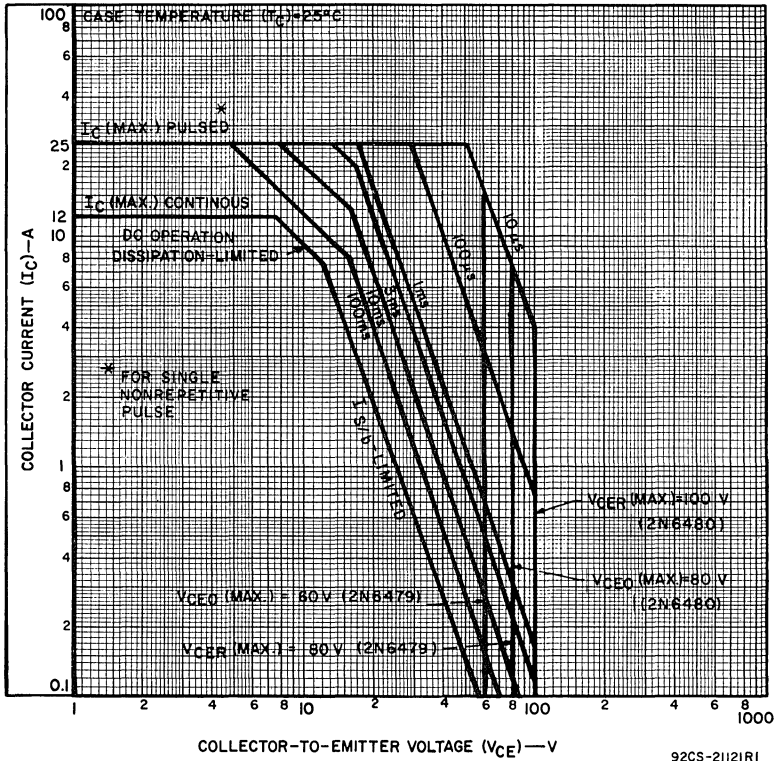


Fig.1 — Maximum operating areas for 2N6479 and 2N6480.

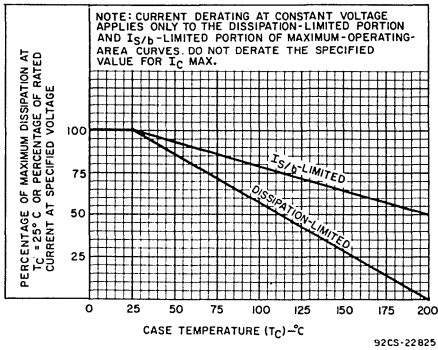


Fig.2 — Derating curves for all types.

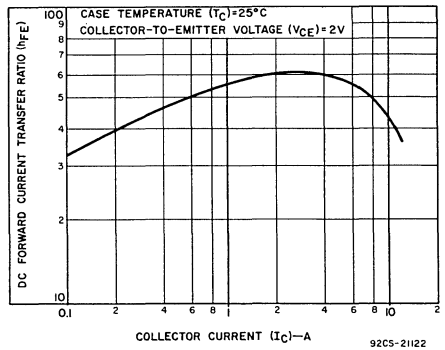
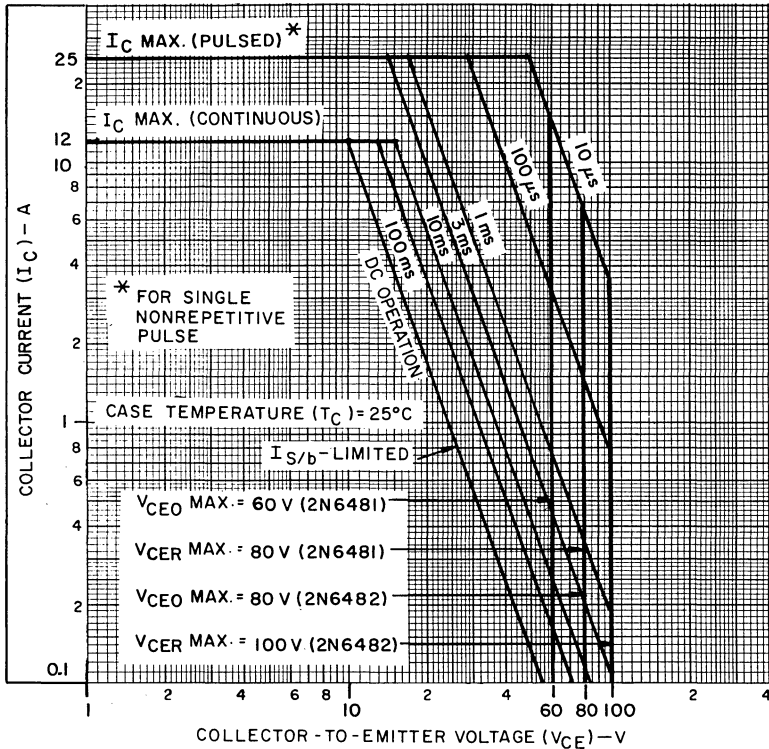


Fig.3 — Typical dc beta characteristic for all types.



92CS-22826

Fig. 4 - Maximum operating areas for 2N6481 and 2N6482.

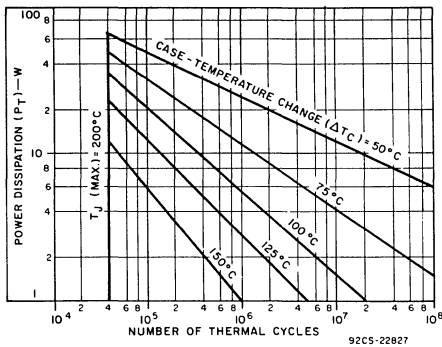


Fig. 5 - Thermal-cycling rating chart for 2N6479 and 2N6480.

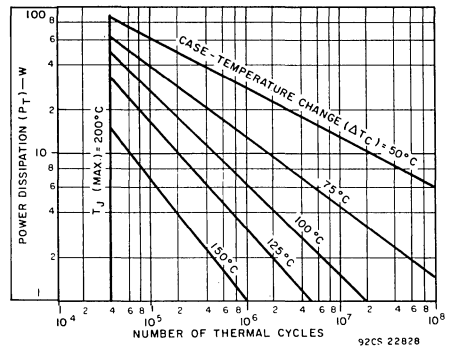


Fig. 6 - Thermal-cycling rating chart for 2N6481 and 2N6482.

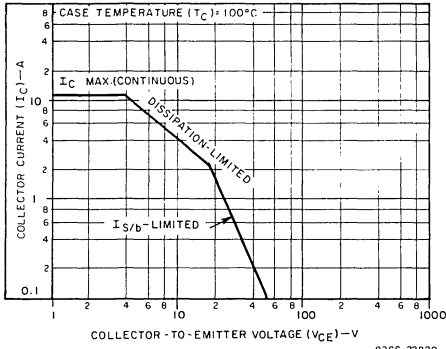


Fig. 7 — Maximum operating area for 2N6479 and 2N6480 at 100°C case temperature.

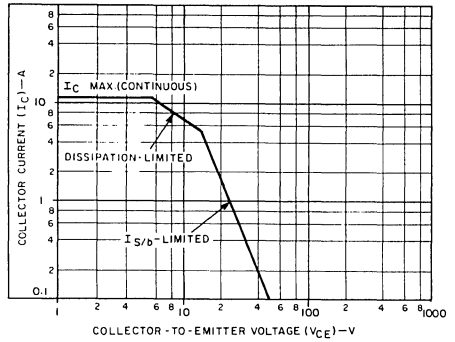


Fig. 8 — Maximum operating area for 2N6481 and 2N6482 at 100°C case temperature.

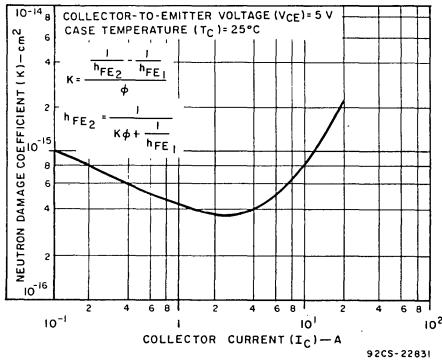


Fig. 9 — Typical 1-MeV-equivalent neutron damage coefficient as a function of collector current for all types.

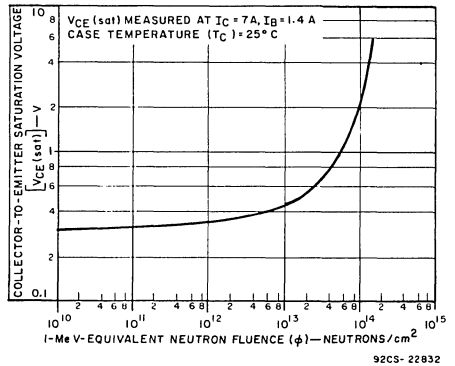


Fig. 10 — Typical collector-to-emitter saturation voltage as a function of 1-MeV-equivalent neutron fluence for all types.

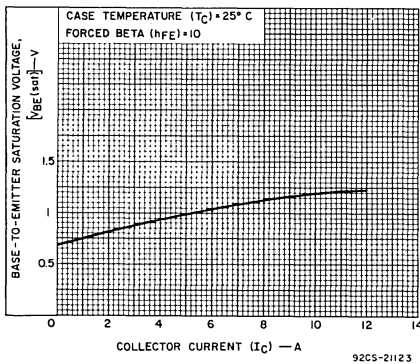


Fig. 11 — Typical base-to-emitter saturation voltage characteristic for all types.

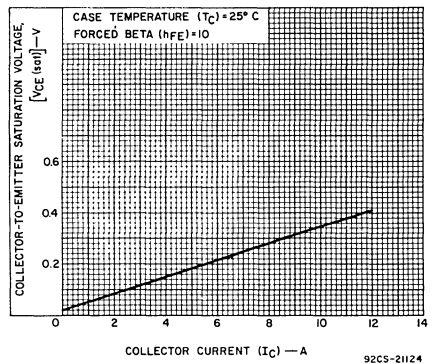


Fig. 12 — Typical collector-to-emitter saturation voltage characteristic for all types.

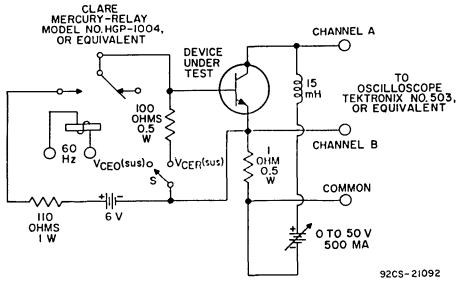
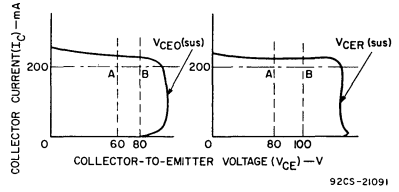


Fig. 13 - Circuit used to measure sustaining voltages  $V_{CE0(sus)}$  and  $V_{CEr(sus)}$ .



The sustaining voltages  $V_{CE0(sus)}$  and  $V_{CEr(sus)}$  are acceptable when the traces fall to the right of point "A" for types 2N6479 and 2N6481. The traces must fall to the right of point "B" for 2N6480 and 2N6482.

Fig. 14 - Oscilloscope display for  $V_{CE0(sus)}$  and  $V_{CEr(sus)}$  measurement. (Test circuit shown in Fig. 13).

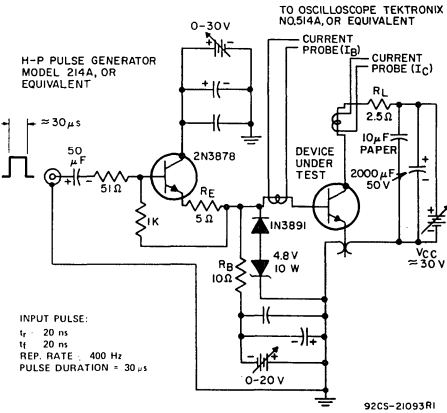


Fig. 15 - Circuit used to measure saturated switching times.

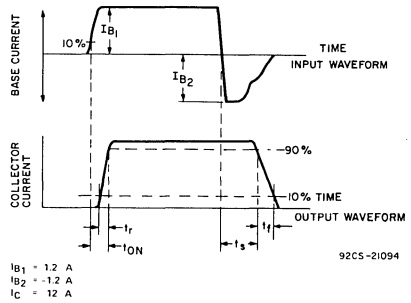


Fig. 16 - Phase relationship between input and output currents showing reference points for specification of switching times. (Test circuit shown in Fig. 15).

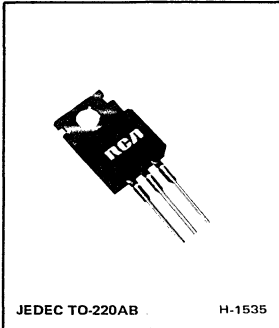
TERMINAL CONNECTIONS

2N6479	2N6481
2N6480	2N6482
Terminal No. 1 - Base	Base
Terminal No. 2 - Collector	Collector, Case
Terminal No. 3 - Emitter	Emitter



# Power Transistors

**2N6486 2N6489**  
**2N6487 2N6490**  
**2N6488 2N6491**



## 15-A, 75-W, Silicon N-P-N and P-N-P Epitaxial-Base VERSAWATT Transistors

Complementary Pairs for General-Purpose Switching and Amplifier Applications

**Features:**

- Thermal-cycling ratings
- Maximum safe-area-of-operation curves
- Color-coded packages of molded-silicone plastic:
  - Green — p-n-p (2N6489, 2N6490, 2N6491)
  - Gray — n-p-n (2N6486, 2N6487, 2N6488)

RCA-2N6486–2N6491<sup>●</sup>, inclusive, are epitaxial-base silicon transistors. The 2N6486, 2N6487, and 2N6488 are n-p-n complements of p-n-p types 2N6489, 2N6490, and 2N6491, respectively. All these devices are intended for a wide variety of medium-power switching and amplifier applications, and are particularly useful in high-fidelity amplifiers utilizing complementary-symmetry circuits.

These devices are supplied in the RCA VERSAWATT package in color-coded molded-silicone plastic; the 2N6489–2N6491 (p-n-p) devices are green, and the 2N6486–2N6488 (n-p-n) devices are gray. All are regularly supplied in the JEDEC TO-220AB straight-lead version of the package. They are also available on special order in a variety of lead-form configurations.

<sup>●</sup> Formerly RCA Dev. Nos. TA8325, TA8324, TA8323, TA8328, TA8327, and TA8326, respectively.

**MAXIMUM RATINGS, Absolute-Maximum Values:**

* COLLECTOR-TO-BASE VOLTAGE . . . . .	V <sub>CB0</sub>				V
COLLECTOR-TO-EMITTER VOLTAGE:					
* With 1.5 volts (V <sub>BE</sub> ) of reverse bias, and external base-to-emitter resistance (R <sub>BE</sub> ) = 100 Ω . . . . .	V <sub>CEX</sub>	50	70	90	V
With external base-to-emitter resistance (R <sub>BE</sub> ) = 100 Ω . . . . .	V <sub>CER</sub>	45	65	85	V
With base open . . . . .	V <sub>CEO</sub>	40	60	80	V
* EMITTER-TO-BASE VOLTAGE . . . . .	V <sub>EBO</sub>	5	5	5	V
* CONTINUOUS COLLECTOR CURRENT . . . . .	I <sub>C</sub>	15	15	15	A
* CONTINUOUS BASE CURRENT . . . . .	I <sub>B</sub>	5	5	5	A
* TRANSISTOR DISSIPATION:	P <sub>T</sub>				
At case temperatures up to 25°C . . . . .		75	75	75	W
At ambient temperatures up to 25°C . . . . .		1.8	1.8	1.8	W
At case temperatures above 25°C . . . . .		Derate linearly 0.6			W/°C
At ambient temperatures above 25°C . . . . .		Derate linearly 0.0144			W/°C
* TEMPERATURE RANGE:					
Storage and operating (Junction) . . . . .		—65 to +150			°C
* LEAD TEMPERATURE (During soldering):					
At distance ≥ 1/8 in. (3.17 mm) from seating plane for 10 s max. . . . .		—235			°C

N-P-N	2N6486	2N6487	2N6488	
P-N-P	2N6489 <sup>◆</sup>	2N6490 <sup>◆</sup>	2N6491 <sup>◆</sup>	
	50	70	90	V
	50	70	90	V
	45	65	85	V
	40	60	80	V
	5	5	5	V
	15	15	15	A
	5	5	5	A
	75	75	75	W
	1.8	1.8	1.8	W
	Derate linearly 0.6			W/°C
	Derate linearly 0.0144			W/°C
	—65 to +150			°C
	—235			°C

<sup>◆</sup> In accordance with JEDEC registration data format JS-6 RFD-2.

<sup>◆</sup> For p-n-p devices, voltage and current values are negative.

ELECTRICAL CHARACTERISTICS, At case temperature ( $T_C$ ) = 25°C unless otherwise specified

CHARACTERISTIC	SYMBOL	TEST CONDITIONS			LIMITS						UNITS
		VOLTAGE V dc		CURR. A dc	2N6486 2N6489♦		2N6487 2N6490♦		2N6488 2N6491♦		
		$V_{CE}$	$V_{BE}$	$I_C$	Min.	Max.	Min.	Max.	Min.	Max.	
Collector-Cutoff Current: With external base-emitter resistance ( $R_{BE}$ ) = 100Ω	$I_{CER}$	35 55 75			-	500	-	-	-	-	μA
* With base-emitter junction reverse biased and external base-to-emitter resistance ( $R_{BE}$ ) = 100Ω	$I_{CEX}$	45 65 85	-1.5 -1.5 -1.5		-	500	-	-	500	-	μA
* At $T_C$ = 150°C		40 60 80	-1.5 -1.5 -1.5		-	5	-	-	5	-	mA
* With base open	$I_{CEO}$	20 30 40			-	1	-	-	-	-	mA
* Emitter-Cutoff Current	$I_{EBO}$		-5	0	-	1	-	1	-	1	mA
* DC Forward-Current Transfer Ratio	$h_{FE}$	4 4		5 <sup>a</sup> 15 <sup>a</sup>	20 5	150	20 5	150	20 5	150	-
* Collector-to-Emitter Sustaining Voltage With base open	$V_{CEO(sus)}$			0.2	40 <sup>b</sup>	-	60 <sup>b</sup>	-	80 <sup>b</sup>	-	V
With external base-emitter resistance ( $R_{BE}$ ) = 100Ω	$V_{CER(sus)}$			0.2	45 <sup>b</sup>	-	65 <sup>b</sup>	-	85 <sup>b</sup>	-	
With base-emitter junction reverse- biased and external base-to-emitter resistance ( $R_{BE}$ ) = 100Ω	$V_{CEX(sus)}$		-1.5	0.2	50 <sup>b</sup>	-	70 <sup>b</sup>	-	90 <sup>b</sup>	-	
* Base-to-Emitter Voltage	$V_{BE}$	4 4		5 <sup>a</sup> 15 <sup>a</sup>	-	1.3 3.5	-	1.3 3.5	-	1.3 3.5	V
* Collector-to-Emitter Saturation Voltage	$V_{CE(sat)}$			5 <sup>a</sup> 15 <sup>a</sup>	-	1.3 3.5	-	1.3 3.5	-	1.3 3.5	V
* Magnitude of Common-Emitter Small-Signal Short-Circuit Forward-Current Transfer Ratio : f = 1 MHz	$ h_{fe} $	4		1	5	-	5	-	5	-	
* Common-Emitter, Small-Signal, Short-Circuit, Forward-Current Transfer Ratio (f = 1 kHz)	$h_{fe}$	4		1	25	-	25	-	25	-	
Thermal Resistance : Junction-to-case	$R_{\theta JC}$				-	1.67	-	1.67	-	1.67	°C/W
Junction-to-ambient	$R_{\theta JA}$				-		-	70	-	70	

\* In accordance with JEDEC registration data format (JS-6 RDF-2). <sup>b</sup> CAUTION: Sustaining voltages  $V_{CEO(sus)}$ ,  $V_{CER(sus)}$ , and  $V_{CEX(sus)}$  MUST NOT be measured on a curve tracer. (See Fig. 19)

<sup>a</sup> Pulsed; pulse duration = 300 μs, duty factor = 1.8%.

♦ For p-n-p devices, voltage and current values are negative.

## TERMINAL CONNECTIONS

Terminal No. 1 - Base  
Terminal No. 2 - Collector  
Terminal No. 3 - Emitter

Mounting Flange Terminal No. 4 - Collector

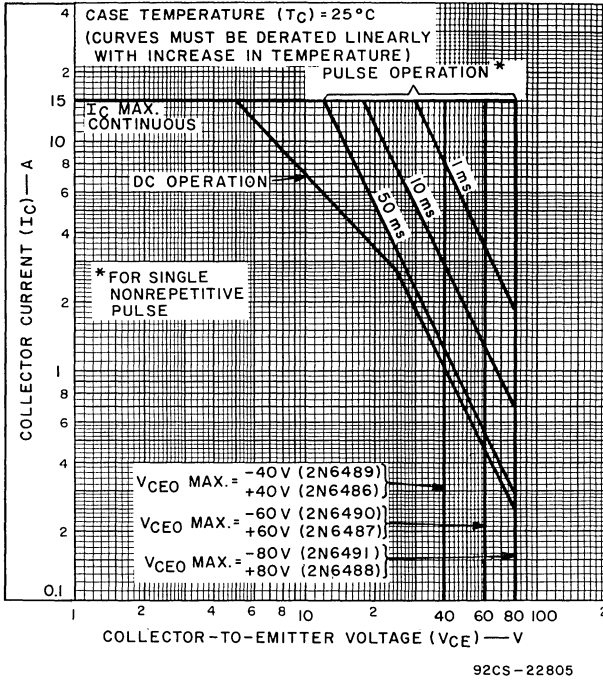


Fig. 1 — Maximum operating areas for all types\*

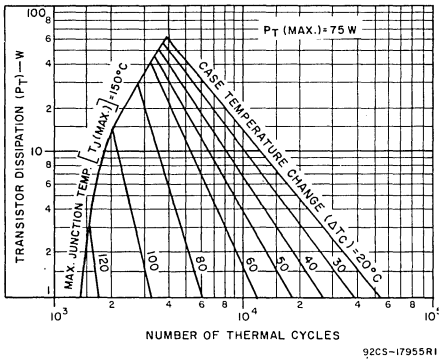


Fig. 2 — Thermal-cycling rating chart for all types.

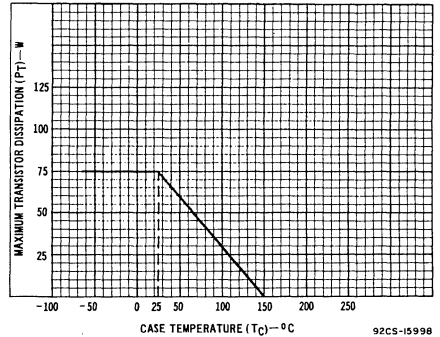


Fig. 3 — Derating chart for all types.

\* For p-n-p devices, voltage and current values are negative.

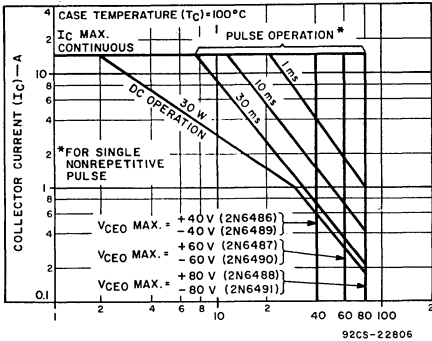


Fig. 4 - Maximum operating areas for all types\*.

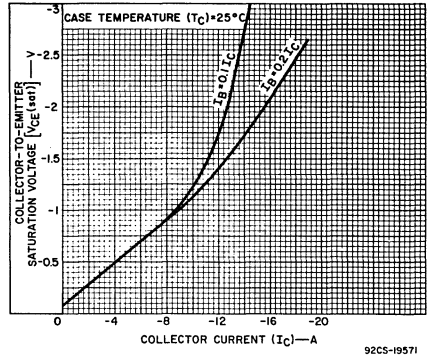


Fig. 5 - Typical collector-to-emitter saturation-voltage characteristics for all types.

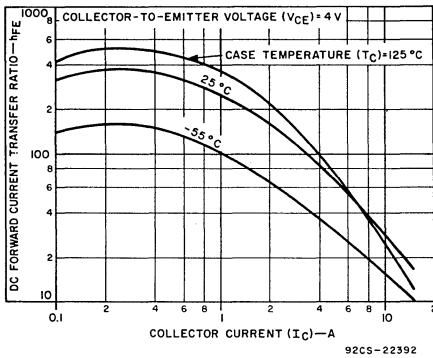


Fig. 6 - Typical dc beta characteristics for 2N6486, 2N6487, and 2N6488.

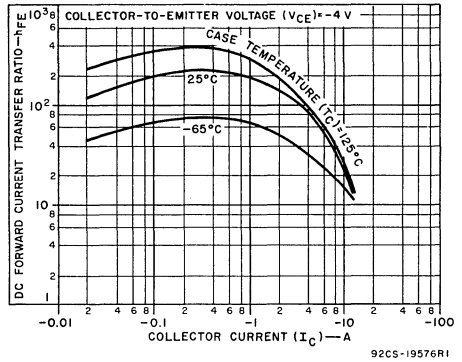


Fig. 7 - Typical dc beta characteristics for 2N6489, 2N6490, and 2N6491.

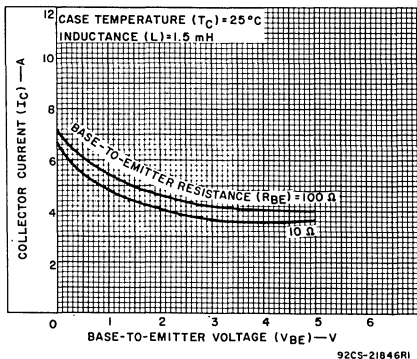


Fig. 8 - Minimum reverse-bias second-breakdown characteristics for all types\*.

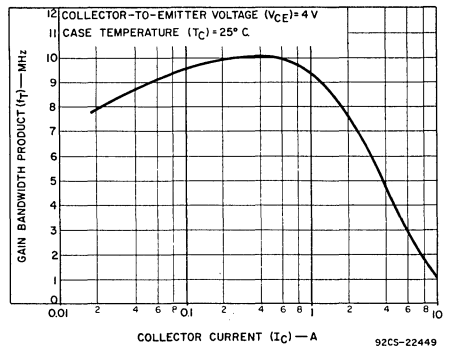


Fig. 9 - Typical gain-bandwidth product vs. collector current for all types\*.

\* For p-n-p devices, voltage and current values are negative.



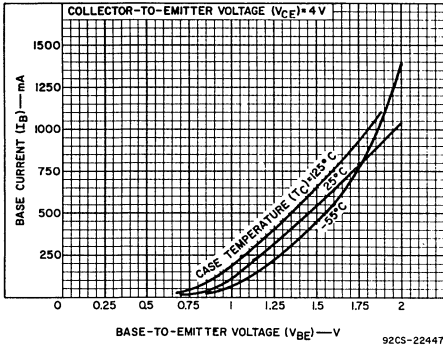


Fig. 10 — Typical input characteristics for all types\*

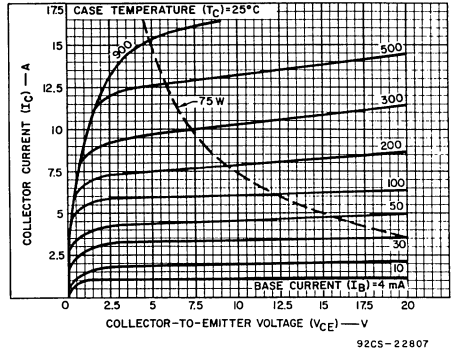


Fig. 11 — Typical output characteristics for all types\*

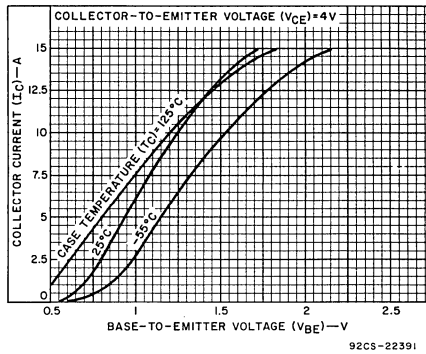


Fig. 12 — Typical transfer characteristics for all types\*

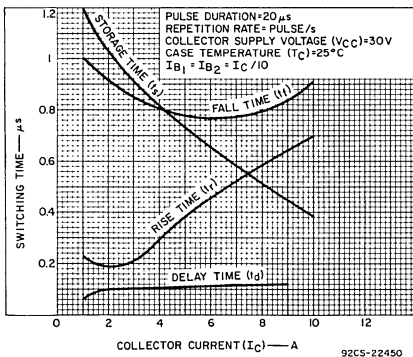


Fig. 13 — Typical saturated switching characteristics for 2N6486, 2N6487, and 2N6488.

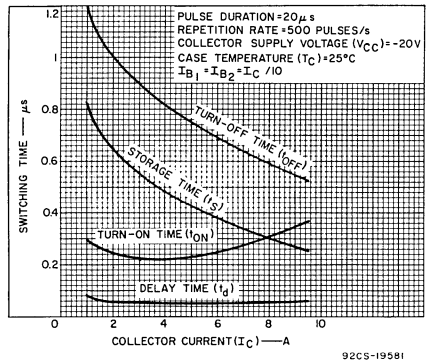
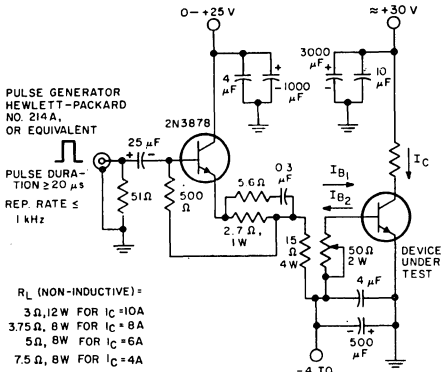


Fig. 14 — Typical saturated switching characteristics for 2N6489, 2N6490, and 2N6491.

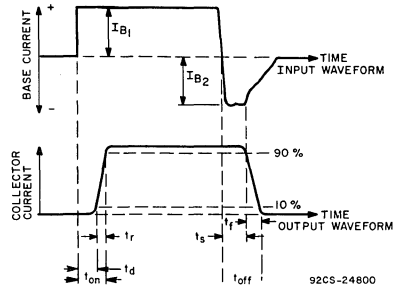
\* For p-n-p devices, voltage and current values are negative.



$R_L$  (NON-INDUCTIVE) =  
 3  $\Omega$ , 12 W FOR  $I_C = 10A$   
 3.75  $\Omega$ , 8 W FOR  $I_C = 6A$   
 5  $\Omega$ , 8 W FOR  $I_C = 6A$   
 7.5  $\Omega$ , 8 W FOR  $I_C = 4A$

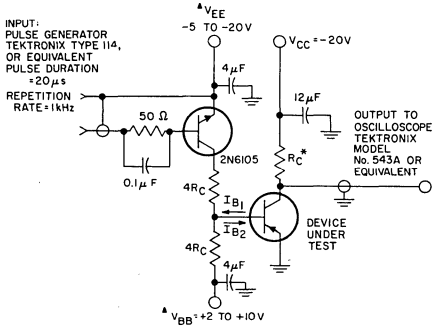
92CS-24801

Fig. 15 - Circuit used to measure switching times for 2N6486, 2N6487, and 2N6488.



92CS-24800

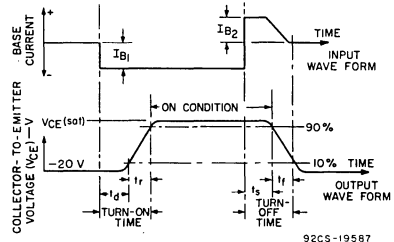
Fig. 16 - Phase relationship between input and output currents showing reference points for specification of switching times (test circuit shown in Fig. 15).



\*  $R_C$  IS CHOSEN FOR  $I_C$   
 $\Delta V_{EE}$  AND  $V_{BB}$  ARE MEASURED FOR  $I_{B1}$  AND  $I_{B2}$   
 $I_{B1}$  AND  $I_{B2}$  ARE MEASURED WITH TEKTRONIX CURRENT PROBE P-6019 AND TYPE 134 AMPLIFIER, OR EQUIVALENT

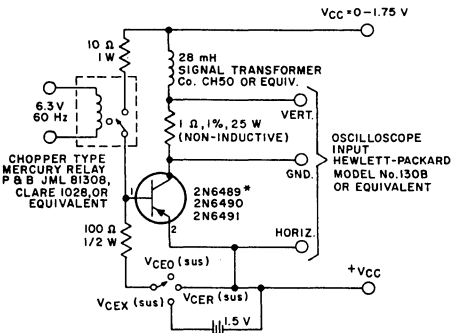
92CS-19586R3

Fig. 17 - Circuit used to measure switching times for 2N6489, 2N6490, and 2N6491.



92CS-19587

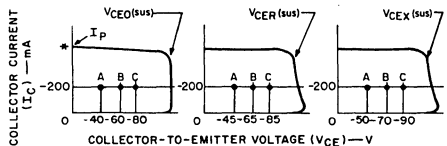
Fig. 18 - Oscilloscope display for measurement for switching times (test circuit shown in Fig. 17).



\* FOR N-P-N TYPES 2N6486, 2N6487, AND 2N6488, REVERSE POLARITY OF BATTERY AND VCC.

92CS-22810

Fig. 19 - Circuit used to measure sustaining voltages  $V_{CE0}(sus)$ ,  $V_{CEr}(sus)$ , and  $V_{CEX}(sus)$  for all types.



\* PULSE CURRENT ( $I_P$ ) RANGE = 0.6-0.8 A

THE SUSTAINING VOLTAGES  $V_{CE0}(sus)$ ,  $V_{CEr}(sus)$ , AND  $V_{CEX}(sus)$  ARE ACCEPTABLE WHEN THE TRACES FALL TO THE RIGHT AND ABOVE POINT "A" FOR TYPES 2N6486 AND 2N6489, POINT "B" FOR 2N6487 AND 2N6490, AND POINT "C" FOR 2N6488 AND 2N6491.

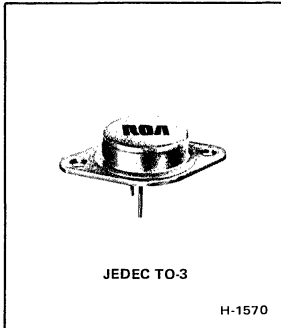
92CS-22811

Fig. 20 - Oscilloscope display for measurement of sustaining voltages (test circuit shown in Fig. 19).



# Power Transistors

## 2N6510-2N6514



### High-Voltage, High-Current Silicon N-P-N Power-Switching Transistors

For Switching Applications in Industrial  
Commercial and Military Equipment

*Features:*

- Fast switching speed
- Epitaxial pi-nu construction
- Hermetic steel package—JEDEC TO-3
- Maximum-safe-area-of-operation curves
- Thermal-cycling rating chart

The RCA-2N6510, -2N6511, -2N6512, -2N6513, and -2N6514<sup>o</sup> are epitaxial silicon n-p-n power transistors with pi-nu construction. They are especially designed for use in electronic ignition circuits and other applications requiring high-voltage, high-energy, and fast-switching-speed capability.

These devices are hermetically sealed in a steel JEDEC TO-3 package. They differ from each other in breakdown-voltage ratings, leakage, and beta characteristics.

<sup>o</sup>Formerly RCA Dev. Nos. TA8847D, TA8847A, TA8847B, TA8847C, and TA8847E, respectively.

#### TERMINAL CONNECTIONS

- Pin 1 — Base
- Pin 2 — Emitter
- Case — Collector
- Mounting Flange — Collector

#### MAXIMUM RATINGS, *Absolute-Maximum Values:*

	2N6510	2N6511	2N6512	2N6513	2N6514
*COLLECTOR-TO-BASE VOLTAGE	250	300	350	400	350
COLLECTOR-TO-EMITTER SUSTAINING VOLTAGE:					
With external base-to-emitter resistance $R_{BE} = 50 \Omega$	250	300	350	400	350
With base open	200	250	300	350	300
*EMITTER-TO-BASE VOLTAGE	6	6	6	6	6
*CONTINUOUS COLLECTOR CURRENT	7	7	7	7	7
*CONTINUOUS BASE CURRENT	3	3	3	3	3
*EMITTER CURRENT	10	10	10	10	10
*TRANSISTOR DISSIPATION:					
At case temperatures up to 25°C	120	120	120	120	120
At case temperatures above 25°C	See Figs. 1 and 2.				
*TEMPERATURE RANGE:					
Storage and Operating (Junction)	-65 to +200				
*PIN TEMPERATURE (During Soldering):					
At distances $\geq 1/32$ in. (0.8 mm) from seating plane for 10 s max.	230				

<sup>o</sup>In accordance with JEDEC registration data format JC-25 RDF-1.

ELECTRICAL CHARACTERISTICS, Case Temperature ( $T_C$ ) = 25°C Unless Otherwise Specified

CHARACTERISTIC	SYMBOL	TEST CONDITIONS				LIMITS						UNITS		
		VOLTAGE V dc		CURRENT A dc		2N6510			2N6511					
		V <sub>CE</sub>	V <sub>BE</sub>	I <sub>C</sub>	I <sub>B</sub>	Min.	Typ.	Max.	Min.	Typ.	Max.			
Collector-Cutoff Current: With base open	I <sub>CEO</sub>	150 200				—	—	5	—	—	—	5	mA	
With base-emitter junction reverse biased	I <sub>CEV</sub>	250 300	—1.5 —1.5			—	—	5	—	—	—	5	mA	
With base-emitter junction reverse biased, T <sub>C</sub> = 100°C		250 300	—1.5 —1.5			—	—	10	—	—	—	10		
Emitter-Cutoff Current	I <sub>EBO</sub>		—6			—	—	3	—	—	—	3	mA	
Collector-to-Emitter Sustaining Voltage: With base open	V <sub>CEO(sus)</sub>			0.2		200 <sup>b</sup>	—	—	250 <sup>b</sup>	—	—	—	V	
With external base-to- emitter resistance: R <sub>BE</sub> = 50 Ω	V <sub>CER(sus)</sub>			0.2		250 <sup>b</sup>	—	—	300 <sup>b</sup>	—	—	—		
Emitter-to-Base Voltage: I <sub>E</sub> = 3 mA	V <sub>EBO</sub>					6	—	—	6	—	—	—	V	
DC Forward-Current Transfer Ratio	h <sub>FE</sub>	3 3		3 <sup>a</sup> 4 <sup>a</sup>		10 —	— —	50 —	— 10	— —	— 50	—		
Base-to-Emitter Saturation Voltage	V <sub>BE(sat)</sub>			3 <sup>a</sup> 4 <sup>a</sup>	0.6 0.8	— —	— —	1.7	—	—	—	—	1.7	V
Collector-to-Emitter Saturation Voltage	V <sub>CE(sat)</sub>			3 <sup>a</sup> 4 <sup>a</sup> 7 <sup>a</sup>	0.6 0.8 3	— — —	— — 1.5	1.5 2.5	—	—	—	1.5 2.5	V	
Output Capacitance: V <sub>CB</sub> = 10 V, f = 1 MHz	C <sub>obo</sub>					100	—	200	100	—	—	200	pF	
Magnitude of Common Emitter, Small-Signal Short-Circuit, Forward- Current Transfer Ratio: f = 1 MHz	h <sub>fe</sub>	10		1		3	—	9	3	—	—	9	MHz	
Forward-Bias, Second- Breakdown Collector Current: t = 1 s, nonrepetitive	I <sub>S/b</sub>	38 200				3.16 0.1	— —	— —	3.16 0.1	— —	— —	— —	A	
Switching Time: <sup>c</sup> (V <sub>CC</sub> = 200 V, I <sub>B1</sub> = I <sub>B2</sub> ):														
Delay Time	t <sub>d</sub>			3 4	0.6 0.8	— —	0.1 —	0.2 —	— —	— 0.1	— —	— 0.2	μs	
Rise Time	t <sub>r</sub>			3 4	0.6 0.8	— —	0.7 —	1.5 —	— —	— 0.7	— —	— 1.5		
Storage Time	t <sub>s</sub>			3 4	0.6 0.8	— —	3 —	5 —	— —	— 3	— —	— 5		
Fall Time	t <sub>f</sub>			3 4	0.6 0.8	— —	0.5 —	1.5 —	— —	— 0.5	— —	— 1.5		
Thermal Resistance: Junction-to-Case	R <sub>θJC</sub>	20		5		—	—	1.46	—	—	—	1.46	°C/W	

<sup>a</sup> Minimum and maximum values and test conditions in accordance with JEDEC registration data format JC-25 RDF-1.

<sup>b</sup> Pulsed; pulse duration = 300 μs, duty factor ≤ 2%.

<sup>b</sup> CAUTION: The sustaining voltages V<sub>CEO(sus)</sub> and V<sub>CER(sus)</sub> MUST NOT be measured on a curve tracer. These sustaining voltages should be measured by means of the test circuit shown in Fig. 11.

<sup>c</sup> See Figs. 8-10.

ELECTRICAL CHARACTERISTICS, Case Temperature ( $T_C$ ) = 25°C Unless Otherwise Specified

CHARACTERISTIC	SYMBOL	TEST CONDITIONS				LIMITS						UNITS
		VOLTAGE V dc		CURRENT A dc		2N6512 2N6514			2N6513			
		V <sub>CE</sub>	V <sub>BE</sub>	I <sub>C</sub>	I <sub>B</sub>	Min.	Typ.	Max.	Min.	Typ.	Max.	
Collector-Cutoff Current: With base open	I <sub>CEO</sub>	250 300				—	—	5	—	—	5	mA
With base-emitter junction reverse biased	I <sub>CEV</sub>	350 400	-1.5 -1.5			—	—	5	—	—	5	mA
With base-emitter junction reverse biased, T <sub>C</sub> = 100°C		350 400	-1.5 -1.5			—	—	10	—	—	10	
Emitter-Cutoff Current	I <sub>EBO</sub>		-6			—	—	3	—	—	3	mA
Collector-to-Emitter Sustaining Voltage: With base open	V <sub>CEO(sus)</sub>			0.2		300 <sup>b</sup>	—	—	350 <sup>b</sup>	—	—	V
With external base-to- emitter resistance: R <sub>BE</sub> = 50 Ω	V <sub>CER(sus)</sub>			0.2		350 <sup>b</sup>	—	—	400 <sup>b</sup>	—	—	
Emitter-to-Base Voltage: I <sub>E</sub> = 3 mA	V <sub>EBO</sub>					6	—	—	6	—	—	V
DC Forward-Current Transfer Ratio: 2N6512, 2N6513 2N6514	h <sub>FE</sub>	3 3		4 <sup>a</sup> 5 <sup>a</sup>		10 10	— —	50 50	10 —	— —	50 —	
Base-to-Emitter Saturation Voltage: 2N6512, 2N6513 2N6514	V <sub>BE(sat)</sub>			4 <sup>a</sup> 5 <sup>a</sup>	0.8 1	— —	— —	1.7 1.7	— —	— —	1.7 —	V
Collector-to-Emitter Saturation Voltage: 2N6512, 2N6513 2N6514 All types	V <sub>CE(sat)</sub>			4 <sup>a</sup> 5 7	0.8 1 3	— — —	— — 1.5	1.5 1.5 2.5	— — —	— — 1.5	1.5 — 2.5	V
Output Capacitance: V <sub>CB</sub> = 10 V, f = 1 MHz	C <sub>obo</sub>					100	—	200	100	—	200	pF
Magnitude of Common Emitter, Small-Signal Short-Circuit, Forward- Current Transfer Ratio: f = 1 MHz	h <sub>fe</sub>	10		1		3	—	9	3	—	9	MHz
Forward-Bias, Second- Breakdown Collector Current: t = 1 s, nonrepetitive	I <sub>S/b</sub>	38 200				3.16 0.1	— —	— —	3.16 0.1	— —	— —	A

\* Minimum and maximum values and test conditions in accordance with JEDEC registration data format JC-25 RDF-1.

<sup>a</sup> Pulsed; pulse duration = 300 μs, duty factor ≤ 2%.

<sup>b</sup> CAUTION: The sustaining voltages V<sub>CEO(sus)</sub> and V<sub>CER(sus)</sub> MUST NOT be measured on a curve tracer. These sustaining voltages should be measured by means of the test circuit shown in Fig. 11.

ELECTRICAL CHARACTERISTICS, Case Temperature ( $T_C$ ) = 25°C Unless Otherwise Specified (Cont'd)

CHARACTERISTIC	SYMBOL	TEST CONDITIONS				LIMITS						UNITS
		VOLTAGE V dc		CURRENT A dc		2N6512 2N6514			2N6513			
		$V_{CE}$	$V_{BE}$	$I_C$	$I_B$	Min.	Typ.	Max.	Min.	Typ.	Max.	
Switching Time: <sup>c</sup> ( $V_{CC} = 200$ V, $I_{B1} = I_{B2}$ ): Delay Time: 2N6512, 2N6513 2N6514	$t_d$			4	0.8	—	0.1	0.2	—	0.1	0.2	$\mu$ s
Rise Time: 2N6512, 2N6513 2N6514		$t_r$			4	0.8	—	0.7	1.5	—	0.7	
Storage Time: 2N6512, 2N6513 2N6514	$t_s$				4	0.8	—	3	5	—	3	
Fall Time: 2N6512, 2N6513 2N6514		$t_f$			4	0.8	—	0.5	1.5	—	0.5	
Thermal Resistance: Junction-to-Case	$R_{\theta JC}$		20		5		—	—	1.46	—	—	1.46

\* Minimum and maximum values and test conditions in accordance with JEDEC registration data format JC-25 RDF-1.

c See Figs. 8-10.

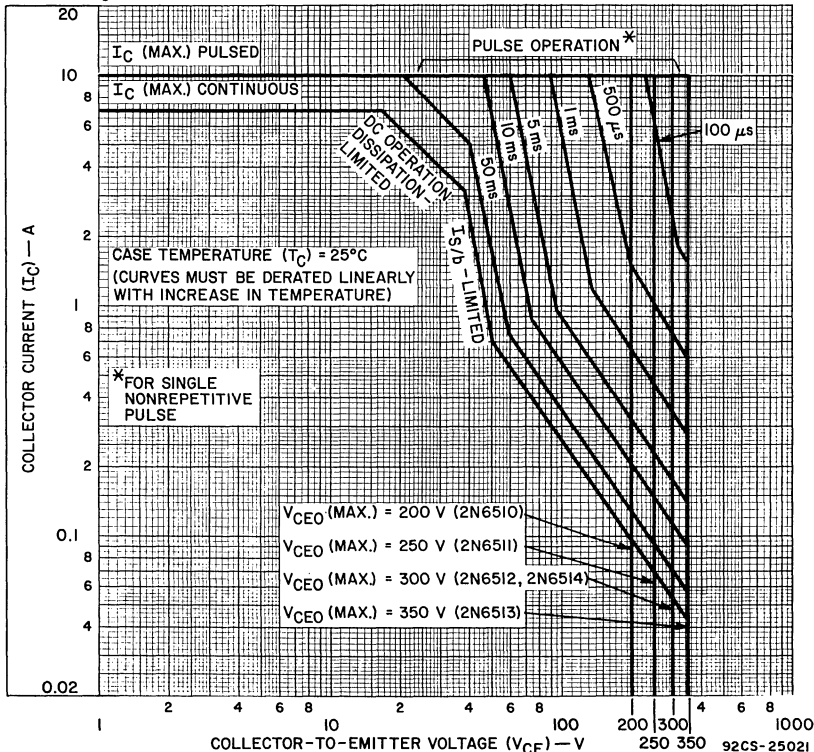


Fig. 1—Maximum operating areas for all types.

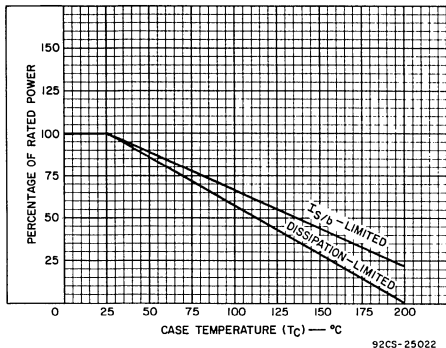


Fig. 2—Derating curve for all types.

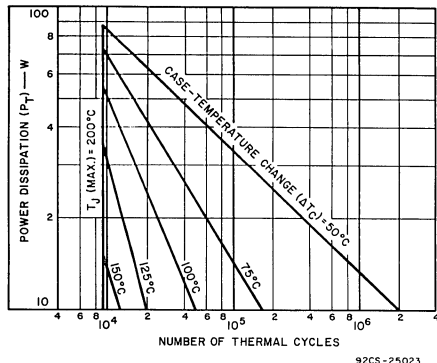


Fig. 3—Thermal-cycling rating chart for all types.

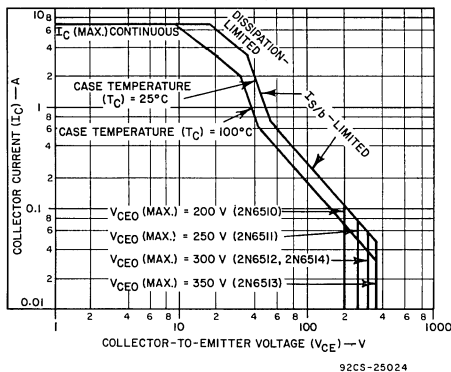


Fig. 4—Maximum operating areas for all types at 25°C and 100°C.

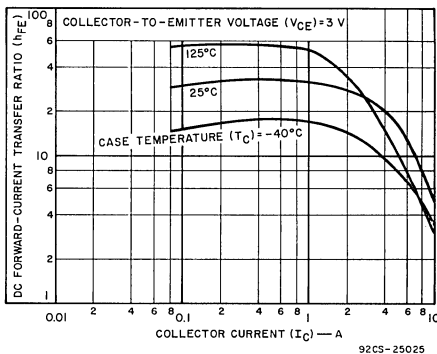


Fig. 5—Typical dc beta characteristic for all types.

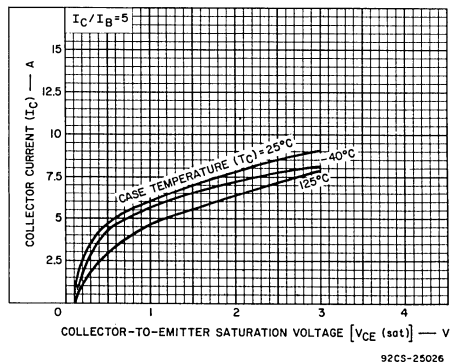


Fig. 6—Typical collector-to-emitter saturation-voltage characteristics for all types.

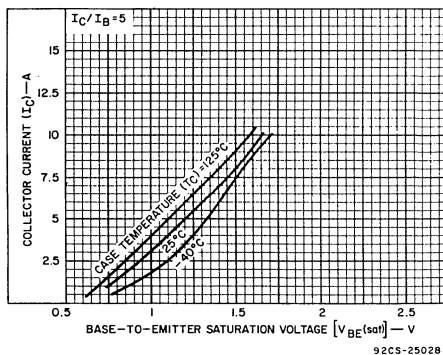


Fig. 7—Typical base-to-emitter saturation-voltage characteristics for all types.

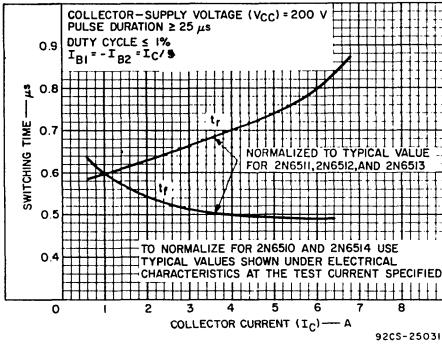


Fig. 8—Typical rise- and fall-time characteristics for all types.

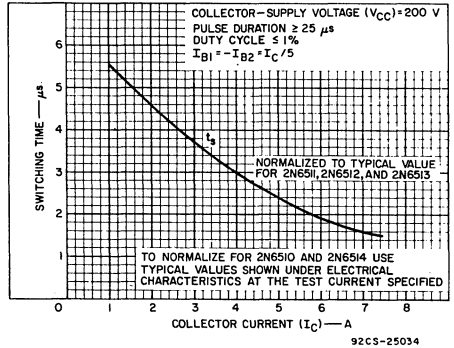


Fig. 9—Typical storage-time characteristic for all types.

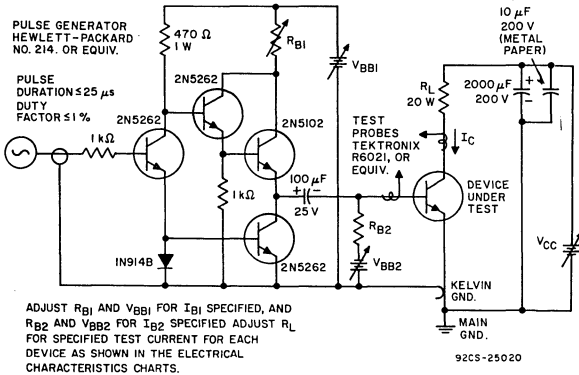


Fig. 10—Circuit used to measure switching times for all types.

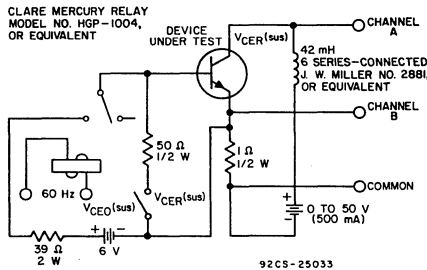
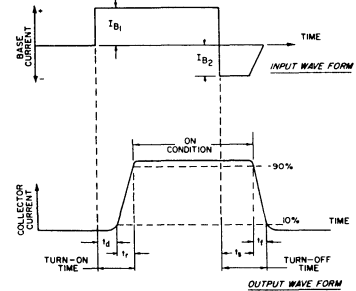


Fig. 11—Circuit used to measure sustaining voltages  $V_{CE0}(sus)$  and  $V_{CER}(sus)$  for all types.

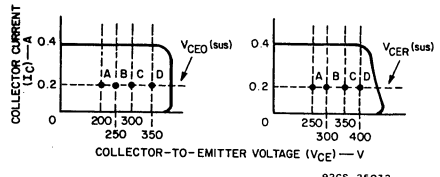


Fig. 12—Oscilloscope display for measurement of sustaining voltages. (Test circuit shown in Fig. 11.)





# Power Transistors

## 40250, 40250V1\*, 40251

RCA-40250, 40250V1, and 40251 are "HOMETAXIAL"-BASE diffused-junction, silicon n-p-n transistors intended for a wide variety of intermediate- and high-power applications. These transistors are especially suitable for use in audio and inverter circuits in 12-volt mobile radio and portable communications equipment.

Type 40250V1, with an attached heat radiator, is intended for those applications which require a rugged transistor for mounting on a printed-circuit board. Tabs are provided on the underside of the radiator for mounting purposes and for making electrical connection to the collector (which is connected internally to the mounting flange of the TO-66 Package).

- Designed to assure freedom from second breakdown in class-A operation at maximum ratings

**40250**

- JEDEC TO-66 package for mounting convenience and positive heat-sink contact

•  $V_{CEV} = 50 \text{ V min.}$

•  $f_T = 1.0 \text{ Mc/s typ.}$

•  $R(\text{sat}) = 1 \Omega \text{ max.}$

**40250V1**

- Heat-radiator package with mounting tabs for printed-circuit-board application

- 5.8-W dissipation capability (at 25°C free-air temperature)

•  $V_{CEV} = 50 \text{ V min.}$

•  $f_T = 1.0 \text{ Mc/s typ.}$

•  $R(\text{sat}) = 1 \Omega \text{ max.}$

**40251**

- High-dissipation capability — 117 W max.

•  $V_{CEV} = 50 \text{ V min.}$

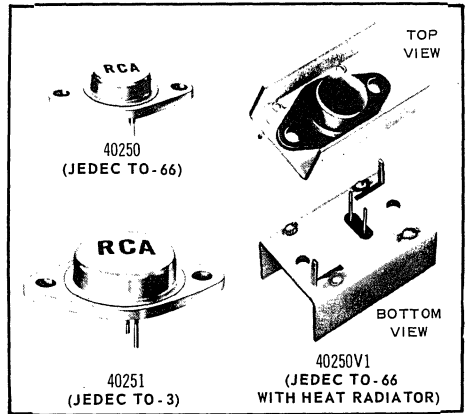
•  $R(\text{sat}) = 0.1875 \Omega \text{ max.}$

•  $f_T = 0.5 \text{ Mc/s typ.}$

# SILICON N-P-N POWER TRANSISTORS

## General-Purpose Types for Industrial and Commercial Applications

\* The "V1" suffix in the type number "40250V1" designates the first variant of the basic type 40250. The V1-version is a type 40250 transistor with an attached heat radiator for free-air operation.



**MAXIMUM RATINGS**

*Absolute-Maximum Values:*

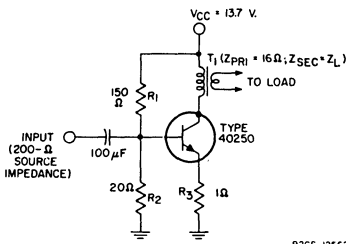
	40250	40250V1	40251	
COLLECTOR-TO-BASE VOLTAGE, $V_{CB0}$ . . . . .	50	50	50	V
COLLECTOR-TO-EMITTER VOLTAGE: With 1.5 volts of reverse bias, $V_{CEV}$ . . . . .	50	50	50	V
With base open, $V_{CEO}$ . . . . .	40	40	40	V
EMITTER-TO-BASE VOLTAGE, $V_{EB0}$ . . . . .	5	5	5	V
COLLECTOR CURRENT, $I_C$ . . . . .	4	4	15	A
BASE CURRENT, $I_B$ . . . . .	2	2	7	A
TRANSISTOR DISSIPATION, $P_T$ : At case temperatures up to 25°C . . . . .	29	-	117	W
At free-air temperatures up to 25°C . . . . .	-	5.8	-	W
At temperatures above 25°C . . . . .	See Fig.3	See Fig.4	See Fig.5	
TEMPERATURE RANGE: Storage & Operating (Junction). . . . .	← -65 to 200 →			°C
PIN TEMPERATURE (During soldering): At distances $\geq 1/32$ in. from seating plane for 10 s max . . . . .	← 235 →			°C

**ELECTRICAL CHARACTERISTICS**

Case Temperature ( $T_C$ ) of 25°C Unless Otherwise Specified

Characteristic	Symbol	TEST CONDITIONS						LIMITS				Units		
		DC Collector Volts		DC Emitter or Base Volts		DC Current (Amperes)		Types 40250 40250V1		Type 40251				
		V <sub>CB</sub>	V <sub>CE</sub>	V <sub>EB</sub>	V <sub>BE</sub>	I <sub>C</sub>	I <sub>E</sub>	I <sub>B</sub>	Min.	Max.	Min.		Max.	
Collector-Cutoff Current	I <sub>CB0</sub>	30					0		-	1	-	-	mA	
	I <sub>CEV</sub>		40		-1.5				-	-	-	2	mA	
	At $T_C = 150^\circ C$	I <sub>CB0</sub>	30					0		-	5	-	-	mA
		I <sub>CEV</sub>		40		-1.5				-	-	-	10	mA
Emitter-Cutoff Current	I <sub>EBO</sub>			5		0			-	5	-	10	mA	
DC Forward-Current Transfer Ratio	h <sub>FE</sub>		4 4			1.5 8			25 -	100 -	- 15	- 60		
Collector-to-Base Breakdown Voltage	BV <sub>CB0</sub>					0.05 0.1			50 -	- -	50 -	- -	V	
Collector-to-Emitter Breakdown Voltage	BV <sub>CEV</sub>				-1.5 -1.5	0.05 0.1			50 -	- -	50 -	- -	V	
Collector-to-Emitter Sustaining Voltage	V <sub>CEO(sus)</sub>					0.1 0.2			40 -	- -	40 -	- -	V	
Emitter-to-Base Breakdown Voltage	BV <sub>EBO</sub>					0 0	0.005 0.01		5 -	- -	5 -	- -	V	
Base-to-Emitter Voltage	V <sub>BE</sub>		4 4			1.5 8			- -	2.2 -	- -	- 2.2	V	
Collector-to-Emitter Saturation Voltage	V <sub>CE(sat)</sub>					1.5 8		0.15 0.8	- -	1.5 -	- -	- 1.5	V	
Power Rating Test	PRT		39			3			- -	- -	- -	1	s	
Thermal Resistance: Junction-to-Case	$\theta_{J-C}$								6.0 (max.) 40250	-	1.5		°C/W	
Junction-to-Free-Air	$\theta_{J-FA}$								30 (max.) 40250V1	-	-		°C/W	

**TYPICAL AUDIO-AMPLIFIER CIRCUIT FOR TYPE 40250**

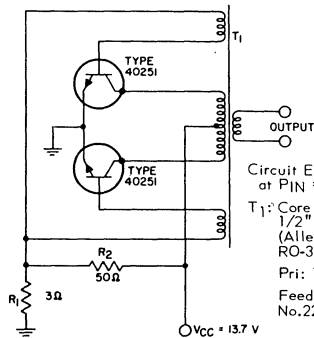


92CS-12562

Distortion = 6.5% at P<sub>OUT</sub> = 4 W  
= 2% at P<sub>OUT</sub> = 400 mW, f = 1 kc/s

Fig.1

**TYPICAL INVERTER CIRCUIT EMPLOYING A PAIR OF TYPE 40251's**



92CS-12563

Circuit Efficiency = 82%  
at P<sub>IN</sub> = 110 W, f = 3.5 kc/s  
T<sub>1</sub>: Core - toroid, 3" o.d.,  
1/2" x 1" cross-section  
(Allen-Bradley T3000H 106B),  
RO-3 material or equivalent.  
Pri: 16 turns, No.20 wire, c.t.  
Feedback Winding: 8 turns,  
No.22 wire, c.t.

Fig.2

DISSIPATION DERATING CURVE  
FOR TYPE 40250

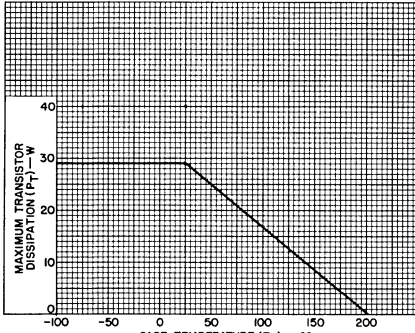


Fig. 3 92CS-13005RI

TYPICAL OPERATION CHARACTERISTICS  
FOR TYPES 40250 & 40250V1

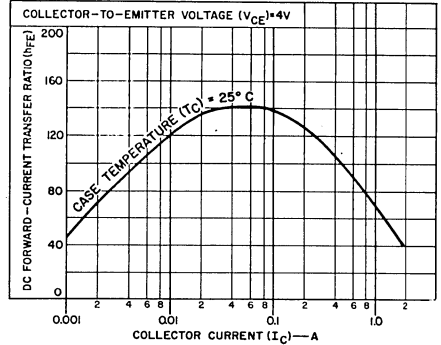


Fig. 6 92CS-12564RI

DISSIPATION DERATING CURVE  
FOR TYPE 40250V1

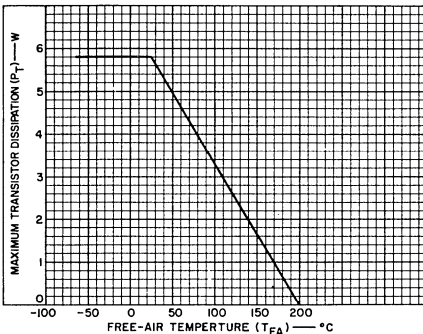


Fig. 4 92CS-13373

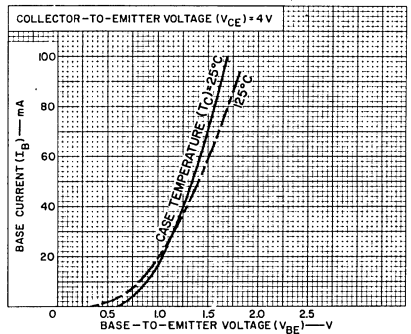


Fig. 7 92CS-12305RI

DISSIPATION DERATING CURVE  
FOR TYPE 40251

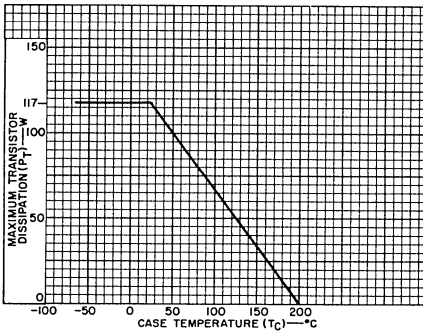


Fig. 5 92CS-1303RI

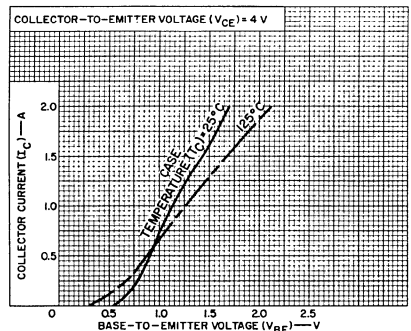


Fig. 8 92CS-12325RI

TYPICAL OPERATION CHARACTERISTICS  
FOR TYPE 40251

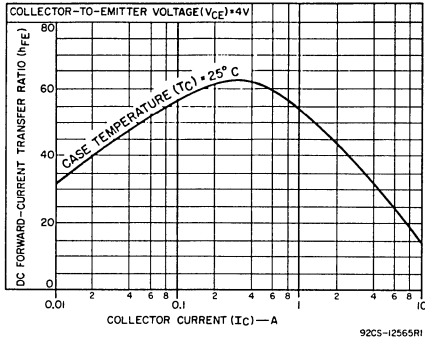


Fig.9

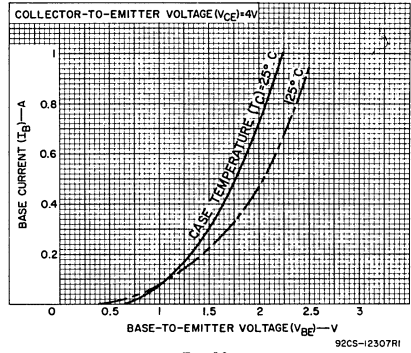


Fig.10

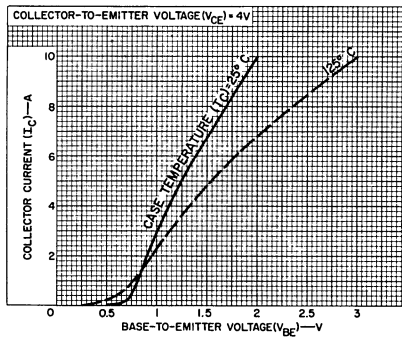


Fig.11

TERMINAL CONNECTIONS  
FOR TYPES 40250, 40250V1, & 40251

Pin 1 - Base

Pin 2 - Emitter

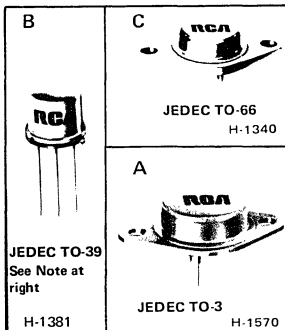
Flange, Case - Collector (For 40250 & 40251)

Heat Radiator - Collector (For 40250V1)

**RCA**  
Solid State  
Division

## Power Transistors

**40309—40328**  
**40360—40364**



## N-P-N and P-N-P Silicon Power Transistors

For Audio-Frequency Amplifier Applications

### Features:

- Hermetically-sealed packages
- Operation at case temperatures up to 257°F
- Pellet bonded to header — for greater power-handling capability for greater shock resistance
- Freedom from second breakdown

These devices are available with either 1½-inch leads (TO-5 package) or ½-inch leads (TO-39 package). The longer-lead versions are specified by suffix "L" after the type number; the shorter-lead versions are specified by suffix "S" after the type number.

RCA transistors 40309—40328 and 40360—40364 are diffused-junction silicon n-p-n and p-n-p transistors intended for specific applications in audio amplifiers, giving high-quality performance economically. These types cover applications from low-level input stages to high-power output

stages of 5 to 50 watts. Supply voltages range from the nominal 12-volt vehicular type to 117-volt ac-dc type.

The use of all-silicon devices permits more flexibility in the mechanical and electrical design of amplifiers since the output heat sinks can be held to a minimum.

### MAXIMUM RATINGS (Absolute-Maximum Values)

CHARACTERISTIC	40309	40323	40311	40315	40314	40317	40319	40320	40326	40321	40327	40360	40361	40362	UNITS
$V_{CE0(sus)}$	18	18	30	35	40	40	-40	40	40	—	—	70	—	—	V
$V_{CER(sus)}^*$	—	—	—	—	—	—	—	—	—	300	300	—	70	-70	V
$V_{CEV}^{**}$	—	—	—	—	—	—	—	—	—	—	—	—	—	—	V
$V_{EBO}$	2.5	2.5	2.5	2.5	2.5	2.5	-2.5	2.5	2.5	5	5	4	4	-4	V
$V_{CBO}$	—	—	—	—	—	—	—	—	—	—	—	—	—	—	V
$I_C$	0.7	0.7	0.7	0.7	0.7	0.7	-0.7	0.7	0.7	1	1	0.7	0.7	-0.7	A
$I_B$	0.2	0.2	0.2	0.2	0.2	0.2	-0.2	0.2	0.2	0.5	0.5	0.2	0.2	-0.2	A
$P_T^{***}$															
$T_C$ up to 25°C	5	5	5	5	5	5	5	5	5	5	5	5	5	5	W
$T_{FA}$ up to 25°C	1	1	1	1	1	1	1	1	1	1	1	1	1	1	W
$T_C$ of 175°C	—	—	—	—	—	—	—	—	—	—	—	—	—	—	W
TEMP. RANGE: Oper. Junction	← -65 to 200°C →														°C

\*  $R_{BE} = 500 \Omega$

$R_{BE} = 1,000 \Omega$  for 40327

$R_{BE} = 200 \Omega$  for 40361,  
40362, & 40363

$R_{BE} = 150 \Omega$  for 40364

\*\*  $V_{BE} = -1.5V$

\*\*\* At other temperatures see derating curves

## MAXIMUM RATINGS (Absolute-Maximum Values) (Cont'd.)

CHARACTERISTIC	40325	40363	40310	40324	40316	40312	40313	40318	40322	40328	40364	UNITS
$V_{CE0}(sus)$	35	-	35	35	-	-	-	-	-	-	-	V
$V_{CER}(sus)^*$	-	70	-	-	40	60	300	300	300	300	60	V
$V_{CEV}^{**}$	35	-	-	-	-	-	-	-	-	-	-	V
$V_{EBO}$	5	4	2.5	2.5	5	2.5	2.5	6	6	6	4	V
$V_{CBO}$	35	-	-	-	-	-	-	-	-	-	-	V
$I_C$	15	15	4	4	4	4	2	2	2	2	7	A
$I_B$	7	7	2	2	2	2	1	1	1	1	5	A
$P_T^{***}$												
$T_C$ up to 25°C	117	115	29	29	29	29	35	35	35	35	35	W
$T_{FA}$ up to 25°C	-	-	-	-	-	-	-	-	-	-	-	W
$T_C$ of 175°C	-	-	-	-	-	-	-	5	5	5	-	W
TEMP. RANGE: Oper. Junction	-65 to 200°C											°C

\* $R_{BE} = 500 \Omega$ \*\* $V_{BE} = -1.5V$ 

\*\*\* At other temperatures see derating curves

 $R_{BE} = 1,000 \Omega$  for 40327 $R_{BE} = 200 \Omega$  for 40361,

40362, &amp; 40363

 $R_{BE} = 150 \Omega$  for 40364

## ELECTRICAL CHARACTERISTICS for Types in TO-3 Package

CHARACTERISTIC	TEST CONDITIONS					LIMITS		UNITS
	$V_{CB}$	$V_{CE}$	$V_{EB}$	$I_C$	$T_C$	40525	40363	
	Volts					mA	°C	
$I_{CBO}(\text{Max.})$	30				25	5		mA
	30				150	10		
$I_{CER}^{\Delta}(\text{Max.})$		60			25		1	mA
		60			150		10	
$I_{EBO}(\text{Max.})$			5			10		mA
			4				5	
$BV_{CEO}(sus)(\text{Min.})$				200		35		V
$V_{CER}(sus)^{\Delta}(\text{Min.})$				200			70	V
$BV_{CBO}(\text{Min.})$				100		35		V
$V_{BE}(\text{Max.})$		4		8A		2		V
		4		4A			1.8	
$V_{CE}(\text{sat})(\text{Max.})$				8A*		1.5		V
				4A**			1.1	
$h_{FE}$		4		8A		12-60		
		4		4A			20-70	
$\theta_{J-C}(\text{Max.})$						1.5	1.5	°C/W
$f_T(\text{Typ.})$		4		3A			700	kHz

\* $I_B = 800 \text{ mA}$ \*\* $I_B = 400 \text{ mA}$  $\Delta R_{BE} = 200 \Omega$

## ELECTRICAL CHARACTERISTICS for Types in TO-5 or TO-39 Package

CHARACTERISTIC	TEST CONDITIONS					LIMITS							UNITS
	V <sub>CB</sub>	V <sub>CE</sub>	V <sub>EB</sub>	I <sub>C</sub>	T <sub>C</sub>	40309	40311	40314	40315	40317	40319	40320	
	Volts			mA	°C								
I <sub>CBO</sub> (Max.)	15				25	0.25	0.25	0.25	0.25	0.25		0.25	μA
	-15				25						-0.25		
	15				150	1	1	1	1	1		1	mA
	-15				150						-1		
I <sub>EBO</sub> (Max.)			2.5			1	1	1	1	1		1	mA
			-2.5								-1		
V <sub>CEO</sub> (sus)(Min.)				100*		18 <sup>o</sup>	30	40	35 <sup>o</sup>	40		40	V
				-100*							-40 <sup>o</sup>		
V <sub>BE</sub> (Max.)		4		50		1	1	1	1				V
		4		10					1		1		
		-4		-50							-1.0		
V <sub>CE</sub> (sat)(Max.)				150 <sup>o</sup>				1.4			-1.4		V
h <sub>FE</sub>		4		50		70-350	70-350	70-350	70-350				
		-4		-50							35-200		
		4		10						40-200		40-200	
θ <sub>J-C</sub> (Max.)						35	35	35	35	35	35	35	°C/W
θ <sub>J-FA</sub> (Max.)						175	175	175	175	175	175		°C/W
f <sub>T</sub> (Typ.)		10		50		100	100		100				mHz
		-4		-50							100		
		4		50				100					

\*Pulsed; pulse duration = 300 μsec, duty factor &lt; 2%.

<sup>o</sup> I<sub>B</sub> = 15 mA<sup>□</sup> R<sub>BE</sub> = 1,000 ohms<sup>o</sup> V<sub>CEO</sub> value.R<sub>BE</sub> = 200 Ω for 40361 & 40362

† Negative value for 40362

## TERMINAL CONNECTIONS

Pin 1 - Base  
 Pin 2 - Emitter  
 Case - Collector  
 Mounting Flange - Collector

## TERMINAL CONNECTIONS

Lead 1 - Emitter  
 Lead 2 - Base  
 Lead 3 - Collector, case

## TERMINAL CONNECTIONS

Pin 1 - Base  
 Pin 2 - Emitter  
 Mounting Flange, Case-Collector

## ELECTRICAL CHARACTERISTICS for Types in TO-5 or TO-39 Package (Cont'd.)

CHARACTERISTIC	TEST CONDITIONS					LIMITS							UNITS
	V <sub>CB</sub>	V <sub>CE</sub>	V <sub>EB</sub>	I <sub>C</sub>	T <sub>C</sub>	40321	40323	40326	40327	40360	40361	40362	
	Volts			mA	°C								
I <sub>CEO</sub> (Max.)		60			25					1			μA
		60			150					250			
I <sub>CBO</sub> (Max.)	15				25		0.25	0.25					μA
	15				150		1	1					mA
	150				150	100			100				μA
I <sub>CER</sub> <sup>■</sup> (Max.)		150				5			5				μA
		60 <sup>†</sup>			25					1	-1		
		60 <sup>†</sup>			150					100	-100		
I <sub>EBO</sub> (Max.)			2.5				1	1					mA
			5			100			100				μA
			4 <sup>†</sup>							1	1	-1	mA
V <sub>CEO(sus)</sub> (Min.)				100*		18 <sup>●</sup>	40			70			V
V <sub>BE</sub> (Max.)		4		50			1				1		V
		4		10			1		1				
		10		50		2		2					
V <sub>CE(sat)</sub> (Max.)				150 <sup>◆</sup>						1.4	1.4	-1.4	V
V <sub>CER(sus)</sub> <sup>■</sup>				50		300			300				V
				100							70	70	
h <sub>FE</sub>		4		50			70-350				70-350		
		-4		-50								35-200	
		4		10				40-200		40-200			
		10		20		25-200			40-250				
θ <sub>J-C</sub> (Max.)						30	35	30	30	35	35	35	°C/W
θ <sub>J-FA</sub> (Max.)							175			175	175	175	°C/W
f <sub>T</sub> (Typ.)		10		50			100						mHz
		-4		-50								100	
		4		50						100	100		

\* Pulsed; pulse duration = 300 μsec, duty factor &lt; 2%.

◆ I<sub>B</sub> = 15 mA■ R<sub>BE</sub> = 1,000 ohms● BV<sub>CEO</sub> value.R<sub>BE</sub> = 200 Ω for 40361 & 40362

† Negative value for 40362



**ELECTRICAL CHARACTERISTICS** for Types in TO-66 Package At  $T_C = 25^{\circ}C$  Unless Otherwise Specified.

CHARACTERISTIC	CONDITIONS					LIMITS								UNITS	
	$V_{CB}$	$V_{CE}$	$V_{EB}$	$I_C$	$T_C$	40310	40312	40313	40316	40318	40322	40324	40328		40364
	Volts			A	$^{\circ}C$										
$I_{CEO}(\text{Max.})$		150						5		5			5		mA
$I_{CEV}(\text{Max.})$		150	$1.5^{\text{D}}$		25					5			10		mA
		300	$1.5^{\text{D}}$					10							
		150	$1.5^{\text{D}}$		150					10			10		
		300	$1.5^{\text{D}}$					10		5			10		
$I_{CER}^{\Delta}(\text{Max.})$		50			25									0.5	mA
		50			150									2	
$I_{CBO}(\text{Max.})$	15				25	10	10		10			10			$\mu A$
	15				150	5	5		5			5			
$I_{EBO}(\text{Max.})$			2.5			5	5	5				5			mA
			5					5							
			6						5	5			5		
			4											5	
$V_{CEO}(\text{sus})(\text{Min.})$				$0.1^*$	$35^{\bullet}$							$35^{\bullet}$			V
$V_{BE}(\text{Max.})$		2		1		1.4	1.4		1.4			1.4			V
		10		0.1				1.5							
		10		0.5					1.5						
		10		1									1.5		
		5		2.5										1.8	
$V_{CE}(\text{sat})(\text{Max.})$				2.5										$2^{\text{D}}$	V
$V_{CER}(\text{sus})(\text{Min.})$				$0.1^*$		60		40							V
				0.2			$300^{\Delta}$		$300^{\Delta}$	$300^{\Delta}$		$300^{\Delta}$	$70^{\text{b}}$		
$h_{FE}(\text{Min. or range})$		2		1		20-120	20-120		20-120			10-120			
		5		0.5										35-175	
		5		2.5										20	
		10		0.1				40-250							
		10		0.5				40		50	75				
		10		0.02						40	40		40		
		10		1									20		

**JEDEC TO-3 PACKAGE**

40325  
40363

**JEDEC TO-5 OR TO-39 PACKAGE**

40309 40319 40327  
40311 40320 40360  
40314 40321 40361  
40315 40323 40362  
40317 40326

**JEDEC TO-66 PACKAGE**

40310 40322  
40312 40324  
40313 40328  
40316 40364  
40318

ELECTRICAL CHARACTERISTICS for Types in TO-66 Package At  $T_C = 25^\circ\text{C}$  Unless Otherwise Specified (Cont'd.)

CHARACTERISTIC	CONDITIONS					LIMITS										UNITS
	$V_{CB}$	$V_{CE}$	$V_{EB}$	$I_C$	$T_C$	40310	40312	40313	40316	40318	40322	40324	40328	40364		
	Volts			A	$^\circ\text{C}$											
$f_T$ (Typ.)		4		0.5		750	750		750			750				kHz
		10		2.5										15		mHz
$I_{S/b}$ # (Min.)		150						150		100	100		100			mA
		40												750		mA
$E_{S/b}$ # (Min.)			4							50	50					$\mu\text{J}$
$\theta_{J-C}$ (Max.)						6	6	5	6	5	5	6	5	5		$^\circ\text{C/W}$

\* Pulsed; Pulse duration = 300  $\mu\text{sec}$ , duty factor  $\leq 2\%$ .

<sup>†</sup>  $R_{BE}$  value

<sup>‡</sup>  $R_{BE} = 200 \Omega$ ,  $L = 5 \text{ mH}$

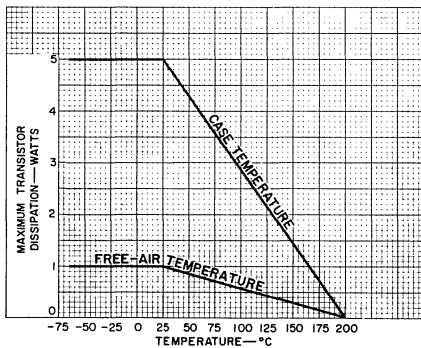
#  $I_{S/b}$  is defined as the current at which second breakdown occurs at a specified collector voltage with the emitter-base junction forward biased

#  $E_{S/b}$  is defined as the energy at which second breakdown occurs under specified reverse bias conditions.  $E_{S/b} = \frac{1}{2} I_C^2 L$ , where L is a series load or leakage inductance and I is the peak collector current.  $R_{BE} = 20 \text{ ohms}$  &  $L = 100 \mu\text{H}$ .

<sup>†</sup>  $R_{BE} = 150 \Omega$

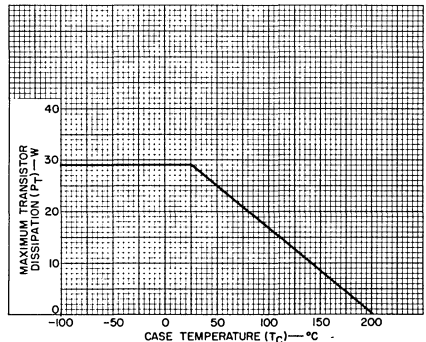
<sup>‡</sup>  $I_B = 0.25 \text{ A}$

\*  $BV_{CEO}$  value.



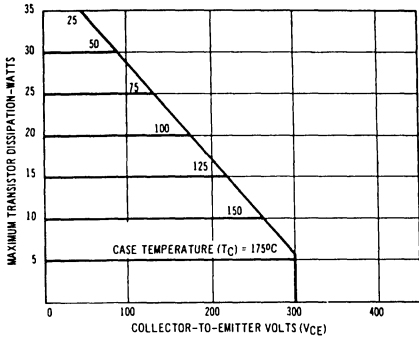
92CS-11172R1

Fig. 1 - Dissipation rating curves for types 40309, 40311, 40314, 40315, 40317, 40319, 40320, 40323, 40326, 40360, 40361, and 40362.



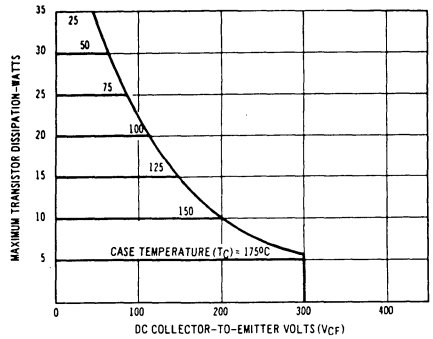
92CS-13005R1

Fig. 2 - Dissipation derating curve for types 40310, 40312, 40316, and 40324.



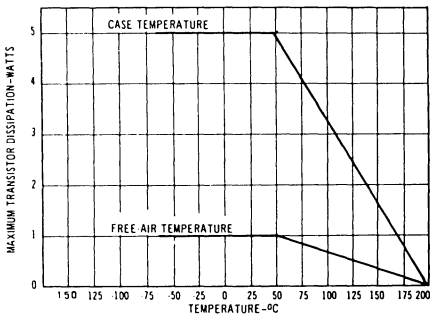
92CS-22431

Fig. 3 - Dissipation derating curve for type 40313.



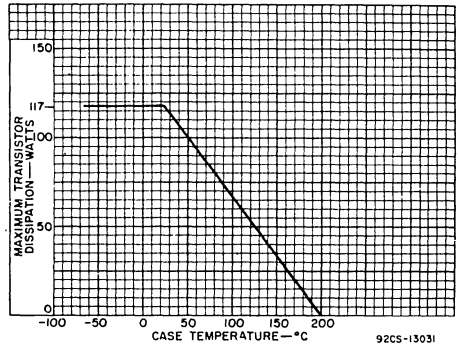
92CS-22432

Fig. 4 - Dissipation derating curve for types 40318, 40322, and 40328.



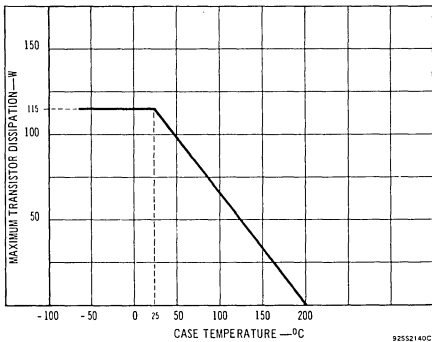
92CS-22433

Fig. 5 - Dissipation derating curves for types 40321 and 40327.



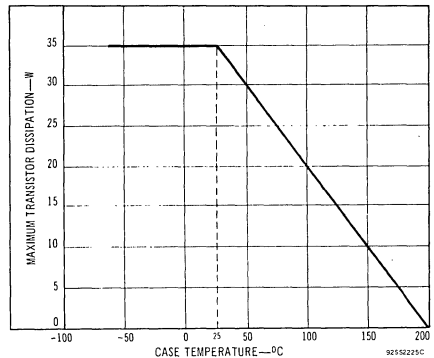
92CS-13031

Fig. 6 - Dissipation derating curve for type 40325.



92S52140C

Fig. 7 - Dissipation derating curve for type 40363.



92S52225C

Fig. 8 - Dissipation derating curve for type 40364.



# Power Transistors

**40346 40346V1 40346V2  
40412 40412V1 40412V2**

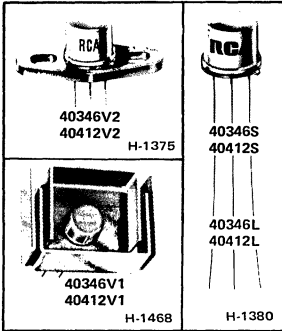
## Medium-Power Silicon N-P-N Planar Transistors

For High-Voltage Switching and  
Linear-Amplifier Applications

**Features:**

- For operation at junction temperature up to 200°C
- Planar construction for low noise and low leakage

These devices are available with either 1/8-inch leads (TO-5 package) or 1/4-inch leads (TO-39 package). The longer-lead versions are specified by suffix "L" after the type number; the shorter-lead versions are specified by suffix "S" after the type number.



RCA-40346, -40346V1, -40346V2, -40412, -40412V1, and -40412V2 are silicon n-p-n transistors having high breakdown voltages, high frequency-response capability, and fast switching speeds.

These transistors are intended for a wide variety of low- and medium-power, high-voltage applications. Types 40346, 40346V1, and 40346V2 are especially useful in such devices as neon indicator and NIXIE\* driver circuits and in differential and operational amplifiers. Types 40412, 40412V1, and 40412V2 are especially suited for class-A ac/dc audio-amplifier service.

Types 40346 and 40412 are supplied in a JEDEC TO-39 (S) or TO-5 (L) package; types 40346V1 and 40412V1, with a factory-attached heat radiator for greater free-air dissipation, capability; and types 40346V2 and 40412V2 are supplied with an attached flange for increased power dissipation and mounting convenience.

\* Nixie is a Registered Trademark of Burroughs Corporation, Electronic Components Division, Plainfield, N. J.

**MAXIMUM RATINGS, Absolute-Maximum Values:**

	40346	40346V1	40346V2	40412	40412V1	40412V2
<b>COLLECTOR-TO-EMITTER VOLTAGE:</b>	<b>V<sub>CE</sub>(sus)</b>					
With R <sub>BE</sub> = 1,000 Ω . . . . .	175	175	175	—	—	— V
With R <sub>BE</sub> = 10,000 Ω . . . . .	—	—	—	250	250	250 V
<b>COLLECTOR CURRENT . . . . .</b>	<b>I<sub>C</sub></b>					
BASE CURRENT . . . . .	<b>I<sub>B</sub></b>					
<b>TRANSISTOR DISSIPATION:</b>	<b>P<sub>T</sub></b>					
At case temperatures up to 25°C . . . . .	10	—	10	10	—	10 W
At free-air temperatures up to 50°C . . . . .	1	—	—	1	—	— W
At free-air temperatures up to 25°C . . . . .	—	4	—	—	4	— W
At other temperatures . . . . .	← See Fig. 1 →					
<b>TEMPERATURE RANGE:</b>						
Storage and Operating . . . . .	← -65 to +200 → °C					

ELECTRICAL CHARACTERISTICS, Case Temperature ( $T_C$ ) = 25°C, Unless Otherwise Specified

CHARACTERISTICS	SYMBOL	VOLTAGE		CURRENT	LIMITS								UNITS	
		V dc			mA dc	40346		40346V1		40412		40412V1		
		$V_{CE}$	$V_{EB}$	$I_C$	Max.	Min.	Max.	Min.	Max.	Min.	Max.	Min.		
Collector-Cutoff Current: With base open With $R = 10,000$ ohms With base reverse-biased: $T_C = 25^\circ\text{C}$ $T_C = 150^\circ\text{C}$ $T_C = 150^\circ\text{C}$	$I_{CEO}$	100	—	—	—	5	—	5	—	—	—	—	$\mu\text{A}$	
	$I_{CER}$	100	—	—	—	—	—	—	—	1	—	1	$\text{mA}$	
	$I_{CEV}$	200	1.5	—	—	10	—	10	—	—	—	—	$\mu\text{A}$	
	$I_{CEV}$	200	1.5	—	—	1	—	1	—	—	—	—	$\text{mA}$	
	$I_{CEV}$	150	1.5	—	—	—	—	—	—	—	2	—	2	$\text{mA}$
Emitter-Cutoff Current	$I_{EBO}$	—	4	—	—	5	—	5	—	—	—	—	$\mu\text{A}$	
	$I_{EBO}$	—	3	—	—	—	—	—	—	100	—	100	$\mu\text{A}$	
Collector-To-Emitter Sustaining Voltage: With external base-to-emitter resistance $R_{BE} = 1,000$ ohms $R_{BE} = 10,000$ ohms	$V_{CER(sus)}$	—	—	50	175	—	175	—	—	—	—	—	V	
	$V_{CER(sus)}$	—	—	50	—	—	—	—	250	—	250	—	V	
Collector-To-Emitter Saturation Voltage: $I_B = 1$ mA	$V_{CE(sat)}$	—	—	10	—	0.5	—	0.5	—	—	—	—	V	
Base-To-Emitter Voltage	$V_{BE}$	10	—	10	—	1	—	1	—	—	—	—	V	
Second-Breakdown Current	$I_{S/b}$	200	—	—	—	—	—	—	—	50	—	50	$\text{mA}$	
DC Forward-Current Transfer Ratio	$h_{FE}$	10	—	10	25	—	25	—	—	—	—	—		
	$h_{FE}$	20	—	30	—	—	—	—	40	—	40	—		
Small-Signal Forward- Current Transfer Ratio: $f = 5$ MHz	$h_{fe}$	10	—	10	2	—	2	—	2	—	2	—		
Output Capacitance: $V_{CB} = 10$ V, $f = 1$ MHz	$C_{ob}$	—	—	—	—	—	—	—	—	—	10	—	10	pF
Thermal Resistance: Junction-to-case Junction-to-free air	$R_{\theta JC}$	—	—	—	—	—	15	—	—	—	15	—	—	$^\circ\text{C/W}$
	$R_{\theta JFA}$	—	—	—	—	—	—	—	45	—	—	—	45	$^\circ\text{C/W}$

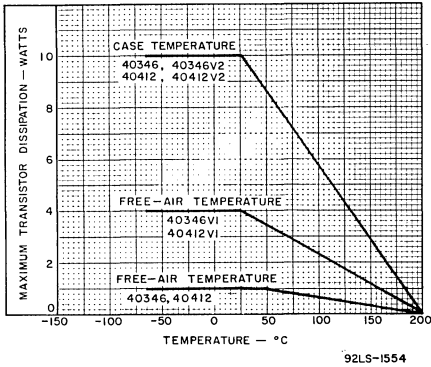


Fig. 1 - Dissipation derating curves.

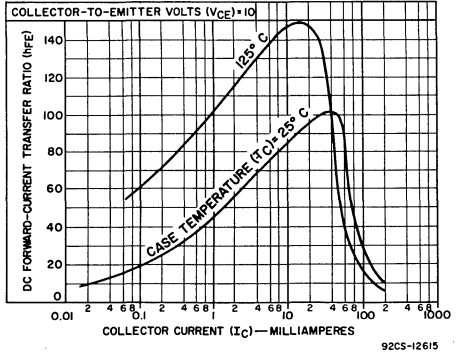


Fig. 2 - Typical dc-beta characteristics for all types.

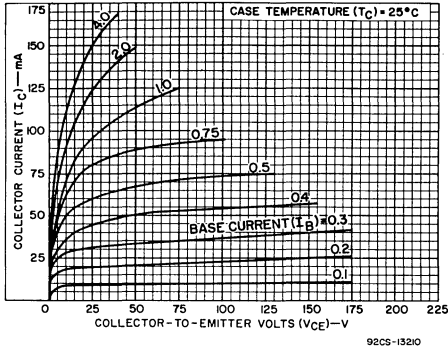


Fig. 3 - Typical output characteristics for all types.

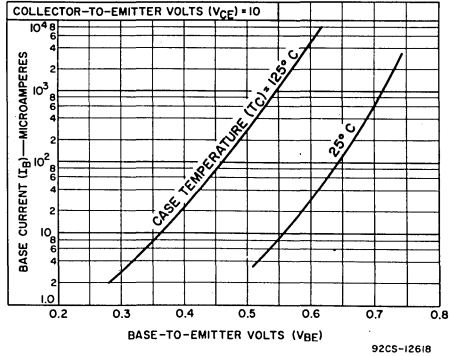


Fig. 4 - Typical input characteristics for all types.

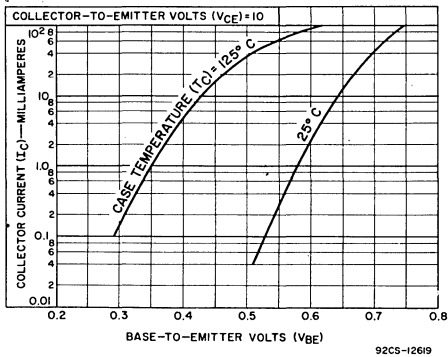


Fig. 5 - Typical transfer characteristics for all types.

**TERMINAL CONNECTIONS  
FOR 40346 AND 40412**

- Lead 1 - Emitter
- Lead 2 - Base
- Case, Lead 3 - Collector

**TERMINAL CONNECTIONS  
FOR 40346V1 AND 40412V1**

- Lead 1 - Emitter
- Lead 2 - Base
- Heat Radiator, Lead 3 - Collector

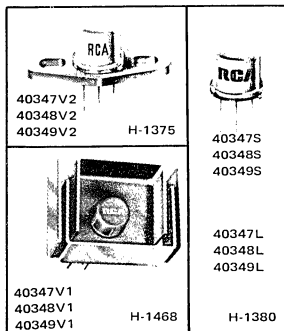
**TERMINAL CONNECTIONS  
FOR 40346V2 AND 40412V2**

- Lead 1 - Emitter
- Lead 2 - Base
- Flange, Lead 3 - Collector



# Power Transistors

40347 40347V1 40347V2  
 40348 40348V1 40348V2  
 40349 40349V1 40349V2



## Hometaxial-Base Silicon N-P-N Medium- and High-Voltage Transistors

General-Purpose Transistors for Industrial and Commercial Equipment

**Features:**

- ▣ High second-breakdown resistance
- ▣  $V_{CE(sat)}$  typically less than 1 V at 1A for 40347 and 40348
- ▣  $V_{CEV(sus)}$  for 40349 = 160 volts min.
- ▣ Hermetically-sealed packages

These devices are available with either 1½-inch leads (TO-5 package) or ½-inch leads (TO-39 package). The longer-lead versions are specified by suffix "L" after the type number; the shorter-lead versions are specified by suffix "S" after the type number.

RCA-40347, 40348, and 40349 are hometaxial-base, silicon n-p-n transistors intended for a wide variety of low- and medium-power applications requiring medium- and high-voltage power transistors. These devices differ primarily in their breakdown-voltage ratings.

Types 40347V1, 40348V1, and 40349V1 are 40347, 40348, and 40349, respectively, with factory-attached heat radiators; they are intended for printed circuit-board applications.

Types 40347V2, 40348V2, and 40349V2, are 40347, 40348, and 40349, respectively, with factory-attached diamond-shaped mounting flanges.

Typical applications for these transistors include switching regulators, converters, inverters, relay controls, oscillators, pulse amplifiers, and audio amplifiers (in low-power driver and output stages). These transistors are especially suitable for use in low-cost ac/dc of amplifier circuits.

**MAXIMUM RATINGS, Absolute-Maximum Values:**

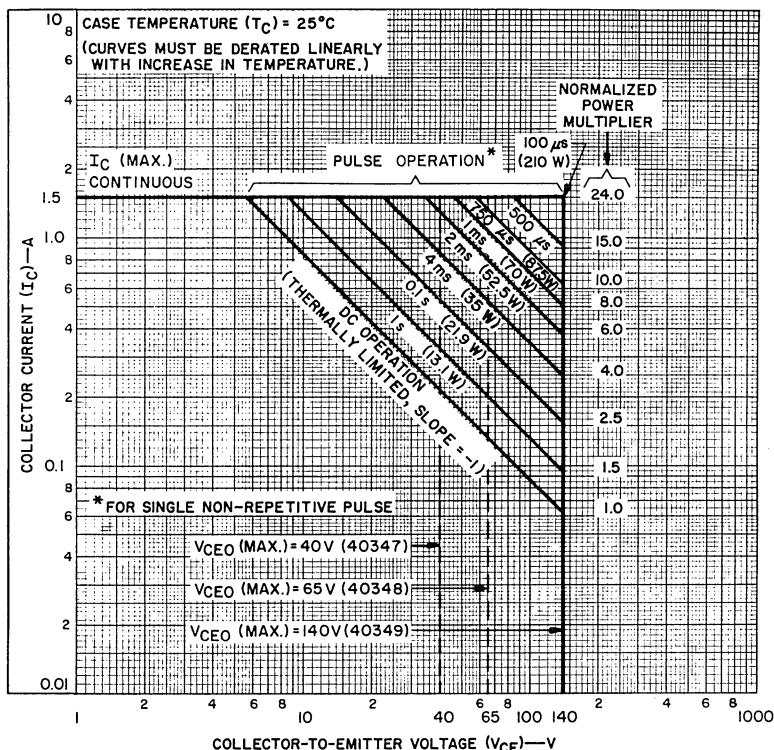
	40347 40347V1 40347V2	40348 40348V1 40348V2	40349 40349V1 40349V2	
COLLECTOR-TO-BASE VOLTAGE .....	$V_{CBO}$ 60	90	160	V
COLLECTOR-TO-EMITTER VOLTAGE:				
With $-1.5 V (V_{BE})$ of reverse bias .....	$V_{CEV}$ 60	90	160	V
With base open .....	$V_{CEO}$ 40	65	140	V
EMITTER-TO-BASE VOLTAGE .....	$V_{EBO}$ 7	7	7	V
CONTINUOUS COLLECTOR CURRENT .....	$I_C$ 1.5	1.5	1.5	A
PEAK COLLECTOR CURRENT .....	$I_{CM}$ 3.0	3.0	3.0	A
CONTINUOUS BASE CURRENT .....	$I_B$ 0.5	0.5	0.5	A
TRANSISTOR DISSIPATION .....	$P_T$			
At case temperature up to 25°C .....	11.7 (40347V2)	11.7 (40348V2)	11.7 (40349V2)	W
At case temperature above 25°C .....	8.75 (40347)	8.75 (40348)	8.75 (40349)	W
At ambient temperature up to 25°C .....	1.0 (40347)	1.0 (40348)	1.0 (40349)	W
At ambient temperature above 25°C .....	4.4 (40347V1)	4.4 (40348V1)	4.4 (40349V1)	W
TEMPERATURE RANGE:				
Storage and Operating (Junction) .....	← -65 to 200 →			°C
LEAD TEMPERATURE (During soldering):				
At distances $\geq 1/32$ in. (0.8 mm) from seating plane for 10 s max. ....	← 230 →			°C

ELECTRICAL CHARACTERISTICS, At Case Temperature ( $T_C$ ) = 25°C unless otherwise specified

Characteristic	Symbol	TEST CONDITIONS				LIMITS						Units
		Voltage V dc		Current A dc		40347		40348		40349		
		$V_{CE}$	$V_{BE}$	$I_C$	$I_B$	Min.	Max.	Min.	Max.	Min.	Max.	
Collector-Cutoff Current With external base-to-emitter resistance ( $R_{BE}$ ) = 1 k $\Omega$	$I_{CER}$	30				—	1	—	—	—	—	$\mu$ A
		60				—	—	—	1	—	—	
90						—	—	—	—	—	2	
With $R_{BE}$ = 1 k $\Omega$ and $T_C$ = 150°C	$I_{CER}$	30				—	1	—	—	—	—	mA
		60				—	—	—	1	—	—	
		90				—	—	—	—	—	1	
Emitter-Cutoff Current	$I_{EBO}$		—7			—	10	—	10	—	10	$\mu$ A
DC Forward-Current Transfer Ratio	$h_{FE}$	4		0.15		—	—	—	—	30	125	V
		4		0.30		—	—	30	125	—	—	
		4		0.45		25	100	—	—	10	—	
		4		1.00		—	—	10	—	—	—	
Collector-to-Emitter Sustaining Voltage: (See Figs. 4, 6, and 8) With base-emitter junction reverse biased	$V_{CEV}$ (sus)		—1.5	0.050		60	—	90	—	160 <sup>a</sup>	—	V
	$V_{CEO}$ (sus)			0.050		40	—	65	—	140 <sup>a</sup>	—	V
Base-to-Emitter Voltage	$V_{BE}$	4		0.15		—	—	—	—	—	1.1	V
		4		0.30		—	—	—	1.3	—	—	
		4		0.45		—	1.5	—	—	—	—	
Collector-to-Emitter Saturation Voltage	$V_{CE}$ (sat)			0.15	15 mA	—	—	—	—	—	0.5	V
				0.30	30 mA	—	—	—	0.75	—	—	
				0.45	45 mA	—	1	—	—	—	—	
Forward-Bias Second Break- down Collector Current (1-s non-repetitive pulse)	$I_{S/b}$	38				345	—	—	—	—	—	mA
		63				—	—	208	—	—	—	
		138				—	—	—	—	95	—	
Thermal Resistance Junction-to-Case	$R_{\theta JC}$					20(max.)		20(max.)		20(max.)		°C/W
						40347		40348		40349		
						15(max.)		15(max.)		15(max.)		
						40347V2		40348V2		40349V2		
Thermal Resistance: Junction-to-Ambient	$R_{\theta JA}$					40(max.)		40(max.)		40(max.)		°C/W
						40347V1		40348V1		40349V1		

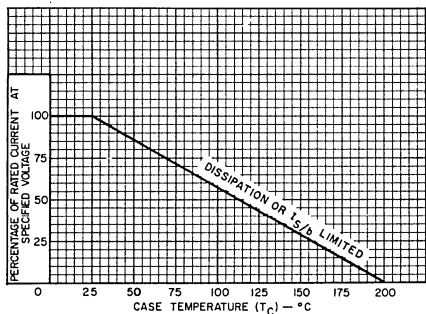
<sup>a</sup> Pulsed; pulse duration = 300  $\mu$ s, duty factor  $\leq$  2%.TERMINAL CONNECTIONS FOR TYPES  
40347, 40348, & 40349Lead 1 - Emitter  
Lead 2 - Base  
Case, Lead 3 - CollectorTERMINAL CONNECTIONS FOR TYPES  
40347V1, 40348V1, & 4049V1Lead 1 - Emitter  
Lead 2 - Base  
Heat Radiator, Lead 3 - CollectorTERMINAL CONNECTIONS FOR TYPES  
40347V2, 40348V2, & 40349V2Lead 1 - Emitter  
Lead 2 - Base  
Flange, Lead 3 - Collector





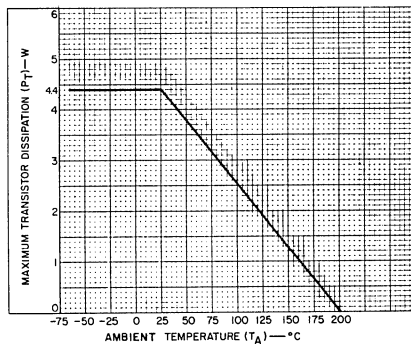
92SS-3586R1

Fig. 1 - Maximum operating areas for types 40347, 40348 and 40349.



92LS-1469R1

Fig. 2 - Dissipation derating curve for types 40347, 40348, and 40349.



92SS-3579R1

Fig. 3 - Dissipation derating curve for types 40347V1, 40348V1, and 40349V1.

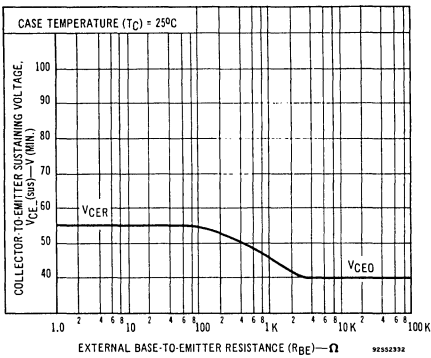


Fig. 4 — Sustaining voltage vs. base-to-emitter resistance for types 40347, 40347V1 and 40347V2.

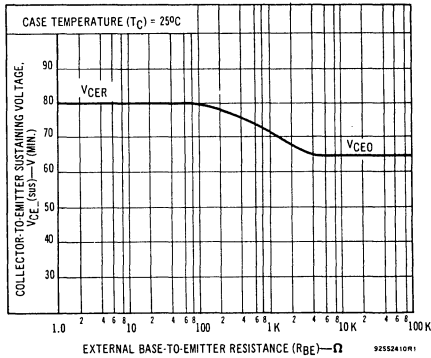


Fig. 6 — Sustaining voltage vs. base-to-emitter resistance for types 40348, 40348V1 and 40348V2.

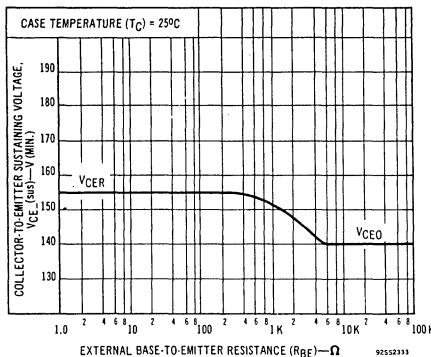


Fig. 8 — Sustaining voltage vs. base-to-emitter resistance for types 40349, 40349V1 and 40349V2.

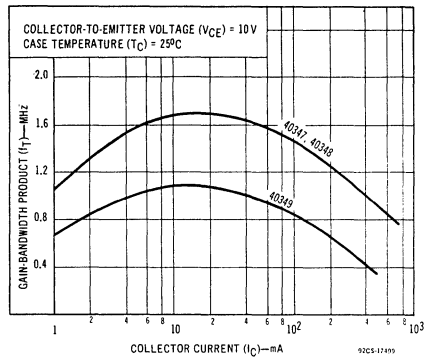


Fig. 5 — Typical gain-bandwidth product vs. collector current for types 40347, 40348 and 40349.

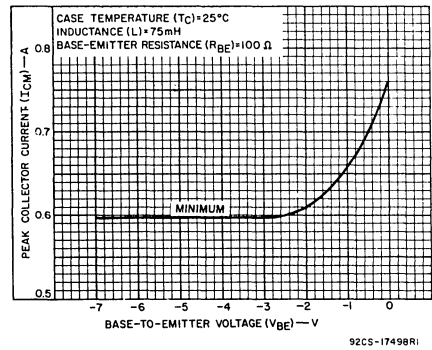


Fig. 7 — Reverse-bias second-breakdown characteristics for types 40347, 40348 and 40349.

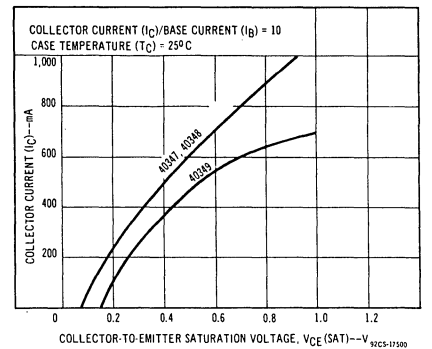


Fig. 9 — Typical saturation characteristic for types 40347, 40348 and 40349.

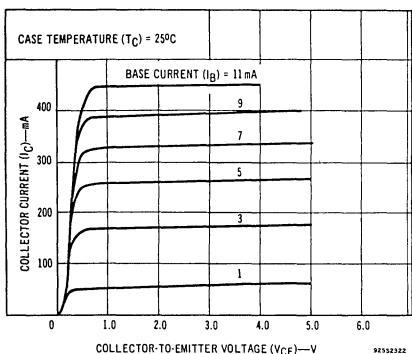


Fig. 10 — Typical output characteristics for type 40347.

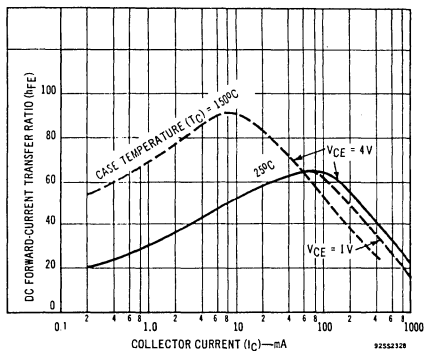


Fig. 11 — Typical dc beta characteristics for type 40347.

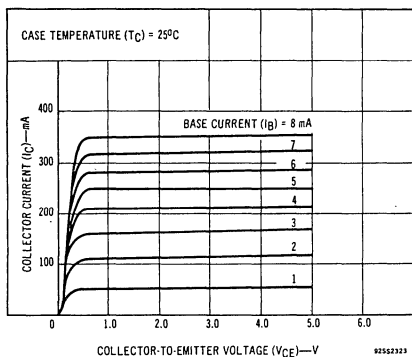


Fig. 12 — Typical output characteristics for type 40348.

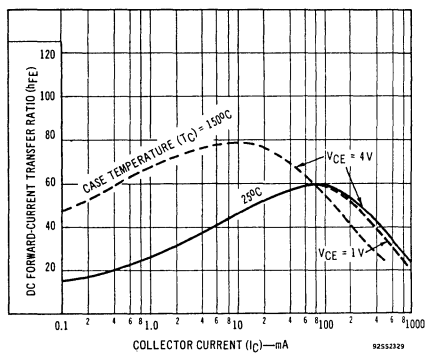


Fig. 13 — Typical dc beta characteristics for type 40348.

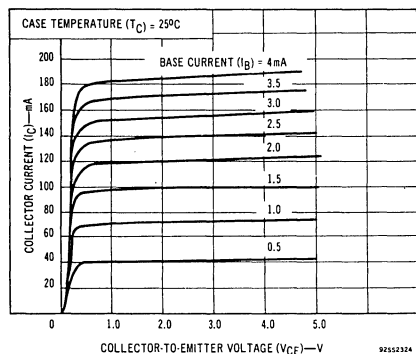


Fig. 14 — Typical output characteristics for type 40349.

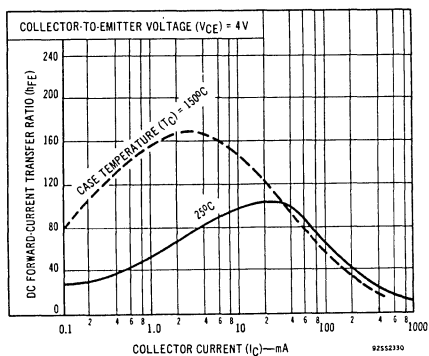


Fig. 15 — Typical dc beta characteristics for type 40349.

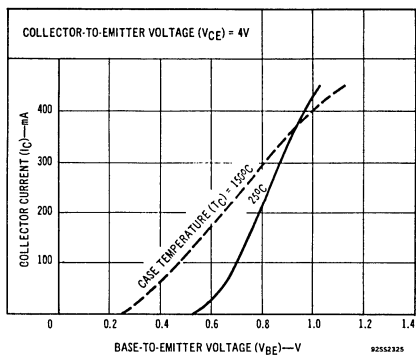


Fig. 16 - Typical transfer characteristics for type 40347.

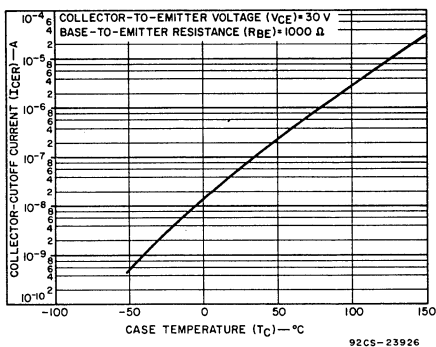


Fig. 17 - Collector-cutoff-current characteristic for type 40347.

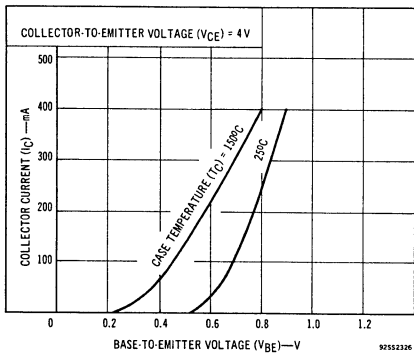


Fig. 18 - Typical transfer characteristics for type 40348.

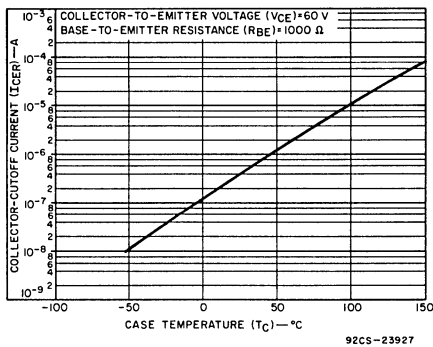


Fig. 19 - Collector-cutoff-current characteristic for type 40348.

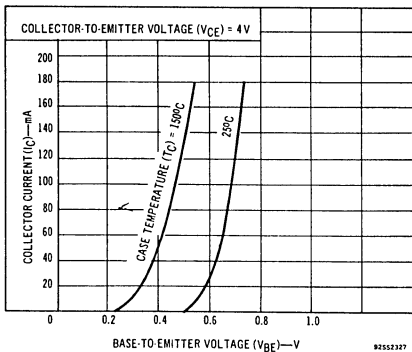


Fig. 20 - Typical transfer characteristics for type 40349.

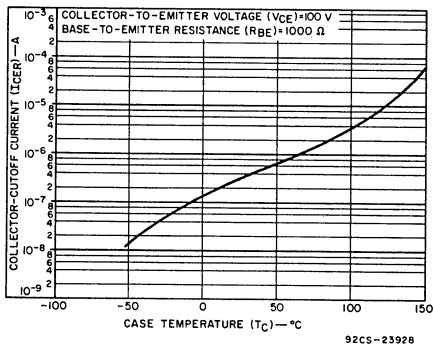
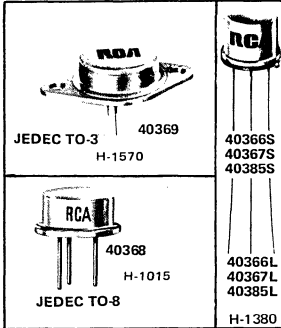


Fig. 21 - Collector-cutoff-current characteristic for type 40349.



# Power Transistors

40366-40369  
40385



## High-Reliability Silicon N-P-N Power Transistors

For Power Switching and Amplifier Applications

### Features

- High reliability assured by five preconditioning steps
- Group A test data included\*
- Transistors utilize JEDEC hermetic packages;

40369 – TO-3  
40368 – TO-8

40366, 40367 } See Note at right  
40385 }

These devices are available with either 1/2-inch leads (TO-5 package) or 1/4-inch leads (TO-39 package). The longer-lead versions are specified by suffix "L" after the type number; the shorter-lead versions are specified by suffix "S" after the type number.

RCA-40366–40369 and 40385 are silicon n-p-n power transistors derived from JEDEC types 2N2102, 2N1482, 2N1486, 2N1490, and 2N3439. They are specially preconditioned for use in power-switching and amplifier applications in those instances where high reliability is a requisite.

- High voltage ratings:

$V_{CEV} = 80 \text{ V max. (40366)}$   
 $V_{CEV} = 100 \text{ V max. (40367, 40368 \& 40369)}$   
 $V_{CEO} = 350 \text{ V max. (40385)}$

- High power-dissipation capability:

$P_T = 5 \text{ W max. (40366, 40367 \& 40385)}$   
 $= 25 \text{ W max. (40368)}$   
 $= 75 \text{ W max. (40369)}$

\* Group A test data shown on pages 2 & 3.

### MAXIMUM RATINGS, Absolute-Maximum Values:

	40366	40367	40368	40369	40385	
COLLECTOR-TO-BASE VOLTAGE . . . . . $V_{CBO}$	120	100	100	100	450	V
COLLECTOR-TO-EMITTER VOLTAGE:						
With external base-to-emitter resistance ( $R_{BE}) \leq 10 \Omega$ . . . . . $V_{CER}$	80	—	—	—	—	V
With $-1.5 \text{ V (} V_{BE})$ of reverse bias . . . . . $V_{CEV}$	—	100	100	100	—	V
With base open . . . . . $V_{CEO}$	65	55	55	55	350	V
EMITTER-TO-BASE VOLTAGE . . . . . $V_{EBO}$	7	12	12	10	7	V
CONTINUOUS COLLECTOR CURRENT . . . . . $I_C$	1	1.5	3	6	1	A
CONTINUOUS BASE CURRENT . . . . . $I_B$	—	1	1.5	3	—	A
TRANSISTOR DISSIPATION:						
At case temperature up to $25^\circ\text{C}$ . . . . . $P_T$	5	5	25	75	10	W
At free-air temperature up to $25^\circ\text{C}$ . . . . .	1	1	—	—	1	W
At temperatures above $25^\circ\text{C}$ . . . . .	← Derate linearly to 0 watts at $200^\circ\text{C}$ →					
TEMPERATURE RANGE:						
Storage & Operating (Junction) . . . . .	← —65 to 200 —→					$^\circ\text{C}$
PIN or LEAD TEMPERATURE (During soldering):						
At distances $\geq 1/32 \text{ in. (0.79 mm)}$ from seating plane for 10 s max. . . . .	255	255	235	235	255	$^\circ\text{C}$

ELECTRICAL CHARACTERISTICS, At Case Temperature ( $T_C$ ) = 25°C

Characteristic	Symbol	TEST CONDITIONS					LIMITS										Units
		Voltage V dc			Current mA dc		40366		40367		40368		40369		40385		
		V <sub>CB</sub>	V <sub>CE</sub>	V <sub>EB</sub>	I <sub>C</sub>	I <sub>B</sub>	Min.	Max.	Min.	Max.	Min.	Max.	Min.	Max.	Min.	Max.	
Collector-Cutoff Current	I <sub>CBO</sub>	30 60					-	-	-	4.0	-	9.0	-	10	-	-	μA nA
	I <sub>CEO</sub>		300			0	-	-	-	-	-	-	-	-	20	-	μA
	I <sub>CEV</sub>		450	1.5			-	-	-	-	-	-	-	-	500	-	μA
Emitter-Cutoff Current	I <sub>EBO</sub>			5 6 10 12	0 0 0 0		-	5.0	-	-	-	-	-	-	-	-	nA μA μA μA
							-	-	-	-	-	-	-	-	6.0	-	μA
							-	-	-	2.0	-	5.0	-	-	-	-	-
DC Forward-Current Transfer Ratio	h <sub>FE</sub>		4		200		-	-	35	100	-	-	-	-	-	-	-
			4		750		-	-	-	-	35	100	-	-	-	-	-
			4		1500		-	-	-	-	-	-	25	75	-	-	-
			10		0.01		10	-	-	-	-	-	-	-	-	-	-
			10		0.1		20	-	-	-	-	-	-	-	-	-	-
			10		2		-	-	-	-	-	-	-	-	-	30	-
			10		20		-	-	-	-	-	-	-	-	-	40	160
			10		150*		40	120	-	-	-	-	-	-	-	-	-
			10		500*		25	-	-	-	-	-	-	-	-	-	-
	10		1000*		10	-	-	-	-	-	-	-	-	-	-		
Collector-to-Base Breakdown Voltage	BV <sub>CBV</sub>			1.5	0.1		120	-	-	-	-	-	-	-	-	-	V
Collector-to-Emitter Breakdown Voltage	BV <sub>CEV</sub>			1.5	0.25		-	-	100	-	100	-	100	-	-	-	V
Emitter-to-Base Breakdown Voltage (I <sub>E</sub> = 0.1 mA)	BV <sub>EBO</sub>						7.0	-	-	-	-	-	-	-	-	-	V
Collector-to-Emitter Sustaining Voltage: With external base-to-emitter resistance (R <sub>BE</sub> ) = 10 Ω	V <sub>CE(sus)</sub>				100*		80	-	-	-	-	-	-	-	-	-	V
	With base open	V <sub>CEO(sus)</sub>			50	0	-	-	55	-	-	-	-	-	350	-	V
				100*	0	65	-	-	-	-	-	-	-	-	-	-	
					100	0	-	-	-	55	-	55	-	-	-	-	
Collector-to-Emitter Saturation Voltage	V <sub>CE(sat)</sub>				50	4	-	-	-	-	-	-	-	-	-	0.5	
					150*	15	-	0.5	-	-	-	-	-	-	-	-	
					200	10	-	-	-	1.4	-	-	-	-	-	-	
					750	40	-	-	-	-	-	0.75	-	-	-	-	
			1300	100	-	-	-	-	-	-	-	1.0	-	-	-		
Base-to-Emitter Saturation Voltage	V <sub>BE(sat)</sub>				150* 50	15 4	- -	1.1 -	- -	- -	- -	- -	- -	- -	- 1.3	-	V
Base-to-Emitter Voltage	V <sub>BE</sub>		4		200		-	-	-	3.0	-	-	-	-	-	-	
			4		750		-	-	-	-	-	2.5	-	-	-	-	
			4		1500		-	-	-	-	-	-	-	2.5	-	-	

\* Pulsed; pulse duration = 300 μs, duty factor = 1.8%.

## GROUP - A TESTS (IN ACCORDANCE WITH MIL - S - 19500)

TEST METHOD PER MIL-STD-750	EXAMINATION OR TEST	CONDITIONS	LTPD*	LIMITS										UNITS			
				40366		40367		40368		40369		40385					
				Min.	Max.	Min.	Max.	Min.	Max.	Min.	Max.	Min.	Max.				
2071	Subgroup 1 Visual and Mechanical Examination	-	10	-	-	-	-	-	-	-	-	-	-	-	-		
3036D	Subgroup 2 ICBO	$V_{CB} = 30V, I_E = 0$ $V_{CB} = 60V, I_E = 0$	5	-	-	-	4.0	-	9.0	-	10	-	-	-	$\mu A$ nA		
3041A	ICEV	$V_{CE} = 450V,$ $V_{BE} = -1.5V$	-	-	-	-	-	-	-	-	-	-	-	500	$\mu A$		
3041D	ICEO	$V_{CE} = 300V,$ $I_E = 0$	-	-	-	-	-	-	-	-	-	-	-	20	$\mu A$		
3061D	IEBO	$V_{EB} = 5V, I_C = 0$ $V_{EB} = 6V, I_C = 0$ $V_{EB} = 10V, I_C = 0$ $V_{EB} = 12V, I_C = 0$	-	-	5.0	-	-	-	-	-	-	-	-	-	nA		
			-	-	-	-	-	-	-	-	-	-	20	$\mu A$			
			-	-	-	-	-	-	-	6.0	-	-	-	$\mu A$			
			-	-	-	2.0	-	5.0	-	-	-	-	-	$\mu A$			
3001A	BVCBV	$I_C = 100\mu A,$ $V_{EB} = 1.5V$	-	120	-	-	-	-	-	-	-	-	-	-	V		
3026D	BVEBO	$I_E = 100\mu A, I_C = 0$	-	7.9	-	-	-	-	-	-	-	-	-	-	V		
3011A	BVCEV	$I_C = 0.25mA,$ $V_{EB} = 1.5V$ $I_C = 0.5mA,$ $V_{EB} = 1.5V$	-	-	-	100	-	100	-	-	-	-	-	-	V		
			-	-	-	-	-	-	-	100	-	-	-	-	V		
3011D	VCEO(sus)	$I_C = 50mA, I_B = 0$ $I_C = 100mA, I_B = 0$ $I_C = 100mA, I_B = 0$	-	-	-	55	-	-	-	-	-	350	-	-	V		
			-	65	-	-	-	-	-	-	-	-	-	V			
			-	-	-	-	55	-	55	-	-	-	-	V			
3011B	VCER(sus)	$I_C = 100mA,$ $R_{BE} = 10\Omega$ $I_C = 50mA,$ $I_B = 4mA$	-	80	-	-	-	-	-	-	-	-	-	-	V		
			-	-	-	-	-	-	-	-	-	-	0.5	V			
3071	VCE(sat)	$I_C = 150mA,$ $I_B = 15mA$ $I_C = 200mA,$ $I_B = 10mA$ $I_C = 750mA,$ $I_B = 40mA$ $I_C = 1.5A,$ $I_B = 100mA$	5	-	0.5	-	-	-	-	-	-	-	-	-	-	V	
			-	-	-	-	1.4	-	-	-	-	-	-	-	-	V	
			-	-	-	-	-	-	0.75	-	-	-	-	-	-	-	V
			-	-	-	-	-	-	-	-	1.0	-	-	-	-	-	V
3066A	VBE(sat)	$I_C = 50mA,$ $I_B = 4mA$ $I_C = 150mA,$ $I_B = 15mA$	-	-	-	-	-	-	-	-	-	-	1.3	-	V		
			-	-	1.1	-	-	-	-	-	-	-	-	-	V		
3066A	VBE	$I_C = 200mA, V_{CE} = 4V$ $I_C = 750mA, V_{CE} = 4V$	-	-	-	-	3.0	-	-	-	-	-	-	-	V		
			-	-	-	-	-	-	2.5	-	-	-	-	-	V		

## GROUP - A TESTS (CONT.)

TEST METHOD PER MIL-STD-750	EXAMINATION OR TEST	CONDITIONS	LTPD*	LIMITS										UNITS	
				40366		40367		40368		40369		40385			
				Min.	Max.	Min.	Max.	Min.	Max.	Min.	Max.	Min.	Max.		
3076	hFE	$I_C = 0.01 \text{ mA}$ , $V_{CE} = 10 \text{ V}$	-	10	-	-	-	-	-	-	-	-	-	-	-
		$I_C = 0.1 \text{ mA}$ , $V_{CE} = 10 \text{ V}$	-	20	-	-	-	-	-	-	-	-	-	-	-
		$I_C = 2 \text{ mA}$ , $V_{CE} = 10 \text{ V}$	-	-	-	-	-	-	-	-	-	-	30	-	-
		$I_C = 20 \text{ mA}$ , $V_{CE} = 10 \text{ V}$	-	-	-	-	-	-	-	-	-	40	60	-	-
		$I_C = 150 \text{ mA}^*$ , $V_{CE} = 10 \text{ V}$	-	40	120	-	-	-	-	-	-	-	-	-	-
		$I_C = 200 \text{ mA}$ , $V_{CE} = 4 \text{ V}$	-	-	-	35	100	-	-	-	-	-	-	-	-
		$I_C = 500 \text{ mA}^*$ , $V_{CE} = 10 \text{ V}$	-	25	-	-	-	-	-	-	-	-	-	-	-
		$I_C = 750 \text{ mA}$ , $V_{CE} = 4 \text{ V}$	-	-	-	-	-	35	100	-	-	-	-	-	-
		$I_C = 1 \text{ A}^*$ , $V_{CE} = 10 \text{ V}$	-	10	-	-	-	-	-	-	-	-	-	-	-
		$I_C = 1.5 \text{ A}$ , $V_{CE} = 4 \text{ V}$	-	-	-	-	-	-	-	25	75	-	-	-	-

\*Pulsed; pulse duration = 300  $\mu\text{s}$ , duty factor = 1.8%.

\*Lot tolerance per cent defective.

The RCA-40366, 40367, 40368, 40369, and 40385 are high-reliability versions of the RCA-2N2102, 2N1482, 2N1486, 2N1490 and 2N3439\*, respectively. These transistors are intended for medium- and high-power switching and amplifier applications in military and industrial equipment.

The 40366 and 40385 are silicon n-p-n types with a power-dissipation capability of 5 watts each. The 40367 is a silicon n-p-n homotaxial type with a power-dissipation capability of 5 watts. These devices are available with either 1- $\frac{1}{2}$ -inch leads (TO-5 package) or  $\frac{1}{2}$ -inch leads (TO-39 package).

The 40368 is a silicon n-p-n homotaxial type in a JEDEC TO-8 package with a power-dissipation capability of 25 watts.

The 40369 is a silicon n-p-n homotaxial type in the popular JEDEC TO-3 package and has a dissipation capability of 75 watts.

The 40366, the high-reliability version of the 2N2102, features linear beta characteristics which are controlled over a wide range of collector currents (0.01 mA to 1 A).

The 40367, 40368, and 40369, the high-reliability versions of the 2N1482, 2N1486, and 2N1490, respectively, feature rugged construction, low saturation voltage, and high beta at high currents, and are designed to assure freedom from forward-bias second breakdown when operated with specified limits.

Typical applications for these transistors include: power-switching circuits such as dc-to-dc converters, inverters, choppers, solenoid- and relay-controls; oscillator, regulator, and pulse-amplifier circuits; Class A and Class B push-pull audio- and servo-amplifiers.

\* Complete data for types 2N1482, 2N1486, 2N1490, 2N2102 and 2N3439 are given in separate technical bulletins (Files 135, 137, 139, 106, and 64, respectively). Bulletins are available upon request from RCA Solid State Division, Box 3200, Somerville, N.J. 08876.



## RELIABILITY TESTING

Each RCA-40366, 40367, 40368, 40369 and 40385 is subjected to the following preconditioning steps:

1. Temperature Cycling-Method 102A of MIL-STD-202, 5 cycles,  $-65^{\circ}\text{C}$  to  $200^{\circ}\text{C}$
2. Bake, 72 hours min.,  $200^{\circ}\text{C}$
3. Helium Leak,  $1 \times 10^{-8}$  cc/s max.
4. (a) Methanol Bomb, 70 psig, 16 hours min. (For 40366)  
(b) Bubble Test (Per MIL-STD-202, COND. A),  $125^{\circ}\text{C}$  min.,  
1 minute, ethylene glycol (For 40367, 40368, 40369 & 40385)
5. Serialization
6. (a) Record  $I_{\text{CBO}}$  and  $h_{\text{FE}}$  (150 mA) (For 40366)  
(b) Record  $I_{\text{CBO}}$  and  $h_{\text{FE}}$  (For 40367, 40368, & 40369)  
(c) Record  $I_{\text{CEV}}$  and  $h_{\text{FE}}$  (20 mA) (For 40385)
7. (a) Power Age,  $T_{\text{FA}} = 25^{\circ}\text{C}$ ,  $V_{\text{CB}} = 60\text{ V}$ ,  $t = 168$  hours,  
 $P_{\text{T}} = 1\text{ W}$ , free-air (For 40366 & 40367)  
(b) Power Age,  $T_{\text{C}} = 125^{\circ}\text{C}$ ,  $V_{\text{CB}} = 24\text{ V}$ ,  $t = 168$  hours,  
 $P_{\text{T}} = 10.5\text{ W}$ , with heat-sink (For 40368)  
 $P_{\text{T}} = 32\text{ W}$ , with heat-sink (For 40369)  
(c) Power Age,  $T_{\text{FA}} = 25^{\circ}\text{C}$ ,  $V_{\text{CB}} = 200\text{ V}$ ,  $t = 168$  hours,  
 $P_{\text{T}} = 800\text{ mW}$ , free air (For 40385)
8. (a) For 40366,  $\uparrow$ record  $I_{\text{CBO}}$ ,  $h_{\text{FE}}$ (150 mA),  $BV_{\text{CBV}}$ ,  $V_{\text{CEO(sus)}}$ ,  $BV_{\text{EBO}}$ ,  
 $V_{\text{CE(sat)}}$ . Data furnished with transistor.  
(b) For 40367, 40368, & 40369,  $\uparrow$ record  $I_{\text{CBO}}$ ,  $h_{\text{FE}}$ ,  $BV_{\text{CEV}}$ ,  $V_{\text{CEO(sus)}}$ ,  $I_{\text{EBO}}$ ,  
 $V_{\text{CE(sat)}}$ . Data furnished with transistors.  
(c) For 40385,  $\uparrow$ record  $I_{\text{CEO}}$ ,  $I_{\text{EBO}}$ ,  $V_{\text{CEO(sus)}}$ ,  $I_{\text{CEV}}$ ,  $V_{\text{CE(sat)}}$ , and  $h_{\text{FE}}$ (20 mA).  
Data furnished with transistor.

$\uparrow$  Delta criteria after 168 hours Power Age:

$$\Delta h_{\text{FE}} \pm 25\% \text{ (For all types)} \quad \Delta I_{\text{CBO}} + 1 \mu\text{A} \text{ (For 40367, 40368, \& 40369)}$$

**TERMINAL CONNECTIONS  
FOR 40366, 40367,  
AND 40385**

Pin 1 - Emitter  
Pin 2 - Base  
Case, Pin 3 - Collector

**TERMINAL CONNECTIONS  
FOR 40368**

Lead 1 - Emitter  
Lead 2 - Base  
Case, Lead 3 - Collector

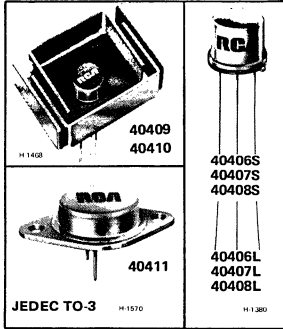
**TERMINAL CONNECTIONS  
FOR 40369**

Pin 1 - Base  
Pin 2 - Emitter  
Case - Collector  
Mounting Flange - Collector



# Power Transistors

**40406 40408 40410**  
**40407 40409 40411**



## Silicon N-P-N and P-N-P Power Transistors

For Audio-Amplifier Applications

Features:

40406 & 40407

- $V_{CEO(sus)} = -50$  V max. (40406)
- $V_{CEO(sus)} = 50$  V max. (40407)
- 40406 is p-n-p complement of 40407
- 1 W dissipation rating

These devices are available with either 1/8-inch leads (TO-5 package) or 1/2-inch leads (TO-39 package). The longer-lead versions are specified by suffix "L" after the type number; the shorter-lead versions are specified by suffix "S" after the type number.

RCA-40406-40411, inclusive, are diffused-junction silicon n-p-n and p-n-p transistors intended for use in audio amplifiers. Giving high-quality performance economically, these six devices have power dissipation ratings of 1 to 150 W.

40408

- $V_{CEO(sus)} = 90$  V max.
- 1 W dissipation rating

40409 & 40410

- $V_{CE(sus)} = 90$  V max. (40409)
- $V_{CE(sus)} = -90$  V max. (40410)
- 40410 is p-n-p complement of 40409
- 3 W free-air dissipation rating

40411

- $V_{CE(sus)} = 90$  max.
- Hometaxial-base construction
- 150 W dissipation rating

**TERMINAL CONNECTIONS FOR 40406-40410**

- Lead 1 - Emitter
- Lead 2 - Base
- Case or Heat Radiator, Lead 3 - Collector

**TERMINAL CONNECTIONS FOR 40411**

- Pin 1 - Base
- Pin 2 - Emitter
- Case - Collector
- Mounting Flange - Collector

**MAXIMUM RATINGS, Absolute-Maximum Values**

	40406	40407	40408	40409	40410	40411
Collector-to-Emitter Sustaining Voltage:						
With base open	$V_{CEO(sus)} -50$	50	90	-	-	-
With $R_{BE} = 100 \Omega$	$V_{CER(sus)} -$	-	-	90	-90	90
Emitter-to-Base Voltage:						
With collector open	$V_{EBO} -4$	4	4	4	-4	4
Collector Current	$I_C -0.7$	0.7	0.7	0.7	-0.7	30
Base Current	$I_B -0.2$	0.2	0.2	0.2	-0.2	15
Transistor Power Dissipation:						
At free-air temperatures up to 25° C	1	1	1	-	-	-
At free-air temperatures up to 50° C	-	-	-	3	3	-
At case temperatures up to 25° C	-	-	-	-	-	150
At other temperatures		See Fig. 1			See Fig. 2	See Fig. 3
Operating Junction Temperature Range	← -65 to +200 → °C					

## ELECTRICAL CHARACTERISTICS

Characteristic	TEST CONDITIONS						LIMITS					
	V <sub>CB</sub>	V <sub>CE</sub>	V <sub>EB</sub>	I <sub>C</sub>	I <sub>B</sub>	T <sub>C</sub>	40406		40407		40408	
	Volts			mA		°C	Min.	Max.	Min.	Max.	Min.	Max.
I <sub>CEO</sub>		40 <sup>a</sup>				25		-1 μA		1 μA		
		80				25						1 μA
		40 <sup>a</sup>				150		-10 μA		100 μA		
		80				150						250 μA
I <sub>CBO</sub>	10								0.25 μA			
I <sub>EBO</sub>			4 <sup>a</sup>					-1 mA		1 mA		1 mA
V <sub>CEO(sus)</sub>				100 <sup>a</sup>			-50 V		50 V		90 V	
V <sub>CE(sat)</sub>				150 <sup>a</sup>	15							1.4 V
V <sub>BE</sub>		-10		-0.1				-0.8 V				
		10		1					0.8 V			
		4		10								1 V
h <sub>FE</sub>		-10		-0.1			30	200				
		10		1					40	200		
		4		10							40	200
h <sub>fe</sub> <sup>c</sup>		10		50					6			
f <sub>T</sub>		4 <sup>a</sup>		50 <sup>a</sup>			← 100 MHz (Typ) →					
θ <sub>J-C</sub>							35° C/W		35° C/W		35° C/W	
θ <sub>J-FA</sub>							175° C/W		175° C/W		175° C/W	
C <sub>ob</sub> <sup>d</sup>	10								15 pF			

<sup>a</sup> Negative for types 40406 & 40410<sup>c</sup> F = 20 MHz<sup>d</sup> F = 1 MHz, I<sub>E</sub> = 0

ELECTRICAL CHARACTERISTICS

Characteristic	TEST CONDITIONS						LIMITS					
	V <sub>CB</sub>	V <sub>CE</sub>	V <sub>EB</sub>	I <sub>C</sub>	I <sub>B</sub>	T <sub>C</sub>	40409		40410		40411	
	Volts			mA		°C	Min.	Max.	Min.	Max.	Min.	Max.
I <sub>CER</sub> <sup>b</sup>		80 <sup>a</sup>				25		1 μA		-1 μA		500 μA
		80 <sup>a</sup>				150		100 μA		-100 μA		2 mA
I <sub>EBO</sub>			4 <sup>a</sup>					1 mA		-1 mA		5 mA
V <sub>CER(sus)</sub> <sup>b</sup>				100 <sup>a</sup>			90 V		-90 V			
				200							90 V	
V <sub>CE(sat)</sub>				150 <sup>a</sup>	15			1.4 V		-1.4 V		
				4 A	400							0.8 V
V <sub>BE</sub>		4 <sup>a</sup>		150 <sup>a</sup>				1 V		-1 V		
		4		4 A								1.2 V
h <sub>FE</sub>		4		150			50	250				
		-4		-150					50	250		
		4		4 A							35	100
f <sub>T</sub>		4 <sup>a</sup>		50 <sup>a</sup>			← 100 MHz (Typ) →					
		4		4 A							800 kHz (Typ)	
θ <sub>J-C</sub>												1.17° C/W
θ <sub>J-FA</sub>							50° C/W		50° C/W			
PRT <sup>e</sup>		40		5 A							1 sec	

<sup>a</sup> Negative for types 40406 & 40410

<sup>b</sup> R<sub>BE</sub> = 100 Ω

<sup>c</sup> Power rating test at 200 watts

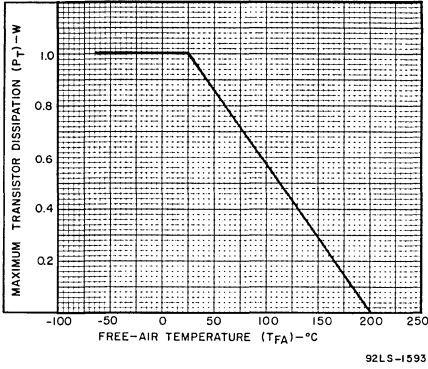


Fig. 1 - Dissipation derating curve for 40406, 40407, and 40408.

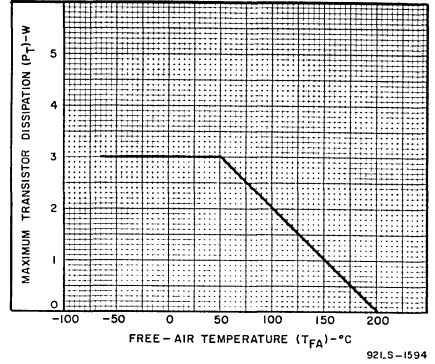


Fig. 2 - Dissipation derating curve for 40409 and 40410.

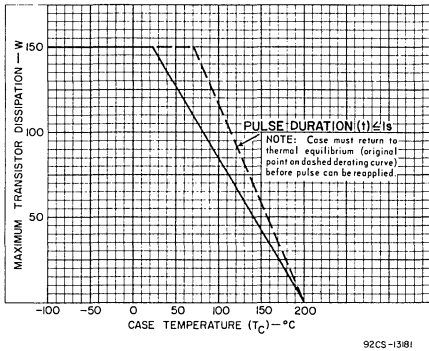


Fig. 3 - Dissipation derating curve for 40411.

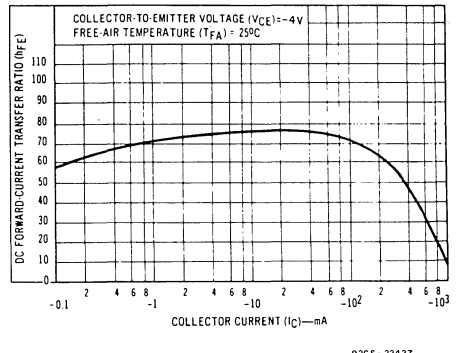


Fig. 4 - Typical dc beta characteristic for 40406 and 40410.

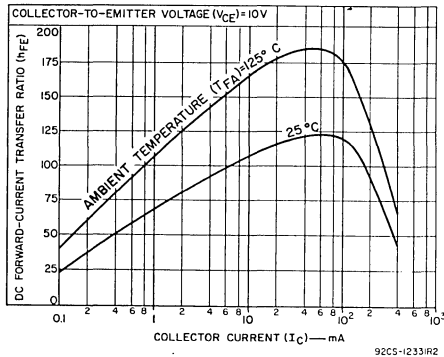


Fig. 5 - Typical dc beta characteristics for 40407, 40408, 40409.

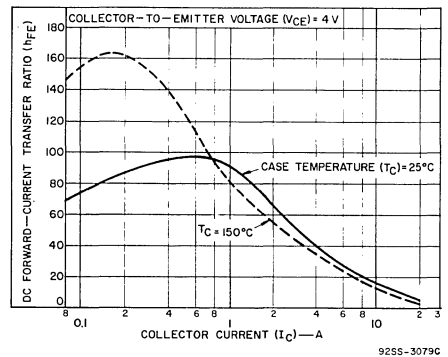


Fig. 6 - Typical dc beta characteristics for 40411.

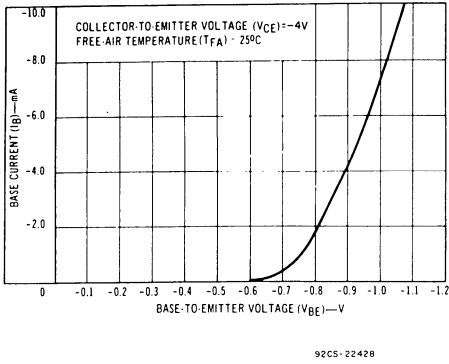


Fig. 7 - Typical input characteristic for 40406 and 40410.

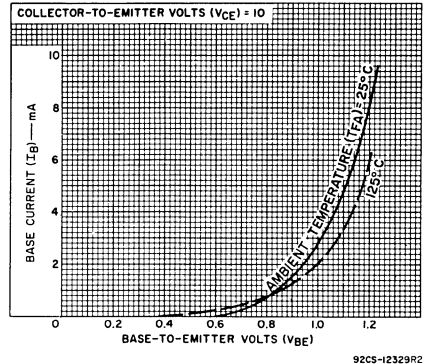


Fig. 8 - Typical input characteristics for 40407, 40408, and 40409.

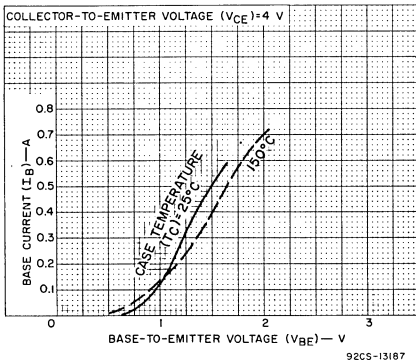


Fig. 9 - Typical input characteristics for 40411.

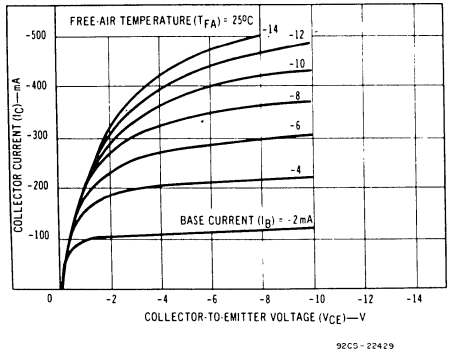


Fig. 10 - Typical output characteristics for 40406 and 40410.

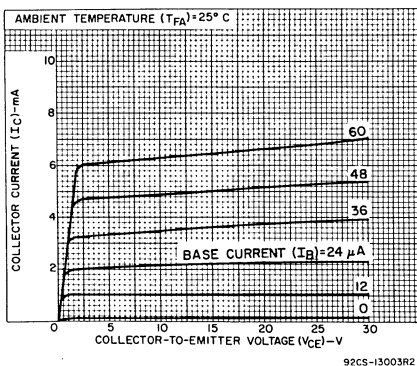


Fig. 11 - Typical output characteristics for 40407, 40408, and 40409.

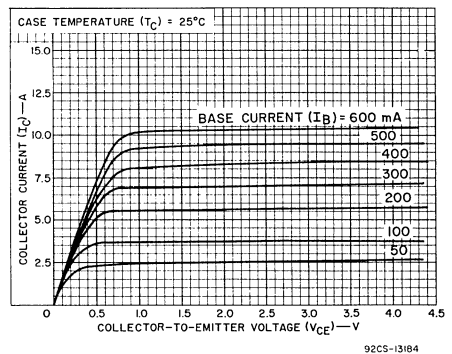
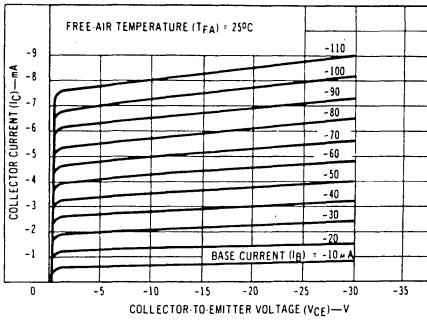
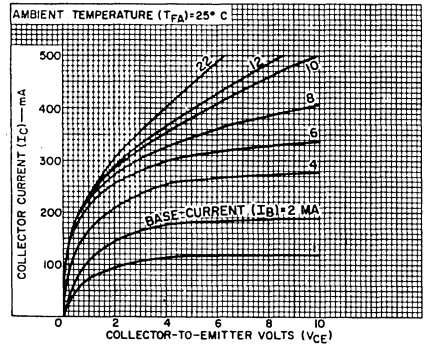


Fig. 12 - Typical output characteristics for 40411.



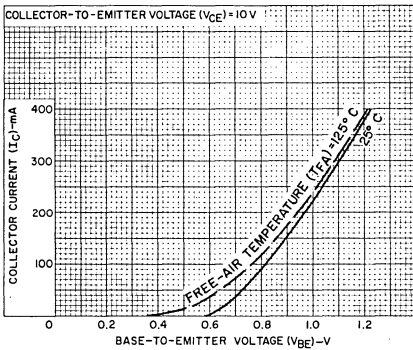
92CS-22430

Fig. 13 - Typical output characteristics for 40406 and 40410.



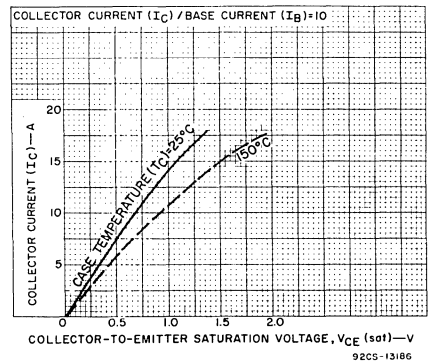
92CS-12327R2

Fig. 14 - Typical output characteristics for 40407, 40408, and 40409.



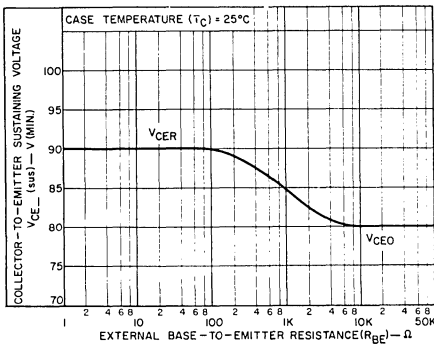
92CS-12328R1

Fig. 15 - Typical transfer characteristics for 40407, 40408, and 40409.



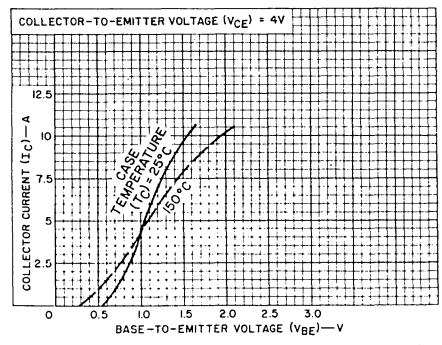
92CS-13186

Fig. 16 - Typical saturation-voltage characteristics for 40411.



92CS-3080C

Fig. 17 - Sustaining voltage vs. external base-to-emitter resistance for 40411.



92CS-13188

Fig. 18 - Typical transfer characteristics for 40411.



# Power Transistors

40537  
40538

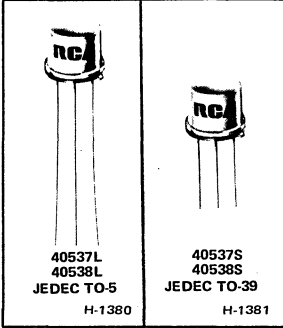
## Silicon P-N-P Transistors

For Driver and Output Stages in  
Audio-Amplifier Circuits

*Features:*

- Planar construction provides low-noise and low-leakage characteristics
- Gain bandwidth product ( $f_T$ ) = 50 MHz min.
- 40538 is p-n-p complement of 40539\*
- Low saturation voltage:  
 $V_{CE(sat)}$  = -1.1 V max. (40537)  
               = -2.0 V max. (40538)
- High pulse beta at high collector current:  
 $h_{FE}$  = 50 min. at  $I_C = -50$  mA (40537)  
       = 15 min. at  $I_C = -500$  mA (40538)

These devices are available with either 1½-inch leads (TO-5 package) or ½-inch leads (TO-39 package). The longer-lead versions are specified by suffix "L" after the type number; the shorter-lead versions are specified by suffix "S" after the type number.



RCA-40537 and 40538 are double-diffused, epitaxial-planar, silicon p-n-p transistors. They differ in the current at which the parameters are controlled.

The 40537 is designed specifically for use as a driver in audio-amplifier circuits. The 40538 is intended as a complement to n-p-n type 40539 in complementary-symmetry output stages\*.

\* Data for type 40539 appear in File No. 303.

	<b>40537</b>	
	<b>40538</b>	
<b>MAXIMUM RATINGS, Absolute-Maximum Values:</b>		
COLLECTOR-TO-EMITTER SUSTAINING VOLTAGE: With external base-to-emitter resistance ( $R_{BE}$ ) = 500 $\Omega$ .....	$V_{CER(sus)}$	-55 V
EMITTER-TO-BASE VOLTAGE .....	$V_{EBO}$	-5 V
COLLECTOR CURRENT .....	$I_C$	-0.7 A
BASE CURRENT .....	$I_B$	-0.2 A
TRANSISTOR DISSIPATION:	$P_T$	
At case temperatures up to 25° C .....	5	W
At free-air temperatures up to 25° C .....	1	W
At temperatures above 25° C .....	Derate linearly to 0 W at 200° C	
TEMPERATURE RANGE:		
Storage and Operating (Junction) .....	-65 to 200	°C
LEAD TEMPERATURE (During soldering):		
At distance $\geq$ 1/32 in. (0.8 mm) from seating plane for 10 s max. ....	230	°C



**ELECTRICAL CHARACTERISTICS, At Case Temperature ( $T_C$ ) = 25°C**

CHARACTERISTIC	SYMBOL	TEST CONDITIONS				LIMITS				UNITS
		DC VOLTAGE (V)		DC CURRENT (mA)		TYPE 40537		TYPE 40538		
		$V_{CE}$	$V_{EB}$	$I_C$	$I_B$	MIN.	MAX.	MIN.	MAX.	
Collector Cutoff Current With external base-to-emitter resistance ( $R_{BE}$ ) = 500 $\Omega$	$I_{CER}$	-45				-	-10	-	-10	$\mu A$
Emitter Cutoff Current	$I_{EBO}$		-5	0		-	-1	-	-1	mA
DC Forward-Current Transfer Ratio	$h_{FE}$	-4		-50		50	300	-	-	
		-4		-500 <sup>a</sup>		-	-	15	90	
Collector-to-Emitter Sustaining Voltage With external base-to-emitter resistance ( $R_{BE}$ ) = 500 $\Omega$	$V_{CER(sus)}$			-100		-55	-	-55	-	V
Base-to-Emitter Voltage	$V_{BE}$	-4		-50		-	-1.8	-	-	V
		-4		-500		-	-	-	-2.7	V
Collector-to-Emitter Saturation Voltage	$V_{CE(sat)}$			-50	-5	-	-1.1	-	-	V
				-500	-50	-	-	-	-2.0	V
Gain-Bandwidth Product	$f_T$	-4		-50		100 (Typ.)		100 (Typ.)		MHz
Thermal Resistance (Junction-to-Free Air)	$R_{\theta JA}$					-	175	-	175	$^{\circ}C/W$

<sup>a</sup>Pulsed; pulse duration = 300  $\mu s$ , duty factor < 2%.

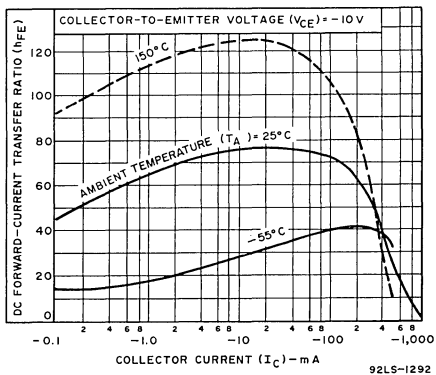


Fig.1 – Typical dc beta characteristics for both types.

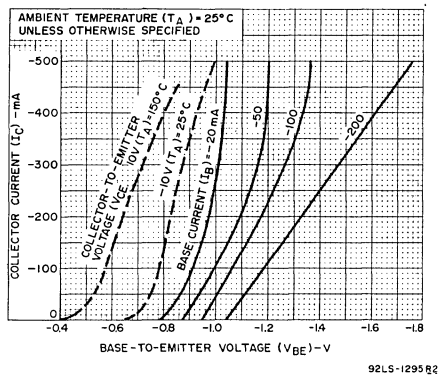


Fig.2 – Typical transfer characteristics for both types.

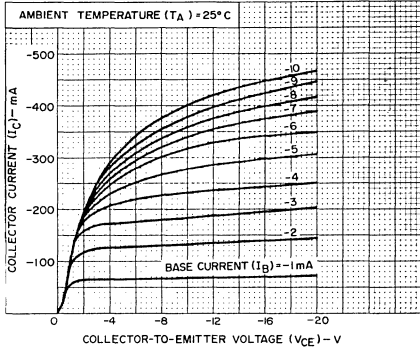


Fig.3 - Typical output characteristics for both types.

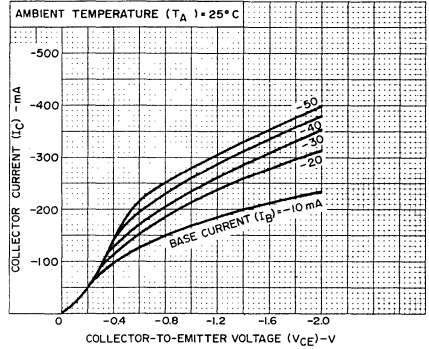


Fig.4 - Typical output characteristics for both types.

TERMINAL CONNECTIONS

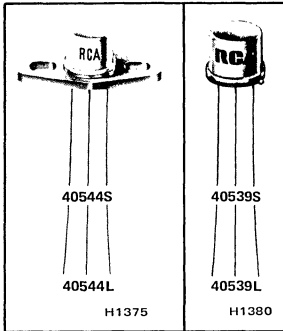
- Lead 1 - Emitter
- Lead 2 - Base
- Case, Lead 3 - Collector



# Power Transistors

## 40539

## 40544



### Medium-Power Silicon N-P-N Planar Transistors

For Driver and Output Stages in Audio-Amplifier Circuits

**Features:**

- Low leakage current
- Low saturation voltage:  
 $V_{CE(sat)} = 1.0 \text{ V Max. (40544)}$   
 $= 2.0 \text{ V Max. (40539)}$
- 40539 is n-p-n complement of 40538\*

These devices are available with either 1½-inch leads (TO-5 package) or ½-inch leads (TO-39 package). The longer-lead versions are specified by suffix "L" after the type number; the shorter-lead versions are specified by suffix "S" after the type number.

RCA-40539 and 40544 are silicon n-p-n planar transistors. Type 40539 employs the JEDEC TO-39 (40539S) or TO-5 (40539L) package; type 40544 is supplied with a factory-attached, diamond-shaped mounting flange.

The 40539 is intended as a complement to p-n-p type 40538 in complementary-symmetry output stages. The 40544 was designed specifically as a driver in audio-amplifier circuits.

\* Data for type 40538 appears in File No. 302.

**MAXIMUM RATINGS, Absolute-Maximum Values:**

	40539	40544	
<b>COLLECTOR-TO-EMITTER SUSTAINING VOLTAGE:</b>			
With external base-to-emitter resistance			
$(R_{BE}) = 100 \Omega$ .....	$V_{CER(sus)}$	50	V
$(R_{BE}) = 500 \Omega$ .....	$V_{CER(sus)}$	—	V
<b>EMITTER-TO-BASE VOLTAGE</b> .....	$V_{EBO}$	5	V
<b>COLLECTOR CURRENT</b> .....	$I_C$	0.7	A
<b>TRANSISTOR DISSIPATION:</b>	$P_T$		
At case temperatures up to 25° C .....	5	7	W
At free-air temperatures up to 25° C .....	1	—	W
At temperatures above 25° C .....	Derate linearly to 0 W at 200°C		
<b>TEMPERATURE RANGE:</b>			
Storage and operating (Junction) .....	← -65 to + 200 →		°C
<b>LEAD TEMPERATURE (During soldering):</b>			
At distance $\geq 1/32$ in. (0.8 mm) from seating plane for 10 s max. ....	← 255 →		°C

ELECTRICAL CHARACTERISTICS, at Case Temperature ( $T_C$ ) = 25°C

Characteristic	Symbol	TEST CONDITIONS				LIMITS				Units
		DC Voltage (V)		DC Current (mA)		Type 40539		Type 40544		
		$V_{CE}$	$V_{EB}$	$I_C$	$I_B$	Min.	Max.	Min.	Max.	
Collector-Cutoff Current With external base-to-emitter resistance ( $R_{BE}$ ) = 100 $\Omega$ = 500 $\Omega$	$I_{CER}$	40 45				- -	- 10	- -	10 -	$\mu A$
Emitter-Cutoff Current	$I_{EBO}$		5	0		-	1.0	-	1.0	mA
DC Forward-Current Transfer Ratio	$h_{FE}$		4 4	500 50		15 -	90 -	- 35	- 200	
Collector-to-Emmitter Sustaining Voltage With external base-to-emitter resistance ( $R_{BE}$ ) = 100 $\Omega$ = 500 $\Omega$	$V_{CER(sus)}$			100 100		- 55	- -	50 -	- -	V
Base-to-Emmitter Voltage	$V_{BE}$	4 4		500 50		- -	2.7 -	- -	- 1.7	V
Collector-to-Emmitter Saturation Voltage	$V_{CE(sat)}$			500 150	50 15	- -	2.0 -	- -	- 1.0	V
Gain-Bandwidth Product	$f_T$		4	50		100 (Typ.)	100 (Typ.)			MHz
Thermal Resistance (Junction-to-Case)	$\theta_{J-C}$					-	35	-	25	°C/W

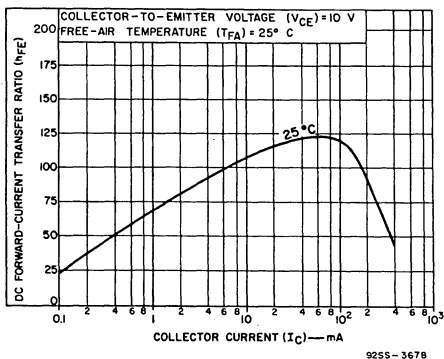


Fig. 1 — Typical dc-beta characteristics for both types.

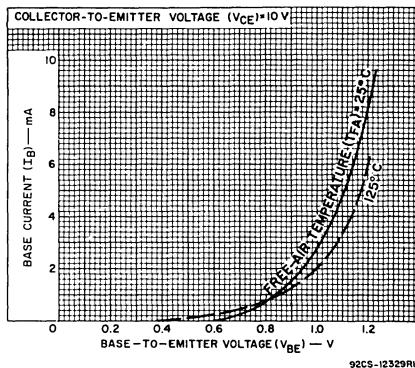


Fig. 2 — Typical input characteristics for both types.

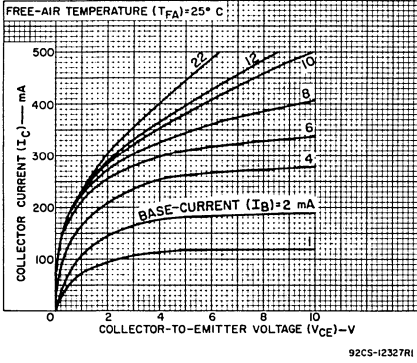


Fig.3 – Typical output characteristics for all types.

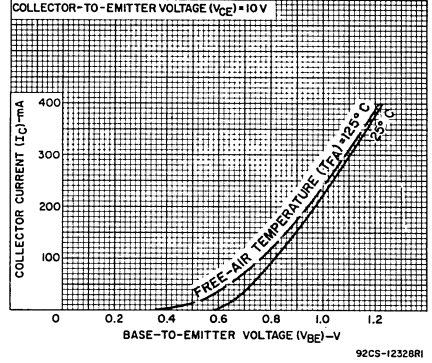


Fig.4 – Typical transfer characteristics for all types.

**TERMINAL CONNECTIONS  
FOR 40539**

- Lead 1 – Emitter
- Lead 2 – Base
- Case, Lead 3 – Collector

**TERMINAL CONNECTIONS  
FOR 40544**

- Lead 1 – Emitter
- Lead 2 – Base
- Flange, Lead 3 – Collector

**RCA**  
Solid State  
Division

## Power Transistors

40542

40543

### SILICON N-P-N, MOLDED SILICONE-PLASTIC HOMETAXIAL-BASE TRANSISTORS

RCA-40542 and -40543 are hometaxial\*\*<sup>\*</sup>-base silicon n-p-n power transistors employing a new plastic package with formed leads which can be inserted into a TO-3 socket.

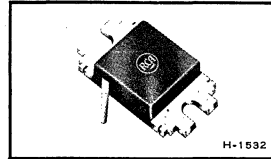
These types differ in voltage ratings and in the current at which the parameters are controlled. The 40542 is intended as a complement to p-n-p type 40051 in complementary-symmetry output stages of audio-amplifier circuits. The 40543 was designed specifically for amplifier applications.

\*Data for type 40051 appears in File No. 67.

\*\*"HOMETAXIAL" was coined by RCA from two words, "homogeneous" and "axial," to provide a name for a transistor structure in which the base region comprises homogeneous resistivity silicon material in the axial direction (emitter-to-collector). Hometaxial types provide greater power-handling capability, lower saturation resistance, and freedom from second breakdown.

#### FOR OUTPUT STAGES IN AUDIO-AMPLIFIER CIRCUITS

40542 -- N-P-N Complement of 40051\*



40542 & 40543  
For TO-3 Sockets

- Molded silicone-plastic package
- Low saturation voltage:

$$V_{CE(sat)} = 1.0 \text{ V max. at } I_C = 2.5 \text{ A (40542)}$$

$$= 1.0 \text{ V max. at } I_C = 3.0 \text{ A (40543)}$$

- Low thermal resistance:  
 $\theta_{J-C} = 1.5 \text{ }^\circ\text{C/W max.}$

#### MAXIMUM RATINGS

Absolute-Maximum Values:		40542	40543	
COLLECTOR-TO-EMITTER SUSTAINING VOLTAGE:				
With external base-to-emitter resistance ( $R_{BE}$ ) = 100 $\Omega$ . . . . .	$V_{CER(sus)}$	50	60	V
EMITTER-TO-BASE VOLTAGE . . . . .	$V_{EBO}$	5	5	V
COLLECTOR CURRENT . . . . .	$I_C$	6	8	A
TRANSISTOR DISSIPATION: . . . . .	$P_T$			
At case temperatures up to 25 $^\circ$ C . . . . .		83	83	W
At temperatures above 25 $^\circ$ C . . . . .		Derate linearly to 0 W at 150 $^\circ$ C.		
TEMPERATURE RANGE:				
Storage & Operating (Junction). . . . .		-65 to 150		$^\circ$ C
LEAD TEMPERATURE (During Soldering):				
At distances $\geq$ 1/16 in. from seating plane for 10 s max. . . . .		235		$^\circ$ C

## ELECTRICAL CHARACTERISTICS

Case Temperature ( $T_C$ ) = 25° C

Characteristic	Symbol	TEST CONDITIONS				LIMITS				Units
		DC Voltage (V)		DC Current (A)		Type 40542		Type 40543		
		$V_{CE}$	$V_{EB}$	$I_C$	$I_B$	Min.	Max.	Min.	Max.	
Collector-Cutoff Current With external base-to-emitter resistance ( $R_{BE}$ ) = 100 $\Omega$	$I_{CER}$	40 50				— —	1.0 —	— —	— 1.0	mA
Emitter-Cutoff Current	$I_{EBO}$		5	0		—	5.0	—	5.0	mA
DC Forward Current Transfer Ratio	$h_{FE}$	4 4		2.5 <sup>a</sup> 3.0 <sup>a</sup>		20 —	70 —	— 20	— 70	
Collector-to-Emitter Sustaining Voltage With external base-to-emitter resistance ( $R_{BE}$ ) = 100 $\Omega$	$V_{CER(sus)}$			0.2 <sup>a</sup>		50	—	60	—	V
Base-to-Emitter Voltage	$V_{BE}$	4 4		2.5 <sup>a</sup> 3.0 <sup>a</sup>		— —	1.7 —	— —	— 1.7	V
Collector-to-Emitter Saturation Voltage	$V_{CE(sat)}$			2.5 <sup>a</sup> 3.0 <sup>a</sup>	0.25 0.3	— —	1.0 —	— —	— 1.0	V
Gain-Bandwidth Product	$f_T$	4		0.5		0.8	2.8	0.8	2.8	MHz
Thermal Resistance (Junction-to-Case)	$\theta_{J-C}$					—	1.5	—	1.5	°C/W

<sup>a</sup>Pulsed; pulse duration = 300  $\mu$ s, duty factor = 1.8%.TERMINAL CONNECTIONS FOR TYPES  
40542 & 40543Lead No. 1 — Base  
Lead No. 2 — Emitter  
Mounting Flange — Collector

TYPICAL DC BETA  
FOR TYPE 40542

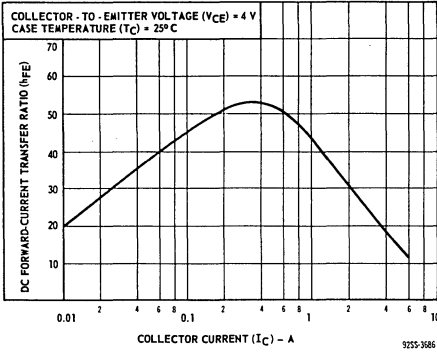


Fig. 1

TYPICAL INPUT CHARACTERISTICS  
FOR TYPE 40542

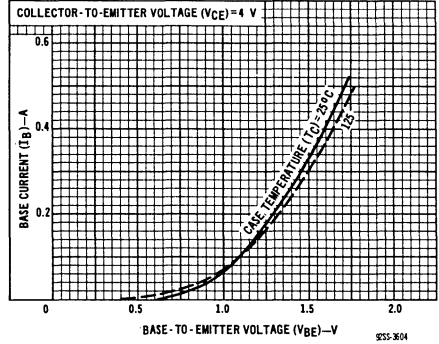


Fig. 2

TYPICAL OUTPUT CHARACTERISTICS  
FOR TYPE 40542

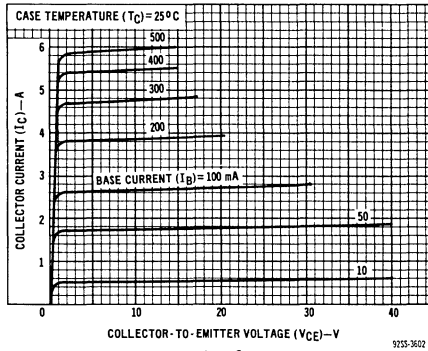


Fig. 3

TYPICAL TRANSFER CHARACTERISTICS  
FOR TYPE 40542

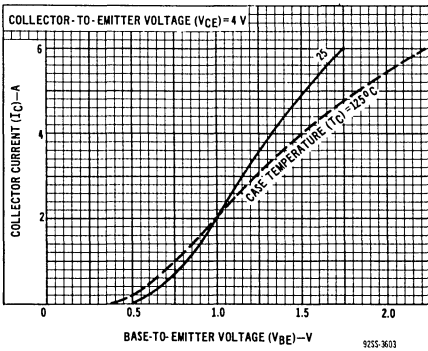


Fig. 4

TYPICAL GAIN-BANDWIDTH PRODUCT  
FOR TYPE 40542

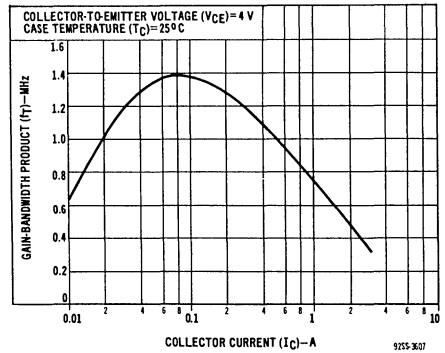


Fig. 5



TYPICAL DC BETA  
FOR TYPE 40543

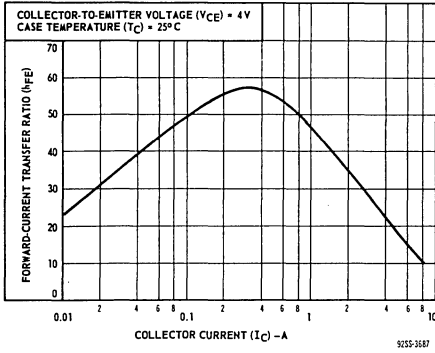


Fig. 6

TYPICAL INPUT CHARACTERISTICS  
FOR TYPE 40543

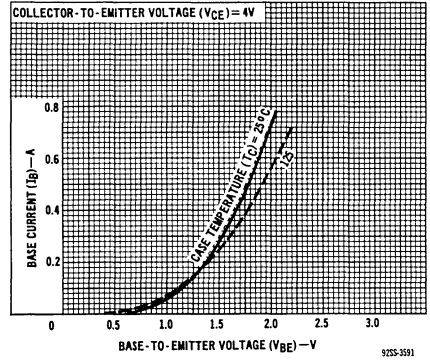


Fig. 7

TYPICAL OUTPUT CHARACTERISTICS  
FOR TYPE 40543

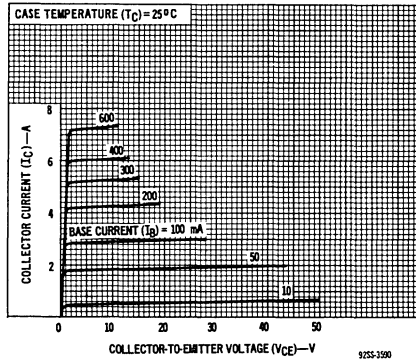


Fig. 8

TYPICAL TRANSFER CHARACTERISTICS  
FOR TYPE 40543

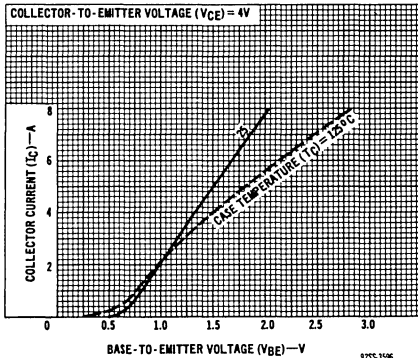


Fig. 9

TYPICAL GAIN-BANDWIDTH PRODUCT  
FOR TYPE 40543

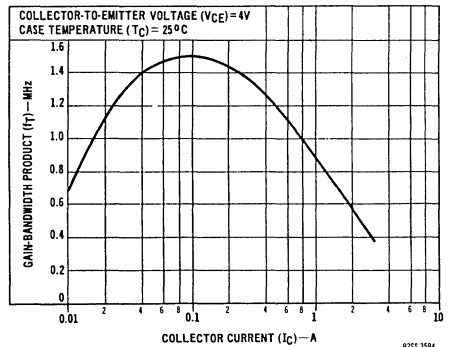





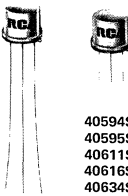
Fig. 10



**Solid State  
Division**

## Power Transistors

40594 40595 40611 40613  
40616 40618 40621 40622  
40624 40625 40627-40632  
40634-40636

 <p>H-1534R1</p> <p>40613 40627 40618 40629 40621 40630 40622 40631 40624 40632</p> <p>JEDEC TO-220AA (For TO-66 Sockets)</p>	 <p>H-1570</p> <p>40636</p> <p>JEDEC TO-3</p>
 <p>H-1468</p> <p>40625L or S 40628L or S</p> <p>With Heat-Radiator</p> <p>See NOTE at right above</p>	 <p>40594S 40595S 40611S 40616S 40634S 40635S</p> <p>40594L 40595L 40611L 40616L 40635L</p> <p>JEDEC TO-39</p> <p>JEDEC TO-5</p> <p>See NOTE at right</p> <p>H-1380 H-1381</p>

## Silicon Transistors for Audio-Frequency Linear-Amplifier Applications

Transistors for Driver Applications:

N-P-N Types

40594 40616 40628  
40611 40625 40635

P-N-P Types

40595 40634

NOTE:

These devices are available with either 1½-inch leads (TO-5 package) or ½-inch leads (TO-39 package). The longer-lead versions are specified by suffix "L" after the type number; the shorter-lead versions are specified by suffix "S" after the type number.

Transistors for Output Applications:

N-P-N Types

40613	40624	40631
40618	40627	40632
40621	40629	40636
40622	40630	

### TERMINAL CONNECTIONS FOR TYPES IN TO-220AA PACKAGE

Lead No.1 — Base  
Stub — Do not use stub as tie point.  
Lead No.3 — Emitter  
Mounting Flange — Collector

### TERMINAL CONNECTIONS FOR 40636

Pin 1 — Base  
Pin 2 — Emitter  
Case — Collector  
Mounting Flange — Collector

RCA-40594, 40595, 40611, 40613, 40616, 40618, 40621, 40622, 40624, 40627-40632, and 40634-40636, inclusive are silicon n-p-n and p-n-p transistors intended for driver and output stages in high-fidelity amplifier circuits.

These devices have been specifically designed for use in complementary-and-quasi-complementary-symmetry audio-amplifier circuits.

### TERMINAL CONNECTIONS FOR TYPES IN TO-5 OR TO-39 PACKAGE

Lead 1 — Emitter  
Lead 2 — Base  
Case, Lead 3 — Collector

### TERMINAL CONNECTIONS FOR 40625 AND 40628

Lead 1 — Emitter  
Lead 2 — Base  
Heat-Radiator, Lead 3 — Collector

## MAXIMUM RATINGS, Absolute-Maximum Values:

RCA Type	$V_{CEO(sus)}$ V	$V_{CER(sus)*}$ V	$V_{EBO}$ V	$I_C$ A	$I_B$ A	$P_T - W^{\circ}$		Temp. Range (Storage & Operating)		
						$T_C = 25^{\circ}C$	$T_A = 25^{\circ}C$	$^{\circ}C$		
								-	to	+
40594	-	95	4	2	1	10	1.2	65	to	200
40595	-	-95	-4	-2	-1	10	1.2	65	to	200
40611	25	-	2.5	0.7	0.2	5	1	65	to	200
40613	25	-	5	4	2	36	1.8	65	to	150
40616	32	-	2.5	0.7	0.2	5	1	65	to	200
40618	30	-	5	4	2	36	1.8	65	to	150
40621	32	-	5	4	2	36	1.8	65	to	150
40622	40	-	5	4	2	36	1.8	65	to	150
40624	45	-	5	6	3	50	1.8	65	to	150
40625	45	-	7	1	-	-	3.5	65	to	200
40627	55	-	5	6	3	50	1.8	65	to	150
40628	55	-	7	1	-	-	3.5	65	to	200
40629	-	35	5	4	2	36	1.8	65	to	150
40630	-	40	5	4	2	36	1.8	65	to	150
40631	-	45	5	4	2	36	1.8	65	to	150
40632	-	60	5	6	3	50	1.8	65	to	150
40634	-	-75	-7	-0.7	-0.2	5	1	65	to	200
40635	-	75	7	0.7	0.2	5	1	65	to	200
40636	-	95	7	15	7	115	-	65	to	200

\*  $R_{BE} = 68 \Omega$  (40612, 40623, & 40626)  
 $= 100 \Omega$  (40594, 40595, 40629, 40630, 40631, 40632, 40633, 40634, 40635, & 40636)

$P_T$  at temperatures above  $25^{\circ}C$ , derate linearly to 0 watts at maximum temperature  
(e.g. +100, +150, or +200 $^{\circ}C$ ).

ELECTRICAL CHARACTERISTICS, At Case Temperature =  $25^{\circ}C$ 

RCA Type	$I_{CBO}$ Max.		$I_{CER}$ Max.				$I_{EBO}$ Max.			$V_{CEO(sus)}$ Min.	
	$\mu A$	$V_{CB}$ V	$\mu A$	mA	$V_{CE}$ V	$R_{BE}$ $\Omega$	$\mu A$	mA	$V_{EB}$ V	V	$I_C$ mA
40611	0.5	15	-	-	-	-	-	1	2.5	25	100
40613	2	25	-	-	-	-	-	1	5	25	100
40616	0.5	15	-	-	-	-	-	1	5	32	100
40618	2	30	-	-	-	-	-	1	5	30	100
40621	0.5	30	-	-	-	-	-	1	5	32	100
40622	-	-	500	-	40	100	-	1	5	40	100
40624	-	-	500	-	45	100	-	1	5	45	100
40625	0.25	60	-	-	-	-	1	-	5	45	100
40627	-	-	500	-	55	100	-	1	5	55	100
40628	0.25	60	-	-	-	-	1	-	5	55	100
40629	-	-	-	0.5	30	100	-	1	5	-	-

ELECTRICAL CHARACTERISTICS, At Case Temperature = 25°C (Cont'd)

RCA Type	I <sub>CBO</sub> Max.		I <sub>CER</sub> Max.				I <sub>EBO</sub> Max.			V <sub>CEQ(sus)</sub> Min.	
	μA	V <sub>CB</sub> V	μA	mA	V <sub>CE</sub> V	R <sub>BE</sub> Ω	μA	mA	V <sub>EB</sub> V	V	I <sub>C</sub> mA
40630	-	-	-	0.5	35	100	-	1	5	-	-
40631	-	-	-	0.5	40	100	-	1	5	-	-
40632	-	-	-	0.5	50	100	-	1	5	-	-
40634	-	-	-10	-	-65	100	-	-0.1	-4	-	-
40635	-	-	10	-	65	100	-	0.1	4	-	-
40636	-	-	-	0.5	85	100	-	1	4	-	-
40594	-	-	10	-	85	100	-	0.1	4	-	-
40595	-	-	-10	-	-85	100	-	-0.1	-4	-	-

V <sub>CER(sus)</sub> Min.			V <sub>CE(sat)</sub> Max.			V <sub>BE</sub> Max.			h <sub>FE</sub>				RCA Type
V	I <sub>C</sub> mA	R <sub>BE</sub> Ω	V	I <sub>C</sub> mA	I <sub>B</sub> mA	V	V <sub>CE</sub> V	I <sub>C</sub> mA	Min.	Max.	I <sub>C</sub> mA	V <sub>CE</sub> V	
-	-	-	-	-	-	-	-	-	70	500	50	4	40611
-	-	-	-	-	-	1.3	4	1000	30	120	1000	4	40613
-	-	-	-	-	-	-	-	-	70	500	50	4	40616
-	-	-	-	-	-	-	-	-	30	120	1000	4	40618
-	-	-	1	1500	150	1.5	4	1500	25	100	1500	4	40621
-	-	-	1	1500	150	1.5	4	1500	25	100	1500	4	40622
-	-	-	1	2500	250	1.7	4	2500	20	100	2500	4	40624
-	-	-	0.5	150	15	1	4	150	100	300	150	10	40625
-	-	-	1	2500	250	1.7	4	2500	20	100	2500	4	40627
-	-	-	0.5	150	15	1	4	150	100	300	150	10	40628
35	100	100	1	1000	100	1.3	4	1000	20	70	1000	4	40629
40	100	100	1	1500	150	1.4	4	1500	20	70	1500	4	40630
45	100	100	1	2000	200	1.5	4	2000	20	70	2000	4	40631
60	100	100	1	3000	300	1.4	4	3000	20	70	3000	4	40632
-75	-100	100	-0.8	-150	-15	-1.4	-4	-150	50	250	-150	-4	40634
75	100	100	0.8	150	15	1.4	4	150	50	250	150	4	40635
95	200	100	1	4000	400	1.4	4	4000	20	70	4000	4	40636
95	100	100	0.8	300	30	1.4	4	300	70	350	300	4	40594
-95	-100	100	-0.8	-300	-30	-1.4	-4	-300	70	350	-300	-4	40595



# RF Power Transistors

40608

RCA-40608 is an epitaxial silicon n-p-n planar transistor. It is especially designed for operation as a Class A, wide-band power amplifier in VHF circuits.

The features of high gain-bandwidth product and low cross-modulation make the 40608 especially suited for use in CATV and MATV systems.

\*Formerly RCA Dev. Type No. TA2761

**MAXIMUM RATINGS, Absolute-Maximum Values:**

COLLECTOR-TO-BASE VOLTAGE . . . $V_{CBO}$	40	V
COLLECTOR-TO-EMITTER VOLTAGE: With external base-to-emitter resistance, ( $R_{BE}$ ) = 100 $\Omega$ . . . . . $V_{CER}$	40	V
EMITTER-TO-BASE VOLTAGE . . . . . $V_{EBO}$	2	V
COLLECTOR CURRENT . . . . . $I_C$	0.4	A
TRANSISTOR DISSIPATION . . . . . $P_T$ At case temperatures up to 25 $^{\circ}$ C . . . . .	3.5	W
At case temperatures above 25 $^{\circ}$ C . . . . . See Fig. 1.		
TEMPERATURE RANGE: Storage & Operating (Junction) . . . . .	-65 to +200	$^{\circ}$ C
LEAD TEMPERATURE (During soldering): At distances $\geq$ 1/32 in. (0.79 mm) from seating plane for 10 s max. . . . .	230	$^{\circ}$ C

## SILICON N-P-N "overlay" TRANSISTOR

For Class A Wide-Band  
CATV and MATV  
Applications



JEDEC TO-39

**Features:**

- o High Gain-Bandwidth Product
- o Low Cross-Modulation

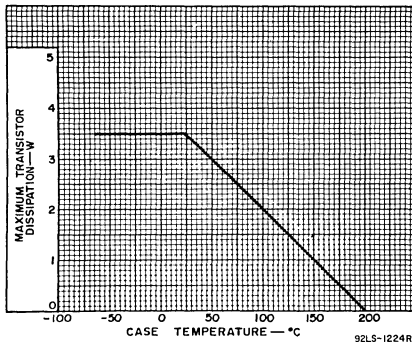
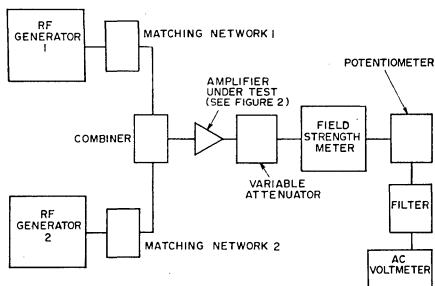


Fig. 1 - Dissipation Derating Curve

## ELECTRICAL CHARACTERISTICS, Case Temperature = 25°C

Characteristic	Symbol	Test Conditions					Limits		Units
		DC Collector Volts		DC Current (mA)			Min.	Max.	
		V <sub>CB</sub>	V <sub>CE</sub>	I <sub>E</sub>	I <sub>B</sub>	I <sub>C</sub>			
Collector-Cutoff Current	I <sub>CEO</sub>		20	0	0		100	μA	
Collector-to-Base Breakdown Voltage	V <sub>(BR)CBO</sub>			0		0.1	40	V	
Collector-to-Emitter Voltage (Sustaining)	V <sub>CER(sus)</sub>					50 <sup>a</sup>	40	V	
Emitter-to-Base Breakdown Voltage	V <sub>(BR)EBO</sub>			0.1		0	2	V	
Collector-to-Emitter Saturation Voltage	V <sub>CE(sat)</sub>			10	50		1.0	V	
Collector-to-Base Capacitance (Measured at 1MHz)	C <sub>ob</sub>	30		0			3.0	pF	
Gain-Bandwidth Product	f <sub>T</sub>		15			50	700	MHz	
DC Forward-Current Transfer Ratio	h <sub>FE</sub>		15			50	35	120	
Voltage Gain (See Fig. 2.)	VG		15			50	11	dB	
Cross Modulation @ 46 dBmV (See Fig. 3.)	CM		15			50	-57 (Typ.)	dB	

<sup>a</sup>Pulsed through an inductor (20 mH); duty factor = 50%; R<sub>BE</sub> = 100 Ω.



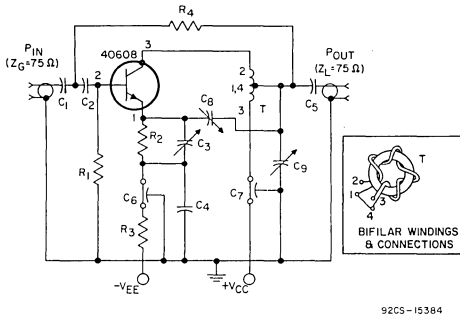
92LS-1225RI

Generator No. 1 & No. 2: Hewlett-Packard, HP608D, or equivalent  
 Matching Network No. 1 & No. 2: 50 to 75 Ω  
 Combiner: 20 dB isolation between generators  
 Variable Attenuator: As required  
 Field Strength Meter, with Detector Output: 50-220 MHz  
 Potentiometer: 100 kΩ  
 Filter: 1000 Hz  
 AC Voltmeter: Ballantine 861, or equivalent

## OPERATING INSTRUCTIONS FOR CROSS-MODULATION TEST

1. Set up equipment as shown in Fig. 2.
2. Set generator No. 1 to 150 MHz modulated 30% by 1000 Hz, and tune field strength meter to 150 MHz.
3. Adjust output of generator No. 1 to give rated output of the amplifier.
4. Adjust potentiometer to calibrate voltmeter for a convenient level. This level then corresponds to 100% cross modulation.
5. Remove modulation.
6. Set generator No. 2 to 210 MHz modulated 30% by 1000 Hz and tune field strength meter to 210 MHz.
7. Adjust output of generator No. 2 to give rated output of the amplifier. (If the amplifier has a flat response then the output of the two signal generators will be equal.)
8. Tune field strength meter to 150 MHz CW and read voltmeter.
9. Turn voltmeter to proper scale for reading. Calculate percentage of cross modulation based upon 100% level set in step 4.

Fig. 2-Block Diagram for Cross-Modulation Test Set-Up

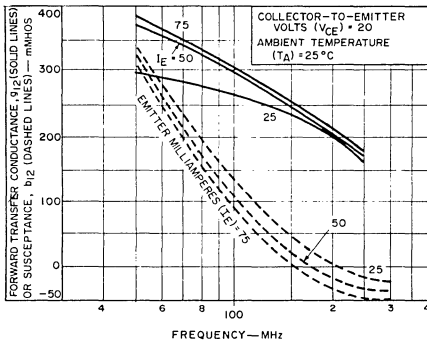


- $C_1, C_2, C_5$ : 0.002  $\mu$ F
- $C_3$ : 7-100 pF, ARCO 423, or equivalent
- $C_4$ : .03  $\mu$ F
- $C_6, C_7$ : 1,500 pF
- $C_8, C_9$ : 8-60 pF, ARCO 404, or equivalent
- $R_1$ : 390  $\Omega$ , 1/2 W
- $R_2$ : 6.8  $\Omega$ , 1/2 W
- $R_3$ : 330  $\Omega$ , 1 W
- $R_4$ : 270  $\Omega$ , 1/2 W
- T: 4 turns No. 30 wire, bifilar wound; toroidal core: 3/8 in. OD, 3/16 in. ID, 1/8 in. thick, IGC\* type Q-1, or equivalent.

\*Indiana General Corp., Electronics/Ferrites Div., Kearsbey, N.J.

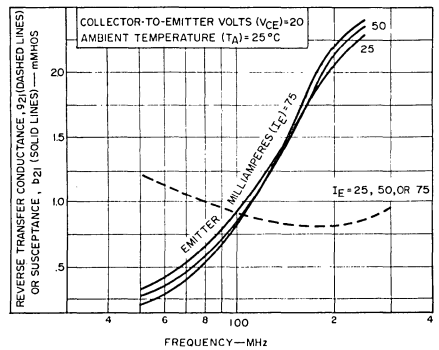
Fig. 3-RF Amplifier Circuit for Voltage Gain Test

TYPICAL ADMITTANCE CHARACTERISTICS  
(Common-Emitter Circuit)



92LS-1234R2

Fig. 4-Forward Transfer Admittance

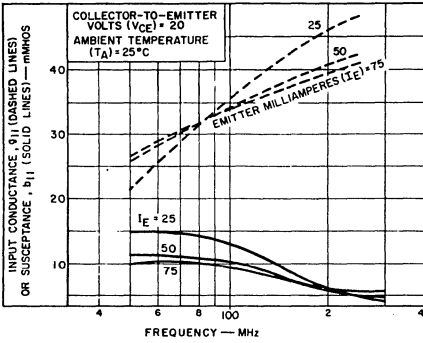


92LS-1238R2

Fig. 5-Reverse Transfer Admittance

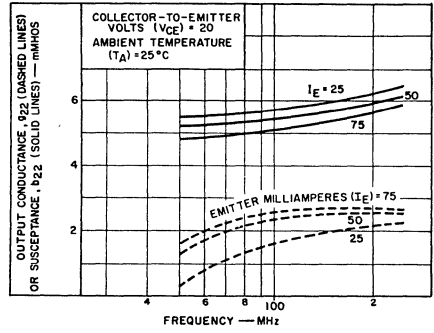
TYPICAL ADMITTANCE CHARACTERISTICS

(Common-Emitter Circuit)



92LS-1236R2

Fig. 6 - Input Admittance



92LS-1237R2

Fig. 7 - Output Admittance

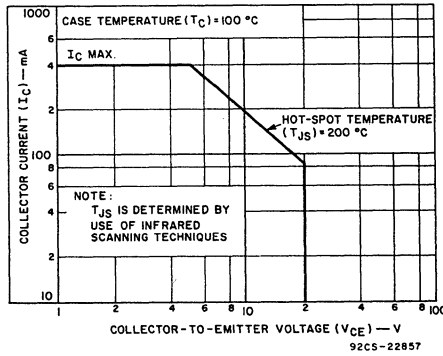


Fig. 8 - Safe Area for DC Operation

TERMINAL CONNECTIONS

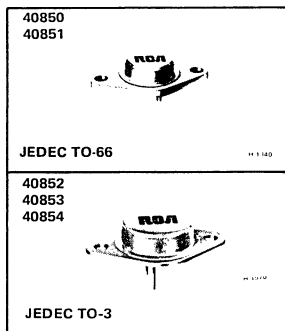
- Lead 1 — Emitter
- Lead 2 — Base
- Lead 3 — Collector, Case



**RCA**  
Solid State  
Division

## Power Transistors

40850 40851  
40852 40853  
40854



### 450-V Silicon N-P-N Types

For Off-Line Switching-Regulator Type  
Power-Supply Applications

#### Features:

- High-voltage ratings for operation from power lines without a step-down transformer
- Popular JEDEC TO-3 and TO-66 hermetic packages

#### Applications:

- For use in switching-regulator supplies which feature:
  - A substantial reduction in size and weight due to elimination of the 60-Hz power transformer.
  - Operation with a substantial reduction of heat

RCA 40850—40854, inclusive, are silicon n-p-n power transistors, selected from RCA's line of silicon power transistors, for power-supply applications. Their high-voltage ratings (450 V) permit operation directly off the power line thereby eliminating the heavy and bulky 60-Hz power transformer.

Their fast switching speeds ( $t_r$  plus  $t_f$  equal to less than 2.0  $\mu$ s) permit operation above the audio-frequency range (20 to 30 kHz) for quiet performance, and permit the use of small ferrite-core transformers for changing the voltage level.

These types have sufficient voltage capability to be used as push-pull inverters or pulse-width-modulated inverters operating directly off the 120-V power line.

- 5-V, off-line supplies with current ratings of 25, 50, 100, or 200 A
- 30-V, off-line supplies with current ratings of 5, 10, 20, or 40 A

Types 40850—40854 have sufficient voltage capability to operate as switching regulators off a 240-V line; for 120-V lines, the prototypes can be used.

A brief description of these types, together with prototype identification, is given in the tables on pages 2, 3, and 4.

#### MAXIMUM RATINGS, Absolute-Maximum Values:

	40850	40851	40852 <sup>■</sup>	40853	40854	
COLLECTOR-TO-BASE VOLTAGE, $V_{CBO}$	450	450	450	450	450	V
COLLECTOR-TO-EMITTER SUSTAINING VOLTAGE:						
With base open, $V_{CEO(sus)}$	300	350	350	300	300	V
With external base-to-emitter resistance ( $R_{BE}$ ) $\leq 50 \Omega$ , $V_{CER(sus)}$	400	375	375	375	325	V
EMITTER-TO-BASE VOLTAGE, $V_{EBO}$	6	9	9	6	6	V
COLLECTOR CURRENT, $I_C$						
Continuous and Average	2	7	7	10	15	A
Peak (10 ms max.)	5	10	10	15	30	A
CONTINUOUS BASE CURRENT, $I_B$	1	4	4	5	10	A

■ Formerly RCA-40832.

Continued on following page.

## MAXIMUM RATINGS (cont'd):

	40850	40851	40852 ■	40853	40854	
TRANSISTOR DISSIPATION, $P_T$ : (Power Dissipation-Limited Region*)						
At case temperatures up to 25°C	35	45	100	100	175	W
At case temperatures above 25°C and in the $I_{S/b}$ -Limited Region*	See derating curves in prototype bulletins .					
TEMPERATURE RANGE: Storage & Operating (Junction)	←----- -65 to +200 °C -----→					
PIN TEMPERATURE (During Soldering): At distances $\geq 1/32$ in. (0.8 mm) from case for 10 s max.	←----- 230°C -----→					

\* Safe-operating-area curves for prototype devices should be extended to the maximum values of collector current given for these devices.

■ Formerly RCA-40832

## TERMINAL CONNECTIONS (All Types)

Pin 1 - Base

Pin 2 - Emitter

Mounting Flange, Case - Collector

Type 40850 (For 5-V, 25-A & 30-V, 5-A Power Supplies)

Package: JEDEC TO-66

Application Information: See "RCA Power Circuits" manual SP-52 and RCA Application Note AN3065

ELECTRICAL CHARACTERISTICS, At Case Temperature ( $T_C$ ) = 25°C Unless Otherwise Specified

CHARACTERISTIC	SYMBOL	TEST CONDITIONS	LIMITS		UNITS
			MIN.	MAX.	
Collector-Cutoff Current: With base reverse biased	$I_{CEV}$	$V_{CE} = 450 \text{ V}, V_{BE} = -1.5 \text{ V}$	—	0.2	mA
	$I_{CEV}$	$V_{CE} = 450 \text{ V}, V_{BE} = -1.5 \text{ V}, T_C = 125^\circ\text{C}$	—	2	mA
Collector-to-Emitter Voltage With base open	$V_{CEO}^a$	$I_C = 0.2 \text{ A}, I_B = 0$	300	—	V
Collector-to-Emitter Voltage With external base-to-emitter resistance ( $R_{BE}$ )	$V_{CER}^a$	$I_C = 0.2 \text{ A}, R_{BE} = 50 \Omega$	400	—	V
Emitter-to-Base Voltage	$V_{EBO}$	$I_E = 5 \text{ mA}, I_C = 0$	6	—	V
DC Forward-Current Transfer Ratio	$h_{FE}$	$I_C = 0.75 \text{ A}, V_{CE} = 10 \text{ V}$	25	—	
Collector-to-Emitter Saturation Voltage	$V_{CE(sat)}$	$I_C = 2 \text{ A}, I_B = 0.4 \text{ A}$	—	2.0	V
Base-to-Emitter Saturation Voltage	$V_{BE(sat)}$	$I_C = 2 \text{ A}, I_B = 0.4 \text{ A}$	—	2.0	V
Second-Breakdown Collector Current: With base forward biased	$I_{S/b}^a$	$V_{CE} = 100 \text{ V}$	0.35	—	A
Second-Breakdown Energy: With base reversed biased	$E_{S/b}^a$	$L = 100 \mu\text{H}, I_C(\text{PEAK}) = 2 \text{ A}, R = 20 \Omega$ $V_{BE} = -4 \text{ V}$	0.2	—	mJ

<sup>a</sup> For characteristics curves and test conditions, refer to published data for prototype 2N3585 (File 138).

**Type 40851** (For 5-V, 50-A & 30-V, 10-A Power Supplies)

**Package:** JEDEC TO-66

**Applications Information:** See "RCA Power Circuits" manual SP-52 and RCA Application Note AN4509

**ELECTRICAL CHARACTERISTICS, At Case Temperature ( $T_C$ ) = 25°C Unless Otherwise Specified**

CHARACTERISTIC	SYMBOL	TEST CONDITIONS	LIMITS		UNITS
			MIN.	MAX.	
Collector-Cutoff Current: With base reverse biased	$I_{CEV}$	$V_{CE} = 450\text{ V}, V_{BE} = -1.5\text{ V}$	–	0.5	mA
	$I_{CEV}$	$V_{CE} = 450\text{ V}, V_{BE} = -1.5\text{ V}, T_C = 125^\circ\text{C}$	–	5	mA
Collector-to-Emitter Voltage With base open	$V_{CEO}^a$	$I_C = 0.2\text{ A}, I_B = 0$	350	–	V
Collector-to-Emitter Voltage With external base-to-emitter resistance ( $R_{BE}$ )	$V_{CER}^a$	$I_C = 0.2\text{ A}, R_{BE} = 50\ \Omega$	375	–	V
Emitter-to-Base Voltage	$V_{EBO}$	$I_E = 1\text{ mA}, I_C = 0$	9	–	V
DC Forward-Current Transfer Ratio	$h_{FE}$	$I_C = 1.2\text{ A}, V_{CE} = 1.0\text{ V}$	12	–	
Collector-to-Emitter Saturation Voltage	$V_{CE(sat)}$	$I_C = 4\text{ A}, I_B = 0.8\text{ A}$	–	3	V
Base-to-Emitter Saturation Voltage	$V_{BE(sat)}$	$I_C = 4\text{ A}, I_B = 0.8\text{ A}$	–	2	V
Second-Breakdown Collector Current: With base forward biased	$I_{S/b}^a$	$V_{CE} = 50\text{ V}$	0.9	–	A
Second-Breakdown Energy: With base reversed biased	$ES/b^a$	$L = 100\ \mu\text{H}, I_C(\text{PEAK}) = 3\text{ A}, R = 50\ \Omega$ $V_{BE} = -4\text{ V}$	0.45	–	mJ

<sup>a</sup> For characteristics curves and test conditions, refer to published data for prototype 2N6079 (File 492).

**Type 40852** (For 5-V, 50-A & 30-V, 10-A Power Supplies)

**Package:** JEDEC TO-3

**Applications Information:** See "RCA Power Circuits" manual SP-52 and RCA Application Note AN4509

**ELECTRICAL CHARACTERISTICS, At Case Temperature ( $T_C$ ) = 25°C Unless Otherwise Specified.**

CHARACTERISTIC	SYMBOL	TEST CONDITIONS	LIMITS		UNITS
			MIN.	MAX.	
Collector-Cutoff Current: With base reverse biased	$I_{CEV}$	$V_{CE} = 450\text{ V}, V_{BE} = -1.5\text{ V}$	–	0.5	mA
	$I_{CEV}$	$V_{CE} = 450\text{ V}, V_{BE} = -1.5\text{ V}, T_C = 125^\circ\text{C}$	–	5	mA
Collector-to-Emitter Voltage With base open	$V_{CEO}^a$	$I_C = 0.2\text{ A}, I_B = 0$	350	–	V
Collector-to-Emitter Voltage With external base-to-emitter resistance ( $R_{BE}$ )	$V_{CER}^a$	$I_C = 0.2\text{ A}, R_{BE} = 50\ \Omega$	375	–	V
Emitter-to-Base Voltage	$V_{EBO}$	$I_E = 1\text{ mA}, I_C = 0$	9	–	V
DC Forward-Current Transfer Ratio	$h_{FE}$	$I_C = 1.2\text{ A}, V_{CE} = 1.0\text{ V}$	12	–	
Collector-to-Emitter Saturation Voltage	$V_{CE(sat)}$	$I_C = 4\text{ A}, I_B = 0.8\text{ A}$	–	3.0	V
Base-to-Emitter Saturation Voltage	$V_{BE(sat)}$	$I_C = 4\text{ A}, I_B = 0.8\text{ A}$	–	2.0	V
Second-Breakdown Collector Current: With base forward biased	$I_{S/b}^a$	$V_{CE} = 40\text{ V}$	2.5	–	A
Second-Breakdown Energy: With base reversed biased	$ES/b^a$	$L = 100\ \mu\text{H}, I_C(\text{PEAK}) = 3\text{ A}, R = 50\ \Omega$ $V_{BE} = -4\text{ V}$	0.45	–	mJ

<sup>a</sup> For characteristics curves and test conditions, refer to published data for prototype 2N5840 (File 410).

**Type 40853** (For 5-V, 100-A & 30-V, 20-A Power Supplies)

**Package:** JEDEC TO-3

**Applications Information:** See "RCA Power Circuits" manual SP-52

**ELECTRICAL CHARACTERISTICS, At Case Temperature ( $T_C$ ) = 25°C Unless Otherwise Specified**

CHARACTERISTIC	SYMBOL	TEST CONDITIONS	LIMITS		UNITS
			MIN.	MAX.	
Collector-Cutoff Current:	$I_{CEV}$	$V_{CE} = 450\text{ V}, V_{BE} = -1.5\text{ V}$	—	1.0	mA
With base reverse biased	$I_{CEV}$	$V_{CE} = 450\text{ V}, V_{BE} = -1.5\text{ V}, T_C = 125^\circ\text{C}$	—	10	mA
Collector-to-Emitter Voltage With base open	$V_{CEO}^a$	$I_C = 0.2\text{ A}, I_B = 0$	300	—	V
Collector-to-Emitter Voltage With external base-to-emitter resistance ( $R_{BE}$ )	$V_{CER}^a$	$I_C = 0.2\text{ A}, R_{BE} = 50\ \Omega$	375	—	V
Emitter-to-Base Voltage	$V_{EBO}$	$I_E = 5\text{ mA}, I_C = 0$	6	—	V
DC Forward-Current Transfer Ratio	$h_{FE}$	$I_C = 5\text{ A}, V_{CE} = 4\text{ V}$	10	—	
Collector-to-Emitter Saturation Voltage	$V_{CE(sat)}$	$I_C = 8\text{ A}, I_B = 1.6\text{ A}$	—	3.0	V
Base-to-Emitter Saturation Voltage	$V_{BE(sat)}$	$I_C = 8\text{ A}, I_B = 1.6\text{ A}$	—	2.0	V
Second-Breakdown Collector Current: With base forward biased	$I_{S/b}^a$	$V_{CE} = 50\text{ V}$	2.2	—	A
Second-Breakdown Energy: With base reversed biased	$E_{S/b}^a$	$L = 50\ \mu\text{H}, I_C(\text{PEAK}) = 5\text{ A}, R = 20\ \Omega$ $V_{BE} = -4\text{ V}$	0.62	—	mJ

<sup>a</sup> For characteristics curves and test conditions, refer to published data for prototype 2N5805 (File 407).

**Type 40854** (For 5-V, 200-A & 30-V, 40-A Power Supplies)

**Package:** JEDEC TO-3

**Applications Information:** See "RCA Power Circuits" manual SP-52

**ELECTRICAL CHARACTERISTICS, At Case Temperature ( $T_C$ ) = 25°C Unless Otherwise Specified.**

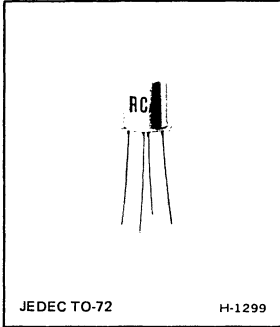
CHARACTERISTIC	SYMBOL	TEST CONDITIONS	LIMITS		UNITS
			MIN.	MAX.	
Collector-Cutoff Current:	$I_{CEV}$	$V_{CE} = 450\text{ V}, V_{BE} = -1.5\text{ V}$	—	1.0	mA
With base reverse biased	$I_{CEV}$	$V_{CE} = 450\text{ V}, V_{BE} = -1.5\text{ V}, T_C = 125^\circ\text{C}$	—	10	mA
Collector-to-Emitter Voltage With base open	$V_{CEO}^a$	$I_C = 0.2\text{ A}, I_B = 0$	300	—	V
Collector-to-Emitter Voltage With external base-to-emitter resistance ( $R_{BE}$ )	$V_{CER}^a$	$I_C = 0.2\text{ A}, R_{BE} = 50\ \Omega$	325	—	V
Emitter-to-Base Voltage	$V_{EBO}$	$I_E = 5\text{ mA}, I_C = 0$	6	—	V
DC Forward-Current Transfer Ratio	$h_{FE}$	$I_C = 10\text{ A}, V_{CE} = 4\text{ V}$	8	—	
Collector-to-Emitter Saturation Voltage	$V_{CE(sat)}$	$I_C = 16\text{ A}, I_B = 3.2\text{ A}$	—	3.0	V
Base-to-Emitter Saturation Voltage	$V_{BE(sat)}$	$I_C = 16\text{ A}, I_B = 3.2\text{ A}$	—	3.0	V
Second-Breakdown Collector Current: With base forward biased	$I_{S/b}^a$	$V_{CE} = 30\text{ V}$	5.8	—	A
Second-Breakdown Energy: With base reversed biased	$E_{S/b}^a$	$L = 50\ \mu\text{H}, I_C(\text{PEAK}) = 10\text{ A}, R = 50\ \Omega$ $V_{BE} = -4\text{ V}$	2.5	—	mJ

<sup>a</sup> For characteristics curves and test conditions, refer to published data for prototype 2N6251 (File 523).



## RF Power Transistors

40894 40896  
40895 40897



### High - Frequency Silicon N-P-N Transistors

For TV-Tuner, FM and AM/FM "Front-End", and IF Amplifier, Oscillator, and Converter Service

#### Features:

- High gain-bandwidth products:
  - $f_T = 1200$  MHz typ. for tuner types
  - $= 800$  MHz typ. for if-amplifier types
- Very low collector-to-base feedback capacitance:
  - $C_{cb} = 0.7$  pF typ. for 40894, 40895
- Low noise figure:
  - 3 dB typ. at 200 MHz for rf amplifier type
- High power gain as neutralized amplifier:
  - $G_{PE} = 15$  dB min. at 200 MHz (40894)
- High power output as uhf oscillator:
  - $P_{OE} = 20$  mW typ. at 500 MHz (40896)
- Low noise figure:
  - NF = 4.5 dB max. at 200 MHz (40894)
- Low collector-to-base time constant:
  - $t_{b'C_c} = 14$  ps max.

RCA-40894, 40895, 40896, and 40897 are high-frequency n-p-n silicon devices characterized especially for rf, mixer, oscillator, and if stages of vhf, SSB, and FM receivers.

These devices utilize a hermetically sealed four-lead JEDEC TO-72 package. All active elements of the transistor are insulated from the case, which may be grounded by means of the fourth lead in applications requiring minimum feedback capacitance, shielding of the device, or both.

#### MAXIMUM RATINGS, Absolute-Maximum Values:

COLLECTOR-TO-EMITTER VOLTAGE .....	$V_{CEO}$	12	V
COLLECTOR-TO-BASE VOLTAGE .....	$V_{CBO}$	20	V
EMITTER-TO-BASE VOLTAGE .....	$V_{EBO}$	2.5	V
CONTINUOUS COLLECTOR CURRENT .....	$I_C$	50	mA
TRANSISTOR DISSIPATION .....	$P_T$		
With heat sink, at case temperatures up to 25°C .....		300	mW
With heat sink, at case temperatures above 25°C .....		Derate linearly 1.71	mW/°C
At ambient temperatures up to 25°C .....		200	mW
At ambient temperatures above 25°C .....		Derate linearly 1.14	mW/°C
TEMPERATURE RANGE:			
Storage & Operating (Junction) .....		-65 to +200	°C
CASE TEMPERATURE (During soldering):			
At distances $\geq 1/32$ in. (0.8 mm) from seating surface for 10 seconds max. ....		265	°C

ELECTRICAL CHARACTERISTICS at Ambient Temperature ( $T_A$ ) = 25°C unless otherwise specified

CHARACTERISTICS	SYMBOLS	TEST CONDITIONS							LIMITS						UNITS
		FREQUENCY MHz	DC COLLECTOR OR EMITTER VOLTAGE V			DC CURRENT mA			TYPE 40894 RF AMPLIFIER			TYPE 40895 MIXER			
			$V_{CB}$	$V_{CE}$	$V_{EB}$	$I_E$	$I_C$	$I_B$	Min.	Typ.	Max.	Min.	Typ.	Max.	
Collector-Cutoff Current  $T_A = 150^\circ\text{C}$	$I_{CBO}$	15			0			-	-	0.02	-	-	0.02	$\mu\text{A}$	
		15			0			-	-	1	-	-	1		
Collector-to-Base Breakdown Voltage <sup>a</sup>	$V_{(BR)CBO}$				0	0.001		20	-	-	20	-	-	V	
Collector-to-Emitter Sustaining Voltage	$V_{CEO(sus)}$					3	0	15	-	-	15	-	-	V	
Emitter-to-Base Breakdown Voltage	$V_{(BR)EBO}$				0.01	0		2.5	-	-	2.5	-	-	V	
Collector-to-Emitter Saturation Voltage	$V_{CE(sat)}$					10	1	-	-	0.4	-	-	0.4	V	
Base-to-Emitter Saturation Voltage	$V_{BE(sat)}$					10	1	-	-	1	-	-	1	V	
Static Forward Current- Transfer Ratio	$h_{FE}$		6			1		50	80	250	40	70	250		
Magnitude of Common- Emitter, Small-Signal Short-Circuit, For- ward Current Transfer Ratio <sup>a</sup>	$ h_{fe} $	100 1 kHz	6 6			5 2		9 25	14 90	20 300	9 25	14 90	20 300		
Collector-to-Base Feedback Capacitance <sup>b</sup>	$C_{cb}$	0.1 to 1	10		0			-	0.7	1	-	0.7	1	pF	
Common-Base Input Capacitance <sup>c</sup>	$C_{ib}$	0.1 to 1		0.5	0			-	-	2	-	-	2	pF	
Collector-to-Base Time Constant <sup>a</sup>	$r_b'C_c$	31.9	6			2		3	7	14	3	7	14	ps	
Small-Signal Power Gain in Neutralized Com- mon-Emitter Ampli- fier Circuit <sup>a</sup> (see Fig. 6)	$G_{pE}$	10.7 200		12 12		5 5		- 15	- 21	- -	- 15	- 21	- -	dB	
Noise Figure <sup>a</sup>	NF	200		6		1.5		-	3	4.5	-	-	-	dB	

<sup>a</sup>Lead No. 4 (case) grounded;  $R_g = 125\Omega$ <sup>b</sup>Three-terminal measurement of the collector-to-base capacitance with the case and emitter leads connected to the guard terminal.<sup>c</sup>Lead No. 4 (case) floating.

ELECTRICAL CHARACTERISTICS at Ambient Temperature ( $T_A$ ) = 25°C unless otherwise specified

CHARACTERISTICS	SYMBOLS	TEST CONDITIONS						LIMITS						UNITS	
		FREQUENCY MHz	DC COLLECTOR OR EMITTER VOLTAGE V			DC CURRENT mA			TYPE 40896 OSCILLATOR			TYPE 40897 IF AMPLIFIER			
			$V_{CB}$	$V_{CE}$	$V_{EB}$	$I_E$	$I_C$	$I_B$	Min.	Typ.	Max.	Min.	Typ.		Max.
Collector-Cutoff Current	$I_{CBO}$		15			0			-	-	0.02	-	-	0.02	$\mu A$
$T_A = 150^\circ C$			15			0			-	-	1	-	-	1	
Collector-to-Base Breakdown Voltage <sup>a</sup>	$V_{(BR)CBO}$					0	0.001		20	-	-	20	-	-	V
Collector-to-Emitter Sustaining Voltage	$V_{CEO(sus)}$						3	0	15	-	-	15	-	-	V
Emitter-to-Base Breakdown Voltage	$V_{(BR)EBO}$					0.01	0		2.5	-	-	2.5	-	-	V
Collector-to-Emitter Saturation Voltage	$V_{CE(sat)}$						10	1	-	-	0.4	-	-	0.4	V
Base-to-Emitter Saturation Voltage	$V_{BE(sat)}$						10	1	-	-	1	-	-	1	V
Static Forward Current- Transfer Ratio	$h_{FE}$			6			1		27	50	250	70	120	250	
Magnitude of Common- Emitter, Small-Signal Short-Circuit, For- ward Current Transfer Ratio <sup>a</sup>	$ h_{fe} $	100 1 kHz		6 6			5 2		9 25	14 90	20 300	9 25	14 90	20 300	
Collector-to-Base Feedback Capacitance <sup>b</sup>	$C_{cb}$	0.1 to 1	10			0			-	0.7	1	-	0.7	1	pF
Common-Base Input Capacitance <sup>c</sup>	$C_{ib}$	0.1 to 1			0.5		0		-	-	2	-	-	2	pF
Collector-to-Base Time Constant <sup>a</sup>	$t_b' C_c$	31.9	6				2		3	7	14	3	7	14	ps
Small-Signal Power Gain in Neutralized Common- Emitter Amplifier Circuit <sup>a</sup> (see Fig. 6)	$G_{PE}$	10.7 200		12 12			5 5		- 15	- 21	- -	18 -	25 -	- -	dB
Noise Figure <sup>a</sup>	NF	200		6			1.5		-	-	-	-	-	-	dB

<sup>a</sup>Lead No. 4 (case) grounded;  $R_g = 125\Omega$ <sup>b</sup>Three-terminal measurement of the collector-to-base capacitance with the case and emitter leads connected to the guard terminal.<sup>c</sup>Lead No. 4 (case) floating.

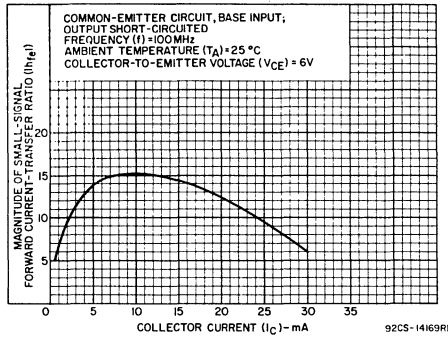


Fig. 1—Small-signal beta characteristic for all types

TWO-PORT ADMITTANCE (y) PARAMETERS AS FUNCTIONS OF FREQUENCY (f) FOR ALL TYPES

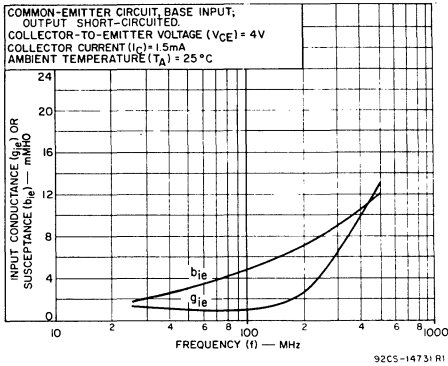


Fig. 2—Input admittance ( $y_{ie}$ )

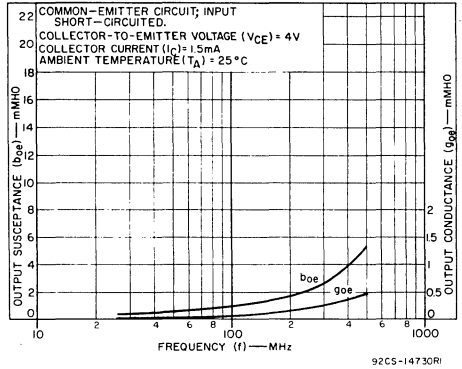


Fig. 3—Output admittance ( $y_{oe}$ )

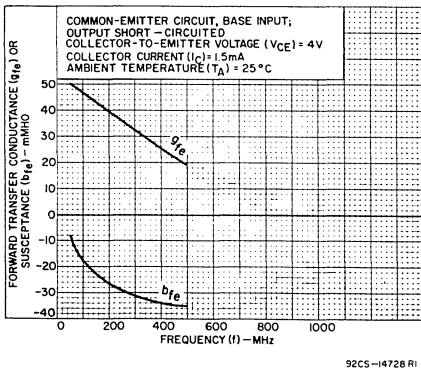


Fig. 4—Forward transmittance ( $y_{fe}$ )

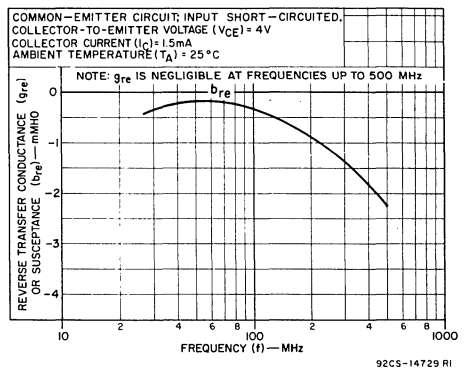
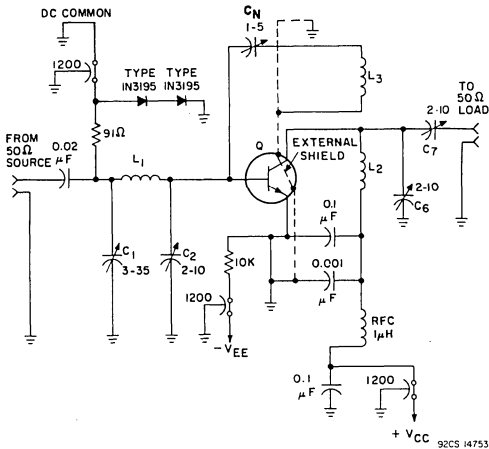


Fig. 5—Reverse transmittance ( $y_{rf}$ )





NOTE: (Neutralization Procedure): (a) Connect a 50-Ω rf voltmeter to the output of a 200-MHz signal generator ( $R_g = 50\Omega$ ), and adjust the generator output to 5 mV. (b) Connect the generator to the input and the rf voltmeter to the output of the amplifier, as shown above. (c) Apply  $V_{EE}$  and  $V_{CC}$ , and adjust the generator output to provide an amplifier output of 5 mV. (d) Tune  $C_2$ ,  $C_6$ , and  $C_7$  for maximum amplifier output, readjusting the generator output as required to maintain an output of 5 mV from the amplifier. (e) Interchange the connections to the signal generator and the rf voltmeter. (f) With sufficient signal applied to the output terminals of the amplifier, adjust  $C_N$  for a minimum indication at the amplifier input. (g) Repeat steps (a), (b), (c), and (d) to determine if retuning is necessary.

Q = Type 40894, 40895, 40896, or 40897

L<sub>1</sub>: 1-3/4 turns No. 18 wire 0.5 in. (12.7 mm) long, 0.5 in. (12.7 mm) ID

L<sub>2</sub>: 2 turns No. 16 wire, 0.5 in. (12.7 mm) long, 0.5 in. (12.7 mm) ID

L<sub>3</sub>: 2 turns No. 18 wire, 0.25 in. (6.35 mm) long, 0.5 in. (12.7 mm) ID. Position approximately 1/4 in. (6.35 mm) from L<sub>2</sub>.

All capacitances in pF unless otherwise specified.

Fig. 6—Neutralized amplifier circuit used to measure power gain and noise figure at 200 MHz for all types

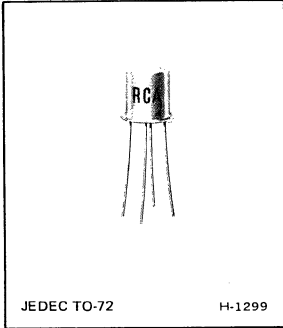
#### TERMINAL CONNECTIONS

- Lead 1 — Emitter
- Lead 2 — Base
- Lead 3 — Collector
- Lead 4 — Connected to case



# RF Transistors

40915



## 0.2-to-1.4-GHz Low-Noise Silicon N-P-N Transistor

For High-Gain Small-Signal Applications

**Features:**

- Low noise figure:
  - NF = 2.5 dB (max.) with 11 dB gain at 450 MHz
  - = 3.0 dB (typ.) at 890 MHz
  - = 4.5 dB (typ.) at 1.3 GHz
- High gain (tuned, unneutralized):
  - $G_{PE}$  = 14 dB (min.) at 450 MHz
  - = 6.5 dB (typ.) at 1.3 GHz
- High gain-bandwidth product
- Large dynamic range
- Low distortion

RCA-40915\* is an epitaxial silicon n-p-n planar transistor intended for low-power, small-signal applications where both low noise and high gain are desirable. It utilizes a hermetically sealed four-lead JEDEC TO-72 package. All of the elements of the transistor are insulated from the case, which may be grounded by means of the fourth lead.

\*Formerly RCA Dev. No. TA8104.

**MAXIMUM RATINGS, Absolute-Maximum Values:**

Collector-to-Base Voltage	$V_{CBO}$	35	V
Collector-to-Emitter Voltage	$V_{CEO}$	15	V
Emitter-to-Base Voltage	$V_{EBO}$	3.5	V
Collector Current (Continuous)	$I_C$	40	mA
Transistor Dissipation:	$P_T$		
At ambient temperatures up to 25°C		200	mW
At ambient temperatures above 25°C		Derate linearly at 1.14 mW/°C	
Temperature Range:			
Storage and Operating (Junction)		-65 to +200 °C	

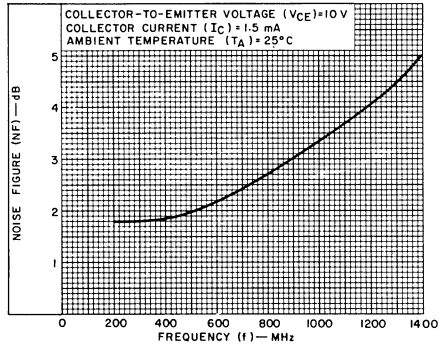


Fig. 1—Typical noise figure vs. frequency.

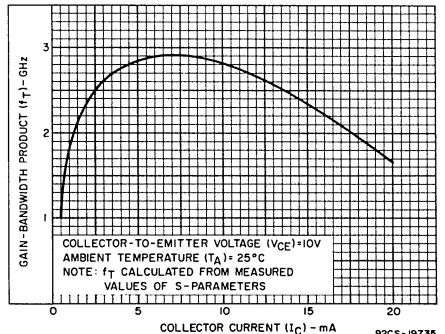


Fig. 2—Gain-bandwidth product vs. collector current.

**ELECTRICAL CHARACTERISTICS at Ambient Temperature ( $T_A$ ) = 25°C**

CHARACTERISTIC	SYMBOL	TEST CONDITIONS					LIMITS		UNITS
		DC COLLECTOR VOLTAGE (V)		DC CURRENT (mA)					
		$V_{CB}$	$V_{CE}$	$I_E$	$I_B$	$I_C$	MIN.	MAX.	

**STATIC**

Collector Cutoff Current	$I_{CBO}$	10		0			–	20	nA
Collector-to-Base Breakdown Voltage	$V_{(BR)CBO}$			0		0.01	35	–	V
Collector-to-Emitter Breakdown Voltage	$V_{(BR)CEO}$				0	0.1	15	–	V
Emitter-to-Base Breakdown Voltage	$V_{(BR)EBO}$			0.01		0	3.5	–	V
DC Forward-Current Transfer Ratio	$h_{FE}$		10			3	20	–	–
Thermal Resistance: (Junction-to-Ambient)	$R_{\theta JA}$						–	880	°C/W

**DYNAMIC**

Device Noise Figure (f = 450 MHz)	NF		10			1.5	–	2.5	dB
Small-Signal Common-Emitter Power Gain (f = 450 MHz) Unneutralized Amplifier	$G_{pE}$		10			1.5	14	–	dB
At minimum noise figure	$G_{pE}$		10			1.5	11.0	–	dB
Collector-to-Base Output Capacitance (f = 1 MHz)	$C_{obo}$	10		0			–	1.0	pF

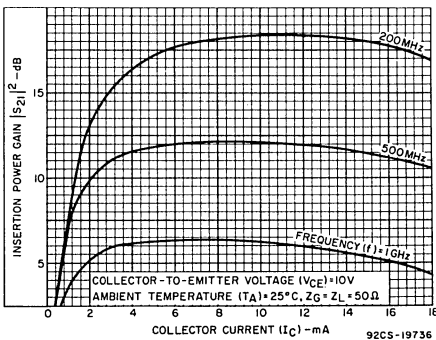


Fig.3—Typical insertion power gain vs. collector current.

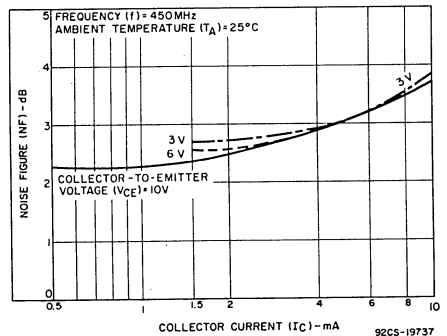


Fig.4—Typical noise figure vs. collector current.

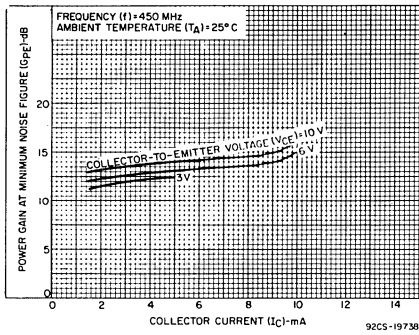


Fig. 5—Typical power gain (at minimum noise figure) vs. collector current.

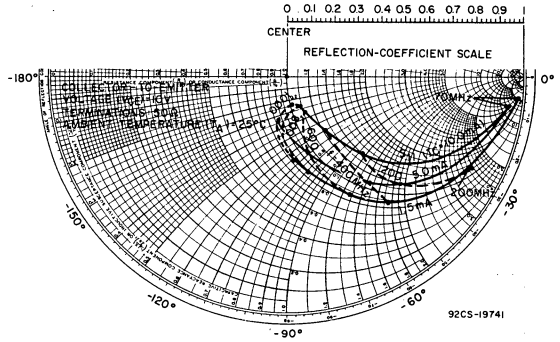


Fig. 8—Typical input reflection coefficient.

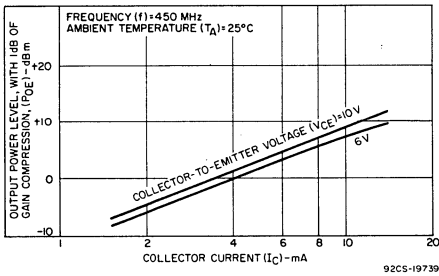


Fig. 6—Typical output power level (with 1 dB of gain compression) vs. collector current.

COLLECTOR-TO-EMITTER VOLTAGE (VCE) = 10 V  
 TERMINATIONS: 50Ω  
 AMBIENT TEMPERATURE (TA) = 25°C

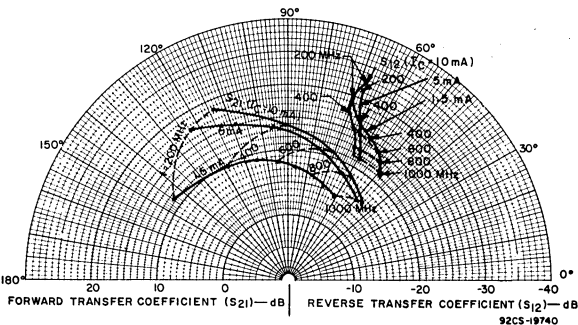
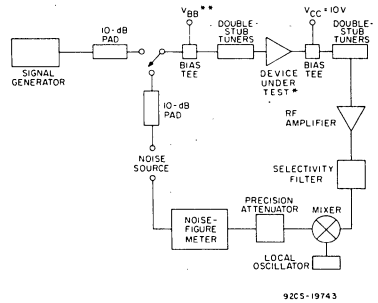


Fig. 7—Typical forward and reverse transfer coefficients.



\* In General Radio type 1607-P44 transistor mount, or equivalent.

\*\* V<sub>BB</sub> adjusted for I<sub>C</sub> = 1.5 mA.

Fig. 9—Block diagram of test setup for measurement of power gain and noise figure.

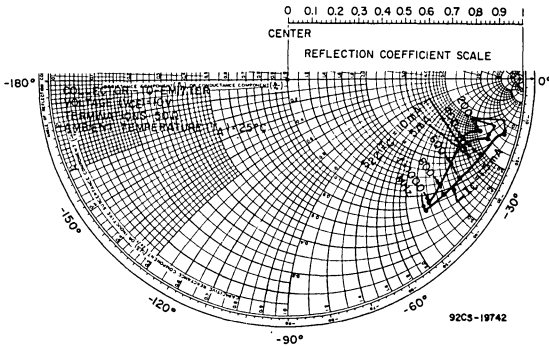
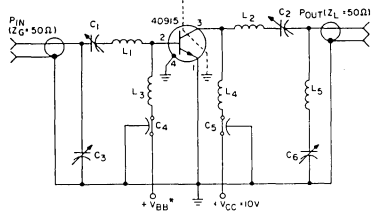


Fig. 10—Typical output reflection coefficient.



- C<sub>1</sub>: 1.0- 30 pF
- C<sub>2</sub>,C<sub>3</sub>: 1.0-20 pF
- C<sub>4</sub>,C<sub>5</sub>: 0.04 μF
- C<sub>6</sub>: 1-10 pF

- L<sub>1</sub>: 2 turns No. 18 wire, 3/16 in. (0.188 mm) ID, 0.10 in. (2.54 mm) long
- L<sub>2</sub>: 3 turns No. 18 wire, 3/16 in. (0.188 mm) ID, 0.15 in. (3.81 mm) long
- L<sub>3</sub>,L<sub>4</sub>: 0.22-μH rf choke
- L<sub>5</sub>: 3 turns No. 18 wire, 3/16 in. (0.188 mm) ID, 0.15 in. (3.81 mm) long

\* V<sub>BB</sub> adjusted for I<sub>C</sub> = 1.5 mA

Fig. 11—Circuit diagram of 450-MHz amplifier (unneutralized) used for measurement of power gain and noise figure.

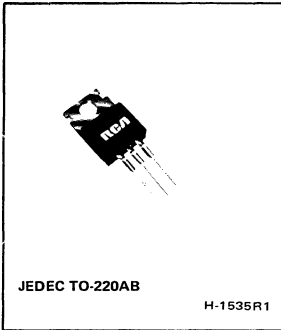
**TERMINAL CONNECTIONS**

- Lead 1 — Emitter
- Lead 2 — Base
- Lead 3 — Collector
- Lead 4 — Case

**RCA**  
Solid State  
Division

## Power Transistors

### 41500



## Epitaxial-Base, Silicon N-P-N VERSAWATT Transistor

General-Purpose Medium-Power Type for  
Switching and Amplifier Applications

### Features

- Low saturation voltages
- VERSAWATT package (molded silicone plastic)
- Maximum safe-area-of-operation curves specified for dc operation

RCA-41500 is an epitaxial-base silicon n-p-n transistor supplied in the JEDEC TO-220AB version of the VERSAWATT package. This transistor is intended for a variety of medium-power switching and amplifier applications, such as series and shunt

regulators and driver and output stages of high-fidelity amplifiers. The 41500 may also be used as the n-p-n complement of p-n-p type 41501. (Data for the 41501 are supplied in bulletin File No. 770.)

### MAXIMUM RATINGS, Absolute-Maximum Values:

COLLECTOR-TO-BASE VOLTAGE .....	$V_{CBO}$	35	V
COLLECTOR-TO-EMITTER VOLTAGE:			
With external base-supply resistance ( $R_{BB}$ ) = 100 $\Omega$ , and base supply voltage ( $V_{BB}$ ) = 0 .....	$V_{CEX}$	35	V
With base open .....	$V_{CEO}$	25	V
EMITTER-TO-BASE VOLTAGE .....	$V_{EBO}$	3	V
COLLECTOR CURRENT (Continuous)			
At case temperature $\leq 106^{\circ}\text{C}$ .....	$I_C$	7	A
BASE CURRENT (Continuous)			
At case temperature $\leq 130^{\circ}\text{C}$ .....	$I_B$	3	A
TRANSISTOR DISSIPATION:	$P_T$		
At case temperatures up to $25^{\circ}\text{C}$ .....		40	W
At case temperatures up to $100^{\circ}\text{C}$ .....		16	W
At ambient temperatures up to $25^{\circ}\text{C}$ .....		1.8	W
At case temperatures above $25^{\circ}\text{C}$ .....			
At case temperatures above $100^{\circ}\text{C}$ .....			
At ambient temperatures above $25^{\circ}\text{C}$ .....			
TEMPERATURE RANGE:			
Storage and Operating (Junction) .....		-65 to 150	$^{\circ}\text{C}$
LEAD TEMPERATURE (During Soldering):			
At distance $\geq 1/8$ in. (3.17 mm) from case for 10 s max. ....		235	$^{\circ}\text{C}$

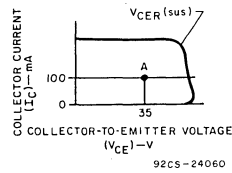
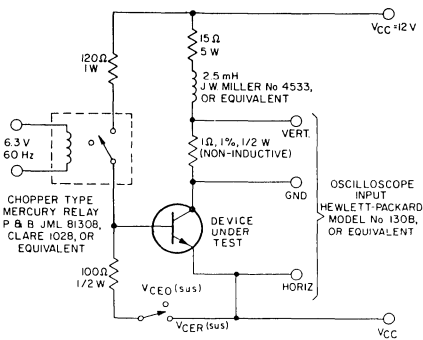
Derate linearly at 0.32 W/ $^{\circ}\text{C}$ , or see Fig. 4,  
Derate linearly at 0.32 W/ $^{\circ}\text{C}$   
Derate linearly at 0.0144 W/ $^{\circ}\text{C}$

ELECTRICAL CHARACTERISTICS, At Case Temperature ( $T_C$ ) = 25°C

CHARACTERISTIC	SYMBOL	TEST CONDITIONS				LIMITS		UNITS
		VOLTAGE V dc		CURRENT A dc		41500		
		V <sub>CE</sub>	V <sub>BE</sub>	I <sub>C</sub>	I <sub>B</sub>	Min.	Max.	
Collector-Cutoff Current: With external base-to-emitter resistance (R <sub>BE</sub> ) = 100 Ω	I <sub>CER</sub>	30				—	0.25	mA
Emitter-Cutoff Current	I <sub>EBO</sub>		-3	0		—	1	mA
Collector-to-Emitter Sustaining Voltage: With base open	V <sub>CEO(sus)</sub>			0.1 <sup>a</sup>	0	25	—	V
With external base-to-emitter resistance (R <sub>BE</sub> ) = 100 Ω	V <sub>CER(sus)</sub>			0.1		35	—	
DC Forward-Current Transfer Ratio	h <sub>FE</sub>	4		1 <sup>a</sup>		25	—	
Base-to-Emitter Voltage	V <sub>BE</sub>	4		1 <sup>a</sup>		—	1.5	V
Collector-to-Emitter Saturation Voltage	V <sub>CE(sat)</sub>			1 <sup>a</sup>	0.1	—	1	V
Common-Emitter, Small-Signal, Short-Circuit, Forward-Current Transfer Ratio (f = 50 kHz)	h <sub>fe</sub>	4		0.5		20	—	
Gain-Bandwidth Product	f <sub>T</sub>	4		0.5		4	—	MHz
Magnitude of Common-Emitter, Small-Signal, Short-Circuit, Forward Current Transfer Ratio (f = 1 MHz)	h <sub>fe</sub>	4		0.5		4	—	
Collector-to-Base Capacitance (f = 1 MHz, V <sub>CB</sub> = 10 V)	C <sub>obo</sub>			0		—	250	pF
Thermal Resistance: Junction-to-Case	R <sub>θJC</sub>					—	3.125	°C/W
Junction-to-Ambient	R <sub>θJA</sub>					—	70	

<sup>a</sup>Pulsed; pulse duration = 300 μs; rep. rate = 60 Hz; duty factor ≤ 2%.

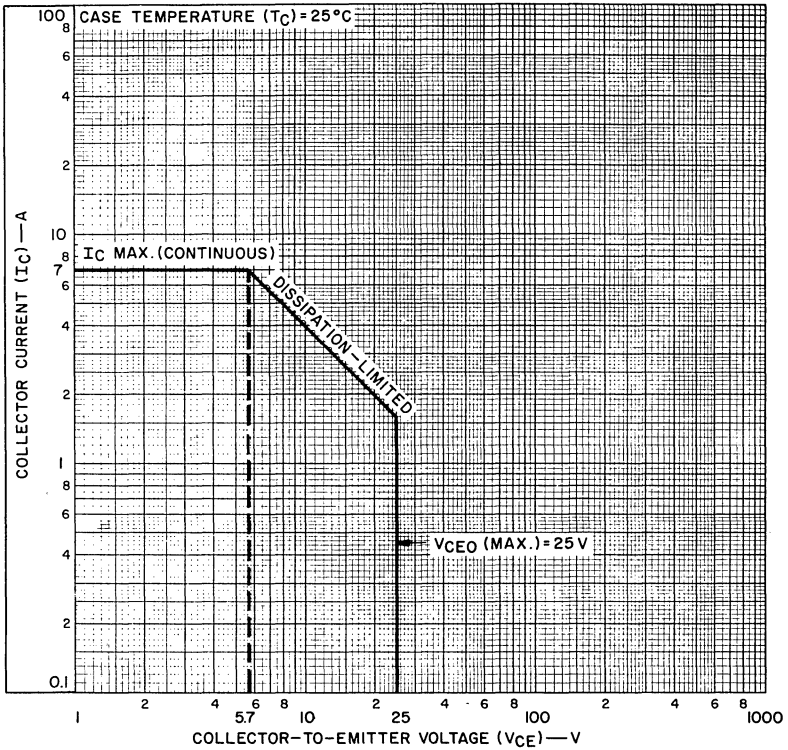
CAUTION: The sustaining voltage V<sub>CER(sus)</sub> MUST NOT be measured on a curve tracer.



The sustaining voltage, V<sub>CER(sus)</sub>, is acceptable when the traces fall to the right and above point "A".

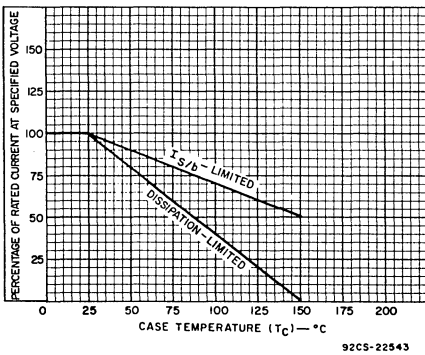
Fig. 1 — Circuit used to measure sustaining voltage V<sub>CER(sus)</sub>.

Fig. 2 — Oscilloscope display for measurement of sustaining voltage (test circuit shown in Fig. 1).



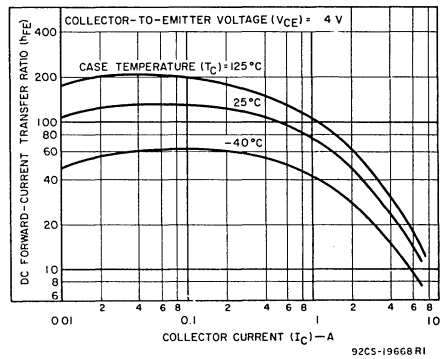
92CS-24061

Fig. 3 - Maximum operating area.



92CS-22543

Fig. 4 - Current derating curves.



92CS-19668 R1

Fig. 5 - Typical dc beta characteristics.



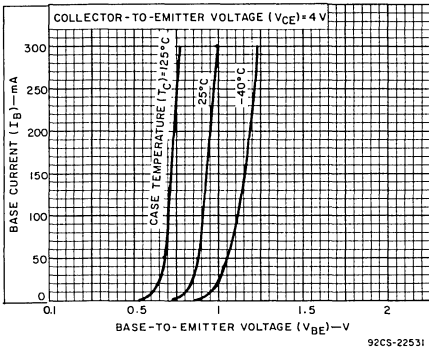


Fig. 6 — Typical input characteristics.

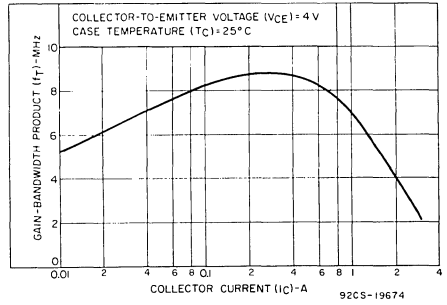


Fig. 7 — Typical gain-bandwidth product.

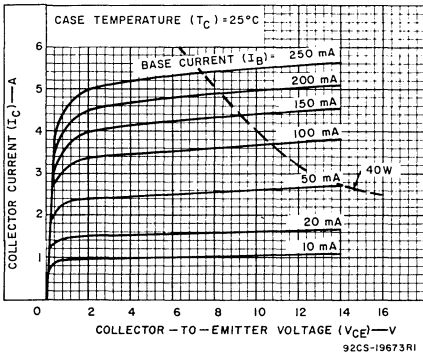


Fig. 8 — Typical output characteristics.

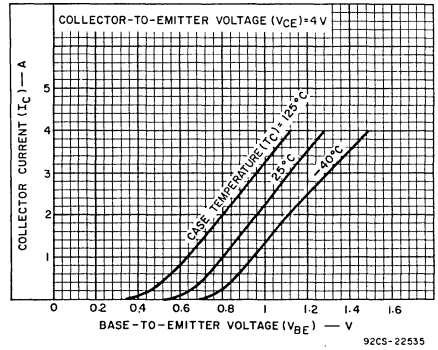


Fig. 9 — Typical transfer characteristics.

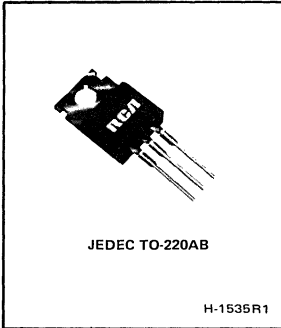
**TERMINAL CONNECTIONS**

- Terminal No. 1 — Base
- Terminal No. 2 — Collector
- Terminal No. 3 — Emitter
- Terminal No. 4 — Collector



# Power Transistors

## 41501



### Epitaxial-Base, Silicon P-N-P VERSAWATT Transistor

General-Purpose Medium-Power Type for  
Switching and Amplifier Applications

#### Features

- Low saturation voltages
- VERSAWATT package (green molded silicone plastic)
- Maximum safe-area-of-operation curve specified for dc operation

RCA-41501 is an epitaxial-base silicon p-n-p transistor supplied in a VERSAWATT package. It is intended for a wide variety of medium-power switching and amplifier applications, such as series and shunt regulators and driver and output stages of high-fidelity amplifiers.

#### TERMINAL CONNECTIONS

- Terminal No. 1 — Base
- Terminal No. 2 — Collector
- Terminal No. 3 — Emitter
- Terminal No. 4 — Collector

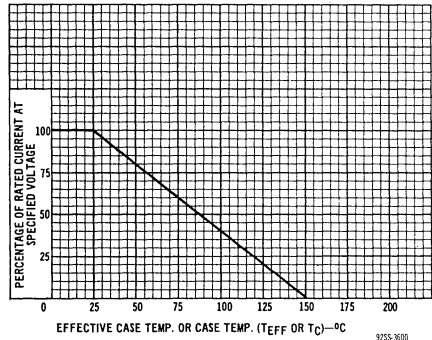


Fig. 1— Derating curve.

#### MAXIMUM RATINGS, Absolute-Maximum Values:

COLLECTOR-TO-BASE VOLTAGE .....	$V_{CBO}$	-35	V
COLLECTOR-TO-EMITTER SUSTAINING VOLTAGE:			
With external base-to-emitter resistance ( $R_{BE}$ ) = 100 $\Omega$ .....	$V_{CER}^{(sus)}$	-35	V
With base open .....	$V_{CEO}^{(sus)}$	-25	V
EMITTER-TO-BASE VOLTAGE .....	$V_{EBO}$	-3	V
COLLECTOR CURRENT .....	$I_C$	-7	A
BASE CURRENT .....	$I_B$	-3	A
TRANSISTOR DISSIPATION:	$P_T$		
At case temperatures up to 25°C .....		40	W
At ambient temperatures up to 25°C .....		1.8	W
At case temperatures above 25°C .....	Derate linearly	0.32 W/°C, or see Fig. 1.	
At ambient temperatures above 25°C .....	Derate linearly	0.0144	W/°C
TEMPERATURE RANGE:			
Storage and operating (Junction) .....		-65 to +150	°C
LEAD TEMPERATURE (During soldering):			
At distance $\geq$ 1/8 in. (3.17 mm) from seating plane for 10 s max. ....		235	°C

**ELECTRICAL CHARACTERISTICS, At Case Temperature ( $T_C$ ) = 25°C unless otherwise specified**

CHARACTERISTIC	SYMBOL	TEST CONDITIONS				LIMITS		UNITS
		VOLTAGE V dc		CURRENT A dc		Min.	Max.	
		V <sub>CE</sub>	V <sub>BE</sub>	I <sub>C</sub>	I <sub>B</sub>			
Collector Cutoff Current: With external base-to-emitter resistance (R <sub>BE</sub> ) = 100 Ω	I <sub>CER</sub>	-30				-	-0.25	mA
Emitter Cutoff Current	I <sub>EBO</sub>		3	0		-	-1	mA
DC Forward-Current Transfer Ratio	h <sub>FE</sub>	-4		-1 <sup>a</sup>		25	-	
Collector-to-Emitter Sustaining Voltage: With base open	V <sub>CEO(sus)</sub>			-0.1 <sup>a</sup>	0	-25 <sup>b</sup>	-	V
With external base-to-emitter resistance (R <sub>BE</sub> ) = 100 Ω	V <sub>CER(sus)</sub>			-0.1 <sup>a</sup>		-35 <sup>b</sup>	-	
Base-to-Emitter Voltage	V <sub>BE</sub>	-4		-1 <sup>a</sup>		-	-1.5	V
Collector-to-Emitter Saturation Voltage	V <sub>CE(sat)</sub>			-1 <sup>a</sup>	-0.1	-	-1	V
Collector-to-Base Capacitance (f = 1 MHz, V <sub>CB</sub> = -10 V)	C <sub>ob</sub>			0		-	250	pF
Thermal Resistance Junction-to-Case	R <sub>θJC</sub>					-	3.125	°C/W
Junction-to-Ambient	R <sub>θJA</sub>					-	70	

<sup>a</sup> Pulsed, pulse duration = 300 μs, duty factor = 1.8%

<sup>b</sup> CAUTION: Sustaining voltages V<sub>CEO(sus)</sub>, and V<sub>CEx(sus)</sub> MUST NOT be measured on a curve tracer.

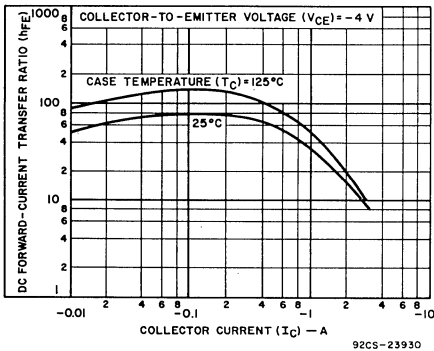


Fig. 2 – Typical dc beta characteristics.

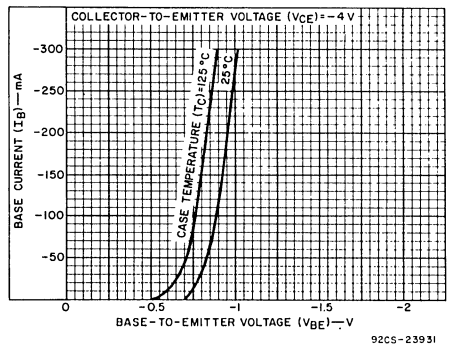


Fig. 3 – Typical input characteristics.

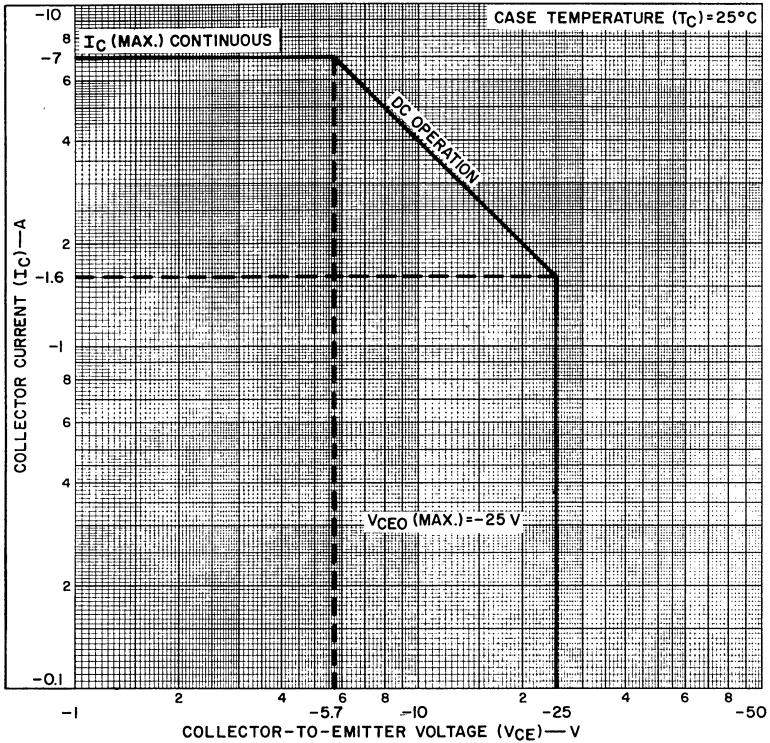


Fig. 4 — Maximum operating areas.

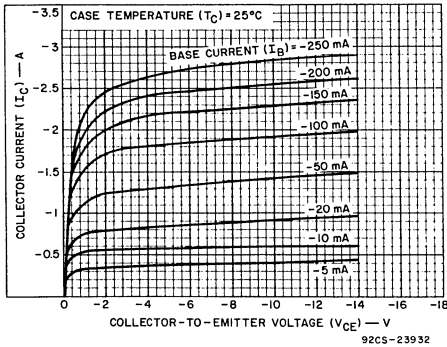


Fig. 5 — Typical output characteristics

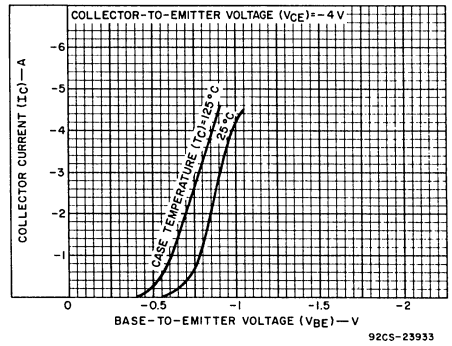
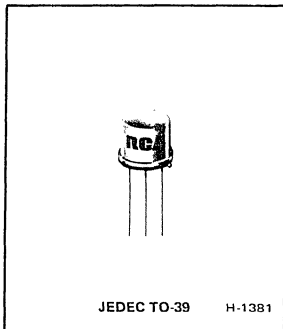


Fig. 6 — Typical transfer characteristics.



## Medium-Power Silicon N-P-N Planar Transistor

For Small-Signal Applications  
In Industrial and Commercial Equipment

### Features:

- ▣ For operation at junction temperature up to 200°C
- ▣ Planar construction for low noise and low leakage
- ▣ Low output capacitance

RCA-41502 is a silicon n-p-n planar transistor intended for a wide variety of small-signal and medium-power applications in commercial and industrial equipment. The device features exceptionally low noise, low leakage, high switching speed, and high pulsed beta.

It is suitable for low-power, low-cost industrial and audio uses, and may be employed as the n-p-n complement to RCA p-n-p type 41503. (Data for the 41503 are supplied in bulletin File No. 774.)

### MAXIMUM RATINGS, *Absolute-Maximum Values:*

#### COLLECTOR-TO-EMITTER SUSTAINING VOLTAGE:

With base open .....	$V_{CEO(sus)}$	30	V
EMITTER-TO-BASE VOLTAGE .....	$V_{EBO}$	4	V
COLLECTOR CURRENT .....	$I_C$	1	A
TRANSISTOR DISSIPATION:	$P_T$		
At case temperatures up to 25°C .....		3	W
At ambient temperatures up to 25°C .....		0.8	W
At temperatures above 25°C .....		See Fig. 1	
TEMPERATURE RANGE:			
Storage and Operating (Junction) .....		-65 to +200	°C
LEAD TEMPERATURE (During soldering):			
At distance $\geq$ 1/16 in. (1.58 mm) from seating plane for 10 s max. ....		300	°C

ELECTRICAL CHARACTERISTICS, At Case Temperature ( $T_C$ ) = 25°C Unless Otherwise Specified

CHARACTERISTIC	SYMBOL	TEST CONDITIONS						LIMITS		UNITS
		VOLTAGE V dc			CURRENT mA dc			41502		
		V <sub>CB</sub>	V <sub>CE</sub>	V <sub>EB</sub>	I <sub>E</sub>	I <sub>B</sub>	I <sub>C</sub>	Min.	Max.	
Collector Cutoff Current: With emitter open	I <sub>CBO</sub>	15			0			—	2	μA
Emitter-to-Base Breakdown Voltage	V <sub>(BR)EBO</sub>				0.1		0	4	—	V
Collector-to-Emitter Sustaining Voltage: With base open	V <sub>CEO(sus)</sub>						0 30 <sup>a</sup>	30	—	V
Collector-to-Emitter Saturation Voltage	V <sub>CE(sat)</sub>					15	150 <sup>a</sup>	—	1.5	V
Base-to-Emitter Voltage	V <sub>BE</sub>		10				150 <sup>a</sup>	—	2.5	V
DC Forward-Current Transfer Ratio:	h <sub>FE</sub>		10				150 <sup>a</sup>	20	—	
Output Capacitance	C <sub>ob</sub>	10			0			—	25	pF
Input Capacitance	C <sub>ib</sub>			0.5			0	—	80	pF
Thermal Resistance: Junction-to-case	R <sub>θJC</sub>							—	58.3	°C/W
Junction-to-ambient	R <sub>θJA</sub>							—	219	

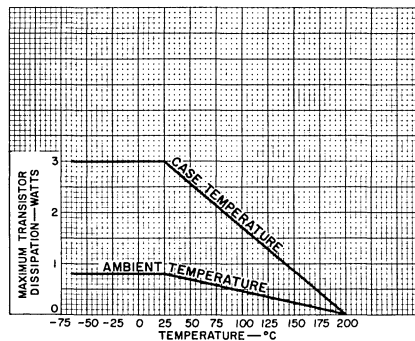
<sup>a</sup> Pulsed. Pulse duration = 300 μsec; duty factor ≤ 2%.

## TERMINAL CONNECTIONS

Lead 1 — Emitter

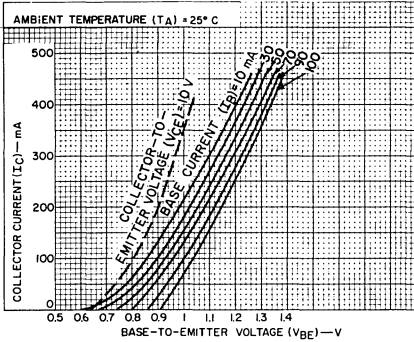
Lead 2 — Base

Lead 3 — Collector, Case



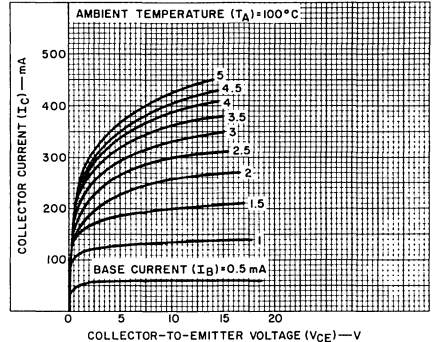
92CS—III73R2

Fig. 1 — Rating chart.



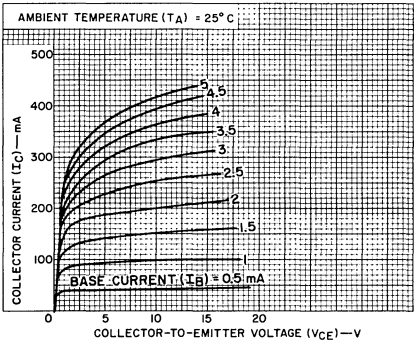
92CS-11185R2

Fig. 2 - Typical transfer characteristics.



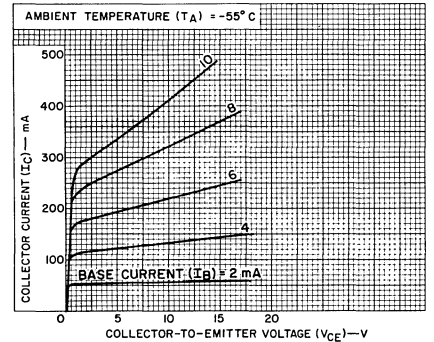
92CS-12665R1

Fig. 3 - Typical output characteristics.



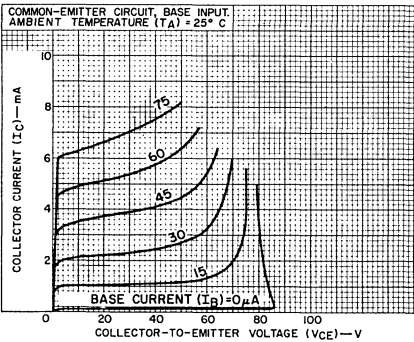
92CS-12667R1

Fig. 4 - Typical output characteristics.



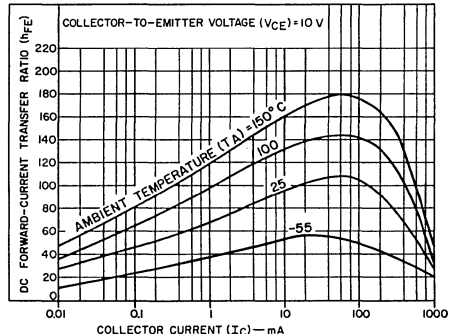
92CS-12668R1

Fig. 5 - Typical output characteristics.



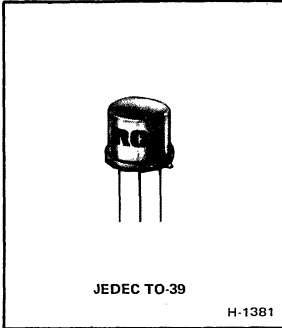
92CS-11175R2

Fig. 6 - Typical output characteristics.



92CS-11181R3

Fig. 7 - Typical dc beta characteristics.



## Medium-Power Silicon P-N-P Planar Transistor

General-Purpose Medium-Power Type for Industrial and Commercial Applications

*Features:*

- Maximum safe-area-of-operation curves specified for dc operation
- Planar construction for low noise and low leakage

RCA-41503 is an epitaxial-planar silicon p-n-p transistor intended for a wide variety of small-signal, medium-power applications. It is suitable for low-power, low-cost industrial and

audio uses, and may be employed as the p-n-p complement to RCA n-p-n type 41502. (Data for the 41502 are supplied in bulletin File No. 773).

**MAXIMUM RATINGS, Absolute-Maximum Values:**

**COLLECTOR-TO-EMITTER SUSTAINING VOLTAGE:**

With base open .....	$V_{CEO(sus)}$	-30	V
EMITTER-TO-BASE VOLTAGE .....	$V_{EBO}$	-4	V
COLLECTOR CURRENT .....	$I_C$	-1	A
BASE CURRENT .....	$I_B$	-0.5	A

**TRANSISTOR DISSIPATION:**

At case temperatures up to 25°C .....	7	W
At ambient temperatures up to 25°C .....	1	W
At temperatures above 25°C .....	See Figs. 1 and 5	

**TEMPERATURE RANGE:**

Storage and operating (Junction) .....	-65 to +200	°C
--	-------------	----

**LEAD TEMPERATURE (During soldering):**

At distances $\geq$ 1/16 in. (1.58 mm) from seating plane for 10s max. ....	230	°C
---	-----	----

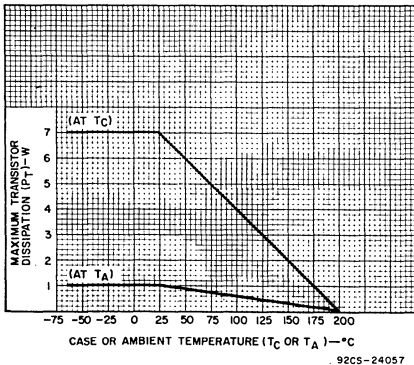


Fig. 1 - Dissipation derating curve.

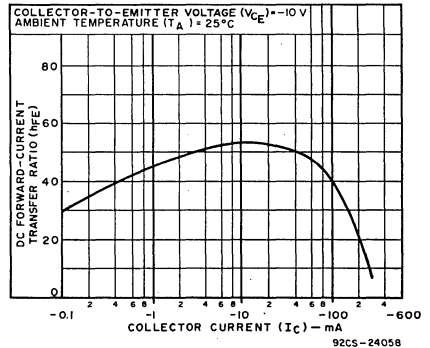


Fig. 2 - Typical dc beta characteristics.



ELECTRICAL CHARACTERISTICS, at Case Temperature ( $T_C$ ) = 25°C

CHARACTERISTIC	SYMBOL	TEST CONDITIONS						LIMITS		UNITS
		VOLTAGE V dc			CURRENT mA dc			41503		
		$V_{CB}$	$V_{CE}$	$V_{EB}$	$I_C$	$I_E$	$I_B$	Min.	Max.	
Collector Cutoff Current: With emitter open	$I_{CBO}$	-15						-	-2	$\mu A$
Emitter-to-Base Breakdown Voltage	$V_{(BR)EBO}$				0	-0.1		-4	-	V
Collector-to-Emitter Sustaining Voltage: (See Figs. 3 and 4) With base open	$V_{CEO(sus)}$				-30 <sup>a</sup>		0	-30	-	V
Collector-to-Emitter Saturation Voltage	$V_{CE(sat)}$				-150		-15	-	-1.5	V
Base-to-Emitter Voltage	$V_{BE}$		-10		-150 <sup>b</sup>			-	-2.5	V
DC Forward-Current Transfer Ratio	$h_{FE}$		-10		-150 <sup>b</sup>			20	-	
Collector-Base Capacitance (at $f = 1$ MHz)	$C_{ob}$	-10				0		-	30	pF
Input Capacitance	$C_{ib}$			-0.5	0			-	90	pF
Thermal Resistance: Junction-to-Case	$R_{\theta JC}$							-	25	°C/W
Junction-to-Ambient	$R_{\theta JA}$							-	165	

<sup>a</sup>CAUTION: The sustaining voltage  $V_{CEO(sus)}$  MUST NOT be measured on a curve tracer. This sustaining voltage should be measured by means of the test circuit shown in Fig. 3.

<sup>b</sup>Pulsed; pulse duration = 300  $\mu s$ , duty factor  $\leq 2\%$ .

TERMINAL CONNECTIONS

- Lead 1 - Emitter
- Lead 2 - Base
- Lead 3 - Collector, Case

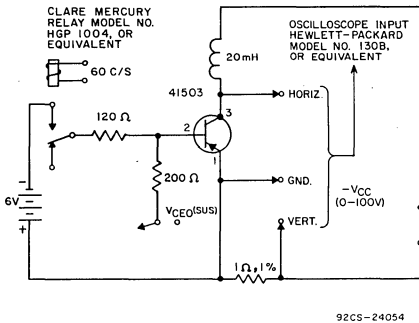
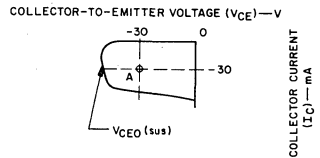


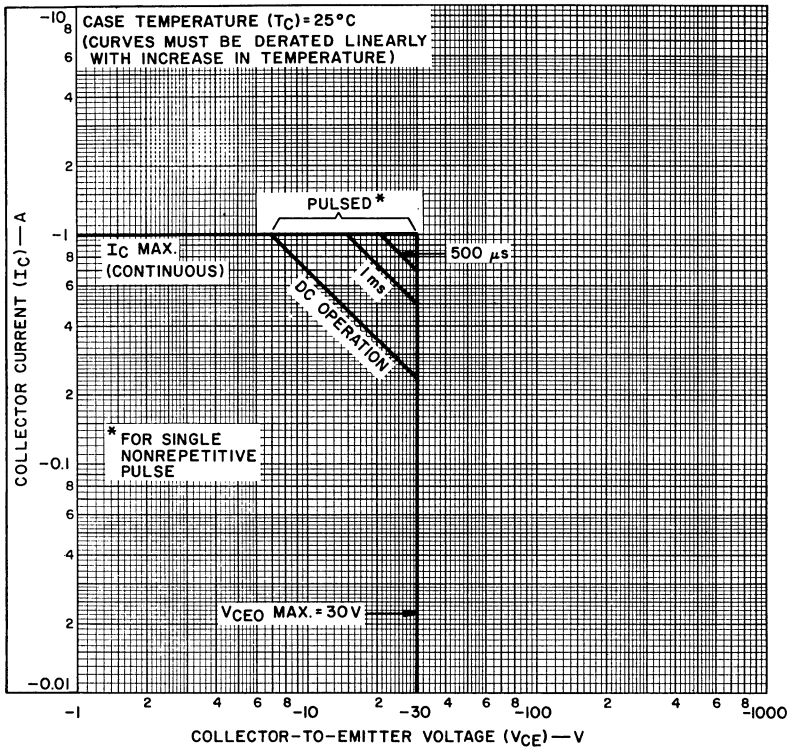
Fig. 3 - Circuit used to measure sustaining voltage,  $V_{CEO(sus)}$ .



92CS-24055

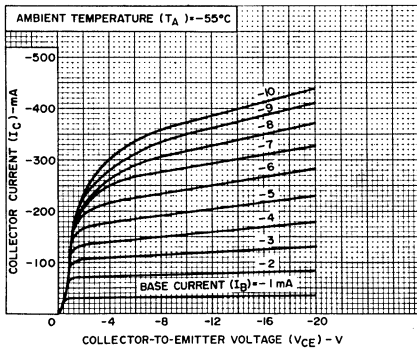
NOTE: The sustaining voltage  $V_{CEO(sus)}$  is acceptable when the traces fall to the left and below point "A".

Fig. 4 - Oscilloscope display for measurement of sustaining voltage (test circuit shown in Fig. 1).



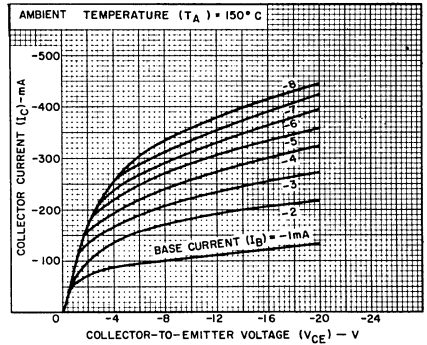
92CS - 24056

Fig. 5 - Maximum operating areas.



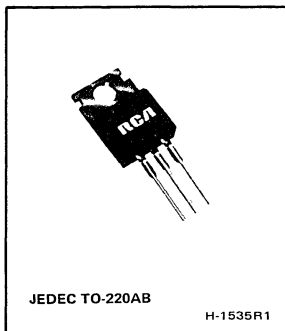
92LS-1282R1

Fig. 6 - Typical output characteristics.



92LS-1289R1

Fig. 7 - Typical output characteristics.



## Hometaxial-Base Silicon N-P-N VERSAWATT Transistor

Designed for Medium-Power  
Linear and Switching Applications

### Features:

- ▣ Low saturation voltages
- ▣ High dissipation ratings

### Applications:

- ▣ Series and shunt regulators
- ▣ High-fidelity amplifiers
- ▣ Power-switching circuits
- ▣ Solenoid drivers

RCA-41504 is a silicon n-p-n transistor intended for a wide variety of medium-power applications. The hometaxial-base construction of this device renders it highly resistant to second breakdown over a wide range of operating conditions. The 41504 is supplied in the JEDEC TO-220AB straight-lead version of the VERSAWATT package.

### TERMINAL CONNECTIONS JEDEC TO-220AB

Terminal No. 1 — Base  
Terminal No. 2 — Collector  
Terminal No. 3 — Emitter  
Terminal No. 4 — Collector

### MAXIMUM RATINGS, *Absolute-Maximum Values:*

#### COLLECTOR-TO-EMITTER SUSTAINING VOLTAGE:

With external base-to-emitter resistance ( $R_{BE}$ ) = 100  $\Omega$  .....  $V_{CER(sus)}$  35 V

EMITTER-TO-BASE VOLTAGE .....  $V_{EBO}$  4 V

CONTINUOUS COLLECTOR CURRENT .....  $I_C$  4 A

CONTINUOUS BASE CURRENT .....  $I_B$  2 A

#### TRANSISTOR DISSIPATION:

At case temperatures up to 25°C .....  $P_T$  36 W

At case temperatures above 25°C ..... See Fig. 1

#### TEMPERATURE RANGE:

Storage and Operating (Junction) ..... -65 to +150 °C

#### PIN TEMPERATURE (During Soldering):

At distances  $\geq 1/32$  in. (0.8 mm) from seating plane for 10 s max. .... 235 °C

ELECTRICAL CHARACTERISTICS, At Case Temperature ( $T_C$ ) = 25°C

CHARACTERISTIC	SYMBOL	TEST CONDITIONS				LIMITS		UNITS
		VOLTAGE V dc		CURRENT A dc		MIN.	MAX.	
		$V_{CE}$	$V_{EB}$	$I_C$	$I_B$			
Collector-Cutoff Current: With external base-to-emitter resistance ( $R_{BE}$ ) = 100 $\Omega$	$I_{CER}$	20				—	5	mA
Emitter-Cutoff Current	$I_{EBO}$		4	0		—	1	mA
Collector-to-Emitter Sustaining Voltage: With external base-to-emitter resistance ( $R_{BE}$ ) = 100 $\Omega$	$V_{CER(sus)}$			0.1 <sup>a</sup>		35	—	V
DC Forward-Current Transfer Ratio	$h_{FE}$	4		1 <sup>a</sup>		25	—	
Collector-to-Emitter Saturation Voltage	$V_{CE(sat)}$			1 <sup>a</sup>	0.05	—	1	V
Base-to-Emitter Voltage	$V_{BE}$	4		1 <sup>a</sup>		—	1.5	V
Magnitude of Common-Emitter, Small-Signal Short-Circuit Forward Current Transfer Ratio (f = 0.4 MHz)	$ h_{fe} $	4		0.2		2	—	
Thermal Resistance: Junction-to-Case	$R_{\theta JC}$					—	3.5	°C/W
Junction-to-Ambient	$R_{\theta JA}$					—	70	

<sup>a</sup> Pulsed: Pulse duration = 300  $\mu$ s, duty factor  $\leq$  2%.

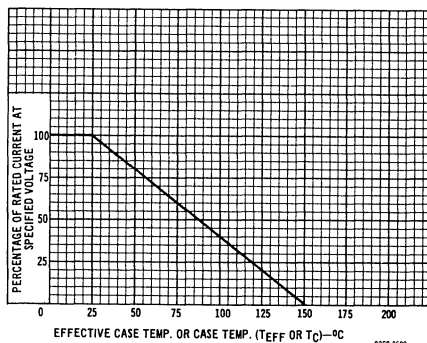


Fig. 1 - Current derating curve.

9255-3600

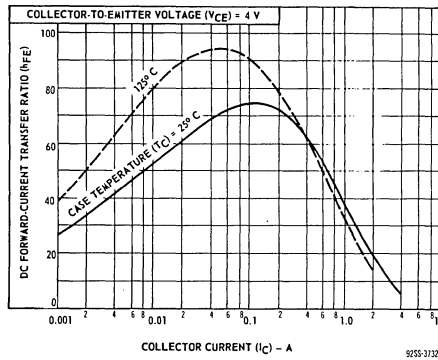


Fig. 2 - Typical dc beta characteristics.

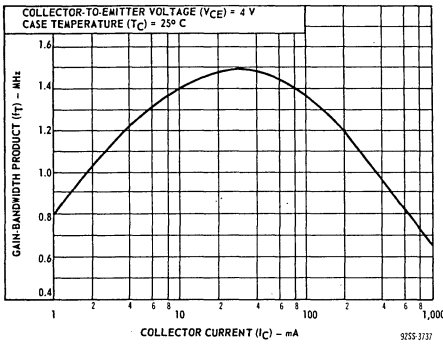


Fig. 3 - Typical gain-bandwidth product.

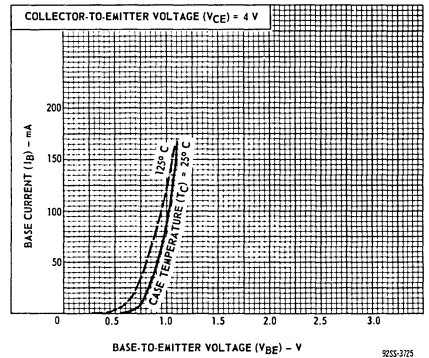


Fig. 4 - Typical input characteristics.

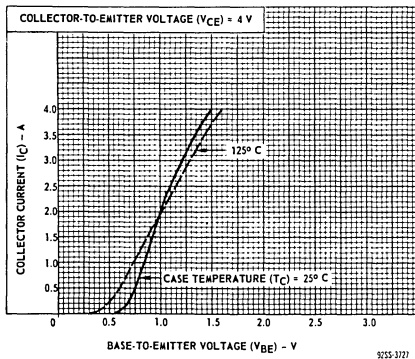


Fig. 5 - Typical transfer characteristics.

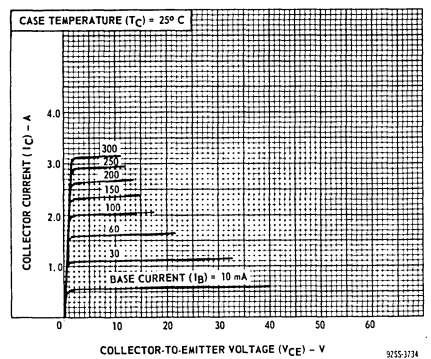
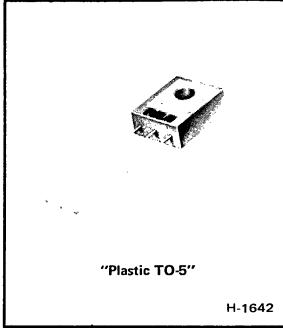


Fig. 6 - Typical output characteristics.



# Power Transistors

41505



## High-Voltage, Medium-Power Silicon N-P-N Transistor

For High-Speed Switching and Linear-Amplifier Applications

### Features

- Thermal fatigue ratings
- High frequency response:  $f_T = 20$  MHz
- Maximum area-of-operation curves for dc and pulse operation
- Designed to assure freedom from second breakdown in class A, B, and C operation at maximum ratings

RCA-41505 is an epitaxial-collector, diffused-base silicon n-p-n transistor with high breakdown voltage, high frequency response, and high switching speed.

Typical applications for this device include TV video output, RGB output, chroma output, TV blanking, solenoid drivers, off-line inverters, regulators, audio output, and electrostatic deflection in display circuits.

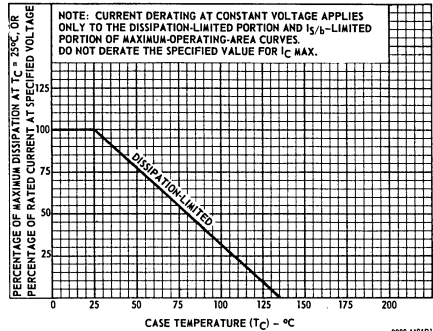


Fig. 1 — Dissipation derating curve.

### MAXIMUM RATINGS, Absolute-Maximum Values:

COLLECTOR-TO-EMITTER-SUSTAINING VOLTAGE . . . . .	$V_{CE0(sus)}$	200	V
EMITTER-TO-BASE VOLTAGE . . . . .	$V_{EBO}$	7	V
COLLECTOR CURRENT . . . . .	$I_C$	1.0	A
BASE CURRENT . . . . .	$I_B$	0.5	A
TRANSISTOR DISSIPATION:			
At case temperatures up to 25°C . . . . .	$P_T$	20	W
At case temperatures above 25°C . . . . .		See Figs. 1 and 4	
For pulse operation . . . . .		See Fig. 4	
TEMPERATURE RANGE:			
Storage and Operating (Junction) . . . . .		-65 to 135	°C
LEAD TEMPERATURE (During soldering):			
At distance $\geq 1/16$ in. (1.59 mm) from case for 10 s max. . . . .		230	°C

ELECTRICAL CHARACTERISTICS, At Case Temperature ( $T_C$ ) = 25°C:

CHARACTERISTIC	SYMBOL	TEST CONDITIONS						LIMITS		UNITS	
		VOLTAGE V dc				CURRENT mA dc			41505		
		V <sub>CB</sub>	V <sub>CE</sub>	V <sub>EB</sub>	V <sub>BE</sub>	I <sub>C</sub>	I <sub>E</sub>	I <sub>B</sub>	MIN.		MAX.
Collector-Cutoff Current: With external base-to-emitter resistance ( $R_{BE}$ ) = 100 $\Omega$	I <sub>CER</sub>		150						—	50	$\mu$ A
DC Forward-Current Transfer Ratio	h <sub>FE</sub>		10 10			50 5			20 10	— —	
Collector-to-Emitter Sustaining Voltage: With base open	V <sub>CEO(sus)</sub>					10		0	200 <sup>a</sup>	—	V
Collector-to-Emitter Saturation Voltage	V <sub>CE(sat)</sub>					50		5	—	2	V
Emitter-to-Base Breakdown Voltage	V <sub>(BR)EBO</sub>					0	1		7	—	V
Output Capacitance (at 1 MHz)	C <sub>ob</sub>	20					0		—	8	pF
Thermal Resistance: Junction-to-Case	R <sub><math>\theta</math>JC</sub>								—	5.5	°C/W
Junction-to-Ambient	R <sub><math>\theta</math>JA</sub>								—	138	

<sup>a</sup> CAUTION: The sustaining voltage V<sub>CEO(sus)</sub> MUST NOT be measured on a curve tracer.

TERMINAL CONNECTIONS

Lead 1 — Emitter

Lead 2 — Base

Lead 3 — Collector

Rectangular Metal Slug — Collector

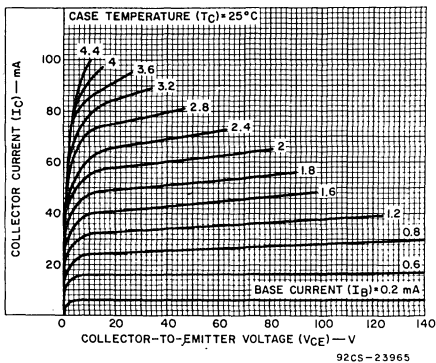


Fig. 2 — Typical output characteristics.

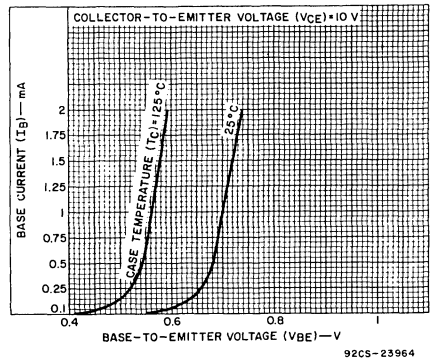


Fig. 3 Typical input characteristics.

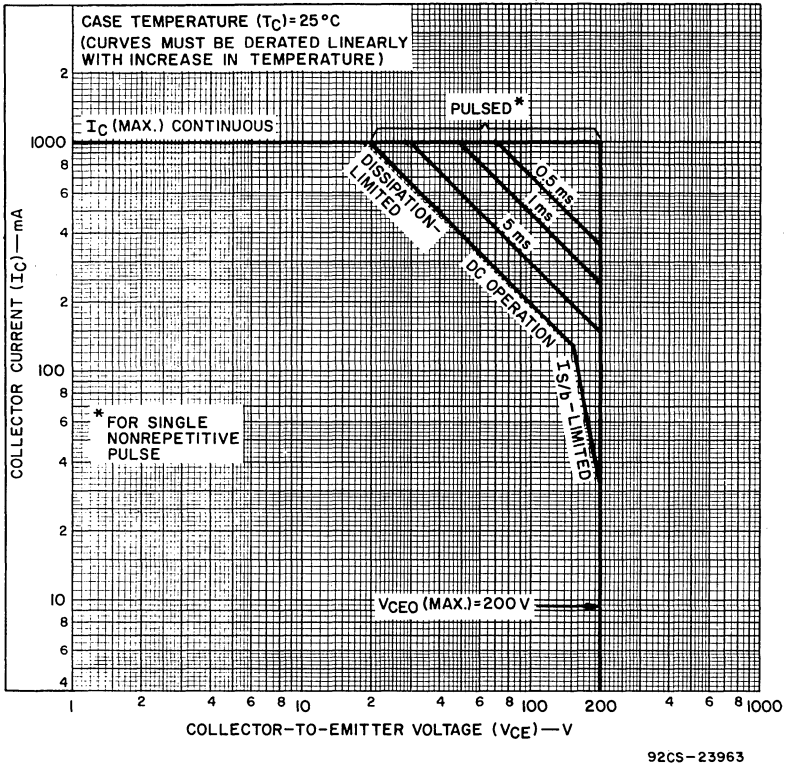


Fig. 4 — Maximum operating areas.

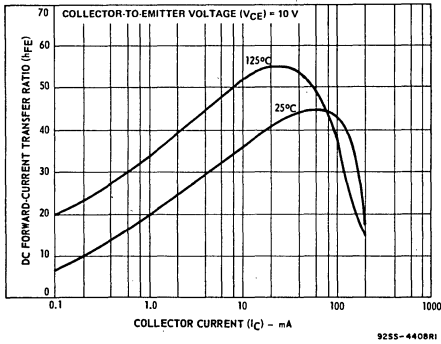


Fig. 5 — Typical dc beta characteristics.

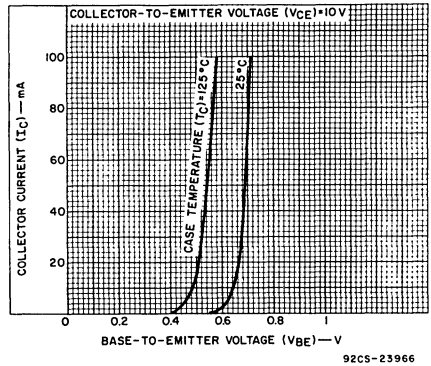
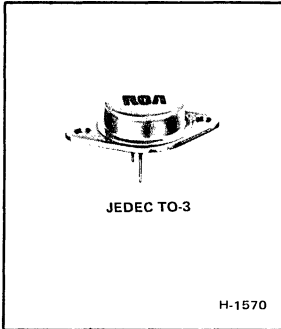


Fig. 6 — Typical transfer characteristics.





## High-Voltage, High-Power Silicon N-P-N Power Transistor

For Switching and Linear Applications

*Features:*

- ▣ Maximum safe-area-of-operation curves
- ▣ Low saturation voltage:  $V_{CE(sat)} = 1.5 \text{ V (max.)}$
- ▣ High voltage rating:  $V_{CEO(sus)} = 200 \text{ V}$
- ▣ High dissipation rating:  $P_T = 100 \text{ W}$

The RCA-41506 is an epitaxial silicon n-p-n power transistor utilizing a multiple-emitter-site structure. This device employs the popular JEDEC TO-3 package. The 41506 features high breakdown-voltage ratings and low

saturation-voltage values and is especially suitable for use in inverters, switching regulators, high-voltage bridge amplifiers, and other high-voltage switching applications.

**MAXIMUM RATINGS, Absolute-Maximum Values:**

COLLECTOR-TO-BASE VOLTAGE . . . . .	$V_{CBO}$	200	V
COLLECTOR-TO-EMITTER SUSTAINING VOLTAGE:			
With base open. . . . .	$V_{CEO(sus)}$	200	V
EMITTER-TO-BASE VOLTAGE . . . . .	$V_{EBO}$	4	V
CONTINUOUS COLLECTOR CURRENT . . . . .	$I_C$	3	A
PEAK COLLECTOR CURRENT . . . . .	$I_{CM}$	5	A
CONTINUOUS BASE CURRENT . . . . .	$I_B$	1.5	A
TRANSISTOR DISSIPATION:	$P_T$		
At case temperatures up to 25°C and $V_{CE}$ up to 40 V . . . . .		100	W
At case temperatures up to 25°C and $V_{CE}$ above 40 V . . . . .			See Fig.4
At case temperatures above 25°C and $V_{CE}$ above 40 V . . . . .			See Figs. 3 and 4
TEMPERATURE RANGE:			
Storage and Operating (Junction) . . . . .		-65 to 200	°C
PIN TEMPERATURE (During Soldering):			
At distances $\geq 1/32$ in. (0.8 mm) from seating plane for 10 s max. . . . .		230	°C

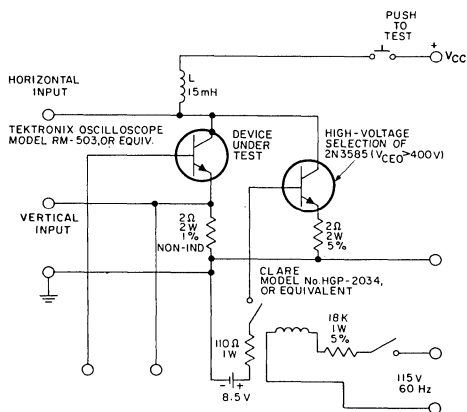
ELECTRICAL CHARACTERISTICS, Case Temperature ( $T_C$ ) = 25°C Unless Otherwise Specified

CHARACTERISTIC	SYMBOL	TEST CONDITIONS				LIMITS		UNITS
		DC VOLTAGE V		DC CURRENT (A)		Min.	Max.	
		$V_{CE}$	$V_{EB}$	$I_C$	$I_B$			
Collector Cutoff Current: With base open	$I_{CEO}$	200				5	mA	
Emitter-Cutoff Current	$I_{EBO}$		4			10	mA	
DC Forward-Current Transfer Ratio	$h_{FE}$	3		2 <sup>a</sup>		8	—	
Collector-to-Emitter Sustaining Voltage: With base open (See Figs. 1 and 2)	$V_{CEO(sus)}$			0.2		200 <sup>b</sup>	—	V
Base-to-Emitter Saturation Voltage	$V_{BE(sat)}$			2 <sup>a</sup>	0.35	—	2	V
Collector-to-Emitter Saturation Voltage	$V_{CE(sat)}$			2 <sup>a</sup>	0.35	—	1.5	V
Second-Breakdown Collector Current: (With base forward-biased) Pulse duration (non-repetitive) = 1 s	$I_{S/bc}$	40				2.5	—	A
Thermal Resistance (Junction-to-Case)	$R_{\theta JC}$	10		5		1.75	—	°C/W

<sup>a</sup> Pulsed; pulse duration  $\leq 350 \mu s$ , duty factor = 2%.

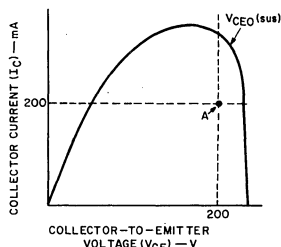
<sup>b</sup> CAUTION: The sustaining voltage  $V_{CEO(sus)}$  MUST NOT be measured on a curve tracer. The sustaining voltage should be measured by means of the test circuit shown in Fig. 1.

<sup>c</sup>  $I_{S/b}$  is defined as the current at which second breakdown occurs at a specified collector voltage with the emitter-base junction forward-biased for transistor operation in the active region.



92CS-19286R1

Fig. 1 — Circuit used to measure sustaining voltage,  $V_{CEO(sus)}$ .



THE SUSTAINING VOLTAGE  $V_{CEO(sus)}$  IS ACCEPTABLE WHEN THE TRACE FALLS TO THE RIGHT AND ABOVE POINT "A".

92CS-24201

Fig. 2 — Oscilloscope display for measurement of sustaining voltage (test circuit shown in Fig. 1).

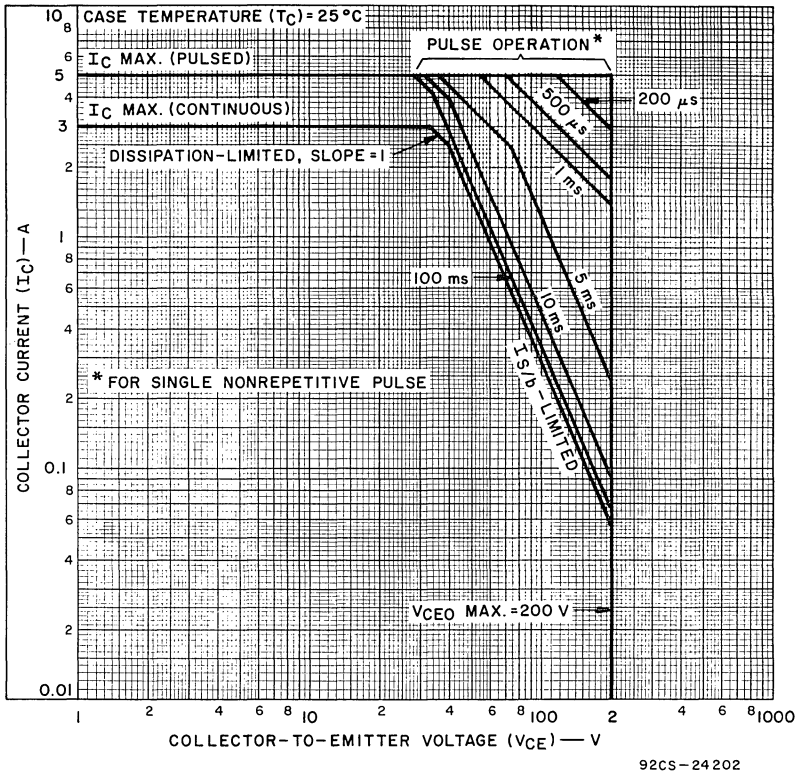


Fig.3 - Maximum operating areas.

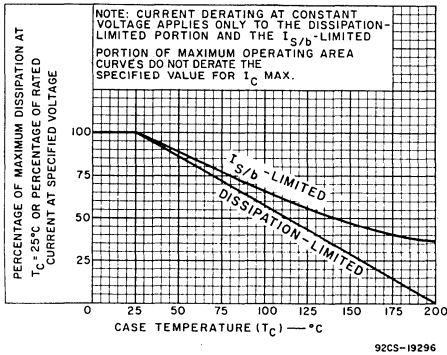


Fig.4 - Dissipation and current derating curves.

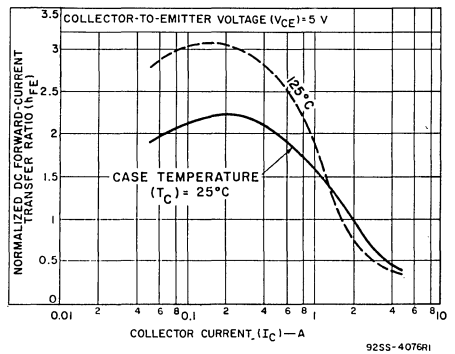


Fig.5 - Typical normalized dc beta characteristics.

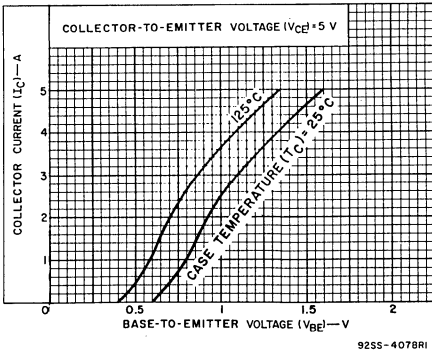


Fig. 6 — Typical transfer characteristics.

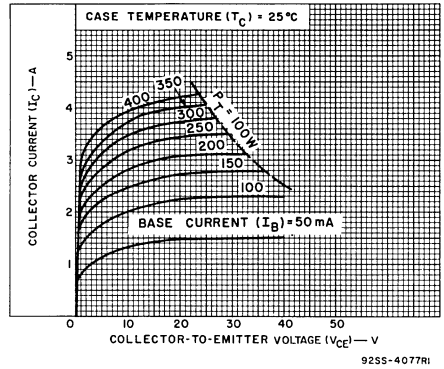
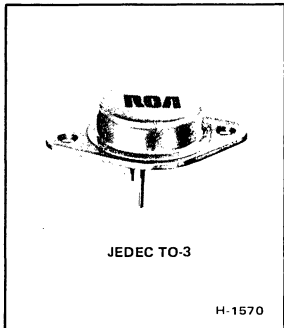


Fig. 7 — Typical output characteristics.

### TERMINAL CONNECTIONS

- Pin 1 — Base
- Pin 2 — Emitter
- Mounting Flange, Case — Collector



## Hometaxial-Base High-Current Silicon N-P-N Transistor

Rugged High-Voltage Device for Applications in Industrial and Commercial Equipment

*Features:*

- High dissipation capability — 150 W
- 8-A specification for  $h_{FE}$ ,  $V_{BE}$ , and  $V_{CE(sat)}$
- $V_{CEX}$  — 160 V min.
- Low saturation voltage with high beta

RCA-43104\* is a hometaxial-base silicon n-p-n transistor intended for a wide variety of high-voltage high-current applications. Typical applications include power-switching circuits, audio amplifiers, series- and shunt-regulator driver and output stages, dc-to-dc converters, inverters, and solenoid (hammer)/relay driver service. The 43104 employs the popular JEDEC TO-3 package.

\* Formerly type RCA508.

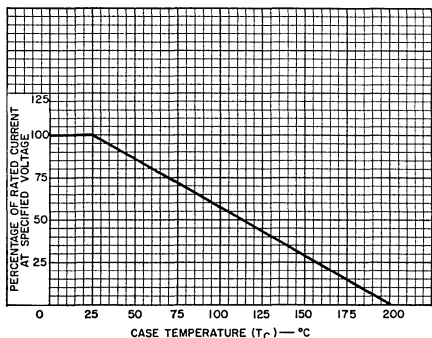


Fig. 1 — Current derating curve.

**MAXIMUM RATINGS, Absolute-Maximum Values:**

COLLECTOR-TO-BASE VOLTAGE .....	$V_{CBO}$	160	V
COLLECTOR-TO-EMITTER VOLTAGE:			
With base open .....	$V_{CEO}$	140	V
With reverse bias ( $V_{BE}$ ) of $-1.5$ V .....	$V_{CEX}$	160	V
EMITTER-TO-BASE VOLTAGE .....	$V_{EBO}$	7	V
COLLECTOR CURRENT:	$I_C$		
Continuous .....		16	A
Peak .....		30	A
BASE CURRENT:	$I_B$		
Continuous .....		4	A
Peak .....		15	A
TRANSISTOR DISSIPATION:	$P_T$		
At case temperatures up to $25^{\circ}C$ .....		150	W
At case temperatures above $25^{\circ}C$ .....		See Fig. 1	
TEMPERATURE RANGE:			
Storage & Operating (Junction) .....		$-65$ to $+200$	$^{\circ}C$
PIN TEMPERATURE (During Soldering):			
At distances $\geq 1/32$ in. (0.8 mm) from case for 10 s max. ....		230	$^{\circ}C$

ELECTRICAL CHARACTERISTICS, At Case Temperature ( $T_C$ ) = 25°C Unless Otherwise Specified

CHARACTERISTIC	SYMBOL	TEST CONDITIONS						LIMITS		UNITS	
		VOLTAGE V dc				CURRENT A dc			43104		
		V <sub>CB</sub>	V <sub>CE</sub>	V <sub>EB</sub>	V <sub>BE</sub>	I <sub>C</sub>	I <sub>E</sub>	I <sub>B</sub>	Min.		Max.
Collector-Cutoff Current: With emitter open	I <sub>CBO</sub>	140					0		–	2	mA
With base-emitter junction reverse-biased	I <sub>CEX</sub>		140		–1.5				–	2	mA
With base-emitter junction reverse-biased and T <sub>C</sub> = 150°C	I <sub>CEX</sub>		140		–1.5				–	10	mA
With base open	I <sub>CEO</sub>		120				0		–	10	mA
Emitter-Cutoff Current	I <sub>EBO</sub>			7		0			–	5	mA
DC Forward-Current Transfer Ratio	h <sub>FE</sub>		4 4			8 <sup>a</sup> 16 <sup>a</sup>			15 5	60 –	
Collector-to-Emitter Sustaining Voltage: With base-emitter junction reverse- biased (R <sub>BE</sub> = 100 Ω)	V <sub>CEX(sus)</sub>				–1.5	0.1			160	–	V
With external base-to-emitter resistance (R <sub>BE</sub> ) = 100 Ω	V <sub>CER(sus)</sub>					0.2 <sup>a</sup>			150	–	V
With base open	V <sub>CEO(sus)</sub>					0.2 <sup>a</sup>	0	140	–	–	V
Base-to-Emitter Voltage	V <sub>BE</sub>		4			8 <sup>a</sup>			–	2.2	V
Collector-to-Emitter Saturation Voltage	V <sub>CE(sat)</sub>					8 <sup>a</sup> 16 <sup>a</sup>	0.8 3.2		– –	1.4 4	V
Second-Breakdown Collector Current: With base forward-biased and 1-s nonrepetitive pulse	I <sub>S/b</sub> <sup>b</sup>		60						2.5	–	A
Second-Breakdown Energy: With base reverse-biased and L = 40 mH, R <sub>BE</sub> = 100 Ω	E <sub>S/b</sub> <sup>c</sup>				–1.5	2.5			0.125	–	J
Magnitude of Common-Emitter, Small-Signal, Short-Circuit, Forward-Current Transfer Ratio (f = 50 kHz)	h <sub>fe</sub>		4			1			4	–	
Common-Emitter, Small-Signal, Short-Circuit, Forward-Current Transfer Ratio (f = 1 kHz)	h <sub>fe</sub>		4			1			40	–	
Thermal Resistance: Junction-to-Case	R <sub>θJC</sub>								–	1.17	°C/W

<sup>a</sup> Pulsed; pulse duration = 300 μs, rep. rate = 60 Hz, duty factor ≤ 2%.

<sup>b</sup> I<sub>S/b</sub> is defined as the current at which second breakdown occurs at a specified collector voltage with the emitter-base junction forward-biased for transistor operation in the active region.

<sup>c</sup> E<sub>S/b</sub> is defined as the energy at which second breakdown occurs under specified reverse-bias conditions. E<sub>S/b</sub> = 1/2LI<sup>2</sup> where L is a series load or leakage inductance and I is the peak collector current.

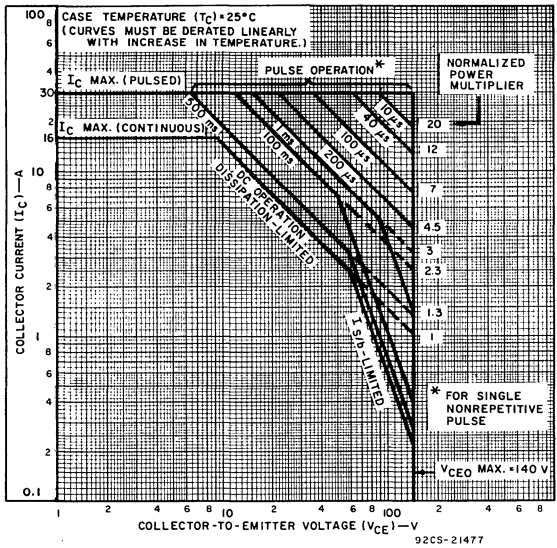


Fig. 2 — Maximum operating areas.

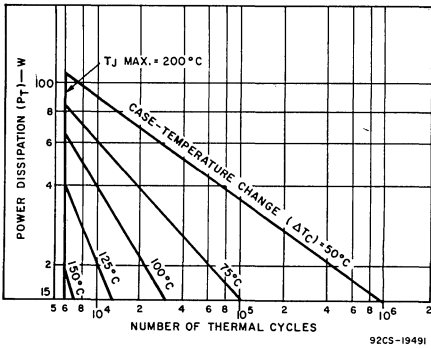


Fig. 3 — Thermal-cycling rating chart.

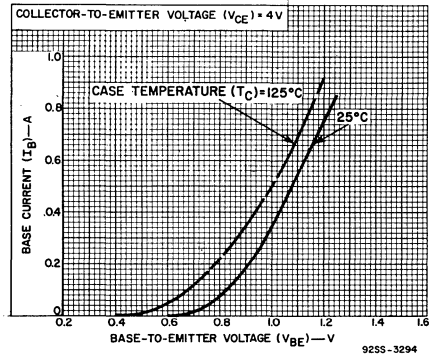


Fig. 4 — Typical input characteristics.

**TERMINAL CONNECTIONS**

- Pin 1 — Base
- Pin 2 — Emitter
- Case — Collector
- Mounting Flange — Collector

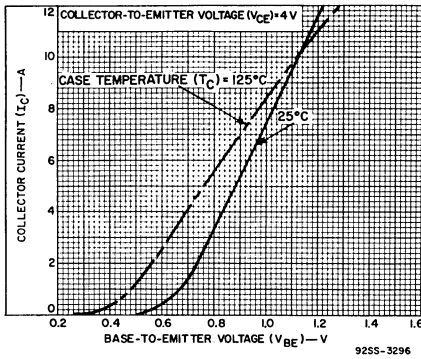


Fig. 5 - Typical transfer characteristics.

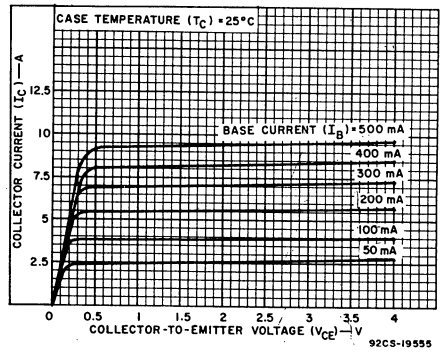


Fig. 6 - Typical output characteristics.

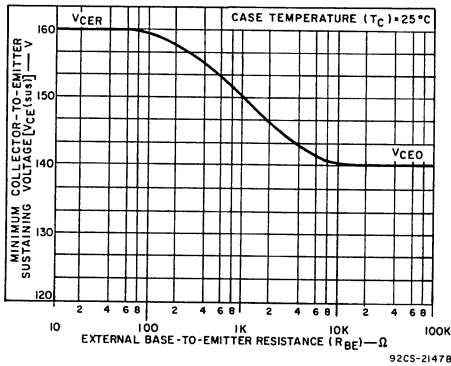


Fig. 7 - Sustaining voltage vs. base-to-emitter resistance.

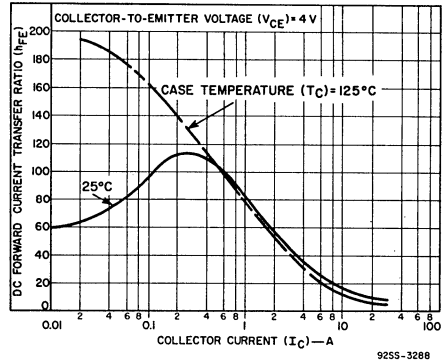


Fig. 8 - Typical dc beta characteristics.

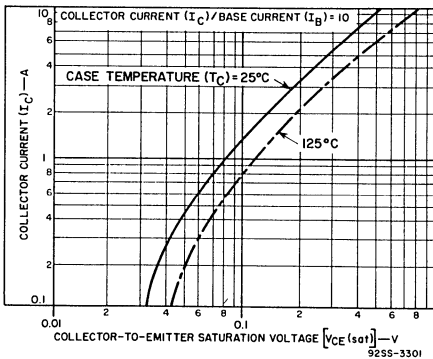


Fig. 9 - Typical saturation-voltage characteristics.

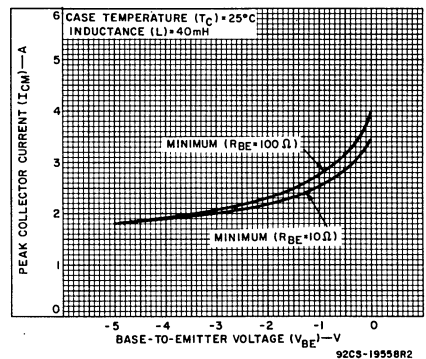


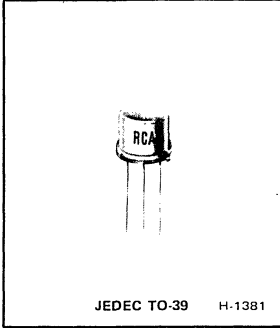
Fig. 10 - Reverse-bias second-breakdown characteristics.





# Power Transistors

## RCA1A01–RCA1A11 RCA1A15–RCA1A19



### Silicon Transistors for Audio-Frequency Linear-Amplifier Applications

#### N-P-N TYPES

RCA1A01	RCA1A11
RCA1A03	RCA1A15
RCA1A06	RCA1A17
RCA1A07	RCA1A18
RCA1A09	

#### P-N-P TYPES

RCA1A02	RCA1A10
RCA1A04	RCA1A16
RCA1A05	RCA1A19
RCA1A08	

"RCA1A-Series" n-p-n and p-n-p silicon transistors are especially characterized for audio-amplifier applications. They are particularly useful as input devices,  $V_{BE}$  multipliers for biasing, current sources, load-line-limiting (protection) circuits, predrivers, and in some instances as complementary drivers. Other applications for these devices include audio power amplifiers, linear modulators, servo amplifiers, and operational amplifiers. The units are supplied in the JEDEC TO-39 package.

#### TERMINAL CONNECTIONS

Lead 1 – Emitter  
Lead 2 – Base  
Lead 3 – Collector, Case

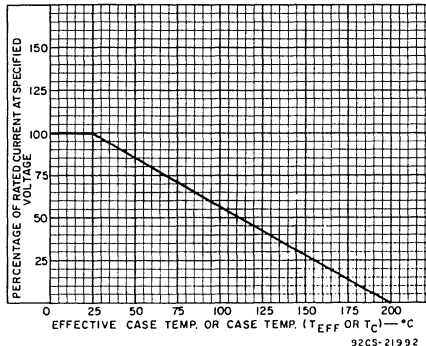


Fig. 1— Derating curve for all types.

MAXIMUM RATINGS, <i>Absolute-Maximum Values:</i>		RCA1A01	RCA1A02	RCA1A03	RCA1A04	RCA1A05	RCA1A06	RCA1A07	RCA1A08	
COLLECTOR-TO-BASE VOLTAGE	$V_{CBO}$	—	—	95	-95	-75	75	50	-50	V
COLLECTOR-TO-EMITTER VOLTAGE:										
With base open	$V_{CEO}$	70	-50	—	—	—	—	40	-40	V
With external base-to-emitter resistance ( $R_{BE}$ ) = 100 $\Omega$	$V_{CER}$	—	—	95	-95	-75	75	50*	-50 <sup>^</sup>	V
EMITTER-TO-BASE VOLTAGE	$V_{EBO}$	4	-4	4	-4	-4	4	3	-5	V
COLLECTOR CURRENT	$I_C$	1	-1	2	-2	-1	1	1	-1	A
BASE CURRENT	$I_B$	0.5	-0.5	1	-1	-0.5	0.5	0.05	-0.05	A
TRANSISTOR DISSIPATION:	$P_T$									
At case temperatures up to 25°C		5	7	10	10	5	5	5	7	W
At case temperatures above 25°C		← See Fig. 1 →								
TEMPERATURE RANGE:										
Storage & Operating (Junction)		← -65 to +200 →								°C
PIN TEMPERATURE (During Soldering):										
At distances $\geq$ 1/32 in. (0.8 mm)		← 230 →								°C
from case for 10 s max.		← 230 →								°C

\* $R_{BE}$  = 10  $\Omega$

<sup>^</sup> $R_{BE}$  = 300  $\Omega$

MAXIMUM RATINGS, <i>Absolute-Maximum Values:</i>		RCA1A09	RCA1A10	RCA1A11	RCA1A15	RCA1A16	RCA1A17	RCA1A18	RCA1A19	
COLLECTOR-TO-EMITTER VOLTAGE:										
With base open	$V_{CEO}$	175	-175	175	100	-100	90	10	-10	V
EMITTER-TO-BASE VOLTAGE	$V_{EBO}$	6	-6	6	5	-5	4	4	-4	V
COLLECTOR CURRENT	$I_C$	1	-1	1	1	-1	1	1	-1	A
BASE CURRENT	$I_B$	0.5	-0.5	0.5	0.5	-0.1	0.5	0.5	-0.5	A
TRANSISTOR DISSIPATION:	$P_T$									
At case temperatures up to 25°C		10	10	10	10	10	5	7	7	W
At case temperatures above 25°C		← See Fig. 1 →								
TEMPERATURE RANGE:										
Storage & Operating (Junction)		← -65 to +200 →								°C
PIN TEMPERATURE (During Soldering):										
At distances $\geq$ 1/32 in. (0.8 mm)		← 230 →								°C
from case for 10 s max.		← 230 →								°C

**Type RCA1A01****Package:** JEDEC TO-39**Construction:** Silicon n-p-n, planar**ELECTRICAL CHARACTERISTICS, At Case Temperature ( $T_C$ ) = 25°C Unless Otherwise Specified**

CHARACTERISTIC	SYMBOL	TEST CONDITIONS	LIMITS		UNITS
			MIN.	MAX.	
Collector Cutoff Current: With base open	$I_{CEO}$	$V_{CE} = 60 \text{ V}, I_B = 0$	—	1	$\mu\text{A}$
Emitter Cutoff Current: With collector open	$I_{EBO}$	$V_{EB} = 4 \text{ V}, I_C = 0$	—	1	mA
Collector-to-Emitter Voltage: With base open	$V_{CEO}$	$I_C = 100 \text{ mA}$	70	—	V
Gain Bandwidth Product	$f_T$	$V_{CE} = 4 \text{ V}, I_C = 50 \text{ mA}$	120	—	MHz
DC Forward-Current Transfer Ratio	$h_{FE}$	$I_C = 10 \text{ mA}, V_{CE} = 4 \text{ V}$	40	200	
Collector-to-Emitter Saturation Voltage	$V_{CE(sat)}$	$I_C = 150 \text{ mA}, I_B = 15 \text{ mA}$	—	1.4	V
Base-to-Emitter Voltage	$V_{BE}$	$I_C = 10 \text{ mA}, V_{CE} = 4 \text{ V}$	—	1	V

For characteristics curves and test conditions, refer to published data for prototype 2N2102 (File 106).

**Type RCA1A02****Package:** JEDEC TO-39**Construction:** Silicon p-n-p, epitaxial planar**ELECTRICAL CHARACTERISTICS, At Case Temperature ( $T_C$ ) = 25°C Unless Otherwise Specified**

CHARACTERISTIC	SYMBOL	TEST CONDITIONS	LIMITS		UNITS
			MIN.	MAX.	
Collector Cutoff Current: With base open	$I_{CEO}$	$V_{CE} = -40 \text{ V}, I_B = 0$	—	-1	$\mu\text{A}$
Emitter Cutoff Current: With collector open	$I_{EBO}$	$V_{EB} = -4 \text{ V}, I_C = 0$	—	-1	mA
Collector-to-Emitter Voltage: With base open	$V_{CEO}$	$I_C = -0.1 \text{ A}$	-50	—	V
Gain Bandwidth Product	$f_T$	$V_{CE} = -4 \text{ V}, I_C = -50 \text{ mA}$	60	—	MHz
DC Forward-Current Transfer Ratio	$h_{FE}$	$I_C = -0.1 \text{ mA}, V_{CE} = -10 \text{ V}$	30	200	
Base-to-Emitter Voltage	$V_{BE}$	$I_C = -0.1 \text{ mA}, V_{CE} = -10 \text{ V}$	—	-0.8	V

For characteristics curves and test conditions, refer to published data for prototype 2N4036 (File 216).

## Type RCA1A03

Package: JEDEC TO-39

Construction: Silicon n-p-n, planar

ELECTRICAL CHARACTERISTICS, At Case Temperature ( $T_C$ ) = 25°C Unless Otherwise Specified

CHARACTERISTIC	SYMBOL	TEST CONDITIONS	LIMITS		UNITS
			MIN.	MAX.	
Collector Cutoff Current: With external base-to-emitter resistance ( $R_{BE}$ )	$I_{CER}$	$V_{CE} = 85 \text{ V}, R_{BE} = 100\Omega$	—	10	$\mu\text{A}$
Emitter Cutoff Current: With collector open	$I_{EBO}$	$V_{EB} = 4 \text{ V}, I_C = 0$	—	0.1	mA
Collector-to-Emitter Voltage: With external base-to-emitter resistance ( $R_{BE}$ )	$V_{CER}$	$I_C = 0.1 \text{ A}, R_{BE} = 100\Omega$	95	—	V
Gain Bandwidth Product	$f_T$	$I_C = 0.1 \text{ A}, V_{CE} = 4 \text{ V}$	50	—	MHz
DC Forward-Current Transfer Ratio	$h_{FE}$	$I_C = 300 \text{ mA}, V_{CE} = 4 \text{ V}$	70	300	
Collector-to-Emitter Saturation Voltage	$V_{CE(sat)}$	$I_C = 300 \text{ mA}, I_B = 30 \text{ mA}$	—	0.8	V
Base-to-Emitter Voltage	$V_{BE}$	$I_C = 300 \text{ mA}, V_{CE} = 4 \text{ V}$	—	1.4	V
Second-Breakdown Collector Current: With base forward biased	$I_{S/b}$	$V_{CE} = 50 \text{ V}, t = 0.4 \text{ s}$	0.2	—	A

For characteristics curves and test conditions, refer to published data for prototype 2N5320 (File 325).

## Type RCA1A04

Package: JEDEC TO-39

Construction: Silicon p-n-p, epitaxial-planar

ELECTRICAL CHARACTERISTICS, At Case Temperature ( $T_C$ ) = 25°C Unless Otherwise Specified

CHARACTERISTIC	SYMBOL	TEST CONDITIONS	LIMITS		UNITS
			MIN.	MAX.	
Collector Cutoff Current: With external base-to-emitter resistance ( $R_{BE}$ )	$I_{CER}$	$V_{CE} = -85 \text{ V}, R_{BE} = 100\Omega$	—	-10	$\mu\text{A}$
Emitter Cutoff Current: With collector open	$I_{EBO}$	$V_{EB} = 4 \text{ V}, I_C = 0$	—	-0.1	mA
Collector-to-Emitter Voltage: With external base-to-emitter resistance ( $R_{BE}$ )	$V_{CER}$	$I_C = -0.1 \text{ A}, R_{BE} = 100\Omega$	-95	—	V
Gain Bandwidth Product	$f_T$	$I_C = -0.1 \text{ A}, V_{CE} = -4 \text{ V}$	50	—	MHz
DC Forward-Current Transfer Ratio	$h_{FE}$	$I_C = -300 \text{ mA}, V_{CE} = -4 \text{ V}$	70	300	
Collector-to-Emitter Saturation Voltage	$V_{CE(sat)}$	$I_C = -300 \text{ mA}, I_B = -30 \text{ mA}$	—	-0.8	V
Base-to-Emitter Voltage	$V_{BE}$	$I_C = -300 \text{ mA}, V_{CE} = -4 \text{ V}$	—	-1.4	V
Second-Breakdown Collector Current: With base forward biased	$I_{S/b}$	$V_{CE} = -35 \text{ V}, t = 0.4 \text{ s}$	-0.285	—	A

For characteristics curves and test conditions, refer to published data for prototype 2N5322 (File 325).

**Type RCA1A05****Package:** JEDEC TO-39**Construction:** Silicon p-n-p epitaxial planar**ELECTRICAL CHARACTERISTICS, At Case Temperature ( $T_C$ ) = 25°C Unless Otherwise Specified**

CHARACTERISTIC	SYMBOL	TEST CONDITIONS	LIMITS		UNITS
			MIN.	MAX.	
Collector Cutoff Current: With external base-to-emitter resistance ( $R_{BE}$ )	$I_{CER}$	$V_{CE} = -65\text{ V}, R_{BE} = 100\Omega$	–	–10	$\mu\text{A}$
Emitter Cutoff Current: With collector open	$I_{EBO}$	$V_{EB} = -4\text{ V}, I_C = 0$	–	–0.1	mA
Collector-to-Emitter Voltage: With external base-to-emitter resistance ( $R_{BE}$ )	$V_{CER}$	$I_C = -0.1\text{ A}, R_{BE} = 100\Omega$	–75	–	V
Gain Bandwidth Product	$f_T$	$I_C = -50\text{ mA}, V_{CE} = -4\text{ V}$	60		MHz
DC Forward-Current Transfer Ratio	$h_{FE}$	$I_C = -150\text{ mA}, V_{CE} = -4\text{ V}$	50	250	
Collector-to-Emitter Saturation Voltage	$V_{CE(sat)}$	$I_C = -150\text{ mA}, I_B = -15\text{ mA}$	–	–0.8	V
Base-to-Emitter Voltage	$V_{BE}$	$I_C = -150\text{ mA}, V_{CE} = -4\text{ V}$	–	–1.4	V
Second-Breakdown Collector Current: With base forward biased	$I_{S/b}$	$V_{CE} = -65\text{ V}, t = 0.4\text{ s}$	–0.1	–	A

For characteristics curves and test conditions, refer to published data for prototype 2N4036 (File 216).

**Type RCA1A06****Package:** JEDEC TO-39**Construction:** Silicon n-p-n, planar**ELECTRICAL CHARACTERISTICS, At Case Temperature ( $T_C$ ) = 25°C Unless Otherwise Specified**

CHARACTERISTIC	SYMBOL	TEST CONDITIONS	LIMITS		UNITS
			MIN.	MAX.	
Collector Cutoff Current: With external base-to-emitter resistance ( $R_{BE}$ )	$I_{CER}$	$V_{CE} = 65\text{ V}, R_{BE} = 100\Omega$	–	10	$\mu\text{A}$
Emitter Cutoff Current: With collector open	$I_{EBO}$	$V_{EB} = 4\text{ V}, I_C = 0$	–	0.1	mA
Collector-to-Emitter Voltage: With external base-to-emitter resistance ( $R_{BE}$ )	$V_{CER}$	$I_C = 100\text{ mA}, R_{BE} = 100\Omega$	75	–	V
Gain Bandwidth Product	$f_T$	$I_C = 50\text{ mA}, V_{CE} = 4\text{ V}$	120	–	MHz
DC Forward-Current Transfer Ratio	$h_{FE}$	$I_C = 150\text{ mA}, V_{CE} = 4\text{ V}$	50	250	
Collector-to-Emitter Saturation Voltage	$V_{CE(sat)}$	$I_C = 150\text{ mA}, I_B = 15\text{ mA}$	–	0.8	V
Base-to-Emitter Voltage	$V_{BE}$	$I_C = 150\text{ mA}, V_{CE} = 4\text{ V}$	–	1.4	V
Second-Breakdown Collector Current: With base forward biased	$I_{S/b}$	$V_{CE} = 65\text{ V}, t = 0.4\text{ s}$	0.077	–	A

For characteristics curves and test conditions, refer to published data for prototype 2N2102 (File 106).

**Type RCA1A07**

Package: JEDEC TO-39

Construction: Silicon n-p-n, planar

ELECTRICAL CHARACTERISTICS, At Case Temperature ( $T_C$ ) = 25°C Unless Otherwise Specified

CHARACTERISTIC	SYMBOL	TEST CONDITIONS	LIMITS		UNITS
			MIN.	MAX.	
Collector Cutoff Current: With base open	$I_{CEO}$	$V_{CE} = 40 \text{ V}$	–	10	$\mu\text{A}$
Emitter Cutoff Current: With collector open	$I_{EBO}$	$V_{EB} = 3 \text{ V}, I_C = 0$	–	0.1	mA
Collector-to-Emitter Voltage: With base open	$V_{CEO}$	$I_C = 100 \text{ mA}$	40	–	V
Collector-to-Emitter Voltage: With external base-to-emitter resistance ( $R_{BE}$ )	$V_{CER}$	$I_C = 100 \text{ mA}, R_{BE} = 10\Omega$	50	–	V
Gain Bandwidth Product	$f_T$	$V_{CE} = 10 \text{ V}, I_C = 50 \text{ mA}$	120	–	MHz
DC Forward-Current Transfer Ratio	$h_{FE}$	$I_C = 3 \text{ mA}, V_{CE} = 10 \text{ V}$	50	250	
Collector-to-Emitter Saturation Voltage	$V_{CE}(\text{sat})$	$I_C = 20 \text{ mA}, I_B = 1 \text{ mA}$	–	1	V
Base-to-Emitter Saturation Voltage	$V_{BE}(\text{sat})$	$I_C = 20 \text{ mA}, I_B = 1 \text{ mA}$	–	1.3	V

For characteristics curves and test conditions, refer to published data for prototype 2N2102 (File 106).

**Type RCA1A08**

Package: JEDEC TO-39

Construction: Silicon p-n-p, epitaxial planar

ELECTRICAL CHARACTERISTICS, At Case Temperature ( $T_C$ ) = 25°C Unless Otherwise Specified

CHARACTERISTIC	SYMBOL	TEST CONDITIONS	LIMITS		UNITS
			MIN.	MAX.	
Collector Cutoff Current: With external base-to-emitter-resistance	$I_{CER}$	$V_{CE} = -40 \text{ V}, R_{BE} = 330\Omega$	–	–10	$\mu\text{A}$
Emitter Cutoff Current: With collector open	$I_{EBO}$	$V_{EB} = -5 \text{ V}$	–	–0.1	mA
Collector-to-Emitter Voltage: With base open	$V_{CEO}$	$I_C = -100 \text{ mA}, I_B = 0$	–40	–	V
Collector-to-Emitter Voltage: With external base-to-emitter resistance ( $R_{BE}$ )	$V_{CER}$	$I_C = -100 \text{ mA}, R_{BE} = 330\Omega$	–50	–	V
Gain Bandwidth Product	$f_T$	$V_{CE} = -10 \text{ V}, I_C = -50 \text{ mA}$	60	–	MHz
DC Forward-Current Transfer Ratio	$h_{FE}$	$I_C = -50 \text{ mA}, V_{CE} = -1.5 \text{ V}$	70	250	
Collector-to-Emitter Saturation Voltage	$V_{CE}(\text{sat})$	$I_C = -100 \text{ mA}, I_B = -5 \text{ mA}$	–	–1.4	V
Base-to-Emitter Saturation Voltage	$V_{BE}(\text{sat})$	$I_C = -100 \text{ mA}, I_B = -5 \text{ mA}$	–	–1.4	V
Second-Breakdown Collector Current: With base forward biased	$I_{S/b}$	$V_{CE} = -35 \text{ V}, t = 0.05 \text{ s}$	–0.12	–	A

For characteristics curves and test conditions, refer to published data for prototype 2N4036 (File 216).

**Type RCA1A09****Package:** JEDEC TO-39**Construction:** Silicon n-p-n, epitaxial**ELECTRICAL CHARACTERISTICS, At Case Temperature ( $T_C$ ) = 25°C Unless Otherwise Specified**

CHARACTERISTIC	SYMBOL	TEST CONDITIONS	LIMITS		UNITS
			MIN.	MAX.	
Collector Cutoff Current: With base open	$I_{CEO}$	$V_{CE} = 90 \text{ V}, I_B = 0$	–	10	$\mu\text{A}$
Emitter Cutoff Current: With collector open	$I_{EBO}$	$V_{EB} = 6 \text{ V}, I_C = 0$	–	100	$\mu\text{A}$
Collector-to-Emitter Voltage: With base open	$V_{CEO}$	$I_C = 10 \text{ mA}, I_B = 0$	175	–	V
Gain Bandwidth Product	$f_T$	$I_C = 10 \text{ mA}, V_{CE} = 10 \text{ V}$	15	–	MHz
DC Forward-Current Transfer Ratio	$h_{FE}$	$I_C = 10 \text{ mA}, V_{CE} = 10 \text{ V}$	20	100	
Collector-to-Emitter Saturation Voltage	$V_{CE(sat)}$	$I_C = 50 \text{ mA}, I_B = 4 \text{ mA}$	–	0.5	V
Base-to-Emitter Voltage	$V_{BE}$	$I_C = 10 \text{ mA}, V_{CE} = 10 \text{ V}$	–	0.9	V
Second-Breakdown Collector Current: With base forward biased	$I_{S/b}$	$V_{CE} = 150 \text{ V}, t = 1 \text{ s}$	0.065	–	A

For characteristics curves and test conditions, refer to published data for prototype 2N3439 (File 64).

**Type RCA1A10****Package:** JEDEC TO-39**Construction:** Silicon p-n-p**ELECTRICAL CHARACTERISTICS, At Case Temperature ( $T_C$ ) = 25°C Unless Otherwise Specified**

CHARACTERISTIC	SYMBOL	TEST CONDITIONS	LIMITS		UNITS
			MIN.	MAX.	
Collector Cutoff Current: With base open	$I_{CEO}$	$V_{CE} = -120 \text{ V}, I_B = 0$	–	–10	$\mu\text{A}$
Emitter Cutoff Current: With collector open	$I_{EBO}$	$V_{EB} = -6 \text{ V}, I_C = 0$	–	–100	$\mu\text{A}$
Collector-to-Emitter Voltage: With base open	$V_{CEO}$	$I_C = -10 \text{ mA}, I_B = 0$	–175	–	V
Gain Bandwidth Product	$f_T$	$I_C = -10 \text{ mA}, V_{CE} = -10 \text{ V}$	15	–	MHz
DC Forward-Current Transfer Ratio	$h_{FE}$	$I_C = -10 \text{ mA}, V_{CE} = -10 \text{ V}$	40	250	
Collector-to-Emitter Saturation Voltage	$V_{CE(sat)}$	$I_C = -10 \text{ mA}, I_B = -1 \text{ mA}$	–	–2	V
Base-to-Emitter Voltage	$V_{BE}$	$I_C = -10 \text{ mA}, V_{CE} = -10 \text{ V}$	–	–0.8	V
Second-Breakdown Collector Current: With base forward biased	$I_{S/b}$	$V_{CE} = -150 \text{ V}, t = 1 \text{ s}$	–0.04	–	A

For characteristics curves and test conditions, refer to published data for prototype 2N5415 (File 336).

## Type RCA1A11

Package: JEDEC TO-39

Construction: Silicon n-p-n, epitaxial

ELECTRICAL CHARACTERISTICS, At Case Temperature ( $T_C$ ) = 25°C Unless Otherwise Specified

CHARACTERISTIC	SYMBOL	TEST CONDITIONS	LIMITS		UNITS
			MIN.	MAX.	
Collector Cutoff Current: With base open	$I_{CEO}$	$V_{CE} = 90 \text{ V}, I_B = 0$	–	10	$\mu\text{A}$
Emitter Cutoff Current: With collector open	$I_{EBO}$	$V_{EB} = 6 \text{ V}, I_C = 0$	–	100	$\mu\text{A}$
Collector-to-Emitter Voltage: With base open	$V_{CEO}$	$I_C = 10 \text{ mA}, I_B = 0$	175	–	V
Gain Bandwidth Product	$f_T$	$I_C = 10 \text{ mA}, V_{CE} = 10 \text{ V}$	15	–	MHz
DC Forward-Current Transfer Ratio	$h_{FE}$	$I_C = 1 \text{ mA}, V_{CE} = 10 \text{ V}$	40	250	
Base-to-Emitter Voltage	$V_{BE}$	$I_C = 1 \text{ mA}, V_{CE} = 10 \text{ V}$	0.5	0.7	V

For characteristics curves and test conditions, refer to published data for prototype 2N3439 (File 64).

## Type RCA1A15

Package: JEDEC TO-39

Construction: Silicon n-p-n, epitaxial

ELECTRICAL CHARACTERISTICS, At Case Temperature ( $T_C$ ) = 25°C Unless Otherwise Specified

CHARACTERISTIC	SYMBOL	TEST CONDITIONS	LIMITS		UNITS
			MIN.	MAX.	
Collector Cutoff Current: With base open	$I_{CEO}$	$V_{CE} = 90 \text{ V}$	–	10	$\mu\text{A}$
Emitter Cutoff Current: With collector open	$I_{EBO}$	$V_{EB} = 5 \text{ V}, I_C = 0$	–	1	mA
Collector-to-Emitter Voltage: With base open	$V_{CEO}$	$I_C = 10 \text{ mA}, I_B = 0$	100	–	V
Gain Bandwidth Product	$f_T$	$V_{CE} = 10 \text{ V}, I_C = 10 \text{ mA}$	15	–	MHz
DC Forward-Current Transfer Ratio	$h_{FE}$	$I_C = 10 \text{ mA}, V_{CE} = 10 \text{ V}$	20	100	
Collector-to-Emitter Saturation Voltage	$V_{CE(sat)}$	$I_C = 10 \text{ mA}, I_B = 1 \text{ mA}$	–	1	V
Base-to-Emitter Voltage	$V_{BE}$	$I_C = 10 \text{ mA}, V_{CE} = 10 \text{ V}$	–	1	V
Second-Breakdown Collector Current: With base forward biased	$I_{S/b}$	$V_{CE} = 50 \text{ V}, t = 0.4 \text{ s}$	0.2	–	A

For characteristics curves and test conditions, refer to published data for prototype 2N3440 (File 64).



**Type RCA1A16****Package:** JEDEC TO-39**Construction:** Silicon p-n-p, epitaxial**ELECTRICAL CHARACTERISTICS, At Case Temperature ( $T_C$ ) = 25°C Unless Otherwise Specified**

CHARACTERISTIC	SYMBOL	TEST CONDITIONS	LIMITS		UNITS
			MIN.	MAX.	
Collector Cutoff Current: With base open	$I_{CEO}$	$V_{CE} = -90 \text{ V}$	—	-10	$\mu\text{A}$
Emitter Cutoff Current: With collector open	$I_{EBO}$	$V_{EB} = -5 \text{ V}, I_C = 0$	—	-1	mA
Collector-to-Emitter Voltage: With base open	$V_{CEO}$	$I_C = -10 \text{ mA}, I_B = 0$	-100	—	V
Gain Bandwidth Product	$f_T$	$V_{CE} = -10 \text{ V}, I_C = -10 \text{ mA}$	15	—	MHz
DC Forward-Current Transfer Ratio	$h_{FE}$	$I_C = -10 \text{ mA}, V_{CE} = -10 \text{ V}$	40	250	
Collector-to-Emitter Saturation Voltage	$V_{CE}(\text{sat})$	$I_C = -10 \text{ mA}, I_B = -1 \text{ mA}$	—	-1	V
Base-to-Emitter Voltage	$V_{BE}$	$I_C = -10 \text{ mA}, V_{CE} = -10 \text{ V}$	—	-1	V
Second-Breakdown Collector Current: With base forward biased	$I_{S/b}$	$V_{CE} = -50 \text{ V}, t = 0.4 \text{ s}$	-0.2	—	A

For characteristics curves and test conditions, refer to published data for prototype 2N5416 (File 336).

**Type RCA1A17****Package:** JEDEC TO-39**Construction:** Silicon n-p-n, planar**ELECTRICAL CHARACTERISTICS, At Case Temperature ( $T_C$ ) = 25°C Unless Otherwise Specified**

CHARACTERISTIC	SYMBOL	TEST CONDITIONS	LIMITS		UNITS
			MIN.	MAX.	
Collector Cutoff Current: With base open	$I_{CEO}$	$V_{CE} = 80 \text{ V}, I_B = 0$	—	1	$\mu\text{A}$
Emitter Cutoff Current: With collector open	$I_{EBO}$	$V_{EB} = 4 \text{ V}, I_C = 0$	—	1	mA
Collector-to-Emitter Voltage: With base open	$V_{CEO}$	$I_C = 100 \text{ mA}, I_B = 0$	90	—	V
Gain Bandwidth Product	$f_T$	$V_{CE} = 4 \text{ V}, I_C = 50 \text{ mA}$	120	—	MHz
DC Forward-Current Transfer Ratio	$h_{FE}$	$I_C = 10 \text{ mA}, V_{CE} = 4 \text{ V}$	40	200	
Collector-to-Emitter Saturation Voltage	$V_{CE}(\text{sat})$	$I_C = 150 \text{ mA}, I_B = 15 \text{ mA}$	—	1.4	V
Base-to-Emitter Voltage	$V_{BE}$	$I_C = 10 \text{ mA}, V_{CE} = 4 \text{ V}$	—	1	V

For characteristics curves and test conditions, refer to published data for prototype 2N2102 (File 106).

## Type RCA1A18

Package: JEDEC TO-39

Construction: Silicon n-p-n, planar

ELECTRICAL CHARACTERISTICS, At Case Temperature ( $T_C$ ) = 25°C Unless Otherwise Specified

CHARACTERISTIC	SYMBOL	TEST CONDITIONS	LIMITS		UNITS
			MIN.	MAX.	
Collector Cutoff Current: With base open	$I_{CEO}$	$V_{CE} = 5 \text{ V}, I_B = 0$	—	10	$\mu\text{A}$
Emitter Cutoff Current: With collector open	$I_{EBO}$	$V_{EB} = 4 \text{ V}, I_C = 0$	—	1	mA
Collector-to-Emitter Voltage: With base open	$V_{CEO}$	$I_C = 10 \text{ mA}, I_B = 0$	10	—	V
Gain Bandwidth Product	$f_T$	$I_C = 50 \text{ mA}, V_{CE} = 4 \text{ V}$	120	—	MHz
DC Forward-Current Transfer Ratio	$h_{FE}$	$I_C = 10 \text{ mA}, V_{CE} = 4 \text{ V}$	40	250	
Collector-to-Emitter Saturation Voltage	$V_{CE}(\text{sat})$	$I_C = 10 \text{ mA}, I_B = 0.5 \text{ mA}$	—	1	V
Base-to-Emitter Voltage	$V_{BE}$	$I_C = 10 \text{ mA}, V_{CE} = 4 \text{ V}$	—	0.78	V

For characteristics curves and test conditions, refer to published data for prototype 2N2102 (File 106).

## Type RCA1A19

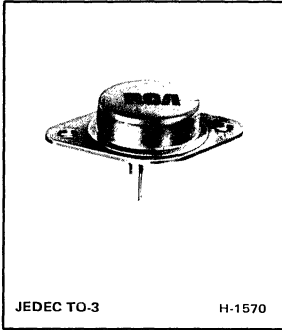
Package: JEDEC TO-39

Construction: Silicon p-n-p, epitaxial planar

ELECTRICAL CHARACTERISTICS, At Case Temperature ( $T_C$ ) = 25°C Unless Otherwise Specified

CHARACTERISTIC	SYMBOL	TEST CONDITIONS	LIMITS		UNITS
			MIN.	MAX.	
Collector Cutoff Current: With base open	$I_{CEO}$	$V_{CE} = -5 \text{ V}, I_B = 0$	—	-10	$\mu\text{A}$
Emitter Cutoff Current: With collector open	$I_{EBO}$	$V_{EB} = -4 \text{ V}, I_C = 0$	—	-1	mA
Collector-to-Emitter Voltage: With base open	$V_{CEO}$	$I_C = -10 \text{ mA}, I_B = 0$	-10	—	V
Gain Bandwidth Product	$f_T$	$I_C = -50 \text{ mA}, V_{CE} = -4 \text{ V}$	60	—	MHz
DC Forward-Current Transfer Ratio	$h_{FE}$	$I_C = -10 \text{ mA}, V_{CE} = -4 \text{ V}$	40	250	
Collector-to-Emitter Saturation Voltage	$V_{CE}(\text{sat})$	$I_C = -10 \text{ mA}, I_B = -0.5 \text{ mA}$	—	-1	V
Base-to-Emitter Voltage	$V_{BE}$	$I_C = -10 \text{ mA}, V_{CE} = -4 \text{ V}$	—	-0.78	V

For characteristics curves and test conditions, refer to published data for prototype 2N4036 (File 216).



**Silicon Transistor for  
70-Watt  
Quasi-Complementary-Symmetry  
Audio Amplifiers  
with  
Hometaxial-Base Output Transistors**

RCA1B01 is an n-p-n hometaxial-base silicon transistor in a JEDEC TO-3 package. This device is particularly suitable for audio-output use, and can be driven by either the RCA1A03 n-p-n or RCA1A04 p-n-p transistor.

The 70-watt amplifier shown in Figs. 1 and 5 uses the

RCA1B01 in conjunction with seven TO-39 transistors, eleven diodes, and an 84-volt split power supply. The amplifier output is directly coupled to an 8-ohm speaker. This amplifier is most useful for instrumentation applications where ruggedness and raw power are essential.

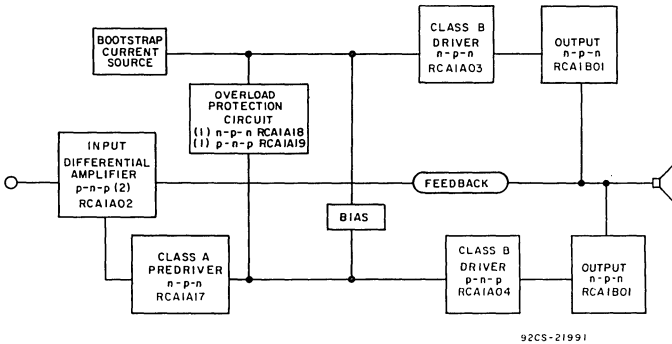


Fig. 1—Block diagram and transistor complement for 70-watt quasi-complementary-symmetry audio amplifier with hometaxial-base output transistors.

**MAXIMUM RATINGS, Absolute-Maximum Values:**

**RCA1B01**

COLLECTOR-TO-BASE VOLTAGE .....	V <sub>CB0</sub>	95	V
COLLECTOR-TO-EMITTER VOLTAGE:			
With external base-to-emitter resistance (R <sub>BE</sub> ) = 100Ω .....	V <sub>CER</sub>	95	V
EMITTER-TO-BASE VOLTAGE .....	V <sub>EB0</sub>	7	V
COLLECTOR CURRENT .....	I <sub>C</sub>	15	A
BASE CURRENT .....	I <sub>B</sub>	7	A
TRANSISTOR DISSIPATION:	P <sub>T</sub>		
At case temperatures up to 25°C .....		115	W
At case temperatures above 25°C .....		See Fig. 2	
TEMPERATURE RANGE:			
Storage & Operating (Junction) .....		-65 to 200	°C
PIN TEMPERATURE (During Soldering):			
At distances ≥ 1/32 in. (0.8 mm) from case for 10 s max .....		230	°C

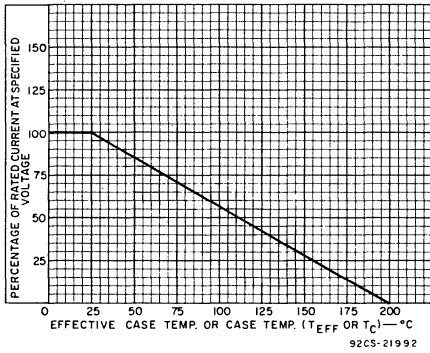


Fig. 2—Derating curves for all types.

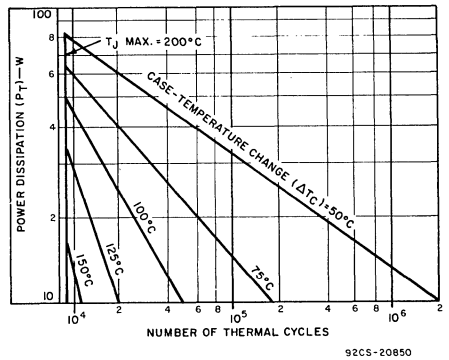


Fig. 3—Thermal-cycling ratings for RCA1B01.

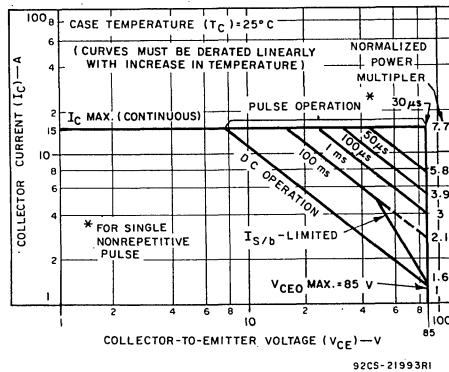
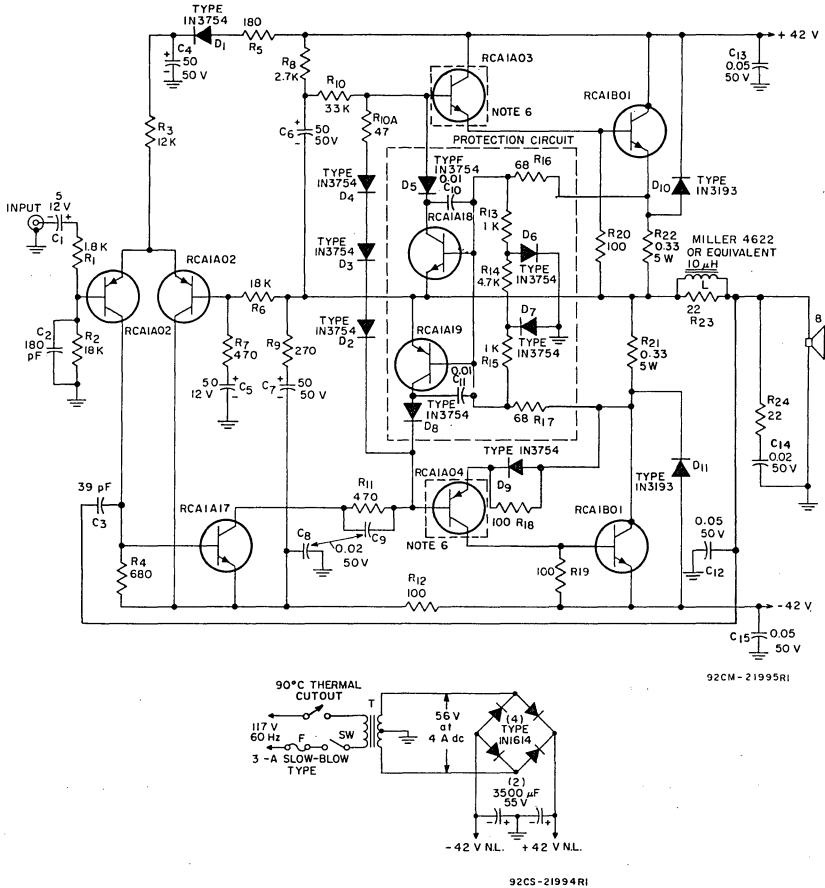


Fig. 4—Maximum operating areas for RCA1B01.



**NOTES:**

1. T: Signal 56-4 (Signal Transformer Co., 1 Junius St., Brooklyn, N.Y. 11212), or equivalent.
2. Resistors are 1/2-watt unless otherwise specified; values are in ohms.
3. Capacitances are in  $\mu\text{F}$  unless otherwise specified.
4. Non-inductive resistors.
5. Provide approx.  $1^\circ\text{C/W}$  heat sinking per output device based on mounding with mica washer and ZnO thermal compound (Dow Corning No. 340, or equivalent) with  $T_A = 45^\circ\text{C}$  max.
6. Mount on heat sink, Wakefield No. 209-AB, or equivalent. (Alternatively, this type may be obtained with a factory-attached integral heat sink.)

Fig. 5-70-Watt amplifier circuit featuring quasi-complementary-symmetry output employing homotaxial-base output transistors.

**TYPICAL PERFORMANCE DATA**  
**For 70-Watt Audio Amplifier**

Measured at a line voltage of 120 V,  $T_A = 25^\circ\text{C}$ , and a frequency of 1 kHz, unless otherwise specified.

<b>Power:</b>	Rated power (8- $\Omega$ load, at rated distortion) . . . . .	70 W	<b>IM Distortion:</b>	10 dB below continuous power output at 60 Hz and 7 kHz (4:1) . . . . .	0.1%
	Typical power (4- $\Omega$ load) . . . . .	100 W	<b>Sensitivity:</b>	At continuous power-output rating . . . . .	700 mV
	Typical power (16- $\Omega$ load) . . . . .	40 W	<b>Hum and Noise:</b>	Below continuous power output:	
	Music power (8- $\Omega$ load, at 5% THD with regulated supply) . . . . .	100 W	Input shorted . . . . .	85 dB	
	Dynamic power (8- $\Omega$ load, at 1% THD with regulated supply) . . . . .	88 W	Input open . . . . .	80 dB	
<b>Total Harmonic Distortion:</b>	Rated distortion . . . . .	1.0%	Input Resistance . . . . .	20 k $\Omega$	

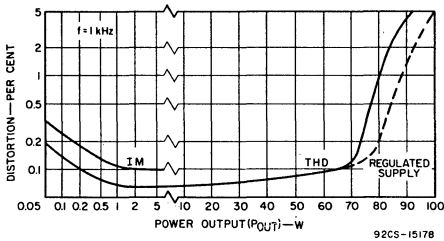


Fig. 6—Distortion vs. power output.

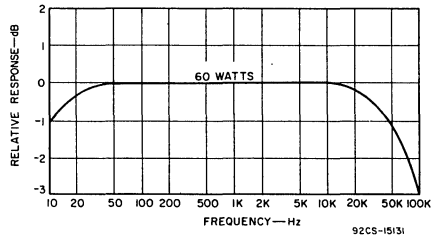


Fig. 7—Response curve.

**Type RCA1B01**

**Package:** JEDEC TO-3

**Construction:** Silicon n-p-n, hometaxial base

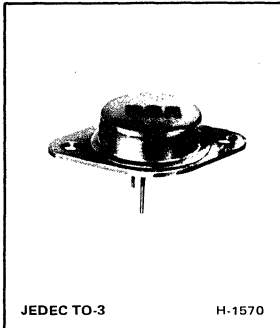
**ELECTRICAL CHARACTERISTICS, At Case Temperature ( $T_C$ ) = 25°C Unless Otherwise Specified**

CHARACTERISTIC	SYMBOL	TEST CONDITIONS	LIMITS		UNITS
			MIN.	MAX.	
Collector Cutoff Current: With external base-to-emitter resistance ( $R_{BE}$ )	$I_{CER}$	$V_{CE} = 85\text{ V}, R_{BE} = 100\Omega$	—	0.5	mA
Emitter Cutoff Current: With collector open	$I_{EBO}$	$V_{EB} = 4\text{ V}, I_C = 0$	—	1	mA
Collector-to-Emitter Voltage: With external base-to-emitter resistance ( $R_{BE}$ )	$V_{CER}$	$I_C = 0.2\text{ A}, R_{BE} = 100\Omega$	95	—	V
Gain Bandwidth Product	$f_T$	$V_{CE} = 4\text{ V}, I_C = 1\text{ A}$	0.8	—	MHz
DC Forward-Current Transfer Ratio	$h_{FE}$	$I_C = 4\text{ A}, V_{CE} = 4\text{ V}$	20	70	
Collector-to-Emitter Saturation Voltage	$V_{CE(sat)}$	$I_C = 4\text{ A}, I_B = 0.4\text{ A}$	—	1	V
Base-to-Emitter Voltage	$V_{BE}$	$I_C = 4\text{ A}, V_{CE} = 4\text{ V}$	—	1.4	V
Second-Breakdown Collector Current: With base forward biased	$I_{S/b}$	$V_{CE} = 60\text{ V}, t = 1\text{ s}$	1.95	—	A

For characteristics curves and test conditions, refer to published data for prototype 2N3055 (File 524).

**TERMINAL CONNECTIONS FOR TYPE RCA1B01**

- Pin 1 — Base
- Pin 2 — Emitter
- Case — Collector
- Mounting Flange — Collector



JEDEC TO-3

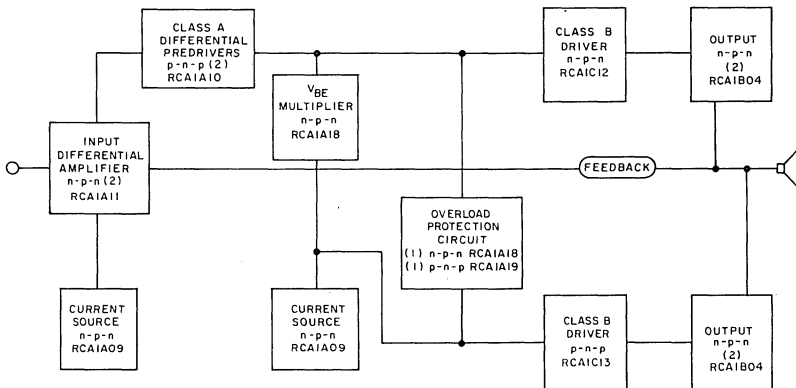
H-1570

## Silicon Transistor for 120-Watt Quasi-Complementary-Symmetry Audio Amplifiers with Parallel Output Transistors

RCA1B04 is an n-p-n silicon pi-nu transistor in a JEDEC TO-3 package. This device is especially characterized for audio applications, and can be driven by RCA1C12 and RCA1C13 transistors.

The 120-watt amplifier circuit in Figs. 1 and 5 uses the RCA1B04 in conjunction with eleven other discrete transistors,

twelve diodes, and a 130-volt split power supply. The amplifier output is directly coupled to an 8-ohm speaker. This RCA 120-watt audio amplifier is especially designed for top-of-the-line quadrasonic use in applications requiring ½ kW of quadrasonic sound with excellent tonal quality.



92CM-22023

Fig. 1— Block diagram and transistor complement for 120-watt quasi-complementary-symmetry audio amplifier with parallel output transistors.

**MAXIMUM RATINGS, Absolute-Maximum Values:**

COLLECTOR-TO-BASE VOLTAGE . . . . .	$V_{CB0}$	225	V
COLLECTOR-TO-EMITTER VOLTAGE:			
With base open . . . . .	$V_{CE0}$	200	V
With external base-to-emitter resistance ( $R_{BE}$ ) = 100 $\Omega$ . . . . .	$V_{CER}$	225	V
EMITTER-TO-BASE VOLTAGE . . . . .	$V_{EBO}$	5	V
COLLECTOR CURRENT . . . . .	$I_C$	7	A
BASE CURRENT . . . . .	$I_B$	2	A
TRANSISTOR DISSIPATION:	$P_T$		
At case temperatures up to 25°C . . . . .		150	W
At case temperatures above 25°C . . . . .		See Fig. 2	
TEMPERATURE RANGE:			
Storage & Operating (Junction) . . . . .		-65 to 200	°C
PIN TEMPERATURE (During Soldering):			
At distances $\geq$ 1/32 in. (0.8 mm) from case for 10 s max. . . . .		230	°C

**RCA1B04**

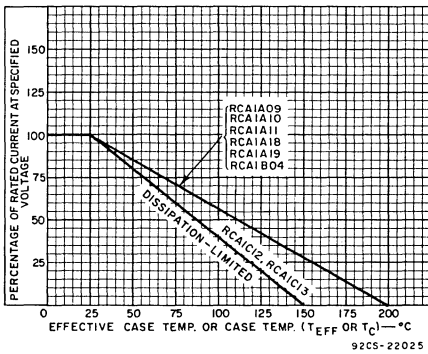


Fig. 2— Derating curves for all types.

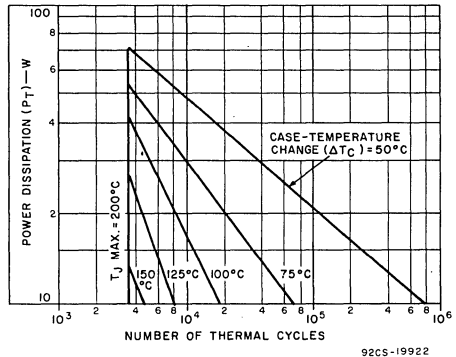


Fig. 3— Thermal-cycling ratings for RCA1B04.

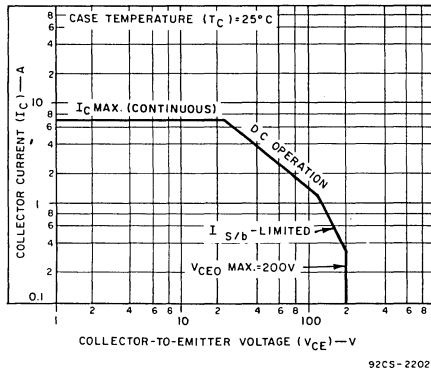


Fig. 4— Maximum operating areas for RCA1B04.



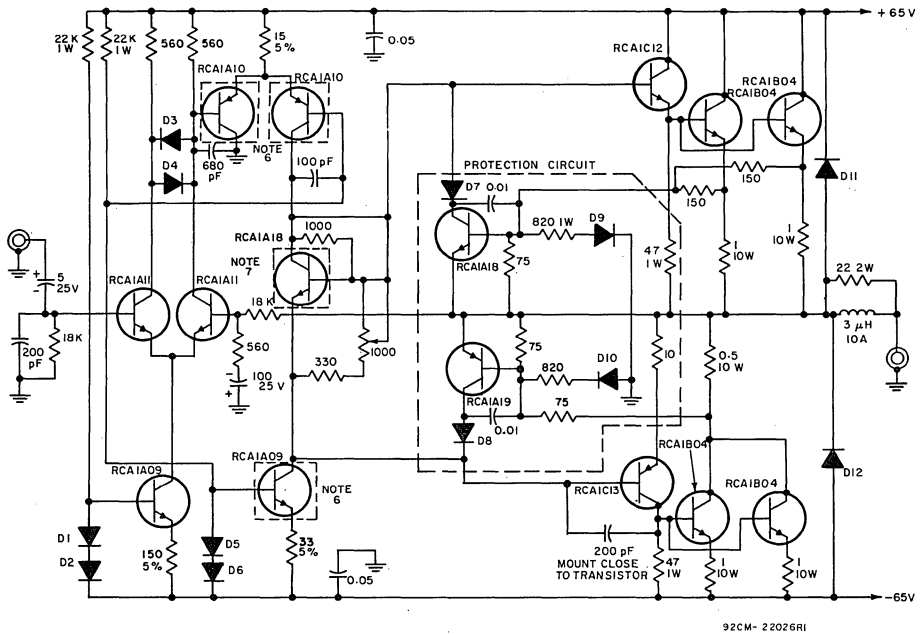
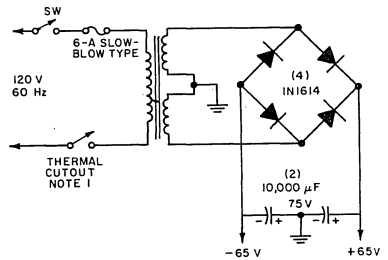


Fig. 5—120-watt amplifier circuit featuring quasi-complementary-symmetry with parallel output transistors.

NOTES FOR FIG. 5:

1. D1—D8 - 1N5391; D9—D10 - 1N914; D11—D12 - 1N5393.
2. Resistors are 1/2-watt,  $\pm 10\%$  unless otherwise specified; values are in ohms.
3. Capacitances are in  $\mu F$  unless otherwise specified.
4. Non-inductive resistors.
5. Provide approx.  $1^\circ C/W$  heat sinking per output device based on mounting with mica washer and ZnO thermal compound (Dow Corning No. 340, or equivalent) with  $T_A = 45^\circ C$  max.
6. Mount on heat sink, Wakefield No. 209-AB, or equivalent. (Alternatively, this type may be obtained with a factory-attached integral heat sink.)
7. Attach heat sink cap (Wakefield No. 260-6SH5E, or equivalent.) on device and mount on same heat sink with output transistor.



NOTES FOR FIG. 6:

1.  $90^\circ C$  thermal cutout attached to heat sink for output transistors.
2. Power transformer: Signal 88-6 (Signal Transformer Co., 1 Junius St., Brooklyn, N.Y. 11212), or equivalent.

Fig. 6—Power supply for 120-watt audio amplifier.

**TYPICAL PERFORMANCE DATA**  
For 120-Watt Audio Amplifier

Measured at a line voltage of 120 V,  $T_A = 25^\circ\text{C}$ , and a frequency of 1 kHz, unless otherwise specified.

Power:

Rated power (8- $\Omega$ load, at rated distortion) .....	120 W
Typical power (4- $\Omega$ load) .....	180 W
Typical power (16- $\Omega$ load) .....	80 W

Total Harmonic Distortion:

Rated distortion .....	0.5%
------------------------	------

IM Distortion:

10 dB below continuous power output at 60 Hz and 7 kHz (4:1) .....	0.2%
--	------

IHF Power Bandwidth:

3 dB below rated continuous power at rated distortion .....	5 Hz to 50 kHz
---	----------------

Sensitivity:

At continuous power output rating .....	900 mV
---	--------

Hum and Noise:

Below continuous power output:

Input shorted .....	104 dB
Input open .....	88 dB
With 2 k $\Omega$ resistance on 20-ft. cable on input .....	104 dB

Input Resistance .....	18 k $\Omega$
------------------------	---------------

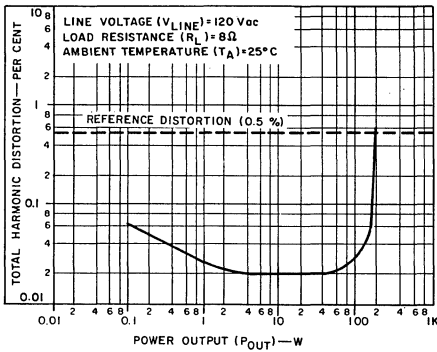


Fig. 7— Typical total harmonic distortion vs. power output for single channel (8  $\Omega$ ), and both channels driven at 1 kHz.

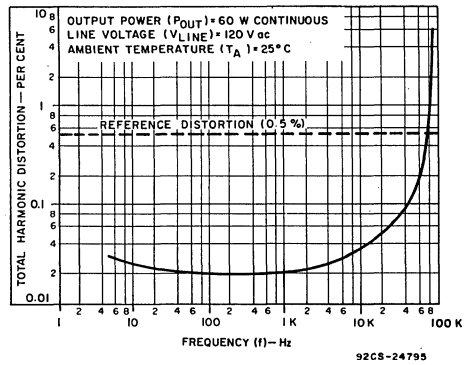


Fig. 8— Typical total harmonic distortion vs. frequency for 60-watt output.

## Type RCA1B04

Package: JEDEC TO-3

Construction: Silicon n-p-n, multiple-epitaxial, pi-nu

ELECTRICAL CHARACTERISTICS, At Case Temperature ( $T_C$ ) = 25°C Unless Otherwise Specified

CHARACTERISTIC	SYMBOL	TEST CONDITIONS	LIMITS		UNITS
			MIN.	MAX.	
Collector Cutoff Current: With external base-to-emitter resistance ( $R_{BE}$ )	$I_{CER}$	$V_{CE} = 120 \text{ V}, R_{BE} = 100 \Omega$	–	1	mA
Emitter Cutoff Current: With collector open	$I_{EBO}$	$V_{EB} = 5 \text{ V}, I_B = 0$	–	1	mA
Collector-to-Emitter Voltage: With base open	$V_{CEO}$	$I_C = 0.2 \text{ A}, I_B = 0$	200	–	V
Collector-to-Emitter Voltage: With external base-to-emitter resistance ( $R_{BE}$ )	$V_{CER}$	$I_C = 0.2 \text{ A}, R_{BE} = 100 \Omega$	225	–	V
Gain Bandwidth Product	$f_T$	$I_C = 0.2 \text{ A}, V_{CE} = 10 \text{ V}$	5	–	MHz
DC Forward-Current Transfer Ratio	$h_{FE}$	$I_C = 2 \text{ A}, V_{CE} = 5 \text{ V}$	15	75	
Collector-to-Emitter Saturation Voltage	$V_{CE(sat)}$	$I_C = 2 \text{ A}, I_B = 0.255 \text{ A}$	–	2	V
Base-to-Emitter Voltage	$V_{BE}$	$I_C = 2 \text{ A}, V_{CE} = 5 \text{ V}$	1	2	V
Second-Breakdown Collector Current: With base forward biased	$I_{S/b}$	$V_{CE} = 120 \text{ V}, t = 1 \text{ s}$	1.25	–	A

For characteristics curves and test conditions, refer to published data for prototype 2N5239 (File 321).

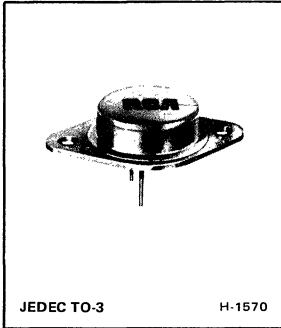
## TERMINAL CONNECTIONS FOR TYPE RCA1B04

Pin 1 – Base  
Pin 2 – Emitter  
Case – Collector  
Mounting Flange – Collector

**RCA**  
Solid State  
Division

# Power Transistors

## RCA1B05

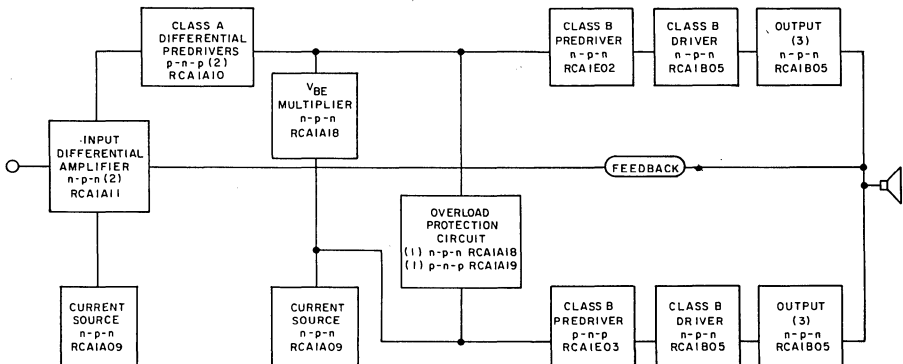


### Silicon Transistor for 200-Watt Quasi-Complementary-Symmetry Audio Amplifiers with Parallel Output Transistors

RCA1B05 is a silicon n-p-n pi-nu transistor in a JEDEC TO-3 package. This device is especially suitable for applications in audio-amplifier circuits, in which it may be used as either driver or output unit.

The 200-watt amplifier shown in Figs. 1 and 5 uses eight RCA1B05 transistors, two as drivers and six as parallel units in

the amplifier output stages. These devices are employed in conjunction with eleven other discrete transistors, twelve diodes, and a 160-volt split power supply. The amplifier output is directly coupled to an 8-ohm speaker. This 200-watt audio amplifier is especially designed to feature ruggedness in combination with high power output and excellent high-fidelity performance.



92CM-22039

Fig. 1—Block diagram and transistor complement for 200-watt quasi-complementary-symmetry audio amplifier with parallel output transistors.

**MAXIMUM RATINGS, Absolute-Maximum Values:**

		<b>RCA1B05</b>	
COLLECTOR-TO-BASE VOLTAGE . . . . .	$V_{CBO}$	275	V
COLLECTOR-TO-EMITTER VOLTAGE:			
With base open . . . . .	$V_{CEO}$	250	V
With external base-to-emitter resistance ( $R_{BE}$ ) = 100 $\Omega$ . . . . .	$V_{CER}$	275	V
EMITTER-TO-BASE VOLTAGE . . . . .	$V_{EBO}$	5	V
COLLECTOR CURRENT . . . . .	$I_C$	7	A
BASE CURRENT . . . . .	$I_B$	2	A
TRANSISTOR DISSIPATION:	$P_T$		
At case temperatures up to 25°C . . . . .		150	W
At case temperatures above 25°C . . . . .		See Fig. 2	
TEMPERATURE RANGE:			
Storage & Operating (Junction) . . . . .		-65 to 200	°C
PIN TEMPERATURE (During Soldering):			
At distances $\geq$ 1/32 in. (0.8 mm) from case for 10 s max. . . . .		230	°C

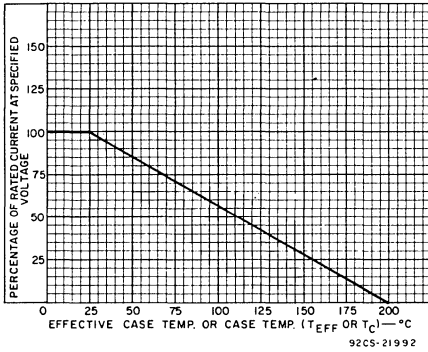


Fig. 2—Derating curves for all types.

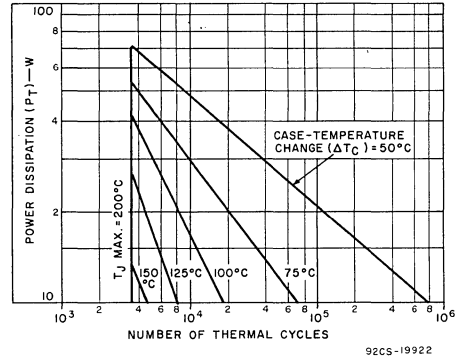


Fig. 3—Thermal-cycling ratings for RCA1B05.

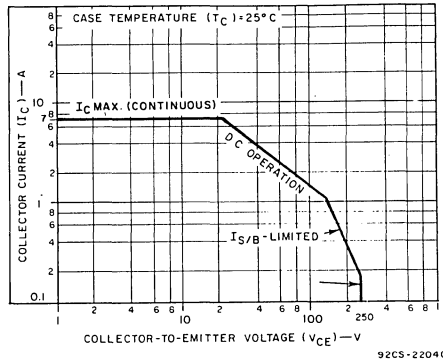
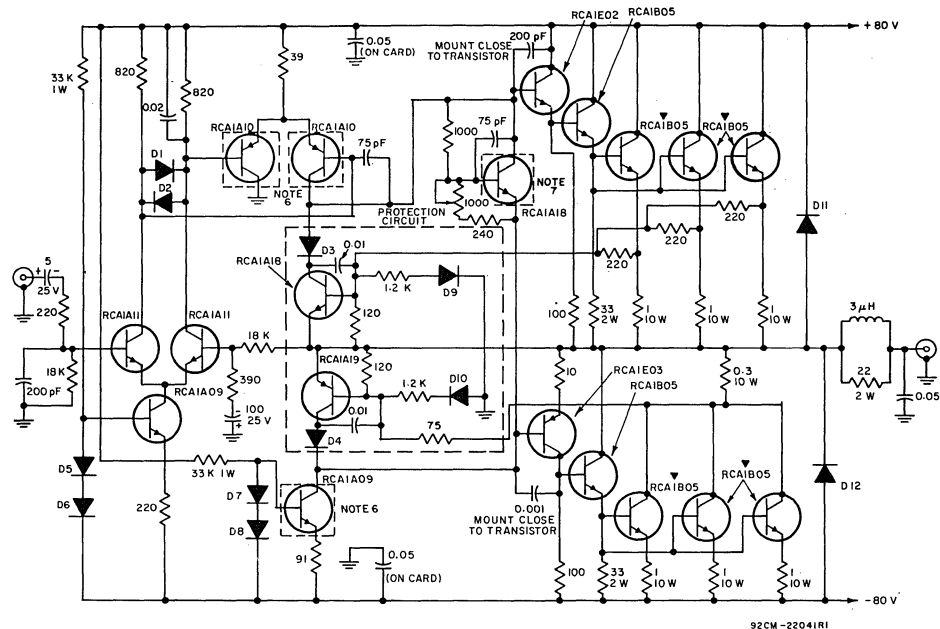


Fig. 4—Maximum operating areas for RCA1B05.

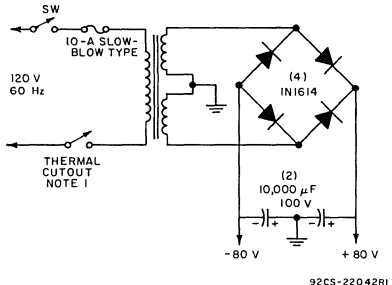


92CM-22041R1

Fig. 5— 120-watt amplifier circuit featuring quasi-complementary-symmetry with parallel output transistors.

NOTES FOR FIG. 5:

1. D1—D8 - 1N5391; D9—D12 - 1N5393.
2. Resistors are 1/2-watt, ± 10% unless otherwise specified; values are in ohms.
3. Capacitances are in μF unless otherwise specified.
4. Non-inductive resistors.
5. ▼ Provide approx. 1°C/W heat sinking per output device based on mounting with mica washer and ZnO thermal compound (Dow Corning No. 340, or equivalent) with T<sub>A</sub> = 45°C max.
6. Mount on heat sink, Wakefield No. 209-AB, or equivalent. (Alternatively, this type may be obtained with a factory-attached integral heat sink.)
7. Attach heat sink cap (Wakefield No. 260-6SH5E, or equivalent) on device and mount on same heat sink with output transistor.



92CS-22042R1

NOTES:

1. 90°C thermal cutout attached to heat sink for output transistors.
2. Power transformer: Signal 120-6(Signal Transformer Co., 1 Junius St., Brooklyn, N.Y. 11212), or equivalent. Use 125-volt primary tap.

Fig. 6— Power supply for 120-watt audio amplifier.

**TYPICAL PERFORMANCE DATA**  
**For 200-Watt Audio Amplifier**

Measured at a line voltage of 120 V,  $T_A = 25^\circ C$ , and a frequency of 1 kHz, unless otherwise specified.

**Power:**

Rated power (8- $\Omega$ load, at rated distortion) .....	200 W
Typical power (4- $\Omega$ load) .....	300 W
Typical power (16- $\Omega$ load) .....	130 W

**Total Harmonic Distortion:**

Rated distortion .....	0.5%
------------------------	------

**IM Distortion:**

10 dB below continuous power output at 60 Hz and 7 kHz (4:1) .....	0.2%
--	------

**IHF Power Bandwidth:**

3 dB below rated continuous power at rated distortion .....	5 Hz to 35 kHz
---	----------------

**Sensitivity:**

At continuous power output rating .....	900 mV
---	--------

**Hum and Noise:**

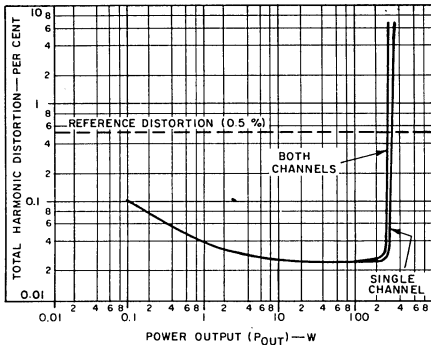
Below continuous power output:

Input shorted .....	96 dB
---------------------	-------

Input open .....	84 dB
------------------	-------

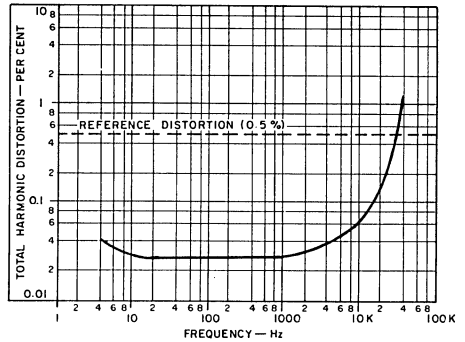
With 2 k $\Omega$ resistance on 20-ft. cable on input .....	94 dB
---	-------

Input Resistance .....	18 k $\Omega$
------------------------	---------------



92CS-22043

Fig. 7— Typical total harmonic distortion vs. power output for single channel and both channels driven at 1 kHz.



92CS-22044

Fig. 8— Typical total harmonic distortion vs. frequency for 100-watt output.

## Type RCA1B05

Package: JEDEC TO-3

Construction: Silicon n-p-n, multiple-epitaxial, pi-nu

**ELECTRICAL CHARACTERISTICS, At Case Temperature ( $T_C$ ) = 25°C Unless Otherwise Specified**

CHARACTERISTIC	SYMBOL	TEST CONDITIONS	LIMITS		UNITS
			MIN.	MAX.	
Collector Cutoff Current: With external base-to-emitter resistance ( $R_{BE}$ )	$I_{CER}$	$V_{CE} = 200 \text{ V}, R_{BE} = 100 \Omega$	—	1	mA
Emitter Cutoff Current: With collector open	$I_{EBO}$	$V_{EB} = 50 \text{ V}, I_C = 0$	—	1	mA
Collector-to-Emitter Voltage: With base open	$V_{CEO}$	$I_C = 0.2 \text{ A}, I_B = 0$	250	—	V
Collector-to-Emitter Voltage: With external base-to-emitter resistance ( $R_{BE}$ )	$V_{CER}$	$I_C = 0.2 \text{ A}, R_{BE} = 100 \Omega$	275	—	V
Gain Bandwidth Product	$f_T$	$I_C = 0.2 \text{ A}, V_{CE} = 10 \text{ V}$	5	—	MHz
DC Forward-Current Transfer Ratio	$h_{FE}$	$I_C = 2 \text{ A}, V_{CE} = 5 \text{ V}$	15	75	
Collector-to-Emitter Saturation Voltage	$V_{CE(sat)}$	$I_C = 2 \text{ A}, I_B = 0.255 \text{ A}$	—	2	V
Base-to-Emitter Voltage	$V_{BE}$	$I_C = 2 \text{ A}, V_{CE} = 5 \text{ V}$	1	2	V
Second-Breakdown Collector Current: With base forward biased	$I_{S/b}$	$V_{CE} = 140 \text{ V}, t = 1 \text{ s}$	1.07	—	A

For characteristics curves and test conditions, refer to published data for prototype 2N5240 (File 321).

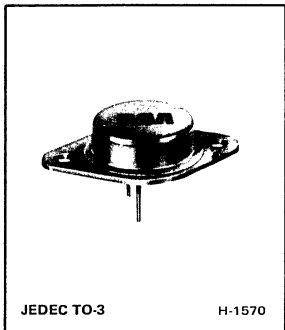
**TERMINAL CONNECTIONS RCA1B05**

Pin 1 — Base

Pin 2 — Emitter

Mounting Flange, Case — Collector



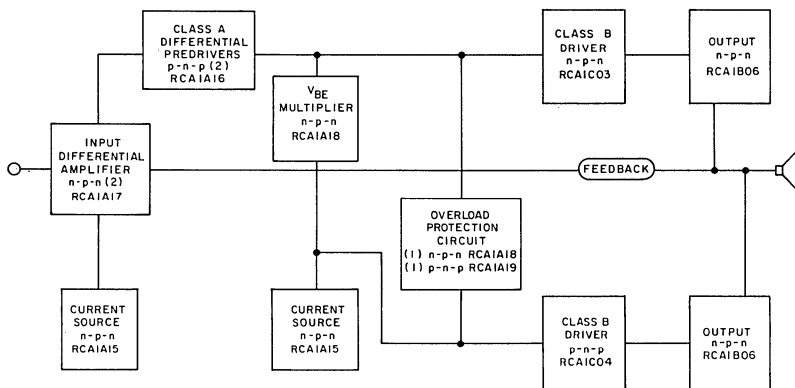


**Silicon Transistor for  
70-Watt  
Quasi-Complementary-Symmetry  
Audio Amplifiers  
with  
Pi-Nu Output Transistors**

RCA1B06 is an n-p-n pi-nu silicon transistor in a JEDEC TO-3 package. This device is especially characterized for audio-amplifier applications, and can be driven by either RCA1C03 or RCA1C04, n-p-n and p-n-p types, respectively.

The 70-watt amplifier shown in Figs. 1 and 5 uses the

RCA1B06 output device in conjunction with eleven other discrete transistors, thirteen diodes, and a 90-volt split power supply. The amplifier output is directly coupled to an 8-ohm speaker. The high-frequency RCA1B06 output transistors used in the amplifier circuit produce excellent transient response at a high power level.



92CM - 22013

Fig. 1—Block diagram and transistor complement for 70-watt quasi-complementary-symmetry audio amplifier with pi-nu output transistors.

**MAXIMUM RATINGS, Absolute-Maximum Values:**

COLLECTOR-TO-BASE VOLTAGE .....	V <sub>CBO</sub>
COLLECTOR-TO-EMITTER VOLTAGE:	
With base open .....	V <sub>CEO</sub>
With external base-to-emitter resistance (R <sub>BE</sub> ) = 100Ω .....	V <sub>CER</sub>
EMITTER-TO-BASE VOLTAGE .....	V <sub>EB0</sub>
COLLECTOR CURRENT .....	I <sub>C</sub>
BASE CURRENT .....	I <sub>B</sub>
TRANSISTOR DISSIPATION:	P <sub>T</sub>
At case temperatures up to 25°C .....	
At case temperatures above 25°C .....	
TEMPERATURE RANGE:	
Storage & Operating (Junction) .....	
PIN TEMPERATURE (During Soldering):	
At distances ≥ 1/32 in. (0.8 mm) from case for 10 s max. ....	

**RCA1B06**

120	V
100	V
120	V
6	V
7	A
2	A
150	W
See Fig. 2	
-65 to 200	°C
230	°C

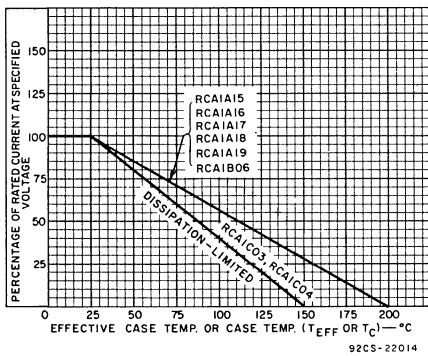


Fig. 2—Derating curves for all types.

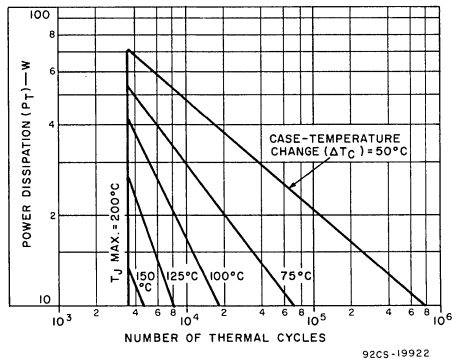


Fig. 3—Thermal-cycling ratings for RCA1B06

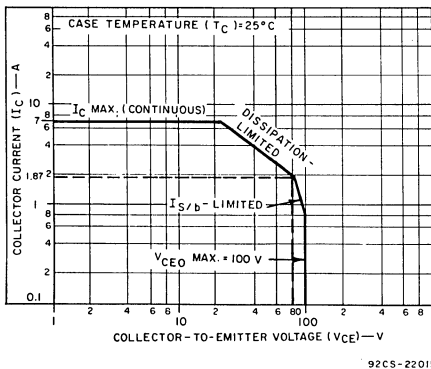
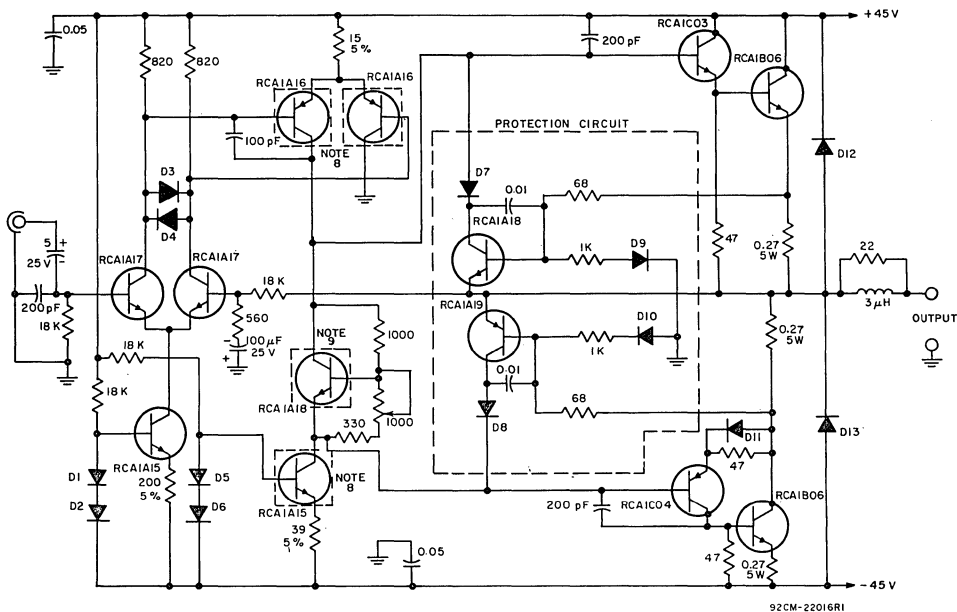


Fig. 4—Maximum operating areas for RCA1B06.

**TERMINAL CONNECTIONS**

- Pin 1 — Base
- Pin 2 — Emitter
- Case — Collector
- Mounting Flange — Collector



NOTES:

1. 90°C thermal cutout attached to heat sink for output transistors.
2. Power transformer: Signal 120-2 (parallel secondary), Signal Transformer Co., 1 Junius St., Brooklyn, N.Y. 11212, or equivalent.
3. Resistors are 1/2-watt unless otherwise specified; values are in ohms.
4. Capacitances are in μF unless otherwise specified.
5. Non-inductive resistors.
6. D1-D8, D11-1N5391  
D9, D10, D12, D13-1N5393.
7. Provide approx. 1°C/W heat sinking per output device based on mounting with mica washer and ZnO thermal compound (Dow Corning No. 340°) with T<sub>A</sub> = 45°C max.
8. Mount on heat sink, Wakefield No. 209-AB, or equivalent. (Alternatively, this type may be obtained with a factory-attached integral heat sink.)
9. Attach heat sink cap (Wakefield No. 260-6SH5E, or equivalent) on device and mount on same heat sink with output transistor.

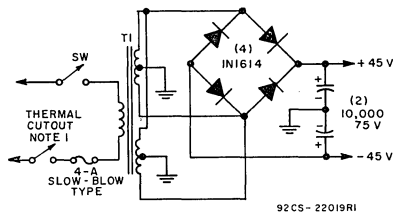


Fig.5-70-Watt amplifier circuit featuring quasi-complementary-symmetry output employing pi-nu construction output transistors.

**TYPICAL PERFORMANCE DATA**  
**For 70-Watt Audio Amplifier**

Measured at a line voltage of 120 V,  $T_A = 25^{\circ}\text{C}$ , and a frequency of 1 kHz, unless otherwise specified.

**Power:**

Rated power (8- $\Omega$ load, at rated distortion) . . . . .	70 W
Typical power (4- $\Omega$ load) . . . . .	100 W
Typical power (16- $\Omega$ load) . . . . .	50 W

**Total Harmonic Distortion:**

Rated distortion . . . . .	0.5%
----------------------------	------

**IM Distortion:**

10 dB below continuous power output at 60 Hz and 7 kHz (4:1) . . . . .	<0.2%
---	-------

**IHF Power Bandwidth:**

3 dB below rated continuous power at rated distortion . . . . .	5 Hz to 50 kHz
Bandwidth at 1 W . . . . .	5 Hz to 100 kHz

**Sensitivity:**

At continuous power-output rating . . . . .	600 mV
---	--------

**Hum and Noise:**

Below continuous power output:

Input shorted . . . . .	100 dB
Input open . . . . .	85 dB
With 2 k $\Omega$ resistance on 20-ft. cable on input . . . . .	97 dB

Input Resistance . . . . .	18 k $\Omega$
----------------------------	---------------

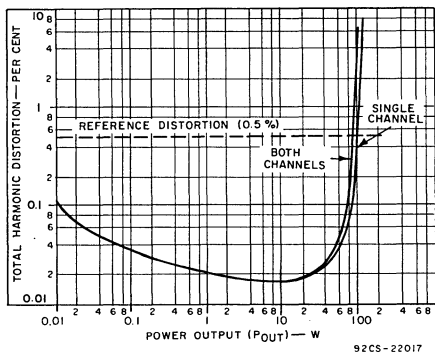


Fig.6—Typical total harmonic distortion vs. power output at 1 kHz.

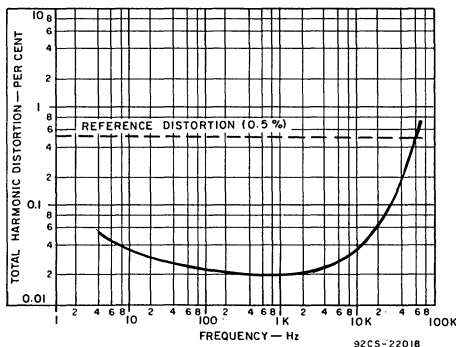
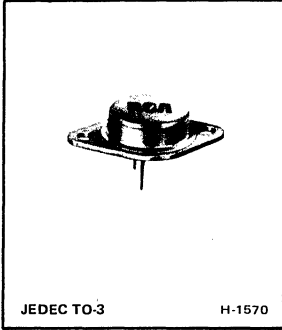


Fig.7—Typical total harmonic distortion vs. frequency at 35 W.



# Power Transistors

**RCA1B07  
RCA1B08**



## Silicon Transistors for 40-Watt Full-Complementary-Symmetry Audio Amplifiers with Darlington Output Transistors

RCA1B07 and RCA1B08 are n-p-n and p-n-p Darlington silicon transistors respectively. They are especially characterized for use as output devices in audio applications, and are provided in the JEDEC TO-3 package.

The 40-watt audio amplifiers shown in Figs. 5 and 6 use RCA1B07 and RCA1B08 transistors as output devices in conjunction with nine TO-39 discrete transistors, and ten diodes. The amplifier shown in Fig. 5 uses a 64-volt split power supply with the output directly coupled to an 8-ohm speaker. Fig. 6 shows an amplifier with a 58-volt split supply with the output directly coupled to a 4-ohm speaker. These 40-watt Darlington full-complementary-symmetry amplifiers combine excellent performance with economy.

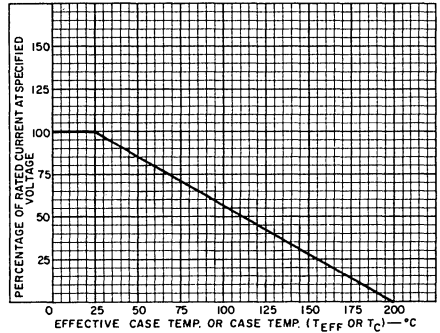


Fig. 1—Derating curves for all types. 92CS-21992

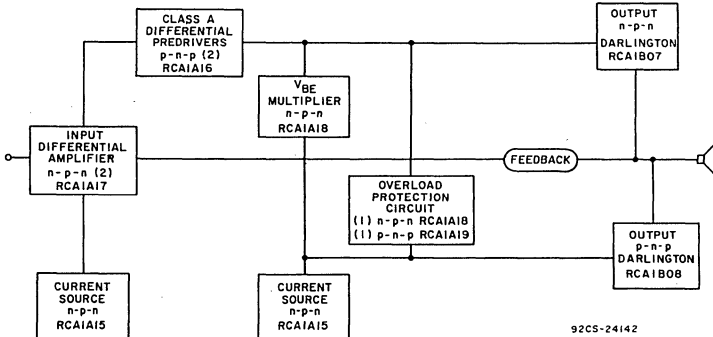


Fig. 2—Block diagram and transistor complement for 40-watt full-complementary-symmetry audio amplifier with Darlington output transistors.

92CS-24142

**MAXIMUM RATINGS, Absolute-Maximum Values:**

	RCA1B07	RCA1B08	
COLLECTOR-TO-BASE VOLTAGE .....	80	-80	V
COLLECTOR-TO-EMITTER VOLTAGE:			
With base open .....	80	-80	V
With external base-to-emitter resistance ( $R_{BE}$ ) = 100 $\Omega$ .....	80	-80	V
EMITTER-TO-BASE VOLTAGE .....	5	-5	V
COLLECTOR CURRENT .....	10	-10	A
BASE CURRENT .....	0.25	-0.25	A
TRANSISTOR DISSIPATION:			
At case temperatures up to 25°C .....	100	100	W
At case temperatures above 25°C .....	See Fig. 1		
TEMPERATURE RANGE:			
Storage and Operating (Junction) .....	-65 to 200		°C
PIN TEMPERATURE (During Soldering):			
At distances $\geq$ 1/32 in. (0.8 mm) from case for 10 s max. ....	230		°C

**Type RCA1B07**

Package: JEDEC TO-3

Construction: Silicon n-p-n, Darlington

**Type RCA1B08\***

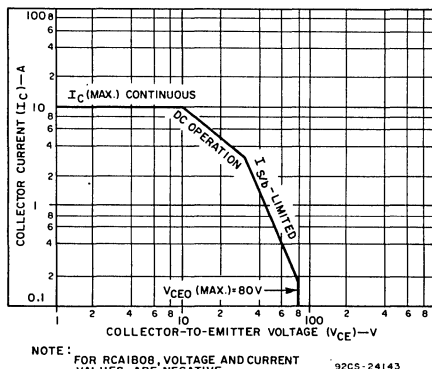
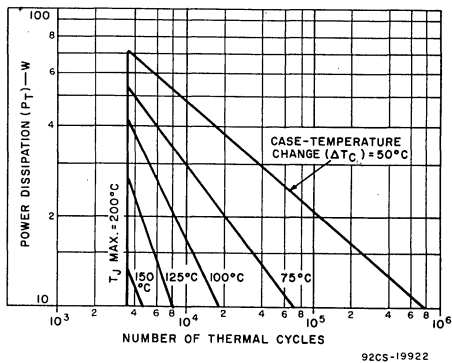
Package: JEDEC TO-3

Construction: Silicon p-n-p, Darlington

**ELECTRICAL CHARACTERISTICS, At Case Temperature ( $T_C$ ) = 25°C**

CHARACTERISTIC	SYMBOL	TEST CONDITIONS*	LIMITS		UNITS
			Min.	Max.	
Collector-to-Emitter Voltage: With base open	$V_{CEO}$	$I_C = 200$ mA, $I_B = 0$	80	-	V
DC Forward-Current Transfer Ratio	$h_{FE}$	$I_C = 5$ A, $V_{CE} = 3$ V	1000	15000	
Collector Cutoff Current: With base open	$I_{CEO}$	$V_{CE} = 80$ V, $I_B = 0$ $T_C = 150^\circ\text{C}$	-	10	mA
Collector-to-Emitter Saturation Voltage	$V_{CE(sat)}$	$I_C = 5$ A, $I_B = 10$ mA	-	2	V
Base-to-Emitter Voltage	$V_{BE}$	$I_C = 5$ A, $V_{CE} = 3$ V	-	2.8	V
Second-Breakdown Collector Current: With base forward biased	$I_{S/b}$	$V_{CE} = 70$ V, $t = 1$ s	0.25	-	A

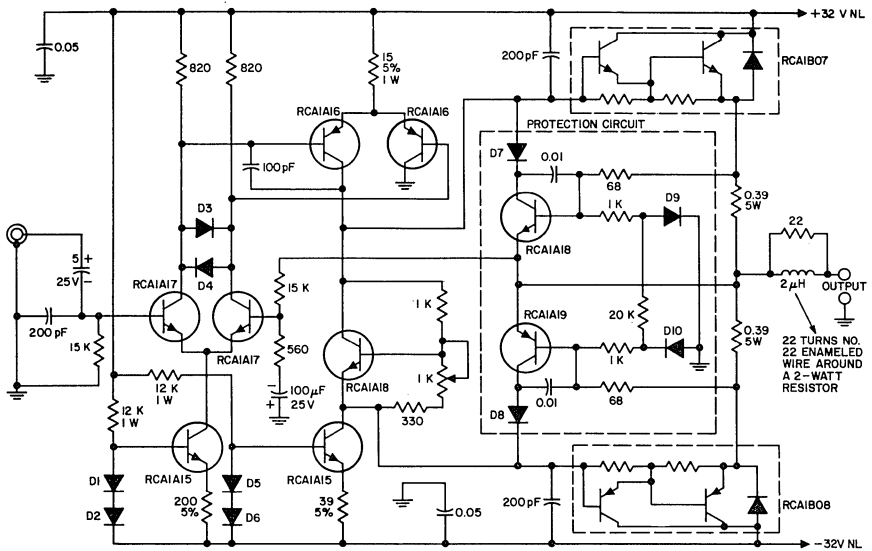
\* For RCA1B08, voltage and current values are negative.



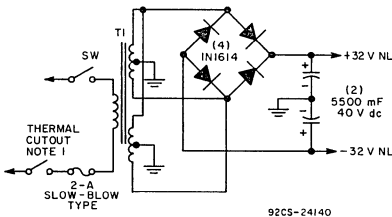
NOTE: FOR RCA1B08, VOLTAGE AND CURRENT VALUES ARE NEGATIVE.

Fig. 3—Thermal-cycling rating chart for RCA1B07 and RCA1B08.

Fig. 4—Maximum operating areas for RCA1B07 and RCA1B08.



92CM-24133



92CS-24140

**TYPICAL PERFORMANCE DATA  
For 40-Watt Audio Amplifier**

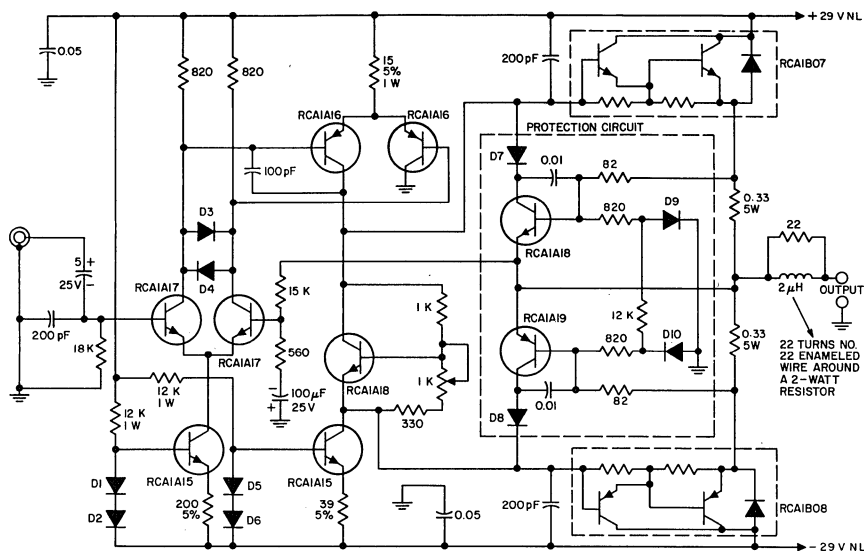
*Measured at a line voltage of 120 V, T<sub>A</sub> = 25°C, and a frequency of 1 kHz, unless otherwise specified.*

Power:	
Rated power (8-Ω load, at rated distortion) . . . . .	40 W
Total Harmonic Distortion:	
Rated distortion . . . . .	0.5%
IM Distortion:	
10 dB below continuous power output at	
60 Hz and 7 kHz (4:1) . . . . .	<0.2%
IHF Power Bandwidth:	
3 dB below rated continuous power at	
rated distortion . . . . .	5 Hz to 50 kHz
Bandwidth at 1 W . . . . .	5 Hz to 100 kHz
Sensitivity:	
At continuous power-output rating . . . . .	700 mV
Hum and Noise:	
Below continuous power output:	
Input shorted . . . . .	100 dB
Input open . . . . .	85 dB
With 2 kΩ resistance on 20-ft.	
cable on input . . . . .	97 dB
Input Resistance . . . . .	18 kΩ

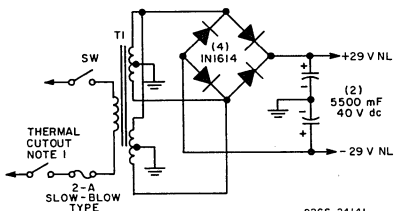
**NOTES:**

1. Provide approximately 1.3°C/W heat sinking per output device, based on mounting with a mica washer and ZnO thermal compound (Dow-Corning No. 340, or equivalent) with T<sub>A</sub> = 45°C max.
2. 90°C thermal cutout attached to heat sink for output transistors.
3. Power transformer: Signal 88-2 (parallel secondary), Signal Transformer Co., 1 Junius St., Brooklyn, N.Y. 11212, or equivalent.
4. Resistors are 1/2-watt unless otherwise specified; values are in ohms.
5. Capacitances are in μF unless otherwise specified.
6. Non-inductive resistors.
7. D1–D10: 1N5391.

Fig. 5—40-watt amplifier circuit featuring full-complementary-symmetry output employing Darlington output transistors.



92CM-24144



92CS-24141

NOTES:

1. Provide approximately 1.3°C/W heat sinking per output device, based on mounting with a mica washer and ZnO thermal compound (Dow-Corning No. 340, or equivalent) with T<sub>A</sub> = 45°C max.
2. 90°C thermal cutout attached to heat sink for output transistors.
3. Power transformer: Signal 80-4 (parallel secondary). Signal Transformer Co., 1 Junius St., Brooklyn, N.Y. 11212, or equivalent.
4. Resistors are 1/2-watt unless otherwise specified; values are in ohms.
5. Capacitances are in µF unless otherwise specified.
6. Non-inductive resistors.
7. D1—D10: 1N5391.

TYPICAL PERFORMANCE DATA  
For 40-Watt Audio Amplifier

Measured at a line voltage of 120 V, T<sub>A</sub> = 25°C, and a frequency of 1 kHz, unless otherwise specified.

Power:	
Rated power (4-Ω load, at rated distortion) . . . . .	40 W
Typical power (8-Ω load) . . . . .	30 W
Total Harmonic Distortion:	
Rated distortion . . . . .	0.5%
IM Distortion:	
10 dB below continuous power output at 60 Hz and 7 kHz (4:1) . . . . .	<0.2%
IHF Power Bandwidth:	
3 dB below rated continuous power at rated distortion . . . . .	5 Hz to 50 kHz
Bandwidth at 1 W . . . . .	5 Hz to 100 kHz
Sensitivity:	
At continuous power-output rating . . . . .	500 mV
Hum and Noise:	
Below continuous power output:	
Input shorted . . . . .	100 dB
Input open . . . . .	85 dB
With 2 kΩ resistance on 20-ft. cable on input . . . . .	97 dB
Input Resistance . . . . .	18 kΩ

Fig. 6—40-watt amplifier circuit featuring full-complementary-symmetry output employing Darlington output transistors.



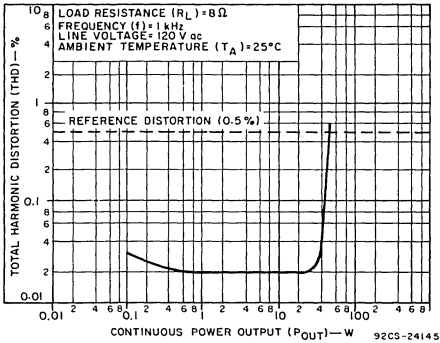


Fig. 7—Typical distortion vs. power output for 40-watt amplifier with 64-volt supply.

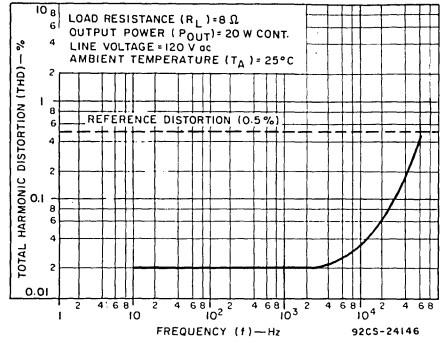


Fig. 8—Typical distortion vs. frequency for 40-watt amplifier with 64-volt supply.

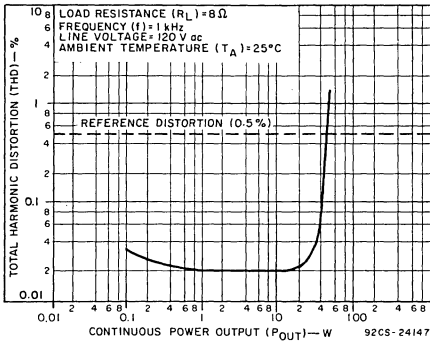


Fig. 9—Typical distortion vs. power output for 40-watt amplifier with 58-volt supply.

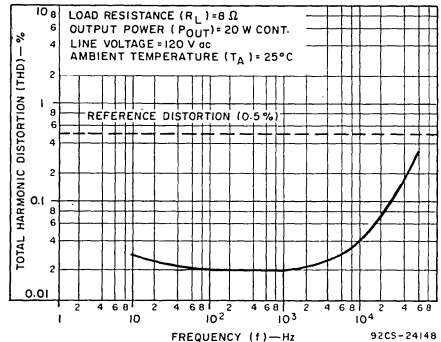


Fig. 10—Typical distortion vs. frequency for 40-watt amplifier with 58-volt supply.

#### TERMINAL CONNECTIONS

Pin 1 — Base

Pin 2 — Emitter

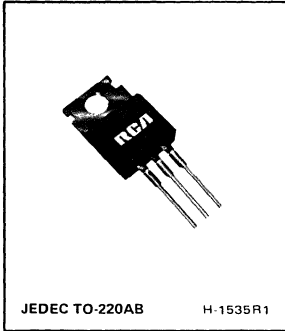
Case — Collector

Mounting Flange — Collector



# Power Transistors

RCA1C03 RCA1C12  
RCA1C04 RCA1C13



## Silicon Transistors for Audio-Frequency Linear-Amplifier Applications

N-P-N and P-N-P Complementary Types

RCA1C03 RCA1C04  
RCA1C12 RCA1C13

RCA1C03, RCA1C04, RCA1C12, and RCA1C13 are complementary silicon n-p-n and p-n-p transistors especially characterized for audio-amplifier applications. These devices, singly or in pairs in complementary- or quasi-complementary-symmetry circuits, are particularly useful as drivers or pre-drivers. They may also be used in audio power amplifiers, linear modulators, servo amplifiers, and operational amplifiers. The units are supplied in the JEDEC TO-220AB version of the plastic VERSAWATT package.

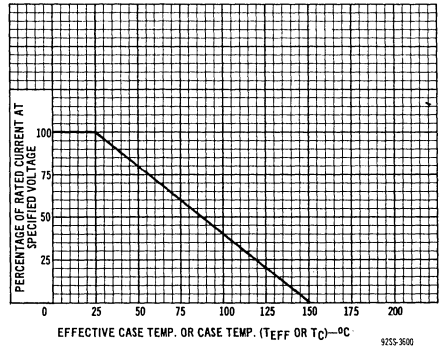


Fig. 1— Derating curve for all types.

**MAXIMUM RATINGS, Absolute-Maximum Values:**

	RCA1C03	RCA1C04	RCA1C12	RCA1C13	
COLLECTOR-TO-BASE VOLTAGE . . . . .	120	-120	140	-140	V
COLLECTOR-TO-EMITTER SUSTAINING VOLTAGE:					
With base open . . . . .	100	-100	120	-120	V
With external base-to-emitter resistance ( $R_{BE}$ ) = 100 $\Omega$ . . . . .	120	-120	140	-140	V
EMITTER-TO-BASE VOLTAGE . . . . .	5	-5	5	-5	V
CONTINUOUS COLLECTOR CURRENT . . . . .	4	-4	4	-4	A
CONTINUOUS BASE CURRENT . . . . .	2	-2	2	-2	A
TRANSISTOR DISSIPATION:					
$P_T$					
At case temperatures up to 25°C . . . . .	40	40	40	40	W
At case temperatures above 25°C . . . . .	← See Fig. 1 →				
TEMPERATURE RANGE:					
Storage and Operating (Junction) . . . . .	← -65 to +150 →				°C
PIN TEMPERATURE (During Soldering):					
At distances $\geq$ 1/32 in. (0.8 mm) from seating plane for 10 s max. . . . .	← 230 →				°C

**Type RCA1C03**

Package: JEDEC TO-220AB

Construction: Silicon n-p-n, epitaxial

**ELECTRICAL CHARACTERISTICS, At Case Temperature ( $T_C$ ) = 25°C Unless Otherwise Specified**

CHARACTERISTIC	SYMBOL	TEST CONDITIONS	LIMITS		UNITS
			MIN.	MAX.	
Collector Cutoff Current: With external base-to-emitter resistance ( $R_{BE}$ )	$I_{CER}$	$V_{CE} = 110\text{ V}, R_{BE} = 100\Omega$	—	1	mA
Emitter Cutoff Current: With collector open	$I_{EBO}$	$V_{EB} = 5\text{ V}, I_C = 0$	—	1	mA
Collector-to-Emitter Voltage: With base open	$V_{CEO}$	$I_C = 0.1\text{ A}, I_B = 0$	100	—	V
Gain Bandwidth Product	$f_T$	$I_C = 0.5\text{ A}, V_{CE} = 4\text{ V}$	4	—	MHz
DC Forward-Current Transfer Ratio	$h_{FE}$	$I_C = 1\text{ A}, V_{CE} = 4\text{ V}$	50	250	
Collector-to-Emitter Saturation Voltage	$V_{CE(sat)}$	$I_C = 1\text{ A}, I_B = 0.1\text{ A}$	—	1	V
Base-to-Emitter Voltage	$V_{BE}$	$I_C = 1\text{ A}, V_{CE} = 4\text{ V}$	—	1.5	V
Second-Breakdown Collector Current: With base forward biased	$I_{S/b}$	$V_{CE} = 40\text{ V}, t = 0.4\text{ s}$	1	—	A

For characteristics curves and test conditions, refer to published data for prototype 2N6293 (File 542).

**Type RCA1C04**

Package: JEDEC TO-220AB

Construction: Silicon p-n-p, epitaxial

**ELECTRICAL CHARACTERISTICS, At Case Temperature ( $T_C$ ) = 25°C Unless Otherwise Specified**

CHARACTERISTIC	SYMBOL	TEST CONDITIONS	LIMITS		UNITS
			MIN.	MAX.	
Collector Cutoff Current: With external base-to-emitter resistance ( $R_{BE}$ )	$I_{CER}$	$V_{CE} = -110\text{ V}, R_{BE} = 100\Omega$	—	-1	mA
Emitter Cutoff Current: With collector open	$I_{EBO}$	$V_{EB} = -5\text{ V}, I_C = 0$	—	-1	mA
Collector-to-Emitter Voltage: With base open	$V_{CEO}$	$I_C = -0.1\text{ A}, I_B = 0$	-100	—	V
Gain Bandwidth Product	$f_T$	$I_C = -0.5\text{ A}, V_{CE} = -4\text{ V}$	10	—	MHz
DC Forward-Current Transfer Ratio	$h_{FE}$	$I_C = -1\text{ A}, V_{CE} = -4\text{ V}$	50	250	
Collector-to-Emitter Saturation Voltage	$V_{CE(sat)}$	$I_C = -1\text{ A}, I_B = -0.1\text{ A}$	—	-1	V
Base-to-Emitter Voltage	$V_{BE}$	$I_C = -1\text{ A}, V_{CE} = -4\text{ V}$	—	-1.5	V
Second-Breakdown Collector Current: With base forward biased	$I_{S/b}$	$V_{CE} = -40\text{ V}, t = 0.4\text{ s}$	-1	—	A

For characteristics curves and test conditions, refer to published data for prototype 2N6476 (File 676).

**TERMINAL CONNECTIONS**

- Lead 1 – Base
- Lead 2 – Collector
- Lead 3 – Emitter
- Lead 4 – Collector

## Type RCA1C12

Package: JEDEC TO-220AB

Construction: Silicon n-p-n, epitaxial

ELECTRICAL CHARACTERISTICS, At Case Temperature ( $T_C$ ) = 25°C Unless Otherwise Specified

CHARACTERISTIC	SYMBOL	TEST CONDITIONS	LIMITS		UNITS
			MIN.	MAX.	
Collector Cutoff Current: With external base-to-emitter resistance ( $R_{BE}$ )	$I_{CER}$	$V_{CE} = 90 \text{ V}$ , $R_{BE} = 100 \Omega$	—	100	$\mu\text{A}$
Emitter Cutoff Current: With collector open	$I_{EBO}$	$V_{EB} = 5 \text{ V}$ , $I_C = 0$	—	1	mA
Collector-to-Emitter Voltage: With base open	$V_{CEO}$	$I_C = 0.1 \text{ A}$ , $I_B = 0$	120	—	V
Collector-to-Emitter Voltage: With external base-to-emitter resistance ( $R_{BE}$ )	$V_{CER}$	$I_C = 0.1 \text{ A}$ , $R_{BE} = 100 \Omega$	140	—	V
Gain Bandwidth Product	$f_T$	$I_C = 0.5 \text{ A}$ , $V_{CE} = 4 \text{ V}$	4	—	MHz
DC Forward-Current Transfer Ratio	$h_{FE}$	$I_C = 1 \text{ A}$ , $V_{CE} = 2 \text{ V}$	40	250	
Base-to-Emitter Voltage	$V_{BE}$	$I_C = 1 \text{ A}$ , $V_{CE} = 2 \text{ V}$	—	1.2	V
Second-Breakdown Collector Current: With base forward biased	$I_{S/b}$	$V_{CE} = 60 \text{ V}$ , $t = 0.4 \text{ s}$	0.66	—	A

For characteristics curves and test conditions, refer to published data for prototype 2N6474 (File 676).

## Type RCA1C13

Package: JEDEC TO-220AB

Construction: Silicon p-n-p, epitaxial

ELECTRICAL CHARACTERISTICS, At Case Temperature ( $T_C$ ) = 25°C Unless Otherwise Specified

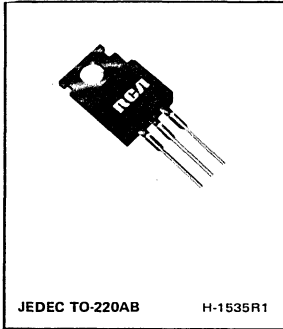
CHARACTERISTIC	SYMBOL	TEST CONDITIONS	LIMITS		UNITS
			MIN.	MAX.	
Collector Cutoff Current: With external base-to-emitter resistance ( $R_{BE}$ )	$I_{CER}$	$V_{CE} = -90 \text{ V}$ , $R_{BE} = 100 \Omega$	—	-100	$\mu\text{A}$
Emitter Cutoff Current: With collector open	$I_{EBO}$	$V_{EB} = -5 \text{ V}$ , $I_C = 0$	—	-1	mA
Collector-to-Emitter Voltage: With base open	$V_{CEO}$	$I_C = -0.1 \text{ A}$ , $I_B = 0$	-120	—	V
Collector-to-Emitter Voltage: With external base-to-emitter resistance ( $R_{BE}$ )	$V_{CER}$	$I_C = -0.1 \text{ A}$ , $R_{BE} = 100 \Omega$	-140	—	V
Gain Bandwidth Product	$f_T$	$I_C = -0.5 \text{ A}$ , $V_{CE} = -4 \text{ V}$	10	—	MHz
DC Forward-Current Transfer Ratio	$h_{FE}$	$I_C = -1 \text{ A}$ , $V_{CE} = -2 \text{ V}$	40	250	
Base-to-Emitter Voltage	$V_{BE}$	$I_C = -1 \text{ A}$ , $V_{CE} = -2 \text{ V}$	—	-1.2	V
Second-Breakdown Collector Current: With base forward biased	$I_{S/b}$	$V_{CE} = -60 \text{ V}$ , $t = 0.4 \text{ s}$	-0.66	—	A

For characteristics curves and test conditions, refer to published data for prototype 2N6476 (File 676).



# Power Transistors

**RCA1C05**  
**RCA1C06**



## Silicon Transistors for 25-Watt Full-Complementary-Symmetry Audio Amplifiers

RCA1C05 and RCA1C06 are n-p-n and p-n-p epitaxial-base silicon power transistors, respectively. These complementary output devices for audio applications are provided in the JEDEC TO-220AB plastic package.

The 25-watt audio-amplifier circuit shown in Figs. 1 and 2 uses RCA1C05 and RCA1C06 as output devices in conjunc-

tion with seven TO-39 discrete transistors, ten diodes, and a 52-volt split power supply. The amplifier output is directly coupled to an 8-ohm speaker. The full-complementary-symmetry output stage provides excellent high-frequency performance at moderate cost.

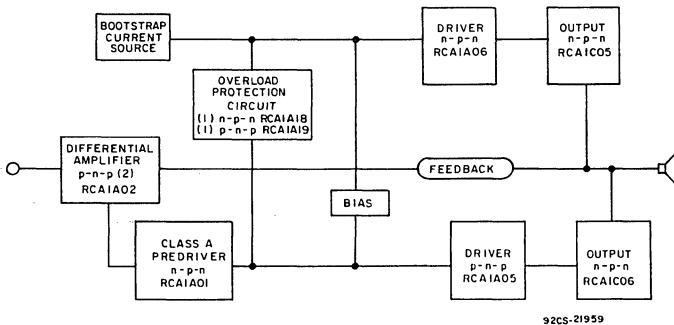


Fig.1— Block diagram and transistor complement for 25-watt full-complementary-symmetry audio amplifier.

**MAXIMUM RATINGS, Absolute-Maximum Values:**

	RCA1C05	RCA1C06	
COLLECTOR-TO-BASE VOLTAGE.....	$V_{CBO}$	60	-60 V
COLLECTOR-TO-EMITTER VOLTAGE:			
With base open .....	$V_{CEO}$	50	-50 V
With external base-to-emitter resistance ( $R_{BE}$ ) = 100 $\Omega$ .....	$V_{CER}$	60	-60 V
EMITTER-TO-BASE VOLTAGE .....	$V_{EBO}$	5	-5 V
COLLECTOR CURRENT .....	$I_C$	7	-7 A
BASE CURRENT .....	$I_B$	3	-3 A
TRANSISTOR DISSIPATION:	$P_T$		
At case temperatures up to 25 $^{\circ}$ C .....		40	40 W
At case temperatures above 25 $^{\circ}$ C .....		← See Fig. 5 →	
TEMPERATURE RANGE:			
Storage & Operating (Junction) .....		← -65 to +150 →	
PIN TEMPERATURE (During Soldering):			
At distances $\geq 1/32$ in. (0.8 mm) from case of 10 s max. ....		← 230 →	

**Type RCA1C05**

Package: JEDEC TO-220AB

Construction: Silicon n-p-n, epitaxial base

**ELECTRICAL CHARACTERISTICS, At Case Temperature ( $T_C$ ) = 25 $^{\circ}$ C Unless Otherwise Specified**

CHARACTERISTIC	SYMBOL	TEST CONDITIONS	LIMITS		UNITS
			MIN.	MAX.	
Collector Cutoff Current: With external base-to-emitter resistance ( $R_{BE}$ )	$I_{CER}$	$V_{CE} = 50 V, R_{BE} = 100\Omega$	-	1	mA
Emitter Cutoff Current: With collector open	$I_{EBO}$	$V_{BE} = 5 V, I_C = 0$	-	1	mA
Collector-to-Emitter Voltage: With external base-to-emitter resistance ( $R_{BE}$ )	$V_{CER}$	$I_C = 0.1 A, R_{BE} = 100\Omega$	60	-	V
Gain Bandwidth Product	$f_T$	$I_C = 0.1 A, V_{CE} = 4 V$	4	-	MHz
DC Forward-Current Transfer Ratio	$h_{FE}$	$I_C = 3 A, V_{CE} = 4 V$	20	120	
Collector-to-Emitter Saturation Voltage	$V_{CE(sat)}$	$I_C = 3 A, I_B = 0.3 A$	-	1	V
Base-to-Emitter Voltage	$V_{BE}$	$I_C = 3 A, V_{CE} = 4 V$	-	1.5	V
Second-Breakdown Collector Current: With base forward biased	$I_{S/b}$	$V_{CE} = 20 V, t = 0.5 s$	2	-	A

For characteristics curves and test conditions, refer to published data for prototype 2N6292 (File 542).

**Type RCA1C06**

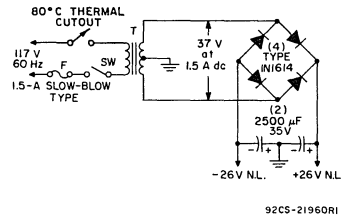
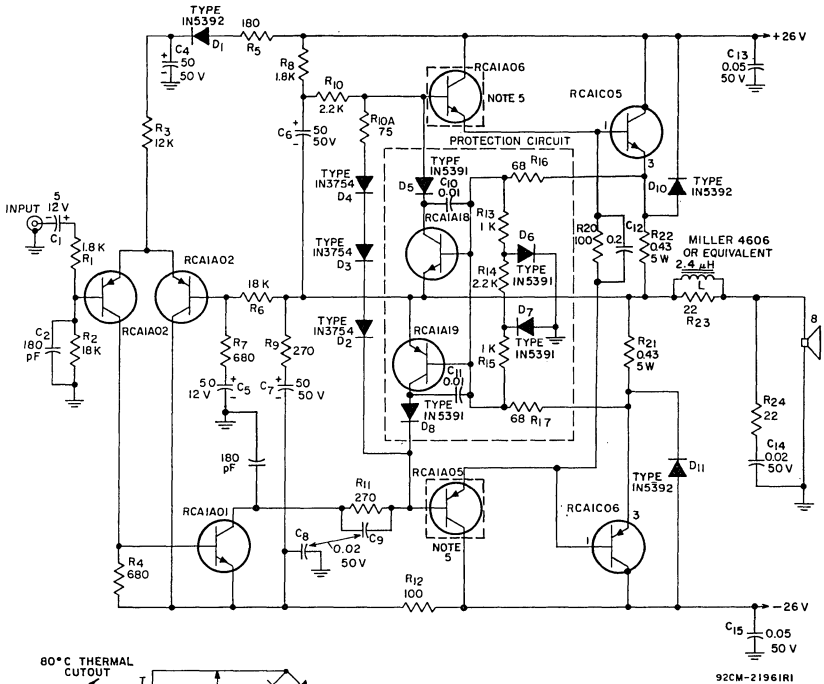
Package: JEDEC TO-220AB

Construction: Silicon p-n-p, epitaxial base

**ELECTRICAL CHARACTERISTICS, At Case Temperature ( $T_C$ ) = 25 $^{\circ}$ C Unless Otherwise Specified**

CHARACTERISTIC	SYMBOL	TEST CONDITIONS	LIMITS		UNITS
			MIN.	MAX.	
Collector Cutoff Current: With external base-to-emitter resistance ( $R_{BE}$ )	$I_{CER}$	$V_{CE} = -50 V, R_{BE} = 100\Omega$	-	-1	mA
Emitter Cutoff Current: With collector open	$I_{EBO}$	$V_{EB} = -5 V, I_C = 0$	-	-1	mA
Collector-to-Emitter Voltage: With external base-to-emitter resistance ( $R_{BE}$ )	$V_{CER}$	$I_C = -0.1 A, R_{BE} = 100\Omega$	-60	-	V
Gain Bandwidth Product	$f_T$	$I_C = -0.1 A, V_{CE} = -4 V$	10	-	MHz
DC Forward-Current Transfer Ratio	$h_{FE}$	$I_C = -3 A, V_{CE} = -4 V$	20	120	
Collector-to-Emitter Saturation Voltage	$V_{CE(sat)}$	$I_C = -3 A, I_B = -0.3 A$	-	-1	V
Base-to-Emitter Voltage	$V_{BE}$	$I_C = -3 A, V_{CE} = -4 V$	-	-1.5	V
Second-Breakdown Collector Current: With base forward biased	$I_{S/b}$	$V_{CE} = -20 V, t = 0.5 s$	-2	-	A

For characteristics curves and test conditions, refer to published data for prototype 2N6107 (File 488).



**TYPICAL PERFORMANCE DATA  
For 25-Watt Audio Amplifier**

Measured at a line voltage of 120 V,  $T_A = 25^\circ\text{C}$ , and a frequency of 1 kHz, unless otherwise specified.

**Power:**

Rated power (8- $\Omega$ load, at rated distortion) . . . . .	25 W
Typical power (4- $\Omega$ load) . . . . .	45 W
Typical power (16- $\Omega$ load) . . . . .	16 W

**Total Harmonic Distortion:**

Rated distortion . . . . .	1.0%
Typical at 20 W . . . . .	0.05%

**IM Distortion:**

10 dB below continuous power output at 60 Hz and 7 kHz (4:1) . . . . .	0.1%
--	------

**IHF Power Bandwidth:**

3 dB below rated continuous power at rated distortion . . . . .	80 kHz
---	--------

**Sensitivity:**

At continuous power-output rating . . . . .	600 mV
---	--------

**Hum and Noise:**

**Below continuous power output:**

Input shorted . . . . .	80 dB
Input open . . . . .	75 dB

<b>Input Resistance</b> . . . . .	20 k $\Omega$
-----------------------------------	---------------

**NOTES:**

1. T: Signal 36-2 (Signal Transformer Co., 1 Junius St., Brooklyn, N.Y. 11212), or equivalent.
2. Resistors are 1/2-watt unless otherwise specified; values are in ohms.
3. Capacitances are in  $\mu\text{F}$  unless otherwise specified.
4. Non-inductive resistors.
5. Mount driver transistors on heat sink, Wakefield No. 209-AB, or equivalent. (Alternatively, this type may be obtained with a factory-attached integral heat sink.)
6. Provide approximately  $2^\circ\text{C}/\text{W}$  heat sinking per output device.

Fig. 2—25-watt amplifier circuit featuring true-complementary symmetry output with load line limiting.

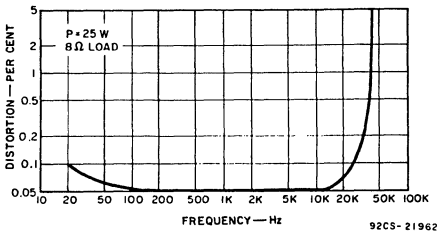


Fig. 3— Typical distortion vs. frequency.

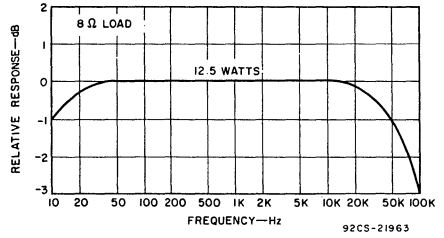


Fig. 4— Response curve.

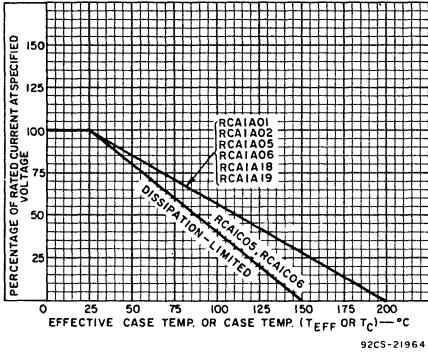


Fig. 5— Derating curve for all types.

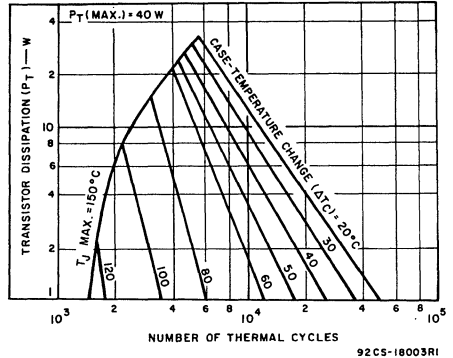


Fig. 6— Thermal-cycling ratings for RCA1C05 and RCA1C06.

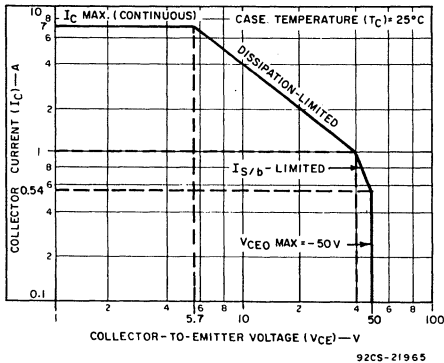


Fig. 7— Maximum operating areas for RCA1C05.

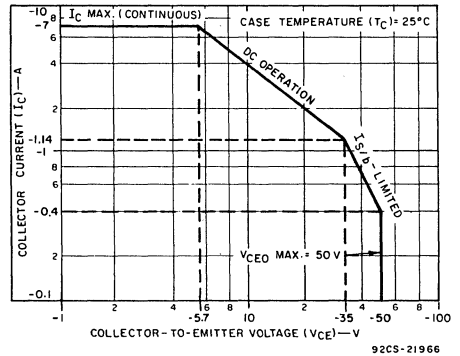
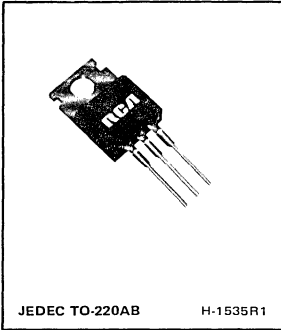


Fig. 8— Maximum operating areas for RCA1C06.

**TERMINAL CONNECTIONS FOR TYPES  
RCA1C05, RCA1C06**

- Lead 1 — Base
- Lead 2 — Collector
- Lead 3 — Emitter
- Lead 4 — Collector





## Silicon Transistors for 40-Watt Full-Complementary-Symmetry Audio Amplifiers

RCA1C07 and RCA1C08 are n-p-n and p-n-p epitaxial-base silicon power transistors, respectively, especially suitable for audio-output applications. These devices are provided in the economical JEDEC TO-220AB version of the VERSAWATT package.

The 40-watt amplifier shown in Figs. 1 and 2 uses the

RCA1C07 and RCA1C08 in conjunction with seven TO-39 transistors, ten diodes, and a 64-volt split power supply. The amplifier output is directly coupled to an 8-ohm speaker. The high-frequency performance of this 40-watt amplifier will provide excellent reproduction for the most critical listener.

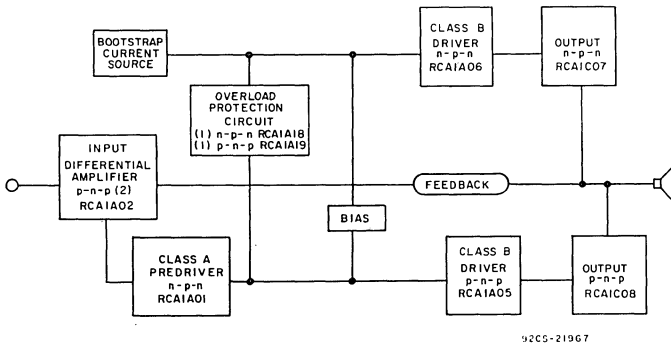


Fig. 1— Block diagram and transistor complement for 40-watt full-complementary-symmetry audio amplifier.

**MAXIMUM RATINGS, Absolute-Maximum Values:**

	RCA1C07	RCA1C08	
COLLECTOR-TO-BASE-VOLTAGE	75	-75	V
COLLECTOR-TO-EMITTER VOLTAGE:			
With base open	V <sub>CEO</sub> 65	-65	V
With external base-to-emitter resistance (R <sub>BE</sub> ) = 100Ω	V <sub>CER</sub> 75	-75	V
EMITTER-TO-BASE VOLTAGE	V <sub>EBO</sub> 5	-5	V
COLLECTOR CURRENT	I <sub>C</sub> 10	-10	A
BASE CURRENT	I <sub>B</sub> 4	-4	A
TRANSISTOR DISSIPATION:			
At case temperatures up to 25°C	P <sub>T</sub> 75	75	W
At case temperatures above 25°C	← See Fig. 5 →		
TEMPERATURE RANGE:			
Storage & Operating (Junction)	← -65 to 150 →		°C
PIN TEMPERATURE (During Soldering):			
At distances ≥ 1/32 in. (0.8 mm) from case for 10 s max.	← 230 →		°C

**Type RCA1C07**

Package: JEDEC TO-220AB

Construction: Silicon n-p-n, epitaxial base

ELECTRICAL CHARACTERISTICS, At Case Temperature (T<sub>C</sub>) = 25°C Unless Otherwise Specified

CHARACTERISTIC	SYMBOL	TEST CONDITIONS	LIMITS		UNITS
			MIN.	MAX.	
Collector Cutoff Current: With external base-to-emitter resistance (R <sub>BE</sub> )	I <sub>CER</sub>	V <sub>CE</sub> = 65V, R <sub>BE</sub> = 100Ω	-	1	mA
Emitter Cutoff Current: With collector open	I <sub>EBO</sub>	V <sub>BE</sub> = 5V, I <sub>C</sub> = 0	-	1	mA
Collector-to-Emitter Voltage: With external base-to-emitter resistance (R <sub>BE</sub> )	V <sub>CER</sub>	I <sub>C</sub> = 0.1A, R <sub>BE</sub> = 100Ω	75	-	V
Gain Bandwidth Product	f <sub>T</sub>	I <sub>C</sub> = 1A, V <sub>CE</sub> = 4V	5	-	MHz
DC Forward-Current Transfer Ratio	h <sub>FE</sub>	I <sub>C</sub> = 4A, V <sub>CE</sub> = 4V	20	120	
Collector-to-Emitter Saturation Voltage	V <sub>CE(sat)</sub>	I <sub>C</sub> = 4A, I <sub>B</sub> = 0.4A	-	1	V
Base-to-Emitter Voltage	V <sub>BE</sub>	I <sub>C</sub> = 4A, V <sub>CE</sub> = 4V	-	1.5	V
Second-Breakdown Collector Current: With base forward biased	I <sub>S/b</sub>	V <sub>CE</sub> = 30V, t = 0.5 s	2.5	-	A

For characteristics curves and test conditions, refer to published data for prototype 2N6488 (File 678).

**Type RCA1C08**

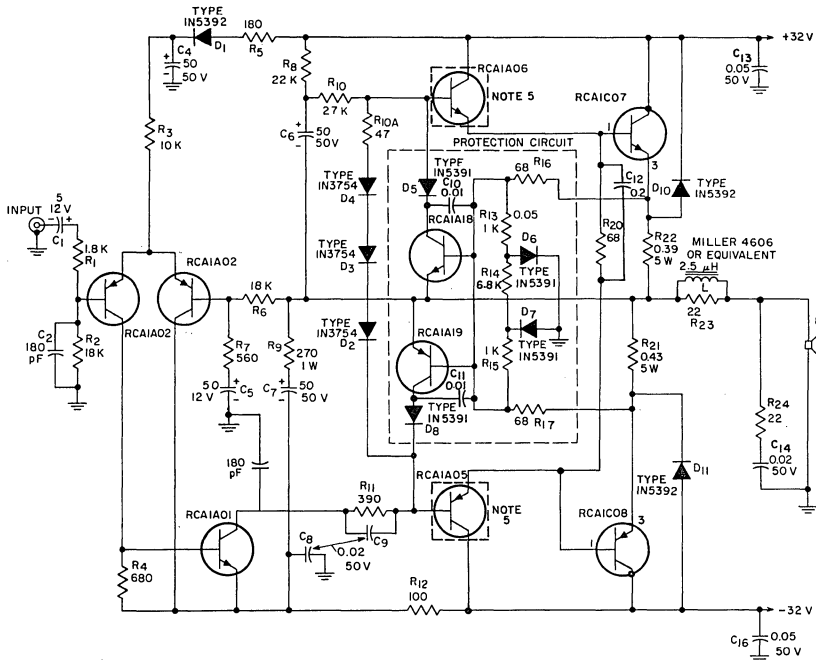
Package: JEDEC TO-220AB

Construction: Silicon p-n-p, epitaxial base

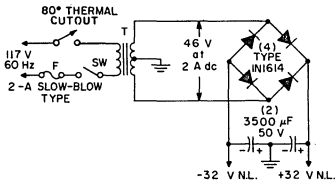
ELECTRICAL CHARACTERISTICS, At Case Temperature (T<sub>C</sub>) = 25°C Unless Otherwise Specified

CHARACTERISTIC	SYMBOL	TEST CONDITIONS	LIMITS		UNITS
			MIN.	MAX.	
Collector Cutoff Current: With external base-to-emitter resistance (R <sub>BE</sub> )	I <sub>CER</sub>	V <sub>CE</sub> = -65V, R <sub>BE</sub> = 100Ω	-	-1	mA
Emitter Cutoff Current: With collector open	I <sub>EBO</sub>	V <sub>EB</sub> = -5V, I <sub>C</sub> = 0	-	-1	mA
Collector-to-Emitter Voltage: With external base-to-emitter resistance (R <sub>BE</sub> )	V <sub>CER</sub>	I <sub>C</sub> = -0.1A, R <sub>BE</sub> = 100Ω	-75	-	V
Gain Bandwidth Product	f <sub>T</sub>	I <sub>C</sub> = -1A, V <sub>CE</sub> = -4V	5	-	MHz
DC Forward-Current Transfer Ratio	h <sub>FE</sub>	I <sub>C</sub> = -4A, V <sub>CE</sub> = -4V	20	120	
Collector-to-Emitter Saturation Voltage	V <sub>CE(sat)</sub>	I <sub>C</sub> = -4A, I <sub>B</sub> = -0.4A	-	-1	V
Base-to-Emitter Voltage	V <sub>BE</sub>	I <sub>C</sub> = -4A, V <sub>CE</sub> = -4V	-	-1.5	V
Second-Breakdown Collector Current: With base forward biased	I <sub>S/b</sub>	V <sub>CE</sub> = -30V, t = 0.5 s	-2.5	-	A

For characteristics curves and test conditions, refer to published data for prototype 2N6491 (File 678).



92CS-21969RI



92CS-21968RI

**TYPICAL PERFORMANCE DATA  
For 40-Watt Audio Amplifier Circuit**

Measured at a line voltage of 120 V,  $T_A = 25^{\circ}C$ , and a frequency of 1 kHz, unless otherwise specified.

**Power:**

Rated power (8-Ω load, at rated distortion) . . . . .	40 W
Typical power (4-Ω load) . . . . .	75 W
Typical power (16-Ω load) . . . . .	25 W

**Total Harmonic Distortion:**

Rated distortion . . . . .	1.0%
Typical at 20 W . . . . .	0.05%

**IM Distortion:**

10 dB below continuous power output at 60 Hz and 7 kHz (4:1) . . . . .	0.1%
--	------

**IHF Power Bandwidth:**

3 dB below rated continuous power at rated distortion . . . . .	80 kHz
---	--------

**Sensitivity:**

At continuous power-output rating . . . . .	600 mV
---	--------

**Hum and Noise:**

Below continuous power output:	
Input shorted . . . . .	80 dB
Input open . . . . .	75 dB
Input Resistance . . . . .	20 kΩ

**NOTES:**

1. T: Signal 88-2 (parallel secondary), Signal Transformer Co., 1 Junius St., Brooklyn, N.Y. 11212, or equivalent.
2. Resistors are 1/2-watt unless otherwise specified; values are in ohms.
3. Capacitances are in  $\mu F$  unless otherwise specified.
4. Non-inductive resistors.
5. Mount driver transistors on heat sink, Wakefield No. 209-AB, or equivalent. (Alternatively, these types may be obtained with a factory-attached integral heat sink.)
6. Provide approximately  $1.3^{\circ}C/W$  heat sinking per output device.

Fig.2— 40-Watt amplifier circuit featuring full-complementary-symmetry output using load line limiting.

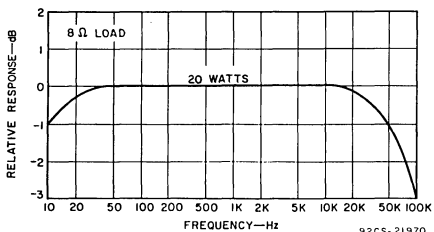


Fig. 3— Response curve.

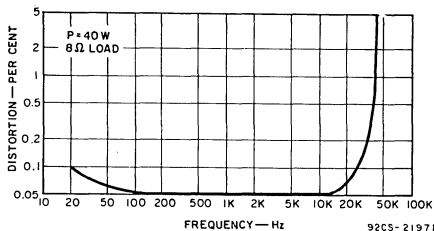


Fig. 4— Typical distortion vs. frequency.

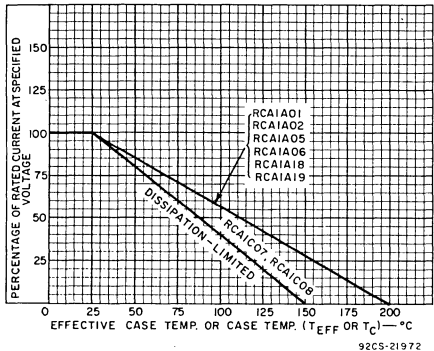


Fig. 5— Derating curve for all types.

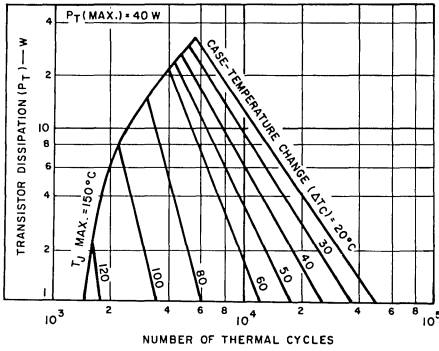


Fig. 6— Thermal-cycling ratings for RCA1C07 and RCA1C08.

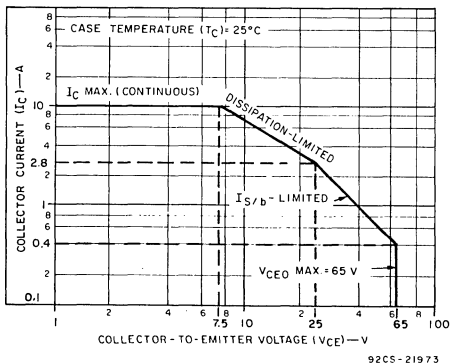


Fig. 7— Maximum operating areas for RCA1C07.

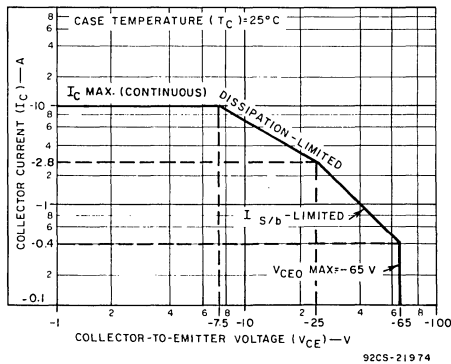
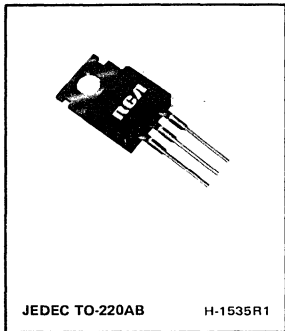


Fig. 8— Maximum operating areas for RCA1C08.

**TERMINAL CONNECTIONS FOR TYPES  
RCA1C07, RCA1C08**

- Lead 1 — Base
- Lead 2 — Collector
- Lead 3 — Emitter
- Lead 4 — Collector



**Silicon Transistor for  
40-Watt  
Quasi-Complementary-Symmetry  
Audio Amplifiers**

RCA1C09 is an n-p-n homotaxial-base silicon power transistor packaged in the JEDEC TO-220AB (VERSAWATT) case. Two of these devices, driven in the class-B mode by the RCA1A06 and RCA1A05 silicon n-p-n and p-n-p transistors, can be used as output devices in audio-amplifier applications.

The 40-watt amplifier shown in Figs. 1 and 5 uses two RCA1C09 transistors as output units in conjunction with seven TO-39 transistors, 11 diodes, and a 64-volt split power supply. The amplifier output is directly coupled to an 8-ohm speaker. This 40-watt amplifier features ruggedness and economy in the mid-power range.

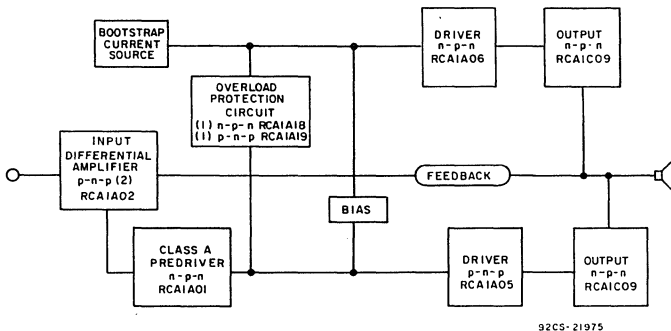


Fig.1— Block diagram and transistor complement for 40-watt quasi-complementary-symmetry audio amplifier.

**MAXIMUM RATINGS, Absolute-Maximum Values:**

COLLECTOR-TO-BASE VOLTAGE.....	$V_{CBO}$
COLLECTOR-TO-EMITTER VOLTAGE:	
With base open.....	$V_{CEO}$
With external base-to-emitter resistance ( $R_{BE}$ ) = 100 $\Omega$ .....	$V_{CER}$
EMITTER-TO-BASE VOLTAGE.....	$V_{EBO}$
COLLECTOR CURRENT.....	$I_C$
BASE CURRENT.....	$I_B$
TRANSISTOR DISSIPATION:	$P_T$
At case temperatures up to 25°C.....	
At case temperatures above 25°C.....	
TEMPERATURE RANGE:	
Storage & Operating (Junction).....	
PIN TEMPERATURE (During Soldering):	
At distances $\geq 1/32$ in. (0.8 mm) from case for 10 s max.....	

RCA1C09

$V_{CBO}$	75	V
$V_{CEO}$	65	V
$V_{CER}$	75	V
$V_{EBO}$	5	V
$I_C$	10	A
$I_B$	4	A
$P_T$		
	75	W
	See Fig. 2	
	-65 to 150	°C
	230	°C

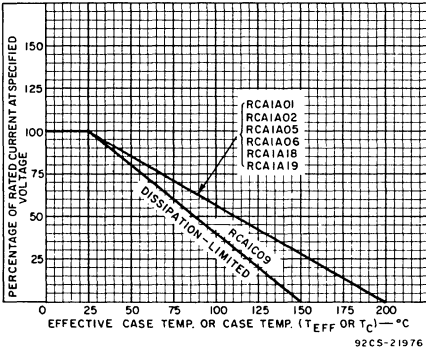


Fig. 2— Derating curves for all types.

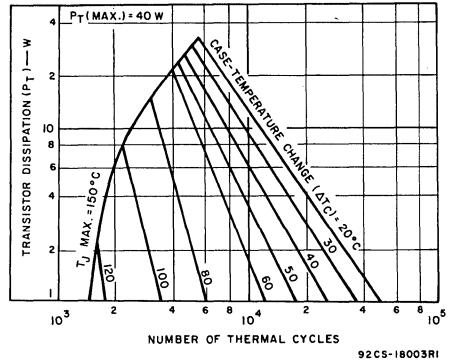


Fig. 3— Thermal-cycling ratings for RCA1C09.

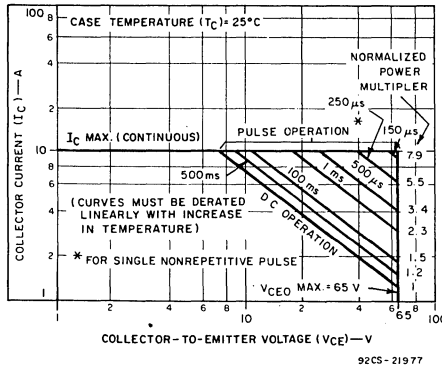
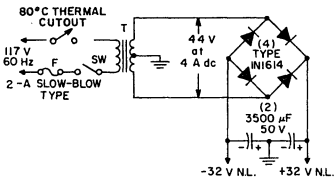
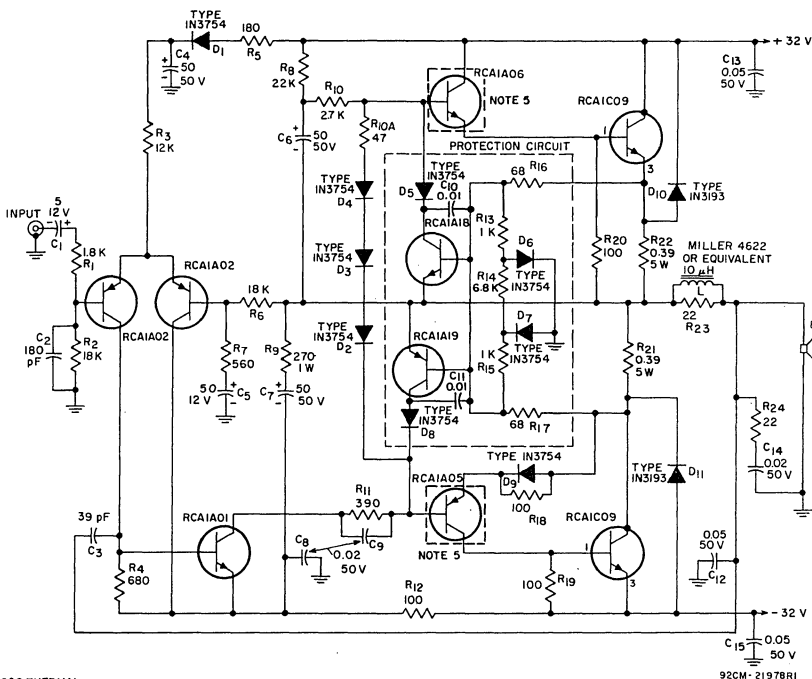


Fig. 4— Maximum operating areas for RCA1C09.



**TYPICAL PERFORMANCE DATA  
For 40-Watt Audio Amplifier Circuit**

Measured at a line voltage of 120 V,  $T_A = 25^{\circ}\text{C}$ , and a frequency of 1 kHz, unless otherwise specified.

Power:

Rated power (8-Ω load, at rated distortion) . . . . .	40 W
Typical power (4-Ω load) . . . . .	55 W
Typical power (16-Ω load) . . . . .	25 W
Music power (8-Ω load, at 5% THD with regulated supply) . . . . .	55 W
Dynamic power (8-Ω load, at 1% THD with regulated supply) . . . . .	50 W

Total Harmonic Distortion:

Rated distortion . . . . .	1.0%
----------------------------	------

IM Distortion:

10 dB below continuous power output at 60 Hz and 7 kHz (4:1) . . . . .	0.1%
--	------

Sensitivity:

At continuous power-output rating . . . . .	600 mV
---	--------

Hum and Noise:

Below continuous power output:	
Input shorted . . . . .	80 dB
With 2 kΩ resistance on 20-ft. cable on input . . . . .	75 dB
Input Resistance . . . . .	20 kΩ

**NOTES:**

1. T: Signal 88-2 (parallel secondary), Signal Transformer Co., 1 Junius St., Brooklyn, N.Y. 11212, or equivalent.
2. Resistors are 1/2-watt unless otherwise specified; values are in ohms.
3. Capacitances are in μF unless otherwise specified.
4. Non-inductive resistors.
5. Mount driver transistors on heat sink, Wakefield No. 209-AB, or equivalent. Alternatively, these types may be obtained with a factory-attached integral heat sink.
6. Provide approximately 1.3°C/W heat sinking per output device.

Fig. 5—40-watt amplifier circuit featuring quasi-complementary-symmetry output.

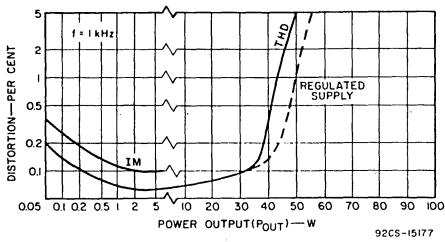


Fig.6— Distortion vs. power output.

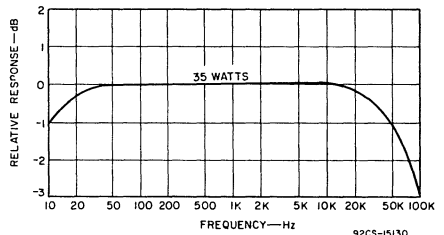


Fig.7— Response curve.

**Type RCA1C09**

Package: JEDEC TO-220AB

Construction: Silicon n-p-n, homotaxial base

**ELECTRICAL CHARACTERISTICS, At Case Temperature ( $T_C$ ) = 25°C Unless Otherwise Specified**

CHARACTERISTIC	SYMBOL	TEST CONDITIONS	LIMITS		UNITS
			MIN.	MAX.	
Collector Cutoff Current: With external base-to-emitter resistance ( $R_{BE}$ )	$I_{CER}$	$V_{CE} = 65 V, R_{BE} = 100\Omega$	—	1	mA
Emitter Cutoff Current: With collector open	$I_{EBO}$	$V_{EB} = 5 V, I_C = 0$	—	1	mA
Collector-to-Emitter Voltage: With external base-to-emitter resistance ( $R_{BE}$ )	$V_{CER}$	$I_C = 0.2 A, R_{BE} = 100\Omega$	75	—	V
Gain Bandwidth Product	$f_T$	$I_C = 0.5 A, V_{CE} = 4 V$	0.8	—	MHz
DC Forward-Current Transfer Ratio	$h_{FE}$	$I_C = 4 A, V_{CE} = 4 V$	20	120	
Collector-to-Emitter Saturation Voltage	$V_{CE(sat)}$	$I_C = 4 A, I_B = 0.4 A$	—	1	V
Base-to-Emitter Voltage	$V_{BE}$	$I_C = 4 A, V_{CE} = 4 V$	—	1.5	V
Second-Breakdown Collector Current: With base forward biased	$I_{S/b}$	$V_{CE} = 40 V, t = 0.5 s$	1.87	—	A

For characteristics curves and test conditions, refer to published data for prototype 2N6103 (File 485).

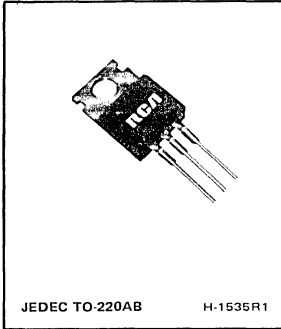
**TERMINAL CONNECTIONS FOR TYPE RCA1C09**

- Lead 1 — Base
- Lead 2 — Collector
- Lead 3 — Emitter
- Lead 4 — Collector



**RCA**  
Solid State  
Division

**Power Transistors**  
**RCA1C10**  
**RCA1C11**



## Silicon Transistors for 12-Watt True-Complementary-Symmetry Audio Amplifiers

RCA1C10 and RCA1C11 are n-p-n and p-n-p epitaxial-base silicon power transistors, respectively, especially characterized for audio-output service. To enhance circuit economics, they are provided in the JEDEC TO-220AB version of the VERSAWATT plastic package.

The 12-watt audio-amplifier circuit shown in Figs. 1 and 7 uses RCA1C10 and RCA1C11 as output devices in conjunction with three discrete transistors, two diodes, and a single 36-volt power supply; the amplifier output is capacitively coupled to an 8-ohm speaker. The choice of a true-complementary-symmetry output stage provides excellent fidelity for a low-cost system.

The 12-watt amplifier circuit shown in Figs. 2 and 10 uses

RCA1C10 and RCA1C11 discrete transistors, an integrated circuit, one diode, and a 36-volt split power supply; the amplifier output is directly coupled to an 8-ohm speaker. The integrated circuit-true-complementary-symmetry combination provides a high-quality, low-cost amplifier.

The RCA CA3094AT integrated circuit provides sufficient drive current for the complementary-symmetry output stage. Tone controls, bass and treble, with functions of "boost" and "cut" are incorporated into the feedback loop of the amplifier, resulting in excellent signal-to-noise ratio and freedom from distortion. Ratings and characteristics of type CA3094AT are given in RCA data bulletin File 598.

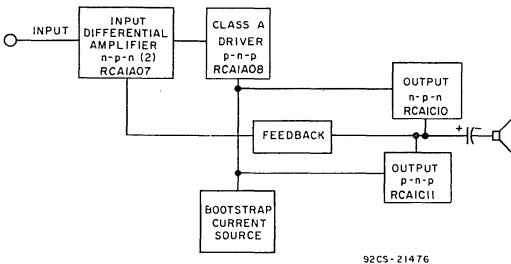


Fig.1— Block diagram and transistor complement for 12-watt true-complementary-symmetry audio amplifier.

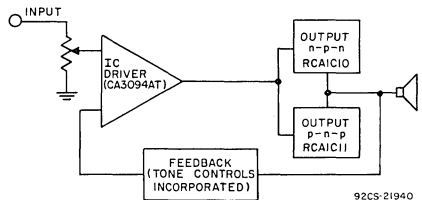


Fig.2— Block diagram and transistor complement for 12-watt true-complementary-symmetry audio amplifier with integrated-circuit driver.

**MAXIMUM RATINGS, Absolute-Maximum Values:**

COLLECTOR-TO-BASE VOLTAGE .....	$V_{CB0}$	40	-40	V
COLLECTOR-TO-EMITTER VOLTAGE:				
With base open .....	$V_{CE0}$	40	-40	V
With external base-to-emitter resistance ( $R_{BE}$ ) = 100 $\Omega$ .....	$V_{CER}$	50	-50	V
EMITTER-TO-BASE VOLTAGE .....	$V_{EB0}$	5	-5	V
COLLECTOR CURRENT .....	$I_C$	7	-7	A
BASE CURRENT .....	$I_B$	3	-3	A
TRANSISTOR DISSIPATION:	$P_T$			
At case temperatures up to 25 $^{\circ}$ C .....		40	40	W
At case temperatures above 25 $^{\circ}$ C .....		← See Fig. 3 →		
TEMPERATURE RANGE:				
Storage & Operating (Junction) .....		← -65 to 150 →		$^{\circ}$ C
PIN TEMPERATURE (During Soldering):				
At distances $\geq$ 1/32 in. (0.8 mm) from case for 10 s max. ....		← 230 →		$^{\circ}$ C

RCA1C10

RCA1C11

$V_{CB0}$	40	-40	V
$V_{CE0}$	40	-40	V
$V_{CER}$	50	-50	V
$V_{EB0}$	5	-5	V
$I_C$	7	-7	A
$I_B$	3	-3	A
$P_T$			
	40	40	W
	← See Fig. 3 →		
		← -65 to 150 →	$^{\circ}$ C
		← 230 →	$^{\circ}$ C

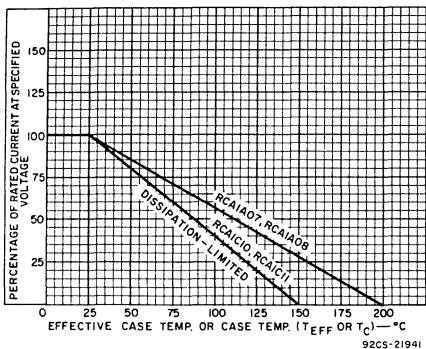


Fig. 3 - Derating curves for all types.

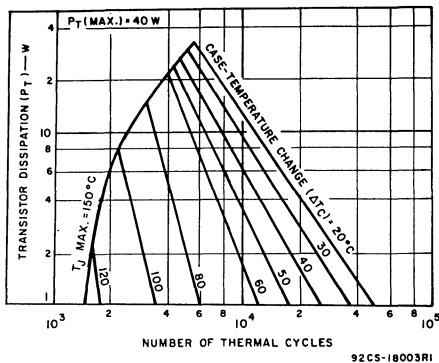


Fig. 4 - Thermal-cycling ratings for RCA1C10 and RCA1C11.

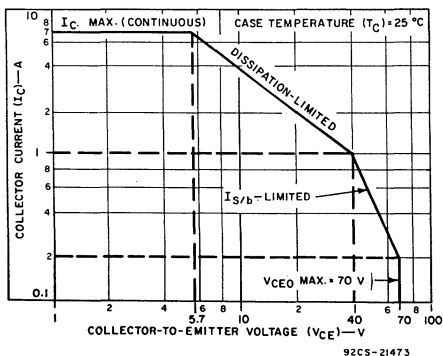


Fig. 5 - Maximum operating areas for RCA1C10.

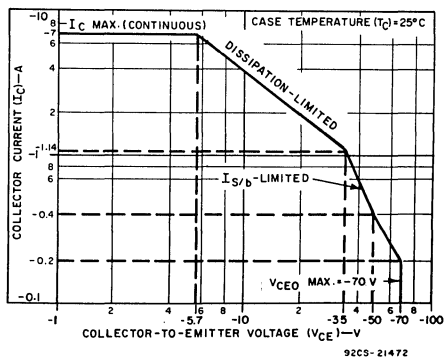


Fig. 6 - Maximum operating areas for RCA1C11.

## Type RCA1C10

Package: JEDEC TO-220AB

Construction: Silicon n-p-n, epitaxial-base

ELECTRICAL CHARACTERISTICS, At Case Temperature ( $T_C$ ) = 25°C Unless Otherwise Specified

CHARACTERISTIC	SYMBOL	TEST CONDITIONS	LIMITS		UNITS
			MIN.	MAX.	
Collector Cutoff Current: With external base-to-emitter resistance ( $R_{BE}$ )	$I_{CER}$	$V_{CE} = 35 \text{ V}, R_{BE} = 100\Omega$	–	10	$\mu\text{A}$
Emitter Cutoff Current: With collector open	$I_{EBO}$	$V_{EB} = 5 \text{ V}$	–	1	mA
Collector-to-Emitter Voltage: With base open	$V_{CEO}$	$I_C = 0.1 \text{ A}, I_B = 0$	40	–	V
Collector-to-Emitter Voltage: With external base-to-emitter resistance ( $R_{BE}$ )	$V_{CER}$	$I_C = 0.1 \text{ A}, R_{BE} = 100\Omega$	50	–	V
Gain Bandwidth Product	$f_T$	$V_{CE} = 4 \text{ V}, I_C = 0.5 \text{ A}$	4	–	MHz
DC Forward-Current Transfer Ratio	$h_{FE}$	$I_C = 1.5 \text{ A}, V_{CE} = 4 \text{ V}$	50	250	
Collector-to-Emitter Saturation Voltage	$V_{CE(sat)}$	$I_C = 1.5 \text{ A}, I_B = 0.075 \text{ A}$	–	1	V
Base-to-Emitter Voltage	$V_{BE}$	$I_C = 1.5 \text{ A}, V_{CE} = 4 \text{ V}$	–	1.5	V
Second-Breakdown Collector Current: With base forward biased	$I_{S/b}$	$V_{CE} = 20 \text{ V}, t = 0.4 \text{ s}$	2	–	A

For characteristics curves and test conditions, refer to published data for prototype 2N6292 (File 542).

TERMINAL CONNECTIONS FOR  
TYPES RCA1C10, RCA 1C11

- Lead 1 – Base
- Lead 2 – Collector
- Lead 3 – Emitter
- Mounting Flange – Collector

## Type RCA1C11

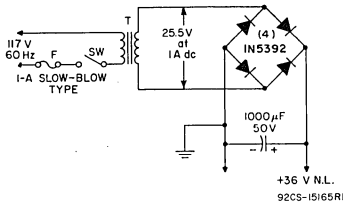
Package: JEDEC TO-220AB

Construction: Silicon p-n-p, epitaxial base

ELECTRICAL CHARACTERISTICS, At Case Temperature ( $T_C$ ) = 25°C Unless Otherwise Specified

CHARACTERISTIC	SYMBOL	TEST CONDITIONS	LIMITS		UNITS
			MIN.	MAX.	
Collector Cutoff Current: With external base-to-emitter resistance ( $R_{BE}$ )	$I_{CER}$	$V_{CE} = -35 \text{ V}, R_{BE} = 100\Omega$	–	–10	$\mu\text{A}$
Emitter Cutoff Current: With collector open	$I_{EBO}$	$V_{EB} = -5 \text{ V}$	–	–1	mA
Collector-to-Emitter Voltage: With base open	$V_{CEO}$	$I_C = -0.1 \text{ A}, I_B = 0$	–40	–	V
Collector-to-Emitter Voltage: With external base-to-emitter resistance ( $R_{BE}$ )	$V_{CER}$	$I_C = -0.1 \text{ A}, R_{BE} = 100\Omega$	–50	–	V
Gain Bandwidth Product	$f_T$	$V_{CE} = -4 \text{ V}, I_C = -0.5 \text{ A}$	10	–	MHz
DC Forward-Current Transfer Ratio	$h_{FE}$	$I_C = -1.5 \text{ A}, V_{CE} = -4 \text{ V}$	50	250	
Collector-to-Emitter Saturation Voltage	$V_{CE(sat)}$	$I_C = -1.5 \text{ A}, I_B = -0.075 \text{ A}$	–	–1	V
Base-to-Emitter Voltage	$V_{BE}$	$I_C = -1.5 \text{ A}, V_{CE} = -4 \text{ V}$	–	–1.5	V
Second-Breakdown Collector Current: With base forward biased	$I_{S/b}$	$V_{CE} = -20 \text{ V}, t = 0.4 \text{ s}$	–2	–	A

For characteristics curves and test conditions, refer to published data for prototype 2N6107 (File 488).



NOTES:

1. T: Thordarson 23V118, Stancor TP4, Triad F-93X, or equivalent (for Stereo Amplifiers).
2. Resistors are 1/2-watt unless otherwise specified; values are in ohms.
3. Capacitances are in  $\mu\text{F}$  unless otherwise specified.
4. Non-inductive resistors.

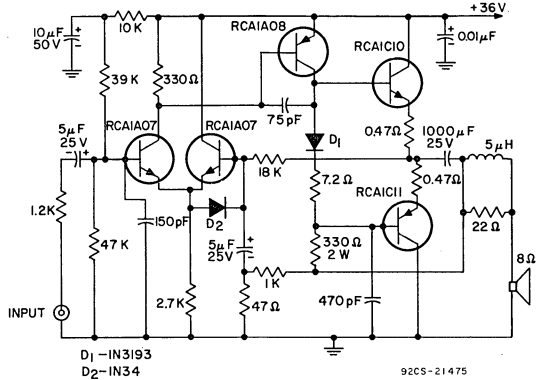


Fig.7— 12-watt amplifier circuit featuring complementary-symmetry output.

TYPICAL PERFORMANCE DATA  
For 12-Watt Audio Amplifier Circuit

Measured at a line voltage of 120 V,  $T_A = 25^\circ\text{C}$ , and a frequency of 1 kHz, unless otherwise specified.

Power:

Rated power (8- $\Omega$ load, at rated distortion) . . . . .	12 W
Typical power (4- $\Omega$ load) . . . . .	12 W
Typical power (16- $\Omega$ load) . . . . .	6.5 W
Music power (8- $\Omega$ load, at 5% THD with regulated supply) . . . . .	15 W
Dynamic power (8- $\Omega$ load, at 1% THD with regulated supply) . . . . .	13 W
Total Harmonic Distortion:	
Rated distortion . . . . .	1.0%

IM Distortion:

10 dB below continuous power output at 60 Hz and 7 kHz (4:1) . . . . .	1.5%
--	------

Sensitivity:

At continuous power-output rating . . . . .	600 mV
---	--------

Hum and Noise:

Below continuous power output:

Input shorted . . . . .	90 dB
Input open . . . . .	70 dB
Input Resistance . . . . .	23 k $\Omega$

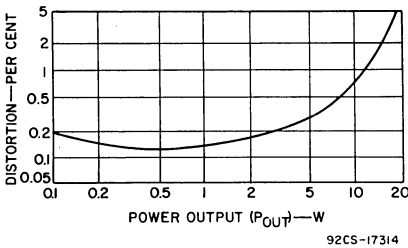


Fig.8—Distortion vs. power output.

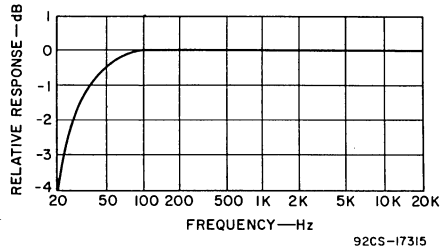
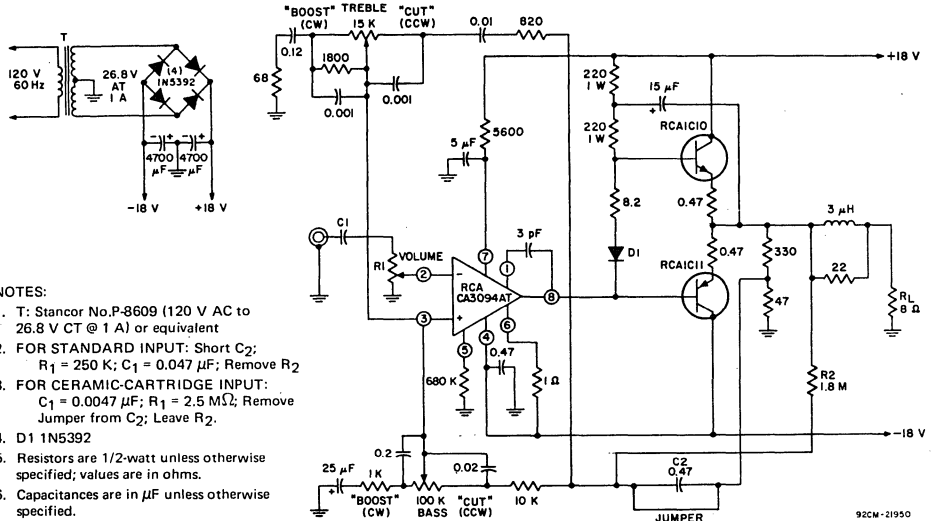


Fig.9—Response curve.



NOTES:

1. T: Stancor No. P-8609 (120 V AC to 26.8 V CT @ 1 A) or equivalent
2. FOR STANDARD INPUT: Short C<sub>2</sub>; R<sub>1</sub> = 250 K; C<sub>1</sub> = 0.047 μF; Remove R<sub>2</sub>
3. FOR CERAMIC-CARTRIDGE INPUT: C<sub>1</sub> = 0.0047 μF; R<sub>1</sub> = 2.5 MΩ; Remove Jumper from C<sub>2</sub>; Leave R<sub>2</sub>.
4. D1 1N5392
5. Resistors are 1/2-watt unless otherwise specified; values are in ohms.
6. Capacitances are in μF unless otherwise specified.
7. Non-inductive resistors.

Fig. 10—12-watt amplifier circuit featuring an integrated-circuit driver and a true-complementary-symmetry output stage.

**TYPICAL PERFORMANCE DATA**  
**For 12-Watt Audio Amplifier Circuit**

Measured at a line voltage of 120 V, T<sub>A</sub> = 25°C, and a frequency of 1 kHz, unless otherwise specified.

Power:

Rated power (8-Ω load, at rated distortion) . . . . .	12 W
Typical power (4-Ω load) . . . . .	9 W
Typical power (16-Ω load) . . . . .	6.5 W
Music power (8-Ω load, at 5% THD with regulated supply) . . . . .	15 W

Total Harmonic Distortion:

Rated distortion . . . . .	1.0%
Typical at 1 W . . . . .	0.05%

IM Distortion:

10 dB below continuous power output at 60 Hz and 2 kHz (4:1) . . . . .	0.2%
--	------

Sensitivity:

At continuous power-output rating (tone controls flat) . . . . .	100 mV
--	--------

Hum and Noise:

Below continuous power output:	
Input open . . . . .	83 dB

Input resistance . . . . .	250 kΩ
Voltage Gain . . . . .	40 dB
Tone Control Range . . . . .	See Fig. 12

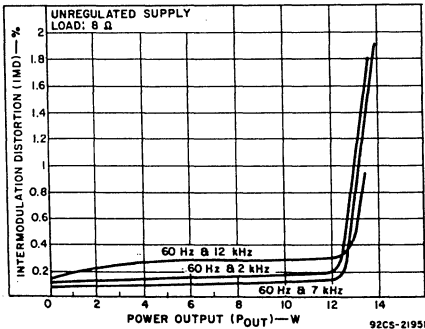


Fig. 11—Intermodulation distortion vs. power output.

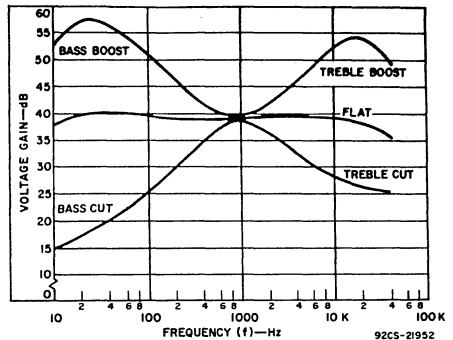
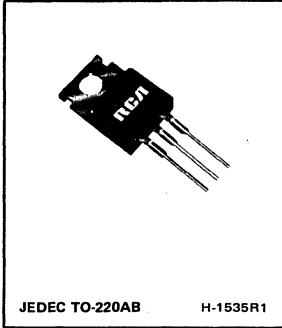


Fig. 12—Voltage gain vs. frequency.

**RCA**  
Solid State  
Division

## Power Transistors

### RCA1C14

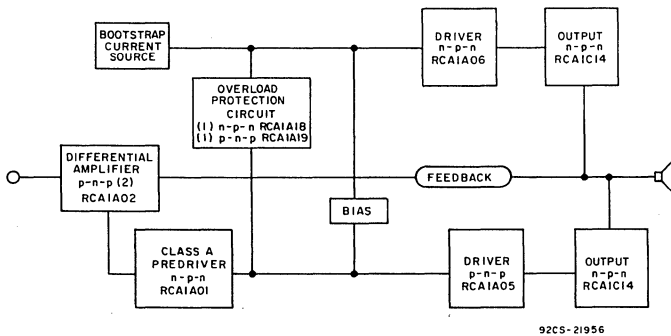


## Silicon Transistor for 25-Watt Quasi-Complementary-Symmetry Audio Amplifiers

RCA1C14 is an n-p-n homotaxial-base silicon power transistor provided in the JEDEC TO-220AB package. This device is ideally suited for use in the output stage of quasi-complementary-symmetry audio amplifiers.

The 25-watt audio-amplifier circuit shown in Figs. 1 and 5

uses two RCA1C14 transistors in conjunction with seven TO-39 low-level audio transistors, 11 diodes, and a 52-volt split supply. The amplifier output is directly coupled to an 8-ohm speaker. Ruggedness and economy are features of this high fidelity amplifier.



92CS-21956

Fig. 1— Block diagram and transistor complement for 25-watt quasi-complementary-symmetry audio amplifier.

**MAXIMUM RATINGS, Absolute-Maximum Values:**

		RCA1C14	
COLLECTOR-TO-BASE VOLTAGE .....	$V_{CBO}$	60	V
COLLECTOR-TO-EMITTER VOLTAGE:			
With base open .....	$V_{CEO}$	40	V
With external base-to-emitter resistance ( $R_{BE}$ ) = 100 $\Omega$ .....	$V_{CER}$	60	V
EMITTER-TO-BASE VOLTAGE .....	$V_{EB0}$	5	V
COLLECTOR CURRENT .....	$I_C$	7	A
BASE CURRENT .....	$I_B$	3	A
TRANSISTOR DISSIPATION:	$P_T$		
At case temperatures up to 25°C .....		50	W
At case temperatures above 25°C .....		See Fig. 2	
TEMPERATURE RANGE:			
Storage & Operating (Junction) .....		-65 to 150	°C
PIN TEMPERATURE (During Soldering):			
At distances $\geq 1/32$ in. (0.8 mm) from case for 10 s max. ....		230	°C

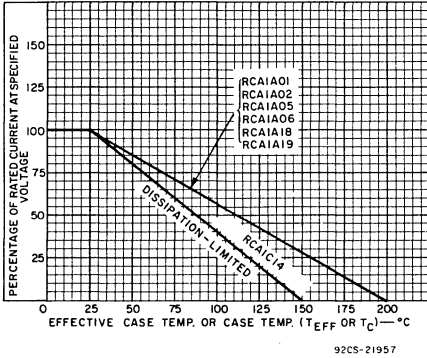


Fig. 2- Derating curves for all types.

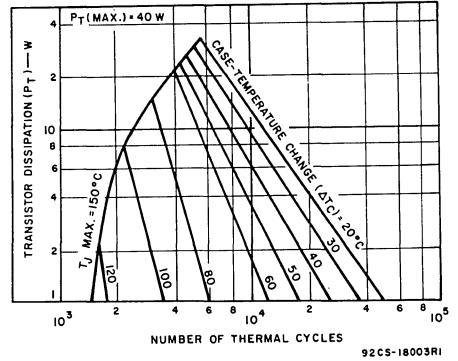


Fig. 3- Thermal-cycling ratings for RCA1C14.

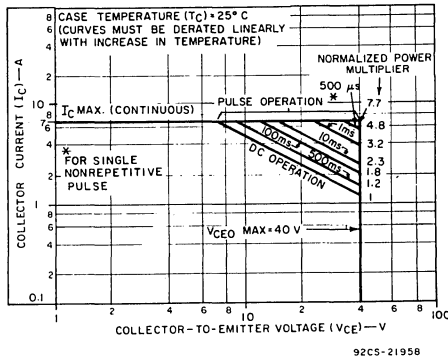
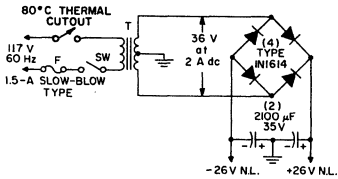
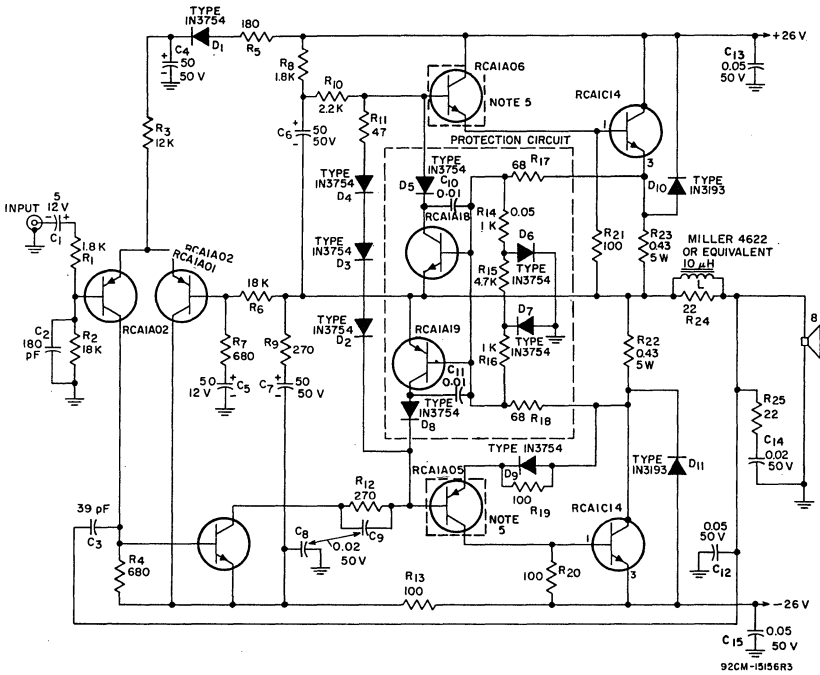


Fig. 4- Maximum operating areas for RCA1C14.



**TYPICAL PERFORMANCE DATA  
For 25-Watt Audio Amplifier**

Measured at a line voltage of 120 V,  $T_A = 25^\circ\text{C}$ , and a frequency of 1 kHz, unless otherwise specified

Power:

Rated power (8- $\Omega$ load, at rated distortion) . . . . .	25 W
Typical power (4- $\Omega$ load) . . . . .	45 W
Typical power (16- $\Omega$ load) . . . . .	16 W
Music power (8- $\Omega$ load, at 5% THD with regulated supply) . . . . .	38 W
Dynamic power (8- $\Omega$ load, at 1% THD with regulated supply) . . . . .	33 W

Total Harmonic Distortion:

Rated distortion . . . . .	1.0%
----------------------------	------

IM Distortion:

10 dB below continuous power output at 60 Hz and 7 kHz (4:1) . . . . .	0.1%
--	------

Sensitivity:

At continuous power-output rating . . . . .	600 mV
---	--------

Hum and Noise:

Below continuous power output:	
Input shorted . . . . .	80 dB
Input open . . . . .	75 dB
Input Resistance . . . . .	20 k $\Omega$

**NOTES:**

1. T: Signal 36-2 (Signal Transformer Co., 1 Junius St., Brooklyn, N.Y. 11212), or equivalent.
2. Resistors are 1/2-watt unless otherwise specified; values are in ohms.
3. Capacitances are in  $\mu\text{F}$  unless otherwise specified.
4. Non-inductive resistors.
5. Mount driver transistors on heat sink, Wakefield No. 209-AB, or equivalent. (Alternatively, this type may be obtained with a factory-attached integral heat sink.)
6. Provide approximately 2<sup>o</sup>/W heat sinking per output device.

Fig. 5—25-watt amplifier circuit featuring quasi-complementary-symmetry output.



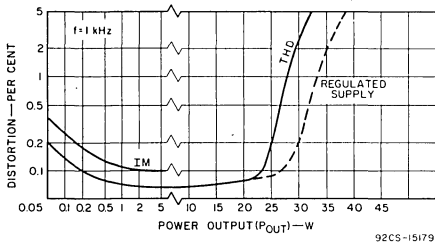


Fig.6- Distortion vs. power output.

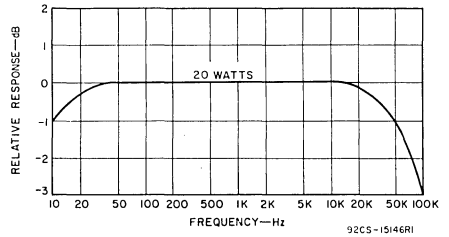


Fig.7- Response curve.

**Type RCA1C14**

**Package:** JEDEC TO-220AB

**Construction:** Silicon n-p-n, hometaxial base

**ELECTRICAL CHARACTERISTICS, At Case Temperature ( $T_C$ ) = 25°C Unless Otherwise Specified**

CHARACTERISTIC	SYMBOL	TEST CONDITIONS	LIMITS		UNITS
			MIN.	MAX.	
Collector Cutoff Current: With external base-to-emitter resistance ( $R_{BE}$ )	$I_{CER}$	$V_{CE} = 50 \text{ V}, R_{BE} = 100\Omega$	-	0.5	mA
Emitter Cutoff Current: With collector open	$I_{EBO}$	$V_{EB} = 5 \text{ V}, I_C = 0$	-	1	mA
Collector-to-Emitter Voltage: With base open	$V_{CEO}$	$I_C = 1 \text{ A}, I_B = 0$	40	-	V
Collector-to-Emitter Voltage: With external base-to-emitter resistance ( $R_{BE}$ )	$V_{CER}$	$I_C = 0.1 \text{ A}, R_{BE} = 100\Omega$	60	-	V
Gain Bandwidth Product	$f_T$	$I_C = 0.5 \text{ A}, V_{CE} = 4 \text{ V}$	0.8	-	MHz
DC Forward-Current Transfer Ratio	$h_{FE}$	$I_C = 3 \text{ A}, V_{CE} = 4 \text{ V}$	20	70	
Collector-to-Emitter Saturation Voltage	$V_{CE(sat)}$	$I_C = 3 \text{ A}, I_B = 0.3 \text{ A}$	-	1	V
Base-to-Emitter Voltage	$V_{BE}$	$I_C = 3 \text{ A}, V_{CE} = 4 \text{ V}$	-	1.4	V
Second-Breakdown Collector Current: With base forward biased	$I_{S/b}$	$V_{CE} = 40 \text{ V}, t = 0.5 \text{ s}$	1.25	-	A

For characteristics curves and test conditions, refer to published data for prototype 2N5495 (File 353).

**TERMINAL CONNECTIONS FOR TYPE RCA1C14**

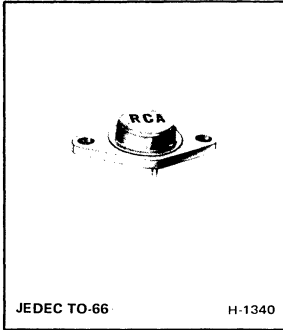
- Lead 1 - Base
- Lead 2 - Collector
- Lead 3 - Emitter
- Lead 4 - Collector



# Power Transistors

## RCA1E02 RCA1E03

### Silicon Transistors for Audio-Frequency Linear-Amplifier Applications



N-P-N  
RCA1E02

P-N-P  
RCA1E03

#### TERMINAL CONNECTIONS

Pin 1 - Base  
Pin 2 - Emitter  
Mounting Flange, Case - Collector

RCA1E02 and RCA1E03 are silicon n-p-n and p-n-p transistors, respectively. These complementary devices are especially characterized for audio-amplifier applications. They may be used singly or as a complementary pair in complementary- or quasi-complementary-symmetry circuits, and are particularly useful as drivers or predrivers. They may also be used in audio power amplifiers, linear modulators, servo amplifiers, and operational amplifiers. The units are supplied in the JEDEC TO-66 package.

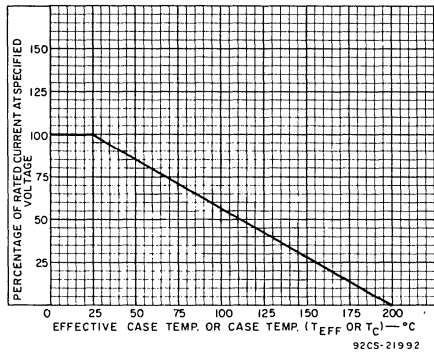


Fig. 1 - Derating curve for all types.

#### MAXIMUM RATINGS, Absolute-Maximum Values:

		RCA1E02	RCA1E03	
COLLECTOR-TO-BASE VOLTAGE . . . . .	V <sub>CBO</sub>	200	-200	V
COLLECTOR-TO-EMITTER VOLTAGE:				
With base open . . . . .	V <sub>CEO</sub>	175	-175	V
With external base-to-emitter resistance (R <sub>BE</sub> ) = 100 Ω . . . . .	V <sub>CER</sub>	200	-200	V
EMITTER-TO-BASE VOLTAGE . . . . .	V <sub>EB0</sub>	5	-5	V
COLLECTOR CURRENT . . . . .	I <sub>C</sub>	2	-2	A
BASE CURRENT . . . . .	I <sub>B</sub>	1	-1	A
TRANSISTOR DISSIPATION:	P <sub>T</sub>			
At case temperatures up to 25°C . . . . .		35	35	W
At case temperatures above 25°C . . . . .		← See Fig. 1 →		
TEMPERATURE RANGE:				
Storage and Operating (Junction) . . . . .		← -65 to +200 →		°C
PIN TEMPERATURE (During Soldering):				
At distances ≥ 1/32 in. (0.8 mm) from case for 10 s max. . . . .		← 230 →		°C

**Type RCA1E02****Package:** JEDEC TO-66**Construction:** Silicon n-p-n, double-epitaxial**ELECTRICAL CHARACTERISTICS, At Case Temperature ( $T_C$ ) = 25°C Unless Otherwise Specified**

CHARACTERISTIC	SYMBOL	TEST CONDITIONS	LIMITS		UNITS
			MIN.	MAX.	
Collector Cutoff Current: With external base-to-emitter resistance ( $R_{BE}$ )	$I_{CER}$	$V_{CE} = 120 \text{ V}, R_{BE} = 100 \Omega$	–	100	$\mu\text{A}$
Emitter Cutoff Current: With collector open	$I_{EBO}$	$V_{EB} = 5 \text{ V}, I_C = 0$	–	1	mA
Collector-to-Emitter Voltage: With base open	$V_{CEO}$	$I_C = 0.1 \text{ A}, I_B = 0$	175	–	V
Collector-to-Emitter Voltage: With external base-to-emitter resistance ( $R_{BE}$ )	$V_{CER}$	$I_C = 0.1 \text{ A}, R_{BE} = 100 \Omega$	200	–	V
DC Forward-Current Transfer Ratio	$h_{FE}$	$I_C = 0.3 \text{ A}, V_{CE} = 2 \text{ V}$	30	150	
Base-to-Emitter Voltage	$V_{BE}$	$I_C = 0.3 \text{ A}, V_{CE} = 2 \text{ V}$	–	1	V
Second-Breakdown Collector Current: With base forward biased	$I_{S/b}$	$V_{CE} = 80 \text{ V}, t = 0.4 \text{ s}$	0.4	–	A

For characteristics curves and test conditions, refer to published data for prototype 2N3583 (File 138).

**Type RCA1E03****Package:** JEDEC TO-66**Construction:** Silicon p-n-p, epitaxial**ELECTRICAL CHARACTERISTICS, At Case Temperature ( $T_C$ ) = 25°C Unless Otherwise Specified**

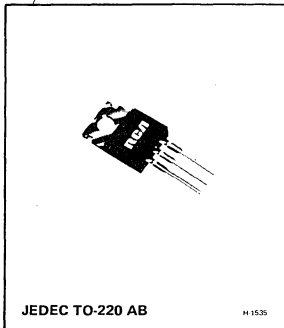
CHARACTERISTIC	SYMBOL	TEST CONDITIONS	LIMITS		UNITS
			MIN.	MAX.	
Collector Cutoff Current: With external base-to-emitter resistance ( $R_{BE}$ )	$I_{CER}$	$V_{CE} = -120 \text{ V}, R_{BE} = 100 \Omega$	–	–100	$\mu\text{A}$
Emitter Cutoff Current: With collector open	$I_{EBO}$	$V_{EB} = -5 \text{ V}, I_C = 0$	–	–1	mA
Collector-to-Emitter Voltage: With base open	$V_{CEO}$	$I_C = -0.1 \text{ A}, I_B = 0$	–175	–	V
Collector-to-Emitter Voltage: With external base-to-emitter resistance ( $R_{BE}$ )	$V_{CER}$	$I_C = -0.1 \text{ A}, R_{BE} = 100 \Omega$	–200	–	V
DC Forward-Current Transfer Ratio	$h_{FE}$	$I_C = -0.3 \text{ A}, V_{CE} = -2 \text{ V}$	30	150	
Base-to-Emitter Voltage	$V_{BE}$	$I_C = -0.3 \text{ A}, V_{CE} = -2 \text{ V}$	–	–1	V
Second-Breakdown Collector Current: With base forward biased	$I_{S/b}$	$V_{CE} = -80 \text{ V}, t = 0.4 \text{ s}$	–0.25	–	A

For characteristics curves and test conditions, refer to published data for prototype 2N6211 (File 507).



# Power Transistors

RCA 29 RCA29B  
RCA29A RCA29C



## Epitaxial-Base, Silicon N-P-N VERSAWATT Transistors

For Power-Amplifier and  
High-Speed-Switching Applications

**Features:**

- 30 W at 25°C case temperature
- 3 A rated collector current
- Min.  $f_T$  of 3 MHz at 10 V, 200 mA
- Designed for complementary use with RCA30, RCA30A, RCA30B, and RCA30C p-n-p types\*

RCA29, RCA29A, RCA29B, and RCA29C are epitaxial-base, silicon n-p-n transistors. They are intended for a wide variety of switching and amplifier applications, such as series and shunt regulators and driver and output stages of high-fidelity

amplifiers. These new plastic power transistors are designed for complementary use with devices in the RCA30 series. They differ from each other in voltage ratings.

\* Technical data for the RCA30-series devices are given in RCA data bulletin File 584.

**MAXIMUM RATINGS, Absolute-Maximum Values:**

	RCA29	RCA29A	RCA29B	RCA29C		
COLLECTOR-TO-BASE VOLTAGE . . . . .	VCBO	40	60	80	100	V
COLLECTOR-TO-EMITTER VOLTAGE:						
With base open . . . . .	VCEO	40	60	80	100	V
EMITTER-TO-BASE VOLTAGE . . . . .	VEBO	5	5	5	5	V
CONTINUOUS COLLECTOR CURRENT . . . . .	IC	3	3	3	3	A
CONTINUOUS BASE CURRENT . . . . .	IB	1	1	1	1	A
TRANSISTOR DISSIPATION:	PT					
At case temperatures up to 25°C . . . . .		30	30	30	30	W
At ambient temperatures up to 25°C . . . . .		2	2	2	2	W
TEMPERATURE RANGE:						
Storage & Operating (Junction) . . . . .		←----- -65 to 150 -----→				°C
LEAD TEMPERATURE (During Soldering):						
At distance 1/8 in. (3.17 mm) from case for 10 s max. . . . .		←----- 235 -----→				°C

ELECTRICAL CHARACTERISTICS, At Case Temperature ( $T_C$ ) = 25°C

CHARACTERISTIC	SYMBOL	TEST CONDITIONS				LIMITS								UNITS
		DC VOLTAGE (V)		DC CURRENT (A)		RCA29		RCA29A		RCA29B		RCA29C		
		$V_{CE}$	$V_{BE}$	$I_C$	$I_B$	MIN.	MAX.	MIN.	MAX.	MIN.	MAX.	MIN.	MAX.	
Collector-Cutoff Current: With base open	$I_{CEO}$	30 60			0 0	— —	0.3 —	— —	0.3 —	— —	— 0.3	— —	— 0.3	mA
With base-emitter junction short-circuited	$I_{CES}$	40 60 80 100	0 0 0 0			— — — —	0.2 — — —	— — — —	— — — —	— — — —	— — 0.2 —	— — — 0.2		
Emitter-Cutoff Current	$I_{EBO}$		-5	0		—	1	—	1	—	1	—	1	mA
Collector-to-Emitter Sustaining Voltage: With base open	$V_{CEO(sus)}$			0.03 <sup>a</sup>	0	40	—	60	—	80	—	100	—	V
DC Forward-Current Transfer Ratio	$h_{FE}$	4 4		0.2 <sup>a</sup> 1 <sup>a</sup>		40 15	— 150	40 15	— 150	40 15	— 150	40 15	— 150	
Base-to-Emitter Voltage	$V_{BE}$	4		1 <sup>a</sup>		—	1.3	—	1.3	—	1.3	—	1.3	V
Collector-to-Emitter Saturation Voltage	$V_{CE(sat)}$			1 <sup>a</sup>	0.125	—	0.7	—	0.7	—	0.7	—	0.7	V
Common-Emitter, Small-Signal, Short-Circuit, Forward Current Transfer Ratio: ( $f = 1$ kHz)	$h_{fe}$	10		0.2		20	—	20	—	20	—	20	—	
Magnitude of Common Emitter, Small-Signal, Short-Circuit, Forward Current Transfer Ratio ( $f = 1$ MHz)	$ h_{fe} $	10		0.2		3	—	3	—	3	—	3	—	
Saturated Switching Time ( $V_{CC} = 30$ V, $R_L = 30 \Omega$ , $I_{B1} = I_{B2}$ ): Turn-on time $t_d + t_r$	$t_{ON}$				1	0.1		0.4 (typ.)		0.4 (typ.)		0.4 (typ.)		$\mu$ s
Turn-off time $t_s + t_f$	$t_{OFF}$				1	0.1		1.2 (typ.)		1.2 (typ.)		1.2 (typ.)		
Thermal Resistance: Junction-to-Case	$R_{\theta JC}$					—	4.17	—	4.17	—	4.17	—	4.17	$^{\circ}$ C/W
Junction-to-Ambient	$R_{\theta JA}$					—	62.5	—	62.5	—	62.5	—	62.5	

<sup>a</sup>Pulsed: Pulse duration = 300  $\mu$ s, duty factor = 2%

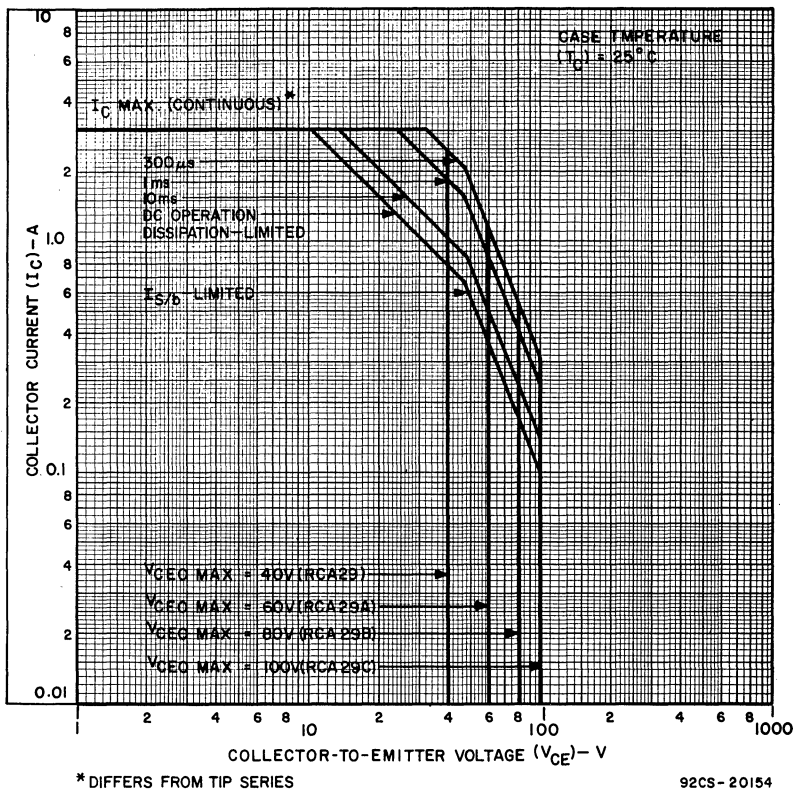


Fig. 1 — Maximum safe operating areas for all types.

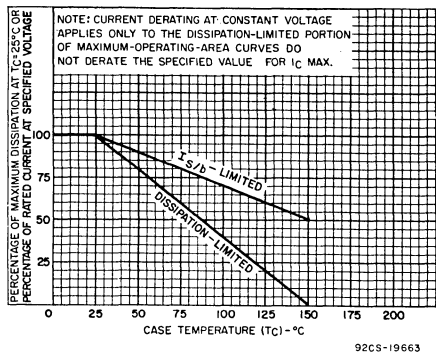


Fig. 2 — Derating curves for all types.

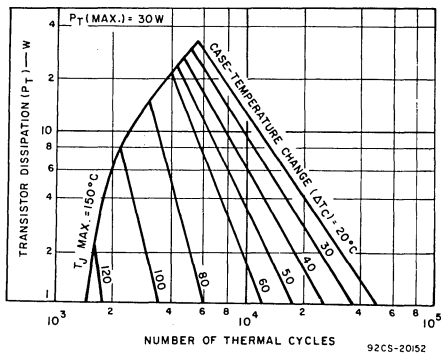


Fig. 3 — Thermal-cycling ratings for all types.

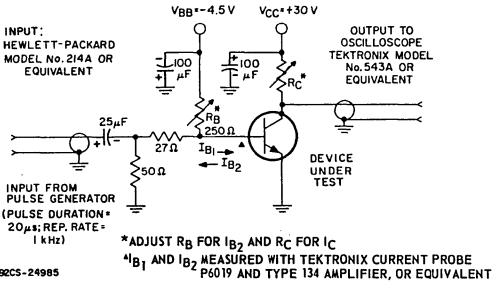


Fig. 4 - Circuit used to measure saturated switching times for all types.

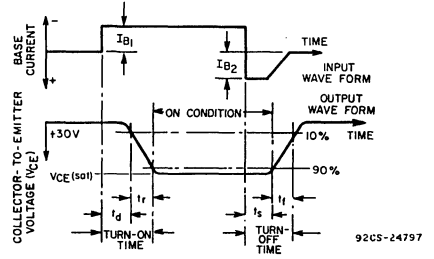


Fig. 5 - Oscilloscope display for measurement of switching times.

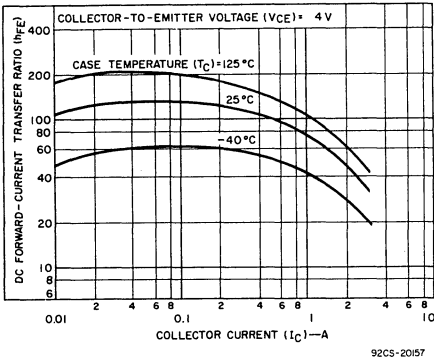


Fig. 6 - Typical dc beta characteristics for RCA29, RCA29A, and RCA29B.

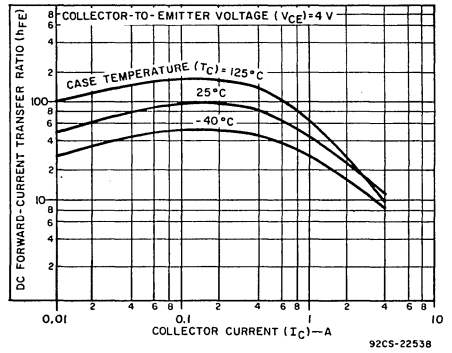


Fig. 7 - Typical dc beta characteristics for RCA29C.

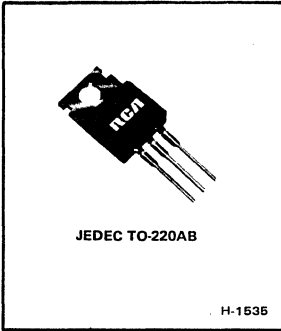
**TERMINAL CONNECTIONS**

- Lead No. 1 - Base
- Lead No. 2 - Collector
- Lead No. 3 - Emitter
- Mounting Flange, Lead No. 4 - Collector



# Power Transistors

## RCA29/SDH RCA29B/SDH RCA29A/SDH RCA29C/SDH



### Hometaxial-Base, Silicon N-P-N VERSAWATT Transistors

For Medium-Power Switching and  
Amplifier Applications

**Features:**

- 50 W at 25°C case temperature
- Low saturation voltage
- Maximum safe-area-of-operation curves
- Thermal-cycle rating curves

**TERMINAL CONNECTIONS**

- Terminal No.1 – Base
- Terminal No.2 – Collector
- Terminal No.3 – Emitter
- Mounting Flange,
- Terminal No.4 – Collector

RCA29/SDH, RCA29A/SDH, RCA29B/SDH, and RCA29C/SDH are single-diffused hometaxial-base silicon n-p-n transistors. These types are essentially hometaxial-base versions of the RCA29, RCA29A, RCA29B, and RCA29C epitaxial-base types, respectively.\* They are intended for a wide variety of switching and amplifier applications, such as series and shunt

regulators and driver and output stages of high-fidelity amplifiers. These new plastic power transistors differ from each other in voltage ratings and in the currents at which the parameters are controlled.

\* RCA29-series types are described in RCA data bulletin File No.583.

**MAXIMUM RATINGS, Absolute-Maximum Values:**

	RCA29/SDH	RCA29A/SDH	RCA29B/SDH	RCA29C/SDH	
COLLECTOR-TO-BASE VOLTAGE . . . . .	40	60	80	100	V <sub>CB0</sub> V
COLLECTOR-TO-EMITTER VOLTAGE:					
With base open. . . . .	40	60	80	100	V <sub>CEO</sub> V
EMITTER-TO-BASE VOLTAGE . . . . .	5	5	5	5	V <sub>EB0</sub> V
* CONTINUOUS COLLECTOR CURRENT . . . . .	4	4	4	2.5	I <sub>C</sub> A
CONTINUOUS BASE CURRENT. . . . .	1	1	1	1	I <sub>B</sub> A
* TRANSISTOR DISSIPATION:					P <sub>T</sub>
At case temperatures up to 25°C . . . . .	36	36	36	50	W
At ambient temperatures up to 25°C . . . . .	1.8	1.8	1.8	1.8	W
At case temperatures above 25°C . . . . .	See Fig.2				
At ambient temperatures above 25°C . . . . .	0.0144				W/°C
TEMPERATURE RANGE:					
Storage & Operating (Junction) . . . . .	-65 to 150				°C
TERMINAL TEMPERATURE (During Soldering):					
At distance 1/8 in. (3.17 mm) from case					
for 10 s max. . . . .	235				°C

\* Differs from RCA29 Series.



ELECTRICAL CHARACTERISTICS, At Case Temperature ( $T_C$ ) = 25°C

CHARACTERISTIC	SYMBOL	TEST CONDITIONS					LIMITS				UNITS
		DC VOLTAGE (V)			DC CURRENT (A)		RCA29/SDH		RCA29A/SDH		
		V <sub>CE</sub>	V <sub>EB</sub>	V <sub>BE</sub>	I <sub>C</sub>	I <sub>B</sub>	MIN.	MAX.	MIN.	MAX.	
Collector-Cutoff Current: With base open	I <sub>CEO</sub>	30				0	–	0.3	–	0.3	mA
With base-emitter junction short-circuited	I <sub>CES</sub>	40 60		0 0			– –	0.2 –	– –	– 0.2	
Emitter Cutoff Current	I <sub>EBO</sub>		5		0		–	1	–	1	mA
Collector-to-Emitter Break-down Voltage: With base open	V <sub>BR(CEO)</sub>				0.03 <sup>a</sup>	0	40	–	60	–	V
* DC Forward-Current Transfer Ratio	h <sub>FE</sub>	4 4			0.2 <sup>a</sup> 1 <sup>a</sup>		40 15	– –	40 15	– –	
Base-to-Emitter Voltage	V <sub>BE</sub>	4			1 <sup>a</sup>		–	1.3	–	1.3	V
Collector-to-Emitter Saturation Voltage	V <sub>CE(sat)</sub>				1 <sup>a</sup>	0.125	–	0.7	–	0.7	V
Common-Emitter, Small-Signal, Short-Circuit, Forward-Current Transfer Ratio (f = 1 kHz)	h <sub>fe</sub>	10			0.2		20	–	20	–	
* Magnitude of Common Emitter, Small-Signal, Short-Circuit, Forward-Current Transfer Ratio (f = 1 MHz)	h <sub>fe</sub>	10			0.2		0.8	–	0.8	–	
Unclamped Inductive Load Energy <sup>b</sup> (L = 20 mH) See Fig. 8		(V <sub>CC</sub> ) 10					–	32	–	32	mJ
* Saturated Switching Time: (R <sub>L</sub> = 30 Ω) See Figs. 10 and 11	t <sub>on</sub>	(V <sub>CC</sub> ) 30			1	0.1 <sup>c</sup>	2.3 (typ.)	5	2.3 (typ.)	5	μs
Turn-on time (t <sub>d</sub> + t <sub>r</sub> )	t <sub>off</sub>	(V <sub>CC</sub> ) 30			1	0.1 <sup>c</sup>	6 (typ.)	15	6 (typ.)	15	
* Thermal Resistance: Junction-to-Case	R <sub>θJC</sub>						–	3.5	–	3.5	°C/W
Junction-to-Ambient	R <sub>θJA</sub>						–	70	–	70	

\* Differs from RCA29 Series.

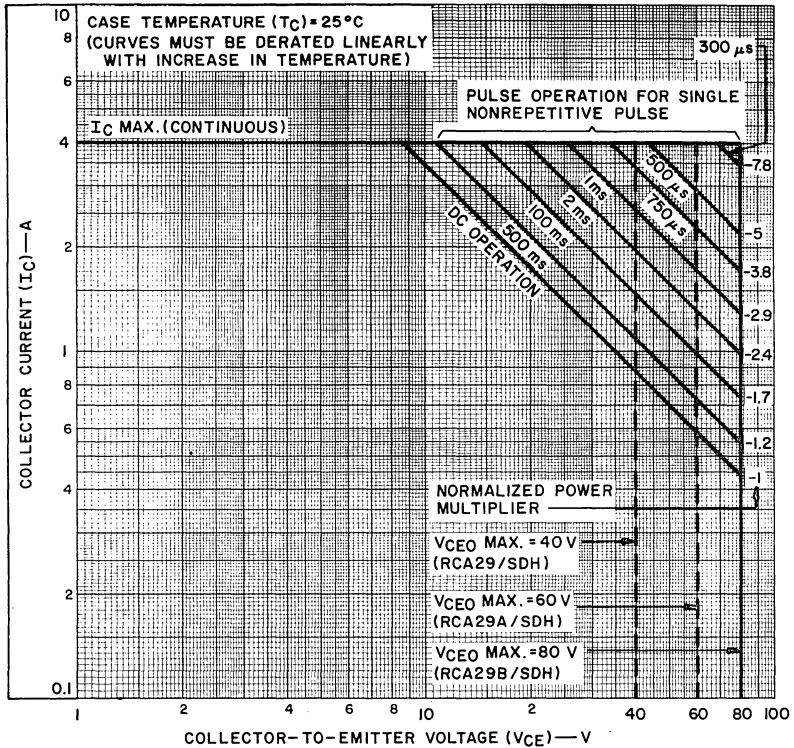
<sup>a</sup> Pulsed: Pulse duration = 300 μs, duty factor = 2%.<sup>b</sup> Based upon ability of device to perform in circuit shown in Fig. 8.<sup>c</sup> I<sub>B1</sub> = I<sub>B2</sub> = value shown.

ELECTRICAL CHARACTERISTICS, At Case Temperature ( $T_C$ ) = 25°C (Cont'd)

CHARACTERISTIC	SYMBOL	TEST CONDITIONS					LIMITS				UNITS
		DC VOLTAGE (V)			DC CURRENT (A)		RCA29B/SDH		RCA29C/SDH		
		V <sub>CE</sub>	V <sub>EB</sub>	V <sub>BE</sub>	I <sub>C</sub>	I <sub>B</sub>	MIN.	MAX.	MIN.	MAX.	
Collector-Cutoff Current: With base open	I <sub>CEO</sub>	60				0	—	0.3	—	0.3	mA
With base-emitter junction short-circuited	I <sub>CES</sub>	80 100		0 0			— —	0.2 —	— —	— 0.2	
Emitter Cutoff Current	I <sub>EBO</sub>		5		0		—	1	—	1	mA
Collector-to-Emitter Break-down Voltage: With base open	V <sub>BR(CEO)</sub>				0.03 <sup>a</sup>	0	80	—	100	—	V
* DC Forward-Current Transfer Ratio	h <sub>FE</sub>	4 4			0.2 <sup>a</sup> 1 <sup>a</sup>		40 15	— —	40 15	— —	
Base-to-Emitter Voltage	V <sub>BE</sub>	4			1 <sup>a</sup>		—	1.3	—	1.3	V
Collector-to-Emitter Saturation Voltage	V <sub>CE(sat)</sub>				1 <sup>a</sup>	0.125	—	0.7	—	0.7	V
Common-Emitter, Small-Signal, Short-Circuit, Forward-Current Transfer Ratio (f = 1 kHz)	h <sub>fe</sub>	10			0.2		20	—	20	—	
* Magnitude of Common Emitter, Small-Signal, Short-Circuit, Forward-Current Transfer Ratio (f = 1 MHz)	h <sub>fe</sub>	10			0.2		0.8	—	0.8	—	
Unclamped Inductive Load Energy <sup>b</sup> (L = 20 mH) See Fig.8		(V <sub>CC</sub> ) 10					—	32	—	32	mJ
* Saturated Switching Time: (R <sub>L</sub> = 30 Ω) See Figs. 10 and 11	t <sub>on</sub>	(V <sub>CC</sub> ) 30			1	0.1 <sup>c</sup>	2.3 (typ.)	5	2.3 (typ.)	5	μs
Turn-on time (t <sub>d</sub> + t <sub>r</sub> )											
Turn-off time (t <sub>s</sub> + t <sub>f</sub> )	t <sub>off</sub>	(V <sub>CC</sub> ) 30			1	0.1 <sup>c</sup>	6 (typ.)	15	6 (typ.)	15	
* Thermal Resistance: Junction-to-Case	R <sub>θJC</sub>						—	3.5	—	2.5	°C/W
Junction-to-Ambient	R <sub>θJA</sub>						—	70	—	70	

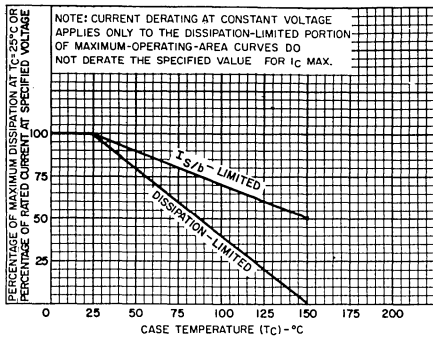
\* Differs from RCA29 Family.

<sup>b</sup> Based upon ability of device to perform in circuit shown in Fig.8.<sup>a</sup> Pulsed: Pulse duration = 300 μs, duty factor = 2%.<sup>c</sup> I<sub>B1</sub> = I<sub>B2</sub> = value shown.



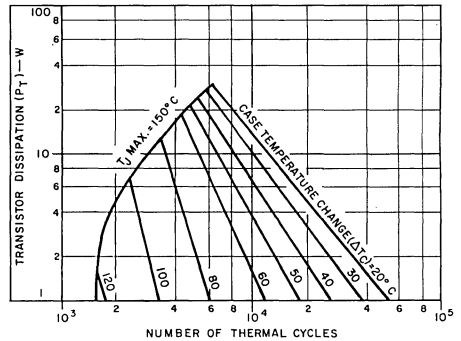
92CS-24197

Fig. 1 - Maximum operating areas for RCA29/SDH, RCA29A/SDH, and RCA29B/SDH.



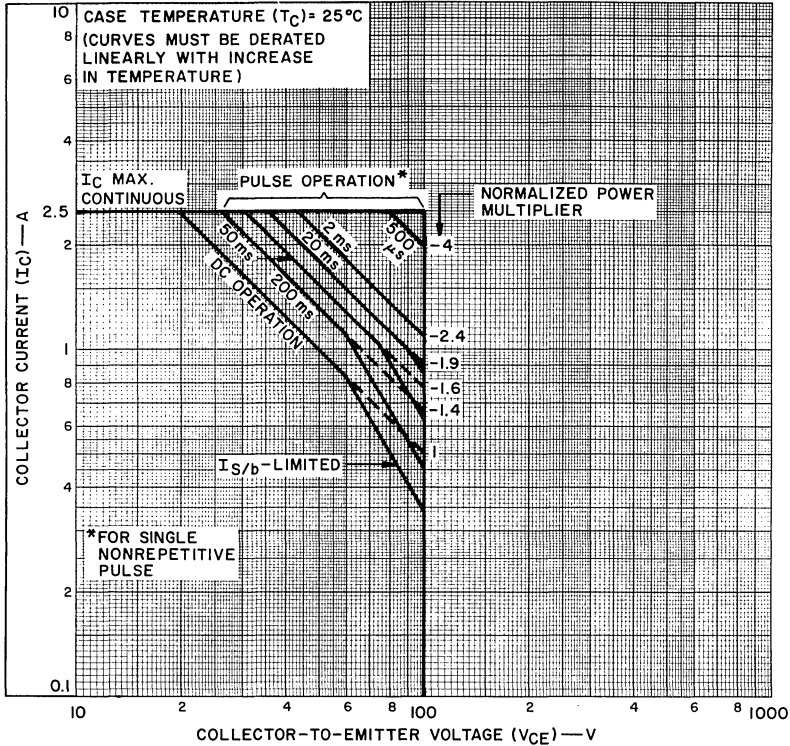
92CS-19663

Fig. 2 - Dissipation and  $I_{S/b}$  derating curves for all types.



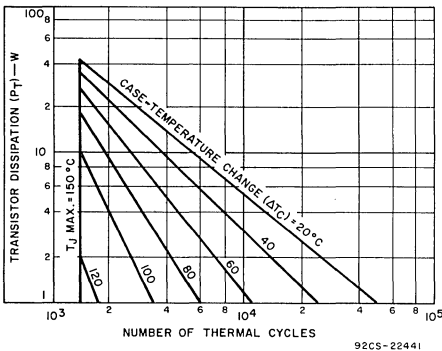
92CS-20108R1

Fig. 3 - Thermal-cycling rating chart for RCA29/SDH, RCA29A/SDH, and RCA29B/SDH.



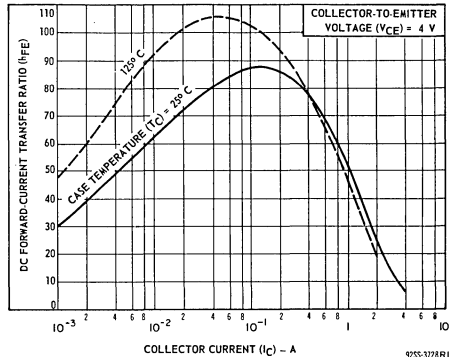
92CS-24198

Fig. 4 - Maximum operating areas for RCA29C/SDH.



92CS-22441

Fig. 5 - Thermal-cycling rating chart for RCA29C/SDH.



92SS-3728R1

Fig. 6 - Typical dc beta characteristics for RCA29/SDH, RCA29A/SDH, and RCA29B/SDH.

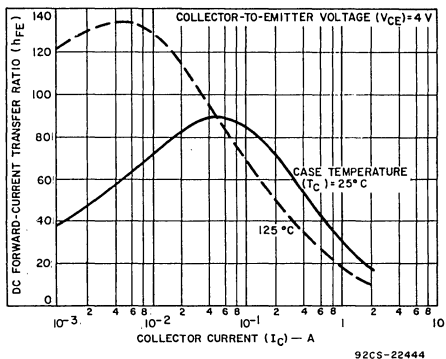


Fig. 7 — Typical dc beta characteristics for RCA29C/SDH.

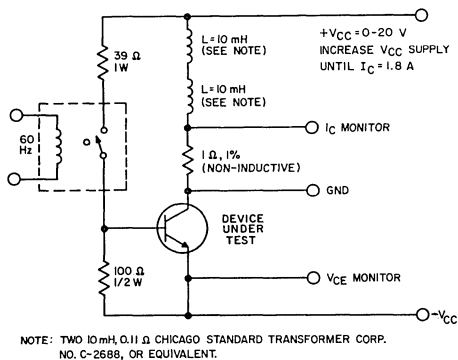


Fig. 8 — Circuit for measuring inductive-load switching for all types.

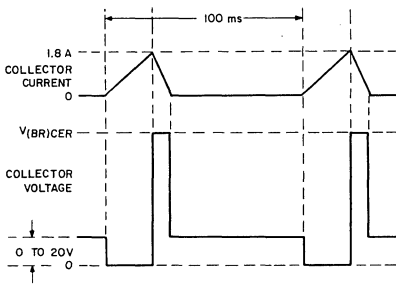


Fig. 9 — Inductive-load switching voltage and current waveforms (test circuit shown in Fig. 8).

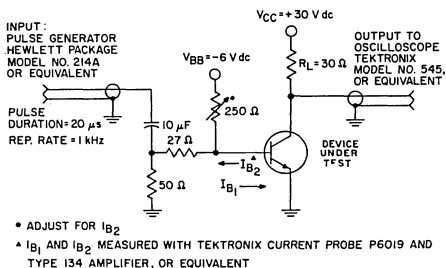


Fig. 10 — Circuit used to measure switching times for all types.

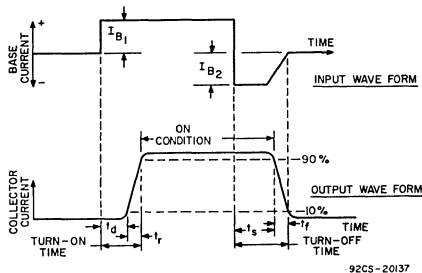


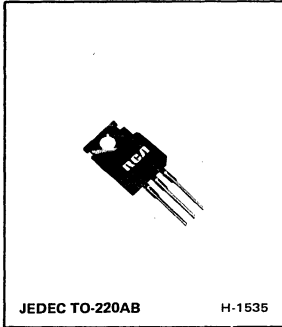
Fig. 11 — Phase relationship between input current and output voltage showing reference points for specification of switching times (test circuit shown in Fig. 10).

**Epitaxial-Base, Silicon P-N-P  
VERSAWATT Transistors**

For Power-Amplifier and  
High-Speed-Switching Applications

*Features:*

- 30 W at 25°C case temperature
- 3 A rated collector current
- Min.  $f_T$  of 3 MHz at 10 V, 200 mA
- Designed for complementary use with RCA29, RCA29A, RCA29B, and RCA29C n-p-n types\*



RCA30, RCA30A, RCA30B, and RCA30C are epitaxial-base, silicon p-n-p transistors. They are intended for a wide variety of switching and amplifier applications, such as series and shunt regulators and driver and output stages of high-fidelity amplifiers.

These new plastic power transistors are designed for complementary use with devices in the RCA29 series. They differ from each other in voltage ratings.

\* Technical data for the RCA29-series devices are given in RCA data bulletin File 583.

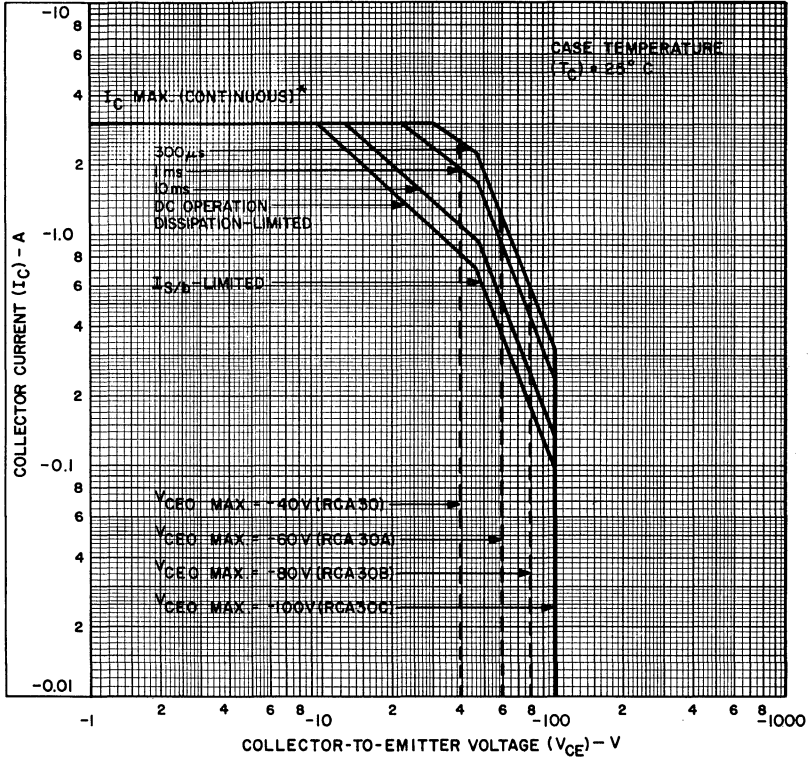
**MAXIMUM RATINGS, Absolute-Maximum Values:**

		<b>RCA30</b>	<b>RCA30A</b>	<b>RCA30B</b>	<b>RCA30C</b>	
COLLECTOR-TO-BASE VOLTAGE .....	$V_{CBO}$	-40	-60	-80	-100	V
COLLECTOR-TO-EMITTER VOLTAGE:						
With base open .....	$V_{CEO}$	-40	-60	-80	-100	V
EMITTER-TO-BASE VOLTAGE .....	$V_{EBO}$	-5	-5	-5	-5	V
CONTINUOUS COLLECTOR CURRENT .....	$I_C$	-3	-3	-3	-3	A
CONTINUOUS BASE CURRENT .....	$I_B$	-1	-1	-1	-1	A
TRANSISTOR DISSIPATION:	$P_T$					
At case temperatures up to 25°C .....		30	30	30	30	W
At ambient temperatures up to 25°C .....		2	2	2	2	W
TEMPERATURE RANGE:						
Storage and Operating (Junction) .....		←-----65 to 150-----→				°C
LEAD TEMPERATURE (During Soldering):						
At distance 1/8 in. (3.17 mm) from case for 10 s max. ...		←-----235-----→				°C

ELECTRICAL CHARACTERISTICS, At Case Temperature ( $T_C$ ) = 25°C

CHARACTERISTIC	SYMBOL	TEST CONDITIONS			LIMITS								UNITS	
		VOLTAGE V dc		CUR- RENT A dc	RCA30		RCA30A		RCA30B		RCA30C			
		V <sub>CE</sub>	V <sub>BE</sub>	I <sub>C</sub>	MIN.	MAX.	MIN.	MAX.	MIN.	MAX.	MIN.	MAX.		
Collector-Cutoff Current: With base open	I <sub>CEO</sub>	-30 -60			-	-0.3	-	-0.3	-	-	-	-	-	mA
With base-emitter junction short-circuited	I <sub>CES</sub>	-40 -60 -80 -100	0 0 0 0		-	-0.2	-	-	-	-	-	-	-	
Emitter-Cutoff Current	I <sub>EBO</sub>		5	0	-	-1	-	-1	-	-1	-	-1	-	mA
Collector-to-Emitter Sustaining Voltage: With base open	V <sub>CEO(sus)</sub>				-0.03 <sup>a</sup>	-40	-	-60	-	-80	-	-100	-	V
DC Forward-Current Transfer Ratio	h <sub>FE</sub>	-4 -4		-0.2 <sup>a</sup> -1 <sup>a</sup>	40 15	- 150	40 15	- 150	40 15	- 150	40 15	- 150	-	
Base-to-Emitter Voltage	V <sub>BE</sub>	-4		-1 <sup>a</sup>	-	-1.3	-	-1.3	-	-1.3	-	-1.3	-	V
Collector-to-Emitter Saturation Voltage: I <sub>B</sub> = -125 mA				-1 <sup>a</sup>	-	-0.7	-	-0.7	-	-0.7	-	-0.7	-	V
Common-Emitter Small-Signal, Short-Circuit, Forward Current Transfer Ratio: f = 1 kHz	h <sub>fe</sub>	-10		-0.2	20	-	20	-	20	-	20	-	-	
Magnitude of Common-Emitter, Small-Signal, Short-Circuit, Forward Current Transfer Ratio: f = 1 MHz	h <sub>fe</sub>	-10		-0.2	3	-	3	-	3	-	3	-	-	
Saturated Switching Time (V <sub>CC</sub> = -30 V, R <sub>L</sub> = 30 Ω, I <sub>B1</sub> = I <sub>B2</sub> = -0.1 A): Turn-on time t <sub>d</sub> + t <sub>r</sub>	t <sub>ON</sub>			-1	0.2 (typ.)		0.2 (typ.)		0.2 (typ.)		0.2 (typ.)		0.2 (typ.)	μs
Turn-off time t <sub>s</sub> + t <sub>f</sub>	t <sub>OFF</sub>			-1	1 (typ.)		1 (typ.)		1 (typ.)		1 (typ.)		1 (typ.)	
Thermal Resistance: Junction-to-Case	R <sub>θJC</sub>				-	4.17	-	4.17	-	4.17	-	4.17	-	°C/W
Junction-to-Ambient	R <sub>θJA</sub>				-	62.5	-	62.5	-	62.5	-	62.5	-	

<sup>a</sup> Pulsed: Pulse duration = 300 μs, duty factor = 2%.



92CS-20149

Fig. 1 - Maximum safe operating areas for all types.

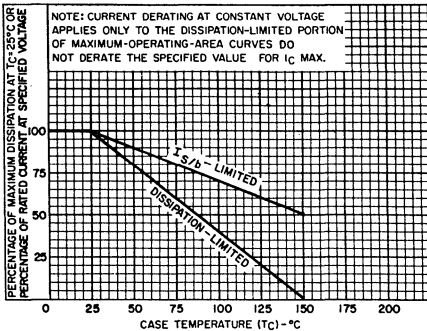


Fig. 2 - Derating curves for all types.

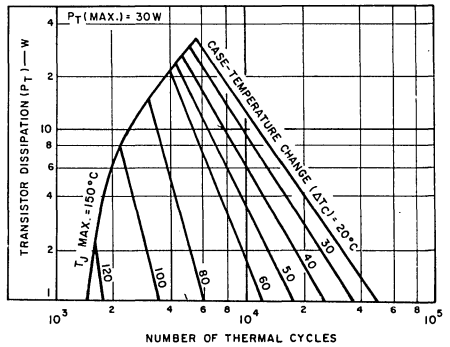
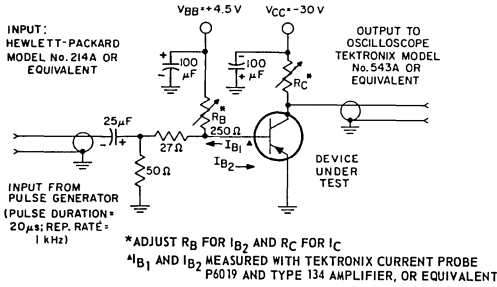


Fig. 3 - Thermal-cycling ratings for all types.





92CS-24796

Fig. 4 - Circuit used to measure saturated switching times for all types.

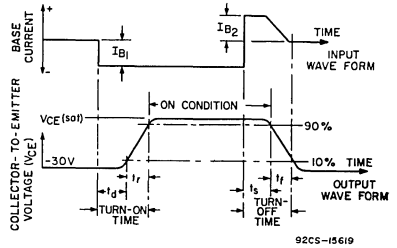


Fig. 5 - Oscilloscope display for measurement of switching times.

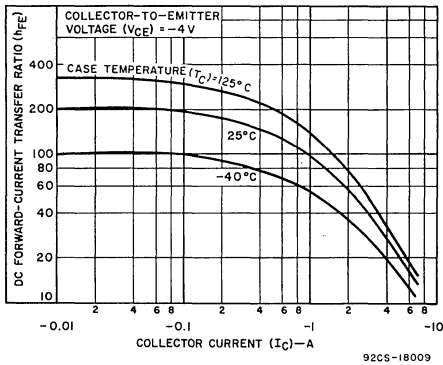


Fig. 6 - Typical dc beta characteristics for RCA30, RCA30A, and RCA30B.

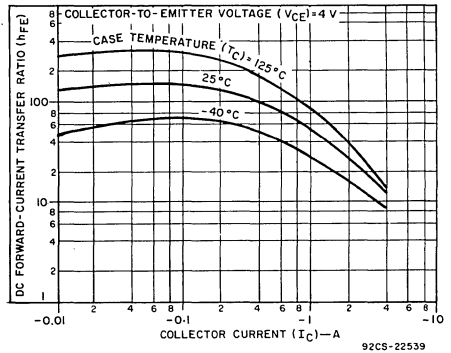


Fig. 7 - Typical dc beta characteristics for RCA30C.

**TERMINAL CONNECTIONS**

- Lead No. 1 - Base
- Lead No. 2 - Collector
- Lead No. 3 - Emitter
- Mounting Flange, Lead No. 4 - Collector



# Power Transistors

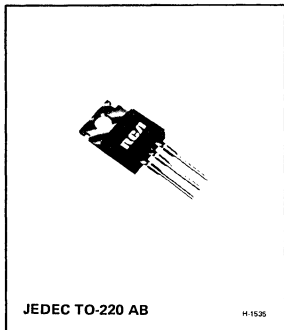
RCA31 RCA31B  
RCA31A RCA31C

## Epitaxial-Base, Silicon N-P-N VERSAWATT Transistors

For Power-Amplifier and  
High-Speed-Switching Applications

*Features:*

- 40 W at 25°C case temperature
- 5 A rated collector current
- Min.  $f_T$  of 3 MHz at 10 V, 500 mA
- Designed for complementary use with RCA32, RCA32A, RCA32B, and RCA32C p-n-p types\*



RCA31, RCA31A, RCA31B, and RCA31C are epitaxial-base, silicon p-n-p transistors. They are intended for a wide variety of switching and amplifier applications, such as series and shunt regulators and driver and output stages of high-fidelity amplifiers.

These new plastic power transistors are designed for complementary use with devices in the RCA32 series. They differ from each other in voltage ratings.

\* Technical data for the RCA32-series devices are given in RCA data bulletin File 586.

**MAXIMUM RATINGS, Absolute-Maximum Values:**

	RCA31	RCA31A	RCA31B	RCA31C	
COLLECTOR-TO-BASE VOLTAGE .....	$V_{CBO}$	40	60	80	100 V
COLLECTOR-TO-EMITTER VOLTAGE:					
With base open .....	$V_{CEO}$	40	60	80	100 V
EMITTER-TO-BASE VOLTAGE .....	$V_{EBO}$	5	5	5	5 V
CONTINUOUS COLLECTOR CURRENT .....	$I_C$	5	5	5	5 A
CONTINUOUS BASE CURRENT .....	$I_B$	1	1	1	1 A
TRANSISTOR DISSIPATION:	$P_T$				
At case temperatures up to 25°C .....		40	40	40	40 W
At ambient temperatures up to 25°C .....		2	2	2	2 W
TEMPERATURE RANGE:					
Storage and Operating (Junction) .....		←----- -65 to 150 -----→			°C
LEAD TEMPERATURE (During Soldering):					
At distance 1/8 in. (3.17 mm) from case for 10 s max. . .		←----- 235 -----→			°C

ELECTRICAL CHARACTERISTICS, At Case Temperature ( $T_C$ ) = 25°C

CHARACTERISTIC	SYMBOL	TEST CONDITIONS			LIMITS								UNITS
		VOLTAGE V dc		CUR- RENT A dc	RCA31		RCA31A		RCA31B		RCA31C		
		V <sub>CE</sub>	V <sub>BE</sub>	I <sub>C</sub>	MIN.	MAX.	MIN.	MAX.	MIN.	MAX.	MIN.	MAX.	
Collector-Cutoff Current: With base open	I <sub>CEO</sub>	30			—	0.3	—	0.3	—	—	—	—	mA
		60			—	—	—	—	—	0.3	—	0.3	
	I <sub>CES</sub>	40	0		—	0.2	—	—	—	—	—	—	
		60	0		—	—	—	0.2	—	—	—	—	
		80	0		—	—	—	—	0.2	—	—		
		100	0		—	—	—	—	—	—	0.2		
Emitter-Cutoff Current	I <sub>EBO</sub>		-5	0	—	1	—	1	—	1	—	1	mA
Collector-to-Emitter Sustaining Voltage: With base open	V <sub>CEO(sus)</sub>			0.03 <sup>a</sup>	40	—	60	—	80	—	100	—	V
DC Forward-Current Transfer Ratio	h <sub>FE</sub>	4		1 <sup>a</sup>	25	—	25	—	25	—	25	—	
		4		3 <sup>a</sup>	10	50	10	50	10	50	10	50	
Base-to-Emitter Voltage	V <sub>BE</sub>	4		3 <sup>a</sup>	—	1.8	—	1.8	—	1.8	—	1.8	V
Collector-to-Emitter Saturation Voltage: I <sub>B</sub> = 375 mA				3 <sup>a</sup>	—	1.2	—	1.2	—	1.2	—	1.2	V
Common-Emitter Small- Signal, Short-Circuit, Forward Current Transfer Ratio: f = 1 kHz	h <sub>fe</sub>	10		0.5	20	—	20	—	20	—	20	—	
Magnitude of Common- Emitter, Small-Signal, Short-Circuit, For- ward Current Transfer Ratio: f = 1 MHz	h <sub>fe</sub>	10		0.5	3	—	3	—	3	—	3	—	
Saturated Switching Time (V <sub>CC</sub> = 30 V, R <sub>L</sub> = 30 Ω, I <sub>B1</sub> = I <sub>B2</sub> = 0.1A): Turn-on-time t <sub>d</sub> + t <sub>r</sub>	t <sub>ON</sub>			1	0.4 (typ.)		0.4 (typ.)		0.4 (typ.)		0.4 (typ.)		μs
	t <sub>OFF</sub>			1	1.2 (typ.)		1.2 (typ.)		1.2 (typ.)		1.2 (typ.)		
Thermal Resistance: Junction-to-Case	R <sub>θJC</sub>				—	3.125	—	3.125	—	3.125	—	3.125	°C/W
					—	62.5	—	62.5	—	62.5	—	62.5	
Junction-to-Ambient	R <sub>θJA</sub>				—	62.5	—	62.5	—	62.5	—	62.5	

<sup>a</sup> Pulsed: Pulse duration = 300 μs, duty factor = 2 %.

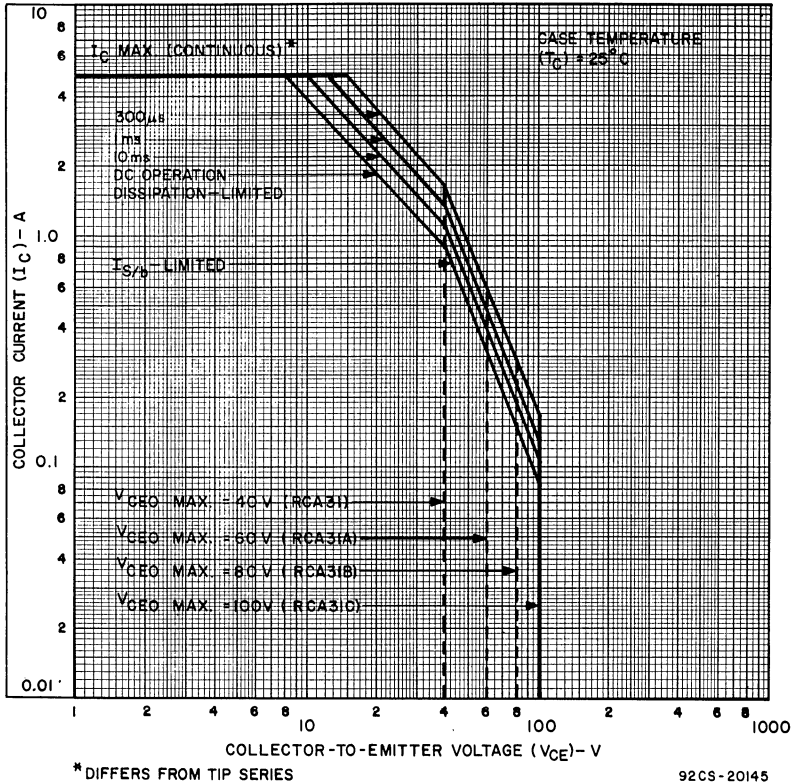


Fig. 1 - Maximum safe operating areas for all types.

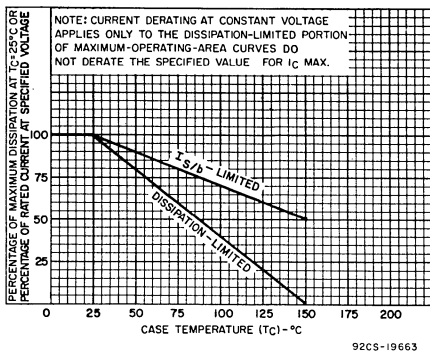


Fig. 2 - Derating curves for all types.

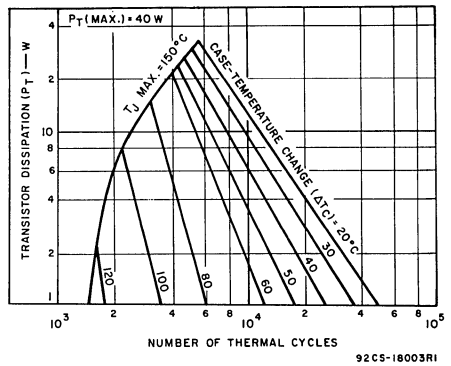
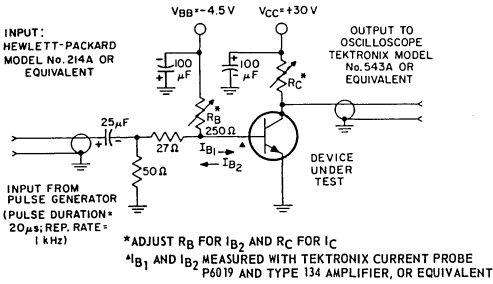
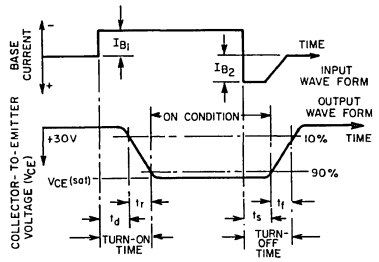


Fig. 3 - Thermal-cycling ratings for all types.



92CS-24985

Fig. 4 — Circuit used to measure saturated switching times for all types.



92CS-24797

Fig. 5 — Oscilloscope display for measurement of switching times.

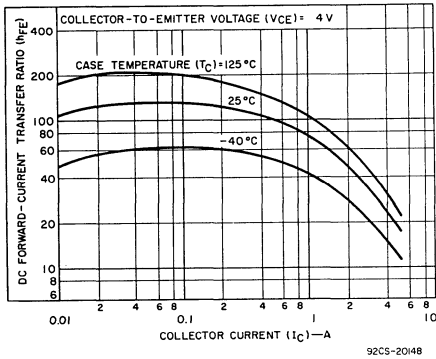


Fig. 6 — Typical dc beta characteristics for RCA31, RCA31A, and RCA31B.

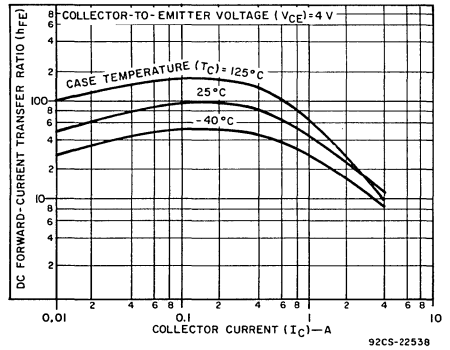


Fig. 7 — Typical dc beta characteristics for RCA31C.

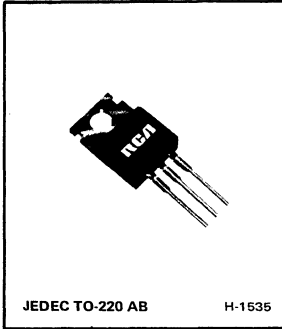
**TERMINAL CONNECTIONS**

- Lead No. 1 — Base
- Lead No. 2 — Collector
- Lead No. 3 — Emitter
- Mounting Flange, Lead No. 4 — Collector



# Power Transistors

**RCA31/SDH    RCA31B/SDH**  
**RCA31A/SDH    RCA31C/SDH**



## Hometaxial-Base, Silicon N-P-N VERSAWATT Transistors

For Medium-Power Switching and  
 Amplifier Applications

*Features:*

- 50 W at 25°C case temperature
- Low saturation voltage
- Maximum safe-area-of-operation curves
- Thermal-cycle ratings curves

**TERMINAL CONNECTIONS**

- Terminal No. 1 – Base
- Terminal No. 2 – Collector
- Terminal No. 3 – Emitter
- Mounting Flange Terminal No. 4 – Collector

RCA31/SDH, RCA31A/SDH, RCA31B/SDH, and RCA31C/SDH are single-diffused hometaxial-base, silicon n-p-n transistors. These types are essentially hometaxial-base versions of the RCA31, RCA31A, RCA31B, and RCA31C epitaxial-base types, respectively. • They are intended for a wide variety of switching and amplifier applications, such as series and shunt

regulators and driver and output stages of high-fidelity amplifiers. These new plastic power-transistors differ from each other in voltage ratings and in the currents at which the parameters are controlled.

• RCA31-series types are described in RCA data bulletin File No. 585.

**MAXIMUM RATINGS, Absolute-Maximum Values:**

	RCA31/SDH	RCA31A/SDH	RCA31B/SDH	RCA31C/SDH	
COLLECTOR-TO-BASE VOLTAGE ..... $V_{CBO}$	40	60	80	100	V
COLLECTOR-TO-EMITTER VOLTAGE:					
With base open ..... $V_{CEO}$	40	60	80	100	V
EMITTER-TO-BASE VOLTAGE ..... $V_{EBO}$	5	5	5	5	V
* CONTINUOUS COLLECTOR CURRENT ..... $I_C$	4	4	4	2.5	A
CONTINUOUS BASE CURRENT ..... $I_B$	1	1	1	1	A
TRANSISTOR DISSIPATION: $P_T$					
At case temperatures up to 25°C .....	36	36	36	50	W
At ambient temperatures up to 25°C .....	1.8	1.8	1.8	1.8	W
At case temperatures above 25°C .....	See Fig. 2				
At ambient temperatures above 25°C.....Derate linearly	0.0144				W/°C
TEMPERATURE RANGE:					
Storage and Operating (Junction) .....	-65 to 150				°C
TERMINAL TEMPERATURE (During Soldering):					
At distance 1/8 in. (3.17 mm) from case for 10 s max.	235				°C

\*Differs from RCA31 Series.

ELECTRICAL CHARACTERISTICS, At Case Temperature ( $T_C$ ) = 25°C

CHARACTERISTIC	SYMBOL	TEST CONDITIONS					LIMITS				UNITS
		DC VOLTAGE (V)			DC CURRENT (A)		RCA31/SDH		RCA31A/SDH		
		V <sub>CE</sub>	V <sub>EB</sub>	V <sub>BE</sub>	I <sub>C</sub>	I <sub>B</sub>	MIN.	MAX.	MIN.	MAX.	
Collector-Cutoff Current: With base open	I <sub>CEO</sub>	30				0	—	0.3	—	0.3	mA
With base-emitter junction short-circuited	I <sub>CES</sub>	40 60		0 0			— —	0.2 —	— —	— 0.2	
Emitter-Cutoff Current	I <sub>EBO</sub>		5		0		—	1	—	1	mA
Collector-to-Emitter Breakdown Voltage: With base open	V <sub>BR(CEO)</sub>				0.03 <sup>a</sup>	0	40	—	60	—	V
* DC Forward-Current Transfer Ratio	h <sub>FE</sub>	4 4			1 <sup>a</sup> 3 <sup>a</sup>		25 10	— —	25 10	— —	
Base-to-Emitter Voltage	V <sub>BE</sub>	4			3 <sup>a</sup>		—	1.8	—	1.8	V
Collector-to-Emitter Saturation Voltage	V <sub>CE(sat)</sub>				3 <sup>a</sup>	0.375	—	1.2	—	1.2	V
Common-Emitter, Small-Signal, Short-Circuit, Forward-Current Transfer Ratio (f = 1 kHz)	h <sub>fe</sub>	10			0.5		20	—	20	—	
* Magnitude of Common-Emitter, Small-Signal, Short-Circuit, Forward-Current Transfer Ratio (f = 1 MHz)	h <sub>fe</sub>	10			0.5		0.8	—	0.8	—	
Unclamped Inductive Load Energy <sup>b</sup> (L = 20 mH) See Fig. 8		(V <sub>CC</sub> ) 10					—	32	—	32	mJ
* Saturated Switching Time: (R <sub>L</sub> = 30 Ω) See Figs. 10 and 11 Turn-on-time (t <sub>d</sub> + t <sub>r</sub> )	t <sub>on</sub>	(V <sub>CC</sub> ) 30			1	0.1 <sup>c</sup>	2.3 (typ.)	5	2.3 (typ.)	5	μs
* Turn-off time (t <sub>s</sub> + t <sub>f</sub> )	t <sub>off</sub>	(V <sub>CC</sub> ) 30			1	0.1 <sup>c</sup>	6 (typ.)	15	6 (typ.)	15	
* Thermal Resistance Junction-to-Case	R <sub>θJC</sub>						—	3.5	—	3.5	°C/W
Junction-to-Ambient	R <sub>θJA</sub>						—	70	—	70	

\*Differs from RCA31 Series.

•Pulsed: Pulse duration = 300 μs, duty factor = 2%.

<sup>b</sup>Based upon ability of device to perform in circuit shown in Fig. 8.<sup>c</sup>I<sub>B1</sub> = I<sub>B2</sub> = value shown.

ELECTRICAL CHARACTERISTICS, At Case Temperature ( $T_C$ ) = 25°C (cont'd)

CHARACTERISTIC	SYMBOL	TEST CONDITIONS					LIMITS				UNITS
		DC VOLTAGE (V)			DC CURRENT (A)		RCA31B/SDH		RCA31C/SDH		
		V <sub>CE</sub>	V <sub>EB</sub>	V <sub>BE</sub>	I <sub>C</sub>	I <sub>B</sub>	MIN.	MAX.	MIN.	MAX.	
Collector-Cutoff Current: With base open	I <sub>CEO</sub>	60				0	—	0.3	—	0.3	mA
With base-emitter junction short-circuited	I <sub>CES</sub>	80 100		0 0			— —	0.2 —	— —	— 0.2	
Emitter-Cutoff Current	I <sub>EBO</sub>		5		0		—	1	—	1	mA
Collector-to-Emitter Breakdown Voltage: With base open	V <sub>BR(CEO)</sub>				0.03 <sup>a</sup>	0	80	—	100	—	V
* DC Forward-Current Transfer Ratio	h <sub>FE</sub>	4 4			1 <sup>a</sup> 3 <sup>a</sup>		25 10	— —	25 10	— —	
Base-to-Emitter Voltage	V <sub>BE</sub>	4			3 <sup>a</sup>		—	1.8	—	1.8	V
Collector-to-Emitter Saturation Voltage	V <sub>CE(sat)</sub>				3 <sup>a</sup>	0.375	—	1.2	—	1.2	V
Common-Emitter, Small-Signal, Short-Circuit, Forward-Current Transfer Ratio (f = 1 kHz)	h <sub>fe</sub>	10			0.5		20	—	20	—	
* Magnitude of Common-Emitter, Small-Signal, Short-Circuit, Forward-Current Transfer Ratio (f = 1 MHz)	h <sub>fe</sub>	10			0.5		0.8	—	0.8	—	
Unclamped Inductive Load Energy <sup>b</sup> (L = 20 mH) See Fig. 8		(V <sub>CC</sub> ) 10					—	32	—	32	mJ
* Saturated Switching Time: (R <sub>L</sub> = 30 Ω) See Figs. 10 and 11 Turn-on-time (t <sub>d</sub> + t <sub>r</sub> )	t <sub>on</sub>	(V <sub>CC</sub> ) 30			1	0.1 <sup>c</sup>	2.3 (typ.)	5	2.3 (typ.)	5	μs
* Turn-off time (t <sub>s</sub> + t <sub>f</sub> )	t <sub>off</sub>	(V <sub>CC</sub> ) 30			1	0.1 <sup>c</sup>	6 (typ.)	15	6 (typ.)	15	
* Thermal Resistance Junction-to-Case	R <sub>θJC</sub>						—	3.5	—	2.5	°C/W
Junction-to-Ambient	R <sub>θJA</sub>						—	70	—	70	

\*Differs from RCA31 Series.

\*Pulsed: Pulse duration = 300 μs, duty factor = 2%.

<sup>b</sup>Based upon ability of device to perform in circuit shown in Fig. 8.<sup>c</sup>I<sub>B1</sub> = I<sub>B2</sub> = value shown.



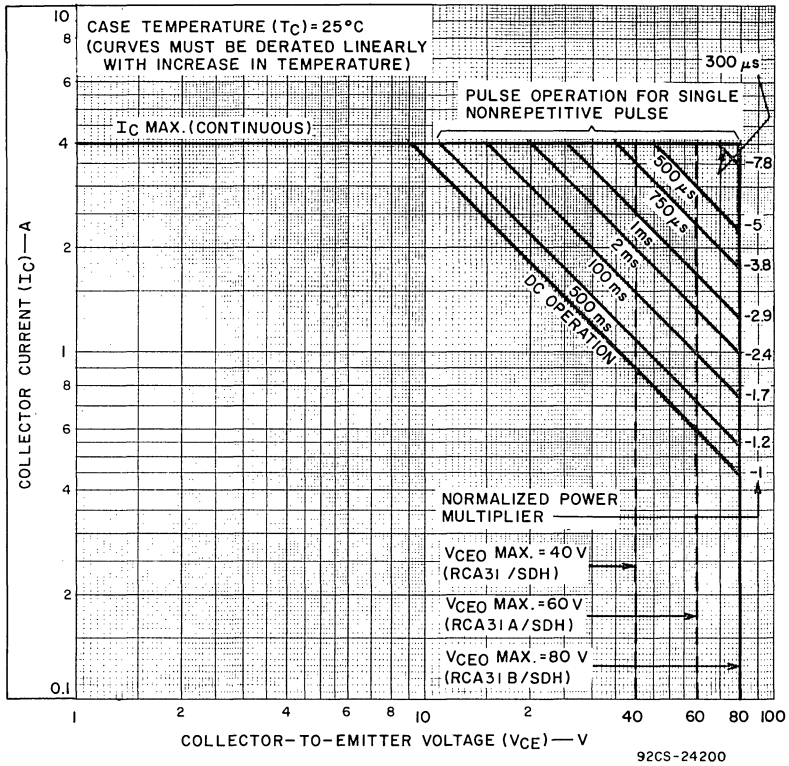


Fig. 1 — Mounting operating areas for RCA31/SDH, RCA31A/SDH, and RCA31B/SDH.

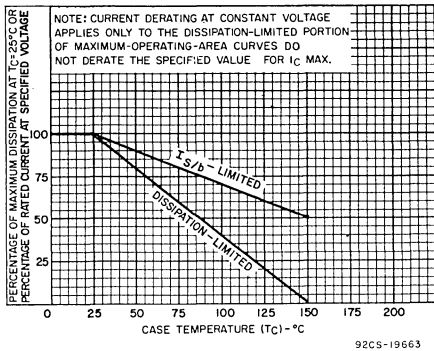


Fig. 2 — Dissipation and  $I_{S/b}$  derating curves for all types.

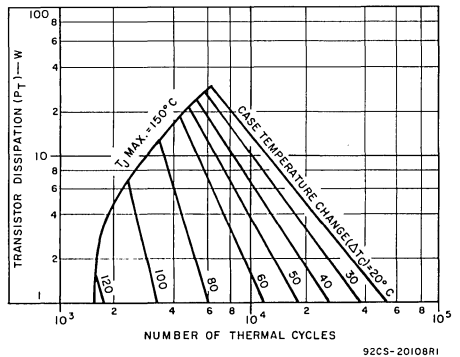


Fig. 3 — Thermal-cycling rating chart for RCA31/SDH, RCA31A/SDH, and RCA31B/SDH.

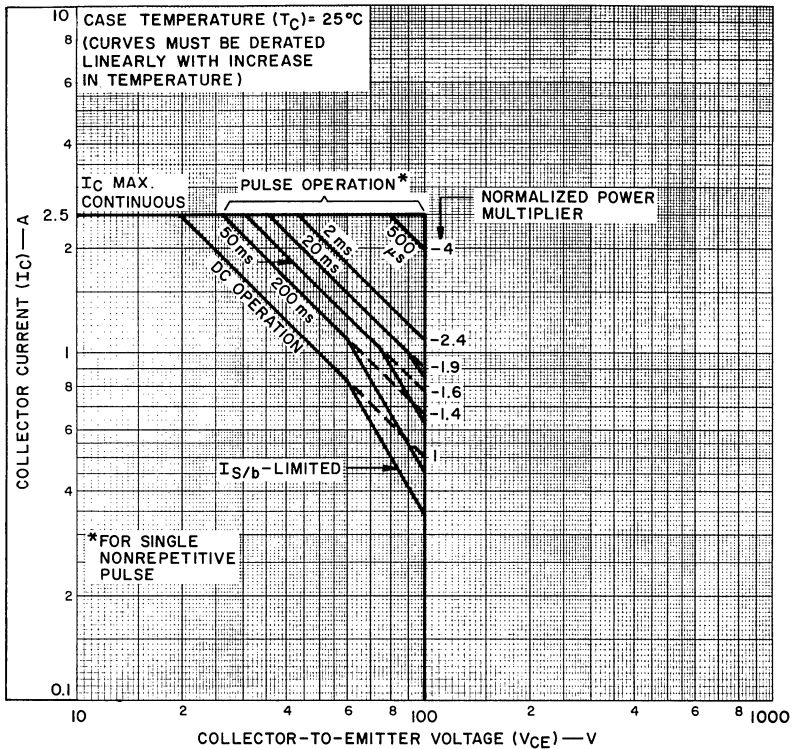


Fig. 4 — Maximum operating areas for RCA31C/SDH.

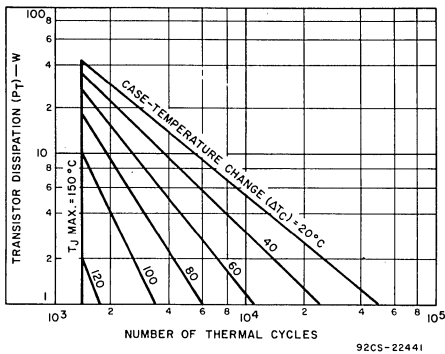


Fig. 5 — Thermal-cycling rating chart for RCA31C/SDH.

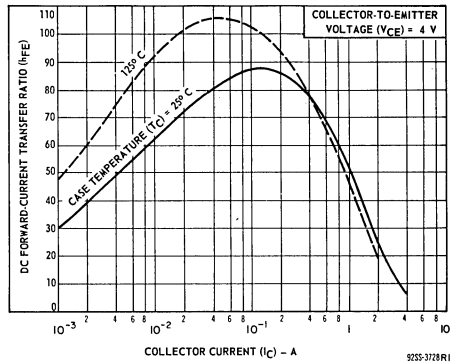


Fig. 6 — Typical dc beta characteristics for RCA31/SDH, RCA31A/SDH, and RCA31B/SDH.

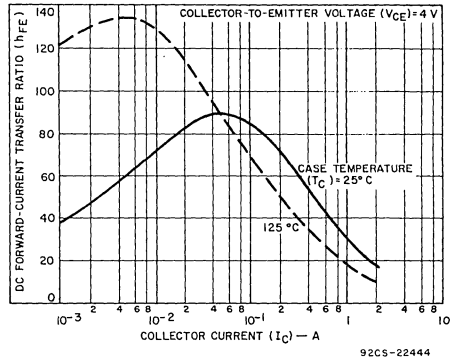


Fig. 7 – Typical dc beta characteristics for RCA31C/SDH.

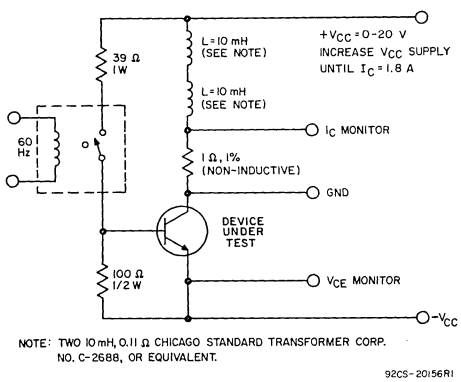


Fig. 8 – Circuit for measuring inductive-load switching for all types.

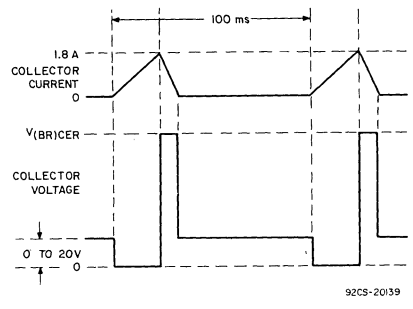


Fig. 9 – Inductive-load voltage and current waveforms (test circuit shown in Fig. 8).

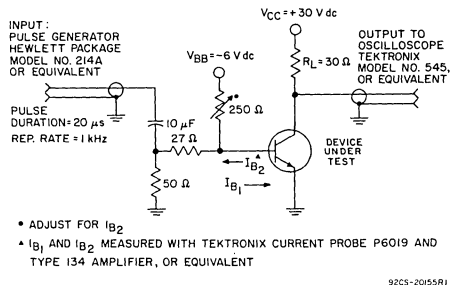


Fig. 10 – Circuit used to measure switching times for all types.

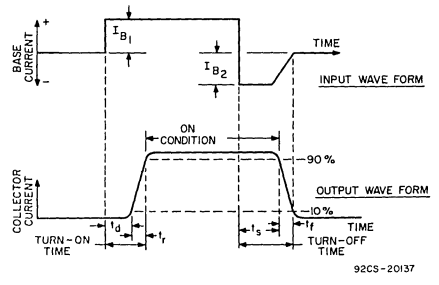
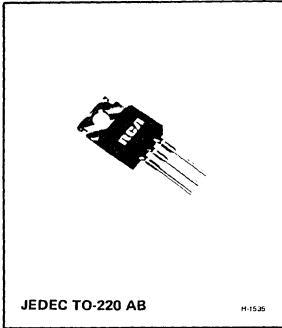


Fig. 11 – Phase relationship between input current and output voltage showing reference points for specification of switching times (test circuit shown in Fig. 10).



# Power Transistors

**RCA32 RCA32B  
RCA32A RCA32C**



## Epitaxial-Base, Silicon P-N-P VERSAWATT Transistors

For Power-Amplifier and  
High-Speed-Switching Applications

**Features:**

- 40 W at 25°C case temperature
- 5 A rated collector current
- Min.  $f_T$  of 3 MHz at 10 V, 500 mA
- Designed for complementary use with RCA31, RCA31A, RCA31B, and RCA31C n-p-n types\*

RCA30, RCA30A, RCA30B, and RCA30C are epitaxial-base, silicon p-n-p transistors. They are intended for a wide variety of switching and amplifier applications, such as series and shunt regulators and driver and output stages of high-fidelity amplifiers.

These new plastic power transistors are designed for complementary use with devices in the RCA31 series. They differ from each other in voltage ratings.

\* Technical data for the RCA32 series devices are given in RCA data bulletin File 583.

**MAXIMUM RATINGS, Absolute-Maximum Values:**

		RCA32	RCA32A	RCA32B	RCA32C	
COLLECTOR-TO-BASE VOLTAGE . . . . .	$V_{CBO}$	-40	-60	-80	-100	V
COLLECTOR-TO-EMITTER VOLTAGE: With base open . . . . .	$V_{CEO}$	-40	-60	-80	-100	V
EMITTER-TO-BASE VOLTAGE . . . . .	$V_{EBO}$	-5	-5	-5	-5	V
CONTINUOUS COLLECTOR CURRENT . . . . .	$I_C$	-5	-5	-5	-5	A
CONTINUOUS BASE CURRENT . . . . .	$I_B$	-1	-1	-1	-1	A
TRANSISTOR DISSIPATION: At case temperatures up to 25°C . . . . .	$P_T$	40	40	40	40	W
At ambient temperatures up to 25°C . . . . .		2	2	2	2	W
TEMPERATURE RANGE: Storage and Operating (Junction) . . . . .		←----- -65 to 150 -----→				°C
LEAD TEMPERATURE (During Soldering): At distance 1/8 in. (3.17 mm) from case for 10 s max. . . . .		←----- 235 -----→				°C

**TERMINAL CONNECTIONS**

- Lead No. 1 – Base
- Lead No. 2 – Collector
- Lead No. 3 – Emitter
- Mounting Flange, Lead No. 4 – Collector

ELECTRICAL CHARACTERISTICS, At Case Temperature ( $T_C$ ) = 25°C

CHARACTERISTIC	SYMBOL	TEST CONDITIONS			LIMITS								UNITS		
		VOLTAGE V dc		CUR- RENT A dc	RCA32		RCA32A		RCA32B		RCA32C				
		V <sub>CE</sub>	V <sub>BE</sub>	I <sub>C</sub>	MIN.	MAX.	MIN.	MAX.	MIN.	MAX.	MIN.	MAX.			
Collector-Cutoff Current: With base open	I <sub>CEO</sub>	-30			-	-0.3	-	-0.3	-	-	-	-	mA		
		-60			-	-	-	-	-	-0.3	-	-0.3			
With base-emitter junction short-circuited	I <sub>CES</sub>	-40	0		-	-0.2	-	-	-	-	-	-	mA		
		-60	0		-	-	-	-0.2	-	-	-	-			
		-80	0		-	-	-	-	-	-0.2	-	-			
		-100	0		-	-	-	-	-	-	-	-0.2			
Emitter-Cutoff Current	I <sub>EBO</sub>		5	0	-	-1	-	-1	-	-1	-	-1	mA		
Collector-to-Emitter Sustaining Voltage: With base open	V <sub>CEO(sus)</sub>				-0.03 <sup>a</sup>	-40	-	-60	-	-80	-	-100	-	V	
DC Forward-Current Transfer Ratio	h <sub>FE</sub>	-4		-1 <sup>a</sup>	25	-	25	-	25	-	25	-	25	-	
		-4		-3 <sup>a</sup>	10	50	10	50	10	50	10	50			
Base-to-Emitter Voltage	V <sub>BE</sub>	-4		-3 <sup>a</sup>	-	-1.8	-	-1.8	-	-1.8	-	-1.8	-	V	
Collector-to-Emitter Saturation Voltage: I <sub>B</sub> = -375 mA					-3 <sup>a</sup>	-	-1.2	-	-1.2	-	-1.2	-	-1.2	V	
Common-Emitter Small-Signal, Short-Circuit, Forward Current Transfer Ratio: f = 1 kHz	h <sub>fe</sub>	-10		-0.5	20	-	20	-	20	-	20	-			
Magnitude of Common-Emitter, Small-Signal, Short-Circuit, Forward Current Transfer Ratio: f = 1 MHz	h <sub>fe</sub>	-10		-0.5	3	-	3	-	3	-	3	-			
Saturated Switching Time (V <sub>CC</sub> = -30 V, R <sub>L</sub> = 30 Ω, I <sub>B1</sub> = I <sub>B2</sub> = -0.1 A): Turn-on-time t <sub>d</sub> + t <sub>r</sub>	t <sub>ON</sub>				-1		0.2 (typ.)		0.2 (typ.)		0.2 (typ.)		0.2 (typ.)	μs	
	Turn-off time t <sub>s</sub> + t <sub>f</sub>	t <sub>OFF</sub>			-1		1 (typ.)		1 (typ.)		1 (typ.)		1 (typ.)		
Thermal Resistance: Junction-to-Case	R <sub>θJC</sub>				-	3.125	-	3.125	-	3.125	-	3.125	-	°C/W	
Junction-to-Ambient	R <sub>θJA</sub>				-	62.5	-	62.5	-	62.5	-	62.5	-		

<sup>a</sup> Pulsed: Pulse duration = 300 μs, duty factor = 2 %.

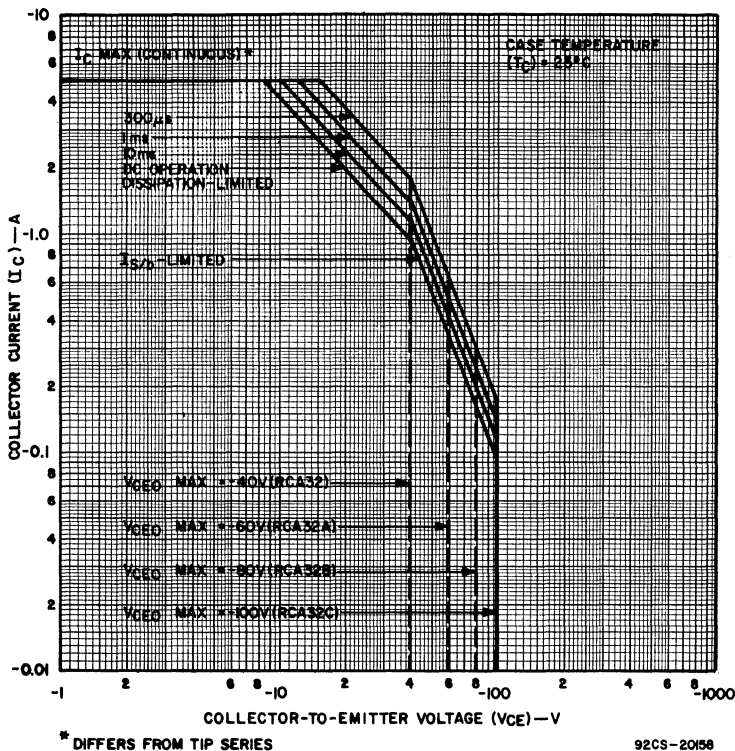


Fig. 1 - Maximum safe operating areas for all types.

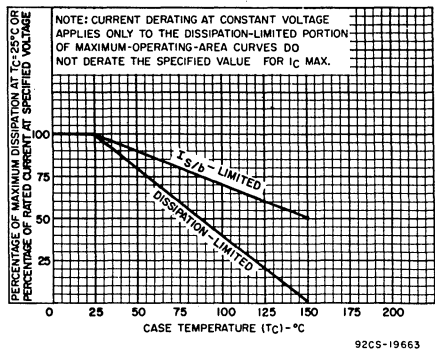


Fig. 2 - Derating curves for all types.

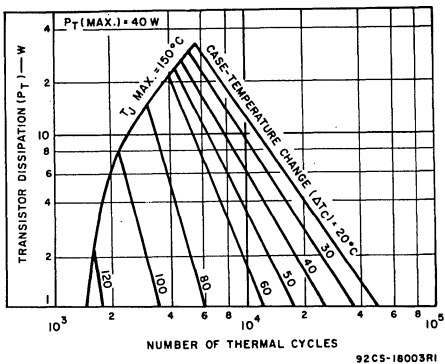
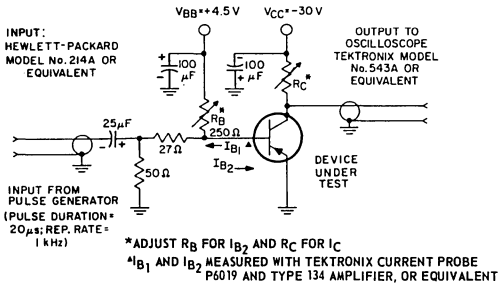


Fig. 3 - Thermal-cycling ratings for all types.



92CS-24796

Fig. 4 - Circuit used to measure saturated switching times for all types.

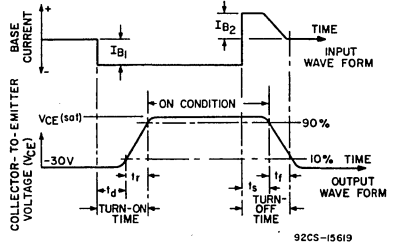


Fig. 5 - Oscilloscope display for measurement of switching times.

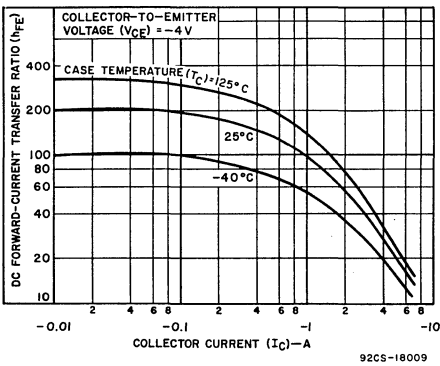


Fig. 6 - Typical dc beta characteristics for RCA31, RCA31A, and RCA31B.

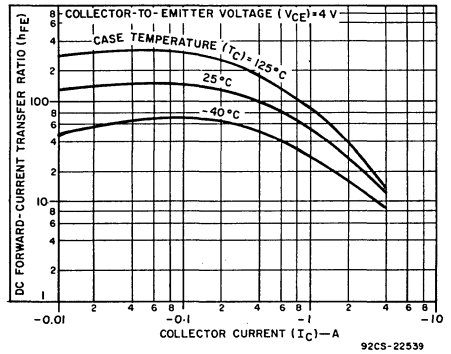


Fig. 7 - Typical dc beta characteristics for RCA31C.



## Power Transistors

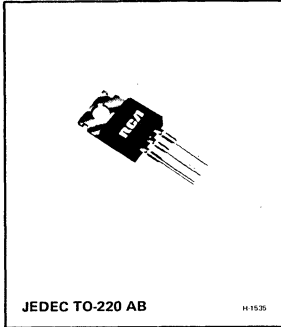
RCA41 RCA41B  
RCA41A RCA41C

### Epitaxial-Base, Silicon N-P-N VERSAWATT Transistors

For Power-Amplifier and  
High-Speed-Switching Applications

#### Features:

- 65 W at 25°C case temperature
- 7 A rated collector current
- Min.  $f_T$  of 3 MHz at 10 V, 500 mA
- Designed for complementary use with RCA42, RCA42A, RCA42B, and RCA42C p-n-p types



JEDEC TO-220 AB

H1535

RCA41, RCA41A, RCA41B, and RCA41C are epitaxial-base, silicon n-p-n transistors. They are intended for a wide variety of switching and amplifier applications, such as series and shunt regulators and driver and output stages of high-fidelity

amplifiers. These new plastic power transistors are designed for complementary use with devices in the RCA42 series. • They differ from each other in voltage ratings.

- RCA42-series transistors are described in RCA data bulletin File No. 588.

#### MAXIMUM RATINGS, Absolute-Maximum Values:

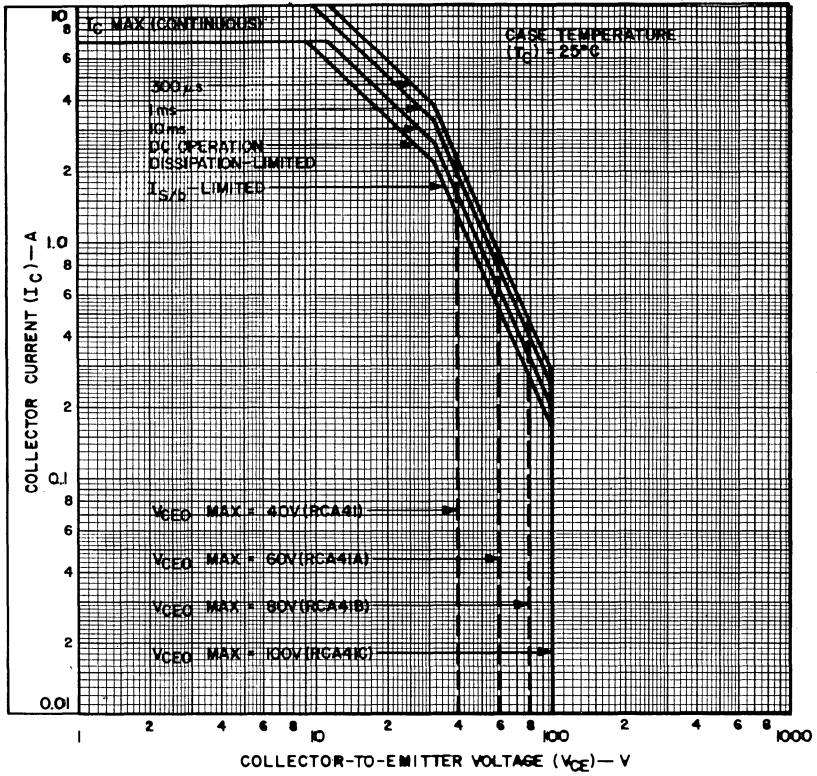
		RCA41	RCA41A	RCA41B	RCA41C	
COLLECTOR-TO-BASE VOLTAGE . . . . .	$V_{CBO}$	40	60	80	100	V
COLLECTOR-TO-EMITTER VOLTAGE:						
With base open . . . . .	$V_{CEO}$	40	60	80	100	V
EMITTER-TO-BASE VOLTAGE . . . . .	$V_{EBO}$	5	5	5	5	V
CONTINUOUS COLLECTOR CURRENT . . . . .	$I_C$	7	7	7	7	A
PEAK COLLECTOR CURRENT . . . . .		10	10	10	10	A
CONTINUOUS BASE CURRENT . . . . .	$I_B$	3	3	3	3	A
TRANSISTOR DISSIPATION:	$P_T$					
At case temperatures up to 25°C . . . . .		65	65	65	65	W
At ambient temperatures up to 25°C . . . . .		2	2	2	2	W
TEMPERATURE RANGE:						
Storage & Operating (Junction) . . . . .		←----- -65 to 150 -----→				°C
LEAD TEMPERATURE (During Soldering):						
At distance 1/8 in. (3.17 mm) from case for 10 s max. . . . .		←----- 235 -----→				°C



ELECTRICAL CHARACTERISTICS, At Case Temperature ( $T_C$ ) = 25°C

CHARACTERISTIC	SYMBOL	TEST CONDITIONS				LIMITS								UNITS	
		DC VOLTAGE (V)		DC CURRENT (A)		RCA41		RCA41A		RCA41B		RCA41C			
		V <sub>CE</sub>	V <sub>BE</sub>	I <sub>C</sub>	I <sub>B</sub>	MIN.	MAX.	MIN.	MAX.	MIN.	MAX.	MIN.	MAX.		
Collector-Cutoff Current: With base open	I <sub>CEO</sub>	30 60			0 0	— —	0.7 —	— —	0.7 —	— —	— 0.7	— —	— 0.7	mA	
With base-emitter junction short-circuited	I <sub>CES</sub>	40 60 80 100	0 0 0 0			— — — —	0.4 — — —	— — — —	— — — —	— — 0.4 —	— — — —	— — — 0.4			
Emitter-Cutoff Current	I <sub>EBO</sub>		5	0		—	1	—	1	—	1	—	1		mA
Collector-to-Emitter Sustaining Voltage: With base open	V <sub>CEO(sus)</sub>			0.03 <sup>a</sup>	0	40	—	60	—	80	—	100	—		V
DC Forward-Current Transfer Ratio	h <sub>FE</sub>	4 4		0.3 <sup>a</sup> 3 <sup>a</sup>		30 15	— 150	30 15	— 150	30 15	— 150	30 15	— 150		
Base-to-Emitter Voltage	V <sub>BE</sub>	4		6 <sup>a</sup>		—	2.2	—	2.2	—	2.2	—	2.2	V	
Collector-to-Emitter Saturation Voltage	V <sub>CE(sat)</sub>			6 <sup>a</sup>	0.6	—	2	—	2	—	2	—	2	V	
Common-Emitter, Small-Signal, Forward-Current Transfer Ratio (f = 1 kHz)	h <sub>fe</sub>	10		0.5		20	—	20	—	20	—	20	—		
Magnitude of Common-Emitter, Small-Signal, Forward-Current Transfer Ratio (f = 1 MHz)	h <sub>fe</sub>	10		0.5		3	—	3	—	3	—	3	—		
Saturated Switching Time: (R <sub>L</sub> = 5 Ω) See Figs. 5 and 6 Turn-on time t <sub>d</sub> + t <sub>r</sub>	t <sub>ON</sub>	(V <sub>CC</sub> ) 30		6	0.6 <sup>b</sup>	0.6 (typ.)		0.6 (typ.)		0.6 (typ.)		0.6 (typ.)		μs	
Turn-off Time t <sub>s</sub> + t <sub>f</sub>	t <sub>OFF</sub>	(V <sub>CC</sub> ) 30		6	0.6 <sup>b</sup>	1.4 (typ.)		1.4 (typ.)		1.4 (typ.)		1.4 (typ.)			
Thermal Resistance: Junction-to-Case	R <sub>θJC</sub>					—	1.92	—	1.92	—	1.92	—	1.92	°C/W	
Junction-to-Ambient	R <sub>θJA</sub>					—	62.5	—	62.5	—	62.5	—	62.5		

<sup>a</sup>Pulsed: Pulse duration = 300 μs, duty factor ≤ 2%<sup>b</sup>I<sub>B1</sub> = I<sub>B2</sub> = value shown



92CS-20135

Fig. 1—Maximum safe operating areas for all types

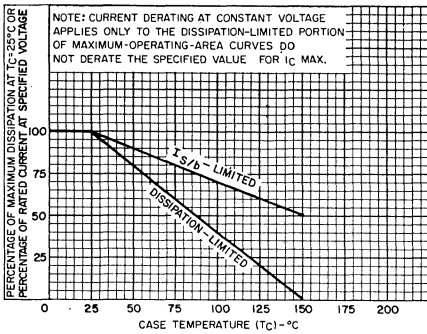


Fig. 2—Derating curves for all types.

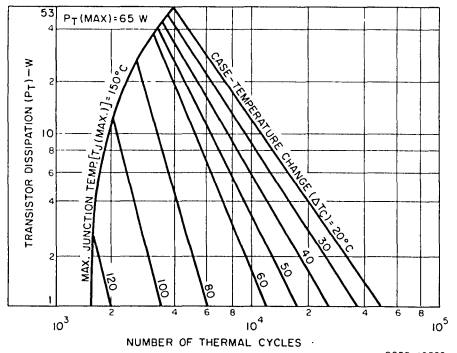


Fig. 3—Thermal-cycling ratings for all types.

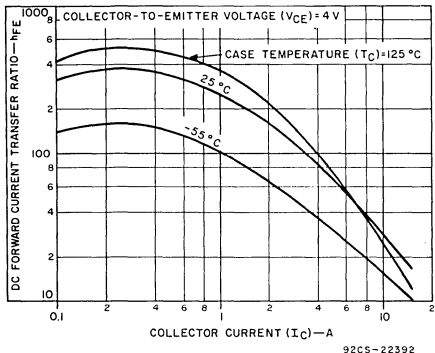


Fig. 4—Typical dc beta characteristics for all types.

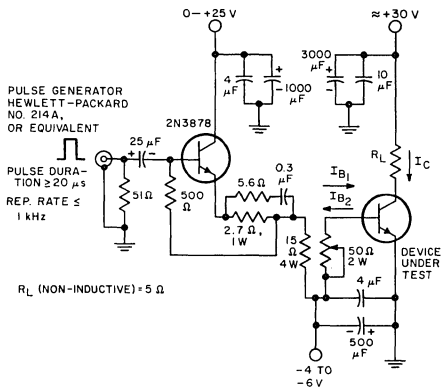


Fig. 5—Circuit used to measure switching times for all types.

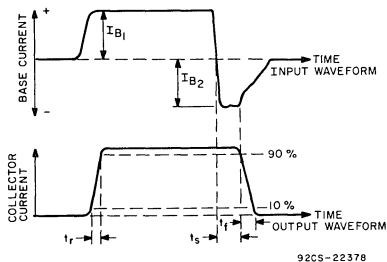


Fig. 6—Phase relationship between input and output currents showing reference points for specification of switching times (Test circuit shown in Fig. 5).

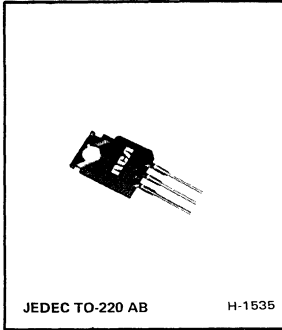
### TERMINAL CONNECTIONS

- Lead No. 1—Base
- Lead No. 2—Collector
- Lead No. 3—Emitter
- Mounting Flange, Lead No. 4—Collector



# Power Transistors

## RCA41A/SDH RCA41B/SDH



### Hometaxial-Base, Silicon N-P-N VERSAWATT Transistors

For Medium-Power Switching and  
Amplifier Applications

*Features:*

- 75 W at 25°C case temperature
- Low saturation voltage
- Maximum safe-area-of-operation curves
- Thermal-cycle rating curves

**TERMINAL CONNECTIONS**

- Terminal No. 1 – Base
- Terminal No. 2 – Collector
- Terminal No. 3 – Emitter
- Mounting Flange Terminal No. 4 – Collector

RCA41/SDH, RCA41A/SDH, and RCA41B/SDH are single-diffused hometaxial-base, silicon n-p-n transistors. These types are essentially hometaxial-base versions of the RCA41, RCA41A, and RCA41B epitaxial-base types, respectively. They are intended for a wide variety of switching and amplifier

applications, such as series and shunt regulators and driver and output stages of high-fidelity amplifiers. These new plastic power transistors differ from each other in voltage ratings.

\*RCA-41 series types are described in RCA data bulletin File No. 587.

**MAXIMUM RATINGS, Absolute-Maximum Values:**

		RCA41/SDH	RCA41A/SDH	RCA41B/SDH	
COLLECTOR-TO-BASE VOLTAGE .....	$V_{CBO}$	40	60	80	V
COLLECTOR-TO-EMITTER VOLTAGE:					
With base open .....	$V_{CEO}$	40	60	80	V
EMITTER-TO-BASE VOLTAGE .....	$V_{EBO}$	5	5	5	V
* CONTINUOUS COLLECTOR CURRENT .....	$I_C$	16	10	10	A
* CONTINUOUS BASE CURRENT .....	$I_B$	4	4	4	A
* TRANSISTOR DISSIPATION:	$P_T$				
At case temperatures up to 25°C .....		75	75	75	W
At ambient temperatures up to 25°C .....		1.8	1.8	1.8	W
At case temperatures above 25°C .....		See Fig. 2			
At ambient temperatures above 25°C .....	Derate linearly ..	0.0144			W/°C
TEMPERATURE RANGE:					
Storage & Operating (Junction) .....		-65 to 150			°C
TERMINAL TEMPERATURE (During Soldering):					
At distance 1/8 in. (3.17 mm) from case for 10 s max. ....		235			°C

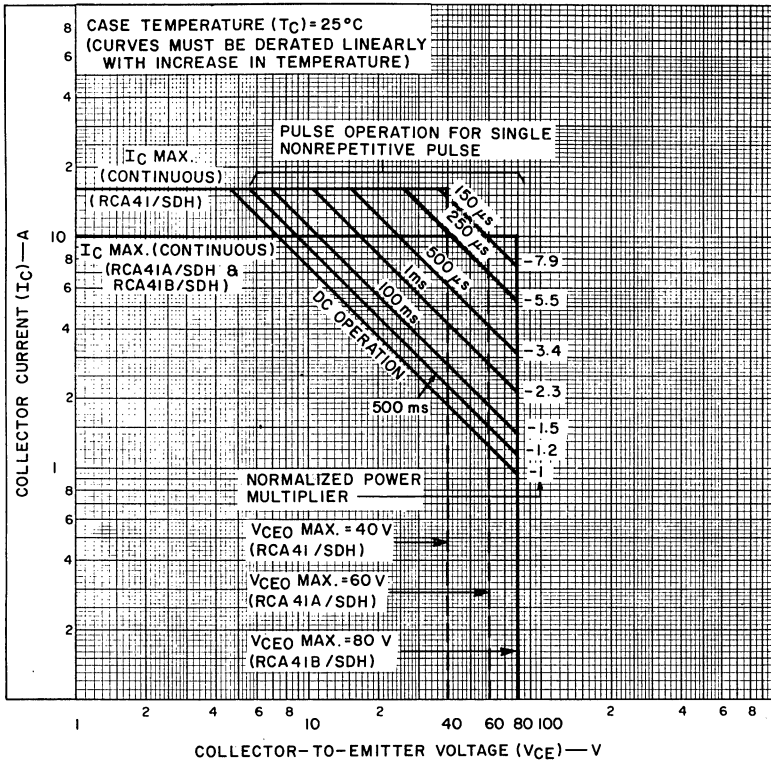
\* Differs from RCA41 Series.

ELECTRICAL CHARACTERISTICS, At Case Temperature ( $T_C$ ) = 25°C

CHARACTERISTIC	SYMBOL	TEST CONDITIONS					LIMITS						UNITS
		DC VOLTAGE (V)			DC CURRENT (A)		RCA41/SDH		RCA41A/SDH		RCA41B/SDH		
		V <sub>CE</sub>	V <sub>EB</sub>	V <sub>BE</sub>	I <sub>C</sub>	I <sub>B</sub>	MIN.	MAX.	MIN.	MAX.	MIN.	MAX.	
Collector-Cutoff Current: With base open	I <sub>CEO</sub>	30 60				0 0	— —	0.7 —	— —	0.7 —	— —	— 0.7	mA
With base-emitter junction short-circuited	I <sub>CES</sub>	40 60 80		0 0 0			— — —	0.4 — —	— — —	— 0.4 —	— — —	— — 0.4	
Emitter-Cutoff Current	I <sub>EBO</sub>		5		0		—	1	—	1	—	1	mA
Collector-to-Emitter Sustaining Voltage: With base open	V <sub>CEO(sus)</sub>				0.03 <sup>a</sup>	0	40	—	60	—	80	—	V
* DC Forward-Current Transfer Ratio	h <sub>FE</sub>	4 4			0.3 <sup>a</sup> 3 <sup>a</sup>		30 15	— —	30 15	— —	30 15	— —	
Base-to-Emitter Voltage	V <sub>BE</sub>	4			6 <sup>a</sup>		—	2.2	—	2.2	—	2.2	V
Collector-to-Emitter Saturation Voltage	V <sub>CE(sat)</sub>				6 <sup>a</sup>	0.6	—	2	—	2	—	2	V
Common-Emitter, Small-Signal, Forward-Current Transfer Ratio (f = 1 kHz)	h <sub>fe</sub>	10			0.5		20	—	20	—	20	—	
* Magnitude of Common-Emitter, Small-Signal, Forward-Current Transfer Ratio (f = 1 MHz)	h <sub>fe</sub>	10			0.5		0.8	—	0.8	—	0.8	—	
Unclamped Inductive Load Energy <sup>b</sup> (L = 20 mH) (See Fig.5)		(V <sub>CC</sub> ) 10					—	62.5	—	62.5	—	62.5	mJ
* Saturated Switching Time: (R <sub>L</sub> = 5Ω) See Figs. 7 and 8 Turn-on time (t <sub>d</sub> + t <sub>r</sub> )	t <sub>on</sub>	(V <sub>CC</sub> ) 30			6	0.6 <sup>c</sup>	3.2 (typ.)	10	3.2 (typ.)	10	3.2 (typ.)	10	μs
Turn-off Time (t <sub>s</sub> + t <sub>f</sub> )	t <sub>off</sub>	(V <sub>CC</sub> ) 30			6	0.6 <sup>c</sup>	3.7 (typ.)	20	3.7 (typ.)	20	3.7 (typ.)	20	
* Thermal Resistance: Junction-to-Case	R <sub>θJC</sub>						—	1.67	—	1.67	—	1.67	°C/W
Junction-to-Ambient	R <sub>θJA</sub>						—	70	—	70	—	70	

\*Differs from RCA41 Series.

<sup>a</sup>Pulsed: Pulse duration = 300 μs, duty factor ≤ 2%.<sup>b</sup>Based upon ability of device to perform in circuit shown in Fig. 5.<sup>c</sup>I<sub>B1</sub> = I<sub>B2</sub> = value shown.



92CS-24199

Fig. 1 — Maximum safe operating areas for all types.

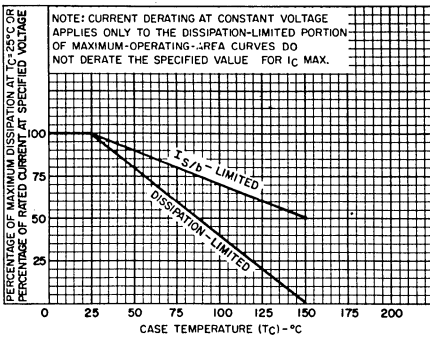


Fig. 2 — Dissipation and  $I_S/I_B$  derating curves for all types.

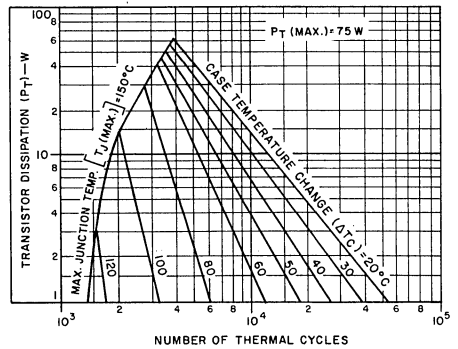


Fig. 3 — Thermal-cycling rating chart for all types.

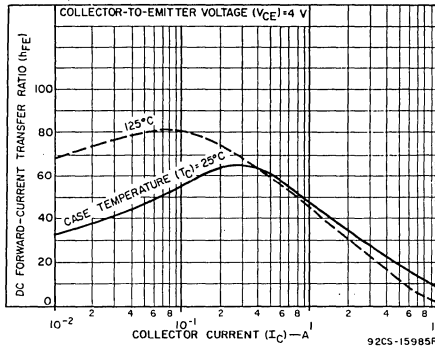
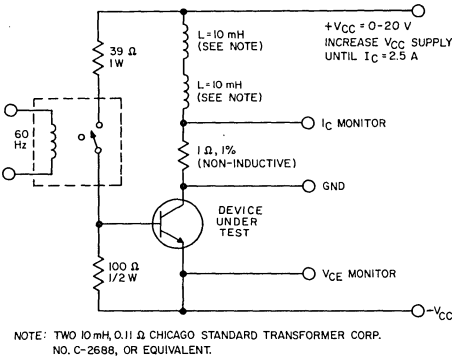
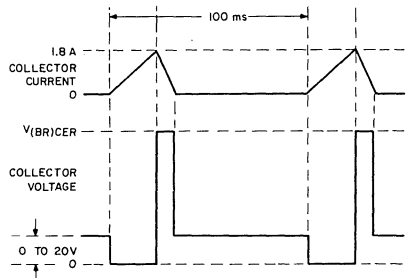


Fig. 4 - Typical dc-beta characteristics for all types.



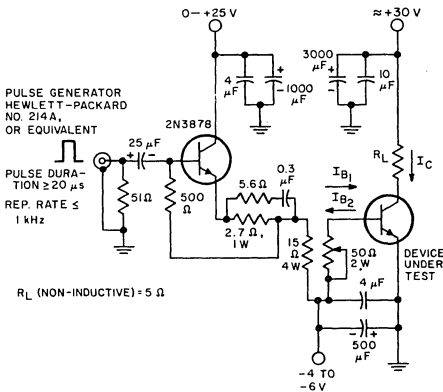
92CS-20138

Fig. 5 - Circuit for measuring inductive-load switching for all types.



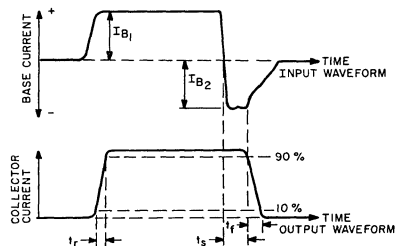
92CS-20139

Fig. 6 - Inductive-load switching voltage and curve waveforms (test circuit shown in Fig. 5).



92CS-23337

Fig. 7 - Circuit used to measure switching times for all types.



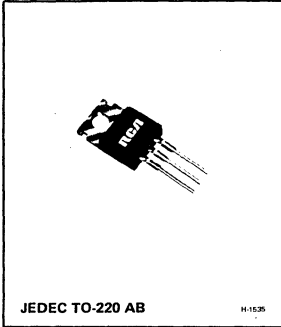
92CS-23378

Fig. 8 - Phase relationship between input and output currents showing reference points for specification of switching times (test circuit shown in Fig. 7).



# Power Transistors

RCA42    RCA42B  
RCA42A    RCA42C



## Epitaxial-Base, Silicon P-N-P VERSAWATT Transistors

For Power-Amplifier and  
High-Speed-Switching Applications

*Features:*

- 65 W at 25°C case temperature
- 7 A rated collector current
- Min.  $f_T$  of 3 MHz at 10 V, 500 mA
- Designed for complementary use with RCA41, RCA41A, RCA41B, and RCA41C n-p-n types.

RCA42, RCA42A, RCA42B, and RCA42C are epitaxial-base, silicon p-n-p transistors. They are intended for a wide variety of switching and amplifier applications, such as series and shunt regulators and driver and output stages of high-fidelity amplifiers.

These new plastic power transistors are designed for complementary use with devices in the RCA41 series. • They differ from each other in voltage ratings.

• RCA41-series transistors are described in RCA data bulletin File No. 587.

**MAXIMUM RATINGS, Absolute-Maximum Values:**

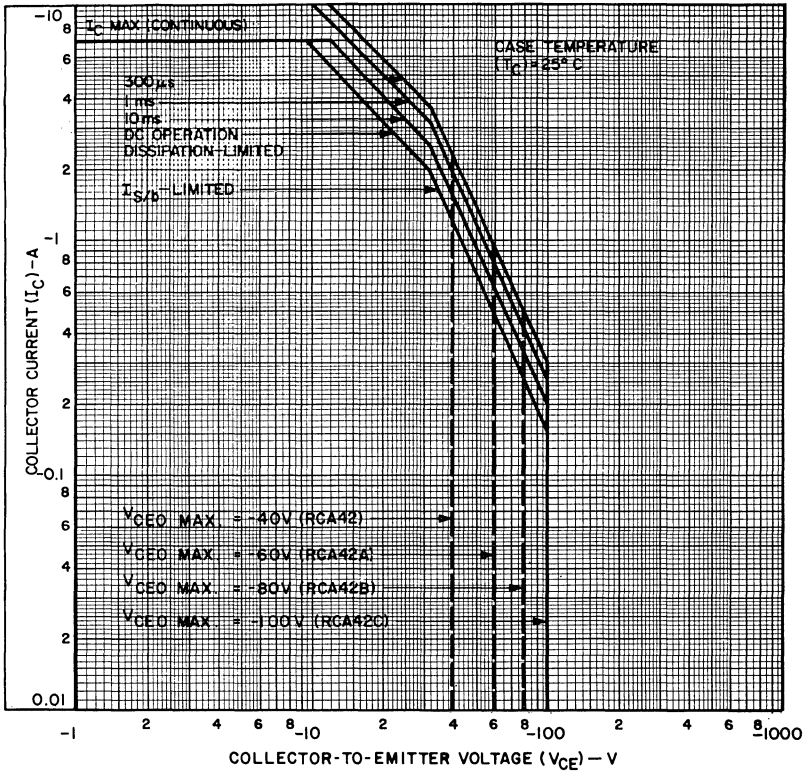
		RCA42	RCA42A	RCA42B	RCA42C	
COLLECTOR-TO-BASE VOLTAGE . . . . .	$V_{CBO}$	-40	-60	-80	-100	V
COLLECTOR-TO-EMITTER VOLTAGE:						
With base open . . . . .	$V_{CEO}$	-40	-60	-80	-100	V
EMITTER-TO-BASE VOLTAGE . . . . .	$V_{EBO}$	-5	-5	-5	-5	V
CONTINUOUS COLLECTOR CURRENT . . . . .	$I_C$	-7	-7	-7	-7	A
PEAK COLLECTOR CURRENT . . . . .		-10	-10	-10	-10	A
CONTINUOUS BASE CURRENT . . . . .	$I_B$	-3	-3	-3	-3	A
TRANSISTOR DISSIPATION:	$P_T$					
At case temperatures up to 25°C . . . . .		65	65	65	65	W
At ambient temperatures up to 25°C . . . . .		2	2	2	2	W
TEMPERATURE RANGE:						
Storage & Operating (Junction) . . . . .		←----- -65 to 150 -----→				°C
LEAD TEMPERATURE (During Soldering):						
At distance 1/8 in. (3.17 mm) from case for 10 s max. . . . .		←----- 235 -----→				°C



ELECTRICAL CHARACTERISTICS, At Case Temperature ( $T_C$ ) = 25°C

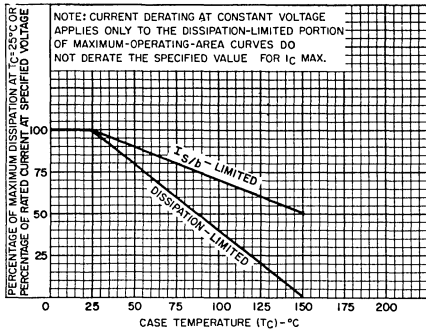
CHARACTERISTIC	SYMBOL	TEST CONDITIONS				LIMITS								UNITS	
		DC VOLTAGE (V)		DC CURRENT (A)		RCA42		RCA42A		RCA42B		RCA42C			
		V <sub>CE</sub>	V <sub>BE</sub>	I <sub>C</sub>	I <sub>B</sub>	MIN.	MAX.	MIN.	MAX.	MIN.	MAX.	MIN.	MAX.		
Collector-Cutoff Current: With base open	I <sub>CEO</sub>	-30 -60			0 0	-	-0.7	-	-0.7	-	-	-	-0.7		mA
With base-emitter junction short-circuited	I <sub>CES</sub>	-40 -60 -80 -100	0 0 0 0			-	-0.4	-	-	-	-	-	-	-0.4	
Emitter-Cutoff Current	I <sub>EBO</sub>		5	0		-	-1	-	-1	-	-1	-	-1		mA
Collector-to-Emitter Sustaining Voltage: With base open	V <sub>CEO(sus)</sub>			-0.03 <sup>a</sup>	0	-40	-	-60	-	-80	-	-100	-		V
DC Forward-Current Transfer Ratio	h <sub>FE</sub>	-4 -4		-0.3 <sup>a</sup> -3 <sup>a</sup>		30 15	- 150	30 15	- 150	30 15	- 150	30 15	- 150		
Base-to-Emitter Voltage	V <sub>BE</sub>	-4		-6 <sup>a</sup>		-	-2.2	-	-2.2	-	-2.2	-	-2.2		V
Collector-to-Emitter Saturation Voltage	V <sub>CE(sat)</sub>			-6 <sup>a</sup>	-0.6	-	-2	-	-2	-	-2	-	-2		V
Common-Emitter Small-Signal, Forward-Current Transfer Ratio (f = 1 kHz)	h <sub>re</sub>	-10		-0.5		20	-	20	-	20	-	20	-		
Magnitude of Common-Emitter, Small-Signal, Forward-Current Transfer Ratio (f=1 MHz)	h <sub>fe</sub>	-10		-0.5		3	-	3	-	3	-	3	-		
Saturated Switching Time: (R <sub>L</sub> = 5 Ω) See Figs. 5 and 6															
Turn-on time t <sub>d</sub> + t <sub>r</sub>	t <sub>ON</sub>	(V <sub>CC</sub> ) -30		-6	-0.6 <sup>b</sup>	0.3 (typ.)		0.3 (typ.)		0.3 (typ.)		0.3 (typ.)			μs
Turn-off time t <sub>s</sub> + t <sub>f</sub>	t <sub>OFF</sub>	(V <sub>CC</sub> ) -30		-6	-0.6 <sup>b</sup>	0.7 (typ.)		0.7 (typ.)		0.7 (typ.)		0.7 (typ.)			
Thermal Resistance: Junction-to-Case	R <sub>θJC</sub>					-	1.92	-	1.92	-	1.92	-	1.92		°C/W
Junction-to-Ambient	R <sub>θJA</sub>					-	62.5	-	62.5	-	62.5	-	62.5		

<sup>a</sup>Pulsed: Pulse duration = 300 μs, duty factor ≤ 2%<sup>b</sup>I<sub>B1</sub> = I<sub>B2</sub> = value shown



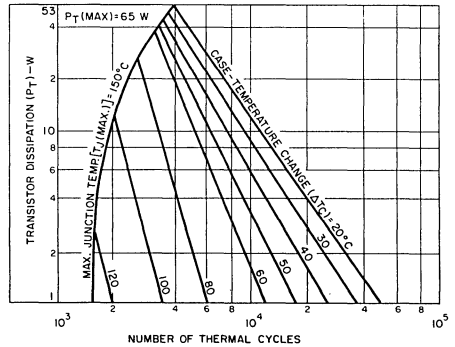
92CS-20140

Fig. 1—Maximum safe operating areas for all types.



92CS-19663

Fig. 2—Derating curves for all types.



92CS-19822

Fig. 3—Thermal-cycling ratings for all types.

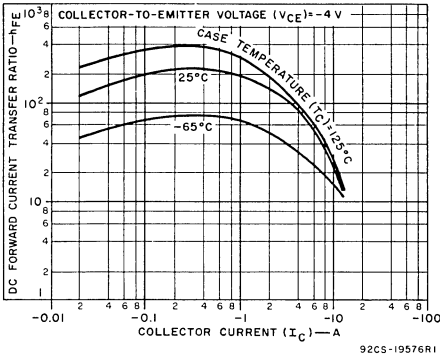


Fig. 4—Typical dc beta characteristics for RCA42, RCA42A, and RCA42B.

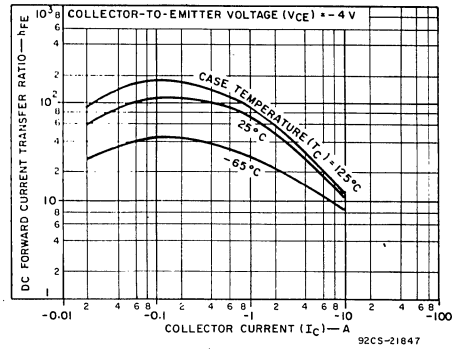
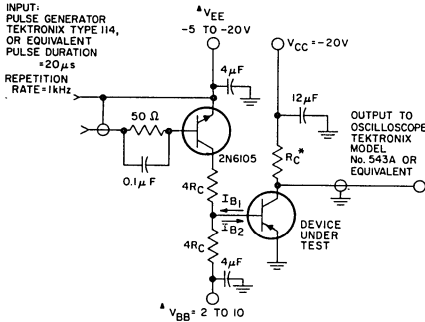


Fig. 5—Typical dc beta characteristics for RCA42C.



\*  $R_C$  IS CHOSEN FOR  $I_C$   
 $\Delta V_{EE}$  AND  $V_{BB}$  ARE MEASURED FOR  $I_{B1}$  AND  $I_{B2}$   
 $I_{B1}$  AND  $I_{B2}$  ARE MEASURED WITH TEKTRONIX CURRENT PROBE P-6019  
 AND TYPE 134 AMPLIFIER, OR EQUIVALENT

Fig. 6—Circuit used to measure switching times for all types.

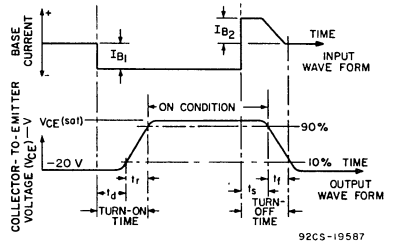


Fig. 7—Phase relationship between input current and output voltage showing reference points for specification of switching times (test circuit shown in Fig. 6).

**TERMINAL CONNECTIONS**

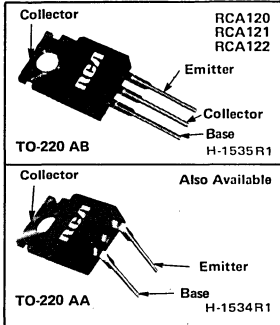
- Lead No. 1 — Base
- Lead No. 2 — Collector
- Lead No. 3 — Emitter

Mounting Flange, Lead No. 4 — Collector



# Power Transistors

## RCA120 RCA121 RCA122



### 8-Ampere N-P-N Darlington Power Transistors

60-80-100 Volts, 60 Watts  
Gain of 500 at 0.5 A  
Gain of 1000 at 3 A

**Features:**

- Operates from IC without predriver
- Low leakage at high temperature
- High reverse second-breakdown capability

**Applications:**

- Power switching
- Audio amplifiers
- Hammer drivers
- Series and shunt regulators

The RCA120, RCA121, and RCA122 are monolithic n-p-n silicon Darlington transistors designed for low- and medium-frequency power applications. The double epitaxial construction of these devices provides good forward and reverse second-breakdown capability; their high gain makes it possible for them to be driven directly from integrated circuits.

These devices are supplied in the JEDEC TO-220AB straight-lead version of the VERSAWATT package. Optional lead configurations are available upon request. For information, contact your nearest RCA Sales Office.

The RCA120 and RCA121 are n-p-n complements of the RCA125 and RCA126 described in File 841.

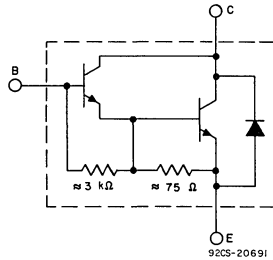


Fig. 1—Schematic diagram for all types.

**MAXIMUM RATINGS, Absolute-Maximum Values:**

	RCA120	RCA121	RCA122	
COLLECTOR-TO-BASE VOLTAGE	60	80	100	V
COLLECTOR-TO-EMITTER VOLTAGE:				
With external base-to-emitter resistance ( $R_{BE}$ ) = 100 $\Omega$ , sustaining	60	80	100	V
With base open, sustaining	60	80	100	V
With base reverse-biased $V_{BE} = -1.5$ V	60	80	100	V
EMITTER-TO-BASE VOLTAGE	5	5	5	V
CONTINUOUS COLLECTOR CURRENT	8	8	8	A
PEAK COLLECTOR CURRENT	10	10	10	A
CONTINUOUS BASE CURRENT	0.25	0.25	0.25	A
TRANSISTOR DISSIPATION:				
At case temperatures up to 25°C	60	60	60	W
At case temperatures above 25°C	See Fig. 3			
TEMPERATURE RANGE:				
Storage and Operating (Junction)	-65 to +150			°C
LEAD TEMPERATURE (During Soldering):				
At distances $\geq 1/8$ in (3.17 mm) from case for 10 s max.	235			°C

ELECTRICAL CHARACTERISTICS, At Case Temperature ( $T_C$ ) = 25°C

CHARACTERISTICS	SYMBOL	TEST CONDITIONS				LIMITS						UNITS
		VOLTAGE V dc		CURRENT A dc		RCA120		RCA121		RCA122		
		V <sub>CE</sub>	V <sub>BE</sub>	I <sub>C</sub>	I <sub>B</sub>	MIN.	MAX.	MIN.	MAX.	MIN.	MAX.	
Collector-Cutoff Current: With emitter open	I <sub>CBO</sub>	60 80 100				—	0.2	—	—	—	—	mA
With base open	I <sub>CEO</sub>	30 40 50		0 0 0	—	0.5	—	—	—	0.2 — 0.5		
Emitter-Cutoff Current	I <sub>EBO</sub>		-5	0	—	3	—	3	—	3	mA	
Collector-to-Emitter Sustaining Voltage: With base open	V <sub>CEO(sus)</sub>			0.2 <sup>a</sup>	0	60	—	80	—	100	—	V
DC Forward Current Transfer Ratio	h <sub>FE</sub>	3 3		3 <sup>a</sup> 0.5 <sup>a</sup>		1000 500	—	1000 500	—	1000 500	—	
Base-to-Emitter Voltage	V <sub>BE</sub>	3		3 <sup>a</sup>		—	2.5	—	2.5	—	2.5	V
Collector-to-Emitter Saturation Voltage	V <sub>CE(sat)</sub>			3 <sup>a</sup> 5 <sup>a</sup>	0.012 0.02	—	2 3	—	2 3	—	2 3	V
Common-Emitter, Small- Signal, Short-Circuit Forward Current Transfer Ratio: f = 1 kHz	h <sub>fe</sub>	5		1		1000	—	1000	—	1000	—	
Magnitude of Common- Emitter, Small-Signal, Short-Circuit, Forward Current Transfer Ratio: f = 1.0 MHz	h <sub>fe</sub>	5		1		20	—	20	—	20	—	
Common Base Output Capacitance: V <sub>CB</sub> = 10 V, f = 1 MHz	C <sub>ob</sub>					—	200	—	200	—	200	pF
Second Breakdown Energy: With base reverse-biased and L = 12 mH, R <sub>BE</sub> = 100 Ω	E <sub>S/b</sub> <sup>b</sup>		-1.5	4.5		120	—	120	—	120	—	mJ
Forward-Bias Second Breakdown Collector Current: t = 0.5-s nonrepetitive	I <sub>S/b</sub>	26.5				2.25	—	2.25	—	2.25	—	A
Thermal Resistance: Junction-to-Case	R <sub>θJC</sub>					—	2.1	—	2.1	—	2.1	°C/W

<sup>a</sup> Pulsed: Pulse duration = 300 μs, duty factor = 1.8%.

<sup>b</sup> E<sub>S/b</sub> is defined as the energy at which second breakdown occurs under specified reverse bias conditions.  
E<sub>S/b</sub> = 1/2LI<sup>2</sup> where L is a series load or leakage inductance, and I is the peak collector current.

## TERMINAL CONNECTIONS

Lead No. 1 — Base

Lead No. 3 — Emitter

Lead No. 2 — Collector

Mounting Flange, Lead No. 4 — Collector

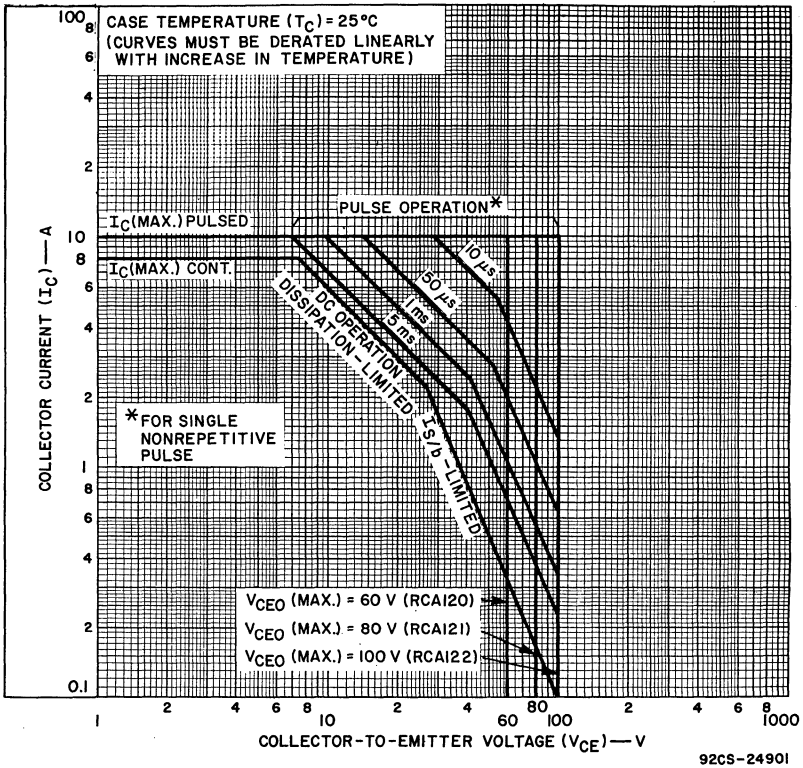


Fig. 2—Maximum operating areas for all types.

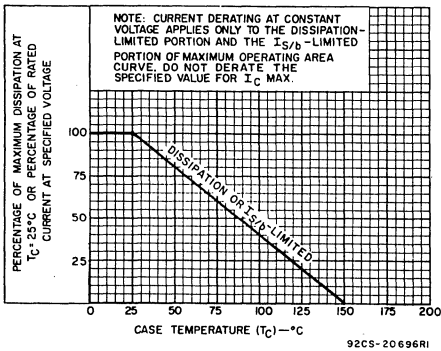


Fig. 3—Dissipation derating curve for all types.

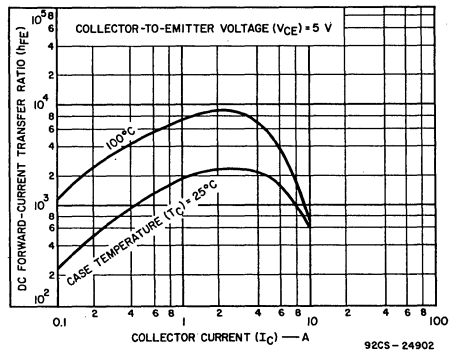


Fig. 4—Typical dc beta characteristics for all types.

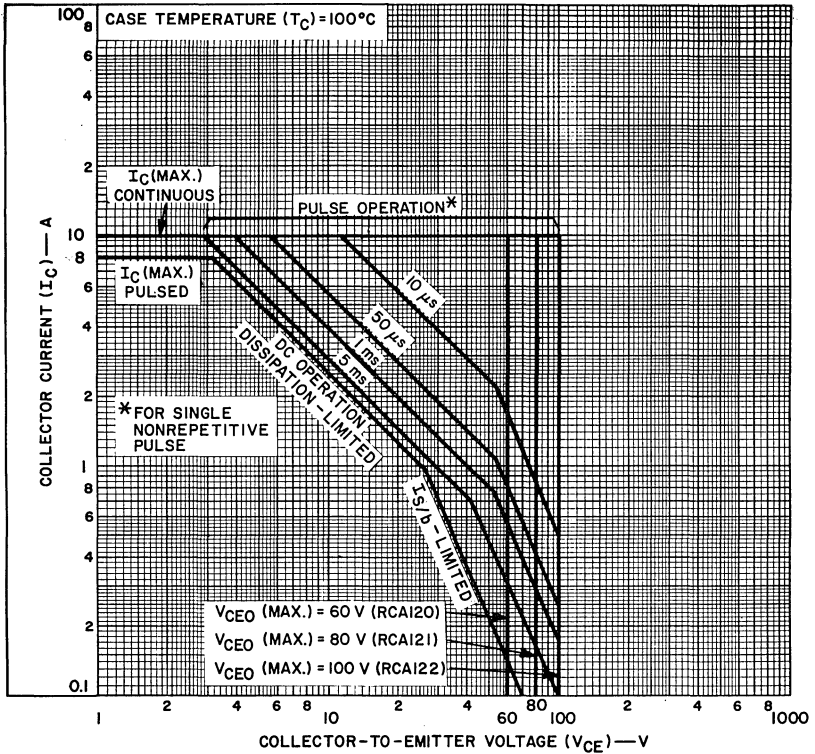


Fig. 5—Maximum operating areas for all types at  $T_C = 100^\circ\text{C}$ .

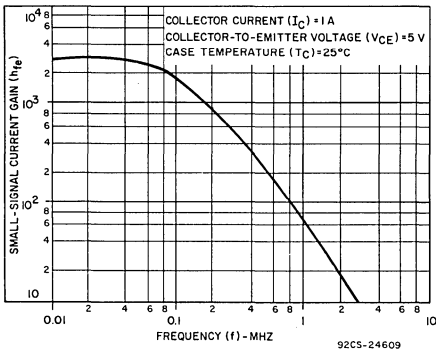


Fig. 6—Typical small-signal current gain for all types.

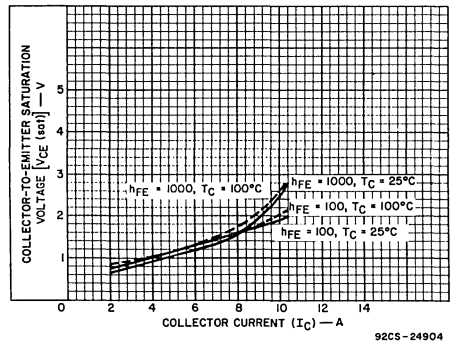


Fig. 7—Typical saturation characteristics for all types.

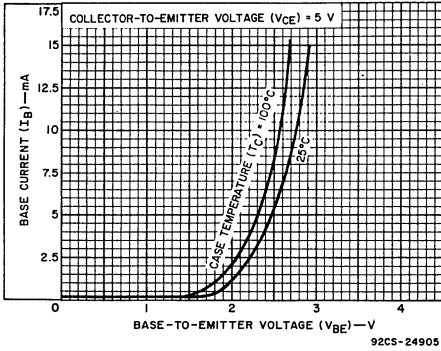


Fig. 8—Typical input characteristics for all types.

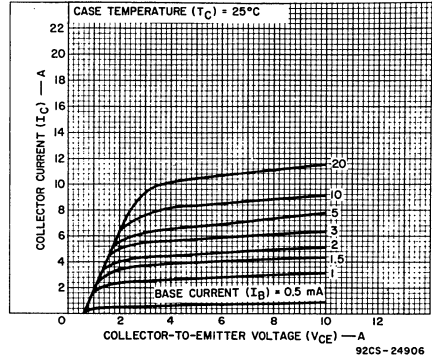


Fig. 9—Typical output characteristics for all types.

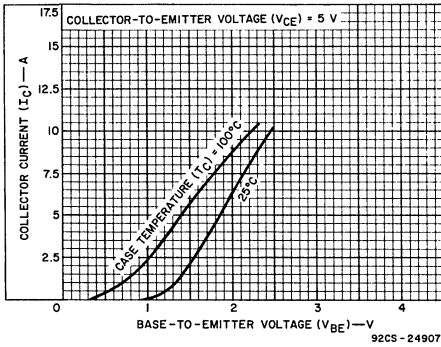


Fig. 10—Typical transfer characteristics for all types.

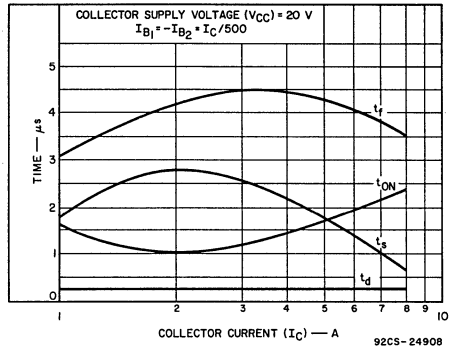
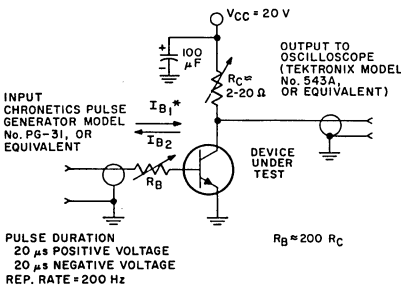


Fig. 11—Typical saturated switching-time characteristics for all types.



\*  $I_{B1}$  AND  $I_{B2}$  ARE MEASURED WITH TEKTRONIX CURRENT PROBE P6019 AND TYPE 134 AMPLIFIER, OR EQUIVALENT

92CS-20699R1

Fig. 12—Circuit used to measure saturated switching times.

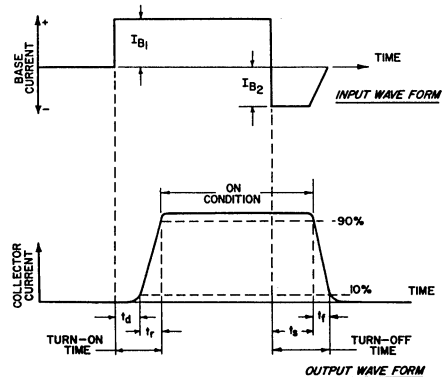


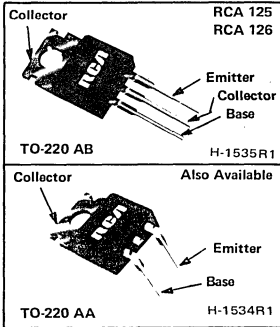
Fig. 13—Phase relationship between input current and output current showing reference points for specification of switching times (test circuit shown in Fig. 12).





# Power Transistors

## RCA125 RCA126



### 8-Ampere P-N-P Darlington Power Transistors

60 and 80 Volts, 60 Watts  
 Gain of 1000 at 3 A  
 Gain of 500 at 0.5 A

**Features:**

- Operates from IC without predriver
- Low leakage at high temperature
- High reverse second-breakdown capability

**Applications:**

- Power switching
- Audio amplifiers
- Hammer drivers
- Series and shunt regulators

The RCA125 and RCA126 are monolithic p-n-p silicon Darlington transistors designed for low- and medium-frequency power applications. The high gain of these devices makes it possible for them to be driven directly from integrated circuits.

These devices are supplied in the JEDEC TO-220 AB straight-lead version of the VERSAWATT package. Optional lead configurations are available upon request. For information, contact your nearest RCA Sales Office.

RCA125 and RCA126 are p-n-p complements of the RCA 120 and RCA121 described in File No. 840.

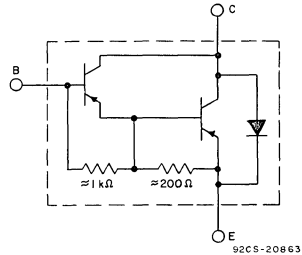


Fig. 1—Schematic diagram for all types.

**MAXIMUM RATINGS, Absolute-Maximum Values:**

	RCA125	RCA126		
COLLECTOR-TO-BASE VOLTAGE	$V_{CBO}$	-60	-80	V
COLLECTOR-TO-EMITTER VOLTAGE:				
With base open	$V_{CEO}$	-60	-80	V
EMITTER-TO-BASE VOLTAGE	$V_{EBO}$	-5	-5	V
CONTINUOUS COLLECTOR CURRENT	$I_C$	-8	-8	A
PEAK COLLECTOR CURRENT	$I_{CM}$	-15	-15	A
CONTINUOUS BASE CURRENT	$I_B$	-0.25	-0.25	A
TRANSISTOR DISSIPATION:	$P_T$			
At case temperatures up to 25°C		60	60	W
At case temperatures above 25°C		See Fig. 5		
TEMPERATURE RANGE:				
Storage & Operating (Junction)		-65 to 150		°C
LEAD TEMPERATURE (During Soldering):				
At distance 1/8 in. (3.17 mm) from case for 10 s max.		235		°C

ELECTRICAL CHARACTERISTICS, At Case Temperature ( $T_C$ ) = 25°C

CHARACTERISTIC	SYMBOL	TEST CONDITIONS				LIMITS				UNITS
		VOLTAGE V dc		CURRENT A dc		RCA125		RCA126		
		V <sub>CE</sub>	V <sub>EB</sub>	I <sub>C</sub>	I <sub>B</sub>	MIN.	MAX.	MIN.	MAX.	
Collector-Cutoff Current: With base open	I <sub>CEO</sub>	-30 -40			0 0	- -	-0.5 -	- -	- -0.5	
Emitter-Cutoff Current	I <sub>EBO</sub>		-5	0		-	-10	-	-10	mA
Collector-to-Emitter Voltage: With base open	V <sub>CEO</sub>			-0.03 <sup>a</sup>	0	-60	-	-80	-	V
DC Forward-Current Transfer Ratio	h <sub>FE</sub>	-3 -3		-0.5 <sup>a</sup> -3 <sup>a</sup>		500 1000	- -	500 1000	- -	
Base-to-Emitter Voltage	V <sub>BE</sub>	-3		-3 <sup>a</sup>		-	-2.5	-	-2.5	V
Collector-to-Emitter Saturation Voltage	V <sub>CE(sat)</sub>			-3 <sup>a</sup> -5 <sup>a</sup>	-0.012 -0.02	- -	-2 -4	- -	-2 -4	V
Common-Emitter-Small- Signal, Forward-Current Transfer Ratio: f = 1 kHz	h <sub>fe</sub>	-5		-1		1000	-	1000	-	
Magnitude of Common- Emitter, Small-Signal, Forward-Current Transfer Ratio: f = 1 MHz	h <sub>fe</sub>	-5		-1		20	-	20	-	
Forward-Bias Second- Breakdown Collector Current: 1- $\mu$ s nonrepetitive pulse	I <sub>S/G</sub>	-20				-3	-	-3	-	A
Saturated Switching Time <sup>b</sup> (V <sub>CC</sub> = -20 V; R <sub>L</sub> = 20 $\Omega$ ; I <sub>B1</sub> = I <sub>B2</sub> ): Turn-on time, t <sub>d</sub> + t <sub>r</sub>	t <sub>ON</sub>			-3	-0.012				1 (typ.)	$\mu$ s
Turn-off time, t <sub>s</sub> + t <sub>f</sub>	t <sub>OFF</sub>			-3	0.012				3 (typ.)	
Thermal Resistance: Junction-to-Case	R <sub><math>\theta</math>JC</sub>					-	2.1	-	2.1	°C/W

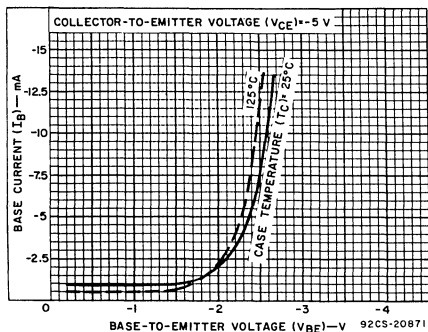
<sup>a</sup>Pulsed: Pulse duration = 300  $\mu$ s, duty factor  $\leq$  2%<sup>b</sup>See Figs. 9, 10, and 11

Fig. 2—Typical input characteristics for both types.

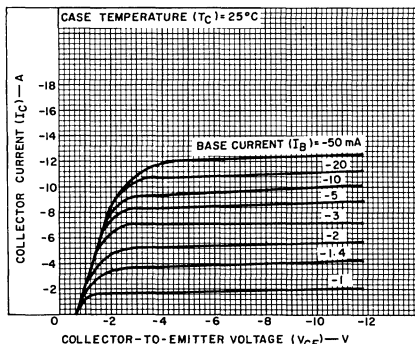


Fig. 3—Typical output characteristics for both types.

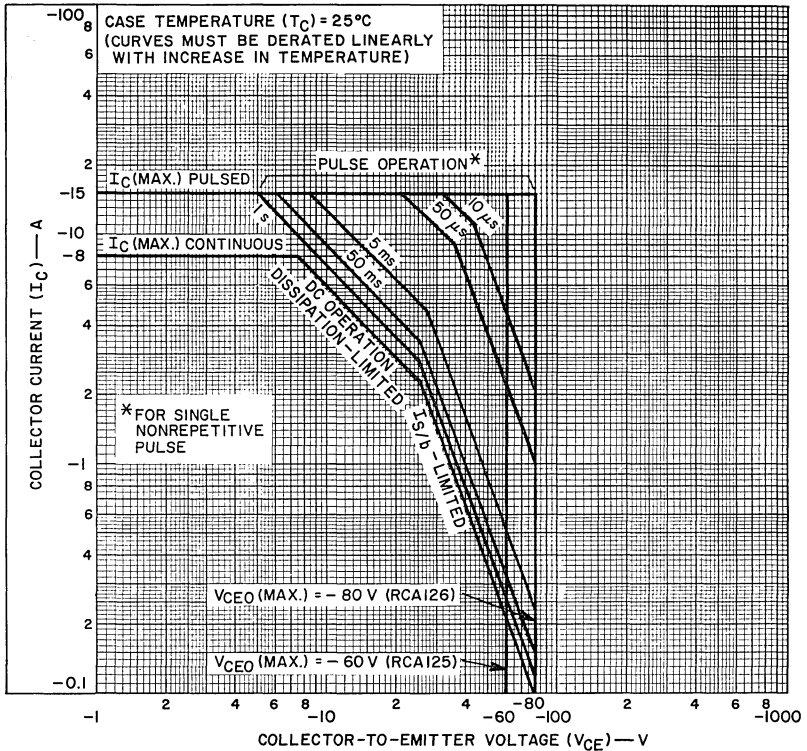


Fig. 4—Maximum operating areas for both types.

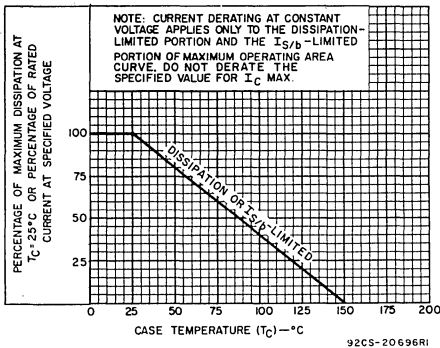


Fig. 5—Dissipation derating curve for both types.

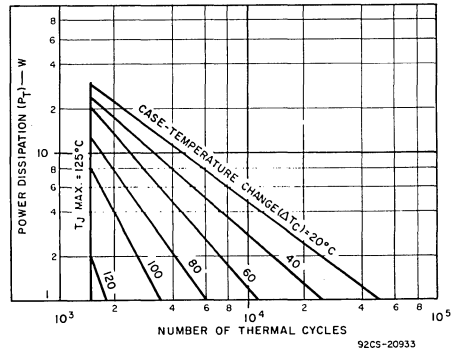


Fig. 6—Thermal-cycling rating chart for both types.

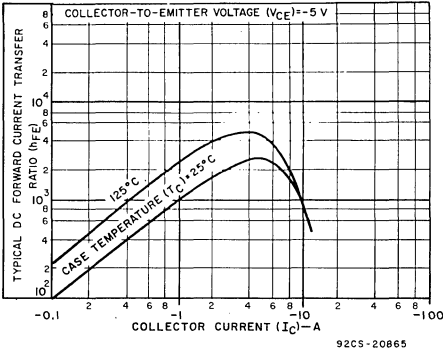


Fig. 7—Typical dc beta characteristics for both types.

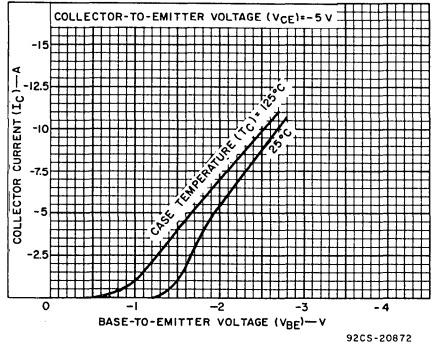


Fig. 8—Typical transfer characteristics for both types.

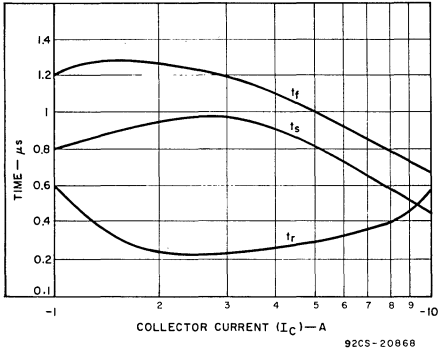


Fig. 9—Typical saturated switching-time characteristics for both types.

**TERMINAL CONNECTIONS  
JEDEC TO-220 AB**

- Lead No.1 — Base
- Lead No.2 — Collector
- Lead No.3 — Emitter
- Mounting Flange — Collector

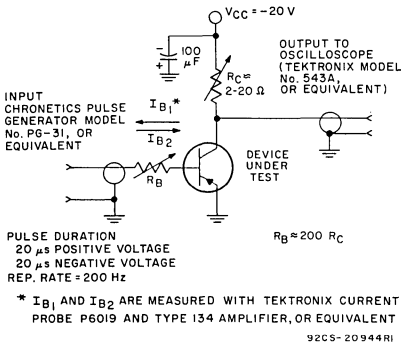


Fig. 10—Circuit used to measure saturated switching times.

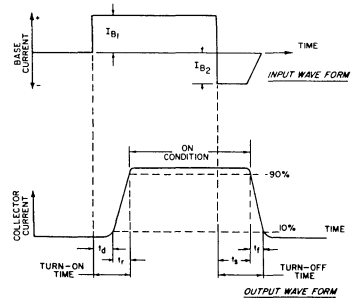
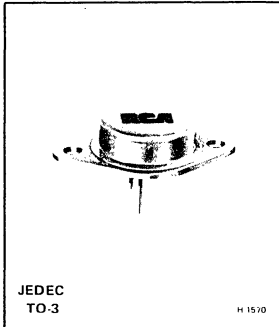


Fig. 11—Phase relationship between input current and output current showing reference points for specification of switching times (test circuit shown in Fig. 10).



## High-Voltage, High-Power Silicon N-P-N Power Transistor

For Switching and Linear Applications in Military, Industrial, and Commercial Equipment

*Features:*

- Maximum safe-area-of-operation curves
- Low saturation voltage:  $V_{CE(sat)} = 0.8 \text{ V (max.)}$
- High voltage rating:  $V_{CE(sus)} = 200 \text{ V}$
- High dissipation rating:  $P_T = 125 \text{ W}$

RCA-410 is an epitaxial silicon n-p-n power transistor utilizing a multiple-emitter-site structure. This device employs the popular JEDEC TO-3 package. Featuring high breakdown-voltage ratings and low saturation-

voltage values, the RCA-410 is especially suitable for use in inverters, deflection circuits, switching regulators, high-voltage bridge amplifiers, ignition circuits, and other high-voltage switching applications.

**MAXIMUM RATINGS, Absolute-Maximum Values:**

COLLECTOR-TO-BASE VOLTAGE, $V_{CBO}$ .....	200 V
COLLECTOR-TO-EMITTER SUSTAINING VOLTAGE With base open, $V_{CEO} \text{ (sus)}$ .....	200 V
EMITTER-TO-BASE VOLTAGE, $V_{EBO}$ .....	5 V
COLLECTOR CURRENT: Continuous, $I_C$ .....	7 A
Peak .....	10 A
BASE CURRENT (Continuous), $I_B$ .....	2 A
TRANSISTOR DISSIPATION, $P_T$ : At case temperatures up to $25^\circ\text{C}$ and $V_{CE}$ up to 75 V .....	125 W
At case temperatures up to $25^\circ\text{C}$ and $V_{CE}$ above 75 V .....	See Fig. 2.
At case temperatures above $25^\circ\text{C}$ and $V_{CE}$ above 75 V .....	See Figs. 1 & 2.
TEMPERATURE RANGE: Storage & Operating (Junction) .....	-65 to +200 $^\circ\text{C}$

**PIN TEMPERATURE (During Soldering):**

At distances $\geq 1/32 \text{ in. (0.8 mm)}$	$230^\circ\text{C}$
from case for 10 s max. ....	230 $^\circ\text{C}$

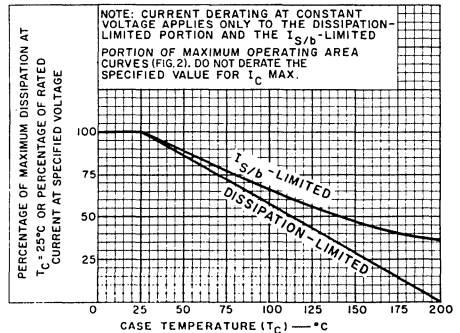


Fig. 1—Dissipation and current derating curves.

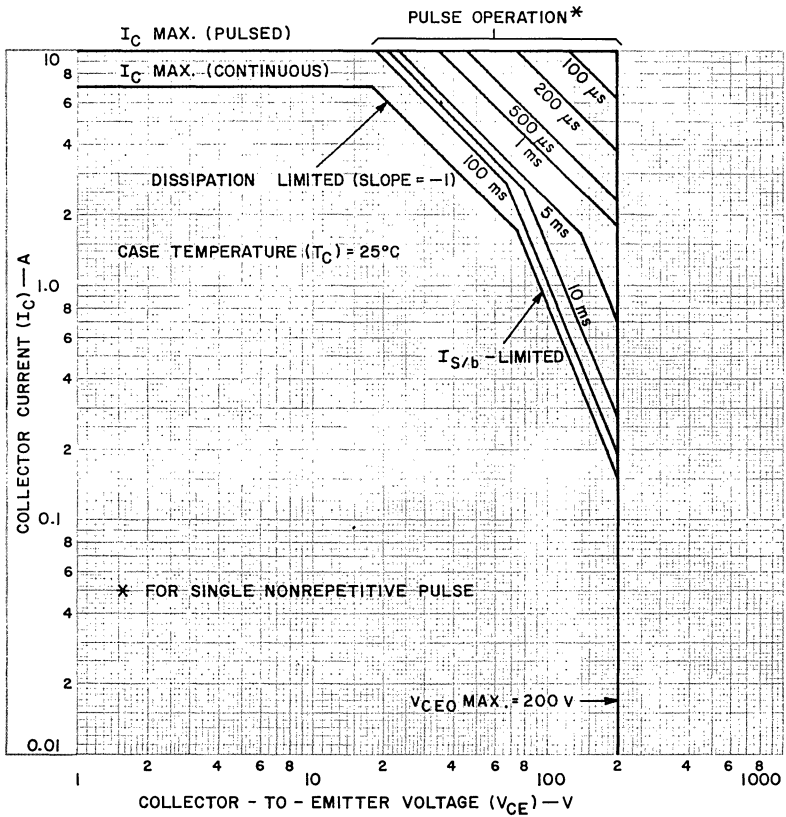
ELECTRICAL CHARACTERISTICS, Case Temperature ( $T_C$ ) = 25°C Unless Otherwise Specified

Characteristic	Symbol	Test Conditions				Limits			Units
		DC Voltage (V)		DC Current (A)		Min.	Typ.	Max.	
		$V_{CE}$	$V_{BE}$	$I_C$	$I_B$				
Collector-Cutoff Current: With base open	$I_{CEO}$	200				–	–	0.25	mA
With base-emitter junction reverse-biased & $T_C = 125^\circ\text{C}$	$I_{CEV}$	200	–1.5			–	–	0.5	
Emitter-Cutoff Current	$I_{EBO}$		–5			–	–	5.0	mA
DC Forward-Current Transfer Ratio	$h_{FE}$	5 5		1.0 <sup>a</sup> 2.5 <sup>a</sup>		30 10	– –	90 –	
Collector-to-Emitter Sustaining Voltage: With base open (See Figs. 3 & 4.)	$V_{CEO}(I_{sus})^b$			0.1		200 <sup>b</sup>	–	–	V
Base-to-Emitter Saturation Voltage	$V_{BE}(sat)$			1.0 <sup>a</sup>	0.1	–	0.9	1.5	V
Collector-to-Emitter Saturation Voltage	$V_{CE}(sat)$			1.0 <sup>a</sup>	0.1	–	0.2	0.8	V
Second-Breakdown Collector Current: (With base forward-biased) Pulse duration (non-repetitive) = 1 s	$I_{S/b}^c$	150				0.3	–	–	A
Gain-Bandwidth Product	$f_T$	10		0.2		–	4.0	–	MHz
Switching Time: ( $I_{B1} = 0.1$ A, $I_{B2} = -0.5$ A)									
Rise (See Figs. 10, 12, & 13.)	$t_r$			1.0		–	0.35	–	$\mu\text{s}$
Storage (See Figs. 11, 12, & 13.)	$t_s$			1.0		–	1.4	–	
Fall (See Figs. 9, 12, & 13.)	$t_f$			1.0		–	0.15	–	
Thermal Resistance (Junction-to-Case)	$R_{\theta JC}$	10		5		–	–	1.4	$^\circ\text{C/W}$

<sup>a</sup> Pulsed; pulse duration  $\leq 350 \mu\text{s}$ , duty factor = 2%

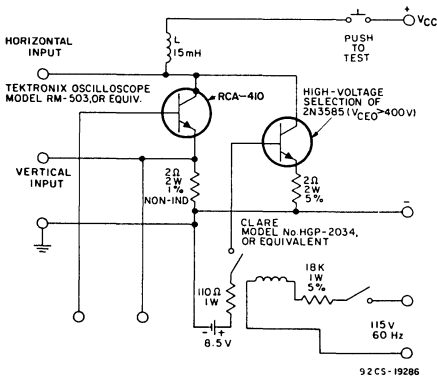
<sup>b</sup> CAUTION: The sustaining voltage  $V_{CEO}(I_{sus})$  MUST NOT be measured on a curve tracer. The sustaining voltage should be measured by means of the test circuit shown in Fig. 3.

<sup>c</sup>  $I_{S/b}$  is defined as the current at which second breakdown occurs at a specified collector voltage with the emitter-base junction forward-biased for transistor operation in the active region.



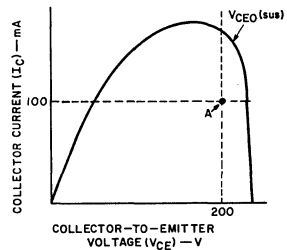
92CS-19249

Fig.2—Maximum operating areas.



92CS-19286

Fig.3—Circuit used to measure sustaining voltage,  $V_{CE0}(sus)$ .



THE SUSTAINING VOLTAGE  $V_{CE0}(sus)$  IS ACCEPTABLE WHEN THE TRACE FALLS TO THE RIGHT AND ABOVE POINT "A".

92CS-19250

Fig.4—Oscilloscope display for measurement of sustaining voltage (test circuit shown in Fig. 3).

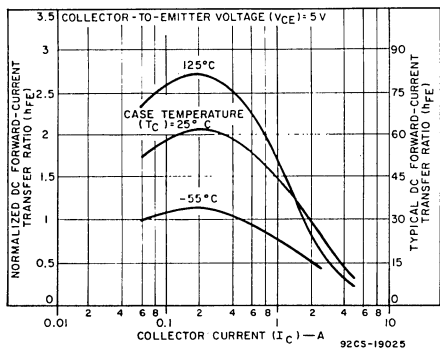


Fig. 5—Typical dc beta characteristics.

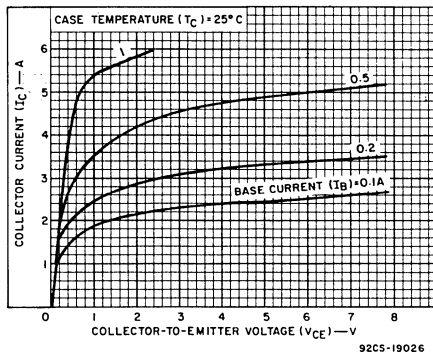


Fig. 6—Typical output characteristics.

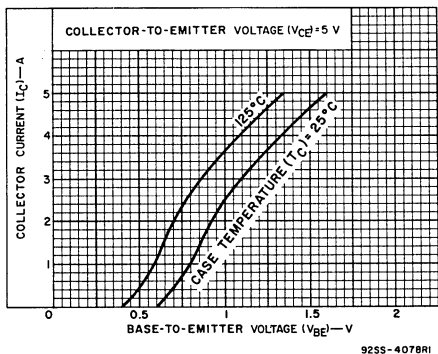


Fig. 7—Typical transfer characteristics.

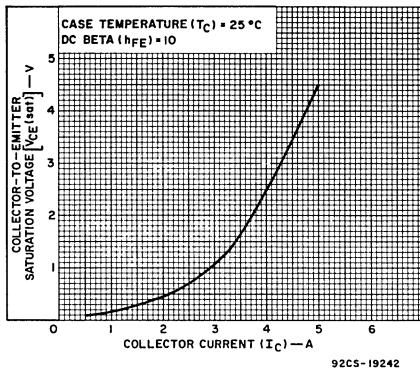


Fig. 8—Typical saturation voltage characteristic.

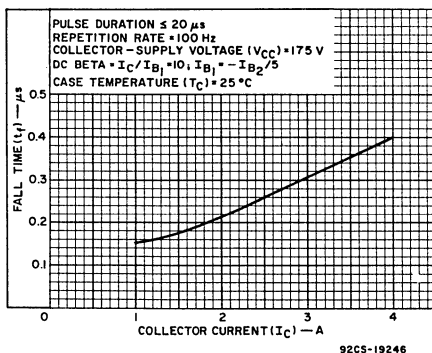


Fig. 9—Typical fall time vs. collector current.



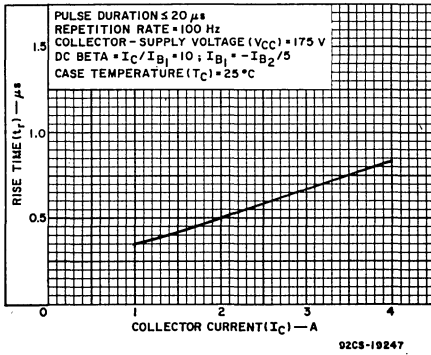


Fig.10—Typical rise time vs. collector current.

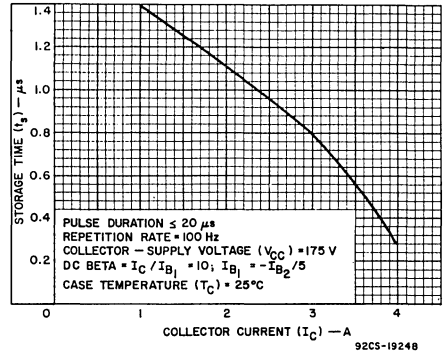


Fig.11—Typical storage time vs. collector current.

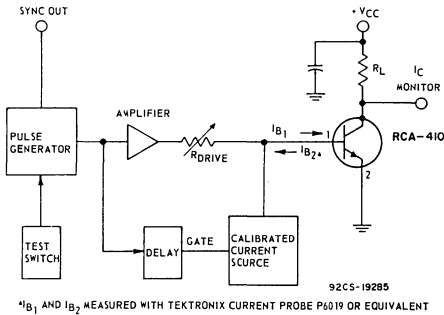


Fig.12—Circuit used to measure switching times.

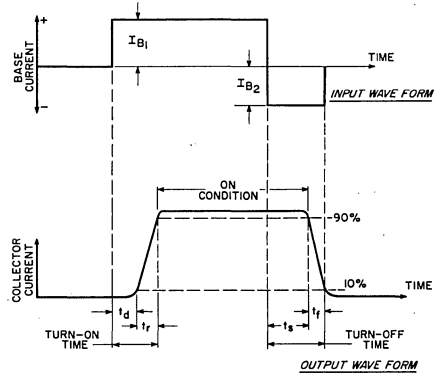


Fig.13—Phase relationship between input and output currents showing reference points for specification of switching times. Test circuit shown in Fig.12).

TERMINAL CONNECTIONS

- Pin 1 — Base
- Pin 2 — Emitter
- Mounting Flange, Case — Collector



# Power Transistors

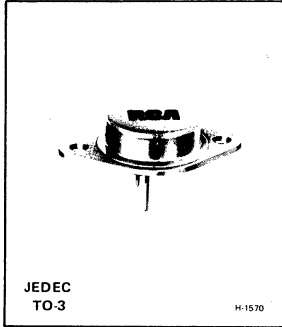
## RCA411

### High-Voltage, High-Power Silicon N-P-N Power Transistor

For Switching and Linear Applications in Military, Industrial, and Commercial Equipment

**Features:**

- Maximum safe-area-of-operation curves
- Low saturation voltage:  $V_{CE(sat)} = 0.8\text{ V (max.)}$
- High voltage rating:  $V_{CEO(sus)} = 300\text{ V}$
- High dissipation rating:  $P_T = 125\text{ W}$



RCA-411 is an epitaxial silicon n-p-n power transistor utilizing a multiple-emitter-site structure. This device employs the popular JEDEC TO-3 package.

Featuring high breakdown-voltage ratings and low saturation-

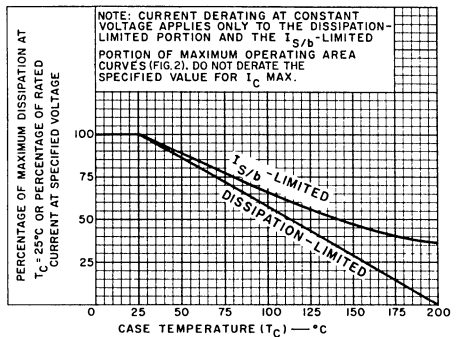
current values, the RCA-411 is especially suitable for use in inverters, deflection circuits, switching regulators, high-voltage bridge amplifiers, ignition circuits, and other high-voltage switching applications.

**MAXIMUM RATINGS, Absolute-Maximum Values:**

COLLECTOR-TO-BASE VOLTAGE, $V_{CB0}$ .....	300 V
COLLECTOR-TO-EMITTER SUSTAINING VOLTAGE: With base open, $V_{CEO(sus)}$ .....	300 V
EMITTER-TO-BASE VOLTAGE, $V_{EBO}$ .....	5 V
COLLECTOR CURRENT: Continuous, $I_C$ .....	7 A
Peak .....	10 A
BASE CURRENT (Continuous), $I_B$ .....	2 A
TRANSISTOR DISSIPATION, $P_T$ : At case temperatures up to 25°C and $V_{CE}$ up to 75 V .....	125 W
At case temperatures up to 25°C and $V_{CE}$ above 75 V .....	See Fig. 2.
At case temperatures above 25°C and $V_{CE}$ above 75 V .....	See Figs. 1 & 2.
TEMPERATURE RANGE: Storage & Operating (Junction) .....	-65 to +200 °C

**PIN TEMPERATURE (During Soldering):**

At distances $\geq 1/32$ in. (0.8 mm) from case for 10 s max. ....	230 °C
--	--------



92CS-19296

Fig. 1—Dissipation and current derating curves.

ELECTRICAL CHARACTERISTICS, Case Temperature ( $T_C$ ) = 25°C Unless Otherwise Specified

Characteristic	Symbol	Test Conditions				Limits			Units
		DC Voltage (V)		DC Current (A)		Min.	Typ.	Max.	
		$V_{CE}$	$V_{BE}$	$I_C$	$I_B$				
Collector-Cutoff Current: With base open	$I_{CEO}$	300				—	—	0.25	mA
With base-emitter junction reverse-biased	$I_{CEV}$	300	-1.5			—	—	0.25	
With base-emitter junction reverse-biased & $T_C = 125^\circ\text{C}$	$I_{CEV}$	300	-1.5			—	—	0.5	
Emitter-Cutoff Current	$I_{EBO}$		-5			—	—	5.0	mA
DC Forward-Current Transfer Ratio	$h_{FE}$	5		1.0 <sup>a</sup>		30	—	90	
		5		2.5 <sup>a</sup>		10	—	—	
Collector-to-Emitter Sustaining Voltage: With base open (See Figs. 3 & 4.)	$V_{CEO(sus)}^b$			0.1		300 <sup>b</sup>	—	—	V
Base-to-Emitter Saturation Voltage	$V_{BE(sat)}$			1.0 <sup>a</sup>	0.1	—	0.9	1.5	V
Collector-to-Emitter Saturation Voltage	$V_{CE(sat)}$			1.0 <sup>a</sup>	0.1	—	0.2	0.8	V
Second-Breakdown Collector Current: (With base forward-biased) Pulse duration (non-repetitive) = 1 s	$I_{S/b}^c$	150				0.3	—	—	A
Gain-Bandwidth Product	$f_T$	10		0.2		—	2.5	—	MHz
Switching Time: ( $I_{B1} = 0.1 \text{ A}$ , $I_{B2} = -0.5 \text{ A}$ )									$\mu\text{s}$
Rise (See Figs. 10, 12, & 13.)	$t_r$			1.0		—	0.35	—	
Storage (See Figs. 11, 12, & 13.)	$t_s$			1.0		—	1.4	—	
Fall (See Figs. 9, 12, & 13.)	$t_f$			1.0		—	0.15	—	
Thermal Resistance (Junction-to-Case)	$R_{\theta/JC}$	10		5		—	—	1.4	$^\circ\text{C/W}$

<sup>a</sup> Pulsed; pulse duration  $\leq 350 \mu\text{s}$ , duty factor = 2%.

<sup>b</sup> CAUTION: The sustaining voltage  $V_{CEO(sus)}$  MUST NOT be measured on a curve tracer. The sustaining voltage should be measured by means of the test circuit shown in Fig. 3.

<sup>c</sup>  $I_{S/b}$  is defined as the current at which second breakdown occurs at a specified collector voltage with the emitter-base junction forward-biased for transistor operation in the active region.

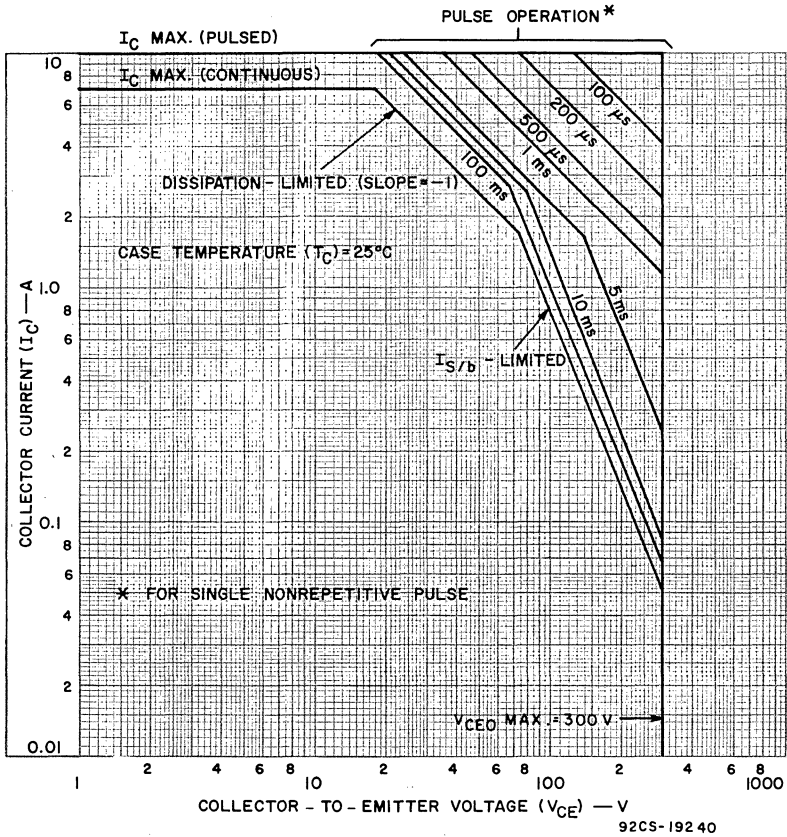


Fig.2—Maximum operating areas.

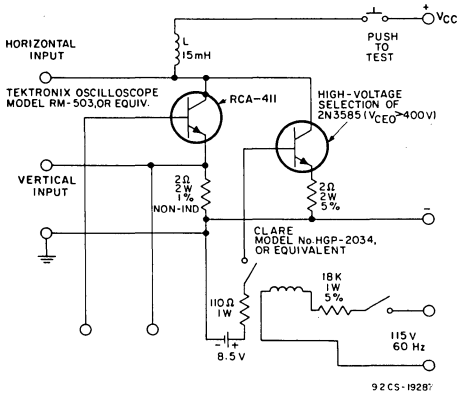


Fig.3—Circuit used to measure sustaining voltage,  $V_{CEO}(sus)$ .

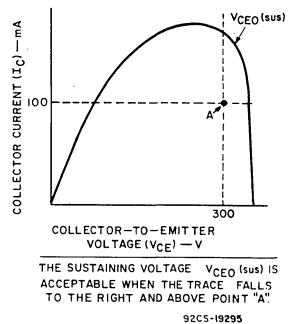


Fig.4—Oscilloscope display for measurement of sustaining voltage (test circuit shown in Fig.3).

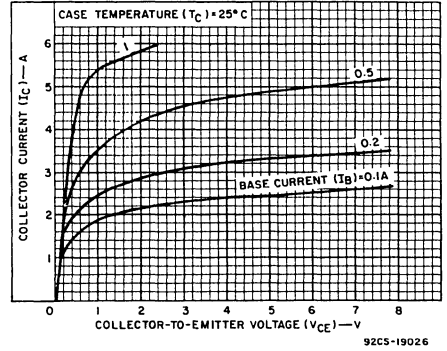
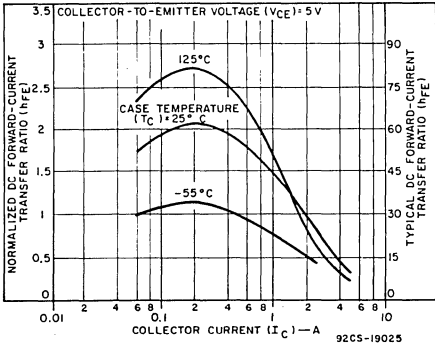


Fig. 5—Typical dc beta characteristics.

Fig. 6—Typical output characteristics.

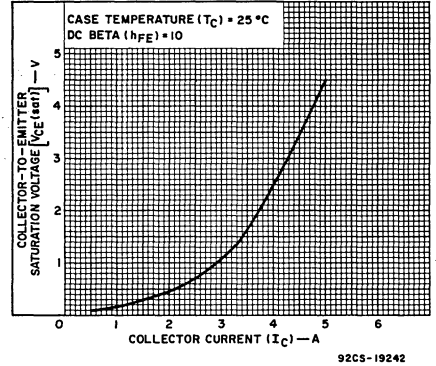
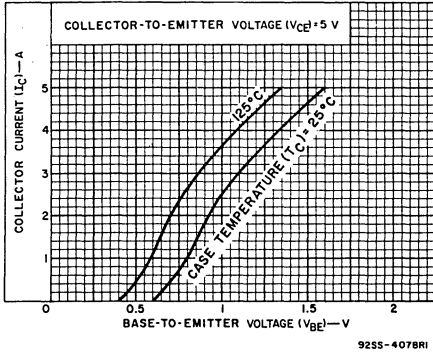


Fig. 7—Typical transfer characteristics.

Fig. 8—Typical saturation voltage characteristic.

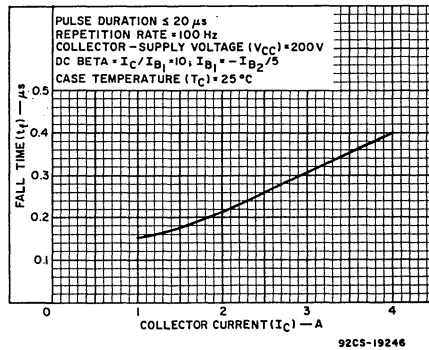


Fig. 9—Typical fall time vs. collector current.

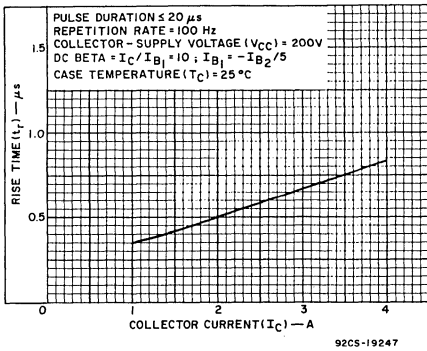


Fig.10—Typical rise time vs. collector current.

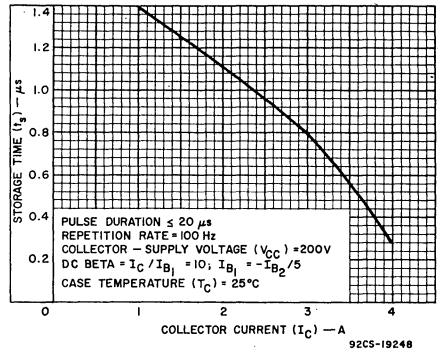


Fig.11—Typical storage time vs. collector current.

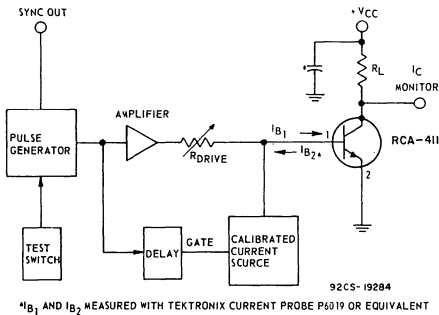


Fig.12—Circuit used to measure switching times.

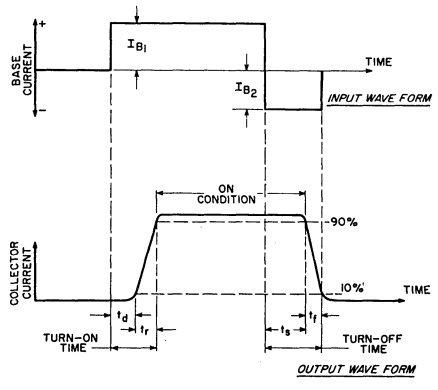
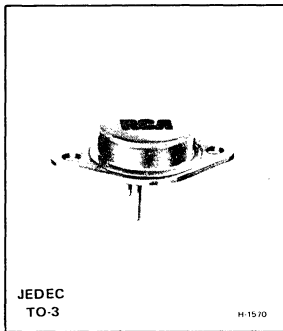


Fig.13—Phase relationship between input and output currents showing reference points for specification of switching times. Test circuit shown in Fig.12).

**TERMINAL CONNECTIONS**

- Pin 1 — Base
- Pin 2 — Emitter
- Mounting Flange, Case — Collector



## High-Voltage, High-Power Silicon N-P-N Power Transistor

For Switching and Linear Applications in Military, Industrial, and Commercial Equipment

*Features:*

- ▣ Maximum safe-area-of-operation curves
- ▣ Low saturation voltage:  $V_{CE(sat)} = 0.8\text{ V (max.)}$
- ▣ High voltage rating:  $V_{CEO(sus)} = 325\text{ V}$
- ▣ High dissipation rating:  $P_T = 125\text{ W}$

RCA-413 is an epitaxial silicon n-p-n power transistor utilizing a multiple-emitter-site structure. This device employs the popular JEDEC TO-3 package.

Featuring high breakdown-voltage ratings and low saturation-

voltage values, the RCA-413 is especially suitable for use in inverters, deflection circuits, switching regulators, high-voltage bridge amplifiers, ignition circuits, and other high-voltage switching applications.

**MAXIMUM RATINGS, Absolute-Maximum Values:**

COLLECTOR-TO-BASE VOLTAGE, $V_{CBO}$ .....	400 V
COLLECTOR-TO-EMITTER SUSTAINING VOLTAGE With base open, $V_{CEO(sus)}$ .....	325 V
COLLECTOR-TO-EMITTER BREAKDOWN VOLTAGE: With base open, $V_{(BR)CEO}$ .....	400 V
EMITTER-TO-BASE VOLTAGE, $V_{EBO}$ .....	5 V
COLLECTOR CURRENT: Continuous, $I_C$ .....	7 A
Peak .....	10 A
BASE CURRENT (Continuous), $I_B$ .....	2 A
TRANSISTOR DISSIPATION, $P_T$ : At case temperatures up to 25°C and $V_{CE}$ up to 75 V .....	125 W
At case temperatures up to 25°C and $V_{CE}$ above 75 V .....	See Fig. 2.
At case temperatures above 25°C and $V_{CE}$ above 75 V .....	See Figs. 1 & 2.
TEMPERATURE RANGE: Storage & Operating (Junction) .....	-65 to +200 °C

**PIN TEMPERATURE (During Soldering):**

At distances  $\geq 1/32$  in. (0.8 mm) from case for 10 s max. .... 230 °C

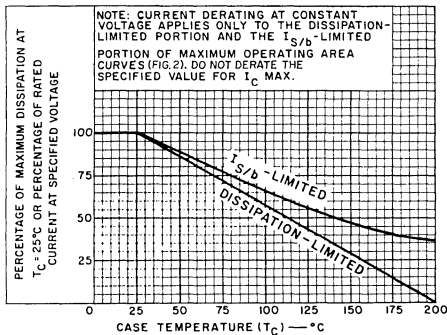


Fig. 1—Dissipation and current derating curves.

ELECTRICAL CHARACTERISTICS, Case Temperature ( $T_C$ ) = 25°C Unless Otherwise Specified

Characteristic	Symbol	Test Conditions				Limits			Units
		DC Voltage (V)		DC Current (A)		Min.	Typ.	Max.	
		$V_{CE}$	$V_{BE}$	$I_C$	$I_B$				
Collector-Cutoff Current: With base open	$I_{CEO}$	400				—	—	0.25	mA
With base-emitter junction reverse-biased	$I_{CEV}$	400	-1.5			—	—	0.25	
With base-emitter junction reverse-biased & $T_C = 125^\circ\text{C}$	$I_{CEV}$	400	-1.5			—	—	0.5	
Emitter-Cutoff Current	$I_{EBO}$		-5			—	—	5.0	mA
DC Forward-Current Transfer Ratio	$h_{FE}$	5 5		0.5 <sup>a</sup> 1.0 <sup>a</sup>		20 15	— —	80 —	
Collector-to-Emitter Sustaining Voltage: With base open (See Figs. 3 & 4.)	$V_{CEO(sus)}^b$			0.1		325 <sup>b</sup>	—	—	V
Base-to-Emitter Saturation Voltage	$V_{BE(sat)}$			0.5 <sup>a</sup>	0.05	—	0.8	1.5	V
Collector-to-Emitter Saturation Voltage	$V_{CE(sat)}$			0.5 <sup>a</sup>	0.05	—	0.15	0.8	V
Second-Breakdown Collector Current: (With base forward-biased) Pulse duration (non-repetitive) = 1 s	$I_{S/b}^c$	150				0.3	—	—	A
Gain-Bandwidth Product	$f_T$	10		0.2		—	4.0	—	MHz
Switching Time: ( $I_{B1} = 0.1 \text{ A}$ , $I_{B2} = -0.5 \text{ A}$ )									$\mu\text{s}$
Rise (See Figs. 10, 12, & 13.)	$t_r$			1.0		—	0.35	—	
Storage (See Figs. 11, 12, & 13.)	$t_s$			1.0		—	1.4	—	
Fall (See Figs. 9, 12, & 13.)	$t_f$			1.0		—	0.15	—	
Thermal Resistance (Junction-to-Case)	$R_{\theta JC}$	10		5		—	—	1.4	$^\circ\text{C/W}$

<sup>a</sup> Pulsed; pulse duration  $\leq 350 \mu\text{s}$ , duty factor = 2%

<sup>b</sup> CAUTION: The sustaining voltage  $V_{CEO(sus)}$  MUST NOT be measured on a curve tracer. The sustaining voltage should be measured by means of the test circuit shown in Fig. 3.

<sup>c</sup>  $I_{S/b}$  is defined as the current at which second breakdown occurs at a specified collector voltage with the emitter-base junction forward-biased for transistor operation in the active region.



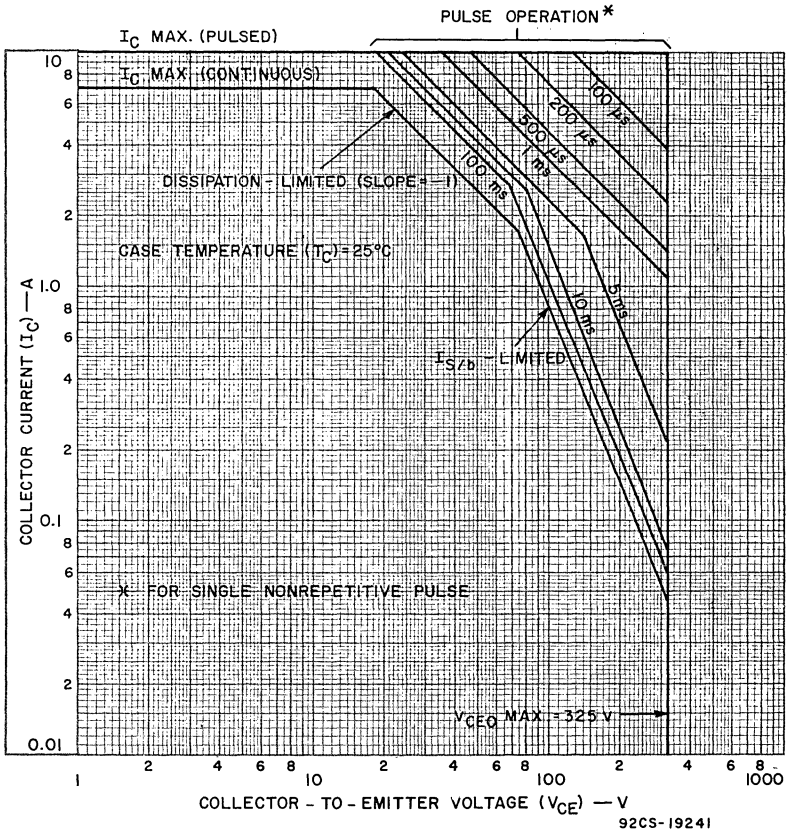


Fig.2—Maximum operating areas.

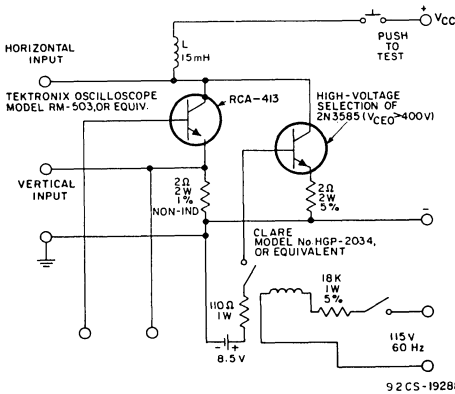


Fig.3—Circuit used to measure sustaining voltage,  $V_{CE0}(sus)$ .

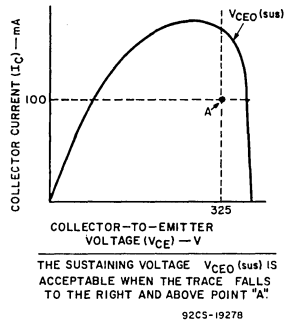


Fig.4—Oscilloscope display for measurement of sustaining voltage (test circuit shown in Fig. 3).

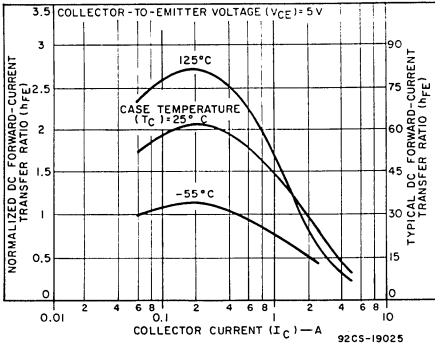


Fig. 5—Typical dc beta characteristics.

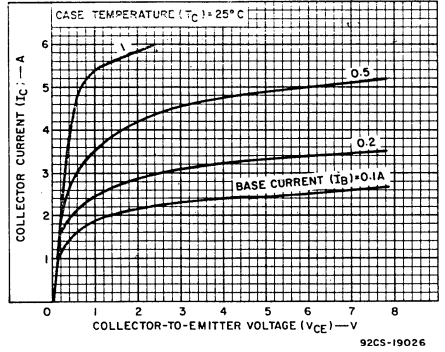


Fig. 6—Typical output characteristics.

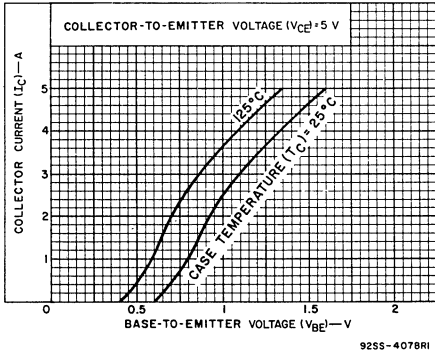


Fig. 7—Typical transfer characteristics.

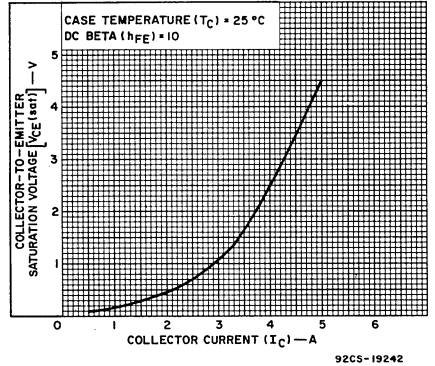


Fig. 8—Typical saturation voltage characteristic.

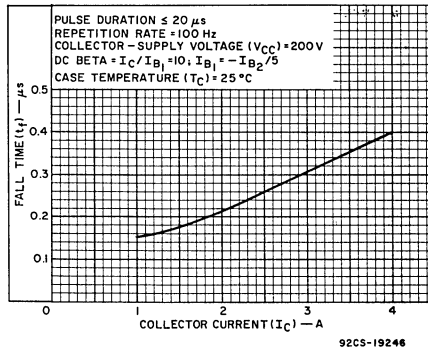


Fig. 9—Typical fall time vs. collector current.

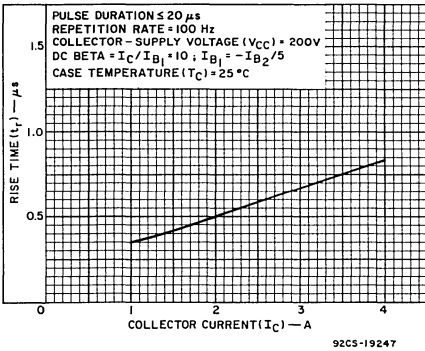


Fig.10—Typical rise time vs. collector current.

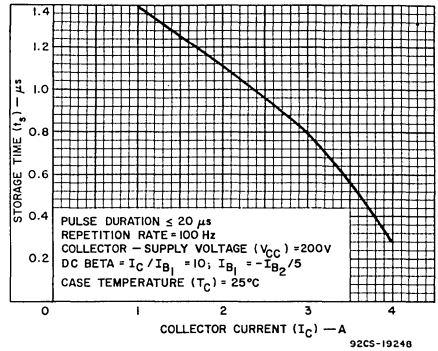


Fig.11—Typical storage time vs. collector current.

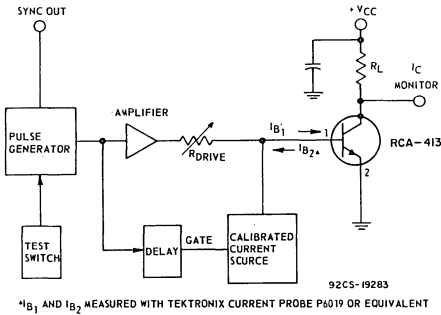


Fig.12—Circuit used to measure switching times.

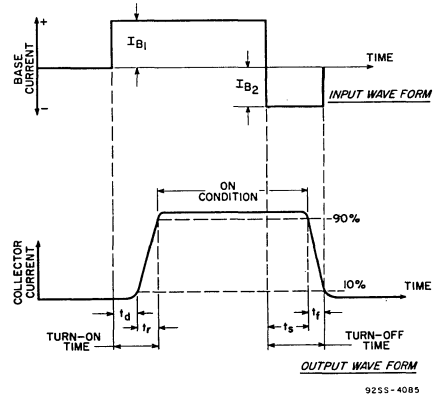


Fig.13—Phase relationship between input and output currents showing reference points for specification of switching times. (Test circuit shown in Fig.12).

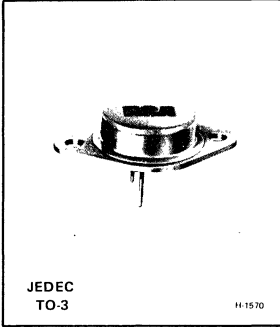
**TERMINAL CONNECTIONS**

- Pin 1 — Base
- Pin 2 — Emitter
- Mounting Flange, Case — Collector



# Power Transistors

## RCA423



### High-Voltage, High-Power Silicon N-P-N Power Transistor

For Switching and Linear Applications in Military, Industrial, and Commercial Equipment

**Features:**

- Maximum safe-area-of-operation curves
- Low saturation voltage:  $V_{CE(sat)} = 0.8 \text{ V (max.)}$
- High voltage rating:  $V_{CEO(sus)} = 325 \text{ V}$
- High dissipation rating:  $P_T = 125 \text{ W}$

RCA-423 is an epitaxial silicon n-p-n power transistor utilizing a multiple-emitter-site structure. This device employs the popular JEDEC TO-3 package. Featuring high breakdown-voltage ratings and low saturation-

voltage values, the RCA-423 is especially suitable for use in inverters, deflection circuits, switching regulators, high-voltage bridge amplifiers, ignition circuits, and other high-voltage switching applications.

**MAXIMUM RATINGS, Absolute-Maximum Values:**

COLLECTOR-TO-BASE VOLTAGE, $V_{CBO}$ .....	400 V
COLLECTOR-TO-EMITTER SUSTAINING VOLTAGE: With base open, $V_{CEO(sus)}$ .....	325 V
COLLECTOR-TO-EMITTER BREAKDOWN VOLTAGE: With base open, $V_{(BR)CEO}$ .....	400 V
EMITTER-TO-BASE VOLTAGE, $V_{EBO}$ .....	5 V
COLLECTOR CURRENT: Continuous, $I_C$ .....	7 A
Peak .....	10 A
BASE CURRENT (Continuous), $I_B$ .....	2 A
TRANSISTOR DISSIPATION, $P_T$ : At case temperatures up to $25^\circ\text{C}$ and $V_{CE}$ up to 75 V .....	125 W
At case temperatures up to $25^\circ\text{C}$ and $V_{CE}$ above 75 V .....	See Fig. 2.
At case temperatures above $25^\circ\text{C}$ and $V_{CE}$ above 75 V .....	See Figs. 1 & 2.
TEMPERATURE RANGE: Storage & Operating (Junction) .....	-65 to +200 $^\circ\text{C}$

**PIN TEMPERATURE (During Soldering):**

At distances  $\geq 1/32$  in. (0.8 mm) from case for 10 s max. .... 230  $^\circ\text{C}$

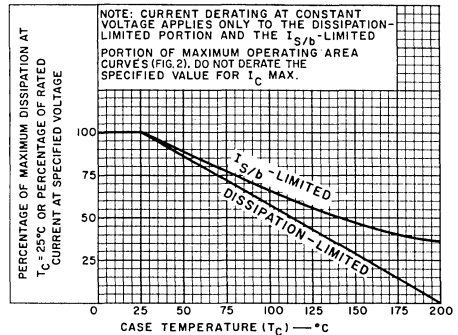


Fig. 1—Dissipation and current derating curves.

ELECTRICAL CHARACTERISTICS, Case Temperature ( $T_C$ ) = 25°C Unless Otherwise Specified

Characteristic	Symbol	Test Conditions				Limits			Units
		DC Voltage (V)		DC Current (A)		Min.	Typ.	Max.	
		$V_{CE}$	$V_{BE}$	$I_C$	$I_B$				
Collector-Cutoff Current: With base open	$I_{CEO}$	400				—	—	0.25	mA
With base-emitter junction reverse-biased	$I_{CEV}$	400	-1.5			—	—	0.25	
With base-emitter junction reverse-biased & $T_C = 125^\circ\text{C}$	$I_{CEV}$		-1.5			—	—	0.5	
Emitter-Cutoff Current	$I_{EBO}$		-5			—	—	5.0	mA
DC Forward-Current Transfer Ratio	$h_{FE}$	5 5		1.0 <sup>a</sup> 2.5 <sup>a</sup>		30 10	— —	90 —	
Collector-to-Emitter Sustaining Voltage: With base open (See Figs. 3 & 4.)	$V_{CEO(sus)}$			0.1		325 <sup>b</sup>	—	—	V
Base-to-Emitter Saturation Voltage	$V_{BE(sat)}$			1.0 <sup>a</sup>	0.1	—	0.9	1.5	V
Collector-to-Emitter Saturation Voltage	$V_{CE(sat)}$			1.0 <sup>a</sup>	0.1	—	0.2	0.8	V
Second-Breakdown Collector Current: (With base forward-biased) Pulse duration (non-repetitive) = 1 s	$I_{S/b}^c$	150				0.3	—	—	A
Gain-Bandwidth Product	$f_T$	10		0.2		—	4.0	—	MHz
Switching Time: ( $I_{B1} = 0.1 \text{ A}$ , $I_{B2} = -0.5 \text{ A}$ )									$\mu\text{s}$
Rise (See Figs. 10, 12, & 13.)	$t_r$			1.0		—	0.35	—	
Storage (See Figs. 11, 12, & 13.)	$t_s$			1.0		—	1.4	—	
Fall (See Figs. 9, 12, & 13.)	$t_f$			1.0		—	0.15	—	
Thermal Resistance (Junction-to-Case)	$R_{\theta JC}$	10		5		—	—	1.4	$^\circ\text{C/W}$

<sup>a</sup> Pulsed; pulse duration  $\leq 350 \mu\text{s}$ , duty factor = 2%.

<sup>b</sup> CAUTION: The sustaining voltage  $V_{CEO(sus)}$  MUST NOT be measured on a curve tracer. The sustaining voltage should be measured by means of the test circuit shown in Fig. 3.

<sup>c</sup>  $I_{S/b}$  is defined as the current at which second breakdown occurs at a specified collector voltage with the emitter-base junction forward-biased for transistor operation in the active region.

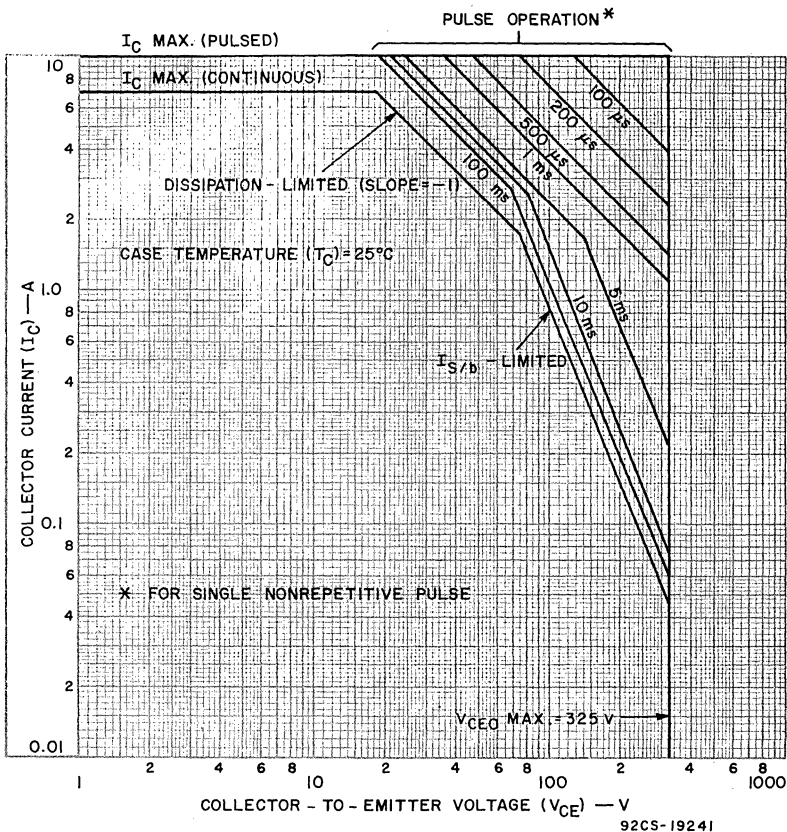


Fig.2—Maximum operating areas.

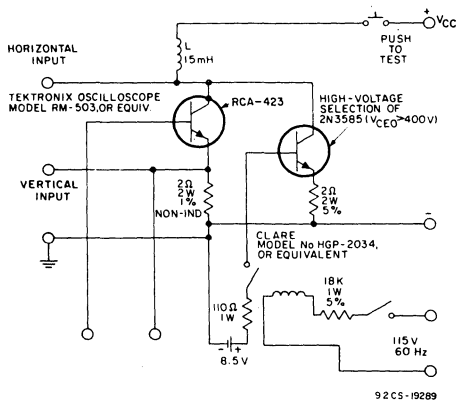
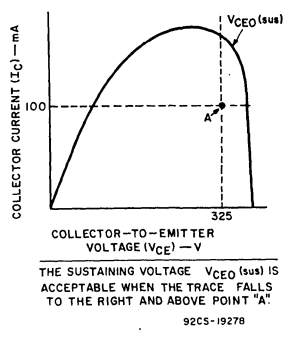


Fig.3—Circuit used to measure sustaining voltage,  $V_{CE(sus)}$ .



THE SUSTAINING VOLTAGE  $V_{CE(sus)}$  IS ACCEPTABLE WHEN THE TRACE FALLS TO THE RIGHT AND ABOVE POINT "A".

Fig.4—Oscilloscope display for measurement of sustaining voltage (test circuit shown in Fig.3).

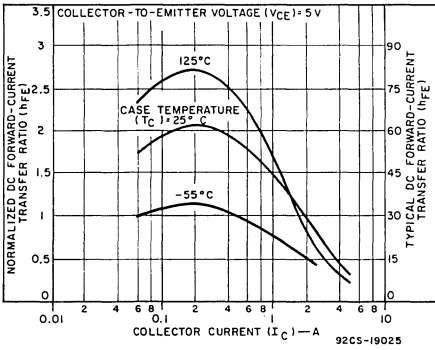


Fig. 5—Typical dc beta characteristics.

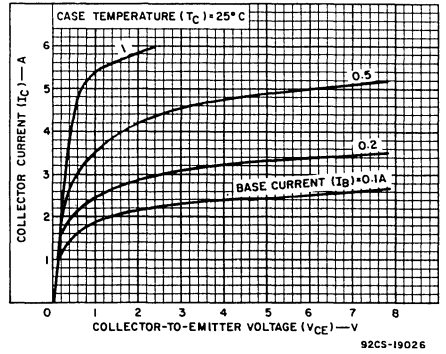


Fig. 6—Typical output characteristics.

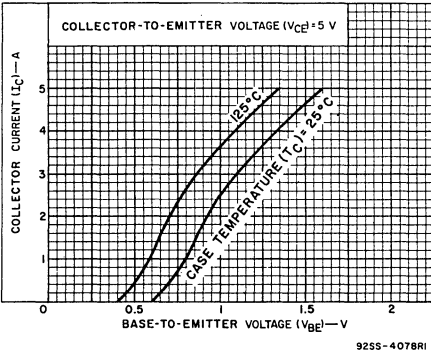


Fig. 7—Typical transfer characteristics.

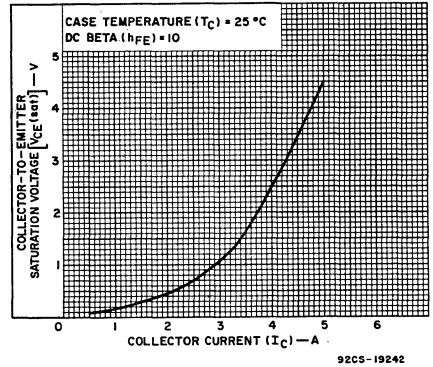


Fig. 8—Typical saturation voltage characteristic.

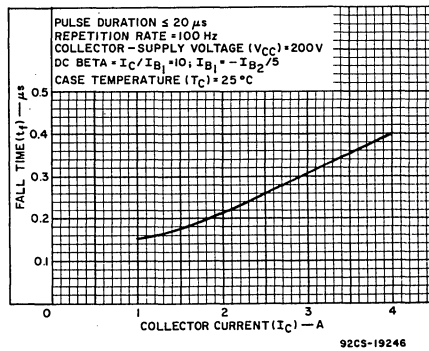


Fig. 9—Typical fall time vs. collector current.

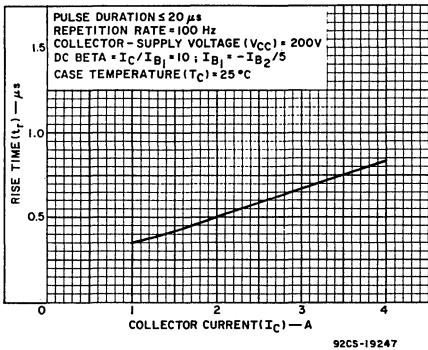


Fig.10—Typical rise time vs. collector current.

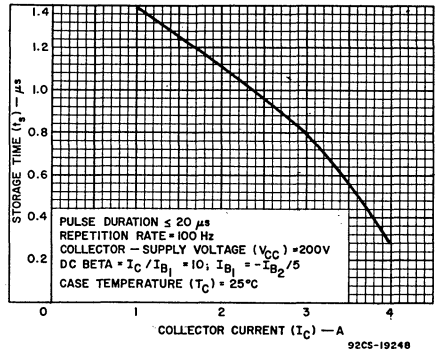


Fig.11—Typical storage time vs. collector current.

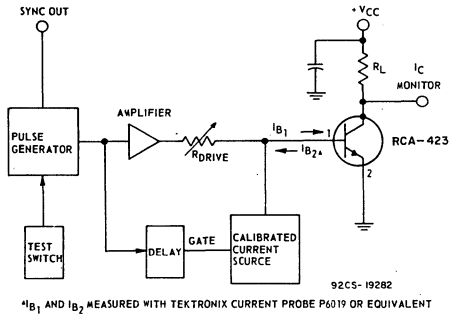


Fig.12—Circuit used to measure switching times.

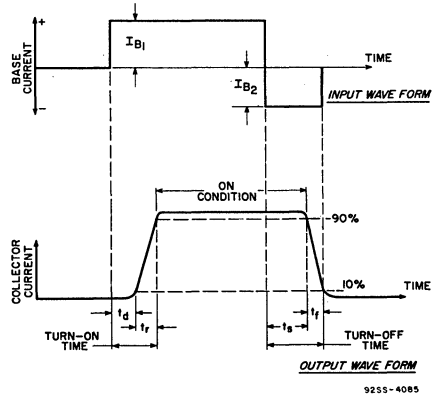
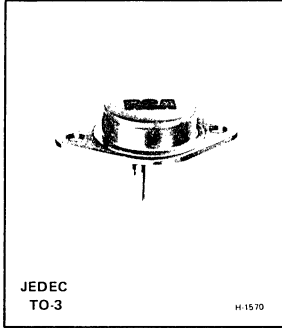


Fig.13—Phase relationship between input and output currents showing reference points for specification of switching times. (Test circuit shown in Fig.12).

**TERMINAL CONNECTIONS**

- Pin 1 — Base
- Pin 2 — Emitter
- Mounting Flange, Case — Collector





## High-Voltage, High-Power Silicon N-P-N Power Transistor

For Switching and Linear Applications in  
Military, Industrial, and Commercial Equipment

*Features:*

- ▣ Maximum safe-area-of operation curves
- ▣ Low saturation voltage:  $V_{CE(sat)} = 0.7 \text{ V (max.)}$
- ▣ High voltage rating:  $V_{CE0(sus)} = 325 \text{ V}$
- ▣ High dissipation rating:  $P_T = 125 \text{ W}$

RCA-431 is an epitaxial silicon n-p-n power transistor utilizing a multiple-emitter-site structure. This device employs the popular JEDEC TO-3 package.

Featuring high breakdown-voltage ratings and low saturation-

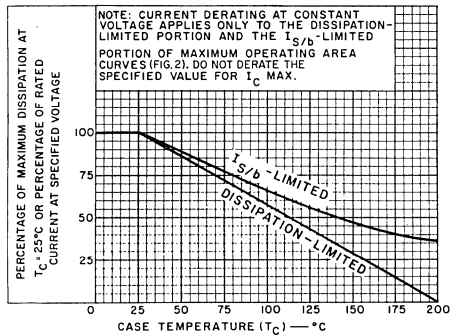
voltage values, the RCA-431 is especially suitable for use in inverters, deflection circuits, switching regulators, high-voltage bridge amplifiers, ignition circuits, and other high-voltage switching applications.

**MAXIMUM RATINGS, Absolute-Maximum Values:**

COLLECTOR-TO-BASE VOLTAGE, $V_{CBO}$ .....	400 V
COLLECTOR-TO-EMITTER SUSTAINING VOLTAGE With base open, $V_{CE0(sus)}$ .....	325 V
COLLECTOR-TO-EMITTER BREAKDOWN VOLTAGE: With base open, $V_{(BR)CEO}$ .....	400 V
EMITTER-TO-BASE VOLTAGE, $V_{EBO}$ .....	5 V
COLLECTOR CURRENT: Continuous, $I_C$ .....	7 A
Peak .....	10 A
BASE CURRENT (Continuous), $I_B$ .....	2 A
TRANSISTOR DISSIPATION, $P_T$ : At case temperatures up to 25°C and $V_{CE}$ up to 75 V .....	125 W
At case temperatures up to 25°C and $V_{CE}$ above 75 V .....	See Fig. 2.
At case temperatures above 25°C and $V_{CE}$ above 75 V .....	See Figs. 1 & 2.

**PIN TEMPERATURE (During Soldering):**

At distances $\geq 1/32$ in. (0.8 mm) from case for 10 s max. ....	230 °C
--	--------



92CS-19296

Fig. 1—Dissipation and current derating curves.

**TEMPERATURE RANGE:**

Storage & Operating (Junction) .....	-65 to +200 °C
--------------------------------------	----------------

ELECTRICAL CHARACTERISTICS, Case Temperature ( $T_C$ ) = 25°C Unless Otherwise Specified

Characteristic	Symbol	Test Conditions				Limits			Units
		DC Voltage (V)		DC Current (A)					
		$V_{CE}$	$V_{BE}$	$I_C$	$I_B$	Min.	Typ.	Max.	
Collector-Cutoff Current: With base open	$I_{CEO}$	400				—	—	2.5	mA
With base-emitter junction reverse-biased	$I_{CEV}$	400	-1.5			—	—	2.5	
With base-emitter junction reverse-biased & $T_C = 125^\circ\text{C}$	$I_{CEV}$	400	-1.5			—	—	5.0	
Emitter-Cutoff Current	$I_{EBO}$		-5			—	—	2.0	mA
DC Forward-Current Transfer Ratio	$h_{FE}$	5 5		2.5 <sup>a</sup> 3.5 <sup>a</sup>		15 10	— —	35 —	
Collector-to-Emitter Sustaining Voltage: With base open (See Figs. 3 & 4.)	$V_{CEO(sus)}^b$			0.1		325 <sup>b</sup>	—	—	V
Base-to-Emitter Saturation Voltage	$V_{BE(sat)}$			2.5 <sup>a</sup>	0.5	—	—	1.5	V
Collector-to-Emitter Saturation Voltage	$V_{CE(sat)}$			2.5 <sup>a</sup>	0.5	—	0.25	0.7	V
Second-Breakdown Collector Current: (With base forward-biased) Pulse duration (non-repetitive) = 1 s	$I_{S/B}^c$	150				0.3	—	—	A
Gain-Bandwidth Product	$f_T$	10		0.2		—	4.0	—	MHz
Switching Time ( $I_{B1} = I_{B2}$ ): Rise (See Figs. 10, 12, & 13.)	$t_r$			2.5	0.5	—	0.35	—	$\mu\text{s}$
Storage (See Figs. 11, 12, & 13.)	$t_s$			2.5	0.5	—	1.8	—	
Fall (See Figs. 9, 12, & 13.)	$t_f$			2.5	0.5	—	0.4	—	
Thermal Resistance (Junction-to-Case)	$R_{\theta JC}$	10		5		—	—	1.4	$^\circ\text{C/W}$

<sup>a</sup> Pulsed; pulse duration  $\leq 350 \mu\text{s}$ , duty factor = 2%

<sup>b</sup> CAUTION: The sustaining voltage  $V_{CEO(sus)}$  MUST NOT be measured on a curve tracer. The sustaining voltage should be measured by means of the test circuit shown in Fig. 3.

<sup>c</sup>  $I_{S/B}$  is defined as the current at which second breakdown occurs at a specified collector voltage with the emitter-base junction forward-biased for transistor operation in the active region.

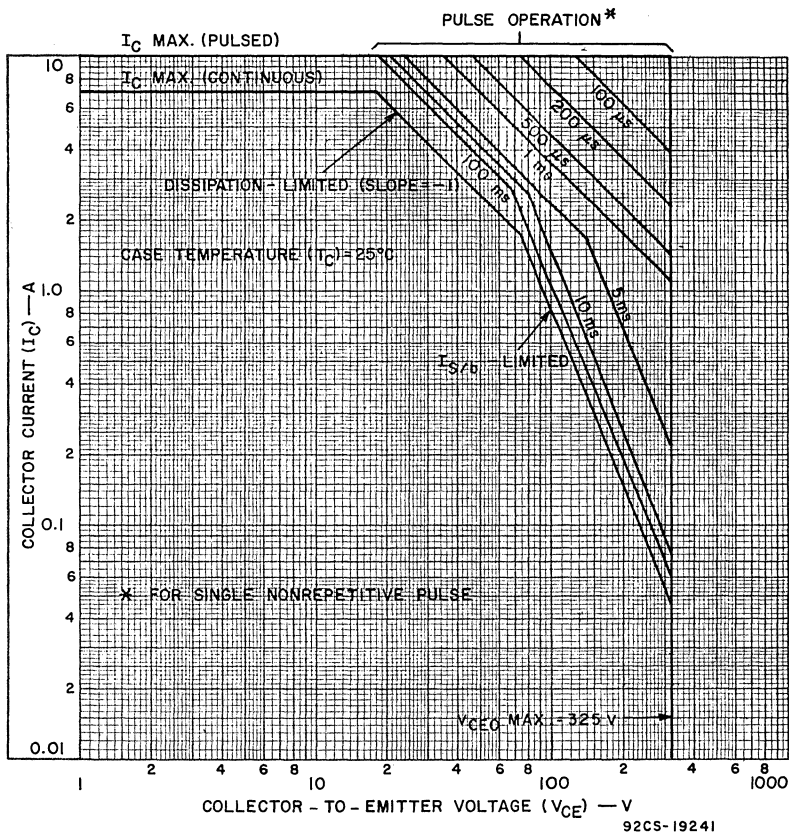


Fig.2—Maximum operating areas.

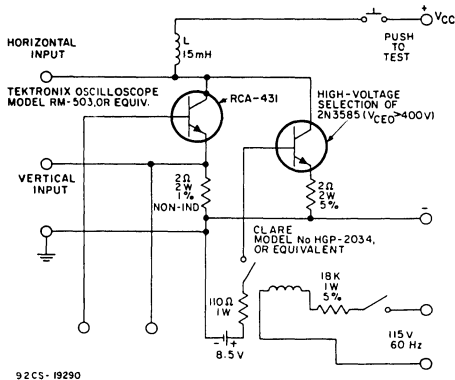


Fig.3—Circuit used to measure sustaining voltage,  $V_{CE(sus)}$ .

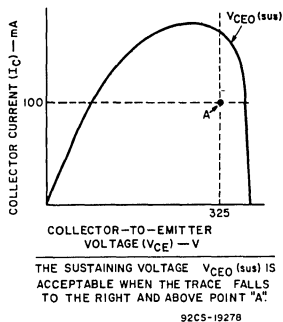


Fig.4—Oscilloscope display for measurement of sustaining voltage (test circuit shown in Fig. 3).

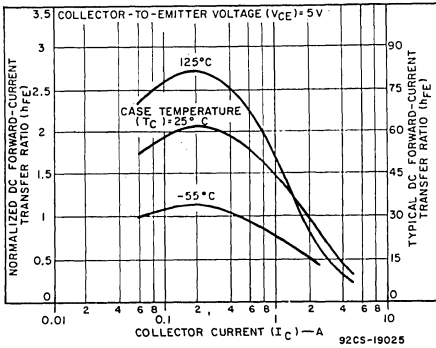


Fig. 5—Typical dc beta characteristics.

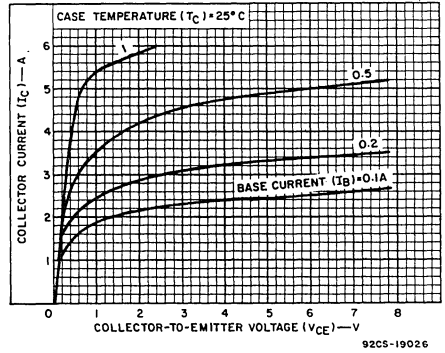


Fig. 6—Typical output characteristics.

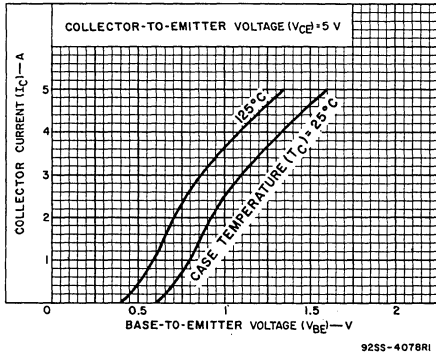


Fig. 7—Typical transfer characteristics.

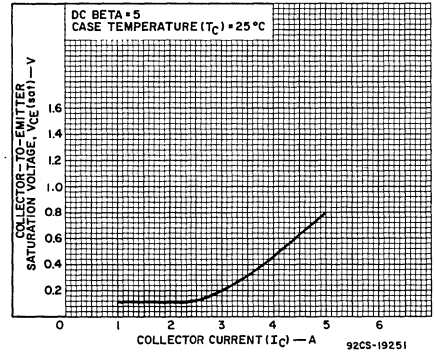


Fig. 8—Saturation voltage vs. collector current.

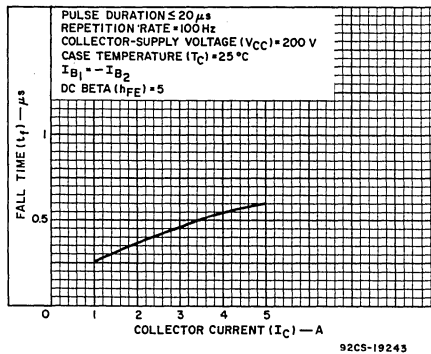
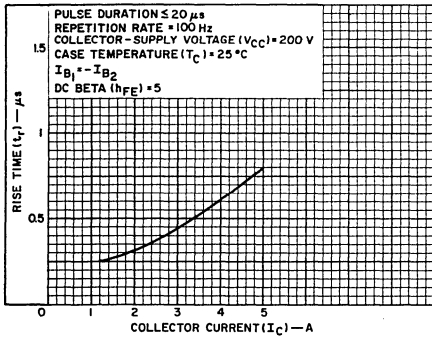
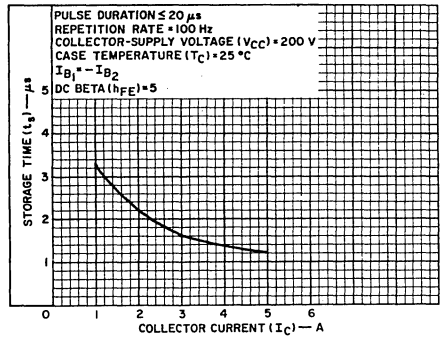


Fig. 9—Typical fall-time characteristic.



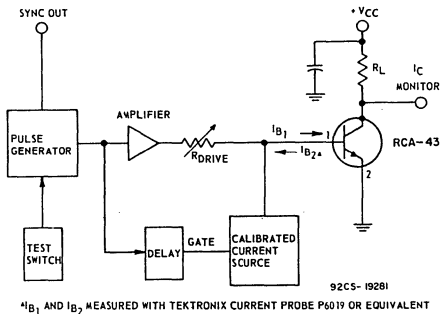
92CS-19244

Fig.10—Typical rise-time characteristic.



92CS-19245

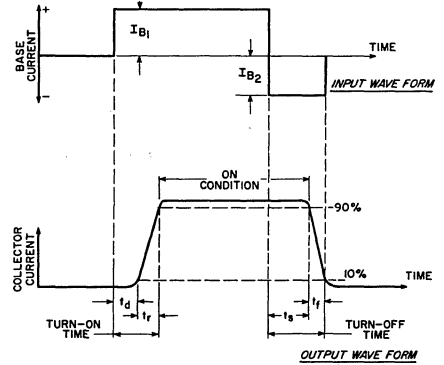
Fig.11—Typical storage-time characteristic (with constant forced gain).



92CS-19281

\*IB<sub>1</sub> and IB<sub>2</sub> MEASURED WITH TEKTRONIX CURRENT PROBE P6019 OR EQUIVALENT

Fig.12—Circuit used to measure switching times.



92SS-4085

Fig.13—Phase relationship between input and output currents showing reference points for specification of switching times. (Test circuit shown in Fig.12).

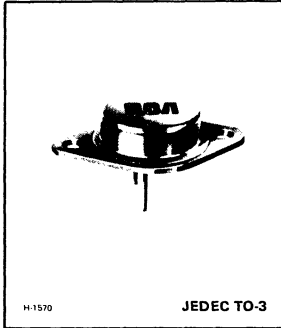
**TERMINAL CONNECTIONS**

- Pin 1 — Base
- Pin 2 — Emitter
- Mounting Flange, Case — Collector

**RCA**  
Solid State  
Division

## Power Transistors

**RCA1000**  
**RCA 1001**



### 8-Ampere Silicon N-P-N Darlington Power Transistors

For Use as Output Devices in General-Purpose  
Switching and Amplifier Applications

#### Features:

- High dc current gain:  
 $h_{FE} = 1000$  min. at  $I_C = 3$  A
- Monolithic construction with built-in  
base-emitter shunt resistors

RCA-1000 and 1001 are monolithic silicon n-p-n Darlington transistors intended for medium-power applications as output devices. The double epitaxial construction of these units provides good forward and reverse second-breakdown capability. Their high gain makes it possible for them to be driven directly from integrated circuits.

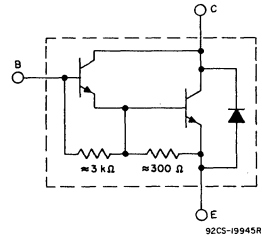


Fig. 1—Schematic diagram of RCA-1000 and  
RCA 1001 Darlington power transistors.

#### MAXIMUM RATINGS, Absolute-Maximum Values:

		RCA 1000	RCA-1001	
COLLECTOR-TO-BASE VOLTAGE:				
With emitter open	$V_{CBO}$	60	80	V
COLLECTOR-TO-EMITTER VOLTAGE:				
With base open	$V_{CEO}$	60	80	V
EMITTER-TO-BASE VOLTAGE:				
With collector open	$V_{EBO}$	5	5	V
COLLECTOR CURRENT:				
Continuous	$I_C$	8	8	A
Pulsed		15	15	A
BASE CURRENT (Continuous)	$I_B$	0.1	0.1	A
TRANSISTOR DISSIPATION:				
At case temperatures up to 25°C	$P_T$	90	90	W
At case temperatures above 25°C, derate linearly at			0.515	W/°C
TEMPERATURE RANGE:				
Storage & Operating (Junction)		-55 to +200		°C
LEAD TEMPERATURE (During Soldering):				
At distance $\geq$ 1/8 in. (3.17 mm) from case to 10 s max.		235		°C

ELECTRICAL CHARACTERISTICS, At Case Temperature ( $T_C$ ) = 25°C unless otherwise specified

CHARACTERISTIC	SYMBOL	TEST CONDITIONS					LIMITS				UNITS
		DC VOLTAGE (V)			DC CURRENT (A)		RCA-1000		RCA-1001		
		$V_{CB}$	$V_{CE}$	$V_{BE}$	$I_C$	$I_B$	MIN.	MAX.	MIN.	MAX.	
Collector Cutoff Current: With base open	$I_{CEO}$		30 40			0 0	— —	500 —	— 500	— —	$\mu A$
With external base-to-emitter resistance ( $R_{BE}$ ) = 1 k $\Omega$ At $T_C = 150^\circ C$	$I_{CER}$	60 80					— —	1 —	— 1	— —	mA
		60 80					— —	5 —	— 5	— —	
Emitter Cutoff Current	$I_{EBO}$			5	0		—	2	—	2	mA
Collector-to-Emitter Breakdown Voltage	$V_{(BR)CEO}$				0.1 <sup>a</sup> 0.1 <sup>a</sup>	0 0	60 —	— —	— 80	— —	V
DC Forward Current Transfer Ratio	$h_{FE}$		3 3		3 4		1000 750	— —	1000 750	— —	
Base-to-Emitter Voltage	$V_{BE}$		3		3 <sup>a</sup>		—	2.5	—	2.5	V
Collector-to-Emitter Saturation Voltage	$V_{CE(sat)}$				3 <sup>a</sup> 8 <sup>a</sup>	0.012 0.04	— —	2 4	— —	2 4	V
Thermal Resistance (Junction-to-Case)	$R_{\theta JC}$						—	1.94	—	1.94	$^\circ C/W$

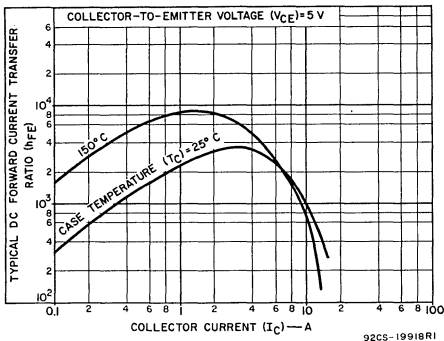


Fig.2—Typical dc beta characteristics for both types.

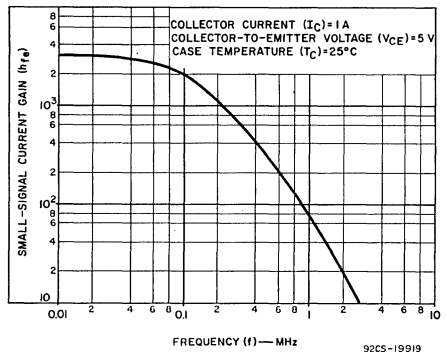


Fig.3—Typical small-signal gain for both types.

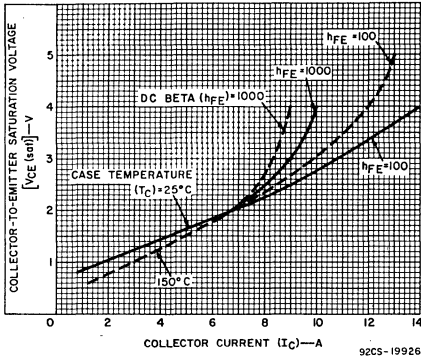


Fig. 4—Typical saturation characteristics for both types.

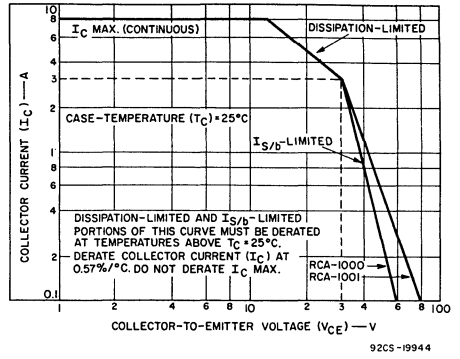


Fig. 5—DC safe-area-of-operation for both types.

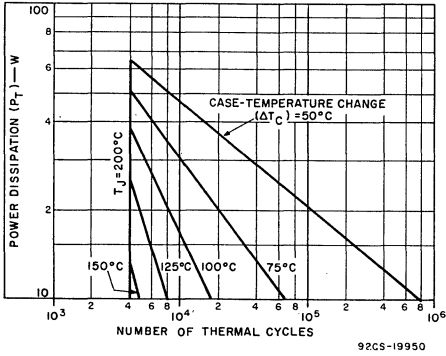


Fig. 6—Thermal-cycling rating chart for both types.

**TERMINAL CONNECTIONS**

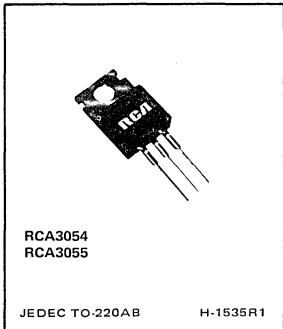
- Pin 1 — Base
- Pin 2 — Emitter
- Case — Collector
- Mounting Flange — Collector





# Power Transistors

## RCA3054 RCA3055



### Hometaxial-Base Silicon N-P-N VERSAWATT Transistors

Designed for Medium-Power Linear and Switching Service in Consumer, Automotive, and Industrial Applications

**Features:**

- ▣ Maximum safe-area-of-operation curves
- ▣ Low saturation voltages
- ▣ High dissipation ratings
- ▣ Thermal-cycle rating curves

**Applications:**

- ▣ Series and shunt regulators
- ▣ High-fidelity amplifiers
- ▣ Power-switching circuits
- ▣ Solenoid drivers

RCA3054 and RCA3055 are silicon n-p-n transistors intended for a wide variety of high-current applications. The hometaxial-base construction of these devices renders them highly resistant to second breakdown over a wide range of operating conditions.

The VERSAWATT case has a proven thermal-cycle capability. This capability is assured by real-time quality controls in our manufacturing locations. The RCA3054 and RCA3055 are

supplied in the JEDEC TO-220AB straight-lead version of the package. They are also available on special order in a variety of lead-form configurations. Two popular variations have leads formed to fit TO-66 sockets (specify formed lead No. 6201) or printed-circuit boards (specify formed lead No. 6207). Detailed information on these and other VERSAWATT outlines is contained in "RCA's Lineup of Power Transistors" (PSP-704).

**MAXIMUM RATINGS, Absolute-Maximum Values:**

	RCA3054	RCA3055	
COLLECTOR-TO-BASE VOLTAGE . . . . .	90	100	V
COLLECTOR-TO-EMITTER SUSTAINING VOLTAGE: With external base-to-emitter resistance ( $R_{BE}$ ) = 100 $\Omega$ . . . . .	60	70	V
With base open . . . . .	55	60	V
With base reverse-biased $V_{BE} = -1.5$ V . . . . .	90	90	V
EMITTER-TO-BASE VOLTAGE . . . . .	7	7	V
CONTINUOUS COLLECTOR CURRENT . . . . .	4	15	A
CONTINUOUS BASE CURRENT . . . . .	2	4	A
TRANSISTOR DISSIPATION: At case temperatures up to 25°C . . . . .	36	75	W
At case temperatures above 25°C . . . . .	See Fig.3		
TEMPERATURE RANGE: Storage and Operating (Junction) . . . . .	-65 to +150		°C
PIN TEMPERATURE (During Soldering): At distances $\geq$ 1/32 in. (0.8 mm) from seating plane for 10 s max.	235		°C

ELECTRICAL CHARACTERISTICS, At Case Temperature ( $T_C$ ) = 25°C unless otherwise specified

CHARACTERISTIC	SYMBOL	TEST CONDITIONS				LIMITS				UNITS
		VOLTAGE V dc		CURRENT A dc		RCA3054		RCA3055		
		$V_{CE}$	$V_{BE}$	$I_C$	$I_B$	MIN.	MAX.	MIN.	MAX.	
Collector-Cutoff Current: With base open	$I_{CEO}$	30			0	—	0.5	—	0.7	mA
With base-emitter junction reverse-biased	$I_{CEX}$	90 100	-1.5 -1.5			— —	1 —	— —	— 5	
At $T_C = 150^\circ\text{C}$	$I_{CEX}$	90 100	-1.5 -1.5			— —	6 —	— —	— 30	
Emitter-Cutoff Current	$I_{EBO}$		-7	0		—	1.0	—	5	mA
Collector-to-Emitter Sustaining Voltage: With base open	$V_{CEO(sus)}$			0.1 <sup>a</sup> 0.2 <sup>a</sup>	0 0	55 —	— —	— 60	— —	V
With external base-to- emitter resistance ( $R_{BE}$ ) = 100 $\Omega$	$V_{CER(sus)}$			0.1 <sup>a</sup> 0.2 <sup>a</sup>		60 —	— —	— 70	— —	
With base-emitter junction reverse-biased	$V_{CEV(sus)}$		-1.5	0.1 <sup>a</sup>		90 —	— —	90 —	— —	
DC Forward-Current Transfer Ratio	$h_{FE}$	4 4 4 4		3 <sup>a</sup> 10 <sup>a</sup> 0.5 <sup>a</sup> 4 <sup>a</sup>		5 — 25 —	— — 100 —	— 5 — 20	— — — 70	
Collector-to-Emitter Saturation Voltage	$V_{CE(sat)}$			0.5 <sup>a</sup> 4 <sup>a</sup>	0.05 <sup>a</sup> 0.4 <sup>a</sup>	— —	1.0 —	— —	— 1.1	V
Base-to-Emitter Voltage	$V_{BE}$	4 4		0.5 <sup>a</sup> 4 <sup>a</sup>		— —	1.7 —	— —	— 1.8	V
Common-Emitter, Small-Signal, Short-Circuit, Forward Current Transfer Ratio Cutoff Frequency	$f_{hfe}$	4 4		0.1 1		30 —	— —	— 10	— —	kHz
Magnitude of Common- Emitter, Small-Signal Short-Circuit Forward Current Transfer Ratio ( $f = 0.4$ MHz)	$ h_{fe} $	4 4		0.1 1		2 —	— —	— 2	— —	
Common-Emitter, Small-Signal, Short- Circuit Forward Current Transfer Ratio ( $f = 1$ kHz)	$h_{fe}$	4 4		0.1 1		25 —	— —	— 15	— 120	
Forward-Bias Second Breakdown Collector Current <sup>b</sup> ( $t \geq 1$ s)	$I_{S/b}$	55 60				0.65 —	— —	— 1.2	— —	A
Thermal Resistance: Junction-to-Case	$R_{\theta JC}$					—	3.5	—	1.67	$^\circ\text{C/W}$
Junction-to-Ambient	$R_{\theta JA}$					—	70	—	70	

<sup>a</sup> Pulsed; Pulse duration = 300  $\mu\text{s}$ , duty factor = 1.8%.<sup>b</sup> Pulsed; 1-second non-repetitive pulse.

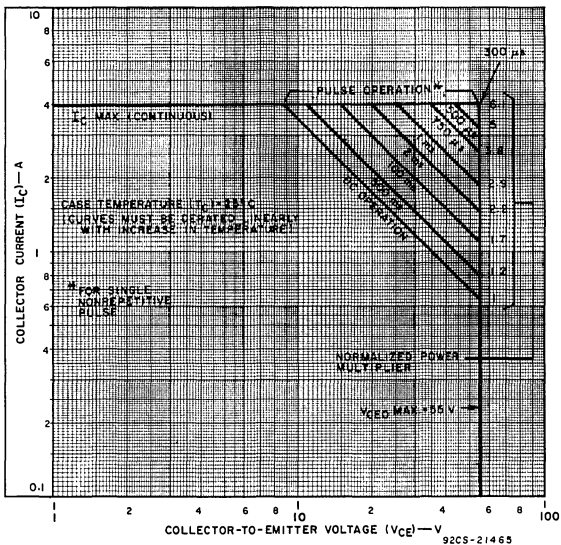


Fig.1—Maximum operating areas for RCA3054.

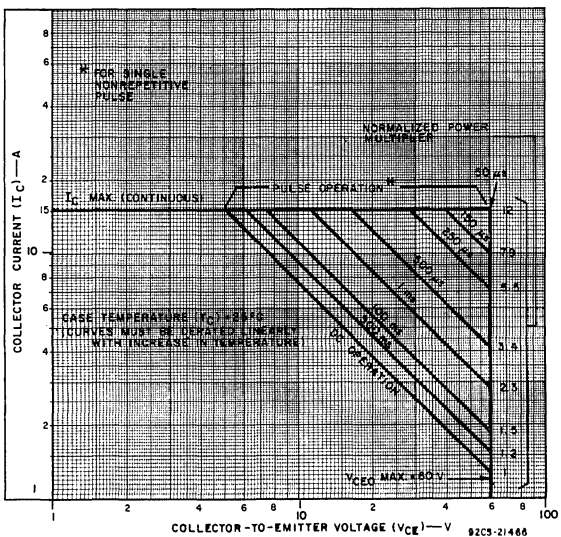


Fig.2—Maximum operating areas for RCA3055.

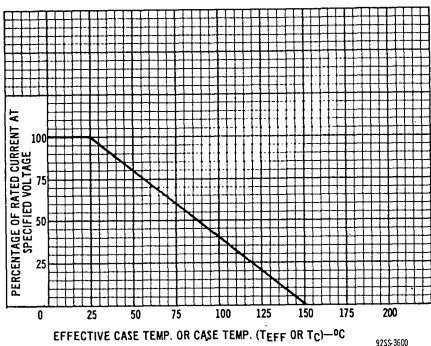


Fig. 3 - Derating curve for both types.

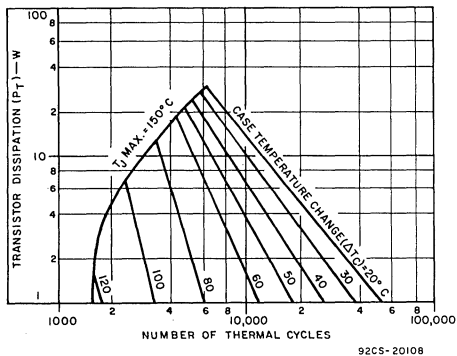


Fig. 4 - Thermal-cycling rating chart for RCA3054.

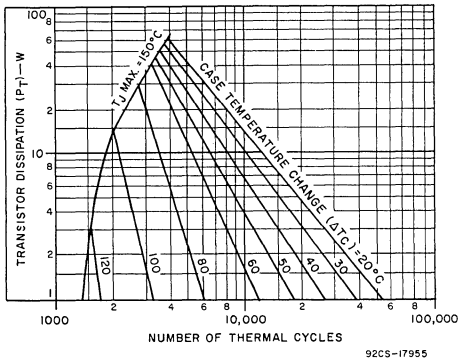


Fig. 5 - Thermal-cycling rating chart for RCA3055.

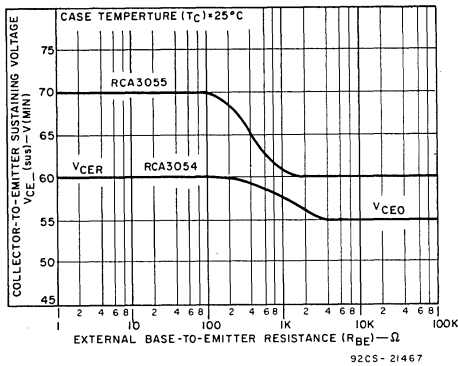


Fig. 6 - Sustaining voltage vs. base-to-emitter resistance for both types.

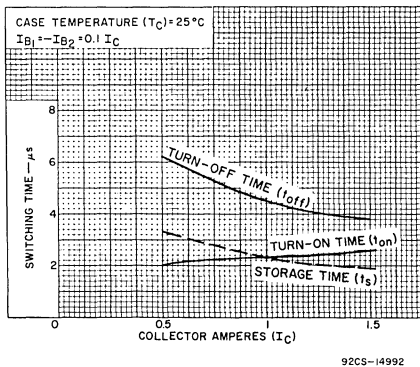


Fig. 7 - Typical saturated switching characteristics for RCA3054.

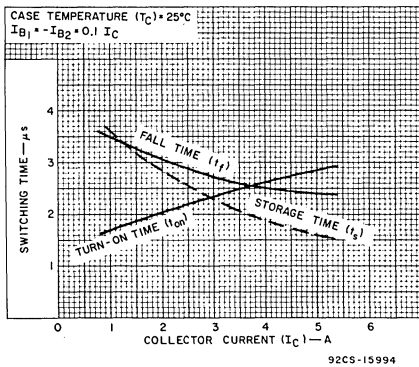


Fig. 8 - Typical saturated switching characteristics for RCA3055.

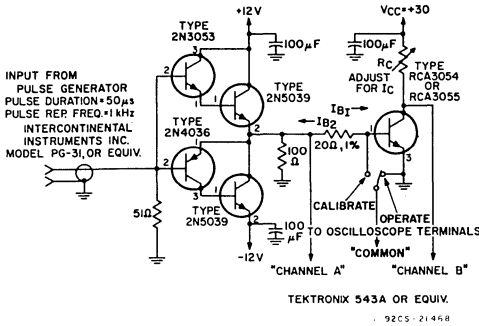


Fig.9 - Circuit used to measure switching times.

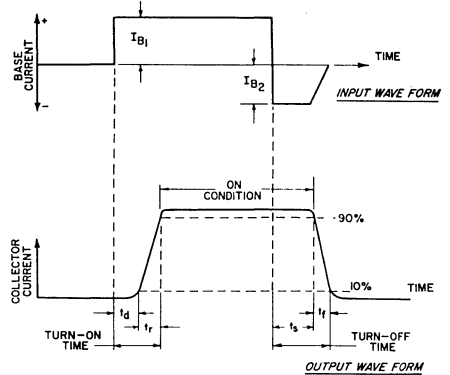


Fig.10 - Phase relationship between input current and output current showing reference points for specification of switching times. (Test circuit shown in Fig.9).

92CS-19996RI

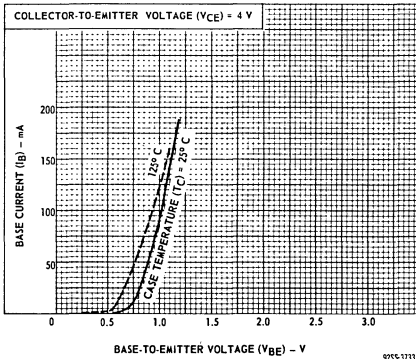


Fig.11 - Typical input characteristics for RCA3054.

92SS-3733

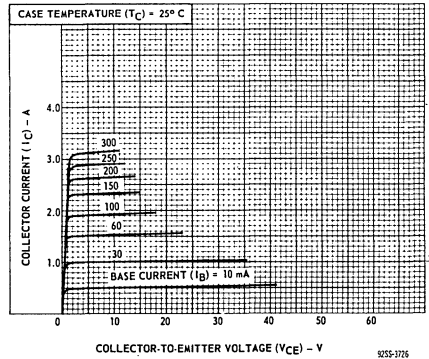


Fig.12 - Typical output characteristics for RCA3054.

92SS-3726

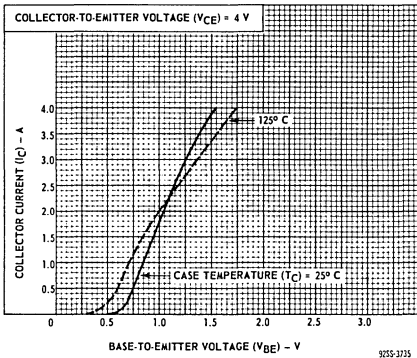


Fig.13 - Typical transfer characteristics for RCA3054.

92SS-3735

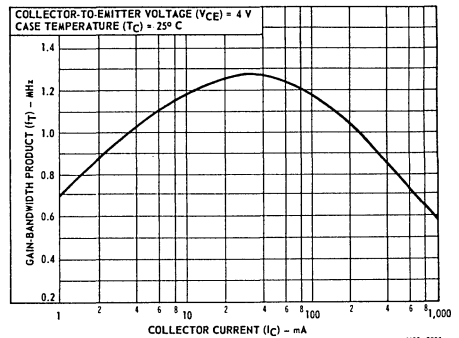


Fig.14 - Typical gain-bandwidth product for RCA3054.

92SS-3736

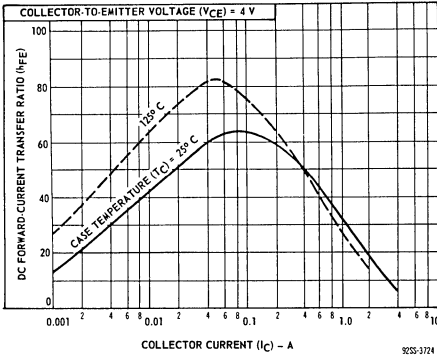


Fig. 15 - Typical dc beta characteristics for RCA3054.

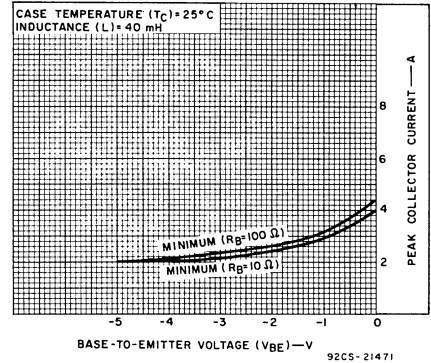


Fig. 16 - Reverse-bias second breakdown characteristics for RCA3054.

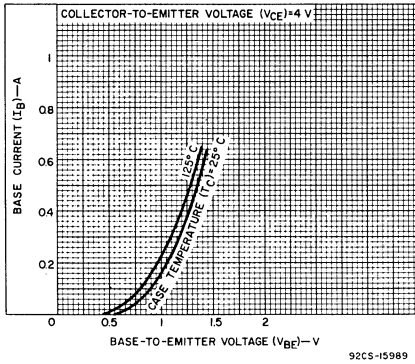


Fig. 17 - Typical input characteristics for RCA3055.

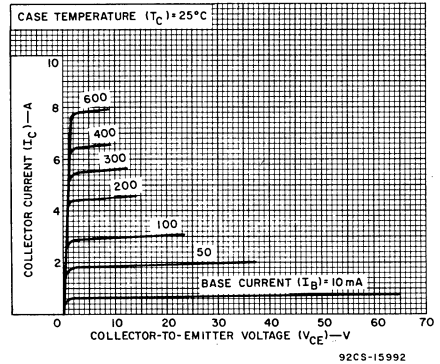


Fig. 18 - Typical output characteristics for RCA3055.

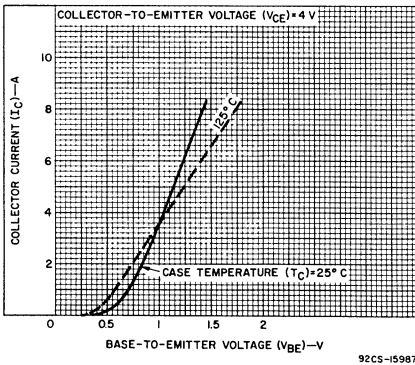


Fig. 19 - Typical transfer characteristics for RCA3055.

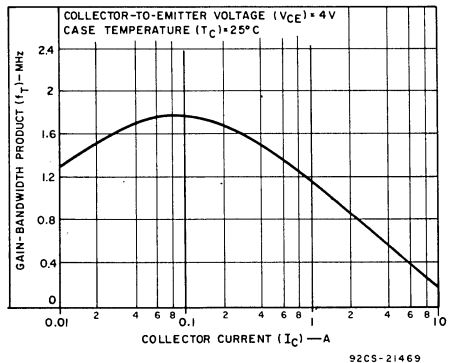


Fig. 20 - Typical gain-bandwidth product for RCA3055.

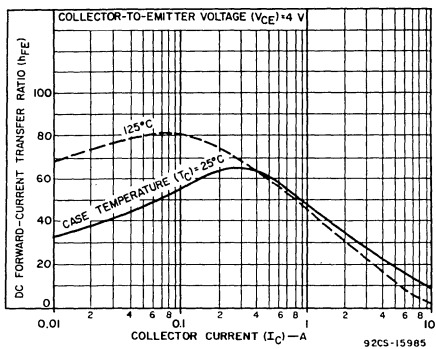


Fig.21 — Typical dc beta characteristics for RCA3055.

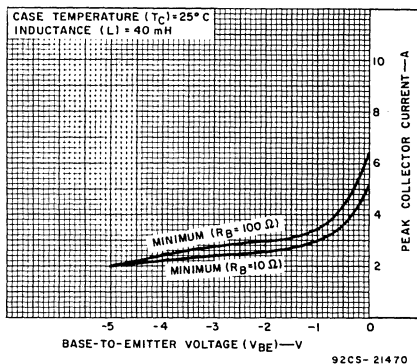


Fig.22 — Reverse-bias second-breakdown characteristics for RCA3055.

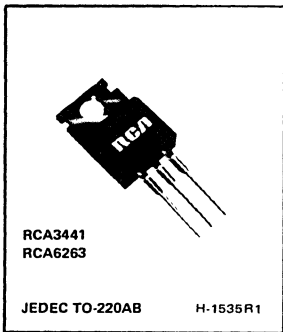
**TERMINAL CONNECTIONS  
JEDEC TO-220AB**

- Terminal No.1 — Base
- Terminal No.2 — Collector
- Terminal No.3 — Emitter
- Terminal No.4 — Collector



# Power Transistors

RCA3441 RCA6263



## Hometaxial-Base Silicon N-P-N VERSAWATT Transistors

Designed for Medium-Power Linear and Switching Service in Consumer, Automotive, and Industrial Applications

**Features:**

- Maximum safe-area-of-operation curves
- Low saturation voltages
- High dissipation ratings
- Thermal-cycling rating curves

**Applications:**

- Series and shunt regulators
- High-fidelity amplifiers
- Power-switching circuits
- Solenoid drivers

RCA3441 and RCA6263 are silicon n-p-n transistors intended for a wide variety of high-current applications. The hometaxial-base construction of these devices renders them highly resistant to second breakdown over a wide range of operating conditions. The VERSAWATT case has a proven thermal-cycling capability. This capability is assured by real-time quality controls in our manufacturing locations. The RCA3441 and RCA6263 are supplied in the JEDEC TO-220AB straight-lead version of the package. They are also available on special order in a variety of lead-form configurations. Two popular variations have leads formed to fit TO-66 sockets (specify formed lead No. 6201) or printed-circuit boards (specify formed lead No. 6207). Detailed information on these and other VERSAWATT outlines is contained in "RCA's Lineup of Power Transistors" (PSP-704).

**TERMINAL CONNECTIONS  
JEDEC TO-220AB**

- Terminal No. 1 – Base
- Terminal No. 2 – Collector
- Terminal No. 3 – Emitter
- Terminal No. 4 – Collector

**MAXIMUM RATINGS, Absolute-Maximum Values:**

		RCA6263	RCA3441	
COLLECTOR-TO-BASE VOLTAGE .....	$V_{CB0}$	140	160	V
COLLECTOR-TO-EMITTER SUSTAINING VOLTAGE:				
With external base-to-emitter resistance ( $R_{BE}$ ) = 100 $\Omega$ .....	$V_{CER(sus)}$	130	150	V
With base open .....	$V_{CEO(sus)}$	120	140	V
With base reverse-biased $V_{BE} = -1.5$ V .....	$V_{CEV(sus)}$	140	160	V
EMITTER-TO-BASE VOLTAGE .....	$V_{EBO}$	7	7	V
CONTINUOUS COLLECTOR CURRENT .....	$I_C$	3	3	A
PEAK COLLECTOR CURRENT .....		4	4	A
CONTINUOUS BASE CURRENT .....	$I_B$	2	2	A
TRANSISTOR DISSIPATION:	$P_T$			
At case temperatures up to 25°C .....		36	36	W
At case temperatures above 25°C .....		See Fig. 4		
TEMPERATURE RANGE:				
Storage and Operating (Junction) .....		-65 to +150		°C
PIN TEMPERATURE (During Soldering):				
At distances $\geq 1/32$ in. (0.8 mm) from seating plane for 10 s max. ....		235		°C



ELECTRICAL CHARACTERISTICS, At Case Temperature ( $T_C$ ) = 25°C unless otherwise specified

CHARACTERISTIC	SYMBOL	TEST CONDITIONS					LIMITS				UNITS	
		VOLTAGE V <sub>dc</sub>			CURRENT A <sub>dc</sub>		RCA6263		RCA3441			
		V <sub>CE</sub>	V <sub>EB</sub>	V <sub>BE</sub>	I <sub>C</sub>	I <sub>B</sub>	MIN.	MAX.	MIN.	MAX.		
Collector-Cutoff Current: With base open	I <sub>CEO</sub>	100 120				0 0	— —	5 —	— —	— 5	mA	
With base-emitter junction reverse-biased	I <sub>CEX</sub>	120 140		+1.5 -1.5			— —	5 —	— —	— 5		
At T <sub>C</sub> = 150°C	I <sub>CEX</sub>	120 140		-1.5 -1.5			— —	10 —	— —	— 10		
Emitter-Cutoff Current	I <sub>EBO</sub>		5			0	—	2	—	2	mA	
Collector-to-Emitter Sustaining Voltage: With base open	V <sub>CEO(sus)</sub>					0.1 <sup>a</sup>	0	120	—	140	—	V
With external base-to- emitter resistance (R <sub>BE</sub> ) = 100 Ω	V <sub>CER(sus)</sub>					0.1 <sup>a</sup>		130	—	150	—	
With base-emitter junction reverse-biased	V <sub>CEV(sus)</sub>			-1.5		0.1 <sup>a</sup>		140	—	160	—	
DC Forward-Current Transfer Ratio	h <sub>FE</sub>	4				0.5 <sup>a</sup>		20	150	20	150	
Collector-to-Emitter Saturation Voltage	V <sub>CE(sat)</sub>					0.5 <sup>a</sup>	0.05 <sup>a</sup>	—	1.2	—	1.2	V
Base-to-Emitter Voltage	V <sub>BE</sub>	4				0.5 <sup>a</sup>		—	2	—	2	V
Gain-Bandwidth Product	f <sub>T</sub>	4				0.2		200	—	200	—	kHz
Common-Emitter, Small-Signal, Short- Circuit Forward- Current Transfer Ratio (f = 1 kHz)	h <sub>fe</sub>	4				0.1		25	—	25	—	
Forward-Bias Second Breakdown Collector Current <sup>b</sup> (t ≥ 1 s)	I <sub>S/b</sub>	120						0.3	—	0.3	—	A
Thermal Resistance: Junction-to-Case	R <sub>θJC</sub>							—	3.5	—	3.5	°C/W
Junction-to-Ambient	R <sub>θJA</sub>							—	70	—	70	

<sup>a</sup>Pulsed: Pulse duration = 300 μs, duty factor = 1.8%.

<sup>b</sup>Pulsed: 1-second non-repetitive pulse.

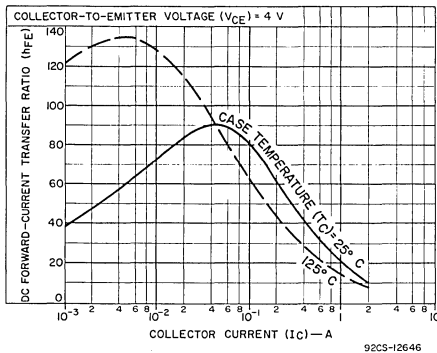


Fig. 1— Typical dc beta characteristics for RCA3441.

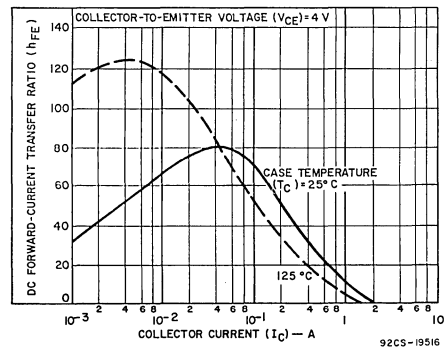
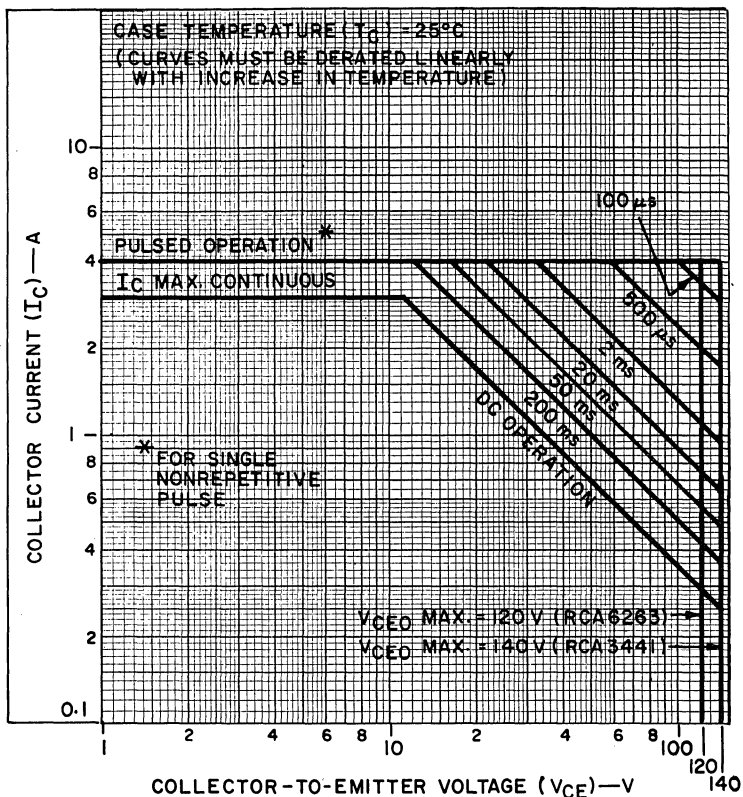


Fig. 2— Typical dc beta characteristics for RCA6263.



92CS-22260

Fig. 3— Maximum operating areas for both types.

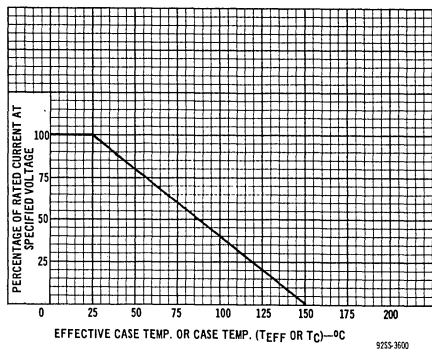


Fig. 4— Current derating curve for both types.

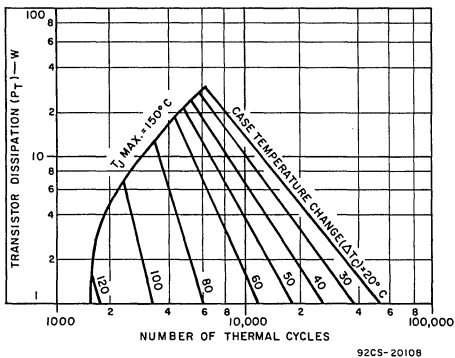


Fig. 5— Thermal-cycling rating chart for both types.

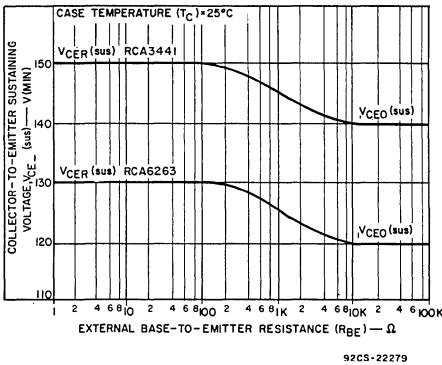


Fig. 6— Sustaining voltage vs. base-to-emitter resistance for both types.

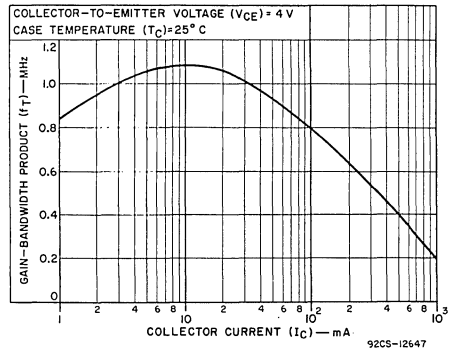


Fig. 7— Typical gain-bandwidth product for both types.

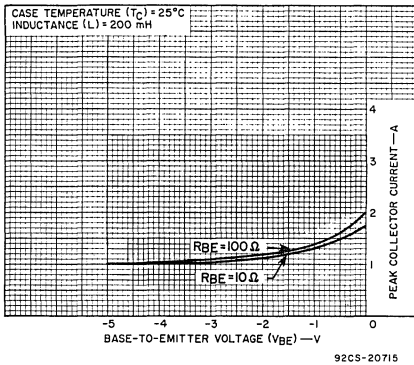


Fig. 8— Minimum reverse-bias second-breakdown characteristics for both types.

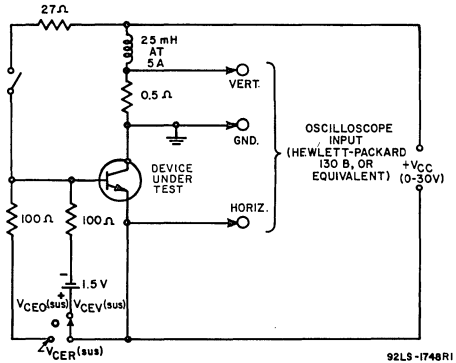


Fig. 9— Circuit used to measure sustaining voltages,  $V_{CE0(sus)}$ ,  $V_{CE(sus)}$ , and  $V_{CEV(sus)}$  for both types.

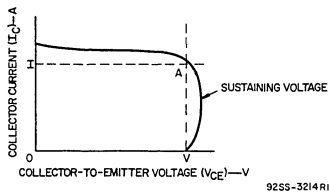


Fig. 10— Oscilloscope display for measurement of sustaining voltages (test circuit shown in Fig. 9).

NOTE: THE SUSTAINING VOLTAGE  $V_{CE0(sus)}$  OR  $V_{CEV(sus)}$  IS ACCEPTABLE WHEN THE TRACE FALLS TO THE RIGHT AND ABOVE POINT "A" FOR TYPES 2N4347 AND 2N3442. (FOR VALUES OF 1 & V, SEE ELECTRICAL CHARACTERISTICS)

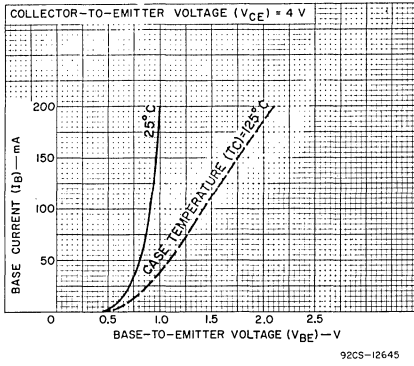


Fig. 11— Typical input characteristics for RCA3441.

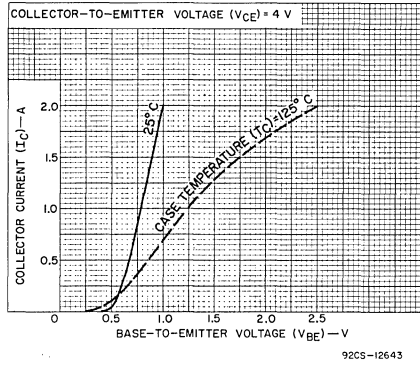


Fig. 12— Typical transfer characteristics for RCA3441.

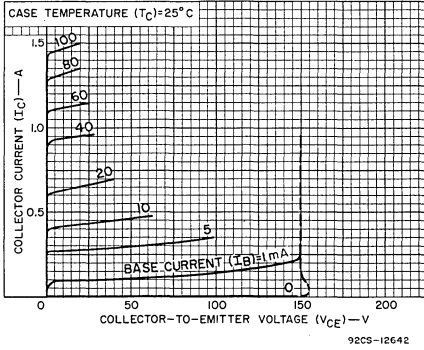


Fig. 13— Typical output characteristics for RCA3441.

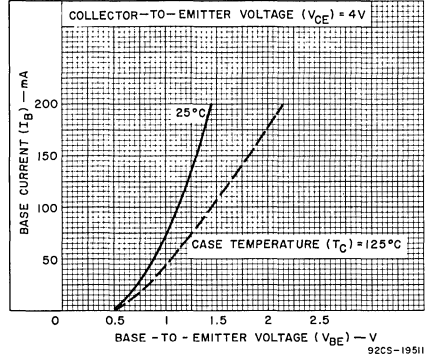


Fig. 14— Typical input characteristics for RCA6263.

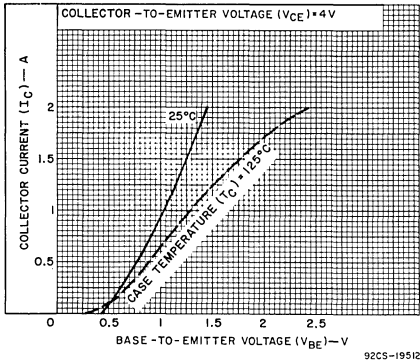


Fig. 15— Typical transfer characteristics for RCA6263.

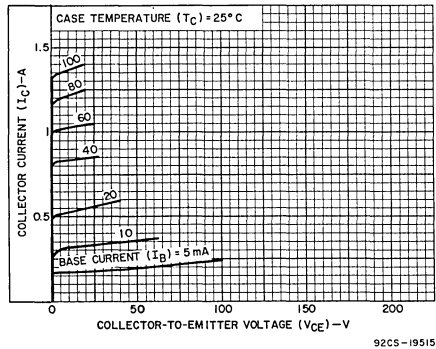


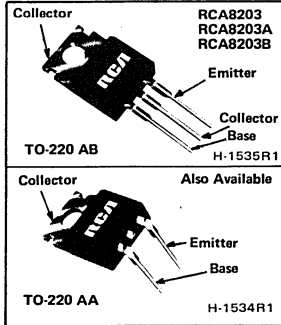
Fig. 16— Typical output characteristics for RCA6263.



# Power Transistors

## RCA8203

### RCA8203A RCA8203B



## 10-Ampere P-N-P Darlington Power Transistors

40-60-80 Volts, 60 Watts  
Gain of 1000 at 5 A (RCA8203A, RCA8203B)  
Gain of 1000 at 3 A (RCA8203)

**Features:**

- Operates from IC without predriver
- Low leakage at high temperature
- High reverse second-breakdown capability

**Applications:**

- Power switching
- Audio amplifiers
- Hammer drivers
- Series and shunt regulators

The RCA8203, RCA8203A and RCA8203B<sup>●</sup> are monolithic p-n-p silicon Darlington transistors designed for low- and medium-frequency power applications. The high gain of these devices makes it possible for them to be driven directly from integrated circuits. They are complementary to the 2N6386, 2N6387, and 2N6388<sup>▲</sup>.

These devices are supplied in the JEDEC TO-220AB straight-lead version of the VERSAWATT package. Optional lead configurations are available upon request. For information, contact your nearest RCA Sales Office.

<sup>●</sup>Formerly RCA Dev. Nos. TA8204, TA8487, and TA8203, respectively.  
<sup>▲</sup>Technical data for 2N6386-2N6388 are given in RCA bulletin File No. 610.

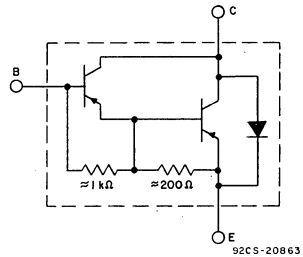


Fig. 1—Schematic diagram for all types.

**MAXIMUM RATINGS, Absolute-Maximum Values:**

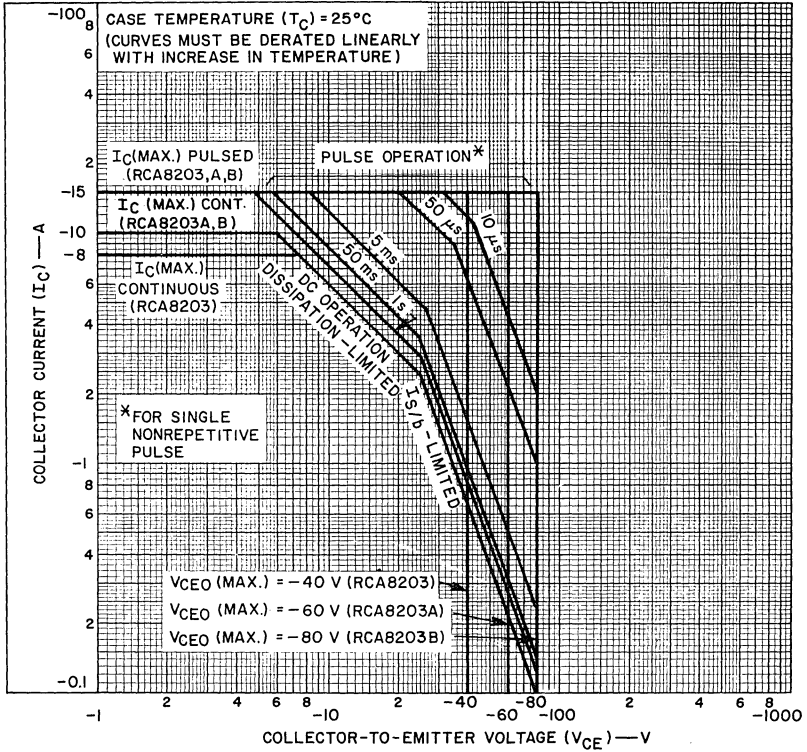
	RCA8203B	RCA8203A	RCA8203		
COLLECTOR-TO-BASE VOLTAGE . . . . .	$V_{CB0}$	-80	-60	-40	V
COLLECTOR-TO-EMITTER SUSTAINING VOLTAGE:					
With external base-to-emitter resistance ( $R_{BE}$ ) = 100 $\Omega$ . . . . .	$V_{CEr(sus)}$	-80	-60	-40	V
With base open . . . . .	$V_{CE0(sus)}$	-80	-60	-40	V
With base reverse-biased $V_{BE} = +1.5$ V . . . . .	$V_{CEV(sus)}$	-80	-60	-40	V
EMITTER-TO-BASE VOLTAGE . . . . .	$V_{EBO}$	-5	-5	-5	V
CONTINUOUS COLLECTOR CURRENT . . . . .	$I_C$	-10	-10	-8	A
PEAK COLLECTOR CURRENT . . . . .	$I_{CM}$	-15	-15	-15	A
CONTINUOUS BASE CURRENT . . . . .	$I_B$	-0.25	-0.25	-0.25	A
TRANSISTOR DISSIPATION:	$P_T$				
At case temperatures up to 25 <sup>o</sup> C . . . . .		60	60	60	W
At case temperatures above 25 <sup>o</sup> C . . . . .		See Fig. 3			
TEMPERATURE RANGE:					
Storage and Operating (Junction) . . . . .		-65 to +150			<sup>o</sup> C
PIN TEMPERATURE (During Soldering):					
At distances $\geq 1/8$ in. (3.17 mm) from case for 10 s max. . . . .		235			<sup>o</sup> C

ELECTRICAL CHARACTERISTICS, At Case Temperature ( $T_C$ ) = 25°C Unless Otherwise Specified

CHARACTERISTIC	SYMBOL	TEST CONDITIONS				LIMITS						UNITS
		VOLTAGE V dc		CURRENT A dc		RCA8203B		RCA8203A		RCA8203		
		V <sub>CE</sub>	V <sub>BE</sub>	I <sub>C</sub>	I <sub>B</sub>	MIN.	MAX.	MIN.	MAX.	MIN.	MAX.	
Collector-Cutoff Current: With base open	I <sub>CEO</sub>	-80			0	-	-1	-	-	-	-	mA
		-60			0	-	-	-	-1	-	-	
		-40			0	-	-	-	-	-	-1	
With base open and T <sub>C</sub> = 150°C		-80			0	-	-10	-	-	-	-	
		-60			0	-	-	-	-10	-	-	
		-40			0	-	-	-	-	-10	-	
With base reverse-biased	I <sub>CEV</sub>	-80	+1.5			-	-0.3	-	-	-	-	mA
		-60	+1.5			-	-	-	-0.3	-	-	
		-40	+1.5			-	-	-	-	-	-0.3	
With base reverse-biased and T <sub>C</sub> = 150°C		-80	+1.5			-	-3	-	-	-	-	
		-60	+1.5			-	-	-	-3	-	-	
		-40	+1.5			-	-	-	-	-3	-	
Emitter-Cutoff Current	I <sub>EBO</sub>		+5	0		-	-10	-	-10	-	-10	mA
Collector-to-Emitter Sustaining Voltage: With base open	V <sub>CEO(sus)</sub>			-0.2 <sup>a</sup>	0	-80	-	-60	-	-40	-	V
With external base-to- emitter resistance (R <sub>BE</sub> ) = 100 Ω	V <sub>CER(sus)</sub>			-0.2 <sup>a</sup>		-80	-	-60	-	-40	-	
With base-emitter junc- tion reverse-biased	V <sub>CEV(sus)</sub>		+1.5	-0.2 <sup>a</sup>		-80	-	-60	-	-40	-	
DC Forward Current Transfer Ratio	h <sub>FE</sub>	-3		-3 <sup>a</sup>		-	-	-	-	1000	20,000	V
		-3		-5 <sup>a</sup>		1000	20,000	1000	20,000	100	-	
		-3		-8 <sup>a</sup>		-	-	-	-	-	-	
		-3		-10 <sup>a</sup>		100	-	100	-	-	-	
Base-to-Emitter Voltage	V <sub>BE</sub>	-3		-3 <sup>a</sup>		-	-	-	-	-	-2.8	V
		-3		-5 <sup>a</sup>		-	-2.8	-	-2.8	-	-	
		-3		-8 <sup>a</sup>		-	-	-	-	-	-4.5	
		-3		-10 <sup>a</sup>		-	-4.5	-	-4.5	-	-	
Collector-to-Emitter Saturation Voltage	V <sub>CE(sat)</sub>			-3 <sup>a</sup>	-0.006 <sup>a</sup>	-	-	-	-	-	-2	V
				-5 <sup>a</sup>	-0.01 <sup>a</sup>	-	-2	-	-2	-	-	
				-8 <sup>a</sup>	-0.08 <sup>a</sup>	-	-	-	-	-	-3	
				-10 <sup>a</sup>	-0.1 <sup>a</sup>	-	-3	-	-3	-	-	
Parallel Diode Forward Voltage Drop	V <sub>F</sub>			-8		-	-	-	-	-	-4	V
				-10		-	-4	-	-4	-	-	
Common-Emitter, Small- Signal, Short-Circuit Forward Current Transfer Ratio: f = 1 kHz	h <sub>fe</sub>	5		-1		1000	-	1000	-	1000	-	
Magnitude of Common- Emitter, Small-Signal, Short-Circuit, Forward Current Transfer Ratio: f = 1.0 MHz	h <sub>fe</sub>	5		-1		20	-	20	-	20	-	
Second Breakdown Energy: With base reverse-biased and L = mH, R <sub>BE</sub> = 100 Ω	E <sub>S/b</sub> <sup>b</sup>		+1.5	-4.5		30	-	30	-	30	-	mJ
Forward-Bias Second Breakdown Collector Current: 1-s non-repetitive pulse	I <sub>S/b</sub>	-20				-3	-	-3	-	-3	-	A
Thermal Resistance: Junction-to-Case	R <sub>θJC</sub>					-	2.1	-	2.1	-	2.1	°C/W

<sup>a</sup> Pulsed: Pulse duration = 300 μs, duty factor = 1.8%.

<sup>b</sup> E<sub>S/b</sub> is defined as the energy at which second breakdown occurs under specified reverse bias conditions  
E<sub>S/b</sub> = 1/2LI<sup>2</sup> where L is a series load or leakage inductance, and I is the peak collector current.



92CS-24910

Fig. 2—Maximum operating areas for all types.

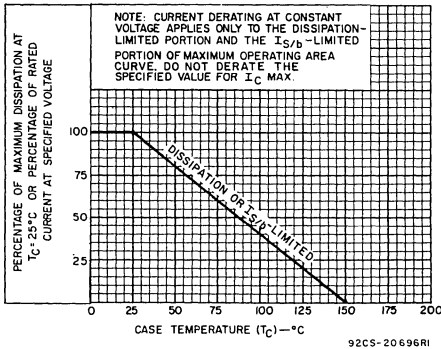


Fig. 3—Dissipation derating curve for all types.

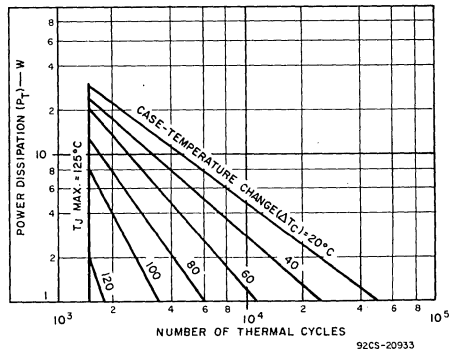


Fig. 4—Thermal-cycling rating chart for all types.

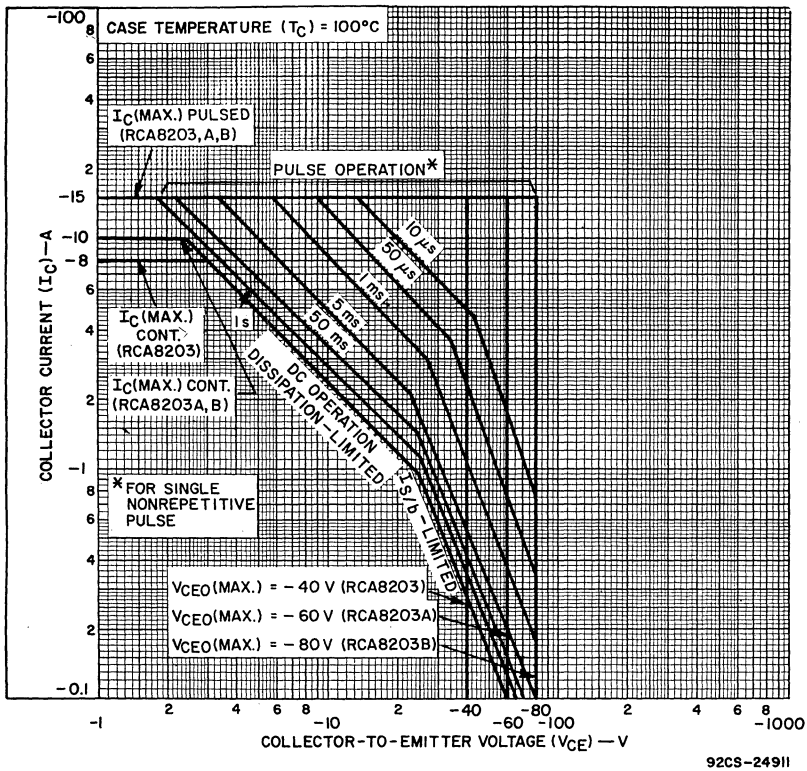


Fig. 5—Maximum operating areas for all types at  $T_C = 100^\circ\text{C}$ .

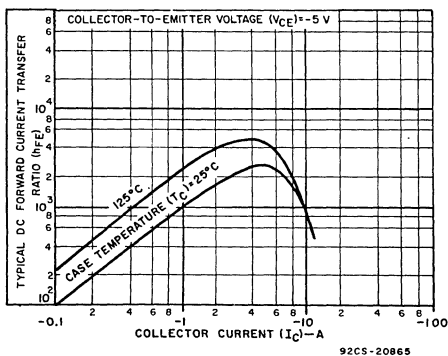


Fig. 6—Typical dc beta characteristics for all types.

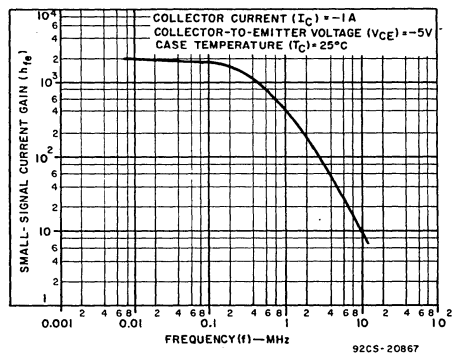


Fig. 7—Typical small-signal gain for all types.



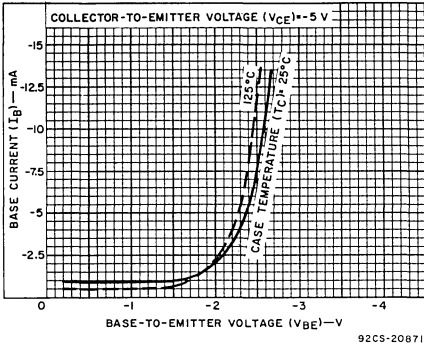


Fig. 8—Typical input characteristics for all types.

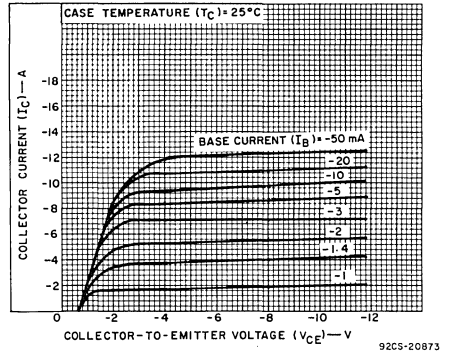


Fig. 9—Typical output characteristics for all types.

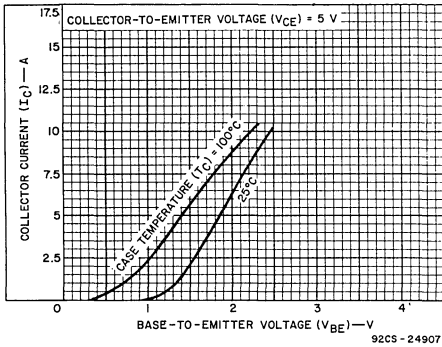


Fig. 10—Typical transfer characteristics for all types.

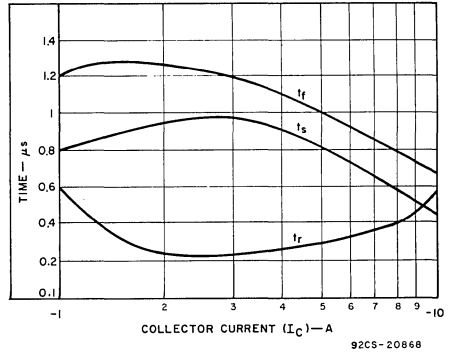


Fig. 11—Typical saturated switching-time characteristics for all types.

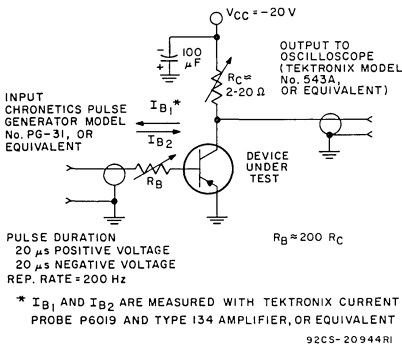


Fig. 12—Circuit used to measure saturated switching times.

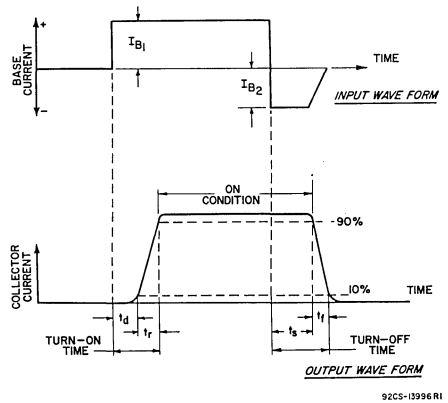


Fig. 13—Phase relationship between input current and output current showing reference points for specification of switching times (test circuit shown in Fig. 12).

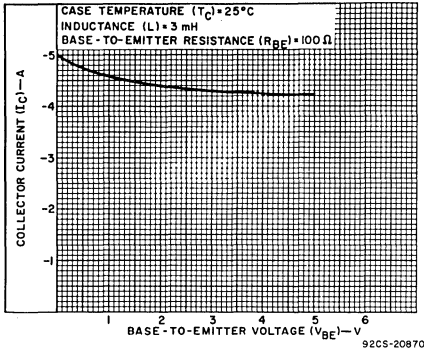


Fig. 14—Minimum values of reverse-bias second breakdown characteristic ( $E_S/p$ ) for all types.

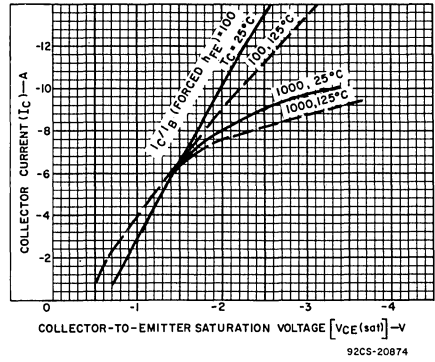


Fig. 15—Typical saturation characteristics for all types.

**TERMINAL CONNECTIONS  
 JEDEC TO-220AB**

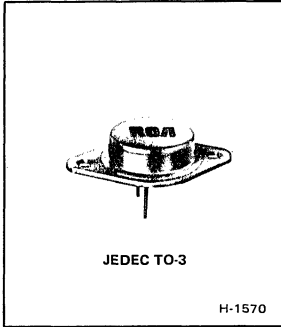
- Terminal No.1 — Base
- Terminal No.2 — Collector
- Terminal No.3 — Emitter
- Terminal No.4 — Collector



# Power Transistors

## RCA8350

### RCA8350A RCA8350B



## 10-Ampere P-N-P Darlington Power Transistors

40-60-80 Volts, 70 Watts  
Gain of 1000 at 5 A

**Features:**

- Operated from IC without predriver
- High reverse second-breakdown capability

**Applications:**

- Power switching
- Audio amplifiers
- Hammer drivers
- Series and shunt regulators

The RCA8350, RCA8350A and RCA8350B<sup>⊖</sup> are monolithic p-n-p silicon Darlington transistors designed for low- and medium-frequency power applications. The high gain of these devices makes it possible for them to be driven directly from integrated circuits. They are complementary to the 2N6383, 2N6384, and 2N6385<sup>▲</sup>.

<sup>⊖</sup>Formerly RCA Dev. Nos. TA8351, TA8488, and TA8350, respectively.  
<sup>▲</sup>Technical data for 2N6383, 2N6384, and 2N6385 are given in RCA bulletin File No. 609.

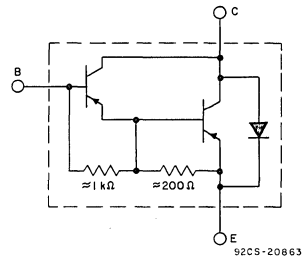


Fig. 1—Schematic diagram for all types.

**MAXIMUM RATINGS, Absolute-Maximum Values:**

COLLECTOR-TO-BASE VOLTAGE .....	V <sub>CB0</sub>
COLLECTOR-TO-EMITTER SUSTAINING VOLTAGE:	
With external base-to-emitter resistance (R <sub>BE</sub> ) = 100 Ω ...	V <sub>CEr(sus)</sub>
With base open .....	V <sub>CEO(sus)</sub>
With base reverse-biased V <sub>BE</sub> = +1.5 V .....	V <sub>CEV(sus)</sub>
EMITTER-TO-BASE VOLTAGE .....	V <sub>EB0</sub>
CONTINUOUS COLLECTOR CURRENT .....	I <sub>C</sub>
PEAK COLLECTOR CURRENT .....	I <sub>CM</sub>
CONTINUOUS BASE CURRENT .....	I <sub>B</sub>
TRANSISTOR DISSIPATION:	P <sub>T</sub>
At case temperatures up to 25°C .....	
At case temperatures above 25°C .....	
TEMPERATURE RANGE:	
Storage and Operating (Junction) .....	
PIN TEMPERATURE (During Soldering):	
At distances ≥ 1/32 in. (0.8 mm) from seating plane for 10 s max. ....	

	RCA8350B	RCA8350A	RCA8350	
	-80	-60	-40	V
	-80	-60	-40	V
	-80	-60	-40	V
	-80	-60	-40	V
	-5	-5	-5	V
	-10	-10	-10	A
	-15	-15	-15	A
	-0.25	-0.25	-0.25	A
	70	70	70	W
	See Fig. 3			
	-65 to +150			°C
	235			°C

ELECTRICAL CHARACTERISTICS, At Case Temperature ( $T_C$ ) = 25°C Unless Otherwise Specified

CHARACTERISTIC	SYMBOL	TEST CONDITIONS				LIMITS						UNITS
		VOLTAGE V dc		CURRENT A dc		RCA8350B		RCA8350A		RCA8350		
		V <sub>CE</sub>	V <sub>BE</sub>	I <sub>C</sub>	I <sub>B</sub>	MIN.	MAX.	MIN.	MAX.	MIN.	MAX.	
Collector-Cutoff Current: With base open	I <sub>CEO</sub>	-80			0	-	-1	-	-	-	-	mA
		-60			0	-	-	-	-1	-	-	
		-40			0	-	-	-	-	-	-1	
With base open and $T_C = 150^\circ\text{C}$	I <sub>CEV</sub>	-80			0	-	-10	-	-	-	-	
		-60			0	-	-	-	-10	-	-	
		-40			0	-	-	-	-	-	-10	
With base reverse-biased	I <sub>CEV</sub>	-80	+1.5			-	-0.3	-	-	-	-	
		-60	+1.5			-	-	-	-0.3	-	-	
		-40	+1.5			-	-	-	-	-	-0.3	
With base reverse-biased and $T_C = 150^\circ\text{C}$	I <sub>CEV</sub>	-80	+1.5			-	-3	-	-	-	-	
		-60	+1.5			-	-	-	-3	-	-	
		-40	+1.5			-	-	-	-	-	-3	
Emitter-Cutoff Current	I <sub>EBO</sub>		5	0		-	-10	-	-10	-	-10	mA
Collector-to-Emitter Sustaining Voltage: With base open	V <sub>CEO(sus)</sub>			-0.2 <sup>a</sup>	0	-80	-	-60	-	-40	-	V
With external base-to-emitter resistance (R <sub>BE</sub> ) = 100 Ω	V <sub>CER(sus)</sub>			-0.2 <sup>a</sup>		-80	-	-60	-	-40	-	
With base-emitter junction reverse-biased	V <sub>CEV(sus)</sub>		+1.5	-0.2 <sup>a</sup>		-80	-	-60	-	-40	-	
DC Forward Current Transfer Ratio	h <sub>FE</sub>	-3 -3		-5 <sup>a</sup> -10 <sup>a</sup>		1000 100	20,000	1000 100	20,000	1000 100	20,000	
Base-to-Emitter Voltage	V <sub>BE</sub>	-3 -3		-5 <sup>a</sup> -10 <sup>a</sup>		-	-2.8 -4.5	-	-2.8 -4.5	-	-2.8 -4.5	V
Collector-to-Emitter Saturation Voltage	V <sub>CE(sat)</sub>			-5 <sup>a</sup> -10 <sup>a</sup>	-0.01 <sup>a</sup> -0.1 <sup>a</sup>	-	-2 -3	-	-2 -3	-	-2 -3	V
Parallel Diode Forward Voltage	V <sub>F</sub>			-10		-	-4	-	-4	-	-4	V
Common-Emitter, Small-Signal, Short-Circuit Forward Current Transfer Ratio: f = 1 kHz	h <sub>fe</sub>	-5		-1		1000	-	1000	-	1000	-	
Magnitude of Common-Emitter, Small-Signal Short-Circuit, Forward Current Transfer Ratio: f = 1.0 MHz	h <sub>fe</sub>	-5		-1		20	-	20	-	20	-	
Second-Breakdown Energy: With base reverse-biased and L = 3 mH, R <sub>BE</sub> = 100 Ω	E <sub>S/b</sub> <sup>b</sup>		+1.5	-4.5		30	-	30	-	30	-	mJ
Forward-Bias Second Breakdown Collector Current: 1-s nonrepetitive pulse	I <sub>S/b</sub>	-35 -20				-1 -5	-	-1 -5	-	-1 -5	-	A
Thermal Resistance: Junction-to-Case	R <sub>θJC</sub>					-	1.75	-	1.75	-	1.75	°C/W

<sup>a</sup> Pulsed: Pulse duration = 300 μs, duty factor = 1.8%.

<sup>b</sup> E<sub>S/b</sub> is defined as the energy at which second breakdown occurs under specified reverse bias conditions.

E<sub>S/b</sub> = 1/2 LI<sup>2</sup> where L is a series load or leakage inductance, and I is the peak collector current.

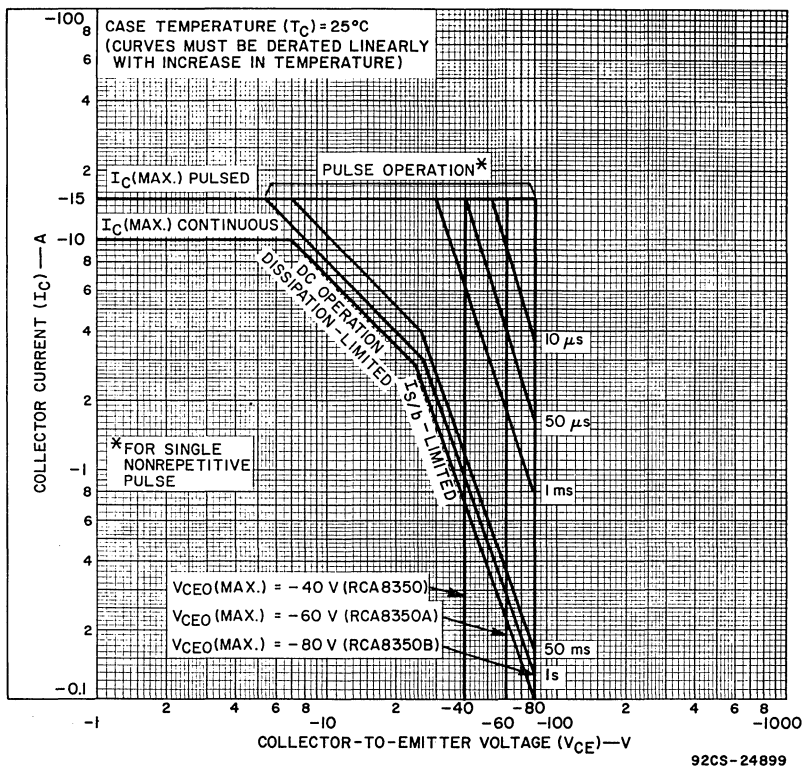


Fig. 2—Maximum operating areas for all types.

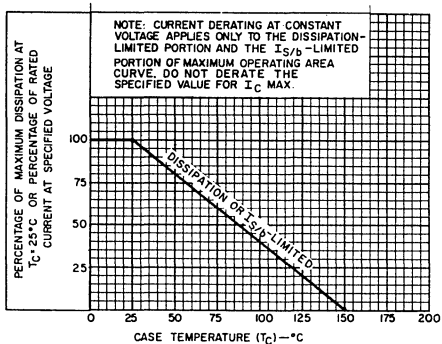


Fig. 3—Dissipation derating curve for all types.

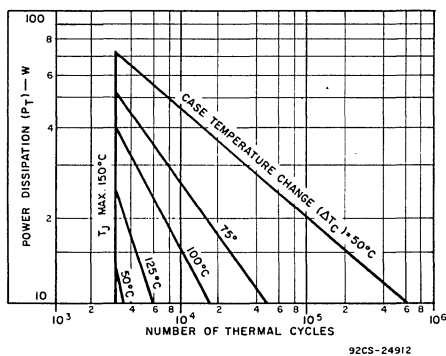


Fig. 4—Thermal-cycling rating chart for all types.

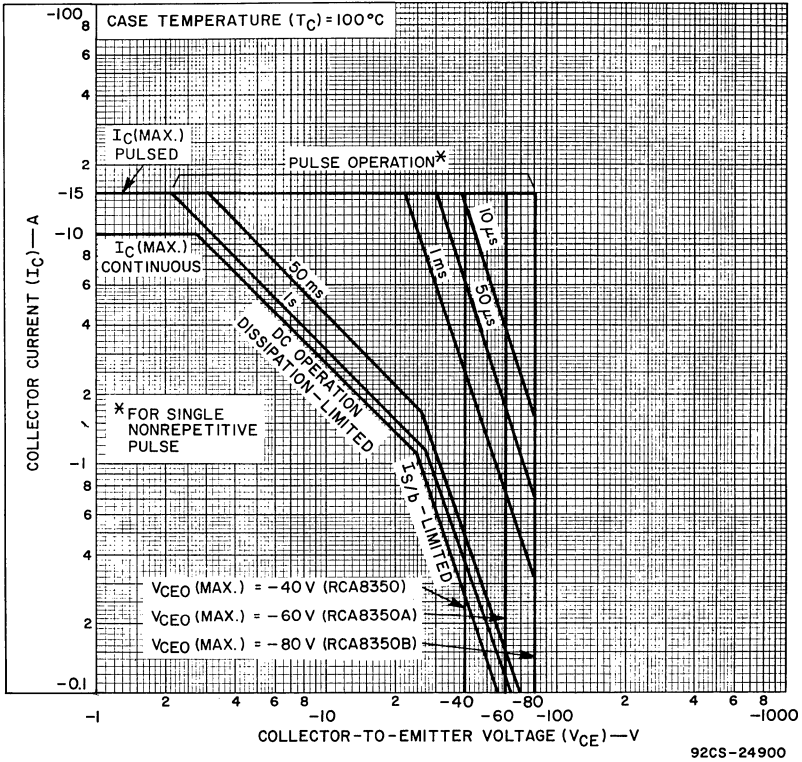


Fig. 5—Maximum operating areas for all types at  $T_C = 100^\circ\text{C}$ .

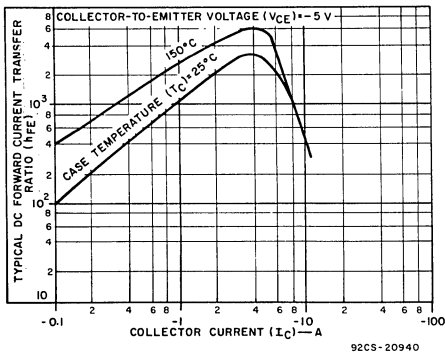


Fig. 6—Typical dc beta characteristics for all types.

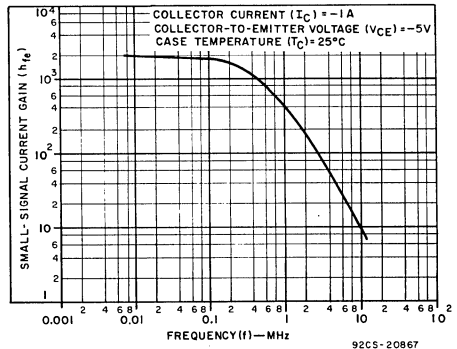


Fig. 7—Typical small-signal gain for all types.

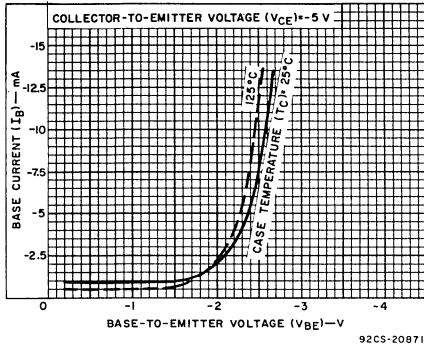


Fig. 8—Typical input characteristics for all types.

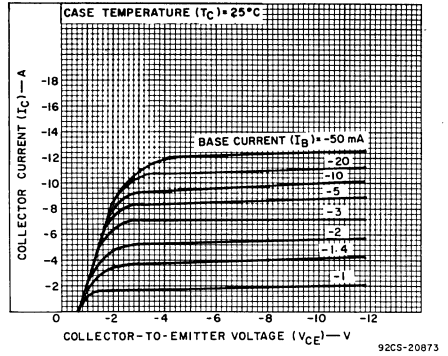


Fig. 9—Typical output characteristics for all types.

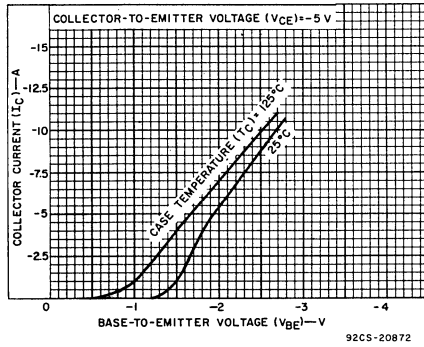


Fig. 10—Typical transfer characteristics for all types.

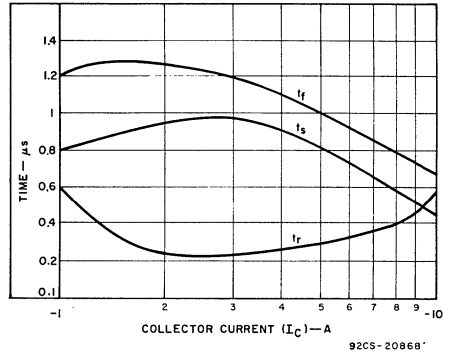
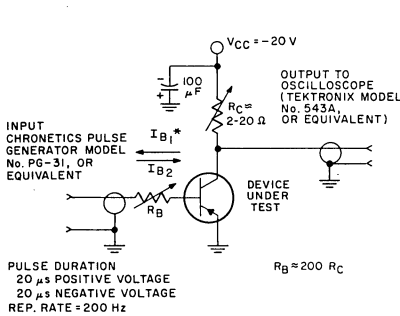


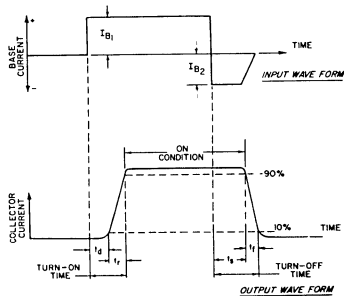
Fig. 11—Typical saturated switching-time characteristics for all types.



\*  $I_{B1}$  AND  $I_{B2}$  ARE MEASURED WITH TEKTRONIX CURRENT PROBE P6019 AND TYPE 134 AMPLIFIER, OR EQUIVALENT

92CS-20944RI

Fig. 12—Circuit used to measure saturated switching times.



92CS-13996RI

Fig. 13—Phase relationship between input current and output current showing reference points for specification of switching times (test circuit shown in Fig. 12).

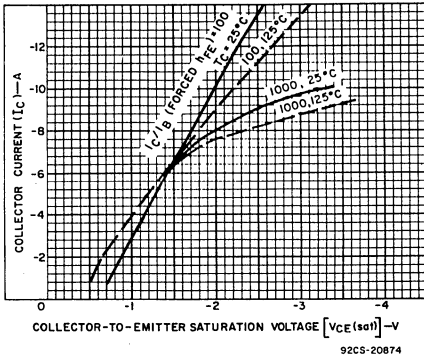


Fig. 14—Typical saturation characteristics for all types.

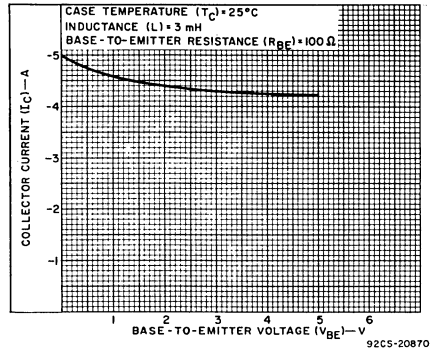


Fig. 15—Minimum values of reverse-bias second breakdown characteristic ( $E_{S/b}$ ) for all types.

**TERMINAL CONNECTIONS**

- Pin 1 — Base
- Pin 2 — Emitter
- Case — Collector
- Mounting Flange — Collector



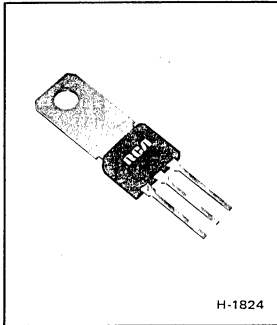


# Power Transistors

## RCP111, RCP113, RCP115, RCP117 Series

### High-Voltage, Medium-Power Silicon N-P-N Power Transistors

For TV Video Output and Linear-Amplifier Applications



H-1824

V <sub>CEO</sub> (V)	h <sub>FE</sub>			
	At V <sub>CE</sub> = 10 V, I <sub>C</sub> = 25 mA			
	50-300	30-150	50 min.	20 min.
350	RCP111D	RCP113D	—	—
300	RCP111C	RCP113C	—	—
250	RCP111B	RCP113B	RCP115B	RCP117B
200	RCP111A	RCP113A	—	—
100	—	—	RCP115	RCP117

Note: Characteristics charts for individual device types show h<sub>FE</sub> measured at additional current levels.

**Features:**

- ▣ Low Miller feedback capacitance: C<sub>b'c</sub> = 2.25 pF max.
- ▣ Thermal-cycling ratings
- ▣ Maximum safe-area-of-operation curves
- ▣ High gain-bandwidth product: f<sub>T</sub> = 80 MHz typ.

The RCP111-, RCP113-, RCP115-, and RCP117-series power transistors are double-diffused, epitaxial-collector silicon n-p-n transistors with planar junctions and field-shield construction. These transistors are designed especially for TV applications such as RGB output, chroma output, and video output. They are also suitable for use in regulators, audio output and amplifier circuits, and electrostatic deflection in display circuits. The devices are supplied in a new molded plastic package.

**MAXIMUM RATINGS, Absolute-Maximum Values:**

	RCP111D RCP113D	RCP111C RCP113C	RCP111B RCP113B	RCP111A RCP113A	RCP115B RCP117B	RCP115 RCP117	
<b>COLLECTOR-TO-EMITTER SUSTAINING VOLTAGE:</b>							
With base open ..... V <sub>CEO(sus)</sub>	350	300	250	200	250	100 V	
<b>EMITTER-TO-BASE VOLTAGE</b> ..... V <sub>EBO</sub>	7	7	7	7	5	5 V	
<b>CONTINUOUS COLLECTOR CURRENT</b> .... I <sub>C</sub>	150	150	150	150	150	150 mA	
<b>CONTINUOUS BASE CURRENT</b> ..... I <sub>B</sub>	50	50	50	50	50	50 mA	
<b>TRANSISTOR DISSIPATION:</b> P <sub>T</sub>							
At case temperatures up to 25°C .....	6.25	6.25	6.25	6.25	6.25	6.25 W	
At ambient temperatures up to 25°C .....	1.56	1.56	1.56	1.56	1.56	1.56 W	
For pulse operation .....	See Fig. 1						
<b>TEMPERATURE RANGE:</b>							
Storage and Operating (Junction) .....	—65 to 150						°C
<b>LEAD TEMPERATURE (During Soldering):</b>							
At distance ≥ 1/16 in. (1.39 mm) from case for 10 s max. ....	230						°C

ELECTRICAL CHARACTERISTICS, At Case Temperature ( $T_C$ ) = 25°C

CHARACTERISTIC	SYMBOL	TEST CONDITIONS				LIMITS				UNITS	
		VOLTAGE V dc			CURRENT mA dc		RCP111D		RCP111C		
		V <sub>CB</sub>	V <sub>CE</sub>	V <sub>BE</sub>	I <sub>C</sub>	I <sub>B</sub>	Min.	Max.	Min.		Max.
Collector Cutoff Current: With emitter open	I <sub>CBO</sub>	350 300					— —	1 —	— —	— 1	μA
With base open	I <sub>CEO</sub>		250 200			0 0	— —	5 —	— —	— 5	μA
Emitter Cutoff Current	I <sub>EBO</sub>			6	0		—	10	—	10	μA
DC Forward-Current Transfer Ratio	h <sub>FE</sub>		10 10		25 <sup>a</sup> 1 <sup>a</sup>		50 25	300 —	50 25	300 —	
Collector-to-Emitter Sustaining Voltage: With base open <sup>b</sup>	V <sub>CEO(sus)</sub>				20 <sup>a</sup>	0	350	—	300	—	V
Base-to-Emitter Voltage	V <sub>BE</sub>		10		25 <sup>a</sup>		—	1	—	1	V
Emitter-to-Base Breakdown Voltage: I <sub>E</sub> = 1 mA	V <sub>(BR)EBO</sub>				0		7	—	7	—	V
Collector-to-Emitter Saturation Voltage	V <sub>CE(sat)</sub>				25 <sup>a</sup>	2.5	—	1	—	1	V
Magnitude of Common-Emitter, Small-Signal, Short-Circuit, Forward-Current Transfer Ratio: f = 20 MHz	h <sub>fe</sub>		20		15		4 (typ.)		4 (typ.)		
Gain-Bandwidth Product	f <sub>T</sub>		20		15		80 (typ.)		80 (typ.)		MHz
Second-Breakdown Collector Current: With base forward-biased and t = 0.05 s	I <sub>S/b</sub>		100				100	—	100	—	mA
Three-Terminal Feedback Capacitance (Miller Capacitance)	C <sub>b'c</sub>		20		25		—	2.25	—	2.25	pF
Thermal Resistance: Junction-to-case	R <sub>θJC</sub>						—	20	—	20	°C/W
Junction-to-ambient	R <sub>θJA</sub>						—	80	—	80	

<sup>a</sup> Pulsed, pulse duration = 300 μs, duty factor ≤ 2%.

<sup>b</sup> CAUTION: Sustaining voltage, V<sub>CEO(sus)</sub>, MUST NOT be measured on a curve tracer.

## TERMINAL CONNECTIONS

Terminal No. 1 — Emitter  
Terminal No. 2 — Base  
Terminal No. 3 — Collector  
Terminal No. 4 — Collector

**ELECTRICAL CHARACTERISTICS, At Case Temperature ( $T_C$ ) = 25°C**

CHARACTERISTIC	SYMBOL	TEST CONDITIONS					LIMITS				UNITS
		VOLTAGE V dc			CURRENT mA dc		RCP111B		RCP111A		
		$V_{CB}$	$V_{CE}$	$V_{BE}$	$I_C$	$I_B$	Min.	Max.	Min.	Max.	
Collector Cutoff Current: With emitter open	$I_{CBO}$	250 200					– 1	– –	– 1	$\mu A$	
With base open	$I_{CEO}$		175 150			0 0	– 5	– –	– 5	$\mu A$	
Emitter Cutoff Current	$I_{EBO}$			6	0		–	10	–	10	$\mu A$
DC Forward-Current Transfer Ratio	$h_{FE}$		10 10		25 <sup>a</sup> 1 <sup>a</sup>		50 25	300 –	50 25	300 –	
Collector-to-Emitter Sustaining Voltage: With base open <sup>b</sup>	$V_{CEO(sus)}$				20 <sup>a</sup>	0	250	–	200	–	V
Base-to-Emitter Voltage	$V_{BE}$		10		25 <sup>a</sup>		–	1	–	1	V
Emitter-to-Base Breakdown Voltage: $I_E = 1$ mA	$V_{(BR)EBO}$				0		7	–	7	–	V
Collector-to-Emitter Saturation Voltage	$V_{CE(sat)}$				25 <sup>a</sup>	2.5	–	1	–	1	V
Magnitude of Common-Emitter, Small-Signal, Short-Circuit, Forward-Current Transfer Ratio: $f = 20$ MHz	$ h_{fe} $		20		15		4 (typ.)		4 (typ.)		
Gain-Bandwidth Product	$f_T$		20		15		80 (typ.)		80 (typ.)		MHz
Second-Breakdown Collector Current: With base forward-biased and $t = 0.05$ s	$I_{S/b}$		100				100	–	100	–	mA
Three-Terminal Feedback Capacitance (Miller Capacitance)	$C_{b'c}$		20		25		–	2.25	–	2.25	pF
Thermal Resistance: Junction-to-case	$R_{\theta JC}$						–	20	–	20	$^{\circ}C/W$
Junction-to-ambient	$R_{\theta JA}$						–	80	–	80	

<sup>a</sup> Pulsed, pulse duration = 300  $\mu s$ , duty factor  $\leq 2\%$ .

<sup>b</sup> CAUTION: Sustaining voltage,  $V_{CEO(sus)}$ , MUST NOT be measured on a curve tracer.

**ELECTRICAL CHARACTERISTICS, At Case Temperature ( $T_C$ ) = 25°C**

CHARACTERISTIC	SYMBOL	TEST CONDITIONS					LIMITS				UNITS		
		VOLTAGE V dc			CURRENT mA dc		RCP113D		RCP113C				
		V <sub>CB</sub>	V <sub>CE</sub>	V <sub>BE</sub>	I <sub>C</sub>	I <sub>B</sub>	Min.	Max.	Min.	Max.			
Collector Cutoff Current: With emitter open	I <sub>CBO</sub>	350 300					—	1	—	—	—	1	μA
With base open	I <sub>CEO</sub>		250 200			0 0	—	5	—	—	—	5	μA
Emitter Cutoff Current	I <sub>EBO</sub>			6	0		—	10	—	—	—	10	μA
DC Forward-Current Transfer Ratio	h <sub>FE</sub>		10 10		25 <sup>a</sup> 1 <sup>a</sup>		30 15	150 —	30 15	150 —			
Collector-to-Emitter Sustaining Voltage: With base open <sup>b</sup>	V <sub>CEO(sus)</sub>				20 <sup>a</sup>	0	350	—	300	—			V
Base-to-Emitter Voltage	V <sub>BE</sub>		10		25 <sup>a</sup>		—	1	—	—	1		V
Emitter-to-Base Breakdown Voltage: I <sub>E</sub> = 1 mA	V <sub>(BR)EBO</sub>				0		7	—	7	—			V
Collector-to-Emitter Saturation Voltage	V <sub>CE(sat)</sub>				25 <sup>a</sup>	2.5	—	1	—	—	1		V
Magnitude of Common-Emitter, Small-Signal, Short-Circuit, Forward-Current Transfer Ratio: f = 20 MHz	h <sub>fe</sub>		20		15		4 (typ.)		4 (typ.)				
Gain-Bandwidth Product	f <sub>T</sub>		20		15		80 (typ.)		80 (typ.)				MHz
Second-Breakdown Collector Current: With base forward-biased and t = 0.05 s	I <sub>S/b</sub>		100				100	—	100	—			mA
Three-Terminal Feedback Capacitance (Miller Capacitance)	C <sub>b'c</sub>		20		25		—	2.25	—	—	2.25		pF
Thermal Resistance: Junction-to-case	R <sub>θJC</sub>						—	20	—	—	20		°C/W
Junction-to-ambient	R <sub>θJA</sub>						—	80	—	—	80		

<sup>a</sup> Pulsed, pulse duration = 300 μs, duty factor ≤ 2%.<sup>b</sup> CAUTION: Sustaining voltage, V<sub>CEO(sus)</sub>, MUST NOT be measured on a curve tracer.

**ELECTRICAL CHARACTERISTICS, At Case Temperature ( $T_C$ ) = 25°C**

CHARACTERISTIC	SYMBOL	TEST CONDITIONS					LIMITS				UNITS
		VOLTAGE V dc			CURRENT mA dc		RCP113B		RCP113A		
		V <sub>CB</sub>	V <sub>CE</sub>	V <sub>BE</sub>	I <sub>C</sub>	I <sub>B</sub>	Min.	Max.	Min.	Max.	
Collector Cutoff Current: With emitter open	I <sub>CBO</sub>	250 200					–	1	–	–	μA
With base open	I <sub>CEO</sub>		175 150			0 0	–	5	–	–	μA
Emitter Cutoff Current	I <sub>EBO</sub>			6	0		–	10	–	10	μA
DC Forward-Current Transfer Ratio	h <sub>FE</sub>		10 10		25 <sup>a</sup> 1 <sup>a</sup>		30 15	150 –	30 15	150 –	
Collector-to-Emitter Sustaining Voltage: With base open <sup>b</sup>	V <sub>CEO(sus)</sub>				20 <sup>a</sup>	0	250	–	200	–	V
Base-to-Emitter Voltage	V <sub>BE</sub>		10		25 <sup>a</sup>		–	1	–	1	V
Emitter-to-Base Breakdown Voltage: I <sub>E</sub> = 1 mA	V <sub>(BR)EBO</sub>				0		7	–	7	–	V
Collector-to-Emitter Saturation Voltage	V <sub>CE(sat)</sub>				25 <sup>a</sup>	2.5	–	1	–	1	V
Magnitude of Common-Emitter, Small-Signal, Short-Circuit, Forward-Current Transfer Ratio: f = 20 MHz	h <sub>fe</sub>		20		15		4 (typ.)		4 (typ.)		
Gain-Bandwidth Product	f <sub>T</sub>		20		15		80 (typ.)		80 (typ.)		MHz
Second-Breakdown Collector Current: With base forward-biased and t = 0.05 s	I <sub>S/b</sub>		100				100	–	100	–	mA
Three-Terminal Feedback Capacitance (Miller Capacitance)	C <sub>b'c</sub>		20		25		–	2.25	–	2.25	pF
Thermal Resistance: Junction-to-case	R <sub>θJC</sub>						–	20	–	20	°C/W
Junction-to-ambient	R <sub>θJA</sub>						–	80	–	80	

<sup>a</sup> Pulsed, pulse duration = 300 μs, duty factor ≤ 2%.

<sup>b</sup> CAUTION: Sustaining voltage, V<sub>CEO(sus)</sub>, MUST NOT be measured on a curve tracer.

**ELECTRICAL CHARACTERISTICS, At Case Temperature ( $T_C$ ) = 25°C**

CHARACTERISTIC	SYMBOL	TEST CONDITIONS					LIMITS				UNITS
		VOLTAGE V dc			CURRENT mA dc		RCP115B		RCP115		
		V <sub>CB</sub>	V <sub>CE</sub>	V <sub>BE</sub>	I <sub>C</sub>	I <sub>B</sub>	Min.	Max.	Min.	Max.	
Collector Cutoff Current: With emitter open	I <sub>CBO</sub>	250 100					— —	50 —	— —	— 50	μA
With base open	I <sub>CEO</sub>		175 70			0 0	— —	100 —	— —	— 100	μA
DC Forward-Current Transfer Ratio	h <sub>FE</sub>		10 10		25 <sup>a</sup> 1 <sup>a</sup>		50 10	— —	50 10	— —	
Collector-to-Emitter Sustaining Voltage: With base open <sup>b</sup>	V <sub>CEO(sus)</sub>				20 <sup>a</sup>	0	250	—	100	—	V
Base-to-Emitter Voltage	V <sub>BE</sub>		10		25 <sup>a</sup>		—	1.5	—	1.5	V
Emitter-to-Base Breakdown Voltage: I <sub>E</sub> = 1 mA	V <sub>(BR)EBO</sub>				0		5	—	5	—	V
Collector-to-Emitter Saturation Voltage	V <sub>CE(sat)</sub>				25 <sup>a</sup>	5	—	2	—	2	V
Magnitude of Common-Emitter, Small-Signal, Short-Circuit, Forward-Current Transfer Ratio: f = 20 MHz	h <sub>fe</sub>		20		15		4 (typ.)		4 (typ.)		
Gain-Bandwidth Product	f <sub>T</sub>		20		15		80 (typ.)		80 (typ.)		MHz
Second-Breakdown Collector Current: With base forward-biased and t = 0.05 s	I <sub>S/b</sub>		75				130	—	130	—	mA
Three-Terminal Feedback Capacitance (Miller Capacitance)	C <sub>b'c</sub>		20		25		—	2.25	—	2.25	pF
Thermal Resistance: Junction-to-case	R <sub>θJC</sub>						—	20	—	20	°C/W
Junction-to-ambient	R <sub>θJA</sub>						—	80	—	80	

<sup>a</sup> Pulsed, pulse duration = 300 μs, duty factor ≤ 2%.

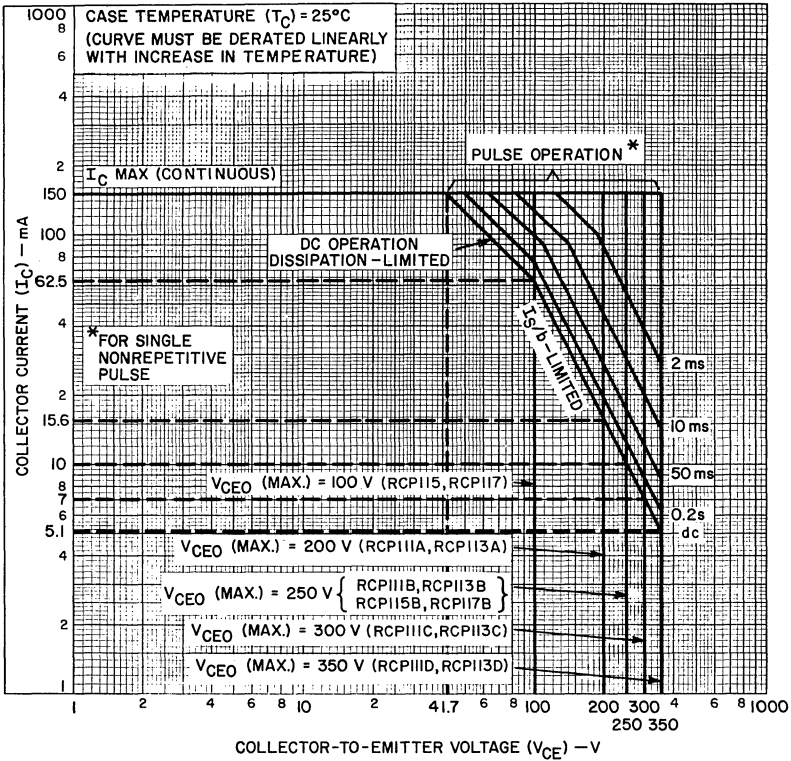
<sup>b</sup> CAUTION: Sustaining voltage, V<sub>CEO(sus)</sub>, MUST NOT be measured on a curve tracer.

ELECTRICAL CHARACTERISTICS, At Case Temperature ( $T_C$ ) = 25°C

CHARACTERISTIC	SYMBOL	TEST CONDITIONS					LIMITS				UNITS	
		VOLTAGE V dc			CURRENT mA dc		RCP117B		RCP117			
		V <sub>CB</sub>	V <sub>CE</sub>	V <sub>BE</sub>	I <sub>C</sub>	I <sub>B</sub>	Min.	Max.	Min.	Max.		
Collector Cutoff Current: With emitter open	I <sub>CBO</sub>	250 100					— —	50 —	— 50	— —	μA	
With base open	I <sub>CEO</sub>		175 70			0 0	— —	100 —	— 100	— —	μA	
DC Forward-Current Transfer Ratio	h <sub>FE</sub>		10 10		25 <sup>a</sup> 1 <sup>a</sup>		20 10	— —	20 10	— —		
Collector-to-Emitter Sustaining Voltage: With base open <sup>b</sup>	V <sub>CEO(sus)</sub>				20 <sup>a</sup>	0	250	—	100	—	V	
Base-to-Emitter Voltage	V <sub>BE</sub>		10		25 <sup>a</sup>		—	1.5	—	1.5	V	
Emitter-to-Base Breakdown Voltage: I <sub>E</sub> = 1 mA	V <sub>(BR)EBO</sub>				0		5	—	5	—	V	
Collector-to-Emitter Saturation Voltage	V <sub>CE(sat)</sub>				25 <sup>a</sup>	5	—	2	—	2	V	
Magnitude of Common-Emitter, Small-Signal, Short-Circuit, Forward-Current Transfer Ratio: f = 20 MHz	h <sub>fe</sub>		20		15			4 (typ.)		4 (typ.)		
Gain-Bandwidth Product	f <sub>T</sub>		20		15			80 (typ.)		80 (typ.)	MHz	
Second-Breakdown Collector Current: With base forward-biased and t = 0.05 s	I <sub>S/b</sub>		75					130	—	130	—	mA
Three-Terminal Feedback Capacitance (Miller Capacitance)	C <sub>b'c</sub>		20		25		—	2.25	—	2.25	pF	
Thermal Resistance: Junction-to-case	R <sub>θJC</sub>						—	20	—	20	°C/W	
Junction-to-ambient	R <sub>θJA</sub>						—	80	—	80		

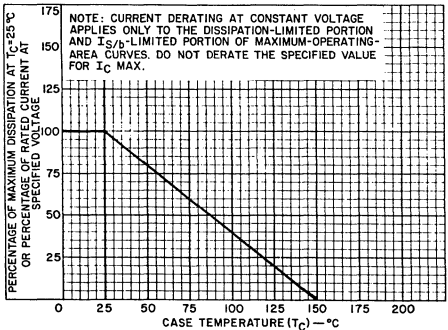
<sup>a</sup> Pulsed, pulse duration = 300 μs, duty factor ≤ 2%.

<sup>b</sup> CAUTION: Sustaining voltage, V<sub>CEO(sus)</sub>, MUST NOT be measured on a curve tracer.



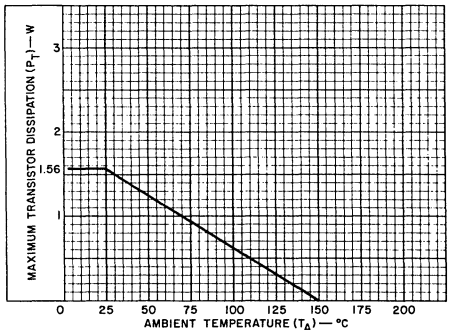
92CS-24102R1

Fig. 1—Maximum operating areas for all types.



92CS-24103

Fig. 2—Dissipation derating curve for all types.



92CS-24104

Fig. 3—Dissipation derating curve at ambient temperature for all types.



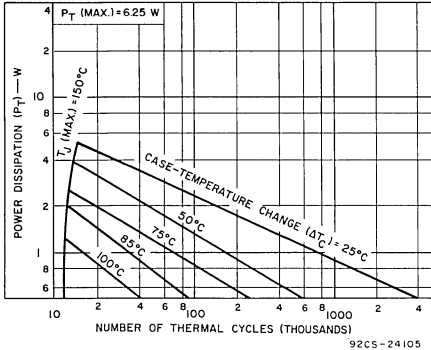


Fig. 4—Thermal-cycling rating chart for all types.

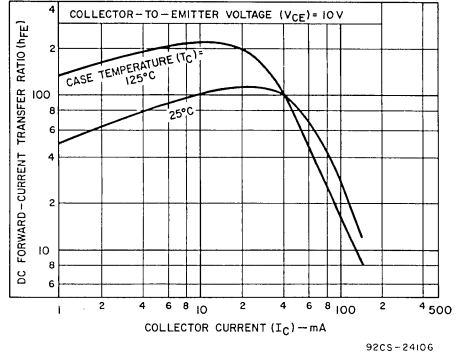


Fig. 5—Typical dc beta characteristics for all types.

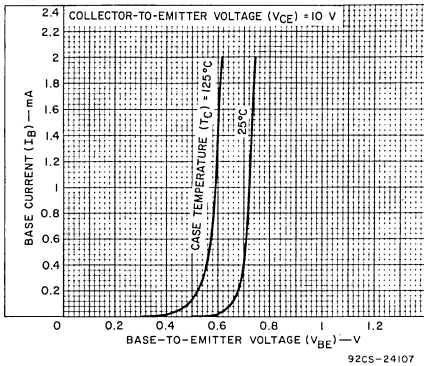


Fig. 6—Typical input characteristics for all types.

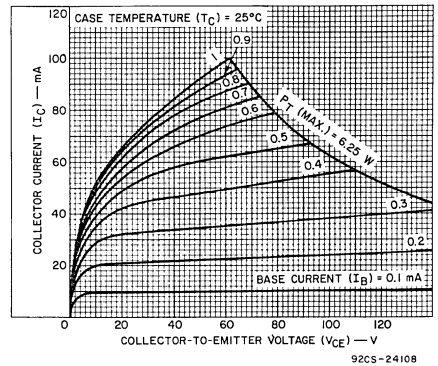


Fig. 7—Typical output characteristics for all types.

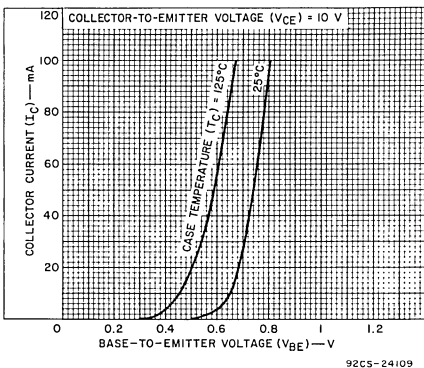


Fig. 8—Typical transfer characteristics for all types.

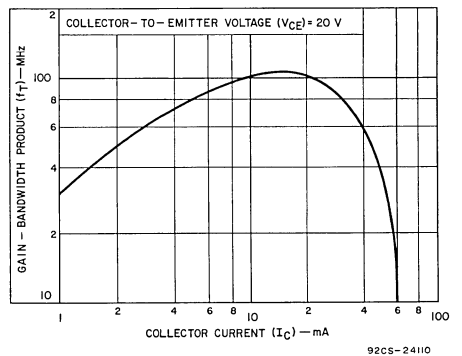


Fig. 9—Typical gain-bandwidth product for all types.

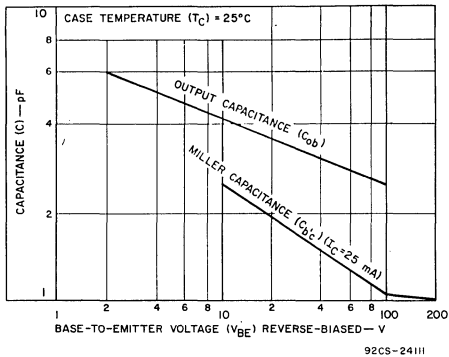


Fig. 10—Typical junction capacitance vs. reverse-bias base-to-emitter voltage.

### CALIBRATION AND USE OF $C_{b'c}$ TEST SET

#### 1. Nulling socket and stray capacitance:

With the socket empty, adjust R3 and R4 for a null output on the readout oscilloscope with the signal generator at approximately half output.

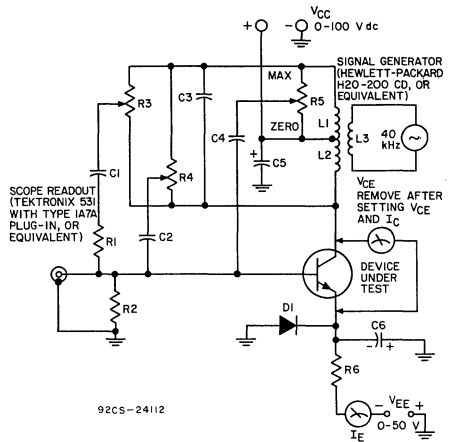
#### 2. Calibration:

With a known capacitor (smaller than C4) across the collector and base terminals of the device-test socket, a null will appear on the oscilloscope at some setting of R5. Calibrate a readout dial (in pF) on R5 by measuring a range of capacitor values.

An alternate method is to connect an accurate capacitor across the collector and base terminals and adjust the signal-generator output for a calibrated scope readout, e.g., 1 pF = 100 microvolts (peak).

#### 3. Set-up of operating point $V_{CE}$ , $I_C$ :

With the set-up transistor in the socket and  $V_{CC}$  supply at 10-20 V, set the  $V_{EE}$  supply to the desired operating current. Attach the voltmeter ( $V_{CE}$ ) as shown in the circuit diagram, and adjust  $V_{CC}$  to the desired conditions. Remove the voltmeter, and test the units by the method chosen from (2) above.



- C1: 1000 pF
  - C2, C4: 5 pF
  - C3: 2000 pF
  - C5: 5  $\mu$ F, 150 V, electrolytic
  - C6: 5  $\mu$ F, 25 V, electrolytic
  - L1, L2: 40 turns No. 30 bifilar
  - L3: 40 turns No. 34 bifilar
- L1, L2, and L3 are wound on one 1/2 in. (12.7 mm) diameter ferrite rod 2 in. (50.8 mm) long.
- R1: 10 Meg $\Omega$
  - R2: 470  $\Omega$
  - R3, R4: 500  $\Omega$  pot., linear taper
  - R5: 5000  $\Omega$  pot., linear taper
  - R6: 1000  $\Omega$
  - D1: 1N3195

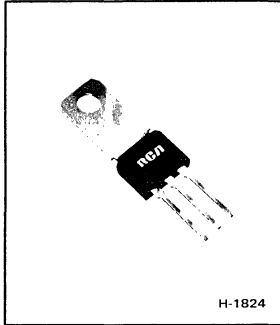
All resistors are carbon, 1/2 W

Fig. 11—Test set used for Miller capacitance ( $C_{b'c}$ ).



# Power Transistors

## RCP700, RCP702, RCP704, RCP706 Series



H-1824

### General-Purpose, Medium-Power Silicon P-N-P Planar Transistors

For Large-Signal Applications

$h_{FE}$ $V_{CE(sus)}$ (V)	At $V_{CE} = 4$ V, $I_C = 500$ mA			
	50-250	30-150	50 min.	20 min.
100	RCP700D	RCP702D	-	-
80	RCP700C	RCP702C	-	-
60	RCP700B	RCP702B	RCP704B	RCP706B
40	RCP700A	RCP702A	-	-
30	-	-	RCP704	RCP706

**Features**

- Maximum safe-area-of-operation curves specified for dc operation
- Planar construction for low noise and low leakage
- High gain at high current
- Fast switching time
- Thermal-cycling ratings
- P-N-P complements of n-p-n types in RCP701, RCP703, RCP705, and RCP707 series

The RCP700-, RCP702-, RCP704-, and RCP706-series power transistors are double-diffused, epitaxial-planar silicon p-n-p transistors. They are intended for a wide variety of large-signal, general-purpose applications such as complementary vertical deflection, TV sound output, regulators, and driver and output stages of audio amplifiers. They are the p-n-p complements of the n-p-n devices in the RCP701, RCP703, RCP705, and RCP707 series\*. These devices are supplied in a molded plastic package.

\* See bulletin File No. 820 for data for the RCP701-, RCP703-, RCP705-, and RCP707-series devices.

**MAXIMUM RATINGS, Absolute-Maximum Values:**

	RCP700D RCP702D	RCP700C RCP702C	RCP700B RCP702B	RCP700A RCP702A	RCP704B RCP706B	RCP704 RCP706	
COLLECTOR-TO-BASE VOLTAGE . . . . . $V_{CBO}$	-125	-105	-85	-55	-85	-45	V
COLLECTOR-TO-EMITTER SUSTAINING VOLTAGE: With base open . . . . . $V_{CE(sus)}$	-100	-80	-60	-40	-60	-30	V
EMITTER-TO-BASE VOLTAGE . . . . . $V_{EBO}$	-7	-7	-7	-7	-5.5	-5.5	V
CONTINUOUS COLLECTOR CURRENT . . . . . $I_C$	-2	-2	-2	-2	-2	-2	A
CONTINUOUS BASE CURRENT . . . . . $I_B$	-1	-1	-1	-1	-1	-1	A
TRANSISTOR DISSIPATION: At case temperatures up to 25°C . . . . . $P_T$	10	10	10	10	10	10	W
At ambient temperatures up to 25°C . . . . .	1.75	1.75	1.75	1.75	1.75	1.75	W
At case temperatures above 25°C . . . . .	Derate linearly 0.08 W/°C						
At ambient temperatures above 25°C . . . . .	Derate linearly 0.014 W/°C						
TEMPERATURE RANGE: Storage & Operating (Junction) . . . . .	-65 to +150						°C
PIN TEMPERATURE (During Soldering) At distances ≥ 1/8 in. (3.17 mm) from seating plane for 10 s max . . . . .	230						°C

ELECTRICAL CHARACTERISTICS, At Case Temperature ( $T_C$ ) = 25°C

CHARACTERISTIC	SYMBOL	TEST CONDITIONS					LIMITS				UNITS
		VOLTAGE V dc			CURRENT mA dc		RCP700D		RCP700C		
		V <sub>CB</sub>	V <sub>CE</sub>	V <sub>BE</sub>	I <sub>C</sub>	I <sub>B</sub>	Min.	Max.	Min.	Max.	
Collector Cutoff Current: With emitter open	I <sub>CBO</sub>	-105 -85					-	-0.5	-	-	μA
With base open	I <sub>CEO</sub>		-75 -60				-	-100	-	-	μA
With base-emitter junction reverse-biased	I <sub>CEV</sub>		-125 -105	1.5 1.5			-	-100	-	-	μA
Emitter Cutoff Current	I <sub>EBO</sub>			7	0		-	-100	-	-100	μA
DC Forward-Current Transfer Ratio	h <sub>FE</sub>		-4 -4		-500 <sup>a</sup> -1000 <sup>a</sup>		50 10	250 -	50 10	250 -	
Collector-to-Emitter Sustaining Voltage: With base open <sup>b</sup>	V <sub>CEO(sus)</sub>				-100 <sup>a</sup>	0	-100	-	-80	-	V
Base-to-Emitter Saturation Voltage	V <sub>BE(sat)</sub>				-500 <sup>a</sup>	-50	-	-1.2	-	-1.2	V
Base-to-Emitter Voltage	V <sub>BE</sub>		-4		-500 <sup>a</sup>		-	-1.1	-	-1.1	V
Collector-to-Emitter Saturation Voltage	V <sub>CE(sat)</sub>				-500 <sup>a</sup>	-50	-	-0.8	-	-0.8	V
Magnitude of Common- Emitter, Small-Signal, Short-Circuit, Forward- Current Transfer Ratio: f = 10 MHz	h <sub>fe</sub>		-4		-50		5	-	5	-	
Gain-Bandwidth Product	f <sub>T</sub>		-4		-50		50	-	50	-	MHz
Second-Breakdown Collector Current: With base forward- biased and t = 50 ms	I <sub>S/b</sub>		-50				-150	-	-150	-	mA
Output Capacitance: f = 1 MHz	C <sub>obo</sub>	-10					20	40	20	40	pF
Saturated Switching Time (V <sub>CC</sub> = 30 V, I <sub>B1</sub> = I <sub>B2</sub> ): Turn-on (t <sub>d</sub> + t <sub>r</sub> )	t <sub>ON</sub>				-500	-50	-	100	-	100	ns
Turn-off (t <sub>s</sub> + t <sub>f</sub> )	t <sub>OFF</sub>				-500	-50	-	1000	-	1000	
Thermal Resistance: Junction-to-case	R <sub>θJC</sub>						-	12.5	-	12.5	°C/W
Junction-to-ambient	R <sub>θJA</sub>						-	71.4	-	71.4	

<sup>a</sup> Pulsed, pulse duration = 300 μs, duty factor ≤ 2%.

<sup>b</sup> CAUTION: Sustaining voltage, V<sub>CEO(sus)</sub>, MUST NOT be measured on a curve tracer.

ELECTRICAL CHARACTERISTICS, At Case Temperature ( $T_C$ ) = 25°C

CHARACTERISTIC	SYMBOL	TEST CONDITIONS				LIMITS				UNITS	
		VOLTAGE V dc			CURRENT mA dc		RCP700B		RCP700A		
		V <sub>CB</sub>	V <sub>CE</sub>	V <sub>BE</sub>	I <sub>C</sub>	I <sub>B</sub>	Min.	Max.	Min.		Max.
Collector Cutoff Current: With emitter open	I <sub>CBO</sub>	-70 -50					-	-0.5 -	-	-	μA
With base open	I <sub>CEO</sub>		-45 -30			0 0	-	-100 -	-	-	μA
With base-emitter junction reverse-biased	I <sub>CEV</sub>		-85 -55	1.5 1.5			-	-100 -	-	-	μA
Emitter Cutoff Current	I <sub>EBO</sub>			7	0		-	-100	-	-100	μA
DC Forward-Current Transfer Ratio	h <sub>FE</sub>		-4 -4		-500 <sup>a</sup> -1000 <sup>a</sup>		50 10	250 -	50 10	250 -	
Collector-to-Emitter Sustaining Voltage: With base open <sup>b</sup>	V <sub>CEO(sus)</sub>				-100 <sup>a</sup>	0	-60	-	-40	-	V
Base-to-Emitter Saturation Voltage	V <sub>BE(sat)</sub>				-500 <sup>a</sup>	-50	-	-1.2	-	-1.2	V
Base-to-Emitter Voltage	V <sub>BE</sub>		-4		-500 <sup>a</sup>		-	-1.1	-	-1.1	V
Collector-to-Emitter Saturation Voltage	V <sub>CE(sat)</sub>				-500 <sup>a</sup>	-50	-	-0.8	-	-0.8	V
Magnitude of Common- Emitter, Small-Signal, Short-Circuit, Forward- Current Transfer Ratio: f = 10 MHz	h <sub>fe</sub>		-4		-50		5	-	5	-	
Gain-Bandwidth Product	f <sub>T</sub>		-4		-50		50	-	50	-	MHz
Second-Breakdown Collector Current: With base forward- biased and t = 50 ms	I <sub>S/b</sub>		-50 -35				-150 -	-	-	-	mA
Output Capacitance: f = 1 MHz	C <sub>obo</sub>	-10					20	40	20	40	pF
Saturated Switching Time (V <sub>CC</sub> = 30 V, I <sub>B1</sub> = I <sub>B2</sub> ): Turn-on (t <sub>d</sub> + t <sub>r</sub> )	t <sub>ON</sub>	-			-500	-50	-	100	-	100	ns
Turn-off (t <sub>s</sub> + t <sub>f</sub> )	t <sub>OFF</sub>				-500	-50	-	1000	-	1000	
Thermal Resistance: Junction-to-case	R <sub>θJC</sub>						-	12.5	-	12.5	°C/W
Junction-to-ambient	R <sub>θJA</sub>						-	71.4	-	71.4	

<sup>a</sup> Pulsed, pulse duration = 300 μs, duty factor ≤ 2%.

<sup>b</sup> CAUTION: Sustaining voltage, V<sub>CEO(sus)</sub>, MUST NOT be measured on a curve tracer.

**ELECTRICAL CHARACTERISTICS, At Case Temperature ( $T_C$ ) = 25°C**

CHARACTERISTIC	SYMBOL	TEST CONDITIONS					LIMITS				UNITS	
		VOLTAGE V dc			CURRENT mA dc		RCP702D		RCP702C			
		V <sub>CB</sub>	V <sub>CE</sub>	V <sub>BE</sub>	I <sub>C</sub>	I <sub>B</sub>	Min.	Max.	Min.	Max.		
Collector Cutoff Current: With emitter open	I <sub>CBO</sub>	-105 -85					-	-0.5	-	-	-0.5	μA
With base open	I <sub>CEO</sub>		-75 -60			0 0	-	-100	-	-	-100	μA
With base-emitter junction reverse-biased	I <sub>CEV</sub>		-125 -105	1.5 1.5			-	-100	-	-	-100	μA
Emitter Cutoff Current	I <sub>EBO</sub>			7	0		-	-100	-	-	-100	μA
DC Forward-Current Transfer Ratio	h <sub>FE</sub>		-4 -4		-500 <sup>a</sup> -1000 <sup>a</sup>		30 10	150 -	30 10	150 -		
Collector-to-Emitter Sustaining Voltage: With base open <sup>b</sup>	V <sub>CEO(sus)</sub>				-100 <sup>a</sup>	0	-100	-	-80	-		V
Base-to-Emitter Saturation Voltage	V <sub>BE(sat)</sub>				-500 <sup>a</sup>	-50	-	-1.2	-	-1.2		V
Base-to-Emitter Voltage	V <sub>BE</sub>		-4		-500 <sup>a</sup>		-	-	-	-		V
Collector-to-Emitter Saturation Voltage	V <sub>CE(sat)</sub>				-500 <sup>a</sup>	-50	-	-0.8	-	-0.8		V
Magnitude of Common- Emitter, Small-Signal, Short-Circuit, Forward- Current Transfer Ratio: f = 10 MHz	h <sub>fe</sub>		-4		-50		5	-	5	-		
Gain-Bandwidth Product	f <sub>T</sub>		-4		-50		50	-	50	-		MHz
Second-Breakdown Collector Current: With base forward- biased and t = 50 ms	I <sub>S/b</sub>		-50				-150	-	-150	-		mA
Output Capacitance : f = 1 MHz	C <sub>obo</sub>	-10					20	40	20	40		pF
Saturated Switching Time (V <sub>CC</sub> = 30 V, I <sub>B1</sub> = I <sub>B2</sub> ): Turn-on (t <sub>d</sub> + t <sub>r</sub> )	t <sub>ON</sub>				-500	-50	-	100	-	100		ns
Turn-off (t <sub>s</sub> + t <sub>f</sub> )	t <sub>OFF</sub>				-500	-50	-	1000	-	1000		
Thermal Resistance: Junction-to-case	R <sub>θJC</sub>						-	12.5	-	12.5		°C/W
Junction-to-ambient	R <sub>θJA</sub>						-	71.4	-	71.4		

<sup>a</sup> Pulsed, pulse duration = 300 μs, duty factor ≤ 2%.

<sup>b</sup> **CAUTION:** Sustaining voltage, V<sub>CEO(sus)</sub>, MUST NOT be measured on a curve tracer.

ELECTRICAL CHARACTERISTICS, At Case Temperature ( $T_C$ ) = 25°C

CHARACTERISTIC	SYMBOL	TEST CONDITIONS				LIMITS				UNITS		
		VOLTAGE V dc			CURRENT mA dc		RCP702B		RCP702A			
		V <sub>CB</sub>	V <sub>CE</sub>	V <sub>BE</sub>	I <sub>C</sub>	I <sub>B</sub>	Min.	Max.	Min.		Max.	
Collector Cutoff Current: With emitter open	I <sub>CBO</sub>	-70 -50					-	-0.5 -	-	-	-0.5	μA
With base open	I <sub>CEO</sub>		-45 -30			0 0	-	-100 -	-	-	-100	μA
With base-emitter junction reverse-biased	I <sub>CEV</sub>		-85 -55	1.5 1.5			-	-100 -	-	-	-100	μA
Emitter Cutoff Current	I <sub>EBO</sub>			7	0		-	-100	-	-100		μA
DC Forward Current Transfer Ratio	h <sub>FE</sub>		-4 -4		-500 <sup>a</sup> -1000 <sup>a</sup>		30 10	150 -	30 10	150 -		
Collector-to-Emitter Sustaining Voltage: With base open <sup>b</sup>	V <sub>CEO(sus)</sub>				-100 <sup>a</sup>	0	-60	-	-40	-		V
Base-to-Emitter Saturation Voltage	V <sub>BE(sat)</sub>				-500 <sup>a</sup>	-50	-	-1.2	-	-1.2		V
Base-to-Emitter Voltage	V <sub>BE</sub>		-4		-500 <sup>a</sup>		-	-1.1	-	-1.1		V
Collector-to-Emitter Saturation Voltage	V <sub>CE(sat)</sub>				-500 <sup>a</sup>	-50	-	-0.8	-	-0.8		V
Magnitude of Common- Emitter, Small-Signal, Short-Circuit, Forward- Current Transfer Ratio: f = 10 MHz	h <sub>fe</sub>		-4		-50		5	-	5	-		
Gain-Bandwidth Product	f <sub>T</sub>		-4		-50		50	-	50	-		MHz
Second-Breakdown Collector Current: With base forward- biased and t = 50 ms	I <sub>S/b</sub>		-50 -35			-	-150 -	-	-	-	-	mA
Output Capacitance: f = 1 MHz	C <sub>obo</sub>	-10					20	40	20	40		pF
Saturated Switching Time (V <sub>CC</sub> = 30 V, I <sub>B1</sub> = I <sub>B2</sub> ): Turn-on (t <sub>d</sub> + t <sub>r</sub> )	t <sub>ON</sub>				-500	-50	-	100	-	100		ns
Turn-off (t <sub>s</sub> + t <sub>f</sub> )	t <sub>OFF</sub>				-500	-50	-	1000	-	1000		
Thermal Resistance: Junction-to-case	R <sub>θJC</sub>						-	12.5	-	12.5		°C/W
Junction-to-ambient	R <sub>θJA</sub>						-	71.4	-	71.4		

<sup>a</sup> Pulsed, pulse duration = 300 μs, duty factor ≤ 2%.

<sup>b</sup> CAUTION: Sustaining voltage, V<sub>CEO(sus)</sub>, MUST NOT be measured on a curve tracer.

ELECTRICAL CHARACTERISTICS, At Case Temperature ( $T_C$ ) = 25°C

CHARACTERISTIC	SYMBOL	TEST CONDITIONS					LIMITS				UNITS	
		VOLTAGE V dc			CURRENT mA dc		RCP704B		RCP704			
		V <sub>CB</sub>	V <sub>CE</sub>	V <sub>BE</sub>	I <sub>C</sub>	I <sub>B</sub>	Min.	Max.	Min.	Max.		
Collector Cutoff Current: With emitter open	I <sub>CBO</sub>	-70 -40					-	-5	-	-	-5	μA
With base open	I <sub>CEO</sub>		-45 -22				-	-1000	-	-	-1000	μA
With base-emitter junction reverse-biased	I <sub>CEV</sub>		-85 -45	1.5 1.5			-	-100	-	-	-100	μA
Emitter Cutoff Current	I <sub>EBO</sub>			5.5	0		-	-100	-	-	-100	μA
DC Forward-Current Transfer Ratio	h <sub>FE</sub>		-4		-500 <sup>a</sup>		50	-	50	-		
Collector-to-Emitter Sustaining Voltage: With base open <sup>b</sup>	V <sub>CEO(sus)</sub>				-100 <sup>a</sup>	0	-60	-	-30	-		V
Base-to-Emitter Saturation Voltage	V <sub>BE(sat)</sub>				-500 <sup>a</sup>	-50	-	-1.6	-	-	-1.6	V
Base-to-Emitter Voltage	V <sub>BE</sub>		-4		-500 <sup>a</sup>		-	-1.5	-	-	-1.5	V
Collector-to-Emitter Saturation Voltage	V <sub>CE(sat)</sub>				-500 <sup>a</sup>	-50	-	-1.2	-	-	-1.2	V
Magnitude of Common- Emitter, Small-Signal, Short-Circuit, Forward- Current Transfer Ratio: f = 10 MHz	h <sub>fe</sub>		-4		-50		5	-	5	-		
Gain-Bandwidth Product	f <sub>T</sub>		-4		-50		50	-	50	-		MHz
Second-Breakdown Collector Current: With base forward- biased and t = 50 ms	I <sub>S/b</sub>		-50 -20				-100 -	-	-	-	-	mA
Output Capacitance: f = 1 MHz	C <sub>obo</sub>	-10					20	40	20	40		pF
Saturated Switching Time (V <sub>CC</sub> = 30 V, I <sub>B1</sub> = I <sub>B2</sub> ): Turn-on (t <sub>d</sub> + t <sub>r</sub> )	t <sub>ON</sub>				-500	-50	-	100	-	100		ns
Turn-off (t <sub>s</sub> + t <sub>f</sub> )	t <sub>OFF</sub>				-500	-50	-	1000	-	1000		
Thermal Resistance: Junction-to-case	R <sub>θJC</sub>						-	12.5	-	12.5		°C/W
Junction-to-ambient	R <sub>θJA</sub>						-	71.4	-	71.4		

<sup>a</sup> Pulsed, pulse duration = 300 μs, duty factor ≤ 2%.

<sup>b</sup> CAUTION: Sustaining voltage, V<sub>CEO(sus)</sub>, MUST NOT be measured on a curve tracer.

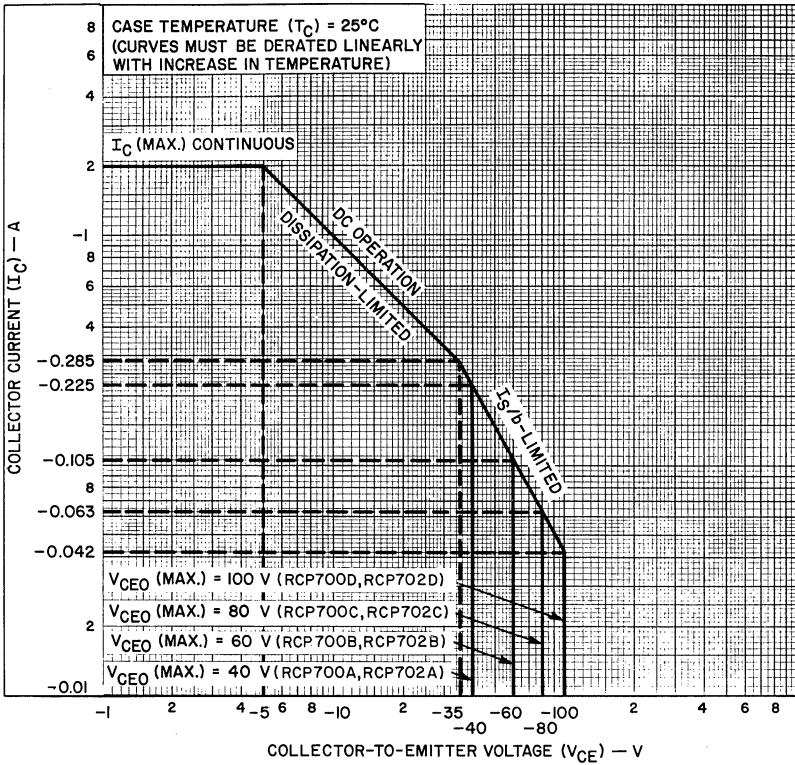


**ELECTRICAL CHARACTERISTICS, At Case Temperature ( $T_C$ ) = 25°C**

CHARACTERISTIC	SYMBOL	TEST CONDITIONS					LIMITS				UNITS
		VOLTAGE V dc		CURRENT mA dc			RCP706B		RCP706		
		V <sub>CB</sub>	V <sub>CE</sub>	V <sub>BE</sub>	I <sub>C</sub>	I <sub>B</sub>	Min.	Max.	Min.	Max.	
Collector Cutoff Current: With emitter open	I <sub>CBO</sub>	-70 -40					-	-5	-	-	μA
With base open	I <sub>CEO</sub>		-45 -22			0 0	-	-1000	-	-	μA
With base-emitter junction reverse-biased	I <sub>CEV</sub>		-85 -45	1.5 1.5			-	-100	-	-	μA
Emitter Cutoff Current	I <sub>EBO</sub>			5.5	0		-	-100	-	-100	μA
DC Forward-Current Transfer Ratio	h <sub>FE</sub>		-4		-500 <sup>a</sup>		20	-	20	-	
Collector-to-Emitter Sustaining Voltage: With base open <sup>b</sup>	V <sub>CEO(sus)</sub>				-100 <sup>a</sup>	0	-60	-	-30	-	V
Base-to-Emitter Saturation Voltage	V <sub>BE(sat)</sub>				-500 <sup>a</sup>	-50	-	-1.6	-	-1.6	V
Base-to-Emitter Voltage	V <sub>BE</sub>		-4		-500 <sup>a</sup>		-	-1.5	-	-1.5	V
Collector-to-Emitter Saturation Voltage	V <sub>CE(sat)</sub>				-500 <sup>a</sup>	-50	-	-1.2	-	-1.2	V
Magnitude of Common- Emitter, Small-Signal, Short-Circuit, Forward- Current Transfer Ratio: f = 10 MHz	h <sub>fe</sub>		-4		-50		5	-	5	-	
Gain-Bandwidth Product	f <sub>T</sub>		-4		-50		50	-	50	-	MHz
Second-Breakdown Collector Current: With base forward- biased and t = 50 ms	I <sub>S/b</sub>		-50 -20				-100 -	-	-	-	mA
Output Capacitance: f = 1 MHz	C <sub>obo</sub>	-10					20	40	20	40	pF
Saturated Switching Time (V <sub>CC</sub> = 30 V, I <sub>B1</sub> = I <sub>B2</sub> ): Turn-on (t <sub>d</sub> + t <sub>r</sub> )	t <sub>ON</sub>				-500	-50	-	100	-	100	ns
Turn-off (t <sub>s</sub> + t <sub>f</sub> )	t <sub>OFF</sub>				-500	-50	-	1000	-	1000	
Thermal Resistance: Junction-to-case	R <sub>θJC</sub>						-	12.5	-	12.5	°C/W
Junction-to-ambient	R <sub>θJA</sub>						-	71.4	-	71.4	

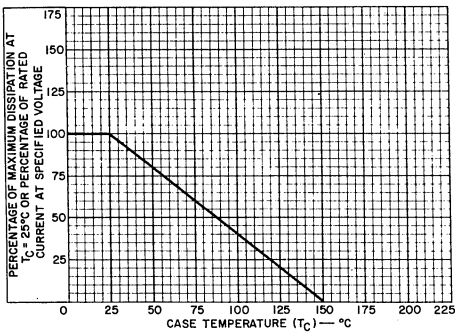
<sup>a</sup> Pulsed, pulse duration = 300 μs, duty factor ≤ 2%.

<sup>b</sup> **CAUTION:** Sustaining voltage, V<sub>CEO(sus)</sub>, MUST NOT be measured on a curve tracer.



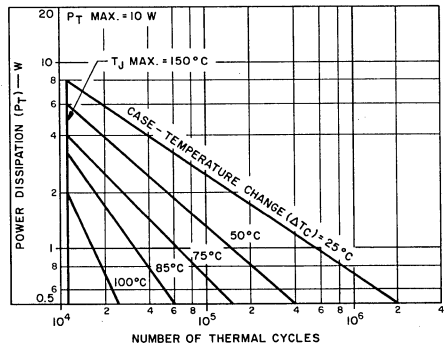
92CS-24187RI

Fig. 1 - Maximum operating areas for RCP700A - RCP700D and RCP702A - RCP702D.



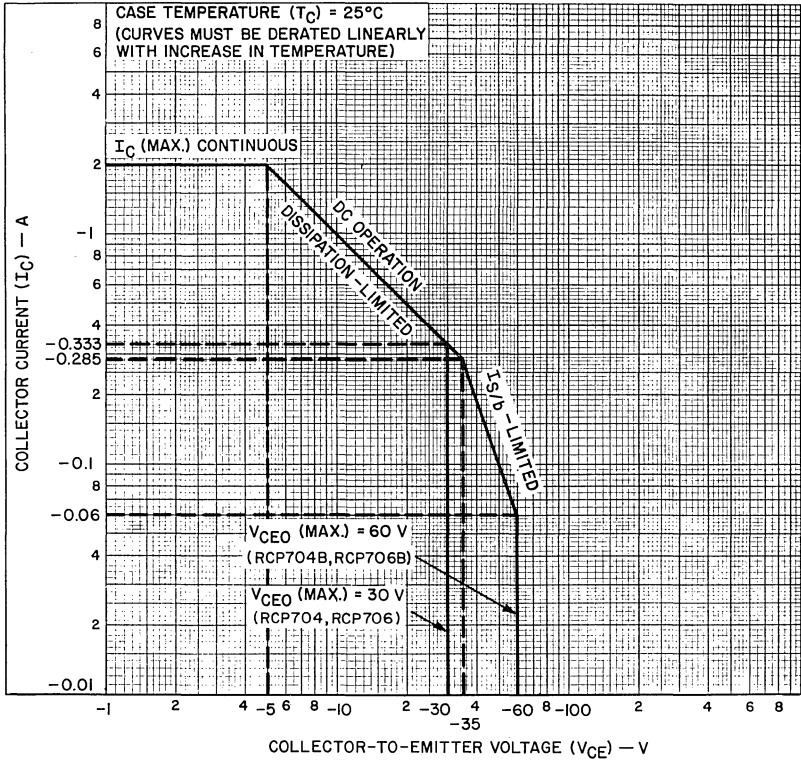
92CS-24188

Fig. 2 - Dissipation derating curve for all types.



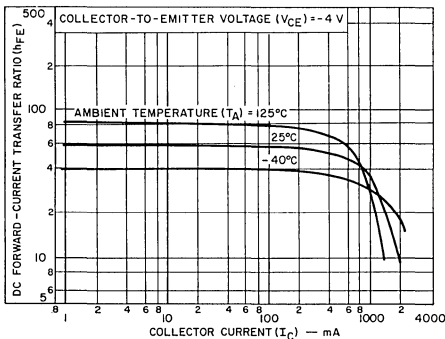
92CS-24189

Fig. 3 - Thermal-cycling rating chart for all types.



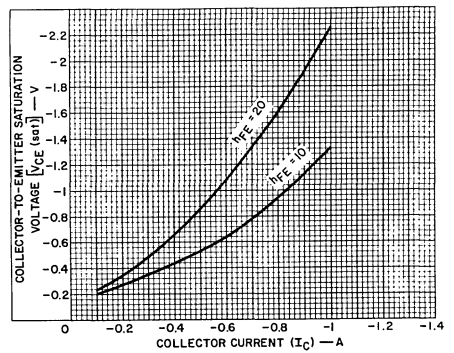
92CS-24190R1

Fig. 4 — Maximum operating areas for RCP704, RCP704B, RCP706, and RCP706B.



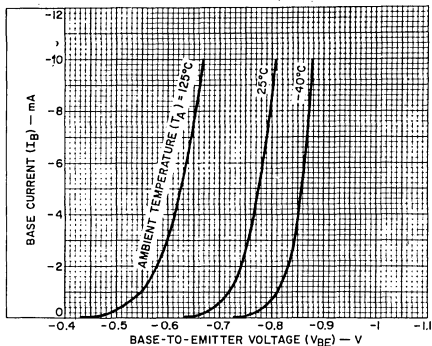
92CS-24191

Fig. 5 — Typical static beta characteristics for all types.



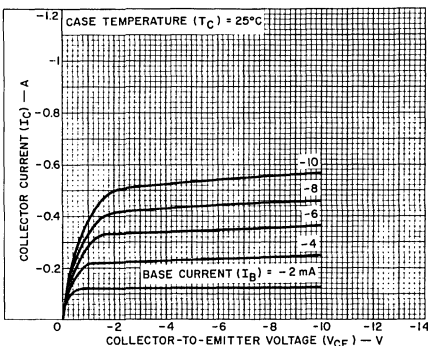
92CS-24192

Fig. 6 — Typical saturation-voltage characteristics for all types.



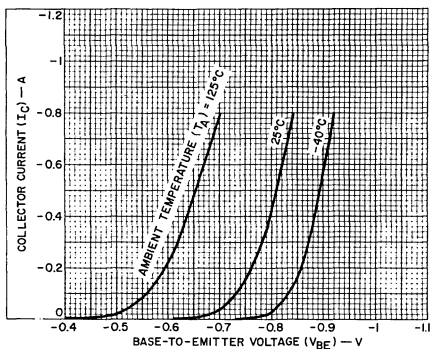
92CS-24193

Fig. 7 - Typical input characteristics for all types.



92CS-24194

Fig. 8 - Typical output characteristics for all types.



92CS-24195

Fig. 9 - Typical transfer characteristics for all types.

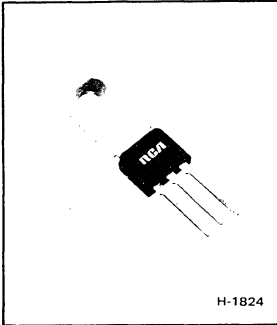
**TERMINAL CONNECTIONS**

- Terminal No. 1 - Emitter
- Terminal No. 2 - Base
- Terminal No. 3 - Collector
- Terminal No. 4 - Collector



# Power Transistors

## RCP701, RCP703, RCP705, RCP707 Series



### General-Purpose, Medium-Power Silicon N-P-N Planar Transistors

For Large-Signal Applications

$V_{CE0(sus)}$ (V)	$h_{FE}$ At $V_{CE} = 4\text{ V}$ , $I_C = 500\text{ mA}$			
	50–250	30–150	50 min.	20 min.
100	RCP701D	RCP703D	—	—
80	RCP701C	RCP703C	—	—
60	RCP701B	RCP703B	RCP705B	RCP707B
40	RCP701A	RCP703A	—	—
30	—	—	RCP705	RCP707

**Features**

- Maximum safe-area-of-operation curves specified for dc operation
- Planar construction for low noise and low leakage
- High gain at high current
- Fast switching time
- Thermal-cycling ratings
- N-P-N complements of p-n-p types in RCP700, RCP702, RCP704, and RCP706 series

The RCP701-, RCP703-, RCP705-, and RCP707-series power transistors are double-diffused, epitaxial-planar silicon p-n-p transistors. They are intended for a wide variety of large-signal, general-purpose applications such as complementary vertical deflection, TV sound output, regulators, and driver and output stages of audio amplifiers. They are the n-p-n complements of the p-n-p devices in the RCP700, RCP702, RCP704, and RCP706 series\*. These devices are supplied in a molded plastic package.

\* See bulletin File No. 821 for data for the RCP700-, RCP702-, RCP704-, and RCP706-series devices.

**MAXIMUM RATINGS, Absolute-Maximum Values:**

	RCP701D RCP703D	RCP701C RCP703C	RCP701B RCP703B	RCP701A RCP703A	RCP705B RCP707B	RCP705 RCP707	
COLLECTOR-TO-BASE VOLTAGE . . . . . $V_{CBO}$	125	105	85	55	85	45	V
COLLECTOR-TO-EMITTER SUSTAINING VOLTAGE: With base open . . . . . $V_{CE0(sus)}$	100	80	60	40	60	30	V
EMITTER-TO-BASE VOLTAGE . . . . . $V_{EBO}$	7	7	7	7	5.5	5.5	V
CONTINUOUS COLLECTOR CURRENT . . . . . $I_C$	2	2	2	2	2	2	A
CONTINUOUS BASE CURRENT . . . . . $I_B$	1	1	1	1	1	1	A
TRANSISTOR DISSIPATION: At case temperatures up to 25°C . . . . . $P_T$	10	10	10	10	10	10	W
At ambient temperatures up to 25°C . . . . .	1.75	1.75	1.75	1.75	1.75	1.75	W
At case temperatures above 25°C . . . . .	Derate linearly 0.08 W/°C						
At ambient temperatures above 25°C . . . . .	Derate linearly 0.014 W/°C						
TEMPERATURE RANGE: Storage & Operating (Junction) . . . . .	—65 to +150						°C
PIN TEMPERATURE (During Soldering) At distances $\geq 1/8$ in. (3.17 mm) from seating plane for 10 s max . . . . .	230						°C

ELECTRICAL CHARACTERISTICS, At Case Temperature ( $T_C$ ) = 25°C

CHARACTERISTIC	SYMBOL	TEST CONDITIONS					LIMITS				UNITS		
		VOLTAGE V dc			CURRENT mA dc		RCP701D		RCP701C				
		V <sub>CB</sub>	V <sub>CE</sub>	V <sub>BE</sub>	I <sub>C</sub>	I <sub>B</sub>	Min.	Max.	Min.	Max.			
Collector Cutoff Current: With emitter open	I <sub>CBO</sub>	105 85						—	0.5	—	—	0.5	μA
With base open	I <sub>CEO</sub>		75 60			0 0	— —	100 —	— —	— 100			μA
With base-emitter junction reverse-biased	I <sub>CEV</sub>		125 105	-1.5 -1.5			— —	100 —	— —	— 100			μA
Emitter Cutoff Current	I <sub>EBO</sub>			-7	0		—	100	—	100			μA
DC Forward Current Transfer Ratio	h <sub>FE</sub>		4 4		500 <sup>a</sup> 1000 <sup>a</sup>		50 10	250 —	50 10	250 —			
Collector-to-Emitter Sustaining Voltage: With base open <sup>b</sup>	V <sub>CEO(sus)</sub>				100 <sup>a</sup>	0	100	—	80	—			V
Base-to-Emitter Saturation Voltage	V <sub>BE(sat)</sub>				500 <sup>a</sup>	50	—	1.2	—	1.2			V
Base-to-Emitter Voltage	V <sub>BE</sub>		4		500 <sup>a</sup>		—	1.1	—	1.1			V
Collector-to-Emitter Saturation Voltage	V <sub>CE(sat)</sub>				500 <sup>a</sup>	50	—	0.8	—	0.8			V
Magnitude of Common- Emitter, Small-Signal, Short-Circuit, Forward- Current Transfer Ratio: f = 10 MHz	h <sub>fe</sub>		4		50		5	—	5	—			
Gain-Bandwidth Product	f <sub>T</sub>		4		50		50	—	50	—			MHz
Second-Breakdown Collector Current: With base forward- biased and t = 50 ms	I <sub>S/b</sub>		50				200	—	200	—			mA
Output Capacitance : f = 1 MHz	C <sub>obo</sub>	10					8	20	8	20			pF
Saturated Switching Time (V <sub>CC</sub> = 30 V, I <sub>B1</sub> = I <sub>B2</sub> ): Turn-on (t <sub>d</sub> + t <sub>r</sub> )	t <sub>ON</sub>				500	50	—	80	—	80			ns
Turn-off (t <sub>s</sub> + t <sub>f</sub> )	t <sub>OFF</sub>				500	50	—	800	—	800			
Thermal Resistance: Junction-to-case	R <sub>θJC</sub>						—	12.5	—	12.5			°C/W
Junction-to-ambient	R <sub>θJA</sub>						—	71.4	—	71.4			

<sup>a</sup> Pulsed, pulse duration = 300 μs, duty factor ≤ 2%.

<sup>b</sup> CAUTION: Sustaining voltage, V<sub>CEO(sus)</sub>, MUST NOT be measured on a curve tracer.

ELECTRICAL CHARACTERISTICS, At Case Temperature ( $T_C$ ) = 25°C

CHARACTERISTIC	SYMBOL	TEST CONDITIONS					LIMITS				UNITS	
		VOLTAGE V dc			CURRENT mA dc		RCP701B		RCP701A			
		V <sub>CB</sub>	V <sub>CE</sub>	V <sub>BE</sub>	I <sub>C</sub>	I <sub>B</sub>	Min.	Max.	Min.	Max.		
Collector Cutoff Current: With emitter open	I <sub>CBO</sub>	70 50					–	0.5 –	–	–	0.5	μA
With base open	I <sub>CEO</sub>		45 30			0 0	–	100 –	–	–	100	μA
With base-emitter junction reverse-biased	I <sub>CEV</sub>		85 55	–1.5 –1.5			–	100 –	–	–	100	μA
Emitter Cutoff Current	I <sub>EBO</sub>			–7	0		–	100	–	–	100	μA
DC Forward-Current Transfer Ratio	h <sub>FE</sub>		4 4		500 <sup>a</sup> 1000 <sup>a</sup>		50 10	250 –	50 10	250 –		
Collector-to-Emitter Sustaining Voltage: With base open <sup>b</sup>	V <sub>CEO(sus)</sub>				100 <sup>a</sup>	0	60	–	40	–		V
Base-to-Emitter Saturation Voltage	V <sub>BE(sat)</sub>				500 <sup>a</sup>	50	–	1.2	–	1.2		V
Base-to-Emitter Voltage	V <sub>BE</sub>		4		500 <sup>a</sup>		–	1.1	–	1.1		V
Collector-to-Emitter Saturation Voltage	V <sub>CE(sat)</sub>				500 <sup>a</sup>	50	–	0.8	–	0.8		V
Magnitude of Common- Emitter, Small-Signal, Short-Circuit, Forward- Current Transfer Ratio: f = 10 MHz	h <sub>fe</sub>		4		50		5	–	5	–		
Gain-Bandwidth Product	f <sub>T</sub>		4		50		50	–	50	–		MHz
Second-Breakdown Collector Current: With base forward- biased and t = 50 ms	I <sub>S/b</sub>		50 20				200 –	– –	– –	– 500		mA
Output Capacitance: f = 1 MHz	C <sub>obo</sub>	10					8	20	8	20		pF
Saturated Switching Time (V <sub>CC</sub> = 30 V, I <sub>B1</sub> = I <sub>B2</sub> ): Turn-on (t <sub>d</sub> + t <sub>r</sub> )	t <sub>ON</sub>				500	50	–	80	–	80		ns
Turn-off (t <sub>s</sub> + t <sub>f</sub> )	t <sub>OFF</sub>				500	50	–	800	–	800		
Thermal Resistance: Junction-to-case	R <sub>θJC</sub>						–	12.5	–	12.5		°C/W
Junction-to-ambient	R <sub>θJA</sub>						–	71.4	–	71.4		

<sup>a</sup> Pulsed, pulse duration = 300 μs, duty factor ≤ 2%.<sup>b</sup> CAUTION: Sustaining voltage, V<sub>CEO(sus)</sub>, MUST NOT be measured on a curve tracer.

ELECTRICAL CHARACTERISTICS, At Case Temperature ( $T_C$ ) = 25°C

CHARACTERISTIC	SYMBOL	TEST CONDITIONS					LIMITS				UNITS
		VOLTAGE V dc			CURRENT mA dc		RCP703D		RCP703C		
		V <sub>CB</sub>	V <sub>CE</sub>	V <sub>BE</sub>	I <sub>C</sub>	I <sub>B</sub>	Min.	Max.	Min.	Max.	
Collector Cutoff Current: With emitter open	I <sub>CBO</sub>	105 85					– –	0.5 –	– –	– 0.5	μA
With base open	I <sub>CEO</sub>		75 60			0 0	– –	100 –	– –	– 100	μA
With base-emitter junction reverse-biased	I <sub>CEV</sub>		125 105	–1.5 –1.5			– –	100 –	– –	– 100	μA
Emitter Cutoff Current	I <sub>EBO</sub>			–7	0		–	100	–	100	μA
DC Forward-Current Transfer Ratio	h <sub>FE</sub>		4 4		500 <sup>a</sup> 1000 <sup>a</sup>		30 10	150 –	30 10	150 –	
Collector-to-Emitter Sustaining Voltage: With base open <sup>b</sup>	V <sub>CEO(sus)</sub>				100 <sup>a</sup>	0	100	–	80	–	V
Base-to-Emitter Saturation Voltage	V <sub>BE(sat)</sub>				500 <sup>a</sup>	50	–	1.2	–	1.2	V
Base-to-Emitter Voltage	V <sub>BE</sub>		4		500 <sup>a</sup>		–	1.1	–	1.1	V
Collector-to-Emitter Saturation Voltage	V <sub>CE(sat)</sub>				500 <sup>a</sup>	50	–	0.8	–	0.8	V
Magnitude of Common- Emitter, Small-Signal, Short-Circuit, Forward- Current Transfer Ratio: f = 10 MHz	h <sub>fe</sub>		4		50		5	–	5	–	
Gain-Bandwidth Product	f <sub>T</sub>		4		50		50	–	50	–	MHz
Second-Breakdown Collector Current: With base forward- biased and t = 50 ms	I <sub>S/b</sub>		50				200	–	200	–	mA
Output Capacitance: f = 1 MHz	C <sub>obo</sub>	10					8	20	8	20	pF
Saturated Switching Time (V <sub>CC</sub> = 30 V, I <sub>B1</sub> = I <sub>B2</sub> ): Turn-on (t <sub>d</sub> + t <sub>r</sub> )	t <sub>ON</sub>				500	50	–	80	–	80	ns
Turn-off (t <sub>s</sub> + t <sub>f</sub> )	t <sub>OFF</sub>				500	50	–	800	–	800	
Thermal Resistance: Junction-to-case	R <sub>θJC</sub>						–	12.5	–	12.5	°C/W
Junction-to-ambient	R <sub>θJA</sub>						–	71.4	–	71.4	

<sup>a</sup> Pulsed, pulse duration = 300 μs, duty factor ≤ 2%.<sup>b</sup> CAUTION: Sustaining voltage, V<sub>CEO(sus)</sub>, MUST NOT be measured on a curve tracer.



ELECTRICAL CHARACTERISTICS, At Case Temperature ( $T_C$ ) = 25°C

CHARACTERISTIC	SYMBOL	TEST CONDITIONS					LIMITS				UNITS
		VOLTAGE V dc			CURRENT mA dc		RCP703B		RCP703A		
		V <sub>CB</sub>	V <sub>CE</sub>	V <sub>BE</sub>	I <sub>C</sub>	I <sub>B</sub>	Min.	Max.	Min.	Max.	
Collector Cutoff Current: With emitter open	I <sub>CBO</sub>	70 50					–	0.5 –	–	– 0.5	μA
With base open	I <sub>CEO</sub>		45 30			0 0	–	100 –	–	– 100	μA
With base-emitter junction reverse-biased	I <sub>CEV</sub>		85 55	–1.5 –1.5			–	100 –	–	– 100	μA
Emitter Cutoff Current	I <sub>EBO</sub>			–7	0		–	100	–	100	μA
DC Forward-Current Transfer Ratio	h <sub>FE</sub>		4 4		500 <sup>a</sup> 1000 <sup>a</sup>		30 10	150 –	30 10	150 –	
Collector-to-Emitter Sustaining Voltage: With base open <sup>b</sup>	V <sub>CEO(sus)</sub>				100 <sup>a</sup>	0	60	–	40	–	V
Base-to-Emitter Saturation Voltage	V <sub>BE(sat)</sub>				500 <sup>a</sup>	50	–	1.2	–	1.2	V
Base-to-Emitter Voltage	V <sub>BE</sub>		4		500 <sup>a</sup>		–	1.1	–	1.1	V
Collector-to-Emitter Saturation Voltage	V <sub>CE(sat)</sub>				500 <sup>a</sup>	50	–	0.8	–	0.8	V
Magnitude of Common- Emitter, Small-Signal, Short-Circuit, Forward- Current Transfer Ratio: f = 10 MHz	h <sub>fe</sub>		4		50		5	–	5	–	
Gain-Bandwidth Product	f <sub>T</sub>		4		50		50	–	50	–	MHz
Second-Breakdown Collector Current: With base forward- biased and t = 50 ms	I <sub>S/b</sub>		50 20				200 –	– –	– 500	– –	mA
Output Capacitance: f = 1 MHz	C <sub>obo</sub>	10					8	20	8	20	pF
Saturated Switching Time (V <sub>CC</sub> = 30 V, I <sub>B1</sub> = I <sub>B2</sub> ): Turn-on (t <sub>d</sub> + t <sub>r</sub> )	t <sub>ON</sub>				500	50	–	80	–	80	ns
Turn-off (t <sub>s</sub> + t <sub>f</sub> )	t <sub>OFF</sub>				500	50	–	800	–	800	
Thermal Resistance: Junction-to-case	R <sub>θJC</sub>						–	12.5	–	12.5	°C/W
Junction-to-ambient	R <sub>θJA</sub>						–	71.4	–	71.4	

<sup>a</sup> Pulsed, pulse duration = 300 μs, duty factor ≤ 2%.<sup>b</sup> CAUTION: Sustaining voltage, V<sub>CEO(sus)</sub>, MUST NOT be measured on a curve tracer.

**ELECTRICAL CHARACTERISTICS, At Case Temperature ( $T_C$ ) = 25°C**

CHARACTERISTIC	SYMBOL	TEST CONDITIONS					LIMITS				UNITS	
		VOLTAGE V dc			CURRENT mA dc		RCP705B		RCP705			
		V <sub>CB</sub>	V <sub>CE</sub>	V <sub>BE</sub>	I <sub>C</sub>	I <sub>B</sub>	Min.	Max.	Min.	Max.		
Collector Cutoff Current: With emitter open	I <sub>CBO</sub>	70 40					–	5	–	–	5	μA
With base open	I <sub>CEO</sub>		45 22			0 0	–	1000	–	–	1000	μA
With base-emitter junction reverse-biased	I <sub>CEV</sub>		85 45	–1.5 –1.5			–	100	–	–	100	μA
Emitter Cutoff Current	I <sub>EBO</sub>			–5.5	0		–	100	–	–	100	μA
DC Forward-Current Transfer Ratio	h <sub>FE</sub>		4		500 <sup>a</sup>		50	–	50	–		
Collector-to-Emitter Sustaining Voltage: With base open <sup>b</sup>	V <sub>CEO(sus)</sub>				100 <sup>a</sup>	0	60	–	30	–		V
Base-to-Emitter Saturation Voltage	V <sub>BE(sat)</sub>				500 <sup>a</sup>	50	–	1.6	–	–	1.6	V
Base-to-Emitter Voltage	V <sub>BE</sub>		4		500 <sup>a</sup>		–	1.5	–	–	1.5	V
Collector-to-Emitter Saturation Voltage	V <sub>CE(sat)</sub>				500 <sup>a</sup>	50	–	1.2	–	–	1.2	V
Magnitude of Common- Emitter, Small-Signal, Short-Circuit, Forward- Current Transfer Ratio: f = 10 MHz	h <sub>fe</sub>		4		50		5	–	5	–		
Gain-Bandwidth Product	f <sub>T</sub>		4		50		50	–	50	–		MHz
Second-Breakdown Collector Current: With base forward- biased and t = 50 ms	I <sub>S/b</sub>		50 20				120 –	– –	– 500	– –	– –	mA
Output Capacitance: f = 1 MHz	C <sub>obo</sub>	10					8	20	8	20		pF
Saturated Switching Time (V <sub>CC</sub> = 30 V, I <sub>B1</sub> = I <sub>B2</sub> ): Turn-on (t <sub>d</sub> + t <sub>r</sub> )	t <sub>ON</sub>				500	50	–	80	–	–	80	ns
Turn-off (t <sub>s</sub> + t <sub>f</sub> )	t <sub>OFF</sub>				500	50	–	800	–	–	800	
Thermal Resistance: Junction-to-case	R <sub>θJC</sub>						–	12.5	–	–	12.5	°C/W
Junction-to-ambient	R <sub>θJA</sub>						–	71.4	–	–	71.4	

<sup>a</sup> Pulsed, pulse duration = 300 μs, duty factor ≤ 2%.<sup>b</sup> CAUTION: Sustaining voltage, V<sub>CEO(sus)</sub>, MUST NOT be measured on a curve tracer.

**ELECTRICAL CHARACTERISTICS, At Case Temperature ( $T_C$ ) = 25°C**

CHARACTERISTIC	SYMBOL	TEST CONDITIONS					LIMITS				UNITS	
		VOLTAGE V dc			CURRENT mA dc		RCP707B		RCP707			
		V <sub>CB</sub>	V <sub>CE</sub>	V <sub>BE</sub>	I <sub>C</sub>	I <sub>B</sub>	Min.	Max.	Min.	Max.		
Collector Cutoff Current: With emitter open	I <sub>CBO</sub>	70 40					–	5	–	–	5	μA
With base open	I <sub>CEO</sub>		45 22			0 0	–	1000	–	–	1000	μA
With base-emitter junction reverse-biased	I <sub>CEV</sub>		85 45	–1.5 –1.5			–	100	–	–	100	μA
Emitter Cutoff Current	I <sub>EBO</sub>			–5.5	0		–	100	–	100	μA	
DC Forward Current Transfer Ratio	h <sub>FE</sub>		4		500 <sup>a</sup>		20	–	20	–		
Collector-to-Emitter Sustaining Voltage: With base open <sup>b</sup>	V <sub>CEO(sus)</sub>				100 <sup>a</sup>	0	60	–	30	–		V
Base-to-Emitter Saturation Voltage	V <sub>BE(sat)</sub>				500 <sup>a</sup>	50	–	1.6	–	1.6		V
Base-to-Emitter Voltage	V <sub>BE</sub>		4		500 <sup>a</sup>		–	1.5	–	1.5		V
Collector-to-Emitter Saturation Voltage	V <sub>CE(sat)</sub>				500 <sup>a</sup>	50	–	1.2	–	1.2		V
Magnitude of Common- Emitter, Small-Signal, Short-Circuit, Forward- Current Transfer Ratio: f = 10 MHz	h <sub>fe</sub>		4		50		5	–	5	–		
Gain-Bandwidth Product	f <sub>T</sub>		4		50		50	–	50	–		MHz
Second-Breakdown Collector Current: With base forward- biased and t = 50 ms	I <sub>S/b</sub>		50 20				120	–	–	–	–	mA
Output Capacitance: f = 1 MHz	C <sub>obo</sub>	10					8	20	8	20		pF
Saturated Switching Time (V <sub>CC</sub> = 30 V, I <sub>B1</sub> = I <sub>B2</sub> ): Turn-on (t <sub>d</sub> + t <sub>r</sub> )	t <sub>ON</sub>				500	50	–	80	–	80		ns
Turn-off (t <sub>s</sub> + t <sub>f</sub> )	t <sub>OFF</sub>				500	50	–	800	–	800		
Thermal Resistance: Junction-to-case	R <sub>θJC</sub>						–	12.5	–	12.5		°C/W
Junction-to-ambient	R <sub>θJA</sub>						–	71.4	–	71.4		

<sup>a</sup> Pulsed, pulse duration = 300 μs, duty factor ≤ 2%.<sup>b</sup> CAUTION: Sustaining voltage, V<sub>CEO(sus)</sub>, MUST NOT be measured on a curve tracer.

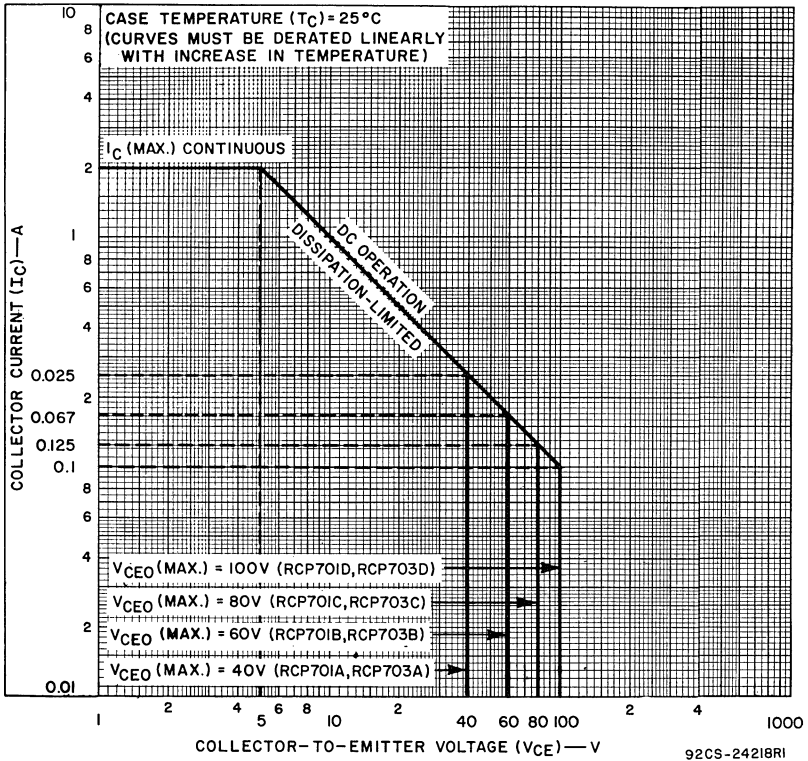


Fig. 1 — Maximum operating for RCP701A — RCP701D, and RCP703A — RCP703D.

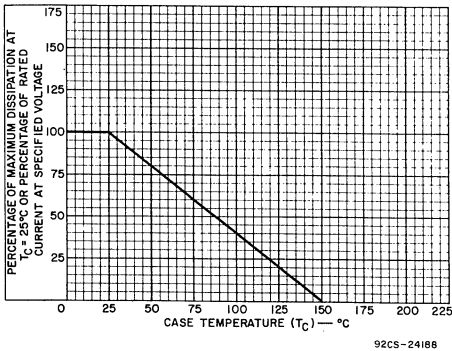


Fig. 2 — Dissipation derating curve for all types.

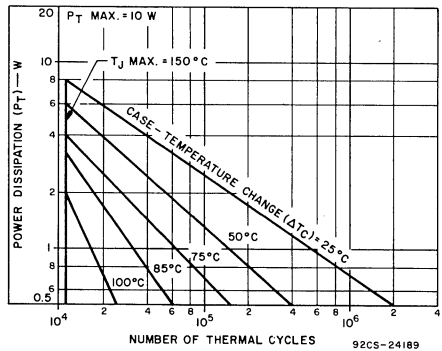


Fig. 3 — Thermal-cycling rating chart for all types.

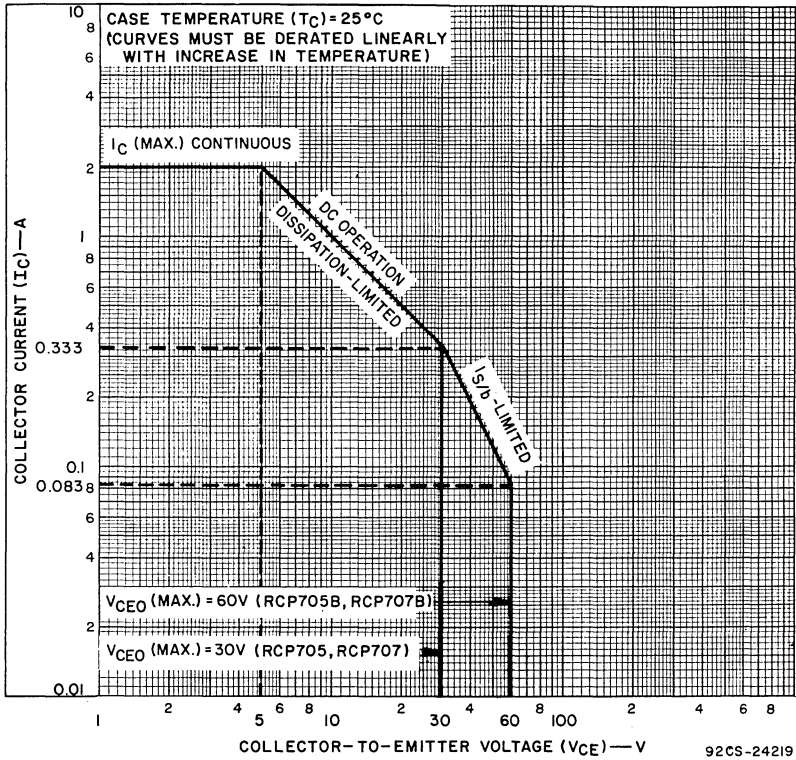


Fig. 4 — Maximum operating areas for RCP705, RCP705B, RCP707 and RCP707B.

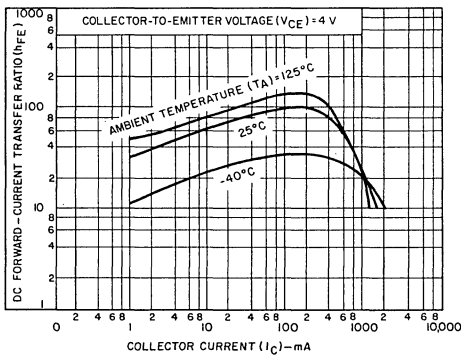


Fig. 5 — Typical static beta characteristics for all types.

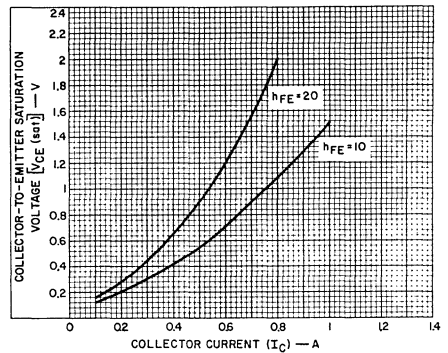
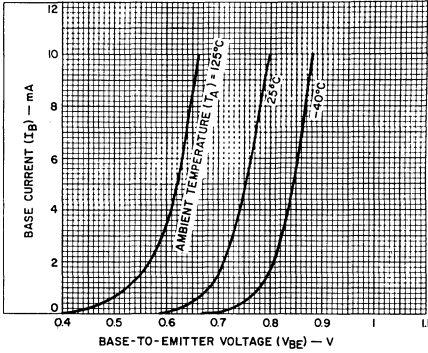
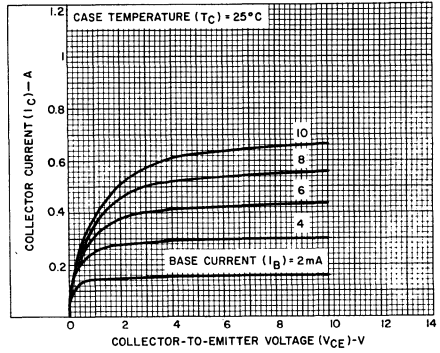


Fig. 6 — Typical saturation-voltage characteristics for all types.



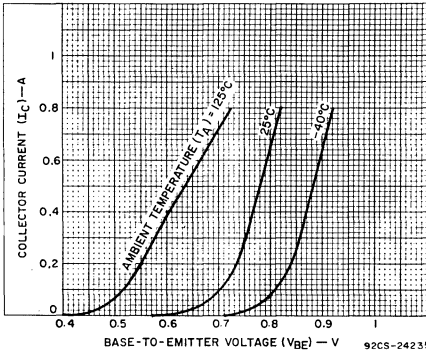
92CS-24214

Fig. 7 - Typical input characteristics for all types.



92CS-24216

Fig. 8 - Typical output characteristics for all types.

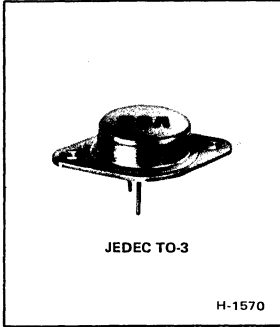


92CS-24235

Fig. 9 - Typical transfer characteristics for all types.

**TERMINAL CONNECTIONS**

- Terminal No. 1 - Emitter
- Terminal No. 2 - Base
- Terminal No. 3 - Collector
- Terminal No. 4 - Collector



## Hometaxial-Base, High-Power Silicon N-P-N Transistor

Rugged, Broadly Applicable Device  
For Industrial and Commercial Use

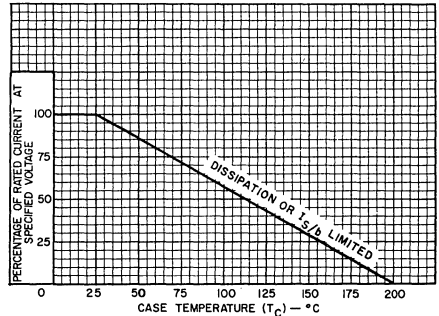
*Features:*

- Maximum safe-area-of-operation curves
- Low saturation voltages
- High dissipation ratings
- Thermal-cycle rating curves

*Applications:*

- Series and shunt regulators
- High-fidelity amplifiers
- Power-switching circuits
- Solenoid drivers

The RCA-RCS242 is a silicon n-p-n transistor intended for a wide variety of high-power applications. The hometaxial-base construction of the device renders it highly resistant to second breakdown over a wide range of operating conditions. The RCS242 is provided in a JEDEC TO-3 hermetic package.



92LS-1469RI

Fig. 1 - Current derating curve.

**MAXIMUM RATINGS, Absolute-Maximum Values:**

COLLECTOR-TO-BASE VOLTAGE .....	V <sub>CBO</sub>	50	V
COLLECTOR-TO-EMITTER SUSTAINING VOLTAGE:			
With external base-to-emitter resistance (R <sub>BE</sub> ) = 100 Ω .....	V <sub>CER(sus)</sub>	50	V
With base open .....	V <sub>CEO(sus)</sub>	40	V
EMITTER-TO-BASE VOLTAGE .....	V <sub>EBO</sub>	4	V
CONTINUOUS COLLECTOR CURRENT .....	I <sub>C</sub>	15	A
CONTINUOUS BASE CURRENT .....	I <sub>B</sub>	7	A
TRANSISTOR DISSIPATION .....	P <sub>T</sub>		
At case temperatures up to 25°C .....		115	W
At case temperatures above 25°C .....		See Fig. 1	
TEMPERATURE RANGE:			
Storage and Operating (Junction) .....		-65 to +200	°C
PIN TEMPERATURE (During Soldering):			
At distances ≥ 1/32 in. (0.8 mm) from seating plane for 10 s max. ....		235	°C

ELECTRICAL CHARACTERISTICS, At Case Temperature ( $T_C$ ) = 25°C

CHARACTERISTIC	SYMBOL	TEST CONDITIONS					LIMITS		UNITS
		VOLTAGE V dc			CURRENT A dc		RCS242		
		$V_{CB}$	$V_{CE}$	$V_{BE}$	$I_C$	$I_B$	Min.	Max.	
Collector-Cutoff Current: With emitter open	$I_{CBO}$	40				0	—	5	mA
Emitter-Cutoff Current	$I_{EBO}$			-4			—	10	mA
Collector-to-Emitter Sustaining Voltage: With base open	$V_{CEO(sus)}$				0.2 <sup>a</sup>	0	40	—	V
With external base-to-emitter resistance ( $R_{BE}$ ) = 100 $\Omega$	$V_{CER(sus)}$				0.2 <sup>a</sup>		50	—	
DC Forward Current Transfer Ratio	$h_{FE}$		4		3 <sup>a</sup>		20	—	
Base-to-Emitter Voltage	$V_{BE}$		4		3 <sup>a</sup>		—	1.8	V
Collector-to-Emitter Saturation Voltage	$V_{CE(sat)}$				3 <sup>a</sup>	0.3	—	1.1	V
Common-Emitter, Small-Signal, Short-Circuit Forward Current Transfer Ratio: f = 1 kHz	$h_{fe}$		4		1		10	—	
Magnitude of Common-Emitter, Small-Signal, Short-Circuit, Forward Current Transfer Ratio: f = 0.4 MHz	$ h_{fe} $		4		1		2	—	
Common-Emitter, Short-Circuit, Small-Signal, Forward Current Transfer Ratio Cutoff Frequency	$f_{hfe}$		4		1		10	—	kHz
Forward-Bias Second Breakdown Collector Current: t = 1 s, nonrepetitive	$I_{S/b}$		40				2.5	—	A
Thermal Resistance: Junction-to-Case	$R_{\theta JC}$						—	1.5	°C/W

<sup>a</sup> Pulsed: pulse duration = 300  $\mu$ s, duty factor  $\leq$  2%.

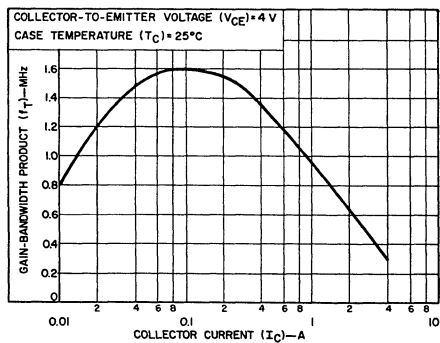


Fig. 2 — Typical gain-bandwidth product.

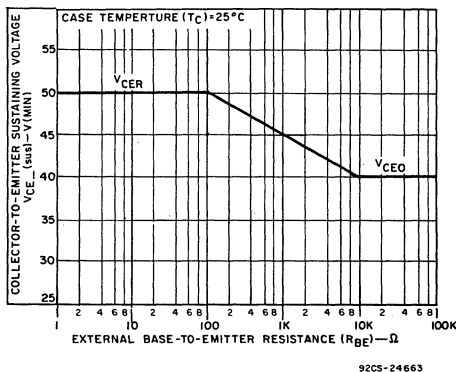


Fig. 3 — Sustaining voltage vs. base-to-emitter resistance.



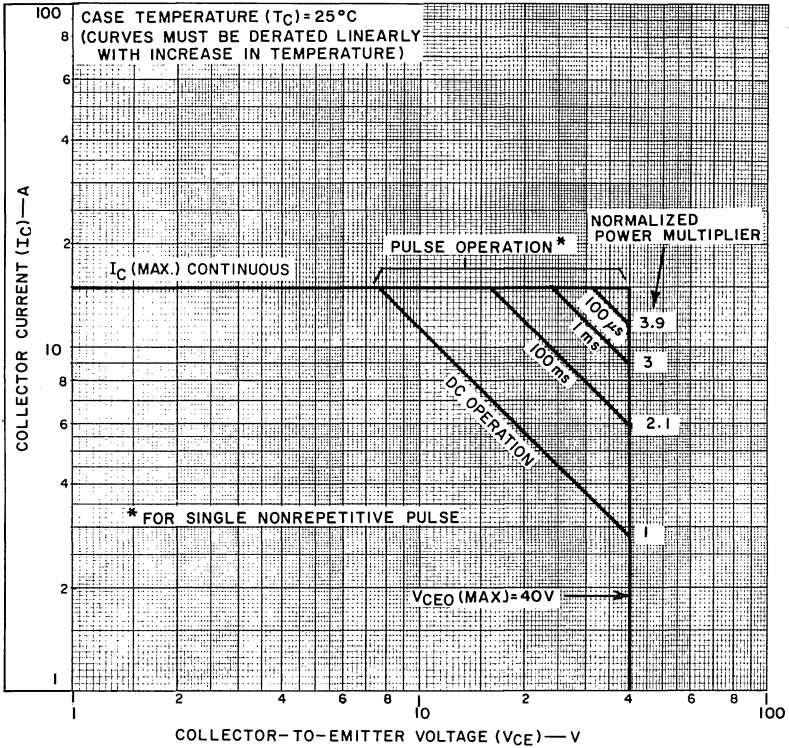


Fig. 4 — Maximum operating areas.

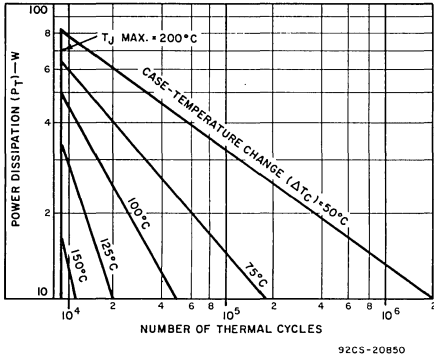


Fig. 5 — Thermal-cycle rating chart.

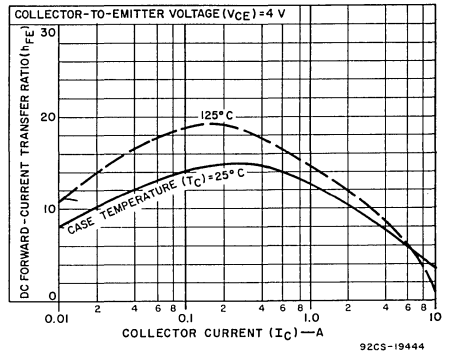


Fig. 6 — Typical dc-beta characteristics.

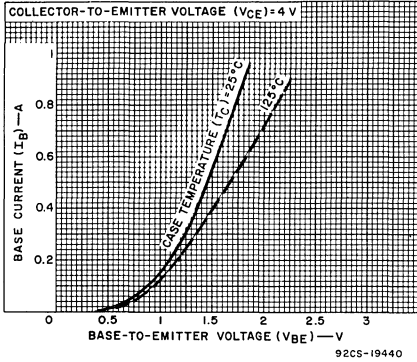


Fig. 7 — Typical input characteristics.

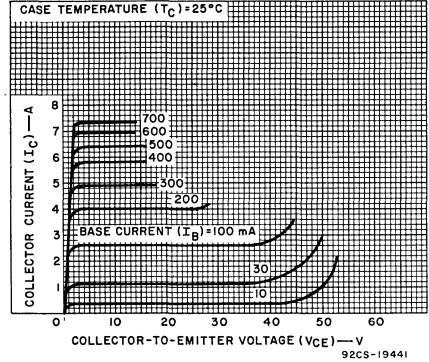


Fig. 8 — Typical output characteristics.

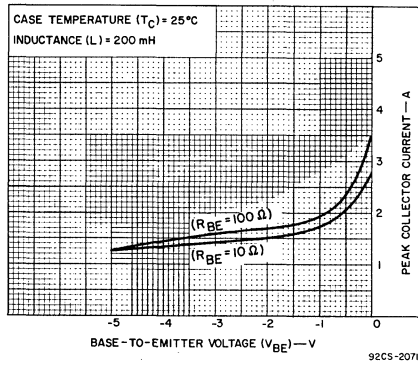


Fig. 9 — Reverse-bias second-breakdown characteristics.

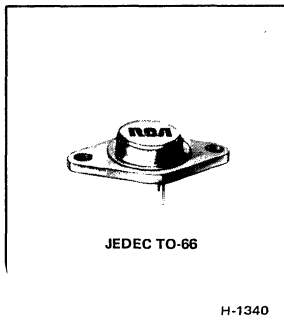
**TERMINAL CONNECTIONS**

- Pin 1 — Base
- Pin 2 — Emitter
- Case — Collector
- Mounting Flange — Collector



# Power Transistors

## RCS559 RCS560



## High-Voltage Medium-Power Silicon P-N-P Transistors

For Switching and Amplifier Applications  
In Military, Industrial, and Commercial Equipment

**Features:**

- High voltage ratings:  
 $V_{CE0(sus)} = -200\text{ V max. (RCS560)}$   
 $= -225\text{ V max. (RCS559)}$
- Large safe-operating area
- Complements to 2N3583 transistor family\*
- Thermal-cycling rating

**Applications:**

- Power-Switching Circuits
- Switching Regulators
- Converters
- Inverters
- High-Fidelity Amplifiers

The RCA-RCS559 and RCS560 are double-epitaxial silicon p-n-p transistors with high breakdown-voltage ratings and fast switching speeds. They are supplied in the popular JEDEC TO-66 package; they differ in breakdown-voltage ratings and leakage-current values.

Data for the 2N3583 transistor family are supplied in bulletin File No. 138.

**TERMINAL CONNECTIONS**

- Pin 1 — Base
- Pin 2 — Emitter

Case, Mounting Flange — Collector

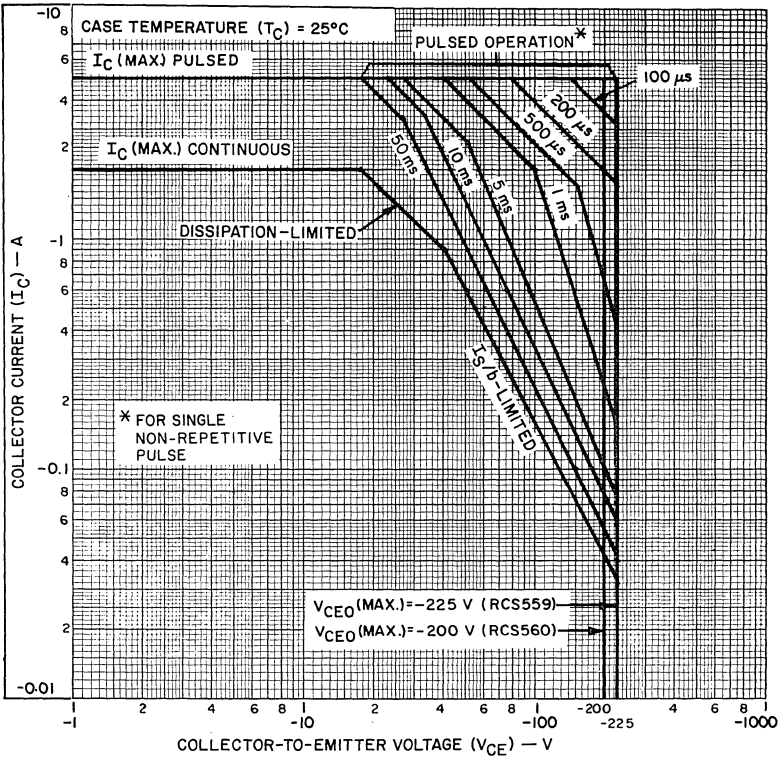
**MAXIMUM RATINGS, Absolute-Maximum Values:**

		RCS559	RCS560	
COLLECTOR-TO-BASE VOLTAGE	$V_{CBO}$	-275	-250	V
COLLECTOR-TO-EMITTER SUSTAINING VOLTAGE:				
With base open	$V_{CE0(sus)}$	-225	-200	V
With external base-to-emitter resistance ( $R_{BE} = 50\ \Omega$ )	$V_{CER(sus)}$	-250	-225	V
With base-emitter junction reverse-biased ( $V_{BE} = 1.5\text{ V}$ )	$V_{CEX(sus)}$	-275	-250	V
EMITTER-TO-BASE VOLTAGE	$V_{EBO}$	-6	-6	V
COLLECTOR CURRENT (Continuous)	$I_C$	-2	-2	A
BASE CURRENT (Continuous)	$I_B$	-1	-1	A
TRANSISTOR DISSIPATION:				
At case temperatures up to 100°C and $V_{CE}$ up to 50 V		20	20	W
At case temperatures up to 25°C and $V_{CE}$ up to 40 V		35	35	W
At case temperatures up to 25°C and $V_{CE}$ above 40 V		See Fig. 1		
At case temperatures above 25°C and $V_{CE}$ above 40 V		See Figs. 1 and 2		
TEMPERATURE RANGE:				
Storage & Operating (Junction)		-65 to 200		°C
LEAD TEMPERATURE (During Soldering):				
At distance $\geq 1/32$ in. (0.8 mm) from case for 10 s max.		230		°C

ELECTRICAL CHARACTERISTICS, at Case Temperature ( $T_C$ ) = 25°C Unless Otherwise Specified

CHARACTERISTIC	SYMBOL	TEST CONDITIONS					LIMITS				UNITS
		Voltage V dc		Current A dc			RCS559		RCS560		
		V <sub>CE</sub>	V <sub>BE</sub>	I <sub>C</sub>	I <sub>E</sub>	I <sub>B</sub>	Min.	Max.	Min.	Max.	
Collector-Cutoff Current: With base open	I <sub>CEO</sub>	-150				0	-	-5	-	-10	mA
With base-emitter junction reverse-biased	I <sub>CEV</sub>	-250	1.5				-	-0.5	-	-	
With base-emitter junction reverse biased and T <sub>C</sub> = 100°C		-225	1.5				-	-	-	-1	
Emitter-Cutoff Current	I <sub>EBO</sub>		6 4	0 0			-	-1	-	-	mA
DC Forward-Current Transfer Ratio	h <sub>FE</sub>	-3		-0.75 <sup>a</sup>			10	100	7.5	-	
Collector-to-Emitter Sustaining Voltage: With base open	V <sub>CEO(sus)</sub>			-0.2 <sup>a</sup>		0	-225 <sup>c</sup>	-	-200 <sup>c</sup>		V
With external base-to-emitter resistance (R <sub>BE</sub> ) = 50 Ω	V <sub>CER(sus)</sub>			-0.2 <sup>a</sup>			-250 <sup>c</sup>	-	-225 <sup>c</sup>	-	
With base-emitter junction reverse-biased and external base-to-emitter resistance (R <sub>BE</sub> ) = 50 Ω	V <sub>CEx(sus)</sub>		1.5	-0.2 <sup>a</sup>			-275 <sup>c</sup>	-	-250 <sup>c</sup>	-	
Emitter-to-Base Saturation Voltage	V <sub>BE(sat)</sub>			-0.75 <sup>a</sup>		-0.075	-	-1.4	-	-1.4	V
Collector-to-Emitter Saturation Voltage	V <sub>CE(sat)</sub>			-0.75 <sup>a</sup>		-0.075	-	-1.5	-	-2	V
Output Capacitance: V <sub>CB</sub> = -10 V, f = 1 MHz	C <sub>obo</sub>					0	-	220	-	220	pF
Forward-Bias, Second-Breakdown Collector Current: t = 1 s, nonrepetitive	I <sub>S/b</sub>	-40					-0.875	-	-0.875	-	A
Magnitude of Common-Emitter, Small-Signal, Short-Circuit, Forward Current Transfer Ratio: f = 5 MHz	h <sub>fe</sub>	-10		-0.2			4	-	4	-	
Saturated Switching Times (V <sub>CC</sub> = -200 V): Rise time	t <sub>r</sub>			-1		-0.125 <sup>b</sup>	-	0.6	-	0.6	μs
Storage time	t <sub>s</sub>			-1		-0.125 <sup>b</sup>	-	2.5	-	2.5	
Fall time	t <sub>f</sub>			-1		-0.125 <sup>b</sup>	-	0.6	-	0.6	
Thermal Resistance: Junction-to-case	R <sub>θJC</sub>	-10		-1			-	5	-	5	°C/W

<sup>a</sup>Pulsed: Pulse duration = 300 μs; duty factor ≤ 2%.<sup>b</sup>I<sub>B1</sub> = I<sub>B2</sub><sup>c</sup>Sustaining voltages, V<sub>CEO(sus)</sub>, V<sub>CER(sus)</sub>, and V<sub>CEx(sus)</sub>, MUST NOT be measured on a curve tracer. They should be tested by using the circuit in Fig. 4.



92CS-24658

Fig. 1 - Maximum operating areas for both types.

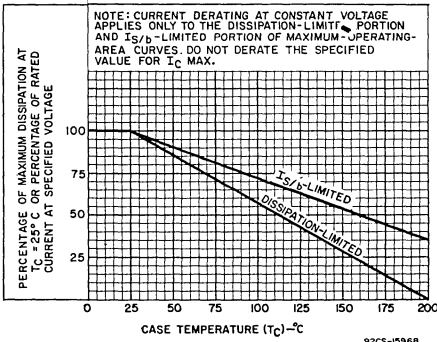


Fig. 2 - Derating curves for both types.

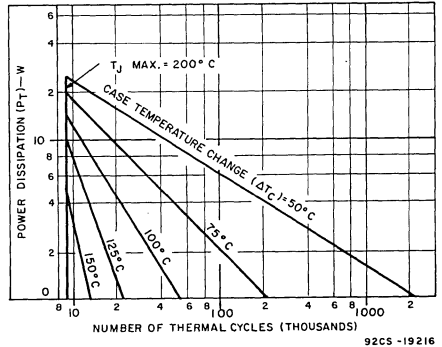


Fig. 3 - Thermal-cycling rating chart for both types.

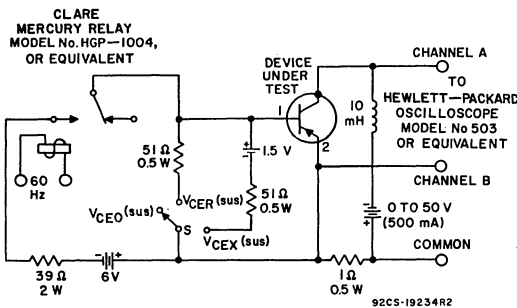


Fig. 4 - Circuit used to measure sustaining voltages  $V_{CE0}(sus)$ ,  $V_{CER}(sus)$  and  $V_{CEX}(sus)$  for both types.

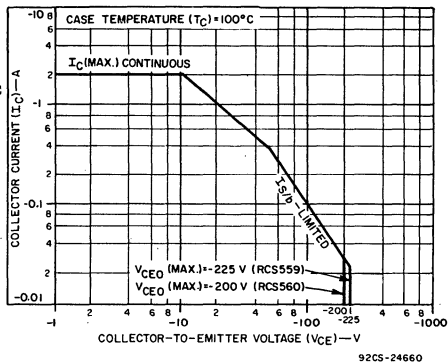


Fig. 5 - Maximum operating areas at  $T_C = 100^\circ C$  for both types.

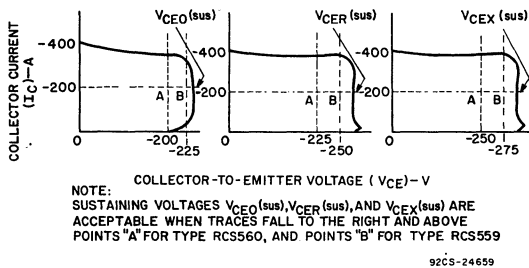


Fig. 6 - Oscilloscope display for measurement of sustaining voltages (test circuit shown in Fig. 4).

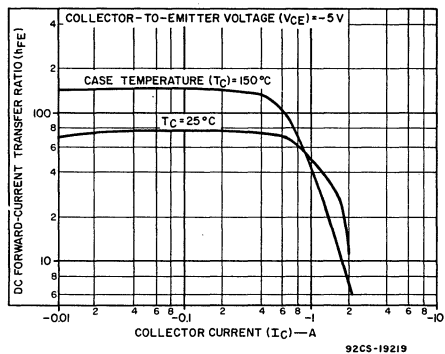


Fig. 7 - Typical dc beta characteristic for both types.

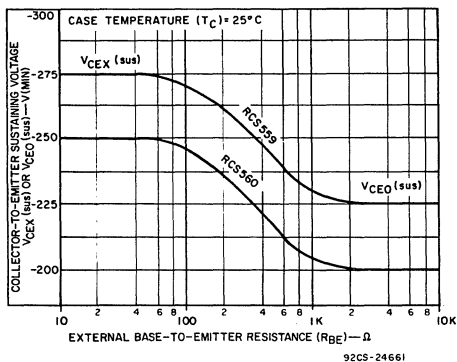


Fig. 8 - Collector-to-emitter sustaining voltage characteristics for both types.

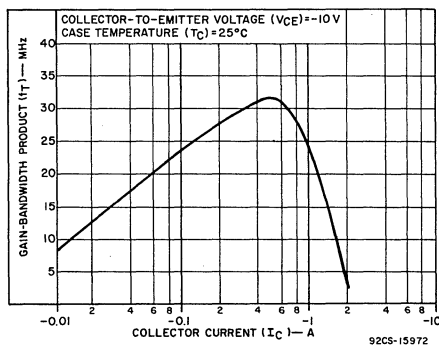


Fig. 9 - Typical gain-bandwidth product for types.

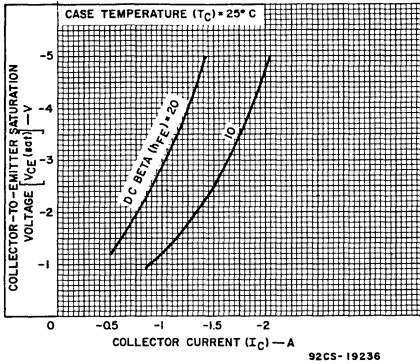


Fig. 10 — Typical saturation-voltage characteristics for both types.

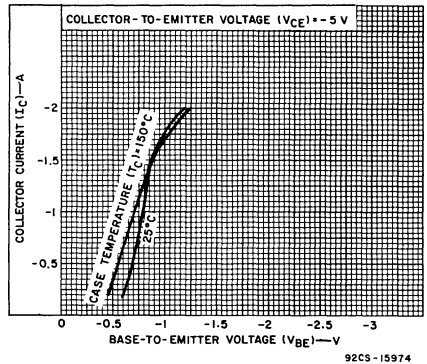


Fig. 11 — Typical transfer characteristics for both types.

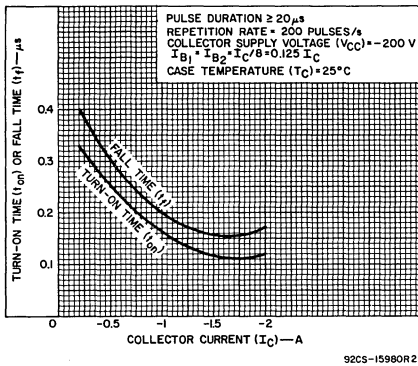


Fig. 12 — Typical turn-on time and fall-time characteristics for both types.

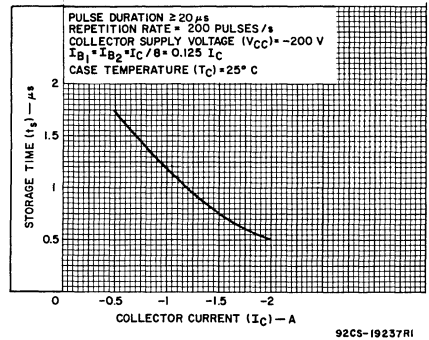


Fig. 13 — Typical storage-time characteristics for both types.

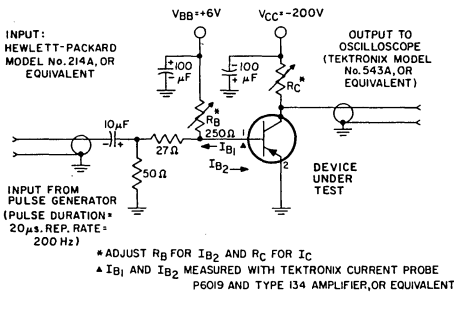


Fig. 14 — Circuit used to measure saturated switching times for both types.

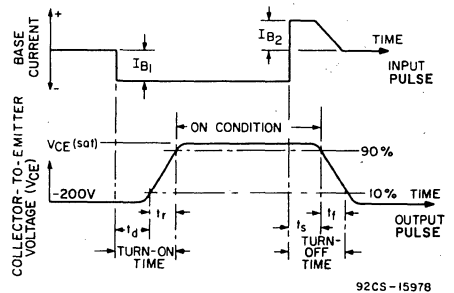
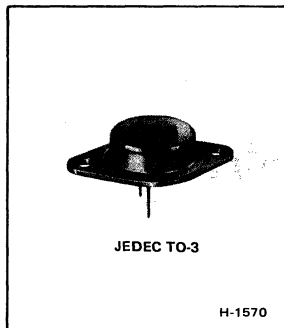


Fig. 15 — Phase relationship between input current and output voltage showing reference points for specification of switching times. (Test circuit shown in Fig. 14).

**RCA**  
Solid State  
Division

## Power Transistors

### RCS564



## 300-V, 30-A, 175-W Silicon N-P-N Switching Transistor

For Switching Applications in  
Industrial and Commercial Equipment

#### Features:

- High voltage ratings:  
 $V_{CBO} = 300\text{ V}$
- Maximum safe-area-of-operation curves
- High dissipation rating:  $P_T = 175\text{ W}$
- Low saturation voltages

The RCA-RCS564 is a multiple epitaxial silicon n-p-n power transistor utilizing a multiple-emitter-site structure. Multiple-epitaxial construction maximizes the volt-ampere characteristic of the device and provides fast switching speeds. Multiple-emitter-site design assures uniform current flow throughout the structure, which produces a high  $I_S/b$  and a large safe-operation area.

The device uses the popular JEDEC TO-3 package.

The exceptional second-breakdown capabilities and high voltage-breakdown ratings of the RCS564 make this transistor especially suitable for off-line inverters, switching regulators, motor controls, and deflection circuit applications.

The high gain and high  $E_S/b$  energy-handling capability of the RCS564 make it an excellent choice for motor-control applications in which large winding inductances are encountered and high surge currents are required to start the motor.

#### MAXIMUM RATINGS, Absolute-Maximum Values:

COLLECTOR-TO-BASE VOLTAGE .....	$V_{CBO}$	300	V
COLLECTOR-TO-EMITTER SUSTAINING VOLTAGE:			
With base open .....	$V_{CE0(sus)}$	200	V
With reverse bias ( $V_{BE} = 0\text{ V}$ (with base-emitter shorted)) .....	$V_{CEX(sus)}$	225	V
With external base-to-emitter resistance ( $R_{BE} \leq 50\ \Omega$ ) .....	$V_{CER(sus)}$	225	V
EMITTER-TO-BASE VOLTAGE .....	$V_{EBO}$	6	V
CONTINUOUS COLLECTOR CURRENT .....	$I_C$	10	A
PEAK COLLECTOR CURRENT .....	$I_{CM}$	30	A
CONTINUOUS BASE CURRENT .....	$I_B$	10	A
TRANSISTOR DISSIPATION:	$P_T$		
At case temperatures up to $25^\circ\text{C}$ and $V_{CE}$ up to 30 V .....		175	W
At case temperatures up to $25^\circ\text{C}$ and $V_{CE}$ above 30 V .....			See Figs. 1 and 2.
At case temperatures above $25^\circ\text{C}$ and $V_{CE}$ above 30 V .....			See Figs. 1, 2, and 4.
TEMPERATURE RANGE:			
Storage & Operating (Junction) .....		-65 to +200	$^\circ\text{C}$
PIN TEMPERATURE (During Soldering):			
At distances $\geq 1/32\text{ in. (0.8 mm)}$ from case for 10 s max. ....		230	



ELECTRICAL CHARACTERISTICS, At Case Temperature ( $T_C$ ) = 25°C unless otherwise specified

CHARACTERISTIC	SYMBOL	TEST CONDITIONS				LIMITS			UNITS
		VOLTAGE V dc		CURRENT A dc		RCS564			
		$V_{CE}$	$V_{BE}$	$I_C$	$I_B$	Min.	Typ.	Max.	
Collector-Cutoff Current: With base open	$I_{CEO}$	150			0	—	—	10	mA
With base-emitter junction reverse-biased	$I_{CEV}$	225	-1.5			—	—	10	
With base-emitter junction reverse-biased, and $T_C = 125^\circ\text{C}$	$I_{CEV}$	225	-1.5			—	—	25	
Emitter-Cutoff Current	$I_{EBO}$		-6			—	—	5	mA
Collector-to-Emitter Sustaining Voltage (see Figs. 11 and 12): With base open	$V_{CEO(sus)}$			0.2		200 <sup>b</sup>	—	—	V
With external base-to-emitter resistance ( $R_{BE}$ ) = 50 $\Omega$	$V_{CER(sus)}$			0.2		225 <sup>b</sup>	—	—	V
DC Forward-Current Transfer Ratio	$h_{FE}$	3		10 <sup>a</sup>		5	—	—	
Base-to-Emitter Saturation Voltage	$V_{BE(sat)}$			10 <sup>a</sup>	2	—	—	3.2	V
Collector-to-Emitter Saturation Voltage	$V_{CE(sat)}$			10 <sup>a</sup>		—	—	2.5	V
Magnitude of Common Emitter, Small-Signal, Short-Circuit, Forward Current Transfer Ratio: $f = 1\text{ MHz}$	$ h_{fe} $	10		1		2.5	8	—	
Second-Breakdown Collector Current: $t = 1\text{ s}$ , nonrepetitive	$I_{S/b}^c$	30				5.8	—	—	A
Reverse-Bias Second-Breakdown Energy: $R_B = 50\ \Omega$ , $L = 50\ \mu\text{H}$	$E_{S/b}^d$		-4	10		2.5	—	—	mJ
Switching Times ( $V_{CC} = 200\text{ V}$ ): <sup>e</sup>									$\mu\text{s}$
Rise Time	$t_r$			10	1	—	0.8	2	
Storage Time	$t_s$			10	1	—	1.8	3.5	
Fall Time	$t_f$			10	1	—	0.5	1	
Thermal Resistance: Junction-to-Case	$R_{\theta JC}$	10		5	—	—	—	1	$^\circ\text{C/W}$

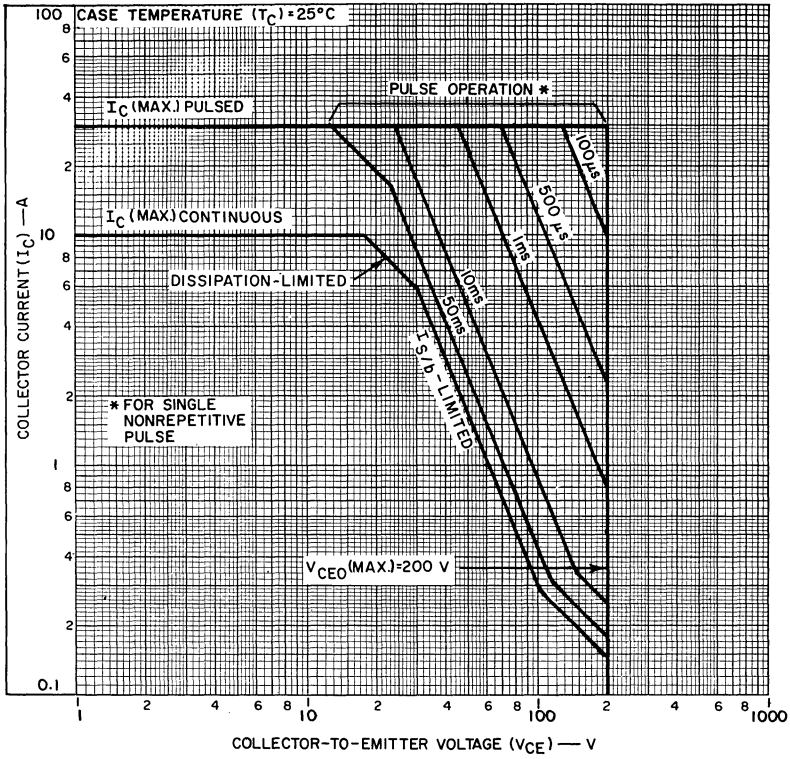
<sup>a</sup>Pulses; pulse duration  $\leq 350\ \mu\text{s}$ , duty factor = 2%.

<sup>b</sup>CAUTION: The sustaining voltages  $V_{CEO(sus)}$  and  $V_{CER(sus)}$  MUST NOT be measured on a curve tracer. These sustaining voltages should be measured by means of the test circuit shown in Fig. 11.

<sup>c</sup> $I_{S/b}$  is defined as the current at which second breakdown occurs at a specified collector voltage with the emitter-base junction forward-biased for transistor operation in the active region.

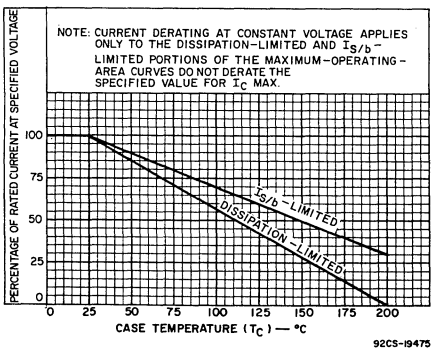
<sup>d</sup> $E_{S/b}$  is defined as the energy at which second breakdown occurs under specified reverse-bias conditions.  $E_{S/b} = 1/2 LI^2$  where L is a series load or leakage inductance, and I is the peak collector current.

<sup>e</sup> $I_{B1} = I_{B2}$  = value shown: see Figs. 13 – 18.



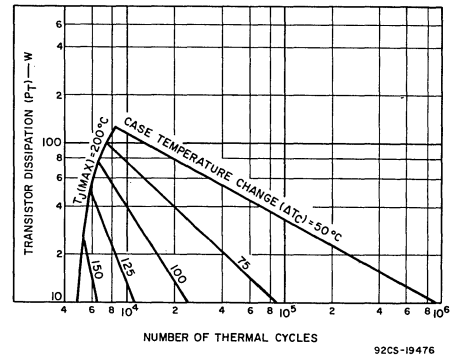
92CS-24683

Fig. 1 — Maximum operating areas.



92CS-19475

Fig. 2 — Dissipation derating and  $I_{S/b}$  derating.



92CS-19476

Fig. 3 — Thermal-cycle rating chart.

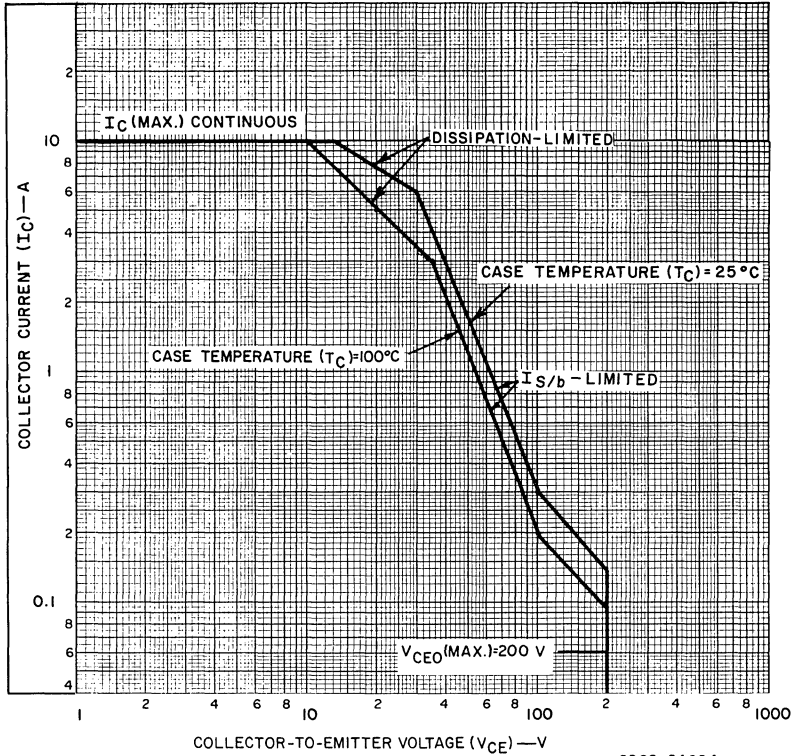


Fig. 4 - Maximum operating areas for dc operation at  $T_C = 25^\circ\text{C}$  and  $100^\circ\text{C}$ .

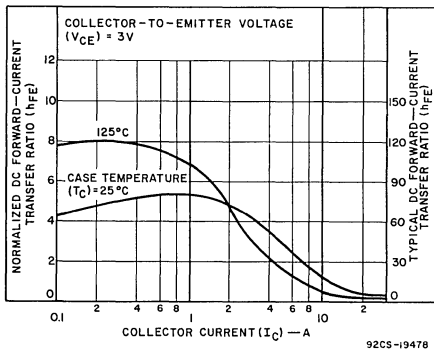


Fig. 5 - Typical normalized dc beta characteristics.

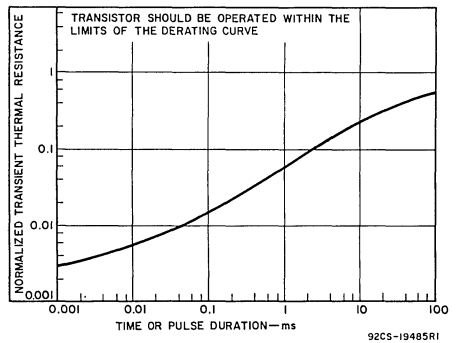


Fig. 6 - Typical thermal response characteristic.

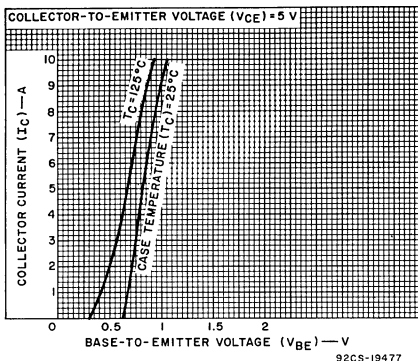


Fig. 7 - Typical transfer characteristics.

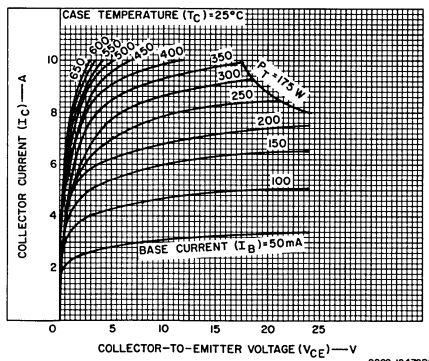


Fig. 8 - Typical output characteristics.

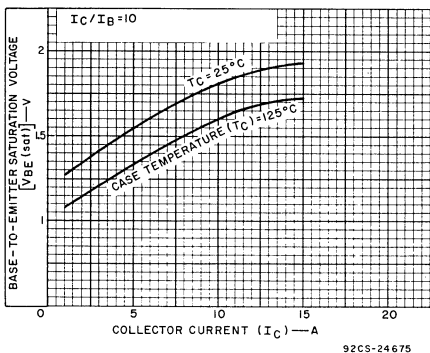


Fig. 9 - Typical base-to-emitter saturation voltage characteristics.

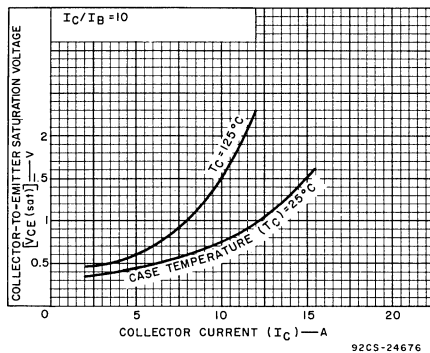


Fig. 10 - Typical collector-to-emitter saturation voltage characteristics.

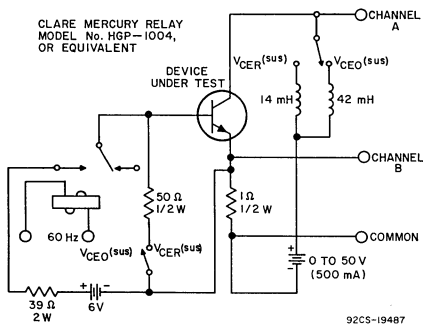


Fig. 11 - Circuit used to measure sustaining voltages  $V_{CE0}(sus)$  and  $V_{CEr}(sus)$ .

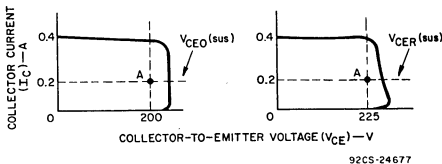


Fig. 12 - Oscilloscope display for measurement of sustaining voltages. (Test circuit shown in Fig. 11).

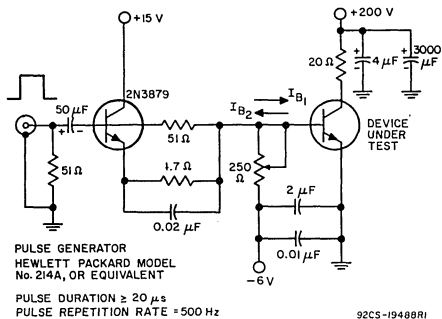


Fig. 13 - Circuit used to measure switching times.

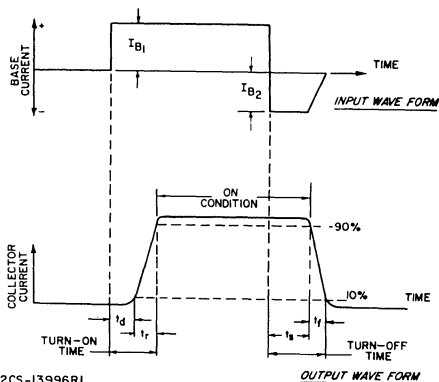


Fig. 14 - Phase relationship between input and output currents showing reference points for specification of switching times. (Test circuit shown in Fig. 13).

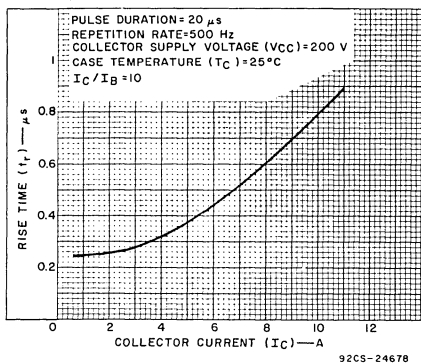


Fig. 15 - Typical rise-time characteristic.

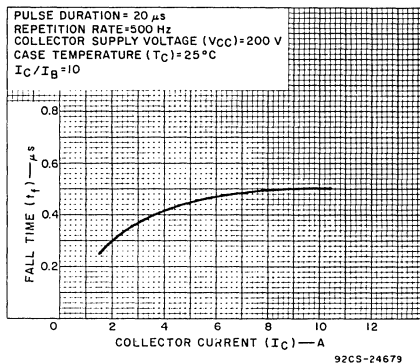


Fig. 16 - Typical fall-time characteristic.

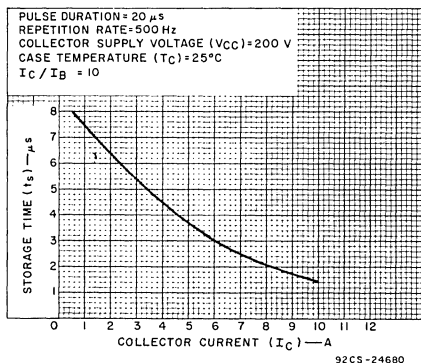


Fig. 17 - Typical storage-time characteristics for all types (with constant forced gain).

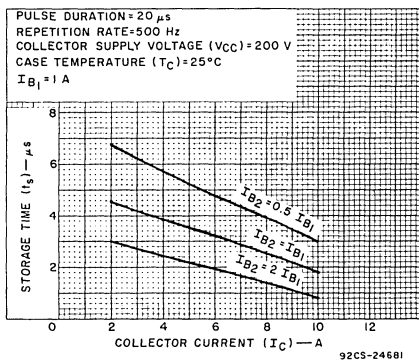


Fig. 18 - Typical storage-time characteristics for all types (with constant base drive).

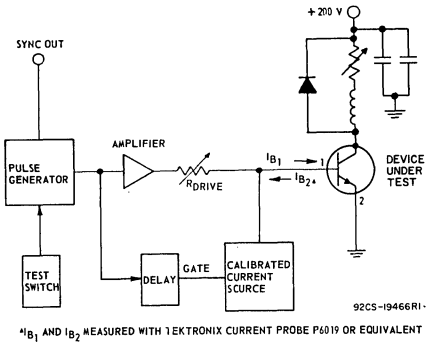


Fig. 19 — Circuit used to measure inductive-load switching times.

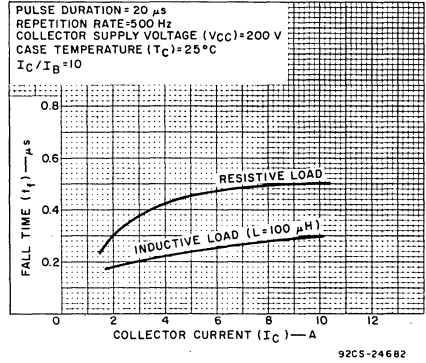
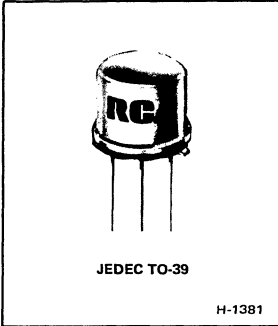


Fig. 20 — Typical inductive- and resistive-load fall-time characteristics.

**TERMINAL CONNECTIONS**

- Pin 1 — Base
- Pin 2 — Emitter
- Case — Collector
- Mounting Flange — Collector



## High-Voltage Silicon P-N-P Transistor

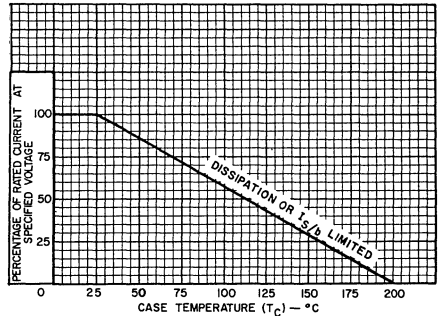
For High-Speed Switching and Linear-Amplifier Applications in Industrial and Commercial Equipment

**Features:**

- Maximum safe-area-of-operation curves
- High voltage rating:  
 $V_{CE0(sus)} = -150\text{ V min.}$

The RCA-RCS880 is an epitaxial silicon p-n-p transistor with high breakdown voltages, high frequency response, and fast switching speeds.

Typical applications include high-voltage differential and operational amplifiers, high-voltage inverters; and high-voltage, low-current switching and series regulators.



92LS-1469R1

Fig. 1 - Dissipation derating curve.

**MAXIMUM RATINGS, Absolute-Maximum Values:**

**COLLECTOR-TO-EMITTER SUSTAINING VOLTAGE:**

With base open .....

$V_{CE0(sus)}$  -150 V

**COLLECTOR CURRENT** .....

$I_C$  -1 A

**BASE CURRENT** .....

$I_B$  -0.5 A

**TRANSISTOR DISSIPATION:**

- At case temperatures up to 25°C .....
- At case temperatures above 25°C .....
- At ambient temperatures up to 50°C .....
- At ambient temperatures above 50°C .....

$P_T$  7.5 W  
See Figs. 1 and 4  
0.75 W  
5  $mW/^\circ C$

**TEMPERATURE RANGE:**

Storage and Operating (Junction) .....

-65 to +200 °C

**LEAD TEMPERATURE (During soldering):**

At distance  $\geq 1/32$  in. (0.8 mm) from seating plane for 10s max. ....

255 °C

ELECTICAL CHARACTERISTICS, At Case Temperature ( $T_C$ ) = 25°C

CHARACTERISTIC	SYMBOL	TEST CONDITIONS				LIMITS		UNITS
		VOLTAGE V dc		CURRENT mA dc		RCS880		
		V <sub>CE</sub>	V <sub>BE</sub>	I <sub>C</sub>	I <sub>B</sub>	Min.	Max.	
Collector-Cutoff Current: With base open	I <sub>CEO</sub>	-100			0	-	-50	μA
With base-emitter junction reverse-biased	I <sub>CEV</sub>	-150	1.5			-	-100	μA
Emitter-Cutoff Current	I <sub>EBO</sub>		4	0		-	-30	μA
DC Forward-Current Transfer Ratio	h <sub>FE</sub>	-10		-50 <sup>c</sup>		20	150	
Collector-to-Emitter Sustaining Voltage: With base open (See Figs.2 and 3)	V <sub>CEO(sus)</sub>			-50	0	-150 <sup>a</sup>	-	V
Base-to-Emitter Saturation Voltage	V <sub>BE</sub>	-10		-50 <sup>c</sup>		-	-2.5	V
Collector-to-Emitter Saturation Voltage	V <sub>CE(sat)</sub>			-50 <sup>c</sup>	-5	-	-3.5	V
Forward-Bias, Second-Breakdown Collector Current: t = 0.20 s, nonrepetitive	I <sub>S/b</sub> <sup>b</sup>	-75				-100	-	mA
Thermal Resistance: Junction-to-Case	R <sub>θJC</sub>					-	23.3	°C/W

<sup>a</sup>CAUTION: The sustaining voltage V<sub>CEO(sus)</sub> MUST NOT be measured on a curve tracer. The sustaining voltage should be measured by means of the test circuit shown in Fig. 2.

<sup>c</sup>Pulsed: Pulse duration = 300 μs; duty factor ≤ 2%.

<sup>b</sup>I<sub>S/b</sub> is defined as the current at which second breakdown occurs at a specified collector voltage.

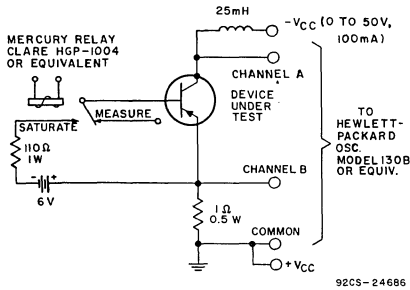


Fig. 2 - Circuit used to measure sustaining voltage V<sub>CEO(sus)</sub>.

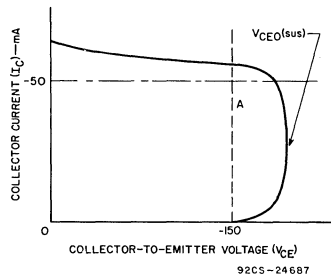


Fig. 3 - Oscilloscope display for measurement of sustaining voltages (test circuit shown in Fig. 2).



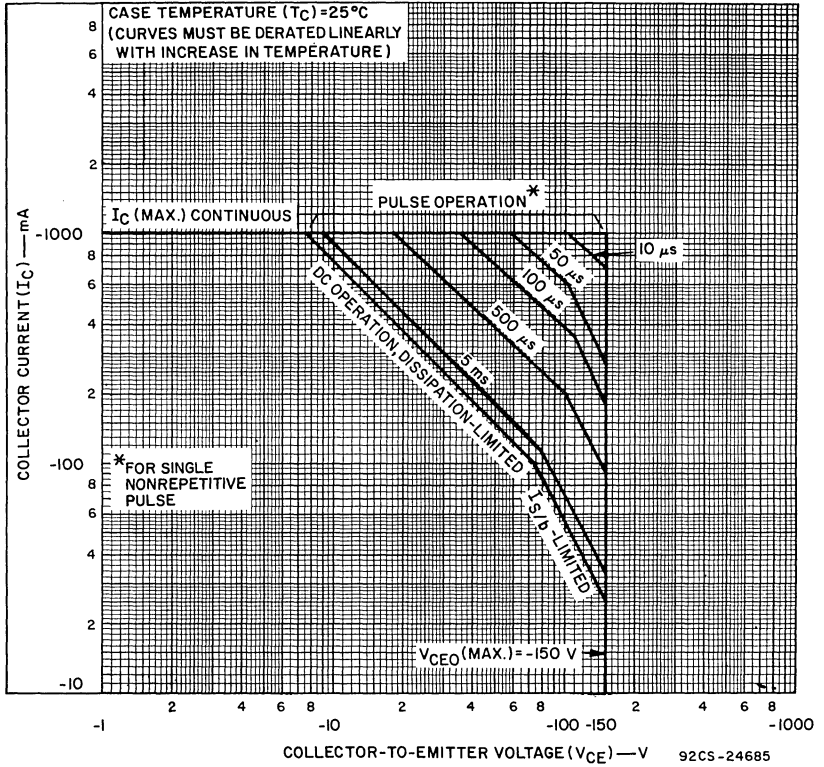


Fig. 4 - Maximum safe operating areas.

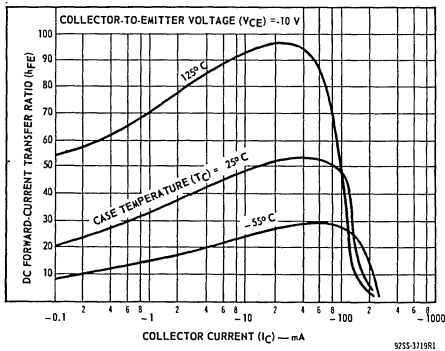


Fig. 5 - Typical dc beta characteristics.

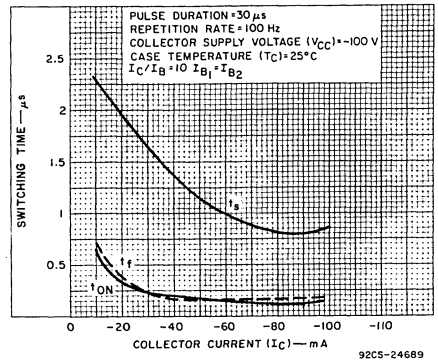


Fig. 6 - Typical switching-time characteristics.

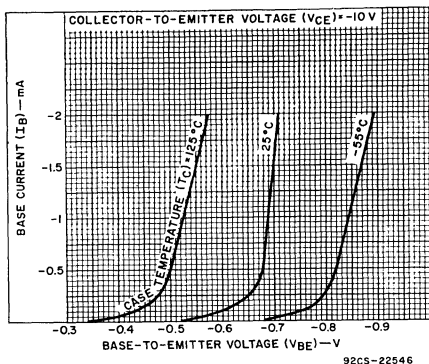


Fig. 7 - Typical input characteristics.

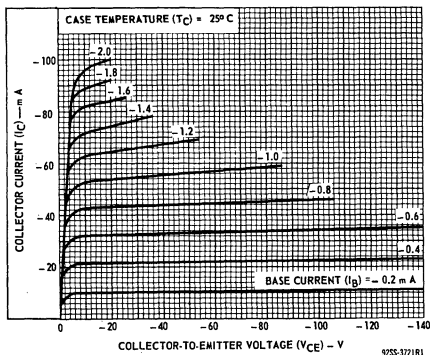


Fig. 8 - Typical output characteristics.

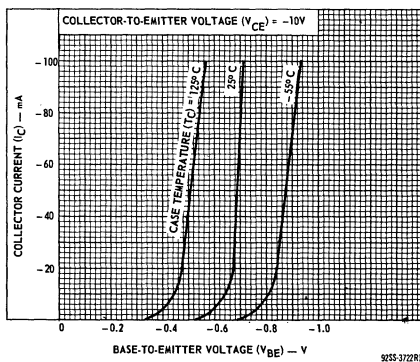
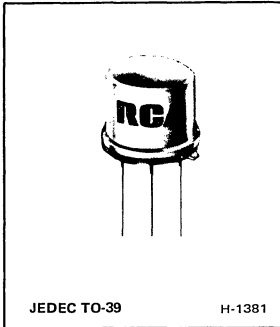


Fig. 9 - Typical transfer characteristics.

**TERMINAL CONNECTIONS**

- Lead 1 - Emitter
- Lead 2 - Base
- Lead 3 - Collector, Case



## High-Voltage Silicon P-N-P Transistor

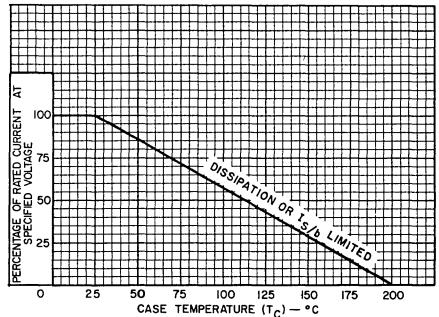
For High-Speed Switching and Linear-Amplifier Applications in Industrial and Commercial Equipment

**Features:**

- Maximum safe-area-of-operation curves
- High voltage ratings:  
 $V_{CEO(sus)} = -250$  V min.

The RCA-RCS881 is an epitaxial silicon p-n-p transistor with high breakdown voltages, high frequency response, and fast switching speeds. It is provided in the JEDEC TO-39 hermetic package.

Typical applications include high-voltage differential and operational amplifiers; high-voltage inverters; and high-voltage, low-current switching and series regulators.



92LS-1469RI

Fig. 1 - Dissipation derating curve.

**MAXIMUM RATINGS, Absolute-Maximum Values:**

COLLECTOR-TO-BASE VOLTAGE .....	$V_{CBO}$	-250	V
COLLECTOR-TO-EMITTER SUSTAINING VOLTAGE:			
With base open .....	$V_{CEO(sus)}$	-250	V
EMITTER-TO-BASE VOLTAGE .....	$V_{EBO}$	-4	V
COLLECTOR CURRENT .....	$I_C$	-1	A
BASE CURRENT .....	$I_B$	-0.5	A
TRANSISTOR DISSIPATION:	$P_T$		
At case temperatures up to 25°C .....		7.5	W
At case temperatures above 25°C .....		See Figs. 1 and 4	
At ambient temperatures up to 50°C .....		0.75	W
At ambient temperatures above 50°C .....	Derate linearly at	5	mW/°C
TEMPERATURE RANGE:			
Storage and Operating (Junction) .....		-65 to +200	°C
At distance $\geq$ 1/32 in. (0.8 mm) from seating plane for 10 s max. ....		255	°C

ELECTRICAL CHARACTERISTICS, Case Temperature ( $T_C$ ) = 25°C

CHARACTERISTIC	SYMBOL	TEST CONDITIONS					LIMITS		UNITS
		VOLTAGE V dc			CURRENT mA dc		RCS881		
		V <sub>CB</sub>	V <sub>CE</sub>	V <sub>BE</sub>	I <sub>C</sub>	I <sub>B</sub>	Min.	Max.	
Collector-Cutoff Current: With emitter open	I <sub>CBO</sub>	-175					-	-50	μA
With base open	I <sub>CEO</sub>		-150			0	-	-50	μA
With base-emitter junction reverse-biased	I <sub>CEV</sub>		-200	1.5			-	-50	μA
Emitter-Cutoff Current	I <sub>EBO</sub>			4	0		-	-20	μA
DC Forward-Current Transfer Ratio	h <sub>FE</sub>		-10		-35 <sup>b</sup>		20	-	
Collector-to-Emitter Sustaining Voltage: With base open	V <sub>CEO(sus)</sub>				-50	0	-250 <sup>a</sup>	-	V
Base-to-Emitter Saturation Voltage	V <sub>BE</sub>		-10		-50 <sup>b</sup>		-	-1.5	V
Collector-to-Emitter Saturation Voltage	V <sub>CE(sat)</sub>				-50 <sup>b</sup>	-5	-	-3	V
Magnitude of Common-Emitter, Small-Signal, Short-Circuit Forward-Current Transfer Ratio: f = 5 MHz	h <sub>fe</sub>		-10		-10		3	-	
Real Part of Common-Emitter Small-Signal, Short-Circuit Impedance: f = 1 MHz	Re(h <sub>ie</sub> )		-10		-5		-	300	Ω
Common-Base, Short-Circuit, Input Capacitance: f = 1 MHz	C <sub>ib</sub>				5	0	-	75	pF
Output Capacitance: f = 1 MHz	C <sub>ob</sub>	-10					-	15	pF
Forward-Bias, Second-Breakdown Collector Current: 0.4-s, non-repetitive pulse	I <sub>S/b</sub>		-75				-100	-	mA
Thermal Resistance: Junction-to-Case	R <sub>θJC</sub>						-	23.3	°C/W

<sup>a</sup>CAUTION: The sustaining voltage V<sub>CEO(sus)</sub> MUST NOT be measured on a curve tracer. The sustaining voltage should be measured by means of the test circuit shown in Fig. 2.

<sup>b</sup>Pulsed: Pulse = 300 μs; duty factor ≤ 2%.

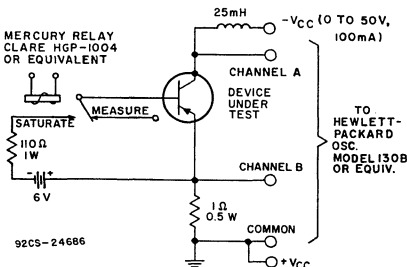
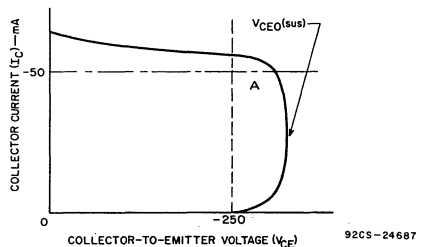
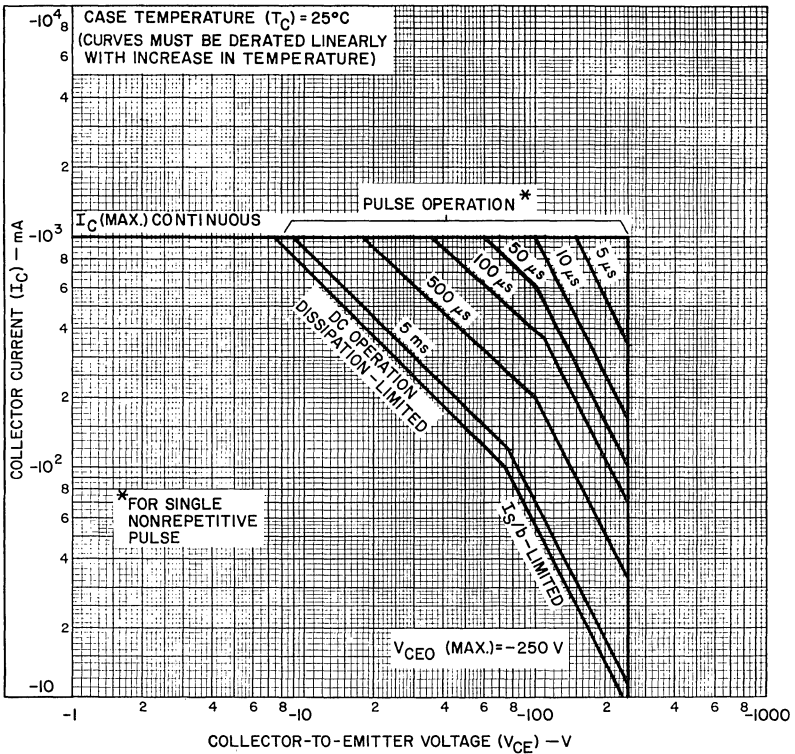


Fig. 2 - Circuit used to measure sustaining voltage V<sub>CEO(sus)</sub>.



The sustaining voltage V<sub>CEO(sus)</sub> is acceptable when the trace falls to the right and above point "A"

Fig. 3 - Oscilloscope display for measurement of sustaining voltages (test circuit shown in Fig. 2).



92CS-24688

Fig. 4 - Maximum safe operating areas.

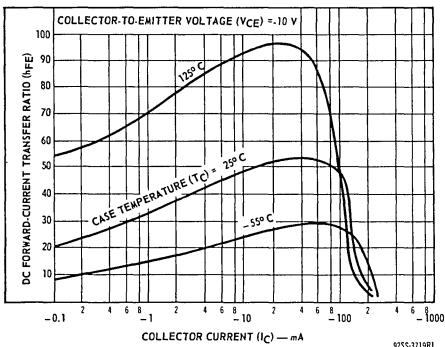


Fig. 5 - Typical dc beta characteristics.

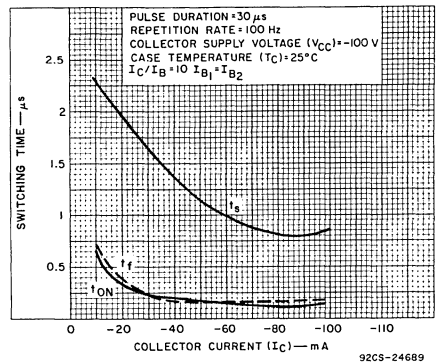


Fig. 6 - Typical saturated switching times.

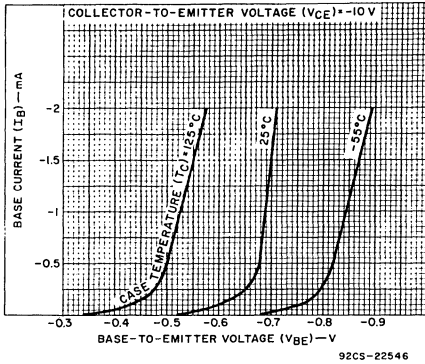


Fig. 7 — Typical input characteristics.

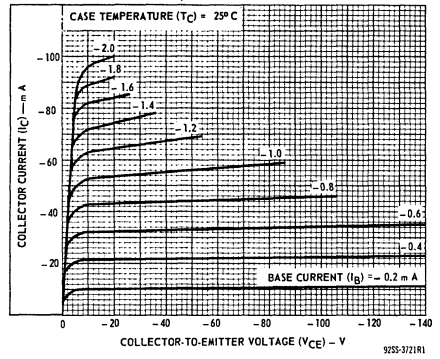


Fig. 8 — Typical output characteristics.

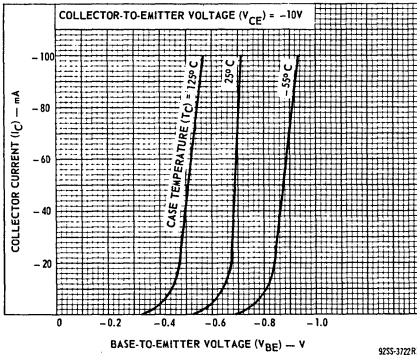
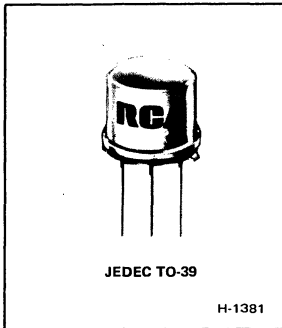


Fig. 9 — Typical transfer characteristics.

**TERMINAL CONNECTIONS**

- Lead 1 — Emitter
- Lead 2 — Base
- Lead 3 — Collector, Case



## High-Voltage Silicon P-N-P Transistor

For High-Speed Switching and Linear-Amplifier Applications in Industrial and Commercial Equipment

*Features:*

- Maximum safe-area-of-operation curves
- High voltage ratings:  
 $V_{CE0(sus)} = -300$  V max.

The RCA-RCS882 is an epitaxial silicon p-n-p transistor with high breakdown voltages, high frequency response, and fast switching speeds. This device is provided in the JEDEC TO-39 hermetic package.

Typical applications include high-voltage differential and operational amplifiers; high-voltage inverters; and high-voltage, low-current switching and series regulators.

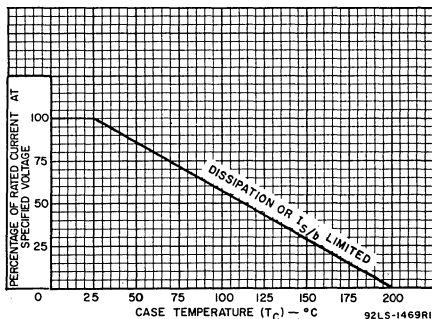


Fig. 1 — Dissipation derating curve.

**MAXIMUM RATINGS, Absolute-Maximum Values:**

COLLECTOR-TO-BASE VOLTAGE .....	$V_{CBO}$	-350	V
COLLECTOR-TO-EMITTER SUSTAINING VOLTAGE:			
With external base-to-emitter resistance ( $R_{BE}$ ) = 50 $\Omega$ .....	$V_{CER(sus)}$	-350	V
With base open .....	$V_{CEO(sus)}$	-300	V
EMITTER-TO-BASE VOLTAGE .....	$V_{EBO}$	-6	V
COLLECTOR CURRENT .....	$I_C$	-1	A
BASE CURRENT .....	$I_B$	-0.5	A
TRANSISTOR DISSIPATION:	$P_T$		
At case temperatures up to 25°C .....		7.5	W
At case temperatures above 25°C .....			See Figs. 1 and 4
At ambient temperatures up to 50°C .....		0.75	W
At ambient temperatures above 50°C .....		5	mW/°C
TEMPERATURE RANGE:			
Storage and Operating (Junction) .....		-65 to +200	°C
LEAD TEMPERATURE (During soldering):			
At distance $\geq$ 1/32 in. (0.8 mm) from seating plane for 10 s max. ....		255	°C

ELECTRICAL CHARACTERISTICS, At Case Temperature ( $T_C$ ) = 25°C

CHARACTERISTIC	SYMBOL	TEST CONDITIONS					LIMITS		UNITS
		VOLTAGE V dc			CURRENT mA dc		RCS882		
		V <sub>CB</sub>	V <sub>CE</sub>	V <sub>BE</sub>	I <sub>C</sub>	I <sub>B</sub>	Min.	Max.	
Collector-Cutoff Current: With emitter open	I <sub>CB0</sub>	-280					-	-50	μA
With base open	I <sub>CEO</sub>		-250			0	-	-50	
With base-emitter junction reverse-biased	I <sub>CEV</sub>		-300	1.5			-	-50	
Emitter-Cutoff Current	I <sub>EBO</sub>			6	0		-	-20	μA
DC Forward-Current Transfer Ratio	h <sub>FE</sub>		-10		-35 <sup>b</sup>		20	-	
Collector-to-Emitter Sustaining Voltage: With base open	V <sub>CEO(sus)</sub>				-50	0	-300 <sup>a</sup>	-	V
With external base-to-emitter resistance (R <sub>BE</sub> ) = 50 Ω	V <sub>CER(sus)</sub>				-50		-350 <sup>a</sup>	-	
Base-to-Emitter Saturation Voltage	V <sub>BE</sub>		-10		-50 <sup>b</sup>		-	-1.5	V
Collector-to-Emitter Saturation Voltage	V <sub>CE(sat)</sub>				-50 <sup>b</sup>	-5	-	-3	V
Magnitude of Common-Emitter, Small-Signal, Short-Circuit Forward-Current Transfer Ratio: f = 5 MHz	h <sub>fe</sub>		-10		-10		3	-	
Real Part of Common-Emitter Small-Signal, Short-Circuit Impedance: f = 1 MHz	Re(h <sub>ie</sub> )		-10		-5		-	300	Ω
Common-Base, Short-Circuit, Input Capacitance: f = 1 MHz	C <sub>ib</sub>			5	0		-	75	pF
Output Capacitance: f = 1 MHz	C <sub>ob</sub>	-10					-	15	pF
Forward-Bias, Second-Breakdown Collector Current: 0.4-s, non-repetitive pulse	I <sub>S/b</sub> <sup>c</sup>	-75					-100	-	mA
Thermal Resistance: Junction-to-Case	R <sub>θJC</sub>						-	23.3	°C/W

<sup>a</sup>CAUTION: The sustaining voltages V<sub>CEO(sus)</sub> and V<sub>CER(sus)</sub> MUST NOT be measured on a curve tracer. The sustaining voltage should be measured by means of the test circuit shown in Fig. 2.

<sup>b</sup>Pulsed: Pulse duration = 300 μs; duty factor ≤ 2%.

<sup>c</sup>I<sub>S/b</sub> is defined as the current at which second breakdown occurs at a specified collector voltage.

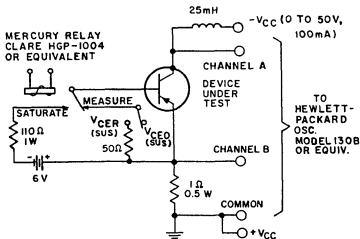
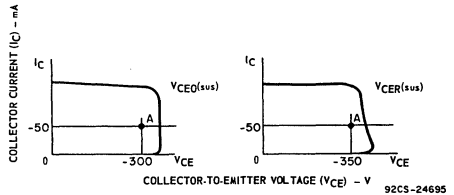


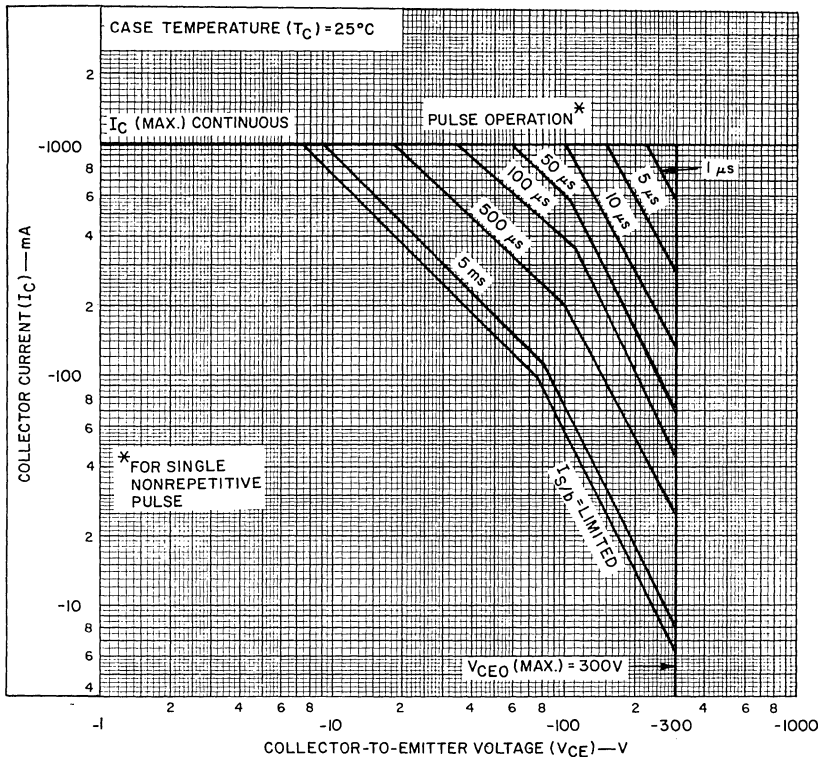
Fig. 2 - Circuit used to measure sustaining voltages, V<sub>CEO(sus)</sub> and V<sub>CER(sus)</sub>.



The sustaining voltages V<sub>CEO(sus)</sub> and V<sub>CER(sus)</sub> are acceptable when the trace falls to the right and above point "A".

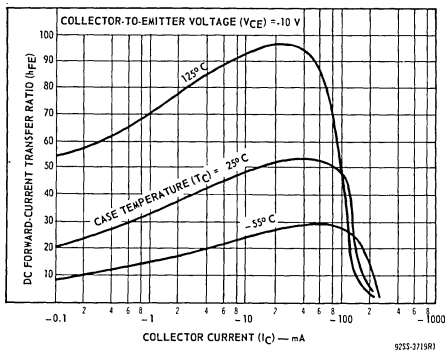
Fig. 3 - Oscilloscope display for measurement of sustaining voltages (test circuit shown in Fig. 2).





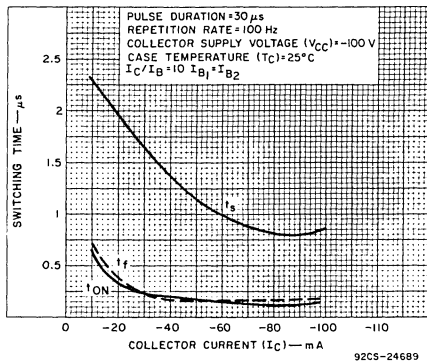
92CS-24693

Fig. 4 - Maximum safe operating areas.



92CS-3715R1

Fig. 5 - Typical dc beta characteristics.



92CS-24689

Fig. 6 - Typical saturated switching times.

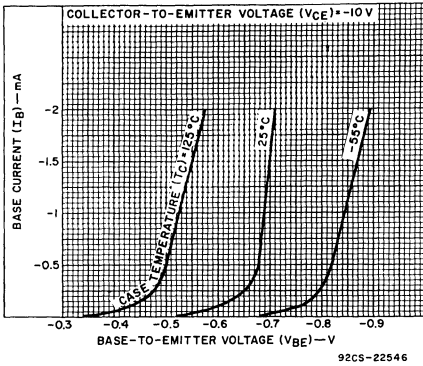


Fig. 7 — Typical input characteristics.

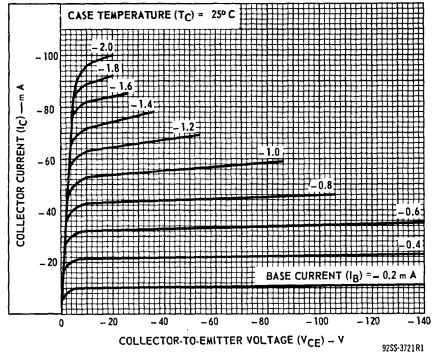


Fig. 8 — Typical output characteristics.

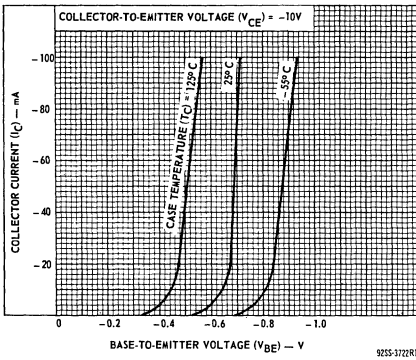


Fig. 9 — Typical transfer characteristics.

**TERMINAL CONNECTIONS**

- Lead 1 — Emitter
- Lead 2 — Base
- Lead 3 — Collector, Case

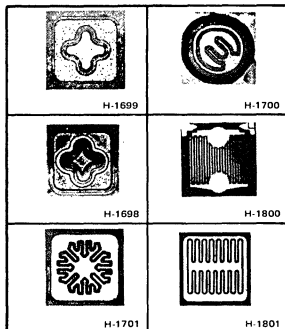
# Power Transistor Chips

**RCA**  
Solid State  
Division

## Power Transistors

CH2102	CH3439	CH5262	CH5322
CH2270	CH3440	CH5320	CH5323
CH2405	CH4036	CH5321	CH6479
CH3053	CH4037		

### Unmounted and Unencapsulated N-P-N and P-N-P Silicon Power Transistor Chips



#### Features:

- Prepared and tested for use in hybrid circuits
- $h_{FE}$  ratings from 30 to 50 (min.)
- ICBO leakage ratings in the 10  $\mu$ A to 1 mA range
- V<sub>CEO</sub> ratings up to 90 V on planar transistor chips;  
up to 325 V on passivated mesa types
- I<sub>C</sub> up to 12 A (CH6479)

The transistor chip families described in this bulletin are selected from the broad line of RCA discrete power transistors. Known also as pellets or dies, these chips represent the essential electronic portion of the transistor. They are especially suited for direct mounting on a heat sink in hybrid circuits. The n-p-n and p-n-p types can be used either singly or in complementary-pair configurations for large-signal medium-power applications.

All of the chip families shown are double-diffused epitaxial types. Six of the families are of planar construction; the other is of a passivated mesa construction. The oxide layer that results from conventional planar processing protects the planar types. The junctions and surfaces of the mesa transistor chips are protected by deposited glass-passivated coverings.

Aluminum has been deposited at the base and emitter electrodes of all the transistor chips for ease of bonding. The base and emitter bonding areas on each chip will accommodate up to a 0.003-inch (0.076-mm)-diameter bond wire except for the CH6479 which will accommodate a 0.010-inch (0.254-mm) wire. Either thermo-compression or ultrasonic bonding can be used to attach gold wires to these electrodes; aluminum wires can also be bonded by conventional ultrasonic techniques.

The collector contact, which is on the underside of the chip, has been metallized with gold for all of the chips except CH6479. For all of the chips, the collector can be attached directly to a heat sink by adhesive or by gold-silicon or gold-germanium eutectic bonding methods.

The CH6479, because of its large size, must be mounted on a heat sink made of material with thermal expansion coefficient close to that of silicon; suitable materials are molybdenum or

beryllium oxide. A special cleaning step is required in mounting the CH6479, as noted on page 5.

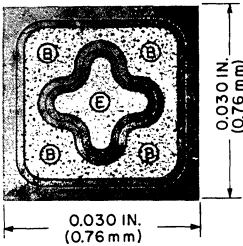
All of the chips must be mounted in an inert or reduced atmosphere. The chips must not be subjected to more than 400°C for a maximum of 1 minute. Because of the specially prepared surfaces of the chips (except as noted for the CH6479), etching of the pellets or the use of flux is not recommended.

The chips are supplied in plastic containers. Each chip is securely held in a recessed partition of the container by a clear plastic cover that also protects the surface from dust and abrasion. For additional protection, the container is sealed in a clear plastic bag. If the sealed shipping container is opened or broken, ruptured, punctured, or damaged in any way, the chips must be stored at a temperature of not more than 40°C and a relative humidity of not more than 50% in a clean, dust-free environment. If the sealed shipping container is damaged on receipt as described above, the product should be immediately returned to RCA.

These unmounted and unencapsulated chips are tested electrically and visually inspected to meet the specifications shown on the following pages. Written notification of non-conformance to such specifications must be made to RCA within 90 days of the date of the shipment by RCA. RCA assumes no responsibility for chips which have been subjected to further processing, such as, but not limited to, lead-bonding or pellet-mounting operations.

RCA has the right to change the chip design and processing without notification.

Assistance in determining proper mounting and bonding procedures is available from RCA.



**2N2102 Family (n-p-n)**

**CH2102 CH2405  
CH2270 CH3053**

RCA-CH2102, CH2270, CH2405, and CH3053 are double-diffused n-p-n epitaxial planar transistor chips similar to RCA-2N2102, 2N2270, 2N2405, and 2N3053 transistors, respectively. They can be used either singly or in complementary-pair configurations with RCA p-n-p chips CH4036 and CH4037 for large-signal medium-power applications.

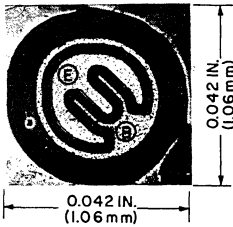
(B) 4 Base Bonding Areas 0.008 in. (0.20 mm) diameter

(E) Emitter Bonding Area 0.008 in. (0.20 mm) diameter

**ELECTRICAL CHARACTERISTICS, at Chip Temperature = 25°C**

Characteristic	Symbol	Test Conditions				Limits								Units
		Voltage V dc		Current mA dc		CH2102		CH2270		CH2405		CH3053		
		V <sub>CB</sub>	V <sub>CE</sub>	I <sub>C</sub>	I <sub>E</sub>	Min.	Max.	Min.	Max.	Min.	Max.	Min.	Max.	
Collector Cutoff Current	I <sub>CBO</sub>	60					10		10		10		10	μA
Emitter-to-Base Breakdown Voltage	V <sub>(BR)EBO</sub>				0.01	5		5		5		5		V
Collector-to-Emitter Sustaining Voltage: Base open <sup>a</sup>	V <sub>CEO(sus)</sub>			20		60		45		90		30		V
DC Forward-Current Transfer Ratio <sup>b</sup>	h <sub>FE</sub>		10	150		50		50		50		50		

<sup>a</sup>CAUTION: This voltage MUST NOT be measured on a curve tracer. <sup>b</sup>Pulse tested; 2% duty factor, less than or equal to 300 μs duration.



**2N3439 Family (n-p-n)**

**CH3439  
CH3440**

RCA-CH3439 and CH3440 are passivated mesa n-p-n transistor chips similar to those used in RCA-2N3439 and 2N3440 high-voltage transistors. Because of their high breakdown voltages, good high-frequency response, and fast switching speeds, these transistor chips can be used in high-voltage differential and operational amplifiers, high-voltage inverters and high-voltage, low-current switching regulators.

(B) Base Bonding Area 0.005 in. (0.13 mm) diameter

(E) Emitter Bonding Area 0.005 in. (0.13 mm) diameter

**ELECTRICAL CHARACTERISTICS, at Chip Temperature = 25°C**

Characteristic	Symbol	Test Conditions				Limits				Units
		Voltage V dc		Current mA dc		CH3439		CH3440		
		V <sub>CB</sub>	V <sub>CE</sub>	I <sub>C</sub>	I <sub>E</sub>	Min.	Max.	Min.	Max.	
Collector Cutoff Current	I <sub>CBO</sub>	200					20		50	μA
Emitter-to-Base Breakdown Voltage	V <sub>(BR)EBO</sub>				0.02	5		5		V
Collector-to-Emitter Sustaining Voltage: Base open <sup>a</sup>	V <sub>CEO(sus)</sub>			20		325		250		V
DC Forward-Current Transfer Ratio <sup>b</sup>	h <sub>FE</sub>		10	20		30		30		

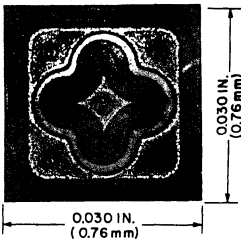
### 2N4036 Family (p-n-p)

**CH4036  
CH4037**

RCA-CH4036 and CH4037 are double-diffused p-n-p epitaxial planar transistor chips similar to RCA-2N4036 and 2N4037 transistors. Their high-voltage ratings and heat-dissipating ability make them ideal for amplifying large signals at a medium power level. They can be used singly or as complements of RCA n-p-n chips CH2102, CH2270, CH2405, and CH3053.

(B) 4 Base Bonding Areas 0.008 in. (0.13 mm) diameter

(E) Emitter Bonding Area 0.008 in. (0.13 mm) diameter



#### ELECTRICAL CHARACTERISTICS, at Chip Temperature = 25°C

Characteristic	Symbol	Test Conditions				Limits				Units
		Voltage V dc		Current mA dc		CH4036		CH4037		
		V <sub>CB</sub>	V <sub>CE</sub>	I <sub>C</sub>	I <sub>E</sub>	Min.	Max.	Min.	Max.	
Collector Cutoff Current	I <sub>CBO</sub>	-60					-10		-10	μA
Emitter-to-Base Breakdown Voltage	V <sub>(BR)EBO</sub>				-0.01	-6.5			-6.6	V
Collector-to-Emitter Sustaining Voltage: Base open <sup>a</sup>	V <sub>CEO(sus)</sub>			-20		-65			-40	V
DC Forward-Current Transfer Ratio <sup>b</sup>	h <sub>FE</sub>		-10	-150		35			35	

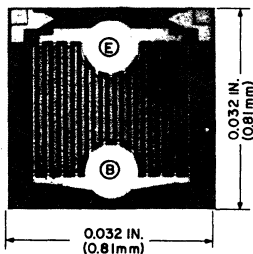
### 2N5262 Family (n-p-n)

**CH5262**

RCA-CH5262 is a double-diffused n-p-n epitaxial planar transistor chip similar to the RCA-2N5262 transistor. Its high speed and high current capability make it ideal for use in driving magnetic systems and in other applications requiring the switching of high currents through inductive loads.

(B) Base Bonding Areas 0.005 in. (0.13 mm) diameter

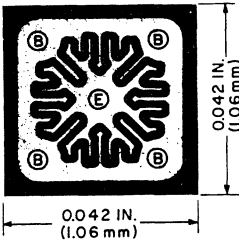
(E) Emitter Bonding Area 0.005 in. (0.13 mm) diameter



#### ELECTRICAL CHARACTERISTICS, at Chip Temperature = 25°C

Characteristic	Symbol	Test Conditions				Limits		Units
		Voltage V dc		Current mA dc		CH5320		
		V <sub>CB</sub>	V <sub>CE</sub>	I <sub>C</sub>	I <sub>E</sub>	Min.	Max.	
Collector Cutoff Current	I <sub>CBO</sub>	60					10	μA
Emitter-to-Base Breakdown Voltage	V <sub>(BR)EBO</sub>				0.01	5		V
Collector-to-Emitter Sustaining Voltage: Base open <sup>a</sup>	V <sub>CEO(sus)</sub>			10		35		V
DC Forward-Current Transfer Ratio <sup>b</sup>	h <sub>FE</sub>		6	100		30		

<sup>a</sup>CAUTION: This voltage MUST NOT be measured on a curve tracer. <sup>b</sup>Pulse tested; 2% duty factor, less than or equal to 300 μs duration.

**2N5320 Family (n-p-n)****CH5320  
CH5321**

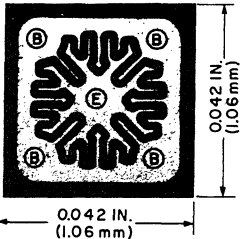
RCA-CH5320 and CH5321 are double-diffused n-p-n epitaxial planar transistor chips similar to RCA-2N5320 and 2N5321 transistors. They can be used singly or as complements of RCA p-n-p chips CH5322 and CH5323.

(B) 4 Base Bonding Areas 0.008 in. (0.20 mm) diameter

(E) Emitter Bonding Area 0.008 in. (0.20 mm) diameter

**ELECTRICAL CHARACTERISTICS, at Chip Temperature = 25°C**

Characteristic	Symbol	Test Conditions				Limits				Units
		Voltage V dc		Current mA dc		CH5320		CH5321		
		V <sub>CB</sub>	V <sub>CE</sub>	I <sub>C</sub>	I <sub>E</sub>	Min.	Max.	Min.	Max.	
Collector Cutoff Current:	I <sub>CBO</sub>	60					10		10	μA
Emitter-to-Base Breakdown Voltage	V <sub>(BR)EBO</sub>				0.01	5		5		V
Collector-to-Emitter Sustaining Voltage: Base open <sup>a</sup>	V <sub>CEO(sus)</sub>			20		80		55		V
DC Forward-Current Transfer Ratio <sup>b</sup>	h <sub>FE</sub>		10	250		30		30		

**2N5323 Family (p-n-p)****CH5322  
CH5323**

RCA-CH5322 and CH5323 are double-diffused p-n-p epitaxial planar transistor chips similar to RCA-2N5322 and 2N5323 transistors. They can be used singly or as complements of RCA n-p-n chips CH5320 and CH5321 for amplifying large signals at a medium power level.

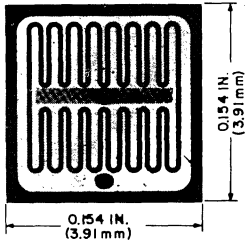
(B) 4 Base Bonding Areas 0.008 in. (0.20 mm) diameter

(E) Emitter Bonding Area 0.008 in. (0.20 mm) diameter

**ELECTRICAL CHARACTERISTICS, at Chip Temperature = 25°C**

Characteristic	Symbol	Test Conditions				Limits				Units
		Voltage V dc		Current mA dc		CH5322		CH5323		
		V <sub>CB</sub>	V <sub>CE</sub>	I <sub>C</sub>	I <sub>E</sub>	Min.	Max.	Min.	Max.	
Collector Cutoff Current	I <sub>CBO</sub>	-60					-10		-10	μA
Emitter-to-Base Breakdown Voltage	V <sub>(BR)EBO</sub>				-0.01	-5		-5		V
Collector-to-Emitter Sustaining Voltage: Base open <sup>a</sup>	V <sub>CEO(sus)</sub>			-20		-80		-55		V
DC Forward-Current Transfer Ratio <sup>b</sup>	h <sub>FE</sub>		-10	-250		30		30		

<sup>a</sup>CAUTION: This voltage MUST NOT be measured on a curve tracer. <sup>b</sup>Pulse tested; 2% duty factor, less than or equal to 300 μs duration.



CH6479 Family (n-p-n)

CH6479

RCA-CH6479 is a double-diffused n-p-n epitaxial planar transistor chip similar to the RCA-2N6479 transistor. Radiation hardening makes this type suitable for aerospace applications, and high-switching speeds make it ideal for use in high-speed inverters, switching regulators, and military hybrid applications.

(B) Base Bonding Area 0.013 in. (0.33 mm) x 0.091 in. (2.31 mm)

(E) Emitter Bonding Area 0.013 in. (0.33 mm) x 0.091 in. (2.31 mm)

ELECTRICAL CHARACTERISTICS, at Chip Temperature = 25°C

Characteristic	Symbol	Test Conditions				Limits		Units
		Voltage V dc		Current mA dc		CH6479		
		V <sub>CB</sub>	V <sub>CE</sub>	I <sub>C</sub>	I <sub>E</sub>	Min.	Max.	
Collector Cutoff Current	I <sub>CBO</sub>	100					1	mA
Emitter-to-Base Breakdown Voltage	V(BR)EBO				1	5		V
Collector-to-Emitter Sustaining Voltage: Base open <sup>a</sup>	V <sub>CEO(sus)</sub>			25		60		V
DC Forward-Current Transfer Ratio <sup>b</sup>	h <sub>FE</sub>		2	500		40		

<sup>a</sup>CAUTION: This voltage MUST NOT be measured on a curve tracer.

<sup>b</sup>Pulse tested; 2% duty factor, less than or equal to 300 μs duration.

CH6479 Chip Special Clean-Up Schedule:

Before eutectic mounting, the CH6479 chip must be etched for 30 seconds in a 10% (by volume) electronic-grade hydrofluoric acid solution at 25°C ± 5°C with agitation. Normal precautions for using hydrofluoric acid should be observed. The chip must then be dried and mounted within 8 hours.

CHIP INSPECTION INFORMATION

Each lot is inspected to a 2.5% AQL (cumulative) according to Mil Std. 105 using 20 times magnification. The following defects determine the inspection criteria:

- Foreign matter adhering to the base and emitter bond areas.
- Improperly cut pellets that include a portion of another pellet.
- Bridging by the metallization which causes a short.
- Blistering, lifting or absence of the aluminum metallization.

- Fractures or edges within 0.0005 in. (0.013) mm of the base collector junction.
- Severed base-contact rings that isolate all the bonding pads and most of the base area.
- Oxide missing from the junction area.

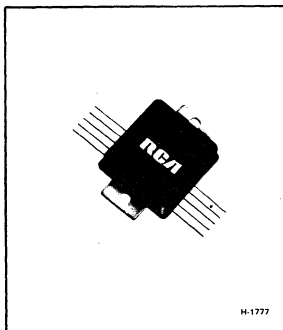


# Power Hybrid Circuits

**RCA**  
Solid State  
Division

## Power Hybrid Circuits

### HC2000H



## Multi-Purpose 7-Ampere Operational Amplifier

Linear Amplifiers for Applications in Industrial and Commercial Equipment

### Features:

- Bandwidth: 30 kHz at 60 W
- High power output: up to 100 W(rms)
- High output current: 7 A (peak)
- Built-in load-line-limiting circuit to protect amplifiers from accidentally short-circuited output terminals
- Stability with resistive or reactive loads
- Reactive-load fault protection
- Single or split power supply (30 to 75 V, total)
- Provision for feedback control
- Direct coupling to load
- Class B output stage
- Rugged package with heavy leads
- Light weight: 100 grams
- Low crossover distortion

RCA-HC2000H\* is a complete solid-state hybrid operational amplifier in a metal hermetic package. The HC2000H is intended for military and critical industrial applications and can be supplied in accordance with applicable portions of MIL-STD.883.

The amplifier employs a quasi-complementary-symmetry class B output circuit with built-in load-fault protection and home-taxial output transistors. The circuit may be operated from a single or split power supply.

Type HC2000H is recommended for the following applications: servo amplifiers (ac, dc, PWM); deflection amplifiers; power operational amplifiers; audio amplifiers; voltage regulators; and driven inverters.

Additional information on hybrid power amplifiers is contained in RCA Application Notes AN-4474, AN-4483, and AN-4782. Single copies of these publications are available upon request from RCA Solid State Division, Box 3200, Somerville, N.J. 08876.

\* Formerly RCA Dev. No. TA7626A.

### MAXIMUM RATINGS, *Absolute-Maximum Values:*

#### SUPPLY VOLTAGE:

Between leads 1 & 10 ..... 75 V

OUTPUT CURRENT (Peak) ..... 7 A

#### TOTAL DISSIPATION:

Per Output Device ..... See Fig. 4 & 5

#### TEMPERATURE RANGE:

Storage ..... -55 to +125°C

Output-Transistor Junction ..... -55 to +150°C

#### LEAD TEMPERATURE (During Soldering):

At distance  $\geq$  1/8 in. (3.17 mm)

from case for 10 s max. .... 235°C

#### LEAD-BENDING RADIUS (Min.)

At distance  $\geq$  0.075 (1.91 mm)

from case ..... 0.04 in. (1.02 mm)

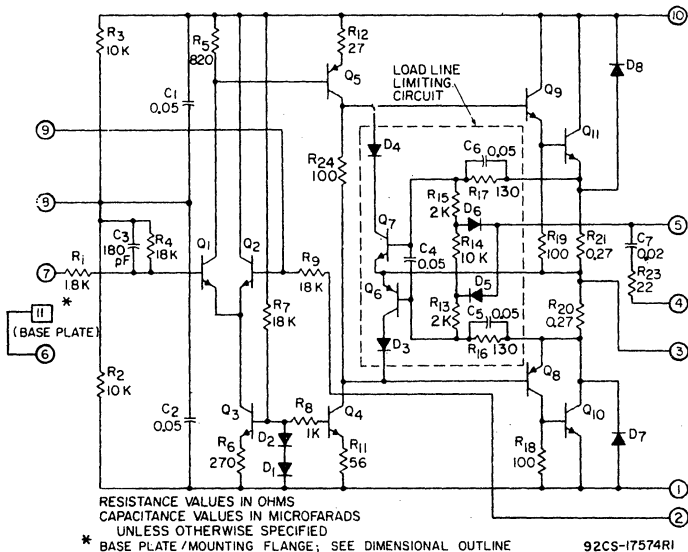


Fig. 1—Schematic diagram of type HC2000H power hybrid circuit operational amplifier.

CAUTION: WITH A SINGLE-SUPPLY SETUP, AN ACCIDENTAL SHORT CIRCUIT FROM LEAD 4 TO GROUND COULD RESULT IN CIRCUIT DAMAGE. HOWEVER, THE BUILT-IN LOAD-LINE LIMITING NETWORK WILL PROTECT THE CIRCUIT IF A SHORT CIRCUIT OCCURS BETWEEN LEADS 4 & 5.

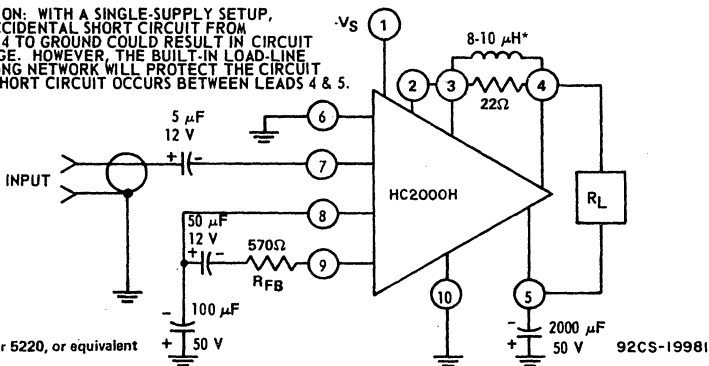


Fig. 2—Type HC2000H power hybrid circuit with external connections for operation with a single power supply.

ELECTRICAL CHARACTERISTICS, At Case Temperature ( $T_C$ ) = 25°C

CHARACTERISTIC	SYMBOL	TEST CONDITIONS				LIMITS			UNITS
		SUPPLY VOLTAGE ( $V_S$ )—V	FREQ. (f)—kHz	OUTPUT POWER ( $P_O$ )—W	LOAD RESIST. ( $R_L$ )— $\Omega$	MIN.	TYP.	MAX.	
Open-Loop Voltage Gain	$\frac{V_{OUT}}{V_{IN}}$	±37.5	4	25	4	4000	5000	—	—
Closed-Loop Voltage Gain (See Fig. 3)	$\frac{V_{OUT}}{V_{IN}}$	±37.5	1	1	4	26	30	—	—
Input Impedance Measured between leads 7 & 8 (See Fig. 3)	$Z_{IN}$	—	—	—	0	16	18	—	k $\Omega$
Quiescent Current	$I_o$	±37.5	—	—	—	15	—	30	mA
Initial Offset Voltage Measured between leads 4 & 5 (See Fig. 3)	$V_{offset}$	±37.5	—	—	4	0	±30	±250	mV
Offset Voltage Drift with Temperature	$\Delta V_{offset}/\Delta T$	±37.5	—	—	4	—	0.5	0.7	mV/°C
Bandwidth (See Figs. 3 & 8)	$f_H$	±37.5	—	1	4	43	—	—	kHz
Total Harmonic Distortion (See Figs. 3 & 9)	THD	±37.5	1	60	4	—	0.4	0.5	%
Short-Circuit Current (See Fig. 11)	$I_S$	±37.5	1	—	0	2	—	3	A
Signal-to-Noise Ratio Signal Source Impedance = 600 $\Omega$	S/N	±37.5	—	—	—	—	+78	—	dB
Slew Rate (Unity gain with peak output current of 4A)	SR	±37.5	1	100	4	10	25	—	V/ $\mu$ s
Thermal Resistance Per Output Device (Junction-to-Case) (See Figs. 4 & 5)	$R_{\theta J-C}$	—	—	—	—	—	—	2	°C/W

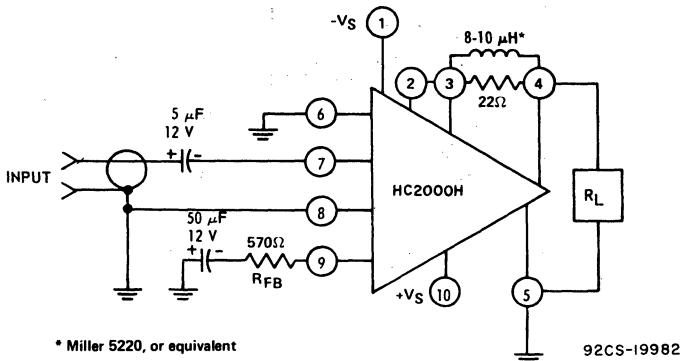


Fig. 3—Type HC2000H power hybrid circuit with external connections (and split power supply) for measuring relative response and distortion; see Figs. 8 & 9.

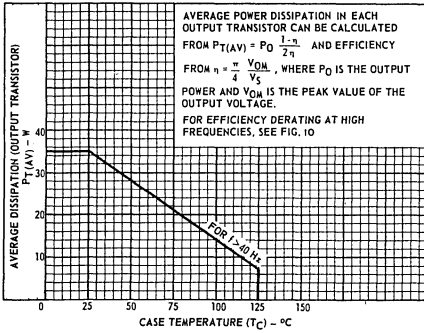


Fig. 4—Dissipation (average) derating curve for each output transistor (for symmetrical waveforms with  $f > 40$  Hz).

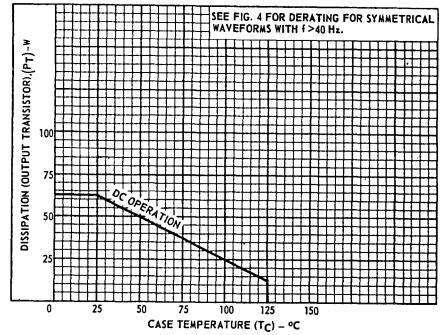


Fig. 5—Dissipation (dc) derating curve for each output transistor.

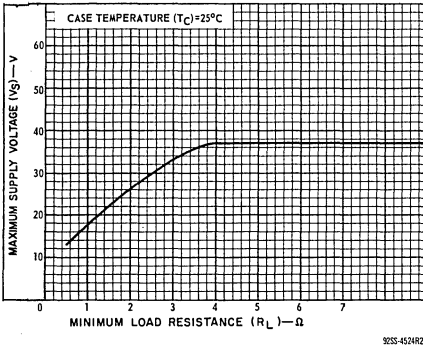


Fig. 6—Maximum allowable supply voltage vs. load resistance.

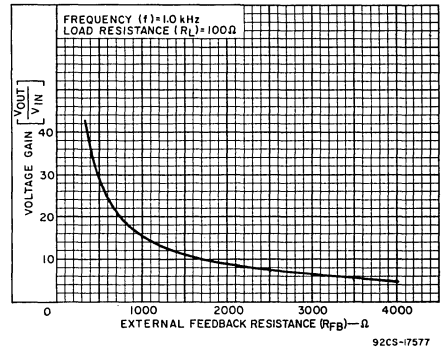


Fig. 7—Closed-loop voltage gain vs. external feedback resistance.

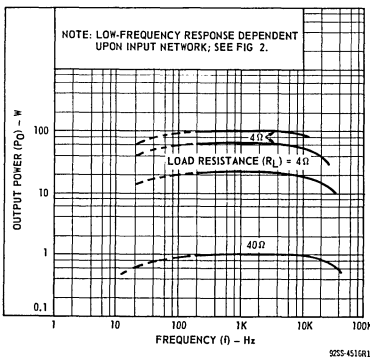


Fig. 8—Output power vs. frequency.

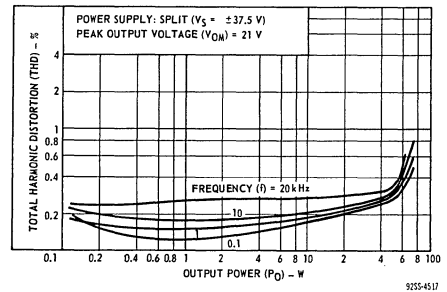


Fig. 9—Total harmonic distortion with split power supply.

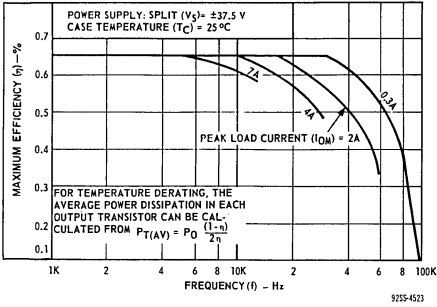


Fig. 10—Maximum efficiency vs. frequency for several values of peak load current.

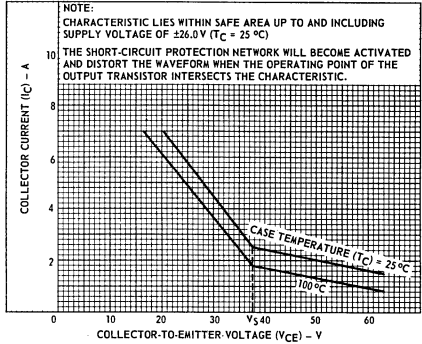


Fig. 11—Characteristics of built-in load-line-limiting circuit.

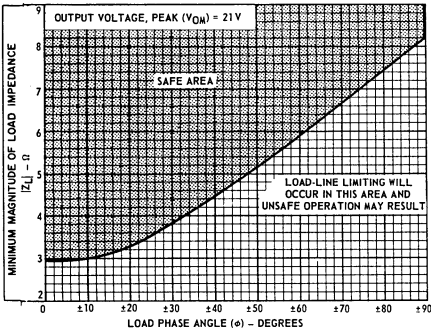


Fig. 12—Minimum load impedance vs. load phase angle and safe area of operation.

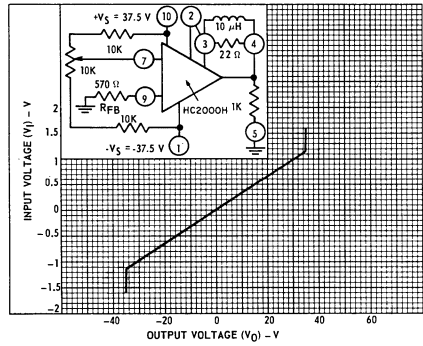


Fig. 13—Gain linearity characteristic.

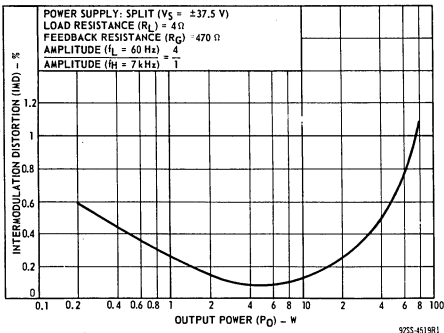


Fig. 14—Intermodulation distortion with split supply and 4-ohm load.

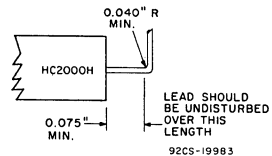
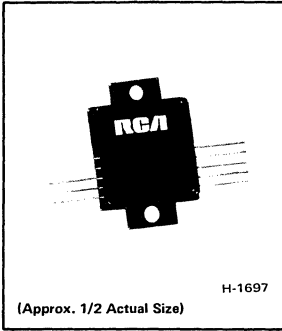


Fig. 15—Recommended lead-bending specification.



## Multi-Purpose, Low-Distortion 7-Ampere Operational Amplifier

Linear Amplifier for Applications in Industrial and Commercial Equipment

**Features:**

- Bandwidth: 30 kHz at 60 W
- High power output: up to 100 W(rms)
- High output current: 7 A (peak)
- Low IMD and THD
- Adjustable idling current
- Stability with resistive or reactive loads
- Single or split power supply (30 to 75 V, single,  $\pm 15$  to  $\pm 37.5$ , split)
- Class AB output stage
- Direct coupling to load
- Socket available
- Rugged package with heavy leads
- Light weight: 100 grams

RCA type HC2500<sup>®</sup> is a complete solid-state hybrid amplifier in a compact hermetic package. It employs a quasi-complementary-symmetry output circuit with homotaxial-base output transistors.

The HC2500 is a low-distortion, 100-watt linear amplifier. The output section can be externally biased class AB for low intermodulation and total harmonic distortion. Terminals are

available for external frequency compensation, external short-circuit protection, and inverting and non-inverting inputs.

The HC2500 is recommended for the following applications; servo amplifiers (ac, dc, PWM), deflection amplifiers, power operational amplifiers, voltage regulators, driven inverters, hi-fi amplifiers, PA systems, and solenoid drivers.

● Derived from RCA Dev. No. TA8651A.

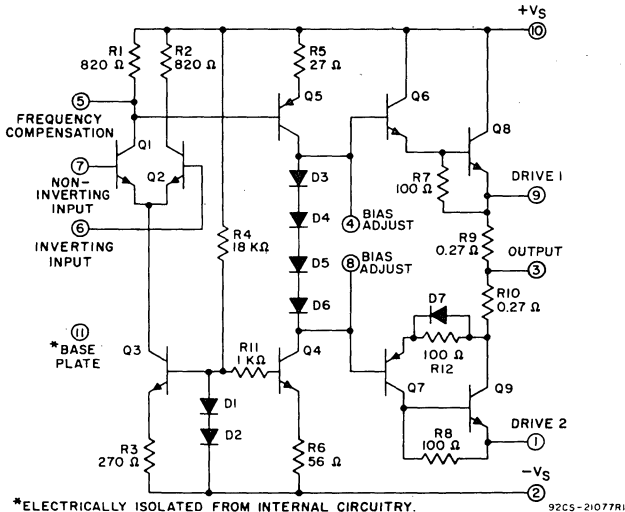


Fig. 1—Schematic diagram of type HC2500 operational amplifier.

**MAXIMUM RATINGS, Absolute-Maximum Values:**

**SUPPLY VOLTAGE:**  
 Between leads 1 and 10 ..... 75 V

**OUTPUT CURRENT (Peak)** ..... 7 A

**TOTAL DISSIPATION:**  
 Per output device ..... See Figs. 4 & 5

**TEMPERATURE RANGE:**  
 Storage ..... -55 to +125°C  
 Output junction ..... -55 to +150°C

**LEAD TEMPERATURE (During Soldering):**  
 At distance  $\geq 1/8$  in. (3.17 mm) from case for 10 s max. .... 235°C

**ELECTRICAL CHARACTERISTICS, At Case Temperature ( $T_C$ ) = 25°C and Supply Voltage ( $V_S$ ) =  $\pm 37.5$  V**

CHARACTERISTIC	SYMBOL	REFER- ENCE FIG. NO.	TEST CONDITIONS				LIMITS			UNITS
			SPECIAL NOTES	FREQ. (f)—kHz	OUTPUT POWER ( $P_O$ )—W	LOAD RESIST. ( $R_L$ )— $\Omega$	MIN.	TYP.	MAX.	
Offset Voltage	$V_{offset}$	3	Measured Pin 3 to Gnd	—	—	4	—	—	$\pm 250$	mV
Quiescent Current	$I_o$	3	Idling Current < 1 mA	—	—	Open	—	—	$\pm 30$	mA
Output Voltage Swing	$V_{OUT}$		Peak dc voltage	0	200	4	28	—	—	V
Closed-Loop Bandwidth	$f_H$	3		—	1	4	43	—	—	kHz
Total Harmonic Distortion	THD	15		1	60	4	—	0.3	0.5	%
Closed-Loop Voltage Gain	$A_{CL}$	3		1	1	4	31	32	—	
Thermal Resistance	$R_{\theta JC}$	5		—	—	—	—	—	2	°C/W

**ELECTRICAL CHARACTERISTICS**

Typical Values (for Design Guidance), At Case Temperature ( $T_C$ ) = 25°C and Supply Voltage ( $V_S$ ) =  $\pm 37.5$

Open-Loop Voltage Gain	$A_{OL}$	8, 19	Idling current = 50 mA	1	25	4	—	70	—	dB
Input Offset Voltage	$V_{IO}$	20		—	0	Open	—	$\pm 10$	—	mV
Input Offset Current	$I_{IO}$	20		—	0	Open	—	7	—	$\mu A$
Input Bias Current	$I_{IB}$	20		—	0	Open	—	20	—	$\mu A$
Common-Mode Input Impedance	$R_{CM}$	22		0.005	0	Open	—	1	—	M $\Omega$
Common-Mode Input-Voltage Range	$V_{ICR}$			0.5	100	4	—	32	—	V
Common-Mode-Rejection Ratio	CMRR			0.005	0	Open	—	50	—	dB
Supply-Voltage Ripple-Rejection Ratio	$V_{RR}$			0.06	0	4	—	30	—	dB
Intermodulation Distortion	IMD	14	Idling current = 50 mA	—	0.05	4	—	0.06	—	%
Slew Rate	SR	18	$A_{CL} = 2$ $C_c = 100$ pF	0.5 Square Wave	—	4	—	4.3	—	V/ $\mu s$
Idling-Current Drift	$\Delta I_i$	17	25°C to 100°C	—	—	4	—	1	—	mA/°C



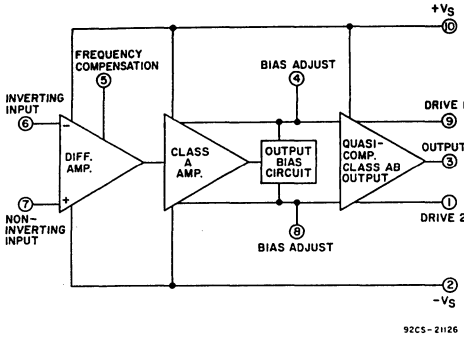


Fig. 2 - Block diagram of HC2500 100-watt class AB amplifier.

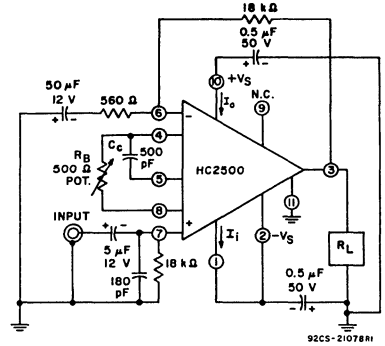


Fig. 3 - Typical test circuit with split supply for measuring  $ACL$ ,  $I_q$ ,  $V_{offset}$ ,  $THD$ , and  $IMD$ .

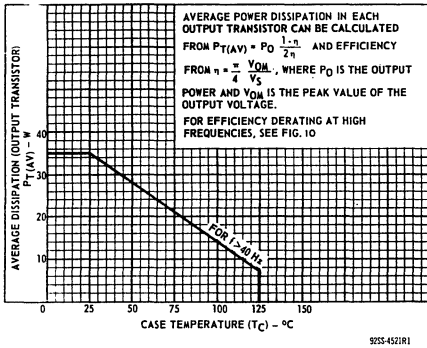


Fig. 4 - Dissipation (average) derating curve for each output transistor (for symmetrical waveforms with  $f > 40$  Hz).

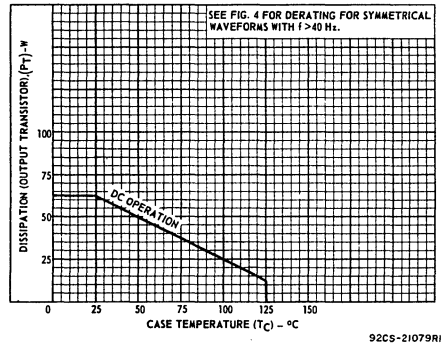


Fig. 5 - Dissipation derating curve for each output transistor.

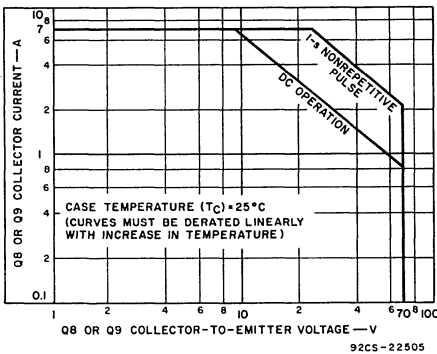


Fig. 6 - Maximum operating area for HC2500.

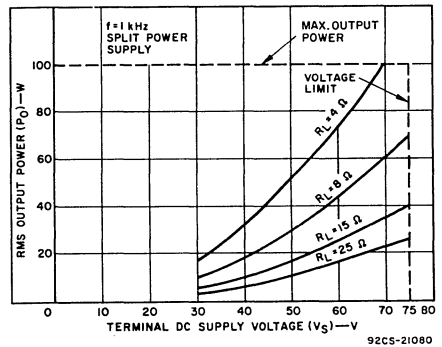


Fig. 7 - Output power as a function of supply voltage, with various values of load resistance, for symmetrical sine-wave operation.

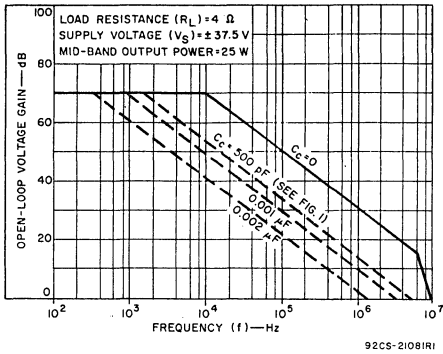


Fig. 8 - Typical open-loop voltage gain vs. frequency.

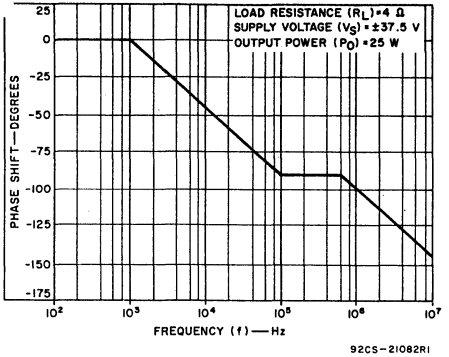


Fig. 9 - Typical open-loop phase shift vs. frequency.

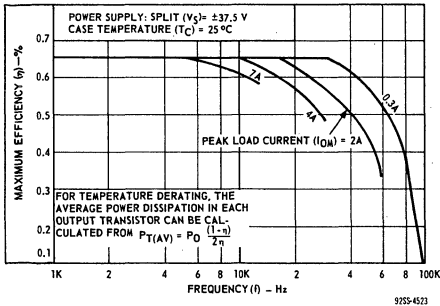


Fig. 10 - Maximum efficiency vs. frequency for several values of peak load current.

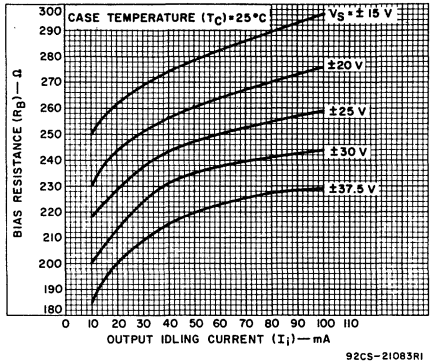


Fig. 11 - Bias resistor ( $R_B$  in Fig. 3) value vs. output idling current ( $I_I$ ).

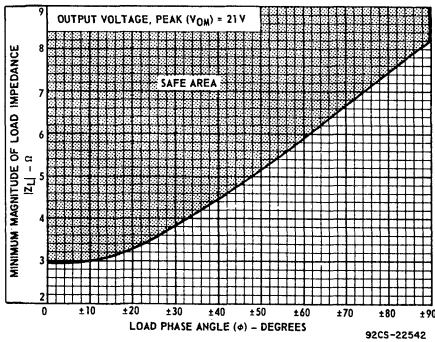


Fig. 12 - Minimum load impedance vs. load phase angle and safe area of operation.

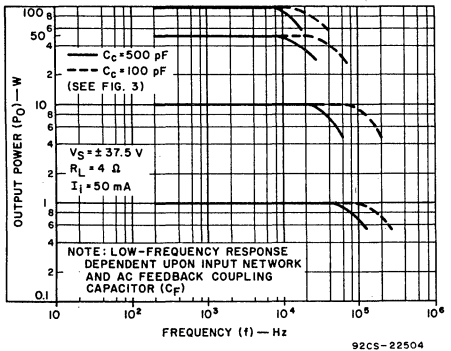


Fig. 13 - Output power vs. frequency.

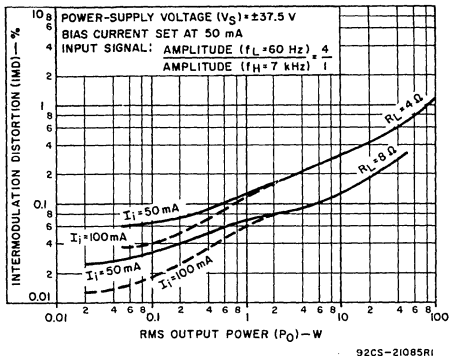


Fig. 14 — Typical intermodulation distortion vs. rms output power.

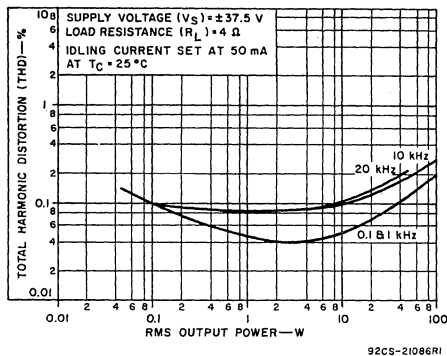


Fig. 15 — Typical total harmonic distortion vs. rms output power.

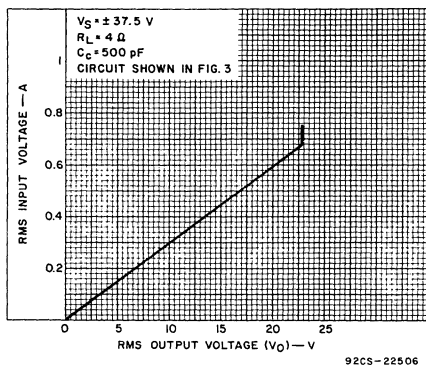


Fig. 16 — Input sensitivity.

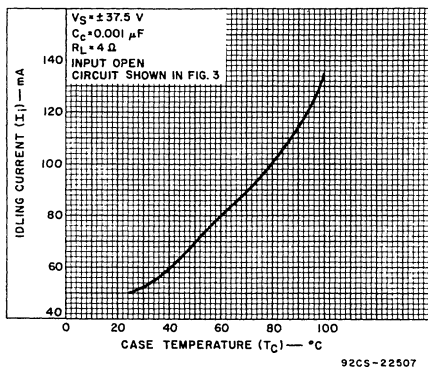


Fig. 17 — Typical idling-current drift.

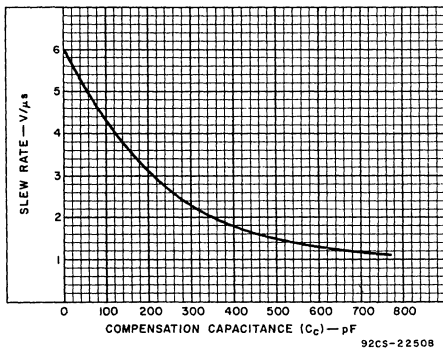


Fig. 18 — Typical slew rate vs. value of compensation capacitor,  $C_C$  (test circuit shown in Fig. 21).

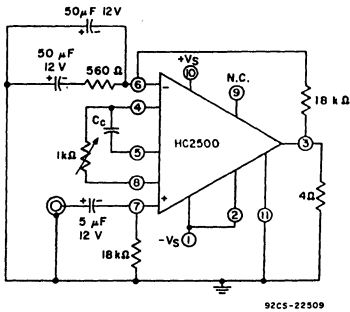
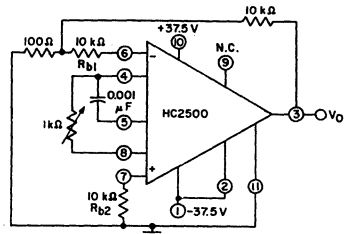


Fig. 19 - Test circuit for open-loop gain and phase response.



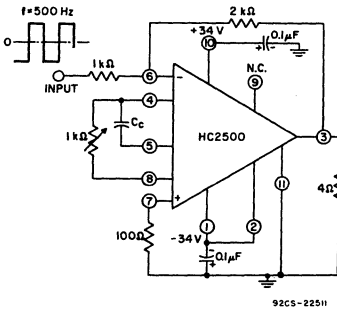
$$V_{IO} = -\frac{V_O}{100} \text{ with } R_{b1} \text{ and } R_{b2} \text{ shorted}$$

$$I_{IO} = -\frac{V_O}{100 R_{b2}}$$

$$I_{Ib} = \frac{V_O}{100 R_{b2}} \text{ with } R_{b1} \text{ shorted}$$

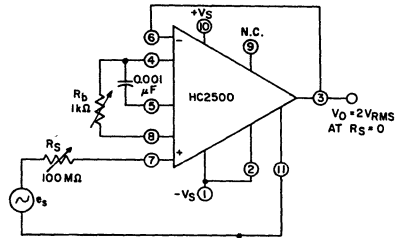
92CS-22510

Fig. 20 - Test circuit for input offset voltage and current test.



92CS-22511

Fig. 21 - Circuit used to test slew rate.

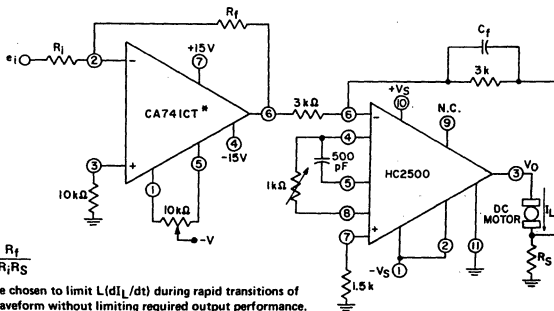


$R_{CM} = 9 R_S$  with series resistance ( $R_S$ ) increased from zero until output-voltage ( $V_O$ ) is reduced by 10%.

92CS-22512

Fig. 22 - Test circuit for measuring common-mode input resistance.

TYPICAL APPLICATION CIRCUITS



$$|L| = |e_i| \frac{R_f}{R_i R_S}$$

$C_f$  should be chosen to limit  $L(dI_L/dt)$  during rapid transitions of the input waveform without limiting required output performance.  
 $R_S$  should be chosen as high as possible without limiting required output performance.

\*See Data Bulletin File 531.

92CM-22513

Fig. 23 - Current-feedback motor-control circuit.

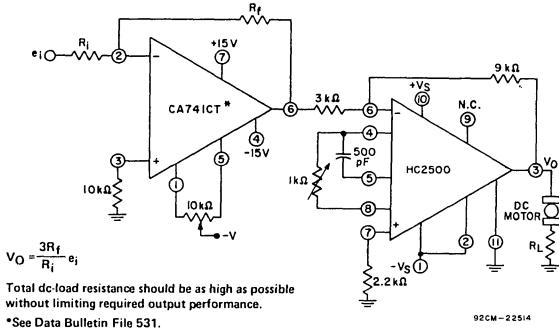


Fig. 24 - Voltage-feedback motor-control circuit.

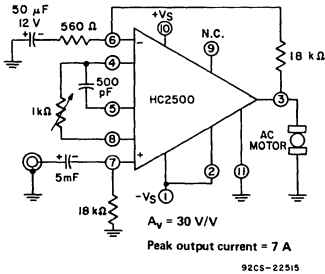


Fig. 25 - AC motor control.

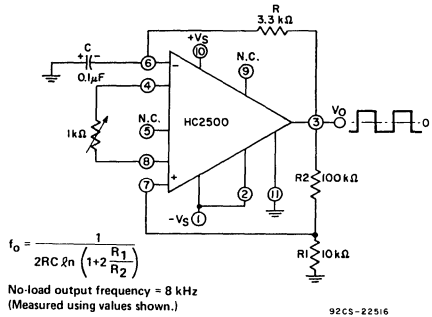


Fig. 26 - High-power astable multivibrator.

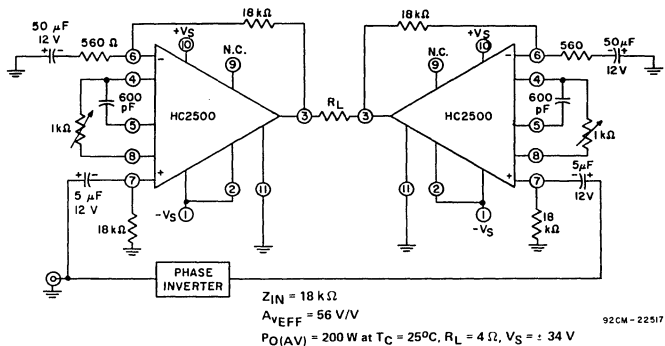
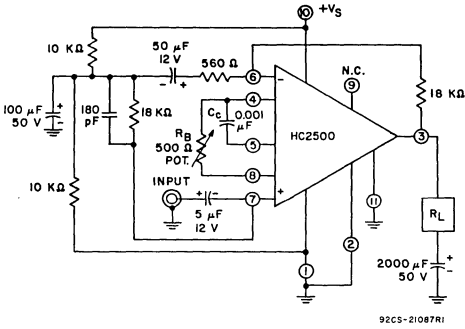


Fig. 27 - Bridge circuit for loads greater than 100 watts.



V <sub>S</sub>	54 V
P <sub>out</sub>	60 W
Idling Current (R <sub>B</sub> = 168 Ω)	50 mA
THD	0.15%
IMD @ 50 mW	0.06%
V <sub>offset</sub> Pin 3 To Gnd.	+ 100 mV
Efficiency	64%
R <sub>L</sub>	4 ohms

Fig. 28 – Typical circuit connections for operation of HC2500 with single-ended supply, and performance data.

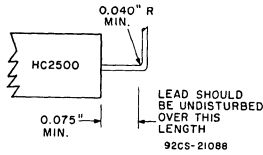


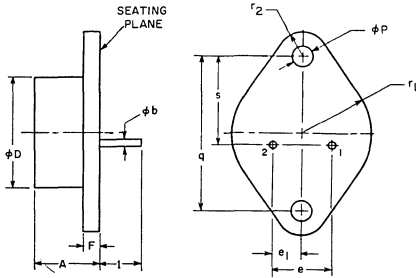
Fig. 29 – Recommended lead-bending specification.

COMPARISON CHART

TYPE	IM DIST. @ 50 mW	OUTPUT PROTECTION NETWORK	OPERATING MODE	FREQUENCY COMPENSATION	COMMUTATING DIODES
HC2500	0.06%	NO	CLASS AB	CAPACITOR ON SIGNAL TERMINALS	NO
HC2000H	5.8%	YES	CLASS B	LC FILTER ON OUTPUT	YES

# **Dimensional Outlines and Suggested Mounting Hardware**

HERMETIC PACKAGES  
JEDEC TO-3



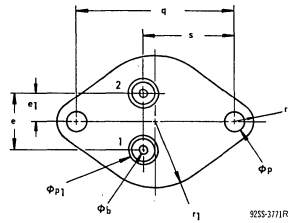
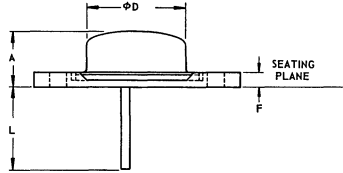
SYMBOL	INCHES		MILLIMETERS		NOTES
	MIN.	MAX.	MIN.	MAX.	
A	0.250	0.450	6.35	11.43	2
phi b	0.038	0.043	0.97	1.09	
phi D		0.875		22.23	
e	0.420	0.440	10.67	11.18	
e1	0.205	0.225	5.21	5.72	
F		0.135		3.43	
l	0.312		7.92		2
phi P	0.151	0.161	3.84	4.09	
q	1.177	1.197	29.90	30.40	
r1		0.525		13.34	
r2		0.188		4.78	
s	0.655	0.675	16.64	17.15	

NOTES:

- These dimensions should be measured at points 0.050 in. (1.27 mm) to 0.055 in. (1.40 mm) below seating plane. When gage is not used, measurement will be made at seating plane.
- Two pins.

92CS-15222

MODIFIED TO-3 (2N6032, 2N6033)



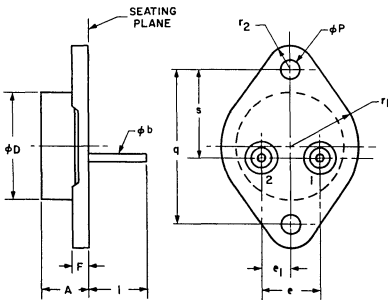
92SS-3771(R)

SYMBOL	INCHES		MILLIMETERS		NOTES
	MIN.	MAX.	MIN.	MAX.	
A	0.416	0.450	10.57	11.43	1
phi b	0.059	0.62	1.499	1.575	
phi D	0.750	0.771	19.05	19.583	
e	0.420	0.440	10.67	11.18	
e1	0.205	0.225	5.21	5.72	
F	0.100	0.114	2.54	2.89	
L	0.595	0.625	15.12	15.87	
phi P	0.151	0.161	3.84	4.09	
phi P1	0.200	0.285	5.08	7.239	
q	1.177	1.197	29.90	30.40	
r1	-	0.525	-	13.34	
r2	-	0.188	-	4.78	
s	0.655	0.675	16.64	17.15	2

NOTES:

- Two pins.
- Clearance holes for both pins should be 0.285 in. (7.24 mm) min. dia.

MODIFIED TO-3 (2N5575, 2N5578)



SYMBOL	INCHES		MILLIMETERS		NOTES
	MIN.	MAX.	MIN.	MAX.	
A	0.300	0.350	7.62	8.89	2
phi b	0.059	0.061	1.50	1.55	
phi D		0.800		20.32	
e	0.420	0.440	10.67	11.18	
e1	0.205	0.225	5.21	5.72	
F		0.114		2.90	
l	0.440	0.470	11.18	11.94	2
phi P	0.151	0.161	3.84	4.09	
q	1.177	1.197	29.90	30.40	
r1		0.525		13.34	
r2		0.188		4.78	
s	0.655	0.675	16.64	17.15	

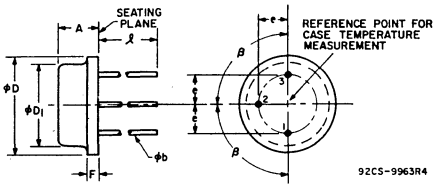
NOTES:

- THESE DIMENSIONS SHOULD BE MEASURED AT POINTS 0.050" (1.27 mm) TO 0.055" (1.40 mm) BELOW SEATING PLANE. WHEN GAGE IS NOT USED, MEASUREMENT WILL BE MADE AT SEATING PLANE.
- TWO LEADS.

92CS-17432



JEDEC TO-8



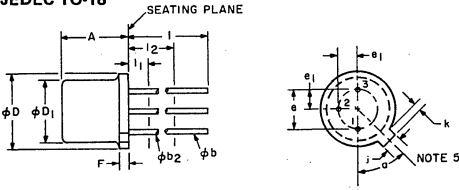
92CS-9963R4

SYMBOL	INCHES		MILLIMETERS		NOTES
	MIN.	MAX.	MIN.	MAX.	
A	0.270	0.330	6.86	8.38	—
ϕb	0.027	0.033	0.686	0.838	1
ϕD	0.550	0.650	13.97	16.51	—
ϕD <sub>1</sub>	0.444	0.524	11.28	13.31	—
e	0.136	0.146	3.45	3.71	—
F	—	0.115	—	2.92	—
λ	0.360	0.440	9.14	11.18	1
β	90° NOMINAL				

NOTE:

1. Three leads.

JEDEC TO-18



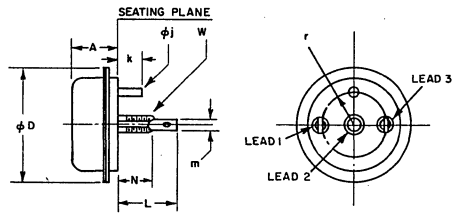
92CS-20223

SYMBOL	INCHES		MILLIMETERS		NOTES
	MIN.	MAX.	MIN.	MAX.	
A	0.170	0.210	4.32	5.33	
ϕb	0.016	0.021	0.406	0.533	1
ϕb <sub>2</sub>	0.016	0.019	0.406	0.483	1
ϕD	0.209	0.230	5.31	5.84	
ϕD <sub>1</sub>	0.178	0.195	4.52	4.95	
e	0.100 T.P.		2.54 T.P.		2, 4
e <sub>1</sub>	0.050 T.P.		1.27 T.P.		2, 4
F	0.030		0.762		
j	0.036	0.046	0.914	1.17	4
k	0.028	0.048	0.711	1.22	3
l	0.500		12.70		1
l <sub>1</sub>	0.050		1.27		1
l <sub>2</sub>	0.250		6.35		1
α	45° T.P.				5

NOTES:

1. (Three leads) ϕb<sub>2</sub> applies between l<sub>1</sub> and l<sub>2</sub>. ϕb applies between l<sub>2</sub> and 0.5 in. (12.70 mm) from seating plane. Diameter is uncontrolled in l<sub>1</sub> and beyond 0.5 in. (12.70 mm) from seating plane.
2. Leads having maximum diameter 0.019 in. (0.483 mm) measured in gaging plane 0.054 in. (1.37 mm) + 0.001 in. (0.025 mm) - 0.00 in. (0.00 mm) below the seating plane of the device shall be within 0.007 in. (0.178 mm) of their true positions relative to a maximum-width tab.
3. Measured from maximum diameter of the actual device.
4. The device may be measured by direct methods or by the gage and gaging procedure described on gage drawing GS-2.
5. Tab centerline.

JEDEC TO-36



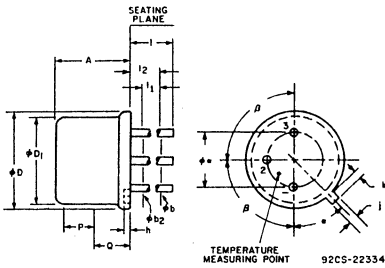
92CS-24690

SYMBOL	INCHES		MILLIMETERS		NOTES
	MIN.	MAX.	MIN.	MAX.	
A	—	0.520	—	13.21	
ϕD	—	1.250	—	31.75	
ϕj	—	0.140	—	3.56	
k	—	0.312	—	7.92	1
L	0.610	0.710	15.49	18.03	
m	—	0.190	—	4.83	
N	0.375	0.500	9.53	12.70	
r	0.345 NOMINAL		8.76 NOMINAL		
w					2

NOTES:

1. INSULATED LOCATOR PIN.
2. 10-32 UNF-2A. MAXIMUM PITCH DIAMETER OF PLATED THREADS SHALL BE BASIC PITCH DIAMETER 0.1697 in. (4.31 mm) REFERENCE (SCREW THREAD STANDARDS FOR FEDERAL SERVICES 1957) HANDBOOK H28 1957 P1.
3. CONTROLLING DIMENSION; INCH.

JEDEC TO-39/TO-5

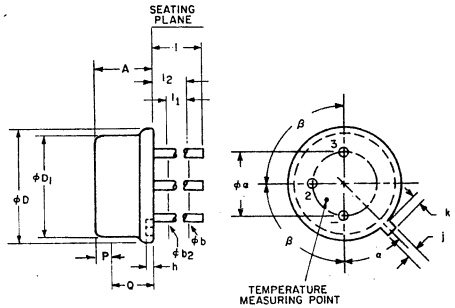


92CS-22334

SYMBOL	INCHES		MILLIMETERS		NOTES
	MIN.	MAX.	MIN.	MAX.	
$\phi a$	0.190	0.210	4.83	5.33	
A	0.240	0.260	6.10	6.60	
$\phi b$	0.016	0.021	0.406	0.533	2
$\phi b2$	0.016	0.019	0.406	0.483	2
$\phi D$	0.350	0.370	8.89	9.40	
$\phi D1$	0.305	0.335	8.00	8.51	
h	0.009	0.041	0.229	1.04	
j	0.028	0.034	0.711	0.864	
k	0.029	0.040	0.737	1.02	3
L (long lead)	1.500		38.10		2
L (short lead)	0.500		12.70		2
l <sub>1</sub>		0.050		1.27	2
l <sub>2</sub>	0.250		6.35		2
P	0.100		2.54		1
Q					4
$\alpha$	45° NOMINAL				
$\beta$	90° NOMINAL				

- Note 1: This zone is controlled for automatic handling. The variation in actual diameter within this zone shall not exceed 0.010 in. (0.254 mm).
- Note 2: (Three leads)  $\phi b_2$  applies between l<sub>1</sub> and l<sub>2</sub>.  $\phi b$  applies between l<sub>2</sub> and l. Diameter is uncontrolled in l<sub>1</sub>.
- Note 3: Measured from maximum diameter of the actual device.
- Note 4: Details of outline in this zone optional.

MODIFIED TO-39

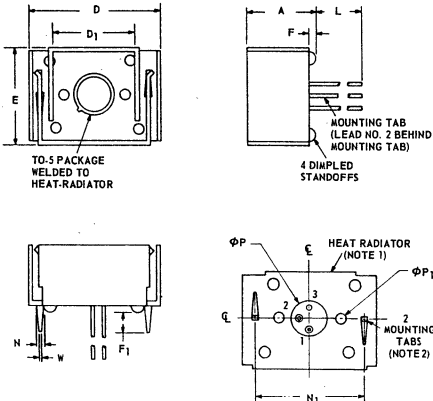


SYMBOL	INCHES		MILLIMETERS		NOTES
	MIN.	MAX.	MIN.	MAX.	
$\phi a$	0.190	0.210	4.83	5.33	
A	0.160	0.180	4.07	4.57	
$\phi b$	0.016	0.021	0.406	0.533	2
$\phi b2$	0.016	0.019	0.406	0.483	2
$\phi D$	0.350	0.370	8.89	9.40	
$\phi D1$	0.315	0.335	8.00	8.51	
h	0.009	0.125	0.229	3.18	
j	0.028	0.034	0.711	0.864	
k	0.029	0.040	0.737	1.02	3
l	0.500		12.70		2
l <sub>1</sub>		0.050		1.27	2
l <sub>2</sub>	0.250		6.35		2
P					1
Q					4
$\alpha$	45° NOMINAL				
$\beta$	90° NOMINAL				

- Note 1: This zone is controlled for automatic handling. The variation in actual diameter within this zone shall not exceed 0.010 in. (0.254 mm).
- Note 2: (Three leads)  $\phi b_2$  applies between l<sub>1</sub> and l<sub>2</sub>.  $\phi b$  applies between l<sub>2</sub> and 0.5 in. (12.70 mm) from seating plane. Diameter is controlled in l<sub>1</sub> and beyond 0.5 in. (12.70 mm) from seating plane.
- Note 3: Measured from maximum diameter of the actual device.
- Note 4: Details of outline in this zone optional.

92CS-20893

TO-39/TO-5 WITH HEAT RADIATOR

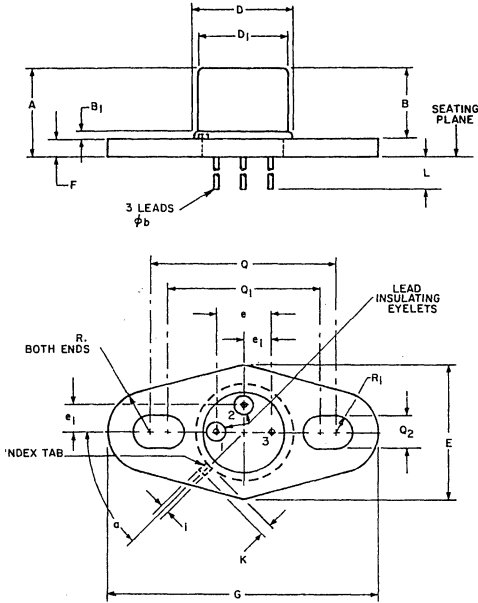


SYMBOL	INCHES		MILLIMETERS		NOTES
	MIN.	MAX.	MIN.	MAX.	
A	—	0.630	—	16.00	
D	1.205	1.235	30.61	31.37	
D <sub>1</sub>	0.775	0.785	19.69	19.93	
E	0.875	0.905	22.22	22.99	
F	0.040	0.055	1.02	1.40	
F <sub>1</sub>	0.160	0.195	4.06	4.95	
L (long lead)	1.410	—	35.81	—	
L (short lead)	0.410	—	10.41	—	
$\phi P$	0.295	0.305	7.493	7.747	
$\phi P1$	0.093	0.095	2.362	2.413	
N	0.048	0.062	1.21	1.57	
N <sub>1</sub>	0.998	1.002	25.349	25.450	3
W	0.048	0.052	1.219	1.320	

- NOTES:
- 0.035 C.R.S., finish—electroless nickel plate.
  - Recommended hole size for printed-circuit board is 0.070 in. (1.78 mm) dia.
  - Measured at bottom of heat-radiator.

92CS-22335

TO-39/TO-5 WITH FLANGE



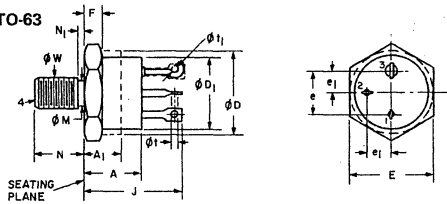
92CS-22333

SYMBOL	INCHES		MILLIMETERS		NOTES
	MIN.	MAX.	MIN.	MAX.	
A	—	0.328	—	8.33	
B	0.240	0.260	6.10	6.60	
B <sub>1</sub>	0.009	0.125	0.229	3.18	
ϕ <sub>b</sub>	0.016	0.019	0.406	0.483	
D	0.335	0.370	8.51	9.40	
D <sub>1</sub>	0.305	0.335	7.75	8.51	
E	0.495	0.505	12.57	12.83	
e	0.200 T.P.		5.08 T.P.		1
e <sub>1</sub>	0.100 T.P.		2.54 T.P.		1
F	0.062	0.068	1.57	1.74	
G	0.995	1.005	25.27	25.53	
i	0.028	0.034	0.711	0.864	
k	0.029	0.045	0.737	1.14	
L long lead	1.430	—	36.32	—	
L short lead	0.430	—	10.92	—	
Q	0.685	0.691	17.40	17.55	
Q <sub>1</sub>	0.559	0.565	14.20	14.35	
Q <sub>2</sub>	0.128	0.132	3.25	3.35	
R	0.156 T.P.		3.96 T.P.		1
R <sub>1</sub>	0.064	0.066	1.63	1.67	
α	45° T.P.				1, 2

NOTES:

1. True position.
2. Tab centerline.

JEDEC TO-63



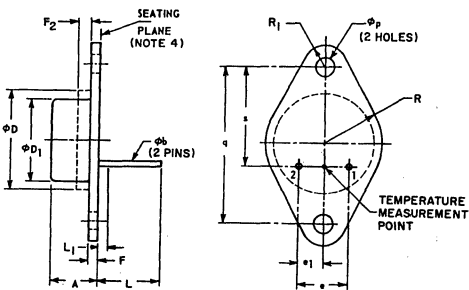
SYMBOL	INCHES		MILLIMETERS		NOTES
	MIN.	MAX.	MIN.	MAX.	
A	0.480	0.535	12.19	13.59	
A <sub>1</sub>	—	0.300	—	7.62	2
ϕD	0.775	0.875	19.69	22.23	2
ϕD <sub>1</sub>	0.745	0.775	18.92	19.69	
E	0.855	0.875	21.72	22.23	
e	0.485	0.515	12.32	13.08	5
e <sub>1</sub>	0.240	0.280	6.10	6.60	5
F	0.090	0.167	2.29	4.24	1
J	0.937	1.030	23.80	26.16	
ϕM	0.278	0.312	7.06	7.92	
N	0.460	0.495	11.68	12.57	
N <sub>1</sub>	—	0.105	—	2.67	
α <sub>t</sub>	0.060	0.105	1.52	2.67	
α <sub>t1</sub>	0.060	0.105	1.52	2.67	4
α <sub>W</sub>	0.2806	0.2854	7.127	7.249	3

NOTES:

1. DIMENSION DOES NOT INCLUDE SEALING FLANGES.
2. PACKAGE CONTOUR OPTIONAL WITH DIMENSIONS SPECIFIED.
3. PITCH DIAMETER - THREAD 5/16-24 UNF-2A (COATED). REFERENCE (SCREW THREAD STANDARDS FOR FEDERAL SERVICES - HANDBOOK H-28).
4. THIS TERMINAL CAN BE FLATTENED AND PIERCED OR HOOK TYPE.
5. POSITION OF LEADS IN RELATION TO THE HEXAGON IS NOT CONTROLLED.

92CS-20225

JEDEC TO-66



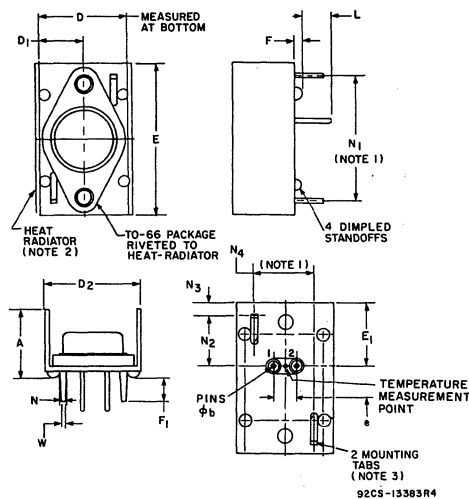
92SS-3738R1

SYMBOL	INCHES		MILLIMETERS		NOTES
	MIN.	MAX.	MIN.	MAX.	
A	0.250	0.340	6.35	8.64	
ϕb	0.028	0.034	0.711	0.863	
ϕD	—	0.620	—	15.75	1
ϕD1	0.470	0.500	11.94	12.70	
e	0.190	0.210	4.83	5.33	2
e1	0.093	0.107	2.36	2.72	2
F1	0.050	0.075	1.27	1.91	
F2	—	0.050	—	1.27	1
L	0.360	—	9.14	—	
L1	—	0.050	—	1.27	3
ϕp	0.142	0.152	3.61	3.86	
q	0.958	0.962	24.33	24.43	
R	—	0.350	—	8.89	
R1	—	0.145	—	3.68	
s	0.570	0.590	14.48	14.99	

NOTES:

1. Body contour is optional within zone defined by ϕD and F2.
2. These dimensions should be measured at points 0.050 in. (1.27 mm) to 0.055 in. (1.40 mm) below seating plane. When gage is not used, measurement will be made at seating plane.
3. ϕb applies between L1 and L. Diameter is uncontrolled in L1.
4. The seating plane of header shall be flat within 0.001 in. (0.025 mm) concave to 0.004 in. (0.10 mm) convex inside a 0.520 in. (13.21 mm) diameter circle on the center of the header and flat within 0.001 in. (0.025 mm) concave to 0.006 in. (0.15 mm) convex overall.

TO-66 WITH HEAT RADIATOR



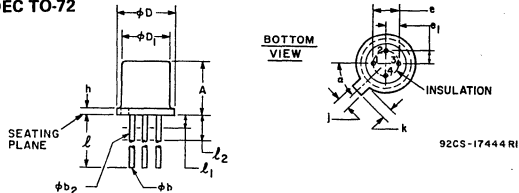
92CS-13383R4

SYMBOL	INCHES		MILLIMETERS		NOTES
	MIN.	MAX.	MIN.	MAX.	
A	—	0.620	—	15.75	
ϕb	0.028	0.034	0.711	0.864	
D	0.750	0.760	19.05	19.30	
D1	0.370	0.385	9.40	9.78	
D2	0.820	0.920	20.83	23.37	
E	1.297	1.327	32.94	33.70	
e	0.546	0.566	13.87	14.37	
e1	0.190	0.210	4.83	5.33	
F	0.30	0.55	7.62	13.97	
F1	0.175	0.210	4.44	5.33	
L	0.270	—	6.86	—	
N	0.052	0.065	1.32	1.65	
N1	1.098	1.102	27.89	27.99	1
N2	0.448	0.452	11.38	11.47	
N3	0.099	0.113	0.25	0.29	
N4	0.498	0.502	12.65	12.75	
W	0.048	0.060	1.22	1.52	

NOTES:

1. Measured at bottom of heat radiator.
2. 0.035 in. (0.889) C.R.S., tin plated.
3. Recommended hole size for printed-circuit board is 0.070 in. (1.778) dia.

JEDEC TO-72



92CS-17444 R1

Note 1: (Four leads). Maximum number leads omitted in this outline, "none" (0). The number and position of leads actually present are indicated in the product registration. Outline designation determined by the location and minimum angular or linear spacing of any two adjacent leads.

Note 2: (All leads) ϕb2 applies between l1 and l2. ϕb applies between l2 and 0.50 in. (12.70 mm) from seating plane. Diameter is uncontrolled in l1 and beyond 0.50 in. (12.70 mm) from seating plane.

Note 3: Measured from maximum diameter of the product.

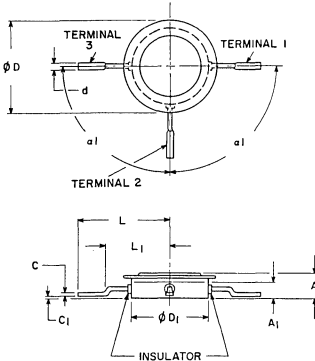
SYMBOL	INCHES		MILLIMETERS		NOTES
	MIN.	MAX.	MIN.	MAX.	
A	0.170	0.210	4.32	5.33	
ϕb	0.016	0.021	0.406	0.533	2
ϕb2	0.016	0.019	0.406	0.483	2
ϕD	0.209	0.230	5.31	5.84	
ϕD1	0.178	0.195	4.52	4.95	
e	0.100 T.P.	—	2.54 T.P.	—	4
e1	0.050 T.P.	—	1.27 T.P.	—	4
i	—	0.030	—	0.762	
j	0.036	0.046	0.914	1.17	
k	0.028	0.048	0.711	1.22	3
l	0.500	—	12.70	—	2
l1	—	0.050	—	1.27	2
l2	0.250	—	6.35	—	2
α	—	45° T.P.	—	45° T.P.	4, 6

Note 4: Leads having maximum diameter 0.019 in. (0.484 mm) measured in gaging plane 0.054 in. (1.37 mm) ±0.001 in. (0.025 mm) — 0.000 (0.000 mm) below the seating plane of the product shall be within 0.007 in. (0.178 mm) of their true position relative to a maximum width tab.

Note 5: The product may be measured by direct methods or by gage.

Note 6: Tab centerline.

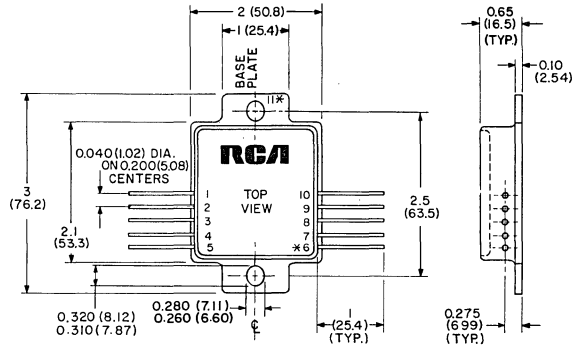
**RADIAL PACKAGE**



SYMBOL	INCHES		MILLIMETERS		NOTES
	MIN.	MAX.	MIN.	MAX.	
A	—	0.200	—	5.08	
A <sub>1</sub>	—	0.125	—	3.17	1
C	0.015	0.019	0.38	0.48	
C <sub>1</sub>	—	0.015	—	0.38	
ϕD	—	0.710	—	18.03	
ϕD <sub>1</sub>	0.615	0.690	15.62	17.52	1
d	0.042	0.046	1.06	1.16	
L	—	0.705	—	17.90	
L <sub>1</sub>	—	0.510	—	12.95	
a <sub>1</sub>	90° ± 2°		90° ± 2°		

NOTE:  
1. CONTROLLED AREA OF THE DIAMETER DOES NOT INCLUDE THE BRAZED AREA AROUND THE CERAMIC AND TERMINAL 2.

**HYBRID-CIRCUIT PACKAGE**

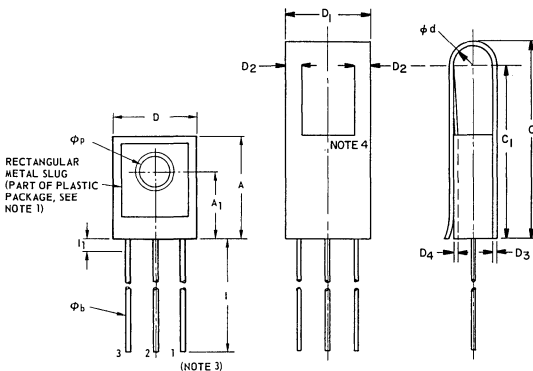


DIMENSIONS IN INCHES AND MILLIMETERS (VALUES IN PARENTHESES)

\*TERMINALS 6 AND 11 ARE CONNECTED INTERNALLY

92CS-1B037R2

**PLASTIC PACKAGES**  
**PLASTIC TO-5 AND PLASTIC TO-5 WITH HEAT CLIP**



SYMBOL	INCHES		MILLIMETERS		NOTES
	MIN.	MAX.	MIN.	MAX.	
A	0.385	0.395	9.78	10.03	
A <sub>1</sub>	0.251	0.261	6.37	6.63	
ϕb	0.016	0.019	0.41	0.48	2
C	0.858		21.79		
C <sub>1</sub>	0.750		19.05		
D	0.305	0.315	7.75	8.00	
D <sub>1</sub>	0.300		7.62		
D <sub>2</sub>	0.070		1.77		
D <sub>3</sub>	0.0329		0.813		
D <sub>4</sub>	0.021	0.041	0.533	1.04	
ϕd	0.073	0.077	1.85	1.95	
E	0.145	0.155	3.68	3.94	
e	0.195	0.205	4.95	5.21	
e <sub>1</sub>	0.095	0.105	2.41	2.67	
e <sub>2</sub>	0.070	0.080	1.78	2.03	
ℓ	0.725	0.745	18.41	18.91	
ℓ <sub>1</sub>	0.125	0.250	3.17	6.35	
ϕp	0.112	0.118	2.84	2.99	

NOTE 1: To attach to heat-sink, use a 4-40 binding-head screw and a No. 4 flat washer. The recommended screw torque (for even distribution of mounting pressure and optimum thermal contact) is 6 in.-lb.

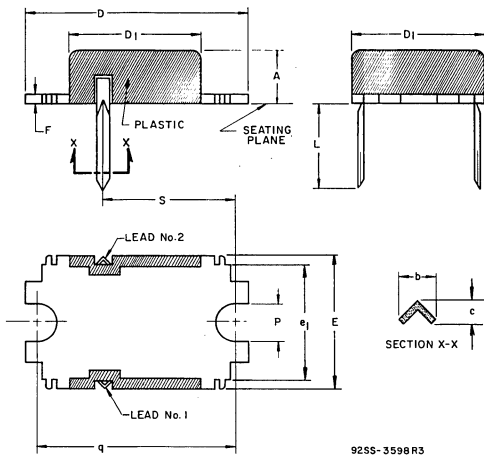
NOTE 2: Three leads. Leads are pretinned to the ℓ<sub>1</sub> dimension.

NOTE 3: Lead numbering from right to left with rectangular metal slug facing observer.

NOTE 4: Tab to be sheared through and set inward as shown.

92CS-19280

JEDEC TO-219AA

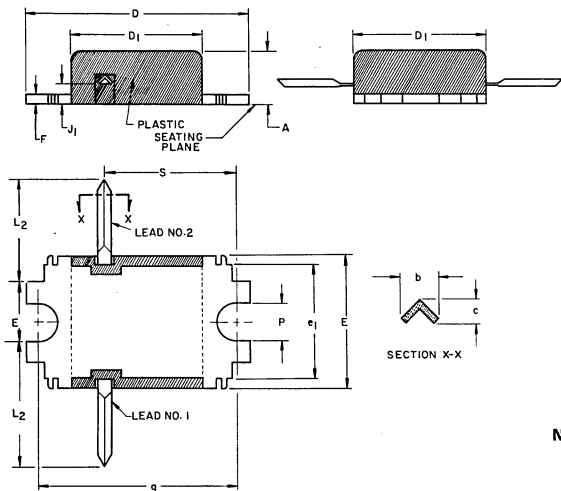


SYMBOL	INCHES		MILLIMETERS		NOTES
	MIN.	MAX.	MIN.	MAX.	
A	0.160	0.200	4.07	5.08	
b	0.045	0.060	1.15	1.52	
c	0.025	0.045	0.64	1.14	
D	0.890	0.910	22.61	23.11	
D <sub>1</sub>	0.480	0.515	12.20	13.08	
E	0.480	0.520	12.20	13.20	
e <sub>1</sub>	0.460	0.505	11.69	12.82	1
F	0.055	0.070	1.40	1.77	
L	0.370	0.450	9.40	11.43	2
P	0.128	0.150	3.26	3.81	
q	0.740	0.760	18.80	19.30	
s	0.500	0.520	12.70	13.20	

NOTES:

1. e<sub>1</sub> is measured at seating plane.
2. Terminal end configurations are optional.

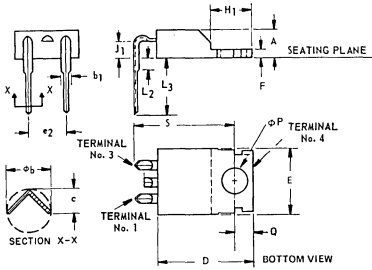
JEDEC TO-219AB



SYMBOL	INCHES		MILLIMETERS	
	MIN.	MAX.	MIN.	MAX.
A	0.160	0.200	4.07	5.08
b	0.045	0.060	1.15	1.52
c	0.025	0.045	0.64	1.14
D	0.890	0.910	22.61	23.11
D <sub>1</sub>	0.480	0.515	12.20	13.03
E	0.480	0.520	12.20	13.20
F	0.055	0.070	1.40	1.77
J <sub>1</sub>	0.100	0.120	2.54	3.04
L <sub>2</sub>	0.415	0.560	10.54	14.22
P	0.128	0.150	3.26	3.81
q	0.740	0.760	18.80	19.30
s	0.500	0.520	12.70	13.20

NOTE: Terminal end configurations are optional.

JEDEC TO-220AA



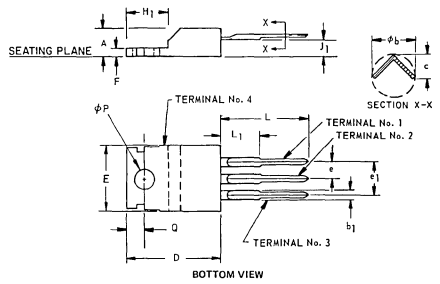
SYMBOL	INCHES		MILLIMETERS		NOTES
	MIN.	MAX.	MIN.	MAX.	
A	0.140	0.190	3.56	4.82	—
$\phi b$	0.02	0.045	0.51	1.14	—
$b_1$	0.045	0.070	1.15	1.77	—
c	0.015	0.030	0.38	0.762	—
D	0.560	0.625	14.23	15.87	—
E	0.380	0.420	9.66	10.66	1
$e_2$	0.190	0.210	4.83	5.33	2
F	0.045	0.055	1.15	1.39	—
$H_1$	0.230	0.270	5.85	6.85	1
$J_1$	0.080	0.115	2.04	2.92	—
$L_2$	—	0.050	—	1.27	—
$L_3$	0.360	0.422	9.15	10.71	—
$\phi P$	0.139	0.147	3.531	3.733	—
Q	0.100	0.120	2.54	3.04	—
S	0.580	0.610	14.74	15.49	—

92CS-17990R 1

NOTES:

1. Tab contour optional within  $H_1$  and E.
2. Position of lead to be measured 0.050 – 0.055 in. (1.27 – 1.40 mm) below seating plane.

JEDEC TO-220AB



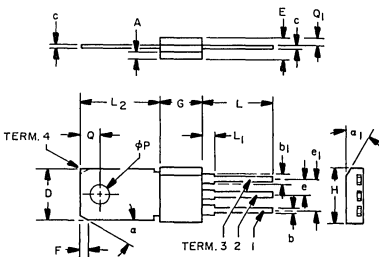
SYMBOL	INCHES		MILLIMETERS		NOTES
	MIN.	MAX.	MIN.	MAX.	
A	0.140	0.190	3.56	4.82	—
$\phi b$	0.020	0.045	0.51	1.14	—
$b_1$	0.045	0.070	1.15	1.77	—
c	0.015	0.030	0.38	0.762	—
D	0.560	0.625	14.23	15.87	—
E	0.380	0.420	9.66	10.66	1
e	0.090	0.110	2.29	2.79	2
$e_1$	0.190	0.210	4.83	5.33	2
F	0.045	0.055	1.15	1.39	—
$H_1$	0.230	0.270	5.85	6.85	1
$J_1$	0.080	0.115	2.04	2.92	—
L	0.500	0.562	12.70	14.27	—
$L_1$	—	0.250	—	6.35	—
$\phi P$	0.139	0.147	3.531	3.733	—
Q	0.100	0.120	2.54	3.04	—

92CS-17991R1

NOTES:

1. Tab contour optional within  $H_1$  and E.
2. Position of lead to be measured 0.250 – 0.255 in. (6.35 – 6.48 mm) from case.

RCP PLASTIC PACKAGE



92CS-24062

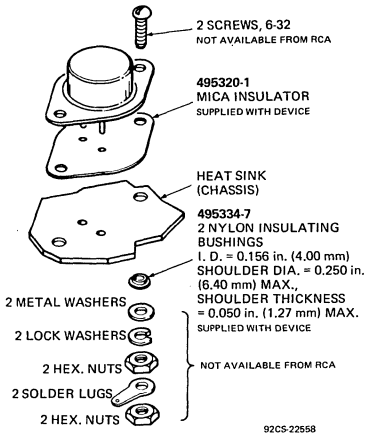
SYMBOL	INCHES		MILLIMETERS		NOTES
	MIN.	MAX.	MIN.	MAX.	
A	—	0.05	—	1.270	1
b	0.023	0.029	0.584	0.736	—
$b_1$	0.045	0.055	1.143	1.397	1
c	0.018	0.026	0.457	0.660	—
D	0.305	0.325	7.747	8.255	—
E	0.130	0.150	3.302	3.810	—
e	0.095	0.105	2.413	2.667	—
$e_1$	0.190	0.210	4.826	5.334	—
F	—	0.08	—	2.032	1
G	0.230	0.250	5.842	6.350	—
H	0.330	0.370	8.382	9.398	—
L	0.400	0.450	10.16	11.43	—
$L_1$	—	0.100	—	2.54	1,2
$L_2$	0.540	0.580	13.71	14.73	—
$\phi P$	0.123	0.127	3.124	3.225	—
Q	0.120	0.130	3.048	3.302	—
$Q_1$	0.039	0.050	0.990	1.270	—
a	—	35°	—	35°	1
$a_1$	—	50°	—	50°	1

NOTES:

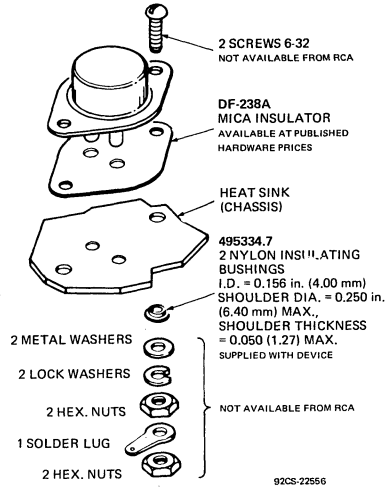
1. Package contour optional within dimensions specified.
2. Lead dimensions uncontrolled in this zone.
3. Chamfer on tab optional.
4. Controlling dimensions: inch.

HERMETIC PACKAGES

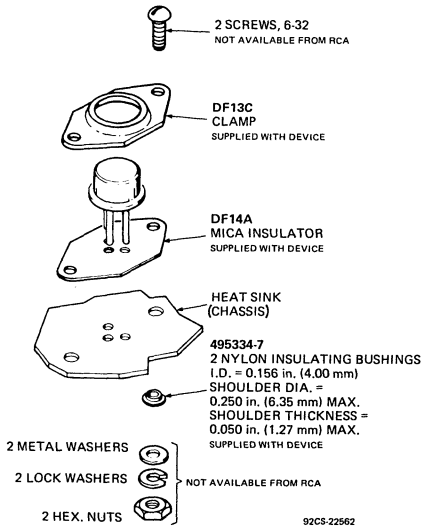
TO-3



Modified TO-3

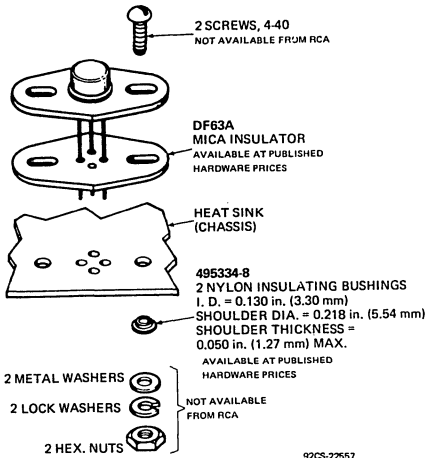


TO-8

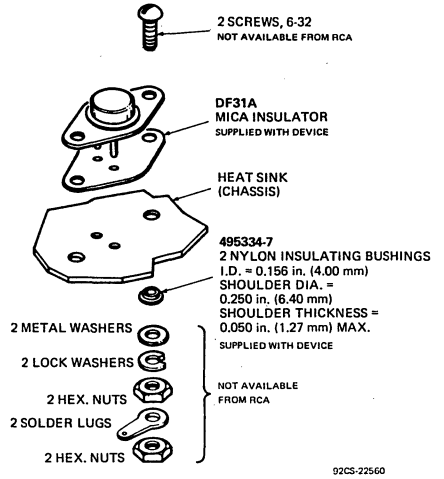




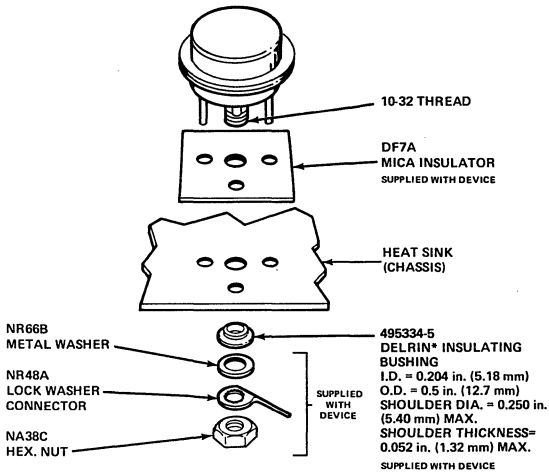
**TO-39 or TO-5  
With Flange**



**TO-66**

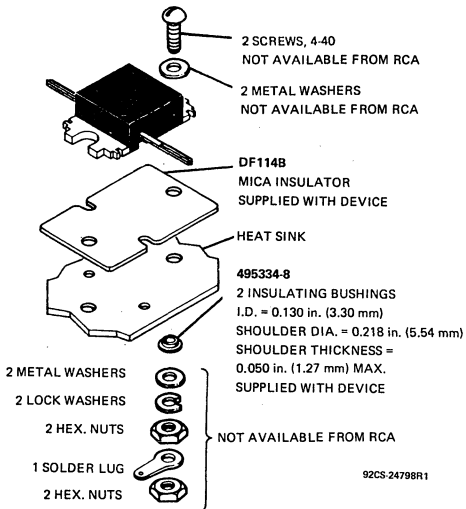


**TO-36**

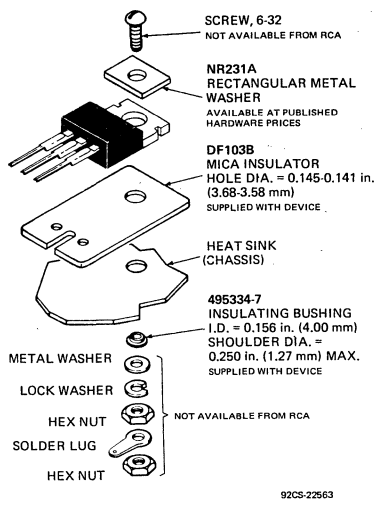


PLASTIC PACKAGES

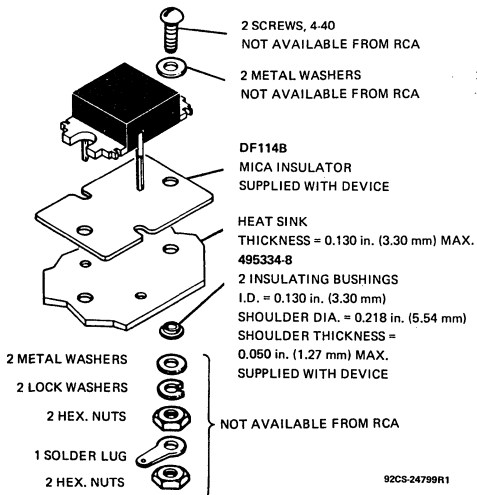
TO-219AB



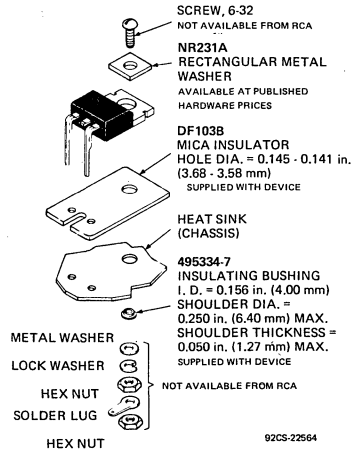
TO-220AB



TO-219AA



TO-220AA



# Application Notes

## **Operating Considerations for RCA Solid State Devices**

Solid state devices are being designed into an increasing variety of electronic equipment because of their high standards of reliability and performance. However, it is essential that equipment designers be mindful of good engineering practices in the use of these devices to achieve the desired performance.

This Note summarizes important operating recommendations and precautions which should be followed in the interest of maintaining the high standards of performance of solid state devices.

The ratings included in RCA Solid State Devices data bulletins are based on the Absolute Maximum Rating System, which is defined by the following Industry Standard (JEDEC) statement:

Absolute-Maximum Ratings are limiting values of operating and environmental conditions applicable to any electron device of a specified type as defined by its published data, and should not be exceeded under the worst probable conditions.

The device manufacturer chooses these values to provide acceptable serviceability of the device, taking no responsibility for equipment variations, environmental variations, and the effects of changes in operating conditions due to variations in device characteristics.

The equipment manufacturer should design so that initially and throughout life no absolute-maximum value for the intended service is exceeded with any device under the worst probable operating conditions with respect to supply-voltage variation, equipment component variation, equipment control adjustment, load variation, signal variation, environmental conditions, and variations in device characteristics.

It is recommended that equipment manufacturers consult RCA whenever device applications involve unusual electrical, mechanical or environmental operating conditions.

### **GENERAL CONSIDERATIONS**

The design flexibility provided by these devices makes possible their use in a broad range of applications and under

many different operating conditions. When incorporating these devices in equipment, therefore, designers should anticipate the rare possibility of device failure and make certain that no safety hazard would result from such an occurrence.

The small size of most solid state products provides obvious advantages to the designers of electronic equipment. However, it should be recognized that these compact devices usually provide only relatively small insulation area between adjacent leads and the metal envelope. When these devices are used in moist or contaminated atmospheres, therefore, supplemental protection must be provided to prevent the development of electrical conductive paths across the relatively small insulating surfaces. For specific information on voltage creepage, the user should consult references such as the JEDEC Standard No. 7 "Suggested Standard on Thyristors," and JEDEC Standard RS282 "Standards for Silicon Rectifier Diodes and Stacks".

The metal shells of some solid state devices operate at the collector voltage and for some rectifiers and thyristors at the anode voltage. Therefore, consideration should be given to the possibility of shock hazard if the shells are to operate at voltages appreciably above or below ground potential. In general, in any application in which devices are operated at voltages which may be dangerous to personnel, suitable precautionary measures should be taken to prevent direct contact with these devices.

Devices should not be connected into or disconnected from circuits with the power on because high transient voltages may cause permanent damage to the devices.

### **TESTING PRECAUTIONS**

In common with many electronic components, solid-state devices should be operated and tested in circuits which have reasonable values of current limiting resistance, or other forms of effective current overload protection. Failure to observe these precautions can cause excessive internal heating of the device resulting in destruction and/or possible shattering of the enclosure.

### TRANSISTORS AND THYRISTORS WITH FLEXIBLE LEADS

Flexible leads are usually soldered to the circuit elements. It is desirable in all soldering operations to provide some slack or an expansion elbow in each lead to prevent excessive tension on the leads. It is important during the soldering operation to avoid excessive heat in order to prevent possible damage to the devices. Some of the heat can be absorbed if the flexible lead of the device is grasped between the case and the soldering point with a pair of pliers.

### TRANSISTORS AND THYRISTORS WITH MOUNTING FLANGES

The mounting flanges of JEDEC-type packages such as the TO-3 or TO-66 often serve as the collector or anode terminal. In such cases, it is essential that the mounting flange be securely fastened to the heat sink, which may be the equipment chassis. Under no circumstances, however, should the mounting flange of a transistor be soldered directly to the heat sink or chassis because the heat of the soldering operation could permanently damage the device. Soldering is the preferred method for mounting thyristors; see "Rectifiers and Thyristors," below. Devices which cannot be soldered can be installed in commercially available sockets. Electrical connections may also be made by soldering directly to the terminal pins. Such connections may be soldered to the pins close to the pin seals provided care is taken to conduct excessive heat away from the seals; otherwise the heat of the soldering operation could crack the pin seals and damage the device.

During operation, the mounting-flange temperature is higher than the ambient temperature by an amount which depends on the heat sink used. The heat sink must have sufficient thermal capacity to assure that the heat dissipated in the heat sink itself does not raise the device mounting-flange temperature above the rated value. The heat sink or chassis may be connected to either the positive or negative supply.

In many applications the chassis is connected to the voltage-supply terminal. If the recommended mounting hardware shown in the data bulletin for the specific solid-state device is not available, it is necessary to use either an anodized aluminum insulator having high thermal conductivity or a mica insulator between the mounting-flange and the chassis. If an insulating aluminum washer is required, it should be drilled or punched to provide the two mounting holes for the terminal pins. The burrs should then be removed from the washer and the washer anodized. To insure that the anodized insulating layer is not destroyed during mounting, it is necessary to remove the burrs from the holes in the chassis.

It is also important that an insulating bushing, such as glass-filled nylon, be used between each mounting bolt and the chassis to prevent a short circuit. However, the insulating bushing should not exhibit shrinkage or softening under the operating temperatures encountered. Otherwise the thermal resistance at the interface between device and heat sink may increase as a result of decreasing pressure.

### PLASTIC POWER TRANSISTORS AND THYRISTORS

RCA power transistors and thyristors (SCR's and triacs) in molded-silicone-plastic packages are available in a wide range of power-dissipation ratings and a variety of package configurations. The following paragraphs provide guidelines for handling and mounting of these plastic-package devices, recommend forming of leads to meet specific mounting requirements, and describe various mounting arrangements, thermal considerations, and cleaning methods. This information is intended to augment the data on electrical characteristics, safe operating area, and performance capabilities in the technical bulletin for each type of plastic-package transistor or thyristor.

#### Lead-Forming Techniques

The leads of the RCA VERSAWATT in-line plastic packages can be formed to a custom shape, provided they are not indiscriminately twisted or bent. Although these leads can be formed, they are not flexible in the general sense, nor are they sufficiently rigid for unrestrained wire wrapping.

Before an attempt is made to form the leads of an in-line package to meet the requirements of a specific application, the desired lead configuration should be determined, and a lead-bending fixture should be designed and constructed. The use of a properly designed fixture for this operation eliminates the need for repeated lead bending. When the use of a special bending fixture is not practical, a pair of long-nosed pliers may be used. The pliers should hold the lead firmly between the bending point and the case, but should not touch the case.

When the leads of an in-line plastic package are to be formed, whether by use of long-nosed pliers or a special bending fixture, the following precautions must be observed to avoid internal damage to the device:

1. Restrain the lead between the bending point and the plastic case to prevent relative movement between the lead and the case.
2. When the bend is made in the plane of the lead (spreading), bend only the narrow part of the lead.
3. When the bend is made in the plane perpendicular to that of the leads, make the bend at least 1/8 inch from the plastic case.
4. Do not use a lead-bend radius of less than 1/16 inch.
5. Avoid repeated bending of leads.

The leads of the TO-220AB VERSAWATT in-line package are not designed to withstand excessive axial pull. Force in this direction greater than 4 pounds may result in permanent damage to the device. If the mounting arrangement tends to impose axial stress on the leads, some method of strain relief should be devised.

Wire wrapping of the leads is permissible, provided that the lead is restrained between the plastic case and the point of the wrapping. Soldering to the leads is also allowed. The maximum soldering temperature, however, must not exceed 275°C and must be applied for not more than 5 seconds at a distance not less than 1/8 inch from the plastic case. When

wires are used for connections, care should be exercised to assure that movement of the wire does not cause movement of the lead at the lead-to-plastic junctions.

The leads of RCA molded-plastic high-power packages are not designed to be reshaped. However, simple bending of the leads is permitted to change them from a standard vertical to a standard horizontal configuration, or conversely. Bending of the leads in this manner is restricted to three 90-degree bends; repeated bendings should be avoided.

#### Mounting

Recommended mounting arrangements and suggested hardware for the VERSAWATT package are given in the data bulletins for specific devices and in RCA Application Note AN-4142. When the package is fastened to a heat sink, a rectangular washer (RCA Part No. NR231A) is recommended to minimize distortion of the mounting flange. Excessive distortion of the flange could cause damage to the package. The washer is particularly important when the size of the mounting hole exceeds 0.140 inch (6-32 clearance). Larger holes are needed to accommodate insulating bushings; however, the holes should not be larger than necessary to provide hardware clearance and, in any case, should not exceed a diameter of 0.250 inch.

Flange distortion is also possible if excessive torque is used during mounting. A maximum torque of 8 inch-pounds is specified. Care should be exercised to assure that the tool used to drive the mounting screw never comes in contact with the plastic body during the driving operation. Such contact can result in damage to the plastic body and internal device connections. An excellent method of avoiding this problem is to use a spacer or combination spacer-isolating bushing which raises the screw head or nut above the top surface of the plastic body. The material used for such a spacer or spacer-isolating bushing should, of course, be carefully selected to avoid "cold flow" and consequent reduction in mounting force. Suggested materials for these bushings are diallphthalate, fiberglass-filled nylon, or fiberglass-filled polycarbonate. Unfilled nylon should be avoided.

Modification of the flange can also result in flange distortion and should not be attempted. The package should not be soldered to the heat sink by use of lead-tin solder because the heat required with this type of solder will cause the junction temperature of the device to become excessively high.

The TO-220AA plastic package can be mounted in commercially available TO-66 sockets, such as UID Electronics Corp. Socket No. PTS-4 or equivalent. For testing purposes, the TO-220AB in-line package can be mounted in a Jetron Socket No. DC74-104 or equivalent. Regardless of the mounting method, the following precautions should be taken:

1. Use appropriate hardware.
2. Always fasten the package to the heat sink before the leads are soldered to fixed terminals.
3. Never allow the mounting tool to come in contact with the plastic case.

4. Never exceed a torque of 8 inch-pounds.
5. Avoid oversize mounting holes.
6. Provide strain relief if there is any probability that axial stress will be applied to the leads.
7. Use insulating bushings to prevent hot-creep problems. Such bushings should be made of diallphthalate, fiberglass-filled nylon, or fiberglass-filled polycarbonate.

The maximum allowable power dissipation in a solid state device is limited by the junction temperature. An important factor in assuring that the junction temperature remains below the specified maximum value is the ability of the associated thermal circuit to conduct heat away from the device.

When a solid state device is operated in free air, without a heat sink, the steady-state thermal circuit is defined by the junction-to-free-air thermal resistance given in the published data for the device. Thermal considerations require that a free flow of air around the device is always present and that the power dissipation be maintained below the level which would cause the junction temperature to rise above the maximum rating. However, when the device is mounted on a heat sink, care must be taken to assure that all portions of the thermal circuit are considered.

To assure efficient heat transfer from case to heat sink when mounting RCA molded-plastic solid state power devices, the following special precautions should be observed:

1. Mounting torque should be between 4 and 8 inch-pounds.
2. The mounting holes should be kept as small as possible.
3. Holes should be drilled or punched clean with no burrs or ridges, and chamfered to a maximum radius of 0.010 inch.
4. The mounting surface should be flat within 0.002 inch/inch.
5. Thermal grease (Dow Corning 340 or equivalent) should always be used on both sides of the insulating washer if one is employed.
6. Thin insulating washers should be used. (Thickness of factory-supplied mica washers range from 2 to 4 mils).
7. A lock washer or torque washer, made of material having sufficient creep strength, should be used to prevent degradation of heat sink efficiency during life.

A wide variety of solvents is available for degreasing and flux removal. The usual practice is to submerge components in a solvent bath for a specified time. However, from a reliability stand point it is extremely important that the solvent, together with other chemicals in the solder-cleaning system (such as flux and solder covers), do not adversely affect the life of the component. This consideration applies to all non-hermetic and molded-plastic components.

It is, of course, impractical to evaluate the effect on long-term device life of all cleaning solvents, which are marketed with numerous additives under a variety of brand names. These solvents can, however, be classified with

respect to their component parts as either acceptable or unacceptable. Chlorinated solvents tend to dissolve the outer package and, therefore, make operation in a humid atmosphere unreliable. Gasoline and other hydrocarbons cause the inner encapsulant to swell and damage the transistor. Alcohol is an acceptable solvent. Examples of specific, acceptable alcohols are isopropanol, methanol, and special denatured alcohols, such as SDA1, SDA30, SDA34, and SDA44.

Care must also be used in the selection of fluxes for lead soldering. Rosin or activated rosin fluxes are recommended, while organic or acid fluxes are not. Examples of acceptable fluxes are:

1. Alpha Reliaros No. 320-33
2. Alpha Reliaros No. 346
3. Alpha Reliaros No. 711
4. Alpha Reliafoam No. 807
5. Alpha Reliafoam No. 809
6. Alpha Reliafoam No. 811-13
7. Alpha Reliafoam No. 815-35
8. Kester No. 44

If the completed assembly is to be encapsulated, the effect on the molded-plastic transistor must be studied from both a chemical and a physical standpoint.

#### RECTIFIERS AND THYRISTORS

A surge-limiting impedance should always be used in series with silicon rectifiers and thyristors. The impedance value must be sufficient to limit the surge current to the value specified under the maximum ratings. This impedance may be provided by the power transformer winding, or by an external resistor or choke.

A very efficient method for mounting thyristors utilizing the "modified TO-5" package is to provide intimate contact between the heat sink and at least one half of the base of the device opposite the leads. This package can be mounted to the heat sink mechanically with glue or an epoxy adhesive, or by soldering, the most efficient method.

The use of a "self-jigging" arrangement and a solder preform is recommended. If each unit is soldered individually, the heat source should be held on the heat sink and the solder on the unit. Heat should be applied only long enough to permit solder to flow freely. For more detailed thyristor mounting considerations, refer to Application Note AN3822, "Thermal Considerations in Mounting of RCA Thyristors".

#### MOS FIELD-EFFECT TRANSISTORS

Insulated-Gate Metal Oxide-Semiconductor Field-Effect Transistors (MOS FETs), like bipolar high-frequency transistors, are susceptible to gate insulation damage by the electrostatic discharge of energy through the devices. Electrostatic discharges can occur in an MOS FET if a type with an unprotected gate is picked up and the static charge, built in the handler's body capacitance, is discharged through the device. With proper handling and applications procedures, however, MOS transistors are currently being extensively used in production by numerous equipment manufacturers in military, industrial, and consumer applica-

tions, with virtually no problems of damage due to electrostatic discharge.

In some MOS FETs, diodes are electrically connected between each insulated gate and the transistor's source. These diodes offer protection against static discharge and in-circuit transients without the need for external shorting mechanisms. MOS FETs which do not include gate-protection diodes can be handled safely if the following basic precautions are taken:

1. Prior to assembly into a circuit, all leads should be kept shorted together either by the use of metal shorting springs attached to the device by the vendor, or by the insertion into conductive material such as "ECCOSORB\* LD26" or equivalent.  
(NOTE: Polystyrene *insulating* "SNOW" is not sufficiently conductive and should not be used.)
2. When devices are removed by hand from their carriers, the hand being used should be grounded by any suitable means, for example, with a metallic wristband.
3. Tips of soldering irons should be grounded.
4. Devices should never be inserted into or removed from circuits with power on.

#### RF POWER TRANSISTORS

##### Mounting and Handling

Stripline rf devices should be mounted so that the leads are not bent or pulled away from the stud (heat sink) side of the device. When leads are formed, they should be supported to avoid transmitting the bending or cutting stress to the ceramic portion of the device. Excessive stresses may destroy the hermeticity of the package without displaying visible damage.

Devices employing silver leads are susceptible to tarnishing; these parts should not be removed from the original tarnish-preventive containers and wrappings until ready for use. Lead solderability is retarded by the presence of silver tarnish; the tarnish can be removed with a silver cleaning solution, such as thiourea.

The ceramic bodies of many rf devices contain beryllium oxide as a major ingredient. These portions of the transistors should not be crushed, ground, or abraded in any way because the dust created could be hazardous if inhaled.

##### Operating

**Forward-Biased Operation.** For Class A or AB operation, the allowable quiescent bias point is determined by reference to the infrared safe-area curve in the appropriate data bulletin. This curve depicts the safe current/voltage combinations for extended continuous operation.

**Load VSWR.** Excessive collector load or tuning mismatch can cause device destruction by over-dissipation or secondary breakdown. Mismatch capability is generally included on the data bulletins for the more recent rf transistors.

See RCA RF Power Transistor Manual, Technical Series RMF-430, pp 39-41, for additional information concerning the handling and mounting of rf power transistors.

\*Trade Mark: Emerson and Cumming, Inc.

## INTEGRATED CIRCUITS

### Handling

All COS/MOS gate inputs have a resistor/diode gate protection network. All transmission gate inputs and all outputs have diode protection provided by inherent p-n junction diodes. These diode networks at input and output interfaces protect COS/MOS devices from gate-oxide failure in handling environments where static discharge is not excessive. In low-temperature, low-humidity environments, improper handling may result in device damage. See ICAN-6000, "Handling and Operating Considerations for MOS Integrated Circuits", for proper handling procedures.

### Mounting

Integrated circuits are normally supplied with lead-tin plated leads to facilitate soldering into circuit boards. In those relatively few applications requiring welding of the device leads, rather than soldering, the devices may be obtained with gold or nickel plated Kovar leads.\* It should be recognized that this type of plating will not provide complete protection against lead corrosion in the presence of high humidity and mechanical stress. The aluminum-foil-lined cardboard "sandwich pack" employed for static protection of the flat-pack also provides some additional protection against lead corrosion, and it is recommended that the devices be stored in this package until used.

When integrated circuits are welded onto printed circuit boards or equipment, the presence of moisture between the closely spaced terminals can result in conductive paths that may impair device performance in high-impedance applications. It is therefore recommended that conformal coatings or potting be provided as an added measure of protection against moisture penetration.

In any method of mounting integrated circuits which involves bending or forming of the device leads, it is extremely important that the lead be supported and clamped between the bend and the package seal, and that bending be done with care to avoid damage to lead plating. In no case should the radius of the bend be less than the diameter of the lead, or in the case of rectangular leads, such as those used in RCA 14-lead and 16-lead flat-packages, less than the lead thickness. It is also extremely important that the ends of the bent leads be straight to assure proper insertion through the holes in the printed-circuit board.

### Operating

#### Unused Inputs

All unused input leads must be connected to either  $V_{SS}$  or  $V_{DD}$ , whichever is appropriate for the logic circuit involved. A floating input on a high-current type, such as the CD4049 or CD4050, not only can result in faulty logic operation, but can cause the maximum power dissipation of 200 milliwatts to be exceeded and may result in damage to the device. Inputs to these types, which are mounted on printed-circuit boards that may temporarily become unterminated, should have a pull-up resistor to  $V_{SS}$  or  $V_{DD}$ . A useful range of values for such resistors is from 10 kilohms to 1 megohm.

### Input Signals

Signals shall not be applied to the inputs while the device power supply is off unless the input current is limited to a steady state value of less than 10 milliamperes. Input currents of less than 10 milliamperes prevent device damage; however, proper operation may be impaired as a result of current flow through structural diode junctions.

### Output Short Circuits

Shorting of outputs to  $V_{SS}$  or  $V_{DD}$  can damage many of the higher-output-current COS/MOS types, such as the CD4007, CD4041, CD4049, and CD4050. In general, these types can all be safely shorted for supplies up to 5 volts, but will be damaged (depending on type) at higher power-supply voltages. For cases in which a short-circuit load, such as the base of a p-n-p or an n-p-n bipolar transistor, is directly driven, the device output characteristics given in the published data should be consulted to determine the requirements for a safe operation below 200 milliwatts.

For detailed COS/MOS IC operating and handling considerations, refer to Application Note ICAN-6000 "Handling and Operating Considerations for MOS Integrated Circuits".

## SOLID STATE CHIPS

Solid state chips, unlike packaged devices, are non-hermetic devices, normally fragile and small in physical size, and therefore, require special handling considerations as follows:

1. Chips must be stored under proper conditions to insure that they are not subjected to a moist and/or contaminated atmosphere that could alter their electrical, physical, or mechanical characteristics. After the shipping container is opened, the chip must be stored under the following conditions:
  - A. Storage temperature, 40°C max.
  - B. Relative humidity, 50% max.
  - C. Clean, dust-free environment.
2. The user must exercise proper care when handling chips to prevent even the slightest physical damage to the chip.
3. During mounting and lead bonding of chips the user must use proper assembly techniques to obtain proper electrical, thermal, and mechanical performance.
4. After the chip has been mounted and bonded, any necessary procedure must be followed by the user to insure that these non-hermetic chips are not subjected to moist or contaminated atmosphere which might cause the development of electrical conductive paths across the relatively small insulating surfaces. In addition, proper consideration must be given to the protection of these devices from other harmful environments which could conceivably adversely affect their proper performance.

\*Mil-M-38510A, paragraph 3.5.6.1 (a), lead material.



## Silicon Transistors for High-Voltage Application

by  
D. T. DeFino

This note discusses several new applications for RCA high-voltage silicon transistors (2N3583, 2N3584, 2N3585, 2N3439 and 2N3440). These devices are triple-diffused n-p-n types featuring high frequency response, fast switching speeds, and low cost. Electrical characteristics are listed in Table I.

The advent of these types has made possible many new applications for transistors. Among these applications are circuits in which, until now, the use of transistors was restricted because of high operating voltages (horizontal-deflection circuits, for example). Other applications include those in which the use of a higher supply voltage can enhance circuit design, performance, and economy. High supply voltages reduce the cost of line-operated amplifiers, and improve the efficiency of inverters. Several other important applications are illustrated.

### Series Voltage Regulator

A voltage regulator provides a constant output voltage when the input voltage and/or output current is varied over a limited range. As shown in Fig. 1,

the pass transistor, acting on a signal from the control circuit, prevents the output voltage  $V_{out}$  from varying. The control circuit receives a sample of the output voltage, compares it with a reference voltage, and

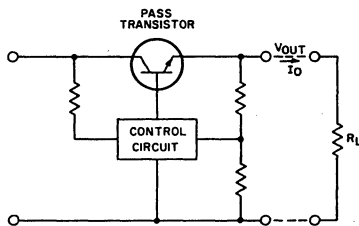


Fig. 1 - Basic form of a transistorized series voltage regulator.

amplifies the difference. The resulting error signal corrects the collector current  $I_C$  of the pass transistor so that the collector-to-emitter voltage  $V_{CE}$  is always

#### Maximum Ratings, Absolute-Maximum Values:

	2N3583	2N3584	2N3585	2N3439	2N3440	
COLLECTOR-TO-BASE VOLTAGE, $V_{CBO}$ ..	250	375	500	450	300	Volts
COLLECTOR-TO-EMITTER VOLTAGE, $V_{CEO(sus)}$ .....	175	250	300	350	250	Volts
EMITTER-TO-BASE VOLTAGE, $V_{EBO}$ .....	6	6	6	7	7	Volts
CONTINUOUS COLLECTOR CURRENT, $I_C$ .....	2	2	2	1	1	Amp
PEAK COLLECTOR CURRENT .....	5	5	5	-	-	Amp
BASE CURRENT, $I_B$ .....	1	1	1	0.5	0.5	Amp
TRANSISTOR DISSIPATION, $P_T$ .....	35	35	35	5	5	Watts

Table I - Electrical characteristics of RCA high-voltage silicon transistors.

the difference between the input voltage  $V_{in}$  and the desired output voltage.

The simplest circuit arrangement for a transistor voltage regulator is shown in Fig. 2. The circuit consists of a transistor, a resistor, and a zener diode. Because the zener diode maintains the base of the transistor at a constant voltage, changes in output can result only from variations in the base-to-emitter voltage  $V_{BE}$  with current and temperature. A zener diode having a high current rating is required if large currents are drawn from the transistor.

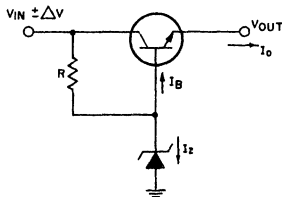


Fig. 2 - Simplest circuit arrangement for a transistor voltage regulator.

The maximum value of resistance  $R$  which can be used in the circuit is determined as follows:

$$R = \frac{V_{in} - \Delta V - V_{out}}{I_B(\max)}$$

Because the maximum base current  $I_B(\max)$  is equal to  $I_O(\max)/h_{FE}(\min)$ , where  $I_O$  is the output current and  $h_{FE}$  is the dc forward-current transfer ratio, the resistance equation can be rewritten as follows:

$$R = \frac{V_{in} - \Delta V - V_{out}}{I_O(\max)} \times h_{FE}(\min)$$

The zener diode must be capable of handling a peak current  $I_Z$  given by

$$I_Z = \frac{V_{in} + \Delta V - V_{out}}{R} = \frac{[V_{in} + \Delta V - V_{out}][I_O(\max)]}{[V_{in} - \Delta V - V_{out}][h_{FE}(\min)]}$$

In the series regulator, the pass transistor must remain always in the active region. For this reason, the pass transistor must be chosen carefully to avoid dc forward-bias second breakdown. As shown in Fig. 3, under the worst-case condition  $I_O(\max)$ ,  $V_{in}(\min)$ , the bias point of the transistor must be within the dc forward-bias second-breakdown rating  $P_{S/b}$ , or the dc power-dissipation rating  $P_{dc}$ , whichever is the limiting factor. From the equations given above, it is obvious that near the operating point  $h_{FE}$  should be as high as possible. In general, leakage current and saturation voltage are not important.

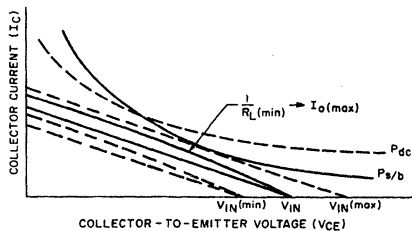


Fig. 3 - Transistor load line.

#### Design Example

The following conditions are specified for a series voltage regulator:

$$\begin{aligned} V_{out} &= 100 \text{ V} \\ I_O(\max) &= 400 \text{ mA} \\ V_{in} &= 135 \pm 15 \text{ V} \\ h_{FE}(\min) &= 20 \end{aligned}$$

Circuit values are then determined as follows:

$$R = \frac{(135 - 15 - 100) 20}{0.4} = \frac{400}{0.4} = 1 \text{ k}\Omega \text{ at } 2.5 \text{ W}$$

$$I_B(\max) = \frac{0.4}{20} = 20 \text{ mA}$$

$$I_Z = \frac{135 + 15 - 100}{1000} = \frac{50}{1000} = 50 \text{ mA}$$

Therefore, the zener-diode requirements are  $V_Z = 100 \text{ V}$ ,  $I_Z = 50 \text{ mA}$ ,  $P_Z = 5 \text{ W}$ . Under worst-case conditions, the transistor must be capable of handling 400 milliamperes at 50 volts, or a dissipation of 20 watts. In addition, the point 50 V and 400 mA must be within the dc second-breakdown rating of the transistor. Fig. 4 shows the circuit values for this regulator.

The power-dissipation rating of the resistor and zener diode can be reduced by addition of another transistor (usually much smaller in dissipation) in a configuration such as that shown in Fig. 5. This arrangement effectively increases the over-all minimum gain. The two transistors can be regarded as one in which the effective  $h_{FE}$  (approximately the product of the gain of the two transistors) can be substituted for  $h_{FE}$  in the previous equations. Because the 2N3440 has a minimum gain of 40 at 20 mA, the minimum effective gain is  $(40)(20) = 800$ . From this value, the new resistor and zener diode requirements can be calculated as follows:

$$R = \frac{(135 - 15 - 100) 800}{0.4} = 40 \text{ k}\Omega \text{ at } 0.062 \text{ W}$$

$$I_Z = \frac{135 + 15 - 100}{40000} = \frac{50}{40000} = 1.25 \text{ mA}$$

$$P_Z = 125 \text{ mW}$$

The maximum power dissipated by the 2N3440 transistor in this circuit is  $(20 \text{ mA})(50 \text{ V}) = 1 \text{ W}$ .

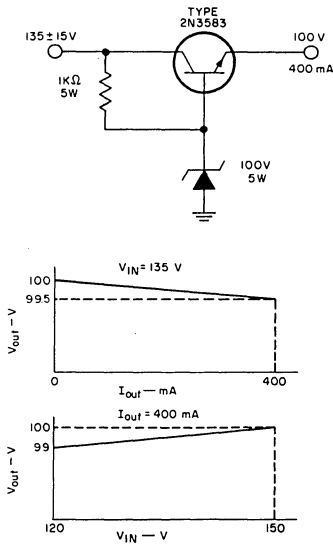


Fig. 4 - Schematic diagram of a simple transistor voltage regulator.

The disadvantage of the circuit of Fig. 5 as compared with that of Fig. 4 is that voltage regulation is less sensitive because there are two junctions to create  $V_{\text{BE}}$  variations with current and voltage changes.

Fig. 6 shows a feedback arrangement designed to improve regulation. In this circuit, the output is sampled and compared with a very stable reference voltage. The resulting error signal is used to adjust the bias on the pass transistor. The requirements for  $Q_3$  are determined in the same manner as those for the zener diode in the preceding circuits. The zener-diode current  $I_{\text{Z(max)}}$  is equal to the collector current  $I_{\text{C(max)}}$  of  $Q_3$  divided by the minimum gain of  $Q_3$  at  $I_{\text{C(max)}}$ .

In general, the full load voltage need not be fed back. Instead, a voltage divider can be used to reduce the voltage requirement on the zener diode. Although the voltage divider also degrades the performance, this method must be used if a variable output voltage is required. Fig. 7 shows a typical high-voltage regulator that provides an output variable from  $175$  to  $225$  volts and delivers up to  $150\text{ mA}$ . Performance curves for this circuit are shown in Fig. 8.

#### Switching Regulator

The advantage of a transistorized switching regulator, such as that shown in Fig. 9, is its extremely high efficiency. It does not, however, provide the

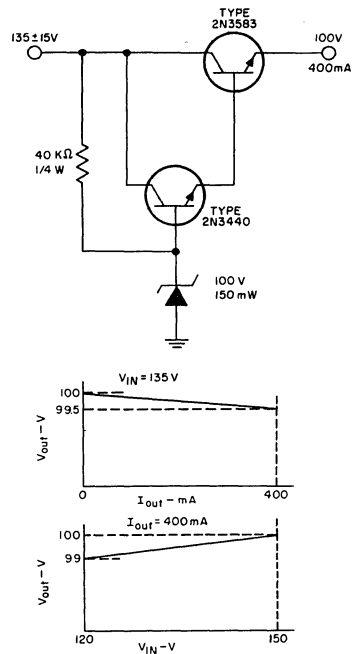


Fig. 5 - Schematic diagram of a series voltage regulator using darlington driver.

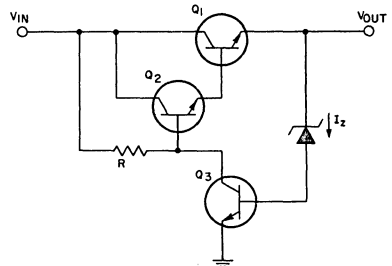


Fig. 6 - Schematic diagram of a series voltage regulator employing feedback amplifier.

excellent regulation obtainable from a series-type regulator. For this reason, a switching regulator is normally used as a coarse or pre-regulator preceding a series regulator. The switching regulator is highly efficient because the transistor switch is either saturated or cut off. Because both of these conditions are states of low dissipation, very little power is lost in the transistor.

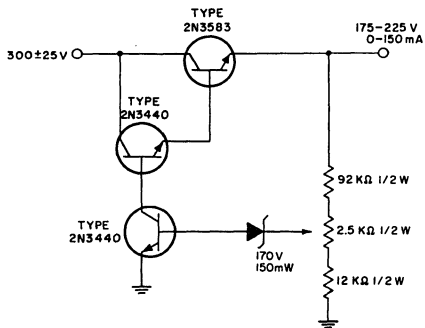


Fig. 7 - Schematic diagram of a typical series high-voltage regulator.

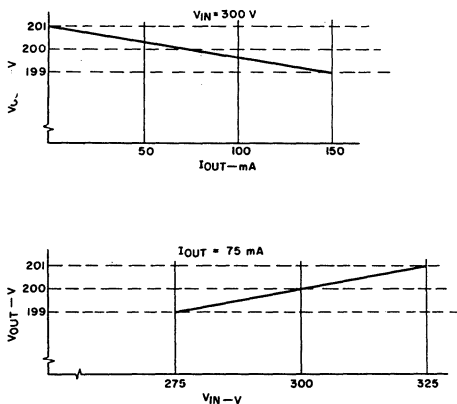


Fig. 8 - Regulation characteristics for circuit shown in Fig. 7.

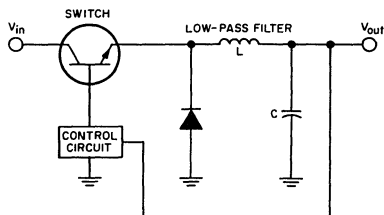


Fig. 9 - Simplest form of a transistor switching regulator.

The function of the feedback circuit is to sample the output voltage and compare it with a reference voltage. The difference between these two voltages is used to modulate the pulse width of a pulse generator. This modulated pulse signal is then applied to the base of the switch. Thus, if the output voltage tends to decrease, the pulse width is increased so that the switch remains ON longer to allow the output to increase. Conversely, if the output tends to increase above the desired value, the duty cycle decreases.

When the transistor switch is ON, current flows into the load and into the output capacitor through the inductor. Energy is stored in the inductor and capacitor so that when the switch is OFF, this energy is available to supply the load. During the ON time, the current through the inductor is a linear ramp. The rate of increase of current ( $\Delta I/\Delta t$ ) is determined by the value of the inductance  $L$  and the voltage across it ( $V_{in} - V_{out}$ ) as follows:

$$\frac{\Delta I}{\Delta t} = \frac{1}{L} (V_{in} - V_{out})$$

The peak current is therefore given by

$$I_p = \frac{V_{in} - V_{out}}{L} (t_{on})$$

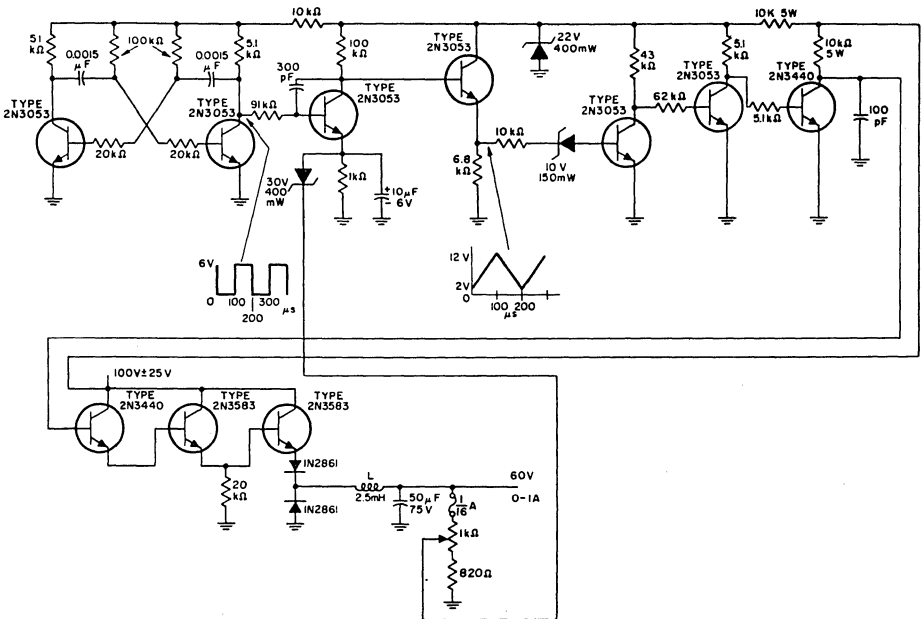
The transistor chosen for this application must provide sufficiently fast switching times, i.e., rise time  $t_r$  and fall time  $t_f$ . For good regulation over a wide range of input voltage and output current, the duty cycle must be variable from 10 to 90 per cent. Consequently, the minimum pulse width should be one-tenth of the period ( $1/10f$ ). For low switching losses, the rise and fall times should be about one-fifth of the minimum pulse width, or one-fiftieth of the frequency of the pulse generator ( $1/50f$ ).

A switching regulator can also be used as a dc step-down transformer. In this application, the regulator provides a very efficient method of obtaining low dc voltage directly from a high-voltage ac line. Fig. 10 shows a typical step-down switching regulator which utilizes the dc voltage obtained by rectification of a 117-volt ac line source to provide a regulated 60-volt supply. Performance characteristics for the circuit are shown in Fig. 11.

### Inverters

An inverter is used to transform dc power to ac power. If the ac output is rectified and filtered to provide dc again, the over-all circuit is referred to as a converter. A converter is normally employed to change the magnitude of an available dc supply.

A transistorized inverter can be made very light in weight and small in size. It is a highly efficient circuit and, unlike its mechanical counterpart, has no



L = 60-turns # 18 wire,  
 core: Carpenter 49 or equiv., 21 E I 0.014-in. laminations  
 not interleaved. Use 0.015-in. air gap.  
 All resistors 1/2-watt unless specified otherwise.

Fig. 10 - Schematic diagram of a typical step-down switching regulator.

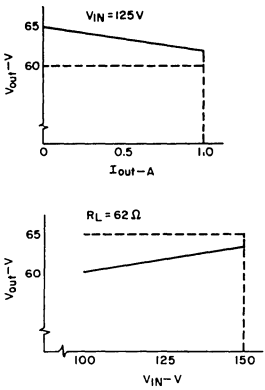


Fig. 11 - Performance curves for circuit shown in Fig. 10.

moving components. The output from the inverter can be used to drive any equipment which requires an ac supply (motors, ac radios, television receivers, fluorescent lights, and the like). Another very important application of an inverter is in driving the electro-mechanical transducers used in ultrasonic equipment (such as ultrasonic cleaners and sonar detection devices).

The operating frequency of an inverter is usually fixed between 60 Hz and 100 kHz, depending upon the application. For applications in which the operating frequency can be chosen by the designer, the highest possible frequency should be selected.

In general, the size and weight of the inverter can be decreased as the supply voltage and frequency are increased. This relation results mainly from the decreasing size of the transformer needed. The upper frequency and supply voltage are limited by the transistors used. The collector-to-emitter breakdown voltage, for example, must be greater than twice the supply voltage, and the gain-bandwidth product  $f_T$  of the device should be greater than ten times the operating frequency. The latter requirement is necessary because switching

losses become significant when the rise and fall times of the transistor are greater than about one-fifth of the pulse width.

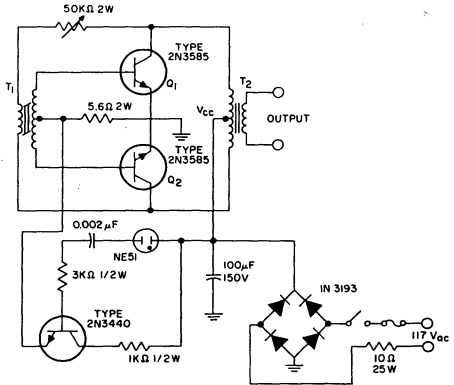
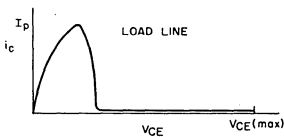
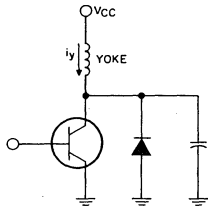
The important parameters to be considered in the selection of a transistor for an inverter circuit are summarized below:

- $V_{CER(sus)} \geq 2V_{CC} + \text{leakage reactance spikes}$
- High gain (to reduce feedback power and increase efficiency)
- $f_T \geq 10f$  (to reduce switching losses)
- $I_{S/b} \geq \text{highest starting bias current at } V_{CC}$
- $E_{S/b} \geq \text{max. energy stored in the output-transformer leakage inductance.}$

Fig.12 shows the circuit diagram for a 100-watt inverter which operates directly from a rectified ac-line voltage. The frequency is varied from 25 kHz to 40 kHz by adjustment of the feedback resistor. At 100 watts output, the efficiency is about 90 to 95 per cent, depending upon the frequency. The supply voltage is nominally 140 volts, but can rise to 155 volts during high ac-line-voltage conditions.

**Magnetic Deflection Circuit**

The electron beam of a magnetically driven display tube is swept across the face of the tube by a linearly changing magnetic field. This deflecting field is produced by a linear ramp of current through the deflection yoke which surrounds the neck of the tube. Fig.13 shows a transistorized magnetic deflection circuit and the corresponding current and voltage waveforms.



- T1 = Allen Bradley RO-3 (E1102H 142A) or equiv.  
primary: 160-turn #32 wire;  
secondary: each 3-turns #32 wire.
- T2 = Indiana General C2 material (CF216) or equiv.  
primary and secondary: 80-turns #28 wire.

Fig.12 - Schematic diagram of a line-operated 100-watt inverter.

The transistor acts as a switch to apply a constant voltage to the inductor. Then, according to the following equation, the current increases linearly to  $I_p$  during one-half the sweep time  $t_s$ :

$$\frac{\Delta I}{\Delta t} = \frac{V}{L} \quad \Delta I = \frac{V_{CC}}{L} \Delta t, \quad I_p = \frac{V_{CC} t_s}{L \cdot 2}$$

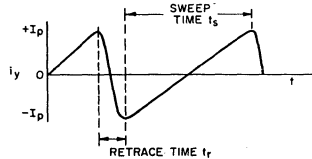


Fig.13 - Basic configuration for a transistor magnetic deflection circuit showing corresponding current and voltage waveforms.

When the transistor is turned off, LC forms a tuned circuit in which the yoke current decreases very rapidly (retrace time  $t_r$ ) through zero to  $-I_p$ . At this point capacitor C has a negative voltage across it, the diode is forward-biased, and the yoke current begins to increase toward zero. At this point the cycle begins again.

During the retrace time, when the yoke current is decreasing from  $I_p$  to  $-I_p$ , the voltage across the transistor becomes quite high. The collector-to-emitter voltage is given by

$$V_{CE(\max)} = V_{CC} + I_p \omega L$$

The term  $\omega$  can be expressed as follows:

$$\omega = \frac{1}{\sqrt{LC}} = \frac{\pi}{t_r}$$

Therefore, the equation for  $V_{CE(\max)}$  may be rewritten as follows:

$$V_{CE(\max)} = V_{CC} + \sqrt{\frac{L}{C}} I_p$$

The energy E supplied to the yoke is given by

$$E = \frac{1}{2} L I_p^2$$

In the design of a deflection circuit, this required energy is fixed by the picture tube being used. The sweep time and retrace time are both fixed by the application. There are, therefore, only three parameters which can be varied by the designer:  $I_p$ ,  $V_{CC}$ , and L. From the energy equation, it is evident that the value chosen for L determines  $I_p$ , and vice versa. However, the value of  $I_p$  is given by

$$I_p = \frac{V_{CC} t_s}{L \cdot 2}$$

Therefore, for a given value of  $I_p$  it is apparent that  $V_{CC}$  also becomes fixed. At this point, the peak voltage swing across the transistor can be calculated from the following equation:

$$V_{CE(\max)} = V_{CC} + I_p \frac{\pi}{t_r} L$$

When these values have been determined, the designer must choose a transistor to meet the requirements imposed by the circuit.

The breakdown voltage ( $BV_{CEO}$ ,  $BV_{CER}$ ,  $BV_{CES}$ ,  $BV_{CEX}$ , depending upon the drive-circuit impedance between the base to emitter of the output transistor), should be greater than 1.3  $V_{EE(\max)}$ , as determined above. This safety factor allows for stray inductance and transients.

A sustaining voltage rating is not required because the collector current drops to zero before the voltage swings out (as shown by the waveform in Fig. 13) if the transistor turn-off time is less than half the retrace time. However, if the turn-off is greater than one-half the retrace time, a sustaining voltage rating should be

used. In addition, the transistor not only must be able to handle the peak collector current, but should also have usable current gain at this level ( $I_C = I_p$ ). At the same time, the  $V_{CE(\text{sat})}$  of the transistor at  $I_p$  should be as low as possible to minimize the power dissipation. In practice, both of these requirements are guaranteed by a specification such as:

$$V_{CE(\text{sat})} \text{ (at } I_C = I_p, I_B = \frac{I_p}{15}) = 1.5 \text{ V max.}$$

Another important parameter of the output transistor is switching speed. For good linearity, the turn-on time of the transistor should be less than one-tenth of the total on-time of the device (approximately half the sweep time). The turn-off time, meanwhile, should be at least one-quarter of the retrace time to reduce the high-energy dissipation, which could cause reverse-biased second-breakdown problems.

#### Design Example

The object of this example is to illustrate the design of a magnetic deflection circuit for a specific yoke. The yoke, Celco HD 428-S560 or equivalent, is used to drive a cathode-ray tube for an alpha-numeric display with a 36-degree full-deflection angle and a 12-kilovolt acceleration potential. The yoke inductance is 250 microhenries and the energy required is 225 microjoules. The sweep time is 50 microseconds and the retrace time 10 microseconds.

From this information, the peak collector current  $I_p$  of the deflection-circuit transistor is calculated as follows:

$$I_p = \sqrt{\frac{2(225) \cdot 10^{-6}}{250 \cdot 10^{-6}}} = 1.35 \text{ A}$$

The supply voltage  $V_{CC}$  required is given by

$$V_{CC} = \frac{2 L I_p}{t_s} = \frac{2(250 \cdot 10^{-6})(1.35)}{50 \cdot 10^{-6}} = 13.5 \text{ V}$$

The tuning-capacitor value C is given by

$$C = \left(\frac{t_r}{\pi}\right)^2 \left(\frac{1}{L}\right) = \frac{100 \cdot 10^{-12}}{(\pi)^2 250 \cdot 10^{-6}} = .040 \mu\text{F}$$

Finally, the maximum collector voltage  $V_{CE}$  is given by

$$V_{CE} = 13.5 + (1.35) \frac{\pi}{(10) \cdot 10^{-6}} 250 \cdot 10^{-6} = 118 \text{ V}$$

The breakdown voltage, therefore, must be greater than  $(118)(1.3) = 155 \text{ V}$ .

The 2N3584 meets all of the requirements for this application. The transistor switching times are short, its gain is 25 minimum at 1 ampere, and its voltage ratings are well above the required minimum. The circuit diagram and waveforms are shown in Figs. 14 and 15, respectively.

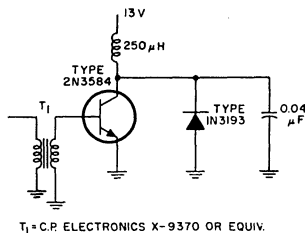


Fig.14 - Schematic diagram of a typical transistor magnetic deflection circuit.

### Line-Operated Audio Amplifier

Fig.16 illustrates how high-voltage silicon transistors can be used to produce a compact, low-cost, high-quality audio-power amplifier. This particular circuit shows a class A, 5-watt, line-operated unit. The line voltage is rectified and filtered directly to provide the required dc supply voltage. This method reduces considerably the size, weight, and cost of the circuit by eliminating the need for a power-supply transformer. Negative feedback from the output transformer produces a linear output and good frequency response. Operation is relatively unaffected by normal line variations between 105 and 135 volts, and by temperatures

up to 257° F. Amplifier performance curves are shown in Figs.17, 18, and 19. A summary of the amplifier characteristics is listed below:\*

Frequency Response: -3 dB from 35 Hz to 35 kHz

Total Harmonic Distortion:

0.6% at 400 Hz and 4 W output

1.5% at 400 Hz and 5 W output

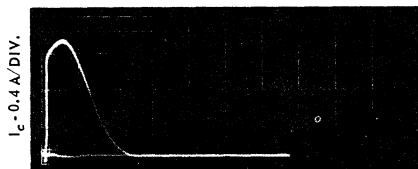
Hum and Noise: 65 dB below 4 W

Input Impedance: 300 ohms

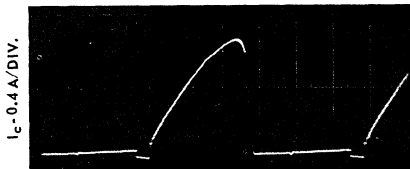
Input Voltage: 0.6 V for power output of 4 W

The 2N3584 transistor used in the output stage satisfies three very important requirements for the successful operation of this amplifier: (1) a high value of voltage breakdown  $V_{CEr}$ ; (2) good gain linearity; (3) a high gain-bandwidth product.

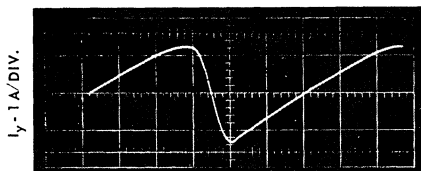
Because the dc supply voltage conceivably can reach 140 volts, the sustaining-voltage rating  $V_{CEr}$  for the output transistor, at  $R_{BE} = 500$  ohms, must be greater than 280 volts. Circuits designed to permit the use of a transistor having a lower  $V_{CEr}$  generally compromise performance and should be avoided. For example, one method of reducing this rating involves decreasing the supply voltage by increasing the size of the current-limiting resistors in the power supply. This procedure, however, not only requires the use of expensive power resistors, but also creates high dissipation losses and reduces the power output of the amplifier.



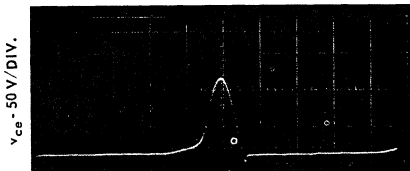
$v_{ce} - 15 \text{ V/DIV.}$



$t - 10 \mu\text{s/DIV.}$



$t - 10 \mu\text{s/DIV.}$



$t - 10 \mu\text{s/DIV.}$

Fig.15 - Current and voltage waveforms produced by circuit shown in Fig.14.

\* Additional information concerning this amplifier circuit is given in RCA publication ATC-402.





must be within the maximum power rating and second-breakdown rating of the device. Fig.20 illustrates this safe-operating region for the 2N3584.

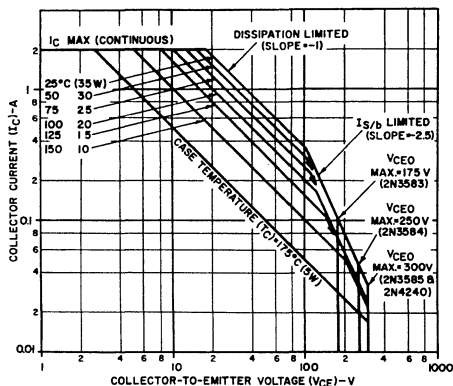


Fig.20 - Safe operating area for the 2N3584 transistor.

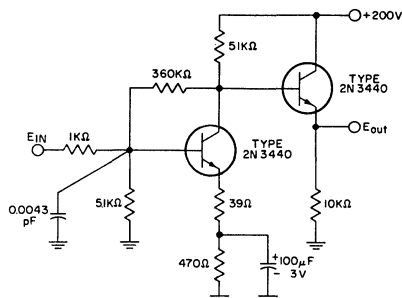
### Operational Amplifier

Operational amplifiers are used to perform mathematical operations on voltage waveforms. Among other things, an operational amplifier can be used to multiply, add, and integrate electrical signals. It is generally used in one of these capacities in an analog computer. Wave-shaping circuits are another important application; for example, a pulse can be integrated to form a linear voltage ramp.

To function properly, an operational amplifier must have very high open-loop gain. It must also be capable of amplification over a wide passband extending from dc to perhaps 50 kHz. Its phase-shift characteristics must be such that a large negative feedback can be applied without causing oscillations. DC drift must be very low. In addition, the amplifier should have very high input impedance and low output impedance, or vice versa. Generally, the high-input-impedance type is used.

To meet all of these requirements, an operational amplifier normally utilizes a chopper amplifier and other stabilizing circuits. This portion of the amplifier can be designed to operate at low supply voltages. The final stage, however, requires a high supply voltage because it must provide a large voltage swing to drive the high input impedance of the next operational amplifier. A typical final stage that meets this requirement

and also provides the necessary low output impedance is shown in Figure 21. Fig.22 shows the performance curves for this circuit.



All resistors are 1/2-watt.

Fig.21 - Schematic diagram of a typical final stage of an operational amplifier.

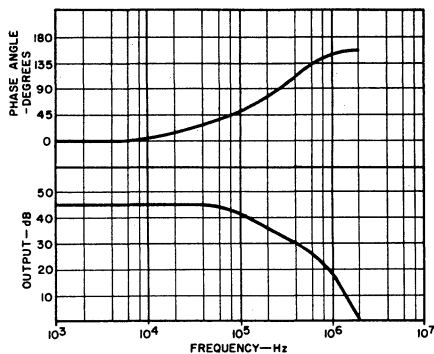


Fig.22 - Performance curves for circuit shown in Fig.21.

In general the transistor requirements for an operational amplifier output are the same as for a class A audio amplifier. These requirements were discussed in detail in the section "Line-Operated Audio Amplifier," and are summarized below:

$V_{CER(sus)} > 2 V_{CC}$

$h_{FE}$ : must be linear over the operating-current range.

$PS/b/PD$ : the dc bias point must be within the safe operating region.

$f_T$ : the gain-bandwidth product should be as high as possible; a rule-of-thumb minimum is 10 MHz.

## A 100-Watt, 18-kHz Inverter Using RCA-2N5202 Silicon Power Transistors

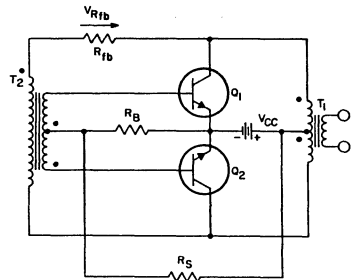
by

D. T. DeFino

This Note describes a two-transistor, two-transformer inverter that demonstrates the excellent switching capabilities of the new RCA-2N5202 power transistor. This silicon epitaxial n-p-n device is supplied in the popular TO-66 package. Its fast switching speed makes it especially suitable for use in switching regulators, switching control amplifiers, converters, and inverters. Pertinent characteristics of the 2N5202 are shown in Table I.

Fig.1 shows a schematic diagram of the two-transistor, two-transformer circuit. A saturable base-drive transformer  $T_2$  controls the inverter switching operation. A linearly operating output transformer  $T_1$  transfers the output power to the load. The output transformer  $T_1$  is not allowed to saturate; therefore, the peak collector current through the transistor is determined principally by the value of the load impedance.

Because no two transistors are perfectly matched, one of the transistors in the inverter circuit conducts more rapidly than the other when the power is turned on. This transistor,  $Q_2$  for example, tends toward saturation and causes positive voltages to appear at the dotted ends of the transformers. Thus, there is an effective positive feedback that causes  $Q_1$  to switch off and  $Q_2$  to switch on. The voltage from the collector of  $Q_1$  to the collector of  $Q_2$  is then positive and equal to twice the collector supply voltage  $V_{CC}$ . The voltage  $V_{Rfb}$  across the feedback resistor  $R_{fb}$  is essentially the product of the resistance  $R_{fb}$  and the base current referred to the primary of  $T_2$ . The voltage across  $T_2$  is equal to  $2 V_{CC} - V_{Rfb}$ .



*Fig.1 - Schematic diagram of two-transistor/two-transformer inverter.*

At the beginning of the next half-cycle, the voltage across  $R_{fb}$  increases very slowly with the slowly increasing magnetizing current through  $T_2$ . When  $T_2$  reaches its saturation flux density, the magnetizing current increases very rapidly and causes a rapid increase in  $V_{Rfb}$ . As a result, the voltage across  $T_2$  decreases rapidly and  $Q_2$  comes out of saturation. The collector voltage of  $Q_2$  then rises, and regenerative action causes  $Q_1$  and  $Q_2$  to reverse states. As these processes are repeated during succeeding half-cycles, oscillations are sustained.

Characteristics of the drive transformer and the output transformer used in the circuit of Fig.1 are de-

TABLE I - TYPICAL CHARACTERISTICS OF RCA-2N5202 SILICON POWER TRANSISTOR

CHARACTERISTICS	SYMBOLS	TEST CONDITIONS	MIN	MAX	UNITS
Collector-Cutoff Current	$I_{CEV}$	$V_{CE} = 100 \text{ V}, V_{BE} = -1.5 \text{ V}$ $V_{CE} = 100 \text{ V}, V_{BE} = -1.5 \text{ V}, T_C = 150^\circ\text{C}$	-	10	mA
Emitter-Cutoff Current	$I_{EBO}$	$V_{EB} = 6 \text{ V}, I_C = 0$	-	10	mA
DC Forward-Current Transfer Ratio	$h_{FE}$	$V_{CE} = 1.2 \text{ V}, I_C = 4 \text{ A}$	10	100	
Collector-to-Emitter Sustaining Voltage	$V_{CER(sus)}$	$R_{BE} = 50 \Omega, I_C = 0.2 \text{ A}$	75	-	V
Base-to-Emitter Voltage	$V_{BE}$	$V_{CE} = 1.2 \text{ V}, I_C = 4 \text{ A}$	-	1.9	V
Collector-to-Emitter Saturation Voltage	$V_{CE(sat)}$	$I_C = 4 \text{ A}, I_B = 0.4 \text{ A}$	-	1.2	V
Small-Signal Forward-Current Transfer Ratio	$h_{fe}$	$V_{CE} = 10 \text{ V}, I_C = 0.5 \text{ A}, f = 10 \text{ MHz}$	6	-	
Output Capacitance	$C_{ob}$	$V_{CB} = 10 \text{ V}, I_E = 0, f = 1 \text{ MHz}$	-	175	pF
Second-Breakdown Collector Current	$I_{S/b}$	$V_{CE} = 40 \text{ V}$ (base forward-biased)	400	-	mA
Second-Breakdown Energy	$E_{S/b}$	$V_{BB} = -4 \text{ V}, R_{BE} = 50 \Omega, L = 50 \mu\text{H}$	0.4	-	mJ
Saturating Switching Times:					
Delay Time	$t_d$	$V_{CC} = 30 \text{ V}, I_C = 4 \text{ A}, I_{B1} = 0.4 \text{ A}$	-	40	ns
Rise Time	$t_r$	$V_{CC} = 30 \text{ V}, I_C = 4 \text{ A}, I_{B1} = 0.4 \text{ A}$	-	400	ns
Storage Time	$t_s$	$V_{CC} = 30 \text{ V}, I_C = 4 \text{ A}, I_{B1} = 0.4 \text{ A}, I_{B2} = -0.4 \text{ A}$	-	800	ns
Fall Time	$t_f$	$V_{CC} = 30 \text{ V}, I_C = 4 \text{ A}, I_{B1} = 0.4 \text{ A}, I_{B2} = -0.4 \text{ A}$	-	400	ns
Thermal Resistance, Junction to Case	$\theta_{J-C}$		-	5	$^\circ\text{C/W}$

terminated by means of the following equation:

$$N_p = \frac{V}{4fAB} \times 10^8$$

where  $N_p$  is the number of turns in the primary winding,  $V$  is the peak voltage across the primary winding,  $f$  is the operating frequency in hertz,  $A$  is the cross-sectional area of the core in square centimeters, and  $B$  is the flux density in gauss. In the design of the drive transformer  $T_2$ , the value of flux density  $B$  is selected to cause the core to saturate. For the output transformer  $T_1$ , the value of  $B$  is selected to assure that  $T_1$  will not saturate. The base resistor  $R_B$  is determined by the voltage at the secondary of  $T_2$  and the base drive required for the transistor. The resistor  $R_S$  is selected so that a voltage of 0.7 volt appears across  $R_B$  when the power is turned on initially.\*

\* A complete discussion of inverter design considerations and design information is given in RCA Application Note SMA-37: "High-Speed Inverters Using Silicon Power Transistors" by H.T. Breece.

Fig.2 shows the circuit diagram for a practical 100-watt, 18-kHz inverter using RCA-2N5202 transistors. Performance characteristics for this inverter are shown in Fig.3, and waveforms of output voltage, collector voltage, and collector current as functions of time are shown in Fig.4.

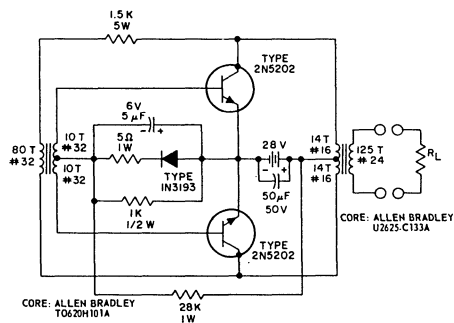


Fig.2 - Circuit diagram for 100-watt, 18-kHz inverter.

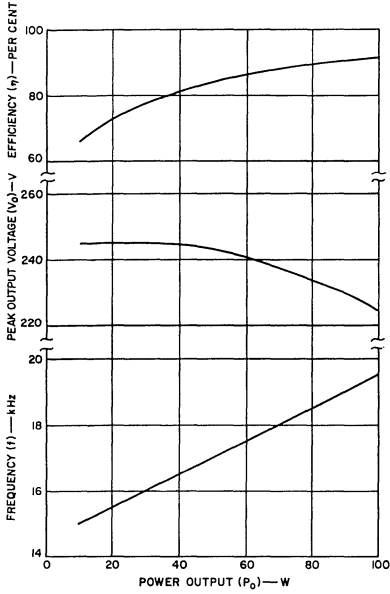


Fig. 3 - Performance characteristics of inverter shown in Fig. 2.

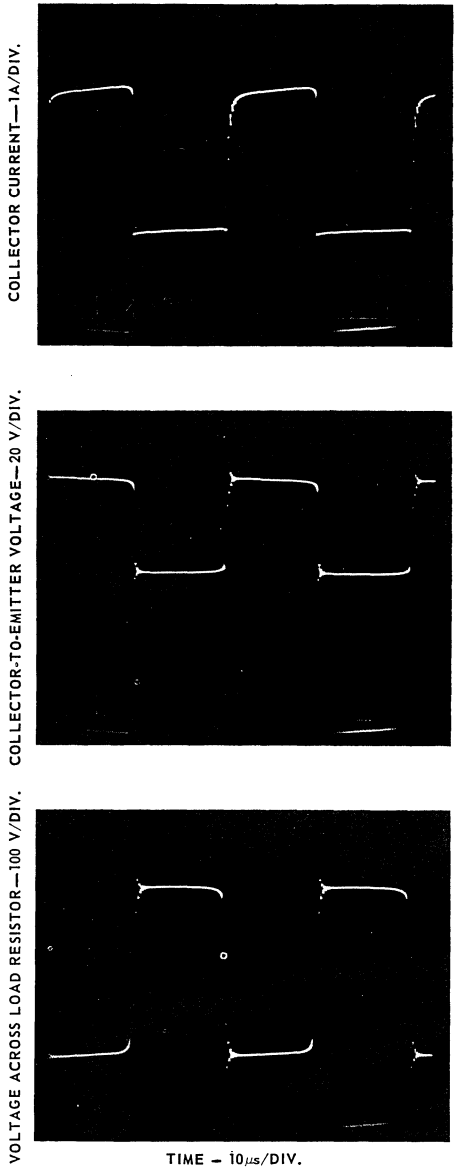


Fig. 4 - Waveforms of output voltage, collector voltage, and collector current in inverter of Fig. 2.

## Handling and Mounting of RCA Molded-Plastic Transistors and Thyristors

by W.J. Hepp, J.S. Vara, and J. Gaylord

RCA power transistors and thyristors (SCR's and triacs) in molded-silicone-plastic packages are available in a wide range of power-dissipation ratings and a variety of package configurations. This Note provides detailed guidelines for handling and mounting of these plastic-package devices, and shows different types of packages and suggested mounting hardware to accommodate various mounting arrangements. Recommendations are made for handling of the packages during the forming of leads to meet specific mounting requirements. Various mounting arrangements, thermal considerations, and cleaning methods are described. This information is intended to augment the data on electrical characteristics, safe operating area, and performance capabilities in the technical bulletin for each type of plastic-package transistor or thyristor. (Data on mechanical and environmental capabilities of RCA plastic-package transistors are also available in a periodically updated Reliability Report, RCA Publication No. HBT-600.)

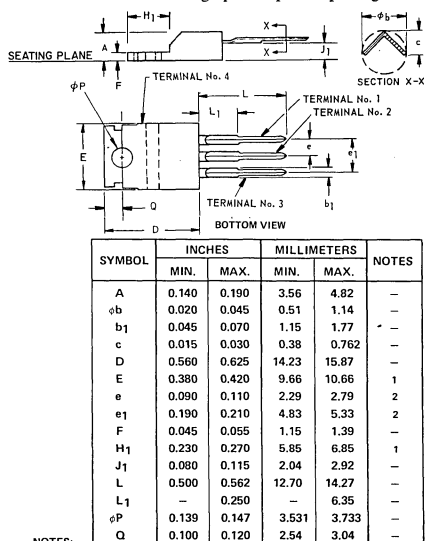
### TYPES OF PACKAGES

Two basic types of molded-plastic packages are used for RCA solid-state power devices. These types include the RCA Versawatt packages for medium-power applications and the RCA high-power plastic packages, both of which are specifically designed for ease of use in many applications. Each basic type offers several different package options, and the user can select the configuration best suited to his particular application.

Figs. 1 through 3 show the options currently available for devices in RCA Versawatt packages. The JEDEC Type TO-220AB in-line-lead version, shown in Fig. 1, represents the basic style. This configuration features leads that can be formed to meet a variety of specific mounting requirements. Fig. 2 shows a package configuration that allows a Versawatt package to be mounted on a printed-circuit board with a 0.100-inch grid and a minimum lead spacing of 0.200 inch. Fig. 3 shows a JEDEC Type TO-220AA version of the Versawatt package. The dimensions of this type of transistor package are such that it can replace the JEDEC TO-66 transistor package in a commercial socket or printed-circuit board without retooling. The pin-connection arrangement

of thyristors supplied in TO-220AA packages, however, differs from that of thyristors supplied in conventional TO-66 packages so that some hardware changes are required to effect a replacement. The TO-220AA Versawatt package is also supplied with an integral heat sink. Fig. 4 shows the dimensional outline for this heat sink. The use of the integral heat sink reduces the junction-to-air thermal resistance of the package from 70°C per watt to 35°C per watt.

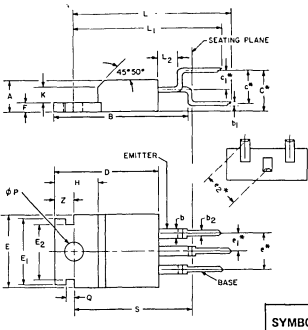
The RCA molded-plastic high-power packages are also supplied in several configurations for flexibility of application. The JEDEC Type TO-219AB, shown in Fig. 5, is the basic high-power plastic package. Fig. 6 shows a JEDEC Type TO-219AA version of the high-power plastic package.



NOTES:

1. Tab contour optional within H<sub>1</sub> and E.
2. Position of lead to be measured 0.250 - 0.255 in. (6.35 - 6.48 mm) from case.

Fig. 1 - Dimensional outline of the JEDEC TO-220AB in-line-lead Versawatt transistor package.



92CS-17175

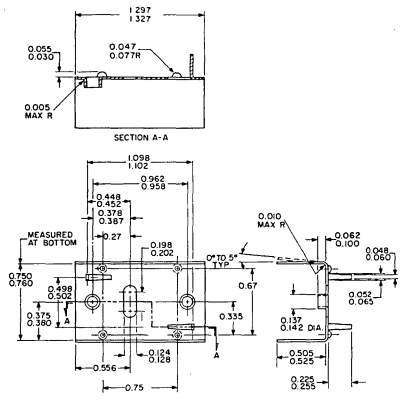
• MEASURED AT SEATING PLANE

SYMBOL	INCHES		MILLIMETERS	
	MIN.	MAX.	MIN.	MAX.
e <sub>2</sub>	0.203	0.243	5.16	6.17
F	0.045	0.055	1.15	1.39
H	0.230	0.270	5.85	6.85
K	0.080	0.085	2.032	2.159
L	0.593	1.033	25.22	26.23
L <sub>1</sub>	0.895	0.935	22.73	23.74
L <sub>2</sub>	0.070	0.090	1.78	2.28
φP	0.139	0.147	3.531	3.734
Q	0.040	0.060	1.02	1.52
S	0.655	0.685	16.64	17.39
Z	0.100	0.120	2.54	3.04

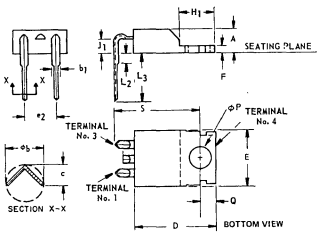
SYMBOL	INCHES		MILLIMETERS	
	MIN.	MAX.	MIN.	MAX.
A	0.140	0.190	3.56	4.82
B	0.850	—	—	21.59
b	0.045	0.070	1.15	1.77
b <sub>1</sub>	0.015	0.030	0.382	0.762
b <sub>2</sub>	0.020	0.038	0.508	0.965
C	0.230	0.270	5.85	6.85
c	0.180	0.220	4.58	5.58
c <sub>1</sub>	0.130	0.170	3.31	4.31
D	0.560	0.625	14.23	15.87
E	0.380	0.420	9.66	10.41
E <sub>1</sub>	0.365	0.385	9.28	9.77
E <sub>2</sub>	0.300	0.320	7.62	8.12
e	0.190	0.210	4.83	5.33
e <sub>1</sub>	0.090	0.110	2.29	2.79

Fig. 2 - Dimensional outline of Versawatt transistor package designed for mounting on printed-circuit boards.



ALL DIMENSIONS ARE IN INCHES UNLESS OTHERWISE SHOWN. TOLERANCES ARE: ±0.02 FOR 2ND PLACE; ±0.005 FOR 3RD PLACE AND ±1/2° FOR ANGULAR DIMENSION.

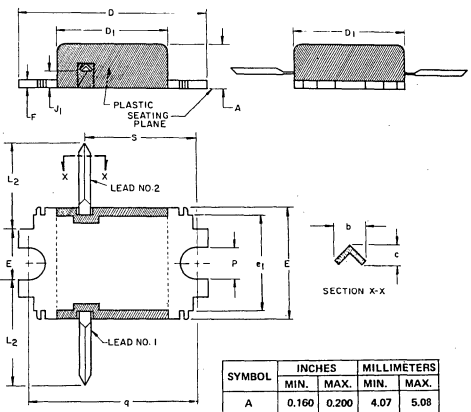
Fig. 4 - Integral heat sink used with the TO-220AA Versawatt package shown in Fig. 3.



SYMBOL	INCHES		MILLIMETERS		NOTES
	MIN.	MAX.	MIN.	MAX.	
A	0.140	0.190	3.56	4.82	—
φb	0.02	0.045	0.51	1.14	—
b <sub>1</sub>	0.045	0.070	1.15	1.77	—
c	0.015	0.030	0.38	0.762	—
D	0.560	0.625	14.23	15.87	—
E	0.380	0.420	9.66	10.66	1
e <sub>2</sub>	0.190	0.210	4.83	5.33	2
F	0.045	0.055	1.15	1.39	—
H <sub>1</sub>	0.230	0.270	5.85	6.85	1
J <sub>1</sub>	0.080	0.115	2.04	2.92	—
L <sub>2</sub>	—	0.050	—	1.27	—
L <sub>3</sub>	0.360	0.422	9.15	10.71	—
φP	0.139	0.147	3.531	3.733	—
Q	0.100	0.120	2.54	3.04	—
S	0.580	0.610	14.74	15.49	—

NOTES:  
 1. Tab contour optional within H<sub>1</sub> and E.  
 2. Position of lead to be measured 0.050 - 0.055 in. (1.27 - 1.40 mm) below seating plane.

92CS-17990R 1



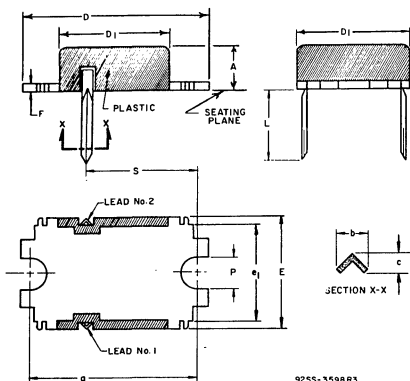
SYMBOL	INCHES		MILLIMETERS	
	MIN.	MAX.	MIN.	MAX.
A	0.160	0.200	4.07	5.08
b	0.045	0.060	1.15	1.52
c	0.025	0.045	0.64	1.14
D	0.890	0.910	22.61	23.11
D <sub>1</sub>	0.480	0.515	12.20	13.03
E	0.480	0.520	12.20	13.20
F	0.055	0.070	1.40	1.77
J <sub>1</sub>	0.100	0.120	2.54	3.04
L <sub>2</sub>	0.415	0.560	10.54	14.22
P	0.128	0.150	3.26	3.81
q	0.740	0.760	18.80	19.30
s	0.500	0.520	12.70	13.20

NOTE: Terminal end configurations are optional.

9255-3599R 2

Fig. 3 - JEDEC TO-220AA Versawatt transistor package designed for direct replacement of the JEDEC TO-66 package.

Fig. 5 - JEDEC TO-219AB high-power molded-plastic transistor package.



SYMBOL	INCHES		MILLIMETERS		NOTES	
	MIN.	MAX.	MIN.	MAX.		
A	0.160	0.200	4.07	5.08	1	
b	0.045	0.060	1.15	1.52		
c	0.025	0.045	0.64	1.14		
D	0.890	0.910	22.61	23.11		
D <sub>1</sub>	0.480	0.515	12.20	13.08		
E	0.480	0.520	12.20	13.20		
e <sub>1</sub>	0.460	0.505	11.69	12.82		
F	0.055	0.070	1.40	1.77		
L	0.370	0.450	9.40	11.43		2
P	0.128	0.150	3.26	3.81		
q	0.740	0.760	18.80	19.30		
s	0.500	0.520	12.70	13.20		

**NOTES:**

1. e<sub>1</sub> is measured at seating plane.
2. Terminal end configurations are optional.

Fig. 6 - JEDEC TO-219AA plastic package designed for use as a direct replacement for the hermetically sealed JEDEC TO-3 transistor package.

The RCA high-power plastic package is also available with an attached header-case lead, as shown in Fig. 7. This three-lead package is designed for mounting on a printed-circuit board.

**LEAD-FORMING TECHNIQUES**

RCA Versawatt plastic packages are both rugged and versatile within the confines of commonly accepted standards for such devices. Although these versatile packages lend themselves to numerous arrangements, provision of a wide variety of lead configurations to conform to the specific requirements of many different mounting arrangements is highly impractical. However, the leads of the Versawatt in-line package can be formed to a custom shape, provided that they are not indiscriminately twisted or bent. Although these leads can be formed, they are not flexible in the general sense, nor are they sufficiently rigid for unrestrained wire wrapping.

Before an attempt is made to form the leads of an in-line package to meet the requirements of a specific application, the desired lead configuration should be determined, and a lead-bending fixture should be designed and constructed. The

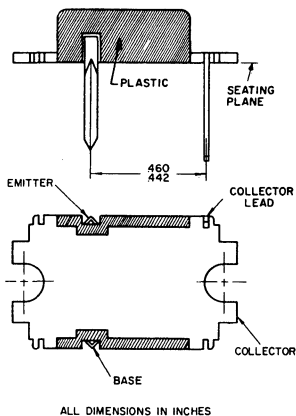


Fig. 7 - TO-219AA plastic transistor package designed for mounting on printed-circuit boards.

use of a properly designed fixture for this operation eliminates the need for repeated lead bending. When the use of a special bending fixture is not practical, a pair of long-nosed pliers may be used. The pliers should hold the lead firmly between the bending point and the case, but should not touch the case. Fig. 8 illustrates the use of long-nosed pliers for lead bending. Fig. 8(a) shows techniques that should be avoided; Fig. 8(b) shows the correct method.

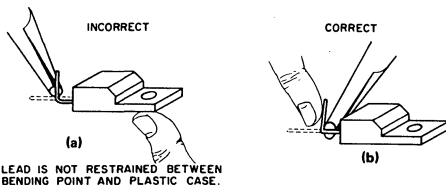


Fig. 8 - Use of long-nosed pliers for lead bending: (a) incorrect method; (b) correct method.

When the leads of an in-line plastic package are to be formed, whether by use of long-nosed pliers or a special bending fixture, the following precautions must be observed to avoid internal damage to the device:

1. Restrain the lead between the bending point and the plastic case to prevent relative movement between the lead and the case.
2. When the bend is made in the plane of the lead (spreading), bend only the narrow part of the lead.
3. When the bend is made in the plane perpendicular to that of the leads, make the bend at least 1/8 inch from the plastic case.
4. Do not use a lead-bend radius of less than 1/16 inch.
5. Avoid repeated bending of leads.



The leads of the TO-220AB Versawatt in-line package are not designed to withstand excessive axial pull. Force in this direction greater than 4 pounds may result in permanent damage to the device. If the mounting arrangement tends to impose axial stress on the leads, some method of strain relief should be devised. Fig. 2 illustrates an acceptable lead-forming method that provides this relief.

Wire wrapping of the leads is permissible, provided that the lead is restrained between the plastic case and the point of the wrapping. Soldering to the leads is also allowed; the maximum soldering temperature, however, must not exceed 275°C and must be applied for not more than 5 seconds at a

distance greater than 1/8 inch from the plastic case. When wires are used for connections, care should be exercised to assure that movement of the wire does not cause movement of the lead at the lead-to-plastic junctions.

The leads of the RCA molded-plastic high-power packages are not designed to be reshaped. Simple bending of the leads, however, is permitted to change them from a standard vertical to a standard horizontal configuration, or conversely. Bending of the leads in this manner is restricted to three 90-degree bends; repeated bendings, therefore, should be avoided.

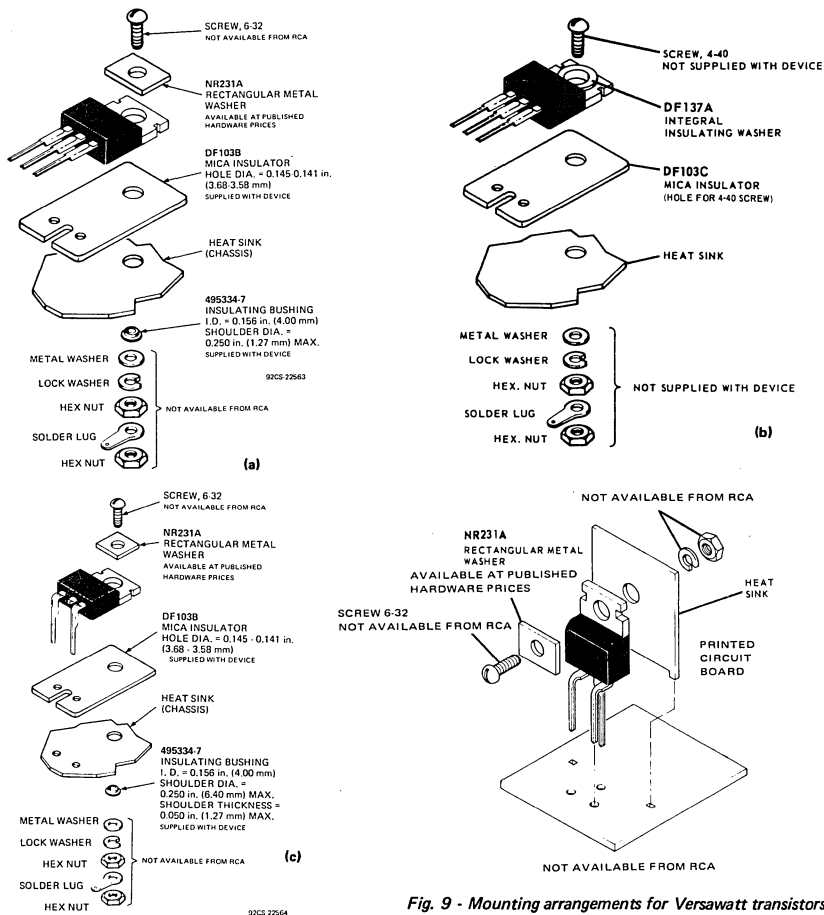


Fig. 9 - Mounting arrangements for Versawatt transistors: (a) and (b) methods of mounting in-line-lead types; (c) chassis mounting; (d) mounting on printed-circuit boards.

## MOUNTING

Fig. 9 shows recommended mounting arrangements and suggested hardware for the Versawatt transistors. The rectangular washer (NR231A) shown in Fig. 9(a) is designed to minimize distortion of the mounting flange when the transistor is fastened to a heat sink. Excessive distortion of the flange could cause damage to the transistor. The washer is particularly important when the size of the mounting hole exceeds 0.140 inch (6-32 clearance). Larger holes are needed to accommodate insulating bushings; however, the holes should not be larger than necessary to provide hardware clearance and, in any case, should not exceed a diameter of 0.250 inch. Flange distortion is also possible if excessive torque is used during mounting. A maximum torque of 8 inch-pounds is specified. Care should be exercised to assure that the tool used to drive the mounting screw never comes in contact with the plastic body during the driving operation. Such contact can result in damage to the plastic body and internal device connections. An excellent method of avoiding this problem is to use a spacer or combination spacer-isolating bushing which raises the screw head or nut above the top surface of the plastic body, as shown in Fig. 10. The material used for such a spacer or spacer-isolating bushing should, of course, be carefully selected to avoid "cold flow" and consequent reduction in mounting force. Suggested materials for these bushings are diallphthalate, fiberglass-filled nylon, or fiberglass-filled polycarbonate. Unfilled nylon should be avoided.

Modification of the flange can also result in flange distortion and should not be attempted. The transistor should not be soldered to the heat sink by use of lead-tin solder because the heat required with this type of solder will cause the junction temperature of the transistor to become excessive.

The TO-220AA plastic transistor can be mounted in commercially available TO-66 sockets, such as UID Electronics Corp. Socket No. PTS-4 or equivalent. For testing purposes, the TO-220AB in-line package can be mounted in a Jetron Socket No. CD74-104 or equivalent. Regardless of the mounting method, the following precautions should be taken:

1. Use appropriate hardware.
2. Always fasten the transistor to the heat sink before the leads are soldered to fixed terminals.
3. Never allow the mounting tool to come in contact with the plastic case.
4. Never exceed a torque of 8 inch-pounds.
5. Avoid oversize mounting holes.
6. Provide strain relief if there is any probability that axial stress will be applied to the leads.
7. Use insulating bushings to prevent hot-creep problems. Such bushings should be made of diallphthalate, fiberglass-filled nylon, or fiberglass-filled polycarbonate.

Fig. 11 shows the recommended hardware and mounting arrangements for RCA high-power molded-plastic transistors. These types can be mounted directly in a socket similar to that shown in Fig. 11(b). The precautions listed for the Versawatt packages should also be followed in the mounting of the high-power molded-plastic packages.

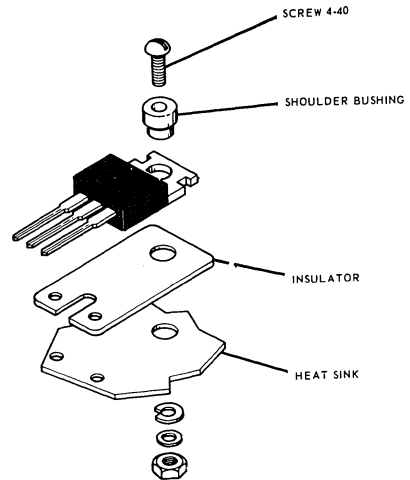


Fig. 10 - Mounting arrangements in which an isolating bushing is used to raise the head of the mounting screw above the plastic body of the Versawatt transistor.

## THERMAL-RESISTANCE CONSIDERATIONS

The maximum allowable power dissipation in a solid-state device is limited by its junction temperature. An important factor to assure that the junction temperature remains below the specified maximum value is the ability of the associated thermal circuit to conduct heat away from the device.

When a solid-state device is operated in free air, without a heat sink, the steady-state thermal circuit is defined by the junction-to-free-air thermal resistance given in the published data on the device. Thermal considerations require that there be a free flow of air around the device and that the power dissipation be maintained below that which would cause the junction temperature to rise above the maximum rating. When the device is mounted on a heat sink, however, care must be taken to assure that all portions of the thermal circuit are considered.

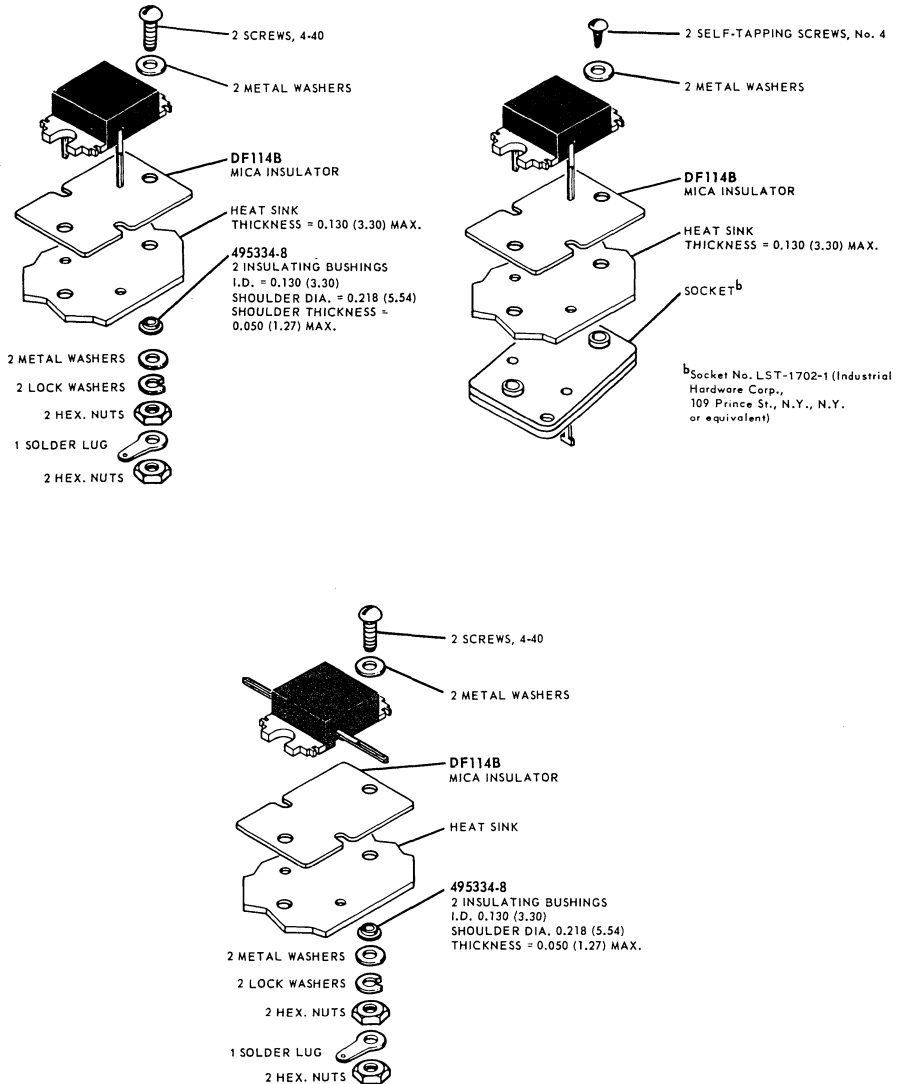


Fig. 11 - Mounting arrangements for high-power plastic-package transistors: (a) chassis mounting; (b) socket mounting; (c) printed-circuit-board mounting.

Fig. 12 shows the thermal circuit for a heat-sink-mounted transistor. This figure shows that the junction-to-ambient thermal circuit includes three series thermal-resistance components, i.e., junction-to-case,  $\theta_{J-C}$ ; case-to-heat-sink,  $\theta_{C-S}$ ; and heat-sink-to-ambient,  $\theta_{S-A}$ . The junction-to-case thermal resistance of the various transistor types is given in the individual technical bulletins on specific types. The heat-sink-to-ambient thermal resistance can be determined from the technical data provided by the heat-sink manufacturer, or from published heat-sink nomographs. The case-to-heat-sink thermal resistance depends on several factors, which include the condition of the heat-sink surface, the type of material and thickness of the insulator, the type of thermal compound, the mounting torque, and the diameter of the mounting hole in the heat-sink.

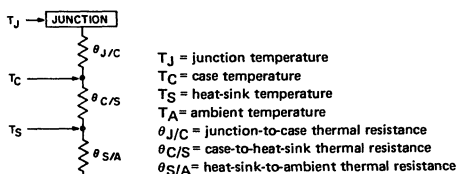


Fig. 12 - Thermal equivalent circuit for a transistor mounted on a heat sink.

Fig. 13 shows a set of curves of typical case-to-heat-sink thermal resistance of the Versawatt transistor as a function of mounting torque for several mounting arrangements. Curves A through D show typical case-to-heat-sink thermal resistance for the mounting arrangements shown in Figs. 9(a) through 9(d). Curves E and F are representative of a Versawatt transistor mounted over a heat-sink mounting hole that has a diameter of 0.140 inch (No. 6 screw clearance). Curve E shows the wide variation in thermal resistance with torque when the transistor is mounted dry. Curve F shows the effect on contact thermal resistance of a thin layer of Dow Corning No. 340 silicone grease applied between transistor and heat sink. For torques within the recommended range of 4 to 8 inch-pounds, contact thermal resistance is reduced to between 18 and 25 per cent of the dry values.

The curves shown in Fig. 14 represent typical case-to-heat-sink thermal resistance of the high-power molded-plastic transistor package as a function of mounting torque. The thermal resistances shown by curves A and C are representative of the mounting arrangements shown in Fig. 11(a) through 11(c). Curves B and D are typical for mounting without mica over heat-sink mounting holes that have a diameter of 0.113 inch (No. 4 screw clearance). The effect of a thin layer of silicone grease on contact thermal resistance is illustrated by a comparison of curves B and D.

Operation of the transistor with heat-sink temperatures of 100°C or greater results in some shrinkage of the insulating bushing normally used to mount power transistors. The degradation of contact thermal resistance (refer to Figs. 13 and 14) is usually less than 25 per cent if a good thermal compound is used. (A more detailed discussion of thermal resistance, including nomographs, can be found in the RCA Solid State Power Circuits, Technical Series SP-52.)

During the mounting of RCA molded-plastic solid-state power devices, the following special precautions should be taken to assure efficient heat transfer from case to heat sink:

1. Mounting torque should be between 4 and 8 inch-pounds.
2. The mounting holes should be kept as small as possible.
3. Holes should be drilled or punched clean with no burrs or ridges, and chamfered to a maximum radius of 0.010 inch.
4. The mounting surface should be flat within 0.002 inch/inch.
5. Thermal grease (Dow Corning 340 or equivalent) should always be used (on both sides of the insulating washer if one is employed).
6. Thin insulating washers should be used (thickness of factory-supplied mica washers ranges from 2 to 4 mils).
7. A lock washer or torque washer should be used, together with materials that have sufficient creep strength to prevent degradation of heat-sink efficiency during life.

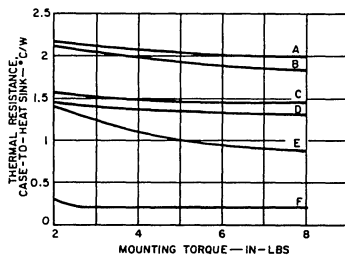
A wide variety of solvents is available for degreasing and flux removal. The usual practice is to submerge components in a solvent bath for a specified time. From a reliability standpoint, however, it is extremely important that the solvent, together with other chemicals in the solder-cleaning system (such as flux and solder covers), not adversely affect the life of the component. This consideration applies to all non-hermetic and molded-plastic components.

It is, of course, impractical to evaluate the effect on long-term transistor life of all cleaning solvents, which are marketed under a variety of brand names with numerous additives. These solvents can, however, be classified with respect to their component parts, as either acceptable or unacceptable. Chlorinated solvents tend to dissolve the outer package and, therefore, make operation in a humid atmosphere unreliable. Gasoline and other hydrocarbons cause the inner encapsulating to swell and damage the transistor. Alcohol is an acceptable solvent. Examples of suitable alcohols are: isopropanol, methanol, and special denatured alcohols, such as SDA1, SDA30, SDA34, and SDA44.

Care must also be used in the selection of fluxes in the soldering of leads. Rosin or activated rosin fluxes are recommended, while organic or acid fluxes are not. Examples of acceptable fluxes are:

1. Alpha Reliaros No. 320-33
2. Alpha Reliaros No. 346
3. Alpha Reliaros No. 711
4. Alpha Reliafoam No. 807
5. Alpha Reliafoam No. 809
6. Alpha Reliafoam No. 811-13
7. Alpha Reliafoam No. 815-35
8. Kester No. 44

If the completed assembly is to be encapsulated, the effect on the molded-plastic transistor must be studied from both a chemical and a physical standpoint.



CURVE	MOUNTING ARRANGEMENT FIGURE	HEAT SINK HOLE DIA. (IN.)	MICA THICKNESS (MILS)	THERMAL COMPOUND
A	9(a)	.250	4	Dow Corning No.340
B	9(b)	.113	4	Dow Corning No.340
C	9(a)	.250	2	Dow Corning No.340
D	9(b)	.113	2	Dow Corning No.340
E	—	.140	None	None
F	—	.140	None	Dow Corning No.340

Fig. 13 - Typical case-to-heat-sink thermal resistance as a function of mounting torque for an RCA Versawatt transistor.

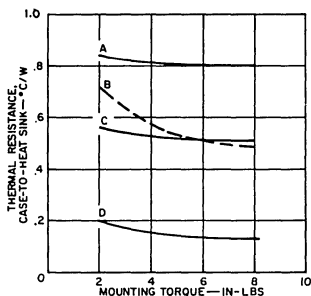
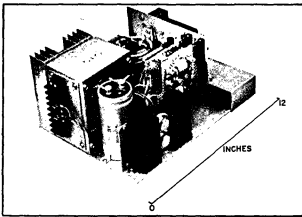


Fig. 14 - Typical case-to-heat thermal resistance as a function of mounting torque for an RCA high-power plastic-package transistor.

CURVE	MOUNTING ARRANGEMENT FIGURE	MICA THICKNESS (MILS)	THERMAL COMPOUND
A	11(a) thru 11(c)	4	Dow Corning No.340
B	—	None	None
C	11(a) thru 11(c)	2	Dow Corning No.340
D	—	None	Dow Corning No.340



## Compact 5-Volt Power Supplies Using High-Voltage Power Transistors

By R.S.Myers

This Note discusses the use of low-cost, industrial-type, high-voltage power transistors and fast-recovery rectifiers to achieve size and weight reductions and efficiency improvements in 5-volt dc power supplies with output currents of 50 amperes or more. The power supplies described, like those used in high-reliability aerospace applications, use switching rather than dissipating regulators to eliminate the need for a 60-Hz power transformer and heat sinks for the transistors. As a result, these supplies achieve three important advantages over conventional power supplies:

- **Size** — Volume is reduced by a factor of four. This size reduction does not cause any cooling problems, because these supplies dissipate very little power (approximately 0.33 W/in.<sup>3</sup>).
- **Efficiency** — Power dissipation in the regulator is virtually eliminated; only the power rectifiers require cooling. The reduction of heat dissipation in a 250-watt supply can be 200 to 300 watts, which represents a substantial economic saving.
- **Weight** — Weight is reduced by a factor of five. Portability is improved, mounting is simplified, and chassis cost is decreased.

A complete switching-regulator power supply that uses high-voltage transistors is described in detail. This unit produces 250 watts at 5 volts with an efficiency of 70 per cent. The performance of this supply is compared with that of a conventional supply in Table I. The design can be modified for more or less power, multiple outputs, or higher output voltages.

### THE POWER-SUPPLY CONCEPT

In a switching-regulator type of power supply, the output voltage is regulated by a technique referred to as "pulse-width modulation", in which pulses of variable duty cycle are averaged with an inductor-capacitor filter. Regulation is accomplished by the variation of the duty cycle. The pulses constitute a two-state signal (power on and power off) that is supplied to the filter, as shown in Fig. 1. However, to permit use of a smaller isolation transformer, the "power-on" state is operated in a push-pull mode that is then rectified by

full-wave power rectifiers. The time ratios of the push, pull, and off conditions are controlled by a modulator circuit.

Table I — Comparison of Power Supplies

	CONVENTIONAL SUPPLY	NEW SUPPLY	
Output Current at 5 volts	25	50	A
Power Losses (Max)	300	100	W
Size	1600	470	in. <sup>3</sup>
Weight	50	10	lb.
Recovery Time	50	500	μs
Regulation (Half load to full load)	>0.25	0.5	%
Line Regulation	>0.25	0.5	%

The on-state voltage is unregulated and is always greater than the required output voltage from the filter. It is supplied by a low-impedance source that consists of a transformer with closely coupled windings, the main supply, and a saturated transistor. The on-state voltage is decreased to the specified output value by an inductor that forms part of the filter. Thus the filter, which converts the ac signals to a dc output, is a "choke-input" type.

The switching-regulator supply operates at a frequency above the audio range to permit use of a small isolation transformer, and also to prevent sound generation.

### POWER-SUPPLY ELEMENTS

The design of a switching-regulator power supply involves the six major elements shown in Figs. 1 and 2: (1)

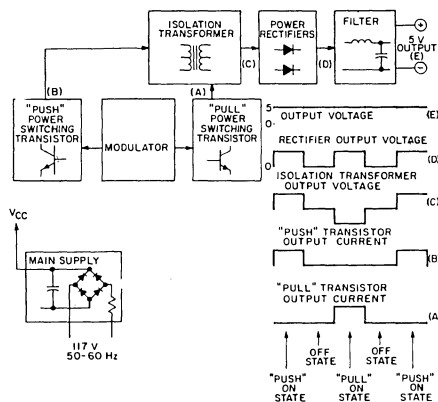


Fig. 1 - Block diagram of switching-regulator power supply, showing voltage waveforms at various points.

the main power supply, (2) the power-switching transistors, (3) the isolation transformer, (4) the modulator circuits, (5) the power rectifiers, and (6) the filter. The important parameters of these elements are discussed below.

**Main Power Supply.** The main supply provides the power that ultimately becomes the output power. It rectifies and filters the line voltage without use of a 60-Hz transformer. The design of such a supply is well covered in available literature<sup>1-3</sup>. In the case of a switching-regulator type of power supply, the main supply may be designed for high ripple without increased regulator losses (such as would occur in a conventional series regulator). Therefore, smaller capacitors and lower-cost rectifiers can be used. Some resistance must be added in series with the power line to prevent damage to the rectifiers during turn-on.<sup>1, 2</sup> The voltage delivered by the main power supply varies with line-voltage and load variations. The peak output voltage of the main supply at the maximum line conditions (with transients) determines both the collector-voltage rating required for the power-switching transistors and the turns ratio of the isolation transformer. Table II shows the relationship between line voltage and transistor collector voltage rating.

**Power-Switching Transistors.** The power-switching transistors are the most important components in the switching-regulator power supply. In the past, the high cost of these devices limited their use to aerospace applications; however, recent developments have made them economically

competitive with other devices. The performance capabilities of the power supply are determined by the switching transistors, because they are the parts least able to withstand overloads such as those caused by load faults or misuse. Therefore, the switching transistors must have the following characteristics (listed in order of importance):

- High forward-bias second-breakdown capability. The transistors must carry high currents at high voltage, as shown in the switching load line of Fig. 3.<sup>2</sup>
- Ability to withstand the collector voltages specified in Table II in the cut-off condition. A leakage current ( $I_{CEV}$ ) specification guarantees this capability.
- Short rise and fall times ( $t_r$  and  $t_f$ ), for low power dissipation in the transistors and thus high efficiency of the power supply.
- Reasonably low  $V_{CE(sat)}$ , for low dissipation and economical transistor heat sinks.
- Stable leakage current ( $I_{CEV}$ ). The magnitude of the leakage is not important (even 20 milliamperes at 500 volts contributes less than 5 watts to the average dissipation per transistor), but it should be stable.

Table III lists the recommended specifications for the switching transistors.

**Isolation Transformer.** The isolation transformer is a ferrite-core transformer that operates at 20 kHz. Its design formulas are the same as those for conventional 60-Hz transformers, but the results are significantly different. The number of turns is never greater than 200, and may be as low as one. These turns always fit in the large "windows" in the ferrite core. Leakage inductance is reduced in the primary turns by sectioning the primary winding.<sup>4</sup> Leakage in the secondary is less important because the secondary is loaded by a filter choke. The copper losses can easily be made negligible, and the copper wire costs are small. The size of the transformer core is determined by the need to dissipate the heat generated in the core material; the Indiana General Co. recommends that dissipation be kept below 0.25 W/in.<sup>2,5,6</sup> The 20-kHz ferrite core is much smaller than a 60-Hz core (3 in.<sup>3</sup> vs. 140 in.<sup>3</sup>), and is much lighter (1 lb. vs. 33 lbs.).

The design of a 20-kHz power transformer involves three basic problems: core material selection, windings to keep peak flux below saturation, and compensation for unbalanced direct currents.

If a core has too much loss, it will overheat. If it has too many turns, the flux density will be below saturation, but the copper losses will be greater than necessary. The number of turns is kept low to avoid unnecessary copper losses, but must be great enough to keep the peak flux in the core below saturation.

The core will saturate if its cross section is too small, if there are not enough turns in the primary winding, or if the primary direct current is unbalanced. Core saturation causes the power-switching transistors to draw excessive currents

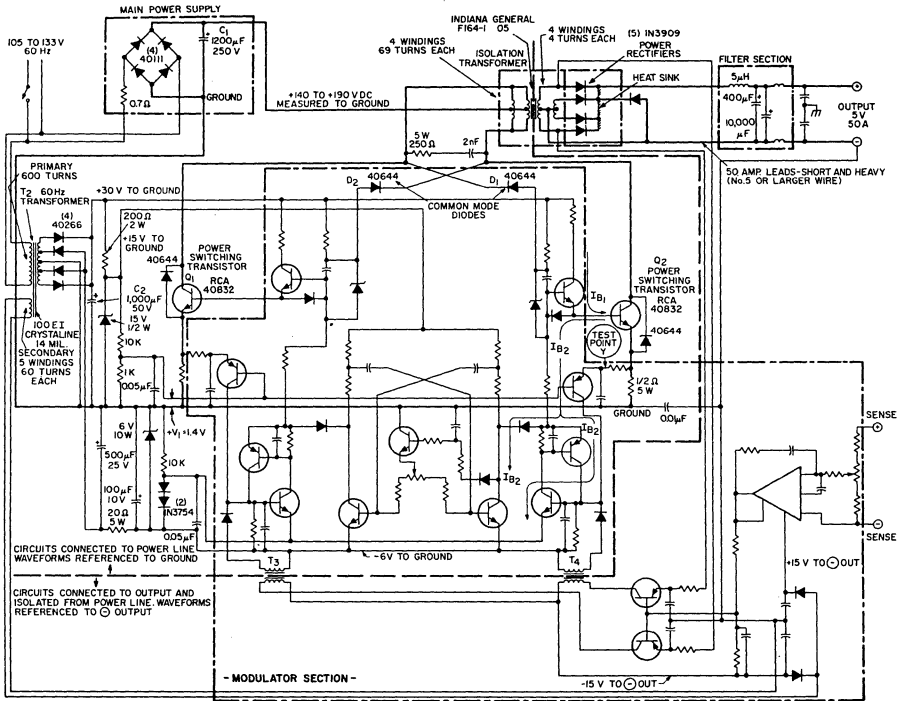


Fig. 2 - Circuit diagram of switching-regulator power supply, with major elements indicated.

that can increase collector dissipation to destructive levels. To prevent these high currents, the power supply includes a monitor circuit that cuts off the base drive to the switching transistors when emitter current reaches the maximum safe value.

Fig. 4 shows the emitter-current waveform of a power-switching transistor, monitored at point Y in Fig. 2, for different numbers of primary turns. If the emitter current is excessive, the circuit reduces the duty cycle to protect the power-switching transistor. Fig. 5 shows the waveforms for unbalanced dc drive. These unbalanced currents result from unequal duty cycles, caused by oscillator unbalance or by unbalance or faults in the modulator. Because such unbalances occur in normal operation, the protective circuits must be included in the power supply design.

*Modulator Circuit (Oscillator, drivers, modulators, and latches).* These circuits, which are indicated in the circuit diagram of Fig. 6 and are described in Table IV, deliver the base drive to the power-switching transistors. The forward drive must be sufficient to keep the transistors saturated under all conditions, and must have a short rise time to provide fast transistor turn-on and low dissipation. The reverse drive must have short rise time and a magnitude equal to or greater than the forward base drive. The circuits also sense excessive emitter current in the power-switching transistors, and compensate by adjustment of the duty cycle, as noted above.

These circuits eliminate common-mode conduction in the power-switching transistors. This conduction occurs in a driven inverter when the transistor that has been "off" is



Table II — Relationship Between Line Voltage and the Required Collector Voltage Rating for the Switching Transistors.

RMS LINE VOLTAGE (V)	PEAK LINE VOLTAGE (V)	NOMINAL COLLECTOR VOLTAGE (V)	SAFE (15% ADDED) COLLECTOR VOLTAGE RATING (V)
90	127.3	254.5	292
95	134.3	268.7	309
100	141.4	282.8	325
105	148.5	296.9	341
110	155.5	311.1	357
115	162.6	325.2	374
120	169.7	339.4	390
125	176.7	353.5	406
130	183.8	367.6	422
135	190.0	381.8	439
140	198.0	395.9	455
145	205.0	410.1	471
150	212.1	424.2	487

turned "on"; the other transistor continues to conduct because of its storage time. For several microseconds both transistors conduct, and the current is not limited by the collector circuit. The transistor that has just been switched on has high current and voltage simultaneously, and therefore high dissipation (perhaps 50 per cent of the rated power-supply output). This power dissipation is wasteful and may even damage the transistor.

The oscillator frequency should be stable to minimize rectifier losses, and should be greater than 20 kHz to eliminate sound. All of the circuits should be insensitive to component-value variations, component drift, and random or stray interference.

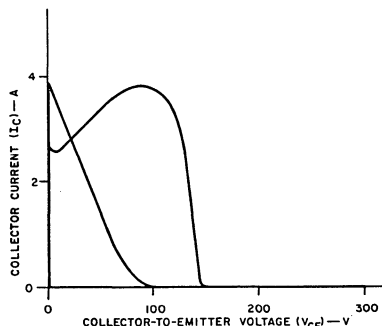


Fig. 3 — Typical load line for a switching transistor in the switching-regulator power supply.

Table III — Recommended Specifications for Switching Transistor

PARAMETER	MEASUREMENT CONDITIONS		VALUE
	GENERAL	FOR TRANSISTORS USED IN DESIGN EXAMPLE	
$I_{CEV}$	$V_{CE}$ from Table II	$V_{CE} = 450 V$	5 mA max.
$I_{EBO}$	$V_{BE} \leq V_{EE}^{(1)}$ $V_{EB} = V_{EE}^{(1)}$	$V_{BE} = 1.5 V$ $V_{EB} = 6 V$	5 mA max.
$I_{S/b}$	$I_C = I_C (\text{max.})$	$I_C = 4 A$	(must pass test)
$V_{CE} (\text{sat})$	$V_{CE} = V_{CC} (\text{max.})$ $t \geq 50 \mu s$	$V_{CE} = 200 V$	
$V_{BE} (\text{sat})$	$I_C = I_C (\text{max.})$ $I_B$ as provided by driver circuit	$I_C = 4 A$ $I_B = 0.8 A$	< 3 V
$t_r$	$I_C = I_C (\text{max.})$ $I_{B1}$ and $I_{B2}$ as provided by driver circuits	conditions <sup>(3)</sup>	< 2 V <sup>(2)</sup> < 1 $\mu s$
$t_f$	"	"	< 1 $\mu s$

(1)  $V_{EE}$  is negative voltage source applied to the base.

(2) Importance depends upon drive-circuit design. For the design shown,  $V_{BE} (\text{sat})$  is not critical.

(3) Because of the great variations in parameters and waveforms, some standard test condition is used for control. The manufacturers standard conditions are usually adequate control.

**Power Recifiers.** Most of the losses in the power supply occur in the power rectifiers. In a 5-volt, 50-ampere supply, for example, each of the four 1N3909 rectifier diodes carries a nominal peak current of 25 amperes at 50-per-cent duty cycle. The forward power loss in the rectifier can be calculated from the current and voltage values. The voltage

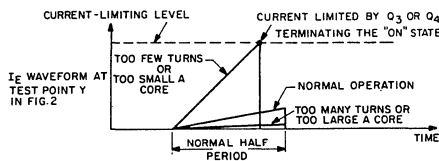


Fig. 4 — Waveform of emitter current in power-switching transistor showing effects of core-size and number of primary turns, with regulation defeated (see note on Fig. 6).

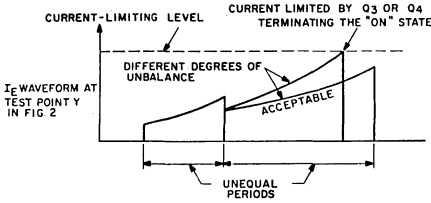


Fig. 5 - Waveform of emitter current in power-switching transistor showing effect of unbalanced direct current, with regulation defeated and load current of 25 amperes.

drop is not specified for 25-ampere operation, but the rectifier has a maximum voltage drop of 1.4 volts at a current of 30 amperes. Because this 30-ampere data is close to 25-ampere operation (and unbalance could cause the current to exceed 25 amperes), the maximum forward-drop rectifier losses can be estimated from the 30-ampere specifications:  $1/2 \times 1.4 \text{ V} \times 30 \text{ A} \times 4 = 84 \text{ watts}$  at maximum rated output.

Reverse recovery losses in the diodes add to the total dissipation; these losses, which are significant at 20 kHz, depend on the rectifiers used, the leakage inductances in the wiring and the isolation transformer, the transistor switching times, and the operating frequency. Because of the many variables (and unknowns) involved, the rectifier losses should

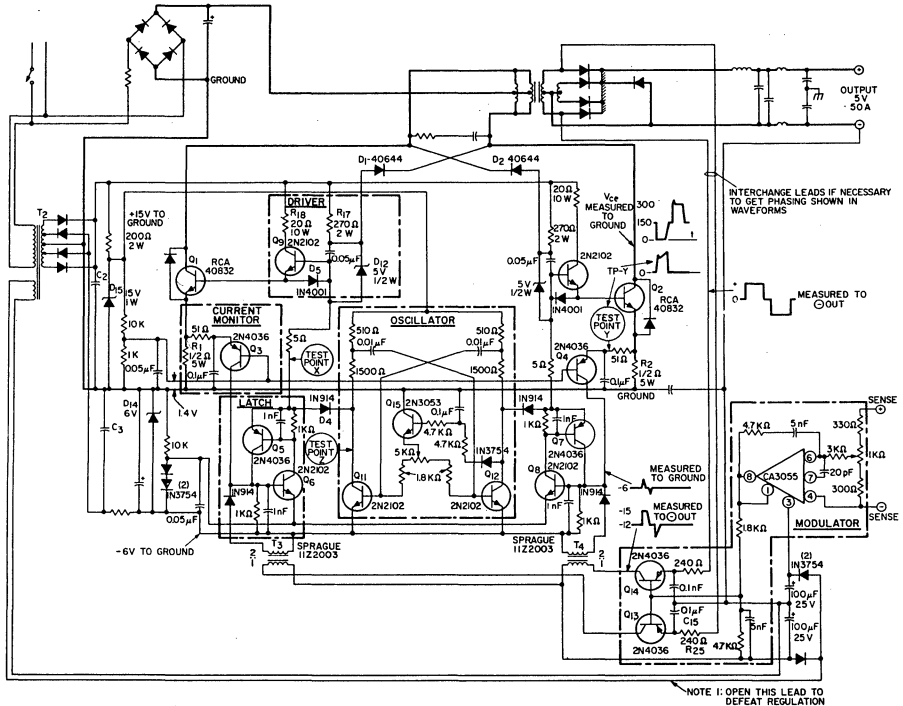


Fig. 6 - Diagram of switching-regulator power supply, with modulator circuits emphasized.

Table IV — Functional Description of Modulator Circuits

MODULATOR CIRCUIT SECTIONS	MAIN PARTS IN SECTION	FUNCTION OF SECTION
Oscillator	Q <sub>11</sub>	Provides basic operating frequency. Holds off driver Q <sub>9</sub> through D <sub>4</sub> to keep Q <sub>1</sub> off for half the period. Provides reverse base drive for Q <sub>1</sub> at 100% duty cycle through D <sub>4</sub> and D <sub>5</sub> .
	Q <sub>15</sub>	Resets the latch circuits. Insures oscillator starts, by removing base drive if Q <sub>12</sub> saturates too long.
Latch	Q <sub>5</sub>	Terminates power-on cycle by latching and causing reverse base to Q <sub>1</sub> .
	Q <sub>6</sub>	Is triggered on by either the current monitor Q <sub>3</sub> or the modulator Q <sub>13</sub> through T <sub>3</sub> , and is held on by regenerative action. Is turned off by the oscillator.
Modulator	Q <sub>13</sub> CA3055 R <sub>25</sub> C <sub>15</sub>	Compares the voltage developed by the CA3055 with a triangular waveform developed by R <sub>25</sub> C <sub>15</sub> . When the triangular voltage exceeds the other, Q <sub>13</sub> conducts and triggers on the latch through T <sub>3</sub> .
Driver	Q <sub>9</sub> D <sub>12</sub> D <sub>5</sub> D <sub>1</sub> D <sub>4</sub> R <sub>18</sub>	Supplies the forward base drive to Q <sub>1</sub> , which is set by R <sub>18</sub> . Prevents common-mode conduction. Diode D <sub>1</sub> senses V <sub>CE</sub> of Q <sub>2</sub> and prevents base drive to Q <sub>9</sub> and thus to Q <sub>1</sub> . Zener D <sub>12</sub> causes Q <sub>1</sub> to be held off until V <sub>CE</sub> of Q <sub>2</sub> exceeds the zener voltage (5V).
Current Monitor	Q <sub>3</sub> R <sub>1</sub>	Limits the emitter current through Q <sub>1</sub> . That current produces a voltage across R <sub>1</sub> which is filtered; if it exceeds 2.0 V, Q <sub>3</sub> conducts and triggers the latch to terminate the power-on cycle.
Low-Voltage Supplies	T <sub>2</sub> C <sub>2</sub> C <sub>3</sub> D <sub>14</sub> D <sub>15</sub>	A 30-volt unregulated supply is used to supply the base drive for Q <sub>1</sub> and Q <sub>2</sub> . It is regulated to 15 volts by D <sub>15</sub> to supply the oscillator. A -12-volt unregulated supply is regulated to -6 V by D <sub>14</sub> . It supplies reverse base drive to Q <sub>1</sub> and Q <sub>2</sub> , and operates the oscillator circuit. An isolated supply operating from T <sub>2</sub> supplies bias to the modulator circuit.

be determined by measurement of circuit efficiency or heat-sink temperature. A total rectifier loss of 45 per cent of the rated output power of the regulator is to be expected.

*Filter.* The use of ac power to generate dc outputs that are free of ac signals requires a good filter. Moreover, in a power supply that delivers high current, the filter components must be of high quality: the inductor must have high Q, and the capacitor must have both low resistance and low inductance.

The inductor carries a current equal to the dc output. It can have small size and low resistance because it has a low inductance (3 to 8 microhenries). The inductance value used is a compromise between the need for a high value to limit peak currents and thus permit good transistor utilization, and the need for a low value to permit fast response to sudden current demands. Fig. 7 shows how the inductor controls the ratio of peak collector current to average collector current in the power-switching transistors under steady-state operation. Smaller inductors cause higher peak currents, which require larger transistors and result in poor utilization of the transistor capabilities. The minimum value of inductance is determined by the peak collector current allowed, as follows:

$$I_{\min} = \frac{t_{\text{off}}(\text{max}) E_{\text{out}}}{n_T I_C(\text{peak}) - I_{\text{load}}}$$

where  $n_T$  is the turns ratio of the isolation transformer. However, as shown in Fig. 8, the inductor also establishes the maximum rate of rise of current to the capacitor, and thus determines the ability of the power supply to respond to sudden demands for load current. For quick response, a low value of inductance is desirable.

The filter capacitors for this application must be selected for 20-kHz operation. Ceramic and paper types are best, but tantalum or high-quality aluminum electrolytics can be used for large values of capacitance. The capacitance must be sufficient to prevent the output voltage from decreasing excessively when the load is suddenly increased and the

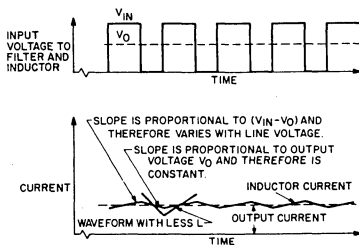


Fig. 7 — Waveforms for filter inductor under steady-state operation at 60-percent duty cycle.

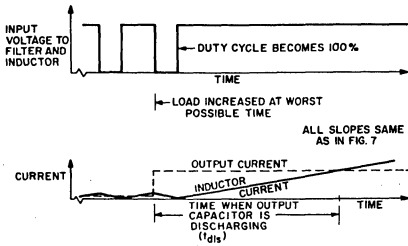


Fig. 8 - Waveforms for filter inductor under sudden increase of load current.

inductor supplies less than the load current. The minimum capacitance is given by

$$C_{\min} = \frac{I_{\text{load}}(t_{\text{dis}} + 2t_{\text{off(max)}})}{2(\Delta V)_{\text{allowed}}}$$

where

$$t_{\text{dis}} = \frac{L I_{\text{load}}}{\frac{V_{\text{CC(min)}}}{n_T} - V_o - 1.0}$$

and  $t_{\text{off(max)}}$  is 12.5 microseconds for this design.

#### A SPECIFIC DESIGN EXAMPLE

A power supply that uses the circuits shown in Figs. 1, 2, and 6 can deliver a load current of 50 amperes at 5 volts. All of the pulse-width modulation circuits, drivers, and latches are duplicated for each power-switching transistor. This duplication uses more than the minimum number of components, but it provides wide design margins and more reliable operation.

Voltage regulation and overload regulation are accomplished by reducing the duty cycle of the power-switching transistors. The duty cycle is reduced by triggering the latches on (see Fig. 6 and Table IV), either from pulse transformers T3 and T4 to regulate the output voltage, or from transistors Q3 and Q4 to prevent excessive emitter currents in the power-switching transistors. The excessive currents could be caused by overloads at the output or by transformer core saturation resulting from unbalanced duty cycles.

Input-to-output isolation is maintained through the main isolation transformer (T1), the 60-Hz transformer (T2), and the pulse transformers (T3 and T4). This circuit isolation is indicated in Fig. 2.

This power supply is capable of operating into any load impedance, including short circuits, without damage. It can

operate at duty cycles from less than 10 per cent to 100 per cent. With a duty cycle of 100 per cent, the supply operates as a straight inverter at the full capacity of the transistors, transformers, and rectifiers.

The base drive for the power-switching transistors is direct-coupled, and is supplied by an unregulated low-voltage power supply that operates from a 60-Hz transformer. Direct coupling of the base drive provides positive control over transistor bias. The reverse base drive is supplied by the two-transistor latch circuits Q5 and Q6 or Q7 and Q8, or by the oscillator transistors (Q11 and Q12) if the duty cycle is 100 per cent. The reverse base voltage is obtained from a 6-volt regulated supply.

The frequency is controlled by the astable transistor oscillator that operates from 15-volt and -6-volt regulated sources. A potentiometer for equalization of the duty cycle is shown, but is not normally required. Transistor Q15 insures that the oscillator does not "hang up."

Common-mode conduction is reduced by cross-coupled diodes D1 and D2. These diodes conduct when  $V_{\text{CE}}$  of the power-switching transistor is less than 5 volts (breakdown of the zener diode), and prevent conduction of the opposite power-switching transistor; this operation is illustrated in the waveforms of Fig. 9. These diodes are of critical importance because the storage time of the power-switching transistors is several microseconds at light load conditions ( $I_{\text{B1}} > 0.5$  amperes and  $I_{\text{C}} < 0.5$  amperes).

A major consideration in the design of this power supply is the protection of the switching transistors and the load circuit from damage caused by transients or faults in the modulator. The faults most likely to occur are lock-up in the oscillator, transient turn-on of the latching transistors caused by  $dv/dt$  at point X in Fig. 6, and magnetic pickup in the pulse transformers. The circuit is designed so that any of these faults will cause the power-switching transistors to turn off; this design protects the transistors and keeps the output voltage low. The overcurrent protection circuit is made independent of the proper functioning of the output regulator or its associated circuits, and is dc-coupled to minimize the possibility of failure. Finally, if the low-voltage supplies fail, the output voltage merely falls to zero without any harmful surges.

Table IV gives a full description of the modulator circuits. For simplicity, the discussion is limited to the components on the left side of the symmetrical circuit layout shown in Fig. 6.

#### VARIATIONS ON THE DESIGN

The design discussed above and shown in Figs. 2 and 6 can be modified for different performance.

**More Output.** Larger transistors, such as the 2N5805, can be used as the power switches to increase the output by as much as 100 per cent. These transistors would require more base drive, which can be supplied by the circuit shown

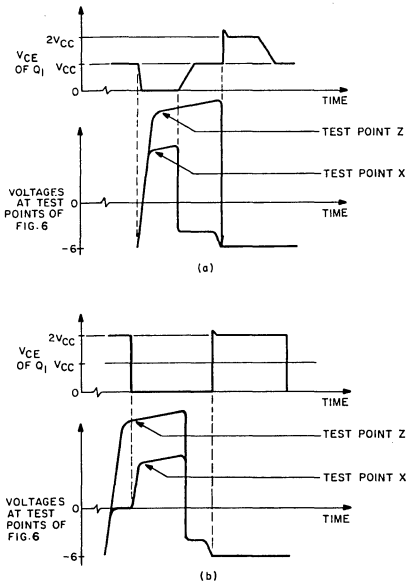


Fig. 9 - Suppression of common-mode conduction: (a) 50-per-cent duty cycle; (b) 100-per-cent duty cycle.

in Fig. 10 if the capacity of the 30-volt supply is increased. **Simpler Construction.** Custom integrated circuits can reduce the number of parts in this unit.

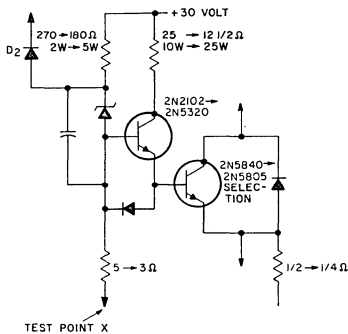


Fig. 10 - Changes in power-switching transistor drive circuit to produce increased output from larger power-switching transistors.

**Smaller Package.** A 20-kHz "off-the-line" inverter can be used in place of the 60-Hz transformer to reduce the size of the supply further. The smaller transformers, capacitors, and resistors for 20-kHz operation would, however, increase the cost.

**Sensing.** The output-voltage sensing can be improved, and output-current sensing can be added if required. The short-circuit protection in the circuit can be improved by adding an IC regulator that senses the output current by means of a current-sampling resistor.

**Low-Voltage Supplies.** Different voltages and different types of regulation can be used in the low-voltage supplies. One alternative, shown in Fig. 11, is the use of an extra winding on the isolation transformer to supply the base-drive transistors. This circuit reduces the cost of smoothing capacitor C2 in Fig. 2, and reduces the size of the 60-Hz transformer.

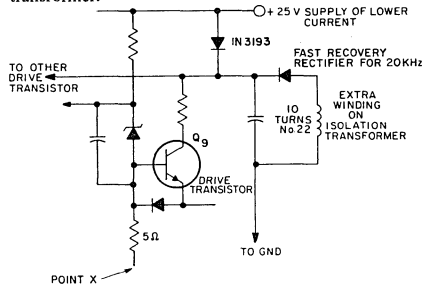


Fig. 11 - Use of a separate isolation-transformer winding to supply the base-drive transistors.

**DESIGN NOTES**

The switching-regulator type of power supply is more complex than a conventional dc series regulator. Because tests must be made with regard to waveforms, an oscilloscope is a required diagnostic tool. A special problem is that most of the components in these supplies are not isolated from the power line. Although the test equipment can be used "floating", the safest practice is to use an isolation transformer during tests of the power supply.

Finally, the design and construction of the filter are important to reduce spikes on the output. The filter unit should be sealed to prevent radiation.

**References**

1. RCA Transistor, Thyristor, & Diode Manual (SC-14); RCA Commercial Engineering, Harrison, N.J.
2. RCA Silicon Power Circuits Manual (SP-51); RCA Commercial Engineering, Harrison, N.J.
3. RCA Silicon Rectifiers (SRS-300A); RCA Commercial Engineering, Harrison, N. J.
4. F. E. Terman, Radio Engineers' Handbook; McGraw-Hill Book Co., 1943, pg. 100.
5. Indiana General Ferramic Components, Indiana General Corp.; Keasbey, N.J. 1970
6. "Applying Ferroxcube Ferrite Cores to the Design of Power Magnetics", Bulletin No. 330; Ferroxcube Corp., Saugerties, N.J. 1966

## A 60-Watt, 20-Volt Regulated Power Supply Using a Single Pass Transistor

by D. Morris and R. H. Smith

This Note discusses a regulated constant-voltage power supply that uses RCA integrated circuits and a rugged RCA homotaxial transistor to attain high output-power capability. A 20-volt, 3-ampere supply that uses a single RCA-2N3055 pass transistor is described in detail; the discussion includes circuit descriptions, operating characteristics, component specifications, and suggestions for layout and construction. Thermal-fatigue effects and safe operating conditions for power transistors are considered. Finally, guidance is provided for those who may want to develop a similar circuit for their own needs.

### DESCRIPTION OF CIRCUIT

Specifications for the 60-watt, 20-volt supply are listed in Table I, and a block diagram is shown in Fig. 1. The circuit uses an external pass transistor and driver to extend the current capability of the RCA-CA3055 integrated-circuit voltage regulator; the overload protection provided by a foldback current-limiting circuit permits operation of the transistor at a dissipation level close to its limit. This foldback circuit achieves high efficiency by use of an RCA-CA3030 integrated-circuit operational amplifier.

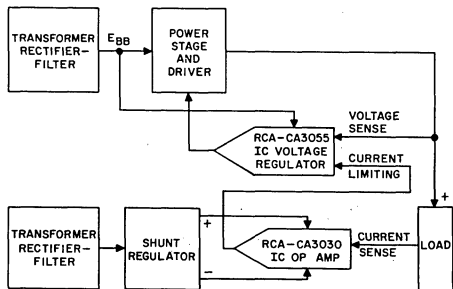
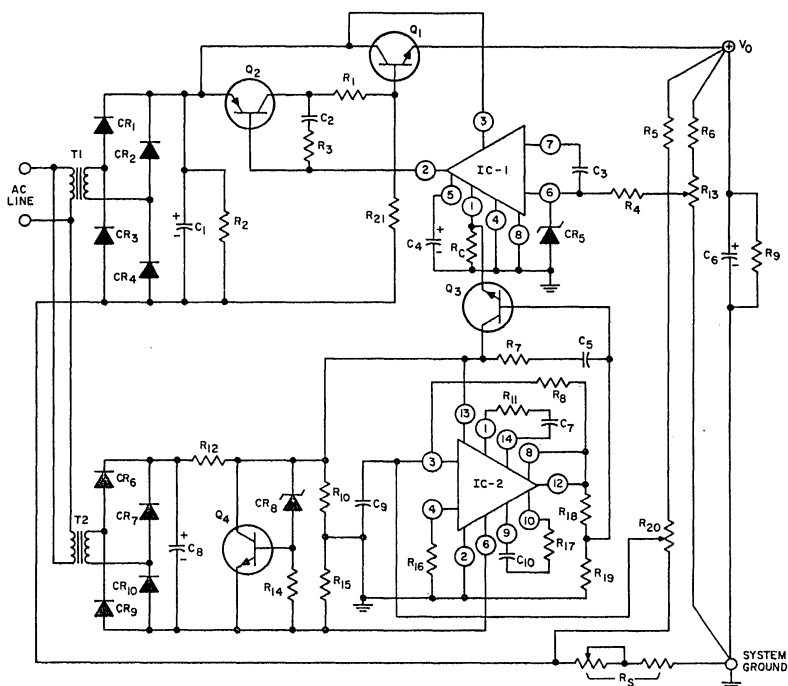


Fig. 1— Block diagram of regulated power supply with foldback current limiting.

Table I - Power-Supply Specifications

$V_{input}$	105-130 V, Single Phase 55-420 cps
$V_{output}$	20 V $\pm$ 0.5 V
$I_{load(max)}$	3 A
Ambient Temperature	0 to +55°C
Voltage spikes	None at turn on or turn off
Regulation	Line: $\pm$ 0.25% Load: $\pm$ 0.25%
Ripple	33 mV pp; 9.5 mV rms
Transients:	
No load to full load:	100 mV, recovery within 50 $\mu$ s
Full load to no load:	100 mV, recovery within 50 $\mu$ s
Drift	20 mV in 8 hours of operation at constant ambient temperature
Short Circuit and overcurrent protection	Foldback technique

The over-all operation of the circuit can be understood with the aid of the schematic diagram shown in Fig. 2. Transformer T1 and its rectifiers supply the raw dc power that is regulated by pass transistor Q1; this pass transistor is driven by driver Q2, which is driven by the control circuit IC1. Transformer T2, with its rectifiers and shunt regulator Q4, provides positive and negative supplies for operational amplifier IC2; this operational amplifier drives the current-limiting control Q3. Output voltage is sensed at resistance string (R6 + R13), and load current is sensed by R5.



T1	Signal Transformer Co., Part No. 24-4 or equivalent	R4	100 ohms, 1/2 watt, carbon, IRC Type RC 1/2 or equivalent
T2	Signal Transformer Co., Part No. 12.8-0.25 or equivalent	R5	430 ohms, 2 watts, wire wound, IRC Type BWH or equivalent
CR1-CR4	RCA-1N1614	R6	9100 ohms, 2 watts, wire wound, IRC Type BWH or equivalent
CR5	Zener Diode, 1N5225 (3.3 V)	R7	470 ohms, 1/2 watt, carbon, IRC type RC 1/2 or equivalent
CR6, CR7, CR9, CR10	Power Rectifier, RCA-1N3193	R8	5100 ohms, 1/2 watt, carbon, IRC type RC 1/2 or equivalent
CR8	Zener Diode, 1N5242 (12 V)	R9, R14	1000 ohms, 2 watts, wire wound, IRC type BWH or equivalent
C1	5900 $\mu$ F, 75 V, Sprague Type 36D592F075BC or equivalent	R10, R15	250 ohms, 2 watts, 1% wire wound, IRC type AS-2 or equivalent
C2	0.005 $\mu$ F, ceramic disc, Sprague TGD50 or equivalent	R11, R17	1000 ohms, 1/2 watt, carbon, IRC type RC 1/2 or equivalent
C3, C7, C10	50pF, ceramic disc, Sprague 30GA-Q50 or equivalent	R12	82 ohms, 2 watts, IRC type BWH or equivalent
C4	2 $\mu$ F, 25 V, electrolytic, Sprague 500D G025BA7 or equivalent	R13	1000 ohms, potentiometer, Clarostat Series U39 or equivalent
C5	0.01 $\mu$ F, ceramic disc, Sprague TG510 or equivalent	R16	1200 ohms, 2 watts, wire wound, IRC type BWH or equivalent
C6	500 $\mu$ F, 50 V, Cornell-Dubilier No. BR500-50 or equivalent	R18	510 ohms, 1/2 watt, carbon, IRC type RC 1/2 or equivalent
C8	250 $\mu$ F, 25 V, Cornell-Dubilier BR 250-25 or equivalent	R19	10,000 ohms, 1/2 watt, carbon, IRC type RC 1/2 or equivalent
C9	0.47 $\mu$ F, film type, Sprague Type 220P or equivalent		
R1	5 ohms, 1 watt, IRC type BWH or equivalent		
R2	1000 ohms, 5 watts, Ohmite type 200-5 1/4 or equivalent		
R3	1200 ohms, 1/2 watt, carbon, IRC type RC 1/2 or equivalent		

Fig. 2— Schematic diagram of 60-watt, 20-volt regulated power supply with foldback current limiting.





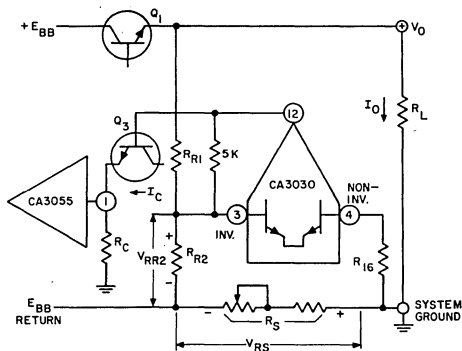


Fig. 5— Circuitry for foldback current limiting.

the inverting input (terminal No. 3) of the differential amplifier. The non-inverting input is tied to system ground through  $R_{16}$ . Thus the base-to-base signal that actuates the differential amplifier is the difference between  $V_{RS}$  ( $=I_O R_S$ ) and  $V_{RR2}$ . The CA3030 output, which is the voltage at terminal No. 12, varies linearly with the actuating voltage, as shown in Fig. 6. When the load current is zero\*,  $V_{RS}$  is zero; therefore  $(V_{RS} - V_{RR2})$  is negative, terminal 12 is negative with respect to ground, and Q3 is back-biased (i.e., cut off). Therefore Q3 does not interfere with the normal voltage-regulated operation of the supply. As the load current increases,  $V_{RS}$  increases and the voltage at terminal 12 increases.

The value of resistor  $R_S$  is adjusted so that when the load current reaches the foldback-activation value (about 3 amperes in the power supply shown), the voltage at terminal No. 12 of the CA3030 becomes positive. At about 0.7 volt, transistor Q3 begins to conduct; current flows through the current-limiting resistor  $R_C$ , with the result that terminal No. 1 of the CA3055 control circuit is driven positive. Q15 of Fig. 3 turns on, and the base-to-emitter voltage of Q13-Q14 is therefore reduced; the base-to-emitter voltage of Q2 is reduced, and the output voltage of the power supply decreases. This decrease of  $V_O$  tends to reduce the load current; however,  $V_{RR2}$  also decreases with  $V_O$ , so that  $(V_{RS} - V_{RR2})$  remains fixed and Q3 continues to conduct at the same emitter current. If the load impedance is reduced, Q3 will be driven even harder, and therefore the output voltage and the load current will decrease even further. Fig. 4 shows the foldback as  $R_L$  decreases.

This process is reversible. If the load impedance  $R_L$  is increased,  $I_O$  and  $V_O$  will increase. When  $I_O$  reaches the

foldback-activation level, Q3 will cut off again and the power supply will return to regulated operation.

The CA3030 must be operated as a linear voltage amplifier in the foldback circuit, so that the gain is as shown in Fig. 6. If the CA3030 is adjusted otherwise, a Schmitt trigger action can occur. Such operation may be desirable in latching-type current protection, e.g., in circuits that switch off at overload. However, those circuits introduce other problems such as lack of automatic turn-on, hysteresis effects on varying loads during the shutdown process, and capacitive and nonlinear loads; therefore, latching protection is not considered in this Note.

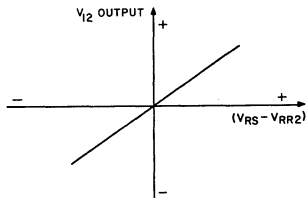


Fig. 6— Output voltage from the CA3030 operational amplifier as a function of actuating voltage.

#### DESIGN CONSIDERATIONS

For maximum performance from this power-supply circuit, several design features must be analyzed. These features include the equivalent source resistance of the rectifier filter circuit, the foldback-circuit parameters, and the maximum power dissipation in the pass transistor. In addition, safe-operation and thermal-fatigue ratings for the transistors are important.

#### Equivalent Resistance of the Raw DC Source

A full-wave bridge rectifier<sup>6</sup> provides the raw dc power for this supply; the rectifier and its filter are shown in Fig. 7(a). The output current and power capability would be improved by use of a custom-wound transformer, and even greater capability would be attained by use of a full-wave center-tapped rectifier circuit with a custom transformer. However, a custom transformer would increase the unit cost, particularly if no winding facilities were available; therefore, a commercially available transformer is used in this supply.

The load regulation of the transformer is approximately 10 per cent. This value is used as the approximate  $R_g/R_L$  parameter in Schade's curves<sup>7</sup> to select input capacitor C1. The value of C1 that will keep peak-to-peak ripple below 2.4 volts is found to be 5900 microfarads. With this capacitance, the measured value of equivalent source (generator) resistance  $R_g$  is 2 ohms. Fig. 7(b) shows the equivalent circuit of the rectifier and filter.

\* The currents in the 1-kilohm bleeder resistor and the 10-kilohm sensing string are neglected in this discussion.

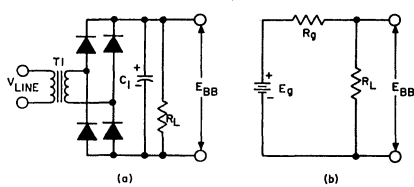


Fig. 7— Full-wave bridge rectifier and filter that provide raw dc for power supply: (a) circuit diagram; (b) equivalent circuit.

At high line voltage (130 volts ac) the cold-temperature, no-load dc voltage of the rectifier filter is 39.4 volts; this value is just below the 40-volt maximum rated voltage of the CA3055. At low line voltage (105 volts ac) the hot full-load dc voltage of the rectifier filter is 25.4 volts; the theoretical minimum necessary voltage for the supply is shown in Appendix A to be 25.4 volts.

#### Foldback-Circuit Parameters

A simple conventional foldback circuit, in which a single-ended amplifier is used instead of the differential amplifier described above, is shown in Fig. 8(a). The equivalent circuit is shown in Fig. 8(b). Analysis of this

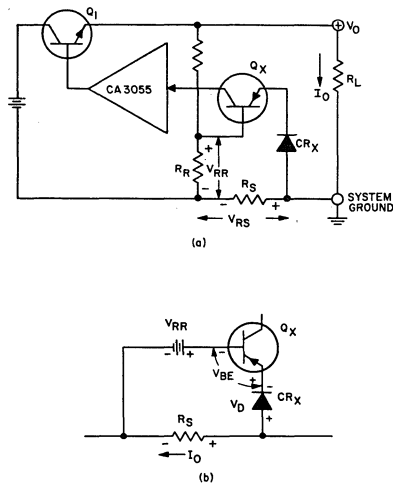


Fig. 8— A simple conventional foldback circuit that uses a single-ended amplifier instead of a differential amplifier: (a) circuit diagram; (b) equivalent circuit.

circuit (see Appendix B) shows that the ratio of maximum load current just before foldback activation,  $I_X$ , to the rated load current  $I_R$ , is approximately given by

$$\frac{I_X}{I_R} = \frac{V_D + V_{BE} + V_{RR}}{V_D + V_{RR}} \quad (1)$$

in which  $V_D$  is the voltage drop across the diode (= 0.7 volt for a silicon diode).  $I_R$  is the zero-bias level for  $Q_X$ ; when  $I_O$  exceeds  $I_R$ ,  $Q_X$  becomes forward-biased and causes loss of regulation.

The ratio of the short-circuit current,  $I_{SC}$ , to the rated load current is approximately given by

$$\frac{I_{SC}}{I_R} = \frac{V_D + V_{BE}}{V_D + V_{RR}} \quad (2)$$

When the values of the circuit components are inserted into these equations, these ratios have the following values:

$$\frac{I_X}{I_R} = 1.23 \quad (3)$$

$$\frac{I_{SC}}{I_R} = 0.47 \quad (4)$$

Eq. (3) shows that the pass transistor must have a current capability 23 per cent greater than the rated current value of the supply, or, equivalently, that the pass transistor is utilized at only 77 per cent of its current and power-dissipation capabilities at rated supply current. This utilization is reduced even further by the source resistance of the generator, as discussed below.

Another disadvantage of the simple foldback circuit is indicated in Appendix A: the minimum voltage across filter capacitor  $C_1$  is increased by at least  $(V_D + V_{BE} + V_{RR})$ .

The foldback circuit used in the supply shown, which uses a differential amplifier and a low actuating signal, is free of the drawbacks encountered in the simple conventional circuit. Actual values measured on the differential-amplifier foldback circuit, set for a 0.2-volt actuating signal and a rated load current of 3 amperes, are as follows:

$$I_{SC} = 0.125 A$$

$$I_X = 3.15 A$$

$$\frac{I_X}{I_R} = \frac{3.15}{3} = 1.05$$

$$\frac{I_{SC}}{I_R} = \frac{0.125}{3.00} = 0.042$$

The maximum load current to actuate foldback is 5 per cent greater than the rated current, and the short-circuit current is 4 per cent of the rated current.

#### Maximum Power Dissipation in the Pass Transistor

Power dissipation in the pass transistor reaches maximum during foldback. This worst-case value can be calculated by the analysis given in Appendix C, which uses the equivalent circuit shown in Fig. 9. (The use of a power-sharing resistor in parallel with the pass transistor is neglected in this discussion because transformer T1 operates at its maximum capacity.) Because the maximum-dissipation situation might occur during operation, the power supply must be designed to withstand this worst-case condition.

Maximum power dissipation occurs when the output voltage is given by

$$V_{OX} = \frac{E_g}{2(1 + \sigma R_g)} \quad (5)$$

where  $E_g$  is the generator voltage,  $\sigma$  is the load conductance ( $\sigma = I_R/V_R = 1/R_L$ ),  $I_R$  is the rated current,  $V_R$  is the rated voltage, and  $R_g$  is the generator resistance. The value of the maximum power,  $P_X$ , is given by

$$P_X = \frac{\sigma E_g^2}{4(1 + \sigma R_g)} \quad (6)$$

The rated current is determined as a function of rated voltage, maximum power, generator voltage, and generator resistance, as follows:

$$I_R = V_R \frac{4P_X}{E_g^2 - 4P_X R_g} \quad (7)$$

The maximum power limit for the pass transistor,  $P_X$ , depends on the heat sink. Appendix D shows that for the particular case under discussion the maximum power is 47 watts. Therefore,  $I_R$  is given by

$$I_R = 20 \frac{4 \times 47}{(40)^2 - 4 \times 47 \times 2} = 3.07 A$$

The value of  $V_{OX}$  is then determined as follows:

$$V_{OX} = \frac{E_g}{2(1 + I_R/V_R R_g)} = \frac{40}{2(1 + \frac{3.07}{20} \times 2)} = 15.4 V \quad (8)$$

Idealized curves of various power-supply parameters in regulated operation and in foldback are shown in Fig. 10. Maximum dissipation is 46 watts, at  $V_{OX} = 15.4$  volts. This condition can occur if the supply is turned on with a load that causes worst-case foldback operation. As the transformer heats up, the capacitor voltage decreases (i.e.,  $R_g$  increases), and dissipation is slightly reduced. Even at maximum dissipation in the transistor, however, the power supply can provide continuous trouble-free operation.

#### Safe Operation of Power Transistors

The current capability of the circuit can be increased almost indefinitely by use of drivers and output transistors with higher current and dissipation capability, by paralleling transistors, or by providing one or more additional stages in a Darlington configuration, along with increased heat sinking, transformer and rectifier capability, and filter capacitance. Information on the proper operation of transistors can be

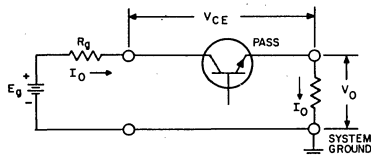


Fig. 9— Equivalent circuit used for calculation of power dissipated in pass transistor.

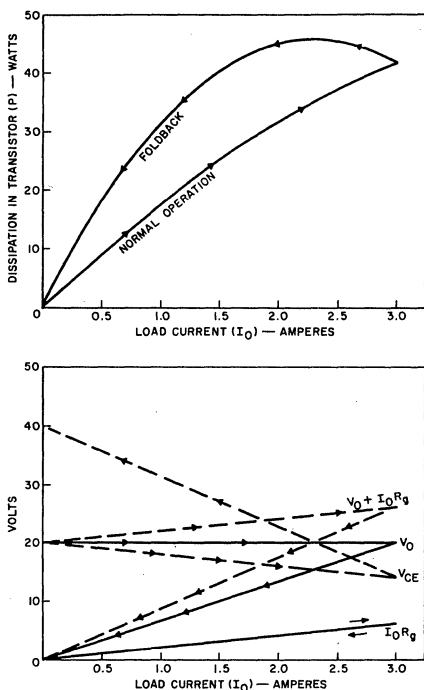


Fig. 10—Idealized operating characteristics of foldback current-limiting circuit.

found in published data sheets.<sup>8,9</sup> Safe-area charts, derating curves, thermal resistance, and maximum junction-temperature specifications are given in the data sheets. Worst-case-operation conditions for the transistors can be determined for a number of possible values of rated voltage and current, and these values can be checked against the specified ratings.

The current capability of linear series regulators is usually limited by the safe dissipation levels of the pass devices, rather than by maximum current ratings or available gain, especially if simple (not foldback) current limiting is used, as for an adjustable voltage supply. Safe operating area encompasses the limitations of power dissipation and second breakdown.<sup>10</sup> RCA homotaxial-base transistors, such as the 2N3055, show little or no second-breakdown limitation in the safe area. Because the published safe area is guaranteed by 100-per-cent factory testing, the user is sure of reliable service even in such severe applications as linear regulators.

### Thermal-Fatigue Considerations

A transistor is constructed of materials that have various thermal-expansion coefficients. When the transistor is subjected to a range of internal temperatures in the course of normal operation, the different coefficients of expansion result in stresses on various parts of the internal transistor structure. These stresses are proportional to the change in temperature, the difference in expansion coefficients between two materials in contact, and the pellet size. When the stresses are severe enough and are repeated enough times, they can cause the transistor to fail, usually by rupture of the solder bonds between the pellet and the top contacts or between the pellet and the mounting base. Large power transistors that operate at high power levels, such as the pass devices in linear series regulators (e.g., the RCA-2N3055 family of transistors in the circuit described in this Note), operate in a mode of high thermal-fatigue stress.

RCA has recognized the thermal-fatigue problem and has developed transistors that are extremely resistant to thermal-fatigue failure. This resistance to thermal-fatigue failure is the result of a proprietary Controlled Solder Process (CSP), by which impurities and voids are reduced or eliminated from the solder system. Impurities enhance the propagation of cracks induced by thermal-fatigue stresses, and thus contribute to early failure of the solder bonds. Voids under the pellet act as insulation, and can lead to hot spots that cause high thermal-fatigue stresses. CSP is now employed on all RCA hermetic power transistors.

RCA has developed power-transistor thermal-cycling ratings that indicate expected life, in number of thermal cycles, as a function of power dissipation and case-temperature change. These ratings are calculated from theoretical models based on actual measurements.<sup>11,12</sup> This rating system shows that the RCA-2N3055 pass transistor, used as described in this Note (maximum power dissipation of 46 watts, case-temperature change of 43°C), can survive more than 50,000 thermal cycles without failure. The RCA-2N5781 and the smaller devices in the circuit should last even longer.

The combination of homotaxial construction for ruggedness and CSP for long thermal-fatigue life makes these power transistors the best choice for power-supply applications.

### OPERATIONAL PERFORMANCE

#### Adjustment of Current-Sensing Resistor $R_S$

The fixed portion of current-sensing resistor  $R_S$  is simply a short length of resistance wire; its resistance is about 0.064 ohm. This resistor must be adjusted on each power supply, because both the over-all loop system gain and the current-limiting voltage across terminals 1 and 8 of the CA3055 can vary from unit to unit. The two-step procedure for adjusting the fixed portion of the  $R_S$  is as follows:

(a) Set the reference voltage by adjusting the 250-ohm potentiometer (R20) until the voltage from the arm of the

potentiometer to ground is 200 millivolts (with the load current zero, and total sensing resistor  $R_S = 0$ ).

(b) Use a variable resistor across the output terminals to set the load current at 3.15 amperes. Then insert the fixed portion of the sensing resistance and increase it until current foldback is just initiated. Initiation of foldback is evidenced by sudden reduction in output voltage.

This fixed resistor should be made of resistance wire such as Driver Harris Manganin #18 (0.176 ohms per foot) or equivalent. Copper wire can be used provided  $I^2R$  heating does not change its resistance, and effects of ambient-temperature change are taken into consideration. (The temperature coefficient of copper wire is  $3.9 \times 10^{-3}$  per  $^{\circ}C$ . If the copper resistor were adjusted at  $20^{\circ}C$ , and the ambient temperature then changed to  $55^{\circ}C$ , the current required to activate foldback would be reduced from 3.15 amperes to 2.7 amperes).

The variable portion of current-sensing resistor  $R_S$  is a 1-ohm potentiometer. It is used to set the current-limitation threshold at levels below 3 amperes, if such operation is desired.

**Adjustment of Current-Limiting Resistor  $R_C$**

The CA3055 voltage regulator would function most effectively if current-limiting resistor  $R_C$  were zero, but  $R_C$  is necessary for foldback operation. Therefore, as a compromise between regulation and protection sensitivity,  $R_C$  is adjusted to provide an over-all regulation of  $\pm 0.25$  per cent for all load currents from 0 to 3 amperes. This value of  $R_C$  results in a reasonable short-circuit current (0.125 amperes). If  $R_C$  is made smaller (to permit better regulation), the ratio  $R_8/R_{16}$  must be increased to provide more gain in the current-limiting circuit. This change may require restabilization of the circuit.

**Power-Supply Performance**

With the circuit adjusted as described above, the power supply performs as shown in Table II.

**CONSTRUCTION**

Fig. 11 shows the assembled power supply; it is 8 inches long, 8 inches wide, and 5 3/4 inches high (these dimensions can be reduced if necessary). The chassis is made of 0.052-inch aluminum, perforated on top and sides for ventilation; a commercial chassis such as the BUD CA1751 or equivalent could also be used.

The control circuit is built on a pre-punched fiber board. Good wiring techniques are observed, all leads to the integrated circuits are kept as short as possible, and heat sinks are attached where required.

The positive and negative supplies for the operational amplifier are also constructed on pre-punched fiber board. The board is attached with an L-bracket to the diode support, as shown in the diagram.

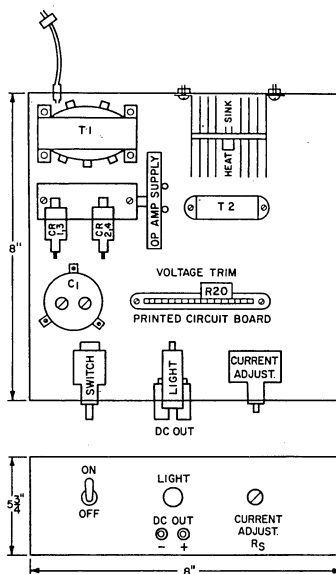


Fig. 11— Layout of power supply.

The pass-transistor heat sink is mounted vertically, with 1/4-inch clearance from the bottom of the chassis to provide adequate convection. The circuit board is mounted as far as possible from the pass-transistor heat sink to achieve maximum thermal isolation.

Construction of this supply is flexible. Wiring is not critical, but heavy wire should be used for the leads that carry high current. The total allowable IR drop in the wiring is 0.1 volt; at a current of 3 amperes, therefore, the total allowable resistance (including contact resistance) is 33 milliohms.

As in all error-detecting systems, the sampling should be accomplished at the terminals of the power supply, i.e., at the +20-volt and ground terminals. Therefore all of the system ground points indicated in Fig. 2 are connected with heavy wire to avoid ground loops. Output capacitor C6 is wired directly to the output terminals.

**APPENDIX A. Minimum Voltage Across Filter Capacitor**

The minimum voltage across filter capacitor C1 is obtained as follows:

$$V_{Cap (min)} = V_O + V_{O-PK} + V_{BE 2N3055} + V_{CE 2N5781} + V_{R1} + V_{TOL} + V_{RS} + V_{LD}$$

Table II - Performance of Regulated Power Supply

Normal Operation: $V_O$ set at 20.000 VDC with $I_O = 3\text{ A}$ @ $V_{\text{line}} = 115\text{ VAC}$ .			
PARAMETER	CONDITIONS	VALUE	
Load regulation	$I_O = 0 \rightleftharpoons 3\text{ A}$ , $V_{\text{Line}} = 105\text{ VAC}$	$\pm 0.25\%$	
Load regulation	$I_O = 0 \rightleftharpoons 3\text{ A}$ , $V_{\text{Line}} = 115\text{ VAC}$	$\pm 0.25\%$	
Load regulation	$I_O = 0 \rightleftharpoons 3\text{ A}$ , $V_{\text{Line}} = 130\text{ VAC}$	$\pm 0.25\%$	
Line regulation	$I_O = 0$ , $V_{\text{Line}} = 105 \rightleftharpoons 130\text{ VAC}$	$\pm 0.25\%$	
Line regulation	$I_O = 3\text{ A}$ , $V_{\text{Line}} = 105 \rightleftharpoons 130\text{ VAC}$	$\pm 0.25\%$	
Total regulation spread	$0 \leq I_O \leq 3\text{ A}$ , $105 \leq V_{\text{Line}} \leq 130\text{ VAC}$	0.77%	
Ripple (peak-to-peak)	$I_O = 3\text{ A}$	33 mV	
Ripple (rms)	$I_O = 3\text{ A}$	9.5 mV	
Transients	Full load (3 A) to no load (0 A)	$\leq 100\text{ mV}$ , $t_{\text{recovery}} \leq 50\ \mu\text{s}$	
Transients	No load (0 A) to full load (3 A)	$\leq 100\text{ mV}$ , $t_{\text{recovery}} \leq 50\ \mu\text{s}$	
Transients	Turn on (105 or 130 VAC)	0	
Transients	Turn off (105 or 130 VAC)	0	
Drift	$I_O = 3\text{ A}$	$\leq 15\text{ mV/8 hours}$	
Case Temperature Rise:	After 8 hours @ $I_O = 3\text{ A}$ and $V_{\text{Line}} = 130\text{ VAC}$		
2N3055		43°C	
2N5781		49°C	
CA3055		15°C	
$I_{\text{SC}}$	$V_{\text{Line}} = 105\text{ or }130\text{ VAC}$	0.125 A	
Abnormal Operation: Circuit in fold back operation at worst-case condition ( $V_O = 15.4\text{ VDC}$ )			
PARAMETER	CONDITIONS	VALUE	
Case Temperature Rise:	After 8 hours in foldback @ $V_{\text{Line}} = 130\text{ VAC}$	<u>Measured</u>	<u>Calculated</u>
2N3055		50°C	60°C
2N5781		63°C	85°C
CA3055		17°C	—

where

$V_O$  = output voltage = 20 V  
 $V_{O-PK}$  = ripple voltage (zero to peak = 1/2 peak to peak) = 1.2 V  
 $V_{BE}$  2N3055 = worst case  $V_{BE}$  of pass transistor = 1.4 V  
 $V_{CE}$  2N5781 = worst case  $V_{CE}$  of driver transistor = 1 V  
 $V_{R1}$  = Voltage across collector resistor  $R_1$  = 1 V  
 $V_{TOL}$  = 0.5-volt tolerance on output = 0.5 V  
 $V_{RS}$  = voltage of current-sensing resistor = 0.2 V  
 $V_{LD}$  = voltage drop in wiring = 0.1 V

Therefore

$$V_{Cap}(\min) = 20 + 1.2 + 1.4 + 1 + 1 + 0.5 + 0.2 + 0.1 = 25.4 \text{ volts}$$

#### APPENDIX B. Foldback Parameters

As a first approximation, the following equations describe the three conditions of load current in the circuit of Fig. 8(b):

$$\text{General equation: } I_{ORS} = V_D + V_{BE} + V_{RR}$$

At rated current  $I_R$ , it is desirable that  $V_{BE} = 0$ .

$$\therefore I_R R_S = V_D + V_{RR}$$

At maximum load current, just before foldback is initiated,

$$I_X R_S = V_D + V_{BE} + V_{RR}$$

At short-circuit current,  $V_O = 0$ , and therefore  $V_{RR} = 0$ .

$$I_{SC} R_S = V_D + V_{BE}$$

By dividing appropriate equations,

$$\frac{I_X}{I_R} = \frac{V_D + V_{BE} + V_R}{V_D + V_{BE}}$$

and

$$\frac{I_R}{I_{SC}} = \frac{V_D + V_R}{V_D + V_{BE}}$$

To make the maximum current close to rated current,

$$V_D + V_{BE} + V_R \approx V_D + V_R$$

$$\therefore (V_D + V_R) \gg V_{BE}$$

However, if  $V_D$  is large, the initiating voltage must also be large. Therefore, the minimum voltage across  $C_1$  must also be increased.

If  $V_D$  is one diode drop (0.7 volt) and if  $(V_D + V_R)$  is 3 volts as a compromise, then  $V_R = 2.3$  volts, and

$$\frac{I_X}{I_R} = \frac{0.7 + 2.3 + 0.7}{0.7 + 2.3} = 1.23$$

and

$$\frac{I_R}{I_{SC}} = \frac{0.7 + 2.3}{0.7 + 0.7} = 2.14$$

$$\therefore I_{SC} = \frac{I_R}{2.14} = 0.468 I_R$$

#### APPENDIX C. Maximum Power Dissipation in the Pass Transistor

The equivalent circuit used to calculate the power dissipation in the pass transistor is shown in Fig. 9.  $R_g$  includes the 64-milliohm resistance used for sensing the 3.15-ampere actuating current. The additional current supplied for  $I_{CO}$  of  $Q_1$  and the current supplied to the CA3055 regulator are neglected.

The voltage across the transistor is given by

$$V_{CE} = E_g - V_O - I_O R_g = E_g - (V_O + I_O R_g)$$

The power dissipated in the transistor is given by

$$P = [E_g - (V_O + I_O R_g)] I_O$$

The ideal foldback characteristic is shown in Figs. 4 and 10. The measured values are within 5 per cent of the ideal values. Therefore a small error is introduced if the ideal characteristic is used for the analysis.

Equations that describe operation during foldback are derived as follows:

$$y = mx + b = mx + 0$$

$$m = \frac{V_R}{I_R}$$

$$V_O = \frac{V_R}{I_R} I_O$$

$$I_O = V_O \frac{I_R}{V_R} = V_O \sigma$$

$$P = E_g I_O - V_O I_O - I_O^2 R_g$$

$$= E_g V_O \sigma - V_O^2 \sigma - V_O^2 \sigma^2 R_g$$

$$P + V_O^2 [\sigma + \sigma^2 R_g] - V_O [\sigma E_g] = 0$$

or

$$P + V_O^2 A - V_O B = 0$$

$$P = BV_O - AV_O^2$$

$$\frac{dP}{dV_O} = B - 2AV_O$$

For maximum power,  $\frac{dP}{dV_O} = 0$ ; therefore,

$$B - 2AV_O = 0$$

$$2AV_O = B$$

$$V_O = \frac{B}{2A} = \frac{1}{2} \left[ \frac{\sigma E_g}{\sigma + \sigma^2 R_g} \right] = \frac{1}{2} \left[ \frac{E_g}{1 + \sigma R_g} \right]$$

Thus maximum power occurs when

$$V_O = \frac{E_g}{2(1 + \sigma R_g)}$$

Substitution of this solution into the power equation yields

$$P = BV_O - AV_O^2$$

$$= \sigma E_g V_O - (\sigma + \sigma^2 R_g) V_O^2$$

$$= \sigma E_g \left[ \frac{E_g}{1 + \sigma R_g} \right] - (\sigma + \sigma^2 R_g) \left[ \frac{\left( \frac{E_g}{2} \right)^2}{(1 + \sigma R_g)^2} \right]$$

However,

$$\sigma + \sigma^2 R_g = \sigma(1 + \sigma R_g)$$

$$\therefore P = \frac{\frac{E_g^2}{2}}{1 + \sigma R_g} - \frac{\sigma(1 + \sigma R_g) \left( \frac{E_g}{2} \right)^2}{(1 + \sigma R_g)^2}$$

$$P = \frac{\frac{E_g^2}{2}}{1 + \sigma R_g} - \frac{\frac{E_g^2}{4}}{1 + \sigma R_g} = \frac{\frac{E_g^2}{4}}{1 + \sigma R_g}$$

$$\frac{4P}{E_g^2} = \frac{\sigma}{1 + \sigma R_g}$$

Let

$$\frac{4P}{E_g^2} = G$$

Solving for  $\sigma$ ,

$$\sigma = G(1 + \sigma R_g)$$

$$\sigma = G + \sigma GR_g$$

$$\sigma(1 - GR_g) = G$$

$$\sigma = \frac{G}{1 - GR_g}$$

Because  $\sigma = \frac{I_R}{V_R}$

then

$$I_R = V_R \left[ \frac{G}{1 - GR_g} \right] = \frac{V_R 4P}{E_g^2 - 4PR_g}$$

#### APPENDIX D. Maximum Power Dissipation Allowable for a Given Thermal Resistance

The heat sink selected is a Wakefield (Delta Division #NC-423) type. This heat sink has a thermal resistance to air in convection cooling of 0.8°C/watt. Any heat sink with similar or lower thermal resistance is suitable.



The case-to-junction thermal resistance of the 2N3055 is rated at  $1.5^{\circ}\text{C}/\text{watt}$ , and the heat-sink-to-case thermal resistance is  $0.5^{\circ}\text{C}/\text{watt}$  maximum if a mica washer and DC340 filled grease or equivalent are used.

The total junction-to-air thermal resistance is:

Ambient to Heat Sink	$0.8^{\circ}\text{C}/\text{watt}$
Heat Sink to Case	0.5
Case to Junction	1.5
TOTAL	$2.8^{\circ}\text{C}/\text{watt}$

If it is assumed that the ambient temperature is  $55^{\circ}\text{C}$  and the junction temperature is  $200^{\circ}\text{C}$ ,

$$200^{\circ}\text{C} - 55^{\circ}\text{C} = 145^{\circ}\text{C}$$

$$145^{\circ}\text{C}/2.8^{\circ}\text{C}/\text{W} = 52 \text{ watts}$$

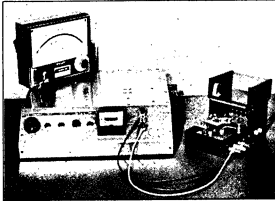
If a 10-per-cent safety factor is allowed, the maximum allowable power dissipation by the pass transistor is  $52 \cdot 5 = 47$  watts.

#### ACKNOWLEDGMENT

The authors wish to thank W. Williams and A. Cole for their helpful suggestions and comments.

#### REFERENCES

- (1) Data bulletin for RCA-CA3055 Voltage Regulator, RCA File No. 395.
- (2) Data bulletin for RCA-CA3030 Monolithic Operational Amplifier, RCA File No. 316.
- (3) "Application of the RCA CA3008, CA3010 Integrated Circuit Operational Amplifiers", RCA Application Note ICAN-5015.
- (4) "Application of the RCA CA3015 and CA3016 Integrated Circuit Operational Amplifiers", RCA Application Note ICAN-5213.
- (5) "Integrated-Circuit Operational Amplifiers", RCA Application Note ICAN-5290.
- (6) "Application of RCA Silicon Rectifiers to Capacitive Loads", RCA Application Note AN-3659.
- (7) O.H. Schade, "Analysis of Rectifier Operation", *Proc. IRE*, vol. 31, pp. 341-361, July 1943.
- (8) Data bulletin for RCA-2N3055 Transistor, RCA File No. 434.
- (9) Data bulletin for RCA Power Transistors, File No. 413.
- (10) C. R. Turner, "Selection of Second-Breakdown-Resistant Transistors", *EEE*, vol. 15, no. 7, pp. 82-95, July 1967.
- (11) G.A. Lang, B.J. Fehder, W.D. Williams, "Thermal Fatigue in Silicon Power Transistors", *IEEE Trans. on Electron Devices*, vol. ED-17, pp. 787-793, September 1970.
- (12) "Thermal-Cycling Rating System for Silicon Power Transistors", RCA Application Note AN-4612.



## Testing for Forward-Bias Second Breakdown in Power Transistors

by D. A. Moe

The addition of "safe-operating-area" curves to power-switching transistor data for JEDEC registration and to manufacturers' data sheets has made necessary the development of non-destructive forward-bias second-breakdown test facilities. This Note describes the design of a test facility which determines the forward-bias second-breakdown safe operating locus for power transistors and shows detailed schematic diagrams of test circuits which can be used for devices with collector-current ratings up to 2.5 amperes and sustaining collector-to-emitter voltage  $V_{CE0(sus)}$  ratings up to 300 volts, or with ratings to 5 amperes and 100 volts.

### Causes of Second Breakdown

The safe operating area of a power transistor is bounded by a locus divided into four discrete segments, each representing a particular limiting condition. As shown in Fig. 1, the limiting factors are the maximum continuous collector-current rating of the transistor, the maximum power-dissipation rating, second breakdown, and the sustaining voltage  $V_{CE0(sus)}$  of the device.

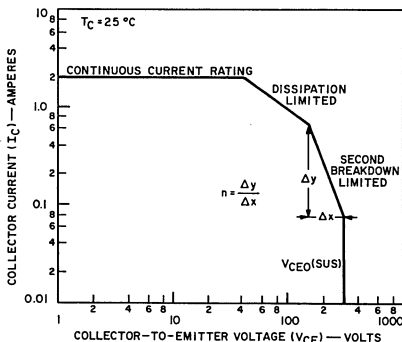


Fig. 1— A typical safe-operating-area curve.

Forward-bias second breakdown ( $I_S/b$ ) in a power device is manifested by localized heating of the transistor pellet, as shown in Fig. 2. The average collector-junction temperature,  $T_J$ , of a power transistor may be calculated as follows:

$$T_J = T_C + P_{avg} \theta_{J-C}$$

where  $T_C$  is the case temperature in  $^{\circ}C$ ,  $P_{avg}$  is the average power dissipation in watts, and  $\theta_{J-C}$  is the junction-to-case thermal resistance in  $^{\circ}C$  per watt. However, the actual junction temperature can vary from point to point on the chip as a result of current-crowding that causes higher isolated dissipation. As a result, a localized thermal runaway may occur. In the forward-biased mode, such local heating is most likely to occur at the emitter edge because, under forward-bias conditions, lateral base current creates an electric field or voltage gradient in the base, as shown in Fig. 2. The direction of this voltage gradient causes greater forward bias at the emitter periphery than at the center. Therefore most injection occurs at the periphery, and the current density is greater. As the concentrated current flows across the depletion region, local power dissipation occurs and causes local heating. If the current density exceeds a

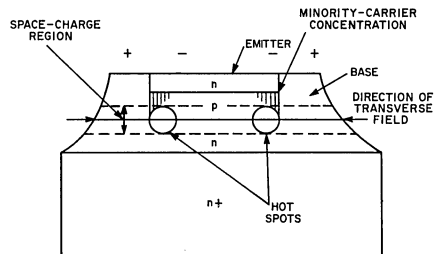


Fig. 2— Cross-section of a power transistor showing development of hot spots under forward bias.

critical level, the heat that is generated causes the local base-to-emitter voltage to decrease to a level that causes further injection, and collector-to-emitter current flow becomes regenerative. If this regenerative process is allowed to continue, device destruction follows. The current crowding may be aggravated by a non-homogeneous collector-base junction or by mounting-system imperfections such as solder voids.

### A Second-Breakdown Test Facility

Fig. 3 shows a simplified schematic of a test set designed to determine the forward-bias second-breakdown safe operating locus for power transistors. This test facility is capable of determining this locus non-destructively, and therefore can be used to perform 100-per-cent tests of transistor capability in production without destroying transistors. This type of production test is usually made at one point of the second-breakdown locus shown on the published data. Determination of the second-breakdown limit for registration of a new device of a particular structure and geometry previously required the destructive finding of the  $I_{S/b}$  limit of many individual transistors. Although each device would yield one data point, the points would not necessarily be on the same second-breakdown locus because the relative second-breakdown capability would vary from device to device. This procedure would therefore not yield accurate information about the actual shape of the  $I_{S/b}$  locus. It has been found that the slope,  $n$ , of the forward-bias second-breakdown locus ( $I = KV^{-n}$ ) plotted on log-log coordinates is essentially constant for a particular device structure and geometry.

The second-breakdown test set shown in Fig. 3 operates in either of two modes: "normal" operation or "shut-down" operation. There are two feedback drive amplifiers in the circuit. One drives the transistor under test to the magnitude of collector current programmed by adjustment of a potentiometer. The current-sensing feedback loop is arranged so that only actual collector current flows through the

sensing resistor; no base current flows in the mesh common to that resistor. The second amplifier compares the collector-to-emitter voltage of a transistor in series with the one being tested to a reference voltage and maintains the pass-transistor voltage constant at six volts, independent of test-current magnitude.

The test voltage,  $V_{CE}$ , is varied by adjustment of the power-supply voltage across the transistor under test, the series pass transistor, and a one-ohm sensing resistor. During a normal test, the pulse generator applies an essentially square pulse of current through the transistor under test; the relatively short rise and fall times can be neglected. The current through the pass transistor tracks the current through the transistor under test. If the device being tested is operating within its safe area, no anomalies in transistor current or voltage occur and no degradation results during the test.

If the transistor is operated beyond its safe operating area, distinct changes occur in current and voltage at the initiation of second breakdown. The collector-to-emitter voltage of the transistor suddenly drops to a low value, while the current rises sharply. The second-breakdown test method shown in Fig. 3 takes advantage of this rapid rise in collector current.

For detection of second breakdown, an air-core inductor is placed in series with collector of the transistor under test. During normal operation of the test set, the voltage developed across this inductor is small because of the relatively long test-current-pulse rise time. During second breakdown, however, the rapidly rising collector current creates a high voltage across the inductor. A secondary winding then couples this voltage to a detection circuit which reverse-biases the series pass transistor. The inductive-detection approach is independent of test-current magnitude and reacts instead to the magnitude of its first derivative.

### The 2.5-Ampere/300-Volt and 5-Ampere/100-Volt Test Circuits

Two forward-bias second-breakdown facilities are shown in Fig. 4. The first is capable of making second-breakdown tests at collector-current levels to 2.5 amperes and collector-to-emitter voltage levels to 300 volts; the second makes similar tests to 5 amperes and 100 volts.

In both facilities a voltmeter  $V$  is placed across the Current-Level-Adjust potentiometer during setting of the test conditions. The drive amplifier is disconnected so that no current flows through the transistor under test. The test transistor must not be preheated before the actual test voltage is applied because the second-breakdown limit decreases with increasing temperature. While the test is being performed, the voltmeter  $V$  is switched across the one-ohm sensing resistor and monitors actual test current.

A test is initiated by application of a pulse to the gate of a 2N3228 SCR, Q1, which begins to conduct and closes a mercury relay. A unijunction transistor fires to end the test. The pulse-width potentiometer can be varied to obtain test conditions varying from dc (2 seconds) to a short pulse (100

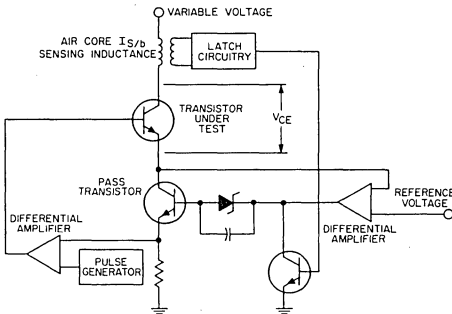


Fig. 3— Simplified schematic of test set for second-breakdown current ( $I_{S/b}$ ).

milliseconds). The setting of the Current-Level-Adjust potentiometer determines the amplitude of the test current during the pulse. The capacitor connected across this potentiometer maintains the rise time of the pulse applied to the differential-drive amplifier at approximately 25 milliseconds, as shown in Fig. 5. If the rise time were too short, the inductive detector would trigger the latch circuitry at the beginning of a pulse and would incorrectly indicate second breakdown.

The pass-transistor regulator maintains a constant voltage across the transistor under test. The series pass transistor is always operated in the active region so that it can turn off the transistor under test within one microsecond if second breakdown occurs.

The two differential amplifiers are stabilized by means of capacitors located at several points. Stabilization of these test facilities is difficult because they are required to perform tests on devices having gain-bandwidth products  $f_T$  up to 100 MHz and at all test currents and voltages within the test-set ratings. The problem is compounded by the fact that  $f_T$  is a function of collector voltage and current and may vary for individual devices at different test conditions.

Particular care is necessary in the physical layout of a second-breakdown test facility to avoid oscillation. High-

frequency oscillations may then incorrectly appear to the inductive detector as second-breakdown failures and cause the protection circuitry to be triggered. Leads should be as short as possible.

In the event of second breakdown, the large current change  $di/dt$  causes a voltage to be coupled to the second-breakdown latch circuitry, Q24 and Q25. This regenerative circuitry drives the pass-transistor regulator, Q16, which then applies instantaneous negative voltage at the base of the pass transistor to interrupt the test current. A light on the front panel of the test set indicates second breakdown. The coupling capacitor in the reset circuitry for the latch is selected so that it cannot override a pulse from the second-breakdown-sensing transformer. If a shorted transistor is placed in the test socket and the reset button is depressed, the resulting instantaneous rise in primary current triggers the latch. Therefore, it is impossible to reset the facility with a shorted transistor in the socket. Although the primary inductance of the sensing transformer is very small, it helps to keep collector current from rising instantly during second breakdown. A diode clamp is employed to damp ringing voltages that might otherwise exceed the avalanche breakdown voltage of the transistor under test.

If the transistor under test has large leakage current, or if a slow thermal runaway occurs, the collector current does not rise fast enough to trigger Q24 and Q25. The latch is then triggered by back-up circuitry. The back-up circuit, which consists of Q21, Q22, and Q23, is a Schmitt trigger set to switch at a collector test current ten per cent higher than the rated value of the test facility. In this case, a relatively long time may be needed to exceed this rating.

#### Transistor Characterization for Forward-Bias Second Breakdown

Actual second-breakdown measurements for the RCA-2N5240 are shown in Fig. 6. The three curves indicate differences in second-breakdown capability at different case temperatures, but show that the second-breakdown loci have essentially identical slopes. The 2N5240 is a double-diffused triple epitaxial silicon power transistor having eight separate emitter sites. A small ballast is provided in series with each emitter to extend second-breakdown limits.

Characterization of a transistor for second breakdown and power handling is performed in two steps. First, the dc and pulsed power-dissipation capability of the device are calculated on the basis of its steady-state and transient thermal resistance. These curves are then checked empirically to determine at what value of collector-to-emitter voltage second breakdown begins to dominate.

To obtain a single point on the curve, the desired collector-to-emitter voltage  $V_{CE}$  is applied to the transistor under test, and a test is performed at a test-current magnitude below the expected capability of the device. If failure does not occur, the test-current magnitude is increased in steps until failure does occur. This procedure is repeated at several values of  $V_{CE}$ . During each trial, the transistor case must be at the temperature for which second-breakdown capability is being determined. Usually a

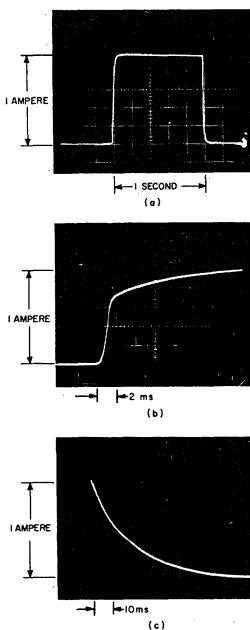


Fig. 5— Waveforms for  $I_S/b$  test circuits of Fig. 4: (a) applied pulse; (b) turn-on time; (c) turn-off time.

RELAY = 12 VDC, 150 OHMS, MAGNEEED W101PCX-10; MAGNECRAFT ELECTRIC CO.  
 SENSING TRANSFORMER: PRIMARY = 54 TURNS No. 20 WIRE  
 SECONDARY = 27 TURNS No. 20 WIRE  
 WOUND BIFILAR ON  $\frac{3}{4}$  - INCH SQUARE TEFLON COIL FORM

N-P-N TRANSISTORS ARE 2N2102  
 P-N-P TRANSISTORS ARE 2N4036  
 RESISTORS ARE  $\frac{1}{2}$  WATT  
 UNLESS SPECIFIED OTHERWISE  
 RESISTANCE VALUES ARE IN OHMS

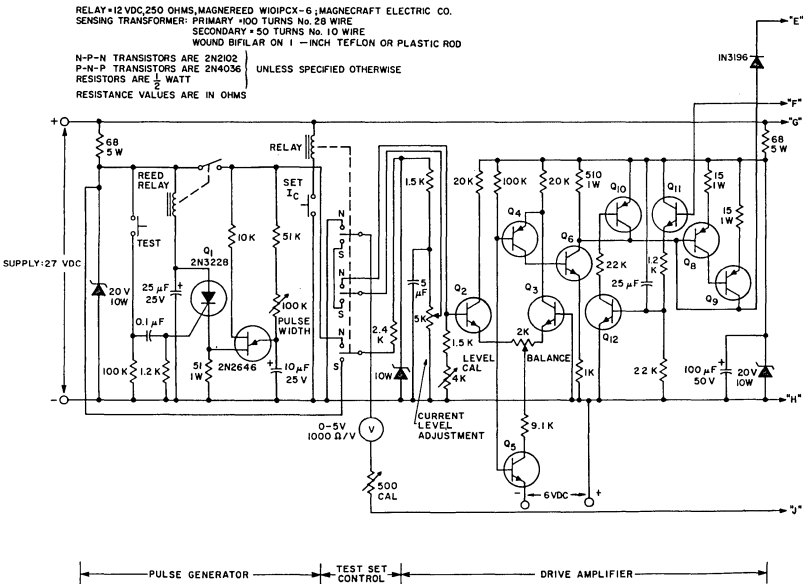
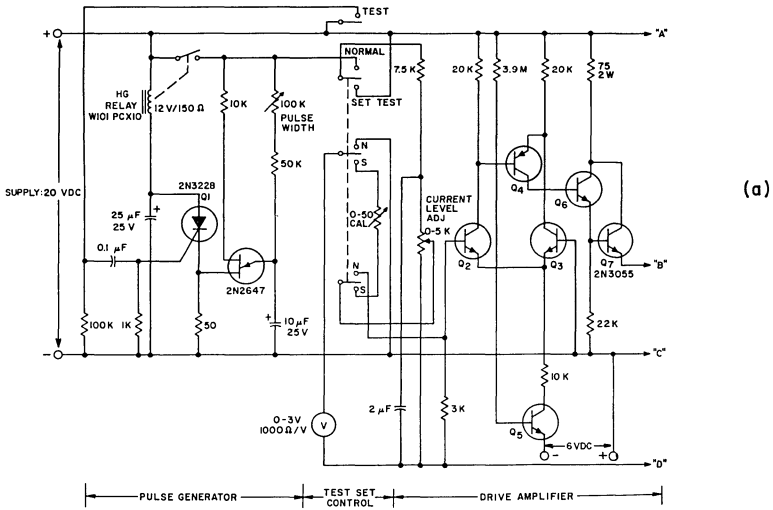


Fig. 4- Schematic diagram of  $I_{S/B}$  test facilities for (a) currents to 2.5 amperes and voltages to 300 volts, and (b) currents to 5 amperes and voltages to 100 volts.



heat sink having a large thermal capacity is used. An approximate test for degradation may be made by repeating the second-breakdown test at the current level just preceding device failure; the device should pass this test. Another

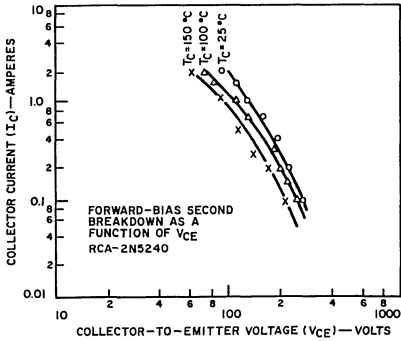


Fig. 6— Forward-bias second breakdown of RCA-2N5240 as a function of collector-to-emitter voltage for different case temperatures.

method is to measure changes in collector cutoff current  $I_{CBO}$  after second-breakdown failure.

The final second-breakdown curve plotted to characterize the device for registration, which is shown in the table of device characteristics on the data sheet, has a slope greater than that of the family of devices represented. To guarantee this published curve, a 100-per-cent test is performed in production at the  $I_S/b$  specification point.

It should be noted that there is not an abrupt change in power-handling capability along the safe-area locus, but rather a gradual change in the slope of the curve. The slope becomes less at lower collector-to-emitter voltages because the electrical base width in the transistor varies as a function of voltage. As  $V_{CE}$  decreases, the depletion-region width decreases and the electrical base width increases. These changes have the effect of decreasing current density because the minority carriers in the base have a greater distance over which to diffuse outward laterally, as shown in Fig. 2.

## **Thermal-Cycling Rating System for Silicon Power Transistors**

by W. D. Williams

Thermal fatigue is a wear-out type of failure that may occur in silicon power transistors as a result of the thermal cycling produced by changes in power dissipation or in the ambient temperature. When a transistor is alternately heated and allowed to cool, cyclic mechanical stresses are produced within the device because of differences in the thermal expansion of the silicon pellet and the metallic materials to which the pellet is attached. In the past, the effect of such stresses has been almost completely ignored in the design of power-transistor circuits. The circuit designer should realize, however, that, just as a wire that is continuously flexed at one point will eventually break because of metal fatigue, cyclic thermal stresses can similarly lead to fatigue failures in power transistors.

This Note briefly analyzes the basic causes of thermal fatigue in silicon power transistors and describes a rating chart that makes it possible for a circuit designer to avoid such failures during the operating life of his equipment. Examples are provided on the use of this chart to determine the transistor operating conditions required to assure a desired thermal-cycling capability and to determine whether the thermal-cycling capability of a transistor is adequate for the requirements of a given application.

### **Analysis of Thermal Fatigue in Silicon Power Transistors**

Power transistors are subjected to some thermal stresses in all practical circuits in which they may be employed. In many common applications, these stresses are very severe, as indicated by the examples of the thermal-cycling requirements of several typical applications listed in Table I. The cyclic stresses may eventually result in physical damage to the semiconductor pellet or the mounting interface.

In most silicon power transistors, the small silicon pellet is bonded to a copper header. The coefficient of thermal expansion for silicon ( $3 \times 10^{-6}$ ) is much less than that of copper ( $17.5 \times 10^{-6}$ ). Temperature variations within the transistor, therefore, result in cyclic stresses at the mounting interface of the silicon pellet and the copper header because of the difference in the thermal expansions of these parts. If a hard solder, such as silicon gold, is used to bond the pellet

to the header, these stresses are transmitted to the silicon pellet. Silicon is relatively weak in tensile strength and is highly "notch sensitive." Such stresses therefore, often result in pellet fractures. In general, however, lead solder is used to bond the silicon pellet to the copper header. The cyclic thermal stresses then are absorbed by non-elastic deformation of the soft lead solder, and very little stress is transmitted to the pellet.

The continuous flexing that results from cyclic temperature changes in the transistor may eventually cause fatigue failures in the lead solder. Such failures are a function of the amount of change in temperature at the mounting interface, the difference in the thermal-expansion coefficients of the silicon pellet and the material to which the pellet is attached, and the maximum dimensions of the mounting interface.<sup>1</sup> Fatigue failures occur whenever the cyclic stresses damage the solder to the point at which the transfer of heat between the pellet and the surface to which it is mounted becomes impaired. This condition may exist in only a small portion of the pellet. This portion, however, overheats, and transistor failure results because of conditions that very closely approximate those encountered during second breakdown.<sup>2</sup>

Thermal-fatigue failures in power transistors are accelerated because of dislocation "pile-ups" that result from impurities in the lead solder.<sup>3</sup> RCA has developed a process that substantially reduces the amount of impurities introduced into the solder. Use of this proprietary "controlled solder process" (CSP) makes it possible to avoid the microcracks that propagate to cause fatigue failure in power transistors and, therefore, greatly increases the thermal-cycling capability of these devices.<sup>4</sup>

### **Thermal-Cycling Rating Chart**

The mathematical relationship among the factors that affect fatigue failure in silicon power transistors can be expressed, in terms of the number of thermal cycles to failure  $N$ , as follows:<sup>1</sup>

$$N = A_e \psi_0 / [\Delta T (a_A - a_B) L]$$



Table I - Thermal-Cycling Requirements for Typical Applications of Power Transistors

Application	Circuit	$P_T$ (W)	$\Delta T_C$ (°C)	Minimum Equipment Life Required (years)	Typical Thermal- Cycling Rating Required (cycles)
Auto radio audio output	Class A	8	75	5	5,000
	Class AB	2	45	5	5,000
Power supply	Series regulator	50	65	5	5,000
	Switching regulator	15	65	5	5,000
Hi-Fi audio amplifier	Class AB	35	50	5	5,000
Computer power supply	Series regulator	50	65	10	10,000
Computer peri- pheral equip.	Solenoid driver	5	5	10	$1.3 \times 10^8$
Television	Vertical output	10	75	5	5,000
	Audio output	8	75	5	5,000
Sonar modulator	Linear amplifier	100	55	10	$144 \times 10^3$

where  $A$  is a constant determined by the mounting system,  $\Delta T$  is the change in temperature at the mounting interface,  $\alpha_A$  and  $\alpha_B$  are the thermal-expansion coefficients of the silicon and the metal under the solder joint,  $\psi_0$  is a material constant proportional to the change in temperature  $\Delta T$  and the difference in the thermal-expansion coefficients  $\alpha_A$  and  $\alpha_B$ , and  $L$  is the maximum length of the solder joint under the pellet.

For a given transistor, the only variable in the thermal-cycling equation that can be controlled by the circuit designer is the change in temperature at the interface of the silicon pellet and the material to which the pellet is mounted. This change in temperature  $\Delta T$  is, of course, less than the change in transistor junction temperature  $\Delta T_J$ , but is greater than the change in case temperature  $\Delta T_C$ .

RCA has devised a rating chart that relates the thermal-cycling capability of a silicon power transistor to total device dissipation and the change in case temperature.

This chart is presented in the form of a log-log presentation in which power dissipation is shown on the vertical axis and the number of thermal cycles is shown on the horizontal axis. Rating curves are shown for various magnitudes of case-temperature swings. Fig. 1 shows an example of a typical rating chart of this type.

A circuit designer may use the rating chart to define the limiting value to which the change in case temperature must be restricted to assure that a power transistor is capable of operation at a specified power dissipation over the number of thermal cycles required in a given application. Conversely, if the power dissipation and the change in case temperature are known, the designer may use the rating chart to determine whether the thermal-cycling capability of the transistor is adequate for the application. These uses of the rating chart are illustrated by examples on the chart shown in Fig. 1.

The chart shows the thermal-cycling ratings for an experimental silicon power transistor that has a thermal

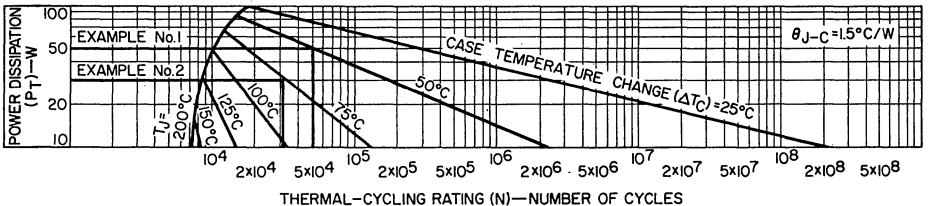


Fig. 1— Thermal cycling rating chart

resistance from junction to case of 1.50°C per watt. If a designer wishes to determine the maximum allowable change in the case temperature of this transistor for the thermal-cycling requirements of a given application, he simply plots the point of intersection of a horizontal projection of the total device dissipation with a vertical projection of the total number of thermal cycles required in the application. If this point lies exactly on one of the power-dissipation curves, the maximum allowable change in case temperature can be read directly from the chart; if not, the allowable temperature change can be approximated by linear interpolation. This use of the rating chart is illustrated by example No. 1 in Fig. 1.

For this example, it is assumed that the transistor is to be operated intermittently at a power dissipation level of 50 watts and that a thermal-cycling capability of  $5.0 \times 10^4$  cycles is required to assure that the life of the transistor exceeds that of the equipment in which it is to be used. The point of intersection of line projections of the power dissipation and the required number of thermal cycles indicates that the change in case temperature must be restricted to a maximum value of 50°C per thermal cycle. This value determines the requirements of the transistor heat sink. If the thermal cycles are long in comparison to the thermal time constant of the heat sink, the total thermal resistance from case to ambient should not exceed 1°C per watt. If the thermal cycles are short relative to the thermal time constant, a higher thermal resistance is permissible provided that the thermal capacitance of the heat sink is sufficient to assure that the change in case temperature does not exceed 50°C during the thermal cycle.

Example No. 2 in Fig. 1 illustrates the use of the rating chart to determine whether the thermal-cycling capability of a transistor is adequate for a given application. In this example, a transistor dissipation of 30 watts and a case-temperature swing (measured) of 75°C are assumed. A vertical projection of the 30-watt point on the  $\Delta T_C = 75^\circ\text{C}$  power-dissipation curve indicates that, for these operating conditions, the transistor has a thermal-cycling rating of  $3.2 \times 10^4$  cycles. If this rating is not adequate for the intended application, either the power dissipation must be reduced or a larger heat sink must be used so that a smaller change in case temperature will result during a thermal cycle.

In many applications, a power transistor may be subjected to thermal cycles that differ in both duration and magnitude. In such instances, the fractional amount of the thermal-cycling life of the transistor used by the total number of thermal cycles of each type during the required life of the equipment must be separately determined and then added together to ascertain whether the thermal-cycling rating of the transistor will be exceeded in the application. The ratio of the total number of cycles of each type to which the transistor will be subjected during the life of the equipment to the total number of cycles of the same type that the transistor is rated to withstand before fatigue failure is obtained for all the dissimilar thermal cycles. If the sum of these ratios is less than unity, the transistor is obviously

operated within ratings in the application. If the sum is greater than unity, the thermal-cycling rating of the transistor is exceeded in the application, and device failure may occur during the operating life of the equipment.

The technique used to determine whether the thermal-cycling ratings of a transistor are exceeded in a specific application in which the transistor is subjected to different types of thermal cycles can be illustrated by use of the examples of different operating conditions shown in Fig. 1. If the transistor is assumed to be subjected to the conditions specified for example No. 1 for  $2.5 \times 10^4$  thermal cycles and to the conditions specified for example No. 2 for  $1.6 \times 10^4$  thermal cycles, the following summation is made to determine whether the transistor will be operated within its thermal-cycling ratings:

$$\frac{2.5 \times 10^4}{5.0 \times 10^4} + \frac{1.6 \times 10^4}{3.2 \times 10^4} = 1$$

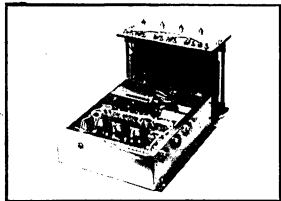
This summation indicates that, for the conditions assumed, the transistor is operated exactly to the limit of its thermal-cycling rating.

The RCA thermal-cycling ratings allow a circuit designer to use silicon power transistors with assurance that no fatigue failures of these devices will occur during the operating life of his equipment. These ratings provide valid indications of the thermal-cycling capability of silicon power transistors for all types of operating conditions and, therefore, enable the circuit designer to "design out" the possibility of transistor thermal-fatigue failures.

Obviously, all power transistors cannot be tested to determine their thermal-cycling capability because such tests are expensive, time consuming, and destructive. The validity of the thermal-cycling ratings results from the application of stringent process controls at each step in the manufacture of the transistors and from the testings of a statistically significant number of samples. Thermal-cycling ratings for silicon power transistors provide the same type of assurance that a device will not fail when operated within ratings as that provided by the more familiar voltage, current, and second-breakdown ratings.

#### Bibliography

1. G.A. Lang, et al, "Thermal Fatigue in Silicon Power Transistors," *IEEE Transactions on Electron Devices*, pp. 787-793, Sept. 1970.
2. C.R. Turner, "Carl Turner of RCA Speaks Out on Second Breakdown," *EEE*, Vol. 15, No. 7, July 1967.
3. J.J. Gilman, "Dislocation Mobility in Crystals," *J. Appl. Phys.*, Vol. 36, pp. 3195-3206, October 1965.
4. *RCA High-Speed, High-Voltage, High Current Power Transistors*, Technical Series PM-80, RCA Solid State Division, Somerville, N.J., May 1970.



## A 750-Watt Three-Phase Frequency Converter

by W. J. Beiswinger

Military equipment frequently uses three-phase 400-Hz power, and industrial plants and laboratories often require power at a variety of low frequencies. Ac-to-ac converters, driven from standard power lines, can be used to meet these requirements. This Note describes a frequency converter with output frequency from 380 Hz to 1250 Hz that delivers up to 750 watts of three-phase power at 120/208 volts rms. The circuit uses a three-phase bridge inverter supplied from a rectified ac line; the input can be single-phase or three-phase, 120 volts or 208 volts, at any frequency from 47 Hz to 1250 Hz. The RCA-2N5805 power transistor used in this converter is especially suited for power-switching circuits.

### CIRCUIT DESCRIPTION

As shown in the block diagram of Fig. 1, the converter has four basic components:

- a power supply, which consists of a rectifier and a filter, to change the ac line power to dc power for the three-phase bridge inverter;
- the three-phase bridge inverter;
- three-phase logic and driver circuits to switch the transistors of the inverter in the proper sequence; and
- an output transformer.

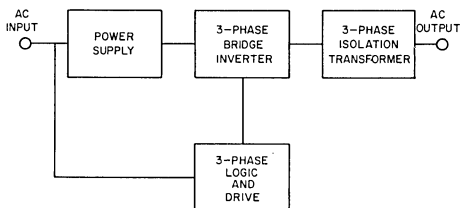


Fig. 1— Block diagram of 750-watt three-phase converter.

Fig. 2 is a schematic diagram that shows the power supply, inverter, and output transformer. The logic and driver circuits are shown in Figs. 3 and 4.

### The Power Supply

The bridge rectifier will operate from either a single-phase or three-phase line; the circuit shown in Fig. 2, which uses 1N1204A rectifiers, is designed for either a 120-volt or a 208-volt line. The 11,000-microfarad filter capacitor keeps ripple below 50 millivolts even when a single-phase input line is used.

### The Inverter

The three-phase bridge inverter uses pairs of RCA-2N5805 switching transistors that are transformer-driven from the logic circuit. The switching transistors in turn control the flow of current through the delta-connected primary of the output transformer.

### The Logic and Driver Circuits

The logic and driver circuits include a low-voltage dc supply, which operates from a single phase of the ac line. A stepdown transformer reduces the line voltage to 12 volts, and provides isolation from the power line. This transformer, T4, has a frequency range from 47 Hz to 1250 Hz; its parameters are shown in Table I. The supply voltage is regulated by a pass transistor and a 12-volt zener diode.

The logic sequence begins with a tunable unijunction oscillator that delivers timing pulses to a six-stage ring counter, as shown in Fig. 3. The timing of these pulses is determined by the oscillator frequency; adjustment of the 75-kilohm potentiometer can set the frequency of the pulse sequence from 380 Hz to 1250 Hz. The output pulses from the ring counter are coupled to a diode matrix, shown in Fig. 4, to activate the inverter drive transistors.

The drive transistors provide drive to the inverter through transformers T1, T2, and T3. The first timing pulse produces a positive voltage across one half of the primary of T1, a negative voltage across one half of the primary of T2, and a



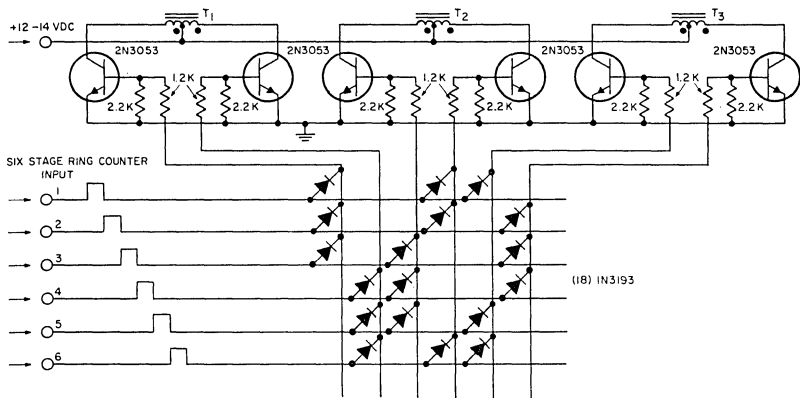


Fig. 4— Diode matrix and driver for output devices of three-phase frequency converter.

Table I — Stepdown Isolation Transformer for Logic Circuit Supply

CORE	— Square Stack 75E1 Microsil (0.006) Magnetic Metals Co. 75E13306
PRIMARY	— 120 Volts 1200 Turns #32 Wire 100 Turns Per Layer 12 Layers
SECONDARY	— 12 Volts 128 Turns #22 Wire 32 Turns Per Layer 4 Layers

Table II — Pulse Polarities at Primary Coils of T1, T2, and T3

Pulse	V <sub>T1</sub>	V <sub>T2</sub>	V <sub>T3</sub>
1	+	-	+
2	+	-	-
3	+	+	-
4	-	+	-
5	-	+	+
6	-	-	+

positive voltage across one half of the primary of T3; the second timing pulse produces a positive voltage across one half of the primary of T1, and a negative voltage across halves of the primaries of T2 and T3; and so forth. The sequence of these voltages is tabulated in Table II and displayed graphically in Fig. 5 to show that the periodic voltages across the three transformers are offset by 120-degree intervals.

Design information on transformers T1, T2, and T3 is shown in Table III.

**The Output Transformer**

The output transformer, T5, isolates the output circuit from the power line, transforms the voltage up or down to produce a 120/208-volt output, and reduces harmonic distortion. The primary is delta-connected, and the secondary is wye-connected to provide three-phase, four-wire service.

The primary coils carry the full supply voltage. The waveshapes in the primary and secondary coils are the same, and are shown in Fig. 6; the polarities of these pulses are

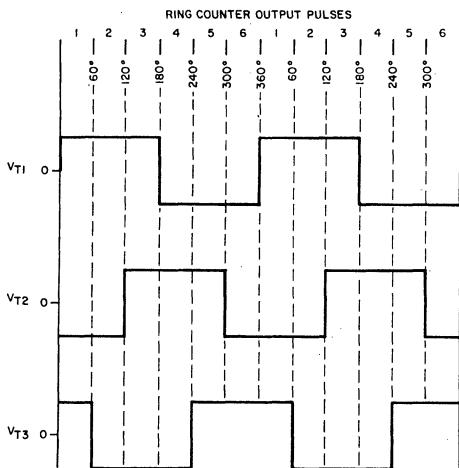
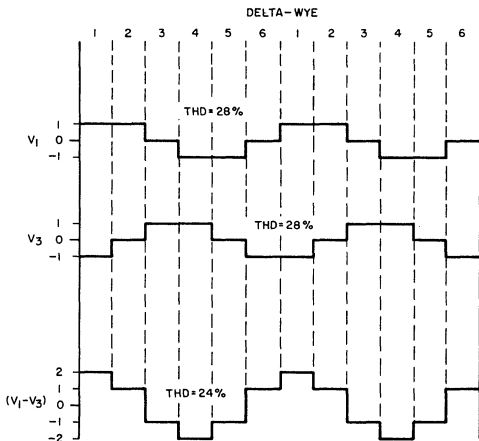


Fig. 5— Sequence of voltages across drive transformers T1, T2, and T3.

shown in Fig. 7. The manner in which the secondary coil voltages add to reduce distortion is also shown in Fig. 6. The voltage across secondary terminals A and C is equal to the difference of the voltages in secondary coils 1 and 3. Subtraction of waveform V3 from waveform V1 results in the output waveform (V1 - V3), which is more sinusoidal than V1 or V3. The measured value of total harmonic distortion (THD) in each coil is 28 per cent; the THD across the output terminals is 24 per cent.

Table III — Driver Transformer Design Information

CORE	— Square Stack 21E1 Microsil (0.006) Magnetic Metals Co. 21E13306
PRIMARY	— 14 Volts 140 Turns Bifilar #29 Wire (in Series) 20 Turns Per Layer 7 Layers
SECONDARY	— 4 Volts 52 Turns Bifilar #29 Wire 13 Turns Per Layer 4 Layers



1	$V_1 - V_3 = 1 - (-1) = 2$
2	$V_1 - V_3 = 1 - 0 = 1$
3	$V_1 - V_3 = 0 - (1) = -1$
4	$V_1 - V_3 = -1 - (1) = -2$
5	$V_1 - V_3 = -1 - 0 = -1$
6	$V_1 - V_3 = 0 - (-1) = 1$

Fig. 6— Phase-to-neutral and phase-to-phase voltages in the delta-wye output transformer.

Design information for the output transformer to operate from a 120-volt line or a 208-volt line is given in Table IV.

Table IV — Output Transformer Design Information

CORE	— Square Stack 1.2E13φ Microsil (0.006) Magnetic Metals Co. 1.2E13φ3306
PRIMARY (DELTA)	— 120 Volts 188 Turns #17 Wire 47 Turns Per Layer 4 Layers
	OR
	— 208 Volts 325 Turns #19 Wire 55 Turns Per Layer 6 Layers
SECONDARY (WYE)	— 120/208 Volts 200 Turns #17 Wire 50 Turns Per Layer 4 Layers

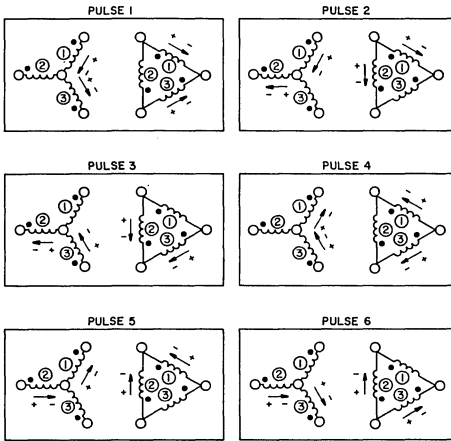


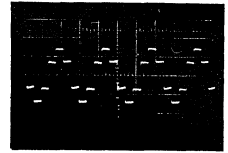
Fig. 7— Pulse polarities in output transformer T5.

**CONVERTER PERFORMANCE**

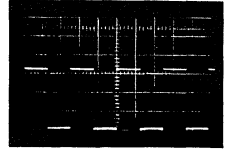
A photograph of the output waveform from the 400-Hz converter is shown in Fig. 8. Waveforms of the collector voltage and current in one of the switching transistors (Q1) are also shown in Fig. 8.

Fig. 9 shows the output performance of the converter. Both the efficiency and the regulation are good. Efficiency rises from 50 per cent at low load current to 75 per cent at the rated load current of 2.1 amperes. The rms output voltage varies by only 10 volts between low- and high-current loading.

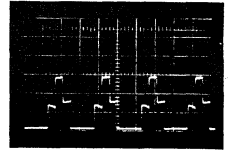
OUTPUT VOLTAGE  
(200 V/DIV.)



COLLECTOR VOLTAGE  
(100 V/DIV.)



COLLECTOR CURRENT  
(1 A/DIV.)



TIME (1ms/DIV.)

Fig. 8— Waveforms of transformer output voltage, collector voltage, and collector current.

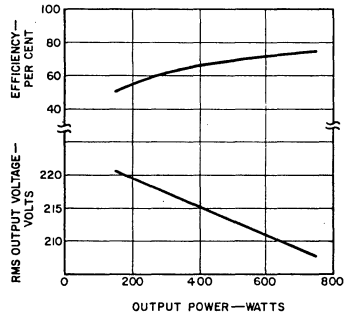


Fig. 9— Performance characteristics of the three-phase converter.

## **Thermal-Cycling Ratings of Power Transistors**

by V. J. Lukach, L. J. Gallace, and W. D. Williams

### **SUMMARY**

This Application Note discusses a testing program used to determine the capability of a particular power transistor for withstanding thermal cycling over a wide range of operating conditions. A sufficient number of tests were performed to verify a rating chart which can be applied by an equipment designer to any practical operating condition. The discussion covers a brief description of thermal fatigue, a method of "scaling the environment" to determine the proper test conditions, specialized test equipment and techniques to insure that the proper stresses were applied to the transistor, and the test results and the transistor predicted capability chart.

### **INTRODUCTION**

Thermal fatigue is a wearout failure mechanism in silicon power transistors caused by repeated temperature cycling from either changes in power dissipation or ambient temperature differences. In a transistor where the silicon die is mounted with lead-tin or other "soft" solder, a failure normally occurs because of a degradation of the joint between the silicon die and the surface to which it is mounted. This degradation results in localized overheating and eventual localized thermal runaway. The failure mode is very similar to that encountered in forward-biased second breakdown<sup>1</sup>. In many cases where the current is not limited during the resulting short circuit, the transistor chip is destroyed and it is impossible to determine what caused the failure.

In a transistor mounted with a gold-silicon eutectic or other "hard" solder, the failure due to thermal fatigue usually results from fracturing of the silicon die, which often also results in a shorted transistor and destruction of the silicon die.

The causative factors in thermal fatigue and device design methods of alleviating it have been covered in the literature<sup>2</sup>. A system of rating a power transistor to clearly delineate thermal-cycling capability was described in an earlier Application Note<sup>3</sup>. This Note describes a testing program to determine whether the rating chart computed by use of the

theory suggested in the above references truly represents the capability of a silicon power transistor over a wide range of stress levels.

### **THERMAL-FATIGUE BACKGROUND**

In almost any application, a silicon power transistor is subjected to some cyclical thermal stress. Often this stress is quite severe and frequent. Table I shows some typical applications of power transistors and the expected thermal-cycling-life requirements. The number N of cycles to failure in terms of the device characteristics and operating conditions has been expressed as<sup>2</sup>

$$N = Ae^{\frac{\psi_0}{\Delta T (\alpha_1 - \alpha_2)L}}$$

where A and  $\psi_0$  are constants for a given power transistor structure,  $(\alpha_1 - \alpha_2)$  is the difference in thermal coefficient of expansion between the silicon die and the material on which it is mounted, L is the maximum dimension of the silicon chip, and  $\Delta T$  is the change in temperature at the interface between the silicon chip and the material to which it is mounted. In practical applications, the temperature swing at this interface is the sum of the case-temperature change and the temperature rise equal to the thermal resistance between the interface and the case multiplied by the power dissipation.

By use of these relationships, and a small amount of empirical data, a thermal-cycling rating chart was drawn for the RCA-2N3055 power transistor, as shown as Fig. 1. Verification and/or correction of this rating chart was one purpose of the testing program described in this Note.

### **TEST PROGRAM**

#### **Objectives**

There were multiple objectives in this program. First was the determination of thermal-fatigue capability for the RCA-2N3055. Second was the mathematical representation



Table I — Thermal-Cycling Requirements for Typical Applications of Power Transistors

Application	Circuit	$P_T$ (W)	$\Delta T_C$ (°C)	Minimum Equipment Life Required (years)	Typical Thermal- Cycling Rating Required (cycles)
Auto radio audio output	Class A	8	75	5	5,000
	Class AB	2	45	5	5,000
Power supply	Series regulator	50	65	5	5,000
	Switching regulator	15	65	5	5,000
Hi-Fi audio amplifier	Class AB	35	50	5	5,000
Computer power supply	Series regulator	50	65	10	10,000
Computer peri- pheral equip.	Solenoid driver	5	5	10	$1.3 \times 10^8$
Television	Vertical output	10	75	5	5,000
	Audio output	8	75	5	5,000
Sonar Modulator	Linear amplifier	100	55	10	$144 \times 10^3$

of this capability in various tables and on appropriate charts. Finally, since thermal-fatigue rating charts were theoretically generated, independent appraisal and statistical approaches were used to compare the predicted response with the actual response.

#### Experimental Design

Because of the interrelationships among variables, this study requires a nonclassical approach. A thermal-fatigue test is basically a cyclical operating-life test. Fig. 2 shows one of the life-test racks used in this program. It accommodates 40

transistors and allows as many as four different thermal-fatigue tests simultaneously. Eight fans cool the units quickly during the "off" cycle. The photograph shows a free-air test; however, the plug-in sockets can be removed and devices on heat sinks or devices of another configuration substituted. Monitoring jacks are available on the front panel. The connections to the power supplies are not shown. Timers and relays are manually set for a variety of on/off conditions. The test circuit, shown in Fig. 3, is a common-emitter circuit that permits a smaller-current base power supply to be used. A common-base circuit could also be used. For room-

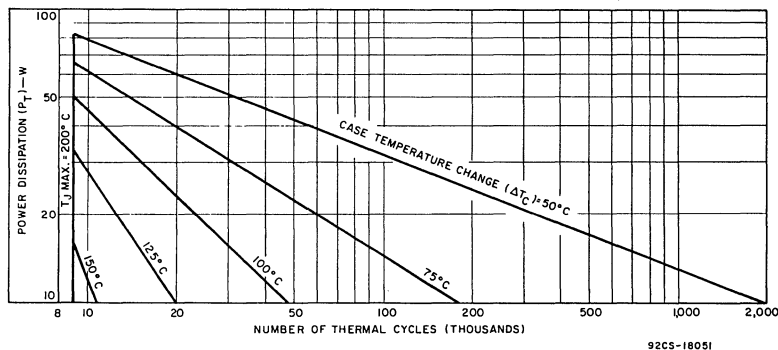


Fig. 1— Thermal-cycling rating chart for the RCA-2N3055 power transistor.

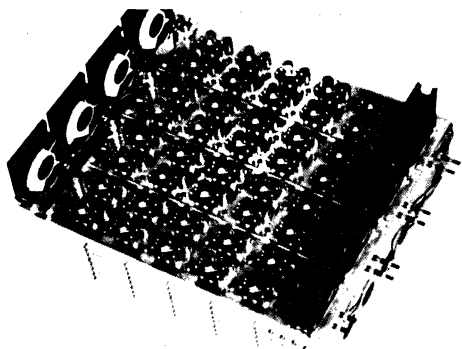


Fig. 2— Thermal-fatigue test rack.

ambient testing, the input variables include the heat-sink size, on/off cycle time, and power dissipation (collector-emitter voltage and collector current,  $V_{CE}$  and  $I_C$ ). The response variables are the change in case temperature  $\Delta T_C$ , and maximum junction temperature  $T_{j(max)}$ . The final response, of course, is the effect on the device, whether it be an open, short, or a change in an electrical parameter. Some of these variables are independent and some dependent. For example, with a given heat sink and cycle time, a change in power dissipation  $P_T$  will change both  $\Delta T_C$  and  $T_{j(max)}$ . It is impossible to preset levels of these variables and achieve these conditions. This key point prevents utilization of a factorial design in a classical statistical approach.

The interdependency of some of the variables requires a complex preliminary set of experiments *before* the performance of a thermal-fatigue test on product capability. This preliminary work is called "scaling the environment". In the case of the 2N3055 transistor, it was necessary to determine 150 practical test (sampling) points that naturally exist when the bounds of the above-mentioned variables are considered. Table II shows parameter values for some of the 150 empirically derived test cells. From this data, test cells

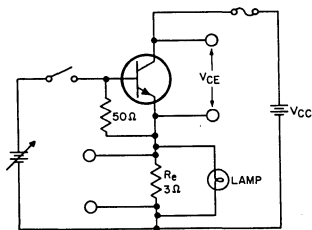


Fig. 3— Test circuit.

Table II — Scaling the Environment

$V_{CE}$ (V)	$I_C$ (A)	$P_D$ (W)	On/Off Time (Sec.)	Heat Sink	$T_{j(max.)}$ (°C)	$\Delta T_{case}$ (°C)
17	1	17	100/200	H <sub>0</sub>	188	150
17	1	17	180/180	H <sub>0</sub>	230	190
30	1	30	50/130	H <sub>0</sub>	190	145
27	1	27	50/130	H <sub>0</sub>	178	125
30	1	30	50/130	H <sub>0</sub>	235	170
30	1.4	41	100/200	H <sub>1</sub>	200	145
30	1	30	100/200	H <sub>1</sub>	165	120
27	1	27	150/300	H <sub>2</sub>	150	100
28	2	56	15/25	H <sub>1</sub>	150	50
33.3	3	100	50/100	H <sub>3</sub>	170	80
33.3	3	100	100/150	H <sub>3</sub>	185	100
5	1	5	50/100	H <sub>0</sub>	70	32
10	1	10	100/200	H <sub>1</sub>	80	58
35	2	70	180/180	H <sub>3</sub>	155	86
7.5	1	7.5	180/180	H <sub>1</sub>	154	113
10	1	10	300/300	H <sub>2</sub>	92	63
45	2	90	50/100	H <sub>3</sub>	150	93
30	1	30	600/600	H <sub>3</sub>	103	61
10	1	10	300/300	H <sub>0</sub>	223	130
5	1	5	150/300	H <sub>2</sub>	54	43

H<sub>0</sub> = Free air

H<sub>1</sub> = 11°C/W thermal resistance

H<sub>2</sub> = 6.3°C/W thermal resistance

H<sub>3</sub> = 1.3°C/W thermal resistance

Thermal resistances of heat sinks are steady-state values

$T_{j(max)} = T_c(max) + \theta_{j-c} P_D$

( $\theta_{j-c} \approx .50^\circ\text{C/W}$ )

were selected to give sizable spread to the primary variables,  $P_T$  ( $V_{CE}$ ,  $I_C$ ) and  $\Delta T_C$ . The points chosen are shown on the theoretical rating chart of Fig. 4. Many of the points are outside of the projected safe area. This fact illustrates another consideration in the total study, time. To minimize testing time and still generate meaningful data, a form of accelerated testing was built into the program. The usual precautions were employed in utilizing accelerated testing; i.e., failure analysis and data analysis were used to verify the existence of a true acceleration and to assure that failures had not been created that had no correlation with a bearing on the more typical lower stress levels.

#### Data

Table III is a tabulation of the data obtained from the 2N3055 thermal-fatigue rating program. Fig. 5 is a graphical representation of the cycles-to-failure for each test group. A visual examination of the data indicates that devices tend to fail sooner on tests with large  $\Delta T_C$  and high junction temperatures, as expected.

Table III – 2N3055 Thermal-Fatigue Ratings

No. of Devices	Power (W)	Heat Sink	T <sub>c</sub> (°C)	ΔT <sub>c</sub> (°C)	T <sub>j(max.)</sub> (°C)	Cycle Time (sec.)		Cycles @ Down Period	Cumulative Cycles	Catastrophic Failures
						On	Off			
20	17	H <sub>0</sub>	30 to 180	150	188.5	100	200	35,952	43,032	1 @ 2000 hrs. 2 @ 40,207 hrs.
20	17	H <sub>0</sub>	30 to 220	190	228.5	180	180	30,525	36,442	1 @ 20,719 hrs. 1 @ 22,185 hrs. 1 @ 28,266 hrs. 1 @ 34,672 hrs.
20	30	H <sub>0</sub>	35 to 180	145	195	50	130	52,851	72,061	1 @ 50,989 hrs. 1 @ 60,138 hrs. 1 @ 68,701 hrs. 1 @ 69,185 hrs.
20	27	H <sub>0</sub>	40 to 165	125	178.5	50	130	53,402	72,479	1 @ 11,520 hrs. 1 @ 40,003 hrs.
20	30	H <sub>0</sub>	50 to 220	170	235	50	130	18,698	70,564	1 @ 6036 hrs. 2 @ 11,808 hrs. 1 @ 18,703 hrs. 1 @ 36,846 hrs. 1 @ 62,616 hrs.
20	30	H <sub>1</sub>	35 to 150	120	165	100	200	14,702	70,901	1 @ 65,200 hrs.
20	41	H <sub>1</sub>	35 to 180	145	200.5	100	200	14,702	41,668	1 @ 449 hrs. 1 @ 1400 hrs. 1 @ 19,917 hrs. 1 @ 25,157 hrs. 1 @ 32,334 hrs. 1 @ 32,642 hrs.
20	27	H <sub>2</sub>	30 to 135	105	148.5	150	300	12,274	62,395	1 @ 50,100 hrs.
20	56	H <sub>2</sub>	70 to 120	50	148	15	25	231,202	264,675	1 @ 8500 hrs. 1 @ 10,480 hrs. 1 @ 144,632 hrs. 1 @ 241,379 hrs.

H<sub>0</sub> = Free air (30°C/W)

H<sub>1</sub> = 11°C/W

H<sub>2</sub> = 6.3°C/W

#### Failure Analysis

The basic failure analysis procedure for all failing devices was as follows:

1. Electrical test
2. Leak test (Helium and freon bubble)
3. Gas Analysis (Mass spectrometer)
4. Decap unit
5. Electrical test
6. Visual inspection
7. Remove silicone conformal coating
8. Retest electrically
9. Remove solder
10. Cross section
11. Check pellet-to-header bond
12. Photograph results

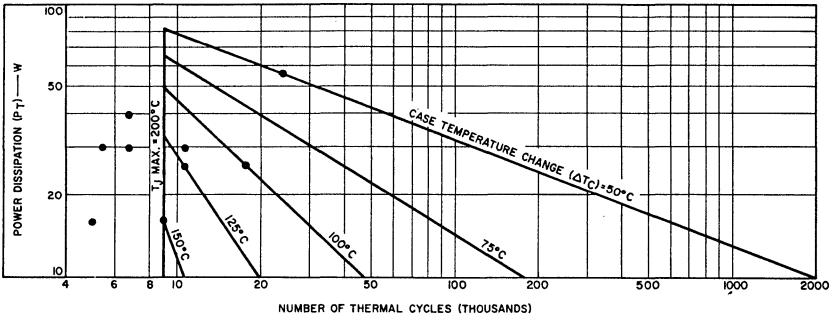


Fig. 4— Theoretical rating chart.

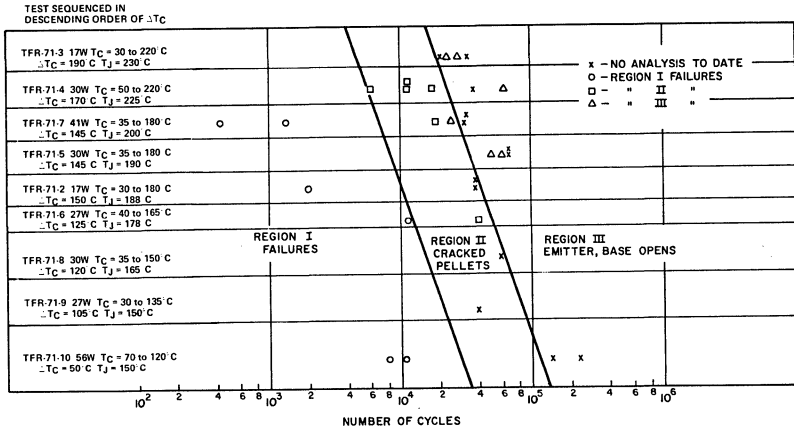


Fig. 5— Graphical representation of the cycles-to-failure number for various test groups.

Three basic types of failures were found in the analysis of failing devices using this procedure. These types were categorized as follows:

1. Non-controlled-solder-process\* failures, Region I
2. Cracked pellets in Region II
3. Open emitter and base contacts (solder fracture) and nickel delamination on both collector and emitter-base side of pellet, Region III

\*The controlled solder process is a proprietary process developed by RCA.

Corrective action has eliminated failures in Region I; such failures will not be discussed further. Figs. 6 and 7 illustrate the types of failures encountered in Regions II and III.

The cracked-pellet failures presented the problem of determining whether the silicon chip was cracked during assembly or as the result of thermal stresses. Analysis indicated that the cracks occur at points where high pressure is applied during assembly or where pellets are located over a solder void. Such failures are not expected to occur in devices using the controlled-solder-process solder system where the total strain of the system is taken up by the solder.

The third category of failures, open emitter and base contacts and pellet lifting, occurs very late in the cycle life of

the device and is probably the only real wearout mechanism encountered in the test program. The interfaces between the emitter, base, and collector contacts consisting of nickel-lead/tin materials expand and contract at different rates during thermal cycling, and, consequently, strain occurs. Because of the difference in the coefficients of expansion of these materials, an appreciable amount of shearing takes place and causes fatigue failure at the contact point.

**Curve Fitting — Predictive Model**

In determining the number  $N(y)$  of cycles to first failure, it is assumed that a function exists and that the form of the function depends upon the measurable variables, as follows:

$$N(y) = f(\Delta T_c, \text{Power}, T_{j(\text{max.})}, \text{Cycle Time } \theta_{h-s})$$



CRACK

Fig. 6— Pellet showing failure as the result of a crack.



OPEN BASE

Fig. 7— Pellet showing failure as the result of an open base.

Regression analysis techniques are used to minimize the estimation error; the method of least squares is employed for multiple regression, i.e.

$$S = \sum_{i=1}^n (N_i - \hat{N}_i)^2$$

is minimized;  $N_i$  is the actual value of failing cycles and  $\hat{N}_i$  is the calculated value of cycles.

Because a functional exponential model exists from the previous theory and because the experimental data imply that an exponential model should be fitted by the regression equation, the following relation is postulated:

$$N(y) = \exp.(C_1 \Delta T_c + C_2 \Delta T_{j(\text{max.})} + C_3 P_D + C_4 \theta_{h-s} t_r + \text{error})$$

where  $\Delta T_c$  is the case-temperature swing,  $T_{j(\text{max.})}$  is the maximum junction temperature,  $t_r$  is the ratio of "on" time  $t_{on}$  to "off" time  $t_{off}$ ,  $P_D$  is the applied power,  $\theta_{h-s}$  is the thermal resistance of the heat sink, and error is approximately normal  $(0, \sigma^2)$

The coefficients of this equation should be highly correlated so that prediction will be restricted to the space from which the data were derived. The correlation matrix, Table IV, shows that the "independent" variables are highly correlated. This correlation illustrates the problem of designing the experiment in the classical manner, as mentioned in an earlier section.

Table IV — Correlation Matrix

	N	$\Delta T_j$	$T_{j(\text{max.})}$	P	$\theta_{h-s}$	$x$	$t_r$
N	1	-0.89	-0.74	0.688			-0.52
$\Delta T_j$		1	-0.928	-0.66			0.724
$T_{j(\text{max.})}$			1	-0.42			0.702
P				1			-0.72
$\theta_{h-s} \times t_r$							1

Table V shows the data used in the regression analysis. No Region I failures are used in the regression analysis since they have been eliminated on future product through corrective action.

Following modified step-wise regression procedures, the equation that best fits the data is  $Y = 724e^{-0.02\Delta T_j}$ , where  $\Delta T_j = \Delta T_c + P_D (\theta_{j-c})$ . Because the present data are limited, especially between the  $\Delta T_c$  range of 50 and 125°C, further data and more analyses may result in slight modifications of this equation. Fig. 8 is a plot of the data and equation.

Table V — Data Used in the Regression Analysis

Power (W)	$\Delta T_j$ (°C)	$\Delta T_c$ (°C)	$T_{jmax.}$ (°C)	$t_r$	$\theta_{h-s} \times t_r$ (°C/W)	Y (First Failure Kc)
17	158.5	150	188	$\frac{100}{200} = 0.5$	15	40,207
17	198.5	190	230	$\frac{180}{180} = 1$	15	20,719
30	160	145	195	$\frac{50}{130} = 0.375$	11.2	50,989
27	138.5	125	178	$\frac{50}{130} = 0.375$	11.2	40,003
30	185	170	235	$\frac{50}{130} = 0.375$	11.2	6,036
30	135	120	165	$\frac{100}{200} = 0.5$	5.5	65,200
41	165.5	145	200	$\frac{100}{200} = 0.5$	5.5	19,917
27	118.5	105	150	$\frac{150}{300} = 0.5$	3.15	50,100
56	78.0	50	150	$\frac{15}{25} = 0.6$	3.8	144,632

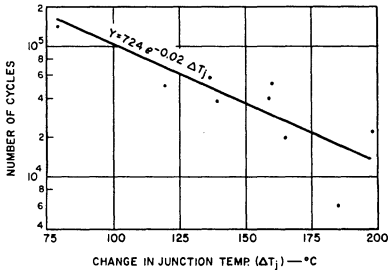


Fig. 8— Plot of change in junction temperature as a function of number of cycles.

### CONCLUSIONS

There are a variety of causes for thermal-fatigue failures. Region I failures were completely corrected by the controlled solder process. Region II cracked-pellet failures are a function of mounting techniques and process control. Region III failures represent a wearout mechanism which occurs well beyond the normal use of the device.

Empirical determination of thermal-cycling capability is a long and difficult process requiring specialized equipment

and techniques. At present, the prime factor affecting thermal-cycling capability is change in junction temperature,  $\Delta T_j = \Delta T_c + (P_D \times \theta_{j-c})$ . The RCA-2N3055 power transistor has demonstrated a thermal-fatigue capability far in excess of theoretically postulated values published in the thermal-fatigue rating chart.

### ACKNOWLEDGMENT

The authors acknowledge the contributions made in "scaling the environment" by F. Wehrfritz.

### REFERENCES

1. "C.R. Turner Speaks Out on Second Breakdown", EEE, Vol. 15, No. 7, July, 1967.
2. G.A. Lang, et al, "Thermal Fatigue in Silicon Power Transistors", IEEE Transactions on Electron Devices, September, 1970.
3. W.D. Williams, "Thermal-Cycling Rating System for Silicon Power Transistors", RCA Application Note AN-4612.
4. Draper and Smith "Applied Regression Analysis", John Wiley and Sons, Inc., 1966.



# Power Transistors

## Application Note

### AN-6145

## A Test Set for Nondestructive Safe-Area Measurements Under High-Voltage, High-Current Conditions

R. B. Jarl and R. Kumbatovic

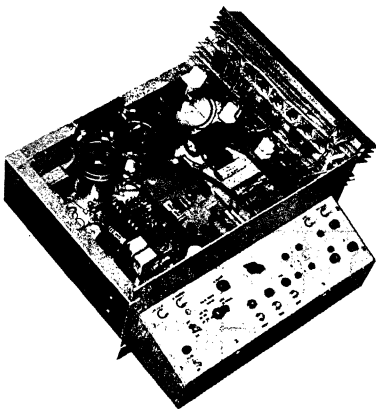
Techniques for determining the safe operating area of power transistors at moderate voltages, currents, and dc conditions have been available for some time. Circuitry for accomplishing this task nondestructively has also been available. A more difficult task has been to test devices nondestructively at high voltage/ampere products under pulsed and repetitive-pulsed conditions which more closely simulate the electrical environment in an actual equipment. The usual method has been to use a statistically significant sample and to test the devices to destruction to produce a rating curve. Then, by comparing the point of failure of the sampled units to the results of the dc tests, the pulse rating of the units is correlated to the dc tests. Because this procedure is obviously rather imprecise, users needing devices with high levels of reliability frequently require that devices be 100-per-cent tested to specific voltage, current, time, and duty-cycle conditions. This testing may be performed in a "sudden death" circuit where

inadequate units are destroyed. However, this situation is unsatisfactory, both analytically and economically.

This Note describes a test equipment designed to perform the tests described above, for the most part, nondestructively. A photograph of the interior of the equipment and the control panel is shown in Fig. 1; an enlargement of this photograph is shown in Fig. 9, page 7. The equipment has a current range of 200 milliamperes to 20 amperes, a voltage range of 10 volts to 350 volts, a pulse width of 10 microseconds to two seconds, and a pulse repetition rate limited only by external equipment restrictions.

### System Philosophy

As shown in the block diagram of Fig. 2, the transistor under test, TUT, is connected in a common-base configuration modified by a series base diode.  $V_{CC}$  is applied, and the TUT emitter is then driven by a constant-current source which is



H-1804

Fig. 1—Interior and control panel of test equipment.

(See Fig. 9, page 7, for enlarged photograph.)

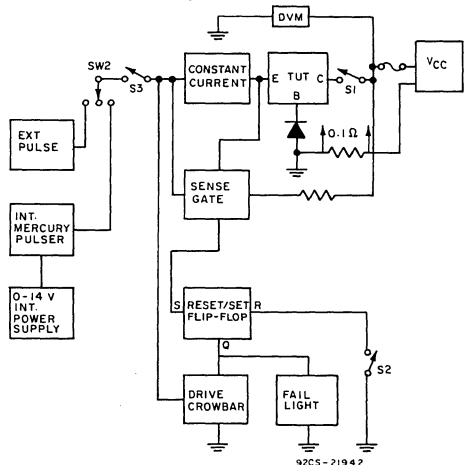


Fig. 2—Block diagram of test equipment.

driven, in turn, by a large-signal pulse generator, such as an HP 214A, or a mercury-wetted relay pulser. Voltage at the TUT emitter is monitored by a sensing network and a high-speed, bistable flip-flop. The collector of the TUT is tied to a  $V_{CC}$  supply appropriately filtered for high-current/fast-rise-time loads.

A device failure is observed as a sudden increase in voltage at the emitter of the TUT, which normally holds at a voltage, below ground, equivalent to twice the drop across the series base diode. A +3-volt, 50-nanosecond change is sufficient to switch the state of the flip-flop. The flip-flop then turns on a crowbar circuit which shorts out the voltage drive to the emitter current source. When the emitter current becomes less than the collector current, the series base diode becomes back-biased and opens the base-collector loop. The total shutdown procedure takes less than 0.5 microseconds.

### System Design

The system is made up of seven "building blocks":

1. The  $V_{CC}$  power supply and filters
2. The  $V_{EE}$  power supply and filters
3. The pulse-timing block
4. The emitter-current-source block

5. The sense-gate, failure-detection, crowbar, and fail-light block
6. The TUT socketing and metering block
7. The relay-sequencing block

These circuits are shown interconnected in the system schematic diagram of Fig. 3. Fig. 4 shows the schematic diagram for the zero-to-20-volt drive power supply,  $V_{BB}$ .

The  $V_{CC}$  supply must have adequate current capability to cover the intended spectrum of pulse widths and duty cycles. Its voltage regulation must be such that any spiking caused by stepped changes in load can be absorbed by reasonable filtering on the TUT test chassis. The filtering arrangement shown in Fig. 3 is adequate for the design current of 20 amperes. Whenever fast rise and fall times are a factor, Mylar<sup>1</sup> or the best quality paper capacitors must be used to supplement the electrolytic capacitors. The filter capacitors must be chosen to act in the same manner as a storage battery for a length of time sufficient for the  $V_{CC}$  supply to recover from the load change.

The same comments apply to the -14-volt  $V_{EE}$  supply, which must not only provide the power for the

<sup>1</sup> Trademark of E. I. duPont de Nemours & Co., Inc.

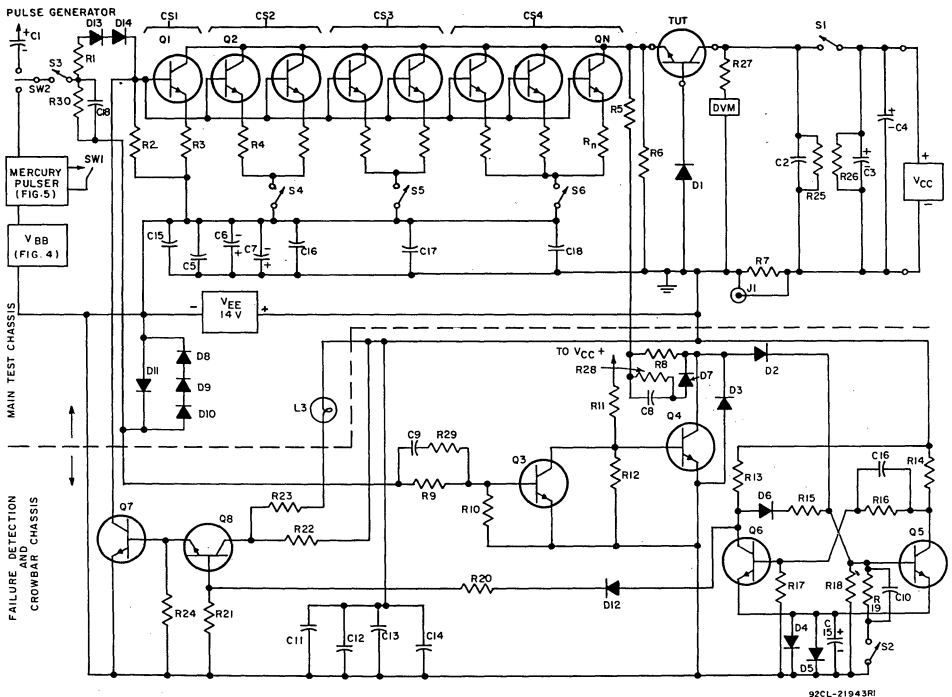


Fig. 3—Schematic diagram of main test chassis (parts list on pages 6 and 8).





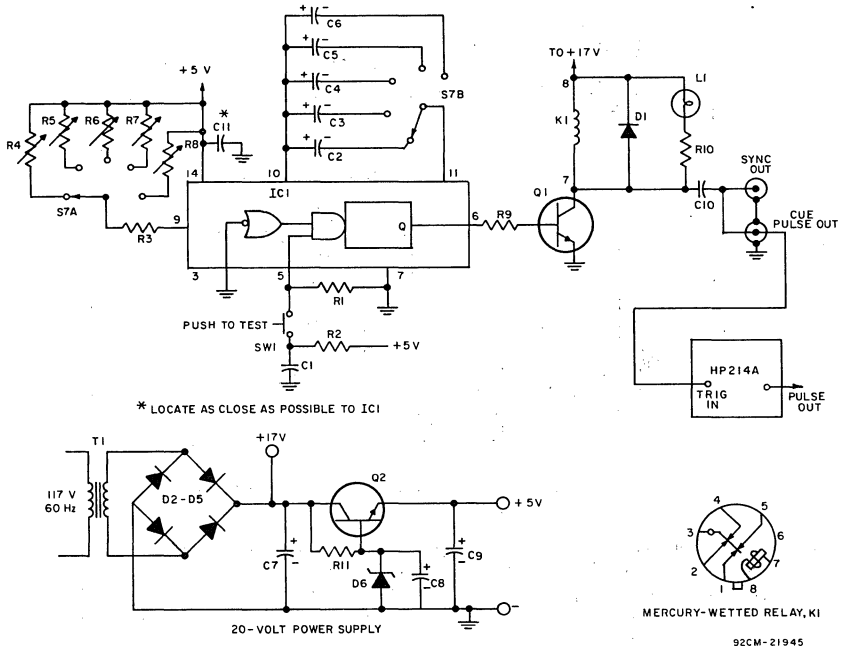


Fig. 5—Schematic diagram of pulse-timing-block components  
(parts list on page 8).

and  $V_{EB}$ . R5 and R6 are connected directly to the emitter terminals, and D1 is connected directly to the base terminal.

The sequencing relay circuit, Fig. 7, is arranged so that the sequence of switching events shown below occurs when the Start button is depressed at the initiation of a test:

1. S1 closes, applies  $V_{CC}$  to the TUT, and lights the Start light.
2. S2 closes momentarily and resets the flip-flop.
3. S3 closes and connects the pulse source to the current drivers.

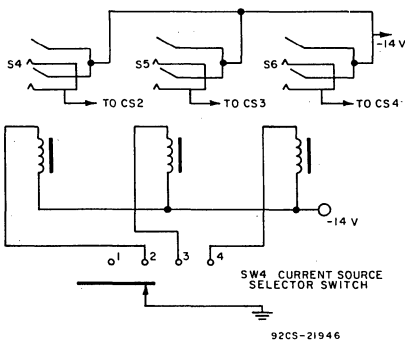


Fig. 6—Relay circuit for current-source selection.

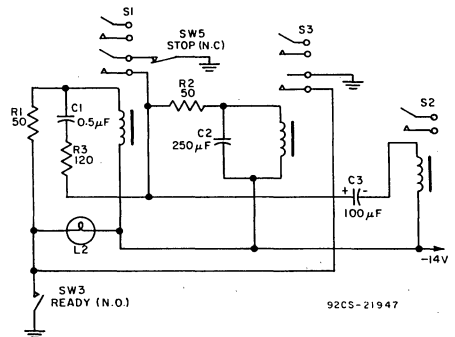


Fig. 7—Sequencing-relay circuit (parts list on page 8).

The sequence at the end of the test when the Stop button is depressed is as follows:

1. S<sub>3</sub> opens and disconnects the pulse drive.
2. S<sub>1</sub> opens and removes V<sub>CC</sub>, and the Start light goes out.

### Construction

Lead dress is not critical; however, there are some wiring restrictions that must be strictly observed:

1. Low-level signals and high-level signals must not be carried in the same wires.
  - a. The -14 volts for the flip-flop and gates must be carried on a separate bus which joins the -14-volt supply at the RI - RN bussing point.
  - b. The common line for the flip-flop and gates must be a separate line and must meet the system common only at the indicated ground point.
  - c. The sense line must connect directly to the emitter jack of the TUT socket.
  - d. The pulse-gate drive line must connect through a separate wire to the bases of the current source.
  - e. The collector of the crowbar transistor, Q<sub>7</sub>, must connect through its own wire to the bases of the current source.
  - f. The disconnect diode, D<sub>1</sub>, must be connected directly to the base jack of the TUT socket, and its anode return must be carried on a separate wire to the ground bus.
  - g. The I<sub>E</sub> and I<sub>C</sub> lines are lengths of RG14 coaxial cable with shields tied to the ground bus at the TUT end.
2. Current-source and protection-circuit filtering functions for the -14-volt supply must be separated and located on appropriate sub-assemblies.
3. Multiple capacitors are used for two reasons:
  - a. To minimize copper losses (IR drops) through leads and foil;
  - b. To achieve complete bypassing and regulation regardless of pulse rise time or duration.
4. Mylar<sup>1</sup> capacitors are used wherever possible because of their higher Q and smaller size.

### EXPLANATION OF CONTROLS AND ACCESS CONNECTIONS

Explanation of controls shown in Figs. 1 and 9:

AC On-Off	- Operates main contactor to provide power for entire system.
Cue Pulse	- Provides trigger pulse to external pulse generator when TEST button is pressed.
Ext.-Int.	- Selects either internal mercury-relay timer or external pulse generator.
IC Monitor	- Connects to vertical input of monitoring oscilloscope from 0.1-ohm, collector-current sensing resistor.

<sup>1</sup> Trademark of E. I. duPont de Nemours & Co., Inc.

Pulse Width	- Sets the width of the desired test pulse on the internal timer.
IC Adjust	- This control is used only with the internal mercury relay timer. It adjusts the voltage drive to the emitter current source.
Sync.	- Provides sync pulse to monitoring oscilloscope.
Ready	- Activates the sequencing relays and applies collector voltage to the TUT, resets the failure-detection circuit, and connects the pulse drive circuits to the current source.
Test	- Activates the internal timer or provides a cue pulse to the external pulse generator.
Stop	- De-energizes the sequencing relays and disconnects the pulse source and the collector voltage.
Ext. Pulse	- Receives drive pulse from external pulse generator.
Current Source Selector (Top middle of control panel)	- Switches in additional current sources CS2 through CS4.

### OPERATION

#### Operation at DC to 25 Milliseconds

The interconnection of the test equipment with the external units, the pulse generator and oscilloscope, is shown in Fig. 8.

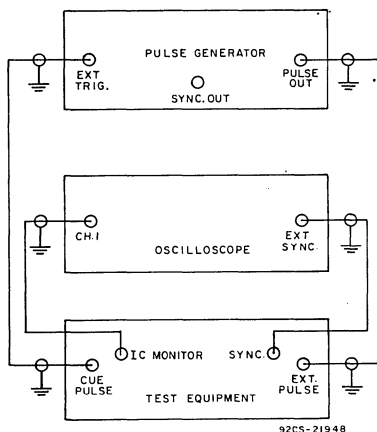


Fig. 8—Test-set interconnections.

The recommended sequence of operation is as follows:

1. Turn all supplies on.
2. Set Ext. - Int. switch to INT.
3. Set Pulse Width switch to 50 milliseconds.

4. Set  $V_{CC}$  at 10 volts.
5. Set sweep rate on oscilloscope to 10 ms/div/ext/ + sync.
6. Set oscilloscope sensitivity to dc 0.1 V/div.
7. Turn IC Adjust full counter-clockwise.
8. Set Current-Source Selector switch to desired range.
9. Insert a device into the test socket.
10. Push Ready button; green start light will flash.
11. Push Test button; yellow test light will flash.
12. Adjust sync controls on oscilloscope to obtain a single trace each time Test button is pushed.
13. Turn IC-Adjust control clockwise to obtain negative vertical deflection indicative of desired test current (in this case, 1 division per ampere); for higher currents, change vertical sensitivity to 0.2 or 0.5 V/div. as needed.
14. Switch Pulse Width to that which is required. Change sweep rate on oscilloscope as well.
15. Set  $V_{CC}$  at desired test voltage.
16. Push Stop button. Remove set-up device.
17. Insert device to be tested.
18. Push Ready.
19. Push Test; observe current trace on oscilloscope.
20. Push Stop and remove units.
21. If a unit fails the test, the red fail light will turn on.
22. The fail circuit and light will reset the next time the Ready button is pushed.
23. The failure-detection circuits may be checked at any time by switching the current-source switch to the next lower range. This action will produce a false failure signal which will trip the protection circuit. Be sure to return the switch to its original position after the test.

#### Operation at 25 Milliseconds and Less

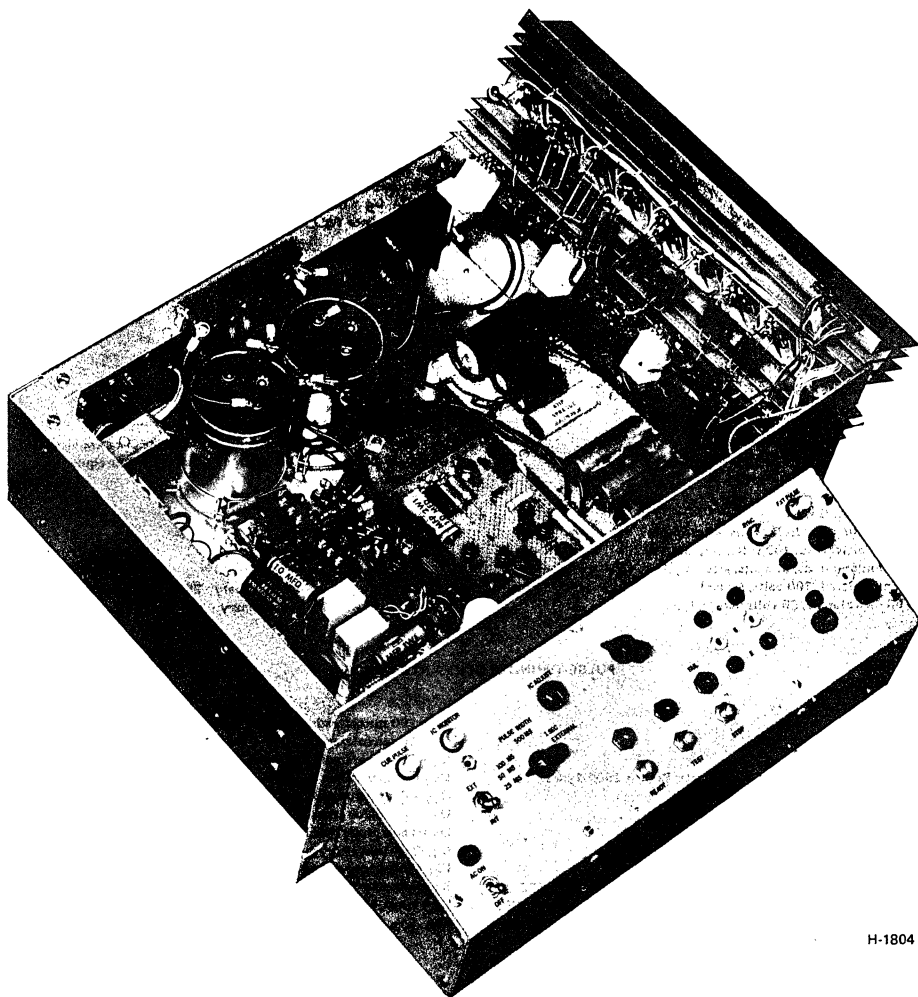
1. Turn all supplies on.
2. Set Ext.-Int. to Ext. This connects the external pulse generator to the test equipment.
3. Set  $V_{CC}$  at 10 volts.
4. Set sweep rate on oscilloscope to range of interest.
5. Set oscilloscope sensitivity to dc 0.1 V/div.
6. Set trigger selector on external generator to ext. Turn pulse amplitude controls to minimum.
7. Set Current-Source Selector switch to desired range.
8. Insert a device into the test socket.
9. Push Ready button; green start light will flash.
10. Push Test button. Adjust synchronizing controls on oscilloscope to give a single trace each time Test button is pushed.
11. Adjust pulse-amplitude control on generator to secure a usable vertical deflection while repeatedly pushing Test button. Then adjust Pulse-Width control to obtain desired current.
12. Re-adjust pulse-amplitude control to obtain desired current.
13. Set desired  $V_{CC}$ .
14. Push Stop. Remove set-up device.
15. Insert device to be tested.
16. Push Ready.
17. Push Test.
18. Push Stop.

The remainder of the procedure is identical to that followed for operation at dc to 25 milliseconds.

#### MAIN-TEST-CHASSIS PARTS LIST (Fig. 3)

$C_1$  = 1000 microfarads, 60 volts, pulse-coupling capacitor  
 $C_2$  = 3 microfarads, 600 volts, paper or Mylar  
 $C_3, C_4$  = 860 microfarads, 450 volts, electrolytic  
 $C_5$  = 10 microfarads, 200 volts, Mylar  
 $C_6, C_7$  = 2000 microfarads, 50 volts, electrolytic  
 $C_{15} - C_{17}$  = 0.05 microfarad, 200 volts, Mylar  
 $R_1$  = 15 ohms, 2 watts, carbon  
 $R_2$  = 100 ohms, 2 watts, carbon  
 $R_3, R_4 - R_N$  = 4 ohms, 6 watts, clusters of three 12-ohm, 2-watt carbon resistors  
 $R_5$  = 0.1 kilohm, 1 watt  
 $R_6$  = 8 kilohms, 1 watt  
 $R_7$  = 0.1 ohm, non-inductive, 20 watts, with Kelvin connections  
 $R_{25}$  = 250 kilohms, 2 watts  
 $R_{26}$  = 8 kilohms, 50 watts, wire-wound  
 $R_{27}$  = 1 kilohm, 1 watt  
 $Q_1, Q_2, Q_N$  = transistor, type 2N5240  
 $J_1$  = current-monitoring jack, BNC female  
 $R_{30}$  = 200 ohms, 2 watts  
 $C_{18}$  = .01 microfarad, 80 volts, Mylar or paper

$L_3$  = failure-indicator lamp, 14 volts, 80 milliamperes  
 $D_1$  = base-disconnect diode, GEA28D or TRWPD2708  
 $S_1$  = collector-current relay, 2 Potter and Brumfield KA14DY, paralleled  
 $S_2$  = flip-flop reset relay, Potter and Brumfield KHP 17D11, 12-volt coil  
 $S_3$  = pulse-source relay, Potter and Brumfield KHP 17D11, 12-volt coil  
 $S_4 - S_6$  = current-source range relays, Potter and Brumfield KHP 17D11, 12-volt coil  
 $SW_1$  = test switch  
 $SW_2$  = pulse-source selector switch  
 $SW_3$  = Ready switch  
 $SW_4$  = current-source selector switch  
 $V_{CC}$  = 0-125 volt, 25-ampere power supply or 0-400 volt, 2-ampere power supply  
 $V_{EE}$  = 14-volt, 15-ampere power supply  
 $V_{BB}$  = 9-20-volt, 2-ampere, variable power supply  
 $D_{13}, D_{14}$  = RCA D2601M diodes



H-1804

Fig. 9 - Interior and control panel of test equipment.

## FAILURE-DETECTION AND CROWBAR-ASSEMBLY PARTS LIST (Fig. 3)

C <sub>9</sub> = .01 microfarad, 200 volts, Mylar	R <sub>13</sub> = 0.1 kilohm, 2 watts
C <sub>8</sub> = 0.05 microfarad, 400 volts, Mylar	R <sub>17</sub> = 10 kilohms, ½ watt
C <sub>9</sub> , C <sub>10</sub> = 0.005 microfarad, 200 volts, Mylar	R <sub>18</sub> = 2.5 kilohms, ½ watt
C <sub>11</sub> , C <sub>12</sub> = 50 microfarads, 50 volts, electrolytic	R <sub>19</sub> = 250 kilohms, ½ watt
C <sub>13</sub> = 1 microfarad, 200 volts, Mylar or paper	R <sub>20</sub> , R <sub>21</sub> = 0.1 kilohm, 1 watt
C <sub>14</sub> = 0.1 microfarad, 200 volts, Mylar or paper	R <sub>22</sub> = 73 ohms, (three 220-ohm, 2-watt, in parallel)
C <sub>15</sub> = 25 microfarads, 25 volts, electrolytic	R <sub>23</sub> = 22 ohms, 2 watts
C <sub>16</sub> = 500 picofarads, 200 volts, ceramic	R <sub>24</sub> = 1 kilohm, 1 watt
R <sub>8</sub> = 20 kilohms, 1 watt	D <sub>2</sub> - D <sub>12</sub> = diode, type 1N914A
R <sub>9</sub> = 750 ohms, ½ watt	Q <sub>3</sub> = transistor, type 2N3261
R <sub>10</sub> = 10 kilohms, ½ watt	Q <sub>4</sub> - Q <sub>6</sub> , Q <sub>8</sub> = transistor, type 2N5262
R <sub>11</sub> = 5 kilohms, 20 watts, (two 10-kilohm, 10-watt, wire-wound, in parallel)	Q <sub>7</sub> = transistor type 2N3878
R <sub>12</sub> , R <sub>14</sub> - R <sub>16</sub> = 0.5 kilohm, 1 watt	R <sub>29</sub> = 47 ohms, ½ watt
	R <sub>28</sub> = 470 kilohms, ½ watt

## ZERO-to-20 VOLT DRIVE POWER-SUPPLY PARTS LIST (Fig. 4)

R <sub>1</sub> = two 1.2-ohm, 2-watt, wire-wound resistors in parallel	C <sub>6</sub> = 100 microfarads, 25 volts, electrolytic
R <sub>2</sub> = 6.8 kilohms, ½ watt	C <sub>7</sub> = 500 microfarads, 25 volts, electrolytic
R <sub>3</sub> = 10 kilohms, ½ watt	C <sub>8</sub> = 500 microfarads, 25 volts, electrolytic
R <sub>4</sub> = 220 ohms, ½ watt	C <sub>9</sub> = 5 microfarads, 50 volts, electrolytic
R <sub>5</sub> = trimpot, 5 kilohms, ½ watt	D <sub>1</sub> - D <sub>4</sub> = 6-ampere bridge assembly, Varo VH247 or equivalent
R <sub>6</sub> = potentiometer, 5 kilohms, 2 watts	D <sub>5</sub> - D <sub>8</sub> = 2-ampere bridge assembly, Varo VS247 or equivalent
R <sub>7</sub> = trimpot, 5 kilohms, ½ watt	D <sub>9</sub> = zener, 6.8 volts, 1 watt
R <sub>8</sub> = 470 ohms, ½ watt	D <sub>10</sub> = zener, 12 volts, 1 watt
R <sub>9</sub> = 220 ohms, ½ watt	D <sub>11</sub> = diode, type 1N1206
C <sub>1</sub> = 2000 microfarads, 50 volts, electrolytic	Q <sub>1</sub> = transistor, type 2N2102
C <sub>2</sub> = 0.01 microfarad, 100 volts, ceramic	Q <sub>2</sub> = transistor, type 2N2102
C <sub>3</sub> = 500 microfarads, 50 volts, electrolytic	Q <sub>3</sub> = transistor, type 2N3772
C <sub>4</sub> = 1 microfarad, 100 volts, Mylar <sup>1</sup>	T <sub>1</sub> = transformer: 117-volts primary - 25.2-volt, 2.8-ampere secondary
C <sub>5</sub> = 50 microfarads, 25 volts, electrolytic	T <sub>2</sub> = transformer: 117-volt primary - 16.6 volt, 0.3-ampere secondary

## PULSE-TIMING-BLOCK PARTS LIST (Fig. 5)

R <sub>1</sub> = 820 ohms, ½ watt	C <sub>7</sub> = 100 microfarads, 25 volts, electrolytic
R <sub>2</sub> = 2.2 megohms, ½ watt	C <sub>8</sub> = 10 microfarads, 25 volts, electrolytic
R <sub>3</sub> = 2 kilohms	C <sub>9</sub> = 25 microfarads, 25 volts, electrolytic
R <sub>4</sub> - R <sub>8</sub> = trimpots, 50 kilohms, ½ watt; Bourns 200P-1-503 or equivalent	C <sub>10</sub> = 1 microfarad, 100 volts, Mylar
R <sub>9</sub> = 100 ohms	C <sub>11</sub> = 0.1 microfarad, 100 volts, ceramic
R <sub>10</sub> = 47 ohms, 1 watt	D <sub>1</sub> - D <sub>5</sub> = diode, type 1N5395
R <sub>11</sub> = 270 ohms, ½ watt	D <sub>6</sub> = zener, type 1N4734A, 5.6 volts, 1 watt
C <sub>1</sub> = 0.01 microfarad, 80 volts, PACER	Q <sub>1</sub> , Q <sub>2</sub> = transistor, type 2N5320
C <sub>2</sub> = 5 microfarads, 50 volts, tantalum; Mallory CL65BJ050KPE	IC <sub>1</sub> = integrated circuit, type SN74121N (Signetics)
C <sub>3</sub> = 22 microfarads, 25 volts, tantalum; Mallory CL65BG220KPE	K <sub>1</sub> = mercury relay, Potter and Brumfield JM11211 or equivalent
C <sub>4</sub> = 68 microfarads, 30 volts, tantalum; Mallory CL65BH681KPE	L <sub>1</sub> = lamp, No. 382; 14 volts, 0.08 amperes
C <sub>5</sub> , C <sub>6</sub> = 100 microfarads, 25 volts, tantalum; Mallory CL65BG101KPE	S <sub>7A</sub> , S <sub>7B</sub> = wafer switches, 2-pole, 5-position (matching contacts tied together to make each wafer a single-pole 5-position switch)

## SEQUENCING-RELAY-CIRCUIT PARTS LIST (Fig. 7)

S <sub>1</sub> = collector power relay	R <sub>3</sub> = 120 ohms, 1 watt
S <sub>2</sub> = flip-flop reset relay — See Main Test Chassis parts list, page 6	C <sub>1</sub> = 0.5 microfarad, 200 volts
S <sub>3</sub> = current-source drive relay	C <sub>2</sub> = 250 microfarads, 50 volts
SW <sub>3</sub> = Ready switch, normally open, push button	C <sub>3</sub> = 100 microfarads, 50 volts
SW <sub>6</sub> = Stop switch, normally closed, push button	L <sub>2</sub> = ready lamp, 80 milliamperes, 14 volts
R <sub>1</sub> , R <sub>2</sub> = 50 ohms, 2 watts	

## Quantitative Measurement of Thermal-Cycling Capability of Silicon Power Transistors

by L. J. Gallace

This Application Note discusses the methods used to test the thermal-cycling capability of power transistors. A brief description of thermal fatigue, application requirements, and rating charts is given. A detailed discussion of the practical design of thermal-cycling racks is also included along with actual test conditions for various power-transistor types. Acceleration factors, failure indicators, failure mechanisms, and real-time control of thermal-cycling capability of factory product are discussed. Some information is also given on hermetic versus plastic-package thermal-cycling reliability.

In silicon power-transistor applications, thermal cycling of transistors may activate a failure mechanism called thermal fatigue. This phenomenon is caused by the mechanical stresses set up by the differentials in thermal expansion of the various materials used in the transistor assembly and heat sink. Thermal fatigue often causes the silicon pellet to crack or to fail at the silicon/mounting interface.

The number of cycles to failure in terms of device characteristics and operating conditions has been expressed as:

$$N = Ae^{\frac{\psi_0}{(a_1 - a_2) \Delta T L}}$$

where  $A$  and  $\psi_0$  are constants for a given power structure,  $(a_1 - a_2)$  is the difference in thermal expansion between the silicon die and the material on which it is mounted,  $\Delta T$  is the change in temperature at the interface between the silicon chip and the material to which it is mounted, and  $L$  is the maximum dimension of the silicon chip.

### APPLICATION REQUIREMENTS

Table I shows typical applications of power transistors and the number of cycles or cycle life required of transistors used in equipment in each application to allow the equipment to fulfill its life expectancy. The importance of cycle life can be shown by examining the following simple expression of the failure-rate equation, which characterizes device failure rates:

$$\lambda = \lambda_T \pi_Q \pi_E \pi_L \pi_P + \lambda_{\Delta T_C}$$

where  $\lambda$  = failure rate  
 $\lambda_T$  = base failure rate due to temperature (Arrhenius)  
 $\pi_Q$  = quality factor  
 $\pi_E$  = environmental factor  
 $\pi_L$  = learning curve  
 $\pi_P$  = package factor  
 $\lambda_{\Delta T_C}$  = change in case temperature

Table I reflects the increasing demand for more thermal-cycle-life capability from equipment manufacturers because of their lengthening warranty periods. This lengthening of warranty period has greatly increased the demand on power-transistor manufacturers to test and ensure product capability over a longer period of time. RCA has developed a rating chart, Fig. 1, that relates the thermal-cycling capability of silicon power transistors to total device dissipation and the change in case temperature. A circuit designer may use the rating chart to define a limiting value below which power dissipation and change in case temperature are not factors in the failure rate equation; i.e., *within this rating chart, the failure rate for power transistors is independent of cycle life.* This statement does not imply that failures will not occur; it does imply, however, that the last term in the failure-rate equation is small enough to be insignificant. Since the change in case temperature is a major consideration in many applications, product with superior capability in this parameter will produce lower field-failure rates.

### FAILURE ANALYSIS

#### Soft-Solder Devices

In soft-solder devices, the metal interfaces between the emitter, base, and collector contacts consist of nickel-lead-tin metals which expand and contract at different rates during thermal cycling, and, consequently, strain occurs. Because of the difference in coefficients of expansion of these materials, an appreciable amount of shearing takes place that causes

TABLE I — THERMAL-CYCLING REQUIREMENTS FOR TYPICAL APPLICATIONS OF POWER TRANSISTORS

APPLICATION	CIRCUIT	P <sub>T</sub> (W)	ΔT <sub>C</sub> (°C)	MINIMUM EQUIPMENT LIFE REQUIRED (YEARS)	TYPICAL THERMAL CYCLING-RATING REQUIRED (CYCLES)
Auto radio	Class A	8	75	5	5,000
Audio output	Class AB	2	45	5	5,000
Power supply	Series regulator	50	65	5	10,000
	Switching regulator	15	65	5	10,000
Hi-Fi audio amplifier	Class AB	35	50	5	5,000
Computer power supply	Series regulator	50	65	10	10,000
Computer peripheral equip.	Solenoid driver	5	5	10	1.3 x 10 <sup>8</sup>
Television	Vertical output	10	75	5	7,500
	Audio output	8	75	5	7,500
Sonar modulator	Linear amplifier	100	55	10	144 x 10 <sup>3</sup>

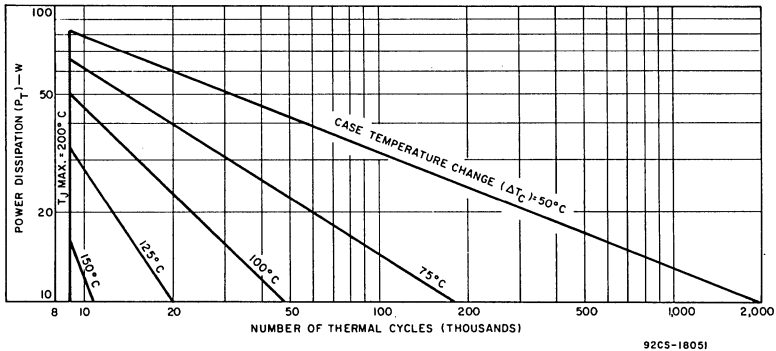


Fig. 1 — Thermal-cycling rating chart for an RCA hermetic power transistor.

fatigue failure at the contact point. The longer the stress continues, the more the solder moves to relieve the stress. If the movement continues long enough, the joints will rupture, and actual physical displacement of the silicon pellet will occur; this displacement is called pellet "walk." Linear movements of as much as 20 mils have occurred.

#### Hard Solder

The predominant failure mechanism in hard-solder devices is failure in the silicon crystal. Since no plastic flow occurs in hard solder, invariably the silicon must take up some of the

strain in the system. Cracks in the silicon, generally under the bonding-wire area, are the most common failure mechanism.

#### PRACTICAL TESTING

Although analytical techniques have been most helpful in developing an understanding of thermal cycling as a failure producer, testing, the experimental approach, must still be used to determine the ultimate thermal-cycling capability of a power transistor.



Fig. 2 is a schematic diagram of the basic test circuit. Depending on the frequency response of the transistor to be tested, this circuit is modified to avoid parasitic oscillation. Modification generally takes the form of capacitors, usually connected collector-to-emitter, or ferrite beads on the emitter and base leads.

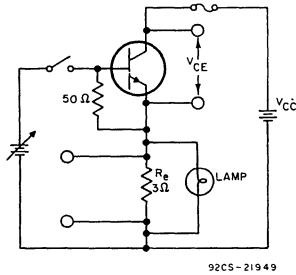


Fig. 2— Test circuit.

Fig. 3 is a photograph of a typical test rack without the associated power supplies. The Appendix contains a complete parts list and mechanical layout for this thermal-cycling rack. In addition, the Appendix shows a layout and parts lists for sockets that accommodate both TO-220 VERSAWATT (plastic) and TO-3 hermetic transistors.

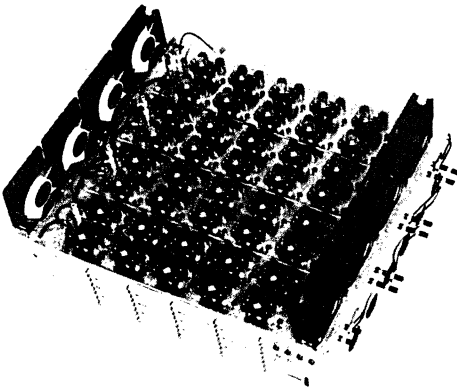


Fig. 3— Test rack used in thermal-fatigue testing.

The design of the test rack stresses simplicity and universal use. By interchanging sockets, 40 devices including almost all power-transistor types can be tested. Eight fans are used to cool the devices on the off cycle. Most tests can be conducted under free-air conditions; however, if heat sinks are used, power levels up to 56 watts per socket can be handled.

Under these higher-power conditions, a temperature gradient will exist across the rack with the highest temperature

at the center. A simple method to compensate for this gradient is to increase the size of the heat sink on the sockets as the distance from the fans increases.

Mechanical timers are used to control the on-off cycle time. For very fast cycle time (40 seconds or less), high-torque motors are recommended for longer timer life. Solid-state timers have also been used.

A thermocouple is used to monitor the cycle temperature continuously. For more important tests, when equipment failure cannot be tolerated, over-temperature controls set 5 to 10°C above the maximum temperatures of the test are used. When activated, the control will open the base drive circuit and keep it open until manually reset. This method may also be used to cycle the tests on and off, but the cost is higher than when mechanical timers are used.

Jacks are provided on the front panel of the rack for monitoring emitter current. The light bulb connected across the emitter resistor is a visual aid to help detect intermittent emitter-base contacts. The number of test cycles is automatically recorded on a counter.

Since thermal cycling of power transistors requires high-current power supplies (50 to 100 amperes), consideration must be given to thermal-fatigue-induced power-supply failures. If 50-per-cent duty cycles are used, then switching can be arranged so that there is a constant load on the power supply. For duty cycles other than 50 per cent, resistive loads can be switched in during the transistor off cycle. Multiple timers driven from the same motor can be used to service up to three racks from one collector power supply when more than one rack uses the same cycle time.

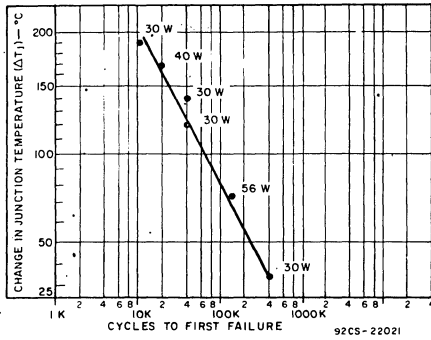
## TEST CONDITIONS

A thermal-fatigue test is basically a cyclical, operating-life test. For room-ambient testing, the important test parameters are:

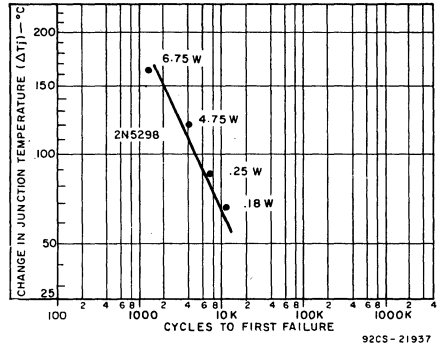
- $P_d$ , collector dissipation;
- $\Delta T_c$ , change in case temperature;
- $\Delta T_j$ , change in junction temperature;
- $T_{jmax}$ , maximum junction temperature;
- $\theta_{jc}$ , junction-to-case thermal resistance; and cycle time.

In empirically determining the power-cycling capability of a power transistor, it was found that the single most important parameter was  $\Delta T_j$ . Although  $T_{jmax}$  and cycle time were also significant factors, it was shown that most of the predictive methods and acceleration factors could be based on  $\Delta T_j$ ; 70 per cent of the experimental data could be explained by this one parameter as long as the power range for  $\Delta T_j$  did not exceed a maximum of 3 to 1.

Fig. 4 shows plots of  $\Delta T_j$  as a function of cycles-to-first-failure on Arrhenius-type paper for a 2N3055 transistor in a hermetic TO-3 package and a 2N5298 transistor in a TO-220 VERSAWATT package. The data show a "good" fit relatively independent of power. These curves can be used to predict power-cycling capability at lower  $\Delta T_j$  values with good accuracy.



(a) 2N3055



(b) 2N5298

Fig.4 — Change in junction temperature as a function of cycles-to-first-failure for a 2N3055 transistor in a hermetic TO-3 package and a 2N5298 transistor in a TO-220 VERSAWATT package.

Some recommended test conditions for evaluating product to the published rating curves are shown in Table II. All of the test conditions given can be achieved on the test rack shown in Fig. 3 and described in the Appendix.

Although most failures are detected while a device is under operation on the thermal-cycling test racks, sufficient down-period readings should be recorded to indicate shifts in parameters that are indicators of changes in the device metallurgical system. The most critical parameters to record as variables data are thermal resistance (junction to case), beta,  $V_{BE}$ ,  $V_{CE(sat)}$ , and  $I_{CEO}$ .

**Package Differences (Hermetic vs. Plastic)**

The thermal-cycling capability of a plastic-packaged device is generally less than that of its hermetically packaged counterpart even though the maximum ratings of the devices are substantially different (150°C plastic, 200°C hermetic). This difference in capability is attributed to the condition which, in the plastic package, allows the emitter and base leads, embedded in the plastic mold, to be continually moved across the silicon chip during thermal cycling, thus causing eventual failure as a result of open contacts. Fig. 5 shows rating curves for the same pellet (2N3055) in both the plastic VERSAWATT and TO-3 hermetic packages.

TABLE II — RECOMMENDED TEST CONDITIONS

PACKAGE TYPE	POWER (WATTS)	$T_c(^{\circ}C)$	$\Delta T_c(^{\circ}C)$	$t_{on}$	$t_{off}$	HEAT SINK
TO-220 VERSAWATT	18	55 to 110	55	3 min.	3 min.	3°C/W
	4.75	35 to 155	120	50s	100s	Free Air
TO-3 Hermetic	16	40 to 130	90	50s	100s	Free Air
	56	70 to 120	50	15s	25s	6.3°C/W
TO-66 Hermetic	8.5	35 to 155	120	50s	100s	Free Air
RCA "TO-5" Plastic	1.5	35 to 135	100	60s	90s	Free Air
TO-5 Hermetic	1.5	30 to 115	85	60s	90s	Free Air

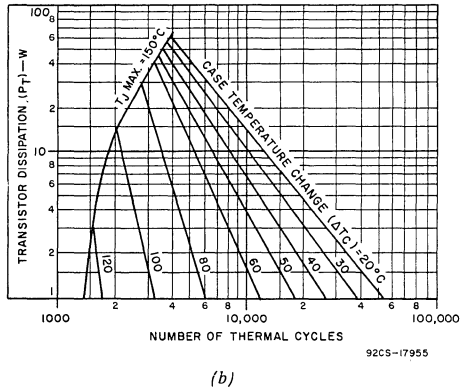
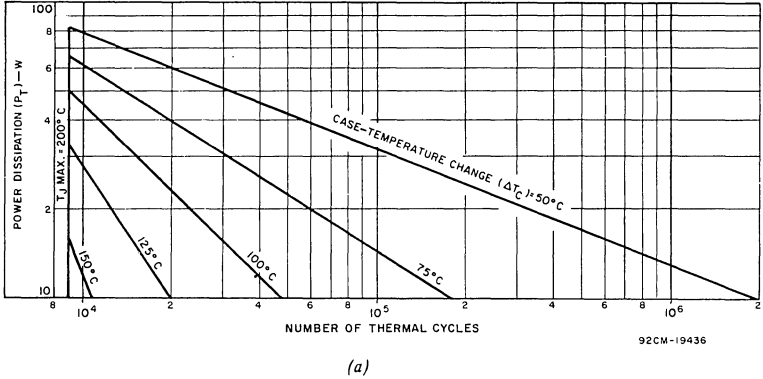


Fig.5 — Thermal-cycling rating curves for a 2N3055 pellet in (a) a TO-3 hermetic package, (b) a plastic VERSAWATT package (2N6103).

There are also cases where performance of a plastic package may be superior to some types of hermetic-package designs. For example, some aluminum TO-3 packages with solder-in emitter-base feedthroughs have shown substantially less capability on thermal cycling than their plastic VERSAWATT counterparts. In addition, the aluminum packages that have been measured become nonhermetic after a relatively low number of thermal cycles (less than 5000). Obviously then, care must be exercised in the selection of power transistors to avoid basing the choice upon package categories as general as "plastic" and "hermetic."

**Real-Time Controls (RTC)**

A major innovation in using the methods described to test for thermal-cycling capability is to monitor the

thermal-cycling capability of factory product on a lot-by-lot basis. Essentially, real-time control, or RTC, makes a continuous acceptance test and interpolation of thermal-cycling data against some established criteria. Information generated internally by RTC on thermal cycling has unquestioned validity because conditions of tests are well controlled and all ambiguities have been removed. Current as well as historical and projected operating information is generated for analysis.

The types of tests which are used in RTC are designed to produce information in three days for providing process control data. Typical examples of real-time control conditions are shown in Table III.

TABLE III - TYPICAL EXAMPLES OF REAL-TIME CONTROL CONDITIONS

TYPE	POWER (WATTS)	T <sub>c</sub> (°C)	ΔT <sub>c</sub> (°C)	CYCLES/DAY	N	TEST DURATION	AC NO.
TO-220	4.75	35 to 155	120	576	40	1700	0
VERSAWATT						3000	1
TO-3	56	70 to 120	50	2200	40	4400	0
Hermetic						6600	1

## BIBLIOGRAPHY

- G. A. Lang, B. J. Fehder, W. D. Williams, "Thermal Fatigue in Silicon Power Transistors", *IEEE Transactions on Electron Devices*, September, 1970.
- W. D. Williams "Thermal Cycling Rating System for Silicon Power Transistors", RCA Application Note AN-4612.
- V. J. Lukach, L. Gallace, and W. D. Williams, "Thermal Cycling Ratings of Power Transistors", RCA Application Note AN-4783.
- John M. Pankratz and Hubert R. Plumlee, "Estimating Fatigue Lifetime of Power-Cycled Solid State Switches", *IEEE Transactions on Electron Devices*, September, 1970.
- RADC (Rome Air Development Center) TR-67-108, Reliability Notebook Vol. II, September, 1967.
- C. M. Ryerson, "Mathematical Modeling for Predicting Failure Rates of Component Parts," Sixth Annual Reliability Physics Symposium, Los Angeles, California, Nov., 1967.

## APPENDIX

Thermal-Cycling Test Rack Parts List  
(Figs. A1, A2, A3, A4)

2	Counters	ITT General Controls CE600BS 602 120 V 60 Hz	40	3 Ohms - 25 W Resistors	Ohrmite No. 0200L Style 270-25
2	Relays*	Potter & Bromfield PR11AY - DPDT - 120 V AC	40	Banana Jacks	Red - E.F.Johnson - No. 108-902
			80	Banana Jacks	Green - E.F.Johnson - No. 108-904
			40	Banana Jacks	Blue - E.F.Johnson - No. 108-910
40	L-10/20 Rated for 10 V Lamps	Mura Corp. Great Neck, N. Y. With Red Lens Cap	4	Binding Posts	Blue - E.F.Johnson - No. 111-110
			2	Binding Posts	White - E.F.Johnson - No. 111-101
			2	Binding Posts	Black - E.F.Johnson - No. 111-103
8	Fans	IMC Magnetics Corp. Boxer Fan Model No. BS2107F	40	Fuses	4 A Littelfuse 312 004
			40	Fuses	½ A Littelfuse 312 500
			2	Fuses	2 A Littelfuse 312 002
4	Barrier Blocks	Three Contacts, Thru-Panel Solder Lugs Cinch-Jones - Series 3-142-Y			<b>Sockets</b>
81	Fuse Holders	Little Fuse Type 342012	80	TO-3	6/32 Screws 3/4 in. long
			80	TO-3	6/32 Nuts 1/4W x 3/32H
1	AC Line Cord	Belden No. 17419 9 Ft. No. 16-3 Type SJ Rubber	80	TO-3	6/32 Nuts 1/4W x 1/2H
			80	TO-3	6 Lock Washers
4	Switches	SP/ST Cutler-Hammer No. 7580K7	40	TO-220	Socket Base Pomona Electronics Company Pomona, California Model 2095
8	Neon Lamps	American Pamcor Paoli, Pa. No. 380627-2			

## APPENDIX (Cont'd)

Sockets (Cont'd)					
		16	TO-3	NC-632-3 (Wakefield Engineering, Delta Division)	
40	TO-220		8	TO-3	Fabricate — See Detailed Drawing (Figs. A6, A7)
					<b>Cycling Control Box</b>
	TO-220		1	Timer	Industrial Timer Corporation Parsippany, New Jersey MC1 with Two Switches (Cycle Time: 4 to 36 secs.) High-Torque Motor With A-36 Gear Rack (115 V - 60 Cycle)
40	TO-66				Tektronix, Inc. No. 013-0070-01
40	TO-3				Cover Plate for Pomona Socket See Detailed Drawing (Fig. A6)
40	TO-3		1	Neon Lamp	American Pamcor Paoli, Pa., No. 380627-2
			2	Banana Jacks	Red - E.F. Johnson - No. 108-902
			2	Banana Jacks	Green - E.F. Johnson - No. 108-904
40	TO-3		2	Banana Jacks	Blue - E.F. Johnson - No. 108-910
			1	Switch	SP/ST Cutler-Hammer No. 7580K7
	TO-3		1	AC Line Cord	Belden No. 17419 9 Ft. No. 16-3 Type SJ
16	TO-3		1	Chassis	Bud - Aluminum 4 x 5 x 6 in. No. AU-1029
					Socket Base Pomona Electronics Company Pomona, California Model 2095
					Socket — E B Y No. 9866-15-1
					Heat Sink: Wakefield Engineering Delta Division
					NC-631-3 (Wakefield Engineering, Delta Division)

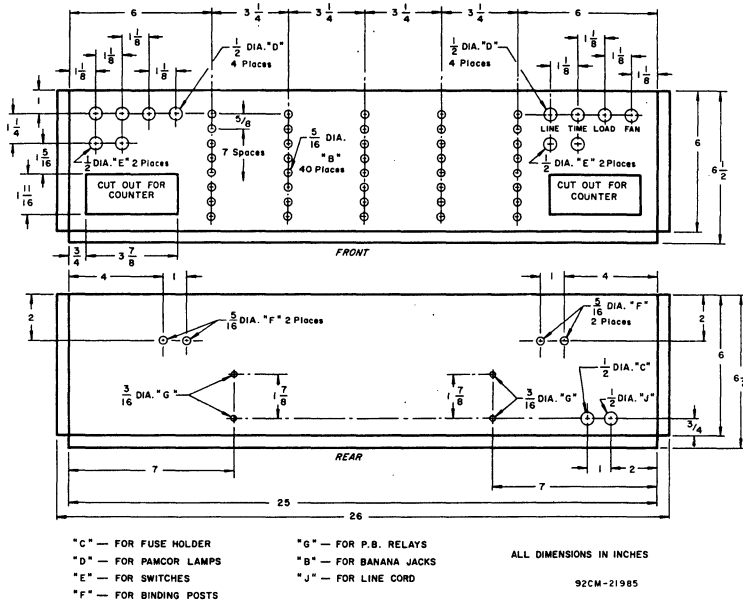


Fig. A1

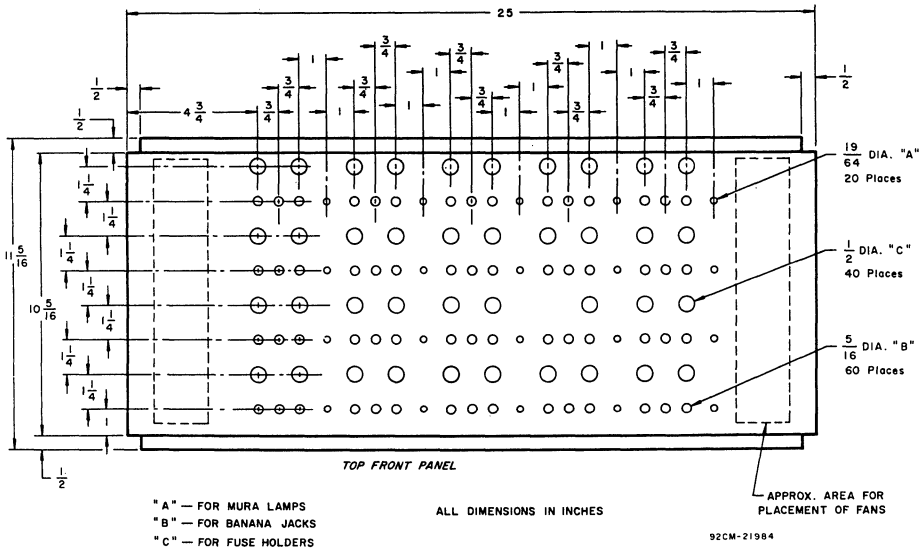


Fig. A2

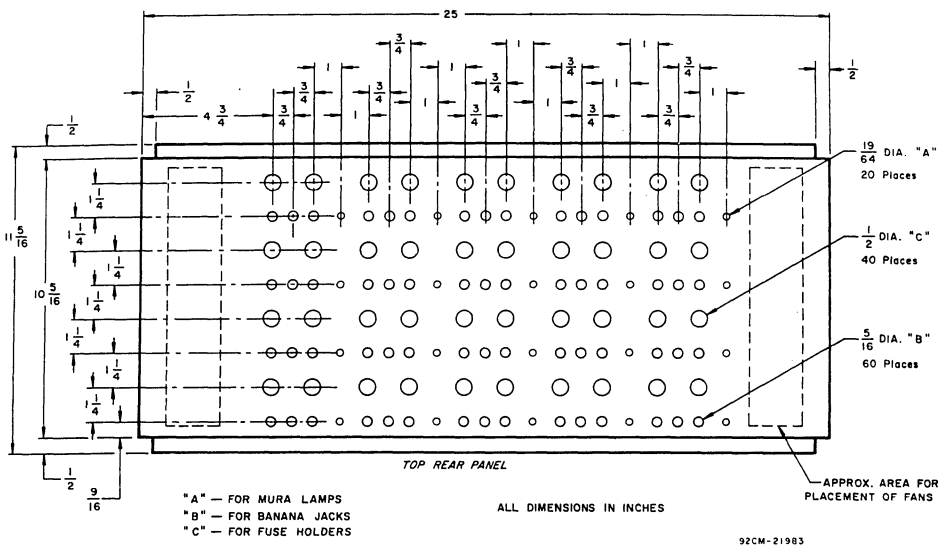


Fig. A3

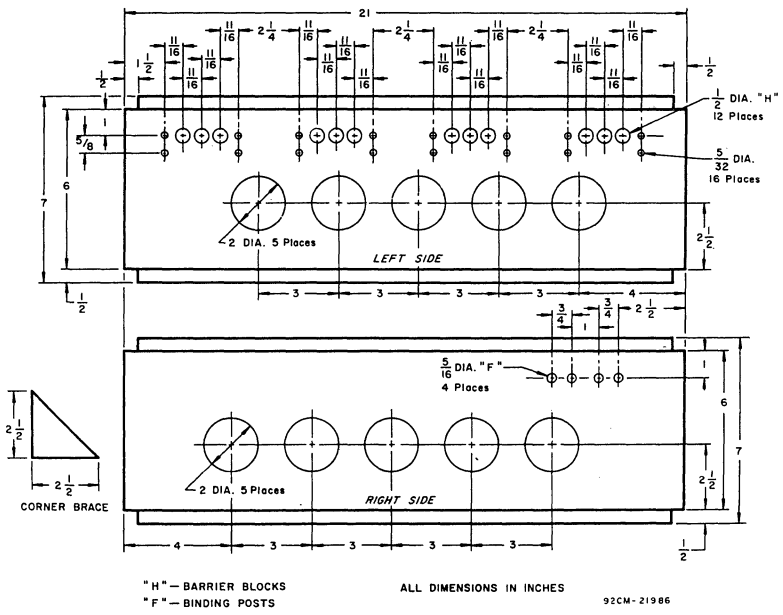
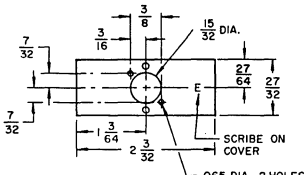
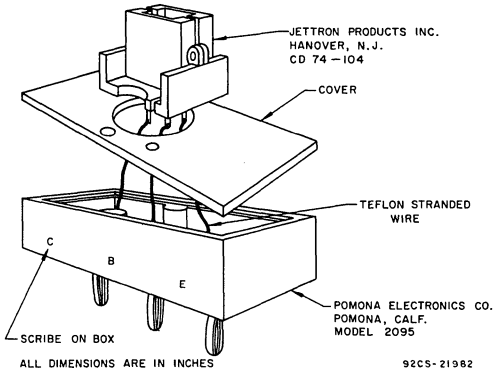


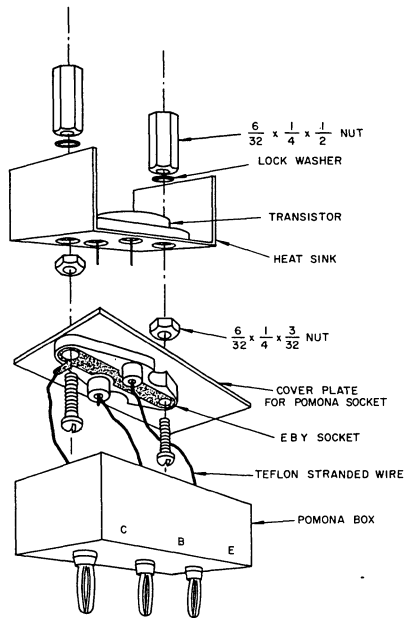
Fig. A4



BLANK COVER SUPPLIED WITH POMONA BOX



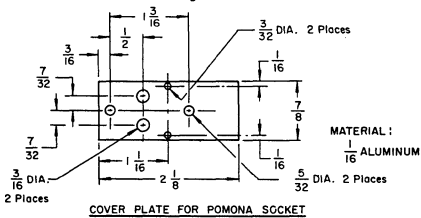
92CS-21982



92CS-21980

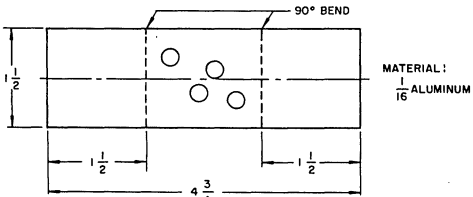
Fig. A7

Fig. A5



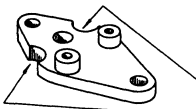
COVER PLATE FOR POMONA SOCKET

MATERIAL:  
1/16 ALUMINUM



MATERIAL:  
1/16 ALUMINUM

HOLE LAYOUT AS PER COMMERCIAL SOCKET NC-631-3-P  
WAKEFIELD ENGINEERING - DELTA DIVISION  
T0-3 - HEAT SINK



GRIND EDGE OF SOCKET TO CLEAR POMONA BOX MOUNTING HOLES

ALL DIMENSIONS ARE INCHES

92CS-21981

Fig. A6



**A Switching Regulator Using An RCA P-N-P Power Darlington Transistor**

by H. Palouda

This Note describes a 20-kHz switching regulator that operates from a 28-volt supply and has a regulated output between 4 and 16 volts dc. The circuit features overload protection which limits the current to about 11 amperes.

The control element of the switching regulator is an RCA8350B, a p-n-p Darlington used as a switch and driven directly from a CA3085, a positive voltage regulator. The regulator does not operate at a fixed clock frequency, but is free running.

**CIRCUIT CONCEPT**

The regulator circuit, shown in Fig. 1, is basically a step-down switching regulator. When the pass unit, Q3 (a p-n-p Darlington, RCA8350B), is switched on, current is charged into L1; when Q3 switches off, the current through L1 continues to flow via the commutating diode, D1.

The dc output voltage is determined by the ratio of R10 to R11, just as in a linear series regulator. Switching action is

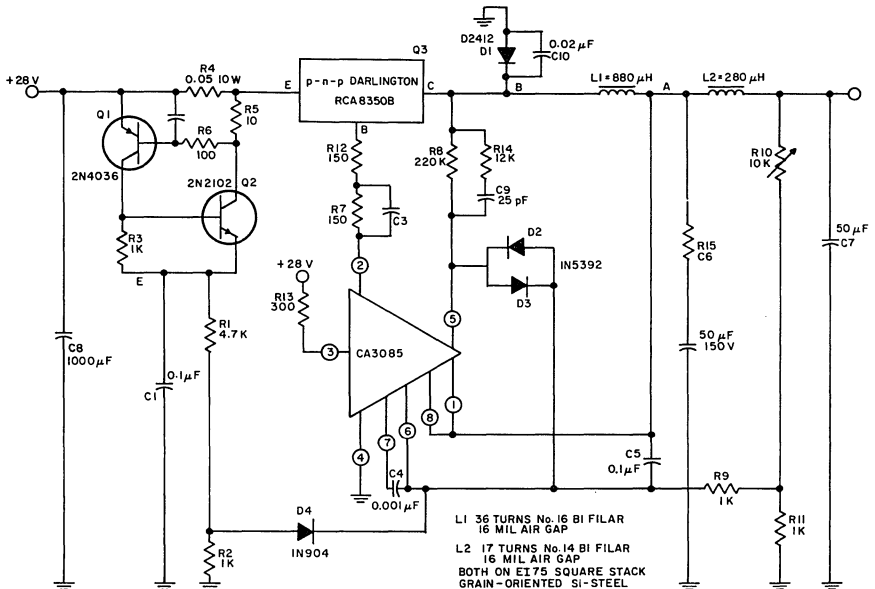


Fig. 1 - The regulator circuit.

92CM-22302

accomplished by comparing a ripple voltage to a hysteresis voltage. The circuit switches on and off, triggered by the ripple of the output voltage. The voltage at pin 6 of the CA3085 (Fig. 2) is determined by R10 and R11 of Fig. 1, and is proportional to the output voltage plus the ripple voltage at point A,  $V_A$ , fed in by capacitor C5. This voltage is compared with the voltage at pin 5. The voltage at pin 5 consists of the built-in reference voltage of the CA3085 plus a variable component proportional to the voltage at point B,  $V_B$ , fed through R8.

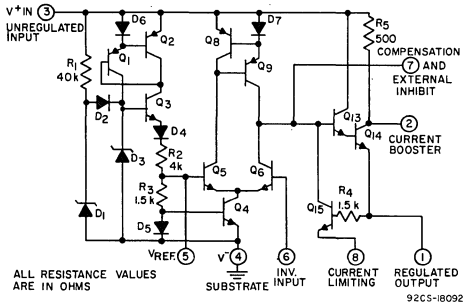


Fig. 2 - The CA3085.

The impedance of C5 at the operating frequency (10-kHz minimum) must be low compared to the input impedance at pin 6. As shown in Fig. 3, the Darlington,

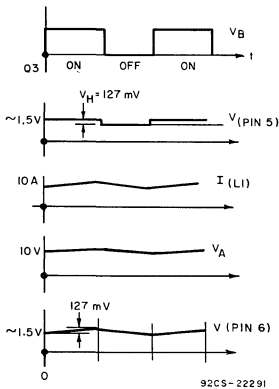


Fig. 3 - Waveforms for normal operation of the Darlington, Q3.

Q3, is switched on when the output voltage becomes too low, i.e., when the voltage at pin 6 becomes less than the voltage at pin 5; when this condition is reversed Q3 is switched off.

Diodes D2 and D3 are added for the protection of the very sensitive input at pin 6. Resistors R7 and R12 and capacitor C3 control the drive current and improve the switching performance of the Darlington, Q3.

L2 and C7 provide additional filtering and isolate point A from the load. Isolation is necessary from loads, capacitive loads, for example, which could drastically affect the ripple voltage at point A. Therefore, at the frequencies involved, L2 must have an impedance which is high compared to R15. L2, together with C7, serves also as a filter to reduce the output ripple.

C10 is a small capacitor placed in parallel with D1 to buffer the surge voltage at point B when Q3 is switched on. C10 reduces the high-frequency ringing (approximate 3 MHz) at point A caused by L1 and its distributed winding capacitance. The combination of C9 and R14 speeds the switching of the CA3085 without changing the hysteresis voltage,  $V_H$ .

Transistors Q1 and Q2 and their associated circuitry provide overload protection. Normally, Q1 and Q2 are off, C1 is discharged, and the voltage at point E,  $V_E$ , is zero. In case of overload, the current through R4 produces a voltage sufficient to turn Q1 on. As a result, Q2 turns on, and C1 charges mainly through Q2 and R5. A voltage proportional to that at point E is fed through diode D4 into pin 6 of the CA3085; this results in Q3 being turned off, even while C1 is still charging. The voltage drop across R5 caused by this charging current holds Q1 on, however, until C1 is fully charged. When C1 becomes fully charged, Q1 and Q2 are turned off, and C1 discharges slowly through R1 and R2. When  $V_E$  becomes low enough, Q3 is switched on again. Since the basic frequency-determining mechanism of the switching regulator is not disturbed (an overload or short circuit is separated or insulated from the inner circuit by the impedance of L2), a few cycles of normal operation occur until the current through R4 has built up again. Fig. 4 shows the voltage at point E,  $V_E$ , the current through inductance L1,  $I_{L1}$ , and the voltage at point B,  $V_B$ , under overload conditions.

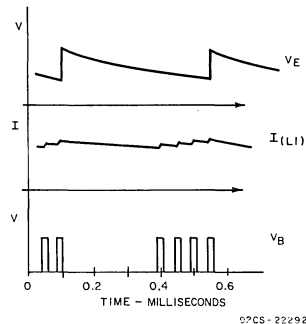


Fig. 4 - Circuit waveforms under overload conditions.

## DESIGN EQUATIONS

## Duty Cycle

The time during which the Darlington, Q3, is conducting is defined at  $t_1$ , and the time during which it is off, at  $t_2$ . The period is then calculated according to Eq. 1 as:

$$T = \frac{1}{f} = t_1 + t_2 \quad (1)$$

where  $f$  is the operating frequency. During one cycle, the energy into the regulator equals the energy out (losses neglected):

$$t_1 \cdot I \cdot V_{BATT} = T \cdot I \cdot V_{out} \quad (2)$$

Therefore, the duty cycle,  $p$  (duty), becomes:

$$P(\text{duty}) = \frac{t_1}{T} \approx \frac{V_{out}}{V_{BATT}} \quad (3)$$

Choice of Inductance  $L_1$ 

$L_1$  is determined primarily by two factors: the operating frequency and the permissible change in current. The current through the Darlington when it is on is not constant, but changes as the inductor is charged. To utilize the peak current capability of the Darlington optimally, it is desirable to use a large inductor and thus minimize  $\Delta I$ .

From  $V = L \frac{di}{dt}$ , the inductance,  $L_1$ , can be derived:

$$L_1 = (V_{BATT} - V_{out}) \cdot \frac{t_1}{\Delta I} \quad (4)$$

Substituting for  $t_1$  from Eq. 3:

$$L_1 = (V_{BATT} - V_{out}) \frac{V_{out}}{V_{BATT}} \cdot \frac{1}{f \Delta I} \quad (5)$$

Differentiating Eq. 5, and setting  $\frac{dL_1}{dV_{out}} = 0$ :

$$\frac{dL_1}{dV_{out}} = (1 - 2 \frac{V_{out}}{V_{BATT}}) \frac{1}{f \Delta I} = 0 \quad (6)$$

The largest value of  $L_1$  is required when:

$$V_{out} = \frac{V_{BATT}}{2}$$

For  $V_{BATT} = 28$  V,  $f = 20$  kHz and  $\Delta I = 0.5$  A.

$$L_1 = (28 - 14) \cdot \frac{14}{28} \cdot \frac{1}{20k(0.5)} = 700 \mu\text{H}$$

## Hysteresis

A hysteresis voltage,  $V_H$ , is fed from point B through R8 into pin 5 which has an input impedance,  $R_{in}$ , of approximately 1 kilohm. As shown in Eq. 7, this voltage is

approximately 127 millivolts for an R8 of 220 kilohms:

$$V_H \approx V_{BATT} \cdot \frac{R_{in}}{R_8} = 28 \text{ V} \cdot \frac{1 \text{ K}\Omega}{220 \text{ K}\Omega} = 127 \text{ mV} \quad (7)$$

This voltage has proven a fairly good value. If  $V_H$  is much lower, the signal into the differential amplifier is not sufficient for satisfactory operation. If  $V_H$  is higher, the ripple at point A is increased, which results in a higher output ripple.

## Darlington During On-State

The time during which the Darlington, Q3, is switched on is  $t_1$ . From  $V = L \frac{di}{dt}$  the ripple current is:

$$\Delta I(t) = \frac{V_{BATT} - V_{out}}{L_1} \cdot t \quad (8)$$

The ripple voltage at point A is the voltage drop of  $\Delta I(t)$  across R16 and C6 because the load is isolated by L2. The CA3085 compares the ripple voltage and the hysteresis voltage,  $V_H$ , and when the ripple voltage becomes higher than  $V_H$ , the Darlington, Q3, is switched off. As shown in the appendix, the out-of-phase voltage across capacitor C6 is zero when the switching occurs, and, therefore, C6 does not influence the frequency, whereas R16 does. The ripple voltage at this point is:

$$\Delta V = V_H = \Delta I(t_1) \cdot R_{16} \quad (9)$$

From Eqs. 8 and 9:

$$V_H = \frac{V_{BATT} - V_{out}}{L_1} \cdot t_1 \cdot R_{16} \quad (10)$$

$$t_1 = \frac{V_H L_1}{(V_{BATT} - V_{out}) \cdot R_{16}} \quad (11)$$

## Operating Frequency

The operating frequency can be derived in terms of  $t_1$  as follows:

$$f = \frac{1}{T} = \frac{P(\text{duty})}{t_1} \quad (12)$$

Substituting for  $p$  (duty) from Eq. 3:

$$f = \frac{1}{t_1} \cdot \frac{V_{out}}{V_{BATT}} \quad (13)$$

Together with Eq. 11 this yields:

$$f = \frac{R_{16}}{V_H L_1} \cdot \frac{V_{out}}{V_{BATT}} = (V_{BATT} - V_{out}) \quad (14)$$

After having chosen the voltages,  $L_1$ ,  $V_H$ , and the operating frequency, R16 can be determined from Eq. 14:

$$R_{16} = \frac{f V_H L_1}{V_{BATT} - V_{out}} \cdot \frac{V_{BATT}}{V_{out}} \quad (15)$$

**Choice of Capacitance C6**

Capacitance C6 does not determine the frequency, and, therefore, for price considerations it can be made small. If it is too small, however, the ripple voltage is increased. In the appendix, C6 is shown to have a minimum value to avoid "overshooting ripple" during t1 and t2, respectively. The minimum value of C6 is determined by either Eq. 16(a) or 16(b), below, whichever results in the larger value.

$$C_6 > \frac{t_1}{2R_{16}} \tag{16a}$$

$$C_6 > \frac{t_2}{2R_{16}} \tag{16b}$$

As to the physical choice, there are three possibilities: An electrolytic capacitor with the proper series resistance built in, a larger electrolytic capacitor with a smaller inherent resistance than is necessary for determining frequency, a paper or mica capacitor. If just the right electrolytic capacitor with the proper series resistance built in is chosen, no external resistance will be necessary to achieve the desired total value of R16; thus, one component may be saved. But the choice will be difficult because the resistance may vary widely from one capacitor to another. Also, shifts in value with time and temperature may occur.

If a larger electrolytic capacitor is chosen, a capacitor which has a smaller inherent resistance than is necessary for determining the frequency, an external resistor will have to be added to achieve the desired value of R16. This method provides better stability, as the shifts in the resistance of the capacitor will have less effect on the total resistance of R16.

Paper or mica capacitors have very low, inherent series resistance, so that, with this method, most of R16 would be provided externally. This method provides the most stable system, but is the most expensive.

**Transistor Dissipation Losses**

**Switching Losses**

At high frequencies, reduction in coil sizes can be realized, but switching losses become significant. Assuming that f = 20 kHz, tf = 1 μs, VBATT = 28 V, and Imax = 10 A, the losses contributed during fall time or turn-off are:

$$P_{(off) \max} = f \cdot t_f \cdot V_{BATT} \cdot I_{\max} \tag{17}$$

$$= 20 \text{ kHz} \times 1 \mu\text{s} \times 28 \text{ V} \times 10 \text{ A} = 5.6 \text{ W}$$

This formula is derived from the idealized conditions shown in Fig. 5(a). The switching curves in this circuit do not quite follow these idealized conditions, however, as shown in Fig. 5(b), and the switching losses are about 3.9 watts.

The losses during turn-on are more dependent on second-order characteristics, such as the distributed winding capacitance of choke L1, and, therefore, do not easily lend themselves to analytic idealization. The transistor switches

into a load which is capacitive at the first moment, and the current rises to the limit which is set by the Darlington. An analysis of the curves of Fig. 5(c) indicates losses of 3.8 watts when I is 10 amperes.

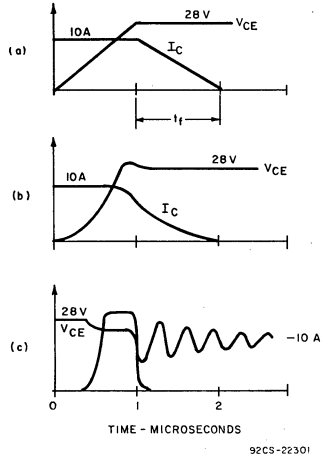


Fig. 5 — Switching curves for the Darlington, Q3; (a) idealized turn-off, (b) actual turn-off, (c) actual turn-on.

**Saturation Losses**

The saturation losses can be calculated from Eq. 18 below, as:

$$P_{\text{sat}} = V_{CE(\text{sat})} \cdot I_{\max} \cdot P(\text{duty}) \tag{18}$$

$$\approx 2 \text{ V} \times 10 \text{ A} \times 50\% = 10 \text{ W}$$

**CRITIQUE OF THE DESIGN EQUATIONS**

The design equations work well, but have limitations. Losses, the storage time of the Darlington, and the capacitance of the coil L1 have been neglected, but each of these influences the performance of the circuit, mainly the operating frequency.

The winding capacitance of L1 is distributed and coupled with the inductance. When the Darlington, Q3, switches on, voltage is applied to L1 in almost a step function, and L1 and its winding capacitance ring, in this model at approximately 3 MHz, damped, for approximately 2.5 microseconds. During the ringing, the median of I rises faster than expected from the formula  $V = L \frac{di}{dt}$  and the on-time, t1, is shortened. At turn-off, the situation is similar. While the duty factor is governed by laws of energy and, therefore, does not change, the operating frequency is determined by the ripple voltage, and a step in this voltage raises the frequency as indicated by Eq. 14. Errors up to double the frequency have been experienced; a low capacitance of coil all but eliminates this effect.

The losses change the duty factor as well as the frequency. At high output currents, the frequency rises because the circuit works at a higher "output" voltage to compensate for the ohmic losses in L1 and L2. The output voltage at the terminals is regulated, of course, and remains constant. This effect shortens the off-time,  $t_2$ , and, therefore, increases the frequency. The effect is especially pronounced at low output voltages when the voltage drop across L1 and L2 is a higher percentage of the total output voltage.

The storage time in the Darlington, Q3, causes it to switch off at a finite time after the CA3085 has switched, thus increasing the on-time,  $t_1$ . The off-time,  $t_2$ , follows the relationship between  $t_1$  and  $t_2$  as determined by the energy balance equation, Eq. 3, and so the frequency decreases. This effect is pronounced at low output currents because Q3 is driven into saturation more quickly.

Finally, the CA3085 has a small hysteresis voltage of its own which adds to the total hysteresis voltage,  $V_H$ . The value of the hysteresis voltage of the IC is about 30 to 40 millivolts, and it results in a lower frequency than would be calculated from Eq. 16.

For the prototype circuit where  $V_{BATT} = 28 \text{ V}$ ,  $L1 = 880 \mu\text{H}$ ,  $V_H = 127 \text{ mV}$ ,  $R16 = 0.35 \text{ ohms}$  (part of an electrolytic capacitance), and  $V_{out} = 12 \text{ V}$ , the frequency from Eq. 14 is:

$$f = \frac{0.35}{127 \text{ mV} \cdot 880 \mu\text{H}} \cdot \frac{12 \text{ V}}{28 \text{ V}} (28 \text{ V} - 12 \text{ V}) = 21.5 \text{ kHz}$$

The measured frequency for a  $V_{out}$  of 12 volts is between 18 and 28 kHz, and the rather simple formula, Eq. 14, while not being overly precise, gives a good enough result for a first evaluation.

## DESIGN PROCEDURE

Output voltage and current and input voltage are normally given. An operating frequency is chosen which is high enough to result in small components but low enough to provide bearable switching losses. The choice of the current ripple,  $\Delta I$ , determines the value of L1; the choice of the value of the hysteresis voltage,  $V_H$ , allows the value of R16 to be determined by Eq. 15. As discussed above under the heading "Choice of Capacitance C6," several factors must be considered when choosing C6 and R16.

After building the circuit, the frequency is checked. Adjustments are best made by changing the value of R16 or the hysteresis voltage.

## PERFORMANCE

The regulator was designed mainly for use in equipment requiring supply voltages of 5 and 12 volts (computers, battery chargers, etc.). With the values of R10 and R11 shown, the voltage can be regulated between 4 and 16 volts. With other values of R10 and R11, the output voltage can be varied over a wider range, approximately 2 to 22 volts. The output voltage varies less than 0.11 volt between 10-percent and full load. After one hour of operation, it dropped 30 millivolts.

The efficiency varies with output voltage as shown in Fig. 6. At 5-volts output efficiency is 66 to 72 percent and at 12-volts output, 76 to 83 percent between 20-percent and full load.

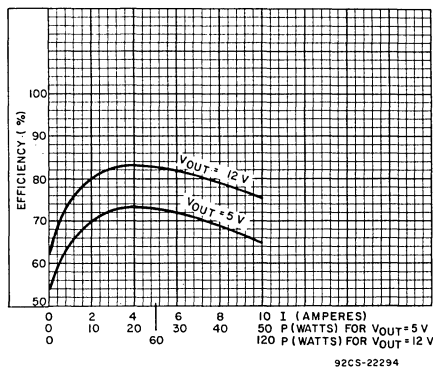


Fig. 6 - Efficiency as a function of output.

As shown in Fig. 7, the operating frequency varies from 12 to 28 kHz for outputs between 5 and 12 volts; at outputs above 30 watts the frequency is above the audible range.

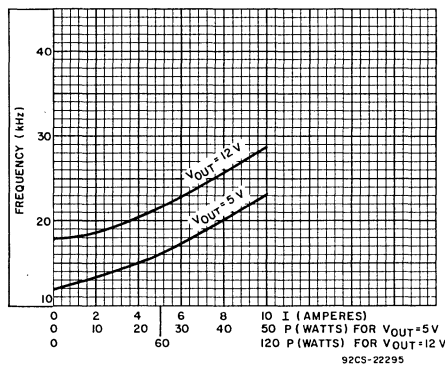


Fig. 7 - Operating frequency as a function of output.

The circuit is relatively insensitive to input voltage ripple. For an input voltage ripple of 4 volts (60-Hz bridge rectified), the output ripple is 0.1-volt peak-to-peak (60 millivolts, 120 Hz, plus 40 millivolts, at approximately 20 kHz). As shown in Fig. 8, the efficiency is not affected by variations of the input voltage. The frequency changes considerably and peaks when  $V_{CC}$  is approximately  $2V_{out}$ .

At 25°C ambient, the operating temperature of Q3 and D1 was 78°C at maximum load; Q3 and D1 were mounted on a common heat sink rated at 2.30C/W. Under short-circuit operation, the diode, D1, reached 88°C, while Q3 ran cooler, 58°C. As mentioned earlier, under short-circuit or overload conditions, the circuit is self-protecting.

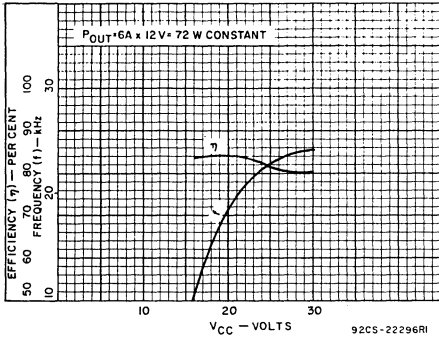


Fig. 8 - Efficiency and operating frequency as a function of input voltage.

Fig. 9 shows efficiency and frequency versus output voltage; Fig. 10 shows the regulation characteristic for a  $V_{OUT}$  of 12 volts.

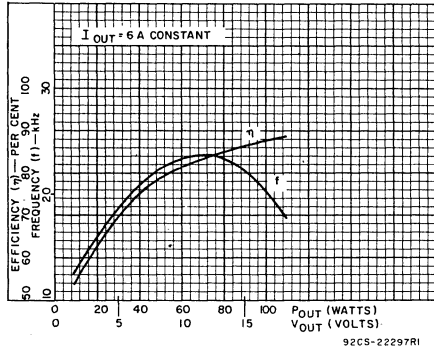


Fig. 9 - Efficiency and operating frequency as a function of output voltage.

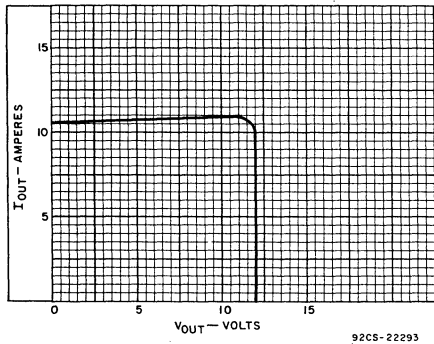


Fig. 10 - Regulation characteristic for an output voltage of 12 volts.

CONCLUSIONS

The free-running switching regulator described in this Note provides a simple circuit which combines good regulation with high efficiency and relatively low output ripple. The equations for designing the regulator are straightforward, and the design procedure, although approximate, works exceedingly well.

APPENDIX

This appendix discusses the ripple voltage produced by a sawtooth-shaped ripple current across an RC series combination (R16 and C6 in the main text). Special emphasis is given to the end points, the points where the switching regulator switches and the ripple current changes its slope; the end points are not necessarily the extremes of the ripple voltage.

Fig. A1 shows the RC network along with a definition of the

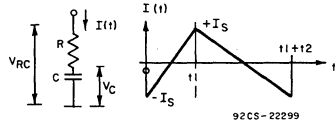


Fig. A1 - The RC network and the current through it.

current waveform through it. The figure shows that the current waveform has no dc component because of the existence of the capacitor. For  $0 < t < t_1$ ,  $I(t)$  can be defined by Eqs. A1 and A2.

$$I(t) = -I_S + \kappa_1 t_1 \tag{A1}$$

$$\kappa_1 t_1 = 2I_S = \Delta I \tag{A2}$$

The total voltage drop,  $V_{RC}(t)$ , is given by Eq. A3:

$$V_{RC}(t) = V_{CO} + \int_0^t \frac{1}{C} I(t) dt + I(t) R \tag{A3}$$

where  $V_{CO}$  is the voltage across C at  $t = 0$ .

Substituting Eq. A1 and integrating:

$$V_{RC}(t) = V_{CO} + \frac{1}{C} \int_0^t (-I_S + \kappa_1 t) dt + (-I_S + \kappa_1 t)R \tag{A4}$$

$$V_{RC}(t) = V_{CO} - \frac{I_S}{C} t + \frac{\kappa_1}{2C} t^2 - I_S R + \kappa_1 t R \tag{A5}$$

The difference in voltage from  $t = 0$  to  $t = t_1$  ( $\Delta V_1$ ) is found from:

$$\Delta V_1 = V(t_1) - V(0) = \frac{I_S}{C} t_1 \frac{\kappa_1}{2C} t_1^2 + \kappa_1 R t_1 \tag{A6}$$

Substituting for  $\kappa_1$  from Eq. A2:

$$\Delta V_1 = -\frac{I_S}{C} t_1 + \frac{I_S}{C} t_1 + \frac{2I_S}{t_1} R t_1 = 2I_S R \tag{A7}$$

With  $2I_S = \Delta I$  (peak-to-peak ripple current):

$$\Delta V_1 = \Delta I \cdot R \tag{A8}$$

For the time  $t_1 < t < t_2$ ,  $\Delta V_2$  can be computed similarly (Fig. A2):

$$I = I_S - \kappa_2 t \quad (A9)$$

$$\kappa_2 t_2 = 2I_S \quad (A10)$$

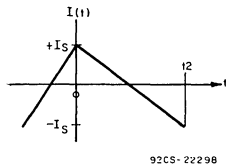


Fig. A2 -  $\Delta V_2$  for  $t_1 < t < t_2$ .

The time reference has been shifted to simplify the arithmetic. Eqs. A11 through A15, below, are used to calculate  $\Delta V_2$ , the difference in voltage from  $t = t_1$  to  $t = t_2$ .  $V_{C0}$  is the voltage across RC at  $t = t_1$ . The voltage across C,  $V_{C0}$ , is the same at the beginning of the second interval as it was at the beginning of the first interval because, during  $0 < t < t_1$ , the capacitor is charged and discharged by the same amount.

$$V = V_{C0} + \int_0^t \frac{1}{C} I(t) dt + I(t) R \quad (A11)$$

$$V = V_{C0} + \frac{1}{C} \int_0^t (I_S - \kappa_2 t) dt + (I_S - \kappa_2 t) R \quad (A12)$$

$$V = V_{C0} + \frac{1}{C} I_S t - \frac{\kappa_2}{2C} t^2 + I_S R - \kappa_2 R t \quad (A13)$$

$$\begin{aligned} \Delta V_2 = V(t_2) - V(0) &= \frac{1}{C} I_S t_2 - \frac{\kappa_2}{2C} t_2^2 - \kappa_2 R t_2 \\ &= \frac{1}{C} I_S t_2 - \frac{2I_S}{2C} t_2 - 2I_S R \quad (A14) \end{aligned}$$

$$\Delta V_2 = -2I_S R = -\Delta I \cdot R \quad (A15)$$

The result, Eq. A15, shows that  $\Delta V_2 = -\Delta V_1$ ; this means that the voltage across the RC combination is the same at  $t = t_1 + t_2 = T$  as it was at the beginning,  $t = 0$ . The equation also shows that the ripple voltage at the switching points is independent of the value of C. This statement is not true for the times between switching points, as shown in Fig. A3. Note that the voltage across C is out of phase with the current; the result is that the value of C does not determine the switching performance of the circuit.

Fig. A3 shows that the peak-to-peak ripple voltage may be

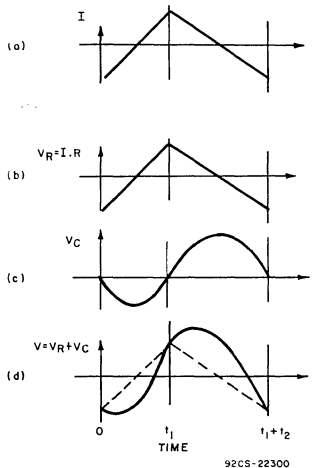


Fig. A3 - Phase relation of circuit currents and voltages at the switching points.

larger than  $\Delta V = V(t_1) - V(0)$ , i.e., that overshoot may occur. This condition will occur when C is very small. A minimum value for RC can be calculated such that the total ripple does not exceed  $V(t_1) - V(0)$ . This critical value of RC may be found from the condition that  $V(t)$  must not have a minimum for  $0 < t < t_1$  nor a maximum for  $t_1 < t < t_2$ .

Consider first the interval  $0 < t < t_1$  where  $V(t)$  is defined by Eq. A5 as:

$$V(t) = V_{C0} - I_S R + \kappa_1 t R - \frac{I_S}{C} t + \frac{\kappa_1}{2C} t^2$$

The derivative is set equal to 0 to find the extremum:

$$\frac{d}{dt} V(t) = \kappa_1 R - \frac{I_S}{C} + \frac{\kappa_1}{C} t = 0$$

This yields:

$$t = \frac{I_S}{\kappa_1} - RC \quad (A16)$$

and with Eq. A2 becomes:

$$t_{\text{extr}} = \frac{t_1}{2} - RC \quad (A17)$$

This expression defines the time at which the extremum occurs. If  $RC < \frac{t_1}{2}$ , the minimum lies within  $0 < t_{\text{extr}} < t_1$ , and overshoot occurs. To eliminate overshoot,  $t_{\text{extr}}$  must be negative or:

$$RC \geq \frac{t_1}{2} \quad (A18)$$

where the equal sign characterizes the marginal value with the extremum at  $t = 0$ .

In the very same way, it can be shown that in the second half-period, during ramping-down of current, overshoot can be avoided by:

$$RC \geq \frac{t_2}{2} \quad (A19)$$

## REFERENCES

1. "Transistorized Voltage Regulators," RCA Technical Publication ICE-254, RCA Solid State Division, December, 1961.
2. RCA Data Sheet for RCA8350, RCA8350A, and RCA8350B, "10-Ampere P-N-P Darlington Power Transistors," File No. 836, RCA Solid State Division, September, 1974.
3. RCA Linear IC Data Sheet for Types CA3085, CA3085A, CA3085B, "Positive Voltage Regulators," File No. 491, RCA Solid State Division, May, 1971.
4. "Solid-State Power Circuits," RCA Technical Series SP-52, RCA Solid State Division, September, 1971.
5. "Power Transistors for Amplification, Switching, and Control," RCA Technical Series PM-81, RCA Solid State Division, April, 1971.





# Power Transistors

## Application Note

### AN-6215

## Interpretation of Voltage Ratings for Transistors

by C. R. Turner

### Introduction

Transistor voltage breakdown is a function of both individual device characteristics and associated circuits. This Note describes basic transistor voltage-breakdown mechanisms and their relationship to external circuits. These mechanisms are then used to explain the various types of voltage ratings used by transistor manufacturers.

Voltage ratings can be readily established for transistors designed for use in specific applications for which both the associated circuit parameters and the required device characteristics are known. For example, specific voltage ratings can be assigned to transistors used in applications such as auto radios, portable radios, and computer circuits, and the large number of transistors produced for these uses can be specially tested to meet these particular ratings.

However, multi-purpose transistors must also have clearly defined voltage ratings which can be easily understood so that these devices can be readily designed into a wide variety of applications. The calculation of these voltage ratings requires a fundamental understanding of transistor voltage-breakdown mechanisms and their circuit dependence.

### Common-Base Avalanche Breakdown

Collector-base breakdown of transistors operating in a common-base connection is caused by avalanche multiplication. When a voltage is applied between collector and base, a depletion layer or space-charge layer is formed at the collector junction and spreads out into both the collector and base regions. Avalanche multiplication takes place in this depletion layer when a high electric field is present. This multiplication effect, which is similar to the "Townsend effect" in gas tubes, is the result of collisions between rapidly accelerating minority carriers that enter the depletion layer and atoms in the crystal lattice. Energy transferred to the atoms as a result of these collisions causes ionization, which releases valence electrons; these electrons are then also accelerated. Avalanche breakdown differs from Zener breakdown in that no multiplication takes place because no free carriers are present in the Zener condition. All the carriers of the Zener

breakdown are formed by stripping of valence electrons in a high-strength field.

The multiplication  $M$  that takes place for a given collector-to-base voltage ( $V_{CB}$ ) is given by the following empirical formula for junction transistors:

$$M = \frac{1}{1 - \left(\frac{V_{CB}}{V_A}\right)^n} \quad (1)$$

where  $V_A$  is the true avalanche or "bulk" breakdown and  $n$  is the rate of multiplication; both terms are constant for a device of a given type. These constants are determined for a particular transistor as follows:

For a common-base circuit using constant-current input, the collector current  $I_C$  is given by

$$I_C = \alpha M I_E + M I_{CBO} \quad (2)$$

where  $\alpha$  (alpha) is the short-circuit common-base current transfer ratio,  $I_E$  is the emitter current, and  $I_{CBO}$  is the collector-to-base leakage current. Both  $I_E$  and  $I_{CBO}$  are multiplied by the multiplication factor  $M$  because they cross the depletion layer (the ohmic leakage components of  $I_{CBO}$  which do not cross the depletion layer and are not affected by multiplication are not considered here).

If the operating point of a transistor in a common-base circuit is selected so that  $I_E$  is much greater than  $I_{CBO}$ , then equation (2) can be simplified as follows:

$$I_C \approx \alpha M I_E \quad (3)$$

The multiplication factor  $M$  is then given by

$$M = \frac{1}{\alpha} \cdot \frac{I_C}{I_E} \quad (4)$$

Because the collector current  $I_C$  is related to the multiplication factor  $M$ , which is in turn related to the collector-base voltage  $V_{CB}$ , particular values of  $M$  for values of  $V_{CB}$  can be obtained from the following rearrangement of equation (1):

$$\log \frac{M-1}{M} = n \log \frac{V_{CB}}{V_A} \quad (5)$$

This equation indicates that a log-log plot of  $(M-1)/M$  as a function of  $V_{CB}$  is a straight line having a slope  $n$  and value of  $V_{CB}$  equal to the true avalanche breakdown  $V_A$  when  $(M-1)/M$  is unity, or when  $M$  approaches infinity.

**Total Alpha**

Equation (3) shows that the "total alpha", or total gain factor, for a transistor in a common-base circuit is reflected by the product  $\alpha M$ . In addition to the multiplication factor  $M$ , therefore, the "total alpha" depends on the short-circuit current transfer ratio  $\alpha$ , which is given by

$$\alpha = \beta_0 \gamma \quad (6)$$

where  $\beta_0$  is a transport factor and  $\gamma$  is the emitting efficiency of the transistor.

The transport factor  $\beta_0$  is a measure of the extent of recombination that takes place in the base region of the transistor; it is given by

$$\beta_0 = 1 - \frac{1}{2} \left(\frac{W}{L}\right)^2; L = \sqrt{Dt} \quad (7)$$

where  $W$  is the active base width,  $L$  is the minority-carrier diffusion length,  $D$  is the minority-carrier diffusion constant for the semiconductor material, and  $t$  is the minority-carrier life-time (i.e., the time required for 63 per cent of the minority carriers to recombine in the base region).

The emitting efficiency  $\gamma$  is the ratio of the carriers injected into the base from the emitter to the sum of these carriers plus the carriers injected into the emitter from the base; it is given by

$$\gamma = 1 - \frac{D_b W N_b}{D_e L_b N_e} \quad (8)$$

where  $D_b$  and  $D_e$  are the minority-carrier diffusion constants of the base region and the emitter region, respectively, and  $N_b$  and  $N_e$  are the carrier concentrations of the base and emitter, respectively.

In a practical transistor, the diffusion length  $L$  is much greater than the active base width  $W$ , and the emitter is much more heavily "doped" than the base (i.e., the emitter conductivity  $\sigma_e$  is much greater than the base conductivity  $\sigma_b$ ). As a result of the heavier "doping", the emitter carrier concentration  $N_e$  is much greater than the base carrier concentration  $N_b$ . Equations (7) and (8) indicate that for

these conditions ( $L \gg W$  and  $N_e \gg N_b$ ) both the transport factor  $\beta_0$  and the emitter efficiency  $\gamma$  are approximately equal to unity.

Collector characteristics for a transistor operated in a common-base circuit with a constant emitter current are shown in Figure 1. The "total alpha" of the transistor,  $\beta_0 \gamma M$ , varies from a value of  $\beta_0 \gamma$  at low voltages, where  $\beta_0 \gamma$  is close to unity and  $M$  equals unity, to a value approaching infinity when  $V_{CB}$  equals  $V_A$  (because  $M$  approaches infinity at this voltage). Because stable operation can be achieved as long as the "total alpha" remains finite, operation of transistors in common base circuits is permissible at all voltages up to the collector-base avalanche voltage  $V_A$ .

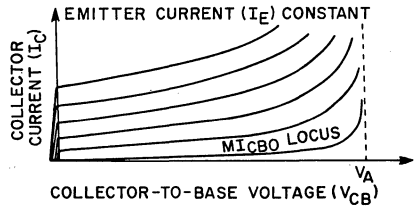


Fig. 1

**Common-Emitter Avalanche Breakdown**

In common-emitter circuits, avalanche breakdown occurs at the collector-to-base voltage at which the common-emitter current transfer ratio beta ( $\beta$ ) becomes infinite.  $\beta$  can be expressed in terms of the common-base current transfer ratio  $\alpha$ , as follows:

$$\beta = \frac{\alpha M}{1 - \alpha M} \quad (9)$$

$\beta$  becomes infinite when  $\alpha M$  equals unity (i.e., when  $M = 1/\alpha = 1/(\beta_0 \gamma)$ ).

Avalanche multiplication increases the number of carriers supplied to the collector side of the junction from the depletion layer. The base is then required to supply a similar number of new carriers to the depletion layer to maintain charge neutrality in the layer. At the collector voltage at which the number of carriers supplied to the depletion layer by the base because of multiplication just equals the number of carriers gained by the base through recombination (transport factor  $\beta_0$ ) plus an effective number of opposite-type carriers injected by the base (emitting efficiency  $\gamma$ )\*, the current transfer ratio becomes infinite because no base current is required to support collector-current flow.

\* The injection of opposite-type carriers by the base is equivalent to a corresponding gain of similar carriers in the base.

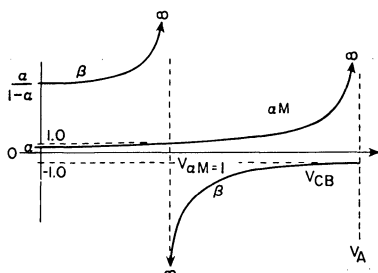
As stated above,  $\beta$  becomes infinite when  $\alpha M$  equals unity, or when  $M = 1/\alpha$ . Substitution of this value in equation (1) produces the following equation for  $\alpha$ :

$$\alpha = 1 - \left( \frac{V_{CB}}{V_A} \right)^n \quad (10)$$

This equation can then be solved for the value of  $V_{CB}$  at which  $\alpha M$  equals unity (this voltage is represented by  $V_{\alpha M = 1}$ ), as follows:

$$V_{\alpha M = 1} = V_A \sqrt[n]{1 - \alpha} \quad (11)$$

For collector voltages smaller than  $V_{\alpha M = 1}$ , base current  $I_B$  flows in the normal direction and  $\beta$  is positive. For voltage greater than  $V_{\alpha M = 1}$ , however, the base-current is reversed and  $\beta$  is negative.  $\beta$  and "total alpha" are shown as functions of  $V_{CB}$  in Figure 2.



COLLECTOR-TO-BASE VOLTAGE

Fig. 2

The collector current  $I_C$  of a transistor operating in a common-emitter circuit with a constant-current input is given by

$$I_C = \beta I_B + (\beta + 1) M I_{CBO} \quad (12)$$

The collector characteristics for such operation are shown in Figure 3.

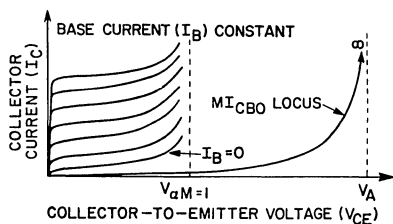


Fig. 3

Although the abscissa for these curves is collector-to-emitter voltage rather than the collector-to-base voltage previously used, no appreciable difference exists between the two except at low collector voltages, where multiplication is negligible in any case.

If negative feedback in the form of emitter resistance is applied to a transistor operating in a common-emitter circuit without constant-current input, as shown in Figure 4, the net effect is an increase in the avalanche breakdown. In the circuit of Figure 4,  $R_B$  is the series Thevenin equivalent of all external resistances presented to the transistor base terminal,  $R_E$  is the sum of both external and internal emitter resistances, and  $V_g$  is the voltage source or Thevenin voltage at the base terminal.

The base-to-emitter voltage  $V_{BE}$  can be assumed to be approximately zero, provided the internal base resistance is small compared to  $R_B$ . The base current  $I_B$  is then given by

$$I_B = \frac{V_g}{R_B} \quad (13)$$

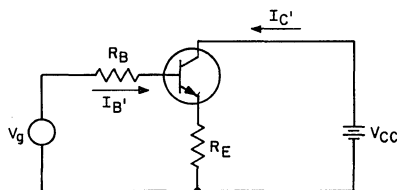


Fig. 4

The collector current  $I_C'$  for the circuit with external emitter resistance can be determined in terms of initial base current  $I_B$ , as follows:

$$I_C' = \beta I_B' = \frac{\beta R_B}{R_B + (\beta + 1) R_E} \times \beta \quad (14)$$

Because the input is a finite source voltage, the effect of the external emitter resistance is to reduce the output or collector current. An artificial current ratio  $\beta'$  can be introduced to account for the change in  $I_C$ , as follows:

$$\beta' = \frac{\alpha'}{1 - \alpha'} = \frac{R_B}{R_B + (\beta + 1) R_E} \times \beta \quad (15)$$

Equation (15) can then be solved to determine an artificial common-base current transfer ratio  $\alpha'$ , as follows:

$$\alpha' = \alpha \times \frac{R_B}{R_B + R_E} \quad (16)$$

This value of  $\alpha'$  is not the true common-base current transfer ratio of the transistor, but it defines the feedback effect which results from the use of external emitter resistance when any

type of source other than a pure current source is applied to the transistor in the common-emitter circuit. The term  $\alpha$  can be used to determine the common-emitter avalanche voltage for non-constant-base-current conditions when external emitter resistance is used. Combination of equations (11) and (16) provides the avalanche voltage, as follows:

$$V_{\alpha'M} = 1 = V_A \sqrt[n]{1 - \frac{R_B}{R_B + R_E} \alpha} \quad (17)$$

The collector characteristics for these conditions are similar to the characteristics shown in Figure 3, except that the voltage  $V_{\alpha M} = 1$  is replaced by the higher voltage  $V_{\alpha'M} = 1$  as defined in equation (17). If  $R_B$  becomes infinite or  $R_E$  becomes zero, the condition for constant-base-current operation is reached and  $V_{\alpha'M} = 1$  reduces to  $V_{\alpha M} = 1$ . If  $R_E$  becomes infinite or  $R_B$  becomes zero,  $V_{\alpha'M} = 1$  reduces to  $V_A$ , the common-base avalanche breakdown voltage. Therefore when a source voltage and external emitter resistance are used, the common-emitter avalanche breakdown voltage can vary from a low of  $V_{\alpha M} = 1$  to a high of  $V_A$ , depending upon the ratio of  $R_B$  to  $R_E$ .

**Common-Emitter Voltage Breakdown as a Function of Circuit Conditions**

The preceding discussion of common-emitter voltage breakdown considers only forward-bias conditions. Other types of breakdown may occur for circuit input conditions when no forward bias is applied. Several of these conditions are discussed below.

**Resistive Source R**

When a transistor is operated in a common-emitter circuit from a resistive source R, as shown in Figure 5, the collector current  $I_C$  is given by

$$I_C = \frac{M_{ICBO}}{1 - \alpha_N \alpha_i} \left[ 1 + \frac{\alpha_N (1 - \alpha_i)}{(1 - \alpha_N) + \frac{K_T (1 - \alpha_N \alpha_i)}{q I_{EBO} R}} \right] \quad (18)$$

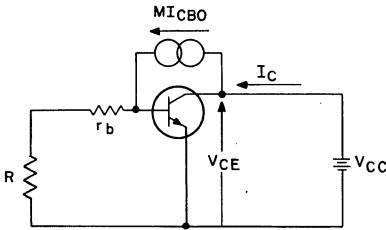


Fig. 5

where  $\alpha_N$  is the normal common-base current transfer ratio for the transistor ( $\alpha_N = \beta_0 \gamma$ ),  $\alpha_i$  is the current transfer ratio for inverted operation,  $I_{EBO}$  is the emitter-to-base leakage current, and the term  $K_T/q$  is equal to 0.026 volt at 25 degrees centigrade.

The total collector leakage current  $M_{ICBO}$  divides at the internal base terminal; a portion flows through the internal base resistance  $r_b$  and the source resistance R, and the balance flows through the base of the transistor to produce the collector current given by equation (18). The voltage produced by the portion flowing through  $r_b + R$  provides a forward bias between the emitter and the base.

It is assumed that the intrinsic emitter-base diode has a step-function V-I characteristic with a threshold voltage  $V_d$ , rather than an exponential characteristic, and also that all leakage current flows through the external base current as long as the forward bias is less than  $V_d$ . For this approximate transistor model, emitter injection takes place when the emitter forward bias equals  $V_d$ , and collector-to-emitter voltage breakdown occurs. The breakdown condition is given by

$$M_{ICBO} (R + r_b) = V_d \quad (19)$$

Because M is related to  $V_{CB}$  and  $V_{CE}$ , equation (19) can be solved for  $V_{CE}$  for any given value of  $V_{CB}$ . The calculated value of  $V_{CE}$  would then be designated as the collector-to-emitter breakdown voltage with source resistance R, and would have the symbol  $BV_{CER}$ . The value of  $BV_{CER}$  is given by

$$BV_{CER} = V_A \sqrt[n]{1 - \frac{I_{CBO} (R + r_b)}{V_d}} \quad (20)$$

Equation (20) indicates that  $V_{CE}$  is inversely proportional to the logarithm of R. Therefore, the highest breakdown voltage occurs when R is equal to zero. This voltage is designated as the shorted-base breakdown voltage, and has the symbol  $BV_{CES}$ .

If the base is opened (R approaching infinity), the threshold voltage  $V_d$  is reached for any finite value of  $M_{ICBO}$ , and transistor operation is governed by the common-emitter current transfer ratio  $\beta$ . For this condition, the entire leakage current  $M_{ICBO}$  must flow through the transistor base to produce a collector current equal to  $(\beta + 1) M_{ICBO}^*$ . This lowest value of breakdown voltage occurs at the collector-to-emitter voltage at which  $\beta$  becomes infinite, which was previously defined as  $V_{\alpha M} = 1$ .

The breakdown voltage for all other source-resistance conditions is greater than  $V_{\alpha M} = 1$ ; i.e., when emitter injection starts, total alpha ( $\alpha M$ ) is greater than unity, and  $\beta$  is negative. Figure 2 shows that when  $V_{CE}$  is greater than  $V_{\alpha M} = 1$ ,  $\beta$  increases negatively as voltage decreases. At breakdown, emitter injection occurs, and the collector current increases rapidly. This increasing current causes a decrease in collector voltage as a result of the presence of collector, emitter, and supply resistances. The decreasing collector voltage in turn causes an increase in  $\beta$  and collector current, so that the effect

\* The intrinsic collector current  $I_C''$  is  $\beta$  times the intrinsic base current  $I_B''$ , for this case  $M_{ICBO}$ . The actual measured collector current is the intrinsic collector current plus the leakage current, i.e.,  $I_C = I_C'' + M_{ICBO}$  and  $I_C'' = \beta I_B'' = \beta M_{ICBO}$ . Therefore,  $I_C = \beta I_B'' + M_{ICBO}$ , which reduces to  $I_C = (\beta + 1) M_{ICBO}$ .

becomes cumulative. This effect produces a negative-resistance breakdown-voltage characteristic that becomes asymptotic to  $V_{aM} = 1$  when  $\beta$  is infinite.

The source-resistance breakdown characteristics are shown in Figure 6.

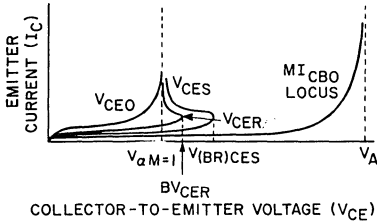


Fig. 6

**Reverse Bias Voltage Source**

When a reverse bias is applied between emitter and base, as shown in Figure 7, the collector breakdown voltage can be increased above the value  $BV_{CES}$ . As in the case of source resistance, no emitter injection takes place as long as the forward emitter bias is less than the threshold voltage  $V_d$ . Injection occurs when the drop across  $r_b$  resulting from  $MI_{CBO}$  is sufficient to overcome both the base supply voltage  $V_{BB}$  and  $V_d$ . This breakdown condition is given by

$$MI_{CBO} r_b = V_d + V_{BB} \tag{21}$$

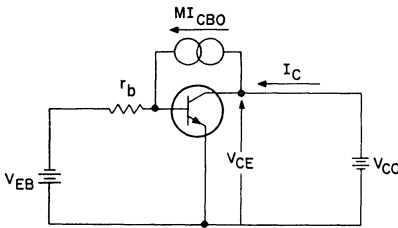


Fig. 7

An increase in  $V_{BB}$  increases the value of both  $M$  and  $V_{CE}$ . Figure 8 shows a series of breakdown curves for difference values of  $V_{BB}$ . Negative resistance occurs when the transistor operates in the region of negative  $\beta$ , as discussed previously. The peak value of each characteristic is designated by  $BV_{CEX}$ . The value of  $BV_{CEX}$  is given by

$$BV_{CEX} = V_A \sqrt[n]{1 - \frac{I_{CBO} (R + r_b)}{V_d + V_{BB}}} \tag{22}$$

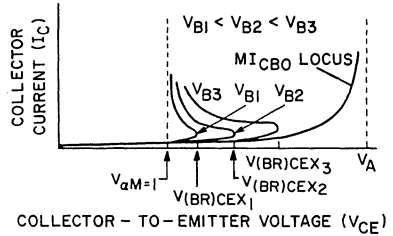


Fig. 8

**Transistor Operating Regions**

The various breakdown voltages discussed up to this point determine the operating regions for general-purpose transistors. In general, transistor characteristics can be divided into two regions of operation, as shown in Figure 9.

The limits of region A, the forward-bias region, are determined by the common-emitter avalanche breakdown voltage  $V_{aM} = 1$  and the maximum collector-current rating for the transistor. Operation anywhere in this region is permissible provided the peak dissipation ratings for the transistor are not exceeded. There are no restrictions on input-circuit conditions unless the region boundary is set by  $V_{aM} = 1$  rather than  $V_{aM} = 1$ ; in this case, the conditions discussed previously apply.

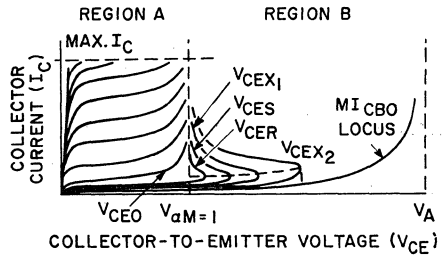


Fig. 9

The lower limit of region B, the negative-resistance is determined by the avalanche breakdown voltage  $V_{aM} = 1$ , and the upper limit by the respective breakdown voltages for particular input conditions, i.e.,  $BV_{CES}$ ,  $BV_{CER}$ ,  $BV_{CEX}$ , etc.

**Additional Considerations**

In the previous discussion of common-emitter avalanche breakdown voltage, the term  $V_{aM} = 1$  was assumed to be independent of collector current. However,  $V_{aM} = 1$  is a function of the common-base current transfer ratio  $\alpha$  (as shown in equation 10), which varies with  $I_C$ . It follows, therefore, that  $V_{aM} = 1$  must change with  $I_C$ .  $\beta$  and  $\alpha$  vary with  $I_C$  differently for abrupt- and graded-junction transistors.

Figure 10 shows the variation of  $\beta$  for typical transistors.

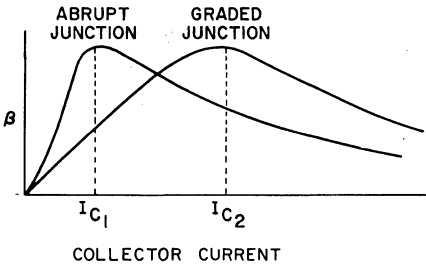


Fig. 10

Because the minimum value of  $V_{aM} = 1$  occurs at the peak of the curves shown in Figure 10, it is possible to construct a locus of points on the  $V_C - I_C$  curves of a transistor where the total alpha  $aM$  is equal to unity, as shown in Figure 11. This locus curve has only a positive-resistance slope for abrupt-junction types, but has both positive and negative-resistance slopes for graded-junction types.

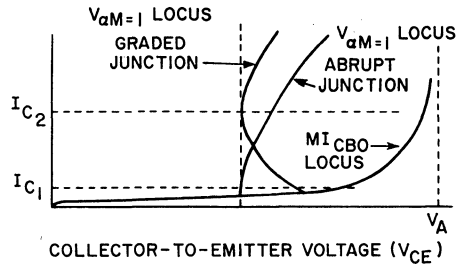


Fig. 11

Because both the forward-bias and reverse-bias curves become asymptotic to  $V_{aM} = 1$  for common-emitter operation, this variation of  $V_{aM} = 1$  with  $I_C$  modifies all the breakdown curves. It also explains why some forward bias curves, such as  $V_{CE0}$  can have a negative resistance component for some types of transistors. This effect is observed for most diffused types that have graded junctions; because alloy transistors have abrupt junctions, these types do not normally have negative-resistance forward-biased voltage characteristics.

## Real-Time Controls of Silicon Power-Transistor Reliability

L. J. Gallace and V. J. Lukach

This Note compares the traditional, classical approach to the reliability-assurance testing of power transistors with a newer classification of testing: Real-Time Control, RTC. The classical approach is commonly referred to as Group B, and involves a series of mechanical, environmental, and life stress tests. RTC is a continuous, systematic evaluation and control in "real time" of basic, potential failure mechanisms. It is an important supplement to a total program intended to assure the reliable performance of power transistors.

### Classical Method of Determining Reliability

When examining semiconductor reliability, the term "reliability" itself must first be defined and understood. Because "reliability" means different things to different people, it becomes necessary to define the degree or level of reliability required in the classical and universal language of statistics. The procedure of accumulating life-test data under conditions which may be application-oriented to obtain MTF (mean-time-to-failure) data is an oversimplified way of demonstrating reliability when one desires millions of device hours with a small number of failures. Unless one is interested in demonstrating only modest levels of reliability, this procedure will be totally inadequate for determining how well the manufacturing process produces devices that meet the intended design criteria.

Table I indicates the enormous sample sizes required to demonstrate very low failure rates by the classical method. The equally enormous expenditures in facilities and time required to test samples of the sizes shown is obvious.

Table I — Sample Size Required for 1000-Hour Life Test

Failure Rate %/ 1000 Hrs.	With Zero Failures at 90% Confidence	With One Failure at 90% Confidence	With Three Failures at 90% Confidence
1.0	231	390	668
0.1	2,303	3,891	6,681
0.01	23,026	38,980	66,808
0.001	230,000	389,000	668,000

Fig. 1(a) shows the "bathtub curve" used in the classical method to characterize the random failure region; this curve is an oversimplification of the three curves shown in Fig. 1(b) representing various failure modes. Clearly, the bathtub-curve method of determining a region which by its very definition is random and largely unpredictable is unsatisfactory.

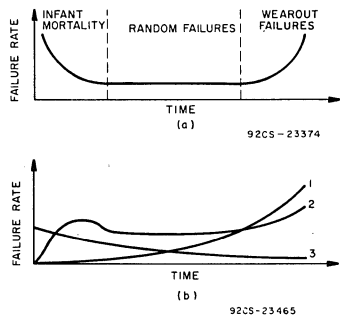


Fig. 1 — (a) Generalized "bathtub" failure-rate curve, (b) family of curves from which the "bathtub" curve in (a) is derived.

### Comparison of Group B and RTC

The classical approach was developed years ago because some over-all protection in the form of reliability assurance was needed by customers. These Group B tests, performed under standardized MIL-STD-750 conditions, were necessary and useful. However, times have changed. Reliability engineers have overstress-tested devices to destruction; in addition, a wealth of customer field information is available. Failure analysis performed on a routine basis has added even more knowledge. The net result is a greater understanding and appreciation of categories of potential failure mechanisms associated with different product designs than was previously possible; RTC is a reliability-assurance testing system that takes advantage of all this information.

Reliability-assurance data published per specific customers' requests has traditionally consisted of Group-B test results. In general, the summation of data shows large sample sizes with near zero total failures. RTC, with its accelerated test conditions, may not show zero failures. Therefore, when RTC data is published externally, customers must be educated in its interpretation. This education usually consists of personal contact and a qualitative explanation of each report.

The foundation of RTC is accelerated testing, tests performed at higher than normal stress levels to increase the failure rate and shorten the time to wearout. There is almost no mechanical, environmental, life, or combined stress test for which accelerated test conditions cannot be achieved. Table II lists the various tests with recommended directions for acceleration. The reliability tests of the future will use accelerated testing techniques that are associated with real-time-control theory to provide meaningful, quick appraisals and predictions of the reliability of solid-state components.

Table III describes some of the most important differences that exist between the classical form of testing and RTC. The power and advantages of RTC are clearly visible.

#### Real-Time Controls

Real-time controls are accelerated tests used to control reliability — a design and process parameter. In the real-time method of determining reliability, a continuous flow of data is interpolated into established criteria to provide an indication of how well the manufacturing process is producing

**Table II — Tests and Acceleration Directions**

Test	Direction of Stress Acceleration
<b>Mechanical</b>	
Lead fatigue	Increase bends to package destruction
Lead pull	Increase weight to package destruction
Lead torque	Increase torque to package destruction
Centrifuge	Increase G-force
Impact shock	Increase G-force
Vibration	Equipment limited
Solderability	Increase preconditioning stress, e.g., 3 hrs. in steam
<b>Environmental</b>	
Moisture resistance/ relative humidity	Increase time; use pressure cooker/ autoclave; use moisture with bias
Salt atmosphere	Increase time
Temperature cycling	Increase cycles; increase $\Delta T$ ambient
Thermal shock	Increase cycles; increase $\Delta T$ liquid
<b>Life</b>	
Operating life	Increase T junction
Storage life	Increase T ambient
Thermal fatigue	Increase $\Delta T_{case}$ ; increase cycles
Reverse bias	Increase T ambient; increase voltage

product that meets the criteria. By comparing actual to historical data, changes required in the manufacturing process to improve the reliability of the product can be made on a day-to-day basis.

The tests used as real-time controls are selected on the basis of extensive reliability-engineering work done during the design

**Table III — Differences Between Classical Group-B Tests and Real-Time Controls**

APPROACH	GROUP-B TESTS	REAL-TIME CONTROLS
1. Test Considerations	At maximum device ratings or less	Overstress many times to destruction
2. Overall	General, multi-subgroups, "shotgun" approach	Specific, predetermined reliability engineering experimentation necessary, "rifle" approach.
3. Types of Failure	Non-predictable multi-failure modes; read 6 to 15 electrical parameters	Visually one failure mode; i.e., look for evidence of one specific failure mechanism. Many times electrical readings not required.
4. Frequency	Usually once per month	Weekly — Daily — Hourly
5. Product Stage	Completed, electrically tested product	All stages of product
6. Sample Size	Large (approximately 150 per each subgroups)	Small (approximately 40), taken more frequently
<b>EFFECTIVENESS</b>		
1. Decisions	Very poor, after the fact	Immediate and Direct
2. Reliability Predictability	Poor, considering current low level failure rates	Excellent, considering protection from accelerated conditions
3. Problem Detection, Feedback, .. Corrective Action	Poor	Excellent, quick response on today's product with measurable quick evaluation of corrective action
4. Efficiency of One Test Rack	8 tests/rack/year (1000 hr. test and down period)	90 tests/rack/year (3 day max. and 1 day for changing product)
5. Test Duration	Approximately 6 weeks	Minutes to three days maximum





circuit for open-emitter or open-base contacts. The failure-rate data for VERSAWATT product tested under the RTC accelerated conditions is shown in Table V.

**Table V — Failure-Rate Data for 1972 for  
VERSAWATT Product Tested Under RTC**

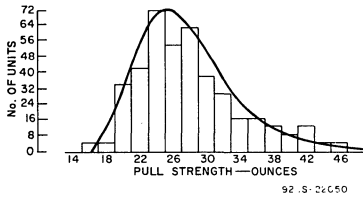
No. of Lots	No. of Units	No. Lots Failed	No. of Units Failed	Per cent Failed
'04	4,150	1	6	0.144

### Pull Strength

RTC may be practiced either on a lot-by-lot or shift basis. For example, each day, 30 samples per shift of power transistors are subjected to the following sequence of tests immediately after the soldering of the emitter, base, and collector contacts, i.e., just before the units are plastic encapsulated:

1. Autoclave (121°C, 30 psia, 4 hours)
2. Pull test on emitter-base contacts

The purpose of the autoclave is to age the unprotected soldered joint so that poor solder contacts are more easily detected. A typical distribution for the pull-strength test is shown in Fig. 5. A contact that cannot withstand at least



*Fig. 5 — A typical pull-strength distribution after autoclave at 30 psia,  $T = 121^{\circ}\text{C}$ , 4 hours.*

10 ounces of pull is a failure. The autoclave-plus-pull-test RTC checks only the mechanical strength of the solder joint, and provides a direct measure of the success of the soldering process on a real-time basis. Deficiencies discovered as a result of the pull-strength test are corrected in subsequent shifts.

### Wire-Bond Test

A thermal shock test of plastic product using wire bonds for emitter-base connections is performed weekly, and is very effective in monitoring a major failure mechanism which manifests itself as intermittent opens under thermal operation. The sampling plan and test conditions for the thermal-shock RTC are as follows:

Sample Size	Conditions	Cycles	Dwell Time
40	$-65^{\circ}\text{C}$ to $150^{\circ}\text{C}$	100	30 sec. at each extreme

The test proceeds as follows:

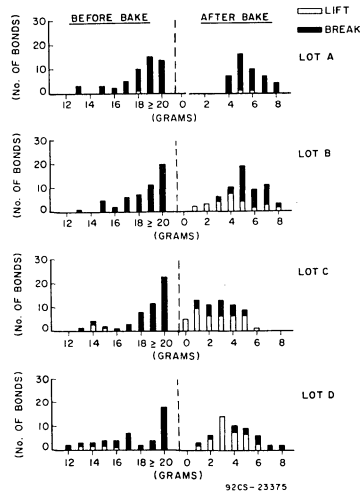
1. Perform end-point test for hot intermittent opens.
2. Make curve-tracer measurement with power applied; allow device to heat to  $125^{\circ}\text{C}$ .
3. Criticize data for stability criteria ("jitter").
4. Reject all unstable product and confirm rejects by failure analysis.

### Aluminum-Gold Bonding

The aluminum-gold bonding RTC was developed to detect the failure mechanism of bond lifts in gold bonds caused by the presence of impurities in the gold. The failure mechanism occurs after life testing at high temperatures ( $200^{\circ}\text{C}$ ) without any apparent force being applied. The test is performed on a lot basis according to the following sampling plan, test conditions, and procedures:

1. Sample size is 15 devices with at least 30 wire bonds, pull-test one half of the wire bonds on each unit.
2. Bake 1 hour at  $390^{\circ}\text{C}$ .
3. Perform pull-test on remaining wires.
4. Observe number of bond-lift failures.

Fig. 6 is a graphical representation of the results of the aluminum-gold bonding test is performed on gold-plated parts for four different lots.



*Fig. 6 — Bond-pull test results before and after  $390^{\circ}\text{C}$  bake.*

### Additional Tests

Additional real-time controls for maintaining the thermal-cycling capability of both hermetic- and plastic-packaged power transistors are shown in Table VI. These tests were developed because of the success of earlier RTC tests on the

### Conclusion

The accelerated tests of the real-time-control method of reliability determination are invaluable tools in attaining the most reliable silicon power transistors. These tests, used in conjunction with or as substitutes for the tests of the Group B

Table VI — Real-Time Thermal-Cycling Test Conditions

PACKAGE	POWER (WATTS)	$T_c$ (°C)	$\Delta T_c$ (°C)	$t_{on}$	$t_{off}$	HEAT SINK
TO-220 VERSAWATT	18	55 to 110	55	3 min.	3 min.	3°C/W
	4.75	35 to 155	125	50s	100s	Free Air
TO-3 Hermetic	16	40 to 130	90	50s	100s	Free Air
	56	70 to 120	50	15s	25s	6.3°C/W
TO-66 Hermetic	8.5	35 to 155	120	50s	100s	Free Air
RCA "TO-5" Plastic	1.5	35 to 135	100	60s	90s	Free Air
TO-5 Hermetic	1.5	30 to 115	85	60s	90s	Free Air

TO-220 plastic-packaged silicon power devices. RTC tests have developed for all silicon power transistors because of demands for increased reliability by automotive and consumer-product manufacturers.

### RTC Used to Achieve a Higher Reliability Level

Real-time controls not only maintain an acceptable reliability level as intended by the design of the product, but, because they are most often highly accelerated tests that show the difference in lot capability or margin of acceptability of the product manufactured, they tend to force the level of reliability higher. Fig. 7 shows how reliability levels are distributed with and without RTC.

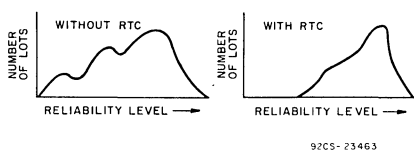


Fig. 7 — Distribution of reliability levels with and without RTC.

or classical method, have been proven more effective than previous tests or applications-oriented derated conditions in predicting and assuring reliability levels. The success of the RTC method is directly related to a complete understanding of device and manufacturing-process capability.

### REFERENCES AND BIBLIOGRAPHY

1. G. A. Lang, B. J. Fehder, W. D. Williams, "Thermal Fatigue in Silicon Power Transistors", IEEE Transactions on Electron Devices, September, 1970.
2. V. J. Lukach, L. Gallace, and W. D. Williams, "Thermal Cycling Ratings of Power Transistors", RCA Application Note AN-4783.
3. L. Gallace, "Quantitative Measurement of Thermal Cycling Capability of Silicon Power Transistors", RCA Application Note, AN-6163.
4. L. J. Gallace and J. S. Vara, "Evaluating Reliability of Plastic Packaged Power Transistors in Consumer Applications", IEEE Transactions on Broadcast and Television, Vol. BTR-19, No. 3, August 1973.
5. D. M. Baugher and L. J. Gallace, "Methods and Test Procedures for Achieving Various Levels of Power Transistor Reliability", Proceedings of "Improving Producibility" Workshop, WESCON, September 1973.
6. C. W. Horsting, "Purple Plague and Gold Purity" 10th Annual Proceedings IEEE Reliability Physics Symposium April 5-7, 1972.

## Characteristics of RCA Monolithic Power Darlington

by W. G. Einthoven  
H. F. Palouda  
A. Todd

This Note describes the design and application of RCA monolithic power Darlington transistors; the Darlington circuit has been in use for some time in applications where high beta is needed, but has only recently been available as a monolithic device. The RCA Power Darlington series 2N6385, Table I, consists of n-p-n circuits that can be driven directly from an integrated circuit and that operate at currents up to 10 amperes and voltages ranging from 40 to 80 volts. The devices are available in both hermetic and plastic packages. The Note also explains the unique solution to electrical connection of the emitter of the

epitaxially on top of the substrate, and the emitter consists of n impurities diffused into the base. The base-collector diode around the periphery of the pellet is mesa etched. The areas where base-to-emitter junctions emerge are protected by passivation (silicon dioxide). The contacts on top and bottom of the pellet are nickel clad and soldered with lead-tin solder.

TABLE I — RCA MONOLITHIC POWER DARLINGTONS

n-p-n * Types	Voltage Capability (Volts)	Maximum Current Capability (Amperes)	Power Dissipation (Watts)	Package Type
2N6383	40	10	100	TO-3
2N6384	60	10	100	TO-3
2N6385	80	10	100	TO-3
2N6386	40	10	40	VERSAWATT
2N6387	60	10	40	VERSAWATT
2N6388	80	10	40	VERSAWATT

\* n-p-n equivalents of these types are in development.

driver transistor to the base of the output transistor used in the RCA Darlington, and presents the electrical characteristics of the Darlington series in terms of the requirements of typical applications: motor controls, hammer drivers, audio amplifiers, and power supplies.

### PHYSICAL DESIGN

The RCA-2N6385-series Darlington, Fig. 1, are double-epitaxial, single-diffused devices. In n-p-n types, such as shown in Fig. 2, the collector consists of an n+ substrate plus an epitaxially grown n-layer; the base is p- material grown

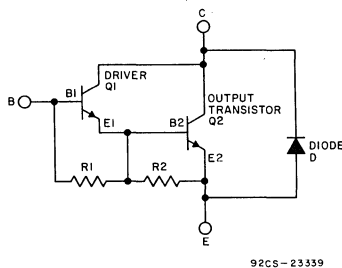


Fig. 1 — Schematic diagram of the RCA monolithic power Darlington design.

Up to this point, the processing of the Darlington device and an epitaxial single-diffused transistor is the same. In the Darlington, the bases of both transistors, B1 and B2, are of the same epitaxial growth; both emitters are diffused in at the same time. However, the horizontal pattern in the Darlington is quite different from that of a single transistor. As shown in Fig. 2, the driver transistor is in the center of the pellet and is surrounded by the output transistor. At the exact center is B1, the base of the driver; around it is E1, the emitter of the driver. The base of the output transistor, B2, is next to E1, and the two are connected by a metallization on the surface of the pellet. The output emitter, E2, is next to B2, and a large periphery between both is provided to improve the current distribution.

The base of the driver, B1, and the base of the output transistor, B2, are connected electrically through the base layer underneath E1, since both are part of the same base material; this

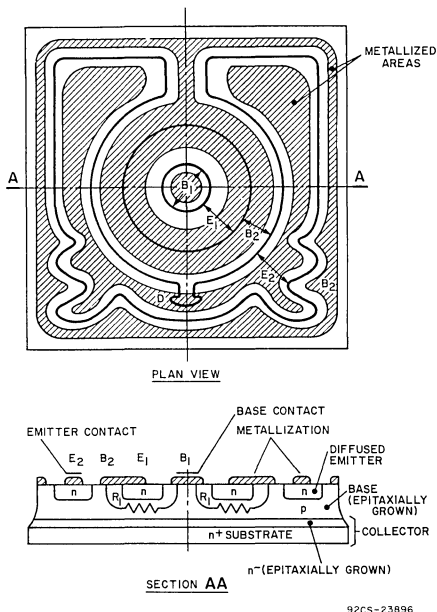


Fig. 2 — Chip design of the 2N6385, n-p-n Darlington.

a resistance, R2 formed by the narrow neck of the area D, which has a value of a few dozen to a few hundred ohms, depending on the actual dimensions.

Fig. 4 shows that the over-metallization associated with D also forms a diode. This diode lies electrically between emitter and collector, and is part of the base-collector diode. By shorting a piece of base area to the emitter, the D area of the transistor is degenerated into a diode. As mentioned above, this connection does not short B2 to E2 because the over-metallized area of the base is physically separated from B2, and is connected to B2 only by the narrow neck area which forms R2.

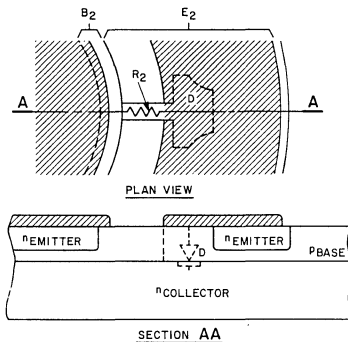


Fig. 4 — Detail of chip for n-p-n Darlington. Shaded areas are metallized; area D is part of B2.

connection is shown in Fig. 3. Fortunately, the bases are not shorted out altogether, but the base material provides a rather large resistance, R1, of several thousand ohms; R1 is also shown in Figs. 1 and 2.

It is desirable to have a resistance between the base and the emitter of the output transistor to improve both switching performance and leakage. (These characteristics are discussed in more detail below.) The resistance is formed by having the pattern for B2 extend into the E2 area to form area D, as shown

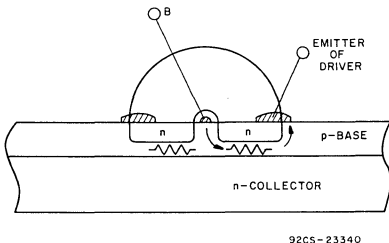


Fig. 3 — Cross section of part of a Darlington chip showing how R1 is derived.

in Figs. 2 and 4. Area D is shorted to the output emitter, E2, by the emitter metallization. Again, this metallization does not short out the emitter and base completely, but connects them by

n-p-n Darlington's are built in essentially the same way. In some types the base, B1, might be shifted from the geometrical center of the pellet into one corner, so that the periphery between B1 and B2 would be decreased, thus increasing R1. This shift is made because, in n-p-n types, the base resistivity is much lower; therefore, R1 would become much less (by approximately one-quarter) than in n-p-n Darlington's.

The special feature of the RCA monolithic power Darlington is the manner in which R1 is achieved, as shown in Fig. 3. The value of R1 is:

$$R_1 = \frac{\rho_{SH}}{2\pi} \ln \frac{d_o}{d_i}$$

where  $\rho_{SH}$  is the sheet resistance of the base under the emitter in  $\Omega/\square$ ,  $d_o$  is the outer diameter of E1, and  $d_i$  is the inner diameter. Using for  $d_o$  and  $d_i$  the values normally used for an RCA n-p-n transistor, this equation can be reduced to:

$$\rho_{SH} = 6.7 R_1$$

**ELECTRICAL CHARACTERISTICS**

**h<sub>FE</sub> — DC Current Amplification**

The emitter current of the driver transistor, Q1, of the Darlington configuration is fed into the base of the output tran-

sistor, Q2. The total dc current amplification,  $h_{FE}$ , is the product of the amplification of each transistor because the base current of the output unit is the emitter current of the driver. Actually, the composite amplification factor may be slightly higher than the product because the collector current of the driver contributes to the total collector current; this contribution is negligible for high values of dc current amplification. Fig. 5 shows the dc current amplification,  $h_{FE}$ , as a function of collector current,  $I_C$ , for transistors Q1 and Q2 and for the Darlington, all in log-log scale. The Darlington has a very rapid roll-off toward high collector currents, as both Q1 and Q2 have falling characteristics.

To construct the dc current-amplification curves for the Darlington from the curves for the individual transistors, the fact that the matching points on the two curves do not lie on a vertical plane (i.e., the same value of collector current) must be considered; the collector current of the output transistor is much higher than that of the driver. The interrelation is given by  $I_{E1} = I_{Base 2}$ , or not quite as exact, but simpler,  $I_{C1} \approx I_{Base 2}$ .

For a given collector current,  $I_O$ , point A is found in Fig. 5 and an  $I_B = \text{constant}$  line followed to  $h_{FE} = 1$  (point B). Here,  $I_C = I_B$  and more especially,  $I_{C1} = I_{Base 2}$ . Point B yields point C, the value of  $h_{FE1}$ , which is then added graphically to  $h_{FE2}$ .  $\overline{BC} = \overline{AD}$ .

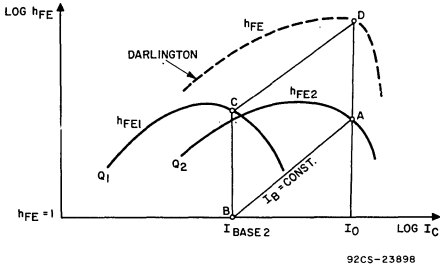


Fig. 5 — DC current amplification curves for the Darlington transistors.

This graphical construction does not take into account that  $I_{C1}$  is contributing to the total  $I_C$ . For a more exact combined  $h_{FE}$ , point D would have to be shifted to the right by the amount  $\log I_{C1}$ , thereby staying on an  $I_{Base 1} = \text{constant}$  line defined by  $\overline{CD}$ .

Some base current is shunted by R1 whose resistance is approximately 2 to 10 kilohms. As long as the product of  $I_B$  and R1 is smaller than approximately 0.3 volt, there is no output current,  $I_C$ . Between 0.3 and 0.6 volt, Q1 turns on. In this  $I_B$  range, the beta of the Darlington is determined by the beta of Q1 since part of the base current now really flows into the base of Q1 and is amplified. As soon as this amplified current is sufficient to drop 0.3 to 0.6 volt across R2, approximately 50 to 300 ohms, Q2 is also turned on -- the circuit works as a Darlington. Part of the base current is still shunted through R1 ( $V_{BE1}$  is approximately 0.6 to 0.8 volt across R1), and this changes the  $h_{FE}$  versus  $I_C$  characteristic of the Darlington, as shown in Fig. 6. Resistance R2 has a similar influence, but it is not as pronounced.

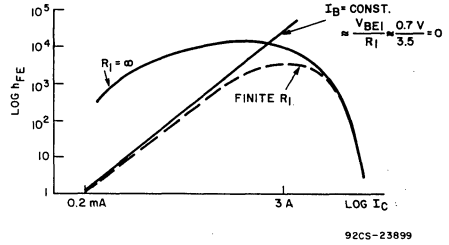


Fig. 6 — DC current amplification as a function of collector current.

**Output Characteristics**

Fig. 7(a) shows the output characteristics for small collector currents. Only Q1 conducts when  $I_C$  is less than 10 milliamperes. Because Q2 needs a  $V_{BE}$  of about 0.6 volt to turn on, R2 is approximately equal to  $\frac{0.6V}{10mA}$ , or 60 ohms. In other words, a current of 10 milliamperes is shunted off B2 through R2 to ground; any current in excess of 10 milliamperes is amplified by Q2.

Fig. 7(b) shows the same output characteristics for a larger collector current. The saturation curve shows an offset voltage of about 0.6 volt, which is the  $V_{BE}$  of the output transistor, Q2. Q2 is not in saturation, even when Q1 is. The total  $V_{CE(sat)}$  is the sum of the  $V_{CE(sat)}$  of Q1 plus the  $V_{BE(act)}$  of Q2. The slope of the curves for constant values of  $I_B$  indicates an output resistance of about 10 ohms. This resistance is lower than it would be for a comparable discrete transistor, and at least part of it can be traced back to the change of R1 with  $V_{CE}$  (see Fig. 16).

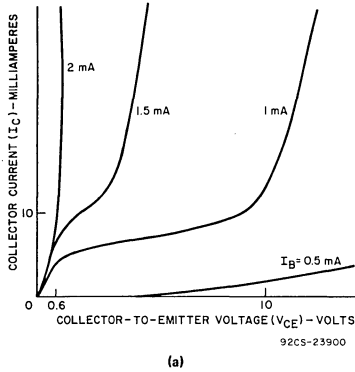
**Saturation Voltage**

One of the disadvantages of a Darlington circuit is its high saturation voltage. It is high because the output unit, Q2, is not really in saturation, but at a voltage  $V_{CE}$  that is the sum of the  $V_{BE(act)}$  of Q2 plus the  $V_{CE(sat)}$  of Q1, as mentioned above. The fact that  $V_{BE(act)}$  is involved means that even at low currents,  $V_{CE(sat)}$  is at least 0.6 volt. At values of  $I_C$  below  $\frac{0.6V}{R_2}$  ( $I_C$  may vary anywhere from a few milliamperes to approximately 30 milliamperes depending on the value of R2), the circuit does not work as a Darlington at all; only Q1 contributes to  $I_C$ . In this region,  $V_{CE(sat)}$  consists of  $V_{CE(sat)}$  of Q1 plus the voltage drop of  $I_{E1}$  across R2 (compare Figs. 7(a) and (b)).

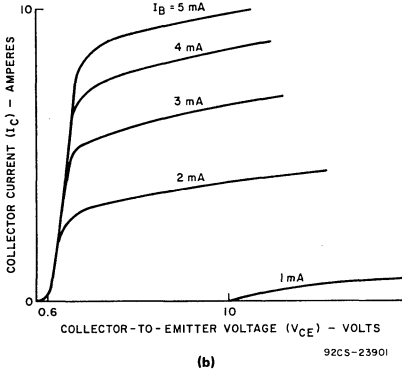
**Sustaining Voltage**

The voltage,  $V_{CE}$ , which can be sustained in breakdown between the collector and emitter of a discrete transistor is dependent on the condition at the base. This is less true for a Darlington with built-in resistances R1 and R2.  $V_{CEO}$  is not really an open-base mode, but is rather a  $V_{CER}$ , even though R1 may be rather high.

In the  $V_{CEX}$  mode, (base to emitter reverse biased), the reverse bias mainly affects Q1 since the reverse voltage is divided



(a)



(b)

Fig. 7(a) — Output characteristic of the Darlington for small collector currents. As  $R_1$  increases with rising  $V_{CE}$ , part of the 0.5-mA  $I_B$  is amplified by Q1. (b) same curve as (a) but for a larger collector current.

down by R1 and R2 and very little reverse bias is applied to B2. Therefore, Q2 will still be in the R mode and will determine the breakdown voltage. For this reason, the  $V_{CEO}$ ,  $V_{CER}$ , and  $V_{CEX}$  for monolithic Darlington's with built-in resistances are identical for all practical purposes.

**Leakage**

Normally, the conditions on the base do not affect leakage, just as they do not affect sustaining voltage. However, when the driver transistor, Q1, leaks enough so that the leakage current cannot be shunted to ground effectively by R2, the condition on B1 does make a difference. This condition holds for leakage at temperatures above 100°C and becomes critical above 150°C.

The leakage of Q1 at high temperatures is voltage dependent, and at a certain voltage it may be large enough to create a voltage drop across R2 sufficient to turn Q2 on. The result is a fully

turned-on unit above a certain  $V_{CE}$ ; this critical value of  $V_{CE}$  drops with rising temperature, as shown in Fig. 8.

The above discussion indicates that a reduction of R2 will improve high-temperature performance (and RCA has done just

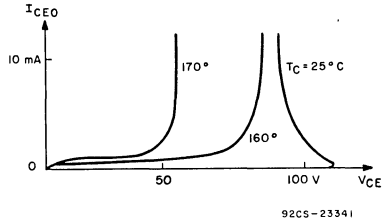


Fig. 8 — Collector current (base open) as a function of collector-to-emitter voltage.

that), but the leakage of Q1 is also of importance. Since the base of Q1 is accessible, reverse bias can be applied and the base drained of carriers, thereby avoiding any beta multiplication effect in Q1. An increased negative bias not only drains B1 more efficiently, but also drains B2 to some extent and improves the leakage situation, as shown in Fig. 9; the voltage limitation in this case is the result of excessive leakage, not a sustaining voltage.

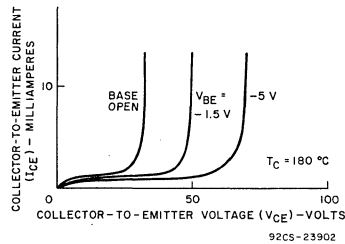


Fig. 9 — Effect of reverse-bias voltage on high-temperature leakage.

When the Darlington is held in the off state by a saturated transistor, a small positive bias occurs. The natural voltage which occurs at the base of the Darlington in an open-base mode is very small (approximately 50 millivolts) and results from the voltage drops caused by leakage currents across R1 and R2 respectively. Any voltage more positive than this open-base voltage tends to increase the leakage by impeding the drainage of the base. This condition is especially important at high temperatures, where the voltage capability is limited by the turn-on voltage dictated by the leakage current, Fig. 10.

**Small-Signal Amplification and Frequency Response**

The monolithic Darlington's are power devices, and the important gain parameter is the dc gain,  $h_{FE}$ . In discussions of the stability of operation, however, the small-signal gain,  $h_{fe}$ , is pertinent, as its value influences the initiation of oscillations.

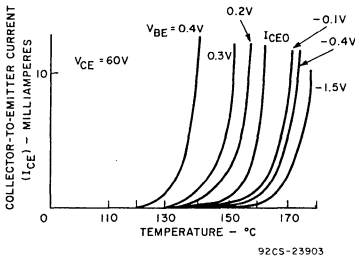


Fig. 10 - Effect of positive bias on high-temperature leakage capability.

At higher collector currents,  $h_{fe}$  will roll off even faster than the dc beta,  $h_{FE}$ , because, in this region, a small incremental increase in base current will have comparatively little effect on the collector current. The reason for the slight effect is that the emitter is depleted of carriers. At low collector currents, the small-signal gain,  $h_{fe}$ , will be considerably higher than the dc beta,  $h_{FE}$ . Under this condition the  $h_{FE}$  is low because part of the base current is shunted by R1. This current through R1 is fairly constant with  $I_B$ , as  $V_{BE}$  is fairly constant, and therefore any change in the ac component of  $I_B$  is transmitted into the base proper.

The frequency response of a transistor is expressed in  $h_{fe}$  or  $f_T$ , Fig. 11. In a Darlington built from two discrete transistors, two different frequency-roll-off curves are superimposed, as

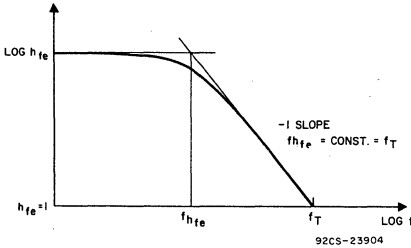


Fig. 11 - Typical frequency roll-off of a single discrete transistor.

shown in Fig. 12, and neither  $f_{h_{fe}}$  nor  $f_T$  can be defined in the classical sense. In monolithic Darlington's, the driver, Q1, and the output unit, Q2, have the same  $f_{h_{fe}}$ . Therefore, the curves

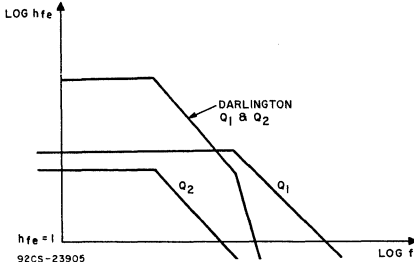


Fig. 12 - Frequency roll-off curves for two single transistors and for a Darlington constructed of two discrete transistors.

shown in Fig. 12 will converge to one, as in Fig. 13, and have only one knee and a roll off of 12 dB per octave (-2 slope in log-log). An  $h_{fe}$  can be defined at the knee of the curve, but an  $f_T$  does not exist. There is, of course, a frequency ( $f_1$  in Fig. 13) at which the Darlington has unity gain ( $h_{fe} = 1$ ), but this does not imply that in the area of the frequency roll off ( $f_{h_{fe}} < f < f_1$ ) the product  $f_1 h_{fe}$  is constant.

The -12 dB-per-octave slope adds an inherent instability because the phase angle shifts as the absolute value of  $h_{fe}$  decreases with frequency. Depending on the rest of the circuitry, the Darlington may tend to oscillate (Nyquist criteria).

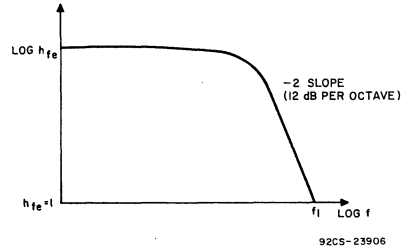


Fig. 13 - Frequency roll-off curve for a monolithic Darlington.

**Emitter-Base Characteristics**

As shown in Fig. 1, there are two base-emitter diodes in series, each with a resistance in parallel. R1 is approximately 2,000 to 10,000 ohms, while the value of R2 is much smaller, as low as 50 ohms or as high as a few hundred ohms.

Fig. 14 shows the "leakage" current  $I_{EB}$  versus the emitter-to-base voltage,  $V_{EB}$ . Only a very small part of  $I_{EB}$  is really leakage; the main portion of the current is determined by R1 and

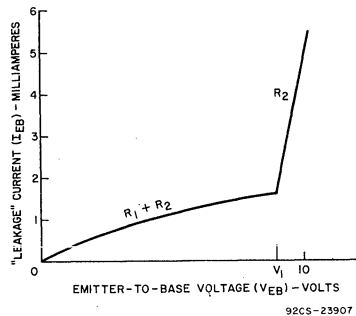


Fig. 14 - "Leakage" current  $I_{EB}$  as a function of emitter-to-base voltage,  $V_{EB}$ .

R2. For  $0 < V_{EB} < V_1$ , the slope corresponds to  $(R_1 + R_2)$  and is slightly non-linear. At  $V_{EB} = V_1$ , the voltage on the emitter-base diode of Q1 is sufficient to cause breakdown, and at  $V_{EB} > V_1$ , resistance R2 determines the slope of  $I_{EB}$  versus  $V_{EB}$ .



While  $R_2$  is relatively insensitive to voltage ( $V_{CE}$ ) and temperature variations,  $R_1$  is very sensitive to both. This sensitivity results from  $R_1$  being the resistance of a certain region of the base under the emitter,  $E_1$ . The resistance of this base region increases with applied voltage,  $V_{CE}$  (or  $V_{CB}$ ), and also increases with temperature. Fig. 15 shows the change of  $R_1$  with  $V_{CE}$ .

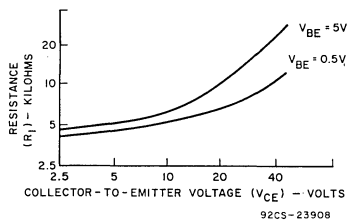


Fig. 15 — Change in  $R_1$  with change in collector-to-emitter voltage in  $Q_1$ .

As  $R_1$  is somewhat non-linear with  $V_{EB}$ , as shown in Fig. 14, its value changes with changes in that voltage. The value of  $R_1$  for low  $V_{EB}$  (approximately 0.5 volt) will have to be considered in determining how much drive current is shunted from the base; the "leakage" at reverse bias is governed by a higher value of  $R_1$ . Fig. 16 shows the variation of  $R_1$  with temperature.

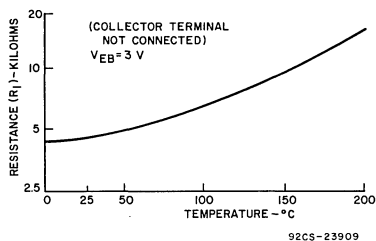


Fig. 16 — Variation of  $R_1$  with temperature.

## Switching Time

The on time of the monolithic Darlington is comparable to that of a discrete transistor of similar construction. The time can be shortened by driving the base harder, e.g. with a speed-up capacitor.

The storage time is determined only by the driver,  $Q_1$ , since the output transistor is not in saturation [ $V_{CE2} = V_{BE2} + V_{CE(sat)}$ ]. Therefore, storage time can be reduced by forced off-drive at  $B_1$ .

The fall time cannot easily be shortened by reverse drive at  $B_1$  since very little of it comes to the base of the output transistor,  $B_2$ . The voltage at  $B_2$  just drifts down governed by the charge of the base, the amount of charge used by the transistor, and the amount of charge shunted to ground through  $R_2$ . Therefore, a lower value of  $R_2$  yields shorter fall times.

## APPLICATIONS

Darlingtons can be used to advantage wherever high beta is needed; they can be driven directly from an integrated circuit. Darlingtons are especially useful in places where space is scarce; for example, they are widely used in line printers as hammer drivers. Their use also reduces the number of components, which tends to increase the reliability of the entire circuit, and which also cuts the number of insertions required on the production line.

Darlingtons can be used in applications where extremely low supply voltages are available, like the 5 volts in a computer or in an automobile during cranking, but the high  $V_{CE(sat)}$  (approximately 1.3 volts at 5 amperes) will decrease the efficiency. In applications where temperatures in excess of  $125^{\circ}\text{C}$  to  $150^{\circ}\text{C}$  are to be expected, the Darlington may be turned on by the leakage of the driver,  $Q_1$ .

Darlingtons are used in switching applications, such as motor controls or hammer drivers, and also in inverters up to a frequency of about 20 kHz where the speed-up of the fall time can be used to improve the efficiency. Examples of linear applications are the output of audio amplifiers and shunt- and series-regulated power supplies where the Darlingtons can be driven directly from integrated circuits.

**Accurate Measurement of Sustaining Voltage of Power Transistors—  
A Pulsed-Breakdown Test Set**

by A. L. Falk

Several techniques for the measurement of the primary (sustaining) breakdown voltage of power transistors are in common use today. The characteristics and limitations of these test methods frequently make rapid and accurate sustaining-voltage readings on power transistors difficult or impossible to make. The test set described in this Note is intended to fill the need for accurate, laboratory-type, sustaining-voltage measuring equipment, although circuitry used in the test set design may be adapted to high-speed testing equipment.

The test-set design is the result of efforts to develop a system which could provide a digital readout of the  $V_{CE(sus)}$  of a transistor at various test currents. Design goals included high accuracy and a minimum of dependence on the test-set operator for the interpretation of waveforms or the interpolation of readings. These efforts produced a test set capable of testing transistors having maximum voltage capabilities to approximately 700-volts, dc. A test pulse width of 200 microseconds is used; pulse repetition rate is three per second. The resulting low duty cycle (approximately 0.06 percent) reduces the average power delivered to the transistor under test to such a low level that heating effects which might affect transistor characteristics are virtually eliminated.

**COMMON TEST METHODS**

**The Inductive-Sweep Method**

The common inductive sweep circuit, Fig. 1(a), operates by driving the transistor under test, TUT, into its saturation region when the contacts marked X in Fig. 1(a) close. An inductor in the collector circuit stores energy equal to  $1/2 L(I_C)^2$  until the contacts open and reduce the base drive,  $I_B$ , to zero. When  $I_B$  is 0, the operating point of the TUT moves very rapidly to point C, Fig. 1(b). Between points C and D, the transistor is in its sustaining voltage region, and an oscilloscope reads out a display of the  $V_{CE(sus)}$ .

By applying a short constant-current pulse to the TUT, the pulsed-breakdown test set eliminates the time-variant

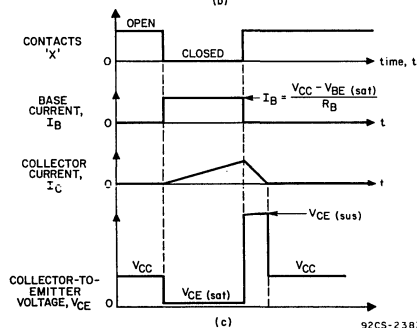
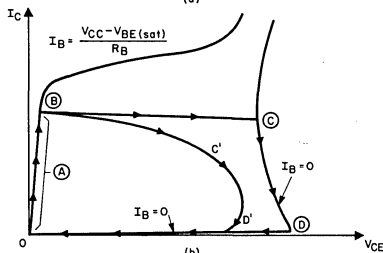
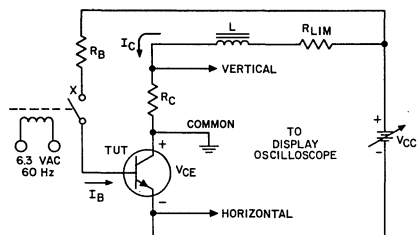


Fig. 1 - (a) Common inductive sweep circuit; (b) movement of TUT operating point for circuit in (a); (c) voltage and current waveforms for circuit of (a).



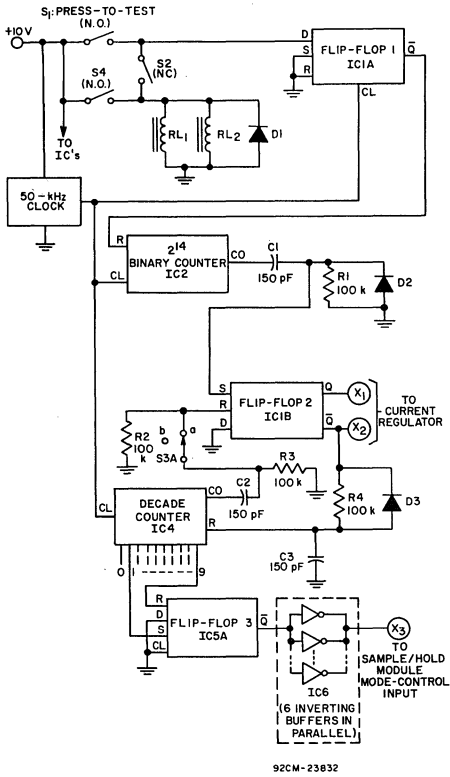


Fig. 4 - Digital timing circuit.

The first positive-going clock pulse after IC1B is set advances IC4 one count. A logic 1 then appears at the 1 output of IC4. This output, which occurs 10 microseconds after IC1B has directed the current regulator to turn on, is used to set flip-flop 3, IC5A. The Q output of IC5A, inverted by the buffers of IC6, provides a signal to the MODE CONTROL input terminal of the sample/hold module, Fig. 6. At this time, the current regulator is causing a constant current to flow through the TUT socket. At the same time, the sample/hold module is being directed to sample, or track, a signal voltage equal to 1/100 the TUT socket voltage. Flip-flop 2 (IC1B) will continue to direct the current regulator to deliver its programmed current until IC1B receives a reset signal. Such a reset signal will be delivered when IC4 counts ten clock pulses. One clock pulse before that, however, the 9 output line of IC4 goes

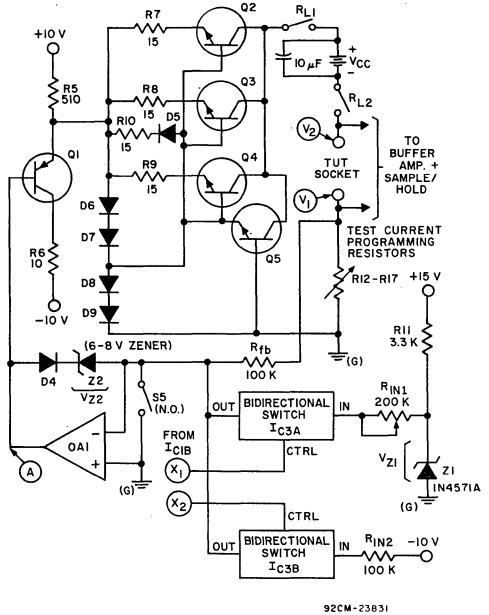


Fig. 5 - Test-current regulator circuit.

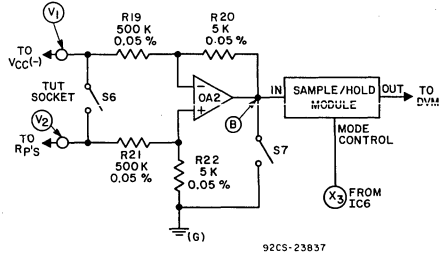


Fig. 6 - Scaling amplifier and sample/hold circuit.

to logic 1, resetting IC5A. At that time, the sample/hold module is switched to the HOLD mode. The tenth count causes the carry-out line of IC4 to go to logic 1. That signal, differentiated by  $R_3$  and  $C_2$ , resets IC1B, which then directs the programmed current pulse to terminate. Fig. 7 is a pulse timing diagram for the sequence described above. Thus, the digital timing circuit always causes the sample/hold module to sample the socket voltage of the TUT (scaled by a factor of 100) during the test current pulse.

By avoiding the use of monostable oscillators for timing purposes, problems of sequential and parallel pulse synchronization are virtually eliminated from this circuit.

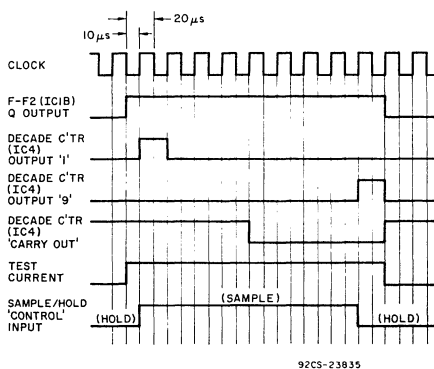


Fig. 7 - Pulse-timing diagram for the circuits of Figs. 6 and 7.

**Test-Current Regulator**

The test-current regulator, Fig. 5, operates as an operational amplifier with current- and voltage-amplification stages, and is designed with a 700-volt, 500-milliamper output capability.

COS/MOS bi-directional switches IC3B and IC3C, whose CONTROL input signals come from the Q and  $\bar{Q}$  outputs, respectively, of IC1B, switch a positive or negative reference current into the inverting input of operational-amplifier OA1. During the test-pulse period, IC1B is SET, with its Q output a logic 1 and its  $\bar{Q}$  output logic 0. These signals, applied to the CONTROL input of bi-directional switches IC3A and IC3B, respectively, turn off IC3B and turn on IC3A. With IC3A on, a signal input current proportional to  $V_{Z1}$ , the voltage of a temperature-compensated zener diode, flows into the inverting input of OA1. The signal current is approximately equal to  $V_{Z1}/R_{in1}$ , and causes a negative-going output to appear at the output of OA1.  $Q_1$ , a type 2N6111 p-n-p transistor, operates as a voltage follower, eventually causing the emitter-base junctions of pass units  $Q_2$  through  $Q_5$  to

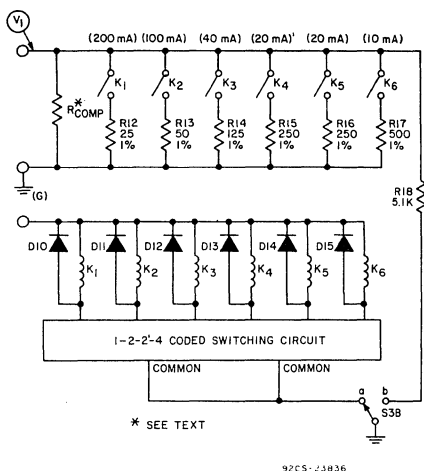


Fig. 8 - Current-programming resistors and relays.

become forward biased. When this happens, current begins to flow through the collectors of the pass units, the  $V_{CC}$  supply, the TUT socket, and the current-programming resistors,  $R_{12-17}$ , Fig. 8. Resistor  $R_6$ , Fig. 5, limits the emitter current of the pass units in the event that the press-to-test button(s) are depressed with the TUT socket open-circuited.

The current flow through the programming resistors causes a voltage drop,  $V_1$ , which results in the current flow through  $R_{fb}$ , Fig. 5, essentially the feedback resistor of a circuit operating as a unity-gain inverter. The loop gain is adjusted in practice by  $R_{in}$ , so that  $V_1$  equals exactly -5 volts, dc, during the test pulse. (This adjustment is explained in detail in the section entitled Calibration and Set-Up, below). If the current diverted through  $R_{fb}$  is ignored, the current through the TUT socket is exactly equal in magnitude to 5 volts divided by the value of the programming resistors.

The test current is set by use of a binary-coded network of resistors connected into the circuit by switch-controlled mercury-wetted relays, Fig. 8. Each resistor,  $R_n$  ( $n=12$  to 17), contributes to the test current exactly  $(5 V/R_n)$  amperes of current. The error introduced into the magnitude of the test current by the shunting effect of  $R_{fb}$  is balanced by the addition of a programming resistor, always in-circuit, equal to  $R_{fb}$ .

In order to assure rapid turn-off of the pass units,  $Q_{2-5}$ , Fig. 5, when IC1B returns to its reset state (between test current pulses), IC3A is turned off and IC3B is turned on. This action causes a negative input current to flow in the inverting input of OA1 and drives the output of OA1 positive until diode  $D_4$  becomes forward biased and zener diode Z2 breaks down. The output of OA1 is clamped to

approximately +6 volts to +8 volts, dc. Current flowing through resistor  $R_5$  and diodes  $D_6$  through  $D_9$  then serves to reverse bias the emitter bases of pass units  $Q_2$  through  $Q_5$ . In addition, since the base of  $Q_1$  is at a higher potential than its emitter,  $Q_1$  is also biased at cutoff. Resistors  $R_7$  through  $R_{10}$  and diode  $D_5$  provide local negative feedback which causes current sharing among transistors  $Q_2$  through  $Q_5$ .

**Current-Programming Circuit**

In the current-programming circuit, Fig. 8, the magnitude of the test-pulse current is controlled by the use of mercury-wetted relays that connect the current-programming resistors in parallel. 1-2-2<sup>1</sup>-4 weighting of coded decimal switching is used to divide the current flow among a greater number of resistors at higher current levels. Rotary switches, toggle switches, or thumbwheel switches can be used. Additional resistors ( $R_{comp}$ ) can be included to compensate for current "lost" to current-regulator feedback and the scaling-amplifier inputs. For the values of  $R_{fb}$  (Fig. 5) and  $R_{21}$  and  $R_{22}$  shown (Fig. 6),  $R_{comp}$  is approximately 83 kilohms.  $S_{3B}$ , Fig. 8, is used in the calibration and set-up procedures for the test set.

**Scaling Amplifier and Sample/Hold Circuit**

OA2 of the scaling-amplifier and sample/hold circuit, Fig. 6, takes the voltage appearing across the TUT socket (subtracting the -5-volt reference pulse), divides it by 100, and feeds the result to the sample/hold module. The sample/hold module, mode-controlled by the output signal from IC6, holds a voltage equal to  $-(1/100)$  of the voltage which is sampled from the TUT socket during the test current pulse. The output of the sample/hold module is input to the terminals of a stable, accurate, digital voltmeter.

**CALIBRATION AND SET-UP OF THE TEST SET**

1. Clock (Fig. 7)

Several-percent inaccuracy in the 50-kHz clock frequency should not affect circuit performance seriously. The digital timing will always strobe the sample/hold module during the test current pulse; the duty cycle of the pulse will not change. However, too short a pulse may not allow sufficient time for the TUT to stabilize in its sustaining region before the SAMPLE pulse from the sample/hold module ends, Fig. 9. Any frequency or period counter of

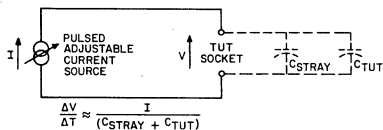
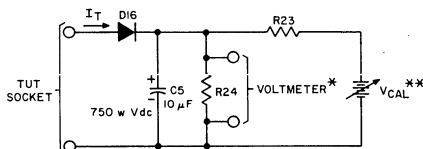


Fig. 9 - Capacitive effects at the TUT socket.

- sufficient accuracy can be used to check the 50-kHz clock frequency, or to calibrate the clock if an adjustable model is used.
2. Balance OA1
    - a. Close switch  $S_5$  (Fig. 5).
    - b. Measure voltage at point A (Fig. 5) using DVM.
    - c. Adjust trim pot of OA1 for null.
    - d. Remove DVM.
    - e. Open  $S_5$ .
  3. -5-Volt Pulse Calibration (Figs. 4, 5, 8).
    - a. Lower  $V_{CC}$  supply to approximately 100 volts, dc.
    - b. Short TUT socket.
    - c. Move switch  $S_3$  (Fig. 8) to position b. This action sets the test current to 1 milliampere and disables the digital feedback circuit, which causes the test pulse to end (Fig. 4).
    - d. Press the press-to-test switch(es)  $S_1$  until IC1B is triggered (approximately 1/3 second).
    - e. Measure voltage  $V_1$  (Fig. 5) using test-set DVM. Adjust  $R_{1N}$  until  $V_1$  is exactly equal to -5 volts, dc.
    - f. Remove short from TUT socket.
    - g. Disconnect DVM.
    - h. Move switch  $S_3$  (Fig. 8) to position a.
  4. Balance OA2
    - a. Close Switch  $S_6$  (Fig. 6).
    - b. Measure voltage at point B, Fig. 6. using DVM.
    - c. Adjust trim pot of OA2 for null.
    - d. Remove DVM.
    - e. Open  $S_6$
  5. Balance Sample/Hold Module
    - a. Close switch  $S_7$  (Fig. 6).
    - b. Measure sample/hold module output using DVM.
    - c. Adjust trim pot of sample/hold module for null.
    - d. Remove DVM.
    - e. Open  $S_7$ .
  6. Calibrate Test Set (or check calibration)
    - a. At desired test current, measure forward drop of diode  $D_{16}$  (use curve tracer or equivalent) to nearest 10 millivolts, dc.
    - b. Connect diode  $D_{16}$  to circuit of Fig. 10 as shown, and connect circuit of Fig. 10 to test-set TUT terminals as shown.



\* JB FLUKE MODEL 803B DIFFERENTIAL VOLTMETER, OR EQUIVALENT  
 \*\* HEWLETT/PACKARD POWER SUPPLY MODEL 6448B, OR EQUIVALENT

92CS-23839

Fig. 10 - Test-set calibration circuit.

**IMPORTANT NOTE:** Voltmeter and  $V_{CAL}$  supply may share common ground, but this ground must be isolated from test-set ground.

- c.. Using VTVM, set  $V_{CAL}$  so that voltmeter reads 500 volts, dc, minus diode drop measured in step 6(a).
- d. Set test current to value used in step 6(a).
- e. Press test button(s); reading should be 500 volts, dc (scaled to -5 volts dc).
- f. With the test current set to zero, and the TUT socket shorted, depression of the test buttons will yield a near zero reading on the digital-voltmeter readout. Any residual offset (typically less than a few millivolts) is compensated by repeating the zeroing of OA2 and the sample/hold module, steps 4 and 5. With the TUT socket shorted, the trim pot for the sample/hold module should be used to cancel any offsets which cannot be accounted for by other means. Low resolution wire-wound trim pots should not be used.

#### BIBLIOGRAPHY

R. D. Thornton, D. Dewitt, E. R. Chenette, P. E. Gray, Semiconductor Electronics Education Committee, John Wiley, New York, 1966.

1. "Handbook of Basic Transistor Circuits and Measurements" Vol. 7, pp 114-115.

"Characteristics and Limitation of Transistors" Vol. 4, pp 24-26, 42-43.

C. R. Turner, "Interpretation of Voltage Ratings for Transistors," RCA Application Note AN-6215.

#### PARTS LIST FOR CIRCUITS SHOWN IN THIS NOTE:

##### Capacitors

$C_1, C_2, C_3$  - 150 pF mica

$C_4, C_5$  - 10  $\mu$ F 750 WVdc electrolytic

##### Diodes

$D_1, D_4$  - 1N914B

$D_2, D_3, D_6-15$  - 1N5193

##### Zener Diodes

$V_{Z1}$  - 6-8V Zener (2N1607 emitter-base)

$V_{Z2}$  - 1N4571A

**Resistors:** (1/2 W, 5%, unless otherwise specified)

$R_1 - R_5, R_{IN2}$	- 100k
$R_6$	- 510 $\Omega$
$R_7$	- 10 $\Omega$
$R_8 - R_{11}$	- 15 $\Omega$
$R_{IN1}$	- 200k Cermet potentiometer
$R_{cb}$	- 100k, 1%
$R_{12}$	- 3.3k
$R_{13}$	- 25 $\Omega$ , 1%
$R_{14}$	- 50 $\Omega$ , 1%
$R_{15}$	- 125 $\Omega$ , 1%
$R_{16}, R_{17}$	- 250 $\Omega$ 1%
$R_{18}$	- 500 $\Omega$ , 1%
$R_{19}$	- 5.1k
$R_{comp}$	- 83k (approx.) (See text)
$R_{20}, R_{22}$	- 500k, 0.05% (Vishay style HA518 or equivalent)
$R_{21}, R_{23}$	- 5k, 0.05% (Vishay part No. 300181: $R_1=R_2=5k$ )
$R_{24}$	- 1K
$R_{25}$	- 510k, 2W, 10%

##### Transistors

$Q_1-2N6111$

$Q_2$  through  $Q_5$ - DTS-804; selected for  $V_{CEO} > 900$  V at

$I_C = 1$  mA

##### Integrated Circuits:

IC1, IC5 - RCA CD4013AE Dual "D" flip-flop with set/reset

IC2 - RCA CD4016AE Quad bilateral switch

IC3 - RCA CD4020AE 14-stage binary/ripple counter

IC5 - RCA CD4017AE Decade counter/divider

IC6 - RCA CD4049AE Hex buffer/converter

##### Miscellaneous

50-kHz clock: Vectron model CO-236T or equivalent.

OA1, OA2: Analog Devices Model 45k or equivalent.

Sample/Hold Module: Burr-Brown Model 4035/15 or equivalent.

$V_{CC}$  Supply: Acopian Model 750UA02L 0-720V @ 20mA or equivalent.

$\pm 15$ -Volt Op-Amp Supply: Acopian Model D15-75 or equivalent.

+10V/-10V (relay, logic) Supplies: Acopian Module A10NT110 or equivalent.

RL1, RL2, K1-6 (relays): Clare Model HGSR51111N00, or equivalent.

DVM: Data Precision Model 2440 Digital Multimeter, or equivalent; options B3, B4.

## Biasing Circuit for the Output Stage of a Power Amplifier—The $V_{BE}$ Multiplier

by M. Glogolja

This Note describes a biasing circuit for the output stage of a power amplifier. The biasing circuit is called a  $V_{BE}$  multiplier; its purpose is to provide proper bias for the output transistors of the amplifier under all operating conditions. The amount of forward bias provided determines the quiescent operating point of the output stage. The criteria for determining the proper quiescent collector current of the output transistors are the output-signal distortion level to be achieved and the need to minimize quiescent current because of dissipation in the output transistors. Fig. 1 shows the circuit of a typical complementary output stage for an audio amplifier. In this circuit, transistor Q3 serves as the biasing element for transistors Q4 and Q5.

Since all transistors are temperature sensitive, the bias circuit should change bias voltage in such a manner that the quiescent collector current of the output transistors remains constant. Typical temperature dependence of a silicon power transistor is shown in Fig. 2. The figure shows that the bias

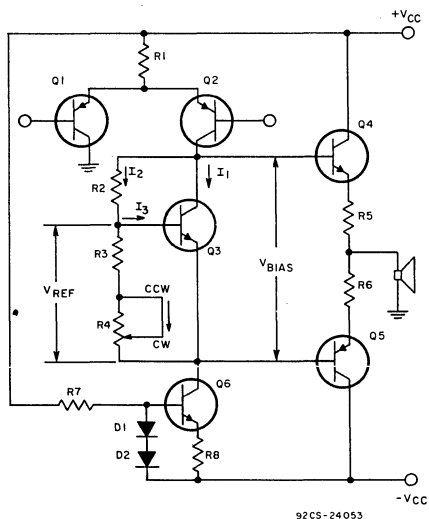


Fig. 1—Complementary output stage for an audio amplifier.

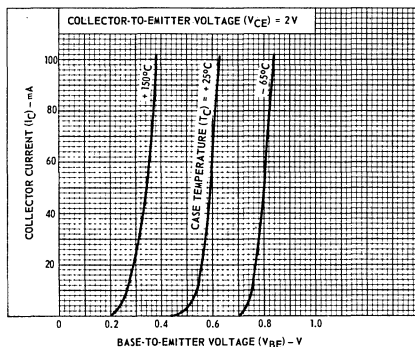


Fig. 2—Temperature dependence of a silicon power transistor.

voltage must decrease approximately  $2 \text{ mV}/^\circ\text{C}$  if the collector current is to be constant. Failure to provide thermal compensation will result in a current change of:

$$\frac{\Delta I_C}{\Delta T} \approx 10\%/^\circ\text{C}$$

A further examination of Fig. 2 shows that an error of 20 millivolts (3 per cent) in the bias voltage will result in a change in the collector current by a factor of 2.

Transistor Q3 in Fig. 1 varies the biasing voltage for the output transistors so that quiescent current does not change with temperature change. This constant-current condition is achieved by mounting Q3, Q4, and Q5 on the same heat sink so that change of the junction temperature of the output transistors will change the heat-sink temperature proportionally and, therefore, the junction temperature of Q3. If, for example,



temperature increases, the collector current of Q3 would tend to increase too, but constant-current source Q6 keeps the collector current of Q3 constant. Under this condition, the  $V_{BE}$  of Q3 will decrease, and  $V_{bias}$  will decrease proportionally. The net result will be the stabilization of the quiescent collector current of Q4 and Q5.

#### Selection of Biasing-Circuit Resistors

The circuit will function properly if resistors R2, R3, and R4 are selected so that:

$$I_1 \gg I_2 \gg I_3 \quad (1)$$

In this case:

$$V_{REF} \approx I_2 (R3 + R4) \quad (2)$$

and

$$V_{REF} \approx \frac{R3 + R4}{R2 + R3 + R4} V_{bias} \quad (3)$$

Let  $R_{REF} = R3 + R4$

so that Eq. (3) can be written as:

$$V_{REF} = \frac{R_{REF}}{R2 + R_{REF}} V_{bias} \quad (4)$$

or

$$V_{bias} = V_{REF} \frac{R2 + R_{REF}}{R_{REF}} \quad (5)$$

Since  $V_{REF}$  is  $V_{BE}$  of the bias transistor Q3, it is evident that  $V_{bias}$  is  $V_{BE}$  multiplied by the ratio  $\frac{R2 + R_{REF}}{R_{REF}}$ , thus the

name,  $V_{BE}$  multiplier.

Resistor values will then be:

$$R2 = R_{REF} \left( \frac{V_{bias}}{V_{REF}} - 1 \right) \quad (6)$$

where  $V_{bias}$  and  $V_{REF}$  are voltages at ambient temperature.

The change in bias voltage provided by the  $V_{BE}$  multiplier circuit is:

$$\Delta V'_{bias} = \left( \frac{R2 + R_{REF}}{R_{REF}} \right) \left( \frac{dV_{REF}}{dT} \right)_{Q3} \Delta T_{JQ3} \quad (7)$$

where  $\Delta T_{JQ3}$  is the temperature change of the junction of Q3. The change in the bias voltage required to maintain constant quiescent collector current in the output transistors is:

$$\Delta V''_{bias} = \left( \frac{dV_{BE}}{dT} \right)_{Q4, Q5} \Delta T_{JQ4, 5} \quad (8)$$

where

$$\frac{(dV_{BE})}{dT} \quad Q4, Q5 = \frac{dV_{BEQ4}}{dT} + \frac{dV_{BEQ5}}{dT} \quad \text{and}$$

$\Delta T_{JQ4, 5}$  is the temperature change of the junction of Q4 or Q5 (ideally, the temperature change is the same for both). Eqs. (7) and (8) must be equal, so that:

$$\left( \frac{R2 + R_{REF}}{R_{REF}} \right) = \left( \frac{dV_{BE}}{dT} \right)_{Q4, Q5} \frac{\Delta T_{JQ4, 5}}{\Delta T_{JQ3}} \quad (9)$$

Eq. (9) shows that if resistors are chosen according to Eq. (6),  $\Delta T_{JQ4, 5}$  and  $\Delta T_{JQ3}$  should be equal. In reality, these expressions are not equal because of thermal resistance between the junctions of the output transistors and the junction of the  $V_{BE}$  multiplier transistor, Q3. As a consequence, the quiescent collector current of the output transistors will vary with temperature change; but if thermal design is done properly, the increase of the quiescent collector current with increase of temperature will be minimal. This is true assuming the change of the base-emitter voltage with temperature change for the  $V_{BE}$  multiplier and the output transistors to be the same. If the change of the base-emitter voltage with temperature change is greater for the  $V_{BE}$  multiplier than for the output transistors, it is possible to get over-compensation with increasing temperature. Thermal design is improved by the use of large heat sinks and transistors with lower values of thermal resistance between the junction and the case.

#### Adjustment of Idling Current

Separation of  $R_{REF}$  into R3 and R4 (Fig. 1) is needed for adjustment of idling current. R3 and R4 should be selected in such a manner that R3 will determine maximum idling current, and the combination (R3 + R4) will determine minimum idling current, based on the typical characteristics of the output transistors.

It should be noted that R4 is placed in the base-emitter circuit of Q3 rather than in the collector-base circuit. If R4 were in the collector-base circuit and became open (a typical failure mode for variable resistors), it would cause simultaneous turn-on of all output transistors and possibly result in their destruction. Such a failure of R4 in the base circuit would result in a reduction of the value of  $V_{bias}$  and greater distortion of the output signal.

Idling current should be adjusted (starting with the wiper of R4 in the CCW position) for the minimum current that will yield acceptable distortion. The idling current should be monitored during the adjustment, because too high a current could cause thermal runaway of the output transistors.

## **Radiation-Hardness Capability of RCA Silicon Power Transistors**

R. B. Jarl

Because all military systems and weaponry may at one time be exposed to nuclear radiation, the effects of this radiation on the electronic system components must be determined and allowed for in the design. This Note describes the types of radiation damage that might be experienced by a power device and the tests used to determine the design most effective in preventing this damage.

### **"RADIATION HARDNESS"**

In reality there is no such thing as a "radiation hard" transistor. A circuit or a device is considered "radiation hard" for a given application; the criteria is whether the entire circuit will perform its intended function after being exposed to a given radiation condition. There are several levels of nuclear radiation for which equipment is designed. For example, a hand-carried transceiver is designed for a radiation level of possibly one thousand times less than the guidance electronics in an ICBM warhead because, in its environment, the transceiver would be destroyed by a nuclear-weapon blast effect while the radiation level was still very low. An ICBM, on the other hand, flies outside the earth's atmosphere; hence, the destructive mechanism might not be blast effect but, more likely, neutron, gamma, and X-ray effects from the defensive missile burst. The levels of radiation from which manned aircraft, weapons stores, missile launch systems and the like have to be protected lie somewhere between the levels for the transceiver and the ICBM.

All transistors suffer degradation in gain, saturation, and leakage when exposed to nuclear radiation. The problem is to acquire sufficient knowledge of the transistor behavior after such exposure to allow the circuit designer to adjust the design for any undesirable changes that may occur in the device characteristics. The transistor designer may optimize a power device for radiation characteristics, but usually at the expense of its dc operating capability.

### **DAMAGE CLASSIFICATION**

The types of radiation damage that may be inflicted upon a power device are classified as follows:

1. Physical Damage
2. Displacement Damage
3. Transient Radiation Energy Effect (TREE)
4. Ionizing Electromagnetic Pulse Effects (IEMP)

**Physical Damage** is inflicted on a device by "flash X-rays" from a nearby nuclear explosion. The X-rays produce a thermo-mechanical shock-wave in the dense material to which the transistor die is attached, usually molybdenum, copper, or gold. This shockwave then propagates into the transistor die and, if strong enough, will cause visible fracturing of the device.

**Displacement Damage** refers to changes in the atomic structure of the silicon crystal caused primarily by the disruption of the crystal lattice by impacting neutrons. The result of this damage is an increased recombination rate in the base and increased collector-body series resistance. The combined effect is manifest by a decrease in current gain and an increase in collector-emitter saturation voltage.

**Transient Radiation Energy Effects (TREE)** are caused mainly by gamma rays which produce large numbers of whole electron pairs in the collector-base and emitter-base junctions and cause large photo-currents to flow in the associated circuits. Intense gamma radiation may also cause current-gain degradation similar to that caused by neutron exposure, but the effect is modest compared to neutron effects.

**Ionizing Electromagnetic Pulse (IEMP) Effects** are the result of an intense ionization of the surroundings of an aircraft or space vehicle that produces a voltage gradient over the hull of several hundred thousand volts. Wherever there is a gap in the metal skin, such as access doors, windows, or antenna feedthroughs, the field will redistribute itself and follow the path of least resistance, possibly down into the vehicle electronics. Should the IEMP suppression be insuffi-

cient, high-current pulses may be induced in the system electronics. In most cases, the protection of the small signal and logic circuits will dictate IEMP suppression well below the capabilities of the power devices. Where a power device will be exposed to an IEMP condition, a pulsed safe-area test may be applied to simulate the situation and verify the device durability.

This Note is confined to the discussion of displacement damage (neutron effects) and transient-radiation effects (photocurrents), the main cause of failure of power devices exposed to nuclear radiation.

#### DEVICES TESTED

Recently, six different RCA power-transistor structures, as detailed in Table I, were subjected to fission spectrum

TABLE I  
IRRADIATED POWER-TRANSISTOR SWITCHES

Transistor	Description	Size (mils)	$V_{CE0}$ (volts)	$f_T$ (MHz)
2N6479	15A pwr sw. n-p-n	155 x 155	≈60-80	100-140
2N5671	30A pwr sw. n-p-n	210 x 220	100-140	60-90
2N5038	20A pwr sw. n-p-n	143 x 182	100-140	70-100
2N3878	7A pwr sw. n-p-n	103 x 103	75-110	60-90
2N5320	1A ampl. & sw. n-p-n	42 x 42	70-120	120-180
2N6247	10A ampl. p-n-p	150 x 150	60-80	4-10

TRANSISTOR TYPE	$V_{CC}$ (VOLTS)	$V_{EE}$ (VOLTS)
2N5038-9	55	4
2N5671-2	55	4
2N6247-8	-45	-3
2N5320	50	4
2N3878-9	50	4
2N6479	10	2

92CS-25129

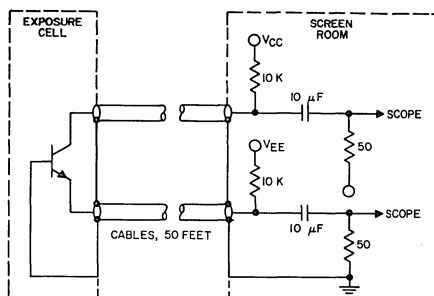


Fig. 1. Circuit and biasing arrangement for measuring photocurrent.

$V_{CE0}$  increased, as did  $f_T$  (current gain bandwidth product), while switching times decreased.  $V_{BE(sat)}$  increased somewhat but was still very manageable.

It is possible to predict  $H_{FE}$  after neutron exposure as a function of an empirically determined damage coefficient,  $K_D$ :

empirically determined damage coefficient,  $K_D$ :

$$K_D \Phi = \frac{1}{H_{FE\Phi}} - \frac{1}{H_{FE0}} \quad (1)$$

or

$$H_{FE\Phi} = \frac{1}{K_D \Phi + \frac{1}{H_{FE0}}} \quad (2)$$

Where:

- $H_{FE\Phi}$  = Current gain after neutron exposure
- $H_{FE0}$  = Current gain before neutron exposure
- $\Phi$  = Cumulative neutron fluence
- $K_D$  = Recombination-rate damage coefficient

(The derivation of Equations 1 and 2 is given in the Appendix.) The more common form of this relationship is:

$$K \Phi \left( \frac{1}{2\pi f_T} \right) = \frac{1}{H_{FE\Phi}} - \frac{1}{H_{FE0}} \quad (3)$$

The factor  $\frac{1}{2\pi f_T}$ , the gain-bandwidth product, is an approximation of the base transit time. Eq. 3 works well with small signal devices, where  $f_T$  may be easily and repeatedly measured at the same collector current and voltage levels as the other parameters of concern. The measurement of  $f_T$  at currents greater than 1 ampere is extremely difficult owing to junction-temperature problems. Furthermore, because of the low output impedances which exist, and the difficulty of obtaining a load impedance which must be even lower, the  $f_T$  results are only qualitative in

neutron exposure and gamma radiation to determine their tolerance to nuclear and space radiation. Each sample consisted of 20 units. Except for the 2N6479, which was designed as a radiation tolerant device, these are standard commercial power transistors. The devices were evaluated for tolerance to neutron exposure and primary and secondary photocurrent generation as a function of gamma-ray intensity. Fig. 1 shows the circuit configuration and biasing used in measuring photocurrent.

#### Neutron Testing

Each unit tested for neutron tolerance received five fission-spectrum neutron exposures; the total fluence was sufficient to produce almost a total degradation in current gain ( $H_{FE}$ ). Before and after each exposure, 5-volt,  $H_{FE}$ , appropriate  $V_{CE(sat)}$ ,  $V_{BE(sat)}$ ,  $I_{CBO}$ ,  $I_{EBO}$  and switching speed data were taken. Only  $H_{FE}$  and  $V_{CE(sat)}$  degradation showed themselves to be of primary concern.  $I_{CBO}$  and  $I_{EBO}$  increased by only small and relatively manageable amounts.

nature. The gain-bandwidth product within members of a given device design are generally uniform; therefore, for this study,  $\frac{1}{2\pi f_T}$  was merged with  $K$  (the recombination-rate damage coefficient) such that:

$$K_D = \frac{K}{2\pi f_T} = \text{composite } H_{FE} \text{ damage coefficient.}$$

Fig.2, 3(a) through 3(m), and 4(a) through 4(f) present the following typical information on the devices tested:

$V_{CE(sat)}$  vs cumulative neutron fluence ( $\Phi$ ) at a forced gain of 4 ( $I_C/I_B=4$ ).

$V_{CE(sat)}$  vs cumulative neutron fluence ( $\Phi$ ) at a forced gain of 8 ( $I_C/I_B=8$ ).

$H_{FE}$  vs  $I_C$  prior to radiation

Recombination-rate damage coefficient ( $K_D$ ) vs  $I_C$ .

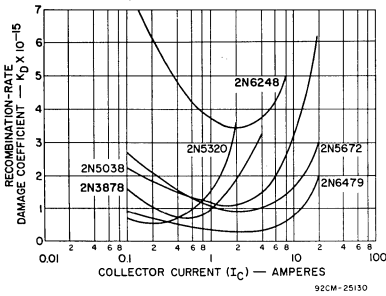
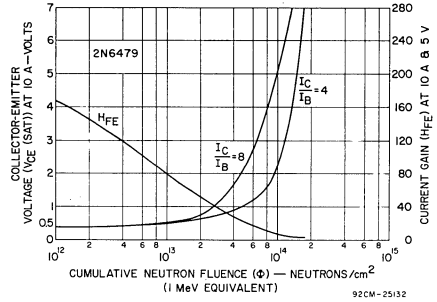
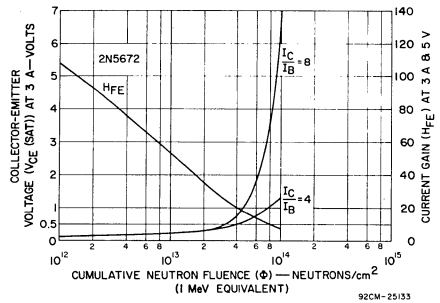


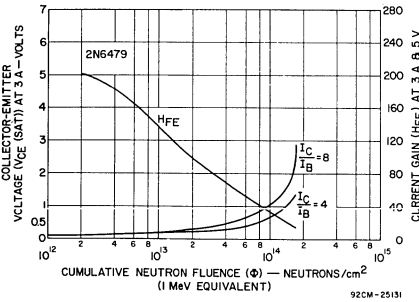
Fig. 2. Composite graph of recombination-rate damage coefficient as a function of collector current for the power transistors discussed in this Note.



(b) 2N6479 (10A)

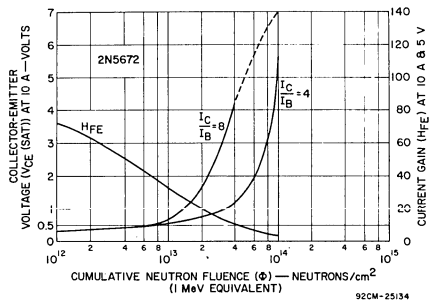


(c) 2N5672 (3A)



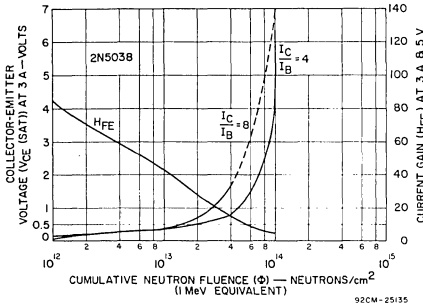
(a) 2N6479 (3A)

Fig. 3. Collector-emitter saturation voltage and current gain as a function of cumulative neutron fluence for the power transistors discussed in this Note.

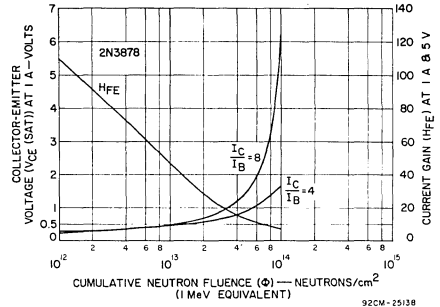


(d) 2N5672 (10A)

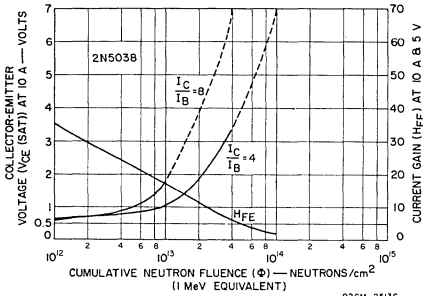
Fig. 3. Collector-emitter saturation voltage and current gain as a function of cumulative neutron fluence for the power transistors discussed in this Note.



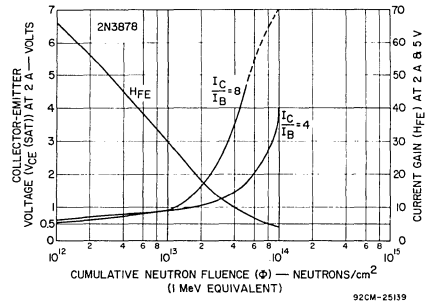
(e) 2N5038 (3A)



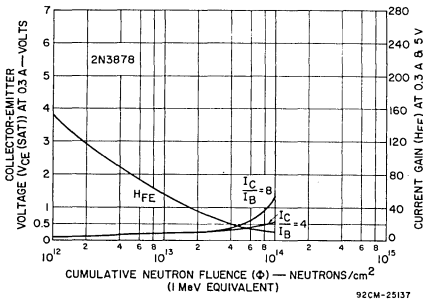
(h) 2N3878 (1A)



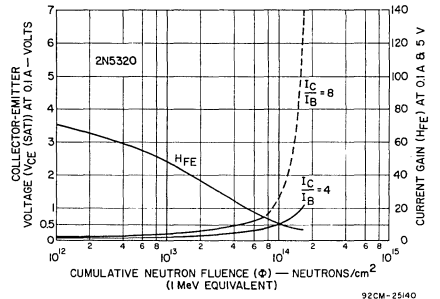
(f) 2N5038 (10A)



(i) 2N3878 (2A)



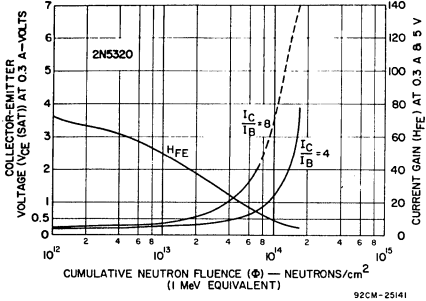
(g) 2N3878 (0.3A)



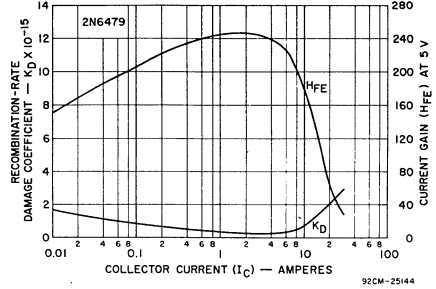
(j) 2N5320 (0.1A)

Fig. 3. Collector-emitter saturation voltage and current gain as a function of cumulative neutron fluence for the power transistors discussed in this Note.

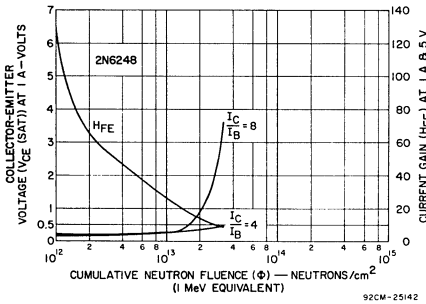
Fig. 3. Collector-emitter saturation voltage and current gain as a function of cumulative neutron fluence for the power transistors discussed in this Note.



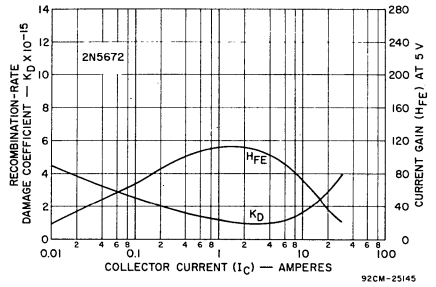
(k) 2N5320 (0.3A)



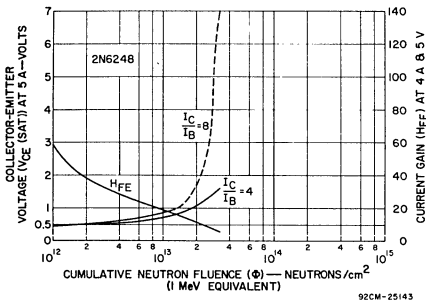
(a) 2N6479



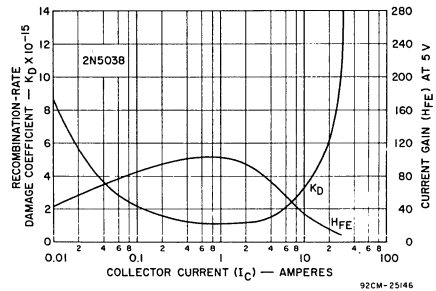
(l) 2N6248 (1A)



(b) 2N5672



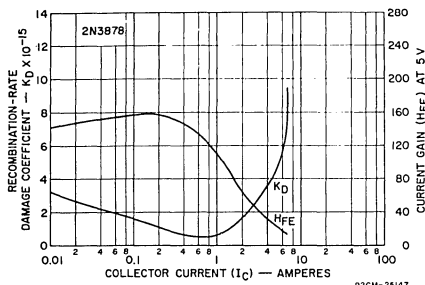
(m) 2N6248 (5A, V<sub>CE</sub>: 4A, H<sub>FE</sub>)



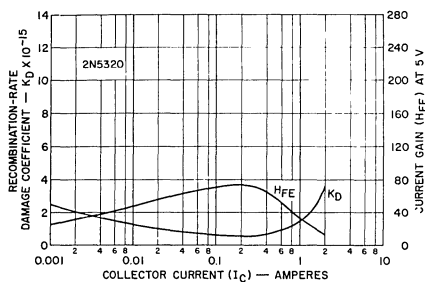
(c) 2N5038

Fig. 3. Collector-emitter saturation voltage and current gain as a function of cumulative neutron fluence for the power transistors discussed in this Note.

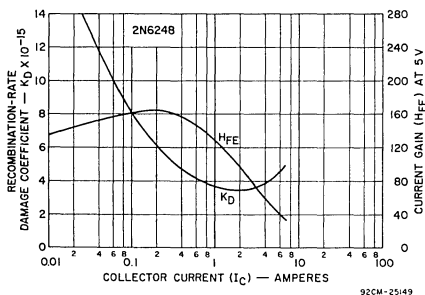
Fig. 4. Recombination-rate damage coefficient and current gain as a function of collector current for the power transistors discussed in this Note.



(d) 2N3878



(e) 2N5320



(f) 2N6248

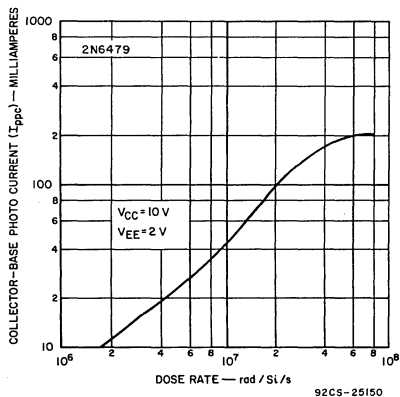
### Photocurrent Testing

The effect on power transistors of high-intensity radiation, such as high-energy electrons, gamma rays, and X-rays, is ionization in the collector-base and emitter-base depletion layers that produces primary photocurrents proportional to the electrical volumes of the junctions. When these photocurrents flow through the biasing networks and are sufficient to produce the appropriate IR drops in the circuit extrinsic to the base-emitter circuit, the device may become forward biased, producing what is known as "secondary photocurrent" by means of conventional  $H_{FE}$  amplification. Primary photocurrent production is predictable and can be stated as a coefficient of  $6.4 \mu\text{A}/\text{rad}(\text{Si})/\text{cm}^3$ . The expression for the collector-base photocurrent,  $I_{ppc}$ , may be written as

$$I_{ppc} = 6.4 \times 10^{-6} \times A \times W$$

where  $A$  is the area of the base in  $\text{cm}^2$  and  $W$  is the width of the collector-base depletion layer in centimeters. Note that  $W$  is to some degree voltage dependent; therefore,  $I_{ppc}$  will also be voltage dependent to the extent that the collector depletion layer widens according to the collector voltage and the impurity ratio between the base and collector layers.

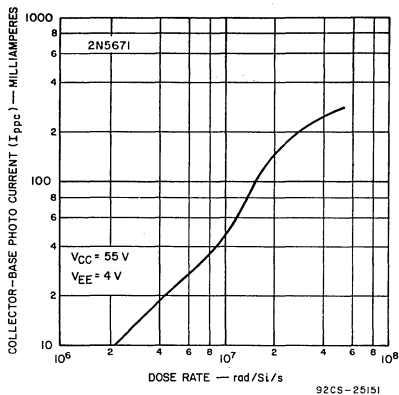
Fig. 1 shows the circuit used for obtaining the photocurrent data in this Note; it is not entirely satisfactory for the levels of photocurrent that may occur in large power devices. Because the photocurrent is measured by monitoring the voltage across a 50-ohm termination resistor, the arrangement saturates at a photocurrent of  $\frac{V_{CC}}{50}$ , thus, the amount of current measured is not a true indication of  $I_{ppc}$  at the higher exposure levels. The curves of Figs. 5(a) through 5(f) should be evaluated with this fact in mind.



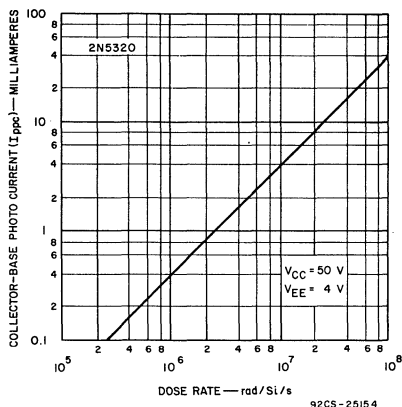
(a) 2N6479

Fig. 4. Recombination-rate damage coefficient and current gain as a function of collector current for the power transistors discussed in this Note.

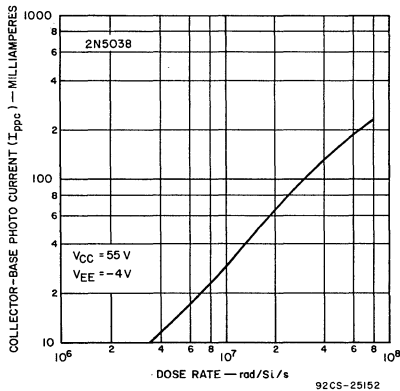
Fig. 5. Collector-base photocurrent as a function of dose rate for the power transistors discussed in this Note.



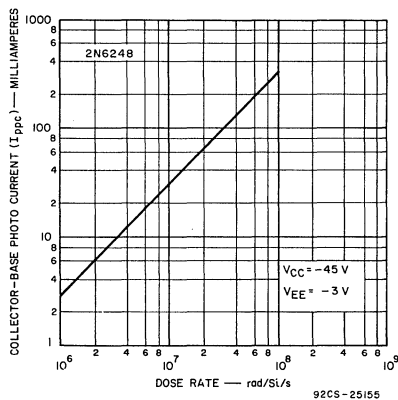
(b) 2N5671



(e) 2N5320

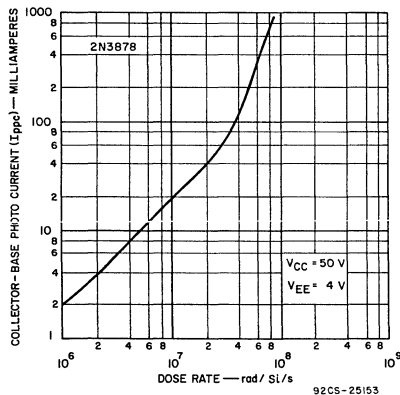


(c) 2N5038



(f) 2N6248

Fig. 5. Collector-base photocurrent as a function of dose rate for the power transistors discussed in this Note.



(d) 2N3878

Fig. 5. Collector-base photocurrent as a function of dose rate for the power transistors discussed in this Note.

Characterization of the devices tested consisted of measuring the primary photocurrents in the transistors and plotting these as functions of radiation dose rate. Tests were performed at the 25 MeV linear-accelerator facility at the White Sands Missile Range, New Mexico. Radiation pulse widths of 5 to 6 microseconds were used to attain equilibrium photocurrent. All testing was performed with the accelerator in the electron-beam mode of operation. Variations in dose rate were obtained by positioning the test device at different distances from the beam port. Dose rates ranged from about  $5 \times 10^5$  to  $2 \times 10^8$  rad(Si)/s and were determined from the responses of a calibrated diode. The radiation response of the diode was, in turn, calibrated against lithium fluoride, Tiny Thermoluminescent Dosimetry Discs (TTDD's), and calcium fluoride impregnated Teflon chips, both of which were positioned in the area normally occupied by the device under test.



The photocurrent characteristics of the various devices evaluated are shown in Table II and described below.

TABLE II  
DEVICE PHOTOCURRENT CHARACTERISTICS

Transistor Type	TOTAL GAMMA DOSE (rads-silicon x 10 <sup>3</sup> )					
	Test No.	1	2	3	4	5
2N6479	.93	2.2	4.2	33.2	79.2	
2N5671	1.2	2.3	3.7	26.7	58	
2N5038	1.5	2.7	4.1	25.1	38	
2N3878	.93	2.13	3.63	24.6	49.6	
2N5320	.85	2.0	3.4	32	73	
2N6247	.83	1.68	2.68	6.1	26.3	

2N6479. Relatively linear collector-base photocurrents were observed. The emitter-base plot was non-linear. Secondary photocurrent began at  $3 \times 10^7$  rad/s. The primary photocurrent generation rates in amperes per rad per second are:

collector-base  $5 \times 10^{-9}$  A/rad/s  
emitter-base  $1 \times 10^{-11}$  A/rad/s (approx.) non-linear

2N5671-2. Both the collector-base and emitter-base junctions exhibit a linear relationship between the photocurrent and the dose rate. However, this transistor type switched into the secondary-photocurrent mode from  $5 \times 10^6$  to  $2 \times 10^7$  rad/s, so that the points of the emitter plot are accordingly reduced in quantity. The plot in Fig. 5(b) yields a primary photocurrent generation rate of:

collector-base  $4.8 \times 10^{-9}$  A/rad/s  
emitter-base  $2 \times 10^{-10}$  A/rad/s

2N5038-9. Linear relationships between the photocurrent and dose rate for both collector-base and emitter-base junctions were obtained. The onset of secondary photocurrent was observed at dose rates of  $2 \times 10^7$  to  $2 \times 10^8$  rad/s. The primary photocurrent generation rates taken from Fig. 5(c) are:

collector-base  $3.1 \times 10^{-9}$  A/rad/s  
emitter-base  $6.5 \times 10^{-11}$  A/rad/s

2N3878-9. The collector-base junction shows a linear relationship between photocurrent and dose rate, whereas the emitter base is very non-linear. The non-linearity holds even though data is plotted from  $5 \times 10^5$  to  $10^8$  rad/s, and secondary photocurrent did not begin until the dose rate was  $3 \times 10^7$  rad/s. The primary photocurrent-generation rates are:

collector-base  $2.4 \times 10^{-9}$  A/rad/s  
emitter-base  $1 \times 10^{-11}$  A/rad/s (approx.) non-linear

2N5320. Linear results. Secondary photocurrent is not observed for this device for dose rates as high as  $3 \times 10^7$  rad/s. The collector-base photocurrent generation rate is  $4 \times 10^{-10}$  A/rad/s.

2N6247-8. Linear relationship between photocurrent and dose rate for both junctions were seen. Secondary photocurrent was observed at about  $3 \times 10^7$  rad/s. Primary photocurrent generation rates are:

collector-base  $2.9 \times 10^{-9}$  A/rad/s  
emitter-base  $2.1 \times 10^{-10}$  A/rad/s

## APPENDIX DERIVATION OF THE NEUTRON-DAMAGE COEFFICIENT

The common-emitter current gain at a constant voltage may be expressed as:

$$H_{FE} = \frac{1}{t_b R} - 1 \quad (A-1)$$

where:

$$t_b = \text{base transit time}$$

$$R = \text{base recombination rate}$$

The recombination rate (R) is proportional to the number of defects produced in the base by neutron radiation. The number of defects is proportional to the total exposure. Therefore, R may be expressed as:

$$R = R_0 + K\Phi \quad (A-2)$$

where:

$$K = \text{a damage coefficient}$$

$$\Phi = \text{total neutron fluence}$$

The base transit time, ( $t_b$ ), may be approximated by the relationship:

$$t_b = \frac{1}{2\pi f_T} \quad (A-3)$$

Manipulation of Eqs. A-1 and A-2 yields the expression:

$$K\Phi = \frac{1}{t_b} \left( \frac{1}{H_{FE\phi} + 1} - \frac{1}{H_{FE0} + 1} \right) \quad (A-4)$$

where:

$$H_{FE0} = H_{FE} \text{ prior to neutron exposure}^1$$

$$H_{FE\phi} = H_{FE} \text{ after neutron exposure}^2$$

Simplifying,

$$H_{FE0} + 1 = H_{FE\phi} \quad (A-5)$$

Eq. A-4 now becomes

$$K\Phi = \frac{1}{t_b} \left( \frac{1}{H_{FE\phi} + 1} - \frac{1}{H_{FE0}} \right) \quad (A-6)$$

A reorganization yields:

$$1 + H_{FE} = \frac{1}{t_b K\Phi + \frac{1}{H_{FE0}}} \quad (A-7)$$

If Eq. A-3 is then substituted in Eq. A-7, the expression becomes:

$$1 + H_{FE} = \frac{1}{\frac{K\Phi}{2\pi f_T} + \frac{1}{H_{FE0}}} \quad (A-8)$$

As described in the main text,  $f_T$  and K may be merged as:

$$\frac{K}{2\pi f_T} = K_D \quad (A-9)$$

$1 + H_{FE\phi}$  is usually expressed as  $H_{FE\phi}$ , and the expression becomes:

$$H_{FE\phi} = \frac{1}{K_D \Phi + \frac{1}{H_{FE0}}} \quad (A-10)$$

## REFERENCES

1. Larin, Radiation Effects in Semiconductors, pp. 17, eq. 2.19, 2.20, John Wiley, New York, 1968
2. Same as ref. 1, pp. 14, eq. 2.11
3. Rockwell International, Internal letter 73-551-012-79, October 15, 1973

## A Safe-Area Rating System for Power Inverters Handling Capacitive and Inductive Loads

Although transistor power inverters have classically been evaluated with resistive loads, the reliability of practical inverters often depends on inductive and capacitive loads and associated starting transient considerations. This paper describes a safe-area rating system for transistors, and relates this system to self-excited single-transformer, self-excited double-transformer, and driven inverters operating into resistive, capacitive, and inductive loads under both steady-state and starting conditions.

Analysis of inverters to determine whether they will operate reliably depends on the safe-area rating of the transistors used in the inverter circuits. The rating system used must be easily related to complex transient waveforms, and must be comprehensive enough to include all conditions that may cause device failure. Most important, the rating system must be realistic, i.e., conformance with the safe-area requirements must assure device reliability.

With a system such as the one described in this paper, the analysis of inverters with complex loads is relatively simple. The general procedure is as follows:

1. The worst-case load lines are measured or calculated.
2. The load-line information is translated into an energy form which can be directly related to the forward- or reverse-bias safe-area rating shown on the transistor data sheet. This translation involves two steps:
  - (a) calculation of actual energy and of equivalent single or repetitive pulses for thermally limited or second-breakdown-limited situations;
  - (b) direct comparison of energy dissipated in the transistor in the inverter with the published rating for the reverse-bias case ( $ES/b$ ).

For inverters operating into inductive loads, it is also necessary to consider the inverse current transfer ratio (beta) and possible diode protection. The safe-area rating system developed by RCA and used throughout this paper for inverter analysis is energy-oriented, i.e., it takes into account transistor capability to absorb short-duration energy pulses.

### Forward-Bias Safe-Area Rating System

In general, a transistor can dissipate energy in either the forward-bias or the reverse-bias mode. The forward-bias mode is defined as the condition under which conventional current flows to the base terminal of a transistor in a direction that results in normal transistor action (i.e., into the base of an n-p-n transistor and out of the base of a p-n-p transistor). An example of a typical forward-bias safe-area curve is shown in Fig. 1. This curve, which is derived on the

basis of a single non-repetitive rectangular pulse occurring at a case temperature of 25°C, is bounded by the maximum current  $I_C(\max)$  and maximum collector-to-emitter voltage  $V_{CE0}(\max)$  ratings for the transistor. According to the accepted definition of active operation, the operating collector-to-emitter voltage  $V_{CE}$  cannot exceed  $V_{CE0}$ .

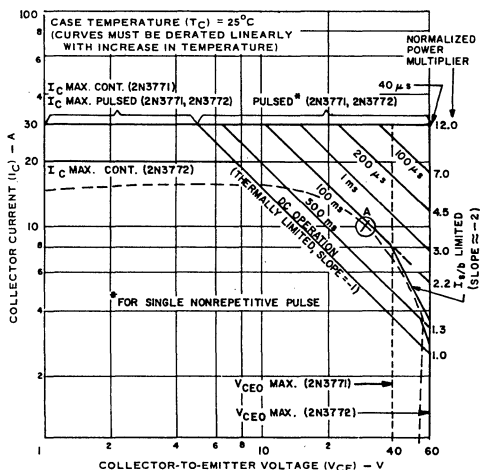


Fig. 1 - Typical forward-bias safe-area curve.

A two-step derating system is used to adapt the safe-area curve to practical cases. First, a single pulse at an elevated case temperature is considered, and all thermal limitations are derated linearly with temperature by use of a

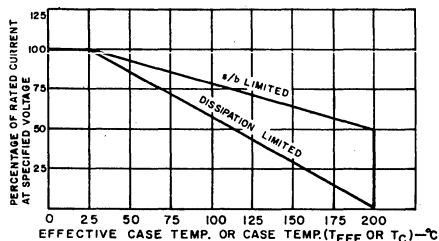


Fig. 2 - Temperature derating chart.

derating chart such as that shown in Fig. 2. Operation of a transistor is sometimes limited by forward-bias second breakdown ( $ES/b$ ) in certain operating regions; published data for the transistor indicate whether separate temperature derating is required in such regions.

The second step in the derating system is the consideration of repetitive rectangular pulses. For such derating, an effective case temperature  $T_{eff}$  is introduced which depends on average power dissipation, as follows:

$$T_{eff} = T_{case} + P_{avg} (\theta_{jc}) \quad (1)$$

where  $T_{case}$  is the actual case temperature,  $P_{avg}$  is the average power, and  $\theta_{jc}$  is the thermal resistance from junction to case. The transistor is derated for the effective case temperature in the same manner used for a single pulse. The reduction of complex power pulses to repetitive rectangular pulses at an arbitrary case temperature permits the processing of virtually any waveform. As an example, Fig. 3 shows an actual power waveform and an equivalent rectangular pulse containing the same energy per cycle and the same peak power.<sup>1</sup>

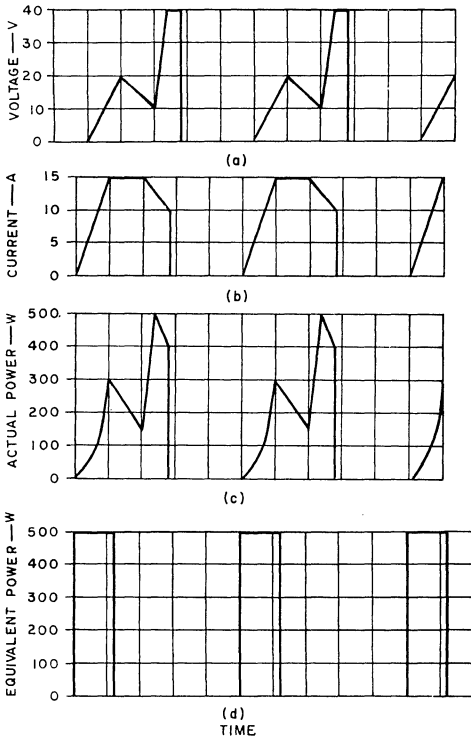


Fig. 3 - Actual voltage, current, and power pulses, and equivalent rectangular power pulse.

An important exception to the procedure of lumping all energy at peak power involves transistors operating near their second-breakdown limit. Because this limit varies inversely with voltage squared (approximately), the point of maximum stress occurs below peak power, but at a higher

voltage. Therefore, the energy should be lumped at a point closest to the second-breakdown limit, i.e., at the worst-case excursion point of the power curve into the safe-area region.<sup>2</sup>

### Reverse-Bias Safe-Area Rating System

The reverse-bias mode of transistor operation is defined as the condition under which conventional current flows to the base terminal of a transistor in a direction which tends to cut off normal operation. If a purely resistive load were being switched off, collector current would be essentially zero and no power would be dissipated after the transistor switched off. However, if some amount of inductance  $L$  is present in the collector circuit of a transistor and an attempt is made to turn the device off, the inductance causes a collector current  $I_C$  to flow through the breakdown voltage of the device, and considerable energy may be dissipated. The energy dissipated in this case is approximately equal to  $LI_C^2/2$ .

The ability of a device to dissipate energy in the reverse-bias mode ( $ES/b$  energy) depends upon the reverse base voltage, the base resistance, and the inductance in the collector circuit. Fig. 4 shows the second-breakdown characteristics of a transistor operating in the reverse-bias mode. The

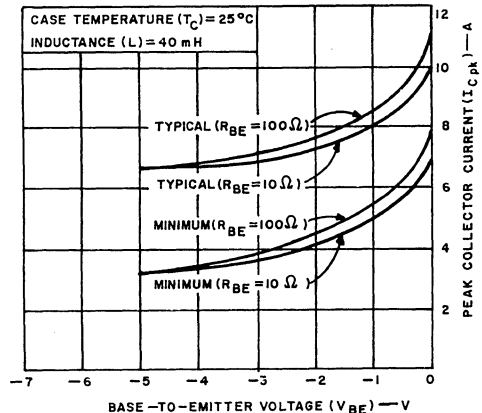


Fig. 4 - Reverse-bias second-breakdown characteristics.

energy  $E$  that the transistor is required to handle in a particular application is determined by the equivalent inductance  $L_{eff}$  in the collector circuit and the maximum current  $I_{max}$  to be switched, and is given by

$$E = \frac{1}{2} L_{eff} I_{max}^2 \quad (2)$$

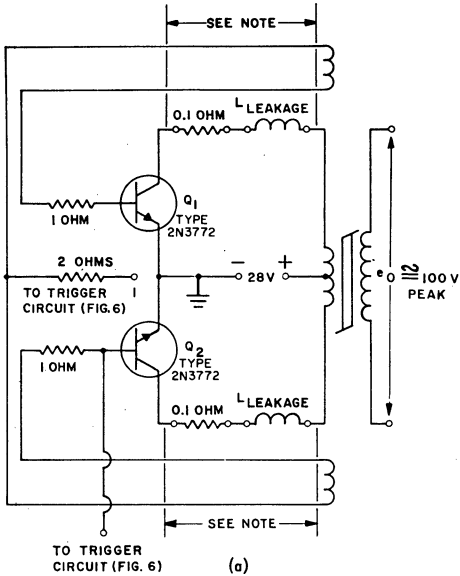
The energy  $ES/b$  that the transistor can handle before second breakdown occurs depends on the circuit inductance  $L$ , the base-to-emitter voltage  $V_{BE}$ , and the base-to-emitter resistance  $R_{BE}$ , as follows:

$$ES/b = \frac{1}{2} L I_{pk}^2 \quad (3)$$

where the value of  $L$  is obtained from published data for the transistor (for the 2N3772,  $L = 40 \times 10^{-3}$  henries) and the peak current  $I_{pk}$  is determined from the values of  $R_{BE}$  and  $V_{BE}$ . Comparison of Eqs. (2) and (3) indicates whether the circuit is operating safely from a reverse-bias safe-area viewpoint.

### Types of Inverters

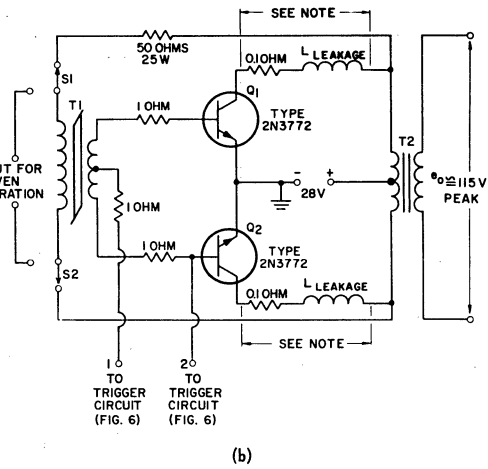
Two inverters were constructed to permit evaluation of typical inverter operation by the safe-area rating system described. These circuits, a single-transformer type and a



(a)

Transformer Characteristics

Core	Sq. Orthonol; Magnetics Inc. No.52001-2A
Primary	60 turns No.14 wire
Secondary	125 turns No.18 wire
Base Winding	6.turns No.18 wire



(b)

Transformer Characteristics

	T1	T2
Core	Sq. Orthonol; Magnetics Inc. No.52035-2A	Microsil 150 E/0.004; 1.5 by 1 inches
Primary	67 turns No.23 wire	20 turns No.14 wire
Secondary	24 turns No.18 wire	40 turns No.18 wire

Switches S<sub>1</sub> and S<sub>2</sub> are ganged.

Note: The 0.1-ohm resistors and the leakage inductances (L) are used for circuit evaluation only. They are replaced with jumpers during normal operation.

Fig.5 -Typical inverter circuits: (a) 300-watt single-transformer inverter; (b) 400-watt two-transformer inverter.

double-transformer type, are shown in Fig.5. Neither circuit is self-starting; the starting circuit for both inverters is shown in Fig.6. The two-transformer inverter shown in Fig.5(b) also includes provision for external drive to simulate a driven inverter. The oscilloscope trigger shown in the starting circuit facilitates the study of starting transients.

Although the circuits shown in Figs.5 and 6 are practical circuits, they are designed to represent basic circuit operation rather than optimized design for a particular application. However, the data obtained with the aid of these circuits are generally applicable to specific designs. The conventional waveforms shown in Figs.7 and 8 were obtained with the inverters operating into a maximum-power resistive load; these waveforms are used as a basis for inverter analysis. The waveforms obtained for the driven inverter are very similar to those shown in Fig.8.

The waveforms of Figs.7 and 8 indicate the basic switching difference between one- and two-transformer inverters. In a single-transformer inverter, as shown in Fig.7, switching is initiated after a rapid increase of collector current caused by output-transformer saturation (evidenced by

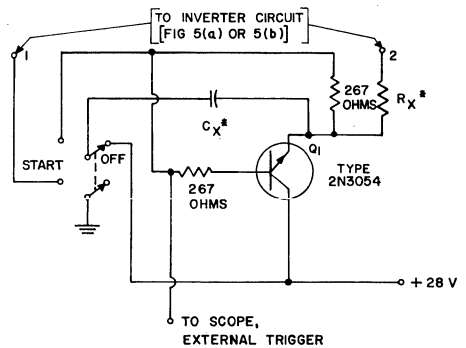


Fig.6 - Starting circuit used with inverters of Fig.5. (\*Values of C<sub>x</sub> and R<sub>x</sub> determine length and amplitude of starting pulse

the spike in the collector-current waveform). In a two-transformer inverter, as shown in Fig.8, switching is initiated after the driven transformer saturates and base current is reduced (as evidenced by the relative absence of a collector-current spike). The small current spike observed for the two-transformer inverter is caused by loading of the output transformer by the saturation of the driver transformer. From a safe-area aspect, the important point is that maximum instantaneous

1. The steady-state power dissipation is established for the transistor under consideration. In the typical circuit of Fig.5(a), each transistor carries a current of approximately 11 amperes at a collector-to-emitter saturation voltage  $V_{CE(sat)}$  of 0.8 volt; therefore, the average power dissipation  $P_{D(avg)}$  is  $(11 \times 0.8) / 2$ , or 4.4 watts.

2. The switching load line, shown in Fig.7(d), is plotted on a safe-area curve, and the worst-case excursion point into

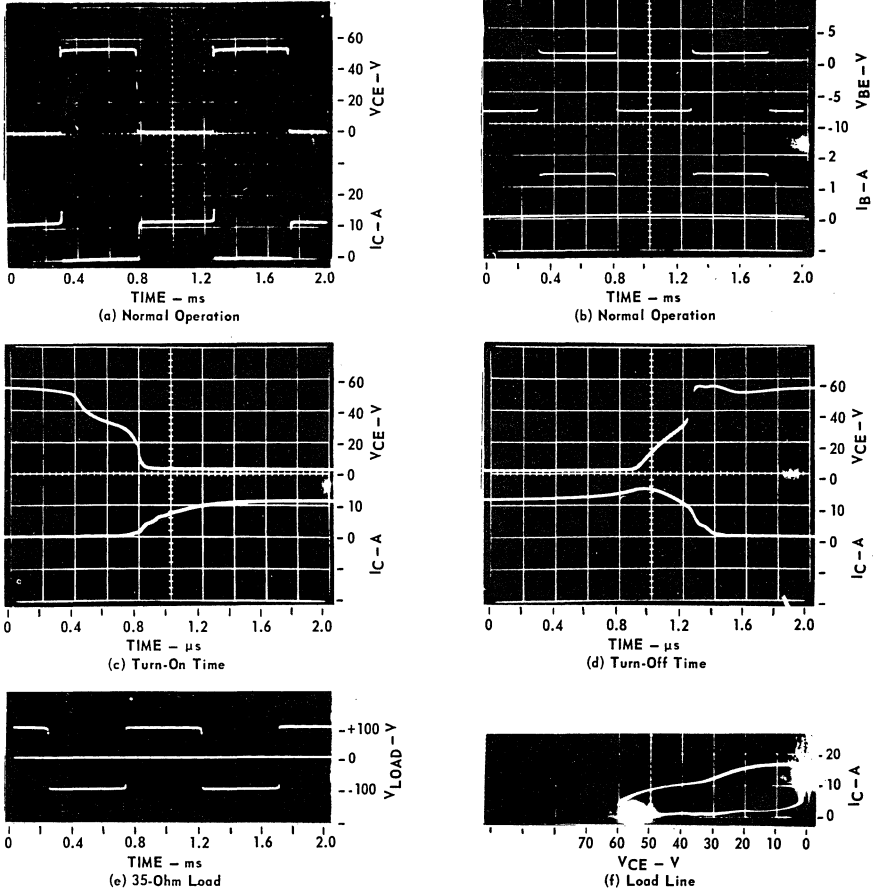


Fig.7 - Single-transformer inverter waveforms.

power occurs during switching in both cases, as shown in Figs.7(d) and 8(d).

#### Resistive-Load-Line Analysis

Prior to consideration of capacitive and inductive loads, it is instructive to outline the general procedure for safe-area analysis of circuits operating with resistive loads only. For a single-transformer inverter, the procedure is as follows:

The safe area is determined. This point, represented by point A in Fig.1, is approximately 300 watts.

3. The switching-time energy is calculated from the switching waveforms. Comparison of Figs.7(c) and 7(d) shows that only the turn-off transient contributes appreciable energy. The switching energy  $E$  is calculated by graphical integration of the pulse shown in Fig.9(a) as 1.1 millijoules.

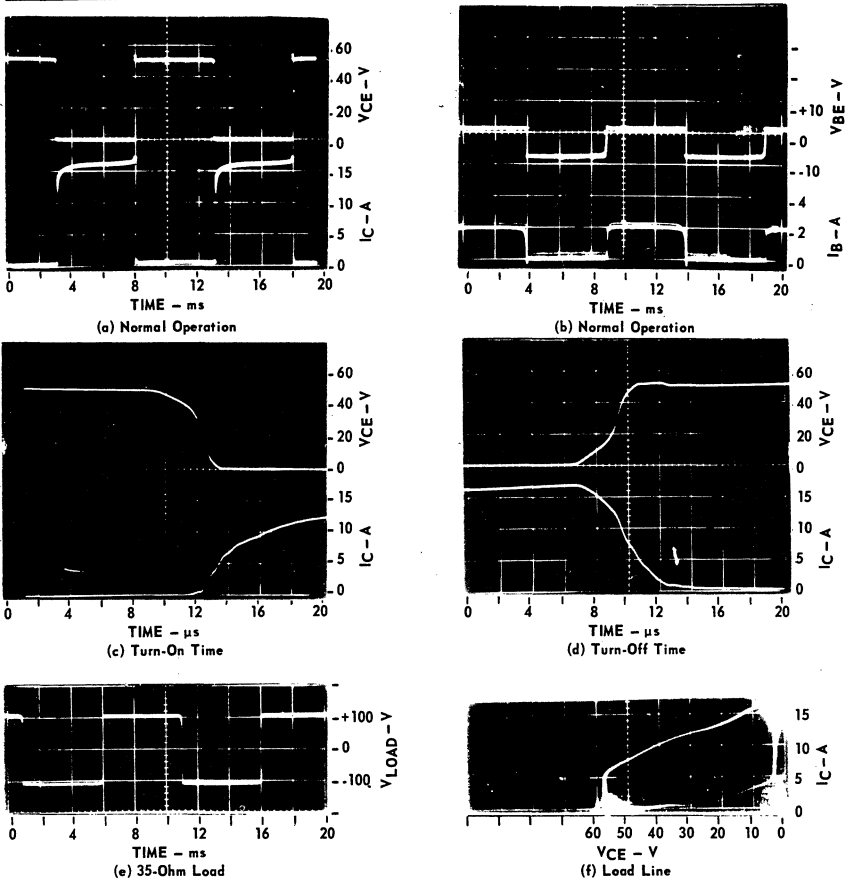


Fig.8 - Two-transformer inverter waveforms.

4. An equivalent pulse is specified to represent the energy calculated. It is assumed that all energy is dissipated at the worst-case power point (300 watts). Fig.9(b) shows the equivalent power pulse. The equivalent pulse width is 1.1 millijoules/300 watts, or 3.7 microseconds. This pulse corresponds to an average power of 1.1 watts.

5. The effective case temperature  $T_{eff}$  is calculated from Eq.(1) as follows:

$$T_{eff} = T_{case} + P_{avg} (\theta_{jc})$$

$$T_{eff} = T_{case} + (4.4 + 1.1) (\theta_{jc})$$

For the 2N3772 power transistor, the thermal resistance  $\theta_{jc}$  is 1.17°C per watt; therefore  $T_{eff} = T_{case} + 6.5°C$ .

6. The maximum case temperature permissible for safe operation is determined by use of the normalized power multiplier on the safe-area curve for the equivalent pulse width

determined above. For a pulse width of 3.7 microseconds, the safe-area curve of Fig.1 indicates a multiplier of 12 (this figure is used for all pulse widths of 40 microseconds or less). The actual power ratio is then determined as the ratio of peak power to 25°C steady-state power. For the case considered, this ratio is 300/150 watts, or 2. Therefore, the temperature derating factor is from 12 to 2, or 17 per cent of full rating. Fig.10 shows that this derating corresponds to an effective case temperature  $T_{eff}$  of 171°C.

7. The maximum permissible case temperature  $T_{case}$  is then calculated as follows:

$$T_{eff} = T_{case} + 6.5°C$$

$$T_{case} = T_{eff} - 6.5°C$$

$$T_{case} = 171 - 6.5 = 164°C$$

That is, the inverter will operate reliably up to a case temperature of 138°C.

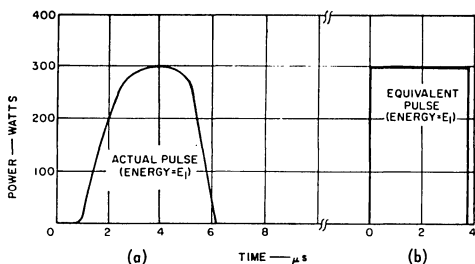


Fig. 9 - Actual and equivalent power pulses for a single-transformer inverter. Energy  $E_1$  is 1.1 millijoules.

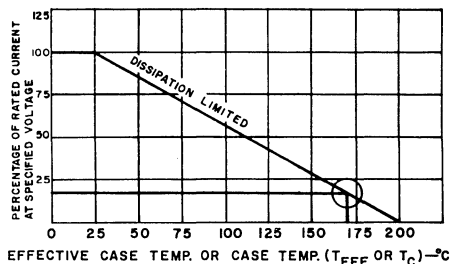


Fig. 10 - A dissipation derating curve.

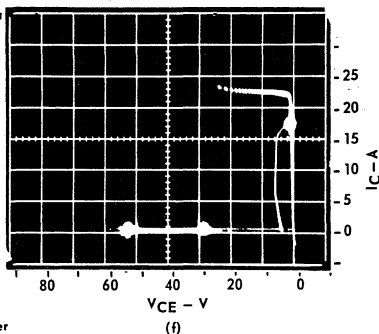
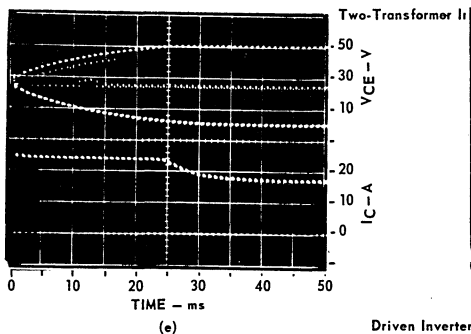
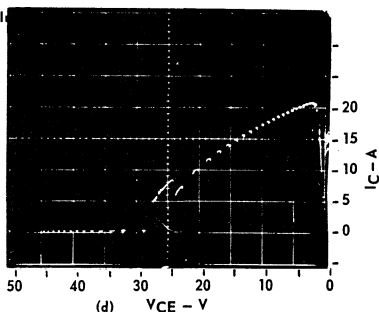
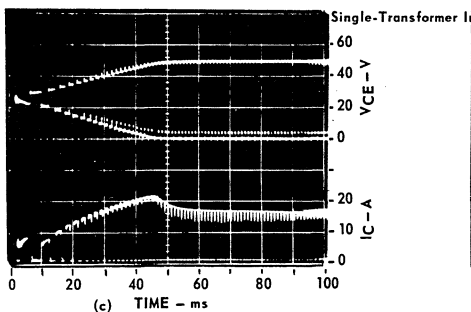
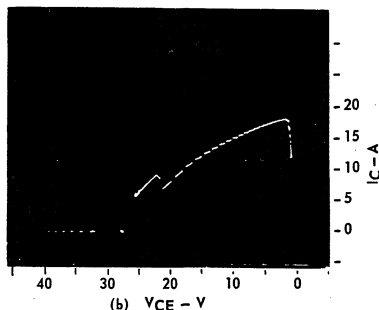
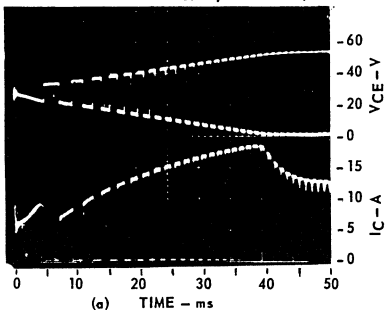


Fig. 11 - Capacitive load lines for single-, two-transformer and driven inverters.

If this analysis were made on the basis of average dissipation only, the derating factor would be 3.7 per cent of 150 watts, and the maximum case temperature would be 193°C. Operation under such conditions would almost certainly impair the reliability of transistor performance.

### Capacitive Load Lines

When a full-wave bridge rectifier and a filter capacitor are added to the output of an inverter circuit, the primary effect from a safe-area viewpoint is a starting transient which exists until the filter capacitor is charged. Fig.11 shows starting transients for three types of inverter circuits operating into a 400-microfarad filter capacitor and a 35-ohm load. For the self-excited inverters, as shown in Figs.11(a) through 11(d), the maximum current reached in the first few cycles of operation depends entirely upon the drive supplied by the starting circuit and the gain of the transistors. The inverter frequency is determined by the supply voltage minus the collector-to-emitter voltage  $V_{CE}$  of the unsaturated transistors (i.e., the voltage across the transformer primary). As the starting-circuit drive decreases, the feedback drive increases with the increasing output voltage across the capacitor. In the driven inverter, as shown in Figs.11(e) and 11(f), base drive and frequency are constant, regardless of output voltage. Although initial peak power in the self-excited inverters can be controlled to some extent by proper control of the starting circuit, sufficient drive must be provided for sure starting. In all three cases, the transistors cannot saturate until the filter capacitor is charged; therefore, a period of high dissipation exists.

Although the procedure for safe-area analysis of capacitive load lines outlined below describes a single-transformer inverter; it also applies for other inverter types.

1. The initial turn-on load line and the locus of all succeeding load lines are determined, as shown in Fig.11(b).<sup>2</sup>

2. The total energy dissipated in the starting transient is calculated. First, the waveforms of collector-to-emitter voltage  $V_{CE}$  and collector current  $I_C$  as functions of time are redrawn as shown in Fig.12, and a third curve is plotted of power as a function of time. The total energy  $E_T$  handled by the transistor in 42 milliseconds is given by

$$E_T = E_1 + E_2 + E_3/2$$

where the energy values are determined from Fig.12. The final term  $E_3/2$  indicates that each transistor handles only one-half the energy  $E_3$ . The total energy, therefore, is given by

$$E_T = (0.9 + 0.3 + 2.4) = 3.6 \text{ joules}$$

The load line for this case, shown in Fig.13, indicates that the worst-case power point P occurs at approximately 200 watts and 23 volts.

3. An equivalent single power pulse is calculated. It is assumed that all pulse energy is dissipated at the worst-case power point. With a peak power of 200 watts, the equivalent square-wave pulse duration  $\tau_{eq}$  is given by

$$\tau_{eq} = 3.6 \text{ joules}/200 \text{ watts} = 18 \text{ milliseconds}$$

The safe-area curve of Fig.13 indicates that a pulse of 200 watts and 23 volts can be handled for 500 milliseconds when the transistor case temperature is 25°C.

4. The maximum allowable case temperature  $T_{case}$  is then determined. First, the 18-millisecond duration of the equivalent square-wave pulse is plotted on the safe-area curve, as shown in Fig.13. The intersection of this line with the

normalized-power-multiplier scale indicates that 2.8 times rated power can be handled for a period of 18 milliseconds. Because the power to be dissipated is 200 watts, or 1.3 times a rated power of 150 watts, the derating factor is 1.3/2.8, or

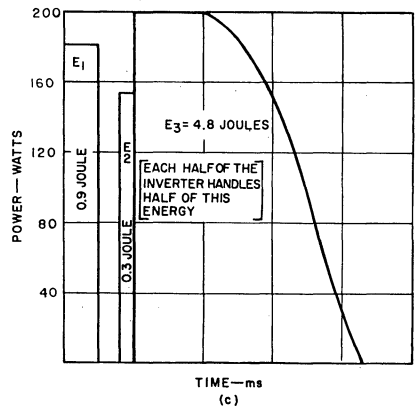
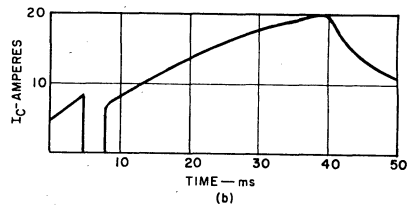
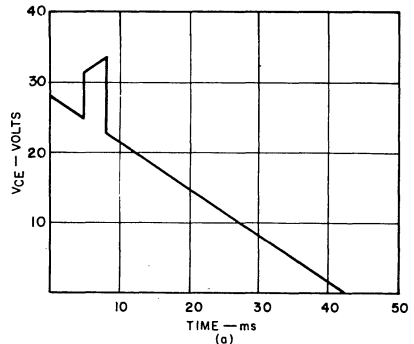


Fig.12 - Voltage, current, and power as functions of time for a single-transformer inverter with a capacitive load.

46 per cent. Fig.10 shows that this percentage corresponds to a maximum case temperature of 120°C. Therefore, the single-transformer inverter will start safely with a 400-microfarad filter capacitor at case temperatures up to 120°C.



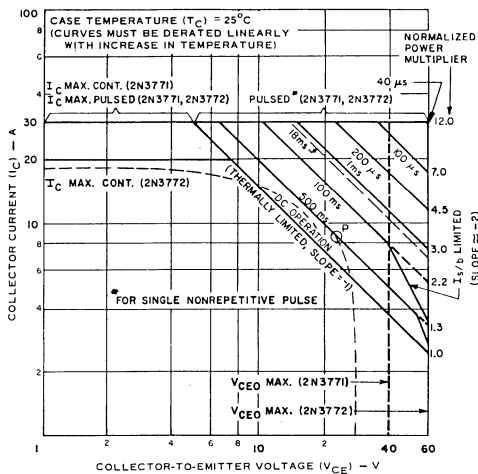


Fig. 13 - Capacitive load line for a single-transformer inverter plotted on a forward-bias safe-area curve.

For consideration of repetitive starting, the analysis must be modified in the same manner as that used for repetitive pulses in the case of resistive load lines. If the starting circuit for a self-excited inverter supplies too much starting current, the safe-area curve will be exceeded, as illustrated in Fig. 14. In the driven inverter, the availability of full drive at all times presents a problem. The circuit used to obtain the curve shown in Fig. 11(f) operates outside the safe area and requires some adjustment in drive or substitution of a transistor that has a higher rating to conform to safe-area requirements.

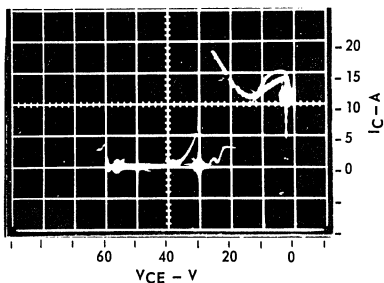


Fig. 14 - Waveform exhibited by a single-transformer inverter with excessive starting current.

**Inductive Load Lines**

Typical waveforms for a two-transformer inverter operating into a highly inductive load are shown in Fig. 15. These waveforms show no unusually high dissipation regions. Curves of  $V_{CE}$ ,  $V_{BE}$ , and  $I_B$  are essentially the same as for a resistive load, and only collector current  $I_C$  and load current  $I_L$  differ substantially. The most evident change in operation is the appearance of a reverse collector current when the transistor turns on. This phenomenon is described in detail below

for a single-transformer inverter; the description also applies to other types of inverters.

Fig. 16 illustrates steady-state operation in the bottom half of a single-transformer inverter at the instant before turn-on. As the upper transistor begins to turn off, the load current  $I_L$  tends to remain constant because of the inductance  $L$ . This constant current induces a voltage at  $N_1$  and  $N_2$  of a polarity that tends to keep  $I_2$  constant and to drive the square-loop output transformer back into the active region. As a result,  $I_2$  remains constant as the induced voltage across  $N_2$  increases toward the value of the supply voltage. The magnetic coupling between  $N_3$  and  $N_1$  and  $N_2$ , because of conservation of flux linkage, causes the sum of  $I_1$  and  $I_2$  to remain constant as long as  $I_L$  does not change.

When the induced voltage across  $N_2$  exceeds the supply voltage  $V_{CC}$ , the current  $I_2$  from the top loop may be commutated to the current  $I_1$  in the bottom loop. Because such commutation requires  $I_1$  to flow in a direction opposite to the normal flow of current, the effect of the resultant reverse voltage on  $Q_1$  must be determined. The equivalent circuit for this instant of time is shown in Fig. 17. If  $Q_1$  acts as a low impedance in this configuration,  $I_1$  is equal in magnitude to  $I_2$  at the previous instant, and flows in the direction shown.

For analysis of transistor performance under the reverse voltage imposed by  $I_1$ , it is convenient to use the diagram shown in Fig. 18(a). The terminals in this diagram are identified only by numbers to illustrate that the collector can act as an emitter under certain conditions. For example, Fig. 19 shows collector current  $I_C$  as a function of collector-to-emitter voltage  $V_{CE}$  for both positive and negative values of  $V_{CE}$ . For determination of bias conditions, the diode equivalent circuit of Fig. 18(a) is drawn as shown in Fig. 18(b). If  $D_1$  and  $D_2$  are considered to be ideal diodes (no forward drop and no leakage), it is evident that the diode current  $I_{D1}$  decreases to zero and diode  $D_1$  turns off as the collector current  $I_{C1}$  approaches the value of the base current  $I_B$ . If  $I_{C1}$  becomes greater than  $I_B$ , a reverse voltage builds up across  $D_1$ . The value of this reverse voltage  $V_{D1}(rev)$  is given by

$$V_{D1}(rev) = (I_{C1} - I_B) R_B \tag{4}$$

Under the bias condition shown, the transistor operates in an "inverse-beta" mode, i.e., the collector and emitter interchange roles. If sufficient inverse beta is available, a large  $I_{C1}$  can be carried with a very small voltage drop across the transistor. In effect, the transistor operates in saturation in an inverse-beta mode.

Because dissipation in the inverse-beta mode is very low, no unusual safe-area problem exists. However, if the transistor experiences insufficient inverse beta, it comes out of saturation and the effective collector voltage  $V_{BE}$  increases in direct proportion to the excess  $I_{C1}$  that must flow through  $R_B$ . Fig. 20 illustrates the effect of insufficient inverse beta with high load current. It can be seen that the value of  $V_{CE}$  must increase to approximately -8 volts.

A condition of insufficient inverse beta is usually intolerable from a safe-area viewpoint because it represents considerable power dissipation in the emitter-to-base junction. Because the emitter is not tied directly to a heat sink (as is the collector) and is usually not designed to handle high levels of power, such dissipation presents a reliability hazard. In addition, manufacturers do not usually control inverse-beta characteristics. The problem of insufficient inverse beta can be eliminated, however, by use of a diode clamp across the collector and emitter leads, as shown in Fig. 21. When such a clamp is used, any excess collector current that cannot be handled by the transistor is simply shunted by the diode.

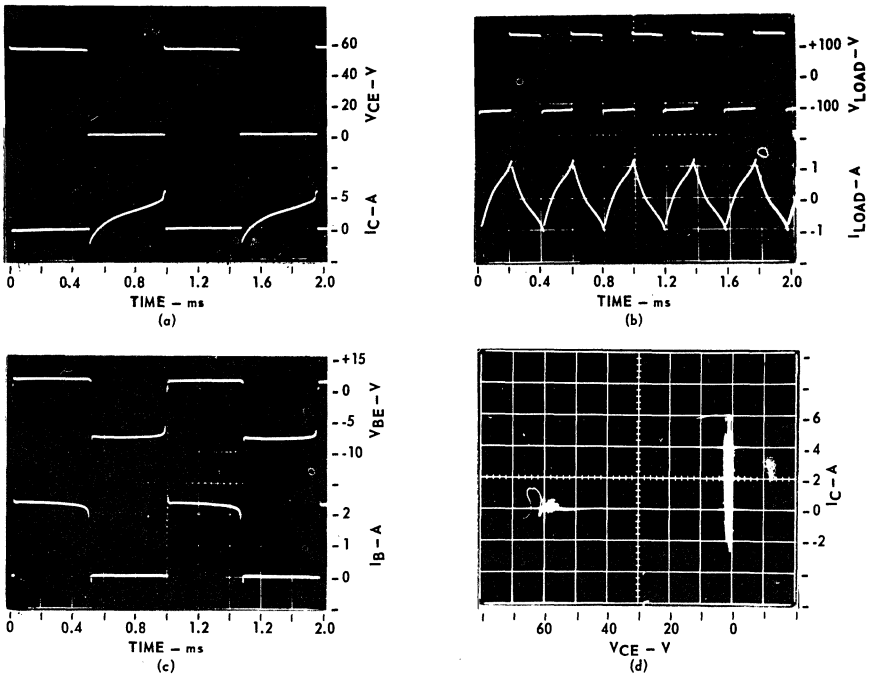


Fig.15 - Waveforms for a two-transformer inverter with a highly inductive load.

**Leakage Reactance Effects**

Fig.22 shows the equivalent circuit for one side of an inverter just before turn-off when there is leakage reactance  $L_1$  present. The leakage reactance supplies the difference between the induced voltage and the supply voltage  $V_{CC}$ , and keeps the collector current  $I_C$  flowing. As a result, the energy dissipated in  $Q_2$  can be much larger than the energy stored in

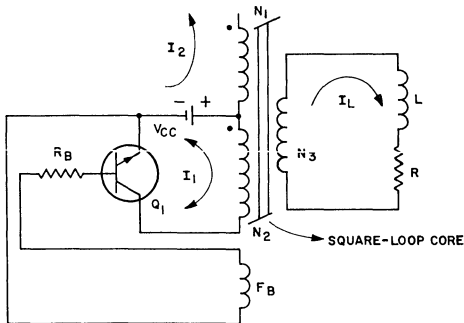


Fig.16 - A single-transformer inverter circuit with inductive load at the instant before turn-on.

the leakage reactance  $L_1$ .<sup>3</sup> (When  $Q_2$  switches off, the energy stored in the leakage reactance cannot be commutated and thus increases the switching energy dissipated in  $Q_2$ .) A conservative estimate of energy requirements can be obtained by calculation of an effective leakage reactance  $L_1(\text{eff})$ , which is then equated to the energy dissipated in  $Q_2$ .<sup>2</sup> However, if load lines are available, the energy requirement can be calculated graphically.

For this analysis, the single-transformer inverter was tested with an inductance of approximately 18 microhenries inserted in each collector lead to simulate leakage or other non-commutated inductance. The turn-off waveforms of VCF and IC as functions of time are shown in Fig.23; the charts

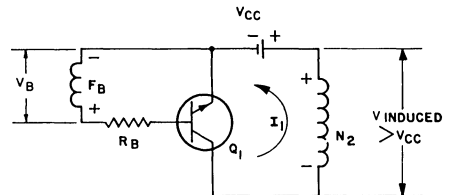


Fig.17 - The circuit of Fig.16 at the instant of commutation of  $I_2$  to  $I_1$ .

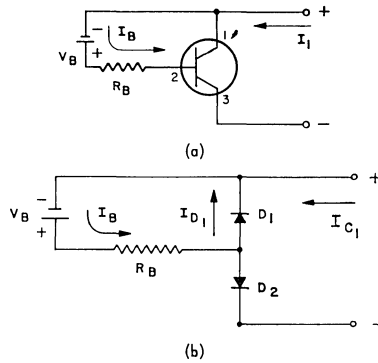


Fig.18 : Circuits used to analyse transistor performance under reverse-voltage conditions: (a) transistor with emitter and collector not designated; (b) diode equivalent circuit of (a).

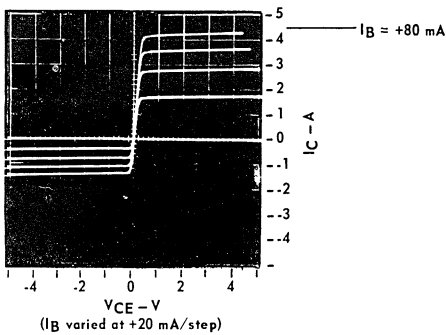


Fig.19 - Waveforms showing inverse-beta characteristics.

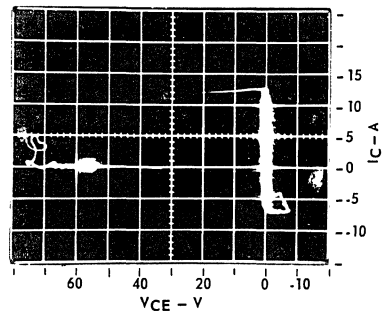


Fig.20 - Waveforms showing the effect of insufficient inverse-beta with high load current.

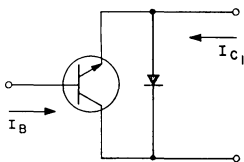


Fig.21 - Diode-clamp arrangement used to eliminate problems of insufficient inverse beta in a transistor.

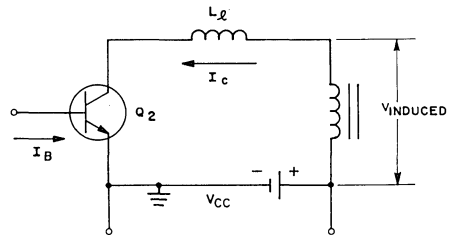


Fig.22 - Conditions in the ON side of an inverter just before turn-off with leakage reactance present.

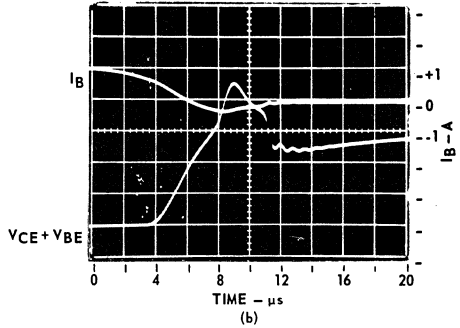
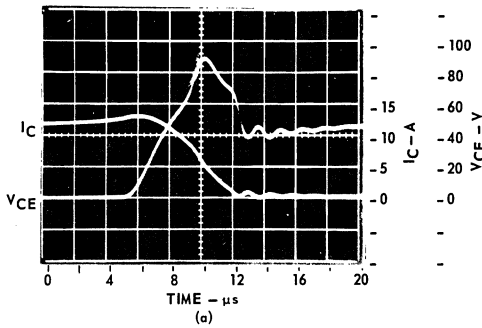


Fig.23 - Switching waveforms for an inverter circuit with leakage reactance.

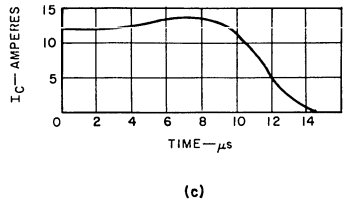
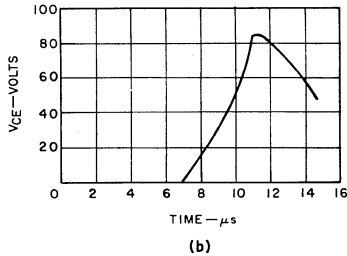
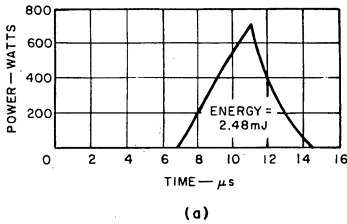


Fig.24 - Actual energy pulse calculated for an inverter circuit with leakage reactance.

used in the calculation of energy are shown in Fig.24. Because reverse base current flows for an appreciable part of the turn-off time, a reverse-bias energy capability is required. Fig.25 shows that the 2N3772 can accommodate a reverse-bias second-breakdown energy ( $ES/b$ ) of at least 180 millijoules ( $1/2LI^2$ ) with an RBE of 10 ohms and a  $V_{BE}$  of -7 volts. Although the actual value of RBE used in the test circuit was less than 10 ohms, Fig.25 shows little dependence of  $ES/b$  on  $R_B$  (for this type) and it can safely be assumed that the circuit under discussion is operating safely.

This preliminary calculation shows only that the transistors will not fail because of reverse-bias second breakdown. For determination of the maximum case temperature, the energy of 2.48 millijoules shown in Fig.24 is used to calculate an equivalent pulse, as in the case of resistive load line analysis. In other words, reverse-bias second breakdown  $ES/b$  is considered as a separate failure mechanism; if the

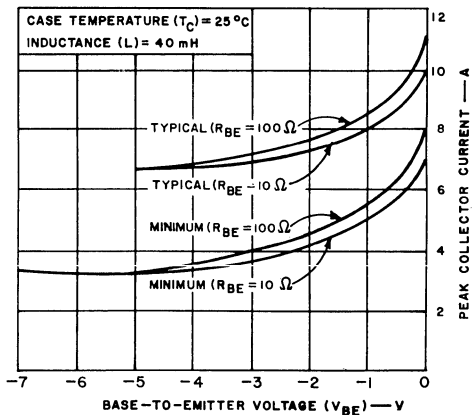


Fig.25 - Reverse-bias second-breakdown characteristic curves used in thermal analysis of a single-transformer inverter with leakage reactance present.

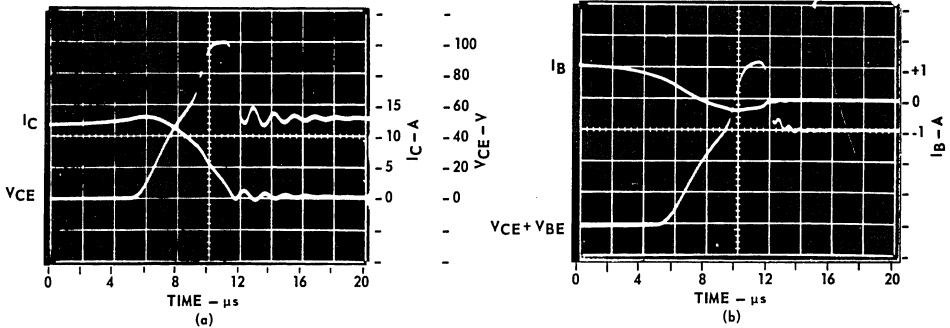


Fig. 26 - Waveforms showing the effect of unbalanced leakage reactance on load lines.

device operates safely from the standpoint of  $ES/b$ , it is still necessary to establish that it can operate safely from a thermal viewpoint. For thermal analysis, only the thermally limited lines and dashed-line extensions of the safe-area curve (Fig. 1 or Fig. 13) are used.

Fig. 26 shows the effect of unbalanced leakage reactance on load lines. The load lines shown were observed with 18 microhenries only on the side shown. Comparison of these load lines with the ones in Fig. 23 shows that those of Fig. 26 are more severe. The difference can be explained with reference to the diagram shown in Fig. 27. As described previously, the energy dissipated in  $Q_2$  depends on the induced voltage and the supply voltage  $V_{CC}$ . The presence of  $L_{L1}$ , however, reduces the induced voltage by  $V_{L1}$ , the voltage across  $L_{L1}$  when  $Q_1$  turns on and  $Q_2$  turns off. [This effect is illustrated in Fig. 23(a), where  $V_{CE}$  after the transient is lower than the normal value of induced voltage plus  $V_{CC}$ , which is typically close to  $2V_{CC}$ .] The effect of no  $L_{L1}$  is to increase the induced voltage and hence increase the dissipation of  $Q_2$ . As a result, the absolute values of  $L_{L1}$  and  $L_{L2}$  and the unbalance between them are important. Unbalanced inductance has a similar effect in two-transformer and driven inverters.

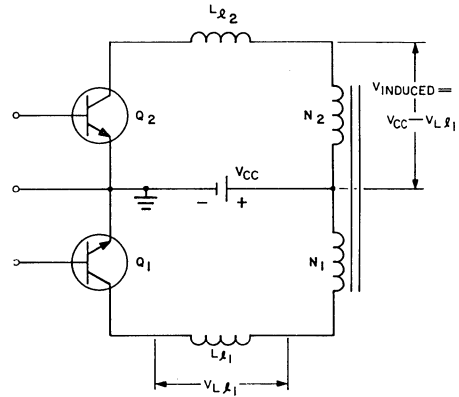


Fig. 27 - Circuit used to explain the effect of unbalanced leakage reactance.

#### REFERENCES

- Gutzwiller, F. W., and T. D. Sylvan, "Power Semiconductor Ratings Under Transient and Intermittent Loads", *Communications and Electronics*, January 1961.
- Turner, C. R., "Second-Breakdown and Safe-Area Ratings of Power Transistors", *EEE*, July 1967.
- Baugh, D. M. and L. H. Gibbons, Jr., "Energy Considerations for Devices Switching Inductive Loads", *EEE*, (To be published).
- "Converter and Inverter Design", Magnetics, Inc., Butler, Penna., Form 109-62.
- RCA Silicon Power Circuits Manual*, Technical Series SP-50, Radio Corporation of America, 1967.
- "Design Manual Featuring Tape Wound Cores", Magnetics, Inc., Butler, Penna., TWC-300.
- Schiff, P., "Second Breakdown in Transistors Under Conditions of Cutoff", RCA Application Note, SMA-30.

#### Acknowledgment

The author thanks P. J. Schneider for construction of the inverter circuits used in the analysis described.

# Subject Index

	Page Nos.		Page Nos.
<b>A</b>		<b>Darlington transistors: (Continued)</b>	
Accurate measurement of sustaining voltage of power transistors—a pulsed-breakdown test set (AN-6281)	840	Characteristics (AN-6272)	835
Calibration and set-up of test set (AN-6281)	844	Physical design (AN-6272)	834
Curve-tracer test method (AN-6281)	841	Switching regulator using (AN-6195)	815
Inductive-sweep test method (AN-6281)	840	Technical data (File Nos. 609, 610, 835)	350, 356, 627
Pulsed-breakdown test set (AN-6281)	841	Deflection circuit, magnetic (AN-3065)	740
Alpha, total (AN-6215)	824	<b>E</b>	
Amplifiers, audio, circuits (File Nos. 642-650 and 791)	489-507 515-532	Economics, amplifier (AN-3065)	741
Audio-frequency linear amplifiers, transistors for (selection charts)	24, 25	Epitaxial-base power transistors (selection charts)	16-18
Audio amplifier, line-operated (AN-3065)	735	<b>F</b>	
Audio power transistors, special (selection charts)	24, 25	Forward-bias second breakdown, testing for (AN-4573)	776
Avalanche breakdown (AN-6215)	823	Forward-bias safe-area rating system (AN-6330)	856
Common-base (AN-6215)	823	Frequency converter, three-phase, 750-watt (AN-4673)	785
Common-emitter (AN-6215)	824	Circuit description (AN-4673)	785
Avalanche multiplication (AN-6215)	824	Inverter (AN-4673)	785
<b>B</b>		Logic and driver circuits (AN-4673)	785
Biasing circuit for output stage of power amplifier—the $V_{BE}$ multiplier (AN-6297)	846	Output transformer (AN-4673)	787
Bridge rectifier (AN-4673)	785	Performance (AN-4673)	789
<b>C</b>		Power supply for (AN-4673)	785
Characteristics of RCA monolithic power Darlington (AN-6272)	834	<b>H</b>	
Applications (AN-6272)	839	High-current transistors (technical data, File No. 359, 462, 525, 526, 698)	231, 271, 135, 143, 174
Electrical characteristics (AN-6272)	835	High-speed switching power transistors (selection charts)	22-23
Physical design (AN-6272)	834	High-voltage application of silicon transistors (AN-3065, AN-3565)	735, 745
Chips, transistor (technical data, File No. 632)	698	High-voltage power transistors (selection charts)	19-21
Common-base avalanche breakdown (AN-6215)	823	Hometaxial-base power transistors (selection charts)	12-15
Common-emitter avalanche breakdown (AN-6215)	824	Hybrid circuit operational amplifiers (technical data, File Nos. 566, 681)	704, 709
Current limiting, foldback (AN-4558)	766	<b>I</b>	
Curve-tracer test method for measuring sustaining voltage (AN-6281)	841	Inductive-sweep test method for measuring sustaining voltage (AN-6281)	840
<b>D</b>		Inverters (AN-3065, AN-3565, AN-6330)	738, 745, 857
Darlington transistors (selection chart)	11	Safe-area rating system for (AN-6330)	856
Darlington transistors:		Three-phase bridge types (AN-4673)	785
Applications (AN-6272)	834	100-Watt, 18-kHz (AN-3565)	745
Audio amplifier using (circuit) (File No. 791)	507		

# Subject Index

	Page Nos.		Page Nos.
<b>L</b>		Power Darlingtons, monolithic:	
Lead-forming techniques (1CE-402)	731	Characteristics of (AN-6272)	834
Line-operated audio amplifier (AN-3065)	742	Selection chart	11
		Switching regulator using (AN-6195)	815
		Used as output devices in audio amplifier (circuit) (File No. 791)	507
<b>M</b>		Power hybrid circuits (technical data, File Nos. 566, 681)	704, 709
Magnetic deflection circuit (AN-3065)	740	Power supplies, compact, high-current, 5-volt, regulated (AN-4509)	756
Measurement of sustaining voltage of power transistors (AN-6281)	840	Basic design concept (AN-4509)	756
Pulsed-breakdown test set (AN-6281)	841	Design example (AN-4509)	762
Measurement of thermal-cycling capability (AN-6163)	805	Major elements (AN-4509)	756
Medium-power p-n-p transistors (technical data, File No. 216, 325, 507, 562)	162, 214, 318, 310	Transistors for (File No. 498)	439
Medium-power transistors, Hometaxial II types (technical data, File Nos. 527, 529)	85, 109	Power supplies using high-voltage power transistors (AN-4509)	756
Monolithic power Darlingtons:		Power supply, bridge rectifier (AN-4673)	785
Characteristics of (AN-6272)	834	Power supply, regulated, 60-watt, 20-volt (AN-4558)	764
Selection chart	11	Circuit description (AN-4558)	764
Mounting of transistors:		Construction (AN-4558)	771
General, all types (1CE-402)	732	Design considerations (AN-4558)	767
Plastic-package types (AN-4124)	748	Foldback current limiting (AN-4558)	766
		Performance (AN-4558)	770
		Voltage regulation (AN-4558)	766
		Power-transistor chips (technical data, File No. 632)	698
<b>N</b>		Power transistors, selection charts:	
Neutron-damage coefficient, derivation of (AN-6320)	855	Epitaxial-base types	16-18
Neutron testing for radiation tolerance (AN-6320)	849	High-speed switching types	22-23
Nondestructive safe-area measurements (AN-6145)	797	High-voltage types	19-21
		Hometaxial-base types	12-15
		Monolithic Darlington types	11
		Types for audio-frequency linear amplifiers	24-25
		Power transistors, thermal-cycling ratings for (AN-4612, AN-4783, AN-6163, AN-6249)	782, 790, 805, 829
<b>O</b>		Power transistors, thermal-cycling requirements (AN-4612, AN-4783)	782, 790
Off-line power supplies (AN-4509)	756	Pulsed-breakdown test set for measurement of sustaining voltages (AN-6281)	841
Operational amplifier (AN-3065)	744		
<b>P</b>		<b>R</b>	
Photocurrent testing for radiation tolerance (AN-6320)	853	Radiation, effect on power transistors:	
Plastic-package transistors:		Displacement damage (AN-6320)	848
Lead-forming techniques (AN-4124)	750	Photocurrents (AN-6320)	853
Mounting (AN-4124)	748	Radiation-hardened silicon n-p-n transistors (technical data, File No. 702)	372
Thermal-resistance considerations (AN-4124)	752	Radiation-hardness capability of silicon power transistors (AN-6320)	848
Types of packages (AN-4124)	748		

# Subject Index

	Page Nos.		Page Nos.
Real-time controls of silicon power-transistor reliability (AN-6249)	829	Test set for safe-area measurements (AN-6145)	797
Reverse-bias safe-area rating system (AN-6330)	857	Construction (AN-6145)	801
		Controls and connections (AN-6145)	801
		Operation (AN-6145)	801
		Schematic diagram (AN-6145)	798
		System design (AN-6145)	798
		System philosophy (AN-6145)	797
<b>S</b>		Thermal-cycling rating system (AN-4612, AN-4783, AN-6163, AN-6249)	782, 790, 805, 831
Safe-area measurements, test set for:		Rating chart (AN-4783)	791
Construction (AN-6145)	801	Test program (AN-4783)	790
Controls and connections (AN-6145)	801	Thermal-cycling rating system (AN-4612)	782
Operation (AN-6145)	801	Analysis of thermal fatigue in power transistors (AN-4612)	782
Schematic diagram (AN-6145)	799	Thermal-cycling rating chart (AN-4612)	782
System design (AN-6145)	798	Thermal cycling, real-time control program (AN-6249)	829
System philosophy (AN-6145)	797	Thermal fatigue, power transistor, analysis of (AN-4612)	782
Safe-area rating system for power inverters handling capacitive and inductive loads: (AN-6330)	856	Transistor power supplies, compact, 5-volt (AN-4509)	756
Forward-bias rating system (AN-6330)	856	Basic concept (AN-4509)	756
Inverters, types of (AN-6330)	857	Circuit elements (AN-4509)	756
Reverse-bias rating system (AN-6330)	857	Design example (AN-4509)	762
Second breakdown, forward-bias:		Transistor, high-voltage, medium-power, silicon n-p-n (technical data, File Nos. 353, 432, 508, 527, 529, 680)	225, 80, 304, 85, 109, 366
Causes of (AN-4573)	776	Transistors, high-current (technical data, File Nos. 359, 525, 526, 698)	231, 135, 143, 174
Test facility for (AN-4573)	777	Transistors, high-voltage, high-power silicon n-p-n (technical data, File Nos. 410, 492, 509, 510, 511, 512, 513, 523)	258, 281, 587, 592, 597, 602, 607, 332
Test circuits (AN-4573)	777	Transistors, high-power, silicon n-p-n types (technical data, File Nos. 524, 525, 607, 677)	92, 135, 345, 323
Transistor characterization for (AN-4573)	778	Transistors, medium-power, silicon n-p-n types (technical data, File Nos. 527, 529)	85, 109
Silicon transistors for high-voltage applications (AN-3065)	735	Transistors, voltage ratings, interpretation of (AN-6215)	823
Silicon transistors, high-current, n-p-n, homotaxial II (technical data, File Nos. 525, 526)	135, 143	<b>V</b>	
Silicon transistors, high-power, n-p-n, homotaxial II (technical data, File Nos. 524, 607)	92, 345	$V_{BE}$ multiplier, biasing circuit for output stage of a power amplifier (AN-6297)	846
Silicon transistors, high-voltage, n-p-n, homotaxial II (technical data, File No. 528)	116	VERSAWATT transistors, Darlington (technical data, File Nos. 610, 835)	356, 627
Silicon transistors, medium-power (technical data, File Nos. 106, 353, 508, 527, 529, 680)	85, 109, 366	VERSAWATT transistors, epitaxial-base, silicon (technical data, File Nos. 676, 678)	293, 379
Sustaining voltage test methods (AN-6281)	840	VERSAWATT transistors, high-current, silicon n-p-n (technical data, File No. 485)	287
Switching regulator (AN-3065, AN-6195)	737, 815		
Switching-regulator ballasts (AN-3065)	740		
Switching regulator using RCA p-n-p power Darlington transistors (AN-6195)	815		
Circuit concept (AN-6195)	815		
Performance (AN-6195)	819		
Switching transistors (selection charts)	22-23		
<b>T</b>			
Testing for forward-bias second breakdown (AN-4573)	776		



# Subject Index

	Page Nos.		Page Nos.
VERSAWATT transistors, homotaxial-base silicon n-p-n (technical data, File Nos. 322, 353, 485, 680, 792, 793, 794)	207, 225, 287, 366, 546, 556, 570	Voltage ratings for transistors, interpretation of (AN-6215) (Continued)	
VERSAWATT transistors, handling and mounting (AN-4124)	748	Common-base avalanche breakdown (AN-6215)	823
VERSAWATT transistors, silicon, p-n-p (technical data, File Nos. 676, 678)	293, 379	Common-emitter avalanche breakdown (AN-6215)	826
Voltage breakdown, transistor (AN-6215)	823	Effect of circuit conditions (AN-6215)	826
Voltage ratings for transistors, interpretation of (AN-6215)	823	Total alpha (AN-6215)	824
Avalanche multiplication (AN-6215)	824	Transistor operating regions (AN-6215)	827
		Voltage regulation (AN-4558)	764
		Voltage regulator, series type (AN-3065)	735



