

ONKYO®

Super Audio CD & DVD Audio/Video Player

DV-SP504/ DV-SP504E

Instruction Manual

Thank you for purchasing the Onkyo DV-SP504/
DV-SP504E Super Audio CD & DVD Audio/
Video player. Read this manual carefully before
using your new DVD player. A good understand-
ing of its features and operation will allow you to
achieve optimum performance and enjoyment.

Keep this manual for future reference.

Contents

Overview2

Connections18

Getting Started and Setting up27

Basic Playback28

Playback Techniques34

Detailed Settings43

Miscellaneous information55



WARNING:

TO REDUCE THE RISK OF FIRE OR ELECTRIC SHOCK, DO NOT EXPOSE THIS APPARATUS TO RAIN OR MOISTURE.

CAUTION:

TO REDUCE THE RISK OF ELECTRIC SHOCK, DO NOT REMOVE COVER (OR BACK). NO USER-SERVICEABLE PARTS INSIDE. REFER SERVICING TO QUALIFIED SERVICE PERSONNEL.



WARNING
RISK OF ELECTRIC SHOCK
DO NOT OPEN

AVIS
RISQUE DE CHOC ELECTRIQUE
NE PAS OUVRIR



The lightning flash with arrowhead symbol, within an equilateral triangle, is intended to alert the user to the presence of uninsulated “dangerous voltage” within the product’s enclosure that may be of sufficient magnitude to constitute a risk of electric shock to persons.



The exclamation point within an equilateral triangle is intended to alert the user to the presence of important operating and maintenance (servicing) instructions in the literature accompanying the appliance.

Important Safety Instructions

1. Read these instructions.
2. Keep these instructions.
3. Heed all warnings.
4. Follow all instructions.
5. Do not use this apparatus near water.
6. Clean only with dry cloth.
7. Do not block any ventilation openings. Install in accordance with the manufacturer’s instructions.
8. Do not install near any heat sources such as radiators, heat registers, stoves, or other apparatus (including amplifiers) that produce heat.
9. Do not defeat the safety purpose of the polarized or grounding-type plug. A polarized plug has two blades with one wider than the other. A grounding type plug has two blades and a third grounding prong. The wide blade or the third prong are provided for your safety. If the provided plug does not fit into your outlet, consult an electrician for replacement of the obsolete outlet.
10. Protect the power cord from being walked on or pinched particularly at plugs, convenience receptacles, and the point where they exit from the apparatus.
11. Only use attachments/accessories specified by the manufacturer.
12. Use only with the cart, stand, tripod, bracket, or table specified by the manufacturer, or sold with the apparatus. When a cart is used, use caution when moving the cart/apparatus combination to avoid injury from tip-over.

PORTABLE CART WARNING
S3125A
13. Unplug this apparatus during lightning storms or when unused for long periods of time.
14. Refer all servicing to qualified service personnel. Servicing is required when the apparatus has been damaged in any way, such as power-supply cord or plug is damaged, liquid has been spilled or objects have fallen into the apparatus, the apparatus has been exposed to rain or moisture, does not operate normally, or has been dropped.
15. Damage Requiring Service
Unplug the apparatus from the wall outlet and refer servicing to qualified service personnel under the following conditions:
 - A. When the power-supply cord or plug is damaged,
 - B. If liquid has been spilled, or objects have fallen into the apparatus,
 - C. If the apparatus has been exposed to rain or water,
 - D. If the apparatus does not operate normally by following the operating instructions. Adjust only those controls that are covered by the operating instructions as an improper adjustment of other controls may result in damage and will often require extensive work by a qualified technician to restore the apparatus to its normal operation,
 - E. If the apparatus has been dropped or damaged in any way, and
 - F. When the apparatus exhibits a distinct change in performance this indicates a need for service.
16. Object and Liquid Entry
Never push objects of any kind into the apparatus through openings as they may touch dangerous voltage points or short-out parts that could result in a fire or electric shock.
The apparatus shall not be exposed to dripping or splashing and no objects filled with liquids, such as vases shall be placed on the apparatus.
Don’t put candles or other burning objects on top of this unit.
17. Batteries
Always consider the environmental issues and follow local regulations when disposing of batteries.
18. If you install the apparatus in a built-in installation, such as a bookcase or rack, ensure that there is adequate ventilation.
Leave 20 cm (8") of free space at the top and sides and 10 cm (4") at the rear. The rear edge of the shelf or board above the apparatus shall be set 10 cm (4") away from the rear panel or wall, creating a flue-like gap for warm air to escape.

Precautions

1. **Recording Copyright**—Unless it's for personal use only, recording copyrighted material is illegal without the permission of the copyright holder.
2. **AC Fuse**—The AC fuse inside the unit is not user-serviceable. If you cannot turn on the unit, contact your Onkyo dealer.
3. **Care**—Occasionally you should dust the unit all over with a soft cloth. For stubborn stains, use a soft cloth dampened with a weak solution of mild detergent and water. Dry the unit immediately afterwards with a clean cloth. Don't use abrasive cloths, thinners, alcohol, or other chemical solvents, because they may damage the finish or remove the panel lettering.

4. Power

WARNING

BEFORE PLUGGING IN THE UNIT FOR THE FIRST TIME, READ THE FOLLOWING SECTION CAREFULLY.

AC outlet voltages vary from country to country. Make sure that the voltage in your area meets the voltage requirements printed on the unit's rear panel (e.g., AC 230 V, 50 Hz or AC 120 V, 60 Hz).

The power cord plug is used to disconnect this unit from the AC power source. Make sure that the plug is readily operable (easily accessible) at all times.

Pressing the [STANDBY/ON] button to select Standby mode does not fully shutdown the unit. If you do not intend to use the unit for an extended period, remove the power cord from the AC outlet.

5. **Never Touch this Unit with Wet Hands**—Never handle this unit or its power cord while your hands are wet or damp. If water or any other liquid gets inside this unit, have it checked by your Onkyo dealer.
6. **Handling Notes**
 - If you need to transport this unit, use the original packaging to pack it how it was when you originally bought it.
 - Do not leave rubber or plastic items on this unit for a long time, because they may leave marks on the case.
 - This unit's top and rear panels may get warm after prolonged use. This is normal.
 - If you do not use this unit for a long time, it may not work properly the next time you turn it on, so be sure to use it occasionally.
 - When you've finished using this unit, remove all discs and turn off the power.
7. **Installing this Unit**
 - Install this unit in a well-ventilated location.
 - Ensure that there's adequate ventilation all around this unit, especially if it's installed in an audio rack. If the ventilation is inadequate, the unit may overheat, leading to malfunction.

- Do not expose this unit to direct sunlight or heat sources, because its internal temperature may rise, shortening the life of the optical pickup.
 - Avoid damp and dusty places, and places subject to vibrations from loudspeakers. Never put the unit on top of, or directly above a loudspeaker.
 - Install this unit horizontally. Never use it on its side or on a sloping surface, because it may cause a malfunction.
 - If you install this unit near a TV, radio, or VCR, the picture and sound quality may be affected. If this occurs, move this unit away from the TV, radio, or VCR.
8. **To Obtain a Clear Picture**—This unit is a high-tech, precision device. If the lens on the optical pickup, or the disc drive mechanism becomes dirty or worn, the picture quality may be affected. To maintain the best picture quality, we recommend regular inspection and maintenance (cleaning or worn part replacement) every 1,000 hours of use depending on the operating environment. Contact your Onkyo dealer for details.

9. Moisture Condensation

Moisture condensation may damage this unit.



Read the following carefully:

Moisture may condense on the lens of the optical pickup, one of the most important parts inside this unit.

- Moisture condensation can occur in the following situations:
 - The unit is moved from a cold place to a warm place.
 - A heater is turned on, or cold air from an air conditioner is hitting the unit.
 - In the summer, when this unit is moved from an air conditioned room to a hot and humid place.
 - The unit is used in a humid place.
- Do not use this unit when there's the possibility of moisture condensation occurring. Doing so may damage your discs and certain parts inside this unit.

If condensation does occur, remove all discs and leave this unit turned on for two to three hours. By this time, the unit will have warmed up and any condensation will have evaporated.

Precautions—Continued

10. Region Numbers—The DVD standard uses region numbers to control how discs can be played around the world, the world being divided into six regions. This unit will only play DVD discs that match its region number, which can be found on its rear panel (e.g., , , ).

11. About this Manual—This manual explains how to use all of this unit's functions. Although the DVD standard offers many special features, not all discs use them all, so depending on the disc being played, this unit may not respond to certain functions. See the disc's sleeve notes for supported features.

This unit contains a semiconductor laser system and is classified as a "CLASS 1 LASER PRODUCT". So, to use this model properly, read this Instruction Manual carefully. In case of any trouble, please contact the store where you purchased the unit.

To prevent being exposed to the laser beam, do not try to open the enclosure.

CAUTION:

CLASS 1M VISIBLE AND INVISIBLE LASER RADIATION WHEN OPEN. DO NOT VIEW DIRECTLY WITH OPTICAL INSTRUMENTS. THIS PRODUCT UTILIZES A LASER. USE OF CONTROLS OR ADJUSTMENTS OR PERFORMANCE OF PROCEDURES OTHER THAN THOSE SPECIFIED HEREIN MAY RESULT IN HAZARDOUS RADIATION EXPOSURE.

The label on the right is applied on the rear panel.



1. This unit is a CLASS 1 LASER PRODUCT and employs a laser inside the cabinet.
2. To prevent the laser from being exposed, do not remove the cover. Refer servicing to qualified personnel.

For U.S. models

FCC Information for User

CAUTION:

The user changes or modifications not expressly approved by the party responsible for compliance could void the user's authority to operate the equipment.

NOTE:

This equipment has been tested and found to comply with the limits for a Class B digital device, pursuant to Part 15 of the FCC Rules. These limits are designed to provide reasonable protection against harmful interference in a residential installation.

This equipment generates, uses and can radiate radio frequency energy and, if not installed and used in accordance with the instructions, may cause harmful interference to radio communications. However, there is no guarantee that interference will not occur in a particular installation. If this equipment does cause harmful interference to radio or television reception, which can be determined by turning the equipment off and on, the user is encouraged to try to correct the interference by one or more of the following measures:

- Reorient or relocate the receiving antenna.
- Increase the separation between the equipment and receiver.
- Connect the equipment into an outlet on a circuit different from that to which the receiver is connected.
- Consult the dealer or an experienced radio/TV technician for help.

For European Models

Declaration of Conformity

We, ONKYO EUROPE ELECTRONICS GmbH
LIEGNITZERSTRASSE 6,
82194 GROEBENZELL,
GERMANY



declare in own responsibility, that the ONKYO product described in this instruction manual is in compliance with the corresponding technical standards such as EN60065, EN55013, EN55020 and EN61000-3-2, -3-3.

GROEBENZELL, GERMANY



K. MIYAGI

ONKYO EUROPE ELECTRONICS GmbH

Precautions—Continued

For Canadian Models

NOTE: THIS CLASS B DIGITAL APPARATUS COMPLIES WITH CANADIAN ICES-003.

For models having a power cord with a polarized plug:

CAUTION: TO PREVENT ELECTRIC SHOCK, MATCH WIDE BLADE OF PLUG TO WIDE SLOT, FULLY INSERT.

Modèle pour les Canadien

REMARQUE: CET APPAREIL NUMÉRIQUE DE LA CLASSE B EST CONFORME À LA NORME NMB-003 DU CANADA.

Sur les modèles dont la fiche est polarisée:

ATTENTION: POUR ÉVITER LES CHOCS ÉLECTRIQUES, INTRODUIRE LA LAME LA PLUS LARGE DE LA FICHE DANS LA BORNE CORRESPONDANTE DE LA PRISE ET POUSSER JUSQU'AU FOND.

For British models

Replacement and mounting of an AC plug on the power supply cord of this unit should be performed only by qualified service personnel.

IMPORTANT

The wires in the mains lead are coloured in accordance with the following code:

Blue: Neutral

Brown: Live

As the colours of the wires in the mains lead of this apparatus may not correspond with the coloured markings identifying the terminals in your plug, proceed as follows:

The wire which is coloured blue must be connected to the terminal which is marked with the letter N or coloured black.

The wire which is coloured brown must be connected to the terminal which is marked with the letter L or coloured red.

IMPORTANT

The plug is fitted with an appropriate fuse. If the fuse needs to be replaced, the replacement fuse must be approved by ASTA or BSI to BS1362 and have the same ampere rating as that indicated on the plug. Check for the ASTA mark or the BSI mark on the body of the fuse. If the power cord's plug is not suitable for your socket outlets, cut it off and fit a suitable plug. Fit a suitable fuse in the plug.

Supplied Accessories

Make sure you have the following accessories:

RC-657DV

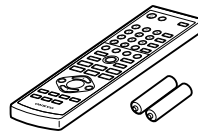

Remote controller & 2 batteries (AA/R6)

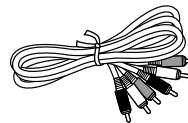

AV cable (RCA) (1.5 m)

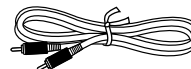

Coaxial cable (1.0 m)

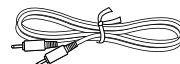

RI cable (0.8 m)

This cable is used to connect the DVD player to other **RI**-compatible Onkyo components for **RI** (Remote Interactive) control.

To use **RI**, in addition to an **RI** connection, you must make an analog audio connection (RCA) between the DVD player and your Onkyo AV receiver.

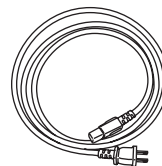

Power cord (1.8 m, 2 m for Australian model)

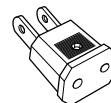

Power-plug adapter

Only supplied in certain countries. Use this adapter if your AC outlet does not match with the plug on the DVD player's power cord. (Adapter varies from country to country.)

Introduction

Features

Highlights

- **Dolby^{*1} Digital, DTS^{*2}**
- **DVD-Video, Video CD, audio CD**
- **MP3, WMA,^{*3} JPEG, DivX^{®*4} (not North American model)**
- **DVD-Audio and Super Audio CD**
- **CD-R/RW, DVD-R/RW, and DVD+R/RW compatible**
- **HDMI^{*5} digital interface**
- **5.1-channel analog audio output**

Video

- Advanced 108 MHz/14-bit video D/A converter
- Component, S-Video, and composite video outputs
- Repeat/A-B Repeat/Random/Memory playback
- Supports 4:3 and 16:9 aspect ratio TVs
- Parental Lock function
- Screen Saver function

Audio

- 192 kHz/24-bit D/A converter
- Optical / Coaxial digital output
- VLSC^{*6} (Vector Linear Shaping Circuitry) on all channels
- Dynamic Range Control setting

Others

- Adjustable display brightness
- Full-function remote controller

*1 Manufactured under license from Dolby Laboratories. “Dolby”, “Pro Logic” and the double-D symbol are trademarks of Dolby Laboratories.

*2 “DTS” and “DTS Digital Surround” are registered trademarks of Digital Theater Systems, Inc.

*3 Windows Media, and the Windows logo are trademarks, or registered trademarks of Microsoft Corporation in the United States and/or other countries.



*4 DivX, DivX Certified, and associated logos are trademarks of DivX, Inc. and are used under license.



*5 HDMI, the HDMI logo and High-Definition Multimedia Interface are trademarks or registered trademarks of HDMI licensing LLC.

*6 VLSC and the VLSC logo are registered trademarks of Onkyo Corporation.

Contents

Basic Operation

Overview

Important Safety Instructions	2
Precautions	3
Supplied Accessories	5
Introduction	6
Features	6
Disc Notes	8
Before Using the DVD player	11
Installing the Batteries	11
Using the Remote Controller	11
Front & Rear Panels	12
Front Panel	12
Display	13
Rear Panel	14
Remote Controller	16

Connections

Connecting the DVD player	18
AV Cables & Connectors	18
Video Output/Video Setting Matrix	19
Audio Output/Audio Setting Matrix	19
Before Making Any Connections	20
Basic Setup	20
Connecting Your TV (video connection)	21
Connecting to an AV Receiver	22
Connecting RI -compatible Components	23
Connecting your HDTV or AV receiver with an HDMI Input	24
Using the Multiroom Control Kits (North American model only)	25
Connecting the Power/Turning on the DVD player	26

Getting Started and Setting up

Initial Setup	27
First Time Setup	27

Basic Playback

Playing Discs	28
Starting, Pausing & Stopping Playback	28
Select Next & Previous track/chapter	29
Fast Forward & Reverse	30
Forward Frame-by-Frame Playback	30
Slow-motion Playback	30
Navigating DVD & VCD Disc Menus	31
Navigating CDs & Super Audio CDs	31
Navigating MP3, WMA, and DivX Discs	32
Viewing a Slideshow of JPEG Images	33

Advanced Operation

Playback Techniques

Advanced Playback	34
Selecting Chapters/Titles/Tracks/Folders by Number	34
Searching by Time	35
Repeat Playback	36
A-B Repeat Playback	36
Random Playback	37
Memory Playback	38
Last Memory	39
Zooming	40
Selecting Camera Angles	40
Selecting Soundtracks	41
Selecting Subtitles	41
Displaying Information	42

Detailed Settings

HDMI and Progressive Settings	43
Setting the HDMI	43
Selecting Progressive or Interlaced	43
Configuring the DVD player	44
Using the Onscreen Setup Menus	45
Picture Menu	46
Audio Menu	48
Language Menu	50
Display Menu	52
Operation Setting Menu	53

Miscellaneous information

Additional information	55
Resetting the player	55
Adjusting the Display Brightness	55
DVD-Video regions	55
Disc Content Organization	55
Glossary	56
Troubleshooting	58
Specifications	62

Disc Notes

Supported Discs

The DVD player supports the following discs.

Disc	Logo	Format or file type
DVD-Video		*1
DVD-Audio		DVD-Audio
Super Audio CD		Super Audio CD (single layer, dual layer, hybrid)
DVD-R*2		DVD-Video, MP3, WMA, JPEG
DVD-RW*2		DVD-Video, VR format*3, MP3, WMA, JPEG
Video CD		Including PBC
Audio CD*4		PCM
CD-R*2		Audio CD, MP3, WMA, JPEG, DivX
CD-RW*2		Audio CD, MP3, WMA, JPEG
JPEG CD		JPEG

– DVD+R/RW –

The DVD player supports DVD+R/RW discs recorded in the following formats:

- Discs recorded in DVD-Video mode.
- Discs recorded in ISO 9660 Level 2 or Joliet format containing MP3, WMA, or JPEG files.

*1 The DVD player's region number is printed on the rear panel. If you attempt to play a disc intended for another region, the message appears onscreen.

*2 MP3, WMA, and JPEG files are supported on discs recorded in ISO 9660 Level 2 or Joliet format. (See "MP3/WMA/JPEG Compatibility" on page 9 for more details.) However, some CD-R, CD-RW, DVD-R, and DVD-RW discs may not work properly for any of the following reasons: incomplete disc finalization, disc burner characteristics, disc characteristics, the disc is damaged or dirty, the disc contains only a small amount of data. Discs that contain different types of files, JPEG, MP3, WMA, DivX, and so on, are not supported. See the manual supplied with your disc burner for more information. Condensation or dirt on the optical pickup lens can also affect playback.

*3 The DVD player does not support DVD-VR discs that use CPRM (Content Protection for Recordable Media).

*4 Some audio CDs feature copy protection that doesn't conform to the official CD standard. Since these are nonstandard discs, they may not play properly in the DVD player.

- The DVD player does not support disc types not listed.
- The DVD player supports 8 cm and 12 cm discs.
- Don't use discs with an unusual shape, such as those shown below, because you may damage the DVD player.











- Don't use discs that have residue from adhesive tape, rental discs with peeling labels, or discs with custom-made labels or stickers. Doing so may damage the DVD player and you may not be able to remove the disc properly.

About playing copy-controlled CDs

Some copy-controlled CDs may not conform to official CD standards. They are special discs and may not play on the DVD player.

Function Support

The following icons are used throughout this manual to indicate which functions can be used with the various disc formats and file types.

Icon	Disc format or file type
	DVD-Video
	DVD-Audio
	Super Audio CD
	Video CD
	Audio CD
	MP3 file
	WMA file
	JPEG file
	DivX® (not North American model)

About this Manual

This manual explains how to use all of the DVD player's functions. Although the DVD standard offers many special features, not all discs use them all, so depending on the disc being played, the DVD player may not respond to certain functions. See your disc's sleeve notes for supported features.

When you attempt to use a DVD feature that is not available, this logo may appear onscreen, indicating that the feature is not supported by the current disc or by the DVD player.



MP3/WMA/JPEG Compatibility

- The DVD player can play/display MP3, WMA, and JPEG files recorded on CD-R, CD-RW, DVD-R, DVD-RW, DVD+R and DVD+RW discs.
- Discs must be in ISO 9660 Level 2 or Joliet format (folders can be up to eight levels deep). Music files recorded on discs that use the HFS (hierarchical file system) cannot be played.
- Discs must be finalized.
- The DVD player can only recognize the first session on multisession discs.
- You can determine the order in which the DVD player plays/displays your MP3/WMA songs and JPEG pictures by prefixing file and folder names with a three-digit number. For example 001.Root, 002.Folder, and so on, and 001.Track.mp3, 002.Track.mp3, and so on.
- Only the first eight characters of folder and track names (excluding the filename extension) are displayed.
- The folder numbered “001” appears as “ROOT” in the Disc Navigator.
- The DVD player supports up to 255 folders and up to 255 files per folder.
- If you try to play an incompatible file, the message “This format cannot be played” appears on the display.

■ MP3

- MP3 files must be MPEG1 Audio Layer 3 format, 44.1 or 48 kHz, fixed bit-rate.
- MP3 files must have a “.mp3” or “.MP3” filename extension.
- Variable bit-rates (VBR) from 32 kbps to 320 kbps are supported. (Playing times may display incorrectly with VBR.)

■ WMA

- WMA files must have the copyright option turned off.
- Sampling rates 44.1/48 kHz are supported.
- Variable bit-rates (VBR) from 48 kbps to 192 kbps (44.1 kHz) and 128 kbps to 192 kbps (48 kHz) are supported. (Playing times may display incorrectly with VBR.)
- WMA files must have a “.wma” or “.WMA” filename extension.

■ JPEG

- JPEG files must have a “.jpg” or “.JPG” filename extension.
- JPEG files must be less than 5 megabytes in size.
- JPEG files up to 5,700 x 3,800 pixels are supported.

About WMA

WMA is an acronym for Windows Media Audio and refers to an audio compression technology developed by Microsoft Corporation. WMA content can be encoded by using Windows Media® Player version 7/7.1 or 8.

About DivX

DivX is a compressed digital video format created by the DivX® video codec from DivXNetworks, Inc. This player can play DivX video files burned on CD-R discs. When naming files on a disc prior to burning, keep in mind that by default they will be played in alphabetical order.

Note:

- North American models do not support DivX Video.

DivX video compatibility



- Official DivX® Certified product.
- Plays DivX® 5, DivX® 4, DivX® 3 and DivX® VOD video content (in compliance with DivX® Certified technical requirements).

DivX® disc compatibility with this player is limited as follows:

Playable discs	CD-R CD-RW not recommended
File system	ISO9660 Level 1, 2, or Joliet
File name	A file name should be in alphabet and numerals only, and must incorporate “AVI” extension. e.g. “*****.AVI”
Total number of folders	Less than 255
Total number of files	Less than 255

Handling Discs

- Never touch the underside of a disc. Always hold discs by the edge, as shown.

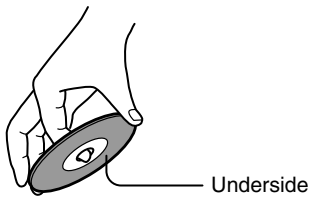

- Never attach adhesive tape or sticky labels to discs.



Cleaning Discs

- For best results, keep your discs clean. Fingerprints and dust can affect the sound and picture quality and should be removed as follows. Using a clean soft cloth, wipe from the center outwards, as shown. Never wipe in a circular direction.



- To remove stubborn dust or dirt, wipe the disc with a damp soft cloth, and then dry it with a dry cloth.
- Never use solvent-based cleaning fluids, such as thinner or benzine, commercially available cleaners, or antistatic sprays intended for vinyl records, because they may damage the disc.

Storing Discs

- Don't store discs in places subject to direct sunlight, or near heat sources.
- Don't store discs in places subject to moisture or dust, such as in a bathroom or near a humidifier.
- Always store discs in their cases and vertically. Stacking, or putting objects on unprotected discs may cause warping, scratches, or other damage.

Copyright

It is forbidden by law to copy, broadcast, show, broadcast on cable, play in public, or rent copyrighted material without permission.

DVD-Video discs are copy-protected, and any recordings made from these discs will be distorted.

This product incorporates copyright protection technology that is protected by method claims of certain U.S. patents and other intellectual property rights owned by Macrovision Corporation and other rights owners. Use of this copyright-protection technology must be authorized by Macrovision Corporation, and is intended for home and other limited viewing uses only, unless otherwise authorized by Macrovision Corporation. Reverse engineering or disassembly is prohibited.

Before Using the DVD player

Installing the Batteries

- 1 Open the battery compartment, as shown.

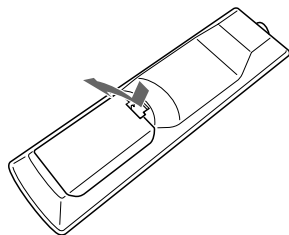

- 2 Insert the two supplied batteries (AA/R6) in accordance with the polarity diagram inside the battery compartment.

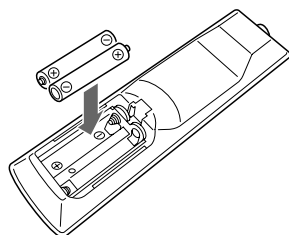

- 3 Close the battery compartment.

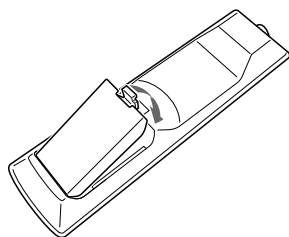

Notes:

- If the remote controller doesn't work reliably, try replacing both batteries.
- Don't mix new and old batteries, or different types of batteries.
- If you intend not to use the remote controller for a long time, remove the batteries to prevent possible leakage and corrosion.
- Flat batteries should be removed as soon as possible to prevent possible leakage and corrosion.

Using the Remote Controller

To use the remote controller, point it at the DVD player's remote control sensor, as shown below.

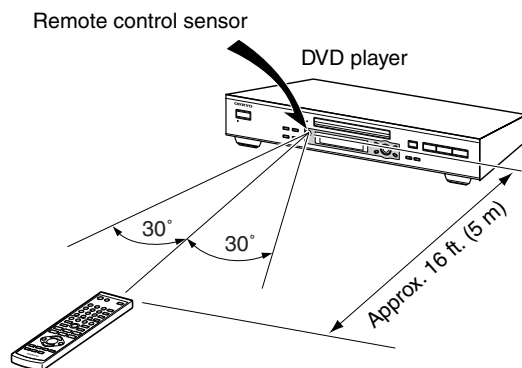

Notes:

- The remote controller may not work reliably if the DVD player is subjected to bright light, such as direct sunlight or inverter-type fluorescent lights. Keep this in mind when installing the DVD player.
- If another remote controller of the same type is used in the same room, or the DVD player is installed close to equipment that uses infrared rays, the remote controller may not work reliably.
- Don't put anything, such as a book, on the remote controller, because the buttons may be pressed inadvertently, thereby draining the batteries.
- The remote controller may not work reliably if the DVD player is installed in a rack behind colored glass doors. Keep this in mind when installing the DVD player.
- The remote controller will not work if there's an obstacle between it and the DVD player's remote control sensor.

Front & Rear Panels

For detailed information, refer to the pages in brackets.

Front Panel

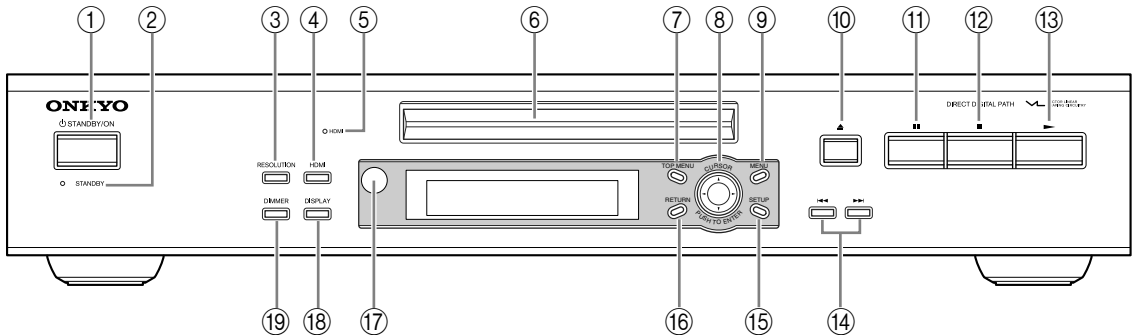

- ① **STANDBY/ON button [26]**
This button is used to set the DVD player to On or Standby.
- ② **STANDBY indicator [26]**
This indicator lights up when the DVD player is in Standby.
- ③ **RESOLUTION button [43]**
This button is used to select the video resolution for the HDMI output, and select progressive or interlaced scanning.
- ④ **HDMI button [43]**
This button is used to turn HDMI on or off.
- ⑤ **HDMI indicator [43]**
This indicator lights up when a HDMI signal is being output.
- ⑥ **Disc tray [28]**
Discs are loaded here.
- ⑦ **TOP MENU button [31, 33]**
With DVD discs, this button displays the main menu. With a JPEG disc, it displays thumbnails of the images. With a Video CD, it turns PBC on or off.
- ⑧ **Cursor ◀/▶/▲/▼ & ENTER buttons [45]**
The four cursor buttons located around the central [ENTER] button are used to navigate DVD-Video menus and the onscreen setup menus. The central [ENTER] button is used to start playback of the selected title, chapter, or track and to confirm settings.
- ⑨ **MENU button [31, 33]**
This button is used to display a menu on a DVD or to open the Disc Navigator when using a JPEG disc.
- ⑩ **▲ (open/close) button [28]**
This button is used to open and close the disc tray.
- ⑪ **|| (pause) button [28, 30]**
This button is used to pause playback.
- ⑫ **■ (stop) button [29]**
This button is used to stop playback.
- ⑬ **▶ (play) button [28]**
This button is used to start playback.
- ⑭ **◀◀/▶▶ buttons [29]**
The Previous button is used to select the previous chapter or track. During playback it selects the beginning of the current track. The Next button is used to select the next chapter or track.
- ⑮ **SETUP button [45]**
This button is used to open and close the onscreen setup menus.
- ⑯ **RETURN button**
This button is used to exit the onscreen setup.
- ⑰ **Remote control sensor [11]**
This sensor receives control signals from the remote controller.
- ⑱ **DISPLAY button [42]**
This button is used to display information about the title, chapter, or track, including the elapsed time, remaining time, total time, and so on. Press it repeatedly to display more information.
- ⑲ **DIMMER button [55]**
This button is used to adjust the display brightness.
→ normal → dim → dimmer

Display

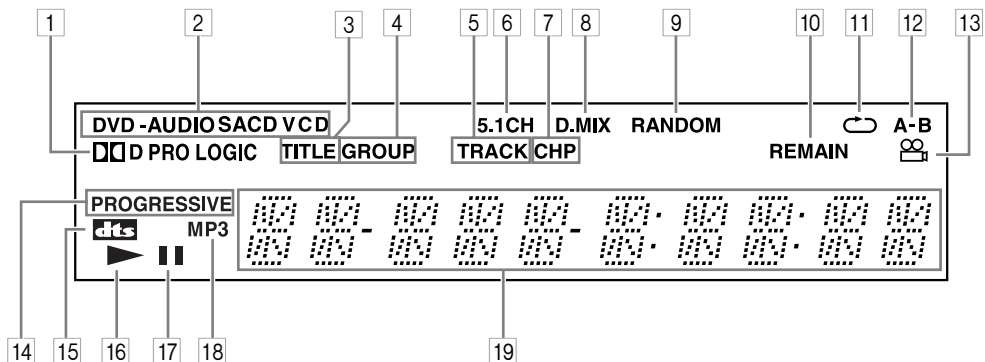

1 D PRO LOGIC indicator

The **D** indicator appears when playing Dolby Digital material. The PRO LOGIC indicator appears when the DVD player's Dolby Pro Logic decoder is on.

2 Disc type indicators

These indicators show the type of disc loaded.

3 TITLE indicator

While stopped, the total number of titles on the current DVD-Video disc is displayed here. During playback, the number of the current title is displayed.

4 GROUP indicator

While stopped, the total number of groups on the current DVD-Audio disc is displayed here. During playback, the number of the current group is displayed.

5 TRACK indicator

This indicator appears while track numbers are being displayed. While stopped, the total number of tracks on the current SACD, Video CD, audio CD, or MP3/WMA disc are displayed. During playback, the number of the current track is displayed.

6 5.1 CH indicator

This indicator appears when playing 5.1-channel material.

7 CHP indicator

This indicator appears while the number of the current chapter is being displayed.

8 D.MIX indicator

During multichannel audio playback, indicates that the output signal has been down mixed from the original audio source. This is an automatic function performed by the player in order to present the most appropriate audio mix to the speakers present in your system.

9 RANDOM indicator

This indicator appears when using the Random function.

10 REMAIN indicator

This indicator appears while the remaining time is being displayed.

11 Repeat icon indicator

This indicator appears when A-B playback or repeat playback is used.

12 A-B indicator

These indicators appear when using the A-B Repeat function.

13 Camera angle icon indicator

This indicator appears if the DVD-Video disc being played features multiple camera angles.

14 PROGRESSIVE indicator

This indicator appears when progressive video is being output by the component video output.

15 DTS indicator

This indicator appears when playing DTS material.

16 Play icon indicator

This indicator is shown during playback.

17 Pause icon indicator

This indicator appears when playback is paused.

18 MP3 indicator

This indicator appears when playing an MP3 disc.

19 Message & time area

Time information, such as total time, remaining time, and so on, is displayed here in hours, minutes, and seconds. Other messages are also displayed.

Front & Rear Panels—Continued

Rear Panel

■ North American model

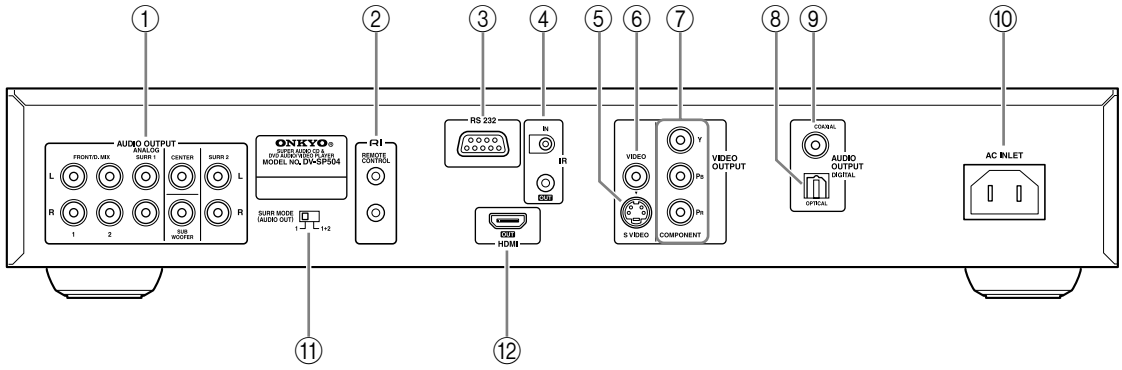

■ European model

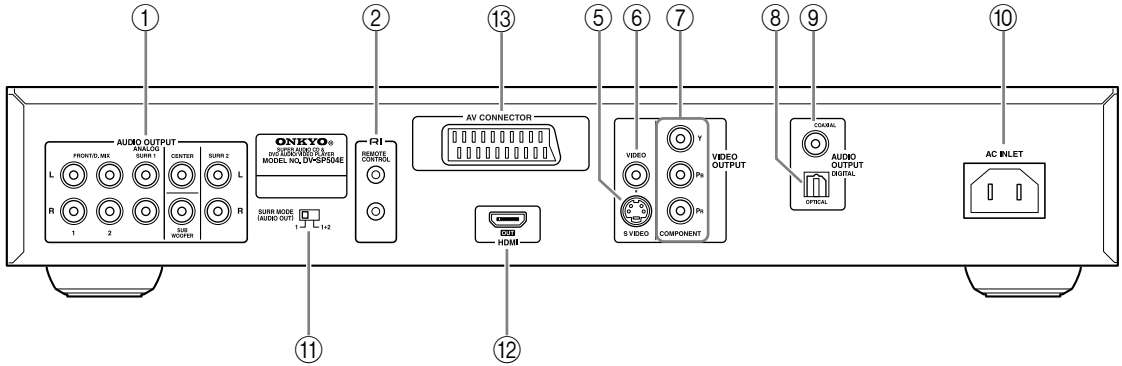

■ Other models

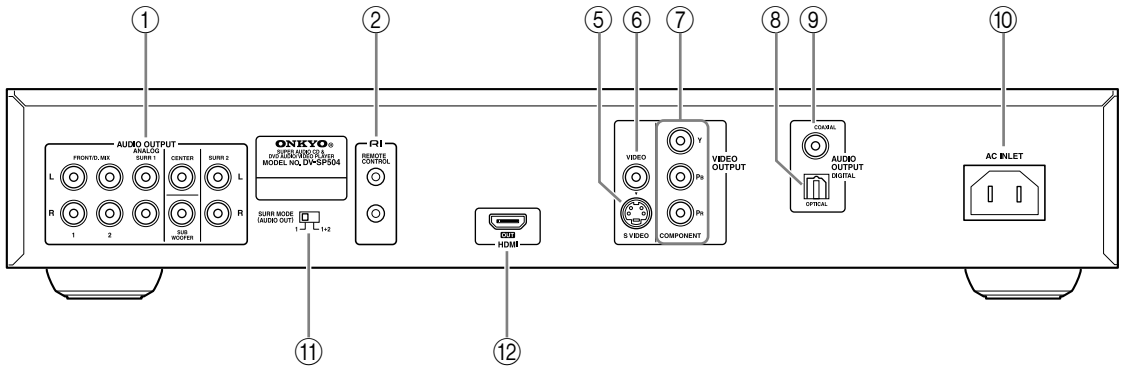

① **AUDIO OUTPUT [20, 22, 23]**

These jacks make up the multichannel analog audio output. The FRONT/D.MIX jacks can be connected to a stereo input on a TV, hi-fi amp, or other component. The 1 and 2 jacks output the same signals, so use either pair. If you use this connection, in the Speaker Configuration (page 48), set the Subwoofer, Center Speaker, and Surround Speaker settings to Off, so that 5.1-channel DVD audio is down mixed into two channels.

If you're using an AV receiver or surround decoder with a 5.1-channel analog audio input, use the FRONT/D.MIX 1 or 2 jacks and the SURR 1 L/R, CENTER, and SUBWOOFER jacks.

If you're using an AV receiver or surround decoder with a 7.1-channel analog audio input, connect the SURR 2 L/R jacks to your amp's surround back L/R jacks, and set the SURR MODE switch to "1+2." The SURR 1 and SURR 2 jacks output the same signals.

② **RI jack [23]**

These **RI** (Remote Interactive) connectors can be connected to the **RI** connectors on your other Onkyo AV components for interactive control. Connecting an **RI** cable only does not make the system operational. You must also connect the audio cables as well.

③ **RS 232 (North American model only)**

This port is for servicing.

④ **IR IN/OUT (North American model only) [25]**

A commercially available IR receiver can be connected to the IR IN jack, allowing you to control the DVD player when it's out of sight, for example, installed in a cabinet.

A commercially available IR emitter can be connected to the IR OUT jack to pass IR (infrared) remote control signals along to other components.

⑤ **S VIDEO OUTPUT [21]**

This connector can be used to connect a TV or projector with an S-Video input.

⑥ **VIDEO OUTPUT [20]**

This RCA connector can be used to connect a TV or projector with a composite video input.

⑦ **COMPONENT VIDEO OUTPUT [21]**

These jacks output component video and can be connected to an component video input on a TV or projector.

⑧ **OPTICAL DIGITAL AUDIO OUTPUT [22]**

This optical digital audio output can be connected to an optical digital audio input on a hi-fi amp, AV receiver, or surround sound decoder (Dolby Digital, DTS).

⑨ **COAXIAL DIGITAL AUDIO OUTPUT [22]**

This coaxial digital audio output can be connected to a coaxial digital audio input on a hi-fi amp, AV receiver, or surround sound decoder (Dolby Digital, DTS) with supplied coaxial cable.

⑩ **AC INLET [26]**

The supplied power cord is connected here. The other of the power cord should be connected to a suitable wall outlet.

⑪ **SURR MODE switch [23]**

This switch is used to turn the AUDIO OUTPUT SURR 2 on or off. To use this output, set the switch to "1+2." The SURR 2 jacks output the same signals as the SURR 1 jacks.

⑫ **HDMI OUT [24]**

This HDMI output can be used to connect a TV or projector with an HDMI input. This HDMI connector outputs digital audio and digital video.

⑬ **AV CONNECTOR (European model only) [21]**

This SCART output can be connected to a TV or projector with a SCART input. This SCART connector outputs 2-channel stereo audio (same signals as the FRONT/D.MIX jacks), composite video, S-Video, and RGB video.

Remote Controller

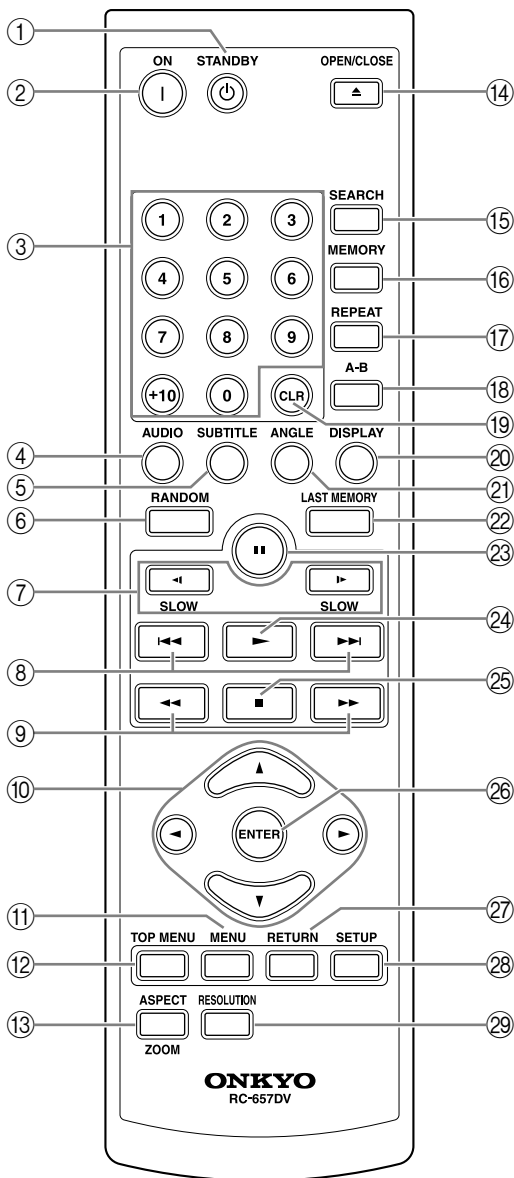









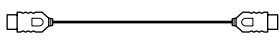

- ① **STANDBY button [26]**
This button is used to set the DVD player to Standby.
- ② **ON button [26]**
This button is used to turn on the DVD player. Don't turn on the DVD player until you've completed, and double checked all connections (pages 20–25).
- ③ **Number buttons [34, 35, 53]**
These buttons are used to enter title, chapter, and track numbers and to enter times for locating specific points in time.
- ④ **AUDIO button [41]**
This button is used to select foreign language soundtracks and audio formats (e.g., Dolby Digital or DTS) on DVD-Video discs. For Video CDs, you can select left-channel, right-channel, mix, or stereo.
- ⑤ **SUBTITLE button [41]**
This button is used to select subtitles on DVD-Video discs.
- ⑥ **RANDOM button [37]**
This button is used with the Random function.
- ⑦ **SLOW <|/|> buttons [30]**
These buttons are used for slow-motion playback.
- ⑧ **Previous/Next <|</>|>> buttons [29]**
The Previous button is used to select the previous chapter or track. During playback it selects the beginning of the current track. The Next button is used to select the next chapter or track.
- ⑨ **Fast Reverse/Fast Forward <<</>>> buttons [30]**
These buttons are used for fast reverse and fast forward.
- ⑩ **Cursor <|>/>/< buttons [45]**
These buttons are used to navigate onscreen menus.
- ⑪ **MENU button [31, 33]**
This button is used to display a menu on a DVD or to open the Disc Navigator when using a JPEG disc.
- ⑫ **TOP MENU button [31, 33]**
With DVD discs, this button displays the main menu. With a JPEG disc, it displays thumbnails of the images. With a Video CD, it turns PBC on or off.
- ⑬ **ASPECT/ZOOM button [40, 46]**
This button is used to change the view mode. Pressing and holding it for a few seconds selects Zoom mode.

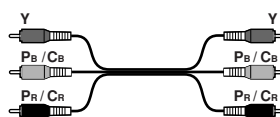
- ⑭ **OPEN/CLOSE ▲ button [28]**
This button is used to open and close the disc tray.
- ⑮ **SEARCH button [34, 35]**
This button is used to search for titles, chapters, groups, folders, tracks, and specific points in time.
- ⑯ **MEMORY button [38]**
This button is used with the Memory function.
- ⑰ **REPEAT button [36]**
This button is used to set the Repeat function.
- ⑱ **A-B button [36]**
This button is used to set the A-B Repeat function.
- ⑲ **CLR button [34, 35, 39]**
This button is used to cancel various functions.
- ⑳ **DISPLAY button [42]**
This button is used to display information about the title, chapter, or track, including the elapsed time, remaining time, total time, and so on. Press it repeatedly to display more information.
- ㉑ **ANGLE button [40]**
This button is used to select camera angles on DVD-Video discs.
- ㉒ **LAST MEMORY button [39]**
This button is used with the Last Memory function.
- ㉓ **Pause ■■ button [28, 30]**
This button is used to pause playback. While playback is paused, pressing this button moves the video forward one frame at a time.
- ㉔ **Play ► button [28]**
This button is used to start playback.
- ㉕ **Stop ■ button [29]**
This button is used to stop playback.
- ㉖ **ENTER button [45]**
This button is used to start playback of the selected title, chapter, or track, and to confirm settings.
- ㉗ **RETURN button**
This button is used to exit the onscreen setup.
- ㉘ **SETUP button [45]**
This button is used to open and close the onscreen setup menus.
- ㉙ **RESOLUTION button [43]**
This button is used to select a video resolution for the HDMI OUT.

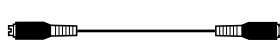

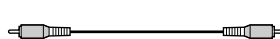

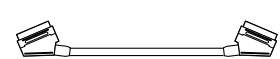

Connecting the DVD player

AV Cables & Connectors

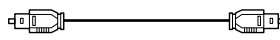
Video

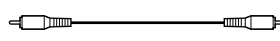
	Cable	Jack	Description
HDMI			HDMI connections can carry uncompressed, standard or high definition digital video and digital audio, for the best picture and sound quality.
Component video			Component video separates the luminance (Y) and color difference signals (Pr, Pb), providing the best picture quality. Some TV manufacturers label their component video inputs differently.
S-Video			S-Video provides better picture quality than composite video.
Composite video (supplied)			Composite video can be found on virtually all TVs, VCRs, and video equipment.
Scart (European model only)			SCART connections carry analog audio and video (composite, S-Video, RGB) all in one cable.

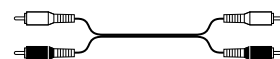
Audio

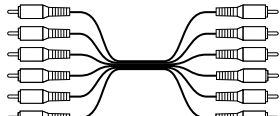
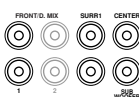
	Cable	Jack	Description
Optical digital			Optical digital audio connections provide better audio quality than analog connections.
Coaxial digital (supplied)			Coaxial digital audio connections provide better audio quality than analog connections.
Analog (supplied)			RCA analog audio connectors can be found on virtually all AV components.
Multichannel analog audio cable (RCA)			This cable carries multichannel analog audio and it's typically used to connect DVD players with individual 5.1 channel analog audio outputs. Several standard analog audio cables can be used instead of a multichannel cable.

Connecting the DVD player—Continued

Video Output/Video Setting Matrix

The following matrix shows how the video outputs work in relation to the various video settings.

Setting	HDMI Output Setting (page 27)				
	On (default)			Off	
	HD Resolution setting (page 43)			Progressive Setting (page 43)	
	Auto	480p/576p (default)	720p, 1080i	Progressive	Interlaced
HDMI	✓	✓	✓ ^{*3}	No output	No output
Component	✓ ^{*1}	✓ ^{*2}	No output	✓ ^{*2}	✓
S-Video	✓ ^{*1}	✓	No output	✓	✓
Composite	✓ ^{*1}	✓	No output	✓	✓
SCART ^{*4} (European model only)	✓ ^{*1}	✓	No output	✓	✓

*1 Depending on the native resolution of your TV, you may get no picture.

*2 If your TV doesn't support progressive scanning, you'll get no picture.

*3 If your TV doesn't support the HD Resolution settings of 720p and 1080i, you'll get no picture.

*4 With the SCART Output Setting, you can choose RGB, S-Video, or composite video for the SCART output. However, when HDMI is on, you cannot select RGB. Also, when RGB is selected, nothing will be output by the component video output (see page 48).

Audio Output/Audio Setting Matrixes

■ Digital Audio Output/Audio Setting Matrix

The following matrix shows how the digital audio outputs work in relation to the Digital/HDMI Audio Out setting.

Setting	Digital/HDMI Audio Out setting (page 48)		
	All (default) ^{*a}	PCM ^{*a}	Off
HDMI	✓	✓ ^{*b}	No output
Digital (optical & coaxial)	✓	✓ ^{*b}	No output

Audio from SACDs is not output by the HDMI OUT or optical or coaxial digital audio outputs. It's only output by the analog audio outputs. Audio from the multichannel area of a DVD-Audio disc is also only output by the analog audio outputs.

*a If your TV or amp doesn't support higher sampling rates, set the Linear PCM Out setting to Down Sample On (page 48).

*b Dolby Digital and DTS sources will be converted to PCM. If your TV or amp doesn't support Dolby Digital and DTS, choose this option.

■ Analog Audio Output/Audio Setting Matrix

The following matrix shows the recommended audio settings for each analog audio output.

Setting	Speaker Configuration (page 48)	
	5.1 channel (default): Subwoofer: On Front: Small Center: Small Surround: Small	2 channel: Subwoofer: Off Front: Large Center: Off Surround: Off
2-channel (FRONT/D.MIX)		✓ ^{*c}
Multichannel	✓	
SCART (European model only)		✓ ^{*c}

For 5.1-channel playback with an SACD, press the [AUDIO] button to select the multichannel area of the disc. For 2-channel playback, select the 2-channel area.

*c If your TV or multichannel amp has a Dolby Pro Logic decoder built in, by setting the Downmix Setting (page 50) to Lt/Rt, multichannel sources can be down mixed and output as an Lt/Rt mix.

Connecting the DVD player—Continued

Before Making Any Connections

- Read the manuals supplied with your AV components.
- Don't connect the power cord until you've completed all audio and video connections.

Optical Digital Outputs

The DVD player's optical digital connectors have a shutter-type cover that opens when an optical plug is inserted, and closes when it's removed. Push the plug in all the way.

Caution: To prevent shutter damage, hold the optical plug straight when inserting and removing.

RCA AV Connection Color Coding

RCA AV connections are usually color coded: red, white, and yellow. Use red plugs to connect right-channel audio inputs and outputs (typically labeled "R"). Use white plugs to connect left-channel audio inputs and outputs (typically labeled "L"). And use yellow plugs to connect composite video inputs and outputs.

The supplied AV cable is made up of an analog audio cable and a composite video cable.

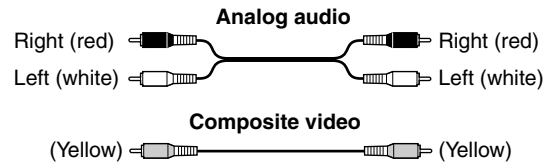

- Push each plug in all the way to make a good connection (loose connections can cause noise or malfunctions).
- To prevent interference, keep audio and video cables away from power cords and speaker cables.

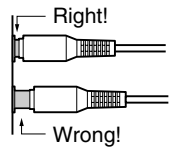

Basic Setup

The setup described here is a basic setup that allows you to play discs using just the cables supplied with the player. In this setup, stereo audio is played through the speakers in your TV.

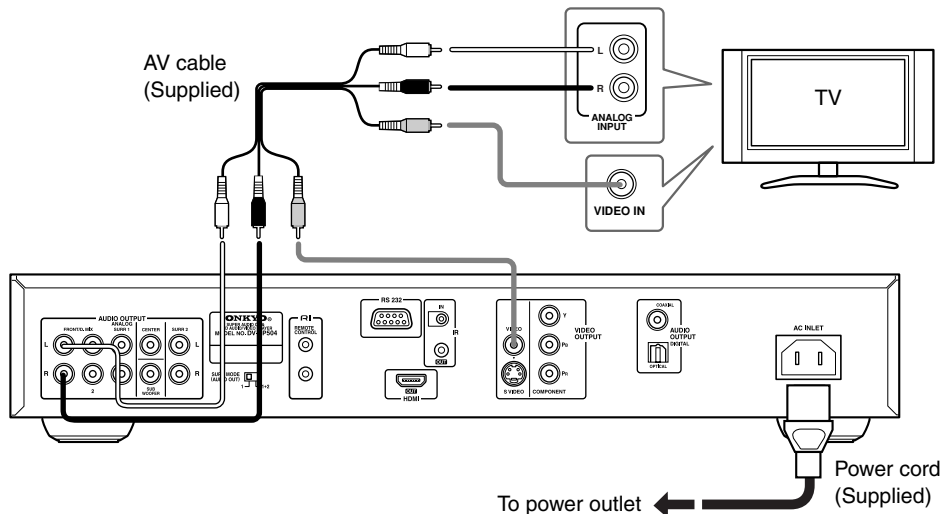

This player is equipped with copy protection technology. Do not connect this player to your TV via a VCR using AV cables, as the picture from this player will not appear properly on your TV. (This player may also not be compatible with some combination TV/VCRs for the same reason; refer to the manufacturer for more information.)

1. Connect the VIDEO OUTPUT and AUDIO OUTPUT FRONT/D.MIX 1 jacks to a set of AV inputs on your TV.

Use the supplied AV cable (RCA), connecting the red and white plugs to the audio outputs and the yellow plug to the video output. See the following page if you want to use other cable for the video connection.

2. Connect the supplied AC power cord to the AC INLET, then plug into a power outlet.

Connecting Your TV (video connection)

- Connect the DVD player directly to your TV. If you connect the DVD player through a VCR, TV/VCR combination, or video selector, the picture may be distorted because DVD-Video discs are usually copy protected.

Using S-Video

If your TV (or other equipment) has an S-Video input, you can use this instead of the standard (composite) output for a better quality picture.

- Use an S-Video cable (not supplied) to connect the S VIDEO OUTPUT to an S-Video input on your TV (or monitor or AV receiver).

Line up the small triangle above the jack with the same mark on the plug before plugging in.

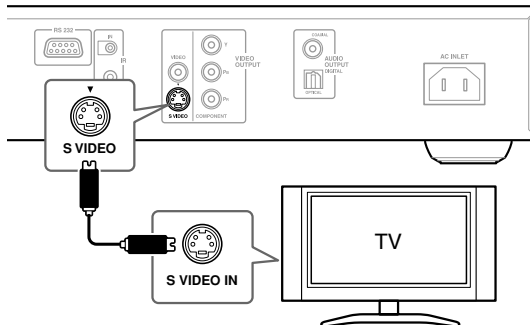

Using Component Video

You can use the component video output instead of the standard video out jack to connect this player to your TV (or other equipment).

This will provide better quality picture than S-Video.

- Use a component video cable (not supplied) to connect the COMPONENT VIDEO OUTPUT jacks to a component video input on your TV (or monitor or AV receiver).

If you connect the component video output to a TV or another component that doesn't support progressive scanning, be sure to turn off HDMI (see page 43).

You can set the component video output to Progressive or Interlaced (see page 43).

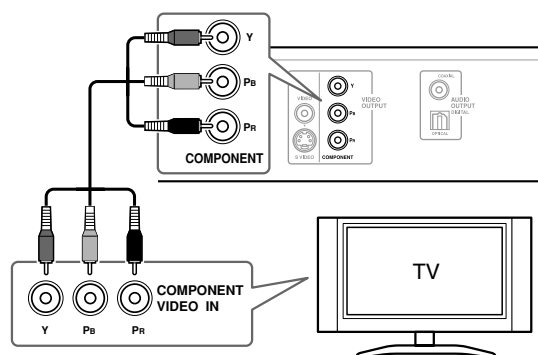

Compatibility of this unit with progressive-scan TVs.

This player is compatible with progressive video Macro Vision System Copy Guard.

CONSUMERS SHOULD NOTE THAT NOT ALL HIGH DEFINITION TELEVISION SETS ARE FULLY COMPATIBLE WITH THIS PRODUCT AND MAY CAUSE ARTIFACTS TO BE DISPLAYED IN THE PICTURE. IN CASE OF 525 OR 625 PROGRESSIVE SCAN PICTURE PROBLEMS, IT IS RECOMMENDED THAT THE USER SWITCH THE CONNECTION TO THE "STANDARD DEFINITION" OUTPUT. IF THERE ARE QUESTIONS REGARDING OUR TV SET COMPATIBILITY WITH THIS MODEL 525p AND 625p DVD PLAYER, PLEASE CONTACT OUR CUSTOMER SERVICE CENTER.

Using SCART (European model only)

If your TV has a SCART-type AV input, you can use a SCART cable to connect this player to your TV. This type of connection carries both the sound and the picture, so there's no need to connect up the AUDIO OUTPUT L/R and VIDEO OUTPUT jacks.

- Use a SCART cable (not supplied) to connect the AV CONNECTOR to an AV input on your TV.

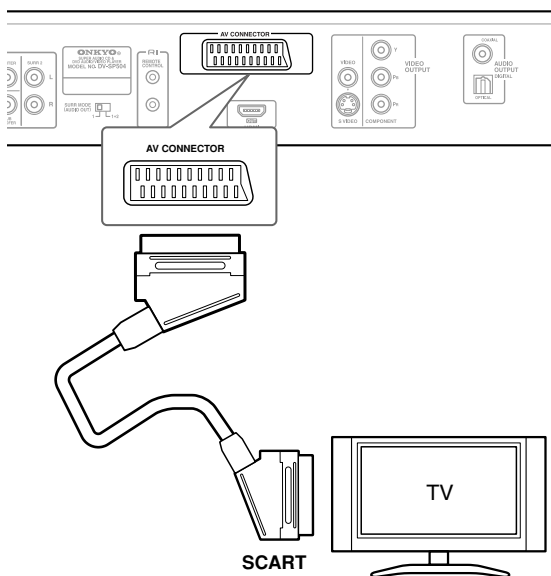

This connector can output composite video, S-Video, or RGB video. The default setting is composite, which should work with all TVs. Consult the manual that came with your TV to see if you can use one of the higher quality settings. See page 48 for how to change the video output.

Connecting to an AV Receiver

Step 1: Audio Connection

You can connect the DVD player to your AV receiver using the multichannel analog audio output or one of the digital audio outputs. In addition, you should also connect a 2-channel analog audio output for compatibility all certain discs.

Step 2: Video Connection (See pages 20–21)

You may also want to connect the DVD player's video output to your AV receiver and connect the AV receiver's video output to a video input on your TV. You can use any of the DVD player's video outputs. Typically, you must use the same type of video cable to connect your DVD player to your AV receiver as you do to connect your AV receiver to your TV.

Before Connecting

- Before making any connections, turn off the DVD player and AV receiver, and disconnect them from the wall outlets. Failure to do so may result in speaker damage.

Connection Hints

- To enjoy Dolby Digital or DTS surround sound, you must connect the DVD player to your AV receiver by using an optical or coaxial digital audio cable or HDMI cable. See page 24 for HDMI connection information.
- To record the audio from a CD-R disc to a cassette deck or CDR recorder that's connected to the AV receiver, or if you want to use your AV receiver's Zone 2 function, you must connect the DVD player's stereo analog audio output to your AV receiver.
- If your AV receiver has an analog multichannel input, we recommend that you connect it to the DVD player's multichannel analog output. This will ensure that you can enjoy all types of discs, including Dolby Digital and DTS DVD-Video discs, and DVD-Audio and SACD discs containing multichannel audio at higher sampling rates.

Connecting the Analog Output

Connect the FRONT/D.MIX 1 or 2 AUDIO OUTPUT jacks on this player to a set of analog audio inputs on your AV receiver with the supplied AV cable (RCA). The FRONT/D.MIX 1 and 2 jacks output the same signals, so use either pair.

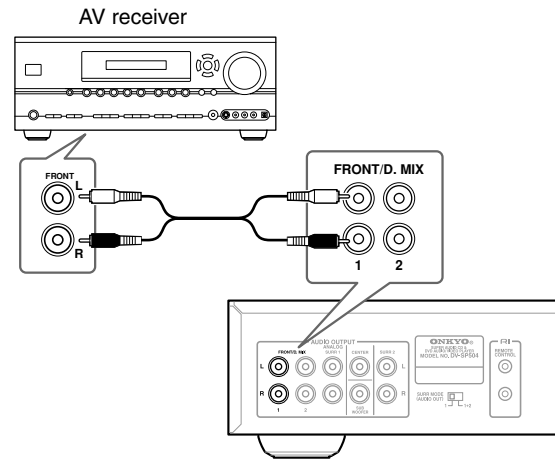

Note:

- If you use this connection, in the Speaker Configuration (page 48), set the Subwoofer, Center Speaker, and Surround Speaker settings to Off, so that multichannel audio sources are down mixed into two channels.

Connecting the Digital Output

Connect one of the DIGITAL AUDIO OUTPUT jacks on this player to a digital input on your AV receiver. A coaxial digital audio cable is supplied with this player.

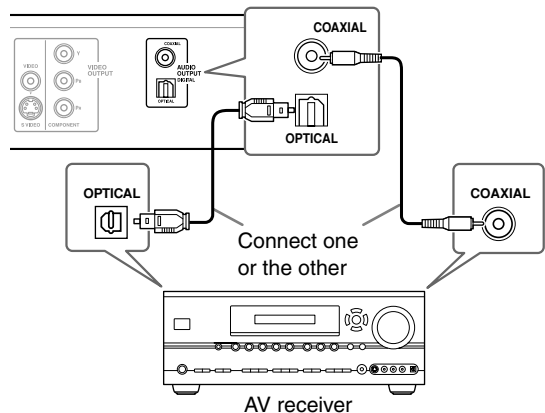

If your AV receiver doesn't support Dolby Digital and DTS, set the Digital/HDMI Audio Out setting to PCM. See page 48, and also refer to the operating instructions that came with your AV receiver.

Note that digital audio is not output when playing SACD discs.

Connecting the DVD player—Continued

Connecting the Multichannel Analog Output

Connect the DVD player's FRONT/D.MIX 1 or 2, SURR 1, CENTER, and SUBWOOFER jacks to the multichannel analog audio input on your AV receiver. You can use three stereo audio cables for this.

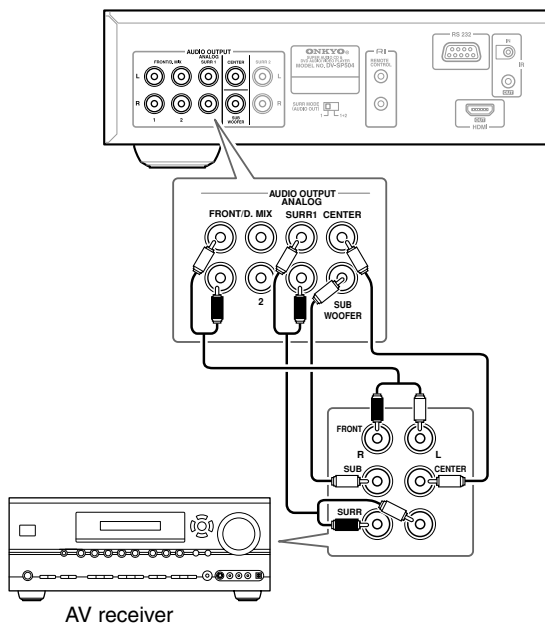

■ If Your AV Receiver has a 7.1-channel Analog Audio Input

Connect the DVD player's SURR 1 jacks to your AV receiver's surround input jacks, and connect the SURR 2 jacks to your AV receiver's surround back input jacks. The SURR 1 and SURR 2 outputs output the same signals.

When you make this connection, set the SURR MODE switch to "1+2."

If you use this connection, the output level will be reduced by 3 dB (i.e., the volume level will be reduced slightly).

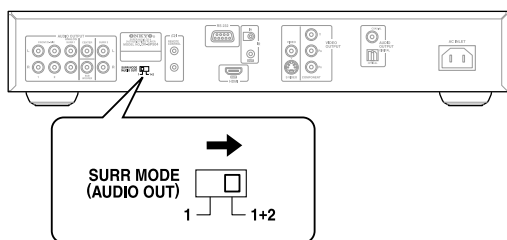

Connecting RI-compatible Components

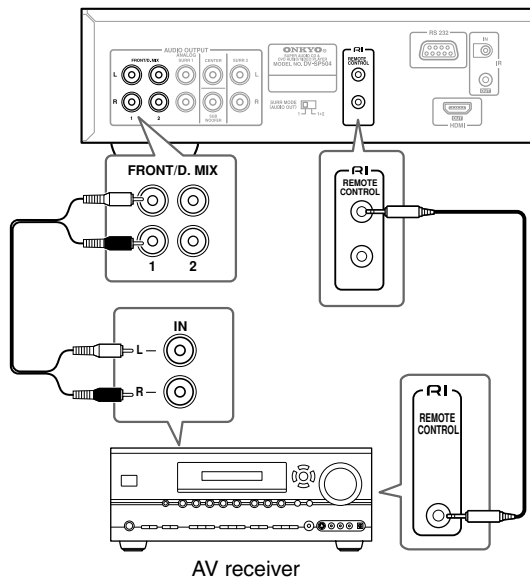

- The remote controller supplied with Onkyo AV receiver or amplifiers can be used to control the DVD player.
- The function of the upper and lower **RI** connectors are the same. Connect to either one.
- To use **RI**, in addition to an **RI** connection, you must also make an analog audio connection (RCA) between the DVD player and your other **RI**-capable components.

Connecting your HDTV or AV receiver with an HDMI Input

This section shows how to connect the DVD player to a AV receiver, HDTV, or projector that has an HDMI input socket.

What is HDMI?

HDMI (High Definition Multimedia Interface) is a new connection format that can carry uncompressed, standard or high definition digital video and digital audio. Until now, several separate video and audio cables have been required to connect AV components together. With HDMI, a single cable is all that's necessary to achieve the best picture and audio quality.

HDMI video is compatible with DVI (Digital Visual Interface). To send HDMI video to a DVI input requires an HDMI-to-DVI cable. The DVD player supports HDCP (High-bandwidth Digital Content Protection), and for an HDMI-to-DVI connection to work, the other component must also support it. Note that this may not work with some DVI components.

Using HDMI

Use the HDMI cable (not supplied) to connect the DVD player's HDMI OUT to an HDMI input on your AV receiver. Alternatively, you can connect the DVD player directly to the HDMI input on your TV.

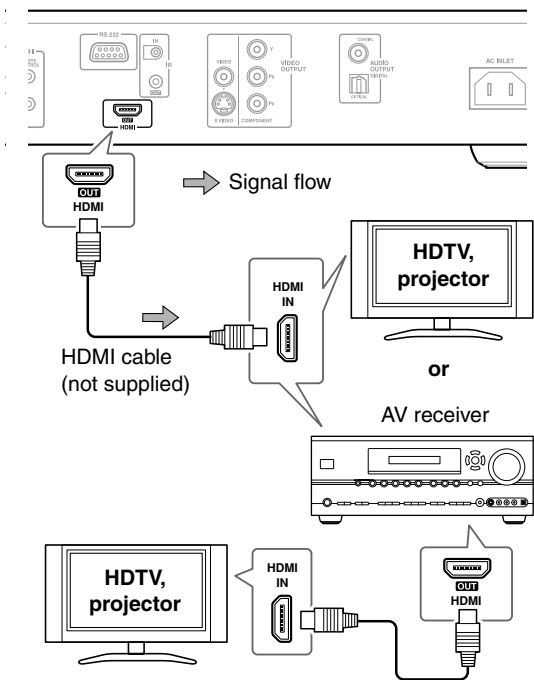

Notes:

- The DVD player supports HDCP (High-bandwidth Digital Content Protection), a protection system for digital video. HDMI components that you connect to the DVD player must also support HDCP.
- The DVD player supports High-Definition Multimedia Interface Specification Information Version 1.0.

HDMI & the DVD player

■ Video

The DVD player's HDMI OUT supports the following video resolutions:

- 720 x 480p (progressive), 60 Hz
- 720 x 576p (progressive), 50 Hz (not North American and Korean models)
- 1280 x 720p (progressive), 50/60 Hz
- 1920 x 1080i (interlaced), 50/60 Hz

If the connected HDTV or projector doesn't support a resolution, you may get no picture.

On the DVD player, you can select a resolution suitable for use with the connected HDTV or projector (see page 43).

■ Audio Formats

The DVD player's HDMI OUT supports the following audio formats:

- PCM (96 kHz, 48 kHz, 44.1 kHz)
- Dolby Digital
- DTS

If your HDMI-compatible TV or projector doesn't support Dolby Digital and DTS, the HDMI OUT will not output digital audio in that format. In this case, set the Digital/HDMI Audio Out setting to PCM (see page 48).

If your TV doesn't support digital audio at high sampling rates, set the Linear PCM Out setting to Down Sample On, so that it's down sampled to below 48 kHz (see page 48).

Note that audio from SACD discs is not output by the HDMI OUT. For this format, you need to use the analog multichannel output (see page 23).

Connecting the DVD player—Continued

Using the Multiroom Control Kits (North American model only)

To control the DVD player with the remote controller when DVD player is located in a cabinet, you'll need a commercially available multiroom remote control kit.

- Multiroom kits are made by Niles and Xantech. These kits can also be used when control other components.

Using a Multiroom Kit with a Cabinet

In this setup, the IR receiver picks up the infrared signals from the remote controller and feeds them to the DVD player located in the cabinet via the connecting block.

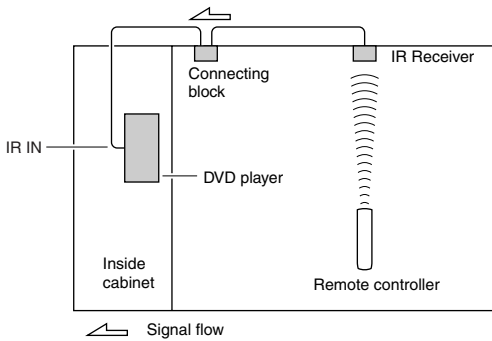

The miniplug cable from the connecting block should be connected to the DVD player's IR IN jack, as shown below.

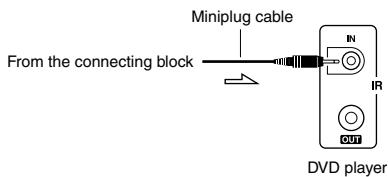

Using a Multiroom Kit with Other Components

In this setup, an IR emitter is connected to the DVD player's IR OUT jack and placed in front of the other component's remote control sensor. Infrared signals received at the DVD player's IR IN jack are fed through to the other component via the IR emitter. Signals picked up by the DVD player's remote control sensor are not output.

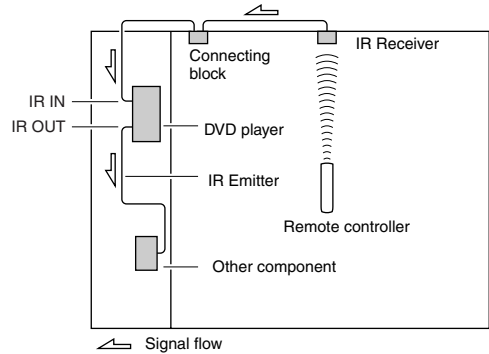

The IR emitter should be connected to the DVD player's IR OUT jack, as shown below.

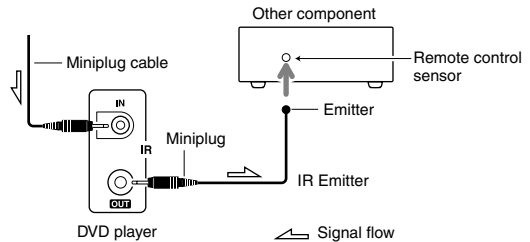

Initial Setup

This chapter explains the settings you need to make the very first time the DVD player is turned on.

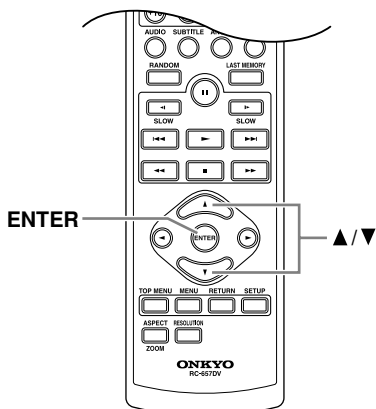

First Time Setup

The very first time you turn on the DVD player, the Initial Setup menu appears onscreen.

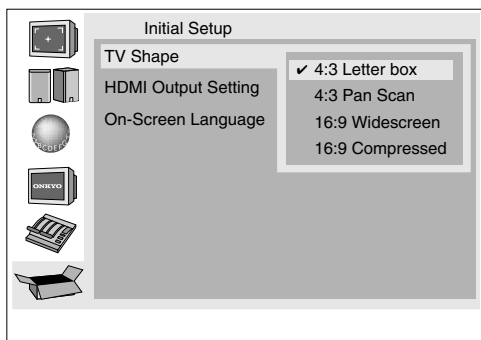

Here you need to make a few settings to get the DVD player up and running. You can change these settings later (see page 45).

1

Remote controller

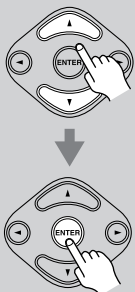

Use the Up and Down [▲]/[▼] buttons to select a TV shape, and then press [ENTER].

Select “4:3 Letter box” or “4:3 Pan Scan” if you have a 4:3 TV. Select “16:9 Widescreen” or “16:9 Compressed” if you have a widescreen TV. See page 46 for more information.

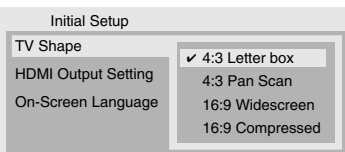

The “HDMI Output Setting” menu appears next.

2

Remote controller

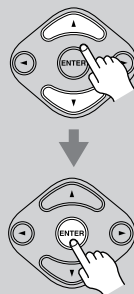

Use the Up and Down [▲]/[▼] buttons to select “On” or “Off” for “HDMI Output Setting,” and then press [ENTER]

Select “On” to use the HDMI output.

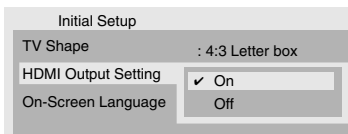

The “On-Screen Language” menu appears next.

3

Remote controller

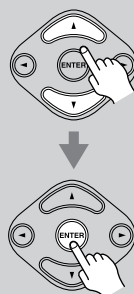

Use the Up and Down [▲]/[▼] buttons to select a language, and then press [ENTER].

See page 50 for more information on the language options.

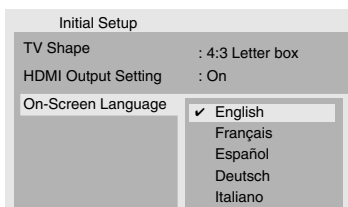

The Initial Setup menu closes and the setup is complete.

The DVD player is now ready to use.

Note:

- You can cancel the Initial Setup by pressing the [SETUP] button and complete the settings later by using the onscreen setup menus (see page 45).

Playing Discs

This chapter covers basic playback. Advanced playback functions are covered in the next chapter.

Important:

- Throughout this manual, the term *DVD* refers to DVD-Video, DVD-Audio, DVD-R/RW, and DVD+R/RW discs. When a function is specific to a particular type of DVD disc, it will be specified.

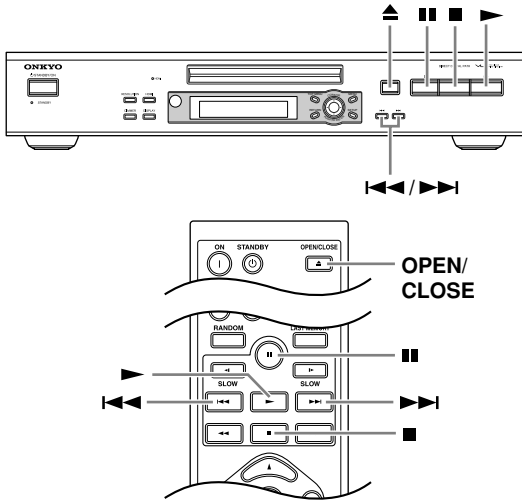

1



Remote controller
OPEN/CLOSE

Press ▲ OPEN/CLOSE to open the disc tray.

2

Load a disc.

Load a disc with the label side facing up, using the disc tray guide to align the disc (if you're loading a double-sided DVD disc, load it with the side you want to play face down).

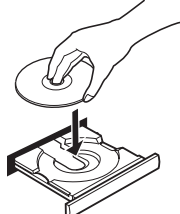

3



Remote controller
OPEN/CLOSE

Press ▲ OPEN/CLOSE.

The disc tray closes and the relevant disc type indicator appears on the display.

Tip:

If you press the Play [▶] button, the disc tray will close and, depending on the type of disc, playback will start automatically.

- For details on playing JPEG picture discs, see "Viewing a Slideshow of JPEG Images" on page 33.

Note:

- Only load discs that are supported by the DVD player. See pages 8 to 10.

Starting, Pausing & Stopping Playback

This section explains how to start, pause, and stop playback.

Start



Remote controller

To start playback, press the Play [▶] button.

Playback starts and the Play ▶ indicator appears on the display.

If you're playing a DVD-Video disc, or a VCD with PBC (Playback Control), you may need to start playback from a menu (see page 31). See page 32 for more on MP3 discs.

Pause



Remote controller

To pause playback, press the Pause [||] button.

Playback pauses and the Pause || indicator appears on the display.

To resume playback, press the Play [▶] button.

Playback resumes and the Pause || indicator disappears.

For DVD-Audio discs, pause cannot be used while a menu is displayed.

■ Stop



Remote controller



To stop playback, press the Stop [■] button.

Playback stops and the Play ► indicator disappears.

- When you stop playback of a DVD-Video disc, the DVD player remembers the point at which playback was stopped and “Resume” appears onscreen. To resume playback from that point, press the Play [►] button. To cancel the Resume function, press the Stop [■] button again. The Resume function is reset when the disc is removed from the DVD player.
- With the Last Memory function you can resume playback from any point even if the disc has been removed (see page 39).

Notes:

- Prolonged display of the same picture or menu may cause irreparable damage to your TV screen known as *screen burn-in*. To prevent this, don't keep playback paused for too long and always press the Stop [■] button when you've finished playing a DVD-Video disc or VCD. The DVD player features a screen saver to protect your TV from the effects of burn-in (see page 52).
- With some DVD-Video discs, you may experience picture noise that is not normally visible with standard TV broadcasts. This is usually because DVD-Video uses a lot of high-resolution video data. The amount of noise, if any, will depend on your particular TV and the problem can sometimes be alleviated by turning down the TV's sharpness control.

Select Next & Previous track/chapter

DVD-V DVD-A SACD VCD CD MP3 WMA DivX JPEG

The North American model does not support DivX.

This section explains how to skip to the next and previous track and chapter.

■ Select Next track/chapter



Remote controller



During Playback, press the Next [▶▶] button to select next track/chapter.

The Next track/chapter starts playback.

■ Select Previous track/chapter



Remote controller



During Playback, press the Previous [◀◀] button to select previous track/chapter.

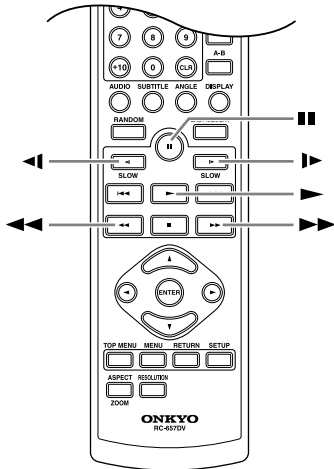

The first press selects the beginning of the current track.



Fast Forward & Reverse

DVD-V DVD-A SACD VCD CD MP3 DivX

The North American model does not support DivX. This section explains how to fast forward and reverse.

<p>■ Fast forward</p> <p>Remote controller</p> 	<p>During playback, press the [▶▶] button to start fast forward.</p> <p>Playback fast forwards and “▶▶x2” appears onscreen.</p> <p>To change the fast-forward speed, press the [▶▶] button repeatedly to select: x2, x4, x8, x16.</p> <p>To resume normal playback, press the Play [▶] button.</p>
<p>■ Fast reverse</p> <p>Remote controller</p> 	<p>During playback, press the [◀◀] button to start fast reverse.</p> <p>Playback reverses and “◀◀x2” appears onscreen.</p> <p>To change the fast-reverse speed, press the [◀◀] button repeatedly to select: x2, x4, x8, x16.</p> <p>To resume normal playback, press the Play [▶] button.</p>

Notes:

- Fast forward and fast reverse may not always work at the speed shown onscreen.
- For discs other than audio CDs, no sound is output during fast forward or fast reverse.
- For DVD-Audio discs, fast forward and fast reverse cannot be used while a menu is displayed.

Forward Frame-by-Frame Playback

DVD-V VCD



With frame-by-frame playback you can view individual picture frames one at a time forward.

<p>■ Forward frame-by-frame</p> <p>Remote controller</p> 	<p>Press the Pause [] button. Press it repeatedly to view subsequent frames.</p> <p>To resume normal playback, press the Play [▶] button.</p>
---	--

Slow-motion Playback

DVD-V

With slow-motion playback you can watch a scene slowly either forward or backward.

<p>■ Forward slow motion</p> <p>Remote controller</p> 	<p>During playback or paused, press the SLOW Forward [▶] button.</p> <p>Forward slow-motion playback starts and “▶1/2” appears onscreen.</p> <p>To change the slow-motion speed, press the SLOW Forward [▶] button repeatedly to cycle through the speeds: 1/2, 1/4, 1/6, 1/8.</p> <p>To resume normal playback, press the Play [▶] button.</p>
<p>■ Backward slow motion</p> <p>Remote controller</p> 	<p>During playback or paused, press the SLOW Back [◀] button.</p> <p>Backward slow-motion playback starts and “◀1/2” appears onscreen.</p> <p>To change the slow-motion speed, press the SLOW Back [◀] button repeatedly to cycle through the speeds: 1/2, 1/4, 1/6, 1/8.</p> <p>To resume normal playback, press the Play [▶] button.</p>

Note:

- Backward slow-motion playback cannot be used with DivX and Video CD. For Video CD, the slow-motion speed cannot be changed.

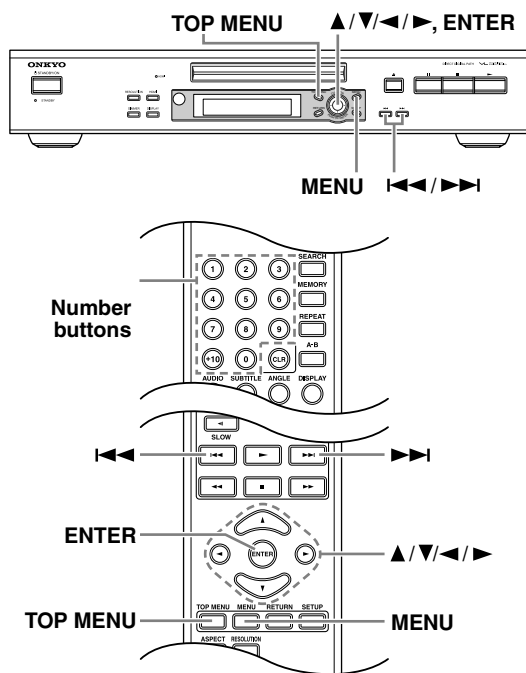

Remote controller

On a VCD menu, use the number buttons to select the tracks.

If the VCD's menu consists of several pages, use the Next [▶▶] and Previous [◀◀] buttons to view them. During playback, you can return to the menu by pressing the [RETURN] button.

- Notes:**
- Not all DVDs and VCDs have menus.
 - Menu operation varies from disc-to-disc. See the disc's sleeve notes for details.
 - On some DVDs, to display the disc menu, press the [MENU] button.

To set VCD's PBC on and off
 PBC menu can be turned on or off by pressing the [TOP MENU] button.

Navigating DVD & VCD Disc Menus



DVD-Video discs usually have a menu from which you can select titles, chapters, and other options, including soundtracks, subtitles, and audio formats (e.g., Dolby Digital or DTS). VCDs that support PBC (Playback Control) may also have an onscreen menu.

1 Load a DVD or VCD.

With DVDs, a menu usually appears when the Play [▶] button is pressed. If it doesn't, try pressing the [TOP MENU] button.

With VCDs that support PBC, you may have to press the Play [▶] button to display the menu.

2 On a DVD menu, use the arrow [▲], [▼], [◀], [▶] buttons to select an item, and then press [ENTER].

Remote controller

Navigating CDs & Super Audio CDs

This section explains how to play audio CDs and Super Audio CDs with the Disc Navigator.

1 Load an audio CD or Super Audio CD.

The Disc Navigator appears.

The tracks are displayed.

2 Use the Up and Down [▲]/[▼] buttons to select a track, and press [ENTER] to start playback.

Remote controller

With SACDs, you can select the multi-channel area, 2-channel area, or CD layer by pressing the [AUDIO] button.

- Note:**
- During random playback or memory playback, the arrow buttons cannot be used.

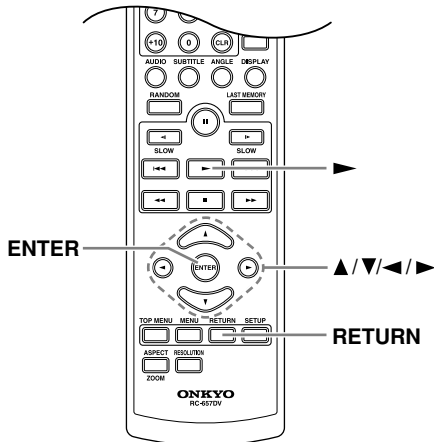

Navigating MP3, WMA & DivX Discs

MP3 > WMA > DivX >

The North American model does not support DivX. This section explains how to play MP3, WMA, and DivX files with the Disc Navigator.

1 Load an MP3, WMA, or DivX disc. The Disc Navigator appears.

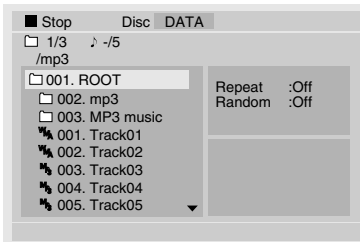

Initially, the folders in the root directory are displayed. The DVD player numbers folders and tracks in hierarchical order. You can use these numbers to select folders and tracks directly with the Search function (see page 34).

2 Remote controller To open a folder, use the Up and Down [▲]/[▼] buttons to select it, and then press [ENTER].

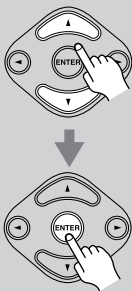

The contents of the folder are displayed.

3 Remote controller Use the Up and Down [▲]/[▼] buttons to select tracks and sub-folders in the open folder.

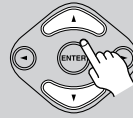

To open a folder in the list, press the [ENTER] button. To close a folder (i.e., move back up the directory tree), press the [RETURN] button. Alternatively, select the item at the top of the list and press the [ENTER] button. Use the Left and Right [◀]/[▶] buttons to display the other folders that contain playable tracks.

4 Remote controller To play the selected track, press the Play [▶] or [ENTER] button.



or



If available, the ID3 tag information, (Title name, Artist name, Album name, and so on) will scroll across the bottom of the screen.



For MP3 playback

Subsequent tracks in the same folder are played in order.

5 Remote controller Press the Stop [■] button to stop playback.



Note:

- During random playback or memory playback, the arrow buttons cannot be used.

Viewing a Slideshow of JPEG Images



This section explains how to display a slideshow of JPEG images on your TV.

1

Load a JPEG disc.

The Disc Navigator appears.

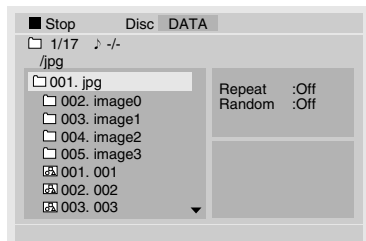

Initially, the folders in the root directory are displayed.

The DVD player numbers folders and files in hierarchical order. You can use these numbers to select folders and files directly with the Search function (see page 34).

2

Remote controller

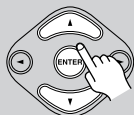

To open a folder, use the Up and Down [▲]/[▼] buttons to select it, and then press [ENTER].

The contents of the folder are displayed.

3

Remote controller



Use the Up and Down [▲]/[▼] buttons to select images and subfolders in the open folder.

A thumbnail-size preview for the currently selected image is displayed.

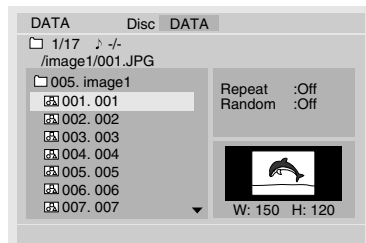

To open a folder in the list, press the [ENTER] button. To close a folder (i.e., move back up the directory tree), press the [RETURN] button. Alternatively, select the item at the top of the list and press the [ENTER] button.

4

Remote controller



or



Use the Left and Right [◀]/[▶] buttons to display other folders that contain JPEG images.

To play a slideshow, press the Play [▶] or [ENTER] button.

Subsequent images are displayed in order, with each image being displayed for five seconds.

To display an image for longer, press the Pause [⏏] button. Press the Play [▶] button to resume.

Use the Previous and Next [◀◀]/[▶▶] buttons to view the previous or next image.

To flip a picture 180 degrees, use the Up and Down [▲]/[▼] buttons (not while zoomed in).

To rotate a picture counterclockwise or clockwise, use the Left and Right [◀]/[▶] buttons (not while zoomed in).

To zoom in or out, use the [▶▶] and [◀◀] buttons. While zoomed in, use the [◀]/[▶]/[▲]/[▼] buttons to move around the picture.

5

Remote controller



To stop the slideshow, press the Stop [■] or [MENU] button.

The slideshow stops automatically when all pictures have been displayed.

■ To display thumbnails

To display thumbnails, in step 3, after opening the folder you want to display, press the [TOP MENU] button.

Use the arrow [▲], [▼], [◀], [▶] buttons to select the thumbnails, and press [ENTER] to start a slideshow. Press the [MENU] button to return to the Disc Navigator.

■ About HD JPEG

If your TV is connected via HDMI and the HDMI resolution is set to 720p or 1080i, you can view your JPEG images in high definition (see page 47).

Advanced Playback

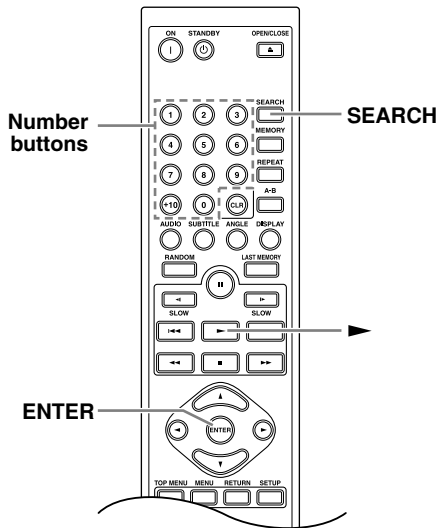

Selecting Chapters/Titles/Tracks/ Folders by Number

DVD-V SACD VCD CD MP3 WMA DivX

The North American model does not support DivX. With the Search function you can select chapters, titles, and tracks by number.

1

Remote controller
SEARCH



Press the [SEARCH] button.

The Search window appears onscreen.

This is what appears for DVDs.

Search		
Disc	Title	Chapter
DVD-VIDEO	Current/Total 12/ 19	Current/Total 5/ 78

This is what appears for CDs.

Search	
Disc	Track
CDDA	Current/Total 2/ 10

2

Remote controller



Use the number buttons to specify a title, chapter, or track number.

To enter, for example, "12," press the [1] button followed by the [2] button.

Search		
Disc	Title	Chapter
DVD-VIDEO	Current/Total 12/ 19	Current/Total 5/ 7

Entered title number appears here

Entered chapter number appears here

If you're playing a DVD, MP3, WMA, or DivX disc, use the Left and Right [◀/▶] buttons to select the Title/Group/Folder and Chapter/Track fields. To clear a number, press the [CLR] button.

3

Remote controller



or



Press the Play [▶] or [ENTER] button to start playback of the specified title, chapter, or track.

Notes:

- During playback, you can select other chapters or tracks directly by using the number buttons (i.e., without pressing the [SEARCH] button). For example, to select chapter #2, simply press [2]. To select chapter #10, press [+10] and [0].
- DVD-Video discs usually have menus for selecting titles and chapters.
- When Video CD PBC is on, you can't search for tracks. Turn PBC off first.
- The [SEARCH] button cannot be used during random playback or memory playback.
- Search may not work with some discs.

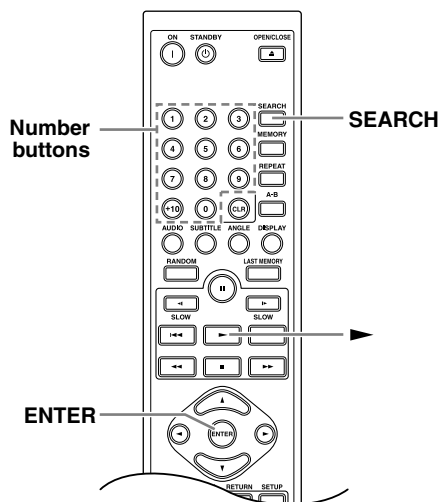

3 Press the Play [▶] or [ENTER] button to start playback of the specified time.

Remote controller



or

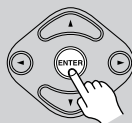

Notes:

- In some cases, playback may start from a slightly different point to the one that you specify.
- Time search may not work with some discs.
- Time search cannot be used while a DVD-Video or Video CD menu is displayed onscreen.
- The [SEARCH] button cannot be used during random playback or memory playback.

Searching by Time



With the Search function you can search by time.

1

Remote controller

SEARCH



During playback, press the [SEARCH] button twice.

The Search window appears onscreen.



2

Remote controller



Use the number buttons to enter a time.

Time search only works within the current title or track.

To enter, for example, 5 minutes, 30 seconds, press [5] [3] [0] buttons.

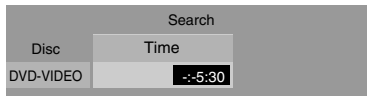

To clear a number, press the [CLR] button.

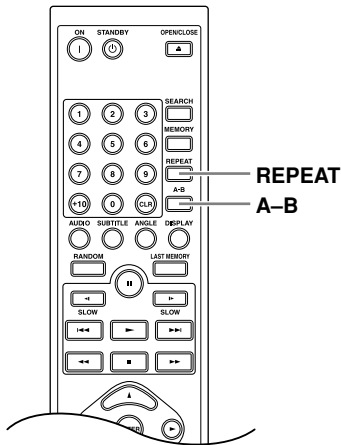

Repeat Playback

DVD-V DVD-A SACD VCD CD MP3 WMA JPEG

With the Repeat function you can play a disc, title, chapter, group, track, or folder over-and-over again.

1

Remote controller

REPEAT



During playback, press the [REPEAT] button repeatedly to select a repeat option.

The selected repeat option appears onscreen.

The available options depend on the type of disc, as follows:

DVD-Video: Chapter Repeat, Title Repeat, Disc Repeat, Repeat Off.

DVD-Audio: Track Repeat, Group Repeat, Repeat Off.

SACD, VCD, CD: Track Repeat, Disc Repeat, Repeat Off.

MP3, JPEG, WMA: Track Repeat, Folder Repeat, Disc Repeat, Repeat Off.

2

Remote controller

REPEAT



To cancel repeat playback, use the [REPEAT] button to select "Repeat Off."

A-B Repeat Playback

DVD-V SACD VCD CD MP3

With the A-B Repeat function you can play a specified section over-and-over again.

1

Remote controller

A-B



During playback, press the [A-B] button to set the A point (i.e., the start of the section you want to repeat).

"Repeat A-" appears onscreen and  A indicator appears on the display.

2

Remote controller

A-B



Press the [A-B] button again to set the B point (i.e., the end of the section you want to repeat).

Playback repeats between the A and B points, and "Repeat A-B" appears onscreen and  AB indicator appears on the display.

3

Remote controller

A-B



To cancel A-B repeat playback, press the [A-B] button.

Notes:

- The A-B Repeat function may not work with some DVD-Video discs and VCDs that support PBC.
- In some cases, the A and B points may be at slightly different points to the ones that you specify.

Notes:

- Repeat playback may not work with some discs.
- If the Memory function is on (see page 38), the selectable options are Memory Repeat, which plays the playlist repeatedly, and Repeat Off.

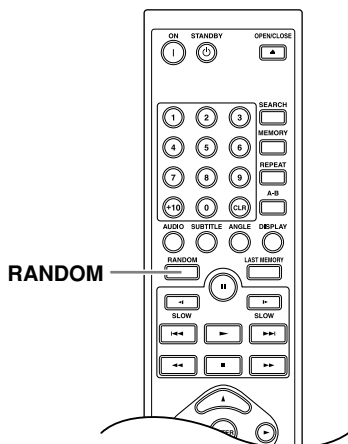

Random Playback

DVD-V > DVD-A > SACD > VCD > CD > MP3 > WMA >

With the Random function you can enjoy a random selection of titles, chapters, groups, tracks, or folders.

1



During playback, press the [RANDOM] button repeatedly to select a random option.

The selected random option appears onscreen.

The options available depends on the type of disc, as follows:

DVD-Video: Title Random, Disc Random, Random Off.

DVD-Audio: Group Random, Random Off.

SACD, VCD, CD: Disc Random, Random Off.

MP3, WMA: Folder Random, Disc Random, Random Off.

With the Title Random option, chapters within the current title are played at random. With the Disc Random option, titles, chapters, groups, tracks, or folders on the disc are played at random.

Random playback begins after the current chapter or track has finished.

Random playback stops automatically when all of the items have been played once.

2

Remote controller

RANDOM



To cancel random playback, use the [RANDOM] button to select “Random Off.”

Notes:

- Random playback may not work with some discs.
- To use the Random function with a VCD that supports PBC, you must first turn off PBC (see page 31).
- If the Memory function is on (page 38), random playback is unavailable.
- You can't use the [SEARCH] button during random playback.
- During random playback, the remote controller's arrow [▲], [▼], [◀], [▶] buttons and number buttons don't work with the Disc Navigator.
- The Random function cannot be used with JPEG files.

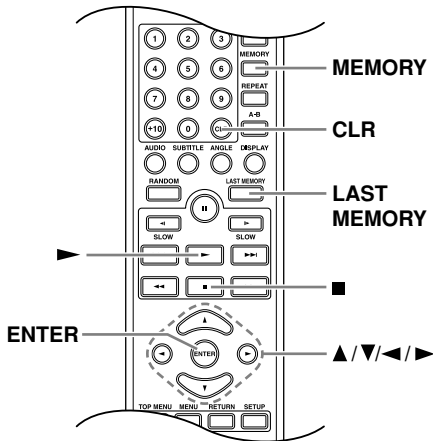

Memory Playback

DVD-V DVD-A SACD VCD CD MP3 WMA

With the Memory Playback function you can create your own memory list of titles, chapters, and tracks.

1 Press the [MEMORY] button.

The Memory List window appears onscreen, as shown.

Remote controller

Memory List		
No.	Title/Folder	Chapter/Track
▶ Current/Total 001 / 019 Current/Total --- / 078		
01	--- / 019	--- / 078
02	--- / 019	--- / 078
03	--- / 019	--- / 078
04	--- / 019	--- / 078
05	--- / 019	--- / 078
06	--- / 019	--- / 078
07	--- / 019	--- / 078
08	--- / 019	--- / 078

The top row (▶) is used to enter title/folder and chapter/track numbers.

The steps in the memory list are numbered.

2 Enter the title/folder, and chapter/track numbers of the item you want to add to the memory list, and then press [ENTER].

Use the remote controller's Left/Right [◀/▶] buttons to select the parameters, and use the number buttons to enter the number.

The new item is added to the memory list as step 01.

Remote controller

3 Repeat step 2 to add more items to the memory list.

You can add up to 32 items to the memory list.

4 To play the memory list, press the Play [▶] button.

The Memory Play Setup window must be open when you press the Play [▶] button.

Remote controller

5 To stop playback, press the Stop [■] button.

While playback is stopped, you can delete the memory list by pressing the [CLR] button.

While playback is stopped, you can cancel the Memory Playback function by pressing the Stop [■] button again.

Remote controller

Adding New Items to the List

1 Use the Up/Down [▲]/[▼] buttons to select the step before which you want to insert the new item, and then press the [ENTER] button.

Remote controller

Memory List		
No.	Title/Folder	Chapter/Track
▶ Current/Total 001 / 019 Current/Total --- / 078		
01	005 / 019	001 / 078
02	002 / 019	012 / 078
03	--- / 019	--- / 078
04	003 / 019	004 / 078
05	010 / 019	003 / 078
06	--- / 019	--- / 078
07	--- / 019	--- / 078
08	--- / 019	--- / 078

2 Enter the title/folder, and chapter/track numbers of the item to be inserted.

Use the remote controller's Left/Right [◀/▶] buttons to select the parameters, and use the number buttons to enter the number.

Remote controller

3 Press the [ENTER] button.

The new item is inserted into the memory list and subsequent items move down the list.

Remote controller

Deleting Items from the List

<p>Remote controller</p> 	<p>Use the Up/Down [▲]/[▼] buttons to select it, and then press the [CLR] button.</p> <p>The item is deleted and subsequent items move up the list.</p>
--	--

Editing Steps

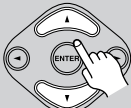
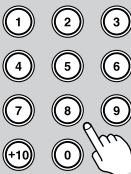
<p>1</p> <p>Remote controller</p> 	<p>Use the Up/Down [▲]/[▼] buttons to select the step.</p>
<p>2</p> <p>Remote controller</p> 	<p>Use the Left/Right [◀]/[▶] buttons and number buttons to edit the title/folder or chapter/track numbers, and then press [ENTER].</p>





Notes:

- To close the Memory List window, press the [RETURN] button.
- The memory list will be deleted when the DVD player is set to Standby or the disc tray is opened.
- To use this function with a VCD that supports PBC, you must first turn off PBC.
- The Memory Playback function cannot be used with some discs.
- JPEG images can be added to the memory list, however, they will not be displayed.

Last Memory



With the Last Memory function you can resume playback from where you left off even if the disc has been removed and the DVD player has been set to Standby. Last Memory also remembers the soundtrack and subtitle settings you were using.

<p>1</p> <p>Remote controller</p> 	<p>During DVD playback, press the [LAST MEMORY] button.</p> <p>The last memory point for the disc is stored, “LAST MEM” appears on the display.</p> <p>If the [LAST MEMORY] button is pressed again, the last memory point is updated.</p>
<p>2</p> <p>Remote controller</p> 	<p>To stop playback, press the Stop [■] button.</p> <p>Now you may remove the disc and turn off the DVD player.</p>
<p>3</p> <p>Remote controller</p> 	<p>To resume playback, load the disc, and then press the Play [▶] button.</p> <p>The Last Memory dialog box appears.</p> <div style="border: 1px solid gray; padding: 5px; margin-top: 10px;"> <p>Last Memory is set. Start playback from memory location?</p> <p style="text-align: center;"> <input type="button" value="Yes"/> <input type="button" value="No"/> <input type="button" value="Memory Clear"/> </p> </div>
<p>4</p> <p>Remote controller</p> 	<p>To resume playback from the last memory point, select “Yes,” and then press [ENTER].</p> <p>To start playback from the beginning, select “No,” and then press [ENTER].</p> <p>To start playback from the beginning and delete the last memory point, select “Memory Clear,” and then press [ENTER].</p>

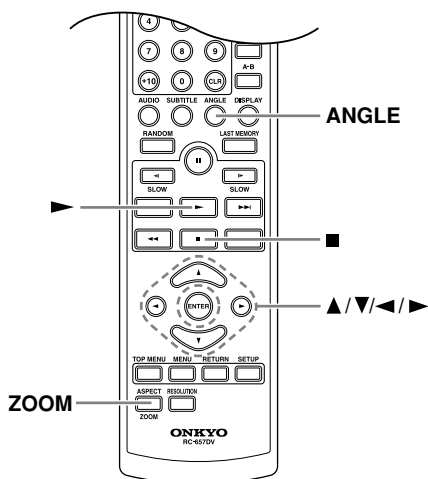

Notes:

- The Last Memory function can store the last point for up to six DVDs. When you set the Last Memory function for a seventh disc, the first disc’s settings are deleted.
- The Last Memory function will not work while a menu is being displayed onscreen.
- The Last Memory function may not work with some DVDs.



Selecting Camera Angles



Some DVDs feature multiple camera angles that allow you to view scenes from different angles. When a DVD features multiple camera angles, the camera  indicator appears on the display. Such discs usually have the camera angle logo () printed on the sleeve.

Remote controller

ANGLE



Press the [ANGLE] button repeatedly to cycle through the available camera angles.

The number of the currently selected camera angle appears onscreen. For example, on a disc with three camera angles, you'd see 1/3, 2/3, and 3/3.

Zooming



With the Zoom function you can enlarge any part of the picture.

1

Remote controller

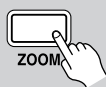

During playback or while playback is paused, press and hold the [ZOOM] button for 2 seconds.

The picture is enlarged.

2

Remote controller

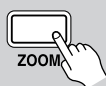

Press the [ZOOM] again repeatedly to zoom in.





The number of zoom steps available depends on the resolution of the disc or file.

After the maximum zoom, the picture returns to its normal size.

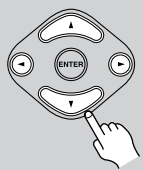
3

Remote controller



To see other areas of the picture while zoomed, use the remote controller's arrow [, [, [, [] buttons.

Notes:

- The Zoom function may not work with some discs.
- The Zoom function can also be used during slow-motion playback.
- The Zoom function cannot be used with HD JPEG.
- The Zoom function cannot be used with disc menus.

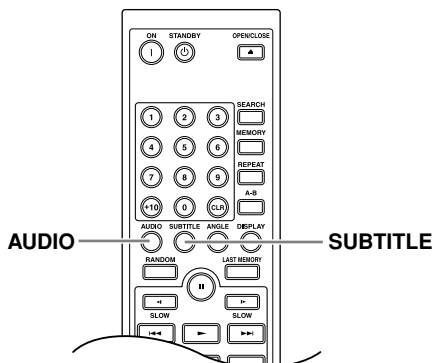

Selecting Soundtracks

DVD-V DVD-A VCD SACD

Some DVD-Video discs feature soundtracks in several languages or audio formats (e.g., Dolby Digital or DTS). Music DVD-Video discs and DVD-Audio discs sometimes feature audio in several formats, such as PCM, Dolby Digital, or DTS. See the disc's sleeve notes for details.

Remote controller



During playback, press the [AUDIO] button repeatedly to cycle through the available soundtracks.

The name of the selected soundtrack appears onscreen for several seconds. For VCDs, you can select Stereo, Mono L (left), Mono R (right), or Mix, so long as all speakers other than the front speakers are turned off in the Speaker Configuration.

For SACDs, you can select the multi-channel area, 2-channel area, or CD layer. If you make a selection during playback, playback will stop.

Notes:

- With DVD-Video discs, when you stop playback and cancel the Resume function (see page 28), the soundtrack language will revert to your default language (see page 50), or the disc's default language.
- With some discs, selecting another soundtrack may cause the picture to skip momentarily.
- With some DVDs you need to select soundtracks from a menu, and you may not be able to select other soundtracks during playback.

Selecting Subtitles

DVD-V

Some DVD-Video discs feature subtitles in several languages. See the disc's sleeve notes for details.

Remote controller



During playback, press the [SUBTITLE] button repeatedly to cycle through the available subtitles.

The name of the selected subtitle appears onscreen for several seconds. To turn off subtitles, use the [SUBTITLE] button to select "Off."

Notes:

- When you stop playback and cancel the Resume function (see page 28), the subtitle language will revert to your default subtitle language (see page 50), or the disc's default subtitle language.
- With some DVDs you can select subtitles from a menu, and you may not be able to select subtitles during playback.

Displaying Information

You can display various information about the current disc, title, chapter, or track as follows.

1

DISPLAY



Remote controller

DISPLAY



During playback, press the [DISPLAY] button repeatedly to cycle through the information.

Various information appears onscreen.

The operating status (e.g., Stop, Play, Resume) and disc type information is displayed along the top of the screen.

The information displayed depends on the type of disc, as follows:

■ DVD-Video

Onscreen:

- Current/total title number, elapsed title time, remaining title time, total title time, selected soundtrack, selected subtitle, and the number of available camera angles.
- Current/total chapter number, elapsed chapter time, remaining chapter time, and total chapter time.

Display:

- Elapsed chapter time
- Remaining title time

■ DVD-Audio

Onscreen:

- Current/total track number, elapsed track time, remaining track time, total track time, and selected soundtrack.
- Current/total group number, elapsed group time, remaining group time, and total group time.

Display:

- Elapsed track time
- Remaining track time

■ Video CD

Onscreen:

- Current/total track number, elapsed track time, remaining track time, and total track time.
- Current/total track number, elapsed track time, remaining disc time, and total disc time.

Display:

- Elapsed track time
- Remaining track time
- Elapsed disc time
- Remaining disc time

Note:

- If PBC is on, no information is displayed when the [DISPLAY] button is pressed.

■ Audio CD, Super Audio CD

Onscreen:

- Current/total track number, elapsed track time, remaining track time, and total track time.
- Current/total track number, elapsed disc time, remaining disc time, and total disc time.

Display:

- Elapsed track time
- Remaining track time
- Elapsed disc time
- Remaining disc time

■ MP3, WMA

Onscreen:

- Current/total folder number, current/total track number in the folder, elapsed track time, remaining track time (MP3 only), and total track time (MP3 only).

Display:

- Elapsed track time
- File name
- Folder name
- Total number of folders

■ JPEG

Display:

- Folder number, track number
- File name
- Folder name
- Total number of folders

■ DivX

Onscreen:

- Current/total track number, elapsed track time, remaining track time, total track time, selected soundtrack, and selected subtitle.

Display:

- Elapsed track time
- File name
- Folder name
- Total number of folders

HDMI and Progressive Settings

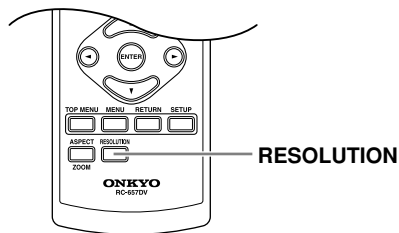
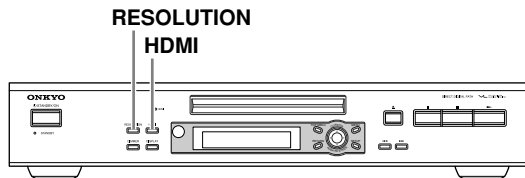

Setting the HDMI

This section explains how to turn on the HDMI OUT and change the video resolution when your TV or projector is connected to the HDMI OUT.

1 	<p>Press the DVD player's [HDMI] button to turn on HDMI.</p>
2 	<p>Press the [RESOLUTION] button repeatedly to change the HDMI resolution.</p> <p>The first button press displays the current resolution onscreen. Press the button again while the resolution is displayed to change the setting.</p>

The DVD player supports the following resolutions:

Auto:

The resolution is automatically set to the native resolution of the TV connected to the HDMI OUT.

If the DVD player does not support the TV's native resolution setting, the resolution 480p/576p will be used.

480p (480p/576p) (default):

The setting displayed depends on the country in which you purchased the DVD player.

720 × 480p 60Hz or 720 × 576p 50Hz

Also output by the DVD player's analog video outputs. With this setting, component video output will be progressive.

720p:

1280 × 720p 50/60Hz

Not output by the DVD player's analog video outputs.

1080i:

1920 × 1080i 50/60Hz

Not output by the DVD player's analog video outputs.

Tip:

These settings can also be changed by using the onscreen setup menus (see pages 46, 47).

Note:

- Be sure to choose a resolution that's supported by your TV. If you select a resolution that your TV doesn't support, there will be no picture.

Selecting Progressive or Interlaced

If your TV supports progressive video, you can set the DVD player to progressive and enjoy progressive video on your TV. If your TV doesn't support progressive video, set the DVD player to interlaced.

When HDMI output is at 480p/576p, the component video output is fixed at progressive and depending on the selected resolution there may be no output, so turn off the HDMI OUT before changing this setting.



1 	<p>Press the DVD player's [HDMI] button to turn off HDMI.</p>
2 	<p>Use the [RESOLUTION] button to select progressive or interlaced.</p> <p>The first button press displays the current setting onscreen. Press the button again while the setting is displayed to change the setting.</p> <p>The PROGRESSIVE indicator appears on the display when progressive is selected.</p>

Configuring the DVD player

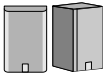

This chapter explains the various functions and settings of the onscreen setup menus.

Functions and settings are arranged into six menus: *Picture*, *Audio*, *Language*, *Display*, *Operation Setting*, and *Initial*.

The following table lists all the functions and settings, with a brief description and page number where you can find full details.

Menu	Setting	Description	Page #
Picture 	TV Shape	Select the aspect ratio that matches your TV.	46
	View Mode	Stretch the picture to fit your TV screen.	46
	HDMI Output Setting	Turn HDMI video output on or off.	46
	Progressive Setting	Set the component video output to progressive or interlaced.	46
	HD Resolution	Select the video resolution for the HDMI OUT.	47
	HD JPEG Mode	For displaying JPEG images at a high resolution on a HDTV.	47
	Video Black Level	Choose a video black level.	47
	Brightness	Adjust the picture brightness.	47
	Sharpness	Adjust the picture sharpness.	47
	PAL Output Setting (not North American and Korean models)	Convert the disc's video format to NTSC or PAL.	47
	Scart Output Setting (European model only)	Selects the video format for the SCART output: RGB, S-Video, or composite.	48
Audio 	Digital/HDMI Audio Out	Settings for the digital signal output by the optical, coaxial, and HDMI digital audio outputs.	48
	Linear PCM Out	Select whether or not the DVD player down samples digital audio.	48
	Subwoofer	Configure the speakers settings for the multichannel analog audio output.	48
	Front Speaker		
	Center Speaker		
	Surround Speaker		
	Test Tone	Test tone for adjusting the level of each channel of your amp's multichannel input.	49
	Center delay	Delay for the multichannel output's center and surround jacks.	49
	Surr. delay		
	Dynamic Range Control	Set the Dynamic Range function.	49
	Pro Logic	Determines how the built-in Dolby Pro Logic decoder works.	49
	SACD Audio Setup	Determines whether DSD or PCM is output when playing SACDs.	50
	Downmix Setting	Dolby and DTS downmix settings.	50
Language 	On-Screen Language	Select a language for the onscreen setup menus and messages.	50
	Disc Menu Language	Select your preferred language for disc menus.	50
	Audio Language	Select your preferred language for soundtracks.	50
	Subtitle Language	Select your preferred language for subtitles.	50
	DivX Subtitle (not North American model)	Select your preferred language for DivX subtitle.	52
Display 	On-Screen Display	Turn on or off onscreen messages and indicators.	52
	On-Screen Display Color	Select a color for onscreen setup menus and messages.	52
	Background	Select a background color for when playback is stopped.	52
	Screen Saver	Set the Screen Saver function.	52

Configuring the DVD player—Continued

Menu	Setting	Description	Page #
Operation Setting 	Parental Lock	Set the Parental Lock function.	53
	Security Code	Change the security code for use with parental lock.	53
	DVD Priority Contents	Determines what's played on DVD-Audio discs with DVD-Video contents.	54
	SACD Priority Contents	Determines how the SACD multichannel and 2-channel area and the CD area are played.	54
	Auto Power Off	Sets the Auto power off function.	54
	DivX Registration (not North American model)	Displays your DivX VOD registration code	54
Initial Setup 	TV Shape	This menu appears automatically the very first time you turn on your DVD player. (These settings are available in other menus.)	27
	HDMI Output Setting		
	On-Screen Language		

Using the Onscreen Setup Menus

This section explains how to navigate the onscreen setup menus.

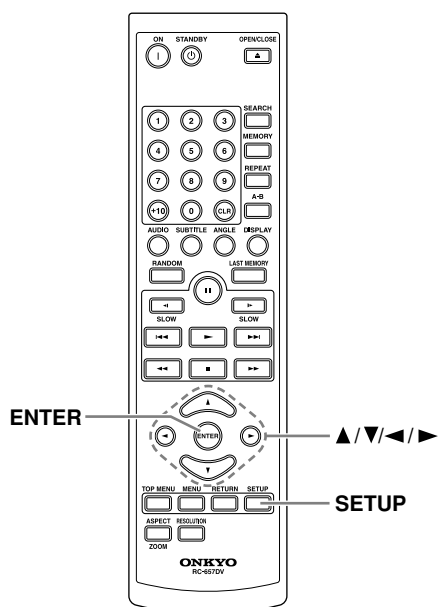

- 1**

Press the [SETUP] button.
The onscreen setup menu appears, as shown.



Picture	
TV Shape	: 4:3 Letter box
View Mode	: Normal
HDMI Output Setting	: Off
Progressive Setting	: Interface
HD Resolution	: 480p
HD JPEG mode	: Off
Video Black Level	: Light
Brightness	: Level 4
Sharpness	: Level 4
Progressive Conversion	: Auto
- 2**

Use the arrow [▲]/[▼]/[◀]/[▶] buttons to navigate the menus, and press the [ENTER] button to see the available options.

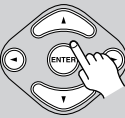
- 3**

Use the Up/Down [▲]/[▼] buttons to select the options, and press the [ENTER] button to confirm your selection.

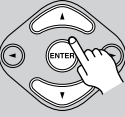
- 4**

When you've finished, press the [SETUP] button again.
The onscreen setup menu closes.



Picture Menu

TV Shape

With this setting you can select a picture format to match the aspect ratio of your TV.

4:3 Letter box (default): Choose this option if you have a standard TV (4:3 aspect ratio). When you watch widescreen DVD-Video movies, the entire picture will be visible and there will be black bars at the top and bottom of the screen, as shown.



4:3 Pan & Scan: Choose this option if you have a standard TV (4:3 aspect ratio) and want to use the full height of the screen when watching widescreen DVD-Video movies. In order to use the full height of the screen, the picture will be cropped on both sides, as shown. This option won't work with discs that don't support pan and scan.



16:9 Widescreen: Choose this option if you have a widescreen TV (16:9 aspect ratio). Depends on TV, the picture appears stretched when watching programs in 4:3 format.

16:9 Compressed: Choose this option if you have a widescreen TV (16:9 aspect ratio) and the picture appears stretched when watching programs in 4:3 format. This option will correct the issue.



Notes:

- This setting does not apply to DVD menus.
- When the HDMI OUT signal is at a resolution of 720p or 1080i, programs in 4:3 format will appear stretched, so we recommend that you select the 16:9 Compressed option.
- With some DVD-Video discs this setting may have no effect. See the disc's sleeve notes to see which picture format is used.

View Mode

With this setting you can adjust the aspect of the picture so that it fits your TV screen. Due to your TV's aspect ratio setting and the DVD's aspect ratio, black bars may appear above and below the picture or at the sides and the aspect of the picture may be unsuitable. In this case, use this setting to adjust the aspect of the picture as you like.

Normal (default): The picture is displayed in its original aspect ratio.

View Mode 1: The picture is stretched horizontally to make it fit the height of the screen.

View Mode 2: The picture is stretched vertically to make it fit the width of the screen.

View Mode 3: The picture is stretched horizontally and vertically.

Tip:

The view mode can also be changed by using the remote controller's [ASPECT] button.



Note:

- This setting does not apply to DVD menus.

HDMI Output Setting

With this setting you can turn the HDMI video output on or off. See page 43 for more information.

On (default): Video is output by the HDMI OUT.

Off: Video is not output by the HDMI OUT.

Tip:

This setting can also be changed by using the [HDMI] button on the front panel (see page 43).

Note:

- When this setting is set to On, video is output by the analog video outputs only when the HD Resolution is set to 480p/576p.

Progressive Setting

With this setting you can set the component video output to progressive or interlaced. While the HDMI Output Setting is set to On, this setting is fixed at Progressive and cannot be changed. See page 43 for more information.

Interlaced: Component video output is interlaced.

Progressive: Component video output is progressive.

Tip:

When the HDMI Output Setting is set to Off, you can also change this setting by using the [RESOLUTION] button on the front panel (see page 43).

HD Resolution

With this setting you can set the video resolution for the HDMI OUT. See page 43 for more information.

Auto: The resolution is automatically set to the native resolution of the TV connected to the HDMI OUT.

480p (480p/576p) (default): The setting displayed depends on the country in which you purchased the DVD player.

720 x 480p 60 Hz or 720 x 576p 50 Hz

720p: 1280 x 720p 50/60 Hz

1080i: 1920 x 1080i 50/60 Hz

Tip:

When the HDMI Output Setting is set to On, you can also change this setting by using the [RESOLUTION] button on the front panel (see page 43).

Note:

- Initially, the DVD player is configured to output both HDMI and analog video. However, if after changing the resolution settings there's no picture, with the analog video connection or HDMI connection in place, press the [RESOLUTION] button repeatedly to restore the picture.

HD JPEG mode

If your TV is connected to the HDMI OUT and the HDMI resolution is set to 720p or 1080i, this setting allows you to display your JPEG pictures in high definition.

On: JPEG pictures displayed in high definition.

Off (default): JPEG pictures displayed as normal.

Notes:

- If your TV is connected to a video output other than the HDMI OUT, or the HDMI output resolution is set to something other than 720p or 1080i, even if this setting is set to On, your JPEG pictures will not be displayed in high definition.
- When using HD JPEG, it may take a while to display each picture. And the Zoom function cannot be used. Also, onscreen status messages such as "Play" and "Stop" are not displayed.

Video Black Level

With this setting you can adjust the picture blackness for the analog video outputs. It does not affect the component video output when its set to progressive.

Light: Blacks are lighter, and the entire picture becomes lighter.

Dark: Blacks are darker, and the entire picture becomes darker.

Brightness

With this setting you can adjust the picture brightness.

Level 1-7: 1 is the darkest. 7 is the brightest. The default brightness is 4 (standard).

Sharpness

With this setting you can adjust the picture sharpness.

Level 1-7: 1 is the softest. 7 is the sharpest. The default sharpness is 4 (standard).

PAL Output Setting (Not North American and Korean models)

With this setting you can specify how the DVD player outputs video signals when playing NTSC format DVD-Video discs or Video CDs.

AUTO (default): Use this option if your TV supports both PAL and NTSC. The DVD player does not convert the video format. When you play a PAL disc, the video output will be PAL format. And when you play an NTSC disc, it'll be NTSC format.

NTSC: Use this option if your TV doesn't support PAL playback, or the picture is distorted when watching PAL discs. The DVD player will convert PAL format video signals to NTSC-compatible format.

PAL: Use this option if your TV doesn't support NTSC playback, or the picture is distorted when watching NTSC discs. The DVD player will convert NTSC format video signals to PAL-compatible format.

Note:

- If you select the wrong setting by mistake and lose the picture, while pressing and holding the Next ►► button, press the [STANDBY/ON] button to return to the previous setting.

SCART Output Setting (European model only)

With this setting you can select the video format to be used for the SCART AV CONNECTOR: RGB, S-Video, or composite video. Before changing this setting, refer to your TV's manual to see if its SCART input can accept video signals in these formats.

Composite (default): Composite video offers standard quality.

S-Video: S-Video offers the next best picture quality.

RGB: This format offers the best picture quality.

Notes:

- If you select a format that is not supported by your TV, the setup menu may disappear from the screen. If this happens, switch off your equipment, connect the DVD player to your TV with a composite video or S-Video cable, and then change this setting.
- When RGB is selected, nothing is output by the component video output and HDMI output.

Audio Menu

Digital/HDMI Audio Out

With this setting you can configure the optical, coaxial, and HDMI digital outputs.

All (default): Dolby Digital and DTS signals are output as they are.

PCM: Dolby Digital and DTS signals are down mixed to 2 channels and output as PCM.

Off: No digital signals are output.

Note:

- MPEG is output as PCM regardless of this setting.

Linear PCM Out

With this setting you can configure the DVD player to output digital audio with higher sampling rates (e.g., 88.2 kHz, 96 kHz) as it is or to down sample it to 48 kHz or below.

If the AV component you connect to the DVD player's digital audio outputs supports 96 kHz digital audio, select Down Sample Off. Otherwise, select Down Sample On.

Down Sample On: 196 kHz and 96 kHz sources are down sampled to 48 kHz, and 176.4 kHz and 88.2 kHz sources are down sampled to 44.1 kHz.

Down Sample Off (default): Sources are output as they are.

Notes:

- Some copy-protected DVD-Video discs may use 96 kHz digital audio only for D/A conversion to the analog audio outputs.

- With some discs, even if you select Down Sample Off, the digital audio will be down sampled, and in some cases may not be output by the DVD player's digital audio outputs.

Speaker Configuration

With these settings, you can specify which speakers are connected and their sizes. These settings only apply to the DVD player's analog multichannel output. If you connect to only the FRONT/D.MIX L/R jacks, set the Subwoofer, Center Speaker, and Surround Speaker settings to Off.

Note:

- The Speaker Configurations have no effect on 192 kHz/176.4 kHz DVD-Audio.
- To use the Speaker Configuration settings with SACD playback, in the SACD Audio Setup, select PCM.

■ Subwoofer

On (default): Select if a subwoofer is connected.

Off: Select if no subwoofer is connected.

■ Front Speaker

Large: Select if the front speakers are large.

Small (default): Select if the front speakers are small.

Note:

- If the Subwoofer setting is set to Off, this setting is fixed at Large and cannot be changed.

■ Center Speaker

Large: Select if the center speaker is large.

Small (default): Select if the center speaker is small.

Off: Select if no center speaker is connected.

Notes:

- If the Front Speaker setting is set to Small, the Large option cannot be selected.
- The Center Speaker and Surround Speaker settings can only be set to the same size.

■ Surround Speaker

Large: Select if the surround speakers are large.

Small (default): Select if the surround speakers are small.

Off: Select if no surround speakers are connected.

Notes:

- If the Front Speaker setting is set to Small, the Large option cannot be selected.
- The Center Speaker and Surround Speaker settings can only be set to the same size.

Test Tone

If you can adjust the volume level of each channel of your amp's multichannel input, with this function, you can output a test tone from each multichannel output jack in turn and adjust each level as necessary.

1. Use the Up/Down [▲]/[▼] buttons to select a speaker, and then press the [ENTER] button.
A test tone is output by each speaker as it's selected.
2. Refer to your AV receiver's instruction manual for details on adjusting the volume level of each channel.

Note:

- The test tone is not output by the digital audio outputs.

Center Delay and Surr. Delay

With these settings, you can adjust the multichannel output signals relative to the listening position.

For 5.1-channel surround playback, ideally your speakers should all be the same distance away from the listening position, but this isn't always practical. By setting a delay time for the center and surround speakers, you can adjust their virtual positions without having to physically move them, creating the ideal listening environment. The diagram below shows the ideal locations for the center and surround speakers.

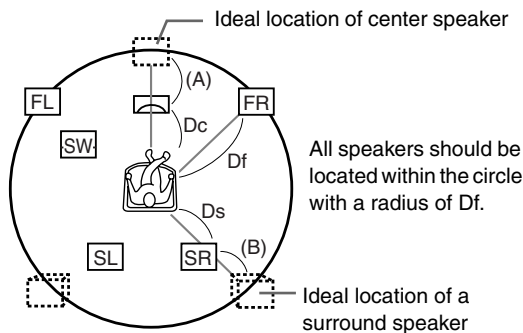

Center Delay

Center Delay (A) = $D_f - D_c$

No Delay (default): When D_f equals D_c .

1msec: When (A) is approx. 1 ft. (0.3 m)

2msec: When (A) is approx. 2 ft. (0.6 m)

3msec: When (A) is approx. 3 ft. (0.9 m)

4msec: When (A) is approx. 4 ft. (1.2 m)

5msec: When (A) is approx. 5 ft. (1.5 m)

Surr. Delay

Surr. Delay (B) = $D_f - D_s$

No Delay (default): When D_f equals D_s .

5msec: When (B) is approx. 5 ft. (1.5 m)

10msec: When (B) is approx. 10 ft. (3 m)

15msec: When (B) is approx. 15 ft. (4.5 m)

Notes:

- The delay settings have no effect on 192 kHz/176.4 kHz DVD-Audio.
- To use the delay settings with SACD playback, in the SACD Audio Setup, select PCM.

Dynamic Range Control (Dolby Digital only)

With the Dynamic Range Control function you can reduce the dynamic range of Dolby Digital material so that you can still hear quiet parts even when listening at low volume levels—ideal for watching movies late at night when you don't want to disturb anyone.

Off (default): The full dynamic range is preserved.

On: The dynamic range of Dolby Digital material is compressed.

Notes:

- The impact of the Dynamic Range Control function depends on the Dolby Digital material that you are playing and with some material there will be little or no effect.
- When the DVD player is set to Standby, this function is automatically set to Off.
- Depending on the Speaker Configuration settings, this setting may be fixed.

Pro Logic

This setting determines how the DVD player's built-in Dolby Pro Logic decoder works with 2-channel material.

On: The Dolby Pro Logic decoder decodes Dolby Surround material and processes the following audio formats: 2-channel Dolby Digital on DVD-Video discs, 48 kHz (16-, 20-, and 24-bit) PCM audio on DVD-Video discs, and 2-channel audio on CDs.

Off (default): The Dolby Pro Logic decoder is off.

Note:

- If the Center Speaker or Surround Speaker is set to Off in the Speaker Configuration settings (page 48), the Dolby Pro Logic decoder will not work even if you select On.

SACD Audio Setup

With this setting you can choose whether DSD (Direct Stream Digital) or PCM is output when playing Super Audio CDs.

When DSD is selected, the Speaker Configuration settings have no effect and the source is output as it is: 2-channel material is output as 2-channels, and multichannel material is output as multichannel.

When PCM is selected, the source is output in accordance with the Speaker Configuration settings and the output is down mixed.

DSD (default): The source signal is output as it is.

PCM: The source signal is output in accordance with the Speaker Configuration settings.

Downmix Setting

With this setting you can configure the FRONT/D.MIX AUDIO OUT jacks and AV CONNECTOR for use with a 2-channel stereo amp or an amp with a built-in Dolby Pro Logic decoder. It determines how multichannel audio sources are down mixed.

In the Speaker Configuration, set the Subwoofer, Center Speaker, and Surround Speaker settings to Off.

Stereo (default): Choose this option if you're connecting the FRONT/D.MIX AUDIO OUT jacks or AV CONNECTOR to a stereo amp or TV. Multichannel audio is down mixed into stereo.

Lt/Rt: Choose this option if you're connecting the FRONT/D.MIX AUDIO OUT jacks or AV CONNECTOR to an AV receiver, TV, or other component with a built-in Dolby Pro Logic decoder. Multichannel audio is down mixed into an Lt/Rt mix, which is a 2-channel mix containing front left, front right, center, and surround channel information.

Language Menu

On-Screen Language

With this setting you can select a language for the onscreen setup menus and messages.

Select one of the displayed languages.

Disc Menu Language

With this setting you can select your preferred language for disc menus. When you play a DVD-Video disc with multiple language disc menus, your preferred language will be selected automatically.

Select "Others" if the language you want is not displayed. See "Selecting Other Languages" on page 51.

Notes:

- Not all DVD-Video discs have menus in multiple languages.
- Even if a DVD-Video disc has menus in multiple languages, this setting may not always work.
- If a DVD has only one menu language, that will be used.
- With some DVD-Video discs you can select languages from a menu.

Audio

With this setting you can select your preferred language for soundtracks. When you play a DVD-Video disc with multiple language soundtracks, your preferred language will be selected automatically.

Select "Others" if the language you want is not displayed. See "Selecting Other Languages" on page 51.

Notes:

- Not all DVD-Video discs have soundtracks in multiple languages.
- Even if a DVD-Video disc has soundtracks in multiple languages, this setting may not always work.
- If a DVD has only one soundtrack, that will be used.
- With some DVD-Video discs you can select languages from a menu.

Subtitle Language

With this setting you can select your preferred language for subtitles. When you play a DVD-Video disc with multiple language subtitles, your preferred language will be selected automatically.

Select "No Subtitle" if you don't want subtitles displayed. Select "Others" if the language you want is not displayed. See "Selecting Other Languages" on page 51.



Notes:

- Not all DVD-Video discs have subtitles.
- Even if a DVD-Video disc has subtitles in multiple languages, this setting may not always work.
- If a DVD has only one subtitle language, that will be used.
- With some DVD-Video discs you can select subtitles from a menu.

Configuring the DVD player—Continued

■ Selecting Other Languages

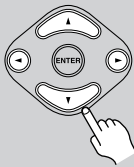
This section explains how to select other languages for disc menus, audio, and subtitles.

1 Remote controller 	Select “Others” from the Disc Menu Language, Audio Language, or Subtitle menu, and then press [ENTER].
2 Remote controller 	Use the Left/Right [◀]/[▶] buttons to select the code. Use the Up/Down [▲]/[▼] buttons to enter a language code. See adjacent table for language codes.
3 Remote controller 	When you’ve finished, press the [ENTER] button.

Use this list when specifying other languages.

Language	Code
Japanese	JA
English	EN
French	FR
German	DE
Italian	IT
Spanish	ES
Chinese	ZH
Dutch	NL
Portuguese	PT
Swedish	SV
Russian	RU
Korean	KO
Greek	EL
Afar	AA
Abkhazian	AB
Afrikaans	AF
Amharic	AM
Arabic	AR
Assamese	AS
Aymara	AY
Azerbaijani	AZ
Bashkir	BA

Language	Code
Kirghiz	KY
Latin	LA
Lingala	LN
Laothian	LO
Lithuanian	LT
Latvian	LV
Malagasy	MG
Maori	MI
Macedonian	MK
Malayalam	ML
Mongolian	MN
Moldavian	MO
Marathi	MR
Malay	MS
Maltese	MT
Burmese	MY
Nauru	NA
Nepali	NE
Norwegian	NO
Occitan	OC
Oromo	OM
Oriya	OR

Language	Code
Byelorussian	BE
Bulgarian	BG
Bihari	BH
Bislama	BI
Bengali	BN
Tibetan	BO
Breton	BR
Catalan	CA
Corsican	CO
Czech	CS
Welsh	CY
Danish	DA
Bhutani	DZ
Esperanto	EO
Estonian	ET
Basque	EU
Persian	FA
Finnish	FI
Fiji	FJ
Faroese	FO
Frisian	FY
Irish	GA
Scots-Gaelic	GD
Galician	GL
Guarani	GN
Gujarati	GU
Hausa	HA
Hindi	HI
Croatian	HR
Hungarian	HU
Armenian	HY
Interlingua	IA
Interlingue	IE
Inupiak	IK
Indonesian	IN
Icelandic	IS
Hebrew	IW
Yiddish	JI
Javanese	JW
Georgian	KA
Kazakh	KK
Greenlandic	KL
Cambodian	KM
Kannada	KN
Kashmiri	KS
Kurdish	KU

Language	Code
Panjabi	PA
Polish	PL
Pashto, Pushto	PS
Quechua	QU
Rhaeto-Romance	RM
Kirundi	RN
Romanian	RO
Kinyarwanda	RW
Sanskrit	SA
Sindhi	SD
Sangho	SG
Serbo-Croatian	SH
Sinhalese	SI
Slovak	SK
Slovenian	SL
Samoan	SM
Shona	SN
Somali	SO
Albanian	SQ
Serbian	SR
Siswati	SS
Sesotho	ST
Sundanese	SU
Swahili	SW
Tamil	TA
Telugu	TE
Tajik	TG
Thai	TH
Tigrinya	TI
Turkmen	TK
Tagalog	TL
Setswana	TN
Tonga	TO
Turkish	TR
Tsonga	TS
Tatar	TT
Twi	TW
Ukrainian	UK
Urdu	UR
Uzbek	UZ
Vietnamese	VI
Volapük	VO
Wolof	WO
Xhosa	XH
Yoruba	YO
Zulu	ZU

DivX Subtitle (Not North American model)

Some DivX video discs include subtitles in one or more languages. The disc packaging will usually inform you about which subtitle languages are available.

With this setting you can select your preferred language for DivX subtitles. When you play a DivX disc with multiple language subtitles, your preferred language will be selected automatically.

You can select DivX subtitle languages by region:

Unicode (UTF-8): Unicode encoding scheme. Two bytes are used to encode each character.

Western European

Turkish

Central European

Cyrillic

Greek

Hebrew

Arabic

Baltic

Vietnam

Note:

- Some external subtitle files may display incorrectly or not at all.

Display Menu

On-Screen Display

With this setting you can turn on or off onscreen messages, such as “Play,” “Stop,” and “Resume.”

Off: Onscreen messages are not displayed.

On (default): Onscreen messages are displayed.

On-Screen Display Color

With this setting you can set the color and theme of the Disc navigation window.

Sapphire

Pearl

Amethyst

Garnet

Background

With this setting you can select the color of the background that’s displayed when the DVD player is stopped.

Blue

Gray

Graphic: The theme picture specified for the On-Screen Display Color setting is used.

Screen Saver

With the Screen Saver function you can protect your TV against screen burn-in, which can occur when the same image or menu is displayed for a long time.

Off: Screen saver off.

On (default): Screen saver on.

When the Screen Saver function is set to On, and playback is stopped for 15 minutes, the Screen Saver function automatically displays a moving image.

Once the screen saver has been activated, you can cancel it by pressing either the Play [▶] button.

Operation Setting Menu

Setting the Parental Lock

With the Parental Lock function you can block access to certain scenes that the authors have flagged as being unsuitable for children.

1	Select “Operation Setting” menu in the setup.
2 Remote controller	Use the Up/Down [▲]/[▼] buttons to select “Parental Lock,” and then press the [ENTER] button. The security code input screen appears.
3 Remote controller	Enter the security code using the remote controller’s number buttons, and then press the [ENTER] button. The default security code is “8888.” You can change the security code in the next section.
4 Remote controller	Use the Up/Down [▲]/[▼] buttons to change the level of parental lock, and then press the [ENTER] button. At level 8 parental lock is off, with level 1 being the strictest level.

Notes:

- When entering a security code, you can use the [CLR] button to delete the numbers entered so far, if necessary.
- Not all discs use parental lock. See the disc’s sleeve notes for details.
- Discs with parental lock may cut certain scenes, replace certain scenes with children-friendly scenes, or prevent playback of the entire disc.

Change the Security Code

To change the Security Code, confirm your existing code then enter a new one.

1	Select “Operation Setting” menu in the setup.
2 Remote controller	Use the Up/Down [▲]/[▼] buttons to select “Security Code,” and then press the [ENTER] button. The security code input screen appears.
3 Remote controller	Enter the existing security code using the remote controller’s number buttons, and then press the [ENTER] button. The default security code is “8888.” Even if a new security code has been entered, the code “8888” can still be used. Once the security code has been entered, the new security code input screen appears.
4 Remote controller	Enter the new security code using the remote controller’s number buttons, and then press the [ENTER] button. The new security code has been set.

Note:

- If you forget your security code, enter “8888” instead. “8888” is a security code that can always be used.

Configuring the DVD player—Continued

DVD Priority Contents

This setting determines what is played when a DVD-Audio disc also contains DVD-Video material.

DVD-AUDIO (default): The DVD-Audio material is played.

DVD-VIDEO: The DVD-Video material is played.

SACD Priority Contents

SACDs have two separate areas for storing audio tracks—one for multichannel audio, the other for 2-channel stereo audio. In addition, hybrid SACDs have an extra layer for playback in standard CD players. With this setting you can determine how SACDs are played by the DVD player.

2 ch Area: The 2-channel stereo audio tracks are played.

Multi ch Area (default): The multichannel audio tracks are played.

CD Area: The CD layer of hybrid SACDs is played.

Notes:

- This setting determines which area of the disc is played initially. If Multi ch Area is selected, and an SACD that contains no multichannel area is loaded, the 2-channel area will be played.

Auto power off

The Auto power off function automatically turns off the DVD player after 20 minutes of inactivity.

Off (default): Auto power off function off.

On: Auto power off function on.

DivX® Registration

To play DivX VOD (video on demand) content on this DVD player, you first need to register it with your DivX VOD content provider. You do this by generating a DivX VOD registration code, which you then submit to your provider.

Your 8-digit registration code is displayed.

Burn DivX VOD content that you download to a blank CD-R.

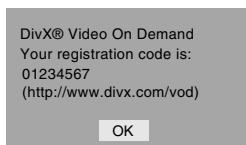

Make a note of the code as you will need it when you register with a DivX VOD provider.

Important:

- DivX VOD content is protected by DRM (digital rights management). This restricts playback of content to specific, registered devices.

Additional information

Resetting the player

Use this procedure to reset all the player's settings to the factory default.

- 1 Turn on the DVD player.**
 Wait until "ONKYO DVD" has disappeared from the display.
- 2 Using the front panel buttons, hold down the Stop [■] button and press [STANDBY/ON] button.**
 "INITIALIZE" appears on the display. When the reset is complete, "COMPLETE" is displayed, and the DVD player enters Standby mode.

Adjusting the Display Brightness

You can adjust the brightness of the display as follows.

- 1 Press the [DIMMER] button repeatedly to cycle through the following options:**
 dim, dimmer, normal.

DVD-Video regions

All DVD-Video discs carry a region mark on the case somewhere that indicates which region(s) of the world the disc is compatible with. Your DVD player also has a region mark, which you can find on the rear panel. Discs from incompatible regions will not play in this player. Discs marked "ALL" will play in any player. The diagram below shows the various DVD regions of the world.

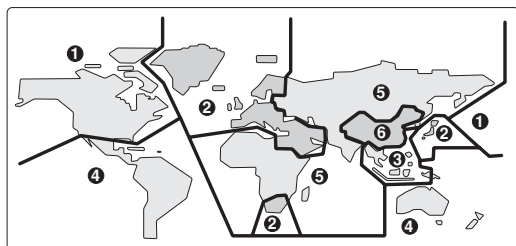

Disc Content Organization

■ DVD-Video Format

DVD-Video discs contain titles, which are usually subdivided into chapters.

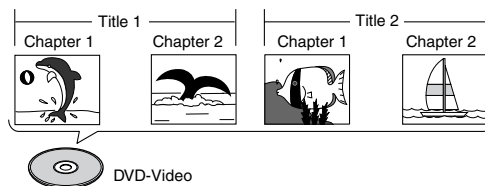

■ DVD-Audio

DVD-Audio discs contain groups and tracks.

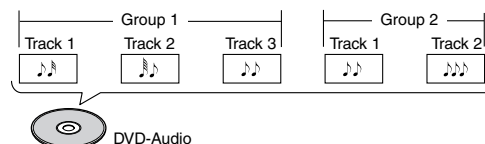

■ SACD

SACDs have two separate areas for storing audio tracks—one for multichannel audio, the other for 2-channel stereo audio. In addition, hybrid SACDs have an extra layer for playback in standard CD players. You can specify how the DVD player handles SACDs on page 50.

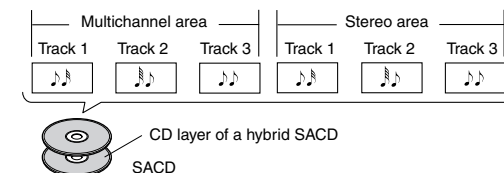

■ VCD

VCDs contain video tracks.

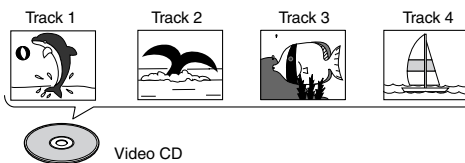

■ Audio CD Format

Audio CDs contain tracks.

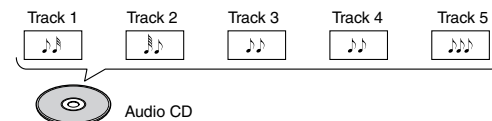

■ MP3, WMA, JPEG & DivX Files

MP3, WMA, JPEG, and DivX files are typically organized into folders. The DVD player handles MP3, WMA, JPEG, and DivX files as tracks.

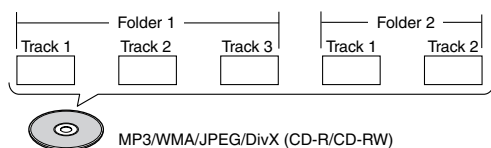

Glossary

Analog audio

An electrical signal that directly represents sound. Compare this to digital audio which can be an electrical signal, but is an indirect representation of sound. See also “Digital audio.”

Aspect ratio

The width of a TV screen relative to its height. Conventional TVs are 4:3 (in other words, the screen is almost square); widescreen models are 16:9 (the screen is almost twice as wide as it is high).

Digital audio

An indirect representation of sound by numbers. During recording, the sound is measured at discrete intervals (44,100 times a second for CD audio) by an analog-to-digital converter, generating a stream of numbers.

On playback, a digital-to-analog converter generates an analog signal based on these numbers. See also “Sampling frequency” and “Analog audio.”

DivX^{*1}



DivX is a media technology created by DivX, Inc. DivX media files contain compressed video. DivX files can also include advanced media features like menus, subtitles, and alternate audio tracks.

Dolby Digital^{*2}



Using a maximum of 5.1 channels of audio, this high quality surround system is used in many of the finer movie theaters around the world.

The on-screen display shows which channels are active, for example showing 3/2.1. The 3 being the two front channels and the center channel; the 2 being the surround channels, and the .1 being the LFE channel.

DRM

DRM (digital rights management) is a type of server software developed to enable secure distribution of paid content over the web, recently incorporated by WMA (Windows Media Audio).

DTS^{*3}



DTS stands for Digital Theater Systems. DTS is a surround system different from Dolby Digital that has become a popular surround sound format for movies.

Dynamic range

The difference between the quietest and loudest sounds possible in an audio signal (without distorting or getting lost in noise).

Dolby Digital and DTS soundtracks are capable of a very wide dynamic range, delivering dramatic cinema-like effects.

File extension

A tag added to the end of a filename to indicate the type of file. For example, “.mp3” indicates an MP3 file.

HD

Abbreviation for high definition, as in HDTV (high-definition TV).

HDCP (High-bandwidth Digital Content Protection)

The video encryption technology developed by Intel for HDMI/DVI. It’s designed to protect video content and requires a HDCP-compatible device to display the encrypted video.

*1. DivX, DivX Certified, and associated logos are trademarks of DivX, Inc. and are used under license.

*2. Manufactured under license from Dolby Laboratories. “Dolby” and the double-D symbol are trademarks of Dolby Laboratories.

*3. “DTS” and “DTS Digital Surround” are registered trademarks of Digital Theater Systems, Inc.

HDMI^{*1}

HDMI (High-Definition Multimedia Interface) is a high-speed digital interface which has the capability to support standard, enhanced, or high-definition video plus standard to multichannel surround-sound audio on a single digital connection. HDMI features include uncompressed digital video, a bandwidth of up to 5 gigabytes per second and communication between the AV source and AV devices such as DTVs.

ISO 9660 format

International standard for the volume and file structure of CD-ROM discs.

JPEG

A file format used for still images, such as photographs and illustrations. JPEG files are identified by the file extension “.jpg” or “.JPG”. Most digital cameras use this format.

MP3

MP3 (MPEG1 audio layer 3) is a compressed audio file format. Files are recognized by their file extension “.mp3” or “.MP3”.

MPEG video

The video format used for Video CDs and DVDs. Video CD uses the older MPEG-1 standard, while DVD uses the newer and much better quality MPEG-2 standard.

PBC (PlayBack Control) (Video CD only)

A system of navigating a Video CD through on-screen menus recorded onto the disc. Especially good for discs that you would normally not watch from beginning to end all at once—karaoke discs, for example.

PCM (Pulse Code Modulation)

The most common system of encoding digital audio, found on CDs and DAT. Excellent quality, but requires a lot of data compared to formats such as Dolby Digital. For compatibility with digital audio recorders (CD, MD, and DAT) and AV amplifiers with digital inputs, this unit can convert Dolby Digital, and DTS to PCM. See also “Digital audio.”

Progressive scan video

All the lines that make up a video picture are updated in one pass (compared to interlace which takes two passes to update the whole picture).

Regions (DVD-Video only)

These associate discs and players with particular areas of the world. This unit will only play discs that have compatible region codes. You can find the region code of your unit by looking on the rear panel. Some discs are compatible with more than one region (or all regions).

Sampling frequency

The rate at which sound is measured to be turned into digital audio data. The higher the rate, the better the sound quality, but the more digital information is generated. Standard CD audio has a sampling frequency of 44.1kHz, which means 44,100 samples (measurements) per second. See also “Digital audio.”

WMA

WMA is short for Windows Media Audio and refers to an audio compression technology developed by Microsoft Corporation. WMA data can be encoded by using Windows Media Player version 8.

*1. HDMI, the HDMI logo and High-Definition Multimedia Interface are trademarks or registered trademarks of HDMI licensing LLC.

Troubleshooting

Symptom	Possible cause	Remedy	
Can't turn on the DVD player?	The power cord is not connected.	Connect the power cord to a suitable wall outlet (page 26).	
	External interference is affecting the DVD player's digital circuitry.	Turn off the DVD player, wait five seconds, then try turning it on again. If that fails, disconnect the power cord from the wall outlet, wait ten seconds, reconnect it, then try turning it on again.	
The DVD player turns itself off when it's not being used?	The Auto power off function will turn the DVD player off automatically after 20 minutes of inactivity.	The Auto power off function can be turned on or off as required (page 54).	
No picture?	The wrong input source is selected on your TV.	On your TV, select the input to which the DVD player is connected.	
	The video cable is not connected properly.	Check the video cable and correct as necessary.	
	The PAL Output Setting is set wrong for your TV.	Change the PAL Output Setting to suit your TV (page 47).	
	The SCART Output Setting is set wrong for your TV.	Make sure your TV supports the selected video output format (page 48).	
	No HDMI Video Output?		
	The HDMI Output Setting is set to Off.	Try pressing the [HDMI] button on the front panel repeatedly to switch the HDMI OUT on, and then pressing the [RESOLUTION] button repeatedly to get picture (page 43).	
	Your TV doesn't support HDMI Resolution settings of 720p and 1080i.		
	The connected component doesn't support HDCP.	If the DVD player is connected to your AV receiver, try connecting it directly to your TV. It will not work if you connect to a component that doesn't support HDCP (page 24).	
	No Component Video Output?		
	Your TV does not support progressive scanning, and the HDMI OUT is on. While the HDMI OUT is on, the component video output outputs progressive video.	Try pressing the [HDMI] button on the front panel repeatedly to switch the HDMI OUT off, and then pressing the [RESOLUTION] button repeatedly to switch to Interlaced (page 43).	
	The HDMI Resolution is not set to 480p (480p/576p).	Press the [RESOLUTION] button repeatedly to select 480p (480p/576p) (page 43).	
	No S-Video or Composite Video Output?		
	The HDMI Resolution is not set to 480p (480p/576p).	Try pressing the [RESOLUTION] button on the front panel repeatedly to get picture (page 19).	
No sound?	The wrong input source is selected on your hi-fi amp or AV receiver.	On your hi-fi amp or AV receiver, select the input to which the DVD player is connected.	
	The audio cable is not connected properly.	Check the audio cable and correct as necessary.	
	Your hi-fi amp or AV receiver is turned off.	Turn on your hi-fi amp or AV receiver.	
	Not all of the analog and digital audio outputs work with all disc types and formats.	See page 19 for details on how the DVD player outputs audio from each output.	

Troubleshooting—Continued

Symptom	Possible cause	Remedy
No sound?	No Sound from the HDMI OUT?	
	The Digital/HDMI Audio Out setting is set to Off.	Change the Digital/HDMI Audio Out setting to either All or PCM (page 48).
	The DVD player is connected to the DVI jack on your TV or AV receiver.	You won't hear any sound from the HDMI OUT if your TV or AV receiver only supports DVI.
	The HDMI setting on your TV or AV receiver is set to DVI.	Change the HDMI setting on your TV or AV receiver to HDMI.
	Your TV or AV receiver doesn't support Dolby or DTS.	Change the Digital/HDMI Audio Out setting to PCM (page 48).
	You're playing an SACD.	SACD audio is not output by the HDMI OUT (page 19).
	Your TV or AV receiver doesn't support 88.2 kHz, 96 kHz, 176.4 kHz or 196 kHz PCM.	Change the Linear PCM Out setting to Down Sample On (page 48).
	No Digital Audio Output?	
	The Digital/HDMI Audio Out setting is set to Off.	Change the Digital/HDMI Audio Out setting to either All or PCM (page 48).
	Your TV or AV receiver doesn't support Dolby or DTS.	Change the Digital/HDMI Audio Out setting to PCM (page 48).
	Your TV or AV receiver doesn't support 88.2 kHz, 96 kHz, 176.4 kHz or 196 kHz PCM.	Change the Linear PCM Out setting to Down Sample On (page 48).
	The picture distorts occasionally?	The disc is dirty.
You're using the Fast Forward or Fast Reverse function.		A little picture distortion may occur when using these functions. This is normal.
Picture instability or noise?	The DVD player is connected to your TV via a VCR or other video equipment whose copy protection system is affecting the picture.	Connect the DVD player directly to your TV (page 20).
Can't start playback?	No disc loaded.	Load a disc (page 28).
	The disc is incompatible.	Load only compatible discs (pages 8, 9).
	The disc is upside down.	Load the disc the correct way up (page 28).
	The disc is not centered in the disc tray.	Place the disc in the center of the disc tray (page 28).
	The disc is dirty.	Remove the disc and clean it (page 10).
	The disc supports parental lock and the Parental Lock function is on.	Turn off the Parental Lock function (page 53).
Can't watch the DVD-Video material on a DVD-Audio disc?	The DVD Priority Contents setting is set to DVD-AUDIO.	Set the DVD Priority Contents setting to DVD-VIDEO (page 54).
Can't play the multichannel area of a hybrid SACD?	The SACD Priority Contents setting is not set to Multi ch Area.	Set the SACD Priority Contents setting to Multi ch Area (page 54).
Can't play MP3 and JPEG discs?	The disc is not ISO 9660 Level 2 format.	Use only ISO 9660 Level 2 format discs (page 9).
	The disc has not been finalized.	Finalize the disc (page 9).
There's a noise when using repeat playback.	During CD 1-Track Repeat playback, the start of the next track may be heard.	This is not a malfunction.

Troubleshooting—Continued

Symptom	Possible cause	Remedy
Can't select MP3 files?	MP3 files without a ".mp3" or ".MP3" filename extension are not recognized.	Use the correct filename extension (page 9).
	The MP3 disc is a multisession disc.	Only files in the first session of a multisession disc can be played (page 9).
Can't play WMA files?	WMA files without a ".wma" or ".WMA" filename extension are not recognized.	Use the correct filename extension (page 9).
	The WMA file's copyright option is on.	Don't use the copyright option (page 9).
Can't view JPEG files?	JPEG files without a ".jpg" or ".JPG" or ".JPEG" filename extension are not recognized.	Use the correct filename extension (page 9).
	The JPEG file is too big.	Use JPEG files that are less than 5 megabytes (page 9).
Can't play a DivX file?	The file is not encoded correctly.	Make sure the DivX file was encoded with DivX Version 5, 4, or 3 Home Theater mode.
DivX plays but there's no sound?	The DVD player may not support the audio format.	Try re-encoding the file with a supported audio format.
Buttons on the DVD player and remote controller don't work?	Power supply voltage fluctuations and other anomalies, such as static electricity, can interfere with normal operation.	Turn off the DVD player, wait five seconds, then turn it on again. If that doesn't resolve the issue, disconnect the power cord from the wall outlet, wait ten seconds, reconnect it, then try again.
	There are no batteries in the remote controller.	Install new batteries (page 11).
	The batteries are flat.	Replace with new batteries (page 11).
	The batteries are installed incorrectly.	Check the batteries and correct as necessary (page 11).
	You're not pointing the remote controller at the DVD player's remote sensor.	Point the remote controller at the DVD player's remote sensor (page 11).
	You're too far away from the DVD player.	Use the remote controller closer to the DVD player (page 11). The remote controller has a range of approximately 16 ft. (5 meters).
	A strong light source is interfering with the DVD player's remote sensor.	Make sure that the DVD player is not subjected to direct sunshine or inverter-type fluorescent lights. Relocate if necessary.
	If the DVD player is installed in a cabinet with colored glass doors, the remote controller may not work reliably when the doors are closed.	Open the doors, or use a cabinet without colored glass.

The DVD player contains a microcomputer for signal processing and control functions. In very rare situations, severe interference, noise from an external source, or static electricity may cause it to lockup. In the unlikely even that this should happen, unplug the power cord from the wall outlet, wait at least ten seconds, and then plug it back in again. Alternatively, press and hold the Stop [■] button until "RESET" appears on the display (about 10 seconds).

Onkyo is not responsible for damages (such as CD rental fees) due to unsuccessful recordings caused by the unit's malfunction. Before you record important data, make sure that the material will be recorded correctly.

■ HDMI Status Mode

If you're using an HDMI connection and there's no picture or sound, you can check the status of the HDMI connection by pressing and holding down the DVD player's [DISPLAY] button for 10 seconds until a message ID appears on the display. Look up the message ID in the following tables and check the HDMI connections and settings on both the DVD player and the connected component.

HDMI connection and HDMI-related settings status

Displayed ID	Message
MSG ID 001 MSG ID 015	Turn the DVD player and the connected component off, then turn them on again. Make sure that the connected component is working properly and that the DVD player's HDMI settings are configured suitably for that component.

No picture from the HDMI connection

Displayed ID	Message
MSG ID 002	The HDMI Output Setting is set to Off. Change it to On (page 43).
MSG ID 003 MSG ID 004	The HDMI cable may not be connected properly. Check the connection. Also, make sure the HDMI input on the TV or AV receiver is correctly configured to receive HDMI.
MSG ID 005 MSG ID 006 MSG ID 007	Make sure the HDMI input on the TV or AV receiver is correctly configured to receive HDMI. The connected component may not support HDCP. Make sure the connected component supports HDCP. Turn the DVD player and the connected component off, then turn them on again. The DVD player may be connected to the other component's DVI jack. Some TVs may not properly receive the video output by the DVD player. Also, with a DVI connection, there will be no sound.
MSG ID 008	The DVD player's HD Resolution setting is set to 720p or 1080i. If your TV doesn't support these resolutions, select another resolution (page 43).
MSG ID 009	The connected component may not be receiving the HDMI signal properly. Try selecting another resolution on the DVD player (page 43).

No sound from the HDMI connection

Displayed ID	Message
MSG ID 010	The DVD player's Digital/HDMI Audio Out setting is set to Off. Change the setting to All or PCM (page 48).
MSG ID 011 MSG ID 014	The connected component may not support 96 kHz PCM. Set the DVD player's Linear PCM Out setting to Down Sample On (page 48).
MSG ID 012 MSG ID 013	The connected component may not support Dolby Digital. Set the DVD player's Digital/HDMI Audio Out setting to PCM (page 48).
MSG ID 016 MSG ID 017	The connected component may not support DTS. Set the DVD player's Digital/HDMI Audio Out setting to PCM (page 48).
MSG ID 020	Audio from SACDs is not output by the HDMI OUT (page 19).

Specifications

Signal System	North American and Korean model: NTSC Other model: PAL/NTSC	
Composite Video Output/Impedance	1.0 V (p-p)/75Ω negative sync, RCA	
S-Video Output/Impedance	Y: 1.0 V (p-p)/75Ω negative sync, 4-pin mini DIN C: 0.286 V (p-p)/75Ω	
Component Video Output/Impedance	Y: 1.0 V (p-p)/75Ω PB/PR: 0.7 V (p-p)/75 Ω RCA/ phono	
AV Connector (European model only)	1.0 V (p-p)/75Ω, Scart	
Component Video Frequency Response	5 Hz–50 MHz	
Frequency response	DVD Audio	4 Hz–88 kHz (192 kHz)
	Super Audio CD	4 Hz–50 kHz
	DVD Linear Sound	4 Hz–44 kHz (96 kHz) 4 Hz–22 kHz (48 kHz)
	Audio CD	4 Hz–20 kHz (44.1 kHz)
S/N Ratio	106 dB	
Audio Dynamic Range	96 dB	
THD (Total Harmonic Distortion)	0.003% (1 kHz)	
Wow and Flutter	Below threshold of measurability	
Audio Output (Digital/Optical)	–22.5 dBm	
Audio Output/Impedance (Digital/Coaxial)	0.5 p-p/75Ω	
Audio Output/Impedance (Analog)	FRONT D.MIX/CENTER/SUBWOOFER: 2.0 V/440Ω SURROUND 1, 2: 2.0 V/440Ω (SURR MODE 1) 1.4 V/440Ω (SURR MODE 1+2)	

■ General

Power Supply	North American model: AC 120 V, 60 Hz Other model: AC 100–240 V, 50/60 Hz
Power Consumption	17 W
Stand-by Power Consumption	0.4 W
Dimensions (W x H x D)	435 x 81 x 309 mm (17 1/8 x 3 3/16 x 12 3/16 ins.)
Weight	3.7 kg (8.2 lbs.)
Operation Condition Temperature and Humidity	5°C–35°C (41°F–95°F), 5%–85%
Disc Compatibility	SACD, DVD-Audio, DVD-video, DVD-R/RW (VR, VIDEO), DVD+R/RW, CD, CD-R/RW, Video CD, MP3, WMA, JPEG, DivX (not North American model) Disc that have not been property finalized may only be partially playable or not playable at all

Specifications and features subject to change without notice.

The letter displayed at the end of the product name found in catalogs and on package represents the color of the DVD player. Though the color varies, the specifications and operations are the same.

Memo

ONKYO CORPORATION

Sales & Product Planning Div. : 2-1, Nisshin-cho, Neyagawa-shi, OSAKA 572-8540, JAPAN
Tel: 072-831-8023 Fax: 072-831-8124

ONKYO U.S.A. CORPORATION

18 Park Way, Upper Saddle River, N.J. 07458, U.S.A.
Tel: 201-785-2600 Fax: 201-785-2650 <http://www.us.onkyo.com/>

ONKYO EUROPE ELECTRONICS GmbH

Liegnitzerstrasse 6, 82194 Groebenzell, GERMANY
Tel: +49-8142-4401-0 Fax: +49-8142-4401-555 <http://www.eu.onkyo.com/>

ONKYO EUROPE UK Office

Suite 1, Gregories Court, Gregories Road, Beaconsfield, Buckinghamshire, HP9 1HQ
UNITED KINGDOM Tel: +44-(0)1494-681515 Fax: +44(0)-1494-680452

ONKYO CHINA LIMITED

Unit 1&12, 9/F, Ever Gain Plaza Tower 1, 88, Container Port Road, Kwai Chung,
N.T., HONG KONG Tel: 852-2429-3118 Fax: 852-2428-9039
<http://www.ch.onkyo.com/>



I0608-1

SN 29344210

(C) Copyright 2006 ONKYO CORPORATION Japan. All rights reserved.



* 2 9 3 4 4 2 1 0 *