

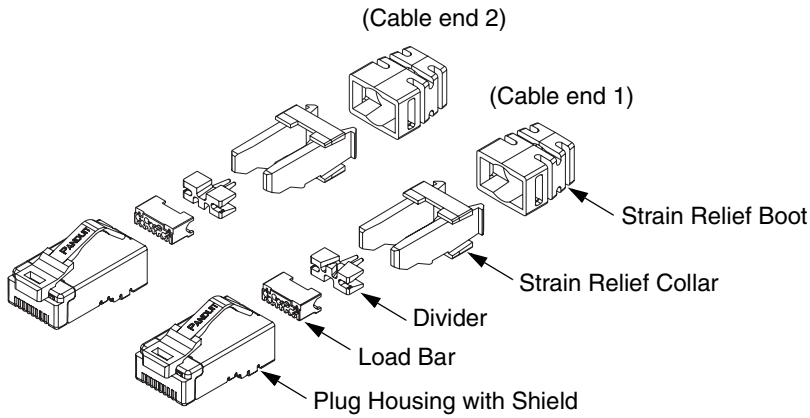

T568B Wiring Scheme



Pin #	8	7	6	5	4	3	2	1
T568B	BRN	BRN/WHT	GRN	BLU/WHT	BLU	GRN/WHT	ORG	ORG/WHT

Specifications

- Cable jacket diameter .225-.250 in.
- 24 AWG Stranded conductor maximum insulated diameter .040 in.
- *PANDUIT* recommends T568B wiring scheme for use with cable constructed with the brown pair opposing the orange pair.
- For use with FTP, ScTP, SFTP and STP/PIMF type cables. Cable must have drain wire or braid.

Load Bar

Conductor holes and Contact slots

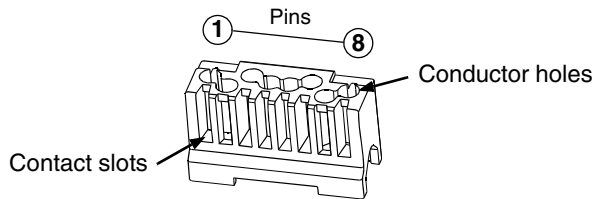

Divider

Conductor slots and "V" channel

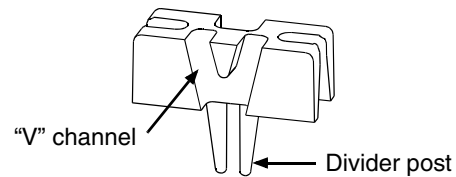

- 1** Thread on Boot and Collar first!
(Cable ends 1 & 2)

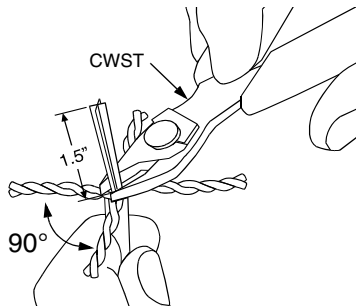
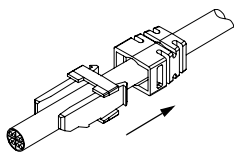

- First thread on the Boot and Collar.
- Remove 1.5" of the outer jacket from the cable end using wire stripping tool (CJAST).
- Cut foil flush to cable jacket end. If cable is braided, form into a drain wire. Bend the drain wire back so it is against the cable jacket.
- Fan twisted pairs into respective quadrants. The brown pair should be opposite the orange pair.
- When a cable spline (X-shaped filler) is present, cut spline flush to fanned pairs using wire snipping tool (CWST).

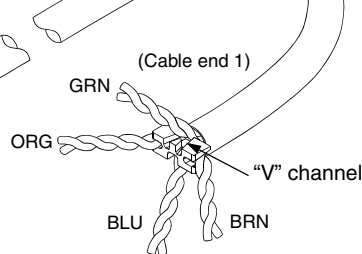
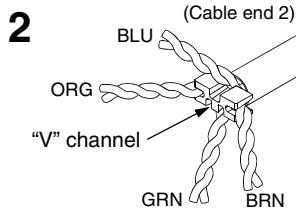

- The "V" channel should be aligned with the green pair.
- Insert Divider posts into the cable. If the cable has an internal spline, insert Divider posts into the brown and orange quadrants of the spline.

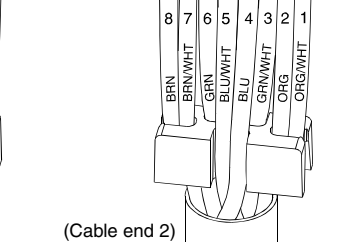
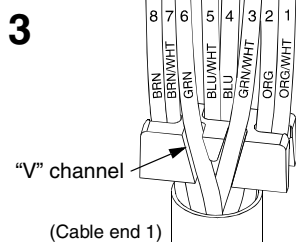

- Arrange conductors to T568B Wiring Scheme while minimizing untwist and smooth conductors.
- Seat conductors into proper Divider slots while holding Divider near the end of the cable jacket.

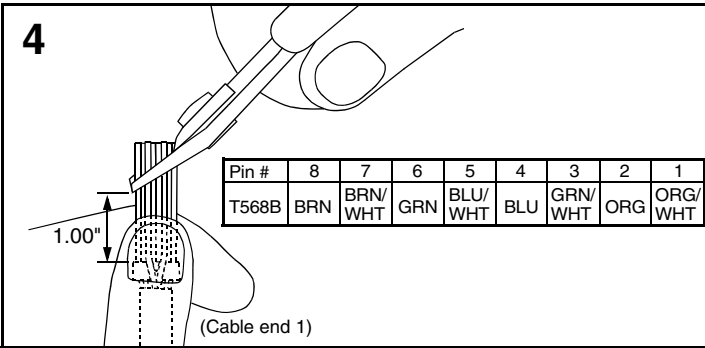

- While holding conductors in respective Divider slots, straighten and align untwisted conductors using a circular motion.
- Do not release grip of conductors until Load Bar is applied in order to maintain conductor alignment.
- Trim conductors on an angle approximately 1.00" from Divider leading edge.

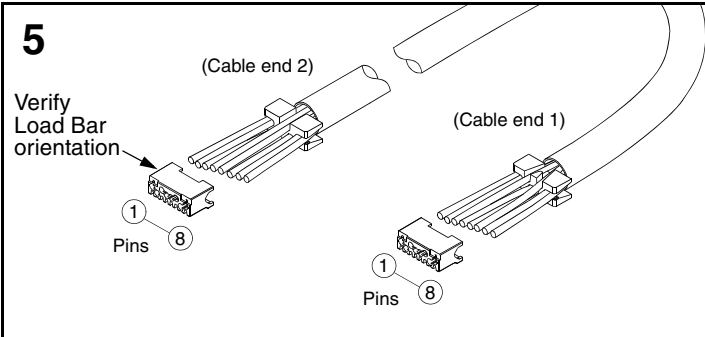

- Orient Load Bar with contact slots facing downward.

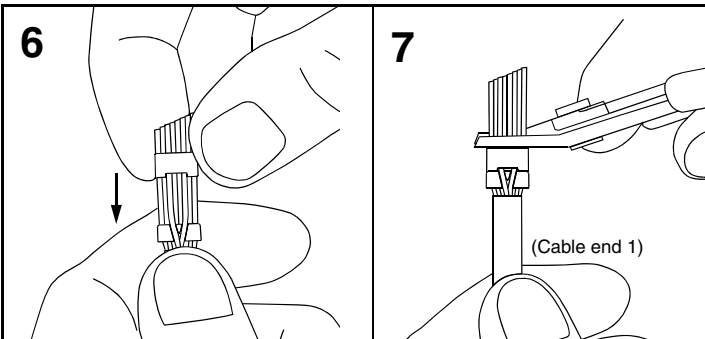

- Guide conductors into Load Bar holes while holding conductors in the Divider.
- Slide Load Bar towards Divider until flush.
- Ensure the Divider/Load Bar is centered and perpendicular to the cable axis.
- Trim conductors flush with Load Bar face.

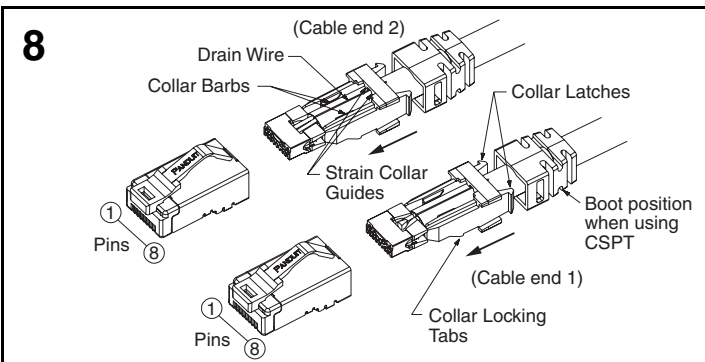

- Orient cable so drain wire is facing up. While holding the Load Bar and Divider stationary, slide the Collar towards the Load Bar and Divider until there is no gap between the Collar and Divider. Ensure the drain wire is routed through the Strain Collar Guides. Do not exert pressure onto the Divider, the Collar can push the Load Bar off the conductors.
- Confirm orientation of Collar. Cable jacket should extend beyond Collar barbs.
- Align Pin #1 of cable sub-assembly (Cable, Load Bar, Divider, Collar with Boot) with Pin #1 of Plug Housing.

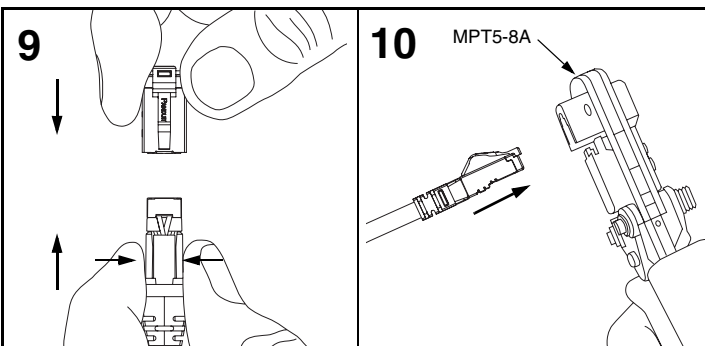

- Grip and squeeze across Collar arms as sub-assembly is inserted into Plug Housing. (Fig. 9)
- Push sub-assembly into Housing until Collar locking tabs clear the Plug Housing pocket. Although not required, TX6 PLUS Plug Assembly Tool (CSPT) is available to facilitate this step.
- Use tool MPT5-8A to complete termination. (Fig. 10)
- Press any excess drain wire between the Collar Latches and the cable jacket. Pull up Boots and engage with Collar. Latches of the Collar should be engaged on the window slot of the boot.
- Assembly is complete. Visually check plug.

T568A Wiring Scheme

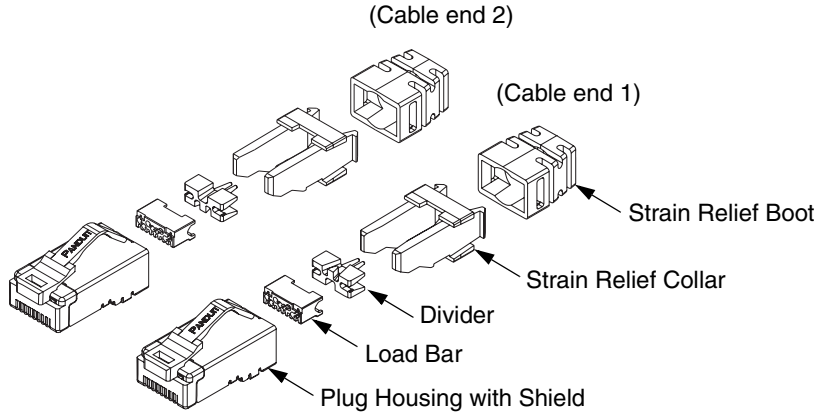

Pin #	8	7	6	5	4	3	2	1
T568A	BRN	BRN/WHT	ORG	BLU/WHT	BLU	ORG/WHT	GRN	GRN/WHT

Specifications

- Cable jacket diameter .225-.250 in.
- 24 AWG Stranded conductor maximum insulated diameter .040 in.
- *PANDUIT* recommends T568A wiring scheme for use with cable constructed with the brown pair opposing the green pair.
- For use with FTP, ScTP, SFTP and STP/PIMF type cables. Cable must have drain wire or braid.

Load Bar

Conductor holes and Contact slots

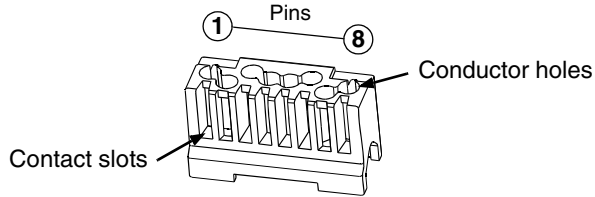

Divider

Conductor slots and "V" channel

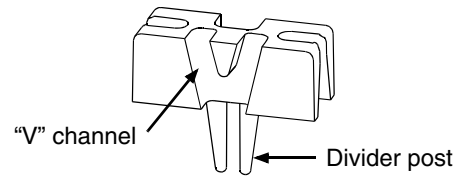

1 Thread on Boot and Collar first!
(Cable ends 1 & 2)

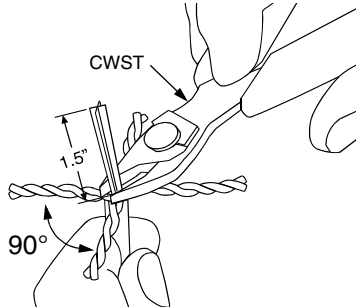
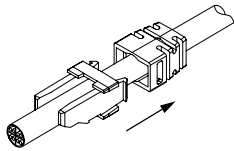

- First thread on the Boot and Collar.
- Remove 1.5" of the outer jacket from the cable end using wire stripping tool (CWST).
- Cut foil flush to cable jacket end. If cable is braided, form into a drain wire. Bend the drain wire back so it is against the cable jacket.
- Fan twisted pairs into respective quadrants. The brown pair should be opposite the green pair.
- When a cable spline (X-shaped filler) is present, cut spline flush to fanned pairs using wire snipping tool (CWST).

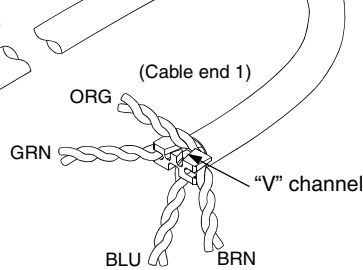
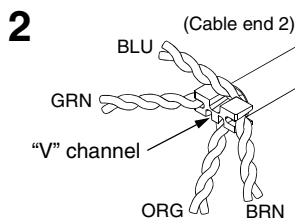

- The "V" channel should be aligned with the orange pair.
- Insert Divider posts into the cable. If the cable has an internal spline, insert Divider posts into the brown and green quadrants of the spline.

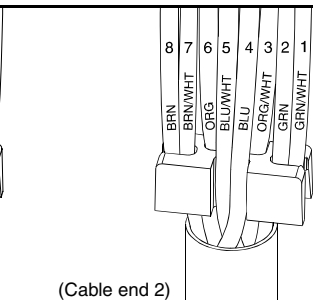
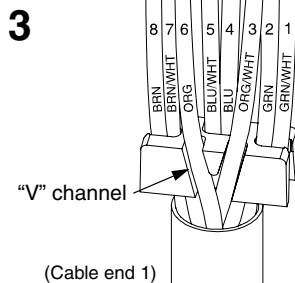

- Arrange conductors to T568A Wiring Scheme while minimizing untwist and smooth conductors.
- Seat conductors into proper Divider slots while holding Divider near the end of the cable jacket.

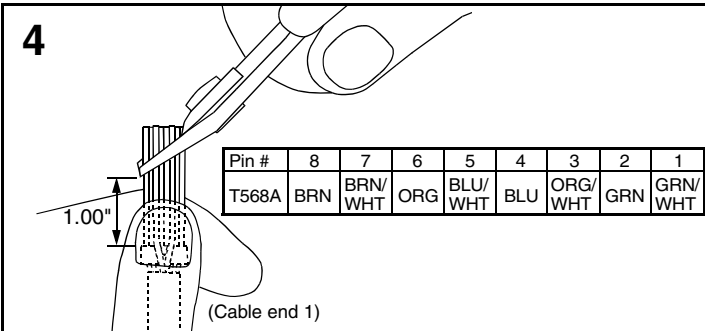

- While holding conductors in respective Divider slots, straighten and align untwisted conductors using a circular motion.
- Do not release grip of conductors until Load Bar is applied in order to maintain conductor alignment.
- Trim conductors on an angle approximately 1.00" from Divider leading edge.

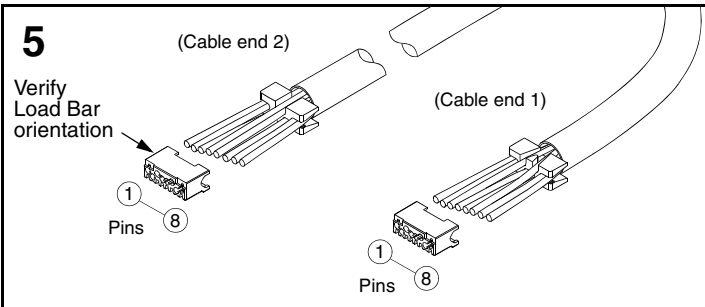

- Orient Load Bar with contact slots facing downward.

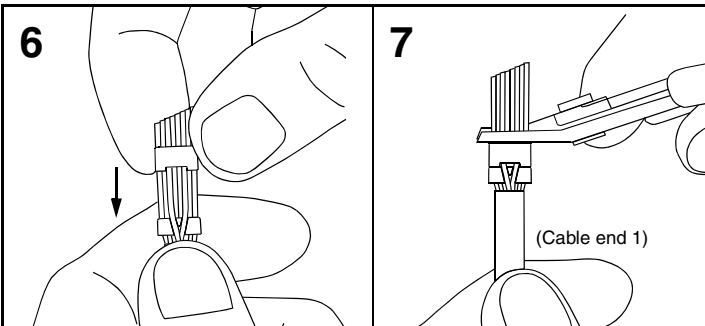

- Guide conductors into Load Bar holes while holding conductors in the Divider.
- Slide Load Bar towards Divider until flush.
- Ensure the Divider/Load Bar is centered and perpendicular to the cable axis.
- Trim conductors flush with Load Bar face.

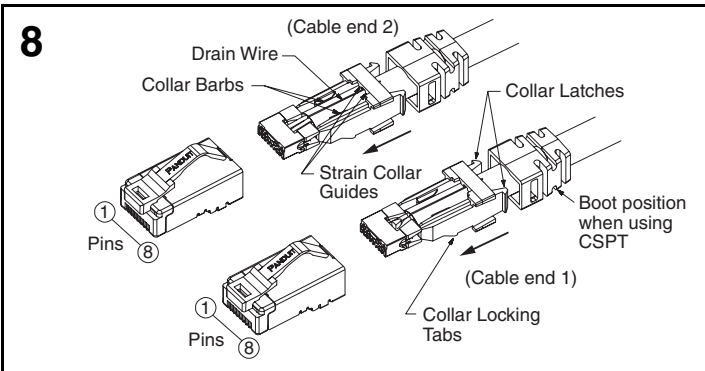

- Orient cable so drain wire is facing up. While holding the Load Bar and Divider stationary, slide the Collar towards the termination point until there is no gap between the Collar and Divider. Ensure the drain wire is routed through the Strain Collar Guides. Do not exert pressure onto the Divider, the Collar can push the Load Bar off the conductors.
- Confirm orientation of Collar. Cable jacket should extend beyond Collar barbs.
- Align Pin #1 of cable sub-assembly (Cable, Load Bar, Divider, Collar with Boot) with Pin #1 of Plug Housing.

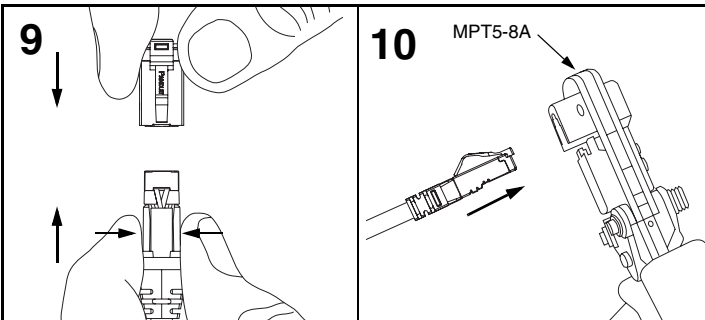

- Grip and squeeze across Collar arms as sub-assembly is inserted into Plug Housing. (Fig. 9)
- Push sub-assembly into Housing until Collar locking tabs clear the Plug Housing pocket. Although not required, TX6 PLUS Plug Assembly Tool (CSPT) is available to facilitate this step.
- Use tool MPT5-8A to complete termination. (Fig. 10)
- Press any excess drain wire between the Collar Latches and the cable jacket. Pull up Boots and engage with Collar. Latches of the Collar should be engaged on the window slot of the boot.
- Assembly is complete. Visually check plug.

For Instructions in Local Languages and Technical Support:
www.panduit.com/resources/install_maintain.asp



E-mail: cs@panduit.com
 Fax: (708) 444-6993