



*Apple IIc Scribe User's Manual
Guide to Apple IIc*

The Apple IIc



Customer Satisfaction

If you discover physical defects in the manuals distributed with an Apple product or in the media on which a software product is distributed, Apple will replace the documentation or media at no charge to you during the 90-day period after you purchased the product.

In addition, If Apple releases a corrective update to a software product during the 90-day period after you purchased the software, Apple will replace the applicable diskettes and documentation with the revised version at no charge to you during the six months after the date of purchase.

In some countries the replacement period may be different; check with your authorized Apple dealer. Return any item to be replaced with proof of purchase to Apple or an authorized Apple dealer.

Limitation on Warranties and Liability

Even though Apple has tested the software described in this manual and reviewed its contents, neither Apple nor its software suppliers make any warranty or representation, either express or implied, with respect to this manual or to the software described in this manual, their quality, performance, merchantability, or fitness for any particular purpose. As a result, this software and manual are sold "as is," and you the purchaser are assuming the entire risk as to their quality and performance. In no event will Apple or its software suppliers be liable for direct, indirect, incidental, or consequential damages resulting from any defect in the software or manual, even if they have been advised of the possibility of such damages. In particular, they shall have no liability for any programs or data stored in or used with Apple products, including the costs of recovering or reproducing these programs or data. Some states do not allow the exclusion or limitation of implied warranties or liability for incidental or consequential damages, so the above limitation or exclusion may not apply to you.

Copyright

This manual and the software (computer programs) described in it are copyrighted by Apple or by Apple's software suppliers, with all rights reserved. Under the copyright laws, this manual or the programs may not be copied, in whole or part, without the written consent of Apple, except in the normal use of the software or to make a backup copy. This exception does not allow copies to be made for others, whether or not sold, but all of the material purchased (with all backup copies) may be sold, given or loaned to another person. Under the law, copying includes translating into another language.

You may use the software on any computer owned by you but extra copies cannot be made for this purpose. For some products, a multi-use license may be purchased to allow the software to be used on more than one computer owned by the purchaser, including a shared-disk system. (Contact your authorized Apple dealer for information on multi-use licenses.)

Product Revisions

Apple cannot guarantee that you will receive notice of a revision to the software described in this manual, even if you have returned a registration card received with the product. You should periodically check with your authorized Apple Dealer.

© 1984 Apple Computer, Inc.
20525 Mariani Avenue
Cupertino, California 95014

Apple, the Apple logo and ProDOS are registered trademarks of Apple Computer, Inc.

Simultaneously published in the U.S.A. and Canada. All rights reserved.

Warning

This equipment has been certified to comply with the limits for a Class B computing device, pursuant to Subpart J of Part 15 of FCC Rules. Only peripherals (computer input/output devices, terminals, printers, etc.) certified to comply with the Class B limits may be attached to this computer. Operation with non-certified peripherals is likely to result in interference to radio and TV reception.



The Apple IIc

*Apple IIc Scribe User's Manual
Part I: Guide to Apple IIc*

Table of Contents

<hr/>	
	List of Figures and Tables ii
<hr/>	
Preface	About This Manual xiii
xiii	What Your Scribe Can Do
xiii	How to Use This Manual
xv	Aids to Understanding
<hr/>	
Chapter 1	Scribe Controls and Parts 1
1	First a Few Names
1	Exterior Features
5	Controls and Indicators
7	Inside Your Scribe
<hr/>	
Chapter 2	Loading Paper and Ribbon 11
11	Choosing A Good Location
11	Installing and Removing the Ribbon Cassette
12	Installing a Ribbon Cassette
13	Removing a Ribbon Cassette
14	Loading Paper
14	Choosing the Right Kind of Paper
15	Loading Pin-Feed Paper
19	Loading Plain Paper
21	Setting the Top of the Page
21	Loading Envelopes
21	Loading Transparencies

Chapter 3	Setting Up The Scribe	23
23	Testing Your Scribe	
25	Connecting The Scribe To Your Apple IIc	
25	What You Need	
26	Scribe Setup	
26	Ready To Print	
Chapter 4	Starting To Print	29
29	Preliminary Setup	
29	Turning On the System	
30	Printing with Applesoft	
31	FYI: A Few Applesoft Hints	
31	If It Doesn't Work the First Time	
Chapter 5	Caring For Your Scribe	35
35	Operating Environment	
36	Cleaning	
36	Replacing the Thermal Print Head	
36	Removal of Thermal Print Head	
38	Installing a New Thermal Print Head	

List of Figures and Tables

■ Chapter 1

Connecting the Plotter to Your Computer

- 1 Table 1-1. Apple Color Plotter DIP Switch Settings
- 2 Figure 1-1. Apple Color Plotter DIP Switches
- 2 Figure 1-2. Connecting the Plotter Connecting Cable to an Apple IIc
- 3 Table 1-2. Default Settings Versus Apple Color Plotter Settings

■ Chapter 2

Using Packaged Software

- 14 Table 2-1. Apple Color Plotter Control Characters

62	Paper Handling Codes
62	Form Feeding
62	Top of Form
62	Line Feed
63	Line Feed Spacing
64	Line Feed Direction
64	Page Length
64	Line Feed Function
65	Automatic Line Feed
65	Carriage Return
66	Auto-Print Action
66	Miscellaneous Codes
66	Print Density
66	Restoring Standard Instructions
67	Canceling Text
67	Duplicate Commands
68	Software Select/Deselect (DC1/DC3)
68	Apple IIc Interface

	Chapter 3	Color Printing	71
---	------------------	-----------------------	-----------

71	Introduction
71	Color Mixing
72	Color Text
72	Color Graphics

	Chapter 4	Graphics Printing	75
--	------------------	--------------------------	-----------

75	Introduction
75	General Graphics Information
76	Low-Resolution Graphics
76	Bit Image Printing
79	Dot Spacing
80	Low-Resolution Graphics Example
81	Dot-Column Repeating Graphics
82	Exact Dot Placement
83	High-Resolution Graphics
83	Bit Image Printing
86	Dot Spacing
86	High-Resolution Graphics Example
87	Dot-Column Repeating Graphics
88	Exact Dot Placement

Appendix A	Troubleshooting	93
Appendix B	Command Summary	97
	97	Printer Power-On Configuration (Standard Instructions)
	97	Miscellaneous Codes
	98	Text Mode Codes
	98	Paper Handling Codes
	99	Color Codes
	99	Low Resolution Graphics Codes
	99	High Resolution Graphics Codes
	100	DIP Switch Settings
Appendix C	ASCII, Binary, and Hexadecimal Codes	103
Appendix D	Character Specifications	107
	108	Letter Mode Characters
	110	Alternate (National) Letter Characters
	112	Draft Characters
	114	Alternate (National) Draft Characters
	116	Superscript and Subscript Characters
Appendix E	Printer Specifications	119
Appendix F	Interface Specifications	123
	123	Specifications
	124	Signal Descriptions
	124	Input Circuit Configuration
	125	Output Circuit Configuration
	126	Protocol
	126	Data Transfer Ready Protocol
	126	XON/XOFF Protocol
	126	Data Byte Length
Appendix G	Repacking Instructions	129
	129	Repacking

	<i>Glossary</i>	131
	<i>Index</i>	137
	<i>Quick Reference Card</i>	
	<i>Tell Apple</i>	

Chapter 1

Scribe Controls and Parts

- 1 Figure 1-1. Front View
- 2 Figure 1-2. Printer Cover
- 3 Figure 1-3. Paper Release Lever Positions
- 4 Figure 1-4. Left Side View
- 4 Figure 1-5. Right Side View
- 5 Figure 1-6. Rear View
- 6 Figure 1-7. Control Cluster
- 7 Figure 1-8. Printer Cover, Removal
- 9 Figure 1-9. Scribe Interior

Chapter 2

Loading Paper and Ribbon

- 12 Figure 2-1. Printer Cover, Removal
- 12 Figure 2-2. Lining Up the Ribbon Cassette
- 12 Figure 2-3. Loading the Ribbon Cassette
- 13 Figure 2-4. Changing the Ribbon Cassette
- 15 Figure 2-5. Printer Lid Open
- 15 Figure 2-6. Inserting Paper
- 16 Figure 2-7. Feeding Paper
- 16 Figure 2-8. Moving Sprocket Release Levers to Rear
- 17 Figure 2-9. Opening the Paper Clamps
- 17 Figure 2-10. Sprockets Lined Up
- 18 Figure 2-11. Paper Holes in Place
- 18 Figure 2-12. Left Paper Clamp Closed
- 19 Figure 2-13. Loading Plain Paper
- 19 Figure 2-14. Plain Paper Alignment
- 20 Figure 2-15. Setting the Top of the Page
- 20 Figure 2-16. Plain Paper Exit

Chapter 3**Setting Up The Scribe**

- 23 Figure 3-1. Scribe Power Connection
- 26 Figure 3-2. Connecting Your Scribe

Chapter 4**Starting To Print**

- 29 Figure 4-1. System Connection
- 29 Figure 4-2. Scribe Power Switch
- 30 Figure 4-3. Apple IIc Power Switch

Chapter 5**Caring for Your Scribe**

- 37 Figure 5-1. Thermal Print Head Removal
- 38 Figure 5-2. Thermal Print Head Installation

Chapter 1	Applesoft and Pascal Programs
42	Figure 1-1. Applesoft Printing Sample
43	Figure 1-2. Applesoft Superscript/Subscript Example
44	Figure 1-3. Applesoft Color Example
Chapter 2	Test And General Control Commands
51	Figure 2-1. DIP Switches
54	Table 2-1. DIP Switches SW1-SW8 Functions
56	Table 2-2. Draft and Letter Font Characteristics
60	Table 2-3. Alternate (National) Language Characters, Draft Mode
60	Table 2-4. Alternate (National) Character Set Codes
Chapter 4	Graphics Printing
78	Figure 4-1. Low-Resolution Data Byte
84	Figure 4-2. High-Resolution Data Bytes
Appendix D	Character Specifications
107	Figure D-1. Thermal Print Head Configuration
108	Table D-1. Standard Letter Characters
110	Table D-2. Alternate (National) Letter Characters
112	Table D-3. Draft Characters
114	Table D-4. Alternate (National) Draft Characters
116	Table D-5. Superscript and Subscript Characters

Appendix F

Interface Specifications

123	Figure F-1. RS232C Connector Pin Assignment
124	Figure F-2. Circuit: SN 75189A, or equivalent
125	Figure F-3. Circuit: SN 75188, or equivalent
125	Figure F-4. Threshold Voltage Level

Radio Frequency Interference Statement

The equipment described in this manual generates and uses radio-frequency energy. If it is not installed and used properly, that is, in strict accordance with our instructions, it may cause interference with radio and television reception.

This equipment has been tested and complies with the limits for a Class B computing device in accordance with the specifications in Subpart J, Part 15, of FCC rules. These rules are designed to provide reasonable protection against such interference in a residential installation. However, there is no guarantee that the interference will not occur in a particular installation, especially if you use a "rabbit ear" television antenna. (A "rabbit ear" antenna is the telescoping-rod type usually contained on TV receivers.)

You can determine whether your computer is causing interference by turning it off. If the interference stops, it was probably caused by the computer or its peripheral devices. To further isolate the problem:

- Disconnect the peripheral devices and their input/output cables one at a time. If the interference stops, it is caused by either the peripheral device or its I/O cable. These devices usually require shielded I/O cables. For Apple peripheral devices, you can obtain the proper shielded cable from your dealer. For non-Apple peripheral devices, contact the manufacturer or dealer for assistance.

If your computer does cause interference to radio or television reception, you can try to correct the interference by using one or more of the following measures:

- Turn the TV or radio antenna until the interference stops.
- Move the computer to one side or the other of the TV or radio.
- Move the computer farther away from the TV or radio.
- Plug the computer into an outlet that is on a different circuit than the TV or radio. (That is, make certain the computer and the radio or television set are on circuits controlled by different circuit breakers or fuses.)
- Consider installing a rooftop television antenna with coaxial cable lead-in between the antenna and TV.

If necessary, you should consult your dealer or an experienced radio/television technician for additional suggestions. You may find helpful the following booklet, prepared by the Federal Communications Commission:

"How to Identify and Resolve Radio-TV Interference Problems."

This booklet is available from the U.S. Government printing Office, Washington, DC 20402, stock number 004-000-00345-4.

About This Manual



Welcome to the Scribe manual for the Apple IIc. To make it easy to use, this manual is divided into two distinct parts, Part I and Part II. Part I pages have red edges; Part II have gray edges.

Part I is for everyone. Part II is for experienced users.

Part I, User's Guide, is the only part of the manual that most users will need. Part I provides all the information you need to set up your Scribe and start printing.

Part II, Reference, contains reference material for the experienced user who may need to take advantage of some of the advanced features of the Scribe. Either the Table of Contents or the Index provides you with a quick means of locating the desired information in Part II.

What Your Scribe Can Do

You can print both words and graphics in black and white, or in color.

Your Scribe can print anything you can put on the Apple IIc monochrome monitor. It can also do anything a typewriter can, plus it can print graphics and color. Given the proper commands, it can for example, underline text, output graphics, and produce multi-color type and graphics. Teamed up with your Apple IIc computer, the Scribe provides you with a whole new kit of tools.

Apple Scribe

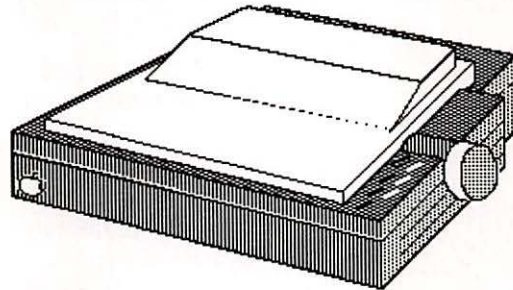

How To Use This Manual

The following is a brief outline of the contents of this manual:

Part I: User's Guide

- Chapter 1 provides a description of Scribe controls and parts.

- Chapter 2 demonstrates how to load paper and ribbon.
- In Chapter 3, you learn how to run a self-test on the Scribe and connect it to your Apple IIc.
- In Chapter 4 you start printing and check your setup.
- Finally, Chapter 5 offers tips to keep your Scribe in good working order.

Part II, Reference

- Chapter 1 provides some printing examples with Applesoft and Pascal.
- Chapters 2 through 4 discuss Scribe control codes.
- Appendix A provides troubleshooting suggestions, and Appendixes B through F provide additional program and firmware information. Appendix G tells you how to repack your Scribe for storage or shipping.

Part II, Reference, is not needed for running pre-packaged programs. The primary purpose of Part II is to aid experienced users or programmers in writing or modifying programs that use the advanced Scribe features.

The following chart recommends chapters and appendixes for various types of readers. You may be a combination of types (for example, you may be a first-time user setting up your own system).

READER	PART I USER'S GUIDE					PART II REFERENCE										
	Chapters					Chapters				Appendixes						
	1	2	3	4	5	1	2	3	4	A	B	C	D	E	F	G
Person setting up the system	•	•	•	•							•					
First-time user wanting to use already connected system with pre-packaged programs	•				•											
Experienced Apple computer user	•	•	•	•	•	•	•	•	•	•	•			•	•	•
Programmer	•	•				•	•	•	•	•	•	•	•			

Aids to Understanding

Look for these visual aids through the manual

By the Way: Gray boxes contain sidelights or interesting pieces of information. Read the boldface tag to decide if you want to read the box.

Important!: Gray boxes like this contain important information.



Warning

Warning boxes like this direct your attention to something that could damage either software or hardware. They also are used to alert you to important safety precautions.

Look for helpful notes in the margins.

Marginal notes are used occasionally to summarize the main point of an adjacent paragraph.

Computer jargon is boldfaced when it is introduced. Sometimes additional information about the term is in the margin; the term is always defined in the glossary.

You will see a special typeface used for what you type:

`it looks like this`

Keys look like this: `(←)`, `(↵)`, `(RETURN)`. When you see a hyphen joining two keys, it means to press them simultaneously. For instance, `(↵)-(CONTROL)-(RESET)` means all three keys should be pressed at the same time.

FYI means *for your information*.

You'll also notice that some information is labeled **FYI** and is in italics. This information is optional reading—it's related to the information in the main text, but it's not vital to your understanding.

Scribe Controls and Parts



First, a Few Names

Before proceeding further, you should take a minute to learn the names of your Apple Scribe's controls and parts. With your Scribe unpacked and sitting on the table in front of you, compare it with the labeled pictures.

Exterior Features

Figures 1-1 through 1-6 show the main external parts of the Scribe.

Figure 1-1. Front View

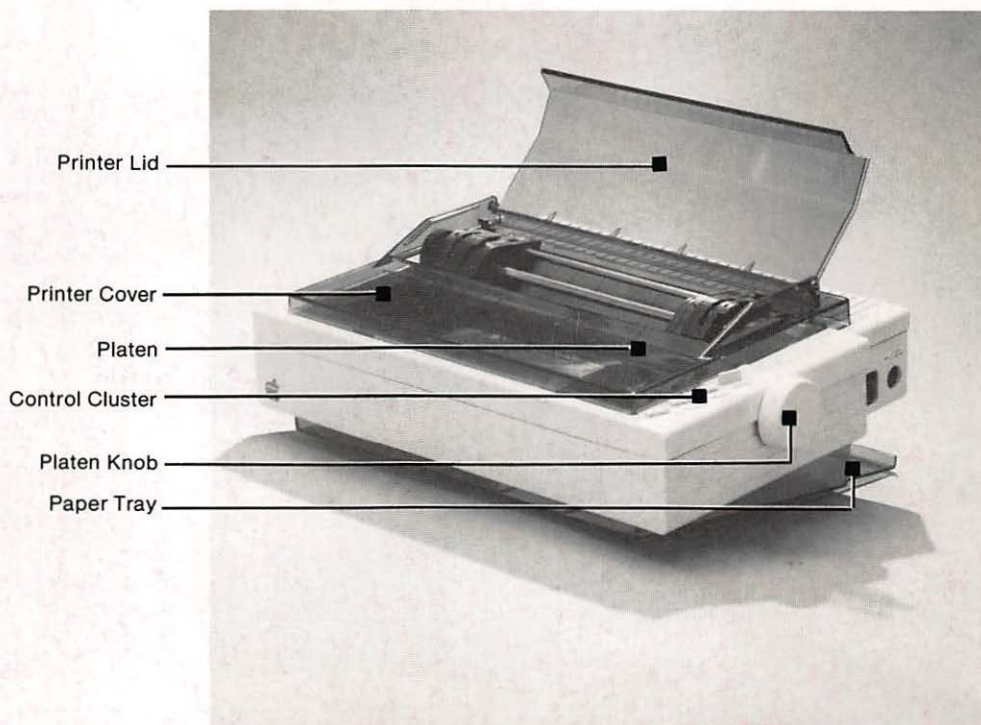

CONTROL CLUSTER:

Contains the Scribe controls and indicators. These are described later in this chapter.

PLATEN:

The platen is used to:

- roll paper forward in the friction feed mode
- provide a back support for the paper to rest against.

PLATEN KNOB:

Used to turn the platen when manually loading paper.

PAPER TRAY:

The paper tray is located under the Scribe and holds a supply of pin-feed paper, approximately 40 sheets.

Loading paper is described in Chapter 2, "Loading Paper and Ribbon."

Figure 1-2. Printer Cover

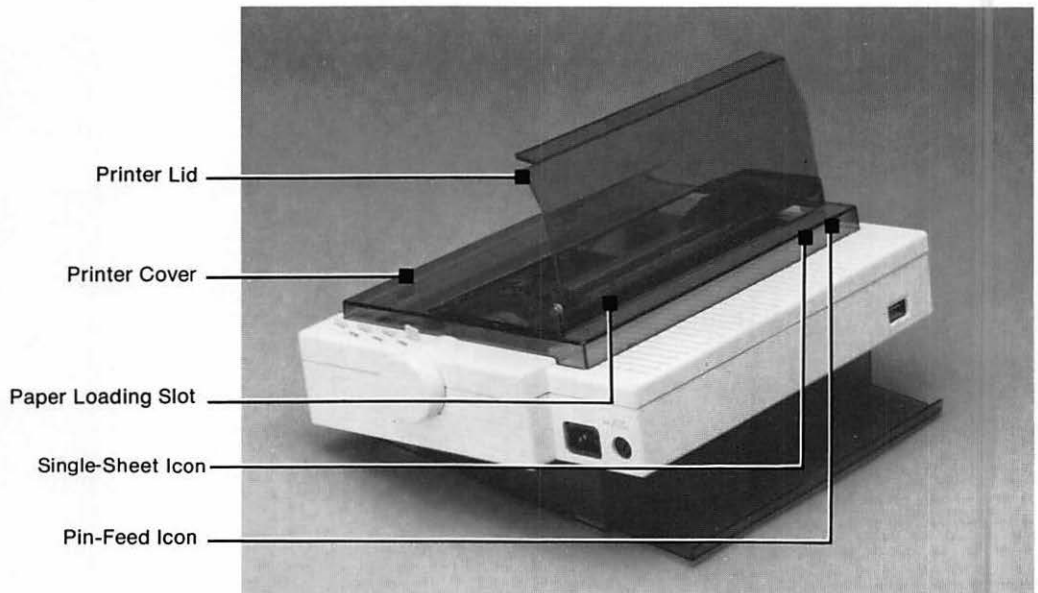

PRINTER LID:

A hinged lid, Figure 1-2, which swings up and back to provide access for loading pin-feed paper, and prevents such things as dirt and paper clips from getting into the printer.

To open the printer lid, place your index finger in the notch in the right front corner of the lid and lift.

PRINTER COVER:

The printer cover, Figure 1-2, provides access for changing the ribbon cassette, and also prevents such things as dirt and paper clips from getting into the printer.

The single-sheet alignment icon on the back of the cover provides a handy reference for the left side of single-sheet paper.

The pin-feed alignment icon on the back of the printer cover provides a handy reference for the left side of pin-feed paper (paper with holes along the margins).

This two-position lever (Figure 1-3) releases platen friction when set in pin-feed (forward) position, as used for pin-feed paper, Figure 1-3.

It applies platen friction when set to friction position (rear), as used for ordinary paper with no pin feed holes, Figure 1-3.

The use of the paper release lever is described in Chapter 2, "Loading Paper and Ribbon."

Figure 1-3. Paper Release Lever Positions

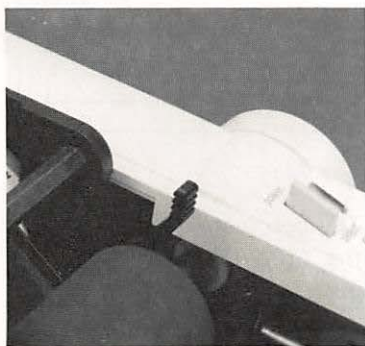

Pin-Feed Position
(Lever to the Front)

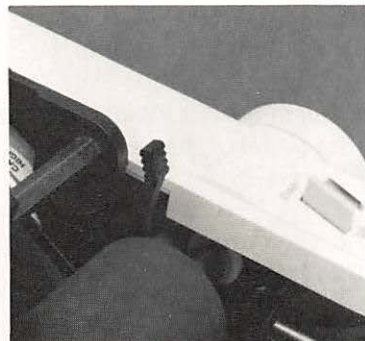

Friction Position
(Lever to the Rear)



PAPER RELEASE LEVER:



Warning

Don't touch the platen knob or paper release lever while the Scribe is printing. This could cause the printer to jam.

Use the shielded interface connector cable to connect the Scribe to your Apple IIc.

INTERFACE CABLE CONNECTOR 

The connector, Figure 1-4, for the Apple Shielded Interface Cable which connects the Scribe to your Apple IIc.

Figure 1-4. Left Side View

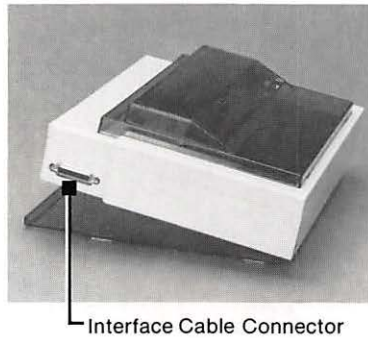
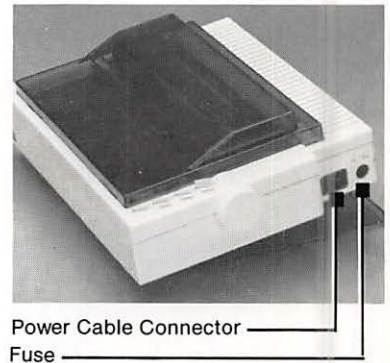

Figure 1-5. Right Side View



POWER CABLE CONNECTOR 

The connector, Figure 1-5, for the 110 Vac power cord supplied with your Scribe.

FUSE 

Provides over-current protection for the Scribe, Figure 1-5.

Normally, DIP switches SW1-SW8 are set by the factory to the off (up) position and don't have to be changed.

DIP SWITCH ASSEMBLY:

The DIP switch assembly, containing switches SW1 through SW8 is located on the rear panel of the Scribe, Figure 1-6.

DIP SWITCH COVER:

Access cover, Figure 1-6, to DIP switches SW1-SW8.

Figure 1-6. Rear View

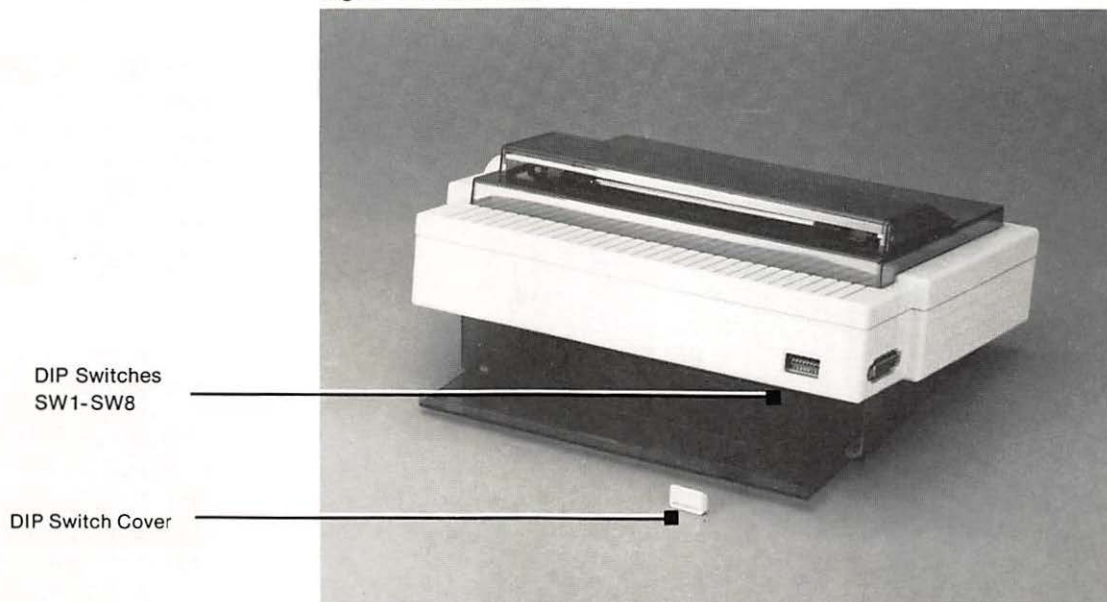

Controls and Indicators

You can operate your Apple Scribe entirely from your Apple IIc, but for convenience some control buttons and associated indicator lights are provided on the printer itself. Figure 1-7 shows the Scribe's controls and indicators.

All switch buttons in the control cluster alternate between two modes. Each time you press the button, the printer changes to the other mode. For example, the POWER switch goes between on and off.



Warning

Do not attempt to plug in or operate your Scribe until you are ready to perform the self-test described in Chapter 3, "Setting Up Your Scribe."

POWER button:

Press to turn the Scribe's power on or off.

POWER light:

Turns on (green) when your Scribe is plugged in and the POWER button is on.

Figure 1-7. Control Cluster, Controls and Indicators

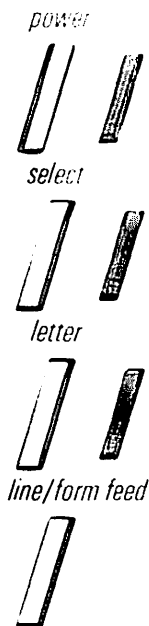

SELECT button:

Press to select or deselect the Scribe.

When the Scribe is selected, it can receive data from the Apple IIc. When it is not selected, the Scribe can be controlled with its control cluster switches, but it cannot receive data from the Apple IIc.

SELECT light:

Turns on (green) when the printer is selected.

When the SELECT light flashes, check for the following: out of paper, printer cover loose, or out of ribbon. If these are O.K., refer to Appendix A, *Troubleshooting*.

By The Way: If you open the paper cover while the Scribe is printing, the SELECT light will go out and the Scribe will stop. To resume printing, close the cover tightly and press the SELECT button.

LINE/FORM FEED button:

Press the button once to move the paper up one line.

This button works only when the SELECT light is off. When the LINE/FORM FEED button is held down, the printer will advance for four line feeds and then on the fifth will feed paper continuously until the top of the next form. You can stop the continuous feed by releasing the LINE/FORM FEED button.

By The Way: You can stop the action of the printer at the end of any printed line by pressing the SELECT button. This deselects the printer, and while it is stopped, you can operate the LINE/FORM FEED button. To resume printing from the place where you stopped, press the SELECT button.

LETTER button	Press to select or deselect letter mode printing.
LETTER light	When the green light is on, letter mode (50 characters per second) is selected. When it is off, draft mode (80 characters per second) is selected.

Your Scribe normally prints at 10 characters per inch. Draft printing at 17 characters per inch can be software selected. The LETTER switch is not operable when printing at 17 characters per inch.

Replacing the ribbon cassette and loading paper are described in Chapter 2. Cleaning and lubrication procedures are provided in Chapter 5.

Figure 1-8. Printer Cover Removal

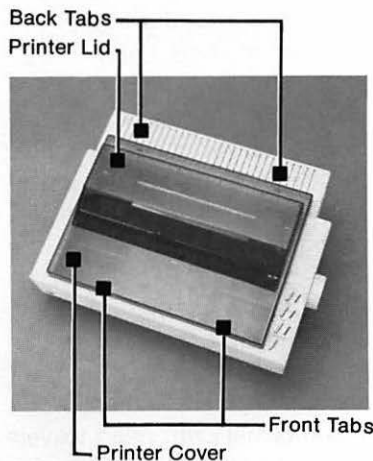

Inside Your Scribe

The only time you'll need to remove the printer cover will be to replace the ribbon cassette, for cleaning about once a year, and very infrequently, to replace the thermal print head. You should leave service of the working parts of your Apple Scribe to a qualified technician.

To locate the interior parts, remove the printer cover as explained in the text accompanying figure 1-8. Then refer to Figure 1-9 which shows the main interior parts. Once you have identified the parts, replace the printer cover.

1. Close the hinged printer lid, Figure 1-8.
2. To remove the printer cover, press and lift simultaneously to free the two back tabs, as shown in Figure 1-8. Then pull the cover slightly toward the back and up to free the tabs in front, Figure 1-8.

The entire printer cover comes off easily. The attached printer lid is hinged to allow access to the inside when loading or adjusting paper. The printer lid is normally kept closed.

Figure 1-9. Scribe Interior

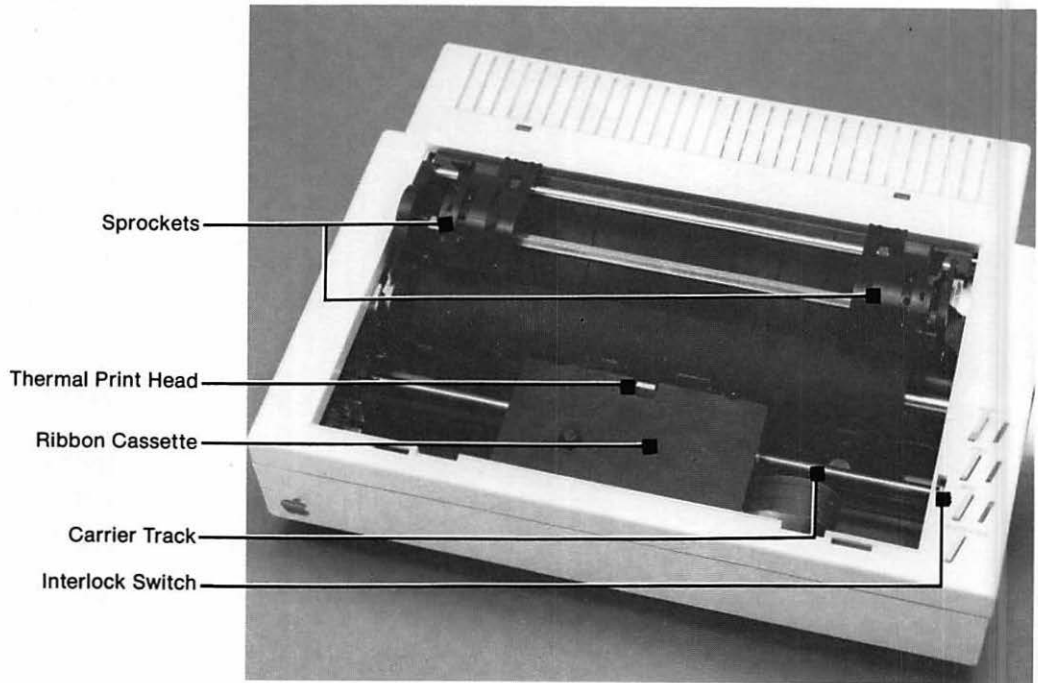

THERMAL PRINT HEAD:

The thermal print head sticks up through the open part of the ribbon cassette. The thermal print head prints characters and graphics by the dot-matrix, thermal-transfer method. Each character or graphic image is formed by a pattern of dots from the ribbon. When using a three-color ribbon, the Scribe prints color characters and graphics.

RIBBON CASSETTE

Replaceable cassette that contains either a black or three-color ribbon.

CARRIER TRACK:

The thermal print head travels back and forth along this track.

INTERLOCK SWITCH:

A switch that stops the printer when the printer cover is not in place.

SPROCKETS:

Toothed wheels that move pin-feed paper through the printer.

You are now familiar with the main parts of the Scribe and how they work. In the next two chapters you'll prepare your Scribe for use.

Loading Paper and Ribbon



This chapter gives you some suggestions about selecting a good location for your Scribe and shows you how to load paper and ribbon.

Choosing A Good Location

Your Apple Scribe works best in a clean, vibration-free environment, away from such hazards as chemical fumes and spilled coffee. Your printer is small, so you can place it on a shelf or on top of a file cabinet, where it will be out of the way; or you can put it on the back of a desk or table, where it will be easy to reach. Because it has its own paper tray for holding pin-feed paper, you do not need extra room for the paper supply. A stack of approximately 40 pages of pin-feed paper will fit in the Scribe paper tray. You will need room either behind the printer or below it for the paper that feeds out the back as it is printed.



Warning

Your Scribe works best at room temperature and out of direct sunlight.

Installing and Removing the Ribbon Cassette

Keep your ribbons out of direct sunlight.

The ribbon cassette supplied with your printer is a special type, made specifically for thermal-transfer, dot-matrix printing with your Scribe. You need to exercise reasonable care with it, just as you would with a video cassette or roll of film. But mainly, you don't want to leave it in direct sunlight or near sources of heat.

You can purchase additional ribbons from your Apple dealer.

Installing a Ribbon Cassette

To install a ribbon, do the following:

1. With no paper in the Scribe, turn the power on to center the thermal print head.
2. Turn the power off again.
3. Carefully remove the printer cover (Figure 2-1) by pushing on the two back corners to free the two tabs, lifting the back of the cover slightly. Pull the cover toward the back of the printer to free the two front tabs, and then lift the cover up and back.
4. Turn the knob on the ribbon cassette so that the printing portion of the ribbon shows, and take up any slack in the ribbon.

Figure 2-1. Printer Cover, Removal

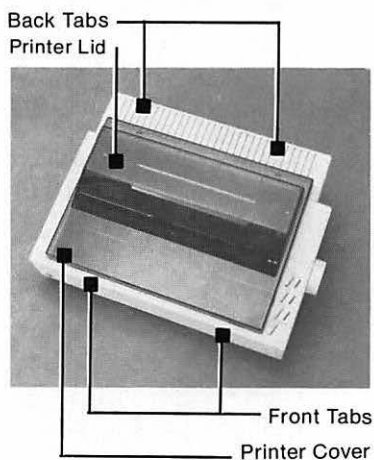

Figure 2-3. Loading the Ribbon Cassette

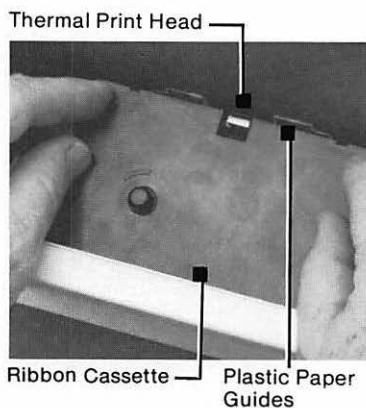
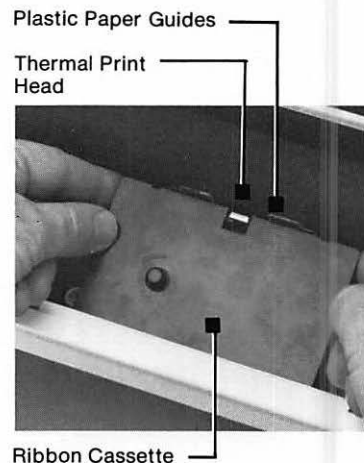

Figure 2-2. Lining Up the Ribbon Cassette



Gently push the ribbon cassette down until it snaps into place.

The two retainer tabs (the parts that stick out from the clear plastic paper guides) fit over the cassette to hold it in place.

Removing the Ribbon Cassette

1. With no paper in the Scribe, turn the power on to center the thermal print head.
2. Turn the power off again.
3. Remove the printer cover (Figure 2-1).

Figure 2-4.
Changing the Ribbon Cassette

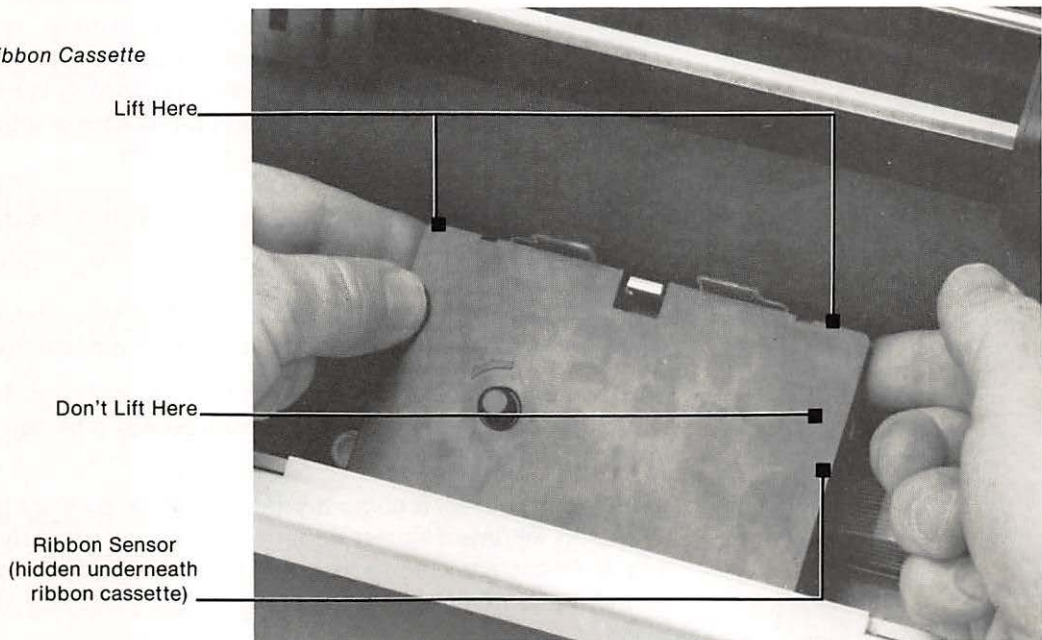

4. Place one finger (index) of left hand under left side of cassette and one finger (index) of right hand under right side of cassette (Figure 2-4).

Be sure that the right hand finger is under the cassette and not under the ribbon sensor (Figure 2-4).

5. Lift up with your fingers to move the ribbon cassette free of the thermal print head and up and out of the printer.

You can use two common types of paper:

1. Single Sheets of Paper
2. Pin-Feed Paper

Choosing the Right Kind of Paper

Many paper styles can be used, including: business forms, letterhead paper, paper-backed transparencies, and labels. You may find it more convenient to use *pin-feed paper* made especially for computer driven printers. With pin-feed paper you don't have to load individual sheets. Pin-feed paper is very convenient as placing the paper on the sprockets takes care of aligning it, and the sprockets automatically feed the paper.

Note: The use of either multiple-part forms or card stock in the Scribe is not recommended.

The Apple Scribe prints best on smooth paper, 16 to 24 pound weight, such as that used for many copying machines.

The smoothness of standard pin-feed paper is satisfactory. The texture of ordinary bond paper may be just a bit too rough for the best print quality.

Standard pin-feed computer paper usually comes in 16 and 20-pound weights. Heavier paper may not feed properly; lighter paper, such as onionskin, may tear. This could also damage the thermal print head and the platen.

You can print labels on your printer, provided the surface of the label is smooth, and its total thickness does not exceed that of 24 pound paper.

Paper Width: You can adjust your Apple Scribe to accept pin-feed paper of from 4 to 10 inches in overall width. This includes standard 9-1/2 inch-wide pin-feed paper, which produces 8-1/2 by 11-inch finished pages after you tear off the perforation strips. It also includes 4 inch-wide pin-feed paper, which produces 3 inch wide finished paper after you tear off the perforation strips. You can use several standard sizes of pin-feed label stock, for jobs such as printing mailing labels.



Warning

Never put paper with staples or paper clips in your Apple Scribe.

Figure 2-5. Printer Lid Open

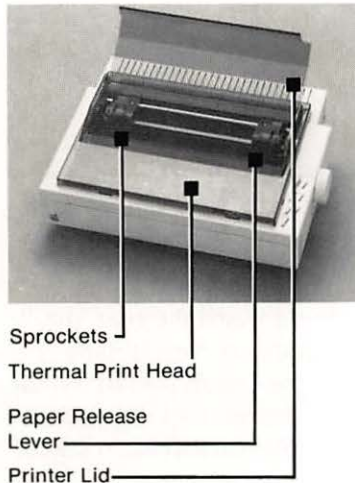
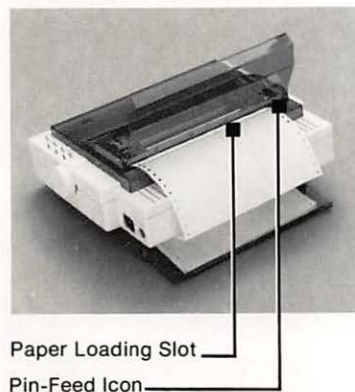

Figure 2-6. Inserting Paper



The next section describes how to load pin-feed paper into your Apple Scribe. If you plan to use single sheets of paper without pin-feed holes, skip ahead to the section called "Loading Plain Paper."

Loading Pin-Feed Paper

The first time you use pin-feed paper in your Apple Scribe you will need to set the spacing of the **sprockets**.

Note: Once you have followed this procedure, you should not need to readjust the positioning of the sprockets. However, you will use the same procedure each time you need to load a new supply of paper into your Apple Scribe.

1. If the end of the paper you are going to use is not straight, tear it off at the nearest perforation.
2. With no paper in the Scribe, turn the power on. This will automatically center the thermal print head.
3. Open the printer lid by placing your index finger in the notch in the right front corner of the lid and lifting.
4. Set the paper release lever to the friction (rear) position (Figure 2-5.) The friction position allows the platen to pull the paper through the Scribe.
5. Insert the pin-feed paper in the paper loading slot (Figure 2-6.)

Figure 2-7. Feeding Paper

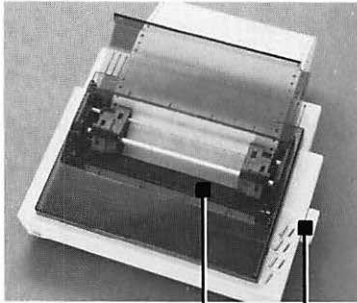

Platen

Platen Knob

6. Align the left side of the pin-feed paper with the pin-feed icon on the rear of the printer cover (Figure 2-6).



7. Feed the paper under the rubber platen and into the printer, as you would in a typewriter, by turning the platen knob clockwise (Figure 2-7).

8. If your pin-feed sprocket width has already been adjusted, skip this step and go to step 9. If not, release the black sprockets by pushing the black release levers at the rear of each sprocket assembly (Figure 2-8).

The black sprocket release levers are on the side of each sprocket.

When the black levers are pushed toward the rear, the sprockets are free to slide along their square shaft. When the levers are forward, the sprockets are locked in place.

Figure 2-8. Moving Sprocket Release Levers to Rear

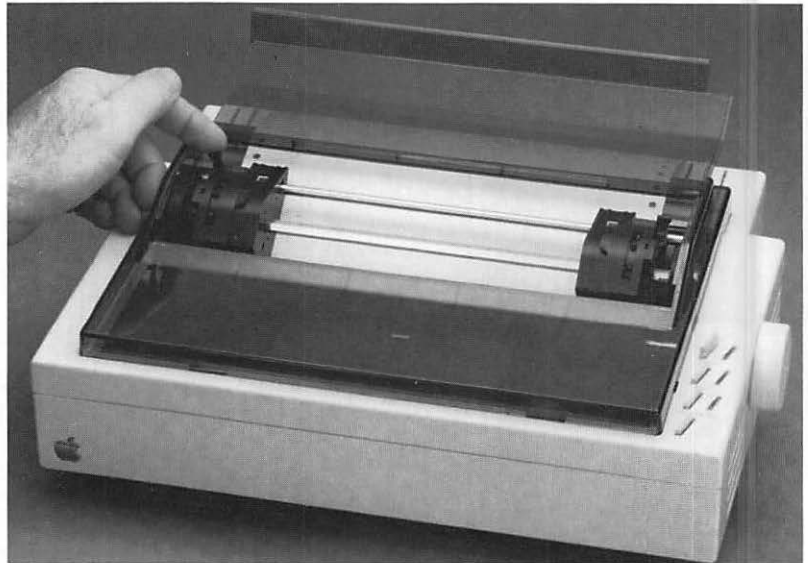
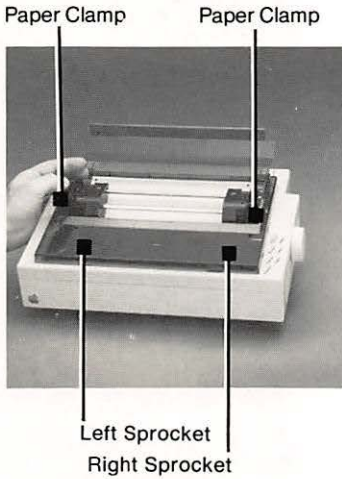

Figure 2-9. Opening the Paper Clamps



9. Open the sprocket paper clamps (Figure 2-9).

10. Turn the platen knob to bring the paper up and over about two of the sprocket pins (Figure 2-10).

The sprockets are the two black plastic rollers with pins, located inside the printer at the rear. Lift the sprocket paper clamps, which are hinged, so that they open up and swing outward.

If necessary, move the sprocket assemblies so that they line up with the perforation holes in the paper. If you have already set the pin-feeder width, it should not be necessary.

Figure 2-10. Sprockets Lined Up

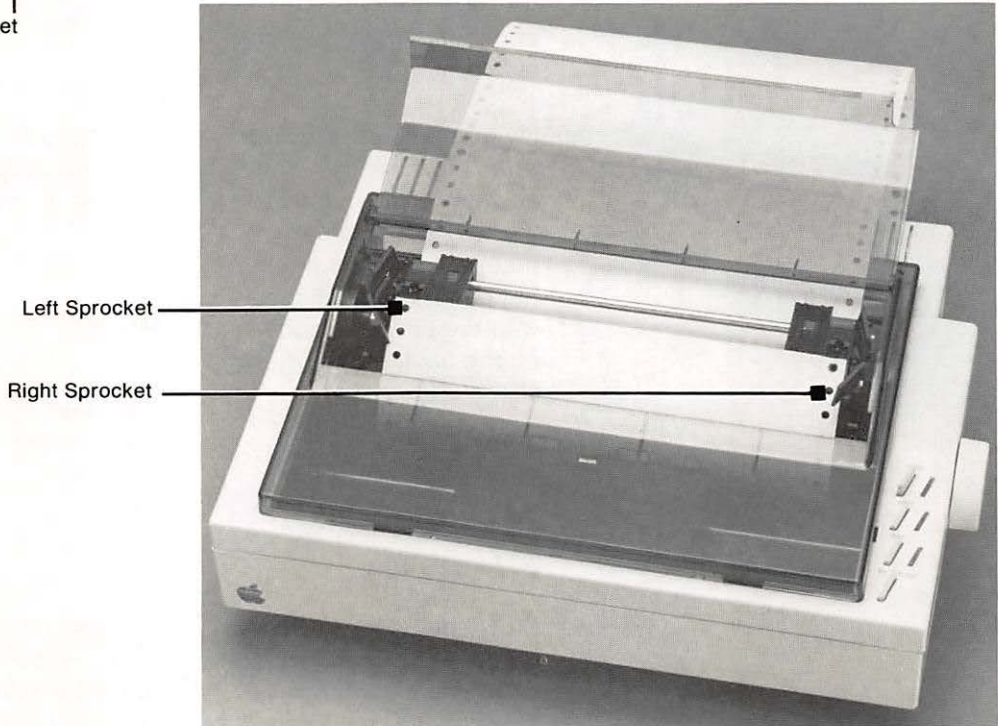
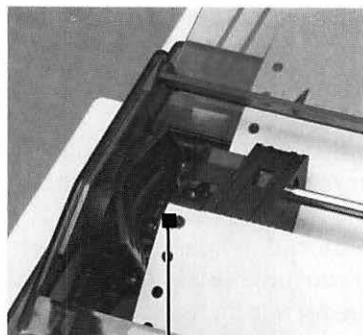
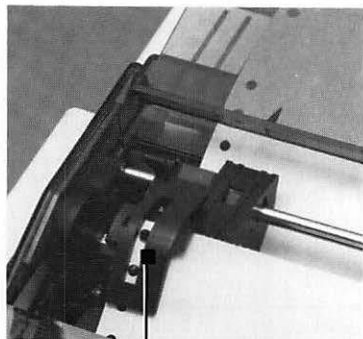

Figure 2-11. Paper Holes in Place Over Left Sprocket Pins



Left Sprocket

Figure 2-12. Left Paper Clamp Closed



Left Paper Clamp

11. Now, pull the paper release lever to the pin-feed position (forward) so that you can move the paper around more easily.

12. Move the paper so that the left sprocket pins fit through the holes in the paper (Figure 2-11).

13. Snap the left paper clamp closed over the paper (Figure 2-12).

14. Repeat Steps 12 and 13 for the sprockets and paper clamp on the right side of the Scribe.

15. If your pin-feed sprocket width has already been adjusted, skip ahead to Step 19. If not, check that the left edge of the paper is still aligned with the pin-feed icon on the back of the printer cover (Figure 2-6).

16. Lock the left sprocket assembly in position by pulling its sprocket release lever forward (Figure 2-10).

17. Move the paper forward and backward an inch or so to make sure that the paper moves smoothly without wrinkling.

This also allows the sprockets to pull the paper through the printer smoothly.

It may be helpful to turn the platen knob slightly.

If not, slide the sprocket assemblies and the paper left or right, as necessary.



If it doesn't move smoothly, give yourself access to the sprocket assemblies by turning the platen knob enough to move the paper backwards so that it just covers a couple of sprocket teeth. Then move the right sprocket assembly right or left as necessary.

18. Pull the right sprocket release lever forward to lock the sprocket assembly in position (Figure 2-10).
19. Turn the platen knob to feed the paper out through the paper loading slot.
20. Line up the first (horizontal) perforation with the top of the ribbon cassette
21. Close the printer lid.

You may need to guide the paper under the printer lid with your hand.

This sets the top of your page, so the paper will advance to the next perforation line when you press and hold down the LINE/FORM FEED button for at least five line feeds. You can then release it.

Figure 2-13. Loading Plain Paper

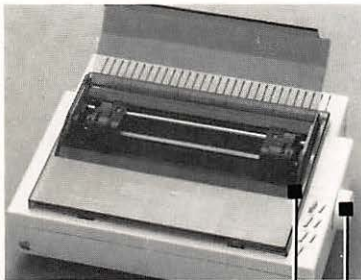

Paper Release Lever
Platen Knob

Loading Plain Paper

Follow these steps to load paper without pin-feed holes.

1. With no paper in the Scribe, turn it on to center the thermal print head automatically.
2. Open the printer lid. Set the paper release lever to the friction(rear) position, (Figure 2-13). Close the printer lid.
3. Align the left edge of the sheet of paper with the single-sheet alignment mark on the back of the printer cover, near the left corner (Figure 2-14).

With the thermal print head centered, paper can be easily loaded without catching on the printer cover.

The friction (rear) position allows the platen to pull the paper through the Scribe.

Figure 2-14. Plain Paper Alignment

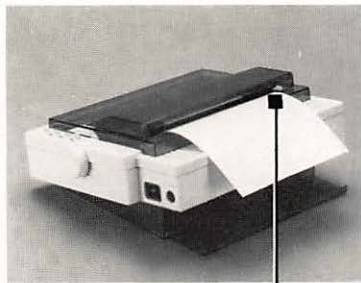

Single-Sheet Alignment Mark



4. Push the end of the paper firmly down into the paper loading slot in the printer cover, so that it is snug against the platen.
5. Feed the paper through the paper loading slot and around the platen as you would in a typewriter, by turning the platen knob clockwise to advance the paper.

Figure 2-15. *Setting the Top of the Page*

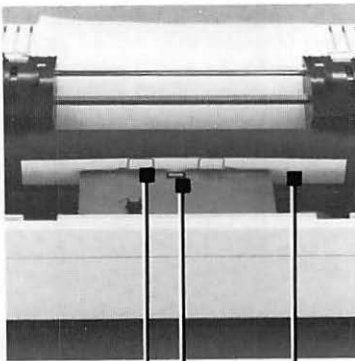

Plastic Guides
Thermal Print Head
Top of Paper

6. Move the top of the paper opposite the two clear plastic guides on the thermal print head assembly (Figure 2-15).

When plain paper advances during printing, it feeds out through the plain paper exit (Figure 2-16).

7. If the paper is aligned exactly, skip the remaining steps. If not, temporarily set the paper release lever to the pin-feed (forward) position.

These guides provide a handy reference mark for setting the top of form when you are using single-sheet paper. You can see the two plastic guides without opening the printer lid.

The pin-feed position releases most of the friction force against the paper so that the paper can easily be moved.

Figure 2-16. *Plain Paper Exit*

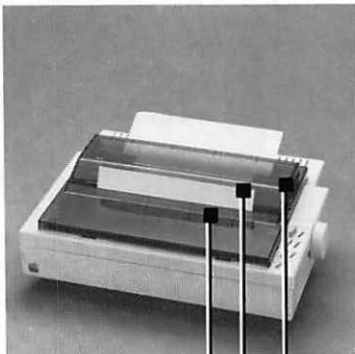

Plain Paper Exit
Top Edge of Paper
Bend in Printer Lid

8. To align the paper exactly, you can pull the top edge of the paper up even with the bend in the printer lid. Then move the paper slightly as necessary so that the top edge of the paper is exactly lined up (parallel) with the bend in the printer lid (Figure 2-16).

9. Return the paper release lever to the friction (rear) position, (Figure 2-13).

The friction (rear) position allows the platen to pull paper with no pin-feed holes through the printer.

Setting the Top of the Page

To reposition the top of the form after you have loaded a new supply of pin-feed paper, make sure the power is off. Then simply turn the platen knob to bring the paper to the desired position. (Usually the top of the page should be level with the top of the ribbon cassette.) Unless you turn the platen knob again or send control sequences to the printer to change the settings, the LINE/FORM FEED button will feed paper to the top of the next page each time you press the button and hold it down until the platen stops turning.

When you first press the LINE/FORM button it will perform four individual line feeds, then after the fifth line feed it will continuously feed paper until it reaches the top of the page. The SELECT light must be off in order for the LINE/FORM FEED button to work.

Note: When you load pin-feed paper, instead of using the platen knob to advance the paper, you can just press the LINE/FORM FEED switch enough times to advance the paper to the top of a page. Be sure to center the thermal print head before doing this so that the paper doesn't jam. With no paper in the printer, the thermal print head is automatically centered when you turn it on. With paper in the printer, center the thermal print head by pressing the SELECT button so that the SELECT light turns off.

Loading Envelopes

To load an envelope, follow the plain paper loading procedure. You may find it desirable to open the printer lid so that you can evenly push down on the envelope to start it moving around the platen as you turn the platen knob.

Loading Transparencies

Transparencies should be backed with paper so that the paper out detector will not give a false "paper out" indication. Many transparencies come pre-backed; if yours is not pre-backed, use a piece of ordinary typing paper along with the transparency.

Setting Up The Scribe



This chapter shows you how to get your Scribe up and running. You'll run the Scribe through a self-test and connect the Scribe to your Apple IIc.

Testing Your Scribe

Your Scribe can perform a self-test without being connected to a computer. It is a handy way to put the Scribe through its paces before connecting it to your system.

To run self-test, follow these steps:

Figure 3-1.
Scribe Power Connection

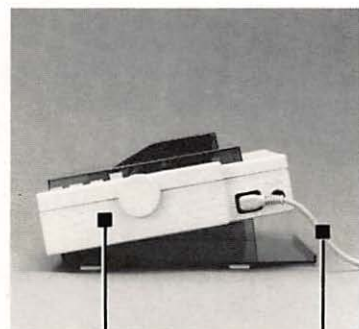

Scribe

Scribe Power Cord

1. If you have not already done so, load paper and ribbon into the printer.
2. Connect the power cord to the Scribe, Figure 3-1, and to a standard 110 Vac, 3-hole outlet. Press the POWER button to turn the Scribe on.

The POWER light and SELECT lights should turn on.

Warning

*All electrical connections to your computer and peripheral equipment **must be grounded!** Your Scribe is equipped with a three-prong power cord. As a safety feature, the plug is designed to fit only into a polarized, grounded three-hole outlet. If you don't have such an outlet, have a licensed electrician install one where you will use your computer system. Do not defeat the purpose of the grounding plug.*

3. Press the SELECT button once to turn off the SELECT light.

4. Press the LINE/FORM FEED button a few times to make sure the paper feeds smoothly through the printer.
5. Turn the power off.
6. Press the LINE/FORM FEED button and continue holding it in while you turn the power back on. Then release the LINE/FORM FEED button.

The DIP switches are set at the factory, and it should not be necessary to change them.

The Apple Scribe will print its complete set of characters repeatedly until you press the POWER switch to turn the power off.

At the top is printed:

SELF-TEST

ROM REV (xx)

DIPSW(00*00000), '1=ON, 0=OFF'

During self-test, the * is printed out for switch 6 regardless of the switch's setting. Switches 5 and 6 are used for setting print density, and are normally set to the OFF (UP) position.

Inside the "ROM REV (xx)" parentheses is the revision level of the Scribe firmware. (Note: This ROM revision message need not concern you; it is service information, only.)

7. To stop the test, turn off the power.
8. Examine the third line of the printout which contains the DIP switch message.

The relation of the printout numbers to the switch positions is as follows:
(00*00000)
SW8.....SW1

Inside the "DIPSW()" message is the present setting of DIP switches SW1-SW8 at the back of the printer. The printout numbers, reading from right to left, correspond to the setting of DIP switches SW1-SW8, respectively. If the message shows "DIPSW(00*00000)", the switch settings are normal and correct. If not, refer to "DIP Switch SW1-SW8 Functions" in Chapter 2, Text and General Control Commands of Part II of this manual.

9. Check the full lines of print that follow the first three lines of the self-test printout.

If the scribe is printing when you press the LETTER button, there is a delay of approximately two lines before the LETTER light turns on or off.

Each full line of print is shifted left by one character position. Self-test always starts out printing in draft mode. To change to letter mode, press the LETTER button. This turns on the LETTER light and switches the Scribe to letter mode. To return to draft mode, just press the LETTER button again.

All the characters should be complete (no dots missing) and neatly aligned.

If you are using a black ribbon, the lines should appear equally black from end to end. Spacing between characters and between lines should be even. If this is not the case, check for correct ribbon insertion and paper loading. If the problem persists, contact your Apple dealer.

If you are using a color ribbon, the lines should alternate colors: yellow, magenta, and cyan. They should appear equally dense from end to end. Spacing between characters and between lines should be even. If this is not the case, check for correct ribbon insertion and paper loading. If the problem persists, contact your Apple dealer.

By the Way: Magenta is a shade of red, and cyan is a shade of blue.

Connecting The Scribe To Your Apple IIc

Do the preceding part of this chapter first.

Chapter 2, "Loading Paper and Ribbon", explains how to prepare the Scribe for operation with your computer. If you haven't done so, read Chapter 2 before proceeding to connect the Scribe to the Apple IIc.

What You Need

To complete the installation of your Scribe, all you need is the shielded Scribe Interface Cable.

The shielded Scribe Interface Cable is included in the Apple Scribe Accessory Kit, for the Apple IIc. The shielded interface cable is used to prevent radio and television interference.

Scribe Setup

When the Apple IIc is turned on, it configures itself for normal operation of your Scribe. There are no special settings required on either your Apple IIc or your Scribe. Therefore, installation can be completed in a very short time by performing the following steps:

Figure 3-2. Connecting Your Scribe

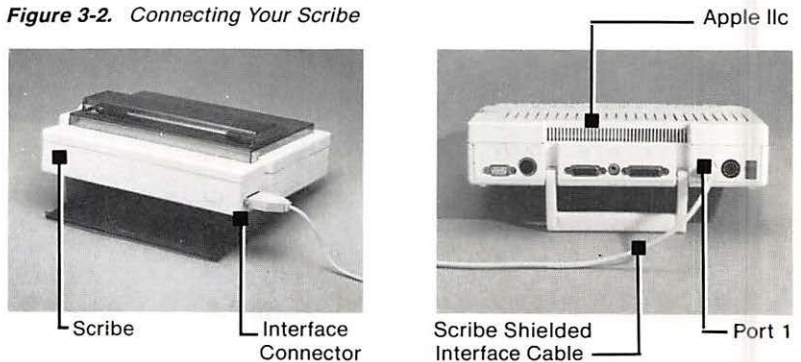

1. Be sure that the Apple IIc power is turned off, that any other attached equipment is turned off, and that the Scribe is turned off.
2. Connect the D-shaped end of the printer's interface cable (the 25-pin end) to the interface connector on the Scribe, see Figure 3-2.
3. Connect the round end of the same interface cable (the 5-pin end) to Port 1 of the Apple IIc, see Figure 3-2.

Ready to Print

Your Scribe is all set for printing. In the next chapter, you'll start printing using the Scribe with your Apple IIc.

Starting to Print



This chapter contains instructions for checking your Apple IIc and Scribe setup. You will be using the Scribe to print from the Apple IIc's built-in Applesoft BASIC.

Preliminary Setup

Figure 4-1. *System Connection*



First, be sure that the Scribe and Apple IIc are connected correctly, Figure 4-1.

If you haven't done this, refer to the instructions in Chapter 3.

Be sure that the Scribe is loaded with paper and that a ribbon cassette has been installed.

If you haven't done this, refer to the instructions in Chapter 2.

Turning on the System

Figure 4-2. *Scribe Power Switch*

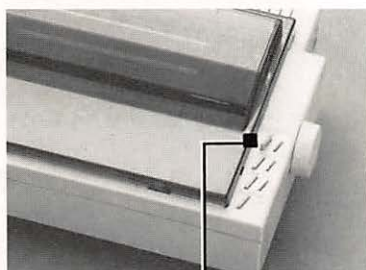

POWER switch

Perform the following steps to turn on the Apple IIc, Monitor, and Scribe:

1. Turn on the Scribe by pressing the POWER button so that the POWER light turns on.
2. Turn on your monitor.

Figure 4-3 Apple IIc Power Switch

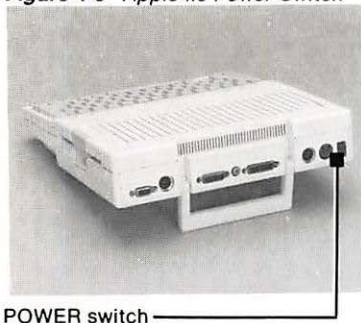

POWER switch

3. Turn on the Apple IIc by setting the power switch to "1". (Press the upper part of the switch.)

If the power lights on the equipment do not turn on, check the power cable connections.

After the monitor warms up (in about 15 seconds) you should see the following display:



4. Ignore the Check Disk Drive message on the screen and proceed to the next section, "Printing with Applesoft."

Printing with Applesoft

The following is a procedure for entering a short program which you can run that will print first on the screen, then on the printer, and then back on the screen. This program is short, but typical of a straightforward BASIC printing routine.

1. Press **(CONTROL)-(RESET)** (Both keys simultaneously).
2. Type HOME and press **(RETURN)**.
The screen will clear and the Applesoft Basic prompt and flashing cursor will move to the top left corner of the screen.
3. Type the following program:
Press **(RETURN)** at the end of each line.

```
100 PRINT "Printing on Screen"  
110 PR#1  
120 PRINT "Printing on Scribe"  
130 PR#0  
140 PRINT "Printing on Screen again"  
150 END
```
4. Type RUN and press **(RETURN)** to run the program.

By the Way: The printing sample in this chapter is in the 40-column mode. For information on the 80-column mode and disk use, refer to the *Applesoft BASIC Programmer's Reference Manual*. This program works differently with ProDos

You can find additional editing techniques in the Applesoft manual for your Apple IIc.

FYI: A Few Applesoft Hints

If you make an error typing in a line of the above program and haven't pressed (RETURN) yet, just backspace and retype the line from the point of the error.

If you make an error and discover it after pressing (RETURN), just type the line over again, being sure to repeat the same line number.

If you type a line you don't want, and discover it after pressing (RETURN), you can get rid of that line by just retyping only the line number and pressing (RETURN).

If your screen gets a little cluttered with replaced lines, just type HOME and press RETURN to clear your screen. Then type LIST and press (RETURN) to list all your current program lines.

If It Doesn't Work the First Time

Don't be discouraged if the Scribe doesn't print the first time. Just refer to the following hints to get the Scribe going.

Is the Scribe POWER light on? *Check that the Scribe is plugged in and turned on. Press the POWER switch to turn on the POWER light.*

Is the fuse blown? *If the POWER light doesn't come on, check the fuse. The fuse receptacle is right next to the power connector on the Scribe. If the wire inside the fuse is broken, replace it with a 1-ampere type 3AG fuse.*

Is the SELECT light on? *The SELECT light must be on for the Scribe to print. Press the SELECT button.*

Is the printer cover closed? *If it is open, an interlock switch prevents the Scribe from printing and turns off the SELECT light.*

Are you out of paper? *When there is less than one-half inch of paper left, an error detector under the platen stops the printer and the SELECT light flashes.*

Are you out of ribbon? *When the ribbon runs out, the printer stops and the SELECT light flashes.*

Are Scribe DIP switches SW1-SW8 set correctly? Run self-test and check the printout. It should show the following for the DIP switches:

*DIP SW(00*00000)*

If not, set DIP switches SW1-SW8 to the off (up) positions. See "DIP Switch SW1-SW8 Functions" in Chapter 2, Text and General Control Commands of Part II.

Is the interface cable loose? Turn off power on both the Apple IIc and the Scribe. Remove and reinstall the Scribe interface cable.

Is the Apple IIc configured correctly? Turn the Apple IIc off and back on again. This resets Port 1 of the Apple IIc to its default configuration, which is correct for the Scribe.

Is the program at fault? Run the Scribe self-test, Chapter 3, Setting Up Your Scribe. If the self-test runs alright, most likely the problem is in the program being run on the Apple IIc.

See also Appendix A, Troubleshooting, for a more comprehensive list of troubleshooting aids. If the problem persists, consult your Apple dealer.

Caring for Your Scribe



Think of your Apple Scribe as a typewriter with a built-in microprocessor. By taking care of it as you would any other fine machine, you will save yourself repair bills and always be assured of getting the results the printer was designed to deliver.

Operating Environment

The Apple Scribe is intended to be used in a reasonably clean indoor location. It will work reliably in temperatures from 41 to 95 degrees Fahrenheit (5 to 35 degrees Celsius) with 10 to 85 percent humidity.

By the Way: Print quality may be degraded at either very low or very high temperatures. At extremely low temperatures, the contrast may not be as good; at extremely high temperatures, the characters may bleed (tend to run together.)

Since the thermal transfer ribbon uses a wax based ink, it is more sensitive to temperature than a standard typewriter ribbon. You should treat the ribbon cassette with the same care you would a phonograph album or video cassette and not expose it to direct sunlight or extremes of temperature.



Warning

When not using your printer you can store it at -4 to $+140$ degrees Fahrenheit (-20 to $+40$ degrees Celsius). Should it be necessary to store the printer at extreme temperatures, remove the ribbon. Never try to run the printer at these temperature extremes.

The Scribe's printer cover gives little protection against liquids or vapors. Spilling any liquid inside, or allowing the printer to be exposed to chemical or solvent fumes (including steam from a coffee maker), can harm it.

Cleaning

To clean the outside of the printer, just wipe it with a soft damp cloth. To remove stains or dirt, add a drop of liquid dish detergent to the cloth and wipe the surface of the printer. Under normal use, a yearly cleaning of the Scribe interior with a small brush or blower to remove paper dust and chips is recommended. Under more frequent use, cleaning should be done more often.



Warning

Never use household cleansers, ammonia, powders, abrasives, or solvents such as cleaning fluid on the outside of the printer; they may damage the plastic.

Replacing the Thermal Print Head.

Depending on the amount of use, the elements of the thermal-transfer print head eventually degrade. If you notice uneven print quality, it may be time to replace the thermal-transfer print head (hereafter called print head).

Important: Before deciding to replace the print head, be sure that everything else is OK. Check the ribbon and the smoothness of paper. Check that SW6 is OFF (up) for printing on plain paper and ON (down) for printing on very smooth paper or transparencies. If you are satisfied that the preceding items are OK, and the print head has performed a lot of printing, it is time to replace it.

Replacement is a quick and easy operation that requires no tools and should take less than a minute.

See your Apple dealer to purchase a new print head. To replace the print head, proceed as follows:

Removal of Thermal Print Head

1. With no paper in the Scribe, turn it on to automatically center the print head.
2. Turn off the power to the Scribe (POWER light goes out).

3. Remove the printer cover and ribbon cassette.

4. Hold the print head connector, (Figure 5-1) by the sides and progressively pull up to disconnect it.

Moving the connector slightly back and forth as you lift will make it easier to remove.

5. Hold the print head, (Figure 5-1) by the sides and progressively pull up to disconnect it.

Moving it slightly side to side as you pull up will help it come out of the grooves on either side.

Figure 5-1. Thermal Print Head Removal

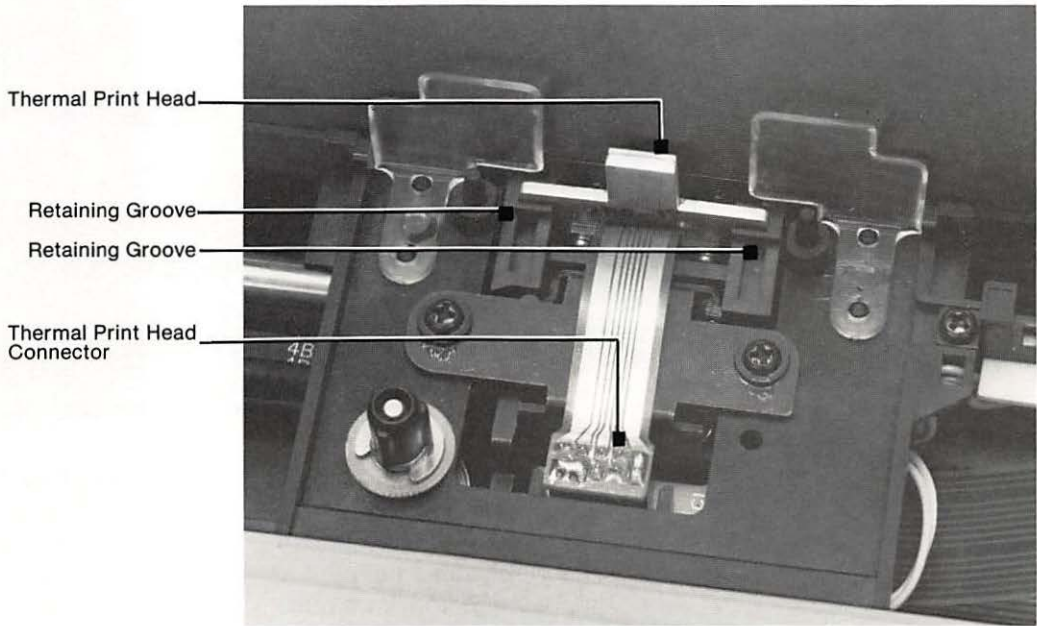

Installing a New Thermal Print Head

1. Holding the print head by the sides, lower it into the two grooves on either side of the print head retaining assembly, (Figure 5-2.)

Figure 5-2. Thermal Print Head Installation

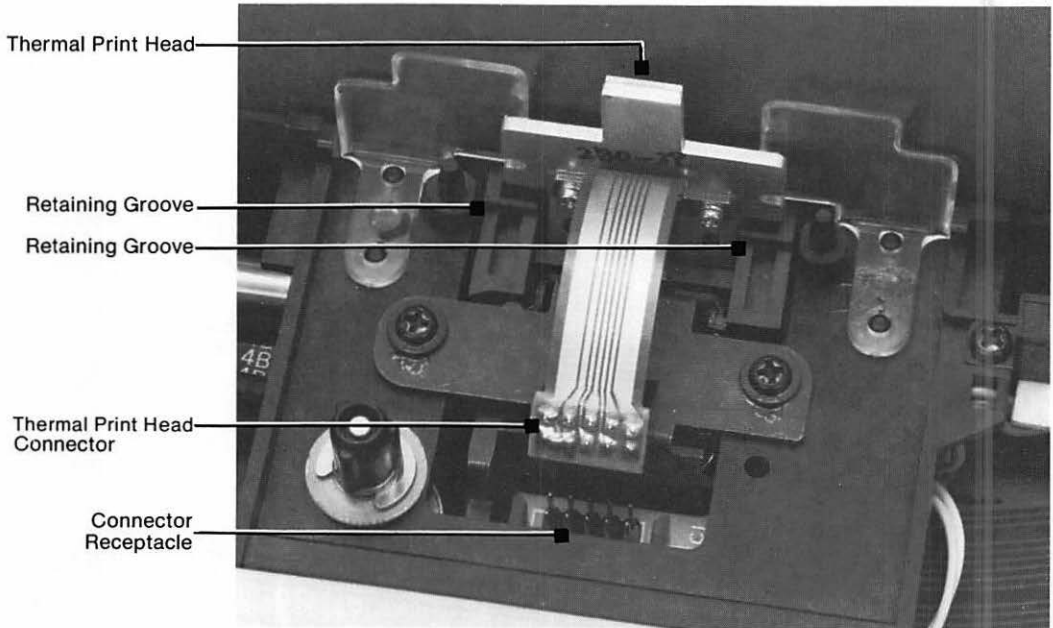

2. Line up the print head connector, Figure 5-2, with the circuit board connector and gently push the print head connector down and into place.
3. Replace the ribbon cassette and printer cover, and then load some paper in the Scribe.
4. Finally, after you have everything in place, run the Scribe's self-test to be sure everything is OK.

Make sure that the pins line up with the matching holes in the print head connector, and that there are no pins left on the outside of the connector.

To perform the self-test, turn the printer off. Then hold the LINE/FORM FEED button down and turn the printer back on. Release the LINE/FORM FEED button. To stop the test, press the POWER switch again to turn off power.



The Apple IIc



*Apple IIc Scribe User's Manual
Part II: Reference*

Applesoft and Pascal Programs

Chapter 1

Applesoft and Pascal Programs

- 41 Printing from Applesoft
- 41 Underlines and Headlines in Applesoft
- 42 Subscript and Superscript in Applesoft
- 43 Printing Color in Applesoft
- 45 Printing from Pascal
- 45 Printing Text Files from Disk
- 45 Printing Keyboard Input
- 45 Pascal Printing Program
- 46 Pascal Printing Features Program
- 47 Pascal Line-by-Line Printing

This chapter gives you different examples of printing from Applesoft and Pascal. It also gives examples of using the underline and headline features, printing in color, and the use of superscript and subscript. The use of these features is typical of how the other Scribe operations can be selected. For more information on these features, refer to *Text Mode Codes* in Chapter 2, "Text and General Control Codes", of this Part II Reference.

Important: The program examples in this chapter assume that you have inserted a ProDOS™ disk and that ProDOS is active. The print commands in the Applesoft BASIC example are for ProDOS.

Printing from Applesoft

Refer to your *Applesoft BASIC Programmer's Reference Manual* and *ProDOS Programming Manual* for more information on the PR# and PRINT commands.

If Applesoft BASIC is the language you use for programming, you'll find you can use it to put the Scribe through its paces. The following demonstration programs show you how.

Underlines and Headlines in Applesoft

The following program shows how various Scribe features can be selected by adding the appropriate control codes to your program. This particular program selects the underline mode and then turns it off; and selects the headline mode and then turns it off.

Type NEW and press **(RETURN)** to clear memory. Now, enter the following program:

```

10 HOME Clears the screen
20 PRINT "Test to Screen"
30 PRINT CHR$ (4);"PR#1" ProDOS type printer cmd,
CHR$(4) = CTL D
40 PRINT "Test to Printer"
50 PRINT CHR$ (27);"X"
60 PRINT "Underlined"
70 PRINT CHR$ (27);"Y"
80 PRINT "Underlined Ended"
90 PRINT CHR$ (14)
100 PRINT "This is the Headline Mode"
110 PRINT CHR$ (15)
120 PRINT "This Ends Headline Mode"
130 PRINT CHR$ (4);"PR#0" ProDOS return to screen cmd
140 END

```

When you run this program, it will display "Test to Screen" on your monitor, then print out five lines to the printer, as shown in Figure 1-1.

Figure 1-1. Applesoft Printing Sample

Test to Printer

Underlined

Underlined Ended

This is the Headline Mode

This Ends Headline Mode

Subscript and Superscript in Applesoft

The following is an Applesoft BASIC program example of printing subscript and superscript characters. The subscript and superscript characters are selected by typing the standard ASCII keyboard characters, "A" for "A" and "2" for "2", for example. The selection of subscript or superscript is a function of the control code, ESC y for subscript and ESC x for superscript, respectively. The subscript and superscript commands are cancelled by ESC z.

Type NEW and press **(RETURN)** to clear memory. Now, enter the following program:

```

10 HOME
20 PRINT "Test to Screen"
30 PRINT CHR$ (4);"PR#1"      ProDOS type printer command
40 PRINT "Test to Printer"
50 PRINT "This is a Subscript Sample:"
60 PRINT "A"; CHR$ (27);"yt"; CHR$ (27);"z = ";
70 PRINT "A"; CHR$ (27);"y1"; CHR$ (27);"z + ";
80 PRINT "A"; CHR$ (27);"y2"; CHR$ (27);"z"
90 PRINT "This is a Superscript Sample:"
100 PRINT "Area = PiR"; CHR$ (27);"x2"; CHR$ (27);"z"
110 PRINT CHR$ (4);"PR#0"    ProDOS return to screen command
200 END

```

When you run this program, it will print out the text shown in Figure 1-2.

Figure 1-2. Applesoft Subscript/Superscript Example

```

Test to Printer
This is a Subscript Sample:
At = A1 + Az
This is a Superscript Sample:
Area = PiRz

```

Printing Color in Applesoft

The following is an Applesoft BASIC program example of printing in color. In the program, the three color commands, ESC K1, ESC K2, and ESC K3, are used to select yellow, magenta, and cyan, respectively.

Important. To save ribbon, it is a good idea to write color commands in the same order that they occur on the ribbon, i.e., yellow, magenta, and cyan. The colors on the ribbon occur sequentially. Thus there will be 8 inches (1 line) of yellow, followed by 8 inches (1 line) of magenta, followed by 8 inches (1 line) of cyane, and then the pattern repeats all over again, continuously to the end of the ribbon. Therefore, you don't want to choose magenta before yellow because the printer will skip the next entire 8 inch yellow band to get to the magenta. For the most efficient use of the ribbon, you want to print the colors in the order they occur on the ribbon.

Type NEW and press RETURN to clear memory. Now, enter the following program:

Figure 1-3. Applesoft Color Example.

Yellow	10 HOME
	20 PRINT "Test to Screen"
	30 PRINT CHR\$ (4);"PR#1"
Magenta	40 PRINT CHR\$ (27);"K1";"Yellow"
	50 PRINT
Cyan	60 PRINT CHR\$ (27);"K2";"Magenta"
	70 PRINT
Orange	80 PRINT CHR\$ (27);"K3";"Cyan"
	90 PRINT
Green	100 PRINT CHR\$ (9);"K"
	110 PRINT CHR\$ (27);"K1";"Orange"; CHR\$ (13); CHR\$ (27);
	"K2";"Orange"
Purple	120 PRINT CHR\$ (9);"L"
	130 PRINT
Black	140 PRINT CHR\$ (9);"K"
	150 PRINT CHR\$ (27);"K1";"Green"; CHR\$ (13); CHR\$ (27);
	"K3";"Green"
	160 PRINT CHR\$ (9);"L"
	170 PRINT
	180 PRINT CHR\$ (9);"K"
	190 PRINT CHR\$ (27);"K2";"Purple"; CHR\$ (13); CHR\$ (27);
	"K3";"Purple"
	200 PRINT CHR\$ (9);"L"
	210 PRINT
	220 PRINT CHR\$ (9);"K"
	230 PRINT CHR\$ (27);"K1";"Black"; CHR\$ (13); CHR\$ (27);
	"K2";"Black";
	CHR\$ (13); CHR\$ (27);"K3";"Black"
	240 PRINT CHR\$ (9);"L"
	250 PRINT
	260 PRINT CHR\$ (4);"PR#0"
	270 PRINT "Back to Screen"
	280 END

When you run this program, it will print out the text shown in Figure 1-3 in the colors indicated.

Printing From Pascal

You can use the Scribe with an Apple IIc Pascal program in a number of different ways.

Printing Text Files From Disk

You can print a disk text file by using the Pascal Filer's Transfer command, like this:

Prompt: Transfer what file?

Response: <filename>

Prompt: To what file?

Response: PRINTER:

Printing Keyboard Input

You can use the Filer to send text that you type directly to your printer by using the Transfer command like this:

Prompt: Transfer what file?

Response: console:,printer:

Whatever you type will appear on the Apple's display screen, until you press **CONTROL-C**; then all that you have typed will be sent to the printer. You can include Scribe command codes in the text that you type (for example to produce underlined or boldface text), as long as you do not use any printer control code that includes **CONTROL-C**.

Pascal Printing Program

Here is an example of a Pascal program that sends characters to the printer:

```
PROGRAM Printer; A trivial program, but it works!
VAR Prntr:TEXT;
BEGIN Open a file for use. In this
  REWRITE(Prntr, 'PRINTER:'); case, Pascal's predefined
                               printer port.
  WRITELN(Prntr, 'This is a test. ');
                               Send characters to the file.
  CLOSE(Prntr); Close the file.
END.
```

For more information on Pascal file and device use, see the *Apple II Pascal Operating System Reference Manual*.

Note that all input and output (I/O) in Pascal programs is through files. The Pascal system predefines Port 1 as belonging to the system printer, called "PRINTER:". If "prntr", or some other filename previously defined as referring to "PRINTER:", had not been included in the WRITELN statement, Pascal would have sent the text to your monitor.

Pascal Printing Features Program

This example adds a couple of statements to the previous program to select the underline feature of the Scribe. Notice that one of the added program statements selects the underline feature and that another statement is required to end the underline mode. This program illustrates the general method for selecting printer features from a Pascal program.

```
PROGRAM Printertwo;

VAR Prntr:TEXT;

BEGIN
    REWRITE(Prntr, 'PRINTER:'); Open a file for use. In this
                                case, Pascal's predefined
                                printer port.
    WRITELN(Prntr, 'This is a test. ');
                                Send characters to the file.
    WRITE(Prntr, chr(27), 'X'); Selects underline feature,
                                ESCAPE X.
    WRITELN(Prntr, 'Underline selected. ');
                                Send characters to the file.
    WRITE(Prntr, chr(27), 'Y'); Ends underline.
    WRITELN(Prntr, 'Underline ended. ');
                                Send characters to the file.

    CLOSE(Prntr); Close the file.
END.
```

When you run this file, it will print the following three lines:

```
This is a test.
Underline selected.
Underline ended.
```

Pascal Line-by-Line Printing

The following simple Pascal program can be used to transfer characters from the keyboard to the printer on a line-by-line basis, allowing you, in effect, to use your printer as a typewriter. Press **CONTROL-C** to exit the program.

```
PROGRAM Typewriter;  
  
VAR    prntr:TEXT;  
       buff:STRING;  
  
BEGIN  
    REWRITE(prntr,'PRINTER:');  
    WRITELN('Keyboard to Printer transfer -  
<ctrlC> to exit');  
    WHILE NOT EOF DO  
        BEGIN  
            READLN(buff);  
            WRITELN(prntr,buff)  
        END;  
    CLOSE(prntr)  
END.
```

Note the Difference: When you use the Transfer command of the Filer to type directly to the printer, the text is *not* sent to the printer line-by-line; it is printed only after you type the end of file character, **CONTROL-C**.

Text and General Control Codes

■ Chapter 2

	Text and General Control Codes
49	Controlling Your Scribe
50	Power-On Configuration (Standard Instructions)
50	DIP Switch Settings
52	Control Codes
52	Single-Character Codes
52	Multi-Character Codes
52	Functions You Can Change
53	DIP Switch SW1-SW8 Functions
55	Text Mode Codes
55	Draft/Letter Mode
55	Character Pitch
56	Headline Type
57	Underlining
57	Subscript/Superscript
58	Slashed/Unslashed Zeros
58	Left Margin Setting
59	Character Repetition
59	Alternate (National) Characters
61	Backspacing
62	Paper Handling Codes
62	Form Feeding
62	Top-of-Form
62	Line Feed
63	Line Feed Spacing
64	Line Feed Direction
64	Page Length
64	Line Feed Function
65	Automatic Line Feed
65	Carriage Return
66	Auto-Print Action
66	Miscellaneous Codes
66	Print Intensity
66	Restoring Standard Instructions
67	Canceling Text
67	Duplicate Codes
68	Software Select/Deselect (DC1/DC3)
68	Apple IIc Interface

■ **Controlling Your Scribe**

This chapter describes how to take advantage of some of the versatile capabilities of the Apple Scribe. With the information in this chapter, you can change the printing *format* of your printer to fit your personal requirements.

The dot- matrix, thermal-transfer printing method gives you maximum flexibility to create written records in exactly the form you want. Besides printing in color, the Scribe lets you print ordinary text with a wide range of typographical options (such as underlining and headlining), and construct page-size *graphics* patterns by the placement of individual dots. Here's what your Apple Scribe can do for you:

- Print all the letters, numbers, and punctuation marks that you can type on your Apple computer keyboard or display on the video screen. In addition, it can print alternate language characters.
- Set the number of characters per inch (*character pitch*) to 10 or 17. Pitches can be mixed within a line.
- Set the spacing between lines (*line feed pitch*) to increments of 1/144 inch, including the standard six lines per inch. Line spacing can be changed between any two lines.
- Feed paper both up and down (single-sheet only), permitting the generation of mathematical formulas. Subscripts and superscripts are available as a built-in feature. When you use them, they are automatically positioned above and below the line, eliminating the need to move the paper.
- Set page length in increments of 1/144 inch to any length up to 9999/144 (70 inches, approximately); or set to 1584/144 for a standard 11-inch page.
- Print in headline (double-width) style.
- Print subscripts and superscripts

- Change the location of the left-hand printed margin. The location of the right-hand margin is usually determined by the program you use in your Apple computer.
- Print drawings, graphs, diagrams, and similar line graphics, by instructing your Apple Scribe to print individual dots in specific locations. The densest high resolution mode of 160 dots to the inch horizontally and 144 to the inch vertically produces sharp, unbroken lines. You can print in either high or low resolution graphics. There are two high-resolution graphics modes and four low-resolution modes.

You can accomplish all of this through the relatively simple programming techniques described in this chapter and the next.

Power-On Configuration (Standard Instructions)

Your printer gets its information on how to behave from three sources:

- its microprocessor, the “brain” of the printer
- The DIP switch inside the printer case
- printing commands from your computer

Each time you turn on the printer, the microprocessor is ready to execute a number of standard instructions which set the power-on configuration. Some of these instructions are stored within the Scribe's ROM memory, while other instructions are determined by DIP switch settings. For example, the microprocessor automatically instructs the printer to print 6 lines per vertical inch; and the way the DIP switch is set at the factory causes the microprocessor to instruct the printer to insert a line feed (LF) after a carriage return (CR).

You can override these rules in two ways: by changing the DIP switch settings and by sending special *control codes* to your printer.

DIP Switch Settings

One way to change the rules is to change the setting of the DIP switches, SW1 through SW8, at the rear of the Scribe. Most DIP switch settings affect printer functions that you seldom need to change, such as baud setting. By setting the appropriate DIP switch in advance, you know that every time you turn the power on, the printer will be set up to:

- Receive data at the proper baud
- Use the proper protocol
- Use the desired national character set
- Select the desired print intensity
- Provide a line feed (LF) after carriage return (CF), if desired.

DIP stands for dual in-line package, which is a technical description of the physical form of the switch assembly. The DIP switch assembly is at the rear of the of the printer and contains eight switches, numbered 1 through 8. The eight individual switches are identified in this manual as SW1 through SW8. For example, switch SW4 is switch number 4 on the DIP switch assembly.

Figure 2-1. DIP Switches

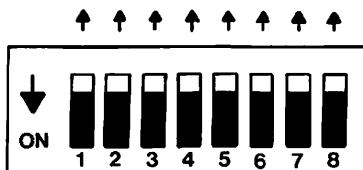

Note: ↑ Switch Handle, Off (Up) Position



↓ Switch Handle, On (Down) Position

To remove the DIP switch cover, insert a small coin in the groove on the cover and pry the cover off.

To change a DIP switch setting, turn the power off, remove the DIP switch cover, and press the small switch handle to the opposite position with a pointed tool. A DIP switch is said to be off (logic 0) when its handle is facing up. It is on (logic 1) when its handle is facing down. Don't forget to turn the power back on when you have finished setting the switch.



Warning

Be sure to turn the power off before adjusting the switches. Don't use a pencil or pen to change a DIP switch setting; they can leave foreign matter behind, which eventually gets into the switch. A round toothpick or small screwdriver works best.

Control Codes

The second and most common way to override the microprocessor rules, and the DIP switch settings as well, is to send special control codes from your computer. You'll want to use control codes for things such as underlining, subscript/superscript, color selection, and so on.

There are two types of control codes: *single-character codes* and *multiple-byte (character) codes*.

Single-Character Codes

The single-character codes are the most often used printer commands. The single-character codes cause a change in the action of the printer. Such codes are: backspace, line feed, carriage return, form feed, deselect of printer, headline mode, or cancelation of current text line.

Multi-Character Codes

Most printer control codes consist of the ESCAPE character followed by a sequence of characters. For example, an ESCAPE X tells your printer to begin underlining.

By the Way: If the first character after an ESCAPE character is not a legitimate control code identifier, both it and the ESCAPE character will be ignored by the printer.

Because many programs use the CONTROL and ESCAPE keys, it is often not possible to send control or escape codes to the printer by simply typing them from the keyboard.

Functions You Can Change

The remainder of this chapter lists and discusses printer functions you can change by resetting a DIP switch or sending a control code. Standard DIP switch settings are signified by all capitals: OFF (UP) or ON (DOWN). Control codes are given in three forms:

- as one or more keyboard characters
- as a sequence of decimal values for the equivalent ASCII codes
- as a sequence of *hexadecimal* values for the equivalent ASCII codes

For a discussion of decimal and hexadecimal ASCII code equivalents, see Appendix C.

For Experienced Users: Those parts of the control codes that consist of letters, numbers, punctuation marks, and other printing characters are easy to send to your printer. However, nonprinting control characters such as ESCAPE and TAB sometimes require special programming techniques. The easiest way to send nonprinting control characters to the printer is to include them in a normal output statement (such as a BASIC print statement or a Pascal write statement). This has the disadvantage that the characters you type are not visible in your program listing. Worse yet, their presence will be detected by the Apple Scribe if you use it to print a copy of your source code, and they will be interpreted as printer control codes during the print-out.

One technique to avoid this problem is to create such characters as ESCAPE, SI, and SO by means of CHR or CHR\$ functions, although this requires longer program statements. The Pascal function CHR(nn) and the BASIC function CHR\$(nn) both return the ASCII character that corresponds to the decimal number nn. For example, if nn is 27, the function returns an ESCAPE character. Thus, the control code to begin underlining, ESCAPE X, can be sent to the printer by the following statements:

```
(Pascal) WRITE (PRINTER, CHR(27), `X`)
```

The following is an Applesoft example under ProDOS:

```
(Applesoft BASIC) PRINT CHR$(4); "PR#1"  
PRINT CHR$(27); "X"
```

The procedures for creating graphics with the Apple Scribe often require that you send the printer ASCII characters containing specific bit patterns. The methods just described are valuable here.

By the Way For the DIP switches, OFF is up, and ON is down.

DIP Switch SW1-SW8 Functions

The DIP switch located at the rear of the SCRIBE determines the power-on default settings of certain Scribe functions. For use with the Apple IIc, all the switches, SW1-SW8 are set to the up position.

Note: When you turn on power to the Apple IIc, its printer port, Port 1, is automatically setup (configured) to communicate with the Scribe. Refer to "Apple IIc Interfaces" at the end of this section.

You can run the Scribe self-test to obtain a printout of the switch positions. A self-test DIP switch setting printout of 00*00000 is the normal indication. The printout, reading from right to left, corresponds to the settings of SW1-SW8, respectively. Switch SW6 indicates an * regardless of its setting.

Table 2-1. DIP Switches SW1-SW8 Functions

The boldfaced switch position indicates the normal position for DIP switches SW1-SW8. Up is the normal physical position of the switches and corresponds to "off" and a logic "0". The down position of the DIP switches is equal to "on" and a logic "1".

DIP switches SW1-SW3 select the default alternate (National) character set. The settings and selections are given in the following:

SW1	SW2	SW3	Language
Off (Up)	Off (Up)	Off (Up)	American
On (Down)	Off (Up)	Off (Up)	Italian
Off (Up)	On (Down)	Off (Up)	American
On (Down)	On (Down)	Off (Up)	British
Off (Up)	Off (Up)	On (Down)	German
On (Down)	Off (Up)	On (Down)	Swedish
Off (Up)	On (Down)	On (Down)	French
On (Down)	On (Down)	On (Down)	Spanish

SW4	
Off (Up)	No line feed after carriage return
On (Down)	Adds line feed after every carriage return

SW5	SW6	Density	Effect
Off (Up)	Off (Up)	1	Plain paper (normal density)
Off (Up)	On (Down)	2	Plain paper (low density)
On (Down)	Off (Up)	3	Transparency (normal density)
On (Down)	On (Down)	4	Transparency (low density)

SW7	
UP	9600 Baud
Down	1200 Baud

SW8	
UP	Data terminal ready
Down	XON/XOFF (not used by Apple IIc)

Text Mode Codes

Draft/Letter Mode

The power-up default for the Scribe is the draft mode. This can be changed to the letter mode by pressing the LETTER switch so that the LETTER light turns off. The draft/letter software commands are as follows:

Code	Decimal	Hex	Effect
ESC M	27 77	\$1B \$4D	Select draft mode (10 or 17 cpi)
ESC m	27 109	\$1B \$6D	Select letter mode (10 cpi only)

Character Pitch

With the Apple Scribe you can print characters in two different widths, at 10 or 17 characters per inch. When the Scribe is turned on, the selected pitch is always pica (10 characters per inch) in the draft mode at 80 characters per second. The 17 character per inch pitch can be software selected in draft mode, also with a speed of 80 characters per second. The character pitch control codes are as follows:

Code	Decimal	Hex	Effect
ESC N	27 78	\$1B \$4E	Pica (10 characters per inch)
ESC Q	27 81	\$1B \$51	Ultracondensed (17 characters per inch)

Pressing the LETTER button (so that the LETTER light turns on) selects the letter mode. The default pitch in letter mode is pica (10 characters per inch) at 50 characters per second.

By the Way: If a pitch of 17 characters per inch is software selected while in the letter mode, the printer will automatically switch over to Draft mode. The 17 character pitch will only print in the draft mode.

Note: To save space in the tables in this manual, ESCAPE is shortened to ESC, and CONTROL is shortened to CTL.

If you would like to see how type looks in the Draft and Letter modes, refer to *Appendix D, "Character Specifications"*. The same draft type style (font) is used at both the 10 and 17 character per inch pitches. The letter type style (font) is used only at a 10 character per inch pitch.

Both the 10 and 17 character per inch pitches can be printed in underline or headline style.

Table 2-2 lists the printing characteristics of the draft and letter fonts:

Table 2-2. Draft and Letter Font Characteristics

Pitch	Printing Speed Char/Sec	Approximate Dots per Inch	Approximate Dots per 8"Line
Letter Mode			
Pica (10 cpi)	50	150	1200
Draft Mode			
Pica (10 cpi)	80	120	960
Ultracondensed (17 cpi)	80	204	1632

Headline Type

Your printer can print double-width characters, which make excellent headlines. To start or end headline printing, use the following control codes:

Code	Decimal	Hex	Effect
CTL-N	14	\$0E	Begins headline mode (Shift Out)
CTL-O	15	\$0F	Returns to normal mode (Shift In)

Note: The CTL key has the effect of subtracting 64 from ASCII keys with the decimal values 64 through 95. (Subtracting 64 is the equivalent to dropping the seventh bit.) Thus, in this example, the ASCII letter "N" is assigned the decimal number 78. But when the CTL key is pressed, 64 is subtracted from 78 to give 14 which is the decimal number assigned to the ASCII character "SO" (Shift Out). The Hex representation of SO is "0E". Refer to the Scribe Reference Card at the back of the manual or Appendix C, "ASCII, Binary, and Hexadecimal Codes" for a listing of all ASCII codes. Therefore, to determine the decimal equivalent of any "CTL" command, subtract 64 from the decimal value of the character associated with the CTL symbol.

You can print headlines in conjunction with the 10 and 17 character pitch options listed previously; the dot spacing remains the same, but you get half as many characters per inch. Thus you can select from two giant typefaces, either 5 characters per inch (pica in draft or letter mode) or 8.5 (ultracondensed in draft mode) characters per inch.

Underlining

The Apple Scribe recognizes a pair of control codes to start and end underlining:

Code	Decimal	Hex	Effect
ESC X	27 88	\$1B \$58	Starts underlining text
ESC Y	27 89	\$1B \$59	Stops underlining text

Your printer underlines characters by printing a line of dots near the bottom of the character matrix in both the draft and letter modes. To see the exact placement, refer to Appendix D. Thus underlining does not require double striking of characters, nor does it affect printing speed. When an ESCAPE X control code is in force, all text is underlined, including spaces and punctuation. You can underline with all character pitches, including headlines (see *Headline Type*).

Subscript/Superscript

The Scribe has a 96 character subscript set and a 96 character superscript set. There is no need to move the paper forward or backwards as the special characters are smaller and print on the same line as the character. The subscript and superscript commands are as follows:

Code	Decimal	Hex	Effect
ESC x	27 120	\$1B \$78	Begin Superscript
ESC y	27 121	\$1B \$79	Begin Subscript
ESC z	27 122	\$1B \$7A	End Subscript/ Superscript

Slashed/Unslashed Zeros

The printing of unslashed or slashed zeros can be forced by the use of the following codes:

Code	Decimal	Hex	Effect
ESC D CTL-@ CTL-A	27 68 0 1	\$1B \$44 \$00 \$01	Print Slashed Zeros
ESC Z CTL-@ CTL-A	27 90 0 1	\$1B \$5A \$00 \$01	Print Unslashed Zeros

Left Margin Setting

When you turn the power on, your Apple Scribe starts each line of print as far left as the type head can travel. This is called position 0 (not 1).

You can change the left print margin at any time by sending the printer the following five-character control code:

Code	Decimal	Hex	Effect
ESC L nnn	27 76 ddd	\$1B \$4C hhh	Sets left margin to position nnn

(where nnn is the margin setting represented as ASCII digits, "d" is the decimal number assigned to each ASCII "n", and each "h" is the Hex equivalent of each "d")

For example, the following control code advances the left margin to the 36th character position:

ESC L nnn	ESC L d d d	ESC	L	h	h	h
ESC L 035	27 76 48 51 53	\$1B	\$4C	\$30	\$33	\$35

Similarly, the control code ESCAPE L000 moves the left margin back to the far left end. The left margin remains at the selected setting until another ESCAPE L control code is sent to the printer, a software reset occurs, or until the power is turned off.

Although the number nnn must always contain three digits, you can replace leading zeros with spaces if desired.

Note that the position of the margin, which is measured by counting characters, depends on the character pitch in force at the time the margin control code is sent. If you subsequently change the character pitch, the margin will not move to accommodate the change.

In setting the left margin, the maximum value for nnn is 79 for 10 cpi (pica) and 135 for 17 cpi.

Character Repetition

You can send a single control code to the Apple Scribe that will cause it to print the same character up to 999 times.

Code	Decimal	Hex	Effect
ESC R nnn c	27 82 ddd d	\$1B \$52 hhh h	Prints nnn repetitions of character c

(where nnn is the number of repetitions, "c" is the character, "d" is the decimal number assigned to each ASCII digit "n", or character "c" in this case, and each "h" is the Hex equivalent of each "d")

For example, the following control code will cause 24 asterisks to be printed one after another:

ASCII Code	Decimal	Hex
ESC R 024 *	27 82 48 50 52 42	\$1B \$52 \$30 \$32 \$34 \$2A

The number nnn in this control code must always be three digits long; however, *leading zeros* may be replaced by spaces.

By the Way: If the number nnn is so large that the repeated characters run beyond the end of the line, the auto-print action must be set to produce a line feed; otherwise the excess characters will print over other characters on the same line. (See Auto-Print Action, described later in this chapter.)

Alternate (National) Characters

Your Apple Scribe has seven different language fonts to aid in printing text in German, French, Italian, Swedish, Spanish, and British English, as well as American English. You can choose any one of these character groups to substitute for these ten American symbols:

@ [\] ` { | } ~

Table 2-3 illustrates the characters in each alternate language font. The Draft Mode characters are shown. Letter Mode characters are the same, except for style. See Appendix D.

Table 2-3. Alternate (National) Language Characters, Draft Mode

Language	Alternate Characters
-----------------	-----------------------------

In this table, the top line shows the American characters. The other lines give the alternate character groups that can be substituted for these characters by using the appropriate control codes. DIP switches SW1, SW2, and SW3 specify the selected character group.

Note: The “\$” (Hex 24) and “^” (Hex 5E) are part of the standard font in all languages. For the Spanish hyphen, use the single quote key “'” (Hex 27), which is also the same for all languages.

Table 2-4 shows the control codes and combinations of positions of the three DIP switches to select the desired alternate character group. Note that there are two different sets of DIP switch settings and two different control codes that produce American symbols; you can use either one as the effects of both are the same.

Table 2-4. Alternate (National) Character Set Codes

Language Font	Code	DIP Switches		
		SW1	SW2	SW3
American	ESC Z CTL-B CTL-@	Off(Up)	Off(Up)	Off(Up)
German	ESC Z CTL-C CTL-@ ESC D CTL-D CTL-@	Off(Up)	Off(Up)	On(Down)
American	ESC Z CTL-E CTL-@ ESC D CTL-B CTL-@	Off(Up)	On(Down)	Off(Up)
French	ESC Z CTL-A CTL-@ ESC D CTL-F CTL-@	Off(Up)	On(Down)	On(Down)
Italian	ESC Z CTL-F CTL-@ ESC D CTL-A CTL-@	On(Down)	Off(Up)	Off(Up)
Swedish	ESC Z CTL-B CTL-@ ESC D CTL-E CTL-@	On(Down)	Off(Up)	On(Down)
British	ESC Z CTL-D CTL-@ ESC D CTL-C CTL-@	On(Down)	On(Down)	Off(Up)
Spanish	ESC D CTL-G CTL-@	On(Down)	On(Down)	On(Down)

You should set DIP switches SW1, SW2 and SW3 to the character group you normally use; this causes that group to be chosen every time you turn on your Apple Scribe. When you wish to switch to another group while printing text, you can use the control codes to do so. For example, even though the DIP switches have been set to select the American character group, the following sequence will print a British pound sign in place of the keyed in “#” symbol:

ESC Z CTL-D CTL-@ ESC D CTL-C CTL-@ #

Then the following sequence will return the printer to the American character group:

ESC Z CTL-G CTL-@

You can choose only one complete alternate group at a time—only one line from the previous table. Once you have chosen an alternate group, the ten special symbols will always print the alternate characters of that group until you choose a different font.

If you would like to see exactly how the alternate language characters are printed, refer to Appendix D, Character Specifications.

Backspacing

You can print any two characters on top of one another by sending the printer a backspace control code between them:

Code	Decimal	Hex	Effect
CTL-H c	8 d	\$08 h	Backspaces one character and prints the character c

(where c is the ASCII character to be backspaced, “d” is the decimal number assigned to the ASCII “c”, and “h” is the Hex equivalent of each “d”)

For example, the following code will print the plus/minus symbol by printing the “+” first, then backspace to print a bar under the plus sign:

Code	Decimal	Hex
+ CTL-H _	43 8 95	\$2B \$08 \$5F

The backspace code is handy for printing certain symbols, such as the plus-or-minus sign or the cents sign (c with a vertical bar through it). If you wish to backspace repeatedly (for example, to print a line with slashes through every character) you must follow each character with CONTROL-H plus the overprinted symbol.

Paper Handling Codes

The codes described in this section include setting line feed spacing, setting top-of-form, and other codes that control the movement of the paper by the printer.

Form Feeding

You can send a control code to your Apple Scribe that has the same effect as pressing and holding the LINE/FORM FEED button:

Code	Decimal	Hex	Effect
CTL-L	12	\$0C	Feeds paper to next top of form

Top of Form

You can set the top of form (TOF) at any point on the page by sending the following control code:

Code	Decimal	Hex	Effect
ESC v	27 118	\$1B \$76	Sets TOF to current position

Line Feed Spacing

This command causes the printer to advance one line. The length and direction of the line feed can be modified through other commands described in the following paragraphs. The line feed code is:

Code	Decimal	Hex	Effect
CTL-J	10	0A	Advance paper one line. (LF)

Line Feed Spacing

When the printer is turned on, it selects by default a vertical line spacing of six lines to the inch. In addition to six lines per inch, you can select any line spacing, in increments of 1/144 of an inch, from 1/144 up to 99/144 of an inch, using the following code:

Code	Decimal	Hex	Effect
ESC T nn	27 84 dd	\$1B \$54 hh	Distance between lines to be nn/144 inch (nn = 01 to 99)

(where nn is distance between lines represented as ASCII digit, each "d" is the decimal number assigned to each ASCII "n" and each "h" is the Hex equivalent of each "d"),

An example of the line feed spacing is:

ESC T nn	ESC T d d	ESC T h h
ESC T 25	27 84 50 53	\$1B \$54 \$32 \$35

The ESCAPE T code affects subsequent end-of-line actions; it does not affect the placement of the line in which it is included. It remains in effect until you set a new line feed pitch, or a software reset occurs, or until you turn the power off.

The vertical distance between dots is 1/144 of an inch, so this control code permits line feeding to be as little as one dot dimension. Although the control code ESCAPE T00 is ignored, the control code ESCAPE T01 can be used to feed the paper the smallest step available, 1/144 of an inch. The control code ESCAPE T18 establishes a line spacing of eight to the inch (144 divided by 18 is 8), and ESCAPE T24, one of six to the inch (144 divided by 24 is 6). (Note: You may find that ESCAPE A is simpler to use than ESCAPE T24 when selecting a line spacing of 6 to the inch.)

Code	Decimal	Hex	Effect
ESC A	27 65	\$1B \$41	6 lines per inch

Since the pin-feed sprockets cannot be relied upon to push paper backwards through the printer, reverse line feed is recommended only when using single-sheet paper.

Line Feed Direction

Paper can feed forward or backward (single-sheet only) through the printer, in response to these control codes:

Code	Decimal	Hex	Effect
ESC f	27 102	\$1B \$66	Forward (normal) line feeding
ESC r	27 114	\$1B \$72	Reverse line feeding

The printer will continue to feed in the direction last selected until it receives the opposite control code. Every time you turn the power on, forward line feeding is automatically selected.

Page Length

The Scribe is set for a standard paper length of 11 inches. The LINE/FORM FEED button in the Scribe control cluster advances the paper one line at a time, or if held down and not released, after the fifth line feed it continuously advances the paper to the top of the next page.

The code for setting page length is as follows:

Code	Decimal	Hex	Function
ESC H nnnn	27 72 dddd	\$1B \$48 hhhh	

Line Feed Function

In the standard mode any line feed causes the printer to execute a carriage return, and then print the next line of characters starting at the left margin:

_____ (LF)

If you enable the optional line feed function, a line feed does not cause the printer to execute a carriage return; the next line of type starts directly below where the previous line left off:

_____ (LF)

The codes for enabling and disabling the line feed function are as follows:

Code	Decimal	Hex	Effect
ESC IO	27 108 48	\$1B \$6C \$30	Disables optional line feed function
ESC I1	27 108 49	\$1B \$6C \$31	Enables optional line feed function

Automatic Line Feed

Many programs automatically add a line feed after every carriage return they send. Others offer this feature as an option.

If your program sends a carriage return character to start a new line, you can cause the printer to add the line feed by itself. If SW4 is closed, a line feed will be added after every carriage return. If SW4 is open, no line feed will be added.

If the program already adds a line feed, you can add an automatic line feed to produce double-spaced printing.

You can also use the following control codes to control automatic line feeds:

Code	Decimal	Hex	Effect
ESC Z @ CTL-@	27 90 128 0	\$1B \$5A \$80 \$00	No line feed added (CR only)
ESC D @ CTL-@	27 68 128 0	\$1B \$44 \$80 \$00	Carriage Return = CR + LF

Important! The |@| in these two codes stands for a *high ASCII* CONTROL-@ (decimal 128, hex \$80). Note: These two codes, ESCAPE D |@| CONTROL-@ and ESCAPE Z |@| CONTROL-@, can't be sent through Applesoft BASIC.

Carriage Return

The carriage return causes the printer to print the contents of a line of data. The default position for the next line of data is the current left margin. An optional line feed is inserted following the carriage return depending on the status of SW4. The carriage return code is:

Code	Decimal	Hex	Effect
CTL-M	13	0D	Return print head to left margin. (CR)

Auto-Print Action

When the printer receives enough text or graphics to fill an entire line, it automatically prints the line. At this time the printer may or may not feed a line of paper. Normally the printer does not feed a line of paper when the line buffer is full, but you can use the following control codes to change the automatic print action:

Code	Decimal	Hex	Effect
ESC Z <u> </u> CTL-@	27 90 32 0	\$1B \$5A \$20 \$00	No line feed added
ESC D <u> </u> CTL-@	27 68 32 0	\$1B \$44 \$20 \$00	Line feed added

Note: The underline () in ESCAPE Z above is used to indicate a space character (ASCII character 32) as shown under the Decimal equivalent of the ASCII code.

Miscellaneous Codes

The following are miscellaneous codes used to perform special functions not directly related to text handling or paper movement.

Print Density

The Scribe prints on “plain” paper and on smooth paper or transparencies. The commands are:

Code	Decimal	Hex	Effect
ESC Z CTL-@ CTL-H	27 90 0 8	\$1B \$5A \$00 \$08	Normal Density
ESC D CTL-@ CTL-H	27 68 0 8	\$1B \$44 \$00 \$08	Low Density

Restoring Standard Instructions

You can restore the printer to its standard (power-on) instructions at any time, by using the ESCAPE c control code:

Code	Decimal	Hex	Effect
ESC c	27 99	\$1B \$63	Restores standard instructions (Software Reset)

When you issue an ESCAPE c control code, the printer prints all data entered prior to the ESCAPE c, restores all operating instructions to the power-on state specified by the DIP switches SW1 through SW8 and microprocessor, including ribbon color sensing. The printer is left selected.

Canceling Text

The CONTROL X code is used to cancel text already sent to the printer. Only one line of text can be canceled, and once a carriage return character has been sent, it's too late to cancel. The cancel code is as follows:

Code	Decimal	Hex	Effect
CTL-X	24	\$18	Cancels current unprinted line.

Duplicate Codes

The following codes are duplicated in order to provide a limited compatibility with other Apple printers:

Code	Decimal	Hex	Effect
ESC e	27 101	\$1B \$65	Same as ESC p
ESC E	27 45	\$1B \$45	Same as ESC p
ESC q	27 113	\$1B \$71	Same as ESC p

In order to avoid confusion to the operator, the Scribe will print ASCII text even if selected from graphics mode; and it will print graphics even if selected from the print mode in accordance with the following commands:

Code	Character Pitch	Graphics Mode(cpi) Mode (cpi)
ESC n	(10)	72 × 72
ESC N	10	72 × 80
ESC e	(17)	(72 × 144)
ESC E	(17)	(72 × 144)
ESC q	(17)	(72 × 144)
ESC Q	17	(72 × 144)
ESC p	(17)	72 × 144
ESC P	(17)	72 × 144
ESC j	(10)	144 × 144
ESC J	(10)	144 × 144

The dot or character pitches contained within parentheses are the default mode as opposed to the intended mode.

Software Select/Deselect (DC1/DC3)

At power-on the DC1/DC3 commands are ignored. The DC3 command is used to deselect the printer, and the DC1 command is used to reselect the printer. The DC1 command can also be used to reselect the printer after an end of paper or end of ribbon condition has been corrected. The DC1/DC3 codes are:

Code	Decimal	Hex	Effect
DC1	17	\$11	Reselect Printer
DC3	20	\$13	Deselect Printer

The action of the DC1/DC3 commands is enabled and disabled by the following codes:

Code	Decimal	Hex	Effect
ESC Z CTL-P CTL-@	27 90 16 0	\$1B \$5A \$10 \$00	Enable DC1/DC3 Response
ESC D CTL-P CTL-@	27 68 16 0	\$1B \$44 \$10 \$00	Ignore DC1/DC3 Response

When the printer is deselected, it will appear busy to the computer. Because of this, sending a DC1 command may not be allowable when the printer is deselected.

Apple IIc Interface

For information on configuring Port 1, the serial printer port of the Apple IIc, refer to the *Apple IIc System Utilities* and the *Apple IIc System Reference* manuals.

You may change the configuration of Port 1 (the printer serial port) on the Apple IIc, but at power-on, it always resets to the default values just described.

When you turn on power to the Apple IIc, its printer serial port, Port 1, is automatically setup (configured) to communicate with the Scribe.

The System Utilities program disk for the Apple IIc uses a PIN (Product Identification-Number) system to simplify configuring the Apple IIc ports for various devices. The default setting for Port 1 of the Apple IIc is specifically set up for the Scribe with a PIN of 166/1124. The breakdown of the 166/1124 is as follows:

	Apple IIc, Port 1 PIN
Printer Mode	= 1
8 Data Bits and 2 Stop Bits	= 6
9600 Baud	= 6
No Parity	= 1
Don't Echo Output	= 1
Insert Line Feed after Carriage Return	= 2
Insert Carriage Return after 80 Characters	= 4

Chapter 3

Color Printing

- 71 Introduction
- 71 Color Mixing
- 72 Color Text
- 72 Color Graphics

Introduction

The Scribe color option is activated when a color ribbon is installed. The color ribbon is divided into three repeating bands of color in the order: yellow, magenta, and cyan. For most efficient use of the ribbon, it is recommended that you print all yellow first, then all magenta, then all cyan. Otherwise, entire 8-inch color bands on the ribbon will be skipped. Each 8-inch color band corresponds to the distance the thermal print head travels in printing the maximum allowable width across a page.

The color to be printed is selected using the following commands:

Command	Hex Code	Description
ESC K 1	1B 4B 31	Yellow
ESC K 2	1B 4B 32	Magenta
ESC K 3	1B 4B 33	Cyan

Color Mixing

Color mixing is done by overprinting one color on top of another. For example, to obtain the color orange, yellow is printed followed by overprinting with magenta. It is standard practice to print the lighter color followed by the darker color.

To print black, first print yellow, followed by overprinting with magenta, then with cyan. This method of printing black uses up ribbon very quickly. When there is a considerable amount of black to be printed along with color, it is recommended that a black ribbon be used. In this case, the color program should include a software command to stop the printer, and send a message to the screen alerting the user to change the ribbon. When the ribbon is changed, and the user presses an indicated key, the program should perform an "ESC c" software reset so that the printer will check the ribbon type.

Color Text

In the text mode, certain commands may be used at any time. Other commands can be used only at the beginning of a line; otherwise color registration will be lost. The following commands may be used without restriction at the beginning of a line or at any time during the printing of the line:

Description	Command
BS	Backspace
SO	Headline
SI	Clear Headline
CAN	Cancel
ESC X	Start Underline
ESC Y	Stop Underline
ESC x	Start Superscript
ESC y	Start Superscript
ESC z	Stop
	Subscript/Superscript
ESC R	Character Repeat

The Scribe determines the location of the color bands on the ribbon by sensing the registration mark at the beginning of each color group (yellow/cyan junction).

All other commands must be used only at the beginning of a line, or they will cause loss of color registration. Correct color registration is not re-established until the ribbon sensor senses the registration mark at the beginning of the next color group.

By the Way. The only time a change of color command should be used is at the beginning of a line, following a carriage return.

Color Graphics

In the graphics mode, certain commands may be used at any time. Other commands can be used only at the beginning of a line, otherwise color registration will be lost. The following commands may be used without restriction at the beginning of a line or at any time during the printing of the line:

Code	Decimal	Hex	Effect
ESC V	27 86	\$1B \$56	Dot Repeat
ESC g	27 103	\$1B \$67	Enhanced Low Resolution
ESC G	27 71	\$1B \$47	Low Resolution
ESC S	27 83	\$1B \$53	Low Resolution
ESC c	27 99	\$1B \$63	High Resolution

Note: ESC G and ESC S are duplicate commands.

Chapter 4

Graphics Printing

75	Introduction
75	General Graphics Information
76	Low-Resolution Graphics
76	Bit Image Printing
79	Dot Spacing
80	Low-Resolution Graphics Example
81	Dot-Column Repeating Graphics
82	Exact Dot Placement
83	High-Resolution Graphics
83	Bit Image Printing
86	Dot Spacing
86	High-Resolution Graphics Example
87	Dot-Column Repeating Graphics
88	Exact Dot Placement

Introduction

The Scribe has six graphics modes, two high-resolution, and four low-resolution. The two high-resolution modes print at a vertical resolution of 144 DPI (dots per inch) and the four low resolution modes print at a vertical resolution of 72 DPI. The horizontal mode resolution depends on which graphics mode is chosen and ranges from 72 DPI in the lowest resolution mode to 160 in the highest resolution mode.

General Graphics Information

There are three primary ways to create graphics patterns with the Apple Scribe:

- by printing a line of many different vertical dot patterns, each up to eight double-dots high (low-resolution) or 24 dots high (high-resolution).
- by repeating a single vertical dot pattern all the way across a line
- by the exact placement of single dots or small groups of dots at one or more positions along a line

In all cases, printed graphics are produced one line at a time. In the low-resolution mode each line can be up to 8 double-dots high and 1280 dots long (8 inches x 160 dots/inch = 1280 dots). In the high resolution mode each line can be up to 24 dots high and 1280 dots long (8 inches x 160 dots/inch = 1280 dots).

In high-resolution graphics, all 24 elements of the thermal print head are used and a line of graphics is 1/6 inch high. In low-resolution graphics, the eight double-dot method uses 16 of the 24 elements of the thermal print head. Therefore, a line of low-resolution graphics occupies 16/24 or 2/3 of the vertical height of a high-resolution line. When low-resolution graphics is selected, the code ESC T16 should be issued to change the line feed spacing to 9 lines to the inch.

Low-Resolution Graphics

The four low-resolution modes are selected with the following codes:

Code	Decimal	Hex	Resolution
ESC n	27 110	1B 6E	72 (V) 72 (H)
ESC N	27 78	1B 4E	72 (V) 80 (H)
ESC p	27 112	1B 70	72 (V) 144 (H)
ESC P	27 80	1B 50	72 (V) 160 (H)

Note: ESC e, ESC E, and ESC q are duplicates of the ESC p code.

The following codes are used in the low-resolution mode together with the ESC n, ESC N, ESC p, or ESC P codes:

Code	Decimal	Hex	Effect
ESC G nnnn	27 71 dddd	\$1B \$47 hhhh	Print nnnn low resolution columns of graphics
ESC S nnnn	27 83 dddd	\$1B \$53 hhhh	Print nnnn low resolution columns of graphics
ESC g nnn	27 103 ddd	\$1B \$67 hhh	Print nnn x 8 low resolution columns of graphics
ESC V nnnn	27 86 dddd	\$1B \$56 hhhh	Low resolution dot column repeat, nnnn times
ESC F nnnn	27 70 dddd	\$1B \$46 hhhh	Dot Address

Note: ESC S and ESC G are duplicate codes. Either one may be used.

Bit Image Printing

The Apple Scribe can print horizontal lines with dots in any pattern you desire. Each vertical column of up to eight double-dots is defined by a separate byte, so that a single line may require up to 1,280 characters (bytes) for its definition (8 inches x 160 dots/inch = 1280 dots). After it prints each line, the printer is ready to receive a new line.

Each control code defining one horizontal line of dot graphics starts with one of the following codes:

Code	Decimal	Hex	Effect
ESC G nnnn	27 71 dddd	\$1B \$47 hhhh	Prints line corresponding to the following nnnn data bytes
ESC S nnnn	27 83 dddd	\$1B \$53 hhhh	Same as ESCAPE G
ESC g nnn	27 103 ddd	\$1B \$67 hhh	Prints line corresponding to the following nnn x 8 data bytes.

(where n is the number of data bytes, each "d" is the decimal number assigned to each ASCII digit "n", and each "h" is the Hex equivalent of each "d")

Note: ESC S and ESC G are identical and may be used interchangeably.

The number nnnn after ESCAPE G or ESCAPE S consists of four ASCII digits that specify the number of data bytes (up to 1280, maximum) that follow. This six-character prefix plus the data bytes themselves constitute the complete control code. The following table specifies the number of dots available in each of the low resolution graphics modes:

Code	Graphics	Range nnnn
ESC n	72 (V) × 72 (H)	0001 - 0576
ESC N	72 (V) × 80 (H)	0001 - 0640
ESC p	72 (V) × 144 (H)	0001 - 1152
ESC P	72 (V) × 160 (H)	0001 - 1280

The number nnn after the ESCAPE g consists of three ASCII digits; it specifies the number of data bytes in groups of eight times eight (up to a full line, or $8 \times 160 = 1280$) that follow. ESCAPE g operates somewhat faster than ESCAPE G and ESCAPE S, but otherwise is the same; for example, ESCAPE g 010 and ESCAPE G 0080 are equivalent. The following table specifies the the number of dots available with the ESC g code:

Code	Graphics Density	Range nnn	Total Bytes
ESC n	72 (V) x 72 (H)	001 - 072	0008 - 0576
ESC N	72 (V) x 80 (H)	001 - 080	0008 - 0640
ESC p	72 (V) x 144 (H)	001 - 144	0008 - 1152
ESC P	72 (V) x 160 (H)	001 - 160	0008 - 1280

Remember: In this and other control codes, you can replace leading zeros with spaces.

In the low resolution mode, one data byte defines a vertical column of eight double-dots printed by the thermal print head. See Figure 3-1. A double-dot is printed for each bit set to 1 in the data byte. Bit 7 causes the double-dot at the bottom of the column to be printed and bit 0 causes the double-dot at the top to be printed.

Figure 4-1. Low-Resolution Data Byte

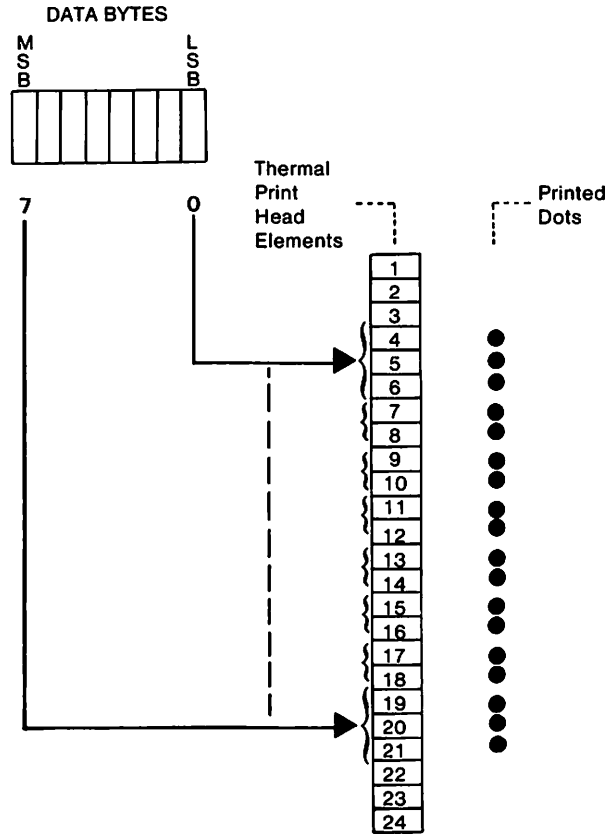

The columns print from left to right, starting at the left margin of the page.

Data bytes are frequently non-printing characters. Most graphics patterns, however, are generated by programs written for the specific purpose, in which case the data bytes are often specified by Pascal CHR or BASIC CHR\$ functions. (See A Graphics Example, later in this chapter.)

By the Way. The shift out "SO" code used while printing low resolution graphics causes the printer to print two identical dot columns for every one byte of data. The "SO" code must be sent before entering the bit image modes, otherwise the "SO" character will be interpreted as graphics data.

The ESC G nnnn code indicates to the printer that the next nnnn bytes of data are to be printed as bit image graphics. The number nnnn is a decimal number sent out to the printer in ASCII. The least significant bit corresponds to the upper-most printed dot in each column.

For example: If the printer receives "ESC G 0005 ABCDE" (note: spaces are added for clarity only), the following pattern is printed. (The X represents a pair of printed dots.):

		A	B	C	D	E
LSB	0	X		X		X
	-		X	X		
	-				X	X
	-					
	-					
	-	X	X	X	X	X
MSB	7					

Note: The Scribe treats all input as ASCII digits or characters, as applicable. For example, "A" is equivalent to Hex 41 or 0100 0001, and corresponds to the pattern shown for the first vertical column.

Dot Spacing

The vertical spacing of the thermal elements in the thermal print head is 1/144 of an inch. Since the low resolution mode prints 8 double-dots per line and there are normally 9 lines per inch, this gives a vertical resolution of 72 dots per inch. Therefore, if you select a horizontal resolution of 72 dots per inch, this will give a uniform matrix of 72 (H) x 72 (V) dots per inch. The dot size is such that horizontal and vertical lines appear connected for this matrix.

To produce a continuous unbroken (vertically) graphics pattern, select a line feed of 9 lines to the inch by using ESCAPE T16.

Low-Resolution Graphics Example

Suppose you are using your Apple Scribe to print custom business forms in which you want to crosshatch certain areas. The following Pascal procedure, when included in the program that generates the form, does this. It takes three previously declared integer variables passed to it from the main program:

- LEFTEDGE: the character position of the left edge of the crosshatched block
- WIDTH: the width, in ninths of an inch, of the block
- HEIGHT: the height, in ninths of an inch, of the block

This procedure assumes that the printer has been opened with a REWRITE procedure and assigned the text file identifier PRINTER.

```
PROCEDURE HATCH;  
VAR N, M : INTEGER; BEGIN  
    WRITE (PRINTER, CHR(27), 'L', LEFTEDGE:3);  
    WRITE (PRINTER, CHR(27), 'n', CHR(27), 'T16');  
    FOR N := 1 TO HEIGHT DO BEGIN  
        WRITE (PRINTER, CHR(27), 'G', (WIDTH * 8):4);  
        FOR M := 1 TO WIDTH DO BEGIN  
            WRITE (PRINTER, CHR(24), CHR(36), CHR(66), CHR(129));  
            WRITE (PRINTER, CHR(129), CHR(66), CHR(36), CHR(24))  
            END;  
        WRITELN (PRINTER)  
        END;  
    END;
```

Set left margin.

Set character and line pitch for 72 per inch.

Set graphics mode and width.

8 bytes to produce diamond pattern.

Type each line when complete.

Dot-Column Repeating Graphics

You can send control codes to your Apple Scribe that cause it to repeat a single vertical pattern for up to one line of graphics. A line of graphics can be up to 1280 dot-columns (8 inches x 160 dots/inch). The result is a set of horizontal lines whose thickness and spacing (within the 1/9 inch height of the 16 out of 24 elements of the thermal print head used in low-resolution graphics) are determined by a binary number.

The dot-column code is as follows:

Code	Decimal	Hex	Effect
ESC V nnnn c	27 86 dddd d	\$1B \$56 hhhh h	Types nnnn repetitions of the dot column specified by c

(where each "n" or "c" represents an ASCII digit or character as required, each "d" is the decimal number assigned to each ASCII "n" or "c", and each "h" is the Hex equivalent of each "d")

The character *c* is the ASCII equivalent of an eight-bit binary number specifying where dots appear in the column. Bit 0 is at the top of the column and bit 7 is at the bottom, with a 1 wherever a dot is to be printed.

The dot column repeat code causes the byte that follows to be printed as bit image graphics. The number nnnn tells how many times this pattern will be repeated.

For example, if the printer receives the code "ESC V 0005 K", the following pattern will be printed (the X represents a pair of dots):

```
          K K K K K
LSB  0  X X X X X
      -  X X X X X
      -
      -  X X X X X
      -
      -
      -  X X X X X
MSB  7
```

This control code is also useful for generating the horizontal rules used in tables and forms. The length of the rule is controlled precisely by the number nnnn of horizontal dots (for a table of the number of dots per inch printed by various character pitches. The

number nnnn must always have four digits; however, you can replace leading zeros with spaces. For example, to produce three hairline rules, use the character *l*, because its digital ASCII representation is 01001001.

Here are some handy values for the specifying character *c*:

One hairline rule:	@
Two hairline rules:	H
Three hairline rules:	l
One heavy rule:	0
Two heavy rules:	f
One extra-heavy rule:	8

Exact Dot Placement

For the greatest flexibility and accuracy in creating graphics with your Apple Scribe, use the following dot placement control code:

The ESCAPE F code is useful for skipping large amounts of white space on a line when printing graphics.

Code	Decimal	Hex	Effect
ESC F nnnn	27 70 dddd	\$1B \$46 hhhh	Places succeeding printing nnnn dot positions from left margin

(where *n* is the number of data bytes, each "d" is the decimal number assigned to each ASCII digit "n", and each "h" is the Hex equivalent of each "d")

The number nnnn consists of four ASCII digits, but you can replace leading zeros with spaces. The resulting placement depends on the graphics mode you have in force at the time you send this control code.

By the Way: Dot positions are counted from the left margin as set by the ESCAPE L control code.

Follow each ESCAPE F control code with at least one printing control code. This may consist of an ordinary character (in which case that character is printed at the location specified), a dot column control code such as ESCAPE G or ESCAPE V, or another ESCAPE F control code.

By the Way: In order for multiple ESCAPE F control codes to be executed correctly, send them to the printer in ascending numerical order (from left to right).

High-Resolution Graphics

The two high-resolution modes are summarized in the following:

Code	Decimal	Hex	Resolution
ESC j	27 106	\$1B \$6A	144 (V) × 144 (H)
ESC J	27 74	\$1B \$4A	144 (V) × 160 (H)

The following codes are used in the high resolution mode together with the ESC j and ESC J codes:

Code	Decimal	Hex	Effect
ESC C nnnn	27 66 dddd	\$1B \$43 hhhh	Print nnnn high resolution columns of graphics
ESC U nnnn	27 85 dddd	\$1B \$55 hhhh	High resolution dot column repeat, nnnn times
ESC F nnnn	27 70 dddd	\$1B \$46 hhhh	Dot Address

Bit Image Printing

The Apple Scribe can print horizontal lines with dots in any pattern you desire. Each vertical column of up to 24 dots is defined by three bytes, so that a single line may require up to 3,840 characters (bytes) for its definition (8 inches x 160 columns/inch x 3 bytes/column = 3840 bytes). After it prints each line, the printer is ready to receive a new line.

Each control code defining one horizontal line of dot graphics starts with the following code:

Code	Decimal	Hex	Effect
ESC C nnnn	27 66 dddd	\$1B \$43 hhhh	Prints line corresponding to the following nnnn data bytes

(where n is the number of data bytes, each "d" is the decimal number assigned to each ASCII digit n, and each "h" is the Hex equivalent of each "d")

The number nnnn after the ESCAPE C consists of four ASCII digits that specify the number of vertical columns consisting of three bytes per column for a total of 3840 bytes. This six-character prefix plus the data bytes themselves constitute the complete control code. The following table specifies the number of dots available in the two high resolution modes:

Mode	Graphics Density	Range nnnn
ESC J	144 (V) × 144 (H)	0001 - 1152
ESC J	144 (V) × 160 (H)	0001 - 1280

Remember: In this and other control codes, you can replace leading zeros with spaces.

In the high resolution modes, three data bytes define a vertical column of 24 dots printed by the thermal print head. See Figure 4-2. A dot is printed for each bit set to 1 in the three data bytes. Bit 23 (Bit 7 of byte 3) causes the dot at the bottom of the column to be printed and bit 0 of byte 1 causes the dot at the top to be printed. The columns print from left to right, starting at the left margin of the page.

Figure 4-2. High-Resolution Data Bytes

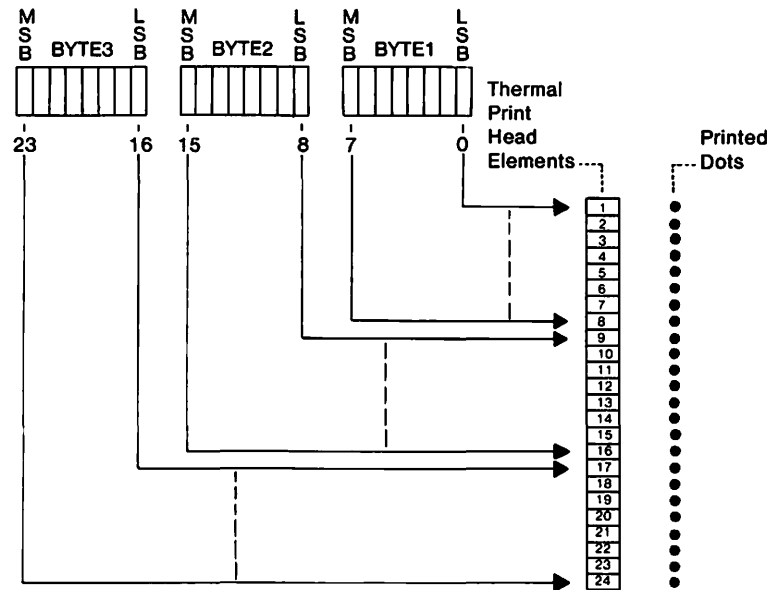

Data bytes are frequently non-printing characters. Most graphics patterns, however, are generated by programs written for the specific purpose, in which case the data bytes are often specified by Pascal CHR or BASIC CHR\$ functions.

By the Way. The shift out “SO” code used while printing high resolution graphics causes the printer to print two identical dot columns for every three bytes of data. The “SO” code must be sent before entering the bit image modes, otherwise the “SO” character will be interpreted as graphics data.

The ESC C nnnn code works in a similar manner to the ESC G code except that three bytes of data are needed to define a vertical column of dots. Remember that the number nnnn specifies the number of vertical columns, not the number of bytes of graphics data to be sent. The number of bytes of graphic data to be sent would be nnnn x 3.

For example, if the printer receives “ESC C 0004 ABCabcABCabc”, the following dot pattern will be printed (the X represents one printed dot).

		A	a	A	a
		B	b	B	b
		C	c	C	c
LSB	0	X	X	X	X
	-				
	-				
	-				
	-	X	X	X	X
	-		X		X
MSB	7				
LSB	0				
	-	X	X	X	X
	-				
	-				
	-				
	-	X	X	X	X
	-		X		X
MSB	7				
LSB	0	X	X	X	X
	-	X	X	X	X
	-				
	-				
	-				
	-	X	X	X	X
MSB	7		X		X

Note: The Scribe treats all input as ASCII digits or characters, as applicable. For example, "A" is equivalent to Hex 41 or 0100 0001, "B" is equivalent to Hex 42 or 0100 0010, and C is equivalent to Hex 43 or 0100 0011. Thus, ABC corresponds to the pattern shown for the first vertical column.

Dot Spacing

The vertical spacing of the elements in the thermal print head is 1/144 of an inch. Since the high resolution mode prints 24 dots per line and there are normally 6 lines per inch, this gives a vertical resolution of 144 dots per inch. Therefore, if you select a horizontal resolution of 144 dots per inch, this will give a uniform matrix of 144 (H) x 144 (V) dots per inch. The dot size is such that horizontal and vertical lines appear connected for this matrix.

To produce a continuous unbroken (vertically) graphics pattern, select a line feed of 6 lines to the inch by using the ESCAPE T24 code.

High-Resolution Graphics Example

The following program is short example to illustrate the use of high-resolution graphics:

```
PROGRAM Hires; {Graphics Pascal Program}
VAR Prntr:TEXT;
    X: Interger
BEGIN
  REWRITE(Prntr,'PRINTER:');
  WRITE(Prntr,CHR(27),'j');
  WRITE(Prntr,'This is a sample of a hires graphics box:');
  WRITE(Prntr,CHR(27),'C0024');
  WRITE(Prntr,CHR(255)CHR(255)CHR(255));
  FOR X:= 1 to 22 do WRITE(Prntr,CHR(1),CHR(0),CHR(128));
  WRITE(Prntr,CHR(255)CHR(255)CHR(255));
  WRITEln(Prntr, '.');

  CLOSE(Prntr);
END.
```

Dot-Column Repeating Graphics

You can send control codes to your Apple Scribe that cause it to repeat a single vertical dot pattern for up to one line of graphics. A line of graphics can be up to 1280 dot-columns (8 inches x 160 columns/inch). The result is a set of horizontal lines whose thickness and spacing (within the 1/6 inch height of the type head) are determined by a binary number.

The dot-column command is given in the following table:

Code	Decimal	Hex	Effect
ESC U nnnn ccc	27 86 dddd ddd	\$1B \$56 hhhh hhh	Prints nnnn repetitions of the dot column specified by the 3 bytes ccc.

(where each "n" or "c" represents an ASCII digit or character as required, each "d" is the decimal number assigned to each ASCII "n" or "c", and each "h" is the Hex equivalent of each "d")

The character *c* is the ASCII equivalent of an eight-bit binary number specifying where dots appear in the column. Bit 0 is at the top of the column and bit 23 is at the bottom, with a 1 wherever a dot is to be printed.

The dot column repeat code causes the bytes that follow to be printed as bit image graphics. The number nnnn tells how many times this pattern will be repeated. Three bytes of data are needed to define each vertical column.

For example, if the printer receives the code "ESC U 0005 ABC", the following pattern will be printed (the X represents a single printed dot):

By the Way: Dot positions are counted from the left margin as set by the ESCAPE L control code.

Follow each ESCAPE F control code with at least one printing control code. This may consist of an ordinary character (in which case that character is printed at the location specified), a dot column control code such as ESCAPE U or another ESCAPE F control code.

By the Way: In order for multiple ESCAPE F control codes to be executed correctly, send them to the printer in ascending numerical order (from left to right).

■	Appendix A	Troubleshooting	93
■	Appendix B	Command Summary	97
	97	Printer Power-On Configuration (Standard Instructions)	
	97	Miscellaneous Codes	
	98	Text Mode Codes	
	98	Paper Handling Codes	
	99	Color Codes	
	99	Low Resolution Graphics Codes	
	99	High Resolution Graphics Codes	
	100	DIP Switch Settings	
■	Appendix C	ASCII, Binary, and Hexadecimal Codes	103
■	Appendix D	Character Specifications	107
	108	Letter Mode Characters	
	110	Alternate (National) Letter Characters	
	112	Draft Characters	
	114	Alternate (National) Draft Characters	
	116	Superscript and Subscript Characters	
■	Appendix E	Printer Specifications	119

■ Appendix F	Interface Specifications	123
123	Specifications	
124	Signal Descriptions	
124	Input Circuit Configuration	
125	Output Circuit Configuration	
126	Protocol	
126	Data Transfer Ready Protocol	
126	XON/XOFF Protocol	
126	Data Byte Length	
<hr/>		
■ Appendix G	Repacking Instructions	129
129	Repacking	

Troubleshooting



After you've checked out and installed your Apple Scribe, what happens if it doesn't run? You may have one of these common problems.

- **SELECT lamp lights, but Scribe still doesn't print?** Try the Scribe self-test, Chapter 3 of Part I. If self-test is OK, check settings of Scribe switches SW1 through SW8 and also check that interface cable connectors are securely seated.
- **Is the printer cover open?** The Scribe has an interlock switch that prevents it from running unless the printer cover is completely closed and latched. If the Scribe stops printing because the printer cover is opened, you can restart it by replacing the cover and pressing the SELECT button.
- **Are you out of paper?** When the last sheet is down to less than one half inch of paper, the paper error detector underneath the platen halts the printer and starts the SELECT light flashing approximately once every two seconds.



Warning

Do not print without paper under the thermal print head. You'll damage both the platen and the thermal print head.

- **Are you out of ribbon?** When the ribbon runs out, the SELECT light starts flashing at approximately three times per second.
- **Is the fuse blown?** It's easy to overlook the small cartridge fuse mounted next to the power connector on the side of the printer. If the printer won't work and the power light does not come on, unplug the power cord and remove the fuse by unscrewing the plastic cap in a counterclockwise direction. Look to see if the thin metal wire inside the fuse is broken. If it is, replace it with a 1-ampere type 3AG fuse, obtainable at most electronic supply or automobile part stores. If the fuse blows again, consult your Apple dealer.

Replace the fuse with a 1-ampere type 3AG fuse.

- **Is an interface connection loose?** Sometimes the hookup between the printer and the Apple computer can work loose. If you suspect this problem, first turn off the power and then unplug and reconnect the interface cable to the Scribe interface connector and to the port 1 interface connector on the Apple IIc. Make sure that the interface cable is not damaged or pinched.
- **Are Scribe switches SW1 through SW8 set correctly?** Check the settings. See Chapter 3, *Setting Up Your Scribe*, in Part I of this manual. It tells you how to run self-test and check the print out for the SW1-SW8 settings.
- **Is your system correctly configured?** If you are running a pre-packaged program, it may be changing the Port 1 default setting of your Apple IIc. Try running the Scribe self-test and then the short printing program. See Chapter 3, *Setting Up Your Scribe*, and Chapter 4, *Starting to Print* in Part I of this manual. If self-test and the sample programs run OK, you may have to reconfigure your Apple IIc to run the given program. See the Apple IIc System Utilities Manual for information on configuring Port 1 of your Apple IIc.
- **Is the program at fault?** Sometimes software problems seem the same as hardware problems. The printer may fail to produce clean copy not because there is something wrong with its mechanism, but because the commands it receives from the computer are confusing. A quick way to check this is to run the Scribe self-test; see Chapter 3, *Setting Up Your Scribe*. This test exercises most of the mechanical functions of the printer, as well as its internal microprocessor. If the test runs properly, you can be fairly certain that any format problems—garbled or missing text, overprinted lines—lie in the program, or possibly in the interface. Try a program that you know works, to check out the system as a whole.
- **Is there a Scribe Problem?** In addition to paper out, ribbon out, and printer cover open, other errors are recorded by the select light flashing. If you have checked the paper, ribbon, and printer cover, and the light still flashes, try turning the Scribe off and then on again. If the condition persists, this indicates a problem with the Scribe itself and you need to contact your Apple dealer.
- **Pin-feed paper holes torn?** Check position of the paper release lever. It should be in the pin-feed (forward) position.

- **Is the Scribe over printing?** The line length could be too long. See "Auto-Print Action", in Chapter 2, *Text and General Control Commands*, of Part II. Check that there isn't too much friction on the paper; be sure that paper release lever is in the pin-feed (forward) position when using pin-feed paper. Also, be sure that paper is free to flow out of box or container in which it is stored.
- **Is the Scribe printing garbled data?** Check baud setting of Scribe SW7. It should be set to OFF (UP) for 9600 baud.
- **Prints OK for a while, then prints erroneous text?** Check that protocol switch, SW8 is set to OFF (UP), Data Terminal Ready.
- **Not all dots print, or poor image on paper?** Check ribbon and check smoothness of paper. Check that LETTER light (green) is on if you want the best printing quality. Check that SW 6 is OFF (UP) for printing on plain paper and ON (DOWN) for printing on very smooth paper or transparencies. Also, after continual use, it may be time to replace the thermal print head. This is a straightforward operation which can be done in less than a minute with no tools. See *Caring for Your Scribe*, Chapter 5 in Part I.

If it becomes necessary to return the Scribe to your dealer, refer to Appendix G for repacking instructions.

Command Summary



This appendix is a complete collection of all Apple Scribe control codes and DIP switch settings.

Printer Power-on Configuration (Standard Instructions)

The following are the default settings for various functions of the Apple Scribe.

Function	Power-On Settings
Draft/Letter	Mode Draft
Character pitch	Pica (10 dpi)
Underlining	Off
Headline Type	Off
Line Feed Pitch	6 lines per inch
Optional Line Feed Function	Disabled
Line Feed Direction	Forward
Left Margin	Character Position Zero
Print Color	Black
Page Length	11 inches

Miscellaneous Codes

Code	Decimal	Hex	Effect
ESC Z CTL-@ CTL-H	27 90 0 8	\$1B \$5A \$00 \$08	Print on plain paper
ESC D CTL-@ CTL-H	27 68 0 8	\$1B \$44 \$00 \$08	Print on transparencies
ESC c	27 99	\$1B \$63	Software reset
CTL-X	24	\$18	Cancel current unprinted line
DC1	17	\$11	Reselect Printer
DC3	20	\$13	Deselect Printer
ESC Z CTL-P CTL-@	27 90 16 0	\$1B \$5A \$10 \$00	Enable DC1/DC3 response
ESC D CTL-P CTL-@	27 68 16 0	\$1B \$44 \$10 \$00	Disable DC1/DC3 response

Text Mode Codes

Code	Decimal	Hex	Effect
ESC M	27 77	\$1B \$4D	Draft Mode
ESC m	27 109	\$1B \$6D	Letter Mode (10 CPI Only)
ESC N	27 78	\$1B \$4E	Select 10 CPI
ESC Q	27 81	\$1B \$51	Select 17 CPI
CTL-N	14	\$0E	Begin Headline
CTL-O	15	\$0F	End Headline
ESC X	27 88	\$1B \$58	Begin Underline
ESC Y	27 89	\$1B \$59	End Underline
ESC x	27 120	\$1B \$78	Begin Superscript
ESC y	27 121	\$1B \$79	Begin Subscript
ESC z	27 122	\$1B \$7A	End Super/ Subscript
ESC D CTL-@ CTL-A	27 68 0 1	\$1B \$44 \$00 \$01	Print Slashed Zeros
ESC Z CTL-@ CTL-A	27 90 0 1	\$1B \$5A \$00 \$01	Print Un-slashed Zeros
ESC L nnn	27 76 ddd	\$1B \$4C hhh	Set Left Margin
ESC R nnn c	27 82 ddd d	\$1B \$52 hhh h	Character Repeat
CTL-H	8	\$08	Backspace (BS)

Paper Handling Codes

Code	Decimal	Hex	Function
CTL-L	12	\$0C	Advance paper to top of next form
ESC v	27 118	\$1B \$76	Set top of form
CTL-J	10	\$0A	Advance paper one line (LF)
ESC T nn	27 84 dd	\$1B \$54 hh	Set line feed to nn/144"
ESC A	27 65	\$1B \$41	Set line feed to 1/6"
ESC f	27 102	\$1B \$66	Set forward line feed
ESC r	27 114	\$1B \$72	Set reverse line feed
ESC H nnnn	27 72 dddd	\$1B \$48 hhhh	Set page length to n/144"
ESC l 0	27 108 48	\$1B \$6C \$30	Optional line feed off
ESC l 1	27 108 49	\$1B \$6C \$31	Optional line feed on
ESC Z (@) CTL-@	27 90 128 0	\$1B \$5A \$80 \$00	CR only
ESC D (@) CTL-@	27 68 128 0	\$1B \$44 \$80 \$00	CR = CR + LF
CTL-M	13	\$0D	Carriage Return (CR)
ESC Z (SPACE) CTL-@	27 90 32 0	\$1B \$5A \$20 \$00	No Lf after auto print
ESC D (SPACE) CTL-@	27 68 32 0	\$1B \$44 \$20 \$00	Lf after auto print

Color Codes

Code	Decimal	Hex	Effect
ESC K 1	27 75 49	\$1B \$4B \$31	Yellow
ESC K 2	27 75 50	\$1B \$4B \$32	Magenta
ESC K 3	27 75 51	\$1B \$4B \$33	Cyan

Low Resolution Graphics Codes

Code	Decimal	Hex	Resolution
ESC n	27 110	\$1B \$6E	72 (V) x 72 (H)
ESC N	27 78	\$1B \$4E	72 (V) x 80 (H)
ESC p	27 112	\$1B \$70	72 (V) x 144 (H)
ESC P	27 80	\$1B \$50	72 (V) x 160 (H)
ESC G nnnn	27 71 dddd	\$1B \$47 hhhh	Print nnnn low resolution columns of graphics
ESC S nnnn	27 83 dddd	\$1B \$53 hhhh	Print nnnn low resolution columns of graphics
ESC g nnn	27 103 ddd	\$1B \$67 hhh	Print nnn x 8 low resolution columns of graphics
ESC V nnnn	27 86 dddd	\$1B \$56 hhhh	Low resolution dot column repeat, nnnn times
ESC F nnnn	27 70 dddd	\$1B \$46 hhhh	Dot Address

High Resolution Graphics Codes

Code	Decimal	Hex	Resolution
ESC j	27 106	\$1B \$6A	144 (V) x 144 (H)
ESC J	27 74	\$1B \$4A	144 (V) x 160 (H)
ESC C nnnn	27 66 dddd	\$1B \$43 hhhh	Print nnnn high resolution columns of graphics
ESC U nnnn	27 85 dddd	\$1B \$55 hhhh	High resolution dot column repeat, nnnn times
ESC F nnnn	27 70 dddd	\$1B \$46 hhhh	Dot Address



DIP Switch Settings

The OFF (up) position of the DIP switches is equal to logic "0". The ON (down) position of the DIP switches is equal to logic "1". The standard setting is OFF (up) for all the DIP switches, SW1-SW8.

SW1	SW2	SW3	National Character Set
UP	UP	UP	American
Down	Up	Up	Italian
Up	Down	Up	American
Down	Down	Up	British
Up	Up	Down	German
Down	Up	Down	Swedish
Up	Down	Down	French
Down	Down	Down	Spanish

SW4

UP	No line feed after carriage return
Down	Adds line feed after every carriage return

SW5	SW6	Density	Effect
Off (Up)	Off (Up)	1	Plain paper (normal density)
Off (Up)	On (Down)	2	Plain paper (low density)
On (Down)	Off (Up)	3	Transparency (normal density)
On (Down)	On (Down)	4	Transparency (low density)

SW7

UP	9600 Baud
Down	1200 Baud

SW8

UP	Data terminal ready
Down	XON/XOFF (not used by Apple IIc)

ASCII, Binary, and Hexadecimal Codes

There are 256 possible eight-bit binary numbers, from 00000000 to 11111111. Of these, the first 128 (from 00000000 to 01111111) have been assigned to characters and commands used in data processing and communication. Their standard assignment forms the ASCII character set. (ASCII stands for the American Standard Code for Information Interchange.)

The remaining 128, which differ from the first 128 only because their most significant binary digit (first digit) is 1 instead of 0, are not officially assigned. Nevertheless, they are often called high ASCII characters.

The following chart lists the 128 standard ASCII character assignments. For each character it gives the binary, decimal, and hexadecimal equivalents for both standard and high versions. Note that the first 27 codes are control characters set by pressing the CONTROL key simultaneously with the desired character key.

ASCII	Low ASCII			High ASCII			
	Dec	Hex	76543210	Dec	Hex	76543210	
CONTROL-@	NUL	0	00	00000000	128	80	10000000
CONTROL-A	SOH	1	01	00000001	129	81	10000001
CONTROL-B	STX	2	02	00000010	130	82	10000010
CONTROL-C	ETX	3	03	00000011	131	83	10000011
CONTROL-D	EOT	4	04	00000100	132	84	10000100
CONTROL-E	ENQ	5	05	00000101	133	85	10000101
CONTROL-F	ACK	6	06	00000110	134	86	10000110
CONTROL-G	BEL	7	07	00000111	135	87	10000111
CONTROL-H	BS	8	08	00001000	136	88	10001000
CONTROL-I	HT	9	09	00001001	137	89	10001001
CONTROL-J	LF	10	0A	00001010	138	8A	10001010
CONTROL-K	VT	11	0B	00001011	139	8B	10001011
CONTROL-L	FF	12	0C	00001100	140	8C	10001100
CONTROL-M	CR	13	0D	00001101	141	8D	10001101
CONTROL-N	SO	14	0E	00001110	142	8E	10001110
CONTROL-O	SI	15	0F	00001111	143	8F	10001111
CONTROL-P	DLE	16	10	00010000	144	90	10010000
CONTROL-Q	DC1	17	11	00010001	145	91	10010001
CONTROL-R	DC2	18	12	00010010	146	92	10010010
CONTROL-S	DC3	19	13	00010011	147	93	10010011
CONTROL-T	DC4	20	14	00010100	148	94	10010100
CONTROL-U	NAK	21	15	00010101	149	95	10010101
CONTROL-V	SYN	22	16	00010110	150	96	10010110
CONTROL-W	ETB	23	17	00010111	151	97	10010111
CONTROL-X	CAN	24	18	00011000	152	98	10011000
CONTROL-Y	EM	25	19	00011001	153	99	10011001
CONTROL-Z	SUB	26	1A	00011010	154	9A	10011010

Character Specifications

ASCII	Low ASCII			High ASCII		
	Dec	Hex	78543210	Dec	Hex	78543210
X	88	58	01011000	216	D8	11011000
Y	89	59	01011001	217	D9	11011001
Z	90	5A	01011010	218	DA	11011010
[91	5B	01011011	219	DB	11011011
\	92	5C	01011100	220	DC	11011100
]	93	5D	01011101	221	DD	11011101
^	94	5E	01011110	222	DE	11011110
_	95	5F	01011111	223	DF	11011110
	96	60	01100000	224	E0	11100000
a	97	61	01100001	225	E1	11100001
b	98	62	01100010	226	E2	11100010
c	99	63	01100011	227	E3	11100011
d	100	64	01100100	228	E4	11100100
e	101	65	01100101	229	E5	11100101
f	102	66	01100110	230	E6	11100110
g	103	67	01100111	231	E7	11100111
h	104	68	01101000	232	E8	11101000
i	105	69	01101001	233	E9	11101001
j	106	6A	01101010	234	EA	11101010
k	107	6B	01101011	235	EB	11101011
l	108	6C	01101100	236	EC	11101100
m	109	6D	01101101	237	ED	11101101
n	110	6E	01101110	238	EE	11101110
o	111	6F	01101111	239	EF	11101111
p	112	70	01110000	240	F0	11110000
q	113	71	01110001	241	F1	11110001
r	114	72	01110010	242	F2	11110010
s	115	73	01110011	243	F3	11110011
t	116	74	01110100	244	F4	11110100
u	117	75	01110101	245	F5	11110101
v	118	76	01110110	246	F6	11110110
w	119	77	01110111	247	F7	11110111
x	120	78	01111000	248	F8	11111000
y	121	79	01111001	249	F9	11111001
z	122	7A	01111010	250	FA	11111010
:	123	7B	01111011	251	FB	11111011
;	124	7C	01111100	252	FC	11111100
!	125	7D	01111101	253	FD	11111101
	126	7E	01111110	254	FE	11111110
DEL	127	7F	01111111	255	FF	11111111

Character Specifications

This appendix depicts the printer's stored dot-matrix patterns for all characters. Figure D-1 shows the head configuration for letter and draft mode, and for subscript and superscript which are the same for both the letter and draft mode.

Figure D-1. Thermal Print Head Configuration

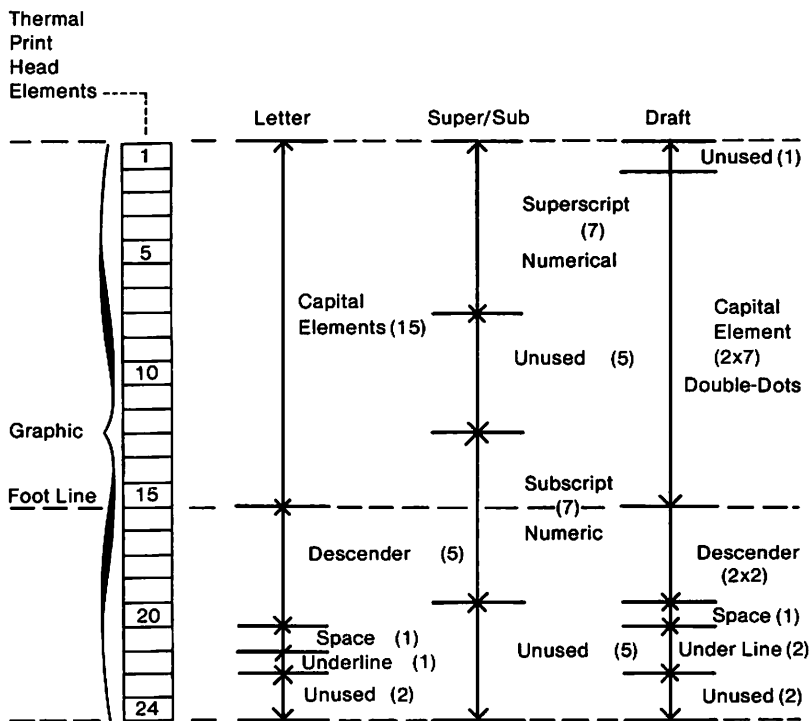





Letter Mode Characters

Table D-1. Standard Letter Characters

All letter mode characters are created by a 12(H) by 15(V) character cell in a 15 by 24 matrix. The right three columns are not used. The footline is at the bottom of the fifteenth element of the print head. Descenders extend the character down 5 more dot

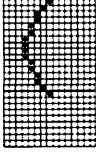
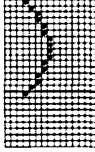
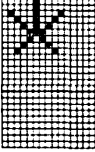
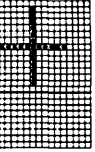
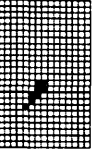
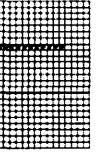
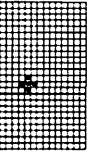
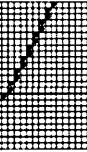
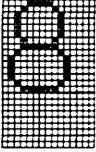
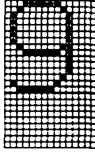
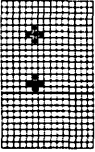
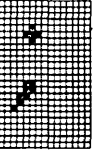
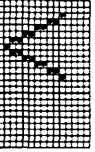
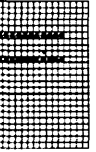
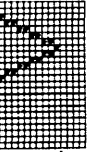
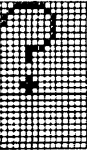
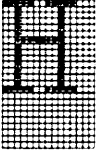
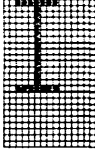
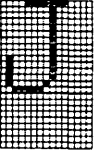
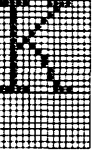
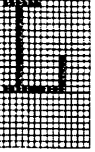
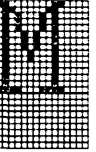
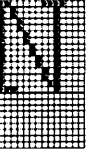
32/\$20	33/\$21	34/\$22	35/\$23	36/\$24	37/\$25	38/\$26	39/\$27
48/\$30	49/\$31	50/\$32	51/\$33	52/\$34	53/\$35	54/\$36	55/\$37
64/\$40	65/\$41	66/\$42	67/\$43	68/\$44	69/\$45	70/\$46	71/\$47
80/\$50	81/\$51	82/\$52	83/\$53	84/\$54	85/\$55	86/\$56	87/\$57
96/\$60	97/\$61	98/\$62	99/\$63	100/\$64	101/\$65	102/\$66	103/\$67
112/\$70	113/\$71	114/\$72	115/\$73	116/\$74	117/\$75	118/\$76	119/\$77

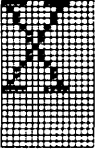
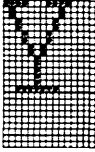
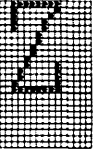
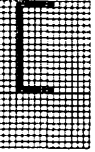
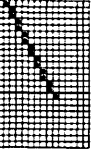
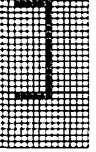
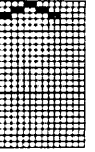
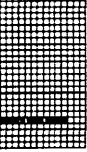
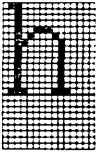
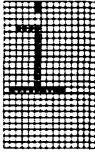
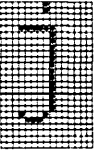
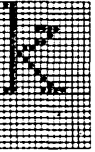
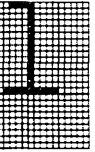
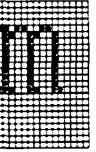
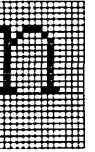
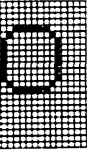
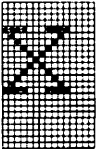
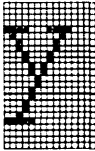
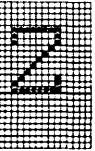
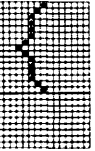
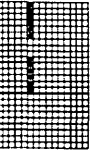
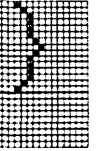
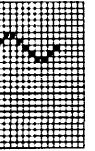
spaces. The 21st dot space is not used, the underline occupies the 22nd dot space, and the 23rd and 24th dot spaces are unused. In the following chart, Table D-1, the decimal and hexadecimal code for each character appears at the top of each matrix.

40/\$28 	41/\$29 	42/\$2A 	43/\$2B 	44/\$2C 	45/\$2D 	46/\$2E 	47/\$2F 
56/\$38 	57/\$39 	58/\$3A 	59/\$3B 	60/\$3C 	61/\$3D 	62/\$3E 	63/\$3F 
72/\$48 	73/\$49 	74/\$4A 	75/\$4B 	76/\$4C 	77/\$4D 	78/\$4E 	79/\$4F 
88/\$58 	89/\$59 	90/\$5A 	91/\$5B 	92/\$5C 	93/\$5D 	94/\$5E 	95/\$5F 
104/\$68 	105/\$69 	106/\$6A 	107/\$6B 	108/\$6C 	109/\$6D 	110/\$6E 	111/\$6F 
120/\$78 	121/\$79 	122/\$7A 	123/\$7B 	124/\$7C 	125/\$7D 	126/\$7E 	127/\$7F 

Alternate (National) Letter Characters

Table D-2. Alternate (National)

The following chart shows the letter mode alternate characters. The decimal and hexadecimal code for each character appears at the top of the column.

ASCII CODE	35/\$23	64/\$40	91/\$5B	92/\$5B	93/\$5D
LANGUAGE					
AMERICAN	#	@	[\]
ITALIAN	E	§	ì	ç	é
BRITISH	E	@	[\]
GERMAN	#	§	Ä	Ö	Ü
SWEDISH	#	@	Ä	Ö	Å
FRENCH	E	ä	ì	ç	§
SPANISH	E	§	í	ñ	¿

96/\$60

123/\$7B

124/\$7C

125/\$7D

126/\$7E

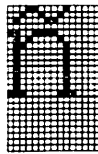
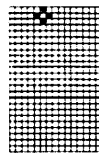
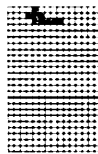
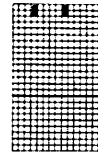
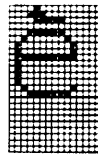
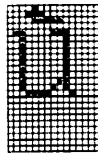
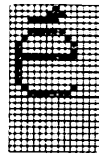
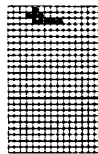
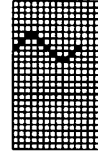
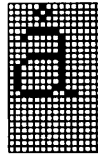
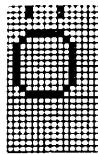
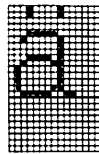
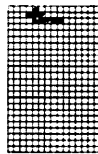
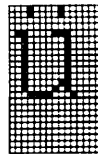
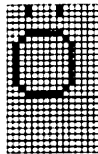
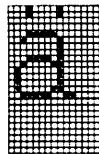
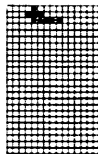
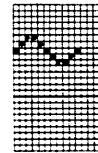
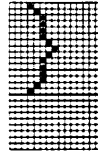
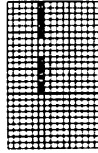
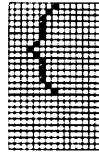
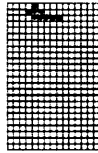
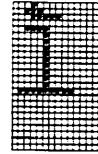
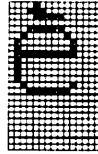
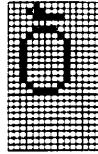
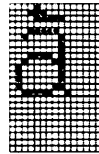
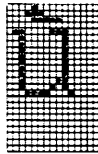
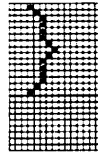
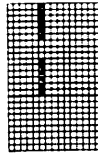
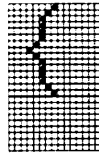
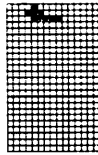



Draft Characters

Table D-3. Standard Draft Characters

Draft characters are created by a 9(H) by 14(V) character cell in a 12 by 24 matrix. Each dot is formed by two vertical elements of the print head. There can be nine dots across the character cell, but no two horizontal dots may be adjacent. The footline lies below the

32/\$20	33/\$21	34/\$22	35/\$23	36/\$24	37/\$25	38/\$26	39/\$27
46/\$30	49/\$31	50/\$32	51/\$33	52/\$34	53/\$35	54/\$36	55/\$37
64/\$40	65/\$41	66/\$42	67/\$43	68/\$44	69/\$45	70/\$46	71/\$47
80/\$50	81/\$51	82/\$52	83/\$53	84/\$54	85/\$55	86/\$56	87/\$57
96/\$60	97/\$61	98/\$62	99/\$63	100/\$64	101/\$65	102/\$66	103/\$67
112/\$70	113/\$71	114/\$72	115/\$73	116/\$74	117/\$75	118/\$76	119/\$77







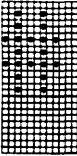
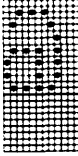
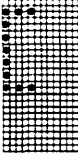
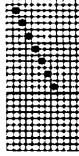
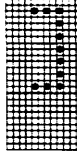
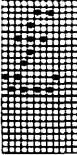
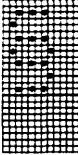
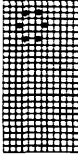
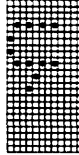

fifteenth element of the print head. Descenders use the four print elements below the footline. The underline uses the 21st and 22nd print elements. The 23rd and 24th elements are not used. In the following chart, the decimal and hexadecimal code for each character appears at the top of each matrix.

40/\$28	41/\$29	42/\$2A	43/\$2B	44/\$2C	45/\$2D	46/\$2E	47/\$2F
56/\$38	57/\$39	58/\$3A	59/\$3B	60/\$3C	61/\$3D	62/\$3E	63/\$3F
72/\$48	73/\$49	74/\$4A	75/\$4B	76/\$4C	77/\$4D	78/\$4E	79/\$4F
88/\$58	89/\$59	90/\$5A	91/\$5B	92/\$5C	93/\$5D	94/\$5E	95/\$5F
104/\$68	105/\$69	106/\$6A	107/\$6B	108/\$6C	109/\$6D	110/\$6E	111/\$6F
120/\$78	121/\$79	122/\$7A	123/\$7B	124/\$7C	125/\$7D	126/\$7E	127/\$7F

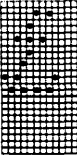
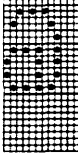
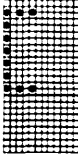
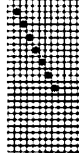
Alternate (National) Draft Characters

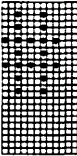
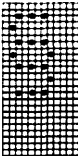
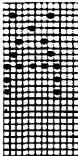
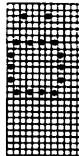
**Table D-4. Alternate
(National Draft Characters (10 CPI))**

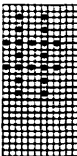
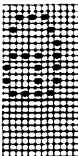
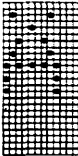
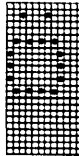
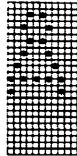
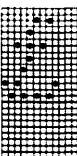
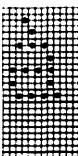
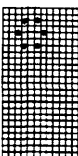
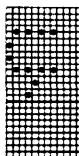
The following chart shows the draft mode alternate characters. The decimal and hexadecimal code for each character appears at the top of the column.

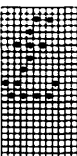
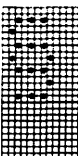
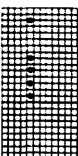
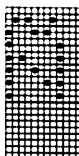
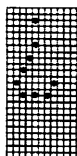
ASCII CODE	35/\$23	64/\$40	91/\$5B	92/\$5B	93/\$5D
LANGUAGE					
AMERICAN					
ITALIAN					
BRITISH					
GERMAN					
SWEDISH					
FRENCH					
SPANISH					

96/\$60

123/\$7B

124/\$7C

125/\$7D

126/\$7E

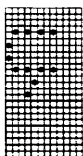
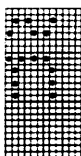
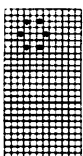
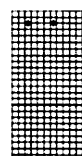
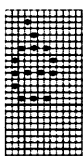
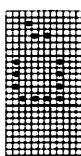
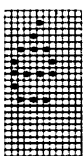
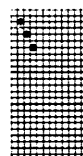
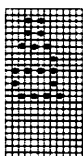
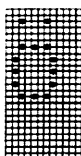
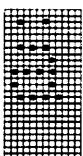
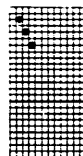
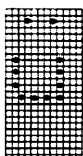
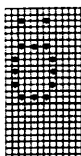
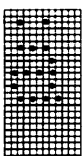
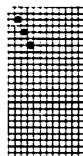
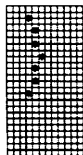
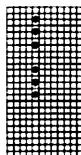
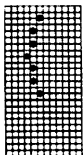
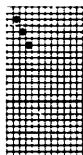
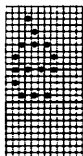
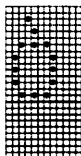
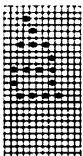
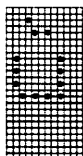
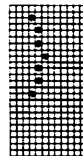
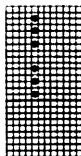
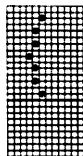
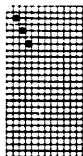



Superscript and Subscript Characters

Table D-5.

Superscript and Subscript Characters

The following chart shows examples of superscript and subscript characters for both the letter and draft modes. The dot patterns for the superscript and subscript characters are the same as those shown in Table D-3 and Table D-4. The differences are that single dots rather than double dots are used, and the pattern is offset up or down in the matrix for the superscript and subscript, respectively. (See Table D-5.) The decimal and hexadecimal code for each character appears at the top of the column.

ASCII CODE	65/\$41	96/\$61	51/\$33
LETTER			
STANDARD			
SUPERSCRIP			
SUBSCRIPT			

ASCII CODE	65/\$41	96/\$61	51/\$33
DRAFT			

STANDARD



SUPERSCRIPT



SUBSCRIPT



Printer Specifications



Print Method:	Thermal-Transfer, Dot matrix	
Printing Speed:	Letter Setting:	10 characters per inch 50 characters per second
	Draft Setting:	10 characters per inch 80 characters per second
Print Throughput:	Letter Setting:	10 characters per inch 20 lines per minute
	Draft Setting:	10 characters per inch 25 lines per minute
Print Head:	24 Elements, in-line vertical	
Graphics Modes:		
	Low-Resolution	
	72 Horizontal × 72 Vertical dots per inch	
	80 Horizontal × 72 Vertical dots per inch	
	144 Horizontal × 72 Vertical dots per inch	
	160 Horizontal × 72 Vertical dots per inch	
	High-Resolution	
	144 Horizontal × 144 Vertical dots per inch	
	160 Horizontal × 144 Vertical dots per inch	
Character Format:	Letter Setting:	12 dots wide by 15 dots high
	Draft Setting:	9 dots wide by 14 dots high
	Subscript/Superscript: 9 dots wide by 7 dots high	

Character Sets: 96 ASCII (alphanumeric and symbols)
25 European language characters

Colors: Color Ribbon Black Ribbon
 Yellow
 Magenta
 Cyan

Vertical Dot Spacing: 1/144 of an inch

Line Length: 8 inches maximum

Text Modes:	Characters per Inch	Characters per Line	Dots per Inch	Dots per 8-Inch Line
Letter Mode				
Pica	10	80	150	1200
Draft Mode				
Pica	10	80	120	960
Ultracondensed	17	136	204	1632

Paper Feed Direction: Forward and reverse

Line Spacing: 1/144 of an inch

Paper Feed: Bi-directional in friction feed mode only (single sheet)
Forward only in sprocket/pin feed mode

Line Feed Speed: 100 msec (6 lines per inch)
180 msec for manual line feed

Forms: Length: 11 inches (Power-On Default)
Adjustable to approximately 70 inches by software control.
Width: 3.5 inches to 9.5 inches pin center distance fan-fold sprocket/pin paper—10 inches maximum overall
Thickness: .003 inches × .007 inches

Paper Feed Method: Selectable, friction or sprocket/pin feed
Width: 3.5 inches to 9.5 inches pin center distance fan-fold sprocket/pin paper—10 inches maximum overall
Thickness: .003 inches × .007 inches

Paper Feed Method: Selectable, friction or sprocket/pin feed

Paper Types: Single sheets
Fanfold sprocketed paper (hole centers 3.5 - 9.5 inches)
Transparencies (paper backed)

Paper Entry: Top rear of printer

Ribbon: Cassette containing one pass thermal transfer ribbon.

Black Ribbon

Three-Color Ribbon

Yellow

Magenta

Cyan

Power Options: 115 volts AC (+6%,-15%) 57 - 63 hertz

Fuse Rating: 1A, Type 3AG

Power Consumption: Operating: 60 watts maximum
Standby 20 watts maximum

Data Interface: 8-bit serial - 1 start bit and 1 stop bit (see Appendix F)

Weight: 6.4 kilograms (14.1 pounds)

Dimensions:	Width	Depth	Height	
	368	315	152	millimeters
	14.5	12.4	6.1	inches

Ambient Temperature:

Operating

5 to 40 degrees Celsius (41 to 104 degrees Fahrenheit)

Storage

- 25 to +60 degrees Celsius (-13 to +140 degrees Fahrenheit)
The ribbon can't be stored at this temperature.

Maximum Humidity:

Operating

80% relative humidity, noncondensing

Storage

80% relative humidity, noncondensing

Interface Specifications

Specifications

- Data Input Form:** 8-bit serial: 1 start bit, 8 data bits, and 1 stop bit (no parity bit)
- Data Input Codes:** Characters: ASCII, 8- or 7-bit
Graphics: 8-bit binary
- Transmission Speed:** 1200 or 9600 (Apple IIc standard) baud
- Input Buffer Size:** 4K bytes (approximately)
- Printer Connector:** DB-25 male, or equivalent
- Mating Connector:** DB-25S female, or equivalent

Figure F-1. RS232C Connector Pin Assignment

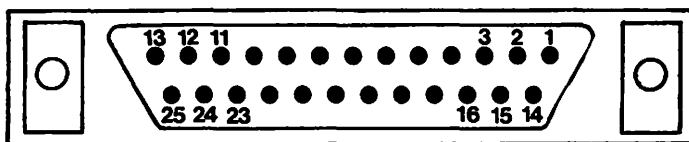

Pin No	Symbol	Description	Direction
1	FG	Frame Ground	
2	SD	Send Data	Output
3	RD	Receive Data	Input
4	RTS	Request to Send	Output
7	SG	Signal Ground	
20	DTR	Data Terminal Ready	Output

Signal Descriptions

Frame Ground:	Grounding line for circuit protection.
Send Data:	Serial data transmission line to the computer from the printer.
Receive Data:	Serial data transmission line to the printer from the computer.
Request to Send:	Output signal from the printer; logic 0 (spacing) when the printer is turned on.
Data Terminal Ready:	Output signal from the printer; logic 0 (spacing) when the printer is on and able to receive data; logic 1 (marking) when unable to receive data.

Input Circuit Configuration

RD signal: Maximum +15V, minimum +5V.

Figure F-2. Circuit: SN 75189A, or equivalent

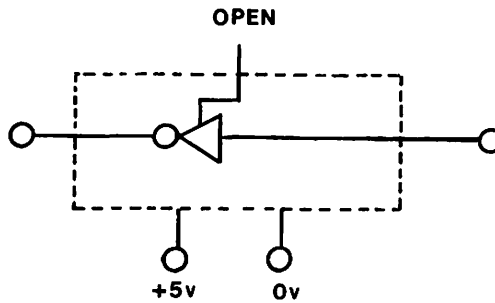

Output Circuit Configuration

SD, RTS, and DTR signals: Nominal +7V

Figure F-3. Circuit: SN 75188, or equivalent

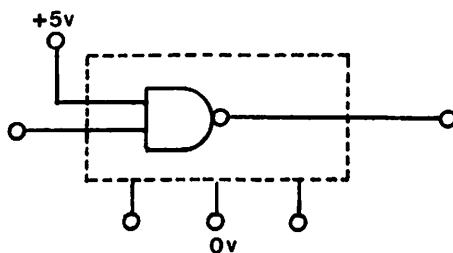
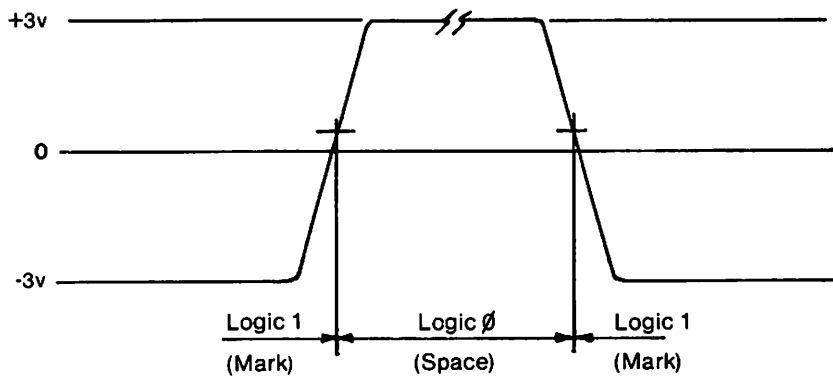

Figure F-4. Threshold Voltage Level





Protocol

The printer is capable of two types of data protocol: XON/XOFF or Data Transfer Ready (DTR). The DTR protocol uses the DTR signal to indicate the printer state. The XON/XOFF protocol uses the serial ASCII codes for XON and XOFF. (Apple IIc does not use XON/XOFF.)

Data Transfer Ready Protocol

Whenever the capacity of the input buffer becomes less than 30 characters, the printer sends a busy signal by setting the DTR line to logic 1. The computer must stop transmission within the next 29 characters; if it does not, the printer will ignore the excess data. The DTR line is also set to logic 1 when the printer is deselected, and when it receives a DC3 character. The DTR line is logic 0 whenever there is room for at least 100 characters in the input buffer, when the printer is turned on, selected, and has received a DC1 character.

XON/XOFF Protocol

Whenever the capacity of the input buffer becomes less than 266 characters, the printer sends an XOFF character. The computer must stop transmission within the next 265 characters after it receives the XOFF character; if it does not, the printer will ignore the excess data. An XOFF character is also sent when the printer is deselected, and when it receives a DC3 character (unless an XOFF character has been sent because the buffer is full). The printer sends an XON character whenever there is room for at least 337 characters in the input buffer, when the printer is turned on, and when the printer is selected (only if an XOFF character has been sent). (Apple IIc does not use XON/XOFF.)

Data Byte Length

Your Apple computer sends text to the printer in eight-bit data bytes. Normal ASCII characters use only the lower seven bits, so usually the highest value bit is ignored. Thus, it usually doesn't matter whether or not your Apple Scribe processes the eighth (highest value) bit of data it receives.

Important! Certain control codes require characters in which the eighth bit is set. The Scribe normally ignores the 8th bit. However, when 8-bit data is required, the Scribe will only then recognize the 8th bit.

Repacking Instructions



Repacking

If you should have to ship or store your printer in the future, the original shipping carton is the best container. To repack the printer, follow these steps:

1. With no paper in the Scribe turn it ON to automatically center the print head.
2. Turn the power off.
3. Remove the power cable, connecting cables, and ribbon cassette. Pack them separately in envelopes or plastic bags.
4. Replace the printer head protector (saved from original packing) inside the printer.
5. Close all covers securely and tape them down.
6. Place the entire printer in its plastic bag.
7. Place the foam forms on each end of the printer, and gently lower the printer (in its plastic bag) into the carton.
8. Put the power cable in the box on top of the printer.
9. Store the interface cable and manual in the accessory kit.
10. Store the ribbon cassette separately, away from temperature extremes and direct sunlight.

Glossary

Applesoft BASIC: A programming language that can be used with Apple computers. BASIC stands for Beginner's All-Purpose Symbolic Instruction Code.

ASCII: Acronym for American Standard Code for Information Interchange, the information code that is sent to the Apple Scribe. It assigns a unique binary number to each character. See Appendix C.

binary: The number system used by most digital computers. Every binary number consists of a string of zeros and ones; the farthest right (least significant) digit has a value of 1, the next a value of 2, then 4, 8, 16, and so on.

bit: A single binary digit, consisting of either a zero or a one.

boot disk: A disk containing the programs and data that the Apple Computer needs to get started when power is turned on.

buffer: A memory area that holds information until it can be processed. The Apple Scribe has an input buffer, which stores excess incoming text until the mechanism has time to print it.

byte: A binary number of fixed length. In the Apple Scribe, bytes are eight bits long. Every character processed by the printer can be expressed as one byte, using the ASCII code.

character: Any letter, number, punctuation mark, or control code that can be acted upon by the printer. There are 256 possible characters, corresponding to the range of eight-bit binary numbers.

character pitch: The number of characters per inch printed along a horizontal line.

character set: The entire set of characters that can be printed by a device such as the Apple Scribe.

clear: To erase information or commands from memory, as when the Apple Scribe clears its horizontal tab stops.

command structure: The nature and interrelations of all the possible instructions that can be sent to a device such as a computer or printer. The Apple Scribe's command structure is summarized in Appendix B.

compile: To convert a program (source file) written by a human being into a file of commands that the computer can follow to make the program work.

control character: A nonprinting ASCII character that allows you to perform special functions with the Apple Scribe.

control code: One or more characters whose function is to change the way the printer acts (as opposed to text, which is simply printed).

control sequence: An ESCAPE character followed by a sequence of characters whose function is to change the nature of the characters that follow.

device: A piece of equipment connected to a computer. The Apple Scribe is a device, along with the video monitor, disk drives, and so on.

DIP switch: A small switch that affects a printer function and can be operated manually. There are 8 DIP switches located at the rear of the Apple Scribe. DIP stands for dual in-line package.

disk drive: A device that records and reads computer disks, somewhat like a phonograph.

dot matrix: The method by which the Apple Scribe prints. Each character is formed by a pattern of dots, each of which is located at one of the intersections of a fixed grid.

editor: A program that helps the user create and change text files by providing commands to insert and delete text, and perform other functions.

end-of-line character: Any character that tells the printer that the preceding text constitutes a full line and may now be printed.

ESCAPE character: An ASCII character that allows you to perform special functions with the Apple Scribe.

escape code: A sequence of characters, beginning with ESCAPE, that constitutes a complete command to the printer.

execute: To perform the actions specified by a program command or sequence of commands.

fanfold paper: Special paper supplied for computer printers such as the Apple Scribe. One continuous sheet, perforated and folded like the letter Z so that it lies in a stack.

file: In a computer, any named, ordered collection of data. Apple computer files are normally stored on disks. Text files are files of text, while data files are files of data and code files are files of code (usually the programs that make it easier for you to use the computer).

font: A complete set of type in one size and style of characters.

format: The general shape and appearance of the printer's output, including page size, character width and spacing, line spacing, and other factors.

function: In a programming language, an instruction that converts data from one form to another. The CHR or CHR\$ function, for example, converts an ASCII code number into its corresponding character.

graphics: Designs and pictures as opposed to written text, when referring to the capabilities of a device such as a printer.

hardware: In computer technology, the physical machinery; opposed to software, the program instructions.

hex, hexadecimal: The base-16 number system. (Ordinary decimal numbers are base-10.) Hexadecimal numerals consist of 0, the numerals 1-9, and the capital letters A-F. See Appendix C.

high ASCII characters: The set of ASCII characters with decimal equivalents from 128 to 255. Called *high* ASCII because their high bit (first binary digit) is set to 1 (for on) rather than 0 (for off).

interface: In computer hardware, the equipment that accepts electrical signals from one part of a system and renders them into a form that can be used by another part.

interlock: In a machine such as a printer, a safety device that prevents operation under certain conditions, such as when the cover is open.

leading zero: A zero occurring at the beginning of a number, deleted by most computing programs.

line feed: An ASCII character (hex code 0A) that instructs a device such as a printer to feed one line of paper. Also refers to a vertical motion of the platen, moving the paper up one print line.

line feed pitch: The number of lines printed per vertical inch.

memory: Any part of a computer system that stores data.

microprocessor: A small circuit component (about the size of a postage stamp) that performs a complete set of basic computing functions.

operating system: The most fundamental program in a computer, which organizes the actions of the various parts of the computer and allows it to use other programs.

overflow: The condition that exists when an attempt is made to put more data into a memory than it can hold.

override: To modify or cancel a longstanding instruction with a temporary one.

Pascal: A higher-level programming language with statements that resemble English sentences. Named after the philosopher and mathematician Blaise Pascal.

pin-feed paper: Multisheet paper that has sprocket holes along both edges, for printers such as the Apple Scribe. Each page is separated from the next by perforations (just like paper towels). The paper is folded at the perforations to make a stack that feeds continuously into the printer.

platen: The rubber roller in a printer, which provides a backing for the printing action.

procedure: In the Pascal programming language, a set of instructions that work as a unit; equivalent to the subprogram in BASIC.

SEL, select: A command to a device such as a printer to place it into a condition to receive data.

software: In general, programs and program instructions; as opposed to hardware, the machinery that runs software.

sprocket: In the Apple Scribe, either of the toothed wheels at the back that engage pin-feed paper and pull it through the machine.

standard instruction: An instruction automatically present when no superseding instruction has been received. The Apple Scribe assumes a set of standard instructions every time power is turned on. These are listed in Appendix B.

TOF, top of form: The very top of a page of text.

Index



A

- aligning ribbon cassette 12
- alternate (national)
 - character set codes 60
 - characters 59-61
 - draft characters 114-115
 - letter characters 110-111
- alternate character group 60
- alternate language 49
- American 59
- Apple IIc
 - connection 25-26
 - power switch 30
- Applesoft 41
 - color example 44
 - hints 31
 - printing sample 42
 - printing with 30-31
 - superscript/subscript example 43
- Applesoft and Pascal programs 41-47
- ASCII 77, 87, 88
 - codes 52
- ASCII, binary, and hexadecimal
 - codes 103-105
- auto-print action 66
- automatic line feed 65

B

- backspacing 61
- BASIC printing routine 30
- bit image
 - graphics 79
 - printing 76-79, 83-86
- black 44
- black ribbon 25
- British 59
- BS 72
- business forms 14

- button 5
- letter 7
- line/form feed 6, 21
- power 5
- select 6

C

- cable, printer interface 26
- CAN 72
- canceling text 67
- card stock 14
- caring for your Scribe 35-38
- carriage return 65
- carrier track 8
- changing the ribbon cassette 13
- character
 - pitch 49, 55-56, 58, 97
 - repetition 59
 - specifications 107-117
- choosing paper 14-15
- CHR 78
- CHR\$ 53, 78
- circuit
 - SN 75188, or equivalent 125
 - SN 75189A, or equivalent 124
- cleaning 36
- color
 - 8-inch band 71
 - codes 99
 - darker 71
 - graphics 72
 - lighter 71
 - mixing 71, 71
 - printing 71-72
 - registration 72
 - text 72
 - commands 43
 - ribbon 25
- command summary 97-100

connecting the Scribe 26
 connecting the Scribe
 to the Apple IIc 25-26
 what you need 25
 connector
 print head 37
 RS232C pin assignment 123
 control buttons 5
 control cluster 2, 6
 control codes 50, 52
 multiple-byte 52
 single-character 52
 CONTROL-H c 61
 CONTROL-J 62
 CONTROL-L 62, 98
 CONTROL-M 65
 CONTROL-N 56, 98
 CONTROL-O 56, 98
 CONTROL-X 67, 97
 controlling your Scribe 49-50
 controls 5-7
 controls and parts, Scribe 1-9
 CTL 55
 cyan 25, 44, 43, 71

 data byte 78, 84
 data byte length 126
 data transfer ready protocol 126
 decimal values 52
 density 66
 deselect 68, 6, 7
 DIP switch
 assembly 4
 cover 4
 settings 50-51, 100, 100
 SW1-SW8 functions 53-54
 DIP switches 24, 51
 SW1-SW8 54
 DIPSW(00*00000) 24
 doesn't work 31-32
 dot column repeat code 87
 dot spacing 79, 86
 dot-column repeating graphics
 81-82, 87-88
 dot-matrix 49
 double-dots 75, 78
 double-width 49
 draft and letter font characteristics
 56
 draft mode 7, 25
 characters 112-113
 draft/letter mode 55, 97
 duplicate codes 67

 electrical connection 23
 elements 36, 75
 envelopes, loading 21
 ESC 55
 ESCAPE A 63, 98
 ESCAPE c 66, 72, 97
 ESCAPE C nnnn 83, 84, 99
 ESCAPE D (SPACE) CONTROL-@
 66, 98
 ESCAPE D {@} CONTROL-@
 65, 98
 ESCAPE D CONTROL-@
 CONTROL-A 58, 98
 ESCAPE D CONTROL-@
 CONTROL-H 66, 97
 ESCAPE D CONTROL-P
 CONTROL-@ 68, 97
 ESCAPE E 67, 67
 ESCAPE f 64, 98
 ESCAPE F nnnn 76, 82, 99, 83,
 88, 89, 99
 ESCAPE g nnn 72,, 76, 77 99
 ESCAPE G nnnn 72, 76, 77, 79,
 84, 99
 ESCAPE H nnnn 64, 98
 ESCAPE j 67, 83, 84, 99, 67, 83,
 84, 99
 ESCAPE K 1 99, 43, 71
 ESCAPE K 2 99, 43, 71
 ESCAPE K 3 99, 43, 71
 ESCAPE l 0 65, 98
 ESCAPE l 1 65, 98
 ESCAPE L nnn 58, 89, 98
 ESCAPE M 55, 98, 55, 98
 ESCAPE N 98, 67, 76, 77, 99, 67,
 76, 77, 99
 ESCAPE p 67, 76, 77, 99, 67, 76,
 77, 99
 ESCAPE q 67, 67, 98
 ESCAPE R 72, 64, 98
 ESCAPE R nnn 59, 98
 ESCAPE S nnnn 72, 76, 77, 99
 ESCAPE T nn 63, 75, 79, 98
 ESCAPE U nnnn 83, 87, 89, 99
 ESCAPE v 62, 98
 ESCAPE V nnnn 72, 76, 81, 99
 ESCAPE x 42, 57, 72, 98, 57, 72, 98
 ESCAPE y 42, 57, 72, 98, 57, 72, 98
 ESCAPE z 42, 57, 72, 98
 ESCAPE Z (SPACE) CONTROL-@
 66, 98
 ESCAPE Z {@} CONTROL-@
 65, 98

ESCAPE Z CONTROL-@
CONTROL-A 58, 98
ESCAPE Z CONTROL-@
CONTROL-H 66, 97
ESCAPE Z CONTROL-P
CONTROL-@ 68, 97
exact dot placement 82, 88-89
exterior, controls and parts 1-5

F

feeding paper 16
firmware 24
form feed 21
form feeding 62
forms 14
forward 64
French 59
friction-feed position 3
front view 1
functions you can change 52-54
fuse 31
fuse blown 93
FYI, Applesoft hints 31

G

general graphics information 75
German 59
graphics
high-resolution mode 75, 83
low-resolution mode 75, 78
mode 72, 75
printing 75-89
green 44
grounding plug 23
guides 20

H

hairline rules 82
head, removal 36-37
headline 41, 49, 57
type 56-57, 97
heat 11
help 31-32
hexadecimal values 52
high temperatures 35
high-resolution
data bytes 84
graphics 83-89
graphics codes 99
graphics example 86
mode 75, 83
horizontal
lines 83
resolution 79, 86

I

icon, pin-feed 16, 18
indicator 5-7
lights 5
input circuit configuration 124
inserting paper 15
inside the Scribe 7-9
installing
ribbon cassette 12
thermal print head 38
interface
cable connector 4
connection loose 94
specifications 123-127
interlock switch 9
Italian 59

J

K

L

labels 14
language fonts 59
leading zeros 77
left margin 58, 97, 50
settings 58
left paper clamp 18
left side view 4
letter
button 7
light 7
button 55
mode 7, 25
letter mode characters 108-109
letterhead 14
light 5
letter 7
power 5
select 6
line feed 49, 62
automatic 65
directions 64
forward 64
function 64
reverse 64
spacing 63
direction 97
function 97
pitch 97
line/form feed, button 21, 6, 62
lining up ribbon cassette 12

- loading
 - envelopes 21
 - pin-feed paper 15-19
 - plain paper 19-20
 - ribbon 12
 - ribbon cassette 12
 - transparencies 21
 - plain paper 19
- location 35, 11
- low temperatures 35
- low-resolution
 - data byte 78
 - graphics 76-82
 - graphics commands 99
 - graphics example 80
 - mode 75, 78
- M*
- magenta 25, 44, 43, 71
- miscellaneous
 - codes 66-68
 - commands 97
- moving sprocket 16
- multi-character codes 52
- multiple-byte, control codes 52
- multiple-part forms 14
- N*
- names, controls and parts 1-9
- O*
- opening the paper 17
- operating environment 35-36
- orange 44, 71
- out of
 - paper 6, 93
 - ribbon 6, 93
- output circuit configuration 125
- overprinting 71
- P*
- page, length 64, 49, 97
- paper 14
 - clamps 17
 - guides 20
 - handling commands 98
 - kind of 14-15
 - loading 15-20
 - pin-feed 11, 15-19
 - plain 19-20
 - release 3
 - setting pin-feeder width 15-19
 - tray 11
 - handling codes 62-66
 - holes in place 18
 - release lever 3, 15
 - tray 2
 - width 14
- parts, exterior 1-5
- parts and controls, Scribe 1-9
- Pascal 41, 80, 86
 - line-by-line printing 47
 - printing features program 46
 - printing program 45-46
- perforation, horizontal 19
- pin-feed 14
 - paper 11
 - icon 3, 16, 18
 - paper 15
 - paper loading 15-19
 - position 3
- pin-feeder, setting the width 15-19
- plain paper 36
 - loading 19-20
 - alignment 19
 - exit 20
- platen 2
 - knob 2
- plus-or-minus sign 61
- Port 1 32, 46, 94
- power
 - button 5
 - light 5
 - cable connector 4
 - connection 23
 - switch 29
- power-on configuration 50-52
- precision paper 20
- print color 97
- print density 66
- print head 71
 - connector 37
 - installation 38
 - replacement 36-38
- print quality 35
- printer, lid open 15
- printer cover 2, 3, 7, 7, 12
 - loose 6
 - open 93
- printer
 - interface cable 26
 - lid 3
 - specifications 119-121
 - standard instructions 97
- PRINTER: 46
- printing 29-32
 - color from Applesoft 43-45
 - from Applesoft 30-31, 41-44
 - from Pascal 45-47
 - keyboard input 45
 - text files from disk 45

problems 31-32
product identification number 68
protocol 126
purple 44

Q

R

radio and television interference
xi, 25
ready to print 26, 29-32
rear view 5
reference manual 39-137
registration mark 72
removal, printer cover 7, 12
removing, ribbon cassette 13
repacking instructions 129
replacing, thermal-transfer print
head 36-38
restoring standard instructions
66-67
retainer tabs 12
reverse 64
ribbon cassette 8, 11, 12, 13
aligning 12
installation 12
loading 12
removal 13
right side view 4
right-hand margin 50
ROM 24
RS232C connector pin
assignment 123

S

Scribe

care 35-38
cleaning 36
connection 25-26
controls 5-7
controls and parts 1-9
indicators 5-7
inside 7-9
interior 8
location 11
operating environment 35-36
outside 1-7
power connection 23
power switch 29
setting up 23-26
setup 26, 29
testing 23-25
what it can do xiii

select 68, 6, 7
button 6
light 6
self-test 23, 25, 32, 38, 93
sequence of characters 52
setting
pin-feeder width 15-19
top of the page 21, 20
top of form 19, 21
up your Scribe 23-26
setup 26, 29
shielded interface cable 25
SI 72
signal descriptions 124
single sheets 14
single-character, control codes
52, 52
single-sheet icon 3, 19
slashed/unsashed zeros 58
smooth paper 14, 36
SO 72, 79, 84
software select/deselect 68
spacing of the sprockets 15
Spanish 59
Spanish hyphen 60
specifications 123-125
sprocket 17
release levers 16
sprockets 9, 17
spacing of 15
standard draft characters 112
standard letter characters 108
starting to print 29-32
subscript 49
subscript and superscript in
Applesoft 42-43
subscript/superscript 57
sunlight 11, 35
superscript 49
superscript and subscript
characters 116
SW1-SW3 60-61
SW1-SW8 4, 24, 50, 53-54, 94, 100
Swedish 59
system connection 29

T

temperature 35
testing your Scribe 23-25
text and general control
codes 49-68
text mode 72
text mode codes 55-61
text mode commands 98

thermal print head 8
 configuration 107
 installation 38
 removal 37
thermal-transfer 49
thermal-transfer print head
 installation 38
 replacement 36-38
threshold voltage level 125
TOF 62
top of form 62, 62
top of the page 62, 19, 20, 21
 setting 21
transparencies 14
 loading 21
troubleshooting 93-95
 fuse blown 93
 out of paper 93
 out of ribbon 93
 printer cover open 93
 self-test 93
turning on the system 29-30

U

underline 41, 46, 55
underlines and headlines in
 Applesoft 41-42
underlining 57, 97

V

vertical
 column 76, 83, 84
 dot pattern 75, 81, 87
 resolution 79, 86

W

width, setting pin-feeder 15-19

X

XON/XOFF protocol 126

Y

yellow 25, 44, 43, 71

Z

zeros
 slashed 58
 unslashed 58

Apple Scribe Character Set

ASCII	Dec	Hex	ASCII	Dec	Hex	ASCII	Dec	Hex	ASCII	Dec	Hex
NUL	00	\$ 0 0	SP	32	\$ 20	②*	64	\$ 40	⑦*	96	\$ 60
SOH	01	\$ 0 1	!	33	\$ 21	A	65	\$ 41	a	97	\$ 61
STX	02	\$ 0 2	..	34	\$ 22	B	66	\$ 42	b	98	\$ 62
ETX	03	\$ 0 3	①*	35	\$ 23	C	67	\$ 43	c	99	\$ 63
EOT	04	\$ 0 4	①*	36	\$ 24	D	68	\$ 44	d	100	\$ 64
ENQ	05	\$ 0 5	%	37	\$ 25	E	69	\$ 45	e	101	\$ 65
ACK	06	\$ 0 6	&	38	\$ 26	F	70	\$ 46	f	102	\$ 66
BEL	07	\$ 0 7	'	39	\$ 27	G	71	\$ 47	g	103	\$ 67
BS	08	\$ 0 8	(40	\$ 28	H	72	\$ 48	h	104	\$ 68
HT	09	\$ 0 9)	41	\$ 29	I	73	\$ 49	i	105	\$ 69
LF	10	\$ 0 A	*	42	\$ 2A	J	74	\$ 4A	j	106	\$ 6A
VT	11	\$ 0 B	+	43	\$ 2B	K	75	\$ 4B	k	107	\$ 6B
FF	12	\$ 0 C	,	44	\$ 2C	L	76	\$ 4C	l	108	\$ 6C
CR	13	\$ 0 D	-	45	\$ 2D	M	77	\$ 4D	m	109	\$ 6D
SO	14	\$ 0 E	.	46	\$ 2E	N	78	\$ 4E	n	110	\$ 6E
SI	15	\$ 0 F	/	47	\$ 2F	O	79	\$ 4F	o	111	\$ 6F
DLE	16	\$ 10	0	48	\$ 30	P	80	\$ 50	p	112	\$ 70
DC1	17	\$ 11	1	49	\$ 31	Q	81	\$ 51	q	113	\$ 71
DC2	18	\$ 12	2	50	\$ 32	R	82	\$ 52	r	114	\$ 72
DC3	19	\$ 13	3	51	\$ 33	S	83	\$ 53	s	115	\$ 73
DC4	20	\$ 14	4	52	\$ 34	T	84	\$ 54	t	116	\$ 74
NAK	21	\$ 15	5	53	\$ 35	U	85	\$ 55	u	117	\$ 75
SYN	22	\$ 16	6	54	\$ 36	V	86	\$ 56	v	118	\$ 76
ETB	23	\$ 17	7	55	\$ 37	W	87	\$ 57	w	119	\$ 77
CAN	24	\$ 18	8	56	\$ 38	X	88	\$ 58	x	120	\$ 78
EM	25	\$ 19	9	57	\$ 39	Y	89	\$ 59	y	121	\$ 79
SUB	26	\$ 1A	..	58	\$ 3A	Z	90	\$ 5A	z	122	\$ 7A
ESC	27	\$ 1B	..	59	\$ 3B	③*	91	\$ 5B	⑧*	123	\$ 7B
FS	28	\$ 1C	<	60	\$ 3C	④*	92	\$ 5C	⑨*	124	\$ 7C
GS	29	\$ 1D	=	61	\$ 3D	⑤*	93	\$ 5D	⑩*	125	\$ 7D
RS	30	\$ 1E	>	62	\$ 3E	⑥*	94	\$ 5E	⑪*	126	\$ 7E
US	31	\$ 1F	?	63	\$ 3F	-	95	\$ 5F	DEL	127	\$ 7F

Note: The reference symbol ○* refers to the Apple Imagewriter Extended Character Set table below for Alternate (National) Languages:

Apple Scribe Alternate Character Set (For National Languages)

Reference Number	0	1	2	3	4	5	6	7	8	9	10	11
Hexadecimal	\$23	\$24	\$40	\$5B	\$5C	\$5D	\$5E	\$60	\$7B	\$7C	\$7D	\$7E
American	#	\$	@	[\]	^	`	{	---	}	~
British	£	\$	@	[\]	^	`	{	---	}	~
German	#	\$	€	•	ö	ü	^	`	ä	ö	ü	ß
French	£	\$	€	•	ö	ü	^	`	ä	ö	ü	ë
Swedish	#	\$	@	•	ö	ä	^	`	ä	ö	ä	~
Italian	£	\$	€	•	€	é	^	`	à	ö	é	~
Spanish	£	\$	€	•	€	é	^	`	à	ö	é	~

DIP Switch Settings

The OFF (up) position of the DIP switches is equal to logic "0". The ON (down) position of the DIP switches is equal to logic "1". The standard setting is OFF (up) for all the DIP switches, SW1-SW8.

SW1	SW2	SW3	National Character Set
UP	UP	UP	American
Down	Up	Up	Italian
Up	Down	Up	American
Down	Down	Up	British
Up	Up	Down	German
Down	Up	Down	Swedish
Up	Down	Down	French
Down	Down	Down	Spanish

SW4

UP	No line feed after carriage return
Down	Adds line feed after every carriage return

SW5	SW6	Density	Effect
Off (Up)	Off (Up)	1	Plain paper (normal density)
Off (Up)	On (Down)	2	Plain paper (low density)
On (Down)	Off (Up)	3	Transparency (normal density)
On (Down)	On (Down)	4	Transparency (low density)

SW7

UP	9600 Baud
Down	1200 Baud

SW8

UP	Data terminal ready
Down	XON/XOFF (not used by Apple IIc)

Printer Power-on Configuration (Standard Instructions)

The following are the default settings for various functions of the Apple Scribe.

Function	Power-On Settings
Draft/Letter	Mode Draft
Character pitch	Pica (10 dpi)
Underlining	Off
Headline Type	Off

High-Resolution Graphics

Code	Decimal	Hex	Resolution
ESC j	27 106	\$1B \$6A	144 (V) x 144 (H)
ESC J	27 74	\$1B \$4A	144 (V) x 160 (H)
ESC C nnnn	27 66 dddd	\$1B \$43 hhhh	Print nnnn high resolution columns of graphics
ESC U nnnn	27 85 dddd	\$1B \$55 hhhh	High resolution dot column repeat, nnnn times
ESC F nnnn	27 70 dddd	\$1B \$46 hhhh	Dot Address

Function	Power-On Settings
Line Feed Pitch	6 lines per inch
Optional Line Feed Function	Disabled
Line Feed Direction	Forward
Left Margin	Character Position Zero
Print Color	Black
Page Length	11 inches

Miscellaneous Codes

Code	Decimal	Hex	Effect
ESC Z CTL-@ CTL-H	27 90 0 8	\$1B \$5A \$00 \$08	Print on plain paper
ESC D CTL-@ CTL-H	27 68 0 8	\$1B \$44 \$00 \$08	Print on transparencies
ESC c	27 99	\$1B \$63	Software reset
CTL-X	24	\$18	Cancel current unprinted line
DC1	17	\$11	Reselect Printer
DC3	20	\$13	Deselect Printer
ESC Z CTL-P CTL-@	27 90 16 0	\$1B \$5A \$10 \$00	Enable DC1/DC3 response
ESC D CTL-P CTL-@	27 68 16 0	\$1B \$44 \$10 \$00	Disable DC1/DC3 response

Text Mode Codes

Code	Decimal	Hex	Effect
ESC M	27 77	\$1B \$4D	Draft Mode
ESC m	27 109	\$1B \$6D	Letter Mode (10 CPI Only)
ESC N	27 78	\$1B \$4E	Select 10 CPI
ESC Q	27 81	\$1B \$51	Select 17 CPI
CTL-N	14	\$0E	Begin Headline
CTL-O	15	\$0F	End Headline
ESC X	27 88	\$1B \$58	Begin Underline
ESC Y	27 89	\$1B \$59	End Underline
ESC x	27 120	\$1B \$78	Begin Superscript
ESC y	27 121	\$1B \$79	Begin Subscript
ESC z	27 122	\$1B \$7A	End Super/ Subscript
ESC D CTL-@ CTL-A	27 68 0 1	\$1B \$44 \$00 \$01	Print Slashed Zeros
ESC Z CTL-@ CTL-A	27 90 0 1	\$1B \$5A \$00 \$01	Print Un-slashed Zeros
ESC L nnn	27 76 ddd	\$1B \$4C hhh	Set Left Margin
ESC R nnn c	27 82 ddd d	\$1B \$52 hhh h	Character Repeat
CTL-H	8	\$08	Backspace (BS)

Paper Handling Codes

Code	Decimal	Hex	Effect
CTL-L	12	\$0C	Advance paper to top of next form
ESC v	27 118	\$1B \$76	Set top of form

Code	Decimal	Hex	Effect
CTL-J	10	\$0A	Advance paper one line (LF)
ESC T nn	27 84 dd	\$1B \$54 hh	Set line feed to nn/144"
ESC A	27 65	\$1B \$41	Set line feed to 1/6"
ESC f	27 102	\$1B \$66	Set forward line feed
ESC r	27 114	\$1B \$72	Set reverse line feed
ESC H nnnn	27 72 dddd	\$1B \$48 hhhh	Set page length to n/144"
ESC I 0	27 108 48	\$1B \$6C \$30	Optional line feed off
ESC I 1	27 108 49	\$1B \$6C \$31	Optional line feed on
ESC Z (@) CTL-@	27 90 128 0	\$1B \$5A \$80 \$00	CR only
ESC D (@) CTL-@	27 68 128 0	\$1B \$44 \$80 \$00	CR = CR + LF
CTL-M	13	\$0D	Carriage Return (CR)
ESC Z (SPACE) CTL-@	27 90 32 0	\$1B \$5A \$20 \$00	No Lf after auto print
ESC D (SPACE) CTL-@	27 68 32 0	\$1B \$44 \$20 \$00	Lf after auto print

Color Codes

Code	Decimal	Hex	Effect
ESC K1	27 75 49	\$1B \$4B \$31	Yellow
ESC K2	27 75 50	\$1B \$4B \$32	Magenta
ESC K3	27 75 51	\$1B \$4B \$33	Cyan

Low-Resolution Graphics

Code	Decimal	Hex	Resolution
ESC n	27 110	\$1B \$6E	72 (V) x 72 (H)
ESC N	27 78	\$1B \$4E	72 (V) x 80 (H)
ESC p	27 112	\$1B \$70	72 (V) x 144 (H)
ESC P	27 80	\$1B \$50	72 (V) x 160 (H)
ESC G nnnn	27 71 dddd	\$1B \$47 hhhh	Print nnnn low resolution columns of graphics
ESC S nnnn	27 83 dddd	\$1B \$53 hhhh	Print nnnn low resolution columns of graphics
ESC g nnn	27 103 ddd	\$1B \$67 hhh	Print nnn x 8 low resolution columns of graphics
ESC V nnnn	27 86 dddd	\$1B \$56 hhhh	Low resolution dot column repeat, nnnn times
ESC F nnnn	27 70 dddd	\$1B \$46 hhhh	Dot Address

Note: ESC e, ESC E, and ESC q are the same as ESC p (72x144 graphics) and are duplicates in order to provide a limited compatibility with other Apple printers.

Tell Apple

About the Apple Scribe

Your Name: _____

Company: _____

Your Title: _____

Address: _____

City/State/ZIP: _____

Apple uses comments and suggestions from Apple owners like you to improve existing products and develop new and better products. Now that you've used your Apple Scribe, we want to know your thoughts and suggestions about your experience. Please use this form to tell Apple what you think.

Your Dealer Can Help: Apple can't respond to your individual questions. If you have a question, would like help, or need service, please contact your Apple dealer.

Part I: Tell Apple About You

1. How much prior experience have you had using computers?
 None Little Moderate Extensive
2. Where do you use your Apple computer?
 Home Work Home and Work
3. Did you own an Apple computer before buying an Apple Scribe?
 Yes No
4. How many people in your family use your Apple Scribe?
 Adults Children

Part II: Tell Apple Your System

1. Which devices are attached to your system?
 Disk Drive Mouse Printer Plotter
 Joystick Hand Controller Other(s) _____
(Please Specify)
2. Which type of display device are you using? (Please check two boxes.)
 Video Monitor Television Color Black & White
 Monochrome
3. Do you plan to write computer programs? Yes No
If yes, which computer language(s) will you use? _____
4. What application programs do you use or plan to use with your Apple Computer?
 Word Processing Data Management Spreadsheet
 Education Games Communication
 Graphics Other: _____
5. Please list products (program, operating system, or language) in use. Please include version number.
Exact Name of Software Version Number Product Number
(if applicable)

6. Please give us any suggestions or comments and tell us about any problems you've had with your Apple Scribe. Feel free to attach additional sheets.

WRITE EXTRA COMMENTS HERE:

FOLD HERE

FOLD HERE

STAPLE HERE

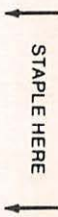

FOLD HERE

FOLD HERE

Part III: Scribe User's Manual

2. What did you like least about the manual?

3. Which topics, if any, were confusing to you? _____

4. Which topics, if any were not explained thoroughly enough?

5. Did you read the manual from cover to cover and try every example?

___ Yes ___ No.

If no, which topics or examples did you skip?

6. Was the information presented appropriately for your level of computer expertise?

___ Too Elementary ___ Just Right ___ Too Complex

8. Please describe specific problems you encountered in the manual. (Page numbers would be helpful. Feel free to attach additional sheets.)

RETURN TO:

Name _____

Address _____

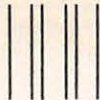

NO POSTAGE
NECESSARY
IF MAILED
IN THE
UNITED STATES

BUSINESS REPLY MAIL

FIRST CLASS

PERMIT #453

CUPERTINO, CA

POSTAGE WILL BE PAID BY:



20525 Mariani Avenue
Cupertino, California 95014

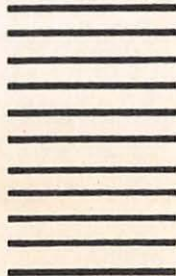

Attn: Accessory Products Group Publications