

# Network Video Recorder

## Installation Manual

Before operating the unit, please read this manual and the Safety Regulations thoroughly and retain them for future reference.

## HAW-SIBU

Software Version 2016 R2 and Later



---

# Table of Contents

<b>Usage Precautions</b> .....	<b>4</b>	Registering License Files to the Unit .....	24
<b>Package Contents</b> .....	<b>6</b>	Starting the Recording Server .....	25
<b>System Requirements</b> .....	<b>7</b>	Registering Cameras .....	25
<b>Names and Functions of Parts</b> .....	<b>8</b>	Configuring the Recording Destinations and Retention Times .....	25
Front (without the HDD Cover) .....	8	Configuring the Archiving Interval .....	26
Rear .....	9	Connecting Multiple Network Video Recorders .....	27
<b>Acquiring Reference Manuals and Technical Documents</b> .....	<b>10</b>	Quitting Management Application .....	28
<b>System Configuration</b> .....	<b>11</b>	<b>Step 5: Verifying Operation</b> .....	<b>28</b>
Single Network Video Recorder Systems .....	11	<b>Step 6: Activation</b> .....	<b>29</b>
Multi Network Video Recorder Systems ...	12	Exporting License Request Files (.lrc) .....	29
<b>Preparation</b> .....	<b>13</b>	Acquiring Activated Software License Files (.lic) .....	29
<b>Step 1: Installation</b> .....	<b>13</b>	Importing Activated Software License Files (.lic) .....	29
Installing without a Rack .....	14	<b>Step 7: Data Backup</b> .....	<b>29</b>
<b>Step 2: Installing the HDDs</b> .....	<b>14</b>	<b>Third Party Software Terms and Conditions</b> .....	<b>30</b>
<b>Step 3: Connections</b> .....	<b>16</b>	Inno Setup License .....	30
Connecting the Monitors .....	16	<b>Troubleshooting</b> .....	<b>56</b>
Connecting the Keyboard and Mouse .....	16	<b>Specifications</b> .....	<b>57</b>
Connecting the Power Cord .....	16		
Connecting to a Network .....	16		
Connecting Other Devices .....	17		
<b>Step 4: System Settings</b> .....	<b>17</b>		
Registering the Software License Code (SLC) and Acquiring the License File .....	17		
Verifying the Software Version .....	17		
Adding Device Licenses .....	18		
Turning On the Unit .....	18		
Initial Setup for Windows .....	18		
Changing the Keyboard Layout .....	19		
Closing the Pagefile Wizard .....	19		
Configuring the Login Password .....	19		
Configuring the IP Address .....	19		
Configuring Monitor Settings .....	20		
Configuring the Recording Disk Settings .....	21		
Updating the Device Pack Version .....	23		
Starting Management Application .....	24		

- Reproduction or duplication, in whole or part, of the software or operation manual supplied with the server, as well as renting or leasing of the software without the authorization of the right holder is prohibited under copyright law.
- Sony assumes no responsibility for damages, loss of income, or any claims from a third party arising out of use of the server or supplied software.
- For complete terms and conditions of the warranty for the server, refer to the warranty card included in the package.
- The software supplied with the server cannot be used with any other servers.
- It is not possible to install any software into the equipment other than the software supplied by Sony specifically for use with the equipment.
- Note that the specifications of the server and supplied software are subject to change for improvement without prior notice.

### **Disclaimer of liability for recorded content**

Sony Corporation does not accept any liability whatsoever for any problems arising from a failure to record, or from damage or erasure of recorded content on this equipment, for any reason. This includes claims for compensation of recorded content, and for any concomitant and consequential damages. Sony Corporation will not repair, restore, or duplicate any recorded content. Your use of this product is subject to these conditions.

# Usage Precautions

## Important Information About Safety

- Be sure to connect the unit to a power source that conforms fully to the electrical specifications of this unit.
- Do not coil the power cord or bundle it with other cords. Do not piggy back connections. If current ratings are exceeded, there is a risk of fire and other accidents.
- Make sure that all AC outlets and power cords are properly grounded.
- Do not use the unit with the cover opened or removed. Otherwise there is a risk of fire and electric shock. Do not attempt to open or remove the cover yourself. Always consult your supplier if opening is necessary.

## Important Information About Installation

### Locations for use/storage

To prolong the life of the product, avoid use or storage in the following locations.

- Locations that can become extremely hot or cold. (Be sure to use the unit that conforms fully to the specifications of this unit.)
- Locations exposed for an extended time to direct sunlight, and locations near heating appliances. (Note that the temperature in a closed car in summer can exceed +50 °C/+122 °F.)
- Locations with high levels of humidity or dust
- Locations subject to strong vibrations
- Locations subject to strong magnetic fields
- Locations in the vicinity of radio or TV transmitters creating a strong magnetic field

### Do not stack units or place the unit on other objects that generate heat

When one unit is stacked on top of another unit, the heat generated by both units can get extremely hot. Do not stack units on top of each other or place the unit on other objects that may generate heat.

### Do not block the ventilation openings

- The ventilation openings on the sides of the unit serve to prevent internal heat buildup. Always leave a clearance on both sides as well as behind and above the unit.
- Do not use the unit in a closed box or other enclosure.

## Precautions for rack installations

When installing the unit on a rack, take the following measures to ensure operation within the specified operating temperature.

- Place a fan to reduce the ambient temperature of the rack.

- Maintain a space of 1U rack-mount size (1.75 in. (approx. 44.5 mm)) or more above and below the unit.
- Do not obstruct the ventilation holes.

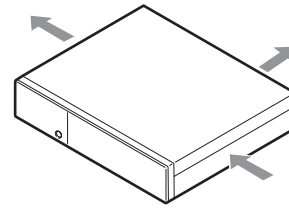

## Use the unit in a horizontal position

- The unit is designed to be operated in a horizontal position.
- Do not install the unit on a slanted surface, and protect the unit from shocks.
- When the unit is dropped or otherwise subject to strong shocks, it can be seriously damaged.

## Maintenance

- Before cleaning the unit or performing any other kind of maintenance, be sure to disconnect the power cord from the AC outlet.
- For cleaning, lightly wipe the cabinet and panels with a dry cloth. To remove stubborn stains, lightly moisten the cloth with a mild, neutral detergent and wipe with a dry cloth afterwards.
- Do not use cleaning alcohol, solvents, benzene, insecticide, or any other volatile substances, because these may damage the finish and lead to discoloration.

## Transport

Use the original packing material or similar packing to protect the unit from shocks.

## Security

SONY WILL NOT BE LIABLE FOR DAMAGES OF ANY KIND RESULTING FROM A FAILURE TO IMPLEMENT PROPER SECURITY MEASURES ON TRANSMISSION DEVICES, UNAVOIDABLE DATA LEAKS RESULTING FROM TRANSMISSION SPECIFICATIONS, OR SECURITY PROBLEMS OF ANY KIND.

Depending on the operating environment, unauthorized third parties on the network may be able to access the unit. When connecting the unit to the network, be sure to confirm that the network is protected securely.

From a safety standpoint, when using the unit connected with the network, it is strongly recommended to access the Control window via a Web browser and change the access limitation settings from the factory preset values. Changing the password regularly is also recommended.

Do not browse any other website in the Web browser while making settings or after making settings. Since the

login status remains in the Web browser, close the Web browser when you complete the settings to prevent unauthorized third parties from using the unit or harmful programs from running.

- Anti-virus software cannot be installed on the unit, so be sure to ensure anti-virus protection via firewalls and routers. In addition, be sure to check for the presence of viruses before connecting USB devices to the unit.
- Do not connect the unit directly to the Internet. When Internet connection is absolutely necessary, be sure to use a firewall.

## Condensation

If the unit is suddenly taken from a cold to a warm location, or if ambient temperature suddenly rises, moisture may form on the outer surface of the unit and/or inside of the unit. This is known as condensation. If condensation occurs, turn off the unit and wait until the condensation clears before operating the unit. Operating the unit while condensation is present may damage the unit.

## Consumable parts

The fan is a consumable part that will need periodic replacement.

When operating at room temperature, a normal replacement cycle will be about 5 years.

However, this replacement cycle represents only a general guideline and does not imply that the life expectancy of this part is guaranteed. For details on parts replacement, contact your dealer.

## Precautions for HDDs

The unit is not supplied with hard disk drives (HDDs) but will not operate without one installed.

HDDs are precision devices. If subject to shock, vibration, static electricity, high temperature or humidity, data loss can occur. When installing HDDs or operating the unit with HDDs installed, observe the following precautions.

### Protect from shocks and vibrations

When subject to shocks or vibrations, the HDD can be damaged and loss of data on the HDD can occur.

- When transporting the unit, use the specified packing material. When transporting on a dolly or similar, use a type which does not transmit excessive vibrations. Excessive shocks and vibrations can damage the HDD.
- Never move the unit while it is powered.
- Do not remove panels or outer parts of the unit.
- When placing the unit on a floor or other surface, make sure that the unit is equipped with the specified rubber feet, and put the unit down carefully. If there are no feet, mount the rubber feet first.

- Do not place the unit near other devices that may become a source of vibrations.

### Wait for 30 seconds after turning power off

For a brief interval after the power is turned off, the platters inside the HDD will still keep spinning and the heads will be in an insecure position. During this interval, the unit is more susceptible to shocks and vibrations than during normal operation. For a period of at least 30 seconds after turning power off, avoid subjecting the unit even to very light shocks. After this period, the hard disk will be fully stopped and the unit can be manipulated.

### Temperature and humidity related precautions

Use and store the unit only in locations where the specified temperature and humidity ranges are not exceeded. (Be sure to use the unit that conforms fully to the specifications of this unit.)

In general, the performance of HDDs tends to diminish when operating in higher ambient temperatures, and this in turn shortens their replacement cycles.

Although normal operation is possible within the specified operating temperature, we recommend operation in an ambient temperature of +25 °C (+77 °F) to improve the HDD's replacement cycle.

### When the HDD seems to be faulty

Even if the HDD is showing signs of malfunction, be sure to observe all the above precautions. This will prevent further damage from occurring until the problem can be diagnosed and corrected.

### Replacement of the HDD and other consumable parts

The HDD and battery are consumable parts that will need periodic replacement. When operating at room temperature, a normal replacement cycle will be about two to three years. However, this replacement cycle represents only a general guideline and does not imply that the life expectancy of these parts is guaranteed. For details on parts replacement, contact your dealer.

### Precautions for using USB devices

- This unit supports USB 2.0, USB 3.0, Mass Storage class devices. However, it does not support USB 2.0, USB 3.0, Mass Storage class HDDs or CD/DVD drives. Do not connect mass storage class devices other than USB flash memory devices to the unit. Be aware that errors may still occur when writing data to a USB 2.0, USB 3.0, Mass Storage class memory device, depending on the type of device used. If errors occur when writing data, use a USB memory device of a different type.
- To ensure proper operation of USB devices, do not connect the devices via a USB hub. Connect the devices directly to the USB connectors on the unit. Operation is not guaranteed when devices are connected via a USB hub, USB switch, or extension cable.

### **Protect data from power interruptions**

If the power supply is interrupted while the unit is in operation, data may be damaged. Be sure to take measures against power outages to protect data.

---

## **Package Contents**

Check that the following items are included in this package:

- HAW-SIBU (1)
- Before Using this Unit (leaflet) (1)
- HDD cover keys (2)
- Installation Manual (this document) (1)
- WEEE booklet (1)
- Safety Regulations (leaflet) (1)
- Warranty booklet (1)
- Rubber feet (4)
- HDD screws (40)

### **Notes**

- This package may contain additional hardware and/or documentation for those options.
- Save the boxes and packing materials for future use.

---

# System Requirements

The hardware required in order to use this unit are as follows.

- Hard disk drives (HDDs)<sup>1)</sup>
- Monitor<sup>2)</sup>
- Sony network cameras<sup>3)</sup>
- USB keyboard<sup>4)</sup> or PS/2 keyboard
- USB mouse<sup>5)</sup> or PS/2 mouse
- Network hub
- 1000Base-T/100Base-TX/10Base-T cable
- USB flash memory device<sup>6)</sup>

- 1) Contact your dealer for details about compatible HDDs.
- 2) HDMI-compatible devices and computer displays that accept RGB input are supported.  
A resolution of at least 1024 × 768 and 16-bit color are the minimum suggested specifications.
- 3) Contact your dealer for details about compatible Sony network cameras.
- 4) Use a USB keyboard with a cable. However, keys other than the standard may not function. Wireless or infrared USB keyboards may also not function properly.
- 5) Use a USB mouse with a cable. Wireless or infrared USB mice may not function properly. Functions such as three-button and wheel operations may also function improperly.
- 6) Required when backing up system information such as logs.
  - This unit supports USB 2.0, USB 3.0, and Mass Storage class devices. However, it does not support USB 2.0, USB 3.0, and Mass Storage class USB HDDs or CD/DVD drives. Do not connect mass storage class devices other than USB flash memory devices to the unit. Be aware that errors may still occur when writing data to a USB 2.0, USB 3.0, and Mass Storage class memory device, depending on the type of device used. If errors occur when writing data, use a USB flash memory device of a different type.

# Names and Functions of Parts

## Front (without the HDD Cover)

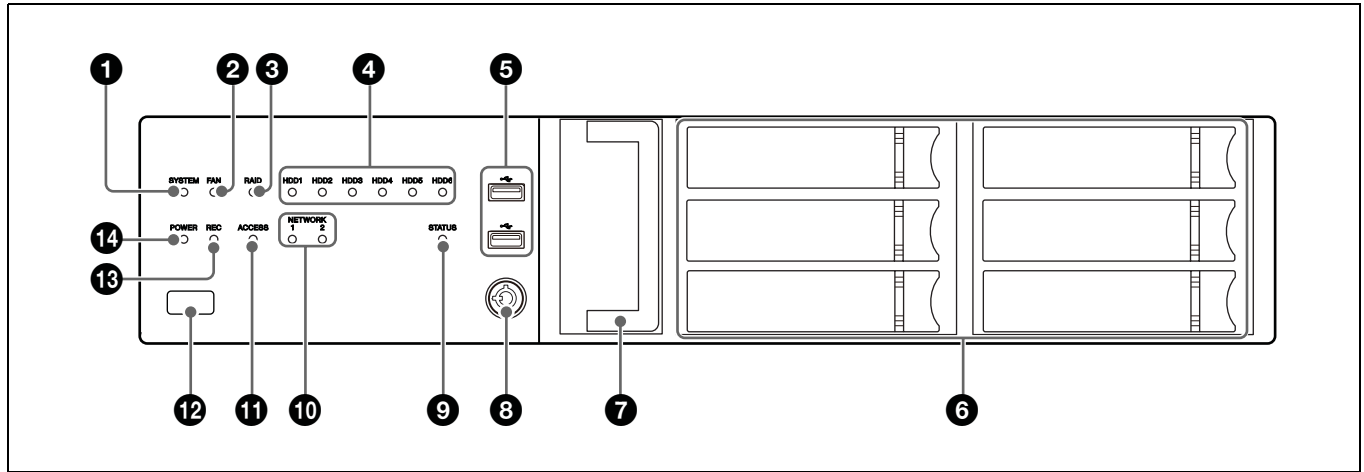

### 1 SYSTEM LED

During operation, this LED is lit green when the system is functioning normally. When a system error or other problem occurs, it lights or blinks red. If this LED lights or blinks red, contact your Sony dealer.

### 2 FAN LED

Lights green when the internal fan is functioning properly. Lights red when a fan failure occurs.

### 3 RAID LED

Lights green when the RAID configuration is functioning properly.  
Lights red if a fatal problem exists with the RAID due to an internal HDD failure, for example.  
Lights amber if the RAID is degraded or rebuilding.

### 4 HDD LEDs (1 to 6)

Light green when the internal hard disk drives are functioning properly.  
Light red when failures or other problem occurs.  
Also, light amber during the rebuilding of RAID.  
These remain unlit when HDDs are not recognized.

### 5 USB 3.0 connectors (1 and 2)

Use these connectors to connect a USB mouse, keyboard, or USB flash memory to the unit.

### 6 HDDs

For details on maintenance, contact your Sony dealer.

### 7 Fan unit

For details on maintenance, contact your Sony dealer.

### 8 Lock

Use this in conjunction with the supplied HDD cover key to lock the HDD cover. When the HDD cover is locked, you cannot remove it.

The fan unit is also locked when the HDD cover is locked.

When attaching the HDD cover, make sure the lock is the unlocked state before you attach the HDD cover. You can distinguish the locked position from the unlocked position by looking at the lock, as illustrated below.

The HDD cover is locked

The HDD cover is unlocked



### 9 STATUS LED

Indicates the operation status when using a USB flash memory device to acquire logs.

Lights green when a USB flash memory device formatted to acquire logs is recognized.

Blinks green when log acquisition starts automatically and is in progress.

Lights green again when log acquisition is successful.  
Lights red if log acquisition fails.

### Caution

Do not remove the USB flash memory device while the LED is blinking.



**10 NETWORK LEDs (1 and 2)**

Light blue when there is a link to the network.  
Blink blue when the network is being accessed.

**11 ACCESS LED**

Blinks blue when the HDDs are accessed.

**12 Power switch**

Press this to turn on the unit.  
Pressing the power switch again during this time turns off the unit.

**Caution**

Pressing and holding down the power switch (approximately 4 seconds) turns off the unit forcefully.

**13 REC LED (intended for future expansion)**

Does not function currently.

**14 POWER LED**

Lights green when the unit is turned on.

**Rear**

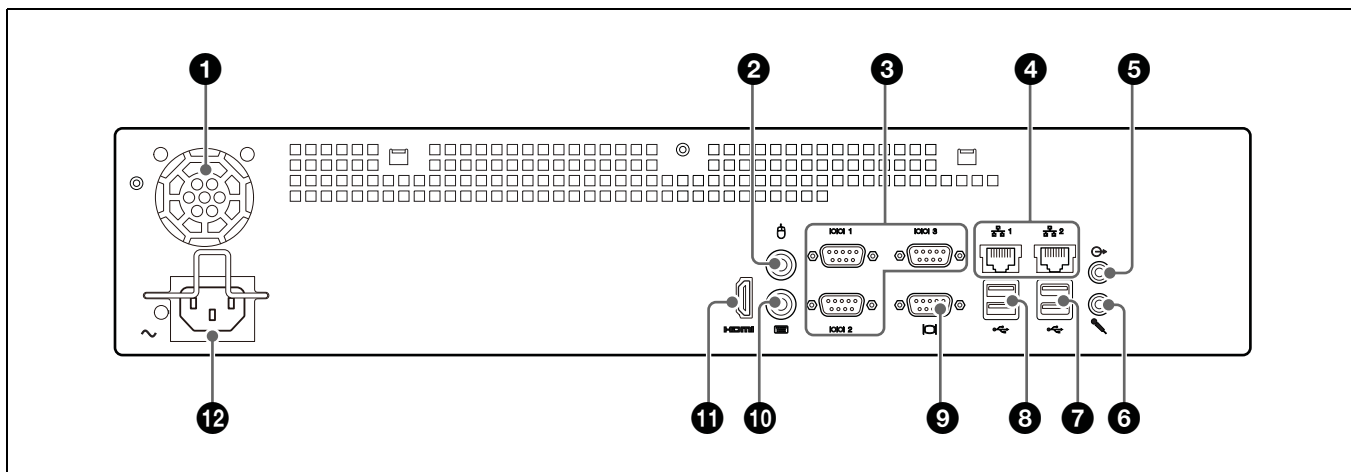

**1 Fan**

**Caution**

Take care not to obstruct the fan grille. If the grille is obstructed, heat may build up in the unit, leading to damage and/or fire.

**2 PS/2 mouse connector**

Use this connector to connect a mouse that supports PS/2.

**3 RS-232C connectors (1 to 3) (used for future expansion)**

**4 LAN connectors (1 and 2)**

Use these connectors to connect 10 Base-T, 100 Base-TX, or 1000 Base-T network cables.  
LAN1: Network cameras  
LAN2: Network cameras (LAN2 can only be used when using a different segment from LAN1.)

**Caution**

• Do not configure LAN connectors 1 and 2 to the same network segment.

• For details on using iSCSI storage, contact your Sony dealer.

**CAUTION**





• For safety, do not connect the connector for peripheral device wiring that might have excessive voltage to the following ports.  
–LAN1 connector  
–LAN2 connector  
Follow the instructions for the above ports.  
• When you connect the LAN cable of the unit to peripheral device, use a shielded-type cable to prevent malfunction due to radiation noise.

**5 AUDIO OUT (line output) connector (stereo)**

Use this connector to output audio to a peripheral audio device.

**6 AUDIO IN (microphone input) connector**

Use this connector to input audio from a peripheral audio device, such as a microphone.  
Plug-In Power microphones are supported.

- 7  **USB 3.0 connectors (1 and 2)**  
Use these connectors to connect a USB mouse, keyboard, or USB flash memory to the unit.
- 8  **USB 2.0 connectors (1 and 2)**  
Use these connectors to connect a USB mouse, keyboard, or USB flash memory to the unit.
- 9  **Monitor connector**  
Use this connector to connect a monitor that supports analog RGB input.
- 10  **PS/2 keyboard connector**  
Use this connector to connect a keyboard that supports PS/2.
- 11 **HDMI monitor connector**  
Use this connector to connect a monitor that supports HDMI input.
- 12  **Power supply connector**  
Use this connector to connect the power cord.

---

## Acquiring Reference Manuals and Technical Documents

Reference manuals and technical documents for the unit are available online.

Access the following websites via the URLs, and download the necessary manuals and documents.

- NVMS Standard Edition Administrator Manual
  - NVMS License Guide
- <https://www.sony.net/CameraSystem/NVMS/Manuals>
- NVMS Standard Edition Maintenance Guide
  - NVMS Standard Edition System Design Requirements
- <https://www.sony.net/CameraSystem/NVMS/Technical-Documents>

# System Configuration

## Single Network Video Recorder Systems

A single Network Video Recorder records camera video and audio data and delivers that data to clients. Start RAID Configuration Tool and Management Application on the unit, and configure RAID settings and recording server settings. You can install Smart Client, a client viewer, on a computer connected to the same network as the unit.

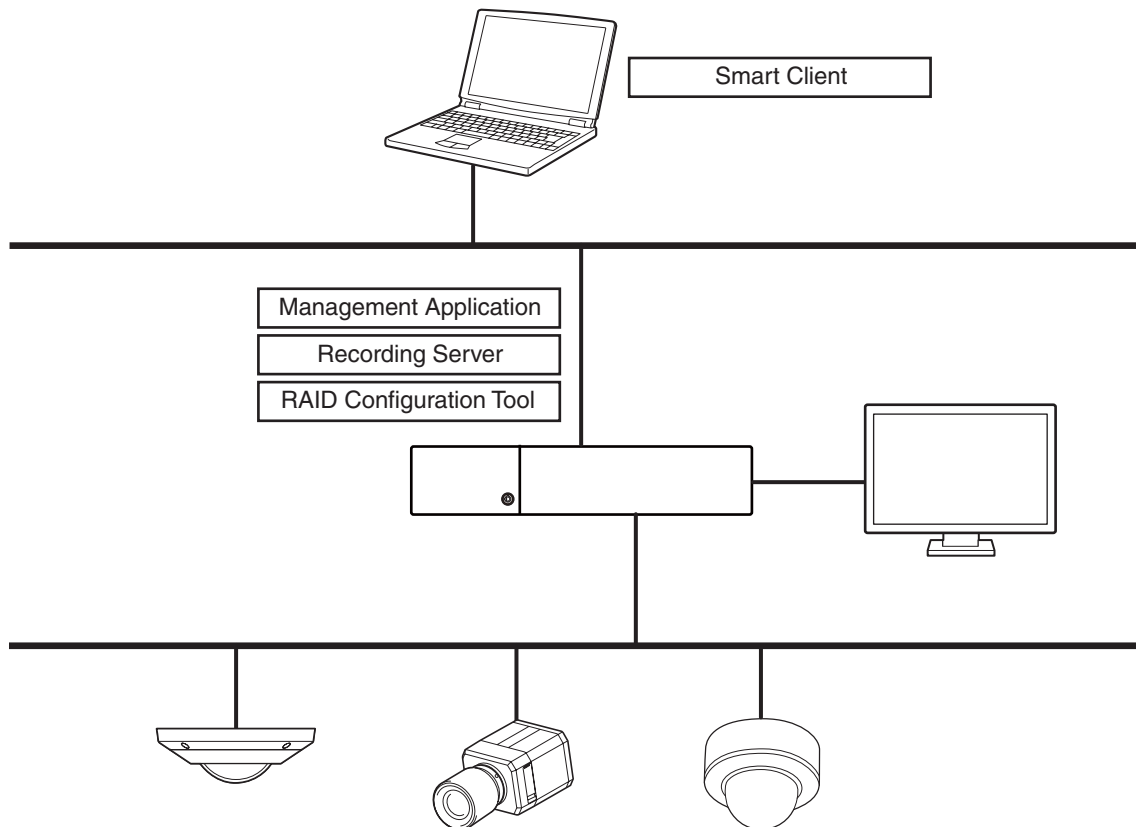

### Notes

- The recording server handles video recording, event processing, and all communication with cameras and other system devices. For details, *refer to the NVMS Standard Edition Administrator Manual*.
- In addition to the recording server, other necessary components for running the Network Video Recorder are installed on the unit. For details, *refer to the NVMS Standard Edition Administrator Manual*.

### Caution

We recommend using separate LAN connectors for connections to the client network and the camera network. However, when using a network storage device, for example, the network configuration may differ depending on the system environment.

## Multi Network Video Recorder Systems

Multiple Network Video Recorders record camera video and audio data and deliver that data to clients. In such cases, configure a single Network Video Recorder as the master unit, and connect the other Network Video Recorders to the master unit as slave units. You can install Smart Client, a client viewer, on a computer connected to the same network as the unit. When using Smart Client, connect it to the master unit.

To configure settings, start RAID Configuration Tool and Management Application on each unit, and configure RAID settings and recording server settings. In addition, licenses must be registered and activated on each unit.

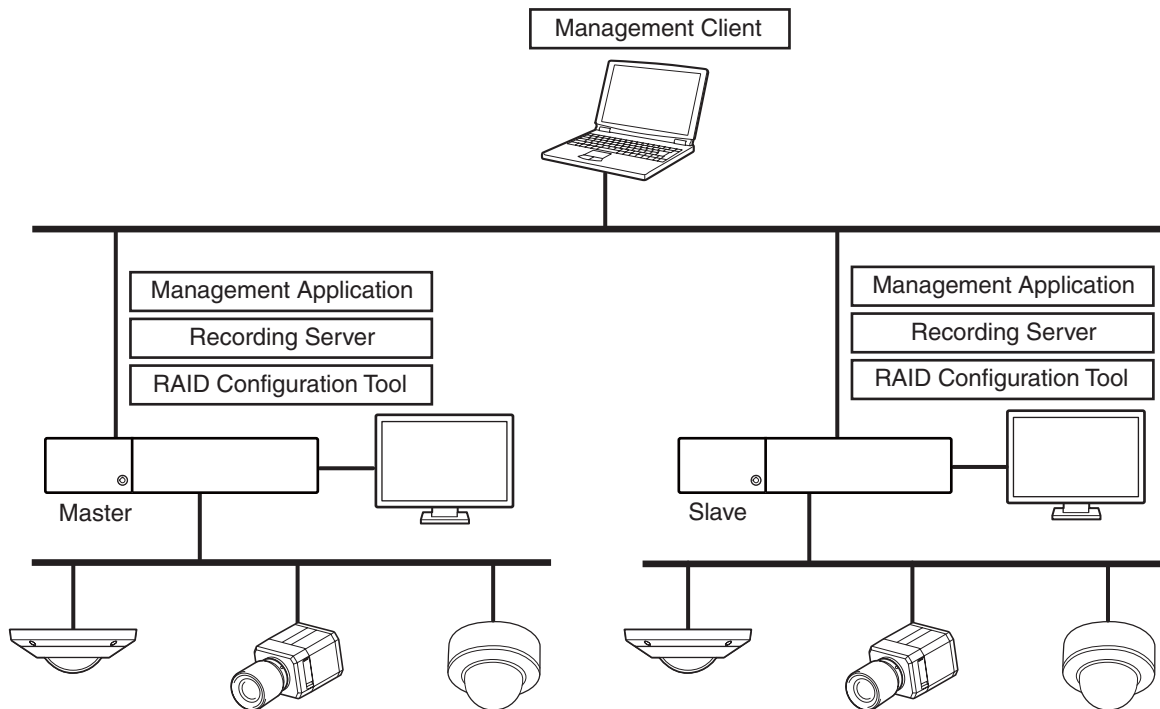

### Notes

- The recording server handles video recording, event processing, and all communication with cameras and other system devices. For details, *refer to the NVMS Standard Edition Administrator Manual*.
- In addition to the recording server, other necessary components for running the Network Video Recorder are installed on the unit. For details, *refer to the NVMS Standard Edition Administrator Manual*.

### Caution

We recommend using separate LAN connectors for connections to the client network and the camera network. However, when using a network storage device, for example, the network configuration may differ depending on the system environment.

# Preparation

Step 1: Installation (page 13)



Step 2: Installing the HDDs (page 14)



Step 3: Connections (page 16)



Step 4: System Settings (page 17)



Step 5: Verifying Operation (page 28)



Step 6: Activation (page 29)



Step 7: Data Backup (page 29)



For details on advanced settings, refer to the *NVMS Standard Edition Administrator Manual*.

# Step 1: Installation

Before setting up, be sure that the location for installation provides sufficient space and strength to support the unit. For the unit weight, see “Specifications” (page 57). The dimensions for the unit are as follows.

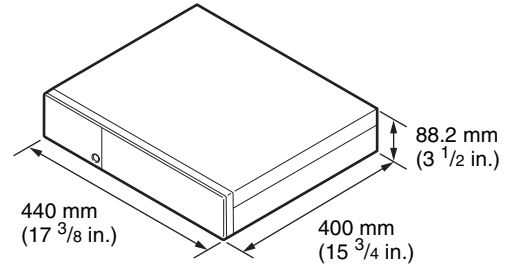

## Top

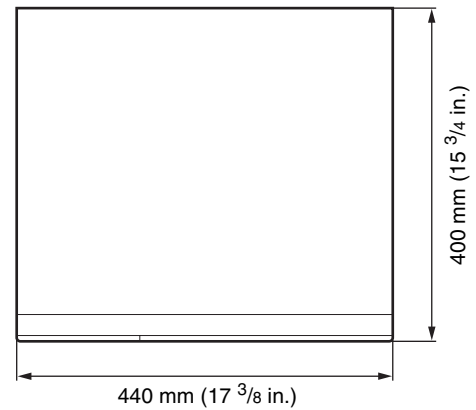

## Side

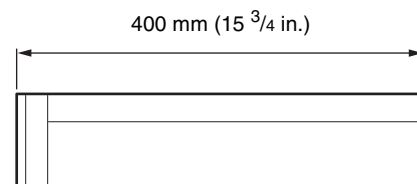

When installing the unit on a rack, use the rack mount kit designed specifically for this unit. For details on the rack mount kit, contact your Sony dealer.

## Installing without a Rack

Attach the provided rubber feet to the unit.  
Place the unit upright so that the bottom surface is visible.  
Then affix the adhesive surfaces of the rubber feet on the bottom of the unit as illustrated below.

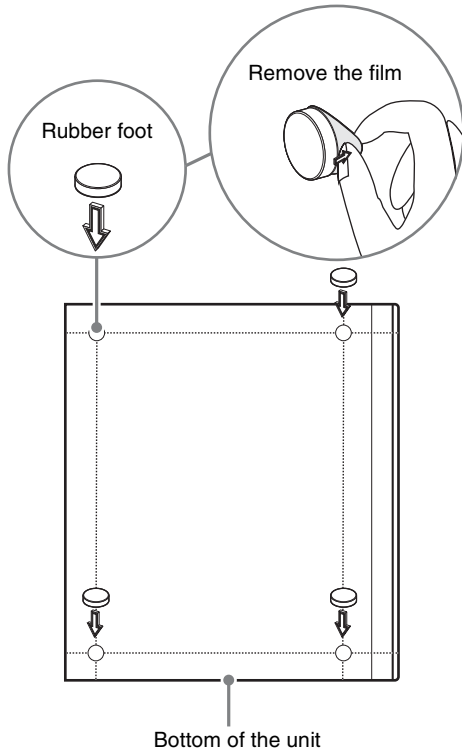

## Step 2: Installing the HDDs

### Note

The unit will not operate without an HDD installed.

- 1 Use the supplied HDD cover key to unlock the front cover, and remove the cover in the direction of the arrow.

Turn the HDD cover key 90 degrees counterclockwise.

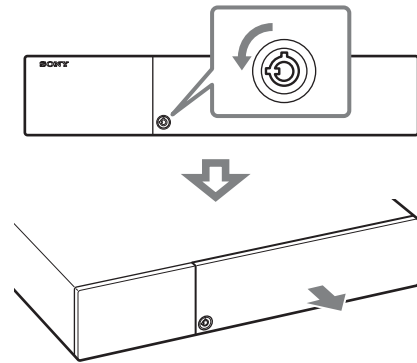

- 2 Remove the HDD lock for the slot in which the HDD will be installed.

To remove the HDD lock, push the tabs inward.

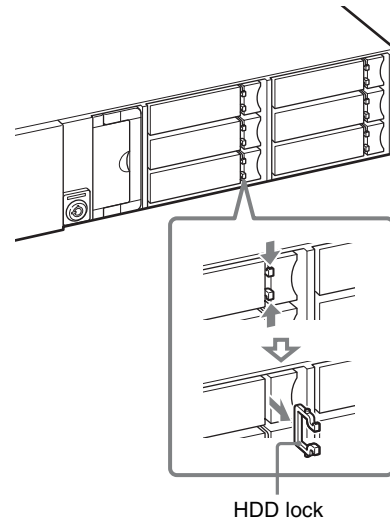

**3** Remove the tray.

To unlatch the tray cover, insert your finger in the indentation on the right and push inward.

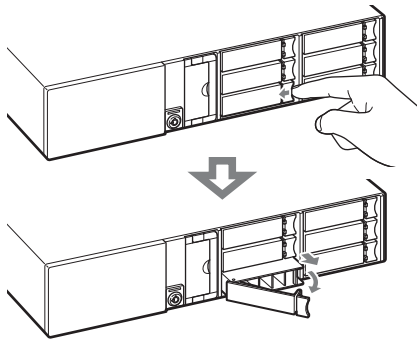

**4** Remove the dummy HDD from the tray, set the actual HDD into the tray in the direction illustrated, and secure it using the four HDD screws (+K, UNC × 5).

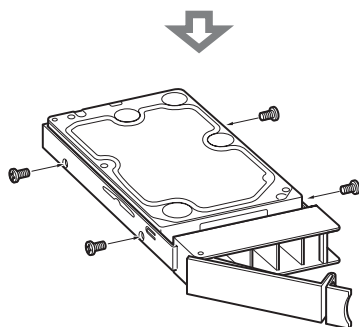
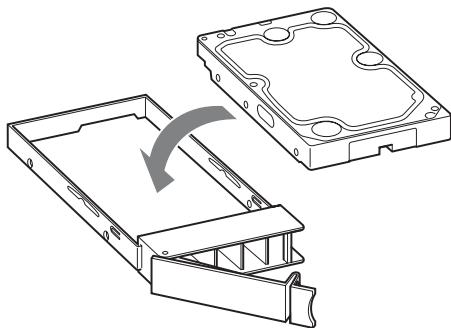
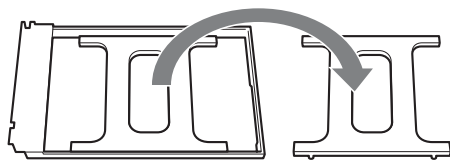

**5** Fully insert the tray in which the HDD is installed into the slot, and lock it into place.

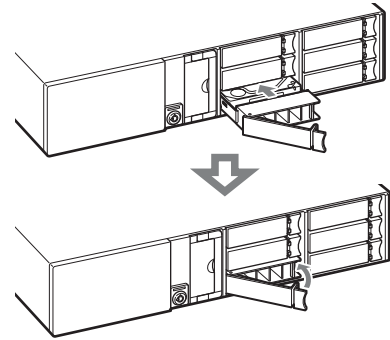

**6** Reinsert the HDD lock removed in step 2.

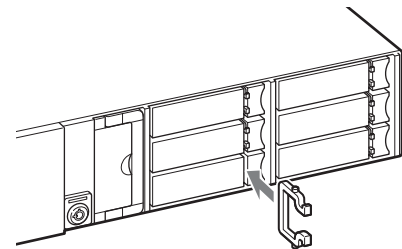

**7** Reattach the front cover, and lock it using the HDD cover key.

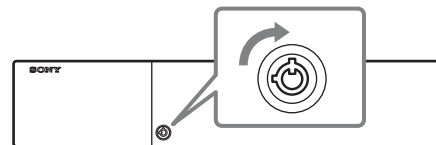

---

## Step 3: Connections

Connect each device to the unit.

---

### Connecting the Monitors

Connect the monitor to the monitor connector.

Example)

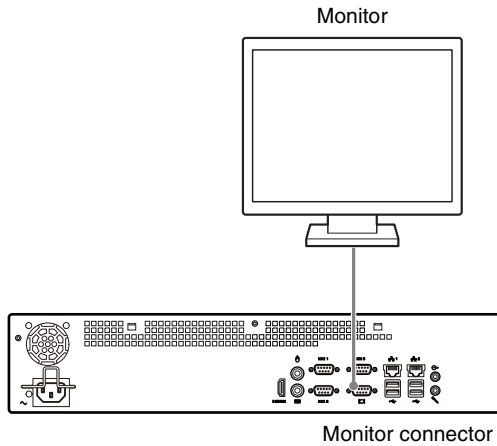

#### Caution

When monitors are connected via a monitor switch, images may not always display. We recommend connecting monitors directly to the unit.

---

### Connecting the Keyboard and Mouse

Connect the devices to the USB connectors, or the PS/2 connectors on the unit.

Example 1) USB keyboard and USB mouse

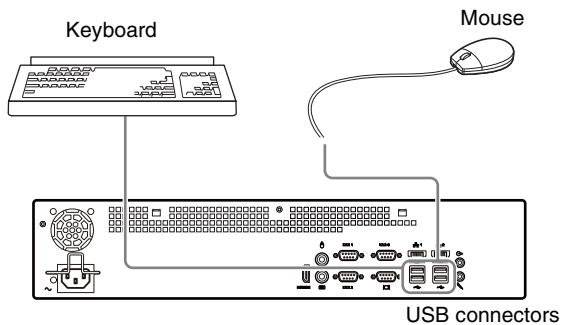

Example 2) PS/2 keyboard and PS/2 mouse

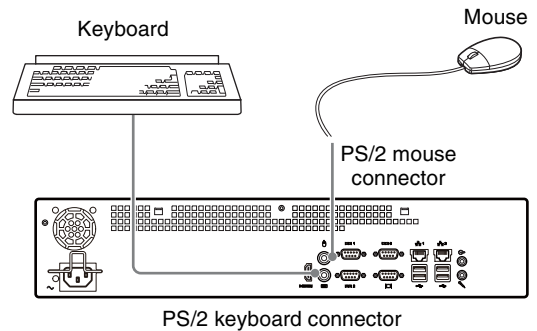

#### Note

When using USB devices, be sure to read "Precautions for using USB devices" (page 5) in the "Usage Precautions" section beforehand.

---

### Connecting the Power Cord

Connect the power cord to the power supply connector. Attach the safety clip to prevent the power cord from disconnecting.

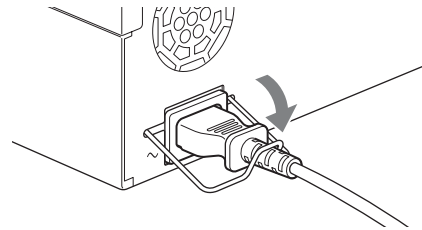

#### Caution

Before installing, carefully read the Safety Regulations (leaflet). When using the unit in combination with multiple HAW units, make sure that the power supply is sufficient.

---

### Connecting to a Network

Connect to the network as follows.



Example)

**Remote client**

Connect LAN connector 2 to the same network as the Windows PC being used as the remote client.

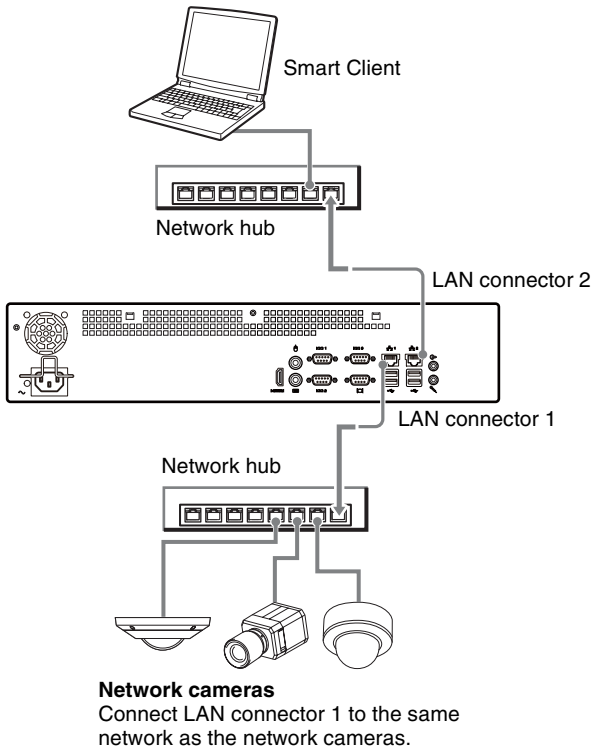

## Connecting Other Devices

### Connecting an audio output device

Connect the audio output device to the line output connector.

Example)

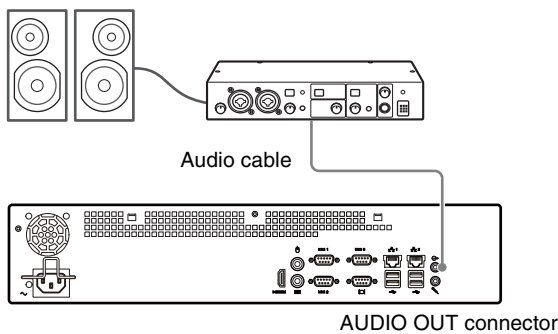

## Step 4: System Settings

This section describes how to turn on the power and the basic procedure for registering cameras and other devices.

### Registering the Software License Code (SLC) and Acquiring the License File

Acquire a software license file using the SLC found on the rear panel of the unit. For details, refer to the *NVMS License Guide*.

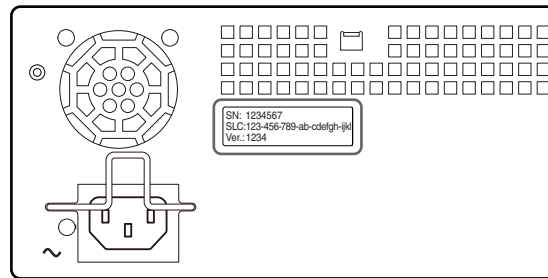

**Note**

For systems with multiple Network Video Recorders, the software license files must be acquired for each unit.

### Verifying the Software Version

Verify that the latest software is installed on the unit, and update the software if it is older.

**Note**

For systems with multiple Network Video Recorders, the same version of the software must be running on all the Network Video Recorders.

- 1 Verify the version indicated on the rear panel of the unit.

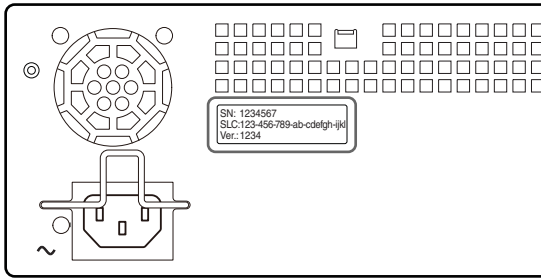

## 2 Verify the latest version.

Download the “NVMS Standard Edition Installation Image Release Note” from the following URL, and verify the software version.

<https://www.sony.net/CameraSystem/NVMS/Software>

## 3 If the version of the software installed on the unit is older, perform a clean installation of the software and acquire the license file for the latest version.

For details on clean installation, refer to the *NVMS Standard Edition Maintenance Guide*. For details on acquiring the license file for the latest version, refer to the *NVMS License Guide*.

## Adding Device Licenses

Purchase and add licenses to increase the maximum number of devices that can be registered. The additional purchased licenses must also be applied to the unit’s license. For details on applying the additional licenses, refer to the *NVMS License Guide*.

### Note

For details on purchasing additional licenses, contact your Sony dealer.

## Turning On the Unit

When you press the power switch at the bottom left of the unit’s front, the unit turns on and the POWER LED lights blue.

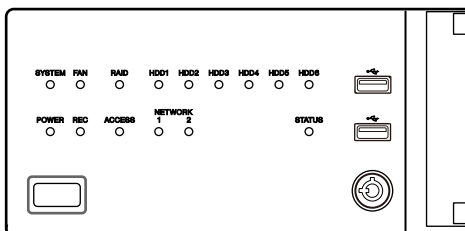

When the unit is turned on for the first time, initial setup for Windows will start. Proceed to the next section, “Initial Setup for Windows.”

## Turning off the unit

Click the Start button (  ) on the left side of the taskbar, and click [Shutdown] in the menu that appears. Alternatively, if you press the power switch, the unit will start the shutdown procedure and turn off after a few minutes.

## Initial Setup for Windows

When the following setup wizard appears after turning on the unit, perform the following.

- 1 Select the system language, and click [Next].
- 2 Select you country or region, time and currency, keyboard layout, and click [Next].
- 3 Enter the user name and computer name that will be used for login, and click [Next].
- 4 Enter the user password and password hint, and click [Next].

Enter the password twice for confirmation. Enter a word or phrase that will remind you of your password for the password hint.

### Note

You can proceed without entering the password here. In such cases, be sure to configure the password after Initial Setup for Windows is complete.

### Caution

Do not forget your password. If you forget the password you configured, you will not be able to log in or change or disable the password.

- 5 Read the software license agreement, select the [I accept...] checkboxes, and click [Next].
- 6 Configure the time zone, date, and time, and click [Next].
- 7 Specify the network you want to use.  
The desktop screen will be displayed.

## Note

This screen appears only when a network is connected to LAN connector 1 or 2.

## Changing the Keyboard Layout

If you selected Japanese in step 1 of “Initial Setup for Windows” (page 18) and want to use a 106/109 keyboard, perform the following to change the keyboard layout. If this is not necessary, proceed to the next procedure.

- 1 Double-click the computer icon on the desktop.  
Explorer appears.
- 2 Double-click [OS(C:)] - [PromiseApp] - [keyboard].
- 3 Double-click “keyboard\_106-109.bat” to start the file.
- 4 Press the Enter key.  
The Network Video Recorder will restart automatically.

## Closing the Pagefile Wizard

A page file is a file created to temporarily save the content of unused memory onto the HDD. The Pagefile wizard is a tool for adding the page file to a recording disk drive. The Pagefile wizard starts automatically when the desktop screen is displayed for the first time. A page file does not need to be created on the recording disk drive, so close this wizard.

- 1 Enter “y” via the keyboard, and press the Enter key.

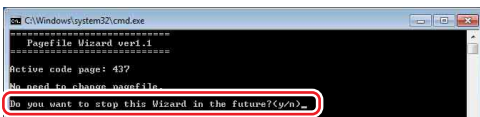

- 2 Press the Enter key.  
Pagefile wizard closes.

## Configuring the Login Password

The login password can be configured during initial setup for Windows. However, if you skipped password configuration for whatever reason, configure it as follows.

- 1 Click the Start button (  ) on the left side of the taskbar.  
The Start menu appears.
- 2 Click [Control Panel] in the Start menu.  
The control panel appears.
- 3 Click [Add or remove user accounts].

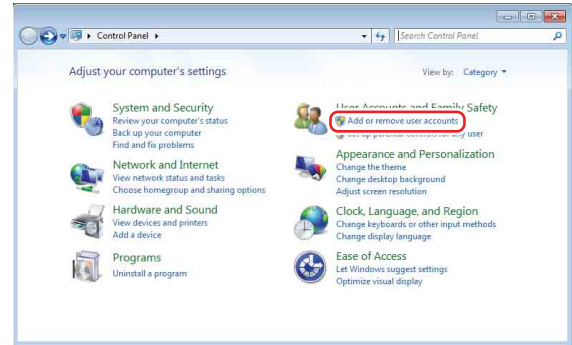

- 4 Click [Administrator].

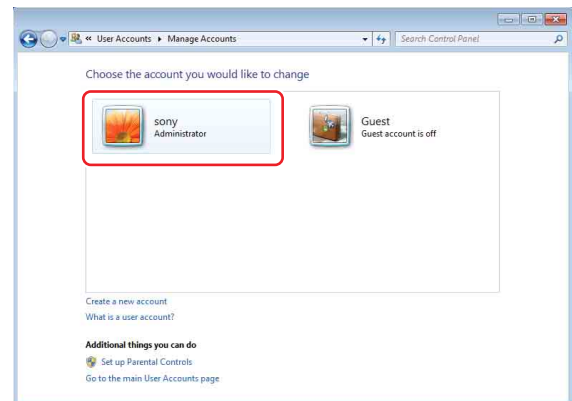

- 5 Click [Create a password].
- 6 Enter a password, and click [Create password].

Enter the password twice for confirmation.  
The password is created.

## Caution

Do not forget your password. If you forget the password you configured, you will not be able to log in or change or disable the password.

## Configuring the IP Address

- 1 Click the Start button (  ) on the left side of the taskbar.

The Start menu appears.

- 2 Click [Control Panel] in the Start menu.

The control panel appears.

- 3 Click [Network and Internet].
- 4 Click [Network and Sharing Center].
- 5 Click [Change adapter settings].

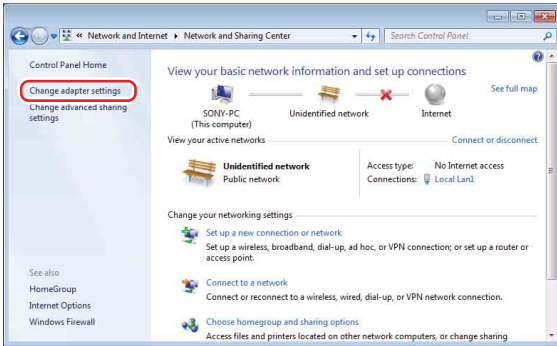

- 6 Right-click the adapter you want to configure, and click [Properties].

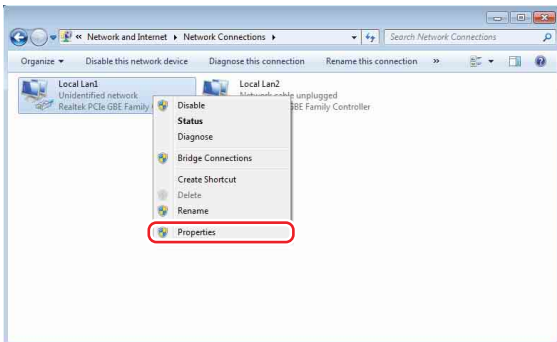

The properties dialog box appears.

- 7 Select [Internet Protocol Version 4 (TCP/IPv4)], and click [Properties].

The [Internet Protocol Version 4 (TCP/IPv4) Properties] dialog box appears.

- 8 Enter the [IP address], [Subnet mask], and [Default gateway] settings, and click [OK].

The network is configured.

## Configuring Monitor Settings

### Changing the monitor resolution

- 1 Right-click a blank area of the desktop, and click [Screen resolution].
- 2 Click the [Resolution] setting, and drag the slider that appears to select the resolution.

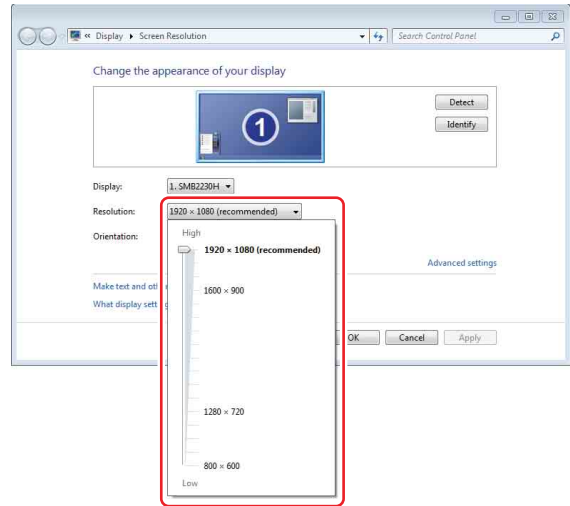

- 3 Click [OK].

The settings are applied.

### Configuring dual display settings

You can connect multiple monitors to the unit and use them as a single display. Be sure to connect the monitors beforehand.

- 1 Right-click a blank area of the desktop, and click [Screen resolution].
- 2 Click the [Multiple displays] setting, and select [Extend these displays].

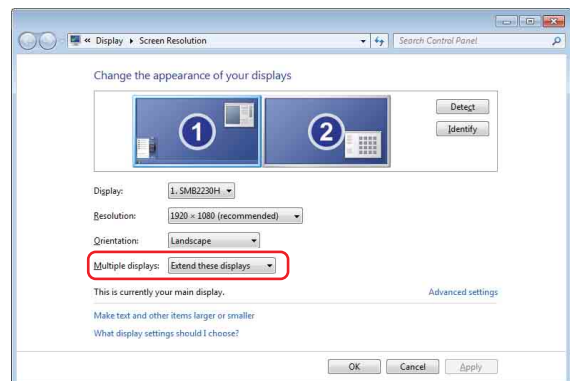

- 3 Drag the displays under [Change the appearance of your displays], and match the positions of displays 1 and 2 with the actual positions of the monitors.

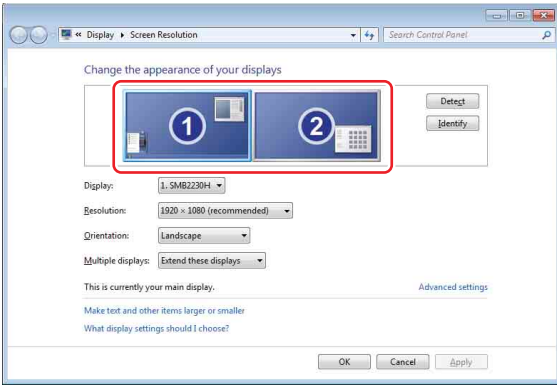

- 4 Click [OK].  
The settings are applied.

## Configuring the Recording Disk Settings

Configure a recording disk for the internal HDDs to be used as the storage destination for recorded video, archives, and exported data. To configure the recording disk, start by creating a disk array using RAID Configuration Tool. After creating the RAID array, create a simple volume.

### Caution

- This document describes settings for RAID5+ hot spare. Be sure to install at least five HDDs on the unit beforehand.
- The procedure described in this section must be performed regardless of the number of HDDs installed on the unit.
- This document describes creation of a single simple volume. The number of simple volumes will vary depending on your operating environment. For details, refer to the *NVMS Standard Edition System Design Requirements*.

## Logging into RAID Configuration Tool

- 1 Double-click the RAID Configuration Tool icon on the desktop.



- 2 Click [Ask me later].

The login screen for RAID Configuration Tool appears.

- 3 Enter the user name and password, and click [Login].

### Note

The default user name and password are as follows.  
– User Name: administrator  
– Password: password

### Caution

Be sure to change the default user name and password.

- 4 Click [Continue to this website (not recommended)].

If a RAID array has not been created, the array configuration screen will appear, regardless of whether HDDs have been installed. The home screen will appear in all other cases.

## Changing the password

- 1 Open [Home] - [Subsystems] - [localhost] - [Administrative Tools] in the RAID Configuration Tool screen's tree list, and click [User Management].

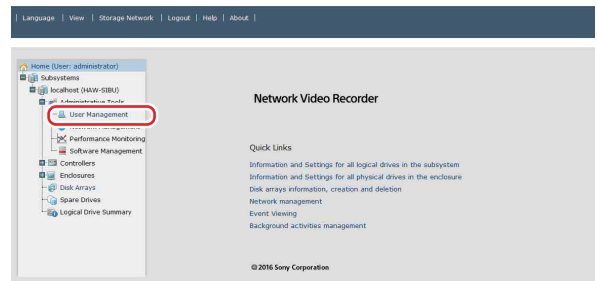

- 2 Click the [Password] tab.

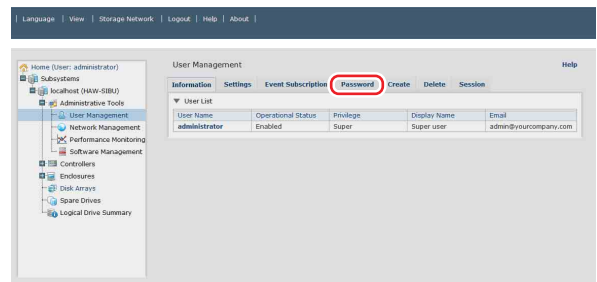

- 3 Enter a password, and click [Submit].

Enter the current password in [Old Password], and enter the new password twice.

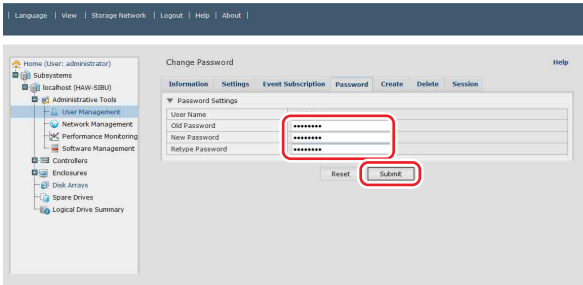

### Caution

Do not forget your password. If you forget the password you configured, you will not be able to log in or change the password.

## Creating disk arrays

- 1 Open [Home] - [Subsystems] - [localhost] in the RAID Configuration Tool screen's tree list, and click [Disk Arrays].

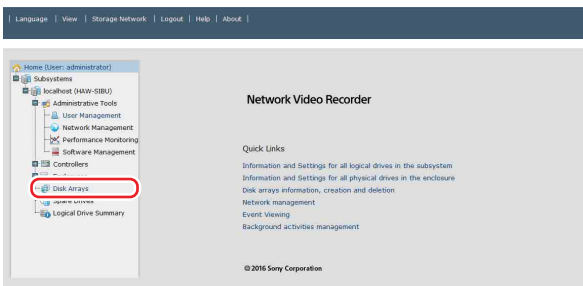

- 2 Click the [Create] tab.

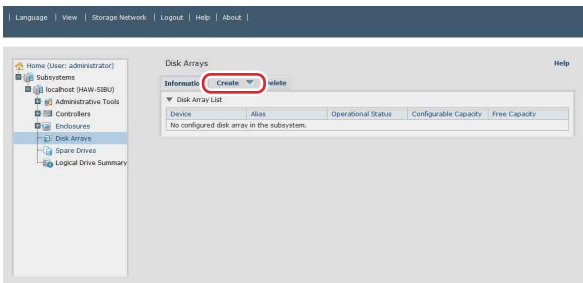

- 3 Click [Automatic Configuration], and click [Next ->].

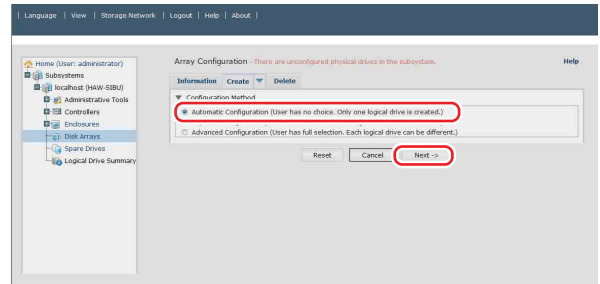

- 4 Verify that the [Number of Physical Drives] value under [Disk Array 1 - Information] is one less than the number of drives installed on the unit and that both [Disk Array 1 - Logical Drives] and [Spare Drives] include one entry (#1), and click [Submit].

If the correct information is not displayed, the HDDs may not be installed properly. Turn off the unit, and check the HDD installations.

For details, see "Step 2: Installing the HDDs" (page 14).

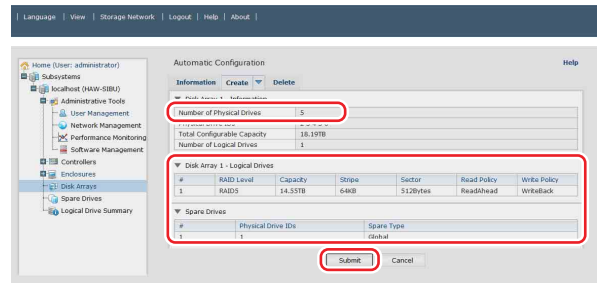

## Logging out of RAID Configuration Tool

- 1 Click [Logout] in the RAID Configuration Tool screen's menu bar.

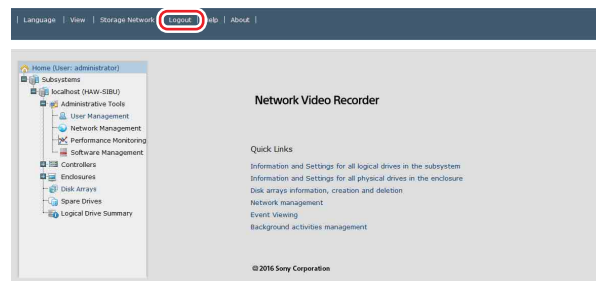

## Creating simple volumes

- 1 Right-click the [Computer] icon on the desktop, and click [Manage] in the menu that appears.

The [Computer Management] screen appears.



2 Click [Disk Management].

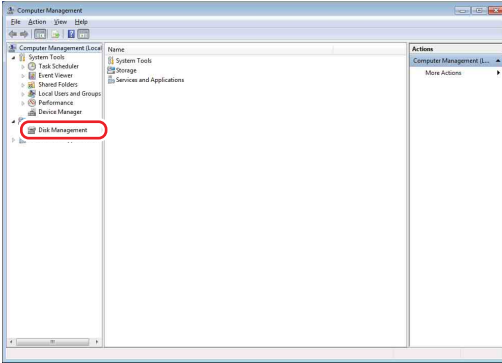

The [Initialize Disk] dialog box appears.

3 Select [GPT (GUID Partition Table)], and click [OK].

4 Right-click the “Unallocated” area of [Disk 1], and click [New Simple Volume...].

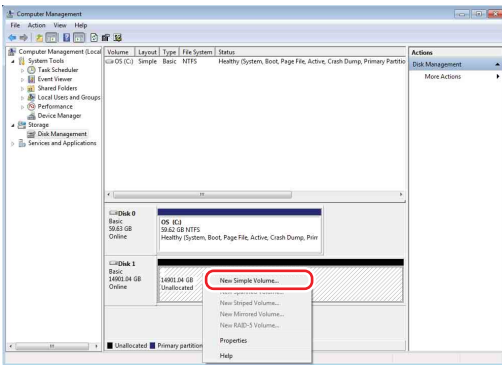

5 Click [Next].

6 Click [Next] again.

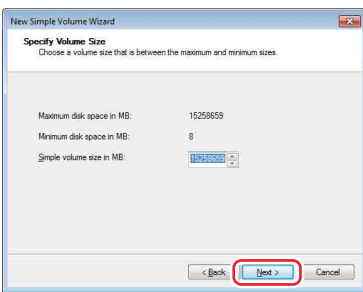

### Notes

- The [Maximum disk space in MB] value depends on the size and number of HDDs installed and the RAID settings.
- Verify that the [Simple volume size in MB] value matches the [Maximum disk space in MB] value.

7 Click [Next].

8 Change the [Allocation unit size] value to [64K], and click [Next].

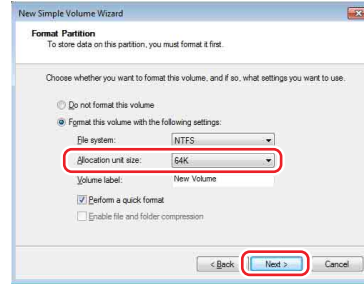

9 Click [Finish].

10 Click  to close the screen.

## Updating the Device Pack Version

Communication between network cameras and video encoders is performed via device drivers developed especially for each device and device drivers for multiple similar devices from the same manufacturer. Device drivers are installed by default during installation of the recording server. However, you can update to the latest device drivers by downloading and installing new versions of the Device Pack.

### Verifying the version of the installed Device Pack

1 Verify the latest version of Device Pack at the following URL.

<https://www.sony.net/CameraSystem/NVMS/Software>

2 Click the Start button () on the left side of the taskbar.

The Start menu appears.

3 Click [Control Panel] in the Start menu.

The control panel appears.

4 Click [Programs].

The programs screen appears.

5 Click [Programs and Features].

The programs and features screen appears.

- 6 Select the Device Pack, and verify the Device Pack product version.

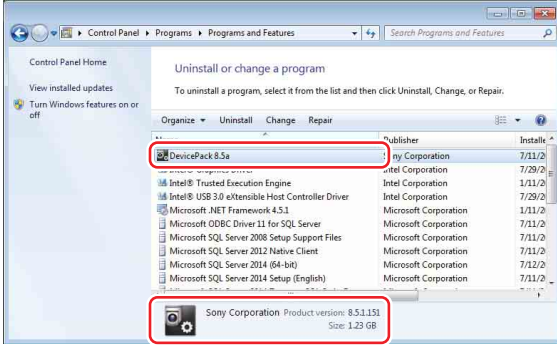

If the installed Device Pack is not the latest version, proceed to the next section, “Updating the Device Pack.”

## Updating the Device Pack

- 1 Download the latest version of Device Pack from the following URL.  
<https://www.sony.net/CameraSystem/NVMS/Software>
- 2 Copy the downloaded Device Pack to a USB flash memory device.
- 3 Connect the USB flash memory device to the unit.
- 4 Double-click the Device Pack installer, and follow the instructions on the screen to perform installation.

## Starting Management Application

- 1 Double-click the Management Application shortcut icon on the desktop.



- 2 Click [Skip].

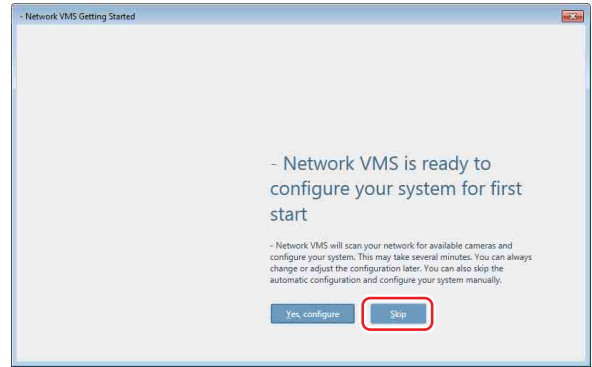

The Management Application screen appears.

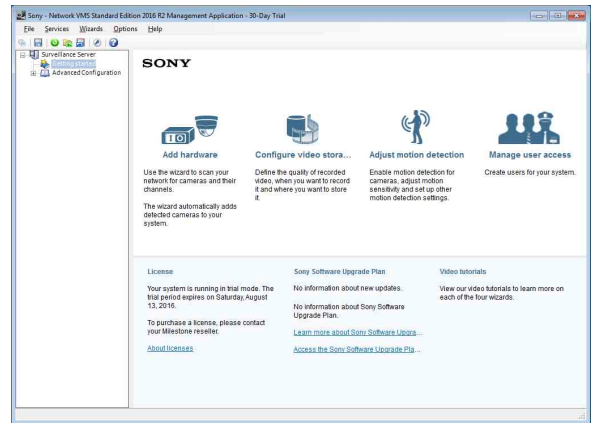

### Notes

- If the following warning appears, click [OK] and proceed to the next procedure.

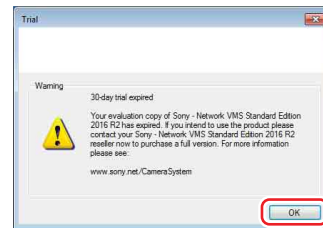

- You can change the display language of Management Client under [Options] - [Settings...] in the menu bar. For details, refer to the *NVMS Standard Edition Administrator Manual*.

## Registering License Files to the Unit

Register the license file acquired in the “Registering the Software License Code (SLC) and Acquiring the License File” procedure to the unit.

- 1 Copy the acquired license file to a USB flash memory device.



- 2 Connect the USB flash memory device to the unit.
  - 3 Click [File] - [Import License] in the Management Application screen's menu bar.
  - 4 Specify the software license file stored on the USB flash memory device, and click [Open].
  - 5 Click [OK].
  - 6 Click [OK] again.
- The license file is registered.

## Starting the Recording Server

- 1 Click on the arrow in the notification area on the taskbar.



All the system icons appear.

- 2 Right-click the recording server icon.



If the recording server icon already appears as , this procedure is complete. Proceed to the next section, "Registering Cameras."

- 3 Click [Start Recording Server Service].

The recording server icon changes to .

## Registering Cameras

Register the cameras within the network to the unit to enable configuration and operation of the cameras.

### Caution

- IP addresses must be configured for the network cameras beforehand.
- Do not assign the same IP address to multiple devices, as this will prevent proper configuration.
- The IP addresses for the network cameras must be configured using the same segment as LAN connectors 1 and 2 of the unit.

- 1 Click [Add hardware] in the Management Application screen.

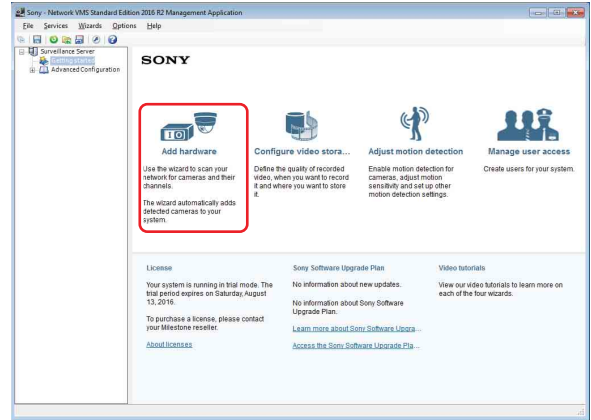

- 2 Click [Scan for hardware].
- 3 Select the [Scan local network] checkbox, and click [Next].
- 4 Click [Next].
- 5 Click [Next] again.
- 6 Click [OK].
- 7 Click [Save] at the top of the screen.

## Configuring the Recording Destinations and Retention Times

- 1 Double-click [Advanced Configuration] - [Cameras and Storage Information] in the Management Application screen.

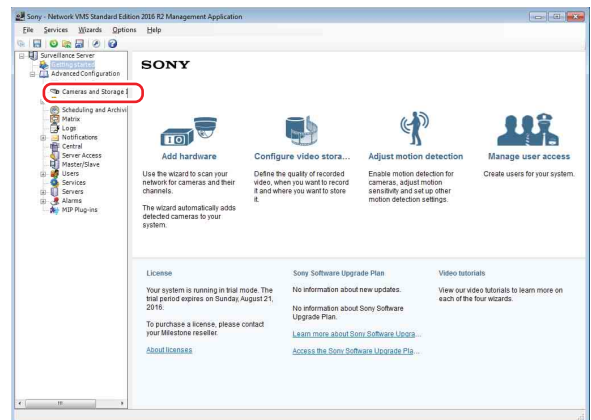

The [Recording and Storage Properties] dialog box appears.

- Enter “D:\MediaDatabase\” for [Recording Path] and [Archiving Path] in the [Recording and Archiving Paths] screen.

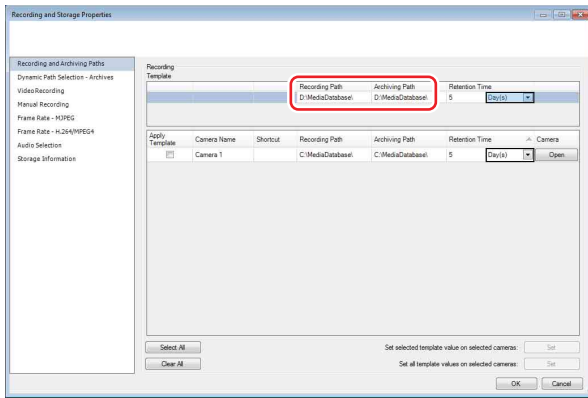

If “D:\MediaDatabase\” already appears for the [Recording Path] and [Archiving Path] values, proceed to the next step.

### Caution

The archive storage location will vary depending on your operating environment. For details, refer to the *NVMS Standard Edition System Design Requirements*.

- Configure [Retention Time].

### Note

The maximum retention time (i.e., the period for which the data will be stored) varies depending on your operating environment. For details, refer to the *NVMS Standard Edition System Design Requirements*.

- Click [Select All], and click [Set] for [Set all template values on selected cameras].

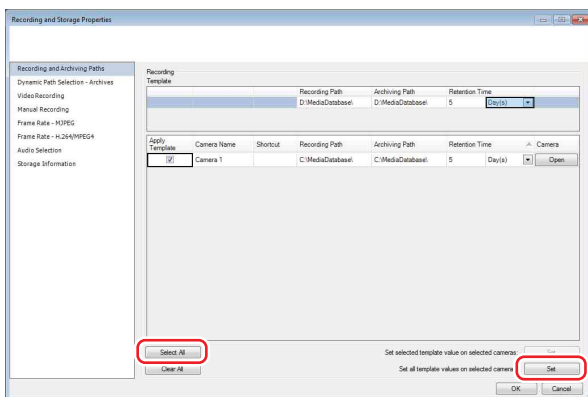

- Click [OK].

- Click [OK].

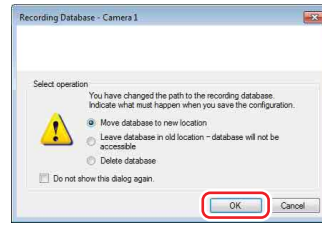

### Note

When registering multiple cameras, this dialog box appears for each camera. Selecting the [Do not show this dialog again] checkbox prevents the dialog boxes for subsequent cameras from appearing.

- Click [OK].



### Note

When registering multiple cameras, this dialog box appears for each camera. Selecting the [Do not show this dialog again] checkbox prevents the dialog boxes for subsequent cameras from appearing.

- Click [Save] at the top of the screen.

## Configuring the Archiving Interval

- Double-click [Advanced Configuration] - [Scheduling and Archiving] in the Management Application screen.

The [Scheduling and Archiving Properties] dialog box appears.

- Click [Archiving].

- Specify the time at which the data will be moved to the archive, and click [Add].

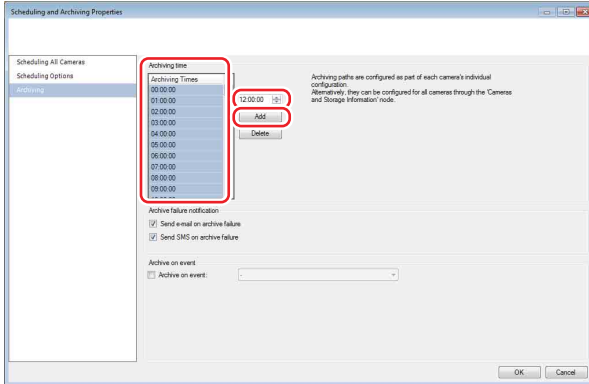

Add all the times at which you want the data moved to the archive.

For details on archiving intervals, refer to the *NVMS Standard Edition System Design Requirements*.

- Click [OK].

## Connecting Multiple Network Video Recorders

You can configure systems that include large numbers of cameras by using multiple Network Video Recorders. In such cases, configure a single Network Video Recorder as the master unit, and connect the other Network Video Recorders to the master unit as slave units. To configure a master/slave system, first configure master settings on the Network Video Recorder that will be used as the master unit, and then configure settings on the slave units.

### Caution

- Configure only one master unit within a system. If a system includes multiple master units, the slave units may not function properly.
- The master unit cannot be used as a slave unit.
- The same user name and password must be configured on all the Network Video Recorders in a master/slave system.

## Specifying the master unit

- Double-click [Advanced Configuration] - [Master/Slave] in the Management Application screen.

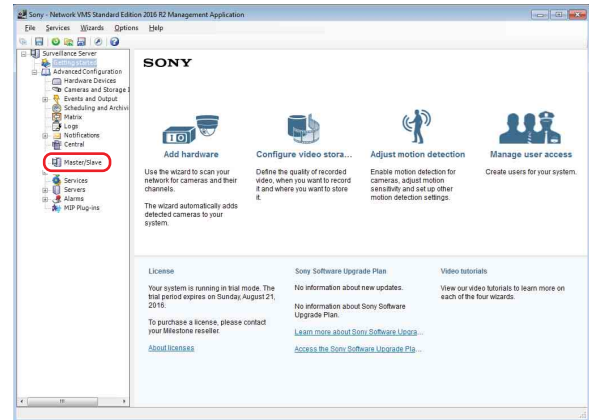

The [Master/Slave Properties] dialog box appears.

- Select the [Enable as master server] checkbox, and click [OK].

- Click [Save] at the top of the screen.

The unit is registered as the master unit.

## Registering slave units

- Double-click [Advanced Configuration] - [Master/Slave] in the Management Application screen.

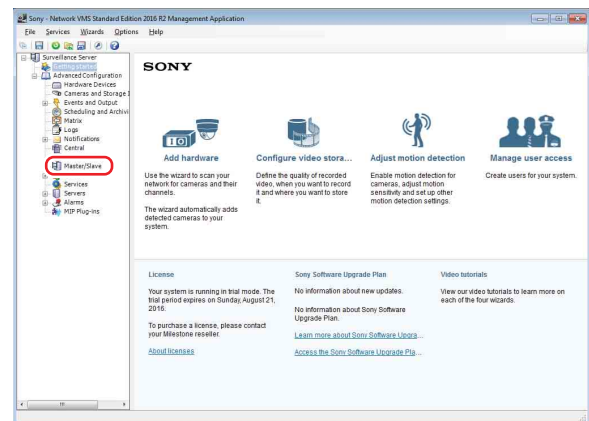

The [Master/Slave Properties] dialog box appears.

- Verify that the [Enable as master server] checkbox is selected, and click [Add].

- Enter the address and port number of the Network Video Recorder to be registered as a slave unit, and click [OK].

- Click [Save] at the top of the screen.

The Network Video Recorder you specified is registered as a slave unit.

---

## Quitting Management Application

**1** Click .

If you changed settings without saving, the [Save changes] warning screen appears.

**2** Click [Yes] to close the Management Application screen.

---

## Step 5: Verifying Operation

Install Smart Client on the computer connected to the unit to verify operation. For details on installation, *refer to the NVMS Smart Client User Manual.*

---

## Step 6: Activation

After registering cameras and configuring settings with the application, licenses must be activated.

---

### Exporting License Request Files (.lrc)

- 1 Connect a USB flash memory device to the unit.
- 2 Click [File] - [Activate License Offline] in the Management Application screen's menu bar.
- 3 Click [Export].
- 4 Select the USB flash memory device in the file saving screen, and click [Save].

The license request file is exported.

#### Caution

Before removing USB flash memory devices from the unit, be sure to right-click the target removable disk in Explorer and perform [Eject].

---

### Acquiring Activated Software License Files (.lic)

Register license request files at the Sony license site, and acquire activated software license files. For details, *refer to the NVMS License Guide*.

---

### Importing Activated Software License Files (.lic)

- 1 Copy the activated license file to a USB flash memory device.
- 2 Connect the USB flash memory device to the unit.
- 3 Click [File] - [Activate License Offline] in the Management Application screen's menu bar.
- 4 Click [Browse].
- 5 Select the authenticated software license file stored on the USB flash memory device in the file opening screen, and click [Open].
- 6 Click [Activate].

---

## Step 7: Data Backup

We recommend backing up your data so it can be restored if a hardware failure occurs, for example.

For details on backing up data, *refer to the NVMS Standard Edition Maintenance Guide*.

# Third Party Software Terms and Conditions

This product may make use of third party software for which specific terms and conditions may apply. For details, refer to the following or the "3rd\_party\_software\_terms\_and\_conditions.txt" file located in the installation folder of the monitoring system.

## Inno Setup License

Except where otherwise noted, all of the documentation and software included in the Inno Setup package is copyrighted by Jordan Russell.

Copyright (C) 1997-2015 Jordan Russell. All rights reserved.  
Portions Copyright (C) 2000-2015 Martijn Laan. All rights reserved.

This software is provided "as-is," without any express or implied warranty. In no event shall the author be held liable for any damages arising from the use of this software.

Permission is granted to anyone to use this software for any purpose, including commercial applications, and to alter and redistribute it, provided that the following conditions are met:

1. All redistributions of source code files must retain all copyright notices that are currently in place, and this list of conditions without modification.
2. All redistributions in binary form must retain all occurrences of the above copyright notice and web site addresses that are currently in place (for example, in the About boxes).
3. The origin of this software must not be misrepresented; you must not claim that you wrote the original software. If you use this software to distribute a product, an acknowledgment in the product documentation would be appreciated but is not required.
4. Modified versions in source or binary form must be plainly marked as such, and must not be misrepresented as being the original software.

Jordan Russell  
jr-2010 AT jrsoftware.org  
<http://www.jrsoftware.org/>

jQuery

Copyright jQuery Foundation and other contributors, <https://jquery.org/>

This software consists of voluntary contributions made by many individuals. For exact contribution history, see the revision history available at <https://github.com/jquery/jquery>

The following license applies to all parts of this software except as documented below:

====

Permission is hereby granted, free of charge, to any person obtaining a copy of this software and associated documentation files (the "Software"), to deal in the Software without restriction, including without limitation the rights to use, copy, modify, merge, publish, distribute, sublicense, and/or sell copies of the Software, and to permit persons to whom the Software is furnished to do so, subject to the following conditions:

The above copyright notice and this permission notice shall be included in all copies or substantial portions of the Software.

THE SOFTWARE IS PROVIDED "AS IS", WITHOUT WARRANTY OF ANY KIND, EXPRESS OR IMPLIED, INCLUDING BUT NOT LIMITED TO THE WARRANTIES OF MERCHANTABILITY, FITNESS FOR A PARTICULAR PURPOSE AND NONINFRINGEMENT. IN NO EVENT SHALL THE AUTHORS OR COPYRIGHT HOLDERS BE LIABLE FOR ANY CLAIM, DAMAGES OR OTHER LIABILITY, WHETHER IN AN ACTION OF CONTRACT, TORT OR OTHERWISE, ARISING FROM, OUT OF OR IN CONNECTION WITH THE SOFTWARE OR THE USE OR OTHER DEALINGS IN THE SOFTWARE.

====

All files located in the node\_modules and external directories are externally maintained libraries used by this software which have their own licenses; we recommend you read them, as their terms may differ from the terms above.

libxml2

Except where otherwise noted in the source code (e.g. the files hash.c, list.c and the trio files, which are covered by a similar licence but with different Copyright notices) all the files are:

Copyright (C) 1998-2012 Daniel Veillard. All Rights Reserved.

Permission is hereby granted, free of charge, to any person obtaining a copy of this software and associated documentation files (the "Software"), to deal in the Software without restriction, including without limitation the rights to use, copy, modify, merge, publish, distribute, sublicense, and/or sell copies of the Software, and to permit persons to whom the Software is furnished to do so, subject to the following conditions:

The above copyright notice and this permission notice shall be included in all copies or substantial portions of the Software.

THE SOFTWARE IS PROVIDED "AS IS", WITHOUT WARRANTY OF ANY KIND, EXPRESS OR IMPLIED, INCLUDING BUT NOT LIMITED TO THE WARRANTIES OF MERCHANTABILITY, FITNESS FOR A PARTICULAR PURPOSE AND NONINFRINGEMENT. IN NO EVENT SHALL THE AUTHORS OR COPYRIGHT HOLDERS BE LIABLE FOR ANY CLAIM, DAMAGES OR OTHER LIABILITY, WHETHER IN AN ACTION OF CONTRACT, TORT OR OTHERWISE, ARISING FROM, OUT OF OR IN CONNECTION WITH THE SOFTWARE OR THE USE OR OTHER DEALINGS IN THE SOFTWARE.

=====  
Open SLP

The following copyright and license is applicable to the entire OpenSLP project (libslp, slpd, and related documentation):

Copyright (C) 2000 Caldera Systems, Inc  
All rights reserved.

Redistribution and use in source and binary forms, with or without modification, are permitted provided that the following conditions are met:

Redistributions of source code must retain the above copyright notice, this list of conditions and the following disclaimer.

Redistributions in binary form must reproduce the above copyright notice, this list of conditions and the following disclaimer in the documentation and/or other materials provided with the distribution.

Neither the name of Caldera Systems nor the names of its contributors may be used to endorse or promote products derived from this software without specific prior written permission.

THIS SOFTWARE IS PROVIDED BY THE COPYRIGHT HOLDERS AND CONTRIBUTORS "AS IS" AND ANY EXPRESS OR IMPLIED WARRANTIES, INCLUDING, BUT NOT LIMITED TO, THE IMPLIED WARRANTIES OF MERCHANTABILITY AND FITNESS FOR A PARTICULAR PURPOSE ARE DISCLAIMED. IN NO EVENT SHALL THE CALDERA SYSTEMS OR CONTRIBUTORS BE LIABLE FOR ANY DIRECT, INDIRECT, INCIDENTAL, SPECIAL, EXEMPLARY, OR CONSEQUENTIAL DAMAGES (INCLUDING, BUT NOT LIMITED TO, PROCUREMENT OF SUBSTITUTE GOODS OR SERVICES; LOSS OF USE, DATA, OR PROFITS; OR BUSINESS INTERRUPTION) HOWEVER CAUSED AND ON ANY THEORY OF LIABILITY, WHETHER IN CONTRACT, STRICT LIABILITY, OR TORT (INCLUDING NEGLIGENCE OR OTHERWISE) ARISING IN ANY WAY OUT OF THE USE OF THIS SOFTWARE, EVEN IF ADVISED OF THE POSSIBILITY OF SUCH DAMAGE.

=====  
ICU

COPYRIGHT AND PERMISSION NOTICE

Copyright (c) 1995-2003 International Business Machines Corporation and others  
All rights reserved.

Permission is hereby granted, free of charge, to any person obtaining a copy of this software and associated documentation files (the "Software"), to deal in the Software without restriction, including without limitation the rights to use, copy, modify, merge, publish, distribute, and/or sell copies of the Software, and to permit persons to whom the Software is furnished to do so, provided that the above copyright notice(s) and this permission notice appear in all copies of the Software and that both the above copyright notice(s) and this permission notice appear in supporting documentation.

THE SOFTWARE IS PROVIDED "AS IS", WITHOUT WARRANTY OF ANY KIND, EXPRESS OR IMPLIED, INCLUDING BUT NOT LIMITED TO THE WARRANTIES OF MERCHANTABILITY, FITNESS FOR A PARTICULAR PURPOSE AND NONINFRINGEMENT OF THIRD PARTY RIGHTS. IN NO EVENT SHALL THE COPYRIGHT HOLDER OR

HOLDERS INCLUDED IN THIS NOTICE BE LIABLE FOR ANY CLAIM, OR ANY SPECIAL INDIRECT OR CONSEQUENTIAL DAMAGES, OR ANY DAMAGES WHATSOEVER RESULTING FROM LOSS OF USE, DATA OR PROFITS, WHETHER IN AN ACTION OF CONTRACT, NEGLIGENCE OR OTHER TORTIOUS ACTION, ARISING OUT OF OR IN CONNECTION WITH THE USE OR PERFORMANCE OF THIS SOFTWARE.

Except as contained in this notice, the name of a copyright holder shall not be used in advertising or otherwise to promote the sale, use or other dealings in this Software without prior written authorization of the copyright holder.

-----  
All trademarks and registered trademarks mentioned herein are the property of their respective owners.

=====

Apache License  
Version 2.0, January 2004  
<http://www.apache.org/licenses/>

## TERMS AND CONDITIONS FOR USE, REPRODUCTION, AND DISTRIBUTION

### 1. Definitions.

"License" shall mean the terms and conditions for use, reproduction, and distribution as defined by Sections 1 through 9 of this document.

"Licensor" shall mean the copyright owner or entity authorized by the copyright owner that is granting the License.

"Legal Entity" shall mean the union of the acting entity and all other entities that control, are controlled by, or are under common control with that entity. For the purposes of this definition, "control" means (i) the power, direct or indirect, to cause the direction or management of such entity, whether by contract or otherwise, or (ii) ownership of fifty percent (50%) or more of the outstanding shares, or (iii) beneficial ownership of such entity.

"You" (or "Your") shall mean an individual or Legal Entity exercising permissions granted by this License.

"Source" form shall mean the preferred form for making modifications, including but not limited to software source code, documentation source, and configuration files.

"Object" form shall mean any form resulting from mechanical transformation or translation of a Source form, including but not limited to compiled object code, generated documentation, and conversions to other media types.

"Work" shall mean the work of authorship, whether in Source or Object form, made available under the License, as indicated by a copyright notice that is included in or attached to the work (an example is provided in the Appendix below).

"Derivative Works" shall mean any work, whether in Source or Object form, that is based on (or derived from) the Work and for which the editorial revisions, annotations, elaborations, or other modifications represent, as a whole, an original work of authorship. For the purposes of this License, Derivative Works shall not include works that remain separable from, or merely link (or bind by name) to the interfaces of, the Work and Derivative Works thereof.

"Contribution" shall mean any work of authorship, including the original version of the Work and any modifications or additions to that Work or Derivative Works thereof, that is intentionally submitted to Licensor for inclusion in the Work by the copyright owner or by an individual or Legal Entity authorized to submit on behalf of the copyright owner. For the purposes of this definition, "submitted" means any form of electronic, verbal, or written communication sent to the Licensor or its representatives, including but not limited to communication on electronic mailing lists, source code control systems, and issue tracking systems that are managed by, or on behalf of, the Licensor for the purpose of discussing and improving the Work, but excluding communication that is conspicuously marked or otherwise designated in writing by the copyright owner as "Not a Contribution."

"Contributor" shall mean Licensor and any individual or Legal Entity on behalf of whom a Contribution has been received by Licensor and subsequently incorporated within the Work.

2. Grant of Copyright License. Subject to the terms and conditions of this License, each Contributor hereby grants to You a perpetual, worldwide, non-exclusive, no-charge, royalty-free, irrevocable copyright license to reproduce, prepare Derivative Works of, publicly display, publicly perform, sublicense, and distribute the Work and such Derivative Works in Source or Object form.

3. Grant of Patent License. Subject to the terms and conditions of this License, each Contributor hereby grants to You a perpetual, worldwide, non-exclusive, no-charge, royalty-free, irrevocable (except as stated in this section) patent license to make, have made, use, offer to sell, sell, import, and otherwise transfer the Work, where such license applies only to those patent claims licensable by such Contributor that are necessarily infringed by their Contribution(s) alone or by combination of their Contribution(s)

with the Work to which such Contribution(s) was submitted. If You institute patent litigation against any entity (including a cross-claim or counterclaim in a lawsuit) alleging that the Work or a Contribution incorporated within the Work constitutes direct or contributory patent infringement, then any patent licenses granted to You under this License for that Work shall terminate as of the date such litigation is filed.

4. Redistribution. You may reproduce and distribute copies of the Work or Derivative Works thereof in any medium, with or without modifications, and in Source or Object form, provided that You meet the following conditions:

(a) You must give any other recipients of the Work or Derivative Works a copy of this License; and

(b) You must cause any modified files to carry prominent notices stating that You changed the files; and

(c) You must retain, in the Source form of any Derivative Works that You distribute, all copyright, patent, trademark, and attribution notices from the Source form of the Work, excluding those notices that do not pertain to any part of the Derivative Works; and

(d) If the Work includes a "NOTICE" text file as part of its distribution, then any Derivative Works that You distribute must include a readable copy of the attribution notices contained within such NOTICE file, excluding those notices that do not pertain to any part of the Derivative Works, in at least one of the following places: within a NOTICE text file distributed as part of the Derivative Works; within the Source form or documentation, if provided along with the Derivative Works; or, within a display generated by the Derivative Works, if and wherever such third-party notices normally appear. The contents of the NOTICE file are for informational purposes only and do not modify the License. You may add Your own attribution notices within Derivative Works that You distribute, alongside or as an addendum to the NOTICE text from the Work, provided that such additional attribution notices cannot be construed as modifying the License.

You may add Your own copyright statement to Your modifications and may provide additional or different license terms and conditions for use, reproduction, or distribution of Your modifications, or for any such Derivative Works as a whole, provided Your use, reproduction, and distribution of the Work otherwise complies with the conditions stated in this License.

5. Submission of Contributions. Unless You explicitly state otherwise, any Contribution intentionally submitted for inclusion in the Work by You to the Licensor shall be under the terms and conditions of this License, without any additional terms or conditions. Notwithstanding the above, nothing herein shall supersede or modify the terms of any separate license agreement you may have executed with Licensor regarding such Contributions.

6. Trademarks. This License does not grant permission to use the trade names, trademarks, service marks, or product names of the Licensor, except as required for reasonable and customary use in describing the origin of the Work and reproducing the content of the NOTICE file.

7. Disclaimer of Warranty. Unless required by applicable law or agreed to in writing, Licensor provides the Work (and each Contributor provides its Contributions) on an "AS IS" BASIS, WITHOUT WARRANTIES OR CONDITIONS OF ANY KIND, either express or implied, including, without limitation, any warranties or conditions of TITLE, NON-INFRINGEMENT, MERCHANTABILITY, or FITNESS FOR A PARTICULAR PURPOSE. You are solely responsible for determining the appropriateness of using or redistributing the Work and assume any risks associated with Your exercise of permissions under this License.

8. Limitation of Liability. In no event and under no legal theory, whether in tort (including negligence), contract, or otherwise, unless required by applicable law (such as deliberate and grossly negligent acts) or agreed to in writing, shall any Contributor be liable to You for damages, including any direct, indirect, special, incidental, or consequential damages of any character arising as a result of this License or out of the use or inability to use the Work (including but not limited to damages for loss of goodwill, work stoppage, computer failure or malfunction, or any and all other commercial damages or losses), even if such Contributor has been advised of the possibility of such damages.

9. Accepting Warranty or Additional Liability. While redistributing the Work or Derivative Works thereof, You may choose to offer, and charge a fee for, acceptance of support, warranty, indemnity, or other liability obligations and/or rights consistent with this License. However, in accepting such obligations, You may act on Your own behalf and on Your sole responsibility, not on behalf of any other Contributor, and only if You agree to indemnify, defend, and hold each Contributor harmless for any liability incurred by, or claims asserted against, such Contributor by reason of your accepting any such warranty or additional liability.

END OF TERMS AND CONDITIONS

APPENDIX: How to apply the Apache License to your work.

To apply the Apache License to your work, attach the following boilerplate notice, with the fields enclosed by brackets "[ ]" replaced with your own identifying information. (Don't include the brackets!) The text should be enclosed in the appropriate comment syntax for the file format. We also recommend that a file or class name and description of purpose be included on the same "printed page" as the copyright notice for easier identification within third-party archives.

Copyright [yyyy] [name of copyright owner]

Licensed under the Apache License, Version 2.0 (the "License"); you may not use this file except in compliance with the License. You may obtain a copy of the License at

<http://www.apache.org/licenses/LICENSE-2.0>

Unless required by applicable law or agreed to in writing, software distributed under the License is distributed on an "AS IS" BASIS, WITHOUT WARRANTIES OR CONDITIONS OF ANY KIND, either express or implied. See the License for the specific language governing permissions and limitations under the License.

#### APACHE HTTP SERVER SUBCOMPONENTS:

The Apache HTTP Server includes a number of subcomponents with separate copyright notices and license terms. Your use of the source code for these subcomponents is subject to the terms and conditions of the following licenses.

For the mod\_mime\_magic component:

```
/*
 * mod_mime_magic: MIME type lookup via file magic numbers
 * Copyright (c) 1996-1997 Cisco Systems, Inc.
 *
 * This software was submitted by Cisco Systems to the Apache Group in July
 * 1997. Future revisions and derivatives of this source code must
 * acknowledge Cisco Systems as the original contributor of this module.
 * All other licensing and usage conditions are those of the Apache Group.
 *
 * Some of this code is derived from the free version of the file command
 * originally posted to comp.sources.unix. Copyright info for that program
 * is included below as required.
 * -----
 * - Copyright (c) Ian F. Darwin, 1987. Written by Ian F. Darwin.
 *
 * This software is not subject to any license of the American Telephone and
 * Telegraph Company or of the Regents of the University of California.
 *
 * Permission is granted to anyone to use this software for any purpose on any
 * computer system, and to alter it and redistribute it freely, subject to
 * the following restrictions:
 *
 * 1. The author is not responsible for the consequences of use of this
 * software, no matter how awful, even if they arise from flaws in it.
 *
 * 2. The origin of this software must not be misrepresented, either by
 * explicit claim or by omission. Since few users ever read sources, credits
 * must appear in the documentation.
 *
 * 3. Altered versions must be plainly marked as such, and must not be
 * misrepresented as being the original software. Since few users ever read
 * sources, credits must appear in the documentation.
 *
 * 4. This notice may not be removed or altered.
 * -----
 */
```

For the modules/mappers/mod\_imagemap.c component:

"macmartinized" polygon code copyright 1992 by Eric Haines, erich@eye.com

For the server/util\_md5.c component:

```
/*
 * NCSA HTTPd Server
 * Software Development Group
 * National Center for Supercomputing Applications
 * University of Illinois at Urbana-Champaign
 * 605 E. Springfield, Champaign, IL 61820
 * http://ncsa.uiuc.edu
 *
 * Copyright (C) 1995, Board of Trustees of the University of Illinois
 *
 * -----
 * md5.c: NCSA HTTPd code which uses the md5c.c RSA Code
 *
 * Original Code Copyright (C) 1994, Jeff Hostetler, Spyglass, Inc.
 * Portions of Content-MD5 code Copyright (C) 1993, 1994 by Carnegie Mellon
 * University (see Copyright below).
 * Portions of Content-MD5 code Copyright (C) 1991 Bell Communications
 * Research, Inc. (Bellcore) (see Copyright below).
 * Portions extracted from mpack, John G. Myers - jgm+@cmu.edu
 */
```

\* Content-MD5 Code contributed by Martin Hamilton (martin@net.lut.ac.uk)

```
*/
/*
 * these portions extracted from mpack, John G. Myers - jgm+@cmu.edu */
/* (C) Copyright 1993,1994 by Carnegie Mellon University
 * All Rights Reserved.
 */
```

```
* Permission to use, copy, modify, distribute, and sell this software
 * and its documentation for any purpose is hereby granted without
 * fee, provided that the above copyright notice appear in all copies
 * and that both that copyright notice and this permission notice
 * appear in supporting documentation, and that the name of Carnegie
 * Mellon University not be used in advertising or publicity
 * pertaining to distribution of the software without specific,
 * written prior permission. Carnegie Mellon University makes no
 * representations about the suitability of this software for any
 * purpose. It is provided "as is" without express or implied
 * warranty.
```

```
* CARNEGIE MELLON UNIVERSITY DISCLAIMS ALL WARRANTIES WITH REGARD TO
 * THIS SOFTWARE, INCLUDING ALL IMPLIED WARRANTIES OF MERCHANTABILITY
 * AND FITNESS, IN NO EVENT SHALL CARNEGIE MELLON UNIVERSITY BE LIABLE
 * FOR ANY SPECIAL, INDIRECT OR CONSEQUENTIAL DAMAGES OR ANY DAMAGES
 * WHATSOEVER RESULTING FROM LOSS OF USE, DATA OR PROFITS, WHETHER IN
 * AN ACTION OF CONTRACT, NEGLIGENCE OR OTHER TORTIOUS ACTION, ARISING
 * OUT OF OR IN CONNECTION WITH THE USE OR PERFORMANCE OF THIS
 * SOFTWARE.
*/
```

```
/*
 * Copyright (c) 1991 Bell Communications Research, Inc. (Bellcore)
 */
```

```
* Permission to use, copy, modify, and distribute this material
 * for any purpose and without fee is hereby granted, provided
 * that the above copyright notice and this permission notice
 * appear in all copies, and that the name of Bellcore not be
 * used in advertising or publicity pertaining to this
 * material without the specific, prior written permission
 * of an authorized representative of Bellcore. BELLCORE
 * MAKES NO REPRESENTATIONS ABOUT THE ACCURACY OR SUITABILITY
 * OF THIS MATERIAL FOR ANY PURPOSE. IT IS PROVIDED "AS IS",
 * WITHOUT ANY EXPRESS OR IMPLIED WARRANTIES.
*/
```

For the srclib/apr/include/apr\_md5.h component:

```
/*
 * This is work is derived from material Copyright RSA Data Security, Inc.
 *
 * The RSA copyright statement and Licence for that original material is
 * included below. This is followed by the Apache copyright statement and
 * licence for the modifications made to that material.
*/
```

```
/* Copyright (C) 1991-2, RSA Data Security, Inc. Created 1991. All
rights reserved.
```

License to copy and use this software is granted provided that it is identified as the "RSA Data Security, Inc. MD5 Message-Digest Algorithm" in all material mentioning or referencing this software or this function.

License is also granted to make and use derivative works provided that such works are identified as "derived from the RSA Data Security, Inc. MD5 Message-Digest Algorithm" in all material mentioning or referencing the derived work.

RSA Data Security, Inc. makes no representations concerning either the merchantability of this software or the suitability of this software for any particular purpose. It is provided "as is" without express or implied warranty of any kind.

These notices must be retained in any copies of any part of this documentation and/or software.

For the srclib/apr/passwd/apr\_md5.c component:

```
/*
 * This is work is derived from material Copyright RSA Data Security, Inc.
 *
 * The RSA copyright statement and Licence for that original material is
 * included below. This is followed by the Apache copyright statement and
 * licence for the modifications made to that material.
*/
```

```
/* MD5C.C - RSA Data Security, Inc., MD5 message-digest algorithm
*/
```

```
/* Copyright (C) 1991-2, RSA Data Security, Inc. Created 1991. All
rights reserved.
```

License to copy and use this software is granted provided that it is identified as the "RSA Data Security, Inc. MD5 Message-Digest Algorithm" in all material mentioning or referencing this software or this function.

License is also granted to make and use derivative works provided



that such works are identified as "derived from the RSA Data Security, Inc. MD5 Message-Digest Algorithm" in all material mentioning or referencing the derived work.

RSA Data Security, Inc. makes no representations concerning either the merchantability of this software or the suitability of this software for any particular purpose. It is provided "as is" without express or implied warranty of any kind.

These notices must be retained in any copies of any part of this documentation and/or software.

```
*/
/*
 * The apr_md5_encode() routine uses much code obtained from the FreeBSD 3.0
 * MD5 crypt() function, which is licenced as follows:
 * -----
 * "THE BEER-WARE LICENSE" (Revision 42):
 * <phk@login.dknet.dk> wrote this file. As long as you retain this notice you
 * can do whatever you want with this stuff. If we meet some day, and you think
 * this stuff is worth it, you can buy me a beer in return. Poul-Henning Kamp
 * -----
 */
```

For the `src/lib/apr-util/crypt/apr_md4.c` component:

```
* This is derived from material copyright RSA Data Security, Inc.
* Their notice is reproduced below in its entirety.
*
* Copyright (C) 1991-2, RSA Data Security, Inc. Created 1991. All
* rights reserved.
*
* License to copy and use this software is granted provided that it
* is identified as the "RSA Data Security, Inc. MD4 Message-Digest
* Algorithm" in all material mentioning or referencing this software
* or this function.
*
* License is also granted to make and use derivative works provided
* that such works are identified as "derived from the RSA Data
* Security, Inc. MD4 Message-Digest Algorithm" in all material
* mentioning or referencing the derived work.
*
* RSA Data Security, Inc. makes no representations concerning either
* the merchantability of this software or the suitability of this
* software for any particular purpose. It is provided "as is"
* without express or implied warranty of any kind.
*
* These notices must be retained in any copies of any part of this
* documentation and/or software.
*/
```

For the `src/lib/apr-util/include/apr_md4.h` component:

```
*
* This is derived from material copyright RSA Data Security, Inc.
* Their notice is reproduced below in its entirety.
*
* Copyright (C) 1991-2, RSA Data Security, Inc. Created 1991. All
* rights reserved.
*
* License to copy and use this software is granted provided that it
* is identified as the "RSA Data Security, Inc. MD4 Message-Digest
* Algorithm" in all material mentioning or referencing this software
* or this function.
*
* License is also granted to make and use derivative works provided
* that such works are identified as "derived from the RSA Data
* Security, Inc. MD4 Message-Digest Algorithm" in all material
* mentioning or referencing the derived work.
*
* RSA Data Security, Inc. makes no representations concerning either
* the merchantability of this software or the suitability of this
* software for any particular purpose. It is provided "as is"
* without express or implied warranty of any kind.
*
* These notices must be retained in any copies of any part of this
* documentation and/or software.
*/
```

For the `src/lib/apr-util/test/testmd4.c` component:

```
*
* This is derived from material copyright RSA Data Security, Inc.
* Their notice is reproduced below in its entirety.
*
* Copyright (C) 1990-2, RSA Data Security, Inc. Created 1990. All
* rights reserved.
*
* RSA Data Security, Inc. makes no representations concerning either
* the merchantability of this software or the suitability of this
* software for any particular purpose. It is provided "as is"
* without express or implied warranty of any kind.
*
* These notices must be retained in any copies of any part of this
* documentation and/or software.
*/
```

For the `src/lib/apr-util/xml/expat/conf/tools/install-sh` component:

```
#
# install - install a program, script, or datafile
# This comes from X11R5 (mit/util/scripts/install.sh).
#
# Copyright 1991 by the Massachusetts Institute of Technology
#
# Permission to use, copy, modify, distribute, and sell this software and its
# documentation for any purpose is hereby granted without fee, provided that
# the above copyright notice appear in all copies and that both that
# copyright notice and this permission notice appear in supporting
# documentation, and that the name of M.I.T. not be used in advertising or
# publicity pertaining to distribution of the software without specific,
# written prior permission. M.I.T. makes no representations about the
# suitability of this software for any purpose. It is provided "as is"
# without express or implied warranty.
#
```

For the test/vb.c component:

```
/* ZeusBench V1.01
=====
```

This program is Copyright (C) Zeus Technology Limited 1996.

This program may be used and copied freely providing this copyright notice is not removed.

This software is provided "as is" and any express or implied warranties, including but not limited to, the implied warranties of merchantability and fitness for a particular purpose are disclaimed. In no event shall Zeus Technology Ltd. be liable for any direct, indirect, incidental, special, exemplary, or consequential damages (including, but not limited to, procurement of substitute good or services; loss of use, data, or profits; or business interruption) however caused and on theory of liability. Whether in contract, strict liability or tort (including negligence or otherwise) arising in any way out of the use of this software, even if advised of the possibility of such damage.

Written by Adam Twiss (adam@zeus.co.uk). March 1996

Thanks to the following people for their input:  
Mike Belshe (mbelshe@netscape.com)  
Michael Campanella (campanella@stevms.enet.dec.com)

```
*/
```

For the `expat xml parser` component:

Copyright (c) 1998, 1999, 2000 Thai Open Source Software Center Ltd and Clark Cooper

Permission is hereby granted, free of charge, to any person obtaining a copy of this software and associated documentation files (the "Software"), to deal in the Software without restriction, including without limitation the rights to use, copy, modify, merge, publish, distribute, sublicense, and/or sell copies of the Software, and to permit persons to whom the Software is furnished to do so, subject to the following conditions:

The above copyright notice and this permission notice shall be included in all copies or substantial portions of the Software.

THE SOFTWARE IS PROVIDED "AS IS", WITHOUT WARRANTY OF ANY KIND, EXPRESS OR IMPLIED, INCLUDING BUT NOT LIMITED TO THE WARRANTIES OF MERCHANTABILITY, FITNESS FOR A PARTICULAR PURPOSE AND NONINFRINGEMENT. IN NO EVENT SHALL THE AUTHORS OR COPYRIGHT HOLDERS BE LIABLE FOR ANY CLAIM, DAMAGES OR OTHER LIABILITY, WHETHER IN AN ACTION OF CONTRACT, TORT OR OTHERWISE, ARISING FROM, OUT OF OR IN CONNECTION WITH THE SOFTWARE OR THE USE OR OTHER DEALINGS IN THE SOFTWARE.

```
=====  
php
```

```
-----  
The PHP License, version 3.01  
Copyright (c) 1999 - 2015 The PHP Group. All rights reserved.  
-----
```

Redistribution and use in source and binary forms, with or without modification, is permitted provided that the following conditions are met:

1. Redistributions of source code must retain the above copyright notice, this list of conditions and the following disclaimer.
2. Redistributions in binary form must reproduce the above copyright notice, this list of conditions and the following disclaimer in the documentation and/or other materials provided with the distribution.
3. The name "PHP" must not be used to endorse or promote products derived from this software without prior written permission. For written permission, please contact group@php.net.
4. Products derived from this software may not be called "PHP", nor may "PHP" appear in their name, without prior written permission from group@php.net. You may indicate that your software works in conjunction with PHP by saying "Foo for PHP" instead of calling

it "PHP Foo" or "phpfoo"

5. The PHP Group may publish revised and/or new versions of the license from time to time. Each version will be given a distinguishing version number.

Once covered code has been published under a particular version of the license, you may always continue to use it under the terms of that version. You may also choose to use such covered code under the terms of any subsequent version of the license published by the PHP Group. No one other than the PHP Group has the right to modify the terms applicable to covered code created under this License.

6. Redistributions of any form whatsoever must retain the following acknowledgment:

"This product includes PHP software, freely available from <<http://www.php.net/software/>>".

THIS SOFTWARE IS PROVIDED BY THE PHP DEVELOPMENT TEAM ``AS IS'' AND ANY EXPRESSED OR IMPLIED WARRANTIES, INCLUDING, BUT NOT LIMITED TO, THE IMPLIED WARRANTIES OF MERCHANTABILITY AND FITNESS FOR A PARTICULAR PURPOSE ARE DISCLAIMED. IN NO EVENT SHALL THE PHP DEVELOPMENT TEAM OR ITS CONTRIBUTORS BE LIABLE FOR ANY DIRECT, INDIRECT, INCIDENTAL, SPECIAL, EXEMPLARY, OR CONSEQUENTIAL DAMAGES (INCLUDING, BUT NOT LIMITED TO, PROCUREMENT OF SUBSTITUTE GOODS OR SERVICES; LOSS OF USE, DATA, OR PROFITS; OR BUSINESS INTERRUPTION) HOWEVER CAUSED AND ON ANY THEORY OF LIABILITY, WHETHER IN CONTRACT, STRICT LIABILITY, OR TORT (INCLUDING NEGLIGENCE OR OTHERWISE) ARISING IN ANY WAY OUT OF THE USE OF THIS SOFTWARE, EVEN IF ADVISED OF THE POSSIBILITY OF SUCH DAMAGE.

-----  
This software consists of voluntary contributions made by many individuals on behalf of the PHP Group.

The PHP Group can be contacted via Email at [group@php.net](mailto:group@php.net).

For more information on the PHP Group and the PHP project, please see <<http://www.php.net/>>.

PHP includes the Zend Engine, freely available at <<http://www.zend.com/>>.

-----  
standard crypt

FreeSec: libercrypt for NetBSD

Copyright (c) 1994 David Burren  
All rights reserved.

Redistribution and use in source and binary forms, with or without modification, are permitted provided that the following conditions are met:

1. Redistributions of source code must retain the above copyright notice, this list of conditions and the following disclaimer.
2. Redistributions in binary form must reproduce the above copyright notice, this list of conditions and the following disclaimer in the documentation and/or other materials provided with the distribution.
3. Neither the name of the author nor the names of other contributors may be used to endorse or promote products derived from this software without specific prior written permission.

THIS SOFTWARE IS PROVIDED BY THE AUTHOR AND CONTRIBUTORS ``AS IS'' AND ANY EXPRESS OR IMPLIED WARRANTIES, INCLUDING, BUT NOT LIMITED TO, THE IMPLIED WARRANTIES OF MERCHANTABILITY AND FITNESS FOR A PARTICULAR PURPOSE ARE DISCLAIMED. IN NO EVENT SHALL THE AUTHOR OR CONTRIBUTORS BE LIABLE FOR ANY DIRECT, INDIRECT, INCIDENTAL, SPECIAL, EXEMPLARY, OR CONSEQUENTIAL DAMAGES (INCLUDING, BUT NOT LIMITED TO, PROCUREMENT OF SUBSTITUTE GOODS OR SERVICES; LOSS OF USE, DATA, OR PROFITS; OR BUSINESS INTERRUPTION) HOWEVER CAUSED AND ON ANY THEORY OF LIABILITY, WHETHER IN CONTRACT, STRICT LIABILITY, OR TORT (INCLUDING NEGLIGENCE OR OTHERWISE) ARISING IN ANY WAY OUT OF THE USE OF THIS SOFTWARE, EVEN IF ADVISED OF THE POSSIBILITY OF SUCH DAMAGE.

-----  
standard crypt's blowfish implementation

The crypt\_blowfish homepage is:

<http://www.openwall.com/crypt/>

This code comes from John the Ripper password cracker, with reentrant and crypt(3) interfaces added, but optimizations specific to password cracking removed.

Written by Solar Designer <[solar@openwall.com](mailto:solar@openwall.com)> in 1998-2011. No copyright is claimed, and the software is hereby placed in the public domain. In case this attempt to disclaim copyright and place the software in the public domain is deemed null and void, then the software is Copyright (c) 1998-2011 Solar Designer and it is hereby released to the general public under the following terms:

Redistribution and use in source and binary forms, with or without modification, are permitted.

There's ABSOLUTELY NO WARRANTY, express or implied.

It is my intent that you should be able to use this on your system, as part of a software package, or anywhere else to improve security, ensure compatibility, or for any other purpose. I would appreciate it if you give credit where it is due and keep your modifications in the public domain as well, but I don't require that in order to let you place this code and any modifications you make under a license of your choice.

This implementation is mostly compatible with OpenBSD's bcrypt.c (prefix "\$2a\$") by Niels Provos <[provos@city.umich.edu](mailto:provos@city.umich.edu)>, and uses some of his ideas. The password hashing algorithm was designed by David Mazieres <[dm@lcs.mit.edu](mailto:dm@lcs.mit.edu)>. For more information on the level of compatibility, please refer to the comments in BF\_set\_key() and to the crypt(3) man page included in the crypt\_blowfish tarball.

There's a paper on the algorithm that explains its design decisions:

<http://www.usenix.org/events/usenix99/provos.html>

Some of the tricks in BF\_ROUND might be inspired by Eric Young's Blowfish library (I can't be sure if I would think of something if I hadn't seen his code).

-----  
json\_parser

Copyright (c) 2005 JSON.org

Permission is hereby granted, free of charge, to any person obtaining a copy of this software and associated documentation files (the "Software"), to deal in the Software without restriction, including without limitation the rights to use, copy, modify, merge, publish, distribute, sublicense, and/or sell copies of the Software, and to permit persons to whom the Software is furnished to do so, subject to the following conditions:

The above copyright notice and this permission notice shall be included in all copies or substantial portions of the Software.

The Software shall be used for Good, not Evil.

THE SOFTWARE IS PROVIDED "AS IS", WITHOUT WARRANTY OF ANY KIND, EXPRESS OR IMPLIED, INCLUDING BUT NOT LIMITED TO THE WARRANTIES OF MERCHANTABILITY, FITNESS FOR A PARTICULAR PURPOSE AND NONINFRINGEMENT. IN NO EVENT SHALL THE AUTHORS OR COPYRIGHT HOLDERS BE LIABLE FOR ANY CLAIM, DAMAGES OR OTHER LIABILITY, WHETHER IN AN ACTION OF CONTRACT, TORT OR OTHERWISE, ARISING FROM, OUT OF OR IN CONNECTION WITH THE SOFTWARE OR THE USE OR OTHER DEALINGS IN THE SOFTWARE.

-----  
rand

The following php\_mt\_...() functions are based on a C++ class MTRand by Richard J. Wagner. For more information see the web page at <http://www-personal.engin.umich.edu/~wagner/MersenneTwister.html>

Mersenne Twister random number generator -- a C++ class MTRand Based on code by Makoto Matsumoto, Takuji Nishimura, and Shawn Cokus Richard J. Wagner v1.0 15 May 2003 [rjwagner@write.com](mailto:rjwagner@write.com)

The Mersenne Twister is an algorithm for generating random numbers. It was designed with consideration of the flaws in various other generators. The period, 2<sup>19937</sup>-1, and the order of equidistribution, 623 dimensions, are far greater. The generator is also fast; it avoids multiplication and division, and it benefits from caches and pipelines. For more information see the inventors' web page at <http://www.math.keio.ac.jp/~matumoto/emt.html>

Reference

M. Matsumoto and T. Nishimura, "Mersenne Twister: A 623-Dimensionally Equidistributed Uniform Pseudo-Random Number Generator", ACM Transactions on Modeling and Computer Simulation, Vol. 8, No. 1, January 1998, pp 3-30.

Copyright (C) 1997 - 2002, Makoto Matsumoto and Takuji Nishimura, Copyright (C) 2000 - 2003, Richard J. Wagner  
All rights reserved.

Redistribution and use in source and binary forms, with or without modification, are permitted provided that the following conditions are met:

1. Redistributions of source code must retain the above copyright notice, this list of conditions and the following disclaimer.
2. Redistributions in binary form must reproduce the above copyright notice, this list of conditions and the following disclaimer in the documentation and/or other materials provided with the distribution.
3. The names of its contributors may not be used to endorse or promote products derived from this software without specific prior written

permission.

THIS SOFTWARE IS PROVIDED BY THE COPYRIGHT HOLDERS AND CONTRIBUTORS "AS IS" AND ANY EXPRESS OR IMPLIED WARRANTIES, INCLUDING, BUT NOT LIMITED TO, THE IMPLIED WARRANTIES OF MERCHANTABILITY AND FITNESS FOR A PARTICULAR PURPOSE ARE DISCLAIMED. IN NO EVENT SHALL THE COPYRIGHT OWNER OR

CONTRIBUTORS BE LIABLE FOR ANY DIRECT, INDIRECT, INCIDENTAL, SPECIAL, EXEMPLARY, OR CONSEQUENTIAL DAMAGES (INCLUDING, BUT NOT LIMITED TO, PROCUREMENT OF SUBSTITUTE GOODS OR SERVICES; LOSS OF USE, DATA, OR PROFITS; OR BUSINESS INTERRUPTION) HOWEVER CAUSED AND ON ANY THEORY OF

LIABILITY, WHETHER IN CONTRACT, STRICT LIABILITY, OR TORT (INCLUDING NEGLIGENCE OR OTHERWISE) ARISING IN ANY WAY OUT OF THE USE OF THIS SOFTWARE, EVEN IF ADVISED OF THE POSSIBILITY OF SUCH DAMAGE.

=====  
scanf.c

This file contains the base code which implements scanf and by extension fscanf. Original code is from TCL8.3.0 and bears the following copyright:

This software is copyrighted by the Regents of the University of California, Sun Microsystems, Inc., Scriptics Corporation, and other parties. The following terms apply to all files associated with the software unless explicitly disclaimed in individual files.

The authors hereby grant permission to use, copy, modify, distribute, and license this software and its documentation for any purpose, provided that existing copyright notices are retained in all copies and that this notice is included verbatim in any distributions. No written agreement, license, or royalty fee is required for any of the authorized uses. Modifications to this software may be copyrighted by their authors and need not follow the licensing terms described here, provided that the new terms are clearly indicated on the first page of each file where they apply.

IN NO EVENT SHALL THE AUTHORS OR DISTRIBUTORS BE LIABLE TO ANY PARTY FOR DIRECT, INDIRECT, SPECIAL, INCIDENTAL, OR CONSEQUENTIAL DAMAGES ARISING OUT OF THE USE OF THIS SOFTWARE, ITS DOCUMENTATION, OR ANY DERIVATIVES THEREOF, EVEN IF THE AUTHORS HAVE BEEN ADVISED OF THE POSSIBILITY OF SUCH DAMAGE.

THE AUTHORS AND DISTRIBUTORS SPECIFICALLY DISCLAIM ANY WARRANTIES, INCLUDING, BUT NOT LIMITED TO, THE IMPLIED WARRANTIES OF MERCHANTABILITY, FITNESS FOR A PARTICULAR PURPOSE, AND NON-INFRINGEMENT. THIS SOFTWARE IS PROVIDED ON AN "AS IS" BASIS, AND THE AUTHORS AND DISTRIBUTORS HAVE NO OBLIGATION TO PROVIDE MAINTENANCE, SUPPORT, UPDATES, ENHANCEMENTS, OR MODIFICATIONS.

GOVERNMENT USE: If you are acquiring this software on behalf of the U.S. government, the Government shall have only "Restricted Rights" in the software and related documentation as defined in the Federal Acquisition Regulations (FARs) in Clause 52.227.19 (c) (2). If you are acquiring the software on behalf of the Department of Defense, the software shall be classified as "Commercial Computer Software" and the Government shall have only "Restricted Rights" as defined in Clause 252.227-7013 (c) (1) of DFARs. Notwithstanding the foregoing, the authors grant the U.S. Government and others acting in its behalf permission to use and distribute the software in accordance with the terms specified in this license.

=====  
strnatcmp.c

strnatcmp.c -- Perform 'natural order' comparisons of strings in C.  
Copyright (C) 2000 by Martin Pool <mbp@humbug.org.au>

This software is provided 'as-is', without any express or implied warranty. In no event will the authors be held liable for any damages arising from the use of this software.

Permission is granted to anyone to use this software for any purpose, including commercial applications, and to alter it and redistribute it freely, subject to the following restrictions:

1. The origin of this software must not be misrepresented; you must not claim that you wrote the original software. If you use this software in a product, an acknowledgment in the product documentation would be appreciated but is not required.
2. Altered source versions must be plainly marked as such, and must not be misrepresented as being the original software.
3. This notice may not be removed or altered from any source distribution.

=====  
uencode

Portions of this code are based on Berkeley's uencode/uudecode implementation.

Copyright (c) 1983, 1993

The Regents of the University of California. All rights reserved.

Redistribution and use in source and binary forms, with or without modification, are permitted provided that the following conditions are met:

1. Redistributions of source code must retain the above copyright

notice, this list of conditions and the following disclaimer.

2. Redistributions in binary form must reproduce the above copyright notice, this list of conditions and the following disclaimer in the documentation and/or other materials provided with the distribution.

3. All advertising materials mentioning features or use of this software must display the following acknowledgement:

This product includes software developed by the University of California, Berkeley and its contributors.

4. Neither the name of the University nor the names of its contributors may be used to endorse or promote products derived from this software without specific prior written permission.

THIS SOFTWARE IS PROVIDED BY THE REGENTS AND CONTRIBUTORS "AS IS" AND ANY EXPRESS OR IMPLIED WARRANTIES, INCLUDING, BUT NOT LIMITED TO, THE IMPLIED WARRANTIES OF MERCHANTABILITY AND FITNESS FOR A PARTICULAR PURPOSE ARE DISCLAIMED. IN NO EVENT SHALL THE REGENTS OR CONTRIBUTORS BE LIABLE FOR ANY DIRECT, INDIRECT, INCIDENTAL, SPECIAL, EXEMPLARY, OR CONSEQUENTIAL DAMAGES (INCLUDING, BUT NOT LIMITED TO, PROCUREMENT OF SUBSTITUTE GOODS OR SERVICES; LOSS OF USE, DATA, OR PROFITS; OR BUSINESS INTERRUPTION) HOWEVER CAUSED AND ON ANY THEORY OF LIABILITY, WHETHER IN CONTRACT, STRICT LIABILITY, OR TORT (INCLUDING NEGLIGENCE OR OTHERWISE) ARISING IN ANY WAY OUT OF THE USE OF THIS SOFTWARE, EVEN IF ADVISED OF THE POSSIBILITY OF SUCH DAMAGE.

=====  
xmlrpc

Copyright 2000 Epinions, Inc.

Subject to the following 3 conditions, Epinions, Inc. permits you, free of charge, to (a) use, copy, distribute, modify, perform and display this software and associated documentation files (the "Software"), and (b) permit others to whom the Software is furnished to do so as well.

1) The above copyright notice and this permission notice shall be included without modification in all copies or substantial portions of the Software.

2) THE SOFTWARE IS PROVIDED "AS IS", WITHOUT ANY WARRANTY OR CONDITION OF ANY KIND, EXPRESS, IMPLIED OR STATUTORY, INCLUDING WITHOUT LIMITATION ANY IMPLIED WARRANTIES OF ACCURACY, MERCHANTABILITY, FITNESS FOR A PARTICULAR PURPOSE OR NON-INFRINGEMENT.

3) IN NO EVENT SHALL EPINIONS, INC. BE LIABLE FOR ANY DIRECT, INDIRECT, SPECIAL, INCIDENTAL OR CONSEQUENTIAL DAMAGES OR LOST PROFITS ARISING OUT OF OR IN CONNECTION WITH THE SOFTWARE (HOWEVER ARISING, INCLUDING NEGLIGENCE), EVEN IF EPINIONS, INC. IS AWARE OF THE POSSIBILITY OF SUCH DAMAGES.

=====  
zip

zip.h -- exported declarations.

Copyright (C) 1999-2009 Dieter Baron and Thomas Klausner

This file is part of libzip, a library to manipulate ZIP archives.  
The authors can be contacted at <libzip@nih.at>

Redistribution and use in source and binary forms, with or without modification, are permitted provided that the following conditions are met:

1. Redistributions of source code must retain the above copyright notice, this list of conditions and the following disclaimer.
2. Redistributions in binary form must reproduce the above copyright notice, this list of conditions and the following disclaimer in the documentation and/or other materials provided with the distribution.
3. The names of the authors may not be used to endorse or promote products derived from this software without specific prior written permission.

THIS SOFTWARE IS PROVIDED BY THE AUTHORS "AS IS" AND ANY EXPRESS OR IMPLIED WARRANTIES, INCLUDING, BUT NOT LIMITED TO, THE IMPLIED WARRANTIES OF MERCHANTABILITY AND FITNESS FOR A PARTICULAR PURPOSE ARE DISCLAIMED. IN NO EVENT SHALL THE AUTHORS BE LIABLE FOR ANY DIRECT, INDIRECT, INCIDENTAL, SPECIAL, EXEMPLARY, OR CONSEQUENTIAL DAMAGES (INCLUDING, BUT NOT LIMITED TO, PROCUREMENT OF SUBSTITUTE GOODS OR SERVICES; LOSS OF USE, DATA, OR PROFITS; OR BUSINESS INTERRUPTION) HOWEVER CAUSED AND ON ANY THEORY OF LIABILITY, WHETHER IN CONTRACT, STRICT LIABILITY, OR TORT (INCLUDING NEGLIGENCE OR OTHERWISE) ARISING IN ANY WAY OUT OF THE USE OF THIS SOFTWARE, EVEN IF ADVISED OF THE POSSIBILITY OF SUCH DAMAGE.

=====  
snprintf.c

Copyright (c) 2002, 2006 Todd C. Miller <Todd.Miller@courtesan.com>

Permission to use, copy, modify, and distribute this software for any

purpose with or without fee is hereby granted, provided that the above copyright notice and this permission notice appear in all copies.

THE SOFTWARE IS PROVIDED "AS IS" AND THE AUTHOR DISCLAIMS ALL WARRANTIES WITH REGARD TO THIS SOFTWARE INCLUDING ALL IMPLIED WARRANTIES OF MERCHANTABILITY AND FITNESS. IN NO EVENT SHALL THE AUTHOR BE LIABLE FOR ANY SPECIAL, DIRECT, INDIRECT, OR CONSEQUENTIAL DAMAGES OR ANY DAMAGES WHATSOEVER RESULTING FROM LOSS OF USE, DATA OR PROFITS, WHETHER IN AN ACTION OF CONTRACT, NEGLIGENCE OR OTHER TORTIOUS ACTION, ARISING OUT OF OR IN CONNECTION WITH THE USE OR PERFORMANCE OF THIS SOFTWARE.

Sponsored in part by the Defense Advanced Research Projects Agency (DARPA) and Air Force Research Laboratory, Air Force Materiel Command, USAF, under agreement number F39502-99-1-0512.

main/spprintf  
Copyright (c) 1995-1998 The Apache Group. All rights reserved.

Redistribution and use in source and binary forms, with or without modification, are permitted provided that the following conditions are met:

- 1. Redistributions of source code must retain the above copyright notice, this list of conditions and the following disclaimer.
- 2. Redistributions in binary form must reproduce the above copyright notice, this list of conditions and the following disclaimer in the documentation and/or other materials provided with the distribution.
- 3. All advertising materials mentioning features or use of this software must display the following acknowledgment: "This product includes software developed by the Apache Group for use in the Apache HTTP server project (<http://www.apache.org/>)."
- 4. The names "Apache Server" and "Apache Group" must not be used to endorse or promote products derived from this software without prior written permission.
- 5. Redistributions of any form whatsoever must retain the following acknowledgment: "This product includes software developed by the Apache Group for use in the Apache HTTP server project (<http://www.apache.org/>)."

THIS SOFTWARE IS PROVIDED BY THE APACHE GROUP "AS IS" AND ANY EXPRESSED OR IMPLIED WARRANTIES, INCLUDING, BUT NOT LIMITED TO, THE IMPLIED WARRANTIES OF MERCHANTABILITY AND FITNESS FOR A PARTICULAR PURPOSE ARE DISCLAIMED. IN NO EVENT SHALL THE APACHE GROUP OR ITS CONTRIBUTORS BE LIABLE FOR ANY DIRECT, INDIRECT, INCIDENTAL, SPECIAL, EXEMPLARY, OR CONSEQUENTIAL DAMAGES (INCLUDING, BUT NOT LIMITED TO, PROCUREMENT OF SUBSTITUTE GOODS OR SERVICES; LOSS OF USE, DATA, OR PROFITS; OR BUSINESS INTERRUPTION) HOWEVER CAUSED AND ON ANY THEORY OF LIABILITY, WHETHER IN CONTRACT, STRICT LIABILITY, OR TORT (INCLUDING NEGLIGENCE OR OTHERWISE) ARISING IN ANY WAY OUT OF THE USE OF THIS SOFTWARE, EVEN IF ADVISED OF THE POSSIBILITY OF SUCH DAMAGE.

This software consists of voluntary contributions made by many individuals on behalf of the Apache Group and was originally based on public domain software written at the National Center for Supercomputing Applications, University of Illinois, Urbana-Champaign. For more information on the Apache Group and the Apache HTTP server project, please see <http://www.apache.org/>.

This code is based on, and used with the permission of, the SIO stdio-replacement strx\_\* functions by Panos Tsirigotis <[panos@alumni.cs.colorado.edu](mailto:panos@alumni.cs.colorado.edu)> for xinetd.

strlcat, strlcpy

Copyright (c) 1998 Todd C. Miller <[Todd.Miller@courtesan.com](mailto:Todd.Miller@courtesan.com)>  
All rights reserved.

Redistribution and use in source and binary forms, with or without modification, are permitted provided that the following conditions are met:

- 1. Redistributions of source code must retain the above copyright notice, this list of conditions and the following disclaimer.
- 2. Redistributions in binary form must reproduce the above copyright notice, this list of conditions and the following disclaimer in the documentation and/or other materials provided with the distribution.
- 3. The name of the author may not be used to endorse or promote products derived from this software without specific prior written permission.

THIS SOFTWARE IS PROVIDED "AS IS" AND ANY EXPRESS OR IMPLIED WARRANTIES, INCLUDING, BUT NOT LIMITED TO, THE IMPLIED WARRANTIES OF MERCHANTABILITY AND FITNESS FOR A PARTICULAR PURPOSE ARE DISCLAIMED. IN NO EVENT SHALL THE AUTHOR BE LIABLE FOR ANY DIRECT, INDIRECT, INCIDENTAL, SPECIAL, EXEMPLARY, OR CONSEQUENTIAL DAMAGES (INCLUDING, BUT NOT LIMITED TO, PROCUREMENT OF SUBSTITUTE GOODS OR SERVICES; LOSS OF USE, DATA, OR PROFITS; OR BUSINESS INTERRUPTION) HOWEVER CAUSED AND ON ANY THEORY OF LIABILITY,

WHETHER IN CONTRACT, STRICT LIABILITY, OR TORT (INCLUDING NEGLIGENCE OR OTHERWISE) ARISING IN ANY WAY OUT OF THE USE OF THIS SOFTWARE, EVEN IF ADVISED OF THE POSSIBILITY OF SUCH DAMAGE.

- 1. libmagic (ext/fileinfo) see ext/fileinfo/libmagic/LICENSE
- 2. Oniguruma (ext/mstring) see ext/mstring/oniguruma/COPYING
- 3. libmbfl (ext/mstring) see ext/mstring/libmbfl/LICENSE
- 4. pcrelib (ext/pcre) see ext/pcre/pcrelib/LICENSE
- 5. ext/standard/crypt
- 6. ext/standard/crypt's blowfish implementation
- 7. Sqlite/Sqlite3 ext/sqlite3 ext/sqlite
- 8. ext/json/json\_parser
- 9. ext/standard/rand
- 10. ext/standard/scanf
- 11. ext/standard/strnatcmp.c
- 12. ext/standard/uencode
- 13. libxmlrpc ext/xmlrpc
- 14. libzip ext/zip
- 15. main/snprintf.c
- 16. main/strlcat
- 17. main/strlcpy
- 18. libgd see ext/gd/libgd/COPYING

5. ext/standard/crypt

FreeSec: libcrypt for NetBSD

Copyright (c) 1994 David Burren  
All rights reserved.

Redistribution and use in source and binary forms, with or without modification, are permitted provided that the following conditions are met:

- 1. Redistributions of source code must retain the above copyright notice, this list of conditions and the following disclaimer.
- 2. Redistributions in binary form must reproduce the above copyright notice, this list of conditions and the following disclaimer in the documentation and/or other materials provided with the distribution.
- 3. Neither the name of the author nor the names of other contributors may be used to endorse or promote products derived from this software without specific prior written permission.

THIS SOFTWARE IS PROVIDED BY THE AUTHOR AND CONTRIBUTORS "AS IS" AND ANY EXPRESS OR IMPLIED WARRANTIES, INCLUDING, BUT NOT LIMITED TO, THE IMPLIED WARRANTIES OF MERCHANTABILITY AND FITNESS FOR A PARTICULAR PURPOSE ARE DISCLAIMED. IN NO EVENT SHALL THE AUTHOR OR CONTRIBUTORS BE LIABLE FOR ANY DIRECT, INDIRECT, INCIDENTAL, SPECIAL, EXEMPLARY, OR CONSEQUENTIAL DAMAGES (INCLUDING, BUT NOT LIMITED TO, PROCUREMENT OF SUBSTITUTE GOODS OR SERVICES; LOSS OF USE, DATA, OR PROFITS; OR BUSINESS INTERRUPTION) HOWEVER CAUSED AND ON ANY THEORY OF LIABILITY, WHETHER IN CONTRACT, STRICT LIABILITY, OR TORT (INCLUDING NEGLIGENCE OR OTHERWISE) ARISING IN ANY WAY OUT OF THE USE OF THIS SOFTWARE, EVEN IF ADVISED OF THE POSSIBILITY OF SUCH DAMAGE.

6. ext/standard/crypt's blowfish implementation

The crypt\_blowfish homepage is:

<http://www.openwall.com/crypt/>

This code comes from John the Ripper password cracker, with reentrant and crypt(3) interfaces added, but optimizations specific to password cracking removed.

Written by Solar Designer <[solar at openwall.com](mailto:solar at openwall.com)> in 1998-2011. No copyright is claimed, and the software is hereby placed in the public domain. In case this attempt to disclaim copyright and place the software in the public domain is deemed null and void, then the software is Copyright (c) 1998-2011 Solar Designer and it is hereby released to the general public under the following terms:

Redistribution and use in source and binary forms, with or without modification, are permitted.

There's ABSOLUTELY NO WARRANTY, express or implied.

It is my intent that you should be able to use this on your system, as part of a software package, or anywhere else to improve security, ensure compatibility, or for any other purpose. I would appreciate it if you give credit where it is due and keep your modifications in the public domain as well, but I don't require that in order to let you place this code and any modifications you make under a license of your choice.

This implementation is mostly compatible with OpenBSD's bcrypt.c (prefix "\$2a\$") by Niels Provos <[provos at citi.umich.edu](mailto:provos at citi.umich.edu)>, and uses some of his ideas. The password hashing algorithm was designed by David Mazieres <[dm at lcs.mit.edu](mailto:dm at lcs.mit.edu)>. For more information on the level of compatibility, please refer to the comments in BF\_set\_key() and to the crypt(3) man page included in the crypt\_blowfish tarball.

There's a paper on the algorithm that explains its design decisions:

<http://www.usenix.org/events/usenix99/provos.html>

Some of the tricks in BF\_ROUND might be inspired by Eric Young's Blowfish library (I can't be sure if I would think of something if I hadn't seen his code).

#### 7. Sqlite/Sqlite3 ext/sqlite3 ext/sqlite

The author disclaims copyright to this source code. In place of a legal notice, here is a blessing:  
May you do good and not evil.  
May you find forgiveness for yourself and forgive others.  
May you share freely, never taking more than you give.

#### 8. ext/json/json\_parser Copyright (c) 2005 JSON.org

Permission is hereby granted, free of charge, to any person obtaining a copy of this software and associated documentation files (the "Software"), to deal in the Software without restriction, including without limitation the rights to use, copy, modify, merge, publish, distribute, sublicense, and/or sell copies of the Software, and to permit persons to whom the Software is furnished to do so, subject to the following conditions:

The above copyright notice and this permission notice shall be included in all copies or substantial portions of the Software.

The Software shall be used for Good, not Evil.

THE SOFTWARE IS PROVIDED "AS IS", WITHOUT WARRANTY OF ANY KIND, EXPRESS OR IMPLIED, INCLUDING BUT NOT LIMITED TO THE WARRANTIES OF MERCHANTABILITY, FITNESS FOR A PARTICULAR PURPOSE AND NONINFRINGEMENT. IN NO EVENT SHALL THE AUTHORS OR COPYRIGHT HOLDERS BE LIABLE FOR ANY CLAIM, DAMAGES OR OTHER LIABILITY, WHETHER IN AN ACTION OF CONTRACT, TORT OR OTHERWISE, ARISING FROM, OUT OF OR IN CONNECTION WITH THE SOFTWARE OR THE USE OR OTHER DEALINGS IN THE SOFTWARE.

#### 9. ext/standard/rand

The following php\_mt\_...() functions are based on a C++ class MTRand by Richard J. Wagner. For more information see the web page at <http://www-personal.engin.umich.edu/~wagner/MersenneTwister.html>

Mersenne Twister random number generator -- a C++ class MTRand  
Based on code by Makoto Matsumoto, Takuji Nishimura, and Shawn Cokus  
Richard J. Wagner v1.0 15 May 2003 [rjwagner@wrieme.com](mailto:rjwagner@wrieme.com)

The Mersenne Twister is an algorithm for generating random numbers. It was designed with consideration of the flaws in various other generators. The period,  $2^{19937}-1$ , and the order of equidistribution, 623 dimensions, are far greater. The generator is also fast; it avoids multiplication and division, and it benefits from caches and pipelines. For more information see the inventors' web page at <http://www.math.keio.ac.jp/~matumoto/emt.html>

#### Reference

M. Matsumoto and T. Nishimura, "Mersenne Twister: A 623-Dimensionally Equidistributed Uniform Pseudo-Random Number Generator", ACM Transactions on Modeling and Computer Simulation, Vol. 8, No. 1, January 1998, pp 3-30.

Copyright (C) 1997 - 2002, Makoto Matsumoto and Takuji Nishimura,  
Copyright (C) 2000 - 2003, Richard J. Wagner  
All rights reserved.

Redistribution and use in source and binary forms, with or without modification, are permitted provided that the following conditions are met:

1. Redistributions of source code must retain the above copyright notice, this list of conditions and the following disclaimer.
2. Redistributions in binary form must reproduce the above copyright notice, this list of conditions and the following disclaimer in the documentation and/or other materials provided with the distribution.
3. The names of its contributors may not be used to endorse or promote products derived from this software without specific prior written permission.

THIS SOFTWARE IS PROVIDED BY THE COPYRIGHT HOLDERS AND CONTRIBUTORS "AS IS" AND ANY EXPRESS OR IMPLIED WARRANTIES, INCLUDING, BUT NOT LIMITED TO, THE IMPLIED WARRANTIES OF MERCHANTABILITY AND FITNESS FOR A PARTICULAR PURPOSE ARE DISCLAIMED. IN NO EVENT SHALL THE COPYRIGHT OWNER OR CONTRIBUTORS BE LIABLE FOR ANY DIRECT, INDIRECT, INCIDENTAL, EXEMPLARY, OR CONSEQUENTIAL DAMAGES (INCLUDING, BUT NOT LIMITED TO, PROCUREMENT OF SUBSTITUTE GOODS OR SERVICES; LOSS OF USE, DATA, OR PROFITS; OR BUSINESS INTERRUPTION) HOWEVER CAUSED AND ON ANY THEORY OF LIABILITY, WHETHER IN CONTRACT, STRICT LIABILITY, OR TORT (INCLUDING NEGLIGENCE OR OTHERWISE) ARISING IN ANY WAY OUT OF THE USE OF THIS

SOFTWARE, EVEN IF ADVISED OF THE POSSIBILITY OF SUCH DAMAGE.

#### 10. ext/standard/scanf scanf.c --

This file contains the base code which implements scanf and by extension fscanf. Original code is from TCL8.3.0 and bears the following copyright:

This software is copyrighted by the Regents of the University of California, Sun Microsystems, Inc., Scriptics Corporation, and other parties. The following terms apply to all files associated with the software unless explicitly disclaimed in individual files.

The authors hereby grant permission to use, copy, modify, distribute, and license this software and its documentation for any purpose, provided that existing copyright notices are retained in all copies and that this notice is included verbatim in any distributions. No written agreement, license, or royalty fee is required for any of the authorized uses. Modifications to this software may be copyrighted by their authors and need not follow the licensing terms described here, provided that the new terms are clearly indicated on the first page of each file where they apply.

IN NO EVENT SHALL THE AUTHORS OR DISTRIBUTORS BE LIABLE TO ANY PARTY FOR DIRECT, INDIRECT, SPECIAL, INCIDENTAL, OR CONSEQUENTIAL DAMAGES ARISING OUT OF THE USE OF THIS SOFTWARE, ITS DOCUMENTATION, OR ANY DERIVATIVES THEREOF, EVEN IF THE AUTHORS HAVE BEEN ADVISED OF THE POSSIBILITY OF SUCH DAMAGE.

THE AUTHORS AND DISTRIBUTORS SPECIFICALLY DISCLAIM ANY WARRANTIES, INCLUDING, BUT NOT LIMITED TO, THE IMPLIED WARRANTIES OF MERCHANTABILITY, FITNESS FOR A PARTICULAR PURPOSE, AND NON-INFRINGEMENT. THIS SOFTWARE IS PROVIDED ON AN "AS IS" BASIS, AND THE AUTHORS AND DISTRIBUTORS HAVE NO OBLIGATION TO PROVIDE MAINTENANCE, SUPPORT, UPDATES, ENHANCEMENTS, OR MODIFICATIONS.

GOVERNMENT USE: If you are acquiring this software on behalf of the U.S. government, the Government shall have only "Restricted Rights" in the software and related documentation as defined in the Federal Acquisition Regulations (FARs) in Clause 52.227.19 (c) (2). If you are acquiring the software on behalf of the Department of Defense, the software shall be classified as "Commercial Computer Software" and the Government shall have only "Restricted Rights" as defined in Clause 252.227-7013 (c) (1) of DFARS. Notwithstanding the foregoing, the authors grant the U.S. Government and others acting in its behalf permission to use and distribute the software in accordance with the terms specified in this license.

#### 11. ext/standard/strnatcmp.c

strnatcmp.c -- Perform 'natural order' comparisons of strings in C.  
Copyright (C) 2000 by Martin Pool <[mbp@humbug.org.au](mailto:mbp@humbug.org.au)>

This software is provided 'as-is', without any express or implied warranty. In no event will the authors be held liable for any damages arising from the use of this software.

Permission is granted to anyone to use this software for any purpose, including commercial applications, and to alter it and redistribute it freely, subject to the following restrictions:

1. The origin of this software must not be misrepresented; you must not claim that you wrote the original software. If you use this software in a product, an acknowledgment in the product documentation would be appreciated but is not required.
2. Altered source versions must be plainly marked as such, and must not be misrepresented as being the original software.
3. This notice may not be removed or altered from any source distribution.

#### 12. ext/standard/unicode

Portions of this code are based on Berkeley's unicode/uencode implementation.

Copyright (c) 1983, 1993  
The Regents of the University of California. All rights reserved.

Redistribution and use in source and binary forms, with or without modification, are permitted provided that the following conditions are met:

1. Redistributions of source code must retain the above copyright notice, this list of conditions and the following disclaimer.
2. Redistributions in binary form must reproduce the above copyright notice, this list of conditions and the following disclaimer in the documentation and/or other materials provided with the distribution.
3. All advertising materials mentioning features or use of this software must display the following acknowledgement:  
This product includes software developed by the University of California, Berkeley and its contributors.
4. Neither the name of the University nor the names of its contributors may be used to endorse or promote products derived from this software without specific prior written permission.

THIS SOFTWARE IS PROVIDED BY THE REGENTS AND CONTRIBUTORS "AS IS" AND ANY EXPRESS OR IMPLIED WARRANTIES, INCLUDING, BUT NOT LIMITED TO, THE IMPLIED WARRANTIES OF MERCHANTABILITY AND FITNESS FOR A PARTICULAR PURPOSE

ARE DISCLAIMED. IN NO EVENT SHALL THE REGENTS OR CONTRIBUTORS BE LIABLE FOR ANY DIRECT, INDIRECT, INCIDENTAL, SPECIAL, EXEMPLARY, OR CONSEQUENTIAL DAMAGES (INCLUDING, BUT NOT LIMITED TO, PROCUREMENT OF SUBSTITUTE GOODS OR SERVICES; LOSS OF USE, DATA, OR PROFITS; OR BUSINESS INTERRUPTION) HOWEVER CAUSED AND ON ANY THEORY OF LIABILITY, WHETHER IN CONTRACT, STRICT LIABILITY, OR TORT (INCLUDING NEGLIGENCE OR OTHERWISE) ARISING IN ANY WAY OUT OF THE USE OF THIS SOFTWARE, EVEN IF ADVISED OF THE POSSIBILITY OF SUCH DAMAGE.

13. libxmlrpc ext/xmlrpc

Copyright 2000 Epinions, Inc.

Subject to the following 3 conditions, Epinions, Inc. permits you, free of charge, to (a) use, copy, distribute, modify, perform and display this software and associated documentation files (the "Software"), and (b) permit others to whom the Software is furnished to do so as well.

1) The above copyright notice and this permission notice shall be included without modification in all copies or substantial portions of the Software.

2) THE SOFTWARE IS PROVIDED "AS IS", WITHOUT ANY WARRANTY OR CONDITION OF ANY KIND, EXPRESS, IMPLIED OR STATUTORY, INCLUDING WITHOUT LIMITATION ANY IMPLIED WARRANTIES OF ACCURACY, MERCHANTABILITY, FITNESS FOR A PARTICULAR PURPOSE OR NON-INFRINGEMENT.

3) IN NO EVENT SHALL EPINIONS, INC. BE LIABLE FOR ANY DIRECT, INDIRECT, SPECIAL, INCIDENTAL OR CONSEQUENTIAL DAMAGES OR LOST PROFITS ARISING OUT OF OR IN CONNECTION WITH THE SOFTWARE (HOWEVER ARISING, INCLUDING NEGLIGENCE), EVEN IF EPINIONS, INC. IS AWARE OF THE POSSIBILITY OF SUCH DAMAGES.

14. libzip ext/zip  
zip.h -- exported declarations.

Copyright (C) 1999-2009 Dieter Baron and Thomas Klausner

This file is part of libzip, a library to manipulate ZIP archives.  
The authors can be contacted at <libzip@nih.at>

Redistribution and use in source and binary forms, with or without modification, are permitted provided that the following conditions are met:

1. Redistributions of source code must retain the above copyright notice, this list of conditions and the following disclaimer.
2. Redistributions in binary form must reproduce the above copyright notice, this list of conditions and the following disclaimer in the documentation and/or other materials provided with the distribution.
3. The names of the authors may not be used to endorse or promote products derived from this software without specific prior written permission.

THIS SOFTWARE IS PROVIDED BY THE AUTHORS "AS IS" AND ANY EXPRESS OR IMPLIED WARRANTIES, INCLUDING, BUT NOT LIMITED TO, THE IMPLIED WARRANTIES OF MERCHANTABILITY AND FITNESS FOR A PARTICULAR PURPOSE ARE DISCLAIMED. IN NO EVENT SHALL THE AUTHORS BE LIABLE FOR ANY DIRECT, INDIRECT, INCIDENTAL, SPECIAL, EXEMPLARY, OR CONSEQUENTIAL DAMAGES (INCLUDING, BUT NOT LIMITED TO, PROCUREMENT OF SUBSTITUTE GOODS OR SERVICES; LOSS OF USE, DATA, OR PROFITS; OR BUSINESS INTERRUPTION) HOWEVER CAUSED AND ON ANY THEORY OF LIABILITY, WHETHER IN CONTRACT, STRICT LIABILITY, OR TORT (INCLUDING NEGLIGENCE OR OTHERWISE) ARISING IN ANY WAY OUT OF THE USE OF THIS SOFTWARE, EVEN IF ADVISED OF THE POSSIBILITY OF SUCH DAMAGE.

15. main/snprintf.c  
Copyright (c) 2002, 2006 Todd C. Miller <Todd.Miller@courtesan.com>

Permission to use, copy, modify, and distribute this software for any purpose with or without fee is hereby granted, provided that the above copyright notice and this permission notice appear in all copies.

THE SOFTWARE IS PROVIDED "AS IS" AND THE AUTHOR DISCLAIMS ALL WARRANTIES WITH REGARD TO THIS SOFTWARE INCLUDING ALL IMPLIED WARRANTIES OF MERCHANTABILITY AND FITNESS. IN NO EVENT SHALL THE AUTHOR BE LIABLE FOR ANY SPECIAL, DIRECT, INDIRECT, OR CONSEQUENTIAL DAMAGES OR ANY DAMAGES WHATSOEVER RESULTING FROM LOSS OF USE, DATA OR PROFITS, WHETHER IN AN ACTION OF CONTRACT, NEGLIGENCE OR OTHER TORTIOUS ACTION, ARISING OUT OF OR IN CONNECTION WITH THE USE OR PERFORMANCE OF THIS SOFTWARE.

Sponsored in part by the Defense Advanced Research Projects Agency (DARPA) and Air Force Research Laboratory, Air Force Materiel Command, USAF, under agreement number F39502-99-1-0512.

main/sprintf  
Copyright (c) 1995-1998 The Apache Group. All rights reserved.

Redistribution and use in source and binary forms, with or without modification, are permitted provided that the following conditions are met:

1. Redistributions of source code must retain the above copyright notice, this list of conditions and the following disclaimer.
2. Redistributions in binary form must reproduce the above copyright notice, this list of conditions and the following disclaimer in the documentation and/or other materials provided with the distribution.
3. All advertising materials mentioning features or use of this software must display the following acknowledgment:  
"This product includes software developed by the Apache Group for use in the Apache HTTP server project (<http://www.apache.org/>)."
4. The names "Apache Server" and "Apache Group" must not be used to endorse or promote products derived from this software without prior written permission.
5. Redistributions of any form whatsoever must retain the following acknowledgment:  
"This product includes software developed by the Apache Group for use in the Apache HTTP server project (<http://www.apache.org/>)."

THIS SOFTWARE IS PROVIDED BY THE APACHE GROUP "AS IS" AND ANY EXPRESSED OR IMPLIED WARRANTIES, INCLUDING, BUT NOT LIMITED TO, THE IMPLIED WARRANTIES OF MERCHANTABILITY AND FITNESS FOR A PARTICULAR PURPOSE ARE DISCLAIMED. IN NO EVENT SHALL THE APACHE GROUP OR ITS CONTRIBUTORS BE LIABLE FOR ANY DIRECT, INDIRECT, INCIDENTAL, SPECIAL, EXEMPLARY, OR CONSEQUENTIAL DAMAGES (INCLUDING, BUT NOT LIMITED TO, PROCUREMENT OF SUBSTITUTE GOODS OR SERVICES; LOSS OF USE, DATA, OR PROFITS; OR BUSINESS INTERRUPTION) HOWEVER CAUSED AND ON ANY THEORY OF LIABILITY, WHETHER IN CONTRACT, STRICT LIABILITY, OR TORT (INCLUDING NEGLIGENCE OR OTHERWISE) ARISING IN ANY WAY OUT OF THE USE OF THIS SOFTWARE, EVEN IF ADVISED OF THE POSSIBILITY OF SUCH DAMAGE.

=====  
This software consists of voluntary contributions made by many individuals on behalf of the Apache Group and was originally based on public domain software written at the National Center for Supercomputing Applications, University of Illinois, Urbana-Champaign. For more information on the Apache Group and the Apache HTTP server project, please see <<http://www.apache.org/>>.

This code is based on, and used with the permission of, the SIO stdio-replacement strx\_\* functions by Panos Tsirigotis <panos@alumni.cs.colorado.edu> for xinetd.

16. main/strlcat  
17. main/strlcpy  
Copyright (c) 1998 Todd C. Miller <Todd.Miller@courtesan.com>  
All rights reserved.

Redistribution and use in source and binary forms, with or without modification, are permitted provided that the following conditions are met:

1. Redistributions of source code must retain the above copyright notice, this list of conditions and the following disclaimer.
2. Redistributions in binary form must reproduce the above copyright notice, this list of conditions and the following disclaimer in the documentation and/or other materials provided with the distribution.
3. The name of the author may not be used to endorse or promote products derived from this software without specific prior written permission.

THIS SOFTWARE IS PROVIDED "AS IS" AND ANY EXPRESS OR IMPLIED WARRANTIES, INCLUDING, BUT NOT LIMITED TO, THE IMPLIED WARRANTIES OF MERCHANTABILITY AND FITNESS FOR A PARTICULAR PURPOSE ARE DISCLAIMED. IN NO EVENT SHALL THE AUTHOR BE LIABLE FOR ANY DIRECT, INDIRECT, INCIDENTAL, SPECIAL, EXEMPLARY, OR CONSEQUENTIAL DAMAGES (INCLUDING, BUT NOT LIMITED TO, PROCUREMENT OF SUBSTITUTE GOODS OR SERVICES; LOSS OF USE, DATA, OR PROFITS; OR BUSINESS INTERRUPTION) HOWEVER CAUSED AND ON ANY THEORY OF LIABILITY, WHETHER IN CONTRACT, STRICT LIABILITY, OR TORT (INCLUDING NEGLIGENCE OR OTHERWISE) ARISING IN ANY WAY OUT OF THE USE OF THIS SOFTWARE, EVEN IF ADVISED OF THE POSSIBILITY OF SUCH DAMAGE.

=====  
ADOdb

ADOdb is dual licensed using BSD and LGPL.

In plain English, you do not need to distribute your application in source code form, nor do you need to distribute ADOdb source code, provided you follow the rest of terms of the BSD license.

For more info about ADOdb, visit <http://adodb.sourceforge.net/>

BSD Style-License

=====  
Copyright (c) 2000, 2001, 2002, 2003, 2004 John Lim  
All rights reserved.

Redistribution and use in source and binary forms, with or without modification, are permitted provided that the following conditions are met:

Redistributions of source code must retain the above copyright notice, this list of conditions and the following disclaimer.

Redistributions in binary form must reproduce the above copyright notice, this list of conditions and the following disclaimer in the documentation and/or other materials provided with the distribution.

Neither the name of the John Lim nor the names of its contributors may be used to endorse or promote products derived from this software without specific prior written permission.

#### DISCLAIMER:

THIS SOFTWARE IS PROVIDED BY THE COPYRIGHT HOLDERS AND CONTRIBUTORS "AS IS" AND ANY EXPRESS OR IMPLIED WARRANTIES, INCLUDING, BUT NOT LIMITED TO, THE IMPLIED WARRANTIES OF MERCHANTABILITY AND FITNESS FOR A PARTICULAR PURPOSE ARE DISCLAIMED. IN NO EVENT SHALL JOHN LIM OR CONTRIBUTORS BE LIABLE FOR ANY DIRECT, INDIRECT, INCIDENTAL, SPECIAL, EXEMPLARY, OR CONSEQUENTIAL DAMAGES (INCLUDING, BUT NOT LIMITED TO, PROCUREMENT OF SUBSTITUTE GOODS OR SERVICES; LOSS OF USE, DATA, OR PROFITS; OR BUSINESS INTERRUPTION) HOWEVER CAUSED AND ON ANY THEORY OF LIABILITY, WHETHER IN CONTRACT, STRICT LIABILITY, OR TORT (INCLUDING NEGLIGENCE OR OTHERWISE) ARISING IN ANY WAY OUT OF THE USE OF THIS SOFTWARE, EVEN IF ADVISED OF THE POSSIBILITY OF SUCH DAMAGE.

=====  
GNU LESSER GENERAL PUBLIC LICENSE  
Version 2.1, February 1999

Copyright (C) 1991, 1999 Free Software Foundation, Inc.  
59 Temple Place, Suite 330, Boston, MA 02111-1307 USA  
Everyone is permitted to copy and distribute verbatim copies of this license document, but changing it is not allowed.

[This is the first released version of the Lesser GPL. It also counts as the successor of the GNU Library Public License, version 2, hence the version number 2.1.]

#### Preamble

The licenses for most software are designed to take away your freedom to share and change it. By contrast, the GNU General Public Licenses are intended to guarantee your freedom to share and change free software--to make sure the software is free for all its users.

This license, the Lesser General Public License, applies to some specially designated software packages--typically libraries--of the Free Software Foundation and other authors who decide to use it. You can use it too, but we suggest you first think carefully about whether this license or the ordinary General Public License is the better strategy to use in any particular case, based on the explanations below.

When we speak of free software, we are referring to freedom of use, not price. Our General Public Licenses are designed to make sure that you have the freedom to distribute copies of free software (and charge for this service if you wish); that you receive source code or can get it if you want it; that you can change the software and use pieces of it in new free programs; and that you are informed that you can do these things.

To protect your rights, we need to make restrictions that forbid distributors to deny you these rights or to ask you to surrender these rights. These restrictions translate to certain responsibilities for you if you distribute copies of the library or if you modify it.

For example, if you distribute copies of the library, whether gratis or for a fee, you must give the recipients all the rights that we gave you. You must make sure that they, too, receive or can get the source code. If you link other code with the library, you must provide complete object files to the recipients, so that they can relink them with the library after making changes to the library and recompiling it. And you must show them these terms so they know their rights.

We protect your rights with a two-step method: (1) we copyright the library, and (2) we offer you this license, which gives you legal permission to copy, distribute and/or modify the library.

To protect each distributor, we want to make it very clear that there is no warranty for the free library. Also, if the library is modified by someone else and passed on, the recipients should know that what they have is not the original version, so that the original author's reputation will not be affected by problems that might be introduced by others.

Finally, software patents pose a constant threat to the existence of any free program. We wish to make sure that a company cannot effectively restrict the users of a free program by obtaining a restrictive license from a patent holder. Therefore, we insist that any patent license obtained for a version of the library must be consistent with the full freedom of use specified in this license.

Most GNU software, including some libraries, is covered by the ordinary GNU General Public License. This license, the GNU Lesser General Public License, applies to certain designated libraries, and is quite different from the ordinary General Public License. We use this license for certain libraries in order to permit linking those libraries into non-free programs.

When a program is linked with a library, whether statically or using a shared library, the combination of the two is legally speaking a combined work, a derivative of the original library. The ordinary General Public License therefore permits such linking only if the entire combination fits its criteria of freedom. The Lesser General Public License permits more lax criteria for linking other code with the library.

We call this license the "Lesser" General Public License because it does Less to protect the user's freedom than the ordinary General Public License. It also provides other free software developers Less of an advantage over competing non-free programs. These disadvantages are the reason we use the ordinary General Public License for many libraries. However, the Lesser license provides advantages in certain special circumstances.

For example, on rare occasions, there may be a special need to encourage the widest possible use of a certain library, so that it becomes a de-facto standard. To achieve this, non-free programs must be allowed to use the library. A more frequent case is that a free library does the same job as widely used non-free libraries. In this case, there is little to gain by limiting the free library to free software only, so we use the Lesser General Public License.

In other cases, permission to use a particular library in non-free programs enables a greater number of people to use a large body of free software. For example, permission to use the GNU C Library in non-free programs enables many more people to use the whole GNU operating system, as well as its variant, the GNU/Linux operating system.

Although the Lesser General Public License is Less protective of the users' freedom, it does ensure that the user of a program that is linked with the Library has the freedom and the wherewithal to run that program using a modified version of the Library.

The precise terms and conditions for copying, distribution and modification follow. Pay close attention to the difference between a "work based on the library" and a "work that uses the library". The former contains code derived from the library, whereas the latter must be combined with the library in order to run.

#### TERMS AND CONDITIONS FOR COPYING, DISTRIBUTION AND MODIFICATION

0. This License Agreement applies to any software library or other program which contains a notice placed by the copyright holder or other authorized party saying it may be distributed under the terms of this Lesser General Public License (also called "this License"). Each licensee is addressed as "you".

A "library" means a collection of software functions and/or data prepared so as to be conveniently linked with application programs (which use some of those functions and data) to form executables.

The "Library", below, refers to any such software library or work which has been distributed under these terms. A "work based on the Library" means either the Library or any derivative work under copyright law: that is to say, a work containing the Library or a portion of it, either verbatim or with modifications and/or translated straightforwardly into another language. (Hereinafter, translation is included without limitation in the term "modification".)

"Source code" for a work means the preferred form of the work for making modifications to it. For a library, complete source code means all the source code for all modules it contains, plus any associated interface definition files, plus the scripts used to control compilation and installation of the library.

Activities other than copying, distribution and modification are not covered by this License; they are outside its scope. The act of running a program using the Library is not restricted, and output from such a program is covered only if its contents constitute a work based on the Library (independent of the use of the Library in a tool for writing it). Whether that is true depends on what the Library does and what the program that uses the Library does.

1. You may copy and distribute verbatim copies of the Library's complete source code as you receive it, in any medium, provided that you conspicuously and appropriately publish on each copy an appropriate copyright notice and disclaimer of warranty; keep intact all the notices that refer to this License and to the absence of any warranty; and distribute a copy of this License along with the Library.

You may charge a fee for the physical act of transferring a copy, and you may at your option offer warranty protection in exchange for a fee.

2. You may modify your copy or copies of the Library or any portion of it, thus forming a work based on the Library, and copy and distribute such modifications or work under the terms of Section 1 above, provided that you also meet all of these conditions:

- The modified work must itself be a software library.
- You must cause the files modified to carry prominent notices stating that you changed the files and the date of any change.
- You must cause the whole of the work to be licensed at no charge to all third parties under the terms of this License.
- If a facility in the modified Library refers to a function or a table of data to be supplied by an application program that uses the facility, other than as an argument passed when the facility is invoked, then you must make a good faith effort to ensure that, in the event an application does not supply such function or table, the facility still operates, and performs whatever part of its purpose remains meaningful.  
(For example, a function in a library to compute square roots has a purpose that is entirely well-defined independent of the application. Therefore, Subsection 2d requires that any application-supplied function or table used by this function must be optional: if the application does not supply it, the square root function must still compute square roots.)

These requirements apply to the modified work as a whole. If identifiable sections of that work are not derived from the Library, and can be reasonably considered independent and separate works in themselves, then this License, and its terms, do not apply to those sections when you distribute them as separate works. But when you distribute the same sections as part of a whole which is a work based on the Library, the distribution of the whole must be on the terms of this License, whose permissions for other licensees extend to the entire whole, and thus to each and every part regardless of who wrote it.

Thus, it is not the intent of this section to claim rights or contest your rights to work written entirely by you; rather, the intent is to exercise the right to control the distribution of derivative or collective works based on the Library.

In addition, mere aggregation of another work not based on the Library with the Library (or with a work based on the Library) on a volume of a storage or distribution medium does not bring the other work under the scope of this License.

3. You may opt to apply the terms of the ordinary GNU General Public License instead of this License to a given copy of the Library. To do this, you must alter all the notices that refer to this License, so that they refer to the ordinary GNU General Public License, version 2, instead of to this License. (If a newer version than version 2 of the ordinary GNU General Public License has appeared, then you can specify that version instead if you wish.) Do not make any other change in these notices.

Once this change is made in a given copy, it is irreversible for that copy, so the ordinary GNU General Public License applies to all subsequent copies and derivative works made from that copy.

This option is useful when you wish to copy part of the code of the Library into a program that is not a library.

4. You may copy and distribute the Library (or a portion or derivative of it, under Section 2) in object code or executable form under the terms of Sections 1 and 2 above provided that you accompany it with the complete corresponding machine-readable source code, which must be distributed under the terms of Sections 1 and 2 above on a medium customarily used for software interchange.

If distribution of object code is made by offering access to copy from a designated place, then offering equivalent access to copy the source code from the same place satisfies the requirement to distribute the source code, even though third parties are not compelled to copy the source along with the object code.

5. A program that contains no derivative of any portion of the Library, but is designed to work with the Library by being compiled or linked with it, is called a "work that uses the Library". Such a work, in isolation, is not a derivative work of the Library, and therefore falls outside the scope of this License.

However, linking a "work that uses the Library" with the Library creates an executable that is a derivative of the Library (because it contains portions of the Library), rather than a "work that uses the library". The executable is therefore covered by this License. Section 6 states terms for distribution of such executables.

When a "work that uses the Library" uses material from a header file that is part of the Library, the object code for the work may be a derivative work of the Library even though the source code is not. Whether this is true is especially significant if the work can be linked without the Library, or if the work is itself a library. The threshold for this to be true is not precisely defined by law.

If such an object file uses only numerical parameters, data structure layouts and accessors, and small macros and small inline functions (ten lines or less in length), then the use of the object file is unrestricted, regardless of whether it is legally a derivative work. (Executables containing this object code plus portions of the Library will still fall under Section 6.)

Otherwise, if the work is a derivative of the Library, you may distribute the object code for the work under the terms of Section 6. Any executables containing that work also fall under Section 6, whether or not they are linked directly with the Library itself.

6. As an exception to the Sections above, you may also combine or link a "work that uses the Library" with the Library to produce a work containing portions of the Library, and distribute that work under terms of your choice, provided that the terms permit modification of the work for the customer's own use and reverse engineering for debugging such modifications.

You must give prominent notice with each copy of the work that the Library is used in it and that the Library and its use are covered by this License. You must supply a copy of this License. If the work during execution displays copyright notices, you must include the copyright notice for the Library among them, as well as a reference directing the user to the copy of this License. Also, you must do one of these things:

- Accompany the work with the complete corresponding machine-readable source code for the Library including whatever changes were used in the work (which must be distributed under Sections 1 and 2 above); and, if the work is an executable linked with the Library, with the complete machine-readable "work that uses the Library", as object code and/or source code, so that the user can modify the Library and then relink to produce a modified executable containing the modified Library. (It is understood that the user who changes the contents of definitions files in the Library will not necessarily be able to recompile the application to use the modified definitions.)
- Use a suitable shared library mechanism for linking with the Library. A suitable mechanism is one that (1) uses at run time a copy of the library already present on the user's computer system, rather than copying library functions into the executable, and (2) will operate properly with a modified version of the library, if the user installs one, as long as the modified version is interface-compatible with the version that the work was made with.
- Accompany the work with a written offer, valid for at least three years, to give the same user the materials specified in Subsection 6a, above, for a charge no more than the cost of performing this distribution.
- If distribution of the work is made by offering access to copy from a designated place, offer equivalent access to copy the above specified materials from the same place.
- Verify that the user has already received a copy of these materials or that you have already sent this user a copy.

For an executable, the required form of the "work that uses the Library" must include any data and utility programs needed for reproducing the executable from it. However, as a special exception, the materials to be distributed need not include anything that is normally distributed (in either source or binary form) with the major components (compiler, kernel, and so on) of the operating system on which the executable runs, unless that component itself accompanies the executable.

It may happen that this requirement contradicts the license restrictions of other proprietary libraries that do not normally accompany the operating system. Such a contradiction means you cannot use both them and the Library together in an executable that you distribute.

7. You may place library facilities that are a work based on the Library side-by-side in a single library together with other library facilities not covered by this License, and distribute such a combined library, provided that the separate distribution of the work based on the Library and of the other library facilities is otherwise permitted, and provided that you do these two things:

- Accompany the combined library with a copy of the same work based on the Library, uncombined with any other library facilities. This must be distributed under the terms of the Sections above.
- Give prominent notice with the combined library of the fact that part of it is a work based on the Library, and explaining where to find the accompanying uncombined form of the same work.

8. You may not copy, modify, sublicense, link with, or distribute the Library except as expressly provided under this License. Any attempt otherwise to copy, modify, sublicense, link with, or distribute the Library is void, and will automatically terminate your rights under this License. However, parties who have received copies, or rights, from you under this License will not have their licenses terminated so long as such parties remain in full compliance.

9. You are not required to accept this License, since you have not signed it. However, nothing else grants you permission to modify or distribute the Library or its derivative works. These actions are prohibited by law if you do not accept this License. Therefore, by modifying or distributing the Library (or any work based on the Library), you indicate your acceptance of this License to do so, and all its terms and conditions for copying, distributing or modifying the Library or works based on it.

10. Each time you redistribute the Library (or any work based on the Library), the recipient automatically receives a license from the original licensor to copy, distribute, link with or modify the Library subject to these terms and conditions. You may not impose any further restrictions on the recipients' exercise of the rights granted herein. You are not responsible for enforcing compliance by third parties with this License.

11. If, as a consequence of a court judgment or allegation of patent infringement or for any other reason (not limited to patent issues), conditions are imposed on you (whether by court order, agreement or otherwise) that contradict the conditions of this License, they do not excuse you from the conditions of this License. If you cannot distribute so as to satisfy simultaneously your obligations under this License and any other pertinent obligations, then as a consequence you may not distribute the Library at all. For example, if a patent license would not permit royalty-free redistribution of the Library by all those who receive copies directly or indirectly through you, then the only way you could satisfy both it and this License would be to refrain entirely from distribution of the Library.

If any portion of this section is held invalid or unenforceable under any particular circumstance, the balance of the section is intended to apply, and the section as a whole is intended to apply in other circumstances.

It is not the purpose of this section to induce you to infringe any patents or other property right claims or to contest validity of any such claims; this section has the sole purpose of protecting the integrity of the free software distribution system which is implemented by public license practices. Many people have made generous contributions to the wide range of software distributed through that system in reliance on consistent application of that system; it is up to the author/donor to decide if he or she is willing to distribute software through any other system and a licensee cannot impose that choice.

This section is intended to make thoroughly clear what is believed to be a consequence of the rest of this License.

12. If the distribution and/or use of the Library is restricted in certain countries either by patents or by copyrighted interfaces, the original copyright holder who places the Library under this License may add an explicit geographical distribution limitation excluding those countries, so that distribution is permitted only in or among countries not thus excluded. In such case, this License incorporates the limitation as if written in the body of this License.

13. The Free Software Foundation may publish revised and/or new versions of the Lesser General Public License from time to time. Such new versions will be similar in spirit to the present version, but may differ in detail to address new problems or concerns.

Each version is given a distinguishing version number. If the Library specifies a version number of this License which applies to it and "any later version", you have the option of following the terms and conditions either of that version or of any later version published by the Free Software Foundation. If the Library does not specify a license version number, you may choose any version ever published by the Free Software Foundation.

14. If you wish to incorporate parts of the Library into other free programs whose distribution conditions are incompatible with these, write to the author to ask for permission. For software which is copyrighted by the Free Software Foundation, write to the Free Software Foundation; we sometimes make exceptions for this. Our decision will be guided by the two goals of preserving the free status of all derivatives of our free software and of promoting the sharing and reuse of software generally.

#### NO WARRANTY

15. BECAUSE THE LIBRARY IS LICENSED FREE OF CHARGE, THERE IS NO WARRANTY FOR THE LIBRARY, TO THE EXTENT PERMITTED BY APPLICABLE LAW. EXCEPT WHEN OTHERWISE STATED IN WRITING THE COPYRIGHT HOLDERS AND/OR OTHER PARTIES PROVIDE THE LIBRARY "AS IS" WITHOUT WARRANTY OF ANY KIND, EITHER EXPRESSED OR IMPLIED, INCLUDING, BUT NOT LIMITED TO, THE IMPLIED WARRANTIES OF MERCHANTABILITY AND FITNESS FOR A PARTICULAR PURPOSE. THE ENTIRE RISK AS TO THE QUALITY AND PERFORMANCE OF THE LIBRARY IS WITH YOU. SHOULD THE LIBRARY PROVE DEFECTIVE, YOU ASSUME THE COST OF ALL NECESSARY SERVICING, REPAIR OR CORRECTION.

16. IN NO EVENT UNLESS REQUIRED BY APPLICABLE LAW OR AGREED TO IN WRITING WILL ANY COPYRIGHT HOLDER, OR ANY OTHER PARTY WHO MAY MODIFY AND/OR REDISTRIBUTE THE LIBRARY AS PERMITTED ABOVE, BE LIABLE TO YOU FOR DAMAGES, INCLUDING ANY GENERAL, SPECIAL, INCIDENTAL OR CONSEQUENTIAL DAMAGES ARISING OUT OF THE USE OR INABILITY TO USE THE LIBRARY (INCLUDING BUT NOT LIMITED TO LOSS OF DATA OR DATA BEING RENDERED INACCURATE OR LOSSES SUSTAINED BY YOU OR THIRD PARTIES OR A FAILURE OF THE LIBRARY TO OPERATE WITH ANY OTHER SOFTWARE), EVEN IF SUCH HOLDER OR OTHER PARTY HAS BEEN ADVISED OF THE POSSIBILITY OF SUCH DAMAGES.

#### END OF TERMS AND CONDITIONS

#### FPDF

Permission is hereby granted, free of charge, to any person obtaining a copy of this software to use, copy, modify, distribute, sublicense, and/or sell copies of the software, and to permit persons to whom the software is furnished to do so.



THE SOFTWARE IS PROVIDED "AS IS", WITHOUT WARRANTY OF ANY KIND, EXPRESS OR IMPLIED.

=====

Copyright (c) 2007-2009, Andrei Nigmatulin  
All rights reserved.

Redistribution and use in source and binary forms, with or without modification, are permitted provided that the following conditions are met:

1. Redistributions of source code must retain the above copyright notice, this list of conditions and the following disclaimer.
2. Redistributions in binary form must reproduce the above copyright notice, this list of conditions and the following disclaimer in the documentation and/or other materials provided with the distribution.

THIS SOFTWARE IS PROVIDED BY AUTHOR AND CONTRIBUTORS "AS IS" AND ANY EXPRESS OR IMPLIED WARRANTIES, INCLUDING, BUT NOT LIMITED TO, THE IMPLIED WARRANTIES OF MERCHANTABILITY AND FITNESS FOR A PARTICULAR PURPOSE ARE DISCLAIMED. IN NO EVENT SHALL AUTHOR OR CONTRIBUTORS BE LIABLE FOR ANY DIRECT, INDIRECT, INCIDENTAL, SPECIAL, EXEMPLARY, OR CONSEQUENTIAL DAMAGES (INCLUDING, BUT NOT LIMITED TO, PROCUREMENT OF SUBSTITUTE GOODS OR SERVICES; LOSS OF USE, DATA, OR PROFITS; OR BUSINESS INTERRUPTION) HOWEVER CAUSED AND ON ANY THEORY OF LIABILITY, WHETHER IN CONTRACT, STRICT LIABILITY, OR TORT (INCLUDING NEGLIGENCE OR OTHERWISE) ARISING IN ANY WAY OUT OF THE USE OF THIS SOFTWARE, EVEN IF ADVISED OF THE POSSIBILITY OF SUCH DAMAGE.

=====

GD  
Portions copyright 1994, 1995, 1996, 1997, 1998, 1999, 2000, 2001, 2002 by Cold Spring Harbor Laboratory. Funded under Grant P41-RR02188 by the National Institutes of Health.

Portions copyright 1996, 1997, 1998, 1999, 2000, 2001, 2002 by Boutell.Com, Inc.

Portions relating to GD2 format copyright 1999, 2000, 2001, 2002 Philip Warner.

Portions relating to PNG copyright 1999, 2000, 2001, 2002 Greg Roelofs.

Portions relating to gdtf.c copyright 1999, 2000, 2001, 2002 John Ellson (ellson@lucent.com).

Portions relating to gdtf.c copyright 2001, 2002 John Ellson (ellson@lucent.com).

Portions copyright 2000, 2001, 2002, 2003, 2004, 2005, 2006, 2007 2008, 2009 Pierre-Alain Joye (pierre@libg.org).

Portions relating to JPEG and to color quantization copyright 2000, 2001, 2002, Doug Becker and copyright (C) 1994, 1995, 1996, 1997, 1998, 1999, 2000, 2001, 2002, Thomas G. Lane. This software is based in part on the work of the Independent JPEG Group. See the file README-JPEG.TXT for more information.

Portions relating to WBMP copyright 2000, 2001, 2002 Maurice Szmurlo and Johan Van den Brande.

Permission has been granted to copy, distribute and modify gd in any context without fee, including a commercial application, provided that this notice is present in user-accessible supporting documentation.

This does not affect your ownership of the derived work itself, and the intent is to assure proper credit for the authors of gd, not to interfere with your productive use of gd. If you have questions, ask. "Derived works" includes all programs that utilize the library. Credit must be given in user-accessible documentation.

This software is provided "AS IS." The copyright holders disclaim all warranties, either express or implied, including but not limited to implied warranties of merchantability and fitness for a particular purpose, with respect to this code and accompanying documentation.

Although their code does not appear in gd, the authors wish to thank David Koblas, David Rowley, and Hutchison Avenue Software Corporation for their prior contributions.

=====

=====

=====

Group's free JPEG software. You are welcome to redistribute this software and to use it for any purpose, subject to the conditions under LEGAL ISSUES, below.

Serious users of this software (particularly those incorporating it into larger programs) should contact IJG at jpeg-info@uunet.uu.net to be added to our electronic mailing list. Mailing list members are notified of updates and have a chance to participate in technical discussions, etc.

This software is the work of Tom Lane, Philip Gladstone, Jim Boucher, Lee Crocker, Julian Minguillon, Luis Ortiz, George Phillips, Davide Rossi, Guido Vollbeding, Ge' Weijers, and other members of the Independent JPEG Group.

IJG is not affiliated with the official ISO JPEG standards committee.

## DOCUMENTATION ROADMAP

=====

This file contains the following sections:

OVERVIEW	General description of JPEG and the IJG software.
LEGAL ISSUES	Copyright, lack of warranty, terms of distribution.
REFERENCES	Where to learn more about JPEG.
ARCHIVE LOCATIONS	Where to find newer versions of this software.
RELATED SOFTWARE	Other stuff you should get.
FILE FORMAT WARS	Software *not* to get.
TO DO	Plans for future IJG releases.

Other documentation files in the distribution are:

User documentation:

install.doc	How to configure and install the IJG software.
usage.doc	Usage instructions for cjpeg, djpeg, jpegtran, rdjpgcom, and wrjpgcom.
*.1	Unix-style man pages for programs (same info as usage.doc).
wizard.doc	Advanced usage instructions for JPEG wizards only.
change.log	Version-to-version change highlights.

Programmer and internal documentation:

libjpeg.doc	How to use the JPEG library in your own programs.
example.c	Sample code for calling the JPEG library.
structure.doc	Overview of the JPEG library's internal structure.
filelist.doc	Road map of IJG files.
coderules.doc	Coding style rules --- please read if you contribute code.

Please read at least the files install.doc and usage.doc. Useful information can also be found in the JPEG FAQ (Frequently Asked Questions) article. See ARCHIVE LOCATIONS below to find out where to obtain the FAQ article.

If you want to understand how the JPEG code works, we suggest reading one or more of the REFERENCES, then looking at the documentation files (in roughly the order listed) before diving into the code.

## OVERVIEW

=====

This package contains C software to implement JPEG image compression and decompression. JPEG (pronounced "jay-peg") is a standardized compression method for full-color and gray-scale images. JPEG is intended for compressing "real-world" scenes; line drawings, cartoons and other non-realistic images are not its strong suit. JPEG is lossy, meaning that the output image is not exactly identical to the input image. Hence you must not use JPEG if you have to have identical output bits. However, on typical photographic images, very good compression levels can be obtained with no visible change, and remarkably high compression levels are possible if you can tolerate a low-quality image. For more details, see the references, or just experiment with various compression settings.

This software implements JPEG baseline, extended-sequential, and progressive compression processes. Provision is made for supporting all variants of these processes, although some uncommon parameter settings aren't implemented yet. For legal reasons, we are not distributing code for the arithmetic-coding variants of JPEG; see LEGAL ISSUES. We have made no provision for supporting the hierarchical or lossless processes defined in the standard.

We provide a set of library routines for reading and writing JPEG image files, plus two sample applications "cjpeg" and "djpeg", which use the library to perform conversion between JPEG and some other popular image file formats. The library is intended to be reused in other applications.

In order to support file conversion and viewing software, we have included considerable functionality beyond the bare JPEG coding/decoding capability; for example, the color quantization modules are not strictly part of JPEG decoding, but they are essential for output to colormapped file formats or colormapped displays. These extra functions can be compiled out of the library if not required for a particular application. We have also included "jpegtran", a utility for lossless transcoding between different JPEG processes, and "rdjpgcom" and "wrjpgcom", two simple applications for inserting and extracting textual comments in JFIF files.

The emphasis in designing this software has been on achieving portability and flexibility, while also making it fast enough to be useful. In particular, the software is not intended to be read as a tutorial on JPEG. (See the REFERENCES section for introductory material.) Rather, it is intended to be reliable, portable, industrial-strength code. We do not claim to have achieved that goal in every aspect of the software, but we strive for it.

We welcome the use of this software as a component of commercial products.

No royalty is required, but we do ask for an acknowledgement in product documentation, as described under LEGAL ISSUES.

## LEGAL ISSUES

In plain English:

1. We don't promise that this software works. (But if you find any bugs, please let us know!)
2. You can use this software for whatever you want. You don't have to pay us.
3. You may not pretend that you wrote this software. If you use it in a program, you must acknowledge somewhere in your documentation that you've used the IJG code.

In legalese:

The authors make NO WARRANTY or representation, either express or implied, with respect to this software, its quality, accuracy, merchantability, or fitness for a particular purpose. This software is provided "AS IS", and you, its user, assume the entire risk as to its quality and accuracy.

This software is copyright (C) 1991-1998, Thomas G. Lane.  
All Rights Reserved except as specified below.

Permission is hereby granted to use, copy, modify, and distribute this software (or portions thereof) for any purpose, without fee, subject to these conditions:

- (1) If any part of the source code for this software is distributed, then this README file must be included, with this copyright and no-warranty notice unaltered; and any additions, deletions, or changes to the original files must be clearly indicated in accompanying documentation.
- (2) If only executable code is distributed, then the accompanying documentation must state that "this software is based in part on the work of the Independent JPEG Group".
- (3) Permission for use of this software is granted only if the user accepts full responsibility for any undesirable consequences; the authors accept NO LIABILITY for damages of any kind.

These conditions apply to any software derived from or based on the IJG code, not just to the unmodified library. If you use our work, you ought to acknowledge us.

Permission is NOT granted for the use of any IJG author's name or company name in advertising or publicity relating to this software or products derived from it. This software may be referred to only as "the Independent JPEG Group's software".

We specifically permit and encourage the use of this software as the basis of commercial products, provided that all warranty or liability claims are assumed by the product vendor.

ansi2knr.c is included in this distribution by permission of L. Peter Deutsch, sole proprietor of its copyright holder, Aladdin Enterprises of Menlo Park, CA. ansi2knr.c is NOT covered by the above copyright and conditions, but instead by the usual distribution terms of the Free Software Foundation; principally, that you must include source code if you redistribute it. (See the file ansi2knr.c for full details.) However, since ansi2knr.c is not needed as part of any program generated from the IJG code, this does not limit you more than the foregoing paragraphs do.

The Unix configuration script "configure" was produced with GNU Autoconf. It is copyright by the Free Software Foundation but is freely distributable. The same holds for its supporting scripts (config.guess, config.sub, ltconfig, ltmain.sh). Another support script, install-sh, is copyright by M.I.T. but is also freely distributable.

It appears that the arithmetic coding option of the JPEG spec is covered by patents owned by IBM, AT&T, and Mitsubishi. Hence arithmetic coding cannot legally be used without obtaining one or more licenses. For this reason, support for arithmetic coding has been removed from the free JPEG software. (Since arithmetic coding provides only a marginal gain over the unpatented Huffman mode, it is unlikely that very many implementations will support it.) So far as we are aware, there are no patent restrictions on the remaining code.

The IJG distribution formerly included code to read and write GIF files. To avoid entanglement with the Unisys LZW patent, GIF reading support has been removed altogether, and the GIF writer has been simplified to produce "uncompressed GIFs". This technique does not use the LZW algorithm; the resulting GIF files are larger than usual, but are readable by all standard GIF decoders.

We are required to state that

"The Graphics Interchange Format(c) is the Copyright property of CompuServe Incorporated. GIF(sm) is a Service Mark property of CompuServe Incorporated."

## REFERENCES

We highly recommend reading one or more of these references before trying to understand the innards of the JPEG software.

The best short technical introduction to the JPEG compression algorithm is Wallace, Gregory K. "The JPEG Still Picture Compression Standard",

Communications of the ACM, April 1991 (vol. 34 no. 4), pp. 30-44. (Adjacent articles in that issue discuss MPEG motion picture compression, applications of JPEG, and related topics.) If you don't have the ACM issue handy, a PostScript file containing a revised version of Wallace's article is available at <ftp://ftp.uu.net/graphics/jpeg/wallace.ps.gz>. The file (actually a preprint for an article that appeared in IEEE Trans. Consumer Electronics) omits the sample images that appeared in CACM, but it includes corrections and some added material. Note: the Wallace article is copyright ACM and IEEE, and it may not be used for commercial purposes.

A somewhat less technical, more leisurely introduction to JPEG can be found in "The Data Compression Book" by Mark Nelson and Jean-loup Gailly, published by M&T Books (New York), 2nd ed. 1996, ISBN 1-55851-434-1. This book provides good explanations and example C code for a multitude of compression methods including JPEG. It is an excellent source if you are comfortable reading C code but don't know much about data compression in general. The book's JPEG sample code is far from industrial-strength, but when you are ready to look at a full implementation, you've got one here...

The best full description of JPEG is the textbook "JPEG Still Image Data Compression Standard" by William B. Pennebaker and Joan L. Mitchell, published by Van Nostrand Reinhold, 1993, ISBN 0-442-01272-1. Price US\$59.95, 638 pp. The book includes the complete text of the ISO JPEG standards (DIS 10918-1 and draft DIS 10918-2). This is by far the most complete exposition of JPEG in existence, and we highly recommend it.

The JPEG standard itself is not available electronically; you must order a paper copy through ISO or ITU. (Unless you feel a need to own a certified official copy, we recommend buying the Pennebaker and Mitchell book instead; it's much cheaper and includes a great deal of useful explanatory material.) In the USA, copies of the standard may be ordered from ANSI Sales at (212) 642-4900, or from Global Engineering Documents at (800) 854-7179. (ANSI doesn't take credit card orders, but Global does.) It's not cheap: as of 1992, ANSI was charging \$95 for Part 1 and \$47 for Part 2, plus 7% shipping/handling. The standard is divided into two parts, Part 1 being the actual specification, while Part 2 covers compliance testing methods. Part 1 is titled "Digital Compression and Coding of Continuous-tone Still Images, Part 1: Requirements and guidelines" and has document numbers ISO/IEC IS 10918-1, ITU-T T.81. Part 2 is titled "Digital Compression and Coding of Continuous-tone Still Images, Part 2: Compliance testing" and has document numbers ISO/IEC IS 10918-2, ITU-T T.83.

Some extensions to the original JPEG standard are defined in JPEG Part 3, a newer ISO standard numbered ISO/IEC IS 10918-3 and ITU-T T.84. IJG currently does not support any Part 3 extensions.

The JPEG standard does not specify all details of an interchangeable file format. For the omitted details we follow the "JFIF" conventions, revision 1.02. A copy of the JFIF spec is available from:

Literature Department  
C-Cube Microsystems, Inc.  
1778 McCarthy Blvd.  
Milpitas, CA 95035  
phone (408) 944-6300, fax (408) 944-6314

A PostScript version of this document is available by FTP at <ftp://ftp.uu.net/graphics/jpeg/jfif.ps.gz>. There is also a plain text version at <ftp://ftp.uu.net/graphics/jpeg/jfif.txt.gz>, but it is missing the figures.

The TIFF 6.0 file format specification can be obtained by FTP from <ftp://ftp.sgi.com/graphics/tiff/TIFF6.ps.gz>. The JPEG incorporation scheme found in the TIFF 6.0 spec of 3-June-92 has a number of serious problems. IJG does not recommend use of the TIFF 6.0 design (TIFF Compression tag 6). Instead, we recommend the JPEG design proposed by TIFF Technical Note #2 (Compression tag 7). Copies of this Note can be obtained from <ftp.sgi.com> or from <ftp://ftp.uu.net/graphics/jpeg/>. It is expected that the next revision of the TIFF spec will replace the 6.0 JPEG design with the Note's design. Although IJG's own code does not support TIFF/JPEG, the free libtiff library uses our library to implement TIFF/JPEG per the Note. libtiff is available from <ftp://ftp.sgi.com/graphics/tiff/>.

## ARCHIVE LOCATIONS

The "official" archive site for this software is <ftp.uu.net> (Internet address 192.48.96.9). The most recent released version can always be found there in directory [graphics/jpeg](ftp://ftp.uu.net/graphics/jpeg/). This particular version will be archived as <ftp://ftp.uu.net/graphics/jpeg/jpegsr.v6b.tar.gz>. If you don't have direct Internet access, UUNET's archives are also available via UUCP; contact [help@uunet.uu.net](mailto:help@uunet.uu.net) for information on retrieving files that way.

Numerous Internet sites maintain copies of the UUNET files. However, only <ftp.uu.net> is guaranteed to have the latest official version.

You can also obtain this software in DOS-compatible "zip" archive format from the SimTel archives (<ftp://ftp.simtel.net/pub/simtelnet/msdos/graphics/>), or on CompuServe in the Graphics Support forum (GO CIS:GRAPHSUP), library 12 "JPEG Tools". Again, these versions may sometimes lag behind the <ftp.uu.net> release.

The JPEG FAQ (Frequently Asked Questions) article is a useful source of general information about JPEG. It is updated constantly and therefore is not included in this distribution. The FAQ is posted every two weeks to Usenet newsgroups [comp.graphics.misc](mailto:comp.graphics.misc), [news.answers](mailto:news.answers), and other groups. It is available on the World Wide Web at <http://www.faqs.org/faqs/jpeg-faq/> and other [news.answers](mailto:news.answers) archive sites, including the official [news.answers](mailto:news.answers) archive at [rtfm.mit.edu](mailto:rtfm.mit.edu): <ftp://rtfm.mit.edu/pub/usenet/news.answers/jpeg-faq/>. If you don't have Web or FTP access, send e-mail to [mail-server@rtfm.mit.edu](mailto:mail-server@rtfm.mit.edu)

with body  
send usenet/news.answers/jpeg-faq/part1  
send usenet/news.answers/jpeg-faq/part2

## RELATED SOFTWARE

Numerous viewing and image manipulation programs now support JPEG. (Quite a few of them use this library to do so.) The JPEG FAQ described above lists some of the more popular free and shareware viewers, and tells where to obtain them on Internet.

If you are on a Unix machine, we highly recommend Jef Poskanzer's free PBMPPLUS software, which provides many useful operations on PPM-format image files. In particular, it can convert PPM images to and from a wide range of other formats, thus making cjpeg/djpeg considerably more useful. The latest version is distributed by the NetPBM group, and is available from numerous sites, notably <ftp://wuarchive.wustl.edu/graphics/graphics/packages/NetPBM/>. Unfortunately PBMPPLUS/NETPBM is not nearly as portable as the IJG software is; you are likely to have difficulty making it work on any non-Unix machine.

A different free JPEG implementation, written by the PVRG group at Stanford, is available from <ftp://havefun.stanford.edu/pub/jpeg/>. This program is designed for research and experimentation rather than production use; it is slower, harder to use, and less portable than the IJG code, but it is easier to read and modify. Also, the PVRG code supports lossless JPEG, which we do not. (On the other hand, it doesn't do progressive JPEG.)

## FILE FORMAT WARS

Some JPEG programs produce files that are not compatible with our library. The root of the problem is that the ISO JPEG committee failed to specify a concrete file format. Some vendors "filled in the blanks" on their own, creating proprietary formats that no one else could read. (For example, none of the early commercial JPEG implementations for the Macintosh were able to exchange compressed files.)

The file format we have adopted is called JFIF (see REFERENCES). This format has been agreed to by a number of major commercial JPEG vendors, and it has become the de facto standard. JFIF is a minimal or "low end" representation. We recommend the use of TIFF/JPEG (TIFF revision 6.0 as modified by TIFF Technical Note #2) for "high end" applications that need to record a lot of additional data about an image. TIFF/JPEG is fairly new and not yet widely supported, unfortunately.

The upcoming JPEG Part 3 standard defines a file format called SPIFF. SPIFF is interoperable with JFIF, in the sense that most JFIF decoders should be able to read the most common variant of SPIFF. SPIFF has some technical advantages over JFIF, but its major claim to fame is simply that it is an official standard rather than an informal one. At this point it is unclear whether SPIFF will supersede JFIF or whether JFIF will remain the de-facto standard. IJG intends to support SPIFF once the standard is frozen, but we have not decided whether it should become our default output format or not. (In any case, our decoder will remain capable of reading JFIF indefinitely.)

Various proprietary file formats incorporating JPEG compression also exist. We have little or no sympathy for the existence of these formats. Indeed, one of the original reasons for developing this free software was to help force convergence on common, open format standards for JPEG files. Don't use a proprietary file format!

## TO DO

The major thrust for v7 will probably be improvement of visual quality. The current method for scaling the quantization tables is known not to be very good at low Q values. We also intend to investigate block boundary smoothing, "poor man's variable quantization", and other means of improving quality-vs-file-size performance without sacrificing compatibility.

In future versions, we are considering supporting some of the upcoming JPEG Part 3 extensions --- principally, variable quantization and the SPIFF file format.

As always, speeding things up is of great interest.

Please send bug reports, offers of help, etc. to [jpeg-info@uunet.uu.net](mailto:jpeg-info@uunet.uu.net).

libmagic

Author: Christos Zoulas <[christos@zoulas.com](mailto:christos@zoulas.com)>  
Download: <ftp://ftp.astron.com/pub/file/>

Files: \*

Copyright:

(C) 1985-1995 Ian F. Darwin

(C) 1994-2009 Christos Zoulas <[christos@zoulas.com](mailto:christos@zoulas.com)>

License: BSD

This software is not subject to any export provision of the United States Department of Commerce, and may be exported to any country or planet.

Redistribution and use in source and binary forms, with or without modification, are permitted provided that the following conditions are met:

1. Redistributions of source code must retain the above copyright notice immediately at the beginning of the file, without modification, this list of conditions, and the following disclaimer.
2. Redistributions in binary form must reproduce the above copyright notice, this list of conditions and the following disclaimer in the documentation and/or other materials provided with the distribution.

THIS SOFTWARE IS PROVIDED BY THE AUTHOR AND CONTRIBUTORS "AS IS" AND ANY EXPRESS OR IMPLIED WARRANTIES, INCLUDING, BUT NOT LIMITED TO, THE IMPLIED WARRANTIES OF MERCHANTABILITY AND FITNESS FOR A PARTICULAR PURPOSE ARE DISCLAIMED. IN NO EVENT SHALL THE AUTHOR OR CONTRIBUTORS BE LIABLE FOR ANY DIRECT, INDIRECT, INCIDENTAL, SPECIAL, EXEMPLARY, OR CONSEQUENTIAL DAMAGES (INCLUDING, BUT NOT LIMITED TO, PROCUREMENT OF SUBSTITUTE GOODS OR SERVICES; LOSS OF USE, DATA, OR PROFITS; OR BUSINESS INTERRUPTION) HOWEVER CAUSED AND ON ANY THEORY OF LIABILITY, WHETHER IN CONTRACT, STRICT LIABILITY, OR TORT (INCLUDING NEGLIGENCE OR OTHERWISE) ARISING IN ANY WAY OUT OF THE USE OF THIS SOFTWARE, EVEN IF ADVISED OF THE POSSIBILITY OF SUCH DAMAGE.

libmfl

GNU LESSER GENERAL PUBLIC LICENSE  
Version 2.1, February 1999

Copyright (C) 1991, 1999 Free Software Foundation, Inc.  
59 Temple Place, Suite 330, Boston, MA 02111-1307 USA  
Everyone is permitted to copy and distribute verbatim copies of this license document, but changing it is not allowed.

[This is the first released version of the Lesser GPL. It also counts as the successor of the GNU Library Public License, version 2, hence the version number 2.1.]

### Preamble

The licenses for most software are designed to take away your freedom to share and change it. By contrast, the GNU General Public Licenses are intended to guarantee your freedom to share and change free software--to make sure the software is free for all its users.

This license, the Lesser General Public License, applies to some specially designated software packages--typically libraries--of the Free Software Foundation and other authors who decide to use it. You can use it too, but we suggest you first think carefully about whether this license or the ordinary General Public License is the better strategy to use in any particular case, based on the explanations below.

When we speak of free software, we are referring to freedom of use, not price. Our General Public Licenses are designed to make sure that you have the freedom to distribute copies of free software (and charge for this service if you wish); that you receive source code or can get it if you want it; that you can change the software and use pieces of it in new free programs; and that you are informed that you can do these things.

To protect your rights, we need to make restrictions that forbid distributors to deny you these rights or to ask you to surrender these rights. These restrictions translate to certain responsibilities for you if you distribute copies of the library or if you modify it.

For example, if you distribute copies of the library, whether gratis or for a fee, you must give the recipients all the rights that we gave you. You must make sure that they, too, receive or can get the source code. If you link other code with the library, you must provide complete object files to the recipients, so that they can relink them with the library after making changes to the library and recompiling it. And you must show them these terms so they know their rights.

We protect your rights with a two-step method: (1) we copyright the library, and (2) we offer you this license, which gives you legal permission to copy, distribute and/or modify the library.

To protect each distributor, we want to make it very clear that there is no warranty for the free library. Also, if the library is modified by someone else and passed on, the recipients should know that what they have is not the original version, so that the original author's reputation will not be affected by problems that might be introduced by others.

Finally, software patents pose a constant threat to the existence of any free program. We wish to make sure that a company cannot effectively restrict the users of a free program by obtaining a restrictive license from a patent holder. Therefore, we insist that any patent license obtained for a version of the library must be consistent with the full freedom of use specified in this license.

Most GNU software, including some libraries, is covered by the ordinary GNU General Public License. This license, the GNU Lesser General Public License, applies to certain designated libraries, and is quite different from the ordinary General Public License. We use

this license for certain libraries in order to permit linking those libraries into non-free programs.

When a program is linked with a library, whether statically or using a shared library, the combination of the two is legally speaking a combined work, a derivative of the original library. The ordinary General Public License therefore permits such linking only if the entire combination fits its criteria of freedom. The Lesser General Public License permits more lax criteria for linking other code with the library.

We call this license the "Lesser" General Public License because it does Less to protect the user's freedom than the ordinary General Public License. It also provides other free software developers Less of an advantage over competing non-free programs. These disadvantages are the reason we use the ordinary General Public License for many libraries. However, the Lesser license provides advantages in certain special circumstances.

For example, on rare occasions, there may be a special need to encourage the widest possible use of a certain library, so that it becomes a de-facto standard. To achieve this, non-free programs must be allowed to use the library. A more frequent case is that a free library does the same job as widely used non-free libraries. In this case, there is little to gain by limiting the free library to free software only, so we use the Lesser General Public License.

In other cases, permission to use a particular library in non-free programs enables a greater number of people to use a large body of free software. For example, permission to use the GNU C Library in non-free programs enables many more people to use the whole GNU operating system, as well as its variant, the GNU/Linux operating system.

Although the Lesser General Public License is Less protective of the users' freedom, it does ensure that the user of a program that is linked with the Library has the freedom and the wherewithal to run that program using a modified version of the Library.

The precise terms and conditions for copying, distribution and modification follow. Pay close attention to the difference between a "work based on the library" and a "work that uses the library". The former contains code derived from the library, whereas the latter must be combined with the library in order to run.

#### GNU LESSER GENERAL PUBLIC LICENSE TERMS AND CONDITIONS FOR COPYING, DISTRIBUTION AND MODIFICATION

0. This License Agreement applies to any software library or other program which contains a notice placed by the copyright holder or other authorized party saying it may be distributed under the terms of this Lesser General Public License (also called "this License"). Each licensee is addressed as "you".

A "library" means a collection of software functions and/or data prepared so as to be conveniently linked with application programs (which use some of those functions and data) to form executables.

The "Library", below, refers to any such software library or work which has been distributed under these terms. A "work based on the Library" means either the Library or any derivative work under copyright law: that is to say, a work containing the Library or a portion of it, either verbatim or with modifications and/or translated straightforwardly into another language. (Hereinafter, translation is included without limitation in the term "modification".)

"Source code" for a work means the preferred form of the work for making modifications to it. For a library, complete source code means all the source code for all modules it contains, plus any associated interface definition files, plus the scripts used to control compilation and installation of the library.

Activities other than copying, distribution and modification are not covered by this License; they are outside its scope. The act of running a program using the Library is not restricted, and output from such a program is covered only if its contents constitute a work based on the Library (independent of the use of the Library in a tool for writing it). Whether that is true depends on what the Library does and what the program that uses the Library does.

1. You may copy and distribute verbatim copies of the Library's complete source code as you receive it, in any medium, provided that you conspicuously and appropriately publish on each copy an appropriate copyright notice and disclaimer of warranty; keep intact all the notices that refer to this License and to the absence of any warranty; and distribute a copy of this License along with the Library.

You may charge a fee for the physical act of transferring a copy, and you may at your option offer warranty protection in exchange for a fee.

2. You may modify your copy or copies of the Library or any portion of it, thus forming a work based on the Library, and copy and distribute such modifications or work under the terms of Section 1 above, provided that you also meet all of these conditions:

a) The modified work must itself be a software library.

b) You must cause the files modified to carry prominent notices stating that you changed the files and the date of any change.

c) You must cause the whole of the work to be licensed at no charge to all third parties under the terms of this License.

d) If a facility in the modified Library refers to a function or a table of data to be supplied by an application program that uses the facility, other than as an argument passed when the facility is invoked, then you must make a good faith effort to ensure that, in the event an application does not supply such function or table, the facility still operates, and performs whatever part of its purpose remains meaningful.

(For example, a function in a library to compute square roots has a purpose that is entirely well-defined independent of the application. Therefore, Subsection 2d requires that any application-supplied function or table used by this function must be optional: if the application does not supply it, the square root function must still compute square roots.)

These requirements apply to the modified work as a whole. If identifiable sections of that work are not derived from the Library, and can be reasonably considered independent and separate works in themselves, then this License, and its terms, do not apply to those sections when you distribute them as separate works. But when you distribute the same sections as part of a whole which is a work based on the Library, the distribution of the whole must be on the terms of this License, whose permissions for other licensees extend to the entire whole, and thus to each and every part regardless of who wrote it.

Thus, it is not the intent of this section to claim rights or contest your rights to work written entirely by you; rather, the intent is to exercise the right to control the distribution of derivative or collective works based on the Library.

In addition, mere aggregation of another work not based on the Library with the Library (or with a work based on the Library) on a volume of a storage or distribution medium does not bring the other work under the scope of this License.

3. You may opt to apply the terms of the ordinary GNU General Public License instead of this License to a given copy of the Library. To do this, you must alter all the notices that refer to this License, so that they refer to the ordinary GNU General Public License, version 2, instead of to this License. (If a newer version than version 2 of the ordinary GNU General Public License has appeared, then you can specify that version instead if you wish.) Do not make any other change in these notices.

Once this change is made in a given copy, it is irreversible for that copy, so the ordinary GNU General Public License applies to all subsequent copies and derivative works made from that copy.

This option is useful when you wish to copy part of the code of the Library into a program that is not a library.

4. You may copy and distribute the Library (or a portion or derivative of it, under Section 2) in object code or executable form under the terms of Sections 1 and 2 above provided that you accompany it with the complete corresponding machine-readable source code, which must be distributed under the terms of Sections 1 and 2 above on a medium customarily used for software interchange.

If distribution of object code is made by offering access to copy from a designated place, then offering equivalent access to copy the source code from the same place satisfies the requirement to distribute the source code, even though third parties are not compelled to copy the source along with the object code.

5. A program that contains no derivative of any portion of the Library, but is designed to work with the Library by being compiled or linked with it, is called a "work that uses the Library". Such a work, in isolation, is not a derivative work of the Library, and therefore falls outside the scope of this License.

However, linking a "work that uses the Library" with the Library creates an executable that is a derivative of the Library (because it contains portions of the Library), rather than a "work that uses the library". The executable is therefore covered by this License. Section 6 states terms for distribution of such executables.

When a "work that uses the Library" uses material from a header file that is part of the Library, the object code for the work may be a derivative work of the Library even though the source code is not. Whether this is true is especially significant if the work can be linked without the Library, or if the work is itself a library. The threshold for this to be true is not precisely defined by law.

If such an object file uses only numerical parameters, data structure layouts and accessors, and small macros and small inline functions (ten lines or less in length), then the use of the object file is unrestricted, regardless of whether it is legally a derivative work. (Executables containing this object code plus portions of the Library will still fall under Section 6.)

Otherwise, if the work is a derivative of the Library, you may distribute the object code for the work under the terms of Section 6. Any executables containing that work also fall under Section 6, whether or not they are linked directly with the Library itself.

6. As an exception to the Sections above, you may also combine or link a "work that uses the Library" with the Library to produce a work containing portions of the Library, and distribute that work under terms of your choice, provided that the terms permit modification of the work for the customer's own use and reverse engineering for debugging such modifications.

You must give prominent notice with each copy of the work that the Library is used in it and that the Library and its use are covered by this License. You must supply a copy of this License. If the work during execution displays copyright notices, you must include the copyright notice for the Library among them, as well as a reference directing the user to the copy of this License. Also, you must do one of these things:

- a) Accompany the work with the complete corresponding machine-readable source code for the Library including whatever changes were used in the work (which must be distributed under Sections 1 and 2 above); and, if the work is an executable linked with the Library, with the complete machine-readable "work that uses the Library", as object code and/or source code, so that the user can modify the Library and then relink to produce a modified executable containing the modified Library. (It is understood that the user who changes the contents of definitions files in the Library will not necessarily be able to recompile the application to use the modified definitions.)
- b) Use a suitable shared library mechanism for linking with the Library. A suitable mechanism is one that (1) uses at run time a copy of the library already present on the user's computer system, rather than copying library functions into the executable, and (2) will operate properly with a modified version of the library, if the user installs one, as long as the modified version is interface-compatible with the version that the work was made with.
- c) Accompany the work with a written offer, valid for at least three years, to give the same user the materials specified in Subsection 6a, above, for a charge no more than the cost of performing this distribution.
- d) If distribution of the work is made by offering access to copy from a designated place, offer equivalent access to copy the above specified materials from the same place.
- e) Verify that the user has already received a copy of these materials or that you have already sent this user a copy.

For an executable, the required form of the "work that uses the Library" must include any data and utility programs needed for reproducing the executable from it. However, as a special exception, the materials to be distributed need not include anything that is normally distributed (in either source or binary form) with the major components (compiler, kernel, and so on) of the operating system on which the executable runs, unless that component itself accompanies the executable.

It may happen that this requirement contradicts the license restrictions of other proprietary libraries that do not normally accompany the operating system. Such a contradiction means you cannot use both them and the Library together in an executable that you distribute.

7. You may place library facilities that are a work based on the Library side-by-side in a single library together with other library facilities not covered by this License, and distribute such a combined library, provided that the separate distribution of the work based on the Library and of the other library facilities is otherwise permitted, and provided that you do these two things:

- a) Accompany the combined library with a copy of the same work based on the Library, uncombined with any other library facilities. This must be distributed under the terms of the Sections above.
- b) Give prominent notice with the combined library of the fact that part of it is a work based on the Library, and explaining where to find the accompanying uncombined form of the same work.

8. You may not copy, modify, sublicense, link with, or distribute the Library except as expressly provided under this License. Any attempt otherwise to copy, modify, sublicense, link with, or distribute the Library is void, and will automatically terminate your rights under this License. However, parties who have received copies, or rights, from you under this License will not have their licenses terminated so long as such parties remain in full compliance.

9. You are not required to accept this License, since you have not signed it. However, nothing else grants you permission to modify or distribute the Library or its derivative works. These actions are prohibited by law if you do not accept this License. Therefore, by modifying or distributing the Library (or any work based on the

Library), you indicate your acceptance of this License to do so, and all its terms and conditions for copying, distributing or modifying the Library or works based on it.

10. Each time you redistribute the Library (or any work based on the Library), the recipient automatically receives a license from the original licensor to copy, distribute, link with or modify the Library subject to these terms and conditions. You may not impose any further restrictions on the recipients' exercise of the rights granted herein. You are not responsible for enforcing compliance by third parties with this License.

11. If, as a consequence of a court judgment or allegation of patent infringement or for any other reason (not limited to patent issues), conditions are imposed on you (whether by court order, agreement or otherwise) that contradict the conditions of this License, they do not excuse you from the conditions of this License. If you cannot distribute so as to satisfy simultaneously your obligations under this License and any other pertinent obligations, then as a consequence you may not distribute the Library at all. For example, if a patent license would not permit royalty-free redistribution of the Library by all those who receive copies directly or indirectly through you, then the only way you could satisfy both it and this License would be to refrain entirely from distribution of the Library.

If any portion of this section is held invalid or unenforceable under any particular circumstance, the balance of the section is intended to apply, and the section as a whole is intended to apply in other circumstances.

It is not the purpose of this section to induce you to infringe any patents or other property right claims or to contest validity of any such claims; this section has the sole purpose of protecting the integrity of the free software distribution system which is implemented by public license practices. Many people have made generous contributions to the wide range of software distributed through that system in reliance on consistent application of that system; it is up to the author/donor to decide if he or she is willing to distribute software through any other system and a licensee cannot impose that choice.

This section is intended to make thoroughly clear what is believed to be a consequence of the rest of this License.

12. If the distribution and/or use of the Library is restricted in certain countries either by patents or by copyrighted interfaces, the original copyright holder who places the Library under this License may add an explicit geographical distribution limitation excluding those countries, so that distribution is permitted only in or among countries not thus excluded. In such case, this License incorporates the limitation as if written in the body of this License.

13. The Free Software Foundation may publish revised and/or new versions of the Lesser General Public License from time to time. Such new versions will be similar in spirit to the present version, but may differ in detail to address new problems or concerns.

Each version is given a distinguishing version number. If the Library specifies a version number of this License which applies to it and "any later version", you have the option of following the terms and conditions either of that version or of any later version published by the Free Software Foundation. If the Library does not specify a license version number, you may choose any version ever published by the Free Software Foundation.

14. If you wish to incorporate parts of the Library into other free programs whose distribution conditions are incompatible with these, write to the author to ask for permission. For software which is copyrighted by the Free Software Foundation, write to the Free Software Foundation; we sometimes make exceptions for this. Our decision will be guided by the two goals of preserving the free status of all derivatives of our free software and of promoting the sharing and reuse of software generally.

#### NO WARRANTY

15. BECAUSE THE LIBRARY IS LICENSED FREE OF CHARGE, THERE IS NO WARRANTY FOR THE LIBRARY, TO THE EXTENT PERMITTED BY APPLICABLE LAW. EXCEPT WHEN OTHERWISE STATED IN WRITING THE COPYRIGHT HOLDERS AND/OR OTHER PARTIES PROVIDE THE LIBRARY "AS IS" WITHOUT WARRANTY OF ANY KIND, EITHER EXPRESSED OR IMPLIED, INCLUDING, BUT NOT LIMITED TO, THE IMPLIED WARRANTIES OF MERCHANTABILITY AND FITNESS FOR A PARTICULAR PURPOSE. THE ENTIRE RISK AS TO THE QUALITY AND PERFORMANCE OF THE LIBRARY IS WITH YOU. SHOULD THE LIBRARY PROVE DEFECTIVE, YOU ASSUME THE COST OF ALL NECESSARY SERVICING, REPAIR OR CORRECTION.

16. IN NO EVENT UNLESS REQUIRED BY APPLICABLE LAW OR AGREED TO IN WRITING WILL ANY COPYRIGHT HOLDER, OR ANY OTHER PARTY WHO MAY MODIFY AND/OR REDISTRIBUTE THE LIBRARY AS PERMITTED ABOVE, BE LIABLE TO YOU FOR DAMAGES, INCLUDING ANY GENERAL, SPECIAL, INCIDENTAL OR CONSEQUENTIAL DAMAGES ARISING OUT OF THE USE OR INABILITY TO USE THE LIBRARY (INCLUDING BUT NOT LIMITED TO LOSS OF DATA OR DATA BEING RENDERED INACCURATE OR LOSSES SUSTAINED BY YOU OR THIRD PARTIES OR A FAILURE OF THE LIBRARY TO OPERATE WITH ANY OTHER SOFTWARE), EVEN IF SUCH HOLDER OR OTHER PARTY HAS BEEN ADVISED OF THE POSSIBILITY OF SUCH DAMAGES.

END OF TERMS AND CONDITIONS

OC18

The PHP License, version 3.01  
Copyright (c) 1999 - 2014 The PHP Group. All rights reserved.

Redistribution and use in source and binary forms, with or without modification, is permitted provided that the following conditions are met:

1. Redistributions of source code must retain the above copyright notice, this list of conditions and the following disclaimer.
2. Redistributions in binary form must reproduce the above copyright notice, this list of conditions and the following disclaimer in the documentation and/or other materials provided with the distribution.
3. The name "PHP" must not be used to endorse or promote products derived from this software without prior written permission. For written permission, please contact [group@php.net](mailto:group@php.net).
4. Products derived from this software may not be called "PHP", nor may "PHP" appear in their name, without prior written permission from [group@php.net](mailto:group@php.net). You may indicate that your software works in conjunction with PHP by saying "Foo for PHP" instead of calling it "PHP Foo" or "phpfoo".
5. The PHP Group may publish revised and/or new versions of the license from time to time. Each version will be given a distinguishing version number.  
Once covered code has been published under a particular version of the license, you may always continue to use it under the terms of that version. You may also choose to use such covered code under the terms of any subsequent version of the license published by the PHP Group. No one other than the PHP Group has the right to modify the terms applicable to covered code created under this License.
6. Redistributions of any form whatsoever must retain the following acknowledgment:  
"This product includes PHP software, freely available from <http://www.php.net/software/>".

THIS SOFTWARE IS PROVIDED BY THE PHP DEVELOPMENT TEAM "AS IS" AND ANY EXPRESSED OR IMPLIED WARRANTIES, INCLUDING, BUT NOT LIMITED TO, THE IMPLIED WARRANTIES OF MERCHANTABILITY AND FITNESS FOR A PARTICULAR PURPOSE ARE DISCLAIMED. IN NO EVENT SHALL THE PHP DEVELOPMENT TEAM OR ITS CONTRIBUTORS BE LIABLE FOR ANY DIRECT, INDIRECT, INCIDENTAL, SPECIAL, EXEMPLARY, OR CONSEQUENTIAL DAMAGES (INCLUDING, BUT NOT LIMITED TO, PROCUREMENT OF SUBSTITUTE GOODS OR SERVICES; LOSS OF USE, DATA, OR PROFITS; OR BUSINESS INTERRUPTION) HOWEVER CAUSED AND ON ANY THEORY OF LIABILITY, WHETHER IN CONTRACT, STRICT LIABILITY, OR TORT (INCLUDING NEGLIGENCE OR OTHERWISE) ARISING IN ANY WAY OUT OF THE USE OF THIS SOFTWARE, EVEN IF ADVISED OF THE POSSIBILITY OF SUCH DAMAGE.

This software consists of voluntary contributions made by many individuals on behalf of the PHP Group.

The PHP Group can be contacted via Email at [group@php.net](mailto:group@php.net).

For more information on the PHP Group and the PHP project, please see <http://www.php.net>.

PHP includes the Zend Engine, freely available at <http://www.zend.com>.

Oniguruma

Oniguruma LICENSE

/\*\_

\* Copyright (c) 2002-2007 K.Kosako <sndgk393 AT ybb DOT ne DOT jp>  
\* All rights reserved.

\* Redistribution and use in source and binary forms, with or without modification, are permitted provided that the following conditions are met:

- \* 1. Redistributions of source code must retain the above copyright notice, this list of conditions and the following disclaimer.
- \* 2. Redistributions in binary form must reproduce the above copyright notice, this list of conditions and the following disclaimer in the documentation and/or other materials provided with the distribution.

\* THIS SOFTWARE IS PROVIDED BY THE AUTHOR AND CONTRIBUTORS "AS IS" AND \* ANY EXPRESS OR IMPLIED WARRANTIES, INCLUDING, BUT NOT LIMITED TO, THE \* IMPLIED WARRANTIES OF MERCHANTABILITY AND FITNESS FOR A PARTICULAR PURPOSE \* ARE DISCLAIMED. IN NO EVENT SHALL THE AUTHOR OR CONTRIBUTORS BE LIABLE

\* FOR ANY DIRECT, INDIRECT, INCIDENTAL, SPECIAL, EXEMPLARY, OR CONSEQUENTIAL DAMAGES (INCLUDING, BUT NOT LIMITED TO, PROCUREMENT OF SUBSTITUTE GOODS \* OR SERVICES; LOSS OF USE, DATA, OR PROFITS; OR BUSINESS INTERRUPTION) \* HOWEVER CAUSED AND ON ANY THEORY OF LIABILITY, WHETHER IN CONTRACT, STRICT LIABILITY, OR TORT (INCLUDING NEGLIGENCE OR OTHERWISE) ARISING IN ANY WAY \* OUT OF THE USE OF THIS SOFTWARE, EVEN IF ADVISED OF THE POSSIBILITY OF \* SUCH DAMAGE.  
\*/

PCRE

PCRE LICENCE

PCRE is a library of functions to support regular expressions whose syntax and semantics are as close as possible to those of the Perl 5 language.

Release 8 of PCRE is distributed under the terms of the "BSD" licence, as specified below. The documentation for PCRE, supplied in the "doc" directory, is distributed under the same terms as the software itself.

The basic library functions are written in C and are freestanding. Also included in the distribution is a set of C++ wrapper functions, and a just-in-time compiler that can be used to optimize pattern matching. These are both optional features that can be omitted when the library is built.

THE BASIC LIBRARY FUNCTIONS

Written by: Philip Hazel  
Email local part: ph10  
Email domain: cam.ac.uk

University of Cambridge Computing Service,  
Cambridge, England.

Copyright (c) 1997-2013 University of Cambridge  
All rights reserved.

PCRE JUST-IN-TIME COMPILATION SUPPORT

Written by: Zoltan Herczeg  
Email local part: hzmester  
Email domain: freemail.hu

Copyright(c) 2010-2013 Zoltan Herczeg  
All rights reserved.

STACK-LESS JUST-IN-TIME COMPILER

Written by: Zoltan Herczeg  
Email local part: hzmester  
Email domain: freemail.hu

Copyright(c) 2009-2013 Zoltan Herczeg  
All rights reserved.

THE C++ WRAPPER FUNCTIONS

Contributed by: Google Inc.

Copyright (c) 2007-2012, Google Inc.  
All rights reserved.

THE "BSD" LICENCE

Redistribution and use in source and binary forms, with or without modification, are permitted provided that the following conditions are met:

\* Redistributions of source code must retain the above copyright notice, this list of conditions and the following disclaimer.

\* Redistributions in binary form must reproduce the above copyright notice, this list of conditions and the following disclaimer in the documentation and/or other materials provided with the distribution.

\* Neither the name of the University of Cambridge nor the name of Google Inc. nor the names of their contributors may be used to endorse or promote products derived from this software without specific prior written permission.

THIS SOFTWARE IS PROVIDED BY THE COPYRIGHT HOLDERS AND CONTRIBUTORS "AS IS" AND ANY EXPRESS OR IMPLIED WARRANTIES, INCLUDING, BUT NOT LIMITED TO, THE

IMPLIED WARRANTIES OF MERCHANTABILITY AND FITNESS FOR A PARTICULAR PURPOSE ARE DISCLAIMED. IN NO EVENT SHALL THE COPYRIGHT OWNER OR CONTRIBUTORS BE LIABLE FOR ANY DIRECT, INDIRECT, INCIDENTAL, SPECIAL, EXEMPLARY, OR CONSEQUENTIAL DAMAGES (INCLUDING, BUT NOT LIMITED TO, PROCUREMENT OF SUBSTITUTE GOODS OR SERVICES; LOSS OF USE, DATA, OR PROFITS; OR BUSINESS INTERRUPTION) HOWEVER CAUSED AND ON ANY THEORY OF LIABILITY, WHETHER IN CONTRACT, STRICT LIABILITY, OR TORT (INCLUDING NEGLIGENCE OR OTHERWISE) ARISING IN ANY WAY OUT OF THE USE OF THIS SOFTWARE, EVEN IF ADVISED OF THE POSSIBILITY OF SUCH DAMAGE.

End

PEAR

Copyright (c) 1997-2009, Stig Bakken <ssb@php.net>, Gregory Beaver <cellog@php.net>, Helgi Pormar Þorbjörnsson <helgi@php.net>, Tomas V.V.Cox <cox@idecnet.com>, Martin Jansen <mj@php.net>. All rights reserved.

Redistribution and use in source and binary forms, with or without modification, are permitted provided that the following conditions are met:

- \* Redistributions of source code must retain the above copyright notice, this list of conditions and the following disclaimer.
\* Redistributions in binary form must reproduce the above copyright notice, this list of conditions and the following disclaimer in the documentation and/or other materials provided with the distribution.

THIS SOFTWARE IS PROVIDED BY THE COPYRIGHT HOLDERS AND CONTRIBUTORS "AS IS" AND ANY EXPRESS OR IMPLIED WARRANTIES, INCLUDING, BUT NOT LIMITED TO, THE IMPLIED WARRANTIES OF MERCHANTABILITY AND FITNESS FOR A PARTICULAR PURPOSE ARE DISCLAIMED. IN NO EVENT SHALL THE COPYRIGHT OWNER OR CONTRIBUTORS BE LIABLE FOR ANY DIRECT, INDIRECT, INCIDENTAL, SPECIAL, EXEMPLARY, OR CONSEQUENTIAL DAMAGES (INCLUDING, BUT NOT LIMITED TO, PROCUREMENT OF SUBSTITUTE GOODS OR SERVICES; LOSS OF USE, DATA, OR PROFITS; OR BUSINESS INTERRUPTION) HOWEVER CAUSED AND ON ANY THEORY OF LIABILITY, WHETHER IN CONTRACT, STRICT LIABILITY, OR TORT (INCLUDING NEGLIGENCE OR OTHERWISE) ARISING IN ANY WAY OUT OF THE USE OF THIS SOFTWARE, EVEN IF ADVISED OF THE POSSIBILITY OF SUCH DAMAGE.

Phar

The PHP License, version 3.01
Copyright (c) 1999 - 2005 The PHP Group. All rights reserved.

Redistribution and use in source and binary forms, with or without modification, is permitted provided that the following conditions are met:

- 1. Redistributions of source code must retain the above copyright notice, this list of conditions and the following disclaimer.
2. Redistributions in binary form must reproduce the above copyright notice, this list of conditions and the following disclaimer in the documentation and/or other materials provided with the distribution.
3. The name "PHP" must not be used to endorse or promote products derived from this software without prior written permission. For written permission, please contact group@php.net.
4. Products derived from this software may not be called "PHP", nor may "PHP" appear in their name, without prior written permission from group@php.net. You may indicate that your software works in conjunction with PHP by saying "Foo for PHP" instead of calling it "PHP Foo" or "phpfoo"
5. The PHP Group may publish revised and/or new versions of the license from time to time. Each version will be given a distinguishing version number. Once covered code has been published under a particular version of the license, you may always continue to use it under the terms of that version. You may also choose to use such covered code under the terms of any subsequent version of the license published by the PHP Group. No one other than the PHP Group has the right to modify the terms applicable to covered code created under this License.
6. Redistributions of any form whatsoever must retain the following acknowledgment:

"This product includes PHP software, freely available from <http://www.php.net/software/>".

THIS SOFTWARE IS PROVIDED BY THE PHP DEVELOPMENT TEAM ``AS IS" AND ANY EXPRESSED OR IMPLIED WARRANTIES, INCLUDING, BUT NOT LIMITED TO, THE IMPLIED WARRANTIES OF MERCHANTABILITY AND FITNESS FOR A PARTICULAR PURPOSE ARE DISCLAIMED. IN NO EVENT SHALL THE PHP DEVELOPMENT TEAM OR ITS CONTRIBUTORS BE LIABLE FOR ANY DIRECT, INDIRECT, INCIDENTAL, SPECIAL, EXEMPLARY, OR CONSEQUENTIAL DAMAGES (INCLUDING, BUT NOT LIMITED TO, PROCUREMENT OF SUBSTITUTE GOODS OR SERVICES; LOSS OF USE, DATA, OR PROFITS; OR BUSINESS INTERRUPTION) HOWEVER CAUSED AND ON ANY THEORY OF LIABILITY, WHETHER IN CONTRACT, STRICT LIABILITY, OR TORT (INCLUDING NEGLIGENCE OR OTHERWISE) ARISING IN ANY WAY OUT OF THE USE OF THIS SOFTWARE, EVEN IF ADVISED OF THE POSSIBILITY OF SUCH DAMAGE.

This software consists of voluntary contributions made by many individuals on behalf of the PHP Group.

The PHP Group can be contacted via Email at group@php.net.

For more information on the PHP Group and the PHP project, please see <http://www.php.net>.

PHP includes the Zend Engine, freely available at <http://www.zend.com>.

phar\_tar\_octal() based on an implementation Copyright (c) 2003-2007 Tim Kientzle from libarchive, licensed with this license:

Copyright (c) 2003-2007 Tim Kientzle
All rights reserved.

Redistribution and use in source and binary forms, with or without modification, are permitted provided that the following conditions are met:

- 1. Redistributions of source code must retain the above copyright notice, this list of conditions and the following disclaimer.
2. Redistributions in binary form must reproduce the above copyright notice, this list of conditions and the following disclaimer in the documentation and/or other materials provided with the distribution.

THIS SOFTWARE IS PROVIDED BY THE AUTHOR(S) ``AS IS" AND ANY EXPRESS OR IMPLIED WARRANTIES, INCLUDING, BUT NOT LIMITED TO, THE IMPLIED WARRANTIES OF MERCHANTABILITY AND FITNESS FOR A PARTICULAR PURPOSE ARE DISCLAIMED. IN NO EVENT SHALL THE AUTHOR(S) BE LIABLE FOR ANY DIRECT, INDIRECT, INCIDENTAL, SPECIAL, EXEMPLARY, OR CONSEQUENTIAL DAMAGES (INCLUDING, BUT NOT LIMITED TO, PROCUREMENT OF SUBSTITUTE GOODS OR SERVICES; LOSS OF USE, DATA, OR PROFITS; OR BUSINESS INTERRUPTION) HOWEVER CAUSED AND ON ANY THEORY OF LIABILITY, WHETHER IN CONTRACT, STRICT LIABILITY, OR TORT (INCLUDING NEGLIGENCE OR OTHERWISE) ARISING IN ANY WAY OUT OF THE USE OF THIS SOFTWARE, EVEN IF ADVISED OF THE POSSIBILITY OF SUCH DAMAGE.

regex

Copyright 1992, 1993, 1994 Henry Spencer. All rights reserved. This software is not subject to any license of the American Telephone and Telegraph Company or of the Regents of the University of California.

Permission is granted to anyone to use this software for any purpose on any computer system, and to alter it and redistribute it, subject to the following restrictions:

- 1. The author is not responsible for the consequences of use of this software, no matter how awful, even if they arise from flaws in it.
2. The origin of this software must not be misrepresented, either by explicit claim or by omission. Since few users ever read sources, credits must appear in the documentation.
3. Altered versions must be plainly marked as such, and must not be misrepresented as being the original software. Since few users ever read sources, credits must appear in the documentation.
4. This notice may not be removed or altered.

Structures\_Graph

GNU LESSER GENERAL PUBLIC LICENSE
Version 2.1, February 1999

Copyright (C) 1991, 1999 Free Software Foundation, Inc.
59 Temple Place, Suite 330, Boston, MA 02111-1307 USA
Everyone is permitted to copy and distribute verbatim copies of this license document, but changing it is not allowed.

[This is the first released version of the Lesser GPL. It also counts as the successor of the GNU Library Public License, version 2, hence the version number 2.1.]

## Preamble

The licenses for most software are designed to take away your freedom to share and change it. By contrast, the GNU General Public Licenses are intended to guarantee your freedom to share and change free software—to make sure the software is free for all its users.

This license, the Lesser General Public License, applies to some specially designated software packages—typically libraries—of the Free Software Foundation and other authors who decide to use it. You can use it too, but we suggest you first think carefully about whether this license or the ordinary General Public License is the better strategy to use in any particular case, based on the explanations below.

When we speak of free software, we are referring to freedom of use, not price. Our General Public Licenses are designed to make sure that you have the freedom to distribute copies of free software (and charge for this service if you wish); that you receive source code or can get it if you want it; that you can change the software and use pieces of it in new free programs; and that you are informed that you can do these things.

To protect your rights, we need to make restrictions that forbid distributors to deny you these rights or to ask you to surrender these rights. These restrictions translate to certain responsibilities for you if you distribute copies of the library or if you modify it.

For example, if you distribute copies of the library, whether gratis or for a fee, you must give the recipients all the rights that we gave you. You must make sure that they, too, receive or can get the source code. If you link other code with the library, you must provide complete object files to the recipients, so that they can relink them with the library after making changes to the library and recompiling it. And you must show them these terms so they know their rights.

We protect your rights with a two-step method: (1) we copyright the library, and (2) we offer you this license, which gives you legal permission to copy, distribute and/or modify the library.

To protect each distributor, we want to make it very clear that there is no warranty for the free library. Also, if the library is modified by someone else and passed on, the recipients should know that what they have is not the original version, so that the original author's reputation will not be affected by problems that might be introduced by others.

Finally, software patents pose a constant threat to the existence of any free program. We wish to make sure that a company cannot effectively restrict the users of a free program by obtaining a restrictive license from a patent holder. Therefore, we insist that any patent license obtained for a version of the library must be consistent with the full freedom of use specified in this license.

Most GNU software, including some libraries, is covered by the ordinary GNU General Public License. This license, the GNU Lesser General Public License, applies to certain designated libraries, and is quite different from the ordinary General Public License. We use this license for certain libraries in order to permit linking those libraries into non-free programs.

When a program is linked with a library, whether statically or using a shared library, the combination of the two is legally speaking a combined work, a derivative of the original library. The ordinary General Public License therefore permits such linking only if the entire combination fits its criteria of freedom. The Lesser General Public License permits more lax criteria for linking other code with the library.

We call this license the "Lesser" General Public License because it does Less to protect the user's freedom than the ordinary General Public License. It also provides other free software developers Less of an advantage over competing non-free programs. These disadvantages are the reason we use the ordinary General Public License for many libraries. However, the Lesser license provides advantages in certain special circumstances.

For example, on rare occasions, there may be a special need to encourage the widest possible use of a certain library, so that it becomes a de-facto standard. To achieve this, non-free programs must be allowed to use the library. A more frequent case is that a free library does the same job as widely used non-free libraries. In this case, there is little to gain by limiting the free library to free software only, so we use the Lesser General Public License.

In other cases, permission to use a particular library in non-free programs enables a greater number of people to use a large body of free software. For example, permission to use the GNU C Library in non-free programs enables many more people to use the whole GNU operating system, as well as its variant, the GNU/Linux operating system.

Although the Lesser General Public License is Less protective of the users' freedom, it does ensure that the user of a program that is linked with the Library has the freedom and the wherewithal to run that program using a modified version of the Library.

The precise terms and conditions for copying, distribution and

modification follow. Pay close attention to the difference between a "work based on the library" and a "work that uses the library". The former contains code derived from the library, whereas the latter must be combined with the library in order to run.

## GNU LESSER GENERAL PUBLIC LICENSE TERMS AND CONDITIONS FOR COPYING, DISTRIBUTION AND MODIFICATION

0. This License Agreement applies to any software library or other program which contains a notice placed by the copyright holder or other authorized party saying it may be distributed under the terms of this Lesser General Public License (also called "this License"). Each licensee is addressed as "you".

A "library" means a collection of software functions and/or data prepared so as to be conveniently linked with application programs (which use some of those functions and data) to form executables.

The "Library", below, refers to any such software library or work which has been distributed under these terms. A "work based on the Library" means either the Library or any derivative work under copyright law: that is to say, a work containing the Library or a portion of it, either verbatim or with modifications and/or translated straightforwardly into another language. (Hereinafter, translation is included without limitation in the term "modification".)

"Source code" for a work means the preferred form of the work for making modifications to it. For a library, complete source code means all the source code for all modules it contains, plus any associated interface definition files, plus the scripts used to control compilation and installation of the library.

Activities other than copying, distribution and modification are not covered by this License; they are outside its scope. The act of running a program using the Library is not restricted, and output from such a program is covered only if its contents constitute a work based on the Library (independent of the use of the Library in a tool for writing it). Whether that is true depends on what the Library does and what the program that uses the Library does.

1. You may copy and distribute verbatim copies of the Library's complete source code as you receive it, in any medium, provided that you conspicuously and appropriately publish on each copy an appropriate copyright notice and disclaimer of warranty; keep intact all the notices that refer to this License and to the absence of any warranty; and distribute a copy of this License along with the Library.

You may charge a fee for the physical act of transferring a copy, and you may at your option offer warranty protection in exchange for a fee.

2. You may modify your copy or copies of the Library or any portion of it, thus forming a work based on the Library, and copy and distribute such modifications or work under the terms of Section 1 above, provided that you also meet all of these conditions:

- The modified work must itself be a software library.
- You must cause the files modified to carry prominent notices stating that you changed the files and the date of any change.
- You must cause the whole of the work to be licensed at no charge to all third parties under the terms of this License.
- If a facility in the modified Library refers to a function or a table of data to be supplied by an application program that uses the facility, other than as an argument passed when the facility is invoked, then you must make a good faith effort to ensure that, in the event an application does not supply such function or table, the facility still operates, and performs whatever part of its purpose remains meaningful.

(For example, a function in a library to compute square roots has a purpose that is entirely well-defined independent of the application. Therefore, Subsection 2d requires that any application-supplied function or table used by this function must be optional: if the application does not supply it, the square root function must still compute square roots.)

These requirements apply to the modified work as a whole. If identifiable sections of that work are not derived from the Library, and can be reasonably considered independent and separate works in themselves, then this License, and its terms, do not apply to those sections when you distribute them as separate works. But when you distribute the same sections as part of a whole which is a work based on the Library, the distribution of the whole must be on the terms of this License, whose permissions for other licensees extend to the entire whole, and thus to each and every part regardless of who wrote it.

Thus, it is not the intent of this section to claim rights or contest your rights to work written entirely by you; rather, the intent is to exercise the right to control the distribution of derivative or collective works based on the Library.

In addition, mere aggregation of another work not based on the Library



with the Library (or with a work based on the Library) on a volume of a storage or distribution medium does not bring the other work under the scope of this License.

3. You may opt to apply the terms of the ordinary GNU General Public License instead of this License to a given copy of the Library. To do this, you must alter all the notices that refer to this License, so that they refer to the ordinary GNU General Public License, version 2, instead of to this License. (If a newer version than version 2 of the ordinary GNU General Public License has appeared, then you can specify that version instead if you wish.) Do not make any other change in these notices.

Once this change is made in a given copy, it is irreversible for that copy, so the ordinary GNU General Public License applies to all subsequent copies and derivative works made from that copy.

This option is useful when you wish to copy part of the code of the Library into a program that is not a library.

4. You may copy and distribute the Library (or a portion or derivative of it, under Section 2) in object code or executable form under the terms of Sections 1 and 2 above provided that you accompany it with the complete corresponding machine-readable source code, which must be distributed under the terms of Sections 1 and 2 above on a medium customarily used for software interchange.

If distribution of object code is made by offering access to copy from a designated place, then offering equivalent access to copy the source code from the same place satisfies the requirement to distribute the source code, even though third parties are not compelled to copy the source along with the object code.

5. A program that contains no derivative of any portion of the Library, but is designed to work with the Library by being compiled or linked with it, is called a "work that uses the Library". Such a work, in isolation, is not a derivative work of the Library, and therefore falls outside the scope of this License.

However, linking a "work that uses the Library" with the Library creates an executable that is a derivative of the Library (because it contains portions of the Library), rather than a "work that uses the library". The executable is therefore covered by this License. Section 6 states terms for distribution of such executables.

When a "work that uses the Library" uses material from a header file that is part of the Library, the object code for the work may be a derivative work of the Library even though the source code is not. Whether this is true is especially significant if the work can be linked without the Library, or if the work is itself a library. The threshold for this to be true is not precisely defined by law.

If such an object file uses only numerical parameters, data structure layouts and accessors, and small macros and small inline functions (ten lines or less in length), then the use of the object file is unrestricted, regardless of whether it is legally a derivative work. (Executables containing this object code plus portions of the Library will still fall under Section 6.)

Otherwise, if the work is a derivative of the Library, you may distribute the object code for the work under the terms of Section 6. Any executables containing that work also fall under Section 6, whether or not they are linked directly with the Library itself.

6. As an exception to the Sections above, you may also combine or link a "work that uses the Library" with the Library to produce a work containing portions of the Library, and distribute that work under terms of your choice, provided that the terms permit modification of the work for the customer's own use and reverse engineering for debugging such modifications.

You must give prominent notice with each copy of the work that the Library is used in it and that the Library and its use are covered by this License. You must supply a copy of this License. If the work during execution displays copyright notices, you must include the copyright notice for the Library among them, as well as a reference directing the user to the copy of this License. Also, you must do one of these things:

a) Accompany the work with the complete corresponding machine-readable source code for the Library including whatever changes were used in the work (which must be distributed under Sections 1 and 2 above); and, if the work is an executable linked with the Library, with the complete machine-readable "work that uses the Library", as object code and/or source code, so that the user can modify the Library and then relink to produce a modified executable containing the modified Library. (It is understood that the user who changes the contents of definitions files in the Library will not necessarily be able to recompile the application to use the modified definitions.)

b) Use a suitable shared library mechanism for linking with the Library. A suitable mechanism is one that (1) uses at run time a copy of the library already present on the user's computer system, rather than copying library functions into the executable, and (2) will operate properly with a modified version of the library, if the user installs one, as long as the modified version is

interface-compatible with the version that the work was made with.

c) Accompany the work with a written offer, valid for at least three years, to give the same user the materials specified in Subsection 6a, above, for a charge no more than the cost of performing this distribution.

d) If distribution of the work is made by offering access to copy from a designated place, offer equivalent access to copy the above specified materials from the same place.

e) Verify that the user has already received a copy of these materials or that you have already sent this user a copy.

For an executable, the required form of the "work that uses the Library" must include any data and utility programs needed for reproducing the executable from it. However, as a special exception, the materials to be distributed need not include anything that is normally distributed (in either source or binary form) with the major components (compiler, kernel, and so on) of the operating system on which the executable runs, unless that component itself accompanies the executable.

It may happen that this requirement contradicts the license restrictions of other proprietary libraries that do not normally accompany the operating system. Such a contradiction means you cannot use both them and the Library together in an executable that you distribute.

7. You may place library facilities that are a work based on the Library side-by-side in a single library together with other library facilities not covered by this License, and distribute such a combined library, provided that the separate distribution of the work based on the Library and of the other library facilities is otherwise permitted, and provided that you do these two things:

a) Accompany the combined library with a copy of the same work based on the Library, uncombined with any other library facilities. This must be distributed under the terms of the Sections above.

b) Give prominent notice with the combined library of the fact that part of it is a work based on the Library, and explaining where to find the accompanying uncombined form of the same work.

8. You may not copy, modify, sublicense, link with, or distribute the Library except as expressly provided under this License. Any attempt otherwise to copy, modify, sublicense, link with, or distribute the Library is void, and will automatically terminate your rights under this License. However, parties who have received copies, or rights, from you under this License will not have their licenses terminated so long as such parties remain in full compliance.

9. You are not required to accept this License, since you have not signed it. However, nothing else grants you permission to modify or distribute the Library or its derivative works. These actions are prohibited by law if you do not accept this License. Therefore, by modifying or distributing the Library (or any work based on the Library), you indicate your acceptance of this License to do so, and all its terms and conditions for copying, distributing or modifying the Library or works based on it.

10. Each time you redistribute the Library (or any work based on the Library), the recipient automatically receives a license from the original licensor to copy, distribute, link with or modify the Library subject to these terms and conditions. You may not impose any further restrictions on the recipients' exercise of the rights granted herein. You are not responsible for enforcing compliance by third parties with this License.

11. If, as a consequence of a court judgment or allegation of patent infringement or for any other reason (not limited to patent issues), conditions are imposed on you (whether by court order, agreement or otherwise) that contradict the conditions of this License, they do not excuse you from the conditions of this License. If you cannot distribute so as to satisfy simultaneously your obligations under this License and any other pertinent obligations, then as a consequence you may not distribute the Library at all. For example, if a patent license would not permit royalty-free redistribution of the Library by all those who receive copies directly or indirectly through you, then the only way you could satisfy both it and this License would be to refrain entirely from distribution of the Library.

If any portion of this section is held invalid or unenforceable under any particular circumstance, the balance of the section is intended to apply, and the section as a whole is intended to apply in other circumstances.

It is not the purpose of this section to induce you to infringe any patents or other property right claims or to contest validity of any such claims; this section has the sole purpose of protecting the integrity of the free software distribution system which is implemented by public license practices. Many people have made generous contributions to the wide range of software distributed through that system in reliance on consistent application of that system; it is up to the author/donor to decide if he or she is willing to distribute software through any other system and a licensee cannot impose that choice.

This section is intended to make thoroughly clear what is believed to be a consequence of the rest of this License.

12. If the distribution and/or use of the Library is restricted in certain countries either by patents or by copyrighted interfaces, the original copyright holder who places the Library under this License may add an explicit geographical distribution limitation excluding those countries, so that distribution is permitted only in or among countries not thus excluded. In such case, this License incorporates the limitation as if written in the body of this License.

13. The Free Software Foundation may publish revised and/or new versions of the Lesser General Public License from time to time. Such new versions will be similar in spirit to the present version, but may differ in detail to address new problems or concerns.

Each version is given a distinguishing version number. If the Library specifies a version number of this License which applies to it and "any later version", you have the option of following the terms and conditions either of that version or of any later version published by the Free Software Foundation. If the Library does not specify a license version number, you may choose any version ever published by the Free Software Foundation.

14. If you wish to incorporate parts of the Library into other free programs whose distribution conditions are incompatible with these, write to the author to ask for permission. For software which is copyrighted by the Free Software Foundation, write to the Free Software Foundation; we sometimes make exceptions for this. Our decision will be guided by the two goals of preserving the free status of all derivatives of our free software and of promoting the sharing and reuse of software generally.

NO WARRANTY

15. BECAUSE THE LIBRARY IS LICENSED FREE OF CHARGE, THERE IS NO WARRANTY FOR THE LIBRARY, TO THE EXTENT PERMITTED BY APPLICABLE LAW. EXCEPT WHEN OTHERWISE STATED IN WRITING THE COPYRIGHT HOLDERS AND/OR OTHER PARTIES PROVIDE THE LIBRARY "AS IS" WITHOUT WARRANTY OF ANY KIND, EITHER EXPRESSED OR IMPLIED, INCLUDING, BUT NOT LIMITED TO, THE IMPLIED WARRANTIES OF MERCHANTABILITY AND FITNESS FOR A PARTICULAR PURPOSE. THE ENTIRE RISK AS TO THE QUALITY AND PERFORMANCE OF THE LIBRARY IS WITH YOU. SHOULD THE LIBRARY PROVE DEFECTIVE, YOU ASSUME THE COST OF ALL NECESSARY SERVICING, REPAIR OR CORRECTION.

16. IN NO EVENT UNLESS REQUIRED BY APPLICABLE LAW OR AGREED TO IN WRITING WILL ANY COPYRIGHT HOLDER, OR ANY OTHER PARTY WHO MAY MODIFY AND/OR REDISTRIBUTE THE LIBRARY AS PERMITTED ABOVE, BE LIABLE TO YOU FOR DAMAGES, INCLUDING ANY GENERAL, SPECIAL, INCIDENTAL OR CONSEQUENTIAL DAMAGES ARISING OUT OF THE USE OR INABILITY TO USE THE LIBRARY (INCLUDING BUT NOT LIMITED TO LOSS OF DATA OR DATA BEING RENDERED INACCURATE OR LOSSES SUSTAINED BY YOU OR THIRD PARTIES OR A FAILURE OF THE LIBRARY TO OPERATE WITH ANY OTHER SOFTWARE), EVEN IF SUCH HOLDER OR OTHER PARTY HAS BEEN ADVISED OF THE POSSIBILITY OF SUCH DAMAGES.

END OF TERMS AND CONDITIONS

How to Apply These Terms to Your New Libraries

If you develop a new library, and you want it to be of the greatest possible use to the public, we recommend making it free software that everyone can redistribute and change. You can do so by permitting redistribution under these terms (or, alternatively, under the terms of the ordinary General Public License).

To apply these terms, attach the following notices to the library. It is safest to attach them to the start of each source file to most effectively convey the exclusion of warranty; and each file should have at least the "copyright" line and a pointer to where the full notice is found.

<one line to give the library's name and a brief idea of what it does.>  
Copyright (C) <year> <name of author>

This library is free software; you can redistribute it and/or modify it under the terms of the GNU Lesser General Public License as published by the Free Software Foundation; either version 2.1 of the License, or (at your option) any later version.

This library is distributed in the hope that it will be useful, but WITHOUT ANY WARRANTY; without even the implied warranty of MERCHANTABILITY or FITNESS FOR A PARTICULAR PURPOSE. See the GNU Lesser General Public License for more details.

You should have received a copy of the GNU Lesser General Public License along with this library; if not, write to the Free Software Foundation, Inc., 59 Temple Place, Suite 330, Boston, MA 02111-1307 USA

Also add information on how to contact you by electronic and paper mail.

You should also get your employer (if you work as a programmer) or your school, if any, to sign a "copyright disclaimer" for the library, if necessary. Here is a sample; alter the names:

Yoyodyne, Inc., hereby disclaims all copyright interest in the library 'Frob' (a library for tweaking knobs) written by James Random Hacker.

<signature of Ty Coon>, 1 April 1990  
Ty Coon, President of Vice

That's all there is to it!

TSRM

Copyright (c) 1999-2006, Andi Gutmans, Sascha Schumann, Zeev Suraski. All rights reserved.

Redistribution and use in source and binary forms, with or without modification, are permitted provided that the following conditions are met:

- Redistributions of source code must retain the above copyright notice, this list of conditions and the following disclaimer.

- Neither name of the copyright holders nor the names of their contributors may be used to endorse or promote products derived from this software without specific prior written permission.

THIS SOFTWARE IS PROVIDED BY THE COPYRIGHT HOLDERS AND CONTRIBUTORS "AS IS" AND ANY EXPRESS OR IMPLIED WARRANTIES, INCLUDING, BUT NOT LIMITED TO, THE IMPLIED WARRANTIES OF MERCHANTABILITY AND FITNESS FOR A PARTICULAR PURPOSE ARE DISCLAIMED. IN NO EVENT SHALL THE COPYRIGHT HOLDERS OR CONTRIBUTORS BE LIABLE FOR ANY DIRECT, INDIRECT, INCIDENTAL, SPECIAL, EXEMPLARY, OR CONSEQUENTIAL DAMAGES (INCLUDING, BUT NOT LIMITED TO, PROCUREMENT OF SUBSTITUTE GOODS OR SERVICES; LOSS OF USE, DATA, OR PROFITS; OR BUSINESS INTERRUPTION) HOWEVER CAUSED AND ON ANY THEORY OF LIABILITY, WHETHER IN CONTRACT, STRICT LIABILITY, OR TORT (INCLUDING NEGLIGENCE OR OTHERWISE) ARISING IN ANY WAY OUT OF THE USE OF THIS SOFTWARE, EVEN IF ADVISED OF THE POSSIBILITY OF SUCH DAMAGE.

ucgendat

The OpenLDAP Public License  
Version 2.8, 17 August 2003

Redistribution and use of this software and associated documentation ("Software"), with or without modification, are permitted provided that the following conditions are met:

- 1. Redistributions in source form must retain copyright statements and notices,
- 2. Redistributions in binary form must reproduce applicable copyright statements and notices, this list of conditions, and the following disclaimer in the documentation and/or other materials provided with the distribution, and
- 3. Redistributions must contain a verbatim copy of this document.

The OpenLDAP Foundation may revise this license from time to time. Each revision is distinguished by a version number. You may use this Software under terms of this license revision or under the terms of any subsequent revision of the license.

THIS SOFTWARE IS PROVIDED BY THE OPENLDAP FOUNDATION AND ITS CONTRIBUTORS "AS IS" AND ANY EXPRESSED OR IMPLIED WARRANTIES, INCLUDING, BUT NOT LIMITED TO, THE IMPLIED WARRANTIES OF MERCHANTABILITY AND FITNESS FOR A PARTICULAR PURPOSE ARE DISCLAIMED. IN NO EVENT SHALL THE OPENLDAP FOUNDATION, ITS CONTRIBUTORS, OR THE AUTHOR(S) OR OWNER(S) OF THE SOFTWARE BE LIABLE FOR ANY DIRECT, INDIRECT, INCIDENTAL, SPECIAL, EXEMPLARY, OR CONSEQUENTIAL DAMAGES (INCLUDING, BUT NOT LIMITED TO, PROCUREMENT OF SUBSTITUTE GOODS OR SERVICES; LOSS OF USE, DATA, OR PROFITS; OR BUSINESS INTERRUPTION) HOWEVER CAUSED AND ON ANY THEORY OF LIABILITY, WHETHER IN CONTRACT, STRICT LIABILITY, OR TORT (INCLUDING NEGLIGENCE OR OTHERWISE) ARISING IN ANY WAY OUT OF THE USE OF THIS SOFTWARE, EVEN IF ADVISED OF THE POSSIBILITY OF SUCH DAMAGE.

The names of the authors and copyright holders must not be used in advertising or otherwise to promote the sale, use or other dealing in this Software without specific, written prior permission. Title to copyright in this Software shall at all times remain with copyright holders.

OpenLDAP is a registered trademark of the OpenLDAP Foundation.

Copyright 1999-2003 The OpenLDAP Foundation, Redwood City, California, USA. All Rights Reserved. Permission to copy and distribute verbatim copies of this document is granted.

Zend

The Zend Engine License, Version 2.00  
Copyright (c) 1999-2006 Zend Technologies Ltd. All rights reserved.

Redistribution and use in source and binary forms, with or without modification, is permitted provided that the following conditions are met:

- 1. Redistributions of source code must retain the above copyright notice, this list of conditions and the following disclaimer.
2. Redistributions in binary form must reproduce the above copyright notice, this list of conditions and the following disclaimer in the documentation and/or other materials provided with the distribution.
3. The names "Zend" and "Zend Engine" must not be used to endorse or promote products derived from this software without prior permission from Zend Technologies Ltd.
4. Zend Technologies Ltd. may publish revised and/or new versions of the license from time to time.
5. Redistributions of any form whatsoever must retain the following acknowledgment:
6. All advertising materials mentioning features or use of this software must display the following acknowledgment:

THIS SOFTWARE IS PROVIDED BY ZEND TECHNOLOGIES LTD. "AS IS" AND ANY EXPRESSED OR IMPLIED WARRANTIES, INCLUDING, BUT NOT LIMITED TO, THE IMPLIED WARRANTIES OF MERCHANTABILITY AND FITNESS FOR A PARTICULAR PURPOSE ARE DISCLAIMED.

Zip

Copyright (C) 1999-2008 Dieter Baron and Thomas Klausner
The authors can be contacted at <libzip@nih.at>

Redistribution and use in source and binary forms, with or without modification, are permitted provided that the following conditions are met:

- 1. Redistributions of source code must retain the above copyright notice, this list of conditions and the following disclaimer.
2. Redistributions in binary form must reproduce the above copyright notice, this list of conditions and the following disclaimer in the documentation and/or other materials provided with the distribution.
3. The names of the authors may not be used to endorse or promote products derived from this software without specific prior written permission.

THIS SOFTWARE IS PROVIDED BY THE AUTHORS "AS IS" AND ANY EXPRESS OR IMPLIED WARRANTIES, INCLUDING, BUT NOT LIMITED TO, THE IMPLIED WARRANTIES OF MERCHANTABILITY AND FITNESS FOR A PARTICULAR PURPOSE ARE DISCLAIMED.

fake sendmail for windows

fake sendmail for windows

Copyright (c) 2004-2011, Byron Jones, sendmail@glob.com.au
All rights reserved.

Redistribution and use in source and binary forms, with or without modification, are permitted provided that the following conditions are met:

- \* Redistributions of source code must retain the above copyright notice, this list of conditions and the following disclaimer.
\* Redistributions in binary form must reproduce the above copyright

notice, this list of conditions and the following disclaimer in the documentation and/or other materials provided with the distribution.

\* Neither the name of the glob nor the names of its contributors may be used to endorse or promote products derived from this software without specific prior written permission.

THIS SOFTWARE IS PROVIDED BY THE COPYRIGHT HOLDERS AND CONTRIBUTORS "AS IS" AND ANY EXPRESS OR IMPLIED WARRANTIES, INCLUDING, BUT NOT LIMITED TO, THE IMPLIED WARRANTIES OF MERCHANTABILITY AND FITNESS FOR A PARTICULAR PURPOSE ARE DISCLAIMED.

OpenSSL

LICENSE ISSUES

The OpenSSL toolkit stays under a dual license, i.e. both the conditions of the OpenSSL License and the original SSLeay license apply to the toolkit. See below for the actual license texts.

OpenSSL License

/\* Copyright (c) 1998-2008 The OpenSSL Project. All rights reserved.
\* Redistribution and use in source and binary forms, with or without modification, are permitted provided that the following conditions are met:
\* 1. Redistributions of source code must retain the above copyright notice, this list of conditions and the following disclaimer.
\* 2. Redistributions in binary form must reproduce the above copyright notice, this list of conditions and the following disclaimer in the documentation and/or other materials provided with the distribution.
\* 3. All advertising materials mentioning features or use of this software must display the following acknowledgment:
\* "This product includes software developed by the OpenSSL Project for use in the OpenSSL Toolkit. (http://www.openssl.org/)"
\* 4. The names "OpenSSL Toolkit" and "OpenSSL Project" must not be used to endorse or promote products derived from this software without prior written permission.
\* 5. Products derived from this software may not be called "OpenSSL" nor may "OpenSSL" appear in their names without prior written permission of the OpenSSL Project.
\* 6. Redistributions of any form whatsoever must retain the following acknowledgment:
\* "This product includes software developed by the OpenSSL Project for use in the OpenSSL Toolkit (http://www.openssl.org/)"
\* THIS SOFTWARE IS PROVIDED BY THE OpenSSL PROJECT "AS IS" AND ANY EXPRESS OR IMPLIED WARRANTIES, INCLUDING, BUT NOT LIMITED TO, THE IMPLIED WARRANTIES OF MERCHANTABILITY AND FITNESS FOR A PARTICULAR PURPOSE ARE DISCLAIMED.
\* THIS PRODUCT INCLUDES SOFTWARE DEVELOPED BY THE OpenSSL PROJECT FOR USE IN THE OpenSSL TOOLKIT (http://www.openssl.org/)

Original SSLeay License

/\* Copyright (C) 1995-1998 Eric Young (eay@cryptsoft.com)
\* All rights reserved.
\* This package is an SSL implementation written
\* by Eric Young (eay@cryptsoft.com).
\* The implementation was written so as to conform with Netscapes SSL.

\* This library is free for commercial and non-commercial use as long as  
 \* the following conditions are adhered to. The following conditions  
 \* apply to all code found in this distribution, be it the RC4, RSA,  
 \* lhash, DES, etc., code; not just the SSL code. The SSL documentation  
 \* included with this distribution is covered by the same copyright terms  
 \* except that the holder is Tim Hudson (tjh@cryptsoft.com).  
 \*  
 \* Copyright remains Eric Young's, and as such any Copyright notices in  
 \* the code are not to be removed.  
 \* If this package is used in a product, Eric Young should be given attribution  
 \* as the author of the parts of the library used.  
 \* This can be in the form of a textual message at program startup or  
 \* in documentation (online or textual) provided with the package.  
 \*  
 \* Redistribution and use in source and binary forms, with or without  
 \* modification, are permitted provided that the following conditions  
 \* are met:  
 \* 1. Redistributions of source code must retain the copyright  
 \* notice, this list of conditions and the following disclaimer.  
 \* 2. Redistributions in binary form must reproduce the above copyright  
 \* notice, this list of conditions and the following disclaimer in the  
 \* documentation and/or other materials provided with the distribution.  
 \* 3. All advertising materials mentioning features or use of this software  
 \* must display the following acknowledgement:  
 \* "This product includes cryptographic software written by  
 \* Eric Young (eay@cryptsoft.com)"  
 \* The word 'cryptographic' can be left out if the routines from the library  
 \* being used are not cryptographic related :-).  
 \* 4. If you include any Windows specific code (or a derivative thereof) from  
 \* the apps directory (application code) you must include an acknowledgement:  
 \* "This product includes software written by Tim Hudson (tjh@cryptsoft.com)"  
 \*  
 \* THIS SOFTWARE IS PROVIDED BY ERIC YOUNG ``AS IS'' AND  
 \* ANY EXPRESS OR IMPLIED WARRANTIES, INCLUDING, BUT NOT LIMITED TO, THE  
 \* IMPLIED WARRANTIES OF MERCHANTABILITY AND FITNESS FOR A PARTICULAR  
 \* PURPOSE  
 \* ARE DISCLAIMED. IN NO EVENT SHALL THE AUTHOR OR CONTRIBUTORS BE  
 \* LIABLE  
 \* FOR ANY DIRECT, INDIRECT, INCIDENTAL, SPECIAL, EXEMPLARY, OR  
 \* CONSEQUENTIAL  
 \* DAMAGES (INCLUDING, BUT NOT LIMITED TO, PROCUREMENT OF SUBSTITUTE  
 \* GOODS  
 \* OR SERVICES; LOSS OF USE, DATA, OR PROFITS; OR BUSINESS INTERRUPTION)  
 \* HOWEVER CAUSED AND ON ANY THEORY OF LIABILITY, WHETHER IN CONTRACT,  
 \* STRICT  
 \* LIABILITY, OR TORT (INCLUDING NEGLIGENCE OR OTHERWISE) ARISING IN ANY  
 \* WAY  
 \* OUT OF THE USE OF THIS SOFTWARE, EVEN IF ADVISED OF THE POSSIBILITY OF  
 \* SUCH DAMAGE.  
 \*  
 \* The licence and distribution terms for any publically available version or  
 \* derivative of this code cannot be changed. i.e. this code cannot simply be  
 \* copied and put under another distribution licence  
 \* [including the GNU Public Licence.]  
 \*/

=====

Webalizer

webalizer - a web server log analysis program

Copyright (C) 1997-2011 Bradford L. Barrett

This program is free software; you can redistribute it and/or modify  
 it under the terms of the GNU General Public License as published by  
 the Free Software Foundation; either version 2 of the License, or  
 (at your option) any later version, and provided that the above  
 copyright and permission notice is included with all distributed  
 copies of this or derived software.

This program is distributed in the hope that it will be useful,  
 but WITHOUT ANY WARRANTY; without even the implied warranty of  
 MERCHANTABILITY or FITNESS FOR A PARTICULAR PURPOSE. See the  
 GNU General Public License for more details.

You should have received a copy of the GNU General Public License  
 along with this program; if not, write to the Free Software  
 Foundation, Inc., 59 Temple Place - Suite 330, Boston, MA 02111-1307, USA

-----

GNU GENERAL PUBLIC LICENSE  
 Version 2, June 1991

Copyright (C) 1989, 1991 Free Software Foundation, Inc.  
 59 Temple Place - Suite 330, Boston, MA 02111-1307, USA  
 Everyone is permitted to copy and distribute verbatim copies  
 of this license document, but changing it is not allowed.

Preamble

The licenses for most software are designed to take away your  
 freedom to share and change it. By contrast, the GNU General Public  
 License is intended to guarantee your freedom to share and change free  
 software--to make sure the software is free for all its users. This  
 General Public License applies to most of the Free Software  
 Foundation's software and to any other program whose authors commit to  
 using it. (Some other Free Software Foundation software is covered by  
 the GNU Library General Public License instead.) You can apply it to  
 your programs, too.

When we speak of free software, we are referring to freedom, not  
 price. Our General Public Licenses are designed to make sure that you  
 have the freedom to distribute copies of free software (and charge for  
 this service if you wish), that you receive source code or can get it  
 if you want it, that you can change the software or use pieces of it  
 in new free programs; and that you know you can do these things.

To protect your rights, we need to make restrictions that forbid  
 anyone to deny you these rights or to ask you to surrender the rights.  
 These restrictions translate to certain responsibilities for you if you  
 distribute copies of the software, or if you modify it.

For example, if you distribute copies of such a program, whether  
 gratis or for a fee, you must give the recipients all the rights that  
 you have. You must make sure that they, too, receive or can get the  
 source code. And you must show them these terms so they know their  
 rights.

We protect your rights with two steps: (1) copyright the software, and  
 (2) offer you this license which gives you legal permission to copy,  
 distribute and/or modify the software.

Also, for each author's protection and ours, we want to make certain  
 that everyone understands that there is no warranty for this free  
 software. If the software is modified by someone else and passed on, we  
 want its recipients to know that what they have is not the original, so  
 that any problems introduced by others will not reflect on the original  
 authors' reputations.

Finally, any free program is threatened constantly by software  
 patents. We wish to avoid the danger that redistributors of a free  
 program will individually obtain patent licenses, in effect making the  
 program proprietary. To prevent this, we have made it clear that any  
 patent must be licensed for everyone's free use or not licensed at all.

The precise terms and conditions for copying, distribution and  
 modification follow.

GNU GENERAL PUBLIC LICENSE  
 TERMS AND CONDITIONS FOR COPYING, DISTRIBUTION AND MODIFICATION

0. This License applies to any program or other work which contains  
 a notice placed by the copyright holder saying it may be distributed  
 under the terms of this General Public License. The "Program", below,  
 refers to any such program or work, and a "work based on the Program"  
 means either the Program or any derivative work under copyright law:  
 that is to say, a work containing the Program or a portion of it,  
 either verbatim or with modifications and/or translated into another  
 language. (Hereinafter, translation is included without limitation in  
 the term "modification".) Each licensee is addressed as "you".

Activities other than copying, distribution and modification are not  
 covered by this License; they are outside its scope. The act of  
 running the Program is not restricted, and the output from the Program  
 is covered only if its contents constitute a work based on the  
 Program (independent of having been made by running the Program).  
 Whether that is true depends on what the Program does.

1. You may copy and distribute verbatim copies of the Program's  
 source code as you receive it, in any medium, provided that you  
 conspicuously and appropriately publish on each copy an appropriate  
 copyright notice and disclaimer of warranty; keep intact all the  
 notices that refer to this License and to the absence of any warranty;  
 and give any other recipients of the Program a copy of this License  
 along with the Program.

You may charge a fee for the physical act of transferring a copy, and  
 you may at your option offer warranty protection in exchange for a fee.

2. You may modify your copy or copies of the Program or any portion  
 of it, thus forming a work based on the Program, and copy and  
 distribute such modifications or work under the terms of Section 1  
 above, provided that you also meet all of these conditions:

a) You must cause the modified files to carry prominent notices  
 stating that you changed the files and the date of any change.

b) You must cause any work that you distribute or publish, that in  
 whole or in part contains or is derived from the Program or any  
 part thereof, to be licensed as a whole at no charge to all third  
 parties under the terms of this License.

c) If the modified program normally reads commands interactively  
 when run, you must cause it, when started running for such  
 interactive use in the most ordinary way, to print or display an  
 announcement including an appropriate copyright notice and a  
 notice that there is no warranty (or else, saying that you provide  
 a warranty) and that users may redistribute the program under  
 these conditions, and telling the user how to view a copy of this  
 License. (Exception: if the Program itself is interactive but  
 does not normally print such an announcement, your work based on  
 the Program is not required to print an announcement.)

These requirements apply to the modified work as a whole. If  
 identifiable sections of that work are not derived from the Program,  
 and can be reasonably considered independent and separate works in

themselves, then this License, and its terms, do not apply to those sections when you distribute them as separate works. But when you distribute the same sections as part of a whole which is a work based on the Program, the distribution of the whole must be on the terms of this License, whose permissions for other licensees extend to the entire whole, and thus to each and every part regardless of who wrote it.

Thus, it is not the intent of this section to claim rights or contest your rights to work written entirely by you; rather, the intent is to exercise the right to control the distribution of derivative or collective works based on the Program.

In addition, mere aggregation of another work not based on the Program with the Program (or with a work based on the Program) on a volume of a storage or distribution medium does not bring the other work under the scope of this License.

3. You may copy and distribute the Program (or a work based on it, under Section 2) in object code or executable form under the terms of Sections 1 and 2 above provided that you also do one of the following:

- a) Accompany it with the complete corresponding machine-readable source code, which must be distributed under the terms of Sections 1 and 2 above on a medium customarily used for software interchange; or,
- b) Accompany it with a written offer, valid for at least three years, to give any third party, for a charge no more than your cost of physically performing source distribution, a complete machine-readable copy of the corresponding source code, to be distributed under the terms of Sections 1 and 2 above on a medium customarily used for software interchange; or,
- c) Accompany it with the information you received as to the offer to distribute corresponding source code. (This alternative is allowed only for noncommercial distribution and only if you received the program in object code or executable form with such an offer, in accord with Subsection b above.)

The source code for a work means the preferred form of the work for making modifications to it. For an executable work, complete source code means all the source code for all modules it contains, plus any associated interface definition files, plus the scripts used to control compilation and installation of the executable. However, as a special exception, the source code distributed need not include anything that is normally distributed (in either source or binary form) with the major components (compiler, kernel, and so on) of the operating system on which the executable runs, unless that component itself accompanies the executable.

If distribution of executable or object code is made by offering access to copy from a designated place, then offering equivalent access to copy the source code from the same place counts as distribution of the source code, even though third parties are not compelled to copy the source along with the object code.

4. You may not copy, modify, sublicense, or distribute the Program except as expressly provided under this License. Any attempt otherwise to copy, modify, sublicense or distribute the Program is void, and will automatically terminate your rights under this License. However, parties who have received copies, or rights, from you under this License will not have their licenses terminated so long as such parties remain in full compliance.

5. You are not required to accept this License, since you have not signed it. However, nothing else grants you permission to modify or distribute the Program or its derivative works. These actions are prohibited by law if you do not accept this License. Therefore, by modifying or distributing the Program (or any work based on the Program), you indicate your acceptance of this License to do so, and all its terms and conditions for copying, distributing or modifying the Program or works based on it.

6. Each time you redistribute the Program (or any work based on the Program), the recipient automatically receives a license from the original licensor to copy, distribute or modify the Program subject to these terms and conditions. You may not impose any further restrictions on the recipients' exercise of the rights granted herein. You are not responsible for enforcing compliance by third parties to this License.

7. If, as a consequence of a court judgment or allegation of patent infringement or for any other reason (not limited to patent issues), conditions are imposed on you (whether by court order, agreement or otherwise) that contradict the conditions of this License, they do not excuse you from the conditions of this License. If you cannot distribute so as to satisfy simultaneously your obligations under this License and any other pertinent obligations, then as a consequence you may not distribute the Program at all. For example, if a patent license would not permit royalty-free redistribution of the Program by all those who receive copies directly or indirectly through you, then the only way you could satisfy both it and this License would be to refrain entirely from distribution of the Program.

If any portion of this section is held invalid or unenforceable under any particular circumstance, the balance of the section is intended to apply and the section as a whole is intended to apply in other circumstances.

It is not the purpose of this section to induce you to infringe any patents or other property right claims or to contest validity of any such claims; this section has the sole purpose of protecting the integrity of the free software distribution system, which is implemented by public license practices. Many people have made generous contributions to the wide range of software distributed through that system in reliance on consistent application of that system; it is up to the author/donor to decide if he or she is willing to distribute software through any other system and a licensee cannot impose that choice.

This section is intended to make thoroughly clear what is believed to be a consequence of the rest of this License.

8. If the distribution and/or use of the Program is restricted in certain countries either by patents or by copyrighted interfaces, the original copyright holder who places the Program under this License may add an explicit geographical distribution limitation excluding those countries, so that distribution is permitted only in or among countries not thus excluded. In such case, this License incorporates the limitation as if written in the body of this License.

9. The Free Software Foundation may publish revised and/or new versions of the General Public License from time to time. Such new versions will be similar in spirit to the present version, but may differ in detail to address new problems or concerns.

Each version is given a distinguishing version number. If the Program specifies a version number of this License which applies to it and "any later version", you have the option of following the terms and conditions either of that version or of any later version published by the Free Software Foundation. If the Program does not specify a version number of this License, you may choose any version ever published by the Free Software Foundation.

10. If you wish to incorporate parts of the Program into other free programs whose distribution conditions are different, write to the author to ask for permission. For software which is copyrighted by the Free Software Foundation, write to the Free Software Foundation; we sometimes make exceptions for this. Our decision will be guided by the two goals of preserving the free status of all derivatives of our free software and of promoting the sharing and reuse of software generally.

#### NO WARRANTY

11. BECAUSE THE PROGRAM IS LICENSED FREE OF CHARGE, THERE IS NO WARRANTY FOR THE PROGRAM, TO THE EXTENT PERMITTED BY APPLICABLE LAW. EXCEPT WHEN OTHERWISE STATED IN WRITING THE COPYRIGHT HOLDERS AND/OR OTHER PARTIES PROVIDE THE PROGRAM "AS IS" WITHOUT WARRANTY OF ANY KIND, EITHER EXPRESSED OR IMPLIED, INCLUDING, BUT NOT LIMITED TO, THE IMPLIED WARRANTIES OF MERCHANTABILITY AND FITNESS FOR A PARTICULAR PURPOSE. THE ENTIRE RISK AS TO THE QUALITY AND PERFORMANCE OF THE PROGRAM IS WITH YOU. SHOULD THE PROGRAM PROVE DEFECTIVE, YOU ASSUME THE COST OF ALL NECESSARY SERVICING, REPAIR OR CORRECTION.

12. IN NO EVENT UNLESS REQUIRED BY APPLICABLE LAW OR AGREED TO IN WRITING WILL ANY COPYRIGHT HOLDER, OR ANY OTHER PARTY WHO MAY MODIFY AND/OR REDISTRIBUTE THE PROGRAM AS PERMITTED ABOVE, BE LIABLE TO YOU FOR DAMAGES, INCLUDING ANY GENERAL, SPECIAL, INCIDENTAL OR CONSEQUENTIAL DAMAGES ARISING OUT OF THE USE OR INABILITY TO USE THE PROGRAM (INCLUDING BUT NOT LIMITED TO LOSS OF DATA OR DATA BEING RENDERED INACCURATE OR LOSSES SUSTAINED BY YOU OR THIRD PARTIES OR A FAILURE OF THE PROGRAM TO OPERATE WITH ANY OTHER PROGRAMS), EVEN IF SUCH HOLDER OR OTHER PARTY HAS BEEN ADVISED OF THE POSSIBILITY OF SUCH DAMAGES.

#### END OF TERMS AND CONDITIONS

#### Appendix: How to Apply These Terms to Your New Programs

If you develop a new program, and you want it to be of the greatest possible use to the public, the best way to achieve this is to make it free software which everyone can redistribute and change under these terms.

To do so, attach the following notices to the program. It is safest to attach them to the start of each source file to make it clear that the "copyright" line and a pointer to where the full notice is found.

<one line to give the program's name and a brief idea of what it does.>  
Copyright (C) 19yy <name of author>

This program is free software; you can redistribute it and/or modify it under the terms of the GNU General Public License as published by the Free Software Foundation; either version 2 of the License, or (at your option) any later version.

This program is distributed in the hope that it will be useful, but WITHOUT ANY WARRANTY; without even the implied warranty of MERCHANTABILITY or FITNESS FOR A PARTICULAR PURPOSE. See the GNU General Public License for more details.

You should have received a copy of the GNU General Public License along with this program; if not, write to the Free Software Foundation, Inc., 59 Temple Place - Suite 330, Boston, MA 02111-1307, USA

Also add information on how to contact you by electronic and paper mail.

If the program is interactive, make it output a short notice like this when it starts in an interactive mode:

```
Gnomovision version 69, Copyright (C) 19yy name of author
Gnomovision comes with ABSOLUTELY NO WARRANTY; for details type `show w'.
This is free software, and you are welcome to redistribute it
under certain conditions; type `show c' for details.
```

The hypothetical commands `show w' and `show c' should show the appropriate parts of the General Public License. Of course, the commands you use may be called something other than `show w' and `show c'; they could even be mouse-clicks or menu items--whatever suits your program.

You should also get your employer (if you work as a programmer) or your school, if any, to sign a "copyright disclaimer" for the program, if necessary. Here is a sample; alter the names:

```
Yoyodyne, Inc., hereby disclaims all copyright interest in the program
`Gnomovision' (which makes passes at compilers) written by James Hacker.
```

```
<signature of Ty Coon>, 1 April 1989
Ty Coon, President of Vice
```

This General Public License does not permit incorporating your program into proprietary programs. If your program is a subroutine library, you may consider it more useful to permit linking proprietary applications with the library. If this is what you want to do, use the GNU Library General Public License instead of this License.

=====

GNU GENERAL PUBLIC LICENSE  
Version 2, June 1991

Copyright (C) 1989, 1991 Free Software Foundation, Inc.  
675 Mass Ave, Cambridge, MA 02139, USA  
Everyone is permitted to copy and distribute verbatim copies of this license document, but changing it is not allowed.

Preamble

The licenses for most software are designed to take away your freedom to share and change it. By contrast, the GNU General Public License is intended to guarantee your freedom to share and change free software--to make sure the software is free for all its users. This General Public License applies to most of the Free Software Foundation's software and to any other program whose authors commit to using it. (Some other Free Software Foundation software is covered by the GNU Library General Public License instead.) You can apply it to your programs, too.

When we speak of free software, we are referring to freedom, not price. Our General Public Licenses are designed to make sure that you have the freedom to distribute copies of free software (and charge for this service if you wish), that you receive source code or can get it if you want it, that you can change the software or use pieces of it in new free programs; and that you know you can do these things.

To protect your rights, we need to make restrictions that forbid anyone to deny you these rights or to ask you to surrender the rights. These restrictions translate to certain responsibilities for you if you distribute copies of the software, or if you modify it.

For example, if you distribute copies of such a program, whether gratis or for a fee, you must give the recipients all the rights that you have. You must make sure that they, too, receive or can get the source code. And you must show them these terms so they know their rights.

We protect your rights with two steps: (1) copyright the software, and (2) offer you this license which gives you legal permission to copy, distribute and/or modify the software.

Also, for each author's protection and ours, we want to make certain that everyone understands that there is no warranty for this free software. If the software is modified by someone else and passed on, we want its recipients to know that what they have is not the original, so that any problems introduced by others will not reflect on the original authors' reputations.

Finally, any free program is threatened constantly by software patents. We wish to avoid the danger that redistributors of a free program will individually obtain patent licenses, in effect making the program proprietary. To prevent this, we have made it clear that any patent must be licensed for everyone's free use or not licensed at all.

The precise terms and conditions for copying, distribution and modification follow.

## GNU GENERAL PUBLIC LICENSE TERMS AND CONDITIONS FOR COPYING, DISTRIBUTION AND MODIFICATION

0. This License applies to any program or other work which contains a notice placed by the copyright holder saying it may be distributed under the terms of this General Public License. The "Program", below, refers to any such program or work, and a "work based on the Program" means either the Program or any derivative work under copyright law; that is to say, a work containing the Program or a portion of it, either verbatim or with modifications and/or translated into another language. (Hereinafter, translation is included without limitation in the term "modification".) Each licensee is addressed as "you".

Activities other than copying, distribution and modification are not covered by this License; they are outside its scope. The act of running the Program is not restricted, and the output from the Program is covered only if its contents constitute a work based on the Program (independent of having been made by running the Program). Whether that is true depends on what the Program does.

1. You may copy and distribute verbatim copies of the Program's source code as you receive it, in any medium, provided that you conspicuously and appropriately publish on each copy an appropriate copyright notice and disclaimer of warranty; keep intact all the notices that refer to this License and to the absence of any warranty; and give any other recipients of the Program a copy of this License along with the Program.

You may charge a fee for the physical act of transferring a copy, and you may at your option offer warranty protection in exchange for a fee.

2. You may modify your copy or copies of the Program or any portion of it, thus forming a work based on the Program, and copy and distribute such modifications or work under the terms of Section 1 above, provided that you also meet all of these conditions:

a) You must cause the modified files to carry prominent notices stating that you changed the files and the date of any change.

b) You must cause any work that you distribute or publish, that in whole or in part contains or is derived from the Program or any part thereof, to be licensed as a whole at no charge to all third parties under the terms of this License.

c) If the modified program normally reads commands interactively when run, you must cause it, when started running for such interactive use in the most ordinary way, to print or display an announcement including an appropriate copyright notice and a notice that there is no warranty (or else, saying that you provide a warranty) and that users may redistribute the program under these conditions, and telling the user how to view a copy of this License. (Exception: if the Program itself is interactive but does not normally print such an announcement, your work based on the Program is not required to print an announcement.)

These requirements apply to the modified work as a whole. If identifiable sections of that work are not derived from the Program, and can be reasonably considered independent and separate works in themselves, then this License, and its terms, do not apply to those sections when you distribute them as separate works. But when you distribute the same sections as part of a whole which is a work based on the Program, the distribution of the whole must be on the terms of this License, whose permissions for other licensees extend to the entire whole, and thus to each and every part regardless of who wrote it.

Thus, it is not the intent of this section to claim rights or contest your rights to work written entirely by you; rather, the intent is to exercise the right to control the distribution of derivative or collective works based on the Program.

In addition, mere aggregation of another work not based on the Program with the Program (or with a work based on the Program) on a volume of a storage or distribution medium does not bring the other work under the scope of this License.

3. You may copy and distribute the Program (or a work based on it, under Section 2) in object code or executable form under the terms of Sections 1 and 2 above provided that you also do one of the following:

a) Accompany it with the complete corresponding machine-readable source code, which must be distributed under the terms of Sections 1 and 2 above on a medium customarily used for software interchange; or,

b) Accompany it with a written offer, valid for at least three years, to give any third party, for a charge no more than your cost of physically performing source distribution, a complete machine-readable copy of the corresponding source code, to be distributed under the terms of Sections 1 and 2 above on a medium customarily used for software interchange; or,

c) Accompany it with the information you received as to the offer to distribute corresponding source code. (This alternative is allowed only for noncommercial distribution and only if you received the program in object code or executable form with such

an offer, in accord with Subsection b above.)

The source code for a work means the preferred form of the work for making modifications to it. For an executable work, complete source code means all the source code for all modules it contains, plus any associated interface definition files, plus the scripts used to control compilation and installation of the executable. However, as a special exception, the source code distributed need not include anything that is normally distributed (in either source or binary form) with the major components (compiler, kernel, and so on) of the operating system on which the executable runs, unless that component itself accompanies the executable.

If distribution of executable or object code is made by offering access to copy from a designated place, then offering equivalent access to copy the source code from the same place counts as distribution of the source code, even though third parties are not compelled to copy the source along with the object code.

4. You may not copy, modify, sublicense, or distribute the Program except as expressly provided under this License. Any attempt otherwise to copy, modify, sublicense or distribute the Program is void, and will automatically terminate your rights under this License. However, parties who have received copies, or rights, from you under this License will not have their licenses terminated so long as such parties remain in full compliance.

5. You are not required to accept this License, since you have not signed it. However, nothing else grants you permission to modify or distribute the Program or its derivative works. These actions are prohibited by law if you do not accept this License. Therefore, by modifying or distributing the Program (or any work based on the Program), you indicate your acceptance of this License to do so, and all its terms and conditions for copying, distributing or modifying the Program or works based on it.

6. Each time you redistribute the Program (or any work based on the Program), the recipient automatically receives a license from the original licensor to copy, distribute or modify the Program subject to these terms and conditions. You may not impose any further restrictions on the recipients' exercise of the rights granted herein. You are not responsible for enforcing compliance by third parties to this License.

7. If, as a consequence of a court judgment or allegation of patent infringement or for any other reason (not limited to patent issues), conditions are imposed on you (whether by court order, agreement or otherwise) that contradict the conditions of this License, they do not excuse you from the conditions of this License. If you cannot distribute so as to satisfy simultaneously your obligations under this License and any other pertinent obligations, then as a consequence you may not distribute the Program at all. For example, if a patent license would not permit royalty-free redistribution of the Program by all those who receive copies directly or indirectly through you, then the only way you could satisfy both it and this License would be to refrain entirely from distribution of the Program.

If any portion of this section is held invalid or unenforceable under any particular circumstance, the balance of the section is intended to apply and the section as a whole is intended to apply in other circumstances.

It is not the purpose of this section to induce you to infringe any patents or other property right claims or to contest validity of any such claims; this section has the sole purpose of protecting the integrity of the free software distribution system, which is implemented by public license practices. Many people have made generous contributions to the wide range of software distributed through that system in reliance on consistent application of that system; it is up to the author/donor to decide if he or she is willing to distribute software through any other system and a licensee cannot impose that choice.

This section is intended to make thoroughly clear what is believed to be a consequence of the rest of this License.

8. If the distribution and/or use of the Program is restricted in certain countries either by patents or by copyrighted interfaces, the original copyright holder who places the Program under this License may add an explicit geographical distribution limitation excluding those countries, so that distribution is permitted only in or among countries not thus excluded. In such case, this License incorporates the limitation as if written in the body of this License.

9. The Free Software Foundation may publish revised and/or new versions of the General Public License from time to time. Such new versions will be similar in spirit to the present version, but may differ in detail to address new problems or concerns.

Each version is given a distinguishing version number. If the Program specifies a version number of this License which applies to it and "any later version", you have the option of following the terms and conditions either of that version or of any later version published by the Free Software Foundation. If the Program does not specify a version number of this License, you may choose any version ever published by the Free Software Foundation.

10. If you wish to incorporate parts of the Program into other free programs whose distribution conditions are different, write to the author to ask for permission. For software which is copyrighted by the Free Software Foundation, write to the Free Software Foundation; we sometimes make exceptions for this. Our decision will be guided by the two goals of preserving the free status of all derivatives of our free software and of promoting the sharing and reuse of software generally.

NO WARRANTY

11. BECAUSE THE PROGRAM IS LICENSED FREE OF CHARGE, THERE IS NO WARRANTY FOR THE PROGRAM, TO THE EXTENT PERMITTED BY APPLICABLE LAW. EXCEPT WHEN OTHERWISE STATED IN WRITING THE COPYRIGHT HOLDERS AND/OR OTHER PARTIES PROVIDE THE PROGRAM "AS IS" WITHOUT WARRANTY OF ANY KIND, EITHER EXPRESSED OR IMPLIED, INCLUDING, BUT NOT LIMITED TO, THE IMPLIED WARRANTIES OF MERCHANTABILITY AND FITNESS FOR A PARTICULAR PURPOSE. THE ENTIRE RISK AS TO THE QUALITY AND PERFORMANCE OF THE PROGRAM IS WITH YOU. SHOULD THE PROGRAM PROVE DEFECTIVE, YOU ASSUME THE COST OF ALL NECESSARY SERVICING, REPAIR OR CORRECTION.

12. IN NO EVENT UNLESS REQUIRED BY APPLICABLE LAW OR AGREED TO IN WRITING WILL ANY COPYRIGHT HOLDER, OR ANY OTHER PARTY WHO MAY MODIFY AND/OR REDISTRIBUTE THE PROGRAM AS PERMITTED ABOVE, BE LIABLE TO YOU FOR DAMAGES, INCLUDING ANY GENERAL, SPECIAL, INCIDENTAL OR CONSEQUENTIAL DAMAGES ARISING OUT OF THE USE OR INABILITY TO USE THE PROGRAM (INCLUDING BUT NOT LIMITED TO LOSS OF DATA OR DATA BEING RENDERED INACCURATE OR LOSSES SUSTAINED BY YOU OR THIRD PARTIES OR A FAILURE OF THE PROGRAM TO OPERATE WITH ANY OTHER PROGRAMS), EVEN IF SUCH HOLDER OR OTHER PARTY HAS BEEN ADVISED OF THE POSSIBILITY OF SUCH DAMAGES.

END OF TERMS AND CONDITIONS

Appendix: How to Apply These Terms to Your New Programs

If you develop a new program, and you want it to be of the greatest possible use to the public, the best way to achieve this is to make it free software which everyone can redistribute and change under these terms.

To do so, attach the following notices to the program. It is safest to attach them to the start of each source file to most effectively convey the exclusion of warranty; and each file should have at least the "copyright" line and a pointer to where the full notice is found.

<one line to give the program's name and a brief idea of what it does.>  
Copyright (C) 19yy <name of author>

This program is free software; you can redistribute it and/or modify it under the terms of the GNU General Public License as published by the Free Software Foundation; either version 2 of the License, or (at your option) any later version.

This program is distributed in the hope that it will be useful, but WITHOUT ANY WARRANTY; without even the implied warranty of MERCHANTABILITY or FITNESS FOR A PARTICULAR PURPOSE. See the GNU General Public License for more details.

You should have received a copy of the GNU General Public License along with this program; if not, write to the Free Software Foundation, Inc., 675 Mass Ave, Cambridge, MA 02139, USA.

Also add information on how to contact you by electronic and paper mail.

If the program is interactive, make it output a short notice like this when it starts in an interactive mode:

Gnomovision version 69, Copyright (C) 19yy name of author  
Gnomovision comes with ABSOLUTELY NO WARRANTY; for details type `show w'.  
This is free software, and you are welcome to redistribute it under certain conditions; type `show c' for details.

The hypothetical commands `show w' and `show c' should show the appropriate parts of the General Public License. Of course, the commands you use may be called something other than `show w' and `show c'; they could even be mouse-clicks or menu items—whatever suits your program.

You should also get your employer (if you work as a programmer) or your school, if any, to sign a "copyright disclaimer" for the program, if necessary. Here is a sample; alter the names:

Yoyodyne, Inc., hereby disclaims all copyright interest in the program  
`Gnomovision' (which makes passes at compilers) written by James Hacker.

<signature of Ty Coon>, 1 April 1989  
Ty Coon, President of Vice

This General Public License does not permit incorporating your program into

# Troubleshooting

Check the following items before contacting your Sony dealer, and contact them if the problem persists.

## The unit does not operate.

- Check whether the power switch is turned on.
- Check whether the power cord is properly connected.
- Check whether the wall outlet has power. Test it by plugging another device.
- Check that the HDDs are not being accessed (the ACCESS LED on the front panel of the unit is not blinking), turn the unit off forcibly by pressing and holding the power switch at the front panel of the unit for approximately 4 seconds, and then restart the unit.
- During the startup procedure, the unit checks the file system. The length of this check varies depending on the amount of data on the unit. During the file system check, the ACCESS LED on the front panel of the unit blinks.

## The monitor remains blank.

- Check whether the unit is turned on.
- Check whether the power cord is properly connected.
- Check whether the monitor cable is properly connected.
- Check whether the monitor is connected to the appropriate connector.

## External devices connected to the USB connectors do not operate.

- The unit supports standard USB 2.0 and USB 3.0 mass storage class devices. However, depending on the type of USB device, errors may occur when writing data to the device. If errors occur when writing data, try using a USB flash memory device of a different type.
- To ensure proper operation of USB devices, do not connect the devices via a USB hub. Connect the devices directly to the USB connectors on the unit. Operation is not guaranteed when devices are connected via a USB hub, USB switch, or extension cable.
- Refer to the documentation supplied with the USB device.

## The HDDs cannot be accessed.

- Check that the HDD is properly installed.
- Check the HDD LEDs on the front panel of the unit. Identify the defective HDD via the drive LEDs. A defective HDD LED lights red.



## The system shuts down automatically.

When the internal temperature of the unit rises to an abnormal level, the system shuts down automatically. Make sure that nothing is blocking the ventilation openings on the front, sides, and rear of the unit, and that dust has not accumulated in them.

---

# Specifications

## External connectors

Front	USB: USB 3.0 (2)
Rear	Monitor output: Analog RGB (mini D-SUB 15 pin) (1) HDMI (1) Line output (1) Microphone input (1) LAN (1000 Base-T/100 Base-TX/ 10 Base-T) (RJ-45) (2) USB: USB 2.0 (2) USB 3.0 (2) PS/2: Keyboard (1) Mouse (1) Serial connector: RS-232C (3)

## Operating environment

Operating temperature	5 °C to 40 °C (41 °F to 104 °F)
Operating humidity	20% to 80% (no condensation)
Temperature range for storage	-20 °C to +60 °C (-4 °F to +140 °F)
Humidity range for storage	20% to 90% (no condensation)

## Power and miscellaneous

Power	100 V to 240 V AC (50/60 Hz)
Rated current	3.5 A
Dimensions	440 × 88.5 × 395 mm (17 <sup>3</sup> / <sub>8</sub> × 3 <sup>1</sup> / <sub>2</sub> × 15 <sup>5</sup> / <sub>8</sub> in.) (W/H/D, excluding protrusions)
Mass	Approx. 7.5 kg (16 lb. 8.6 oz.) (excluding the HDD units)

Design and specifications are subject to change without notice.

## Notes

- Always make a test recording, and verify that it was recorded successfully.  
SONY WILL NOT BE LIABLE FOR DAMAGES OF ANY KIND INCLUDING, BUT NOT LIMITED TO, COMPENSATION OR REIMBURSEMENT ON ACCOUNT OF FAILURE OF THIS UNIT OR ITS RECORDING MEDIA, EXTERNAL STORAGE SYSTEMS OR ANY OTHER MEDIA OR STORAGE SYSTEMS TO RECORD CONTENT OF ANY TYPE.
- Always verify that the unit is operating properly before use. SONY WILL NOT BE LIABLE FOR DAMAGES OF ANY KIND INCLUDING, BUT NOT LIMITED TO, COMPENSATION OR REIMBURSEMENT ON ACCOUNT OF THE LOSS OF PRESENT OR PROSPECTIVE PROFITS DUE TO FAILURE OF THIS UNIT, EITHER DURING THE WARRANTY PERIOD OR AFTER EXPIRATION OF THE WARRANTY, OR FOR ANY OTHER REASON WHATSOEVER.
- SONY WILL NOT BE LIABLE FOR CLAIMS OF ANY KIND MADE BY USERS OF THIS UNIT OR MADE BY THIRD PARTIES.
- SONY WILL NOT BE LIABLE FOR THE LOSS, REPAIR, OR REPRODUCTION OF ANY DATA RECORDED ON THE INTERNAL STORAGE SYSTEM, RECORDING MEDIA, EXTERNAL STORAGE SYSTEMS OR ANY OTHER MEDIA OR STORAGE SYSTEMS.
- SONY WILL NOT BE LIABLE FOR THE TERMINATION OR DISCONTINUATION OF ANY SERVICES RELATED TO THIS UNIT THAT MAY RESULT DUE TO CIRCUMSTANCES OF ANY KIND.

## Trademarks

- Microsoft and Windows are registered trademarks of Microsoft Corporation in the United States and/or other countries.
- HDMI, HDMI logo and High-Definition Multimedia Interface are trademarks or registered trademarks of HDMI Licensing LLC.
- Other products or system names appearing in this document are trademarks or registered trademarks of their respective owners. Further, the <sup>TM</sup> or ® symbols are not used in the text.

