



2017 Rider's Manual

Victory Vision[®] Tour

California Proposition 65 Warning

This product contains or emits
chemicals known to the state of
California to cause cancer and birth
defects or other reproductive harm.



2017 Rider's Manual

Victory Vision® Tour

Copyright 2016 Polaris Industries Inc.

All material in this publication is based on the latest product information at the time of publication. Due to constant improvements in the design and quality of production components, some minor discrepancies may result between the actual vehicle and the information presented in this publication. Depictions and/or procedures in this publication are intended for reference use only.

No liability can be accepted for omissions or inaccuracies. Polaris Industries reserves the right to make changes at any time, without notice and without incurring obligation to make the same or similar changes to previously manufactured vehicles. Any reprinting or reuse of the depictions and/or procedures contained within, whether whole or in part, is expressly prohibited.

The following are registered trademarks of Polaris Industries Inc.:

POLARIS®, FREEDOM®, VICTORY®, VICTORY VISION® and VICTORY MOTORCYCLES®.

DUNLOP® is a registered trademark of Dunlop Tire Corporation.

Sirius® and XM® and all related marks and logos are trademarks of Sirius XM Radio Inc.

iPod® is a registered trademark of Apple Inc.

Garmin® and zumo® are trademarks of Garmin Ltd. or its subsidiaries.

Printed in U.S.A.

9927117

⚠ WARNING

Improper vehicle use can result in SEVERE INJURY or DEATH.

NEVER Operate:

- If you are under the age of 16 and without a driver's license with motorcycle endorsement
- Under the influence of drugs or alcohol
- Off-road
- With more than one passenger (motorcycle must be equipped with passenger foot pegs)
- With weight that exceeds maximum weight rating

ALWAYS:

- Wear a helmet, eye protection, gloves, long-sleeve shirt, long pants and over-the-ankle boots.
- Make sure any passenger reads and understands all safety labels.
- Be aware of your surroundings and driving conditions.
- Keep both hands on the handlebars and both feet on the footrests when riding.
- Use only genuine VICTORY accessories designed for your model



ALWAYS USE AN
APPROVED HELMET AND
PROTECTIVE GEAR.



NEVER USE WITH
DRUGS OR ALCOHOL.

READ RIDER'S MANUAL. FOLLOW ALL INSTRUCTIONS AND WARNINGS.

SAFETY TRAINING

Safety training is a top priority for POLARIS. POLARIS strongly encourages you to take a rider education course from the **Motorcycle Safety Foundation** or another qualified instructor. The course will help you develop or refresh your expertise in safe riding habits through instruction and riding.

For information on **Motorcycle Safety Foundation** rider education courses in your area, call 1-800-446-9227 or visit their home page at www.msf-usa.org.

Introduction 7

Safety 9

Identification 23

Instruments, Features and Controls 27

Pre-Ride Inspections 51

Operation. 63

Maintenance. 77

Cleaning and Storage 127

Warranties 135

Specifications 145

Audio System Overview 149

Audio System Operation. 153

CB Radio / ICOM System 159

AUX - iPod 165

SiriusXM Radio 169

NAV MP3 173

Maintenance Log 175

INTRODUCTION

Thank you for purchasing a Polaris vehicle, and welcome to our world-wide family of Polaris owners. We proudly produce an exciting line of utility and recreational products.

- Snowmobiles
- All-terrain vehicles (ATVs)
- Low emission vehicles (LEVs)
- *RANGER*® utility vehicles
- *BRUTUS*® work vehicles
- *SLINGSHOT*® three wheel motorcycles
- *RZR*® sport vehicles
- *GEM*® electric vehicles
- *VICTORY*® motorcycles
- *INDIAN*® motorcycles
- *POLARIS POWER*® generators
- *POLARIS DEFENSE*® combat vehicles

For the safe and enjoyable operation of your vehicle, be sure to follow the instructions and recommendations in this rider's manual. Keep this manual with the motorcycle, especially when ownership changes. If your rider's manual is misplaced or damaged, please purchase a replacement from your *VICTORY* dealer.

All references in this manual to *RIGHT*, *LEFT*, *FRONT* or *REAR* are from the operator's perspective when seated in a normal riding position. If you have questions about the operation or maintenance of your motorcycle after you've read this manual, your authorized *VICTORY* dealer can assist. To locate the nearest authorized *VICTORY* dealer, call 1-877-737-7172 or visit www.victorymotorcycles.com.

VICTORY motorcycles comply with all federal, state and local safety and emission regulations for the area of intended sale.

SAFETY

ABOUT THE RIDER'S MANUAL

 WARNING

Failure to follow recommended precautions and procedures could result in severe injury or death. Always heed all safety precautions and follow all operation, inspection and maintenance procedures outlined in this manual.

This rider's manual contains information that is essential to safe riding and proper maintenance of your VICTORY motorcycle. Anyone who uses the motorcycle (operators and passengers) must read the rider's manual before riding. Carefully read and understand the information found in the *Safety* section. Understand and follow the procedures outlined in the *Maintenance* section to keep your VICTORY motorcycle in top condition on the road or in storage. Bring the manual with you when you ride. Following the precautions and procedures in the manual will add to your enjoyment and help keep you riding safely. If you lose or damage this manual, you can purchase a new one through any authorized VICTORY dealer. The rider's manual should be considered part of the motorcycle and remain with it if sold.

SAFETY

SAFETY SYMBOLS AND SIGNAL WORDS

The following signal words and symbols appear throughout this manual. Your safety and the safety of others is involved when these words and symbols are used. Become familiar with their meanings before reading the manual.



The safety alert symbol indicates a potential for personal injury.

DANGER

A **DANGER** indicates a hazardous situation that, if not avoided, will result in death or serious injury.

WARNING

A **WARNING** indicates a hazardous situation that, if not avoided, could result in death or serious injury.

CAUTION

A **CAUTION** indicates a hazardous situation that, if not avoided, could result in minor or moderate injury.

NOTICE

A **NOTICE** indicates a situation that could result in property damage.



The Prohibition Safety Sign indicates an action **NOT** to take in order to avoid a hazard.



The Mandatory Action Sign indicates an action that **NEEDS** to be taken to avoid a hazard.

SAFE RIDING PRACTICES

WARNING

Improper use of this motorcycle can result in serious injury or death to you, your passenger and others. To minimize the risk of injury, read and understand the information contained in this section before operating the motorcycle. This section contains safety information specific to the VICTORY motorcycle, as well as information about general motorcycle safety. Anyone who rides the motorcycle (operators and passengers) must follow these safety precautions.

MOTORCYCLING HAS INHERENT RISKS.

You can minimize those risks, but you can't eliminate them completely. Even if you're an experienced motorcycle operator or passenger, read all of the safety information in this manual before operating the motorcycle.

- Take a rider education course from the Motorcycle Safety Foundation or another qualified instructor. The course will help you develop or refresh your expertise in safe riding habits through instruction and riding. For information on Motorcycle Safety Foundation rider education courses in your area, call 1-800-446-9227 or visit their web site at www.msfsa.org.
- Read and understand all information in this rider's manual.
- Observe all maintenance requirements specified in this manual. For more information, see the *VICTORY Service Manual*. Your authorized VICTORY dealer can assist.

DESIGN CHARACTERISTICS AFFECT HOW YOU SHOULD RIDE THE VICTORY MOTORCYCLE:

- The motorcycle is designed for on-road use with one rider and one passenger. See the manufacturer's label (on the left side of the frame at the steering head). The label contains the Vehicle Identification Number (VIN) and Gross Vehicle Weight Rating (GVWR) and Gross Axle Weight Rating (GAWR) information. *Never exceed the GVWR or the GAWR.*
- Riding off-road, riding with more than one passenger, or carrying weight exceeding the maximum weight rating can make handling difficult, which could cause loss of control.
- During the first 500 miles (800 km) of operation, follow all break-in procedures as outlined in the break-in section beginning on page 63. Failure to do so can result in serious engine damage.
- Some VICTORY motorcycles include saddlebags, a windshield, a trunk, or a passenger backrest as standard equipment. To maintain stability, be prepared to reduce the operating speed of motorcycles equipped with these items.

FOLLOW THESE GENERAL SAFE RIDING PRACTICES:

- Before each ride, perform the pre-ride inspections as outlined beginning on page 51.
- Until you're thoroughly familiar with the motorcycle and all of its controls, practice riding where there is little or no traffic. Practice riding at a moderate speed on various road surfaces and in different weather conditions.
- Know your skills and limits, and ride within them.
- Allow only licensed, experienced operators to ride your motorcycle, and then only after they have become familiar with its controls and operation. Make sure all riders read and understand this rider's manual before riding.
- Do not ride when you're fatigued, ill or under the influence of alcohol, prescription drugs, over-the-counter drugs or any other drugs. Fatigue, illness, alcohol and drugs can cause drowsiness, loss of coordination and loss of balance. They can also affect your awareness and judgment.
- If your motorcycle operates abnormally, correct the problem immediately. For more information, see the *VICTORY Service Manual*. Your authorized VICTORY dealer can assist.
- Ride defensively, as if you are invisible to other motorists, even in broad daylight. *A motorist's failure to see or recognize a motorcycle is the leading cause of automobile/motorcycle accidents.* Ride where you're clearly visible to other motorists, and observe their behavior carefully.
- Be especially cautious at intersections, as these are the most likely places for an accident.
- To prevent loss of control, keep your hands on the handlebars and your feet on the footrests.
- Do not move or operate the motorcycle with the steering locked (if equipped), as the severely restricted steering could result in loss of control.
- Obey the speed limit and adjust your speed and riding technique based on road, weather and traffic conditions. As you travel faster, the influence of all other conditions increases, which can affect the motorcycle's stability and increase the possibility of losing control.

- Reduce speed when:
 - the road has potholes, or is otherwise rough or uneven.
 - the road contains sand, dirt, gravel or other loose substances.
 - the road is wet, icy or oily.
 - the road contains painted surfaces, manhole covers, metal grating, railway crossings or other slippery surfaces.
 - The weather is windy, rainy or otherwise causing slippery or rapidly changing conditions.
 - Traffic is heavy, congested, not allowing sufficient space between vehicles or otherwise not flowing smoothly.
 - You are being passed in either direction by a large vehicle that may produce a wind blast in its wake.
- To maximize braking effectiveness, *use the front and rear brakes together*. Improper braking may cause loss of control or may not slow the vehicle in time to avoid a collision. Be aware of the following braking facts and practices:
 - The rear brake provides 40% of the motorcycle's stopping power, at most. Use the front and rear brakes together.
 - To avoid skidding, apply the brakes gradually when the road is wet or rough, or contains loose or other slippery substances.
 - If possible, avoid applying the brakes while making a turn. Motorcycle tires have less traction during turns, so braking will increase the possibility of skidding. Bring the motorcycle to the upright position before applying the brakes.
- When approaching a curve, choose a speed and lean angle that allows you to pass through the curve in your own lane without applying the brakes. Excessive speed, improper lean angle or braking in a curve can cause loss of control.
- Ground clearance is reduced when the motorcycle leans. Do not allow components to contact the road surface when leaning the motorcycle in a curve, as this could cause loss of control.
- Retract the sidestand fully before riding. If the sidestand is not fully retracted, it could contact the road surface and cause loss of control.
- Do not tow a trailer. Towing a trailer can make the motorcycle hard to handle.

ANTI-LOCK BRAKE SYSTEM RESPONSE (IF EQUIPPED)

- When the anti-lock brakes engage during a braking event, the rider will feel pulsing at the brake levers. *Continue to apply steady pressure to the brakes for the best stopping performance.*

SAFETY

CARRYING A PASSENGER

Do not carry a passenger unless the motorcycle is equipped with passenger seat and passenger footrests.

TO CARRY A PASSENGER SAFELY:

- Do not exceed the gross vehicle weight rating (GVWR) for your motorcycle. See the manufacturer's label (on the left side of the frame at the steering head).
- Direct the passenger to hold onto you, the passenger hand grips, or the seat strap (if equipped) with both hands and to keep both feet on the passenger footrests. Do not carry a passenger who cannot place both feet firmly on the passenger footrests. A passenger who is not holding on properly, or who cannot reach the passenger footrests, can shift their body erratically, which can make the motorcycle hard to handle and cause loss of control.
- To obtain the best ride and handling characteristics, adjust the rear shock absorber air pressure. See page 89.
- Before riding, be sure your passenger knows safe riding procedures. Discuss any safety information unfamiliar to your passenger. A passenger who is unaware of safe riding procedures may distract you or make movements that make the motorcycle hard to handle.
- Adjust your riding style to compensate for the differences in handling, acceleration and braking caused by the additional weight of the passenger. Failure to do so can cause loss of control.

PROTECTIVE APPAREL

Wear protective apparel to decrease the risk of injury and increase riding comfort.

- Always wear a helmet that meets or exceeds established safety standards. Approved helmets in the USA and Canada bear a U.S. Department of Transportation (DOT) label. Laws in some areas *require* that you wear an approved helmet. Head injuries are the leading cause of fatalities in accidents involving motorcycles. Statistics prove that an approved helmet is the most effective protection in preventing or reducing head injuries.
- Wear eye protection to protect eyes from wind or airborne particles and objects. Laws in some areas *require* that you wear eye protection. VICTORY recommends that you wear approved Personal Protective Equipment (PPE) bearing markings such as VESC 8, V-8, Z87.1, or CE. Make sure protective eyewear is kept clean.
- All riders should wear bright or light-colored and/or reflective clothing to improve visibility to other motorists. *A motorist's failure to see or recognize a motorcycle is the leading cause of automobile/motorcycle accidents.*
- Wear gloves, a jacket, heavy boots and long pants to prevent or reduce injury from abrasions, lacerations or burns should the motorcycle fall. Wear boots with low heels, as high heels can catch on pedals or footrests. The combination of boots and pants should completely cover legs, ankles and feet, protecting skin from engine and exhaust system heat.
- Do not wear loose, flowing clothing or long boot laces, as they can catch on handlebars, levers or footrests, or they can become entangled in the wheels, causing loss of control and serious injury.

USE OF ACCESSORIES

Because VICTORY cannot test and make specific recommendations concerning every accessory or combination of accessories sold, the operator is responsible for determining that the motorcycle can be safely operated with any accessories or additional weight. Use the following guidelines when choosing and installing accessories:

- Do not install accessories that impair the stability, handling or operation of the motorcycle or operator visibility. Before installing an accessory, be sure that it does not:
 - Reduce ground clearance when the motorcycle is either leaned or in a vertical position.
 - Limit suspension or steering travel or your ability to operate controls.
 - Displace you from your normal riding position.
 - Obscure lights or reflectors.
- Bulky or large accessories can cause instability (due to the lifting or buffeting effects of wind) and loss of control.
- Do not install electrical accessories that exceed the capacity of the motorcycle's electrical system. Never install higher wattage light bulbs than those supplied as original equipment. An electrical failure could result and cause hazardous loss of engine power or lights, or damage to the electrical system.
- Use only genuine VICTORY accessories designed for your model.

MODIFICATIONS

Modifying the motorcycle by removing any equipment or by adding equipment not approved by VICTORY may void your warranty. Such modifications could make the motorcycle unsafe to ride and could result in severe injury to operator or passengers, as well as damage to the motorcycle. Some modifications may not be legal in your area of operation. If in doubt, contact your authorized VICTORY dealer. If in doubt, your authorized VICTORY dealer can assist.

PARKING THE MOTORCYCLE

When leaving the motorcycle unattended, turn the engine off. Remove the ignition key to prevent unauthorized use by minors or those without proper motorcycle certification and training.

Park the motorcycle where people are not likely to touch the hot engine or exhaust system or place combustible materials near these hot areas. Do not park near a flammable source such as a kerosene heater or an open flame, where hot components could ignite combustible materials.

Park the motorcycle on a firm, level surface. Sloped or soft surfaces may not support the motorcycle. If you must park on a slope or soft surface, follow the precautions outlined on page 72.

CARRYING CARGO

Use the following guidelines when attaching cargo or accessories to the motorcycle. Where applicable, these guidelines also refer to the contents of any accessories.

- Keep cargo and accessory weight to a minimum, and keep items as close to the motorcycle as possible to minimize a change in the motorcycle's center of gravity. Changing the center of gravity can cause loss of stability and handling and could cause loss of control.
- Distribute weight evenly on both sides of the motorcycle. Maintain even weight distribution by checking accessories and cargo to make sure they're securely attached to the motorcycle before riding and whenever you take a break from riding. Uneven weight distribution, or accessories or cargo that shift suddenly while you're riding can make the motorcycle hard to handle, can cause loss of control, or cargo could fall from the motorcycle creating a hazard for surrounding vehicles.
- Do not attach large or heavy cargo such as sleeping bags, duffel bags or tents to the handlebars, front fork area or front fender. Cargo or accessories placed in these areas can cause instability (due to improper weight distribution or aerodynamic changes) and could cause loss of control. Such items can also block air flow to the engine and cause overheating that can damage the engine.
- Do not exceed the maximum cargo weight limit of any accessory (see accessory instructions and labels). Do not attach cargo to an accessory not designed for that purpose. Either circumstance could result in an accessory failure that could cause loss of control.
- Do not attach anything to the motorcycle unless specifically designed for that purpose by VICTORY.

SADDLEBAGS AND TRUNK

Whenever operating a motorcycle with saddlebags:

- Never ride at speeds exceeding 80 MPH (120 km/h). Depending on load and weather conditions, the maximum safe operating speed may be less. Saddlebags, combined with the lifting or buffeting effects of wind, can make the motorcycle unstable and cause loss of control.
- Distribute weight evenly in each of the saddlebags.
- Do not exceed the individual weight limit of each saddlebag or the trunk. A weight capacity label is attached inside for reference.
- NEVER EXCEED GROSS VEHICLE WEIGHT RATING (GVWR) or the GROSS AXLE WEIGHT RATING (GAWR), regardless of whether or not the saddlebags and/or trunk are loaded to capacity. Exceeding the weight rating can reduce stability and handling and cause loss of control.

TRANSPORTING THE MOTORCYCLE

If you must transport the motorcycle:

- Use a truck or trailer. Do not tow the motorcycle with another vehicle, as towing will impair the motorcycle's steering and handling.
- Position and restrain the motorcycle so it remains upright on the truck or trailer. If the motorcycle leans to one side, gasoline may leak from the fuel tank and result in a fire hazard or damage to the finish.
- Do not restrain the motorcycle using the handlebars. In front, hook the tiedowns in the loop provided in the bottom of the frame. Place tiedowns as wide apart as possible on the truck or trailer bed for best stability.

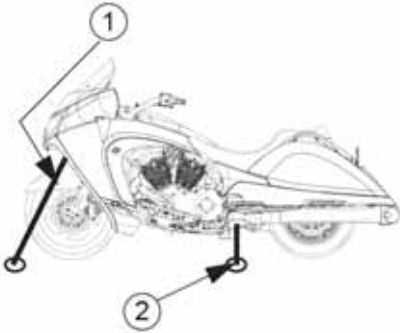

① To loop on frame (one tiedown each side)

② To shock/strut mount, or rear tip-over bar (one tiedown each side)

FUEL AND EXHAUST SAFETY

WARNING

Gasoline is highly flammable and explosive under certain conditions.

- Always exercise extreme caution whenever handling gasoline.
- Always turn off the engine before refueling.
- Always refuel outdoors or in a well-ventilated area.
- Open the fuel cap slowly. Do not overfill the tank. Do not fill the tank neck.
- Do not smoke or allow open flames or sparks in or near the area where refueling is performed or where gasoline is stored.

WARNING

Gasoline and gasoline vapors are poisonous and can cause severe injury.

- Do not swallow gasoline, inhale gasoline vapors, or spill gasoline. If you swallow gasoline, inhale more than a few breaths of gasoline vapor, or get gasoline in your eyes, see a physician immediately.
- If gasoline spills on your skin or clothing, immediately wash it off with soap and water and change clothing.
- If gasoline spills on the any part of the motorcycle, immediately rinse it off with water.

WARNING

Exhaust gases contain carbon monoxide, a colorless, odorless gas that can cause loss of consciousness or death in a short time.

- Never start the engine or let it run in an enclosed area.
- Never inhale exhaust gases.

SAFETY MAINTENANCE

WARNING

Failure to perform safety maintenance as recommended can result in difficult handling and loss of control, which could result in serious injury or death. Always perform the safety maintenance procedures as recommended in this manual. Perform safety-related maintenance and repairs promptly as outlined in the VICTORY service manual, or see your authorized VICTORY dealer for service.

- Before each ride, perform the Pre-Ride Inspections. See page 51.
- Perform all periodic maintenance at the recommended intervals outlined in the Periodic Maintenance section beginning on page 78.
- Always maintain proper tire pressure, tread condition and wheel and tire balance. Inspect tires regularly and replace worn or damaged tires promptly. Use only approved replacement tires. For more information, see the *VICTORY Service Manual*. Your authorized VICTORY dealer can assist.
- Always ensure proper steering head bearing adjustment. Regularly inspect the rear shock absorber and the front forks for fluid leaks or damage. Make any necessary repairs promptly.
- Clean the motorcycle thoroughly to reveal items in need of repair.
- Fasteners must meet original specifications for quality, finish and type to ensure safety. Use only genuine VICTORY replacement parts, and ensure that all fasteners are tightened to the proper torque.

ELECTROMAGNETIC INTERFERENCE

This vehicle complies with the requirements of European directive 97/24/EC Chapter 8, United Nations ECE regulation 10 and Canadian ICES-002.

GROSS VEHICLE WEIGHT RATING (GVWR)

WARNING

Exceeding the gross vehicle weight rating of your motorcycle can reduce stability and handling and could cause loss of control. NEVER exceed the GVWR of your motorcycle.

The *maximum load capacity* of your motorcycle is the maximum weight you may add to your motorcycle *without exceeding the GVWR*. This capacity is determined by calculating the difference between your motorcycle's GVWR and wet weight.

Refer to the specification section beginning on page 145 or the Manufacturing Information/VIN label on the motorcycle frame for model-specific information. See page 21.

When determining the weight you will be adding to your motorcycle, and to ensure you do not exceed the maximum load capacity, include the following:

- operator body weight
- passenger body weight
- weight of all riders' apparel and items in or on apparel
- weight of any accessories *and their contents*
- weight of any additional cargo on the motorcycle

REPORTING SAFETY DEFECTS

If you believe that your vehicle has a defect that could result in a crash or cause injury or death, you should immediately inform the National Highway Traffic Safety Administration (NHTSA) in addition to notifying Polaris Industries in writing.

If NHTSA receives similar complaints, it may open an investigation, and if it finds that a safety defect exists in a group of vehicles, it may order a recall and remedy campaign. However, NHTSA cannot become involved in individual problems between you, your dealer or Polaris Industries.

To contact NHTSA, or obtain other information about motor vehicle safety, you may call the Vehicle Safety Hotline toll free at 1-888-327-4236 (TTY: 1-800-424-9153), visit the NHTSA web site at www.safercar.gov, or write to:

ADMINISTRATOR, NHTSA
1200 New Jersey Avenue, SE
West Building
Washington, DC 20590

SAFETY AND INFORMATION LABELS

Labels are model-specific and market-specific. Your motorcycle may not contain all of the labels shown. See page 115 for seat removal instructions.

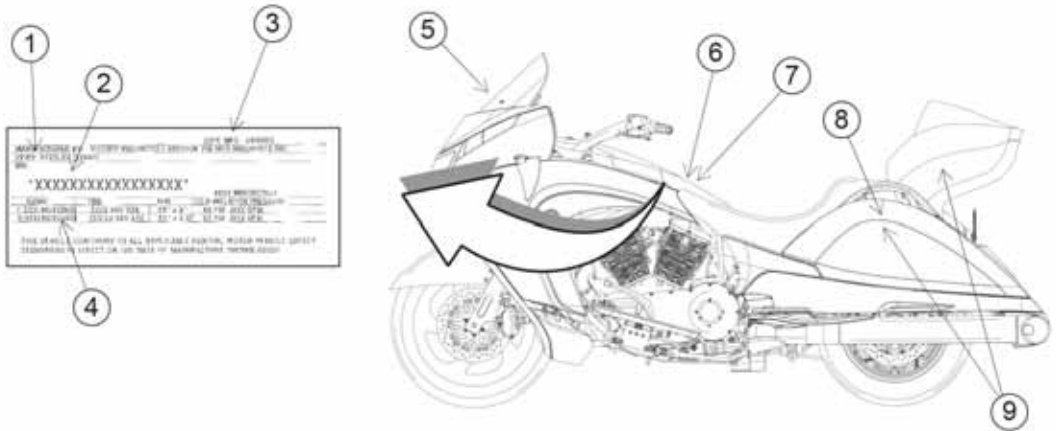

① GVWR Information	⑥ Vehicle Identification Number (VIN) (on frame, under rear console cover)
② VIN Number	⑦ Operator/Fuel Warning (on rear console cover)
③ Date of Manufacture	⑧ Vehicle/Noise Emission Control Information (VECI/NECI) (inside left saddlebag)
④ Tire & Wheel Information / GAWR Information	⑨ Cargo Information (in saddlebags and trunk, if equipped)
⑤ Windshield Label	

IDENTIFICATION

IGNITION KEY NUMBER

The ignition key number ① is stamped on the small metal tag attached to the key ring. *Remove* the tag and record the number on page 148. Store the tag in a safe place.

Additional keys can be copied from one of the original keys. A VICTORY key blank is required. If you lose both original keys, you will need the following:

- Key number (recorded on page 148)
- A new key blank from a VICTORY dealer
- Proof of ownership
- A locksmith or VICTORY dealer with the equipment necessary to cut a new key

ENGINE IDENTIFICATION NUMBER

The engine identification number ① is stamped into the right crankcase half behind the rear cylinder. The first 8 digits are the engine model number. The last 5 digits are the serial number. Record the number in the space provided on page 148.

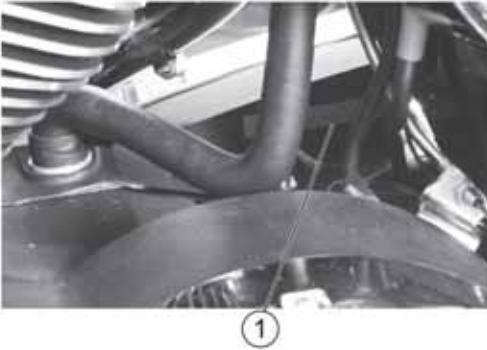

IDENTIFICATION

LEFT SIDE VIEW

1. Spark Plugs
2. Power Port
3. Front Brake Caliper
4. Gear Shift Pedal
5. Operator Footrest
6. Sidestand
7. Oil Drain Plug
8. Oil Filter
9. Passenger Footrest
10. Rear Brake Caliper
11. Diagnostic Connector (in saddlebag)
12. Running Light (Tour)
13. Rear Speakers (Tour)
14. Passenger Hand Grip
15. Rear Shock Air Fitting (under saddlebag door)

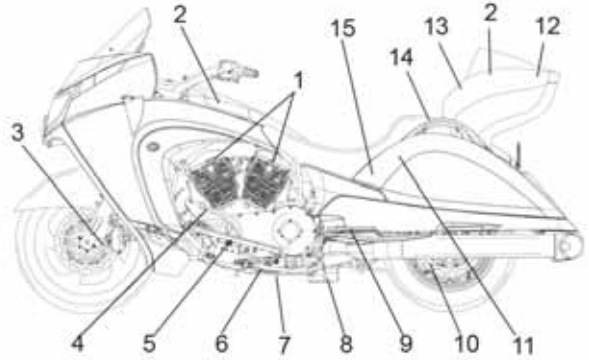

RIGHT SIDE VIEW

1. Drive Belt Guard
2. Drive Belt
3. Passenger Footrest
4. Drive Sprocket (under cover)
5. Speed Sensor (top of crankcase)
6. Engine Oil Fill Cap / Dipstick
7. Rear Brake Pedal
8. Operator Footrest
9. Front Brake Caliper
10. Passenger Hand Grip
11. Reflector

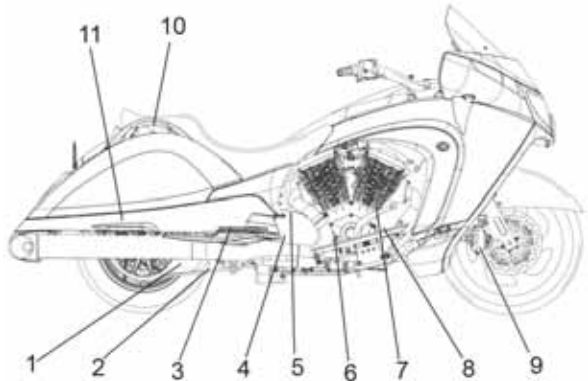

TOP VIEW

1. Windshield
2. Radio Antenna (under dash)
3. Mirror
4. Clutch Fluid Reservoir
5. Clutch Lever
6. Glove Compartment Door
7. Operator Seat
8. Passenger Seat
9. Saddlebag Latch
10. Trim Panel (if equipped)
11. Front Brake Lever
12. Front Brake Fluid Reservoir
13. Fuel Filler Cap Access Door

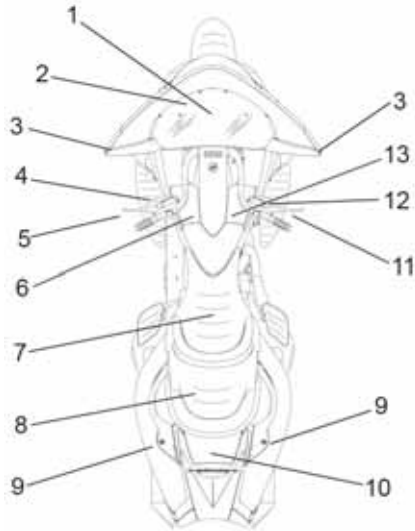

FRONT VIEW

1. Front Turn Signal (outer light, each side)
2. Wind Deflector
3. Headlamp
4. Driving Lamp (or HID lamp if equipped)
5. Air Filter (front of frame)
6. Tiedown Loop (on frame)
7. Rear Brake Fluid Reservoir
8. Battery
9. Oil Cooler
10. Horn
11. Evaporative Emissions Canister
12. Fuel Tank (one each side)
13. Running Light (inner light, each side)

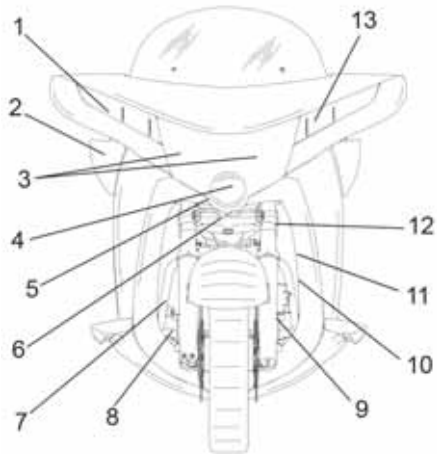

IDENTIFICATION

REAR VIEW

1. Turn Signals (uppermost in lens)
2. Tail Lamps (3 each side)
3. Brake Lamps
4. Exhaust Mufflers
5. License Plate Bracket

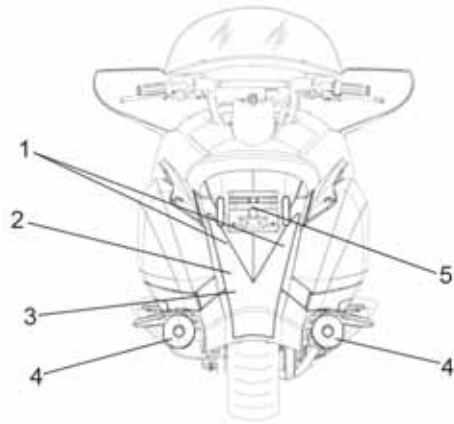

CONSOLE

1. Speakers
2. Fuel Gauge
3. Speedometer
4. Indicator Lamp Display
5. Multi-Function Display
6. Tachometer
7. Volt Meter
8. Cruise Control Switches (if equipped)
9. Radio Controls
10. Left Handlebar Switch/Audio Control

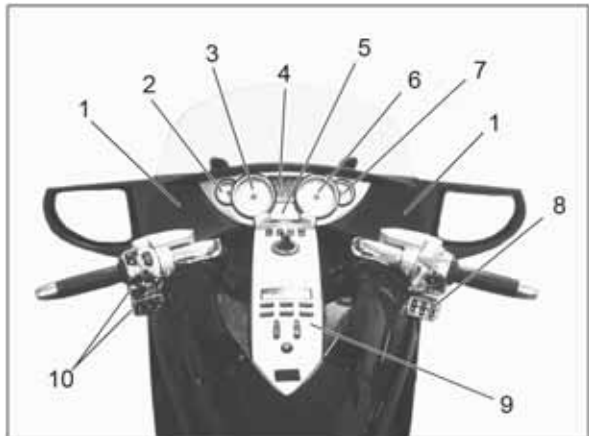

INSTRUMENTS, FEATURES AND CONTROLS

IGNITION SWITCH

Place the ignition key in the ignition switch to operate the following functions of the switch.

OFF	All electrical circuits are off. The key can be removed.
ON	All electrical circuits are on. The ignition key cannot be removed. Headlamp, taillight, running lights, radio and instrument lights illuminate. Hazard flashers and turn signals can be activated.
ACC	Power is supplied to accessory circuits, radio, instruments, turn signals, brake light, windshield motor, horn and hazard (flasher). The key can be removed.
LOCK	All electrical circuits are off. The fuel door and glove compartment are locked when the steering is locked. The key can be removed. See page 27 for instructions.
FUEL DOOR	See page 28 for instructions.

IGNITION KEY

The ignition key operates the ignition switch, fuel door, saddlebag door locks and trunk door lock (if equipped). Read the engine starting procedures beginning on page 65 before starting the engine. Store the spare key in a safe place separate from the main key.

TIP: Use a key ring that won't scratch the finish on the console.

IGNITION LOCK

Use the ignition lock feature to lock the steering. When locked, the key can be removed.

TIP: The fuel door and glove compartment are locked when the steering is locked.

1. Turn the handlebars full left.
2. Turn the key to the OFF position.
3. Push the key down while moving it counter-clockwise to the LOCK position.
4. Release the key.



Locked

INSTRUMENTS, FEATURES AND CONTROLS

FUEL DOOR LOCK

1. Turn the handlebars full left.
2. Turn the key to the OFF position.

TIP: Do not push the key down when unlocking the fuel door.

3. Turn the ignition key counter-clockwise ① to release the fuel door ② latch. The door will open under light spring tension. See page 64 for fueling procedure.
4. Remove the fuel cap and place it in the cap holder ③ while fueling. Reinstall the fuel cap securely before closing the fuel door.
5. Close the fuel door and press downward to engage the latch.

TIP: The fuel door and glove compartment are locked when the steering is locked.

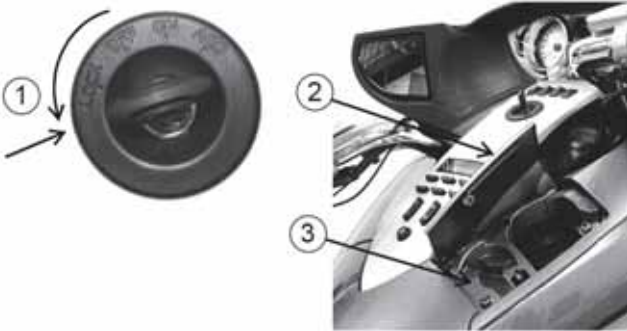

INSTRUMENT CLUSTER

The instrument cluster includes the speedometer, tachometer, fuel gauge, volt meter, indicator lamps and multi-function display.

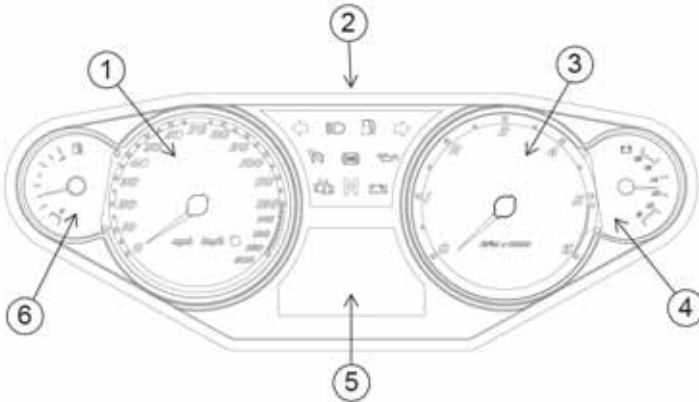

- | | |
|-------------------|--------------------------|
| ① Speedometer | ④ Volt Meter |
| ② Indicator Lamps | ⑤ Multi-Function Display |
| ③ Tachometer | ⑥ Fuel Gauge |

SPEEDOMETER

The speedometer displays vehicle speed in either miles per hour (MPH) or kilometers per hour (km/h).

TACHOMETER

The tachometer displays engine speed in revolutions per minute (RPM). A red line on the face of the gauge indicates the maximum safe engine speed.

⚠ WARNING

Excessive engine speed can cause engine damage or failure, which could result in serious injury or death. Do not allow engine speed to exceed the red line.

FUEL GAUGE

The fuel gauge displays fuel level. The key must be in the ON or ACC position. For the most accurate reading, sit on the motorcycle and bring it to the upright position.

VOLT METER





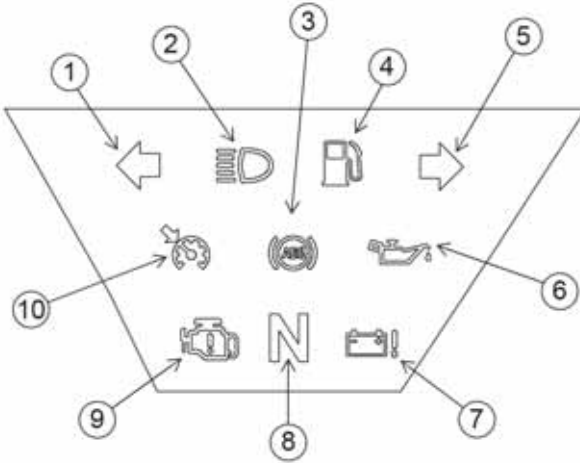



When the key is in the ON position, the volt meter displays battery voltage. If the engine is not running, approximate battery voltage displays. If the engine is running, approximate charging voltage displays.

INDICATOR LAMPS



- | | |
|--|-------------------|
| ① Left Turn | ⑥ Oil Pressure |
| ② High Beam | ⑦ Battery Warning |
| ③ Anti-Lock Brake System (ABS) (if equipped) | ⑧ Neutral |
| ④ Low Fuel | ⑨ Check Engine |
| ⑤ Right Turn | ⑩ Cruise Control |

INSTRUMENTS, FEATURES AND CONTROLS

LAMP	INDICATES	CONDITION
	Neutral	This lamp illuminates when the transmission is in neutral and the ignition key is in the ON or ACC position.
	High Beam	This lamp illuminates when the headlamp switch is set to high beam.
	Check Engine	This lamp illuminates momentarily when the ignition switch is in the ON position and the engine is off. This indicates proper function. <i>If this lamp illuminates while the engine is running, prompt service is required.</i> Your authorized VICTORY dealer can assist. The light will remain on if the tilt sensor shuts down the engine. See page 36. If abnormal sensor or engine operation is detected the light will remain on as long as the fault condition exists. Retrieve the error codes for diagnosis. See page 32. This lamp is also known as a malfunction indicator lamp (MIL).
	Turn Signal	One arrow flashes when the corresponding turn signal is activated. Both arrows flash when the hazard signal is activated. <i>If a bulb fails, or if there is a short circuit in the signal system, the lamp flashes at more than twice the normal rate.</i>
	Low Oil Pressure	This lamp illuminates when the ignition switch is in the ON position and the engine is off, indicating that the indicator circuit is functioning properly. This lamp also illuminates if engine oil pressure drops below safe operating pressure. If this lamp illuminates while the engine is running, turn the engine off as soon as safely possible and check the oil level. <i>If the oil level is correct and the lamp remains on after the engine is restarted, turn the engine off immediately.</i>
	Low Fuel	This lamp illuminates when approximately one gallon (3.8 liters) of fuel remains in the fuel tank.
	Low Battery Warning	This lamp illuminates when battery voltage is low. Make sure the charging system is operating properly. See page 125.
	Cruise Control Engaged	Before using the cruise control, read the safety and operation procedures beginning on page 69.
	Anti-Lock Brake System Not Activated (if equipped)	The ABS indicator always illuminates when the key is in the ON position and remains on until the anti-lock system activates, which occurs when vehicle speed exceeds 6 MPH (10 km/h). When the lamp is illuminated, the anti-lock brakes will not activate, but the conventional brake system will continue to operate normally.

MULTI-FUNCTION DISPLAY

Use the mode button to toggle through the modes of the multi-function display. See page 36. Modes available include:

- clock ①
- gear position ②
- ambient temperature ④
- odometer/trip odometer ③
- fuel range
- average fuel consumption rate
- fuel economy
- trip time (and other trip information)

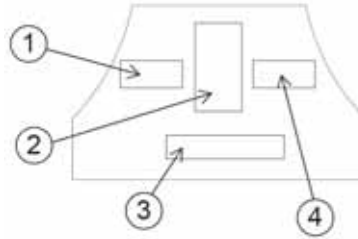

ENGINE ERROR CODES

The error screen displays only when the CHECK ENGINE light is on or when it goes on and off during one ignition cycle. Error codes are not stored. When the key is turned OFF, the code and message is lost, but will reappear if the fault reoccurs after restarting the engine.

If the CHECK ENGINE indicator lamp illuminates, retrieve the error codes from the display.

1. If the error codes are not displayed, use the mode button to toggle until "Err" displays in the clock area.
2. Record the three code numbers displayed in the gear position, temperature and odometer displays.
3. Your authorized VICTORY dealer can provide code details and diagnosis.

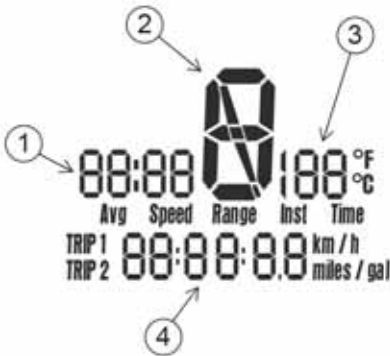

① "Err"

② Error Code Number (0-9)

③ Failure Mode Indicator (FMI)

④ Suspect Parameter Number (SPN)

DISPLAY UNITS (STANDARD/METRIC)

The display can be changed to display either standard or metric units of measurement.

TIP: To exit the set-up mode at any time, wait 10 seconds. The display automatically exits and returns to the odometer display.

	STANDARD DISPLAY	METRIC DISPLAY	
Distance	Miles	Kilometers	
Fuel	U.S. Gallons	l = Imperial Gallons	Liter = Liters
Temperature	Fahrenheit	Celsius	
Time	12-Hour Clock	24-Hour Clock	

1. Turn the key to the OFF position.
2. Press and *hold* the mode button while turning the key to the ON or ACC position.
3. When the display flashes the distance setting, tap the mode button to advance to the desired setting.
4. Press and *hold* the mode button to save the setting and advance to the next display option.
5. Repeat the procedure to change remaining display settings.

INSTRUMENTS, FEATURES AND CONTROLS

CLOCK

TIP: The clock must be reset any time the battery has been disconnected or discharged.

1. Turn the key to ON or ACC. Use the mode button to toggle to the odometer display.

TIP: If LOW FUEL is flashing, the display will not enter the CLOCK SET mode.

2. Press and *hold* the mode button until the hour segment flashes. Release the button.
3. With the segment flashing, tap the mode button to advance to the desired setting.
4. Press and *hold* the mode button until the next segment flashes. Release the button.
5. Repeat steps 3-4 twice to set the 10-minute and 1-minute segments. After completing the 1-minute segment, step 4 will save the new settings and exit the clock mode.
6. Turn the key to the OFF position.

ODOMETER/TRIP ODOMETER

The odometer displays the total distance traveled by the vehicle. The trip odometer displays distance traveled since the trip odometer was reset. To view the trip odometer, turn the key to the ON position. Use the mode button to toggle to the trip odometer.

To reset the trip odometer, toggle to the trip odometer, then press and hold the mode button until the trip odometer resets.

GEAR POSITION

A gear position displays only when the transmission is in gear and the motorcycle is moving.

Two dashes (–) display if the stop/run switch is in the RUN position and the motorcycle is not moving while in gear. The dashes also display if the stop/run switch is in the STOP position.

“N” displays when the stop/run switch is in the RUN position and the transmission is in neutral.

TEMPERATURE

The key must be in the ON or ACC position to display ambient air temperature.

CONSOLE SWITCHES

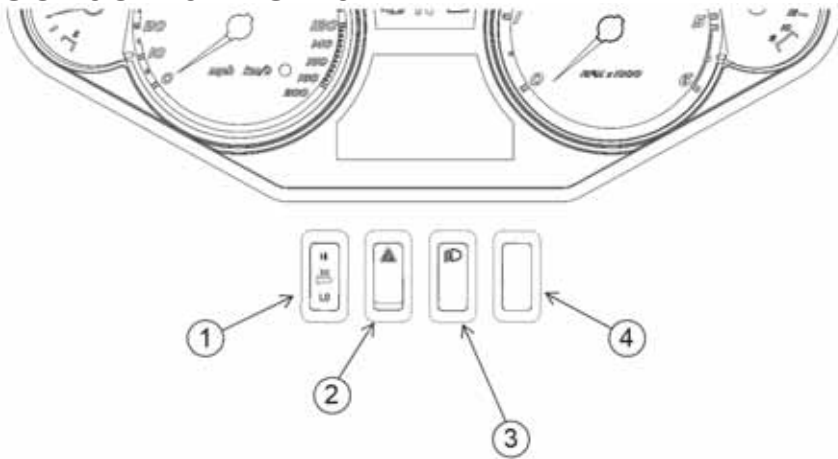

① Hand Grip Heater Switch	③ Driving Lamp Switch
② Hazard Switch	④ Optional Accessory Switch

HAND GRIP HEATER SWITCH



Press the top ① (high heat) or bottom ③ (low heat) of the rocker switch to turn the hand grip heaters on. Move the switch to the center position ② to turn the heaters off.

HAZARD SWITCH/EMERGENCY FLASHERS

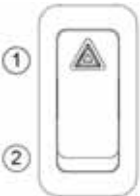

All turn signals flash when the emergency flashers are activated. Press the top ① of the hazard switch to turn the flashers on. Press the bottom ② of the switch to turn the flashers off.

DRIVING LAMP SWITCH

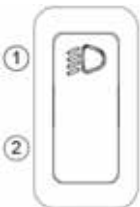

The driving lamp is an additional low beam lamp not controlled by the headlamp high/low switch. This lamp is a center headlamp (or HID lamp, if equipped). The ignition key must be on to use the driving lamp. Press the top ① of the rocker switch to turn the light on. Press the bottom ② of the switch to turn the light off.

INSTRUMENTS, FEATURES AND CONTROLS

SEAT HEATER SWITCHES

Seat heater switches (if equipped) are located on the seat under the left passenger hand grip. The low heat setting is adequate for most conditions. Use the high heat setting with caution.

- The front switch controls the driver's seat heater.
- The rear switch controls the passenger's seat heater.

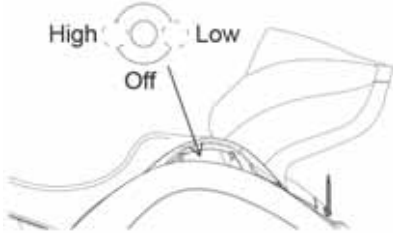

TILT SENSOR

A tilt sensor (if equipped) stops the engine if the motorcycle tips beyond 45 degrees to one side. The check engine light will also illuminate. To restart the engine, cycle the ignition switch to the OFF position, wait 10 seconds, then restart the engine.

MODE BUTTON

The mode button is located on the front side of the left handlebar switch. Use the mode button to toggle through the modes of the multi-function display. See page 32. Use the mode button to set the display units to either standard or metric units of measurement. See page 33.

TIP: If "Err" displays while toggling through the features, a system error has been logged. See page 32.



MIRRORS

Adjust the rear view mirrors by applying light pressure at the outer edges of the mirror.

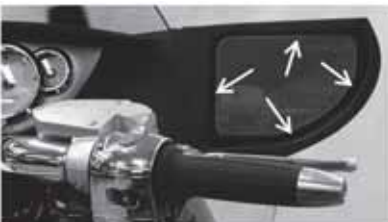

HEADLAMP SWITCH (HIGH/LOW)

The headlamp switch is located on the left handlebar. Use the switch to toggle the headlamp to high beam or low beam . The key must be in the ON or ACC position.

TIP: To turn the headlamp on, turn the ignition key to ON and tap or press the start switch.

- Press the top of the switch ① to activate high beam.
- Press the bottom of the switch ② to activate low beam.

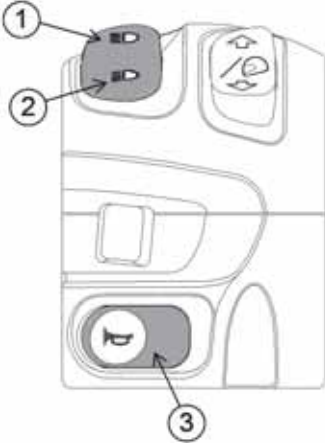

HORN SWITCH

The horn switch ③ is located on the left handlebar. Press the horn switch to sound the horn. The key must be in the ON or ACC position.

INSTRUMENTS, FEATURES AND CONTROLS

WINDSHIELD ADJUSTMENT SWITCH

The motorized windshield adjustment switch (if equipped) is located on the left handlebar. Use the switch to change the height and angle of the windshield. The key must be in the ON or ACC position.

TIP: Do not continuously cycle the windshield switch more than once in a 60-second period

- Press the top of the switch ① to raise the windshield.
- Press the bottom of the switch ② to lower the windshield.

For models not equipped with this feature, use the manual windshield adjustment procedure. See page 46.

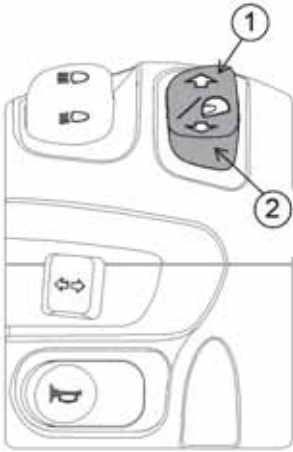

TURN SIGNAL SWITCH

The turn signal switch ① is located on the left handlebar. Use the switch to activate a turn signal. The key must be in the ON or ACC position.

- Push the switch to the left to activate the left turn signals.
- Push the switch to the right to activate the right turn signals.

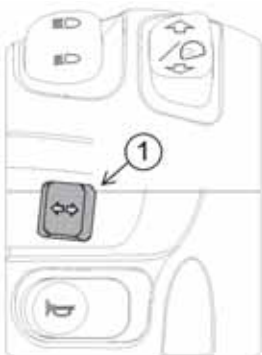

Turn signals automatically cancel after predetermined speed and distance conditions are met. To *manually* cancel a signal, move the switch to the center position and press it inward.

TIP: The momentary signal feature is useful when passing or changing lanes. To use the momentary feature, push and *hold* the switch through at least one complete flash cycle (at least one second) to activate the feature. The signal will then cancel the moment the switch is released.

INSTRUMENTS, FEATURES AND CONTROLS

CLUTCH LEVER

The clutch lever ① is located on the left handlebar. Disengage the clutch before shifting gears. For smooth clutch operation, pull the lever quickly and release it gradually.

- To disengage the clutch, pull the lever toward the handlebar.
- To engage the clutch, gradually release the lever.



STARTER INTERLOCK SWITCH

The starter interlock switch ② is located on the left handlebar. This switch prevents the electric starter from operating when the transmission is in gear and the clutch is engaged (lever released). Read the engine starting procedures beginning on page 65 before starting the engine.

WARNING! Never start the engine with the transmission in gear and the clutch disengaged unless you are properly seated with the front brake applied.

ENGINE STARTER SWITCH

The starter switch is located on the right handlebar. Use the starter switch to start the engine, turn the headlights on and operate in reverse (if equipped). The switch will operate only when the engine stop/run switch is in the RUN position and the transmission is in neutral (or the clutch is disengaged). The reverse lever (if equipped) must also be disengaged.

TIP: If the reverse system fuse has blown, the starter switch will not function even if the reverse lever is disengaged. Replace the fuse. See page 121.

Read the engine starting procedures before starting the engine. See page 65.

- Press the right side of the starter switch ① to engage the starter motor.
- Tap the starter switch to turn the headlight on without starting the engine.
- See page 74 for reverse operation.

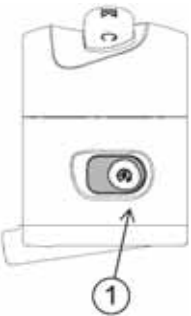

ENGINE STOP/RUN SWITCH

The engine stop/run switch is located on the right handlebar. This switch completes or interrupts the ignition, starter and fuel pump circuits. Use the engine stop/run switch to turn the engine off quickly. Turn the key off after the engine stops.

- Press the bottom of the switch ① (RUN) to complete the circuits and allow the engine to start and run.
- Press the top of the switch ② (STOP) to interrupt the circuits and stop the engine. The engine should not start or run when the switch is in the STOP position.



THROTTLE CONTROL GRIP

The throttle control grip is located on the right handlebar. Use the throttle control grip to control engine speed. While seated in the proper riding position:

- Rotate the top of the grip rearward ① to increase engine speed and power.
- Rotate the top of the grip forward ② to decrease engine speed and power.

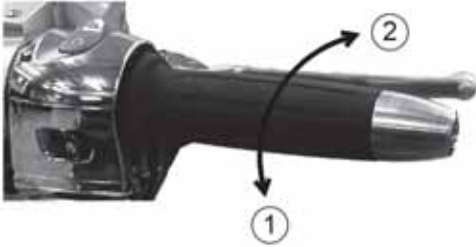

BRAKES

LINKED BRAKING SYSTEM

The front and rear brakes on the motorcycle are linked. The front brake lever activates only the front brake calipers. The rear brake pedal activates the rear brake caliper fully while simultaneously activating one of the three pistons in each front brake caliper.

For maximum brake effectiveness, apply the front brake lever and the rear brake pedal together, as with a conventional (non-linked) brake system.

ANTI-LOCK BRAKE SYSTEM (ABS)

This system is a linked brake system. The anti-lock brake system automatically reduces or increases brake pressure as needed to provide optimum braking control, reducing the chance of wheel lock-up during hard braking events or when braking on rough, uneven, slippery or loose surfaces. See page 11.

- The anti-lock brake system cannot be turned off.
- The ABS indicator always illuminates when the key is in the ON or ACC position and remains on until the anti-lock system activates, which occurs when vehicle speed exceeds 6 MPH (10 km/h).
- When the lamp is illuminated, the anti-lock brakes will not activate, but the conventional brake system will continue to operate normally.
- When the anti-lock brakes engage during a braking event, the rider will feel pulsing at the brake levers. *Continue to apply steady pressure to the brakes for the best stopping performance.*
- Service the indicator lamp if the ABS light does not come on when the key is turned to the ON or ACC position. Your authorized VICTORY dealer can assist.
- If the lamp continues to illuminate after vehicle speed exceeds 6 MPH (10 km/h), the ABS system is not functioning. Prompt service is required. Your authorized VICTORY dealer can assist.

ANTI-LOCK BRAKE SYSTEM (ABS)

- Operating with non-recommended tires or improper tire pressure may reduce the effectiveness of the anti-lock brake system. Always use the recommended size and type of tires specified for your vehicle. Refer to the specification section beginning on page 145. Always maintain the recommended tire pressure.
- The anti-lock brake system will not prevent wheel lockup, loss of traction or loss of control *under all conditions*. Always adhere to all safe motorcycle-riding practices as recommended.
- It is not unusual to leave tire marks on the road surface during a hard braking event.
- The anti-lock brake system does not compensate for or reduce the risks associated with:
 - excessive speed
 - reduced traction on rough, uneven or loose surfaces
 - poor judgment
 - improper operation

FRONT BRAKE LEVER

The front brake lever ① is located on the right handlebar. This lever controls only the front brakes. The front brakes should be applied simultaneously with the rear brakes.

To apply the front brake, pull the lever toward the handlebar.

See page 68 for braking procedures.



REAR BRAKE PEDAL

The rear brake pedal ① is located on the right side of the motorcycle. Press downward on the rear brake pedal to apply the rear brake.

The rear brake pedal activates the rear brake caliper fully while simultaneously activating one of the three pistons in each front brake caliper.

See page 45 for pedal adjustment options.

See page 68 for braking procedures.



GEAR SHIFT PEDAL

The gear shift pedal ① is located on the left side of the motorcycle.

- Press downward on the gear shift pedal to shift to a lower gear.
- Lift up on the gear shift pedal to shift to a higher gear.

See page 45 for pedal adjustment options. See page 66–page 67 for gear shifting procedures.



PEDAL ADJUSTMENT

The brake pedal and gear shift pedal controls can be adjusted to a front, rear or center position. The center position ① is the factory setting.

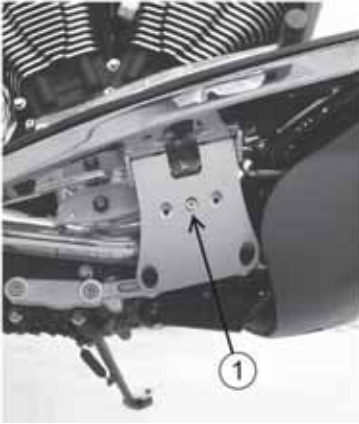

TIP: An accessory linkage rod is needed to fully adjust the gear shift pedal control.

1. Remove the screw from the footwell support.

Tool: 6 mm Allen wrench

2. Slide the control forward or rearward in its track until the threaded hole of the control aligns with the desired hole in the footrest support.
3. Reinstall the screw.

TORQUE: 96 in-lbs (11 Nm)

4. After adjusting the shift pedal, always readjust the shift linkage rod. Loosen both jam nuts on the linkage and turn the shaft until the footpeg is about 90 mm from the floorboard (or to desired height). Tighten both jam nuts.

TORQUE: 96 in-lbs (11 Nm).

WINDSHIELD ADJUSTMENT

Use the motorized windshield adjustment switch (if equipped) to adjust the windshield. See page 38. If the motorcycle is not equipped with this feature, you can manually adjust the windshield.

1. Park the motorcycle on a firm, level surface. Turn the key to the OFF position.
2. Remove the windshield trim panel. See page 115.
3. Remove the retaining clip ①.
4. Hold slight downward pressure on the bottom of the windshield (it is under slight upward spring pressure). Remove the clevis pin ②.
5. Slide the windshield inner bracket to align with one of the optional holes in the outer bracket. Reinstall the clevis pin. Reinstall the retaining clip in the clevis pin.
6. Reinstall the windshield trim panel.



GLOVE COMPARTMENT

Before opening the glove compartment, turn the handlebars slightly to the right.

1. Press and release the inner edge of the compartment door. The door will open under light spring tension.



2. To close the glove compartment door, press the inner edge of the door downward firmly to secure the latch.
3. To lock the glove compartment door, turn the ignition key to the LOCK position.

TIP: The fuel door and glove compartment are locked when the steering is locked.

SIDESTAND

The sidestand is located on the left side of the motorcycle.

WARNING! An improperly retracted sidestand could contact the ground and cause a loss of control resulting in serious injury or death. Always retract the sidestand fully before operating the motorcycle.

To park the motorcycle, swing the end of the sidestand downward and away from the motorcycle until it is fully extended. Lean the motorcycle to the left until the sidestand firmly supports the motorcycle.



To retract the sidestand, straddle the motorcycle and bring it to the fully upright position. Swing the end of the sidestand upward and toward the motorcycle until it is fully retracted.

SADDLEBAG AND TRUNK DOOR LOCKS

Use the ignition key to lock and unlock the trunk and saddlebag doors. The doors should be locked before riding.

To lock a door, place the key in the lock and turn it counter-clockwise ①. To unlock a door, turn the key clockwise ②.

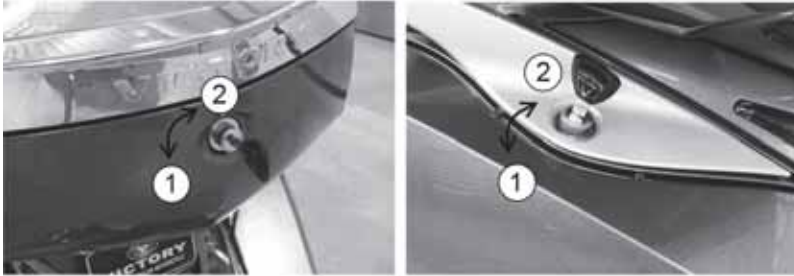

After unlocking a door, press the door lock to release the latch and open the door.

Refer to the Gross Vehicle Weight Rating information beginning on page 20 for loading information.

RADIO/AUDIO SYSTEMS

Refer to the Audio System section of this manual (beginning on page 149) for radio and accessory audio systems ① operation.



TOOL KIT

The tool kit can be used to perform most basic maintenance items. Tools provided in the tool kit include:

1. 4 mm Ball Drive Allen Wrench
2. 4 mm / 6 mm Open End Wrench
3. 6 mm Ball Drive Allen Wrench
4. 8 mm / 10 mm Open End Wrench
5. Combination Phillips / Slot Screw Driver
6. Rear Shock Absorber / Tire Pressure Gauge

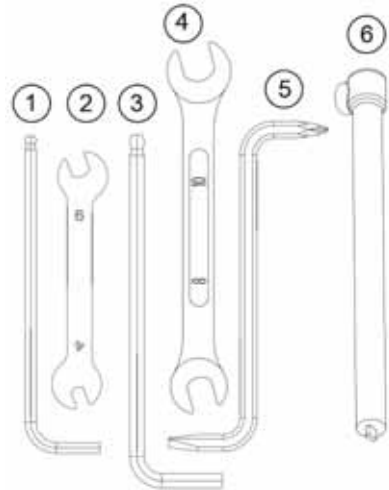

PRE-RIDE INSPECTIONS

To keep your motorcycle in safe operating condition, always perform the recommended pre-ride inspections before each ride. This is especially important before making a long trip and when removing the motorcycle from storage.

WARNING

Failure to perform the recommended pre-ride inspections could result in component failure while riding, which could result in serious injury or death. Always perform the pre-ride inspections before each ride.

You must be familiar with all instruments and controls to perform the pre-ride inspections.

TIP

During the pre-ride inspections you may use products that are potentially hazardous, such as oil or brake fluid. When using any of these products, always follow the instructions and warnings on the product packaging.

When inspections reveal the need for adjustment, replacement or repair:

- Refer to the maintenance section of this manual.
- Refer to the *VICTORY Service Manual*.
- Your authorized VICTORY dealer can assist.

PRE-RIDE INSPECTIONS

PRE-RIDE INSPECTIONS

Turn the ignition key to the ON position and move the stop/run switch to RUN before performing the following electrical inspections. Return the ignition key to the OFF position after completing these inspections. If inspection of any electrical item reveals component failure, repair or replace the component before operating the motorcycle.

ITEM	INSPECTION PROCEDURE
Electrical	
Headlamp	Tap the starter switch to verify that the headlamp illuminates. Switch to high beam. Verify that the high beam indicator comes on and that lamp brightness increases. See page 120 for adjustment procedures.
Taillight/Brakelight	Verify that the taillight and license plate light illuminate. If a turn signal is activated, only the two lower lamps will illuminate. Verify that the taillight lamps increase in brightness when the front brake lever is applied and also when the rear brake pedal is applied.
Turn Signals	Move the turn signal switch to the left. Verify that front and rear left turn signals flash, as well as the corresponding light on the indicator panel. Push the switch inward to cancel the signal. Verify that the signals and the indicator light stop flashing. Repeat the procedure for the right turn signals.
Emergency Flashers	Press the top of the hazard switch to turn the flashers on. Verify that all four turn signals flash, as well as the lamps on the indicator panel. Turn the flashers off. Verify that all signals and indicator lamps stop flashing.
Horn	Press the horn button. Verify that the horn sounds loudly.
Neutral Indicator	Place the transmission in neutral. Verify that the neutral indicator lamp illuminates and that the letter "N" displays in the gear position display.
Low Oil Pressure Indicator	Verify that the low oil pressure lamp illuminates. Start the engine and verify that the low oil pressure lamp goes off.
Engine Stop/Run Switch	Start the engine. Move the stop/run switch to the STOP position. Verify that the engine stops. Attempt to restart the engine to verify that the engine WILL NOT start.
General	
Engine Oil Level	Check the oil level on the dipstick.
Fuel Level	View the fuel gauge.
Tires	Inspect condition, pressure and tread depth.
Brake Operation	Inspect pedal and lever movement.
Brake Fluid Levels	Check front and rear brake fluid levels.
Brake Components	Inspect hoses, connections, brake pads.
Throttle	Inspect hand grip and throttle freeplay.
Clutch (Hydraulic)	Check fluid level and lever operation.
Clutch (Mechanical)	Check lever operation and freeplay.
Front Suspension	Check for leaks, debris and damage.
Steering	Check for smooth operation.
Rear Suspension	Check shock movement and air pressure, verify ground clearance.
Drive Belt	Check for wear, damage, proper deflection.
Sidestand	Verify smooth operation, inspect pivot bolt, spring and pad.
Fasteners	Inspect for loose, damaged or missing fasteners.
Mirrors	Adjust for proper rear view.

ENGINE OIL LEVEL

Polaris recommends the use of only VICTORY Semi-Synthetic 20W-40 oil, Synthetic 15W-60 oil or an equivalent oil designed for use with wet clutches (such as those with a JASO MA rating).

The oil fill cap/dipstick is located on the right side of the vehicle. Always use the recommended oil. See page 148.

TIP: The engine must be at normal operating temperature when checking the oil level.

1. Place the transmission in neutral.
2. Start the engine and allow it to idle for several minutes.
3. Stop the engine and wait 3-5 minutes before checking the oil level.
4. On level ground, straddle the motorcycle and bring it to the fully upright position.
5. Remove the oil fill cap/dipstick ① and wipe it clean. Reinstall the dipstick and turn the cap clockwise until it seats.

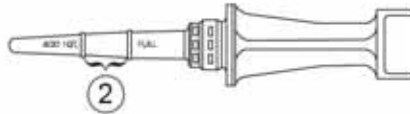
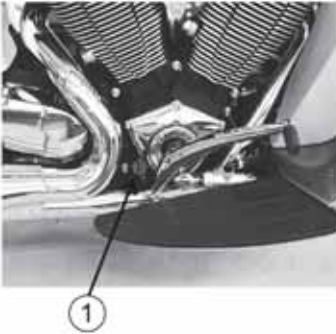

6. Remove the dipstick and view the oil level.
7. Add or remove oil as needed to bring the level into the safe operating range ② (between the FULL and ADD marks) on the dipstick.

WARNING! Operating the engine with too much or too little oil can cause serious engine damage or engine seizure, which could result in loss of control and serious injury or death. Do not operate the motorcycle with the oil level above the FULL mark or below the ADD mark.

PRE-RIDE INSPECTIONS

FUEL LEVEL

1. On level ground, straddle the motorcycle and bring it to the fully upright position.
2. Turn the ignition switch to the ON or ACC position. Observe the fuel level in the fuel gauge ①.
3. Refuel as needed. See page 148 for fuel specifications.

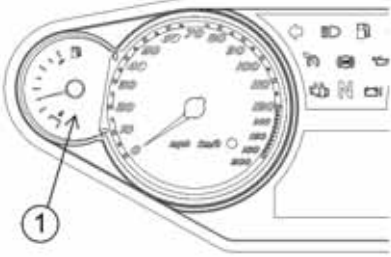

TIRES

TIRE PRESSURE

Check tire pressure before riding, when the tires are cold. This will provide the most accurate reading, as riding warms the tires and increases tire air pressure.

Adjust tire pressure as needed based on the total weight of your intended load. Refer to the tire pressure table. See page 107.

TIRE CONDITION

Inspect the tire sidewalls, road contact surface and tread base. If inspection reveals cuts, punctures, cracks or other wear or damage, replace the tire before riding. Use only approved replacement tires. For more information, see the *VICTORY Service Manual*. Your authorized VICTORY dealer can assist.

TIRE TREAD DEPTH

Wear bars (if equipped) are easily visible tread depth indicators. When the road contact surface has worn to the top of the wear bars, replace the tire. Measure the tread depth near the center of the tread on both tires. See page 107. Replace any tire with a tread depth of less than 1/16" (1.7 mm).

FRONT BRAKE LEVER

1. Pull the front brake lever toward the handlebar and hold it. The lever should move freely and smoothly. It should not move more than 3/4 inch (19 mm) ① before resistance is firm. It should continue to feel firm, without loss of pressure, until the lever is released.
2. Release the lever. It should return to its rest position quickly when released.
3. If the front brake lever fails to perform as stated, service the brake lever before riding.



FRONT BRAKE FLUID LEVEL

1. Straddle the motorcycle and bring it to the fully upright position. Position the handlebars so that the fluid reservoir is level.
2. View the fluid level through the sight glass. The fluid should be clear. Replace cloudy or contaminated fluid.
3. The fluid level should be at or above the top of the sight glass. Add brake fluid if necessary. See page 104.

REAR BRAKE PEDAL

1. Press downward on the rear brake pedal. It should move freely and smoothly. It should not move more than 3/8 inch (8 mm) ① before resistance is firm. It should continue to feel firm, without loss of pressure, until the pedal is released.
2. Release the pedal. It should return to its rest position quickly when released.
3. If the rear brake pedal fails to perform as stated or travels too far before beginning to engage the brake, service the brakes before riding.
4. See page 45 for rear brake pedal adjustments.



PRE-RIDE INSPECTIONS

REAR BRAKE FLUID LEVEL

The rear brake fluid reservoir is located near the rear brake pedal, just inside the right lower leg fairing. View the reservoir from the front right side of the vehicle.

1. Position the motorcycle on level ground in the fully upright position.
2. View the brake fluid through the reservoir.
3. The fluid should be clear. Replace cloudy or contaminated fluid.
4. The fluid level should be between the minimum ① and maximum ② marks on the reservoir. Add brake fluid as needed. See page 103.

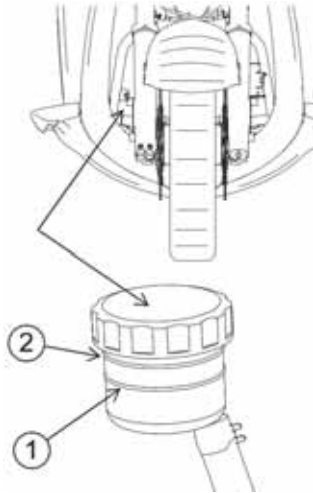

BRAKE LINES

Inspect all brake hoses and connections for dampness or stains from leaking or dried fluid. Tighten any leaking connections and replace components as necessary. For more information, see the *VICTORY Service Manual*. Your authorized VICTORY dealer can assist.

TIP

For torque values, see the *VICTORY Service Manual*. Your authorized VICTORY dealer can assist.

⚠ WARNING

Brake fluid leaks or low brake fluid levels could cause brake system failure, which could result in serious injury or death. Do not operate the vehicle with low brake fluid levels or when leaks are evident (dampness or stains from dried fluid). Your authorized VICTORY dealer can assist.

BRAKE PADS

Inspect each front brake pad on both sides of the front disc. Inspect each rear brake pad on both sides of the rear disc. When the thinnest point of the friction material has worn to the minimum recommended thickness, replace the brake pad. For more information, see the *VICTORY Service Manual*. Your authorized VICTORY dealer can assist.

- Replace brake pads when friction material ① thickness reaches 1.0 mm.

When checking brake pad friction material thickness, check each brake caliper for dampness or stains from leaking or dried brake fluid. If inspection reveals signs of fluid leakage, do not operate the vehicle. For more information, see the *VICTORY Service Manual*. Your authorized VICTORY dealer can assist.

See page 105 for brake disc inspection.



Minimum: 1.0 mm



Front



Rear

PRE-RIDE INSPECTIONS

THROTTLE

Rotate the throttle control grip. It should rotate smoothly from the rest position to the completely open position. It should return to the rest position quickly when released.

THROTTLE CABLE INSPECTION

1. Remove the right side access cover ①. Inspect throttle cables for frayed ends ②.
2. Service the throttle system if throttle operation is not smooth, if throttle grip does not return properly, or if cable ends are frayed. For more information, see the *VICTORY Service Manual*. Your authorized VICTORY dealer can assist.

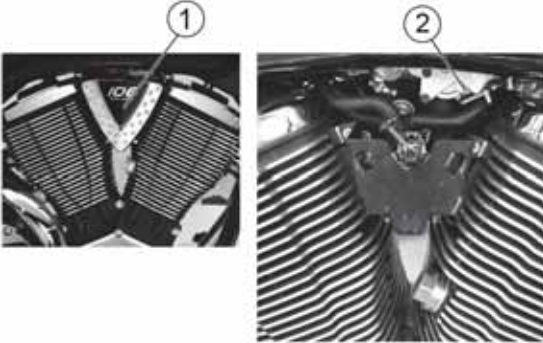

THROTTLE FREEPLAY

Throttle freeplay is the amount of throttle control grip movement from the rest position to the point of cable resistance. Measure this distance.

Freeplay should be 2-4 mm ①. Adjust throttle freeplay as needed. See page 97.



HYDRAULIC CLUTCH

1. Position the motorcycle on level ground in the fully upright position. Position the handlebars so that the clutch fluid reservoir is level.
2. View the fluid level through the sight glass. The fluid should be clear. Replace cloudy or contaminated fluid.
3. The fluid level should be at or above the top of the sight glass. Add DOT 4 brake fluid as needed. See page 98.
4. Squeeze and release the clutch lever. It should move freely and smoothly, and it should return to the rest position quickly when released. If the lever fails to perform as stated, service the lever before riding.
5. Check for any signs of clutch fluid leaks around the hoses, fittings, fluid reservoir and slave cylinder ① located at the rear of the left engine (primary) cover.



MECHANICAL CLUTCH

1. Squeeze the clutch lever ① toward the handlebar and release it. It should move freely and smoothly, and it should return to the rest position quickly when released. If the lever fails to perform as stated, service the clutch lever before riding.
2. Freeplay (gap) is the amount of lever movement from the rest position to the point of cable resistance. Clutch lever freeplay should be 0.5-1.5 mm ②. Measure the gap between the clutch lever and the lever housing ③. Adjust clutch lever freeplay if necessary. See page 99.

TIP

The starter interlock switch is dependent on the clutch lever freeplay being set correctly to ensure activation of the clutch safety switch.



FRONT SUSPENSION

Inspect the front forks for oil leaks or damage, and verify smooth suspension operation. See page 93.

STEERING

1. On level ground, straddle the motorcycle and bring it to the fully upright position. Turn the handlebars from stop to stop. The action should be smooth, but not loose.
2. Make sure wires, hoses and control cables do not interfere with smooth steering.

REAR SUSPENSION

1. Check rear shock absorber movement and air pressure to ensure the correct amount of suspension travel and ground clearance.
2. For air pressure adjustment information, see page 89 or refer to the suspension air pressure label located in the left saddlebag.

WARNING! Inadequate ground clearance could result in components contacting the ground, causing loss of control and serious injury or death. Always ensure ground clearance is at specification.

DRIVE BELT

1. Check drive belt ① tension. See page 84. The drive belt should fit tightly.

TIP: The drive belt system must be cool, clean and dry to accurately measure belt tension (deflection). Do not measure belt tension when the belt or drive system is wet, or when it is hot (such as immediately after riding).

2. Check the drive belt teeth for stones or other debris.
3. Inspect drive belt condition. If you discover cracks, broken teeth or frayed edges, replace the drive belt before riding. For more information, see the *VICTORY Service Manual*. Your authorized VICTORY dealer can assist.

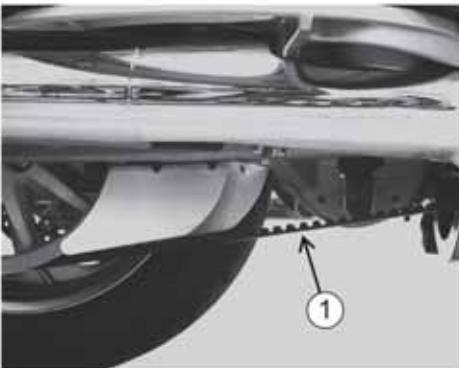

SIDESTAND

1. On level ground, straddle the motorcycle and bring it to the fully upright position.
2. Move the sidestand up to the stored position and down to the fully extended position several times. It should move smoothly and quietly. Make sure the return spring holds the sidestand tightly in place when the sidestand is in the stored position. Adjust or replace a loose spring.
3. Inspect the sidestand pivot bolt ① for looseness or wear. Tighten or replace a loose or worn bolt.
4. Inspect the sidestand rubber pad. Make sure the pad is firmly attached to the sidestand. Check the wear indicator ② on the leading edge of the pad. Replace the pad when it's worn beyond the wear limit line.



Front of Motorcycle

FASTENERS

1. Inspect the entire motorcycle chassis and engine for loose, damaged or missing fasteners. Tighten loose fasteners to the proper torque. For more information, see the *VICTORY Service Manual*. Your authorized VICTORY dealer can assist.
2. Always replace stripped, damaged or broken fasteners before riding. Use genuine VICTORY fasteners of equal size and strength.

OPERATION

The operation section describes how to operate your VICTORY motorcycle to ensure the best performance and longevity of the engine and other components. Information includes:

- Engine Break-in Period
- Fueling and Fill Height
- Starting the Engine
- Shifting Gears
- Accelerating
- Braking
- Stopping the Engine
- Parking

Follow all safe riding practices outlined in the safety section. See page 9.

During the first 500 miles (800 km), critical engine parts require special wear-in procedures so they seat and mate properly. Read, understand and use the following rules for operating the motorcycle during the first 500 miles (800 km).

NOTICE

Do not put unnecessary load on the engine during the first 500 miles (800 km). Avoid prolonged full throttle operation or any condition that creates excessive engine heat.

ENGINE BREAK-IN

NOTICE

If engine trouble should occur during the engine break-in period, prompt service is required. For more information, see the *VICTORY Service Manual*. Your authorized VICTORY dealer can assist.

Failure to perform the initial maintenance as recommended could result in less than desirable engine performance in the future. Perform the initial maintenance as recommended.

ODOMETER READING		INSTRUCTIONS
MILES	KM	
0-90	0-145	Do not operate for extended periods of time at throttle positions above 1/3 throttle. Vary the engine speed frequently. Do not operate for extended periods of time at any one throttle position.
90-300	146-483	Do not operate for extended periods of time at throttle positions above 1/2 throttle. Vary the engine speed frequently. Do not operate for extended periods of time at any one throttle position.
300-500	483-800	Do not operate for extended periods of time at throttle positions above 3/4 throttle.
At 500	At 800	Perform the break-in maintenance outlined in the maintenance section of this manual. Break-in maintenance can be performed by an authorized VICTORY dealer. Break-in maintenance must include inspection, adjustments, fastener tightening and an engine oil and filter change. Performing break-in maintenance at the required odometer reading helps ensure peak engine performance, minimal exhaust emissions and maximum service life of the engine.

FUELING

Always refuel on level ground with the sidestand down. Review the fuel warnings. See page 18. Use only the recommended fuel. See page 148. Hold the nozzle while filling. Do not rest the weight of the nozzle and hose on the filler neck. Do not leave the nozzle unattended.

WARNING

Overflows or spilled gasoline could contact a hot engine or exhaust system and cause a fire, which could result in serious injury or death. Do not allow gasoline to contact hot components.

1. Insert the fuel nozzle 2-3 inches (5-7 cm) into the fuel tank filler neck.
2. Fill the last 1/4 tank slowly to allow the left fuel tank to fill completely. Fill the fuel tank to a level just below the bottom of the fuel filler insert.

WARNING

Fuel expands in the fuel tank. Do not overfill. To prevent leaks, make sure the fuel filler cap is properly seated.

NOTICE

Fuel can damage painted surfaces and plastic parts. If gasoline spills on the any part of the motorcycle, immediately rinse it off with water or wipe it dry with a clean cloth.

PRIMING THE FUEL SYSTEM

If the motorcycle runs out of fuel, prime the fuel system before attempting to restart the engine.

1. Fill the fuel tank.
2. Turn the ignition key to the ON position.
3. Move the engine stop/run switch from the STOP position to the RUN position.
4. Allow the fuel pump to run until it stops (about 3 seconds).
5. Move the engine stop/run switch to the STOP position and wait 20 seconds.
6. Repeat steps 3-5 four to five times.
7. Turn the key to the OFF position.
8. Start the engine. See page 65.

STARTING THE ENGINE

The starter interlock system allows the engine to be started only when the transmission is in neutral, or when the transmission is in gear with the clutch disengaged (clutch lever pulled in).

TIP: If the motorcycle runs out of fuel, prime the system before attempting to restart the engine. See page 64.

1. Perform the Pre-Ride Inspections. See page 51. Properly secure any cargo.
 2. Straddle the motorcycle and bring it to the fully upright position.
 3. Retract the sidestand.
 4. Insert the key into the ignition switch. Turn the key to the ON position.
 5. Move the engine stop/run switch to the RUN position. You should hear the fuel pump run momentarily as it pressurizes the fuel system.
 6. If the neutral indicator is not illuminated, shift the transmission to neutral.
 7. Apply the front brakes.
 8. Leaving the throttle closed, press and hold the starter switch to start the engine. Release the switch promptly when the engine starts. If the engine does not start within 10 seconds, release the starter switch. Wait five seconds, then try again.
-

TIP: Hold the starter switch for as short a time as possible to minimize battery drain. Do not hold the starter switch for more than 10 seconds at one time.

9. If either the check engine indicator or the low oil pressure indicator does not go out after the engine starts, stop the engine *immediately*. Refer to either the check engine indicator information on page 30 or the low oil pressure indicator information on page 30.
 10. Leave the throttle closed and allow the engine to idle. Idle speed will gradually slow to normal as the engine warms to operating temperature.
-

TIP: Do not rev the engine or put the transmission in gear immediately after starting the engine. Allow the engine to idle for about 30 seconds after a warm start or at least one minute after a cold start (longer in cold weather). This will allow oil to reach all areas before the engine is put under load.

SHIFTING GEARS

⚠ WARNING

Forced shifting (with clutch engaged) could cause damage to the engine, transmission and drive train. Such damage could cause loss of control, which could result in serious injury or death. Always pull the clutch lever fully toward the handlebars to disengage the clutch before shifting gears.

This motorcycle is equipped with a six-speed transmission. The sixth gear is overdrive ①. Neutral ② is located between first and second gear.

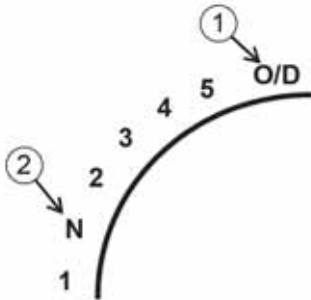

TIP

The transmission is in neutral if you can move the motorcycle forward or rearward freely without disengaging the clutch. If the ignition switch is in the ON position, the neutral indicator illuminates when the transmission is in neutral.

1. Start the engine. See page 51.
2. With the engine at idle speed, apply the front brakes.
3. Disengage the clutch (pull the clutch lever fully toward the handlebar).
4. Push the shift pedal downward until you feel it stop in first gear.

TIP

Shift to a higher gear by lifting the front of the gear shift pedal with your toe. Shift to a lower gear by pressing the pedal downward.

5. Release the brake lever.
6. Simultaneously release the clutch lever while opening the throttle (rolling the throttle control grip rearward) in one smooth motion. As the clutch begins to engage, the motorcycle will move forward.

7. To shift to a higher gear, accelerate smoothly to the recommended shift point. See page 67. With a quick motion, simultaneously close the throttle completely and disengage the clutch. Raise the shift pedal until you feel it stop at the next gear. Simultaneously release the clutch lever and open the throttle in one smooth motion.

TIP

Within the recommended speed ranges (see page 67), you can downshift to slow the motorcycle or to increase power. You may want to downshift when climbing a hill or passing. Downshifting also helps to decrease speed when combined with closing the throttle.

8. To shift to a lower gear (downshift), simultaneously pull the clutch lever toward the handlebar and close the throttle. Move the shift pedal downward until you feel it stop at the next gear. Simultaneously release the clutch lever while opening the throttle.

⚠ WARNING

Downshifting improperly could cause transmission damage, loss of traction and loss of control, which could result in serious injury or death.

- Reduce speed before downshifting. Always downshift within the recommended shift points.
- Use extreme caution when downshifting on wet, slippery or other low traction surfaces. Release the clutch lever very gradually in these conditions.
- Avoid downshifting in a curve. Downshift before entering the curve.

RECOMMENDED SHIFT POINTS

UPSHIFTING (ACCELERATING)		DOWNSHIFTING (DECELERATING)	
Gear Change	Recommended Speed	Gear Change	Recommended Speed
1 to 2	18 MPH (29 km/h)	O/D to 5 (if equipped)	50 MPH (80 km/h)
2 to 3	30 MPH (48 km/h)	5 to 4	35 MPH (56 km/h)
3 to 4	40 MPH (64 km/h)	4 to 3	25 MPH (40 km/h)
4 to 5	50 MPH (80 km/h)	3 to 2	15 MPH (24 km/h)
5 to O/D (if equipped)	60 MPH (96 km/h)	2 to 1	10 MPH (16 km/h)

OPERATION

ACCELERATING

Accelerate by opening the throttle (rolling the throttle control grip rearward). The more quickly you open the throttle, the more quickly the motorcycle accelerates. For even acceleration, open the throttle with a smooth, continuous motion. When you reach the recommended speed for upshifting, shift up one gear.

WARNING

Accelerating abruptly could cause your body to shift rearward suddenly, which could result in loss of control. Accelerating abruptly could also cause loss of control on low traction surfaces. Loss of control could result in serious injury or death. Always accelerate gradually, especially on wet, slippery or other low traction surfaces.

BRAKING

Always allow sufficient stopping distance so that brakes can be applied gradually.

TIP: Applying slightly more front brake than rear brake generally provides the best braking performance.

1. To slow the motorcycle with the brakes, close the throttle and apply the front and rear brakes evenly and gradually.

TIP: If the anti-lock brake system activates while braking (if equipped) you'll feel pulsing at the foot brake or hand brake. Continue applying equal pressure to the brakes to slow or stop the motorcycle. See page 13.

2. As the motorcycle slows, disengage the clutch, or downshift each time vehicle speed reaches a downshift point.

WARNING! Braking improperly could result in loss of control, which could result in serious injury or death. Avoid braking abruptly. Always apply the brakes gradually, especially on wet, slippery or other low traction surfaces. Avoid braking in a curve or turn. Bring the motorcycle to the upright position before applying the brakes.

USING CRUISE CONTROL

If equipped, the cruise control is located on the right handlebar ①. Make sure you read this section and understand how to safely operate this feature before using the cruise control.



Cruise Type R: Verify which type of cruise control is installed on your vehicle by checking for a label in the left saddlebag. If a “Cruise Type R” label is affixed, additional operation information for your controls is noted throughout the following pages as “Type R”.

WARNING! Improper operation of cruise control could cause loss of control and result in serious injury or death. Follow all cruise operation procedures carefully. Never use cruise control when roads are wet or slippery. Do not use cruise control when riding in heavy or congested traffic.

CRUISE CONTROL TIPS

- Cruise control can be set in any gear.
- Vehicle speed must be above 25 MPH (40 km/h).
- Set speed will vary slightly in hilly terrain.
- Cruise control will not resume a pre-set speed if the resulting acceleration or deceleration rate is too high or too low. For example, resuming a set speed from 40 MPH (64 km/h) while in 6th gear may cause cruise to disengage.
- Cruise control will not engage if brake lights are not operating properly.

OPERATION

SET SPEED

1. Press the cruise control ON switch ①. A red dot (power indicator ②) at the center of the switch will illuminate to indicate when cruise control can be engaged. (*Type R*: The cruise control indicator lamp will illuminate whenever the ON or OFF switch is pressed.)
2. Accelerate to the desired speed and press the SET switch ③. The cruise control indicator lamp will illuminate. (*Type R*: You must wait at least 3 seconds after turning cruise control on before pressing SET. This is a safety feature that prevents cruise control from engaging if a button is stuck. To continue using cruise control, turn the power off and on. Wait 3 seconds before pressing SET.)

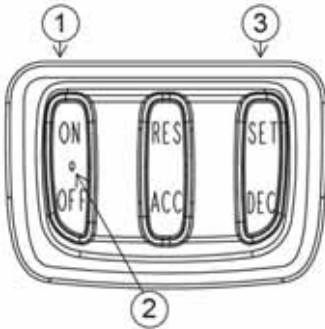

RESUME SPEED

1. Disengage the cruise control with the brake, throttle or clutch.
2. Press the resume button ① (RES) to return to the set speed. (*Type R*: You must wait at least 3 seconds after disengaging cruise control before pressing resume. If the resume button is pressed within 3 seconds of disengaging, the cruise control may not engage, even if the indicator illuminates. This is a safety feature that prevents cruise control from engaging if a button is stuck. To continue using cruise control, disengage it and wait 3 seconds before pressing resume.)

TIP: Turning the cruise control master switch off will erase the set speed from memory and disengage the cruise control.

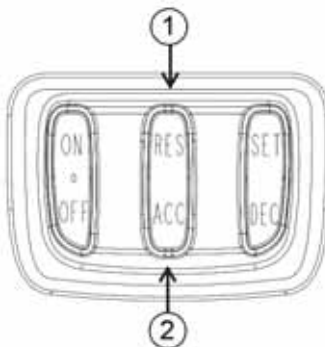

ACCELERATE

Tap and release the accelerate (ACC) button ② to increase speed in approximately 1 MPH (1-2 km/h) increments. Press and hold the ACC button to accelerate to a new SET speed (resets when button is released). On vehicles *without* Type R cruise control, the speed will reset when the button is released or after a maximum acceleration of approximately 10 MPH (16 km/h), whichever comes first.

TIP: If you use the throttle to accelerate and then release it, the cruise control will resume the previously set speed.

DECELERATE

Tap and release the decelerate (DEC) button ① to decrease speed in approximately 1 MPH (1-2 km/h) increments. Press and hold the DEC button to decelerate to a new SET speed (resets when button is released), or to the minimum cruise speed of 25 MPH (40 km/h).

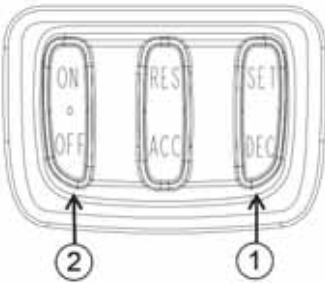

CANCEL CRUISE CONTROL

To temporarily cancel the cruise control and allow use of the resume feature:

- apply the brakes
- close the throttle
- disengage the clutch

To cancel the cruise control and erase the set speed from memory, press OFF ②.

STOPPING THE ENGINE

Before stopping the engine, bring the motorcycle to a complete stop. Shift to neutral or disengage the clutch.

WARNING

Stopping the engine with the transmission in gear while the motorcycle is moving could cause loss of rear wheel traction or engine and transmission damage, which could cause loss of control and serious injury or death. Always stop the engine after the motorcycle is fully stopped and the transmission is in neutral. If the engine stops unexpectedly while the motorcycle is moving, guide the motorcycle to a safe location off the road and away from traffic.

1. When fully stopped, shift into neutral.
2. Move the engine stop/run switch to the STOP position.
3. Move the ignition switch to the OFF position. Remove the ignition key.

TIP

Idle air control (IAC) noise is a normal engine management calibration process that occurs each time the engine stop/run switch is put into the STOP position or when the key is turned off.

PARKING

Choose a firm level surface to park the motorcycle.

1. When fully stopped, shift into neutral.
2. Stop the engine.
3. Fully extend the sidestand.
4. Turn the handlebars to the left and lean the motorcycle to the left until the sidestand firmly supports the motorcycle.
5. Remove the ignition key.

PARKING ON A SLOPE

If parking on a slope is unavoidable, position the front of the motorcycle toward the top of the slope. Place the transmission in gear and position the motorcycle so that it is stable when it rests on the sidestand.

PARKING ON A SOFT SURFACE

If parking on a soft surface is unavoidable, place a sidestand footrest under the foot of the sidestand to provide a firm surface. The sidestand footrest must be strong enough and large enough to support the motorcycle's weight without sinking into the parking surface.

Asphalt becomes soft in hot weather. A sidestand can sink into soft asphalt and the motorcycle may fall. When parking on asphalt in hot weather, use a sidestand footrest.

CAUTION

Hot engine and exhaust components can cause burns to skin and can ignite a fire if exposed to flammable materials. Always park the motorcycle clear of flammable materials and where people are not likely to contact hot components.

REVERSE OPERATION (IF EQUIPPED)

NOTICE

Do not attempt to engage or disengage the reverse system when the motorcycle is moving.

BEFORE OPERATING IN REVERSE:

- always sit on the motorcycle with legs astride and both feet on the ground.
- always check for obstacles or people behind the motorcycle.
- always retract the sidestand fully.
- always make sure the motorcycle is completely stopped.

NEVER OPERATE IN REVERSE:

- when not properly seated.
- when in an area where obstacles or bystanders are present.
- with a passenger on board. A passenger can obstruct your view and maneuverability.
- when on loose or slippery surfaces. Loss of foot traction could cause a tip-over.
- while the motorcycle is moving forward.
- when on a grade or uneven surfaces.

REVERSE OPERATION PROCEDURE

1. Always check for obstacles or people behind the motorcycle. Be aware that the front wheel may travel outward and require a larger operating area.
2. Make sure the motorcycle is stationary.
3. Dismount any passenger.
4. Sit on the operator's seat with legs astride and both feet on the ground.
5. Retract the sidestand (if down).
6. Place the transmission in neutral.
7. With the engine idling, lift the reverse lever and verify that the reverse indicator (R) displays in the multi-function display.

NOTICE

NEVER shift the transmission into gear with the reverse engaged. Doing so WILL result in damage to the reverse system.

8. Recheck the area behind and around the motorcycle to ensure a clear operating area.
9. While balancing the motorcycle with your legs and feet, press and hold the starter switch to begin moving in reverse. Release the switch to stop moving.

NOTICE

NEVER shift the transmission into gear with the reverse engaged. Doing so WILL result in damage to the reverse system.

10. If parking the motorcycle, wait until it's completely stopped, then move the reverse lever down to the disengaged position. Verify that the neutral indicator (N) displays before stopping the engine.

MAINTENANCE

SAFETY DURING SERVICE PROCEDURES

WARNING

Failure to follow recommended precautions and procedures could result in severe injury or death. Always heed all safety precautions and follow all operation, inspection and maintenance procedures outlined in this manual.

- Improperly installed or adjusted components can make the motorcycle unstable or hard to handle. Improperly installed electrical components can cause engine or electrical system failure. In either event, damage or serious injury could result. If you do not have the time, tools and expertise necessary to complete a procedure properly, a qualified dealer can perform these operations.
- Review the safety-related maintenance information on page 19.
- Before beginning any maintenance procedure, read the instructions for the entire procedure.
- Always position the motorcycle on a firm level surface before performing service. Make sure the motorcycle will not tip or fall while elevated or while on the sidestand.
- Hot engine and exhaust components can cause burns to skin and can ignite a fire if exposed to flammable materials. Always park the motorcycle clear of flammable materials and where people are not likely to contact hot components.
- Wear eye and face protection when using pressurized air.
- Never start the engine or let it run in an enclosed area. Engine exhaust fumes are poisonous and can cause loss of consciousness or death in a short time.
- During some procedures you may use potentially hazardous products such as oil or brake fluid. Always follow the instructions and warnings on the product packaging.

Any qualified repair shop or person may maintain, replace, or repair the emission control devices or systems on your vehicle. An authorized VICTORY dealer can perform any service that may be necessary for your vehicle. VICTORY also recommends VICTORY parts for emissions-related service, however equivalent parts may be used for such service. It is a potential violation of the Clean Air Act if a part supplied by an aftermarket parts manufacturer reduces the effectiveness of the vehicle's emission controls. Tampering with emission controls is prohibited by federal law.

Owners are responsible for performing the scheduled maintenance identified in this owner's manual.

Proper maintenance assures the highest level of safety, durability and dependability for your motorcycle.

- Your VICTORY dealer can perform the initial maintenance procedures when the motorcycle's odometer registers 500 miles (800 km).
- Perform the recommended periodic maintenance at the intervals specified in the periodic maintenance table beginning on page 79.

ROAD TESTS

Before returning the motorcycle to regular use after performing service, road test it in a safe environment. Pay special attention to the proper fit and operation of all serviced components. Make any corrections or additional adjustments necessary to ensure safe vehicle performance.

BREAK-IN MAINTENANCE

Perform the break-in maintenance procedures when the motorcycle's odometer registers 500 miles (800 km). Your authorized VICTORY dealer can provide this service.

Performing the break-in maintenance will help ensure optimum engine performance for the entire service life of the engine. Your dealer can change engine oil, inspect all fluids and serviceable components, ensure that all fasteners are tightened and make other adjustments as needed.

MAJOR MAINTENANCE

For major repair information, refer to the *VICTORY Service Manual*. Major repairs typically require technical skills and specially designed tools. Emission system service requires special tools and training and should be performed by a qualified dealer.

PERIODIC MAINTENANCE

Inspect, clean, lubricate, adjust and replace parts as necessary. When inspection reveals the need for replacement parts, genuine VICTORY parts available from your VICTORY dealer may be used. Equivalent parts may be used for emissions-related service. Record service and maintenance information in the Maintenance Log beginning on page 175.

Perform maintenance at the intervals specified in the periodic maintenance table. See page 79. *Vehicles subjected to severe use must be inspected and serviced more frequently.*

SEVERE USE DEFINITION

- high speed operation for extended periods
- low speed operation for extended periods
- operation in dusty or otherwise adverse conditions
- operation in cold weather (temperatures below freezing)

PERIODIC MAINTENANCE TABLE

Component	Page	Odometer Reading in Miles (Kilometers)													
		500 (800)	5000 (8000)	10000 (16000)	15000 (24000)	20000 (32000)	25000 (40000)	30000 (48000)	35000 (56000)	40000 (64000)	45000 (72000)	50000 (80000)			
Air Filter	page 82	I	I	R	I	R	I	R	I	R	I	R	I	R	
Battery	page 110	I	I	I	I	I	I	I	I	I	I	I	I	I	
Brake Fluid**	page 102	I	I	I	I	I	I	R	I	I	I	I	I	I	
Brake Pads	page 57	I	I	I	I	I	I	I	I	I	I	I	I	I	
Clutch Cable (Mechanical)	page 100	I	I	L	I	L	I	L	I	L	I	L	I	L	
Clutch Fluid	page 98	I	I	I	I	I	I	R	I	I	I	I	I	I	
Clutch Lever (Hydraulic)	page 98	L	I	I	I	I	I	I	I	I	I	I	I	I	
Clutch Lever (Mechanical)	page 100	I	I	L	I	L	I	L	I	L	I	L	I	L	
Control Cables	page 100	I	I	L	I	L	I	L	I	L	I	L	I	L	
Crankcase Vent	page 95	I	I	I	I	I	I	I	I	I	I	I	I	I	
Drive Belt	page 61	I	I	I	I	I	I	R	I	I	I	I	I	I	
Drive Belt Adjustment	page 87	P	Adjust with each tire change thereafter												
Engine Oil & Filter*	page 80	R	R	R	R	R	R	R	R	R	R	R	R	R	
Evaporative Emission Control System (if equipped)	page 94	I	I	I	I	I	I	I	I	I	I	I	I	I	
Exhaust System	page 109	I	I	I	I	I	I	I	I	I	I	I	I	I	
Fasteners	page 62	I	I	I	I	I	I	I	I	I	I	I	I	I	
Front Brake Lever	page 101	L	L	L	L	L	L	L	L	L	L	L	L	L	
Front Fork Oil**	page 93	I	I	I	R	I	I	R	I	I	I	R	I	I	
Front Fork / Axle	page 93	I	I	I	I	I	I	I	I	I	I	I	I	I	
Fuel System	page 95	I	I	I	I	I	I	I	I	I	I	I	I	I	
Headlamp	page 120	I	I	I	I	I	I	I	I	I	I	I	I	I	
Ignition Switch & Locks	page 114	I	L	L	L	L	L	L	L	L	L	L	L	L	
Radio/Radio Software	page 150	Update annually. Please see your dealer.													
ABS Components	page 42	I	I	I	I	I	I	I	I	I	I	I	I	I	
Rear Wheel Align	page 88	I	I	I	I	I	I	I	I	I	I	I	I	I	
Rear Shock	page 89	I	I	I	I	I	I	I	I	I	I	I	I	I	
Rear Brake Pedal	page 101	I	I	L	I	L	I	L	I	L	I	L	I	L	
Road Test	page 123	P	P	P	P	P	P	P	P	P	P	P	P	P	
Sidestand	page 114	I	I	L	I	L	I	L	I	L	I	L	I	L	
Sidestand Pad	page 62	I	I	I	I	I	I	I	I	I	I	I	I	I	
Spark Plugs	page 108	I	I	I	I	I	I	R	I	I	I	I	I	I	
Steering Head Bearings	page 94	I	I	I	L	I	I	L	I	I	I	L	I	I	
Swingarm	page 92	I	I	I	I	I	I	I	I	I	I	I	I	I	
Throttle Cable	page 97	I	I	L	I	L	I	L	I	L	I	L	I	L	
Tires	page 107	I	I	I	I	I	I	I	I	I	I	I	I	I	

Maintenance Key: I = Inspect, clean, adjust, correct or replace if necessary; P = Perform; R = Replace / Rebuild
 L = Lubricate w/ proper lubricant; * = Replace at specified interval or annually; ** = Replace as specified or every 2 years

MAINTENANCE

ENGINE OIL / FILTER CHANGE

Change the engine oil at the intervals specified in the periodic maintenance table beginning on page 79.

1. Start the engine and allow it to idle for several minutes. Stop the engine.

TIP: The engine must be at normal operating temperature before changing the oil.

CAUTION! Hot engine and exhaust components can cause burns to skin and can ignite a fire if exposed to flammable materials. Always park the motorcycle clear of flammable materials and where people are not likely to contact hot components.

2. Position the motorcycle securely on the sidestand.
3. Place a drain pan under the drain plug ① and oil filter ②. Remove the drain plug and seal. Allow the oil to drain completely.

Tool: 6 mm Allen wrench

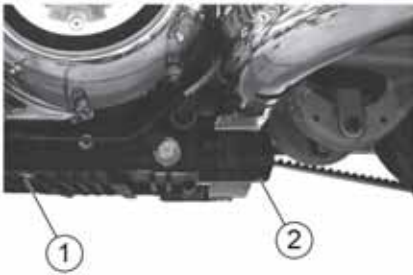

4. Slowly loosen the oil filter. Allow the oil to drain completely.

Tool: 2 1/2 inch (63.5 mm) oil filter wrench

5. Clean the drain plug sealing surface on the crankcase. Reinstall the drain plug with a new seal. DO NOT overtighten.

TORQUE: 15 ft-lbs (20 Nm)

6. Clean the oil filter mounting threads and gasket sealing surface on the crankcase. Make sure the new oil filter gasket is properly seated in the new oil filter. Apply a thin film of clean engine oil to the gasket. Screw the new filter on until the gasket contacts the sealing surface. Tighten the filter by hand an additional 3/4 turn.
7. Remove the oil fill cap/dipstick. Add approximately 4.5 quarts (4.25 liters) of the recommended oil. Reinstall the oil fill cap.

NOTICE: Do not add chemical additives to the engine oil. Some automotive engine oils contain additives that could damage or reduce the service life of the wet clutch in your motorcycle.

8. Start the engine and allow it to idle for several minutes. Stop the engine.

NOTICE: After an oil change, the low oil pressure indicator remains illuminated longer than usual before going out. Revving the engine while the low oil pressure indicator is illuminated can damage the engine.

9. Stop the engine. Check for leaks around the drain plug and oil filter.

10. Check the oil level ④ and adjust if needed ③.

11. Recycle the used oil and filter properly.

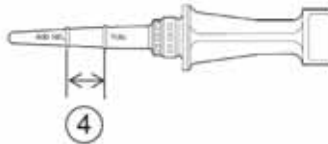

OIL CAPACITIES	
Engine Oil Capacity at Oil Change (including filter)	4.5 qt. (4.25 liter) (approximately)
Engine Oil Capacity at Oil Change (not including filter)	4.0 qt. (3.8 liter) (approximately)

MAINTENANCE

AIR FILTER

Inspect the air filter often if riding in unusually wet or dusty conditions. Do not apply air filter oil to this air filter.

1. Remove the two air filter retaining screws ①.

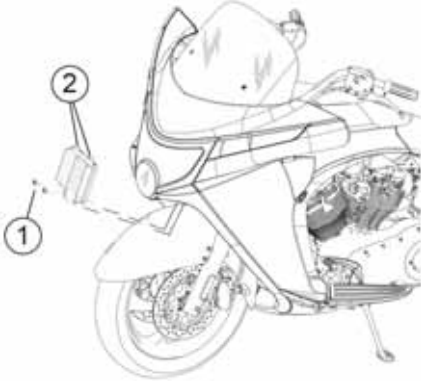

2. Pull the lower edge of the filter toward the front of the motorcycle, then lower it to release the two tabs at the top edge ②. Remove the filter.
3. Clean the filter sealing surface on the frame.
4. Install the new air filter, engaging the tabs at the top of the filter with the filter case.
5. Reinstall the retaining screws.

TORQUE: 87 in-lbs (10 Nm)

DRIVE BELT CONDITION

Replace the drive belt if it is cracked or has broken teeth or frayed edges. No matter its condition, the drive belt should be replaced at periodic intervals. For more information, see the *VICTORY Service Manual*. Your authorized VICTORY dealer can assist.

DO NOT attempt to check belt tension if the belt has been exposed to rain or washing within a 24 hour period or if the belt is hot from riding. Allow the belt to cool down to ambient temperature before measuring belt tension. Replace the drive belt and both sprockets as a set if the drive belt has over 5,000 miles (8,000 km) of service at the time of damage or failure.

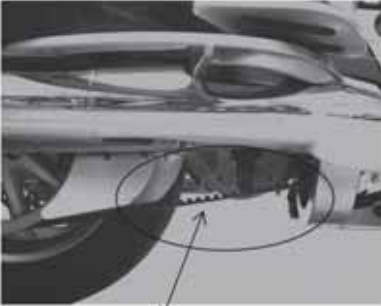

DRIVE BELT WEAR ANALYSIS

<p>Internal tooth cracks (hairline): OK to run, but monitor condition</p>	<p>External tooth cracks: Replace belt</p>	<p>Missing teeth: Replace belt</p>	<p>Chipping (not serious): OK to run, but monitor condition</p>
<p>Fuzzy edge cord: OK to run, but monitor condition</p>	<p>Hook wear: Replace belt</p>	<p>Stone damage: Replace belt if damage is on edge</p>	<p>Bevel wear (outboard edge only): OK to run, but monitor condition</p>

MAINTENANCE

DRIVE BELT TENSION DATA

Specifications are listed below for deflection and sonic tension. Sonic tension measurement requires Gates Sonic Tension Meter 507C or an equivalent.

DRIVE BELT DEFLECTION (USING PV-43532 TENSION GAUGE)

Deflection	32 mm ± 0.5 mm
------------	----------------

DRIVE BELT SONIC TENSION (USING SONIC TENSION METER)

REQUIRED DATA		SONIC TENSION
Span	708.6	20 Hz ± 1
Belt Width	28 mm	
Belt Mass Constant	8.4	

DRIVE BELT TENSION INSPECTION

On new drive systems or belt, adjust belt tension after the first 500 miles (800 km). Adjust tension at each tire change thereafter.

TIP

Do not inspect or adjust drive belt tension when the belt is wet. Improper adjustment will result.

Checking drive belt tension involves using the belt tension gauge (P/N PV-43532). You can also use a Sonic Tension Meter if available. Before beginning this procedure:

- Make sure the drive system is clean, *dry*, and at *room temperature* (belt and sprockets).
- Be sure suspension is properly adjusted.
- Belt tension must be adjusted at the tightest spot.

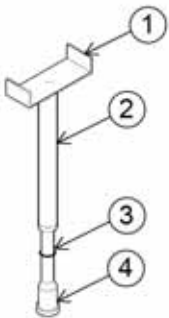

- ① Base
- ② Belt Tension Gauge
- ③ Small O-Ring
- ④ Plunger

DRIVE BELT TENSION INSPECTION

1. Elevate and support the motorcycle with the rear tire slightly off the floor.

CAUTION! Make sure the motorcycle is stable when elevated. Injury may occur if the motorcycle tips or falls.

2. Place the transmission in neutral.
3. Rotate the rear wheel in a forward direction until the valve stem is at the bottom. This is your reference point for determining the tight spot to make your adjustment (if necessary).
4. Position the small O-ring on the tension gauge directly over the 10 lbs. mark on the plunger.
5. Place a tape measure or steel rule ① next to the drive belt ③, mid-way between the sprockets. Support the rule or tape so it does not move.

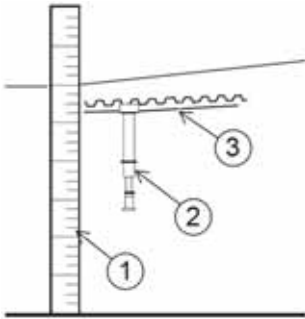

6. Note the graduation mark on the rule that aligns with the lower edge of the belt. This position represents *zero force*.
7. Place the support base of the tension gauge ② squarely against the lower surface of the belt as close as possible to the rule or tape.
8. Keeping the tension gauge perpendicular to the belt surface and parallel with its length, push the plunger upward until the small O-ring touches the tension gauge body.

MAINTENANCE

9. Be sure the tension gauge is seated squarely ⑤ against the belt ④, and note the graduation mark on the rule that now aligns with the lower edge of the belt. This position represents *10 lbs. force*.

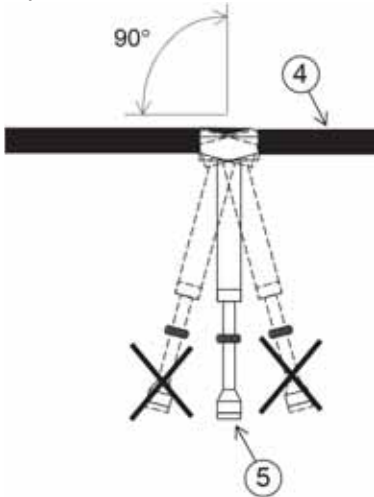

10. To calculate belt tension (deflection) subtract the smaller measurement from the larger measurement and record it.

Determine The Tightest Spot

11. Repeat the above deflection measurements with the tire's valve stem ⑥ at the rear most position, top, and front most positions (90 degrees rotation each time), recording each measurement.

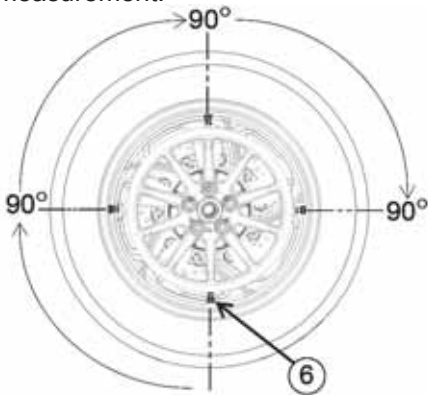

12. If the *tightest* measurement is not within the recommended range (see page 84), belt tension must be adjusted.

DRIVE BELT TENSION ADJUSTMENT

1. Move the wheel to the tight spot location determined previously.
2. Loosen the rear axle nut ② on the left side.

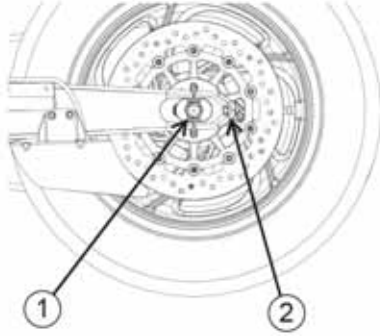

3. Turn each axle adjuster nut ① *clockwise* an equal amount to tighten the belt (reduce deflection) or an equal amount *counter-clockwise* to loosen the belt (increase deflection).

Tool: 13 mm deep socket

4. Tighten the rear axle nut.

TORQUE: 65 ft-lbs (88 Nm)

5. Pump the rear brake pedal to re-set the pads against the brake disc.
6. Verify proper belt tension and wheel alignment.

DRIVE BELT / REAR WHEEL ALIGNMENT

1. Look at the alignment reference marks on each side of the swingarm ① and the marks on the axle plates ② to verify proper wheel alignment. Axle plate mark to reference mark alignment must be the same on both sides.
2. If the marks are not aligned, perform all steps of the Belt Tension Adjustment procedure. See page 87.
3. Before and after tightening the axle nut, verify proper belt tension and wheel alignment.

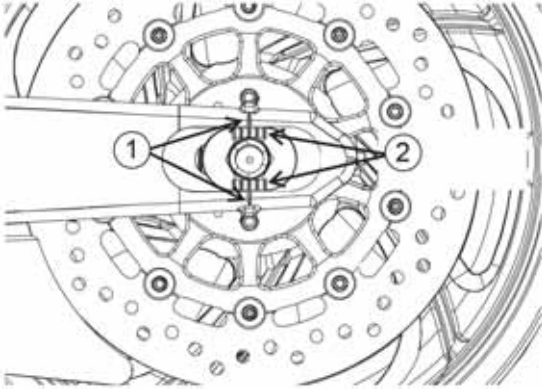

DRIVE BELT CLEANING

Cleaning the drive belt will maximize belt and sprocket life and minimize drive line noise. Clean the belt at every tire change. Clean the belt more often if riding in dirty, dusty or high debris environments.

1. Mix a few drops of mild dish soap with a cup of warm water.
2. Use a soft nylon brush to clean the belt and sprocket teeth with the soapy water. Clean well in corner areas where road debris and belt dust can collect.
3. Rinse the belt with clear water, then dry thoroughly.

TIP

Do not inspect or adjust drive belt tension when the belt is wet. Improper adjustment will result.

REAR SUSPENSION ADJUSTMENT

For riding comfort and to ensure proper ground clearance, adjust rear shock air pressure as specified on the label ① located in left saddlebag area (see below).



Follow these guidelines when adjusting:

- Park the motorcycle with the sidestand down on a firm, level surface. Remove all riders and cargo.
- DO NOT exceed 72 PSI (496 kPa) in the shock.
- Use the VICTORY Air Pump & Gauge (PV-48909). Follow the instructions on the following pages.

MAINTENANCE

If the VICTORY air pump and gauge are not available, use the gauge provided in the tool kit, and a pressurized air source with a maximum line pressure of 72 PSI (496 kPa). After using this gauge, remove it quickly to minimize leakage. Expect to lose about 4 PSI (27.6 kPa) with each pressure check when using this gauge. *Use only a dry air source*, such as a system with a water separator or air line dryer, to prevent moisture from entering the shock.

CAUTION! Air pressure increases VERY quickly when using pressurized air. Wear eye and face protection.

AIR SUSPENSION ADJUSTMENT (SHOCK LABEL 7174258)		
Set desired pressure with bike <u>unloaded</u> on side stand		
	No Trunk	Trunk
Total Cargo & Occupant Weight (lbs)	Air Pressure (psi)	
100	0	0
125	0	6
150	0	10
175	4	13
200	10	19
225	14	23
250	19	28
275	24	33
300	30	39
325	35	44
350	40	49
375	46	55
400	51	60
425	57	66
450	62	71
MAX PRESSURE 72 PSI		

REAR SUSPENSION ADJUSTMENT

1. Park the motorcycle with the sidestand down on a firm, level surface. Remove all riders and cargo.
2. Open the left saddlebag door. Remove the cap from the air fitting ④.

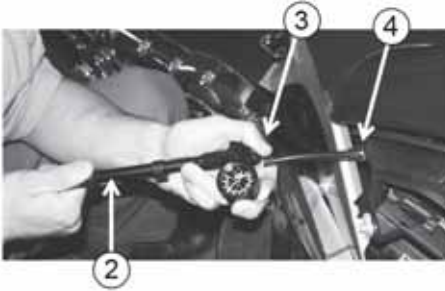

3. Refer to the shock label to determine the recommended air pressure.
4. Install the hose fitting of the recommended gauge securely onto the air fitting. Read the air pressure on the gauge.

TIP: A small oil leak from the air fitting is acceptable when pressure is adjusted. Service is required if more than 5 cc of oil leaks from the fitting. Your authorized VICTORY dealer can assist.

5. To *reduce* air pressure, push the bleed button ③ on the gauge. Bleed pressure in small amounts until the desired pressure is attained.
6. To *increase* pressure, pump the handle ② until pressure increases to the desired amount.

CAUTION! DO NOT exceed 72 PSI (496 kPa) in the shock.

7. Remove the hose from the air fitting and reinstall the cap.

SWING ARM / REAR AXLE INSPECTION

1. Sit in the operator's seat and slowly bounce the rear suspension a few times. Make sure the suspension moves freely without binding. Listen for abnormal noises.
2. Elevate and support the motorcycle with the rear tire slightly off the floor.

CAUTION

Make sure the motorcycle is stable when elevated. Injury may occur if the motorcycle tips or falls.

3. Grasp the rear-most surface of the rear tire and attempt to move the wheel side-to-side. If there is movement at the front of the swingarm, check the swingarm pivot nut torque and swingarm pivot bearings.
4. Service is required if you detect noise or movement at the swingarm pivot. Your authorized VICTORY dealer can assist.
5. Grasp the top or bottom surface of the tire and try to move it side to side. If there is movement at the rear axle, inspect wheel bearings and rear axle nut torque.
6. Service is required if you detect noise or movement at the wheel bearings. Your authorized VICTORY dealer can assist.
7. With the transmission in neutral, slowly rotate the rear wheel. If the wheel does not rotate smoothly, inspect the wheel bearings, rear axle, belt adjustment and wheel alignment. For more information, see the *VICTORY Service Manual*. Your authorized VICTORY dealer can assist.

FRONT FORK / SUSPENSION INSPECTION

1. Place the motorcycle on the sidestand and inspect the front forks. Make sure there is no fork oil present on the outer fork tubes, around the fork seals or around the inner tubes.
2. Clean the fork tubes ① to remove bugs, tar or buildup which may cause seal wear or leakage.

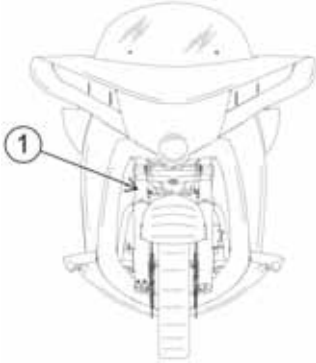

3. Inspect the outer surfaces of the inner fork tubes for scratches or damage from foreign objects.
4. Straddle the motorcycle and bring it to the fully upright position. Apply the front brake and push downward (hard) on the handlebars several times. The front suspension should operate smoothly and quietly.
5. Fork oil condition and level affects front suspension performance and internal component wear. Replace fork oil at the recommended intervals. Special tools are required to perform this procedure. For more information, see the *VICTORY Service Manual*. Your authorized VICTORY dealer can assist.

STEERING HEAD INSPECTION

1. Elevate and support the motorcycle with the front tire slightly off the floor. View from the front ①.

CAUTION! Make sure the motorcycle is stable when elevated. Injury may occur if the motorcycle tips or falls.

2. Turn the handlebars from stop to stop. The action should be smooth but not loose. Make sure wires, hoses and control cables do not interfere with smooth steering.
3. Alternately push and pull on the lower fork legs and feel for movement in the steering head area. If any movement is detected, see the *VICTORY Service Manual*. Your authorized VICTORY dealer can assist.

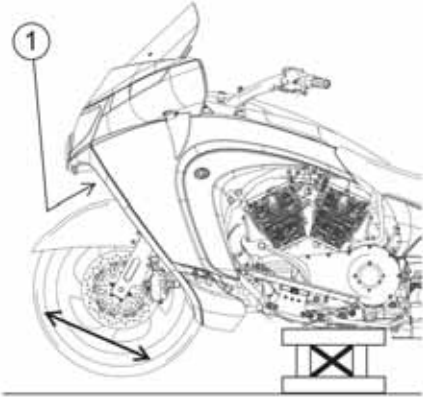

EVAPORATIVE EMISSION CONTROL SYSTEM

1. Inspect all evaporative emission control system hoses and connections ①. Make sure all connections are tight.
2. Inspect connections at the evaporative emissions canister to be sure they are secure. The canister is located on the left side of the motorcycle near the oil cooler.



FUEL SYSTEM COMPONENTS

1. Inspect fuel hoses for cracks or damage.
2. Inspect hose connections at the fuel tank and at the fuel rail for dampness or stains from leaks.

FAST IDLE

A fast idle speed during warm up of between 1200 and 2000 RPM is automatically set by the EFI system Idle Air Control (IAC). Periodic adjustment is not required.

CRANKCASE BREATHER HOSE

Inspect the crankcase breather hose ① for cracks or damage. Be sure the clamps are in place and secure.

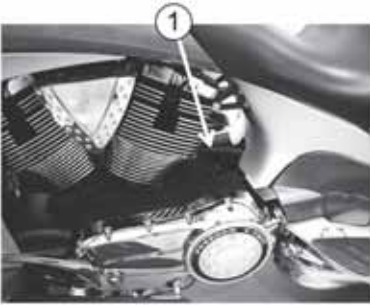

THROTTLE CONTROL INSPECTION

1. With the engine OFF, rotate the throttle control grip fully open and then release it. It should rotate smoothly from the rest position to the completely open position. It should return to the rest position quickly when released.
2. Repeat the twist and release process with the handlebars turned fully *right* and fully *left*.
3. Remove the right side access cover.
4. Inspect throttle cables ① for frayed ends.
5. Service the throttle system if throttle operation is not smooth, if throttle grip does not return properly, or if cable ends are frayed. For more information, see the *VICTORY Service Manual*. Your authorized VICTORY dealer can assist.



THROTTLE CABLE FREEPLAY

Throttle freeplay is the amount of throttle control grip movement from the rest position to the point of cable resistance. Measure this distance. Freeplay should be 2-4 mm. Adjust throttle freeplay as needed.

1. Position the front wheel straight ahead. Stop the engine.
2. Hold the adjuster nuts securely and loosen the lock nuts on both cables. Turn the lock nuts away from the adjuster nuts as far as possible.
3. Turn both adjuster nuts toward the lock nuts as far as possible for maximum freeplay in both cables.
4. Turn the adjuster on the throttle opening cable (front cable) away from the lock nut until throttle freeplay is 2-4 mm ①.
5. To adjust the closing cable (rear cable), hold the throttle grip lightly in the closed position. Turn the adjuster ② slowly outward until slight resistance is felt.
6. Turn the lock nuts ③ on both cables until they are seated against the adjuster nuts. Hold each adjuster nut and tighten each lock nut securely.
7. Repeat the throttle control inspection. See page 96.

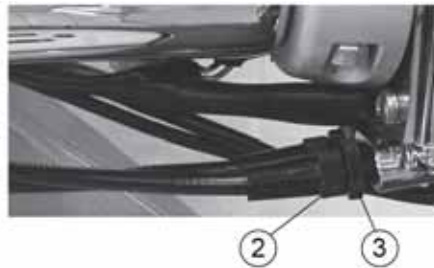

THROTTLE CABLE LUBRICATION

Lubricate control cable ends at the intervals recommended in the periodic maintenance table beginning on page 79.

NOTICE

External casings are factory-lubricated. Additional lubrication could be detrimental to cable performance.

Verify proper routing and smooth movement. Inspect for damage to the external casing, and inspect exposed cable wire for fraying, kinks or corrosion. Replace any damaged, sticky or sluggish cable.

1. Disconnect the cable at the throttle body.
2. Apply a light film of VICTORY All Purpose Grease or equivalent to the barrel end.
3. Reconnect the cable and adjust freeplay as needed.

CRUISE CONTROL CABLE INSPECTION (IF EQUIPPED)

1. Remove the right side access cover.
2. Inspect the throttle body end of the cruise control cable ① for fraying and be sure the end is secured in the bracket.

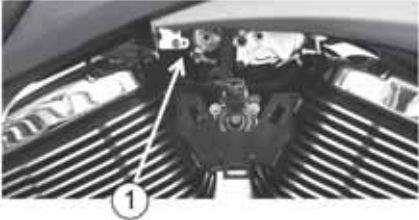

HYDRAULIC CLUTCH LEVER LUBRICATION

Lubricate the pivot bushing ① at the intervals recommended in the periodic maintenance table beginning on page 79. Also lubricate any time binding is evident. Use VICTORY All Purpose Grease or equivalent.



HYDRAULIC CLUTCH FLUID

Check the hydraulic clutch fluid level. See page 59. The fluid level should be at or above the top of the sight glass. Add fluid as needed. Replace cloudy or contaminated fluid.

Use DOT 4 brake fluid in the hydraulic clutch reservoir. Use fluid only from a sealed, clean container. Review the brake fluid precautions on page 102.

Do not operate the clutch while the reservoir cover is removed. Fluid could overflow from the reservoir and cause air to enter the fluid system.

WARNING! Using the wrong fluid or allowing air or contaminants into the fluid system can damage the system seals or result in a malfunction that could lead to serious injury or death.

HYDRAULIC CLUTCH FLUID

1. Straddle the motorcycle and bring it to the fully upright position. Position the handlebars so that the fluid reservoir is level.

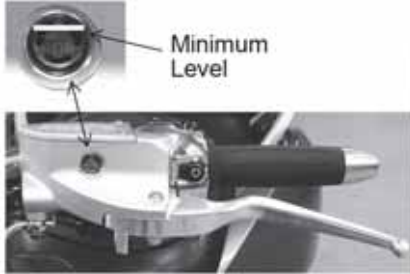

2. Wipe the fluid container and the area around the reservoir cover with a clean cloth.
3. If the fluid level is low, check hoses, lines and the slave cylinder for leaks.
4. To add fluid, remove the three reservoir cover screws. Remove the cover and diaphragm. Carefully add fluid to the top of the sight glass.
5. Reinstall the diaphragm, cover and screws.

TORQUE: 25 in-lbs (3 Nm)

6. Wipe away any fluid spills. Check for signs of fluid leaks around hoses, fittings, reservoir, and slave cylinder. Check for deterioration of hoses.

MECHANICAL CLUTCH LEVER FREEPLAY

1. Remove the right side access cover.
2. Hold the clutch cable and loosen the adjuster lock nut.
3. While holding the cable, turn the cable adjuster inward or outward until clutch lever freeplay is 0.5-1.5 mm ①.



4. While holding the cable, tighten the adjuster lock nut securely.
5. Reinstall the right side cover.
6. Verify that the safety switch activates properly. The engine should not start in gear with the clutch lever released.

TIP: The starter interlock switch is dependent on the clutch lever freeplay being set correctly to ensure activation of the clutch safety switch.

MECHANICAL CLUTCH LEVER LUBRICATION

1. Remove the right side access cover. Loosen the clutch cable adjuster lock nut.
2. Turn the cable adjuster completely inward to provide maximum lever freeplay.
3. Remove the clutch lever pivot nut ① and screw ②. Disconnect the clutch cable from the clutch lever.
4. Remove any old grease and dirt from the lever and housing. Lubricate the clutch lever and pivot screw with VICTORY Moly Assembly Grease or VICTORY All Purpose Grease.
5. Reconnect the clutch cable. Reinstall the lever, pivot screw and nut. Hold the screw down and tighten the nut.

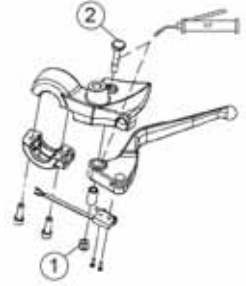

TORQUE

40 in-lbs (5 Nm)

6. Adjust clutch lever freeplay. See page 99.

MECHANICAL CLUTCH CABLE LUBRICATION

Lubricate control cable ends at the intervals recommended in the periodic maintenance table beginning on page 79.

NOTICE

External casings are factory-lubricated. Additional lubrication could be detrimental to cable performance.

Verify proper routing and smooth movement. Inspect for damage to the external casing, and inspect exposed cable wire for fraying, kinks or corrosion. Replace any damaged, sticky or sluggish cable.

1. Disconnect the cable at the clutch lever and at the primary cover.
2. Lubricate the barrel ends with VICTORY All Purpose Grease or equivalent.
3. Reconnect the cable and adjust freeplay as needed.

FRONT BRAKE LEVER

1. Lubricate the pivot bushing ① at the intervals recommended in the periodic maintenance table beginning on page 79. Also lubricate any time binding is evident. Use VICTORY All Purpose Grease or equivalent.
2. Inspect brake pads as outlined on page 57.



REAR BRAKE PEDAL

1. See page 45 for rear brake pedal adjustments.
2. Lubricate the pivot bushing at the intervals recommended in the periodic maintenance table beginning on page 79. Also lubricate any time binding is evident. Use VICTORY All Purpose Grease or equivalent.
3. Inspect brake pads as outlined on page 57.

BRAKE FLUID PRECAUTIONS

WARNING

Using the wrong fluid or allowing air or contaminants into the fluid system can damage the system seals or result in a malfunction that could lead to serious injury or death. Use only DOT 4 brake fluid from a sealed container.

Do not operate the front brake with the reservoir cover removed. Fluid could overflow from the reservoir and allow air to enter the system. Air in the brake system could cause the brakes to malfunction.

An over-full reservoir may cause brake drag or brake lock-up, which could result in serious injury or death. Maintain brake fluid at the recommended level. Do not overfill.

NOTICE

Brake fluid will damage painted surfaces and plastic parts. Always clean spilled brake fluid immediately with water and a mild detergent.

REAR BRAKE FLUID

Change the brake fluid at the intervals recommended in the periodic maintenance table beginning on page 79 or every two years, whichever comes first.

1. Position the motorcycle on level ground in the fully upright position.
2. The rear brake fluid reservoir is located near the rear brake pedal, just inside the right lower leg fairing. Wipe the fluid container and the area around the reservoir cover with a clean cloth.
3. If the fluid level is low, inspect brake pads as outlined on page 57. If pads are not worn beyond the service limit, inspect the brake system for leaks.
4. To add fluid, remove the reservoir cover. Carefully add fluid to the recommended level. *Do not overfill.*
5. Reinstall the cover and diaphragm.
6. Wipe away any fluid spills. Check for signs of brake fluid leaks around hoses, fittings, reservoir, and brake calipers.

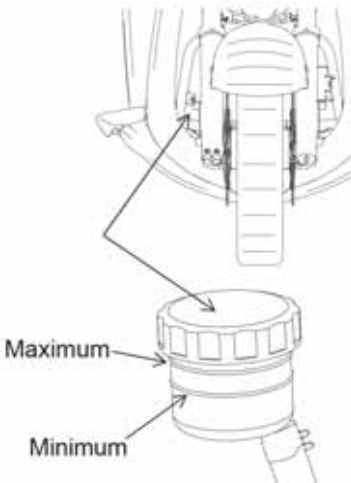

MAINTENANCE

FRONT BRAKE FLUID

Change the brake fluid at the intervals recommended in the periodic maintenance table beginning on page 79 or every two years, whichever comes first. Do not attempt to change the anti-lock brake system fluid. For more information, see the *VICTORY Service Manual*. Your authorized VICTORY dealer can assist.

1. Straddle the motorcycle and bring it to the fully upright position. Position the handlebars so that the fluid reservoir is level. Wipe the fluid container and the area around the reservoir cover with a clean cloth.



2. If the fluid level is low, inspect brake pads as outlined on page 57. If pads are not worn beyond the service limit, inspect the brake system for leaks.
3. To add fluid, remove the three reservoir cover screws. Remove the cover and diaphragm. Carefully add fluid to the top of the sight glass. *Do not overfill*. Reinstall the diaphragm, cover and screws.

TORQUE: 25 in-lbs (3 Nm)

4. Wipe away any fluid spills. Check for signs of brake fluid leaks around hoses, fittings, reservoir, and brake calipers. Check for deterioration of hoses.

BRAKE DISC INSPECTION / CLEANING

1. Inspect brake pads as outlined on page 57.
2. Inspect brake discs for nicks, scratches, cracks or other damage. Inspect the thickness of each brake disc at four or more locations around the disc. If any disc is worn to the minimum thickness at the thinnest point, or if a disc is damaged, replacement is required. Your authorized VICTORY dealer can assist.
3. Clean discs if minor squeaks develop due to dirt or dust. Apply VICTORY Brake Cleaner (P/N 2872191) to a clean shop towel and wipe disc. **DO NOT** allow brake cleaner to contact painted or plastic parts. Read all precautions on the label.

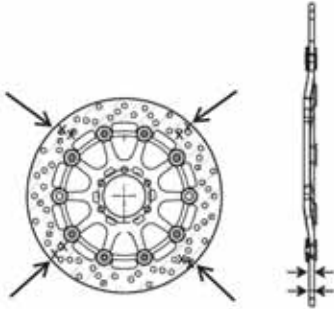

Minimum Thickness:

Front: 4.5 mm

Rear: 6.5mm

BRAKE HOSES / CONNECTIONS

Inspect all brake hoses and connections for dampness or stains from leaking or dried fluid. Tighten any leaking connections and replace components as necessary. For more information, see the *VICTORY Service Manual*. Your authorized VICTORY dealer can assist.

WHEEL INSPECTION

Inspect both wheels for cracks or damage and replace damaged wheels promptly. Do not operate the motorcycle if wheels are damaged or cracked. For more information, see the *VICTORY Service Manual*. Your authorized VICTORY dealer can assist.

ANTI-LOCK BRAKE SYSTEM (ABS) TONE RING/SENSOR INSPECTION

1. Visually inspect for damaged teeth ① on the front and rear ABS tone rings. Inspect for nicks and dents on the face of the teeth. The teeth edges should be consistent in appearance. If a tone ring is damaged, see your VICTORY dealer for replacement as soon as possible. For more information, see the *VICTORY Service Manual*. Your authorized VICTORY dealer can assist.
2. Inspect for debris adhering to the end of the wheel speed sensors ②. If contamination is observed, or if you are unable to visually inspect, slide a thin towel across the face of the sensor between the sensor and the tone ring to remove any potential debris.

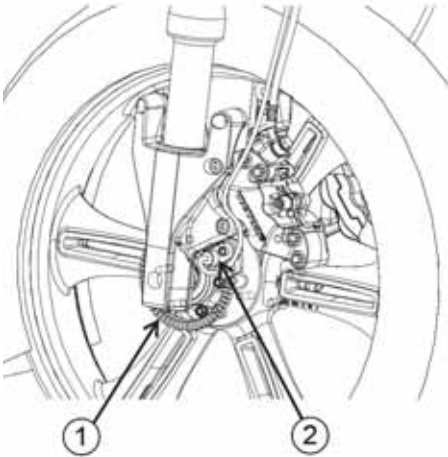

TIRES

WARNING

Operating the motorcycle with improper tires or with improper or uneven tire pressure could cause loss of control or accident. Always use the correct size and type of tires specified for your vehicle. Always maintain proper tire pressure as recommended in the Rider's Manual and on safety labels.

TIRE CONDITION

Inspect the tire sidewalls, road contact surface and tread base. If inspection reveals cuts, punctures, cracks or other wear or damage, replace the tire before riding. Use only approved replacement tires. For more information, see the *VICTORY Service Manual*. Your authorized VICTORY dealer can assist.

TIRE TREAD DEPTH

The raised areas at the base of the tread are wear bars. When the road contact surface has worn to the top of the wear bars, replace the tire. For more precise measurement, and for tires not equipped with wear bars, use a depth gauge or an accurate ruler to measure the depth of the center tire tread. Replace the tire if the tread depth is less than 1/16 inch (1.6 mm).



TIRE PRESSURE

Riding warms the tires and increases tire air pressure. For an accurate reading, check tire pressure before riding. Adjust tire pressure as recommended for the total weight of your intended load (see table).

WARNING! Do not exceed the maximum recommended inflation pressure to seat the bead. Tire or rim failure may result.

Location	Size	Brand	Type	Recommended Pressure	
				Load Weight up to 200 lbs (91 kg)	Load weight up to vehicle's maximum load capacity
Front	130/70R18 63H	Dunlop	Elite 3	38 psi (262 kPa)	40 psi (276 kPa)
Rear	180/60R16 M/C 80H	Dunlop	Elite 3	38 psi (262 kPa)	40 psi (276 kPa)

MAINTENANCE

SPARK PLUGS

Replace spark plugs at the intervals recommended in the periodic maintenance table. See page 79. Always replace spark plugs in pairs.

SPARK PLUG SPECIFICATIONS	
Spark Plug Type	NGK DCPR6E
Spark Plug Gap ①	.031-.035 inch (0.8-0.9 mm)
Spark Plug Torque	10.8-14.5 ft-lbs (14.6-19.7 Nm)

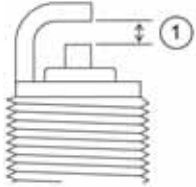

1. Make sure the engine is at room temperature.
2. Pull upward on the spark plug boot (not the wire) to remove the boot.

CAUTION

Wear eye and face protection when using pressurized air.

3. To prevent debris from entering the spark plug hole, use compressed air to clean the area around the plugs before removing them. Remove the spark plugs.

Tool: 5/8-inch plug socket

TIP

Both spark plugs should have the same light or medium tan color deposits on the insulator around the electrode tip. The spark plug electrode tip and bridge should have sharp, square edges.

4. Reinstall the spark plugs or install new plugs. Apply anti-seize compound sparingly to the threads.



- ② Electrode Bridge
- ③ Electrode Tip
- ④ Insulator

5. If spark plugs are in good condition and are not due for replacement, clean them with a non-metallic stiff bristle brush, set the gap with a spark plug gap tool, clean the mating surface on the cylinder head, and install the spark plug with a spark plug socket. Reinstall both spark plug wires.

TIP

Spark plugs with bright white or sooty black deposits or with damaged insulators or electrodes can indicate engine problems. If these conditions exist, or if the condition of one plug is markedly different from the other, see the *VICTORY Service Manual* or your authorized VICTORY can assist.

ENGINE COMPRESSION TEST

An engine compression test can be performed to monitor general engine condition. For more information, see the *VICTORY Service Manual*. Your authorized VICTORY dealer can assist.

EXHAUST SYSTEM INSPECTION

Check the exhaust system for stains from leaking exhaust gasses. Replace damaged or leaking exhaust gaskets. For more information, see the *VICTORY Service Manual*. Your authorized VICTORY dealer can assist.

Check all exhaust system fasteners. Tighten loose clamps and fasteners. Do not overtighten.

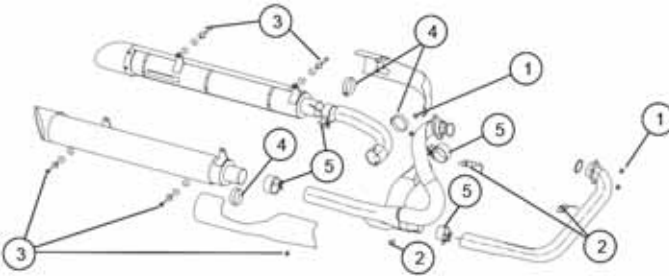

FASTENER TORQUES

① 12 ft-lbs (16 Nm)	④ 35 in-lbs (4 Nm)
② 35 ft-lbs (47.5 Nm)	⑤ 31 ft-lbs (42 Nm)
③ 8 ft-lbs (11 Nm)	

BATTERY

The motorcycle battery is a sealed, maintenance-free battery. Do not remove the battery cap strip for any reason. Keep the battery connections clean and tight at all times.

 **WARNING**

Battery electrolyte is poisonous. It contains sulfuric acid. Serious burns can result from contact with skin, eyes or clothing.

Antidote:

External: Flush with water.

Internal: Drink large quantities of water or milk. Follow with milk of magnesia, beaten egg, or vegetable oil. Call physician immediately.

Eyes: Flush with water for 15 minutes and get prompt medical attention.

Batteries may produce explosive gases.

- Keep sparks, flame, cigarettes, etc. away.
- Ventilate when charging or using in an enclosed space.
- Always shield eyes when working near batteries
- KEEP OUT OF REACH OF CHILDREN.

BATTERY REMOVAL

1. Turn the handlebars full right.
2. Remove the five belly pan screws.

Tool: 6mm Allen wrench

3. Remove the screw that joins the two side grills.

TIP: The grill screw is placed in the FRONT hole. The center belly pan screw uses the rear hole.

WARNING! Improperly connecting or disconnecting battery cables can result in an explosion and cause serious injury or death. When removing the battery, always disconnect the negative (black) cable first. When reinstalling the battery, always connect the negative (black) cable last.

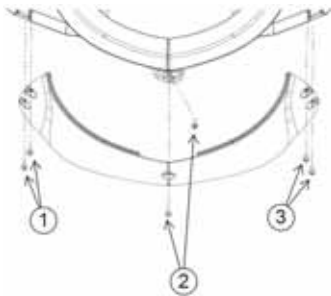

TORQUE: ① 85 in-lbs (10 Nm)

TORQUE: ② 36 in-lbs (4 Nm)

TORQUE: ③ 85 in-lbs (10 Nm)

4. Remove the negative (-) battery cable ④ from the battery terminal. **Tool:** 10 mm wrench
5. Remove the red protective boot from the positive (+) cable end to expose the terminal. Remove the positive cable ⑤ from the battery terminal.
6. Remove the front battery box bolt ⑥. **Tool:** 10 mm socket
7. Tip the front box forward and lift the battery up (to clear the case) and then out the bottom side.

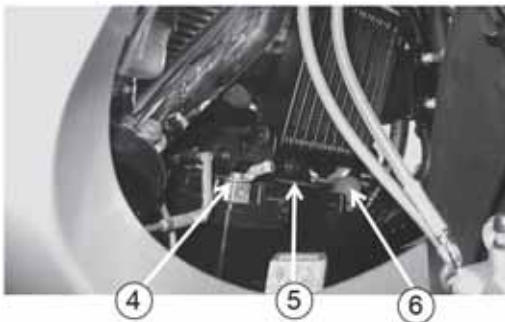

BATTERY INSTALLATION

WARNING! Improperly connecting or disconnecting battery cables can result in an explosion and cause serious injury or death. When removing the battery, always disconnect the negative (black) cable first. When reinstalling the battery, always connect the negative (black) cable last.

1. Ensure the front battery box tabs are engaged with the inner box slots . Replace any damaged or missing foam pads. Slide the battery into the battery box with terminals forward.
2. Tip the front battery box toward the inner box and install the top bolt. Torque to specification.
3. Install the positive (+) battery cable first. Torque the bolt to specification. Install the red protective boot over the terminal.
4. Install the negative (-) cable last. Torque the bolt to specification.
5. Reinstall all remaining components.

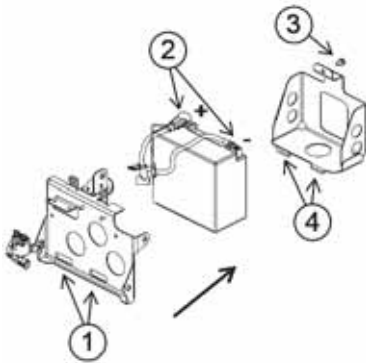

① Tab Slots

② Torque to 36 in-lbs (4 Nm)

③ Torque to 85 in-lbs (10 Nm)

④ Tabs

BATTERY CHARGING

TIP: If your VICTORY motorcycle will not be used for a period of 6 months or longer, a maintenance charger should be connected to the battery. An accessory maintenance charger and accessory fused charging harness can be purchased at your authorized VICTORY dealer.

1. Following the charger manufacturer's instructions, use a battery charger designed for use with 12-volt batteries. The charger should have a maximum charging rate of 1.8 amps. Charge the battery for approximately 10 hours at a rate of 1.8 amps. If you use a taper or trickle charger, it will take longer to charge the battery.
 2. After charging the battery, allow the battery to sit 1-2 hours before checking the state of charge with a DC volt meter. The charge should be a minimum of 12.5 DC volts. Repeat the charging cycle if the charge is less than 12.5 DC volts. Replace the battery if it fails to reach 12.5 volts after the second charge.
-

TIP: An accessory maintenance charger is available through your authorized VICTORY dealer.

MAINTENANCE

IGNITION SWITCH / LOCK LUBRICATION

Periodically lubricate the ignition switch and door locks. We recommend the use of VICTORY Multi-Purpose Lubricant.

1. Spray lubricant directly into the ignition switch and into each lock cylinder for 1-2 seconds.
2. Insert each key into its lock and turn it to all positions to distribute the lubricant.
3. Wipe away any excess lubricant.



SIDESTAND LUBRICATION

Periodically lubricate the sidestand pivot and the ends of the spring ①. See page 62 for sidestand inspections.



FASTENER INSPECTION

1. Inspect the entire motorcycle chassis and engine for loose, damaged or missing fasteners. Tighten loose fasteners to the proper torque.

TIP: Refer to the specifications section of this manual or the service manual for fastener torque values. Your authorized VICTORY dealer can assist.

2. Always replace stripped, damaged or broken fasteners before riding. Use genuine VICTORY fasteners of equal size and strength.

SEAT REMOVAL / INSTALLATION

1. Open the glove compartment door and the fuel door.
2. Lift the console trim panel straight upward at each corner to remove it. Do not tip the panel rearward.
3. Remove the two seat bolts.

Tool: 4 mm Allen wrench

4. Unplug the seat heater power connector (if equipped). Lift the front of the seat upward and pull forward to disengage the tab at the rear of the seat.
5. To install, reverse the above process, being sure to engage the tab at the back of the seat.
6. Tighten the seat bolts ①.

TORQUE: 36 in-lbs (4 Nm)

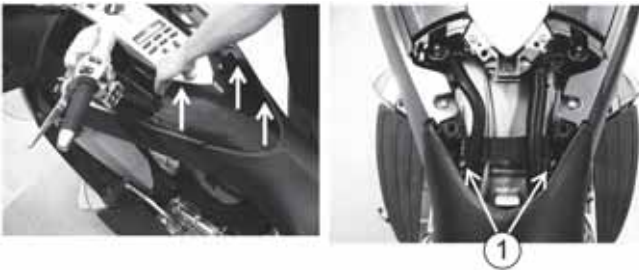

WINDSHIELD TRIM PANEL REMOVAL

Remove the windshield trim panel to access fuse boxes, the manual windshield adjustment mechanism, the headlamp adjustment knob and the front turn signal bulbs.

1. Lift each panel end upward to release the ends.
2. Carefully slide the panel slightly toward the windshield to disengage the lower tabs. Remove the panel.
3. Unplug the antenna.
4. Reverse all steps to reinstall the trim panel.



STREET TRIM PANEL REMOVAL

1. Remove the seat, license plate and bracket. See page 115.
2. Open the saddlebags.
3. Working from top ① to bottom ③, lift each edge of the tail molding to release the tabs. Lift the tail molding just enough to provide clearance to remove the trim panel ④.

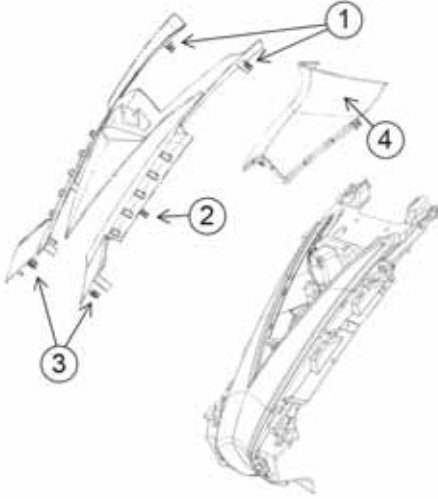

4. Lift the trim panel straight upward to release all four tabs at the corners.
5. Install the trunk. See page 117.
6. Align the tail molding. Working from bottom to top, press at each tab to secure the molding.
7. Reinstall the license plate and seat. Tighten the fasteners.

TORQUE: 36 in-lbs (4 Nm)

STREET TRIM PANEL INSTALLATION

1. Remove the seat, license plate and bracket.
2. Open the saddlebags.
3. Working from top to bottom, lift each edge of the tail molding to release the tabs. Lift the tail molding just enough to provide clearance to install the trim panel.
4. Remove the trunk.
5. Align the trim panel and press downward evenly to seat all four tabs in the tab slots.
6. Align the tail molding. Working from bottom to top, press at each tab to secure the molding.
7. Reinstall the license plate and seat. Tighten the fasteners.

TORQUE: 36 in-lbs (4 Nm)

TRUNK REMOVAL

1. Remove the seat. See page 115.
2. Disconnect the trunk wire harness ①.



3. Remove the license plate.
4. Remove the two 4 mm Allen screws ② from bottom of the license plate bracket. Remove the bracket.
5. Open the trunk and remove all contents.
6. Remove the compartment cover by squeezing between the two notches.
7. Remove three of the four trunk mount bolts. Support the trunk before removing the last bolt.

Tool: 13 mm socket, extension, drive handle

8. Install the street trim panel. See page 116.

TRUNK INSTALLATION

1. Remove the street trim panel. See page 116.
2. Reverse the trunk removal instructions to reinstall the trunk.
3. Tighten the trunk mounting bolts.

TORQUE: 26 ft-lbs (35 Nm)

4. Tighten the license plate bracket screws.

TORQUE: 36 in-lbs (4 Nm)



HEADLAMP BULB REPLACEMENT

1. Remove the air filter. See page 82.
2. Pull the sealing boot away from the back of the bulbs and housing.
3. Press the looped end of the wire bulb retainer clip and swing the end toward the center of the bulb to release it from the latch tab.
4. With the wire connector attached, pull the bulb out.

TIP: When servicing a halogen lamp, avoid touching the lamp with bare fingers. Oil from your skin leaves a residue, causing a hot spot that will shorten the life of the lamp. If fingers do touch a lamp, clean it with denatured alcohol.

5. Disconnect the wire harness. Install the new bulb and secure the retainer.
6. Reinstall the sealing boot. Make sure it seals tightly around the bulb base and lens to prevent condensation.
7. Reinstall the air filter.

FRONT TURN SIGNAL BULB REPLACEMENT

1. Remove the windshield trim panel. See page 115.
2. Disconnect the wire harness from the socket *before* removing the socket from the lens. Lift the lock tab on the connector and push the connector off the socket.
3. Rotate the bulb socket counter-clockwise 1/4 turn and remove the socket with bulb. Remove the bulb and install a new bulb. Reinstall the socket and rotate it 1/4 turn clockwise.
4. Reconnect the wire harness. Be sure it snaps securely into place over the connector lock tab.

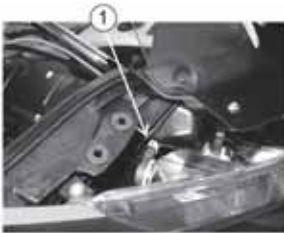

IMPORTANT

Disconnect the wire harness from the socket *before* removing the socket from the lens.

RUNNING LIGHT BULB REPLACEMENT

Replace the running light bulb (innermost bulb) using the same procedure as the turn signal bulb, but leave the wire harness attached to the bulb socket when removing the socket from the lens.

TAILLIGHT / BRAKE LIGHT / TURN SIGNAL BULB REPLACEMENT

1. Open the saddlebags.

TIP: Removal of the trunk or street panel is not necessary.

2. Remove the license plate and bracket. See page 115.
3. Working from top to bottom, lift each edge of the tail molding to release the tabs.
4. Remove the six button-head screws from the lower rear bumper ①. Remove the five button-head screws that secure the taillight lenses ②.

Tool: 4 mm Allen wrench

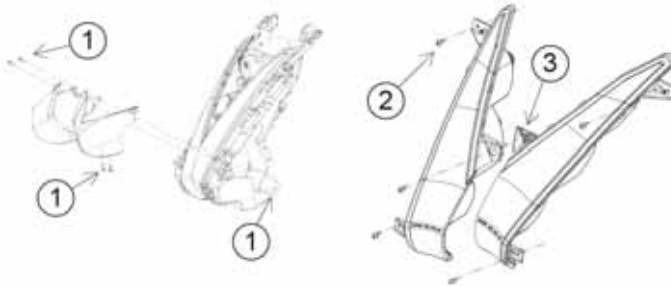

5. Pull both taillights straight rearward to release all spring tabs from the rear fender and expose the bulb socket ③. Make a note of bulb socket orientation for reassembly.
6. Rotate the socket 1/4 turn counter-clockwise to remove it. Pull the bulb straight out of the socket and install a new bulb.
7. Reverse all steps to reassemble components. Tighten the button-head screws.

TORQUE: 36 in-lbs (4 Nm)

HEADLAMP AIM ADJUSTMENT

The high beam should shine straight forward. The low beam will spread more toward the right (U.S./Canada).

1. Verify that tire pressure is at specification. See page 107. Verify that rear suspension ride height (preload) is at specification. See page 89.
2. Position the motorcycle on a level surface with the headlight approximately 25 ft. (7.6 m) from a wall ①. Measure the distance from the floor to the center of the headlight and make a mark ② on the wall at the same height.

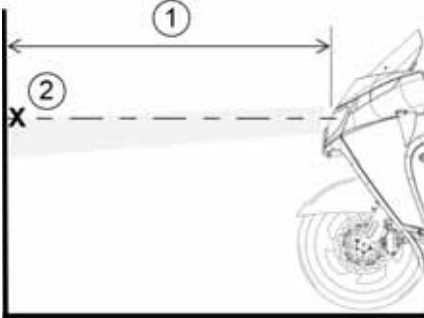

3. Sit in the operator's seat. Bring the motorcycle to the fully upright position.
4. Move the ignition switch to the ON position and switch the headlamp to high beam. Observe the headlight aim on the wall. The top of the beam should be slightly below the mark on the wall.
5. Remove the windshield trim panel. See page 115. Reach through the opening ③ in the headlamp housing mount.



6. To lower the headlamp beam, turn the knob clockwise ④ (as viewed from the operator's seat).
7. To raise the headlamp beam, turn the knob counter-clockwise ⑤.

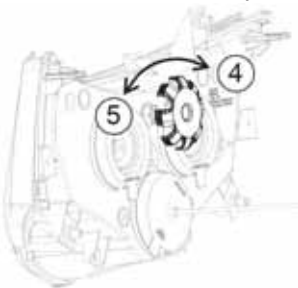

FUSE BOXES

Remove the windshield trim panel to access the fuses, auto-reset circuit breakers and relays. See page 115.

Left Fuse Box

IGNITION 10A	HEADLIGHT POWER RELAY	HORN RELAY	SECONDARY LIGHTS RELAY
HEADLIGHT 20A			
GAUGES 5A	RADIO 25A	HORN 20A	TURN SIGNAL/BRAKE RELAY 7174111
SPARE FUSE	SECONDARY LIGHTS 20A	TS/BRAKE 20A	

Right Fuse Box

HEADLIGHT CONTROL RELAY	ENGINE RELAY	FUEL PUMP/ IGNITION COIL RELAY	CHASSIS ELECTRICAL RELAY
SPARE FUSE	ENGINE 15A	FP/IGN COIL 15A	HEADLIGHT SWITCHING RELAY 7175380
SPARE FUSE	WINDSHIELD 20A	CHASSIS 20A	

FUSE REPLACEMENT

1. Remove the windshield trim panel. See page 115.
2. Push the center of the dart upward to remove a fuse box cover panel.
3. Pull the tab to release a fuse box cover.

TIP: The reverse system fuse is located on the left rear side of the motorcycle, under the seat.

NOTICE: Always use the recommended fuse to prevent electrical system damage. Refer to the label on the fuse box cover.

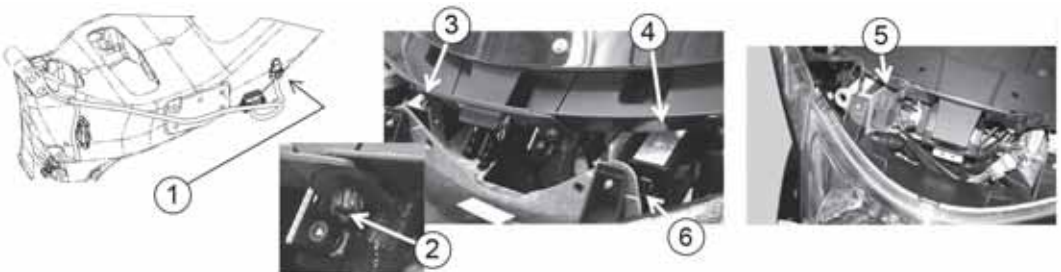

① Reverse System 25 amp mini fuse (if equipped)	④ Left Fuse Box
② Dart	⑤ ABS Fuses (if equipped)
③ Right Fuse Box	⑥ Tab

ELECTRICAL PRECAUTIONS

Be aware of the following “DO’s” and “DO NOT’s” regarding the electrical system to avoid disruption of electrical signals and possible system malfunction.

DO:

- DO use ONLY genuine VICTORY parts and accessories designed for your model and follow the instructions provided.
- DO use the accessory power jack provided in the glove compartment (or trunk). The glove compartment power jack is powered whenever the ignition key is in the ON or ACC position. The trunk power jack is powered at all times.
- If it is necessary to provide power to an item that does not use one of the previously mentioned power jacks, connect to the load side of the main circuit breaker (under the cover behind the oil cooler), and connect the ground wire to the engine ground at the front left side of the crankcase (near the circuit breaker).

DO NOT:

- DO NOT splice or cut any wires.
- DO NOT tap in to any power or ground on the motorcycle unless specifically directed to do so by the VICTORY instructions that come with the kit.
- DO NOT back-probe electrical connectors on the vehicle unless directed to do so by the Service Manual.
- DO NOT power any accessories from the diagnostic connector (inside the left saddlebag near the rear suspension air pressure label).

ELEVATING THE MOTORCYCLE

WARNING

Serious injury or death can occur if the motorcycle tips or falls. Make sure the motorcycle will not tip or fall while elevated or while on the sidestand.

Some procedures require raising the motorcycle to remove weight from the component being inspected. Elevate the motorcycle by placing a stable, flat platform jack or lift mechanism on a firm, flat surface and lifting under the engine crankcase. The platform should be a minimum of 12 inches (30 cm) square. DO NOT attempt to lift the motorcycle without proper equipment. Always secure the motorcycle properly before lifting so it cannot tip or fall when elevated.

ROAD TEST

Before returning the motorcycle to regular use, perform a road test in a safe area. Pay special attention to the proper fit and operation of all serviced components.

Make any corrections or additional adjustments promptly to ensure safe, reliable and enjoyable vehicle performance.

FASTENER TORQUE

Refer to the service manual or an authorized VICTORY dealer for procedures and fastener torques not listed in this manual.

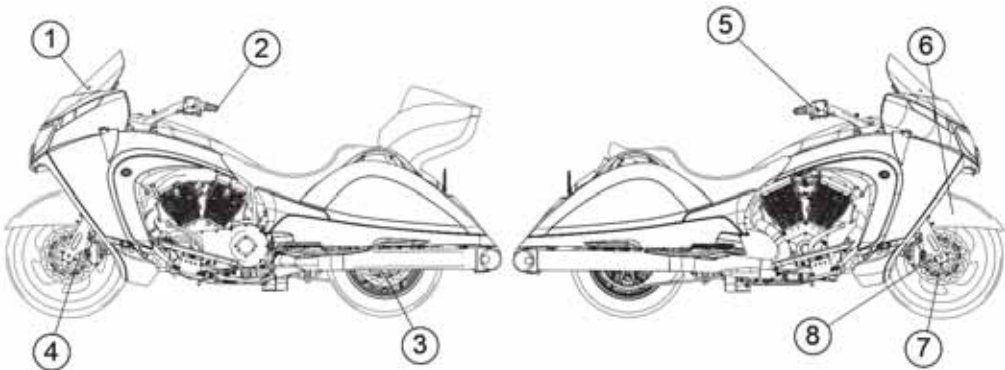

① Windshield Screws 36 in-lbs (4 Nm)	⑤ Switch Screws 25 in-lbs (3 Nm)
② Handlebar End Cap Screws 84 in-lbs (10 Nm)	⑥ Front Fender 8 ft-lbs (11 Nm)
③ Rear Axle Nut (Apply grease to threads) 65 ft-lbs (88 Nm)	⑦ Front Axle 52 ft-lbs (71 Nm)
④ Front Brake Caliper Mounting Screws 31 ft-lbs (42 Nm)	⑧ Front Axle Pinch Bolts 17 ft-lbs (23 Nm)

MAINTENANCE

TROUBLESHOOTING

For your personal safety, do not attempt inspection or repairs not fully described in this rider's manual. Contact an authorized dealer or other qualified person for service if you cannot determine the cause of a problem or if the inspection / repair exceeds your mechanical ability or tool resources. Do not perform any inspection or repair with the engine running.

ENGINE CRANKS BUT WILL NOT START

POSSIBLE CAUSE	POSSIBLE REMEDY/ACTION
Low Fuel	Verify fuel level
Fuel pump inoperative	Turn engine STOP switch to RUN. Turn key ON. The fuel pump should run momentarily and then stop. If you do not hear the fuel pump run, check the fuel pump / ignition circuit breaker. See page 121. <i>A momentary clicking sound from the IAC valve is normal when the key is first turned to the OFF position.</i>
Battery Discharged	Fully charge the battery. See page 113.
Spark Plug(s) Fouled	Inspect spark plugs. See page 108.
Spark Plug Wire(s) Disconnected or Loose	Be sure spark plug wires are securely fastened.

STARTER MOTOR DOES NOT TURN OR TURNS SLOWLY

POSSIBLE CAUSE	POSSIBLE REMEDY/ACTION
Engine Stop / Run Switch in Stop Position	Place switch in RUN position.
Battery Discharged	Fully charge the battery. See page 113.
Battery Cables Loose or Corroded	Inspect battery cables.
Transmission In Gear	Shift transmission into neutral or pull the clutch lever in to disengage the clutch. See starting procedures on page 65.

ENGINE STARTS BUT MISSES OR RUNS POORLY

TIP

Turn engine OFF before inspecting any of these items.

POSSIBLE CAUSE	POSSIBLE REMEDY/ACTION
Battery Discharged	Fully charge the battery. See page 113.
Battery Cables Loose or Corroded	Inspect battery cables and connections.
Spark Plug(s) Fouled	Inspect spark plugs. See page 108.
Spark Plug Wire(s) Loose or Wet	Inspect spark plug wires, ensure dry/secure.
Contaminated Fuel	Inspect fuel for water / contamination. Your authorized VICTORY dealer can assist.
Engine Oil Level Incorrect Or Wrong Type	Inspect level and quality of oil. See page 53.
Loose, Broken, Shorted Ignition Coil Wires	Inspect coil primary wires. Your authorized VICTORY dealer can assist.
Air Intake Restricted	Inspect air filter. See page 82.

SHIFTING DIFFICULTIES OR HARD TO FIND NEUTRAL

POSSIBLE CAUSE	POSSIBLE REMEDY/ACTION
Shift Linkage Bushings Dry Or Worn	Lubricate shift linkage.
Engine Oil Level Incorrect Or Wrong Type	Inspect level and quality of oil. See page 53.
Hydraulic Clutch Fluid Contaminated	Flush hydraulic clutch fluid. Your authorized VICTORY dealer can assist.
Air In Hydraulic Clutch System	Bleed system. Your authorized VICTORY dealer can assist.
Clutch Slave Cylinder Bracket Loose	Inspect / tighten loose parts.
Hydraulic Clutch Fluid Leak	Inspect system for leaks. Your authorized VICTORY dealer can assist.
Clutch Damage	Replace clutch.

BATTERY CHARGING RATE LOW OR BATTERY DISCHARGES

POSSIBLE CAUSE	POSSIBLE REMEDY/ACTION
Loose/Corroded Charging Circuit Connection	Check/clean battery cable connections. Check/clean charging circuit connections. Your authorized VICTORY dealer can assist.
Accessory Load Exceeds Charge Rate	Use ACC position and limit accessory operation when engine is off.
Improperly Wired Accessory (Current Draw)	Check charging system output and current draw. Your authorized VICTORY dealer can assist.
Battery discharges when motorcycle not in use.	Check key OFF current draw. Your authorized VICTORY dealer can assist.

BRAKE NOISE / POOR BRAKE PERFORMANCE

TIP

Your authorized VICTORY dealer can assist if brake performance does not return after these inspections.

POSSIBLE CAUSE	POSSIBLE REMEDY/ACTION
Dust / Dirt On Brake Disc(s)	Clean disc. See page 105.
Worn Pads Or Disc / Brake Disc Damage	Inspect pads. See page 57 and page 105.
Brake Fluid Level Low Or Fluid Contaminated	Inspect fluid level / fluid. See page 55 and page 56.

ANTI-LOCK BRAKE LIGHT REMAINS ILLUMINATED OR ILLUMINATES INTERMITTENTLY

POSSIBLE CAUSE	POSSIBLE REMEDY/ACTION
Blown fuse	Check the fuses. See page 121.
Loose or damaged pulse ring	Inspect pulse ring for looseness or chipped teeth.
Debris lodged in components	Inspect wheel speed sensor and pulse ring for debris.
Damage caused by debris	Inspect wheel speed sensor for cracked housing.
Damaged components	Your authorized VICTORY dealer can assist.

CLEANING AND STORAGE

VICTORY CLEANING PRODUCTS

This section provides tips on the very best way to clean, polish and preserve every surface of your beautiful new VICTORY motorcycle. We recommend the use of our VICTORY cleaning and polishing products and accessories, which have been specially designed to offer the best care possible for your VICTORY motorcycle.

In addition to the products recommended in this section for cleaning and polishing, VICTORY also has specialty products for:

- removing scratches, scuffs and swirls
- enhancing black and silver engines
- cleaning engines, tires and wheels
- removing brake dust

After cleaning the motorcycle, inspect for damage to the painted surfaces. Chips or scratches should be repaired promptly to prevent corrosion.

For Suede Paint (Matte Clear Coat) Finish Care, see page 128.

For Gloss Clear Coat Finish Care, see page 129.

Your dealer can provide more information and answers to your cleaning and detailing questions.

WASHING THE MOTORCYCLE

NOTICE

Do not use pressurized water to wash the motorcycle. Water may seep in and deteriorate wheel bearings, brake caliper assemblies, brake master cylinders, electrical connectors, steering head bearings, and transmission seals.

Do not direct any water stream at air intakes, exhaust outlets, electrical connectors or audio system speakers.

Electrical components may be damaged by water. Do not allow water to contact electrical components or connectors.

1. Before washing, make sure exhaust pipes are cool. Cover each pipe opening with a plastic bag secured with a strong rubber band. Check that the spark plugs, spark plug wire caps, oil fill cap and fuel caps are properly seated.
2. Do not use abrasive cleaners.
3. Rinse off as much dirt and mud as possible with water running at low pressure. Use as little water as possible when washing near the air intake or the exhaust pipe openings. Dry these components thoroughly before using the motorcycle.
4. Clean the front fork tubes thoroughly to reduce fork seal wear and leakage.
5. After washing, remove the rubber bands and plastic bags from the exhaust pipes. Start the engine and let it idle for a few minutes.
6. Make sure the brakes are functioning properly before riding.

CLEANING AND STORAGE

WINDSHIELD CARE (IF EQUIPPED)

Clean the windshield with a soft cloth and plenty of warm water. Dry with a soft clean cloth. Remove minor scratches with a high-quality polishing compound designed for use on polycarbonate surfaces.

NOTICE

Brake fluid and alcohol will permanently damage the windshield. Do not use glass cleaners, water or soil repellents, and petroleum or alcohol based cleaners on the windshield, as these products can damage the windshield.

SUEDE PAINT (MATTE CLEAR COAT) FINISH CARE

Suede paint finishes are prone to trapping dirt, oils and other contaminants. Always clean this type of finish with warm water and a mild dish-washing detergent. Use a soft sponge to gently rub the surface, then rinse with clean warm water. For stubborn stains such as grease or oil, use a citrus-based cleaner. Spray the cleaner onto the area and rub gently with a soft sponge. Allow the cleaner to sit for a couple of minutes, then rinse well with clean warm water. Repeat as needed.

Apply VICTORY Suede Finish Protectant. Follow the instructions on the container.

NOTICE

Never use a polishing/buffing wax or any sponge that has an abrasive surface when cleaning a matte finish. These products will buff the matte surface of the finish and result in a glossy finish. Never clean matte finishes with a pressure washer, as this will further imbed contaminants into the clear coat and may damage labels and decals.

GLOSS CLEAR COAT FINISH CARE

The Axalta Sports and Equipment Finish System was used to provide the original gloss finish on your motorcycle. This finish system provides superior protection against the elements. To maximize the benefits of this system, use the following guide to care for the gloss finish on your motorcycle.

- During the first 30 days, when the finish is still fresh, clean the motorcycle with a water rinse only.
- Do not wax the motorcycle for the first 60 days. Doing so can cause loss of the gloss. After 60 days, use only waxes designed for new clear coat finishes.
- Do not use pressurized water to wash the motorcycle. When paint is still fresh, pressurized water could damage the finish. If using a pressure washer is unavoidable, keep the spray nozzle at least 24 inches (60 cm) away from the surface of the motorcycle.
- Wash your motorcycle often, especially when exposed to salty, dusty, acidic or alkaline environments.
- Use warm or cool water and a soft cloth for cleaning.
- Use soaps that are non-abrasive and have a neutral pH (non acidic/non alkaline detergents).
- Do not use solvent-based solutions.
- Do not use a dry cloth to remove dust.
- Do not use a stiff bristle brush, which can scratch the surface.
- Do not wash with extremely hot water.
- Do not wash the motorcycle while the surface is hot and avoid washing the motorcycle in the hot sun. Minerals in the water may be difficult to remove once dried on the surface of the motorcycle.
- Do not allow spilled gasoline, motor oil or brake fluid to stand on the paint. Remove these substances immediately by rinsing with water. Use a soft cloth to absorb any remaining residue and dab dry.
- To remove bug remnants or road tar, use only products that are specifically designed for this purpose. Follow the product manufacturer's recommendations to prevent potential damage to the finish. Follow with a wash using the methods described in this section.
- Always brush away any ice or snow, do not scrape off.
- Chips or scratches should be repaired promptly to prevent corrosion.

POLISHED ALUMINUM CARE

When a VICTORY motorcycle is new, the polished aluminum wheels, hand levers and shifter shine like chrome. Ultraviolet (UV) rays and oxidation will cause polished aluminum to grow dull, however, if it's not properly polished and protected.

VICTORY Awesome Metal Polish will clean, polish and protect these aluminum surfaces. This metal polish will restore that factory chrome-like shine and leave a protective coating that resists future oxidation for several months.

1. Shake the polish container well before using.
2. Apply the product with a terry cotton or microfiber cloth or pad.
3. Rub gently until the black begins to come to the surface or until shine begins to show through the haze.
4. Allow the product to haze.
5. Remove the haze with a terry cotton or microfiber cloth and buff to a long-lasting chrome-like shine.
6. Do not polish the spokes on painted spoked wheels.

POLISHING PAINT AND CHROME

There are two totally different styles of polishing or protecting your paint and chrome, standard polishing and premium polishing.

NOTICE

Do not polish matte finishes.

STANDARD METHOD OF POLISHING PAINT AND CHROME

VICTORY Windshield, Paint and Chrome Polish is a unique formula designed to produce a glass-like shine on painted or clear-coated finishes and chrome surfaces. It provides long-lasting protection from oxidation, corrosion, UV rays and heat.

- Use it on chrome-plated accessories to prevent surface rust and create a glass-like shine.
 - This product creates a high reflective index point, giving a deep, shiny finish without silicone.
 - It repels water from windshields and keeps bugs from sticking.
 - Use it to polish and fill light scratches on Plexiglas, Lexan, Acrylic and factory-coated windshields.
1. Shake the container well before using.
 2. Apply with a VICTORY Plush Microfiber Towel in a circular motion or straight line to a clean surface. It can be applied in direct sunlight.
 3. Rub the product until it is almost clear, then allow to dry to a haze before removal. The entire motorcycle can be treated before removing polish.
 4. Use a clean, dry microfiber towel to wipe it off easily and dust-free.
 5. For best results on a windshield, apply to a clean windshield. Once applied, rain water beads and blows off, enhancing rain visibility. The glass-like finish keeps bugs from sticking and permits their easy removal.

POLISHING THE MOTORCYCLE

PREMIUM POLISHING FOR LONG-LASTING PROTECTION

The premium method of polishing paint and chrome utilizes the latest in high-quality polymer technology that provides the longest-lasting protection available in the polish industry today. VICTORY Liquid Spray Wax for windshields, paint and chrome is formulated for polishing after washing and can be sprayed on wet or dry surfaces. Liquid Spray Wax quickly produces a durable, high-gloss shine with minimal effort. It contains NO ABRASIVES and is clear coat-safe. It contains NO PETROLEUM DISTILLATES or SILICONES.

1. Shake container well before use.
2. Begin by washing and rinsing the motorcycle.
3. Spray Liquid Spray Wax on a wet or dry bike, one section at a time. (For best results, the bike's surface should be cool.)
4. Wipe dry one section at a time with a VICTORY microfiber towel.
5. When finished drying, buff the entire motorcycle with a clean, dry microfiber towel for a clean and luxurious shine.

TIP

Liquid Spray Wax can also be applied to clean and dry clear coats, windshields and chrome. Apply to one section at a time and wipe dry. When finished, use a second towel to buff to a luxurious, long-lasting shine.

LEATHER, RUBBER AND VINYL CARE

WARNING

Never use a non-recommended protectant on seats, footrests, hand grips or tires. Slippery seats, footrests or hand grips can cause loss of control. Slippery tires can cause loss of traction and loss of control. Both situations could result in serious injury or death.

For the finest leather care, use Pure VICTORY Leather, Vinyl & Rubber Conditioner, a unique, pleasantly scented formula of premium-quality polymers designed to restore luster and softness to vinyl, leather and rubber *without making them slippery*. This conditioner is available in the VICTORY Travel Kit.

This product is a true conditioner, not a coating. It does not close the pores of the surfaces but penetrates, nourishes and softens the material. It protects against ultra violet (UV) rays and cracking, repels water and prolongs the life and like-new appearance of the materials. Applied to rubber, this product creates a water-repellent, like-new appearance. This product can also be used to restore or maintain the factory finish on a VICTORY instrument panel/dash and rear storage compartment black vinyl surfaces. Regular use increases soil resistance.

1. Apply the product on a clean dry surface using a VICTORY microfiber towel.
2. Rub the product into the material. Repeat the treatment if the surface is extremely dry.
3. Wipe dry with a clean, dry microfiber towel to remove excess product. Buff lightly with the towel for additional luster.

CLEANING AND STORAGE

CLEANING AND STORAGE

If you will not operate the motorcycle for several months, such as during the winter, store the motorcycle to prevent damage to the fuel system and the battery and to protect components from corrosion or deterioration. During storage you might use products that are potentially hazardous; such as fuel stabilizer. When using any of these products, follow the instructions and warnings on the product packaging.

This section includes instructions for preparing the motorcycle for storage, maintaining it during storage and removing it from storage.

STORAGE AREA PREPARATION

Choose a dry, well-ventilated storage location, inside a garage or other structure if possible. The location should have a firm, flat surface and allow enough space for the motorcycle.

To best preserve tire condition:

- The storage area should have a relatively constant and moderate temperature.
- The storage surface should be free of oil and gasoline.
- The motorcycle should not be near a radiator or other heat source, or any type of electric motor.

CLEAN AND PROTECT THE MOTORCYCLE

To prepare the motorcycle for storage, begin by cleaning and polishing the motorcycle as outlined beginning on page 127. Polish chromed and other metal surfaces. Apply protectant to exposed rubber, vinyl and plastic parts. *Do not apply rubber protectant to the tire tread surfaces.*

FUEL STABILIZER

Using a mixture of fuel and the recommended amount of VICTORY Premium Carbon Clean Plus or other gasoline stabilizer, fill the fuel tank only to the top of the filler insert.

Ride the motorcycle or start and run the engine for 15 minutes in a well ventilated area to pass the stabilized fuel through entire fuel-injection system.

TIRE INFLATION

Inflate the tires to normal pressure. See page 107.

ENGINE PROTECTION

Change the engine oil. See page 80. Carbon deposits and combustion acids, normally suspended in the engine oil when in service, settle on internal engine components during storage. Settled deposits can cause engine damage or internal corrosion.

BATTERY CARE

- Remove the battery. See page 111.
- Clean the battery terminals first with a wire brush to remove any loose deposits.
- Wash the posts and the ends of the battery cables with a solution of 1 part baking soda to 16 parts water. Rinse with clean water and wipe dry.
- Apply a thin film of dielectric grease (available from your VICTORY dealer) to the posts and cable connectors.
- Clean the outside of the battery with a solution of mild detergent and warm water.
- Store the battery in a dry area with a temperature of 32° to 90° F (0° to 32° C).
- While in storage, fully charge the battery once a month. See page 113.

PARK AND COVER THE MOTORCYCLE

Park the motorcycle in its storage location. Cover it with a genuine VICTORY motorcycle cover, or a cover made from a durable, breathable material designed for storage. Covering the motorcycle helps protect it from dust and other airborne materials. The cover must be of a breathable material to prevent moisture from building up on the motorcycle which can cause oxidation of metal surfaces.

RODENTS

Mice and other rodents are often the worst enemy of a stored motorcycle. If the motorcycle will be stored in an area where mice are a concern (particularly in rural areas, barns, sheds, etc.) be sure to take extra measures to deter their infestation. This may include placing a screen mesh over any intake or exhaust openings (just be sure to remember to remove them when you take the motorcycle from storage).

MAINTENANCE DURING STORAGE

During extended storage periods, maintain tire pressure and battery voltage at the recommended levels.

REMOVAL FROM STORAGE

1. Remove the cover and unlock the front forks (if locked).
2. Verify that tire pressure is at specification.
3. Install the battery and perform an electrical inspection.
4. Check the oil level. If the motorcycle was stored in an area subject to wide swings in temperature and humidity (such as outdoors), change the engine oil before starting the engine.

NOTICE

During storage, temperature and humidity changes can cause condensation to form in the crankcase and mix with engine oil. Running the engine with oil that contains condensation can cause engine damage.

5. Inspect the storage area for signs of fluid leaks. Identify and perform service to any leaking components.
6. Install new spark plugs if necessary.
7. Perform the pre-ride inspections. See page 51.
8. Perform a road test. See page 78.
9. Wash and polish the motorcycle. Wax, polish, or apply protectant to appropriate components.

WARRANTIES

VICTORY MOTORCYCLES WARRANTY POLICY

LIMITED WARRANTY

Victory Motorcycles Division, Polaris Industries Inc., 2100 Highway 55, Medina, Minnesota 55340 gives a TWO YEAR LIMITED WARRANTY on all components of your VICTORY motorcycle against defects in material or workmanship. This warranty covers parts and labor charges for repair or replacement of defective parts and begins on the date of purchase by the original retail purchaser. This warranty is transferable to another owner during the warranty period through an authorized VICTORY MOTORCYCLES dealer, but any such transfer will not extend the original term of the warranty. The duration of this warranty may vary by international region based upon local laws and regulations.

REGISTRATION

At the time of sale, the Warranty Registration Form must be completed by your dealer and submitted to VICTORY MOTORCYCLES within ten days of purchase. Upon receipt of this registration, VICTORY MOTORCYCLES will record the registration for warranty. No verification of registration will be sent to the purchaser as the copy of the Warranty Registration Form will be your proof of warranty coverage. If you have not signed the original registration and received the customer copy, please contact your dealer immediately. **NO WARRANTY COVERAGE WILL BE ALLOWED UNLESS YOUR MOTORCYCLE IS REGISTERED WITH VICTORY MOTORCYCLES.** Initial dealer preparation and set-up of your motorcycle is very important in ensuring trouble-free operation. Purchasing a vehicle in the crate or without proper dealer set-up will void your warranty coverage.

WARRANTIES

WARRANTY COVERAGE AND EXCLUSIONS: LIMITATIONS OF WARRANTIES AND REMEDIES

This limited warranty excludes any failures that are not caused by a defect in material or workmanship. THIS WARRANTY DOES NOT COVER CLAIMS OF DEFECTIVE DESIGN. This warranty also does not cover acts of God, accidental damage, normal wear and tear, abuse or improper handling. This warranty also does not cover any motorcycle, component, or part that has been altered structurally, modified, neglected, improperly maintained or used for racing, competition or purposes other than for which it was designed.

This warranty excludes damages or failures resulting from: improper lubrication; improper engine timing; improper fuel; surface imperfections caused by external stress, heat, cold or contamination; operator error or abuse; improper component alignment, tension, adjustment or altitude compensation; snow, water, dirt or other foreign substance ingestion/contamination; improper maintenance; modified components; use of aftermarket or unapproved components, accessories, or attachments; unauthorized repairs; or repairs made after the warranty period expires or by an unauthorized repair center.

This warranty excludes damages or failures caused by abuse, accident, fire, or any other cause other than a defect in materials or workmanship and provides no coverage for consumable components, general wear items, or any parts exposed to friction surfaces, stresses, environmental conditions and/or contamination for which they were not designed or not intended, including but not limited to the following items:

- Wheels and tires
- Suspension components
- Brake components
- Seat components
- Clutches and components
- Steering components
- Batteries
- Light bulbs/Sealed beam lamps
- Filters
- Lubricants
- Bushings
- Finished and unfinished surfaces
- Fuel injectors/Throttle body components
- Engine components
- Drive belts
- Hydraulic components and fluids
- Circuit breakers/Fuses
- Electronic components
- Spark plugs
- Sealants
- Coolants
- Bearings

WARRANTY COVERAGE AND EXCLUSIONS: LIMITATIONS OF WARRANTIES AND REMEDIES

LUBRICANTS AND FLUIDS

1. Mixing oil brands or using non-recommended oil may cause engine damage. We recommend the use of VICTORY MOTORCYCLES engine oil.
2. Damage or failure resulting from the use of non-recommended lubricants or fluids is not covered by this warranty.

This warranty provides no coverage for personal loss or expense, including mileage, transportation costs, hotels, meals, shipping or handling fees, motorcycle pick-up or delivery, replacement rentals, loss of vehicle use, loss of profits, or loss of vacation or personal time.

THE EXCLUSIVE REMEDY FOR BREACH OF THIS WARRANTY SHALL BE, AT VICTORY MOTORCYCLES' OPTION, REPAIR OR REPLACEMENT OF ANY DEFECTIVE MATERIALS, COMPONENTS, OR PRODUCTS. THE REMEDIES SET FORTH IN THIS WARRANTY ARE THE ONLY REMEDIES AVAILABLE TO ANY PERSON FOR BREACH OF THIS WARRANTY. VICTORY MOTORCYCLES SHALL HAVE NO LIABILITY TO ANY PERSON FOR INCIDENTAL, CONSEQUENTIAL OR SPECIAL DAMAGES OF ANY DESCRIPTION, WHETHER ARISING OUT OF EXPRESS OR IMPLIED WARRANTY OR ANY OTHER CONTRACT, NEGLIGENCE, OR OTHER TORT OR OTHERWISE. THIS EXCLUSION OF CONSEQUENTIAL, INCIDENTAL, AND SPECIAL DAMAGES IS INDEPENDENT FROM AND SHALL SURVIVE ANY FINDING THAT THE EXCLUSIVE REMEDY FAILED OF ITS ESSENTIAL PURPOSE.

THE IMPLIED WARRANTY OF FITNESS FOR A PARTICULAR PURPOSE IS EXCLUDED FROM THIS LIMITED WARRANTY. ALL OTHER IMPLIED WARRANTIES (INCLUDING BUT NOT LIMITED TO THE IMPLIED WARRANTY OF MERCHANTABILITY) ARE LIMITED IN DURATION TO THE ABOVE 24 MONTH WARRANTY PERIOD. VICTORY MOTORCYCLES DISCLAIMS ALL EXPRESS WARRANTIES NOT STATED IN THIS WARRANTY. SOME STATES DO NOT PERMIT THE EXCLUSION OR LIMITATION OF INCIDENTAL OR CONSEQUENTIAL DAMAGES OR ALLOW LIMITATIONS ON THE DURATION OF IMPLIED WARRANTIES, SO THE ABOVE LIMITATIONS MAY NOT APPLY TO YOU IF INCONSISTENT WITH CONTROLLING STATE LAW.

WARRANTIES

HOW TO OBTAIN WARRANTY SERVICE

If your motorcycle requires warranty service, you must take it to a VICTORY MOTORCYCLES Servicing Dealer. When requesting warranty service you must present your copy of the Warranty Registration Form to the dealer. (THE COST OF TRANSPORTATION TO AND FROM THE DEALER IS YOUR RESPONSIBILITY.) VICTORY MOTORCYCLES suggests that you use your original selling dealer; however, you may use any VICTORY MOTORCYCLES Servicing Dealer to perform warranty service.

IN THE COUNTRY WHERE YOUR MOTORCYCLE WAS PURCHASED:

Warranty or Service Bulletin repairs must be done by an authorized VICTORY MOTORCYCLES dealer. If you move or are traveling within the country where your motorcycle was purchased, Warranty and Service Bulletin repairs may be requested from any authorized VICTORY MOTORCYCLES dealer.

OUTSIDE THE COUNTRY WHERE YOUR MOTORCYCLE WAS PURCHASED:

If you are traveling temporarily outside the country where your motorcycle was purchased, you should take your motorcycle to an authorized VICTORY MOTORCYCLES dealer. You must show the dealer photo identification from the country of the selling dealer's authorized location as proof of residence. Upon residence verification, the servicing dealer will be authorized to perform the warranty repair.

IF YOU MOVE:

If you move to another country, be sure to contact VICTORY MOTORCYCLES Customer Assistance and the customs department of the destination country before you move. Vehicle importation rules vary considerably from country to country. You may be required to present documentation of your move to VICTORY MOTORCYCLES in order to continue your warranty coverage. You may also be required to obtain documentation from VICTORY MOTORCYCLES in order to register your motorcycle in your new country. You should warranty register your motorcycle at a local VICTORY MOTORCYCLES dealer in your new country immediately after you move to continue your warranty coverage and to ensure that you receive information and notices regarding your motorcycle.

IF YOU PURCHASE FROM A PRIVATE PARTY:

If you purchase a VICTORY motorcycle from a private party, to be kept and used outside of the country in which the motorcycle was originally purchased, all warranty coverage will be denied. You must nonetheless register your motorcycle under your name and address with a local VICTORY MOTORCYCLES dealer in your country to ensure that you receive safety information and notices regarding your motorcycle.

EXPORTED VEHICLES

EXCEPT WHERE SPECIFICALLY REQUIRED BY LAW, THERE IS NO WARRANTY OR SERVICE BULLETIN COVERAGE ON THIS VEHICLE IF IT IS SOLD OUTSIDE THE COUNTRY OF THE SELLING DEALER'S AUTHORIZED LOCATION. This policy does not apply to vehicles that have received authorization for export from VICTORY MOTORCYCLES. Dealers may not give authorization for export. You should consult an authorized dealer to determine this vehicle's warranty or service coverage if you have any questions. This policy does not apply to vehicles registered to government officials or military personnel on assignment outside the country of the selling dealer's authorized location. This policy does not apply to Safety Bulletins.

NOTICE

If your vehicle is registered outside of the country where it was purchased and you have not followed the procedure set above, your vehicle will no longer be eligible for warranty or service bulletin coverage of any kind, other than safety bulletins. Vehicles registered to government officials or military personnel on assignment outside of the country where the vehicle was purchased will continue to be covered by the Limited Warranty.

Please work with your dealer to resolve any warranty issues. Should your dealer require any additional assistance, they will contact the appropriate person at VICTORY MOTORCYCLES.

This warranty gives you specific legal rights, and you may also have other rights which vary from state to state or in different countries. If any of the above terms are void because of federal, state, local law, all other warranty terms will remain in effect.

WARRANTIES

MOTORCYCLE NOISE REGULATION

Tampering with noise control systems is prohibited. Federal law prohibits the following acts or causing thereof:

- The removal or rendering inoperative by any person other than for the purposes of maintenance, repair or replacement of any device or element of design incorporated into any new vehicle for the purpose of noise control prior to its sale or delivery to the ultimate purchaser or while it is in use, or
- The use of the vehicle after such device or element of design has been removed or rendered inoperative by any person.

Among those acts presumed to constitute tampering are:

- Removal or puncturing of the muffler, baffles, header pipes, or any other component which conducts exhaust gasses.
- Removal or puncturing of any part of the intake system.
- Lack of proper maintenance.
- Replacing any moving part of the vehicle, or parts of the exhaust system or intake system, with parts other than those specified by the manufacturer.

This product should be checked for repair or replacement if the motorcycle noise has increased significantly through use. Otherwise, the owner may become subject to penalties under state and local ordinances.

NOISE EMISSION WARRANTY

VICTORY MOTORCYCLES warrants that this exhaust system, at the time of sale, meets all applicable U.S. EPA Federal noise standards. This warranty extends to the first person who buys this exhaust system for purposes other than resale, and to all subsequent buyers.

Warranty claims should be directed to:

- An authorized VICTORY MOTORCYCLES dealer, or
- VICTORY MOTORCYCLES, 2100 Highway 55, Medina, MN 55340. Phone Number: 877-737-7172

EMISSIONS CONTROL SYSTEM WARRANTY

Victory Motorcycle Division, Polaris Industries Inc. - Emission Control System Warranty Statement

YOUR WARRANTY RIGHTS AND OBLIGATIONS

The California Air Resources Board and VICTORY MOTORCYCLES (hereinafter VICTORY) are pleased to explain the emission control system warranty on your 2014 or later VICTORY motorcycle. In California, new motor vehicles must be designed, built and equipped to meet the state's stringent anti-smog standards. VICTORY must warrant the emission control system on your motorcycle for the periods of time listed below provided there has been no abuse, neglect or improper maintenance of your motorcycle. Your emission control system may include parts such as the fuel-injection system, the ignition system, catalytic converter and engine computer. Also included may be hoses, belts, connectors and other emission-related assemblies. Where a warrantable condition exists, VICTORY will repair your motorcycle at no cost to you, including diagnosis, parts and labor.

MANUFACTURER'S WARRANTY COVERAGE

Class III motorcycles (280 cc and larger): for a period of use of five (5) years or 30,000 kilometers (18,641 miles), whichever first occurs. If an emission-related part on your motorcycle is defective, the part will be repaired or replaced by VICTORY. This is your emission control system DEFECTS WARRANTY.

OWNER'S WARRANTY RESPONSIBILITIES

As the motorcycle owner, you are responsible for the performance of the required maintenance listed in your Rider's manual.

VICTORY recommends that you retain all receipts covering maintenance on your motorcycle, but VICTORY cannot deny warranty solely for the lack of receipts or for your failure to ensure the performance of all scheduled maintenance. For warranty repairs, you are responsible for presenting your motorcycle to a VICTORY dealer as soon as a problem exists. The warranty repairs should be completed in a reasonable amount of time, not to exceed 30 days. As the motorcycle owner, you should be aware that VICTORY may deny your warranty coverage if your motorcycle or part has failed due to abuse, neglect, improper maintenance or unapproved modifications.

If you have any questions regarding your warranty rights and responsibilities, you should contact Victory Motorcycle Division, Polaris Industries Inc., 2100 Highway 55, Medina, Minnesota 55340 (Phone 877-737-7172) or the California Air Resources Board, P.O. Box 8001, 9528 Telstar Avenue, El Monte, CA 91731.

WARRANTIES

EMISSIONS CONTROL SYSTEM WARRANTY

VICTORY MOTORCYCLES - Limited Warranty on Emission Control System

VICTORY MOTORCYCLES (hereinafter VICTORY) warrants that each new 2014 and later VICTORY motorcycle that includes as standard equipment a headlight, taillight and stoplight, and is street legal:

- A. is designed, built and equipped so as to conform at the time of initial retail purchase with all applicable regulations of the United States Environmental Protection Agency, and the California Air Resources Board; and
- B. is free from defects in material and workmanship which cause such motorcycle to fail to conform with applicable regulations of the United States Environmental Protection Agency or the California Air Resources Board for a period of use, depending on the engine displacement, of 12,000 kilometers (7,456 miles) if the motorcycle's engine displacement is less than 170 cubic centimeters; of 18,000 kilometers (11,185 miles) if the motorcycle's engine displacement is equal or greater than 170 cubic centimeters but less than 280 cubic centimeters; or of 30,000 kilometers (18,641 miles) if the motorcycle's engine displacement is 280 cubic centimeters or greater; or 5 (five) years from the date of initial retail delivery, whichever occurs first.

EMISSIONS CONTROL SYSTEM WARRANTY

I. COVERAGE

Warranty defects shall be remedied during customary business hours at any authorized VICTORY dealer located within the United States of America in compliance with the Clean Air Act and applicable regulations of the United States Environmental Protection Agency and the California Air Resources Board. Any part or parts replaced under this warranty shall become the property of VICTORY.

In the State of California only, emission-related warranted parts are specifically defined by the state's Emission Warranty Parts List. These warranted parts are: carburetor and internal parts; intake manifold; fuel tank; fuel injection system; spark advance mechanism; crankcase breather; air cutoff valves; fuel tank cap for evaporative emission controlled vehicles; oil filler cap; pressure control valve; fuel/vapor separator; canister; igniters; breaker governors; ignition coils; ignition wires; ignition points; condensers, and spark plugs if failure occurs prior to the first scheduled replacement; and hoses, clamps, fittings and tubing used directly in these parts. Since emission-related parts may vary from model to model, certain models may not contain all of these parts and certain models may contain functionally equivalent parts.

In the State of California only, Emission Control System emergency repairs, as provided for in the California Administrative Code, may be performed by other than an authorized VICTORY dealer. An emergency situation occurs when an authorized VICTORY dealer is not reasonably available, a part is not available within 30 days or a repair is not complete within 30 days.

Any replacement part can be used in an emergency repair. VICTORY will reimburse the owner for expenses, including diagnosis, not to exceed VICTORY's suggested retail price for all warranted parts replaced and labor charges based on VICTORY's recommended time allowance for the warranty repair and the geographically appropriate hourly labor rate. The owner may be required to keep receipts and failed parts in order to receive compensation.

II. LIMITATIONS

This Emission Control System Warranty shall not cover any of the following:

- A. Repair or replacement required as a result of:
 - Accident
 - Misuse
 - Repairs improperly performed or replacements improperly installed
 - Use of replacement parts or accessories not conforming to VICTORY specifications which adversely affect performance and/or
 - Use in competitive racing or related events.
- B. Inspections, replacement of parts, and other services and adjustments necessary for required maintenance
- C. Any motorcycle on which the odometer mileage has been changed so that actual mileage cannot be readily determined.

WARRANTIES

III. LIMITED LIABILITY

A. The liability of VICTORY under this Emission Control System Warranty is limited solely to the remedying of defects in material or workmanship by an authorized VICTORY dealer at its place of business during customary business hours. This warranty does not cover inconvenience or loss of use of the motorcycle or transportation of the motorcycle to or from the VICTORY dealer. VICTORY SHALL NOT BE LIABLE FOR ANY OTHER EXPENSES, LOSS OR DAMAGE, WHETHER DIRECT, INCIDENTAL, CONSEQUENTIAL OR EXEMPLARY ARISING IN CONNECTION WITH THE SALE OR USE OF OR INABILITY TO USE THE VICTORY FOR ANY PURPOSE. SOME STATES DO NOT ALLOW THE EXCLUSION OR LIMITATION OF ANY INCIDENTAL OR CONSEQUENTIAL DAMAGES, SO THE ABOVE LIMITATIONS MAY NOT APPLY TO YOU.

B. NO EXPRESS EMISSION CONTROL SYSTEM WARRANTY IS GIVEN BY VICTORY EXCEPT AS SPECIFICALLY SET FORTH HEREIN. ANY EMISSION CONTROL SYSTEM WARRANTY IMPLIED BY LAW, INCLUDING ANY WARRANTY OF MERCHANTABILITY OR FITNESS FOR A PARTICULAR PURPOSE, IS LIMITED TO THE EXPRESS EMISSION CONTROL SYSTEM WARRANTY TERMS STATED IN THIS WARRANTY. THE FOREGOING STATEMENTS OF WARRANTY ARE EXCLUSIVE AND IN LIEU OF ALL OTHER REMEDIES. SOME STATES DO NOT ALLOW LIMITATIONS ON HOW LONG AN IMPLIED WARRANTY LASTS SO THE ABOVE LIMITATIONS MAY NOT APPLY TO YOU.

C. No dealer is authorized to modify this VICTORY Limited Emission Control System Warranty.

IV. LEGAL RIGHTS

THIS WARRANTY GIVES YOU SPECIFIC LEGAL RIGHTS, AND YOU MAY ALSO HAVE OTHER RIGHTS WHICH VARY FROM STATE TO STATE.

V. THIS WARRANTY IS IN ADDITION TO THE VICTORY LIMITED MOTOR-CYCLE WARRANTY

VI. ADDITIONAL INFORMATION

Any replacement part that is equivalent in performance and durability may be used in the performance of any maintenance or repairs. However, VICTORY is not liable for these parts. The owner is responsible for the performance of all required maintenance. Such maintenance may be performed at a service establishment or by any individual. The warranty period begins on the date the motorcycle is delivered to an ultimate purchaser.

VICTORY MOTORCYCLES
2100 Highway 55
Medina, MN 55340
ATTN: Warranty Department
877-737-7172

SPECIFICATIONS

SPECIFICATIONS

	VISION TOUR
Dimensions (Dimensions and specifications may vary with features, options and accessories)	
Overall Length	106.4 in. (270.2 cm)
Overall Width	44.8 in. (113.9 cm)
Overall Height	56.3 in. (143.1 cm)
Seat Height	26.5 in. (67.3 cm)
Wheel Base	65.7 in. (167 cm)
Ground Clearance	5.8 in. (14.7 cm)
Rake & Trail	29°/5.4 in. (137 mm)
Weight	
Dry Weight	851 lbs. (386 kg)
Wet Weight	900 lbs. (408 kg)
Maximum Load Capacity (riders, cargo, accessories, options)	514 lbs. (233 kg)
Gross Vehicle Weight Rating-GVWR(see page 20)	1414 lbs. (643 kg)
Gross Axle Weight Rating (GAWR)	Front Axle: 513 lbs. (233 kg)
	Rear Axle: 901 lbs. (409 kg)

SPECIFICATIONS

VISION TOUR	
Capacities	
Engine Oil	5 qts. (4.73 l) Approximately 4.5 qts. (4.25 l) at oil change
Fuel	6.0 gallons (22.7 l)
Fuel Reserve	1.0 gallon (3.8 l)
Engine	
Engine Type	VICTORY Freedom® 106 / 6 V-Twin
Configuration	50° V-Twin 4 Stroke SOHC
Displacement	106 Cubic Inch (1731 cc)
Cooling System	Air & Oil
Compression Ratio	9.4:1
Valve Train	4 Valves per cylinder. Hydraulic Lifters & Self-Adjusting Cam Chains
Bore & Stroke	101 x 108 mm
Throttle Body Bore	45 mm
Electronic Fuel Injection System	Closed Loop
Lubrication System	Wet Sump
Spark Plug / Gap	NGK DCPR6E / .031-.035 inch (0.8-0.9 mm)
Exhaust	Split dual exhaust with crossover
Chassis	
Front Suspension Type / Travel	Telescopic Fork / 5.1 in. (13 cm)
Front Fork Tube Diameter	46 mm
Rear Suspension Type / Travel	Single Monotube Air Adjustable Shock: 4.7 in. (12 cm)
Swingarm	Cast Aluminum with Rising Rate Linkage
Front Brakes	Dual Disc / Floating Rotor / 3 Piston Calipers
Rear Brakes	Disc / Floating Rotor / 2 Piston Caliper
Total Storage Volume	3370 Cubic In. (55,224 Cubic Centimeters)
Drive System	
Final Drive Type	Carbon Fiber Reinforced Belt
Transmission Type	6 Speed Constant Mesh with True Overdrive
Primary Drive Type (Reduction Ratio)	Gear Drive with Torque Compensator (1.48:1)
Gear Shift Pattern	1 Down 5 Up
Internal Gear Ratios	
1st	3.13:1
2nd	2.02:1
3rd	1.50:1
4th	1.20:1
5th	1:1
6th (Overdrive)	.87:1
Final Drive Ratio	2.12:1
Clutch Type	Wet, Multi Plate, Diaphragm Spring

	VISION TOUR
Wheels And Tires	
Front Wheel Type / Size	Cast 18 x 3.0 inch
Front Tire Type / Size	DUNLOP D418F Elite 3 - 130/70R18 63H Radial
Rear Wheel Type / Size	Cast 16 x 5.0 inch
Rear Tire Type / Size	DUNLOP D418F Elite 3 - 180/60R16 M/C 80H Radial
Electrical	
Alternator	48 Amp Maximum Output
Battery	12 Volt / 18 Amp Hour / 310 CCA / Yuasa YTX20HL
Lights	
Headlamp (High / Low)	High H4 LL 60W / Low H4 LL 55W
Driving Lamp (Standard)	HS1 35W
Driving Lamp (HID)	D1R 35W
Tail / Brake Lamp	3157 27/ 7W
Turn Signal Lamp	10W / Auto-Cancel System
License Plate Lamp	Non-Serviceable LED
Trunk Lamps (Running Lights)	W5W 5W
Courtesy Lamp (Trunk, if equipped)	6411 10W
Speedometer/Indicator Lamps	Non-Serviceable LED
Fuses / Circuit Breakers	
Left Fuse Box	
Ignition	10A Breaker
Headlight	20A Breaker
Gauges	5A
Radio	25A
Secondary Lights	20A
Horn	20A
Turn Signal / Brake	20A
Right Fuse Box	
Engine	15A Breaker
Windshield (Electric)	20A
Fuel Pump / Ignition Coil	15A
Anti-Lock Brake System	30A (2)

SPECIFICATIONS

FUEL RECOMMENDATION

For best performance, use only unleaded gasoline with a 91 pump octane minimum (R+M/2 Method).

DO NOT USE E-85 GASOLINE OR GASOLINE CONTAINING METHANOL. Using E85 or gasoline / methanol blends can result in poor starting and driveability, and may damage critical fuel system components.

Gasoline containing up to 10% Ethanol can be used.

In the event that the recommended premium unleaded gasoline is not available and low octane fuel must be used, fill the fuel tank only partially with unleaded regular gasoline, then fill the tank fully with premium unleaded gasoline as soon as possible.

ENGINE OIL RECOMMENDATION

Polaris recommends the use of only VICTORY Semi-Synthetic 20W-40 oil, Synthetic 15W-60 oil or an equivalent oil designed for use with wet clutches (such as those with a JASO MA rating).

FORK OIL

We recommend the use of VICTORY Fork Oil or an equivalent for your motorcycle.

BRAKE FLUID

We recommend the use of VICTORY DOT 4 Brake Fluid or an equivalent for both brake master cylinders.

SERVICE MANUAL AVAILABILITY

Some procedures are beyond the scope of this manual. See your dealer to purchase a *VICTORY Service Manual* for your motorcycle.

IDENTIFICATION NUMBER RECORD

Record important identification numbers below.

Vehicle Identification Number (VIN) (see page 21)	
Engine Identification Number (see page 23)	
Ignition Key Number (see page 23)	

AUDIO SYSTEM OVERVIEW

AUDIO SYSTEM INTRODUCTION

Not all motorcycles are equipped with all components discussed in the audio section of this manual. Components not installed at the factory can be purchased from and installed by your local VICTORY dealer.

SOFTWARE UPDATES

Radio system software should be updated annually to ensure the best performance. Please see your authorized VICTORY dealer for this service.

RADIO FREQUENCIES

North America	
AM	520 to 1720 kHz
FM	87.9 to 107.9 MHz
WX	162.40 to 162.55 MHz

European	
FM	87.5 to 108.00 MHz
MW	522 to 1602 kHz
LW	144 to 288 kHz

AUDIO SYSTEM OVERVIEW

MAIN USER INTERFACE

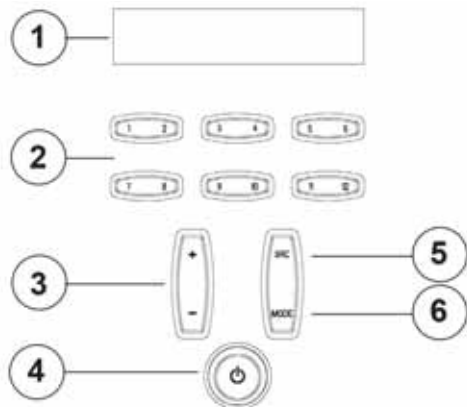

1. **LCD screen:** The LCD screen displays information for the active sources. **LCD screen:** The LCD screen displays information for the active sources.

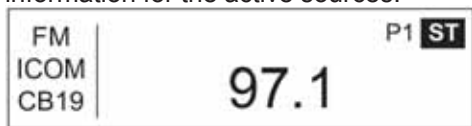

2. **Memory Presets:** Presets allow the operator to store and recall up to 12 radio stations or access up to 11 iPod user-defined playlists.



3. **Volume/Menu Option:** Adjust volume or cycle through menu options in the mode menus.



4. **Power ON/OFF:** Press the power button to turn the system on or off.

TIP: The ignition key must be in the ACC or ON position to use the audio system.



5. **Source (SRC):** Press SRC to cycle through available sources or to exit mode menus.



6. **Mode:** Press and release the MODE button to enter the audio system mode menus. Continue to press and release the MODE button until the desired mode menu displays.

TIP: Sources and menu options will be displayed only for installed components.

MAIN USER INTERFACE

U.S.A. SOURCES

- FM
- WX
- SiriusXM Radio
- AM
- AUX (NAV MP3, AUX or iPod)

EUROPEAN SOURCES

- FM
- LW
- MW
- AUX (NAV MP3, AUX or iPod)

MODE MENU OPTIONS

- Bass
- Treble
- Fader
- External Speakers
- Automatic Volume Control
- CB Headset ENT Mode
- ICOM Volume
- CB Volume
- CB Local/Distant
- Tuning Mode
- Radio Data System
- AUX Mode
- SiriusXM Display
- SiriusXM Category
- SiriusXM Tune Mode

TIP: Some mode menu options have sub-menus.

AUDIO CONTROLS

Operation of the left handlebar audio controls is outlined in greater detail on the following pages.

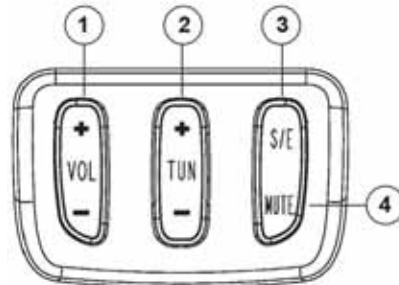

1. **Volume:** Press to increase (+) or decrease (-) audio volume. Press and hold to rapidly increase or decrease volume.
2. **Tuner:** Press (+) or (-) to change radio stations or iPod tracks. Press and hold to automatically seek or scan.
3. **Source/Exit (S/E):** Press S/E to cycle through available sources or to exit the current mode.
4. **Mute:** Press MUTE to silence audio and pause the iPod.

CITIZENS BAND (CB) RADIO CONTROLS

If equipped, the operator's CB radio controls are located on the left handlebar above the audio controls. Operation of these controls is outlined in greater detail on the following pages.

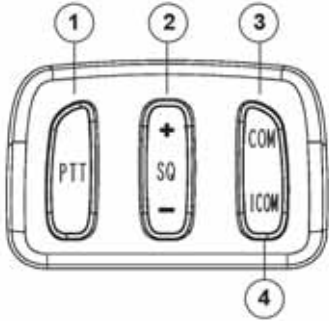

1. **Push-to-Talk (PTT):** Press and hold the top or bottom of the button to transmit. See page 160.
2. **Squelch:** Press SQ (+) or SQ (-) to adjust CB radio channel reception sensitivity. See page 161.
3. **COM:** Press COM to turn the CB radio on or off. Press and hold COM to select a COM channel.
4. **ICOM:** Press ICOM to turn the driver/passenger intercom on or off. Press and hold ICOM to access Voice-Activated Switch (VOX) settings. See page 162.

PASSENGER CB CONTROLS

1. **Push-to-Talk (PTT):** Press and hold the button to transmit.



2. **Rear Volume:** Press (+) or (-) on the passenger control to raise or lower volume.

AUDIO SYSTEM POWER

The ignition key must be in the ACC or ON position to use the audio system.

With the key in the ACC or ON position and audio system OFF, the screen will display "VICTORY".



TIP: To prevent battery drain, do not leave the key in the ACC position for long periods. VICTORY recommends using the audio system only when the engine is running.

Press the power button to turn the audio system on. The screen will display the active sources.

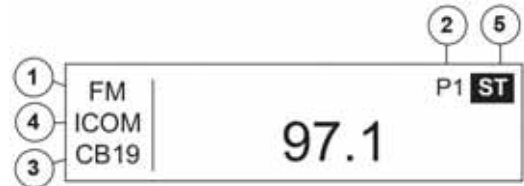

1. Current audio source:
 - (U.S.) FM / AM / WX / iPod - AUX / SiriusXM
 - (Euro) FM / MW / LW / iPod - AUX
2. Station preset number (P1-P12)
3. CB radio active channel (if equipped)
4. Intercom system active (if equipped)
5. Stereo indicator

TIP: The audio system will always display the last active source when turned on.

AUDIO SYSTEM OPERATION

AUDIO VOLUME CONTROL

The driver can adjust volume for the front and rear speakers, turn the speakers off or on and mute the system audio.

AUDIO MUTE

Press and release MUTE to drop audio system volume. To resume volume to the prior level, press and release MUTE again



AUDIO VOLUME

Press and release (+) or (-) on the console to raise or lower volume. You can also press VOL (+) or VOL (-) on left control.

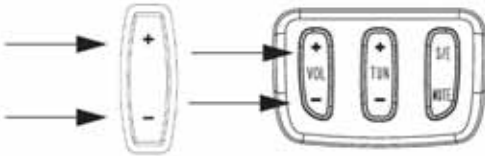

PASSENGER VOLUME CONTROL

The passenger can control the rear headset volume. Press (+) or (-) on the passenger control to adjust the volume.

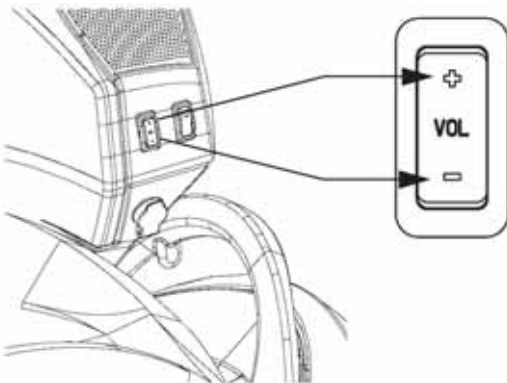

SELECTING AUDIO SOURCES

Press and release S/E or SRC until the desired source is active.

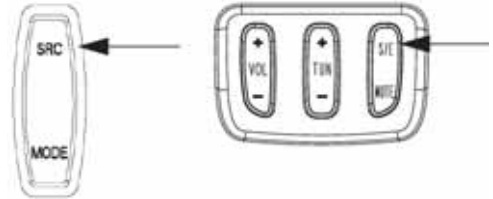

FM SOURCE ACTIVE: U.S. / European models



AM SOURCE ACTIVE: U.S. models only



WX (WEATHER) SOURCE ACTIVE: U.S. models only



AUDIO SYSTEM OPERATION

NAV MP3 SOURCE ACTIVE:

U.S. / European models



IPOD SOURCE ACTIVE:

U.S. / European models (skipped if not equipped)



AUX SOURCE ACTIVE:

U.S. / European models



SIRIUSXM RADIO SOURCE ACTIVE:

U.S. models only (skipped if not equipped)

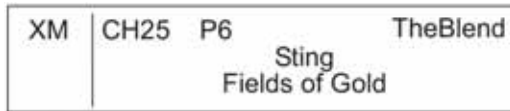

MW (MEDIUM WAVE) SOURCE:

European models only

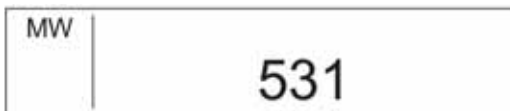

LW (LONG WAVE) SOURCE:

European models only



AUDIO TUNING

Use the tuner on the left control to select radio stations.

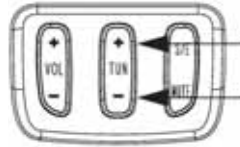

Press and *release* TUNE (+) or TUNE (-) to locate stations in single-step increments.

Press and *hold* TUNE (+) or TUNE (-) to seek or scan for stations depending on mode setting.

Press and release TUNE or S/E to exit the seek or scan function.

MEMORY PRESETS

The audio system features 12 user-defined presets for storing favorite stations.

To set a preset, select the desired source (FM, AM, WX, XM, MW or LW).

Use TUNE or seek/scan to locate a radio station.

Press and hold one of the console preset buttons (1-12) until the audio sound is muted for 1/2 second.



The preset location displays on the screen.

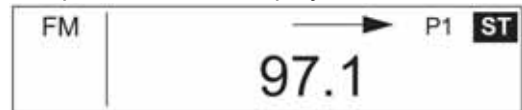

AUDIO MODE MENUS

ENTERING MODE MENUS

Press and release the MODE button on the console panel to enter the audio system mode menus. Continue to press and release the MODE button until the desired menu displays.

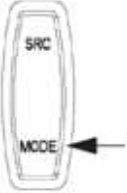

EXITING MODE MENUS

Press S/E on the left control to exit the screen and return to the main display. Pressing SRC on the control panel will also exit the screen.

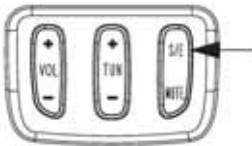

TIP: After 5 seconds of inactivity, the system will exit the menu and return to the default display.

To change mode settings, enter the mode menu. Press (+) or (-) on the console panel to change settings. Press S/E to save and exit.

BASS SETTING

Press (+) or (-) on the console panel to adjust the level.

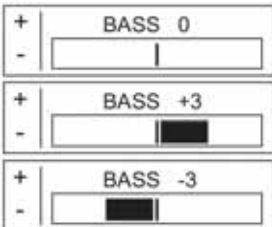

TREBLE SETTING

Press (+) or (-) on the console panel to adjust the level.

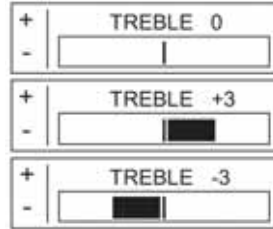

FADER SETTING

Press (+) or (-) on the console panel to change settings.

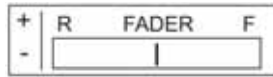

EXTERNAL SPEAKERS

Press (+) or (-) on the console panel to turn the speakers on or off.



AUTOMATIC VOLUME CONTROL (AVC)

When set, this feature will lower or raise the speaker/headset volume automatically, based on vehicle speed.

Off: Volume will not adjust

Low: Least aggressive setting

Medium: Moderate setting

High: Most aggressive setting

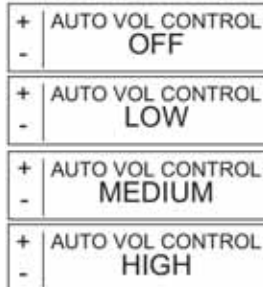

AUDIO SYSTEM OPERATION

CB HEADSET VOLUME CONTROLS (IF EQUIPPED)

The headsets have three separate volume settings: Intercom (ICOM) volume, CB receive volume and entertainment (ENT) volume. Always position headsets with the speakers directly over your ears to ensure the best sound quality and volume.

TIP: The driver can turn off the external speakers and listen to audio only through the headsets. See page 155.

ITEM	DRIVER CONTROLS	PASSENGER CONTROLS
ENT Volume	Press VOL (+) or VOL (-) on the left control or press the console panel (+/-) (while listening to ENT).	Press (+) or (-) on the passenger control.
ICOM Volume	Press VOL (+) or VOL (-) on the left control (when VOX is in use) or press the console panel (+/-) when the ICOM volume screen is active from the mode menu.	
CB Receive Volume	Press VOL (+) or VOL (-) on the left control (when receiving a CB transmission) or press the console panel (+/-) when the CB volume screen is active from the mode menu.	

CB HEADSET ENT MODE (IF EQUIPPED)

To change mode settings, enter the mode menu. Press (+) or (-) on the console panel to change settings. Press S/E to save and exit.

OFF: Only communications are audible in the headsets. Riders can listen to navigation commands and entertainment with the external speakers while reserving the headset for communication.

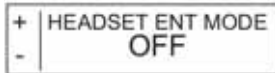

MIX: The audio source volume drops lower than the ICOM volume whenever the voice-operated switch (VOX) is opened. The audio source volume gradually returns to its original level after the VOX is closed.

MUTE: The audio source volume is muted when the VOX is opened. The audio source volume gradually returns to its original level after the VOX is closed.

AUDIO MODE MENUS

To change mode settings, enter the mode menu. Press (+) or (-) on the console panel to change settings. Press S/E to save and exit.

TIP: Sources and menu options will be displayed only for installed components.

ICOM VOLUME

Press (+) or (-) on the console panel to change settings.

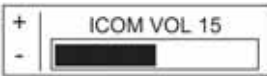

CB VOLUME

Press (+) or (-) on the console panel to change settings.

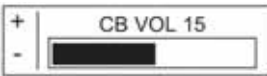

CB LO/DX MODE

Press (+) or (-) on the console panel to change settings. See page 161 for more detailed information.



TUNING (SEEK/SCAN MODES)

Press (+) or (-) on the console panel to set the tuner SEEK or SCAN mode.



RADIO DATA SYSTEM (RDS)

Press (+) or (-) on the console panel to turn the radio data system on, off or to FULL.

ON: Station name and song information displays.

FULL: Additional song information displays (if available in the radio signal).



AUX MODE

Press (+) or (-) on the console panel to set the mode to AUX (for iPod or any other MP3 player use) or to NAV MP3 for navigation unit MP3 player use.



TIP: NAV MP3 mode will override any device connected with an input cable in the left console storage bin.

TIP: If using NAV MP3 mode, always pause the GARMIN unit before changing sources. Otherwise, music from the NAV unit will interrupt the new source, interpreting it as navigation commands, not music.

SIRIUSXM DISPLAY

Press (+) or (-) on the console panel to set the screen to display channel name or category when the SiriusXM radio is active.



AUDIO SYSTEM OPERATION

AUDIO MODE MENUS

To change mode settings, enter the mode menu. Press (+) or (-) on the console panel to change settings. Press S/E to save and exit.

SIRIUSXM CATEGORY

Press (+) or (-) on the console panel to set the music selection category when tuning SiriusXM. These categories are downloaded from SiriusXM whenever the SiriusXM antenna is receiving a signal and may change from time to time.



TIP: Selecting a category will then limit the channels available to those within that category until ALL CHANNELS or another category is selected.

SIRIUSXM TUNE MODE

Press (+) or (-) on the console panel to change the mode. In SCAN mode, TUNE (+) or TUNE (-) will tune to the next higher or lower SiriusXM channel, remain there for up to 5 seconds, then automatically tune to the next higher or lower channel until TUNE (+) or TUNE (-) is pressed again.



WEATHER BAND (WX)

Weather band channels are broadcast by the National Oceanic and Atmospheric Administration (NOAA). NOAA operates more than 940 transmitters covering the United States, Puerto Rico, the U.S. Virgin Islands, the U.S. Pacific Territories and adjacent coastal waterways.

Press and release S/E or SRC until the desired source is active. When the WX source is selected, a total of 7 weather band channels are available.

Typically, only one weather band channel will be available for a given location. When traveling, if a channel becomes unavailable, search for another active channel.

Press P1-P7 on the console to access a channel, or use TUNE (+) or TUNE (-).



WX CHANNELS

WX CH.	FREQ.
1	162.400
2	162.425
3	162.450
4	162.475
5	162.500
6	162.525
7	162.550

CB RADIO / ICOM SYSTEM

CB/ICOM INTRODUCTION

In the U.S.A., refer to the Federal Communications Commission (FCC) Plain Rules pamphlet accompanying this rider's manual for a comprehensive guide of citizens band (CB) radio rules and regulations.

HEADSET USE

The use of helmet-mounted headsets may be restricted or prohibited in some areas. Always obey all applicable regulations and laws.

The headsets have three separate volume settings: Intercom (ICOM) volume, CB receive volume and entertainment (ENT) volume. See page 156.

GETTING STARTED

TIP: To minimize distractions while riding, always make adjustments to the CB/ICOM system prior to operating your motorcycle.

TIP: To prevent battery drain, do not leave the key in the ACC position for long periods. VICTORY recommends using the audio system only when the engine is running.

The ignition key must be in the ACC or ON position to use the audio system.

1. Press the power button to turn the audio system on.



2. Press COM on the left control to activate the CB/COM system.

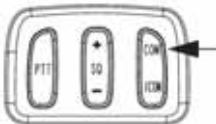

CB CHANNELS

When the CB radio system is active, "CB" and the active channel will display.



Press and hold COM on the upper left control to access the CHANNEL ADJUST screen.

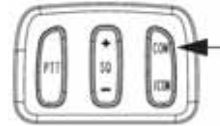

Push COM or ICOM on the left control or (+) or (-) on the console panel to change channels.



TIP: Changing to a new channel may require changing the squelch setting.

Press S/E on the left control to exit the screen and return to the main display.

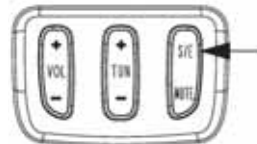

PUSH-TO-TALK (PTT)

Press and hold the top or bottom of the PTT button to transmit over CB radio. The passenger must push and hold the rear PTT button.

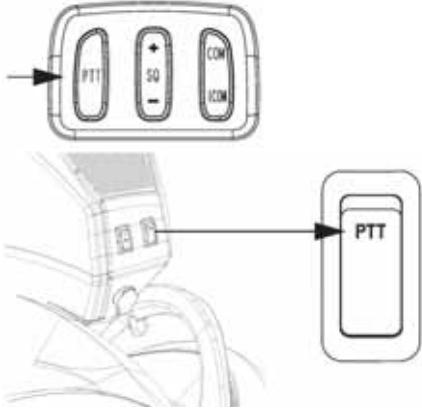

“TX” will display on the console screen when one of the PTT buttons is pressed. “RX” will display when the CB is receiving a transmission.



Transmitting



Receiving

PASSENGER CB RADIO VOLUME

The passenger can control rear headset volume when Entertainment, CB radio or ICOM is active.

TIP: Each volume setting is independently adjustable.

Press (+) or (-) on the passenger control to raise or lower volume.



SQUELCH

Squelch blocks undesired signals and noise by allowing the reception of signals only over a specified level.

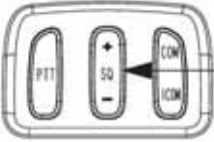

Press and release the SQ (+) or SQ (-) buttons to adjust the squelch to any level between OPEN and CLOSED.

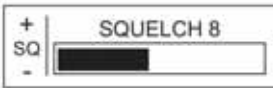

When squelch is set to OPEN, no filtering occurs. Setting squelch to CLOSED blocks all signals, including strong signals.

To set the squelch level, first lower the squelch level until noise or static is audible. Gradually increase the squelch level until the noise or static is gone.

Press S/E on the left control to exit the screen and return to the main display.

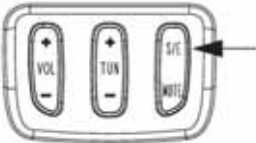

DRIVER CB RADIO VOLUME

To change settings, enter the mode menu. Press (+) or (-) on the console panel to adjust settings. Press S/E to save and exit.

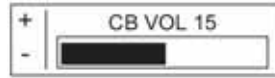

TIP: The CB volume can also be set using the hand control when the CB is receiving.

LOCAL/DISTANT CB RADIO MODE

To change mode settings, enter the mode menu. Press (+) or (-) on the console panel to set the CB to local (LO) or distant (DX) mode. Press S/E to save and exit.

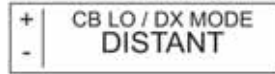

Distant: Use this setting for weaker signals. Receiver sensitivity will be increased. Static and noise levels are increased.

Local: Use this setting for stronger signals or in high density areas. Receiver sensitivity will be decreased. Static and noise levels are decreased.

CB RADIO FREQUENCIES

The FCC has designated 40 citizen band (CB) channels for consumer use. Channel 9 is designated as an EMERGENCY channel for emergency use only.

CB CHANNELS / FREQUENCIES

CH.	FREQ.	CH.	FREQ.	CH.	FREQ.	CH.	FREQ.	CH.	FREQ.	CH.	FREQ.
1	26.965	8	27.055	15	27.135	22	27.225	29	27.295	36	27.365
2	26.975	9	27.065	16	27.155	23	27.255	30	27.305	37	27.375
3	26.985	10	27.075	17	27.165	24	27.235	31	27.315	38	27.385
4	27.005	11	27.085	18	27.175	25	27.245	32	27.325	39	27.395
5	27.015	12	27.105	19	27.185	26	27.265	33	27.335	40	27.405
6	27.025	13	27.115	20	27.205	27	27.275	34	27.345		
7	27.035	14	27.125	21	27.125	28	27.285	35	27.355		

ICOM SYSTEM

Press and release ICOM on the left control to activate the intercom system.

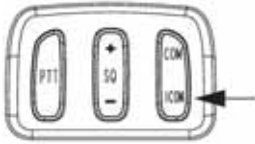

When the intercom system is active, ICOM will display on the console screen.

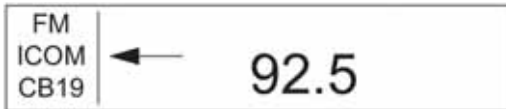

VOX BREAK SETTING

The intercom is opened and closed using a voice-operated switch (VOX). The volume sensitivity level required to open the intercom can be adjusted using the VOX sensitivity setting.

Press and hold ICOM on the upper left control to access the VOX sensitivity set screen.

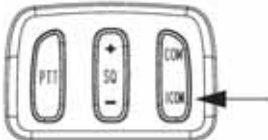

VOX BREAK SETTING

Push COM or ICOM or (+) or (-) on the console panel to adjust the sensitivity setting.

TIP: Lower settings require less volume to open the intercom. If wind or ambient vehicle noise trigger the VOX to open, set the VOX sensitivity to a higher level.

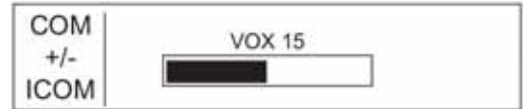

Press S/E on the left control to exit the screen and return to the main display.

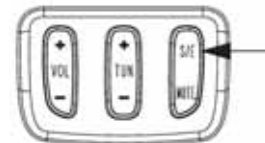

“VOX” will display on the console screen whenever the driver or passenger are communicating over the intercom system.



DRIVER ICOM VOLUME

To change settings, enter the mode menu. Press (+) or (-) on the console panel to adjust settings. Press S/E to save and exit.



TIP: Intercom volume can also be adjusted with the hand control when the VOX circuit is open.

PASSENGER ICOM VOLUME

The passenger can control rear speaker volume only when the CB radio, ICOM or rear headset speakers are active.

Press (+) or (-) on the passenger control to raise or lower volume.



HEADSET RECEPTACLES

The driver's headset receptacle ① is located on the console. The passenger's receptacle ② (if equipped) is located near the passenger's audio controls.

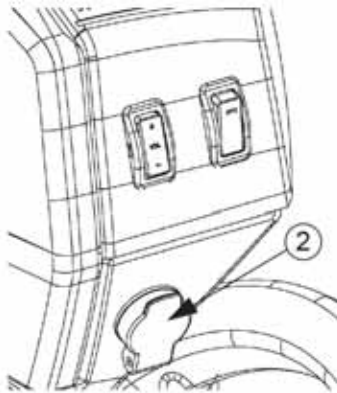
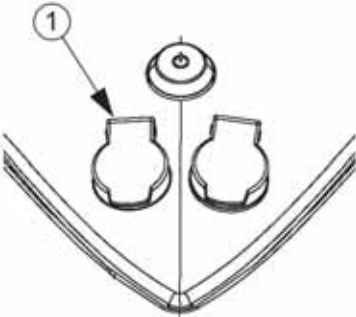

AUX - IPOD INPUT CABLE SETUP

The AUX ① and iPod ② input cables are connected to the audio system through a small hole in the left console storage bin. Only one input cable can be connected at any given time.

To use the iPod, connect the iPod input cable.

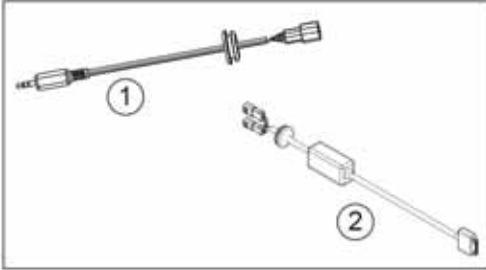

To change an input cable:

1. Open the left console storage bin.
2. Locate the input cable ③ and sealing grommet at the bottom of the bin.
3. Carefully pull the cable inside the bin.
4. Disconnect the cable from the harness by carefully pushing up on the green tab.
DO NOT ALLOW THE HARNESS TO DROP BACK THROUGH THE HOLE.
5. Install the desired input cable.
6. Carefully push the sealing grommet back into the hole.

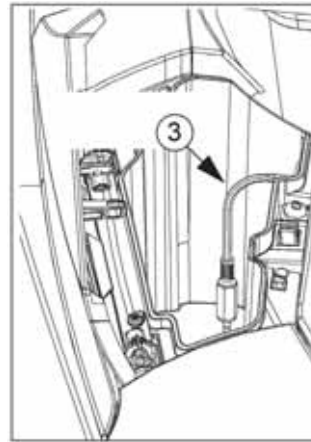

GETTING STARTED

The ignition key must be in the ACC or ON position to use the audio system.

TIP: To prevent battery drain, do not leave the key in the ACC position for long periods. VICTORY recommends using the audio system only when the engine is running.

Press the power button to turn the audio system on. Press and release the S/E button on the left control, or SRC on the console panel, until AUX or iPod is active.

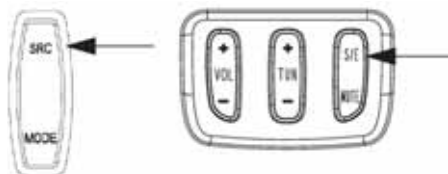

When AUX is active, the console screen will display "AUX" as the active source.



When iPod is active, the console screen will display "iPod" as the active source and iPod information in the display screen.

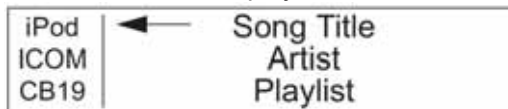

To change the mode, press the MODE button on the console repeatedly to toggle to the AUX mode.

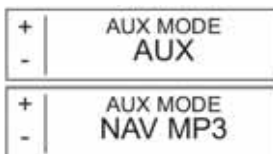

TIP: NAV MP3 mode will override any device connected with an input cable in the left console storage bin.

IPOD PLAYLISTS

Access the iPod's main music library and user-defined playlists with the console preset buttons.



TIP: Generic MP3 players can play music, but cannot be controlled through the audio system (for example, selecting tracks or playlists).

Press and release preset button 1 to access the iPod's main music library.

iPod	Artist
ICOM	Song Title
CB19	My iPod

Press and release preset buttons 2-12 to access the iPod's user-defined playlists.

iPod	Artist
ICOM	Song Title
CB19	My Playlist 3

IPOD TUNING

Press TUNE (+) or TUNE (-) once to move one track forward or backward. Press the button twice (double click) to bring up the track selection screen, then use the TUNE button to move forward and backward through the playlist.

When the desired track is highlighted, press any preset button on the console to select the track.

TIP: To exit the screen without changing tracks, press S/E.

+	TUNE	-	Track 1
			Track 2
			Track 3

TIP: Press and *hold* TUNE (+) or TUNE (-) to fast-forward or fast-reverse the track.

To browse tracks by artist, playlist or album, press and hold any preset button to bring up the selection screen. Press TUNE (+) or TUNE (-) to make a selection.

+	TUNE	-	Artist
			Playlist
			Album

Press and release any preset button to bring up the items in the selected list. Press TUNE (+) or TUNE (-) to make a selection. Press and release any preset button to start playing the track.

+	TUNE	-	90's Music
			My iPod
			On-The-Go

SIRIUSXM RADIO

ABOUT SIRIUSXM SATELLITE RADIO (FOR U.S.A. AND CANADIAN PRODUCTS)

SiriusXM Radio offers an extraordinary variety of commercial-free music, plus premier sports, news, talk radio, stand-up comedy, children's and entertainment programming over 160 digital radio channels. SiriusXM is broadcast via satellite in 100% superior digital audio from coast to coast. Refer to document (AD-1) for more details.

MORE ABOUT SIRIUSXM SATELLITE RADIO

For more information, program schedules, and to subscribe or extend subscription after complimentary trial period, visit our web site.

U.S.A. customers: www.siriusxm.com

Canadian customers: www.siriusxm.ca

LEGAL DISCLAIMERS

Subscription fee, other fees, taxes, and one time activation fee may apply. Subscription fee is consumer only. All fees and programming subject to change. Subscriptions subject to Customer Agreement available at www.siriusxm.com. Only available in the 48 contiguous United States and Canada*

*Canada - some deterioration of service may occur in extreme northern territories. This is beyond the control of SiriusXM Satellite Radio.

Explicit Language Notice - Channels with frequent explicit language are indicated with an "XL". Channel blocking is available for SiriusXM Satellite Radio receivers by visiting:

U.S.A. - www.siriusxm.com or calling US: 1-866-635-2349

Canada - www.siriusxm.ca or calling XM 1-877-438-9677 or Sirius 1-888-539-7474

A WARNING AGAINST REVERSE ENGINEERING

It is prohibited to copy, decompile, disassemble, reverse engineer, hack, manipulate or otherwise make available any technology incorporated in receivers compatible with the SiriusXM Satellite Radio System or that support the SiriusXM web site, the Online Service or any of its content. Furthermore, the AMBE® voice compression software included in this product is protected by intellectual property rights including patent rights, copyrights, and trade secrets of Digital Voice Systems, Inc. You also agree not to upload, post, transmit or otherwise make available any material that contains software viruses or any other computer code, files or programs designed to interrupt, disable or limit the functionality of the SiriusXM web site or the Online Service. Furthermore, the music, talk, news, entertainment, data and other content on the Services are protected by copyright and other intellectual property laws and all ownership rights remain with the respective content and data service providers. You are prohibited from any export of the data (or derivative thereof) except in compliance with applicable export laws, rules and regulations. The user of this or any other software contained in an SiriusXM Radio or the SiriusXM web site and all software used in connection with either is explicitly prohibited from attempting to copy, decompile, reverse engineer, or disassemble the object code, or in any other way convert the object code into human-readable form. The software is licensed solely for use within this product.

SIRIUSXM RADIO

GETTING STARTED

The ignition key must be in the ACC or ON position to use the audio system.

TIP: To prevent battery drain, do not leave the key in the ACC position for long periods. VICTORY recommends using the audio system only when the engine is running.

Press the power button to turn the audio system on.

Press and release the S/E button on the left control, or SRC on the console panel, until the SiriusXM radio is the active source.

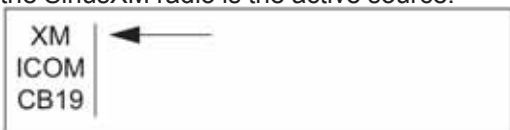

When the SiriusXM radio is active, the console screen will display radio channel, preset number (if applicable), channel name or category, artist, and song title.

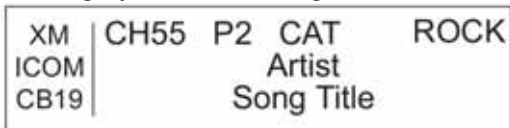

SIRIUSXM RADIO RECEPTION

If the SiriusXM radio system is not receiving a signal due to being indoors (or any overhead obstruction), "No Signl" appears on the display.



TIP: If the antenna is disconnected, "Antenna" will display.

SIRIUSXM RADIO MENU OPTIONS

The SiriusXM radio system has unique menus that apply only to this system when the SiriusXM radio is the active source. Some settings such as bass, treble, fader, etc. apply to both the audio system and the SiriusXM radio system.

Menus specific to the SiriusXM radio system are:

XM Display (Category or Channel Name)

XM Category (Rock, Country, Traffic, Sports, All Channels, Talk News, etc.)

XM Tune Mode (Seek/Scan)

TIP: XM Tune Mode is unique to the SiriusXM radio system.

SIRIUSXM RADIO SETTINGS

To access the menus, turn the audio system power on and change the active source to SiriusXM Radio.

Press the MODE button on the console repeatedly to toggle to the XM DISPLAY menu.



Press (+) or (-) on the console panel to select CATEGORY or CHANNEL NAME.

In the CATEGORY mode, the category of a selected station will display in the upper right corner of the screen.

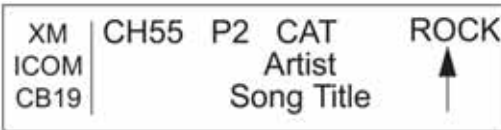

In the CHANNEL NAME mode, the name of the selected channel will display.



SIRIUSXM RADIO CATEGORIES

With SiriusXM as the active source, use the MODE button on the console to scroll to the XM Category menu.

Press TUNE (+) or TUNE (-) on the left control to change the category.



Press S/E to save and exit.

SIRIUSXM RADIO CHANNELS

Press TUNE (+) or TUNE (-) on the left control to change the channel.

The ALL CHANNELS category must be selected to scroll through every available channel in numerical order.

If a specific category (other than ALL CHANNELS) is selected, only channels within that category will be selected with the TUNE button.

TIP: If a preset button is used to tune a station that is not within the currently active category and the TUNE button is used to change the channel, it will tune stations within the previously selected category, not within the category of the preset station.

NAV MP3

NAVIGATION MP3 INTRODUCTION

Please read this manual and the GARMIN ZUMO 660 NAV MP3 information provided with your player to become familiar with all unit features and operation.

The audio integration kit must be installed to enable outputs from the NAV MP3 (such as navigation instructions or user-loaded MP3 media files) to play through the headsets or speakers. The unit is fully functional without the kit installed, but there will be no interface with the vehicle's audio system.

NAVIGATION MP3 OPERATION TIPS

- Signals coming from the NAV MP3 unit will override any source of the motorcycle's audio system to ensure navigation instructions are communicated when needed. The signals will also override the MP3 player.
- You must set volume levels within the NAV MP3 unit. Volume settings in the motorcycle's audio system control NAV MP3 volume, but navigation instructions may be difficult to hear if volume levels in the unit are set too low. See the GARMIN information for setting procedures. The recommended initial settings are 100/80/80: MASTER 100%, NAVIGATION 80%, MEDIA 80%.
- Pause or stop the MP3 player to switch to radio.
- To switch from radio to MP3 player, change the active source to AUX. For best sound quality, change the AUX mode setting on the radio from AUX to NAV MP3 when listening to the MP3 player. Audio works in the AUX setting, but the levels are not optimized.
- If playing MP3 files from the GARMIN ZUMO 660 unit, you may need to turn down the "media volume" on the GARMIN unit to avoid distortion.

CHANGING TO NAV MP3 MODE

The ignition key must be in the ACC or ON position to use the audio system.

Press the power button to turn the audio system on.

Press and release the S/E button on the left control, or SRC on the console panel, until AUX is the active source.

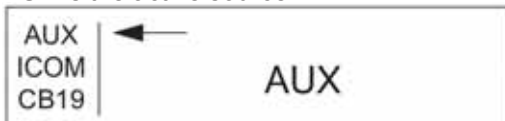

To change the mode, press the MODE button on the console repeatedly to toggle to the AUX mode.

Press (+) or (-) on the console panel to set the mode to AUX (for iPod or any other MP3 player use) or to NAV MP3 for navigation unit MP3 player use.

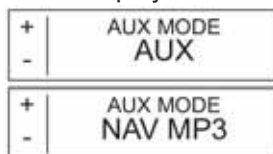

A

Accelerating	68
Accessories, Use	15
Air Filter	82
Anti-Lock Brake System	42–43
Anti-Lock Brake System Inspection	106
Audio Controls	151
Audio Mode Menus	157
Audio Mute	153
Audio Sources, Selecting	153
Audio System	48, 149
Audio System Power	152
Audio Tuning	154
Audio Volume	153
Audio Volume Control	153
Audio, Main User Interface	150
Automatic Volume Control	155

B

Bass Setting	155
Battery	110
Battery Care	133
Battery Charging	113
Battery Installation	112
Battery Removal	111
Brake Connections	105
Brake Disc Inspection	105
Brake Fluid	148
Brake Fluid Precautions	102
Brake Hoses	105
Brake Light Bulb Replacement	119
Brake Lines	56
Brake Pads	57
Braking	68
Break-In Maintenance	78

C

Carrying a Passenger	14
Carrying Cargo	16
CB Channels	162
CB Frequencies	162
CB Headset ENT Mode	156
CB Headset Volume	156
CB LO/DX Mode	157
CB Radio	159
CB Radio Frequencies	162
Citizens Band Radio Controls	152
Cleaning	105
Cleaning and Storage	132
Clear Coat Finish Care	129
Clock	34

Clutch Lever	40
Console	26
Crankcase Breather Hose	95
Cruise Control	69
Cruise Control Cable Inspection	98
Cruise Control Tips	69
Cruise Control, Cancel	71

D

Display Units	33
Drive Belt	61
Drive Belt Alignment	88
Drive Belt Cleaning	88
Drive Belt Condition	83
Drive Belt Tension Adjustment	87
Drive Belt Tension Inspection	84
Drive Belt Wear Analysis	83
Driver ICOM Volume	163
Driving Lamp Switch	35

E

Electrical Precautions	122
Electromagnetic Interference	19
Elevating the Motorcycle	123
Emergency Flashers	35
Engine Break-In	63
Engine Compression Test	109
Engine Error Codes	32
Engine Filter Change	80
Engine Identification Number	23
Engine Oil Change	80
Engine Oil Level	53
Engine Oil Recommendation	148
Engine Protection	133
Engine Run Switch	41
Engine Starter Switch	41
Engine Stop Switch	41
Evaporative Emission Control System	94
Exhaust System Inspection	109
Exiting Mode Menus	155
Exported Vehicles	139
External Speakers	155

F

Fader Setting	155
Fast Idle	95
Fastener Inspection	114
Fastener Torque	123
Fasteners	62

INDEX

Finish Care	128
Front Brake Fluid	104
Front Brake Fluid Level	55
Front Brake Lever	43, 55, 101
Front Fork Inspection	93
Front Suspension	61
Front Turn Signal Bulb Replacement	118
Fuel and Exhaust Safety	18
Fuel Door Lock	28
Fuel Gauge	29
Fuel Level	54
Fuel Recommendation	148
Fuel Stabilizer	132
Fuel System Components	95
Fueling	64
Fuse Boxes	121
Fuse Replacement	121

G

Gear Position	34
Gear Shift Pedal	44
Getting Started	166
Gloss Clear Coat	129
Glove Compartment	47
Gross Vehicle Weight Rating	20

H

Hand Grip Heater Switch	35
Hazard Switch	35
Headlamp Aim Adjustment	120
Headlamp Bulb Replacement	118
Headlamp Switch	37
Headset Receptacles	163
Headset Use	159
Horn Switch	37
Hydraulic Clutch	59
Hydraulic Clutch Fluid	98–99
Hydraulic Clutch Lever Lubrication	98

I

ICOM System	159, 162
Identification Number Record	148
Ignition Key	27
Ignition Key Number	23
Ignition Lock	27
Ignition Switch	27, 114
Indicator Lamps	30
Information Labels	21
Input Cable Setup	165
Instrument Cluster	29

iPod Playlists	167
iPod Tuning	167

L

Leather Care	131
Limited Warranty	135
Linked Braking System	42
Lock Lubrication	114

M

Maintenance	77
Maintenance During Storage	133
Maintenance Log	175
Major Maintenance	78
Manufacturer's Warranty Coverage	141
Mechanical Clutch	60
Mechanical Clutch Cable Lubrication	100
Mechanical Clutch Lever Freeplay	99
Mechanical Clutch Lever Lubrication	100
Memory Presets	154
Mirrors	36
Mode Button	36
Modifications	15
Multi-Function Display	32

N

NAV MP3 Mode	173
Navigation MP3	173
Notice	139

O

Odometer	34
Owner's Warranty Responsibilities	141

P

Park and Cover the Motorcycle	133
Parking	72
Parking on a Slope	72
Parking on a Soft Surface	72
Parking the Motorcycle	15
Part Identification	24
Passenger CB Controls	152
Passenger ICOM Volume	163
Passenger Volume Control	153
Pedal Adjustment	45
Periodic Maintenance	78

Periodic Maintenance Table	79	Squelch	161
Polished Aluminum Care	130	Starter Interlock Switch	40
Polishing Chrome	130	Starting the Engine	65
Polishing Paint	130	Steering	61
Polishing Paint and Chrome	130	Steering Head Inspection	94
Pre-Ride Inspections	51–52	Stopping the Engine	72
Priming the Fuel System	64	Storage Area Preparation	132
Protective Apparel	14	Storage, Removal From	134
Push-to-Talk	160	Storage, Rodents	133
R		Street Trim Panel Installation	116
Radio Data System	157	Street Trim Panel Removal	116
Radio Frequencies	149	Suede Paint	128
Radio System	48	Suspension Inspection	93
Rear Axle Inspection	92	Swing Arm	92
Rear Brake Fluid	103	T	
Rear Brake Fluid Level	56	Tachometer	29
Rear Brake Pedal	43, 55, 101	Taillight Bulb Replacement	119
Rear Suspension	61	Temperature Display	34
Rear Suspension Adjustment	89, 91	Throttle	58
Rear Wheel Alignment	88	Throttle Cable Freeplay	97
Recommended Shift Points	67	Throttle Cable Inspection	58
Reporting Safety Defects	20	Throttle Cable Lubrication	97
Reverse Operation	74	Throttle Control Grip	42
Road Test	123	Throttle Control Inspection	96
Road Tests	78	Throttle Freeplay	58
Rubber Care	131	Tilt Sensor	36
Running Light Bulb Replacement	118	Tire Condition	54, 107
S		Tire Inflation	132
Saddlebag Locks	48	Tire Pressure	54, 107
Saddlebag Safety	16	Tire Tread Depth	54, 107
Safe Riding Practices	11	Tires	107
Safety During Service Procedures	77	Tone Ring Inspection	106
Safety Labels	21	Tone Sensor Inspection	106
Safety Maintenance	19	Tool Kit	49
Safety Symbols	10	Transporting the Motorcycle	17
Seat Heater Switches	36	Treble Setting	155
Seat Installation	115	Troubleshooting	124
Seat Removal	115	Trunk Door Locks	48
Service Manual Availability	148	Trunk Installation	117
Shifting Gears	66	Trunk Removal	117
Sidestand	47, 62	Trunk Safety	16
Sidestand Lubrication	114	Turn Signal Bulb Replacement	119
Signal Words	10	Turn Signal Switch	39
SiriusXM Category	158	V	
SiriusXM Radio	169	VICTORY Cleaning Products	127
SiriusXM Tune Mode	158	Vinyl Care	131
Spark Plugs	108	Volt Meter	29
Specifications	145	VOX Break Setting	162
Speedometer	29		

W

Washing the Motorcycle 127
Weather Band 158
Wheel Inspection 105
Windshield Adjustment 46
Windshield Adjustment Switch 38
Windshield Care 128
Windshield Trim Panel Removal 115
WX Channels 158



To locate your nearest dealer,
call 1-877-737-7172
or visit www.victorymotorcycles.com

Victory Motorcycles
2100 Highway 55
Medina, MN 55340

Part No. 9927117 Rev 01
Printed in USA

