



INSTALLATION GUIDE

XR150FC/XR550FC Series

DIGITAL MONITORING PRODUCTS, INC.

© 2021

MODEL XR150FC/XR550FC SERIES PANEL INSTALLATION GUIDE

FCC NOTICE

This equipment generates and uses radio frequency energy and, if not installed and used properly in strict accordance with the manufacturer's instructions, may cause interference with radio and television reception. It has been type tested and found to comply with the limits for a Class A computing device in accordance with the specification in Subpart J of Part 15 of FCC Rules, which are designed to provide reasonable protection against such interference in a residential installation. If this equipment does cause interference to radio or television reception, which can be determined by turning the equipment off and on, the installer is encouraged to try to correct the interference by one or more of the following measures:

Reorient the receiving antenna

Relocate the computer with respect to the receiver

Move the computer away from the receiver

Plug the computer into a different outlet so that computer and receiver are on different branch circuits

If necessary, the installer should consult the dealer or an experienced radio/television technician for additional suggestions. The installer may find the following booklet, prepared by the Federal Communications Commission, helpful:

"How to identify and Resolve Radio-TV Interference Problems."

This booklet is available from the U. S. Government Printing Office, Washington D. C. 20402

Stock No. 004-000-00345-4

© 2021 Digital Monitoring Products, Inc.

Information furnished by DMP is believed to be accurate and reliable.

This information is subject to change without notice.

TABLE OF CONTENTS

About the Panel	1
Zone Expansion	1
Output Expansion	1
Compliance Instructions	1
Specifications Summary	2
Power Supply	2
Communication	2
Panel Zones	2
Keypad Bus	2
LX-Bus	2
Outputs	2
System Components	3
Lightning Protection	3
Network Surge Protection	3
Install the panel	4
Mount the Enclosure	4
Fire Command Center LCD Keypad	5
Mounting Additional Keypads, Zone Expanders, and Modules	5
Wire the panel	6
Wiring Specifications	6
Wire the Transformer	6
Wire the Batteries	7
Power Requirements	8
Standby Battery Selection	10
LX-Bus Expansion	11
Wireless Bus Expansion	11
Ethernet Connection	11
Phone Line RJ Connector	11
RESET and TAMPER Headers	12
Bell Output	13
Keypad Bus	13
Smoke and Glassbreak Detector Output	13
Protection zones	14
Powered Zones for 2-Wire Smoke Detectors	15
Dry Contact Relay Outputs	15
Annunciator Outputs	16

Ordering Information 17
Accessories..... 17

FCC Information 21
Part 15 21
Part 68..... 21

ABOUT THE PANEL

The DMP XR150FC/XR550FC Series system consists of an alarm panel with a built-in communicator, an enclosure with built-in Fire Command Center keypad, and a 16 VAC 56 VA transformer. Each panel is a versatile 12 VDC, combined access control, burglary, and fire communicator panel. A complete system can provide:

- 142 or 574 programmable inputs and outputs for commercial and industrial fire alarm service
- Eight onboard grounded burglary zones
- Two onboard 12 VDC Class B powered zones

The powered zones have a reset capability to provide for 2-wire smoke detectors, relays, or other latching devices. Connect a 12 or 24 VDC regulated, power limited power supply listed for Fire Protective Signaling Systems to distribute notification appliance power between Model 865, 866 or 867 NAC outputs. Addressable smoke detectors and input modules round out the XR150FC/XR550FC Series panel to deliver a truly flexible and expansive fire detection and notification system. The Fire Alarm Control Panel is shipped pre-wired in a red steel enclosure.

Zone Expansion

Up to 574 additional zones are available on the XR150FC/XR550FC Series panel using DMP LCD keypad remote zone capability and zone expansion modules. The panel keypad data bus supports up to fifteen supervised device addresses with each address supporting up to four programmable expansion zones.

Up to 500 zones are available using the on board LX-Bus connections, along with any combination of single, four, eight, or sixteen-zone expansion modules and single-zone LX-Bus detectors.

Output Expansion

In addition to the two SPDT relays and four programmable open collector outputs on the panel, you can also connect up to 25 programmable Model 716 Output Expansion Modules to each LX-Bus. These modules can provide an additional 100 or 500 programmable SPDT relays.

The panel provides 100 Output Schedules you can use for programming the 716 to perform a variety of annunciation and control functions. You can also assign the 716 outputs to any panel Output Options such as Fire Alarm, Communication Fail, or Phone Trouble Outputs. For more information, refer to the 716 Installation Guide (LT-0183).

The LX-Bus also supports the Model 717 Graphic Annunciator Module. Each 717 module supplies 20 switched ground outputs that follow the state of their assigned zones. The 717 supports the first eight Keypad Bus addresses. To use Keypad Bus addresses 9-16, install multiple 716 modules. Refer to the 717 Installation Guide (LT-0235) and 716 Installation Guide (LT-0183).

Compliance Instructions

For applications that must conform to a local authorities installation standard or a National Recognized Testing Laboratory certification standard, refer to the Compliance Listing Guide (LT-1330).

SPECIFICATIONS SUMMARY

For a full list of compatible panel accessories, refer to "Ordering Information".

Power Supply

Transformer Input—Primary input: 120 VAC 60 Hz; Primary Output: 16 VAC 56 VA

Standby Battery—12 VDC, 1.0 Amps Max. charging current

Smoke and Auxiliary—12 VDC output at 0.5 Amp Max

Bell Output—12 VDC at 0.7 Amp Max

The combined Auxiliary and Bell outputs total cannot exceed 1.2 Amps with a 56 VA transformer. All circuits are power limited except the red battery wire and AC terminal.

Communication

- Built-in network communication to SCS-1R and SCS-VR Receivers
- Built-in dialer communication to SCS-1R Receivers
- Optional cellular communication to SCS-1R and SCS-VR Receivers
- Built-in Contact ID communication to SCS-1R Receivers
- Optional 893A Dual Phone Line Module with phone line supervision
- Can operate as a local panel

Panel Zones

Eight 1k or 2.2k Ohm EOL burglary zones (1-8) and two 3.3k Ohm EOL powered zones with reset (9-10). To select either 1k or 2.2k for zones 1 to 8, program the EOL value in **REMOTE OPTIONS**.

Keypad Bus

You can connect the following supervised keypads and expansion modules to the Keypad Bus:

- Alphanumeric keypads
- Sixteen, eight, four, and single-zone expansion modules
- Single zone detectors
- Access control modules

LX-Bus

You can connect the following devices to the LX-Bus connections provided on the panel. See Accessory Devices for information about specific connections.

- Graphic annunciator modules
- Sixteen, eight, four, and single-zone expansion modules
- Relay output expansion modules
- Smoke Detectors

Outputs

The XR150FC/XR550FC Series panel provides two Single Pole, Double Throw (SPDT) relay outputs which require the installation of two Model 305 relays, each rated 1 Amp at 30 VDC resistive (power limited sources only). A Model 431 Output Harness is required to use these outputs.

The panel also provides four open collector outputs rated for 50 mA each. The open collector outputs provide ground connection for a positive voltage source. A Model 300 Output Harness is required to use these outputs.

SYSTEM COMPONENTS

Figure 1 shows some of the accessory modules you can connect for use in various applications. A brief description of each module follows in the Accessory Devices section.

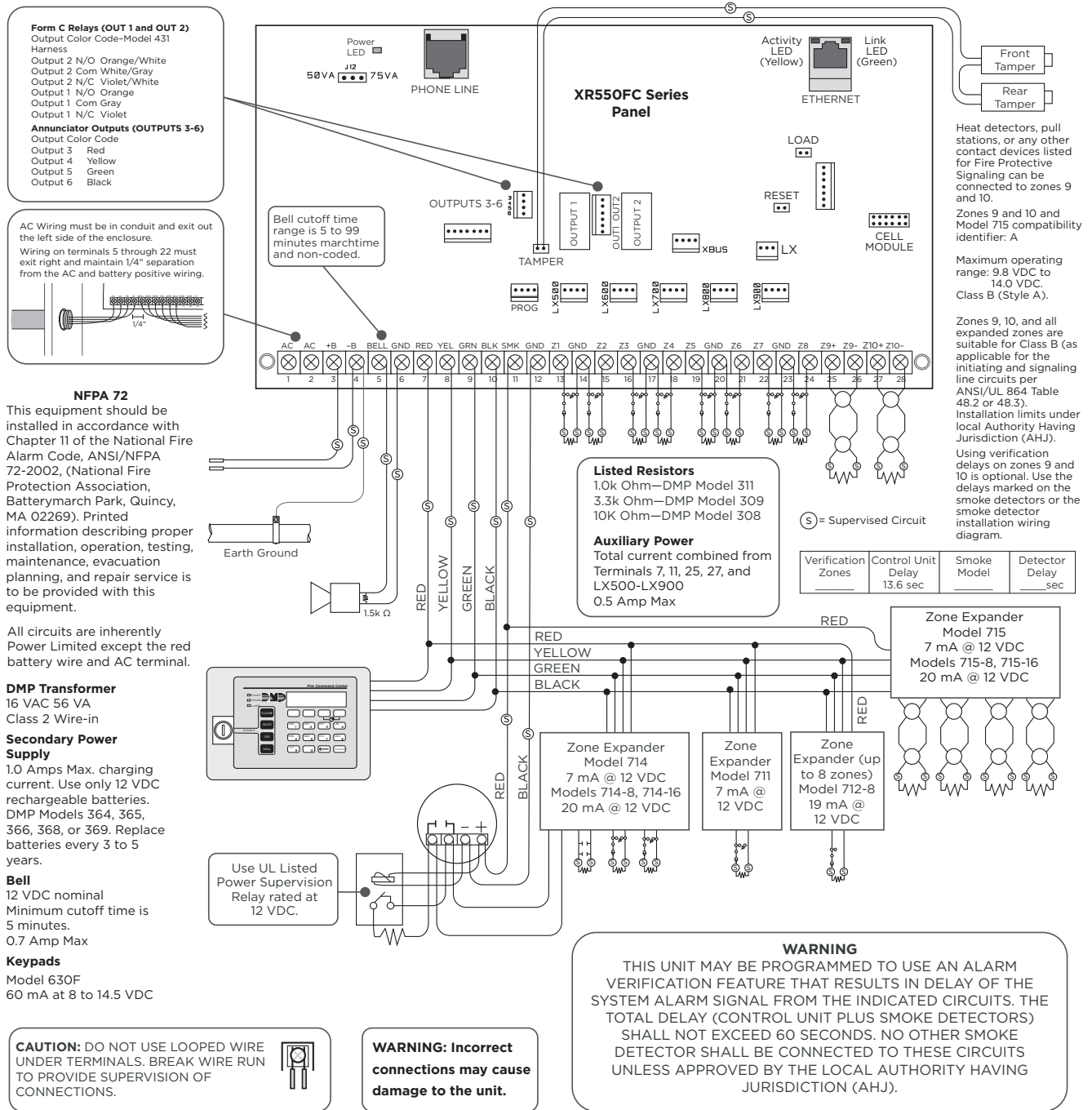

Figure 1: XR150FC/XR550FC Series Wiring Diagram

Lightning Protection

Metal Oxide Varistors and Transient Voltage Suppressors help protect against voltage surges on panel input and output circuits. Additional surge protection is available with Model 370 or 370RJ Lightning Suppressors. For more information, refer to the 370/370RJ Installation Sheet (LT-0181).

Network Surge Protection

The Model 270 Network Transient Suppression Module protects the panel from surges on the Ethernet port. For more information, refer to the Model 270 Installation Guide (LT-1316).

INSTALL THE PANEL

Mount the Enclosure

The XR150FC/XR550FC Series panel enclosure must be mounted using the four mounting holes shown in Figure 2. Mount the enclosure in a secure, dry place to protect the panel from damage from tampering or the elements. It is not necessary to remove the panel PCB when installing the enclosure.

The enclosure dimensions are 13.44" H X 17.1" W X 4.8" D.

 **Note:** When using the XR150FC/XR550FC Series panel for listed applications, use the Model 350, 349, 341, or 352S enclosure for standby batteries.

- A** Panel
- B** Transformer
- C** Enclosure Mounting Holes
- D** Dual 1-3/4" and 1-3/8" Knockouts
- E** Module Mounting Holes
- F** Battery Shelf

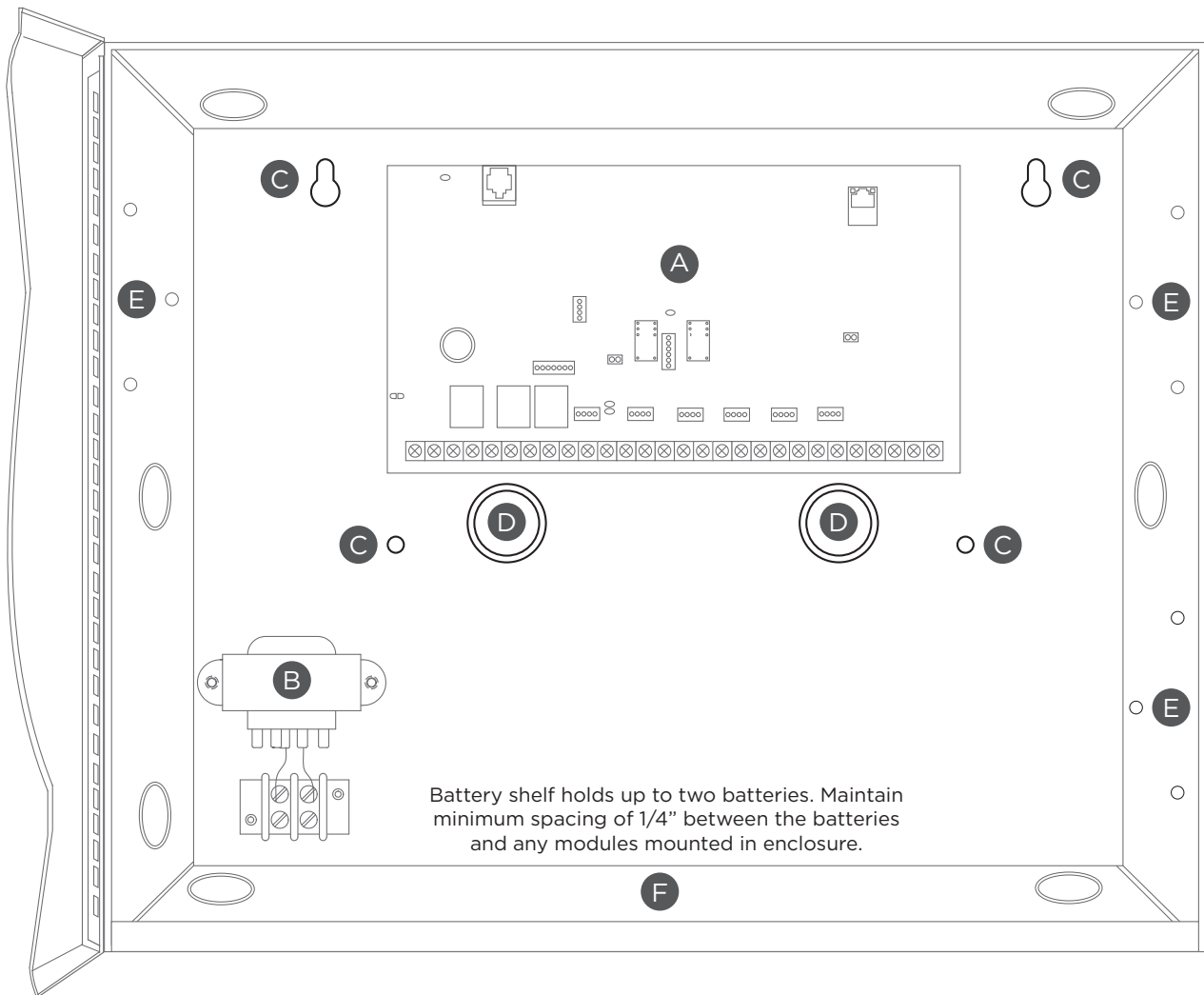

Figure 2: XR150FC/XR550FC Enclosure

Fire Command Center LCD Keypad

A Fire Command Center LCD Keyboard is factory installed on the panel enclosure door. The installed, pre-wired keyswitch is located to the left of the keyboard. The user can turn the keyswitch to enable the four function keys without opening the enclosure door. The display and keyboard are factory pre-wired to the PROG header. For standby battery calculations, the LCD display draws 92 mA of current in normal, standby, or alarm condition. For more information, refer to "Power Requirements".

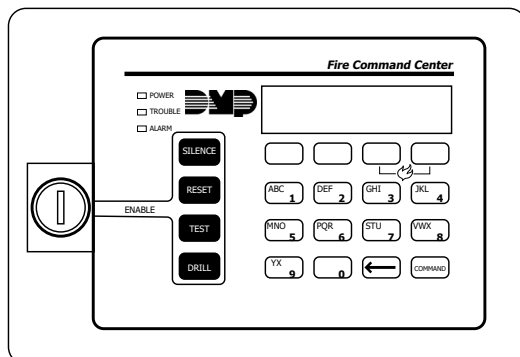

Figure 3: Fire Command Center LCD and Keypad

Mounting Additional Keypads, Zone Expanders, and Modules

DMP keypads have removable covers that allow you to easily mount the keypad to a wall or other flat surface using the screw holes on each corner of the base. Before mounting the base, connect the keypad wire harness leads to the panel and to any applicable devices. Then, attach the harness to the pin connector to the PCB, mount the base, and install the keypad cover making sure all of the keys extend through their respective holes.

For mounting additional keypads on solid walls, or for applications where conduit is required, use the Model 695 1-1/2" deep backbox or the Model 696 1/2" deep backbox.

The DMP 711, 712-8, 714, 715, 716, and 717 zone expanders are each contained in molded plastic housings with removable covers. The base provides you with mounting holes for installing the unit to a wall, switch plate, or other surface.

Mount any additional modules in the panel enclosure using the standard 3-hole mounting pattern. Refer to the appropriate product guides for installation instructions.

WIRE THE PANEL

Wiring Specifications

DMP recommends using 18 or 22 AWG for all LX-Bus and Keypad Bus connections. The maximum wire distance between any module and the DMP Keypad Bus or LX-Bus circuit is 1,000 feet. To increase the wiring distance, install an auxiliary power supply, such as a DMP Model 505-12. Maximum voltage drop between a panel or auxiliary power supply and any device is 2.0 VDC. If the voltage at any device is less than the required level, add an auxiliary power supply at the end of the circuit.

To maintain auxiliary power integrity when using 22-gauge wire on Keypad Bus circuits, do not exceed 500 feet. When using 18-gauge wire, do not exceed 1,000 feet. Maximum distance for any bus circuit is 2,500 feet regardless of wire gauge. Each 2,500 foot bus circuit supports a maximum of 40 LX-Bus devices. To increase the wire length or to add devices, install an additional power supply that is listed for Fire Protective Signaling, power limited, and regulated (12 VDC nominal) with battery backup.

For additional information refer to the LX-Bus/Keypad Bus Wiring Application Note (LT-2031) and the 710 Bus Splitter/ Repeater Module Installation Guide (LT-0310).

Wire the Transformer

The XR150FC/XR550FC Series panel comes with a 16 VAC 56 VA transformer. The 16 VAC transformer must be wired to a dedicated, unswitched 120 VAC 60 Hz circuit with at least 0.87 Amps available.

⚡ Caution: Never share the Fire Alarm Control Panel circuit with any other equipment. Always ground the panel before applying power to any devices and use 18 AWG or larger for all power connections.

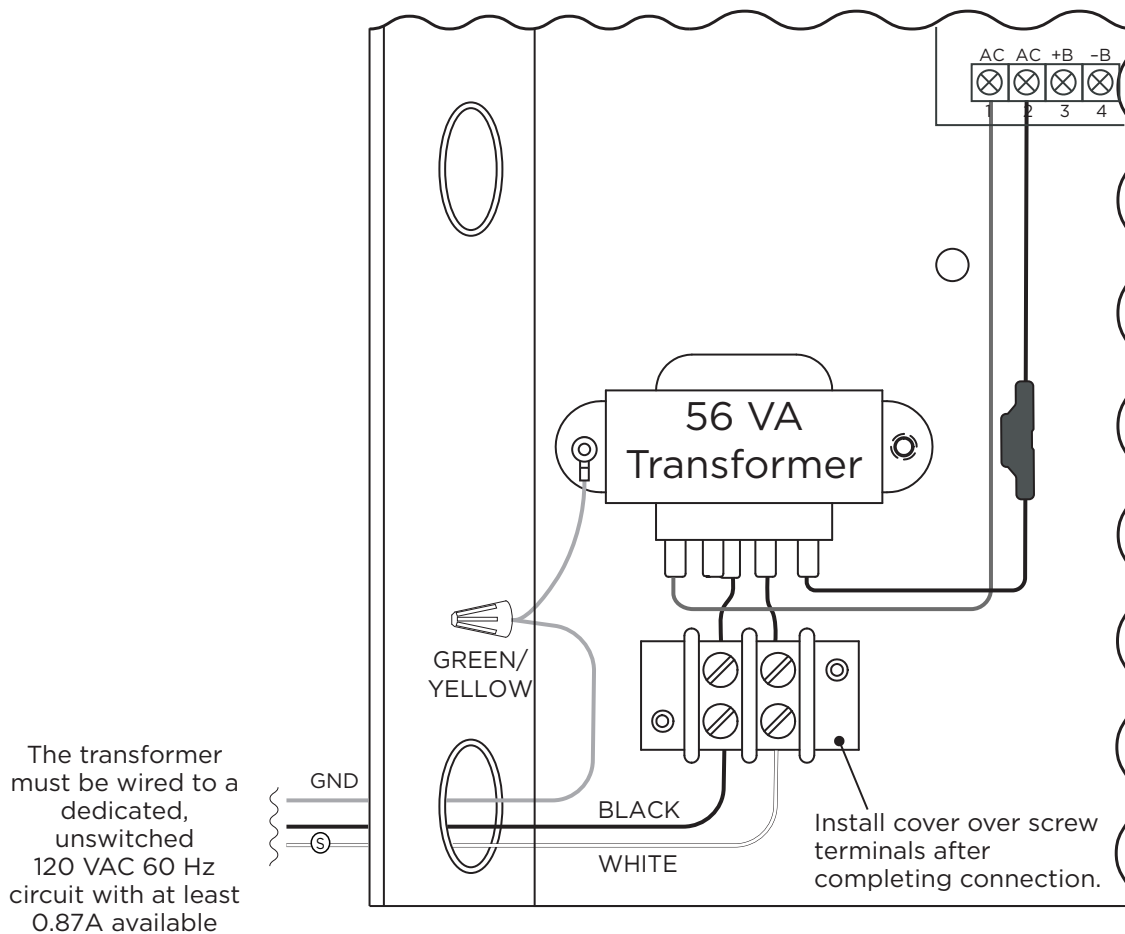

Figure 4: Transformer Wiring

Wire the Batteries

DMP recommends replacing batteries every 3 to 5 years under normal use. Connect the black battery lead to the negative battery terminal. The negative terminal connects to the enclosure ground internally through the panel PCB. Connect the red battery lead to the battery positive terminal. You can add a second battery in parallel using the DMP Model 318 Dual Battery Harness. Refer to Figure 5 for wiring information.

Note: DMP requires that wiring in a battery harness is separated by a PTC to protect batteries from a reversal or short within the circuit.

For listed installations, batteries can be installed in a DMP Model 341, 349, 350 or 352S enclosure and all wiring shall run through conduit. The enclosure shall be installed to the left of the panel enclosure to ensure Battery and AC wire separation.

Caution: Use sealed lead-acid batteries only. Batteries supplied by DMP have been tested to ensure proper charging with DMP products. Do not use gel cell batteries.

Earth Ground (GND)

To provide proper transient suppression, panel Terminal 4 (battery negative) must be connected to an earth ground using wire 14-gauge or larger.

DMP recommends connecting to a cold water pipe, ground rod, or building ground only. Do not connect to an electrical ground or conduit, sprinkler or gas pipes, or to a telephone company ground.

Battery Only Restart

When powering up the XR150FC/XR550FC Series panel without AC power, briefly short the battery start pads to pull in the battery cutoff relay. Once the relay has been pulled in, the battery voltage holds it in that condition.

If the panel is powered up with an AC transformer, the battery cutoff relay is pulled in automatically. For more information refer to Figure 1.

Discharge/Recharge

The XR150FC/XR550FC Series panel battery charging circuit float charges at 13.9 VDC at a maximum current of 1.0 Amps using a 56 VA transformer. Battery voltage level conditions are determined by the following voltage ranges:

- **Battery Trouble**—Below 11.9 VDC
- **Battery Cutoff**—Below 10.2 VDC
- **Battery Restored**—Above 12.6 VDC

Battery Supervision

The panel tests the battery when AC power is present. The test is done every three minutes and lasts for five seconds. During the test, the panel places a load on the battery. If the battery voltage falls below 11.9 VDC a low battery is detected. If AC power is not present, a low battery is detected any time the battery voltage falls below 11.9 VDC. When battery voltage drops below 10.2 VDC, the panel performs a battery cutoff to prevent deep discharge damage.

If a low battery is detected with AC power present, the test repeats every two minutes until the battery charges above 12.6 VDC. If a weak battery is replaced with a fully charged battery, the restored battery will not be detected until the next test is completed.

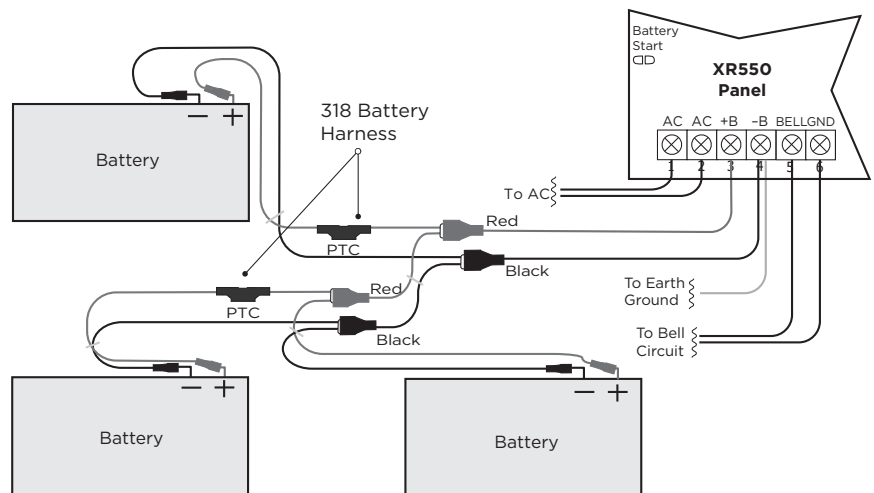

Figure 5: Wiring Multiple Batteries

Power Requirements

During AC power failure, the panel and all connected auxiliary devices draw their power from the battery. All devices must be taken into consideration when calculating the battery standby capacity. Use Table 1 to determine your system's total required amp-hours, then proceed to Standby Battery Selection.

Standby Battery Power Calculations	Standby Current	Alarm Current
2W-BLX, 2WT-BLX Smoke Detectors	Qty___ x 11 mA = _____mA	Qty___ x 31 mA ¹ = _____mA
263LTE Cellular Communicator	Qty___ x 20 mA = _____mA	Qty___ x 20 mA = _____mA
277 Buzzer Module	Qty___ x 5 mA = _____mA	Qty___ x 5 mA = _____mA
630F Remote Fire Command Center	Qty___ x 63 mA = _____mA	Qty___ x 92 mA = _____mA
710 Bus Splitter/Repeater Module	Qty___ x 32 mA = _____mA	Qty___ x 32 mA = _____mA
711 Zone Expansion Module	Qty___ x 11 mA = _____mA	Qty___ x 11 mA = _____mA
Active Zone (EOL Installed)	Qty___ x 1.6 mA = _____mA	Qty___ x 2 mA ¹ = _____mA
711S Zone Expansion Module	Qty___ x 4.2 mA = _____mA	Qty___ x 4.7 mA = _____mA
712-8 Zone Expansion Module	Qty___ x 17 mA = _____mA	Qty___ x 17 mA = _____mA
Active Zones (EOL Installed)	Qty___ x 1.6 mA = _____mA	Qty___ x 2 mA ¹ = _____mA
714 Zone Expansion Module	Qty___ x 7 mA = _____mA	Qty___ x 7 mA = _____mA
Active Zones (EOL Installed)	Qty___ x 1.6 mA = _____mA	Qty___ x 2 mA ¹ = _____mA
714-8, 714-16 Zone Expansion Module	Qty___ x 20 mA = _____mA	Qty___ x 20 mA = _____mA
Active Zones (EOL Installed)	Qty___ x 1.6 mA = _____mA	Qty___ x 2 mA ¹ = _____mA
715 Zone Expansion Module	Qty___ x 7 mA = _____mA	Qty___ x 7 mA = _____mA
Active Zones (EOL Installed)	Qty___ x 4 mA = _____mA	Qty___ x 30 mA ¹ = _____mA
2-Wire Smokes	Qty___ x 0.1 mA = _____mA	Qty___ x 0.1 mA = _____mA
715-8, 715-16 Zone Expansion Modules	Qty___ x 20 mA = _____mA	Qty___ x 20 mA = _____mA
Active Zones (EOL Installed)	Qty___ x 4 mA = _____mA	Qty___ x 30 mA ¹ = _____mA
2-Wire Smokes	Qty___ x 0.1 mA = _____mA	Qty___ x 0.1 mA = _____mA
716 Output Expansion Module	Qty___ x 13 mA = _____mA	Qty___ x 13 mA = _____mA
Active Form C Relays		Qty___ x 12 mA = _____mA
717 Graphic Annunciator Module	Qty___ x 10 mA = _____mA	Qty___ x 10 mA = _____mA
Annunciator Outputs		Qty___ x 1 mA = _____mA
734 Wiegand Interface Module	Qty___ x 240 mA = _____mA	Qty___ x 260 mA = _____mA
Active Zones (EOL Installed)	Qty___ x 1.6 mA = _____mA	Qty___ x 2 mA ¹ = _____mA
Annunciator (ON)		Qty___ x 20 mA = _____mA
Proximity Reader	Qty___ x 200 mA = _____mA	Qty___ x 200 mA = _____mA
736P POPIT Interface Module	Qty___ x 25 mA = _____mA	Qty___ x 25 mA = _____mA
736V V-Plex Module	Qty___ x 45 mA = _____mA	Qty___ x 45 mA = _____mA
Active Zones	= _____mA	= _____mA
738A Ademco Wireless Interface Module	Qty___ x 75 mA = _____mA	Qty___ x 75 mA = _____mA
738T Wireless Translator	Qty___ x 50 mA = _____mA	Qty___ x 50 mA = _____mA
738Zplus Z-Wave Interface Module	Qty___ x 40 mA = _____mA	Qty___ x 40 mA = _____mA
763 Wi-Fi Module	Qty___ x 31 mA = _____mA	Qty___ x 31 mA = _____mA
860 Relay Output Module, one relay active	Qty___ x 34 mA = _____mA	Qty___ x 34 mA = _____mA
All four relays active	138 mA = _____mA	138 mA = _____mA
865 Style Y or Z Notification Module	Qty___ x 26 mA = _____mA	Qty___ x 85 mA = _____mA
Subtotal currents	Subtotal standby = _____mA	Subtotal alarm = _____mA

¹ Based on 10% of active zones in alarm.

² For systems that are not central station monitored, multiply alarm current by 12.

Table 1: Standby Battery Power Calculations

Standby Battery Power Calculations	Standby Current	Alarm Current
866 Style W Notification Module	Qty___ x 45 mA = ___mA	Qty___ x 76 mA = ___mA
867 LX-Bus Style W Notification Module	Qty___ x 30 mA = ___mA	Qty___ x 86 mA = ___mA
869 Dual Style D Initiating Module	Qty___ x 25 mA = ___mA	Qty___ x 75 mA = ___mA
893A Dual Phone Line Module	Qty___ x 12 mA = ___mA	Qty___ x 50 mA = ___mA
1100X Wireless Receiver	Qty___ x 46 mA = ___mA	Qty___ x 46 mA = ___mA
1100XH Wireless High Power Receiver	Qty___ x 160 mA = ___mA	Qty___ x 160 mA = ___mA
7060/7160 Thinline/7060A Aqualite Keypad	Qty___ x 72 mA = ___mA	Qty___ x 80 mA = ___mA
7063/7163 Thinline/7063A Aqualite Keypad	Qty___ x 85 mA = ___mA	Qty___ x 100 mA = ___mA
7070/7170 Thinline/7070A Aqualite Keypad	Qty___ x 72 mA = ___mA	Qty___ x 87 mA = ___mA
Active Zones (EOL Installed)	Qty___ x 1.6 mA = ___mA	Qty___ x 2 mA ¹ = ___mA
7073/7173 Thinline/7073A Aqualite Keypad	Qty___ x 85 mA = ___mA	Qty___ x 100 mA = ___mA
Active Zones (EOL Installed)	Qty___ x 1.6 mA = ___mA	Qty___ x 2 mA ¹ = ___mA
7872 Graphic Touchscreen Keypad	Qty___ x 145 mA = ___mA	Qty___ x 215 mA = ___mA
Active Zones (EOL Installed)	Qty___ x 1.6 mA = ___mA	Qty___ x 2 mA ¹ = ___mA
7873 Graphic Touchscreen Keypad	Qty___ x 143 mA = ___mA	Qty___ x 243 mA = ___mA
Active Zones (EOL Installed)	Qty___ x 1.6 mA = ___mA	Qty___ x 2 mA ¹ = ___mA
XR150FC/XR550FC Series Control Panel	Qty <u>1</u> x 174 mA = <u>174</u> mA	Qty <u>1</u> x 217 mA = <u>217</u> mA
Relay Outputs 1-2 (ON)	Qty___ x 30 mA = ___mA	Qty___ x 30 mA = ___mA
Switch Grounds 3-6 (ON)	Qty___ x 5 mA = ___mA	Qty___ x 5 mA = ___mA
Active Zones 1-8	Qty___ x 1.6 mA = ___mA	Qty___ x 2 mA ¹ = ___mA
Active Zones 9-10	Qty___ x 4 mA = ___mA	Qty___ x 30 mA = ___mA
2-Wire Smoke Detectors	Qty___ x 0.1 mA = ___mA	Qty___ x 0.1 mA = ___mA
Panel Bell Output (max 1500 mA)		= ___mA
Aux. power devices on Terminals 7 and 11 except keypads and LX-Bus modules	= ___mA	= ___mA
Subtotal currents this page	Subtotal standby = ___mA	Subtotal alarm = ___mA
Subtotal currents previous page	Subtotal standby + ___mA	Subtotal alarm + ___mA
Total currents	Total standby current = mA	Total alarm current = mA
Total required standby current	_____ hours Required standby hours x _____ mA Total standby current = mAh Total required standby current	
Total required alarm current	_____ minutes Required Minimum alarm time ÷ <u>60</u> minutes Convert to hours = _____ hours Total required alarm time x _____ mA Total alarm current = mAh Total required alarm current	
Calculate total required amp-hours		
_____mAh Total required standby current		
+ _____mAh Total required alarm current		
= _____mAh Total required milliamp-hours		
+ _____mAh Percentage of total required mAh (optional)		
= _____mAh Total required milliamp-hours (optional)		
÷ <u>1000</u> h Convert mAh to Ah		
= Ah Total required amp-hours (round up to whole number)		

¹ Based on 10% of active zones in alarm.

² For systems that are not central station monitored, multiply alarm current by 12.

Table 1: Standby Battery Power Calculations

Standby Battery Selection

After performing the calculations in Power Requirements, complete the following steps to select standby batteries:

 **Note:** If the Power Requirements calculation is greater than any Max. Ah Available shown on a table, add power supplies to reduce the required amp hours. See the 710 Bus Splitter/Repeater Installation Guide (LT-0310) for more information.

1. Select the desired standby hours required from the following table: 24, 60, or 72 hours.
2. Select the desired battery size, then select a Max. Ah Available that slightly exceeds the number of total required Ah calculated in Power Requirements.
3. Install the number of batteries shown in the corresponding No. of Batteries column.

Example: If total required amp hours equals 22 Ah for 24 hours of standby time and you want to use 5.0 Ah batteries, install six Model 368 (12 VDC, 5.0 Ah) batteries.

For listed installations, batteries can be installed in a DMP Model 341, 349, 350 or 352S enclosure and all wiring shall run through conduit. The enclosure shall be installed to the left of the XR150FC/XR550FC Series panel enclosure to ensure Battery and AC wire separation. For a list of compatible batteries, refer to "Batteries and Battery Accessories".

24 hours standby power, 48 hours recharge time

5.0 Ah Batteries		7 Ah Batteries		7.7 Ah Batteries		9 Ah Batteries		18 Ah Batteries	
Max. Ah Available	No. of Batteries	Max. Ah Available	No. of Batteries	Max. Ah Available	No. of Batteries	Max. Ah Available	No. of Batteries	Max. Ah Available	No. of Batteries
8	2	6	1	6	1	8	1	16	1
12	3	12	2	13	2	16	2	32	2
16	4	18	3	20	3	24	3	48	3
20	5	24	4	27	4	32	4		
24	6	31	5	34	5	40	5		
28	7	37	6	41	6				
32	8	43	7						
36	9								
40	10								

60 hours standby power, 48 hours recharge time

7 Ah Batteries		7.7 Ah Batteries		9 Ah Batteries		18 Ah Batteries	
Max. Ah Available	No. of Batteries	Max. Ah Available	No. of Batteries	Max. Ah Available	No. of Batteries	Max. Ah Available	No. of Batteries
13	2	14	2	17	2	17	1
20	3	22	3	26	3	34	2
27	4	29	4	34	4	52	3
33	5	37	5	43	5	69	4
40	6	44	6	52	6		
47	7	52	7	61	7		
54	8	59	8	69	8		
60	9	67	9				
67	10						

72 hours standby power, 72 hours recharge time

9 Ah Batteries		18 Ah Batteries	
Max. Ah Available	No. of Batteries	Max. Ah Available	No. of Batteries
16	2	16	1
25	3	33	2
33	4	50	3
42	5	67	4
50	6		
59	7		
67	8		

Table 1: Standby Battery Specifications

LX-Bus Expansion

There are five LX-Bus headers near the bottom of the panel:

- LX500 provides zones 500-599 (XR150FC/XR550FC)
- LX600 provides zones 600-699 (XR550FC only)
- LX700 provides zones 700-799 (XR550FC only)
- LX800 provides zones 800-899 (XR550FC only)
- LX900 provides zones 900-999 (XR550FC only)

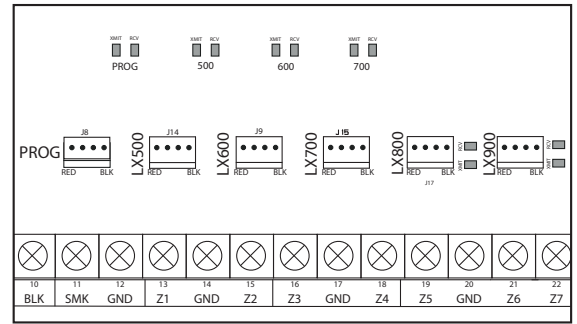

Figure 6: LX-Bus Headers and LEDs

Wireless Bus Expansion

The Wireless Bus (XBUS) header provides connection for the 1100X or 1100XH Wireless Receiver. The XBUS provides up to 500 wireless zones numbered 500-999. Refer to the 1100X Wireless Receiver Install Guide (LT-0708) or the 1100XH Wireless Receiver Install Guide (LT-0970) for complete information.

- XR150FC provides up to 100 zones.
- XR550FC provides up to 500 zones.

Wireless Bus LEDs

The two LEDs, located above the XBUS header, indicate data transmission and receipt. The left LED flashes green to indicate the panel is transmitting data. The right LED flashes yellow to indicate the panel is receiving data.

Ethernet Connection

Description

The ETHERNET connector on the XR150FC/XR550FC Series panel allows you to connect directly to an Ethernet network using a standard Cat 5 cable. The ETHERNET connector supports 100 Mbps full duplex operation and the maximum impedance is 100 Ohms.

Ethernet LEDs

The two LEDs located on the top edge of the connector indicate network connection. The right Link LED (green) lights to indicate a valid receive connection from the host network. The Activity LED (yellow) lights when connected to a 100 Mbps network and is off when connected to a 10 Mbps network connection.

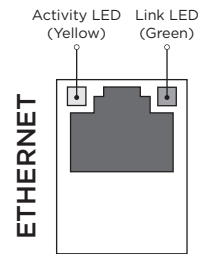

Figure 7: Ethernet Connector and LEDs

Network Transient Suppression

For listed fire applications, use a Model 270 Network Transient Suppression Module to provide transient surge protection for the ETHERNET connector.

Phone Line RJ Connector

Connect the panel to the public telephone network by installing a DMP 356 RJ Cable between the panel PHONE LINE connector and the RJ31X or RJ38X phone block. The maximum impedance is 100 Ohms.

Caution: To reduce the risk of fire, only use 26 AWG or higher telecommunication line cord, such as a DMP Model 356 Series Phone Cord.

893A OR 277 Connector

Allows connection of an 893A Dual Phone Line Module or a 277 Trouble Sounder to the 893A OR 277 connector on the panel. Refer to the 893A Installation Sheet (LT-0135) or the 277 Installation Sheet (LT-1304) for complete information.

Notification

The user must not repair registered terminal equipment. In case of trouble, immediately unplug the device from the telephone jack. Registered terminal equipment may not be used on a shared or public line. Provide the telephone company the following information:

- The particular lines where the service is connected
- The FCC registration number as listed
- The ringer equivalence
- The device make, model, and serial number

Phone Line Monitor

The XR150FC/XR550FC Series panel has a built-in telephone monitor that monitors the phone line voltage to verify the connection to the central station. Figure 8 and Table 2 identify the phone block pin layout, wire numbers, and colors.

The wires on the RJ31 that feed pins 4 and 5 should be the only wires on the DMARC. All other house phone wiring should be tied to pins 1 and 8 coming back from the RJ31.

Dial tone must come in to RJ31X on pins 4 and 5 and go back to house phones from pins 1 and 8. Follow these steps to determine if the panel is seizing the line:

1. Unplug phone cord from RJ31X
2. Place a butt-set on pins 4 and 5
3. Confirm the presence of a dial tone, then lift the wire from either pins 1 or 8.
4. If a dial tone is still present, the RJ31X wiring is correct. If no dial tone is present, the RJ31X wiring is backwards. Rewire the phone block so the dial tone is coming in on pins 4 and 5, then retest the connection.

If you still have trouble with the phone line after rewiring the phone block, you may need to replace the RJ cord. If the dial tone is still not present after replacing the phone cord, replace the RJ31X phone block.

RESET and TAMPER Headers

RESET Header

The RESET header is used to reset the panel. To reset the panel when installing the system, place the jumper across both RESET pins before applying power to the panel. After connecting the AC and battery, remove the reset jumper.

To reset the panel while the system is operational, install the reset jumper without powering down the system. Remove the reset jumper after one or two seconds.

After resetting the panel, begin programming within 30 minutes. Otherwise, you must reset the panel again to enter the PROG menu.

TAMPER Header

The TAMPER header is designed to connect to a tamper switch with a tamper harness. One or more tamper switches can be mounted inside the panel enclosure to supervise unauthorized removal or opening of an enclosure. Refer to the wiring diagram on the enclosure door for correct tamper switch wiring.

If the enclosure is opened or removed while one or more of the system areas are armed, the system goes into alarm. If all areas are disarmed, a tamper trouble is indicated by the panel.

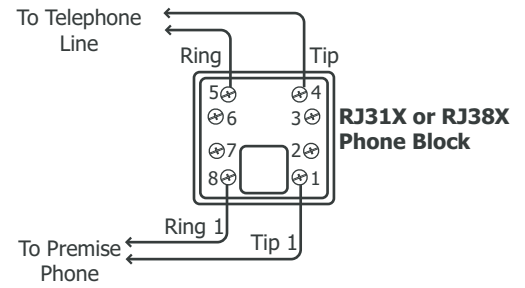

Figure 8: Phone Jack Wiring

Wire Number	Wire Color
1	Gray
2	Orange
3	Black
4	Red
5	Green
6	Yellow
7	Blue
8	Brown

Table 2: Phone Jack Wiring

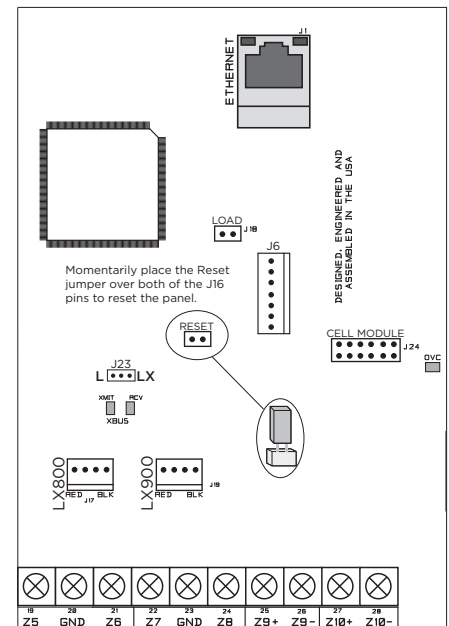

Figure 9: XR550FC Series Panel Showing the RESET Jumper

Bell Output

Terminals 5 and 6

Supplies positive 12 VDC to power alarm bells or horns. This output can be steady, pulsed, or temporal, depending on the Bell Action specified in Bell Options. Terminal 6 is the ground reference for the bell circuit. This supervised output reads resistance of 1k Ohms or less as normal. The indicating appliance can supply this resistance. If using a horn or siren, install the included 1k Ohm 0.5 W resistor across the bell circuit to provide supervision. See the Notification Appliance section in the Compliance Listing Guide (LT-1330) for wiring diagrams and a list of approved notification appliances.

Keypad Bus

Description

The panel Keypad Bus includes Terminals 7, 8, 9, and 10. You can connect up to fifteen supervised keypads and multiple unsupervised keypads to the panel. In addition to DMP keypads, you can also connect any combination of zone expansion modules. Refer to the specific device installation sheet for the maximum number of Keypad Bus devices. Refer to the LX-Bus section for more information about LX-Bus expansion.

Terminal 7 - RED

Supplies positive and regulated 12 VDC to power DMP LCD keypads and zone expansion modules. Terminal 7 also supplies power for any auxiliary device. The ground reference for Terminal 7 is Terminal 10.

The output current is shared with the smoke power output on Terminal 11 and zones 9 and 10. Current draw for all connected devices must not exceed the panel maximum current rating. See Power Supply in the Compliance Listing Guide (LT-1330) for maximum current in a fire listed application.

Terminal 8 - YELLOW

Receives data from keypads and zone expansion modules. It cannot be used for any other purpose.

Terminal 9 - GREEN

Transmits data to keypads and zone expansion modules. It cannot be used for any other purpose.

Terminal 10 - BLACK

The ground reference for DMP keypads, zone expansion modules, and all auxiliary devices being powered by Terminal 7.

Programming (PROG) Connection

A 4-pin PROG header is provided to connect a keypad when using a DMP Model 330 Programming Cable. This provides a quick connection for panel programming. You may also use the PROG Header to connect Keypad Bus devices.

OVC LEDs

The Overcurrent LED (OVC) lights red when the devices connected to the Keypad Bus and LX-Bus draw current that exceeds the panel rating. The OVC LED is located to the left of the 893A connector on the panels.

XR150FC/XR550FC Series panels have an additional OVC LED to the right of the CELL MODULE connector. The LEDs turn a steady red when lit. When the OVC LEDs light red, the LX-Buses and Keypad Bus are shut down.

Smoke and Glassbreak Detector Output

Terminals 11 and 12

Supplies positive and regulated 12 VDC to power 4-wire smoke detectors and other powered devices. This output can be turned off by the user for 5 seconds using the Sensor Reset User Menu option to allow latched devices to reset. Terminal 12 is the ground reference for Terminal 11.

Current Rating

The Output current from Terminal 11 is shared with Terminals 7, 25, and 27.

The total current draw of all devices powered from the panel must be included with Terminal 11 calculations and must not exceed the maximum output rating.

Protection zones

Terminals 13-24

Zones 1 to 8 (Terminals 13 to 24) on the panel are grounded burglary zones. For programming purposes, the zone numbers are 1 through 8.

Terminal	Function	Terminal	Function
13	Zone 1 voltage sensing	19	Zone 5 voltage sensing
14	Ground for zones 1 and 2	20	Ground for zones 5 and 6
15	Zone 2 voltage sensing	21	Zone 6 voltage sensing
16	Zone 3 voltage sensing	22	Zone 7 voltage sensing
17	Ground for zones 3 and 4	23	Ground for zones 7 and 8
18	Zone 4 voltage sensing	24	Zone 8 voltage sensing

Table 3: Terminal 13-24 Specifications

The voltage sensing Terminal measures the voltage across a 1k Ohm EOL resistor to ground. Use Model 311 1k Ohm resistors. Dry contact sensing devices can be used in series (normally-closed) or in parallel (normally-open) with any of the burglary protection zones.

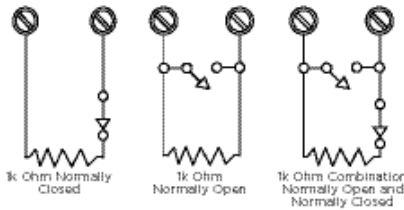

Figure 10: Protection Zone Wiring

Operational Parameters

Each protection zone detects three conditions: Open, Normal, and Short. Voltage and resistance parameters for each condition are listed in Table 4

Condition	Resistance on zone	Voltage on positive terminal
Open	Over 1300 ohms	Over 2.0 VDC
Normal	600 to 1300 ohms	1.2 to 2.0 VDC
Short	Under 600 ohms	Under 1.2 VDC

Table 4: Protection Zone Parameters

Zone Response Time

A condition must be present on a zone for 500 milliseconds before it is detected by the panel. Ensure detection devices used on the protection zones are rated for use with this delay. Zones 1-10 can also be programmed for a fast response delay of 160 milliseconds.

Keyswitch Arming Zone

Using a keyswitch on an arming zone type allows you to arm and disarm selected areas without having to enter a user code.

Powered Zones for 2-Wire Smoke Detectors

Terminals 25–26 and 27–28

Panel Terminals 25 through 28 provide two resettable Class B, Style A, 2-wire powered zones. For programming purposes the zone numbers are 9 and 10. See the Compliance Listing Guide LT-1330 for a list of the compatible 2-wire smoke detectors. Do not mix detectors from different manufacturers on the same zone.

 **Caution:** Performing a Sensor Reset momentarily drops power to the devices on zones 9 and 10. The panel views these zones as Open while power is absent.

When wiring powered zones for 2-wire smoke detectors, refer to the following specifications:

- **Maximum wire length**—3000 feet (18 AWG) or 1000 feet (22 AWG)
- **Maximum voltage**—14 VDC
- **Maximum normal standby current**—1.25 mA DC
- **Maximum line impedance**—100 Ohms
- **Maximum short circuit current**—56 mA

Dry Contact Relay Outputs

The panel provides two programmable auxiliary SPDT relays when equipped with two DMP Model 305 relays in sockets OUTPUT 1 and OUTPUT 2 and a Model 431 Output Harness on the OUT1-OUT2 6-pin header. Each relay provides one SPDT set of contacts that can be operated by any of the functions listed below:

- Activation by zone condition—Steady, Pulsing, Momentary, and Follow
- Activation by 24-hour 7-day schedule—One on and one off time a day for each relay
- Manual activation from the DMP LCD keypad menu
- Communication failure
- Armed area annunciation
- Fire Alarm, Fire Trouble, or Supervisory
- Ambush Alarm
- Exit and Entry timers
- System Ready
- Late to Close

Refer to the XR150/XR550 Series Programming Guide (LT-1232) for more information.

Contact Rating

The Model 305 relay contacts are rated for 1 Amp at 30 VDC (allows 0.35 power factor). You can connect auxiliary power to the Relay Output 1 common terminal by installing the gray harness wire to Terminal 7. Current draw for all connected devices must not exceed the panel maximum current rating.

Model 431 Output Harness Wiring

The relay contacts are accessible by installing the DMP 431 Output Harness on the 6-pin OUT1 OUT2 header. OUTPUT 2 uses the top three prongs, and OUTPUT 1 uses the bottom three prongs. The relay contacts must be connected to devices located within the same room as the panel. The wire harness colors and contact locations are shown below:

Annunciator Outputs

The four programmable annunciator outputs can be programmed to indicate the activity of the panel zones or conditions occurring on the system. Annunciator outputs do not provide voltage. Instead, they switch voltage from another source to ground. The outputs can respond to any of the conditions listed in Dry Contact Relays. Maximum voltage is 30 VDC at 50 mA.

Output 1		Output 2	
Contact	Color	Contact	Color
Normally Closed	Violet	Normally Closed	Violet with white stripe
Common	Gray	Common	White with gray stripe
Normally Open	Orange	Normally Open	Orange with white stripe

Table 5: Model 431 Output Wiring

Model 300 Harness Wiring

Access the open collector outputs by installing DMP 300 Harness on the 4-pin OUTPUTS header. The output locations are shown below. For listed applications, devices connected to the outputs must be located within the same room as the panel.

Output	Color	Wire	Output	Color	Wire
3	Red	1	5	Green	3
4	Yellow	2	6	Black	4

Table 6: Model 300 Wiring

Model 860 Relay Module

Connect a Model 860 Relay Module to the OUTPUTS header on the panel to provide relays for outputs 3-6. Use these relays for electrical isolation between the alarm panel and other systems or for switching voltage to control various functions. Power is supplied to the relay coils from a single wire connected to the panel auxiliary power Terminal 7.

The module includes one relay and provides three additional sockets for expansion of up to four relays. Mount the 860 inside the panel enclosure using the 3-hole pattern and plastic standoffs. Refer to the 860 Module Install Sheet (LT-0484) as needed. Relay Contact Rating is 1 Amp at 30 VDC (allows 0.35 power factor).

ORDERING INFORMATION

Panels	
XR150DFC-R	XR150 Fire Control Panel with Dialer and 270 Transient Suppression Module
XR150DNFC-R	XR150 Fire Control Panel with Network and 270 Transient Suppression Module
XR550DNFC-R	XR550 Fire Control Panel with Network and 270 Transient Suppression Module

Accessories

Keypads	
630F LCD Remote Fire Command	32-character LCD Fire keypad with keyswitch. ORDER: 630F-R
Power Supplies	
505-12 Power Supply	A power-limited, switching power supply that meets UL, CSFM, NFPA and FCC compliance standards. Installed in a 350 (L) or 350A (A) enclosure to allow adequate space for up to two back-up batteries and includes a transformer and battery leads. The 505-12 is rated for 12 VDC at 5 amps maximum. ORDER: 505-12-G, 505-12-R
505-12LX Power Supply	A power-limited, switching power supply that meets UL, CSFM, NFPA and FCC compliance standards. 505-12LX is rated for 12 VDC at 5 amps maximum. Provides two independent Class B NAC outputs. Each power supply includes a transformer, battery leads and a metal enclosure. ORDER: 505-12LX-G, 505-12LX-R
Batteries and Battery Accessories	
Batteries	365 9.0 Ah 12 VDC (ORDER: 365) 366 18.0 Ah 12 VDC (ORDER: 366) 368 5.0 Ah 12 VDC (ORDER: 368) 369 7.0 Ah 12 VDC (ORDER: 369)
341 Small Enclosure	Steel kiosk-size enclosure with dual 3/4" or 1/2" knockouts and module mounting holes. Dimensions: 12.75" W x 6.55" H x 2.9" D ORDER: 341-G
349 Small Enclosure	Standard panel enclosure with dual-size knockouts, lock and key, and module mounting holes. Dimensions: 13.5" W x 11.66" H x 3.55" D ORDER: 349-G
350 Large Enclosure	Holds three 7.7 Ah batteries or two 18.0 Ah batteries, one transformer, and module mounting holes. Dimensions: 17.5" W x 13.5" H x 3.5" D ORDER: 350-G, 350-R , 350-GCAN
352S Extra Large Battery Enclosure	Features five adjustable shelves to hold batteries for standby power. Dimensions: 14.5" x 32" x 4" (lid adds 0.5" on each side) ORDER: 352S-G
Battery Harnesses	318 Standard battery leads (ORDER: 318) 318R Ring-style battery leads (ORDER: 318R) 318T Terminal-style battery leads (ORDER: 318T) 318EXT 48" Battery lead extension (ORDER: 318EXT)
Cellular Communicators	
263LTE-V LTE Verizon Cellular Communicator	Provides wireless communication for XT Series and XR Series panels. ORDER: 263LTE-V, 263LTE-V/381-2
263LTE-A LTE AT&T Cellular Communicator	Provides wireless communication for XT Series and XR Series Panels. ORDER: 263LTE-A, 263LTE-A/381-2

Expansion Modules	
710 Bus Splitter/Repeater	Expands the number of devices and length of wire on the LX-Bus or keypad bus. Also provides wire connections for up to three additional LX-Bus circuits. ORDER: 710
711 Single Zone Expander	Single-zone expander with screw terminal connections. Includes EOL resistors. ORDER: 711
711S Single Zone Expander	Single-zone expander with flying lead connections. Includes EOL resistor. ORDER: 711S
714 Zone Expansion Module	Expander with four 5 VDC Class B zones and rotary-switch addressing. Includes EOL resistors and 12-wire harness. ORDER: 714
714-8 Zone Expander	Terminal block installation for eight burglary or Class B non-powered fire devices. Includes enclosure with lock and key plus EOL resistors. ORDER: 714-8 , 714-8-R, 714-8L-G, 714-8L-R, 714-8PCB
714-16 Zone Expander	Terminal block installation for 16 burglary or Class B non-powered fire devices. Includes enclosure with lock and key plus EOL resistors. ORDER: 714-16 , 714-16-R, 714-16L-G, 714-16L-R, 714-16PCB
715 Zone Expansion Module	Provides 4 Class B zones (12 VDC) for two-wire smoke detectors and other powered or non-powered devices. Includes 3.3k EOL resistors and 12-wire harness. ORDER: 715
715-8 Zone Expander	Provides eight powered zones (12 VDC) supporting two-wire smoke detectors or other fire alarm initiating devices. Includes red 340 enclosure and EOL resistors. ORDER: 715-8, 715-8PCB, 715-16PCB
715-16 Zone Expander	Provides 16 powered zones (12 VDC) supporting two-wire smoke detectors or other fire alarm initiating devices. Includes red 340 enclosure and EOL resistors. ORDER: 715-16
716 Output Expander	Provides 4 programmable Form C (SPDT) relays and four open collector annunciator outputs. Use the outputs for remote zone and system annunciation or environmental control applications. Harness included. ORDER: 716
717 Graphic Annunciator	Provides 20 annunciator outputs (open collector) that follow the armed or bypassed state of the panel's zones. ORDER: 717
Auxiliary Modules	
860 Relay Output Module	Provides electrical isolation between the alarm panel and other systems or for switching voltage to control various functions. ORDER: 860
865 Style W/X Notification Circuit Module	Provides supervision for ground faults, opens and shorts on notification appliance circuits. Suitable for use with style W or X 12 or 24 VDC circuits. ORDER: 865
866 Style W Notification Circuit Module	Supervises one Style W Notification circuit that supervises opens, shorts and ground faults. Capable of switching 12 VDC internal or 24 VDC external power supply. ORDER: 866
867 LX-Bus Notification Circuit Module	Provides one supervised Style W circuit for 12 or 24 VDC notification devices. The 867 connects to the LX-Bus and supervises Ground Fault, Open and Short conditions on the notification circuit. ORDER: 867
869 Style D Class A Initiating Circuit Module	Provides two Style D initiating 4-wire circuits for waterflow switches and nonpowered burglary and fire devices. Supervises both zones for Opens, Shorts and Ground Fault conditions. ORDER: 869
893A Dual Phone Line Module	Supervises the main and backup phone lines for sustained drop in voltage. ORDER: 893A

Pull Stations	
850 Series Pull Stations	Single or dual action pull stations with gold-plated SPST contacts and terminal strip connections. ORDER: 850D, 850D/711, 850D/711S, 850S, 850S/711, 850S/711S
Smoke/Heat Detectors	
2W-BLX Conventional Smoke Detector	A photoelectric detector that includes an addressable single point module for connection to the LX-Bus of the XR Series panels. ORDER: 2W-BLX
2WT-BLX Conventional Smoke/Heat Detector	A photoelectric detector that includes an addressable single point module with a restorable, built-in fixed temperature thermal detector and is capable of sensing a temperature higher than 135 °F. ORDER: 2WT-BLX
Miscellaneous Accessories	
270 Network Transient Suppressor	Provides Ethernet surge suppression for DMP panels. In UL applications, the Model 270 must be used if the switch is not installed in the same room as the panel. ORDER: 270
277 Commercial Fire Buzzer Module	An audible trouble alert that may be installed in place of the Model 893A Module for XR150/XR550 Series control panels. ORDER: 277, 277CAN
335 Intrusion Siren	Offers dual tones, steady and warble, is load-tested to four hours, is indoor surface-mounted and is made out of UV-resistant, high-impact ABS plastic. 105 dB. ORDER: 335
370 Lightning Suppressor	Provides lightning suppression for any DMP or other manufacturer's panel. ORDER: 370, 370RJ
861 Power Distribution Module	Provides multiple auxiliary power terminals and additional keypad and/or LX-Bus connectors for a clean installation. Maximum current handling capacity of 8 amps on power and ground in terminals. ORDER: 861
Wiring harnesses, cables, and tampers	300 Four-wire Harness (ORDER: 300) 303 Silence/Reset Push Button (ORDER: 303) 305 Plug-in Output Relay (ORDER: 305, 305/10) 306 Tamper Harness (ORDER: 306) 307-S Screw-On Tamper Switch (ORDER: 307-S) 374 Surge Voltage Suppressor (ORDER: 374) 3012 Clip-On Tamper Switch (ORDER: 3012) 381 Coax Extension Cable (ORDER: 381-12, 381-25) 431 Output Harness (ORDER: 431)
Monitoring Center Receivers	
SCS-1R	Network Enabled Receiver compatible with central station receivers that accept Standard CID, DD or DMP Serial 3 messaging.
SCS-VR Virtual Receiver	Software-only solution that runs on a server for network IP and cellular communications.

DMP Wireless	
1100X Receiver	Provides Two-Way, supervised communication using 900 MHz frequency hopping-spread spectrum technology. 1100XE-W features 128-bit AES encryption. ORDER: 1100X-W, 1100XE-W
1100XH High-Power Receiver	Provides additional transmit and receive amplification for improved performance at greater distance or harsh building environments. 1100XHE-W features 128-bit AES encryption. ORDER: 1100XH-W, 1100XHE-W
1100R Repeater	Provides increased communication range. Up to eight repeaters can be installed on a wireless system. This model includes the 376L power supply. 1100RE-W features 128-bit AES encryption. ORDER: 1100R-W, 1100RE-W, 1100R-W/376L
1103 Universal Transmitter, External Contact	Includes an internal magnetic reed switch, an on board terminal block for external contact wiring, and an end-of-line resistor. 1103E-W features 128-bit AES encryption. ORDER: 1103-W, 1103E-W
1164 Wireless Smoke Detector with Synchronized Sounder	Causes sounders to initiate when any fire zone is tripped on the panel, which also triggers any other wired strobes and strobe horns. The cadence is dictated by the panel, synchronizing the alarm tones of all wired and wireless devices. ORDER: 1164-W
1164NS-W Wireless Smoke Detector with No Sounder	Has the same functionality as the 1164 Smoke Detectors without the built-in sounder. The 1164NS is intended for use in installations with existing sounder/notification devices. ORDER: 1164NS-W
1168 Wireless Smoke/CO/Low Temp Detector	Provides multi-criteria smoke sensing using a combination of photoelectric heat, IR flame flicker, carbon monoxide (CO) indicators, and a low temp sensor. The 1168 reports carbon monoxide, fire alarms, and low temp to the control panel. ORDER: 1168
1183-135 Heat Detector	The 1183-135F is a fixed temperature detector that reacts to heat by responding to the fixed 135 degree temperature setting. The 1183-135R model is a combination rate-of-rise and fixed temperature detector that detects heat quickly by responding to a rapid temperature increase or a fixed 135 degree temperature setting. ORDER: 1183-135F, 1183-135R
1184 Carbon Monoxide Detector	A 3 V battery-powered wireless carbon monoxide (CO) detector that provides early warning when the electrochemical sensing technology measures carbon monoxide levels in the air. The transmitter can send alarm, trouble, tamper and low battery condition messages to the alarm panel. ORDER: 1184-W

FCC INFORMATION

Part 15

This device complies with Part 15 of the FCC Rules. Operation is subject to the following two conditions:

1. This device may not cause harmful interference, and
2. This device must accept any interference received, including interference that may cause undesired operation.

The antenna used for this transmitter must be installed to provide a separation distance of at least 20 cm (7.874 in) from all persons. It must not be located or operated in conjunction with any other antenna or transmitter.

Changes or modifications made by the user and not expressly approved by the party responsible for compliance could void the user's authority to operate the equipment.



Note: This equipment has been tested and found to comply with the limits for a Class B digital device, pursuant to part 15 of the FCC Rules. These limits are designed to provide reasonable protection against harmful interference in a residential installation. This equipment generates, uses and can radiate radio frequency energy and, if not installed and used in accordance with the instructions, may cause harmful interference to radio communications. However, there is no guarantee that interference will not occur in a particular installation. If this equipment does cause harmful interference to radio or television reception, which can be determined by turning the equipment off and on, the user is encouraged to try to correct the interference by one or more of the following measures:

- Reorient or relocate the receiving antenna.
- Increase the separation between the equipment and receiver.
- Connect the equipment into an outlet on a circuit different from that to which the receiver is connected.
- Consult the dealer or an experienced radio/TV technician for help.

Part 68

The Model XR150FC/XR550FC Series panel complies with Part 68 of the FCC rules and the requirements adopted by the ACTA. On the outside of the enclosure of this equipment is a label that contains, among other information, a product identifier in the format US:CCKALO0BXR550. If requested this number must be provided to the telephone company.

A plug and jack used to connect this equipment to the premises wiring and telephone network must comply with the applicable FCC Part 68 rules and requirements adopted by the ACTA. See installation instructions for details.

The Ringer Equivalence Number (REN) is used to determine the number of devices that may be connected to a telephone line. Excessive RENs on a telephone line may result in the devices not ringing in response to an incoming call. In most but not all areas, the sum of RENs should not exceed five (5.0). To be certain of the number of devices that may be connected to a line, as determined by the total RENs, contact the local telephone company.

If the XR150FC/XR550FC Series panel causes harm to the telephone network, the telephone company will notify you in advance that temporary discontinuance of service may be required. But if advance notice isn't practical, the telephone company will notify the customer as soon as possible. Also, you will be advised of your right to file a complaint with the FCC if you believe it is necessary.

The telephone company may make changes in its facilities, equipment, operations or procedures that could affect the operation of the equipment. If this happens the telephone company will provide advance notice in order for you to make necessary modifications to maintain uninterrupted service.

If trouble is experienced with the Model XR150FC/XR550FC Series panel, for repair or warranty information, please contact DMP at the address and telephone number listed on the back of this document. If the equipment is causing harm to the telephone network, the telephone company may request that you disconnect the equipment until the problem is resolved.

If your premises has specially wired alarm equipment connected to the telephone line, ensure the installation of the XR150FC/XR550FC Series panel does not disable your alarm equipment. If you have questions about what will disable alarm equipment, consult your telephone company or a qualified installer.



Caution: To ensure proper operation, this equipment must be installed according to the installation instructions in this manual. To verify that the equipment is operating properly and can successfully report an alarm, this equipment must be tested immediately after installation, and periodically thereafter, according to the test instructions in this document and the XR150/XR550 Series Programming Guide (LT-1232). Verification of Line Seize capability should also be performed immediately after installation, and periodically thereafter, in order to ensure that this equipment can initiate a call even when other equipment (telephone, answering system, computer modem, etc.) connected to the same line is in use.

XR150FC/XR550FC SERIES PANELS

Specifications

Primary Power	16 VAC 56 VA transformer
Secondary Power	12 VDC Battery
Output Rating	
Bell	Up to 0.7 Amps at 12 VDC
Smoke/Auxiliary	Up to 0.5 Amps at 12 VDC
Current Draw	180 mA
Enclosure Material	Cold-rolled steel (Red)
Dimensions	13.44" H X 17.10" W X 4.80" D

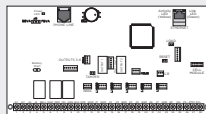

Certifications

California State Fire Marshal (CSFM)

Los Angeles Fire Department

FCC Part 15

FCC Part 68 Registration ID CCKAL00BXR550

New York City (FDNY)

Underwriters Laboratories (UL) Listed

ANSI/UL 294	Access Control System Units
ANSI/UL 1610	Central Station Burglar
ANSI/UL 2017	General Purpose Signaling Devices and Systems
ANSI/UL 864	Fire Protective Signaling

Compatible with Devices listed for:

ANSI/UL 268	Smoke-Automatic Fire Detectors
ANSI/UL 346	Waterflow Indicators for Fire Protective Signaling Systems
ANSI/UL 636	Holdup Alarm Units and Systems Accessory



Designed, engineered, and
manufactured in Springfield, MO
using U.S. and global components.

LT-1297 20133

© 2021

INTRUSION • FIRE • ACCESS • NETWORKS

2500 North Partnership Boulevard
Springfield, Missouri 65803-8877

800.641.4282 | DMP.com