



## GENESIS BRANDED VEHICLE OWNER PRIVACY POLICY

Your Genesis Branded Vehicle may be equipped with technologies and services that use information collected, generated, recorded or stored by the vehicle. We have created a Vehicle Owner Privacy Policy to explain how these technologies and services collect, use, and share this information.

You may read our Vehicle Owner Privacy Policy on the GenesisMotorsUSA.com website at <http://www.genesismotorsusa.com/privacy-policy.html>  
If you would like to receive a hard copy of our Vehicle Owner Privacy Policy, please contact Customer Care at:

Genesis Customer Care  
P.O. Box 20850  
Fountain Valley, CA 92728  
844-340-9741  
CustomerCare@genesismotorsusa.com

Genesis Customer Care representatives are available Monday through Friday, between the hours of 5:00 AM and 7:00 PM PST and Saturday and Sunday between 6:30 AM and 3:00 PM PST (English).  
For Customer Care assistance in Spanish or Korean, representatives are available Monday through Friday between 6:30 AM and 3:00 PM PST.

Roadside Assistance: **1-844-340-9742**  
SiriusXM® Radio: **1-800-967-2346**  
Genesis Customer Care &  
Connected Services: **1-844-340-9741**  
**www.MyGenesisusa.com**



Driver position memory system  
Page 03



Instrument cluster  
Page 11

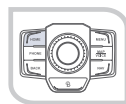

Clock adjustment  
Page 29



Navigation  
Page 27

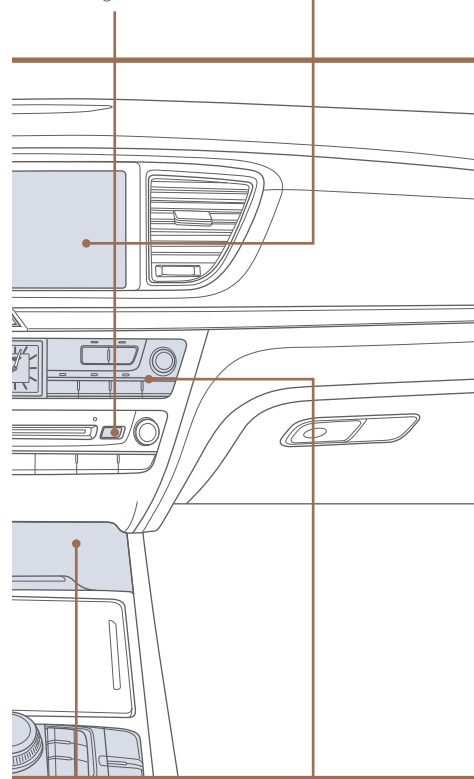
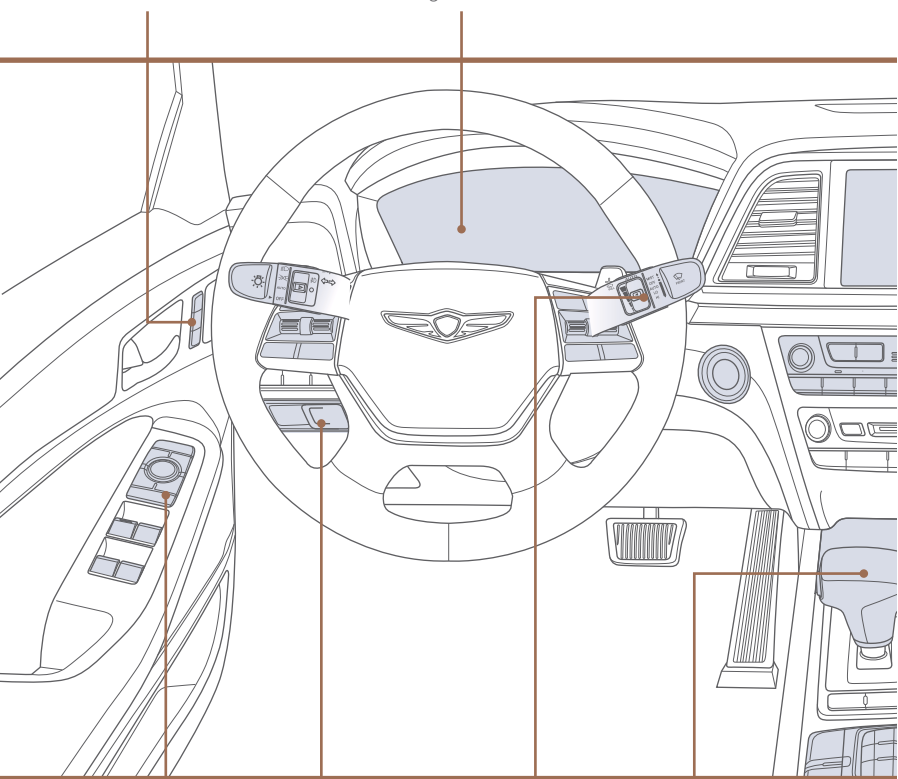

Driver's main controls  
Page 07



Electric Parking Brake (EPB)  
Page 32



Wiper and washer  
Page 10



Shift by wire  
Page 31



USB port  
Page 28

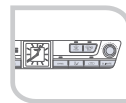

Climate control system  
Page 15

## FEATURES AND CONTROLS

Climate control system	15
Driver's main controls	07
Headlights and fog lights	09
Head-up display	14
Instrument cluster	11
Interior lights	08
LCD display control/modes	13
Panoramic Sunroof	08
Seat-Driver position memory system	03
Seat-Front seat adjustment	02
Seat-Headrest adjustment	03
Seat-Seat warmer & cooler	04
Smart key	01
Smart trunk	06
Trunk operation	05
Trunk lid control button	06
Warnings and indicators	14
Wipers and washer	10

## INFOTAINMENT

Android Auto	21
Apple CarPlay™	23
Bluetooth Phone Pairing	17
Clock adjustment	29
Genesis Connected Services	18
Homelink wireless garage control system	30
Navigation	27
USB port	28
Wireless cellular phone charging system	28

## DRIVING

Blind-Spot Collision-Avoidance Assist (BCA)	34
Blind-Spot Collision Warning (BCW)	34
Driver Attention Warning (DAW)	31
Electronic Parking Brake (EPB)	32
Forward Collision-Avoidance Assist (FCA)	35
Lane Keeping Assist (LKA)	32
Parking Assist System (PAS)	35
Shift by Wire (Electronic type shifter)	31
Smart Cruise Control	33
Tire Pressure Monitoring System (TPMS)	36

### ⚠ WARNING!

To reduce the risk of serious injury to yourself and others, read and understand the important SAFETY INFORMATION in your Owner's Manual.

Use this Quick Reference Guide to learn about the features that will enhance your enjoyment of your Vehicle. More detailed information about these features are available in your Owner's Manual.





\*Some vehicles may not be equipped with all the listed features.

This QRG provides instructional videos that are accessible by scanning the QR Codes found throughout the QRG with your smartphone/tablet.

In order to scan a QR Code, you will need to use a QR Code Reader App on your mobile device. You can download the app onto your device through an app store or marketplace.

### SMART KEY



-  Lock
-  Unlock
-  Trunk open
-  Panic

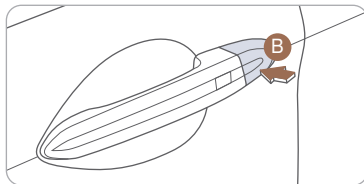

**Driver's side door Lock / Unlock**  
Smart key must be within 20-40 in. from the outside door handle.

**Press:** Once – Unlock driver door  
Twice – Unlock all doors  
Third – Lock all doors

NOTE: User selectable option: Please see section 3 from your Owner's Manual for more details.

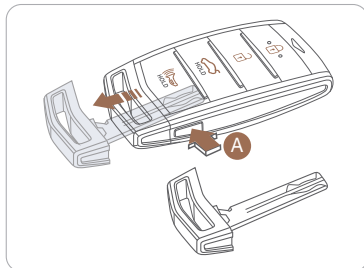

#### Remove mechanical key.

Press and hold the release button **A** to remove the mechanical key.

NOTE: The key hole is located under the key hole cover **B** on driver door.

### FRONT SEAT ADJUSTMENT

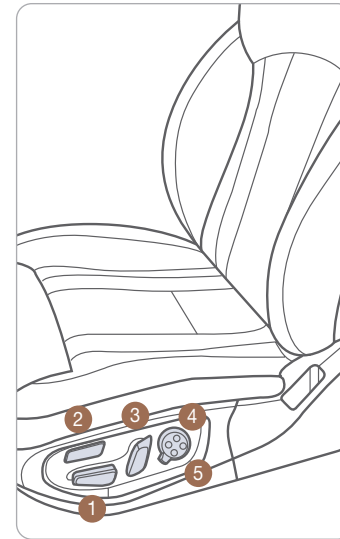

#### Forward and backward **1**



#### Seat cushion length (for driver's seat) **2**



#### Seatback angle **3**

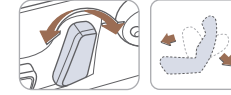

#### Seat cushion height **1**

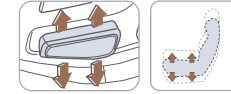

#### Lumbar support **4**

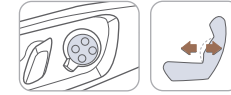

#### Seat bolster adjustment (for driver's seat) **5**



## HEADREST ADJUSTMENT

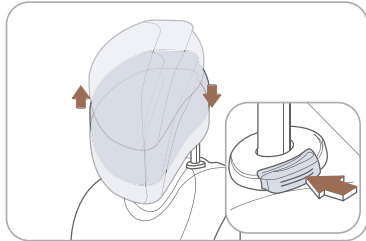

**To Raise Headrest:**  
Pull headrest up.

**To Lower Headrest:**  
Press lock button while pressing down on headrest.

**To adjust headrest forward (front seats only):**  
Pull forward to 1 of 3 positions.

**To adjust headrest rearward (front seats only):**  
Pull it fully forward to the farthest position and release it.

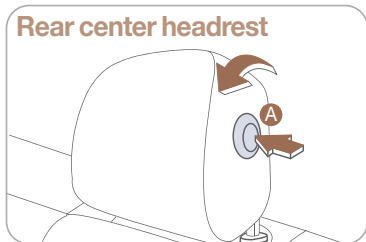

Rear center headrest

**To Raise Center Headrest:**  
Rotate headrest forward.  
Lift headrest up.

**To Lower Center Headrest:**  
Press lock button while pressing down on headrest.  
Press button **A** to rotate headrest down.

## DRIVER POSITION MEMORY SYSTEM

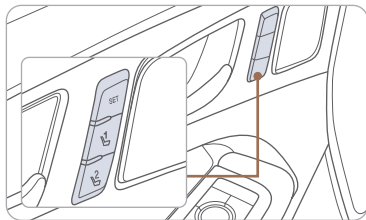

### To Store Settings

1. Adjust the driver's seat, outside rearview mirrors, steering wheel, instrument panel illumination and head up display.
2. Press the SET button. The system will beep once.
3. Press one of the memory buttons (1 or 2) within 5 seconds. The system will beep twice.

**NOTE:** Transmission must be in P (Park).

### To Recall

Press the desired memory button (1 or 2). The system will beep once.

**NOTE:** To reset the system, please refer to the Owner's Manual.

## SEAT WARMER (front seats)

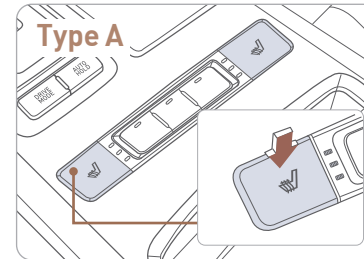

Type A

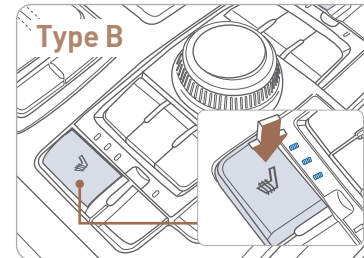

Type B

Each time you push the button, the setting is changed as follows:

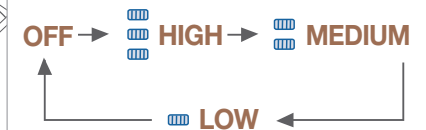

To turn off immediately, press and hold the button.

## SEAT WARMER/COOLER (front seats)

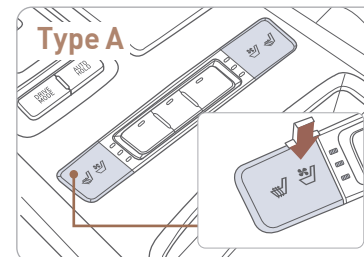

Type A

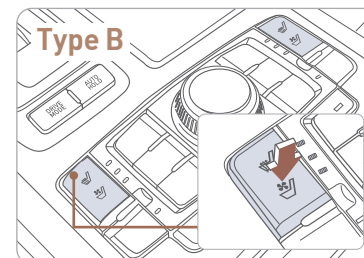

Type B

- Heat
- Air Ventilation

Each time you push the button, the setting is changed as follows:



To turn off immediately, press and hold the button.

## TRUNK OPERATION

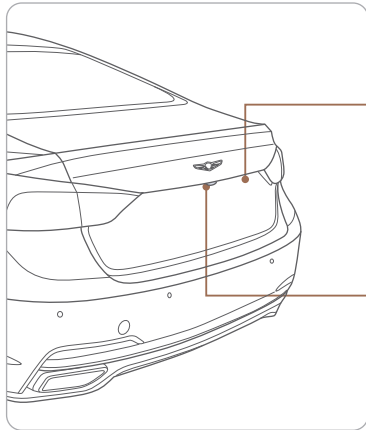

### Power trunk open button

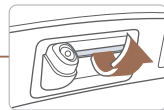

Press to open.  
Smart key needs to be within the range.

### Power trunk open button on the smart key



Press and hold.

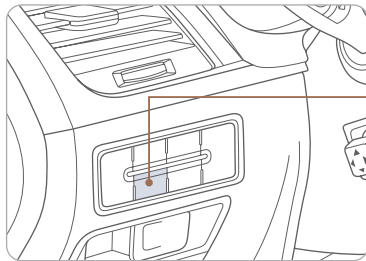

### Power trunk main control button

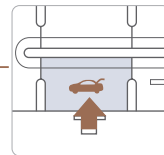

Press to open.  
Press and hold to close.

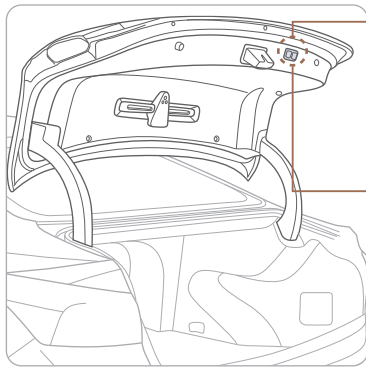

### Power trunk close button

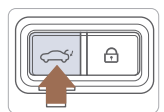

Press to close.

### Power trunk lock button



Press to lock the trunk and doors will lock as well.  
Smart key needs to be within range.

**NOTES:** Trunk opening height adjustment is available in the Vehicle setup options. Please refer to your Owner's Manual for further information.

## TRUNK LID CONTROL BUTTON

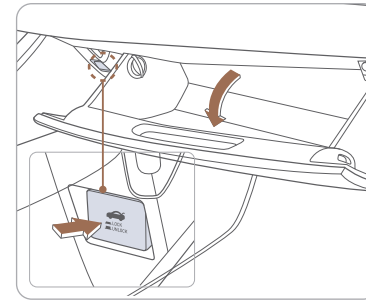

The trunk lid control button is used to prevent unauthorized access to the trunk.

1. Open the glove box.
2. Press the trunk lid control button. In this LOCK position, the trunk can only be opened with the mechanical key.
3. Close and lock the glove box with the mechanical key.

**NOTE:** Without the mechanical key, the smart key can only start the engine and operate door locks. Please refer to your Owner's manual to learn how to access the mechanical key.

## SMART TRUNK

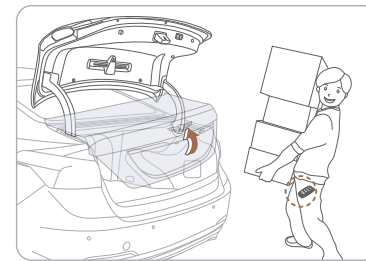

### Smart Trunk

When smart key is within range for 3 seconds, the trunk will automatically open.

### To enable Smart Trunk function:

Vehicle must be in P (Park) to adjust the settings located in the setup menu in the AVN system screen.

1. Select Setup > Vehicle > Door/Trunk
2. Check "Smart Trunk".

**NOTE:** Function is active after 15 seconds when all doors are closed and locked. The vehicle will also provide an audible and visual alarm while activating. Please refer to your Owner's Manual for further information.



## DRIVER'S MAIN CONTROLS

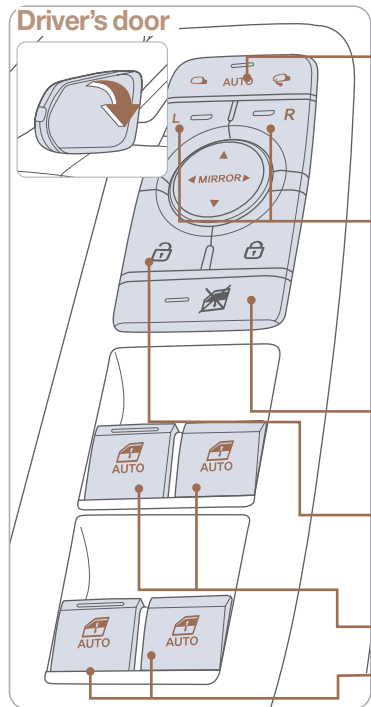

**Driver's door**

**Outside Rearview Mirror**

- Press switch left/right to unfold/fold mirrors. Press the lock or unlock button on the smart key, and the mirrors will be folded or unfolded when AUTO is set.
- Press the L or R button to adjust the mirror by using the directional switch. If L or R button is still selected, both mirrors will tilt downward when reversing. Deselect L or R will disable the auto tilt down feature.

**Power window lock button**

- Disables the power window switches on the rear passenger doors.

**Door Lock**

- Locks/unlocks all doors.

**Window Switches**

- Front power window switches.
- Rear power window switches.

## PANORAMIC SUNROOF

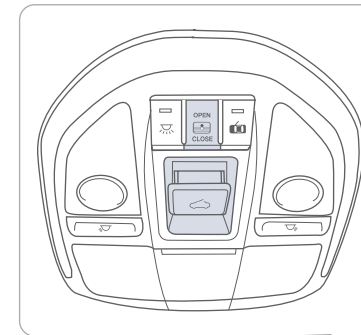

### Sunshade



### Sliding the sunroof

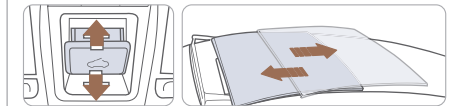

### Tilting the sunroof

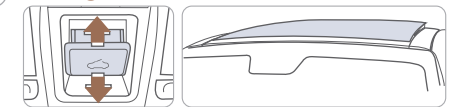

## INTERIOR LIGHTS

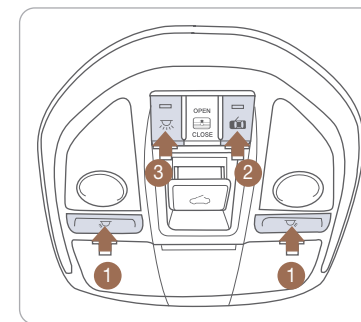

**Front map lamp** ①  
Press the button to turn the map lamp on or off.

**Front door lamp** (☾) ②  
Lights will turn on when any door is open.

**Front room lamp** (☾) ③  
Push the switch to turn the room lamp on.

**Front room lamp** (☾) ③  
Push the switch to turn the room lamp off.

## HEADLIGHTS AND FOG LIGHTS

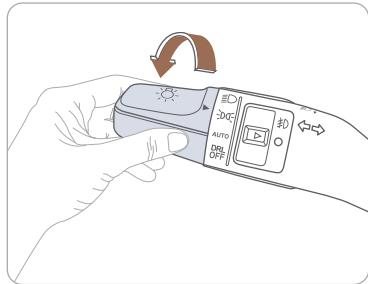

- ▶ | Headlights
- ▶ | Parking lights
- ▶ | **AUTO** Auto headlights
- ▶ | **OFF** All lights Off

### Headlight delay

Headlights may stay on for 15 seconds after exiting and locking up the vehicle. Press the remote lock button twice to turn the headlights off. Please refer to your Owner's Manual for further information.

Turn signals **A** and lane change **B** signals

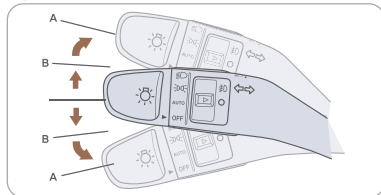

Flashing headlights

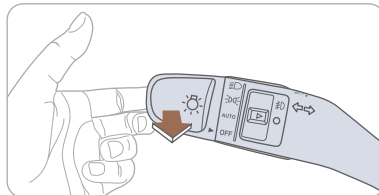

High beam

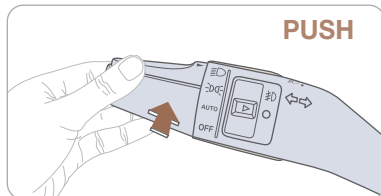

**NOTE:** To turn off the high beam, pull the lever towards you.

Smart high beam

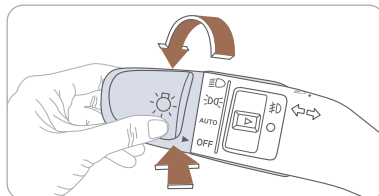

### Smart High Beam Function

1. Select auto position on stalk.
2. Push lever forward to engage Auto High beam.
3. Push lever forward again to disengage.

## WIPERS AND WASHER

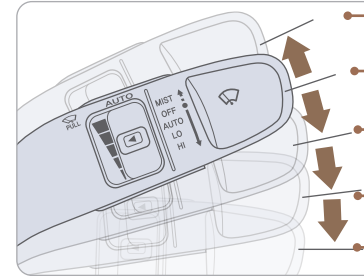

- **MIST** - Single wipe
- **OFF**
- **AUTO** - Auto control wipe
- **LO** - Low wiper speed
- **HI** - High wiper speed



Scan to view a video of: Windshield Wiper

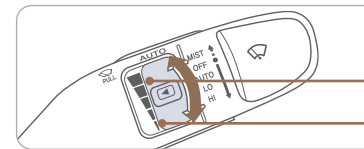

### Auto Control Wipe Adjustment

- Adjust the control knob.
- Fastest wiper speed
- Slowest wiper speed

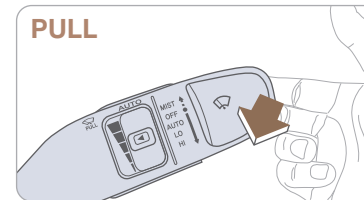

**PULL**

### Windshield Washer

Pull the lever gently toward you to spray washer fluid onto the windshield and to run the wipers 1-3 cycles.

### Headlamp Washer

Fluid will spray on headlamp assemblies when headlamps are turned ON. Will activate only once for every ignition key cycle or only once every 15 minutes.

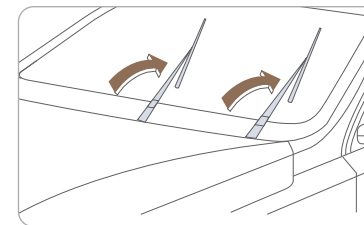

This vehicle has a "hidden" wiper design which means they can't be lifted in their bottom resting position

### Wiper Blade Removal

1. Within 20 seconds of turning off the engine, lift and hold the wiper lever up to MIST position for about 2 second until the wipers move to the top wipe position
2. At this position, you are able to lift the wipers off the windshield.
3. Gently put wipers back down onto windshield
4. Turn the wipers to any ON position to return to resting position

**NOTE:** To prevent damage to the hood and wiper arms, the wiper arms should only be lifted when in the top wiping position.



**INSTRUMENT CLUSTER**

**Type A with 4.3" LCD Display**

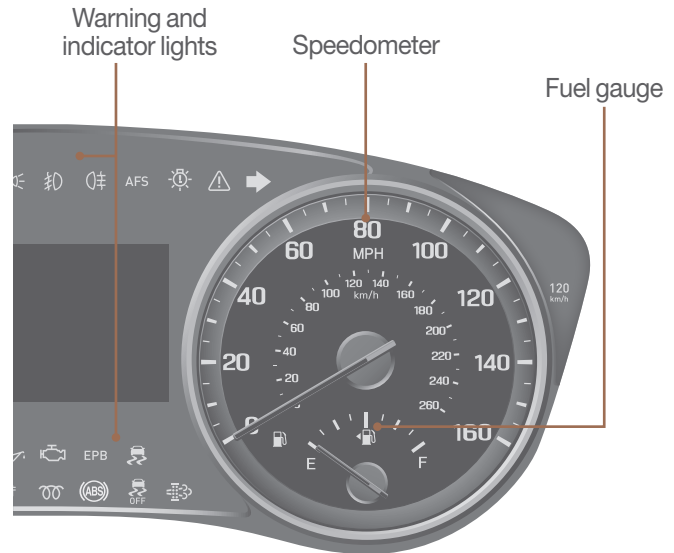
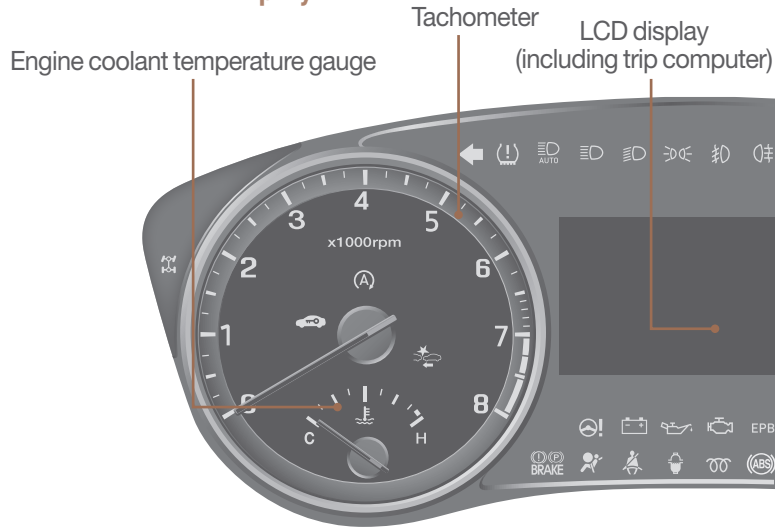

**Type B with 7" LCD Display**

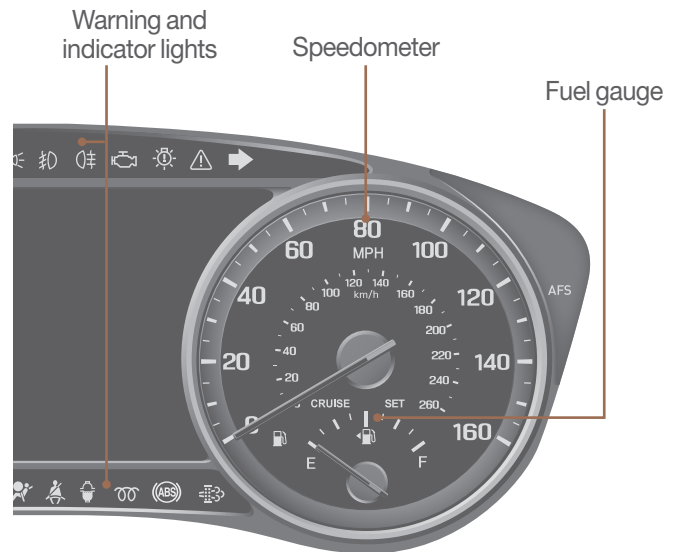

## LCD DISPLAY MODES

Modes	Symbol	Explanation
Trip Computer		This mode displays driving information like the tripmeter, fuel economy, and so on.
Turn By Turn (TBT) (if equipped)		This mode displays the navigation turn by turn guidance.
Assist (if equipped)		This mode displays the state of the Driver Attention Warning (DAW) system and Tire Pressure Monitoring System (TPMS).
Warning		Display service internal warning messages and tire pressures.
User Settings		Changes settings.

## LCD DISPLAY CONTROL

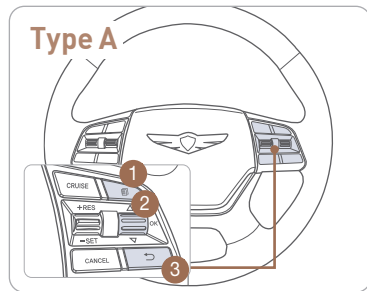

- 1 : MODE button for changing modes
- 2 : MOVE switch for changing items
- OK (Press) : SELECT/RESET button for setting or resetting the selected item
- 3 : BACK button for moving to upper level menu (if equipped)

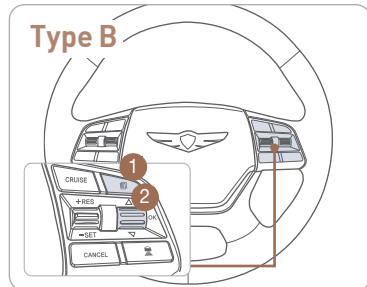

## WARNINGS AND INDICATORS

Air bag warning light	Seat belt warning	Parking brake & Brake fluid warning light
Anti-lock Brake System (ABS) warning light	Electronic Brake Force Distribution (EBD) system warning light	
Electric Power Steering (EPS) warning light	Malfunction Indicator Lamp (MIL)	Charging system warning light
Engine coolant temperature warning light	Engine oil pressure warning light	Low fuel level warning light
Low tire pressure warning light	Door open warning light	Trunk open warning light
AWD warning light	EPB Electric Parking Brake (EPB) warning light	Forward Collision Avoidance Assist (FCA)
Master warning light	Electronic Stability Control (ESC) indicator	Electronic Stability Control (ESC) OFF indicator
Immobilizer indicator	Turn signal indicator	Low beam indicator
High beam indicator	Light ON indicator	Smart high beam indicator
Front fog light indicator	Cruise indicator	AFS Adaptive Front Lighting System
AUTO HOLD indicator	SPORT mode indicator	SNOW mode indicator
ECO indicator	Lane Keeping Assist (LKA)	LED Headlight warning indicator

## HEAD-UP DISPLAY

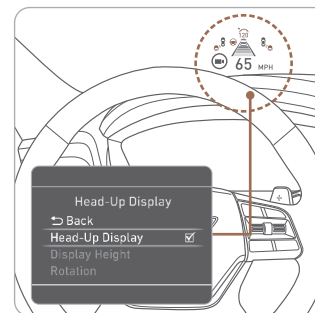

The Head-Up display is a transparent display which projects an image of selected information of the instrument cluster and navigation onto the windshield glass.

To activate the head up display, select Head-Up Display in the User Settings Mode in the LCD display. Adjust Head-Up Display height until in view.

**NOTE:** If you wear polarizing-filter sunglasses, it's difficult to read the Head Up Display information.



## CLIMATE CONTROL SYSTEM



### Front

#### Type A

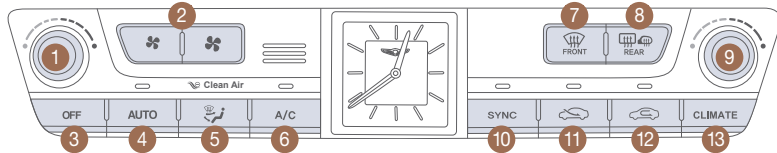

#### Type B

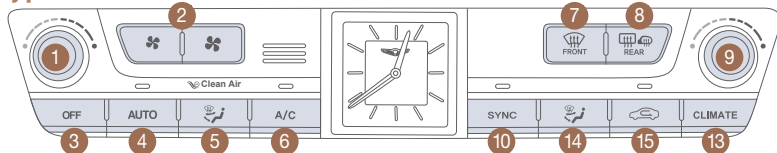

- |                                     |  |
|-------------------------------------|--|
| 1 Driver's temperature control knob | 6 Air conditioning ON/OFF button       |
| 2 Fan speed control button          | 7 Front windshield defrost button      |
| 3 OFF button                        | 8 Rear window defrost button           |
| 4 AUTO (automatic control) button   | 9 Passenger's temperature control knob |
| 5 Driver's Mode selection button    |  |

### Rear

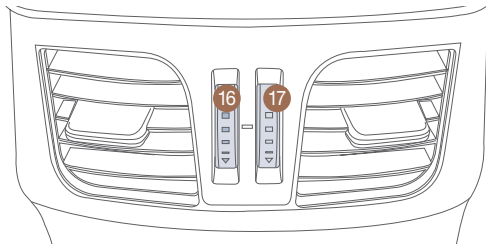

- |  |  |
|--|--|
| 10 SYNC button (sync driver and passenger front air temperature) | 13 Climate information screen selection button |
| 11 Air intake control button (Outside air)                       | 14 Mode selection button (Passenger)           |
| 12 Air intake control button (Recirculated air)                  | 15 Air intake control button                   |
|  | 16 Rear temperature control thumbwheel         |
|  | 17 Rear vent ON/OFF thumbwheel                 |

### DEFOGGING/DEFROSTING

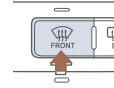

1. Press the front defrost button.

**NOTE:** Outside (fresh) air position will be selected when front defrost button is selected.

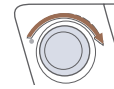

2. Select warmest temperature.



3. Set the fan speed to the highest speed setting.

**NOTE:** To reduce window fogging and improve visibility, keep the interior surface of the windshield clean by wiping it with a clean cloth and glass cleaner. In addition, position the air intake control to circulate fresh air whenever possible while operating the vehicle.

### SYSTEM OFF

Pressing the OFF button will place the system in below settings.

- Front blower will turn off.
- Outside (fresh) air position will be selected.
- Vented air will be at last set temperature.

### MODE SELECTION



Direction of air flow will change as follows when pressing the mode button.

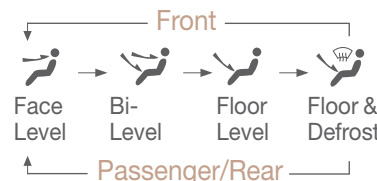

### AIR INTAKE CONTROL



Recirculated air position



Outside (fresh) air position (type A)



Outside (fresh) air position (type B) (light off)

### SMART VENT

If cabin humidity and carbon dioxide levels increase while Climate Control is off, fresh air will be circulated into the cabin.

Please refer to the Owner's Manual for further details.

### AUTOMATIC HEATING / AIR CONDITIONING

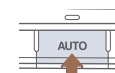

Automatically controls the modes, fan speeds, air intake and air-conditioning functions.

## BLUETOOTH PHONE PAIRING

### Pairing a new device

**NOTE:** Vehicle must be in (P) Park to complete pairing process.

1. Press the PHONE button in the head unit (or DIS navigation system) or  button in the steering wheel remote control.

### Standard Navigation

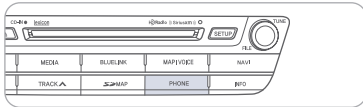

### Premium Navigation System

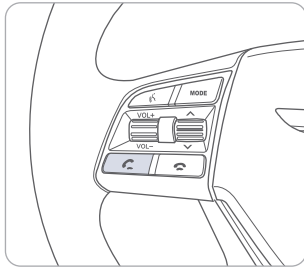
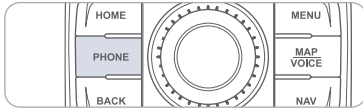

2. Search for the device name as displayed on your mobile phone and pair.

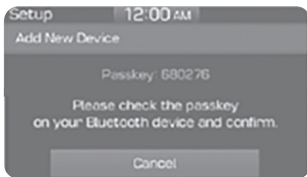

3. Confirm the 6-digit passkey displayed on the audio screen and the Bluetooth device identical.

4. Press OK in your Bluetooth device.
5. Pairing is complete.

## GENESIS CONNECTED SERVICES

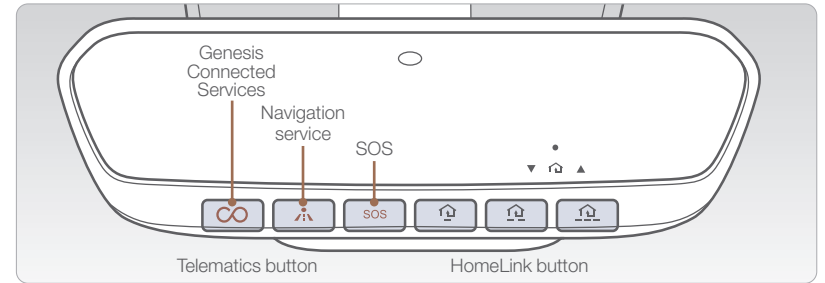

Genesis Connected Services subscription is required. To enroll, please visit your dealership or [MyGenesisUSA.com](http://MyGenesisUSA.com).

Press the  button for access to the voice-response menu of services.

- You can say:
- Roadside Assistance
- Service Link
- Account Assistance

Press the  button for Destination Search by Voice.

Press the **SOS** button for SOS Emergency Assistance.

Visit [MyGenesisUSA.com](http://MyGenesisUSA.com) for more information or refer to your Genesis Connected Services User's Manual for detailed information on system operation.

For immediate assistance with subscription services, please call 1-844-340-9741.

## Genesis Intelligent Assistant App



You can download the Genesis Intelligent Assistant App to your compatible smart phone from the following sites:

- iPhone® — Apple® App Store
- Android™ — Google Play™

## Remote Start

Remote Start enables you to remotely start your vehicle virtually from anywhere. For vehicles equipped with full-automatic temperature control, you can also enable climate control remotely and turn on the front window defroster, ensuring a warm or cool car is ready to go when you are.

-  To use this feature, you must have a Genesis Connected Services Personal Identification Number (PIN). To create or change your PIN, log in to [MyGenesisUSA.com](http://MyGenesisUSA.com).

### Remember:

- Remote Start will automatically shut off after 10 minutes or after selected engine timer runs out in navigation vehicles.
- While this feature is active, the parking lights will blink until the vehicle is turned off or when vehicle is in operation.
- To continue to operate the vehicle, the proximity key must be inside the vehicle with the driver, prior to pressing the brake and being able to move the gearshift from the P (Park) position.

### Preconditions:

- Ignition is OFF
- Alarm is armed (i.e., vehicle locked by key fob or Remote Door Lock)
- Gearshift level is in the P (Park) position
- Brake pedal is not depressed
- Engine hood is securely closed
- All the doors are closed and locked
- The tailgate or trunk lid is closed
- The security / panic system is not activated
- The proximity key is not inside the vehicle
- The battery power is not low
- Vehicle is located in an open area
- It has been less than 4 days since last vehicle ignition off
- Vehicle located in area with good cell reception

### Remote Start will terminate:

- After 10 minutes or after selected engine timer runs out in navigation vehicles
- Brake is pressed without the proximity key inside the vehicle
- Alarm is triggered without the proximity key inside the vehicle
- Door / trunk is opened from inside the vehicle

**Notice:** Laws in some communities may restrict the use of the features that remotely start the engine. For example, some laws may require a person using the remote start feature to have the vehicle in view when doing so, or limit the length of time a vehicle engine may idle. Please check local and state regulations for any requirements and restrictions on remote starting of vehicles and engine idling time.

### WARNING!

Do not remote start vehicle in an enclosed environment (i.e., closed garage). Prolonged operation of a motor vehicle in an enclosed environment can cause a harmful build-up of carbon monoxide. Carbon monoxide is harmful to your health. Exposure to high levels of carbon monoxide can cause headaches, dizziness or in extreme cases unconsciousness and / or death. Do not leave children or animals unattended in a vehicle while using the remote start function.

### CAUTION!

If the vehicle's windshield wipers are left on when the vehicle was last driven, then the wipers will turn on if the remote start function is activated. To avoid damage to the wiper blades (i.e., due to heavy ice or snow accumulated on the windshield), please always turn the vehicle's windshield wipers off when parking the vehicle.

## ANDROID AUTO™

### REQUIREMENTS:

- USB cable
- OS Android™ 5.0 or higher
- Compatible Android Phone
- Data and wireless plan for applicable features

### BEFORE YOU BEGIN:

- Android Auto features may operate differently than on your phone.
- Message and data charges may apply when using Android Auto.
- Android Auto relies on the performance of your phone. If you experience performance issues:
  - Close all apps and then restart them or
  - Disconnect and then reconnect your phone
- Using the USB cable that was provided with your phone is recommended.
- When Android Auto is active, your in-vehicle voice recognition system is disabled and you will be using talk to Google™ to make your requests.

### ANDROID AUTO SUPPORT



<https://support.google.com/androidauto/>

## PHONE SETUP

Turn on Bluetooth® on your phone and connect the micro USB cable to your phone and the USB port on the vehicle.

Phone will prompt you to download the Android Auto app and update other needed apps (i.e. Google Maps™, Google Play Music™, Google Now™).

**NOTE:** Vehicle must be parked.

- Location mode setting should be set to High accuracy.
- Car and phone setup should be completed in one sitting. If phone setup needs to be resumed, recommend to Force Stop the Android Auto app on the Phone then reopen the app and accept the Disclaimer notifications.

## CAR SETUP

1. Press the SETUP button.
2. Touch the “Phone Projection” icon on screen.
3. Select “On” for Android Auto.
4. Connect your Android phone to the vehicle USB port. Agree to the notification and disclaimers on your phone then the “Android Auto” icon will appear confirming the setup.

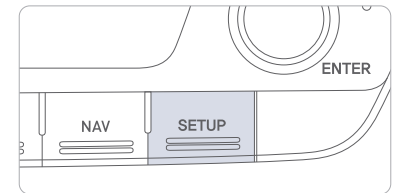

For more detailed information on how to operate Android Auto, please refer to your navigation manual.

For additional Android Auto support, please refer to the Android Auto Support Website  
<https://support.google.com/androidauto/>

Android Auto, Google Play, Android, and other marks are trademarks of Google Inc.



## APPLE CARPLAY™

### REQUIREMENTS

- Apple Lightning® cable
- Latest iOS
- iPhone® 5 or above
- Data and wireless plan for applicable features

### BEFORE YOU BEGIN

- Apple® CarPlay features may operate differently than on your phone.
- Message and data charges may apply when using Apple CarPlay.
- Apple CarPlay relies on the performance of your phone. If you experience performance issues:
  - Close all apps and then restart them or
  - Disconnect and then reconnect your phone
- Using the Apple Lightning cable that was provided with your phone is recommended.
- When Apple CarPlay is active, your voice recognition system is disabled and you will be using Siri® to make your requests.

### PHONE SETUP

On your phone, go to Settings > General > CarPlay to allow CarPlay access.

On your phone, go to Settings > Siri and ensure Siri is turned ON.

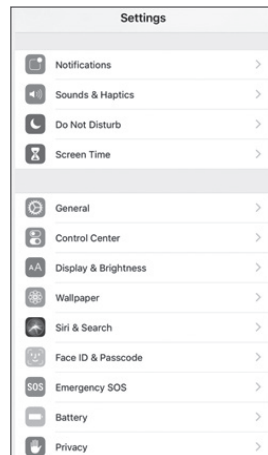

## CAR SETUP

1. Press the SETUP button.
2. Touch the “Phone Projection” icon on the screen.
3. Touch “Apple CarPlay” on the Connectivity Settings screen. Then touch “On” to enable Apple CarPlay.
4. Connect your Apple iPhone to the vehicle USB port then touch ‘OK’ when the pop-up message appears. The Apple CarPlay icon will now appear on the vehicle Home screen confirming the setup.

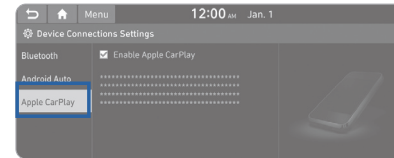

Apple CarPlay, Apple, and other marks are trademarks of Apple Inc.

## CarPlay Home Screen

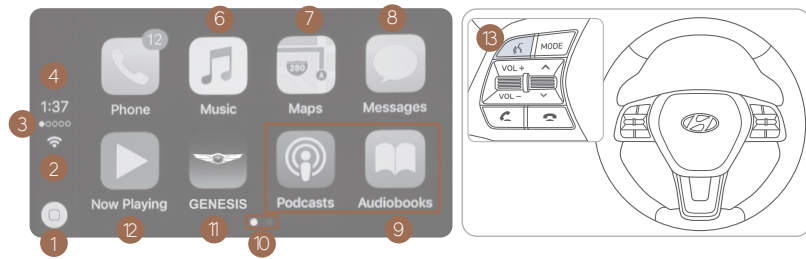

- |                         |                                  |
|-------------------------|----------------------------------|
| 1 HOME ICON             | 7 APPLE MAPS                     |
| 2 WIRELESS CONNECTIVITY | 8 MESSAGES                       |
| 3 CELLULAR SIGNAL       | 9 3RD PARTY APPS                 |
| 4 PHONE TIME            | 10 SCREEN PAGE INDICATOR         |
| 5 PHONE                 | 11 EXIT TO HOME SCREEN           |
| 6 APPLE MUSIC™          | 12 CURRENT CARPLAY AUDIO PLAYING |

## SIRI

Apple CarPlay uses Siri to perform many actions like sending messages, placing calls, and looking up/setting POI/Destinations. A Siri session can be initiated on any screen by:

1. Touch and holding the HOME icon 1 on the CarPlay screen or
2. Press the steering wheel VOICE RECOGNITION 13 button.

Note: Ensure Siri feature is set to ON in your phone (Go to Settings > General > Siri).

3. Say any of the following commands;
  - “Text <John Smith> ‘Call you later’” to send a text message.
  - “Read text messages” to read available text message.
  - “Call <John Smith>” to make a phone call.
  - “Find <POI/Destination>” to locate a POI/Destination.

## PHONE

Touch the PHONE 5 icon to access the Phone screen. Siri will automatically asks ‘Who you would like to call’ when the PHONE 5 icon is selected.

NOTE: Phone call sound quality is dependent on the wired connection. Using the Lightning cable that came with the phone is recommended.

## APPLE MUSIC

Touch the APPLE MUSIC 6 icon to access the Apple Music screen.

## APPLE MAPS

Touch the APPLE MAPS 7 icon to access the Apple Map screen.

## MESSAGES

Touch the MESSAGES 8 icon to access the Message screen. Siri will automatically asks ‘To hear unread messages or create a new one’ when the MESSAGE icon is selected.

## 3rd PARTY APPS

Supported CarPlay apps that are downloaded on your phone will appear on the CarPlay screen. Touch the apps icons to access those supported apps.

NOTE: A list of the supported CarPlay supported apps can be found at <http://www.apple.com/ios/carplay/>

Ensure phone has latest version of the 3rd Party Apps.

## NAVIGATION

### Map position

#### Standard Navigation



- 1 Move to the Home Screen
- 2 Map view mode  
The map view can be switch between Head Up and North Up.
- 3 Navigation Voice Guidance On/Off
- 4 Zoom in the map
- 5 Map scale  
Set the zoom level automatically according to the guidance.
- 6 Zoom out the map
- 7 [MENU] button
- 8 Unified Search
- 9 Touch to scroll the map
- 10 Set a waypoint to the current route
- 11 Save frequently used address to address book
- 12 Find a POI (Point Of Interest) around the current position
- 13 Vehicle position

#### Premium Navigation



- 1 Clock display
- 2 Move to the Home Screen
- 3 Change the map view mode
- 4 Navigation voice guidance on/off
- 5 Zoom in the map
- 6 Map scale display
- 7 Zoom out the map
- 8 [MENU] button
- 9 Route guidance
- 10 Vehicle position
- 11 Current position and Destination
- 12 Remaining distance display/ Remaining time
- 13 Cancel Route
- 14 [Route] button

## USB PORT

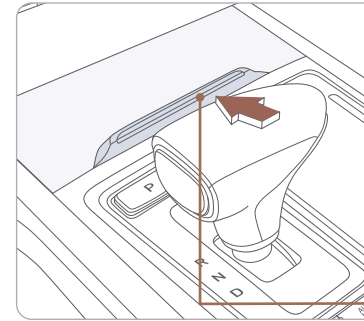

Plug in a USB cable to connect a compatible audio device and listen to it through the audio system in your vehicle.

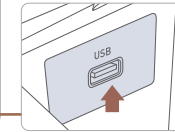

## WIRELESS CELLULAR PHONE CHARGING SYSTEM

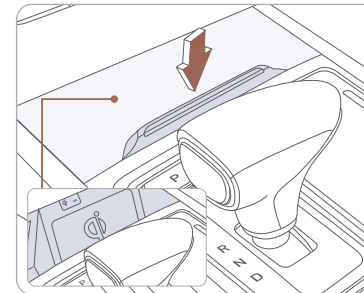

There is a wireless cellular phone charging system inside the front console. The system operates with all doors closed, and the ignition switch is in the ACC/ON position.

### NOTE:

The wireless cellular phone charging system supports only the Qi-enabled cellular phones (Qi).

**NOTE:** Do not place any metallic items such as coins, keys on the charger. Avoid putting credit cards, etc. on the charger as they might get damaged by the magnetic field.

## CLOCK ADJUSTMENT

### With Premium Navigation

1. Press "HOME" button.

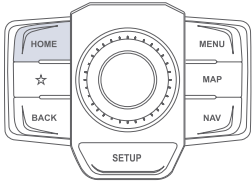

2. Press "Settings" icon on the screen, then press "Clock".
3. To set your preferred Time Setting:
  - Check "GPS Time" to adjust the time automatically.
  - Press "Time Setting" to adjust the clock manually. GPS Time must not be selected.
  - If "Daylight Savings Time" is selected, the clock will be adjusted forward by one hour.

### With Standard Navigation

1. Press the "SETUP" button.

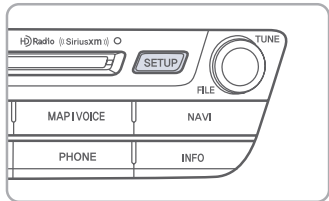

2. Press "Clock" icon on the screen.
3. To set your preferred Time Setting:
  - Check "GPS Time" to adjust the time automatically.
  - Press "Date/Time Setting" to adjust the clock manually. GPS Time must not be selected.
  - If "Daylight Savings Time" is selected, the clock will be adjusted forward by one hour.





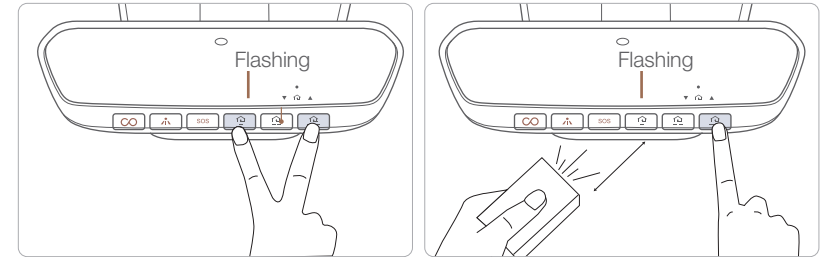

**NOTE:** Once the digital clock is adjusted, the analog clock will be updated accordingly.

## HOMELINK WIRELESS GARAGE CONTROL SYSTEM



### Standard Programming

1. For first time programming, press and hold the two outside buttons (  ,  ) until the indicator light starts to flash. (to reprogram buttons, skip this step)
  2. Press and hold the desired button (  ,  or  ) and your transmitter's button at the same time until the Homelink indicator light changes from a slow to a rapid blink.  
(The transmitter has to be 1 to 3 inches away from the mirror)The desired Homelink button is now programmed.
- NOTE:** If you have a rolling code garage door opener, complete additional steps:
3. Locate the "Learn" or "Smart" button on your garage door opener. Press and release the button and complete Step 4 within 30 seconds.
  4. Return to the vehicle and press the programmed Homelink button up to 4 times (or until the garaged door operates)

For more detailed information, please refer to your Owner's manual or visit [www.homelink.com](http://www.homelink.com) or call (800) 355-3515

## SHIFT BY WIRE (Electronic type shifter)

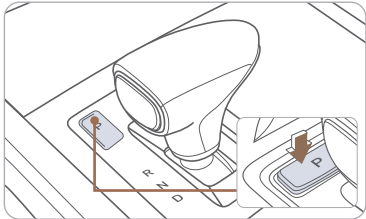

**P (Park)**  
Always stop completely before shifting into P (Park). To shift the gear from R (Reverse), N (Neutral), D (Drive) or Manual mode to P (Park), press the [P] button while depressing the brake pedal.

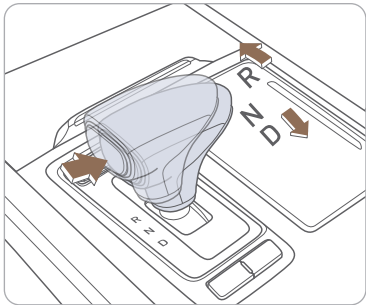

**R (Reverse) / N (Neutral) / D (Drive)**  
To select gear, press the [UNLOCK] button while depressing the brake pedal and then move the shift lever forward (R side) or backward (D side).

## DRIVER ATTENTION WARNING (DAW)

The Driver Attention Warning (DAW) system is designed as a safety feature to help reduce drowsy or inattentive driving.

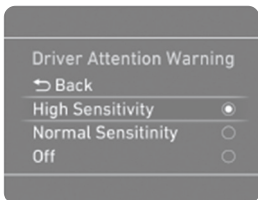

- To adjust the Driver Attention Alert sensitivity, go to: User Settings > Driving Assist > Driver Attention Warning > Normal or High in the instrument cluster.

**OFF** - System is deactivated.

**NORMAL** - Alerts the driver of his/her fatigue level or inattentive driving practices.

**HIGH** - Alerts system alerts the driver of his/her fatigue level or inattentive driving practices faster than Normal mode.

The Driver Attention Warning system is operable, when driving speed is between 40 mph and 110 mph

## LANE KEEPING ASSIST (LKA)

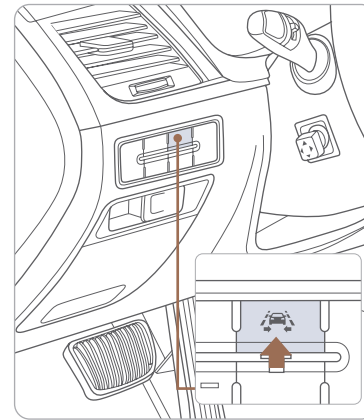

The Lane Keeping Assist (LKA) system helps detect lane markers on the road, and assists the driver's steering to help keep the vehicle between lanes.

- To turn LKA on, press the LKA switch.
- To turn LKA off, press the switch again.

LKA operates only when the vehicle speed is above 40 mph and when the LKA icon in the instrument cluster is green. LKA will not operate properly if the following conditions are present:

- the lane line is not clear
- on sharp bend in a road
- heavy fog

Refer to the Owner's Manual for more detailed information.

**NOTE:** During operation, you may feel the sensation of steering wheel movement. Depending on the road condition (gradient), the deflection driving may occur. LKA settings can be adjusted in the User Settings page of the instrument cluster.

## ELECTRONIC PARKING BRAKE (EPB)

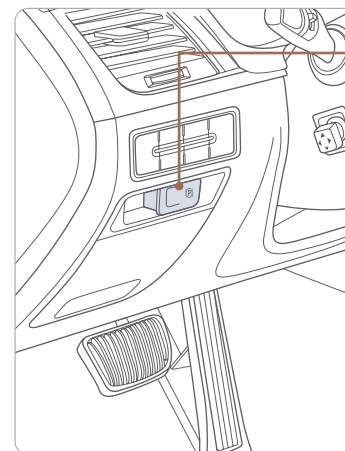

**Applying**



Stop the vehicle then pull the EPB switch.

**Releasing**



Move shift lever from P to R, N or D while depressing the brake pedal.  
or



Press the EPB switch while depressing the brake pedal.

**NOTE:** If necessary, emergency braking is possible by pulling and holding the EPB switch.

## SMART CRUISE CONTROL

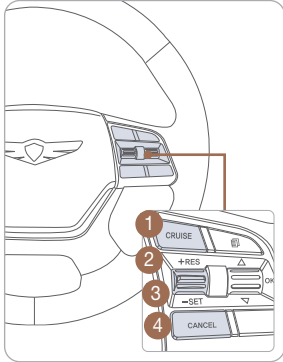

The cruise control system allows you to program the vehicle to maintain a desired speed.

- 1 To turn On/Off cruise control.
- 2 Toggle switch UP to Resume or Increase the cruise control speed.
- 3 Toggle switch DOWN to Set or Decrease the cruise control speed.
- 4 To Cancel the Cruise Control.



Scan to view a video of: Smart Cruise Control

### Setting Cruise Control

1. Press the “CRUISE” button 1 to turn on Cruise Control. The icon will illuminate in the instrument cluster.
2. Toggle “-SET” switch 3 DOWN to set cruising speed.

### Adjusting the vehicle speed

1. Toggle “+RES” switch 2 UP to increase cruising speed.
2. Toggle “-SET” switch 3 DOWN to decrease cruising speed.

**NOTE:** Quick toggle up/down will change speed by 1 mph. Holding switch up/down will change speed by 5 mph.

### To Cancel Cruise Control

Press the “CANCEL” button 4 or depress the brake pedal.

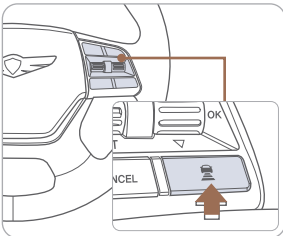

### Setting Vehicle Distance

Set and maintain the distance from the vehicle ahead of you by pressing the vehicle distance button.

The vehicle to vehicle distance will automatically activate when you set the cruise speed.

Each time the vehicle distance set button is pressed, the vehicle to vehicle distance changes as follows:



## BLIND-SPOT COLLISION WARNING (BCW)

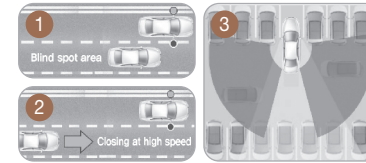

The Blind-Spot Collision Warning (BCW) uses radar sensors in the rear bumper to monitor and warn the driver of an approaching vehicle in the driver's blind spot area.



Scan to view a video of: Blind-Spot Collision Warning (BCW)

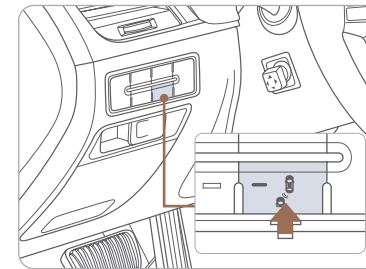

BCW aids the driver with the following features:

- 1 Blind spot detection
- 2 Lane change assist
- 3 Rear cross traffic alert

- To turn BCW on, press the BCW button. (indicator illuminated)
- To turn BCW off, press the BCW button again.

The BCW system will activate once the vehicle speed exceeds 20 mph.

The rear cross traffic alert will activate once the vehicle is in reverse at speeds below 6 mph and BCW is activated.

## BLIND-SPOT COLLISION-AVOIDANCE ASSIST (BCA)



The Blind-Spot Collision-Avoidance Assist (BCA) system helps detect the front lane through the camera installed on the upper front windshield side/rear areas through radar sensors during lane changes.

The Blind-Spot Collision-Avoidance Assist system may activate the Electronic Stability Control (ESC) to avoid a potential collision.



## FORWARD COLLISION-AVOIDANCE ASSIST (FCA)

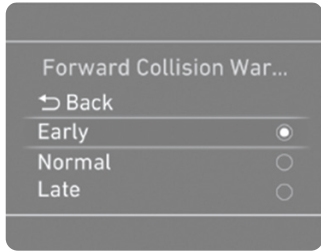

The Forward Collision Avoidance (FCA) system is designed to detect and monitor the vehicle ahead and warn the driver if a collision is imminent. On vehicles equipped with both camera and radar sensor, pedestrian detection is also available.

To operate the system, select the FCA (Forward Collision Avoidance Assist) sub menu in the LCD cluster display under User Settings. Please refer to your Owner's Manual for further information.

**Early:** This setting maximizes the amount of distance between the vehicle or pedestrian ahead before the initial warning occurs.

**Normal:** This setting allows for a nominal amount of distance between the vehicle or pedestrian ahead before the initial warning occurs.

**Late:** This setting reduces the amount of distance between the vehicle or pedestrian ahead before the initial warning occurs.

**NOTE:** If driver does not maneuver to avoid impact when system detects a slower/stopped vehicle or pedestrian ahead, system applies automatic braking

## PARKING ASSIST SYSTEM (PAS)

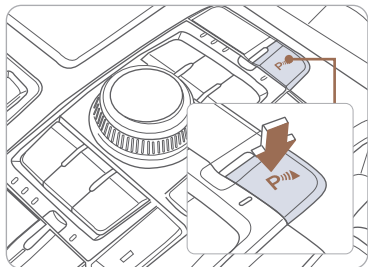

The parking assist system assists the driver during movement of the vehicle by chiming if any object is sensed within the distance of 3.3 ft in front and 4 ft behind the vehicle.

### PAS ON/OFF

Press button to turn ON/OFF:

ON – Led on

OFF – Led off

If the PAS is OFF, the system will turn ON automatically when in Reverse.

The system will automatically turn OFF when vehicle is driven forward at speed above 6 mph.

**NOTE:** Front parking sensor will not operate if the PAS is OFF.

## TIRE PRESSURE MONITORING SYSTEM (TPMS)

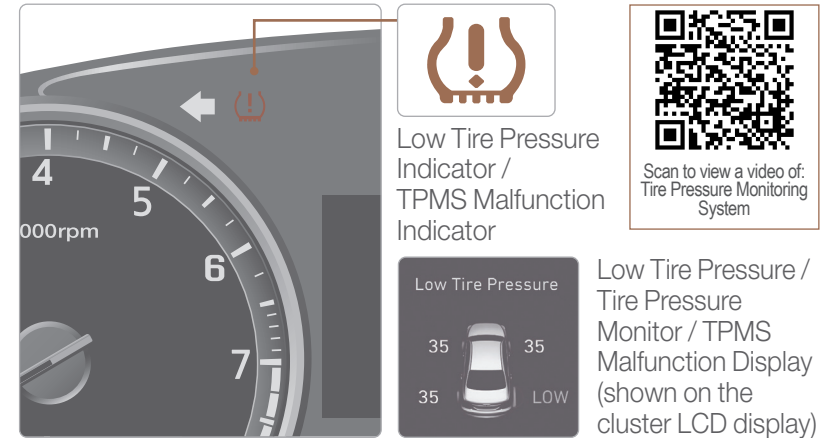

### LOW TIRE PRESSURE INDICATOR

Illuminates if one or more of your tires are significantly under-inflated.

### TPMS MALFUNCTION INDICATOR

Blinks for approximately one minute, then remains illuminated when there is a malfunction with the TPMS. Inspect all tires and adjust tire pressure to specification. If the lamp remains illuminated, have the system checked by an authorized retailer of Genesis Brand Products as soon as possible.

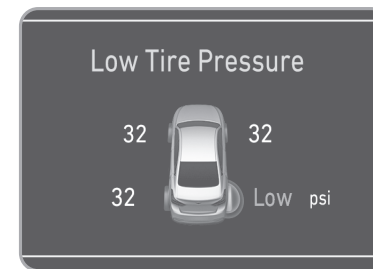

To access the TPMS menu within the LCD display, press the Assist mode button on the steering wheel to display tire pressure.

Tire pressures will display after driving a short distance. If a tire pressure drops lower than predetermined specification, the Low Tire Pressure Indicator (⚠️) will illuminate and the LCD display will indicate tire(s) requiring air.

## Program Coverage Summary

Genesis Service Valet is included for the first 3 years or 36,000 miles, whichever comes first, of ownership.			
Complimentary Services	Service Valet	Complimentary Loaner Vehicle	Maintenance
Original Owner or Lessee	Yes	Yes	Yes
Subsequent Owner or Lessee	Warranty Only	Warranty Only	No

See below for program terms and conditions.

### SERVICE VALET

Service Valet is available while your vehicle is receiving complimentary maintenance, wear items, or warranty repairs by an authorized Genesis retailer. Simply contact your authorized Genesis retailer's Service Experience Manager or contact the Customer Care Center at 844-340-9741 to make your appointment. The retailer will work with you to arrange your pickup and delivery time and location.

- Valet appointments must be made at least 2 business days in advance.
- Valet area of coverage is valid only within an estimated 1 hour drive time distance (based on traffic, weather, and road conditions) from the participating retailer location to the pickup/delivery location.
- Valet pickup and delivery must occur during normal business hours. After-hours pickup and delivery are at the discretion of your participating retailer.
- You must notify your Genesis Service Experience Manager 1 business day in advance if location or time of valet services changes. If a change or cancellation is not made at least 1 business day in advance, you may be charged a fee, or Service Valet may be cancelled.
- You will be charged a fee if you elect to extend the use of the courtesy replacement vehicle or delay the delivery of your vehicle.
- Prior to or at the time of your vehicle pickup, you will need to provide your valet with the following information if a courtesy replacement vehicle is needed:
  - Insurance company name, policy number, and expiration date
  - Driver's license number, state, expiration, and date of birth
  - Credit card number and expiration date (standard requirement for rental car use)
  - The above information for any additional drivers

Genesis brand vehicle owner must provide the valet with the Genesis brand vehicle that is currently registered in compliance with local and state laws. Road tolls incurred during the Service Valet may be charged to the vehicle owner.

### COMPLIMENTARY LOANER VEHICLE

We come to you and provide you with alternative transportation. While your vehicle is being serviced under this program, qualified drivers will be provided a courtesy replacement Genesis brand vehicle at no additional cost. You must be at least 25 years of age (in most states) with a valid driver's license to drive a loaner vehicle. Please provide your Service Advocate with the following information:

- Insurance company name, policy number, and expiration date
- Driver's license number, state, expiration and birth date
- Credit card number and expiration date (standard requirement for rental car use)
- The above information for any additional drivers

### COMPLIMENTARY MAINTENANCE COVERAGE

#### Vehicle Eligibility

For original retail owners of the Genesis vehicle, all factory-recommended scheduled maintenance are covered for the first 3 years or 36,000 miles, whichever comes first. The Service Valet Program is applicable to all 2017 - 2019 model year Genesis brand vehicle United States specification vehicles purchased in the United States from authorized Genesis retailers. The program is not in effect outside of the United States.

- Vehicle coverage begins on the date of first retail sale. Fleet vehicles are excluded from this program.
- If the vehicle becomes damaged (such as by accident, fire, act of nature, etc.) and is subsequently titled salvaged, flooded, or reconstructed, it is no longer eligible for the benefits of the Genesis G80 complimentary maintenance Program.

#### Guidelines for Scheduling Maintenance

The Service Valet Program covers factory-recommended scheduled maintenance for the first 3 years or 36,000 miles, whichever comes first. Covered maintenance costs include all labor and parts necessary to complete the factory recommended service. Having your vehicle serviced at the specified time/mile intervals is critical in maintaining long-term durability. Failure to have your vehicle serviced at the specified interval may invalidate the warranty under certain circumstances.

If for any reason a service is missed, the authorized Genesis retailer will perform the next or missed major service.

Some owners may wish to have their oil changed more frequently. The customer must pay for any additional services performed on the vehicle. Service procedures not specifically referenced in the Genesis Customer Care Quick Reference Guide must be preauthorized by a Genesis District Parts and Service Manager.

