



EcoStruxure Power connected products
Catalogue 2021



Focus on

+ Connected circuit breaker with EIFE Ethernet add-on module for new drawout MasterPact MTZ

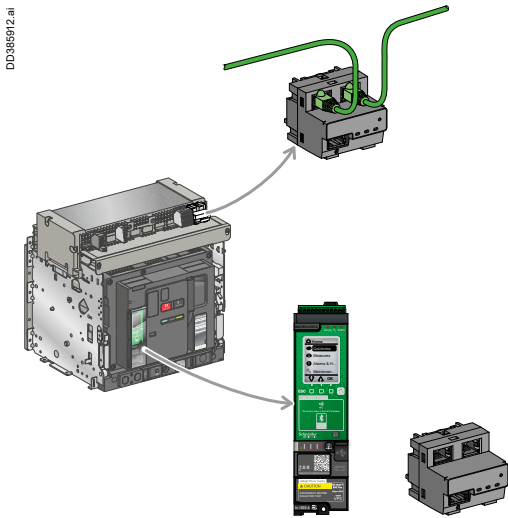

Ethernet connection with EIFE Ethernet add-on module or Micrologic X + IFE interface

The EIFE module is directly mounted on the chassis saving space and wiring. Therefore, an IP address is provided to drawout MasterPact MTZ. The IFE interface remains the solution for fixed version. Micrologic X trip unit + IFE interface is an alternative for connecting any MasterPact MTZ to Ethernet, with extended possibilities (refer to MasterPact MTZ catalogue).

+ Wireless solution for connecting panels

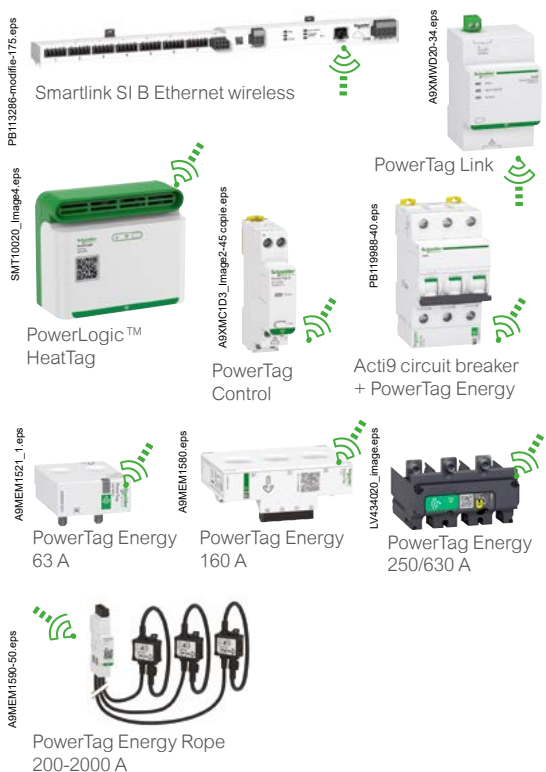

Wireless solutions allow you to quickly add functions to measure circuit consumption, temperature and humidity in an electrical panel. Wireless solutions also add control and monitoring functions to application.

- Smartlink SI B, PowerTag Link gateways give access to diagnostic and optimization services via the internet.
- HeatTag: temperature and humidity measurement in a panel.
- PowerTag Energy: Energies (Class 1 accuracy), voltages, currents, frequency, power factor, power measurements, range up to 2000 A.

PowerTag Control modules provide contactor or impulse relay wireless control and status monitoring.

Focus on

+ Simple and real-time operation with connected gateways and servers



Gateways (Smartlink SI B Ethernet) and switchboard server (IFE) provide valuable information through a common media: Ethernet. Locally and from the distance, any authorized operator gets a clear vision of the building or process. Vital values (temperature, pressure, electrical, etc.) and operational status are displayed on his Smart Panel interface. Necessary actions can be taken immediately.

+ Optimized energy and operation monitoring with Enerlin'X Ethernet gateways and servers

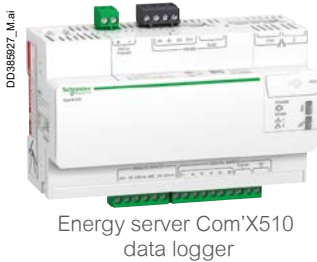

Com'X 510: ComPacT plug and play gateways and data logger. It is an important part of an entry level energy management system, used to collect and store building data.

- Aggregation of WAGES (Water, Air, Gas, Electricity, and Steam).
- Environmental parameters (Temperature, Humidity, CO₂).

Com'X 510 provides access to reports such as on-board device and circuit summary pages, as well as on-board data logging. Data can be securely accessed in real time or transmitted as a report to an Internet database server.

IFE switchboard server: it is mainly dedicated to communication with circuit breakers (ULP protocole or Modbus), where it is used to collect and store circuit breakers status, electrical values.

Focus on

+ Quicker, easier Smart Panel projects with EcoStruxure Power Commission software



EcoStruxure Power Commission software for PC is an invaluable tool during commissioning, testing and maintenance phases of the project life cycle.

Thanks to its connected devices automatic discovery, communication tests and other functions, a lot of time can be saved and errors minimized.

EcoStruxure Power Commission generates reports and creates a repository of projects in the Cloud.

+ Improved maintenance team efficiency with EcoStruxure™ Facility Expert

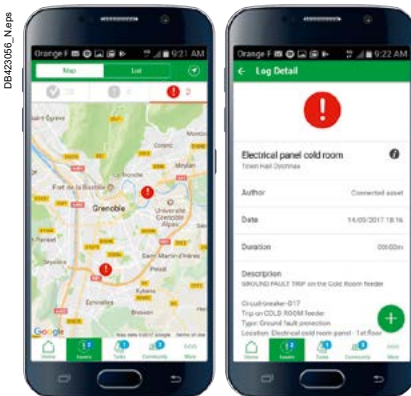

EcoStruxure™ Facility Expert helps facility managers and maintenance teams keep key assets up and running and improve maintenance efficiency.

Whether EcoStruxure™ Facility Expert is used on a smartphone, tablet, online or offline, it will greatly simplify operation & maintenance:

- automated notifications in case of an issue, see where the problem is and quickly implement corrective actions
- immediate access to all data needed to maintain assets efficiently (operations history, maintenance plan, technical documentation), from anywhere
- information sharing with the maintenance team in real time for more efficient, traceable troubleshooting.

EcoStruxure™ Facility Expert gathers data, generates maintenance reports, stores and sends them to the right person.

+ Energy performance follow-up and improvement with EcoStruxure™ Facility Expert



EcoStruxure™ Facility Expert helps business owners and site managers reduce their energy costs.

On a web portal, it provides insights into energy data and gives you the visibility you need to reduce energy consumption.

Facility managers get a clear vision on real-time energy consumption for all managed sites from any location.

Advanced management functions are provided: energy allocation per zone and usage, performance comparison with relevant indicators, overrun power demand tracking. With EcoStruxure™ Facility Expert, organizations can easily comply with ISO 5001 and buildings meet quality certification such as LEED, Nabers...

Contents

Presentation	3
EcoStruxure™ Power empowers you for the future.....	4
Ethernet-READY SMART PANELS	6
>> FUTURE TIME SAVINGS, PEACE-OF-MIND	7
>> DAY-TO-DAY ENERGY MANAGEMENT	8
>> POWER AVAILABILITY & QUALITY, ENERGY PERFORMANCE.....	9
MEASUREMENT AND PROTECTION DEVICES PORTFOLIO	10
Ethernet-READY SMART PANELS	12
SMART PANEL ARCHITECTURES.....	14
SMART PANEL CONFIGURATION TOOLS.....	15
Example	17
Power and energy management in a hotel chain.....	18
The solution architecture	20
Smart Panel design	23
Communication architecture: global overview	24
Communication architecture: examples.....	25
Communication architecture: products and functions	26
Locate sources of useful information in the switchboard	28
Get circuit breaker status and electrical values	30
Get circuit breaker status, electrical values and control loads	34
Com'X energy data logger / server	37
Com'X 210	38
Com'X 510	40
Com'X 210/510	42
Enerlin'X display & communication components	45
FDM128 Ethernet switchboard display	46
FDM121 Switchboard display	48
IFE Interface IFE switchboard server	50
EIFE embedded Ethernet interface for drawout MasterPact MTZ	52
IFM Modbus interface	54
I/O application module.....	56
PowerTag system gateways and display	59
Smartlink SI B	60
PowerTag Link	67
PowerTag Link Display	70
PowerLogic™ wireless devices	73
PowerTag Energy Introduction and common principle	74
PowerTag Energy 63 A	76
PowerTag Energy Flex 160 A.....	83
PowerTag Energy Rope 200 to 2000 A	87
PowerTag Energy Monoconnect 250 A - 630 A	91
HeatTag temperature and humidity sensor	98
PowerTag Control modules	102
Design and monitoring software	
Maintenance mobile application	109
EcoStruxure Power Commission	110
EcoStruxure™ Facility Expert	112
Index of commercial references	114
Meters and auxiliaries overview for 'Measure' functions	115
Index of commercial references	116



Act

Connect

Measure

Protect

EcostruXure™ Power
brings building energy
under control



EcoStruxure™ delivers Innovation at Every Level:

From connected products to edge control, and apps, analytics and services on six domains of expertise – Power, IT, Building, Machine, Plant, and Grid – EcoStruxure™ delivers enhanced value around safety, reliability, operational efficiency, sustainability, and connectivity to our customers.

EcoStruxure Facility Expert and Facility Advisor are two key contributors to the EcoStruxure Power platform. An edge control solution, Facility Expert is a suite of cloud-based software that offers operation monitoring and information sharing, contributing to business continuity while reducing energy and maintenance costs.

Deliver even more with EcoStruxure Facility Advisor – a powerful service combining advanced building analytics and expert advice from Schneider Electric professionals. Identify higher potential savings, make informed decisions, and provide data-based recommendations for your customers. Reach unparalleled building performance and operational efficiency as a Schneider Electric partner.

Unleash the full potential of your electrical panels and energy management system by connecting latest hardware with innovative software and services – like Facility Expert and Facility Advisor – helping you to optimize operations, save energy, and improve efficiency where it counts.

EcoStruxure™ Power empowers you for the future

EcoStruxure™ Power gives you a complete solution approach to:

- Deliver more reliable and efficient power
- Protect your assets, processes, and people
- Provide tailored, future-ready solutions for the new digital economy
- Enable new services in energy and operation management
- Create new business opportunities for your company

EcoStruxure™ has been deployed in 480,000+ sites, with the support of 20,000+ system integrators and developers, connecting over 1.6 million assets under management through 40+ digital services.

As a partner of Schneider Electric, grow your business by adding valuable new services while increasing customer satisfaction and retention.



Ethernet-READY SMART PANELS

Ethernet-ready Smart Panels enable electrical distribution control and expertise. 'Protect' - 'Measure' - 'Connect' are the 3 pillars of their technology.

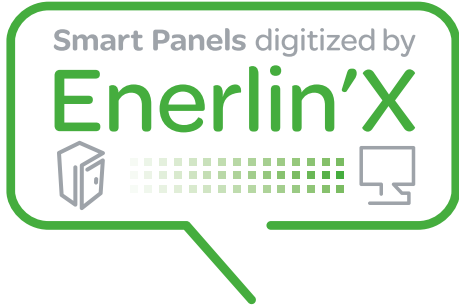

PE115755_M.pptd



Act

Connect

Give a voice to the panel

Ethernet network data transmission is now part of the intrinsic design of protection and metering devices.

Measure

Keeping a close eye on energy flows

The switchboard plays a key role in capturing building related data, by gathering the protection and metering component's data.

Protect

Electrical protection is at the core of Smart Panels

High-performance technology is present in every breaker and every residual current device.

> FUTURE TIME SAVINGS, PEACE-OF-MIND

Access to Smart Panel status and values are important for taking advantage of monitoring and management services, locally or remotely.

Act in small/medium buildings

with FDM128, Com'X 510, PowerView, EcoStruxure™ Facility Expert



Electrical device monitoring and control with FDM128, locally



Optimizing energy-efficiency

- Visualize, record energy consumption and WAGES
- Comply with regulations



Com'X 510 web pages direct display, or Cloud based pages from other devices with PowerView.



Improving continuity of service

- Get instant notifications
- Manage with assets-maintenance platform
- Get and analyze data for quick crisis-recovery



Distance management with EcoStruxure™ Facility Expert on Smartphone, tablet, PC



Increasing maintenance efficiency

- Operate preventive maintenance tools
- Follow maintenance & planning
- Provide business owner instant access to maintenance reports

> DAY-TO-DAY ENERGY MANAGEMENT

For simply dealing with building user's needs and energy constraints. EcoStruxure™ Building Management provides electrical management, monitoring and energy accounting.

Act in large non-critical buildings

with EcoStruxure™ Energy Expert



Managing equipment & key assets

- Check operating status, faults on custom one-line diagrams



Monitoring electrical network

- Observe voltage disturbances, harmonics on graphics
- Read power factor



Accounting energy

- Record power meter data on dashboards
- Allocate energy consumption with costs
- Follow conservation goals

> POWER AVAILABILITY & QUALITY, ENERGY PERFORMANCE

Energy decisions are often crucial in large critical buildings.
EcoStruxure™ Power Monitoring Expert (software for PC) collects Smart Panels values to provide expert analysis.

Act in large critical buildings with EcoStruxure™ Power Monitoring Expert^[1]

DB425657.ai



Analysing Power Events

- Helps speed up downtime crisis recovery
- Helps determine incident root cause, events sequence
- Helps troubleshoot power quality issues

DB425658.ai



Monitoring Power quality

- Be alerted of equipment affected by power quality issue
- Compare power quality against industry standards
- Collect facts for future discussion with utility

DB425659.ai



Analysing Energy Performance

- Evaluate building energy saving performance
- Identify underperforming loads
- Analyze Energy Conservation Measures (ECMs) according to an ISO50001 program



[1] EcoStruxure™ Power Monitoring Expert, <http://pmedemo.biz/web/>
ID: demo & Password: demo

MEASUREMENT AND PROTECTION DEVICES PORTFOLIO

Switchboards are the most convenient location to collect data about electrical supplies throughout the building

Schneider Electric provides best-in-class devices for electrical protection, control, and measurement, as well as efficient switchboard build-up systems.

We also create new digital possibilities through better connectivity, thanks to the Enerlin'X system components embedded in our power operating devices.

30% of energy used in commercial buildings is wasted on average

Source: US Environmental Protection Agency, US Department of Energy 2016.

Power and energy stand-alone metering



PowerLogic meters

Monitor key distribution points 24 hours a day, from generators, substations, and service entrances, to mains, feeders, and loads. All data is accessible locally or remotely. Help improve network reliability by tracking real-time power quality, equipment status, trending loads, and logging events and alarms.



PowerLogic Energy meters

Energy meters for a variety of applications: single-phase (iEM2000 series) or three-phase (iEM3000 series) circuits, basic kWh meters for elementary applications to MID-compliant meters for billing applications, and advanced energy meters capable of measuring a variety of electrical parameters. Data is visible locally or accessible remotely.

The new PowerTag Energy meters solution brings new advantages:

- simplicity as the PowerTag Energy is simply plugged on the circuit breaker terminal
- wireless communication with the gateway
- class 1 precision Currents, Voltages, Frequency, Power, Power Factor, Energies measurement.

Power supply and protection monitoring, class 1 embedded metering



MasterPact, ComPacT, PowerPact circuit breakers with Micrologic control units

Operating status, electrical measurements, diagnosis, maintenance information. The embedded, pluggable control units reduce the installation cost and provide valuable data to facility managers and maintenance technicians in their daily and periodic tasks. MasterPact MTZ Mobile App makes information from main breaker visible on a smartphone.



Acti9 circuit breakers, residual current devices, surge arresters

Each Acti9 protection device also contributes to electrical supply reliability. Easy-to-fit auxiliaries transmit real-time status to the communication system and additional RCA modules enable digitally controlled resetting after a trip.

Circuit and load controls



Acti9 contactors and impulse relays, remote controlled ComPacT and MasterPact

To improve user comfort, lighting or other loads are switched on and off, independently or together, via the digital system. Can be done via remote instruction or predefined schedule.

Ethernet-READY SMART PANELS

DD365114.ai



Simply plug
the switchboard
to the Ethernet LAN

Ethernet is the most widespread communication protocol in professional buildings, providing fast data transmission. Today, switchboards can be connected via Ethernet like any other device through an RJ45 socket.

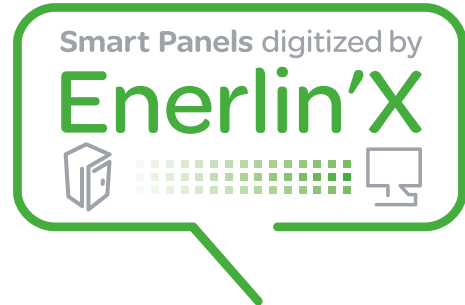

DB406758-50.eps



PB114326-30.eps



Com'X 210 energy data logger

- Collects WAGES data from various devices throughout the building
- Delivers batches of data ready to be processed by EcoStruxure™ Facility Expert or any online service

DB406891-50.eps



A3XMM20-28.eps



PowerTag system gateways

Digital interfaces for Acti9, ComPacT NSX, or third-party devices

- Smartlink SI B:
RF with PowerTag Energy meters + Modbus master + Ethernet
- PowerTag Link:
RF with PowerTag Energy meters + Ethernet Modbus TCP/IP
- Automatic e-mail sent upon events (configurable), status and alarms
- Embedded web pages for energy monitoring & control master

The design of Enerlin'X components is largely inspired by feedback from professionals working with switchboards. They asked for:

- grouping of similar functions in the smart components (e.g. Smartlink)
- easy cabling, fast connection-disconnection
- space-savings in the enclosure.



Com'X 510 energy server

- Collects WAGES ⁽¹⁾ data from device sensors throughout the building
- Provides detailed and global views of energy consumption allowing to detect the most important savings opportunities accessible via a web browser

⁽¹⁾ Water, Air, Gas, Electricity, Stream



Enerlin'X IFE

- Ethernet communication interface for power circuit breakers
- Embedded web pages for energy control, and maintenance
- Modbus master, with automatic detection and configuration of "slave" devices
- Switchboard server aggregates, computes, and displays data from all devices in the switchboard, connected either by Modbus serial or Ethernet
- Automatic e-mail sent upon configured events



Enerlin'X IFM

- Modbus connection and data collection for one ComPacT or MasterPact device



Enerlin'X IO

- Provides tailored additional functions such as withdrawal cradle position

SMART PANEL ARCHITECTURES

Tested, validated, documented architecture

Smart Panels have been certified through Schneider Electric's "TVDA" quality process.

Tested in performance labs by experts, in various possible configurations.

Validated full functional compatibility of devices.

Documented, with user guide, predefined CAD panel designs & wiring diagrams.

Numerous tests carried out in Schneider Electric labs ensure Smart Panels digital architectures are validated and ready to implement.

Technical guides available online explain, step by step, how to arrange Enerlin'X components to transform switchboards into Smart Panels.

Design

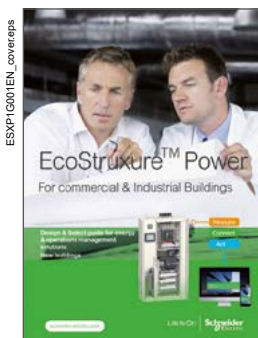

Create the exact list of items (auxiliaries, interfaces, connections) to collect data from each breaker or meter in the switchboard.

Assemble



Principles of digitized switchboard assembly. How to optimize space, electromagnetic compatibility and take advantage of Prisma system conveniences.

Configure



Full description of component parameters. How to configure and test Smart Panel functionalities.

SMART PANEL CONFIGURATION TOOLS



EcoStruxure Power Commission software: customer engineering tool

As a part of the Schneider Electric services library, EcoStruxure Power Commission software is dedicated to project management

With EcoStruxure Power Commission, electrical devices are configured, tested and commissioned in the simplest way.

EcoStruxure Power Commission reduces the commissioning time of Smart Panels by 70% and supports the system during operation & maintenance.

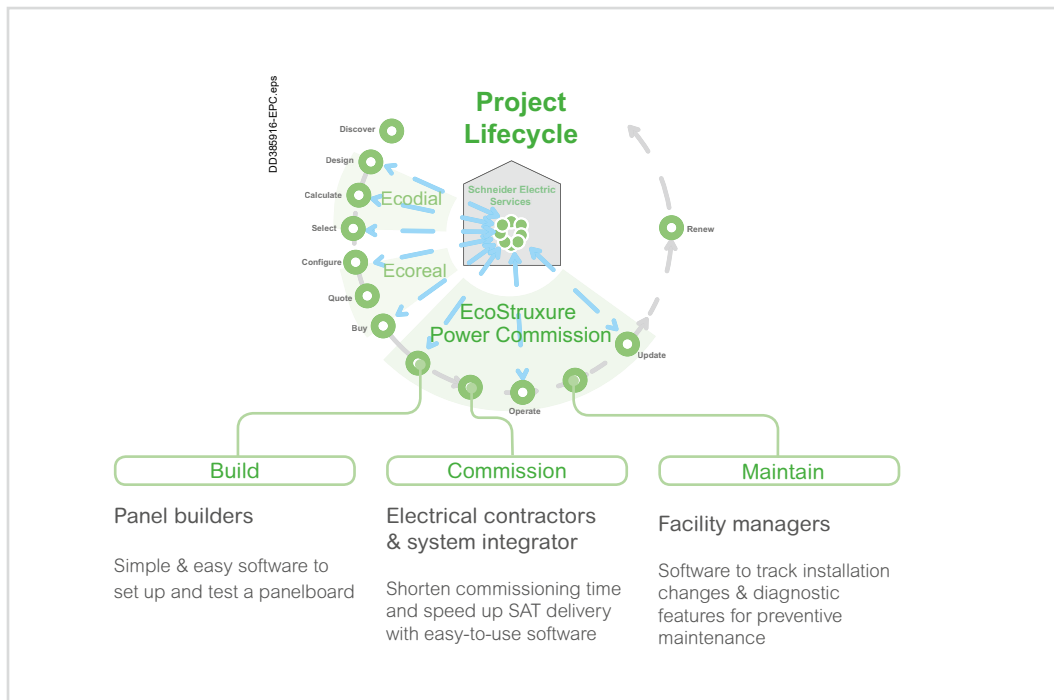

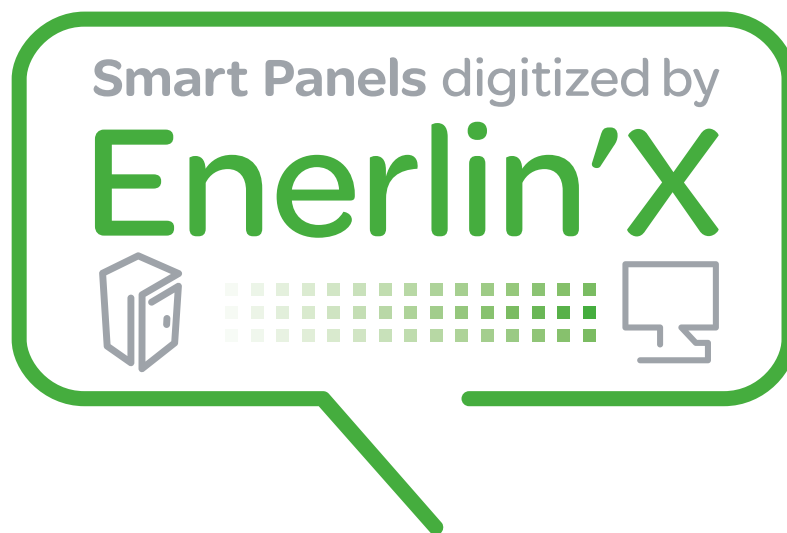

Example

Power and energy management in a hotel chain

Power and energy management in a hotel chain

Our customer, an operator of a large chain of hotels, wanted to implement a global energy monitoring system

Our customer's challenge

- Ensure and monitor customer comfort across all branches.
- Boost confidence regarding customer health and security and increase regulatory compliance.
- Optimize energy and fluid consumption, to save money and enable green marketing.

'I was doubtful about the final cost to setup this system. But there was no bad surprise at all. And our facility managers kept it working without any problem.'

Financial director



DD365923.eps



Increased comfort and security of guests

When an issue occurs that might impact guest comfort and security, hotel staff are immediately informed.

Comfort and security dashboards are widespread

Every staff member has continuous access to a real-time comfort and security dashboard showing:

- deep freezer temperature
- heating and air conditioning system key values
- sanitary hot water temperature
- air temperature and humidity on each floor.

Business efficiency

Historical data from alarms from all hotels enables an evolution towards predictive maintenance, with clear benefits for planning and budgeting.

Best practices shared across the company

Every three months, hotel managers meet together with corporate technical and financial directors to share best practices and compare improvements. One manager said: 'We decided to equip a pilot site with solar water heating. By relating its energy consumption to the other sites, we could calculate the savings and payback, and decide upon investing in this equipment for other sites'.

DD365924.eps



Full staff involvement

Each hotel manager and his technical staff have full-time access to details of energy consumption. The entire staff is informed about energy and water savings. The system detects and flags abnormal consumption, and breaks electrical consumption down into:

- HVAC
- food conservation (deep freezers and fridges)
- general lighting and lifts
- cooking and dishwashing equipment
- guest rooms.

Sustainability information and green marketing

Screens inform guests of environment-friendly behaviors and display recent resource saving achieved thanks to their support and awareness.

'We understood why we regularly had penalties from energy providers. The rated power was exceeded everyday for several minutes, when all rooftops were starting. We rescheduled all automatic equipment, and we could even lower our rated power subscription'

Hotel director

The solution architecture

- E-mail notifications
- Access to dashboards

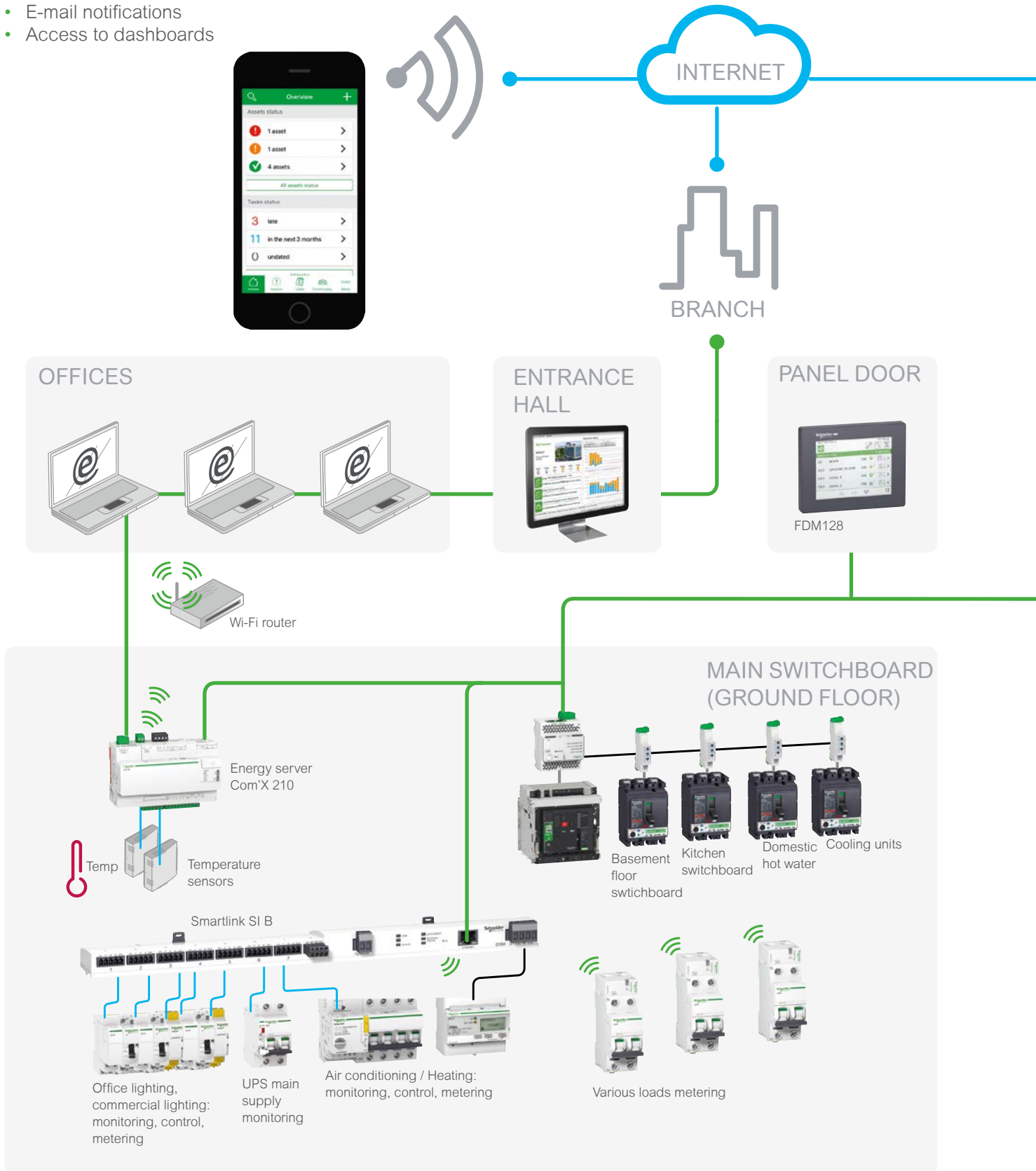

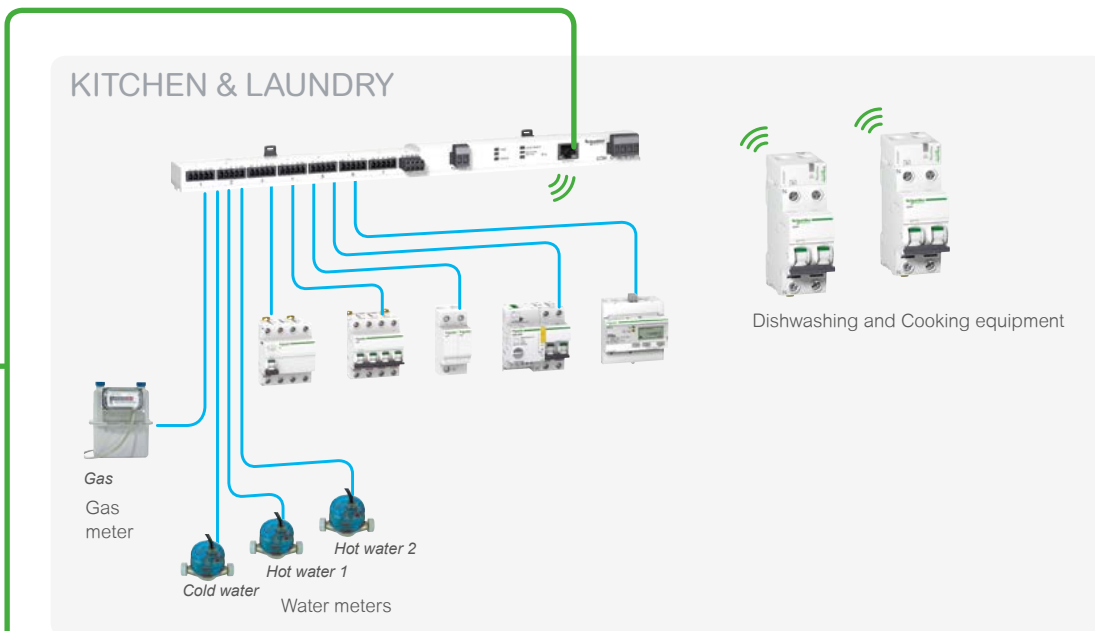





'Most surprising was how each local electrical contractor could replicate and connect the system in each hotel, without much technical coordination'

Corporate energy officer



-  Ethernet
-  Modbus
-  ULP
-  Hard wired
-  Wireless

PB115795_M.jpg



Smart Panel design

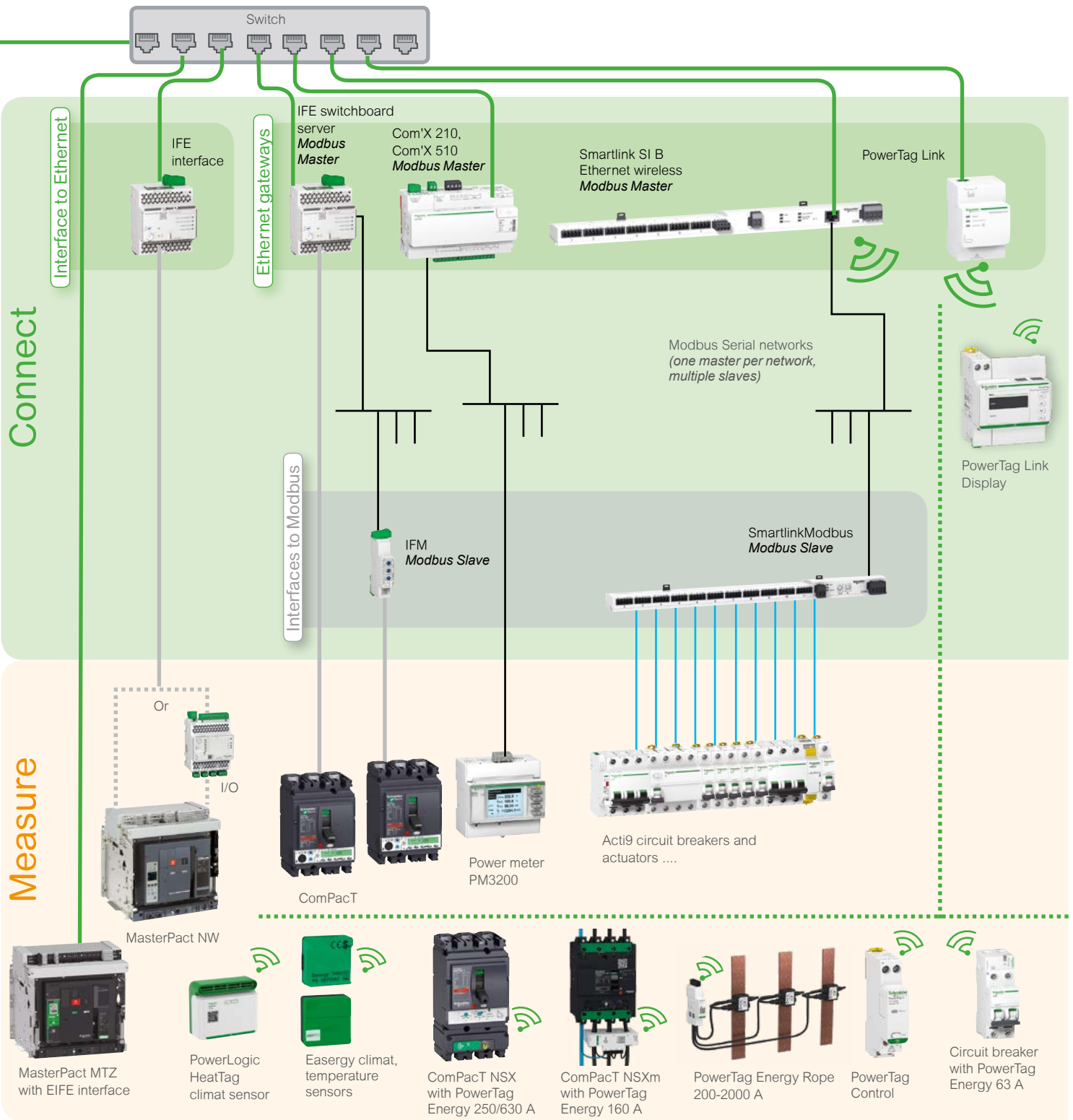

- This diagram clearly shows the equipment involved into the "Measure" and "Connect" functionalities defining the Smart Panel concept.
- Interface: provides a network port to one or several devices (circuit breakers, actuators, counters,...) from their hard wired or ULP links.
- Gateway: provides the communication between two networks with different protocols (Ethernet and Modbus).

Smart Panel design

Communication architecture: examples

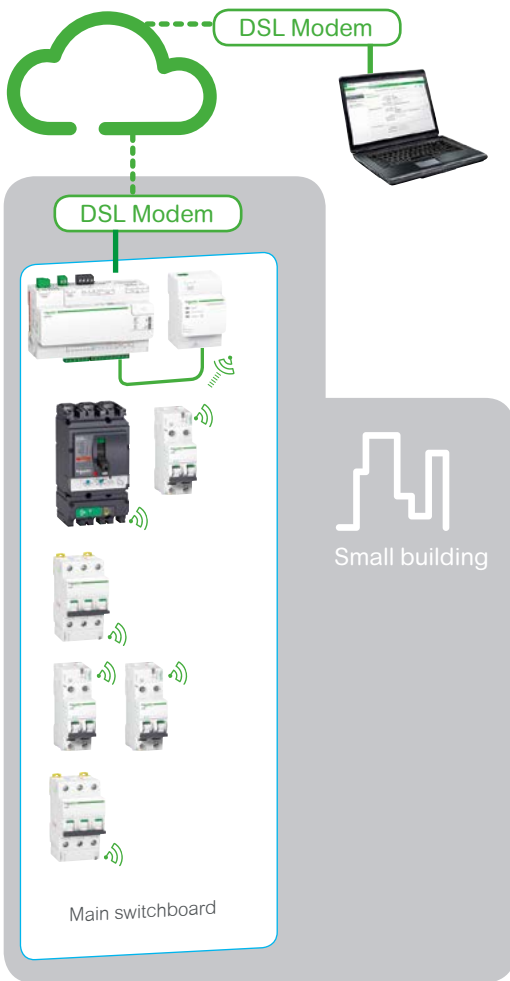
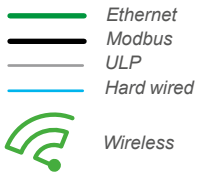

Unique switchboard:

PowerTag Link acts as a wireless data concentrator: collects all PowerTag Energy values and alerts, such as power loss on circuit breakers.

The Com'X 210 acts as a gateway, connecting the switchboard to the Cloud via a DSL modem.

Display

The related energy dashboards generated by the Energy Operation web services are available on any PC connected to the web.

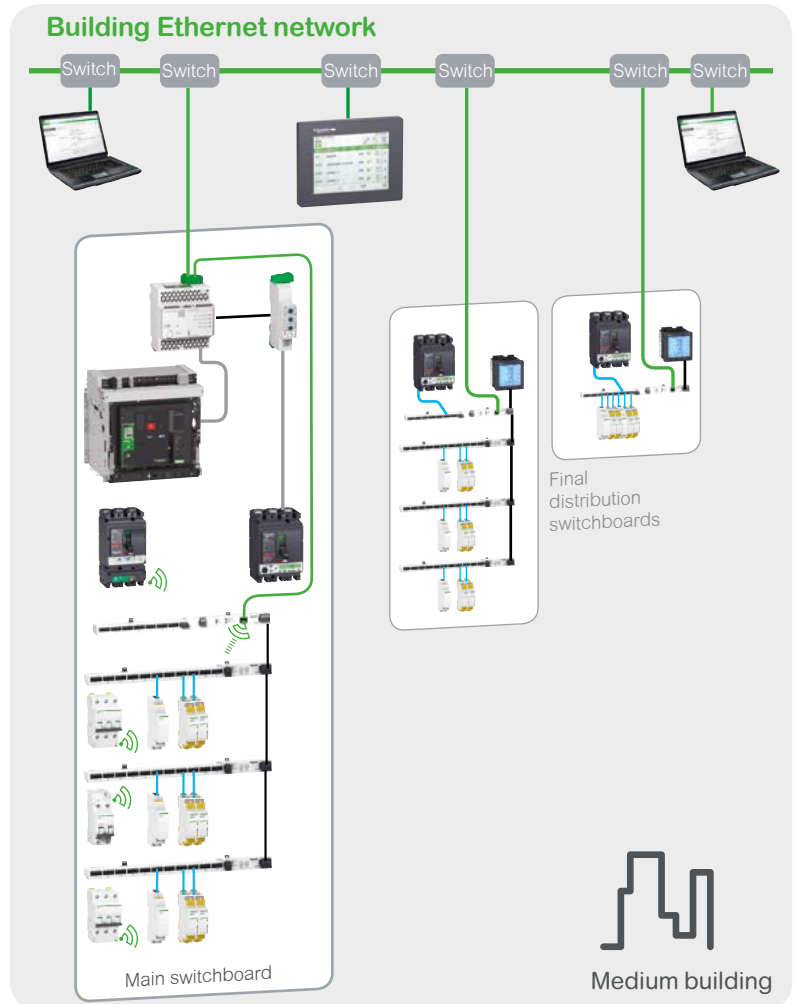

Main switchboard:

Smartlink Modbus provide the monitoring and control of circuit breakers and actuators, the Smartlink SI B Ethernet Wireless collects the PowerTag Energy values on single - phase circuit breakers. The main incomer is monitored and controlled directly by the IFE switchboard server, through an ULP link. Other circuit breakers are connected to IFM interfaces, through ULP links, as well.

The data from the Smartlink Modbus slaves are collected by the master, an Smartlink SIB.

The IFE interface concentrates the data from:

- the Smartlinks through an Ethernet liaison
- the IFM's through DIN rail connectors (see page 54)
- the main incomer through its ULP link.

Display

As the choice was made for a local monitoring and control, an LCD touch panel FDM128 or PC with standard browser is connected to the building Ethernet network, shared by all the switchboards. The web pages generated by the local IFE switchboard server and Acti9 Smartlink Ethernet are displayed on it.

Final distribution switchboards

An Smartlink SI B Ethernet provides the connection of each switchboard to the local Ethernet network. The same principle as in the main switchboards applies for the status and values monitoring.

Smart Panel design

Communication architecture: products and functions

Enerlin'X communication system provides access to status, electrical values and devices control using Ethernet and Modbus SL communication protocols.

Ethernet has become the universal link between switchboards, computers and communication devices inside the building. The large amount of information which can be transferred makes the connection of Enerlin'X to hosted web services of Schneider Electric a reality. More advantages are offered to integrators thanks to configuration web pages available remotely or on the local Ethernet network.

Modbus SL is the most widely used communication protocol in industrial networks. It operates in master-slave mode. The devices (slaves) communicate one after the other with a gateway (master).

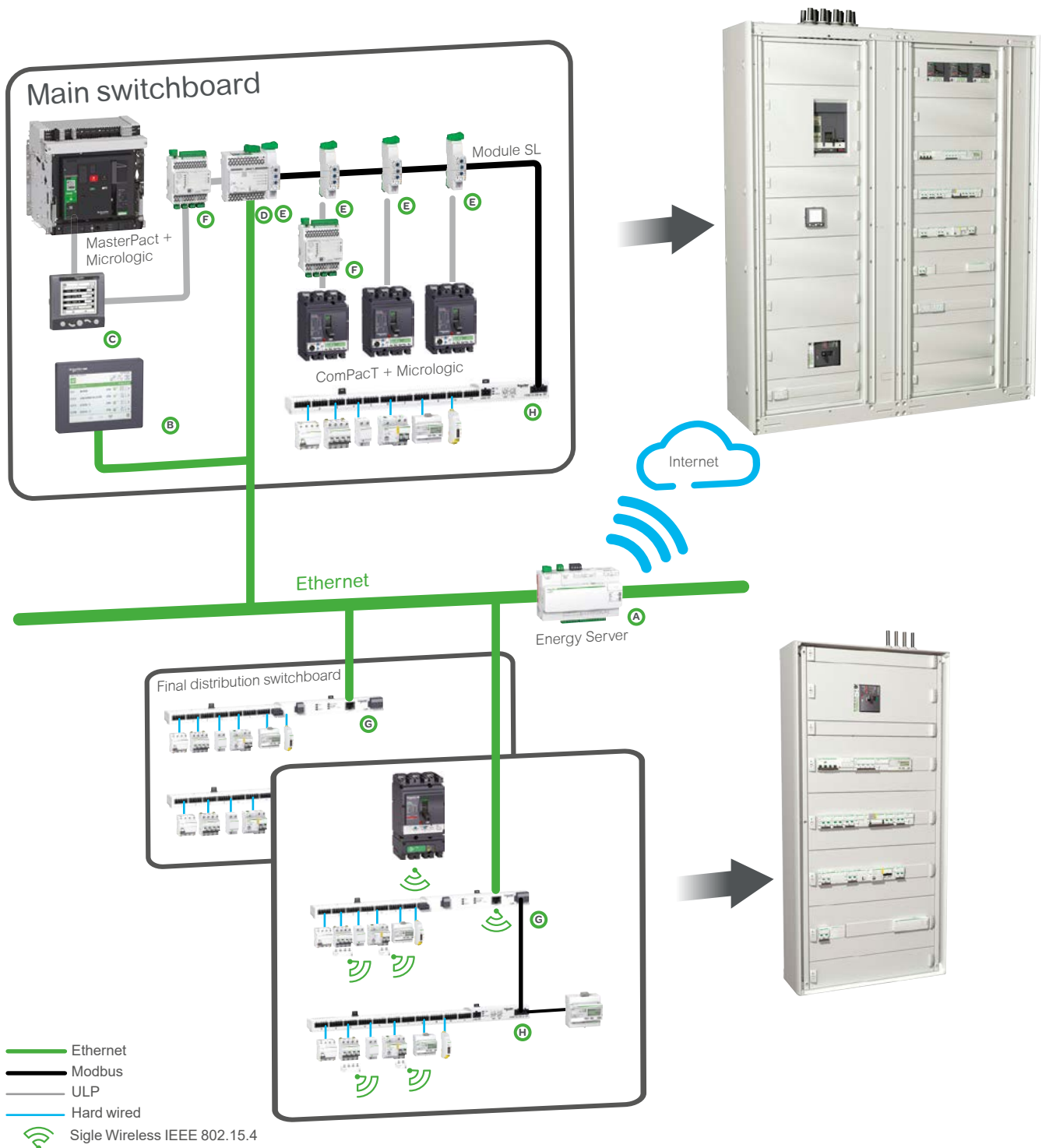

Communication architecture: products and functions

Communication & display components							
	Name	Function	Port (to device)	Port (to server)	Inputs	Outputs	Cial. Ref.
A	Com'X 210	Energy data logger + Ethernet Gateway	Ethernet Modbus Master, wireless to meters	Ethernet cable + WiFi	64 devices: 6 binary 2 analog 32 Modbus devices + other Ethernet devices (Modbus TCP)	-	EBX210
	Com'X 510 24 V DC + PoE	Energy server + Ethernet Gateway					EBX510
B	FDM128	Ethernet LCD colour touch screen	-	Ethernet		-	LV434128
C	FDM121	LCD display for circuit breaker	ULP	-	1 circuit breaker	-	TRV00121
D	IFE Switchboard server	Switchboard server	Modbus Master & ULP	Ethernet	20 circuit breakers	-	LV434002
	IFE interface	Ethernet interface for circuit breakers	ULP	Ethernet	1 circuit breaker	-	LV434001
	EIFE embedded interface	Ethernet interface for MasterPact MTZ drawout circuit breaker	ULP	Ethernet	1 circuit breaker	-	LV851001
E	IFM	Modbus interface for circuit breaker	ULP	Modbus Slave	1 circuit breaker	-	LV434000
F	I/O	Input/Output application module for circuit breaker	ULP	ULP	6 binary 1 analog (PT100 sensor)	3	LV434063
G	Smartlink SI B Ethernet wireless	Ethernet server for I/O and Modbus slave devices	Modbus Master & Wireless to PowerTag Energy	Ethernet	14 binary 2 analog	7	A9XMZA08
H	Smartlink Modbus slave	Modbus interface with Input/Output functions	-	Modbus Slave	22 binary	11	A9XMSB11

Ethernet Gateway or Interface: routes an internal traffic (ULP or other protocols) to the Internet, the outgoing messages are coded with Modbus TCP/IP protocol.

Server (Switchboard, Energy): routes the internal traffic to the Internet. Other complementary functions such as data logging and storage. Provides device status and energy trends on internal web pages...

Smart Panel design

Locate sources of useful information in the switchboard

MasterPact ①, ComPacT ②, PowerPact⁽¹⁾ circuit breakers

Auxiliary contacts indicate breaker status.
 Embedded sensors provide electrical values.
 Status contacts and sensors are monitored by the embedded Micrologic control unit.

Web pages generated by IFE Interface, IFE switchboard server (or embedded EIFE with drawout MasterPact MTZ)

IFE interface, and EIFE imbedded interface (for drawout MasterPact MTZ)

Monitoring of electrical values - Breaker status

Basic Readings: Micrologic H (Arch 1)

Load Current (A)
 Power
 Voltage LL
 Voltage LN

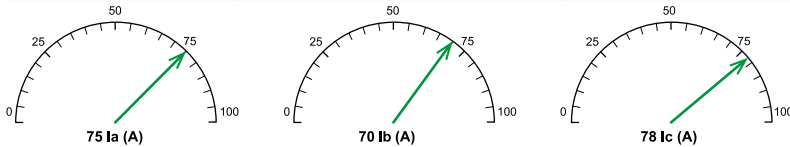

Parameter	Minimum	Present	Maximum
Breaker Status		Open	

Information for Maintenance

Micrologic H (Arch 1)

Breaker operation Counters

Counters	Value
Total number of indication contacts (OF) operation	54
Indication contacts (OF) operation since last reset	54
Trip indication contact (SD) operation	---
Trip indication contact (SDE) operation	78

Breaker operation Counters

Counters	Value
Contact wear indicator	--- %

Cradle Counters

Counters	Value
Cradle connected	62
Cradle disconnected	20
Cradle test	7

(1) Except PowerPact M

DB400736-46-eps

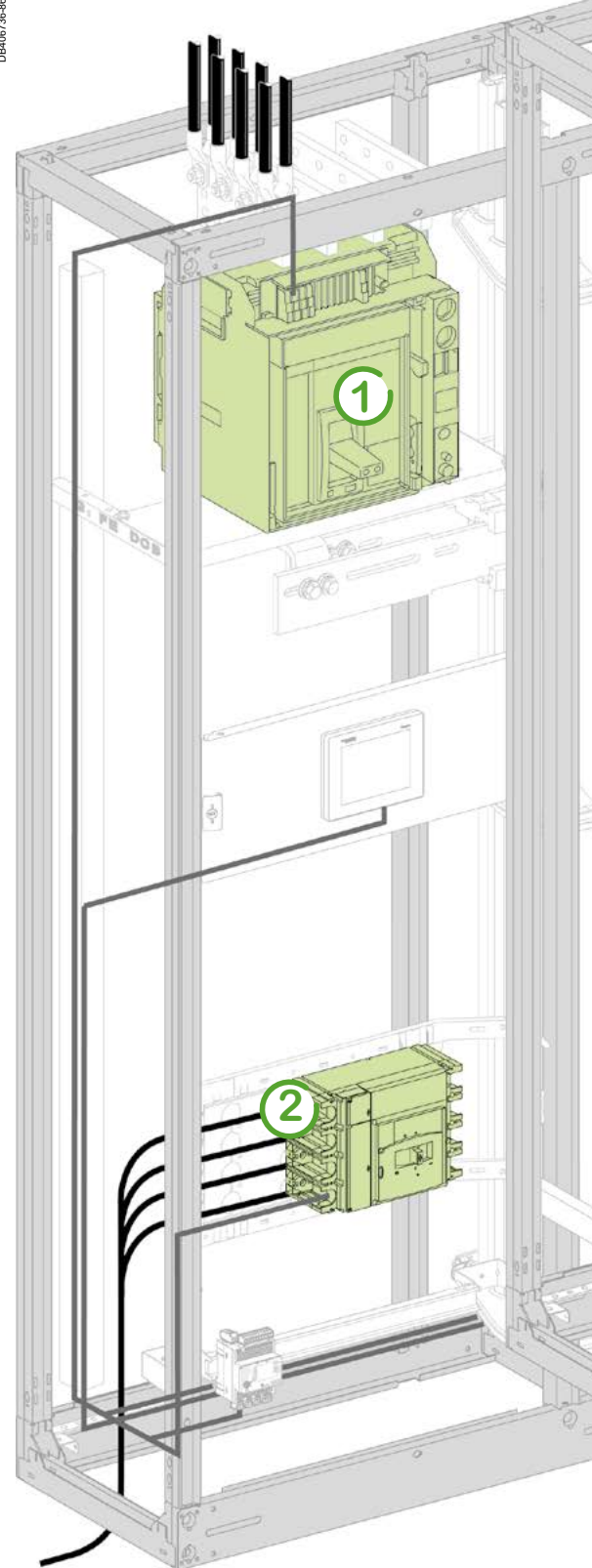

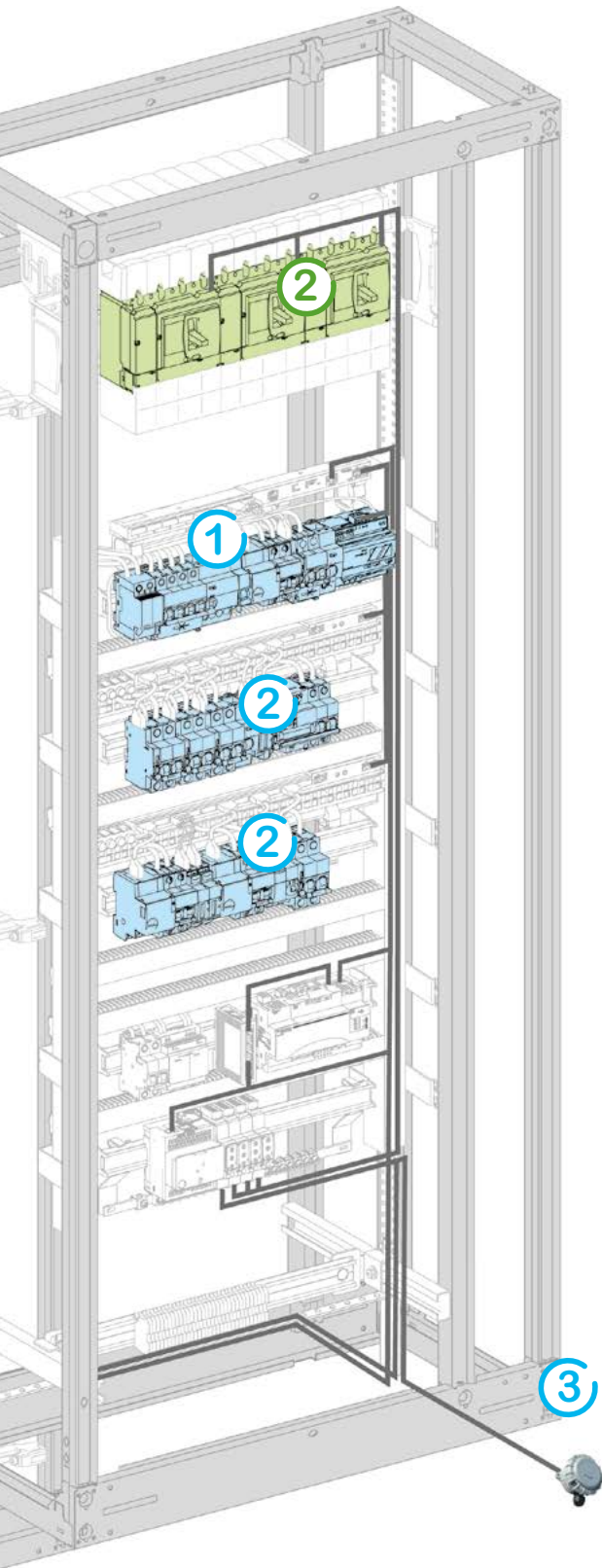

Miniature circuit breakers, remote controlled MCB (Reflex), actuators (relays, impulse relays) ①

Auxiliary contacts indicate open/closed status.
Specific input on actuators and Reflex provides remote control.

Web pages (partial) generated by Smartlink Ethernet SIB

Digital Channels

Name	Status	Control	Product	Label
Lighting 1.1		OPEN CLOSE	OF+SD24	L1.1
Lighting 1.2		OPEN CLOSE	OF+SD24	L1.2
Lighting 2.1		OPEN CLOSE	OF+SD24	L2.1
Lighting 2.2		OPEN CLOSE	OF+SD24	L2.2
Lighting 2.3		OPEN CLOSE	OF+SD24	L2.3
Ventilation 1		OPEN CLOSE	OF+SD24	V1

Energy meters ②

Meters: periodical Wh pulse on binary output - Wireless metering modules: periodical values sent

Web pages (partial) generated by Smartlink Ethernet SIB Monitoring energy meters

Pulse Meters

Name	Value	Product	Label
Lighting 1	1276 kWh	iEM2000T	L1
Lighting 2	5413 kWh	iEM2000T	L2
Lighting 3	213 kWh	PowerTag Energy	L3
Ventilation 1	187 kWh	PowerTag Energy	V1
Ventilation 2	311 kWh	PowerTag Energy	V2

Analog sensor ③

Temperature sensor sends a 0-10 V signal.

Web pages (partial) generated by Smartlink Ethernet SIB Monitoring analog sensors

Analog Channels

Name	Value	Product	Label
Outside temperature	18°C	Crouzet 89750150	Text 1

Get circuit breaker status and electrical values

MasterPact, ComPacT NS, PowerPact P, R



MasterPact MTZ with Micrologic trip unit

The first air circuit breaker to embed Class 1 accuracy for active power and energy measurement, compliant and third-party certified as per IEC 61557-12.

The Micrologic X trip unit and its EIFE interface module make the MasterPact MTZ a connected circuit breaker, providing data, wireless and Ethernet communication for mobile smart devices.

MasterPact NT/NW, ComPacT NS, PowerPact P, R with Micrologic trip unit



BCM ULP communication module
Provides ULP communication port to a Micrologic trip unit, giving monitoring and control access from upper networks.

Available functions	Micrologic type			
Status indications				
ON/OFF (O/F)	A	E	P	H
Spring charged CH	A	E	P	H
Ready to close	A	E	P	H
Trip SDE	A	E	P	H
Connected / disconnected / test position CE/CD/CT	A	E	P	H
Controls				
MX1 open	A	E	P	H
XF close	A	E	P	H
Measurements				
Instantaneous measurement information	A	E	P	H
Averaged measurement information		E	P	H
Maximeter / minimeter	A	E	P	H
Energy metering		E	P	H
Demand for current and power		E	P	H
Power quality				H
Operating assistance				
Protection and alarm settings			P	H
Histories		E	P	H
Time stamped event tables			P	H
Maintenance indicators	A	E	P	H

Micrologic trip units: A, E, P, H

MasterPact, ComPacT NS, PowerPact P, R circuit breakers can be equipped with a Micrologic trip unit. This adjustable unit is mainly designed for tripping the circuit breaker in case of necessity and monitoring the downstream circuit. Alarms may be programmed for remote indications. Electrical measurements, operation data for predictive maintenance, are provided for local display or distant monitoring. The new Micrologic X provides data, wireless and Ethernet and communication for mobile smart devices.

Get circuit breaker status and electrical values

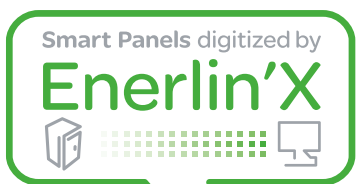

Architecture overview

Example of digitized switchboard architecture

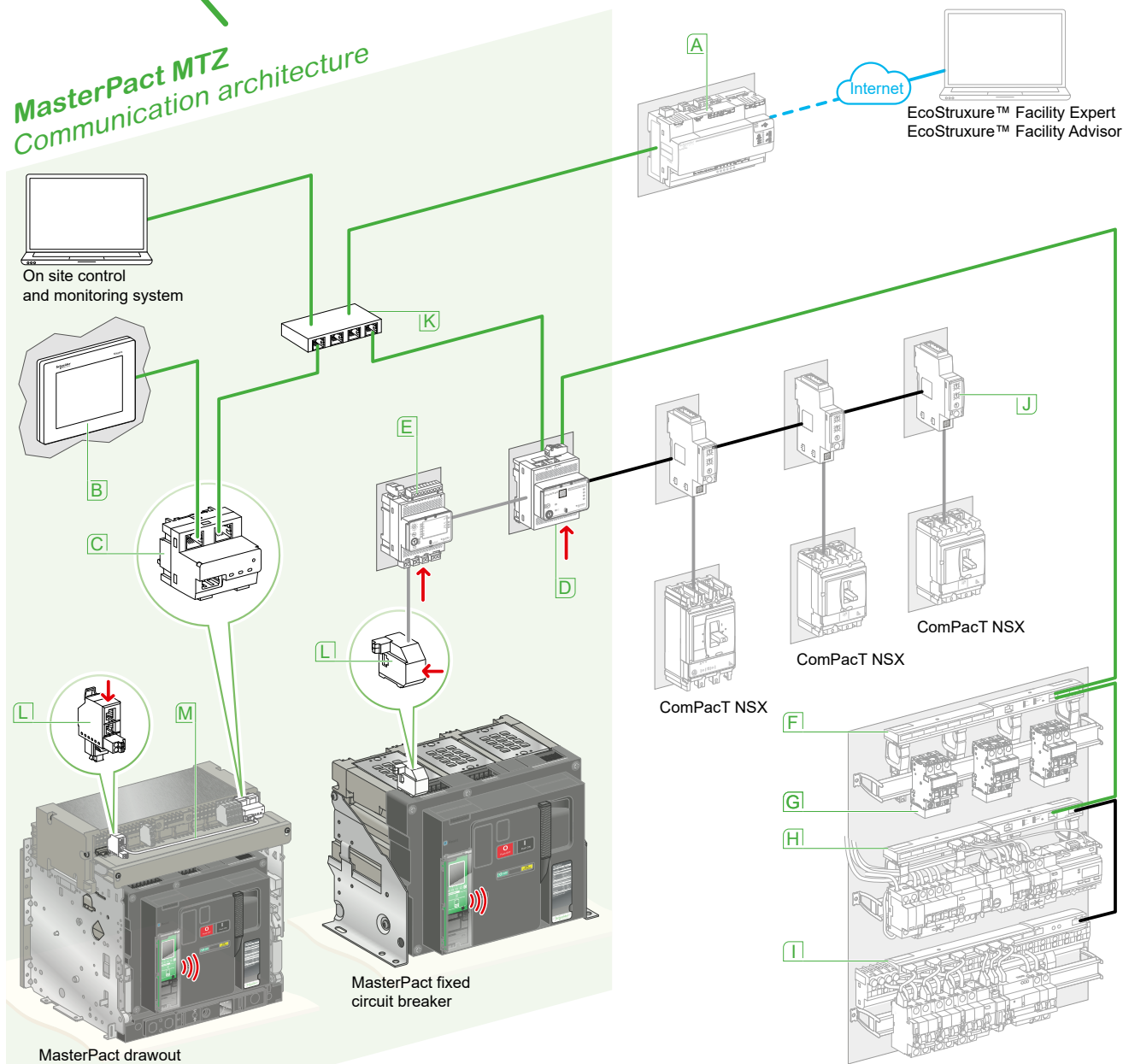

ULP is a fast communication link dedicated to circuit breaker monitoring and control

- 24 V DC
- Ethernet
- Modbus SL
- ULP
- Internet
-))) Wireless proprietary connectivity

- A** Com'X
- B** FDM128
- C** EIFE
- D** IFE
- E** I/O
- F** Acti9 Smartlink SIB Ethernet
- G** PowerTag Energy with radio frequency communication
- H** Smartlink Ethernet
- J** Smartlink Modbus
- J** IFM
- K** Switch
- L** ULP port
- M** ULP cord

Note: for every MasterPact MTZ the 24 V DC supply of all the associated interface modules (ULP port, IFE, IFM, I/O) must be delivered from the same 24 V DC power supply.

ComPacT NSX, PowerPact H, J, L

ComPacT NSX, PowerPact H,J, L with Micrologic trip unit



Micrologic trip units for 3 poles, 4 poles ComPacT circuit breakers

MicroLogic E available functions
Status indications
ON/OFF (O/F)
Fault-trip SDE
Connected / disconnected / test position CE/CD/CT (I/O module only)
Controls
Open
Close
Measurements
Instantaneous measurement information
Averaged measurement information
Maximeter / minimeter
Energy metering
Demand for current and power
Power quality
Operating assistance
Protection and alarm settings
Histories
Time stamped event tables
Maintenance indicators

Embedded trip unit and communication module



Micrologic trip unit

All ComPacT circuit breakers are equipped with a Micrologic trip unit. This adjustable unit is mainly designed for tripping the circuit breaker in case of necessity and monitoring the downstream circuit. Alarms may be programmed for remote indications. Electrical measurements, operation data for predictive maintenance, are provided for local display or distant monitoring.

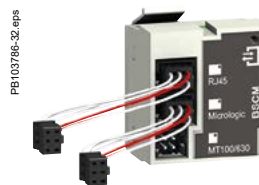

BSCM module

This module provides an ULP communication port to a Micrologic trip unit, giving monitoring and control access from upper networks, Modbus or Ethernet.

Architecture overview

Fixed ComPacT NSX circuit breaker

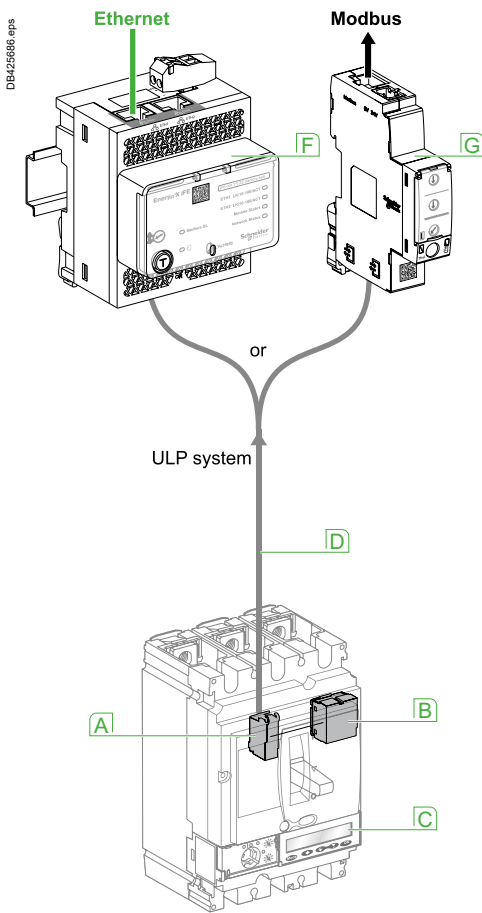

Drawout ComPacT NSX circuit breaker

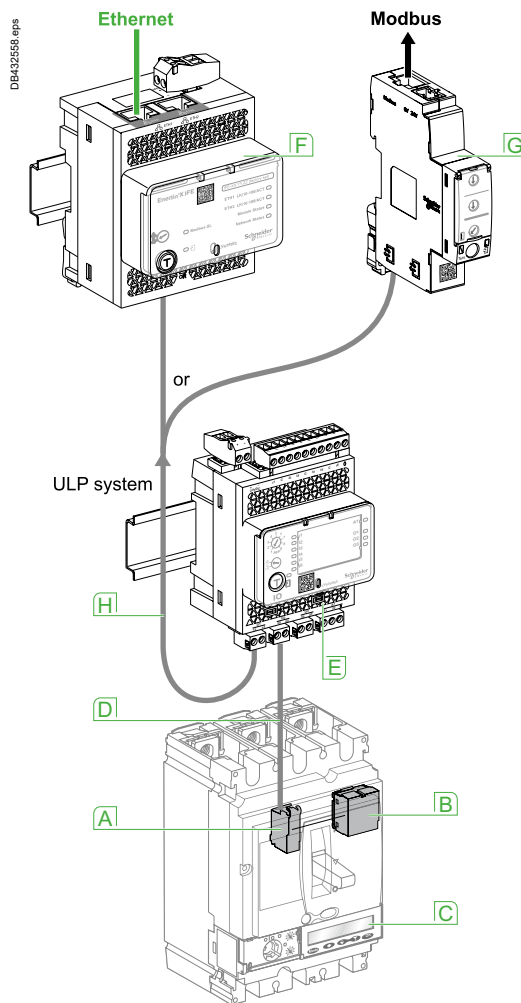

- A** Internal terminal block for communication via NSX cord
- B** BSCM module
- C** Micrologic trip unit
- D** NSX cord
- E** I/O module
- F** IFE interface module
- G** IFM module
- H** ULP cable

ULP system

is a fast communication link dedicated to circuit breaker monitoring and control. Based on a RS485 physical liaison with cable segments up to 5 meters, it is well adapted to severe environment. A choice of 6 pre-connectorized cables with different length is provided.

IFE interface ULP to Ethernet interface module

Provides an IP address to any circuit breaker fitted with an ULP port. The IFE interface makes all available data from the circuit breaker accessible from an Ethernet compatible display (FDM128), a PC with common browser, or IFE switchboard server which generates its own web pages.

IFM ULP to Modbus Interface module

Makes all available data of a circuit breaker fitted with an ULP port accessible via a Modbus network. IFM acts as a Modbus slave, accessible from a Modbus master (IFE switchboard server, Acti 9 Smartlink Ethernet or Com'X).

I/O I/O application module

I/O is dedicated to circuit breaker with ULP liaison. It provides the monitoring and control of any application around the circuit breaker (lighting or load control, cooling system, pulse metering acquisition...).

Smart Panel design

Get circuit breaker status, electrical values and control loads

PowerTag system



Available functions	PowerTag system type		
	SI B Ethernet wireless	PowerTag Link	Modbus Slave
Applications			
Breaker status monitoring	●	(1)	●
Load alarming	●	●	-
Basic energy metering (E)	●	●	●
Extended load monitoring (E,U,I,PPF)	●	●	-
Load control	●	-	●
Scheduling (App)	●	-	-
User interfaces			
Embedded web pages (web server)	●	●	-
Web (via Cloud)	-	●	-
BMS, controller (via Ethernet or Modbus TCP/IP)	●	●	●
Device connectivity (nb of devices)			
	> 7		> 7
Pulse output meters	●	-	●
Modbus RS485 meters	●	-	-
Wireless energy sensors (PowerTag Energy)	●	●	-
Analog sensors	●	-	-
Binary aux. contacts	●	(1)	●
Relays (coil control)	●	(1)	●

(1) with PowerTag Control I/O

Monitored auxiliaries and devices

<i>iOF+SD24 OF+SD24</i>	<i>iEM2000T</i>	<i>iEM3110</i>	<i>PowerTag Energy connected to circuit breaker</i>	<i>PowerTag Energy 250/630 A</i>
Circuit breaker OF/SD auxiliaries Open/Closed/Trip indication	Energy meters 1 or 3 phase power + energy (class1) metering			

Controlled, monitored auxiliaries and devices

<i>iATL 24</i>	<i>iACT 24</i>	<i>RCA iC60</i>	<i>ReflexTM iC60</i>
Impulse relay auxiliary 24 V or 230 V impulse relay control and monitoring	Contactor auxiliary 24 V or 230 V contactor control and monitoring	Circuit breaker remote control Remote Open/Close/Reset Status monitoring	Circuit breaker with integrated monitoring and control Remote Open/Close/Reset Status monitoring

Smart Panel design

Architecture overview

Smartlink SI B Ethernet wireless

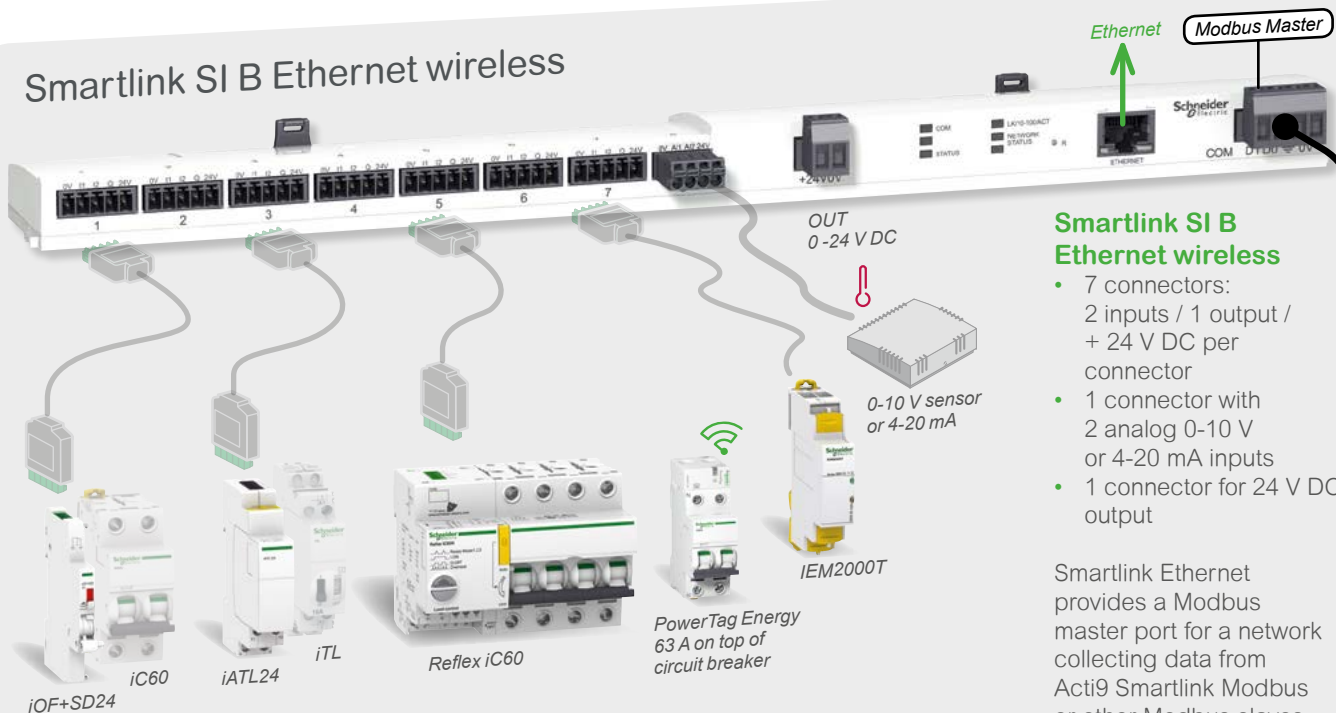

Smartlink SI B Ethernet wireless

- 7 connectors: 2 inputs / 1 output / + 24 V DC per connector
- 1 connector with 2 analog 0-10 V or 4-20 mA inputs
- 1 connector for 24 V DC output

Smartlink Ethernet provides a Modbus master port for a network collecting data from Acti9 Smartlink Modbus or other Modbus slaves (counters, power meters...).

Wireless communication with PowerTag Energy sensors. It also provides an Ethernet gateway facility.

Acti9 circuit breakers, pulse relays

They are monitored or controlled By the I/O's via specific adaptors (iOF+SD24 and iATL24)

Remote controlled circuit breakers, actuators, counters

Reflex iC60, relays, energy meters with impulse output are directly connected

Smartlink Modbus slave

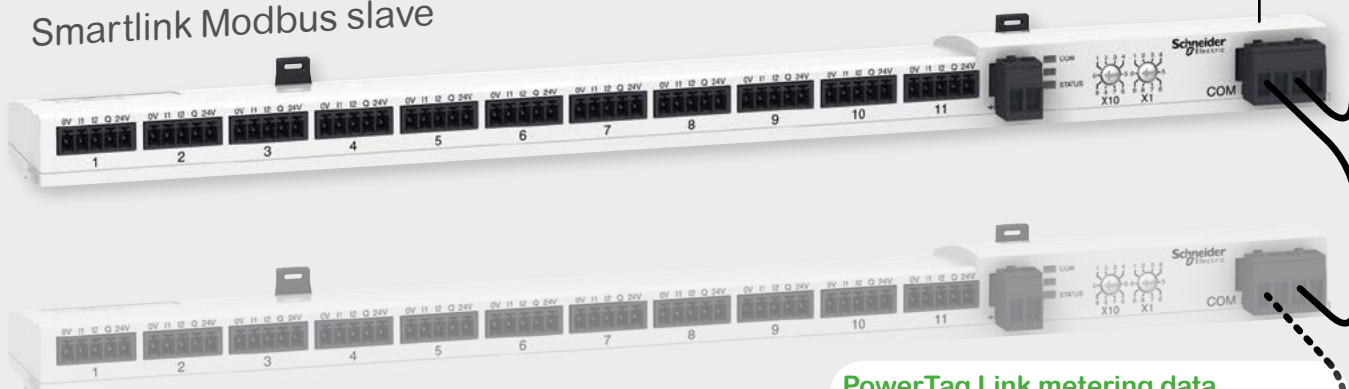

Smartlink Modbus slave

- 11 connectors: 2 inputs / 1 output / + 24 V DC per connector
- 1 connector for 24 V DC output

Smartlink Modbus provides a Modbus slave interface facility for Acti9 components.

Smartlink cables

A standard connection design with the corresponding cables have been developed for fast cabling.



PowerTag Link metering data concentrator

PowerTag Energy sensors monitor circuit electrical values. They are simply plugged in top or bottom circuit breaker terminals. Values are sent wireless to PowerTag Link. PowerTag Control I/O can be used to control a relay, collect a contact status..



Smart Panels digitized by

Enerlin'X



Com'X energy data logger /
server

Main functions

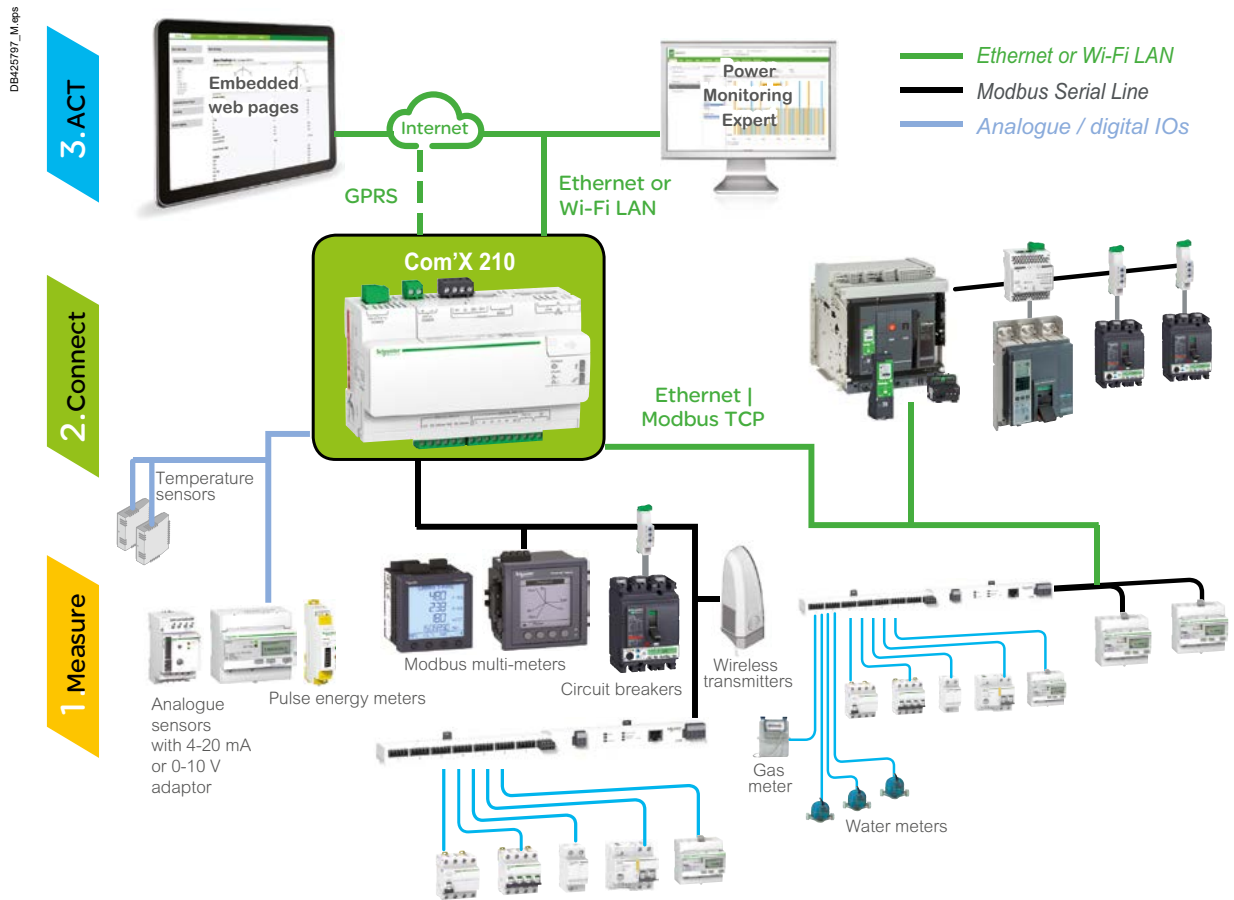

Data collector

Collects and stores energy data from up to 64 field devices, connected to either:

- Ethernet TCP/IP field network
- modbus Serial line network (up to 32 devices)
- embedded digital and analogue inputs.

"Field devices" consist of:

- PowerLogic meters for power and energy monitoring
- MasterPact, PowerPact, or ComPacT circuit breakers for protection and monitoring
- Acti9 protection devices, meters, remote controlled switches, etc
- water, Air, Gas, Electricity, and Steam consumption meters, from specialized manufacturers, delivering pulses as per standard (see table at end of this document)
- environmental sensors such as temperatures, humidity, and CO2 levels in a building, providing analogue information.

Data logging and storage capabilities include:

- data logging period: configurable from every minute to once a week
- data storage duration: up to 2 years, depending on quantity of collected data.

Com'X energy data logger / server

Com'X 210

Functions and characteristics

PB0114328-58.eps

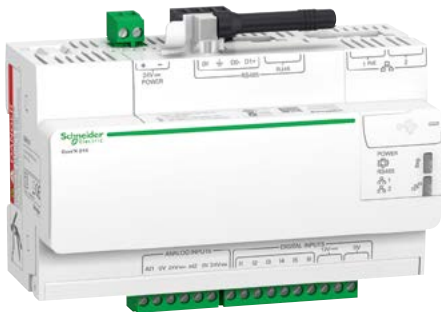

Energy Server Com'X 210 data logger

Data publisher

Batches of collected data periodically transmitted to an Internet server, as:

- XML files, for processing by EcoStruxure™ web services, such as Facility Expert
- CSV files for viewing in Excel or transformed for upload into programs such as StruxureWare™ Power Monitoring Expert or any compatible software
- support for Weather Sentry™.

Data publishing function supports 4 transfer protocols over Ethernet or Wi-Fi:

- HTTP
- HTTPS
- FTP
- SMTP.

Additional functions

Gateway

If selected by the user, the Com'X 210 can also make all data from connected devices available in real-time:

- in Modbus TCP/IP format over Ethernet
- for requests by an energy management software

Modbus packets can be sent from managing software to field devices through Modbus serial line or Modbus TCP/IP over Ethernet.

Com'X 210 Commercial reference numbers

Com'X 210 data logger 24 V DC power supplied UL rated	EBX210
---	--------

Com'X energy data logger / server

Com'X 510 Energy server

Main functions

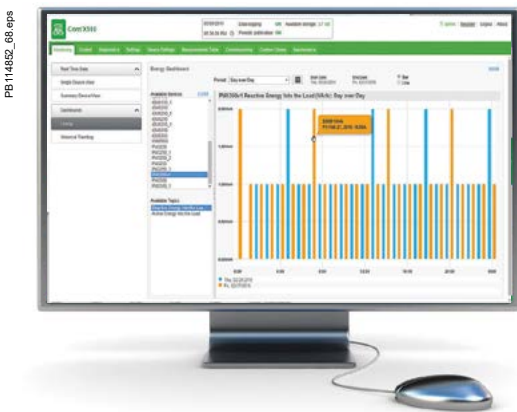
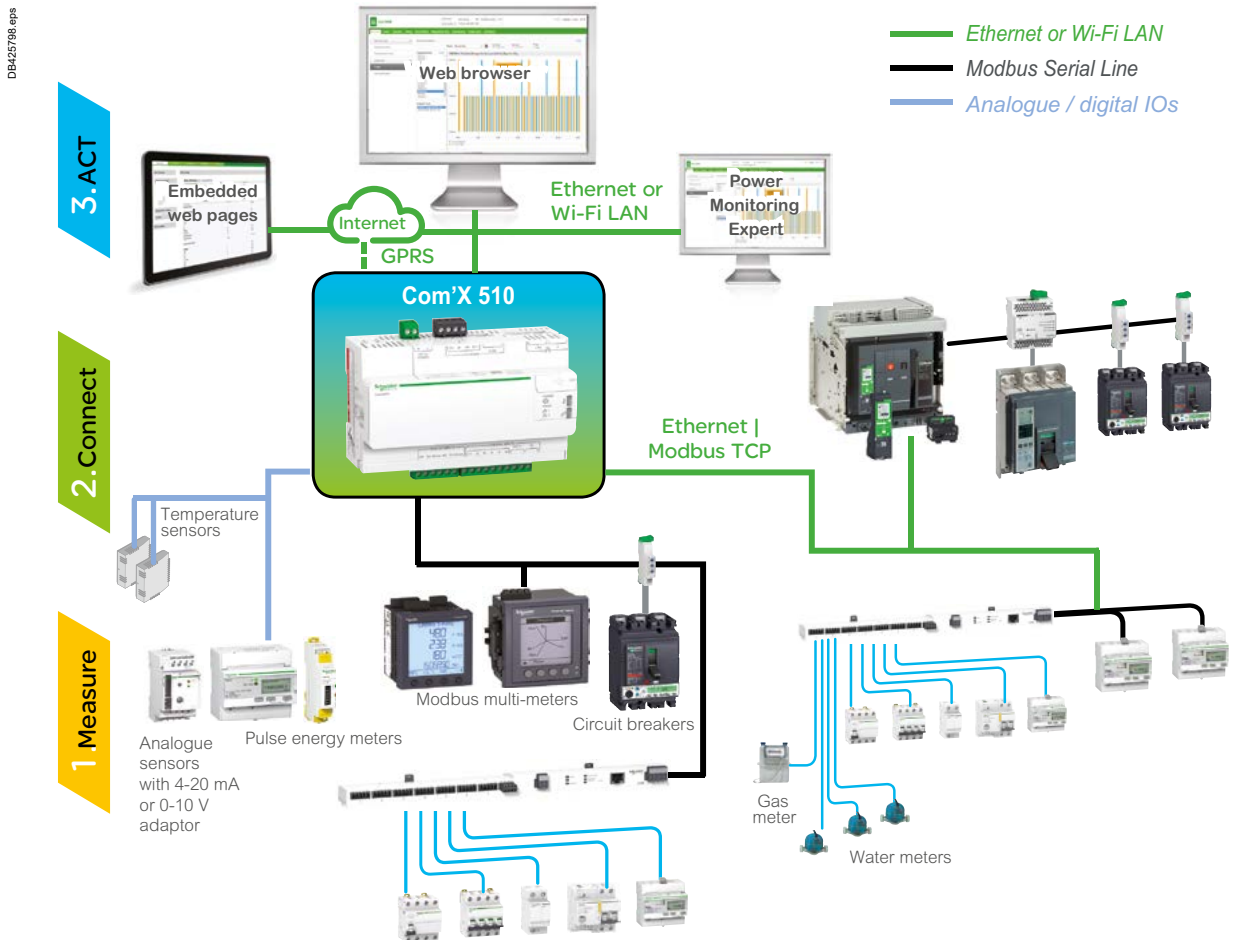

Energy dashboard comparing accumulated over time energy values (partial screen)

Data collector

Collects and stores energy data from up to 64 field devices, connected to either:

- Ethernet TCP/IP field network
- Modbus Serial line network (up to 32 devices)
- embedded digital and analogue inputs.

"Field devices" consist of:

- PowerLogic meters for power and energy monitoring
- MasterPact, PowerPact, or ComPacT circuit breakers for protection and monitoring
- Acti9 protection devices, meters, remote controlled switches, etc
- water, Air, Gas, Electricity, and Steam consumption meters, from specialized manufacturers, delivering pulses as per standard (see table at end of this document)
- environmental sensors such as temperatures, humidity, and CO2 levels in a building, providing analogue information.

Data logging and storage capabilities include:

- data logging period: configurable from every minute to once a week
- data storage duration: up to 2 years, depending on quantity of collected data
- able to set time and send reset instructions to field devices.

Embedded energy management software

The Com'X provides the end-user with immediate visibility into energy consumption throughout the site. As soon as the Com'X is connected to the Local Area Network (LAN), several web pages are accessible via any standard web browser, (without plug-in or additional components).

These web pages display real-time data as it is collected, in easy to understand tabular and summary formats. In addition, users can get simple analysis of historical data in bar graph or trending formats.

Com'X energy data logger / server

Com'X 510 Energy server

PB114327_00.eps

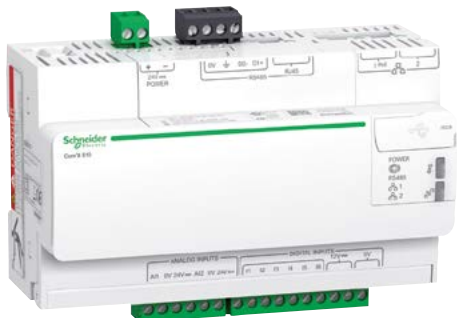

Energy Server Com'X 510 data logger

PB114854-07.eps



Raw data and measurements from one field device (partial screen)

PB114855-07.eps

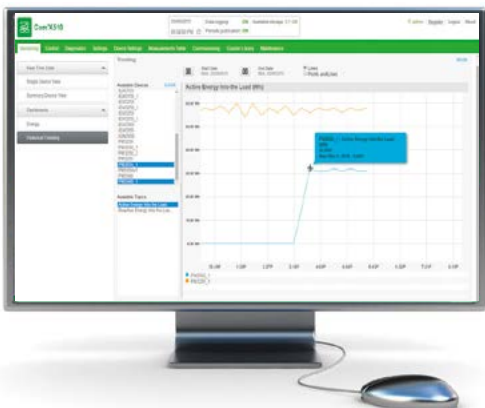

Historical trend comparing multiple devices or multiple topics (partial screen)

Additional functions

Data publisher

Batches of collected data can also be periodically transmitted to an Internet server, as:

- XML files, for processing by EcoStruxure™ web services, such as Facility Insights
- CSV files for viewing in Excel or transformed or uploading to programs such as EcoStruxure™ Power Monitoring Expert or any compatible software.

Data publishing function supports 4 transfer protocols over Ethernet:

- HTTP
- HTTPS
- FTP
- SMTP.

Gateway

If selected by the user, the Com'X510 can make data from connected devices available in real time:

- in Modbus TCP/IP format over Ethernet or Wi-Fi
- for requests by energy management software

Modbus packets can be sent from managing software to field devices through Modbus serial line or Modbus TCP/IP over Ethernet.

Com'X 510 Commercial reference numbers

Com'X 510 energy server 24 V DC power supplied UL rated EBX510

Com'X energy data logger / server

Com'X 210/510

Connectivity

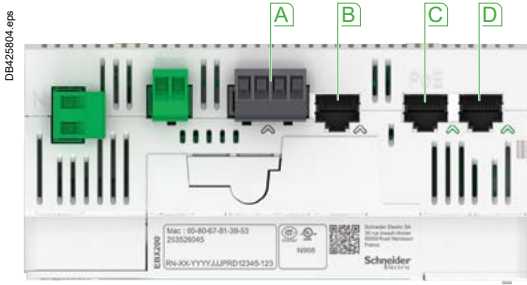

Connection points

- A** Terminal block
- B** RJ45 cable
- C** Ethernet port #1
- D** Ethernet port #2



Power supply to analogue and digital inputs

Connectivity

Modbus Serial /RS485 connections to field devices

- By cable with RJ45 connector.

2 Ethernet ports

- used to either separate upstream connection from field devices network or to daisy chain Ethernet devices
- RJ45 10/100 Base connectors
- static IP address.

Ethernet port #1

- Connection to Local Area Network (LAN)
- PoE Class 3 (802.3af) can act as main/backup power supply for the Com'X
- DHCP client.

Ethernet port #2

- connection to field devices
- DHCP client or server.

Power supply to analogue and digital outputs

Outputs to supply sensors and inputs when Com'X is supplied through 24 V DC input on top:

- 12 V DC– 60 mA for digital inputs
- 24 V DC for analogue inputs.

Compliant with electrical switchboard environment (temperature, electromagnetic compatibility).

2 inputs for analogue sensors

- PT100 or PT1000 temperature probes.
- Various sensors (humidity, CO2, etc.) with 0-10 V output.
- Various sensors with 4-20 mA output.

6 inputs for dry contact sensors or pulse counters

- Max 25 pulses per second (min duration 20 ms).
- IEC 62053-31 Class A.

Com'X energy data logger / server

Com'X 210/510

Setup and configuration

PB114857-07_eps



Device settings page (partial), as displayed after auto-discovery, enabling user to assign circuit identifications and select data for logging and publication.

Installation

- DIN rail fitting (Front face IP40, terminals IP20)
- weight 450 g
- dimensions (H x W x D) 91 x 144 x 65.8 mm.

Setup and configuration

Connection to LAN

As soon as they are connected to the LAN, it can be detected and assigned an IP address by DHCP. Your operating system's DPWS feature allows your computer to automatically recognize the device as Com'X. Embedded web pages are then immediately accessible by clicking each Com'X device icon or by typing the assigned IP address into your web browser.

Field device auto-discovery

The user-activated device discovery function automatically identifies all field devices connected to Modbus Serial, Ethernet port or wireless dongle.

- Schneider Electric devices display with the product image.
- Other devices appear as "unknown", allowing the user to manually assign a device type.
- User can assign their own device types.
- Users can complete additional device identification fields, such as circuit ID or building zone.

Data selection for logging and publication

Web page configuration tabs allow you to configure, in just a few clicks, which connected field devices collect and publish data.

Advanced diagnostics and troubleshooting features

- Modbus serial and TCP/IP device statistics.
- Ethernet network statistics.
- Communications check wizard.
- Direct reading of register values from local and remote devices.

Additional features and benefits

- Cyber security - integrates with your cyber security architecture.
- 2 Ethernet ports to separate upstream cloud connection, or to daisy chain with other Ethernet devices, from field device network.
- Data storage in case of loss of communication.
- Local backup of configuration parameters - back up your system to a USB storage device and have it available for system restore or to duplicate the configuration on another box.

When associated with Schneider Electric Services:

- remotely managed (configuration backup, troubleshooting, parameter setting)

Note: For correct installation of all products please consult the appropriate Schneider Electric **Installation Guide**.

Com'X energy data logger / server

Com'X 210/510

Specifications

Com'X 210/510 environment			
Operating temperature	-25 to +70 °C (-13 to 158 °F)	Com'X 210/510	
Storage temperature	-40 to +85 °C (-40 to +185 °F)		
Humidity	5 to 95% relative humidity (without condensation) at +55 °C		
Pollution	Class III		
Safety standards / regulation			
International (CB scheme)	IEC 60950		
USA	UL 508		
	UL 60950 (Com'X 210 and Com'X 510 only)		
Canada	cUL 60950 (Com'X 210 and Com'X 510 only)		
	cULus 508		
Europe	EN 60950		
Quality brands			
	CE, UL		
Power supply		Com'X 210	Com'X 510
DC	24 V (±10%)	■	■
Power over Ethernet	15.4 W DC	■	■
Max power	26 W max	■	■
Mechanical			
IP	Front face IP40, terminals IP20	■	■
Dimensions (H x W x D)	91 x 144 x 65.8 mm	■	■
Weight	450 g	■	■

Enerlin'X display & communication components

Enerlin'X display & communication components

FDM128 Ethernet switchboard display

Micrologic measurement capabilities come into full play with the FDM128 switchboard display. It connects to Ethernet communication via RJ45 port and displays Micrologic information. The result is a true integrated unit combining a circuit breaker and a Power Meter. Additional operating assistance functions can also be displayed.



FDM128 display.
ref.: LV434128

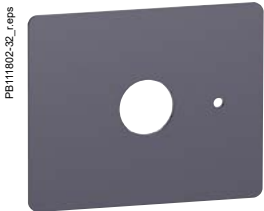

Surface mount accessory.



FDM128: ref. LV434128

The FDM128 is an intelligent Ethernet display. It collects the data from up to 8 devices via Ethernet network.

The FDM128 switchboard display unit can be connected to a Micrologic COM option (BCM ULP via IFE). It uses the sensors and processing capacity of the Micrologic control unit. It is easy to use and requires no special software or settings.

The FDM128 is a large display, but requires very little depth. The anti-glare graphic screen is backlit for very easy reading even under poor ambient lighting and at sharp angles.

Display of Micrologic measurements and trips

The FDM128 is intended to display Micrologic A/E measurements, trips and operating information. It cannot be used to modify the protection settings. Measurements may be easily accessed via a menu.

Trips are automatically displayed.

A pop-up window displays the time-stamped description of the trip.

Status indications

When the circuit breaker is equipped with the Breaker Status Command Module (BSCM) and NSX cord, the FDM128 display can also be used to view circuit breaker status conditions:

- O/F: ON/OFF
- SDE: Fault-trip indication (overload, short-circuit, ground fault)
- CE, CD cradle management with I/O application module.

Remote control

When the circuit breaker is equipped with the BSCM, NSX cord and Communicating Motor Mechanism (MTc), the FDM128 display can also be used to control (open/close) the circuit breaker.

Main characteristics

- 115.2 x 86.4 mm with 5.7" QVGA display 320 x 240 pixels.
- Color TFT LCD, LED backlight.
- Wide viewing angle: vertical $\pm 80^\circ$, horizontal $\pm 70^\circ$.
- High resolution: excellent reading of graphic symbols.
- Operating temperature range -10°C to $+55^\circ\text{C}$.
- CE / UL / CSA marking (pending).
- 24 V DC power supply, with tolerances 24 V (limit 20.4 - 28.8 V DC).
- Consumption ≤ 6.8 W.

Mounting

The FDM128 is easily installed in a switchboard.

- Standard door hole $\varnothing 22$ mm.

The FDM128 degree of protection is IP65 in front and IP54.

Connection

The FDM128 is equipped with:

- a 24 V DC terminal block:
 - power supply range of 24 V DC (limit 20.4 - 28.8 V DC). The FDM128 display unit has a 2-point screw connector on the rear panel of the module for this purpose.
- One RJ45 Ethernet jacks.

The Micrologic connects to the internal communication terminal block on the MasterPact via the breaker ULP cord and Ethernet connection through IFE.

Enerlin'X display & communication components

FDM128 Ethernet switchboard display



Product identification.

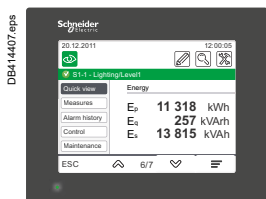

Metering: meter.

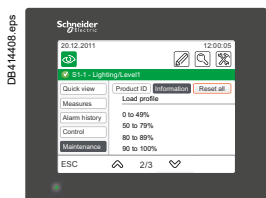

Services.

Navigation

Touch screen is used for intuitive and fast navigation.

The user can select the display language (Chinese, English, French, German, Italian, Portuguese, Spanish, etc.).

Screens

Main menu



Quick view



Alarms



Metering



Maintenance



Control

When not in use, the screen is automatically shifted to low back-lighting.

Fast access to essential information

■ "Quick view" provides access to five screens that display a summary of essential operating information (I, U, f, P, E, THD, circuit breaker On / Off).

Access to detailed information

■ "Metering" can be used to display the measurement data (I, U-V, f, P, Q, S, E, THD, PF) with the corresponding min/max values.

■ Alarms displays the trip history.

■ Services provides access to the operation counters, energy and maximeter reset function, maintenance indicators, identification of modules connected to the internal bus and FDM128 internal settings (language, contrast, etc.).

Enerlin'X display & communication components

FDM121 Switchboard display

For MasterPact, ComPacT, PowerPact circuit breakers

Micrologic measurement capabilities come into full play with the FDM121 switchboard display. It connects to COM option (BCM ULP) via a breaker ULP cord and displays Micrologic information. The result is a true integrated unit combining a circuit breaker and a Power Meter. Additional operating assistance functions can also be displayed.



FDM121 display.
Ref.: TRV00121



Surface mount accessory.



Connection with FDM121 display unit.

FDM121: ref. TRV00121

An FDM121 switchboard display unit can be connected to a ULP IMU using a prefabricated cord to display all measurements, alarms, histories and event tables, maintenance indicators, management of installed devices on a screen. The result is a veritable 96 x 96 mm Power Meter.

The FDM121 display unit requires a 24 V DC power supply.

The FDM121 is a switchboard display unit that can be integrated in the ComPacT NSX100 to 630 A, PowerPact H/J/L/P/R, ComPacT NS or MasterPact systems. It uses the sensors and processing capacity of the Micrologic trip unit. It is easy to use and requires no special software or settings. It is immediately operational when connected to the ComPacT NSX by a simple cord. Also, it provides monitoring and control with the use of the I/O application module, the motor mechanism module, or the Breaker Status module.

The FDM121 is a large display, but requires very little depth. The anti-glare graphic screen is backlit for very easy reading even under poor ambient lighting and at sharp angles.

Display of Micrologic measurements and alarms

The FDM121 is intended to display Micrologic 5 / 6 measurements, alarms and operating information. It cannot be used to modify the protection settings. Measurements may be easily accessed via a menu. All user-defined alarms are automatically displayed. The display mode depends on the priority level selected during alarm set-up:

- high priority: a pop-up window displays the time-stamped description of the alarm and the orange LED flashes
- medium priority: the orange "Alarm" LED goes steady on
- low priority: no display on the screen.

All faults resulting in a trip automatically produce a high-priority alarm, without any special settings required. In all cases, the alarm history is updated. Micrologic saves the information in its non-volatile memory in the event of an FDM121 power failure.

Status indications and remote control

When the circuit breaker is equipped with the Breaker Status Module, the FDM121 display can also be used to view circuit breaker status conditions:

- O/F: ON/OFF
- SD: trip indication
- SDE: Fault-trip indication (overload, short-circuit, ground fault).

When the circuit breaker system is equipped with the I/O Application module, the FDM121 can monitor and control:

- cradle management
- circuit breaker operation
- light and load control
- custom application.

When the circuit breaker system is equipped with the motor mechanism module, the FDM121 offers remote closing and opening control.

Main characteristics

- 96 x 96 x 30 mm screen requiring 10 mm behind the door (or 20 mm when the 24 V power supply connector is used).
 - White backlighting.
 - Wide viewing angle: vertical $\pm 60^\circ$, horizontal $\pm 30^\circ$.
 - High resolution: excellent reading of graphic symbols.
 - Alarm LED: flashing orange for alarm pick-up, steady orange after operator reset if alarm condition persists.
 - Operating temperature range -10°C to $+55^\circ\text{C}$.
 - CE / UL / CSA marking (pending).
 - 24 V DC power supply, with tolerances 24 V -20% (19.2 V) to 24 V $+10\%$ (26.4 V).
- When the FDM121 is connected to the communication network, the 24 V DC can be supplied by the communication system wiring system.
- Consumption 40 mA.

Mounting

The FDM121 is easily installed in a switchboard.

- Standard door cut-out 92 x 92 mm.
- Attached using clips.

To avoid a cut-out in the door, an accessory is available for surface mounting by drilling only two 22 mm diameter holes.

The FDM121 degree of protection is IP54 in front. IP54 is maintained after switchboard mounting by using the supplied gasket during installation.

Connection

The FDM121 is equipped with:

- a 24 V DC terminal block:
- plug-in type with 2 wire inputs per point for easy daisy-chaining
- power supply range of 24 V DC -20% (19.2 V) to 24 V DC $+10\%$ (26.4 V).

A 24 V DC type auxiliary power supply must be connected to a single point on the ULP system. The FDM121 display unit has a 2-point screw connector on the rear panel of the module for this purpose. The ULP module to which the auxiliary power supply is connected distributes the supply via the ULP cable to all the ULP modules connected to the system and therefore also to Micrologic.

Enerlin'X display & communication components

FDM121 Switchboard display

For MasterPact, ComPacT, PowerPact circuit breakers

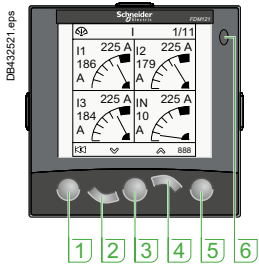

- 1 escape
- 2 down
- 3 ok
- 4 up
- 5 context
- 6 alarm LED

Two RJ45 jacks.

The Micrologic connects to the internal communication terminal block on the ComPacT NSX via the NSX cord. Connection to one of the RJ45 connectors on the FDM121 automatically establishes communication between the Micrologic and the FDM121 and supplies power to the Micrologic measurement functions. When the second connector is not used, it must be fitted with a line terminator.

Navigation

Five buttons are used for intuitive and fast navigation.

The "Context" button may be used to select the type of display (digital, bargraph, analogue).

The user can select the display language (Chinese, English, French, German, Italian, Portuguese, Spanish, etc.).

Screens

Main menu

When powered up, the FDM121 screen automatically displays the ON/OFF status of the device.

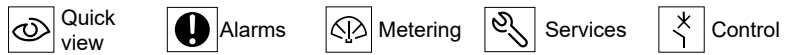

When not in use, the screen is not backlit. Backlighting can be activated by pressing one of the buttons. It goes off after 3 minutes.

Fast access to essential information

"Quick view" provides access to five screens that display a summary of essential operating information (I, U, f, P, E, THD, circuit breaker On / Off).

Access to detailed information

- "Metering" can be used to display the measurement data (I, U-V, f, P, Q, S, E, THD, PF) with the corresponding min/max values.
- Alarms displays active alarms and the alarm history.
- Services provides access to the operation counters, energy and maximeter reset
- function, maintenance indicators, identification of modules connected to the internal bus and FDM121 internal settings (language, contrast, etc.).

Communication components and FDM121 connections

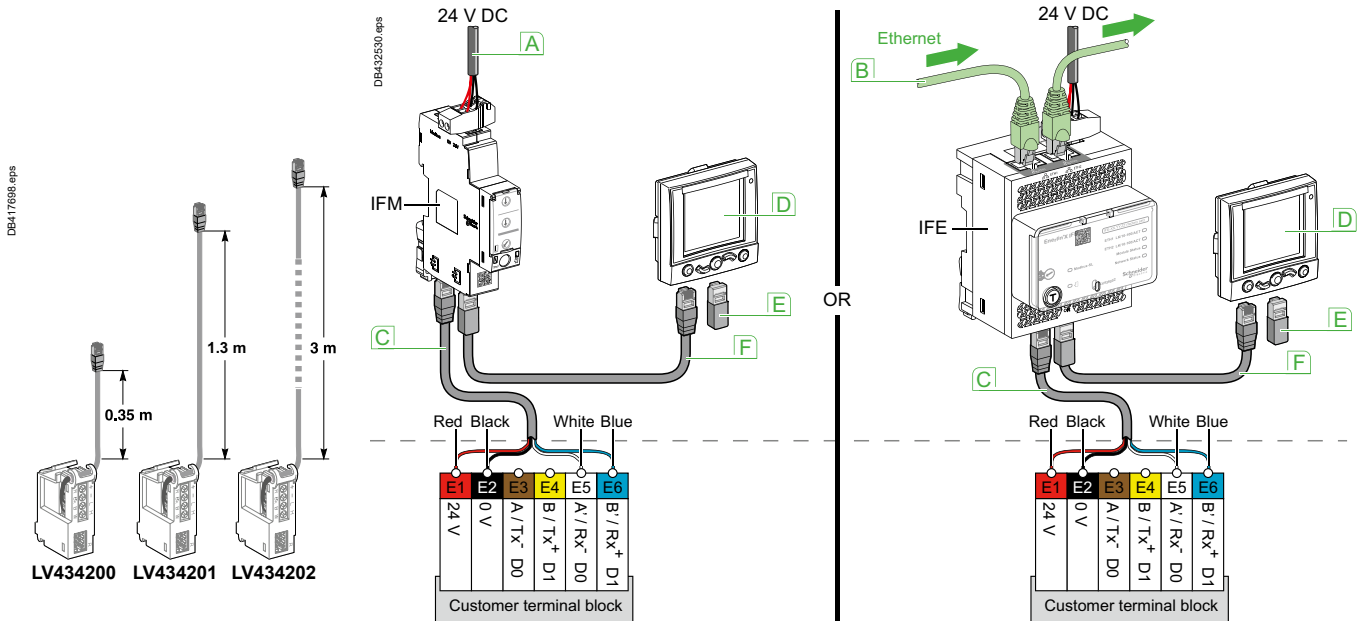

Connections

■ ComPacT NSX is connected to the ULP devices (FDM121 display, IFM, IFE or I/O) unit via the NSX cord.

- cord available in three lengths: 0.35 m, 1.3 m and 3 m.
- ULP lengths up to 10 m possible using extensions.

- A Modbus network
- B Ethernet network
- C NSX cord

- D FDM121 display
- E ULP termination
- F ULP cable

Enerlin'X display & communication components

IFE Interface IFE Switchboard server

PB115632.eps



IFE interface, ref.: LV434010

PB115636.eps



IFE switchboard server, ref.: LV434011

DB406743.07.eps

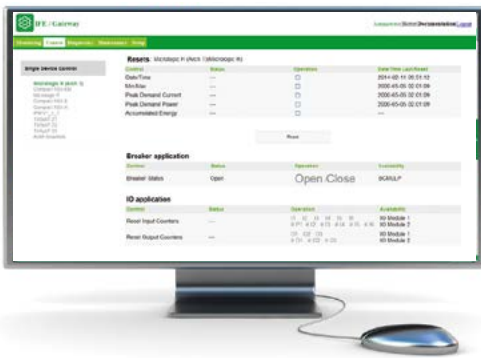

IFE interface: ref. LV434001

Function

The IFE interface and IFE switchboard server enable a single LV circuit breaker as MasterPact NT/NW, ComPact NSX or PowerPact to be connected to an Ethernet network via its ULP port.

IFE switchboard server: ref. LV434002

Provides an Ethernet access up to 20 LV circuit breakers.

Functions

- Interface - one circuit breaker is connected to the IFE interface via its ULP port.
- Server: several circuit breakers on a Modbus network are connected via the IFE switchboard server master Modbus port.
- Collects and provides web pages from multiple IP devices (other IFE LV434002, Smartlink Ethernet, PM5000 Ethernet...).

IFE interface, IFE switchboard server features

- Dual 10/100 Mbps Ethernet port for simple daisy chain connection.
- Device profile web service for discovery of the IFE interface, IFE switchboard server on the LAN.
- ULP compliant for localization of the IFE interface in the switchboard.
- Ethernet interface for ComPact, MasterPact and PowerPact circuit breakers.
- Gateway for Modbus-SL connected devices (IFE switchboard server only).
- Embedded set-up web pages.
- Embedded monitoring web pages.
- Embedded control web pages.
- Built-in e-mail alarm notification.
- Automatic recovering of Smartlink I/O configurations, allowing contextual I/O status display on web pages (IFE switchboard server only).

Mounting

The IFE interface, IFE switchboard server are DIN rail mounting devices. A stacking accessory enables the user to connect several IFMs (ULP to Modbus interfaces) to an IFE switchboard server without additional wiring.

24 V DC power supply

The IFE interface, IFE switchboard server must always be supplied with 24 V DC. The IFMs stacked to an IFE switchboard server are supplied by the IFE switchboard server, thus it is not necessary to supply them separately. It is recommended to use an UL listed and recognized limited voltage/limited current or a class 2 power supply with a 24 V DC, 3 A maximum.

IFE interface, IFE switchboard server firmware update

The firmware can be updated using:

- FTP
- customer engineering tool
- EcoStruxure Power Commission software.

Required circuit breaker communication modules

The connection to IFE interface or IFE switchboard server requires a communication module embedded into the circuit breaker:

- ComPact NS, PowerPact P, PowerPact R: BCM ULP communication module
 - ComPact NSX: NSX cord and/or BSCM module
 - MasterPact NT/NW or ComPact NS, PowerPact P, PowerPact R (Fixed electrically operated): BCM ULP communication module
 - drawout MasterPact NT/NW or a withdrawable ComPact NS, PowerPact P, PowerPact R: BCM ULP and its respective I/O (Input/Output) application module.
- All connection configurations for MasterPact NT/NW, ComPact NS, PowerPact P, PowerPact R require the breaker ULP cord. The insulated NSX cord is mandatory for system voltages greater than 480 V AC. When the second ULP RJ45 connector is not used, it must be closed with an ULP terminator (TRV00880).

Enerlin'X display & communication components

IFE Interface IFE Switchboard server

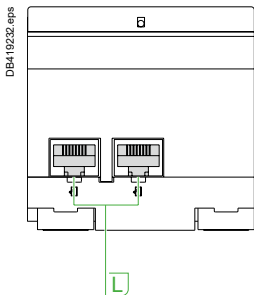
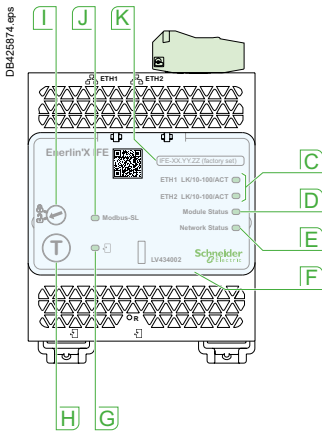
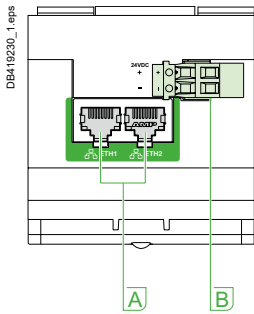

- A** Ethernet 1 and Ethernet 2 communication port.
- B** 24 Vdc power supply terminal block.
- C** Ethernet communication LEDs:
yellow: 10 Mb
green: 100 Mb.
- D** Module status LED:
steady off: no power
steady green: device operational
steady red: major unintended event
flashing green: standby
flashing red: minor unintended event
flashing green/red: self-test.
- E** Network status LED:
steady off: no power/no valid IP address
steady green: connected, valid IP address
steady orange: default IP address
steady red: duplicated IP address
flashing green/red: self-test.
- F** Sealable transparent cover.
- G** ULP status LED.
- H** Test button (accessible closed cover).
- I** Locking pad.
- J** Modbus traffic status LED (LV434002 only).
- K** Device name label.
- L** ULP ports.

General characteristics	
Environmental characteristics	
Conforming to standards	UL 508, UL 60950, IEC 60950, 60947-6-2
Certification	cULus, GOST, FCC, CE
Ambient temperature	-20 to +70°C (-4 to +158 °F)
Relative humidity	5–85 %
Level of pollution	Level 3
Flame resistance	ULV0
Mechanical characteristics	
Shock resistance	1000 m/s ²
Resistance to sinusoidal vibrations	5 Hz < f < 8.4 Hz
Electrical characteristics	
Resistance to electromagnetic discharge	Conforming to IEC/EN 61000-4-3
Immunity to radiated fields	10 V/m
Immunity to surges	Conforming to IEC/EN 61000-4-5
Consumption	120 mA at 24 V input
Physical characteristics	
Dimensions	72 x 105 x 71 mm (2.83 x 4.13 x 2.79 in.)
Mounting	DIN rail
Weight	182.5 g (0.41 lb)
Degree of protection of the installed I/O application module	On the front panel (wall mounted enclosure): IP4x Connectors: IP2x Other parts: IP3x
Connections	Screw type terminal blocks
Technical characteristics - 24 V DC power supply	
Power supply type	Regulated switch type
Rated power	72 W
Input voltage	100–120 V AC for single phase 200–500 V AC phase-to-phase
PFC filter	With IEC 61000-3-2
Output voltage	24 V DC
Power supply out current	3 A

Note: it is recommended to use an UL listed/UL listed recognized limited voltage/Limited current or a class 2 power supply with a 24 V DC, 3 A maximum.

IFE interface, IFE switchboard server web page description	
Monitoring web page	
Real time data	■
Device logging	■
Control web page	
Single device control	■
Diagnostics web page	
Statistics	■
Device information	■
IMU information	■
Read device registers	■
Communication check	■
Maintenance web page	
Maintenance log	■
Maintenance counters	■
Setup web page	
Device localization/name	■
Ethernet configuration (dual port)	■
IP configuration	■
Modbus TCP/IP filtering	■
Serial port	■
Date and time	■
E-mail server configuration	■
Alarms to be e-mailed	■
Device list	■
Device logging	■
Device log export	■
SNMP parameters	■
Documentation links	■
Preferences	■
Advanced services control	■
User accounts	■
Web page access	■

Enerlin'X display & communication components

EIFE embedded Ethernet interface for drawout MasterPact MTZ



EIFE embedded Ethernet interface
ref. LV851001

EIFE embedded Ethernet interface: ref. LV851001

Introduction

The EIFE embedded Ethernet interface module enables a single drawout MasterPact MTZ circuit breaker to be connected to an Ethernet network via its ULP port.

It provides digital access to all the data provided by the MasterPact control unit Micrologic X. In addition it monitors the three positions of the circuit breaker when inserted in its chassis:

- Circuit breaker racked IN,
- Circuit breaker racked OUT,
- Circuit breaker in test position.

EIFE is a strong solution for high uptime demanding switchboards.

EIFE interface features

- Dual 10/100 Mbps Ethernet port for simple daisy chain connection.
- Device profile web service for discovery of the EIFE interface on the LAN.
- Ethernet interface for drawout MasterPact circuit breakers.
- Embedded set-up web pages.
- Embedded monitoring web pages.
- Embedded control web pages.
- Chassis status management (CE, CD, CT)
- Built-in e-mail alarm notification.

Mounting

The EIFE interface is mounted on the chassis of the Drawout circuit breaker. There are two types of dedicated ULP cable, one for the MTZ1 and one for MTZ2/MTZ3.

24 Vdc power supply

The EIFE power supply is provided by the ULP port through the dedicated ULP cable.

EIFE interface firmware update

The firmware can be updated using EcoStruxure Power Commission software.

Required circuit breaker communication accessory

The connection to EIFE interface requires an ULP communication port on the chassis of the drawout MasterPact MTZ circuit breakers.

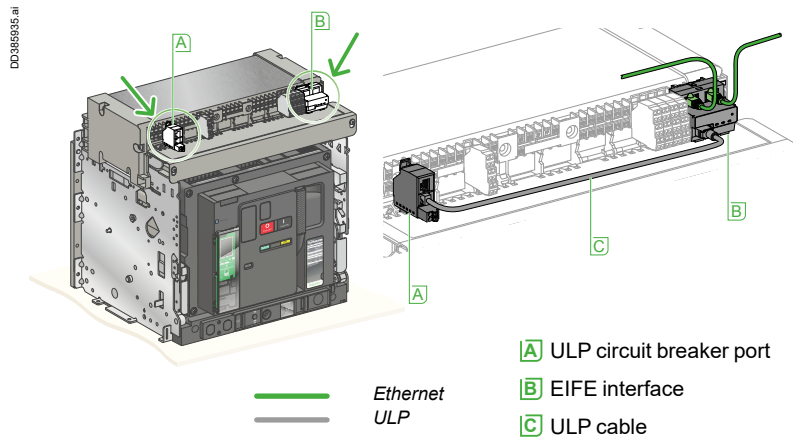

EIFE mounting and cabling

Enerlin'X display & communication components

EIFE embedded Ethernet interface

for drawout MasterPact MTZ

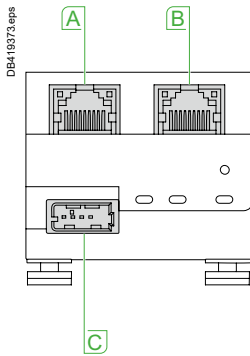

- A** Ethernet port 1
- B** Ethernet port 2
- C** ULP port

General characteristics	
Environmental characteristics	
Conforming to standards	IEC 60950, IEC 60947-6-2, UL 508, UL 60950, IACS E10
Certification	CE, c UL us, EAC, FCC markings
Ambient temperature	Storage -40 to +85 °C Operation -25 to +70 °C
Relative humidity	5 - 85 %
Level of pollution	Level 3
Flame resistance	ULV0 conforming to IEC/EN 60068-2-30
Mechanical characteristics	
Shock resistance	As the EIFE is mounted on the circuit breaker it complies with its mechanical characteristics
Resistance to sinusoidal vibrations	
Electrical characteristics	
Consumption	250 mA at 24 Vdc at room temperature
Resistance to electrostatic discharge	Conforming to IEC/EN 61000-4-2 8 kV AD
Immunity to radiated fields	Conforming to IEC/EN 61000-4-3 10 V/m
Immunity to surges	Conforming to IEC/EN 61000-4-5 Class 2
Physical characteristics	
Dimensions	51 x 51 x 52.5 mm
Mounting	Breaker DIN rail of MTZ1 & MTZ2/MTZ3
Weight	75 grams EIFE alone
Degree of protection of the installed module	■ IP20 for connectors ■ IP30 for other areas
Connections	■ RJ45 for Ethernet ■ Industrial USB connector for ULP

EIFE web page description

Monitoring web page:

- real time data
- device logging.

Control web page:

- single device control.

Diagnostics web page:

- statistics
- device information
- IMU information
- read device registers
- communication check.

Maintenance web page:

- maintenance log
- circuit breaker health status
- maintenance counters.

Setup web page:

- device localization/name
- Ethernet configuration (dual port)
- IP configuration
- Modbus TCP/IP filtering
- date and time
- e-mail server configuration
- alarms to be e-mailed
- device logging
- device log export
- SNMP parameters
- preferences
- advanced services control
- user accounts
- web page access.

Enerlin'X display & communication components

IFM Modbus interface



IFM Modbus communication interface.
Ref.: LV434000.

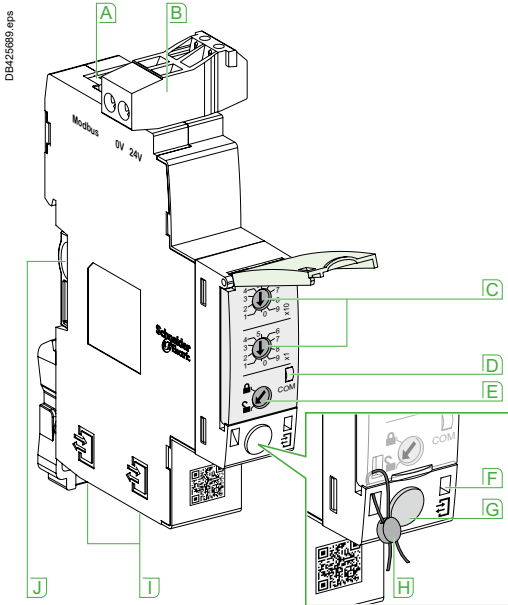

- A** Modbus Serial RJ45 port.
- B** 0-24 V DC power supply.
- C** Modbus address switches.
- D** Modbus traffic LED.
- E** Modbus locking pad.
- F** ULP activity LED.
- G** Test button.
- H** Mechanical lock and locking seal.
- I** ULP RJ45 connectors.
- J** Stacking accessory connection.

IFM Modbus communication interface: ref. LV434000

Function

A IFM - Modbus communication interface - is required for connection of a MasterPact or ComPacT to a Modbus network as long as this circuit breaker is provided with a ULP (Universal Logic Plug) port. The port is available on respectively a BCM ULP or BSCM embedded module.

The IFM is defined as an IMU (Intelligent Modular Unit) in the ULP connection System documentation.

Once connected, the circuit breaker is considered as a slave by the Modbus master. Its electrical values, alarm status, open/close signals can be monitored or controlled by a Programmable Logic Controller or any other system.

Characteristics

ULP port

2 RJ45 sockets, internal parallel wiring.

- Connection of a single circuit breaker (eventually via its I/O application module).
- A ULP line terminator or an FDM121 display unit must be connected to the second RJ45 ULP socket.

The RJ45 sockets deliver a 24 VDC supply fed from the Modbus socket.

Built-in test function, for checking the correct connection to the circuit breaker and FDM121 display unit.

Modbus slave port

- Top socket for screw-clamp connector, providing terminals for:

- 24 VDC input supply (0V, +24V)
- Modbus line (D1, D2, Gnd).

- Lateral socket, for Din-rail stackable connector.

Both top and lateral sockets are internally parallel wired.

- Multiple IFM can be stacked, thus sharing a common power supply and Modbus line without individual wiring.

- On the front face:

- Modbus address setting (1 to 99): 2 coded rotary switches
- Modbus locking pad: enables or disable the circuit breaker remote control and modification of IFM parameters.
- Self adjusting communication format (Baud rate, parity).

Enerlin'X display & communication components

IFM Modbus interface

Catalogue numbers

IFM Modbus communication interface		
Type	Set of	Cat. no.
IFM -Modbus communication interface module	-	LV434000
Stacking accessories if more than 1 IFM	10	TRV00217
ULP line terminator	-	TRV00880
2-wire RS 485 isolated repeater module (Modbus network outside the switchboard)	-	TRV00211

Technical characteristics

IFM Modbus communication interface		
Dimensions		18 x 72 x 96 mm
Maximum number of stacked IFM		12
Degree of protection of the installed module	Part projecting beyond the escutcheon	IP4x
	Other module parts	IP3x
	Connectors	IP2x
Operating temperature		-25...+70°C
Power supply voltage		24 V DC -20 %/+10 % (19.2...26.4 V DC)
Consumption	Typical	21 mA/24 V DC at 20°C
	Maximum	30 mA/19.2 V DC at 60°C
Certification		
CE		IEC/EN 60947-1
UL		UL 508 - Industrial Control Equipment
CSA		No. 142-M1987 - Process Control Equipment CAN/CSA C22.2 No. 0-M91 - General requirements - Canadian Electrical Code Part CAN/CSA C22.2 No. 14-05 - Industrial Control Equipment

Simplified IFM installation

Stacking IFM

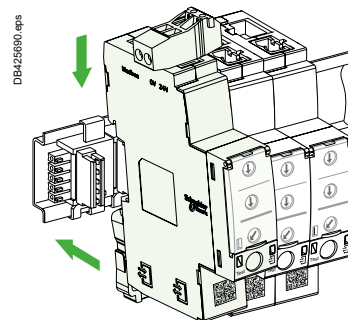
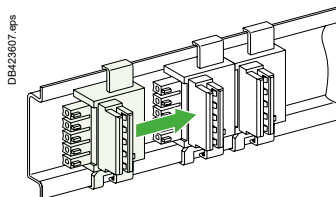

Stacking accessories

Stacking an IFE interface + gateway with IFMs

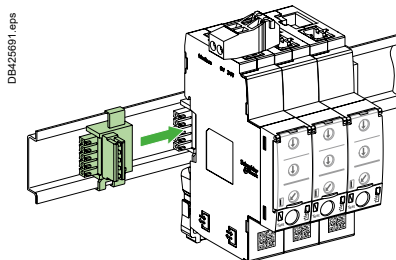

Up to 12 stacked IFMs

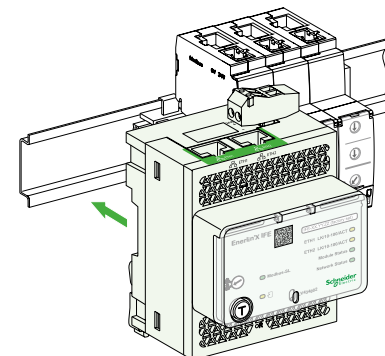

Enerlin'X display & communication components

I/O application module



I/O application module
ref.: LV434063.

I/O application module: ref. LV434063

Description

The I/O input/output application module for LV breaker is one of the components of ULP architecture. Built in functionalities and applications enhance control and monitoring needs.

ULP system architecture including I/O modules can be built without any restrictions using a wide range of circuit breakers:

- MasterPact MTZ1/MTZ2/MTZ3,
- ComPacT NS1600b-3200,
- ComPacT NS630b-1600,
- ComPacT NSX100-630 A.

The I/O application module is compliant with the ULP system specifications. Two I/O application modules can be connected in the same ULP architecture.

I/O input/output interface for LV breaker resources

The I/O application module resources are the following:

- 6 digital inputs that are self powered for either NO and NC dry contact or pulse counter,
- 3 digital outputs that are bistable relay (5 A maximum),
- 1 analog input for Pt100 temperature sensor.

Pre-defined applications

Pre-defined applications improve the IMU approach (Intelligent Modular Unit) in a simple way.

A 9-position rotary switch on the front of the I/O module allows to select the pre-defined applications. Each position is assigned to a pre-defined application except position 9 which allows the user to define a specific application by means of the customer engineering tool. The switch is set in factory to the pre-defined application 1.

For each application the input/output assignment and the wiring diagram are pre-defined. No additional setting with the customer engineering tool is required. The I/O and other resources not assigned to the pre-defined applications are free for user specific applications.

User applications

The user applications with the corresponding resources are defined by means of EcoStruxure Power Commission engineering tool. They use the resources not assigned to the predefined applications. User applications may be required for:

- Protection improvement,
- Circuit breaker control,
- Motor control,
- Energy management,
- Monitoring.

24 Vdc power supply

The I/O module can be supplied with a 24 Vdc AD power supply or with any other 24 Vdc power supply having the same characteristics.

Mounting

The I/O is a DIN rail mounting device.

Setting locking pad

The setting locking pad on the front panel of the I/O enables the setting of the I/O by EcoStruxure Power Commission engineering tool.

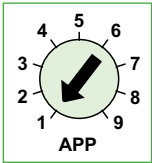

DB41557/8.eps

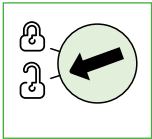

DB41557/9.eps

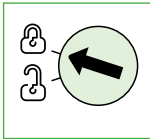

DB41560.eps

Enerlin'X display & communication components

I/O application module

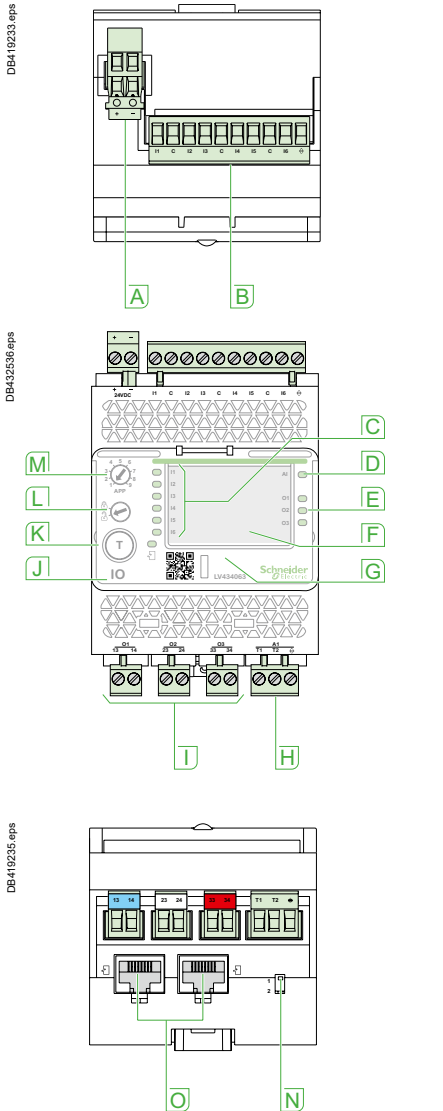

- A** 24 Vdc power supply terminal block.
- B** Digital input terminal block: 6 inputs, 3 commons and 1 shield.
- C** 6 input status LEDs.
- D** Analog input status LED.
- E** 3 output status LEDs.
- F** I/O application module identification labels.
- G** Sealable transparent cover.
- H** Analog input terminal block.
- I** Digital output terminal blocks.
- J** ULP status LED.
- K** Test/reset button (accessible with cover closed).
- L** Setting locking pad.
- M** Application rotary switch: 1 to 9.
- N** Switch for I/O addressing (I/O 1 or I/O 2).
- O** ULP connectors.

General characteristics

Environmental characteristics

Conforming to standards	UL 508, UL 60950, IEC 60950, IEC 60947-6-2
Certification	cULus, GOST, FCC, CE
Ambient temperature	-20 to +70 °C (-4 to +158 °F)
Relative humidity	5 - 85 %
Level of pollution	Level 3
Flame resistance	ULV0

Mechanical characteristics

Shock resistance	1000 m/s ²
Resistance to sinusoidal vibrations	5 Hz < f < 8.4 Hz

Electrical characteristics

Resistance to electromagnetic discharge	Conforming to IEC/EN 61000-4-3
Immunity to radiated fields	10 V/m
Immunity to surges	Conforming to IEC/EN 61000-4-5
Consumption	165 mA

Physical characteristics

Dimensions	71.7 x 116 x 70.6 mm
Mounting	DIN rail
Weight	229.5 g (0.51 lb)
Degree of protection of the installed I/O application module	On the front panel (wall mounted enclosure): IP4x I/O parts: IP3x Connectors: IP2x
Connections	Screw type terminal blocks

Digital inputs

Digital input type	Self powered digital input with current limitations as per IEC 61131-2 type 2 standards (7 mA)
Input limit values at state 1 (close)	19.8 - 25.2 V DC, 6.1 - 8.8 mA
Input limit values at state 0 (open)	0 - 19.8 V DC, 0 mA
Maximum cable length	10 m (33 ft)

Note: for a length greater than 10 m (33 ft) and up to 300 m (1.000 ft), it is mandatory to use a shielded twisted cable. The shield cable is connected to the I/O functional ground of the I/O application module.

Digital outputs

Digital output type	Bistable relay
Rated load	5 A at 250 Vac
Rated carry current	5 A
Maximum switching voltage	380 Vac, 125 Vdc
Maximum switch current	5 A
Maximum switching power	1250 VA, 150 W
Minimum permissible load	10 mA at 5 V DC
Contact resistance	30 mΩ
Maximum operating frequency	18000 operations/hr (Mechanical) 1800 operations/hr (Electrical)
Digital output relay protection by an external fuse	External fuse of 5 A or less
Maximum cable length	10 m (33 ft)

Analog inputs

I/O application module analog input can be connected to a Pt100 temperature sensor.		
Range	-30 to 200 °C	-22 to 392 °F
Accuracy	±2 °C from -30 to 20 °C ±1 °C from 20 to 140 °C ±2 °C from 140 to 200 °C	±3.6 °F from -22 to 68 °F ±1.8 °F from 68 to 284 °F ±3.6 °F from 284 to 392 °F
Refresh interval	5 s	5 s

Smart Panels digitized by

Enerlin'X



PowerTag system gateways and display

PowerTag system gateways

Smartlink SI B



PB107797-47



DE404502



Smartlink SI B: ref. A9XMZA08

Introduction

The Smartlink SI B is an open IEC/EN 61131-2 system that remotely measures, balances, monitors and controls final distribution.

It is designed to fit into tertiary building projects and integrates in a Building Management System or an Energy Management System.

It consists of:

- a Modbus Slave version (Smartlink Modbus)
- a Modbus Master version (Smartlink SI B) with the following functions: radio hub, Modbus gateway and embedded web server: this provides web pages for configuring the system, and real-time monitoring of values (status of circuit breakers, energy meters, alarms and monitoring and control). These modules transmit data to a PLC or monitoring system.

The system supports

- Alarm monitoring on current, voltage, power factor, tripping, power, consumption thresholds and their transmission by email.
- Monitoring and control via web pages of loads, energy and power by zone and by usage.
- Single access point for a full analysis of the status of switchboard power distribution (measurements, protection status, temperature, consumption, alarms, control and monitoring).

Functions

Transmission of data collected by Acti9 switchgear assemblies

- Circuit breakers, residual current circuit breakers and residual current devices:
 - open/closed state, tripped state,
 - number of opening/closing cycles,
 - number of tripping actions.
- Contactors, impulse relays, Reflex iC60:
 - opening and closing control,
 - open/closed state,
 - number of opening/closing cycles,
 - total period of operation of the load (device closed).
- Remote controlled circuit breaker/Reflex iC60:
 - opening control ,
 - closing control ,
 - contactor open/closed state,
 - circuit breaker open/closed state,
 - number of opening/closing cycles,
 - total period of operation of the load.
- Pulse meters (energy, water, gas, etc.):
 - number of pulses recorded,
 - pulse value setting (default: 10 Wh),
 - total consumption recorded,
 - possibility of resetting energy meters.
- Digital inputs/outputs.

PowerTag system gateways Smartlink SI B



DB429005

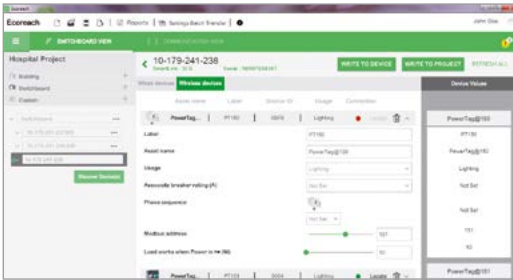

Functions (cont.)

Transmission of additional data collected by Acti9 Smartlink SI B

- Power meters (Modbus slaves).
- Analog sensors:
 - CO₂ sensor,
 - light sensor,
 - humidity sensor,
 - temperature sensor,
 - any 0..10 V or 4..20 mA compatible sensor.
- PowerTag wireless-communication energy sensors (ComPacT NSX, Acti9 iC60, iC40, DT60, DT40 ranges):
 - total and partial energy,
 - active power, phase-to-phase voltage, phase-to-neutral,
 - currents I1, I2, I3,
 - power factor,
 - voltage loss and overload information.
- Load monitoring:
 - alarm sent by the sensor in the event of a voltage loss,
 - pre-alarms on predefined thresholds (50 %, 80 %) or customized thresholds (thresholds on currents, power, voltages and cumulative energies),
 - load running time counter.
- Alarm management on current/voltage/load level thresholds by e-mail.
- Display of alarms and pre-alarms on Acti9 Smartlink SI B embedded web pages.
- Easy integration into any upper system using Com'X 210, Com'X 510 and other Schneider Electric software and third-party Building Management Systems (BMS's) thanks to the EcoStruxure Power Commission report in pdf format. A report provides dynamically all the Modbus registers and associated meanings for an easy integration into the system.
- Remote metering capability using the Acti9 Smartlink SI B monitoring page.

All the data are stored in memory: number of cycles, consumption, period of operation, even in the event of a power interruption.

Acti9 Smartlink can also exchange data with any device having 24 V DC digital inputs/outputs (e.g. low-level contacts 29452 for position of the ComPacT NSX). No configuration of the products connected to the Ti24 channels is required.

At power up, Acti9 Smartlink Modbus adapts automatically to the communication parameters of the Modbus master (PLC, supervisor, etc.).

Installation

- Assembly in switchboards:
 - width 24 modules per row,
 - minimum spacing between rails 150 mm.
- Mounting on:
 - DIN rail with mounting kit **A9XMFA04**,
 - Linergy FM 80 A, with bolts provided,
 - Linergy FM 200 A, with mounting kit **A9XM2B04**,
 - back of enclosure with mounting kit **A9XMBP02**,
- Installation in Pragma and Kaedra enclosures with mounting kit **A9XMVA01**.

Test

- The communication and cabling test on the connected devices can be performed using the EcoStruxure Power Commission software.

DB-405140

Test software: EcoStruxure Power Commission



- To test wired and wireless communication of analog and Modbus devices
- To edit a complete test report (pdf) with the Modbus communication registers for easy integration into a supervision system
- Windows XP, Windows 7, Windows 8 and Windows 10 compatible
- Downloadable from: schneider-electric.com

Download



EcoStruxure Power Commission
Get the software for free.



Scan or click
on QR code
to download
the installer.

PowerTag system gateways Smartlink SI B



Smartlink SI B



Smartlink Modbus

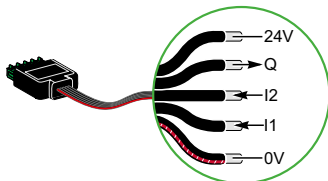

A9XCAU06

Catalogue numbers

Smartlink			
Type		Set of	
Smartlink SI B		1	A9XMZA08
Supplied with	4-pin connector for analog inputs	1	
	Modbus connector	1	
	24 V DC power supply connector	1	
	Bolts for mounting on Linergy FM 80	2	
Smartlink Modbus		1	A9XMSB11
Supplied with	Modbus connector	1	
	24 V DC power supply connector	1	
	Bolts for mounting on Linergy FM 80	2	
Accessories			
USB/Modbus connecting cables for Acti9 Smartlink test		1	A9XCATM1
Prefabricated cables			
With 2 connectors	100 mm	6	A9XCAS06
	160 mm	6	A9XCAM06
	450 mm	6	A9XCAH06
	870 mm	6	A9XCAL06
With 1 connector	870 mm	6	A9XCAU06
	4000 mm	1	A9XCAC01
Connectors	5-pin connectors (Ti24)	12	A9XC2412
Mounting kit	DIN rail (4 feet, 4 earthing straps, 4 adapters)	1	A9XMFA04
	Linergy FM 200 A (4 adapters)	1	A9XM2B04
	Back of enclosure (2 brackets)	1	A9XMBP02
	Vertical for Kaedra enclosures	1	A9XMVA01
	Vertical or horizontal for Pragma enclosures		
Spare parts	Bolts for Linergy FM 80 A (2 bolts)	1	A9XMLA02

Connectable devices

With Ti24 interface		
Type	Reference	Description
iACT24	A9C15924	Low-level control and indication auxiliary for iCT contactors
iATL24	A9C15424	Low-level control and indication auxiliary for iTL impulse relays
iOF+SD24	A9A26897 A9A26898	Low-level indication auxiliary for iC60, iID, ARA, RCA, iSW-NA
OF+SD24	A9N26899	Low-level indication auxiliary for C60, C120, DPN, RCCB/iD, C60H-DC
RCA iC60	See module CA904011	Remote control with Ti24 interface
Reflex iC60	See module CA904012	Reflex iC60 with Ti24 interface
Without Ti24 interface		
Power meters with pulse output, e.g. iEM2000T		
Pulse meters complying with the IEC 62053-21 standard		
24 V DC indicator lamps, Harmony range type XVL		
All loads not exceeding 100 mA, 24 V DC		
Timers, thermostats, time switches, load shedding devices		
All 24 V DC auxiliary contacts, IEC 61131-2 type 1		
With Modbus connector systems		
Power meters: iEM3150, iEM3250, iEM3350, iEM3155, iEM3255, iEM3355, all Modbus slave RS485 equipment		
With wireless-communication systems		
PowerTag Energy sensors *. See PowerLogic catalog PLSED309005EN		
With analog outputs		
Any 0...10 V and 4...20 mA compatible sensor (temperature, humidity, luminosity, etc.)		

(*) for additional information and a list of Schneider Electric compatible devices, refer to the selection guide CA908058E.

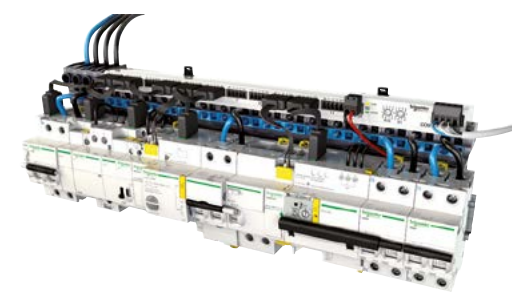

PowerTag system gateways Smartlink SI B



Example of an installation

Modbus master
■ Acti9 Smartlink SI B

Ethernet link
■ Ethernet 10/100 MB, Modbus TCP server

Wireless communication
■ No additional wiring
■ Up to 20 sensors connected

Analog inputs
■ 2 analog inputs, 0..10 V or 4..20 mA, e.g.: connection of a temperature probe

Modbus communication
■ Up to 8 Acti9 Smartlink Modbus or other Modbus slaves connected

Modbus slave
■ Smartlink Modbus

Prefabricated cables
■ Simplified and faster cabling

Ethernet network connection

Smartlink SI B has an embedded Web server used to display data showing the state of circuit breakers, energy meters, power data, phase unbalance and current alarms. Manual control is also possible via the Web page.

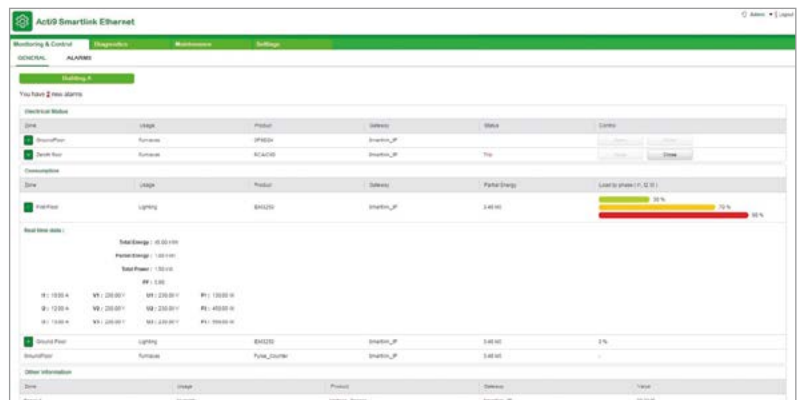

■ The Web server sets the parameters of the connection to the network servers (SNTP, SMTP), as well as the parameters of user emails and of the connection to the Facility Hero.com service

Smartlink SI B



Smartlink SI B (A9XMZA08)

Ti24 connector 7 input/output channels

- Input protected against voltage reversals
- Output protected by current limiting
- Pin 1: 0 V
- Pin 2: I1 Input 1
- Pin 3: I2 Input 2
- Pin 4: Q Output
- Pin 5: +24 V DC

24 V DC power supply connector

- Input protected against voltage reversals
- Pin1: 0 V
- Pin2:+24 V DC

Ethernet connector 100 Base T - RJ45

Analog connector

- 2 configurable input points, either 0-10 V or 4-20 mA
- Pin 1: 0 V
- Pin 2: AI1 Input 1
- Pin 3: AI2 Input 2
- Pin 4: +24 V DC

Indication

- Indication of operation of the communication system and the state of the Acti9 Smartlink SI B

Serial port connector

- Modbus (Master) RS485
- Pin 1: D1 Modbus
- Pin 2: D0 Modbus
- Pin 3: shielding
- Pin 4: common/0 V

20 PowerTag Energy sensors

- Radio-frequency communication
 - ISM band 2.4 GHz (2.4 GHz to 2.4835 GHz)
 - Channels 11 to 16 as per IEEE 802.15.4
- Note: Smartlink SI B and the PowerTag Energy sensors must be installed in the same switchboard*



Smartlink Modbus (A9XMSB11)

Ti24 connector 11 input/output channels

- Input protected against voltage reversals
- Output protected by current limiting
- Pin 1: 0 V
- Pin 2: I1 Input 1
- Pin 3: I2 Input 2
- Pin 4: Q Output
- Pin 5: +24 V DC

24 V DC power supply connector

- Input protected against voltage reversals
- Pin1: 0 V
- Pin2:+24 V DC

Serial port connector

- Modbus (Master) RS485
- Pin 1: D1 Modbus
- Pin 2: D0 Modbus
- Pin 3: shielding
- Pin 4: common/0 V

Indication

- indication of operation of the communication system and the state of the Acti9 Smartlink Modbus

Thumbwheels

- Definition of the address in the Modbus network

PowerTag system gateways

Smartlink SI B



Common technical characteristics

Power supply		
Nominal		24 V DC \pm 20 %
Maximum input current		1.5 A
Maximum inrush current		3 A
Meter		
Capacity		2 ³² pulses per input
Input characteristics		
Number of channels	Smartlink Modbus (A9XMSB11)	11 2-input channels
	Smartlink SI B (A9XMZA08)	7 2-input channels
Type of input		Current collector Type 1 IEC 61131-2
Maximum cable length		500 m
Rated voltage		24 V DC
Voltage limits		24 V DC \pm 20 %
Rated current		2.5 mA
Maximum current		5 mA
Filtering time	A l'état 1	2 ms
	A l'état 0	2 ms
Isolation		No isolation between channels
Negative sequence voltage protection		Yes
Output characteristics		
Number of output channels	Smartlink Modbus (A9XMSB11)	11
	Smartlink SI B (A9XMZA08)	7
Type of output		24 V DC - 0.1 A current source
Maximum cable length		500 m
Rated voltage	Voltage	24 V DC
	Maximum current	100 mA
Filtering time	In state 1	2 ms
	In state 0	2 ms
Voltage drop (voltage in state 1)		1 V max
Maximum inrush current		500 mA
Leakage current		0.1 mA
Overvoltage protection		33 V DC
Environmental characteristics		
Temperature	Operating	-25°C ... +60°C (if vertical mounting, limited to 50°C)
	Storage	-40°C ... +80°C
Tropicalization		Treatment 2 (relative humidity of 93 % at 40°C)
Resistance to voltage dips		10 ms, class 3 as per IEC 61000-4-29
Degree of protection		IP20
Pollution degree		3
Altitude	Operating	0 ... 2000 m
Vibration resistance	As per IEC 60068.2.6	1 g / \pm 3.5 mm - 5 Hz to 300 Hz - 10 cycles
Shock resistance	As per IEC 60068.2.27	15 g / 11 ms
Immunity to electrostatic discharge	As per IEC 61000-4-2	Air: 8 kV Contact: 4 kV
Immunity to radiated magnetic fields	As per IEC 61000-4-3	10 V/m - 80 MHz to 3 GHz
Immunity to fast transients	As per IEC 61000-4-4	1 kV for inputs/outputs and Modbus communication. 2 kV for 24 V DC power supply - 5 kHz - 100 kHz
Immunity to conducted magnetic fields	As per IEC 61000-4-6	10 V from 150 kHz to 80 MHz
Immunity to magnetic fields at mains frequency	As per IEC 61000-4-8	30 A/m
Resistance to corrosive atmospheres	As per IEC 60721-3-3	Level 3C2 on H ₂ S / SO ₂ / NO ₂ / Cl ₂
Fire resistance	For live parts	At 960°C 30 s / 30 s as per IEC 60 695-2-10 and IEC 60 695-2-11
	For other parts	At 650°C 30 s / 30 s as per IEC 60 695-2-10 and IEC 60 695-2-11
Salt spray test	As per IEC 60068.2.52	Severity 2
Environment		In compliance with the RoHS directive
Prefabricated cable characteristics		
Dielectric strength		1 kV / 5 min
Minimum draw-out resistance		20 N
Electromagnetic compatibility		
Reference standards	Immunity	EN 55024
	Emissions	EN 55022
	Electromagnetic compatibility and Radio spectrum Matters (ERM)	EN 300328 EN 301489-1 EN 301489-17

Smartlink SI B



Smartlink Modbus (A9XMSB11) technical characteristics

Characteristics of the Modbus link		
Link	Modbus, RTU, RS485 serial connection	
Transmission	Transfer rate	9600 baud ... 19200 baud, self-adaptable
	Medium	Shielded cable, double twisted pair
Protocol	Master/Slave	
Type of device	Slave	
Modbus addressing range	1 to 99	
Maximum length of the bus	1000 m	
Type of bus connector	4-pin connector	

Smartlink SI B (A9XMZA08) technical characteristics

Characteristics of the Ethernet link		
Link	Ethernet 10/100 MB	
Protocol	Modbus TCP server	
	http (web pages)	
Addressing mode	Static and dynamic (supplied, by default, in dynamic mode)	
Gateway characteristics		
Protocol	Modbus TCP/IP -> Modbus SL	
Number of Modbus slaves	8	
Modbus addressing range	1 to 247	
Characteristics of the Modbus Master link		
Link	Modbus, RTU, RS485 serial connection	
Transmission	Transfer rate	9600 bauds ... 19200 bauds
	Medium	Shielded cable, double twisted pair
Maximum length of the bus	1000 m	
Type of bus connector	4-pin connector	
Characteristics of analog inputs		
Number	2	
Type	Independent settings for each input, either 0-10 V or 4-20 mA	
Measuring accuracy	1/100 full scale	
Resolution	12 bits	
Acquisition time	500 ms	
Isolation	No isolation between channels	
Power supply	0-24 V DC	
Cable type	Shielded cable, twisted pair	
Maximum cable length	30 m	
Protection	Short-circuit protection	
Characteristics of the wireless-communication link		
Compatible devices	PowerTag Energy sensors	
Maximum number of sensors	20	
Radio-frequency communication	2.4 GHz to 2.4835 GHz at 0 dBm	

Dimensions (mm)

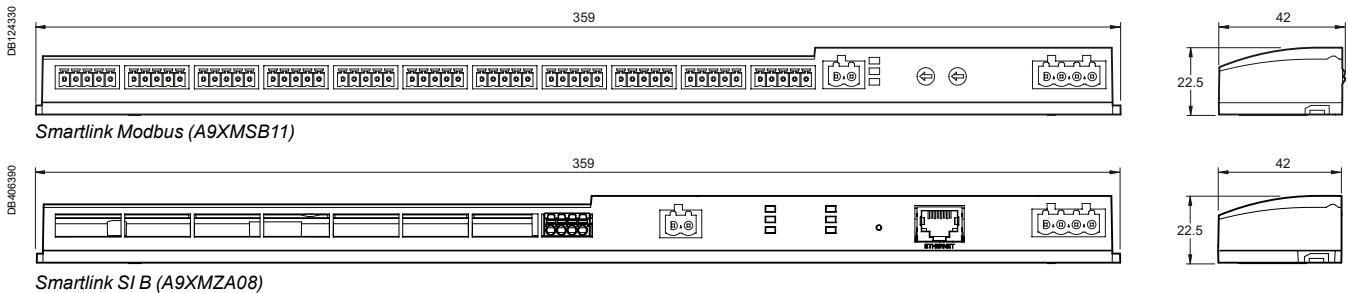

Weight (g)

Smartlink	
Type	
Smartlink Modbus (A9XMSB11)	195
Smartlink SI B (A9XMZA08)	180

PowerTag Link



PowerTag Link
ref.: A9XMWD20



Commissioning software: EcoStruxure Power Commission (*)

- Configuration and communication test of wireless devices
 - Editing of a complete test report (pdf) with the Modbus communication registers for easy integration into a supervision system
 - Windows XP, Windows 7, Windows 8 and Windows 10 compatible
 - Downloadable from:
https://www.schneider-electric.com/ww/en/download/document/Ecoreach_Installer
- (*): new name of Ecoreach software

PowerTag Link: ref. A9XMWD20

Introduction

Ethernet connection concentrator (Modbus TCP/IP) for wireless devices with data display web pages.
The associated PowerTag Energy sensors allow alarms to be managed via email for terminal loads, and energy, power, current and voltage to be measured accurately in real time.
The associated PowerTag Control modules are designed to monitor and control a circuit and notify wirelessly to the concentrator the information status of a contact (OF, SD, CT or TL position indication...)
The associated PowerTag Link Display allows user to visualize data from energy sensors connected to the gateway.
The entire system can easily be installed in existing LV equipments using Multi9/Acti9/Compact NSX type circuit breakers, TeSys and competitor's devices.

Data transmitted:

- Total and partial energy.
- Active, apparent and reactive power, phase-to-phase and phase-to-neutral voltage.
- Currents I1, I2, I3.
- Power factor (cos phi).
- Voltage loss and overload information.
- Control order to a circuit.
- Information status of a contact.

Functions

PowerTag Link permits:

- Concentration of PowerTag Energy wireless sensor data.
- Ethernet connection via the RJ45 port.
- Load monitoring:
 - alarm sent by the energy sensor in the event of a voltage loss,
 - pre-alarms on predefined thresholds (50 %, 80 %) or customized thresholds (thresholds on currents, power, voltages and cumulative energies),
 - load running time counter,
 - power synthesis (kW).
- Alarm management on current/voltage/load level thresholds by e-mail.
- Send control orders to PowerTag Control output to operate a load remotely and get load status thanks to feedback loop on associated input.
- Collect status of contact from PowerTag Control input.
- Display of alarms and pre-alarms on PowerTag Link embedded web pages.
- Easy integration into system with Com'X 200, Com'X 510 and other Schneider Electric software and third-party Building Management Systems (BMS) thanks to EcoStruxure Power Commission report in pdf format. This report provides dynamically all the Modbus registers and associated meanings for an easy integration into the system.
- Remote metering capability using the PowerTag Link monitoring page.
- Send measured data and alarms to the PowerTag Link Display that can be installed locally

Installation

- On DIN rail (width 54 mm).
- 230 V AC power supply.

Testing and start-up

- Pairing of wireless devices must be performed via the EcoStruxure Power Commission software, freely available by downloading.
- The software makes it possible, in particular, to attribute to each circuit a name, a use and the current rating (useful for alarms).

Catalog numbers



PowerTag Link

Type		Width in 9-mm modules
Ethernet concentrator (Modbus TCP/IP) up to 20 wireless devices	A9XMWD20	6
Ethernet concentrator (Modbus TCP/IP) up to 100 wireless devices	A9XMWD100	

PowerTag Link



Compatible products
■ Circuit breakers and switches
See catalog module CA908058



PE11988-40_1.eps

PowerTag Link
■ Installation on DIN rail
■ 230 V AC power supply



ABXWWD20-34.eps

PowerTag Link Display
■ Installation on DIN rail or flush mounted
■ 277 V AC power supply
■ one single display per gateway



PE120358-8.psd

Wireless communication
■ No wiring required
■ Up to 100 sensors connected

PowerTag Energy sensors



LV434021_image-8.eps

Ethernet

Ethernet connector
■ 100 Base T - RJ45

PowerTag Control I/O module



A9XWIC1D3-27.eps



PE120384-8.psd

PowerTag Energy sensors

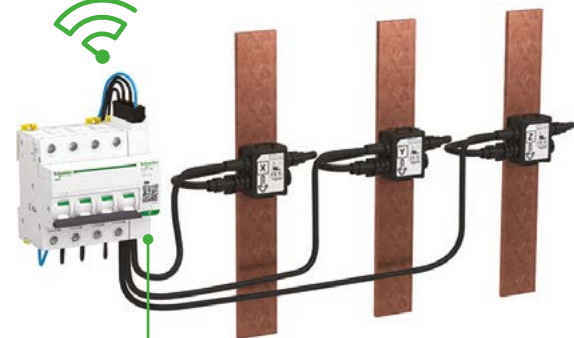

PowerTag Link



Weight (g)

PowerTag Link	
Type	
PowerTag Link	133

Dimensions (mm)

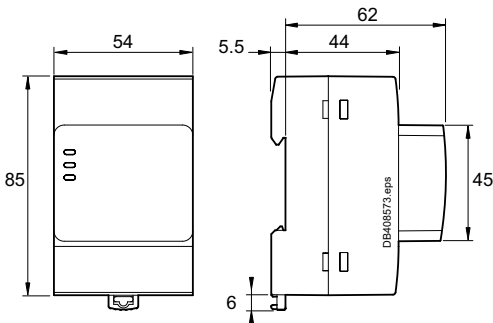

PowerTag Link

Technical characteristics

Main characteristics		
Supply voltage	Us	110/230 V AC ± 20 %, 2 A
Frequency		50/60 Hz
Power consumption		5 VA
Communication interface		Ethernet 10/100 BASE-T, Cable length ≤ 100 m Cat.6 STP
Wireless communication		Up to 20 or 100 PowerTag Energy sensors
Integrated connection type		DHCP client (Ethernet port)
Local indication	Product state	Green, orange and red LED
	Ethernet state (LAN ST)	Green, orange and red LED
Overvoltage category		III
Radio-frequency communication	ISM band 2.4 GHz	2.4 GHz to 2.4835 GHz
Degree of protection (IEC 60529)	Device only	IP20
	Device in modular enclosure	IP40 Insulation class II
Fire resistance		650°C, 30 s
Environment		In compliance with the RoHS directive REACH Regulations

Additional characteristics		
Operating temperature		-25°C to +60°C
Storage temperature		-40°C to +85°C
Pollution degree		2
Tropicalization (IEC 60068-2-30)		Treatment 2 (relative humidity of 93 % at 40°C)
Operating altitude		0 to 2000 m
Electromagnetic compatibility	Reference standards	
	Immunity	EN 55035
	Emissions	EN 55032
	Electromagnetic compatibility and Radio spectrum Matters (ERM)	EN 300328 EN 301489-1 EN 301489-17

PowerTag system display

PowerTag Link Display



PB120368-8.pdf

PowerTag Link Display
Ref.: A9XMWRD

PowerTag Link Display: ref. A9XMWRD

Functions

PowerTag Link Display ensures the following functions in conformity with IEC61010-1 standard:

- Display data of maximum 19 wireless devices for PowerTag Link (A9XMWD20) and 20 wireless devices for PowerTag Link HD (A9XMWD100):
 - Current per phase (A),
 - Phase-to-phase and phase-to-neutral voltage (V),
 - Active energy total and per phase (kWh),
 - Active power, total and per phase (kW),
 - Power factor.
- Display alarms if voltage loss or overloads.
- 5 languages: French, English, German, Italian, Spanish.

Installation

- Power supply on DIN rail (width 18 mm).
- Display on DIN rail or flush mounted (width 72 mm).

Testing and start-up

Commissioning the PowerTag Link Display can be performed via the EcoStruxure Power Commission software, freely available by downloading, or through gateway web pages.

Both make it possible, in particular, to attribute to each circuit a name when data is displayed.

Data displayed

PowerTag Energy measurements

Energy: per phase and total

Current: per phase and neutral

Phase-to-phase and phase-to-neutral voltage: per phase

Active power: per phase and total

Power factor

Alarms

PowerTag Energy

Voltage loss alarm

Overcurrent at voltage loss

PowerTag Control I/O module

D-in switch (Digital input 230V status)

Catalog number



PowerTag Link Display

Type		Width in 9-mm modules
PowerTag Link Display	A9XMWRD	8

PowerTag system display

PowerTag Link Display



Total Weight (g)

PowerTag Link Display	
Type	
PowerTag Link Display	137

Dimensions (mm)

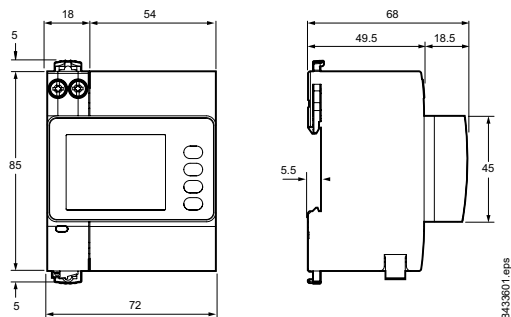

PowerTag Link

Technical characteristics

Main characteristics		
Power supply voltage		110/277 V AC \pm 15%
Display voltage		24 V DC \pm 20%
Display power consumption		2.7 W
Overvoltage category		III
Environment		In compliance with the RoHS directive REACH Regulations
Additional characteristics		
Operating temperature		-25°C to +60°C
Storage temperature		-40°C to +85°C
Pollution degree		3
Tropicalization	Operating (IEC 60068-2-78)	Relative humidity of 95 % at 45°C
	Storage (IEC 60068-2-30)	Relative humidity of 95 % at 55°C
Operating altitude		0 to 2000 m
Shock immunity (in operation)		IK06 (IEC 60068-2-75)
Degree of protection		IP41 for HMI when flush mounted (IEC60529)
		Insulation class II
Electromagnetic compatibility	Reference standards	EN 61326
	Electromagnetic compatibility and Radio spectrum Matters (ERM)	EN 300328 EN 301489-1 EN 301489-17

Smart Panels digitized by

Enerlin'X



PowerLogic™ wireless devices

PowerTag Energy sensors



Introduction & common principles

PowerTag Energy is a wireless-communication energy sensor

PowerTag Energy is designed specifically for Energy Management, Load Monitoring and Power Availability applications.

Associated to a concentrator or a gateway, PowerTag Energy provides a full wireless class 1 solution to monitor energy at any level of a distribution panel.

PowerTag Energy supports and enables Energy efficiency programs and standards such as:

- European Energy Efficiency Directive (EED).
- Energy Performance of Buildings Directive (EPBD).
- IEC 60364-8-1 "Low Voltage Electrical installations - Energy efficiency".
- EN 17267 "Energy Measurement and Monitoring plan".
- ISO 50001 "Energy Management System".

Main characteristics

PowerTag Energy sensor incorporates every features required to perform accurate real-time measurements (U, V, I, P, PF) and energy values up to 2000 A. Used together with a concentrator or a gateway to collect and process the data, it provides circuit monitoring and diagnosis down to load level.

- Wireless-communication technology simplifies switchboard wiring and commissioning operations: no wiring is required for the PowerTag Energy to communicate with the concentrator or the gateway.
- System scalability: PowerTag Energy can be quickly and easily installed in new or existing panels at any time.
- Different designs of PowerTag Energy are available to ensure it fits the protective device on which it is mounted on:
 - PowerTag Energy Monoconnect (M): mounted directly on the device, no additional wiring is required.
 - PowerTag Energy PhaseNeutral (P): for DIN offers with 9mm pitch between phase and neutral.
 - PowerTag Energy Flex (F): can be mounted on a wide range of protective devices thanks to its design.
 - PowerTag Energy Rope (R): with openable current sensors are easy to install on busbars or wires in new installations and in retrofit applications.

PowerTag Energy sensor is acting as an autonomous meter. Energy counters are stored inside PowerTag Energy sensor.



PowerTag Energy Monoconnect 63 A (M63)

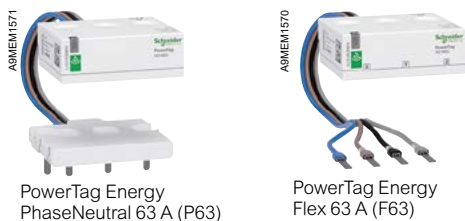

PowerTag Energy PhaseNeutral 63 A (P63)

PowerTag Energy Flex 63 A (F63)



PowerTag Energy Flex 160 A (F160)



PowerTag Energy Monoconnect 250 A (M250)



PowerTag Energy Rope 2000 A (R2000)



PowerTag Energy

PowerTag Energy sensors

Introduction & common principles

Connection possibilities

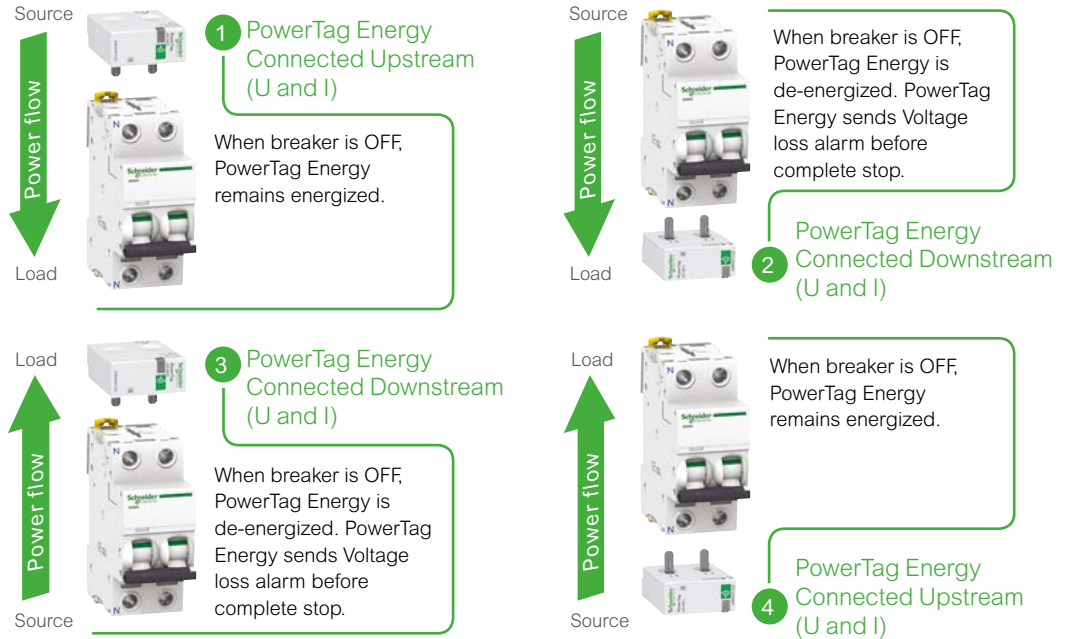

Note:

- In association with a contactor, a Variable Speed Drive or a motor starter: PowerTag Energy can ONLY be installed UPSTREAM these devices.
- Some PowerTag Energy can be installed either on the TOP or on the BOTTOM of the protective devices.
- Check the possible mounting position as indicated in the "Catalog numbers" chapter.

Connection (Voltage and Current)	Features
Upstream Preferred installation to take full benefit of voltage loss alarming in diagnosing the load	1 • Energy management: consumption in kWh 4 • Load monitoring: real-time measurements
Downstream Preferred installation to take full benefit of voltage loss alarming in diagnosing the load	2 • Energy management: consumption in kWh 3 • Load monitoring: real-time measurements • Power availability: voltage loss alarming

PowerTag Energy 63 A



Functions and characteristics

PB104437.eps



AGMEM1522.eps



PowerTag Energy Monoconnect 63 A (M63)

AGMEM1572_image.eps



PowerTag Energy PhaseNeutral 63 A (P63)

PB120058.eps



PowerTag Energy Flex 63 A (F63)

IEC 61557-12 PMD-I/DD/K55/1

As per the above standard:

With its compact design and innovative concept, PowerTag Energy 63 A fits directly on the protective device and as a result has no impact on DIN rail occupancy and switchboard size.

It is therefore well adapted to be mounted from head of group down to final circuits.

Since voltage and current are measured directly at the same point on the circuit to be monitored, it provides accurate measurement and relevant information such as voltage loss.

PowerTag Energy is compatible with SE product ranges as per the selection guide CA908058.

Main characteristics

PowerTag Energy measures the following values in accordance with the IEC 61557-12 standard PMD-I/DD/K55/1:

■ Energy:

□ Active energy (kWh): total and partial, delivered and received.

■ Real-time measurement values:

□ Voltages (V): phase-to-phase and phase-to-neutral.

□ Currents (A): per phase.

□ Power:

- Active power (W): total and per phase.

- Apparent power (VA): total.

□ Power factor.

■ Voltage loss alarms:

□ PowerTag Energy sends a "voltage loss" alarm and the current-per-phase value before being de-energized.

□ At "voltage loss", PowerTag Energy adds an overload alarm if the current is higher than the rated current of the associated protective device.

Note: Functions listed above depends on Concentrator/Gateway.



PowerTag Energy

PowerTag Energy 63 A



Functions and characteristics



PowerTag Energy
"Top"

Designed to be mounted on the Top of the circuit breaker.



Designed to be mounted on the Bottom of the circuit breaker.

PowerTag Energy
"Bottom"

Product selection

Neutral position

Some references of PowerTag Energy 63 A (Monoconnect and PhaseNeutral) exist in Top or Bottom version. This is linked to the position of the neutral of the PowerTag Energy.

Note:

- Some PowerTag Energy can be installed either on the TOP or on the BOTTOM of the protective devices.
- Check the possible mounting position as indicated in the "Catalog numbers" chapter.
- In association with a contactor, a Variable Speed Drive or a motor starter: PowerTag Energy can ONLY be installed UPSTREAM these devices.



Number of poles

Choose the PowerTag Energy according to the number of poles of the protective device: one PowerTag Energy per protective device.

Ex.: 3 Pole PowerTag Energy 63 A for a 3 pole CB.



PowerTag Energy 63 A



Functions and characteristics

Technical specifications

Main characteristics				
Rated voltage	1P+N / 1P+W	Un	Phase-to-neutral	200... 240 V AC ± 20 %
	3P	Un	Phase-to-phase	380... 415 V AC ± 20 %
	3P+N	Un	Phase-to-neutral	220... 240 V AC ± 20 %
			Phase-to-phase	380... 415 V AC ± 20 %
	A9MEM1543	Un	Phase-to-phase	200... 240 V AC ± 20 %
	A9MEM1564	Un	Phase-to-neutral	100... 127 V AC ± 20 %
	A9MEM1574	Un	Phase-to-neutral	120... 137 V AC ± 20 %
Phase-to-phase			208... 240 V AC ± 20 %	
Frequency				50/60 Hz
Maximum current	I _{max}		63 A	
Basic current	I _b		10 A	
Saturation current				130 A
Maximum consumption			1P+N	≤ 1 VA
			3P/3P+N	≤ 2 VA
Starting current	I _{st}		40 mA	
Additional characteristics				
Operating temperature				-25°C to +60°C
Storage temperature				-40°C to +85°C
Overvoltage category			As per IEC 61010-1	Cat. III
Measuring category			As per IEC 61010-2-030	Cat. III
Pollution degree				3
Altitude				≤ 2000 m
Degree of protection			Device only	IP20
			IK	05
Radio-frequency communication				
ISM band 2.4 GHz				2.4 GHz to 2.4835 GHz
Channels			As per IEEE 802.15.4	11 to 26
Isotropic Radiated Power			Equivalent (EIRP)	0 dBm
Maximum transmission time				< 5 ms
Channel occupancy			Messages sent every	5 seconds minimum
Characteristics of measuring functions				
Function	Symbol	Performance category as per IEC 61557-12 (PMD-I/DD/K55/1)		Measuring range
		Class		
Active power	P	1		9 W to 63 kW
Active energy	E _a	1		Total and partial 0 to 99999999.9 kWh
Current	I	1		40 mA to 63 A
Voltage	U	0.5		Un ± 20 %
Power factor	PFA	1		0 to 1

PowerTag Energy 63 A

Functions and characteristics

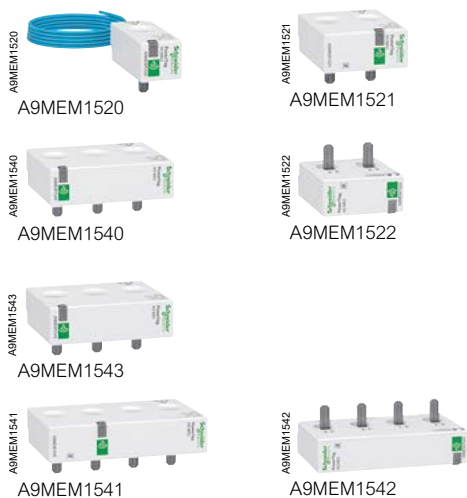

PowerTag Energy Monoconnect 63 A Commercial reference numbers

PowerTag Energy for Acti9 and Multi9 **Monoconnect** offers: «Single-terminal» circuit breakers, RCDs and switches with **18 mm pitch between phase and neutral**, rating less than or equal to 63 A.



Commercial ref.number	Type	Mounting	Description
A9MEM1520	1P+wire	Top or bottom	PowerTag Energy M63 1PW
A9MEM1521	1P+N	Top	PowerTag Energy M63 1PN T
A9MEM1522		Bottom	PowerTag Energy M63 1PN B
A9MEM1540	3P	Top or bottom	PowerTag Energy M63 3P
A9MEM1543 (1)			PowerTag Energy M63 3P 230V LL
A9MEM1541	3P+N	Top	PowerTag Energy M63 3PN T
A9MEM1542		Bottom	PowerTag Energy M63 3PN B

Designed to fit the following devices: iC60, Reflex iC60, DT60, iLD.
For additional information and the list of Schneider Electric compatible devices and Concentrators/Gateways, refer to the selection guide CA908058.

(1) Not compatible with Acti9 Smartlink SI D (A9XMWA20) and Acti9 Smartlink SI B (A9XMZA08)

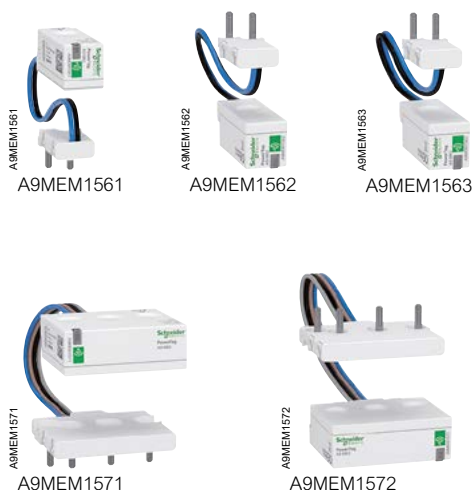

PowerTag Energy PhaseNeutral 63 A Commercial reference numbers

PowerTag Energy for Acti9 and Multi9 **PhaseNeutral** offers: «Single-terminal» circuit breakers, RCDs and switches at **pitch of 9 mm between phase and neutral**, rating less than or equal to 63 A.



Commercial ref.number	Type	Mounting	Description
A9MEM1561	1P+N	Top	PowerTag Energy P63 1PN T
A9MEM1562	1P+N	Bottom	PowerTag Energy P63 1PN B
A9MEM1563	1P+N RCBO	Bottom	PowerTag Energy P63 1PN B RCBO
A9MEM1571	3P+N	Top	PowerTag Energy P63 3PN T
A9MEM1572	3P+N	Bottom	PowerTag Energy P63 3PN B

Designed to fit the following devices: DT40, iDPN, C40, iDPN Vigi.
For additional information and the list of Schneider Electric compatible devices and Concentrators/Gateways, refer to the selection guide CA908058.

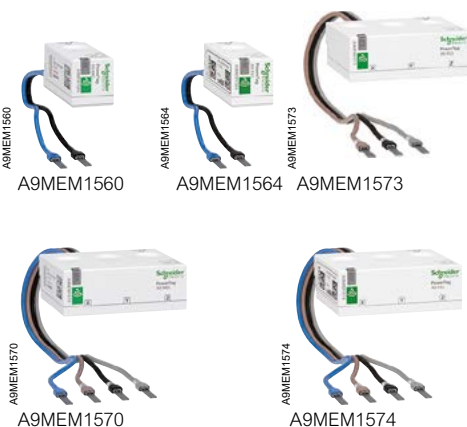

PowerTag Energy Flex 63 A Commercial reference numbers

PowerTag Energy **Flex** for other devices and specific installations, rating less than or equal to 63 A.



Commercial ref.number	Type	Mounting	Description
A9MEM1560	1P+N	Top or bottom	PowerTag Energy F63 1PN
A9MEM1564 (2)	1P+N	Top or bottom	PowerTag Energy F63 1PN 110V
A9MEM1573 (2)	3P	Top or bottom	PowerTag Energy F63 3P
A9MEM1570	3P+N	Top or bottom	PowerTag Energy F63 3PN
A9MEM1574 (2)	3P+N	Top or bottom	PowerTag Energy F63 3PN 127/220V

Designed to fit the following devices: Vigi iDT40, Vigi iC40, Vigi iC60, iC60 double terminal, iLD double terminal.

For additional information and the list of Schneider Electric compatible devices and concentrators/gateways, refer to the selection guide CA908058.

(2) Not compatible with Acti9 PowerTag Link C (A9XELC10), Smartlink SI D (A9XMWA20) and Smartlink SI B (A9XMZA08)

PowerTag Energy Monoconnect 63 A

Dimensions and connection

Connection

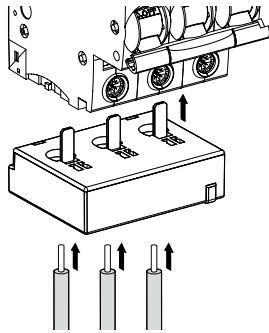

Stripping length	Copper cables					
	Rigid		Flexible		Flexible with ferrule	
18 mm	1.5 to 16 mm ² AWG: 16...6	2 x 1.5 to 2.5 mm ² AWG: 16...14	1.5 to 16 mm ² AWG: 16...6	2 x 1.5 to 2.5 mm ² AWG: 16...14	1.5 to 16 mm ² AWG: 16...6	2 x 1.5 to 2.5 mm ² AWG: 16...14

Mounting with 18 mm ferrule recommended.

Dimensions (mm)

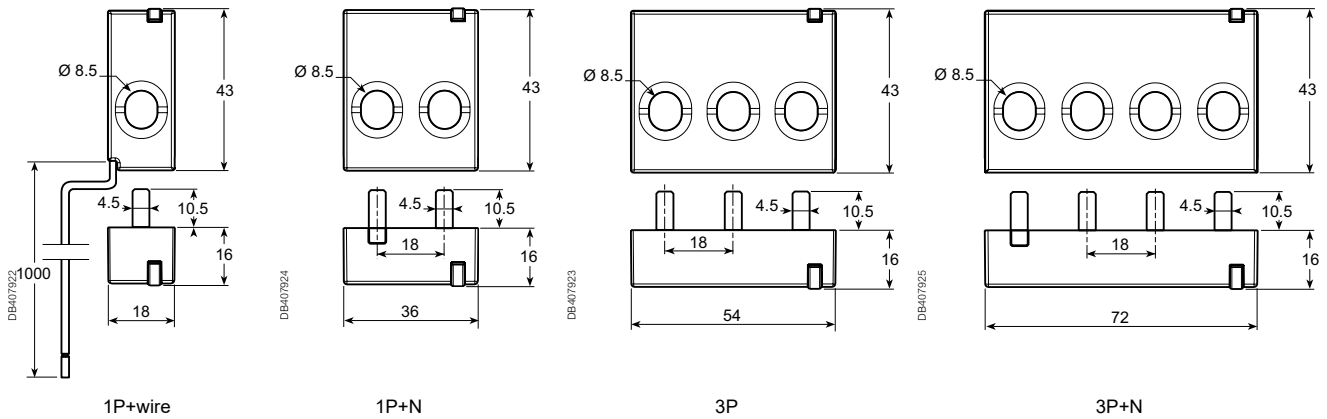

Weight





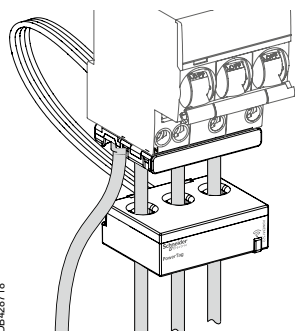

Type	Weight (g)
1P+wire	16.4
1P+N	17.5
3P	28
3P+N	35

PowerTag Energy Phase-Neutral 63 A

Dimensions and connection



Connection

Copper cables					
Rigid		Flexible		Flexible with ferrule	
					
1.5 to 16 mm ² AWG: 16...6	2 x 1.5 to 2.5 mm ² AWG: 16...14	1.5 to 16 mm ² AWG: 16...6	2 x 1.5 to 2.5 mm ² AWG: 16...14	1.5 to 16 mm ² AWG: 16...6	2 x 1.5 to 2.5 mm ² AWG: 16...14

Stripping length: respect the stripping length stated on the device the PowerTag Energy is associated with.

Dimensions (mm)

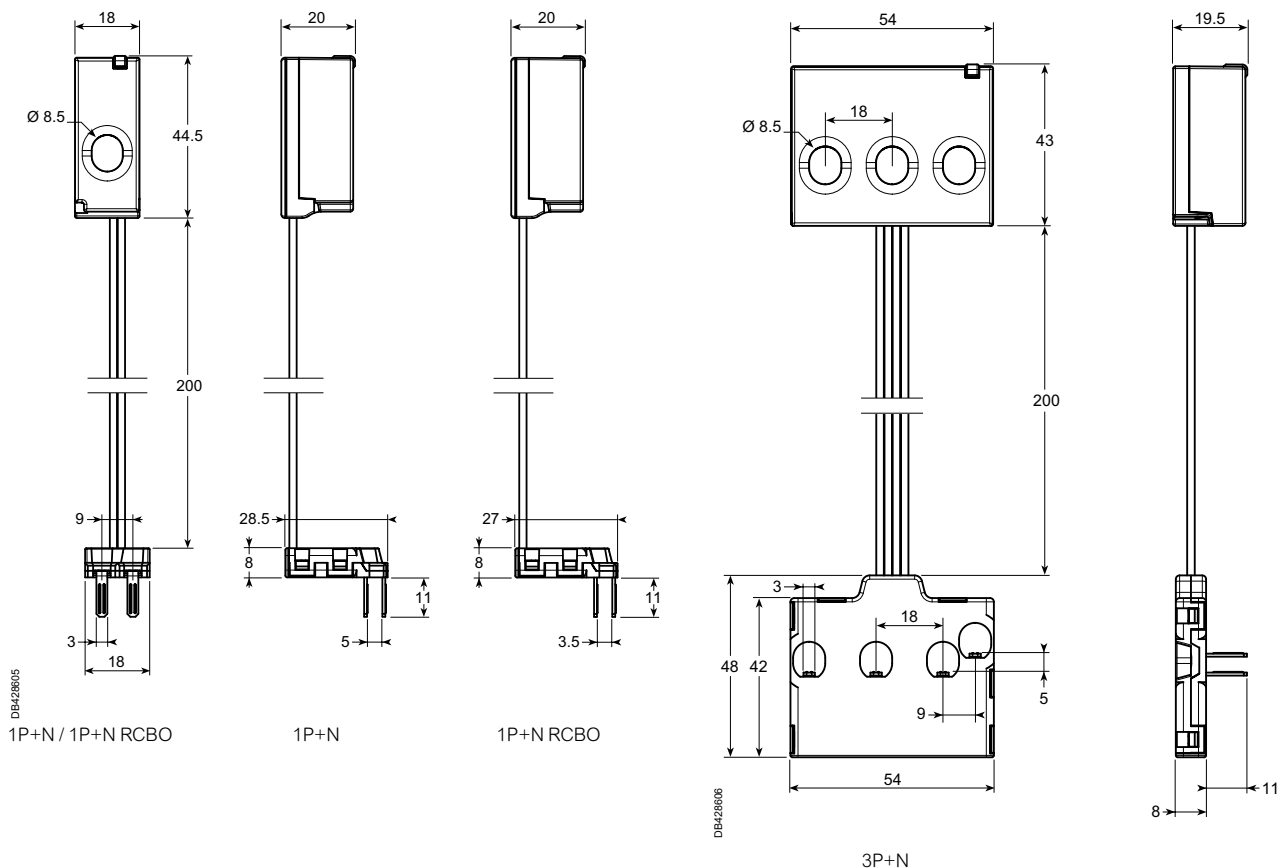

Weight

Type	Weight (g)
1P+N	18
3P+N	48

PowerTag Energy Flex 63 A

Dimensions and connection

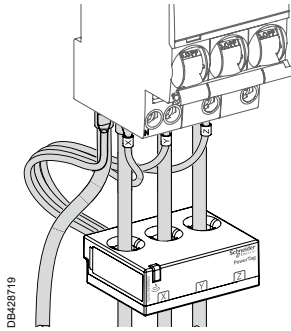

Connection

Copper cables					
Rigid	Flexible		Flexible with ferrule		
1.5 to 16 mm ² AWG: 16...6	2 x 1.5 to 2.5 mm ² AWG: 16...14	1.5 to 16 mm ² AWG: 16...6	2 x 1.5 to 2.5 mm ² AWG: 16...14	1.5 to 16 mm ² AWG: 16...6	2 x 1.5 to 2.5 mm ² AWG: 16...14

Stripping length: respect the stripping length stated on the device the PowerTag Energy is associated with.

Dimensions (mm)

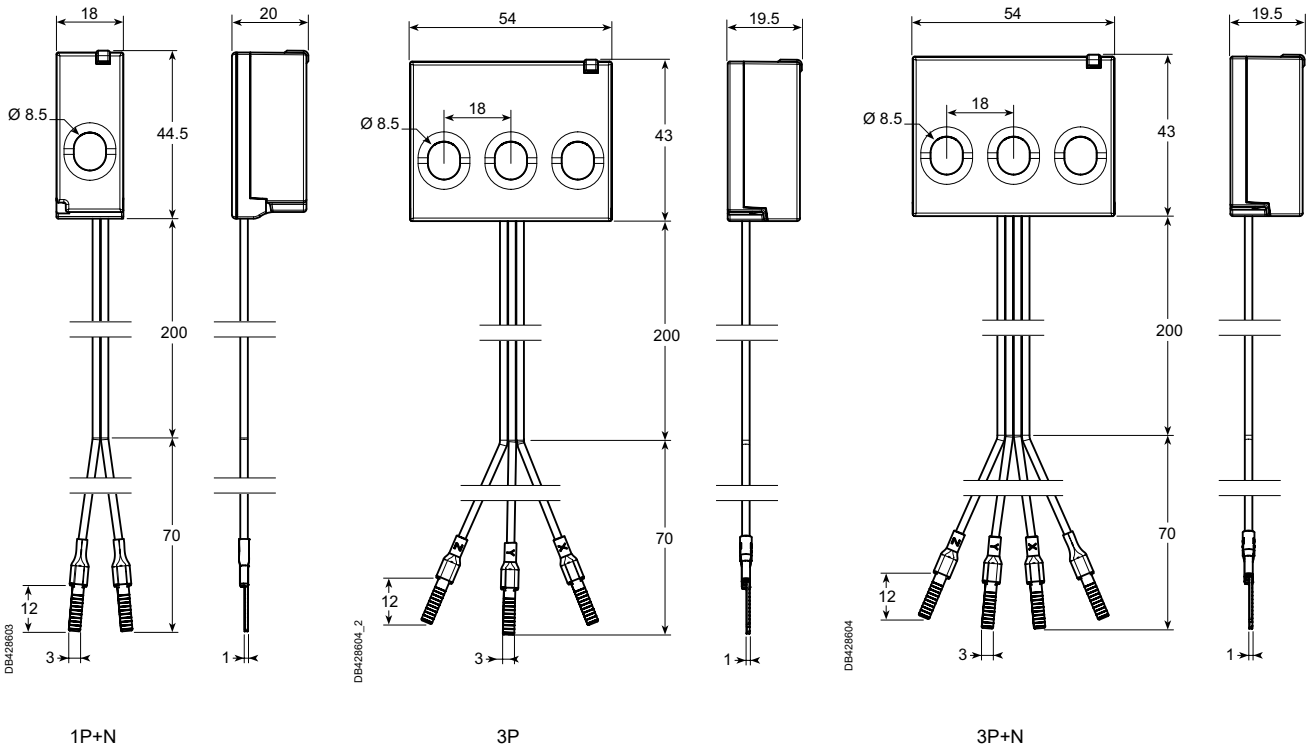

Weight

Type	Weight (g)
1P+N	16
3P	38
3P+N	40

PowerTag Energy Flex 160 A



Functions and characteristics

ARMEM1600



PowerTag Energy Flex 160 A

IEC 61557-12 PMD-II/DD/K70/1

As per the above standard:

With its flex design this PowerTag Energy can be used on many products or group of loads up to 160 A on 3P or 3P+N networks. Its removable spring connector for voltage picking facilitates its installation, and shapes for brackets allows to mount and maintain it where needed in a panel.

Main characteristics

PowerTag Energy Flex 160 A measures the following values in accordance with the IEC 61557-12 standard PMD-II/DD/K70/1:

■ Energy (4 quadrants):

- Active energy (kWh): total and partial, delivered and received.
- Active energy per phase (kWh): total and partial, delivered and received.
- Reactive energy (kVARh): total and partial, delivered and received.
- Reactive energy per phase (kVARh): total and partial, delivered and received.
- Apparent energy (kVAh): total and partial.
- Apparent energy per phase (kVAh): total and partial.

■ Real-time measurement values:

- Voltages (V): phase-to-phase (U12, U23, U31) and phase-to-neutral (V1N, V2N, V3N).
- Currents (A): per phase (I1, I2, I3), calculated neutral current when connected (IN).
- Power:
 - Active power (W): total and per phase.
 - Reactive power (VAR): total and per phase.
 - Apparent power (VA): total and per phase.
- Frequency (Hz).
- Power factor: total and per phase.

■ Voltage loss alarms:

- PowerTag Energy Flex sensor sends a "voltage loss" alarm and the current-per-phase value before being de-energized.
- At "voltage loss", PowerTag Energy Flex adds an overload alarm if the current is higher than the rated current of the associated protective device

Note: Functions listed above depends on Concentrator/Gateway.



PowerTag Energy

PowerTag Energy Flex 160 A



Functions and characteristics

PB120394



Installation

PowerTag Energy Flex 160 A can be installed in a panel directly on cables or busbars, associated to a product or not. Voltage pickings removable spring terminal has to be wired by 1 copper wire per phase with following characteristics:

Wire range

Solid	Stranded	Stranded with terminal ends
0.2...1.5 mm ²	0.2...2.5 mm ²	0.25...1.5 mm ²
24...16 AWG	24...14 AWG	24...16 AWG

Neutral picking shall be connected to have phase-to-neutral voltages, energy per phase and power per phase provided.

PowerTag Energy Flex 160 A is mainly advised for ComPact NSXm, ComPact INS160, Acti9 NG125, Acti9 C120, PowerPact B, TeSys GV4, and all other devices with a rating between 63 A and 160 A.

PowerTag Energy Flex 160 A

Functions and characteristics



Technical specifications

Main characteristics (as per IEC 61557-12)				
Rated voltage	Un	Phase-to-neutral	100...277 VAC ± 20 %	
		Phase-to-phase	173...480 VAC ± 20 %	
Frequency			50/60 Hz	
Maximum current	I _{max}		160 A	
Maximum operating current			1.2 x I _{max}	
Saturation current			2 x I _{max}	
Maximum consumption			3 VA	
Starting current	I _{st}		100 mA	
Basic current	I _b		25 A	
Additional characteristic				
Operating temperature			-25 °C to +70 °C	
Storage temperature			-40 °C to +85 °C	
Overvoltage category		As per IEC 61010-1	Cat. IV	
Measuring category		As per IEC 61010-2-030	Cat. IV	
Pollution degree			3	
Altitude			Up to 2000 m without derating ⁽¹⁾	
Degree of protection device			IP20	
			IK05	
Radio-frequency communication				
ISM band 2.4 GHz			2.4 GHz to 2.4835 GHz	
Channels		As per IEEE 802.15.4	11 to 26	
Isotropic Radiated Power		Equivalent (EIRP)	0 dBm	
Maximum transmission time			< 5 ms	
Channel occupancy		For 1 device	messages sent every 5 seconds	
Characteristics of measuring functions				
Function	Symbol	Performance category as per IEC 61557-12 (PMD-II/DD/K70/1)		Measuring range
		Class	Measuring range	
Total active power (Active power per phase)	P	1	2.5 to 160 A	24 W (8 W) to 192 kW
Total reactive power (Reactive power per phase)	QA	2		30 VAR (10 VAR) to 192 kVAR
Total apparent power (Apparent power per phase)	SA	2		38 VA (13 VA) to 192 kVA
Active Energy: per phase, total, partial, delivered and received	Ea	1		0 to 281.109 kWh
Reactive energy: per phase, total, partial, delivered and received	ErA	2		0 to 281.109 kVARh
Apparent energy: per phase, total, partial	EapA	2		0 to 281.109 kVAh
Frequency	f	1	50 / 60 Hz ± 2 %	45 to 65 Hz
Phase current	I	1	5 to 160 A	100 mA to 320 A
Neutral current	INC	2		
Voltages (Line to Line)	U	0.5	Un ± 20 %	138 to 576 VAC
Power factor (per phase, total)	PFA	1	From 0.5 inductive to 0.8 capacitive	-1 to 1

(1) Above 2000 m, please consult us.

PowerTag Energy Flex 160 A

Functions and characteristics



A9MEM1580

A9MEM1580

Commercial reference numbers

Commercial ref. number	Type	Description
A9MEM1580	F160 3P/3P+N	PowerTag Energy Flex 160 A 3P / 3P+N

For the list of Schneider Electric compatible devices and concentrators, refer to the selection guide CA908058.

Dimensions

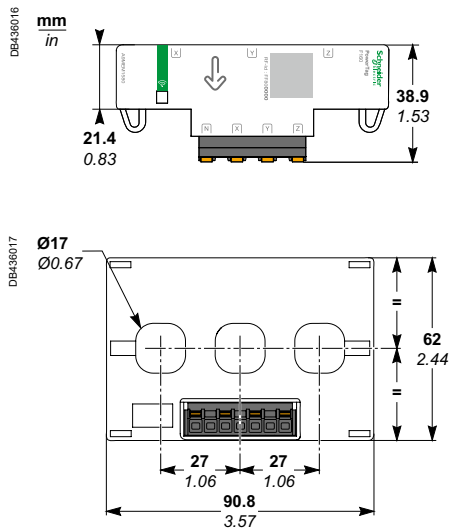

Weight

Type	Weight (g)
F160 3P/3P+N	100

Contact your Schneider Electric representative for complete ordering information.

Please refer to PowerTag Energy Flex 160 A Installation Sheet for accurate and complete information on the installation of this product.

PowerTag Energy Rope 200 to 2000 A



Functions and characteristics

ADM/EM1/550



PowerTag Energy Rope



PowerTag Energy

IEC 61557-12 PMD-II/DD/K70/1

As per the above standard:

With its flexible and openable current sensors, this PowerTag Energy Rope can be installed easily on busbars and cables without having to disconnect the conductors, and is suitable for 3P or 3P+N networks. Its removable spring connector for voltage picking facilitates its installation, and the module can be mounted on a DIN rail or maintained with brackets where needed in a panel.

Main characteristics

PowerTag Energy Rope measures the following values in accordance with the IEC 61557-12 standard PMD-II/DD/K70/1:

- Energy (4 quadrants):
 - Active energy (kWh): total and partial, delivered and received.
 - Active energy per phase (kWh): total and partial, delivered and received.
 - Reactive energy (kVARh): total and partial, delivered and received.
 - Reactive energy per phase (kVARh): total and partial, delivered and received.
 - Apparent energy (kVAh): total and partial.
 - Apparent energy per phase (kVAh): total and partial.
- Real-time measurement values:
 - Voltages (V): phase-to-phase (U12, U23, U31) and phase-to-neutral (V1N, V2N, V3N).
 - Currents (A): per phase (I1, I2, I3), calculated neutral current when connected (IN).
 - Power:
 - Active power (W): total and per phase.
 - Reactive power (VAR): total and per phase.
 - Apparent power (VA): total and per phase.
 - Frequency (Hz).
 - Power factor: total and per phase.
- Voltage loss alarms:
 - PowerTag Energy Rope sensor sends a “voltage loss” alarm and the current-per-phase value before being de-energized.
 - At “voltage loss”, PowerTag Energy Rope adds an overload alarm if the current is higher than the rated current of the associated protective device.

Note: Functions listed above depends on Concentrator/Gateway.

PowerTag Energy Rope 200 to 2000 A

Functions and characteristics

PB120437-7.eps

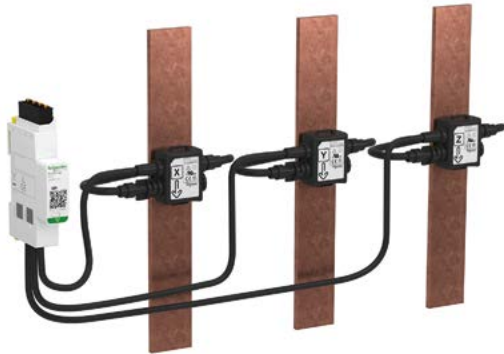

Installation

PowerTag Energy Rope 18 mm module can be mounted on DIN rail or fastened with brackets anywhere in a panel. Then its openable current sensors have to be installed around conductors, cables or busbars, whatever they are insulated or not. Voltage pickings removable spring terminal has to be wired by 1 copper wire per phase with following characteristics:

Wire range

Solid	Stranded	Stranded with terminal ends
0.2...1.5 mm ²	0.2...2.5 mm ²	0.25...1.5 mm ²
24...16 AWG	24...14 AWG	24...16 AWG

Neutral picking shall be connected to have phase-to-neutral voltages, energy per phase and power per phase provided. PowerTag Energy Rope is mainly advised for ComPact NS, MasterPact NT and NW, MasterPact MTZ NA and HA, for retrofit, for group of loads, and for all other devices with a rating up to 2000 A.

PowerTag Energy Rope 200 to 2000 A



Technical specifications

Main characteristics (as per IEC 61557-12)			
Rated voltage	Un	Phase-to-neutral	100...277 VAC ± 20 %
		Phase-to-phase	173...480 VAC ± 20 %
Frequency			50/60 Hz
Maximum current	I _{max}		200 A / 600 A / 1000 A / 2000 A
Maximum operating current			1.2 x I _{max}
Saturation current			2 x I _{max}
Maximum consumption			3 VA
Starting current	I _{st}		120 mA / 400 mA / 600 mA / 1.2 A
Basic current	I _b		30 A / 100 A / 150 A / 300 A
Additional characteristic			
Operating temperature			-25 °C to +70 °C
Maximum primary conductor temperature			100 °C
Storage temperature			-40 °C to +85 °C
Overvoltage category		As per IEC 61010-1	Cat. IV
Measuring category		As per IEC 61010-2-030	Cat. IV
Pollution degree			3
Altitude			Up to 2000 m without derating ⁽¹⁾
Degree of protection device			IP20 (IP40 front face) IK05
Radio-frequency communication			
ISM band 2.4 GHz			2.4 GHz to 2.4835 GHz
Channels		As per IEEE 802.15.4	11 to 26
Isotropic Radiated Power		Equivalent (EIRP)	0 dBm
Maximum transmission time			< 5 ms
Channel occupancy		For 1 device	messages sent every 5 seconds
Characteristics of measuring functions			
Function	Symbol	Performance category as per IEC 61557-12 (PMD-II/DD/K70/1)	Measuring range (200 A / 600 A / 1000 A / 2000 A)
		Class	Measuring range (200 A / 600 A / 1000 A / 2000 A)
Total active power (Active power per phase)	P	1	3 to 200 A / 10 to 600 A / 15 to 1000 A / 30 to 2000 A
Total reactive power (Reactive power per phase)	Q _A	2	
Total apparent power (Apparent power per phase)	S _A	2	
Active Energy: per phase, total, partial, delivered and received	E _a	1	
Reactive energy: per phase, total, partial, delivered and received	E _{rA}	2	
Apparent energy: per phase, total, partial	E _{spA}	2	
Frequency	f	0.5	50 / 60 Hz ± 2 %
Phase current	I	1	6 to 200 A / 20 to 600 A / 30 to 1000 A / 60 to 2000 A
Neutral current	I _{NC}	2	
Voltages (Line to Line)	U	0.5	Un ± 20 %
Power factor (per phase, total)	PF _A	1	From 0.5 inductive to 0.8 capacitive

(1) Above 2000 m, please consult us.

PowerTag Energy Rope 200 to 2000 A

Functions and characteristics



Commercial reference numbers



A9MEM159●



Commercial ref. number	Type	Description
A9MEM1590	R200 3P/3P+N	PowerTag Energy Rope 200 A 3P / 3P+N
A9MEM1591	R600 3P/3P+N	PowerTag Energy Rope 600 A 3P / 3P+N
A9MEM1592	R1000 3P/3P+N	PowerTag Energy Rope 1000 A 3P / 3P+N
A9MEM1593	R2000 3P/3P+N	PowerTag Energy Rope 2000 A 3P / 3P+N

For the list of Schneider Electric compatible devices and concentrators, refer to the selection guide CA908058.

Dimensions

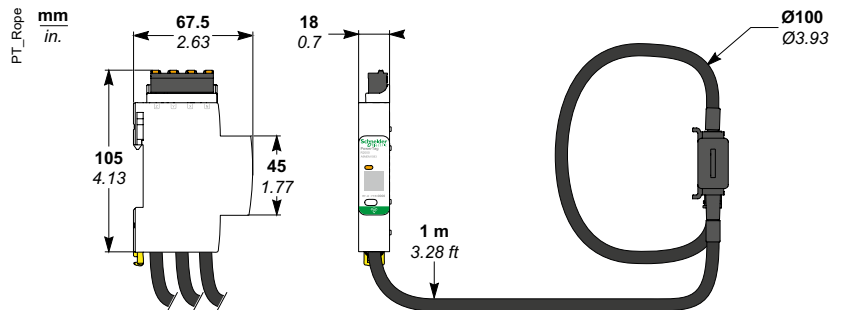

Weight

Type	Weight (g)
R200 3P/3P+N	360
R600 3P/3P+N	
R1000 3P/3P+N	
R2000 3P/3P+N	

Contact your Schneider Electric representative for complete ordering information.

Please refer to PowerTag Energy Rope 200 A to 2000 A Installation Sheet for accurate and complete information on the installation of this product.

PowerTag Energy Monoconnect for ComPacT



PowerTag Energy Monoconnect for ComPacT Communication with Smartlink SI B

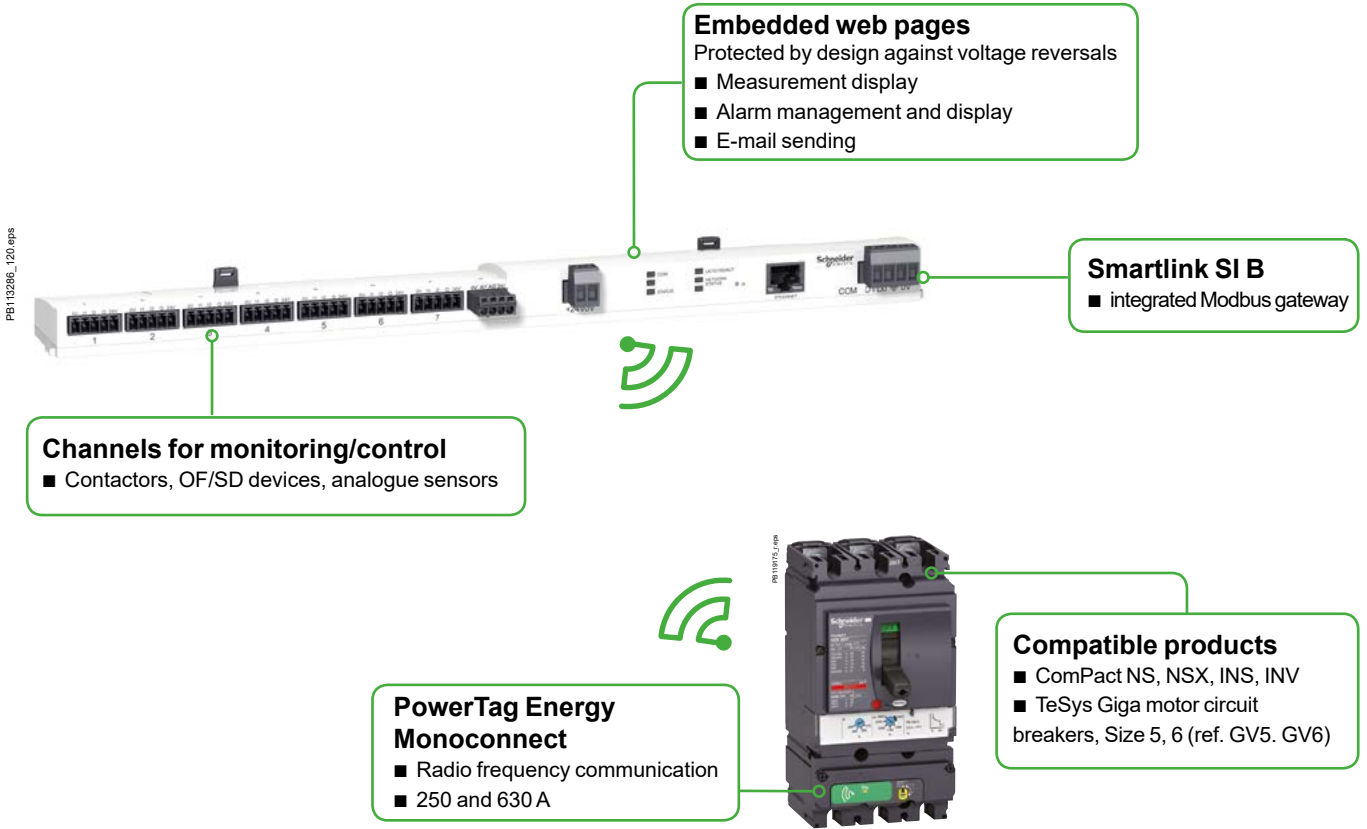

PowerTag Monoconnect for ComPacT Communication with Smartlink SI D

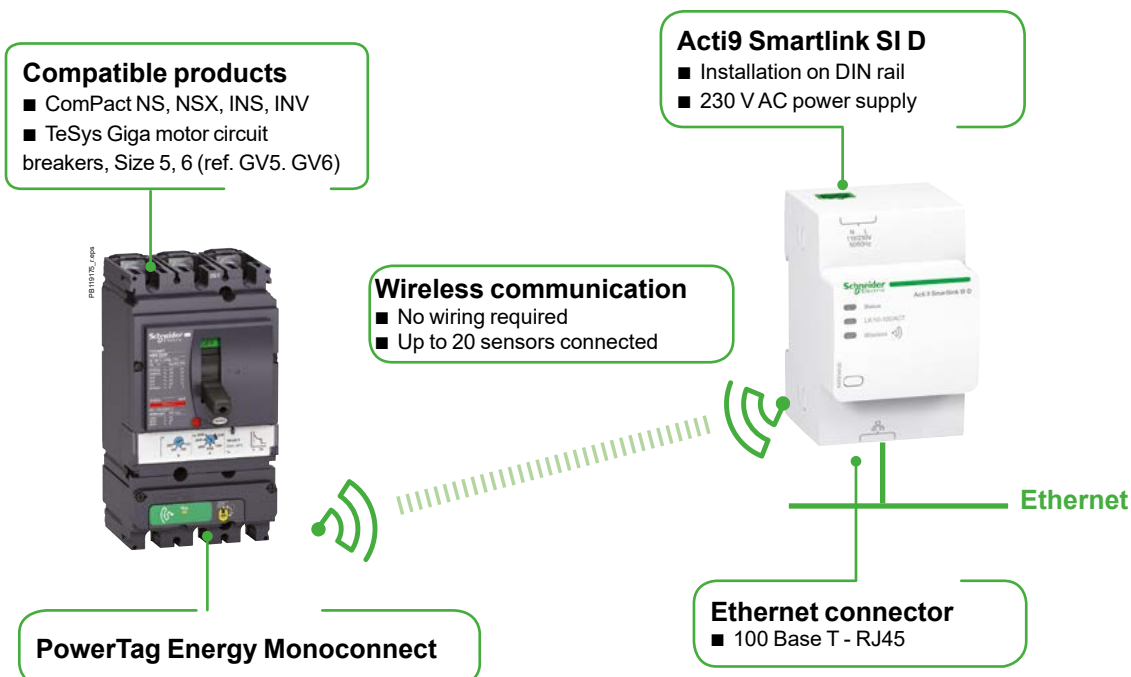

PowerTag Energy Monoconnect 250 A & 630 A



LV434020-5-eps



PowerTag Energy Monoconnect 250 A



PowerTag Energy

IEC 61557-12 PMD-II/DD/K70/1

As per the above standard:

PowerTag Energy M250/M630 is designed for Molded Case Circuit Breakers and Switches (ComPact and TeSys) for 3P and 3P+N electrical networks.

This PowerTag Energy is mounted directly on the bottom side of the circuit breaker or the Vigi add-on if any. Thanks to its integrated design, it does not require any specific wiring, and is compatible with the same connection accessories than the device it is mounted on.

Main characteristics

PowerTag Energy M250/M630 measures the following values in accordance with the IEC 61557-12 standard

PMD-II/DD/K70/1:

■ Energy (4 quadrants):

- Active energy (kWh): total and partial, delivered and received.
- Active energy per phase (kWh): total.
- Reactive energy (kVARh): partial, delivered and received.

■ Real-time measurement values:

- Voltages (V): phase-to-phase (U12, U23, U31) and phase-to-neutral (V1N, V2N, V3N).
- Currents (A): per phase (I1, I2, I3).
- Power:
 - Active power (W): total and per phase.
 - Reactive power (VAR): total.
 - Apparent power (VA): total.
- Frequency (Hz).
- Power factor.

■ Voltage loss alarms:

- PowerTag Energy sends a “voltage loss” alarm and the current-per-phase value before being de-energized.
- At “voltage loss”, PowerTag Energy adds an overload alarm if the current is higher than the rated current of the associated protective device.

Note: Functions listed above depends on Concentrator/Gateway.

PowerTag Energy Monoconnect 250 A & 630 A



LV634020_image04.eps



Installation

The module is self-powered and is installed for fixed devices directly on the bottom side of the circuit breaker or Vigi add-on terminals. For plug-in devices, it has to be installed on the base itself, top or bottom.

PowerTag Energy M250/M630 3P has to be used with 3P devices, and an external neutral voltage tap is provided in case of the installation has a neutral to provide phase-to-neutral voltages, active energy per phase and power per phase.

PowerTag Energy M250/M630 3P+N has to be used with 4P devices and with ComPact INS/INV switches.

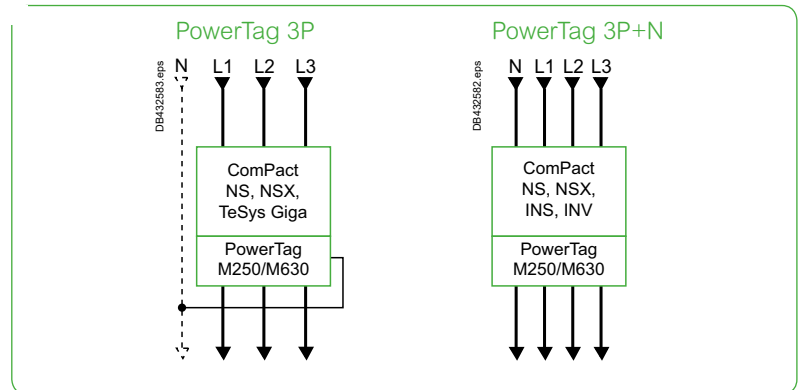

PowerTag M250/M630 modules are compatible with:

- ComPact NSX100/160/250,
- ComPact NSX400/630,
- ComPact INS250-100A to 250A,
- ComPact INS320/400/500/630,
- ComPact INV100/160/200/250,
- ComPact INV320/400/500/630,
- ComPact NS100/160/250,
- ComPact NS400/630,
- TeSys Giga motor circuit breakers, Size 5, 6 (ref. GV5. GV6).

In case of retrofit, following points have to be checked:

- Clearance to be able to add PowerTag Energy module and to respect bending radius of cables.
- Condition of power connectors: to be replaced if damaged.
- Tightening torques depending of the connector used.

PowerTag Energy Monoconnect 250 A & 630 A



Technical specifications

Main characteristics			
Rated voltage	Un	Phase-to-neutral	230 VAC ± 20 %
		Phase-to-phase	400 VAC ± 20 %
Frequency			50/60 Hz
Maximum current	I _{max}		250 A / 630 A
Maximum operating current			1.2 x I _{max}
Saturation current			2 x I _{max}
Maximum consumption			3.7 VA
Starting current	I _{st}		160 mA / 400 mA
Basic current	I _b		40 A / 100 A
Additional characteristic			
Operating temperature			-25 °C to +70 °C
Storage temperature			-50 °C to +85 °C
Overvoltage category		As per IEC 61010-1	Cat. IV
Measuring category		As per IEC 61010-2-030	Cat. III
Pollution degree			3
Altitude			Up to 2000 m without derating ⁽¹⁾
Degree of protection device			IP20
			IK07
Radio-frequency communication			
ISM band 2.4 GHz			2.4 GHz to 2.4835 GHz
Channels		As per IEEE 802.15.4	11 to 26
Isotropic Radiated Power		Equivalent (EIRP)	0 dBm
Maximum transmission time			< 5 ms
Channel occupancy		For 1 device	messages sent every 5 seconds
Characteristics of measuring functions			
Function	Symbol	Performance category as per IEC 61557-12 (PMD-II/DD/K70/1)	Measuring range (250 A / 630 A)
		Class	Measuring range (250 A / 630 A)
Total active power (Active power per phase)	P	1	4 to 250 A / 10 to 630 A
Total reactive power (Reactive power per phase)	Q _A	2	
Total apparent power (Apparent power per phase)	S _A	2	
Active Energy: per phase, total, partial, delivered and received	E _a	1	
Reactive energy: per phase, total, partial, delivered and received	E _{rA}	2	
Frequency	f	1	45 to 55 Hz
Phase current	I	1	8 to 250 A / 20 to 630 A
Voltages (Line to Line)	U	0.5	Un ± 20 %
Power factor	PF _A	1	From 0.5 inductive to 0.8 capacitive

(1) Above 2000 m, please consult us.

PowerTag Energy Monoconnect 250 A & 630 A



LV434020



LV434021



LV434022



LV434023

Commercial reference numbers



Commercial reference number	Type	Description	Connection adapter for mounting on plug-in base only
LV434020	M250 3P	PowerTag Energy 250 A 3P	LV429306
LV434021	M250 3P+N	PowerTag Energy 250 A 3P+N	LV429307
LV434022 (1)	M630 3P	PowerTag Energy 630 A 3P	LV432584
LV434023 (1)	M630 3P+N	PowerTag Energy 630 A 3P+N	LV432585

For the list of Schneider Electric compatible devices and concentrators, refer to the selection guide CA908058.

(1) For plug-in devices only: when plate mounted, need to add an intercalary wedging plate under the PowerTag Energy module with following dimensions:

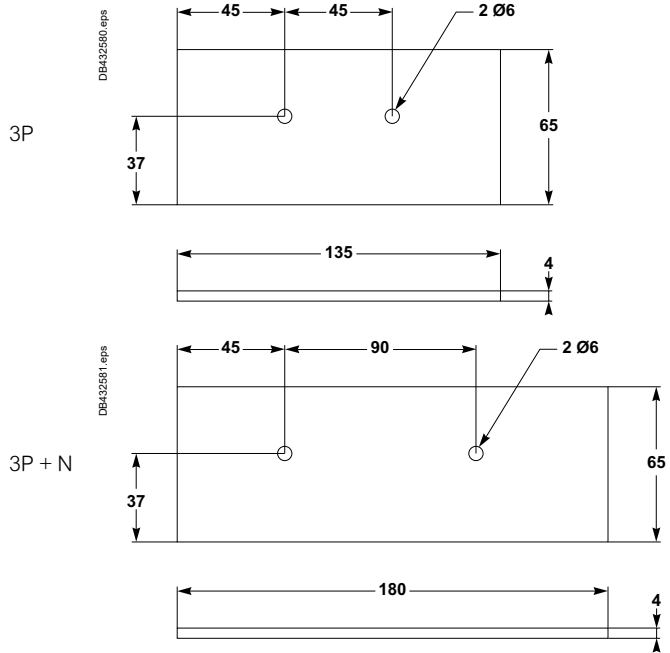

PowerTag Energy Monoconnect 250 A & 630 A



Dimensions

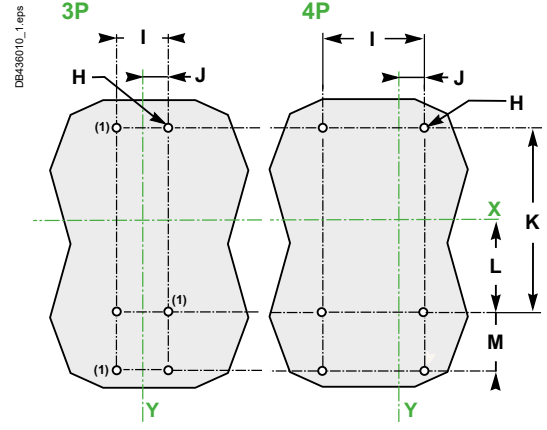
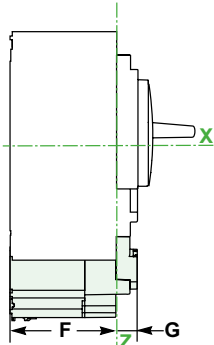
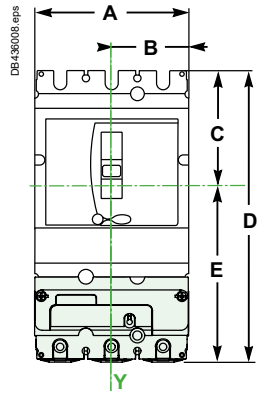

(1) Only for PowerTag M630

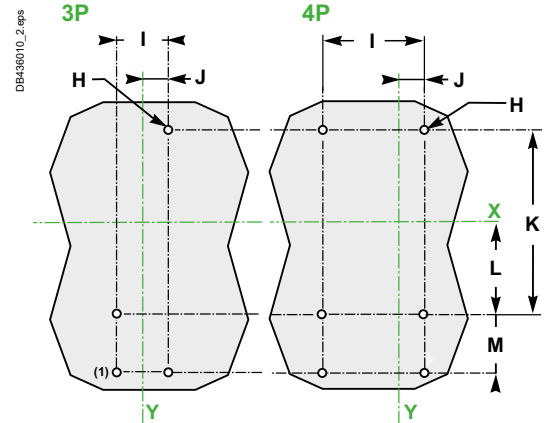
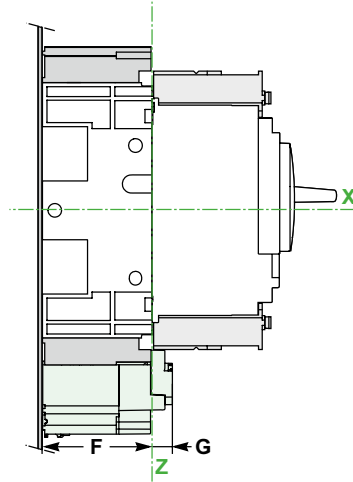
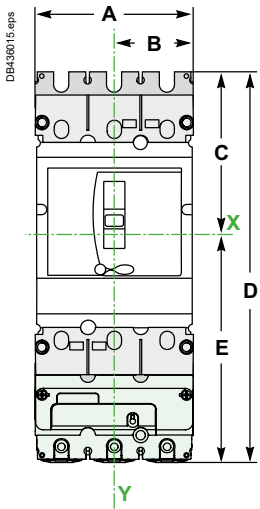

(1) Only for PowerTag M630

mm in	A		B	C	D	E	F	G	H		I		J		K	L	M
	3P	4P							3P	4P	3P	4P	3P	4P			
NSX100-250	105 4.13	140 5.51	52.5 2.06	80.5 3.17	201 7.91	120.5 4.74	72 2.83	14 0.55	3 Ø6 3 Ø0.23	6 Ø6 6 Ø0.23	35 1.34	70 2.75	17.5 0.68	17.5 0.68	125 4.92	62.5 2.46	40 1.57
NSX400-630	140 5.51	185 7.28	70 2.75	127.5 5.02	320 12.59	192.5 7.57	96 3.78	14 0.55	6 Ø6 6 Ø0.23	6 Ø6 6 Ø0.23	45 1.77	90 3.5	22.5 0.88	22.5 0.88	200 7.87	100 3.93	65 2.56
NSX100-250 with plug-in base	105 4.13	140 5.51	52.5 2.06	109 4.29	260 10.23	151 5.94	72 2.83	14 0.55	3 Ø6 3 Ø0.23	6 Ø6 6 Ø0.23	35 1.34	70 2.75	17.5 0.68	17.5 0.68	155 6.10	77.5 3.05	55 2.16
NSX400-630 with plug-in base	140 5.51	185 7.28	70 2.75	153 6.02	406 15.98	253 9.96	100 3.93	14 0.55	4 Ø06 4 Ø0.23	6 Ø6 6 Ø0.23	45 1.77	90 3.5	22.5 0.88	22.5 0.88	250 9.84	125 4.92	83 3.26

Please refer to PowerTag Energy 250 A & 630 A Installation Sheet for accurate and complete information on the installation of this product.

PowerTag Energy Monoconnect 250 A & 630 A



INS250 / INV100-250 / INS320-630 / INV320-630

Dimensions

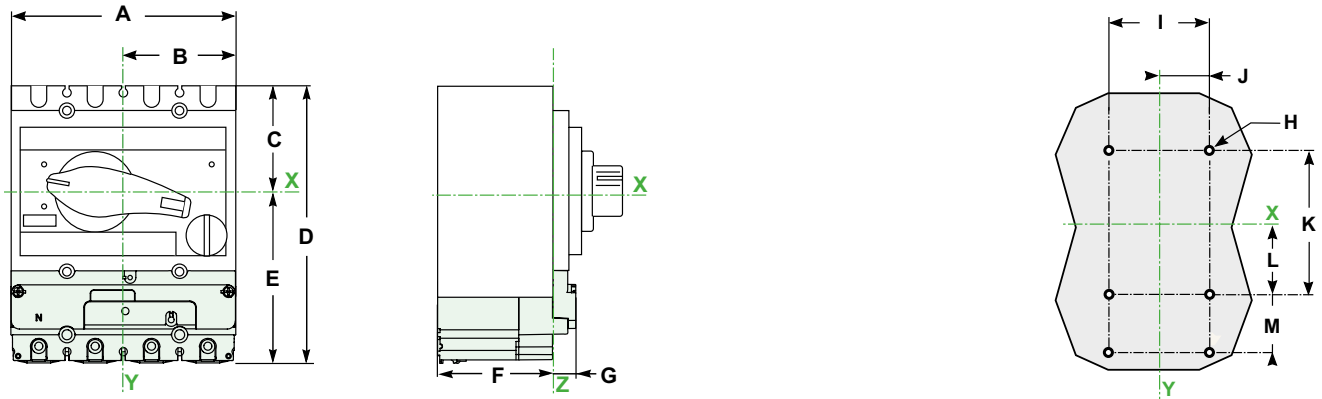

mm	A	B	C	D	E	F	G	H	I	J	K	L	M
in													
INS250	140	70	68	176	108	72	14	6 Ø6	70	35	100	50	40
INV100-250	5.51	2.75	2.67	6.93	4.25	2.83	0.55	6 Ø0.23	2.75	1.37	3.93	1.96	1.57
INS320-630	185	92.5	102.5	270	167.5	96	14	6 Ø6	90	45	150	75	65
INV320-630	7.28	3.64	4.03	10.62	6.59	3.78	0.55	6 Ø0.23	3.5	1.77	5.9	2.95	2.56

Weight

Type	Weight (g)
M250 3P	250
M250 3P+N	300
M630 3P	800
M630 3P+N	1000

HeatTag temperature and humidity sensor



HeatTag
SMT10020

HeatTag is a smart sensor for early detection of overheating wire connections or overheating cables. HeatTag helps prevent electrical switchboards from being damaged, by analyzing gas and particles in the air and sending alerts before any smoke or insulator browning.

Standards

The HeatTag smart sensor complies with the following standards:

- IEC 61010-1:2017 UL/CSA/EU CENELEC deviations
- IEC/EN 61326-1b FCC Part 15B and 15C
- ETSI/EN 300328
- ETSI/EN 301489-1
- IEEE 802.15.4

Note:

Do not use HeatTag as a safety device. HeatTag does not replace the fire protection devices of the building.

HeatTag: ref. SMT10020

Presentation

HeatTag smart sensor for early detection of overheating cables:

- Sends three levels of alert depending on the severity of the situation it detects.
 - Helps prevent potential fire damages by analyzing gas and micro-particles emitted by cable sheaths when overheating.
 - Measures temperature and humidity.
 - Communicates with all Schneider Electric EcoStruxure panel servers or gateways.
 - Is integrated in EcoStruxure solutions.
- The HeatTag sensor must be installed only in non-forced air ventilated switchboards. It must be mounted on a DIN rail.
- During the first 30 minutes after commissioning, HeatTag can generate an alert for test. It then takes another 8 hours for HeatTag to define its nominal environment and to be fully operational. Each time the HeatTag sensor is powered on, these 30-minute and 8-hour sequences are repeated.

Operation

Paired with Schneider Electric panel servers or gateways, HeatTag reports:

- Alerts
- Air quality index
- Temperature and humidity measurement
- Self-diagnosis information

Air Quality

HeatTag provides an air quality index, ranging from 0 to 10, and displays the air quality evolution trend in a table.

When the air quality index is equal or above 10, HeatTag sends an alert. It has detected abnormal cable sheath heating in the switchboard.

Detection Alert

An alert is triggered when HeatTag detects abnormal cable sheath heating in the switchboard, which can be caused by:

- One or more loose connections (too high contact resistance)
- A poorly sized cable compared to the rated current
- Overcurrent and poorly regulated protective equipment
- Alerts are triggered with three severity levels:
 - Low level: a cable is slowly overheating in the installation, you must plan a maintenance visit of the installation.
 - Medium level: a cable is overheating in the installation, you must go quickly to the installation for maintenance.
 - High level: a cable overheats very quickly, you must check the installation immediately.
- The orange application led flashes when HeatTag sends an alert to the panel servers or gateways.

Temperature

HeatTag provides a temperature value with a 30 second default transmission period. The transmission period can be increased by the system in case of high wireless data traffic.

Humidity

The HeatTag provides a humidity rate with a 30 second default transmission period. The transmission period can be increased by the system in case of high wireless data traffic.

Self-Diagnosis

HeatTag carries out two types of diagnosis:

- A minor alert is sent when the fan rpm is 80% of its nominal rpm, which means fan clogging.
- A major alert is sent when HeatTag is faulty. In this case it cannot report measures at all, nor reports incorrect measures.

HeatTag temperature and humidity sensor

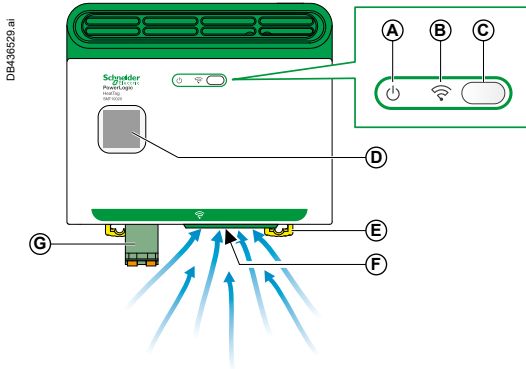

HMI Description

Overview

Legend	Display	Description
A	Operation LED	Indicates the power supply and the alert status.
B	Network status LED	Indicates the communication status with the panel servers or gateways.
C	Operation button	Used for pairing or acknowledging an alert, for unpairing, and for resetting values to factory settings.
D	QR code to access device information	Link to HeatTag product information.
E	DIN clip	Used to fix HeatTag on a DIN rail.
F	Air inlet	Enables aspiration of internal air of the switchboard.
G	Power supply connector	Used to connect the power supply.

Operation LED

Color	Status LED	Description
Green		HeatTag is in test mode.
		HeatTag is in normal operation.
Orange		HeatTag has triggered an alert. Look for the cause of the heat rise in the switchboard.
Red		Minor malfunction detected. Maintenance of HeatTag required.
		Major malfunction detected. Replacement of HeatTag required.

Network Status LED

Color	Status LED	Description
Green		HeatTag is in identification mode.
		HeatTag is in the network, normal communication with the panel servers or gateways.
Orange		HeatTag is searching a panel servers or gateways.
		HeatTag is unpaired with factory settings
Red		Reset to factory settings is in progress.
		Occasional loss of communication.
		Loss of communication with the panel servers or gateways.
		Internal error detected.

HeatTag temperature and humidity sensor

HeatTag Smart Design

- No settings
- Nominal environment auto-learning to avoid false alerts
- Concentrator auto-discovery
- Alerts generated by a powerful algorithm integrated in HeatTag

Electrical Characteristics

Supply voltage	110-277 V AC, -15 % / +15 %
Frequency	50-60 Hz
Max. consumption	0.1 A
Operating temperature	-15 °C / +70 °C (5 °F to 158 °F)
Storage temperature	-20 °C / +85 °C (-4 °F to 185 °F)
Relative humidity in operation	15-90 %
Altitude of use	0-2000 m (0-6500 ft)
Degree of pollution (IEC 60664-1)	3
Overvoltage category	OVC III

Sensor Characteristics

Temperature measurement	Measurement range	-15 °C / +70 °C (5 °F to 158 °F)
	Measurement accuracy	-1.1 °C / +1.1 °C
	Default transmission period	30 seconds (higher in case of high wireless data traffic)
Humidity measurement	Measurement range	15–90 %
	Measurement accuracy	±9 RH %
	Default transmission period	30 seconds (higher in case of high wireless data traffic)
Air quality		Index (0 to 10), alert generation when index ≥ 10
Test alert after pairing		During the first 30 minutes
Environment auto-learning phase		8 hours after the first 30 minutes

Mechanical Characteristics

Dimensions (W x H x D)	108 x 107 x 55 mm
Weight	270 g
Degree of protection (IEC 60529)	IP20

HeatTag temperature and humidity sensor

Dimensions

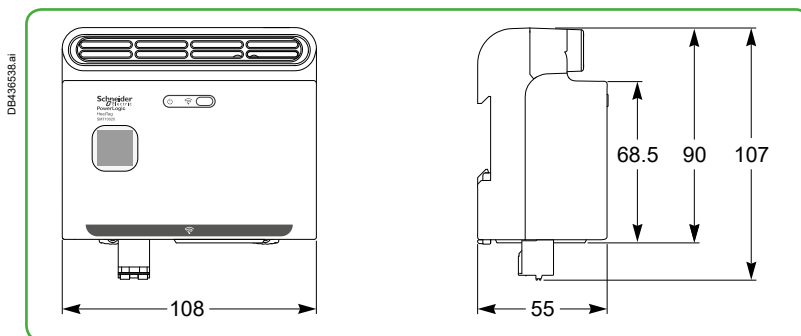

Installation

Mounting

HeatTag must be installed on a DIN rail following the Instruction Sheet recommendations (MFR51738).

It is delivered with a separate connector.

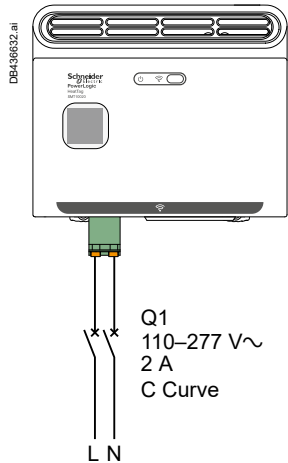
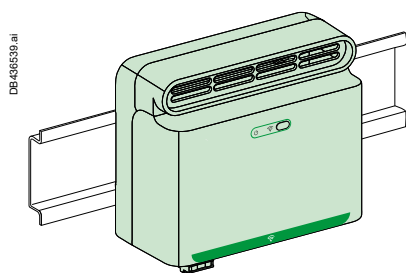

Wiring

The HeatTag must be protected by 2 A breaker.

Communication Architecture

List of compatible communicators:

- EcoStruxure Panel Servers
- PowerTag Link
- PrismaSeT Wireless Panel Server

PowerLogic™ wireless devices

PowerTag Control modules



PowerTag C IO 230V
Ref.: A9XMC1D3



PowerTag C 2DI 230V
Ref.: A9XMC2D3

PowerTag C IO 230V (ref. A9XMC1D3), PowerTag C 2DI 230V (A9XMC2D3)

PowerTag C IO 230V and PowerTag C 2DI 230V are wireless-communication modules designed specifically for Control and Monitoring applications. They are part of PowerTag System and Wisier System, allowing to turn easily a distribution board into a connected panel.

Designed to monitor a circuit, notifying wirelessly to the concentrator the information status of a contact (OF, SD, CT or TL position indication...).

Depending on their functionalities, PowerTag Control modules can operate a load remotely through a contactor, an impulse relay... thanks to wireless control orders from the concentrator.

Refer to the selection guide to select the right module as per the application required.

- Wireless-communication technology simplifies cabling and commissioning operations: no wiring is required for the PowerTag Control modules to communicate with the concentrator.
- System scalability: PowerTag Control modules can be easily installed in new or existing panels at any time with simple commissioning operation.
- PowerTag Control modules are DIN rail mounted.



PowerTag C IO 230V



Acti9 PowerTag Link C

Associated concentrators

For Residential applications

Wiser IP Module



EER31800

For Commercial & Building applications

PowerTag Link



A9XMWD20

PowerTag Link HD



A9XMWD100

For Small Business applications

Acti9 PowerTag Link C



A9XELC10

Refer to the concentrators catalog for more information.

PowerTag Control modules (cont.)



Selection guide

Application	PowerTag C IO 230V		PowerTag C 2DI 230V	
	Control ⁽¹⁾	Monitoring / Back loop ⁽²⁾	Control ⁽¹⁾	Monitoring ⁽²⁾
Digital input 230 V AC	-	1	-	2
Digital output 230 V AC	1	-	-	-
Compatible with	Circuit 2 A Max - 230 V AC: - Contactors 230 V AC - Impulse relays 230 V AC - RCA (cat no A9C7011x) ...	Dry contact 230 V AC: - iACTs - iATLs ...	-	Dry contact 230 V AC: - OF 230 V AC - SD 230 V AC - OF/SD 230 V AC ...
Width in 9-mm modules	2		2	
Catalog numbers	A9XMC1D3		A9XMC2D3	

(1) To operate a circuit remotely (2) To notify a status remotely

Principle diagrams

PowerTag C IO 230V

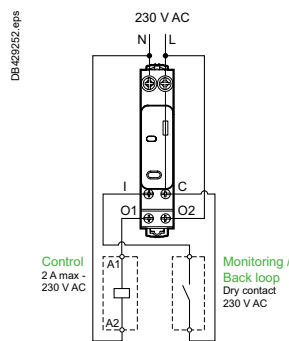

PowerTag C 2DI 230V

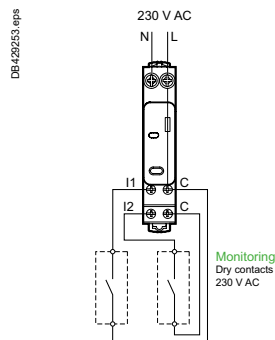

PowerTag Control modules (cont.)

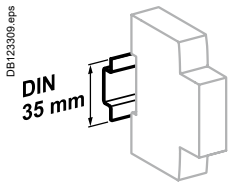

Clip on DIN rail 35 mm.

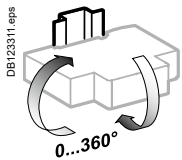

Indifferent position of installation.

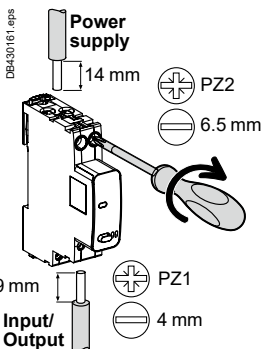
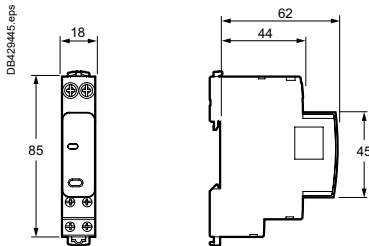
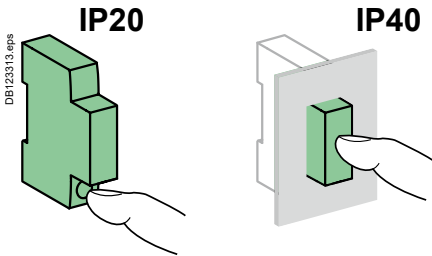

Technical characteristics

Main characteristics		
Power supply		230 V AC ± 20%
Frequency		50/60 Hz
Maximum consumption	IO	≤ 2 VA
	2DI	≤ 3 VA
Operating temperature		-25°C to +60°C
Storage temperature		-40°C to +85°C
Relative humidity (60068-2-78)		93 % at 40°C
Overvoltage category	As per IEC 61010-1	Cat. III
Altitude		≤ 2000 m
Pollution degree		3
Degree of protection according to IEC 60529	Front face	IP40
	Casing	IP20
	IK	05

Characteristics of inputs and outputs		
Digital input		
Type		230 V AC, dry contact
Digital output		
Type		230 V AC, dry contact
Relay type		Normally open or normally closed ⁽³⁾
Applicable voltage on output		230 V AC ± 20%
Minimum/maximum current on output		10 mA / 2 A
Type of output order		Pulse or latch ⁽³⁾
Pulse length in control mode with impulse relay		Nominal: 300 ms
Radio-frequency communication		
ISM band 2.4 GHz		2.4 GHz to 2.4835 GHz
Channels	As per IEEE 802.15.4	11 to 26
Isotropic Radiated Power	Equivalent (EIRP)	0 dBm
Channel occupancy	Messages sent	<ul style="list-style-type: none"> ■ On event ■ Periodically (5s nominal)

(3) Setting adjustable

Weight (g)

PowerTag C	
PowerTag C IO 230 V	80
PowerTag C 2DI 230 V	75

	Terminals Tightening torque	Copper cables		
		Rigid	Flexible	Flexible with ferrule
Power supply (Top)	2 N.m	 1 to 16 mm ² (AWG: 18...6)	 0.5 to 10 mm ² (AWG: 21...8)	-
Input/Output (Bottom)	1 N.m	1x: 1 to 6 mm ² (AWG: 18...10) 2x: 1.5 to 2.5 mm ² (AWG: 16...14)	1x: 0.5 to 4 mm ² (AWG: 21...12) 2x: 1.5 to 2.5 mm ² (AWG: 16...14)	 1x: 0.5 to 4 mm ² (AWG: 21...12) 2x: -

PowerTag Control modules (cont.)



PowerTag C IO 230 V

- Compatible with horizontal comb busbars 9 mm modules
- Automatic cable guiding in the correct position: terminals with guard

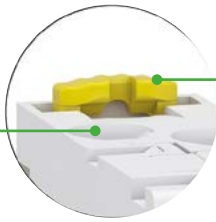

- Assembly and disassembly by operating toggle latches at the top and bottom of the products

Status LED

- Provide information about PowerTag C status

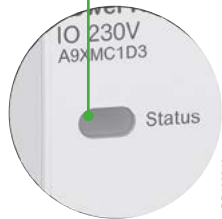

- Insulated terminals IP20



Push button

- Local output control
- Decommissioning

Logo

- Wireless communication device



Monitoring / Back loop circuit

- "I" digital input terminal
- "C" common powered terminal 230 V AC

Control circuit

- Logical output relay
- "O" output terminals 230 V AC - 2 A max.

PowerTag Control modules (cont.)



PowerTag C 2DI 230 V

- Compatible with horizontal comb busbars 9 mm modules
- Automatic cable guiding in the correct position: terminals with guard

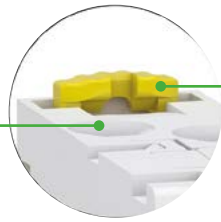

DB430243_eps

- Assembly and disassembly by operating toggle latches at the top and bottom of the products

Status LED

- Provide information about PowerTag C status



DB430244_eps

- Insulated terminals IP20



AGXMC2D3_image2-65_eps

Logo

- Wireless communication device



DB430245_eps

Flush mounted push button

- Decommissioning

Monitoring circuits

- "I" digital input terminals
- "C" common powered terminals 230 V AC



DB430242_eps

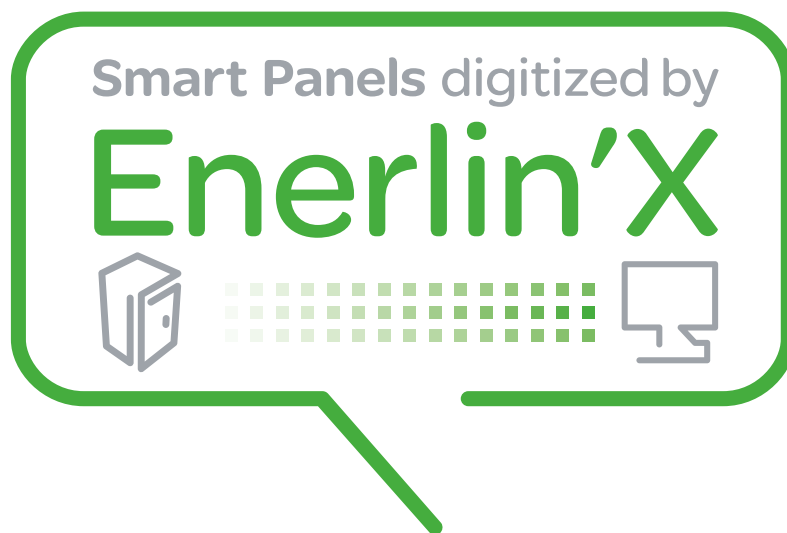



Design and
monitoring software
Maintenance mobile
application

Design and monitoring software Maintenance mobile application EcoStruxure™ Power Commission

Digitized electrical distribution management software

EcoStruxure Power Commission is dedicated to electrical asset management. It brings great support during build, commission and maintenance phases of Smart Panels projects.

Office or onsite: setting preparation of multiple digitized panels of a single installation (circuit breakers and Enerlin'X communication interfaces...).

Onsite: simultaneous dialogue with panels via LAN for commissioning and testing. Automatic report generation.

Projects database: saved in a protected cloud account.

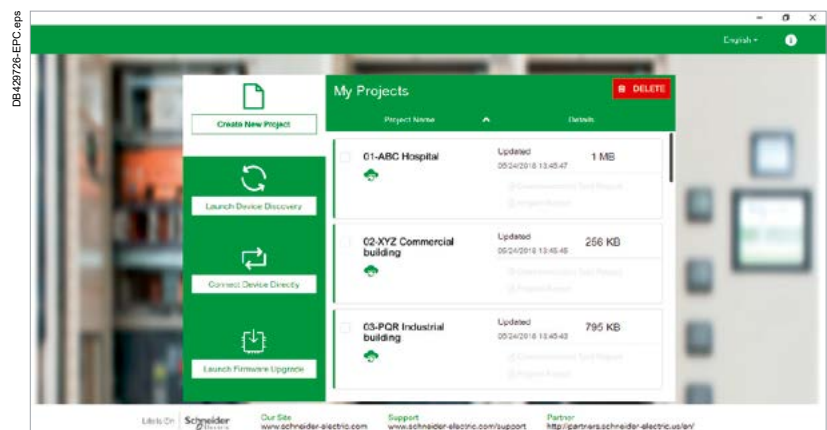

Panel design and build

- Offline design of electrical distribution architectures: electrical and communication devices description with their ratings and settings.
- Save as a new project: architecture and all related documents (of any file types).
- Projects library management: save, load project.
- Reuse of existing project: modify, save as a new project.

Devices commissioning

- Automatic discovery of devices in a digitized switchboard.
- Settings download, upload.
- Communication tests.
- Automatic communication report generation.

Circuit breakers commissioning

- Trip units settings download.
- Online checks, tests.
- Automatic report generation.

Design and monitoring software Maintenance mobile application EcoStruxure Power™ Commission

Operation and Maintenance

- Devices monitoring and control.
- Measurement parameter logs.
- Log reports.
- Download of current devices settings, compare with previous settings saved in EcoStruxure Power Commission.
- Firmware upgrade and compatibility matrix.

Compatibility

Devices

Configuration of below devices through the range of Enerlin'X interfaces devices.

- Circuit breakers: MasterPact NT/NW, ComPact NSX ranges.
- Circuit breakers and control components: Acti 9 range.

EcoStruxure Power Commission software for PC

- Compatible with Windows 7, Windows 8/8.1 and Windows 10.

Download



EcoStruxure Power Commission
Get the software for free.



Scan or click on QR code to download the installer.

Example of EcoStruxure Power Commission window

DB42973:EPC.jpg

IP ADDRESS	MODULE ADDRESS	DEVICE NAME	MAC ADDRESS
10.179.90.80	10.179.90.80	mpStruxure-1676	30:80:F4:81:16:76
10.179.90.82	10.179.90.82	8080	30:80:F4:81:8D:87
10.179.90.85	10.179.90.85	FE-ES884	30:80:F4:81:8D:84
10.179.90.20	10.179.90.20	mpStruxure-004E	30:80:F4:81:8D:4E
10.179.90.29	10.179.90.29	mpStruxure-4275	30:80:F4:81:8D:75
10.179.90.171	10.179.90.171	FDN-2016-171	30:80:F4:81:8D:4E
10.179.90.30	10.179.90.30	ComPact_NSX-136	30:80:47:93:3E:36
10.179.90.48	10.179.90.48	ComPact_NSX-44	30:80:47:93:3E:44
10.179.90.54	10.179.90.54	ComPact_NSX-5E	30:80:47:93:3E:5E
10.179.90.55	10.179.90.55	ComPact_NSX-5A	30:80:47:93:3E:5A

Design and monitoring software Maintenance mobile application

EcoStruxure™ Facility Expert

Cloud based Software



Click or scan QR code

Presentation video:
EcoStruxure™ Power
for Small and Medium buildings

EcoStruxure™ Facility Expert, a software for operation & maintenance

EcoStruxure™ Facility Expert helps Business owners and Site Managers to improve the performance of their buildings at lower operating costs, while ensuring at the same time the business continuity. It is a cloud based software available on PCs and mobile devices that provides valuable information on energy costs and on asset conditions along with tools to manage the maintenance activities.

EcoStruxure™ Facility Expert is fully adapted to multi-sites projects delivering performance views and reports to site manager while maintenance manager and field technicians get access to detailed dashboard, instant alerts and maintenance tasks.

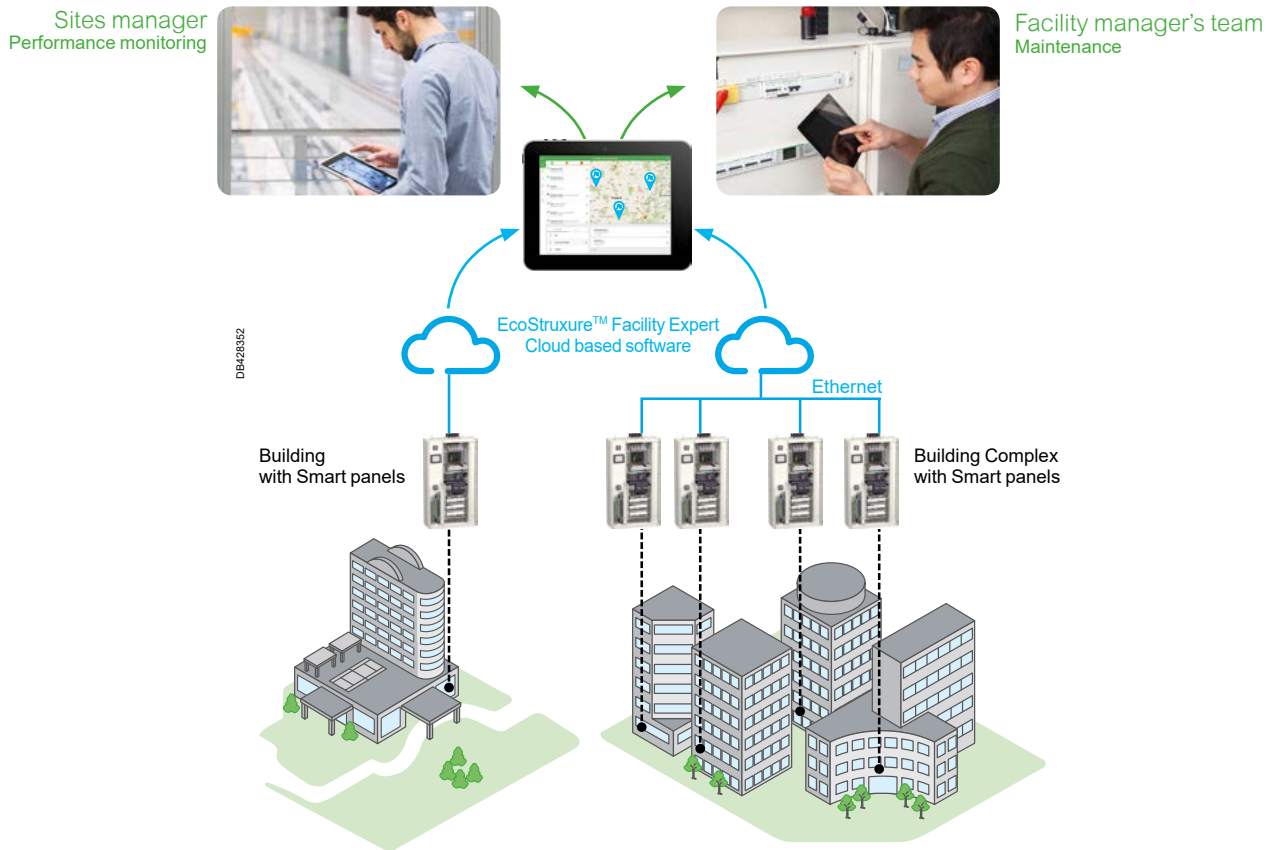

EcoStruxure™ Facility Expert leverages all communication capabilities of Smart Panels and Enerlin'X components to retrieve energy and operational data on the cloud via Ethernet or cellular network.

Dashboard are pre-configured which enables a simple commissioning. Tested and proven architecture make devices and software simply work. This ensures no extra costs on construction phase.

Schneider Electric partners network

Schneider Electric local partners are trained and certified to sell, install and commission EcoStruxure™ Facility Expert. They can also operate the solution if the site manager wants to delegate this task.

Design and monitoring software Maintenance mobile application

EcoStruxure™ Facility Expert

Cloud based Software

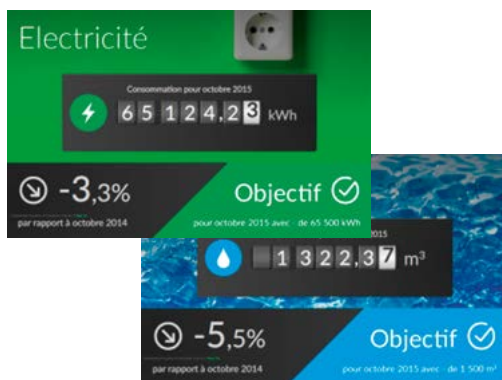

Energy Performance monitoring features

Provide energy, cost, performance information for building energy efficiency. A set of simple and relevant graphs and charts is available on a web portal.

- Main energy **consumptions tracking**
- Power demand overrun and low power factor tracking and **alerts**
- Consumption **per zones & usage**
- **Multi-site** comparison
- **Energy cost** allocation
- **Building performance:** benchmarking against local energy performance scale (regulatory compliance to ISO5001, LEED, NABERS).

Energy kiosk:

- Displayed on building public TV screens show the site green image to visitors and promote occupant ecofriendly behaviors.

Operation and Maintenance features

Provide maintenance alarms and information shared on maintenance team's mobile devices, to reduce mean time to repair with faster troubleshooting.

- Standard alarms on equipment unintended event
- Custom alerts on crossing thresholds status change
- Events tracking
- Maintenance & repair log records
- Asset information shared by all maintenance contributors.

Commercial references





EcoStruxure™ Facility Expert		Part number
Smart Power subscription 5 energy meters, 5 connected assets, 2 maintenance contributors	For 1 site	SVSFE001
1 additional connected meter	Optional	SVSFEOPT001
1 additional connected asset	Optional	SVSFEOPT002
Energy cost dashboard	Optional	SVSFEOPT00A
Energy kiosk	Optional	SVSFEOPT007
1 additional maintenance contributor	Optional	SVSFEOPT003







Software and options can be purchased from our website:
<http://godigital.schneider-electric.com/smp/home/home.page>



Index of commercial references





Index of commercial references



Meters and auxiliaries overview for 'Measure' functions

Energy meters				
Type	Pulse output		Modbus	Wireless
				
Series	iEM2000T, iEM2010	iEM2105	iEM3110, iEM3210	iEM215x, iEM315x, iEM325x, iEM335x

Multifunction meters						
Output type	Pulse	Modbus TCP, Modbus RTU, PowerLogic multifunction meters PM5xxx range, PM8xxx range				
						
Series	PM200P	ION6200	PM3000	PM5300	PM5560	PM8000

Circuit breakers with built-in power meter			
Series			
			
Series	ComPacT NSX + Micrologic E	MasterPact + Micrologic E, H, P	MasterPact MTZ + Micrologic X

Acti9 auxiliaries for connection to Smartlink					
Type	Circuit breaker monitoring		Actuator monitoring and remote control		
					
Series	iOF+SD24	oF+SD24	iATL 24	iACT 24	RCA iC60

Heat / Humidity wireless sensors			
Type	Circuit breaker monitoring	Actuator monitoring and remote control	
			
Series	PowerLogic HeatTag SMT 10020	Product ref. ZBR111 Easergy CL110	Product ref. EMS59440 Easergy TH110

Other devices

Analog sensors	Series Modbus / TCP / IP Modbus gateways
RTD (Pt100, Pt1000) 4...20 mA sensor 0...10 V sensor	Link150, COM'X510

Compatible counters, power meters (old ranges)

Pulse counters
ME1Zr, ME3zr, ME4zr, PM9p, PM200p, EN40 P
Power meters – Modbus exchange protocol
PM9c, PM500 series, PM700 series, PM1200, EM6400 series

Index of commercial references

Product	Description	Lot of	Commercial ref.
Interfaces + gateways			
Com'X 210 Ethernet Energy data logger			EBX210
Com'X 510 Ethernet Energy server			EBX510
IFE switchboard server			LV434002
Smartlink SI B Ethernet			A9XMZA08
PowerTag Link			A9XMWD20
PowerTag Link HD			A9XMWD100
Interfaces			
Smartlink Modbus			A9XMSB11
IFM			LV434000
IFE interface			LV434001
EIFE interface			LV851001
I/O modules			
Enerlin'X IO application module			LV434063
PowerTag C IO 230V (1 input + 1 output)			A9XMC1D3
PowerTag C 2DI 230V (2 inputs)			A9XMC2D3
Displays			
FDM128 Ethernet switchboard display			LV434128
FDM121 switchboard display			TRV00121
PowerTag Link Display			A9XMWRD
Accessories for Smartlink			
USB cable link / Modbus	for Smartlink test	1	A9XCATM1
Prefabricated cables 2 connectors	Length: 100 mm	6	A9XCAS06
	Length: 160 mm	6	A9XCAM06
	Length: 450 mm	6	A9XCAH06
	Length: 870 mm	6	A9XCAL06
Prefabricated cables 1 connector	Long: 870 mm	6	A9XCAU06
Connectors	5-pin connectors (Ti24)	12	A9XC2412
Mounting kit	DIN rail (4 feet, 4 straps, 4 adapters)	1	A9XMFA04
	Linerly FM 200 A (4 adapters)	1	A9XM2B04
Spare parts	Lock for Linergy FM 80 A (2 clips)	1	A9XMLA02
Connection adapters for Acti9 components			
iACT24	Low-level control and indication auxiliary for iCT contactors		A9C15924
iATL24	Low-level control and indication auxiliary for iTL impulse relays		A9C15424
iOF+SD24	Low-level indication auxiliary for iC60, iID, ARA, RCA, iSWNA		A9A26897
OF+SD24	Low-level indication auxiliary for C60, C120, DPN, RCCB/ ID, C60H-DC		A9N26899
Accessories for IFM			
Stacking accessories			TRV00217
ULP line terminator			TRV00880
Modbus line terminator			VW3A8306RC
RJ45 T connector 0.3 m			VW3A8306TF03
RJ45 T connector 1 m			VW3A8306TF10
Modbus splitter box			LU9GC3
EcoStruxure™ Facility Expert			
Smart Power subscription	For 1 site		SVSFE1001
5 energy meters, 5 connected assets 2 maintenance contributors			
1 additional connected meter	Optional		SVSFEOPT001
1 additional connected asset	Optional		SVSFEOPT002
Energy cost dashboard	Optional		SVSFEOPT00A
Energy kiosk	Optional		SVSFEOPT007
1 additional maintenance contributor	Optional		SVSFEOPT003

Index of commercial references

Product	Description	Commercial ref.
PowerTag Energy sensors		
M63	1P+Wire	A9MEM1520
	1P+N TOP	A9MEM1521
	1P+N BOTTOM	A9MEM1522
	3P	A9MEM1540
	3P+N TOP	A9MEM1541
	3P+N BOTTOM	A9MEM1542
	3P 230 V LL	A9MEM1543
F63	1P+N	A9MEM1560
	1P+N 110 V	A9MEM1564
	3P+N	A9MEM1570
	3P	A9MEM1573
	3P+N 127 V / 220 V	A9MEM1574
P63	1P+N TOP	A9MEM1561
	1P+N BOTTOM RCBO 18 mm	A9MEM1562
	1P+N BOTTOM	A9MEM1563
	3P+N TOP	A9MEM1571
	3P+N BOTTOM	A9MEM1572
F160	3P/3P+N	A9MEM1580
M250	3P	LV434020
	3P+N	LV434021
M630	3P	LV434022
	3P+N	LV434023
R200	3P/3P+N	A9MEM1590
R600	3P/3P+N	A9MEM1591
R1000	3P/3P+N	A9MEM1592
R2000	3P/3P+N	A9MEM1593

Life Is n

Schneider
 Electric

Schneider Electric Industries SAS

35, rue Joseph Monier
CS 30323
92506 Rueil Malmaison Cedex
France

RCS Nanterre 954 503 439
Capital social 896 313 776 €
www.schneider-electric.com

February, 2021
LVCATENLX_EN

© 2021 - Schneider Electric. All Rights Reserved.
All trademarks are owned by Schneider Electric Industries SAS or its affiliated companies.
LVCATENLX_EN

This document has been
printed on recycled paper

