

# User Guide

Analog Output Transmitter

**Indigo 201**

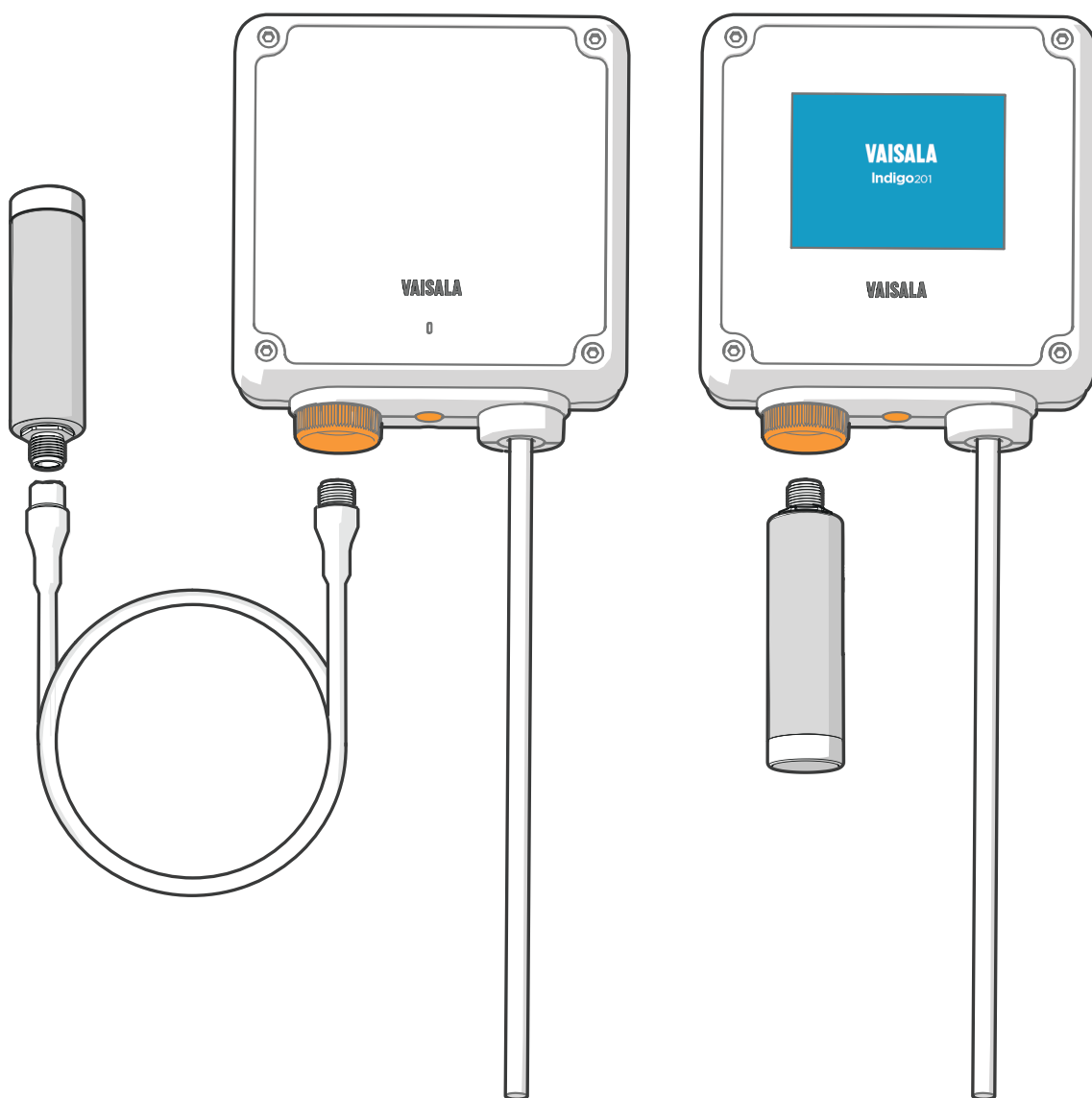

**VAISALA**

PUBLISHED BY

Vaisala Oyj  
Vanha Nurmijärventie 21, FI-01670 Vantaa, Finland  
P.O. Box 26, FI-00421 Helsinki, Finland  
+358 9 8949 1

Visit our Internet pages at [www.vaisala.com](http://www.vaisala.com).

© Vaisala Oyj 2018

No part of this manual may be reproduced, published or publicly displayed in any form or by any means, electronic or mechanical (including photocopying), nor may its contents be modified, translated, adapted, sold or disclosed to a third party without prior written permission of the copyright holder. Translated manuals and translated portions of multilingual documents are based on the original English versions. In ambiguous cases, the English versions are applicable, not the translations.

The contents of this manual are subject to change without prior notice.

Local rules and regulations may vary and they shall take precedence over the information contained in this manual. Vaisala makes no representations on this manual's compliance with the local rules and regulations applicable at any given time, and hereby disclaims any and all responsibilities related thereto.

This manual does not create any legally binding obligations for Vaisala towards customers or end users. All legally binding obligations and

agreements are included exclusively in the applicable supply contract or the General Conditions of Sale and General Conditions of Service of Vaisala.

This product contains software developed by Vaisala or third parties. Use of the software is governed by license terms and conditions included in the applicable supply contract or, in the absence of separate license terms and conditions, by the General License Conditions of Vaisala Group.

This product may contain open source software (OSS) components. In the event this product contains OSS components, then such OSS is governed by the terms and conditions of the applicable OSS licenses, and you are bound by the terms and conditions of such licenses in connection with your use and distribution of the OSS in this product. Applicable OSS licenses are included in the product itself or provided to you on any other applicable media, depending on each individual product and the product items delivered to you.

## Table of Contents

<b>1.</b>	<b>About This Document</b> .....	5
1.1	Version Information.....	5
1.2	Related Manuals.....	5
1.3	Documentation Conventions.....	6
1.4	Trademarks.....	6
<b>2.</b>	<b>Product Overview</b> .....	7
2.1	Introduction to Indigo Transmitters.....	7
2.2	Indigo 201 Basic Features and Options.....	8
2.3	Probe Compatibility.....	8
2.3.1	Probe and Indigo Software Compatibility.....	8
2.4	Indigo Transmitter Parts.....	10
2.5	Display and LED Indicator.....	11
2.5.1	Graph Display Mode.....	12
2.5.2	Measurement Reading Locked.....	13
2.5.3	LED Indicator.....	13
2.6	Wireless Configuration Interface Overview.....	15
2.7	Receiving Analog Output Settings from Probe.....	16
<b>3.</b>	<b>Installation</b> .....	17
3.1	Opening and Mounting.....	17
3.2	Indigo Transmitter Base.....	18
3.3	Wiring Options.....	19
3.4	Attaching Probes and Cables.....	20
3.5	Input and Output Specification.....	21
3.6	Disabling WLAN Functionality with DIP Switch.....	22
<b>4.</b>	<b>Wireless Configuration Interface</b> .....	25
4.1	Wireless Interface Menus.....	25
4.2	Connecting to Wireless Configuration Interface.....	26
4.2.1	Connecting with a Computer.....	26
4.2.2	Connecting with a Mobile Device.....	27
4.3	Logging in to Wireless Configuration Interface.....	28
4.3.1	Changing User Level.....	29
4.3.2	Changing Administrator Password.....	30
4.3.3	Resetting Administrator Password.....	30
4.4	Measurements View.....	31
4.5	Status View.....	32
4.5.1	Status View: General.....	33
4.5.2	Status View: Analog Outputs.....	34
4.5.3	Status View: Relays.....	34
4.6	Calibration Menu.....	35
4.7	General Settings.....	35
4.7.1	Date and Time.....	36
4.7.2	WLAN Settings.....	36
4.7.3	User Access Settings (Administrator Password).....	36
4.7.4	Display Settings.....	37
4.7.5	Factory Reset and Clearing Analog Output Settings.....	38
4.7.6	License Information.....	39
4.8	Output Settings.....	39
4.9	Relay Settings.....	41
4.10	Probe Settings.....	42

<b>5. Configuring Analog Outputs</b>	45
5.1 Analog Output Configuration Overview	45
5.2 Analog Output Configuration Example	46
5.3 Clearing Analog Output Settings from Indigo	47
5.4 Analog Output Overage Behavior	47
5.4.1 Analog Output Overage Example	47
<b>6. Configuring Relays</b>	49
6.1 Relay Configuration Overview	49
6.2 Setting Relay Activation Limit Without Hysteresis	50
6.3 Setting Relay Activation Limit Using Hysteresis	51
6.4 Selecting Relay Error State	52
<b>7. Calibration and Adjustment</b>	53
7.1 Calibration Overview	53
7.1.1 Starting and Closing Calibration Mode	54
7.1.2 Restoring Factory Adjustment	55
7.1.3 Calibration PIN Code	56
7.2 Environmental Compensation	56
7.3 Measurements Tab	59
7.4 Diagnostics Tab	59
7.5 Configuration Tab	60
7.6 GMP252 Example: 2-point CO <sub>2</sub> Adjustment	61
<b>8. Maintenance and Troubleshooting</b>	65
8.1 Cleaning	65
8.2 Indigo Wireless Connection Troubleshooting	65
8.3 Additional WLAN Settings when Connecting to Indigo	66
8.3.1 Connection Option 1: Use Without Internet (iPhone example)	67
8.3.2 Connection Option 2: Disable Auto-Login (iPhone Example)	68
8.4 Display Messages	68
<b>9. Technical Data</b>	71
9.1 Specifications	71
9.2 Spare Parts and Accessories	73
9.3 Dimensions	74
<b>EU Declaration of Conformity</b>	77
<b>Warranty</b>	78
<b>Technical Support</b>	79
<b>Recycling</b>	79



## List of Figures

Figure 1	Indigo 201 With and Without Display, Wireless Interface Examples.....	7
Figure 2	Indigo Transmitter Parts.....	10
Figure 3	Indigo 201 Display with One Parameter .....	11
Figure 4	Indigo 201 Display with Relays, Three Parameters and WLAN Notification.....	11
Figure 5	Indigo Display in Graph Mode.....	12
Figure 6	Purge in Progress Message from Probe on Indigo Display.....	13
Figure 7	Desktop and Mobile Example Views.....	15
Figure 8	Clearing Analog Output Settings .....	16
Figure 9	Indigo 201 Transmitter Base Main Parts and Screw Positions.....	18
Figure 10	Indigo Wiring Options.....	19
Figure 11	Attaching Probes and Cables to Indigo.....	20
Figure 12	WLAN OFF/ON DIP Switch on Indigo Circuit Board.....	22
Figure 13	Wireless Configuration Interface, Desktop Browser View.....	25
Figure 14	Enabling and Accessing Indigo's Wireless Configuration Interface...	26
Figure 15	Indigo Login View.....	28
Figure 16	User Level (User/Admin) in Upper Right Corner of Menu View.....	29
Figure 17	Measurements View (Desktop Browser).....	31
Figure 18	Latest Values Tab, H <sub>2</sub> O <sub>2</sub> Probe Example (Desktop Browser).....	31
Figure 19	Status View (CO <sub>2</sub> Probe Example, Desktop Browser).....	32
Figure 20	Calibration Menu (CO <sub>2</sub> Probe Example, Desktop Browser).....	35
Figure 21	Analog Output Configuration Options.....	45
Figure 22	Example of Analog Output Overrange Behavior .....	48
Figure 23	Relay Configuration Options (CO <sub>2</sub> Probe Example).....	49
Figure 24	Relay Icons on the Optional Display (Relay A Active, Relay B Not Active).....	50
Figure 25	Calibration Menu Main View.....	53
Figure 26	Start Calibration Button.....	54
Figure 27	Measurement Selections, CO <sub>2</sub> Probe Example.....	57
Figure 28	Compensation Setpoint and Power-Up Default Selection, CO <sub>2</sub> Probe Example.....	58
Figure 29	Measurements Tab, CO <sub>2</sub> Probe Example.....	59
Figure 30	Diagnostics Tab, CO <sub>2</sub> Probe Example.....	60
Figure 31	Configuration Tab, CO <sub>2</sub> Probe Example.....	61
Figure 32	Additional Steps Needed to Connect Notification.....	66
Figure 33	Indigo Transmitter Dimensions in Millimeters (mm).....	74

## List of Tables

Table 1	Document Versions (English).....	5
Table 2	Indigo 200 Series Transmitter and Probe Software Version Compatibility.....	8
Table 3	LED Indicator States.....	14
Table 4	Inputs and Outputs.....	21
Table 5	Indigo Transmitter Messages Shown on Display.....	69
Table 6	Inputs and Outputs.....	71
Table 7	General.....	71
Table 8	Standards and Compliance.....	72
Table 9	Wireless Access Point (Module With Internal Chip Antenna).....	72
Table 10	Operating and Storage Environment.....	72
Table 11	Mechanics.....	73
Table 12	Spare Parts and Accessories.....	73

# 1. About This Document

## 1.1 Version Information

This document provides detailed instructions for using and maintaining Vaisala Indigo 201 analog output transmitter.

Table 1 Document Versions (English)

Document Code	Date	Description
M211877EN-F	Oct 2018	<p>This document.</p> <ul style="list-style-type: none"> <li>Power supply input specification changed from 15 ... 30 VDC (20 ... 22 VAC) to 15 ... 30 VDC (24VAC+10%) due to component board update.</li> <li>Updated the information on disabling autologin and other additional WLAN settings when connecting to Indigo wireless configuration interface.</li> <li>Clarified the user level requirements (admin login required) for configuring settings.</li> <li>Updated probe compatibility information.</li> <li>Probe locking wheel color changed.</li> </ul>
M211877EN-E	Dec 2017	<p>Previous version. User interface updates in place from transmitter software version 1.3.0 onwards.</p> <ul style="list-style-type: none"> <li><b>Measurements</b> view updated to include graph display on/off selection and numerical measurements tab.</li> <li>Updated transmitter cover opening instructions.</li> <li>Date and time configuration added to the <b>Settings &gt; General</b> menu.</li> <li>Updated probe compatibility information.</li> <li>Added information on the display measurement reading behavior during probe processes.</li> </ul>
M211877EN-D	Jun 2017	<p>User interface updates in place from transmitter software version 1.2.0 onwards.</p> <ul style="list-style-type: none"> <li>Calibration procedure and menu interface updated.</li> <li>Added information on changing and resetting administrator password.</li> <li>Added information on enabling and disabling WLAN functionality with DIP switch.</li> <li>Added SRRC approval (CMIIT ID 2017DJ3476).</li> </ul>

## 1.2 Related Manuals

Document Code	Name
M211876EN	Indigo 201 Analog Output Transmitter Quick Guide
M211966EN	Indigo 202 Digital Transmitter User Guide
M211967EN	Indigo 202 Digital Transmitter Quick Guide
M211799EN	Vaisala CARBOCAP® Carbon Dioxide Probe GMP251 User Guide

Document Code	Name
M211897EN	Vaisala CARBOCAP® Carbon Dioxide Probe GMP252 User Guide
M211972EN	Vaisala PEROXCAP® Hydrogen Peroxide, Humidity and Temperature Probe HPP272 User Guide
M212022EN	Vaisala HUMICAP® Humidity and Temperature Probes HMP4, HMP5, HMP7, HMP8, TMP1 User Guide

## 1.3 Documentation Conventions



**WARNING!** alerts you to a serious hazard. If you do not read and follow instructions carefully at this point, there is a risk of injury or even death.



**CAUTION!** warns you of a potential hazard. If you do not read and follow instructions carefully at this point, the product could be damaged or important data could be lost.



Note highlights important information on using the product.



Tip gives information for using the product more efficiently.

## 1.4 Trademarks

Vaisala® is a registered trademark of Vaisala Oyj.

Indigo™ is a trademark of Vaisala Oyj.

Chrome™ is a trademark of Google Inc.

Firefox® is a registered trademark of Mozilla Foundation.

Microsoft®, Windows®, Internet Explorer®, and Edge™ are either registered trademarks or trademarks of Microsoft Corporation in the United States and/or other countries.

Safari™ is a trademark of Apple Inc, registered in the U.S. and other countries.

All other product or company names that may be mentioned in this publication are trade names, trademarks, or registered trademarks of their respective owners.

## 2. Product Overview

### 2.1 Introduction to Indigo Transmitters



Figure 1 Indigo 201 With and Without Display, Wireless Interface Examples

Vaisala Indigo transmitters are a plug-and-play host device platform for Vaisala Indigo-compatible probes. Indigo transmitters extend the feature set of connected probes with a range of additional options for outputs, measurement viewing, status monitoring, and configuration interface access.

Depending on the Indigo transmitter model, a display is available as an optional selection or as a standard feature. In the non-display model, an LED indicator is used for notifications. Probes can be connected either directly on the transmitter from the probe's connector, or by using a cable between Indigo and the probe.

The configuration interface of Indigo transmitters is a browser-based wireless UI that requires a mobile device or computer that supports wireless connectivity (IEEE 802.11 b/g/n WLAN).

The Indigo 201 transmitter is designed for analog output applications. The transmitter's output options include 3 analog output channels (current or voltage) and 2 relays.

For more information on Indigo transmitter models, see [www.vaisala.com/indigo](http://www.vaisala.com/indigo).

#### More Information

- [Indigo 201 Basic Features and Options \(page 8\)](#)
- [Specifications \(page 71\)](#)

## 2.2 Indigo 201 Basic Features and Options

- All Vaisala Indigo-compatible probes can be connected to all Indigo transmitter models
- Plug-and-play probe installation: when unconfigured, Indigo automatically adapts the analog output configuration of the connected Indigo-compatible probe
- Wireless configuration interface: connect to the scalable browser-based UI of Indigo 201 to change probe and transmitter settings, view measurements and review probe and transmitter status
- 3.5" TFT LCD color display or non-display model with LED indicator
- Power supply input 15 ... 30 VDC (24 VAC +/-10% 50/60Hz)
- 3 current (mA) or voltage (V) analog outputs
- 2 configurable relays

### More Information

- [Wireless Interface Menus \(page 25\)](#)
- [Display and LED Indicator \(page 11\)](#)
- [Input and Output Specification \(page 21\)](#)
- [Receiving Analog Output Settings from Probe \(page 16\)](#)
- [Analog Output Configuration Overview \(page 45\)](#)
- [Relay Configuration Overview \(page 49\)](#)

## 2.3 Probe Compatibility

All Indigo-compatible probes can be used with all Indigo transmitter models. Note that the manufacturing date of Indigo transmitters or Indigo-compatible probes can predate support for the transmitter or probe.

If your Indigo transmitter has been manufactured before the release date of the probe series you want to connect to Indigo, it is possible that the transmitter software does not include support for the newer probe. Similarly, older probes that have been manufactured before the release of the Indigo transmitter series do not include Indigo support.

### More Information

- [Probe and Indigo Software Compatibility \(page 8\)](#)

### 2.3.1 Probe and Indigo Software Compatibility

The following table shows the compatibility of different Indigo 200 series transmitter software versions and the software versions of Indigo-compatible probes.

Table 2 Indigo 200 Series Transmitter and Probe Software Version Compatibility

Support for Indigo 200 Series in Probe SW	Support for Probe in Indigo 200 Series Transmitters
GMP251: SW 1.2.8 and above	Indigo SW 1.0.0 and above (all transmitters)

Support for Indigo 200 Series in Probe SW	Support for Probe in Indigo 200 Series Transmitters
GMP252: SW 1.2.8 and above	Indigo SW 1.0.0 and above (all transmitters)
HPP272: probes with SW 1.2.6 or earlier	Indigo SW 1.3.2 and above <sup>1)</sup>
HPP272: probes with SW version above 1.2.6 <sup>2)</sup>	Indigo SW 1.4.0 and above <sup>3)</sup>
HPP271: SW 1.0.0 and above (all probes)	Indigo SW 1.4.0 and above <sup>3)</sup>
HMP4, 5, 7, 8 and TMP1: SW 1.0.0 and above (all probes)	Indigo SW 1.3.2 and above <sup>1)</sup>

1) Support for probe starting from Indigo transmitter serial number N4650357 (serial numbers running in alphabetical and numerical order)

2) HPP272 probes starting from probe serial number P3940796

3) Support for probe starting from Indigo transmitter serial number P3930284 (serial numbers running in alphabetical and numerical order)

## 2.4 Indigo Transmitter Parts

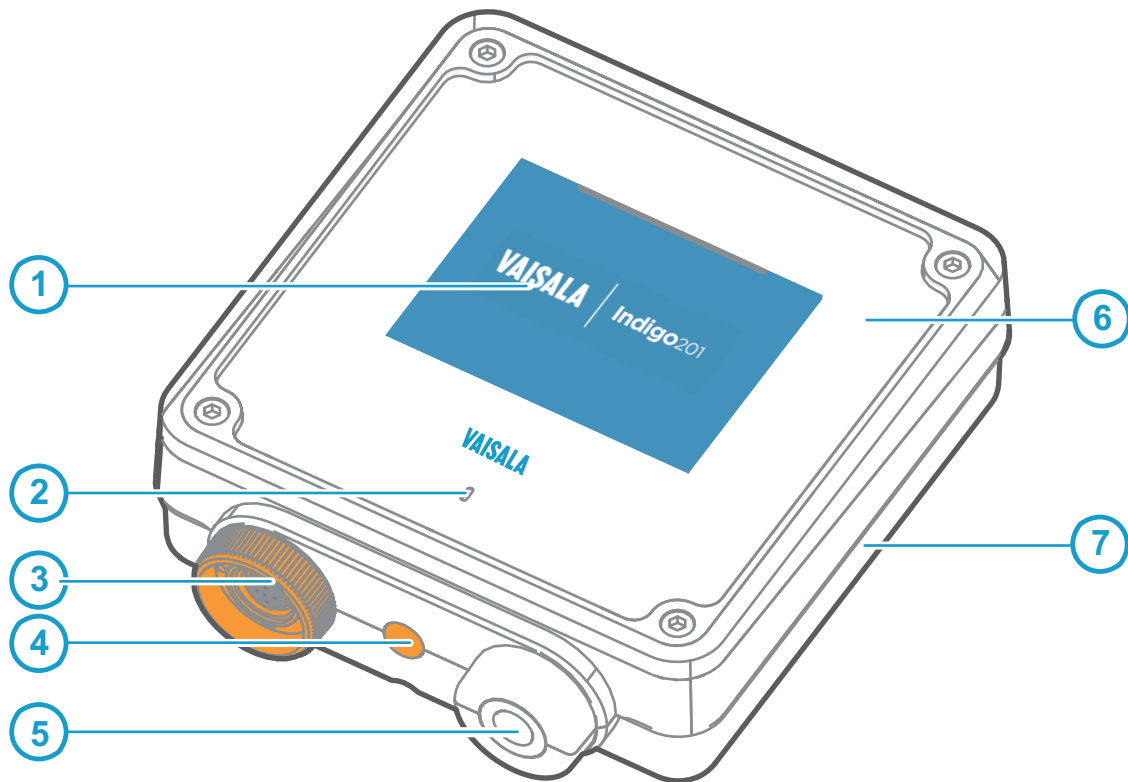

Figure 2 Indigo Transmitter Parts

- 1 Display (optional)
- 2 LED indicator (in non-display model)
- 3 Probe and probe cable connector, locking wheel
- 4 Wireless (WLAN) configuration interface activation button
- 5 Rubber lead-through with strain relief for input/output cable
- 6 Top cover of the transmitter: LED/display, circuit board and connector pins
- 7 Transmitter base: input and output wiring (screw terminals), mounting base



**CAUTION!** Only use Vaisala Indigo-compatible probes with the transmitter. Attempting to connect incompatible probes or probe cables can damage the equipment.

### More Information

- [Dimensions \(page 74\)](#)
- [Indigo Transmitter Base \(page 18\)](#)
- [Spare Parts and Accessories \(page 73\)](#)



## 2.5 Display and LED Indicator

Indigo 201 can be ordered either with the optional display, or as a non-display model that uses an LED indicator for notifications.

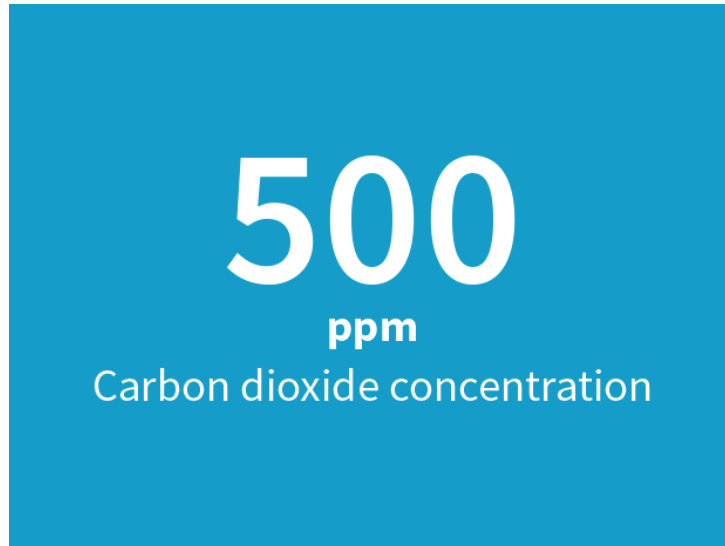

Figure 3 Indigo 201 Display with One Parameter

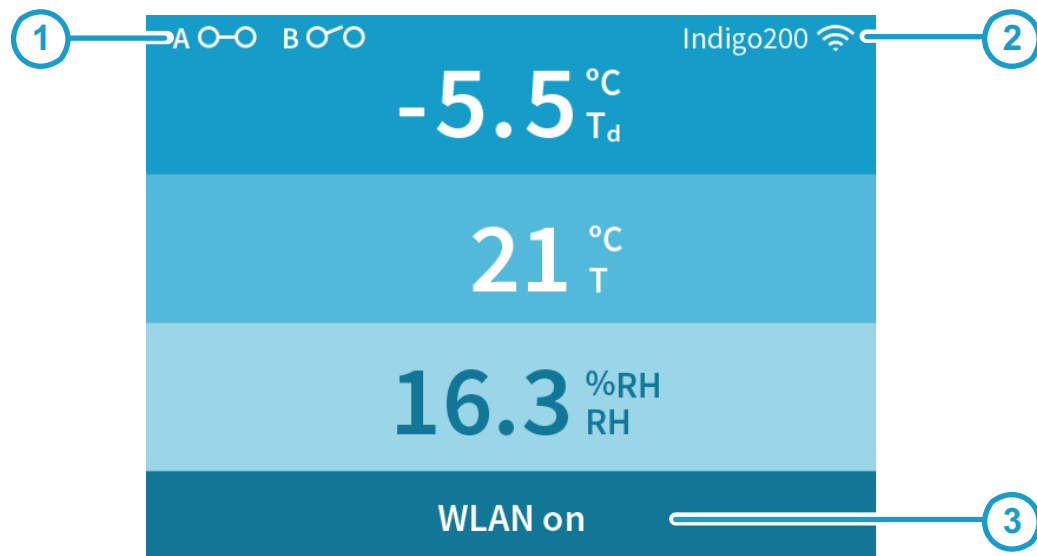

Figure 4 Indigo 201 Display with Relays, Three Parameters and WLAN Notification

- 1 Relay A and relay B status
- 2 Wireless configuration interface indicator (SSID text and WLAN symbol)
- 3 Message field for notifications, warnings and errors

The Indigo display can be configured to show 1-3 measurement parameters. Information about the transmitter and connected probe (for example, notifications and warnings) is shown on a message row at the bottom of the display. Relay and wireless access point activity is also shown on the display.

The parameters shown on the display, display brightness and display mode (numeric or graph) can be configured with the wireless configuration interface in the **Settings > General** menu.

#### More Information

- [Status View \(page 32\)](#)
- [Display Settings \(page 37\)](#)
- [Display Messages \(page 68\)](#)

## 2.5.1 Graph Display Mode

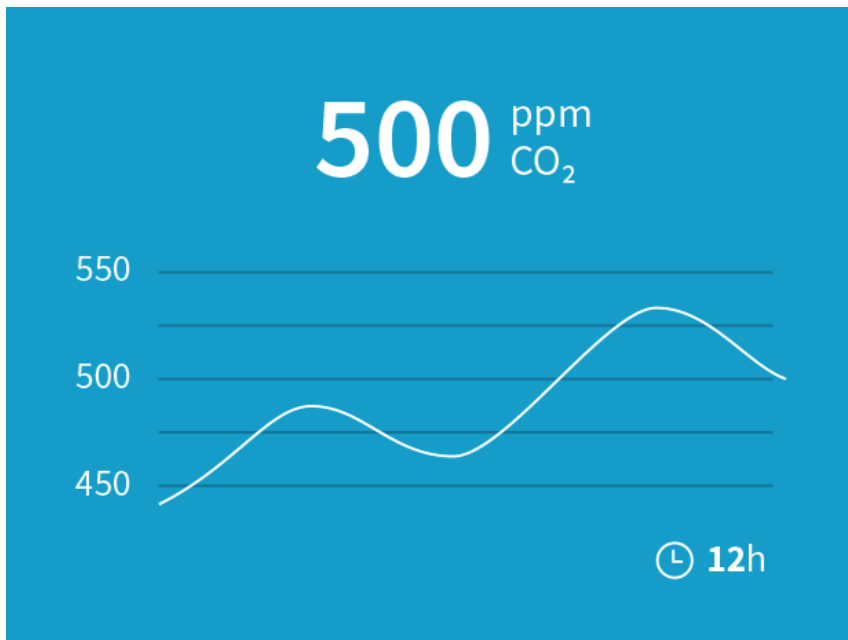

Figure 5 Indigo Display in Graph Mode

You can set the Indigo display to show the connected probe's measurement data as a graph. The display mode can be changed in the wireless configuration interface's **Settings > General** menu.

#### More Information

- [Display Settings \(page 37\)](#)

## 2.5.2 Measurement Reading Locked

Certain probe-specific features cause the measurement reading to lock to its current value until the probe has finished its action. One such example is probe purge, which heats up the probe's sensor to remove contamination. While the purge cycle is running, measurements are not updated.

In the case of purge, the Indigo display shows either the probe message **Purge in progress** or, depending on the connected probe, the high-level transmitter message **Waiting for measurements**.

Similarly, when the probe is initializing at start-up or has been restarted, up-to-date measurement data is not available and the Indigo display shows the message **Waiting for measurements**.

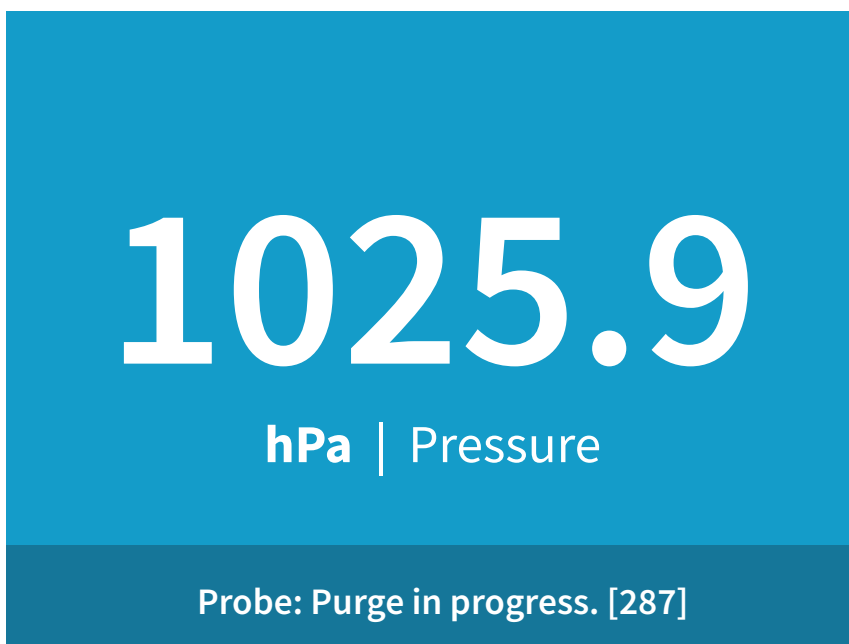

Figure 6 Purge in Progress Message from Probe on Indigo Display





### More Information

- [Display Messages \(page 68\)](#)

## 2.5.3 LED Indicator

In the display model, notifications, warnings and other messages are shown on the display as text rows and indicator graphics. In the LED indicator model, the status of the transmitter and probe is indicated by LED color and whether the LED blinks. The following table lists the LED notifications:

Table 3 LED Indicator States

LED Color and Flashes	Description
Solid green LED:   ● — OK	A solid green LED means that the transmitter and probe are working normally.
Blinking green LED:   ● ●● Starting/WLAN Active	The LED blinks green when the transmitter is starting up, and changes to a steady green when the transmitter is ready for use.  The LED also blinks green when the wireless connection is active, and changes to a steady green when the connection ends.
Solid orange LED:   ● — No Probe	A solid orange LED is shown when a probe is not connected to the transmitter (or the probe is not properly connected and the transmitter does not recognize it).
Solid red LED:   ● — Error	A solid red LED means that an alarm or a notification is active, or the probe or the transmitter is in an error state.  To view information about the alarm or notification, connect to Indigo's wireless configuration interface with your web browser and open the <b>Status</b> menu.

### More Information

- [Status View \(page 32\)](#)
- [Connecting to Wireless Configuration Interface \(page 26\)](#)

## 2.6 Wireless Configuration Interface Overview

Indigo transmitters are configured using a wireless browser-based configuration interface (requires a mobile device or computer with IEEE 802.11 b/g/n WLAN wireless connectivity). In addition to probe and transmitter configuration and calibration, you can also use the wireless interface to view measurement data and status information.



Figure 7 Desktop and Mobile Example Views

The wireless configuration interface has two user levels:

- All users have view-only access (no configuration rights, not password protected).
- Personnel that carry out configuration tasks can log in with an administrative password that allows changing the transmitter and probe settings.

To use the wireless configuration interface to modify the settings of your Indigo transmitter and the connected probe, you must first enable the transmitter's wireless connection and then connect to Indigo with your mobile device or computer. Most major browsers (for example, Firefox, Chrome, Safari, and Internet Explorer) are supported: using the most recent version is recommended.

### More Information

- ▶ [Connecting to Wireless Configuration Interface \(page 26\)](#)
- ▶ [Logging in to Wireless Configuration Interface \(page 28\)](#)
- ▶ [Wireless Interface Menus \(page 25\)](#)
- ▶ [Indigo Wireless Connection Troubleshooting \(page 65\)](#)

## 2.7 Receiving Analog Output Settings from Probe

When you take Indigo 201 in use for the first time and have not entered an analog output configuration, the transmitter automatically adapts the analog output configuration of the first Vaisala Indigo-compatible probe you connect.

If an analog output configuration already exists in Indigo 201 (that is, you have previously connected a probe or configured the settings), you need to set the analog output configuration of the new probe manually. Analog output from the transmitter is halted and does not resume until you have set the new probe's configuration.

Alternatively, you can clear the analog output settings in Indigo 201 configuration. This returns the transmitter to a state where it automatically starts using the analog output configuration of the next connected probe. The analog output settings can be cleared from the **Settings > General** menu.

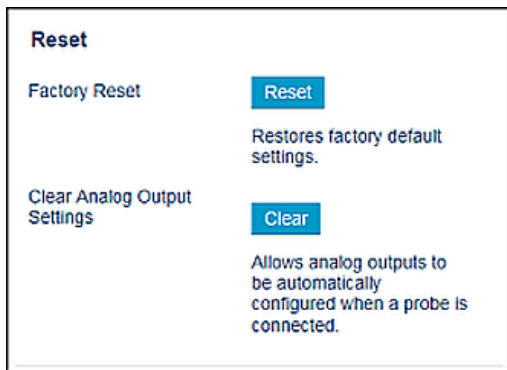

Figure 8 Clearing Analog Output Settings

### More Information

- [Attaching Probes and Cables \(page 20\)](#)
- [Analog Output Configuration Overview \(page 45\)](#)
- [Clearing Analog Output Settings from Indigo \(page 47\)](#)

## 3. Installation

### 3.1 Opening and Mounting

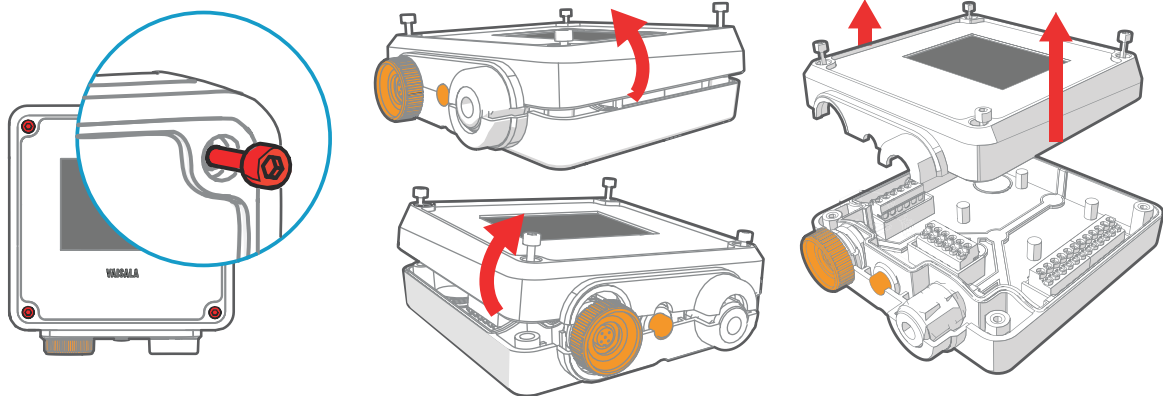

**CAUTION!** To avoid damaging the connector pins of the transmitter, pull the transmitter cover off the base in a straight angle. Do not twist or bend.

- ▶ 1. Loosen the 4 screws on the transmitter cover.
2. Carefully open the transmitter cover part of the way from both sides so it is easier to pull the cover off the base.
3. Pull the transmitter cover off the base in a straight angle. Do not twist or bend.
4. Place the transmitter base on the installation surface and mount it with 3 screws. See the screw positions in [Figure 9 \(page 18\)](#).

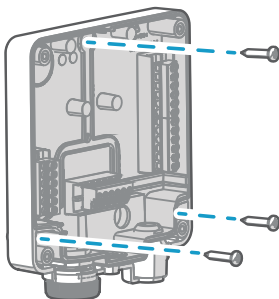

5. Lead the input/output cable inside the transmitter (see [Wiring Options \(page 19\)](#)). If you are wiring through the lead-through on the bottom of the transmitter, test that the strain relief works with your cable.
6. Connect the input/output cable's wiring to the screw terminals (see [Indigo Transmitter Base \(page 18\)](#)) and reattach the cover when done.

## 3.2 Indigo Transmitter Base

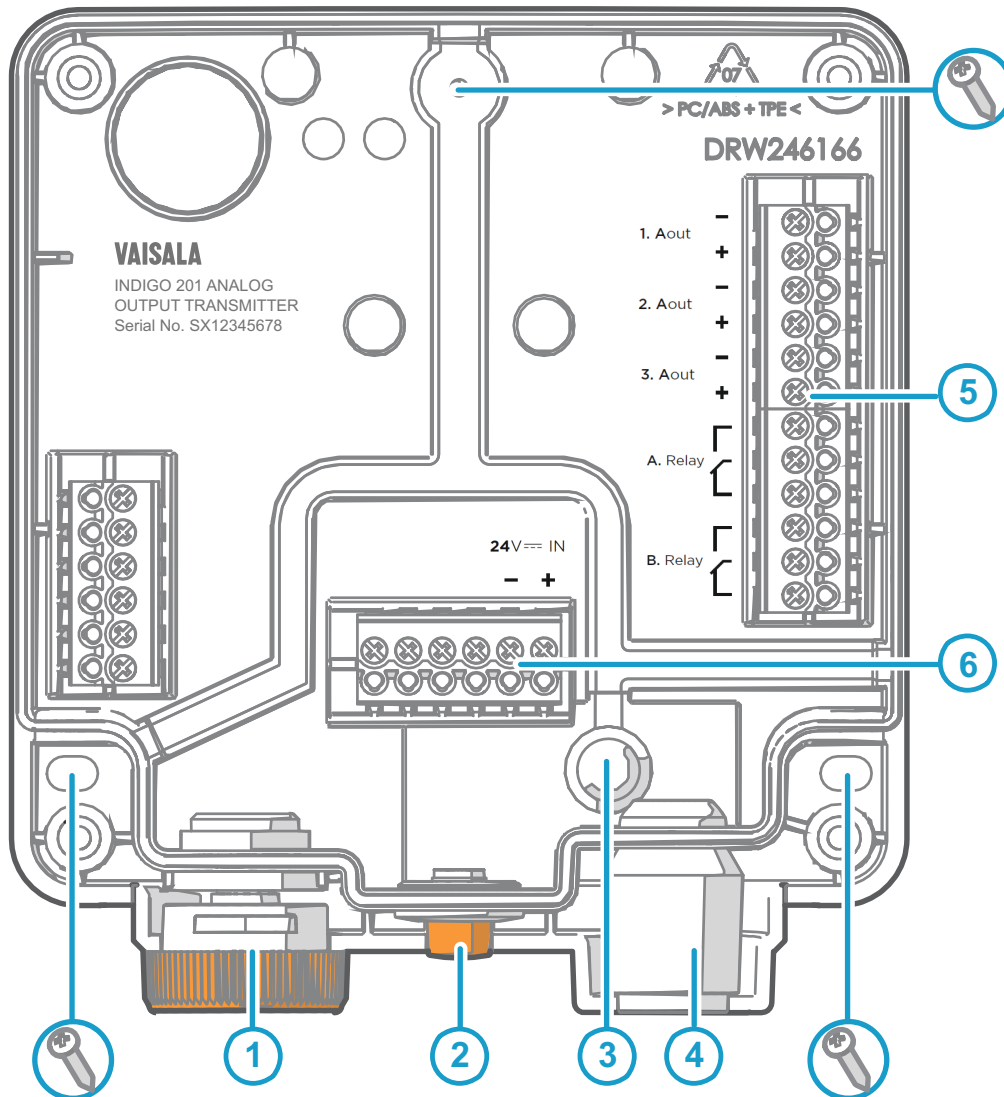

Figure 9 Indigo 201 Transmitter Base Main Parts and Screw Positions

- 1 Probe and probe cable connector inside the locking wheel
- 2 Wireless (WLAN) configuration interface activation button
- 3 Wiring from the back: cut open the seal
- 4 Rubber cable lead-through with strain relief
- 5 Screw terminals for analog outputs 1-3 and relays A and B
- 6 Screw terminals for 24 V power supply input



**CAUTION!** Do not energize the power supply before the wiring has been connected.



## 3.3 Wiring Options

You can wire an input/output cable either through the opening on the back of the transmitter, or through the rubber lead-through on the bottom of the transmitter.

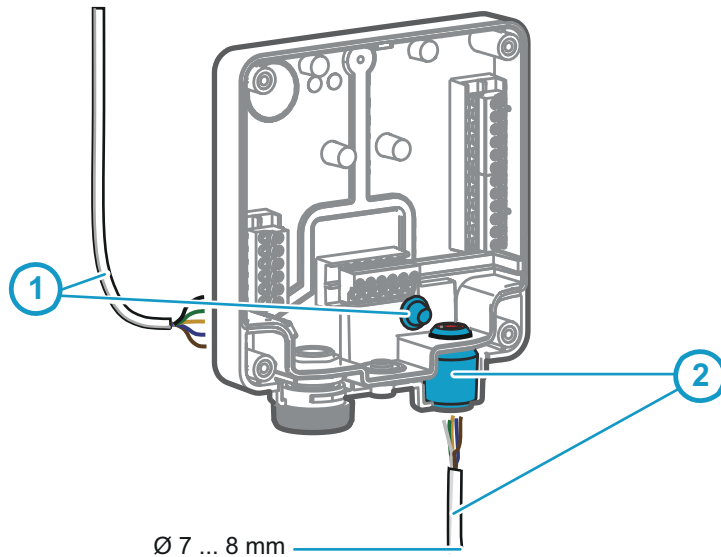

Figure 10 Indigo Wiring Options

- 1 Wiring from the back: cut the seal open
- 2 Wiring through the rubber lead-through on the bottom of the transmitter

- ▶ 1. To wire the input/output cable through the back of the transmitter:
  - a. Cut off as much of the seal as is needed to fit your cable through the opening.
  - b. Lead the cable through the opening and attach a strain relief as needed.
  - c. If you wire only through the back, plug or seal the lead-through on the bottom.
- 2. To wire the input/output cable through the rubber lead-through on the bottom:
  - a. Push the input/output cable through the lead-through.
  - b. The lead-through provides strain relief and holds the cable in place. Tightening is not required.



The recommended cable diameter for wiring through the rubber lead-through is 7 ... 8 mm. If you use a different cable size, test that the strain relief works as intended.

## 3.4 Attaching Probes and Cables

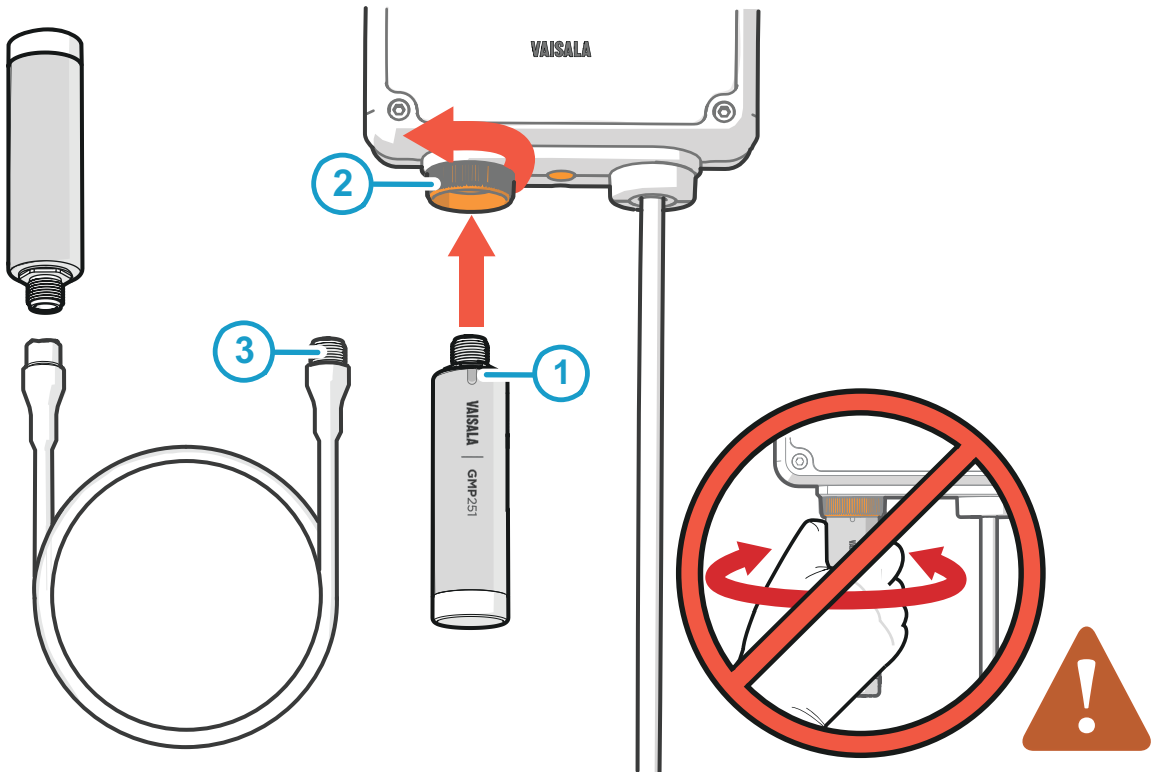

Figure 11 Attaching Probes and Cables to Indigo

- 1 Insert probes into the probe connector with the orientation mark facing out.
- 2 Probes are locked in place with the locking wheel. **Never turn from the probe body.**
- 3 Connect probe cables in the same way as probes: insert the cable in the connector and hold in place while turning the locking wheel.

- ▶ 1. Insert the probe into the probe connector with the orientation mark on the probe body facing out.
- 2. Hold the probe in the probe connector and lock it in place by turning the locking wheel counterclockwise. Do not turn the probe body when attaching, only the locking wheel on the transmitter.
- 3. If no previous configuration exists (that is, this is the first time a probe is connected to Indigo, and no configuration has been set manually), Indigo adapts the analog output settings of the connected Vaisala Indigo-compatible probe automatically.



If a configuration that differs from the attached probe's configuration exists in the transmitter, you must configure the new probe manually to enable analog output. See [Receiving Analog Output Settings from Probe \(page 16\)](#).

## 3.5 Input and Output Specification

Table 4 Inputs and Outputs

Property	Specification
Analog outputs	3 voltage (V) or current (mA) outputs: <ul style="list-style-type: none"> <li>0 ... 10 V / 0 ... 5 V / 0 ... 1 V / 1 ... 5 V (min. load 1k<math>\Omega</math>)</li> <li>0 ... 20 mA / 4 ... 20 mA (max. load 500 <math>\Omega</math>)</li> </ul>
Accuracy of analog outputs at +20 °C (+68 °F)	$\pm$ 0.1 % full scale
Relays	2 configurable relays (VAC/VDC) Device maximum specification (resistive load): <ul style="list-style-type: none"> <li>Max. switching power 30 W / 37.5 VA</li> </ul> UL-rated maximum specification (resistive load): <ul style="list-style-type: none"> <li>AC: max. 28 V / 0.5 A</li> <li>DC: max. 40 V / 0.24 A</li> <li>Up to 30 VDC:               <ul style="list-style-type: none"> <li>max. switching current 1 A</li> <li>max. switching power 30 W</li> </ul> </li> </ul>
Power supply input <sup>1)</sup>	15 ... 30 VDC (24 VAC +/-10% 50/60Hz)
Maximum current	Transmitter and connected probe max. 1 A
Power consumption	Transmitter max. 3 W (+ connected probe, varies depending on probe type)
Probe connector	M12/5 connector for probe or probe cable connection (Vaisala Indigo-compatible probes)
Cable lead-throughs	2 options: rubber lead-through on the bottom of the transmitter, and opening with a seal at the back of the transmitter
Screw terminal wire size	0.2 ... 1.5 mm <sup>2</sup>

1) Using a power supply with overload protection is recommended for electrical safety.



Depending on the production date of your transmitter, the power supply input voltage specification can be either 15 ... 30 VDC (20 ... 22 VAC) or 15 ... 30 VDC (24 VAC+/-10%). Check the type label on the back of the transmitter for information specific to your device.



**CAUTION!** Do not modify the unit or use it in ways not described in the documentation. Improper modification may lead to safety hazards, equipment damage, failure to perform according to specification, or decreased equipment lifetime.

**More Information**

- [Specifications \(page 71\)](#)

## 3.6 Disabling WLAN Functionality with DIP Switch

If your application requires removing WLAN communication from use, use the DIP switch on the Indigo circuit board.

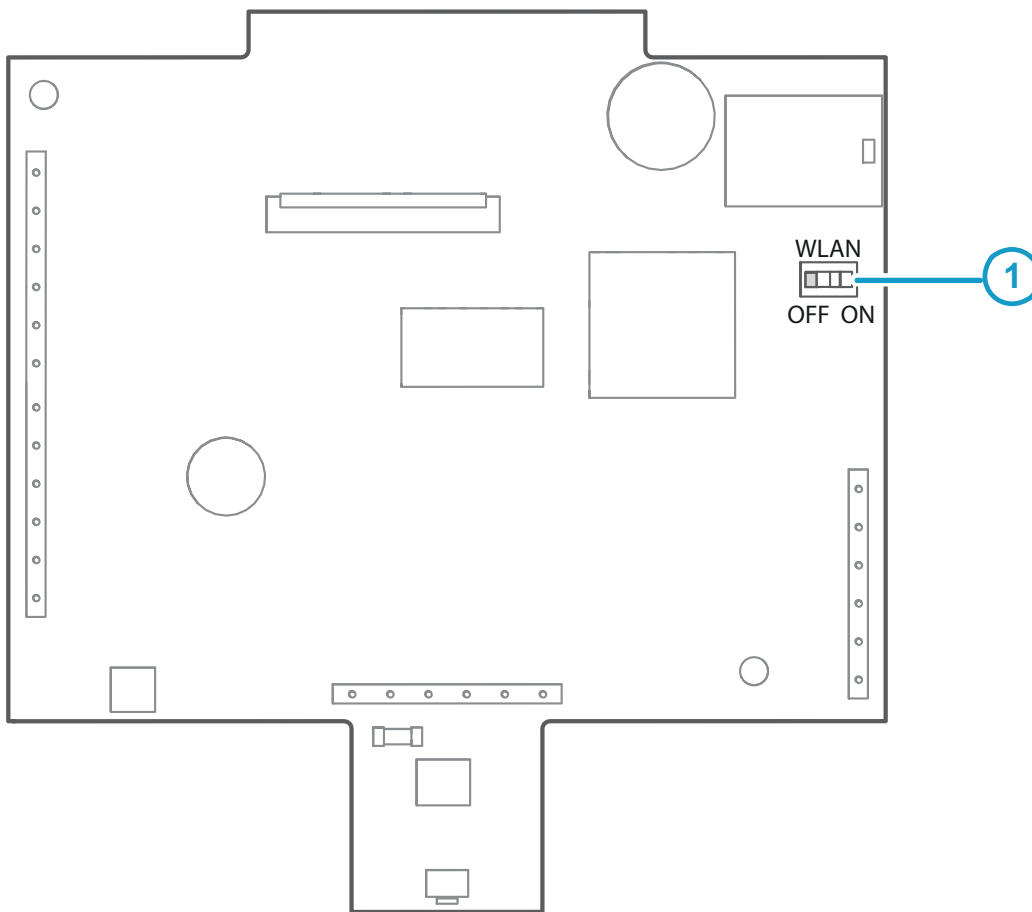

Figure 12 WLAN OFF/ON DIP Switch on Indigo Circuit Board

- 1 WLAN functionality OFF or ON

To switch WLAN communication OFF or ON with the DIP switch:

- ▶ 1. Power off the transmitter.

2. Open the transmitter cover.



**CAUTION!** To avoid damaging the connector pins of the transmitter, pull the transmitter cover off the base in a straight angle. Do not twist or bend.

3. Use a small screwdriver or a similar tool to change the position of the WLAN DIP switch (1).
4. When done, close the transmitter cover and power on Indigo.



Indigo does not display a notification about the WLAN functionality being disabled when a user attempts to enable it with the wireless connection activation button.



# 4. Wireless Configuration Interface

## 4.1 Wireless Interface Menus

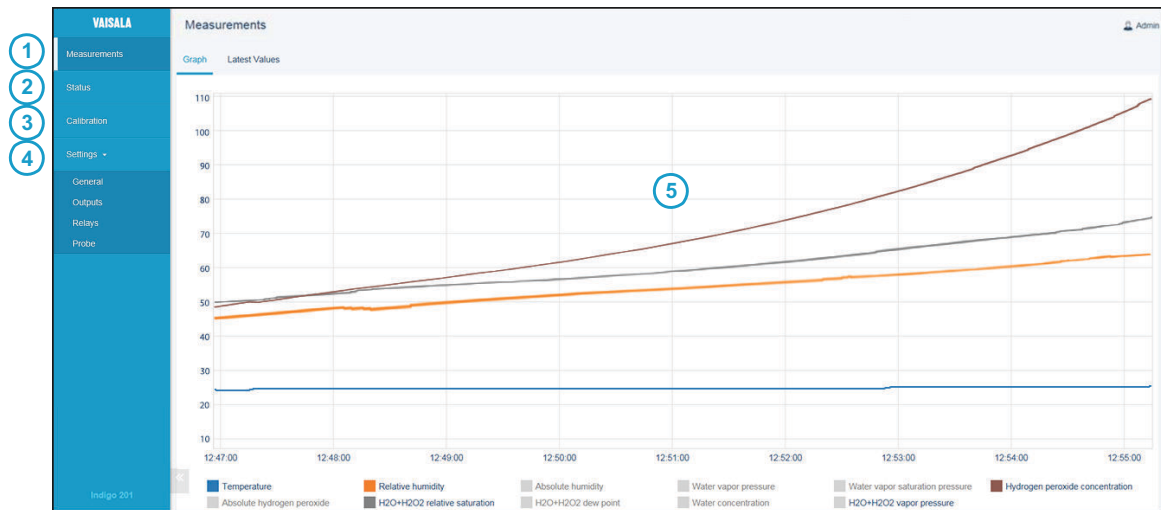

Figure 13 Wireless Configuration Interface, Desktop Browser View

- 1 **Measurements:** displays the measurement data of the connected probe
- 2 **Status:** contains information about the status of Indigo and the connected probe (for example, notifications and alarms)
- 3 **Calibration:** calibrate and adjust probes using references. Available options (for example, adjustment points) vary depending on the probe model.
- 4 **Settings:** contains options for configuring the connection and display settings, outputs, relays, probe-specific settings, and general device preferences
  - **General** submenu: device information and general settings, wireless connection and display settings
  - **Outputs** submenu: configuration options for analog outputs 1-3
  - **Relays** submenu: settings for controlling relays A and B
  - **Probe** submenu: probe-specific settings such as environmental compensations and filtering factor
- 5 Main display area for menus and measurement information (desktop browser example)



You must be logged in as **Admin** to change settings with the wireless configuration interface. Logging in as **User** gives view-only access.

### More Information

- [Connecting to Wireless Configuration Interface \(page 26\)](#)

## 4.2 Connecting to Wireless Configuration Interface

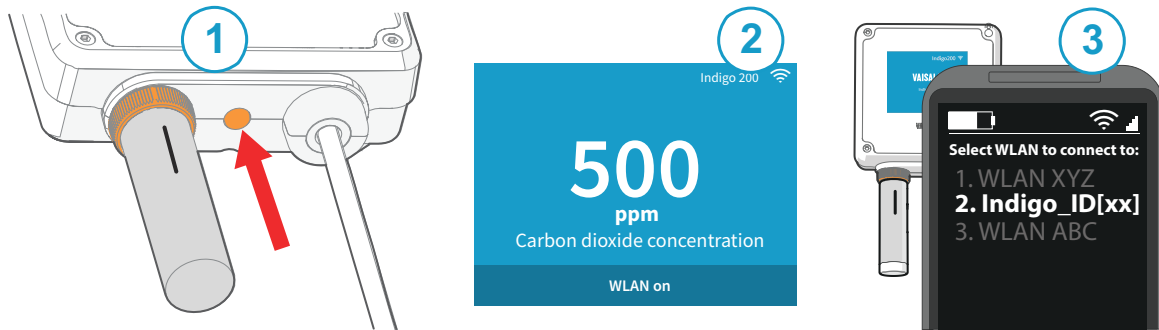

Figure 14 Enabling and Accessing Indigo's Wireless Configuration Interface

- 1 Wireless connection activation button
- 2 Wireless connection indicator (WLAN symbol) on the Indigo display
- 3 Choose Indigo (**Indigo\_ID[xx]**) from your wireless device's list of available connections

### More Information

- [Logging in to Wireless Configuration Interface \(page 28\)](#)
- [Indigo Wireless Connection Troubleshooting \(page 65\)](#)

### 4.2.1 Connecting with a Computer

To connect to the Indigo wireless configuration interface with a computer:

1. Enable wireless connectivity (WLAN) from your computer's settings.
2. Press the wireless connection activation button on the bottom of the Indigo transmitter until the transmitter notifies about a WLAN connection being active.
3. Open your computer's wireless connections menu and choose **Indigo\_ID[xx]** (transmitter-specific SSID) from the list of available connections.



4. When you have established a connection, open your browser. Depending on your browser and system, you are either directed to the wireless configuration interface's login screen, or you may need to:
  - a. open a new browser tab or window, or close and restart your browser, if the browser was already open when you connected to Indigo's access point.
  - b. acknowledge the connection in a notification prompt before opening your browser or a new browser tab or window.



The default IP address of the Indigo transmitter is **http://192.168.1.1/**. If you have trouble opening the wireless configuration interface in your browser, try entering the IP address in the browser's address bar.

5. When the wireless configuration interface opens in your browser, you are prompted to log in. For instructions, see [Logging in to Wireless Configuration Interface \(page 28\)](#).

## 4.2.2 Connecting with a Mobile Device

To connect to the Indigo wireless configuration interface with a mobile device (phone or tablet):

- ▶ 1. Enable wireless connectivity (WLAN) from your mobile device's settings.
2. Press the wireless connection activation button on the bottom of the Indigo transmitter until the transmitter notifies about a WLAN connection being active.
3. Open your device's wireless connections menu and select **Indigo\_ID[xx]** (transmitter-specific SSID) from the list of available connections.
4. Depending on device settings, the Indigo wireless configuration interface either opens automatically in your browser, or you may need to:
  - a. Open your browser application manually after connecting to Indigo
  - b. Acknowledge the connection in a wireless network prompt (check your device's notifications) before opening your browser.
5. When the wireless configuration interface opens in your browser, you are prompted to log in. For instructions, see [Logging in to Wireless Configuration Interface \(page 28\)](#).

### More Information

- ▶ [Additional WLAN Settings when Connecting to Indigo \(page 66\)](#)
- ▶ [Changing Administrator Password \(page 30\)](#)

## 4.3 Logging in to Wireless Configuration Interface

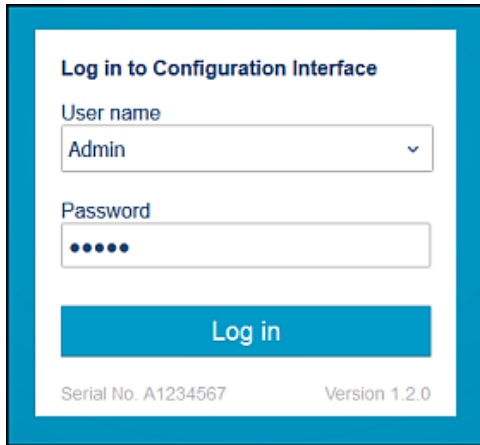

Figure 15 Indigo Login View

When you open Indigo's wireless configuration interface in your browser, you are prompted to log in. There are 2 available user levels:

- **User:** view-only access available for all users. Does not require a password.
- **Admin:** password-protected access. To change settings, you must log in as admin.

To log in:

- ▶ 1. Enter the user name and password:
  - a. To log in as user (view-only access, no configuration rights), select **User** from the **User name** dropdown. Leave the **Password** field empty.
  - b. To log in as admin (required for configuration), select **Admin** in the **User name** dropdown and type the admin password (default: **12345**) in the **Password** field.
2. Select **Log in** after entering the login credentials. The wireless configuration interface opens in the **Measurements** view.



The user level (**User** or **Admin**) is shown in the upper right corner of all menu views. Select the user/admin icon in the upper right corner to change the user level.

### More Information

- ▶ [Changing User Level \(page 29\)](#)
- ▶ [Changing Administrator Password \(page 30\)](#)
- ▶ [Resetting Administrator Password \(page 30\)](#)

### 4.3.1 Changing User Level

A link that allows logging in with a different user level is included in the upper right corner of all menu views. The text of the link shows the current user level.

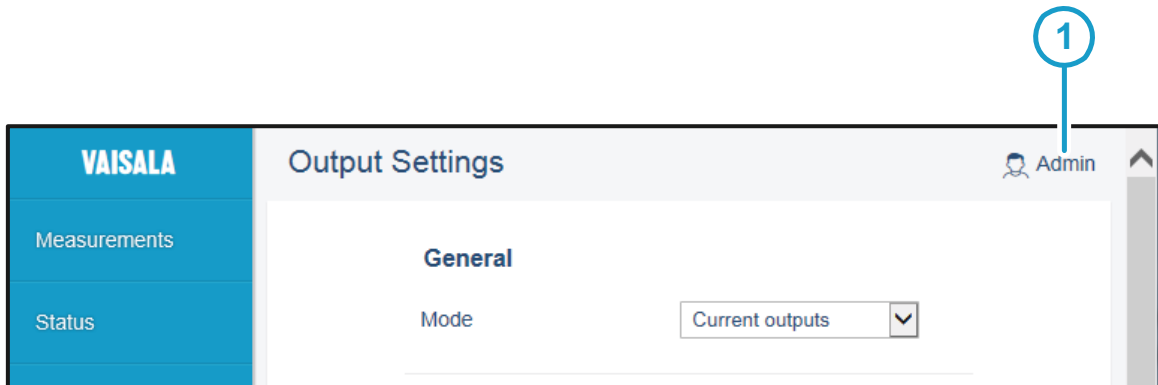

Figure 16 User Level (User/Admin) in Upper Right Corner of Menu View

- 1 Current user level (**User/Admin**): select the text or icon to log in with a different user level

To change between the **User** and **Admin** user levels:

1. Select the link that shows the current user level (**User** or **Admin**) on the upper right corner of any menu view.



Selecting the link logs you out of the interface, and a new login is required.

2. The login screen opens. Log in as **User** or **Admin**.



**CAUTION!** You must be logged in as **Admin** to start and close the calibration mode. When you have started calibration mode, you must always close the calibration mode to return to normal operating mode. Measurement performance can be affected when operating in calibration mode.

#### More Information

- [Starting and Closing Calibration Mode \(page 54\)](#)

### 4.3.2 Changing Administrator Password

To change the administrator password:

1. Connect to the wireless configuration interface and log in as an administrator (default password: **12345**). The user level (**User** or **Admin**) can be also changed by selecting the user level icon in the upper right corner of any menu view.
2. Open the **Settings > General** menu.
3. In the **User Access** section, enter the new password (max. 25 characters) in the **Administrator Password** field.

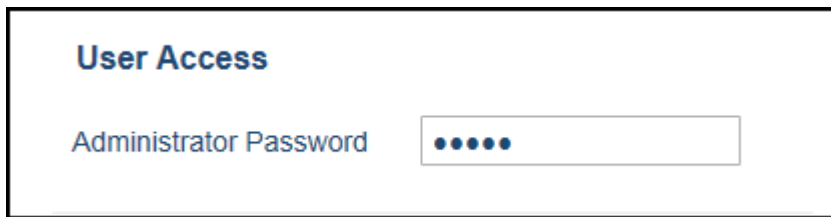

The screenshot shows a mobile application interface with a white background and a black border. At the top, the text "User Access" is displayed in a blue font. Below this, the text "Administrator Password" is shown in a blue font, followed by a text input field containing five blue dots, representing a masked password.

4. The new password is saved when you tap or click outside the text field, and is in use at the next login.

### 4.3.3 Resetting Administrator Password

If you have lost or forgotten the administrator password and cannot log in, you can reset the password back to default (**12345**). Note that this requires powering the transmitter off and on.

To reset the password:

1. Power off the transmitter.
2. Keep the wireless connection activation button on the bottom of the transmitter pressed down.
3. While pressing the wireless connection activation button, power on the transmitter. Keep the button pressed down until the transmitter start-up is complete (a measurement is shown on the display). In the LED indicator model, the LED blinks yellow when the password reset is complete.
4. The administrator password has now been reset to the default **12345**.

## 4.4 Measurements View

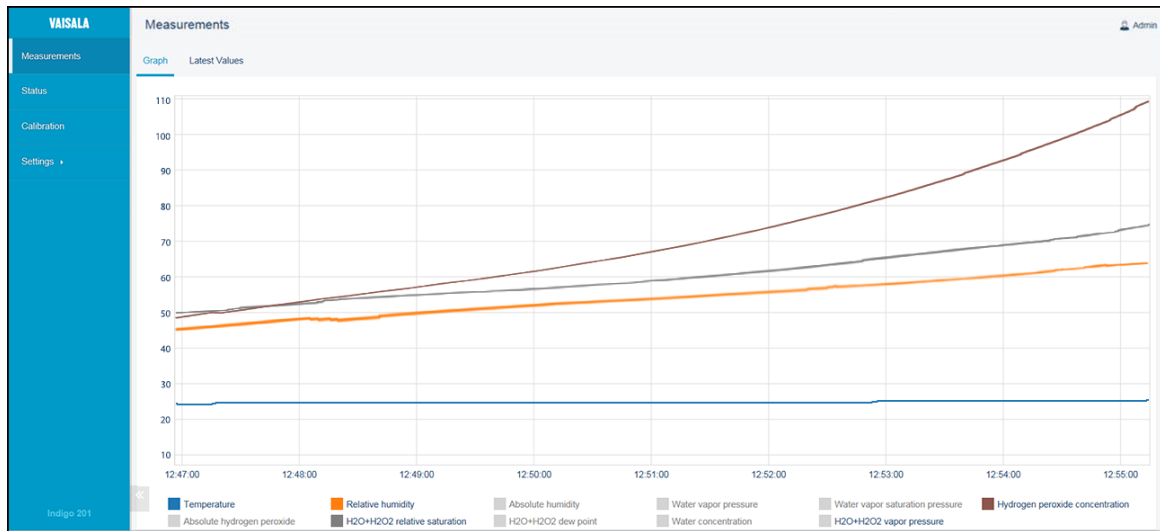

Figure 17 Measurements View (Desktop Browser)

The **Measurements** view shows the measurement data from the connected probe in numeric and graph format. When you log in to Indigo, the wireless interface opens in this view.

There are 2 tabs in the **Measurements** view: **Graph** and **Latest values**. The **Graph** tab is the initial view that shows the measurement information of the connected probe in graph format. You can hide and show the graphs of available measurements by selecting the parameter. The **Latest values** tab shows the most recent measurement of each available parameters in numeric format.

Quantity	Value	Unit
Hydrogen peroxide concentration	1	ppm
H <sub>2</sub> O+H <sub>2</sub> O <sub>2</sub> relative saturation	62.6	%RS
Temperature	23.4	°C
Relative humidity	62.5	%RH
Absolute hydrogen peroxide	1.6	mg/m <sup>3</sup>
H <sub>2</sub> O+H <sub>2</sub> O <sub>2</sub> dew point	15.9	°C
H <sub>2</sub> O+H <sub>2</sub> O <sub>2</sub> vapor pressure	18.1	hPa
Water concentration	18131	ppm
Water vapor pressure	18	hPa
Absolute humidity	13.2	g/m <sup>3</sup>
Water vapor saturation pressure	28.9	hPa

Figure 18 Latest Values Tab, H<sub>2</sub>O<sub>2</sub> Probe Example (Desktop Browser)

## 4.5 Status View

**VAISALA** Status Admin

Measurements

Status

Calibration

Settings ▾

### General

- Indigo Status: OK
- Indigo Serial Number: A1234567
- WLAN Access Point Name: Indigo 201
- WLAN MAC Address: aa:aa:aa:01:02:05
- Probe: GMP251 (M0220028) connected

### Analog Outputs

Output	Signal Level	Mode	Parameter
1	0.06	0...5 V	Carbon dioxide concentration
2		Off	Temperature
3		Off	Off

### Relays

Relay	State	Mode	Parameter
A		Off	Off
B		Off	Off

Figure 19 Status View (CO<sub>2</sub> Probe Example, Desktop Browser)

The **Status** view shows the transmitter status, general information about the Indigo transmitter, and the status of the analog outputs 1-3 and relays A and B.

### More Information

- [Status View: General \(page 33\)](#)
- [Status View: Analog Outputs \(page 34\)](#)
- [Status View: Relays \(page 34\)](#)

## 4.5.1 Status View: General

The **General** section of the **Status** menu shows general information about the transmitter and the connected probe.

General	
Indigo Status	OK
Indigo Serial Number	A1234567
WLAN Access Point Name	Indigo 200
WLAN MAC Address	aa:aa:aa:01:02:05
Probe	GMP251 (M0220028) connected

- **Indigo Status:** shows the current status of the transmitter. Errors and notifications are displayed here.
- **Indigo Serial Number:** the transmitter's serial number.
- **WLAN Access Point Name:** the network name (SSID) of the transmitter. Can be configured in the **Settings** menu.
- **WLAN MAC Address:** unique hardware address of the unit. Cannot be changed.
- **Probe:** the type and serial number of the probe that is connected to Indigo.

### More Information

- [WLAN Settings \(page 36\)](#)

## 4.5.2 Status View: Analog Outputs

The **Analog Outputs** section of the **Status** menu shows information about the status of Indigo's analog outputs 1-3.

Output	Signal Level	Mode	Parameter
1	0.06	0...5 V	Carbon dioxide concentration
2		Off	Temperature
3		Off	Off

- **Output:** The number of the analog output channel (1-3).
- **Signal Level:** The level of the analog output signal: shows the present measurement as scaled in the analog output settings.
- **Mode:** The mode and range selected for the analog output (voltage, current or off).
- **Parameter:** The measured parameter that is sent on the analog output channel.

### More Information

- [Analog Output Configuration Overview \(page 45\)](#)

## 4.5.3 Status View: Relays

Relay	State	Mode	Parameter
A	Active	Active above trigger level	Carbon dioxide concentration
B	Inactive	Active below trigger level	Carbon dioxide concentration

- **Relay:** relay A or relay B
- **State:** Shows whether the relay is active (set) or not.
- **Mode:** Relay activation mode (above or below a trigger level, or off)



- **Parameter:** The parameter that controls the relay

#### More Information

- [Relay Configuration Overview \(page 49\)](#)

## 4.6 Calibration Menu

The screenshot shows the Vaisala Calibration menu. On the left is a blue sidebar with the Vaisala logo and navigation links: Measurements, Status, Calibration, and Settings. The main content area is titled 'Calibration' and has sub-tabs for Calibration, Configuration, Diagnostics, and Measurements. A 'Start calibration' button is at the top. Below it, the 'Calibration information' section has input fields for 'Calibration date' (2017-05-13) and 'Calibration text' (ppmCO2 at lab). The 'T adjustment' section has input fields for 'Reference value, point 1' and 'Measured value, point 1', both with a °C unit. At the bottom of this section are 'Store adjustment' and 'Restore factory adjustment' buttons.

Figure 20 Calibration Menu (CO<sub>2</sub> Probe Example, Desktop Browser)

In the **Calibration** menu, you can calibrate and adjust the measurement of the probe connected to the transmitter with the help of references such as calibration gases that have a known concentration. You can also view the current adjustments and restore the probe's factory adjustments.



The available options vary depending on the type of the connected probe (for example, applicable environmental compensations and the number of adjustment points).

#### More Information

- [Calibration Overview \(page 53\)](#)

## 4.7 General Settings

The **Settings > General** menu contains the following configuration options:

- [Date and Time \(page 36\)](#)
- [WLAN Settings \(page 36\)](#)
- [User Access Settings \(Administrator Password\) \(page 36\)](#)
- [Display Settings \(page 37\)](#)

- [Factory Reset and Clearing Analog Output Settings \(page 38\)](#)
- [License Information \(page 39\)](#)

### 4.7.1 Date and Time



**Date and Time**

Date and Time

Enter the date and time in the following format: YYYY-MM-DD HH:MM:SS.

### 4.7.2 WLAN Settings

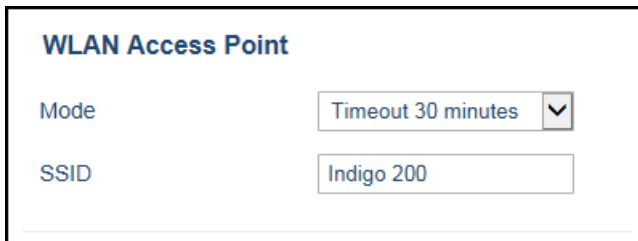

**WLAN Access Point**

Mode  ▼

SSID

- **Mode:** Select the timeout period for disconnecting the wireless configuration interface, or remove the timeout from use.
- **SSID:** The network name that is used to identify the transmitter when connecting to it (default: **Indigo\_ID[xx]**).

### 4.7.3 User Access Settings (Administrator Password)

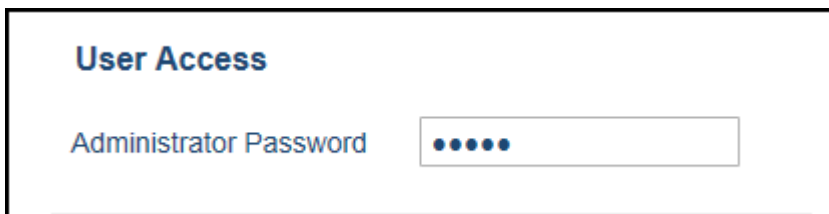

**User Access**

Administrator Password

Enter a new administrator password and exit the text entry field. The new password is in use in the next login.



If you have forgotten or lost the password, you can reset the password back to the default one (**12345**). For more information, see the login instructions.

## 4.7.4 Display Settings

**Display**

Brightness

Mode

**Graph View**

Parameter

Unit

Rounding

Time Scale

**Numeric View**

Parameter 1

Unit for Parameter 1

Rounding for Parameter 1

Parameter 2

Unit for Parameter 2

Rounding for Parameter 2

Parameter 3

Unit for Parameter 3

Rounding for Parameter 3

General display settings:

- **Brightness:** set the brightness of the display (20%, 50%, 100% or off).
- **Mode:** Select whether the display shows the measurement information in graph or numeric format.

Graph view settings:

- **Parameter:** Select which parameter's measurement is shown in the graph view.
- **Unit:** Select the unit that the measurement is shown in (for example, ppmCO<sub>2</sub> or %CO<sub>2</sub>).
- **Rounding:** Choose how many decimals of the measurement are shown in the numeric reading shown alongside the graph view.
- **Time Scale:** Select the time period shown in the measurement graph (1 minute ... 6 hours).

Numeric view settings:

- **Parameter (1-3):** Select the measurement parameter or parameters shown in the numeric view (up to 3 parameters can be shown simultaneously in the numeric view).
- **Unit for Parameter (1-3):** Select the unit the measurement is shown in (for example, ppmCO<sub>2</sub> or %CO<sub>2</sub>).
- **Rounding for Parameter (1-3):** Choose how many decimals of the measurement are shown in the numeric view.

#### More Information

- [Display and LED Indicator \(page 11\)](#)
- [Graph Display Mode \(page 12\)](#)

## 4.7.5 Factory Reset and Clearing Analog Output Settings

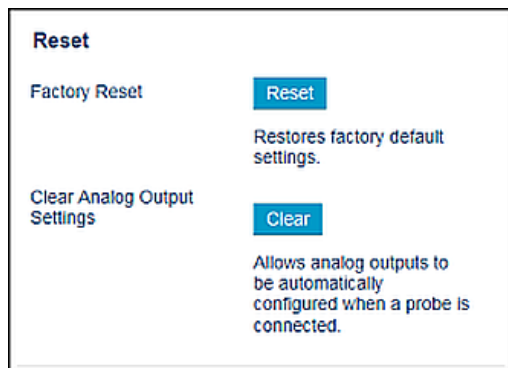

- **Factory Reset:** select this to restore the configuration of the transmitter to factory default settings.
- **Clear Analog Output Settings:** this option removes the current analog output settings from Indigo's memory. When you clear the analog output settings, Indigo automatically adapts the analog output settings of the next probe you connect.

#### More Information

- [Receiving Analog Output Settings from Probe \(page 16\)](#)
- [Clearing Analog Output Settings from Indigo \(page 47\)](#)

## 4.7.6 License Information

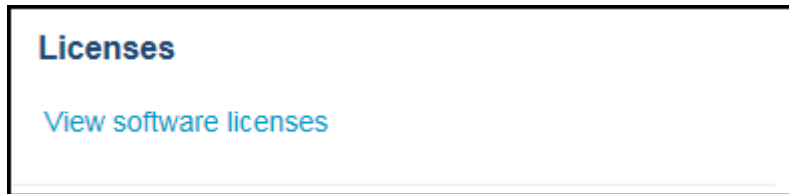

Select the **View software licenses** link to view information on Indigo 201 software licenses.

## 4.8 Output Settings

The **Settings > Outputs** menu contains the configuration options for analog outputs 1-3.

General	
Mode	Current outputs
Analog Output 1	
Output Type	4...20 mA
Parameter	Carbon dioxide concen ▼
Unit	%
Scale Low End	0.00 %
Scale High End	20.00 %
Clipping Limit	1.00 %
Error Limit	2.00 %
Error Output Voltage	11.50
Error Output Current	3.60



The analog output settings are automatically imported from the probe if the Indigo transmitter does not have an analog output configuration in place. For more information, see [Receiving Analog Output Settings from Probe \(page 16\)](#).

#### General output settings:

- **Mode:** Select whether the analog outputs 1-3 are used for current (mA) or voltage (V) output.

#### Settings for analog outputs 1-3:

- **Output Type:** Select the voltage or current range used for the output (for example, **0 ... 10 V**).
- **Parameter:** The measurement parameter that is sent on the analog output channel.
- **Unit:** The unit used for the output (for example, **%** if the output is used for %CO<sub>2</sub> measurements).
- **Scale Low End:** The lower limit of the measurement scale (for example, **0** if the scale is 0 ... 20 %CO<sub>2</sub>).
- **Scale High End:** The upper limit of the measurement scale (for example, **20** if the scale is 0 ... 20 %CO<sub>2</sub>).
- **Clipping Limit:** The point (in % above the output range) when the output is clipped due to being out of range. For more information, see [Analog Output Overrange Behavior \(page 47\)](#).
- **Error Limit:** The point (in % above the output range) when the output switches to error state due to being out of range. For more information, see [Analog Output Overrange Behavior \(page 47\)](#).
- **Error Output Voltage:** The voltage that is output in an error state.
- **Error Output Current:** The current that is output in an error state.

#### More Information

- [Analog Output Configuration Overview \(page 45\)](#)

## 4.9 Relay Settings

The **Settings > Relay** menu contains the configuration options for controlling relays A and B. Both relays have the same configuration options (relay A example shown here).

**Relay A**

Output Mode Active above trigger le ▾

Parameter Carbon dioxide concen ▾

Unit % ▾

Low Trigger Level 1.00 %

High Trigger Level 2.00 %

Error State Active ▾

- Output Mode** Select whether the relay is activated when the measurement exceeds the set trigger, or when the measurement falls below the set trigger. Set to **Off** if the relay is not in use.
- Parameter** Select which measurement parameter controls the relay.
- Unit** Select the unit of the measurement parameter (for example, % if the measurement is in %CO<sub>2</sub>).
- Low Trigger Level and High Trigger Level** If you want to activate the relay above or below a single setpoint without using hysteresis, enter the same value for the low trigger and the high trigger. The **Output Mode** selection defines whether the relay activates above or below this value. If you want to set a hysteresis, define the limits of the hysteresis with the low and high triggers.
- Error State** Choose the behavior of the relay when an error state occurs (switched on or off, or remains in its current state).



When you use a single setpoint without hysteresis, set the same value for **Low Trigger Level** and **High Trigger Level**. For instructions on using hysteresis, see [Setting Relay Activation Limit Using Hysteresis \(page 51\)](#).

### More Information

- [Relay Configuration Overview \(page 49\)](#)

## 4.10 Probe Settings

The **Settings > Probe** menu contains probe-specific configuration options (for example, filtering factor and environmental compensations).

This menu also includes the **Calibration PIN Code** entry field. The PIN code must be in place in order to calibrate probes. The PIN code is in place by default.



The available options depend on the features of the connected probe. The examples here show the probe settings for Vaisala CARBOCAP® Carbon Dioxide Probe GMP251.

<b>General</b> Calibration PIN Code <input type="text" value="1300"/>	<b>Compensation setpoints</b> Temperature <input type="text" value="25.00"/> °C Relative humidity <input type="text" value="0.00"/> %RH Pressure <input type="text" value="1013.00"/> hPa Oxygen concentration <input type="text" value="0.00"/> %
<b>Measurement</b> Filtering factor <input type="text" value="100"/> Pressure compensation on/off <input type="text" value="On"/> Temperature compensation mode <input type="text" value="Setpoint"/> Humidity compensation on/off <input type="text" value="Off"/> Oxygen compensation on/off <input type="text" value="Off"/>	<b>Compensation power-up defaults</b> Temperature <input type="text" value="25.00"/> °C Relative humidity <input type="text" value="0.00"/> %RH Pressure <input type="text" value="1013.00"/> hPa Oxygen concentration <input type="text" value="0.00"/> %

### General (All Probes)

The **Calibration PIN Code** must be in place to enable probe calibration and adjustment in the **Calibration** menu. The PIN code is in place by default.



If the PIN code has been removed and you need to enter it, check the probe's documentation for information on the code used in the probe model.



## Measurement (GMP251 Example)

Measurement	
Filtering factor	<input type="text" value="100"/>
Pressure compensation on/off	<input type="text" value="On"/>
Temperature compensation mode	<input type="text" value="Setpoint"/>
Humidity compensation on/off	<input type="text" value="On"/>
Oxygen compensation on/off	<input type="text" value="On"/>

### Filtering factor

Defines how much past measurements affect the output (measurement averaging over time). For details, see probe documentation.

### Temperature compensation mode

Select whether the probe sensor's measurement or a manually entered setpoint is used to set the temperature compensation.

### Pressure/humidity/oxygen compensation ON/OFF

Enable or disable the environmental compensations.

## Compensation Setpoints (GMP251 Example)

Compensation setpoints	
Temperature	<input type="text" value="25.00"/> °C
Relative humidity	<input type="text" value="0.00"/> %RH
Pressure	<input type="text" value="1013.00"/> hPa
Oxygen concentration	<input type="text" value="0.00"/> %

Enter the setpoint values for the environmental compensations that are in use (enabled in the **Measurement** selections).

## Compensation Power-up Defaults (GMP251 Example)

Compensation power-up defaults	
Temperature	<input type="text" value="25.00"/> °C
Relative humidity	<input type="text" value="0.00"/> %RH
Pressure	<input type="text" value="1013.00"/> hPa
Oxygen concentration	<input type="text" value="0.00"/> %

The power-up default values are stored to the probe memory and remain in use also after you disconnect or reset the probe.

Note that the environmental compensations you set in the **Settings > Probe** menu and the compensations you set in the **Calibration** menu are interconnected: the configuration set in either menu is applied to both.

### More Information

- [Environmental Compensation \(page 56\)](#)

# 5. Configuring Analog Outputs

## 5.1 Analog Output Configuration Overview

Indigo 201 has 3 analog outputs that can be configured with the wireless configuration interface's **Settings > Outputs** menu. Each output has the same set of configuration options (analog output 1 shown in example):

General	
Mode	Current outputs
Analog Output 1	
Output Type	4...20 mA
Parameter	Carbon dioxide concen ▼
Unit	%
Scale Low End	0.00 %
Scale High End	20.00 %
Clipping Limit	1.00 %
Error Limit	2.00 %
Error Output Voltage	11.50
Error Output Current	3.60

Figure 21 Analog Output Configuration Options



Note that the **Mode** selection (under **General**) defines whether the outputs are used for voltage or current output.

### Receiving Analog Output Settings Automatically from Probe

Indigo can receive the analog output settings automatically from the connected probe in the following cases:

- the transmitter is a new unit and has not been configured yet, or
- you have removed the analog output configuration from Indigo manually.



It is recommended to always check the analog output settings from the wireless configuration interface's **Settings > Outputs** menu after connecting a probe.

#### More Information

- [Receiving Analog Output Settings from Probe \(page 16\)](#)
- [Clearing Analog Output Settings from Indigo \(page 47\)](#)

## 5.2 Analog Output Configuration Example

This example shows how to configure analog output 1 to use the following settings when a CO<sub>2</sub> probe is connected to Indigo:

- 4 ... 20 mA current output
- Carbon dioxide measurement scaled to 0 ... 20 %CO<sub>2</sub>
- Clipping limit 5%, error limit 10%, and error output 3.6 mA



When you enter a value into a field, the value is saved automatically when you exit the input field (for example, tap on an area outside of the field).

To configure the output:

- ▶ 1. Launch the Indigo 201 wireless configuration interface.
2. Open the **Settings > Outputs** menu.
3. Select **Current outputs** from the **Mode** dropdown.
4. Select **4 ... 20 mA** from the **Output Type** dropdown.
5. Select **Carbon dioxide concentration** from the **Parameter** dropdown.
6. Select **%** from the **Unit** dropdown.
7. Type **0** in the **Scale Low End** field.
8. Type **20** in the **Scale High End** field.
9. Type **5** in the **Clipping Limit** field and **10** in the **Error Limit** field.
10. Type **3.6** in the **Error Output Current** field.

#### More Information

- [Output Settings \(page 39\)](#)

## 5.3 Clearing Analog Output Settings from Indigo

If you need to restore Indigo 201 to a state where no analog output configuration exists in the transmitter, you can clear the current configuration from the **Settings > General** menu.



When you remove the analog output configuration from Indigo, Indigo automatically adapts the analog output settings of the next probe that you connect.

To clear the configuration:

- ▶ 1. Launch the Indigo 201 wireless configuration interface.
2. Open the **Settings > General** menu.
3. Go to the **Reset > Clear Analog Output Settings** section and select **Clear**.

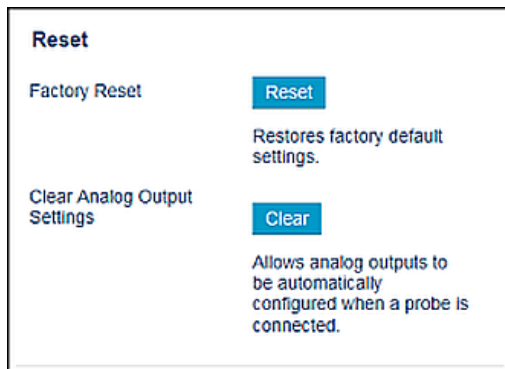

## 5.4 Analog Output Overrange Behavior

The analog output of the probe has a defined behavior when the values measured by the probe are outside the scaled analog output range. At first, the output is clipped when the measurement exceeds a set limit (the measurement continues, but the output does not change from the clipped value).

When the measurement exceeds the second limit (error limit), the analog output switches to the error state defined for the output.

The same clipping and error limits are applied when the measured value drops back to the scaled range: at first the output returns to the clipped value from the error state, and then to normal output.

### 5.4.1 Analog Output Overrange Example

Consider a probe with 0 ... 5 V output, scaled to 0 ... 200 000 ppm (= 0 ... 20 %) CO<sub>2</sub>.

- When the measured CO<sub>2</sub> rises above 20 %, the output rises above 5 V.

- The output keeps rising until the measurement is 21 %CO<sub>2</sub>, at which point the probe outputs 5.25 V.
- If the CO<sub>2</sub> level rises above 21 %CO<sub>2</sub>, the output still remains at 5.25 V.
- If the CO<sub>2</sub> level rises above 22 %CO<sub>2</sub>, the output enters the error state, which is 0 V for the 0 ... 5 V output.

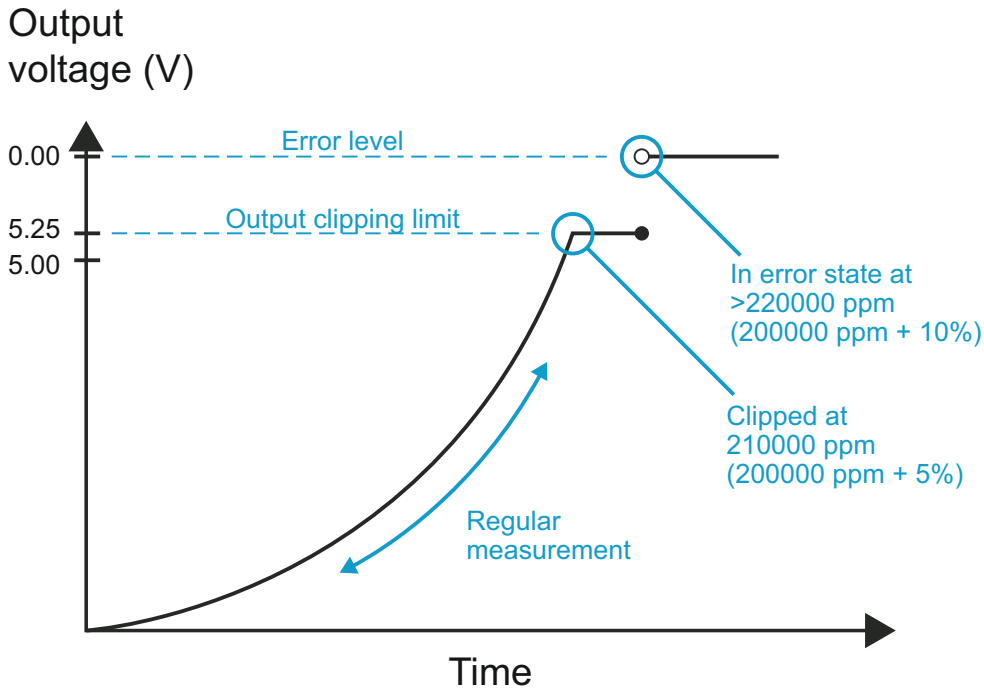

Figure 22 Example of Analog Output Overage Behavior

This example uses output scaled to 0 ... 5 V and 0 ... 200000 ppm, error level set to 0 V, clipping set to 5 % overrange, and error limit set to 10 % overrange. CO<sub>2</sub> concentrations (ppm) are indicated for the clipping point and error limit point.

## 6. Configuring Relays

### 6.1 Relay Configuration Overview

Indigo transmitters have 2 configurable relays (relay A and relay B). Both relays have configuration options for selecting the parameter that is used to control the relay, activation triggers, hysteresis, and error state behavior.

**Relay A**

Output Mode	Active above trigger le ▾	1
Parameter	Carbon dioxide concen ▾	2
Unit	% ▾	3
Low Trigger Level	1.00	4
High Trigger Level	2.00	4
Error State	Active ▾	5

Figure 23 Relay Configuration Options (CO<sub>2</sub> Probe Example)

- Output Mode:** Select whether the relay activates above or below a set value (or set the relay **Off**).
- Parameter:** The measurement that is used to control the relay.
- Unit:** Select the unit of the measurement parameter that controls the relay (for example, % if the measurement is in %CO<sub>2</sub>).
- Low Trigger Level** and **High Trigger Level:** If you want to activate the relay above or below a single setpoint without using hysteresis, enter the same value for the low trigger and the high trigger. The **Output Mode** selection defines whether the relay activates above or below this value.  
If you want to set a hysteresis, define the limits of the hysteresis with the low and high triggers.
- Error State:** Select which state the relay is set to when an error occurs (on, off, or remains in its current state).

## Relay State Information

When one or both relays are enabled, the relay state (active/not active) is shown on the optional display. You can also check the status of the relays in the **Status** view of the wireless configuration interface.

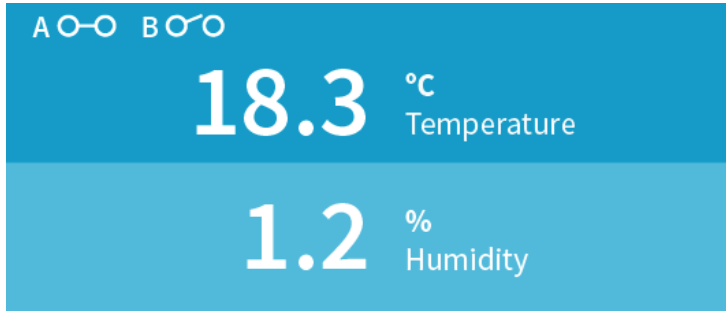

Figure 24 Relay Icons on the Optional Display (Relay A Active, Relay B Not Active)

## Relay Activation Setpoint and Hysteresis

You can define whether the relay is activated when the measurement falls below a set limit (**Active below trigger level**), or when the measurement exceeds a set limit (**Active above trigger level**). To prevent the relay switching back and forth when the measured value is near to the setpoint value, you can set a hysteresis with the **Low Trigger Level** and **High Trigger Level** settings.

For example, if you want the relay to activate when the measurement exceeds (**Active above trigger level**) 2000 units, but do not want the relay to switch off if the measurement momentarily falls between 2000 and 1980 units, set the **High Trigger Level** to 2000 and **Low Trigger Level** to 1980. With this configuration, the relay activates when the measurement exceeds 2000, but does not switch off until the measurement falls below 1980.

## 6.2 Setting Relay Activation Limit Without Hysteresis

You can set the relay to activate when the probe measurement exceeds or falls below a set limit. When you configure a single setpoint for relay activation without hysteresis, the relay switches on or off immediately when the measurement moves over or below the setpoint (depending on the low/high activation mode selection).



When you enter a value into a field, the value is saved automatically when you exit the input field (for example, tap on an area outside of the field).



To define a single setpoint for relay activation:

- ▶ 1. Open the **Settings > Relays** menu in the wireless configuration interface.
- 2. In the **Relays** menu, select the relay activation mode from the **Output Mode** dropdown menu:
  - a. Select **Active above trigger level** if you want the relay to activate when the probe measurement exceeds the set limit
  - b. Select **Active below trigger level** if you want the relay to activate when the probe measurement falls below the set limit
- 3. Select the measurement parameter that is used to control the relay with the **Parameter** dropdown.
- 4. Set the unit of the measurement parameter with the **Unit** dropdown.
- 5. Enter the same measurement limit to both the **Low Trigger Level** and the **High Trigger Level** field.



With this configuration, there is no hysteresis. The relay activates or switches off immediately after passing this point.

- 6. Select the **Error State** for the relay.

## 6.3 Setting Relay Activation Limit Using Hysteresis

If the measurement you are using to control the relay is likely to move back and forth close to the activation setpoint, you can set a hysteresis that prevents the relay switching on and off too frequently.

When hysteresis is used, the relay activates at the defined limit, but does not switch off immediately when the measurement moves back to the other side of the activation limit. Instead, with hysteresis, the relay remains active until the measurement reaches the defined tolerated variation limit.

To set a relay activation limit with hysteresis:

- ▶ 1. Open the **Settings > Relays** menu in the wireless configuration interface.
- 2. In the **Relays** menu, select the relay activation mode from the **Output Mode** dropdown menu:
  - a. Select **Active above trigger level** if you want the relay to activate when the probe measurement exceeds a set limit
  - b. Select **Active below trigger level** if you want the relay to activate when the probe measurement falls below a set limit

3. Select the measurement parameter that is used to control the relay with the **Parameter** dropdown.
4. Set the unit of the measurement parameter with the **Unit** dropdown.
5. Enter the relay activation limit either to the **Low Trigger Level** or the **High Trigger Level** field:
  - a. If you are using **Active above trigger level** (relay activation when the measurement exceeds a set limit), enter the limit to the **High Trigger Level** field.
  - b. If you are using **Active below trigger level** (relay activation when the measurement falls below a set limit), enter the limit to the **Low Trigger Level** field.
6. To define the hysteresis value:
  - a. If you are using **Active above trigger level**, enter the limit for tolerated variation below the setpoint to the **Low Trigger Level** field.



With this option, the relay activates when the measurement exceeds the limit entered in **High Trigger Level**, and switches off when the measurement falls below the limit entered in the **Low Trigger Level** field.

- b. If you are using **Active below trigger level**, enter the limit for tolerated variation above the setpoint to the **High Trigger Level** field.



With this option, the relay activates when the measurement falls below the limit entered in **Low Trigger Level**, and switches off when the measurement exceeds the limit entered in the **High Trigger Level** field.

7. Select the **Error State** for the relay.

## 6.4 Selecting Relay Error State

You can define whether the relay is switched off or on in an error state, or whether the relay remains in the state it is on the moment an error state occurs.

- ▶ 1. Open the **Settings > Relays** menu in the wireless configuration interface.
- 2. In the **Relays** menu, select the relay error state from the **Error State** dropdown menu:
  - a. To set the relay to release when an error occurs, select **Inactive**.
  - b. To set the relay to activate when an error occurs, select **Active**.
  - c. To keep the relay in the same state as it was when the error occurred, select **No change**.

# 7. Calibration and Adjustment

## 7.1 Calibration Overview

The **Calibration** menu of the wireless configuration interface contains options for calibrating and adjusting the measurement of the probe you have connected to the transmitter. You can also view the current adjustment and restore the probe's factory adjustments.



The calibration menu interface described in this document is in use from Indigo software version 1.2.0 onwards. See manual revision *M211877EN-C* or earlier for instructions on using the previous version of the interface.

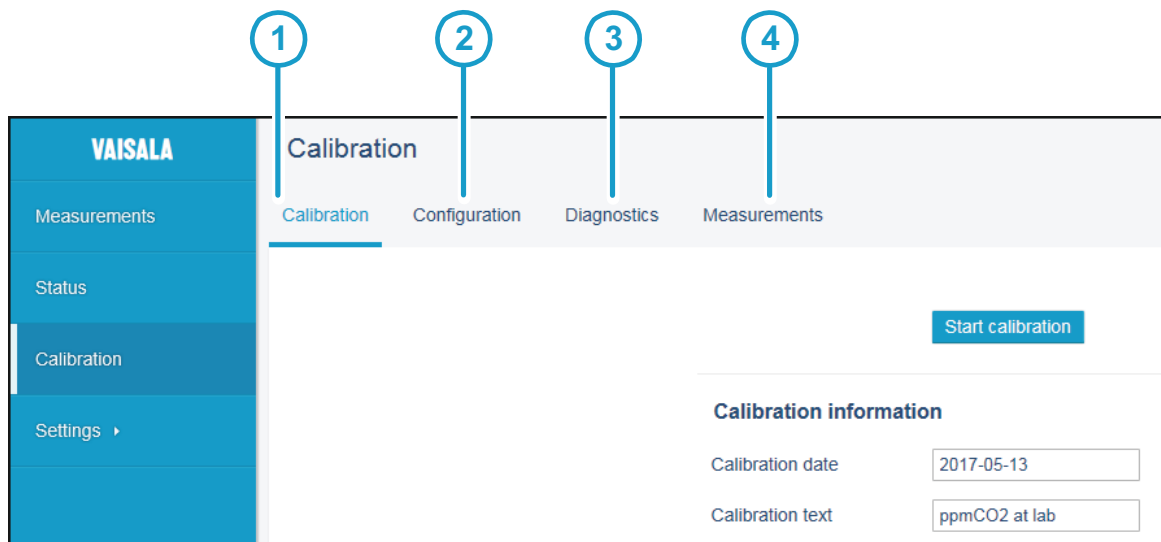

Figure 25 Calibration Menu Main View

- 1 **Calibration** tab
- 2 **Configuration** tab
- 3 **Diagnostics** tab
- 4 **Measurements** tab

There are 4 tabs in the **Calibration** menu:

- **Calibration:** the main adjustment view with options for making adjustments, viewing adjustments, and restoring factory adjustments.
- **Configuration:** options for using environmental compensations (probe-specific range of options) that allow compensating for the conditions present in the calibration environment, for example, pressure, temperature, and background gases. Also includes probe-specific configuration options that are not mandatory for use with Indigo.

- **Diagnostics:** this tab contains information about the status of the measurement and the probe, and shows the current environmental compensation configuration.
- **Measurements:** this tab shows the current probe measurement in numeric format (use this view, for example, when you need to follow measurement stabilization in a reference environment without leaving the **Calibration** menu).



**CAUTION!** Before adjusting a probe's measurement, make sure that you have familiarized yourself with the probe-specific calibration requirements such as possible adjustment limits and environmental compensation interdependencies. See the probe's documentation set for probe-specific information.



The range of available options for certain parameters (for example, environmental compensations and the number of adjustment points) varies depending on the features of the connected probe. The menu examples presented here show the calibration options for Vaisala CARBOCAP® Carbon Dioxide Probe GMP252 (ppmCO<sub>2</sub> measurement).

## 7.1.1 Starting and Closing Calibration Mode

In order to be able to use the calibration options, you must switch the operation of the probe and Indigo to calibration mode with the **Start calibration** button.

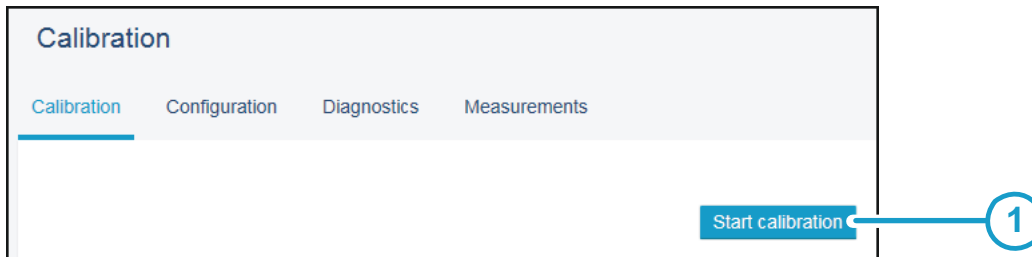

Figure 26 Start Calibration Button

- 1 **Start calibration** button on the **Calibration** tab

When you start the calibration mode, the **Start calibration** button is replaced with the **Stop calibration** button. The calibration mode remains active until you close it by selecting **Stop calibration**.

You can use other menus while the calibration mode is active, and return to the **Calibration** menu later to complete your adjustments.



Always close the calibration mode to return the probe and Indigo to normal operating mode. The measurement performance of the probe can be affected when used in calibration mode. You must close the calibration mode with the **Stop calibration** button also when no changes are made.

### More Information

- ▶ [Changing User Level \(page 29\)](#)

## 7.1.2 Restoring Factory Adjustment



Always restore factory adjustment before entering a new adjustment. This prevents any possible earlier adjustments having an effect on the new adjustment you make.

To restore factory adjustment:

- ▶ 1. Connect to the wireless configuration interface and open the **Calibration** menu.
2. Start the calibration mode with the **Start calibration** button.
3. On the **Calibration** tab, scroll down to the parameter you want to adjust (for example, **CO2 adjustment**) and select **Restore factory adjustment**.

**CO2 adjustment**

Reference value, point 1

Measured value, point 1

Reference value, point 2

Measured value, point 2

4. Restore the factory adjustment with the **Restore factory adjustment** button for each parameter separately as needed.
5. To verify that the factory adjustment was restored, check the adjustment data information at the bottom of the **Calibration** tab view.
6. Close the calibration mode with the **Stop calibration** button.

### 7.1.3 Calibration PIN Code



The screenshot shows a 'General' settings panel. Under the heading 'General', there is a label 'Calibration PIN Code' followed by a text input field containing the value '1300'.

Probe calibration can be locked and unlocked with a calibration PIN code in the **Settings > Probe** menu. By default, the calibration PIN code is in place and calibration is enabled. Do not remove the PIN code from the probe settings unless you need to block access to calibration settings.



If the PIN code has been removed and you need to re-enter it, check the probe's documentation for information on the code used in the probe model.

## 7.2 Environmental Compensation

When making adjustments, you can enter information about the environment in which you perform the adjustment. This allows compensating for environmental factors that have an effect on the measurement (for example, temperature, pressure, or background gases). The selection of environmental compensations available in the Indigo calibration settings depends on the features and configuration of the connected probe.

The environmental compensation selections are available on the **Configuration** tab of the **Calibration** menu. To use environmental compensations, first enable the compensation from the **Measurement** selections, and then enter the compensation in the **Compensation setpoints** fields. You can also set the power-up default compensations that remain in use also after probe reset.

## Measurement

Measurement	
Filtering factor	<input type="text" value="100"/>
Pressure compensation on/off	<input type="text" value="Off"/>
Temperature compensation mode	<input type="text" value="Measured"/>
Humidity compensation on/off	<input type="text" value="Off"/>
Oxygen compensation on/off	<input type="text" value="Off"/>

Figure 27 Measurement Selections, CO<sub>2</sub> Probe Example

### Filtering factor

Defines how much past measurements affect the output (measurement averaging over time). For details, see probe documentation.

### Temperature compensation mode

Select whether the probe sensor's measurement or a manually entered setpoint is used to set the temperature compensation.

### Pressure/humidity/oxygen compensation ON/OFF

Enable or disable the environmental compensations.

## Compensation Setpoints and Power-Up Defaults

### Compensation setpoints

Temperature	<input type="text" value="25.00"/>	°C
Relative humidity	<input type="text" value="50.00"/>	%RH
Pressure	<input type="text" value="1013.00"/>	hPa
Oxygen concentration	<input type="text" value="21.00"/>	%

---

### Compensation power-up defaults

Temperature	<input type="text" value="25.00"/>	°C
Relative humidity	<input type="text" value="50.00"/>	%RH
Pressure	<input type="text" value="1013.00"/>	hPa
Oxygen concentration	<input type="text" value="21.00"/>	%

---

Refresh Content

Figure 28 Compensation Setpoint and Power-Up Default Selection, CO<sub>2</sub> Probe Example



Environmental compensations can have interdependencies: for example, accurate RH measurement requires that also the temperature and pressure configuration match the measurement environment. For more information on the environmental compensation features of the connected probe, refer to the probe's documentation.

Note that the environmental compensations you set in the **Settings > Probe** menu and the compensations you set in the **Calibration** menu are interconnected: the configuration set in either menu is applied to both.

### More Information

- [Probe Settings \(page 42\)](#)



## 7.3 Measurements Tab

The **Measurements** tab of the **Calibration** menu shows the current measurement data in numeric format. The measurement data updates automatically at a 2-second interval.

The information shown in this tab is probe-specific: the example here shows the measurement information for a CO<sub>2</sub> probe.

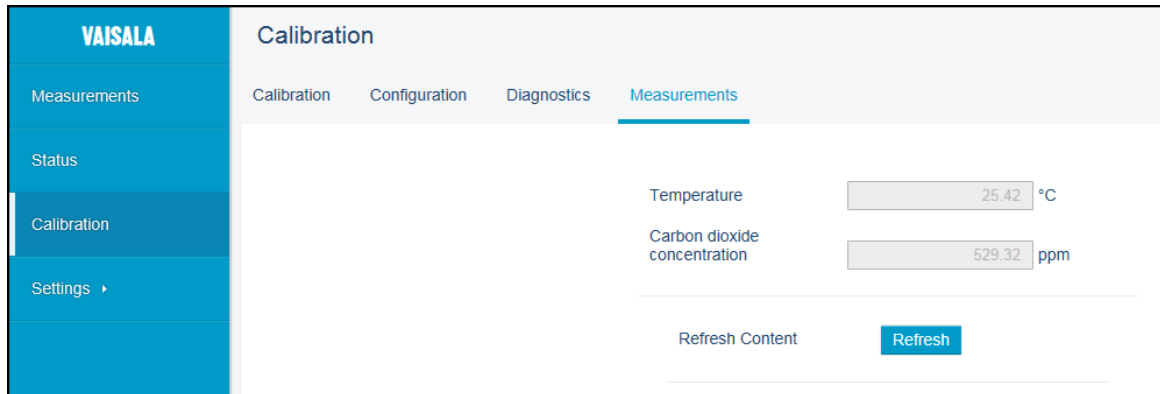

Figure 29 Measurements Tab, CO<sub>2</sub> Probe Example

## 7.4 Diagnostics Tab

The **Diagnostics** tab of the **Calibration** menu contains status and diagnostics codes. When carrying out diagnostics (for example, contacting Vaisala support), you can identify issues by referring to this information.

In addition to the diagnostics information, this view also shows the environmental compensation values that are currently in use. The status and compensation fields are both read-only.

The information shown on the diagnostics tab is probe-specific: the following figure shows an example of the diagnostics tab information when using a CO<sub>2</sub> probe.

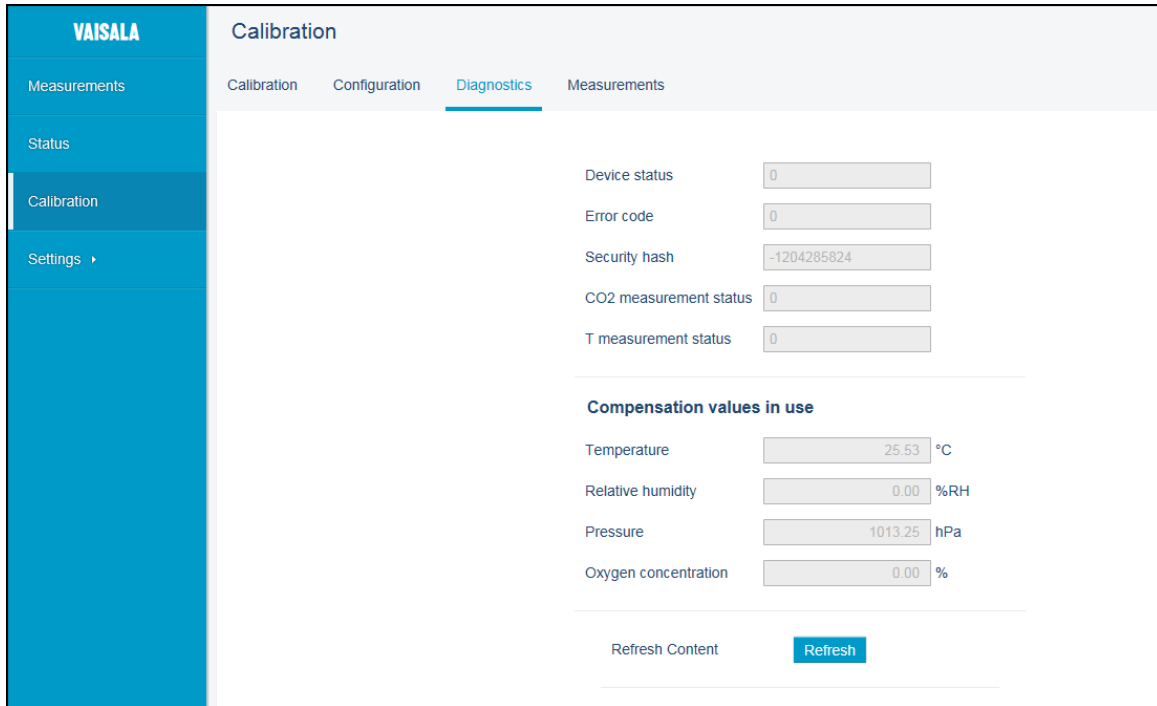

Figure 30 Diagnostics Tab, CO<sub>2</sub> Probe Example

## 7.5 Configuration Tab

The **Configuration** tab of the **Calibration** menu contains probe-specific configuration options and the environmental compensation options.

Note that the probe configuration options available in this view are not always necessary for use with Indigo. For example, the **Communication** options shown in the following CO<sub>2</sub> probe example apply only to the probe's own communication settings. The communication settings of the Indigo transmitter are configured in a separate menu.

Similarly, the analog output settings shown here apply only for the probe's analog output channels, which are not used when the probe is connected to an Indigo transmitter that has its own output channels and settings.

The information shown in this tab is probe-specific: the example here shows the configuration view for a CO<sub>2</sub> probe.

The screenshot displays the Vaisala Calibration Configuration interface. On the left, a sidebar contains 'Measurements', 'Status', 'Calibration', and 'Settings'. The main area is titled 'Calibration' and has sub-tabs for 'Calibration', 'Configuration', 'Diagnostics', and 'Measurements'. The 'Configuration' sub-tab is active, showing two sections: 'Communication' and 'Analog output 1'. The 'Communication' section includes input fields for Address (240), Bit rate (19200 b/s), Response delay (16 ms), Parity (None), and Stop bits (1), along with a 'Restart device' button. The 'Analog output 1' section includes input fields for Output mode (0...10 V), Output parameter (0), Scale low end (0.00), Scale high end (5000.00), and Error output (0.00 V).

Figure 31 Configuration Tab, CO<sub>2</sub> Probe Example

## 7.6 GMP252 Example: 2-point CO<sub>2</sub> Adjustment

To make a 2-point adjustment, you need a low reference and a high reference (select references that are near the low and high ends of your measurement range). Prepare the calibration references (for example, reference gases with known concentrations) before starting the adjustment.



Check the possible probe-specific adjustment limits and requirements for 2-point calibration (for example, the minimum difference between the low and high reference points) from the probe's documentation.

To make a 2-point adjustment (GMP252 ppmCO<sub>2</sub> example):

1. Connect to the wireless configuration interface and open the **Calibration** menu.

2. Start the calibration mode with the **Start calibration** button.



If you cannot enter configurations after selecting **Start calibration**, check that the calibration PIN code is in place in the **Settings > Probe** menu.

3. If you need to set environmental compensations, enable and set the required compensations on the **Configuration** tab.



Note that the environmental compensations you set on the **Configuration** tab and the compensations you set in the **Settings > Probe** menu are interconnected: the configuration set in either menu is applied to both.

4. Remove any possible previous adjustments by restoring the factory adjustment: select **Restore factory adjustment** for each parameter you are adjusting.

**CO2 adjustment**

Reference value, point 1

Measured value, point 1

Reference value, point 2

Measured value, point 2

5. Enter the calibration date and calibration information into the corresponding text fields.

**Calibration information**

Calibration date

Calibration text

6. Place the probe in the first reference environment (adjustment point 1) and wait until the measurement has stabilized. You can follow the stabilization from the **Measurements** tab.
7. Enter the value of the first reference (for example, **0** if calibrating with a 0 ppmCO<sub>2</sub> reference gas) into the **Reference value, point 1** field.
8. After you enter the reference value, the value of the **Measured value, point 1** field updates automatically.

9. Place the probe in the second reference environment (adjustment point 2) and wait until the measurement has stabilized.
10. Enter the value of the second reference (for example, **2000** if calibrating with a 2000 ppmCO<sub>2</sub> reference gas) into the **Reference value, point 2** field.
11. When both reference points have been entered, select **Store adjustment** to save the adjustment.
12. Close the calibration mode with the **Stop calibration** button.
13. To check that the adjustment was carried out correctly, review the information in the **Adjustment data** fields at the bottom of the view.



# 8. Maintenance and Troubleshooting

## 8.1 Cleaning

You can clean the Indigo transmitter body by wiping it with a moist cloth. Standard cleaning agents can be used.



Refer to the probe-specific cleaning instructions when cleaning the probe connected to Indigo. Do not spray anything directly on the probe connected to Indigo, since that may deposit impurities on the sensor.

### Chemical tolerance

The following chemicals can be used to clean Indigo:

- H<sub>2</sub>O<sub>2</sub> (6000 ppm), non-condensing
- Alcohol-based cleaning agents such as ethanol and IPA (70 % Isopropyl Alcohol, 30 % water)
- CaOCl (hypochlorite) max. 0.5 %
- QAC (quaternary ammonium cations) max. 0.5 %



Avoid exposing the transmitter to chemicals for unnecessarily long periods of time. Do not immerse it in a chemical, and wipe chemicals off the surfaces after cleaning.

## 8.2 Indigo Wireless Connection Troubleshooting

Problem	Possible Cause	Remedy
The wireless device has connected to the Indigo access point, but the configuration interface does not launch.	The device you are using to connect to Indigo does not launch the browser automatically after connecting to the access point.	After connecting to Indigo, open your browser application.
	The wireless connection requires an authentication or acknowledgement before the Indigo interface opens in your browser.	Check your device's notifications to see if an authentication or login prompt is present for the Indigo connection. Acknowledge the connection and open your browser application if the interface does not launch automatically.

Problem	Possible Cause	Remedy
The Indigo access point does not show up in your device's list of available WLAN connections.	Indigo access point is not enabled or an error is has occurred.	Switch off the Indigo WLAN connection, enable the connection again and retry.
	Your device is too far from the transmitter or obstacles are blocking the signal.	Move closer to the transmitter and refresh your device's access point list.
Indigo shows up in the list of available wireless connections, but connecting to it does not work.	A device is already connected to the Indigo access point.	Ensure that your device is the only one that is connecting to the wireless configuration interface.
The interface does not open in the browser.	The browser has issues with loading the landing page.	Enter the default Indigo IP address <b>http://192.168.1.1</b> in the browser's address bar.
Cannot connect to the Indigo access point with iPhone or tablet.	The tablet's or iPhone's WLAN settings (for example, auto-login) prevent establishing a connection.	See the instructions in <a href="#">Additional WLAN Settings when Connecting to Indigo (page 66)</a> .
Indigo does not respond when pressing the wireless connection activation button.	WLAN functionality has been disabled with the WLAN ON/OFF DIP switch on Indigo's circuit board.	Enable WLAN functionality with the WLAN ON/OFF DIP switch.

### 8.3 Additional WLAN Settings when Connecting to Indigo

When you are connecting to Indigo's wireless configuration interface with certain tablet models or cellphones (for example, iPhone), it may be necessary to change your device's WLAN settings. The following notification is shown on your device when additional steps are required:



Figure 32 Additional Steps Needed to Connect Notification



Depending on the current settings in your mobile device, you can connect to Indigo by either disabling the **Auto-Login** feature or with the **Use Without Internet** option (iPhone example).

### 8.3.1 Connection Option 1: Use Without Internet (iPhone example)

Activate Indigo's wireless (WLAN) configuration interface with the button on the bottom of the transmitter and select Indigo from your phone's list of available WLAN connections.

To connect to Indigo's wireless configuration interface using the **Use Without Internet** option:

1. When the notification about additional steps being required is shown, select **Cancel**.



If selecting **Cancel** returns you to the list of available WLAN connections, select Indigo from the list and then select **Cancel** again in the notification screen.

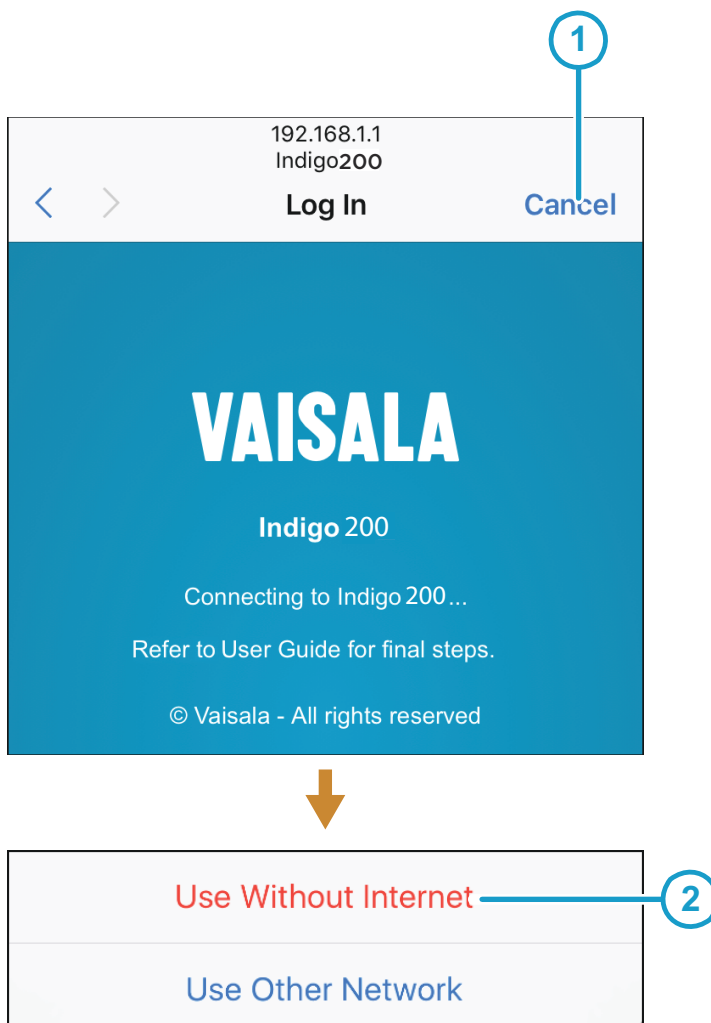

2. In the next dialog, select **Use Without Internet**.
3. Open you browser application (for example, Safari).
4. If the Indigo login screen does not launch automatically when you open your browser, enter Indigo's default IP address **192.168.1.1** in the browser's address bar.

### 8.3.2 Connection Option 2: Disable Auto-Login (iPhone Example)

To connect to Indigo's wireless configuration interface by disabling the auto-login feature (iPhone example):

- ▶ 1. Press the wireless configuration interface activation button on the bottom of the Indigo transmitter.
2. When Indigo's wireless connection has activated, find Indigo from your device's list of available WLAN connections. Select the info icon next to Indigo.

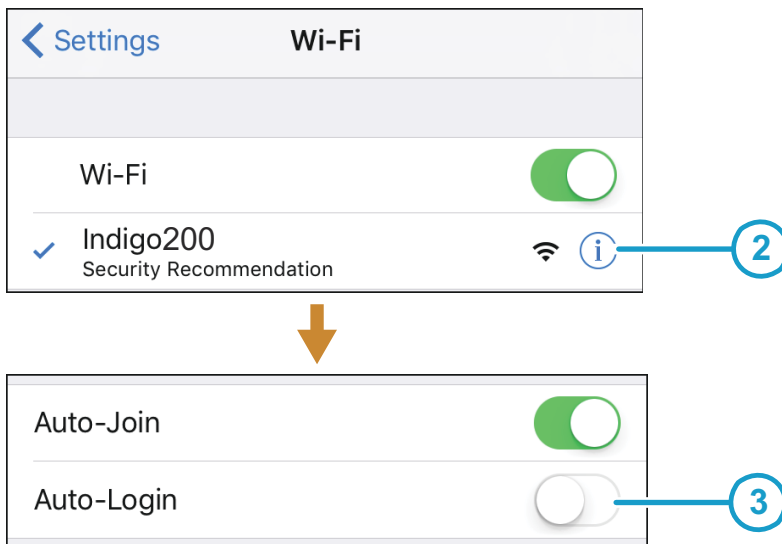

3. In the next menu view, disable the **Auto-Login** feature.
4. Return to the list of WLAN connections and select Indigo.
5. Open you browser application (for example, Safari).
6. If the Indigo login screen does not launch automatically when you open your browser, enter Indigo's default IP address **192.168.1.1** in the browser's address bar.

## 8.4 Display Messages

The following table lists the display messages that Indigo 201 uses to inform you about the transmitter's state.

In addition to the Indigo transmitter messages, the connected probes have probe-specific messages that are also shown on the display. Messages from the connected probe start with **Probe:**. For more information on the probe-specific messages, see the probe's documentation.

Table 5 Indigo Transmitter Messages Shown on Display

Display Message	Description	Recommended Action
<b>Errors</b>		
<b>Low supply voltage</b>	The supply voltage is below the minimum (range: 15 ... 30 VDC or 24 VAC +/-10% 50/60Hz).	The error clears when the supply voltage returns to the specified range. Check your power supply and restart Indigo if needed.
<b>No legal measurement probe</b>	The connected probe is not compatible with Indigo or a restriction (probe name or serial number) on allowed probes is in place.	Check your probe's Indigo compatibility and possible restrictions on allowed probes.
<b>Analog output 1 out of range</b>	The output of analog output 1 has gone out of range.	The error clears when the output returns to range. Check the analog output configuration.
<b>Analog output 2 out of range</b>	See above	See above
<b>Analog output 3 out of range</b>	See above	See above
<b>WLAN error</b>	There is a problem with the wireless connection.	Go through the troubleshooting instructions in <a href="#">Indigo Wireless Connection Troubleshooting (page 65)</a> .
<b>Warnings</b>		
<b>Outputs configured for different probe</b>	An analog output configuration already exists in Indigo, and the settings cannot be received automatically from the probe you are connecting.	Configure the analog output settings for the new probe manually, or reset the analog output settings in Indigo to enable automatic receiving of analog output settings.
<b>No measurement probe</b>	The measurement probe is not connected, or the probe is connected poorly and cannot be recognized by Indigo.	Check that you have fastened the probe correctly with the locking wheel.
<b>Notifications</b>		
<b>Probe connected:</b>	Indigo displays the name of the connected probe.	
<b>WLAN on</b>	The WLAN connection is active and you can connect to the wireless configuration interface.	
<b>Waiting for measurements</b>	The connected probe is preparing measurements (for example, at start-up or after a probe restart).	

Display Message	Description	Recommended Action
<b>Unable to measure all quantities</b>	Some of the measurements you have configured to be displayed are currently not available. This can be caused, for example, by the probe heating feature: parameters that are affected by heating cannot be shown while the heating cycle is ongoing.	

**More Information**

- [Analog Output Configuration Overview \(page 45\)](#)
- [Receiving Analog Output Settings from Probe \(page 16\)](#)
- [Measurement Reading Locked \(page 13\)](#)

# 9. Technical Data

## 9.1 Specifications

Table 6 Inputs and Outputs

Property	Specification
Analog outputs	3 voltage (V) or current (mA) outputs: <ul style="list-style-type: none"> <li>• 0 ... 10 V / 0 ... 5 V / 0 ... 1 V / 1 ... 5 V (min. load 1k<math>\Omega</math>)</li> <li>• 0 ... 20 mA / 4 ... 20 mA (max. load 500 <math>\Omega</math>)</li> </ul>
Accuracy of analog outputs at +20 °C (+68 °F)	± 0.1 % full scale
Relays	2 configurable relays (VAC/VDC)
	Device maximum specification (resistive load): <ul style="list-style-type: none"> <li>• Max. switching power 30 W / 37.5 VA</li> </ul>
	UL-rated maximum specification (resistive load): <ul style="list-style-type: none"> <li>• AC: max. 28 V / 0.5 A</li> <li>• DC: max. 40 V / 0.24 A</li> <li>• Up to 30 VDC:               <ul style="list-style-type: none"> <li>• max. switching current 1 A</li> <li>• max. switching power 30 W</li> </ul> </li> </ul>
Power supply input <sup>1)</sup>	Range 15 ... 30 VDC (24 VAC +/-10% 50/60Hz) <sup>2)</sup>
Maximum current	Transmitter and connected probe max. 1 A
Power consumption	Transmitter max. 3 W (+ connected probe, varies depending on probe type)
Probe connector	M12/5 connector for probe or probe cable connection (Vaisala Indigo-compatible probes)
Cable feed throughs	2 options: rubber lead-through on the bottom of the transmitter, and opening with a seal at the back of the transmitter
Screw terminal wire size	0.2 ... 1.5 mm <sup>2</sup>

1) Using a power supply with overload protection is recommended for electrical safety.

2) Depending on the production date of your transmitter, the power supply input voltage specification can be either 15 ... 30 VDC (20 ... 22 VAC) or 15 ... 30 VDC (24 VAC +/-10%). Check the type label on the back of the transmitter for information specific to your device.

Table 7 General

Display (optional)	3.5" TFT LCD color display
--------------------	----------------------------

Configuration interface	Browser-based wireless configuration interface (IEEE 802.11 b/g/n WLAN)
Wireless configuration interface browser support	<ul style="list-style-type: none"> <li>• Microsoft Internet Explorer: version 11.0 onward</li> <li>• Google Chrome: version 57 onward</li> <li>• Mozilla Firefox: version 50 onward</li> <li>• Apple Safari: version 10 onward</li> </ul>

Table 8 Standards and Compliance

Property	Specification
Safety standard	IEC/UL/EN 61010-1
Networking standards (wireless configuration interface WLAN access point)	IEEE 802.11 b/g/n compliant
Electromagnetic compatibility	Complies with EMC standard <i>EN61326-1 Generic Environment</i>
Contains	FCC ID QOQ-WGM110 IC 5123A-WGM110
当該機器には電波法に基づく、技術基準適合証明等を受けた特定無線設備を装着している。	 209-J00197
CMIIT ID	2017DJ3476

Table 9 Wireless Access Point (Module With Internal Chip Antenna)

Property	Specification
Networking standards	IEEE 802.11 b/g/n
Data rates	802.11 b: 1, 2, 5.5, 11 Mbps 802.11 g: 6, 9, 12, 18 Mbps
Frequency band	2402 - 2480 MHz
Modulation	802.11b: DSSS (CCK-11, CCK-5.5, DQPSK-2, DBPSK-1) 802.11g: OFDM Wi-Fi
Security	WEP (128-bit), WPA, WPA2 (Personal)
Output power	+16 dBm
Receiver sensitivity	-85 dBm typical

Table 10 Operating and Storage Environment

Property	Specification
Operating temperature range	Model without display: -40 ... + 60 °C (-40 ... + 140 °F) Model with display: -20 ... + 60 °C (-4 ... + 140 °F)
Storage temperature range	-40 ... +70 °C (-40 ... 158 °F)

Property	Specification
Operating humidity range	0 ... 100 %RH (non-condensing)
Chemical tolerance	Temporary exposure during cleaning: <ul style="list-style-type: none"> <li>• H<sub>2</sub>O<sub>2</sub> (6000 ppm, non-condensing)</li> <li>• Alcohol-based cleaning agents such as ethanol and IPA (max. 70 % concentrate)</li> <li>• CaOCl (hypochlorite) max. 0.5 %</li> <li>• QAC (quaternary ammonium cations) max. 0.5 %</li> </ul>

Table 11 Mechanics

Property	Specification
Housing classification	IP65
Housing color	White (RAL9003)
Housing material	PC/ABS plastic
Display window material	PMMA plastic
Connection screw terminals	26 AWG ... 20 AWG
Plastic material flammability (UL rating)	UL94 HB
Weight	402 g (14.18 oz)
Dimensions (H×W×D)	149×135×43 mm (5.87×5.31×1.7 in)
Input/output cable recommended diameter (with cable gland strain relief)	7 ... 8 mm (0.25 ... 0.31 in)

## 9.2 Spare Parts and Accessories



Information on spare parts, accessories, and calibration products is available online at [www.vaisala.com](http://www.vaisala.com) and [store.vaisala.com](http://store.vaisala.com).

Table 12 Spare Parts and Accessories

Description	Order Code
Probe connection cable, 1 m	INDIGOCABLE1M
Probe connection cable, 3 m	INDIGOCABLE3M
Probe connection cable, 5 m	INDIGOCABLE5M
Probe connection cable, 10 m	INDIGOCABLE10M

## 9.3 Dimensions

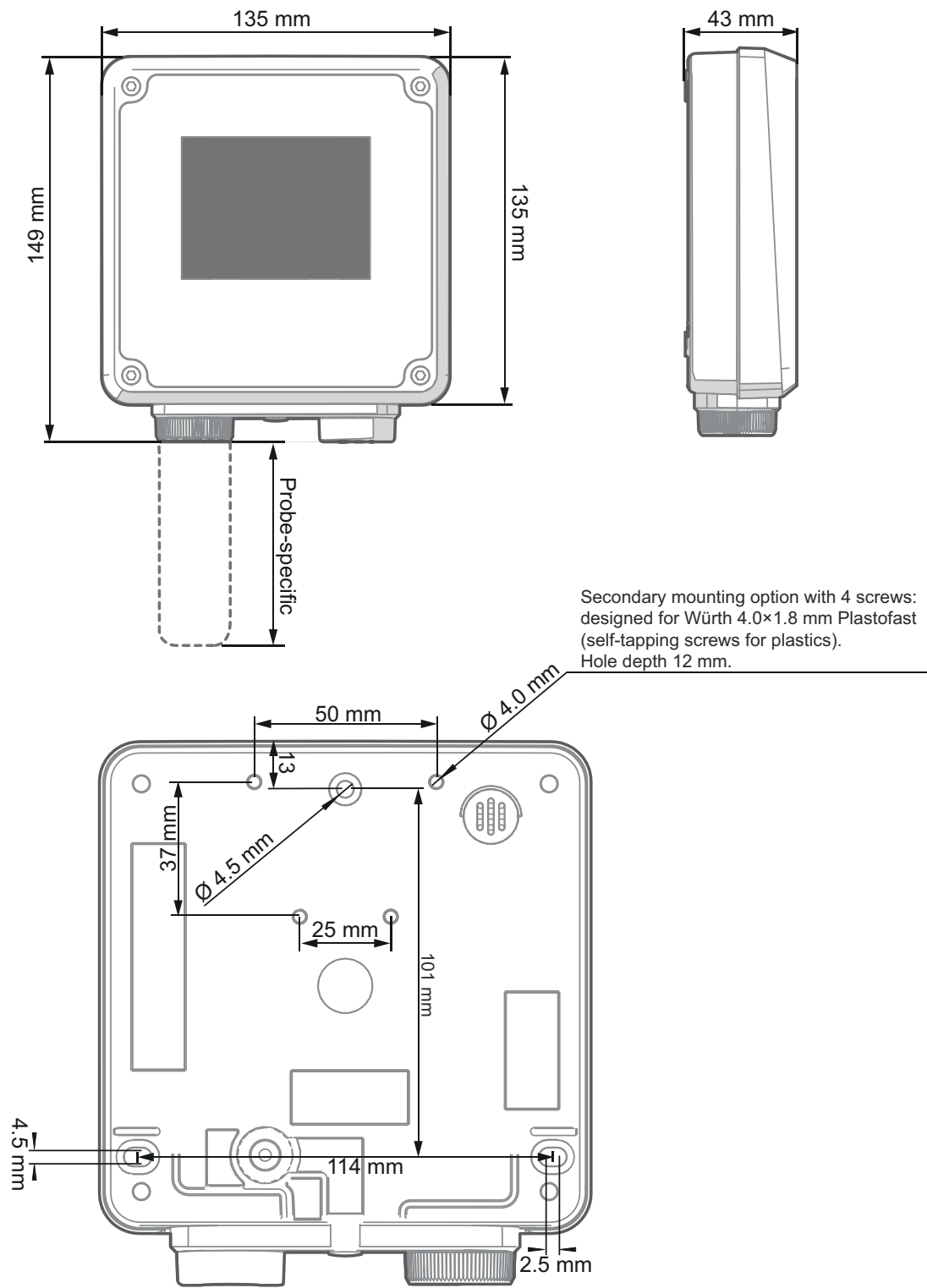

Figure 33 Indigo Transmitter Dimensions in Millimeters (mm)







# EU Declaration of Conformity

**BG:** С настоящото Vaisala Oyj декларира, че този тип радиосъоръжение Indigo 201 е в съответствие с Директива 2014/53/ЕС. Цялостният текст на ЕС декларацията за съответствие може да се намери на следния интернет адрес: [www.vaisala.com/declarationofconformity](http://www.vaisala.com/declarationofconformity)

**CS:** Tímto Vaisala Oyj prohlašuje, že typ rádiového zařízení Indigo 201 je v souladu se směrnicí 2014/53/EU. Úplné znění EU prohlášení o shodě je k dispozici na této internetové adrese: [www.vaisala.com/declarationofconformity](http://www.vaisala.com/declarationofconformity)

**DA:** Hermed erklærer Vaisala Oyj , at radioudstyrstypen Indigo 201 er i overensstemmelse med direktiv 2014/53/EU. EU-overensstemmelseserklæringens fulde tekst kan findes på følgende internetadresse: [www.vaisala.com/declarationofconformity](http://www.vaisala.com/declarationofconformity)

**DE:** Hiermit erklärt Vaisala Oyj , dass der Funkanlagentyp Indigo 201 der Richtlinie 2014/53/EU entspricht. Der vollständige Text der EU-Konformitätserklärung ist unter der folgenden Internetadresse verfügbar: [www.vaisala.com/declarationofconformity](http://www.vaisala.com/declarationofconformity)

**EL:** Με την παρούσα ο/η Vaisala Oyj , δηλώνει ότι ο ραδιοεξοπλισμός Indigo 201 πληροί την οδηγία 2014/53/ΕΕ. Το πλήρες κείμενο της δήλωσης συμμόρφωσης ΕΕ διατίθεται στην ακόλουθη ιστοσελίδα στο διαδίκτυο: [www.vaisala.com/declarationofconformity](http://www.vaisala.com/declarationofconformity)

**EN:** Hereby, Vaisala Oyj declares that the radio equipment type Indigo 201 is in compliance with Directive 2014/53/EU. The full text of the EU declaration of conformity is available at the following internet address: [www.vaisala.com/declarationofconformity](http://www.vaisala.com/declarationofconformity)

**ES:** Por la presente, Vaisala Oyj declara que el tipo de equipo radioeléctrico Indigo 201 es conforme con la Directiva 2014/53/UE. El texto completo de la declaración UE de conformidad está disponible en la dirección Internet siguiente: [www.vaisala.com/declarationofconformity](http://www.vaisala.com/declarationofconformity)

**ET:** Käesolevaga deklareerib Vaisala Oyj , et käesolev raadioseadme tüüp Indigo 201 vastab direktiivi 2014/53/EL nõuetele. ELi vastavusdeklaratsiooni täielik tekst on kättesaadav järgmisel internetiaadressil: [www.vaisala.com/declarationofconformity](http://www.vaisala.com/declarationofconformity)

**FI:** Vaisala Oyj vakuuttaa, että radiolaitetyyppi Indigo 201 on direktiivin 2014/53/EU mukainen. EU-vaatimustenmukaisuusvakuutuksen täysimittainen teksti on saatavilla seuraavassa internetosoitteessa: [www.vaisala.com/declarationofconformity](http://www.vaisala.com/declarationofconformity)

**FR:** Le soussigné, Vaisala Oyj , déclare que l'équipement radioélectrique du type Indigo 201 est conforme à la directive 2014/53/UE. Le texte complet de la déclaration UE de conformité est disponible à l'adresse internet suivante: [www.vaisala.com/declarationofconformity](http://www.vaisala.com/declarationofconformity)

**HR:** Vaisala Oyj ovime izjavljuje da je radijska oprema tipa Indigo 201 u skladu s Direktivom 2014/53/EU. Cjeloviti tekst EU izjave o sukladnosti dostupan je na sljedećoj internetskoj adresi: [www.vaisala.com/declarationofconformity](http://www.vaisala.com/declarationofconformity)

**HU:** Vaisala Oyj igazolja, hogy a Indigo 201 típusú rádióberendezés megfelel a 2014/53/EU irányelvnek. Az EU-megfelelőségi nyilatkozat teljes szövege elérhető a következő internetes címen: [www.vaisala.com/declarationofconformity](http://www.vaisala.com/declarationofconformity)

**IT:** Il fabbricante, Vaisala Oyj , dichiara che il tipo di apparecchiatura radio Indigo 201 è conforme alla direttiva 2014/53/UE. Il testo completo della dichiarazione di conformità UE è disponibile al seguente indirizzo Internet: [www.vaisala.com/declarationofconformity](http://www.vaisala.com/declarationofconformity)

**LT:** Aš, Vaisala Oyj, patvirtinu, kad radijo įrenginių tipas Indigo 201 atitinka Direktyvą 2014/53/ES. Visas ES atitikties deklaracijos tekstas prieinamas šiuo interneto adresu: [www.vaisala.com/declarationofconformity](http://www.vaisala.com/declarationofconformity)

**LV:** Ar šo Vaisala Oyj deklarē, ka radioiekārta Indigo 201 atbilst Direktīvai 2014/53/ES. Pilns ES atbilstības deklarācijas teksts ir pieejams šādā interneta vietnē: [www.vaisala.com/declarationofconformity](http://www.vaisala.com/declarationofconformity)

**MT:** B'dan, Vaisala Oyj, niddikjara li dan it-tip ta' tagħmir tar-radju Indigo 201 huwa konformi mad-Direttiva 2014/53/UE. It-test kollu tad-dikjarazzjoni ta' konformità tal-UE huwa disponibbli f'dan l-indirizz tal-Internet li ġej: [www.vaisala.com/declarationofconformity](http://www.vaisala.com/declarationofconformity)

**NL:** Hierbij verklaar ik, Vaisala Oyj, dat het type radioapparatuur Indigo 201 conform is met Richtlijn 2014/53/EU. De volledige tekst van de EU-conformiteitsverklaring kan worden geraadpleegd op het volgende internetadres: [www.vaisala.com/declarationofconformity](http://www.vaisala.com/declarationofconformity)

**PL:** Vaisala Oyj niniejszym oświadcza, że typ urządzenia radiowego Indigo 201 jest zgodny z dyrektywą 2014/53/UE. Pełny tekst deklaracji zgodności UE jest dostępny pod następującym adresem internetowym: [www.vaisala.com/declarationofconformity](http://www.vaisala.com/declarationofconformity)

**PT:** O(a) abaixo assinado(a) Vaisala Oyj declara que o presente tipo de equipamento de rádio Indigo 201 está em conformidade com a Diretiva 2014/53/UE. O texto integral da declaração de conformidade está disponível no seguinte endereço de Internet: [www.vaisala.com/declarationofconformity](http://www.vaisala.com/declarationofconformity)

**RO:** Prin prezenta, Vaisala Oyj declară că tipul de echipamente radio Indigo 201 este în conformitate cu Directiva 2014/53/UE. Textul integral al declarației UE de conformitate este disponibil la următoarea adresă internet: [www.vaisala.com/declarationofconformity](http://www.vaisala.com/declarationofconformity)

**SK:** Vaisala Oyj týmto vyhlasuje, že rádiové zariadenie typu Indigo 201 je v súlade so smernicou 2014/53/EÚ. Úplné EÚ vyhlásenie o zhode je k dispozícii na tejto internetovej adrese: [www.vaisala.com/declarationofconformity](http://www.vaisala.com/declarationofconformity)

**SL:** Vaisala Oyj potrjuje, da je tip radijske opreme Indigo 201 skladen z Direktivo 2014/53/EU. Celotno besedilo izjave EU o skladnosti je na voljo na naslednjem spletnem naslovu: [www.vaisala.com/declarationofconformity](http://www.vaisala.com/declarationofconformity)

**SV:** Härmed försäkrar Vaisala Oyj att denna typ av radioutrustning Indigo 201 överensstämmer med direktiv 2014/53/EU. Den fullständiga texten till EU-försäkran om överensstämmelse finns på följande webbadress: [www.vaisala.com/declarationofconformity](http://www.vaisala.com/declarationofconformity)

## Warranty

For standard warranty terms and conditions, see [www.vaisala.com/warranty](http://www.vaisala.com/warranty).

Please observe that any such warranty may not be valid in case of damage due to normal wear and tear, exceptional operating conditions, negligent handling or installation, or unauthorized modifications. Please see the applicable supply contract or Conditions of Sale for details of the warranty for each product.

# Technical Support



Contact Vaisala technical support at [helpdesk@vaisala.com](mailto:helpdesk@vaisala.com). Provide at least the following supporting information:

- Product name, model, and serial number
- Name and location of the installation site
- Name and contact information of a technical person who can provide further information on the problem

For more information, see [www.vaisala.com/support](http://www.vaisala.com/support).

# Recycling



Recycle all applicable material.



Follow the statutory regulations for disposing of the product and packaging.





# VAISALA

[www.vaisala.com](http://www.vaisala.com)

