

OWNER'S MANUAL

Operation
Maintenance
Specifications

All information in this Owner's Manual is current at the time of publication. However, HYUNDAI reserves the right to make changes at any time so that our policy of continual product improvement may be carried out.

This manual applies to all HYUNDAI models and includes descriptions and explanations of optional as well as standard equipment. As a result, you may find material in this manual that does not apply to your specific vehicle.

CAUTION: MODIFICATIONS TO YOUR HYUNDAI

Your HYUNDAI should not be modified in any way. Such modifications may adversely affect the performance, safety or durability of your HYUNDAI and may, in addition, violate conditions of the limited warranties covering the vehicle. Certain modifications may also be in violation of regulations established by the U.S. Department of Transportation and other federal or state agencies.

TWO-WAY RADIO OR CELLULAR TELEPHONE INSTALLATION

Your vehicle is equipped with electronic fuel injection and other electronic components. It is possible for an improperly installed/adjusted two-way radio or cellular telephone to adversely affect electronic systems. For this reason, we recommend that you carefully follow the radio manufacturer's instructions or consult your HYUNDAI dealer for precautionary measures or special instructions if you choose to install one of these devices.

SAFETY AND VEHICLE DAMAGE WARNING

This manual includes information titled as DANGER, WARNING, CAUTION and NOTICE.

These titles indicate the following:

DANGER

DANGER indicates a hazardous situation which, if not avoided, will result in death or serious injury.

WARNING

WARNING indicates a hazardous situation which, if not avoided, could result in death or serious injury.

CAUTION

CAUTION indicates a hazardous situation which, if not avoided, could result in minor or moderate injury.

NOTICE

NOTICE indicates a situation which, if not avoided, could result in vehicle damage.

HYUNDAI VEHICLE OWNER PRIVACY POLICY

Your Hyundai vehicle may be equipped with technologies and services that use information collected, generated, recorded or stored by the vehicle. Hyundai has created a Vehicle Owner Privacy Policy to explain how these technologies and services collect use and share this information.

You may read our Vehicle Owner Privacy Policy on the Hyundaiusa.com website at:
<https://www.hyundaiusa.com/owner-privacy-policy.aspx>

If you would like to receive a hard copy of our Vehicle Owner Privacy Policy, please contact our Customer Connect Center at:

Hyundai Customer Care
P.O. Box 20850
Fountain Valley, CA 92728
800-633-5151
consumeraffairs@hmausa.com

Hyundai's Customer Connect Center representatives are available Monday through Friday, between the hours of 5:00 AM and 7:00 PM PST and Saturday and Sunday between 6:30 AM and 3:00 PM PST (English).

For Customer Connect Center assistance in Spanish or Korean, representatives are available Monday through Friday between 6:30 AM and 3:00 PM PST.

INTRODUCTION

Congratulations, and thank you for choosing HYUNDAI. We are pleased to welcome you to the growing number of discerning people who drive HYUNDAs. We are very proud of the advanced engineering and high-quality construction of each HYUNDAI we build.

Your Owner's Manual will introduce you to the features and operation of your new HYUNDAI. To become familiar with your new HYUNDAI, so that you can fully enjoy it, read this Owner's Manual carefully before driving your new vehicle.

This manual contains important safety information and instructions intended to familiarize you with your vehicle's controls and safety features so you can safely operate your vehicle.

This manual also contains information on maintenance designed to enhance safe operation of the vehicle. It is recommended that all service and maintenance on your vehicle be performed by an authorized HYUNDAI dealer. HYUNDAI dealers are prepared to provide high-quality service, maintenance and any other assistance that may be required.

This Owner's Manual should be considered a permanent part of your vehicle, and should be kept in the vehicle so you can refer to it at any time. The manual should stay with the vehicle if you sell it to provide the next owner with important operating, safety and maintenance information.

HYUNDAI MOTOR AMERICA

CAUTION

Severe engine and transmission damage may result from the use of poor quality fuels and lubricants that do not meet HYUNDAI specifications. You must always use high quality fuels and lubricants that meet the specifications listed on Page 8-7 in the Vehicle Specifications section of the Owner's Manual.

Copyright 2020 HYUNDAI Motor America. All rights reserved. No part of this publication may be reproduced, stored in any retrieval system or transmitted in any form or by any means without the prior written permission of HYUNDAI Motor America.

GUIDE TO HYUNDAI GENUINE PARTS

1. What are HYUNDAI Genuine Parts?

HYUNDAI Genuine Parts are the same parts used by HYUNDAI Motor Company to manufacture vehicles. They are designed and tested for the optimum safety, performance, and reliability for our customers.

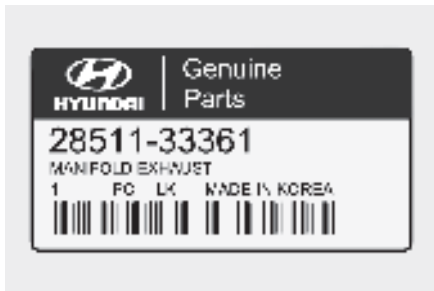

2. Why should you use genuine parts?

HYUNDAI Genuine Parts are engineered and built to meet rigid manufacturing requirements. Damage caused by using imitation, counterfeit or used salvage parts is not covered under the HYUNDAI New Vehicle Limited Warranty or any other HYUNDAI warranty.

In addition, any damage to or failure of HYUNDAI Genuine Parts caused by the installation or failure of an imitation, counterfeit or used salvage part is not covered by any HYUNDAI Warranty.

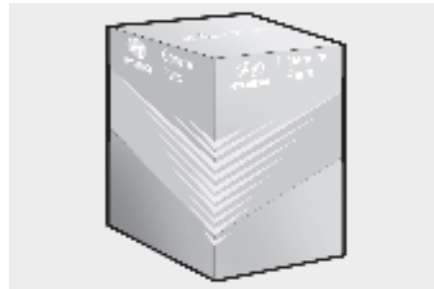

3. How can you tell if you are purchasing HYUNDAI Genuine Parts?

Look for the HYUNDAI Genuine Parts Logo on the package (see below).

HYUNDAI Genuine Parts exported to the U.S. are packaged with labels written only in English.

HYUNDAI Genuine Parts are only sold through authorized HYUNDAI Dealerships.

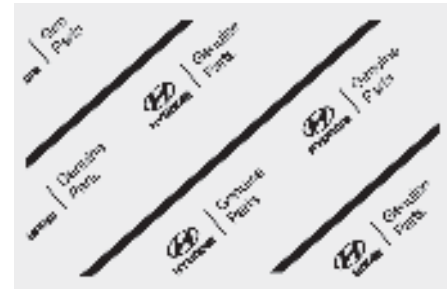

HOW TO USE THIS MANUAL

We want to help you get the greatest possible driving pleasure from your vehicle. Your Owner's Manual can assist you in many ways. To gain an overview of the contents of your Owner's Manual, use the Table of Contents in the front of the manual. The first page of each Chapter includes a detailed Table of Contents of the topics in that Chapter.

To quickly locate information about your vehicle, use the Index in the back of the manual. It is an alphabetical list of what is in this manual and the page number where it can be found.

For your convenience, we have incorporated tabs on the right-hand page edges. These tabs are coded with the Chapter titles to assist you with navigating through the manual.

SAFETY MESSAGES

Your safety, and the safety of others, is very important. This Owner's Manual provides you with many safety precautions and operating procedures. This information alerts you to potential hazards that may hurt you or others, as well as damage to your vehicle.

Safety messages found on vehicle labels and in this manual describe these hazards and what to do to avoid or reduce the risks.

Warnings and instructions contained in this manual are for your safety. Failure to follow safety warnings and instructions can lead to serious injury or death.

Throughout this manual DANGER, WARNING, CAUTION, NOTICE and the SAFETY ALERT SYMBOL will be used.



This is the safety alert symbol. It is used to alert you to potential physical injury hazards. Obey all safety messages that follow this symbol to avoid possible injury or death. The safety alert symbol precedes the signal words DANGER, WARNING and CAUTION.

DANGER

DANGER indicates a hazardous situation which, if not avoided, will result in death or serious injury.

WARNING

WARNING indicates a hazardous situation which, if not avoided, could result in death or serious injury.

CAUTION

CAUTION indicates a hazardous situation which, if not avoided, could result in minor or moderate injury.

NOTICE

NOTICE indicates a situation which, if not avoided, could result in vehicle damage.

FUEL REQUIREMENTS

Your new vehicle is designed to obtain maximum performance with UNLEADED FUEL, as well as minimize exhaust emissions and spark plug fouling.

Your new vehicle is designed to perform optimally using premium unleaded fuel having an octane number $((R+M)/2)$ of 91 (Research Octane Number 95) or higher. (Do not use methanol blended fuels)

NOTICE

Using unleaded gasoline that is lower than octane number $((R+M)/2)$ of 91 (Research Octane Number 95) could result in reduced engine power and increased fuel consumption.

NOTICE

To prevent damage to the engine and engine components, never add any fuel system cleaning agents to the fuel tank other than what has been specified.

Consult an authorized HYUNDAI dealer for additional information.

WARNING

- **Do not "top off" after the nozzle automatically shuts off when refueling.**
- **Always check that the fuel cap is installed securely to prevent fuel spillage in the event of an accident.**

Gasoline containing alcohol or methanol

Gasohol, a mixture of gasoline and ethanol (also known as grain alcohol) are being marketed along with or instead of leaded or unleaded gasoline. For example, "E15" is a gasohol comprised of 15% ethanol and 85% gasoline.

Do not use gasohol containing more than 15% ethanol, and do not use gasoline or gasohol containing any methanol. Either of these fuels may cause drivability problems and damage to the fuel system, engine control system and emission control system.

Discontinue using gasohol of any kind if drivability problems occur.

"E85" fuel is an alternative fuel comprised of 85 percent ethanol and 15 percent gasoline, and is manufactured exclusively for use in Flexible Fuel Vehicles. "E85" is not compatible with your vehicle. Use of "E85" may result in poor engine performance and damage to your vehicle's engine and fuel system. HYUNDAI recommends that customers do not use fuel with an ethanol content exceeding 15 percent.

NOTICE

To prevent damage to your vehicle's engine and fuel system:

- **Never use gasohol which contains methanol.**
- **Never use gasohol containing more than 15% ethanol.**
- **Never use leaded fuel or leaded gasohol.**
- **Never use "E85" fuel.**

Your New Vehicle Limited Warranty does not cover damage to the fuel system or any performance problems caused by the use of "E85" fuel.

Using Fuel Additives (except Detergent Fuel Additives)

Using fuel additives such as:

- Silicone fuel additive
 - Ferrocene (iron-based) fuel additive
 - Other metallic-based fuel additives
- may result in cylinder misfire, poor acceleration, engine stalling, damage to the catalyst, or abnormal corrosion, and may cause damage to the engine resulting in a reduction in the overall life of the powertrain.
- The Malfunction Indicator Lamp (MIL) may illuminate.

NOTICE

Damage to the fuel system or performance problem caused by the use of these fuels or fuel additives may not be covered by your New Vehicle Limited Warranty.

Gasoline containing MMT

Some gasoline contains harmful manganese-based fuel additives such as MMT (Methylcyclopentadienyl Manganese Tricarbonyl).

HYUNDAI does not recommend the use of gasoline containing MMT.

This type of fuel can reduce vehicle performance and affect your emission control system.

The malfunction indicator lamp on the cluster may come on.

Detergent Fuel Additives

HYUNDAI recommends that you use good quality gasolines treated with detergent additives such as TOP TIER Detergent Gasoline, which help prevent deposit formation in the engine. These gasolines will help the engine run cleaner and enhance performance of the Emission Control System. For more details on TOP TIER Detergent Gasoline, please go to the website (www.toptiergas.com).

For customers who do not use TOP Tier Detergent Gasoline regularly, and have problems starting or the engine does not run smoothly, detergent-based fuel additives that you can purchase separately may be added to the gasoline. If TOP TIER Detergent Gasoline is not available, one bottle of additive added to the fuel tank according to the maintenance schedule is recommended (refer to the Maintenance Schedule in chapter 7).

Additives are available from your authorized HYUNDAI dealer along with information on how to use them. Do not mix other additives.

Operation in foreign countries

If you are going to drive your vehicle in another country, be sure to:

- Observe all regulations regarding registration and insurance.
- Determine that acceptable fuel is available.

VEHICLE MODIFICATIONS

- This vehicle should not be modified. Modification of your vehicle could affect its performance, safety or durability and may even violate governmental safety and emissions regulations.

In addition, damage or performance problems resulting from any modification may not be covered under warranty.

- If you use unauthorized electronic devices, it may cause the vehicle to operate abnormally, wire damage, battery discharge and fire. For your safety, do not use unauthorized electronic devices.

VEHICLE BREAK-IN PROCESS

By following a few simple precautions for the first 600 miles (1,000 km) you may add to the performance, economy and life of your vehicle.

- Do not race the engine.
- While driving, keep your engine speed (rpm, or revolutions per minute) between 2,000 rpm and 4,000 rpm.
- Do not maintain a single speed for long periods of time, either fast or slow. Varying engine speed is needed to properly break-in the engine.
- Avoid hard stops, except in emergencies, to allow the brakes to seat properly.
- Do not use Launch Control during the break-in process.

 **WARNING**

**CALIFORNIA PROPOSITION 65
WARNING**

Items contained in motor vehicles or emitted from them are known to the State of California to cause cancer and birth defects or reproductive harm. These include:

- Gasoline and its vapors
- Engine exhaust
- Used engine oil
- Interior passenger compartment components and materials
- Component parts which are subject to heat and wear

In addition, battery posts, terminals and related accessories contain lead, lead compounds and other chemicals known to the State of California to cause cancer and reproductive harm.

VEHICLE DATA COLLECTION AND EVENT DATA RECORDERS

This vehicle is equipped with an event data recorder (EDR). The main purpose of an EDR is to record, in certain crash or near crash-like situations, such as an air bag deployment or hitting a road obstacle, data that will assist in understanding how a vehicle's systems performed. The EDR is designed to record data related to vehicle dynamics and safety systems for a short period of time, typically 30 seconds or less. The EDR in this vehicle is designed to record such data as:

- How various systems in your vehicle were operating;
- Whether or not the driver and passenger safety belts were buckled/fastened;
- How far (if at all) the driver was depressing the accelerator and/or brake pedal; and,
- How fast the vehicle was traveling.

These data can help provide a better understanding of the circumstances in which crashes and injuries occur. **NOTE:** EDR data are recorded by your vehicle only if a non-trivial crash situation occurs; no data are recorded by the EDR under normal driving conditions and no personal data (e.g., name, gender, age, and crash location) are recorded. However, other parties, such as law enforcement, could combine the EDR data with the type of personally identifying data routinely acquired during a crash investigation.

To read data recorded by an EDR, special equipment is required, and access to the vehicle or the EDR is needed. In addition to the vehicle manufacturer, other parties, such as law enforcement, that have the special equipment, can read the information if they have access to the vehicle or the EDR.

TABLE OF CONTENTS

Your vehicle at a glance

1

Safety system of your vehicle

2

Convenient features of your vehicle

3

Infotainment System

4

Driving your vehicle

5

What to do in an emergency

6

Maintenance

7

Specifications, Consumer Information and Reporting Safety Defects

8

Index

I

Your vehicle at a glance

Exterior Overview	1-2
Interior Overview	1-4
Instrument Panel Overview	1-5
Engine Compartment	1-6

EXTERIOR OVERVIEW

■ Front view



The actual shape may differ from the illustration.

1. Hood	3-25	5. Tires and wheels	7-32
2. Headlamp	3-68, 7-63	6. Side view mirror	3-18
3. Daytime running light (DRL).....	3-72	7. Wiper blade	7-26
4. Turn signal lamp	7-64	8. Windows	3-21

OBU018001N

■ Rear view

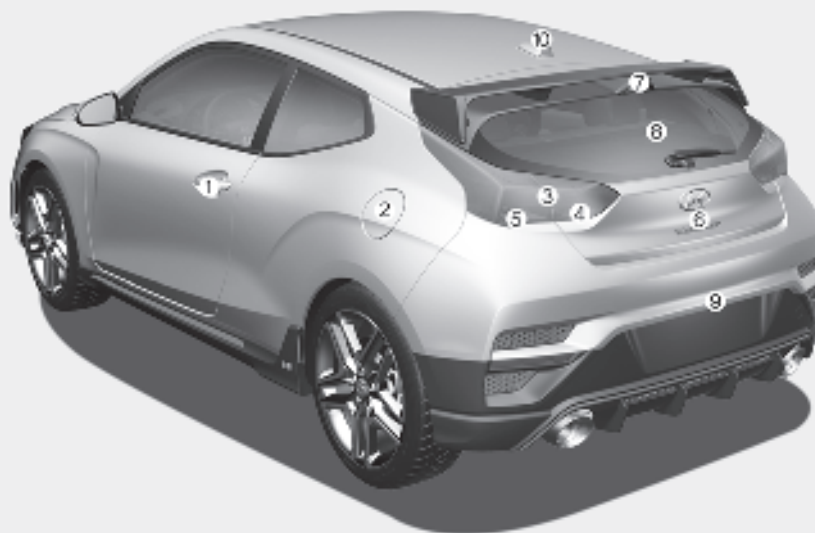

The actual shape may differ from the illustration.

1. Door	3-10	6. Liftgate	3-26
2. Fuel filler door	3-28	7. High mounted stop lamp	7-68
3. Rear combination lamp	7-65	8. Defroster.....	3-101
4. Back-up lamp	7-67	9. Rear view camera	3-82
5. Turn signal lamp	7-66	10. Antenna	4-2

OBU018002N

INTERIOR OVERVIEW

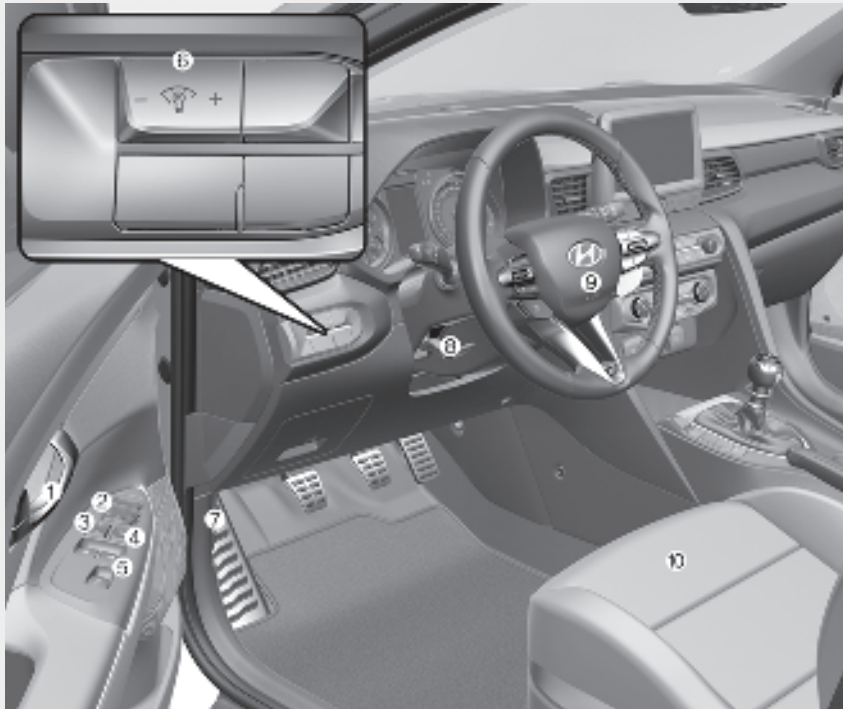

1. Inside door handle	3-11
2. Side view mirror control	3-19
3. Central door lock switch	3-11
4. Power window lock switch.....	3-24
5. Power window switches	3-22
6. Instrument panel illumination control button	3-32
7. Hood release lever	3-25
8. Steering wheel tilt/telescopic lever	3-16
9. Steering wheel	3-15
10. Seat.....	2-3

The actual shape may differ from the illustration.

INSTRUMENT PANEL OVERVIEW

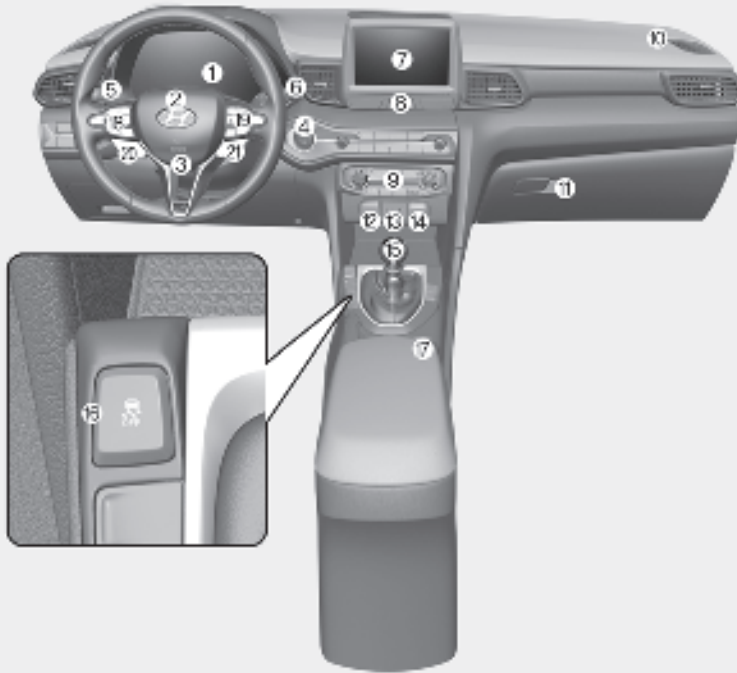

The actual shape may differ from the illustration.

1. Instrument cluster	3-31
2. Horn	3-16
3. Driver's front air bag	2-40
4. Engine Start/Stop button	5-6
5. Light control/Turn signals.....	3-68
6. Wiper/Washer	3-79
7. Display audio system	4-4
8. Hazard warning flasher switch.....	6-2
9. Manual climate control system/	3-83
Automatic climate control system	3-91
10. Passenger's front air bag.....	2-40
11. Glove box	3-105
12. Power outlet	3-108
13. AUX, USB and iPod® port	4-2
14. USB charger	3-109
15. Manual transmission shift lever	5-12
16. ESC OFF button	5-40
17. Cup holder	3-107
18. Steering wheel audio controls/	4-3
Bluetooth® wireless technology	
hands-free controls	4-4
19. Driving Assist button	5-103
20. DRIVE MODE button.....	5-49
21. N button	5-51

ENGINE COMPARTMENT

■ Gasoline Engine (2.0 T-GDI)

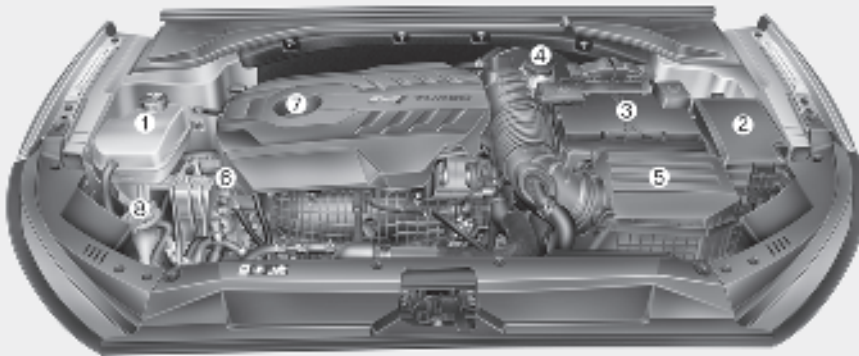

- 1. Engine coolant reservoir7-18
- 2. Fuse box7-47
- 3. Battery7-29
- 4. Brake/clutch fluid reservoir7-22
- 5. Air cleaner.....7-24
- 6. Engine oil dipstick7-16
- 7. Engine oil filler cap7-16
- 8. Windshield washer fluid reservoir7-23

The actual engine compartment in the vehicle may differ from the illustration.

OJSN078001

Safety system of your vehicle

This chapter provides you with important information about how to protect yourself and your passengers. It explains how to properly use your seats and seat belts, and how your air bags work. Additionally, this chapter explains how to properly restrain infants and children in your vehicle.

Important safety precautions	2-2	Child restraint system (CRS)	2-27
Always Wear Your Seat Belt	2-2	Children Always in the Rear	2-27
Restrain All Children	2-2	Selecting a Child Restraint System (CRS)	2-28
Air Bag Hazards.....	2-2	Installing a Child Restraint System (CRS).....	2-30
Driver Distraction	2-2	Air bag	
Control Your Speed.....	2-2	- advanced supplemental restraint system	2-38
Keep Your Vehicle in Safe Condition.....	2-2	Where Are the Air Bags?	2-40
Seats	2-3	How Does the Air Bag System Operate?.....	2-43
Safety Precautions	2-4	What to Expect After an Air Bag Inflates.....	2-48
Front Seats	2-5	Occupant Classification System (OCS).....	2-49
Rear Seats.....	2-8	Why Didn't My Air Bag Go Off in a Collision?	2-54
Head Restraints	2-10	SRS Care.....	2-59
Seat belts	2-14	Additional Safety Precautions	2-60
Seat Belt Safety Precautions.....	2-14	Air Bag Warning Labels.....	2-61
Seat Belt Warning Light	2-15		
Seat Belt Restraint System.....	2-17		
Additional Seat Belt Safety Precautions.....	2-23		
Care of Seat Belts.....	2-26		

IMPORTANT SAFETY PRECAUTIONS

You will find many safety precautions and recommendations throughout this section, and throughout this manual. The safety precautions in this section are among the most important.

Always Wear Your Seat Belt

A seat belt is your best protection in all types of accidents. Air bags are designed to supplement seat belts, not replace them. So even though your vehicle is equipped with air bags, **ALWAYS** make sure you and your passengers wear your seat belts, and wear them properly.

Restrain All Children

All children under age 13 should ride in your vehicle properly restrained in a rear seat, not the front seat. Infants and small children should be restrained in an appropriate child restraint. Larger children should use a booster seat with the lap/shoulder belt until they can use the seat belt properly without a booster seat.

Air Bag Hazards

While air bags can save lives, they can also cause serious or fatal injuries to occupants who sit too close to them, or who are not properly restrained. Infants, young children, and shorter adults are at the greatest risk of being injured by an inflating air bag. Follow all instructions and warnings in this manual.

Driver Distraction

Driver distraction presents a serious and potentially deadly danger, especially for inexperienced drivers. Safety should be the first concern when behind the wheel and drivers need to be aware of the wide array of potential distractions, such as drowsiness, reaching for objects, eating, personal grooming, other passengers, and using cellular phones.

Drivers can become distracted when they take their eyes and attention off the road or their hands off the wheel to focus on activities other than driving. To reduce your risk of distraction or getting into an accident:

- **ALWAYS** set up your mobile devices (i.e., MP3 players, phones, navigation units, etc.) when your vehicle is parked or safely stopped.

- **ONLY** use your mobile device when allowed by laws and when conditions permit safe use. **NEVER** text or email while driving. Most states have laws prohibiting drivers from texting. Some states and cities also prohibit drivers from using handheld phones.
- **NEVER** let the use of a mobile device distract you from driving. You have a responsibility to your passengers and others on the road to always drive safely, with your hands on the wheel as well as your eyes and attention on the road.

Control Your Speed

Excessive speed is a major factor in crash injuries and deaths. Generally, the higher the speed, the greater the risk, but serious injuries can also occur at lower speeds. Never drive faster than is safe for current conditions, regardless of the maximum speed posted.

Keep Your Vehicle in Safe Condition

Having a tire blowout or a mechanical failure can be extremely hazardous. To reduce the possibility of such problems, check your tire pressures and condition frequently, and perform all regularly scheduled maintenance.

SEATS

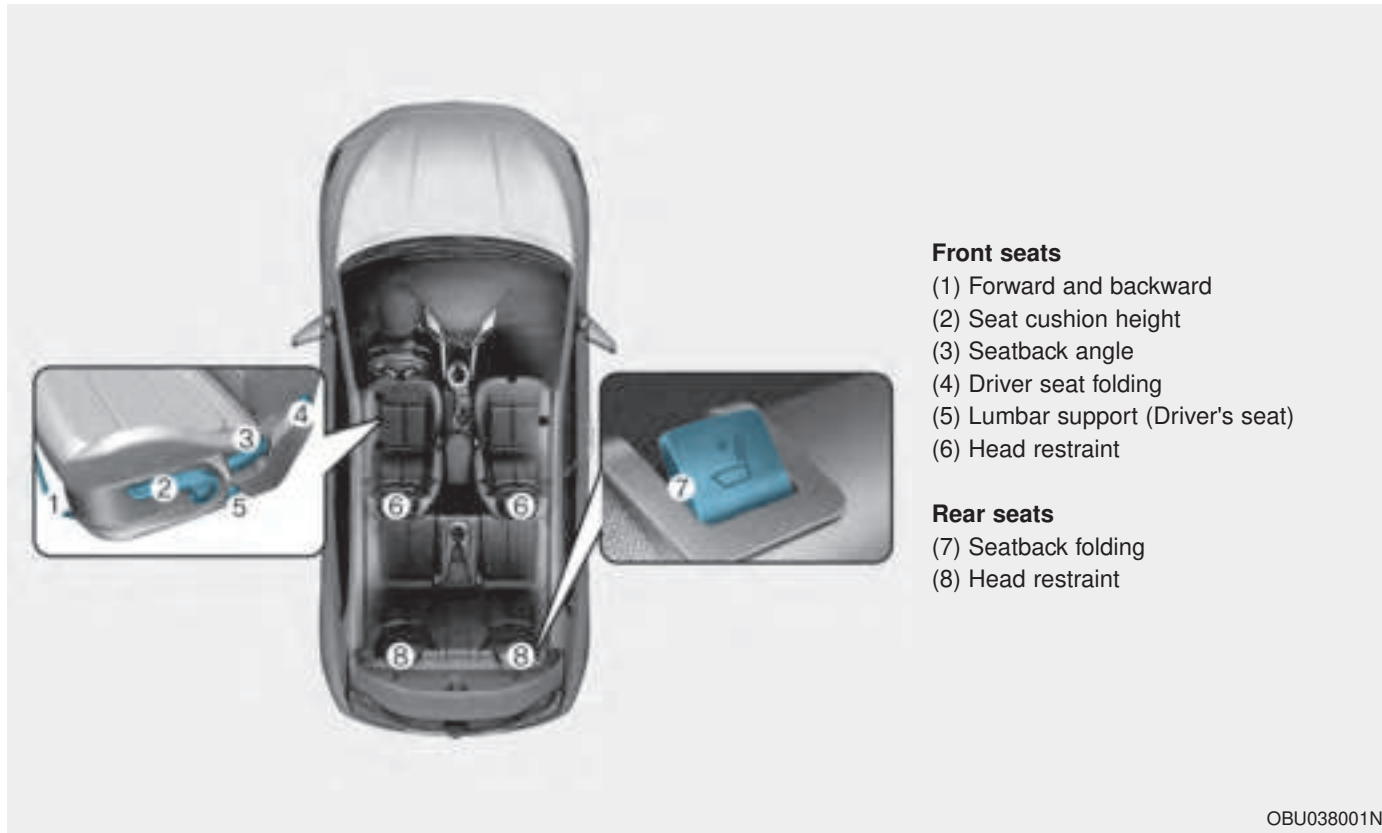

Safety Precautions

Adjusting the seats so that you are sitting in a safe, comfortable position plays an important role in driver and passenger safety together with the seat belts and air bags in an accident.

WARNING

Do not use a cushion that reduces friction between the seat and the passenger. The passenger's hips may slide under the lap portion of the seat belt during an accident or a sudden stop. Serious or fatal internal injuries could result because the seat belt cannot operate properly.

Air bags

You can take steps to reduce the risk of being injured by an inflating air bag. Sitting too close to an air bag greatly increases the risk of injury in the event the air bag inflates.

The National Highway Traffic Safety Administration (NHTSA) recommends that drivers allow at least 10 inches (25 cm) between the center of the steering wheel and their chest.

WARNING

To reduce the risk of serious injury or death from an inflating air bag, take the following precautions:

- **Adjust the driver's seat as far to the rear as possible while maintaining the ability to maintain full control of the vehicle.**
- **Adjust the front passenger seat as far to the rear as possible.**
- **Hold the steering wheel by the rim with hands at the 9 o'clock and 3 o'clock positions to minimize the risk of injuries to your hands and arms.**
- **NEVER place anything or anyone between the steering wheel and the air bag.**
- **Do not allow the front passenger to place feet or legs on the dashboard to minimize the risk of leg injuries.**

Seat belts

Always fasten your seat belt before starting any trip.

At all times, passengers should sit upright and be properly restrained. Infants and small children must be restrained in appropriate child restraint systems. Adults and children who have outgrown a booster seat must be restrained using the seat belts.

WARNING

Take the following precautions when adjusting your seat belt:

- **NEVER use one seat belt for more than one occupant.**
- **Always position the seatback upright with the lap portion of the seat belt snug and low across the hips.**
- **NEVER allow children or small infants to ride on a passenger's lap.**
- **Do not route the seat belt across your neck, across sharp edges, or reroute the shoulder strap away from your body.**
- **Do not allow the seat belt to become caught or jammed.**

Front Seats

WARNING

Take the following precautions when adjusting your seat:

- **NEVER** attempt to adjust the seat while the vehicle is moving. The seat could respond with unexpected movement and may cause loss of vehicle control resulting in an accident.
- Do not place anything under the front seats. Loose objects in the driver's foot area could interfere with the operation of the foot pedals, causing an accident.
- Do not allow anything to interfere with the normal position and proper locking of the seat-back.
- Do not place a cigarette lighter on the floor or seat. When you operate the seat, gas may exit out of the lighter causing a fire.

- Use extreme caution when picking up small objects trapped under the seats or between the seat and the center console. Your hands might be cut or injured by the sharp edges of the seat mechanism.

CAUTION

To prevent injury:

- Do not adjust your seat while wearing your seat belt. Moving the seat cushion forward may cause strong pressure on your abdomen.
- Do not allow your hands or fingers to get caught in the seat mechanisms while the seat is moving.

Manual adjustment

The front seat can be adjusted by using the levers located on the outside of the seat cushion. Before driving, adjust the seat to the proper position so that you can easily control the steering wheel, foot pedals and controls on the instrument panel.



Forward and rearward adjustment

To move the seat forward or rearward:

1. Pull up the seat slide adjustment lever and hold it.
2. Slide the seat to the position you desire.
3. Release the lever and make sure the seat is locked in place. Move forward and rearward without using the lever. If the seat moves, it is not locked properly.

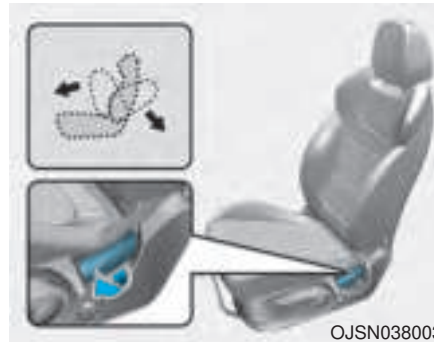

Seatback angle

To recline the seatback:

1. Lean forward slightly and lift up the seatback lever.
2. Carefully lean back on the seat and adjust the seatback to the position you desire.
3. Release the lever and make sure the seatback is locked in place. (The lever **MUST** return to its original position for the seatback to lock.)

Reclining seatback

Sitting in a reclined position when the vehicle is in motion can be dangerous. Even when buckled up, the protection of your restraint system (seat belts and air bags) is greatly reduced by reclining your seatback.

WARNING

NEVER ride with a reclined seatback when the vehicle is moving.

Riding with a reclined seatback increases your chance of serious or fatal injuries in the event of a collision or sudden stop.

Drivers and passengers should ALWAYS sit well back in their seats, properly belted, and with the seatbacks upright.

Seat belts must be snug against your hips and chest to work properly. When the seatback is reclined, the shoulder belt cannot do its job because it will not be snug against your chest. Instead, it will be in front of you. During an accident, you could be thrown into the seat belt, causing neck or other injuries.

The more the seatback is reclined, the greater chance the passenger's hips will slide under the lap belt or the passenger's neck will strike the shoulder belt.

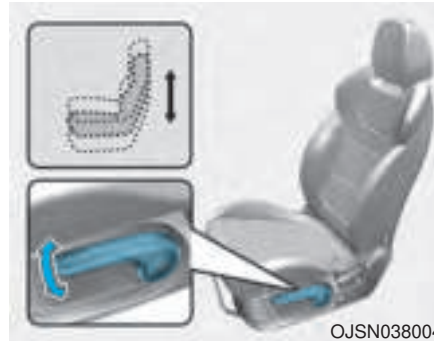

Seat cushion height

To change the height of the seat cushion:

- Push down on the lever several times, to lower the seat cushion.
- Pull up on the lever several times, to raise the seat cushion.

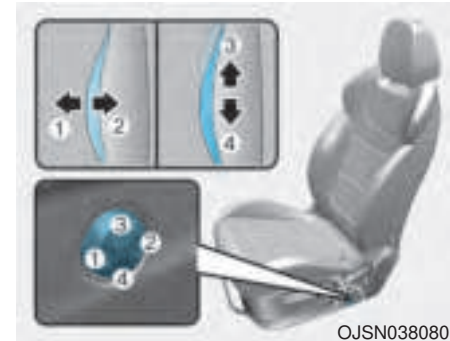

Lumbar support (if equipped)

To adjust the lumbar support:

- Press the front portion of the switch (1) to increase support or the rear portion of the switch (2) to decrease support.
- To move the support position up or down, press switch (3) or (4). The lumbar support does not operate up or down when the lumbar support is in the rearmost position. In this case, to use the system, slightly increase support by pushing the front portion of the switch (1).

Driver seat folding lever

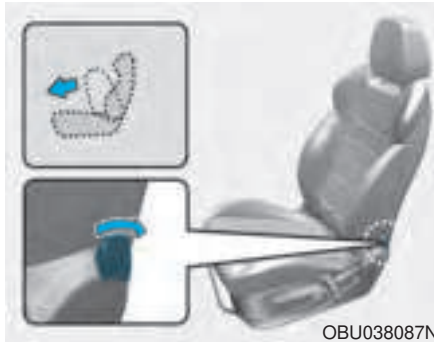

To get in or get out of the driver's door from the rear seat, the driver's seat should be folded by pulling the lever toward the rear of the vehicle.

⚠ WARNING

Do not pull the lever when driving. Sudden movement of the seatback may cause loss of vehicle control resulting in an accident.

Rear Seats

Folding the rear seat

The rear seatbacks can be folded to facilitate carrying long items or to increase the luggage capacity of the vehicle.

⚠ WARNING

- **Never allow passengers to sit on top of the folded down seatback while the vehicle is moving. This is not a proper seating position and no seat belts are available for use. This could result in serious injury or death in case of an accident or sudden stop.**
- **Objects carried on the folded down seatback should not extend higher than the top of the front seatbacks. This could allow cargo to slide forward and cause injury or damage during sudden stops.**

To fold down the rear seatback:

1. Set the front seatback to the upright position and if necessary, slide the front seat forward.



2. Move the seatbelt toward the outboard position before folding down the seatback to avoid the seatbelt system interfering with the seatback.



3. Remove the belt from the clip (1) and pull up the seatback folding lever (2), then fold the seat toward the front of the vehicle.



4. To use the rear seat, lift and unfold the seatback to the upright position. Push the seatback firmly until it clicks into place. Make sure the seatback is locked in place.

Be careful when returning the rear seatback to prevent damage to the seatbelt. Insert the belt in the clip.

⚠ WARNING

When returning the rear seatback from a folded to an upright position, hold the seatback and return it slowly. Ensure that the seatback is completely locked into its upright position by pushing on the top of the seatback. In an accident or sudden stop, the unlocked seatback could allow cargo to move forward with great force and enter the passenger compartment, which could result in serious injury or death.

⚠ WARNING

Do not place objects in the rear seats, since they cannot be properly secured and may hit vehicle occupants in a collision causing serious injury or death.

WARNING

Make sure the vehicle is off, the shift lever is in N (Neutral), and the parking brake is securely applied whenever loading or unloading cargo. Failure to take these steps may allow the vehicle to move if the shift lever is inadvertently moved to another position.

CAUTION

- Be careful when loading cargo through the rear passenger seats to prevent damage to the vehicle interior.
- When cargo is loaded through the rear passenger seats, ensure the cargo is properly secured to prevent it from moving while driving.
- Unsecured cargo in the passenger compartment can cause damage to the vehicle or injury to its occupants.

Head Restraints

The vehicle's front and rear seats have head restraints. The head restraints provide comfort for passengers, but more importantly they are designed to help protect passengers from whiplash and other neck and spinal injuries during an accident, especially in a rear impact collision.

WARNING

To reduce the risk of serious injury or death in an accident, take the following precautions when adjusting your head restraints:

- Always properly adjust the head restraints for all passengers **BEFORE** starting the vehicle.
- **NEVER** let anyone ride in a seat with the head restraints removed or reversed.

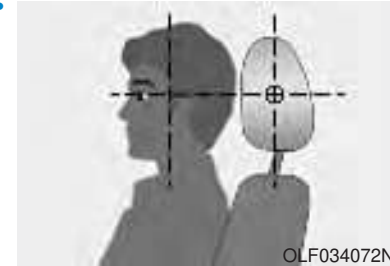

Adjust the head restraints so the middle of the head restraint is at the same height as the height of the top of the eyes.

- **NEVER** adjust the head restraint position of the driver's seat when the vehicle is in motion.
- Adjust the head restraint as close to the passenger's head as possible. Do not use a seat cushion that holds the body away from the seatback.
- Make sure the head restraint locks into position after adjusting it.

NOTICE

To prevent damage, **NEVER** hit or pull on the head restraints.

Front seat head restraints



The vehicle's front and passenger's seats are equipped with adjustable head restraints for the passengers safety and comfort.



Forward and rearward adjustment

The head restraint may be adjusted forward to 3 different positions by pulling the head restraint forward to the desired detent. To adjust the head restraint to it's furthest rearwards position, pull it fully forward to the farthest position and release it.

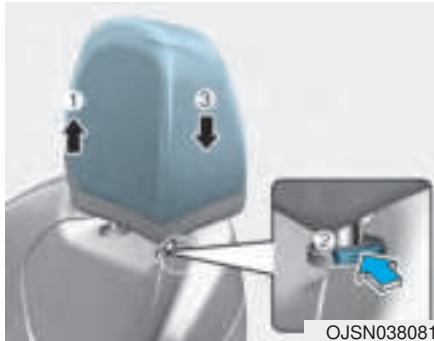

Adjusting the height up and down

To raise the head restraint:

1. Pull it up to the desired position (1).

To lower the head restraint:

1. Push and hold the release button (2) on the head restraint support.
2. Lower the head restraint to the desired position (3).



NOTICE

If you recline the seatback towards the front with the head restraint and seat cushion raised, the head restraint may come in contact with the sunvisor or other parts of the vehicle.

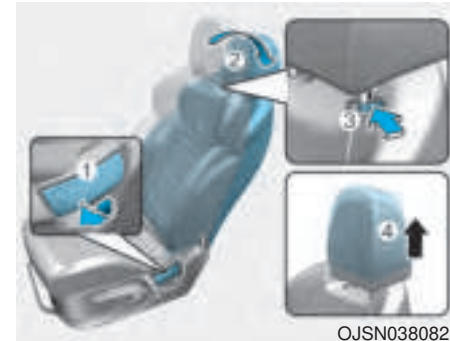

Removal/Reinstallation

To remove the head restraint:

1. Recline the seatback (2) rearward using the seatback angle lever (1).
2. Raise the head restraint as far as it can go.
3. Press the head restraint release button (3) while pulling the head restraint up (4).

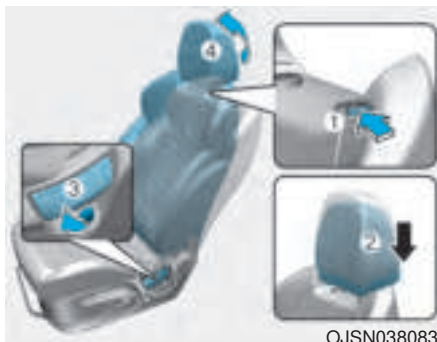

To reinstall the head restraint:

1. Put the head restraint poles (2) into the holes while pressing the release button (1).
2. Adjust the head restraint to the appropriate height.
3. Adjust the seatback (4) forward using the seatback angle lever (3).



Seat emblem lights (if equipped)

The emblem light on the seat operates the same as the button condition of the front door lamp.

For more details, refer to "Interior Lights" section in chapter 3.

Rear seat head restraints



The rear seats are equipped with head restraints in all the seating positions for the passenger's safety and comfort.

SEAT BELTS

This section describes how to use the seat belts properly. It also describes some of the things to avoid when using seat belts.

Seat Belt Safety Precautions

Always fasten your seat belt and make sure all passengers have fastened their seat belts before starting any trip. Air bags are designed to supplement the seat belt as an additional safety device, but they are not a substitute. Most states require all occupants of a vehicle to wear seat belts.

WARNING

Seat belts must be used by ALL passengers whenever the vehicle is moving. Take the following precautions when adjusting and wearing seat belts:

- **ALWAYS** properly restrain children under age 13 in the rear seats.

- **NEVER** allow children to ride in the front passenger seat. If a child age 13 or older must be seated in the front seat, move the seat as far back as possible and properly restrain them in the seat.
- **NEVER** allow an infant or child to be carried on an occupant's lap.
- **NEVER** ride with the seatback reclined when the vehicle is moving.
- Do not allow children to share a seat or seat belt.
- Do not wear the shoulder belt under your arm or behind your back.
- Always wear both the shoulder portion and lap portion of the lap/shoulder belt.
- Do not use the seat belt if it is twisted. A twisted seat belt will not protect you properly in an accident.
- Do not use a seat belt if the webbing or hardware is damaged.

- Do not latch the seat belt into the buckles of other seats.
- **NEVER** unfasten the seat belt while driving. This may cause loss of vehicle control resulting in an accident.
- Make sure there is nothing in the buckle interfering with the seat belt latch mechanism. This may prevent the seat belt from fastening securely.
- No modifications or additions should be made by the user which will either prevent the seat belt adjusting devices from operating to remove slack, or prevent the seat belt assembly from being adjusted to remove slack.

WARNING

Damaged seat belts and seat belt assemblies will not operate properly. Always replace:

- Frayed, contaminated, or damaged webbing
- Damaged hardware
- The entire seat belt assembly after it has been worn in an accident, even if damage to webbing or assembly is not apparent

Seat Belt Warning Light

***Seat belt warning light
(for driver's seat)***



As a reminder to the driver, the seat belt warning light will illuminate for approximately 6 seconds each time you place the ignition switch to the ON position regardless of belt fastening. At this time, if the seat belt is not fastened a warning chime will sound for 6 seconds.

If you continue not to fasten the seat belt and you drive over 6 mph (9 km/h), the warning light will stay illuminated.

If you continue not to fasten the seat belt and you drive over 12 mph (20 km/h) the seat belt warning chime will sound for approximately 100 seconds and the corresponding warning light will blink.

If you unfasten the seat belt while driving under 12 mph (20 km/h), the seat belt warning light will illuminate until the seat belt is fastened.

If you unfasten the seat belt while driving over 12 mph (20 km/h), the seat belt warning chime will sound for approximately 100 seconds and the corresponding warning light will blink.

Seat belt warning light (for front passenger's seat)



As a reminder to the front passenger, the front passenger's seat belt warning lights will illuminate for approximately 6 seconds each time you place the ignition switch to the ON position regardless of belt fastening.

If you continue not to fasten the seat belt and you drive over 6 mph (9 km/h), the warning light will stay illuminated.

If you continue not to fasten the seat belt and you drive over 12 mph (20 km/h) the seat belt warning chime will sound for approximately 100 seconds and the corresponding warning light will blink.

If you unfasten the seat belt while driving under 12 mph (20 km/h) the seat belt warning light will illuminate until the seat belt is fastened.

If you unfasten the seat belt while driving over 12 mph (20 km/h), the seat belt warning chime will sound for approximately 100 seconds and the corresponding warning light will blink.

⚠ WARNING

The front passenger's seat belt warning light may not properly operate if the front passenger does not sit properly in the seat.

i Information

- Although the front passenger seat is not occupied, the seat belt warning light will blink or illuminate for 6 seconds. Also, when the front passenger gets off the vehicle while the warning is activating, the warning may continue for 6 seconds even after the passenger gets off.
- The front passenger's seat belt warning may operate when luggage, laptop or other electronic device is placed on the front passenger seat.

Seat Belt Restraint System



WARNING

Improperly positioned seat belts may increase the risk of serious injury in an accident. Take the following precautions when adjusting the seat belt:

- Position the lap portion of the seat belt as low as possible across your hips, not on your waist, so that it fits snugly.

- Position one arm under the shoulder belt and the other over the belt, as shown in the illustration.
- Always position the shoulder belt anchor into the locked position at the appropriate height.
- Never position the shoulder belt across your neck or face.

Seat Belt-Driver's 3-point system with emergency locking retractor



To fasten your seat belt:

Pull the seat belt out of the retractor and insert the metal tab (1) into the buckle (2). There will be an audible "click" when the tab locks into the buckle.



You should place the lap belt (1) portion across your hips and the shoulder belt (2) portion across your chest.

The seat belt automatically adjusts to the proper length after the lap belt portion is adjusted manually so that it fits snugly around your hips. If you lean forward in a slow, easy motion, the belt will extend and move with you.

If there is a sudden stop or impact, the belt will lock into position. It will also lock if you try to lean forward too quickly.

NOTICE

If you are not able to smoothly pull enough of the seat belt out from the retractor, firmly pull the seat belt out and release it. After release, you will be able to pull the belt out smoothly.



To release your seat belt:

Press the release button (1) in the locking buckle.

When it is released, the belt should automatically draw back into the retractor. If this does not happen, check the belt to be sure it is not twisted, then try again.

Shoulder belt extension guide

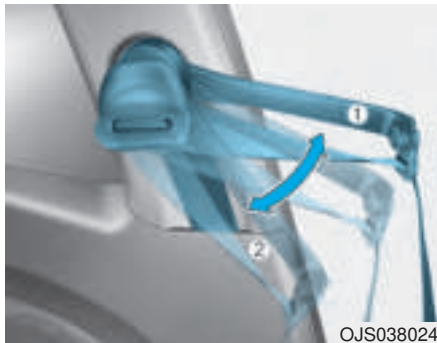

You can adjust the extension guide to allow easy access to the seat belt and for the rear seat passengers to easily enter and exit the vehicle.

When fastening the seat belt, put the extension guide in position (1) and move it to position (2) when riding in the rear seat through the front seat.

WARNING

- **Verify the shoulder belt extension guide is locked into position at the appropriate height. Never position the shoulder belt across your neck or face. Improperly positioned seat belts can cause serious injuries in an accident.**
- **Failure to replace seat belts after an accident could leave you with damaged seat belts that will not provide protection in the event of another collision leading to personal injury or death. Replace your seat belts after being in an accident as soon as possible.**

Rear Seat Belt – Passenger's 3-point system with convertible locking retractor

This type of seat belt combines the features of both an emergency locking retractor seat belt and an automatic locking retractor seat belt. Convertible retractor type seat belts are installed in the rear seat positions to help accommodate the installation of child restraint systems. Although a convertible retractor is also installed in the front passenger seat position, NEVER place any infant/child restraint system in the front seat of the vehicle.

To fasten your seat belt:

Pull the seat belt out of the retractor and insert the metal tab into the buckle. There will be an audible "click" when the tab locks into the buckle. When not securing a child restraint, the seat belt operates in the same way as the driver's seat belt (Emergency Locking Retractor Type). It automatically adjusts to the proper length only after the lap belt portion of the seat belt is adjusted manually so that it fits snugly across your hips.

When the seat belt is fully extended from the retractor to allow the installation of a child restraint system, the seat belt operation changes to allow the belt to retract, but not to extend (Automatic Locking Retractor Type). Refer to the "Using a Child Restraint System" section in this chapter.

NOTICE

Although the seat belt retractor provides the same level of protection for seated passengers in either emergency or automatic locking modes, the emergency locking mode allows seated passengers to move freely in their seat while keeping some tension on the belt. During a collision or sudden stop, the retractor automatically locks the belt to help restrain your body.

To deactivate the automatic locking mode, unbuckle the seat belt and allow the belt to fully retract.

Pre-tensioner seat belt (Driver and front passenger)



OTL035053

Your vehicle is equipped with driver's and front passenger's Pre-tensioner Seat Belts (Retractor Pretensioner and Emergency Fastening Device System). The purpose of the pre-tensioner is to make sure the seat belts fit tightly against the occupant's body in certain frontal or side collision(s). The Emergency Fastening Device System may be activated in certain crashes where the frontal collision(s) is severe enough, together with the air bags.

When the vehicle stops suddenly, or if the occupant tries to lean forward too quickly, the seat belt retractor will lock into position. In certain frontal or side collision(s), the pre-tensioner will activate and pull the seat belt into tighter contact against the occupant's body.

(1) Retractor Pretensioner

The purpose of the retractor pretensioner is to make sure that the shoulder belts fit in tightly against the occupant's upper body in certain frontal or side collision(s).

(2) Emergency Fastening Device System

The purpose of the Emergency Fastening Device System is to make sure that the pelvis belts fit in tightly against the occupant's lower body in certain frontal collision(s).

If the system senses excessive tension on the driver or passenger's seat belt when the pre-tensioner system activates, the load limiter inside the retractor pretensioner will release some of the pressure on the affected seat belt.

 **WARNING**

- **Always wear your seat belt and sit properly in your seat.**
- **Do not use the seat belt if it is loose or twisted. A loose or twisted seat belt will not protect you properly in an accident.**
- **Do not place anything near the buckle. This may adversely affect the buckle and cause it to function improperly.**
- **Always replace your pre-tensioners after activation or an accident.**
- **NEVER inspect, service, repair or replace the pre-tensioners yourself. This must be done by an authorized HYUNDAI dealer.**
- **Do not hit the seat belt assemblies.**

 **WARNING**

Do not touch the pre-tensioner seat belt assemblies for several minutes after they have been activated. When the pre-tensioner seat belt mechanism deploys during a collision, the pre-tensioners become hot and can burn you.

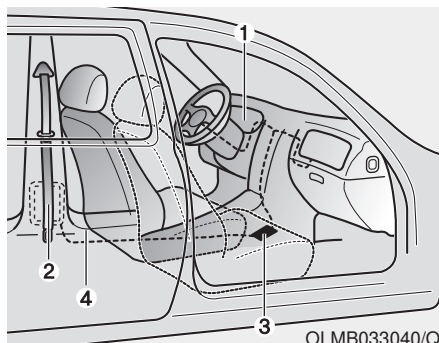

The Pre-Tensioner Seat Belt System consists mainly of the following components. Their locations are shown in the illustration above:

1. SRS air bag warning light
2. Retractor pre-tensioner
3. SRS control module
4. Emergency Fastening Device System

NOTICE

The sensor that activates the SRS air bag is connected with the pre-tensioner seat belts. The SRS air bag warning light on the instrument panel will illuminate for approximately 6 seconds after the ignition switch is in the ON position, and then it should turn off.

If the pre-tensioner is not working properly, the warning light will illuminate even if the SRS air bag is not malfunctioning. If the warning light does not illuminate, stays illuminated or illuminates when the vehicle is being driven, have an authorized HYUNDAI dealer inspect the pre-tensioner seat belts and SRS air bags as soon as possible.

NOTICE

- Both the driver's and front passenger's pre-tensioner seat belts may be activated in certain frontal or side collisions or rollovers.
- When the pre-tensioner seat belts are activated, a loud noise may be heard and fine dust, which may appear to be smoke, may be visible in the passenger compartment. These are normal operating conditions and are not hazardous.
- Although it is non-toxic, the fine dust may cause skin irritation and should not be inhaled for prolonged periods. Wash all exposed skin areas thoroughly after an accident in which the pre-tensioner seat belts were activated.

WARNING

- Fasten your seat belt while sitting properly in an upright position to maximize the effectiveness of the pre-tensioner seat belt system.
- A pre-tensioner seat belt system is designed to activate only once. Replace the pre-tensioner seat belt system, if it was activated in an accident.

Additional Seat Belt Safety Precautions

Seat belt use during pregnancy

The seat belt should always be used during pregnancy. The best way to protect your unborn child is to protect yourself by always wearing the seat belt.

Pregnant women should always wear a lap-shoulder seat belt. Place the shoulder belt across your chest, routed between your breasts and away from your neck. Place the lap belt line so that it fits snugly and as low as possible across the hips, not across the abdomen.

WARNING

- A pregnant woman or a patient is more vulnerable to any impacts on the abdomen during an abrupt stop or accident. If you are in an accident while pregnant, we recommend you consult your doctor.
- To reduce the risk of serious injury or death to an unborn child during an accident, pregnant women should **NEVER** place the lap portion of the seat belt above or over the area of the abdomen where the unborn child is located.

Seat belt use and children

Infant and small children

All 50 states have child restraint laws which require children to travel in approved child restraint devices, including booster seats. The age at which seat belts can be used instead of child restraints differs among states, so you should be aware of the specific requirements in your state, and where you are travelling. Infant and child restraints must be properly placed and installed in a rear seat. For more details refer to the "Child Restraint Systems" section in this chapter.

WARNING

ALWAYS properly restrain infants and small children in a child restraint appropriate for the child's height and weight.

To reduce the risk of serious injury or death to a child and other passengers, NEVER hold a child in your lap or arms when the vehicle is moving. The violent forces created during an accident will tear the child from your arms and throw the child against the interior of the vehicle.

Small children are best protected from injury in an accident when properly restrained in the rear seat by a child restraint system that meets the requirements of the Federal Motor Vehicle Safety Standards. Before buying any child restraint system, make sure that it has a label certifying that it meets Federal Motor Vehicle Safety Standard FMVSS 213. The restraint must be appropriate for your child's height and weight. Check the label on the child restraint for this information. Refer to the "Child Restraint Systems" section in this chapter.

Larger children

Children under age 13 and who are too large for a booster seat must always occupy the rear seat and use the available lap/shoulder belts. A seat belt should lie across the upper thighs and be snug across the shoulder and chest to restrain the child safely. Check belt fit periodically. Children are afforded the most safety in the event of an accident when they are restrained by a proper restraint system and/or seat belts in the rear seat. Always have the LATCH system inspected by your authorized HYUNDAI dealer after an accident. An accident can damage the LATCH system and may not properly secure the child restraint.

If a larger child over age 13 must be seated in the front seat, the child must be securely restrained by the available lap/shoulder belt and the seat should be placed in the rear-most position.

If the shoulder belt portion slightly touches the child's neck or face, try placing the child closer to the center of the vehicle. If the shoulder belt still touches their face or neck they need to be returned to an appropriate booster seat in the rear seat.

WARNING

- **Always make sure children are wearing their seat belts and that they are properly adjusted before driving.**
- **NEVER allow the shoulder belt to contact the child's neck or face.**
- **Do not allow more than one child to use a single seat belt.**

Transporting an injured person

A seat belt should be used when an injured person is being transported. Consult a physician for specific recommendations.

One person per belt

Two people (including children) should never attempt to use a single seat belt. This could increase the severity of injuries in case of an accident.

Do not lie down

Sitting in a reclined position when the vehicle is in motion can be dangerous. Even when buckled up, the protections of your restraint system (seat belts and air bags) is greatly reduced by reclining your seatback.

To reduce the chance of injuries in the event of an accident and to achieve the maximum effectiveness of the restraint system, all passengers should be sitting up and the front and rear seats should be in an upright position when the car is moving.

A seat belt cannot provide proper protection if the person is lying down in the rear seat or if the front or rear seats are in a reclined position.

WARNING

- **NEVER ride with a reclined seatback when the vehicle is moving.**
- **Riding with a reclined seatback increases your chance of serious or fatal injuries in the event of a collision or sudden stop.**
- **Drivers and passengers should always sit well back in their seats, properly belted, and with the seatbacks upright.**

Care of Seat Belts

Seat belt systems should never be disassembled or modified. In addition, care should be taken to assure that seat belts and belt hardware are not damaged by seat hinges, doors or other abuse.

Periodic inspection

All seat belts should be inspected periodically for wear or damage of any kind. Any damaged parts should be replaced as soon as possible by an authorized HYUNDAI dealer.

Keep belts clean and dry

Seat belts should be kept clean and dry. If belts become dirty, they can be cleaned by using a mild soap solution and warm water. Bleach, dye, strong detergents or abrasives should not be used because they may damage and weaken the fabric.

When to replace seat belts

The entire seat belt assembly or assemblies should be replaced if the vehicle has been involved in an accident. This should be done even if no damage is visible. Additional questions concerning seat belt operation should be directed to an authorized HYUNDAI dealer.

CHILD RESTRAINT SYSTEM (CRS)

Children Always in the Rear

WARNING

Always properly restrain children in the rear seats of the vehicle.

Children of all ages are safer when restrained in the rear seat. A child riding in the front passenger seat can be forcefully struck by an inflating air bag resulting in SERIOUS INJURY or DEATH.

Children under age 13 must always ride in the rear seats and must always be properly restrained to minimize the risk of injury in an accident, sudden stop or sudden maneuver. According to accident statistics, children are safer when properly restrained in the rear seats than in the front seat. **Even with air bags, children can be seriously injured or killed.** Children too large for a child restraint must use the seat belts provided.

All 50 states have child restraint laws which require children to travel in approved child restraint devices. The laws governing the age or height/weight restrictions at which seat belts can be used instead of child restraints differs among states, so you should be aware of the specific requirements in your state, and where you are travelling.

Child restraint systems must be properly placed and installed in the rear seat. You must use a commercially available child restraint system that meets the requirements of the Federal Motor Vehicle Safety Standards (FMVSS 213).

Child restraint systems are generally designed to be secured in a vehicle seat by lap belt portion of a lap/shoulder belt, or by a LATCH system in the rear seats of the vehicle.

Child restraint system (CRS)

Infants and younger children must be restrained in an appropriate rear-facing or forward-facing CRS that has first been properly secured to the rear seat of the vehicle. Read and comply with the instructions for installation and use provided by the manufacturer of the child restraint.

WARNING

An improperly secured child restraint can increase the risk of SERIOUS INJURY or DEATH in an accident. Always take the following precautions when using a child restraint system:

- **NEVER** install a child or infant restraint in the front passenger's seat.
- Always properly secure the child restraint to a rear seat of the vehicle.
- Always follow the child restraint system manufacturer's instructions for installation and use.

- **Always properly restrain your child in the child restraint.**
- **If the vehicle head restraint prevents proper installation of a child seat (as described in the child restraint system manual), the head restraint of the respective seating position shall be readjusted or entirely removed.**
- **Do not use an infant carrier or a child safety seat that "hooks" over a seatback, it may not provide adequate protection in an accident.**
- **After an accident, have a HYUNDAI dealer check the child restraint system, seat belts, tether anchors and lower anchors.**

Selecting a Child Restraint System (CRS)

When selecting a CRS for your child, always:

- Make sure the CRS has a label certifying that it meets applicable Federal Motor Vehicle Safety Standards (FMVSS 213).
- Select a child restraint based on your child's height and weight. The required label or the instructions for use typically provide this information.
- Select a child restraint that fits the vehicle seating position where it will be used.
- Read and comply with the warnings and instructions for installation and use provided with the child restraint system.

Child restraint system types

There are three main types of child restraint systems: rear-facing seats, forward-facing seats, and booster seats. They are classified according to the child's age, height and weight.

Rear-facing child seats

⚠ WARNING

NEVER install a child or infant restraint in the front passenger's seat.

Placing a rear-facing child restraint in the front seat can result in SERIOUS INJURY or DEATH if the child restraint is struck by an inflating air bag.

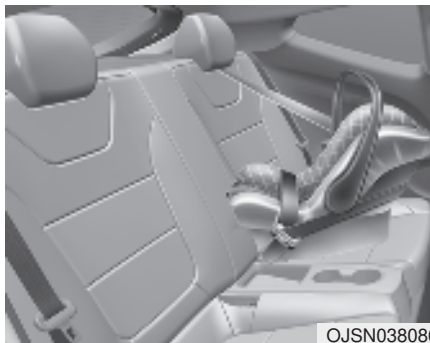

A rear-facing child seat provides restraint with the seating surface against the back of the child. The harness system holds the child in place, and in an accident, acts to keep the child positioned in the seat and reduce the stress to the neck and spinal cord.

All children under age one must always ride in a rear-facing infant child restraint.

Convertible and 3-in-1 child seats typically have higher height and weight limits for the rear-facing position, allowing you to keep your child rear-facing for a longer period of time.

Continue to use a rear-facing child seat for as long as your child will fit within the height and weight limits allowed by the child seat manufacturer. It's the best way to keep them safe. Once your child has outgrown the rear-facing child restraint, your child is ready for a forward-facing child restraint with a harness.



Forward-facing child restraints

A forward-facing child seat provides restraint for the child's body with a harness. Keep children in a forward-facing child seat with a harness until they reach the top height or weight limit allowed by your child restraint's manufacturer.

Once your child outgrows the forward-facing child restraint, your child is ready for a booster seat.

Booster seats

A booster seat is a restraint designed to improve the fit of the vehicle's seat belt system. A booster seat positions the seat belt so that it fits properly over the lap of your child.

Keep your child in a booster seat until they are big enough to sit in the seat without a booster and still have the seat belt fit properly. For a seat belt to fit properly, the lap belt must lie snugly across the upper thighs, not the stomach. The shoulder belt should lie snug across the shoulder and chest and not across the neck or face. Children under age 13 must always ride in the rear seats and must always be properly restrained to minimize the risk of injury.

Installing a Child Restraint System (CRS)

WARNING

Before installing your child restraint system always:

- Read and follow the instructions provided by the manufacturer of the child restraint.
- Read and follow the instructions regarding child restraint systems in this manual.

Failure to follow all warnings and instructions could increase the risk of the SERIOUS INJURY or DEATH if an accident occurs.

WARNING

If the vehicle headrest prevents proper installation of a child seat (as described in the child seat system manual, the headrest of the respective seating position shall be readjusted or entirely removed.

After selecting a proper child seat for your child, check to make sure it fits properly in your vehicle. Follow the instructions provided by the manufacturer when installing the child seat. Note these general steps when installing the seat to your vehicle:

- **Properly secure the child restraint to the vehicle.** All child restraints must be secured to the vehicle with the lap part of a lap/shoulder belt or with the LATCH system. If using the lap/shoulder belt for your child restraint, the convertible locking retractor should be pulled all the way out to engage the "automatic locking" mode. (See page 2-37.)
- **Make sure the child restraint is firmly secured.** After installing a child restraint to the vehicle, push and pull the seat forward-and-back and side-to-side to verify that it is securely attached to the seat. A child restraint secured with a seat belt should be installed as firmly as possible. However, some side-to-side movement can be expected.

- **Secure the child in the child restraint.** Make sure the child is properly strapped in the child restraint according to the manufacturer instructions.

CAUTION

A child restraint in a closed vehicle can become very hot. To prevent burns, check the seating surface and buckles before placing your child in the child restraint.

Lower Anchors and Tether for Children (LATCH System)

The LATCH system holds a child restraint during driving and in an accident. This system is designed to make installation of the child restraint easier and reduce the possibility of improperly installing your child restraint. The LATCH system uses anchors in the vehicle and attachments on the child restraint. The LATCH system eliminates the need to use seat belts to secure the child restraint to the rear seats.

Lower anchors are metal bars built into the vehicle. There are two lower anchors for each LATCH seating position that will accommodate a child restraint with lower attachments.

To use the LATCH system in your vehicle, you must have a child restraint with LATCH attachments.

The child seat manufacturer will provide you with instructions on how to use the child seat with its attachments for the LATCH lower anchors.

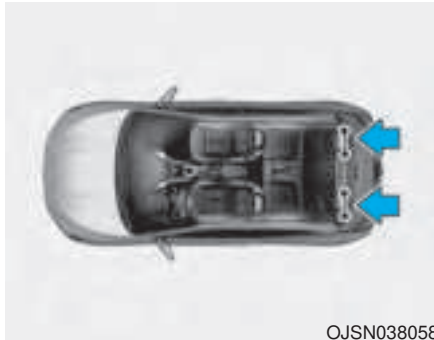

LATCH anchors have been provided in the left and right outboard rear seating positions. Their locations are shown in the illustration. There are no LATCH anchors provided for the center rear seating position.

WARNING

Do not attempt to install a child restraint system using LATCH anchors in the rear center seating position. There are no LATCH anchors provided for this seat. Using the outboard seat anchors can damage the anchors which may break or fail in a collision resulting in serious injury or death.

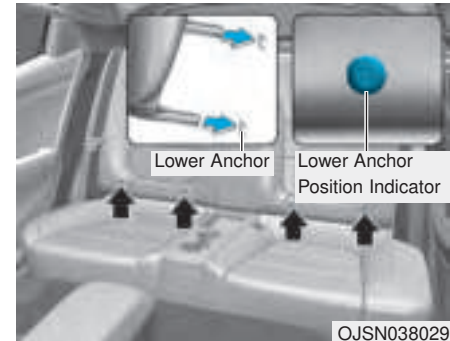

The lower anchor position indicator symbols are located on the left and right rear seat backs to identify the position of the lower anchors in your vehicle (see arrows in illustration).

The LATCH anchors are located between the seatback and the seat cushion of the rear seat left and right outboard seating positions.

Securing a child restraint with the LATCH anchors system

To install a LATCH-compatible child restraint in either of the rear outboard seating positions:

1. Move the seat belt buckle away from the lower anchors.
2. Move any other objects away from the anchors that could prevent a secure connection between the child restraint and the lower anchors.
3. Place the child restraint on the vehicle seat, then attach the seat to the lower anchors according to the instructions provided by the child restraint manufacturer.
4. Follow the child restraint instructions for properly adjusting and tightening the lower attachments on the child restraint to the lower anchors.

WARNING

Take the following precautions when using the LATCH system:

- **Read and follow all installation instructions provided with your child restraint system.**
- **To prevent the child from reaching and taking hold of unretracted seat belts, buckle all unused rear seat belts and retract the seat belt webbing behind the child. Children can be strangled if a shoulder belt becomes wrapped around their neck and the seat belt tightens.**
- **NEVER attach more than one child restraint to a single anchor. This could cause the anchor or attachment to come loose or break.**
- **Always have the LATCH system inspected by your authorized HYUNDAI dealer after an accident. An accident can damage the LATCH system and may not properly secure the child restraint.**

NOTICE

The recommended weight for the LATCH system is under 65 lb (30 kg).

How to determine an appropriate child restraint weight:

Child weight + Child restraint weight < 65 lb (30kg)

Securing a child restraint seat with "Tether Anchor" system



First secure the child restraint with the LATCH lower anchors or the seat belt. If the child restraint manufacturer recommends that the top tether strap be attached, attach and tighten the top tether strap to the top tether strap anchor.

Child restraint hook holders are located on the floor of the luggage room.

WARNING

Take the following precautions when installing the tether strap:

- Read and follow all installation instructions provided with your child restraint system.
- **NEVER** attach more than one child restraint to a single tether anchor. This could cause the anchor or attachment to come loose or break.
- **Do not attach the tether strap to anything other than the correct tether anchor. It may not work properly if attached to something else.**
- **Do not use the tether anchors for adult seat belts or harnesses, or for attaching other items or equipment to the vehicle.**



To install the tether anchor:

1. Route the child restraint tether strap over the child restraint seatback. Route the tether strap under the head restraint and between the head restraint posts, or route the tether strap over the top of the vehicle seatback. Make sure the strap is not twisted.
2. Connect the tether strap hook to the tether anchor, then tighten the tether strap according to the child seat manufacturer's instructions to firmly secure the child restraint to the seat.
3. Check that the child restraint is securely attached to the seat by pushing and pulling the seat forward-and-back and side-to-side.

Securing a child restraint with lap/shoulder belt

When not using the LATCH system, all child restraints must be secured to a vehicle rear seat with the lap part of a lap/shoulder belt.

⚠ WARNING

ALWAYS place a rear-facing child restraint in the rear seat of the vehicle.

Placing a rear-facing child restraint in the front seat can result in serious injury or death if the child restraint is struck by an inflating air bag.

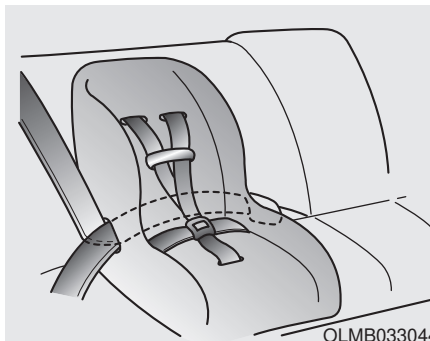

Automatic locking mode

Since all passenger seat belts move freely under normal conditions and only lock under extreme or emergency conditions (emergency locking mode), you must manually pull the seat belt all the way out to shift the retractor to the "Automatic Locking" mode to secure a child restraint.

The "Automatic Locking" mode will help prevent the normal movement of the child in the vehicle from causing the seat belt to loosen and compromise the child restraint system. To secure a child restraint system, use the following procedure.

To install a child restraint system on the rear seats, do the following:

1. Place the child restraint system on a rear seat and route the lap/shoulder belt around or through the child restraint, following the restraint manufacturer's instructions.

Be sure the seat belt webbing is not twisted.

NOTICE

When using the rear center seat belt, you should also refer to the "Rear Seat Belt – Passenger's 3-point system" section in this chapter.

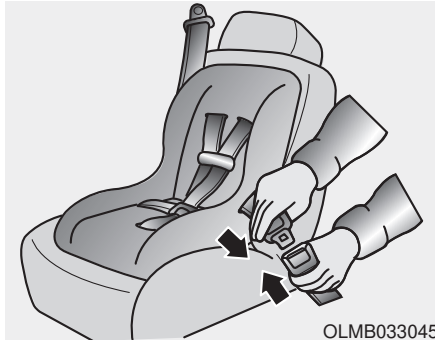

2. Fasten the lap/shoulder belt latch into the buckle. Listen for the distinct "click" sound.

i Information

Position the release button so that it is easy to access in case of an emergency.

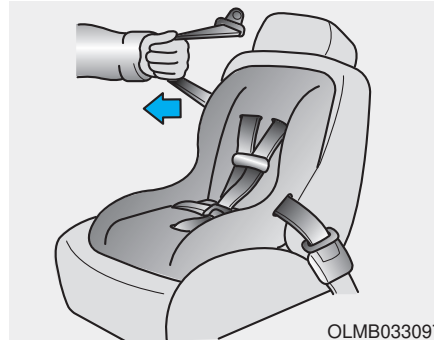

3. Pull the shoulder portion of the seat belt all the way out. When the shoulder portion of the seat belt is fully extended, it will shift the retractor to the "Automatic Locking" (child restraint) mode.

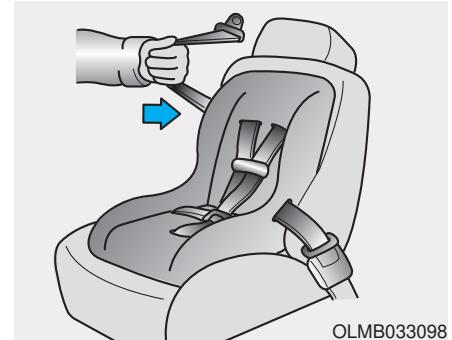

4. Slowly allow the shoulder portion of the seat belt to retract and listen for an audible "clicking" or "ratcheting" sound. This indicates that the retractor is in the "Automatic Locking" mode. If no distinct sound is heard, repeat steps 3 and 4.
5. Remove as much slack from the belt as possible by pushing down on the child restraint system while feeding the shoulder belt back into the retractor.
6. Push and pull on the child restraint system to confirm that the seat belt is holding it firmly in place. If it is not, release the seat belt and repeat steps 2 through 6.

7. Double check that the retractor is in the "Automatic Locking" mode by attempting to pull more of the seat belt out of the retractor. If you cannot, the retractor is in the "Automatic Locking" mode.

If your CRS manufacturer instructs or recommends you to use a tether anchor with the lap/shoulder belt, refer to the previous pages for more details.

NOTICE

When the seat belt is allowed to retract to its fully stowed position, the retractor will automatically switch from the "Automatic Locking" mode to the emergency lock mode for normal adult usage.

WARNING

If the retractor is not in the "Automatic Locking" mode, the child restraint can move when your vehicle turns or stops suddenly. A child can be seriously injured or killed if the child restraint is not properly anchored in the car, including manually pulling the seat belt all the way out to shift the retractor to the "Automatic Locking" mode.

To remove the child restraint, press the release button on the buckle and then pull the lap/shoulder belt out of the restraint and allow the seat belt to retract fully.

AIR BAG – ADVANCED SUPPLEMENTAL RESTRAINT SYSTEM

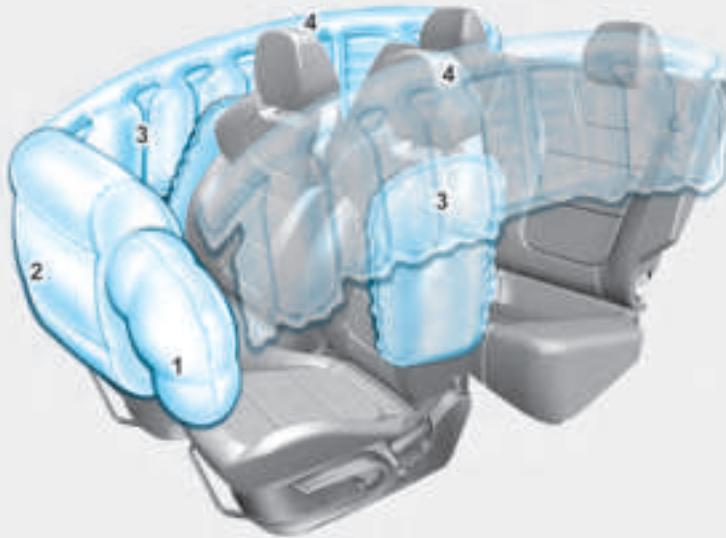

1. Driver's front air bag
2. Passenger's front air bag
3. Side air bag
4. Curtain air bag

The actual air bags in the vehicle may differ from the illustration.

OBU038089N

This vehicle is equipped with an Advanced Supplemental Air Bag System for the driver's seat and front passenger's seats.

The front air bags are designed to supplement the three-point seat belts. For these air bags to provide protection, the seat belts must be worn at all times when driving.

You can be severely injured or killed in an accident if you are not wearing a seat belt. Air bags are designed to supplement seat belts, but do not replace them. Also, air bags are not designed to deploy in every collision. In some accidents, the seat belts are the only restraint protecting you.

WARNING

AIR BAG SAFETY PRECAUTIONS

ALWAYS use seat belts and child restraints - every trip, every time, everyone! Even with air bags, you can be seriously injured or killed in a collision if you are improperly belted or not wearing your seat belt when the air bag inflates.

NEVER place a child in any child restraint or booster seat in the front passenger seat. An inflating air bag could forcefully strike the infant or child causing serious or fatal injuries.

ABC - Always Buckle Children under age 13 in the back seat. It is the safest place for children of any age to ride. If a child age 13 or older must be seated in the front seat, he or she must be properly belted and the seat should be moved as far back as possible.

All occupants should sit upright with the seatback in an upright position, centered on the seat cushion with their seat belt on, legs comfortably extended and their feet on the floor until the vehicle is parked and is turned off. If an occupant is out of position during an accident, the rapidly deploying air bag may forcefully contact the occupant causing serious or fatal injuries.

You and your passengers should never sit or lean unnecessarily close to the air bags or lean against the door or center console.

Move your seat as far back as possible from front air bags, while still maintaining control of the vehicle. The U.S. National Highway Traffic Safety Administration (NHTSA) recommends that drivers allow at least 10 inches (25 cm) between the center of the steering wheel and the chest.

Where Are the Air Bags?

Driver's and passenger's front air bags

Your vehicle is equipped with a Advanced Supplemental Restraint System (SRS) and lap/shoulder belts at both the driver and passenger seating positions.

The SRS consists of air bags which are located in the center of the steering wheel, in the driver's side lower crash pad below the steering wheel column and the passenger's side front panel pad above the glove box.

The air bags are labeled with the letters "AIR BAG" embossed on the pad covers.

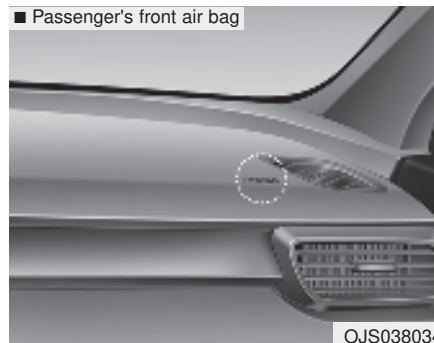

The purpose of the SRS is to provide the vehicle's driver and front passengers with additional protection than that offered by the seat belt system alone.

The advanced SRS offers the ability to control the air bag inflation within two levels. A first stage level is provided for moderate-severity impacts. A second stage level is provided for more severe impacts.

According to the impact severity, the SRS Control Module (SRSCM) controls the air bag inflation. Failure to properly wear seat belts can increase the risk or severity of injury in an accident.

WARNING

To reduce the risk of serious injury or death from an inflating front air bags, take the following precautions:

- Seat belts must be worn at all times to help keep occupants positioned properly.
- Move your seat as far back as possible from front air bags, while still maintaining control of the vehicle.
- Never lean against the door or center console.
- Do not allow the front passenger to place their feet or legs on the dashboard.
- No objects (such as crash pad cover, cellular phone holder, cup holder, perfume or stickers) should be placed over or near the air bag modules on the steering wheel, instrument panel, windshield glass, and the front passenger's panel above the glove box. Such objects could cause harm if the vehicle is in a crash severe enough to cause the air bags to deploy.

Side air bags



Your vehicle is equipped with a side air bag in each front seat.

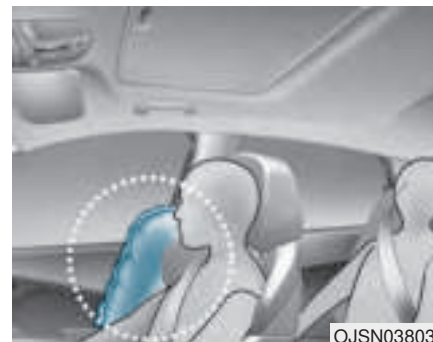

The purpose of the air bag is to provide the vehicle's driver and the front passenger with additional protection than that offered by the seat belt alone.

The side air bags are designed to deploy during certain side impact collisions, depending on the crash severity.

The side and curtain air bags on both sides of the vehicle may deploy if a rollover or possible rollover is detected.

The side air bags are not designed to deploy in all side impact or rollover situations.

WARNING

To reduce the risk of serious injury or death from an inflating side air bag, take the following precautions:

- Seat belts must be worn at all times to help keep occupants positioned properly.
- Do not allow passengers to lean their heads or bodies onto doors, put their arms on the doors, stretch their arms out of the window, or place objects between the doors and seats.
- Hold the steering wheel at the 9 o'clock and 3 o'clock positions, to minimize the risk of injuries to your hands and arms.
- Do not use any accessory seat covers. This could reduce or prevent the effectiveness of the system.

- Do not place any objects over the air bag or between the air bag and yourself. Also, do not attach any objects around the area the air bag inflates such as the door, side door glass, front and rear pillar.
- Do not place any objects between the door and the seat. They may become dangerous projectiles if the side air bag inflates.
- Do not install any accessories on the side or near the side air bags.
- Do not put any objects between the side airbag label and seat cushion. It could cause harm if the vehicle is in a crash severe enough to cause the air bags to deploy.
- Do not cause impact to the doors when the ignition switch button is in the ON position as this may cause the side air bags to inflate.
- If the seat or seat cover is damaged, have the vehicle checked and repaired by an authorized HYUNDAI dealer.

Curtain air bags

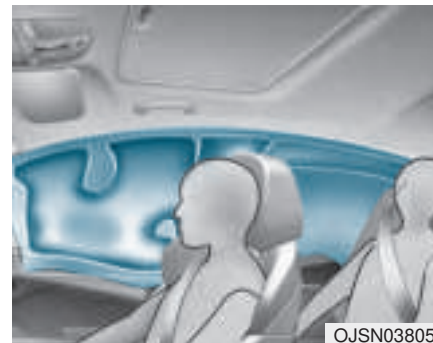

Curtain air bags are located along both sides of the roof rails above the front and rear doors.

They are designed to help protect the heads of the front seat occupants and the rear outboard seat occupants in certain side impact collisions.

The curtain air bags are designed to deploy during certain side impact collisions, depending on the crash severity.

The side and curtain air bags on both sides of the vehicle may deploy if a rollover or possible rollover is detected.

The curtain air bags are not designed to deploy in all side impact or rollover situations.

⚠ WARNING

To reduce the risk of serious injury or death from an inflating curtain air bag, take the following precautions:

- **All seat occupants must wear seat belts at all times to help keep occupants positioned properly.**

- **Properly secure child restraints as far away from the door as possible.**
- **Do not place any objects over the air bag. Also, do not attach any objects around the area the air bag inflates such as the door, side door glass, front and rear pillar, roof side rail.**
- **Do not hang other objects except clothes, especially hard or breakable objects. In an accident, it may cause vehicle damage or personal injury.**
- **Do not allow passengers to lean their heads or bodies onto doors, put their arms out of the doors, stretch their arms out of the window, or place objects between the doors and seats.**
- **Do not open or repair the side curtain air bags.**

How Does the Air Bag System Operate?

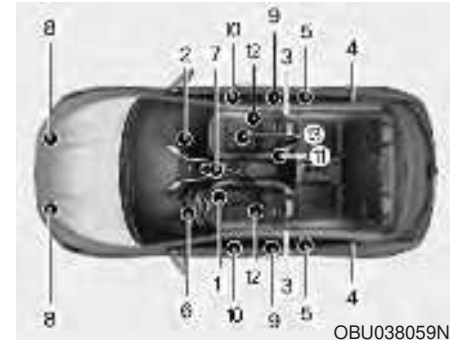

The SRS consists of the following components:

1. Driver's front air bag module
2. Passenger's front air bag module
3. Side air bag modules
4. Curtain air bag modules
5. Retractor pre-tensioner
6. Air bag warning light
7. SRS control module (SRSCM)/ Rollover sensor
8. Front impact sensors
9. Side impact sensors

10. Side pressure sensors
11. Seat belt buckle sensor
12. Emergency Fastening Device System
13. Occupant classification system

The SRSCM (Supplemental Restraint System Control Module) continually monitors all SRS components while the ignition switch is in the ON position to determine if a crash impact is severe enough to require air bag deployment or pre-tensioner seat belt deployment.



SRS warning light

The SRS (Supplement Restraint System) air bag warning light on the instrument panel displays the air bag symbol depicted in the illustration. The system checks the air bag electrical system for malfunctions. The light indicates that there is a potential malfunction with your air bag system, which could include your side and curtain air bags used for rollover protection.

WARNING

If your SRS malfunctions, the air bag may not inflate properly during an accident increasing the risk of serious injury or death.

If any of the following conditions occur, your SRS is malfunctioning:

- **The light does not turn on for approximately six seconds when the Engine Start/Stop button is in the ON position.**
- **The light stays on after illuminating for approximately six seconds.**
- **The light comes on while the vehicle is in motion.**
- **The light blinks when the engine is running.**

Have an authorized HYUNDAI dealer inspect the SRS as soon as possible if any of these conditions occur.

During a frontal collision, sensors will detect the vehicle's deceleration. If the rate of deceleration is high enough, the control unit will inflate the front air bags.

The front air bags help protect the driver and front passenger by responding to frontal impacts in which seat belts alone cannot provide adequate restraint. When needed, the side air bags help provide protection in the event of a side impact or rollover.

- Air bags are activated (able to inflate if necessary) only when the Engine Start/Stop button is in the ON position.
- Air bags inflate in the event of certain frontal or side collisions to help protect the occupants from serious physical injury.
- Generally, air bags are designed to inflate based upon the severity of a collision, its direction, etc. These two factors determine whether the sensors produce an electronic deployment/inflation signal.

- The front air bags will completely inflate and deflate in an instant. It is virtually impossible for you to see the air bags inflate during an accident. It is much more likely that you will simply see the deflated air bags hanging out of their storage compartments after the collision.

- In addition to inflating in certain side collisions, vehicles equipped with a rollover sensor, side and curtain air bags will inflate if the sensing system detects a rollover.

When a rollover is detected, side and curtain air bags will remain inflated longer to help provide protection from ejection, especially when used in conjunction with the seat belts.

- To help provide protection, the air bags must inflate rapidly. The speed of air bag inflation is a consequence of extremely short time in which to inflate the air bag between the occupant and the vehicle structures before the occupant impacts those structures. This speed of inflation reduces the risk of serious or life-threatening injuries and is thus a necessary part of air bag design.

However, the rapid air bag inflation can also cause injuries which can include facial abrasions, bruises and broken bones because the inflation speed also causes the air bags to expand with a great deal of force.

- There are even circumstances under which contact with the air bag can cause fatal injuries, especially if the occupant is positioned excessively close to the air bag.

You can take steps to help reduce the risk of being injured by an inflating air bag. The greatest risk is sitting too close to the air bag. An air bag needs about 10 inches (25 cm) of space to inflate. NHTSA recommends that drivers allow at least 10 inches (25 cm) between the center of the steering wheel and the chest.

WARNING

To reduce the risk of serious injury or death from an inflating air bag, take the following precautions:

- **NEVER place a child restraint in the front passenger seat.**

Always properly restrain children under age 13 in the rear seats of the vehicle.

- **Adjust the front passenger's and driver's seats as far to the rear as possible while allowing you to maintain full control of the vehicle.**
- **Hold the steering wheel with hands at the 9 o'clock and 3 o'clock positions.**
- **Never place anything or anyone between the air bag and the seat occupant.**
- **Do not allow the front passenger to place their feet or legs on the dashboard.**



When the SRSCM detects a sufficiently severe impact to the front of the vehicle, it will automatically deploy the front air bags.

■ Driver's front air bag (2)



OTLA035108

Upon deployment, tear seams molded directly into the pad covers will separate under pressure from the expansion of the air bags. Further opening of the covers allows full inflation of the air bags.

A fully inflated air bag, in combination with a properly worn seat belt, slows the driver or the front passenger forward motion, reducing the risk of head and chest injury.

■ Driver's front air bag (3)



OTLA035109

■ Passenger's front air bag



OLMB033057

After complete inflation, the air bag immediately starts deflating, enabling the driver to maintain forward visibility and the ability to steer or operate other controls.

⚠ WARNING

To prevent objects from becoming dangerous projectiles when the passenger's air bag inflates:

- Do not install or place any objects (drink holder, CD holder, stickers, etc.) on the front passenger's panel above the glove box where the passenger's air bag is located.
- Do not install a container of liquid air freshener near the instrument cluster or on the instrument panel surface.

What to Expect After an Air Bag Inflates

After a frontal or side air bag inflates, it will deflate very quickly. Air bag inflation will not prevent the driver from seeing out of the windshield or being able to steer. Curtain air bags may remain partially inflated for some time after they deploy.

WARNING

After an air bag inflates, take the following precautions:

- **Open your windows and doors as soon as possible after impact to reduce prolonged exposure to the smoke and powder released by the inflating air bag.**
- **Do not touch the air bag storage area's internal components immediately after an air bag has inflated. The parts that come into contact with an inflating air bag may be very hot.**

- **Always wash exposed skin areas thoroughly with cold and mild soap.**
- **Always have an authorized HYUNDAI dealer replace the air bag immediately after deployment. Air bags are designed to be used only once.**

Noise and smoke from inflating air bag

When the air bags inflate, they make a loud noise and may produce smoke and powder in the air inside of the vehicle. This is normal and is a result of the ignition of the air bag inflator. After the air bag inflates, you may feel substantial discomfort in breathing because of the contact of your chest with both the seat belt and the air bag, as well as from breathing the smoke and powder. The powder may aggravate asthma for some people. If you experience breathing problems after an air bag deployment, seek medical attention immediately.

Though the smoke and powder are nontoxic, they may cause irritation to the skin, eyes, nose, throat, etc. If this is the case, wash and rinse with cold water immediately and seek medical attention if the symptoms persist.

Occupant Classification System (OCS)

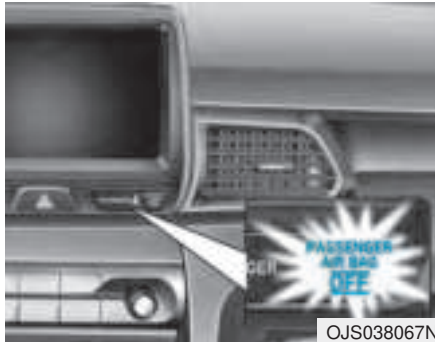

Your vehicle is equipped with an Occupant Classification System (OCS) in the front passenger's seat.

Main components of the Occupant Classification System

- A detection device located within the front passenger seat cushion.
- Electronic system to determine whether the passenger air bag systems should be activated or deactivated.
- An indicator light located on the instrument panel which illuminates the words "PASSENGER AIR BAG OFF" indicating the front passenger air bag system is deactivated.
- The instrument panel air bag indicator light is interconnected with the OCS.

The OCS is designed to help detect the presence of a properly-seated front passenger and determine if the passenger's front air bag should be enabled (may inflate) or not.

The purpose is to help reduce the risk of injury or death from an inflating air bag to certain front passenger seat occupants, such as children, by requiring the air bag to be automatically turned OFF.

For example, if a child restraint of the type specified in the regulations is on the seat, the occupant classification sensor can detect it and cause the air bag to turn OFF.

Front passenger seat adult occupants who are properly seated and wearing the seat belt properly, should not cause the passenger air bag to be automatically turned OFF. For small adults it may be turned OFF, however, if the occupant does not sit in the seat properly (for example, by not sitting upright, by sitting on the edge of the seat, or by otherwise being out of position), this could cause the sensor to turn the air bag OFF.

You will find the "PASSENGER AIR BAG OFF" indicator on the center fascia panel. This system detects the conditions 1-4 in the following table and activates or deactivates the front passenger air bag based on these conditions.

Always be sure that you and all vehicle occupants are seated properly and wearing the seat belt properly for the most effective protection by the air bag and the seat belt.

The OCS may not function properly if the passenger takes actions which can affect the classification system. These include:

- Failing to sit in an upright position.
- Leaning against the door or center console.
- Sitting towards the sides of the front of the seat.
- Putting their legs on the dashboard or resting them on other locations which reduce the passenger weight on the front seat.
- Wearing the seat belt improperly.
- Reclining the seatback.
- Wearing a thick cloth like ski wear or hip protection wear.
- Putting an additional thick cushion on the seat.
- Putting electrical devices (e.g. notebook, satellite radio) on the seat with inverter charging.

Condition and operation in the front passenger Occupant Classification System

Condition detected by the occupant classification system	Indicator/Warning light		Devices
	"PASSENGER AIR BAG OFF" indicator light	SRS warning light	Front passenger air bag
1. Adult *1	Off	Off	Activated
2. Infant *2 or child restraint system with 12 months old *3 *4	On	Off	Deactivated
3. Unoccupied	On	Off	Deactivated
4. Malfunction in the system	Off	On	Activated

*1 The system judges a person of adult size as an adult. When a smaller adult sits in the front passenger seat, the system may recognize him/her as a child depending on his/her physique and posture.

*2 Do not allow children to ride in the front passenger seat. When a larger child who has outgrown a child restraint system sits in the front passenger seat, the system may recognize him/her as an adult depending upon his/her physique or sitting position.

*3 Never install a child restraint system on the front passenger seat.

*4 The PASSENGER AIR BAG "OFF" indicator may turn on or off when a child above 12 months to 12 years old (with or without child restraint system) sits in the front passenger seat. This is a normal condition.

WARNING

Riding in an improper position or placing weight on the front passenger's seat when it is unoccupied by a passenger adversely affects the OCS. To reduce the risk of serious injury or death:



- NEVER put a heavy load in the front seat or seatback pocket.



- NEVER ride with the seatback reclined when the vehicle is moving.



- NEVER place your feet on the front passenger seatback.



- NEVER place your feet or legs on the dashboard.



- NEVER sit with your hips shifted towards the front of the seat.



- NEVER lean on the door or center console or sit on one side of the front passenger seat.



- Do not sit on the passenger seat wearing heavily padded clothes such as ski wear and hip protector.



- Do not place electronic devices such as laptops, DVD player, or conductive materials such as water bottles on the passenger seat.
- Do not use electronic devices such as laptops and satellite radios which use inverter chargers.



- Do not use car seat accessories such as thick blankets and cushions which cover up the car seat surface.



- If large quantity of liquid has been spilled on the passenger seat, the air bag warning light may illuminate or malfunction. Therefore, make sure the seat has been completely dried before driving the vehicle.

- Do not place sharp objects on the front passenger seat. These may damage the occupant detection system, if they puncture the seat cushion.
- Do not place any items under the front passenger seat.
- When changing or replacing the seat or seat cover, use original items only. The OCS has been developed based on using original HYUNDAI car seats only. Altering or changing the authentic parts may result in system malfunction and increase risk of injury when in collision. Any of the above could interfere with the proper operation of the OCS sensor thereby increasing the risk of an injury in an accident.

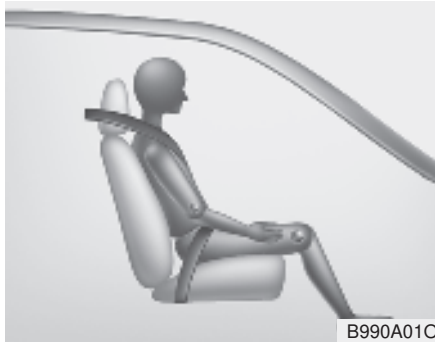

B990A010

Proper seated position for OCS

If the "PASSENGER AIR BAG OFF" indicator is on when an adult is seated in the front passenger seat, place the Engine Start/Stop button in the OFF position and ask the passenger to sit properly (sitting upright with the seat back in an upright position, centered on the seat cushion with their seat belt on, legs comfortably extended and their feet on the floor). Restart the engine and have the person remain in that position. This will allow the system to detect the person and to enable the passenger air bag. If the "PASSENGER AIR BAG OFF" indicator is still on, ask the passenger to move to the rear seat.

WARNING

Never allow an adult passenger to ride in the front passenger seat when the "PASSENGER AIR BAG OFF" indicator is illuminated. During a collision, the air bag will not inflate if the indicator is illuminated. Have your passenger reposition himself in the seat. If the "PASSENGER AIR BAG OFF" indicator remains illuminated after the passenger repositions himself properly and the vehicle is restarted, have the passenger move to the rear seat because the air bag will not inflate.

NOTICE

The "PASSENGER AIR BAG OFF" indicator illuminates for approximately 4 seconds after the Engine Start/Stop button is in the ON position or after the engine is started. If the front passenger seat is occupied, the OCS will then classify the front passenger after several more seconds.

Do Not Install a Child Restraint in the Front Passenger's Seat



Even though your vehicle is equipped with the OCS, never install a child restraint in the front passenger's seat. An inflating air bag can forcefully strike a child or child restraint resulting in serious or fatal injury.

 **WARNING**

- **NEVER place a rear-facing or front-facing child restraint in the front passenger's seat of the vehicle.**
- **An inflating frontal air bag could forcefully strike a child resulting in serious injury or death.**
- **Always properly restrain children in an appropriate child restraint in the rear seat of the vehicle.**

Why Didn't My Air Bag Go Off in a Collision?

Air bags are not designed to inflate in every collision. There are certain types of accidents in which the air bag would not be expected to provide additional protection. These include rear impacts, second or third collisions in multiple impact accidents, as well as low speed impacts. Damage to the vehicle indicates a collision energy absorption, and is not an indicator of whether or not an air bag should have inflated.

Air bag collision sensors

 **WARNING**

To reduce the risk of an air bag deploying unexpectedly and causing serious injury or death:

- **Do not hit or allow any objects to impact the locations where air bags or sensors are installed.**

- **Do not perform maintenance on or around the air bag sensors. If the location or angle of the sensors is altered, the air bags may deploy when they should not or may not deploy when they should.**
- **Do not install bumper guards or replace the bumper with a non-genuine HYUNDAI parts. This may adversely affect the collision and air bag deployment performance.**
- **Place the ignition switch in the LOCK/OFF or ACC position when the vehicle is being towed to prevent inadvertent air bag deployment.**
- **Have all air bag repairs conducted by an authorized HYUNDAI dealer.**



1. SRS control module/Rollover sensor
2. Front impact sensor
3. Side pressure sensor
4. Side impact sensor



OBU038037N/OJS038038/OJS038039N/OJS038040N/OJS038041N

Air bag inflation conditions



Front air bags

Front air bags are designed to inflate in a frontal collision depending on the severity of impact of the front collision.



Side and curtain air bags

Side and curtain air bags are designed to inflate when an impact is detected by side collision sensors depending on the severity of impact resulting from a side impact collision.

Although the driver's and front passenger's air bags are designed to inflate only in frontal collisions, they also may inflate in other types of collisions if the front impact sensors detect a sufficient impact. Side and curtain air bags are designed to inflate only in side impact collisions or rollover situations, but they may inflate in other collisions if the side impact sensors detect a sufficient impact.

If the vehicle chassis is impacted by bumps or objects on unimproved roads, the air bags may deploy. Drive carefully on unimproved roads or on surfaces not designed for vehicle traffic to prevent unintended air bag deployment.

Air bag non-inflation conditions



In certain low-speed collisions the air bags may not deploy. The air bags are designed not to deploy in such cases because they may not provide benefits beyond the protection of the seat belts.



Front air bags are not designed to inflate in rear collisions, because occupants are moved backward by the force of the impact. In this case, inflated air bags would not provide any additional benefit.



Front air bags may not inflate in side impact collisions, because occupants move in the direction of the collision, and thus in side impacts, front air bag deployment would not provide additional occupant protection.

However, side and curtain air bags may inflate depending on the severity of impact.

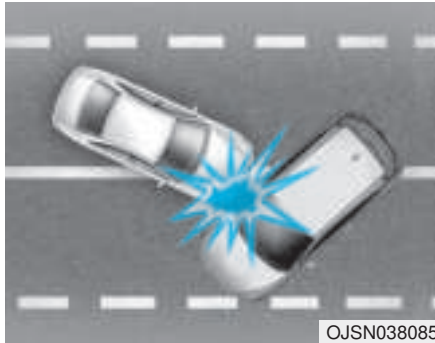

In an angled collision, the force of impact may direct the occupants in a direction where the air bags would not be able to provide any additional benefit, and thus the sensors may not deploy any air bags.

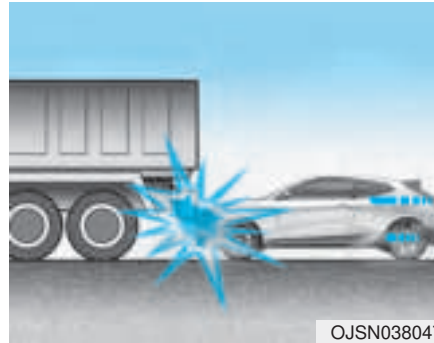

Just before impact, drivers often brake heavily. Such heavy braking lowers the front portion of the vehicle causing it to "ride" under a vehicle with a higher ground clearance. Air bags may not inflate in this "under-ride" situation because deceleration forces that are detected by sensors may be significantly reduced by such "override" collisions.



Front air bags may not inflate in rollover accidents because air bag deployment could not provide protection to the occupants.

However, side and curtain air bags may inflate when the vehicle is rolled over by a side impact collision.



OJSN038048

Air bags may not inflate if the vehicle collides with objects such as utility poles or trees, where the point of impact is concentrated and the collision energy is absorbed by the vehicle structure.

SRS Care

The SRS is virtually maintenance-free and there are no parts you can safely service by yourself. If the SRS air bag warning light does not illuminate when the ignition switch is in the ON position, or continuously remains on, have your vehicle immediately inspected by an authorized HYUNDAI dealer.

Any work on the SRS system, such as removing, installing, repairing, or any work on the steering wheel, the front passenger's panel, front seats and roof rails must be performed by an authorized HYUNDAI dealer. Improper handling of the SRS system may result in serious personal injury.

WARNING

To reduce the risk of serious injury or death, take the following precautions:

- **Do not attempt to modify or disconnect the SRS components or wiring, including the addition of any kind of badges to the pad covers or modifications to the body structure.**
- **Do not place objects over or near the air bag modules on the steering wheel, instrument panel, or the front passenger's panel above the glove box.**
- **Clean the air bag pad covers with a soft cloth moistened with plain water. Solvents or cleaners could adversely affect the air bag covers and proper deployment of the system.**
- **Always have inflated air bags replaced by an authorized HYUNDAI dealer.**

- **If components of the air bag system must be discarded, or if the vehicle must be scrapped, certain safety precautions must be observed. Consult an authorized HYUNDAI dealer for the necessary information. Failure to follow these precautions could increase the risk of personal injury.**

Additional Safety Precautions

Passengers should not move out of or change seats while the vehicle is moving. A passenger who is not wearing a seat belt during a crash or emergency stop can be thrown against the inside of the vehicle, against other occupants, or be ejected from the vehicle.

Do not use any accessories on seat belts. Devices claiming to improve occupant comfort or reposition the seat belt can reduce the protection provided by the seat belt and increase the chance of serious injury in a crash.

Do not modify the front seats.

Modification of the front seats could interfere with the operation of the supplemental restraint system sensing components or side air bags.

Do not place items under the front seats. Placing items under the front seats could interfere with the operation of the supplemental restraint system sensing components and wiring harnesses.

Do not cause impact to the doors.

Impact to the doors when the Engine Start/Stop button is in the ON position may cause the air bags to inflate.

Modifications to accommodate disabilities. If you require modification to your vehicle to accommodate a disability, contact the HYUNDAI Customer Connect Center at 800-633-5151.

Adding equipment to or modifying your air bag equipped vehicle

If you modify your vehicle by changing your vehicle's frame, bumper system, front end or side sheet metal or ride height, this may affect the operation of your vehicle's air bag system.

Air Bag Warning Labels



Air bag warning labels, required by the U.S. National Highway Traffic Safety Administration (NHTSA), are attached to alert the driver and passengers of potential risks of the air bag system. Be sure to read all of the information about the air bags that are installed on your vehicle in this Owners Manual.

Convenient features of your vehicle

Accessing Your Vehicle	3-3	Instrument cluster	3-31
Smart Key	3-3	Instrument Cluster Control	3-32
Immobilizer System	3-8	Gauges and Meters	3-33
Door Locks	3-10	Transmission shift indicator	3-36
Operating Door Locks from Outside the Vehicle	3-10	Warning and Indicator Lights	3-38
Operating Door Locks from Inside the Vehicle	3-11	LCD Display Messages	3-48
Automatic Door Lock and Unlock Features	3-13	LCD Display	3-54
Child-Protector Rear Door Locks	3-13	LCD Display Control	3-54
Theft-Alarm System	3-14	LCD Display Modes	3-55
Steering Wheel	3-15	Trip Computer	3-64
Electric Power Steering (EPS)	3-15	Lighting	3-68
Tilt Steering / Telescope Steering	3-16	Exterior Lights	3-68
Horn	3-16	Interior Lights	3-72
Mirrors	3-17	High Beam Assist (HBA)	3-75
Inside Rearview Mirror	3-17	System operation	3-76
Side View Mirrors	3-18	System malfunction and limitations	3-77
Windows	3-21	Wipers And Washers	3-79
Power Windows	3-22	Windshield Wipers	3-79
Exterior Features	3-25	Windshield Washers	3-80
Hood	3-25	Rear Window Wiper and Washer	3-81
Liftgate	3-26	Rear View Monitor (RVM)	3-82
Fuel Filler Door	3-28		

Manual Climate Control System	3-83
Heating and Air Conditioning	3-84
System Operation.....	3-87
System Maintenance.....	3-89
Automatic Climate Control System	3-91
Automatic Temperature Control Mode	3-92
Manual Temperature Control Mode	3-93
System Operation.....	3-97
System Maintenance.....	3-99
Windshield Defrosting and Defogging	3-101
Rear Window Defroster	3-103
Climate Control Additional Features	3-104
Automatic Ventilation.....	3-104
Storage Compartment	3-105
Center Console Storage	3-105
Glove Box.....	3-105
Sunglass Holder.....	3-106
Interior Features	3-107
Cup Holder	3-107
Sunvisor	3-108
Power Outlet	3-108
USB charger	3-109
Clock.....	3-110
Clothes Hanger	3-110
Floor Mat Anchor(s).....	3-111
Cargo Area Cover.....	3-112

ACCESSING YOUR VEHICLE

Smart Key

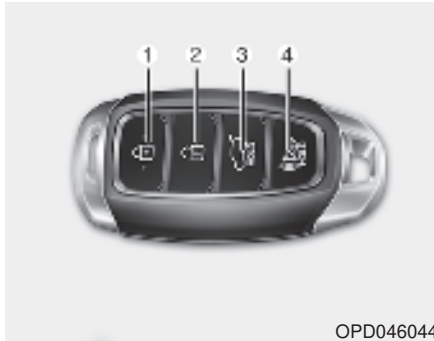

Your HYUNDAI uses a Smart Key, which you can use to lock or unlock the driver and passenger doors or the rear liftgate.

1. Door Lock
2. Door Unlock
3. Liftgate Unlock
4. Panic

Locking your vehicle

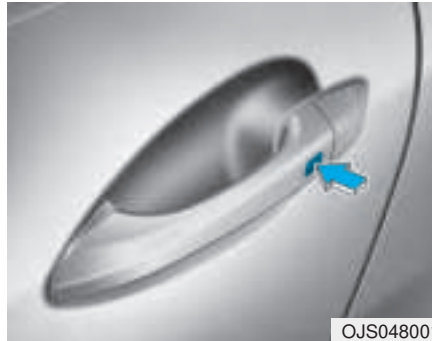

To lock your vehicle using the door handle button or the Smart Key:

1. Close all doors, hood and liftgate.
2. Either press the door handle button or press the Door Lock button (1) on the smart key.
3. The hazard warning lights will blink and the chime will sound once.
4. When the doors are locked, the indicator light on the central door lock/unlock switch will be illuminated.

i Information

The door handle button will only operate when the smart key is within 28~40 inches (0.7~1 m) from the outside door handle.

Note that you cannot lock your vehicle using the door handle button if any of the following occur:

- The Smart Key is in the vehicle.
- The Engine Start/Stop button is in ACC or ON position.
- Any of the doors are open except for the liftgate.

⚠ WARNING

Do not leave the Smart Key in your vehicle with unsupervised children. Unattended children could press the Engine Start/Stop button and may operate power windows or other controls, or even make the vehicle move, which could result in serious injury or death.

Unlocking your vehicle

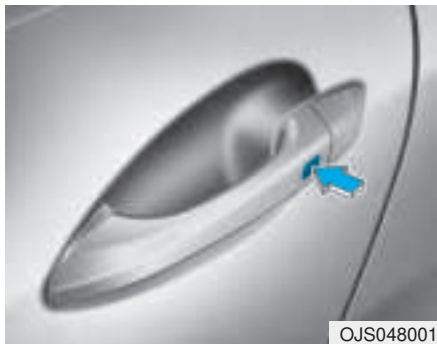

To unlock your vehicle:

1. Make sure you have the smart key in your possession.
2. Press either the button on the door handle or the Door Unock button (2) on the smart key. The driver's door will unlock and the hazard warning lights will blink two times.

3. Two Press Unlock Feature

The priority for unlocking the driver door only, or unlocking all the doors with one press may be adjusted in the User Settings menu in the LCD cluster display.

The Two Press Unlock feature, when enabled, will require the user to press the door unlock button once for driver door only and twice for unlocking all the doors.

Select or Deselect the Two Press Unlock Feature in the User Settings menu in the LCD cluster display. The option can be found under the following menu:

USER SETTINGS → DOOR → TWO PRESS UNLOCK

The Two Press Unlock Feature can also be enabled or disabled by pressing the door lock and unlock buttons simultaneously on the Key FOB:

Press and hold both the DOOR LOCK button and the DOOR UNLOCK button simultaneously until the hazard warning lights blink.

This will enable or disable the Two Press Unlock feature. Repeat this procedure to enable/disable the mode again.

i Information

- **The door handle buttons will only operate when the smart key is within 28-40 inches (0.7~1 m) from the outside door handle**
- **Either the driver or front passenger door can be opened with the door handle button when the smart key is within this range**
- **If you press the front passenger outside door handle with the smart key in your possession, all the doors will unlock**

Opening the liftgate

To unlock and open the liftgate:

1. Make sure you have the smart key in your possession.
2. Press either the liftgate handle release button on the vehicle or press and hold the Liftgate Unlock button on the smart key for more than one second. The hazard warning lights will blink two times and the liftgate latch will unlock.

NOTICE

The liftgate must be operated manually to open the liftgate. Once the liftgate latch is unlocked, pull upward on the liftgate handle to fully open the liftgate.

3. Once the liftgate is opened and then closed, the liftgate will lock automatically.

i Information

- **The liftgate handle button will only operate when the smart key is within 28 inches (0.7 m) from the liftgate handle.**
- **The Liftgate Unlock button (3) will only unlock the liftgate. It will not release the latch and open the liftgate automatically. If the Liftgate Unlock button is used, someone must still press the liftgate handle button to open the liftgate.**

Panic button

Press and hold the Panic button (4) for more than one second. The horn sounds and hazard warning lights blink for about 30 seconds. To cancel the panic mode, press any button on the Smart Key.

Start-up

You can start the vehicle without inserting the key.

For information, refer to the "Engine Start/Stop Button" section in chapter 5.

NOTICE

To prevent damaging the smart key:

- **Keep the smart key in a cool, dry place to avoid damage or malfunction. Exposure to moisture or high temperature may cause the internal circuit of the smart key to malfunction which may not be covered under warranty.**
- **Avoid dropping or throwing the smart key.**
- **Protect the smart key from extreme temperatures.**

Mechanical key

If the Smart Key does not operate normally, you can lock or unlock the driver's door by using the mechanical key.



To remove the mechanical key from the smart key FOB, slide the release lever in the direction of the arrow (1) and then pull the mechanical key (2) outward.

To unlock the vehicle using the mechanical key, insert the mechanical key into the key hole in the driver door.

To reinstall the mechanical key into the FOB, insert the key in the top of the key FOB and push inward until a click sound is heard.

Loss of a smart key

A maximum of two Smart Keys can be registered to a single vehicle. If you happen to lose your smart key, you should immediately take the vehicle and remaining keys to your authorized HYUNDAI dealer or tow the vehicle, if necessary.

Smart key precautions

The smart key may not work if any of the following occur:

- The smart key is close to a radio transmitter such as a radio station or an airport which can interfere with normal operation of the transmitter.
- The smart key is near a mobile two way radio system or a cellular phone.
- Another vehicle's smart key is being operated close to your vehicle.

If the smart key does not work correctly, open and close the door with the mechanical key. If you have a problem with the smart key, contact an authorized HYUNDAI dealer.

If the smart key is in close proximity to your mobile phone, the signal could be blocked by your mobile phone's normal operational signals. This is specifically relevant when the phone is active such as making and receiving calls, text messaging, and/or sending/receiving emails. When possible, avoid keeping the smart key and your mobile phone in the same location such as a pants or jacket pocket in order to avoid interference between the two devices.

NOTICE

Keep the smart key away from electromagnetic materials that blocks electromagnetic waves to the key surface.

NOTICE

Always have the smart key with you when leaving the vehicle. If the smart key is left near the vehicle, the vehicle battery may be discharged.

i Information

This device complies with Part 15 of the FCC rules.

Operation is subject to the following three conditions:

- 1. This device may not cause harmful interference.**
- 2. This device must accept any interference received, including interference that may cause undesired operation.**
- 3. Changes or modifications not expressly approved by the party responsible for compliance could void the user's authority to operate the device.**

Battery replacement



If the Smart Key is not working properly, try replacing the battery with a new one.

Battery Type: CR2032

To replace the battery:

1. Remove the mechanical key.
2. Use a slim tool to pry open the rear cover of the smart key.
3. Remove the old battery and insert the new battery. Make sure the battery position is correct.
4. Reinstall the rear cover of the smart key.

If you suspect your smart key might have sustained some damage, or you feel your smart key is not working correctly, contact an authorized HYUNDAI dealer.

i Information



An inappropriately disposed battery can be harmful to the environment and human health. Dispose of the battery according to your local law(s) or regulations.

Immobilizer System

The immobilizer system protects your vehicle from theft. If an improperly coded key (or other device) is used, the engine's fuel system is disabled.

When the ignition switch is placed in the ON position, the immobilizer system indicator should come on briefly, then go off. If the indicator starts to blink, the system does not recognize the coding of the key.

Turn the ignition switch to the LOCK/OFF position, then turn the ignition switch to the ON position again.

In some circumstances, the vehicle may not recognize your smart key if another smart key device is nearby or a metal object such as a key chain is causing interference with the smart key.

If this occurs, your vehicle may not start. Remove any metal objects or additional keys near the smart key before attempting to start the vehicle again.

If the system repeatedly does not recognize the coding of the key, it is recommended that you contact your HYUNDAI dealer.

Do not attempt to alter this system or add other devices to it. Electrical problems could result that may make your vehicle inoperable.

WARNING

In order to prevent theft of your vehicle, do not leave spare keys anywhere in your vehicle. Your immobilizer password is a customer unique password and should be kept confidential.

NOTICE

The transponder in your key is an important part of the immobilizer system. It is designed to give years of trouble-free service, however you should avoid exposure to moisture, static electricity and rough handling. Immobilizer system malfunction could occur.

i Information

This device complies with Part 15 of the FCC rules.

Operation is subject to the following three conditions:

1. This device may not cause harmful interference.
2. This device must accept any interference received, including interference that may cause undesired operation.
3. Changes or modifications not expressly approved by the party responsible for compliance could void the user's authority to operate the device.

DOOR LOCKS

Operating Door Locks from Outside the Vehicle

Mechanical key

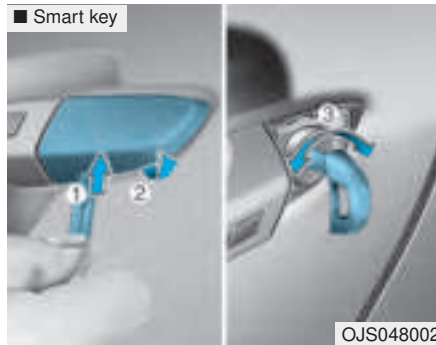

If you lock the driver's door with a mechanical key, all vehicle doors will lock.

If you unlock the driver's door with a mechanical key, you can open and close the driver's door only.

Once the doors are unlocked, they may be opened by pulling the door handle. When closing the door, push the door by hand. Make sure that doors are closed securely.

Smart key

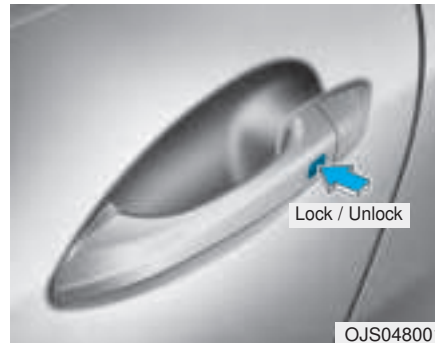

Press the button on the driver's outside door handle while carrying the Smart Key with you or press the Door Unlock button on the Smart Key, the driver's door will unlock.

If you press the button on the front passenger's outside door, all doors will unlock.

Once the doors are unlocked, they may be opened by pulling the door handle.

When closing the door, push the door by hand. Make sure that doors are closed securely.

i Information

- In cold and wet climates, door lock and door mechanisms may not work properly due to freezing conditions.
- If the door is locked/unlocked multiple times in rapid succession with either the vehicle key or door lock switch, the system may stop operating temporarily in order to protect the circuit and prevent damage to system components.
- Two press unlock setting can be changed in the User Settings mode on the cluster.

Operating Door Locks from Inside the Vehicle

With the door lock button



- To unlock a door, push the door lock button (1) to the "Unlock" position. The red mark (2) on the door lock button will be visible.
- To lock a door, push the door lock button (1) to the "Lock" position. If the door is locked properly, the red mark (2) on the door lock button will not be visible.
- To open a door, pull the door handle (3) outward.

- If the inner door handle of either the driver door or passenger door is pulled when the door lock button is in the lock position, the button is unlocked and the door will open.
- For Push Button Start Vehicles (Smart Key)

The doors cannot be locked if the smart key fob is inside the vehicle and any of the doors are open.

i Information

If a power door lock ever fails to function while you are in the vehicle try one or more of the following techniques to exit:

- **Operate the door unlock feature repeatedly (both electronic and manual) while simultaneously pulling on the door handle.**
- **Operate the other door locks and handles, front and rear.**
- **Lower a front window and use the mechanical key to unlock the door from outside.**

With the central door lock switch



The driver side door armrest is equipped with a central door lock switch. The lock button is indicated by a (🔒) symbol. The unlock button is indicated by a (🔓) symbol.

When the lock button (1) is pressed, all the vehicle doors will lock.

When the unlock button (2) is pressed, all the vehicle doors will unlock.

Convenient features of your vehicle

- For Push Button Start Vehicles (Smart Key)

If the smart key is in the vehicle and any door is open, the doors will not lock even though the lock button (2) is pressed.

WARNING

- The doors should always be fully closed and locked while the vehicle is in motion. If the doors are unlocked, the risk of being thrown from the vehicle in a crash is increased.
- Do not pull the inner door handle of the driver's or passenger's door while the vehicle is moving.

WARNING

Do not leave children or animals unattended in your vehicle. An enclosed vehicle can become extremely hot, causing death or serious injury to unattended children or animals who cannot escape the vehicle. Children might operate features of the vehicle that could injure them, or they could encounter other harm, possibly from someone gaining entry to the vehicle.

WARNING

Always secure your vehicle.

Leaving your vehicle unlocked increases the potential risk to you or others from someone hiding in your vehicle.

To secure your vehicle, while depressing the brake, move the shift lever to the 1st gear when the vehicle is parked on a uphill and to R (Reverse) on a downhill, engage the parking brake, and place the ignition switch in the LOCK/OFF position, close all windows, lock all doors, and always take the key with you.

CAUTION

Opening a door when something is approaching may cause damage or injury. Be careful when opening doors and watch for vehicles, motorcycles, bicycles or pedestrians approaching the vehicle in the path of the door.

WARNING

If you stay in the vehicle for a long time while the weather is very hot or cold, there are risks of injuries or danger to life. Do not lock the vehicle from the outside when someone is in the vehicle.

Automatic Door Lock and Unlock Features

Your vehicle is equipped with features that will automatically lock or unlock your vehicle based on settings you select in the LCD cluster display.

Auto LOCK - Enable on Speed

When this feature is set in the LCD cluster display, all the doors will be locked automatically when the vehicle exceeds 9 mph (15 kph).

Additional Unlock Safety Feature - Air Bag Deployment

As an additional safety feature, all doors will be automatically unlocked when an impact causes the air bags to deploy.

Child-Protector Rear Door Locks



The child safety lock is provided to help prevent children seated in the rear from accidentally opening the rear doors. The rear door safety locks should be used whenever children are in the vehicle.

The child safety lock is located on the edge of each rear door. When the child safety lock is in the lock position, the rear door will not open if the inner door handle is pulled.

To lock the child safety lock, insert a small flat blade tool (like a screwdriver or similar) (1) into the slot and turn it to the lock position as shown.

To allow a rear door to be opened from inside the vehicle, unlock the child safety lock.

WARNING

If children accidentally open the rear doors while the vehicle is in motion, they could fall out of the vehicle. The rear door safety locks should always be used whenever children are in the vehicle.

THEFT-ALARM SYSTEM

This system helps to protect your vehicle and valuables. The horn will sound and the hazard warning lights will blink continuously if any of the following occur:

- A door is opened without using the smart key.
- The liftgate is opened without using the smart key.
- The engine hood is opened.

The alarm continues for 30 seconds, then the system resets. To turn off the alarm, unlock the doors with the smart key.

The Theft Alarm System automatically sets 30 seconds after you lock the doors and the liftgate. For the system to activate, you must lock the doors and the liftgate from outside the vehicle with the smart key or by pressing the button on the outside of the door handle with the smart key in your possession.

The hazard warning lights will blink and the chime will sound once to indicate the system is armed.

Once the security system is set, opening any door, the liftgate, or the hood without using the smart key will cause the alarm to activate.

The Theft Alarm System will not set if the hood, the liftgate, or any door is not fully closed. If the system will not set, check the hood, the liftgate, or the doors are fully closed.

Do not attempt to alter this system or add other devices to it.

Information

- **Do not lock the doors until all passengers have left the vehicle. If the remaining passenger leaves the vehicle when the system is armed, the alarm will be activated.**
- **If the vehicle is not disarmed with the smart key, open the doors by using the mechanical key and start the engine by directly pressing the ignition switch with the smart key.**
- **If the system is disarmed by unlocking the vehicle, but neither a door or the liftgate is opened within 30 seconds, the doors will relock and the system will rearm automatically.**

STEERING WHEEL

Electric Power Steering (EPS)

The system assists you with steering the vehicle. If the vehicle is turned off or if the power steering system becomes inoperative, you may still steer the vehicle, but it will require increased steering effort.

Should you notice any change in the effort required to steer during normal vehicle operation, have the system checked by an authorized HYUNDAI dealer.

CAUTION

- If the Electric Power Steering System does not operate normally, the warning light (⊖!) will illuminate on the instrument cluster. You may steer the vehicle, but it will require increased steering efforts. Take your vehicle to an authorized HYUNDAI dealer and have the system checked as soon as possible.

- When abnormality is detected in the electric power steering system, to prevent an accident, the steering assist function will stop. At this time, the warning light turns on or blinks on the cluster. The steering wheel may become difficult to control or operate. Have your vehicle checked immediately, after moving the vehicle to a safe zone.

Information

The following symptoms may occur during normal vehicle operation:

- The steering effort may be high immediately after placing the ignition switch in the ON position.
This happens as the system performs the EPS system diagnostics. When the diagnostics are completed, the steering wheel effort will return to its normal condition.
- When the battery voltage is low, you might have to put more steering effort. However, it is a temporary condition so that it will return to normal condition after charging the battery.

- When the battery voltage is low, you might have to put more steering effort. However, it is a temporary condition so that it will return to normal condition after charging the battery.
- A click noise may be heard from the EPS relay after the ignition switch is in the ON or LOCK/OFF position.
- Motor noise may be heard when the vehicle is at a stop or at a low driving speed.
- When you operate the steering wheel in low temperatures, abnormal noise may occur. If the temperature rises, the noise will disappear. This is a normal condition.
- When an error is detected from the EPS, the steering effort assist function will not be activated in order to help prevent fatal accidents. Instrument cluster warning lights may be on or the steering effort may be high. If these symptoms occur, drive the vehicle to a safe area as soon as it is safe to do so. Have the system checked by an authorized HYUNDAI dealer as soon as possible.

Tilt Steering / Telescope Steering

When adjusting the steering wheel to a comfortable position, adjust the steering wheel so that it points toward your chest, not toward your face. Make sure you can see the instrument cluster warning lights and gauges. After adjusting, push the steering wheel both up and down to be certain it is locked in position. Always adjust the position of the steering wheel before driving.

WARNING

NEVER adjust the steering wheel while driving. This may cause loss of vehicle control resulting in an accident.



OJSN048007

To adjust the steering wheel angle and height:

1. Pull down the lock-release lever (1).
2. Adjust the steering wheel to the desired angle (2) and distance forward/back (3).
3. Pull up the lock-release lever to lock the steering wheel in place.

Information

Sometimes the lock release lever may not engage completely. This may occur when the gears of the locking mechanism do not completely mesh. If this occurs, pull down on the lock-release lever, readjust the steering wheel again, and then pull back up on the release lever to lock the steering wheel in place.

Horn



OPDEN047014

To sound the horn, press the area indicated by the horn symbol on your steering wheel (see illustration). The horn will operate only when this area is pressed.

NOTICE

Do not strike the horn severely to operate it, or hit it with your fist. Do not press on the horn with a sharp-pointed object.

MIRRORS

Inside Rearview Mirror

Before driving your vehicle, check to see that your inside rearview mirror is properly positioned. Adjust the rearview mirror so that the view through the rear window is properly centered.

WARNING

Make sure your line of sight is not obstructed. Do not place objects in the rear seat, cargo area, or behind the rear head-rests which could interfere with your vision through the rear window.

WARNING

To prevent serious injury during an accident or deployment of the air bag, do not modify the rearview mirror and do not install a wide mirror.

WARNING

NEVER adjust the mirror while driving. This may cause loss of vehicle control resulting in an accident.

NOTICE

When cleaning the mirror, use a paper towel or similar material dampened with glass cleaner. Do not spray glass cleaner directly on the mirror as this may cause the liquid cleaner to enter the mirror housing.

Day/night rearview mirror



[A] : Day, [B] : Night

Make this adjustment before you start driving and while the day/night lever is in the day position.

Pull the day/night lever towards you to reduce glare from the headlights of the vehicles behind you during night driving.

Remember that you lose some rearview clarity in the night position.

Blue Link® center



For details, refer to the Blue Link® Owner's Guide, Navigation Manual or Audio Manual.

Side View Mirrors



Make sure to adjust the side view mirrors to your desired position before you begin driving.

Your vehicle is equipped with both left-hand and right-hand side view mirrors. The mirrors can be adjusted remotely with the remote switch. The side view mirrors can be folded to help prevent damage when going through an automatic car wash or when passing through a narrow street.

The right side view mirror is convex. Objects seen in the mirror are closer than they appear.

Use the inside rear view mirror or look back directly to determine the actual distance of other vehicles prior to changing lanes.

WARNING

Do not adjust or fold the side view mirrors while driving. This may cause loss of vehicle control resulting in an accident.

NOTICE

- **Do not scrape ice off the mirror face; this may damage the surface of the glass.**
- **If the mirror is jammed with ice, do not adjust the mirror by force. Use an approved spray de-icer (not radiator antifreeze) spray, or a sponge or soft cloth with very warm water, or move the vehicle to a warm place and allow the ice to melt.**

Blind spot mirror

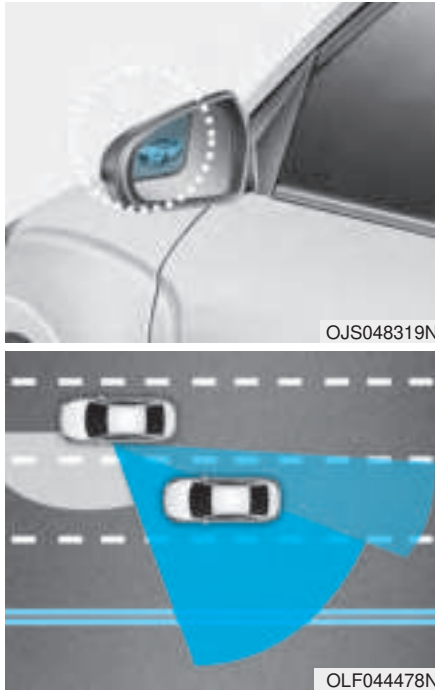

The Blind Spot Mirror (BSM) is a supplemental mirror that minimizes the driver's blind spot zone by expanding the field of view on the rear side of the vehicle.

The blind spot mirror is equipped on the driver's left side view mirror.

WARNING

- Always check the road condition while driving for unexpected situations even though the vehicle is equipped with a blind spot mirror.
- The blind spot mirror is intended as a supplemental device to assist the driver before changing lanes. Do not solely rely on the blind spot mirror as a precaution. Always pay attention to traffic conditions around you.

NOTICE

Do not clean the mirror with harsh abrasives, fuel or other petroleum based cleaning products.

Side View Mirror Adjustment



Adjusting the side view mirrors:

1. Press either the L (driver's side) or R (passenger's side) button (1) to select the side view mirror you would like to adjust.
2. Use the mirror adjustment control switch to position the selected mirror up, down, left or right.
3. After adjustment, put the button into neutral (center) position to prevent inadvertent adjustment.

NOTICE

- The mirrors stop moving when they reach the maximum adjusting angles, but the motor continues to operate while the switch is pressed. Do not press the switch longer than necessary, because this can damage the motor.
- Do not attempt to adjust the side view mirrors by hand, because this can damage the motor.

Folding the side view mirrors



To fold the side view mirrors, grasp the housing of the mirror and then fold it inwards.

WINDOWS

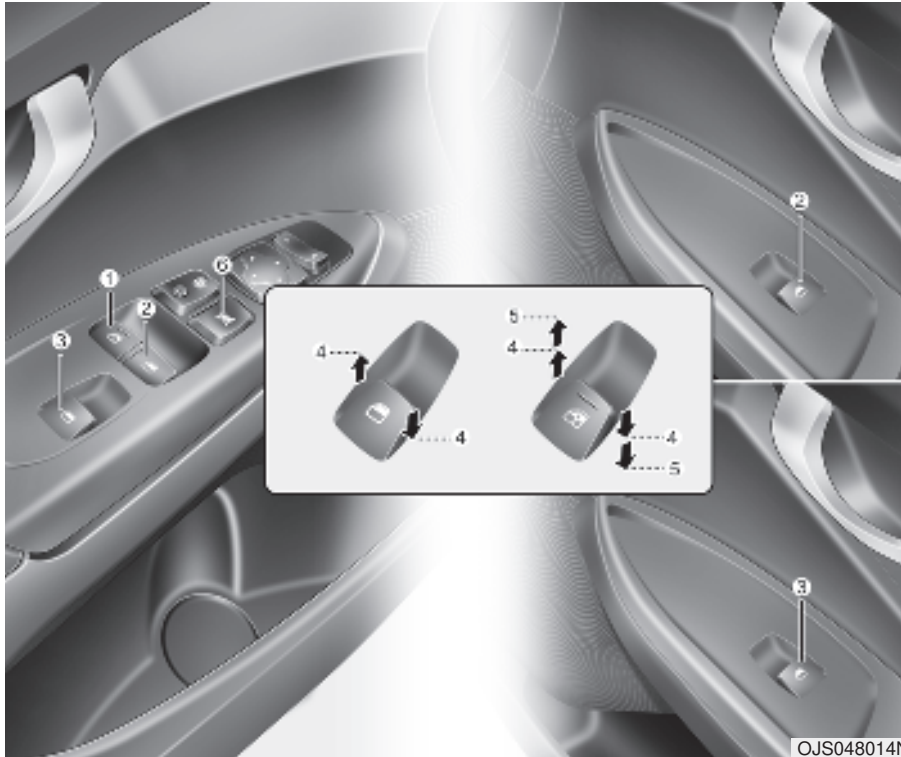

- (1) Driver's door power window switch
 - (2) Front passenger's door power window switch
 - (3) Rear door (right) power window switch
 - (4) Window opening and closing
 - (5) Automatic power window*
 - (6) Power window lock switch
- * : if equipped

Power Windows

The ignition switch must be in the ON position to be able to raise or lower the windows. Each door has a Power Window switch to control that door's window. The driver has a Power Window Lock switch which can block the operation of rear passenger windows. The power windows will operate for approximately 30 seconds after the ignition switch is placed in the ACC or LOCK/OFF position. However, if the front doors are opened, the Power Windows will not operate even within the 30 second period.

WARNING

To avoid serious injury or death, do not extend your head, arms or body outside the windows while driving.

Information

- **In cold and wet climates, power windows may not work properly due to freezing conditions.**
- **While driving with the rear windows down, your vehicle may demonstrate a wind buffeting or pulsation noise. This noise is normal and can be reduced or eliminated by taking the following actions. If the noise occurs with one or both of the rear windows down, partially lower both front windows approximately one inch.**

Window opening and closing

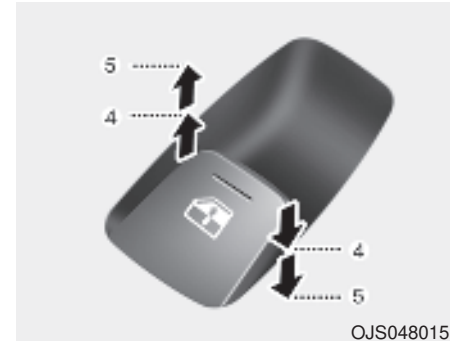

To open:

Press the window switch down to the first detent position (4). Release the switch when you want the window to stop.

To close:

Pull the window switch up to the first detent position (4). Release the window switch when you want the window to stop.

Auto down window (if equipped)

Pressing the power window switch momentarily to the second detent position (5) completely lowers the window even when the switch is released. To stop the window at the desired position while the window is in operation, pull up or press down and release the switch.

Auto up/down window (if equipped)

Pressing or pulling up the power window switch momentarily to the second detent position (5) completely lowers or lifts the window even when the switch is released. To stop the window at the desired position while the window is in operation, pull up or press down and release the switch.

To reset the power windows

If the power windows do not operate normally, the automatic power window system must be reset as follows:

1. Place the ignition switch to the ON position.
2. Close the window and continue pulling up on the power window switch for at least one second.

If the power windows do not operate properly after resetting, have the system checked by an authorized HYUNDAI dealer.

⚠ WARNING

The automatic reverse feature doesn't activate while resetting the power window system. Make sure body parts or other objects are safely out of the way before closing the windows to avoid injuries or vehicle damage.

Automatic reverse (if equipped)

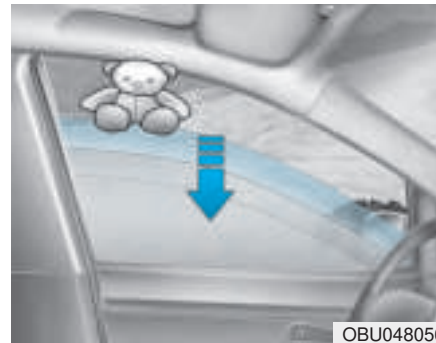

If a window senses any obstacle while it is closing automatically, it will stop and lower approximately 12 inches (30 cm) to allow the object to be cleared.

If the window detects the resistance while the power window switch is pulled up continuously, the window will stop upward movement then lower approximately 1 inch (2.5 cm).

If the power window switch is pulled up continuously again within 5 seconds after the window is lowered by the automatic window reverse feature, the automatic window reverse will not operate.

i Information

The automatic reverse feature is only active when the "Auto Up" feature is used by fully pulling up the switch to the second detent.

⚠ WARNING

Make sure body parts or other objects are safely out of the way before closing the windows to avoid injuries or vehicle damage.

Objects less than 0.16 inch (4 mm) in diameter caught between the window glass and the upper window channel may not be detected by the automatic reverse window and the window will not stop and reverse direction.

NOTICE

Do not install any accessories on the windows. The automatic reverse feature may not operate.

Power window lock switch



The driver can disable the power window switches on the rear passenger doors by pressing the power window lock switch.

When the power window lock switch is pressed:

- The rear passenger control will not be able to operate the rear passenger power window
- Note that the front passenger control is still able to operate the front passenger window, and that the driver master control can still operate all the power windows.

⚠ WARNING

Do not allow children to play with the power windows. Keep the driver's door power window lock switch in the LOCK position. Serious injury or death can result from unintentional window operation by a child.

NOTICE

- To prevent possible damage to the power window system, do not open or close two windows or more at the same time. This will also ensure the longevity of the fuse.
- Never try to operate the main switch on the driver's door and the individual door window switch in opposite directions at the same time. If this is done, the window will stop and cannot be opened or closed.

EXTERIOR FEATURES

Hood

Opening the hood



1. Park the vehicle and set the parking brake.
2. Pull the release lever to unlatch the hood. The hood should pop open slightly.

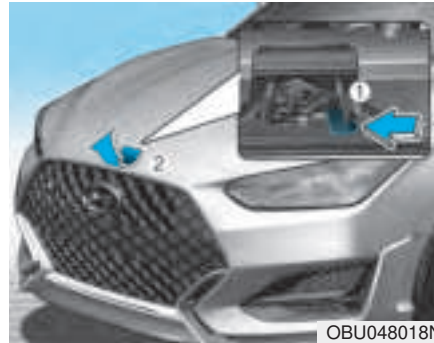

3. Go to the front of the vehicle, raise the hood slightly, push up the secondary latch (1) inside the hood center and lift the hood (2).

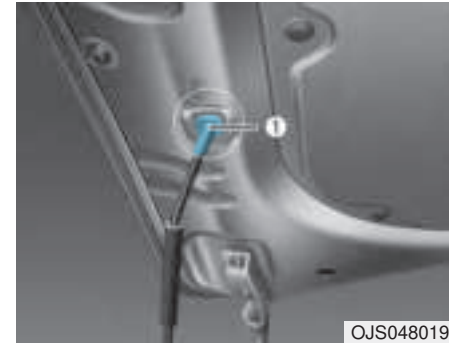

4. Pull out the support rod and hold the hood open with the support rod (1).

WARNING

- When handling the support rod, grasp the rod in the area wrapped with rubber only. In some cases where the engine has been running the support rod may be hot. Caution should be taken to avoid getting burned by the support rod.

- The support rod must be inserted completely into the hole provided whenever you inspect the engine compartment. This will prevent the hood from becoming dislodged and falling and causing potential injury.

Closing the hood

1. Before closing the hood, check in and around the engine compartment to ensure the following:
 - Any tools or other loose objects are removed from the engine room area or hood opening area
 - All glove, rags, or other combustible material is removed from the engine compartment
 - All filler caps are tightly and correctly installed
2. Lower the hood halfway (lifted approximately 12 inches (30 cm) from the closed position) and push down to securely lock in place. Then double check to be sure the hood is secure. If the hood can be raised slightly, it is not securely locked. Open it again and close it with more force.

WARNING

- Before closing the hood, ensure all obstructions are removed from around the hood opening.
- Always double check to be sure that the hood is firmly latched before driving away. Check there is no hood open warning light or message displayed on the instrument cluster. Driving with the hood opened may cause a total loss of visibility, which might result in an accident.
- **Do not move the vehicle with the hood in the raised position, as vision is obstructed, which might result in an accident, and the hood could fall or be damaged.**

Liftgate

Opening the liftgate



Before attempting to open the liftgate, make sure the vehicle is in N (Neutral). To open the liftgate, perform the following:

1. Unlock all doors with the Door Unlock button on your smart key. Press the liftgate handle button and open the liftgate.
2. Press and hold the Liftgate Unlock button on the smart key. Press the liftgate handle button and open the liftgate.
3. With the Smart Key in your possession, press the liftgate handle button and open the liftgate.

Closing the liftgate



Lower the liftgate lid and press down until it locks. To be sure the liftgate lid is securely fastened, always check by trying to pull it up again without pressing the liftgate handle button.

i Information

In cold and wet climates, door lock and door mechanisms may not work properly due to freezing conditions.

⚠ WARNING

The liftgate swings upward. Make sure no objects or people are near the rear of the vehicle when opening the liftgate.

NOTICE

Make certain that you close the liftgate before driving your vehicle. Possible damage may occur to the liftgate struts and mounting hinges if the liftgate is not closed prior to driving.

⚠ WARNING

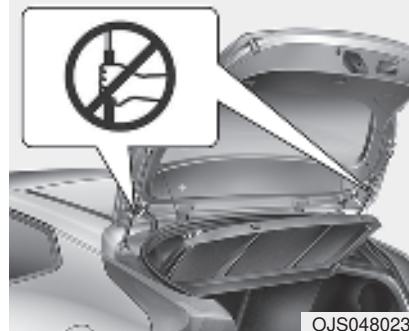

Do not hold on to or try to pull on the liftgate strut. Be aware that the deformation of the liftgate strut may cause vehicle damage and risk of injury.

Emergency liftgate safety release



Your vehicle is equipped with an emergency liftgate safety release lever located on the bottom of the liftgate inside the vehicle.

To unlock and open the liftgate manually from inside the luggage compartment, perform the following steps:

1. Insert the mechanical key from the key fob or a small screwdriver into the slot at the bottom of the liftgate inside the luggage compartment.

- Slide the key or screwdriver to the right to engage the safety release lever.
- Push the liftgate outward and upward.

WARNING

- **Be aware of the location of the emergency liftgate safety release lever in your vehicle and know how to open the liftgate using the safety release lever.**
- **No one should be allowed to occupy the luggage compartment of the vehicle at any time. The luggage compartment is a very dangerous location in the event of a crash.**
- **Use the release lever for emergencies only. Use extreme caution, especially while the vehicle is in motion.**

Fuel Filler Door

Opening the fuel filler door



The fuel filler door is opened from inside the vehicle using the fuel filler door release lever.

1. Turn the engine off. Locate the fuel filler door release lever on the floor on the left side of the driver seat.
2. Pull up on the release lever.



3. Pull the fuel filler door (1) outward to access the fuel tank cap.
4. To remove the fuel tank cap (2), turn it counterclockwise. You may hear a hissing noise as the pressure inside the tank equalizes.
5. Place the cap on the fuel filler door.

Information

If the fuel filler door does not open because ice has formed around it, tap lightly or push on the door to break the ice and release the door. Do not pry on the door. If necessary, spray around the door with an approved de-icer fluid (do not use radiator anti-freeze) or move the vehicle to a warm place and allow the ice to melt.

Closing the fuel filler door

1. To install the fuel tank cap, turn it clockwise until it "clicks" one time.
2. Close the fuel filler door until it is latched securely.

WARNING

Gasoline is highly flammable and explosive. Failure to follow these guidelines may result in SERIOUS INJURY or DEATH:

- Read and follow all warnings posted at the gas station.
- Before refueling, note the location of the Emergency Gasoline Shut-Off, if available, at the gas station.
- Before touching the fuel nozzle, you should eliminate the potential build-up of static electricity by touching a metal part of the vehicle, a safe distance away from the fuel filler neck, nozzle, or other gas source, with your bare hand.
- Do not use cellular phones while refueling. Electric current and/or electronic interference from cellular phones can potentially ignite fuel vapors and cause a fire.

- Do not get back into a vehicle once you have begun refueling. You can generate a build-up of static electricity by touching, rubbing or sliding against any item or fabric capable of producing static electricity. Static electricity discharge can ignite fuel vapors causing a fire. If you must re-enter the vehicle, you should once again eliminate potentially dangerous static electricity discharge by touching a metal part of the vehicle, away from the fuel filler neck, nozzle or other gasoline source, with your bare hand.
- When using an approved portable fuel container, be sure to place the container on the ground prior to refueling. Static electricity discharge from the container can ignite fuel vapors causing a fire.

Once refueling has begun, contact between your bare hand and the vehicle should be maintained until the filling is complete.

- Use only approved portable plastic fuel containers designed to carry and store gasoline.
- When refueling, always move the shift lever to the 1st gear when the vehicle is parked on a uphill and to R (Reverse) on a downhill, set the parking brake, and place the ignition switch to the LOCK/OFF position. Sparks produced by electrical components related to the engine can ignite fuel vapors causing a fire.
- Do not use matches or a lighter and do not smoke or leave a lit cigarette in your vehicle while at a gas station, especially during refueling.
- Do not over-fill or top-off your vehicle tank, which can cause gasoline spillage.

- If a fire breaks out during refueling, leave the vicinity of the vehicle, and immediately contact the manager of the gas station and then contact the local fire department. Follow any safety instructions they provide.
- If pressurized fuel sprays out, it can cover your clothes or skin and thus subject you to the risk of fire and burns. Always remove the fuel cap carefully and slowly. If the cap is venting fuel or if you hear a hissing sound, wait until the condition stops before completely removing the cap.
- Always check that the fuel cap is installed securely to prevent fuel spillage in the event of an accident.

Information

Make sure to refuel your vehicle according to the "Fuel Requirements" suggested in the Introduction chapter.

NOTICE

- Do not spill fuel on the exterior surfaces of the vehicle. Any type of fuel spilled on painted surfaces may damage the paint.
- If the fuel filler cap requires replacement, use only a genuine HYUNDAI cap or the equivalent specified for your vehicle. An incorrect fuel filler cap can result in a serious malfunction of the fuel system or emission control system.

INSTRUMENT CLUSTER



1. Tachometer
2. Speedometer
3. Engine coolant temperature gauge
4. Fuel gauge
5. Warning and indicator lights
6. LCD display (including Trip computer)

**The actual cluster in the vehicle may differ from the illustration.
For more details, refer to the "Gauges and Meters" in this chapter.**

Instrument Cluster Control

Adjusting instrument cluster illumination



When the vehicle's position lights or headlights are on, press the illumination control button to adjust the brightness of the instrument panel illumination.

When pressing the illumination control button, the interior switch illumination intensity is also adjusted.

WARNING

Never adjust the instrument cluster while driving. Doing so could lead to driver distraction which may cause an accident and lead to vehicle damage, serious injury, or death.



- The brightness of the instrument panel illumination is displayed.
- If the brightness reaches the maximum or minimum level, a chime will sound.

For information regarding the illumination setting on your audio display, refer to the "Setup" section of your Audio or Navigation manual.

Gauges and Meters

Speedometer



OPDEN047109

The speedometer indicates the speed of the vehicle and is calibrated in miles per hour (MPH) and/or kilometers per hour (km/h).

Variable LED tachometer



OBU048146N

The tachometer indicates the approximate number of engine revolutions per minute (rpm).

Use the tachometer to select the correct shift points and to prevent lugging and/or over-revving the engine.



OBU048147N

The yellow and red LEDs show the range of recommended engine operation speed. As the engine oil temperature warms up, the recommended engine speed range also extends.

Avoid driving with engine speeds in the yellow and red warning fields. In particular, do not drive with the engine speed in the red warning field.

Doing so may damage the engine.

Engine coolant temperature gauge



This gauge indicates the temperature of the engine coolant when the ignition switch is in the ON position.

NOTICE

If the gauge pointer moves beyond the normal range area toward the "H" position, it indicates overheating that may damage the engine.

Do not continue driving with an overheated engine. If your vehicle overheats, refer to "If the Engine Overheats" in chapter 6.

WARNING

Never remove the radiator cap or reservoir cap when the engine is hot. The engine coolant is under pressure and could severely burn. Wait until the engine is cool before adding coolant to the reservoir.

Fuel gauge



This gauge indicates the approximate amount of fuel remaining in the fuel tank.

Information

- The fuel tank capacity is given in chapter 8.
- The fuel gauge is supplemented by a low fuel warning light, which will illuminate when the fuel tank is nearly empty.
- On inclines or curves, the fuel gauge pointer may fluctuate or the low fuel warning light may come on earlier than usual due to the movement of fuel in the tank.

WARNING

Running out of fuel can expose vehicle occupants to danger.

You must stop and obtain additional fuel as soon as possible after the warning light comes on or when the gauge indicator comes close to the "E (Empty)" level.

NOTICE

Avoid driving with an extremely low fuel level. Running out of fuel could cause the engine to misfire damaging the catalytic converter.

Outside temperature gauge

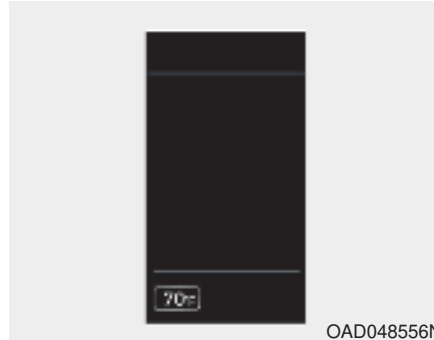

OAD048556N

This gauge indicates the current outside air temperature by 1°F (1°C).

- Temperature range : -40°F ~ 140°F
(-40°C ~ 60°C)

Note that the temperature indicated on the LCD display may not change as quickly as the outside temperature (there may be a slight delay before the temperature changes.)

You can change the temperature unit from °F to °C or °C to °F in the User Settings mode in the cluster:

- Go to User Settings Mode → Other
→ Temperature Unit.

For vehicles equipped with Automatic Climate Control, you can also:

- Press and hold the AUTO and OFF buttons on the climate control unit for 3 seconds

Both the temperature unit on the cluster LCD display and climate control screen will change.

Odometer



OAD048552N

The odometer indicates the total distance that the vehicle has been driven and should be used to determine when periodic maintenance should be performed.

Range



- The range is the estimated distance the vehicle can be driven with the remaining fuel.
- If the estimated distance is below 1 mi. (1 km), the trip computer will display "----" as range.

i Information

- If the vehicle is not on level ground or the battery power has been interrupted, the range function may not operate correctly.
- The range may differ from the actual driving distance as it is only an estimate of the available driving range for the vehicle and driving conditions.
- The trip computer may not register additional fuel if less than 1.6 gallon (6 liters) of fuel are added to the vehicle.
- The range may vary significantly based on driving conditions, driving habits, and condition of the vehicle.

Transmission shift indicator

Manual transmission shift indicator



1. Transmission shift indicator
2. Current shift lever position

This indicator informs which gear is recommended while driving, to save fuel.

- Shifting up : ▲2, ▲3, ▲4, ▲5, ▲6
- Shifting down : ▼1, ▼2, ▼3, ▼4, ▼5

For example

- ▲ 3 : Indicates that shifting up to the 3rd gear is recommended (currently the shift lever is in the 2nd or 1st gear).
- ▼ 3 : Indicates that shifting down to the 3rd gear is recommended (currently the shift lever is in the 4th, 5th, or 6th gear).

This indicator is displayed when driving in NORMAL/ECO mode.

Shift lights



The number of LEDs illuminated indicates the relevant engine speed. Different colored LEDs will be illuminated as engine speed nears the maximum allowed speed.

You may select in which mode to display the gear shift indicator in the Infotainment system screen.

Go to 'N mode → Performance Options → Shift Indicator → ECO/NORMAL/SPORT/N/CUSTOM'.

Each gear and drive mode has different LED operation range. In SPORT mode and N mode, LED operation is broader than NORMAL mode and ECO mode to further support the driver under sporty and track driving conditions.

Warning and Indicator Lights

i Information

Make sure that all warning lights are OFF after starting the engine. If any light is still ON, this indicates a situation that needs attention.

Supplemental Restraint System Warning Light



This warning light illuminates:

- When you place the ignition switch to the ON position.
 - The air bag warning light illuminates for about 6 seconds and then turns off when all checks have been performed
- The air bag warning light will remain illuminated if there is a malfunction with the Safety Restraint System (SRS) air bag operation.

In this case, have the vehicle inspected by an authorized HYUNDAI dealer.

Seat Belt Warning Light



This warning light informs the driver that the seat belt is not fastened.

For more details, refer to "Seat Belts" in chapter 2.

Parking Brake & Brake Fluid Warning Light



This warning light illuminates:

- When you place the ignition switch to the ON position.
 - The parking brake light illuminates for about 3 seconds and will then turn off once the parking brake is released.
- Whenever the parking brake is applied.
- Whenever the brake fluid level in the reservoir is low.
 - If the warning light illuminates with the parking brake released, it indicates the brake fluid level in the reservoir is low.

If the brake fluid level in the reservoir is low:

1. Drive carefully to the nearest safe location and stop your vehicle.
2. With the engine stopped, check the brake fluid level immediately and add fluid as required (**For more details, refer to "Brake Fluid" in chapter 7**). After adding brake fluid, check all brake components for fluid leaks. If a brake fluid leak is found, or if the warning light remains on, or if the brakes do not operate properly, do not drive the vehicle. Have the vehicle inspected by an authorized HYUNDAI dealer.

Dual-diagonal braking system

Your vehicle is equipped with dual-diagonal braking systems. This means you still have braking on two wheels even if one of the dual systems should fail.

With only one of the dual systems working, more than normal pedal travel and greater pedal pressure is required to stop the vehicle.

Also, the vehicle will not stop in as short a distance with only a portion of the brake system working.

If the brakes fail while you are driving, shift to a lower gear for additional engine braking and stop the vehicle as soon as it is safe to do so.

WARNING

Parking Brake & Brake Fluid Warning Light

Driving the vehicle with a warning light ON is dangerous. If the Parking Brake & Brake Fluid Warning Light illuminates with the parking brake released, it indicates that the brake fluid level is low.

In this case, have the vehicle inspected by an authorized HYUNDAI dealer.

Anti-lock Brake System (ABS) Warning Light



This warning light illuminates:

- When you place the ignition switch to the ON position.
 - The ABS warning light illuminates for about 3 seconds and then turns off.
- Whenever there is a malfunction with the ABS.

Note that the hydraulic braking system will still be operational even if there is a malfunction with the ABS.

Electronic Brake Force Distribution (EBD) System Warning Light



These two warning lights illuminate at the same time while driving:

- When the ABS and regular brake system may not work normally. In this case, have the vehicle inspected by an authorized HYUNDAI dealer.

⚠ WARNING

Electronic Brake Force Distribution (EBD) System Warning Light

When both ABS and Parking Brake & Brake Fluid Warning Lights are on, the brake system will not work normally and you may experience an unexpected and dangerous situation during sudden braking.

In this case, avoid high speed driving and abrupt braking.

Have the vehicle inspected by an authorized HYUNDAI dealer as soon as possible.

i Information - Electronic Brake Force Distribution (EBD) System Warning Light

When the ABS Warning Light is on or both ABS and Parking Brake & Brake Fluid Warning Lights are on, the speedometer, odometer, or tripmeter may not work. Also, the EPS Warning Light may illuminate and the steering effort may increase or decrease.

In this case, have the vehicle inspected by an authorized HYUNDAI dealer as soon as possible.

Electric Power Steering (EPS) Warning Light



This warning light illuminates:

- When you place the ignition switch to the ON position.
 - The Electric Power Steering Warning light illuminates for about 3 seconds and then goes off.
- Whenever there is a malfunction with the EPS.

If this occurs, have the vehicle inspected by an authorized HYUNDAI dealer.

Malfunction Indicator Lamp (MIL)

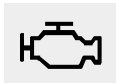

This indicator light illuminates:

- When you place the ignition switch to the ON position.
 - The malfunction indicator light illuminates for about 3 seconds and then goes off.
- Whenever there is a malfunction with either the emission control system or the engine or the vehicle powertrain.

If this occurs, have the vehicle inspected by an authorized HYUNDAI dealer.

NOTICE

Driving with the Malfunction Indicator Lamp (MIL) on may cause damage to the emission control system which could affect drivability and/or fuel economy.

NOTICE

If the Malfunction Indicator Lamp (MIL) illuminates, potential catalytic converter damage is possible which could result in loss of engine power.

In this case, have the vehicle inspected by an authorized HYUNDAI dealer as soon as possible.

Charging System Warning Light



When this warning light illuminates while the engine is running, the battery is not being charged. Immediately turn OFF all electrical accessories. Try not to use electrically operated controls, such as the power windows. Keep the engine running.

Have the vehicle inspected by an authorized HYUNDAI dealer as soon as possible.

Engine Oil Pressure Warning Light



This warning light illuminates:

- When the engine oil pressure is low.

If the engine oil pressure is low:

1. Drive carefully to the nearest safe location and stop your vehicle.
2. Turn the engine off and check the engine oil level (**For more details, refer to "Engine Oil" in chapter 7**). If the level is low, add oil as required. If the warning light remains on after adding oil or if oil is not available, have the vehicle inspected by an authorized HYUNDAI dealer as soon as possible.

NOTICE

- If the engine does not stop immediately after the Engine Oil Pressure Warning Light is illuminated, severe damage could result.
- If the warning light stays on while the engine is running, it indicates that there may be serious engine damage or malfunction. In this case:
 1. Stop the vehicle as soon as it is safe to do so.
 2. Turn off the engine and check the oil level. If the oil level is low, fill the engine oil to the proper level.
 3. Start the engine again. If the warning light stays on after the engine is started, turn the engine off immediately. In this case, have the vehicle inspected by an authorized HYUNDAI dealer.

Low Fuel Level Warning Light



This warning light illuminates:

- When the fuel tank is nearly empty. Add fuel as soon as possible.

NOTICE

Driving with the Low Fuel Level warning light on or with the fuel level below "E" can cause the engine to misfire and damage the catalytic converter.

Master Warning Light



This warning light illuminates:

- When there is a malfunction in operation in any of the following systems:
 - Low washer fluid
 - Exterior lamp malfunction (if equipped)
 - Tire Pressure Monitoring System (TPMS)

To identify the details of the warning, look at the LCD display.

Low Tire Pressure Warning Light



This warning light illuminates:

- When you place the ignition switch ON position.
 - It illuminates for approximately 3 seconds and then goes off.
- When one or more of your tires are significantly underinflated. (The location of the underinflated tires are displayed on the LCD display.)

For more details, refer to "Tire Pressure Monitoring System (TPMS)" in chapter 6.

This warning light remains ON after blinking for approximately 60 seconds, or repeatedly blinks ON and OFF in 3 second intervals:

- When there is a malfunction with the TPMS.

In this case, have the vehicle inspected by an authorized HYUNDAI dealer as soon as possible.

For more details, refer to "Tire Pressure Monitoring System (TPMS)" in chapter 6.

WARNING

Safe Stopping

- The TPMS cannot alert you to severe and sudden tire damage caused by external factors.
- If you notice any vehicle instability, immediately take your foot off the accelerator pedal, apply the brakes gradually with light force, and slowly move to a safe position off the road.

Electronic Stability Control (ESC) Indicator Light



This indicator light illuminates:

- When you place the ignition switch to the ON position.
 - The Electronic Stability Control indicator light illuminates for about 3 seconds and then goes off.
- Whenever there is a malfunction with the ESC system.

If this occurs, have the vehicle inspected by an authorized HYUNDAI dealer.

This indicator light blinks:

- While the ESC is operating.

For more details, refer to "Electronic Stability Control (ESC)" in chapter 5.

Electronic Stability Control (ESC) OFF Indicator Light



This indicator light illuminates:

- When you place the ignition switch to the ON position.
 - It illuminates for approximately 3 seconds and then goes off.
- When you deactivate the ESC system by pressing the ESC OFF button.

For more details, refer to "Electronic Stability Control (ESC)" in chapter 5.

ESC SPORT Indicator Light



This indicator light illuminates:

- When ESC SPORT is activated.

For more details, refer to "Electronic Stability Control" in chapter 5.

Immobilizer Indicator Light



This indicator light illuminates for up to 30 seconds:

- When the vehicle detects the smart key in the vehicle with the Engine Start/Stop button in the ACC or ON position.
 - Once the smart key is detected, you can start the engine.
 - The indicator light goes off after starting the engine.

This indicator light blinks for a few seconds:

- When the smart key is not in the vehicle.
 - If the smart key is not detected, you cannot start the engine.

This indicator light illuminates for 2 seconds and goes off:

- If the smart key is in the vehicle and the Engine Start/Stop button is ON, but the vehicle cannot detect the smart key.

In this case, have the vehicle inspected by an authorized HYUNDAI dealer.

This indicator light blinks:

- When the battery voltage of the smart key is low.
 - If this occurs, you will not be able to start the engine by simply pressing the Start/Stop button. However, you can still start the engine by pressing the Start/Stop button directly with the smart key. **(Refer to "Starting the Engine" in chapter 5.)**
- When there is a malfunction with the immobilizer system.

In this case, have the vehicle inspected by an authorized HYUNDAI dealer.

Turn Signal Indicator Light



This indicator light blinks:

- When you operate the turn signal indicator stalk.

If any of the following occur, there may be a malfunction with the turn signal system.

- The turn signal indicator light illuminates but does not blink
- The turn signal indicator light blinks rapidly
- The turn signal indicator light does not illuminate at all

If any of these conditions occur, have your vehicle inspected by an authorized HYUNDAI dealer.

High Beam Indicator Light



This indicator light illuminates:

- When the headlights are on and in the high beam position
- When the turn signal lever is pulled into the Flash-to-Pass position.

Light ON Indicator Light



This indicator light illuminates:

- When the tail lights or headlights are on.

LED Headlight Warning Light (if equipped)



This warning light illuminates:

- When you place the ignition switch to the ON position.
- When there is a malfunction with the LED headlight.

If this occurs, have the vehicle inspected by an authorized HYUNDAI dealer.

This warning light blinks:

When there is a malfunction with a LED headlight related part.

In this case, have the vehicle inspected by an authorized HYUNDAI dealer.

NOTICE

Continuous driving with the LED Headlight Warning Light on or blinking can reduce LED headlight life.

High Beam Assist (HBA) indicator light (if equipped)



This indicator light illuminates :

- When the high-beam is on with the light switch in the AUTO light position.
- If your vehicle detects oncoming or preceding vehicles, High Beam Assist will switch the high beam to low beam automatically.

For more details, refer to "High Beam Assist (HBA)" in this chapter.

Icy Road Warning Light (if equipped)



This warning light is to warn the driver the road may be icy.

When the outside temperature gauge reads below 40°F (4°C), the Icy Road Warning Light and Outside Temperature Gauge blinks and then illuminates. Also, the warning chime sounds 1 time.

***i* Information**

If the icy road warning light illuminates while driving, it means that the outside temperature has reduced and that the road conditions may be icy. As a precaution you should reduce your speed and drive more carefully and with greater attention to the road conditions.

Cruise Indicator Light (if equipped)



This indicator light illuminates:

- When Cruise Control is enabled.

For more details, refer to "Cruise Control (CC)" in chapter 5.

SPORT Mode Indicator Light



This indicator light illuminates:

- When you select "SPORT" mode as drive mode.

For more details, refer to "Drive Mode Integrated Control System" in chapter 5.

SMART Mode Indicator Light (if equipped)



This indicator light illuminates:

- When you select "SMART" mode as drive mode.

For more details, refer to "Drive Mode Integrated Control System" in chapter 5.

ECO Mode Indicator Light



This indicator light illuminates:

- When you select "ECO" mode as drive mode.

For more details, refer to "Drive Mode Integrated Control System" in chapter 5.

CUSTOM Mode Indicator Light



This indicator light illuminates:

- When you select "CUSTOM" mode as drive mode.

For more details, refer to "Drive Mode Integrated Control System" in chapter 5.

N Mode Indicator Light



This indicator light illuminates:

- When you select "N" mode as drive mode.

For more details, refer to "Drive Mode Integrated Control System" in chapter 5.

REV (Rev Matching) Indicator Light



This indicator light illuminates:

[White] When Rev Matching is turned on in NORMAL mode.

[Yellow] When Rev Matching is turned on in SPORT mode.

[Red] When Rev Matching is turned on in N mode.

For more details, refer to "Rev Matching" in chapter 5.

CREEP OFF Indicator Light (if equipped)

CREEP
OFF

When Creep Start is set to OFF in custom mode, vehicle will not automatically move and CREEP OFF indicator will turn on even if you take your foot off the brake pedal while vehicle is stopped at D (Drive) or M (Manual mode) driving position of dual clutch transmission.

For more details, refer to “N button” in chapter 5.

CREEP OFF operation and indicator lighting conditions

- Driving mode : Custom
- Creep start setting : OFF
- Vehicle status : Stopping

WARNING

CREEP START OFF allows the vehicle to stop without depressing the brake pedal on a flat surface and accelerate immediately when the accelerator pedal is depressed.

When using this function, always be careful as the vehicle may move depending on the incline and road conditions.

LCD Display Messages

Low key battery

This warning message is displayed if the battery of the smart key is discharged while changing the Engine Start/Stop button to the OFF position.

Press clutch pedal to start engine

This warning message is displayed if the Engine Start/Stop button changes to the ACC position twice by pressing the button repeatedly without depressing the clutch pedal. You can start the engine by depressing the clutch pedal to.

Key not in vehicle

This warning message is displayed if the smart key is not in the vehicle when you press the Engine Start/Stop button.

When attempting to start the vehicle, always have the smart key with you.

Key not detected

This warning message is displayed if the smart key is not detected when you press the Engine Start/Stop button.

Press START button again

This message is displayed if you were unable to start the vehicle when the Engine Start/Stop button was pressed.

If this occurs, attempt to start the engine by pressing the Engine Start/Stop button again.

If the warning message appears each time you press the Engine Start/Stop button, have your vehicle inspected by an authorized HYUNDAI dealer.

Battery discharging due to external electrical devices

This message is displayed if the battery voltage is weak due to any non-factory electrical accessories (ex. dashboard camera) while parking. Be careful that the battery is not discharged.

If the warning message appears after removing the non-factory electrical accessories, we recommend that you have the vehicle inspected by an authorized HYUNDAI dealer.

Press START button with key

This warning message is displayed if you press the Engine Start/Stop button while the warning message "Key not detected" is displayed.

At this time, the immobilizer indicator light blinks.

Check BRAKE SWITCH fuse

This warning message is displayed if the brake switch fuse is disconnected.

You need to replace the fuse with a new one before starting the engine.

If that is not possible, you can start the engine by pressing the Engine Start/Stop button for 10 seconds in the ACC position.

Door, Hood, Liftgate Open Indicator

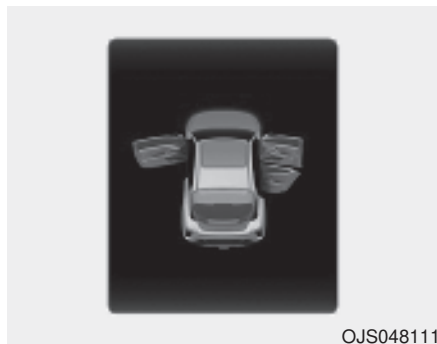

This warning is displayed if any door or the hood or the liftgate is left open. The warning will indicate which door is open in the display.

CAUTION

Before driving the vehicle, you should confirm that the door/hood/liftgate is fully closed. Also, check there is no door/hood/liftgate open warning light or message displayed on the instrument cluster.

Low Pressure



This warning message is displayed if the tire pressure is low. The corresponding tire on the vehicle will be illuminated.

For more details, refer to "Tire Pressure Monitoring System (TPMS)" in chapter 6.

Turn FUSE SWITCH on

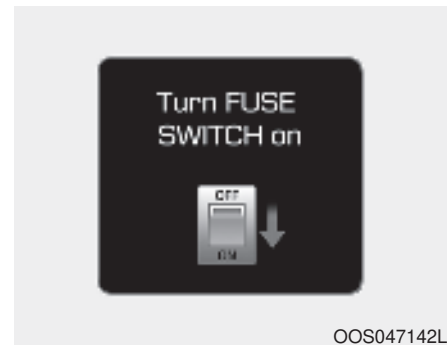

This warning message is displayed if the fuse switch located on the fuse box under the steering wheel is OFF. The fuse switch is turned OFF to minimize battery draw when the vehicle is in storage or in transportation where the vehicle will not be operated for some time.

Under normal conditions, the fuse switch should be set to the ON position.

For more details, refer to "Fuses" in chapter 7.

Lights Mode

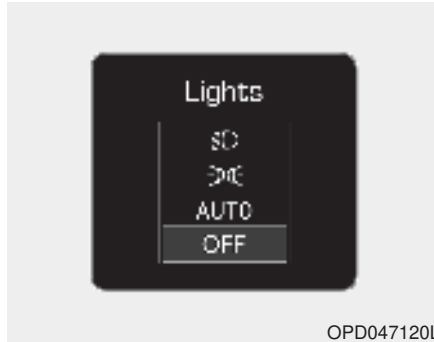

This indicator displays which exterior light is selected using the lighting control.

Wiper



This indicator displays which wiper speed is selected using the wiper control.

Low washer fluid

This warning message is displayed if the washer fluid level in the reservoir is nearly empty.

Have the washer fluid reservoir refilled.

Low fuel

This warning message is displayed if the fuel tank is almost out of fuel.

When this message is displayed, the low fuel level warning light in the cluster will come on.

It is recommended to look for the nearest fueling station and refuel as soon as possible.

Add fuel as soon as possible.

Engine overheated

This warning message is displayed when the engine coolant temperature is above 248°F (120°C). This means that the engine is overheated and may be damaged.

If your vehicle is overheated, refer to "If the Engine Overheats" in chapter 6.

Check headlight

This warning message is displayed if the headlights are not operating properly. A headlight bulb may need to be replaced.

***i* Information**

Make sure to replace the burned out bulb with a new one of the same wattage rating.

Tire size mismatch. Check all tire sizes

This warning message is displayed when different tires (size, type, etc.) are detected between front and rear. To use the Electronic Limited Slip Differential, equip the vehicle with the same tires on front and rear.

For more details, refer to "Electronic Limited Slip Differential" in chapter 5.

Check limited slip differential

This warning message is displayed if there is a problem with the Limited Slip Differential system.

In this case, have your vehicle inspected by an authorized dealer of HYUNDAI.

For more details, refer to "Electronic Limited Slip Differential" in chapter 5.

Check Electronic Suspension

This warning message is displayed if there is a problem with the Electronic Control Suspension (ECS) system.

In this case, have your vehicle inspected by an authorized dealer of HYUNDAI.

For more details, refer to "Electronic Control Suspension (ECS)" in chapter 5.

Downshift Alert. Downshifting at high RPMs may result in engine damage

If transmission input rpm is too high (over rev limit) due to shifting, a warning message will appear and a warning chime will sound.



For more details, refer to "Rev Matching" in chapter 5.

LCD DISPLAY

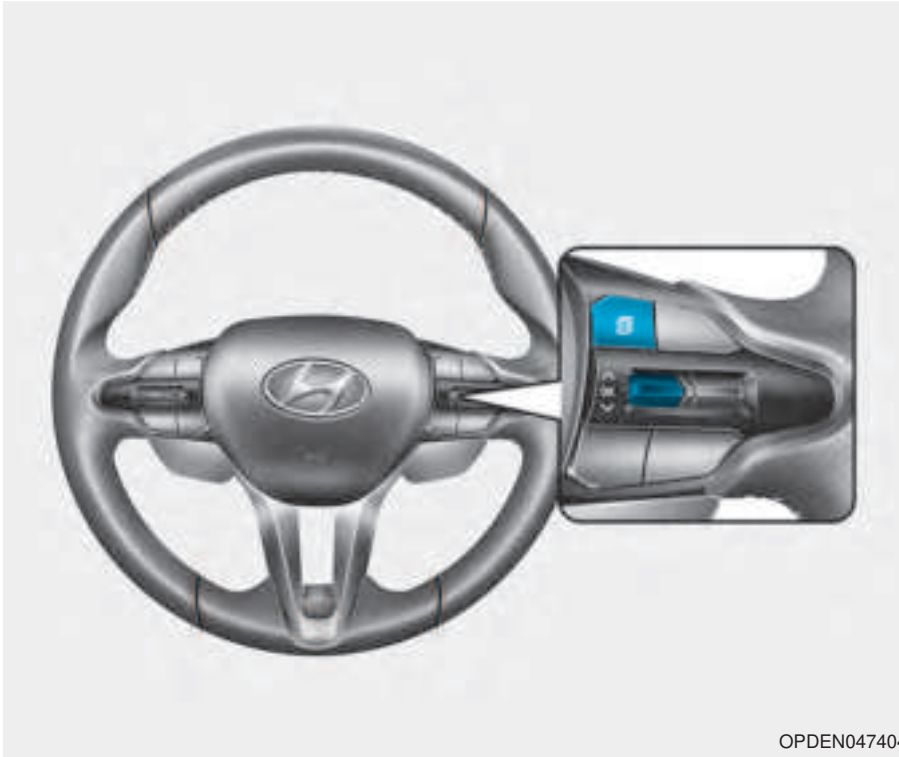
LCD Display Control







The LCD display modes can be changed by using the control buttons.

- (1)  : MODE button for changing modes
- (2) ,  : MOVE switch for changing items
- (3) OK : SELECT/RESET button for setting or resetting the selected item

OPDEN047404

LCD Display Modes

Modes	Symbol	Explanation
Sport		The Sport menu displays Gauge, Lap Timer and G-Force. For more details, refer to the following pages.
Trip Computer		The Trip Computer menu displays driving information such as the tripmeter, fuel economy, etc. For more details, refer to "Trip Computer" in this chapter.
Driving Assist		The Driving Assist mode displays the status of Tire Pressure. For more details, refer to "Tire Pressure Monitoring System (TPMS)" in chapter 6.
User Settings		The User Settings menu provides user options for a variety of settings including door lock/unlock features, convenience features, driver assistance settings, etc.
Master Warning		The Master Warning mode displays warning messages related to the vehicle when one or more systems is not operating normally.

The information provided may differ depending on which functions are applicable to your vehicle.

Sport mode



Gauges

This mode displays information related to your engine such as engine oil temperature (1), current torque (2) and turbo boost pressure (3).

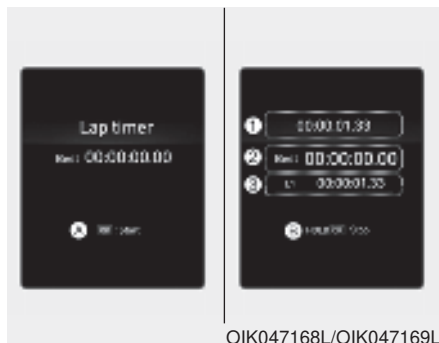

Lap timer

- (1) Total time
- (2) Best lap
- (3) Current lap

To start (A):

Press the OK button shortly on the steering wheel. The lap timer will start counting the current lap (3).

To stop (B):

Press and hold the OK button for more than 1 second on the steering wheel while the lap timer is counting the current lap (3).



To reset (C):

Press and hold the OK button for more than 1 second on the steering wheel when the lap timer has stopped counting the current lap (3). If the OK button is pressed shortly, the lap timer will continue counting from the time it has been stopped.

To save laps:

Press the OK button shortly on the steering wheel while the lap timer is counting the current lap (3). The timer can save L1~ L3 (4). The best lap (2) will be displayed automatically.

The saved laps can be reset when the current lap is reset.

To start a new lap press the OK button when the current lap is reset.



G-Force

This mode displays the force delivered to the vehicle laterally while the vehicle is in motion.

Trip computer mode



The trip computer mode displays information related to vehicle driving parameters including fuel economy, tripmeter information and vehicle speed.

For more details, refer to "Trip Computer" in this chapter.

Assist mode



Tire Pressure



This mode displays information related to Tire Pressure.

For more details, refer to "Tire Pressure Monitoring System (TPMS)" in chapter 6.

Master warning mode

This warning light informs the driver the following situations.

- Lamp malfunction
- Tire Pressure Monitoring System (TPMS) malfunction

The Master Warning Light illuminates if one or more of the above warning situations occur. At this time, the LCD Modes Icon will change from () to ().

If the warning situation is solved, the master warning light will be turned off and the LCD Modes Icon will be changed back to its previous icon ().

User settings mode

In this mode, you can change the settings of the instrument cluster, doors, lamps, etc.

1. Driver Assistance
2. Door
3. Lights
4. Sound
5. Convenience
6. Service interval
7. Other
8. Language
9. Reset

The information provided may differ depending on which functions are applicable to your vehicle.

Information

Settings only available with parking brake engaged and gear in neutral.

This warning message illuminates if you try to select an item from the User Settings mode while driving.

For your safety, change the User Settings after engaging the parking brake and shifting the gear to neutral.

1. Door

Items	Explanation
Auto Lock	<ul style="list-style-type: none"> - Disable: The auto door lock operation will be canceled. - Enable on speed: All doors will be automatically locked when the vehicle speed exceeds 9.3 mph (15 km/h).
Auto Unlock	<ul style="list-style-type: none"> - Disable: The auto door unlock operation will be canceled. - Vehicle Off: All doors will be automatically unlocked when the Engine Start/Stop button is set to the OFF position.
Two Press Unlock	<ul style="list-style-type: none"> - Off: The two press unlock function will be deactivated. Therefore, all doors will unlock if the door unlock button is pressed. - On: Only the driver's door will unlock if the door unlock button is pressed. When the door unlock button is pressed again within 4 seconds, the remaining doors will unlock.

2. Lights

Items	Explanation
One Touch Turn Signal	<ul style="list-style-type: none"> - Off: The one touch turn signal function will be deactivated. - 3, 5, 7 Flashes: The turn signal indicator will blink 3, 5, or 7 times when the turn signal lever is moved slightly. <p>For more details, refer to "Lighting" in this chapter.</p>
Headlight Delay	<p>To activate or deactivate the headlight delay function.</p> <p>For more details, refer to "Lighting" in this chapter.</p>

3. Sound

Items	Explanation
Cluster Voice Guidance Volume	To adjust the Cluster Voice Guidance volume. - Level 1 / Level 2 / Level 3
Welcome Sound	To activate or deactivate the welcome sound function.

4. Convenience

Items	Explanation
Wiper/Lights Display	To activate or deactivate the Wiper/Light mode. When activated, the LCD display shows the selected Wiper/Light mode whenever you change the mode.
Auto Rear Wiper (in R)	To activate or deactivate the rear wiper while the vehicle is in reverse with the front wiper ON. For more details, refer to "Wipers and Washers" in this chapter.

5. Service interval

Items	Explanation
Service Interval	To activate or deactivate the service interval function.
Adjust Interval	If the service interval menu is activated, you may adjust the time and distance.

i Information

To use the service interval menu, consult an authorized HYUNDAI dealer.

If the service interval is activated and the time and distance is adjusted, messages are displayed in the following situations each time the vehicle is turned on.

- Service in: Displayed to inform the driver the remaining mileage and days to service.
- Service required: Displayed when the mileage and days to service has been reached or passed.

i Information

If any of the following conditions occur, the mileage and number of days to service may be incorrect.

- **The battery cable is disconnected.**
- **The fuse switch is turned off.**
- **The battery is discharged.**

6. Other

Items	Explanation
Fuel Economy Reset	<ul style="list-style-type: none"> - Off: The average fuel economy will not reset automatically whenever refueling. - After ignition: When the engine has been OFF for 4 hours or longer the average fuel economy will reset automatically. - After refueling: The average fuel economy will reset automatically after adding 1.6 gallons (6 liters) of fuel or more and after driving speed exceeds 1 mph (1 km/h). <p>For more details, refer to "Trip Computer" in this chapter.</p>
Speed Unit	To select the speed unit. - km / mile
Fuel Economy Unit	To select the fuel economy unit. - US gallon / UK gallon
Temperature Unit	To select the temperature unit. - °C / °F
Torque Unit	To select the torque unit. - Nm / lb-ft
Turbo Boost Pressure Unit	To select the turbo boost pressure unit. - psi / kPa / bar
Tire Pressure Unit	To select the tire pressure unit. - psi / kPa / bar

7. Language

Items	Explanation
Language	To select language.

8. Reset

Items	Explanation
Reset	You can reset the menus in the User Settings mode. All menus in the User Settings mode are reset to factory settings, except language and service interval.

TRIP COMPUTER

The trip computer is a microcomputer-controlled driver information system that displays information related to driving.

i Information

Some driving information stored in the trip computer (for example Average Vehicle Speed) resets if the battery is disconnected.

Trip modes

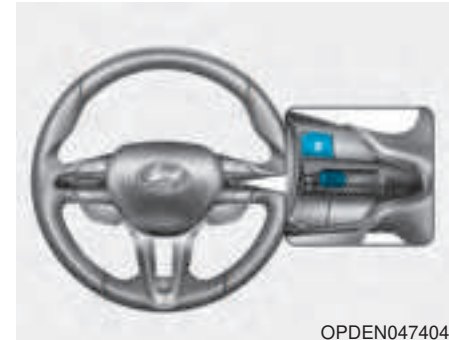
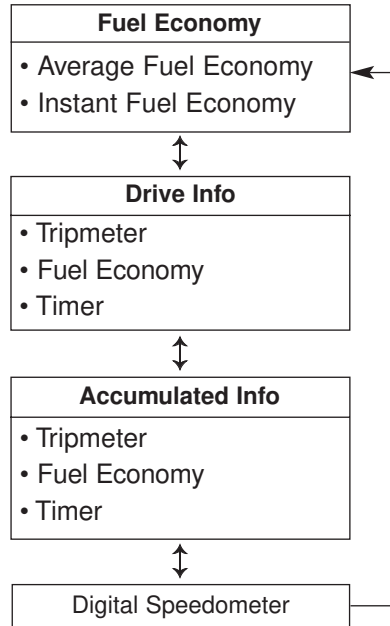

To change the trip mode, toggle the " \wedge , \vee " switch on the steering wheel.

Average fuel economy/ Instant fuel economy



OJS048325N

Average Fuel Economy

- The average fuel economy is calculated by the total driving distance and fuel consumption since the last average fuel economy reset.
- The average fuel economy can be reset both manually and automatically.

Manual reset

To clear the average fuel economy manually, press the OK button on the steering wheel for more than 1 second when the average fuel economy is displayed.

Automatic reset

To automatically reset the average fuel economy, select between "After Ignition" or "After Refueling" in the User Settings mode on the LCD display.

- After Ignition: When the engine has been OFF for 4 hours or longer the average fuel economy will reset automatically.
- After Refueling: The average fuel economy will reset automatically after adding 1.6 gallons (6 liters) of fuel or more and after driving speed exceeds 1 mph (1 km/h).

i Information

The vehicle must be driven for a minimum of 0.19 miles (300 meters) since the last ignition key cycle before the average fuel economy will be recalculated.

Instant Fuel Economy

- The instantaneous fuel economy is displayed according to the bar graph in the LCD display while driving.

Accumulated Info display



OJS048326N

This display shows the accumulated trip distance (1), the average fuel economy (2), and the total driving time (3).

The information is accumulated starting from the last reset.

To reset the information, press and hold the OK button when viewing the Accumulated driving info. The trip distance, the average fuel economy, and total driving time will reset simultaneously.

The accumulated driving information will continue to be counted while the engine is still running (for example, when the vehicle is in traffic or stopped at a stop light).

i Information

The vehicle must be driven for a minimum of 0.19 miles (300 meters) since the last ignition key cycle before the average fuel economy will be recalculated.

Drive Info display

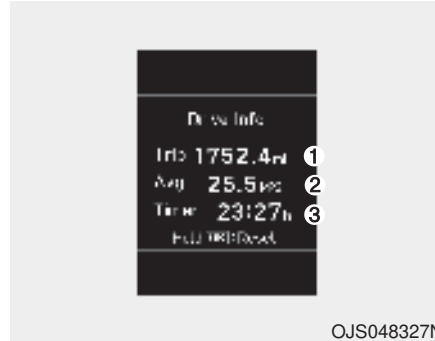

This display shows the trip distance (1), the average fuel economy (2), and the total driving time (3).

The information is combined for each ignition cycle. However, when the engine has been OFF for 4 hours or longer the Drive Info screen will reset.

To manually reset the information, press and hold the OK button when viewing the Drive Info. The trip distance, the average fuel economy, and total driving time will reset simultaneously.

The driving information will continue to be counted while the engine is still running (for example, when the vehicle is in traffic or stopped at a stop light).

i Information

The vehicle must be driven for a minimum of 0.19 miles (300 meters) since the last ignition key cycle before the average fuel economy will be recalculated.

Digital speedometer

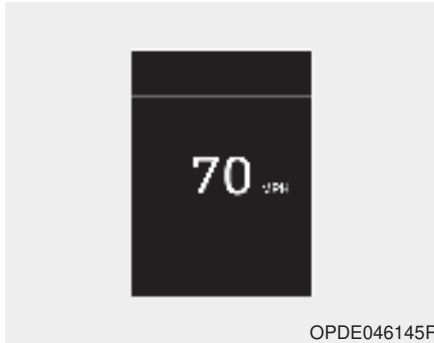

The digital speedometer display shows the speed of the vehicle.

LIGHTING

Exterior Lights

Lighting control

To operate the lights, turn the knob at the end of the control lever to one of the following positions:

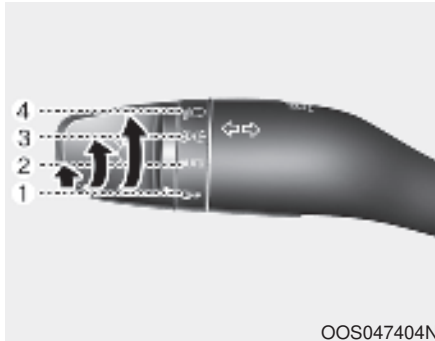

1. OFF position
2. AUTO headlamp position
3. Parking lamp position
4. Headlamp position

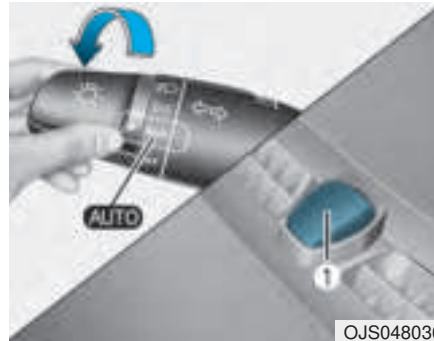

AUTO light position

The parking lamp and headlamp will be turned ON or OFF automatically depending on the amount of daylight as measured by the ambient light sensor on the center dash.

Even with the AUTO headlamp feature in operation, it is recommended to manually turn ON the headlamps when driving at night or in a fog, driving in the rain, or when you enter dark areas, such as tunnels and parking facilities.

NOTICE

- Do not cover or spill anything on the sensor (1) located in front of the instrument panel.
- Do not clean the sensor using a window cleaner, the cleanser may leave a light film which could interfere with sensor operation.
- If your vehicle has window tint or other types of metallic coating on the front windshield, the AUTO headlamp system may not work properly.



OOS047405N

Parking lamp position (☰)

The parking lamp, license plate lamp and instrument panel lamp are turned ON.



OOS047406N

Headlamp position (☰)

The headlamp, parking lamp, license plate lamp and instrument panel lamp are turned ON.

i Information

The ignition switch must be in the ON position to turn on the headlamp.

High beam operation



OOS047407N

To turn on the high beam headlamp, push the lever away from you. The lever will return to its original position.

The high beam indicator will light when the headlamp high beams are switched on.

To turn off the high beam headlamp, pull the lever towards you. The low beams will turn on.

⚠ WARNING

Do not use high beam when there are other vehicles approaching you. Using high beam could obstruct the other driver's vision.

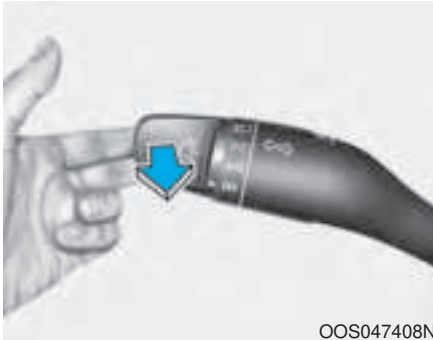

OOS047408N

To flash the high beam headlamp, pull the lever towards you, then release the lever. The high beams will remain ON as long as you hold the lever towards you.

Turn signals and lane change signals

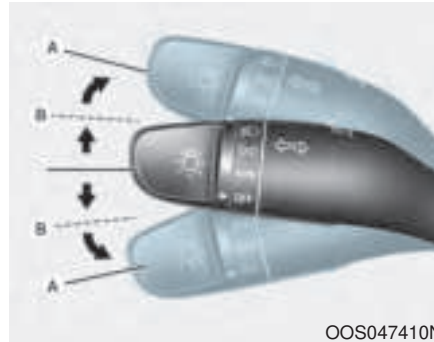

OOS047410N

To signal a turn, push down on the lever for a left turn or up for a right turn in position (A).

If an indicator stays on and does not flash or if it flashes abnormally, one of the turn signal bulbs may be burned out and will require replacement.

Onetouch turn signal function

To activate the One Touch Turn Signal function, push the turn signal lever up or down to position (B) and then release it.

The lane change signals will blink 3, 5 or 7 times.

You can activate or deactivate the One Touch Turn Signal function or choose the number of blinks (3, 5, or 7) from the User Settings mode in the LCD display.

For more details, refer to the "LCD Display" section in this chapter.

Battery saver function

The purpose of this feature is to prevent the battery from being discharged. The system automatically turns off the parking lamp when the driver turns the vehicle off and opens the driver-side door.

With this feature, the parking lamps will turn off automatically if the driver parks on the side of road at night.

If necessary, to keep the lamps on when the vehicle is turned off, perform the following:

- 1) Open the driver-side door.
- 2) Turn the parking lamps OFF and ON again using the headlamp switch on the steering column.

Headlamp delay function

If the key is removed from the ignition switch or placed in the ACC position or the LOCK/OFF position with the headlamps ON, the headlamps (and/or parking lamps) remain on for about 5 minutes. However, if the driver's door is opened and closed, the headlights are turned off after 15 seconds. Also, with the engine off if the driver's door is opened and closed, the headlamps (and/or parking lamps) are turned off after 15 seconds.

The headlamps (and/or parking lamps) can be turned off by pressing the lock button on the smart key twice or turning the headlamp switch to the OFF or AUTO position.

You can activate or deactivate the Headlamp Delay function from the User Settings Mode in the LCD display.

For more details, refer to the "LCD Display" section in this chapter.

NOTICE

If the driver exits the vehicle through another door besides the driver door, the battery saver function does not operate and the headlamp delay function does not turn OFF automatically.

This may cause the battery to discharge. To avoid battery discharge, turn OFF the headlamps manually from the headlamp switch before exiting the vehicle.

Daytime running light (DRL)

The Daytime Running Lights (DRL) can make it easier for others to see the front of your vehicle during the day, especially after dawn and before sunset.

The DRL system will turn the dedicated lamp OFF when :

- The headlamps are ON.
- The parking lamps are ON.
- The vehicle is turned off.
- The parking brake is engaged.

Interior Lights

⚠ WARNING

Do not use the interior lights when driving in the dark. The interior lights may obscure your view and cause an accident.

NOTICE

Do not use the interior lights for extended periods when the vehicle is turned off or the battery will discharge.

Interior lamp AUTO cut

The interior lamps will automatically go off approximately 20 minutes after the engine is turned off and the doors are closed. If a door is opened, the lamp will go off 40 minutes after the engine is turned off. If the doors are locked by the smart key and the vehicle enters the armed stage of the theft alarm system, the lamps will go off five seconds later.

Front lamps



OPD046041



Front Map Lamp (1) :

Press either lenses to turn the map lamp on or off. This light produces a spot beam for convenient use as a map lamp at night or as a personal lamp for the driver and the front passenger.

Front Door Lamp (2) ():

The front or rear room lamps come on when the front or rear doors are opened if the engine is running or not. When doors are unlocked by the smart key, the front and rear lamps come on for approximately 30 seconds as long as any door is not opened. The front and rear room lamps go out gradually after approximately 30 seconds when the door is closed. However, if the ignition switch is in the ON position or all doors are locked, the front and rear lamps will turn off. If a door is opened with the ignition switch in the ACC position or the OFF position, the front and rear lamps stay on for about 20 minutes.

Front room lamp

-  (3) :
Press the button to turn ON the room lamp for the front/rear seats.
-  (4) :
Press the button to turn OFF the room lamp for the front/rear seats regardless of front or rear door open position.

Rear lamp (if equipped)



Rear Room Lamp ():

Press this switch to turn the rear room lamp on and off.

Luggage compartment lamp



The luggage compartment lamp comes on when the liftgate is opened.



NOTICE

The luggage compartment lamp comes on as long as the liftgate is open. To prevent unnecessary battery system drain, close the liftgate securely after using the luggage compartment.

Vanity mirror lamp



Push the switch to turn the light on or off.

-  : The lamp will turn on if this button is pressed.
-  : The lamp will turn off if this button is pressed.

NOTICE

Always have the switch in the off position when the vanity mirror lamp is not in use. If the sunvisor is closed without the lamp off, it may discharge the battery or damage the sunvisor.

HIGH BEAM ASSIST (HBA) (IF EQUIPPED)



OIK047090

High Beam Assist will automatically adjust the headlamp range (switches between high beam and low beam) depending on the brightness of detected vehicles and certain road conditions.

Detecting sensor



OBU050218N

[1] : Front view camera

The front view camera is used as a detecting sensor to detect ambient light and brightness while driving.

Refer to the picture above for the detailed location of the detecting sensor.

NOTICE

Always keep the front view camera in good condition to maintain optimal performance of High Beam Assist.

For more details on the precautions of the front view camera, refer to “Forward Collision-Avoidance Assist (FCA)” section in chapter 5.

System operation

Display and control

- High Beam Assist will operate by following the procedure below.
 - Place the headlamp switch in the AUTO position and push the headlamp lever towards the instrument cluster. The High Beam Assist (AUTO) indicator light will illuminate on the cluster and the system will be enabled.
 - When the system is enabled, high beam will turn on when vehicle speed is above 25 mph (40 km/h). When vehicle speed is below 15 mph (25 km/h), high beam will not turn on.
 - The High Beam (HBM) indicator light will illuminate on the cluster when high beam is on.
- When High Beam Assist is operating, if the headlamp lever or switch is used, the system operates as follow:
 - If the headlamp lever is pulled towards you when the high beam is off, the high beam will turn on without High Beam Assist canceled. When you let go of the headlamp lever, the lever will move to the middle and the high beam will turn off.
 - If the headlamp lever is pulled towards you when the high beam is on by High Beam Assist, low beam will be on and the system will turn off.
 - If the headlamp switch is placed from AUTO to another position (headlamp/position/off), High Beam Assist will turn off and the corresponding lamp will turn on.
- When High Beam Assist is operating, high beam switches to low beam if any of the following conditions occur:
 - When the headlamp of an oncoming vehicle is detected.
 - When the tail lamp of a vehicle in front is detected.
 - When the headlamp or tail lamp of a motorcycle or a bicycle is detected.
 - When the surrounding ambient light is bright enough that high beams are not required.
 - When streetlights or other lights are detected.

System malfunction and limitations

System malfunction

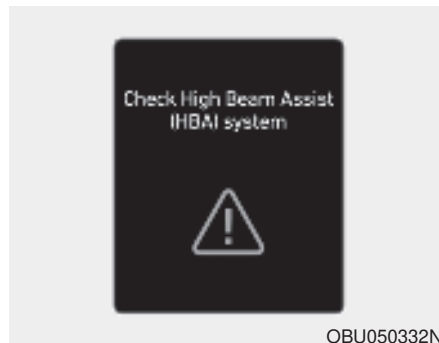

When High Beam Assist is not working properly, the 'Check High Beam Assist (HBA) system' warning message will appear and  warning light will illuminate on the cluster. We recommend that the system be inspected by an authorized HYUNDAI dealer.

Limitations of the system

High Beam Assist may not work properly in the following situations:

- Light from a vehicle is not detected because of lamp damage, or because it is hidden from sight, etc.
- Headlamp of a vehicle is covered with dust, snow or water.
- A vehicle's headlamps are off but the fog lamps are on and etc.
- There is a lamp that has a similar shape as a vehicle's lamp.
- Headlamps have been damaged or not repaired properly.
- Headlamps are not aimed properly.
- Driving on a narrow curved road, rough road, uphill or downhill.
- Vehicle in front is partially visible on a crossroad or curved road.
- There is a traffic light, reflecting sign, flashing sign or mirror ahead.
- There is a temporary reflector or flash ahead (construction area).
- The road conditions are bad such as being wet, iced or covered with snow.

- A vehicle suddenly appears from a curve.
- The vehicle is tilted from a flat tire or is being towed.
- Light from a vehicle is not detected because of exhaust fume, smoke, fog, snow, etc.

For more details on the limitations of the front view camera, refer to "Forward Collision-Avoidance Assist (FCA)" section in chapter 5.

WARNING

- **At times, High Beam Assist may not work properly. It is the responsibility of the driver for safe driving practices and always check the road conditions for your safety.**
- **When High Beam Assist does not operate normally, change the headlamp position manually between high beam and low beam.**

WIPERS AND WASHERS

■ Front windshield wiper/washer

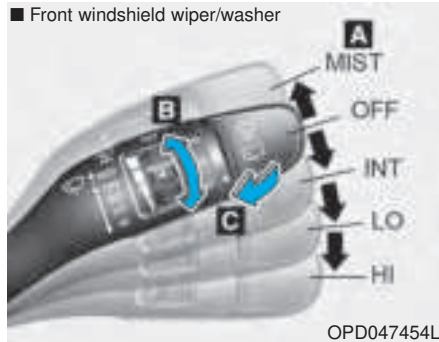

■ Rear windshield wiper/washer



A : Wiper speed control

- MIST – Single wipe
- OFF – Off
- INT – Intermittent wipe
- LO – Low wiper speed

- HI – High wiper speed

B : Intermittent control wipe time adjustment

C : Wash with brief wipes (pull lever towards you)

D : Rear wiper/washer control

- HI – High wiper speed
- LO – Low wiper speed
- OFF – Off

E : Wash with brief wipes (rear) (push lever away from you)

Windshield Wipers

Operates as follows when the ignition switch is in the ON position.

MIST : For a single wiping cycle, push the lever upward and release. The wipers will operate continuously if the lever is held in this position.

OFF : Wiper is not in operation.

INT : Wiper operates intermittently at the same wiping intervals. To vary the speed setting, move the speed control lever. The top most setting will run the wipers most frequently (for more rain). The bottom setting will run the wipers the least frequently (for less rain).

LO : The wiper runs at a lower speed.

HI : The wiper runs at a higher speed.

Information

If there is heavy accumulation of snow or ice on the windshield, defrost the windshield for about 10 minutes, or until the snow and/or ice is removed before using the windshield wipers to ensure proper operation.

If you do not remove the snow and/or ice before using the wiper and washer, it may damage the wiper and washer system.

Windshield Washers

In the OFF position, pull the lever gently toward you to spray washer fluid on the windshield and to run the wipers 1-3 cycles. The spray and wiper operation will continue until you release the lever. If the washer does not work, you may need to add washer fluid to the washer fluid reservoir.

WARNING

When the outside temperature is below freezing, ALWAYS warm the windshield using the defroster to help prevent the washer fluid from freezing on the windshield and obscuring your vision which could result in an accident and serious injury or death.

NOTICE

- To prevent possible damage to the washer pump, do not operate the washer when the fluid reservoir is empty.
- To prevent possible damage to the wipers or windshield, do not operate the wipers when the windshield is dry.
- To prevent damage to the wiper arms and other components, do not attempt to move the wipers manually.
- To prevent possible damage to the wipers and washer system, use anti-freezing washer fluids in the winter season or cold weather.

Rear Window Wiper and Washer

The rear window wiper and washer switch is located at the end of the wiper and washer switch lever. Turn the switch to the desired position to operate the rear wiper and washer.

HI – High wiper speed

LO – Low wiper speed

OFF – Off

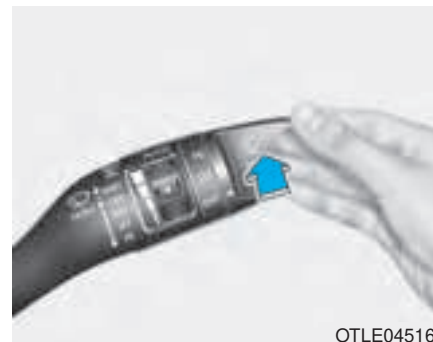

Push the lever away from you to spray rear washer fluid and to run the rear wipers 1~3 cycles. The spray and wiper operation will continue until you release the lever.

Auto rear wiper

The rear wiper will operate while the vehicle is in reverse with the front wiper ON by selecting the function on the LCD display.

Go to 'User Settings → Convenience → Auto Rear Wiper (in R)'.

REAR VIEW MONITOR (RVM)



Rear View Monitor will activate when the engine is running and the shift lever is in the R (Reverse) position.

This is a supplemental function that helps provide a view of the area behind the vehicle through the audio display while the vehicle is in the R (Reverse) position.

WARNING

Rear View Monitor is not a safety device. It only serves to assist the driver in identifying objects directly behind the middle of the vehicle. The camera does NOT cover the complete area behind the vehicle.

WARNING

- Never rely solely on Rear View Monitor when backing-up.
- **ALWAYS** look around your vehicle to make sure there are no objects or obstacles before moving the vehicle in any direction to prevent a collision.
- Always pay close attention when the vehicle is driven close to objects, particularly pedestrians, and especially children.

- During winter the rear view-camera image may be foggy due to the exhaust gas if the vehicle is stopped for a long time or parked in an indoor parking lot and when you park or stop your vehicle on hills.
- Due to the location of the camera, the license plate may be partially shown on the bottom of the rear view screen.

NOTICE

Always keep the rear view camera lens clean. The rear view camera may not work normally if the lens is covered with dirt, water or snow.

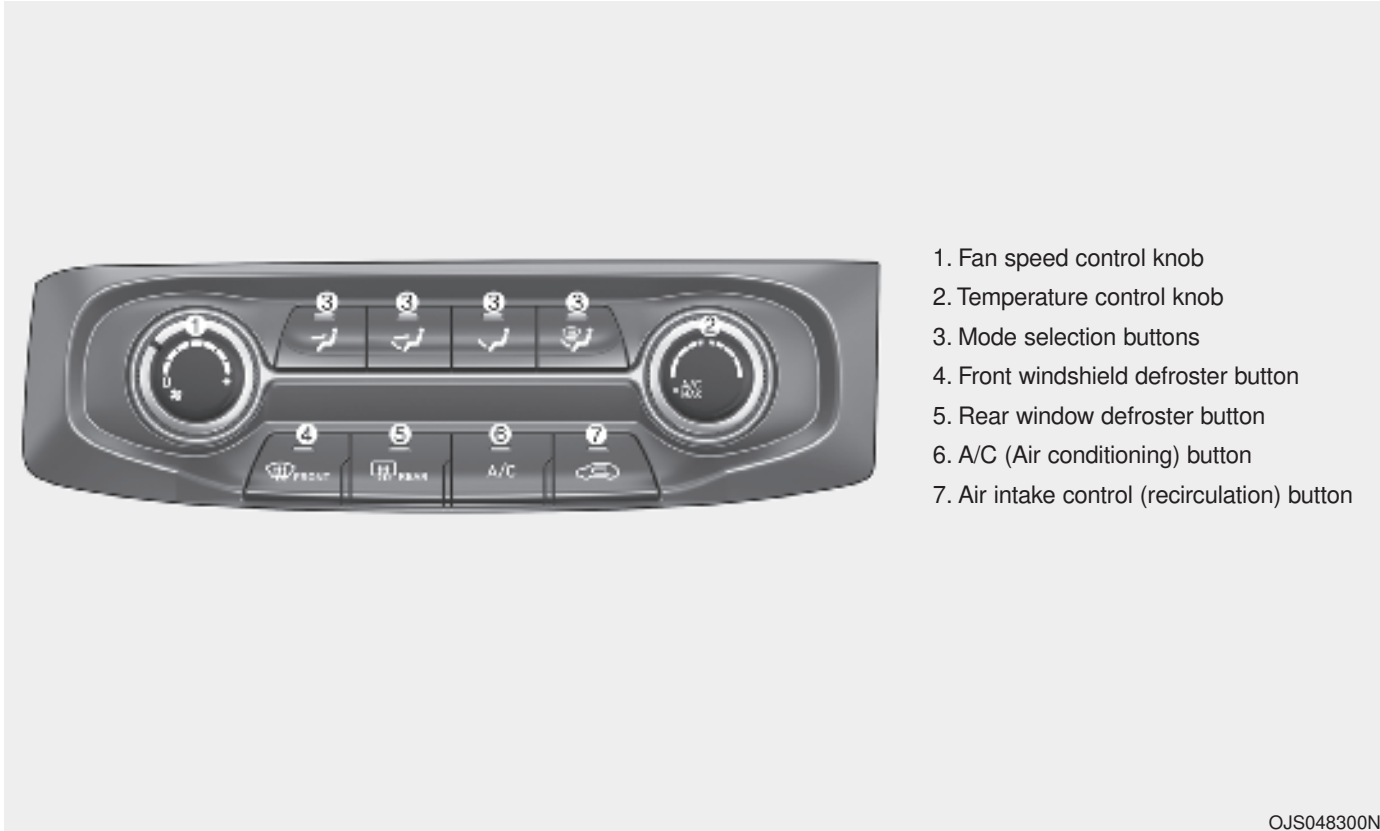

MANUAL CLIMATE CONTROL SYSTEM (IF EQUIPPED)



Heating and Air Conditioning

1. Start the engine.
2. Set the mode to the desired position.

To improve the effectiveness of heating and cooling, select the mode according to the following:

- Heating: 
- Cooling: 

3. Set the temperature control to the desired position.
4. Set the air intake control to improve the effectiveness of heating and cooling, select the mode according to the following:
5. Set the fan speed control to the desired speed.
6. If air conditioning is desired, turn the air conditioning system on.

Mode selection



OJSN048304

The mode selection button controls the direction of the air flow through the ventilation system. Air can be directed to the floor, dashboard outlets, or windshield. Five symbols are used to represent Face, Bi-Level, Floor, Floor-Defrost and Defrost air position.



Air flow is directed toward the upper body and face. Additionally, each outlet can be controlled to direct the air discharged from the outlet.



Air flow is directed towards the face and the floor.



Most of the air flow is directed to the floor, with a small amount of the air being directed to the windshield and side window defrosters.



Most of the air flow is directed to the floor and the windshield with a small amount directed to the side window defrosters.



Most of the air flow is directed to the windshield with a small amount of air directed to the side window defrosters.



MAX A/C-Level (B, D)

The MAX A/C mode is used to cool the inside of the vehicle faster. Air flow is directed toward the upper body and face.

In this mode, the A/C button and the Recirculation mode button cannot be selected. Turn the fan speed mode to adjust.

After the interior cabin has cooled sufficiently, move the temperature knob away from the MAX A/C setting and adjust the knob to the desired position.

If you wish to continue using A/C ON, make sure the A/C button LED is illuminated.

Instrument panel vents



The instrument panel vent air flow can be directed up/down or left/right using the vent adjustment lever.

The air flow can also be CLOSED using the vent adjustment lever. The instrument panel air vents are the "click-to-close" type.

To CLOSE the instrument panel vents perform the following:

- For the driver side vents, slide the vent adjustment lever to the LEFT until it clicks.
- For the passenger side vents, slide the vent adjustment lever to the right until it clicks.

Temperature control (2)

The temperature will increase by turning the knob to the right.

The temperature will decrease by turning the knob to the left.

Air intake control (7)

The air intake control button is used to select either Fresh mode (outside air) or Recirculation mode (cabin air).

Recirculation mode



When Recirculation mode is selected, air from the passenger compartment will be recirculated through the system and heated or cooled according to the function selected.

Fresh mode



When Fresh mode is selected, air enters the vehicle from outside and is heated or cooled according to the function selected.

Information

Using the system primarily in Fresh mode and Recirculation mode only when needed is recommended for best results.

Prolonged operation of the heater in Recirculation mode and without the A/C ON can cause fogging of the windshield.

In addition, prolonged use of the A/C ON in Recirculation mode may result in excessively dry, dehumidified air in the cabin.

WARNING

- Continued use of the climate control system operation in Recirculation mode for a prolonged period of time may cause drowsiness to the occupants in the cabin. This may lead to loss of vehicle control which may lead to an accident.
- Continued use of the climate control system operation in Recirculation mode with the A/C OFF may allow humidity to increase inside the cabin. This may cause condensation to accumulate on the windshield and obscure visibility.
- Do not sleep in your vehicle or remain parked in your vehicle with the windows up and either the heater or the air conditioning ON for prolonged periods of time. Doing so may increase the levels of carbon dioxide in the cabin which may lead to serious injury or death.

Fan speed control (1)

Turn the knob to the right to increase the fan speed and airflow. Turn the knob to the left to decrease fan speed and airflow.

Setting the fan speed control knob to the "0" position turns off the fan.

NOTICE

Operating the fan speed when the ignition switch is in the ON position could cause the battery to discharge. Operate the fan speed when the engine is running.

Air conditioning (6)

Push the A/C button to turn the system on (indicator light will illuminate) and off.

System Operation

Cooling / Ventilation

1. Select the Face Level  mode.
2. Set the air intake control to fresh mode.
3. Set the temperature control to the desired position.
4. Set the fan speed control to the desired speed.

Heating

1. Select the Floor Level  mode.
2. Set the air intake control to fresh mode.
3. Set the temperature control to the desired position.
4. Set the fan speed control to the desired speed.
5. If desired, turn the air conditioning ON with the temperature control knob set to heat in order to dehumidify the air before it enters into the cabin.

If the windshield fogs up, select the Floor & Defrost  mode or press the Front Defrost  mode.

Operation Tips

- To keep dust or unpleasant fumes from entering the vehicle through the ventilation system, temporarily set the air intake control to recirculation mode. Return the control to Fresh mode when the unpleasant air outside has diminished. This will help keep the driver alert and comfortable.
- To help prevent the inside of the windshield from fogging, set the air intake control to fresh mode and fan speed to the desired position, turn on the air conditioning system, and adjust the temperature control to the desired temperature.

Air conditioning

Your HYUNDAI vehicle air conditioning system is filled with R-1234yf refrigerant.

1. Start the engine.
2. Press the air conditioning button.
3. Set the mode to the Face Level  mode.
4. Set the air intake control to Recirculation mode temporarily to allow the cabin to cool quickly. When the desired temperature in the cabin is reached, change the air intake control back to Fresh mode.
5. Adjust the fan speed control and temperature control to maintain maximum comfort.

When maximum cooling is desired, set the temperature control to the MAX A/C position, then set the fan speed control to the highest setting.

NOTICE

When using the air conditioning system, monitor the engine temperature gauge closely while driving up hills or in heavy traffic when outside temperatures are high. Air conditioning system operation when climbing a steep grade or in high outside ambient temperatures can cause engine overheating.

Continue to use the fan, but turn the air conditioning system off if the engine temperature gauge indicates engine overheating.

Air conditioning system operation tips

- If the vehicle has been parked in direct sunlight during hot weather, open the windows for a short time to let the hot air inside the vehicle escape.
- After sufficient cooling has been achieved, switch back from the recirculated air to the fresh outside air position.
- To help reduce moisture inside of the windows on rainy or humid days, decrease the humidity inside the vehicle by operating the air conditioning system with the windows closed.
- Use the air conditioning system every month only for a few minutes to ensure maximum system performance.
- If you operate air conditioner excessively, the difference between the temperature of the outside air and that of the windshield could cause the outer surface of the windshield to fog up, causing loss of visibility. In this case, set the mode selection knob or button to the  position and fan speed control to the lower speed.

System Maintenance

Cabin air filter

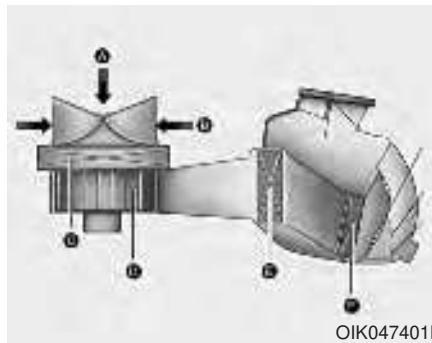

[A] : Outside air, [B] : Recirculated air
 [C] : Climate control air filter, [D] : Blower
 [E] : Evaporator core, [F] : Heater core

The cabin air filter is installed behind the glove box. It filters the dust or other pollutants that enter the vehicle through the heating and air conditioning system.

Have the cabin air filter replaced by an authorized HYUNDAI dealer according to the maintenance schedule. If the vehicle is being driven in severe conditions such as dusty or rough roads, more frequent cabin air filter inspections and changes are required.

If the air flow rate suddenly decreases, the system should be checked at an authorized HYUNDAI dealer.

Checking the amount of air conditioner refrigerant and compressor lubricant

When the amount of refrigerant is low, the performance of the air conditioning is reduced. Overfilling also reduces the performance of the air conditioning system.

Therefore, if abnormal operation is found, have the system inspected by an authorized HYUNDAI dealer.

NOTICE

It is important that the correct type and amount of oil and refrigerant is used. Otherwise, damage to the compressor and abnormal system operation may occur.

To prevent damage, the air conditioning system in your vehicle should only be serviced by trained and certified technicians.

⚠ WARNING

Vehicles equipped with R-1234yf



Since the refrigerant is mildly flammable and operated at high pressure, the air conditioning system should only be serviced by trained and certified technicians.



It is important that the correct type and amount of oil and refrigerant are used.

All refrigerants should be reclaimed with proper equipment.

Venting refrigerants directly to the atmosphere is harmful to individuals and environment. Failure to heed these warnings can lead to serious injuries.

Air Conditioning refrigerant label



You can find out which air conditioning refrigerant is applied to your vehicle on the label located inside of the hood.

■ Example

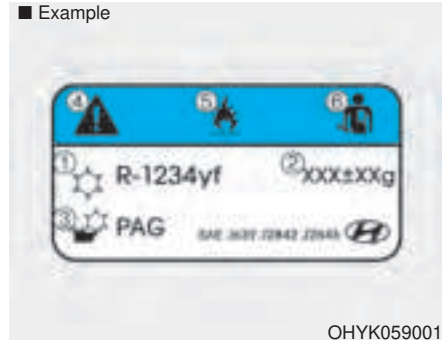

OHYK059001

Each symbols and specification on the air conditioning refrigerant label is represented as below:

1. Classification of refrigerant
2. Amount of refrigerant
3. Classification of compressor lubricant
4. Caution
5. Flammable refrigerant
6. To require registered technician to service air conditioning system
7. Service manual

AUTOMATIC CLIMATE CONTROL SYSTEM



1. Temperature control knob
2. Fan speed control knob
3. AUTO (automatic control) button
4. Air conditioning button
5. OFF button
6. Mode selection button
7. Climate control information button
8. Front windshield defroster button
9. Rear window defroster button
10. Air intake control button

Automatic Temperature Control Mode

The Automatic Climate Control System is controlled by setting the desired temperature.

1. Press the AUTO button (3).

The modes, fan speeds, air intake and air-conditioning will be controlled automatically by the temperature setting you select.

2. Turn the temperature control knob (1) to the desired temperature. If the temperature is set to the lowest setting (Lo), the air conditioning system will operate continuously. After the interior has cooled sufficiently, adjust the knob to a higher temperature set point whenever possible.

To turn the automatic operation off, select any button of the following:

- Mode selection button
- Front windshield defroster button (Press the button one more time to deselect the front windshield defroster function. The 'AUTO' sign will illuminate on the information display once again.)
- Fan speed control button

The selected function will be controlled manually while other functions operate automatically.

For your convenience and to improve the efficiency of the climate control, use the AUTO button and set the temperature to 72°F (22°C).

To change the temperature unit from °F to °C or °C to °F:

- Press and hold the AUTO and OFF buttons on the climate control unit for 3 seconds.





NOTICE

Never place anything near the ambient light/solar sensor to ensure better control of the heating and cooling system.

Manual Temperature Control Mode

The heating and cooling system can be controlled manually by pushing buttons other than the AUTO button. In this case, the system works sequentially according to the order of buttons selected.

When pressing any button except the AUTO button while using automatic operation, the functions not selected will be controlled automatically.

1. Start the engine.
2. Set the mode to the desired position.
To improve the effectiveness of heating and cooling, select the mode according to the following:
 - Heating: 
 - Cooling: 
3. Set the temperature control to the desired position.
4. Set the air intake control to Fresh mode or Recirculation mode position.
5. Set the fan speed control to the desired speed.
6. If air conditioning is desired, turn the air conditioning system on.
7. Press the AUTO button to convert to full automatic control of the system.

When starting the vehicle in cold weather a more efficient way to heat the passenger compartment is to do the following.

- Turn off or lower the blower, right after starting the engine.
- Engine temperature is still low and the air flow from the heater is still cold.
- After a few minutes of engine warm up, turn on or set the fan to a higher level and adjust the temperature setting to hot.

Mode selection



OJSN048304

The mode selection button controls the direction of the air flow through the ventilation system.

The air flow outlet direction is cycled as follows:



 **Face-Level (B, D)**

Air flow is directed toward the upper body and face. Additionally, each outlet can be controlled to direct the air discharged from the outlet.

 **Bi-Level (B, C, D)**

Air flow is directed towards the face and the floor.



Most of the air flow is directed to the floor and the windshield with a small amount directed to the side window defrosters.



Most of the air flow is directed to the floor, with a small amount of the air being directed to the windshield and side window defrosters.



Most of the air flow is directed to the windshield with a small amount of air directed to the side window defrosters.

Instrument panel vents



The instrument panel vent air flow can be directed up/down or left/right using the vent adjustment lever.

The air flow can also be CLOSED using the vent adjustment lever. The instrument panel air vents are the "click-to-close" type.

To CLOSE the instrument panel vents perform the following:

- For the driver side vents, slide the vent adjustment lever to the LEFT until it clicks.
- For the passenger side vents, slide the vent adjustment lever to the right until it clicks.

Temperature control (1)

Turn the knob to the right to increase the temperature. Turn the knob to the left to decrease temperature.

The temperature will increase or decrease by 1°F/0.5°C for each incremental location. When set to the lowest temperature setting, the air conditioning will operate continuously.

Air intake control (10)

The air intake control button is used to select either Fresh mode (outside air) or Recirculation mode (cabin air).

Recirculation mode



When Recirculation mode is selected, air from the passenger compartment will be recirculated through the system and heated or cooled according to the function selected.

Fresh mode



When Fresh mode is selected, air enters the vehicle from outside and is heated or cooled according to the function selected.

i Information

Using the system primarily in Fresh mode and Recirculation mode only when needed is recommended for best results.

Prolonged operation of the heater in Recirculation mode and without the A/C ON can cause fogging of the windshield.

In addition, prolonged use of the A/C ON in Recirculation mode may result in excessively dry, dehumidified air in the cabin.

Fan speed control (2)

The fan speed can be set as desired by pushing the fan speed control button.

More air is delivered with higher fan speeds.

Pressing the OFF button turns off the fan.

i Information

For better sound quality, fan speed may automatically slow down for a couple of minutes when you activate voice recognition or hands free.

NOTICE

Operating the fan when the ignition switch is in the ON position could cause the battery to discharge. Operate the fan when the engine is running.

Air conditioning (4)

Push the A/C button to manually turn the system on (indicator light will illuminate) and off.

OFF mode (5)

Push the OFF button to turn the climate control system off. You can still operate the mode and air intake buttons as long as the ignition switch is in the ON position.

System Operation

Cooling / Ventilation

1. Select the Face Level  mode.
2. Set the air intake control to fresh mode.
3. Set the temperature control to the desired position.
4. Set the fan speed control to the desired speed.

Heating

1. Select the Floor Level  mode.
2. Set the air intake control to fresh mode.
3. Set the temperature control to the desired position.
4. Set the fan speed control to the desired speed.
5. If desired, turn the air conditioning ON with the temperature control knob set to heat in order to dehumidify the air before it enters into the cabin.

If the windshield fogs up, select the Floor & Defrost  mode or press the Front Defrost  mode.

⚠ WARNING

- **Continued use of the climate control system operation in Recirculation mode for a prolonged period of time may cause drowsiness to the occupants in the cabin. This may lead to loss of vehicle control which may lead to an accident.**
- **Continued use of the climate control system operation in Recirculation mode with the A/C OFF may allow humidity to increase inside the cabin. This may cause condensation to accumulate on the windshield and obscure visibility.**
- **Do not sleep in your vehicle or remain parked in your vehicle with the windows up and either the heater or the air conditioning ON for prolonged periods of time. Doing so may increase the levels of carbon dioxide in the cabin which may lead to serious injury or death.**

Operation Tips

- To keep dust or unpleasant fumes from entering the car through the ventilation system, temporarily set the air intake control to the recirculation mode. Return the control to the Fresh mode when the unpleasant air outside has diminished. This will help keep the driver alert and comfortable.
- To help prevent the inside of the windshield from fogging, set the air intake control to fresh mode and the fan speed to the desired position, turn on the air conditioning system, and adjust the temperature control to the desired temperature.

Air conditioning

Your HYUNDAI vehicle air conditioning system is filled with R-1234yf refrigerant.

1. Start the engine.
2. Press the air conditioning button.
3. Set the mode to the Face Level  mode.
4. Set the air intake control to Recirculation mode temporarily to allow the cabin to cool quickly. When the desired temperature in the cabin is reached, change the air intake control back to Fresh mode.
5. Adjust the fan speed control and temperature control to maintain maximum comfort.

When maximum initial cooling is desired, set the temperature control to the MAX A/C position, then set the fan speed control to the highest setting.

NOTICE

When using the air conditioning system, monitor the engine temperature gauge closely while driving up hills or in heavy traffic when outside temperatures. Air conditioning system operation when climbing a steep grade or in high outside ambient temperatures can cause engine overheating. Continue to use the fan, but turn the air conditioning system off if the engine temperature gauge indicates engine overheating.

Air conditioning system operation tips

- If the vehicle has been parked in direct sunlight during hot weather, open the windows for a short time to let the hot air inside the vehicle escape.
- After sufficient cooling has been achieved, switch back from the recirculated air to the fresh outside air position.

- To help reduce moisture inside of the windows on rainy or humid days, decrease the humidity inside the vehicle by operating the air conditioning system with the windows closed.
- Use the air conditioning system every month only for a few minutes to ensure maximum system performance.
- If you operate air conditioner excessively, the difference between the temperature of the outside air and that of the windshield could cause the outer surface of the windshield to fog up, causing loss of visibility. In this case, set the mode selection knob or button to the  position and fan speed control to the lower speed.

System Maintenance

Cabin air filter

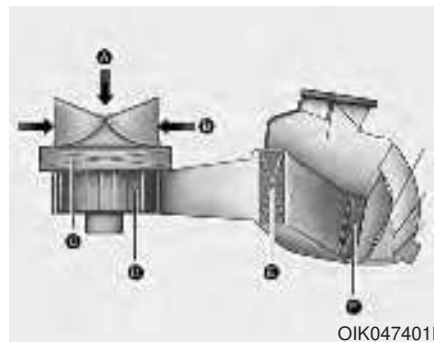

[A] : Outside air, [B] : Recirculated air
 [C] : Climate control air filter, [D] : Blower
 [E] : Evaporator core, [F] : Heater core

The cabin air filter is installed behind the glove box. It filters the dust or other pollutants that enter the vehicle through the heating and air conditioning system.

Have the The cabin air filter replaced by an authorized HYUNDAI dealer according to the maintenance schedule. If the vehicle is being driven in severe conditions such as dusty or rough roads, more frequent cabin air filter inspections and changes are required.

If the air flow rate suddenly decreases, the system should be checked at an authorized HYUNDAI dealer.

Checking the amount of air conditioner refrigerant and compressor lubricant

When the amount of refrigerant is low, the performance of the air conditioning is reduced. Overfilling also reduces the performance of the air conditioning system.

Therefore, if abnormal operation is found, have the system inspected by an authorized HYUNDAI dealer.

NOTICE

It is important that the correct type and amount of oil and refrigerant is used. Otherwise, damage to the compressor and abnormal system operation may occur.

To prevent damage, the air conditioning system in your vehicle should only be serviced by trained and certified technicians.

▲ WARNING

Vehicles equipped with R-1234yf



Since the refrigerant is mildly flammable and operated at high pressure, the air conditioning system should only be serviced by trained and certified technicians.



It is important that the correct type and amount of oil and refrigerant are used.

All refrigerants should be reclaimed with proper equipment.

Venting refrigerants directly to the atmosphere is harmful to individuals and environment. Failure to heed these warnings can lead to serious injuries.

Air Conditioning refrigerant label



You can find out which air conditioning refrigerant is applied to your vehicle on the label located inside of the hood.

■ Example

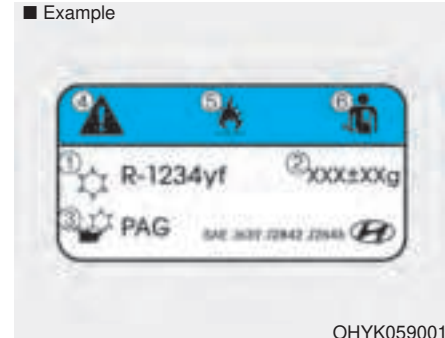

OHYK059001



Each symbols and specification on the air conditioning refrigerant label is represented as below:

1. Classification of refrigerant
2. Amount of refrigerant
3. Classification of compressor lubricant
4. Caution
5. Flammable refrigerant
6. To require registered technician to service air conditioning system
7. Service manual

WINDSHIELD DEFROSTING AND DEFOGGING

WARNING

Windshield heating

Do not use the  or  position during cooling operation in extremely humid weather. The difference between the temperature of the outside air and that of the windshield could cause the outer surface of the windshield to fog up, causing loss of visibility could cause an accident resulting in serious injury or death. In this case, set the mode selection knob or button to the  position and fan speed control knob or button to a lower speed.

- For maximum defrost performance, set the temperature control knob to the highest temperature setting (rotated all the way to the right) and the fan speed control to the highest setting.
- If warm air to the floor is desired while defrosting or defogging, set the mode to the floor-defrost position.
- Before driving, clear all snow and ice from the windshield, rear window, side view mirrors, and all side windows.
- Clear all snow and ice from the hood and air inlet in the cowl grill to improve heater and defroster efficiency and to reduce the probability of fogging up the inside of the windshield.



NOTICE

If the engine temperature is still cold after starting, then a brief engine warm up period may be required for the vented air flow to become warm or hot.

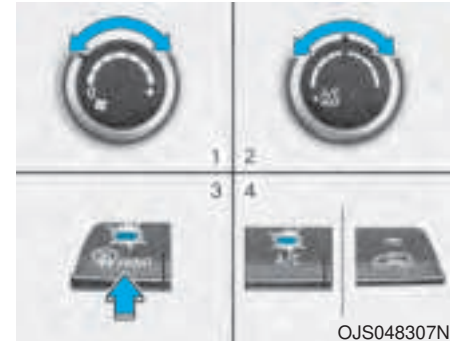
Manual Climate Control System



To defog inside windshield

1. Select any fan speed except "0" position.
2. Select the desired temperature.
3. Select the  or  position.
4. Fresh mode will be selected automatically. Additionally, the air conditioning will automatically operate if the mode is selected to the  position.

Check to make sure the A/C is ON. If the A/C ON LED is not illuminated, press the A/C button once to turn the air conditioner ON.

Convenient features of your vehicle

Check to make sure the air intake control is in Fresh mode. If the air intake control LED is illuminated, press the button once to enable Fresh mode (LED OFF).

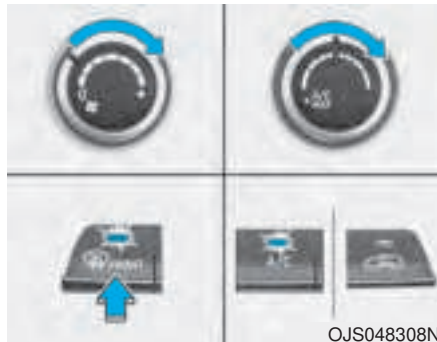

OJS048308N

To defrost outside windshield

1. Set the fan speed to the highest setting (knob rotated all the way to the right).
2. Set the temperature control to the highest temperature setting.
3. Select the  position.
4. Fresh mode (Recirculation OFF) and A/C ON will automatically be selected.

Automatic Temperature Control System (if equipped)



OJS048309

To defog inside windshield

1. Select the desired fan speed.
2. Select the desired temperature.
3. Press the defroster button ()
4. Fresh mode will be selected automatically.

Check to make sure the air intake control is in Fresh mode. If the air intake control LED is illuminated, press the button once to enable Fresh mode (LED OFF).

If the  position is selected, the fan speed is automatically increased.





OJS048310

To defrost outside windshield

1. Set the fan speed to the highest (extreme right) position.
2. Set the temperature to the extreme hot (HI) position.
3. Press the defroster button ()
4. The outside (fresh) air position will be selected automatically.

If the  position is selected, lower fan speed is adjusted to a higher fan speed.

Defogging logic

To reduce the probability of fogging up the inside of the windshield, the air intake or air conditioning are controlled automatically according to certain conditions such as  or  positions. To cancel or reset the defogging logic, do the following.

Manual climate control system

1. Turn the ignition switch to the ON position.
2. Press the defroster button () .
3. Press the air intake control button at least 5 times within 3 seconds.

The LED indicator on the A/C ON button will blink 3 times to indicate that the defogging logic has been disabled.

Repeat the steps again to re-enable the defogging logic.

If the battery has been discharged or disconnected, it resets to the defog logic status.

Automatic climate control system

1. Turn the ignition switch to the ON position.
2. Press the defroster button () .
3. While pressing the air conditioning button (A/C), press the air intake control button at least 5 times within 3 seconds.

The Automatic Temperature Control information screen will blink 3 times to indicate that the defogging logic has been disabled.

Repeat the steps again to re-enable the defogging logic.

If the battery has been discharged or disconnected, it resets to the defog logic status.

Rear Window Defroster

NOTICE

To prevent damage to the rear window defroster conducting elements bonded to the inside surface of the rear window, never use sharp instruments or window cleaners containing abrasives to clean the window.

If you want to defrost and defog the front windshield, refer to the "Windshield Defrosting and Defogging" section in this chapter.

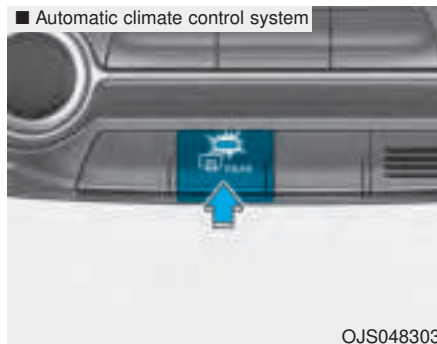
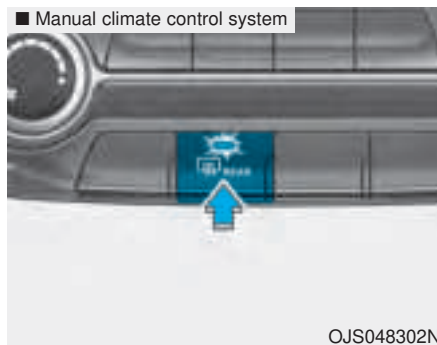

The defroster heats the window to remove frost, fog and thin ice from the interior and exterior of the rear window, while the engine is running.

- To activate the rear window defroster, press the rear window defroster button located on the climate control instrument panel display. The indicator on the rear window defroster button illuminates when the defroster is ON.
- To turn off the defroster, press the rear window defroster button again.

i Information

- **If there is heavy accumulation of snow on the rear window, brush it off before operating the rear defroster.**
- **The rear window defroster automatically turns off after approximately 20 minutes or when the ignition switch is in the LOCK/OFF position.**

Side view mirror defroster

If your vehicle is equipped with the side view mirror defrosters, they will operate at the same time you turn on the rear window defroster.

CLIMATE CONTROL ADDITIONAL FEATURES (IF EQUIPPED)

Automatic Ventilation

When the ignition switch is in the ON position or when the engine is running and temperature is below 59°F (15°C) with the recirculation mode selected more than five minutes, the air intake position will automatically change to fresh mode.

To cancel or reset the Automatic Ventilation

When the air conditioning system is on, press the mode selection button and the recirculation mode button five times within three seconds.

When the Automatic Ventilation feature is enabled, the Recirculation button LED indicator will blink 6 times.

When the Automatic Ventilation feature is disabled, the Recirculation button LED indicator will blink 3 times.

STORAGE COMPARTMENT

WARNING

Never store cigarette lighters, propane cylinders, or other flammable/explosive materials in the vehicle. These items may catch fire and/or explode if the vehicle is exposed to hot temperatures for extended periods.

WARNING

ALWAYS keep the storage compartment covers closed securely while driving. Items inside your vehicle are moving as fast as the vehicle. If you have to stop or turn quickly, or if there is a crash, the items may fly out of the compartment and may cause an injury if they strike the driver or a passenger.

NOTICE

To avoid possible theft, do not leave valuables in the storage compartments.

Center Console Storage



To open :
Grab and hold the latch (1) on the arm rest then lift the lid.

Glove Box



To open:
Pull the lever (1).

WARNING

ALWAYS close the glove box door after use.

An open glove box door can cause serious injury to the passenger in an accident, even if the passenger is wearing a seat belt.

Sunglass Holder

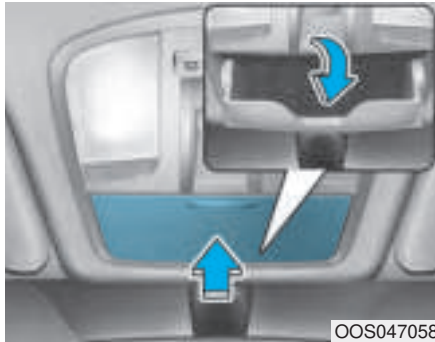

To open:

Push and release the cover and the holder will slowly open. Place your sunglasses in the compartment door with the lenses facing out.

To close:

Push back into position.

Make sure the sunglasses holder is closed while driving.

WARNING

- Do not keep objects except sunglasses inside the sunglasses holder. Such objects can be thrown from the holder in the event of a sudden stop or an accident, possibly injuring the passengers in the vehicle.
- Do not open the sunglasses holder while the vehicle is moving. The rear view mirror of the vehicle can be blocked by an open sunglasses holder.
- Do not put the glasses forcibly into a sunglasses holder. It may cause personal injury if you try to open it forcibly when the glasses are jammed in holder.

INTERIOR FEATURES

Cup Holder

■ Front

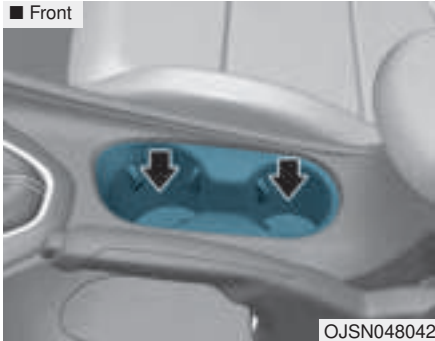

■ Rear



Cups or small beverages cups may be placed in the cup holders.

WARNING

- Avoid abrupt starting and braking when the cup holder is in use to prevent spilling your drink. If hot liquid spills, you could be burned. Such a burn to the driver could cause loss of vehicle control resulting in an accident.
- Do not place uncovered or unsecured cups, bottles, cans, etc., in the cup holder containing hot liquid while the vehicle is in motion. Injuries may result in the event of a sudden stop or collision.
- Only use soft cups in the cup holders. Hard objects can injure you in an accident.

WARNING

Keep cans or bottles out of direct sun light and do not put them in a hot vehicle. It may explode.

NOTICE

- Keep your drinks sealed while driving to prevent spilling your drink. If liquid spills, it may get into the vehicle's electrical/electronic system and damage electrical/electronic parts.
- When cleaning spilled liquids do not use hot air to blow out or dry the cup holder. This may damage the interior.

Sunvisor



To use the sunvisor, pull it downward.

To use the sunvisor to block the sun from the side window, pull it downward, release it from the bracket (1) and swing it to the side (2) towards the window.

To use the vanity mirror, pull down the sunvisor and slide the mirror cover (3).

Adjust the sunvisor forward or backward (4) as needed (if equipped). Use the ticket holder (5) to hold tickets (if equipped).

NOTICE

Close the vanity mirror cover securely and return the sunvisor to its original position after use.

WARNING

For your safety, do not block your view when using the sunvisor.

NOTICE

Do not put multiple tickets in the ticket holder at one time. This could cause damage to the ticket holder.

Power Outlet



The power outlet is designed to provide power for mobile telephones or other devices designed to operate with vehicle electrical systems. The devices should draw less than 180 W with the engine running.

WARNING

Avoid electrical shocks. Do not place your fingers or foreign objects (pin, etc.) into a power outlet or touch the power outlet with a wet hand.

NOTICE

To prevent damage to the Power Outlets :

- Use the power outlet only when the engine is running and remove the accessory plug after use. Using the accessory plug for prolonged periods of time with the engine off could cause the battery to discharge.
- Only use 12V electric accessories which are less than 180 W in electric capacity.
- Adjust the air-conditioner or heater to the lowest operating level when using the power outlet.
- Close the cover when not in use.

- Some electronic devices can cause electronic interference when plugged into a vehicle's power outlet. These devices may cause excessive audio static and malfunctions in other electronic systems or devices used in your vehicle.
- Push the plug in as far as it will go. If good contact is not made, the plug may overheat and the fuse may open.
- Plug in battery equipped electrical/electronic devices with reverse current protection. The current from the battery may flow into the vehicle's electrical/electronic system and cause system malfunction.

USB charger



The USB charger is designed to recharge batteries of small size electrical devices using a USB cable.

The electrical devices can be recharged when the ignition switch is in the ACC/ON position.

Insert the USB charger into the USB port, and re-charge a smart phone or a tablet PC.

The battery charging state may be monitored on the electrical device.

Disconnect the USB cable from the USB port after use.

- A smart phone or a tablet PC may get warmer during the re-charging process. It does not indicate any malfunction with the charging system.
- A smart phone or a tablet PC, which adopts a different re-charging method, may not be properly re-charged. In this case, use an exclusive charger of your device.
- The charging terminal is only to recharge a device. Do not use the charging terminal either to turn ON an audio or to play media in the infotainment system.

Clock

WARNING

Do not attempt to adjust the clock while driving. Doing so may result in distracted driving which may lead to an accident involving personal injury or death.

Vehicles with display audio system

Select the **[SETUP]** button on the audio system → Select [Date/Time].

- Set time: Set the time displayed on the audio screen.
- Time format: Choose between 12-hour and 24-hour time formats.

Clothes Hanger



These hangers are not designed to hold large or heavy items.

WARNING

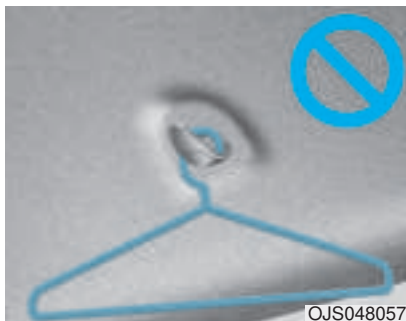

Do not hang other objects such as hangers or hard objects except clothes. Also, do not put heavy, sharp or breakable objects in the clothes pockets. In an accident or when the curtain air bag is inflated, it may cause vehicle damage or personal injury.

Floor Mat Anchor(s)



ALWAYS use the Floor Mat Anchors to attach the front floor mats to the vehicle. The anchors on the front floor carpet keep the floor mats from sliding forward.

WARNING

Do not overlay additional mats or liners over the floor mats. If using All Weather mats, remove the carpeted floor mats before installing them. Only use floor mats designed to connect to the anchors.

WARNING

The following must be observed when installing ANY floor mat to the vehicle.

- **Ensure to remove a protective film attached on the carpet before attaching a floor mat on the front floor carpet. Otherwise, the floor mat may move freely on the protective film and it could result in unintentional braking or accelerating.**
- **Ensure that the floor mats are securely attached to the vehicle's floor mat anchor(s) before driving the vehicle.**
- **Do not use ANY floor mat that cannot be firmly attached to the vehicle's floor mat anchors.**
- **Do not stack floor mats on top of one another (e.g. all-weather rubber mat on top of a carpeted floor mat). Only a single floor mat should be installed in each position.**

IMPORTANT - Your vehicle was manufactured with driver's side floor mat anchors that are designed to securely hold the floor mat in place. To avoid any interference with pedal operation, HYUNDAI recommends that the HYUNDAI floor mat designed for use in your vehicle be installed.

Cargo Area Cover



Use the cover to hide items stored in the cargo area.

The cargo area cover will lift when the liftgate is opened.

Disconnect the strap (1) from the holder if you want to return the cover to the original position. To remove the cargo area cover completely, lift the cover to a 50-degree angle and pull it out (2).

NOTICE

Since the cargo area cover may be damaged or deformed, do not put luggage on it when it is being used.

WARNING

- Do not place objects on the cargo area cover while driving. Such objects may be thrown about inside the vehicle and possibly injure vehicle occupants during an accident or when braking.
- Never allow anyone to ride in the luggage compartment. It is designed for luggage only.
- Maintain balance of the vehicle and locate the weight as far forward as possible.

Infotainment System

Infotainment System.....	4-2
USB Port.....	4-2
Antenna	4-2
Steering Wheel Audio Controls.....	4-3
<i>Bluetooth</i> [®] Wireless Technology Hands-Free.....	4-4
Display Audio System.....	4-4

INFOTAINMENT SYSTEM

NOTICE

- If you install an aftermarket HID head lamp, your vehicle's audio and electronic devices may not function properly.
- Prevent chemicals such as perfume, cosmetic oil, sun cream, hand cleaner, and air freshener from contacting the interior parts because they may cause damage or discoloration.

USB Port



You can use a USB port to plug in a USB.

i Information

When using a portable audio device connected to the power outlet, noise may occur during playback. If this happens, use the portable audio device's power source.

Antenna



The roof antenna receives transmitted data. (For example : AM/FM)

Steering Wheel Audio Control



NOTICE

Do not operate multiple audio remote control buttons simultaneously.

VOLUME (VOL + / -) (1)

- Press the VOLUME switch up to increase volume.
- Press the VOLUME switch down to decrease volume.

SEEK/PRESET (^ / v) (2)

If the SEEK/PRESET switch is pressed up or down and held for 0.8 second or more, it will function in the following modes:

RADIO mode

It will function as the AUTO SEEK select button. It will SEEK until you release the button.

MEDIA mode

It will function as the FF/RW button.

If the SEEK/PRESET switch is pressed up or down, it will function in the following modes:

RADIO mode

It will function as the PRESET STATION UP/DOWN button.

MEDIA mode

It will function as the TRACK UP/DOWN button.

MODE (3)

Press the MODE button to toggle through Radio, SXM, or AUX modes.

MUTE () (4)

- Press the MUTE button to mute the sound.
- Press the MUTE button again to activate the sound.

i Information

Detailed information for audio control buttons are described in the separately supplied manual with the vehicle.

Bluetooth® Wireless Technology Hands-Free



OPDEN047422



OOS047076

With the *Bluetooth®* Wireless Technology in the vehicle, you can use the phone wireless.

- (1) Call / Answer button
- (2) Call end button
- (3) Microphone

Detailed information for the *Bluetooth®* Wireless Technology hands-free is described in the Car Infotainment User's Manual.

Display Audio System

Detailed information for the display audio system is described in the Car Infotainment User's Manual.

Driving your vehicle

Before driving	5-4
Before Entering the Vehicle	5-4
Before Starting	5-4
Engine Start/Stop Button.....	5-6
Ignition switch	5-6
Manual transmission	5-12
Manual Transmission Operation	5-12
Good Driving Practices	5-14
Rev matching.....	5-15
Dual clutch transmission	5-19
Dual clutch transmission operation	5-19
DCT warning messages.....	5-21
Parking.....	5-29
Good driving practices	5-29
Braking system	5-31
Power Brakes.....	5-31
High Performance Brake.....	5-32
Disc Brakes Wear Indicator	5-32
Parking Brake	5-33
Anti-lock Brake System (ABS)	5-34
Electronic Stability Control (ESC).....	5-36
Vehicle Stability Management (VSM).....	5-42
Hill-Start Assist Control (HAC)	5-44
Good Braking Practices	5-44
Electronic control suspension (ECS)	5-46
Electronic limited slip differential	5-47
Warning messages.....	5-48
Drive Mode Integrated Control System	5-49
DRIVE MODE button.....	5-49
P button.....	5-51
NGS (P Grin Shift)	5-52
Vehicle characteristic.....	5-54
Performance option	5-56
Performance option settings	5-56
Launch Control	5-56
Shift Indicator	5-59
P Track Sense Shift	5-59
P Dual Clutch Transmission)	5-61
P Power Shift (For Dual Clutch Transmission).....	5-62
Declaration of conformity	5-63
Forward Collision-Avoidance Assist (FCA) (Front view camera only)	5-64
System settings	5-65
System operation	5-67
System malfunction and limitations	5-70
Lane Keeping Assist (LKA)	5-77
System settings	5-77
System operation	5-79
System malfunction and limitations	5-81

Blind-Spot Collision Warning (BCW)	5-84
System settings	5-85
System operation	5-87
System malfunction and limitations	5-89
Driver Attention Warning (DAW)	5-94
System settings	5-95
System operation	5-96
System malfunction and limitations	5-98
CRUISE CONTROL (CC)	5-102
System operation	5-102
Increase setting speed	5-103
Temporary speed increase	5-103
Lane Following Assist (LFA)	5-107
System settings	5-107
System operation	5-108
System malfunction and limitations	5-111
Rear Cross-Traffic Collision Warning (RCCW)	5-112
System settings	5-113
System operation	5-114
System malfunction and limitations	5-116
Special driving conditions	5-120
Hazardous Driving Conditions	5-120
Rocking the Vehicle	5-120
Smooth Cornering	5-121
Driving at Night	5-121
Driving in the Rain	5-121
Driving in Flooded Areas	5-122
Highway Driving	5-122
Winter driving	5-123
Snow or Icy Conditions	5-123
Winter Precautions	5-126
Vehicle load limit	5-128
Tire Loading Information Label	5-129
Trailer Towing	5-133

WARNING

Carbon monoxide (CO) gas is toxic. Breathing CO can cause unconsciousness and death.

Engine exhaust contains carbon monoxide which cannot be seen or smelled.

Do not inhale engine exhaust.

If at any time you smell engine exhaust inside the vehicle, open the windows immediately. Exposure to CO can cause unconsciousness and death by asphyxiation.

Be sure the exhaust system does not leak.

The exhaust system should be checked whenever the vehicle is raised to change the oil or for any other purpose. If you hear a change in the sound of the exhaust or if you drive over something that strikes the underneath side of the vehicle, have the exhaust system checked as soon as possible by an authorized HYUNDAI dealer.

Do not run the engine in an enclosed area.

Letting the engine idle in your garage, even with the garage door open, is a hazardous practice. Run the engine only long enough to start the engine and to move the vehicle out of the garage.

Avoid idling the engine for prolonged periods with people inside the vehicle.

If it is necessary to idle the engine for a prolonged period with people inside the vehicle, be sure to do so only in an open area with the air intake set at "Fresh" and fan control set to high so fresh air is drawn into the interior.

Keep the air intakes clear.

To assure proper operation of the ventilation system, keep the ventilation air intakes located in front of the windshield clear of snow, ice, leaves, or other obstructions.

If you must drive with the liftgate open:

Close all windows.

Open instrument panel air vents.

Set the air intake control at "Fresh", the air flow control at "Floor" or "Face", and the fan control set to high.

 **WARNING**

**CALIFORNIA PROPOSITION 65
WARNING**

Engine exhaust and a wide variety of automobile components including components found in the interior furnishings in a vehicle, contain or emit harmful chemicals known to the State of California to cause cancer and birth defects and reproductive harm. In addition, certain fluids contained in vehicles and certain products of components contain or emit chemicals known to the State of California to cause cancer and birth defects or other reproductive harm.

BEFORE DRIVING

Before Entering the Vehicle

- Be sure all windows, outside mirror(s), and outside lights are clean and unobstructed.
- Remove frost, snow, or ice.
- Visually check the tires for uneven wear and damage.
- Check under the vehicle for any sign of leaks.
- Be sure there are no obstacles behind you if you intend to back up.

Before Starting

- Make sure the hood, the liftgate, and the doors are securely closed and locked.
- Adjust the position of the seat and steering wheel.
- Adjust the inside and side view mirrors.
- Verify all the lights work.
- Fasten your seatbelt. Check that all passengers have fastened their seatbelts.
- Check the gauges and indicators in the instrument panel and the messages on the instrument display when the ignition switch is in the ON position.
- Check that any items you are carrying are stored properly or fastened down securely.

WARNING

To reduce the risk of **SERIOUS INJURY** or **DEATH**, take the following precautions:

- **ALWAYS** wear your seat belt. All passengers must be properly belted whenever the vehicle is moving. For more details, refer to "Seat Belts" in chapter 2.
- Always drive defensively. Assume other drivers or pedestrians may be careless and make mistakes.
- Stay focused on the task of driving. Driver distraction can cause accidents.
- Leave plenty of space between you and the vehicle in front of you.

WARNING

NEVER drink or take drugs and drive.

Drinking or taking drugs and driving is dangerous and may result in an accident and **SERIOUS INJURY** or **DEATH**.

Drunk driving is the number one contributor to the highway death toll each year. Even a small amount of alcohol will affect your reflexes, perceptions and judgment. Just one drink can reduce your ability to respond to changing conditions and emergencies and your reaction time gets worse with each additional drink.

Driving while under the influence of drugs is as dangerous or more dangerous than driving under the influence of alcohol.

You are much more likely to have a serious accident if you drink or take drugs and drive. If you are drinking or taking drugs, don't drive. Do not ride with a driver who has been drinking or taking drugs. Choose a designated driver or call a taxi.

IGNITION SWITCH

Engine Start/Stop Button



Whenever the front door is opened, the Engine Start/Stop button will illuminate and will go off 30 seconds after the door is closed.

WARNING

To reduce risk of serious injury or death, **NEVER** allow children or any person who is unfamiliar with the vehicle to touch the Engine Start/Stop button or related parts. Unexpected and sudden vehicle movement can occur.

WARNING

To turn the engine off in an emergency:

Press and hold the Engine Start/Stop button for more than two seconds OR rapidly press and release the Engine Start/Stop button three times (within three seconds).

If the vehicle is still moving, you can restart the engine without depressing the brake pedal by pressing the Engine Start/Stop button with the shift lever in the N (Neutral) position.

WARNING



- **NEVER** press the Engine Start/Stop button while the vehicle is in motion except in an emergency. This will result in the engine turning off and loss of power assist for the steering and brake systems.

This may lead to loss of directional control and braking function, which could cause an accident.



- Before leaving the driver's seat, always make sure the shift lever is in the 1st gear when the vehicle is parked on a uphill and in R (Reverse) on a downhill, set the parking brake, press the Engine Start/Stop button to the OFF position, and take the Smart Key with you. Unexpected vehicle movement may occur if these precautions are not followed.
- **NEVER** reach through the steering wheel for the Engine Start/Stop button or any other control while the vehicle is in motion. The presence of your hand or arm in this area may cause a loss of vehicle control resulting in an accident.

Engine Start/Stop button positions

- Vehicle with manual transmission

Button Position	Action	Notice
OFF  Not illuminated	To turn off the engine, stop the vehicle and then press the Engine Start/Stop button.	
ACC  Orange indicator	Press the Engine Start/Stop button when the button is in the OFF position without depressing the clutch pedal. Electrical accessories are usable.	If you leave the Engine Start/Stop button in the ACC position for more than one hour, the battery power will turn off automatically to prevent the battery from discharging.

- Vehicle with manual transmission

Button Position	Action	Notice
<p style="text-align: center;">ON</p>  <p style="text-align: center;">Blue indicator</p>	<p>Press the Engine Start/Stop button while it is in the ACC position without depressing the clutch pedal.</p> <p>The warning lights can be checked before the engine is started.</p>	<p>If you leave the Engine Start/Stop button in the ON position for more than one hour, the battery power will turn off automatically to prevent the battery from discharging.</p>
<p style="text-align: center;">START</p>  <p style="text-align: center;">Not illuminated</p>	<p>To start the engine, depress the clutch and brake pedals and press the Engine Start/Stop button with the shift lever in neutral.</p>	<p>If you press the Engine Start/Stop button without depressing the clutch pedal, the engine does not start and the Engine Start/Stop button changes as follows: OFF → ACC → ON → OFF</p>

Starting the engine

WARNING

- Always wear appropriate shoes when operating your vehicle. Unsuitable shoes, such as high heels, ski boots, sandals, flip-flops, etc., may interfere with your ability to use the brake and accelerator pedals.
- Do not start the vehicle with the accelerator pedal depressed. The vehicle can move and lead to an accident.
- Wait until the engine rpm is normal. The vehicle may suddenly move if the brake pedal is released when the rpm is high.

Information

- The engine will start by pressing the Engine Start/Stop button, only when the smart key is in the vehicle.
- Even if the smart key is in the vehicle, if it is far away from the driver, the engine may not start.
- When the Engine Start/Stop button is in the ACC or ON position, if any door is open, the system checks for the smart key. If the smart key is not in the vehicle, the " " indicator will blink and the warning "Key not in vehicle" will come on and if all doors are closed, the chime will also sound for about 5 seconds. Keep the smart key in the vehicle when using the ACC position or if the vehicle engine is ON.

Vehicle with manual transmission:

1. Always carry the smart key with you.
2. Make sure the parking brake is applied.
3. Make sure the shift lever is in neutral.
4. Depress the clutch and brake pedals.
5. Press the Engine Start/Stop button.

Information

Depress the brake pedal and clutch pedal until the engine starts.

i Information

- Do not wait for the engine to warm up while the vehicle remains stationary. Start driving at moderate engine speeds. (Aggressive accelerating and decelerating should be avoided.)
- Always start the vehicle with your foot on the brake pedal. Do not depress the accelerator while starting the vehicle. Do not rev the engine while warming it up.

NOTICE

To prevent damage to the vehicle:

- If traffic and road conditions permit, you may put the shift lever in the N (Neutral) position while the vehicle is still moving and press the Engine Start/Stop button in an attempt to restart the engine.
- Do not push or tow your vehicle to start the engine.

NOTICE

To prevent damage to the vehicle: When the stop lamp switch fuse is blown, you can't start the engine normally. Replace the fuse with a new one. If you are not able to replace the fuse, you can start the engine by pressing and holding the Engine Start/Stop button for 10 seconds with the Engine Start/Stop button in the ACC position.

Do not press the Engine Start/Stop button for more than 10 seconds except when the stop lamp switch fuse is blown.

For your safety always depress the brake pedal before starting the engine.

Starting and stopping the engine for turbocharger intercooler

1. Do not race or accelerate the engine immediately after starting the engine.

If the engine is cold, idle for several seconds before sufficient lubrication is ensured in the turbocharger.

2. After high speed or extended driving that requires heavy engine load, idle the engine about 1 minute before turning the engine off. This idle time will allow the turbocharger to cool prior to shutting the engine off.

NOTICE

Do not turn off the engine immediately after it has been subjected to a heavy load. Doing so may cause severe damage to the engine or turbocharger.

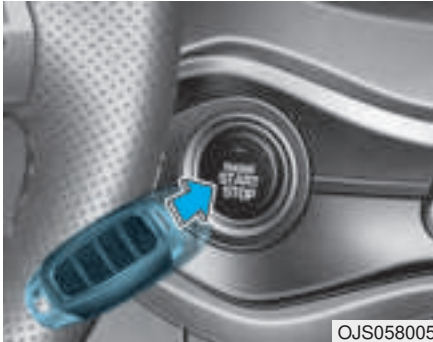

i Information

If the smart key battery is weak or the smart key does not work correctly, you can start the engine by pressing the Engine Start/Stop button with the smart key in the direction of the picture above.

Turning off the engine

1. Stop the vehicle and depress the clutch and brake pedals at the same time.
2. With the clutch and brake pedals depressed, put the shift lever in neutral.
3. Press the Engine Start/Stop button to the off position and apply the parking brake.

MANUAL TRANSMISSION

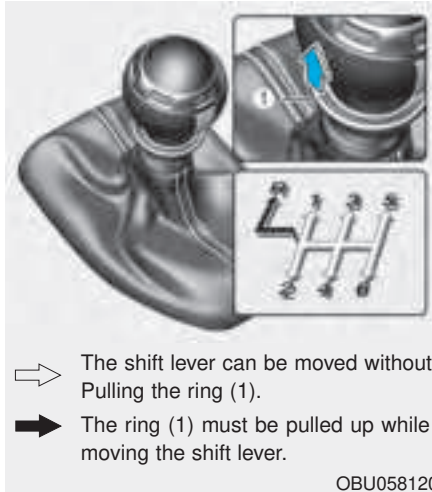

- ⇒ The shift lever can be moved without Pulling the ring (1).
- ➔ The ring (1) must be pulled up while moving the shift lever.

OBU058120

Manual Transmission Operation

The manual transmission has 6 forward gears. The transmission is fully synchronized in all forward gears so shifting to either a higher or a lower gear is easily accomplished.

WARNING

Before leaving the driver's seat, always make sure the shift lever is in 1st gear when the vehicle is parked on a uphill and in R (Reverse) on a downhill, set the parking brake, and place the ignition switch in the LOCK/OFF position. Unexpected vehicle movement may occur if these precautions are not followed.

To shift to R (Reverse), make sure the vehicle has completely stopped, and then move the shift lever to neutral before moving into R (Reverse).

When you've come to a complete stop and it's hard to shift into 1st gear or R (Reverse):

1. Put the shift lever in neutral and release the clutch pedal.
2. Depress the clutch pedal, and then shift into 1 (First) or R (Reverse) gear.

Information

During cold weather, shifting may be difficult until the transmission lubricant has warmed up.

Using the clutch

The clutch pedal should be depressed all the way before:

- Starting the engine

The engine will not start without depressing the clutch pedal.

- Shifting into gear, up shifting to the next higher gear, or down shifting to the next lower gear.

When releasing the clutch pedal, release it slowly. The clutch pedal should always be fully released while driving.

NOTICE

To prevent unnecessary wear or damage to the clutch:

- **Do not rest your foot on the clutch pedal while driving.**
- **Do not hold the vehicle with the clutch on an incline, while waiting for the traffic light, etc.**
- **Always depress the clutch pedal down fully to prevent noise or damage.**
- **Do not depress the clutch pedal again until it is fully released.**
- **Do not start with the 2nd gear engaged except when you start on a slippery road.**
- **Do not drive with cargo loaded more than required loading capacity.**

Downshifting

Down shift to a lower gear when slowing down in heavy traffic or driving up a steep hill to prevent high engine loads.

Also, downshifting reduces the chance of stalling and helps reaccelerate the vehicle when you need to increase your speed.

When the vehicle is going downhill, downshifting helps maintain safe speed by providing engine braking (brake power from the engine) and results in less wear on the brakes.

NOTICE

To prevent damage to the engine, clutch and transmission:

- **When downshifting from 5th gear to 4th gear, be careful not to inadvertently push the shift lever sideways engaging the 2nd gear. A drastic downshift may cause the engine speed to increase to the point the tachometer will enter the red-zone and may cause engine, clutch and the transmission damage.**
- **Do not downshift more than two gear at a time or downshift the gear when the engine is running at high speed (5,000 RPM or higher).**

Such down shifting may damage the engine, clutch and the transmission.

Good Driving Practices

- Never take the vehicle out of gear and coast down a hill. This is extremely dangerous.
- Don't "ride" the brakes. This can cause the brakes and related parts to overheat and malfunction.
When you are driving down a long hill, slow down and shift to a lower gear. Engine braking will help slow down the vehicle.
- Slow down before shifting to a lower gear. This will help avoid over-revving the engine, which can cause damage.
- Slow down when you encounter cross winds. This gives you much better control of your vehicle.
- Be sure the vehicle is completely stopped before you shift into R (Reverse) to prevent damage to the transmission.

- Exercise extreme caution when driving on a slippery surface. Be especially careful when braking, accelerating or shifting gears. On a slippery surface, an abrupt change in vehicle speed can cause the drive wheels to lose traction and may cause loss of vehicle control resulting in an accident.

WARNING

Do not use aggressive engine braking (shifting from a higher gear to a lower gear) on slippery roads. This could cause the tires to slip and may result in an accident.

WARNING

To reduce the risk of **SERIOUS INJURY** or **DEATH**:

- **ALWAYS** wear your seatbelt. In a collision, an unbelted occupant is significantly more likely to be seriously injured or killed than a properly belted occupant.
- Avoid high speeds when cornering or turning.
- Do not make quick steering wheel movements, such as sharp lane changes or fast, sharp turns.
- The risk of rollover is greatly increased if you lose control of your vehicle at highway speeds.
- Loss of control often occurs if two or more wheels drop off the roadway and the driver over steers to reenter the roadway.

- In the event your vehicle leaves the roadway, do not steer sharply. Instead, slow down before pulling back into the travel lanes.
- **HYUNDAI** recommends you follow all posted speed limits.

Rev matching

The Rev Matching system automatically helps synchronize engine rpm with the optimal speed of the gear about to be engaged which reduces the impact of clutch connection and improves gear shift response.

Information

- Fully depress the clutch pedal. Without the clutch pedal fully depressed, the system may not response correctly.
- The system does not operate when backing up.
- Rev Matching controls the engine speed up to the rev limit, but the function cannot prevent over-revving caused by shifting mistake.

Rev Matching activation

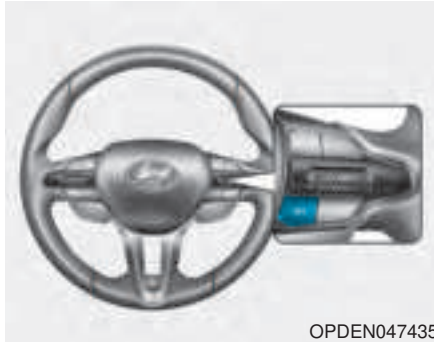

1. Press REV button (ON/OFF)

- Press the REV button to turn on the system. A message appears "Rev Matching On" with a REV indicator on the cluster LCD display.
- Press the REV button again to turn off the system. A message appears "Rev Matching Off" and the REV indicator disappears.

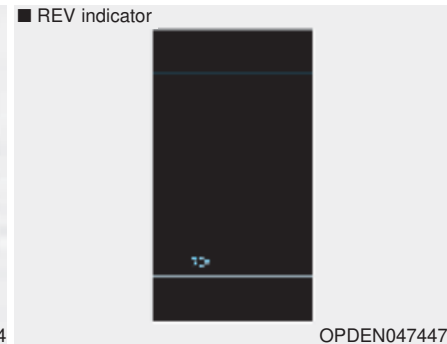
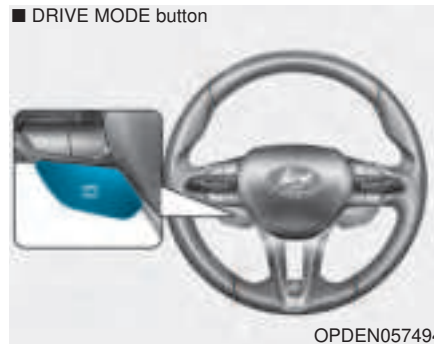

2. Select Drive Mode.

DRIVE MODE button

Use Rev Matching in normal driving conditions in below modes.

- When ECO mode is selected:
 - Rev Matching cannot be activated even if the driver presses the REV button.
 - REV indicator is off.
- When NORMAL mode is selected:
 - Rev Matching activates if Rev Matching is turned on by the REV button.
 - White REV indicator illuminates.
 - Engine rpm response during gear shift is smooth.
- When SPORT mode is selected:
 - Rev Matching activates if Rev Matching is turned on by the REV button.
 - Yellow REV indicator illuminates.
 - Engine rpm response is faster than NORMAL mode.

The system must be turned on by pressing the REV button whenever the engine is turned on.

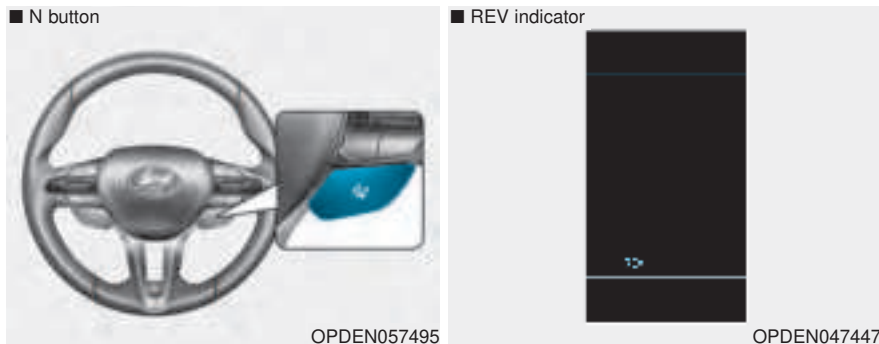

N button

Use Rev Matching when driving on race tracks, etc. in N mode.

- When N mode (SPORT+) is selected:
 - REV Matching is turned on automatically. To turn off Rev Matching, press the REV button.
 - Red REV indicator illuminates.
 - Engine speed is automatically adjusted to the shifted gear without the accelerator pedal depressed.
 - Engine rpm response is faster than SPORT mode when downshifting with heavy braking such as when driving on a race track.
- When CUSTOM mode is selected:
 - You may select the drive mode you prefer from the display audio screen Custom setting page. (OFF/NORMAL/SPORT/SPORT+).

For more details on "Custom Mode" refer to the Audio manual in chapter 4 or the separately supplied Multimedia manual.

Rev Matching operation

Engine speed is automatically synchronized with the next selected gear. The accelerator pedal does not have to be depressed to speed up the engine rpm.

- Clutch depressed with the gear engaged

At once, engine speed automatically decreases right after the clutch is disengaged, but the selected gear is fixed and then the engine rpm reverts to the selected gear's target speed. This operation method gives more comfortable feeling in public road driving.

- Upshifting

Engine speed will automatically decrease and stay at the target engine speed before the clutch is engaged.

- Downshifting

Engine speed will automatically increase and stay at the target engine speed.

Warning message

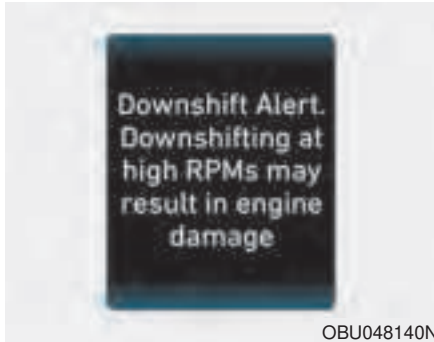

Downshift Alert. Downshifting at high RPMs may result in engine damage

If transmission input rpm is too high (over rev limit) due to shifting, a warning message will appear and a warning chime will sound.

DUAL CLUTCH TRANSMISSION (IF EQUIPPED)

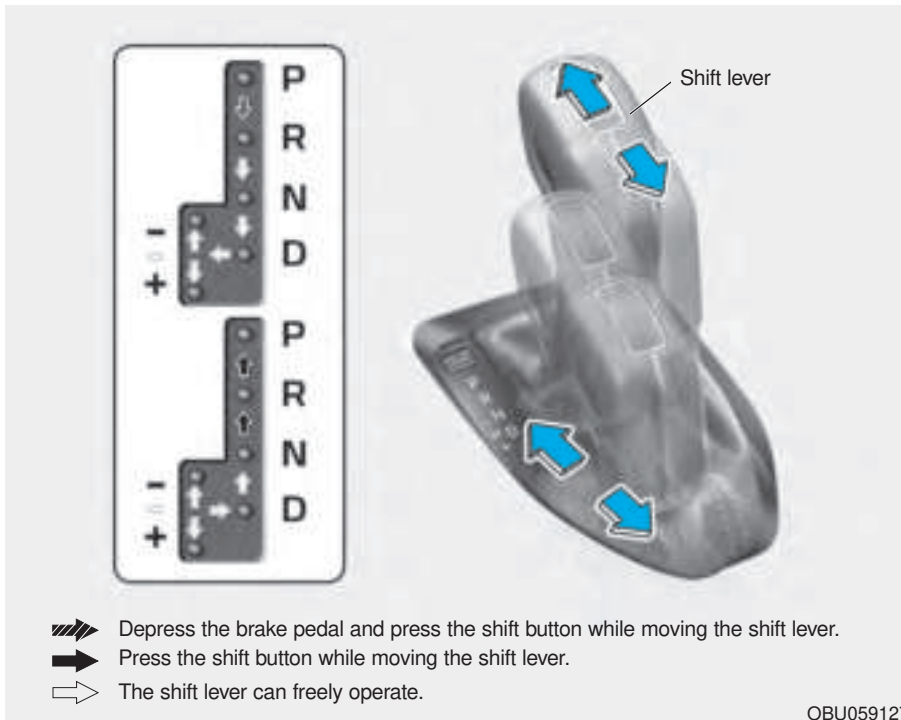

* To move the shift lever from/to P (Parking) or between R (Reverse) and D (Drive), you must depress the brake pedal for the vehicle to stand still.

Dual clutch transmission operation

The dual clutch transmission has eight forward speeds and one reverse speed. The individual speeds are selected automatically when the shift lever is in the D (Drive) position.

WARNING

To reduce the risk of serious injury or death:

- **ALWAYS** check the surrounding areas near your vehicle for people, especially children, before shifting a vehicle into D (Drive) or R (Reverse).
- Before leaving the driver's seat, always make sure the shift lever is in the P (Park) position, set the parking brake, and place the ignition switch in the LOCK/OFF position. Unexpected and sudden vehicle movement can occur if these precautions are not followed.

- **When using Manual Shift Mode, use caution when shifting from a higher gear to a lower gear on slippery roads. This could cause the tires to slip and may result in an accident.**
- **To avoid damage to your transmission, do not try to accelerate with the shift lever in R (Reverse) or any forward gear position with the brake engaged.**
- **When stopped on a slope, do not hold the vehicle with accelerator pedal. Engage the service brake or the parking brake.**

- The Dual Clutch Transmission gives the driving feel of a manual transmission, yet provides the ease of a fully automatic transmission. Unlike a traditional automatic transmission, the gear shifting can be felt (and heard) on the dual clutch transmission.
 - Think of it as an automatically shifting manual transmission.
 - Shift into Drive range and get fully automatic shifting, similar to a conventional automatic transmission.
- Dual clutch transmission adopts wet-type dual clutch, which is different from torque converter of automatic transmission, and shows better acceleration performance during driving. But, initial launch might be little bit slower than Automatic Transmission.
- The wet-type clutch transfers torque and provides a direct driving feeling which may feel different from a conventional automatic transmission with a torque converter. This may be more noticeable when starting from a stop or low vehicle speed.
- When rapidly accelerating at low vehicle speed, engine could rev at high rpm depending on vehicle drive condition.
- For smooth launch uphill, press down the accelerator pedal smoothly depending on the current conditions.
- If you release your foot from the accelerator pedal at low vehicle speed, you may feel strong engine brake, which is similar to manual transmission.
- When driving downhill, you may use Sports Mode to downshift to a lower gear in order to control your speed without using the brake pedal excessively.
- When you turn the engine on and off, you may hear clicking sounds as the system goes through a self test. This is a normal sound for the Dual Clutch Transmission.
- Always come to a complete stop before shifting into D (Drive) or R (Reverse).
- Do not put the shift lever in N (Neutral) while driving.

NOTICE

- Always come to a complete stop before shifting into D (Drive) or R (Reverse).
- Do not put the shift lever in N (Neutral) while driving.

⚠ WARNING

Due to transmission failure, you may not continue to drive and the position indicator (D, P) on the instrument cluster will blink. We recommend that you contact an authorized HYUNDAI dealer and have the system checked.

DCT warning messages

Steep grade



This warning message is displayed when vehicle is driven slowly on a grade and the vehicle detects that the brake pedal is not applied.

Steep grade

Driving up hills or on steep grades:

- To hold the vehicle on an incline use the foot brake or the parking brake.
- When in stop-and-go traffic on an incline, keep some distance ahead before moving the vehicle forward. Then hold the vehicle on the incline with the foot brake.

- If the vehicle is held on a hill by applying the accelerator pedal or by creeping with brake pedal disengaged, the clutch and transmission may overheat which can result in damage. At this time, a warning message will appear on the LCD display.
- If the LCD warning is active, the foot brake must be applied.
- Ignoring the warnings can lead to damage to the transmission.

Transmission high temperature



- Under certain conditions, such as repeated stop-and-go launches on steep grades, sudden take off or acceleration, or other harsh driving conditions, the transmission clutch temperatures will increase excessively. Finally the clutch in transmission could be overheated.
 - When the clutch is overheated, the safe protection mode engages and the gear position indicator on the cluster blinks with a chime. At this time, "Transmission temperature is high! Stop safely" warning message will appear on the LCD display and driving may not be smooth.
- If this occurs, pull over to a safe location, stop the vehicle with the engine running, apply the brakes and shift the vehicle to P (Park), and allow the transmission to cool.
 - If you ignore this warning, the driving condition may become worse. You may experience abrupt shifts, frequent shifts, or jerkiness. To return to the normal driving condition, stop the vehicle and apply the foot brake or shift into P (Park). Then allow the transmission to cool for a few minutes with engine on, before driving off.
 - When possible, drive the vehicle smoothly.

Transmission overheated

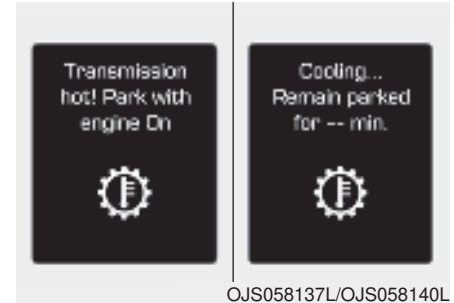

- If the vehicle continues to be driven and the clutch temperatures reach the maximum temperature limit, the "Transmission hot! Park with engine On" warning will be displayed. When this occurs the clutch is disabled until the clutch cools to normal temperatures.

- The warning will display a time to wait for the transmission to cool.
- If this occurs, pull over to a safe location, stop the vehicle with the engine running, apply the brakes and shift the vehicle to P (Park), and allow the transmission to cool.
- When the message "Transmission cooled down. Resume driving" appears you can continue to drive your vehicle.
- When possible, drive the vehicle smoothly.

If any of the warning messages in the LCD display continue to blink, for your safety, we recommend you contact an authorized HYUNDAI dealer and have the system checked.

Transmission ranges

The indicator in the instrument cluster displays the shift lever position when the ignition switch is in the ON position.

P (Park)

Always come to a complete stop before shifting into P (Park).

To shift from P (Park), you must depress firmly on the brake pedal and make sure your foot is off the accelerator pedal.

If you have done all of the above and still cannot shift the lever out of P (Park), see "Shift-Lock Release" in this chapter.

The shift lever must be in P (Park) before turning the engine off.

WARNING

- **Shifting into P (Park) while the vehicle is in motion may cause you to lose control of the vehicle.**
- **After the vehicle has stopped, always make sure the shift lever is in P (Park), apply the parking brake, and turn the engine off.**
- **When parking on an incline, block the wheels to prevent the vehicle from rolling down.**
- **For safety, always engage the parking brake with the shift lever in the P (Park) position except for the case of emergency parking.**
- **Do not use the P (Park) position in place of the parking brake.**

R (Reverse)

Use this position to drive the vehicle backward.

NOTICE

Always come to a complete stop before shifting into or out of R (Reverse); you may damage the transmission if you shift into R (Reverse) while the vehicle is in motion.

N (Neutral)

The wheels and transmission are not engaged.

Use N (Neutral) if you need to restart a stalled engine, or if it is necessary to stop with the engine ON. Shift into P (Park) if you need to leave your vehicle for any reason.

WARNING

- **Do not shift gear unless your foot is firmly on the brake pedal. Shifting into gear when the engine is running at high speed can cause the vehicle to move very rapidly. You could lose control of the vehicle and hit people or objects.**
- **Do not drive with the shift lever in N (Neutral). The engine brake will not work and may lead to an accident.**

CAUTION

Always park the vehicle in P (Park) for safety and engage the parking brake.

D (Drive)

This is the normal driving position. The transmission will automatically shift through a 8-gear sequence, providing the best fuel economy and power.

For extra power when passing another vehicle or driving uphill, depress the accelerator fully. The transmission will automatically downshift to the next lower gear (or gears, as appropriate).

To stop the vehicle during driving, Please depress brake pedal fully to prevent unintended movement.

WARNING

- Do not shift into gear unless your foot is firmly on the brake pedal. Shifting into gear when the engine is running at high speed can cause the vehicle to move very rapidly. You may lose control of the vehicle and cause accidents.
- Do not drive with the shift lever in N (Neutral). The engine brake will not work and may lead to an accident.

NOTICE

Always make sure the vehicle is stationary, at a complete stop, before selecting D (Drive).

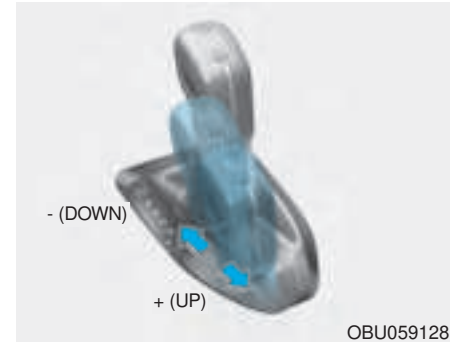

Manual shift mode

Whether the vehicle is stationary or in motion, manual shift mode is selected by pushing the shift lever from the D (Drive) position into the manual gate. To return to D (Drive) range operation, push the shift lever back into the main gate.

Manual shift mode manages the driving dynamics by automatically adjusting the steering effort, and the engine and transmission control logic for enhanced driver performance.

In manual shift mode, moving the shift lever backwards and forwards will allow you to select the desired range of gears for the current driving conditions.

M : Drive mode is shifted to manual shift mode when shifting lever is operated at M stage.

Up (+) : Pull the lever backwards once to shift down one gear.

Down (-) : Push the lever forward once to shift up one gear.

i Information

- If the driver presses the lever to +(Up) or – (Down) position, the transmission may not make the requested gear change if the next gear is outside of the allowable engine rpm range. The driver must execute upshifts in accordance with road conditions, taking care to keep the engine rpms below the red zone.
- In manual shift mode, only the 8 forward gears can be selected. To reverse or park the vehicle, move the shift lever to the R (Reverse) or P (Park) position as required, and only when the vehicle is stopped and not moving.
- In manual shift mode, downshifts are made automatically when the vehicle slows down. When the vehicle stops, 1st gear is automatically selected.
- To maintain the required levels of vehicle performance and safety, the system may not execute certain gearshifts when the shift lever is operated.
- In manual shift mode, the fuel efficiency may decrease.

NOTICE

While stopping the vehicle by applying parking brake in D gear, even if you release the parking brake, the vehicle may not move. In this case, you can drive the vehicle by applying the foot brake and release, applying the accelerator or shifting the lever (D → N → D).

Paddle shifter (if equipped)

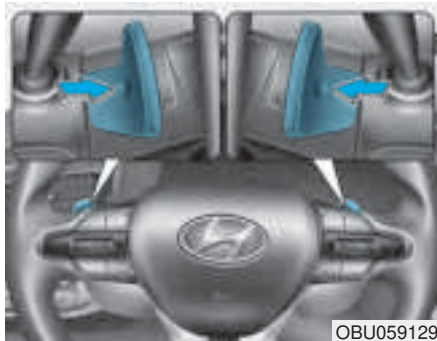

The paddle shifter is functional when the shift lever is in the D (Drive) position or the manual shift mode.

With the shift lever in the D position

The paddle shifter will operate when the vehicle speed is more than 10km/h.

Pull the [+] or [-] paddle shifter once to shift up or down one gear and the system changes from automatic mode to manual mode.

When the vehicle speed is lower than 10km/h, if you depress the accelerator pedal for more than 5 seconds or if you move the shift lever from D (Drive) to manual shift mode and move it from manual shift mode to D (Drive) again, the system changes from manual mode to automatic mode.

When the engine reaches maximum rpm in manual shift mode by paddle shifting at shift lever D (driving) position, the shift is automatically performed.

With the shift lever in the manual shift mode

Pull the [+] or [-] paddle shifter once to shift up or down one gear.

In the manual shift mode (+, -) position, even when the engine reaches full speed, it does not shift automatically.

***i* Information**

If the [+] and [-] paddle shifters are pulled at the same time, gear shift may not occur.

Shift-lock system

For your safety, the dual clutch transmission has a shift-lock system which prevents shifting the transmission from P (Park) into R (Reverse) unless the brake pedal is depressed.

To shift the transmission from P (Park) into R (Reverse):

1. Depress and hold the brake pedal.
2. Start the engine or place the ignition switch in the ON position.
3. Move the shift lever.

⚠ WARNING

Always fully depress the brake pedal before and while shifting out of the P (Park) position into another position to avoid inadvertent motion of the vehicle which could injure persons in or around the vehicle.

Shift-lock release

If the shift lever cannot be moved from the P (Park) position into R (Reverse) position with the brake pedal depressed, continue depressing the brake, and then do the following:



1. Place the ignition switch in the LOCK/OFF position.
2. Apply the parking brake.
3. Push the shift-lock release button (1).
4. Move the shift lever while pushing the shift-lock release button.
5. Stop pushing the shift-lock release button.

6. Depress the brake pedal, and the restart the engine.

If you need to use the shift-lock release, we recommend that the system be inspected by an authorized HYUNDAI dealer immediately.

Ignition key interlock system (if equipped)

The ignition key cannot be removed unless the shift lever is in the P (Park) position.

Parking

Always come to a complete stop and continue to depress the brake pedal. Move the shift lever into the P (Park) position, apply the parking brake, and place the ignition switch in the LOCK/OFF position. Take the Key with you when exiting the vehicle.

WARNING

When you stay in the vehicle with the engine running, be careful not to depress the accelerator pedal for a long period of time. The engine or exhaust system may overheat and start a fire.

The exhaust gas and the exhaust system are very hot. Keep away from the exhaust system components.

Do not stop or park over flammable materials, such as dry grass, paper or leaves. They may ignite and cause a fire.

Good driving practices

- Never move the shift lever from P (Park) or N (Neutral) to any other position with the accelerator pedal depressed.
 - Never move the shift lever into P (Park) when the vehicle is in motion.
 - Be sure the vehicle is completely stopped before you attempt to shift into R (Revers) or D (Drive).
 - Never take the vehicle out of gear and coast down a hill. Always leave the vehicle in gear when moving.
 - Do not “ride” the brakes. This can cause them to overheat and malfunction. Instead, when you are driving down a long hill, slow down and shift to a lower gear. When you do this, engine braking will help slow the car.
 - When driving in manual shift mode, slow down before shifting to a lower gear. Otherwise, the lower gear may not be engaged if the engine rpms are outside of the allowable range.
- Always apply the parking brake when leaving the vehicle. Do not depend on placing the transmission in P (Park) to keep the vehicle from moving.
 - Exercise extreme caution when driving on a slippery surface. Be especially careful when braking, accelerating or shifting gears. On a slippery surface, an abrupt change in vehicle speed can cause the drive wheels to lose traction and may cause loss of vehicle control resulting in an accident.
 - Optimum vehicle performance and economy is obtained by smoothly depressing and releasing the accelerator.

 **WARNING**

To reduce the risk of **SERIOUS INJURY** or **DEATH**:

- When driving uphill or downhill, always shift to D (Drive) for driving forward or shift to R (Reverse) for driving rearwards. After selecting D (Drive) or R (Reverse), check the gear position indicated on the cluster before driving. If you drive in the opposite direction of the selected gear, the engine will turn off and a serious accident might occur due to degraded brake performance.
- Always buckle-up! In a collision, an unbelted occupant is significantly more likely to be seriously injured or killed than a properly belted occupant.
- Avoid high speeds when cornering or turning.

- Do not make quick steering wheel movements, such as sharp lane changes or fast, sharp turns.
- The risk of rollover is greatly increased if you lose control of your vehicle at highway speeds.
- Loss of control often occurs if two or more wheels drop off the roadway and the driver over steers to reenter the roadway.
- In the event your vehicle leaves the roadway, do not steer sharply. Instead, slow down before pulling back into the travel lanes.
- **HYUNDAI** recommends you follow all posted speed limits.

 **WARNING**

If your vehicle is stuck in snow, mud, sand, etc., you may attempt to free the vehicle by rocking it back and forth. Do not attempt this procedure if people or objects are anywhere near. Vehicle may suddenly move forward or backward as it becomes unstuck, causing injury or damage to nearby people or objects.

BRAKING SYSTEM

Power Brakes

Your vehicle has power-assisted brakes that adjust automatically through normal usage.

If the engine is not running or is turned off while driving, the power assist for the brakes will not work. You can still stop your vehicle by applying greater force to the brake pedal than typical. The stopping distance, however, will be longer than with power brakes.

When the engine is not running, the reserve brake power is partially depleted each time the brake pedal is applied. Do not pump the brake pedal when the power assist has been interrupted.

Pump the brake pedal only when necessary to maintain steering control on slippery surfaces.

WARNING

Take the following precautions:

- **Do not drive with your foot resting on the brake pedal. This will create abnormal high brake temperatures, excessive brake lining and pad wear, and increased stopping distances.**
- **When descending down a long or steep hill, move the gear shift lever to Manual Shift Mode and manually downshift to a lower gear in order to control your speed without using the brake pedal excessively. Applying the brakes continuously will cause the brakes to overheat and could result in a temporary loss of braking performance.**

- **Wet brakes may impair the vehicle's ability to safely slow down; the vehicle may also pull to one side when the brakes are applied. Applying the brakes lightly will indicate whether they have been affected in this way. Always test your brakes in this fashion after driving through deep water. To dry the brakes, lightly tap the brake pedal to heat up the brakes while maintaining a safe forward speed until brake performance returns to normal. Avoid driving at high speeds until the brakes function correctly.**

High Performance Brake

As this vehicle is equipped with the High Performance Brake (large-diameter brakes for enhanced braking performance), noise such as a squeal, squeak or groan is generated while braking. This is normal and the friction may create circle patterns on the disc surface. This is also a normal situation which does not affect braking performance.

NOTICE

- Occasional brake noise is normal. If a continuous grinding or continuous squeal sound is present, the brake lining may be worn-out. Have the vehicle checked by an authorized HYUNDAI dealer.
- If the vehicle has continuous vibration or shudder in the steering wheel while braking, have the vehicle be checked by an authorized HYUNDAI dealer.

WARNING

Frequent speeding and braking may deform components and wear the disc brake causing vibration when braking. Prevent brake damage by avoiding excessive braking.

Brake wear, noise, vibration from excessive braking or deformation of the brakes caused by repeatedly braking in high speed, racing on tracks, etc. can be excluded from warranty coverage.

Disc Brakes Wear Indicator

When your brake pads are worn and new pads are required, you will hear a high pitched warning sound from your front or rear brakes. You may hear this sound come and go or it may occur whenever you depress the brake pedal.

Note that some driving conditions or climates may cause a brake squeal when you first apply (or lightly apply) the brakes. This is normal and does not indicate a problem with your brakes.

NOTICE

To avoid costly brake repairs, do not continue to drive with worn brake pads.

Information

Always replace brake pads as complete front or rear axle sets.

Parking Brake



Always set the parking brake before leaving the vehicle. To apply the parking brake:

Firmly depress the brake pedal.

Pull up the parking brake lever as far as possible.

WARNING

To reduce the risk of **SERIOUS INJURY** or **DEATH**, do not operate the parking brake while the vehicle is moving except in an emergency situation. It could damage the brake system and lead to an accident.



To release:

Firmly depress the brake pedal.

While pressing the release button (1), slightly pull up on the parking brake lever then lower the parking brake lever (2).

If the parking brake does not release or does not release all the way, have your vehicle checked by an authorized HYUNDAI dealer.

WARNING

- Whenever leaving the vehicle or parking, always come to a complete stop and continue to depress the brake pedal. Move the shift lever into the 1st gear when the vehicle is parked on a uphill and in R (Reverse) on a downhill, then apply the parking brake, and place the ignition switch in the LOCK/OFF position.

Vehicles with the parking brake not fully engaged are at risk for moving inadvertently and causing injury to yourself or others.

- When parking on an incline, block the wheels to prevent the vehicle from rolling down.
- **NEVER** allow anyone who is unfamiliar with the vehicle to touch the parking brake. If the parking brake is released unintentionally, serious injury may occur.

- Only release the parking brake when you are seated inside the vehicle with your foot firmly on the brake pedal.

NOTICE

- Do not apply the accelerator pedal while the parking brake is engaged. If you depress the accelerator pedal with the parking brake engaged, warning will sound. Damage to the parking brake may occur.
- Driving with the parking brake on can overheat the braking system and cause premature wear or damage to brake parts. Make sure the parking brake is released and the Brake Warning Light is off before driving.



Check the Parking Brake Warning Light by placing the ignition switch to the ON position (do not start the engine).

This light will be illuminated when the parking brake is applied with the ignition switch in the START or ON position.

Before driving, be sure the parking brake is released and the Brake Warning Light is OFF.

If the Parking Brake Warning Light remains on after the parking brake is released while engine is running, there may be a malfunction in the brake system. Immediate attention is necessary.

If at all possible, cease driving the vehicle immediately. If that is not possible, use extreme caution while operating the vehicle and only continue to drive the vehicle until you can reach a safe location.

Anti-lock Brake System (ABS)

WARNING

An Anti-Lock Braking System (ABS) or an Electronic Stability Control (ESC) system will not prevent accidents due to improper or dangerous driving maneuvers. Even though vehicle control is improved during emergency braking, always maintain a safe distance between you and objects ahead of you. Vehicle speeds should always be reduced during extreme road conditions. The braking distance for cars equipped with ABS or ESC may be longer than for those without these systems in the following road conditions.

Drive your vehicle at reduced speeds during the following conditions:

- Rough, gravel or snow-covered roads.
- On roads where the road surface is pitted or has different surface height.

- Tire chains are installed on your vehicle.

The safety features of an ABS or ESC equipped vehicle should not be tested by high speed driving or cornering. This could endanger the safety of yourself or others.

ABS is an electronic braking system that helps prevent a braking skid. ABS allows the driver to steer and brake at the same time.

Using ABS

To obtain the maximum benefit from your ABS in an emergency situation, do not attempt to modulate your brake pressure and do not try to pump your brakes. Depress your brake pedal as hard as possible.

When you apply your brakes under conditions which may lock the wheels, you may hear sounds from the brakes, or feel a corresponding sensation in the brake pedal. This is normal and it means your ABS is active.

ABS does not reduce the time or distance it takes to stop the vehicle.

Always maintain a safe distance from the vehicle in front of you.

ABS will not prevent a skid that results from sudden changes in direction, such as trying to take a corner too fast or making a sudden lane change. Always drive at a safe speed for the road and weather conditions.

ABS cannot prevent a loss of stability. Always steer moderately when braking hard. Severe or sharp steering wheel movement can still cause your vehicle to veer into oncoming traffic or off the road.

On loose or uneven road surfaces, operation of the anti-lock brake system may result in a longer stopping distance than for vehicles equipped with a conventional brake system.

The ABS warning light () will stay on for several seconds after the ignition switch is in the ON position. During that time, the ABS will go through self-diagnosis and the light will go off if everything is normal. If the light stays on, you may have a problem with your ABS. Contact an authorized HYUNDAI dealer as soon as possible

 **WARNING**

If the ABS warning light () is on and stays on, you may have a problem with the ABS. Your power brakes will work normally. To reduce the risk of serious injury or death, contact your HYUNDAI dealer as soon as possible.

 **CAUTION**

When you drive on a road having poor traction, such as an icy road, and apply your brakes continuously, the ABS will be active continuously and the ABS warning light () may illuminate. Pull your car over to a safe place and turn the engine off.

Restart the engine. If the ABS warning light is off, then your ABS system is normal.

Otherwise, you may have a problem with your ABS system. Contact an authorized HYUNDAI dealer as soon as possible.

 **Information**

When you jump start your vehicle because of a drained battery, the ABS warning light () may turn on at the same time. This happens because of the low battery voltage. It does not mean your ABS is malfunctioning. Have the battery recharged before driving the vehicle.

Electronic Stability Control (ESC)

The Electronic Stability Control (ESC) system helps to stabilize the vehicle during cornering maneuvers. ESC checks where you are steering and where the vehicle is actually going. ESC applies braking pressure to any one of the vehicle's brakes and intervenes in the engine management system to assist the driver with keeping the vehicle on the intended path. It is not a substitute for safe driving practices. Always adjust your speed and driving to the road conditions.

 **WARNING**

Never drive too fast for the road conditions or too quickly when cornering. The ESC system will not prevent accidents.

Excessive speed in turns, abrupt maneuvers, and hydroplaning on wet surfaces can result in severe accidents.

ESC operation

ESC ON condition



When the ignition switch is in the ON position, the ESC and the ESC OFF indicator lights illuminate for approximately three seconds and goes off, then the ESC is turned on. (After a new ignition cycle, the ESC ON mode is always activated (default setting).)

You may select between the following state of ESC:

- ESC NORMAL activated (ESC ON)
- ESC SPORT activated (ESC SPORT indicator illuminates)
- ESC deactivated (ESC OFF indicator illuminates)

When operating

When the ESC is in operation, the ESC indicator light blinks:

- When you apply your brakes under conditions which may lock the wheels, you may hear sounds from the brakes, or feel a corresponding sensation in the brake pedal. This is normal and it means your ESC is active.
 - When the ESC operates, the engine may not respond to the accelerator as it does under routine conditions.
 - If the Cruise Control was in use when the ESC activates, the Cruise Control automatically disengages. The Cruise Control can be reengaged when the road conditions allow. **See "Cruise Control System" later in this chapter.** (if equipped)
- When moving out of the mud or driving on a slippery road, the engine rpm (revolutions per minute) may not increase even if you press the accelerator pedal deeply. This is to maintain the stability and traction of the vehicle and does not indicate a problem.

Deactivating / Activating ESC



You may select between the following state of ESC:

- ESC NORMAL activated
- ESC SPORT activated (ESC SPORT indicator illuminates)
- ESC deactivated (ESC OFF indicator illuminates)

Press the ESC OFF button shortly
ESC NORMAL ← → ESC SPORT

Press and hold the ESC OFF button for over 3 seconds
ESC NORMAL → ESC OFF
ESC SPORT → ESC OFF

Press the ESC OFF button shortly
ESC OFF → ESC NORMAL

WARNING

- If you deactivate ESC, ESC no longer stabilizes the vehicle. There is an increased risk of skidding and an accident.
- When ESC SPORT mode is activated, the stability support from ESC will be less than in "ESC ON mode", there is a greater risk of skidding and an accident.

Only deactivate ESC or activate ESC SPORT in the situations described in the following.

In the following situations, it may be better to activate ESC SPORT or deactivate ESC (ESC OFF):

- When using snow chains
- Driving in deep snow
- Driving in sand or gravel
- Driving on specially designed roads where oversteering and understeering characteristics are desired

We recommend only qualified and experienced drivers to drive the vehicle with the ESC deactivated or ESC SPORT activated.

CAUTION

After the above situations are over, activate ESC immediately. If not, the vehicle can be unstable due to vehicle slip or wheel spin.



ESC SPORT

• To activate ESC SPORT mode

Press the ESC OFF button briefly. The ESC SPORT indicator light illuminates on the cluster LCD display. In this state, ESC only stabilizes the vehicle to a limited degree.

When ESC SPORT mode is activated:

- ESC only improves driving stability to a limited degree.
- Traction control is still activated, but with less wheel control (more slip).
- Engine torque can partially be limited for the vehicle's stability and the driving wheel spin may be restricted for better traction.

• To deactivate ESC SPORT mode

Press the ESC OFF button briefly. The ESC SPORT indicator light will go off on the cluster LCD display.

To deactivate ESC (ESC OFF)



Press and hold the ESC OFF button continuously for more than 3 seconds. The ESC OFF indicator light and message "Traction & Stability Control disabled" illuminates and a warning chime sounds. In this state, both the traction control function of ESC (engine management) and the brake control function of ESC (braking management) are disabled.

To activate the ESC again, briefly press the ESC OFF button. The ESC OFF indicator light will go off.

Indicator lights

- ESC indicator light (blinks)



- ESC OFF indicator light (comes on)



When the ignition switch is in the ON position, the ESC indicator light illuminates, then goes off if the ESC system is operating normally.

The ESC indicator light blinks whenever the ESC is operating.

If the ESC indicator light stays on, your vehicle may have a malfunction with the ESC system. When this warning light illuminates have your vehicle inspected by an authorized HYUNDAI dealer.

The ESC OFF indicator light comes on when the ESC is turned off with the button.

WARNING

When the ESC is blinking, this indicates the ESC is active:

Drive slowly and NEVER attempt to accelerate. NEVER turn the ESC off while the ESC indicator light is blinking or you may lose control of the vehicle resulting in an accident.

NOTICE

Driving with wheels and tires with different sizes may cause the ESC system to malfunction. Before replacing tires, make sure all four tires and wheels are the same size. Never drive the vehicle with different sized wheels and tires installed.

WARNING

Don't use ESC SPORT mode or ESC OFF while using a mini spare tire or a tire repair kit is in use!

ESC OFF usage

When Driving

The ESC OFF mode should only be used briefly to help free the vehicle if stuck in snow or mud, by temporarily stopping operation of the ESC, to maintain wheel torque.

To turn ESC off while driving, press the ESC OFF button while driving on a flat road surface.

NOTICE

To prevent damage to the transmission:

- **Do not allow wheel(s) of one axle to spin excessively while the ESC, ABS, and parking brake warning lights are displayed. The repairs would not be covered by the vehicle warranty. Reduce engine power and do not spin the wheel(s) excessively while these lights are displayed.**
- **When operating the vehicle on a dynamometer, make sure the ESC is turned off (ESC OFF light illuminated).**

i Information

Turning the ESC off does not affect ABS or standard brake system operation.

Drive mode selection

When the ESC is on, the characteristic of ESC varies according to which drive mode is selected by pressing the DRIVE MODE or N button on the steering wheel.

Mode button	Selected mode	Characteristic of ESC
DRIVE MODE button	ECO mode	NORMAL
	NORMAL mode	NORMAL
	SPORT mode	NORMAL
N button	N mode	SPORT
	N CUSTOM mode	NORMAL/SPORT/OFF

For more details, refer to "Drive Mode Integrated Control System" in this chapter.

CUSTOM mode

You may select the drive mode you prefer from the display audio screen.

- Select CUSTOM mode by pressing the N button on the steering wheel. The display audio screen will display the CUSTOM mode menu. From the CUSTOM mode menu, select 'ESC → NORMAL / SPORT / OFF'.
- You may directly go to the CUSTOM mode menu by touching the display audio screen.

For more details, refer to the display audio manual.



When ESC is turned off or on from the CUSTOM mode, you may not turn OFF/ON the system with the ESC OFF button. If the ESC OFF button is pressed, a message "ESC disabled in CUSTOM mode settings. Hold flag button 3 sec to acknowledge" will appear on the cluster LCD display. You may change the state of ESC (NORMAL, SPORT, OFF) from the CUSTOM mode.

Vehicle Stability Management (VSM)

The Vehicle Stability Management (VSM) is a function of the Electronic Stability Control (ESC) system. It helps ensure the vehicle stays stable when accelerating or braking suddenly on wet, slippery and rough roads where traction over the four tires can suddenly become uneven.

WARNING

Take the following precautions when using the Vehicle Stability Management (VSM):

- **ALWAYS check the speed and the distance to the vehicle ahead. The VSM is not a substitute for safe driving practices.**
- **Never drive too fast for the road conditions. The VSM system will not prevent accidents. Excessive speed in bad weather, slippery and uneven roads can result in severe accidents.**

VSM operation

VSM ON condition

The VSM operates when:

- The Electronic Stability Control (ESC) is on.
- Vehicle speed is approximately above 9 mph (15 km/h) on curve roads.
- Vehicle speed is approximately above 12 mph (20 km/h) when the vehicle is braking on rough roads.

When operating

When you apply your brakes under conditions which may activate the ESC, you may hear sounds from the brakes, or feel a corresponding sensation in the brake pedal. This is normal and it means your VSM is active.

NOTICE

The VSM does not operate when:

- **Driving on a banked road such as gradient or incline.**
- **Driving rearward.**
- **ESC OFF indicator light is on.**
- **EPS (Electric Power Steering) warning light (⊕!) is on or blinks.**

⚠ WARNING

If ESC indicator light (⊕) or EPS warning light (⊕!) stays on or blinks, your vehicle may have a malfunction with the VSM system. When the warning light illuminates, have your vehicle checked by an authorized HYUNDAI dealer as soon as possible.

Driving with wheels and tires with different sizes may cause the ESC system to malfunction. Before replacing tires, make sure all four tires and wheels are the same size. Never drive the vehicle with different sized tires and wheels installed.

Hill-Start Assist Control (HAC)

The Hill-Start Assist Control (HAC) helps prevent the vehicle from rolling backwards when starting a vehicle from a stop on a hill. The system operates the brakes automatically for approximately 2 seconds and releases the brake after 2 seconds or when the accelerator pedal is depressed.

WARNING

Always be ready to depress the accelerator pedal when starting off on a incline. The HAC activates only for approximately 2 seconds.

NOTICE

- The HAC does not operate when the shift lever is in N (Neutral).
- The HAC activates even though the ESC (Electronic Stability Control) is off but does not activate when the ESC has malfunctioned.

Good Braking Practices

WARNING

Whenever leaving the vehicle or parking, always come to a complete stop and continue to depress the brake pedal. Move the shift lever into the 1st gear when the vehicle is parked on a uphill and in R (Reverse) on a downhill, then apply the parking brake, and place the ignition switch in the LOCK/OFF position.

Vehicles parked with the parking brake not applied or not fully engaged may roll inadvertently and may cause injury to the driver and others. ALWAYS apply the parking brake before exiting the vehicle.

Wet brakes can be dangerous! The brakes may get wet if the vehicle is driven through standing water or if it is washed. Your vehicle will not stop as quickly if the brakes are wet. Wet brakes may cause the vehicle to pull to one side.

To dry the brakes, apply the brakes lightly until the braking action returns to normal, taking care to keep the vehicle under control at all times. If the braking action does not return to normal, stop as soon as it is safe to do so and call an authorized HYUNDAI dealer for assistance.

DO NOT drive with your foot resting on the brake pedal. Even light, but constant pedal pressure can result in the brakes overheating, brake wear, and possibly even brake failure.

If a tire goes flat while you are driving, apply the brakes gently and keep the vehicle pointed straight ahead while you slow down. When you are moving slowly enough for it to be safe to do so, pull off the road and stop in a safe location.

Keep your foot firmly on the brake pedal when the vehicle is stopped to prevent the vehicle from rolling forward.

WARNING

Brake override system

The system assists safe deceleration by reducing the engine power when the accelerator pedal is jammed or stuck and when you continue depressing the brake pedal.

However, the system is deactivated when ESC is OFF in N mode. When the system is disabled, the brake distance may be longer than when the system is activated.

NOTICE

- **Be cautious when parking on a hill. Firmly engage the parking brake and place the shift lever in the 1st gear when the vehicle is parked on a uphill and in R (Reverse) on a downhill. If your vehicle is facing downhill, steer the front wheels to the curb to help prevent the vehicle from rolling. If your vehicle is facing uphill, turn the front wheels away from the curb to help prevent the vehicle from rolling. If there is no curb or if the vehicle has to be kept from rolling due to conditions block the wheels.**
- **Under some conditions your parking brake can freeze in the engaged position. This is most likely to happen when there is an accumulation of snow or ice around or near the rear brakes or if the brakes are wet. If there is a risk of brake freezing, apply the brake temporarily while you put the shift lever in the 1st gear when the vehicle is parked on a uphill and in R (Reverse) on a downhill and block the rear wheels so the vehicle cannot roll. Then release the parking brake.**
- **Do not hold the vehicle on the incline with the accelerator pedal. This can cause the transmission to overheat. Always use the brake pedal or parking brake.**

ELECTRONIC CONTROL SUSPENSION (ECS)

The Electronic Control Suspension (ECS) controls the vehicle suspension automatically to maximize driving comfort by taking into account the driving conditions such as speed, surface of the road, cornering, stopping requirements and acceleration.

System malfunction



Check Electronic Suspension

If the ECS warning message comes on, have the system checked by an authorized HYUNDAI dealer.

ELECTRONIC LIMITED SLIP DIFFERENTIAL (IF EQUIPPED)

Electronic Limited Slip Differential refers to a feature equipped with a mechanism that controls the differential functions of the wheels.

The Electronic Limited Slip Differential helps:

- Improve handling performance when circling at high speed.
- Improve launching performance.
- Prevent slipping on rainy or snowy roads due to dissimilar friction of the left and right wheels.

WARNING

Never run wheels with one of them lifted by the jack. It is extremely dangerous for a vehicle equipped with Electronic Limited Slip Differential.

Drive mode selection

The characteristic of e-LSD varies according to which drive mode is selected by pressing the DRIVE MODE or N button on the steering wheel.

Mode button	Selected mode	Characteristic of e-LSD
DRIVE MODE button	ECO mode	NORMAL
	NORMAL mode	NORMAL
	SPORT mode	SPORT
N button	N mode	SPORT
	N CUSTOM mode	NORMAL/SPORT

For more details, refer to "Drive Mode Integrated Control System" in this chapter.

CUSTOM mode

You may select the drive mode you prefer from the display audio screen.

- Select CUSTOM mode by pressing the N button on the steering wheel. The display audio screen will display the CUSTOM mode menu. From the CUSTOM mode menu, select 'e-LSD → NORMAL/SPORT'.
- You may directly go to the CUSTOM mode menu by touching the display audio screen.

For more details, refer to the display audio manual.

Warning messages



Electronic Limited Slip Differential temporarily disabled due to overheating

Overheating of related parts will temporarily disable e-LSD. Wait until the vehicle cools down.



Tire size mismatch. Check all tire sizes

If your vehicle is equipped with different tires (size, type, etc.) on the front, the message will appear. To use the Electronic Limited Slip Differential, equip the vehicle with the same tires on the front.

System malfunction



Check Limited Slip Differential

If the Electronic Limited Slip Differential warning message comes on, have the system checked by an authorized HYUNDAI dealer.

DRIVE MODE INTEGRATED CONTROL SYSTEM

DRIVE MODE button



OPDEN057494

The drive mode may be selected according to the driver's preference or road condition.

The system resets to be in the NORMAL mode, when the engine is restarted.

The mode changes, whenever the DRIVE MODE button is pressed.



OPDEN047185L

ECO mode



When the Drive Mode is set to ECO mode, the engine and transmission control logic are changed to maximize fuel efficiency.

- When the ECO mode is selected by pressing the DRIVE MODE button, the ECO indicator will illuminate.

i Information

Fuel efficiency depends on the driver's driving habit and road condition.

When ECO mode is activated:

- The acceleration response may be slightly reduced as the accelerator pedal is depressed moderately.
- The air conditioner performance may be limited.
- The engine noise may get louder.

The above situations are normal conditions when ECO mode is activated, to improve fuel efficiency.

Limitation of ECO mode operation:

If the following conditions occur while ECO mode is operating, the system operation is limited even though there is no change in ECO indicator.

- When the coolant temperature is low:

The system will be limited until engine performance becomes normal.

- When driving up a hill:

The system will be limited to gain power when driving uphill because engine torque is restricted.

The system will be limited due to the shift location.

- When the accelerator pedal is deeply depressed for a few seconds:

The system will be limited, judging that the driver wants to speed up.

SPORT mode

The image shows a rectangular icon with the word "SPORT" in a bold, sans-serif font. The icon is set against a light gray background with a subtle gradient and a thin border.

SPORT mode manages the driving dynamics by automatically adjusting the steering effort, the engine and transmission control logic for enhanced driving performance.

- When SPORT mode is selected by pressing the DRIVE MODE button, the SPORT indicator will illuminate.
- When SPORT mode is activated:
 - The engine rpm will tend to remain raised over a certain length of time even after releasing the accelerator
 - Upshifts are delayed when accelerating

Information

In SPORT mode, the fuel efficiency may decrease.

N button



N mode or CUSTOM mode may be selected by pressing the N button.

The system resets to be in the NORMAL mode, when the engine is restarted.

The mode changes, whenever the N button is pressed.



N mode



N mode selects the proper driving mode among SPORT and SPORT+ for each of the components that will effect the performance of a high-performance vehicle.

- When N mode is selected by pressing the N button, the N indicator will illuminate.
- N mode (SPORT/SPORT+) manages the driving dynamics by automatically adjusting the steering effort, and the engine and transmission control logic for enhanced driver performance.
- When N mode (SPORT/SPORT+) is activated:
 - The engine rpm will tend to remain raised over a certain length of time even after releasing the accelerator
 - Upshifts are delayed when accelerating

NOTICE

In SPORT/SPORT+ mode, the fuel efficiency may decrease.

CUSTOM mode

CUSTOM In CUSTOM mode, the driver can select the drive mode for each component they prefer on the display audio screen.

- Engine : NORMAL/SPORT/SPORT+
- Transmission (for DCT) : NORMAL/SPORT/SPORT+ and CREEP START function*1 ON/OFF (For DCT)
- Rev matching (for MT) :OFF/NORMAL/SPORT/SPORT+
- E-LSD (Electronic Limited Slip Differential) : NORMAL/SPORT
- Suspension : NORMAL/SPORT/SPORT+
- Steering : NORMAL/SPORT/SPORT+
- ESC (Electronic Stability Control) : NORMAL/SPORT/OFF
- Exhaust sound : NORMAL/SPORT/SPORT+

*1 CREEP START function (default setting ON) :

When OFF is set, vehicle will not start automatically even if the brake pedal is not pressed in D stop state.

For more details, refer to the separately supplied Multimedia manual.

NGS (N Grin Shift)

Controls engine / transmission to maximum performance when pressing NGS button on the steering wheel remote control in situations where rapid acceleration is required.

Functional description and operating conditions

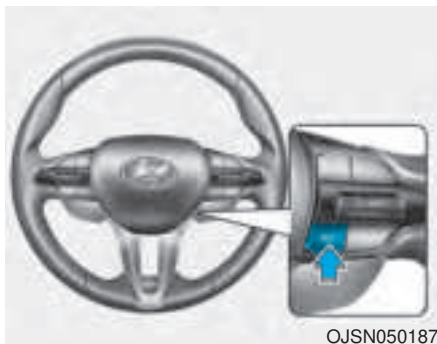

When NGS button is pressed:

- Automatically shifts to the lowest allowable gear
(Automatic shifting is not performed in manual shift mode)
- Engine overboost operates when accelerating
- N Grin Shift is available for 20 Seconds
- N Grin Shift can be reused 3 minutes later after using the function for 20 seconds

N Grin Shift will turn off during operation or will not operate when:

- Changing Drive-mode during N Grin Shift operation
- Engine check light is on
- Transmission high temperature (overheating) lights on
- Transmission malfunction
- Shift lever is in P/ R/ N
- Using N Grin Shift within 3 minutes after using the function for 20 seconds



CAUTION

- The driver should hold the responsibility to safely drive and control the vehicle when using N Grin Shift.
- Do not attempt dangerous driving while using N Grin Shift.
- It is recommended to use after vehicle break-in and continuous use of N Grin Shift can overload the vehicle components such as transmission, engine and drive shaft.

Vehicle characteristic

The characteristic of each component varies according to which drive mode is selected by pressing the DRIVE MODE or N button on the steering wheel.

M/T	Component	DRIVE MODE Button			N Button	
		ECO mode	NORMAL mode	SPORT mode	N mode	CUSTOM mode
Engine & Driving	Engine	ECO	NORMAL	SPORT	SPORT+	NORMAL / SPORT / SPORT+
	Rev matching	OFF	NORMAL	SPORT	SPORT+	OFF / NORMAL / SPORT / SPORT+
	e-LSD *1	NORMAL	NORMAL	SPORT	SPORT	NORMAL / SPORT
Chassis	Suspension	NORMAL	NORMAL	SPORT	SPORT+	NORMAL / SPORT / SPORT+
	Steering	NORMAL	NORMAL	SPORT	SPORT+	NORMAL / SPORT / SPORT+
	ESC *2	NORMAL	NORMAL	NORMAL	SPORT	NORMAL / SPORT / OFF
Sound	Exhaust sound *3	ECO	NORMAL	SPORT	SPORT+	NORMAL / SPORT / SPORT+

The information provided may differ depending on which features are applicable to your vehicle.

*1 : Electronic Limited Slip Differential

*2 : Electronic Stability Control

*3 : a) The volume of the exhaust sound made by the exhaust gas flap (if equipped) changes according to the mode selected.

[Quietest] ECO/NORMAL mode < SPORT mode < N mode **[Loudest]**

- b) An exhaust crackle sound, to deliver emotional effect, is produced while driving when the accelerator pedal is released right after being depressed. This exhaust sound effect will be heard when SPORT+ is selected for the Sound component. To turn it off, select NORMAL or SPORT for the Engine component in CUSTOM mode.
- c) Please be aware and be mindful when using exhaust sound system in SPORT+ mode as the pops and bangs can cause disturbance to your neighbors when using it in a crowded public area, closed parking spaces, and/or residential area. We strongly recommend to use it with consideration.

M/T : Manual Transmission

DCT	Component	DRIVE MODE Button			N Button		NGS Button (N Grin Shift)
		ECO mode	NORMAL mode	SPORT mode	N mode	CUSTOM mode	
Engine & Driving	Engine	ECO	NORMAL	SPORT	SPORT+	NORMAL / SPORT / SPORT+	SPORT+
	Transmission*4	ECO	NORMAL	SPORT	SPORT+	NORMAL / SPORT / SPORT+	SPORT+
	e-LSD *1	NORMAL	NORMAL	SPORT	SPORT	NORMAL / SPORT	Maintain mode before entering NGS
Chassis	Suspension	NORMAL	NORMAL	SPORT	SPORT+	NORMAL / SPORT / SPORT+	
	Steering	NORMAL	NORMAL	SPORT	SPORT+	NORMAL / SPORT / SPORT+	
	ESC *2	NORMAL	NORMAL	NORMAL	SPORT	NORMAL / SPORT / OFF	
Sound	Exhaust sound *3	ECO	NORMAL	SPORT	SPORT+	NORMAL / SPORT / SPORT+	SPORT+

*1 : Electronic Limited Slip Differential

*2 : Electronic Stability Control

*3 : a) The volume of the exhaust sound made by the exhaust gas flap (if equipped) changes according to the mode selected.
[Quietest] ECO/NORMAL mode < SPORT mode < N mode **[Loudest]**

b) An exhaust crackle sound, to deliver emotional effect, is produced while driving when the accelerator pedal is released right after being depressed. This exhaust sound effect will be heard when SPORT+ is selected for the Sound component. To turn it off, select NORMAL or SPORT for the Engine component in CUSTOM mode.

c) Please be aware and be mindful when using exhaust sound system in SPORT+ mode as the pops and bangs can cause disturbance to your neighbors when using it in a crowded public area, closed parking spaces, and/or residential area. We strongly recommend to use it with consideration.

*4 : Automatic creep start function can be turned ON / OFF in CUSTOM setup menu.

DCT : Dual Clutch Transmission

PERFORMANCE OPTION (IF EQUIPPED)

CAUTION

Please note that using high performance exhaust sound in a crowded public area, closed parking spaces, and/or residential area can cause disturbance to your neighbors.

Performance option settings

1. Press 'N mode' in Infotainment system home screen to go to N mode settings screen.
2. In the 'N Mode' screen, press 'Menu → 'Performance Options'. The Performance options settings screen will appear.

Launch Control



Launch Control system controls the vehicle to reduce wheel spin or slip on a hard acceleration from a standing start.

Prerequisite for activation

Launch Control gets ready to be activated, when the following prerequisites are satisfied.

- The engine is warmed up.
- The driver's seatbelt is fastened.
- All doors, hood and liftgate are closed.
- The vehicle is at a complete stop.
- Malfunction warning lights related to the engine and ESC (Electronic Stability Control) is off.

NOTICE

- **Launch Control is intended for use at a closed race track and not intended for use on public roads. It will not compensate for driver's who are inexperienced or lack familiarity with the race track.**
- **Do not use Launch Control during break-in period of the vehicle.**
- **Constant use of Launch Control can put enormous stress on the vehicle resulting in premature wear of related components.**

How to activate Launch Control



1. Press the 'Launch Control' tab.
2. Press the '▲ (Up)' or '▼ (Down)' to set the engine RPM for launch control.
3. Press 'Activate' to enter Launch Control ready state.
4. Press 'Reset RPM' to reset engine RPM to default launch control engine speed.

Launch control on and off (For Manual Transmission)

1. Select N mode with 'N' button (N mode indicator will illuminate on the cluster) or select SPORT+ for the engine mode in CUSTOM mode.
2. Check that the ESC mode is ESC SPORT or ESC OFF. If not, press ESC OFF button to set the ESC mode to ESC SPORT or ESC OFF. (Indicator illuminates on the cluster) (Electronic Stability Control (ESC) does not operate when ESC OFF.)
3. Select 'Performance Options → Launch Control' to set engine RPM from the Infotainment system screen. After setting RPM, press 'Activate'.
4. Align the steering wheel straight
5. Depress the clutch pedal.
6. Shift to 1st gear.
7. While depressing the clutch pedal with your left foot, quickly and fully depress the accelerator pedal with your right foot. Launch control will be in the ready state. The message 'Launch Control Ready' will appear on the cluster. If necessary, adjust engine rpm with the cruise control switch (+/-).
8. A smooth, quick release of the clutch pedal within 8 seconds, while maintaining full depression of the accelerator pedal will initiate launching of the vehicle. The message 'Launch Control Active' will appear on the cluster.
9. Control will deactivate when the accelerator pedal is released.

Launch control on and off (For Dual Clutch Transmission)

1. Select N mode with 'N' button (N mode indicator will illuminate on the cluster) or select SPORT+ for the engine mode in CUSTOM mode.
2. Check that the ESC mode is ESC SPORT or ESC OFF. If not, press ESC OFF button to set the ESC mode to ESC SPORT or ESC OFF. (Indicator illuminates on the cluster) (Electronic Stability Control (ESC) does not operate when ESC OFF.)
3. Shift the gear to D (Drive) or M (Manual shift mode). (When Manual shift mode is selected, driver must shift manually.)
4. Select 'Performance Options → Launch Control' to set engine RPM from the Infotainment system screen. After setting RPM, press 'Activate'.
5. Align the steering wheel straight
6. Depress the brake pedal to the maximum with your left foot.
7. While depressing the brake pedal with your left foot, quickly and fully depress the accelerator pedal with your right foot. Launch control will be in the ready state. The message 'Launch Control Ready' will appear on the cluster. If necessary, adjust engine rpm with the cruise control switch (+/-).
8. A smooth, quick release of the brake pedal within 8 seconds, while maintaining full depression of the accelerator pedal will initiate launching of the vehicle. The message 'Launch Control Active' will appear on the cluster.
9. Launch Control will deactivate when the accelerator pedal is released.

CAUTION

(For Manual Transmission)

- If you depress the clutch pedal and the accelerator pedal at the same time and then release the accelerator pedal, Launch Control is released.
- Launch Control is available again after it is cooled down by driving the vehicle for at least 2 minutes (above 18 mph (20 km/h)) or the vehicle is at a standstill for 5 minutes.
- If you do not launch the vehicle within 8 seconds in launch control "READY" state, launch control will be automatically aborted.

CAUTION

(For Dual Clutch Transmission)

- If you depress the brake pedal and the accelerator pedal at the same time and then release the accelerator pedal, Launch Control is released.
- Launch Control is available again after it is cooled down by driving the vehicle for at least 2 minutes (above 18 mph (20 km/h)) or the vehicle is at a standstill for 5 minutes.
- If you do not launch the vehicle within 8 seconds in launch control "READY" state, launch control will be automatically aborted.

CAUTION

Performance of Launch Control is highly dependent on clutch release technique, tire friction and road conditions. In other words, the use of Launch Control does not always guarantee the maximum launch performance.

Shift Indicator



When engine is operating in a high rpm area, it is indicated by LEDs according to the corresponding engine rpm.

As the engine rpm approaches to the limit, each LED lights up sequentially, and when all five LEDs flashes, it is time to shift (upshift) immediately.

In the Performance Option's "Shift Indicator" tab of the infotainment system's N Mode, you can set which mode is displayed and the target RPM speed.

(N Mode → Performance Option → Shift Indicator)

How to set shift indicator

1. Press 'Shift Indicator' tab in Performance Options.



2. Select drive mode to activate shift indicator. (ECO/NORMAL/SPORT/N/CUSTOM)
3. Set up target rpm by pressing ▲ (Up) and ▼ (Down). (6000rpm ~ 6700rpm)
4. Press 'Alert Sound' to choose whether or not to execute.
5. Press 'Reset RPM' to reset the target RPM speed.

※ Engine speed change notification (LED blinks and beeps) is sent before engine speed reaches to the set value to shift at set target RPM speed.

Shift Indicator operation table (For Dual Clutch Transmission)

Blinking of all 5 LEDs, works only in the fixed shift mode where manual upshift is required.

Shift lever position	Shift mode	LED step lighting	All LED blink (upshift shift notification)
D	Automatic shift mode	X	X
	N Grin Shift operation	O	X
	N Track Shift operation	O	X
	Temporary manual shift mode (enter D stage paddle shifter operation)	O	X
M	Fixed shift mode (no automatic upshift)	O	O

N Track Sense Shift (For Dual Clutch Transmission)

N Track Sense Shift is automatically activated when dynamic driving condition with lots of cornering maneuver is detected. (i.e. Race track driving).

The program enables stress-free track driving by automatically shifting down at the entry of corner and maintains lower gear during cornering as if you are shifting manually in professional manner. N Track Sense Shift provides lower gear when level of driving aggression increases.

How to set N Track Sense Shift



OJSN050213

1. Press 'N Mode → Performance Option → N Track Sense Shift' on the infotainment system home screen to enter the N Track Sense Shift setting screen.
 2. In N Track Sense Shift setup screen, press 'Activate' to select enable/disable features.
- * When the vehicle is released for the first time, function is activated.
 - * Active/Deactivated setting is saved even when the vehicle is restarted.

Operating condition

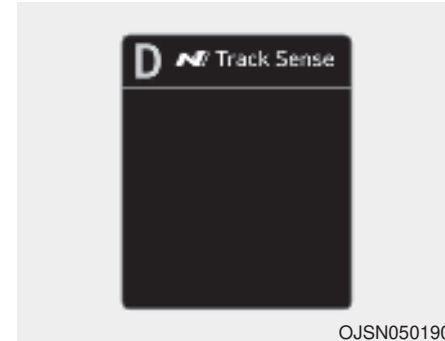

OJSN050190

- N Track Sense Shift is enabled in the Performance Options settings
- Shift lever in D (Drive) position
- Transmission mode is SPORT or SPORT+ (Including SPORT or N Riding Mode)
- Vehicle speed is above 21 mph (35km/h)
- Cornering-oriented dynamic driving detection
- * When N Track Sense Shift is operating, a message is displayed in the instrument cluster LCD screen as shown below.

Non-operating conditions

- N Track Sense Shift is disabled in Performance Options settings
 - Shift lever position is in P/R/N
 - Changing Transmission mode during operation (Transmission mode does not work in ECO, NORMAL or manual shift mode.)
 - Cruise Control is operating
 - Engine warning light is on
 - Vehicle speed is below 21 mph (35 km/h)
- ✳ When N Track Sense Shift is deactivated, the displayed message will disappear from the instrument LCD screen.

CAUTION

Vehicle safety and control must be at your own discretion and do not attempt to drive dangerously to operate N Track Sense Shift.

N Power Shift (For Dual Clutch Transmission)



OJSN050214

When the driver depresses the accelerator pedal fully (100%) in N mode for faster acceleration, it controls by (up-) shifting with minimal energy loss.

N Power Shift can be deactivated by pressing 'Activate' on the screen. When N Power Shift is deactivated, vehicle shifting is similar to normal shifting. However, it is activated when the engine is restarted.

DECLARATION OF CONFORMITY (IF EQUIPPED)

The radio frequency components (Rear Corner Radar) complies:

- **FOR USA**



OANATEL002

This device complies with Part 15 of the FCC Rules. Operation is subject to the following two conditions:

- (1) this device may not cause harmful interference, and
- (2) this device must accept any interference received, including interference that may cause undesired operation.

CAUTION TO USERS

Changes or modifications not expressly approved by the party responsible for compliance could void the user's authority to operate the equipment.

OANATEL003

FORWARD COLLISION-AVOIDANCE ASSIST (FCA) (FRONT VIEW CAMERA ONLY) (IF EQUIPPED)

Basic function

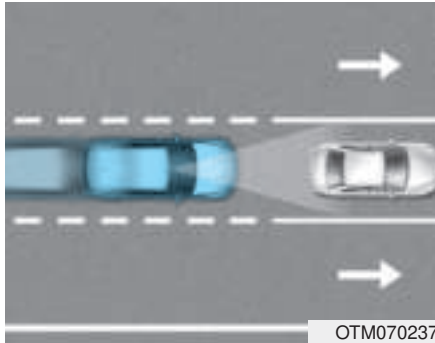

Forward Collision-Avoidance Assist is designed to help detect and monitor the vehicle ahead or help detect a pedestrian in the roadway and warn the driver that a collision is imminent with a warning message and an audible warning, and if necessary, apply emergency braking.

Detecting sensor



[1] : Front view camera

Refer to the picture above for the detailed location of the detecting sensor.

CAUTION

Take the following precautions to maintain optimal performance of the detecting sensor:

- Never disassemble the detecting sensor or sensor assembly, or apply any impact on it.
- If the detecting sensors have been replaced or repaired, we recommend that you have your vehicle inspected by an authorized HYUNDAI dealer.
- Never install any accessories or stickers on the front windshield, or tint the front windshield.
- Pay extreme caution to keep the front view camera dry.
- Never place any reflective objects (i.e. white paper, mirror) over the dashboard. Any light reflection may prevent the system from functioning properly.

System settings functions for the system



Forward Safety

With the engine on, select or deselect 'Driver Assistance → Forward Safety' from the Settings menu to set whether or not to use each function.

- If 'Auto OFF in N Mode' is selected Forward Collision-Avoidance Assist that is linked with N mode will be off automatically and when canceled 'Auto OFF in N Mode' is canceled.

- If 'Active Assist' is selected, the system will warn the driver with a warning message and an audible warning depending on the collision risk levels. Braking assist will be applied depending on the collision risk.
- If 'Warning Only' is selected, the system will warn the driver with a warning message and an audible warning depending on the collision risk levels. Braking will not be assisted.
- If 'Off' is selected, the system will turn off. The  warning light will illuminate on the cluster.

The driver can monitor Forward Collision-Avoidance Assist ON/OFF status from the Settings menu. If the  warning light remains ON when the system is ON, we recommend that the system be inspected by an authorized HYUNDAI dealer.

WARNING

When the engine is restarted, Forward Collision-Avoidance Assist will always turn on.

However, if 'Off' is selected after the engine is restarted, you cannot get help from the system so the driver should always be aware of the surroundings and drive safely.

CAUTION

If 'Warning Only' is selected, braking is not assisted.

Information

Forward Collision-Avoidance Assist will turn off when ESC is turned off by pressing and holding the ESC OFF button for more than 3 seconds. The  warning light will illuminate on the cluster.

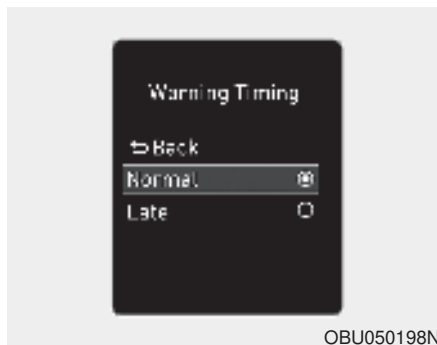

Warning Timing

With the Engine Start/Stop button in the ON position, select 'Driver Assistance → Warning Timing' from the Settings menu to change the initial warning activation time for Forward Collision-Avoidance Assist.

When the vehicle is first delivered, Warning Timing is set to 'Normal'. If you change the Warning Timing, the warning time of other Driver Assistance systems may change.

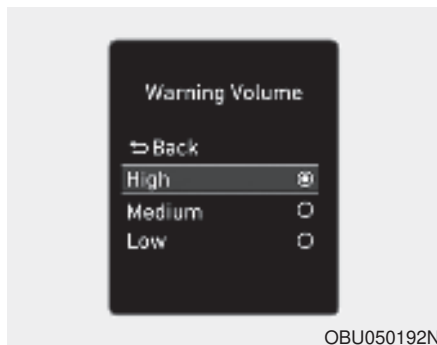

Warning Volume

With the Engine Start/Stop button in the ON position, select 'Driver Assistance → Warning Volume' from the Settings menu to change the Warning Volume to 'High', 'Medium', or 'Low' for Forward Collision-Avoidance Assist.

If you change the warning volume, the Warning Volume of other Driver Assistance systems may change.

CAUTION

- The setting of the Warning Timing and Warning Volume applies to all functions of Forward Collision-Avoidance Assist.
- Even though 'Normal' is selected for Warning Timing, if the front vehicle suddenly stops, the initial warning activation time may not seem late.
- Select 'Late' for Warning Timing when traffic is light and when driving speed is slow.

i Information

If the engine is restarted, Warning Timing and Warning Volume will maintain the last setting.

System operation

Basic function

System warning and control

The basic function for Forward Collision-Avoidance Assist is to warn and control the vehicle depending on the collision level: 'Collision Warning', 'Emergency Braking' and 'Stopping vehicle and ending brake control'.



Collision Warning

- To warn the driver of a collision, the 'Collision Warning' warning message will appear on the cluster and an audible warning will sound.
- If a vehicle is detected in front, the system will operate when your vehicle speed is between approximately 6~112 mph (10~180km/h).
- If a pedestrian is detected in front, the system will operate when your vehicle speed is between approximately 6~37 mph (10~60km/h).
- If 'Active Assist' is selected, braking may be assisted.

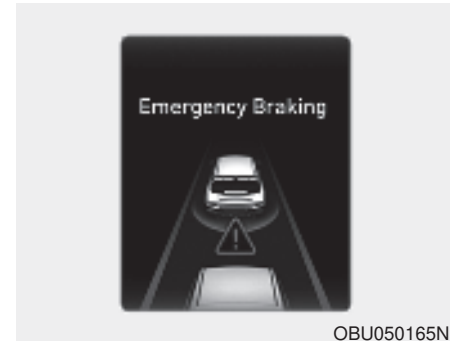

Emergency Braking

- To warn the driver that emergency braking will occur, the 'Emergency Braking' warning message will appear on the cluster and an audible warning will sound.
- If a vehicle is detected in front, the system will operate when your vehicle speed is between approximately 6~37 mph (10~60km/h).
- If a pedestrian is detected in front, the system will operate when your vehicle speed is between approximately 6~37 mph (10~60km/h).
- In emergency braking situation, braking is assisted with strong braking power by the system to help prevent collision with the vehicle or pedestrian ahead.

5-67



Stopping vehicle and ending brake control

- When the vehicle is stopped due to emergency braking, the 'Emergency Braking complete' warning message will appear on the cluster.

For your safety, the driver should depress the brake pedal immediately and check the surroundings.

- Brake control will end after the vehicle is stopped by emergency braking for approximately 2 seconds.

WARNING

Take the following precautions when using Forward Collision-Avoidance Assist:

- For your safety, change the Settings after parking the vehicle at a safe location.
- With 'Active Assist' or 'Warning Only' selected, when ESC is turned off by pressing and holding the ESC OFF button for more than 3 seconds, Forward Collision-Avoidance Assist will turn off automatically. In this case, the system cannot be set from the Settings menu and the  warning light will illuminate on the cluster which is normal. If ESC is turned on by pressing the ESC OFF button, Forward Collision-Avoidance Assist will maintain the last setting.

- Forward Collision-Avoidance Assist does not operate in all situations or cannot avoid all collisions.
- The driver should hold the responsibility to control the vehicle. Do not solely depend on Forward Collision-Avoidance Assist. Rather, maintain a safe braking distance, and if necessary, depress the brake pedal to reduce driving speed or to stop the vehicle.
- Never deliberately operate Forward Collision-Avoidance Assist on people, animal, objects, etc. It may cause serious injury or death.
- Forward Collision-Avoidance Assist may not operate if the driver depresses the brake pedal to avoid collision.
- Depending on the road and driving conditions, Forward Collision-Avoidance Assist may warn the driver late or may not warn the driver.

- During Forward Collision-Avoidance Assist operation, the vehicle may stop suddenly injuring passengers and shifting loose objects. Always have the seat belt on and keep loose objects secured.
- If any other system's warning message is displayed or audible warning is generated, Forward Collision-Avoidance Assist warning message may not be displayed and audible warning may not be generated.
- You may not hear the warning sound of Forward Collision-Avoidance Assist if the surrounding is noisy.
- Forward Collision-Avoidance Assist may turn off or may not operate properly or may operate unnecessarily depending on the road conditions and the surroundings.

WARNING

- Even if there is a problem with Forward Collision-Avoidance Assist, the vehicle's basic braking performance will operate normally.
- During emergency braking, braking control by the system will automatically cancel when the driver excessively depresses the accelerator pedal or sharply steers the vehicle.

CAUTION

Depending on the condition of the vehicle, pedestrian in front and the surroundings, the speed range to operate Forward Collision-Avoidance Assist may reduce. The system may only warn the driver, or the system may not operate.



Information

In a situation collision is imminent, braking may be assisted by Forward Collision-Avoidance Assist when braking is insufficient by the driver.

System malfunction and limitations

System malfunction





When Forward Collision-Avoidance Assist is not working properly, the 'Check Emergency Braking' system warning message will appear, and the  and  warning lights will illuminate on the cluster. We recommend that the system be inspected by an authorized HYUNDAI dealer.

System disabled



When the front windshield where the front view camera is located or the sensor is covered with foreign material, such as snow or rain, it can reduce the detecting performance and temporarily limit or disable Forward Collision-Avoidance Assist.

If this occurs the 'Forward Collision Avoidance Assist (FCA) system disabled. Camera obscured.' warning message, and the  and  warning lights will illuminate on the cluster.

The system will operate normally when snow, rain or foreign matter is removed.

If the system does not operate normally after it is removed, we recommend that the system be inspected by an authorized HYUNDAI dealer.

WARNING

- Even though the warning message or warning light does not appear on the cluster, Forward Collision-Avoidance Assist may not properly operate.
- Forward Collision-Avoidance Assist may not properly operate in an area (e.g. open terrain), where any substance are not detected after turning ON the engine.

Limitations of the system

Forward Collision-Avoidance Assist may not operate normally, or the system may operate unexpectedly under the following circumstances:

- The detecting sensor or the surroundings are contaminated or damaged
- The temperature around the front view camera is high or low
- The camera lens is contaminated due to tinted, filmed or coated windshield, damaged glass, or stuck of foreign material (sticker, bug, etc.) on the glass
- Moisture is not removed or frozen on the windshield
- Washer fluid is continuously sprayed, or the wiper is on
- Driving in heavy rain or snow, or thick fog
- The field of view of the front view camera is obstructed by sun glare
- Street light or light from an oncoming vehicle is reflected on the wet road surface, such as a puddle on the road
- An object is placed on the dashboard
- Your vehicle is being towed
- The surrounding is very bright
- The surrounding is very dark, such as in a tunnel, etc.
- The brightness changes suddenly, for example when entering or exiting a tunnel
- The brightness outside is low, and the headlamps are not on or are not bright
- Driving through steam, smoke or shadow
- Only part of the vehicle, pedestrian is detected
- The vehicle in front is a bus, heavy truck, truck with a unusually shaped luggage, trailer, etc.
- The vehicle in front has no tail lights, tail lights are located unusually, etc.
- The brightness outside is low, and the tail lamps are not on or are not bright
- The rear of the front vehicle is small or the vehicle does not look normal, such as when the vehicle is tilted, overturned, or the side of the vehicle is visible, etc.
- The front vehicle's ground clearance is low or high
- A vehicle, pedestrian suddenly cuts in front
- The vehicle in front is detected late
- The vehicle in front is suddenly blocked by a obstacle
- The vehicle in front suddenly changes lane or suddenly reduces speed
- The vehicle in front is bent out of shape
- The front vehicle's speed is fast or slow
- The vehicle in front steers in the opposite direction of your vehicle to avoid a collision
- With a vehicle in front, your vehicle changes lane at low speed
- The vehicle in front is covered with snow

- You are departing or returning to the lane
- Unstable driving
- You are on a roundabout and the vehicle in front is not detected
- You are continuously driving in a circle
- The vehicle in front has an unusual shape
- The vehicle in front is driving uphill or downhill
- The pedestrian is not fully detected, for example, if the pedestrian is leaning over or is not fully walking upright
- The pedestrian is wearing clothing or equipment that makes it difficult to detect as a pedestrian

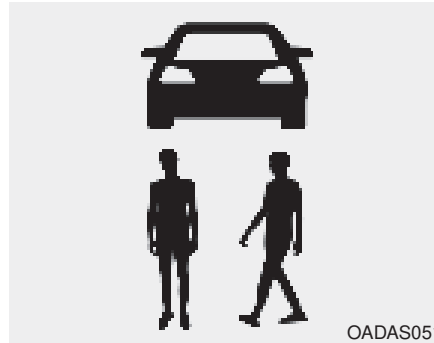

- The illustration above shows the image the front view camera will detect as a vehicle and pedestrian.
- The pedestrian in front is moving very quickly
- The pedestrian in front is short or is posing a low posture
- The pedestrian in front has impaired mobility
- The pedestrian in front is moving intersected with the driving direction
- There is a group of pedestrians, or a large crowd in front
- The pedestrian is wearing clothing that easily blends into the background, making it difficult to detect

- The pedestrian is difficult to distinguish from the similar shaped structure in the surroundings
- You are driving by a pedestrian, traffic signs, structures, etc. near the intersection
- Driving in a parking lot
- Driving through a tollgate, construction area, unpaved road, partial paved road, uneven road, speed bumps, etc.
- Driving on an incline road, curved road, etc.
- Driving through a roadside with trees or streetlights
- The adverse road conditions cause excessive vehicle vibrations while driving
- Your vehicle height is low or high due to heavy loads, abnormal tire pressure, etc.
- Driving through a narrow road where trees or grass or overgrown
- There is interference by electromagnetic waves, such as driving in an area with strong radio waves or electrical noise

WARNING

- Driving on a curve

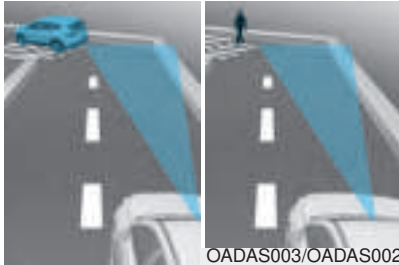

Forward Collision-Avoidance Assist may not detect other vehicles, pedestrians in front of you on curved roads adversely affecting the performance of the sensors.

This may result in no warning, braking assist when necessary.

When driving on a curve, you must maintain a safe braking distance, and if necessary, steer the vehicle and depress the brake pedal to reduce your driving speed in order to maintain a safe distance.

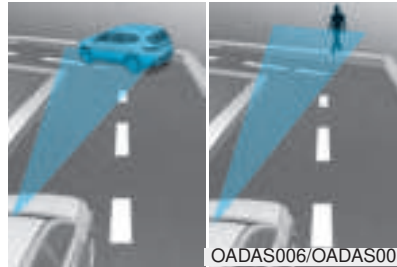

Forward Collision-Avoidance Assist may detect a vehicle, pedestrian in the next lane or outside the lane when driving on a curved road.

If this occurs, the function may unnecessarily warn the driver and control the brake. Always check the traffic conditions around the vehicle.

- Driving on a slope

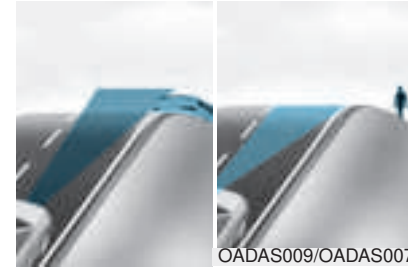

Forward Collision-Avoidance Assist may not detect other vehicles, pedestrians in front of you while driving uphill or downhill adversely affecting the performance of the sensors.

This may result in unnecessary warning, braking assist or no warning, braking assist when necessary.

Also, vehicle speed may rapidly decrease when a vehicle, pedestrian ahead is suddenly detected.

Always have your eyes on the road while driving uphill or downhill and if necessary, steer your vehicle and depress the brake pedal to reduce your driving speed in order to maintain a safe distance.

- Changing lanes



[A] : Your vehicle, [B] : Lane changing vehicle

When a vehicle moves into your lane from an adjacent lane, it cannot be detected by the sensor until it is in the sensor's detection range.

Forward Collision-Avoidance Assist may not immediately detect the vehicle when the vehicle changes lanes abruptly. In this case, you must maintain a safe braking distance, and if necessary, steer your vehicle and depress the brake pedal to reduce your driving speed in order to maintain a safe distance.



OADAS033

[A] : Your vehicle, [B] : Lane changing vehicle,
[C] : Same lane vehicle

When a vehicle in front of you merges out of the lane, Forward Collision-Avoidance Assist may not immediately detect the vehicle that is now in front of you.

In this case, you must maintain a safe braking distance, and if necessary, steer your vehicle and depress the brake pedal to reduce your driving speed in order to maintain a safe distance.

- Detecting vehicle

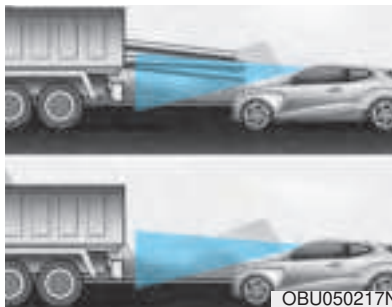

If the vehicle in front of you has cargo that extends rearward from the cab, or when the vehicle in front of you has higher ground clearance, additional special attention is required. Forward Collision-Avoidance Assist may not be able to detect the cargo extending from the vehicle.

In these instances, you must maintain a safe braking distance from the rearmost object, and if necessary, steer your vehicle and depress the brake pedal to reduce your driving speed in order to maintain distance.

 **WARNING**

- When you are towing a trailer or another vehicle, we recommend that Forward Collision-Avoidance Assist is turned off due to safety reasons.
- Forward Collision-Avoidance Assist may operate if objects that are similar in shape or characteristics to vehicles and pedestrians are detected.
- Forward Collision-Avoidance Assist does not operate on bicycles, motorcycles, or smaller wheeled objects, such as luggage bags, shopping carts, or strollers.
- Forward Collision-Avoidance Assist may not operate normally if interfered by strong electromagnetic waves.
- Forward Collision-Avoidance Assist may not operate for 15 seconds after the vehicle is started, or the front view camera is initialized.

 **Information**

This device complies with Part 15 of the FCC rules.

Operation is subject to the following two conditions:

1. This device may not cause harmful interference.
2. This device must accept any interference received, including interference that may cause undesired operation.

LANE KEEPING ASSIST (LKA) (IF EQUIPPED)

Lane Keeping Assist is designed to help detect lane markings while driving over a certain speed. The system will warn the driver if the vehicle leaves the lane without using the turn signal, or will automatically assist the driver's steering to help prevent the vehicle from departing the lane.

Detecting sensor



[1] : Front view camera

The front view camera is used as a detecting sensor to detect lane markings (or road edges).

Refer to the picture above for the detailed location of the detecting sensor.

CAUTION

For more details on the precautions of the front view camera, refer to “Forward Collision-Avoidance Assist (FCA)” section in this chapter.

System settings

Setting functions for the system



Lane Safety

With the Engine Start/Stop button in the ON position, select or deselect ‘Driver Assistance → Lane Safety’ from the Settings menu to set whether or not to use each function.

- If ‘Lane Keeping Assist’ is selected, the system will automatically assist the driver's steering when lane departure is detected to help prevent the vehicle from moving out of its lane.

- If 'Lane Departure Warning' is selected, the functions for the system will warn the driver with an audible warning when lane departure is detected. The driver must steer the vehicle.
- If 'Off' is selected, the functions for the system will turn off. The  indicator light will turn off on the cluster.

WARNING

- If 'Lane Departure Warning' is selected, steering is not assisted.
- Lane Keeping Assist does not control the steering wheel when the vehicle is driven in the middle of the lane.
- The driver should always be aware of the surroundings and steer the vehicle if 'Off' is selected.



Turning the system On/Off

With the Engine Start/Stop is ON and the Lane Safety button is pushed, the system turns on and the white indicator  appears on the instrument cluster.

If you press the Lane Safety button when the Lane Keeping Assist is ON, the system turns off.

If the Engine Start/Stop is shifted from OFF to ON, the system turns on and the white indicator  appears on the instrument cluster.

If you press the Lane Safety button when the Lane Keeping Assist is ON, the system turns off.

Information

If the engine is restarted, Lane Keeping Assist will maintain the last setting.

When Lane Keeping Assist is turned off with the Lane Safety button, Lane Safety settings will turn off.



OBU050198N

Warning Timing

With the engine on, select 'Driver Assistance → Warning Timing' from the Settings menu to change the initial warning activation time for Lane Keeping Assist.

When the vehicle is first delivered, Warning Timing is set to 'Normal'. If you change the Warning Timing, the warning time of other Driver Assistance systems may change.



OBU050192N

Warning Volume

With the Engine Start/Stop button in the ON position, select 'Driver Assistance → Warning Volume' from the Settings menu to change the Warning Volume to 'High', 'Medium', or 'Low' for Lane Keeping Assist.

If you change the Warning Volume, the Warning Volume of other Driver Assistance systems may be changed.

System operation

System warning and control

Lane Keeping Assist will warn and control the vehicle with Lane Departure Warning and Lane Keeping Assist.

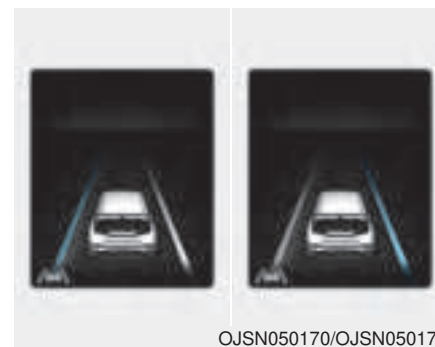

OJSN050170/OJSN050171

Lane Departure Warning

- To warn the driver that the vehicle is departing from the projected lane in front, the green  indicator light will blink on the cluster, the lane line will blink on the cluster depending on which direction the vehicle is veering, and an audible warning will sound.

- The system will operate when your vehicle speed is between approximately 40~120 mph (60~200 km/h).

Lane Keeping Assist

- To warn the driver that the vehicle is departing from the projected lane in front, the green  indicator light will blink on the cluster, and the steering wheel will make adjustments to keep vehicle inside the lane.
- The system will operate when your vehicle speed is between approximately 40~120 mph (60~200 km/h).



Hands-off warning

If the driver takes their hands off the steering wheel for several seconds, the 'Keep hands on the steering wheel' warning message will appear on the cluster, and an audible warning will sound in stages.

WARNING

- The steering wheel may not be assisted if the steering wheel is held very tight or the steering wheel is steered over a certain degree.
- Lane Keeping Assist does not operate at all times. It is the responsibility of the driver to safely steer the vehicle and to maintain the vehicle in its lane.
- The hands-off warning message may appear late depending on road conditions. Always have your hands on the steering wheel while driving.
- If the steering wheel is held very lightly, the hands-off warning message may appear because the system may not recognize that the driver has their hands on the steering wheel.
- If you attach objects to the steering wheel, the hands-off warning may not work properly.

i Information

- You may change settings from the instrument cluster (User Settings), refer to 'LCD display' section in chapter 3.
- When lane markings are detected, the lane lines on the cluster will change from grey to white and the green  indicator light will illuminate.



- **Even though the steering is assisted by Lane Keeping Assist, the driver may control the steering wheel.**
- **The steering wheel may feel heavier or lighter when the steering wheel is assisted by Lane Keeping Assist than when it is not.**

System malfunction and limitations

System malfunction



When Lane Keeping Assist is not working properly, the 'Check Lane Keeping Assist (LKA) system' warning message will appear and the yellow indicator light will illuminate on the cluster. If this occurs, we recommend that the system be inspected by an authorized HYUNDAI dealer.

 **WARNING**

Take the following precautions when using Lane Keeping Assist:

- The driver should hold the responsibility to safely drive and control the vehicle. Do not solely rely on the system and drive dangerously.
 - The operation of Lane Keeping Assist can be cancelled or not work properly depending on road conditions and surroundings. Always be cautious while driving.
 - Refer to “Limitations of the System” if the lane is not detected properly.
 - When you are towing a trailer or another vehicle, we recommend that Lane Keeping Assist is turned off due to safety reasons.
- If the vehicle is driven at high speed, the steering wheel will not be controlled. The driver must always follow the speed limit when using the system.
 - If any other system’s warning message is displayed or audible warning is generated, Lane Keeping Assist warning message may not be displayed and audible warning may not be generated.
 - You may not hear the warning sound of Lane Keeping Assist if the surrounding is noisy.
 - If you attach objects to the steering wheel, steering may not be assisted properly.
 - Lane Keeping Assist may not operate for 15 seconds after the vehicle is started, or the front view camera is initialized.
- Lane Keeping Assist will not operate when:
 - The turn signal or hazard warning flasher is turned on
 - The vehicle is not driven in the center of the lane when the system is turned on or right after changing a lane
 - ESC (Electronic Stability Control) or VSM (Vehicle Stability Management) is activated
 - The vehicle is driven on a sharp curve
 - Vehicle speed is below 35 mph (55 km/h) or above 130 mph (210 km/h)
 - The vehicle makes sharp lane changes
 - The vehicle brakes suddenly

Limitations of the system

Lane Keeping Assist may not operate normally or may operate unexpectedly under the following circumstances:

- The lane is contaminated or difficult to distinguish because,
 - The lane markings is covered with rain, snow, dirt, oil, etc.
 - The color of the lane marking is not distinguishable from the road
 - There are markings on the road near the lane or the markings on the road looks similar to the lane markings
 - The lane marking is indistinct or damaged
 - The shadow is on the lane marking by a median strip, trees, guardrail, noise barriers, etc.
- There are more than two lane markings on the road
- The lane number increases or decreases, or the lane markings are crossing
- The lane markings are complicated or a structure substitutes for the lines, such as a construction area
- There are road markings, such as zigzag lanes, crosswalk markings and road signs
- The lane suddenly disappears, such as at the intersection
- The lane is very wide or narrow
- There is a road edge without a lane
- There is a boundary structure in the roadway, such as a tollgate, sidewalk, curb, etc.
- The distance to the front vehicle is extremely short or the vehicle in front is covering the lane marking

CAUTION

For more details on the limitations of the front view camera, refer to “Forward Collision-Avoidance Assist (FCA)” section in this chapter.

BLIND-SPOT COLLISION WARNING (BCW) (IF EQUIPPED)

Blind-Spot Collision Warning is designed to help detect and monitor approaching vehicles in the driver's blind spot area and warn the driver of a possible collision with a warning message and audible warning.

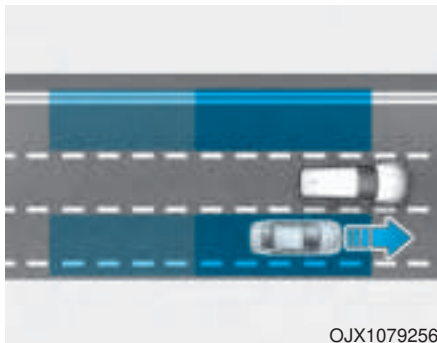

Blind-Spot Collision Warning helps detect and inform the driver that a vehicle is in the blind spot.

CAUTION

The detecting range may vary depending on the speed of your vehicle. However, even if there is a vehicle in the blind spot, the system may not warn you when you pass by at high speed.

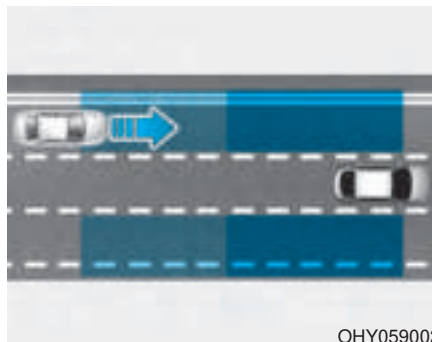

Blind-Spot Collision Warning helps detect and inform the driver that a vehicle is approaching at high speed from the blind spot area.

CAUTION

Warning timing may vary depending on the speed of the vehicle approaching at high speed.

Information

In the following text, Blind-Spot Collision Warning will be referred as Blind-Spot Safety system.

Detecting sensor



[1] : Rear corner radar

Refer to the picture above for the detailed location of the detecting sensor.

CAUTION

Take the following precautions to maintain optimal performance of the detecting sensor:

- Never disassemble the rear corner radar or radar assembly, or apply any impact on it.

- If the rear corner radars have been replaced or repaired, we recommend that the vehicle be inspected by an authorized HYUNDAI dealer.
- If there is impact on the rear corner radar or near the radar, even though the warning message does not appear on the cluster, Blind-Spot Safety system may not operate properly. We recommend that the system be inspected by an authorized HYUNDAI dealer.
- Use only genuine parts to repair the rear bumper where the rear corner radar is located.
- Do not apply license plate frame or objects, such as a bumper sticker, film or a bumper guard near the rear corner radar.
- The system may not work properly if the bumper has been replaced, or the surroundings of the rear corner radar has been damaged or paint has been applied.

- If a trailer, carrier, etc. is installed, it may adversely affect the performance of the rear corner radar or the function may not operate.

CAUTION

For more details on the precautions of the front view camera, refer to “Forward Collision-Avoidance Assist (FCA)” section in this chapter.

System settings

Setting functions for the system

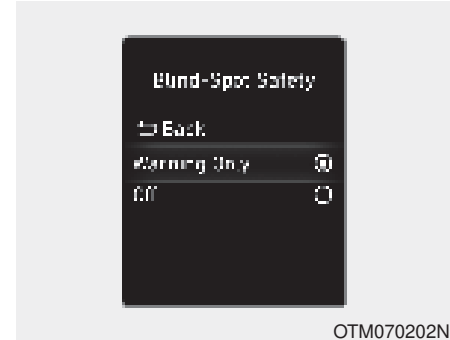

Blind-Spot Safety

With the Engine Start/Stop button in the ON position, select or deselect ‘Driver Assistance → Blind-Spot Safety’ from the Settings menu to set whether or not to use each function.

If ‘Warning Only’ is selected, the system will warn the driver with a warning message and an audible warning depending on the collision risk levels. Braking will not be assisted.

If ‘Off’ is selected, the system will turn off.



Turning the system On/Off (Blind-Spot Safety button)

With the Engine Start/Stop button in the ON position, press the Blind Spot Safety button to turn on Blind-Spot Safety system. The indicator on the button will turn on and the warning light on the side view mirror will blink for 3 seconds.

Press the button again to turn off the system.

WARNING

If you turn off by pressing the button, the driver should always be aware of the surroundings and drive safely.

Information

If the engine is restarted, Blind-Spot Safety system will maintain the last setting.

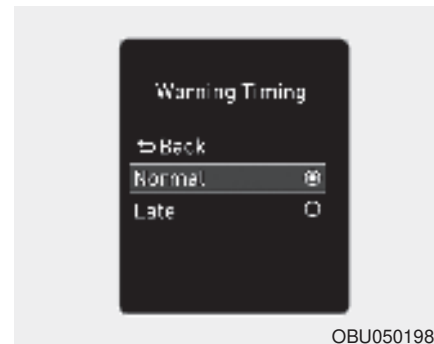

Warning Timing

With the engine on, select 'Driver Assistance → Warning Timing' from the Settings menu to change the initial warning activation time for Blind-Spot Safety.

When the vehicle is first delivered, Warning Timing is set to 'Normal'. If you change the Warning Timing, the warning time of other Driver Assistance systems may change.

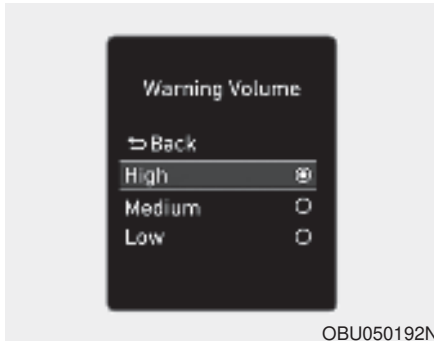

Warning Volume

With the Engine Start/Stop button in the ON position, select 'Driver Assistance → Warning Volume' from the Settings menu to change the Warning Volume to 'High', 'Medium', or 'Low' for Blind-Spot Safety system.

If you change the Warning Volume, the warning volume of other Driver Assistance systems may change.

CAUTION

- The setting of the Warning Timing and Warning Volume applies to all functions of the Blind-Spot Safety system.
- Even though 'Normal' is selected for Warning Timing, if the vehicles approaches at high speed, the initial warning activation time may seem late.
- Select 'Late' for Warning Timing when traffic is light and when driving speed is slow.

System operation

System warning

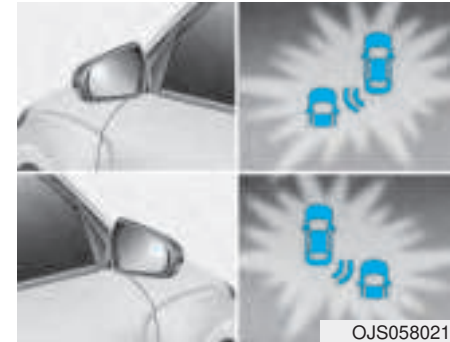

Vehicle detection

To warn the driver a vehicle is detected, the warning light on the side view mirror will illuminate.

The system will operate when your vehicle speed is above 19 mph (30 km/h).

Collision warning

- Collision warning will operate when the turn signal is turned on in the direction of the detected vehicle.
- To warn the driver of a collision, the warning light on the side view mirror will blink. At the same time, an audible warning will sound.
- When the turn signal is turned off or you move away from the lane, the collision warning will be canceled and the system will return to vehicle detection state.

WARNING

- **The detecting range of the rear corner radar is determined by the standard road width, therefore, on a narrow road, the system may detect other vehicles in the next next lane and warn you. In contrast, on a wide road, the system may not be able to detect a vehicle driving in the next lane and may not warn you.**
- **When the hazard warning light is on, the collision warning by the turn signal will not operate.**

Information

If the driver's seat is on the left side, the collision warning may occur when you turn left. Maintain a proper distance with the vehicles in the left lane. If the driver's seat is on the right side, the collision warning may occur when you turn right. Maintain a proper distance with the vehicles in the right lane.

WARNING

Take the following precautions when using Blind-Spot Safety system:

- **For your safety, change the Settings after parking the vehicle at a safe location.**
- **If any other system's warning message is displayed or audible warning is generated, Blind-Spot Safety system's warning message may not be displayed and audible warning may not be generated.**
- **You may not hear the warning sound of Blind-Spot Safety system if the surrounding is noisy.**
- **Blind-Spot Safety system may warn the driver late or may not warn the driver depending on the road and driving conditions.**

- Driver should maintain control of the vehicle at all times. Do not depend on Blind-Spot Safety system. Maintain a safe braking distance, and if necessary, depress the brake pedal to reduce driving speed or to stop the vehicle.

System malfunction and limitations

System malfunction

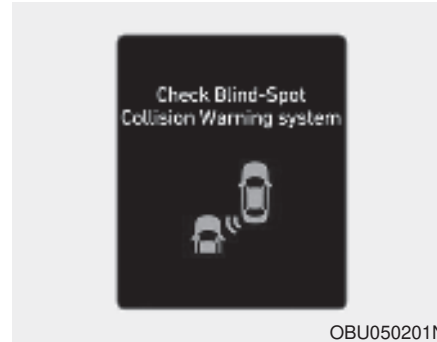

When Blind-Spot Safety system is not working properly, the 'Check Blind-Spot Collision Warning system' warning message will appear on the cluster, and the system will turn off automatically, or the system will be limited. We recommend that the system be inspected by an authorized HYUNDAI dealer.

System disabled

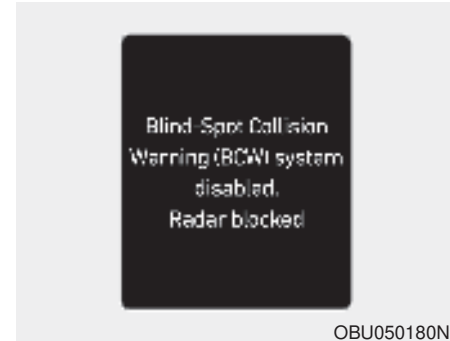

When the rear bumper around the rear corner radar or sensor is covered with foreign material, such as snow or rain, or installing a trailer or carrier, it can reduce the detecting performance and temporarily limit or disable Blind-Spot Safety system.

If this occurs, the 'Blind-Spot Collision Warning system disabled, Radar blocked' warning message will appear on the cluster.

The System will operate normally when such foreign material or trailer, etc. is removed, and then the engine is restarted.

If the system does not operate normally after it is removed, we recommend that the system be inspected by an authorized HYUNDAI dealer.

WARNING

- Even though the warning message does not appear on the cluster, Blind-Spot Safety system may not properly operate.
- Blind-Spot Safety system may not properly operate in an area (e.g. open terrain), where any substance are not detected right after the engine is turned on, or when the detecting sensor is blocked with foreign material right after the engine is turned on.

CAUTION

Turn off Blind-Spot Safety system to install a trailer, carrier, etc., or remove the trailer, carrier, etc. to use Blind-Spot Safety system.

Limitations of the system

Blind-Spot Safety system may not operate normally, or the system may operate unexpectedly under the following circumstances:

- There is inclement weather, such as heavy snow, heavy rain, etc.
- The rear corner radar is covered with snow, rain, dirt, etc.
- The temperature around the rear corner radar is high or low
- Driving on a highway ramp
- The road pavement (or the peripheral ground) abnormally contains metallic components (i.e. possibly due to subway construction)
- There is a fixed object near the vehicle, such as sound barriers, guardrails, central dividers, entry barriers, street lamps, signs, tunnels, walls, etc. (including double structures)
- Driving in large areas where there are few vehicles or structures (i.e. desert, meadow, suburb, etc.)
- Driving through a narrow road where trees or grass are overgrown

- Driving on a wet road surface, such as a puddle on the road
- The other vehicle drives very close behind your vehicle, or the other vehicle passes by your vehicle in close proximity
- The speed of the other vehicle is very fast that it passes by your vehicle in a short time
- Your vehicle passes by the other vehicle
- Your vehicle changes lane
- Your vehicle has started at the same time as the vehicle next to you and has accelerated
- The vehicle in the next lane moves two lanes away from you, or when the vehicle two lanes away moves to the next lane from you
- A trailer or carrier is installed around the rear corner radar
- The bumper around the rear corner radar is covered with objects, such as a bumper sticker, bumper guard, bike rack, etc.
- The bumper around the rear corner radar is impacted, damaged or the radar is out of position

- The bumper around the rear corner radar is blocked by a vehicle, pillar or wall
- Your vehicle height is low or high due to heavy loads, abnormal tire pressure, etc.

Blind-Spot Safety system may not operate normally, or the system may operate unexpectedly when the following objects are detected:

- A motorcycle or bicycle is detected
- A vehicle such as a flat trailer is detected
- A big vehicle such as a bus or truck is detected
- A moving obstacle such as a pedestrian, animal, shopping cart or a baby stroller is detected
- A vehicle with low height such as a sports car is detected

WARNING

- **Driving on a curve**



OHY059008

Blind-Spot Safety system may not operate properly when driving on a curved road. The system may not detect the vehicle in the next lane.

Always pay attention to road and driving conditions while driving.



OHY059009

Blind-Spot Safety system may not operate properly when driving on the curved road. The system may recognize the vehicle in the same lane.

Always pay attention to road and driving conditions while driving.

- **Driving where the road is merging/dividing**

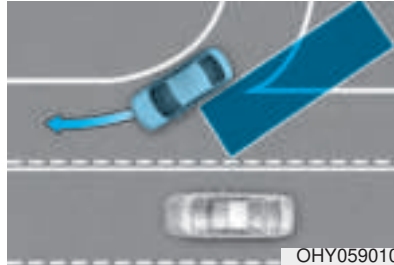

OHY059010

Blind-Spot Safety system may not operate properly when driving where the road merges or divides. The system may not detect the vehicle in the next lane.

Always pay attention to road and driving conditions while driving.

- **Driving on a slope**

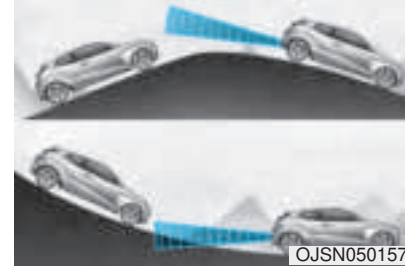

OJSN050157

Blind-Spot Safety system may not operate properly when driving on a slope. The system may not detect the vehicle in the next lane or may incorrectly detect the ground or structure.

Always pay attention to road and driving conditions while driving.

- Driving where the heights of the lanes are different

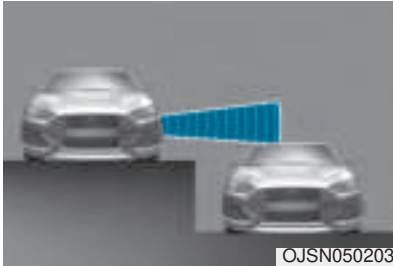

Blind-Spot Safety system may not operate properly when driving where the heights of the lanes are different. The system may not detect the vehicle on a road with different lane heights (underpass joining section, grade separated intersections, etc.).

Always pay attention to road and driving conditions while driving.

WARNING

- When you are towing a trailer or another vehicle, make sure that you turn off Blind-Spot Safety system.
- Blind-Spot Safety system may not operate normally if interfered by strong electromagnetic waves.
- Blind-Spot Safety system may not operate for 3 seconds after the vehicle is started, or the rear corner radars are initialized.

Information

This device complies with Part 15 of the FCC rules.

Operation is subject to the following two conditions:

1. This device may not cause harmful interference.
2. This device must accept any interference received, including interference that may cause undesired operation.

DRIVER ATTENTION WARNING (DAW) (IF EQUIPPED)

Basic function

Driver Attention Warning will help determine the driver's attention level by analyzing driving pattern, driving time, etc. while vehicle is being driven. The system will recommend a break when the driver's attention level falls below a certain level.

Leading Vehicle Departure Alert function

Leading Vehicle Departure Alert function will inform the driver when the front vehicle departs from a stop.

Detecting sensor



[1] : Front view camera

The front view camera is used as a detecting sensor to detect driving patterns and front vehicle departure while vehicle is being driven.

Refer to the picture above for the detailed location of the detecting sensor.

CAUTION

Always keep the front view camera in good condition to maintain optimal performance of Driver Attention Warning.

For more details on the precautions of the front view camera, refer to “Forward Collision-Avoidance Assist (FCA)” section in this chapter.

System settings

Setting functions for the system

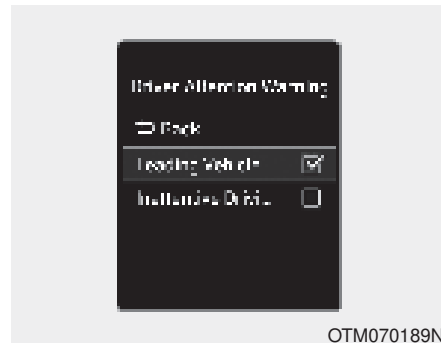

OTM070189N

Driver Attention Warning

With the Engine Start/Stop button in the ON position, select or deselect 'Driver Assistance → Driver Attention Warning' from the Settings menu to set whether or not to use each function.

- If 'Inattentive Driving Warning' is selected, the system will inform the driver the driver's attention level and will recommend taking a break when the level falls below a certain level.

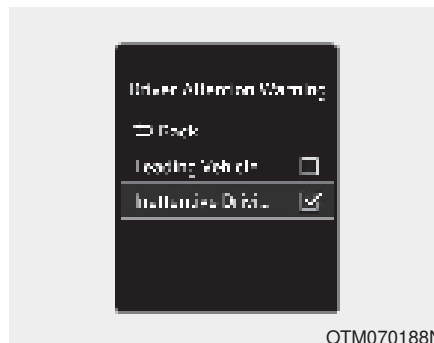

OTM070188N

Leading Vehicle Departure Alert

- If 'Leading Vehicle Departure Alert' is selected, the system will inform the driver when the front vehicle departs from a stop.

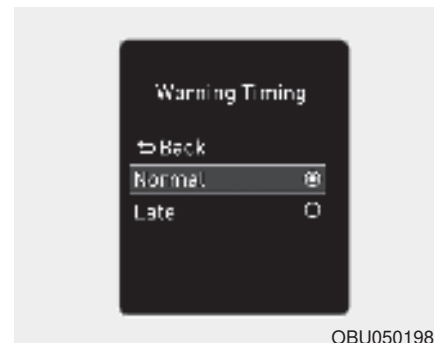

OBU050198N

Warning Timing

With the Engine Start/Stop button in the ON position, select 'Driver Assistance → Warning Timing' from the Settings menu to change the initial warning activation time for Driver Attention Warning.

When the vehicle is first delivered, Warning Timing is set to 'Normal'. If you change the Warning Timing, the warning time of other Driver Assistance systems may change.

i Information

If the engine is restarted, Driver Attention Warning will maintain the last setting.

System operation

Basic function

System display and warning

The basic function of Driver Attention Warning is to inform the driver the 'Attention Level' and to warn the driver to 'Consider taking a break'.

Attention level

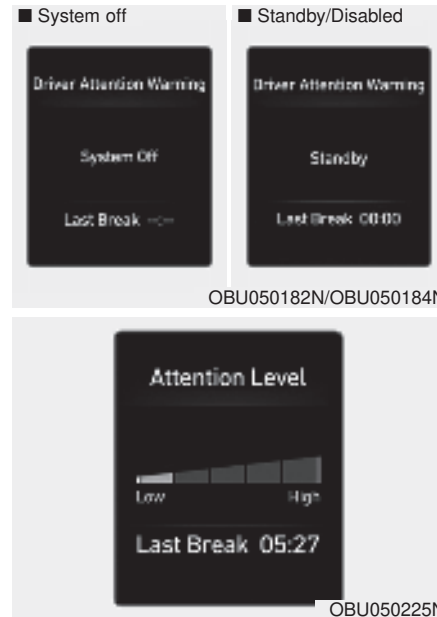

- The system will operate when vehicle speed is between 0~110 mph (0~180 km/h).
- When vehicle speed is not within the operating speed, the message 'Standby' will be displayed.
- The driver's attention level is displayed on the scale of 1 to 5. The lower the level is, the more inattentive the driver is.
- The level decreases when the driver does not take a break for a certain period of time.

- The driver can monitor his/her driving conditions on the cluster.
 - When the 'Inattentive Driving Warning' is deselected from the Settings menu, 'System Off' is displayed.

Taking a break

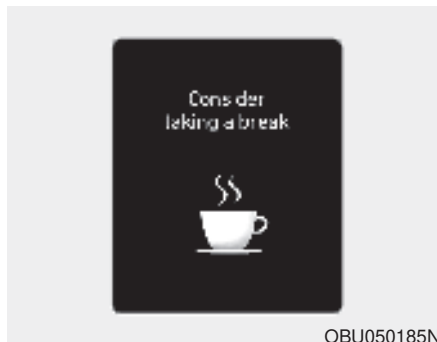

- The 'Consider taking a break' message will appear on the cluster and an audible warning will sound to suggest that the driver take a break, when the driver's attention level is below 1.
- Driver Attention Warning will not suggest a break when the total driving time is shorter than 10 minutes or 10 minutes has not passed after the last break was suggested.

WARNING

For your safety, change the Settings after parking the vehicle at a safe location.

CAUTION

- Driver Attention Warning may suggest a break depending on the driver's driving pattern or habits, even if the driver doesn't feel fatigue.
- Driver Attention Warning is a supplemental system and may not be able to determine whether the driver is inattentive.
- The driver who feels fatigued should take a break at a safe location, even though there is no break suggestion by Driver Attention Warning.

Information

- You may change settings from the instrument cluster (User Settings), refer to 'LCD display' section in chapter 3.
- Driver Attention Warning will reset the last break time to 00:00 in the following situations:
 - The engine is turned off
 - The driver unfastens the seat belt and opens the driver's door
 - The vehicle is stopped for more than 10 minutes
- When the driver resets Driver Attention Warning, the last break time is set to 00:00 and the driver's attention level is set to High.

Leading Vehicle Departure Alert function



When the front vehicle departs from a stop, Leading Vehicle Departure Alert will inform the driver by displaying the 'Leading vehicle is driving away' message on the cluster and an audible warning will sound.

WARNING

- If any other system's warning message is displayed or audible warning is generated, Leading Vehicle Departure Alert's warning message may not be displayed and audible warning may not be generated.
- The driver should hold the responsibility to safely drive and control the vehicle.

CAUTION

- **Leading Vehicle Departure Alert is a supplemental function and may not alert the driver whenever the front vehicle departs from a stop.**
- **Always check the front of the vehicle and road conditions before departure.**

System malfunction and limitations

System malfunction

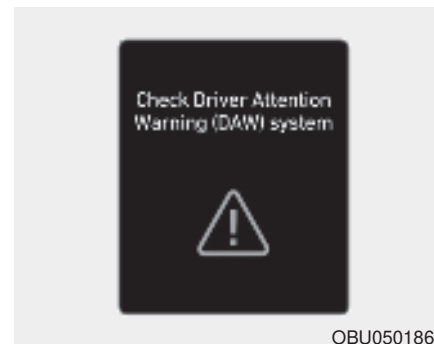

When Driver Attention Warning is not working properly, the 'Check Driver Attention Warning (DAW) system' warning message will appear on the cluster. If this occurs, we recommend that the system be inspected by an authorized HYUNDAI dealer.

Limitations of the system

Driver Attention Warning may not work properly in the following situations:

- The vehicle is driven violently
- The vehicle intentionally crosses over lanes frequently
- The vehicle is controlled by Driver Assistance system, such as Lane Keeping Assist

Leading Departure Alert feature

- When the vehicle cuts in

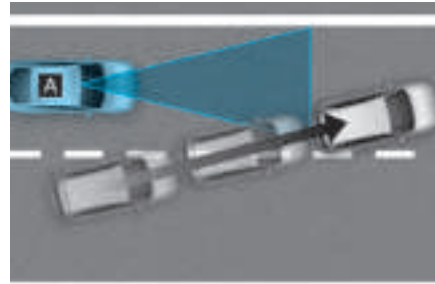

OADAS021SD

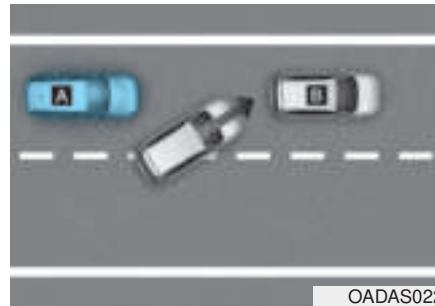

OADAS022

[A] : Your vehicle, [B] : Front vehicle

If a vehicle cuts in front of your vehicle, Leading Departure Alert may not operate properly.

- When the vehicle ahead sharply steers

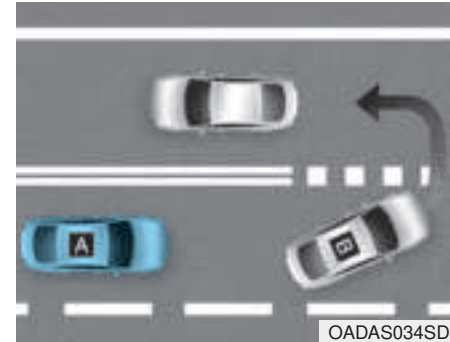

OADAS034SD

[A] : Your vehicle, [B] : Front vehicle

If the vehicle in front makes a sharp turn, such as to turn left or right or make a Uturn, etc., Leading Vehicle Departure Alert may not operate properly.

Driving your vehicle

- When the vehicle ahead abruptly departs

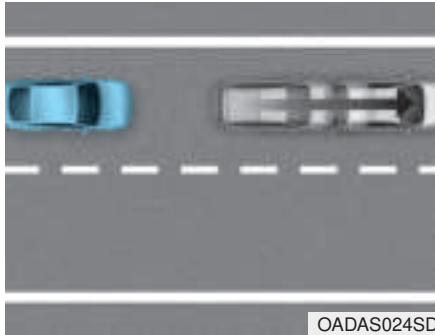

If the vehicle in front abruptly departs, Leading Vehicle Departure Alert may not operate properly.

- When a pedestrian or bicycle is between you and the vehicle ahead



If there is a pedestrian(s) or bicycle(s) in between you and the vehicle in front, Leading Vehicle Departure Alert may not operate properly.

- When in a parking lot

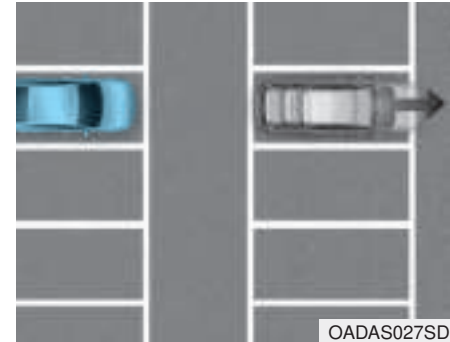

If a vehicle parked in front drives away from you, Leading Vehicle Departure Alert may alert you that the parked vehicle is driving away.

- When driving at a tollgate or intersection, etc.

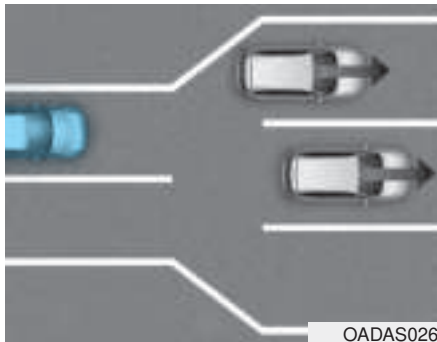

If you pass a tollgate or intersection with lots of vehicles or you drive where lanes are merged or divided frequently, Leading Vehicle Departure Alert may not operate properly.

CAUTION

For more details on the precautions of the front view camera, refer to “Forward Collision-Avoidance Assist (FCA)” section in this chapter.

CRUISE CONTROL (CC)





- (1) Cruise indicator
- (2) Set speed

Cruise Control will allow you to drive at speeds above 20 mph (30 km/h) without depressing the accelerator pedal.

System operation

To set speed



1. Press the Driving Assist  button.
The set speed and Cruise ( CRUISE) indicator will illuminate on the cluster.
2. Release the accelerator pedal.
Vehicle speed will maintain the set speed even when the accelerator pedal is not depressed.

Information

On a steep slope, the vehicle may slightly slow down or speed up while driving uphill or downhill.

To increase speed

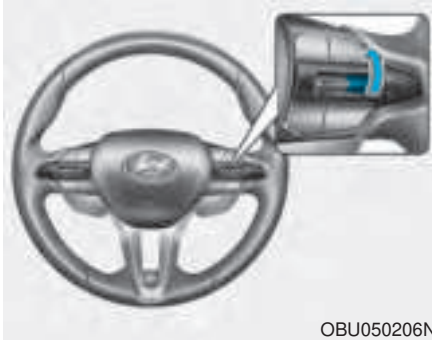

- Push the + switch up and release it immediately. The cruising speed will increase by 1 mph/h (1 km) each time the switch is operated in this manner.
- Push the + switch up and hold it while monitoring the set speed on the cluster. The cruising speed will increase by 5 mph (10 km/h) each time the switch is operated in this manner.

Release the switch when the desired speed is shown and the vehicle will accelerate to that speed.

To decrease speed

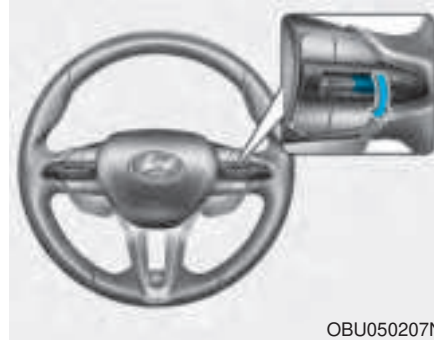

- Push the - switch down and release it immediately. The cruising speed will decrease by 1 mph/h (1 km) each time the switch is operated in this manner.
- Push the - switch down and hold it while monitoring the set speed on the cluster. The cruising speed will decrease by 5 mph (10 km/h) each time the switch is operated in this manner.

Release the switch at the speed you want to maintain.

Temporary speed increase

To temporarily accelerate

If you want to speed up temporarily when Cruise Control is on, depress the accelerator pedal.

To return to the set speed, take your foot off the accelerator pedal.

If you push the + switch up or - switch down at increased speed, the cruising speed will be set to the current increased speed.

To temporarily pause the system

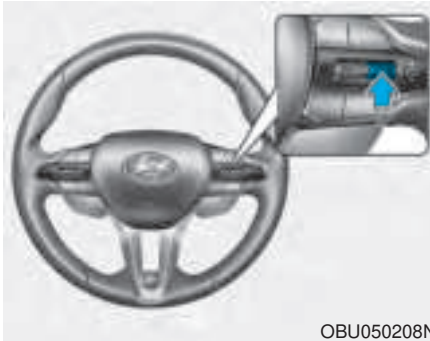

Cruise Control will be paused when:

Manually

- Depressing the brake pedal
- Pushing the  button

Automatically

- Shifting the gear to N (Neutral)
- The parking brake is applied
- Decreasing vehicle speed to less than approximately 15 mph (25 km/h)
- ESC (Electronic Stability Control) is operating
- N Grin Shift (NGS) is operating

The set speed will turn off but the Cruise ( CRUISE) indicator will stay on.

NOTICE

If Cruise Control pauses during a situation that is not mentioned, have the vehicle inspected by an authorized HYUNDAI dealer.

To resume the system

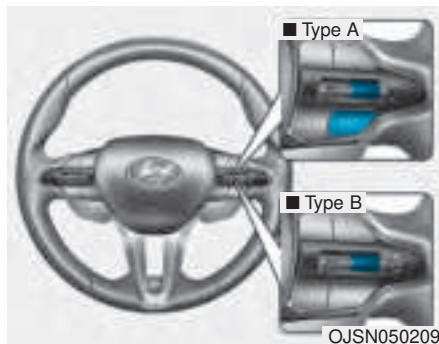

Push the +, - or (||↻) switch.

If you push the + switch up or - switch down, vehicle speed will be set to the current speed on the cluster.

If you push the (||↻) switch, vehicle speed will resume to the preset speed.

Vehicle speed must be above 20 mph (30 km/h) for the system to resume.

WARNING

Check the driving condition before using the ||↻ switch. Driving speed may sharply increase or decrease when you press the ||↻ switch.

To turn off the system



Press the Driving Assist to turn Cruise Control off. The Cruise (CRUISE) indicator will go off.

Always press the Driving Assist button to turn Cruise Control off when not in use.

 **WARNING**

Take the following precautions when using Cruise Control:

- Always set the vehicle speed to the speed limit where you are driving.
 - Keep Cruise Control off when the system is not in use, to avoid inadvertently setting a speed. Check that the Cruise (Ⓢ CRUISE) indicator is off.
 - Cruise Control does not substitute for proper and safe driving. It is the responsibility of the driver to always drive safely and should always be aware of unexpected and sudden situations from occurring.
 - Always drive cautiously to prevent unexpected and sudden situations from occurring. Pay attention to the road conditions at all times.
- Do not use Cruise Control when it may be unsafe to keep the vehicle at a constant speed:
 - When driving near a highway interchange or tollgate
 - When driving in heavy traffic, or when traffic conditions make it difficult to drive at a constant speed
 - When driving on rainy, icy, or snow-covered roads
 - When driving on hilly or windy roads
 - When driving in windy areas
 - When driving with limited view (possibly due to bad weather, such as fog, snow, rain and sandstorm)
 - Do not use Cruise Control when towing a vehicle.

LANE FOLLOWING ASSIST (LFA) (IF EQUIPPED)

Lane Following Assist is designed to help detect lane markings and/or vehicles on the road, and assist the driver's steering to help keep the vehicle between lanes.

Detecting sensor



[1] : Front view camera

The front view camera is used as a detecting sensor to detect lane markings and front vehicles.

Refer to the picture above for the detailed location of the detecting sensor.

CAUTION

For more details on the precautions of the front view camera, refer to “Forward Collision-Avoidance Assist (FCA)” section in this chapter.

System settings

Setting functions for the system

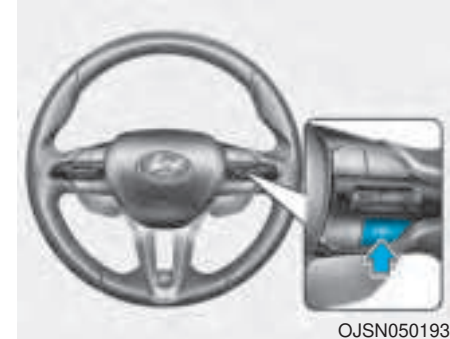

Turning the system On/Off

With the Engine Start/Stop button in the ON position, shortly press the Lane Driving Assist button located on the steering wheel to turn on Lane Following Assist. The white or green  indicator light will illuminate on the cluster.

Press the button again to turn off the system.

If the engine is restarted, Lane Following Assist will maintain the last setting.

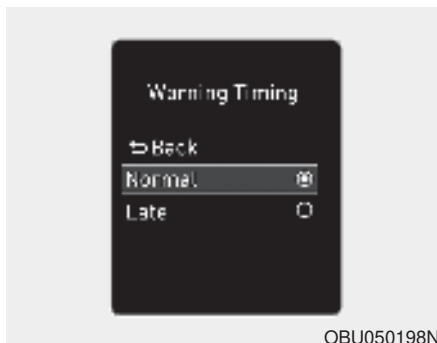

Warning Timing

With the engine on, select 'Driver Assistance → Warning Timing' from the Settings menu to change the initial warning activation time for Lane Following Assist.

When the vehicle is first delivered, Warning Timing is set to 'Normal'. If you change the Warning Timing, the warning time of other Driver Assistance systems may change.

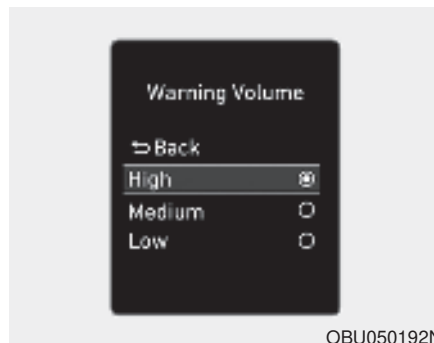

Warning Volume

With the Engine Start/Stop button in the ON position, select 'Driver Assistance → Warning Volume' from the Settings menu to change the Warning Volume to 'High', 'Medium', or 'Low' for Hands-off warning.

If you change the Warning Volume, the Warning Volume of other Driver Assistance systems may change.

System operation

System warning and control



Lane Following Assist

If the vehicle ahead and/or both lane markings are detected and your vehicle speed is below 120 mph (200 km/h), the green  indicator light will illuminate on the cluster, and the system will help the vehicle stay in lane by assisting the steering wheel.

CAUTION

When the steering wheel is not assisted, the green  indicator light will blink and change to white.

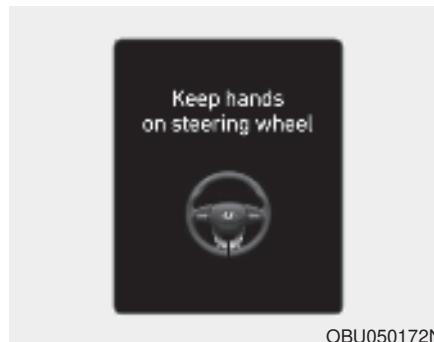

Hands-off warning

If the driver takes their hands off the steering wheel for several seconds, the 'Keep hands on the steering wheel' warning message will appear and an audible warning will sound in stages.

First stage : Warning message

Second stage : Warning message
(red steering wheel)
and audible warning



If the driver still does not have their hands on the steering wheel after the hands-off warning, the 'Lane Following Assist (LFA) canceled' warning message will appear and Lane Following Assist will be automatically canceled.

WARNING

- The steering wheel may not be assisted if the steering wheel is held very tight or the steering wheel is steered over a certain degree.
- Lane Following Assist does not operate at all times. It is the responsibility of the driver to safely steer the vehicle and to maintain the vehicle in its lane.
- The hands-off warning message may appear late depending on road conditions. Always have your hands on the steering wheel while driving.
- If the steering wheel is held very lightly the hands-off warning message may appear because the system may not recognize that the driver has their hands on the steering wheel.
- If you attach objects to the steering wheel, the hands-off warning may not work properly.

Information

- You may change settings from the instrument cluster (User Settings), refer to 'LCD display' section in chapter 3.
- When both lane markings are detected, the lane lines on the cluster will change from grey to white.

■ Lane undetected



OJSN050177

■ Lane detected



OBU050337N

- If lane markings are not detected, steering wheel control by Lane Following Assist can be limited depending on whether a vehicle is in front or the driving conditions of the vehicle.

- Even though the steering is assisted by Lane Following Assist, the driver may control the steering wheel.
- The steering wheel may feel heavier or lighter when the steering wheel is assisted by Lane Following Assist than when it is not.

System malfunction and limitations

System malfunction



When Lane Following Assist is not working properly, the 'Check Lane Following Assist (LFA) system' warning message will appear on the cluster. If this occurs, we recommend that the system be inspected by an authorized HYUNDAI dealer.

Limitations of the system

For more details on system limitations, refer to "Lane Keeping Assist (LKA)" section in this chapter.

WARNING

For more details on the system precautions, refer to "Lane Keeping Assist (LKA)" section in this chapter.

REAR CROSS-TRAFFIC COLLISION WARNING (RCCW) (IF EQUIPPED)

Rear Cross-Traffic Collision Warning Assist is designed to help detect vehicles approaching from the left and right side while your vehicle is reversing, and warn the driver that a collision is imminent with a warning message and an audible warning.

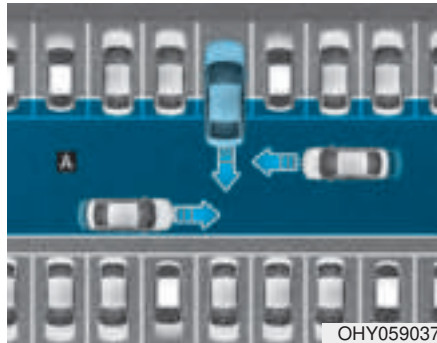

OHY059037

[A] : Rear Cross-Traffic Collision Warning operating range

CAUTION

The time of warning may vary depending on vehicle speed of the approaching vehicle.

Information

In the following text, Rear Cross-Traffic Collision Warning will be referred as Rear Cross-Traffic Safety system.

Detecting sensor



Refer to the picture above for the detailed location of the detecting sensor.

CAUTION

For more details on the precautions of the rear corner radar, refer to “Blind-Spot Collision-Avoidance Warning (BCW)” section in this chapter.

System settings

Setting functions for the system



Rear Cross-Traffic Safety

With the Engine Start/Stop button in the ON position, select 'Driver Assistance → Parking Safety → Rear Cross-Traffic Safety' from the Settings menu to turn on Rear Cross-Traffic Safety system and deselect to turn off the system.

 **WARNING**

When the engine is restarted, Rear Cross-Traffic Safety system will always turn on. However, if 'Off' is selected after the engine is restarted, the driver should always be aware of the surroundings and drive safely.



Warning Timing

With the engine on, select 'Driver Assistance → Warning Timing' from the Settings menu to change the initial warning activation time for Rear Cross-Traffic Safety system.

When the vehicle is first delivered, Warning Timing is set to 'Normal'. If you change the Warning Timing, the warning time of other Driver Assistance systems may change.

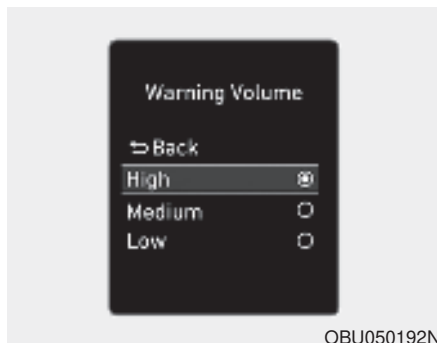

OBU050192N

Warning Volume

With the Engine Start/Stop button in the ON position, select 'Driver Assistance → Warning Volume' from the Settings menu to change the Warning Volume to 'High', 'Medium', 'or 'Low' for Rear Cross-Traffic Safety system.

If you change the Warning Volume, the Warning Volume of other Driver Assistance systems may change.

CAUTION

The setting of the Warning Timing and Warning Volume applies to all functions of the Rear Cross-Traffic Safety.

Even though 'Normal' is selected for Warning Timing, if the vehicles from the left and right side approaches at high speed, the initial warning activation time may seem late.

Select 'Late' for Warning Timing when traffic is light and when driving speed is slow.

Information

If the engine is restarted, Warning Timing and Warning Volume will maintain the last setting.

System operation

System warning



OBU050192N/OJSN050199

Rear Cross-Traffic Safety system will warn the driver when a collision is imminent.

Collision Warning

- To warn the driver of an approaching vehicle from the rear left/right side of your vehicle, the side view mirror will blink and a warning will appear on the cluster. At the same time, an audible warning will sound. If the Rear View Monitor is operating, a warning will also appear on the infotainment system screen.

- The system will operate when all the following conditions are satisfied:
 - The gear is shifted to R (Reverse)
 - Vehicle speed is below 5 mph (8 km/h)
 - The approaching vehicle is within approximately 82 ft. (25 m) from the left and right side of your vehicle
 - The speed of the vehicle approaching from the left and right is above 3 mph (5 km/h)

Information

If the operating conditions are satisfied, there will be a warning whenever the vehicle approaches from the left or right side even though your vehicle speed is 0 mph (0 km/h).

WARNING

Take the following precautions when using Rear Cross-Traffic Safety system:

- For your safety, change the Settings after parking the vehicle at a safe location.
- If any other system's warning message is displayed or audible warning is generated, Rear Cross-Traffic Safety system's warning message may not be displayed and audible warning may not be generated.
- You may not hear the warning sound of Rear Cross-Traffic Safety system if the surrounding is noisy.
- Rear Cross-Traffic Safety system may warn the driver late or may not warn the driver depending on the road and driving conditions.

- The driver should hold the responsibility to control the vehicle. Do not solely depend on Rear Cross-Traffic Safety system. Rather, maintain a safe braking distance, and if necessary, depress the brake pedal to reduce driving speed or to stop the vehicle.

System malfunction and limitations

System malfunction

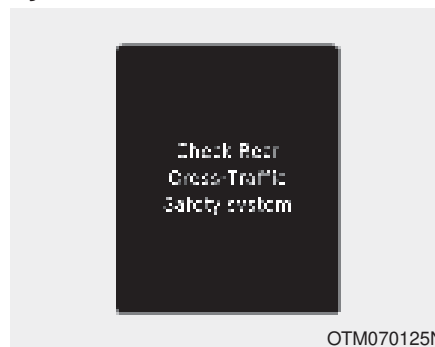

When Rear Cross-Traffic Safety system is not working properly, the 'Check Rear Cross-Traffic Safety system' warning message will appear on the cluster, and the system will turn off automatically, or the system will be limited. We recommend that the system be inspected by an authorized HYUNDAI dealer.

System disabled

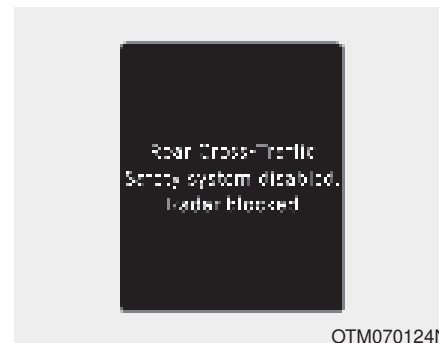

When the rear bumper around the rear corner radar or sensor is covered with foreign material, such as snow or rain, or installing a trailer or carrier, it can reduce the detecting performance and temporarily limit or disable Rear Cross-Traffic Safety system.

If this occurs, the 'Rear Cross-Traffic Safety system disabled. Radar blocked' warning message will appear on the cluster.

The system will operate normally when such foreign material or trailer, etc. is removed.

If the system does not operate normally after it is removed, we recommend that the system be inspected by an authorized HYUNDAI dealer.

WARNING

- Even though the warning message does not appear on the cluster, Rear Cross-Traffic Safety system may not operate properly.
- Rear Cross-Traffic Safety system may not operate properly in an area (for example: open terrain), where any substance are not detected after turning ON the engine.

CAUTION

Turn off Rear Cross-Traffic Safety system to install a trailer, carrier, etc., or remove the trailer, carrier, etc. to use Rear Cross-Traffic Safety system.

Limitations of the system

Rear Cross-Traffic Safety system may not operate normally, or the system may operate unexpectedly under the following circumstances:

- Departing from where trees or grass are overgrown
- Departing from where roads are wet
- Speed of the approaching vehicle is fast or slow

CAUTION

For more details on the limitations of the rear corner radar, refer to “Blind-Spot Collision-Avoidance Warning (BCW)” section in this chapter.

WARNING

- Driving near a vehicle or structure

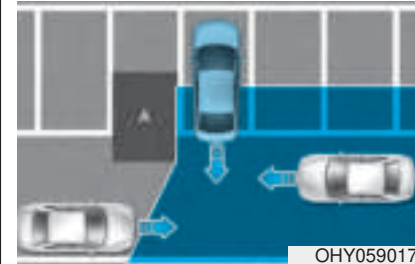

[A] : Structure

Rear Cross-Traffic Safety system may be limited when driving near a vehicle or structure, and may not detect the vehicle approaching from the left or right. If this occurs, the system may not warn the driver when necessary.

Always check your surroundings while backing up.

- When the vehicle is in a complex parking environment

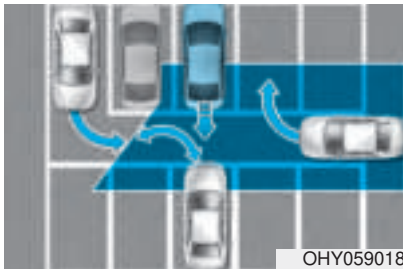

OHY059018

Rear Cross-Traffic Safety system may detect vehicles which are parking or pulling out near your vehicle (for example: a vehicle leaving beside your vehicle, a vehicle parking or pulling out in the rear area, a vehicle approaching your vehicle making a turn, etc.). If this occurs, the system may unnecessarily warn the driver.

Always check your surroundings while backing up.

- When the vehicle is parked diagonally



OHY059019

[A] : Vehicle

Rear Cross-Traffic Safety system may be limited when backing up diagonally, and may not detect the vehicle approaching from the left or right. If this occurs, the system may not warn the driver when necessary.

Always check your surroundings while backing up.

- When the vehicle is on or near a slope

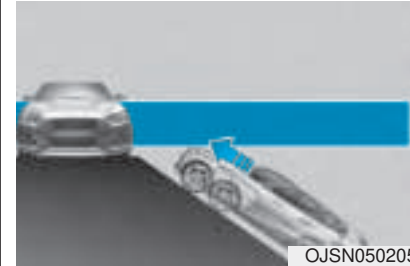

OJSN050205

Rear Cross-Traffic Safety system may be limited when the vehicle is on a uphill or downhill slope, or near it, and may not detect the vehicle approaching from the left or right. If this occurs, the system may not warn the driver when necessary.

Always check your surroundings while backing up.

- Pulling into the parking space where there is a structure

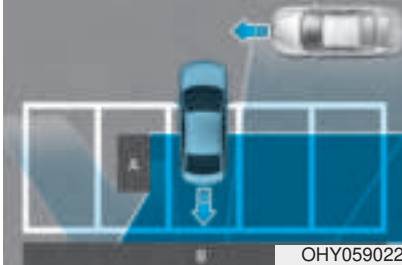

[A] : Structure, [B] : Wall

Rear Cross-Traffic Safety system may detect vehicles passing by in front of you when parking backwards into a parking space with a wall or structure in the rear or side area. If this occurs, the system may unnecessarily warn the driver.

Always check your surroundings while backing up.

- When the vehicle is parked rearward

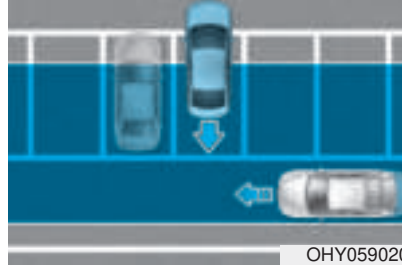

Rear Cross-Traffic Safety system may detect vehicles passing by behind you when parking backwards into a parking space. If this occurs, the system may unnecessarily warn the driver.

Always check your surroundings while backing up.

⚠ WARNING

- Rear Cross-Traffic Safety system may not operate normally if interfered by strong electromagnetic waves.
- Rear Cross-Traffic Safety system may not operate for 3 seconds after the vehicle is started, or the rear corner radars are initialized.

i Information

This device complies with Part 15 of the FCC rules.

Operation is subject to the following two conditions:

1. This device may not cause harmful interference.
2. This device must accept any interference received, including interference that may cause undesired operation.

SPECIAL DRIVING CONDITIONS

Hazardous Driving Conditions

When hazardous driving elements are encountered such as water, snow, ice, mud and sand, take the below suggestions:

- Drive cautiously and keep a longer braking distance.
- Avoid abrupt braking or steering.
- When your vehicle is stuck in snow, mud, or sand, use second gear. Accelerate slowly to avoid unnecessary wheel spin.
- Put sand, rock salt, tire chains or other non-slip materials under the wheels to provide additional traction while the vehicle becomes stuck in ice, snow, or mud.

Rocking the Vehicle

If it is necessary to rock the vehicle to free it from snow, sand, or mud, first turn the steering wheel right and left to clear the area around your front wheels. Then, shift back and forth between R (Reverse) and a forward gear.

Try to avoid spinning the wheels, and do not race the engine.

To prevent transmission wear, wait until the wheels stop spinning before shifting gears. Release the accelerator pedal while shifting, and press lightly on the accelerator pedal while the transmission is in gear. Slowly spinning the wheels in forward and reverse directions causes a rocking motion that may free the vehicle.

WARNING

If the vehicle is stuck and excessive wheel spin occurs, the temperature in the tires can increase very quickly. If the tires become damaged, a tire blow out or tire explosion can occur. This condition is dangerous - you and others may be injured. Do not attempt this procedure if people or objects are anywhere near the vehicle.

If you attempt to free the vehicle, the vehicle can overheat quickly, possibly causing damage to the engine and other components. Try to avoid spinning the wheels as much as possible to prevent overheating of either the tires or the engine. DO NOT allow the vehicle to spin the wheels above 35 mph (56 km/h).

i Information

The ESC system must be turned OFF before rocking the vehicle.

NOTICE

If you are still stuck after rocking the vehicle a few times, have the vehicle pulled out by a tow vehicle to avoid engine overheating, possible damage to the transmission, and tire damage. See "Towing" in chapter 6.

Smooth Cornering

Avoid braking or gear changing in corners, especially when roads are wet. Ideally, corners should always be taken under gentle acceleration.

Driving at Night

Night driving presents more hazards than driving in the daylight. Here are some important tips to remember:

- Slow down and keep more distance between you and other vehicles, as it may be more difficult to see at night, especially in areas where there may not be any street lights.
- Adjust your mirrors to reduce the glare from other driver's headlamps.
- Keep your headlamps clean and properly aimed. Dirty or improperly aimed headlamps will make it much more difficult to see at night.
- Avoid staring directly at the headlamps of oncoming vehicles. You could be temporarily blinded, and it will take several seconds for your eyes to readjust to the darkness.

Driving in the Rain

Rain and wet roads can make driving dangerous. Here are a few things to consider when driving in the rain or on slick pavement:

- Slow down and allow extra following distance. A heavy rainfall makes it harder to see and increases the distance needed to stop your vehicle.
- Turn OFF your Cruise Control.
- Replace your windshield wiper blades when they show signs of streaking or missing areas on the windshield.
- Tires should be properly maintained with at least 2/32nds of an inch of tread depth. If your tires do not have enough tread, making a quick stop on wet pavement can cause a skid and possibly lead to an accident. **See "Tire Replacement" in chapter 7.**
- Turn on your headlamps to make it easier for others to see you.

- Driving too fast through large puddles can affect your brakes. If you must go through puddles, try to drive through them slowly.
- If you believe your brakes may be wet, apply them lightly while driving until normal braking operation returns.

Hydroplaning

If the road is wet enough and you are going fast enough, your vehicle may have little or no contact with the road surface and actually ride on the water. The best advice is SLOW DOWN when the road is wet.

The risk of hydroplaning increases as the depth of tire tread decreases, refer to "Tire Replacement" in chapter 7.

Driving in Flooded Areas

Avoid driving through flooded areas unless you are sure the water is no higher than the bottom of the wheel hub. Drive through any water slowly. Allow adequate stopping distance because brake performance may be reduced.

After driving through water, dry the brakes by gently applying them several times while the vehicle is moving slowly.

Highway Driving

Tires

Adjust the tire inflation, as specified. Under-inflation may overheat or damage the tires.

Do not install worn-out or damaged tires, which may reduce traction or adversely affect vehicle handling. This could lead to sudden tire failure that may cause loss of vehicle control resulting in an accident.

Information

Never over-inflate your tires above the maximum inflation pressure, as specified on your tires.

Fuel, engine coolant and engine oil

Driving at higher speeds on the highway consumes more fuel and is less efficient than driving at a slower, more moderate speed. Maintain a moderate speed in order to conserve fuel when driving on the highway.

Be sure to check both the engine coolant level and the engine oil before driving.

Drive belt

A loose or damaged drive belt may overheat the engine.

WINTER DRIVING

The severe weather conditions of winter quickly wear out tires and cause other problems. To minimize winter driving problems, you should take the following suggestions:

Snow or Icy Conditions

You need to keep sufficient distance between your vehicle and the vehicle in front of you.

Apply the brakes gently. Speeding, rapid acceleration, sudden brake applications, and sharp turns are potentially very hazardous practices. During deceleration, use engine braking to the fullest extent. Sudden brake applications on snowy or icy roads may cause the vehicle to skid.

To drive your vehicle in deep snow, it may be necessary to use snow tires or to install tire chains on your tires.

Always carry emergency equipment. Some of the items you may want to carry include tire chains, tow straps or chains, a flashlight, emergency flares, sand, a shovel, jumper cables, a window scraper, gloves, ground cloth, coveralls, a blanket, etc.

Snow tires

We recommend you use snow tires when road temperature is below 45°F (7°C). Refer to the below chart, and mount the recommended snow tire for your vehicle.

Standard tire		Recommended snow tire	
Tire size	Wheel size	Tire size	Wheel size
225/40ZR18	7.5Jx18	225/40R18	7.5Jx18
235/35R19	8.0Jx19		

If you mount snow tires on your vehicle, make sure to use the same inflation pressure as the original tires. Mount snow tires on all four wheels to balance your vehicle's handling in all weather conditions. The traction provided by snow tires on dry road may not be as high as your vehicle's original equipment tires. Check with the tire dealer for maximum speed recommendations.

Information

Do not install studded tires without first checking local, state and municipal regulations for possible restrictions against their use.

Summer tires

- Summer tires are used to maximize the driving performance on dry roads.
- If the temperature is below 45°F (7°C) or you are driving on snowy or icy roads, the summer tires lose their brake performance and traction as the tire grip weakens significantly.
- If the temperature is below 45°F (7°C) or you are driving on snowy or icy roads, mount snow tires or all-season tires of the same size with your vehicle's standard tire for safe driving. Both snow and all-season tires have M+S markings.
- When using the M+S tires, use tires with the same tread produced by the same manufacturer for safe driving.
- When driving with the M+S tires with the lower maximum allowable speed than that of the vehicle's standard summer tire, be careful not to exceed the speed allowed for the M+S tires.

Tire chains

Since the sidewalls of radial tires are thinner than other types of tires, they may be damaged by mounting some types of tire chains on them.

Therefore the use of snow tires is preferred over the use of tire chains.

Do not mount tire chains on vehicles equipped with aluminum wheels; if unavoidable, use a wire or fabric type snow chain.

If the road and weather conditions require the use of tire chains, be sure to use tire chains that have been properly selected for the size of tire on your HYUNDAI vehicle.

Be sure to follow the guidelines and installation instructions provided from the tire chain manufacturer.

Damage to your vehicle caused by improper tire chain use is not covered by your vehicle manufacturer's warranty.

NOTICE

If your vehicle has 235/35R19 size tires, do not use tire chain; they can damage your vehicle (wheel, suspension and body).

WARNING

The use of tire chains may adversely affect vehicle handling:

- **Drive less than 20 mph (30 km/h) or the chain manufacturer's recommended speed limit, whichever is lower.**
- **Drive carefully and avoid bumps, holes, sharp turns, and other road hazards, which may cause the vehicle to bounce.**
- **Avoid sharp turns or locked wheel braking.**

Information

- **Install tire chains on both left and right front tires. It should be noted that installing tire chains on the tires will provide a greater driving force, but will not prevent side skids.**
- **Do not install studded tires without first checking local, state and municipal regulations for possible restrictions against their use.**



OJSN058036

Chain installation

When installing tire chains, follow the manufacturer's instructions and mount them as tightly possible. Drive slowly (less than 20 mph (30 km/h)) with chains installed. If you hear the chains contacting the body or chassis, stop and tighten them. If they still make contact, slow down until the noise stops. Remove the tire chains as soon as you begin driving on cleared roads.

When mounting snow chains, park the vehicle on level ground away from traffic. Turn on the vehicle Hazard Warning Flasher and place a triangular emergency warning device behind the vehicle (if available). Always place the vehicle in N (Neutral), apply the parking brake and turn off the engine before installing snow chains.

NOTICE

- When using tire chains:

- **Make sure to use the right size and type of snow chains for your tires. Incorrect snow chains can cause damage to the vehicle body and suspension. Damage to your vehicle caused by improper tire chain use is not covered by your vehicle manufacturer's warranty.**
- **If you hear noise caused by chains contacting the body, retighten the chain to prevent contact with the vehicle body.**
- **To prevent body damage, retighten the chains after driving 0.3~0.6 miles (0.5~1.0 km).**
- **Do not use tire chains on vehicles equipped with aluminum wheels. If unavoidable, use a wire type snow chain.**
- **Use wire chains less than 0.47 inch (12 mm) wide to prevent damage to the chain's connection.**

Winter Precautions

Use high quality ethylene glycol coolant

Your vehicle is delivered with high quality ethylene glycol coolant in the cooling system. It is the only type of coolant that should be used because it helps prevent corrosion in the cooling system, lubricates the water pump and prevents freezing. Be sure to replace or replenish your coolant in accordance with the maintenance schedule in chapter 7. Before winter, have your coolant tested to assure that its freezing point is sufficient for the temperatures anticipated during the winter.

Change to "winter weight" oil if necessary

In some climates it is recommended that a lower viscosity "winter weight" oil be used during cold weather. See chapter 8 for recommendations. If you aren't sure what weight oil you should use, consult an authorized HYUNDAI dealer.

Check battery and cables

Winter puts additional burdens on the battery system. Visually inspect the battery and cables as described in chapter 7. The level of charge in your battery can be checked by an authorized HYUNDAI dealer or a service station.

Check spark plugs and ignition system

Inspect your spark plugs as described in chapter 7 and replace them if necessary. Also check all ignition wiring and components to be sure they are not cracked, worn or damaged in any way.

Use approved window washer anti-freeze in system

To keep the water in the window washer system from freezing, add an approved window washer anti-freeze solution in accordance with instructions on the container. Window washer anti-freeze is available from an authorized HYUNDAI dealer and most auto parts outlets. Do not use engine coolant or other types of anti-freeze as these may damage the paint finish.

Do not let your parking brake freeze

Under some conditions your parking brake can freeze in the engaged position. This is most likely to happen when there is an accumulation of snow or ice around or near the rear brakes or if the brakes are wet. If there is a risk the parking brake may freeze, apply it only temporarily while you have parked the vehicle and blocked the rear wheels so the car cannot roll. Then release the parking brake.

Do not let ice and snow accumulate underneath

Under some conditions, snow and ice can build up under the fenders and interfere with the steering. When driving in severe winter conditions where this may happen, you should periodically check underneath the car to be sure the movement of the front wheels and the steering components is not obstructed.

Don't place foreign objects or materials in the engine compartment

Placement of foreign object or materials which prevent cooling of the engine, in the engine compartment, may cause a failure or combustion. The manufacturer is not responsible for the damage caused by such placement.

To keep locks from freezing

To keep the locks from freezing, squirt an approved de-icer fluid or glycerine into the key opening. If a lock is covered with ice, squirt it with an approved de-icing fluid to remove the ice. If the lock is frozen internally, you may be able to thaw it out by using a heated key. Handle the heated key with care to avoid injury.

VEHICLE LOAD LIMIT

Two labels on your driver's door sill show how much weight your vehicle was designed to carry: the Tire and Loading Information Label and the Certification Label.

Before loading your vehicle, familiarize yourself with the following terms for determining your vehicle's weight ratings, from the vehicle's specifications and the Certification Label:

Base Curb Weight

This is the weight of the vehicle including a full tank of fuel and all standard equipment. It does not include passengers, cargo, or optional equipment.

Vehicle Curb Weight

This is the weight of your new vehicle when you picked it up from your dealer plus any aftermarket equipment.

Cargo Weight

This figure includes all weight added to the Base Curb Weight, including cargo and optional equipment.

GAW (Gross Axle Weight)

This is the total weight placed on each axle (front and rear) - including vehicle curb weight and all payload.

GAWR (Gross Axle Weight Rating)

This is the maximum allowable weight that can be carried by a single axle (front or rear). These numbers are shown on the Certification Label. The total load on each axle must never exceed its GAWR.

GVW (Gross Vehicle Weight)

This is the Base Curb Weight plus actual Cargo Weight plus passengers.

GVWR (Gross Vehicle Weight Rating)

This is the maximum allowable weight of the fully loaded vehicle (including all options, equipment, passengers and cargo). The GVWR is shown on the Certification Label located on the driver's door sill.

Tire Loading Information Label

■ Type A

TIRE LOADING INFORMATION RENSEIGNEMENTS SUR LES PNEUS ET LE CHARGEMENT			
SEVERE DUTY MORSELS D'USURE		NORM. DUTY USURE	
The number of people and cargo should never exceed 14 (4) or 15 (5) respectively. Le nombre des occupants et du chargement ne doit jamais dépasser 14 (4) ou 15 (5).			
TYPE DE VOITURE	SEVERE DUTY MORSELS D'USURE	NORM. DUTY USURE	SET OVERS PNEUS, PNEUS D'USURE
TYPE DE VOITURE	SEVERE DUTY MORSELS D'USURE	NORM. DUTY USURE	SET OVERS PNEUS, PNEUS D'USURE
TYPE DE VOITURE	SEVERE DUTY MORSELS D'USURE	NORM. DUTY USURE	SET OVERS PNEUS, PNEUS D'USURE
TYPE DE VOITURE	SEVERE DUTY MORSELS D'USURE	NORM. DUTY USURE	SET OVERS PNEUS, PNEUS D'USURE

OBU060033N

■ Type B

TIRE LOADING INFORMATION RENSEIGNEMENTS SUR LES PNEUS ET LE CHARGEMENT			
SEVERE DUTY MORSELS D'USURE		NORM. DUTY USURE	
The number of people and cargo should never exceed 14 (4) or 15 (5) respectively. Le nombre des occupants et du chargement ne doit jamais dépasser 14 (4) ou 15 (5).			
TYPE DE VOITURE	SEVERE DUTY MORSELS D'USURE	NORM. DUTY USURE	SET OVERS PNEUS, PNEUS D'USURE
TYPE DE VOITURE	SEVERE DUTY MORSELS D'USURE	NORM. DUTY USURE	SET OVERS PNEUS, PNEUS D'USURE
TYPE DE VOITURE	SEVERE DUTY MORSELS D'USURE	NORM. DUTY USURE	SET OVERS PNEUS, PNEUS D'USURE
TYPE DE VOITURE	SEVERE DUTY MORSELS D'USURE	NORM. DUTY USURE	SET OVERS PNEUS, PNEUS D'USURE

OBU068034N

The label located on the driver's door sill gives the original tire size, cold tire pressures recommended for your vehicle, the number of people that can be in your vehicle and vehicle capacity weight.

Vehicle capacity weight

699 lbs. (317 kg)

Vehicle capacity weight is the maximum combined weight of occupants and cargo. If your vehicle is equipped with a trailer, the combined weight includes the tongue load.

Seating capacity

Total : 4 persons
(Front seat : 2 persons,
Rear seat : 2 persons)

Seating capacity is the maximum number of occupants including a driver, your vehicle may carry. However, the seating capacity may be reduced based upon the weight of all of the occupants, and the weight of the cargo being carried or towed. Do not overload the vehicle as there is a limit to the total weight, or load limit including occupants and cargo, the vehicle can carry.

Towing capacity

We do not recommend using this vehicle for trailer towing.

Cargo capacity

The cargo capacity of your vehicle will increase or decrease depending on the weight and the number of occupants and the tongue load, if your vehicle is equipped with a trailer.









Steps for determining correct load limit

1. Locate the statement "The combined weight of occupants and cargo should never exceed XXX kg or XXX lbs." on your vehicle's placard.
2. Determine the combined weight of the driver and passengers that will be riding in your vehicle.
3. Subtract the combined weight of the driver and passengers from XXX kg or XXX lbs.
4. The resulting figure equals the available amount of cargo and luggage load capacity. For example, if the "XXX" amount equals 1400 lbs. and there will be five 150 lb passengers in your vehicle, the amount of available cargo and luggage load capacity is 650 lbs. (eg. 1400 - 750 = 650 lbs.)

5. Determine the combined weight of luggage and cargo being loaded on the vehicle. That weight may not safely exceed the available cargo and luggage load capacity calculated in Step 4.
6. If your vehicle will be towing a trailer, load from your trailer will be transferred to your vehicle. Consult this manual to determine how this reduces the available cargo and luggage load capacity of your vehicle.

WARNING

Do not overload the vehicle as there is a limit to the total weight, or load limit, including occupants and cargo, the vehicle can carry. Overloading can shorten the life of the vehicle. If the GVWR or the GAWR is exceeded, parts on the vehicle can break, and it can change the handling of your vehicle. These could cause you to lose control and result in an accident.

<p>Example 1</p>	 <p>Maximum Load (1400 lbs.) (635 kg)</p>	\geq	 <p>Passenger Weight (150 lbs. \times 2 = 300 lbs.) (68 kg \times 2 = 136 kg)</p>	$+$	 <p>Cargo Weight (1100 lbs.) (499 kg)</p>
<p>Example 2</p>	 <p>Maximum Load (1400 lbs.) (635 kg)</p>	\geq	 <p>Passenger Weight (150 lbs. \times 5 = 750 lbs.) (68 kg \times 5 = 340 kg)</p>	$+$	 <p>Cargo Weight (650 lbs.) (295 kg)</p>
<p>Example 3</p>	 <p>Maximum Load (1400 lbs.) (635 kg)</p>	\geq	 <p>Passenger Weight (172 lbs. \times 5 = 860 lbs.) (78 kg \times 5 = 390 kg)</p>	$+$	 <p>Cargo Weight (540 lbs.) (245 kg)</p>

Certification label



The certification label is located on the driver's door sill at the center pillar and shows the maximum allowable weight of the fully loaded vehicle. This is called the GVWR (Gross Vehicle Weight Rating). The GVWR includes the weight of the vehicle, all occupants, fuel and cargo.

This label also tells you the maximum weight that can be supported by the front and rear axles, called Gross Axle Weight Rating (GAWR).

The total weight of the vehicle, including all occupants, accessories, cargo, and trailer tongue load must not exceed the Gross Vehicle Weight Rating (GVWR) or the Gross Axle Weight Rating (GAWR). To find out the actual loads on your front and rear axles, you need to go to a weigh station and weigh your vehicle. Be sure to spread out your load equally on both sides of the centerline.

WARNING

Overloading

- Never exceed the GVWR for your vehicle, the GAWR for either the front or rear axle and vehicle capacity weight. Exceeding these ratings can affect your vehicle's handling and braking ability, and cause an accident.
- Do not overload your vehicle. Overloading your vehicle can cause heat buildup in your vehicle's tires and possible tire failure, increased stopping distances and poor vehicle handling—all of which may result in a crash.

NOTICE

Overloading your vehicle may cause damage. Repairs would not be covered by your warranty. Do not overload your vehicle.

 **WARNING**

If you carry items inside your vehicle (e.g., suitcases, tools, packages, or anything else), they are moving as fast as the vehicle. If you have to stop or turn quickly, or if there is a crash, the items will keep going and can cause an injury if they strike the driver or a passenger.

- Put items in the cargo area of your vehicle. Try to spread the weight evenly.
- Do not stack items, like suitcases, inside the vehicle above the tops of the seats.
- Do not leave an unsecured child restraint in your vehicle.
- When you carry something inside the vehicle, secure it.

TRAILER TOWING

We do not recommend using this vehicle for trailer towing.

What to do in an emergency

Hazard Warning Flasher	6-2	Towing	6-21
In Case of an Emergency While Driving.....	6-2	Towing Service.....	6-21
If the Engine Stalls While Driving	6-2	Dinghy towing.....	6-22
If the Engine Stalls at a Crossroad or Crossing.....	6-2	Removable Towing Hook.....	6-22
If you Have a Flat Tire While Driving	6-3	Emergency Towing.....	6-23
If the Engine Will Not Start.....	6-3	Tie-down Hook.....	6-25
If the Engine Doesn't Turn Over			
or Turns Over Slowly.....	6-3		
If the Engine Turns Over Normally but			
Doesn't Start	6-3		
Jump Starting.....	6-4		
If the Engine Overheats.....	6-6		
Tire Pressure Monitoring System (TPMS).....	6-8		
Check Tire Pressure	6-8		
Tire Pressure Monitoring System	6-9		
Low Tire Pressure Telltale	6-10		
Low Tire Pressure LCD Display with			
Position Indicator	6-10		
TPMS Malfunction Indicator	6-11		
Changing a Tire with TPMS.....	6-12		
If You Have a Flat Tire.....	6-14		
With Tire Mobility Kit (TMK).....	6-14		

HAZARD WARNING FLASHER



The hazard warning flasher serves as a warning to other drivers to exercise extreme caution when approaching, overtaking, or passing your vehicle.

It should be used whenever emergency repairs are being made or when the vehicle is stopped near the edge of a roadway.

To turn the hazard warning flasher on or off, press the hazard warning flasher button. The button is located in the center fascia panel. Both the left and right turn signal lights will flash simultaneously.

- The hazard warning flasher operates whether your vehicle is running or not.
- The turn signals do not work when the hazard flasher is on.

IN CASE OF AN EMERGENCY WHILE DRIVING

If the Engine Stalls While Driving

- Reduce your speed gradually, keeping a straight line. Move cautiously off the road to a safe place.
- Turn on your hazard warning flasher.
- Try to start the engine again. If your vehicle will not start, contact an authorized HYUNDAI dealer or seek other qualified assistance.

If the Engine Stalls at a Crossroad or Crossing

If the engine stalls at a crossroads or crossing, if safe to do so, move the shift lever to the N (Neutral) position and then push the vehicle to a safe location.

If you Have a Flat Tire While Driving

If a tire goes flat while you are driving:

- Take your foot off the accelerator pedal and let the vehicle slow down while driving straight ahead. Do not apply the brakes immediately or attempt to pull off the road as this may cause loss of vehicle control resulting in an accident. When the vehicle has slowed to such a speed that it is safe to do so, brake carefully and pull off the road. Drive off the road as far as possible and park on firm, level ground. If you are on a divided highway, do not park in the median area between the two traffic lanes.
- When the vehicle is stopped, press the hazard warning flasher button, move the shift lever into N (Neutral), and apply the parking brake, and place the ignition switch in the LOCK/OFF position.
- Have all passengers get out of the vehicle. Be sure they all get out on the side of the vehicle that is away from traffic.
- When changing a flat tire, follow the instructions provided later in this chapter.

IF THE ENGINE WILL NOT START

If the Engine Doesn't Turn Over or Turns Over Slowly

- Be sure the shift lever is in N (Neutral). The engine starts only when the shift lever is in N (Neutral).
- Check the battery connections to be sure they are clean and tight.
- Turn on the interior light. If the light dims or goes out when you operate the starter, the battery is drained.

Do not push or pull the vehicle to start it. This could cause damage to your vehicle. See instructions for "Jump Starting" provided in this chapter.

CAUTION

Push or pull starting the vehicle may cause the catalytic converter to overload which can lead to damage to the emission control system.

If the Engine Turns Over Normally but Doesn't Start

Check the fuel level and add fuel if necessary.

If the engine still does not start, have your vehicle checked by an authorized HYUNDAI dealer.

JUMP STARTING

Jump starting can be dangerous if done incorrectly. Follow the jump starting procedure in this section to avoid serious injury or damage to your vehicle. If in doubt about how to properly jump start your vehicle, we strongly recommend that you have a service technician or towing service do it for you.

WARNING

To prevent **SERIOUS INJURY** or **DEATH** to you or bystanders, always follow these precautions when working near or handling the battery:



Always read and follow instructions carefully when handling a battery.



Wear eye protection designed to protect the eyes from acid splashes.



Keep all flames, sparks, or smoking materials away from the battery.



Hydrogen is always present in battery cells, is highly combustible, and may explode if ignited.



Keep batteries out of reach of children.



Batteries contain sulfuric acid which is highly corrosive. Do not allow acid to contact your eyes, skin or clothing.

If acid gets into your eyes, flush your eyes with clean water for at least 15 minutes and get immediate medical attention. If acid gets on your skin, thoroughly wash the area. If you feel pain or a burning sensation, get medical attention immediately.

- When lifting a plastic-cased battery, excessive pressure on the case may cause battery acid to leak. Lift with a battery carrier or with your hands on opposite corners.
- Do not attempt to jump start your vehicle if your battery is frozen.
- **NEVER** attempt to recharge the battery when the vehicle's battery cables are connected to the battery.

- The electrical ignition system works with high voltage. **NEVER** touch these components with the engine running or when the ignition switch is in the ON position.

i Information



An inappropriately disposed battery can be harmful to the environment and human health. Dispose of the battery according to your local law(s) or regulations.

NOTICE

To prevent damage to your vehicle:

- Only use a 12-volt power supply (battery or jumper system) to jump start your vehicle.
- Do not attempt to jump start your vehicle by push-starting.

Jump starting procedure

1. Position the vehicles close enough that the jumper cables will reach, but do not allow the vehicles to touch.
2. Avoid fans or any moving parts in the engine compartment at all times, even when the vehicles are turned off.
3. Turn off all electrical devices such as radios, lights, air conditioning, etc. Put the vehicles in N (Neutral) and set the parking brakes. Turn both vehicles OFF.

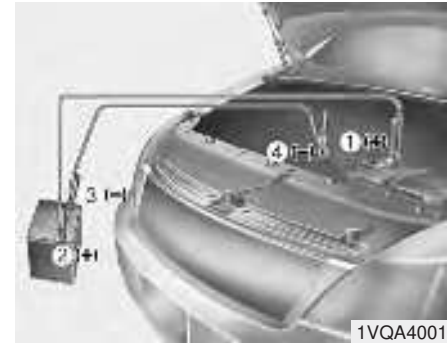

4. Connect the jumper cables in the exact sequence shown in the illustration. First connect one jumper cable to the red, positive (+) jumper terminal of your vehicle (1).
5. Connect the other end of the jumper cable to the red, positive (+) battery/jumper terminal of the assisting vehicle (2).
6. Connect the second jumper cable to the black, negative (-) battery/chassis ground of the assisting vehicle (3).

7. Connect the other end of the second jumper cable to the black, negative (-) chassis ground of your vehicle (4).

Do not allow the jumper cables to contact anything except the correct battery or jumper terminals or the correct ground. Do not lean over the battery when making connections.

8. Start the engine of the assisting vehicle and let it run at approximately 2,000 rpm for a few minutes. Then start your vehicle.

If your vehicle will not start after a few attempts, it probably requires servicing. In this event please seek qualified assistance. If the cause of your battery discharging is not apparent, have your vehicle checked by an authorized HYUNDAI dealer.

Disconnect the jumper cables in the exact reverse order you connected them:

1. Disconnect the jumper cable from the black, negative (-) chassis ground of your vehicle (4).
2. Disconnect the other end of the jumper cable from the black, negative (-) battery/chassis ground of the assisting vehicle (3).
3. Disconnect the second jumper cable from the red, positive (+) battery/jumper terminal of the assisting vehicle (2).
4. Disconnect the other end of the jumper cable from the red, positive (+) jumper terminal of your vehicle (1).

IF THE ENGINE OVERHEATS

If your temperature gage indicates overheating, you experience a loss of power, or hear loud pinging or knocking, the engine may be overheating. If this happens, you should:

1. Pull off the road and stop as soon as it is safe to do so.
2. Place the shift lever in N (Neutral) and set the parking brake. If the air conditioning is ON, turn it OFF.
3. If engine coolant is running out under the vehicle or steam is coming out from the hood, stop the engine. Do not open the hood until the coolant has stopped running or the steaming has stopped. If there is no visible loss of engine coolant and no steam, leave the engine running and check to be sure the engine cooling fan is operating. If the fan is not running, turn the engine off.

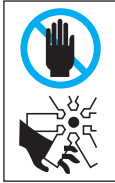
⚠ WARNING

While the engine is running, keep hands, clothing and tools away from the moving parts such as the cooling fan and drive belt to prevent serious injury.

4. Check for coolant leaking from the radiator, hoses or under the vehicle. (If the air conditioning had been in use, it is normal for cold water to be draining from it when you stop.)
5. If engine coolant is leaking out, stop the engine immediately and call the nearest authorized HYUNDAI dealer for assistance.

⚠ WARNING

Your vehicle is equipped with a pressurized coolant reserve tank. **NEVER** remove the engine coolant reservoir tank/radiator cap or the drain plug while the engine and radiator are **HOT**. Hot coolant and steam may blow out under pressure, causing serious injury.

Turn the engine off and wait until the engine cools down. Use extreme care when removing the engine coolant reservoir tank/radiator cap. Wrap a towel or thick rag around it, and turn it counterclockwise slowly to release some of the pressure from the system. Step back while the pressure is released.

When you are sure all the pressure has been released, continue turning the cap counterclockwise to remove it.

6. If you cannot find the cause of the overheating, wait until the engine temperature has returned to normal. Then, if coolant has been lost, carefully add coolant to the reservoir to bring the fluid level in the reservoir up to the halfway mark.
7. Proceed with caution, keeping alert for further signs of overheating. If overheating happens again, call an authorized HYUNDAI dealer for assistance.

⚠ CAUTION

Serious loss of coolant indicates a leak in the cooling system and should be checked as soon as possible by an authorized HYUNDAI dealer.

TIRE PRESSURE MONITORING SYSTEM (TPMS)



OJSN068003



OJS068004L

- (1) Low Tire Pressure / TPMS Malfunction Indicator Lamp
- (2) Low Tire Pressure / Tire Pressure Monitor / TPMS Malfunction Display (shown on the cluster LCD display)

6-8

Check Tire Pressure



OBU040119N

- You can check the tire pressure in the Assist mode on the cluster.
Refer to the "LCD Display Mode" section in chapter 3.
- A "Drive to display" message will appear for the first few minutes of driving after initial engine start up. If the tire pressure is not displayed after a few minutes of driving, check the tire pressures.

- The displayed tire pressure values may differ from those measured with a tire pressure gage.
- You can change the tire pressure unit in the User Settings mode on the cluster.
 - psi, kpa, bar (**Refer to the "User Settings Mode" section in chapter 3).**)

Tire Pressure Monitoring System

WARNING

Over-inflation or under-inflation can reduce tire life, adversely affect vehicle handling, and lead to sudden tire failure that may cause loss of vehicle control resulting in an accident.

Each tire, including the spare (if provided), should be checked monthly when cold and inflated to the inflation pressure recommended by the vehicle manufacturer on the vehicle placard or tire inflation pressure label. A cold tire means the vehicle has been sitting for 3 hours and driven for less than 1 mile (1.6 km) in that 3 hour period.

Allow the tire to cool before measuring the inflation pressure. Always be sure the tire is cold before inflating to the recommended pressure. If your vehicle has tires of a different size than the size indicated on the vehicle placard or tire inflation pressure label, you should determine the proper tire inflation pressure for those tires.

As an added safety feature, your vehicle has been equipped with a tire pressure monitoring system (TPMS) that illuminates a low tire pressure telltale when one or more of your tires is significantly under-inflated. Accordingly, when the low tire pressure telltale illuminates, you should stop and check your tires as soon as possible, and inflate them to the proper pressure. Driving on a significantly under-inflated tire causes the tire to overheat and can lead to tire failure.

Under-inflation also reduces fuel efficiency and tire tread life, and may affect the vehicle's handling and stopping ability.

Please note that the TPMS is not a substitute for proper tire maintenance, and it is the driver's responsibility to maintain correct tire pressure, even if under-inflation has not reached the level to trigger illumination of the TPMS low tire pressure telltale.

Your vehicle has also been equipped with a TPMS malfunction indicator to indicate when the system is not operating properly. The TPMS malfunction indicator is combined with the low tire pressure telltale. When the system detects a malfunction, the telltale will flash for approximately one minute and then remain continuously illuminated. This sequence will continue upon subsequent vehicle start-ups as long as the malfunction exists.

When the malfunction indicator is illuminated, the system may not be able to detect or signal low tire pressure as intended. TPMS malfunctions may occur for a variety of reasons, including the installation of replacement or alternate tires or wheels on the vehicle that prevent the TPMS from functioning properly.

Always check the TPMS malfunction telltale after replacing one or more tires or wheels on your vehicle to ensure that the replacement or alternate tires and wheels allow the TPMS to continue to function properly.

NOTICE

If any of the below happens, have the system checked by an authorized HYUNDAI dealer.

1. The Low Tire Pressure TPMS Malfunction Indicator does not illuminate for 3 seconds when the ignition switch is placed to the ON position or engine is running.
2. The TPMS Malfunction Indicator remains illuminated after blinking for approximately 1 minute.
3. The Low Tire Pressure LCD display remains illuminated



Low Tire Pressure
Telltale



OJS068006L

Low Tire Pressure
LCD Display with
Position Indicator

When the tire pressure monitoring system warning indicators are illuminated and the warning message is displayed on the cluster LCD display, one or more of your tires is significantly under-inflated. The LCD position indicator will indicate which tire is significantly under-inflated by illuminating the corresponding position light.

If any of your tire pressures are indicated as being low, immediately reduce your speed, avoid hard cornering, and anticipate increased stopping distances. You should stop and check your tires as soon as possible. Inflate the tires to the proper pressure as indicated on the vehicle's placard or tire inflation pressure label located on the driver's side center pillar outer panel.

The Low Tire Pressure LCD position indicator will remain on and the TPMS Malfunction Indicator may blink for one minute and then remain illuminated until you have the low pressure tire repaired and replaced on the vehicle.

 **CAUTION**

In winter or cold weather, the Low Tire Pressure Telltale may be illuminated if the tire pressure was adjusted to the recommended tire inflation pressure in warm weather. It does not mean your TPMS is malfunctioning because the decreased temperature leads to a proportional lowering of tire pressure.

When you drive your vehicle from a warm area to a cold area or from a cold area to a warm area, or the outside temperature is greatly higher or lower, you should check the tire inflation pressure and adjust the tires to the recommended tire inflation pressure.

 **WARNING****Low pressure damage**

Significantly low tire pressure makes the vehicle unstable and can contribute to loss of vehicle control and increased braking distances.

Continued driving on low pressure tires can cause the tires to overheat and fail.

**TPMS Malfunction Indicator**

The TPMS Malfunction Indicator will illuminate after it blinks for approximately one minute when there is a problem with the Tire Pressure Monitoring System.

Have the system checked by an authorized HYUNDAI dealer as soon as possible.

NOTICE

If there is a malfunction with the TPMS, the individual tire pressures in the cluster LCD display will not be available. Have the system checked by an authorized HYUNDAI dealer as soon as possible.

NOTICE

The TPMS Malfunction Indicator may illuminate after blinking for one minute if the vehicle is near electric power supply cables or radio transmitters such as police stations, government and public offices, broadcasting stations, military installations, airports, transmitting towers, etc.

Additionally, the TPMS Malfunction Indicator may illuminate if snow chains are used or electronic devices such as computers, chargers, remote starters, navigation, etc. This may interfere with normal operation of the TPMS.

Changing a Tire with TPMS

If you have a flat tire, the Low Tire Pressure and LCD position indicator will come on. Have the flat tire repaired by an authorized HYUNDAI dealer as soon as possible.

CAUTION

Never use a puncture-repairing agent not approved by HYUNDAI dealer to repair and/or inflate a low pressure tire. Tire sealant not approved by HYUNDAI dealer may damage the tire pressure sensor.

Once the original tire equipped with a tire pressure monitoring sensor is reinflated to the recommended pressure and reinstalled on the vehicle, the Low Tire Pressure LCD position indicator and TPMS Malfunction Indicator will go off within a few minutes of driving.

If the indicators do not disappear after a few minutes, please visit an authorized HYUNDAI dealer.

Each wheel is equipped with a tire pressure sensor mounted inside the tire behind the valve stem. You must use TPMS specific wheels. It is recommended that you always have your tires serviced by an authorized HYUNDAI dealer.

You may not be able identify a tire with low pressure by simply looking at it. Always use a good quality tire pressure gage to measure the tire's inflation pressure. Please note that a tire that is hot (from being driven) will have a higher pressure measurement than a tire that is cold.

A cold tire means the vehicle has been sitting for 3 hours and driven for less than 1 mile (1.6 km) in that 3 hour period.

Allow the tire to cool before measuring the inflation pressure. Always be sure the tire is cold before inflating to the recommended pressure.

⚠ WARNING

- The TPMS cannot alert you to severe and sudden tire damage caused by external factors such as nails or road debris.
- If you feel any vehicle instability, immediately take your foot off the accelerator, apply the brakes gradually with light force, and slowly move to a safe position off the road.

⚠ WARNING

Tampering with, modifying, or disabling the Tire Pressure Monitoring System (TPMS) components may interfere with the system's ability to warn the driver of low tire pressure conditions and/or TPMS malfunctions. Tampering with, modifying, or disabling the Tire Pressure Monitoring System (TPMS) components may void the warranty for that portion of the vehicle.

i Information

This device complies with Part 15 of the FCC rules.

Operation is subject to the following three conditions:

1. This device may not cause harmful interference.
2. This device must accept any interference received, including interference that may cause undesired operation.
3. Changes or modifications not expressly approved by the party responsible for compliance could void the user's authority to operate the equipment.

IF YOU HAVE A FLAT TIRE With Tire Mobility Kit (TMK)



For safe operation, carefully read and follow the instructions in this manual before use.

- (1) Compressor
- (2) Sealant bottle

The Tire Mobility Kit is a temporary fix to the tire and the tire should be inspected by an authorized HYUNDAI dealer as soon as possible.

CAUTION

One sealant bottle for one tire

When two or more tires are flat, do not use the tire mobility kit because the supported one sealant of Tire Mobility Kit is only used for one flat tire.

WARNING

Tire wall

Do not use the Tire Mobility Kit to repair punctures in the tire walls. This can result in an accident due to tire failure.

WARNING

Temporary fix

Have your tire repaired as soon as possible. The tire may lose air pressure at any time after inflating with the Tire Mobility Kit.

Introduction

With the Tire Mobility Kit you stay mobile even after experiencing a tire flat.

The compressor and sealing compound system effectively and comfortably seals most small punctures in a passenger car tire caused by nails or similar objects and reinflates the tire.

After you ensure that the tire is properly sealed you can drive cautiously on the tire (distance up to 120 miles (200 km)) at a max. speed of (50 mph (80 km/h)) in order to reach a service station or tire dealer for the tire replacement.

It is possible that some tires, especially with larger punctures, cannot be sealed completely.

Air pressure loss in the tire may adversely affect tire performance.

For this reason, you should avoid abrupt steering or other driving maneuvers, especially if the vehicle is heavily loaded or if a trailer is in use.

The Tire Mobility Kit is not designed or intended as a permanent tire repair method and is to be used for one tire only.

This instruction shows you step by step how to temporarily seal the puncture simply and reliably.

Read the section "Notes on the safe use of the Tire Mobility Kit".

Notes on the safe use of the Tire Mobility Kit

- Park your car at the side of the road so that you can work with the Tire Mobility Kit away from moving traffic.
- To be sure your vehicle will not move, even when you're on fairly level ground, always set your parking brake.
- Only use the Tire Mobility Kit for sealing/inflation passenger car tires. Only punctured areas located within the tread region of the tire can be sealed using the tire mobility kit.
- Do not use on motorcycles, bicycles or any other type of tires.
- When the tire and wheel are damaged, do not use Tire Mobility Kit for your safety.
- Use of the Tire Mobility Kit may not be effective for tire damage larger than approximately 0.24 inch (6 mm).

Please contact the nearest HYUNDAI dealership if the tire cannot be made roadworthy with the Tire Mobility Kit.

- Do not use the Tire Mobility Kit if a tire is severely damaged by driving run flat or with insufficient air pressure.
- Do not remove any foreign objects such as nails or screws that have penetrated the tire.
- Provided the car is outdoors, leave the engine running. Otherwise operating the compressor may eventually drain the car battery.
- Never leave the Tire Mobility Kit unattended while it is being used.
- Do not leave the compressor running for more than 10 minutes at a time or it may overheat.
- Do not use the Tire Mobility Kit if the ambient temperature is below -22°F (-30°C).
- In case of skin contact with the sealant, wash the area thoroughly with plenty of water. If the irritation persists, seek medical attention.
- In case of eye contact with the sealant, flush your eyes for at least 15 minutes. If the irritation persists, seek medical attention.

- In case of swallowing the sealant, rinse the mouth and drink plenty of water. However, never give anything to an unconscious person and seek medical attention immediately.
- Long time exposure to the sealant may cause damage to bodily tissue such as kidney, etc.

Components of the Tire Mobility Kit

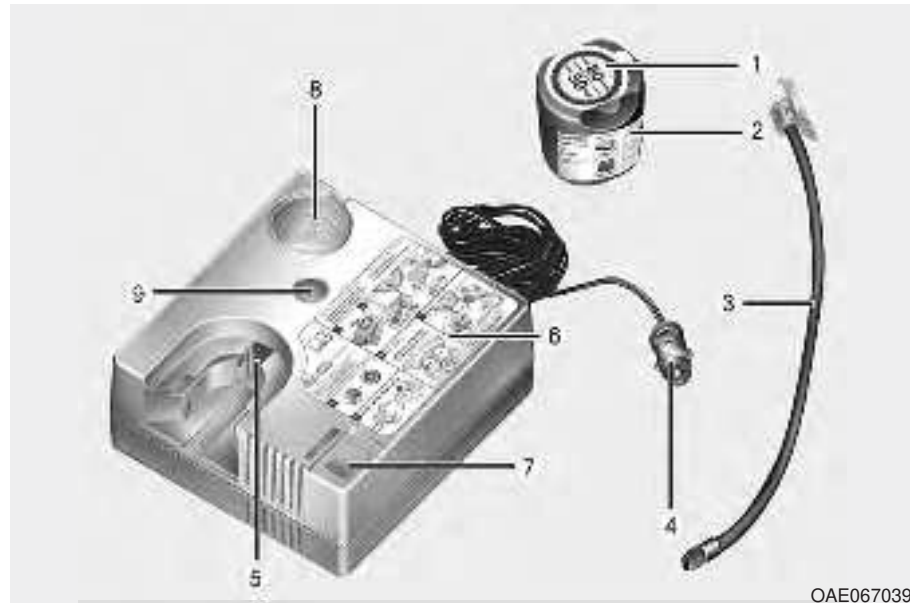

OAE067039

1. Speed restriction label
2. Sealant bottle and label with speed restriction
3. Filling hose from sealant bottle to wheel
4. Connectors and cable for power outlet direct connection
5. Holder for the sealant bottle
6. Compressor
7. ON/OFF switch

8. Pressure gauge for displaying the tire inflation pressure
9. Button for reducing tire inflation pressure

Connectors, cable and connection hose are stored in the compressor housing.

Strictly follow the specified sequence, otherwise the sealant may escape under high pressure.

WARNING

Do not use the tire sealant after the sealant has expired (i.e. pasted the expiration date on the sealant container). This can increase the risk of tire failure.

WARNING

- Keep out of reach of children.
- Avoid contact with eyes.
- Do not swallow.

Using the Tire Mobility Kit

CAUTION



Detach the speed restriction label (1) from the sealant bottle (2), and place it in a highly visible place inside the vehicle such as on the steering wheel to remind the driver not to drive too fast.

1. Shake the sealant bottle (2).



2. Screw the filling hose (3) onto the connector of the sealant bottle (2).
3. Insert the sealant bottle into the housing of the compressor (5) so that the bottle is upright.
4. Ensure that the button (9) on the compressor is not pressed.



5. Unscrew the valve cap from the valve of the defective wheel and screw the filling hose (3) of the sealant bottle onto the valve.
6. Ensure that the compressor is switched OFF.

CAUTION

Securely install the sealant filling hose to the valve. If not, sealant may flow backward, possibly clogging the filling hose.

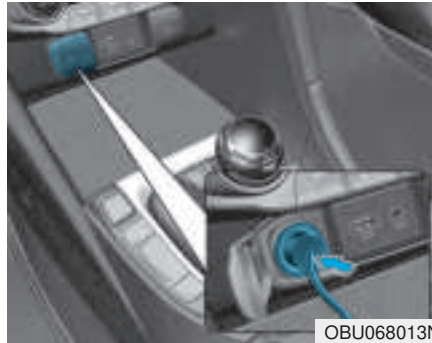

7. Plug the compressor power cord (4) into the vehicle power outlet.
8. With the vehicle ON, switch on the compressor and let it run for approximately 5~7 minutes to fill the sealant up to proper pressure. (refer to the Tire and Wheels, chapter 8). The inflation pressure of the tire after filling is unimportant and will be checked/corrected later.

Be careful not to overinflate the tire and stay away from the tire when filling it.

CAUTION

Do not attempt to drive your vehicle if the tire pressure is below 30 psi (210 kPa). This could result in an accident due to sudden tire failure.

9. Switch off the compressor.
10. Detach the hoses from the sealant bottle connector and from the tire valve.

Return the Tire Mobility Kit to its storage location in the vehicle.

WARNING

Do not leave your vehicle running in a poorly ventilated area for extended periods of time. Carbon monoxide poisoning and suffocation can occur.

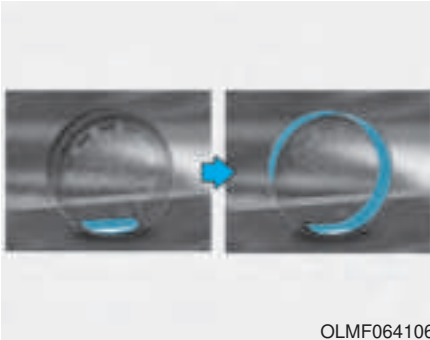

OLMF064106

Distributing the sealant

11. Immediately drive approximately 4~6 miles (7~10 km or about 10 minutes) to evenly distribute the sealant in the tire.

Do not exceed a speed of 50 mph (80 km/h). If possible, do not fall below a speed of 12 mph (20 km/h).

While driving, if you experience any unusual vibration, ride disturbance or noise, reduce your speed and drive with caution until you can safely pull off of the side of the road.

Call for road side service or towing. When you use the Tire Mobility Kit, the tire pressure sensors and wheel may be damaged by sealant, have it inspected at an authorized dealer.

Checking the tire inflation pressure

1. After driving approximately 4~6 miles (7~10 km or about 10 minutes), stop at a safe location.

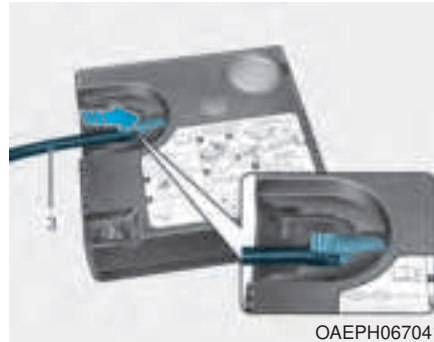

OAEPH067041

2. Connect the filling hose (3) directly into the compressor.



OJSN068012

3. Connect the other end of the filling hose (3) directly into the tire valve.
4. Plug the compressor power cord (4) into the vehicle power outlet.

5. Adjust the tire inflation pressure to the recommended tire inflation.

With the ignition switched on, proceed as follows.

- **To increase the inflation pressure:**

Switch on the compressor. To check the current inflation pressure setting, briefly switch off the compressor.

- **To reduce the inflation pressure:**

Press the button (9) on the compressor.

i Information

The pressure gauge may show higher than actual reading when the compressor is running. To get an accurate tire pressure, the compressor needs to be turned off.

⚠ CAUTION

When you use the Tire Mobility Kit including sealant not approved by HYUNDAI, the tire pressure sensors may be damaged by sealant.

The sealant on the tire pressure sensor and wheel should be removed when you replace the tire with a new one and inspect the tire pressure sensors at an authorized dealer.

i Information

When reinstalling the repaired or replaced tire and wheel on the vehicle, tighten the wheel lug nut to 79~94 lbf·ft (11~13 kgf·m).

TOWING

Towing Service

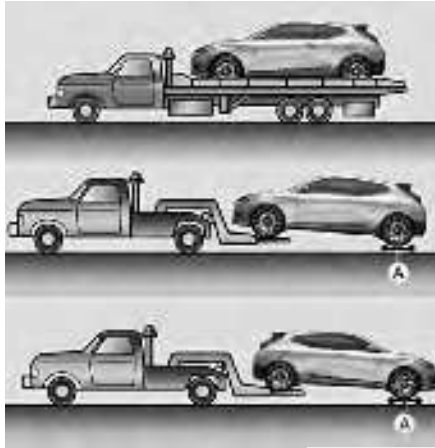

OJSN068008L

[A] : Dollies

If emergency towing is necessary, we recommend having it done by an authorized HYUNDAI dealer or a commercial tow-truck service. Proper lifting and towing procedures are necessary to prevent damage to the vehicle. The use of wheel dollies or flatbed is recommended.

On FWD vehicles, it is acceptable to tow the vehicle with the rear wheels on the ground (without dollies) and the front wheels off the ground. If any of the loaded wheels or suspension components are damaged or the vehicle is being towed with the front wheels on the ground, use a towing dolly under the front wheels.

When being towed by a commercial tow truck and wheel dollies are not used, the front of the vehicle should always be lifted, not the rear.

CAUTION

- Do not tow the vehicle with the front wheels on the ground as this may cause damage to the vehicle.



- Do not tow with sling-type equipment. Use a wheel lift or flatbed equipment.



⚠ WARNING

If your vehicle is equipped with a rollover sensor, place the ignition switch in the LOCK/OFF or ACC position when the vehicle is being towed. The side impact and curtain air bag may deploy if the sensor detects the situation as a rollover.

When towing your vehicle in an emergency without wheel dollies:

1. Place the ignition switch in the ACC position.
2. Place the shift lever in N (Neutral).
3. Release the parking brake.

⚠ CAUTION

Failure to place the shift lever in N (Neutral) when being towed with the front wheels on the ground can cause internal damage to the transmission.

Dinghy towing



Your vehicle is not designed to be dinghy towed (with 4 wheels on the ground) behind a motor home. To avoid serious damage to your vehicle, do not tow your vehicle with four wheels on the ground.

Removable Towing Hook

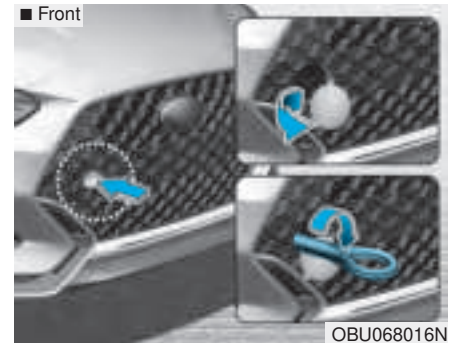

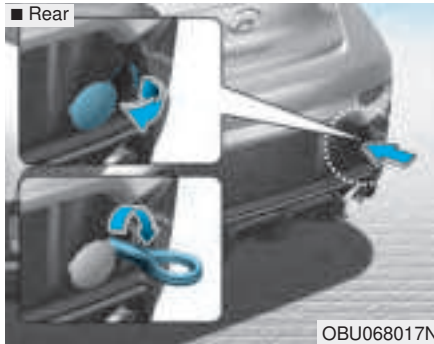

1. Open the liftgate, and remove the towing hook from the tool case.
2. Remove the hole cover pressing the lower part of the cover on the front or rear bumper.
3. Install the towing hook by turning it clockwise into the hole until it is fully secured.
4. Remove the towing hook and install the cover after use.

Emergency Towing

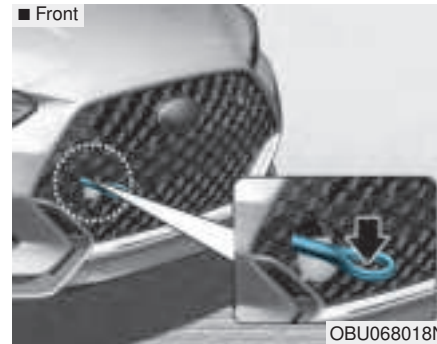

If towing is necessary, we recommend you have it done by an authorized HYUNDAI dealer or a commercial tow truck service.

If a towing service is not available in an emergency, your vehicle may be temporarily towed using a cable or chain secured to the emergency towing hook at the front (or rear) of the vehicle.

Use extreme caution when towing the vehicle with a cable or chain. A driver must be in the vehicle to steer it and operate the brakes.

Towing in this manner may be done only on hard-surfaced roads for a short distance and at low speeds. Also, the wheels, axles, power train, steering and brakes must all be in good condition.

CAUTION

The driver must be in the vehicle for steering and braking operations when the vehicle is being towed. Passengers other than the driver must not be in the vehicle.

What to do in an emergency

Always follow these emergency towing precautions:

- Place the ignition switch in the ACC position so the steering wheel is not locked. (if equipped)
- Place the shift lever in N (Neutral).
- Release the parking brake.
- Depress the brake pedal with more force than normal since you will have reduced braking performance.
- More steering effort will be required because the power steering system will be disabled.
- Use a vehicle heavier than your own to tow your vehicle.
- The drivers of both vehicles should communicate with each other frequently.
- Before emergency towing, check that the hook is not broken or damaged.
- Fasten the towing cable or chain securely to the hook.
- Do not jerk the hook. Apply steady and even force.

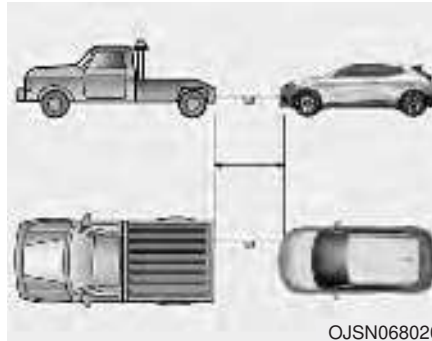

- Use a towing cable or chain less than 16 feet (5 m) long. Attach a white or red cloth (about 12 inch (30 cm) wide) in the middle of the cable or chain for easy visibility.
- Drive carefully so the towing cable or chain remains tight during towing.
- The vehicle should be towed at a speed of 15 mph or less within the distance of 12 mph.

NOTICE

Accelerate or decelerate the vehicle in a slow and gradual manner while maintaining tension on the tow rope or chain to start or drive the vehicle, otherwise tow hooks and the vehicle may be damaged.

NOTICE

To avoid damage to your vehicle and vehicle components when towing:

- **Always pull straight ahead when using the towing hooks. Do not pull from the side or at a vertical angle.**
- **Do not use the towing hooks to pull a vehicle out of mud, sand or other conditions from which the vehicle cannot be driven out under its own power.**

Tie-down Hook

WARNING

Do not use the tie-down hook(s) for towing purposes. If the tie-down hook(s) are used for towing, the tie-down hook(s) or bumper will be damaged and this could lead to serious injury.

Maintenance

Engine Compartment	7-3	Air Cleaner	7-24
Maintenance Services	7-4	Filter Replacement.....	7-24
Owner's Responsibility.....	7-4	Climate Control Air Filter	7-25
Owner Maintenance Precautions.....	7-4	Filter Inspection.....	7-25
Owner Maintenance	7-5	Wiper Blades.....	7-26
Owner Maintenance Schedule.....	7-6	Blade Inspection.....	7-26
Scheduled Maintenance Services.....	7-7	Blade Replacement.....	7-26
Normal Maintenance Schedule.....	7-8	Battery.....	7-29
Maintenance Under Severe Usage Conditions.....	7-11	For Best Battery Service	7-30
Explanation of Scheduled Maintenance		Battery Recharging	7-30
Items	7-13	Reset Features.....	7-31
Engine Oil.....	7-16	Tires and Wheels	7-32
Checking the Engine Oil Level.....	7-16	Tire Care.....	7-33
Checking the Engine Oil and Filter.....	7-17	Recommended Cold Tire Inflation Pressures.....	7-33
Engine Coolant	7-18	Check Tire Inflation Pressure	7-34
Checking the Engine Coolant Level.....	7-18	Tire Rotation.....	7-35
Changing Engine Coolant.....	7-21	Wheel Alignment and Tire Balance	7-36
Brake/Clutch Fluid.....	7-22	Tire Replacement	7-36
Checking the brake/clutch Fluid Level.....	7-22	Wheel Replacement	7-37
Washer Fluid.....	7-23	Tire Traction	7-37
Checking the Washer Fluid Level.....	7-23	Tire Maintenance.....	7-37
Parking Brake.....	7-23	Tire Sidewall Labeling.....	7-37
Checking the Parking Brake.....	7-23		

Tire Terminology and Definitions.....	7-41
All Season Tires.....	7-44
Summer Tires.....	7-44
Snow Tires.....	7-45
Radial-Ply Tires.....	7-45
Low Aspect Ratio Tires.....	7-45
Fuses.....	7-47
Instrument Panel Fuse Replacement.....	7-48
Engine Compartment Panel Fuse Replacement.....	7-49
Fuse/Relay Panel Description.....	7-51
Light Bulbs.....	7-61
Headlamp, Parking lamp, Daytime Running Light, Turn signal lamp and Side marker.....	7-62
Side Repeater Lamp Replacement.....	7-65
Rear Combination Light Bulb Replacement.....	7-65
High Mounted Stop Lamp Replacement.....	7-68
License Plate Light Bulb Replacement.....	7-68
Interior Light Bulb Replacement.....	7-68
Appearance Care.....	7-70
Exterior Care.....	7-70
Interior Care.....	7-75
Emission Control System.....	7-78
Crankcase Emission Control System.....	7-78
Evaporative Emission Control System Including Onboard Refueling Vapor Recovery (ORVR).....	7-78
Exhaust Emission Control System.....	7-79
California Perchlorate Notice.....	7-82

ENGINE COMPARTMENT

■ Gasoline Engine (2.0 T-GDI)

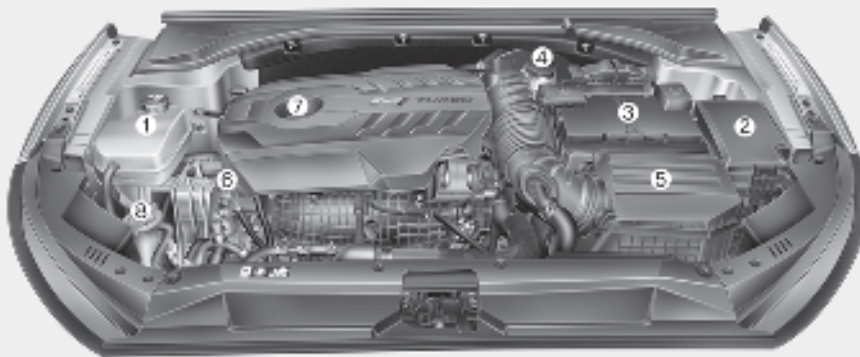

1. Engine coolant reservoir
2. Fuse box
3. Battery
4. Brake/clutch fluid reservoir
5. Air cleaner
6. Engine oil dipstick
7. Engine oil filler cap
8. Windshield washer fluid reservoir

The actual engine compartment in the vehicle may differ from the illustration.

OJSN078001

MAINTENANCE SERVICES

You should exercise the utmost care to prevent damage to your vehicle and injury to yourself whenever performing any maintenance or inspection procedures.

We recommend you have your vehicle maintained and repaired by an authorized HYUNDAI dealer. An authorized HYUNDAI dealer meets HYUNDAI's high service quality standards and receives technical support from HYUNDAI in order to provide you with a high level of service satisfaction.

Owner's Responsibility

Maintenance service and record retention are the owner's responsibility.

You should retain documents that show proper maintenance has been performed on your vehicle in accordance with the scheduled maintenance service charts shown on the following pages. You need this information to establish your compliance with the servicing and maintenance requirements of your vehicle warranties.

Detailed warranty information is provided in your Owner's Handbook & Warranty Information booklet.

Repairs and adjustments required as a result of improper maintenance or a lack of required maintenance are not covered.

Owner Maintenance Precautions

Inadequate, incomplete or insufficient servicing may result in operational problems with your vehicle that could lead to vehicle damage, an accident, or personal injury. This chapter provides instructions only for the maintenance items that are easy to perform. Several procedures can be done only by an authorized HYUNDAI dealer with special tools.

Your vehicle should not be modified in any way. Such modifications may adversely affect the performance, safety or durability of your vehicle and may, in addition, violate conditions of the limited warranties covering the vehicle.

Certain modifications may also be in violation of regulations established by the U.S. Department of Transportation and other federal or state agencies.

NOTICE

Improper owner maintenance during the warranty period may affect warranty coverage. For details, read the separate Owner's Handbook & Warranty Information booklet provided with the vehicle. If you're unsure about any service or maintenance procedure, have it done by an authorized HYUNDAI dealer.

OWNER MAINTENANCE

WARNING

Performing maintenance work on a vehicle can be dangerous. If you lack sufficient knowledge and experience or the proper tools and equipment to do the work, have it done by an authorized HYUNDAI dealer.

ALWAYS follow these precautions for performing maintenance work:

- Park your vehicle on level ground, move the shift lever into the N (Neutral), apply the parking brake, place the ignition switch in the LOCK/OFF position.
- Block the tires (front and back) to prevent the vehicle from moving.

Remove loose clothing or jewelry that can become entangled in moving parts.

- **If you must run the engine during maintenance, do so out doors or in an area with plenty of ventilation.**
- **Keep flames, sparks, or smoking materials away from the battery and fuel-related parts.**

The following lists are vehicle checks and inspections that should be performed by the owner or an authorized HYUNDAI dealer at the frequencies indicated to help ensure safe, dependable operation of your vehicle.

Any adverse conditions should be brought to the attention of your dealer as soon as possible.

These Owner Maintenance vehicle checks are generally not covered by warranties and you may be charged for labor, parts and lubricants used.

Owner Maintenance Schedule

When you stop for fuel:

- Check the engine oil level.
- Check the coolant level in the engine coolant reservoir.
- Check the windshield washer fluid level.
- Check the for low or under-inflated tires.

WARNING

Be careful when checking your engine coolant level when the engine is hot. This may result in coolant being blown out of the opening and cause serious burns and other injuries.

While operating your vehicle:

- Note any changes in the sound of the exhaust or any smell of exhaust fumes in the vehicle.
- Check for vibrations in the steering wheel. Notice if there is any increased steering effort or looseness in the steering wheel, or change in its straight-ahead position.
- Notice if your vehicle constantly turns slightly or "pulls" to one side when traveling on smooth, level road.
- When stopping, listen and check for unusual sounds, pulling to one side, increased brake pedal travel or "hard-to-push" brake pedal.
- If any slipping or changes in the operation of your transmission occurs, check the transmission fluid level.
- Check the parking brake.
- Check for fluid leaks under your vehicle (water dripping from the air conditioning system during or after use is normal).

At least monthly:

- Check coolant level in the engine coolant reservoir.
- Check the operation of all exterior lights, including the brake lights, turn signals and hazard warning flashers.
- Check the inflation pressures of all tires including the spare for tires that are worn, show uneven wear, or are damaged.
- Check for loose wheel lug nuts.

At least twice a year: (i.e., every Spring and Autumn)

- Check radiator, heater and air conditioning hoses for leaks or damage.
- Check windshield washer spray and wiper operation. Clean wiper blades with a clean cloth dampened with washer a fluid.
- Check headlamp alignment.
- Check muffler, exhaust pipes, shields and clamps.
- Check the seat belts for wear and function.

At least once a year:

- Clean body and door drain holes.
- Lubricate door hinges and hood hinges.
- Lubricate door and hood locks and latches.
- Lubricate door rubber weather strips.
- Lubricate door checker.
- Check the air conditioning system.
- Clean the battery and terminals.
- Check the brake fluid level.

SCHEDULED MAINTENANCE SERVICES

Follow Normal Maintenance Schedule if the vehicle is usually operated where none of the following conditions apply. If any of the following conditions apply, you must follow the Maintenance Under Severe Usage Conditions.

- Repeated short distance driving.
- Driving in dusty conditions or sandy areas.
- Extensive use of brakes.
- Driving in areas where salt or other corrosive materials are used.
- Driving on rough or muddy roads.
- Driving in mountainous areas.
- Extended periods of idling or low speed operation.
- Driving for a prolonged period in cold temperatures and/or extremely humid climates.
- More than 50% driving in heavy city traffic during hot weather above 90°F (32°C).

- Engine oil usage which is not recommended (Mineral type, Semi-synthetic, lower grade spec, etc.)

For additional information or assistance see your authorized HYUNDAI dealer.

Normal Maintenance Schedule

MAINTENANCE INTERVALS MAINTENANCE ITEM	Number of months or driving distance, whichever comes first															
	Months	12	24	36	48	60	72	84	96	108	120	132	144	156	168	180
	Miles×1,000	6	12	18	24	30	36	42	48	54	60	66	72	78	84	90
	Km×1,000	10	20	30	40	50	60	70	80	90	100	110	120	130	140	150
Engine oil and engine oil filter	R	R	R	R	R	R	R	R	R	R	R	R	R	R	R	R
Fuel additives *1	Add every 6,000 miles (10,000 km) or 12 months															
Rotate tires	Rotate every 6,000 miles (10,000 km)															
Climate control air filter (for evaporator and blower unit)	Replace every 12,000 miles (20,000 km) or 12 months															
Air cleaner filter		I		R		I		R		I		R		I		
Spark plugs	Replace every 42,000 miles (70,000 km)															
Drive belts *2	At first, inspect at 60,000 miles (100,000 km) or 72 months, after that, inspect every 15,000 miles (24,000 km) or 24 months															
Valve clearance *3	Inspect every 60,000 miles (96,000 km) or 72 months															
Vacuum hose	I	I	I	I	I	I	I	I	I	I	I	I	I	I	I	

I : Inspect and if necessary, adjust, correct, clean or replace.

R : Replace or change.

*1 : If TOP TIER Detergent Gasoline is not available, one bottle of additive is recommended. Additives are available from your authorized HYUNDAI dealer along with information on how to use them. Do not mix other additives.

*2 : The drive belt should be replaced when cracks occur or tension is reduced.

*3 : Inspect for excessive valve noise and/or engine vibration and adjust if necessary. Have an authorized HYUNDAI dealer perform the operation.

Normal Maintenance Schedule (CONT)

MAINTENANCE INTERVALS MAINTENANCE ITEM	Number of months or driving distance, whichever comes first															
	Months	12	24	36	48	60	72	84	96	108	120	132	144	156	168	180
	Miles×1,000	6	12	18	24	30	36	42	48	54	60	66	72	78	84	90
	Km×1,000	10	20	30	40	50	60	70	80	90	100	110	120	130	140	150
Engine coolant	At first, replace at 120,000 miles (200,000 km) or 10 years after that, replace every 24,000 miles (40,000 km) or 24 months															
Intercooler, in/out hose, air intake hose	At first, Inspect at 5,000 miles(8,000km) or 6 months After that, Inspect every 20,000 miles (32,000km) or 24 months															
Battery condition	I	I	I	I	I	I	I	I	I	I	I	I	I	I	I	I
Brake lines, hoses and connections	I	I	I	I	I	I	I	I	I	I	I	I	I	I	I	I
Front brake disc/pads, calipers	I	I	I	I	I	I	I	I	I	I	I	I	I	I	I	I
Rear brake disc/pads	I	I	I	I	I	I	I	I	I	I	I	I	I	I	I	I
Steering gear rack, linkage and boots / lower arm ball joint, upper arm ball joint	I	I	I	I	I	I	I	I	I	I	I	I	I	I	I	I
Driveshaft and boots	I	I	I	I	I	I	I	I	I	I	I	I	I	I	I	I
Suspension mounting bolts	I	I	I	I	I	I	I	I	I	I	I	I	I	I	I	I
Air conditioner refrigerant	I	I	I	I	I	I	I	I	I	I	I	I	I	I	I	I
Air conditioner compressor	I	I	I	I	I	I	I	I	I	I	I	I	I	I	I	I
Exhaust pipe and muffler	I	I	I	I	I	I	I	I	I	I	I	I	I	I	I	I

I : Inspect and if necessary, adjust, correct, clean or replace.

R : Replace or change.

Normal Maintenance Schedule (CONT)

MAINTENANCE INTERVALS MAINTENANCE ITEM	Number of months or driving distance, whichever comes first															
	Months	12	24	36	48	60	72	84	96	108	120	132	144	156	168	180
	Miles×1,000	6	12	18	24	30	36	42	48	54	60	66	72	78	84	90
	Km×1,000	10	20	30	40	50	60	70	80	90	100	110	120	130	140	150
Manual transmission fluid																
Dual clutch transmission (DCT) fluid	Inspect every 60,000km (40,000miles) or 48 months															
Vapor hose, fuel filler cap and fuel tank																
Fuel tank air filter *4																
Fuel filter *4																
Fuel lines, hoses and connections																
Parking brake																
Brake/Clutch fluid	Inspect every 15,000 miles (24,000 km) or 12 months, Replace every 60,000 miles (96,000 km) or 48 months															

I : Inspect and if necessary, adjust, correct, clean or replace.

R : Replace or change.

*4 : Fuel filter & Fuel tank air filter are considered to be maintenance free but periodic inspection is recommended for this maintenance schedule depends on fuel quality. If there are some important safety matters like fuel flow restriction, surging, loss of power, hard starting problem, etc. replace the fuel filter immediately regardless of maintenance schedule and consult an authorized HYUNDAI dealer for details.

Maintenance Under Severe Usage Conditions

The following items must be serviced more frequently on cars normally used under severe driving conditions. Refer to the chart below for the appropriate maintenance intervals.

R : Replace or change.

I : Inspect and if necessary, adjust, correct, clean or replace.

MAINTENANCE ITEM	MAINTENANCE OPERATION	MAINTENANCE INTERVALS	DRIVING CONDITION
Engine oil and filter	R	Every 3,000 miles (5,000 km) or 6 months	A, B, C, D, E, F, G, H, I, J, K, L
Air cleaner filter	I	More frequently	C, E
Spark plugs	R	More frequently	A, B, F, G, H, I, K
Manual transmission fluid	R	Every 72,000 miles (120,000 km)	C, D, E, F, G, H, I, J
Dual clutch transmission (DCT) fluid	R	Every 62,000 miles (100,000 km)	A, C, D, E, F, G, H, I, J
Front brake disc/pads, calipers	I	More frequently	C, D, E, G, H
Rear brake disc/pads	I	More frequently	C, D, E, G, H
Parking brake	I	More frequently	C, D, G, H

MAINTENANCE ITEM	MAINTENANCE OPERATION	MAINTENANCE INTERVALS	DRIVING CONDITION
Steering gear box, linkage & boots/ Lower arm ball joint, upper arm ball joint	I	More frequently	C, D, E, F, G
Drive shafts and boots	I	More frequently	C, D, E, F, G, H, I, J
Climate control air filter (for evaporator and blower unit)	R	More frequently	C, E, G

Severe driving conditions

- A- Repeatedly driving short distances of less than 5 miles (8 km) in normal temperature or less than 10 miles (16 km) in freezing temperature
- B- Extensive engine idling or low speed driving for long distances
- C- Driving on rough, dusty, muddy, unpaved, graveled or salt-spread roads
- D- Driving in areas using salt or other corrosive materials or in very cold weather

- E- Driving in heavy dust conditions
- F- Driving in heavy traffic area
- G- Driving on uphill, downhill, or mountain road
- H- Towing a trailer, or using a camper, or roof rack
- I - Driving as a patrol car, taxi, other commercial use or vehicle towing
- J - Driving over 106 mph (170 km/h)
- K- Frequently driving in stop-and-go conditions
- L : Engine oil usage which is not recommended (Mineral type, Semi-synthetic, lower grade spec, etc.)

EXPLANATION OF SCHEDULED MAINTENANCE ITEMS

Engine Oil and Filter

The engine oil and filter should be changed at the intervals specified in the maintenance schedule. If the vehicle is being driven in severe conditions, more frequent oil and filter changes are required.

Drive Belts

Inspect all drive belts for evidence of cuts, cracks, excessive wear or oil saturation and replace if necessary. Drive belts should be checked periodically for proper tension and adjusted as necessary.

Fuel Filter

A clogged-up fuel filter may limit the vehicle driving speed, damage the emission system, and cause the hard starting. When a considerable amount of foreign substances are accumulated in the fuel tank, the fuel filter should be replaced.

Upon installing a new fuel filter, operate the engine for several minutes, and check the connections for any leakages. Fuel filters should be installed by an authorized HYUNDAI dealer.

Fuel Lines, Fuel Hoses and Connections

Check the fuel lines, fuel hoses and connections for leakage and damage. Have an authorized HYUNDAI dealer replace any damaged or leaking parts immediately.

Vapor Hose and Fuel Filler Cap

The vapor hose and fuel filler cap should be inspected at those intervals specified in the maintenance schedule. Make sure a new vapor hose or fuel filler cap is correctly replaced.

Vacuum Crankcase Ventilation Hoses (if equipped)

Inspect the surface of hoses for evidence of heat and/or mechanical damage. Hard and brittle rubber, cracking, tears, cuts, abrasions, and excessive swelling indicate deterioration. Particular attention should be paid to examine those hose surfaces nearest to high heat sources, such as the exhaust manifold.

Inspect the hose routing to ensure that the hoses do not come in contact with any heat source, sharp edges or moving component which might cause heat damage or mechanical wear. Inspect all hose connections, such as clamps and couplings, to make sure they are secure, and that no leaks are present. Hoses should be replaced immediately if there is any evidence of deterioration or damage.

Air Cleaner Filter

A genuine HYUNDAI air cleaner filter is recommended when the filter is replaced.

Spark Plugs

Make sure to install new spark plugs of the correct heat range.

Cooling System

Check cooling system components, such as radiator, coolant reservoir, hoses and connections for leakage and damage. Replace any damaged parts.

Engine Coolant

The coolant should be changed at the intervals specified in the maintenance schedule.

CAUTION

The use of a non-specified fluid could result in transmission malfunction and failure. Use only the specified transmission fluid (refer to "Recommended Lubricants and Capacities" in chapter 8).

Manual Transmission Fluid

Inspect the manual transmission fluid according to the maintenance schedule.

Brake Hoses and Lines

Visually check for proper installation, chafing, cracks, deterioration and any leakage. Replace any deteriorated or damaged parts immediately.

Brake/Clutch Fluid

Check the brake/clutch fluid level in the brake/clutch fluid reservoir. The level should be between the MIN and the MAX marks on the side of the reservoir. Use only hydraulic brake/clutch fluid conforming to DOT 3 or DOT 4 specification.

Parking Brake

Inspect the parking brake system including the parking brake pedal and cables.

Brake Discs, Pads, Calipers and Rotors

Check the pads for excessive wear, discs for run out and wear, and calipers for fluid leakage.

Exhaust Pipe and Muffler

Visually inspect the exhaust pipes, muffler and hangers for cracks, deterioration, or damage. Start the engine and listen carefully for any exhaust gas leakage. Tighten connections or replace parts as necessary.

Suspension Mounting Bolts

Check the suspension connections for looseness or damage. Retighten to the specified torque.

Steering Gear Box, Linkage & Boots/Lower Arm Ball Joint

With the vehicle stopped and the engine off, check for excessive free-play in the steering wheel. Check the linkage for bends or damage. Check the dust boots and ball joints for deterioration, cracks, or damage.

Replace any damaged parts.

Drive Shafts and Boots

Check the drive shafts, boots and clamps for cracks, deterioration, or damage. Replace any damaged parts and, if necessary, repack the grease.

Air Conditioning Refrigerant

Check the air conditioning lines and connections for leakage and damage.

ENGINE OIL

Checking the Engine Oil Level

1. Follow all of the oil manufacturer's precautions.
2. Be sure the vehicle is on the level ground in N (Neutral) with the parking brake set. If possible, block the wheels.
3. Turn the engine on and allow the engine to reach normal operating temperature.
4. Turn the engine off and wait about ten minutes for the oil to return to the oil pan.
5. Pull the dipstick out, wipe it clean, and re-insert it fully.



OPDE076067

6. Pull the dipstick out again and check the level. The level should be between F and L.



OJSN078006

7. If it is near or at L, add enough oil to bring the level to F.

Use only the specified engine oil. (refer to "Recommended Lubricants and Capacities" in chapter 8).

NOTICE

To prevent damage to your engine:

- Do not overfill with engine oil. Add oil in small quantities and recheck level to ensure engine is not overfilled.
- Do not spill engine oil when adding or changing engine oil. Use a funnel to help prevent oil from being spilled on engine components. Wipe off spilled oil immediately.

Checking the Engine Oil and Filter



Have engine oil and filter changed by an authorized HYUNDAI dealer according to the Maintenance Schedule at the beginning of this chapter.

WARNING

CALIFORNIA PROPOSITION 65 WARNING

Engine oil contains chemicals known to the State of California to cause cancer, birth defects and reproductive harm. Used engine oil may cause irritation or cancer of the skin if left in contact with the skin for prolonged periods of time. Always protect your skin by washing your hands thoroughly with soap and warm water as soon as possible after handling used oil.

ENGINE COOLANT

The high-pressure cooling system has a reservoir filled with year-round antifreeze coolant. The reservoir is filled at the factory.

Check the antifreeze protection and coolant level at least once a year, at the beginning of the winter season and before traveling to a colder climate.

NOTICE

- **When the engine overheats from low engine coolant, suddenly adding engine coolant may cause cracks in the engine. To prevent damage, add engine coolant slowly in small quantities.**
- **Do not drive with no engine coolant. It may cause water pump failure and engine seizure, etc.**

Checking the Engine Coolant Level

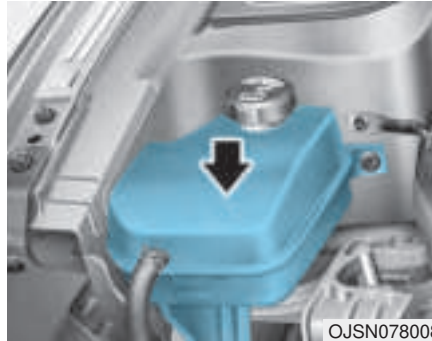

Check the condition and connections of all cooling system hoses and heater hoses. Replace any swollen or deteriorated hoses.

The coolant level should be filled between MAX and MIN (or F (Full) and L (Low)) marks on the side of the coolant reservoir when the engine is cool.

If the coolant level is low, add enough distilled (deionized) water to bring the level to the F mark, but do not overfill. If frequent additions are required, see an authorized HYUNDAI dealer for a cooling system inspection.

Recommended engine coolant

- When adding coolant, use only distilled (deionized) water for your vehicle and never mix hard water in the coolant filled at the factory.
- An improper coolant mixture can result in severe malfunction or engine damage.
- The engine in your vehicle has aluminum engine parts and must be protected by an ethylene-glycol with phosphate based coolant to prevent corrosion and freezing.
- Do not use alcohol or methanol coolant or mix them with the specified coolant.
- Do not use a solution that contains more than 60% antifreeze or less than 35% antifreeze, which would reduce the effectiveness of the solution.

For mixing percentage, refer to the following table:

Ambient Temperature	Mixture Percentage (volume)	
	Antifreeze	Water
5°F (-15°C)	35	65
-13°F (-25°C)	40	60
-31°F (-35°C)	50	50
-49°F (-45°C)	60	40

i Information

If in doubt about the mix ratio, a 50% water and 50% antifreeze mix is the easiest to mix together as it will be the same quantity of each. It is suitable to use for most temperature ranges of - 31°F and higher.

⚠ WARNING

Make sure the coolant cap is properly closed after refilling coolant. Otherwise the engine could be overheated while driving.

■ Engine room front view

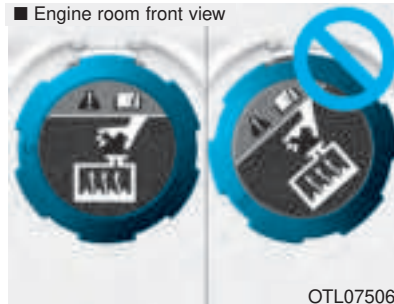

OTL075062

1. Check if the coolant cap label is straight in front.



OPDE076071

2. Make sure that the tiny protrusions inside the coolant cap is securely interlocked.



⚠ WARNING



Never remove the engine coolant cap or the drain plug while the engine and radiator are hot. Hot coolant and steam may blow out under pressure, causing serious injury.

Turn the engine off and wait until the engine cools down. Use extreme care when removing the engine coolant cap. Wrap a thick towel around it, and turn it counterclockwise slowly to the first stop. Step back while the pressure is released from the cooling system. When you are sure all the pressure has been released, press down on the cap, using a thick towel, and continue turning counterclockwise to remove it.

⚠ WARNING



The electric motor for the cooling fan may continue to operate or start up when the engine is not running and can cause serious injury. Keep hands, clothing and tools away from the rotating fan blades of the cooling fan.

The electric motor for the cooling fan is controlled by engine coolant temperature, refrigerant pressure and vehicle speed. As the engine coolant temperature decreases, the electric motor will automatically shut off. This is a normal condition. If your vehicle is equipped with GDI, the electric motor for the cooling fan may begin to operate at any time and continue to operate until you disconnect the negative battery cable.

Changing Engine Coolant

Have coolant changed by an authorized HYUNDAI dealer according to the Maintenance Schedule at the beginning of this chapter.

WARNING

Do not use engine coolant or antifreeze in the washer fluid reservoir.

Engine coolant can severely obscure visibility when sprayed on the windshield and may cause loss of vehicle control resulting in an accident.

Engine coolant may also cause damage to paint and body trim.

NOTICE

To prevent damage to engine parts, put a thick towel around the radiator cap before refilling the coolant to prevent the coolant from overflowing into engine parts, such as the alternator.

BRAKE/CLUTCH FLUID

Checking the brake/clutch Fluid Level



Check the fluid level in the reservoir periodically. The fluid level should be between MAX and MIN marks on the side of the reservoir.

Before removing the reservoir cap and adding brake/clutch fluid, clean the area around the reservoir cap thoroughly to prevent brake/clutch fluid contamination.

If the level is low, add the specified brake/clutch fluid to the MAX level. The level will fall with accumulated mileage. This is a normal condition associated with the wear of the brake/clutch linings. If the fluid level is excessively low, have the brake/clutch system checked by an authorized HYUNDAI dealer.

WARNING

If the brake/clutch system requires frequent additions of fluid this could indicate a leak in the brake/clutch system. Have the vehicle inspected by an authorized HYUNDAI dealer.

WARNING

Do not allow brake/clutch fluid to come in contact with your eyes. If brake/clutch fluid comes in contact with your eyes, flush your eyes with clean water for at least 15 minutes and get immediate medical attention.

NOTICE

- Do not allow brake/clutch fluid to contact the vehicle's body paint, as paint damage will result.
- Brake/clutch fluid, which has been exposed to open air for an extended time should NEVER be used as its quality cannot be guaranteed. It should be disposed of properly.
- Do not use the wrong kind of brake/clutch fluid. A few drops of mineral based oil, such as engine oil, in your brake/clutch system can damage system parts.

Information

Use only the specified brake/clutch fluid (refer to "Recommended Lubricants and Capacities" in chapter 8).

WASHER FLUID

Checking the Washer Fluid Level



Check the fluid level in the washer fluid reservoir and add fluid if necessary. Plain water may be used if washer fluid is not available. However, use washer solvent with antifreeze characteristics in cold climates to prevent freezing.

WARNING

To prevent serious injury or death, take the following safety precautions when using washer fluid:

- Do not use engine coolant or antifreeze in the washer fluid reservoir.
- Engine coolant can severely obscure visibility when sprayed on the windshield and may cause loss of vehicle control resulting in an accident or damage to paint and body trim.
- Do not allow sparks or flames to contact the washer fluid or the washer fluid reservoir. Washer fluid may contain alcohol and can be flammable.
 - Do not drink washer fluid and avoid contact with skin. Washer fluid is harmful to humans and animals.
 - Keep washer fluid away from children and animals.

PARKING BRAKE

Checking the Parking Brake



Check the stroke of the parking brake by counting the number of "clicks" heard while fully applying it from the released position. Also, the parking brake alone should securely hold the vehicle on a fairly steep grade. If the stroke is more or less than specified, have the parking brake adjusted by an authorized HYUNDAI dealer.

Stroke : 5~7 clicks at a force of 44 lbs (20 kg, 196 N)

AIR CLEANER

Filter Replacement

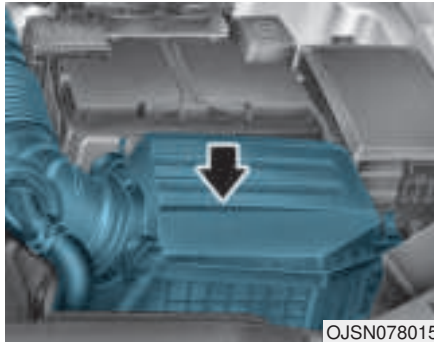

The air cleaner filter can be cleaned for inspection using compressed air. Do not attempt to wash or to rinse it, as water will damage the filter. If soiled, the air cleaner filter must be replaced.



1. Loosen the air cleaner cover attaching clips and open the cover.
2. Wipe the inside of the air cleaner.

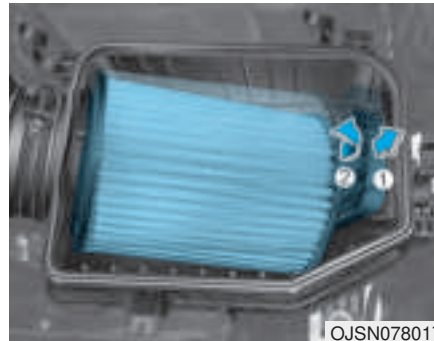

3. Replace the air cleaner filter.

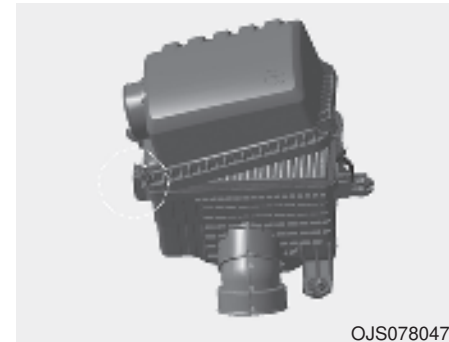

4. Insert the air cleaner cover in the hinge and engage the clamp after closing the cover.
5. Check that the cover is firmly installed.

i Information

If the vehicle is operated in extremely dusty or sandy areas, replace the element more often than the usual recommended intervals (refer to "Maintenance Under Severe Usage Conditions" in this chapter).

NOTICE

- Do not drive with the air cleaner filter removed. This will result in excessive engine wear.
- When removing the air cleaner filter, be careful that dust or dirt does not enter the air intake, or damage may result.
- Use HYUNDAI genuine parts. Use of non-genuine parts could damage the air flow sensor.

CLIMATE CONTROL AIR FILTER

Filter Inspection

The climate control air filter should be replaced according to the Maintenance Schedule. If the vehicle is operated in severely air-polluted cities or on dusty rough roads for a long period, it should be inspected more frequently and replaced earlier. When you replace the climate control air filter, replace it performing the following procedure, and be careful to avoid damaging other components.



1. With the glove box open, remove the stoppers on both sides to allow the glove box to hang freely on the hinges.

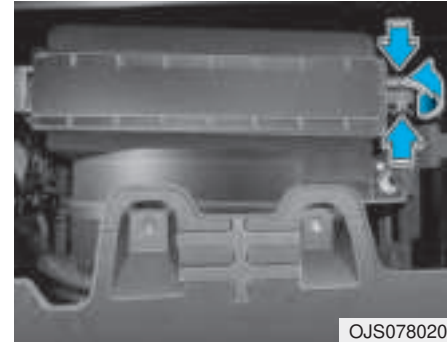

2. Remove the climate control air filter case while pressing the lock on the right side of the cover.

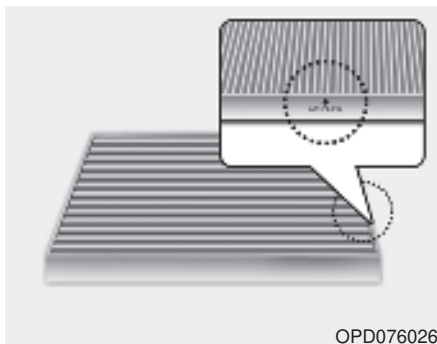

OPD076026

3. Replace the climate control air filter.
4. Reassemble in the reverse order of disassembly.

NOTICE

Install a new climate control air filter in the correct direction with the arrow symbol (↓) facing downwards, otherwise, it may be noisy and the effectiveness of the filter may be reduced.

WIPER BLADES

Blade Inspection

Contamination of either the windshield or the wiper blades with foreign matter can reduce the effectiveness of the windshield wiper functionality. Common sources of contamination are insects, tree sap, and hot wax treatments used by some commercial car washes. If the blades are not wiping properly, clean both the window and the blades with a clean cloth dampened with washer fluid.

NOTICE

To prevent damage to the wiper blades, arms or other components, do not:

- Use gasoline, kerosene, paint thinner, or other solvents on or near them.
- Attempt to move the wipers manually.
- Use non-specified wiper blades.

i Information

Commercial hot waxes applied by automatic car washes have been known to make the windshield difficult to clean.

Blade Replacement

When the wipers no longer clean adequately, the blades may be worn or cracked, and require replacement.

NOTICE

To prevent damage to the wiper arms or other components, do not attempt to move the wipers manually.

NOTICE

The use of a non-specified wiper blade could result in wiper malfunction and failure.

NOTICE

- In order to prevent damage to the hood and the wiper arms, the wiper arms should only be lifted when in the top wiping position.
- Always return the wiper arms to the windshield before driving.

Front windshield wiper blade replacement



1. Put the front windshield wipers into the service position.
2. Raise the wiper arm and slightly rotate the wiper blade assembly to expose the plastic locking clip.

NOTICE

Do not allow the wiper arm to fall against the windshield, since it may chip or crack the windshield.



3. Press the clip (1) and slide the blade assembly downward (2).
4. Lift it off the arm.

5. Install the blade assembly in the reverse order of removal.
6. Return the wiper arm on the windshield.

Rear window wiper blade replacement

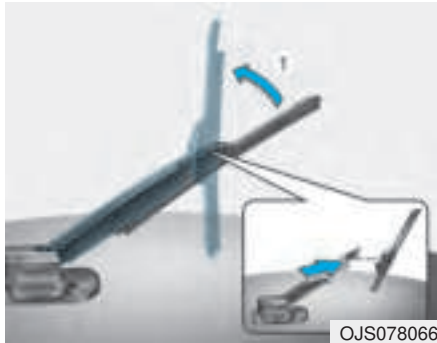

1. Raise the wiper arm and pull out the wiper blade assembly.



2. Install the new blade assembly by inserting the center part into the slot in the wiper arm until it clicks into place.
3. Make sure the blade assembly is installed firmly by trying to pull it slightly.

To prevent damage to the wiper arms or other components, have the wiper blades replaced by an authorized HYUNDAI dealer.

BATTERY

WARNING

To prevent **SERIOUS INJURY** or **DEATH** to you or bystanders, always follow these precautions when working near or handling the battery:



Always read and follow instructions carefully when handling a battery.



Wear eye protection designed to protect the eyes from acid splashes.



Keep all flames, sparks, or smoking materials away from the battery.



Hydrogen is always present in battery cells, is highly combustible, and may explode if ignited.



Keep batteries out of reach of children.



Batteries contain sulfuric acid which is highly corrosive. Do not allow acid to contact your eyes, skin or clothing.

If acid gets into your eyes, flush your eyes with clean water for at least 15 minutes and get immediate medical attention. If acid gets on your skin, thoroughly wash the area. If you feel pain or a burning sensation, get medical attention immediately.

- When lifting a plastic-cased battery, excessive pressure on the case may cause battery acid to leak. Lift with a battery carrier or with your hands on opposite corners.
- Do not attempt to jump start your vehicle if your battery is frozen.

- **NEVER** attempt to recharge the battery when the vehicle's battery cables are connected to the battery.
- The electrical ignition system works with high voltage. **NEVER** touch these components with the engine running or when the ignition switch is in the ON position.

⚠ WARNING

**CALIFORNIA PROPOSITION 65
WARNING**

Battery posts, terminals, and related accessories contain lead and lead compounds, chemicals known to the State of California to cause cancer, birth defects and reproductive harm. Batteries also contain other chemicals known to the State of California to cause cancer. Wash hands after handling.

NOTICE

- When you do not use the vehicle for a long time in a low temperature area, disconnect the battery and keep it indoors.
- Always charge the battery fully to prevent battery case damage in low temperature areas.

For Best Battery Service

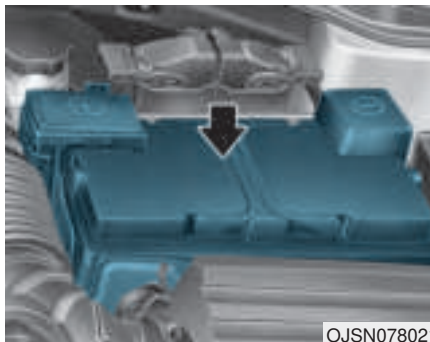

- Keep the battery securely mounted.
- Keep the battery top clean and dry.
- Keep the terminals and connections clean, tight, and coated with petroleum jelly or terminal grease.
- Rinse any spilled acid from the battery immediately with a solution of water and baking soda.

Battery Recharging

⚠ WARNING

Always follow these instructions when recharging your vehicle's battery to avoid the risk of **SERIOUS INJURY** or **DEATH** from explosions or acid burns:

- Before performing maintenance or recharging the battery, turn off all accessories and place the ignition switch to the **LOCK/OFF** position.
- Keep all flames, sparks, or smoking materials away from the battery.
- Always work outdoors or in an area with plenty of ventilation.
- Wear eye protection when checking the battery during charging.
- The battery must be removed from the vehicle and placed in a well ventilated area.

- Watch the battery during charging, and stop or reduce the charging rate if the battery cells begin boiling violently.
- The negative battery cable must be removed first and installed last when the battery is disconnected. Disconnect the battery charger in the following order:
 - (1) Turn off the battery charger main switch.
 - (2) Unhook the negative clamp from the negative battery terminal.
 - (3) Unhook the positive clamp from the positive battery terminal.
- Always use a genuine HYUNDAI approved battery when you replace the battery.

By jump starting

After a jump start from a good battery, drive the vehicle for 20-30 minutes before it is shutoff. The vehicle may not restart if you shut it off before the battery had a chance to adequately recharge. See "Jump Starting" in chapter 6 for more details on jump starting procedures.

***i* Information**



An inappropriately disposed battery can be harmful to the environment and human health. Dispose of the battery according to your local law(s) or regulations.

Reset Features

The following items may need to be reset after the battery has been discharged or the battery has been disconnected. See chapter 3 or 4 for:

- Power Windows
- Trip Computer
- Climate Control System
- Clock
- Audio System

TIRES AND WHEELS

WARNING

Tire failure may cause loss of vehicle control resulting in an accident. To reduce risk of **SERIOUS INJURY** or **DEATH**, take the following precautions:

- Inspect your tires monthly for proper inflation as well as wear and damage.
- The recommended cold tire pressure for your vehicle can be found in this manual and on the tire label located on the driver's side center pillar. Always use a tire pressure gauge to measure tire pressure. Tires with too much or too little pressure wear unevenly causing poor handling.
- Check the pressure of the spare every time you check the pressure of the other tires on your vehicle.

- Replace tires that are worn, show uneven wear, or are damaged. Worn tires can cause loss of braking effectiveness, steering control, or traction.
- **ALWAYS** replace tires with the same size as each tire that was originally supplied with this vehicle. Using tires and wheels other than the recommended sizes could cause unusual handling characteristics, poor vehicle control, or negatively affect your vehicle's Anti-Lock Brake System (ABS) resulting in a serious accident.

Information - Power Hop

When fully accelerating the vehicle from standstill, a front tire oscillation called “Power Hop“ of Veloster N may occur due to the high torque of engine and the characteristics of high performance tire. This may be affected by road condition and temperatures.

Additionally it is a normal phenomenon in powerful front-wheel drive vehicles. Veloster N will act on this phenomenon with the traction control in all ESC modes with the main focus on high performance character.

Tire Care

For proper maintenance, safety, and maximum fuel economy, you must always maintain recommended tire inflation pressures and stay within the load limits and weight distribution recommended for your vehicle.



All specifications (sizes and pressures) can be found on a label attached to the driver's side center pillar.

Recommended Cold Tire Inflation Pressures

All tire pressures (including the spare) should be checked when the tires are cold. "Cold tires" means the vehicle has not been driven for at least three hours or has been driven for less than one mile (1.6 km).

Warm tires normally exceed recommended cold tire pressures by 4 to 6 psi (28 to 41 kPa). Do not release air from warm tires to adjust the pressure or the tires will be under-inflated. For recommended inflation pressure, refer to "Tire and Wheels" in chapter 8.

WARNING

Recommended pressures must be maintained for the best ride, vehicle handling, and minimum tire wear.

Over-inflation or under-inflation can reduce tire life, adversely affect vehicle handling, and lead to sudden tire failure that could result in loss of vehicle control resulting in an accident.

Severe under-inflation can lead to severe heat build-up, causing blowouts, tread separation and other tire failures that can result in the loss of vehicle control resulting in an accident. This risk is much higher on hot days and when driving for long periods at high speeds.

 CAUTION

- **Under-inflation results in excessive wear, poor handling and reduced fuel economy. Wheel deformation is also possible. Keep your tire pressures at the proper levels. If a tire frequently needs refilling, have it checked by an authorized HYUNDAI dealer.**
- **Over-inflation produces a harsh ride, excessive wear at the center of the tire tread, and a greater possibility of damage from road hazards.**

Check Tire Inflation Pressure

Check your tires, including the spare tire, once a month or more.

How to check

Use a good quality tire pressure gauge to check tire pressure. You can not tell if your tires are properly inflated simply by looking at them. Radial tires may look properly inflated when they are under-inflated.

Remove the valve cap from the tire valve stem. Press the tire gauge firmly onto the valve to get a pressure measurement. If the cold tire inflation pressure matches the recommended pressure on the tire label located on the driver's side center pillar or in this manual. No further adjustment is necessary. If the pressure is low, add air until you reach the recommended pressure. Make sure to put the valve caps back on the valve stems. Without the valve cap, dirt or moisture could get into the valve core and cause air leakage. If a valve cap is missing, install a new one as soon as possible.

If you overfill the tire, release air by pushing on the metal stem in the center of the tire valve. Recheck the tire pressure with the tire gauge. Be sure to put the valve caps back on the valve stems. Without the valve cap, dirt or moisture could get into the valve core and cause air leakage. If a valve cap is missing, install a new one as soon as possible.

A cold tire means the vehicle has been sitting for 3 hours and driven for less than 1 mile (1.6 km) in that 3 hour period.

Allow the tire to cool before measuring the inflation pressure. Always be sure the tire is cold before inflating to the recommended pressure.

Tire Rotation

To equalize tread wear, HYUNDAI recommends that the tires be rotated according to the maintenance schedule or sooner if irregular wear develops.

During rotation, check the tires for correct balance.

When rotating tires, check for uneven wear and damage. Abnormal wear is usually caused by incorrect tire pressure, improper wheel alignment, out-of-balance wheels, severe braking or severe cornering. Look for bumps or bulges in the tread or side of the tire. Replace the tire if you find any of these conditions. Replace the tire if fabric or cord is visible. After rotation, be sure to bring the front and rear tire pressures to specification and check lug nut tightness (proper torque is 79~94 lbf·ft [11~13 kgf·m]).

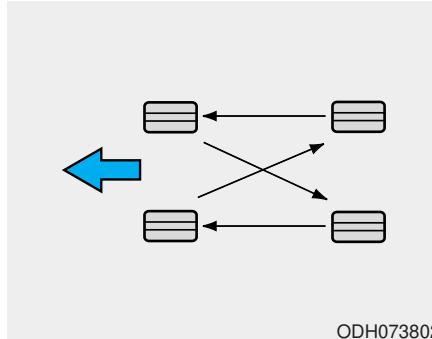

Disc brake pads should be inspected for wear whenever tires are rotated.

i Information

Tires that are asymmetrical or directional can only be installed on the wheel in one direction. The outside and inside of an asymmetrical tire is not easily distinguishable. Pay careful attention to the markings on the sidewalls of the tires, noting the "outside" marking and also the rotating direction before installing them on the vehicle.

⚠ WARNING

- Do not use the compact spare tire for tire rotation.
- Do not mix bias ply and radial ply tires under any circumstances. This may cause unusual handling characteristics that may cause loss of vehicle control resulting in an accident.

Wheel Alignment and Tire Balance

The wheels on your vehicle were aligned and balanced carefully at the factory to give you the longest tire life and best overall performance.

In most cases, you will not need to have your wheels aligned again. However, if you notice unusual tire wear or your vehicle pulling one way or the other, the alignment may need to be reset.

If you notice your vehicle vibrating when driving on a smooth road, your wheels may need to be rebalanced.

NOTICE

Improper wheel weights can damage your vehicle's aluminum wheels. Use only approved wheel weights.

Tire Replacement



If the tire is worn evenly, a tread wear indicator will appear as a solid band across the tread. This shows there is less than 2/32 inch (1.6 mm) of tread left on the tire. Replace the tire when this happens.

Do not wait for the tread surface to become level with the tread wear indicators before replacing the tire.

WARNING

To reduce the risk of DEATH or SERIOUS INJURY:

- Replace tires that are worn, show uneven wear, or are damaged. Worn tires can cause loss of braking effectiveness, steering control, and traction.
- Always replace tires with the same size as each tire that was originally supplied with this vehicle. Using tires and wheels other than the recommended sizes could cause unusual handling characteristics, poor vehicle control, or negatively affect your vehicle's Anti-Lock Brake System (ABS) resulting in a serious accident.

- **Tires degrade over time, even when they are not being used. Regardless of the remaining tread, HYUNDAI recommends that tires be replaced after six (6) years of normal service.**
- **When replacing tires (or wheels), it is recommended to replace the two front or two rear tires (or wheels) as a pair. Replacing just one tire can seriously affect your vehicle's handling. If only replacing one pair of tires, it is recommended to install the pair of new tires on the rear axle.**
- **Heat caused by hot climates or frequent high loading conditions can accelerate the aging process. Failure to follow this warning may cause sudden tire failure, which could lead to a loss of vehicle control resulting in an accident.**

Wheel Replacement

When replacing the metal wheels for any reason, make sure the new wheels are equivalent to the original factory units in diameter, rim width and offset.

Tire Traction

Tire traction can be reduced if you drive on worn tires, tires that are improperly inflated or on slippery road surfaces. Tires should be replaced when the tread depth is at least 2/32 inch (1.6 mm). To reduce the possibility of losing control, slow down whenever there is rain, snow or ice on the road.

Tire Maintenance

In addition to proper inflation, correct wheel alignment helps to decrease tire wear. If you find a tire is worn unevenly, have your dealer check the wheel alignment.

When you have new tires installed, make sure they are balanced. This will increase vehicle ride comfort and tire life. Additionally, a tire should always be rebalanced if it is removed from the wheel.

Tire Sidewall Labeling

This information identifies and describes the fundamental characteristics of the tire and also provides the tire identification number (TIN) for safety standard certification. The TIN can be used to identify the tire in case of a recall.

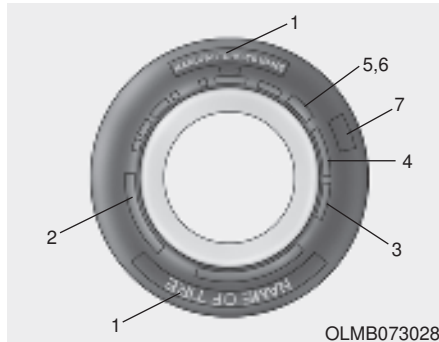

1. Manufacturer or brand name

Manufacturer or brand name is shown.

2. Tire size designation

A tire's sidewall is marked with a tire size designation. You will need this information when selecting replacement tires for your car. The following explains what the letters and numbers in the tire size designation mean.

Example tire size designation:

(These numbers are provided as an example only; your tire size designator could vary depending on your vehicle.)

235/35R19 91Y

235 - Tire width in millimeters.

35 - Aspect ratio. The tire's section height as a percentage of its width.

R - Tire construction code (Radial).

19 - Rim diameter in inches.

91 - Load Index, a numerical code associated with the maximum load the tire can carry.

Y - Speed Rating Symbol. See the speed rating chart in this section for additional information.

Wheel size designation

Wheels are also marked with important information that you need if you ever have to replace one. The following explains what the letters and numbers in the wheel size designation mean.

Example wheel size designation:

8.0J X 19

8.0 - Rim width in inches.

J - Rim contour designation.

19 - Rim diameter in inches.

Tire speed ratings

The chart below lists many of the different speed ratings currently being used for passenger vehicle tires. The speed rating is part of the tire size designation on the sidewall of the tire. This symbol corresponds to that tire's designed maximum safe operating speed.

Speed Rating Symbol	Maximum Speed
S	112 mph (180 km/h)
T	118 mph (190 km/h)
H	130 mph (210 km/h)
V	149 mph (240 km/h)
W	168 mph (270 km/h)
Y	186 mph (300 km/h)

3. Checking tire life (TIN : Tire Identification Number)

Any tires that are over six years old, based on the manufacturing date, (including the spare tire) should be replaced by new ones. You can find the manufacturing date on the tire sidewall (possibly on the inside of the wheel), displaying the DOT Code. The DOT Code is a series of numbers on a tire consisting of numbers and English letters. The manufacturing date is designated by the last four digits (characters) of the DOT code.

DOT : XXXX XXXX OOOO

The front part of the DOT shows a plant code number, tire size and tread pattern and the last four numbers indicate week and year manufactured.

For example:

DOT XXXX XXXX 1420 represents that the tire was produced in the 14th week of 2020.

4. Tire ply composition and material

The number of layers or plies of rubber-coated fabric in the tire. Tire manufacturers also must indicate the materials in the tire, which include steel, nylon, polyester, and others. The letter "R" means radial ply construction; the letter "D" means diagonal or bias ply construction; and the letter "B" means belted-bias ply construction.

5. Maximum permissible inflation pressure

This number is the greatest amount of air pressure that should be put in the tire. Do not exceed the maximum permissible inflation pressure. Refer to the Tire and Loading Information label for recommended inflation pressure.

6. Maximum load rating

This number indicates the maximum load in kilograms and pounds that can be carried by the tire. When replacing the tires on the vehicle, always use a tire that has the same load rating as the factory installed tire.

7. Uniform tire quality grading

Quality grades can be found where applicable on the tire sidewall between tread shoulder and maximum section width.

For example:

TREAD WEAR 200

TRACTION AA

TEMPERATURE A

Tread wear

The tread wear grade is a comparative rating based on the wear rate of the tire when tested under controlled conditions on a specified government test course. For example, a tire graded 150 would wear one-and-a-half times ($1\frac{1}{2}$) as well on the government course as a tire graded 100.

The relative performance of tires depends upon the actual conditions of their use, however, and may depart significantly from the norm due to variations in driving habits, service practices and differences in road characteristics and climate.

These grades are molded on the sidewalls of passenger vehicle tires. The tires available as standard or optional equipment on your vehicle may vary with respect to grade.

Traction - AA, A, B & C

The traction grades, from highest to lowest, are AA, A, B and C. Those grades represent the tire's ability to stop on wet pavement as measured under controlled conditions on specified government test surfaces of asphalt and concrete. A tire marked C may have poor traction performance.

WARNING

The traction grade assigned to this tire is based on straight-ahead braking traction tests, and does not include acceleration, cornering, hydroplaning, or peak traction characteristics.

Temperature - A, B & C

The temperature grades are A (the highest), B and C representing the tire's resistance to the generation of heat and its ability to dissipate heat when tested under controlled conditions on a specified indoor laboratory test wheel.

Sustained high temperature can cause the material of the tire to degenerate and reduce tire life, and excessive temperature can lead to sudden tire failure. Grade C responds to a level of performance which all passenger car tires must meet under the Federal Motor Vehicle Safety Standard No. 109. Grades B and A represent higher levels of performance on the laboratory test wheel than the minimum required by law.

WARNING

The temperature grade for this tire is established for a tire that is properly inflated and not overloaded. Excessive speed, under-inflation, over-inflation, or excessive loading, either separately or in combination, can cause heat build-up and possible sudden tire failure. This may cause loss of vehicle control resulting in an accident.

Tire Terminology and Definitions

Air Pressure

The amount of air inside the tire pressing outward on the tire. Air pressure is expressed in pounds per square inch (psi) or kilopascal (kPa).

Accessory Weight

This means the combined weight of optional accessories. Some examples of optional accessories are power seats and air conditioning.

Aspect Ratio

The relationship of a tire's height to its width.

Belt

A rubber coated layer of cords that is located between the plies and the tread. Cords may be made from steel or other reinforcing materials.

Bead

The tire bead contains steel wires wrapped by steel cords that hold the tire onto the rim.

Bias Ply Tire

A pneumatic tire in which the plies are laid at alternate angles less than 90 degrees to the centerline of the tread.

Cold Tire Pressure

The amount of air pressure in a tire, measured in pounds per square inch (psi) or kilopascals (kPa) before a tire has built up heat from driving.

Curb Weight

This means the weight of a motor vehicle with standard and optional equipment including the maximum capacity of fuel, oil and coolant, but without passengers and cargo.

DOT Markings

A code molded into the sidewall of a tire signifying that the tire is in compliance with the U.S. Department of Transportation motor vehicle safety standards. The DOT code includes the Tire Identification Number (TIN), an alphanumeric designator which can also identify the tire manufacturer, production plant, brand and date of production.

GVWR

Gross Vehicle Weight Rating

GAWR FRT

Gross Axle Weight Rating for the Front Axle.

GAWR RR

Gross Axle Weight Rating for the Rear axle.

Intended Outboard Sidewall

The side of an asymmetrical tire, that must always face outward when mounted on a vehicle.

Kilopascal (kPa)

The metric unit for air pressure.

Light truck(LT) tire

A tire designated by its manufacturer as primarily intended for use on light-weight trucks or multipurpose passenger vehicles.

Load ratings

The maximum load that a tire is rated to carry for a given inflation pressure.

Load Index

An assigned number ranging from 1 to 279 that corresponds to the load carrying capacity of a tire.

Maximum Inflation Pressure

The maximum air pressure to which a cold tire may be inflated. The maximum air pressure is molded onto the sidewall.

Maximum Load Rating

The load rating for a tire at the maximum permissible inflation pressure for that tire.

Maximum Loaded Vehicle Weight

The sum of curb weight; accessory weight; vehicle capacity weight; and production options weight.

Normal Occupant Weight

The number of occupants a vehicle is designed to seat multiplied by 150 pounds (68 kg).

Occupant Distribution

Designated seating positions.

Outward Facing Sidewall

An asymmetrical tire has a particular side that faces outward when mounted on a vehicle. The outward facing sidewall bears white lettering or bears manufacturer, brand, and/or model name molding that is higher or deeper than the same moldings on the inner facing sidewall.

Passenger (P-Metric) tire

A tire used on passenger cars and some light duty trucks and multipurpose vehicles.

Ply

A layer of rubber-coated parallel cords.

Pneumatic tire

A mechanical device made of rubber, chemicals, fabric and steel or other materials, that, when mounted on an automotive wheel provides the traction and contains the gas or fluid that sustains the load.

Pneumatic options weight

The combined weight of installed regular production options weighing over 5 lb. (2.3 kg) in excess of the standard items which they replace, not previously considered in curb weight or accessory weight, including heavy duty breaks, ride levelers, roof rack, heavy duty battery, and special trim.

Recommended Inflation Pressure

Vehicle manufacturer's recommended tire inflation pressure as shown on the tire placard.

Radial Ply Tire

A pneumatic tire in which the ply cords that extend to the beads are laid at 90 degrees to the centerline of the tread.

Rim

A metal support for a tire and upon which the tire beads are seated.

Sidewall

The portion of a tire between the tread and the bead.

Speed Rating

An alphanumeric code assigned to a tire indicating the maximum speed at which a tire can operate.

Traction

The friction between the tire and the road surface. The amount of grip provided.

Tread

The portion of a tire that comes into contact with the road.

Treadwear Indicators

Narrow bands, sometimes called "wear bars", that show across the tread of a tire when only 2/32nds of an inch of tread remains.

UTQGS

Uniform Tire Quality Grading Standards is a tire information system that provides consumers with ratings for a tire's traction, temperature and treadwear. Ratings are determined by tire manufacturers using government testing procedures. The ratings are molded into the sidewall of the tire.

Vehicle Capacity Weight

The number of designated seating positions multiplied by 150 lbs. (68 kg) plus the rated cargo and luggage load.

Vehicle Maximum Load on the Tire

Load on an individual tire due to curb and accessory weight plus maximum occupant and cargo weight.

Vehicle Normal Load on the Tire

Load on an individual tire that is determined by distributing to each axle its share of the curb weight, accessory weight, and normal occupant weight and dividing by 2.

Vehicle Placard

A label permanently attached to a vehicle showing the original equipment tire size and recommended inflation pressure.

All Season Tires

HYUNDAI specifies all season tires on some models to provide good performance for use all year round, including snowy and icy road conditions. All season tires are identified by ALL SEASON and/or M+S (Mud and Snow) on the tire sidewall. Snow tires have better snow traction than all season tires and may be more appropriate in some areas.

Summer Tires

HYUNDAI specifies summer tires on some models to provide superior performance on dry roads. Summer tire performance is substantially reduced in snow and ice. Summer tires do not have the tire traction rating M+S (Mud and Snow) on the tire side wall. If you plan to operate your vehicle in snowy or icy conditions, HYUNDAI recommends the use of snow tires or all season tires on all four wheels.

Snow Tires

If you equip your car with snow tires, they should be the same size and have the same load capacity as the original tires. Snow tires should be installed on all four wheels; otherwise, poor handling may result. Do not drive faster than 75 mph (120 km/h) when your vehicle is equipped with snow tires.

Radial-Ply Tires

Radial-ply tires provide improved tread life, road hazard resistance and smoother high speed ride. The radial-ply tires used on this vehicle are of belted construction, and are selected to complement the ride and handling characteristics of your vehicle.

Radial-ply tires have the same load carrying capacity, as bias-ply or bias belted tires of the same size, and use the same recommended inflation pressure. Mixing of radial-ply tires with bias-ply or bias belted tires is not recommended. Any combinations of radial-ply and bias-ply or bias belted tires when used on the same vehicle will seriously deteriorate vehicle handling. The best rule to follow is: Identical pairs of radial-ply tires should always be used as a set for the front tires and a set for the rear tires.

Longer wearing tires can be more susceptible to irregular tread wear. It is very important to follow the tire rotation interval in this chapter to achieve the tread life potential of these tires. Cuts and punctures in radial-ply tires are repairable only in the tread area, because of sidewall flexing. Consult your tire dealer for radial-ply tire repairs.

WARNING

Do not mix bias ply and radial ply tires under any circumstances. This may cause unusual handling characteristics that may cause loss of vehicle control resulting in an accident.

Low Aspect Ratio Tires

The aspect ratio is lower than 50 on low aspect ratio tires.

Because low aspect ratio tires are optimized for handling and braking, their sidewall is a little stiffer than a standard tire. Also low aspect ratio tires tend to be wider and consequently have a greater contact patch with the road surface. In some instances they may generate more road noise compared with standard tires.

 **CAUTION**

Because the sidewall of a low aspect ratio tire is shorter than a standard tire, the rim of the wheel and the tire itself is more easily susceptible to damage. Use caution when driving and follow the guidelines below to help minimize damage to the wheel and tire:

- When driving on a rough road or off road, drive cautiously because tires and wheels may be damaged. And after driving, inspect tires and wheels.
- When passing over a pothole, speed bump, manhole, or curb stone, drive slowly so that the tires and wheels are not damaged.
- If the tire is subjected to a severe impact, have the tire and wheel inspected by an authorized HYUNDAI dealer.
- Inspect the tire condition and pressure every 1,800 miles (3,000km).

 **CAUTION**

- It is not easy to recognize tire damage with your own eyes. But if there is the slightest hint of tire damage, have the tire checked or replaced because the tire damage may cause air leakage from the tire.
- If the tire is damaged by driving on a rough road, off road, pothole, manhole, or curb stone, it will not be covered by the warranty.

FUSES

■ Blade type



Normal



Blown

■ Cartridge type



Normal



Blown

■ Multi fuse

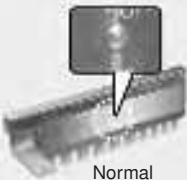

Normal

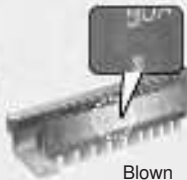

Blown

OLF074075

A vehicle's electrical system is protected from electrical overload damage by fuses.

This vehicle has 2 (or 3) fuse panels, one located in the driver's side panel bolster, the other in the engine compartment near the battery.

If any of your vehicle's lights, accessories, or controls do not work, check the appropriate circuit fuse. If a fuse has blown, the element inside the fuse will be melted or broken.

If the electrical system does not work, first check the driver's side fuse panel. Before replacing a blown fuse, turn the engine and all switches off, and then disconnect the negative battery cable. Always replace a blown fuse with one of the same rating.

If the replacement fuse blows, this indicates an electrical problem. Avoid using the system involved and immediately consult an authorized HYUNDAI dealer.

⚠ WARNING

NEVER replace a fuse with anything but another fuse of the same rating.

- A higher capacity fuse could cause damage and possibly cause a fire.
- Do not install a wire or aluminum foil instead of the proper fuse - even as a temporary repair. It may cause extensive wiring damage and possibly a fire.

NOTICE

Do not use a screwdriver or any other metal object to remove fuses because it may cause a short circuit and damage the system.

Instrument Panel Fuse Replacement



1. Turn the engine off.
2. Turn all other switches OFF.
3. Open the fuse panel cover.
4. Refer to the label on the inside of the fuse panel cover to locate the suspected fuse location.

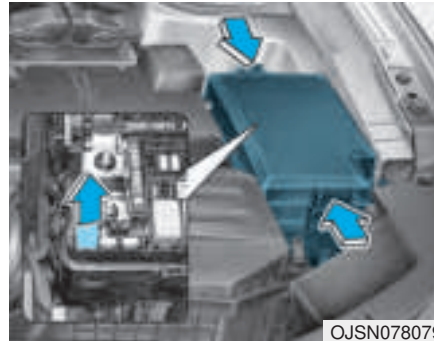

5. Pull the suspected fuse straight out. Use the removal tool provided in the engine compartment fuse panel.
6. Check the removed fuse; replace it if it is blown. Spare fuses are provided in the instrument panel fuse panels (or in the engine compartment fuse panel).
7. Push in a new fuse of the same rating, and make sure it fits tightly in the clips. If it fits loosely, consult an authorized HYUNDAI dealer.

In an emergency, if you do not have a spare fuse, use a fuse of the same rating from a circuit you may not need for operating the vehicle.

If the headlamps or other electrical components do not work and the fuses are undamaged, check the fuse panel in the engine compartment. If a fuse is blown, it must be replaced with the same rating.

Fuse switch



Always, place the fuse switch to the ON position.

If you move the switch to the OFF position, some items such as the audio system and digital clock must be reset and the smart key may not work properly.

i Information

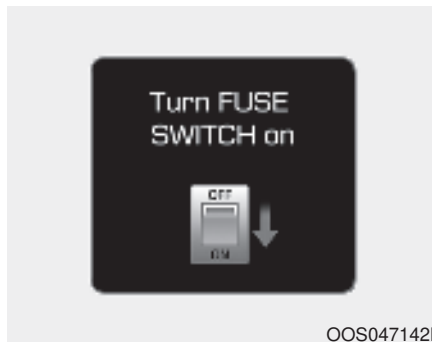

If the fuse switch is OFF, the above message will appear.

NOTICE

- Always place the fuse switch in the ON position while driving the vehicle.
- Do not move the fuse switch repeatedly. The fuse switch may be damaged.

Engine Compartment Panel Fuse Replacement

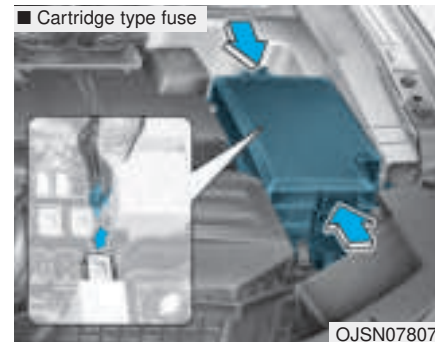
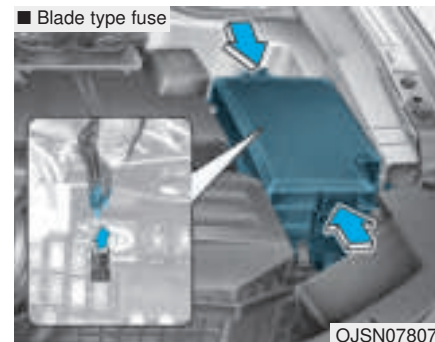

1. Turn the engine off.
2. Turn all other switches OFF.

3. Remove the fuse panel cover by pressing the tab and pulling up.
4. Check the removed fuse; replace it if it is blown. To remove or insert the fuse, use the fuse puller in the engine compartment fuse panel.
5. Push in a new fuse of the same rating, and make sure it fits tightly in the clips. If it fits loosely, consult an authorized HYUNDAI dealer.

CAUTION

After checking the fuse box in the engine compartment securely close the fuse box cover inside the engine compartment, until it clicks.

If the fuse box is not closed properly, water may leak in side, possibly causing a malfunction with the electrical system.

Main fuse

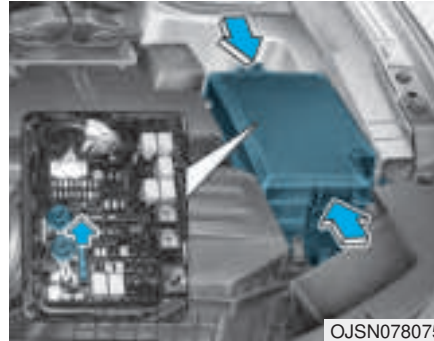

If the main fuse is blown, it must be removed as follows:

1. Turn off the engine.
2. Disconnect the negative battery cable.
3. Remove the fuse panel cover by pressing the tab and pulling it up.
4. Remove the nuts shown in the picture above.
5. Replace the fuse with a new one of the same rating.
6. Reinstall in the reverse order of removal.

Information

If the main fuse is blown, consult an authorized HYUNDAI dealer.

Multi fuse

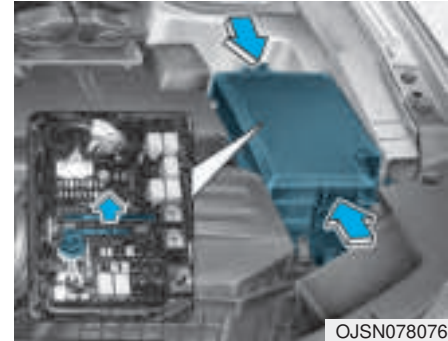

If the multi fuse is blown, it must be removed as follows:

1. Turn off the engine.
2. Disconnect the negative battery cable.
3. Remove the fuse panel cover by pressing the tab and pulling it up.
4. Remove the nuts shown in the picture above.
5. Replace the fuse with a new one of the same rating.
6. Reinstall in the reverse order of removal.

Information

If the multi fuse is blown, consult an authorized HYUNDAI dealer.

Fuse/Relay Panel Description

Instrument panel fuse panel



OJSN078022

Inside the fuse/relay box cover, you can find the fuse/relay label describing fuse/relay names and ratings.

i Information

Not all fuse panel descriptions in this manual may be applicable to your vehicle; the information is accurate at the time of printing. When you inspect the fuse box on your vehicle, refer to the fuse box label.

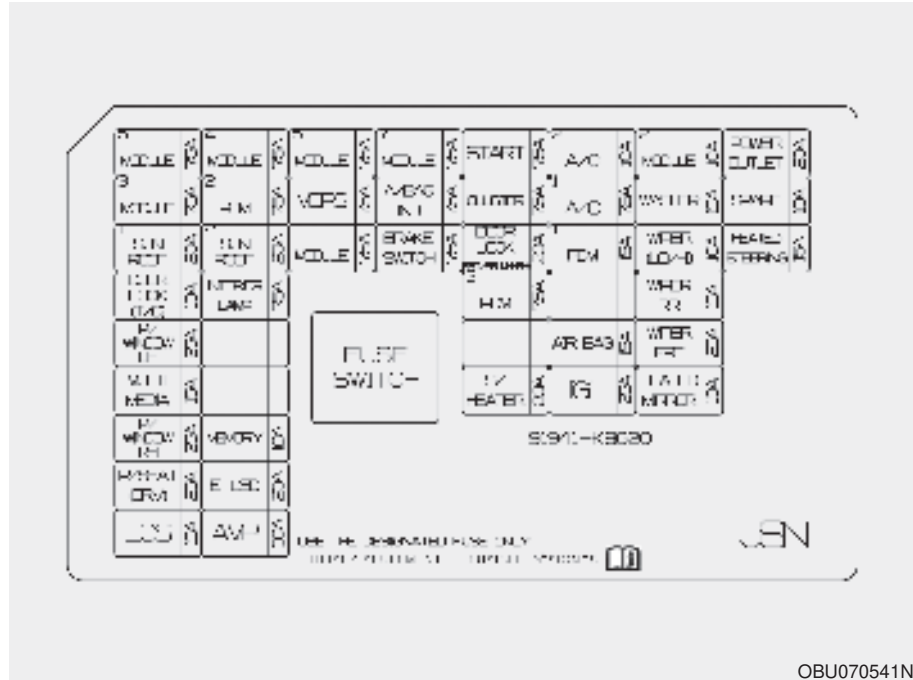

OBU070541N

Instrument panel fuse panel

Fuse Name	Fuse Rating	Protected Component
MODULE5	7.5A	Crash Pad Switch, Electro Chromic Mirror, Audio, A/C Control Module, Front Seat Warmer Module
MODULE3	7.5A	BCM
TAIL GATE OPEN	10A	T/Gate Relay
P/WINDOW LH	25A	Driver Safety Power Window Module
MULTI MEDIA	15A	Audio, Keyboard
P/WINDOW RH	25A	Power Window RH Relay
P/SEAT (DRV)	25A	Driver Seat Manual Switch
MODULE4	7.5A	ECS Unit, LSD Unit, Steering Angle Sensor, Stop Lamp Switch, Active Exhaust Valve, BCM
PDM2	7.5A	Smart Key Control Module
INTERIOR LAMP	7.5A	Overhead Console Lamp, Center Room Lamp, Luggage Lamp, Vanity Lamp LH/RH
MEMORY	10A	Instrument Cluster, A/C Control Module
AMP	30A	AMP

Instrument panel fuse panel

Fuse Name	Fuse Rating	Protected Component
SUNROOF1	20A	Sunroof
SUNROOF2	20A	Sunroof
MODULE6	7.5A	BCM, Smart Key Control Module
MDPS	7.5A	MDPS Unit
MODULE1	7.5A	Data Link Connector, BCM, Hazard Switch
MODULE7	7.5A	Front Seat Warmer Module, ESG Unit, Cooling Fan Control Module
A/BAG IND	7.5A	Instrument Cluster, Hazard Switch
ECS	15A	ECS Unit
START	7.5A	ECM, Smart Key Control Module, E/R Junction Block (Start #1 Relay)
CLUSTER	7.5A	Instrument Cluster
DOOR LOCK	20A	Door Lock/Unlock Relay, ICM Relay Box (T/Turn Unlock & D/Lock Relay)
PDM3	7.5A	Start Stop Button Switch

Instrument panel fuse panel

Fuse Name	Fuse Rating	Protected Component
BRAKE SWITCH	7.5A	Stop Lamp Switch, Smart Key Control Module
S/HEATER	20A	Front Seat Warmer Module
A/C1	7.5A	A/C Control Module, E/R Junction Block (Blower Relay)
PDM1	15A	Smart Key Control Module
AIR BAG	15A	Passenger Occupant Detection Sensor, SRS Control Module
IG1	25A	PCB Block (Fuse - ESC3, ECU3, VACUUM PUMP2)
MODULE2	10A	Keyboard, USB Charge, Audio, BCM, Smart Key Control Module
WASHER	15A	Multifunction Switch
WIPER (LO/HI)	10A	BCM, ECM, Front Wiper Motor, PCB Block (Front Wiper (Low) Relay)

Instrument panel fuse panel

Fuse Name	Fuse Rating	Protected Component
WIPER RR	15A	Rear Wiper Relay, Rear Wiper Motor
WIPER FRT	25A	Front Wiper Motor, PCB Block (Front Wiper (Low) Relay)
HEATED MIRROR	10A	Driver/Passenger Power Outside Mirror, A/C Control Module
POWER OUTLET	20A	Front Power Outlet
HEATED STEERING	15A	BCM
E-LSD	20A	LSD Unit

Engine compartment fuse panel

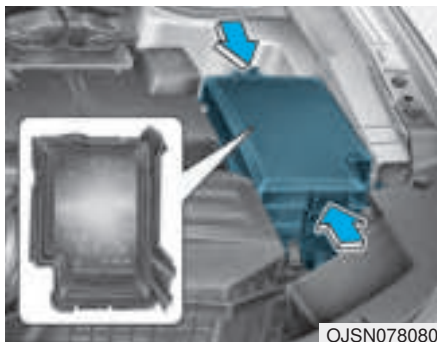

Inside the fuse/relay box cover, you can find the fuse/relay label describing fuse/relay names and ratings.

i Information

Not all fuse panel descriptions in this manual may be applicable to your vehicle; the information is accurate at the time of printing. When you inspect the fuse panel in your vehicle, refer to the fuse panel label.

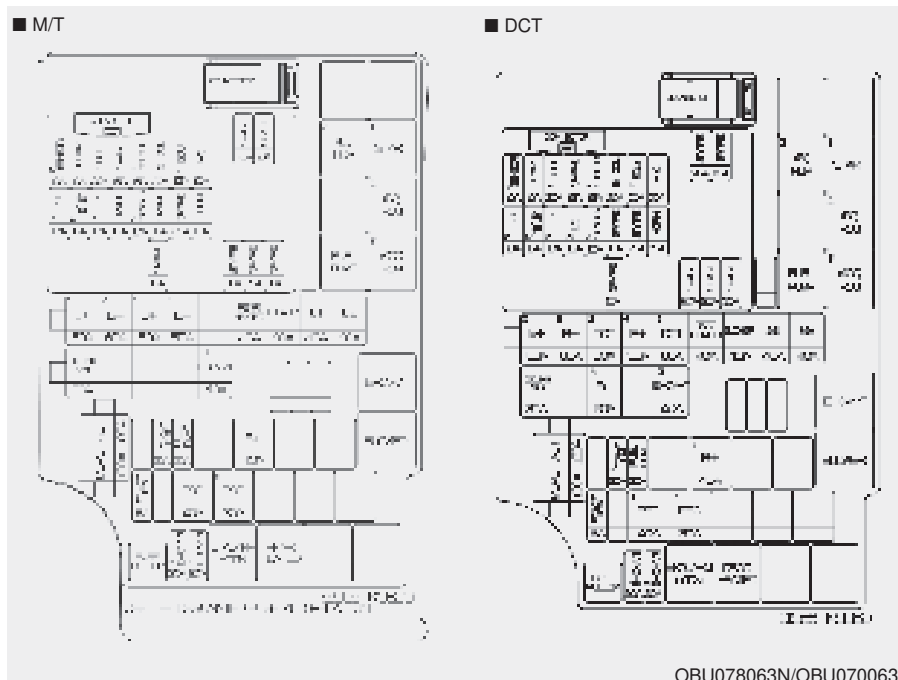

Engine compartment fuse panel

Fuse Name		Fuse Rating	Protected Component
ALT		180A	Alternator, E/R Junction Block (Fuse - MDPS, ESC1, ESC2, B/ALARM HORN)
MDPS		100A	MDPS Unit
B+5		60A	PCB Block (Engine Control Relay, Fuse - ECU2, HORN, A/C)
B+2		60A	IGPM (IPS0/IPS1/IPS2, Fuse - S/HEATER)
B+3	M/T	60A	IGPM (IPS3/IPS4/IPS5/IPS6)
	DCT	50A	
B+4		50A	IGPM (Fuse - ECS, AMP, P/WINDOW LH, P/WINDOW RH, TAIL GATE OPEN, E-LSD, P/SEAT (DRV))
REAR HEATED		40A	Rear Heated Relay
BLOWER		40A	Blower Relay
IG1		40A	E/R Junction Block (PDM #2 (ACC) Relay, PDM #3 (IG1) Relay)
IG2		40A	Start1 Relay, E/R Junction Block (PDM #4 (IG2) Relay)
COOLING FAN		80A	Cooling Fan Control Module

Engine compartment fuse panel

Fuse Name	Fuse Rating	Protected Component
E-CVVT3	40A	E-CVVT Relay
FUEL PUMP	20A	Fuel Pump Relay
VACUUM PUMP1	20A	Electronic Vacuum Pump
B+1	40A	IGPM (Fuse - BRAKE SWITCH, PDM1, PDM3, MODULE1, DOOR LOCK, Leak Current Autocut Device)
B/ALARM HORN	15A	B/Alarm Horn Relay
ESC1	40A	ESC Control Module, Multipurpose Check Connector
ESC2	30A	ESC Control Module
E-CVVT1	20A	ECM
E-CVVT2	20A	ECM

Engine compartment fuse panel

Fuse Name		Fuse Rating	Protected Component
ECU3		10A	ECM
VACUUM PUMP2		15A	Electronic Vacuum Pump, Vacuum Switch
ESC3		10A	ESC Control Module, Multipurpose Check Connector
EWP	DCT2	60A (TCU B+)	Electric Water Pump
	DCT3	15A (TCU IG1)	
SENSOR3		10A	Clutch Pedal Position Sensor, E/R Junction Block (Fuel Pump Relay)
ECU2		15A	ECM
HORN		15A	Horn Relay
SENSOR2		10A	Canister Close Valve, Purge Control Solenoid Valve, Oil Control Valve, Recirculation Valve Control Solenoid Valve, PCB Block (A/Con Comp Relay)
ECU1		20A	ECM
SENSOR1		15A	Oxygen Sensor (Up/Down)
IGN COIL		20A	Ignition Coil #1/#2/#3/#4
A/C		10A	A/Con Comp Relay

**Engine compartment fuse panel
(Battery terminal cover)
(if equipped)**



Inside the fuse/relay box cover, you can find the fuse/relay label describing fuse/relay names and ratings.

i Information

Not all fuse panel descriptions in this manual may be applicable to your vehicle; the information is accurate at the time of printing. When you inspect the fuse panel in your vehicle, refer to the fuse panel label.



NOTICE

After checking the fuse panel in the engine compartment, securely install the cover. If it is not securely latched, electrical failure may occur from water contact.

LIGHT BULBS

Consult an authorized HYUNDAI dealer to replace most vehicle light bulbs. It is difficult to replace vehicle light bulbs because other parts of the vehicle must be removed before you can get to the bulb. This is especially true for removing the headlamp assembly to get to the bulb(s).

Removing/installing the headlamp assembly can result in damage to the vehicle.

i Information

The headlamp and tail lamp lenses could appear frosty if the vehicle is washed after driving or the vehicle is driven at night in wet weather. This condition is caused by temperature difference between the lamp inside and outside and, it does not indicate a problem with your vehicle. When moisture condenses in the lamp, it will be removed after driving with the headlamp on. The removable level may differ depending on lamp size, lamp position and environmental condition. However, if moisture is not removed, we recommend that your vehicle is inspected by an authorized HYUNDAI dealer.

i Information - Desiccant (if equipped)

This vehicle is equipped with desiccant to reduce fogging inside the headlamp due to moisture.

The desiccant is consumable and its performance may change based on the used period or environment.

If fogging inside the headlamp due to moisture continues for a long time, have your vehicle checked by an authorized HYUNDAI dealer.

NOTICE

Light replacement

Be sure to replace the burned out bulb with one of the same wattage rating. Otherwise, it may cause damage to the fuse or electric wiring system.

NOTICE

Headlamp lens

To prevent damage, do not clean the headlamp lens with chemical solvents or strong detergents.

⚠ WARNING

- Prior to replacing a lamp, depress the foot brake, move the shift lever into N (Neutral) apply the parking brake, place the ignition switch to the LOCK/OFF position, and take the key with you when leaving the vehicle to avoid sudden movement of the vehicle and to prevent possible electric shock.
- Be aware the bulbs may be hot and may burn your fingers.

**Headlamp, Parking lamp,
Daytime Running Light, Turn
signal lamp and Side marker**

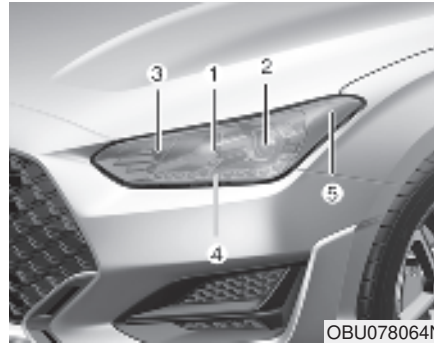

- (1) Headlamp (High)
- (2) Headlamp (Low)
- (3) Turn signal lamp
- (4) Parking lamp & Daytime running light (DRL)
- (5) Side marker

⚠ WARNING



- Handle halogen bulbs with care. Halogen bulbs contain pressurized gas that will produce flying pieces of glass that could cause injuries if broken.
- Wear eye protection when changing a bulb. Allow the bulb to cool down before handling it.

- Always handle them carefully, and avoid scratches and abrasions. If the bulbs are lit, avoid contact with liquids.
- Never touch the glass with bare hands. Residual oil may cause the bulb to overheat and burst when lit.
- A bulb should be operated only when installed in a headlamp.
- If a bulb becomes damaged or cracked, replace it immediately and carefully dispose of it.

Headlamp (Low beam), side marker, parking lamp and daytime running light

If the LED lamp does not operate, have the system be checked by an authorized HYUNDAI dealer.

The LED lamps cannot be replaced as a single unit because it is an integrated unit. The LED lamps has to be replaced with the unit.

A skilled technician should check or repair the LED lamp, for it may damage related parts of the vehicle.



OJS078029

Headlamp (High beam)

1. Open the hood.
2. Disconnect the negative battery cable.
3. Remove the headlamp bulb cover by turning it counterclockwise.
4. Disconnect the headlamp bulb socket-connector.
5. Remove the bulb from the headlamp assembly.

6. Install a new headlamp bulb and snap the headlamp bulb retaining wire into position by aligning the wire with the groove on the bulb.
7. Connect the headlamp bulb socket-connector.
8. Install the headlamp bulb cover by turning it clockwise.

i Information

The headlamp aiming should be adjusted after an accident or after the headlamp assembly is reinstalled at an authorized HYUNDAI dealer.

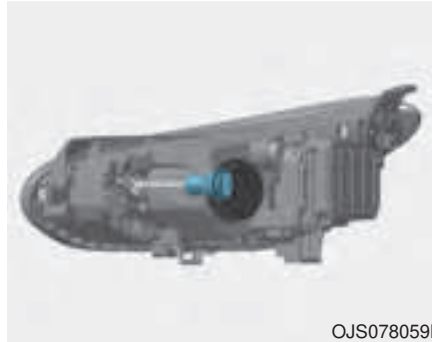

OJS078059L

Turn signal

1. Open the hood.
2. Disconnect the negative battery cable.
3. Remove the socket from the assembly by turning the socket counterclockwise until the tabs on the socket align with the slots on the assembly.
4. Remove the bulb from the socket by pressing it in and rotating it counterclockwise until the tabs on the bulb align with the slots in the socket. Pull the bulb out of the socket.

5. Install a new bulb by inserting it into the socket and rotating it until it locks into place.
6. Install the socket in the assembly by aligning the tabs on the socket with the slots in the assembly.
7. Push the socket into the assembly and turn the socket clockwise.

Side Repeater Lamp Replacement



If the light bulb does not operate, have the vehicle checked by an authorized HYUNDAI dealer.

Rear Combination Light Bulb Replacement

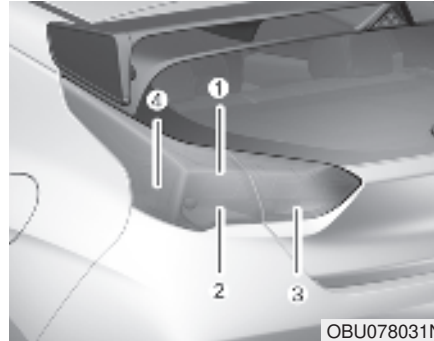

- (1) Stop/Tail lamp
- (2) Turn signal lamp
- (3) Backup lamp
- (4) Side marker

Side marker and Stop/Tail lamp light

If the LED lamp does not operate, have the system be checked by an authorized HYUNDAI dealer.

The LED lamps cannot be replaced as a single unit because it is an integrated unit. The LED lamps has to be replaced with the unit.

A skilled technician should check or repair the LED lamp, for it may damage related parts of the vehicle.

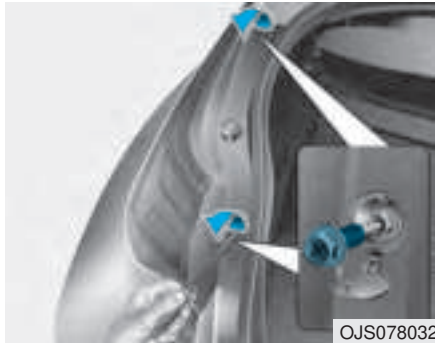

Turn signal lamp

1. Open the liftgate.
2. Open the lamp assembly retaining screw covers.
3. Loosen the lamp assembly retaining screws with a cross-tip screwdriver.



4. Remove the rear combination lamp assembly from the body of the vehicle.
5. Remove the socket from the assembly by turning the socket counterclockwise until the tabs on the socket align with the slots on the assembly.



[A] : Turn signal lamp

6. Remove the bulb from the socket by pressing it in and rotating it counterclockwise until the tabs on the bulb align with the slots in the socket. Pull the bulb out of the socket.
7. Insert a new bulb by inserting it into the socket and rotating it until it locks into place.
8. Install the socket into the assembly by aligning the tabs on the socket with the slots in the assembly. Push the socket into the assembly and turn the socket clockwise.
9. Reinstall the lamp assembly to the body of the vehicle.



Backup lamp

1. Turn off the engine.
2. Open the liftgate.
3. Remove the service cover using a flat-blade screwdriver.



[A] : Backup lamp

4. Remove the socket from the assembly by turning the socket counterclockwise until the tabs on the socket align with the slots on the assembly.
5. Remove the bulb from the socket by pressing it in and rotating it counterclockwise until the tabs on the bulb align with the slots in the socket. Pull the bulb out of the socket.
6. Insert a new bulb by inserting it into the socket and rotating it until it locks into place.
7. Install the socket into the assembly by aligning the tabs on the socket with the slots in the assembly. Push the socket into the assembly and turn the socket clockwise.
8. Reinstall the lamp assembly to the body of the vehicle.

High Mounted Stop Lamp Replacement



If the high mounted stop lamp does not operate, have the vehicle checked by an authorized HYUNDAI dealer.

License Plate Light Bulb Replacement



1. Using a flat-blade screwdriver, gently pry the lens cover from the lamp housing.
2. Remove the bulb by pulling it straight out.
3. Install a new bulb.
4. Reinstall in the reverse order.

Interior Light Bulb Replacement

Map lamp and room lamp



Your vehicle is equipped with LED lamps. LED lamps do not have replacement bulbs. If the LED lamp does not operate, we recommend that you have the vehicle inspected by an authorized HYUNDAI dealer.

Map lamp, room lamp, vanity mirror lamp and luggage compartment lamp

■ Map lamp

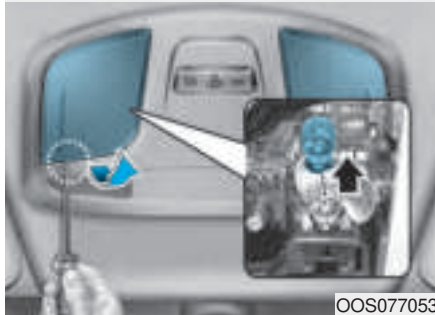

■ Vanity mirror lamp



■ Room lamp

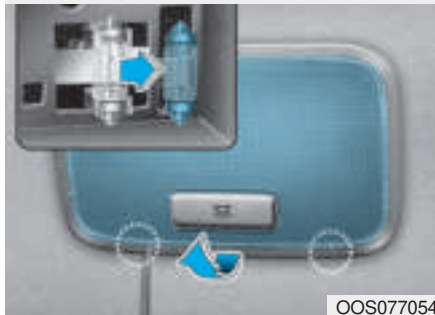

■ Luggage compartment lamp



1. Using a flat-head screwdriver, gently pry the lens from the interior light housing.
2. Remove the bulb by pulling it straight out.

⚠ WARNING

Prior to working on the Interior Lights, ensure that the "OFF" button is depressed to avoid burning your fingers or receiving an electric shock.

3. Install a new bulb in the socket.
4. Align the lens tabs with the interior light housing notches and snap the lens into place.

NOTICE

Be careful not to damage the cover, tab, and plastic housing.

APPEARANCE CARE

Exterior Care

Exterior general caution

It is very important to follow the label directions when using any chemical cleaner or polish. Read all warning and caution statements that appear on the label.

Protecting your vehicle's finish

Washing

To help protect your vehicle's finish from rust and deterioration, wash it thoroughly and frequently at least once a month with lukewarm or cold water.

If you use your vehicle for off-road driving, you should wash it after each off-road trip. Pay special attention to the removal of any accumulation of salt, dirt, mud, and other foreign materials. Make sure the drain holes in the lower edges of the doors and rocker panels are kept clear and clean.

Insects, tar, tree sap, bird droppings, industrial pollution and similar deposits can damage your vehicle's finish if not removed immediately.

Even prompt washing with plain water may not completely remove all these deposits. A mild soap, safe for use on painted surfaces, should be used.

After washing, rinse the vehicle thoroughly with lukewarm or cold water. Do not allow soap to dry on the finish.

WARNING

After washing the vehicle, test the brakes while driving slowly to see if they have been affected by water before getting on the road. If braking performance is impaired, dry the brakes by applying them lightly while maintaining a slow forward speed.

NOTICE

- **Do not use harsh soap, chemical detergents or hot water, and do not wash the vehicle in direct sunlight or when the body of the vehicle is warm.**
- **Be careful when washing the side windows of your vehicle.**
Especially, with high-pressure water, water may leak through the windows and wet the interior.
- **To prevent damage to the plastic parts, do not clean with chemical solvents or strong detergents.**

High-pressure washing

- When using high-pressure washers, make sure to maintain sufficient distance from the vehicle. Insufficient clearance or excessive pressure can lead to component damage or water penetration.
- Do not spray the camera, sensors or its surrounding area directly with a high pressure washer. Shock applied from high pressure water may cause the device to not operate normally.
- Do not bring the nozzle tip close to boots (rubber or plastic covers) or connectors as they may be damaged if they come into contact with high pressure water.
- Do not use any high-pressure nozzles, which induce either one-direct water stream or water swirling.



OBU078046N

NOTICE

- **Water washing in the engine compartment including high pressure water washing may cause the failure of electrical circuits located in the engine compartment.**
- **Never allow water or other liquids to come in contact with electrical/electronic components inside the vehicle as this may damage them.**

NOTICE

Matte paint finish vehicle (if equipped)

Automatic car wash which uses rotating brushes should not be used as this can damage the surface of your vehicle. A steam cleaner which washes the vehicle surface at high temperature may result the oil to adhere and leave stains that is difficult to remove.

Use a soft cloth (e.g. microfiber towel or sponge) when washing your vehicle and dry with a microfiber towel. When you hand wash your vehicle, you should not use a cleaner that finishes with wax. If the vehicle surface is too dirty (sand, dirt, dust, contaminant, etc.), clean the surface with water before washing the car.

Waxing

A good coat of wax provides a barrier between your paint and environmental contamination.

Keeping a good coat of wax on your vehicle will help protect it.

Wax the vehicle when water will no longer bead on the paint.

Always wash and dry the vehicle before waxing. Use a good quality liquid or paste wax, and follow the manufacturer's instructions. Wax all metal trim to protect it and to maintain its luster.

Removing oil, tar, and similar materials with a spot remover will usually strip the wax from the finish. Be sure to re-wax these areas even if the rest of the vehicle does not yet need waxing.

NOTICE

- **Wiping dust or dirt off the body with a dry cloth will scratch the finish.**
- **Do not use steel wool, abrasive cleaners, or strong detergents containing highly alkaline or caustic agents on chrome-plated or anodized aluminum parts. This may result in damage to the protective coating and cause discoloration or paint deterioration.**

NOTICE

Matte paint finish vehicle (if equipped)

Do not use any polish protector such as a detergent, an abrasive and a polish. In case wax is applied, remove the wax immediately using a silicon remover and if any tar or tar contaminant is on the surface use a tar remover to clean. However, be careful not to apply too much pressure on the painted area.

Repairing your vehicle's finish

Deep scratches or stone chips in the painted surface must be repaired promptly. Exposed metal will quickly rust and may develop into a major repair expense.

NOTICE

If your vehicle is damaged and requires any metal repair or replacement, be sure the body shop applies anti-corrosion materials to the parts repaired or replaced.

NOTICE

Matte paint finish vehicle (if equipped)

In case of matte paint finish vehicles, it is impossible to modify only the damaged area and repair of the whole part is necessary. If the vehicle is damaged and painting is required, we recommend that you have your vehicle maintained and repaired by an authorized HYUNDAI dealer. Take extreme care, as it is difficult to restore the quality after the repair.

Bright-metal maintenance

- To remove road tar and insects, use a tar remover, not a scraper or other sharp object.
- To protect the surfaces of bright-metal parts from corrosion, apply a coating of wax or chrome preservative and rub to a high luster.
- During winter weather or in coastal areas, cover the bright metal parts with a heavier coating of wax or preservative. If necessary, coat the parts with non-corrosive petroleum jelly or other protective compound.

Underbody maintenance

Corrosive materials used for ice and snow removal and dust control may collect on the underbody. If these materials are not removed, accelerated rusting can occur on underbody parts such as the fuel lines, frame, floor pan and exhaust system, even though they have been treated with rust protection.

Thoroughly flush the vehicle underbody and wheel openings with lukewarm or cold water once a month, after off-road driving and at the end of each winter. Pay special attention to these areas because it is difficult to see all the mud and dirt. It will do more harm than good to wet down the road grime without removing it. The lower edges of doors, rocker panels, and frame members have drain holes that should not be allowed to clog with dirt; trapped water in these areas can cause rusting.

WARNING

After washing the vehicle, test the brakes while driving slowly to see if they have been affected by water. If braking performance is impaired, dry the brakes by applying them lightly while maintaining a slow forward speed.

Aluminum wheel maintenance

The aluminum wheels are coated with a clear protective finish.

NOTICE

- **Do not use abrasive cleaner, polishing compound, solvent, or wire brushes on aluminum wheels.**
- **Clean the wheel when it has cooled.**
- **Use only a mild soap or neutral detergent, and rinse thoroughly with water. Also, clean the wheels after driving on salted roads.**
- **Do not wash the wheels with high-speed car wash brushes.**
- **Do not use any cleaners containing acid or alkaline detergents.**

Corrosion protection

Protecting your vehicle from corrosion

By using the most advanced design and construction practices to combat corrosion, HYUNDAI produces vehicles of the highest quality. However, this is only part of the job. To achieve the long-term corrosion resistance your vehicle can deliver, the owner's cooperation and assistance is also required.

Common causes of corrosion

The most common causes of corrosion on your vehicle are:

- Road salt, dirt and moisture that is allowed to accumulate underneath the vehicle.
- Removal of paint or protective coatings by stones, gravel, abrasion or minor scrapes and dents which leave unprotected metal exposed to corrosion.

High-corrosion areas

If you live in an area where your vehicle is regularly exposed to corrosive materials, corrosion protection is particularly important. Some of the common causes of accelerated corrosion are road salts, dust control chemicals, ocean air and industrial pollution.

Moisture breeds corrosion

Moisture creates the conditions in which corrosion is most likely to occur. For example, corrosion is accelerated by high humidity, particularly when temperatures are just above freezing. In such conditions, the corrosive material is kept in contact with the car surfaces by moisture that is slow to evaporate.

Mud is particularly corrosive because it is slow to dry and holds moisture in contact with the vehicle. Although the mud appears to be dry, it can still retain the moisture and promote corrosion.

High temperatures can also accelerate corrosion of parts that are not properly ventilated so the moisture can be dispersed. For all these reasons, it is particularly important to keep your vehicle clean and free of mud or accumulations of other materials. This applies not only to the visible surfaces but particularly to the underside of the vehicle.

To help prevent corrosion

Keep your vehicle clean

The best way to prevent corrosion is to keep your vehicle clean and free of corrosive materials. Attention to the underside of the vehicle is particularly important.

- If you live in a high-corrosion area — where road salts are used, near the ocean, areas with industrial pollution, acid rain, etc.—, you should take extra care to prevent corrosion. In winter, hose off the underside of your vehicle at least once a month and be sure to clean the underside thoroughly when winter is over.

- When cleaning underneath the vehicle, pay particular attention to the components under the fenders and other areas that are hidden from view. Do a thorough job; just dampening the accumulated mud rather than washing it away will accelerate corrosion rather than prevent it. Water under high pressure and steam are particularly effective in removing accumulated mud and corrosive materials.
- When cleaning lower door panels, rocker panels and frame members, be sure that drain holes are kept open so that moisture can escape and not be trapped inside to accelerate corrosion.

Keep your garage dry

Don't park your vehicle in a damp, poorly ventilated garage. This creates a favorable environment for corrosion. This is particularly true if you wash your vehicle in the garage or drive it into the garage when it is still wet or covered with snow, ice or mud. Even a heated garage can contribute to corrosion unless it is well ventilated so moisture is dispersed.

Keep paint and trim in good condition

Scratches or chips in the finish should be covered with "touch-up" paint as soon as possible to reduce the possibility of corrosion. If bare metal is showing through, the attention of a qualified body and paint shop is recommended.

Bird droppings are highly corrosive and may damage painted surfaces in just a few hours. Always remove bird droppings as soon as possible.

Interior Care

Interior general precautions

Prevent caustic solutions such as perfume and cosmetic oil, from contacting the interior parts because they may cause damage or discoloration. If they do contact the interior parts, wipe them off immediately. See the instructions for the proper way to clean vinyl.

NOTICE

- **Never allow water or other liquids to come in contact with electrical/electronic components inside the vehicle as this may damage them.**
- **When cleaning leather products (steering wheel, seats etc.), use neutral detergents or low alcohol content solutions. If you use high alcohol content solutions or acid/alkaline detergents, the color of the leather may fade or the surface may get stripped off.**

Cleaning the upholstery and interior trim

Vinyl (if equipped)

Remove dust and loose dirt from vinyl with a whisk broom or vacuum cleaner. Clean vinyl surfaces with a vinyl cleaner.

Fabric (if equipped)

Remove dust and loose dirt from fabric with a whisk broom or vacuum cleaner. Clean with a mild soap solution recommended for upholstery or carpets. Remove fresh spots immediately with a fabric spot cleaner. If fresh spots do not receive immediate attention, the fabric can be stained and its color can be affected. Also, its fire-resistant properties can be reduced if the material is not properly maintained.

NOTICE

Using anything but recommended cleaners and procedures may affect the fabric's appearance and fire-resistant properties.

Leather (if equipped)

• Features of seat leather

- Leather is made from the outer skin of an animal, which goes through a special process to be available for use. Since it is a natural product, each part differs in thickness or density.

Wrinkles may appear as a natural result of stretching and shrinking depending on the temperature and humidity.

- The seat is made of stretchable fabric to improve comfort.
- The parts contacting the body are curved and the side supporting area is high which provides driving comfort and stability.
- Wrinkles may appear naturally from usage. It is not a fault of the products.

CAUTION

- **Wrinkles or abrasions which appear naturally from usage are not covered by warranty.**
- **Belts with metallic accessories, zippers or keys inside the back pocket may damage the seat fabric.**
- **Make sure not to wet the seat. It may change the nature of natural leather.**
- **Jeans or clothes which could bleach may contaminate the surface of the seat covering fabric.**

- Caring for the leather seats
 - Vacuum the seat periodically to remove dust and sand on the seat. It will prevent abrasion or damage of the leather and maintain its quality.
 - Wipe the natural leather seat cover often with dry or soft cloth.
 - Use of proper leather protector may prevent abrasion of the cover and helps maintain the color. Be sure to read the instructions and consult a specialist when using leather coating or protective agent.
 - Light colored (beige, cream beige) leather is easily contaminated and the stain is noticeable. Clean the seats frequently.
 - Avoid wiping with wet cloth. It may cause the surface to crack.
- Cleaning the leather seats
 - Remove all contaminations instantly. Refer to instructions below for removal of each contaminant.
 - Cosmetic products (sunscreen, foundation, etc.)

Apply cleansing cream on a cloth and wipe the contaminated spot. Wipe off the cream with a wet cloth and remove water with a dry cloth.
 - Beverages (coffee, soft drink, etc.)

Apply a small amount of neutral detergent and wipe until contaminations do not smear.
 - Oil

Remove oil instantly with absorbable cloth and wipe with stain remover used only for natural leather.
 - Chewing gum

Harden the gum with ice and remove gradually.

Cleaning the seat belt webbing

Clean the belt webbing with any mild soap solution recommended for cleaning upholstery or carpet. Follow the instructions provided with the soap. Do not bleach or re-dye the webbing because this may weaken the seat belt.

Cleaning the interior window glass

If the interior glass surfaces of the vehicle become fogged (that is, covered with an oily, greasy or waxy film), they should be cleaned with glass cleaner. Follow the directions on the glass cleaner container.

NOTICE

Do not scrape or scratch the inside of the rear window. This may result in damage to the rear window defroster grid.

EMISSION CONTROL SYSTEM

The emission control system of your vehicle is covered by a written limited warranty. Please see the warranty information contained in the Owner's Handbook & Warranty Information booklet in your vehicle.

Your vehicle is equipped with an emission control system to meet all applicable emission regulations. There are three emission control systems, as follows.

- (1) Crankcase emission control system
- (2) Evaporative emission control system
- (3) Exhaust emission control system

In order to ensure the proper function of the emission control systems, it is recommended that you have your vehicle inspected and maintained by an authorized HYUNDAI dealer in accordance with the maintenance schedule in this manual.

NOTICE

For the Inspection and Maintenance Test (with Electronic Stability Control (ESC) system)

- **To prevent the vehicle from misfiring during dynamometer testing, turn the Electronic Stability Control (ESC) system off by pressing the ESC switch (ESC OFF light illuminated).**
- **After dynamometer testing is completed, turn the ESC system back on by pressing the ESC switch again.**

1. Crankcase Emission Control System

The positive crankcase ventilation system is employed to prevent air pollution caused by blow-by gases being emitted from the crankcase. This system supplies fresh filtered air to the crankcase through the air intake hose. Inside the crankcase, the fresh air mixes with blow-by gases, which then pass through the PCV valve into the induction system.

2. Evaporative Emission Control System Including Onboard Refueling Vapor Recovery (ORVR)

The Evaporative Emission Control System is designed to prevent fuel vapors from escaping into the atmosphere. The ORVR system is designed to allow the vapors from the fuel tank to be loaded into a canister while refueling at the gas station, preventing the escape of fuel vapors into the atmosphere.

Canister

Fuel vapors generated inside the fuel tank are absorbed and stored in the onboard canister. When the engine is running, the fuel vapors absorbed in the canister are drawn into the surge tank through the purge control solenoid valve.

Purge Control Solenoid Valve (PCSV)

The purge control solenoid valve is controlled by the Engine Control Module (ECM); when the engine coolant temperature is low during idling, the PCSV closes so that evaporated fuel is not taken into the engine. After the engine warms-up during ordinary driving, the PCSV opens to introduce evaporated fuel to the engine.

3. Exhaust Emission Control System

The Exhaust Emission Control System is a highly effective system which controls exhaust emissions while maintaining good vehicle performance.

When the engine starts or fails to start, excessive attempts to restart the engine may cause damage to the emission system.

Engine exhaust (carbon monoxide) precautions

- Carbon monoxide can be present with other exhaust fumes. If you smell exhaust fumes of any kind in your vehicle, drive with all the windows fully open. Have your vehicle checked and repaired immediately.

WARNING

Engine exhaust gases contain carbon monoxide (CO). Though colorless and odorless, it is dangerous and could be lethal if inhaled. Follow the instructions on this page to avoid CO poisoning.

 **WARNING**

**CALIFORNIA PROPOSITION 65
WARNING**

Engine exhaust and a wide variety of automobile components and parts, including components found in the interior furnishings in a vehicle, contain or emit chemicals known to the State of California to cause cancer and birth defects and reproductive harm. In addition, certain fluids contained in vehicles and certain products of component wear contain or emit chemicals known to the State of California to cause cancer and birth defects or other reproductive harm.

- Do not operate the engine in confined or closed areas (such as garages) any more than what is necessary to move the vehicle in or out of the area.
- When the vehicle is stopped in an open area for more than a short time with the engine running, adjust the ventilation system (as needed) to draw outside air into the vehicle.
- Never sit in a parked or stopped vehicle for any extended time with the engine running.
- When the engine stalls or fails to start, excessive attempts to restart the engine may cause damage to the emission control system.

Operating precautions for catalytic converters (if equipped)

 **WARNING**

The exhaust system and catalytic converter are very hot during and immediately after the engine has been running. To avoid **SERIOUS INJURY or **DEATH**:**

- **Do not park, idle, or drive the vehicle over or near flammable objects, such as grass, vegetation, paper, leaves, etc. A hot exhaust system can ignite flammable items under your vehicle.**
- **Keep away from the exhaust system and catalytic converter or you may get burned.**

Also, Do not remove the heat sink around the exhaust system, do not seal the bottom of the vehicle, and do not coat the vehicle for corrosion control. It may present a fire risk under certain conditions.

Your vehicle is equipped with a catalytic converter emission control device.

To prevent damage to the catalytic converter and to your vehicle, take the following precautions:

- Use only UNLEADED FUEL for gasoline engines.
- Do not operate the vehicle when there are signs of engine malfunction, such as misfire or a noticeable loss of performance.
- Do not misuse or abuse the engine. Examples of misuse are coasting with the engine off and descending steep grades in gear with the engine off.
- Do not operate the engine at high idle speed for extended periods (5 minutes or more).
- Do not modify or tamper with any part of the engine or emission control system. All inspections and adjustments must be made by an authorized HYUNDAI dealer.
- Avoid driving with extremely low fuel level. If you run out of gasoline, it could cause the engine to misfire and result in excessive loading of the catalytic converter.

CALIFORNIA PERCHLORATE NOTICE

Perchlorate Material-special handling may apply, See: www.dtsc.ca.gov/hazardouswaste/perchlorate.

Notice to California Vehicle Dismantlers:

Perchlorate containing materials, such as air bag inflators, seatbelt pretensioners and keyless remote entry batteries, must be disposed of according to Title 22 California Code of Regulations Section 67384.10 (a).

Specifications, Consumer information and Reporting safety defects

Dimensions	8-2
Engine	8-2
Bulb Wattage	8-3
Tires and Wheels	8-4
Volume and Weight.....	8-6
Air Conditioning System.....	8-6
Recommended Lubricants and Capacities	8-7
Recommended SAE viscosity number	8-8
Vehicle Identification Number (VIN)	8-9
Vehicle Certification Label.....	8-9
Tire Specification and Pressure Label	8-10
Engine Number	8-10
Consumer Information.....	8-11
Reporting Safety Defects	8-12

DIMENSIONS

Items			in (mm)
Overall length			167.91 (4,265)
Overall width			71.26 (1,810)
Overall height		225/40ZR18	55.08 (1,399)
		235/35R19	54.88 (1,394)
Front tread	M/T	225/40ZR18	61.30 (1,557)
		235/35R19	61.22 (1,555)
	DCT	235/35R19	61.93 (1,573)
		235/35R19	61.93 (1,573)
Rear tread	M/T	225/40ZR18	61.65 (1,566)
		235/35R19	61.57 (1,564)
	DCT	235/35R19	61.57 (1,564)
Wheelbase			104.33 (2,650)

M/T: Manual Transmission

DCT: Dual Clutch Transmission

ENGINE

Items	Displacement	Bore x Stroke	Firing order	No. of cylinders
2.0 T-GDI	121.9 cu. in (1,998 cc)	3.39 x 3.39 in. (86 x 86 mm)	1-3-4-2	In-line 4 cylinder

BULB WATTAGE

Light Bulb		Bulb Type	Wattage	
Front	Headlamp	Low	LED	
		High	HB3 Hyper L/L	
	Turn signal lamp		28W/8W	28
	Turn signal lamp (Outside mirror)		LED	LED
	Daytime running lamp (DRL) / parking lamp		LED	LED
	Side Marker Lamp		LED	LED
Rear	Rear combination lamp	Stop/Tail	LED	
		Turn signal	PY27W	27
		Back up	W16W	16
	License plate lamp		W5W	5
	High mounted stop lamp		LED	LED
	Side Marker Lamp		LED	LED
Interior	Map lamp		W10W	10
			LED	LED
	Room lamp		FESTOON	8
			LED	LED
	Vanity mirror lamp		FESTOON	5
	Liftgate room lamp		FESTOON	10

TIRES AND WHEELS

Full size tire

Tire Size	Wheel Size	Transmission	Inflation pressure [bar (kPa, psi)]								Wheel lug nut torque [kgf·m (lbf·ft, N·m)]
			Normal Load (less than 100mph or 160km/h)		Maximum Load (less than 100mph or 160km/h)		High-speed driving (over 100mph or 160km/h) *1		Track driving *2		
			Front	Rear	Front	Rear	Front	Rear	Front	Rear	
225/40ZR18	7.5J X 18	M/T	2.5 (250, 36)	2.3 (230, 33)	2.8 (280, 41)	2.8 (280, 41)	2.8 (280, 41)	2.8 (280, 41)	2.5 (250, 36)	2.5 (250, 36)	11~13 (79~94, 107~127)
235/35R19	8.0J X 19	M/T	2.6 (260, 38)	2.4 (240, 35)	2.9 (290, 42)	2.9 (290, 42)	2.9 (290, 42)	2.9 (290, 42)	2.6 (260, 38)	2.6 (260, 38)	
		DCT	2.55 (255,37)	2.4 (240,35)	2.9 (290,42)	2.9 (290,42)	2.9 (290,42)	2.9 (290,42)	2.9 (290,42)	2.9 (290,42)	

M/T : Manual Transmission

DCT : Dual Clutch Transmission

*1 : Must drive only where the speed is legal

*2 : Refers to the recommended inflation pressure for the hot tire condition (state when the tire temperature is increased). Limited number of passengers is 2 with no luggage. After the track driving is complete, change to the appropriate tire inflation recommended for the normal road driving condition.

Tires specified to this vehicle will have "HN" logo molded on the tire.

NOTICE

- It is permissible to add 3 psi to the standard tire pressure specification if colder temperatures are expected soon.
Tires typically loose 1psi (7kPa) for every 12°F temperature drop. If extreme temperature variations are expected, recheck your tire pressure as necessary to keep them properly inflated.
- An air pressure generally decreases, as you drive up to a high-altitude area above sea level. Thus, if you plan to drive a high-altitude area, check the tire pressures in advance. If necessary, inflate them to a proper level. (Air inflation per altitude : +2.4 psi/1 mile)
- Must do not exceed maximum inflation pressure shown on equipped tire sidewall.

CAUTION

When replacing tires, use the same size originally supplied with the vehicle.
Using tires of a different size can damage the related parts or not work properly.

VOLUME AND WEIGHT

Item	2.0 T-GDI	
	M/T	
Gross vehicle weight	lbs. (kg)	4,079 lbs. (1,850 kg)
Luggage volume (SAE)	cu. ft. (l)	Behind 1st Row : 44.5 cu.ft (1,261 l) Behind 2nd Row : 19.9 cu.ft (565 l)

M/T : Manual transmission

AIR CONDITIONING SYSTEM

Items	Weight of Volume	Classification
Refrigerant	oz. (g)	R-1234yf
Compressor lubricant	oz. (cc)	PAG

Contact an authorized HYUNDAI dealer for more details.

RECOMMENDED LUBRICANTS AND CAPACITIES

To help achieve proper engine and powertrain performance and durability, use only lubricants of the proper quality. The correct lubricants also help promote engine efficiency that results in improved fuel economy.

Lubricant		Volume	Classification
Engine oil ^{*1} ^{*2} (drain and refill)		5.07 US qt. (4.8 l)	SAE 0W-30, API Latest / ACEA C2 ^{*3}
Recommends 			
Manual transmission fluid		1.9 ~ 2.0 US qt. (1.8 ~ 1.9 l)	HK SYN MTF 70W (SK) SPIRAX S6 GHME 70W MTF (H.K.SHELL) GS MTF HD 70W (GS CALTEX) API GL-4, SAE 70W
Dual clutch transmission	Gear oil	3.49 ~ 3.59 US qt. (3.3 ~ 3.4 l)	WDGO-1
	Control oil	2.59 ~ 2.64 US qt. (2.45 ~ 2.5 l)	WDHO-1
Coolant		7.8 US qt. (7.4 l)	Mixture of antifreeze and water (Phosphate-based Ethylene glycol coolant for aluminum radiator)
Brake/Clutch fluid		0.74~0.85 US qt. (0.7 ~ 0.8 l)	SAE J1704 DOT4 LV (ISO4925 CLASS6, FMVSS 116 DOT4+)
Fuel		13.2 US gal. (50 l)	Refer to "Fuel requirements" in the Foreword chapter.

^{*1} : Refer to the recommended SAE viscosity numbers on the next page.

^{*2} : Engine oils labeled Energy Conserving Oil are now available. Along with other additional benefits, they contribute to fuel economy by reducing the amount of fuel necessary to overcome engine friction especially in colder weather conditions.

^{*3} : Requires <API Latest (ILSAC Latest) or "ACEA C2" Full synthetic> grade engine oil. If a lower grade engine oil (mineral oil including Semi-synthetic) is used, then the engine oil and engine oil filter must be replaced as indicated severe maintenance condition.

Recommended SAE viscosity number

CAUTION

Always be sure to clean the area around any filler plug, drain plug, or dipstick before checking or draining any lubricant. This is especially important in dusty or sandy areas and when the vehicle is used on unpaved roads. Cleaning the plug and dipstick areas will prevent dirt and grit from entering the engine and other mechanisms that could be damaged.

Engine oil viscosity (thickness) has an effect on fuel economy and cold weather operating (engine start and engine oil flowability). Lower viscosity engine oils can provide better fuel economy and cold weather performance, however, higher viscosity engine oils are required for satisfactory lubrication in hot weather.

Using oils of any viscosity other than those recommended could result in engine damage.

When choosing an oil, consider the range of temperature your vehicle will be operated in before the next oil change. Proceed to select the recommended oil viscosity from the chart.

Temperature Range for SAE Viscosity Numbers										
Temperature	°C	-30	-20	-10	0	10	20	30	40	50
	(°F)	-10	0	20	40	60	80	100	120	
Engine Oil *1						20W-50				
				15W-40						
			10W-30							
	0W-30									

*1 : For better fuel economy, it is recommended to use the engine oil of a viscosity grade SAE 0W30 API SN PLUS / SP or ILSAC GF-6.

An engine oil displaying this API Certification Mark conforms to the international Lubricant Specification Advisory Committee (ILSAC). It is recommended to only use engine oils that uphold this API Certification Mark.



VEHICLE IDENTIFICATION NUMBER (VIN)

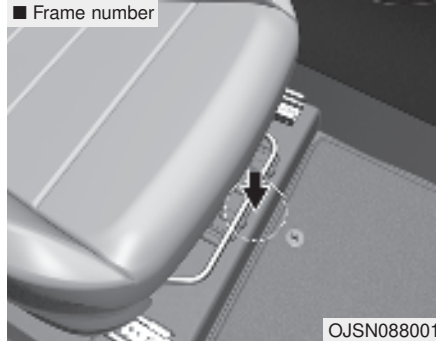

The vehicle identification number (VIN) is the number used in registering your car and in all legal matters pertaining to its ownership, etc.

The number is punched on the floor under the passenger seat. To check the number, open the cover.

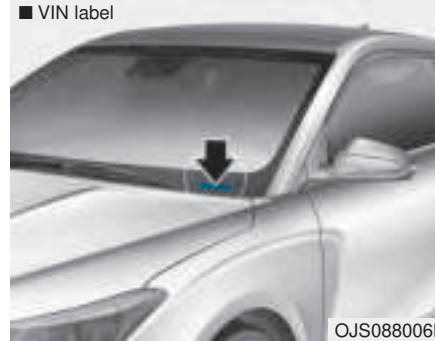

The VIN is also on a plate attached to the top of the dashboard. The number on the plate can easily be seen through the windshield from outside.

VEHICLE CERTIFICATION LABEL



The vehicle certification label attached on the driver's side center pillar gives the Vehicle Identification Number (VIN).

TIRE SPECIFICATION AND PRESSURE LABEL



OBU088003N

The tires supplied on your new vehicle are chosen to provide the best performance for normal driving.

The tire label located on the driver's side center pillar gives the tire pressures recommended for your car.

ENGINE NUMBER

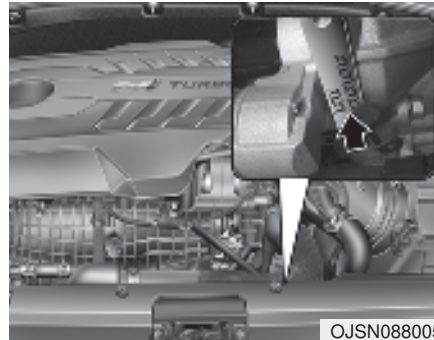

OJSN088005

The engine number is stamped on the engine block as shown in the drawing.

CONSUMER INFORMATION

This consumer information has been prepared in accordance with regulations issued by the National Highway Traffic Safety Administration of the U.S. Department of Transportation. Your HYUNDAI dealer will help answer any questions you may have as you read this information.

HYUNDAI motor vehicles are designed and manufactured to meet or exceed all applicable safety standards.

For your safety, however, we strongly urge you to read and follow all directions in this Owner's Manual, particularly the information under the headings **"NOTICE"**, **"CAUTION"** and **"WARNING"**.

If, after reading this manual, you have any questions regarding the operation of your vehicle, please contact your nearest HYUNDAI Motor America Regional Office as listed in the following:

Eastern Region:

Connecticut, Delaware,
Maine, Massachusetts, New
Hampshire, New Jersey, New York,
Pennsylvania, Rhode Island,
Vermont.

Eastern Region
1122 Cranbury South River Road
Jamesburg, NJ 08831
(800) 633-5151

Southern Region:

Florida, Georgia, Maryland, North
Carolina, South Carolina, Virginia,
West Virginia.

Southern Region
3025 Chastain Meadows Parkway
Suite 100 Marietta, GA 30066
(800) 633-5151

South Central Region:

Alabama, Arkansas, Louisiana,
Mississippi, New Mexico, Oklahoma,
Tennessee, Texas.

South Central Region
1421 South Beltline Road, Suite 400
Coppell, TX 75019
(800) 633-5151

Central Region:

Illinois, Indiana, Iowa, Kentucky,
Michigan, Minnesota, Nebraska,
North Dakota, South Dakota, Ohio,
Wisconsin, Kansas, Missouri.

Central Region
2 Trans Am Plaza Dr #500 Oakbrook
Terrace, IL 60181
(800) 633-5151

Western Region:

Alaska, Hawaii, Arizona, California,
Colorado, Idaho, Montana, Nevada,
Oregon, Utah, Washington,
Wyoming.

Western Region
10550 Talbert Avenue P.O.Box
20850 Fountain Valley, California
92728-0850
(800) 633-5151

REPORTING SAFETY DEFECTS

If you believe that your vehicle has a defect which could cause a crash or could cause injury or death, you should immediately inform the National Highway Traffic Safety Administration (NHTSA) in addition to notifying HYUNDAI MOTOR AMERICA.

To contact NHTSA, you may call the Vehicle Safety Hotline toll-free at 1-888- 327-4236 (TTY: 1-800-424-9153);
go to <http://www.safercar.gov>;
download the SaferCar mobile application;
or write to: Administrator, NHTSA
1200 New Jersey Ave, SE.,
Washington, DC 20590.

You can also obtain other information about motor vehicle safety from <http://www.safercar.gov>.

If NHTSA receives similar complaints, it may open an investigation, and if it finds that a safety defect exists in a group of vehicles, it may order a recall and remedy campaign. However, NHTSA cannot become involved in individual problems between you, your dealer, or HYUNDAI MOTOR AMERICA.

Index

A

Accessing Your Vehicle3-3
 Immobilizer System3-8
 Smart Key.....3-3
 Air bag - advanced supplemental restraint system.....2-38
 Additional Safety Precautions.....2-60
 Air Bag Warning Labels.....2-61
 How Does the Air Bag System Operate?.....2-43
 Occupant Classification System (OCS)2-49
 SRS Care2-59
 What to Expect After an Air Bag Inflates.....2-48
 Where Are the Air Bags?2-40
 Why Didn't My Air Bag Go Off in a Collision?.....2-54
 Air Cleaner.....7-24
 Filter Replacement7-24
 Air Conditioning System8-6
 Appearance care.....7-70
 Exterior care7-70
 Interior care7-75
 Automatic climate control system3-91
 Automatic Temperature Control Mode3-92
 Manual Temperature Control Mode3-93
 System Maintenance3-99
 System Operation3-97

B

Battery.....7-29
 Battery Recharging.....7-30
 For Best Battery Service7-30
 Reset Features7-31
 Before driving5-4
 Before Entering the Vehicle5-4
 Before Starting5-4
 Blind-Spot Collision Warning (BCW).....5-84
 System malfunction and limitations.....5-89
 System operation5-87
 System settings.....5-85
 Brake/Clutch Fluid.....7-22
 Checking the brake/clutch Fluid Level7-22
 Brake system.....5-31
 Anti-lock Brake System (ABS).....5-34
 Disc Brakes Wear Indicator.....5-32
 Electronic Stability Control (ESC).....5-36
 Good Braking Practices.....5-44
 High Performance Brake5-32
 Hill-Start Assist Control (HAC).....5-44
 Parking Brake5-33
 Power Brakes.....5-31
 Vehicle Stability Management (VSM).....5-42
 Bulb Wattage.....8-3

C

California Perchlorate Notice	7-82
Child restraint system (CRS).....	2-27
Children Always in the Rear	2-27
Installing a Child Restraint System (CRS)	2-30
Selecting a Child Restraint System (CRS).....	2-28
Climate Control Additional Features.....	3-104
Automatic Ventilation.....	3-104
Climate Control Air Filter.....	7-25
Filter Inspection.....	7-25
Consumer Information	8-11
Cruise Control (CC).....	5-103
System operation	5-102
Temporary speed increase	5-103

D

Declaration of conformity.....	5-65
Dimensions	8-2
Door Locks	3-10
Automatic Door Lock and Unlock Features	3-13
Child-Protector Rear Door Locks	3-13
Operating Door Locks from Inside the Vehicle	3-11
Operating Door Locks from Outside the Vehicle	3-10
Drive Mode Integrated Control System	5-49
DRIVE MODE button.....	5-49
Functional description and operating conditions	5-53
N button.....	5-51
NGS (N Grin Shift)	5-52
Vehicle characteristic.....	5-54
Driver Assist System.....	3-82
Rear View Monitor (RVM)	3-82
Driver Attention Warning (DAW)	5-95
System malfunction and limitations.....	5-98
System operation	5-96
System settings	5-95
Dual clutch transmission	5-19
DCT warning messages.....	5-21
Dual clutch transmission operation.....	5-19
Good driving practices	5-29
Parking.....	5-29

E

Electronic control suspension (ECS)5-46

Electronic limited slip differential5-47

 Warning messages5-48

Emission Control System7-78

 Crankcase Emission Control System7-78

 Evaporative Emission Control System Including
 Onboard Refueling Vapor Recovery (ORVR)7-78

 Exhaust Emission Control System7-79

Engine8-2

Engine Compartment.....1-6, 7-3

Engine Coolant7-18

 Changing Engine Coolant7-21

 Checking the Engine Coolant Level7-18

Engine Number8-10

Engine Oil7-16

 Checking the Engine Oil and Filter7-17

 Checking the Engine Oil Level7-16

Explanation of Scheduled Maintenance Items7-13

Exterior Features.....3-25

 Fuel Filler Door3-28

 Hood3-25

 Liftgate3-26

Exterior Overview.....1-2

F

Forward Collision-Avoidance Assist (FCA)
(Front view camera only)5-64

 System malfunction and limitations5-70

 System operation5-67

 System settings5-65

Fuses7-47

 Engine Compartment Panel Fuse Replacement7-49

 Fuse/Relay Panel Description7-51

 Instrument Panel Fuse Replacement7-48

H

Hazard Warning Flasher6-2

High Beam Assist (HBA)3-75

 System malfunction and limitations3-77

 System operation3-76

 System settings3-76

I

If the Engine Overheats	6-6
If the Engine Will Not Start.....	6-3
If the Engine Doesn't Turn Over or Turns Over Slowly.....	6-3
If the Engine Turns Over Normally but Doesn't Start	6-3
If You Have a Flat Tire	6-14
With Tire Mobility Kit (TMK).....	6-14
Ignition switch	5-6
Engine Start/Stop Button.....	5-6
Important safety precautions.....	2-2
Air Bag Hazards	2-2
Always Wear Your Seat Belt.....	2-2
Control Your Speed	2-2
Driver Distraction.....	2-2
Keep Your Vehicle in Safe Condition	2-2
Restrain All Children.....	2-2
In Case of an Emergency While Driving	6-2
If the Engine Stalls at a Crossroad or Crossing	6-2
If the Engine Stalls While Driving.....	6-2
If you Have a Flat Tire While Driving.....	6-3
Infotainment System	4-2
Antenna	4-2
Bluetooth® Wireless Technology hands-free	4-4
Display Audio System.....	4-4
Steering Wheel Audio Controls.....	4-3
USB Port	4-2

Instrument cluster	3-31
Gauges and Meters	3-33
Instrument Cluster Control.....	3-32
LCD Display Messages.....	3-48
Transmission shift indicator	3-36
Warning and Indicator Lights.....	3-38
Instrument Panel Overview	1-5
Interior Features	3-107
Cargo Area Cover	3-112
Clock.....	3-110
Clothes Hanger	3-110
Cup Holder	3-107
Floor Mat Anchor(s)	3-111
Power Outlet.....	3-108
Sunvisor.....	3-108
USB charger	3-109
Interior Overview.....	1-4

J

Jump Starting	6-4
---------------------	-----

L

Lane Following Assist (LFA)5-107
 System malfunction and limitations5-111
 System operation5-108
 System settings5-107
 Lane Keeping Assist (LKA)5-77
 System malfunction and limitations5-81
 System operation5-79
 System settings5-77
 LCD Display3-45
 LCD Display Control3-54
 LCD Display Modes3-55
 Light Bulbs7-61
 Headlamp, Parking lamp, Daytime Running Light,
 Turn signal lamp and Side marker7-62
 High Mounted Stop Lamp Replacement7-68
 Interior Light Bulb Replacement7-68
 License Plate Light Bulb Replacement7-68
 Rear Combination Light Bulb Replacement7-65
 Side Repeater Lamp Replacement7-65
 Lighting3-68
 Exterior Lights3-68
 Interior Lights3-72

M

Maintenance Services7-4
 Owner Maintenance Precautions7-4
 Owner's Responsibility7-4
 Manual Climate Control System3-83
 Heating and Air Conditioning3-84
 System Maintenance3-89
 System Operation3-87
 Manual transmission5-12
 Good Driving Practices5-14
 Manual Transmission Operation5-12
 Rev matching5-15
 Mirrors3-17
 Inside rearview mirror3-17
 Side view mirrors3-18

O

Owner Maintenance7-5
 Owner Maintenance Schedule7-6

P

Parking Brake	7-23
Checking the Parking Brake	7-23
Performance option	5-58
Launch Control.....	5-56
N Power Shift (For DCT).....	5-62
N Track Sense Shift (For DCT)	5-61
Shift Indicator.....	5-59

R

Rear Cross-Traffic Collision Warning (RCCW).....	5-112
System malfunction and limitations	5-116
System operation	5-114
System settings	5-113
Recommended Lubricants and Capacities.....	8-7
Recommended SAE viscosity number.....	8-8
Reporting Safety Defects.....	8-12

S

Scheduled Maintenance Services	7-7
Maintenance Under Severe Usage Conditions.....	7-11
Normal Maintenance Schedule	7-8
Seat belts	2-14
Additional seat belt safety precautions	2-23
Care of seat belts	2-26
Seat Belt Restraint System	2-17
Seat Belt Safety Precautions	2-14
Seat Belt Warning Light.....	2-15
Seats	2-3
Front Seats.....	2-5
Head Restraints	2-10
Rear Seats.....	2-8
Safety Precautions	2-4
Special driving conditions	5-120
Driving at Night	5-121
Driving in Flooded Areas	5-122
Driving in the Rain.....	5-121
Hazardous Driving Conditions.....	5-120
Highway Driving.....	5-122
Rocking the Vehicle	5-120
Smooth Cornering	5-121
Steering wheel.....	3-15
Electric Power Steering (EPS)	3-15
Horn.....	3-16
Tilt Steering / Telescope Steering	3-16

Storage Compartment	3-105
Center console storage	3-105
Glove box	3-105
Sunglass holder	3-106

T

Theft-Alarm System	3-14
Tire Pressure Monitoring System (TPMS)	6-8
Changing a Tire with TPMS	6-12
Check Tire Pressure.....	6-8
Low Tire Pressure LCD Display with Position Indicator	6-10
Low Tire Pressure Telltale.....	6-10
Low Tire Pressure Telltale.....	6-9
TPMS Malfunction Indicator	6-11
Tire specification and pressure label	8-10
Tires and wheels	7-32, 8-4
All Season Tires	7-44
Check Tire Inflation Pressure.....	7-34
Low Aspect Ratio Tires	7-45
Radial-Ply Tires.....	7-45
Recommended Cold Tire Inflation Pressures.....	7-33
Snow Tires.....	7-45
Summer Tires	7-44
Tire Care.....	7-33
Tire Maintenance.....	7-37
Tire Replacement.....	7-36
Tire Rotation.....	7-35
Tire Sidewall Labeling	7-37
Tire Terminology and Definitions.....	7-41
Tire Traction	7-37
Wheel Alignment and Tire Balance	7-36
Wheel Replacement.....	7-37
Towing	6-21
Dinghy towing.....	6-22
Emergency Towing.....	6-23
Removable Towing Hook.....	6-22
Tie-down Hook.....	6-25
Towing Service.....	6-21
Trailer towing.....	5-133
Trip computer.....	3-64

V

Vehicle Certification Label	8-9
Vehicle identification number (VIN)	8-9
Vehicle load limit	5-128
Tire Loading Information Label	5-129
Volume and Weight	8-6

W

Washer Fluid	7-23
Checking the Washer Fluid Level	7-23
Windows	3-21
Power Windows	3-22
Windshield Defrosting and Defogging	3-101
Rear Window Defroster	3-103
Winter driving	5-123
Snow or Icy Conditions	5-123
Winter Precautions	5-126
Wiper Blades	7-26
Blade Inspection	7-26
Blade Replacement	7-26
Wipers And Washers	3-79
Rear Window Wiper and Washer	3-81
Windshield Washers	3-80
Windshield Wipers	3-79