

DCS800

Service manual DCS800 Drives (20 to 5200 A)

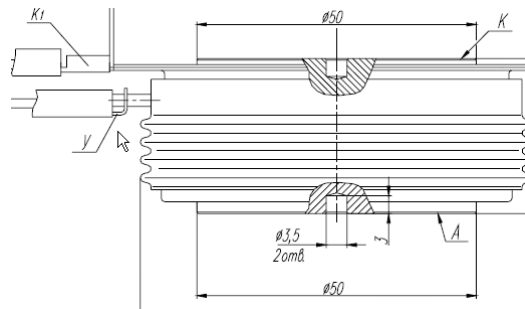
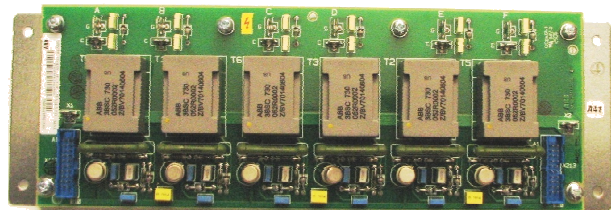
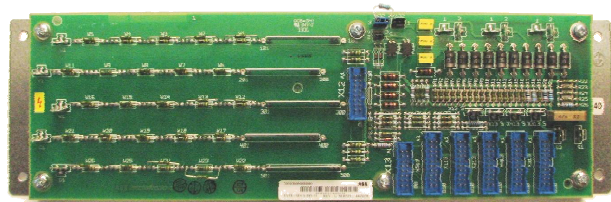
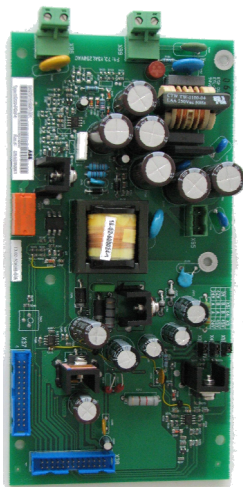

DCS800 Drive Manuals

	Public. number	Language							
		E	D	I	ES	F	CN	RU	PL
DCS800 Quick Guide	3ADW000191	x	x	x	x	x			
DCS800 Tools & Documentation CD	3ADW000211	x							
DCS800 Converter module									
Flyer DCS800	3ADW000190	x	x		x	x			
Technical Catalogue DCS800	3ADW000192	x	x	x	x	x	x	x	
Hardware Manual DCS800	3ADW000194	x	x	x	x	x	x	x	x
Hardware Manual DCS800 update DCF503B/DCF504B	3ADW000194Z0301	x							
Firmware Manual DCS800	3ADW000193	x	x	p	x	x	x	x	x
Installation according to EMC	3ADW000032	x							
Technical Guide	3ADW000163	x							
Service Manual DCS800	3ADW000195	x	x						
12-Pulse Manual	3ADW000196	x							
CMA-2 Board	3ADW000136	p							
Flyer Hard - Parallel	3ADW000213	x							
Drive Tools									
DriveWindow 2.x - User's Manual	3BFE64560981	x							
DriveOPC 2.x - User's Manual	3BFE00073846	x							
Optical DDCS Communication Link	3AFE63988235	x							
DDCS Branching Units - User's Manual	3BFE64285513	x							
DCS800 Applications									
PLC Programming with CoDeSys	CoDeSys_V23	x	x			x			
61131 DCS800 target +tool description - Application Program	3ADW000199	x							
DCS800 Crane Drive									
DCS800 Crane Drive Manual suppl.	3AST004143	x							
DCS800 Crane Drive Product note	PDC5 EN REVA	p							
DCS800 Winder ITC									
DCS800 Winder Product note	PDC2 EN	x							
DCS800 Winder description ITC	3ADW000308	x							
Winder Questionnaire	3ADW000253z	x							
DCS800-E Panel Solution									
Flyer DCS800-E Panel solution	3ADW000210	x							
Hardware Manual DCS800-E	3ADW000224	x							
DCS800-A Enclosed Converters									
Flyer DCS800-A	3ADW000213	x							
Technical Catalogue DCS800-A	3ADW000198	x							
Installation of DCS800-A	3ADW000091	x	x						
DCS800-R Rebuild System									
Flyer DCS800-R	3ADW000007	x	x						
DCS800-R Manual	3ADW000197	x							
DCS500/DCS600 Size A5...A7, C2b, C3 and C4 Upgrade Kits	3ADW000256	x							
Extension Modules									
RAIO-01 Analogue IO Extension	3AFE64484567	x							
RDIO-01 Digital IO Extension	3AFE64485733	x							
RRIA-01 Resolver Interface Module	3AFE68570760	x							
RTAC-01 Pulse Encoder Interface	3AFE64486853	x							
RTAC-03 TTL Pulse Encoder Interface	3AFE68650500	x							
AIMA R-slot extension	3AFE64661442	x							
Serial Communication									
Drive specific serial communication									
NETA Remote diagnostic interface	3AFE64605062	x							
Fieldbus Adapter with DC Drives RPBA- (PROFIBUS)	3AFE64504215	x							
Fieldbus Adapter with DC Drives RCAN-02 (CANopen)									
Fieldbus Adapter with DC Drives RCNA-01 (ControlNet)	3AFE64506005	x							
Fieldbus Adapter with DC Drives RDNA- (DeviceNet)	3AFE64504223	x							
Fieldbus Adapter with DC Drives RMBA (MODBUS)	3AFE64498851	x							
Fieldbus Adapter with DC Drives RETA (Ethernet)	3AFE64539736	x							
x -> existing p -> planned									
Status 04.2010									

DCS800 Drives 20 to 5200 A

Service Manual

Code: 3ADW000195R0501 Rev E

DCS800 Service Manual e e.doc

EFFECTIVE: 03.2011
SUPERSEDES: Rev D 09.2009

Safety instructions

What this chapter contains

This chapter contains the safety instructions you must follow when installing, operating and servicing the drive. If ignored, physical injury or death may follow, or damage may occur to the drive, the motor or driven equipment. Read the safety instructions before you work on the unit.

To which products this chapter applies

The information is valid for the whole range of the product DCS800, the converter modules DCS800-S0x size D1 to D7, field exciter units DCF80x, etc. like the Rebuild Kit DCS800-R00-9xxx.

Usage of warnings and notes

There are two types of safety instructions throughout this manual: warnings and notes. Warnings caution you about conditions which can result in serious injury or death and/or damage to the equipment, and advise on how to avoid the danger. Notes draw attention to a particular condition or fact, or give information on a subject. The warning symbols are used as follows:



Dangerous voltage warning warns of high voltage which can cause physical injury or death and/or damage to the equipment.



General danger warning warns about conditions, other than those caused by electricity, which can result in physical injury or death and/or damage to the equipment.



Electrostatic sensitive devices warning warns of electrostatic discharge which can damage the equipment.

Installation and maintenance work

These warnings are intended for all who work on the drive, motor cable or motor. Ignoring the instructions can cause physical injury or death and/or damage to the equipment.



WARNING!

- **Only qualified electricians are allowed to install and maintain the drive!**
- Never work on the drive, motor cable or motor when main power is applied.
Always ensure by measuring with a multimeter (impedance at least 1 Mohm) that:
 1. Voltage between drive input phases U1, V1 and W1 and the frame is close to 0 V.
 2. Voltage between terminals C+ and D- and the frame is close to 0 V.
- Do not work on the control cables when power is applied to the drive or to the external control circuits. Externally supplied control circuits may cause dangerous voltages inside the drive even when the main power on the drive is switched off.
- Do not make any insulation resistance or voltage withstand tests on the drive or drive modules.
- Isolate the motor cables from the drive when testing the insulation resistance or voltage withstand of the cables or the motor.
- When reconnecting the motor cable, always check that the C+ and D- cables are connected with the proper terminal.

Note:

- The motor cable terminals on the drive are at a dangerously high voltage when the main power is on, regardless of whether the motor is running or not.
 - Depending on the external wiring, dangerous voltages (115 V, 220 V or 230 V) may be present on the relay outputs of the drive system (e.g. SDCS-IOB-2 and RDIO).
 - DCS800 with enclosure extension: Before working on the drive, isolate the whole drive system from the supply.
-

Grounding

These instructions are intended for all who are responsible for the grounding of the drive. Incorrect grounding can cause physical injury, death and/or equipment malfunction and increase electromagnetic interference.



WARNING!

- Ground the drive, motor and adjoining equipment to ensure personnel safety in all circumstances, and to reduce electromagnetic emission and pick-up.
- Make sure that grounding conductors are adequately sized and marked as required by safety regulations.
- In a multiple-drive installation, connect each drive separately to protective earth (PE \oplus).
- Minimize EMC emission and make a 360° high frequency grounding (e.g. conductive sleeves) of screened cable entries at the cabinet lead-through plate.
- Do not install a drive equipped with an EMC filter to an ungrounded power system or a high resistance-grounded (over 30 ohms) power system.

Note:

- Power cable shields are suitable as equipment grounding conductors only when adequately sized to meet safety regulations.
 - As the normal leakage current of the drive is higher than 3.5 mA AC or 10 mA DC (stated by EN 50178, 5.2.11.1), a fixed protective earth connection is required.
-

Printed circuit boards and fiber optic cables

These instructions are intended for all who handle the circuit boards and fiber optic cables. Ignoring the following instructions can cause damage to the equipment.



WARNING! The printed circuit boards contain components sensitive to electrostatic discharge. Wear a grounding wrist band when handling the boards. Do not touch the boards unnecessarily.

Use grounding strip:



ABB order no.: 3ADV050035P0001

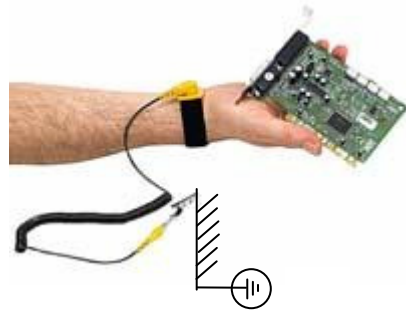

WARNING! Handle the fiber optic cables with care. When unplugging optic cables, always grab the connector, not the cable itself. Do not touch the ends of the fibers with bare hands as the fiber is extremely sensitive to dirt. The minimum allowed bend radius is 35 mm (1.38 in.).

Mechanical installation

These notes are intended for all who install the drive. Handle the unit carefully to avoid damage and injury.



WARNING!



- DCS800 sizes D4 ... D7: The drive is heavy. Do not lift it alone. Do not lift the unit by the front cover. Place units D4 and D5 only on its back.
DCS800 sizes D5 ... D7: The drive is heavy. Lift the drive by the lifting lugs only. Do not tilt the unit. The unit will overturn from a tilt of about 6 degrees.
 - Make sure that dust from drilling does not enter the drive when installing. Electrically conductive dust inside the unit may cause damage or lead to malfunction.
 - Ensure sufficient cooling.
 - Do not fasten the drive by riveting or welding.
-

Operation

These warnings are intended for all who plan the operation of the drive or operate the drive. Ignoring the instructions can cause physical injury or death and/or damage to the equipment.



WARNING!

- Before adjusting the drive and putting it into service, make sure that the motor and all driven equipment are suitable for operation throughout the speed range provided by the drive. The drive can be adjusted to operate the motor at speeds above and below the base speed.
- Do not control the motor with the disconnecting device (disconnecting mains); instead, use the control panel keys  and , or commands via the I/O board of the drive.
- Mains connection
You can use a disconnect switch (with fuses) to disconnect the electrical components of the drive from the mains for installation and maintenance work. The type of disconnect switch used must be as per EN 60947-3, Class B, so as to comply with EU regulations, or a circuit-breaker type which switches off the load circuit by means of an auxiliary contact causing the breaker's main contacts to open. The mains disconnect must be locked in its "OPEN" position during any installation and maintenance work.
- EMERGENCY STOP buttons must be installed at each control desk and at all other control panels requiring an emergency stop function. Pressing the STOP button on the control panel of the drive will neither cause an emergency stop of the motor, nor will the drive be disconnected from any dangerous potential.
To avoid unintentional operating states, or to shut the unit down in case of any imminent danger according to the standards in the safety instructions it is not sufficient to merely shut down the drive via signals "RUN", "drive OFF" or "Emergency Stop" respectively "control panel" or "PC tool".
- Intended use
The operating instructions cannot take into consideration every possible case of configuration, operation or maintenance. Thus, they mainly give such advice only, which is required by qualified personnel for normal operation of the machines and devices in industrial installations.
If in special cases the electrical machines and devices are intended for use in non-industrial installations - which may require stricter safety regulations (e.g. protection against contact by children or similar) - these additional safety measures for the installation must be provided by the customer during assembly.

Note:

- When the control location is not set to Local (L not shown in the status row of the display), the stop key on the control panel will not stop the drive. To stop the drive using the control panel, press the LOC/REM key and then the stop key .
-

Table of contents

Safety instructions	5
What this chapter contains.....	5
To which products this chapter applies.....	5
Usage of warnings and notes	5
Installation and maintenance work.....	6
Grounding.....	7
Mechanical installation.....	9
Operation	10
Table of contents	13
Introduction	16
How to use this manual.....	16
Contents of this manual	16
Target group	16
Associated publications	16
Storage and transport	17
Name plate and type code	17
Type code	18
Current and voltage ratings.....	19
Fault Tracing Thyristors	21
Tools	21
For commissioning and fault tracing.....	21
Additionally for service and preventive maintenance	22
How to detect a faulty thyristor.....	22
A fuse is blown	22
DC-current pulses measured by an oscilloscope	23
Thyristor diagnosis	23
Ripple monitor	23
How to find a faulty thyristor.....	24
Converters size D1 to D4 (20...1000 A).....	24
Blown fuses	24
Converters size D5, D6, and D7 (900...5200 A).....	25
Blown fuses	25
Ripple monitor	25
Handling the Semiconductors	27
General Instruction how to handle the Semiconductors	27
Exchange of Thyristors for Size D1 to D4	29
Installation of OnBoard bridge and thyristor modules in converters size D1 to D4 (20...1000 A)	29
Required Tools	29
Find faulty thyristor modules	29
Remove faulty thyristor modules	30
Install new thyristor modules	34

Remove faulty OnBoard bridge (V1)	36
Install new OnBoard bridge (V1)	36
OnBoard bridge (V1) and thyristor module location in DCS800-S01 (2-Q) units.....	37
OnBoard bridge (V1) and thyristor module location in DCS800-S02 (4-Q) units.....	38
OnBoard bridge and thyristor module terminals	39
Exchange of Thyristors for Size D5	41
Installation of "Disc Type" thyristor in converters size D5 (900...2000 A)	41
Required Tools	41
Disk type thyristors	42
Find faulty thyristor	45
Remove faulty thyristor.....	46
Install new thyristor.....	47
Exchange of Thyristors for Size D6	51
Installation of "Disc Type" thyristor in converters size D6 (1900...3000 A)	51
Required Tools	51
Disk type thyristors	52
BCT thyristors.....	53
Find faulty thyristor	54
Remove faulty thyristor.....	55
Install new thyristor.....	58
Exchange of Thyristors for Size D7	65
Installation of "Disc Type" thyristor in converters size D7 (2050...5200 A)	65
Required Tools	65
Find faulty thyristor	66
Install new thyristor.....	69
Exchange of SDCS-CON-4	75
General	75
Required Tools	75
Overview SDCS-CON-4 exchange.....	75
Service	83
How to remove the converter fans in frames D1 to D3 (two fans)	83
How to remove the converter fans in a frame D3 (four fans)	87
How to remove the converter fan in a frame D6	92
How to remove the converter fan in a frame D7	93
DCS800 firmware download	94
General.....	94
Download SDCS-CON-4 firmware.....	94
Add firmware or text files	107
Create a workspace.....	114
Download SDCS-COM-8 firmware	129
Set type code	131
Type code table	133
DC-Motor neutral zone adjustment	134
Types concerned	134
Summary	134
General.....	134

Preventive Maintenance **135**

- Recommended regular maintenance136
- Maintenance schedule136
- Annual preventive maintenance.....137
- 3 years preventive maintenance140
- 6 years preventive maintenance141
- 9 years preventive maintenance143

Appendix A - Spare Parts List **145**

Introduction

How to use this manual

The purpose of this service manual is to provide detailed information on how to service power converters from the **DCS800** series.

Contents of this manual

[Safety instructions](#)

This chapter is located at the beginning of this manual.

[Introduction](#)

This chapter informs about the contents and the use of this manual as well as the boundary conditions applying and the thyristor power converter rating plate.

[Fault Tracing Thyristors](#)

This chapter describes how to detect and select a faulty thyristor.

[Handling the Semiconductors](#)

This chapter describes the handling of thyristors and thyristor modules.

[Exchange of Thyristors of Sizes D1 to D4](#)

This chapter describes the exchange of thyristors in converters sizes D1 to D4.

[Exchange of Thyristors of Size D5](#)

This chapter describes the exchange of thyristors in converters size D5.

[Exchange of Thyristors of Size D6](#)

This chapter describes the exchange of thyristors in converters size D6.

[Exchange of Thyristors of Size D7](#)

This chapter describes the exchange of thyristors in converters size D7

[Exchange of SDCS-CON-4](#)

This chapter describes the exchange of a SDCS-CON-4

[Service](#)

This chapter contains hardware information and technical hints.

[Preventive Maintenance](#)

This chapter describes the measures for preventive maintenance of the thyristor converters.

[Appendix A Spare Parts list](#)

The *Appendix A* contains the spare parts list of the converters.

Target group

This manual is designed to help those responsible for planning, installing, starting up and servicing the thyristor power converter.

These people should possess:

- basic knowledge of physics and electrical engineering, electrical wiring principles, components and symbols used in electrical engineering, and
- basic experience with DC drives and products.

Associated publications

A list of associated publications is published on the inner page of this manual's cover, see [DCS800 Drive Manuals](#). Here is a list of the most important ones:

- The *DCS800 Hardware Manual* (3ADW000194) describes all hardware

- components of the DCS800, their connections and settings (e.g. jumpers)
- The *DCS800 Firmware Description* (3ADW000193) gives an overview of the DCS800 firmware, describes all parameters, describes the function of the DCS Control Panel, gives support in case of faults and alarms and gives information about communication.

The above listed documentation can be found on the CD-ROM being attached to the *DCS800 Quick Guide* (3ADW000191).



Storage and transport

If the unit has been in storage prior to installation or is transported to another location, care must be taken to ensure that the environmental conditions are complied with (see *Hardware Manual*).

Name plate and type code

For purposes of identification, each thyristor power converter is fitted with name plates, stating the type code and the serial number, which serve for each unit's individual identification.

The type code contains information about the characteristics and the configuration of the unit.

	ABB Automation Products				U ₁	3 ~ 525 V	U ₂	610 V	 LISTED 78WN IND. CONT. EQ.	Made in Germany
	Type: DCS800-S02-0025-05				I ₁	20 A	I ₂	25 A		+K454
	Ser No: 0025421A06294264				f ₁	50/60 Hz	I _f	6 A		+J409
					SCCR	65 kA	Fan	----		

Production year 2006 and week 29	Rated input voltage	Rated input current	Rated output current	Rated internal field exciter current	Rated fan voltage	Plus code
-------------------------------------	---------------------	---------------------	----------------------	--------------------------------------	-------------------	-----------

Example of a name plate

The technical data and specifications are valid as of going to press. ABB reserves the right to make subsequent alterations.

If you have any questions concerning your drive system, please contact your local ABB agent.

Current and voltage ratings

Unit size	2-Q rated current DCS800-01 [ADC]	4-Q rated current DCS800-02 [ADC]	Supply voltage [VAC]						
			400	525	600	690	800	990	1200
D1	20	25	X	X					
	45	50	X	X					
	65	75	X	X					
	90	100	X	X					
	125	140	X	X					
D2	180	200	X	X					
	230	260	X	X					
D3	315	350	X	X	X				
	405	450	X	X					
	470	520	X	X					
D4	610	680	X	X	X				
	740	820	X	X					
	900	1000	X	X					
D5	900	900			X	X			
	1200	1200	X	X					
	1500	1500	X	X	X	X			
	2000	2000	X	X	X ¹	X ¹			
D6	1900	1900					X		
	2050	2050		X	X	X			
	2500	2500	X	X	X	X	X		
	3000	3000	X	X	X	X	X		
D7	2050	2050						X	
	2600	2600						X	X
	3300	3300	X	X	X	X	X	X	X
	4000	4000	X	X	X	X	X	X	X
	4800	4800			X	X	X		
	5200	5200	X	X					

¹ only available as 2-Q drive

Fault Tracing Thyristors

Tools

For commissioning and fault tracing

Following software tools are mandatory:

- DriveWindow Light including commissioning wizard and DWL AP for Adaptive Program **and**
- DriveWindow for fast drive monitoring using SDCS-COM-8.

Following tools are mandatory in addition to standard tools:

- An oscilloscope including memory function with either galvanically isolating transformer or isolating amplifier (probe) for safe measurements. It can also be a hand held (portable) oscilloscope.
- A clamp on current probe. In case the scaling of the DC load current needs to be checked it must be a DC clamp on current probe.
- A voltmeter (at least CAT III 1000 V):



- 1000 V probes and test leads:

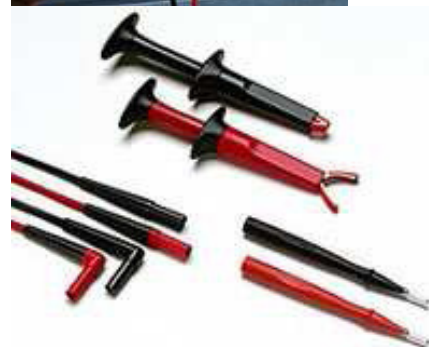

- An ESD-field service kit (ABB Service Finland code 0001ESD / MS-Antistatic):



Make sure that all equipment in use is suitable for the voltage level applied to the power part!

Additionally for service and preventive maintenance

Following additional tools are mandatory for cleaning:

- An ESD safe blower / ESD vacuum cleaner (ABB Service Finland code 0006ESD / MUNTZ 555-ESD-S-E):



How to detect a faulty thyristor

Thyristor problems can be noticed differently:

A fuse is blown

This is an indication, that a strong overcurrent has happened due to one of the following reasons:

- An internal short circuit between the phases (line side) because of a defective thyristor (short circuit inside a thyristor from anode to cathode).
- An internal short circuit between the phases (line side) because of circulating current in a 4-Q converter (malfunction of the control electronics, no thyristor defective).
- An external short circuit at the DC terminals of the converter without sufficient impedance.
- A commutation fault during generating (active braking with high current, high EMF and with low AC voltage) of a 4-Q converter.

Note:

In case of parallel fuses: If one of the parallel fuses is blown, all parallel fuses have to be changed. The 'undamaged' fuses might be 'half-blown' and will blow with the next high current.

DC-current pulses measured by an oscilloscope

Connect an oscilloscope to the fixed AO I-act (X4:9/10 on the SDCS-CON-4 or X4:5/6 on the SDCS-IOB-3) and check for the proper amount of current pulses:

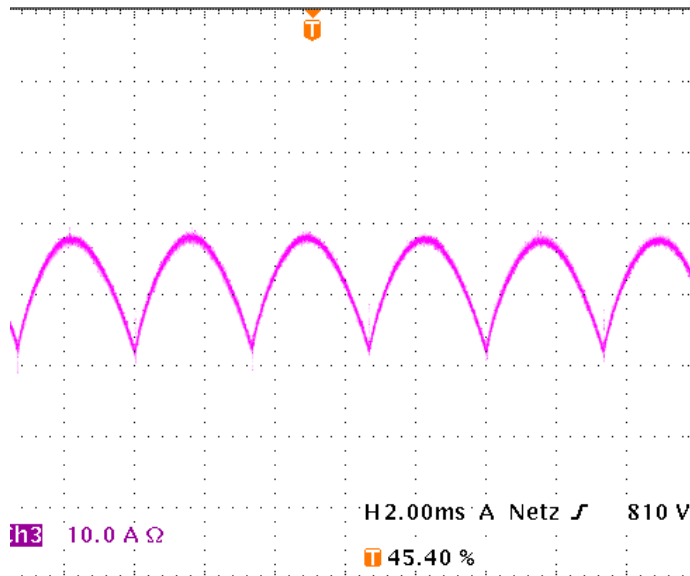

Six current pulses in positive direction

There should be six current pulses in positive direction.

In case of a 4-Q converter also the six current pulses for the negative direction have to be checked.

Thyristor diagnosis

Also the thyristor diagnosis provided by the firmware can be used:

- Switch the drive to local mode (DriveWindow, DriveWindow Light, DCS Control Panel or local I/O).
- Start the thyristor diagnosis by means of *ServiceMode (99.06) = ThyDiagnosis* and set **On** and **Run** within 20 s.
- During the thyristor diagnosis the main contactor will be closed and the thyristors are checked. The field current is not released while the thyristor diagnosis is active and thus the motor should not turn.
- When the thyristor diagnosis is finished check *Diagnosis (9.11)* for details.

Ripple monitor

The ripple monitor indicates that the ripple of the DC current is much higher than normal. In such a case, most often one thyristor does not work. It's missing current contribution causes a deep dip in the direct current.

The structure of the current loop (current controller) will force the other thyristors to compensate the dip by a certain overcurrent in order to keep the average current constant. Such a compensation results in a ripple monitoring fault during motoring mode operation with $\alpha \leq 90^\circ$.

The reason for a current less thyristor may be:

- A fuse has disconnected one of the six thyristors. This is possible only for converters with 900 ... 5200 A (six internal branch fuses). A converter with three external fuses stops working completely at once when one of the three AC input fuses interrupts a phase input of the converter.
- A thyristor does not get firing pulses or does not react to firing pulses.
- The current controller may be totally mismatched to the DC load.
- The AC mains network is causing that fault message. In this case, asymmetrical phase shift, uneven phase voltage or critical designed power factor correction equipment or harmonic reduction equipment can be the reason.

How to find a faulty thyristor

If a blown fuse is suspected in the converter, the problem is caused most often by a faulty thyristor. To make sure, that a thyristor is the reason and needs to be exchanged fault tracing must be done in two different ways, depending on the size of the converter.

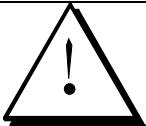

In general, make sure, that all safety instructions, given within this manual or within the safety instructions, related to the machine or the application itself, are obeyed.

Converters size D1 to D4 (20...1000 A)

These converters require semiconductor fuses in the 3 AC lines.

- The converter must be disconnected from the mains.
- One motor armature cable should be disconnected from the converter.

Blown fuses

- Using the OHM function of a normal multimeter, measurements must be made from each AC terminal to each DC terminal (U1 to C1, V1 to C1, W1 to C1, U1 to D1, V1 to D1 and W1 to D1; see picture [Anti-parallel B6-bridges with branching fuses](#) on page 45). Normally, every measurement should show high resistance ($> 1 \text{ k}\Omega$).
- Target: find a short circuit, indicated by low resistance ($< 1 \Omega$) (destroyed thyristor).
- If the converter is designed with half-bridge thyristor modules, then a module consists of two anti-parallel thyristors. In this case it is sufficient to know which thyristor pair or module has a defective thyristor because the complete module must be replaced.
- After a thyristor module is replaced, the above mentioned measurement should be done another time to make sure that all faulty thyristors have been detected!

Note:

The RC circuit could also cause 0Ω result for a short time.

The measurement, showing less resistance than 1Ω should be made a second time with test leads applied to the terminals with opposite polarity; if this measurement shows the same result, one or two thyristors located in that path are faulty; they need to be replaced.

Converters size D5, D6, and D7 (900...5200 A)

These converters are equipped with fuses in the branches of the power part.

- The converter must be disconnected from the mains.

Blown fuses

- In case of a blown fuse, the faulty thyristor or the faulty pair of thyristors are already isolated at one side from the others and therefore the faulty branch is known (see picture [Anti-parallel B6-bridges with branching fuses](#) on page 45).
- The OHM test should be performed, when the thyristor is still clamped. Outside the converter a special thyristor clamping device is needed.
- For 4-Q converters with anti-parallel thyristors or BCT's:
- The selection of a forward or reverse thyristor or BCT (Bidirectional-Controlled-Thyristor) is done during the disassembly. Continue with related part *Exchange of Thyristors for Size [D5](#), [D6](#) or [D7](#)* section *Find faulty thyristor*.
- After a thyristor was replaced, the OHM test should be done another time to make sure that all faulty thyristors have been detected! If the motor is still connected to the converter the result of the measurement may be wrong.

Ripple monitor

If the ripple monitor fault occurred, a fault tracing as described above must be carried out:

- Check the fuses and the thyristors, according to the statements before.
- If the power section seems to be ok, but still one or more thyristors don't take current, something went wrong in between the firing pulse generation and the thyristor's gate; in this case check:
 - Is a firing pulse present on the primary side of the firing pulse transformer?
 - Is a firing pulse present on the secondary side of the firing pulse transformer?
 - Is the firing pulse transferred to the gate of the thyristor? Are there all electrical connections still healthy?
 - Can the thyristor be fired with the applied firing pulse? Is the pulse form of the firing pulse identical at all measuring positions?
- Check the settings of the current controller.
- Check the AC mains network by taking recordings of the line voltage and current at all 3 phases at the same time.

Handling the Semiconductors

General Instruction how to handle the Semiconductors

Thyristor modules, busbars and fuses have to be mounted with the correct torque using a torque screw driver or torque wrench.

In converters sizes D5 (900 ... 2000 A), D6 (1900 ... 3000 A) and D7 (2050 ... 5200 A) the mounting force is indicated by an indicating spring welded to the mounting clamp, which is inside the unit.

Always mark suspected damaged components clearly after removing them from the circuit, to avoid confusion with "good" components.

When removing a damaged semiconductor, write down how and where it was installed (direction, location, connected gate leads and with BCT's the position of the gate connectors).

Check that the new and old components have the same type designation or that the new component can replace the old one. A semiconductor can be replaced by different compatible semiconductor according to the codes in the manufacturers' table.

Semiconductor components are high-precision products. All unnecessary used tools and objects might damage the easily dented and scratched surfaces of the semiconductors.

1. Keep new semiconductors as long as possible in their original packages.
2. Use protective gloves if possible.
3. Clean work area and hands frequently.
4. Use good illumination.

Exchange of Thyristors for Size D1 to D4

Installation of OnBoard bridge and thyristor modules in converters size D1 to D4 (20...1000 A)

All DCS800 size D1 to D4 are equipped with an OnBoard bridge (excitation) and thyristor modules. In order to keep the operating temperature of the semiconductor module low, the joint between the heat sink and the module should have a good heat conducting ability. The electrical conductivity of the connectors must also be good. For this reason the following instructions must be observed with particular care.

Required Tools

Special tools or material needed in addition to standard tools for the exchange of thyristor modules:

- Torx screwdrivers: TX10, TX20, TX25
- Torque spanner: mounting torques for the OnBoard bridge and the thyristor modules to heat sink and electrical connections see table [Nominal mounting torque for OnBoard bridge and thyristor modules](#) on page 35
- Screws are metric type; use appropriate nuts
- Tissue paper
- Solvent (e.g. ethanol)
- Thermal joint compound: type Berulub FZ1 E3 (grease)
 - Manufacturer: Carl Bechem GmbH, 58089 Hagen
 - ABB Service: GHSN 390 011 P 0051
- or
- thermal joint compound: type WLPF 20 (10 ml)
 - ABB Service: GHSN 390 011 P 10



Before the work is started, disconnect the converter from the power supply completely, then check the voltage free condition and make sure, everything is located in an electrical and mechanical safe condition!

Find faulty thyristor modules

See [Fault Tracing Thyristors](#) of this publication.

Remove faulty thyristor modules

1. Remove the DCS Control Panel and design cover:



Remove design cover

2. Remove all plug in options on the intermediate cover e.g.:
 - serial communication modules (R-type),
 - extension I/O modules (RAIO, RDIO),
 - extension modules for second encoder (RTAC) or resolver (RRIA),
 - communication board (SDCS-COM-8),
 - isolated I/O (SDCS-IOB-2x, SDCS-IOB-3) and
 - SDCS-MEM-8 (Memory Card).
3. Remove the intermediate cover by depressing the two locks on the upper right and left hand side of the cover:

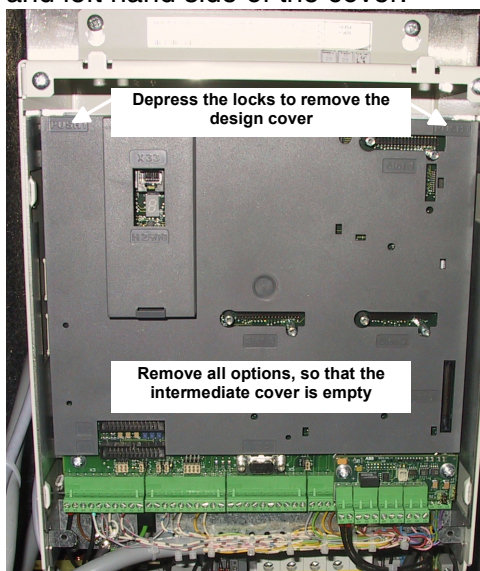

Remove plug in options

4. Disconnect all I/O plugs (X3 to X7) at the SDCS-CON-4 and the plugs at the SDCS-DSL-4 board, if used (X51 to X54):

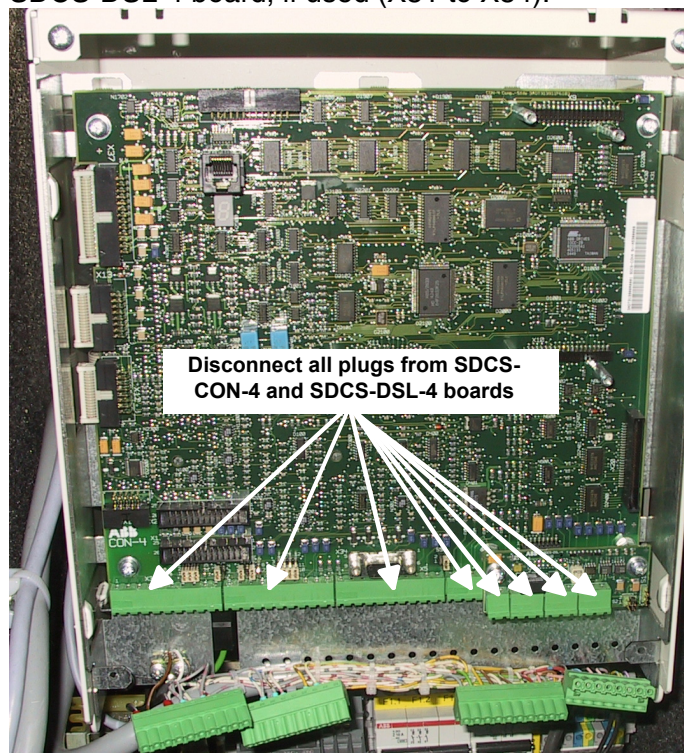

Disconnect all plugs

5. Remove the grounding plug and the holding screw at the electronic tray:

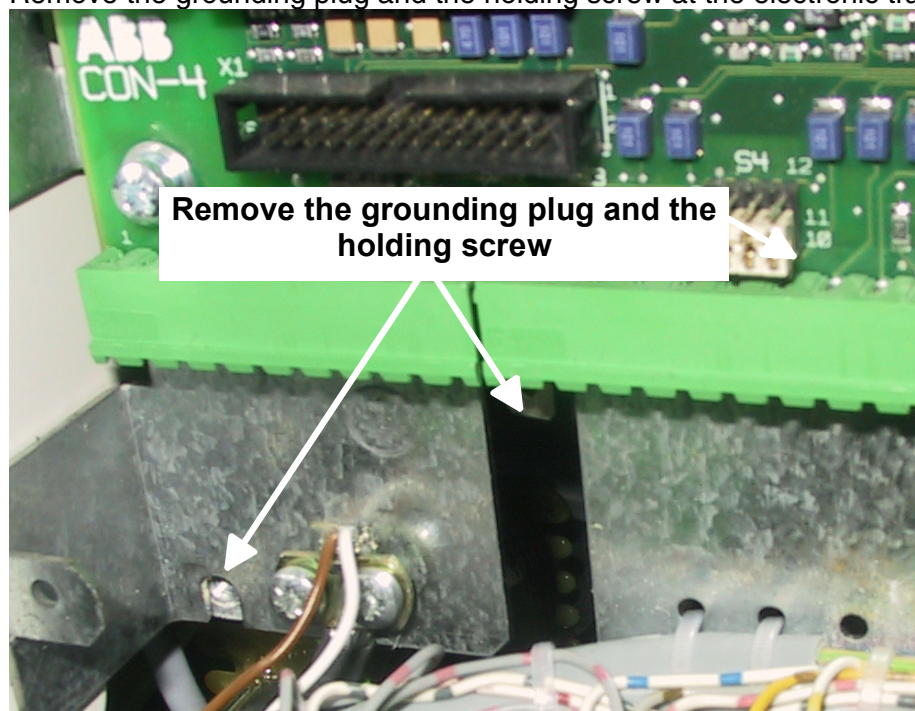

Remove grounding and screws

Exchange of Thyristors for Size D1 to D4

- To unhinge the electronic tray including the SDCS-CON-4 pull it up and then out. Before remove tray completely unplug the flat cables (X12, X13, X37):

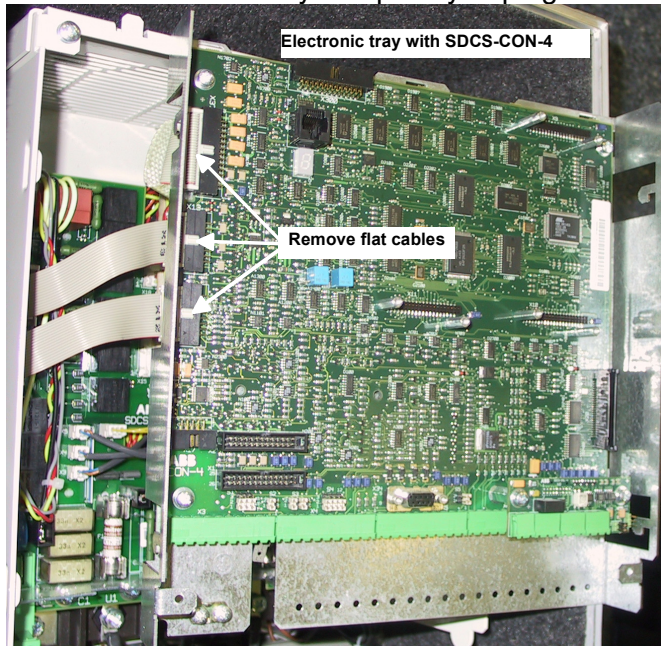

Unhinge electronic tray

- Remove all cables and plugs at the SDCS-PIN-4:

Keep winding direction and amount of windings for T100 in mind.

How to handle X8:

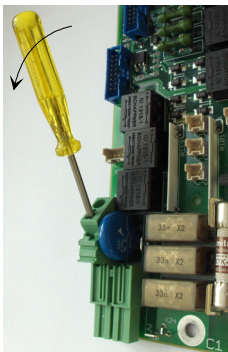

use screw driver

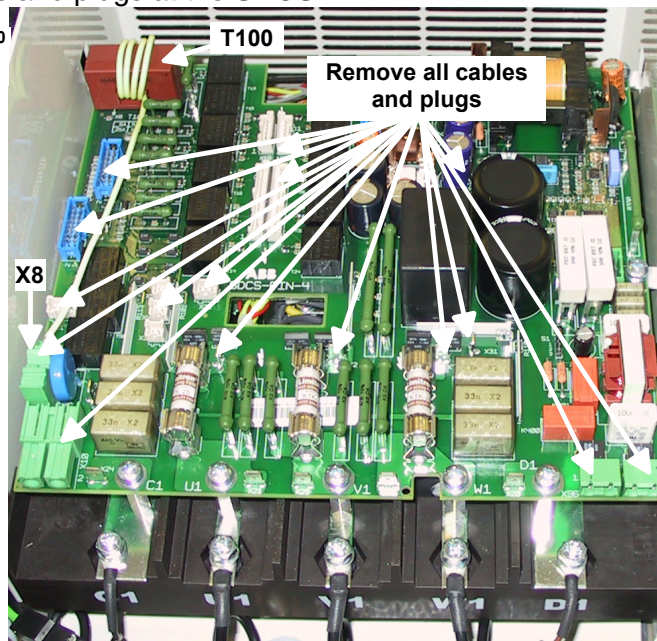

Remove cables at the SDCS-PIN-4

Attention:

Write down the winding direction of the cable through T100!

D1: thread the wire 4 times through the hole in T100 (that equals 3 loops)

D2 - D4: thread the wire 1 time through the hole in T100 (that equals no loops)

Exchange of Thyristors for Size D1 to D4

8. Remove the SDCS-PIN-4 board:

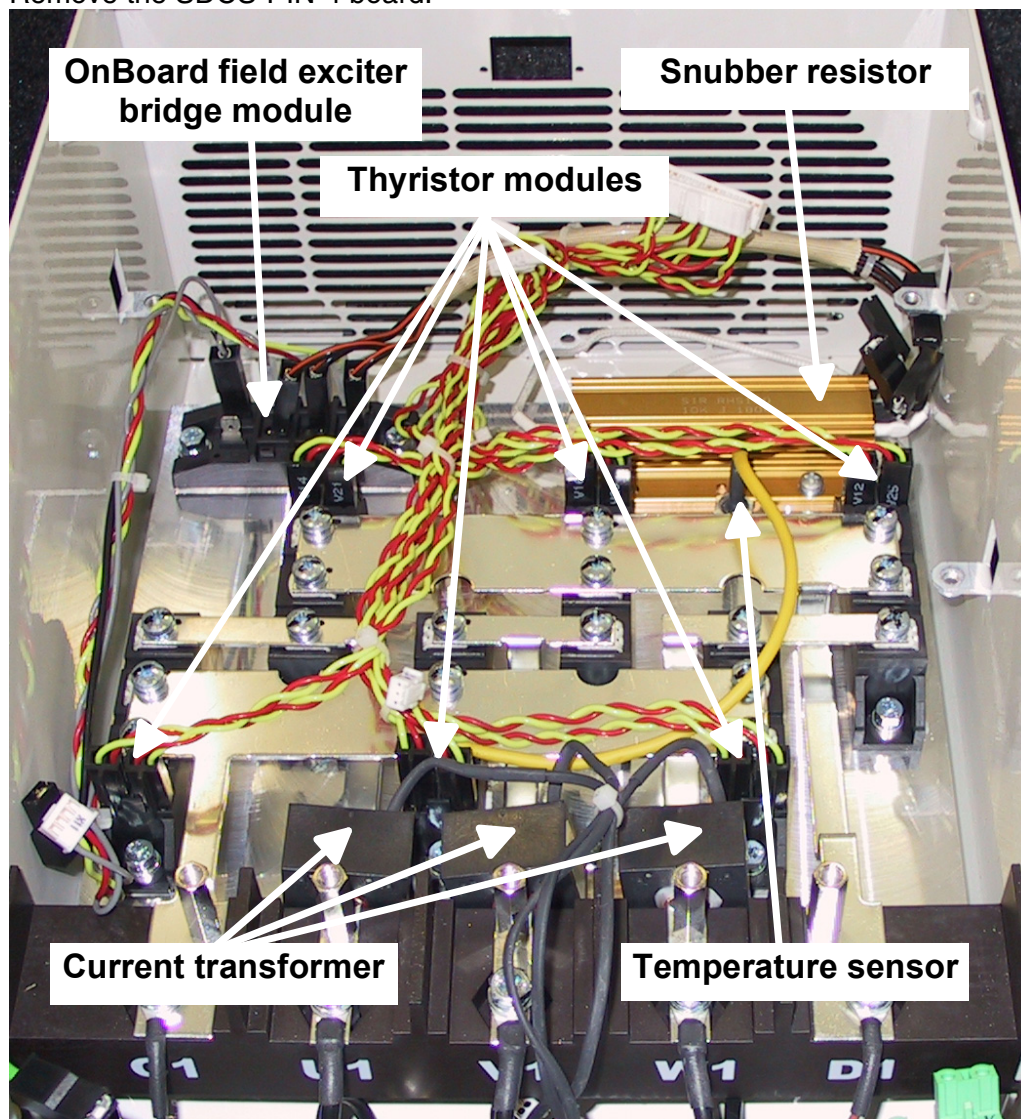

Remove SDCS-PIN-4

9. Remove the gate leads from the faulty thyristor module and mark the connectors clearly.
 10. Remove the busbars necessary to get full access to the faulty thyristor module.
 11. If a current transformer must be removed, mark its position and the connections clearly.
- Note:**
Remove only as many parts as needed around the faulty thyristor module.
12. Remove the faulty thyristor module and mark it clearly as defective.

Install new thyristor modules

1. Ensure that the new thyristor module is of the correct type ([see appendix A](#) of this manual).
2. Remove old heat conducting compound (grease) from the heat sink. Clean the mounting surfaces (heat sink and thyristor module) with an appropriate solvent (e.g. ethanol) by means of tissue paper. When the heat sink is clean, spread out the heat conducting compound with a rubber spatula or by hand.
3. Apply a thin layer of heat conducting compound to the new thyristor module:

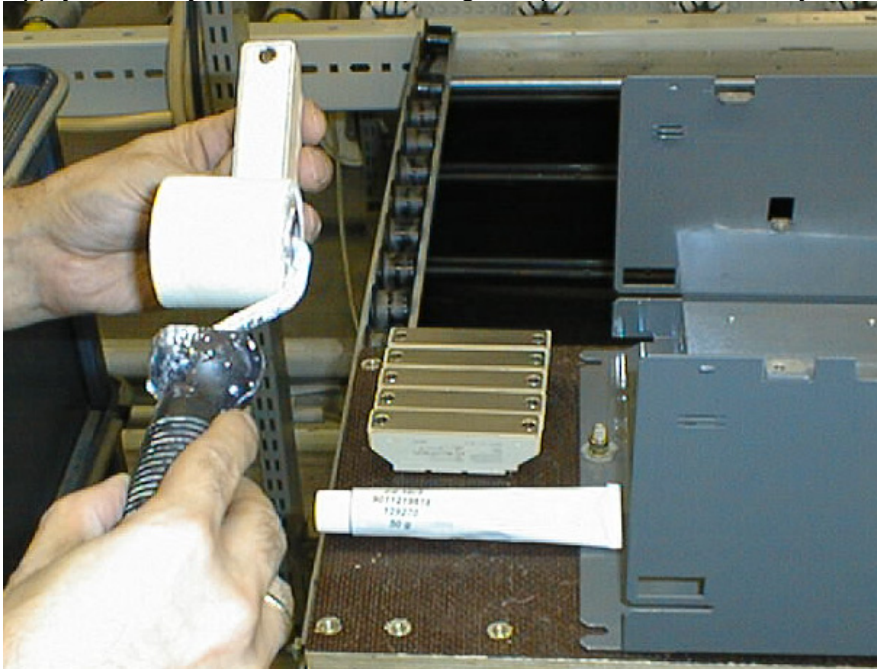

Application of heat conducting compound

4. Spread the heat conducting compound evenly by moving the thyristor module forward and backward on the heat sink.
5. Tighten all clamping screws by hand until the screw heads touch the bottom of the thyristor module. Then tighten the screws to 2.0 Nm torque.

Note:

If the thyristor module is mounted by means of four screws, tighten the screws crosswise.

6. Tighten the screws to nominal torque according to table [Nominal mounting torque for OnBoard bridge and thyristor modules](#) page 35.

OnBoard bridge and thyristor modules		Nominal mounting torque	
Size	Type	Electrical connections	Thyristor module to heat sink
29 mm bridge block	VVZF 70-16	-	5 Nm
20 mm block	SKKT 27, 42, 57, 106	3 Nm	5 Nm
20 mm block	MCC 26, 44, 56, 95	2.5 ... 4 Nm	2.5 ... 4 Nm
34 mm block	MCC 162	4.45 ... 5.5 Nm	2.25 ... 2.75 Nm
34 mm block	SKKT 162	5 Nm	5 Nm
34 mm block	TT 162	6 Nm	6 Nm
50 mm block	MCC 255	11 ... 13 Nm	4.5 ... 7 Nm
50 mm block	TT 250, 330	12 Nm	6 Nm
60 mm block	TT 425, 570	12 Nm	6 Nm

Nominal mounting torque for OnBoard bridge and thyristor modules

7. Reinstall the current transformer, make sure, its position is correct.
8. Reinstall the busbars, make sure, the correct torque is applied according to table [Nominal mounting torque for OnBoard bridge and thyristor modules](#) on page 35.
9. Reconnect all gate leads to the thyristor module.
10. Reinstall the SDCS-PIN-4 board.
11. Reconnect all cables and plugs at the SDCS-PIN-4:
 - snubber resistor (X30, X31),
 - temperature sensor (X22),
 - current transformers (X3, X4, X5),
 - OnBoard excitation (X8, X9, X11), use proper winding direction and amount of windings for T100
 - gate leads (first X16, X18 then X15, X17),
 - OnBoard excitation line voltage (X1, X2, X7),
 - all plugs (X10, X96, X99) and
 - all flat cables (X12, X13, X37), use the lock connectors at the SDCS-PIN-4
12. Reconnect the flat cables at the SDCS-CON-4 (X12, X13, X37) and re-hinge the electronic tray.
13. Reconnect the grounding plug and the holding screw at the electronic tray.
14. Reconnect all I/O plugs at the SDCS-CON-4 (X3 to X7) and the plugs at the SDCS-DSL-4 (X51 to X54).
15. Reinstall the intermediate cover, all plug in options and the design cover.

Remove faulty OnBoard bridge (V1)

1. Follow the instructions [Remove faulty thyristor modules](#) until step 8 is done.
2. Remove all connectors from the faulty OnBoard bridge and mark the connectors clearly.
3. Remove the faulty OnBoard bridge and mark it clearly as defective.

Install new OnBoard bridge (V1)

1. Ensure that the new OnBoard bridge is of the correct type ([see appendix A](#) of this manual).
2. Remove old heat conducting compound (grease) from the heat sink. Clean the mounting surfaces (heat sink and OnBoard bridge) with an appropriate solvent (e.g. ethanol) by means of tissue paper. When the heat sink is clean, spread out the heat conducting compound with a rubber spatula or by hand.
3. Apply a thin layer of heat conducting compound to the new OnBoard bridge.
4. Spread the heat conducting compound evenly by moving the OnBoard bridge forward and backward on the heat sink.
5. Tighten all clamping screws by hand until the screw heads touch the bottom of the thyristor module. Then tighten the screws to 2.0 Nm torque.
6. Tighten the screws to nominal torque according to table [Nominal mounting torque for OnBoard bridge and thyristor modules](#) on page 35.
7. Reconnect all connectors to the OnBoard bridge.
8. Follow the instructions [Install new thyristor modules](#) beginning with step 10.

OnBoard bridge (V1) and thyristor module location in DCS800-S01 (2-Q) units

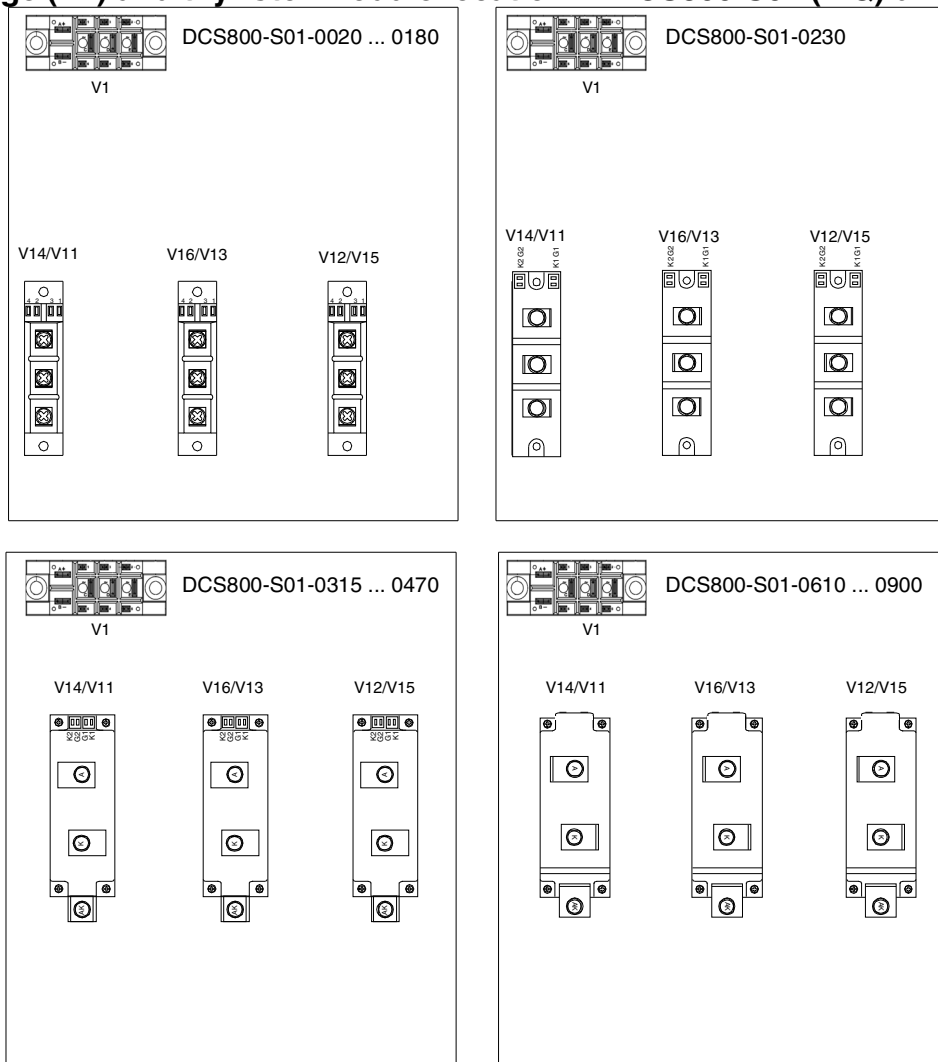

DCS800 loc of mod 1Q.dsf

Location of the OnBoard bridge and thyristor modules in DCS800-S01 (2-Q) units

Note:

This drawing is only showing the location of the OnBoard bridge and thyristor modules, the actual converter module size is different!

OnBoard bridge (V1) and thyristor module location in DCS800-S02 (4-Q) units

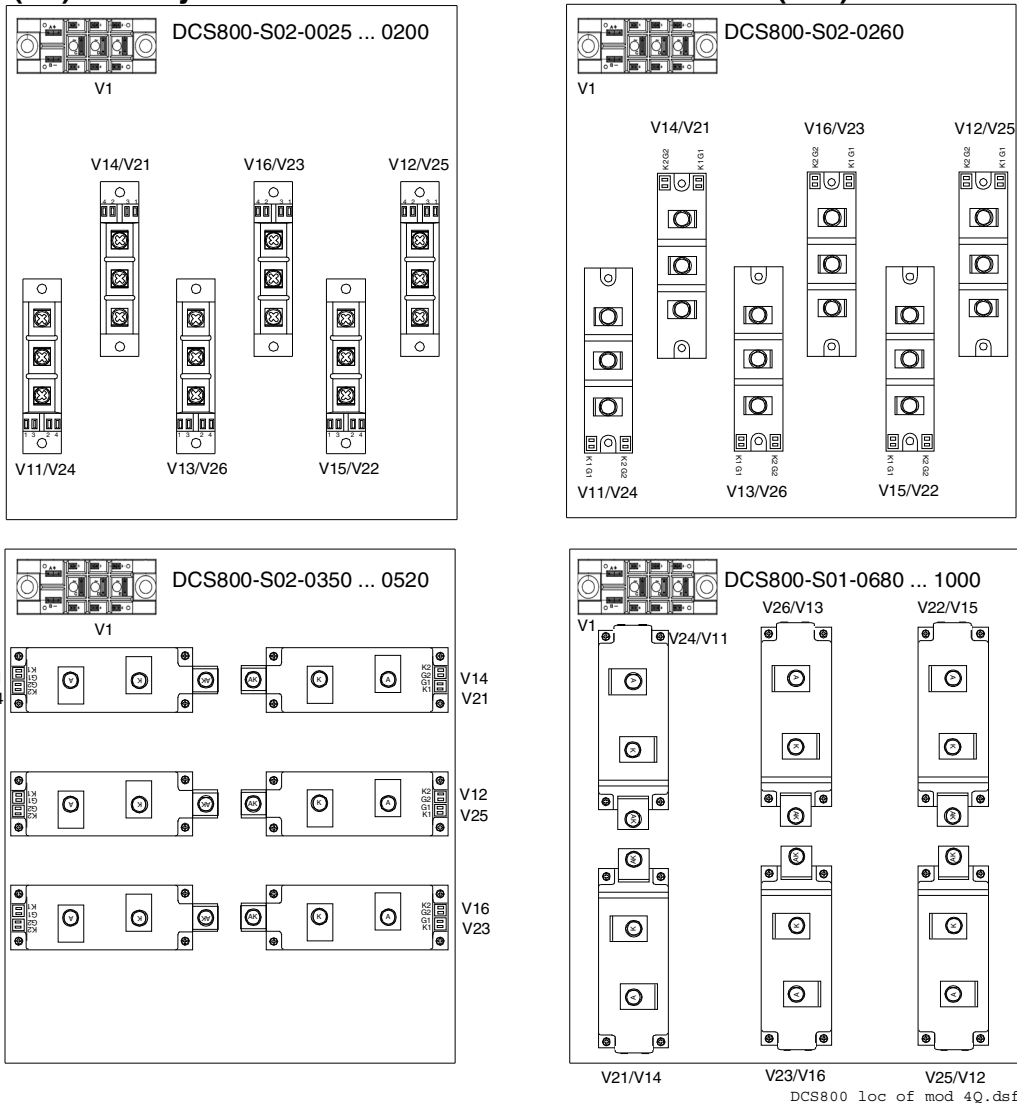

Location of the OnBoard bridge and thyristor modules in DCS800-S02 (4-Q) units

Note:

This drawing is only showing the location of the OnBoard bridge and thyristor modules, the actual converter module size is different!

OnBoard bridge and thyristor module terminals

The next figures show the terminals of the OnBoard bridge and all used thyristor modules. The terminal description is also stamped or marked by a sticker on the OnBoard bridge and all thyristor modules.

For all firing pulse cables is valid:

Yellow is gate lead.

Red is cathode lead.

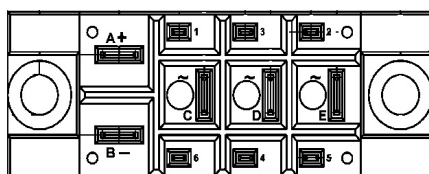

VVZF 70-16

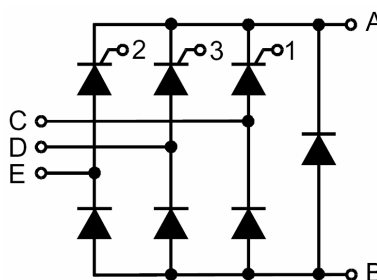

VVZF 70

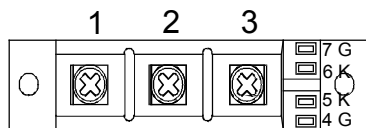
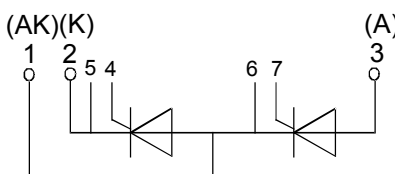

SKKT 27, 42, 57, 106

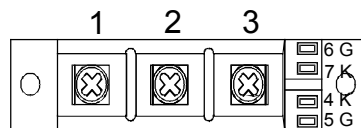
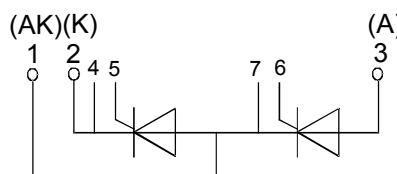

MCC26, 44, 56, 95

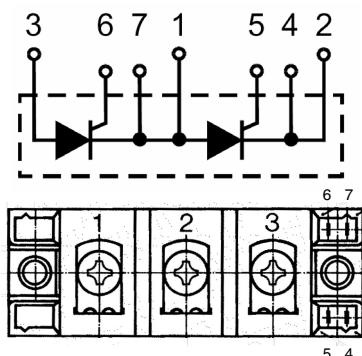

MCC162

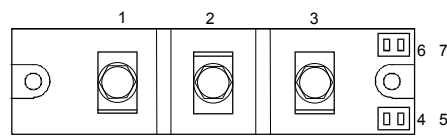
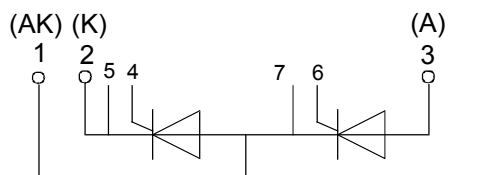

SKTT 162

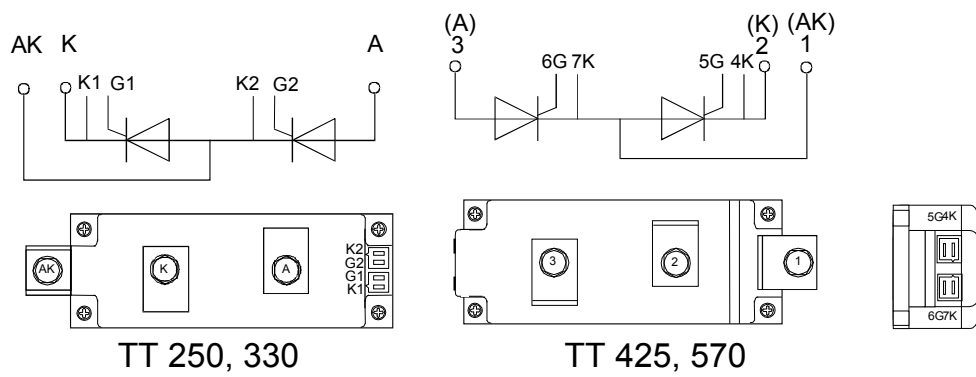
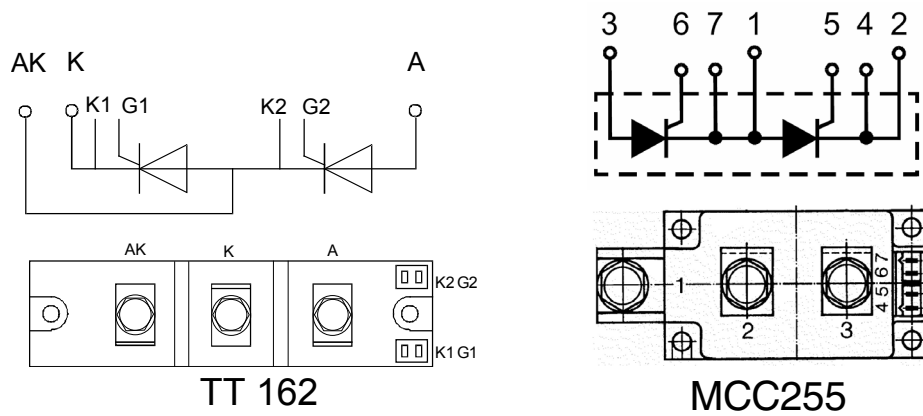

Terminals of the OnBoard bridge and all thyristor modules

Exchange of Thyristors for Size D5

Installation of "Disc Type" thyristor in converters size D5 (900...2000 A)

All DCS800 converters sizes D5/D6/D7 are equipped with disk type thyristors. The structure of the "Disc type" semiconductor component is such that it requires a certain compression force to operate. The prevention of overheating of the component essentially depends on a good heat dissipation between the semiconductor and the conducted heat sink. It is thus important that all joints have good thermal and electrical conduction.

Required Tools

Special tools or material needed in addition to standard tools for the exchange of thyristor modules:

- Torx screwdrivers: TX10, TX20, TX25
- Torque spanner for electrical connections: 13 Nm (M8)
25 Nm (M10)
50 Nm (M12)
- Screws are metric type; use appropriate nuts.
- 17 mm ring spanner for fuse and busbar connections.
- 17 mm ring spanner for press clamp.
- Tissue paper / solvent (e.g. ethanol).
- Thermal joint compound: type **BECHEM-RHUS SU 2**
(grease)

Manufacturer:	Carl Bechem GmbH, 58089 Hagen
ABB Service:	GHSN 390 001 P 0001
- Disassembly tool 3ADT 621 023 P1

Note:

For more detailed information about the wiring of the power part, see *Hardware Manual*.

Therefore strict observance of the build in instructions given below is of utmost importance. Make sure that the new component can replace the old one in accordance with the spare part list ([see Appendix A](#)).

Semiconductors and heat sinks are to be handled carefully to avoid scratches and other damage. Avoid touching the contact surfaces. Do not lift the semiconductor with the gate wire. Do not lift the semiconductor by touching the current contact surfaces. Do not damage the welding flange or the contact surface.



Before you start work, disconnect the converter completely from the power supply then check the voltage free condition and make sure, everything is located in an electrically and mechanically safe condition!

Disk type thyristors

Some converter modules size D5 are equipped with different disc type thyristors. For easy identification the name plate of the converter module is marked with “a” after the voltage identification:

Converter with original thyristor type T459Nxxx Id code: DCA0012007P0001	U_1	Converter with second thyristor type T460Nxxx Id code: 3ADC340105P0001
DCS800-S01-0900-06	3 ~ 600 VAC	DCS800-S01-0900-06 a
DCS800-S02-0900-06	3 ~ 600 VAC	DCS800-S02-0900-06 a
DCS800-S01-0900-07	3 ~ 690 VAC	DCS800-S01-0900-07 a
DCS800-S02-0900-07	3 ~ 690 VAC	DCS800-S02-0900-07 a

Converter with original thyristor type T589Nxxx Id code: DCA0012015P0001	U_1	Converter with second thyristor type T590Nxxx Id code: 3ADC340106P0001
DCS800-S01-1200-04	3 ~ 400 VAC	DCS800-S01-1200-04 a
DCS800-S02-1200-04	3 ~ 400 VAC	DCS800-S02-1200-04 a
DCS800-S01-1200-05	3 ~ 525 VAC	DCS800-S01-1200-05 a
DCS800-S02-1200-05	3 ~ 525 VAC	DCS800-S02-1200-05 a

Parts list

The current and voltage ratings of original and second thyristor type are the same, but the sizes of gate and cathode terminals are different. Thus it is not possible to interchange both thyristor types as spares.

Attention: Use always the correct spare thyristor!

Original thyristor type (900 A)

Converter with **original** thyristor type **T459Nxxx** Id code: DCA0012007P0001

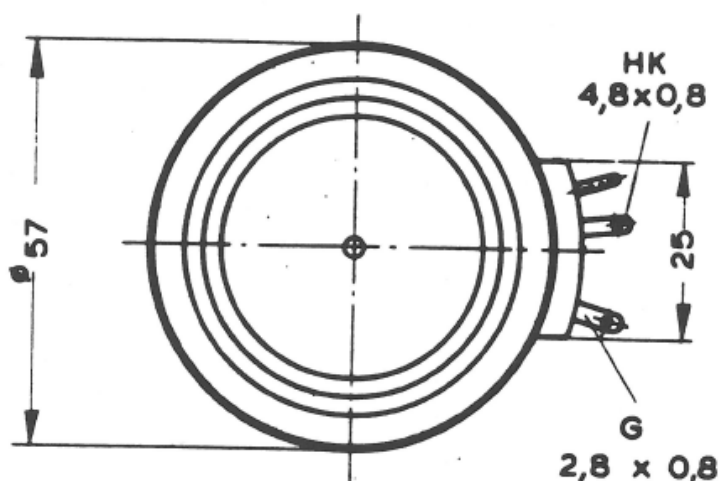

Original thyristor type

Gate (G): Faston 2.8 x 0.8 mm
 Cathode (HK): Faston 4.8 x 0.8 mm
 Conductive plate: Diameter 36 mm

Second thyristor type (900 A)

Converter with **second** thyristor type **T460Nxxx** Id code: 3ADC340105P0001

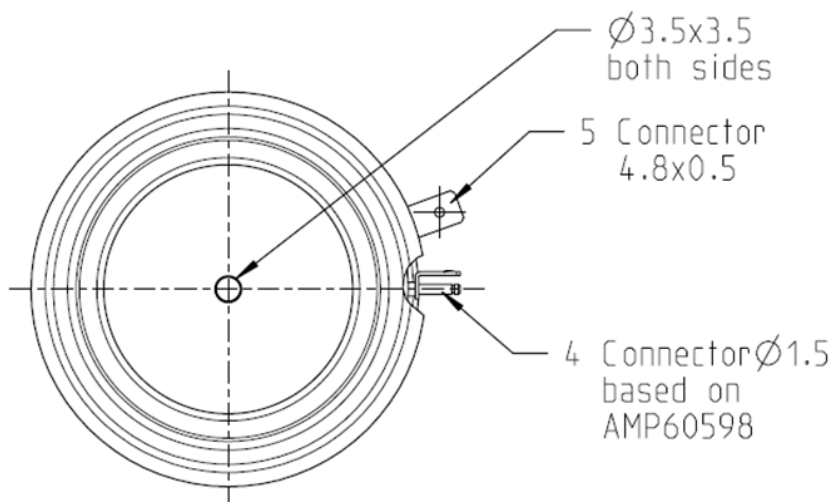

Second thyristor type

Gate (4): Round terminal D = 1.5 mm
 Cathode (5): Faston 4.8 x 0.5 mm
 Conductive plate: Diameter 36 mm

Original thyristor type (1200 A)

Converter with **original** thyristor type **T589Nxxx** Id code: DCA0012015P0001

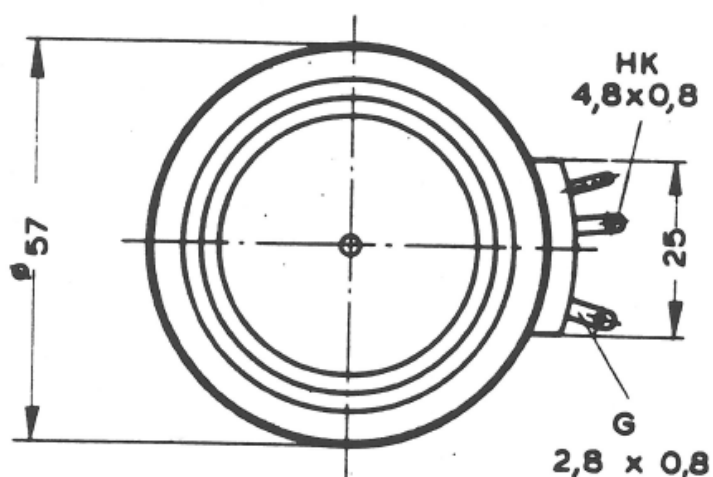

Original thyristor type

Gate (G): Faston 2.8 x 0.8 mm
 Cathode (HK): Faston 4.8 x 0.8 mm
 Conductive plate: Diameter 36 mm

Second thyristor type (1200 A)

Converter with **second** thyristor type **T590Nxxx Id code: 3ADC340106P0001**

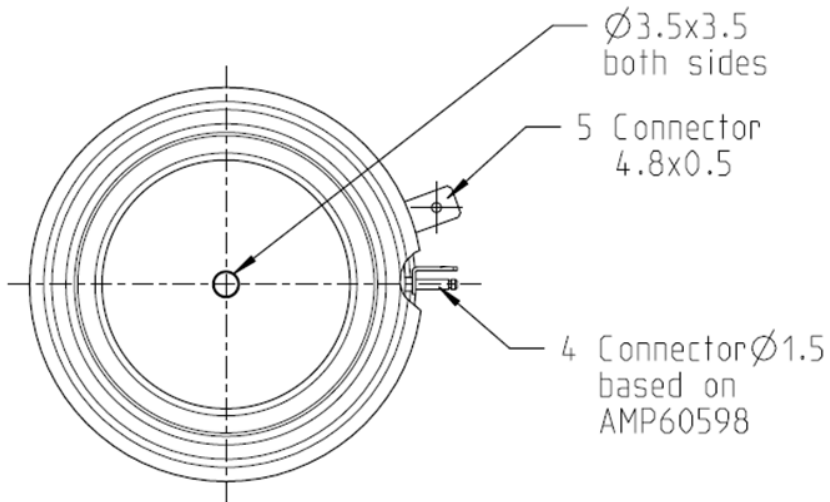

Second thyristor type

Gate (4): Round terminal D = 1.5 mm
 Cathode (5): Faston 4.8 x 0.5 mm
 Conductive plate: Diameter 36 mm

Find faulty thyristor

1. Find the defective branches by performing an OHM test (both polarities) between U1, V1, W1 and C1, D1 (see fig. [Anti-parallel B6-bridges with branching fuses](#) on page 45)

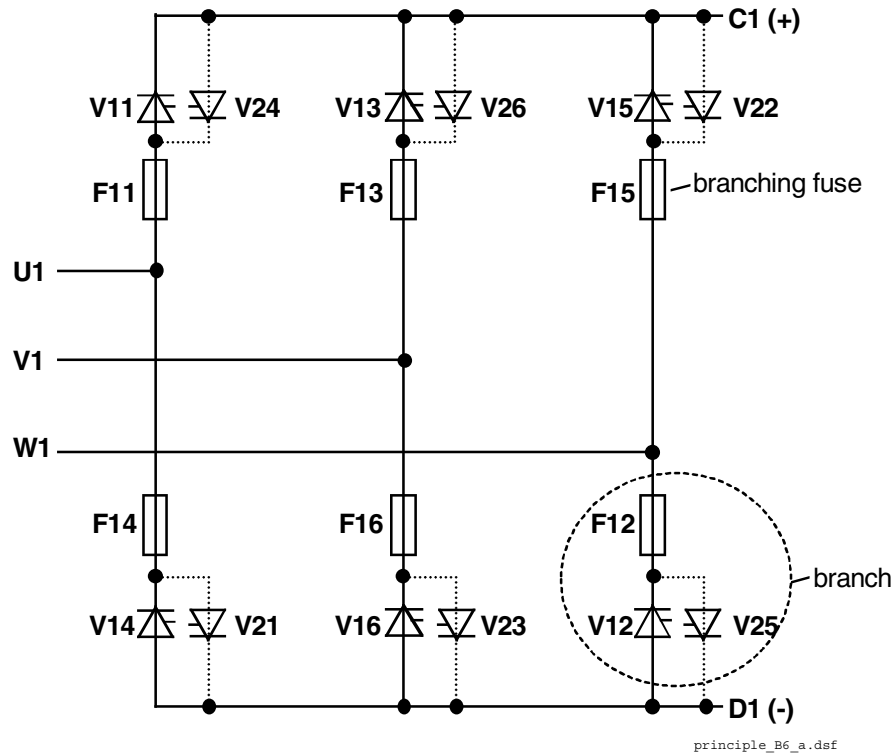

Anti-parallel B6-bridges with branching fuses

2. Disconnect the branching fuses of the defective branches.
3. Find the defective thyristors by performing an OHM test (both polarities) over their heat sinks.
4. In a 4-quadrant converter change both thyristors clamped between the same heatsinks at once.

Note:

Because "Disc Type" semiconductors need a certain compression force to operate properly, a measurement outside the clamped heat sinks might be wrong. To be sure which thyristor is broken change only one thyristor, clamp the heat sinks again and repeat step three.

Remove faulty thyristor

1. Remove the screws of the DC – busbars and branch fuses preventing the stack to be prized open.

Note:

It depends on the location of the defective thyristor which DC – busbar and fuses have to be disconnected.

2. Write down the direction and location of the thyristors to be removed and mark their gate leads.
3. Remove the gate leads if possible.
4. Loosen the mounting clamp (see fig. [Aluminum spring with welded indicating spring on page 47](#)) at the top of the thyristor stack.

Attention: While loosen the mounting clamp the indicating spring must be pulled out a little, otherwise the spring will be damaged!

5. Attach the disassembly tool at the faulty thyristor and prize open the upper and lower heat sinks (see fig. [How to use the disassembly tool page 46](#)).
6. Remove the thyristors.

Attention: To centre the thyristors spring pins are used. The pins are inlayed into all lower heat sinks. Open the gap wide enough that the thyristor and the pins are not damaged while removing the thyristor!

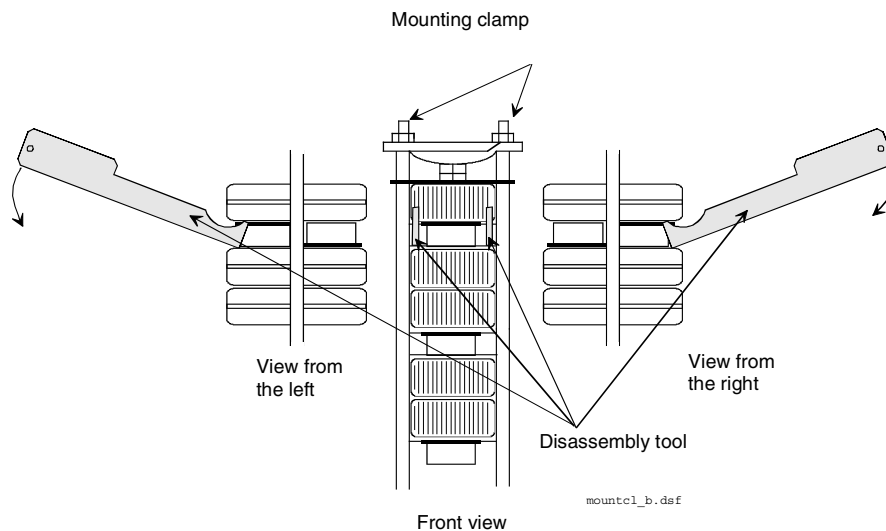

How to use the disassembly tool

Install new thyristor

1. Ensure that the new thyristor is of the correct type ([see Appendix A](#)). Keep the semiconductor and its surroundings clean. If necessary clean them with a piece of tissue paper moistened with solvent.

Note:

Do not touch the polished surfaces of the thyristor.

2. Clean the polished surfaces of the semiconductor with a piece of tissue paper moistened with solvent. Dry all surfaces. Spread a **thin** layer of heat conducting paste on both sides of the thyristor, if necessary use a rubber spatula.
3. Connect the gate leads if possible.
4. Clean all parts with tissue paper moistened with solvent, which have had or will have contact with the thyristor or each other (lower / upper heat sink). Do not clean the surfaces of grease too thoroughly, because the aluminum surfaces will oxidize in a few seconds. Dry all surfaces.
5. Centre the thyristors by means of the spring pins.

Note:

Be sure that the thyristor is installed in the right direction. Do not pinch or cut the gate leads or any other cable.

6. Turn the thyristor so that the gate leads point in the right direction.

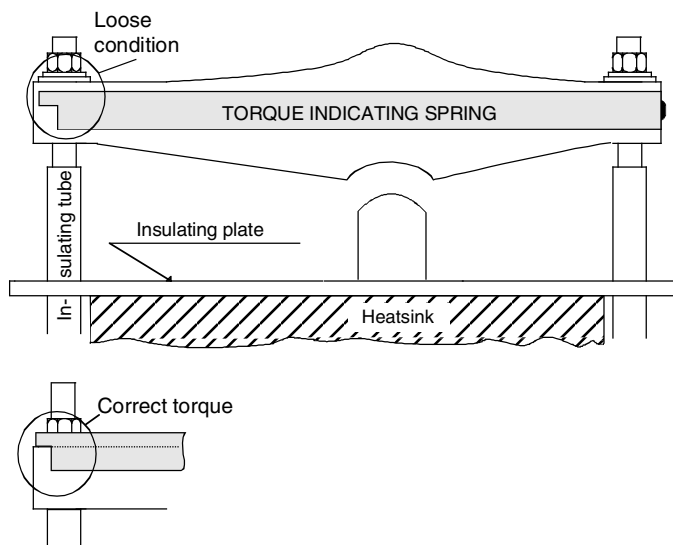

Aluminum spring with welded indicating spring

- Tighten the nuts of the mounting clamp by hand so that the clamp is in parallel with the contact surface of the heat sinks.

Note:

The indicating spring is a very sensitive instrument and must be handled with care.

- Tighten each nut in turn, half a turn at a time with the help of a ring spanner until the indicating spring clicks into position “correct torque” (see fig. [Aluminum spring with welded indicating spring on page 47](#)). Do not tighten the screws any further.

Note:

The correct torque is indicated by means of the welded indicating spring.

- Perform an OHM test to make sure the thyristor is ok.
- Reconnect the DC – busbars, branch fuses and all other dismantled parts.
- Perform an OHM test between U1, V1, W1 and C1, D1 to make sure the power part is ok.

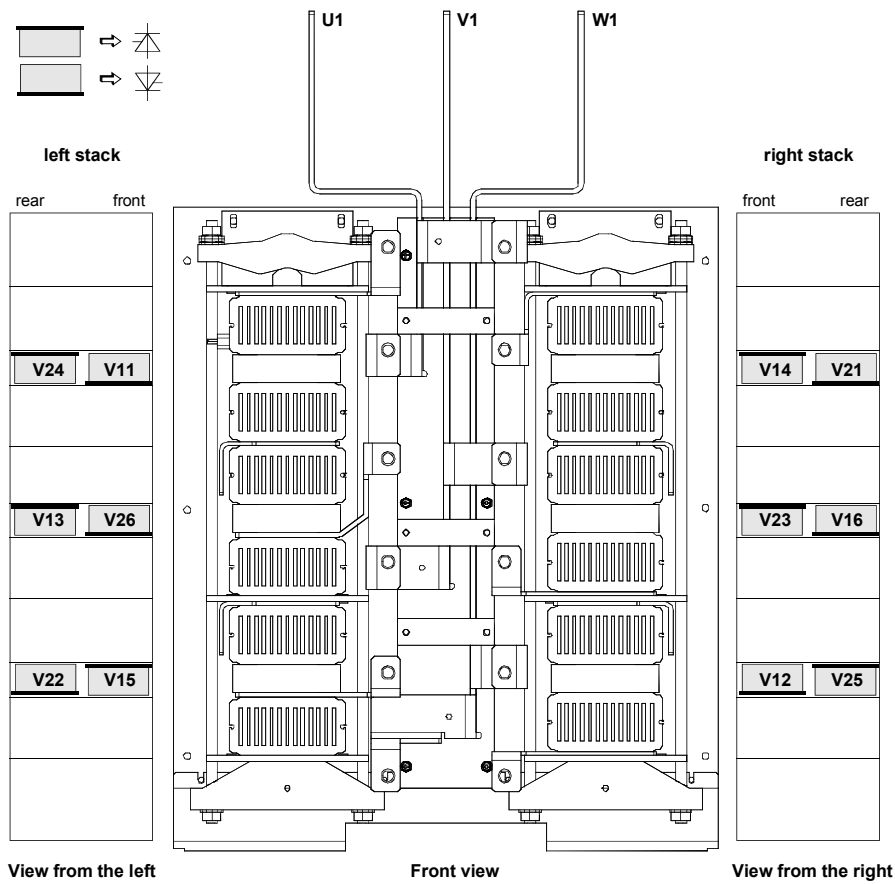

Location of thyristors in frame D5 (4-Q bridge)

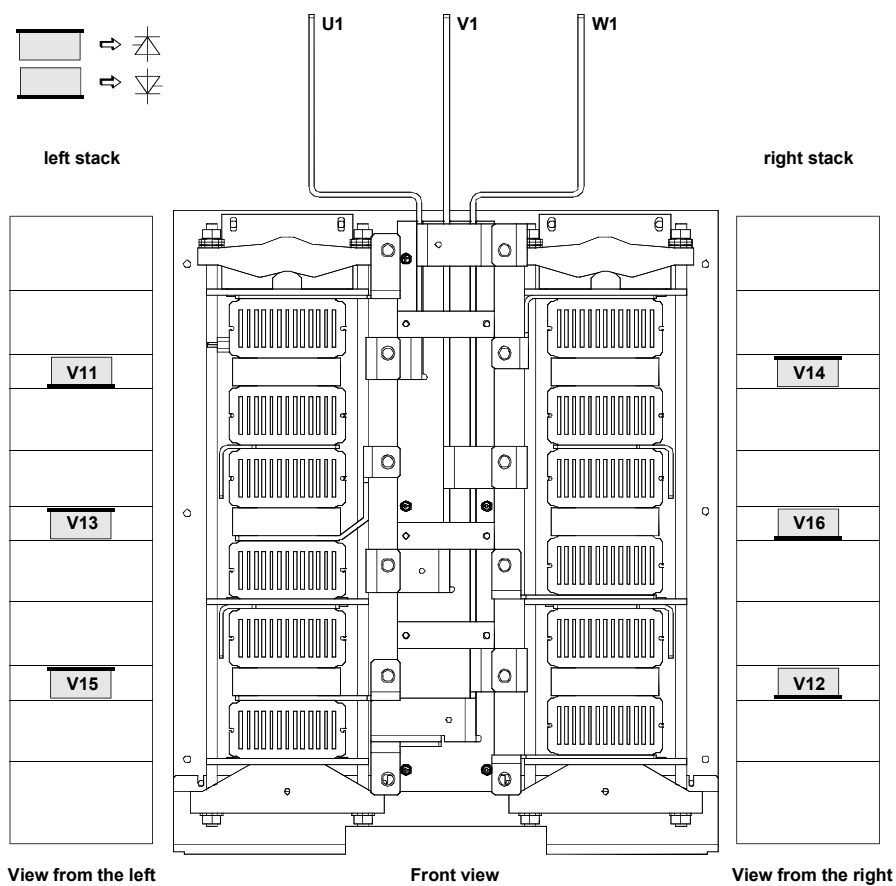

Location of thyristors in frame D5 (2-Q bridge)

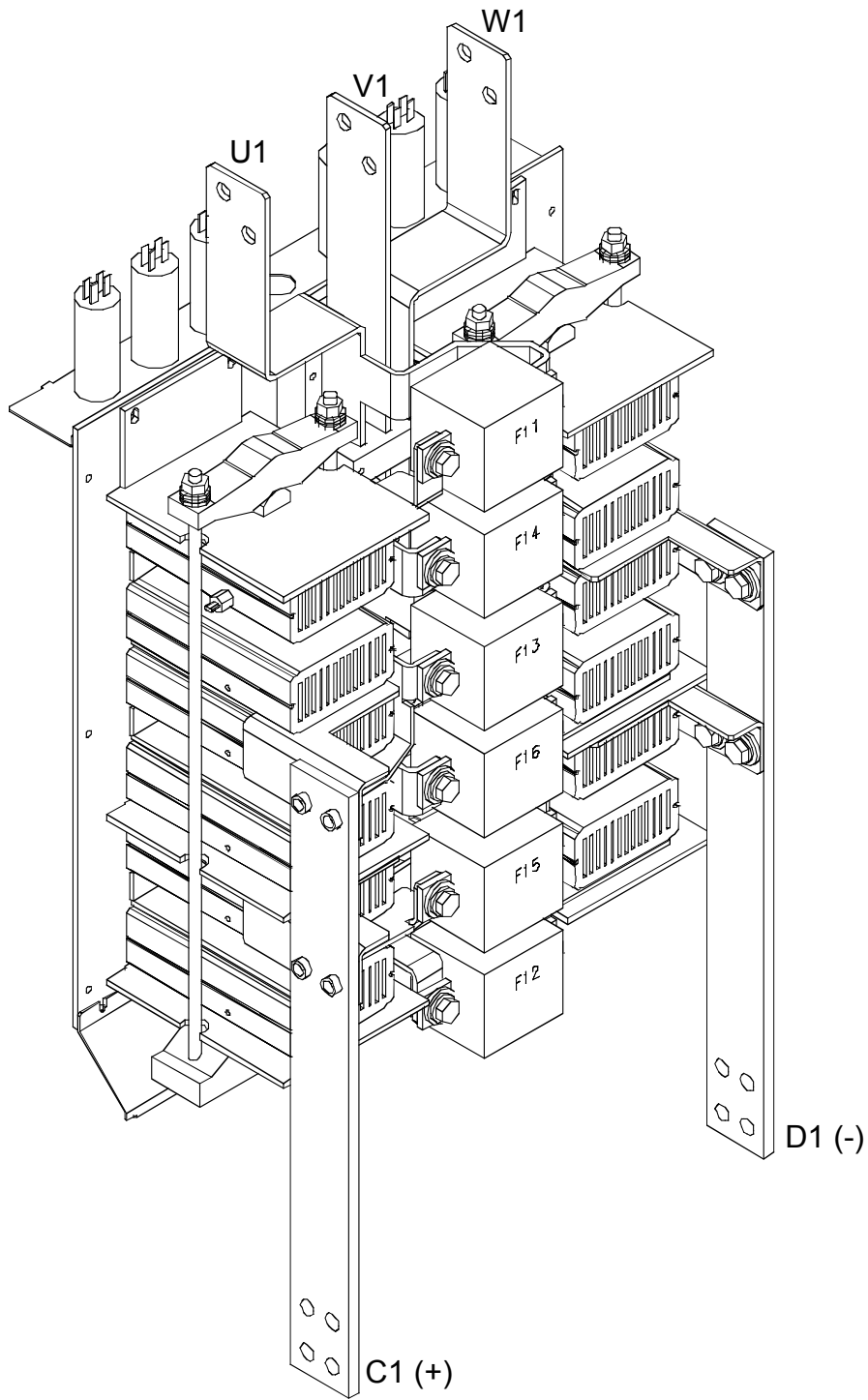

Location of branch fuses frame D5

Exchange of Thyristors for Size D5

Exchange of Thyristors for Size D6

Installation of "Disc Type" thyristor in converters size D6 (1900...3000 A)

All DCS800 converters sizes D5/D6/D7 are equipped with disk type thyristors. The structure of the "Disc type" semiconductor component is such that it requires a certain compression force to operate. The prevention of overheating of the component essentially depends on a good heat dissipation between the semiconductor and the conducted heat sink. It is thus important that all joints have good thermal and electrical conduction.

Required Tools

Special tools or material needed in addition to standard tools for the exchange of thyristor modules:

- Torx screwdrivers: TX10, TX20, TX25
- Torque spanner for electrical connections: 13 Nm (M8)
25 Nm (M10)
50 Nm (M12)
- Screws are metric type; use appropriate nuts.
- 17 mm ring spanner for fuse and busbar connections.
- 24 mm ring spanner for press clamp.
- Tissue paper / solvent (e.g. ethanol).
- Thermal joint compound: type **BECHEM-RHUS SU 2**
(grease)

Manufacturer:	Carl Bechem GmbH, 58089 Hagen
ABB Service:	GHSN 390 001 P 0001
- Disassembly tool DCF 1066721 P1

Note:

For more detailed information about the wiring of the power part, see *Hardware Manual*.

Therefore strict observance of the build in instructions given below is of utmost importance. Make sure that the new component can replace the old one in accordance with the spare part list ([see Appendix A](#)).

Semiconductors and heat sinks are to be handled carefully to avoid scratches and other damage. Avoid touching the contact surfaces. Do not lift the semiconductor with the gate wire. Do not lift the semiconductor by touching the current contact surfaces. Do not damage the welding flange or the contact surface.



Before you start work, disconnect the converter completely from the power supply then check the voltage free condition and make sure, everything is located in an electrically and mechanically safe condition!

Disk type thyristors

Some converter modules size D6 are equipped with different disc type thyristors. For easy identification the name plate of the converter module is marked with “a” after the voltage identification:

Converter with original thyristor type T 1329Nxxx Id code: 3ADC340081P0001	U₁	Converter with second thyristor type T 1xxx-24 Id code: 3ADC340098P0001
DCS800-S01-1900-08	3 ~ 800 VAC	DCS800-S01-1900-08 a
DCS800-S02-1900-08	3 ~ 800 VAC	DCS800-S02-1900-08 a
DCS800-S01-2050-05	3 ~ 525 VAC	DCS800-S01-2050-05 a
DCS800-S02-2050-05	3 ~ 525 VAC	DCS800-S02-2050-05 a
DCS800-S01-2050-06	3 ~ 600 VAC	DCS800-S01-2050-06 a
DCS800-S02-2050-06	3 ~ 600 VAC	DCS800-S02-2050-06 a
DCS800-S01-2050-07	3 ~ 690 VAC	DCS800-S01-2050-07 a
DCS800-S02-2050-07	3 ~ 690 VAC	DCS800-S02-2050-07 a

Parts list

The current and voltage ratings of original and second thyristor type are the same, but the sizes of gate and cathode terminals are different. Thus it is not possible to interchange both thyristor types as spares.

Attention: Use always the correct spare thyristor!

Original thyristor type

Thyristor **T 1329Nxxx** with **Id code 3ADC340081P0001**

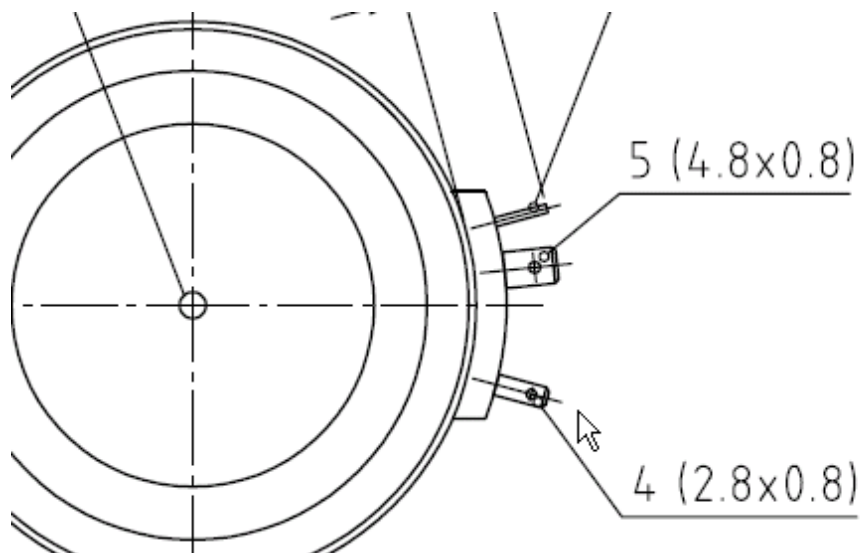

Original thyristor type

Gate (4):	Faston 2.8 x 0.8 mm
Cathode (5):	Faston 4.8 x 0.8 mm
Conductive plate:	Diameter 48 mm

Second thyristor type

Thyristor **T 1xxx-24** with **Id code** 3ADC340098P0001

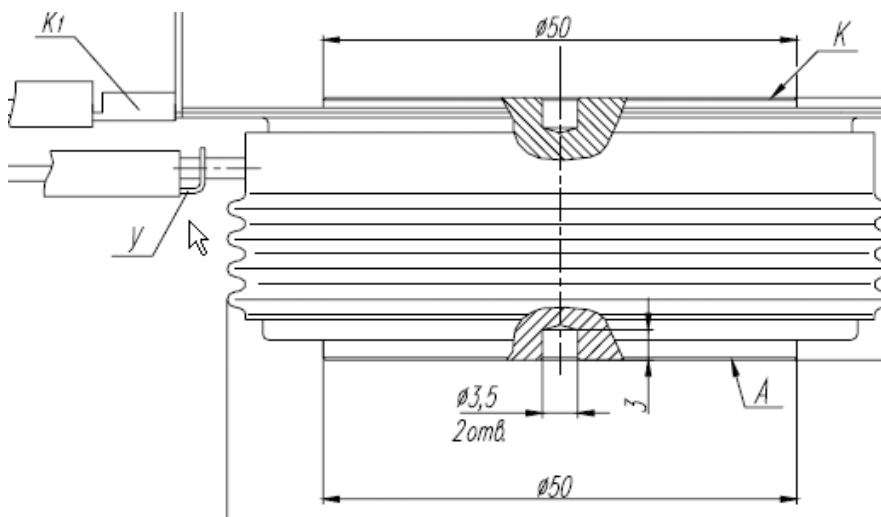

Second thyristor type

Gate (y):	Round terminal D = 1.5 mm
Cathode (K ₁):	Faston 4.8 x 0.5 mm
Conductive plate:	Diameter 50 mm

BCT thyristors

In some converter modules size D6 so called BCT's (**Bidirectional-Controlled-Thyristors**) are used. BCT's are a pair of anti-parallel thyristors in one disk type housing. They can easily be identified by the second pair of gate leads. The second gate is marked with **Gate B** on the thyristor.

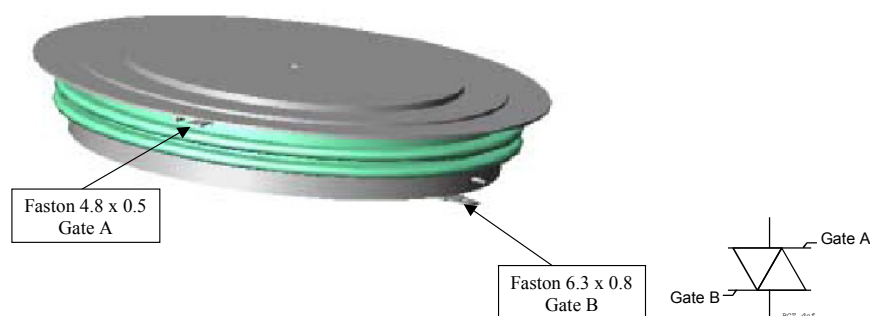

Gates of BCT

Note:

The Faston connectors of the gates are of different size.

Gate A should always be in front of the clamped heat sinks due to cooling reasons.

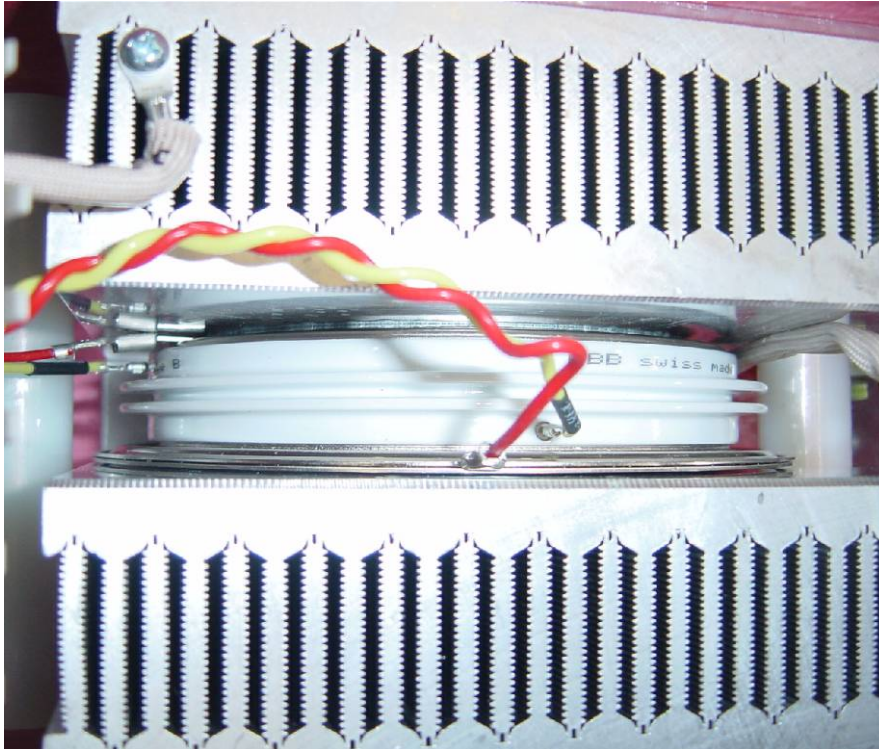

Location of BCT's gate A when built in

Find faulty thyristor

1. Find the defective branches by performing an OHM test (both polarities) between U1, V1, W1 and C1, D1 (see picture [Anti-parallel B6-bridges with branching fuses](#) on page 45).
2. Disconnect the branching fuses of the defective branches.
3. Find the defective thyristors by performing an OHM test (both polarities) over their heat sinks.
4. In a 4 - quadrant converter with BCT's change the BCT.
5. In a 4 - quadrant converter with 2 single thyristors change both thyristors clamped between the same heatsinks at once.

Note:

Because "Disc Type" semiconductors need a certain compression force to operate properly, a measurement outside the clamped heat sinks might be wrong. To be sure which thyristor is broken change only one thyristor, clamp the heat sinks again and repeat step three.

Remove faulty thyristor

1. Replace all blown fuses and reconnect all fuses taken out during search for the faulty thyristor.
2. Remove the screws of the DC - busbar plates adjacent to the defective thyristors

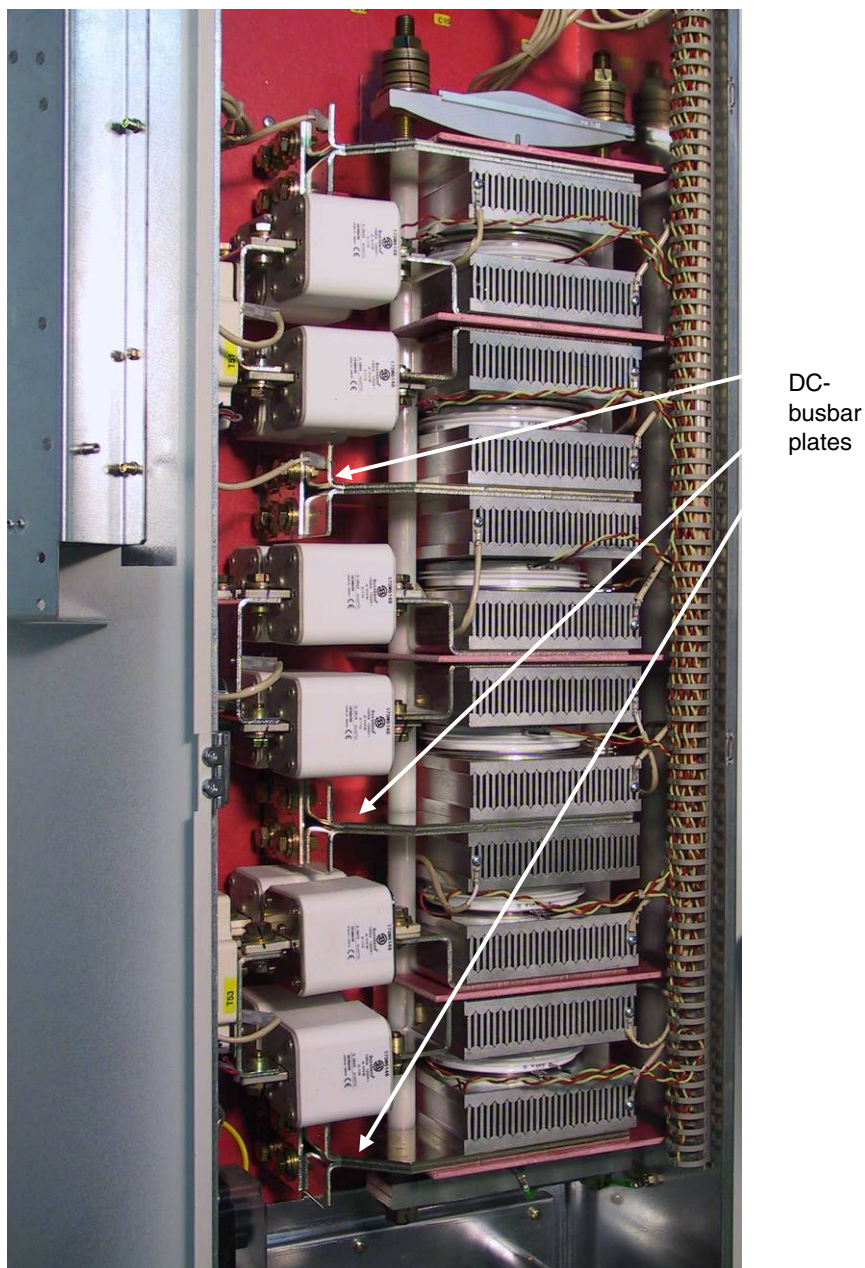

Location of the DC - busbar plates

Note:

It depends on the location of the defective thyristor which DC-busbar plates have to be disconnected.

3. Write down the direction and location of the thyristors to be removed and mark their gate leads. In case of BCT's add the position of the gates.
4. Remove the gate leads if possible.
5. Loosen the mounting clamp at the top of the thyristor stack.

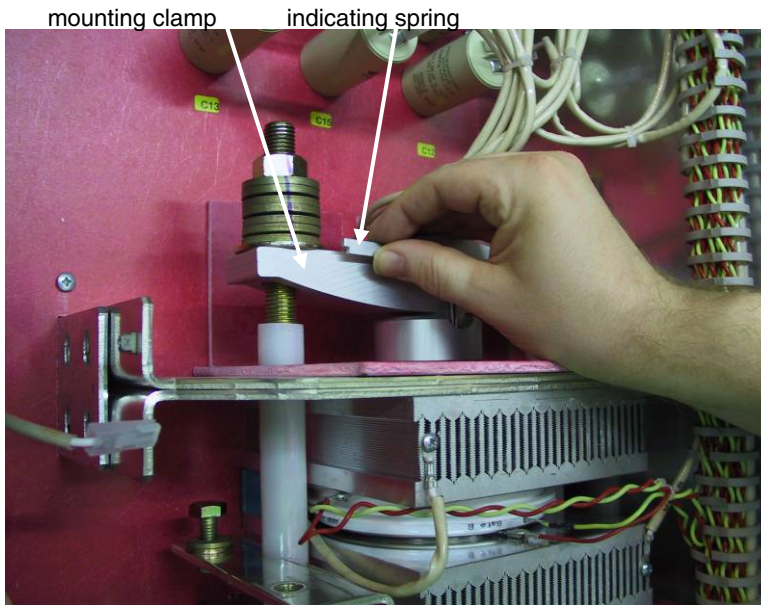

Handling of indicating spring and mounting clamp

Attention: While loosening the mounting clamp the indicating spring must be pulled out a little, otherwise the spring will be damaged!
Do not remove the nuts totally, otherwise the threaded rods will fall down!

6. Pull out both DC-busbar plates.

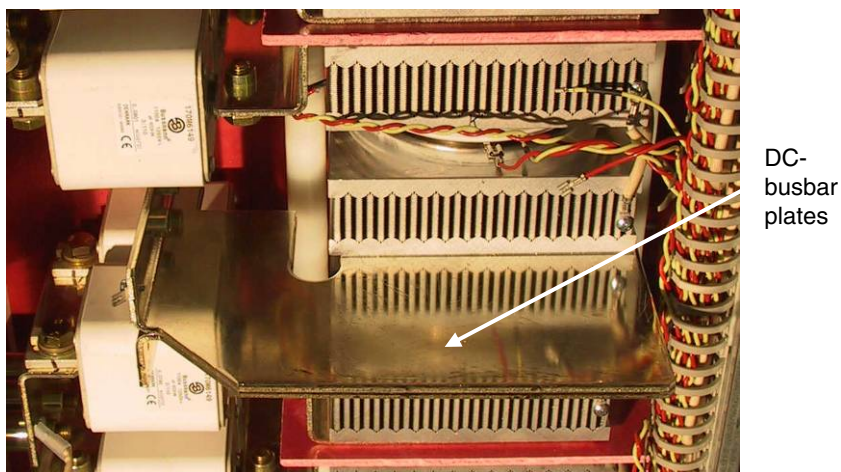

DC-busbar plates

7. Attach the disassembly tool at the faulty thyristor and prize open the upper and lower heat sinks.

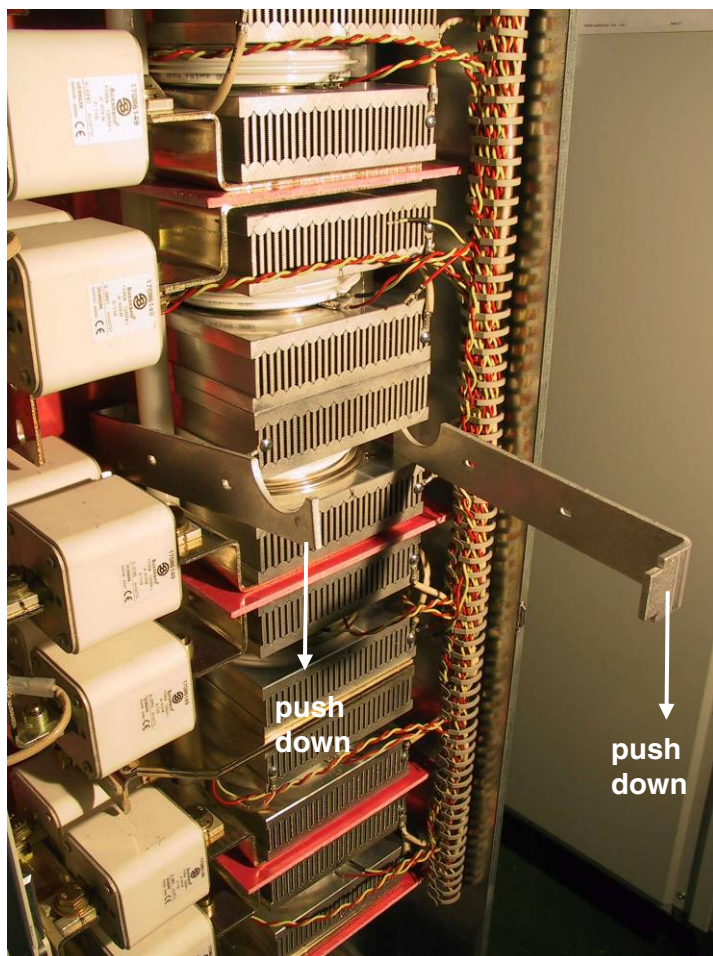

Use of disassembly tool

8. Remove the thyristors with e.g. a pair of pliers.

Attention: To centre the thyristors spring pins are used. The pins are inlaid into all lower heat sinks. Open the gap wide enough that the thyristor and the pins are not damaged while removing the thyristor!

Install new thyristor

1. Ensure that the new thyristor is of the correct type ([see appendix A](#)). Keep the semiconductor and its surroundings clean. If necessary clean them with a piece of tissue paper moistened with solvent.

Note:

Do not touch the polished surfaces of the thyristor.

2. Clean the polished surfaces of the semiconductor with a piece of tissue paper moistened with solvent. Dry all surfaces. Spread a **thin** layer of heat conducting paste on both sides of the thyristor, if necessary use a rubber spatula.



Prepare disk type thyristor

3. Clean all parts with tissue paper moistened with solvent, which have had or will have contact with the thyristor or each other (lower / upper heat sink). Do not clean the surfaces of grease too thoroughly, because the aluminum surfaces will oxidize in a few seconds. Dry all surfaces.
4. Centre the thyristors by means of the spring pins.

Note:

Be sure that the thyristor is installed in the right direction. Do not pinch or cut the gate leads or any other cable.

5. Turn the thyristor so that the gate leads point in the right direction. When changing BCT's make sure, that gate A is in front (see fig. [Gates of BCT](#) on page 53).
6. Connect the gate leads if possible.
7. Insert first the top DC-busbar plate and then the bottom one.

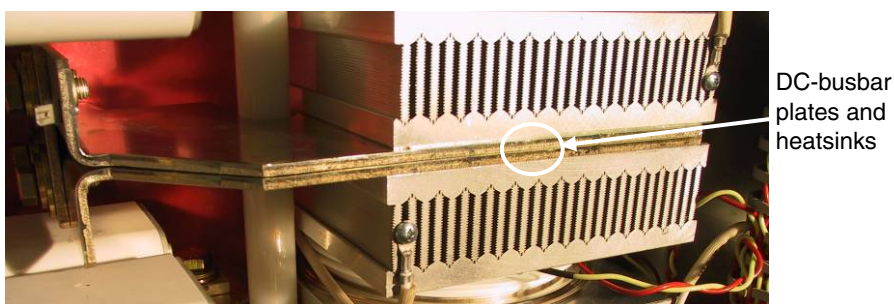

DC-busbar plates and adjacent heat sinks

Note:

The DC - busbar plates should line up with the adjacent heat sinks.

8. Reconnect the DC-busbars.
9. Tighten the nuts of the mounting clamp by hand so that the clamp is in parallel with the contact surface of the heat sinks.

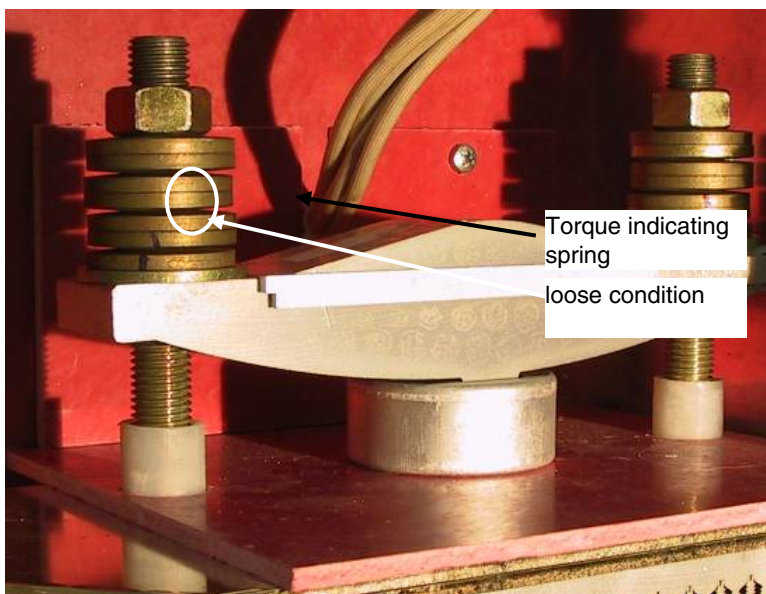

Mounting clamp; loose condition

Note:

The indicating spring is a very sensitive instrument and must be handled with care.

10. Tighten each nut in turn, half a turn at a time with the help of a ring spanner until the indicating spring clicks into position "correct torque". Do not tighten the screws any further.

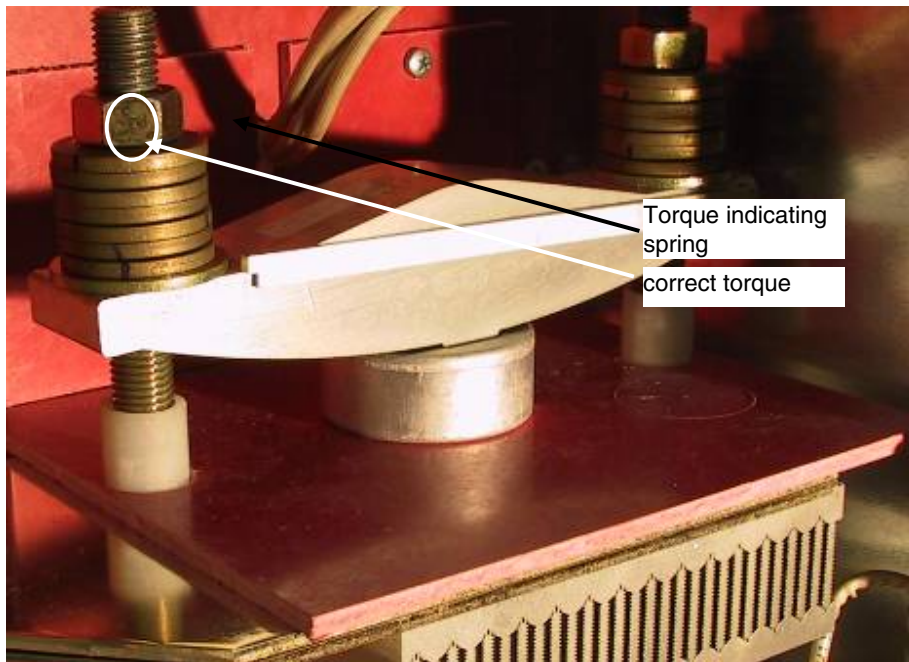

Mounting clamp, correct torque

Note:

The correct torque is indicated by means of the welded indicating spring.

11. Perform an OHM test to make sure the thyristor is ok.
12. Reconnect all other dismantled parts.
13. Perform an OHM test between U1, V1, W1 and C1, D1 to make sure the power part is ok.

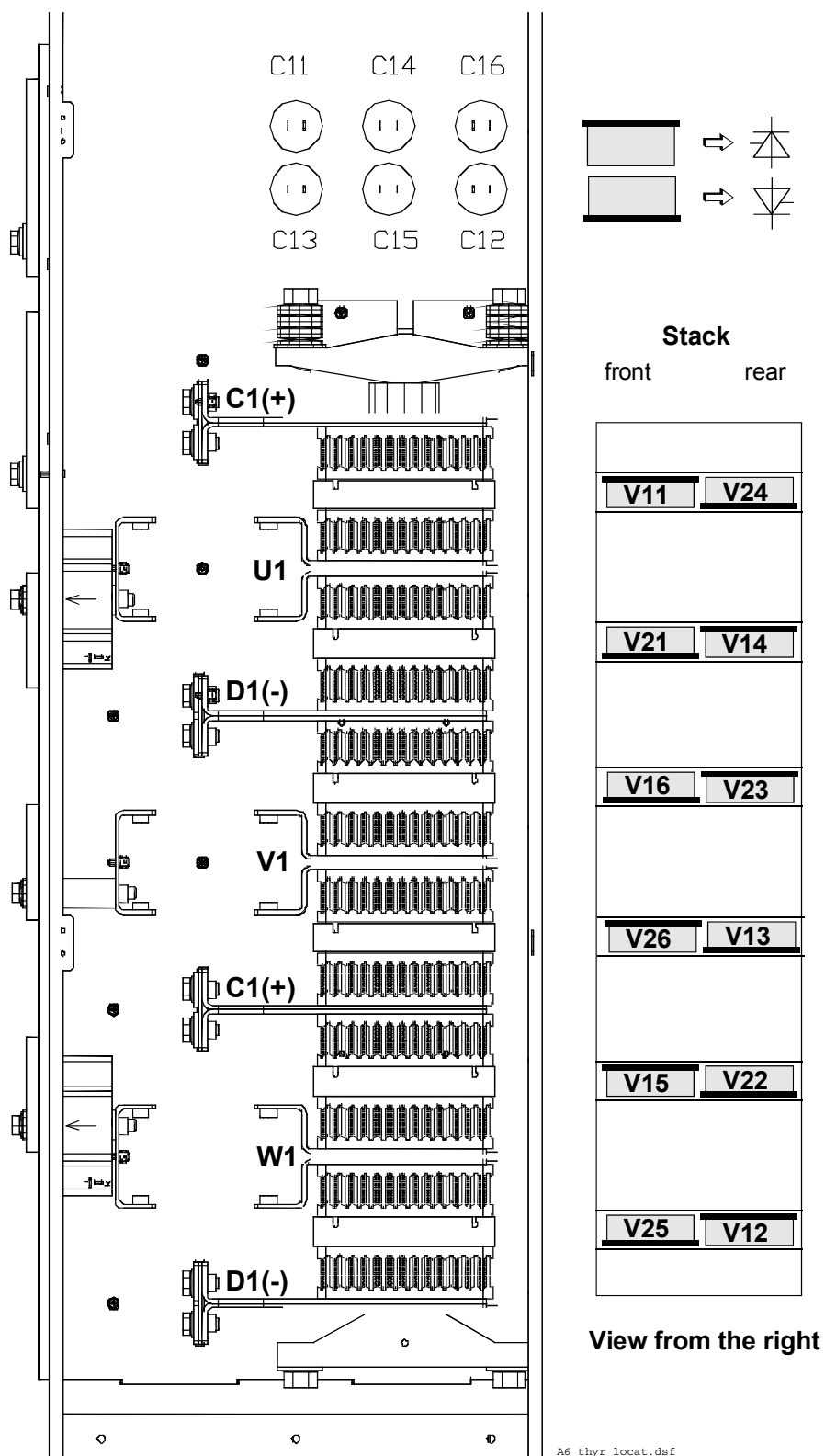

Location of thyristors in frame D6 (4-Q bridge with single thyristors)

Exchange of Thyristors for Size D6

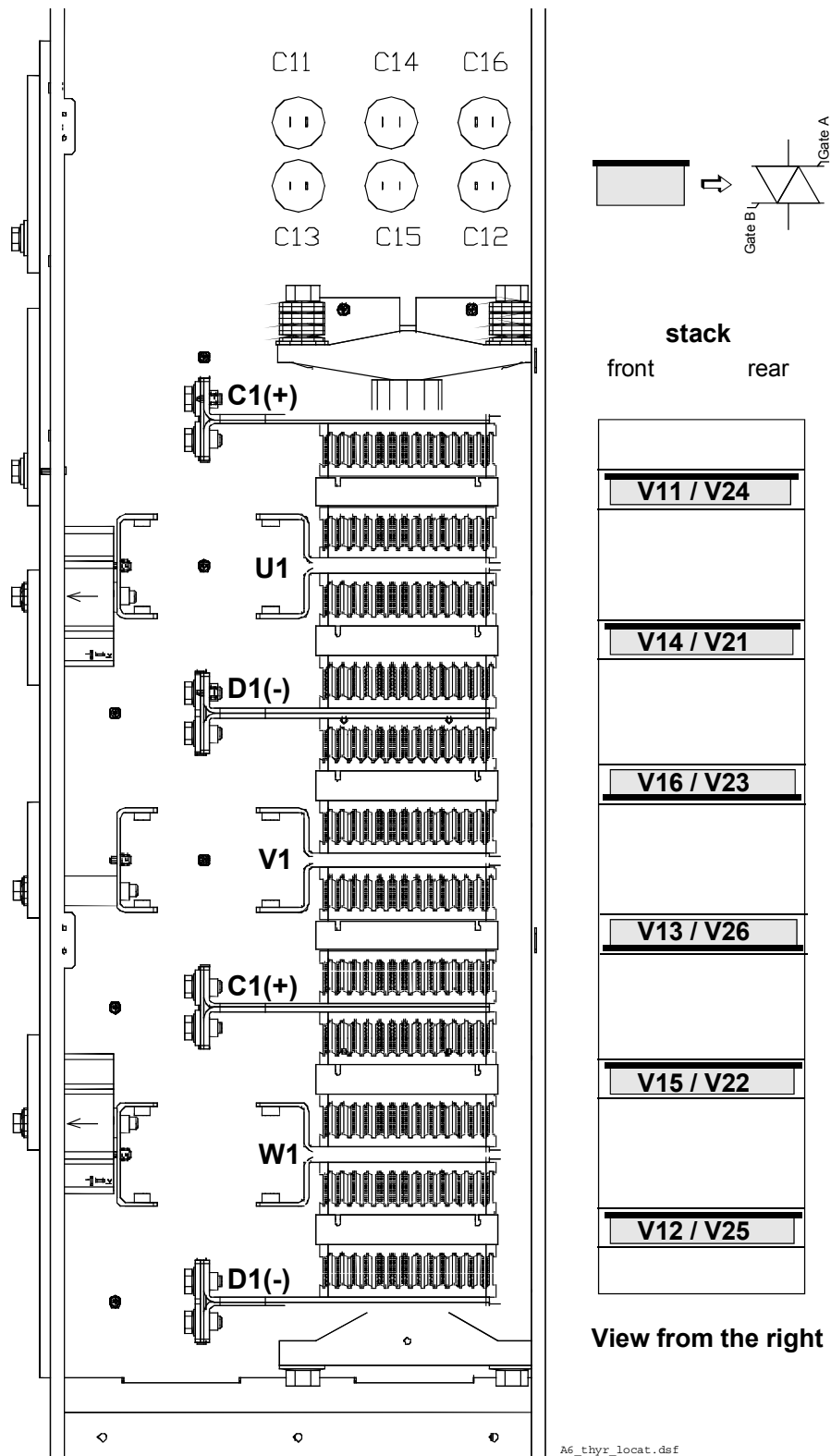

Location of thyristors in frame D6 (4-Q bridge with BCT's)

Exchange of Thyristors for Size D6

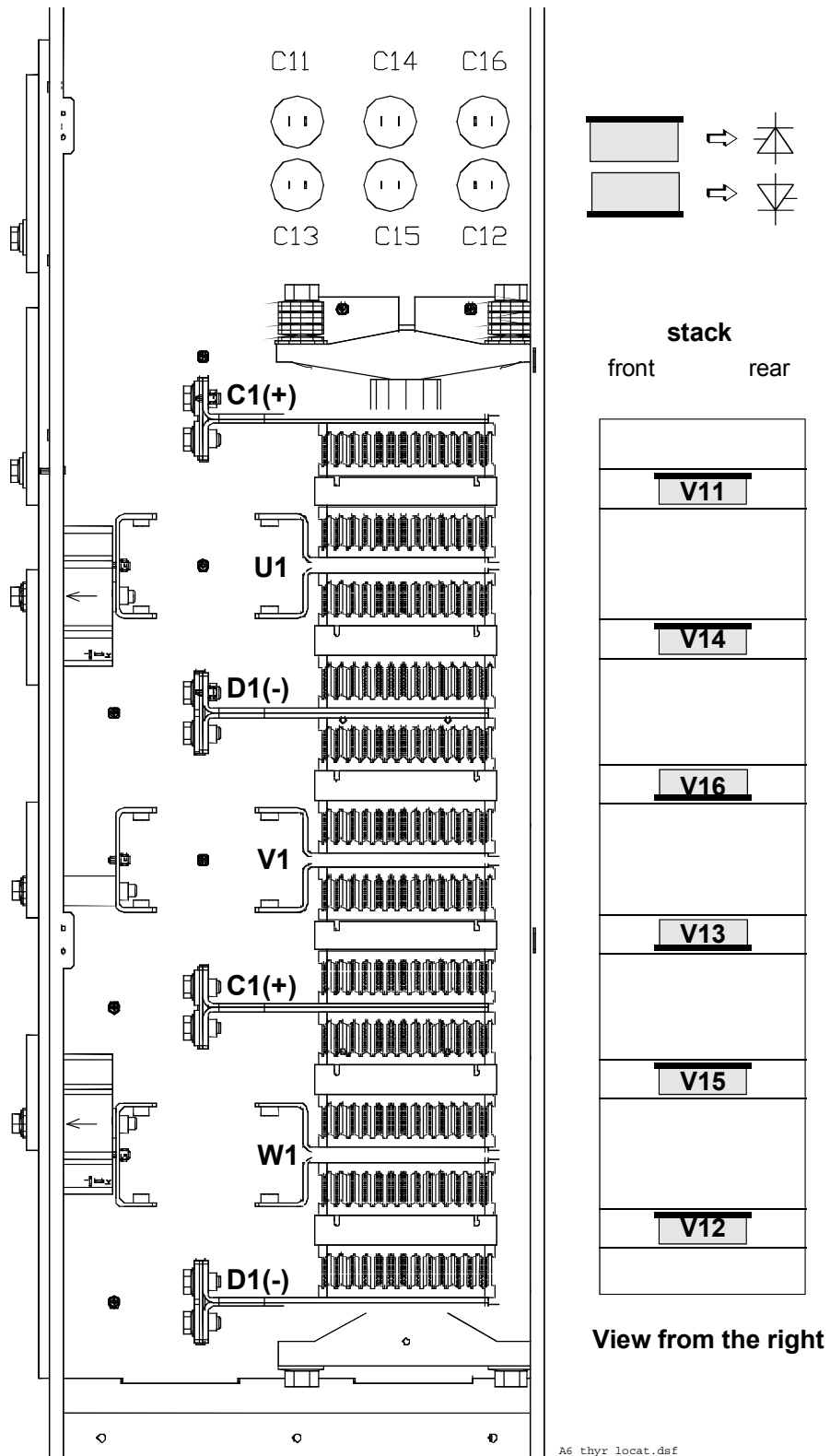

Location of thyristors in frame D6 (2-Q bridge with single thyristors)

Exchange of Thyristors for Size D6

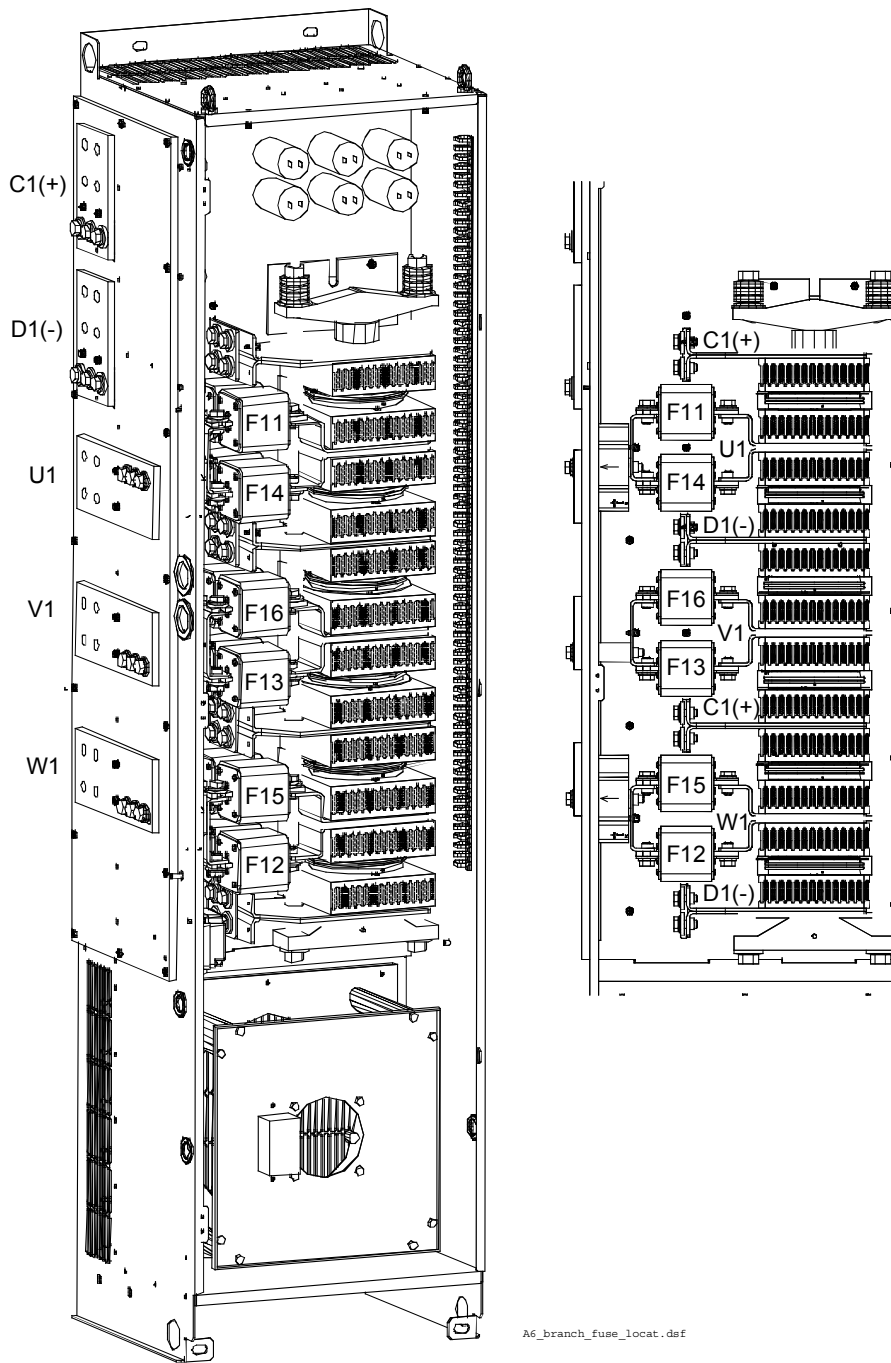

Location of parallel branch fuses frame D6

Exchange of Thyristors for Size D6

Exchange of Thyristors for Size D7

Installation of "Disc Type" thyristor in converters size D7 (2050...5200 A)

All DCS800 converters sizes D5/D6/D7 are equipped with disk type thyristors. The structure of the "Disc type" semiconductor component is such that it requires a certain compression force to operate. The prevention of overheating of the component essentially depends on a good heat dissipation between the semiconductor and the conducted heat sink. It is thus important that all joints have good thermal and electrical conduction.

Required Tools

Special tools or material needed in addition to standard tools for the exchange of thyristor modules:

- Torx screwdrivers: TX10, TX20, TX25
- Torque spanner for electrical connections: 13 Nm (M8)
25 Nm (M10)
50 Nm (M12)
- Screws are metric type; use appropriate nuts.
- 17 mm ring spanner for fuse and busbar connections.
- 24 mm ring spanner for press clamp.
- Tissue paper / solvent (e.g. ethanol).
- Thermal joint compound: type **BECHEM-RHUS SU 2**
(grease)
 - Manufacturer: Carl Bechem GmbH, 58089 Hagen
 - ABB Service: GHSN 390 001 P 0001
- Disassembly tool: DCF 1066721 P1

Note:

For more detailed information about the wiring of the power part, see *Hardware Manual*.

Therefore strict observance of the build in instructions given below is of utmost importance. Make sure that the new component can replace the old one in accordance with the spare part list ([see Appendix A](#)).

All thyristors are always mounted in the same direction, independent of current, voltage, number of quadrants (2-Q or 4-Q), left or right side connection. Semiconductors and heat sinks are to be handled carefully to avoid scratches and other damage. Avoid touching the contact surfaces. Do not lift the semiconductor with the gate wire. Do not lift the semiconductor by touching the current contact surfaces. Do not damage the welding flange or the contact surface.



Before you start work, disconnect the converter completely from the power supply then check the voltage free condition and make sure, everything is located in an electrically and mechanically safe condition!

Find faulty thyristor

1. Find the defective branches by performing an OHM test (both polarities) between U1, V1, W1 and C1, D1 (see picture [Anti-parallel B6-bridges with branching fuses](#) on page 45).
2. Remove the AC busbars, of the defective branches.

4-quadrant converter:

3. Remove all screws of the DC - busbars either above or below the fuses of the defective branches.

Note:

The connection is made with a screw socket, which may fall down, when all screws are removed.

loose AC busbar

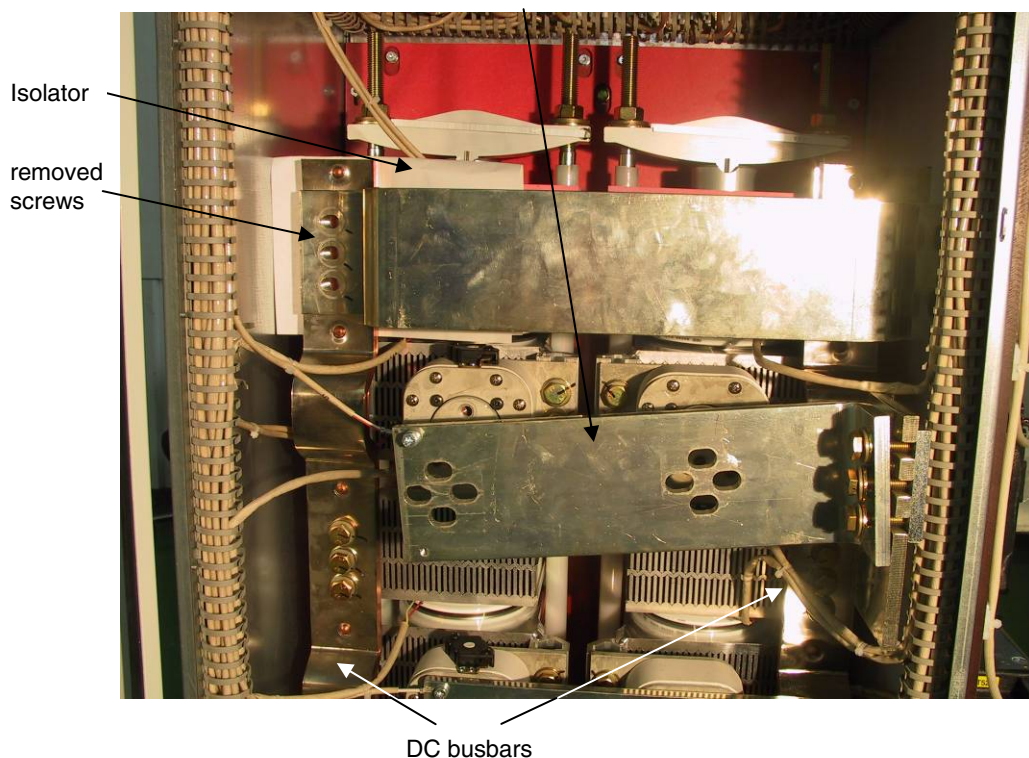

Location of busbars

4. Put a small piece of isolator (e.g. paper) between the DC - busbar and the heat sink to insulate the anti-parallel thyristors from each other.
5. Find the defective thyristors by performing an OHM test (both polarities) over their heat sinks.

2 - quadrant converter:

3. Find the defective thyristors by performing an OHM test (both polarities) over their heat sinks.

Remove faulty thyristor

1. Remove the screws of all DC / AC - busbars preventing the stack to be prized open. Remove the branch fuses, if the defective thyristors are covered by them.

Note:

It depends on the location of the defective thyristors, which DC / AC - busbars have to be disconnected.

2. Loosen the screws holding the backplate and make sure the backplate can move up.

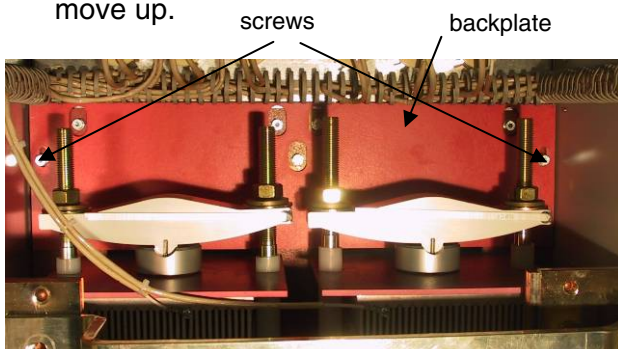

Backplate

3. Write down the direction and location of the defective thyristors to be removed and mark their gate leads.
4. Remove the gate leads if possible.
5. Loosen the mounting clamp at the top of the thyristor stack.

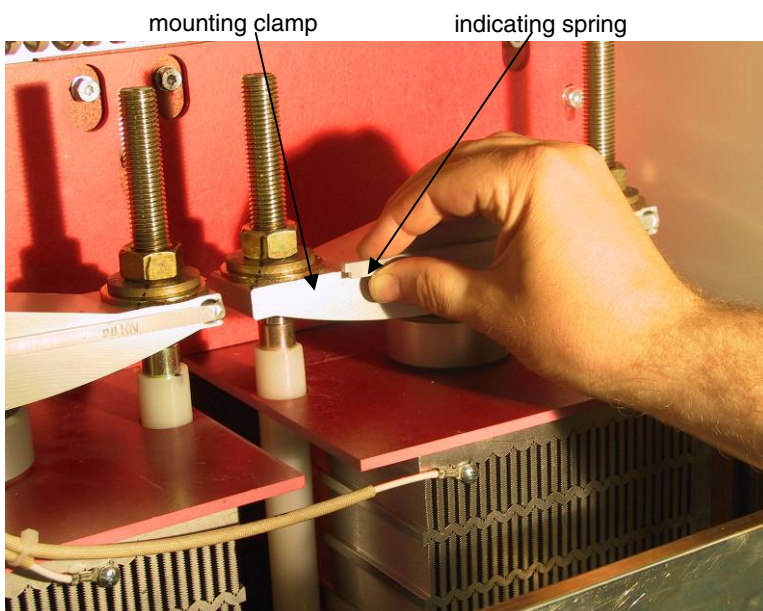

Handling of indicating spring and mounting clamp

Attention: While loosening the mounting clamp the indicating spring must be pulled out a little, otherwise the spring will be damaged!
Do not remove the nuts totally, otherwise the threaded rods will fall down!

6. Attach the disassembly tool at the faulty thyristor and prize open the upper and lower heat sinks.

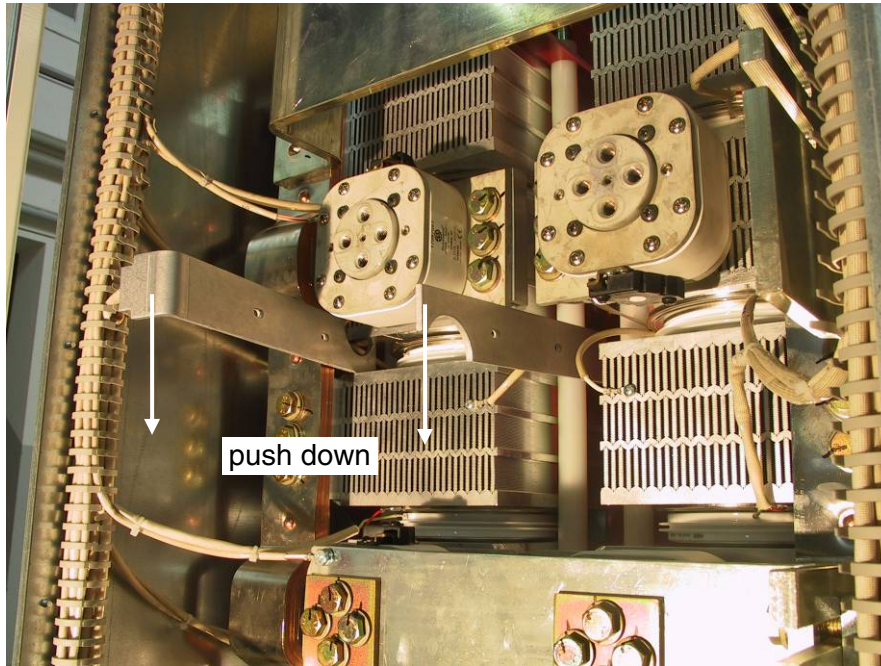

Use of disassembly tool

7. Remove the thyristors with e.g. a pair of pliers.

Attention: To centre the thyristors spring pins are used. The pins are inlaid into all lower heat sinks. Open the gap wide enough that the thyristor and the pins are not damaged while removing the thyristor!

Install new thyristor

1. Ensure that the new thyristor is of the correct type ([see appendix A](#) of this manual). Keep the semiconductor and its surroundings clean. If necessary clean them with a piece of tissue paper moistened with solvent.

Note:

Do not touch the polished surfaces of the thyristor.

2. Clean the polished surfaces of the semiconductor with a piece of tissue paper moistened with solvent. Dry all surfaces. Spread a **thin** layer of heat conducting paste on both sides of the thyristor, if necessary use a rubber spatula.



Prepare disk type thyristor

3. Clean all parts with tissue paper moistened with solvent, which have had or will have contact with the thyristor or each other (lower / upper heat sink). Do not clean the surfaces of grease too thoroughly, because the aluminum surfaces will oxidize in a few seconds. Dry all surfaces.
4. Centre the thyristors by means of the spring pins.

Note:

Be sure that the thyristor is installed in the right direction. Do not pinch or cut the gate leads or any other cable.

5. Turn the thyristor so that the gate leads point in the right direction.
6. Connect the gate leads if possible.
7. Tighten the nuts of the mounting clamp by hand so that the clamp is in parallel with the contact surface of the heat sinks.

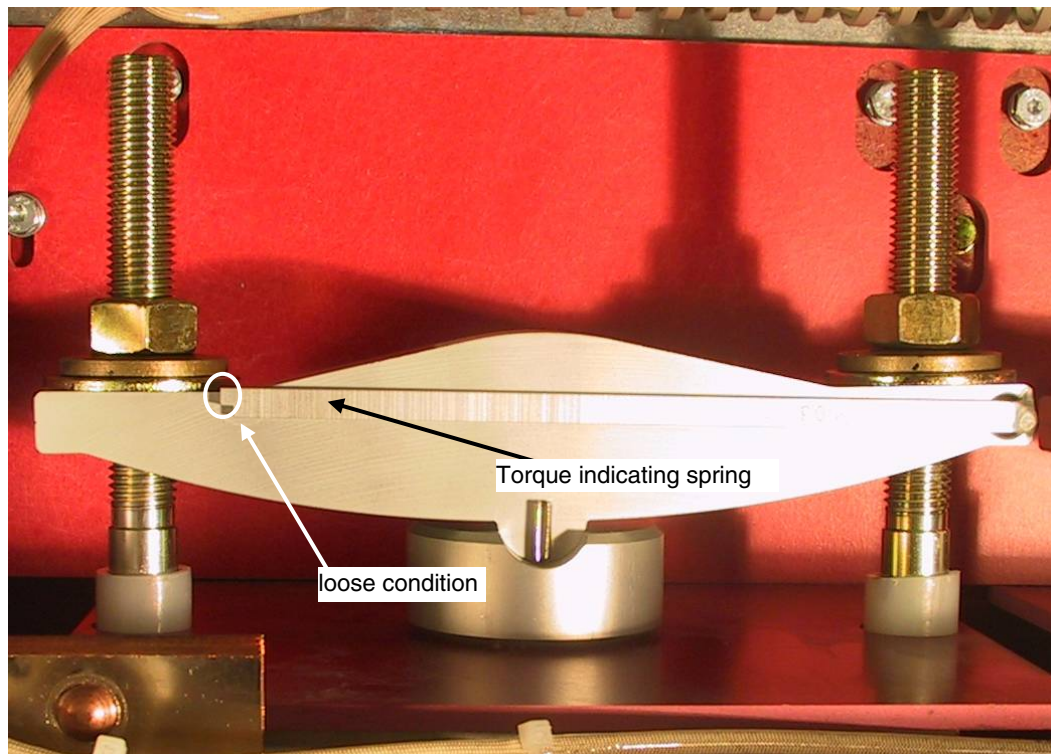

Mounting clamp; loose condition

Note:

The indicating spring is a very sensitive instrument and must be handled with care.

8. Tighten each nut in turn, half a turn at a time with the help of a ring spanner until the indicating spring clicks into position "correct torque". Do not tighten the screws any further.

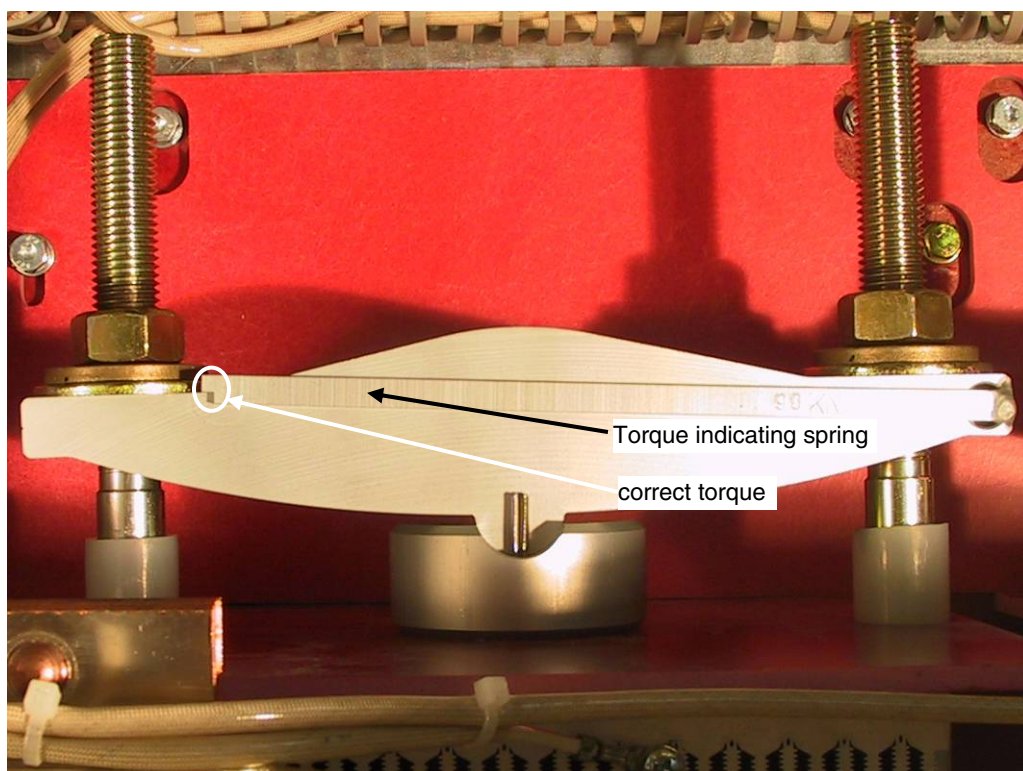

Mounting clamp; correct torque

Note:

The correct torque is indicated by means of the welded indicating spring.

9. Perform an OHM test to make sure the thyristor is ok.
10. Reconnect the backplate, branch fuses, DC- / AC-busbars and all other dismantled parts.
11. Perform an OHM test between U1, V1, W1 and C1, D1 to make sure the power part is ok.

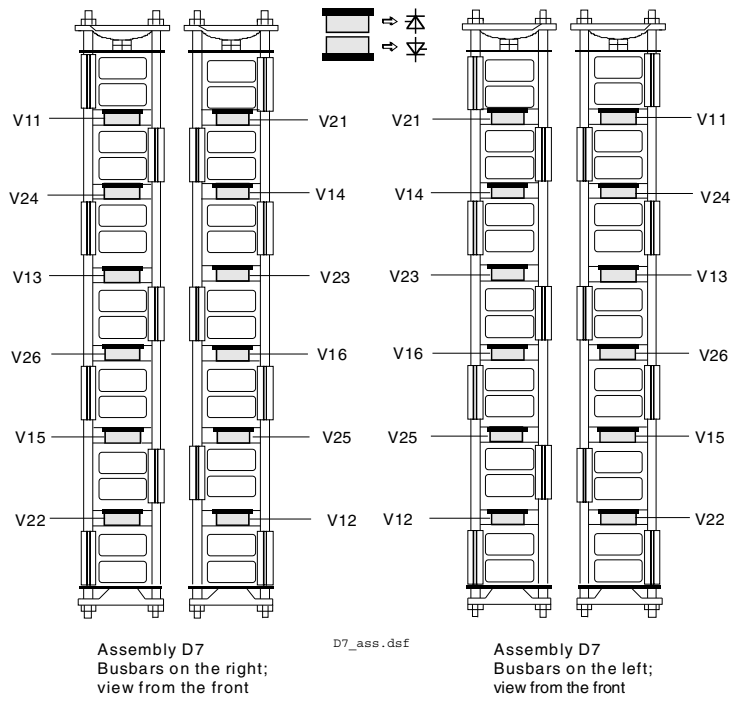

Location of thyristors in frame D7 (4-Q bridge)

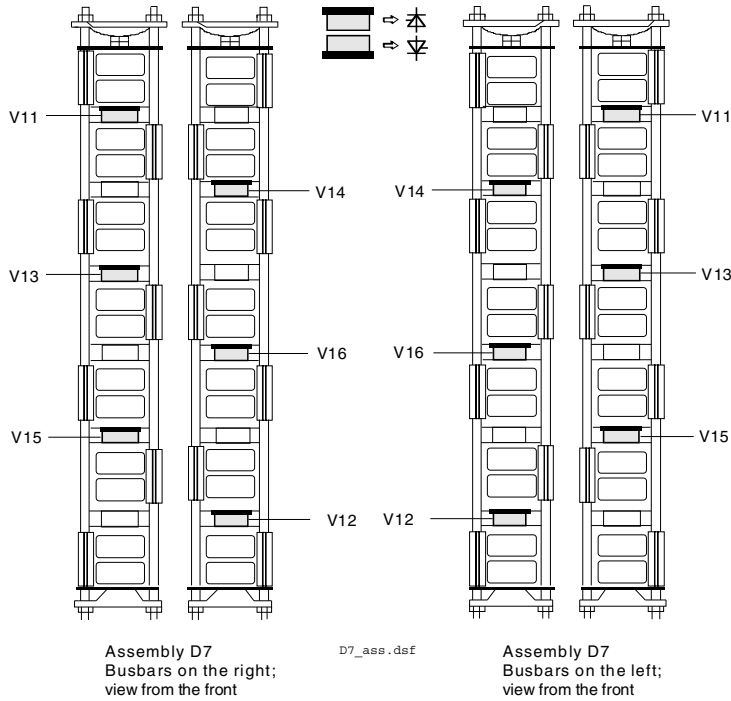

Location of thyristors in frame D7 (2-Q bridge)

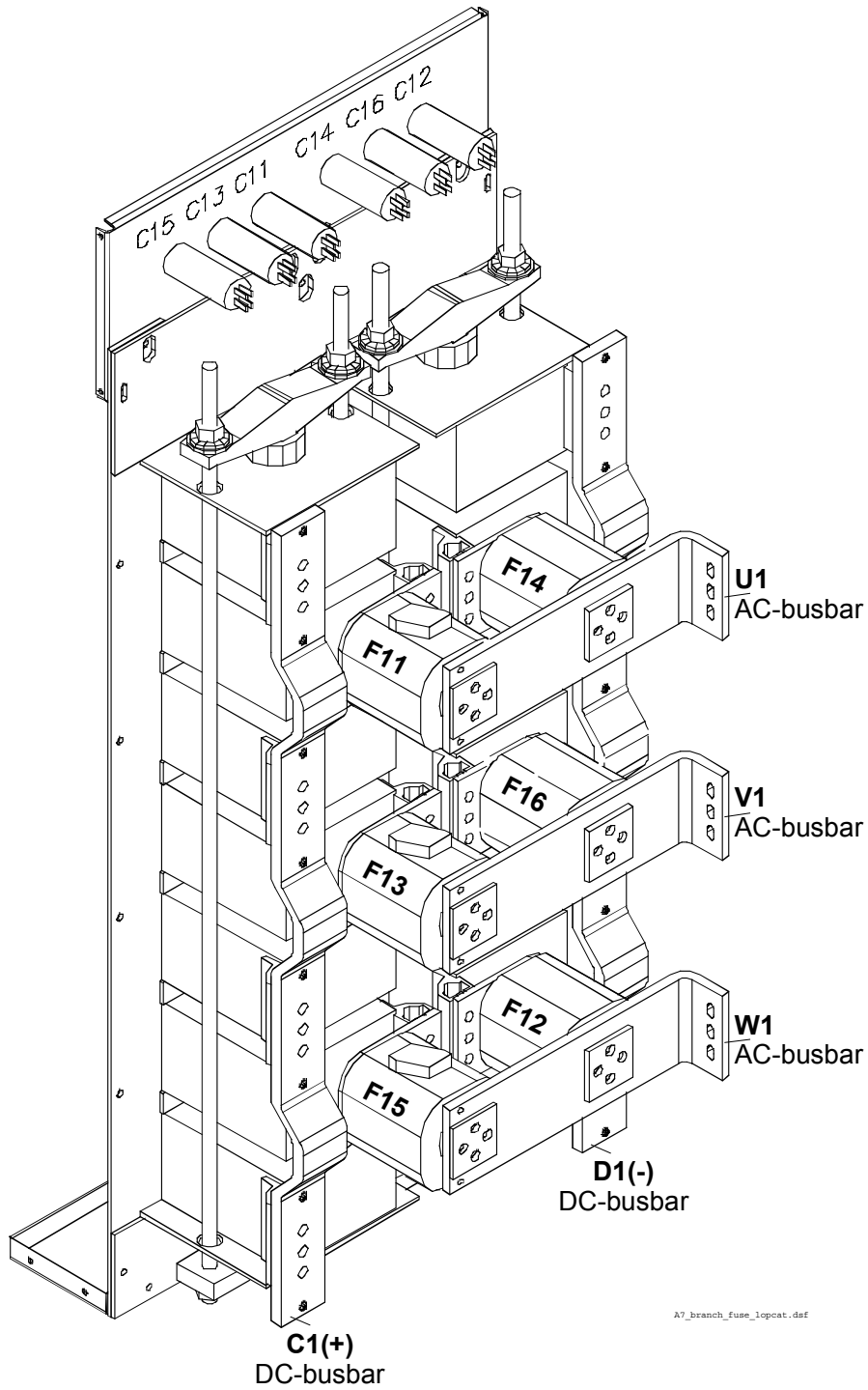

Location of branch fuses frame D7 (busbars on the right)

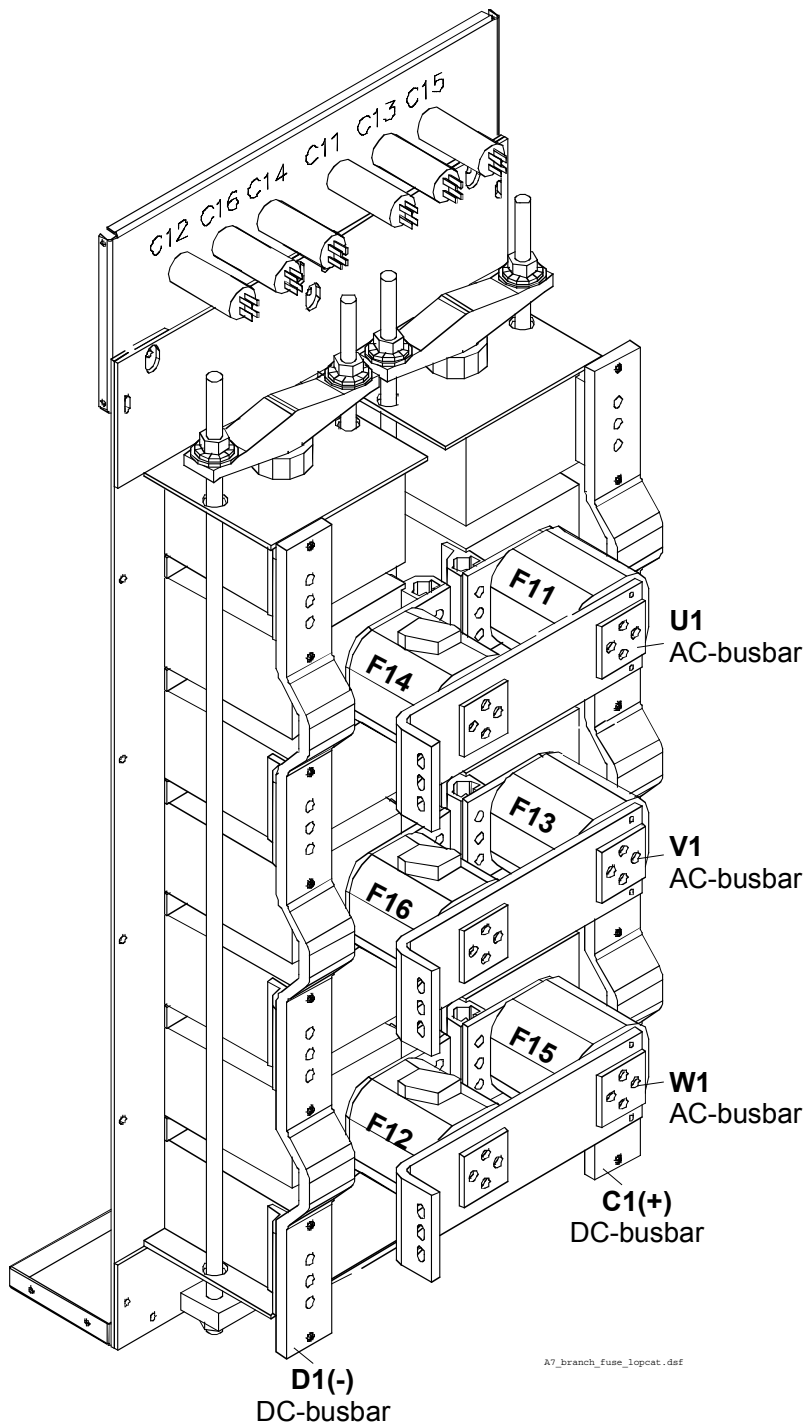

Location of branch fuses frame D7 (busbars on the left)

Exchange of Thyristors for Size D7

Exchange of SDCS-CON-4

General

All DCS800 size D1 to D7 are equipped with the same controller board SDCS-CON-4, thus the exchange of the board is similar for all module sizes.

Required Tools

Special tools or material needed in addition to standard tools for the exchange of the SDCS-CON-4:

- Torx screwdrivers: TX10, TX20, TX25

Overview SDCS-CON-4 exchange

1. Save parameters,
2. Write down type code of the drive,
3. Set jumpers on the new SDCS-CON-4 according to the old SDCS-CON-4,
4. Exchange the SDCS-CON-4,
5. Set type code of the drive,
6. Enable application program and
7. Download and compare parameters.

1. Save parameters

Parameters can be saved by various means:

DCS Control Panel

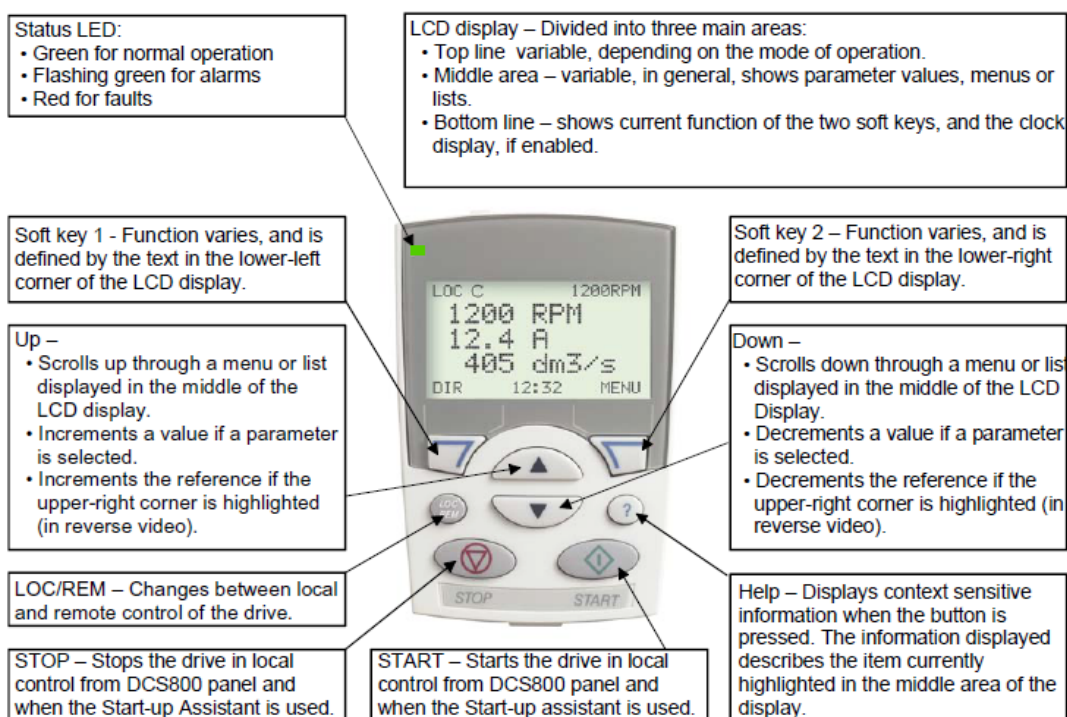

- Press Soft key 1 until the main menu is shown (see picture above),
- Press LOC/REM button, display will show LOC on the upper left side,

- Press Soft key 2 (MENU),
- Scroll with UP / DOWN buttons to menu item PAR BACKUP,
- Confirm with Soft key 2 (ENTER),
- Select UPLOAD TO PANEL and confirm with Soft key 2 (SEL), the upload progress bar will be shown on the display,
- Successful upload will be shown by message,
- Confirm with Soft key 1 (OK),
- Press Soft key 1 until back to the main menu (see picture above),
- The actual parameter set is now stored in the DCS Control Panel.

DriveWindow Light

- Click *File* then *Save As...*

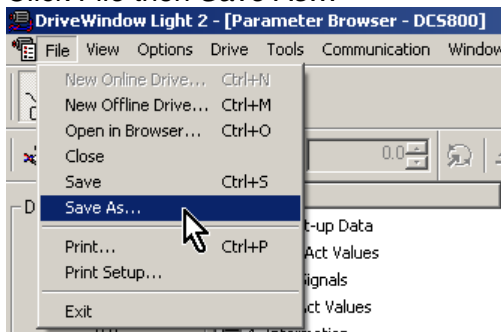

- Click *Save:*

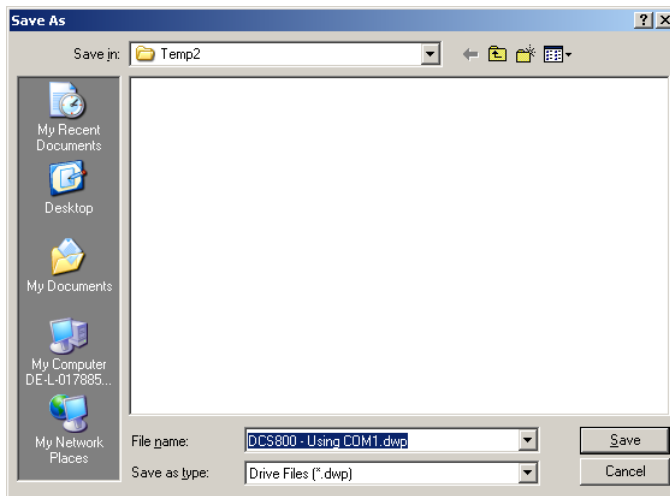

DriveWindow

- Click *File* then *Parameters* and *Save As...*

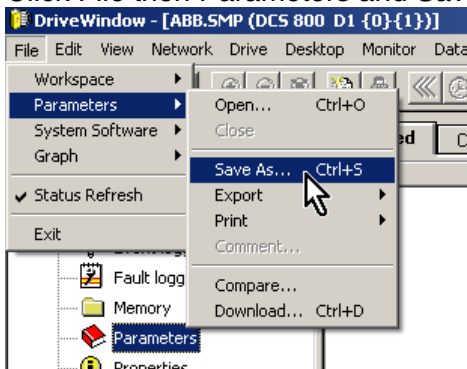

- Click *Save*:

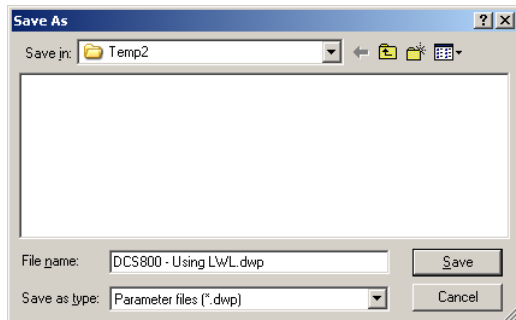

2. Write down type code of the drive

Write down the contents of *TypeCode (97.01)*. This information must be manually set in the new SDCS-CON-4.

3. Set jumpers on the new SDCS-CON-4 according to the old SDCS-CON-4

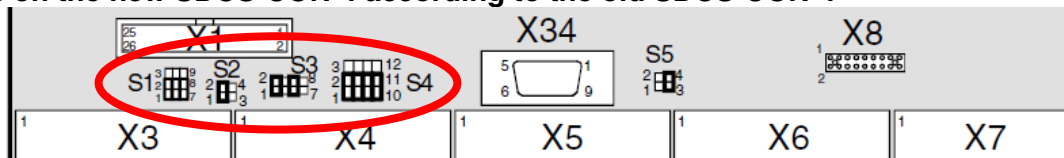

Copy the jumper settings (S1 to S4) of the old SDCS-CON-4 onto the new SDCS-CON-4 accordingly.

4. Exchange the SDCS-CON-4

- Remove the old SDCS-CON-4
1. Remove the DCS Control Panel and design cover:



Remove design cover

2. Remove all plug in options on the intermediate cover e.g.:
 - serial communication modules (R-type),

- extension I/O modules (RAIO, RDIO),
 - extension modules for second encoder (RTAC) or resolver (RRIA),
 - communication board (SDCS-COM-8),
 - isolated I/O (SDCS-IOB-2x, SDCS-IOB-3) and
 - SDCS-MEM-8 (Memory Card).
3. Remove the intermediate cover by depressing the two locks on the upper right and left hand side of the cover:

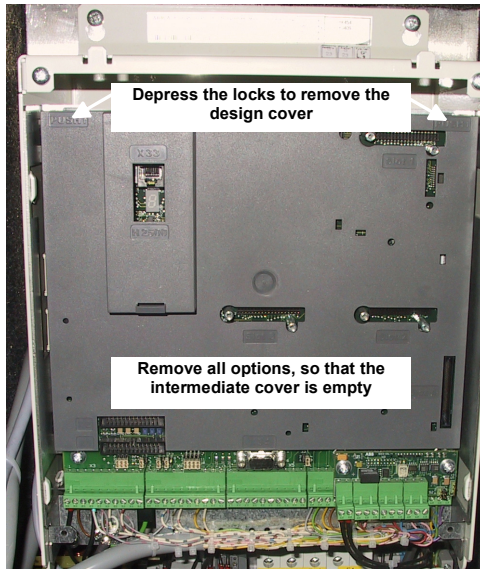

Remove plug in options

4. Disconnect all I/O plugs (X3 to X7) at the SDCS-CON-4 and the plugs at the SDCS-DSL-4 board, if used (X51 to X54):

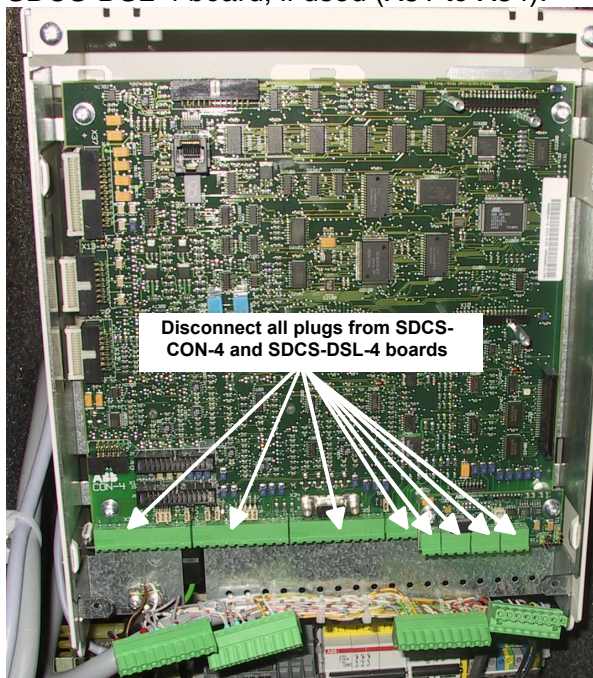

Disconnect all plugs

5. Remove screws and studs:

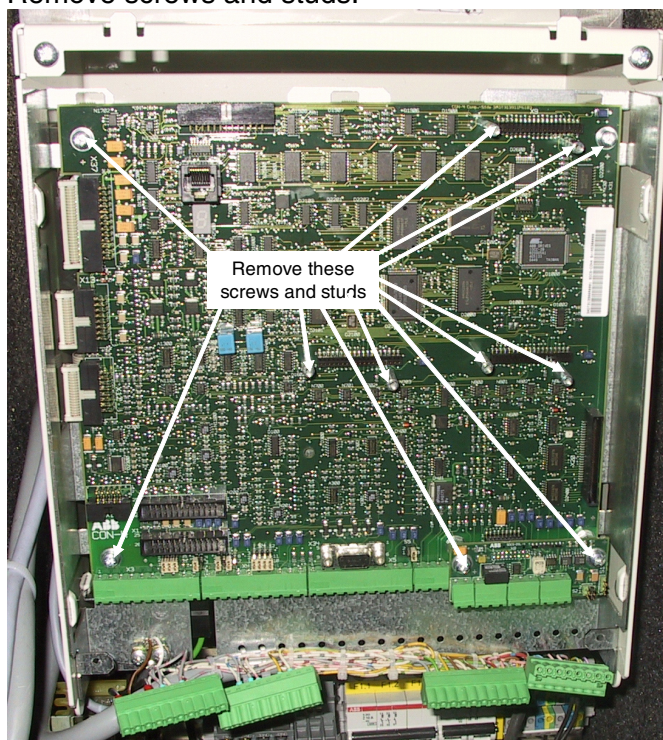

Remove screws and studs

6. Unplug the flat cables (X12, X13, X37):

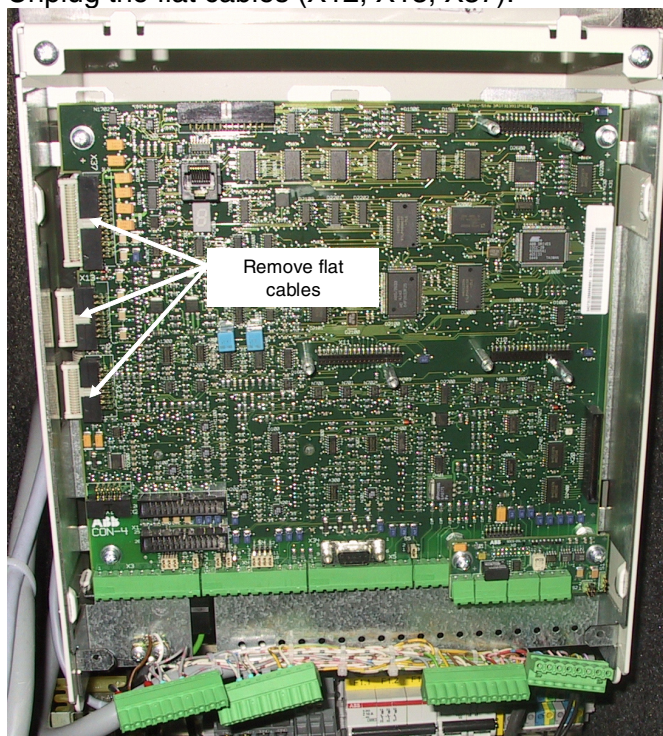

Unplug the flat cables

- Install the new SDCS-CON-4
1. Reconnect the flat cables at the SDCS-CON-4 (X12, X13, X37),
 2. Reconnect all I/O plugs at the SDCS-CON-4 (X3 to X7) and the plugs at the SDCS-DSL-4 (X51 to X54) and
 3. Reinstall the intermediate cover, all plug in options and the design cover.

5. Set type code of the drive

Follow the instructions in chapter [Set type code](#).

6. Enable application program

If a SDCS-MEM-8 (Memory Card) is used the application program must be enabled before the parameters are downloaded. Set:

- *ParApplSave (16.06) = EnableAppl*

7. Download and compare parameters

Parameters can be downloaded and compared by various means:

- DCS Control Panel
- Press Soft key 1 until the main menu is shown,
 - Press LOC/REM button, display will show LOC on the upper left side,
 - Press Soft key 2 (MENU),
 - Scroll with UP / DOWN buttons to menu item PAR BACKUP,
 - Confirm with Soft key 2 (ENTER),
 - Select DOWNLOAD FULL SET and confirm with Soft key 2 (SEL), the download progress bar will be shown on the display,
 - Successful download will be shown by message,
 - Confirm with Soft key 1 (OK),
 - Press LOC/REM button, display will show REM on the upper left side,
 - Press Soft key 1 until back to the main menu and
 - The actual parameter set is now downloaded into the new SDCS-CON-4.

DriveWindow Light

- Click *File* then *Open...*

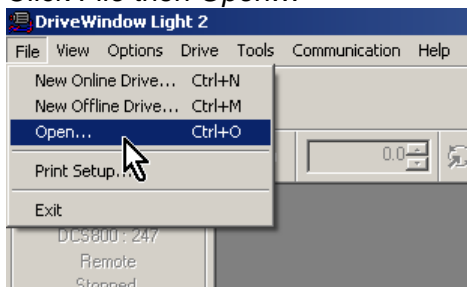

- Choose correct parameter file and click *Open*:

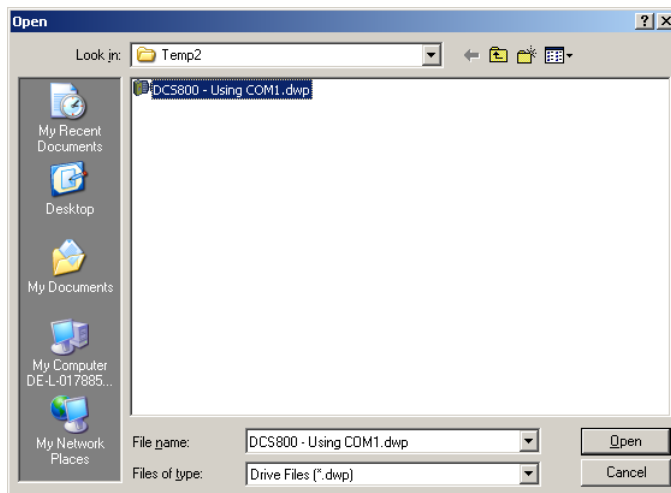

- Click *Drive* then *Parameters & Signals* and *Download All Parameters*

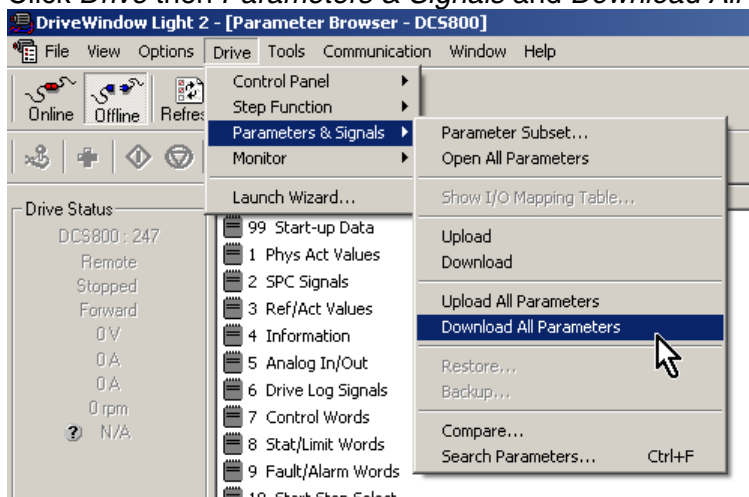

- To check if the parameter download was successful connect the drive with DriveWindow Light and compare drive memory the downloaded parameter set. Click *Drive* then *Parameters & Signals* and *Compare...*

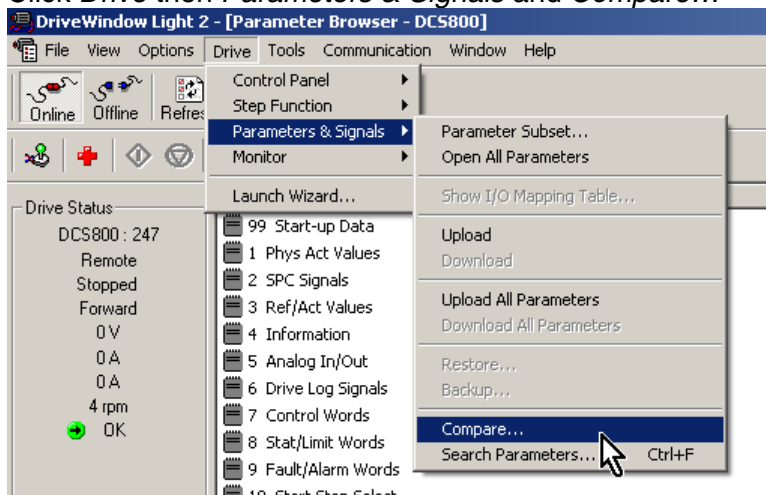

DriveWindow – Click *File* then *Parameters* and *Download...*

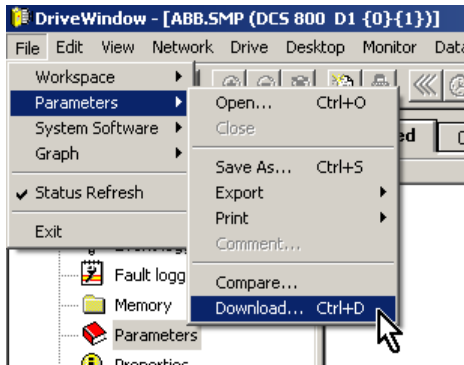

– Click *Open* and follow the instructions:

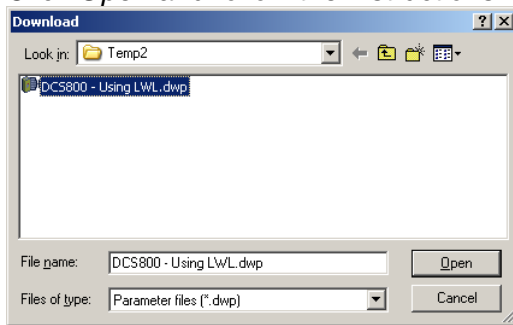

– To check if the parameter download was successful connect the drive with DriveWindow and compare drive memory the downloaded parameter set. Click *File* then *Parameters* and *Compare...*

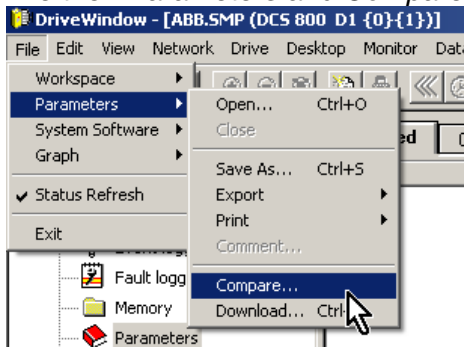

Service

How to remove the converter fans in frames D1 to D3 (two fans)

Converters types DCS800-S01-0045-0x to DCS800-S02-0350-0x using two 115 VAC fans. Depending on the supply voltage they are either connected in series, for 230 VAC, or in parallel, for 115 VAC:

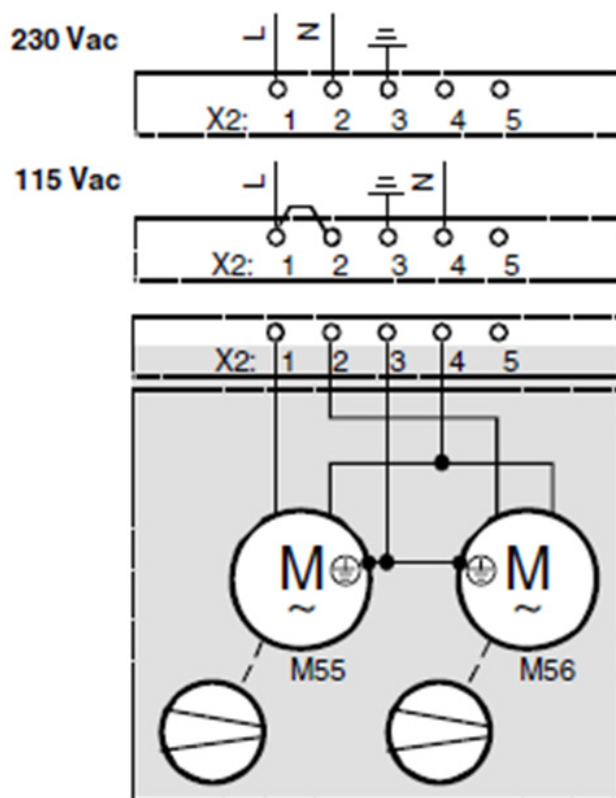

Connector X2 on top of converter housing

Fan configuration D1 to D3

In case a fan fails there are different approaches due to the incoming voltage.

230 VAC:

With a supply voltage of 230 VAC fans M55 and M56 are connected in series. Consequently both fans have to be of the same manufacturer and type. Thus it is not possible to change only the broken fan. In this case both fans have to be changed.

115 VAC:

With a supply voltage of 115 VAC all fans are connected in parallel. Thus it is possible to change only the broken fan.

Removing the converter fans

1. Remove the DCS Control Panel, the design cover and the fan connection plug X2 on the top of the converter housing:

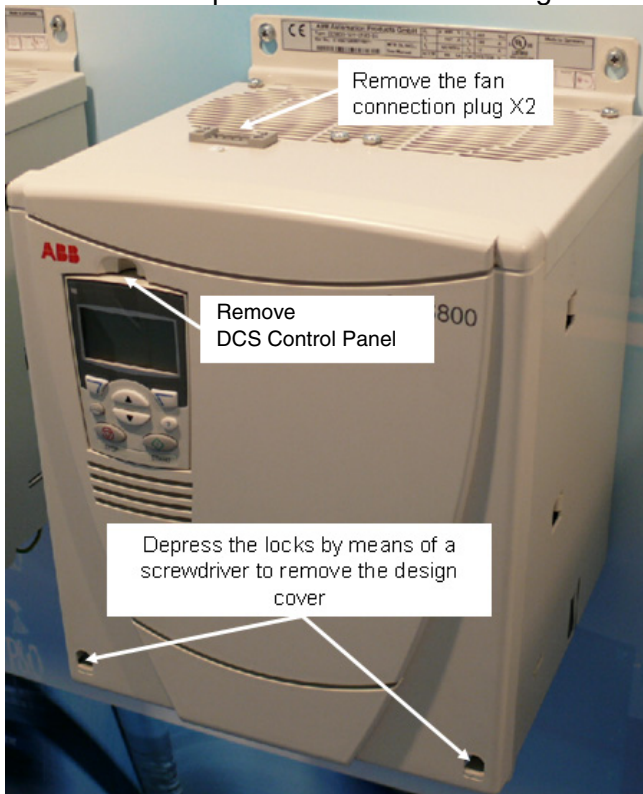

Design cover

2. Remove the two fan arrangement screws:

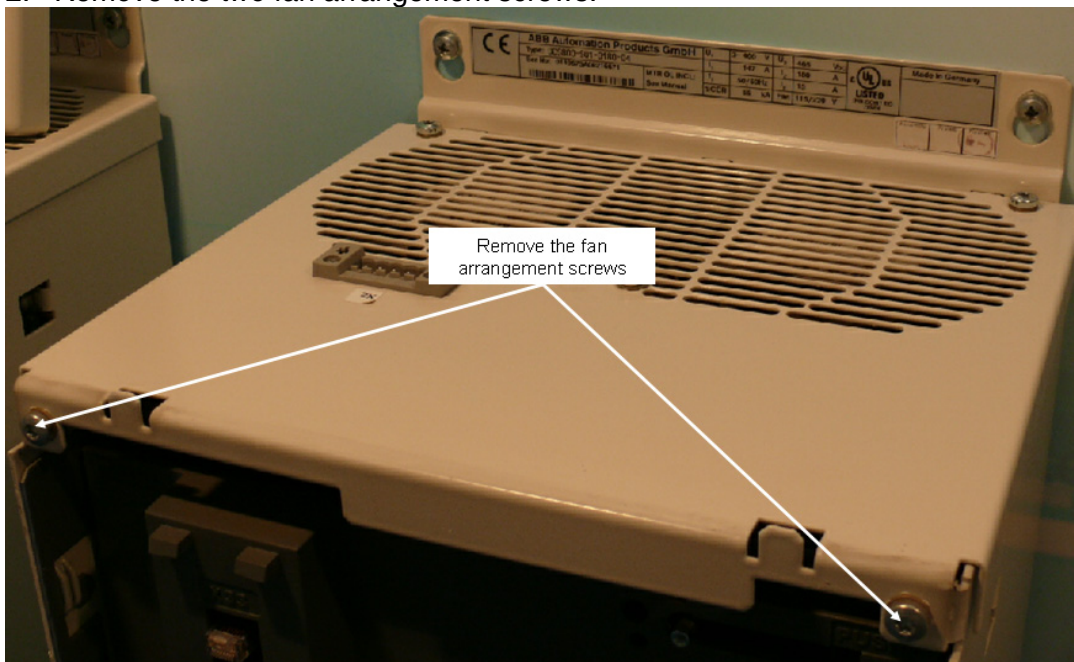

Fan arrangement

3. Move the fan arrangement forward:

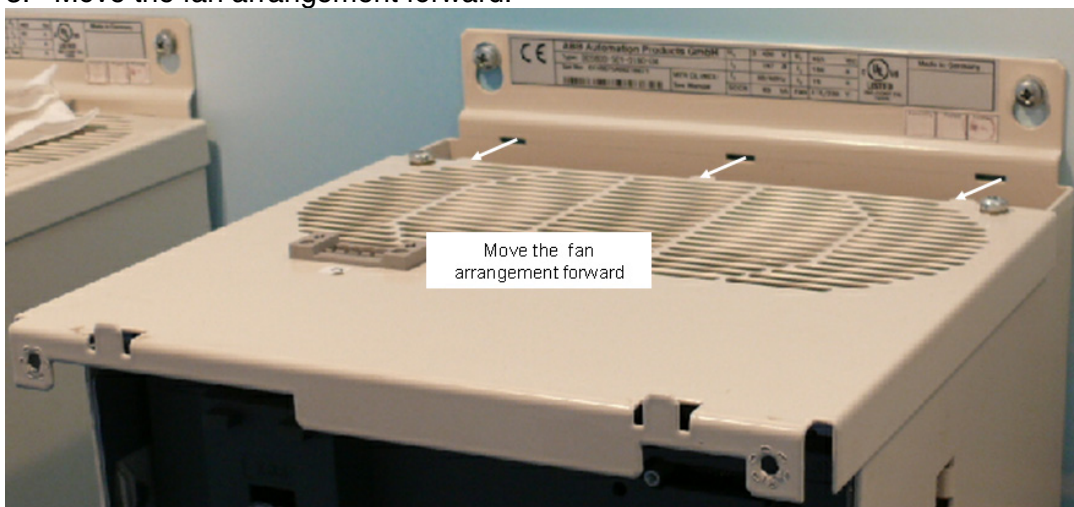

Move fan arrangement

- 4. Remove the fan holding screws:

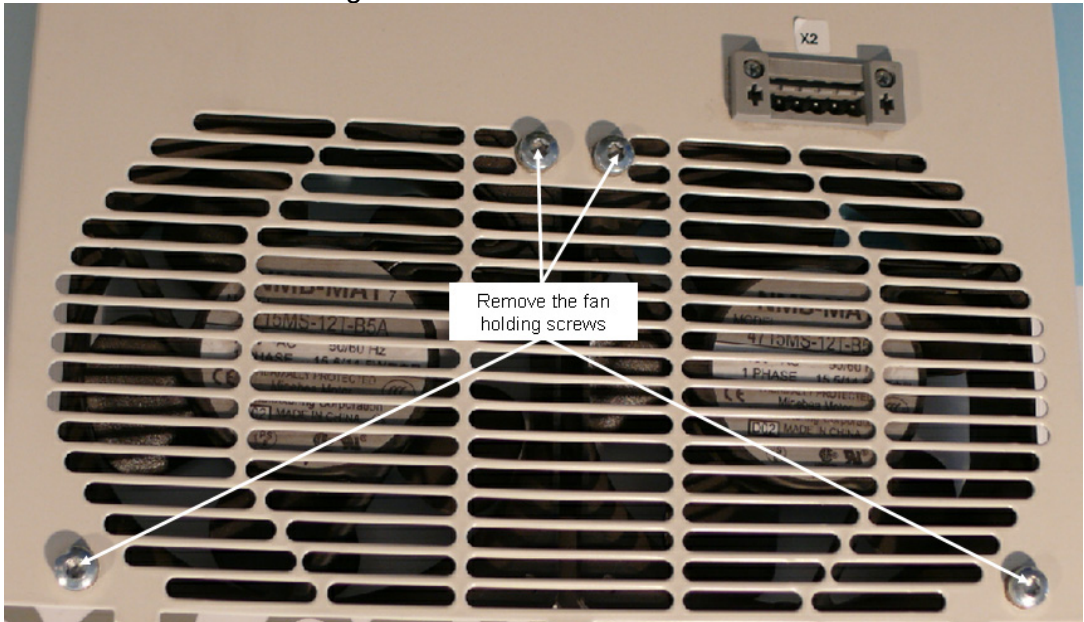

Fan holding screws

- 5. Remove Faston plugs and fans:

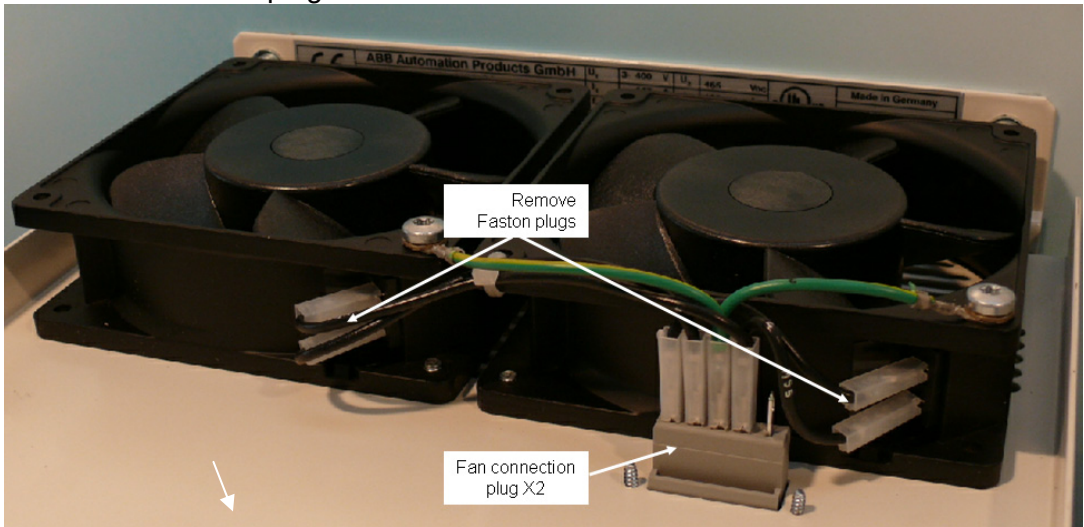

Faston plugs

- 6. Reassemble everything and check for correct blow direction of each fan. The air should be sucked out of the module.

How to remove the converter fans in a frame D3 (four fans)

Converters types DCS800-S01-0405-0x to DCS800-S02-0520-0x using four 115 VAC fans. Depending on the supply voltage they are either connected in series, for 230 VAC, or in parallel, for 115 VAC:

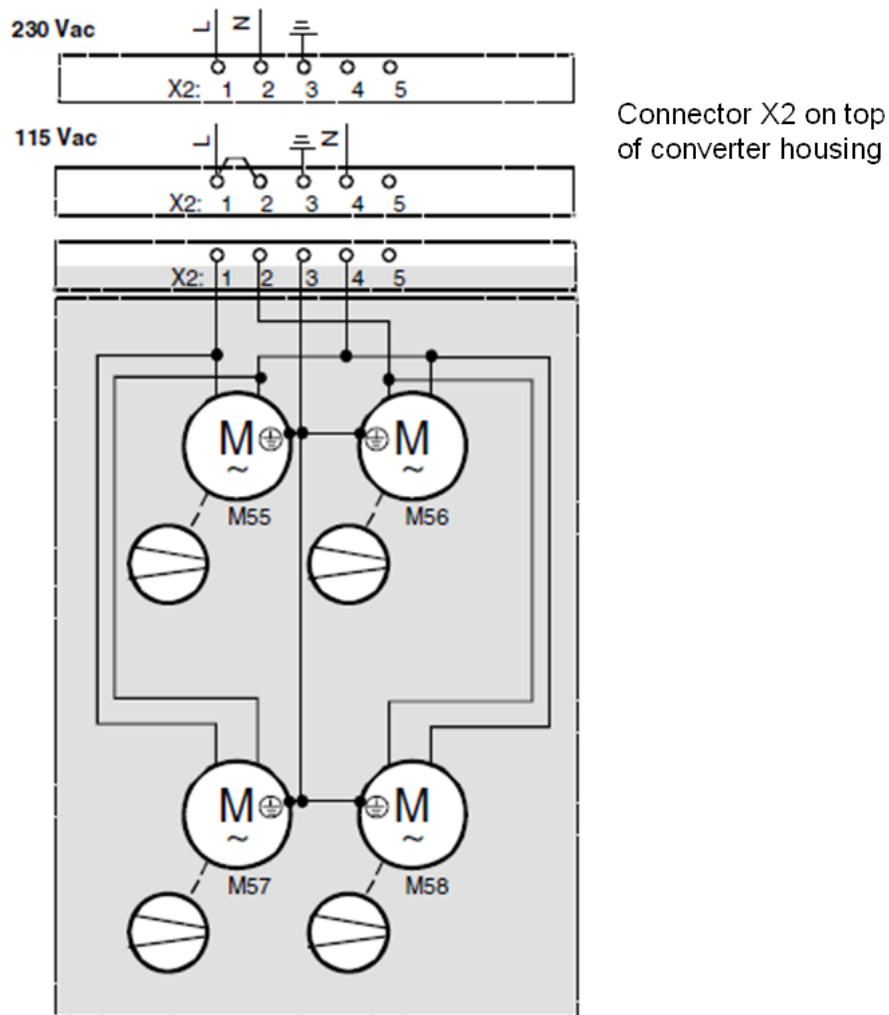

Fan configuration D3

In case a fan fails there are different approaches due to the incoming voltage.

230 VAC:

With a supply voltage of 230 VAC fans M55 and M56 are connected in series as well as fans M57 and M58. Consequently fans connected in series have to be of the same manufacturer and type. Thus it is not possible to change only the broken fan. Always change the two fans connected in series.

115 VAC:

With a supply voltage of 115 VAC all fans are connected in parallel. Thus it is possible to change only the broken fan.

Removing the converter fans

1. Remove the DCS Control Panel, the design cover and the fan connection plug X2 on the top of the converter housing:

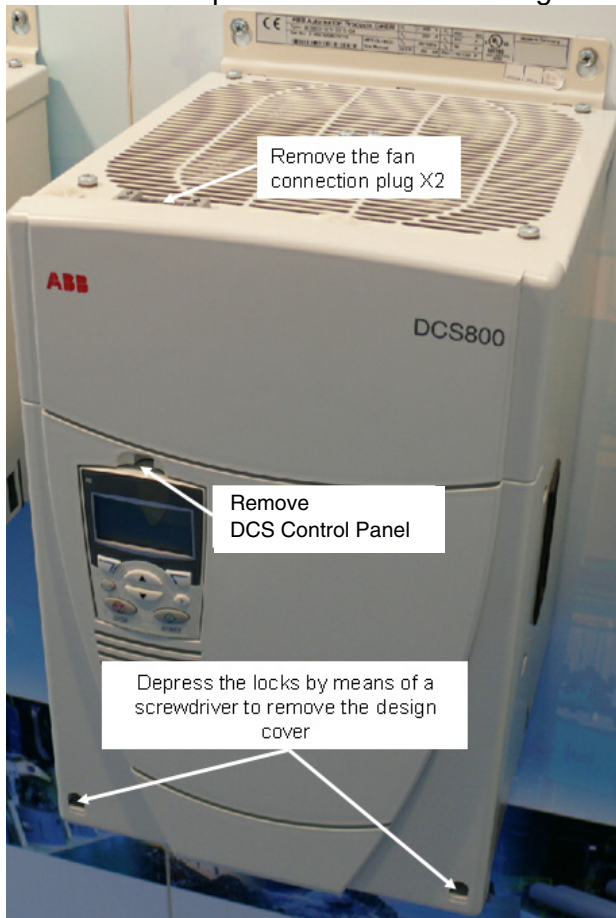

Design cover

2. Remove the two fan arrangement screws:



Fan arrangement

3. Move the fan arrangement forward:



Move fan arrangement

4. Remove the fan holding screws:

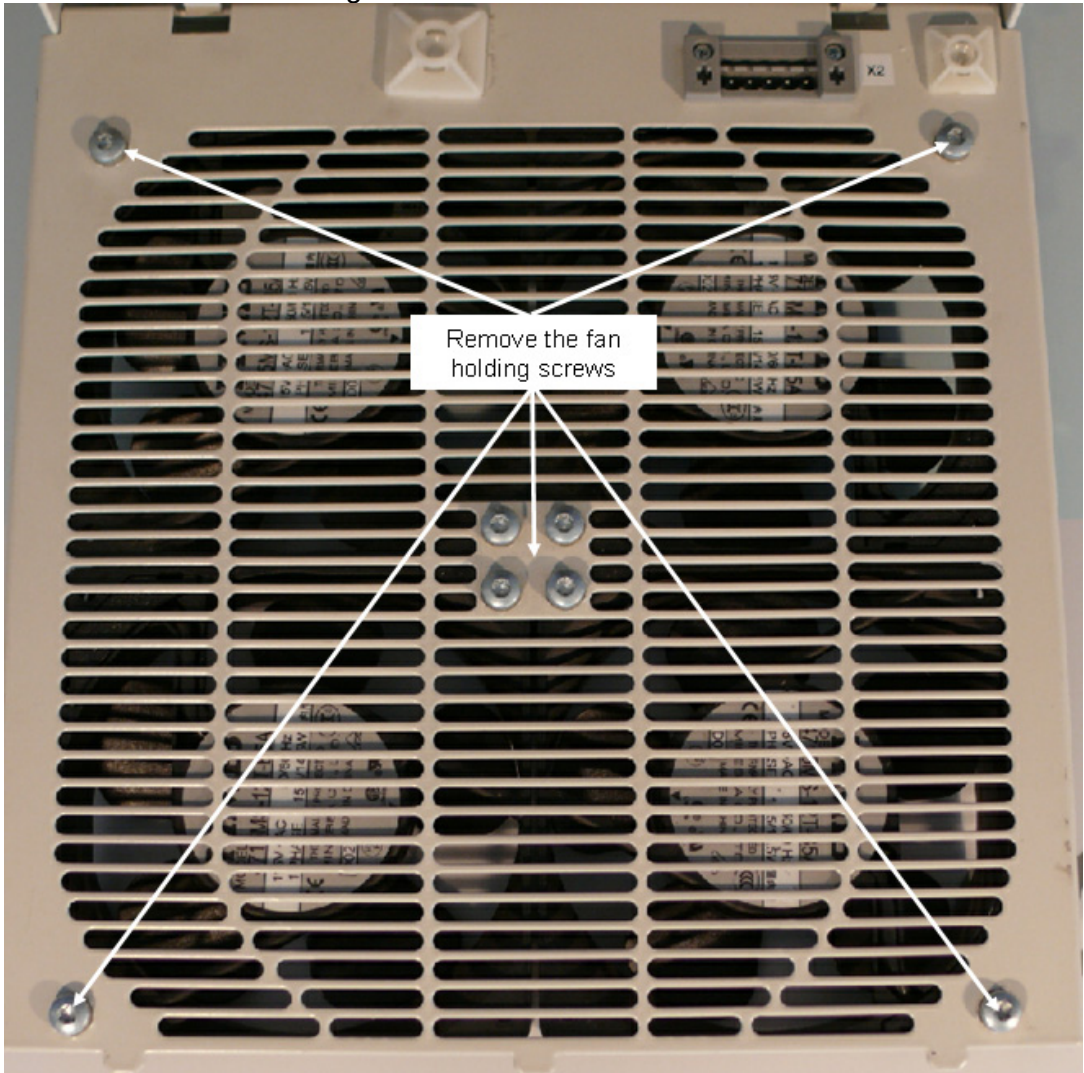

Fan holding screws

5. Remove Faston plugs and fans:

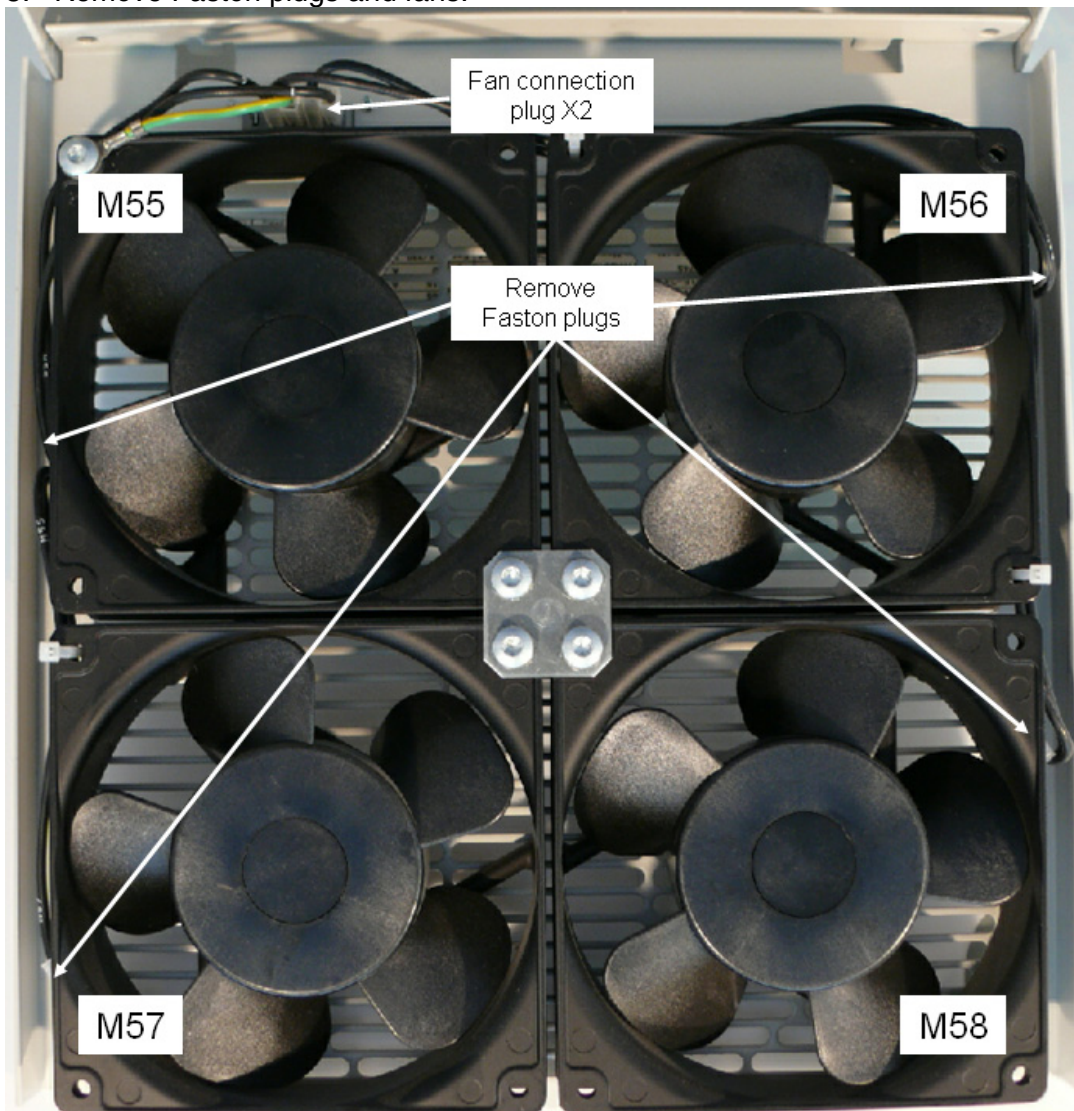

Faston plugs

6. Reassemble everything and check for correct blow direction of each fan. The air should be sucked out of the module.

How to remove the converter fan in a frame D6

1. Remove the three screws at the top of the fan.
2. Disconnect the cables.
3. Lift the fan up and pull it out.



Converter fan in frame D6

How to remove the converter fan in a frame D7

1. Remove the three screws at the bottom of the fan.
2. Disconnect the cables.
3. Pull the fan out.

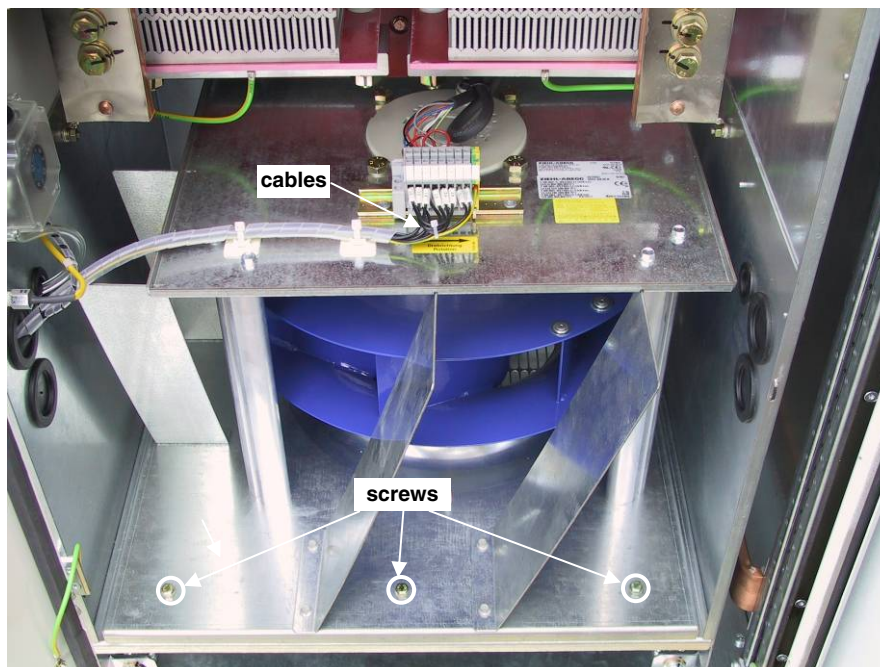

Converter fan in frame D7

DCS800 firmware download

General

This chapter describes how to download firmware into the SDCS-CON-4 and SDCS-COM-8.

Download SDCS-CON-4 firmware

Requirements:

- The Hitachi Flash Development Toolkit 2.2 has to be installed.
- A recent workspace including firmware file and text file should be saved on the PC.

Workspaces

ABB provides workspaces called *DCS800.fdt*. New workspaces have to be saved in:

C:\ABB\DCS800\Firmware\CON-4\Ver x.x

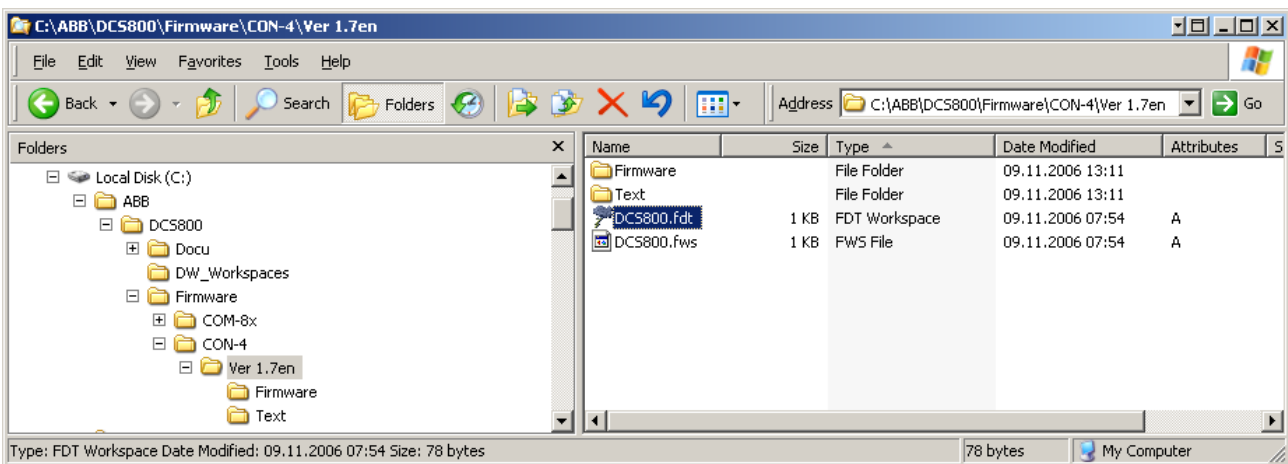

Firmware / text file

The firmware consists of two parts. The firmware file itself and the text file. New firmware files (*.rec) have to be saved in:

C:\ABB\DCS800\Firmware\CON-4\Ver x.x\Firmware

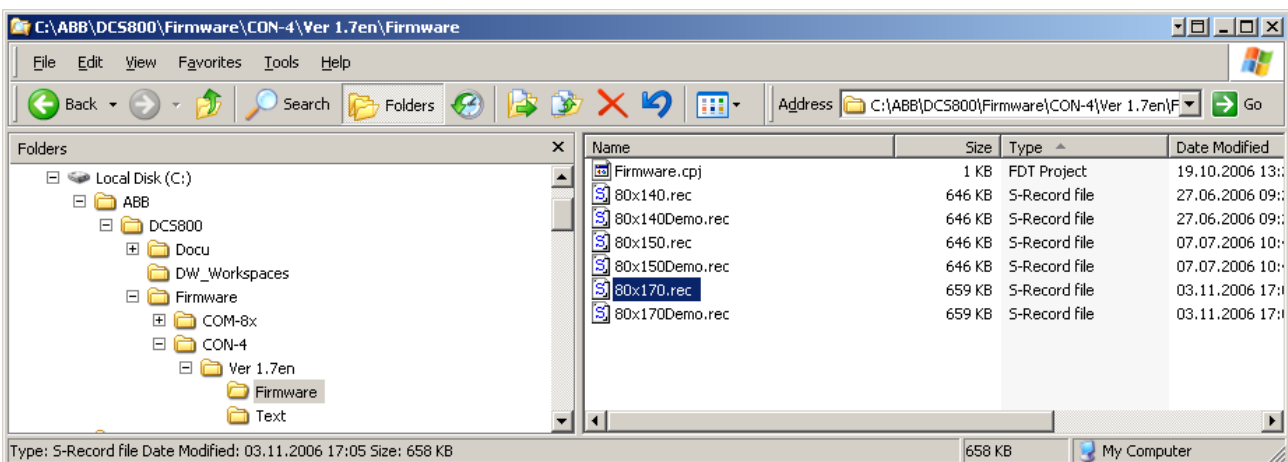

Service

New text files (*.cde) have to be saved in:
C:\ABB\DCS800\Firmware\ CON-4\Ver x.x\Text

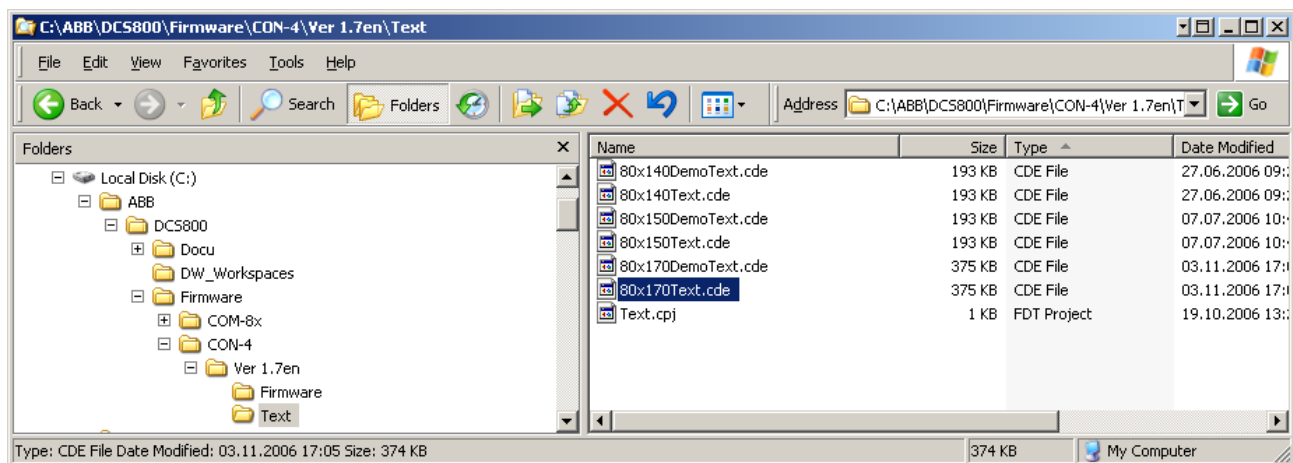

Download firmware file

The firmware download is done via a PC COM Port.

Attention:

If there is no COM Port available an adapter PCMCIA to COM Port has to be used. Adapters USB to COM Port do **not** work reliable.

The download of the firmware is done in two steps:

1. first the firmware file itself and
2. then the text file.

Attention:

A firmware download does not influence the parameter settings! The previous parameter settings are kept.

- De-energize the DCS800 electronics
- Set jumper S5 on SCDS-CON-4 from position 3-4 to position 1-2

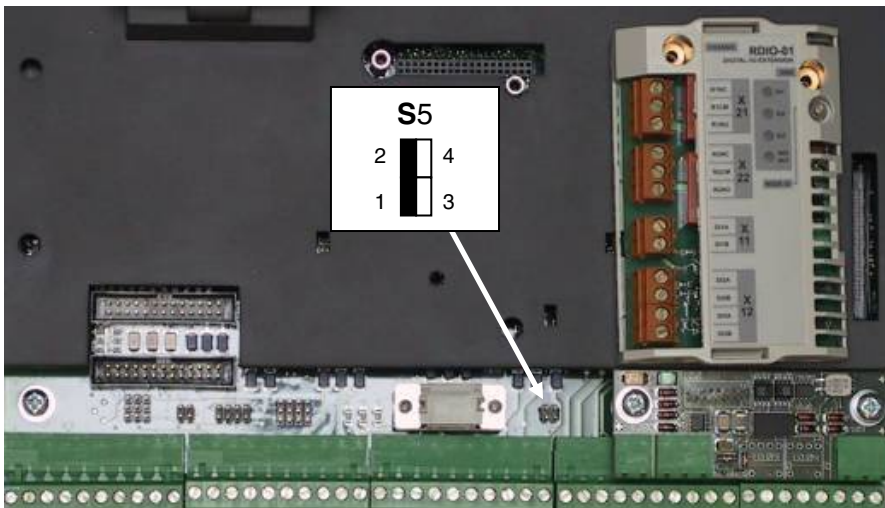

- Connect a RS232 cable between a PC COM Port and DCS800 X34
- Energize the DCS800 electronics, the 7-segment display shows:

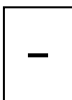

Start download tool:

- Start the Hitachi Flash Development Toolkit 2.2 by means of *Start/Programs/Hitachi/Flash Development Toolkit 2.2/Flash Development Toolkit 2.2*

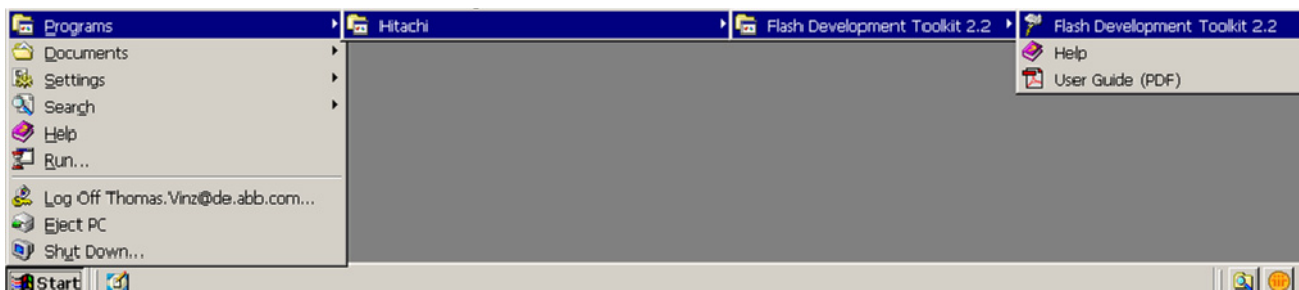
**Choose workspace:**

- Mark *Open an existing Workspace*,
- Confirm with *OK*

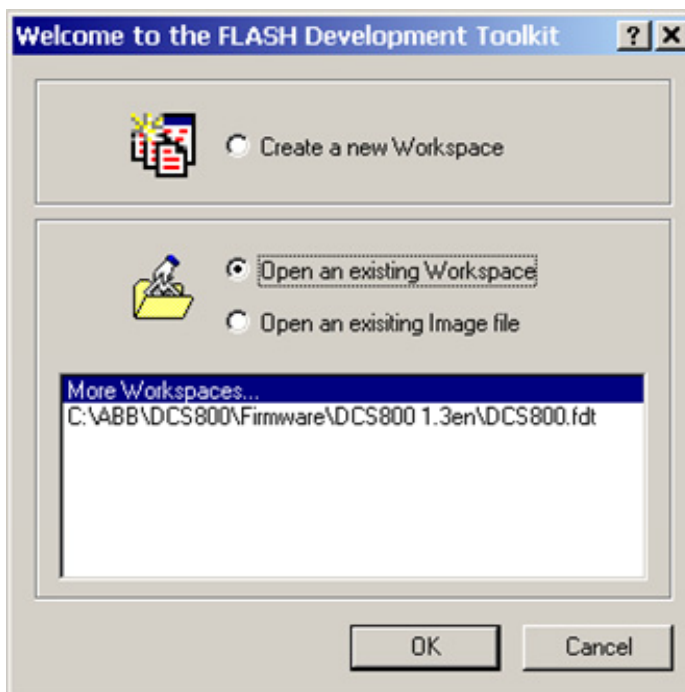

- Select the workspace in directory:
C:\ABB\DCS800\Firmware\CON-4\Ver x.x
- Confirm with *Open*

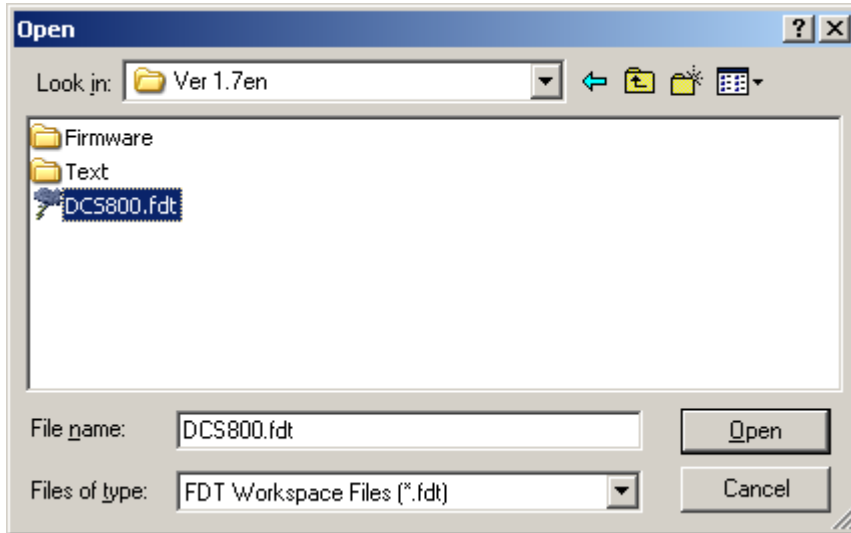

Activate firmware download:

- Select *Firmware* with a right mouse click and choose *Set as Active Project* from the pop up menu

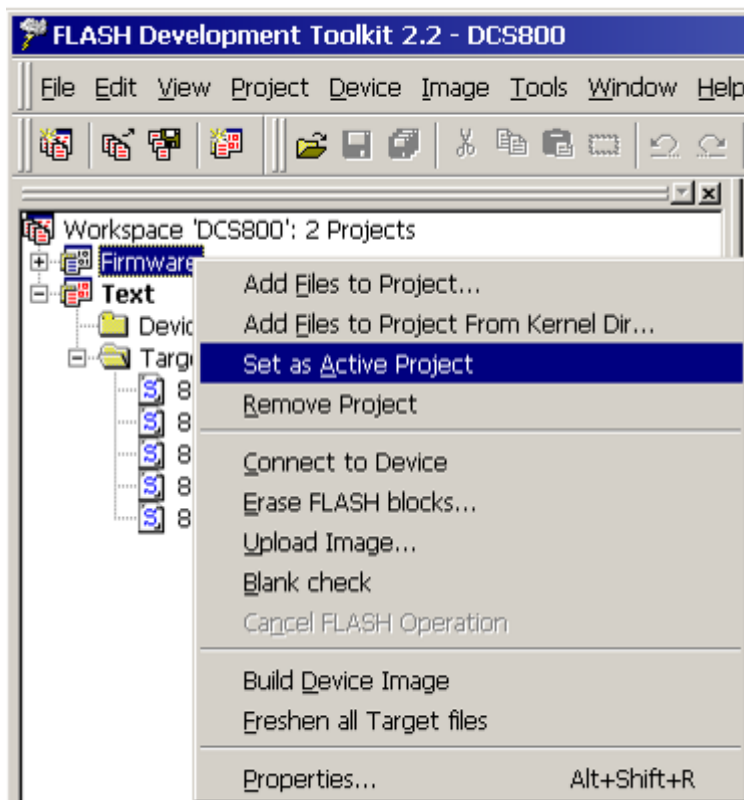

Choose COM Port and communication speed:

- Select *Firmware* with a right mouse click and choose *Properties* from the pop up menu

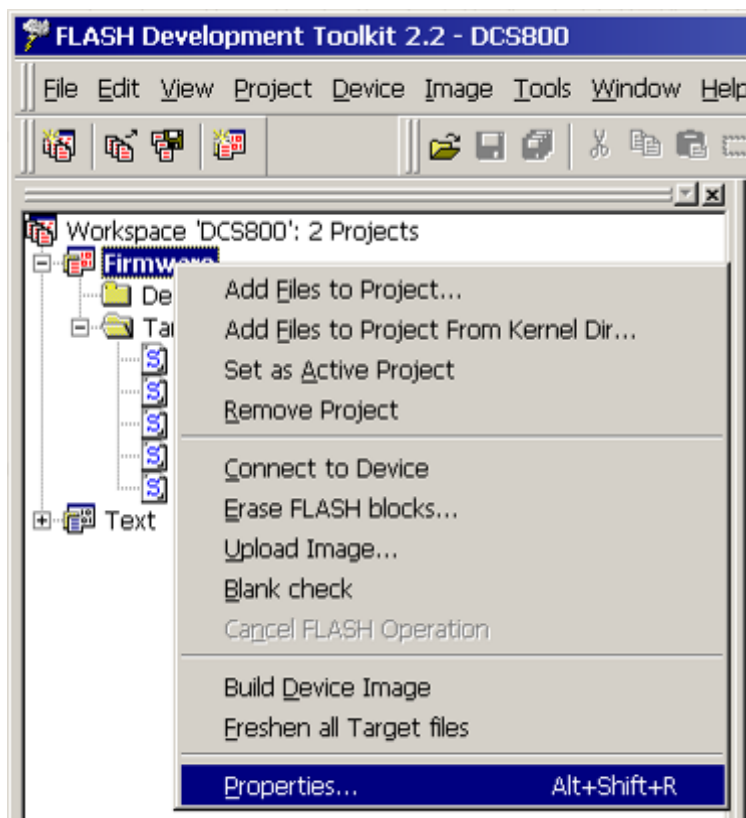

- Select the *Communications* tab, choose the desired *COM Port*, un-tick the box *Use default baud* from the pop up menu and set the *Target Baud Rate* to **38400**.

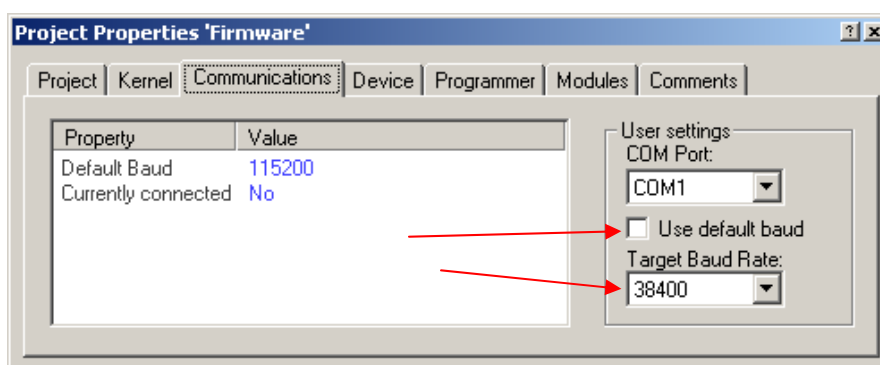

Download firmware file to device:

- Select desired firmware with a right mouse click and choose *Download File to Device* from the pop up menu

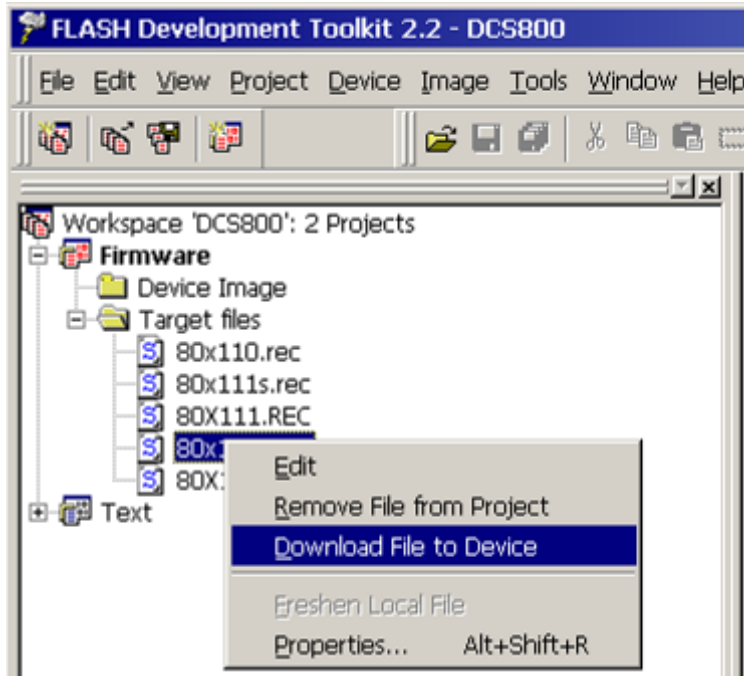

Disconnect tool:

- After the download is complete the FDT2.2 has to be disconnected. Select *Firmware* with a right mouse click and choose *Disconnect* from the pop up menu

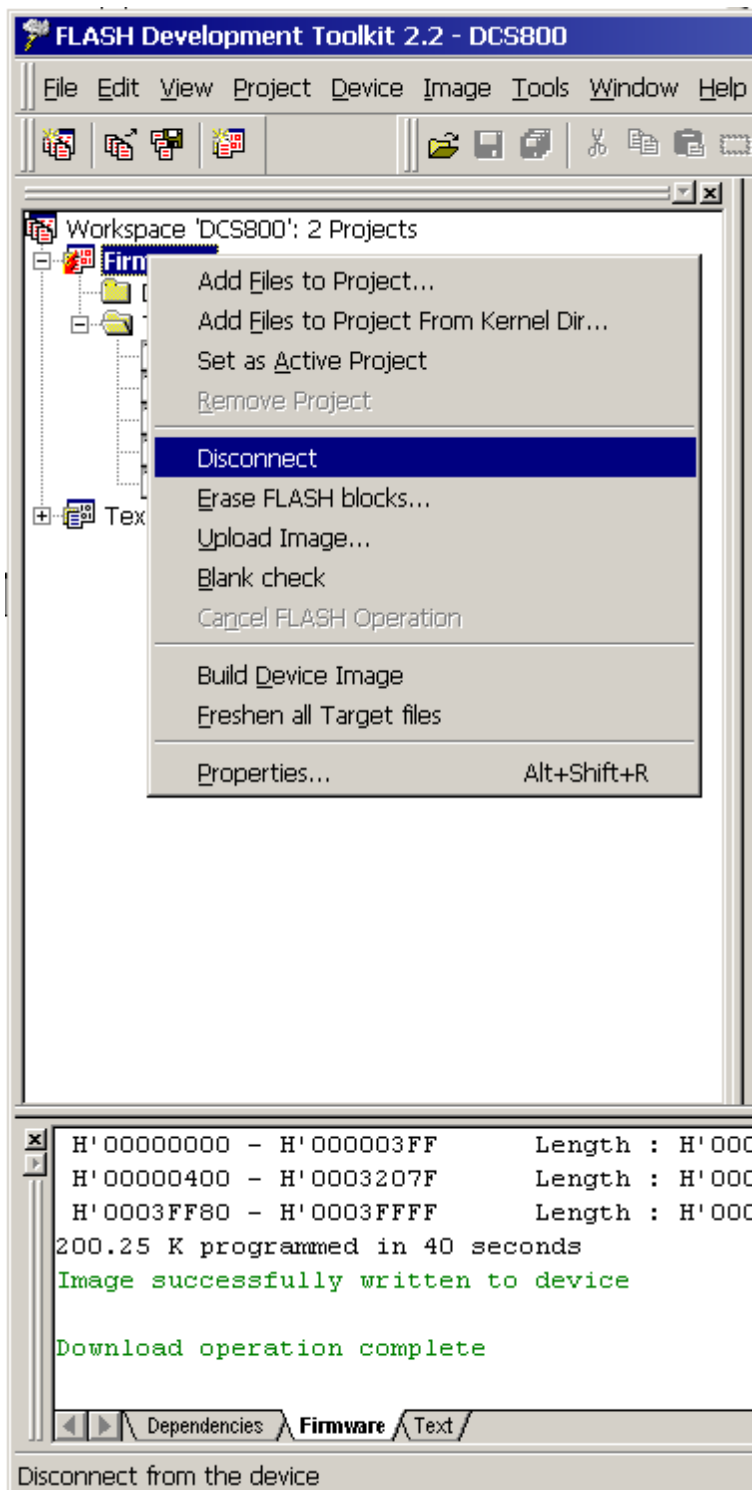

Download text file:

- De-energize the DCS800 electronics
- Set jumper S5 on SCDS-CON-4 from position 1-2 to position 3-4

S5

- Energize the DCS800 electronics. In case the 7-segment display shows a

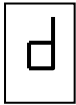

the firmware's corresponding text file has to be downloaded from the workspace. If the 7-segment display shows something else, it is not necessary to download the text file and the download is complete.

Activate text download:

- Select *Text* with a right mouse click and choose *Set as Active Project* from the pop up menu

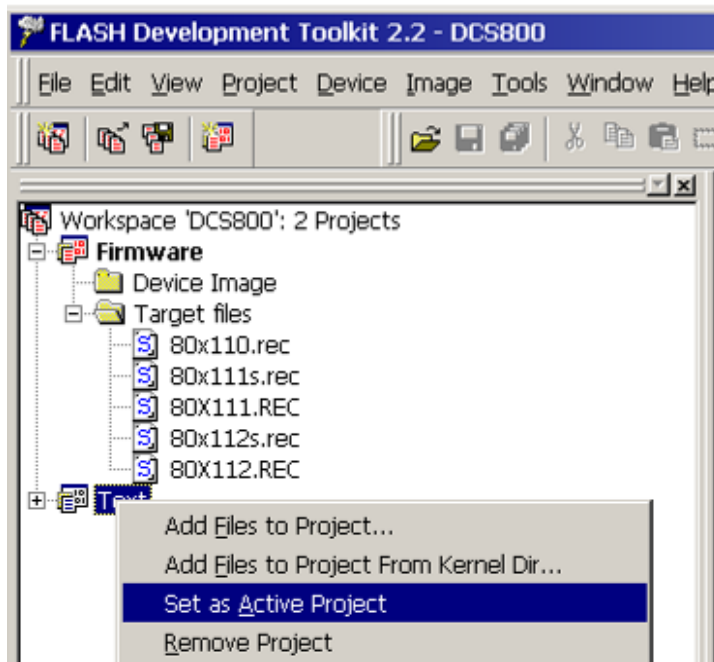

Choose COM Port and communication speed:

- Select *Text* with a right mouse click and choose *Properties* from the pop up menu

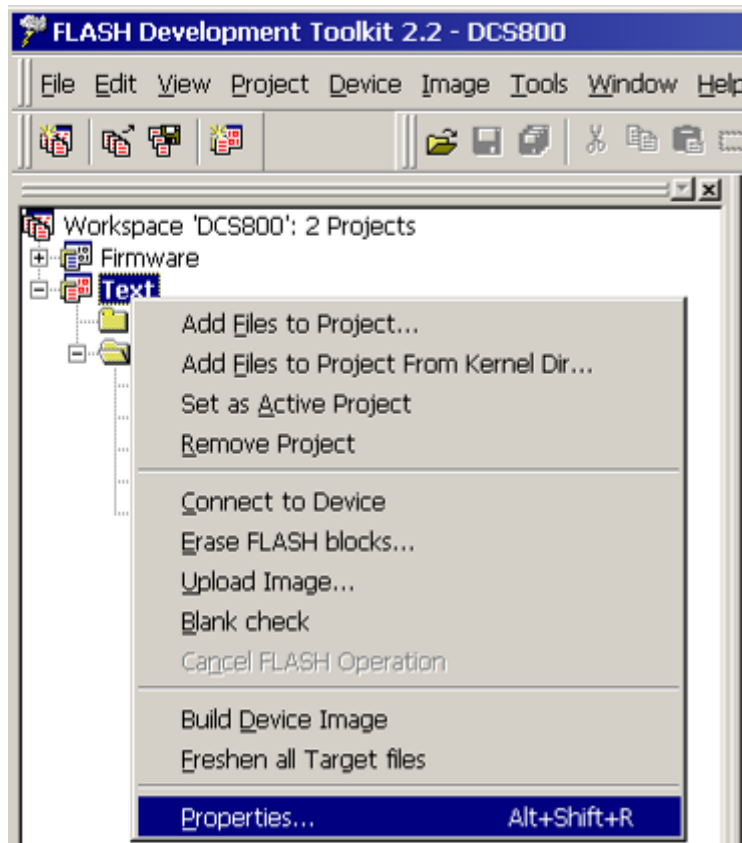

- Select the *Communications* tab, choose the desired *COM Port*, un-tick the box *Use default baud* from the pop up menu and set the *Target Baud Rate*.

Attention:

- For firmware version **80x130/80x130Demo and higher** set the *Target Baud Rate* to **38400**.

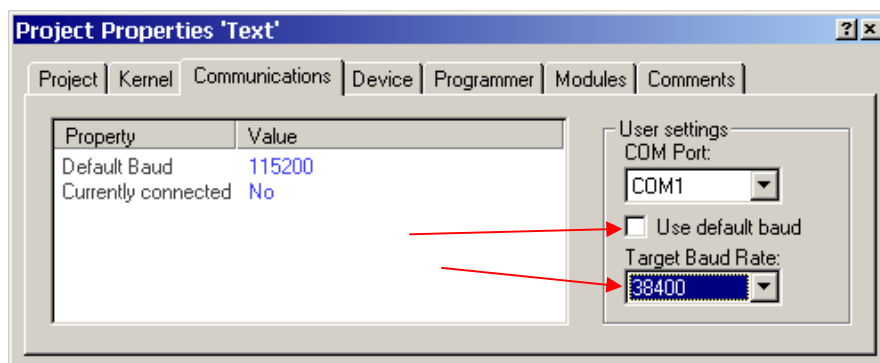

Download text file to device:

- Select desired text file with a right mouse click and choose *Download File to Device* from the pop up menu

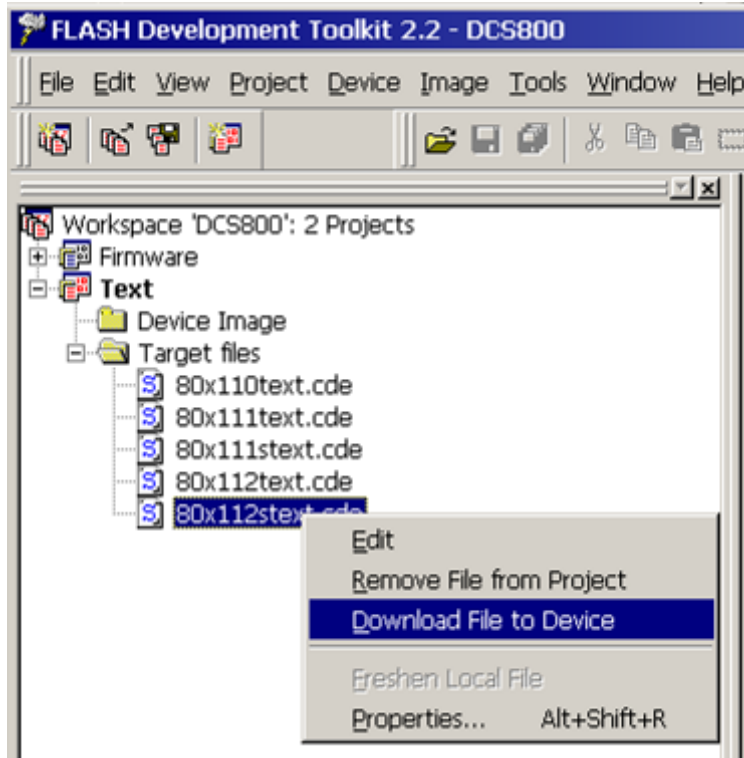

- After the download is complete the 7-segment display shows a:

**Attention:**

Do not de-energize the drive or disconnect the tool while the seven segment display shows the u.

- Wait until the 7-segment display shows:



and



Disconnect tool:

- Now FDT2.2 has to be disconnected. Select *Text* with a right mouse click and choose *Disconnect* from the pop up menu

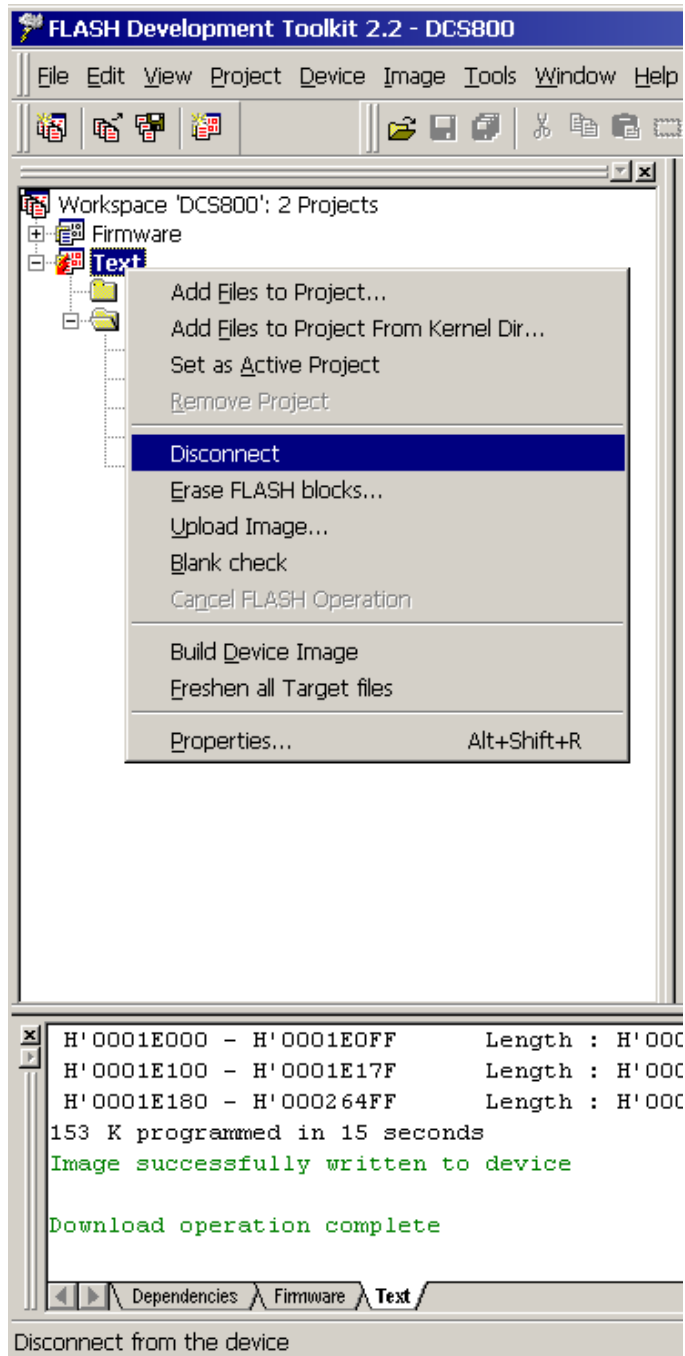

Close download tool

- When closing the FDT2.2 save the workspace only if firmware files or text files have been added.

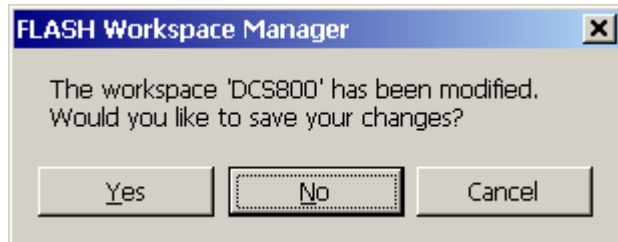

The firmware download is complete now.

Add firmware or text files

Start download tool:

- Start the Hitachi Flash Development Toolkit 2.2 by means of *Start/Programs/Hitachi/Flash Development Toolkit 2.2/Flash Development Toolkit 2.2*

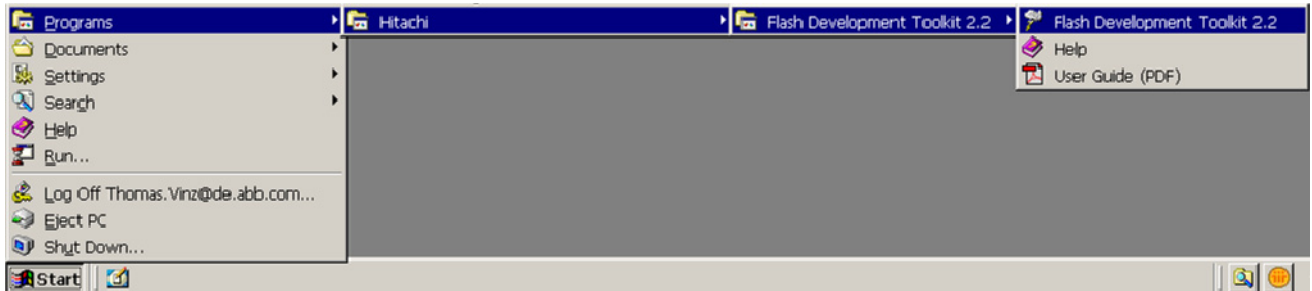

Choose workspace:

- Mark *Open an existing Workspace*,
- Confirm with *OK*

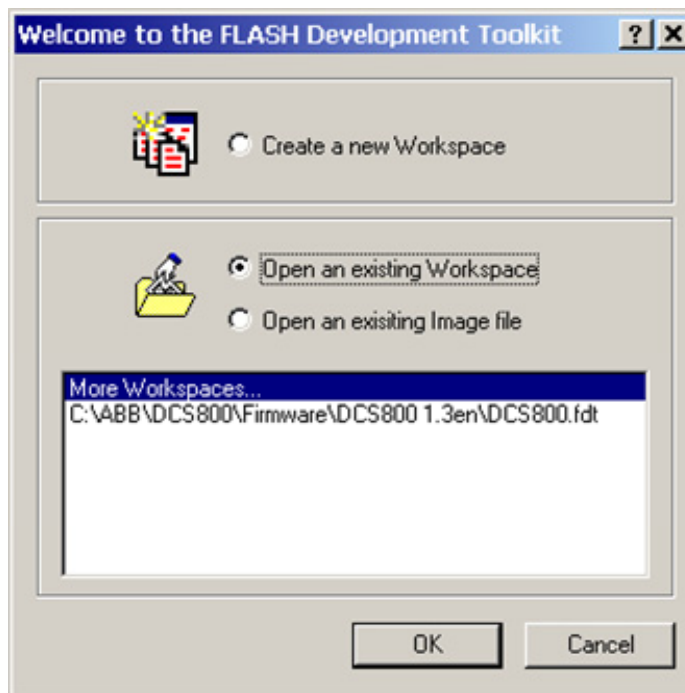

- Select the workspace in directory:
 C:\ABB\DCS800\Firmware\CON-4\Ver x.x
- Confirm with Open

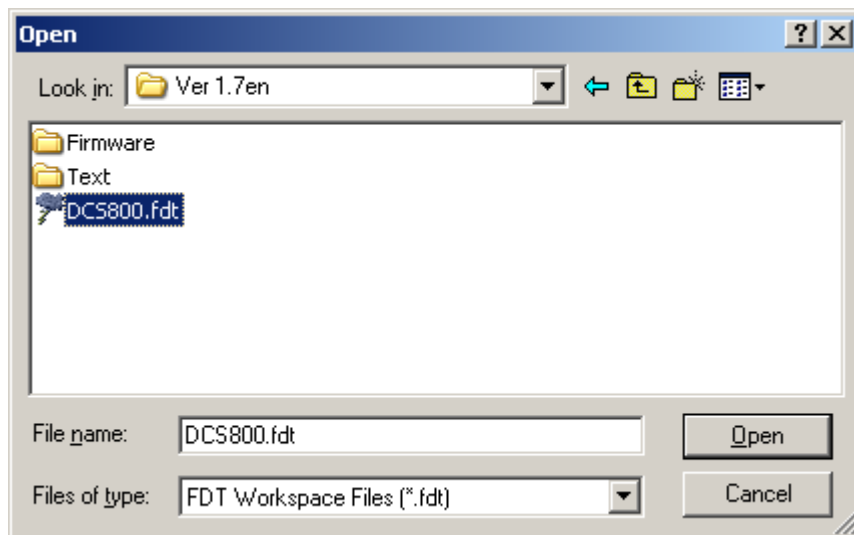

Add firmware files

If the firmware file to be downloaded is not shown under *Target files* the firmware file has to be added

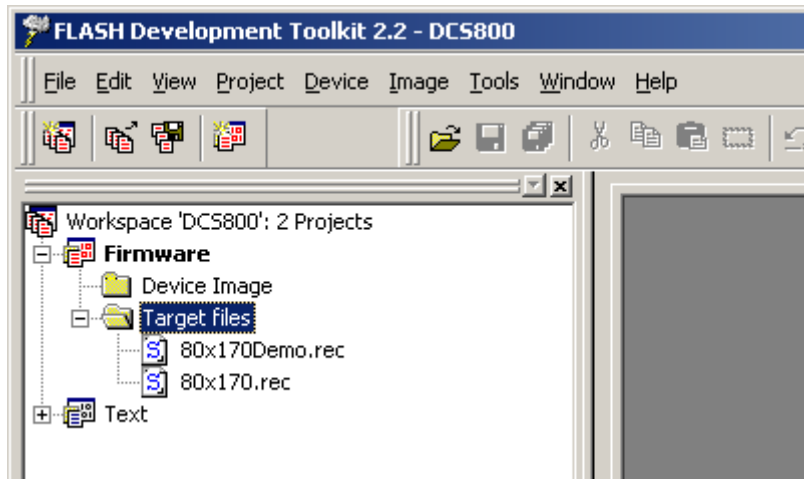

- Select *Firmware* with a right mouse click and choose *Add Files to Project...* from the pop up menu

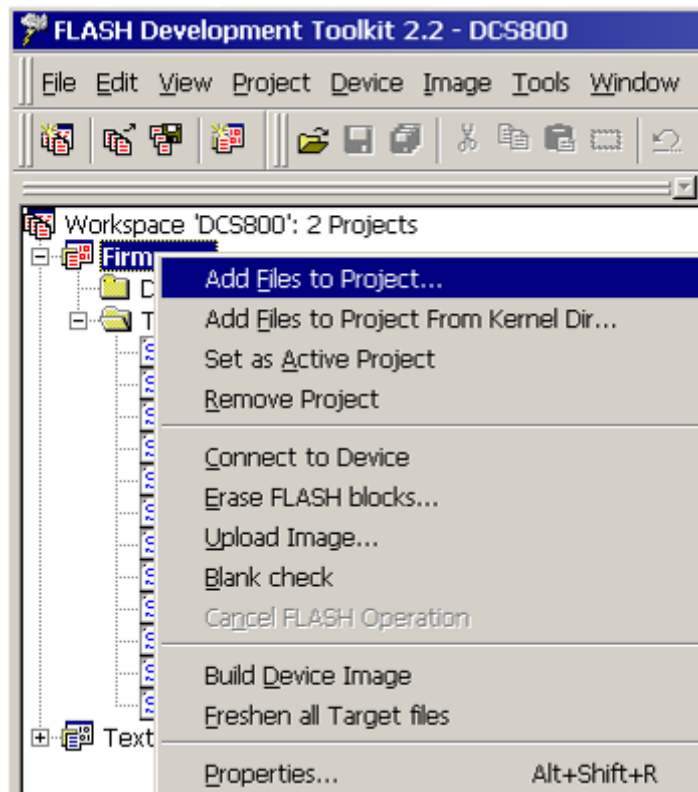

- Go to the directory containing the desired firmware file e.g.

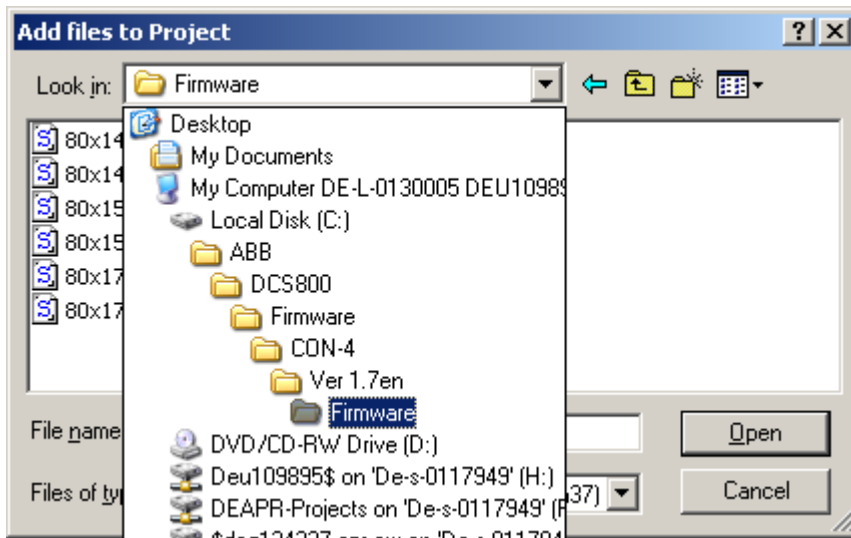

- Choose the desired firmware file and press *Open*:

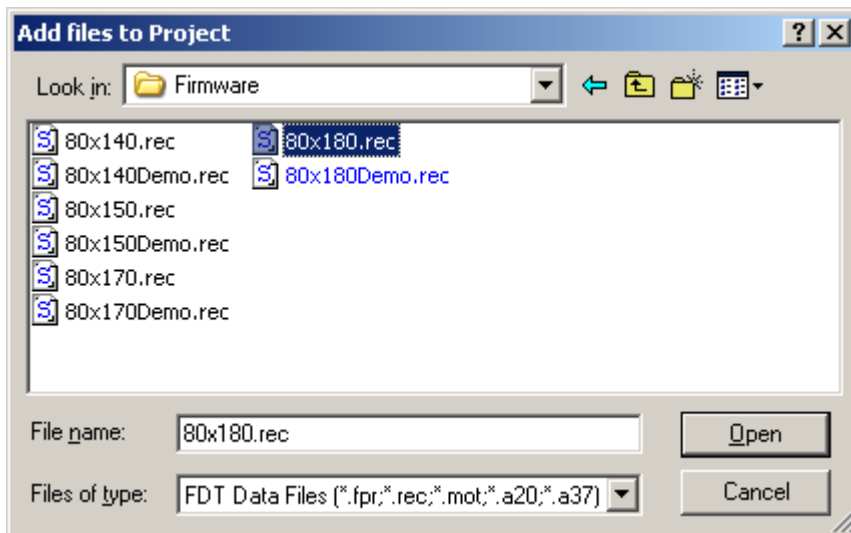

Add text files

If the text file to be downloaded is not shown under *Target files* the text file has to be added

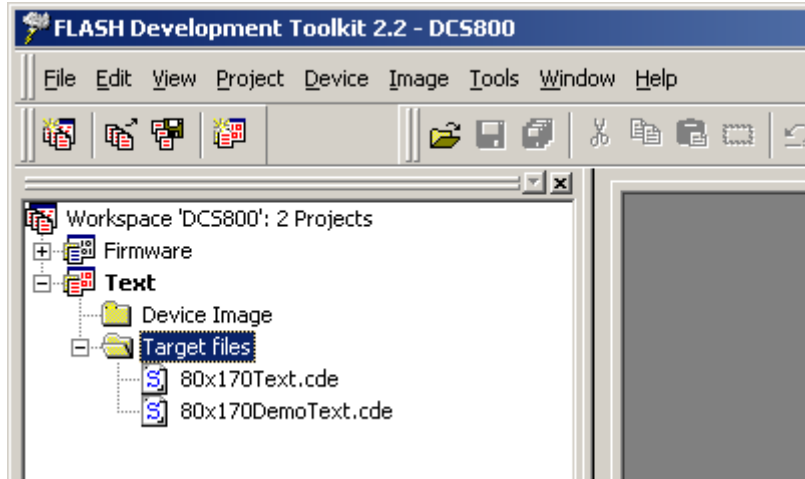

- Select *Text* with a right mouse click and choose *Add Files to Project...* from the pop up menu

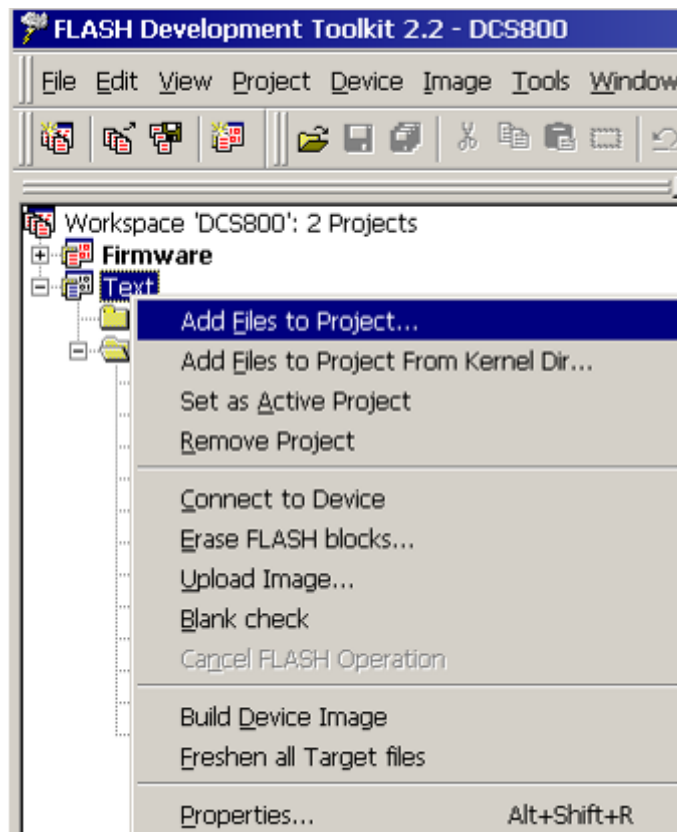

- Go to the directory containing the desired text file e.g.

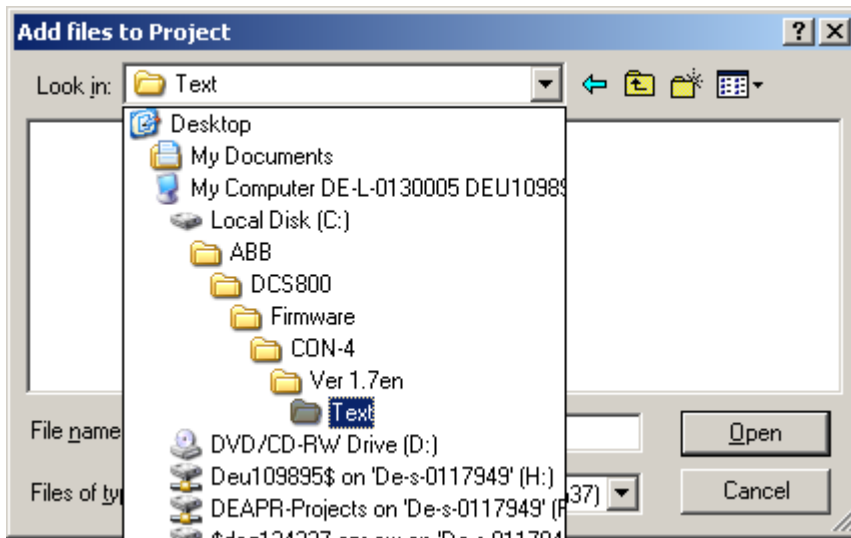

- To display the desired text file write *.* in *File name* and press *Open*:

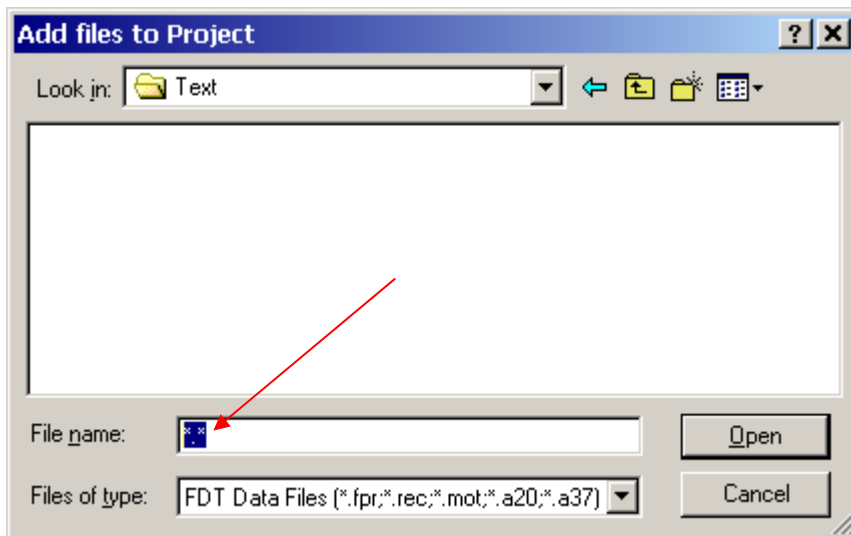

- Choose the desired text file and press Open:

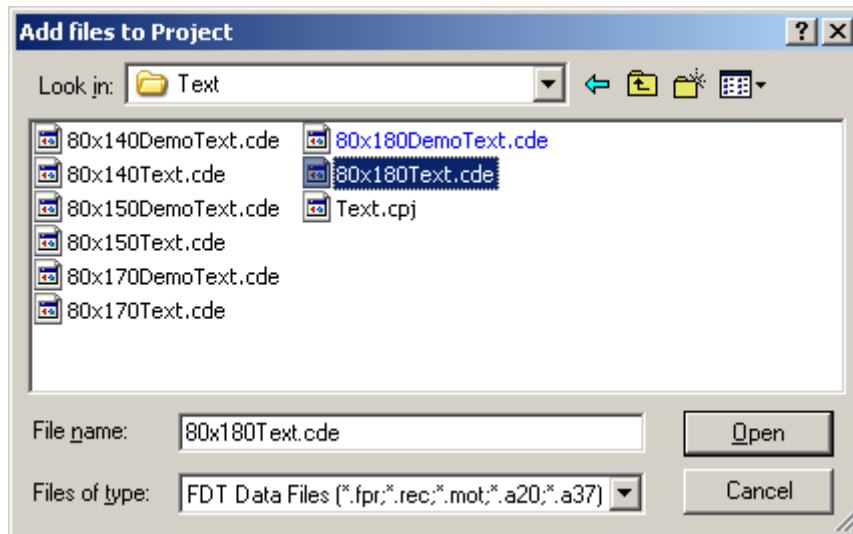

Close download tool:

- When closing the FDT2.2 confirm with Yes

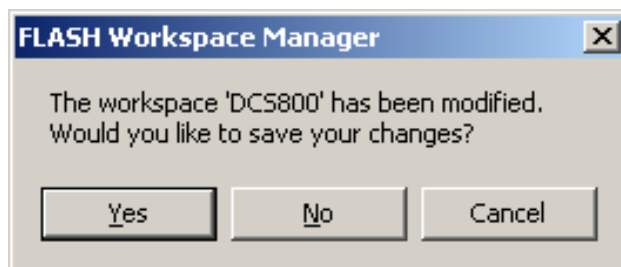

Adding of files is complete now.

Create a workspace

General

In case the Hitachi Flash Development Toolkit 2.2 is not installed at its default location (e.g. using Windows in an different language than English):

C:\Program Files\Hitachi\FDT2.2

it is not possible to use the standard ABB workspace called *DCS800.fdt*. Thus the user has to create a new workspace.

Start download tool:

- Start the Hitachi Flash Development Toolkit 2.2 by means of *Start/Programs/Hitachi/Flash Development Toolkit 2.2/Flash Development Toolkit 2.2*

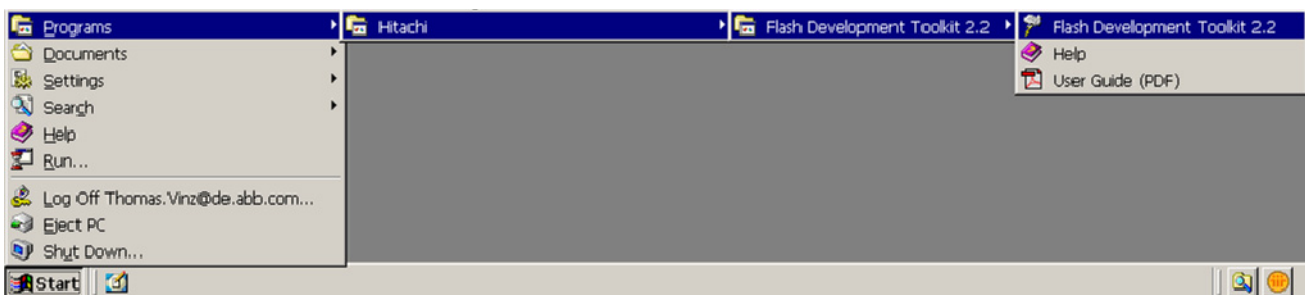

Create new workspace:

- Choose *File → New Workspace...*

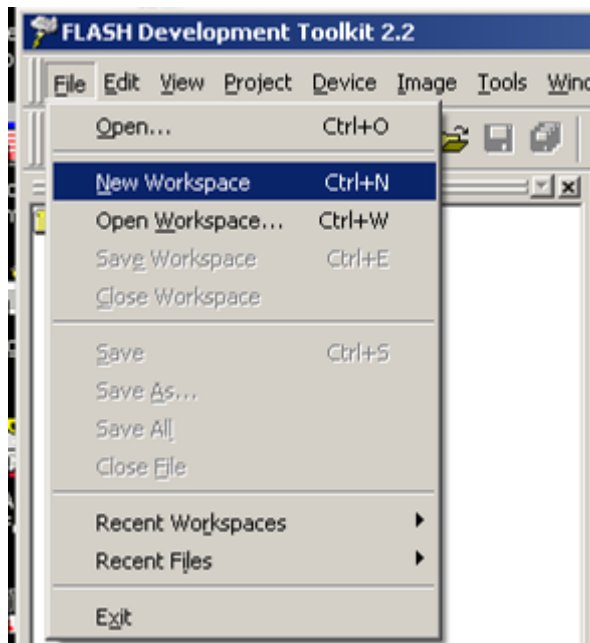

Name new workspace:

- Name the new workspace,
- choose its location and
- confirm with *OK*

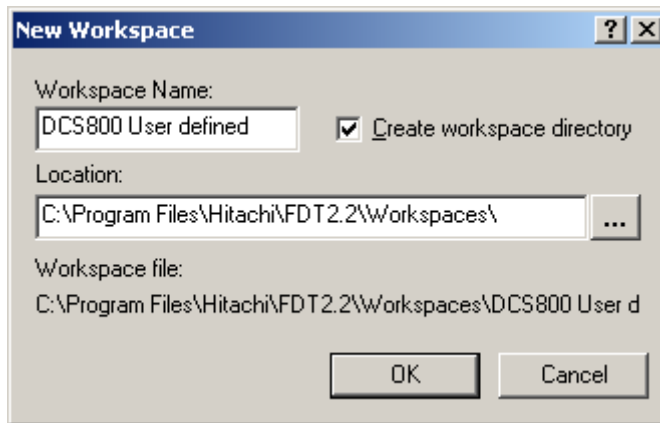

- Choose Yes

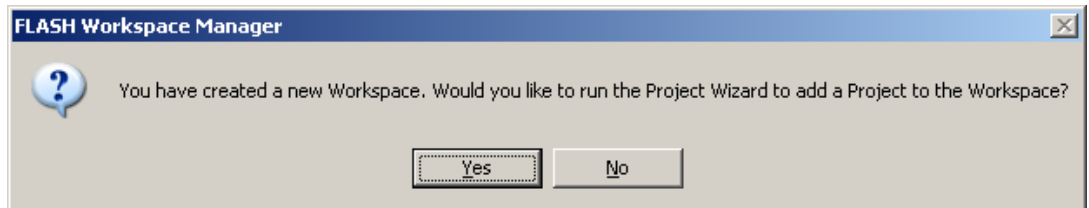

Create the project for the firmware file:

- Name the new project and
- confirm with *Next*

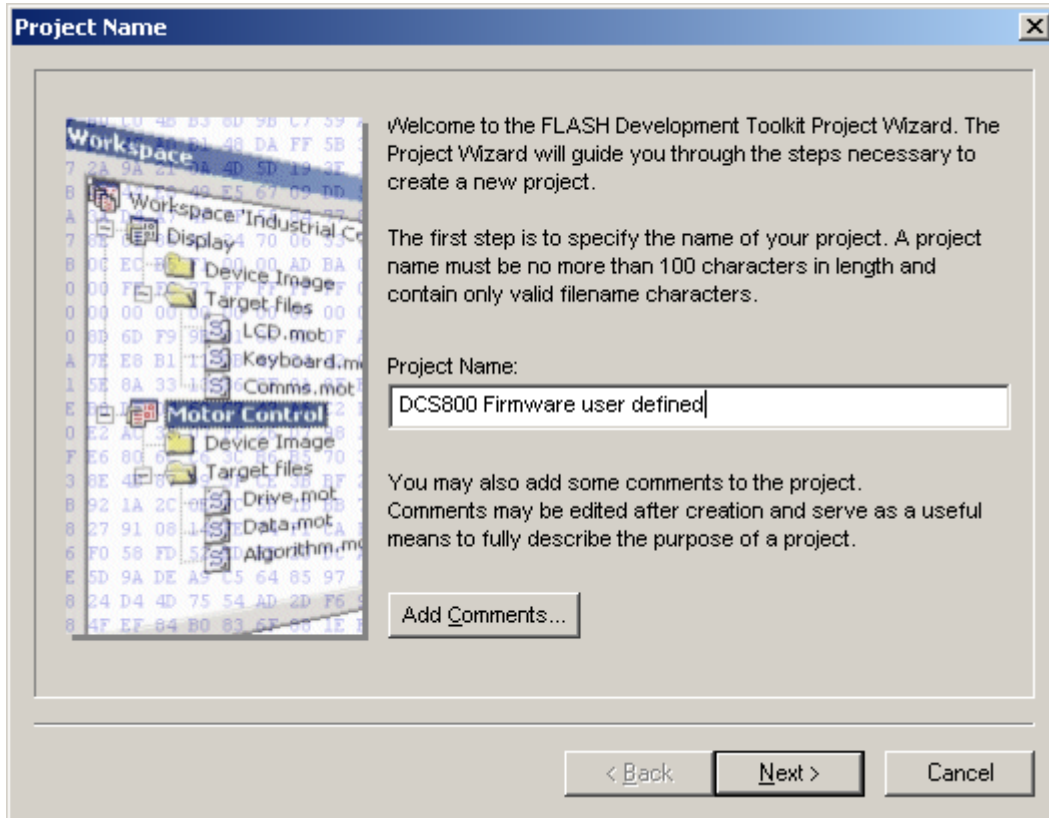

Choose Device And Kernel:

- *Select Device: H8S/2633F and*
- *confirm with Next*

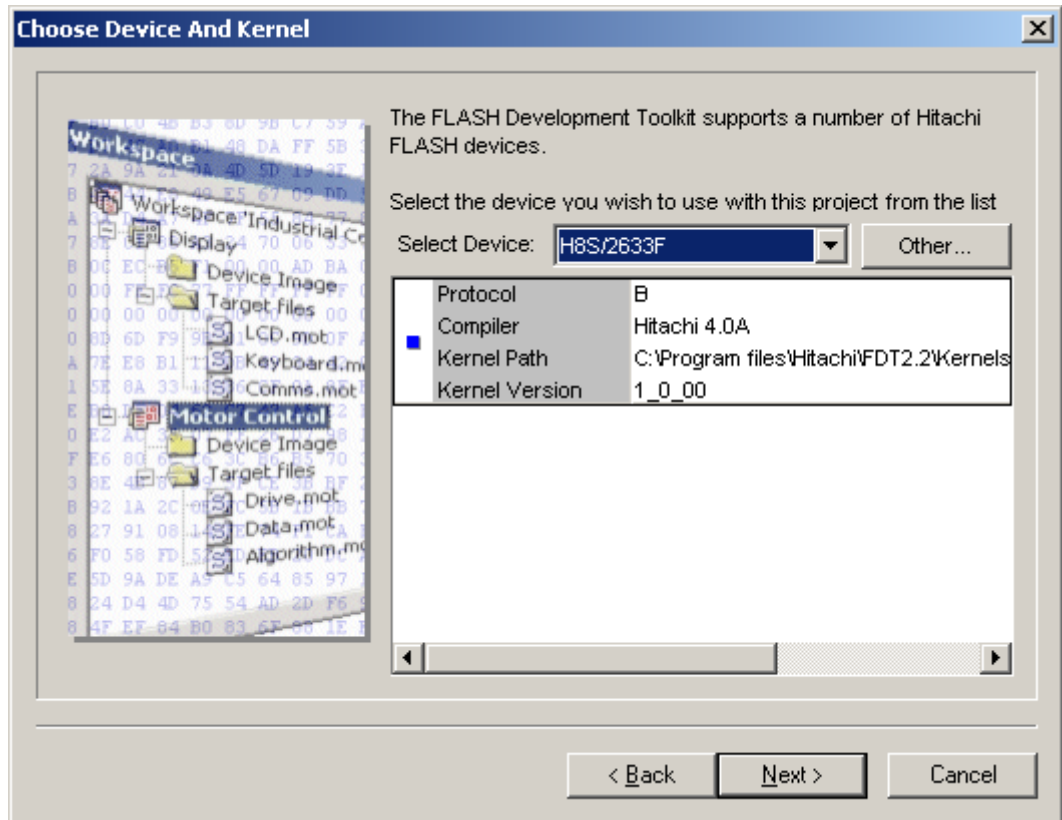

Communication Port:

- Select the proper COM port,
- *Select Baud Rate: 38400,*
- un-tick *Use Default Baud Rate* and
- confirm with *Next*

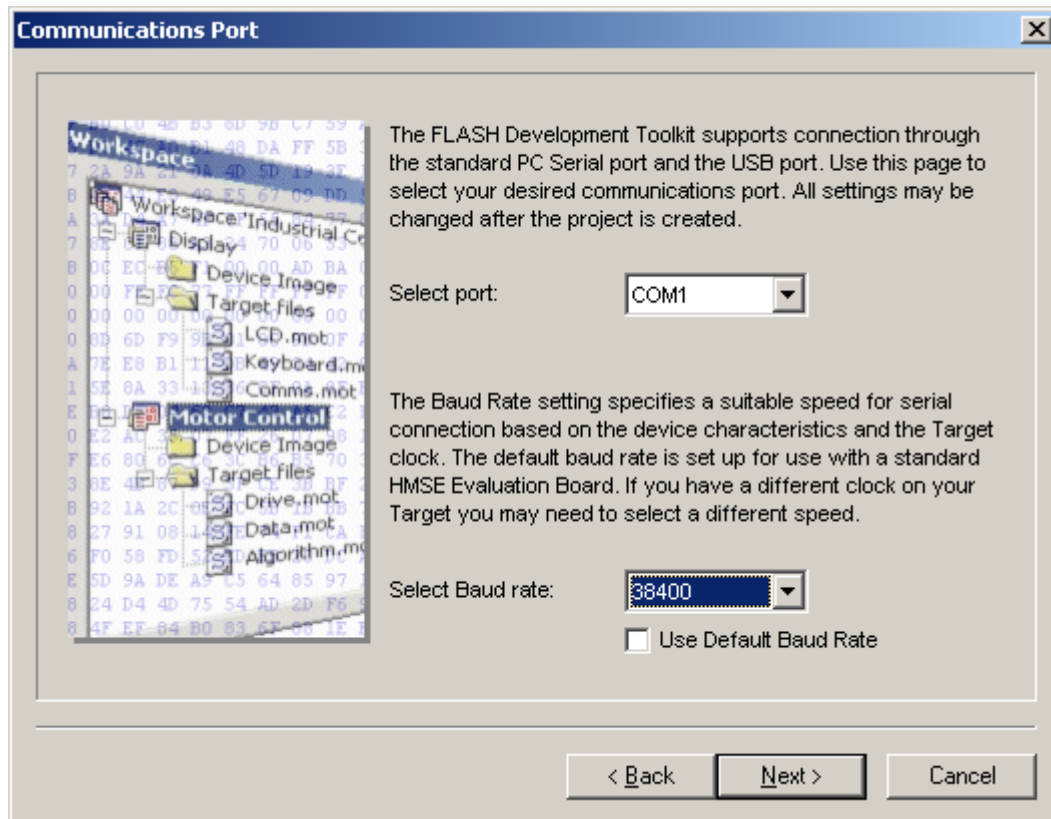

Device Settings:

- Enter the CPU crystal frequency for the selected device: 6.25 MHz,
- Select the multiplier for the main clock frequency (CKM): 4 and
- confirm with *Next*

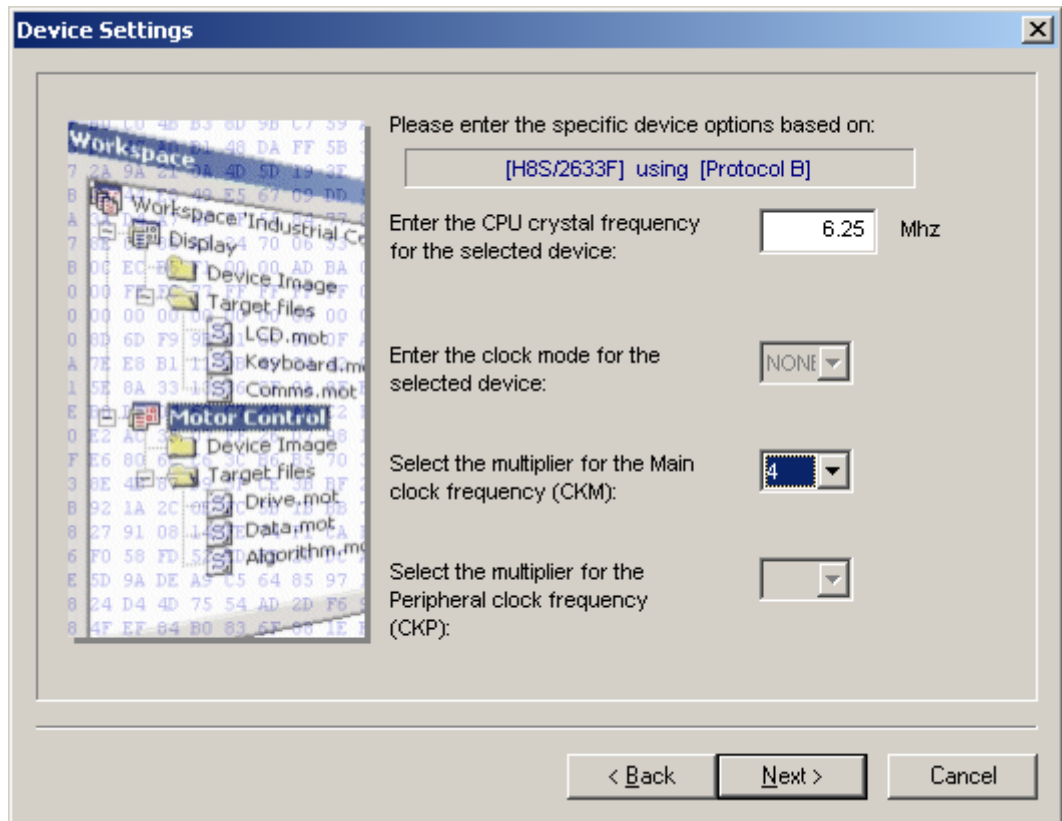

Connection Type:

- Select connection: *BOOT Mode*,
- Select Interface: *Direct Connection*,
- un-tick *Kernel already resident* and
- confirm with *Next*

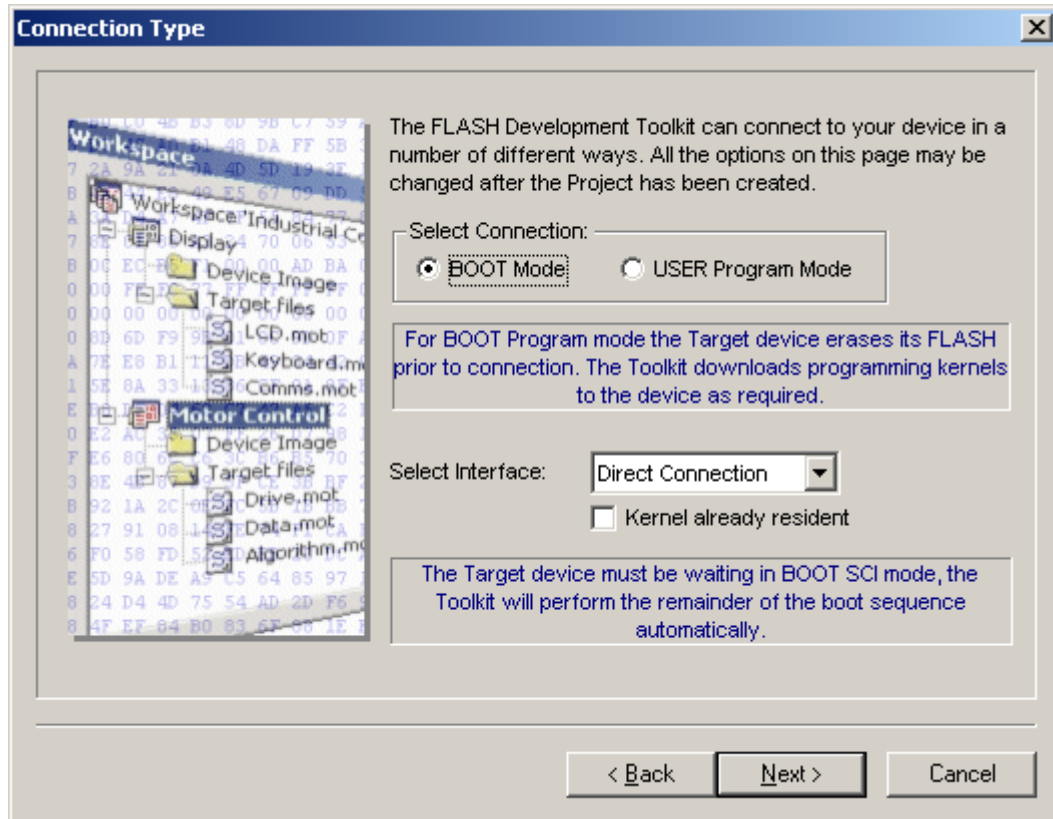

Programming Options:

- *Protection: Automatic* and
- *Messaging: Advanced*,
- confirm with *Finish*

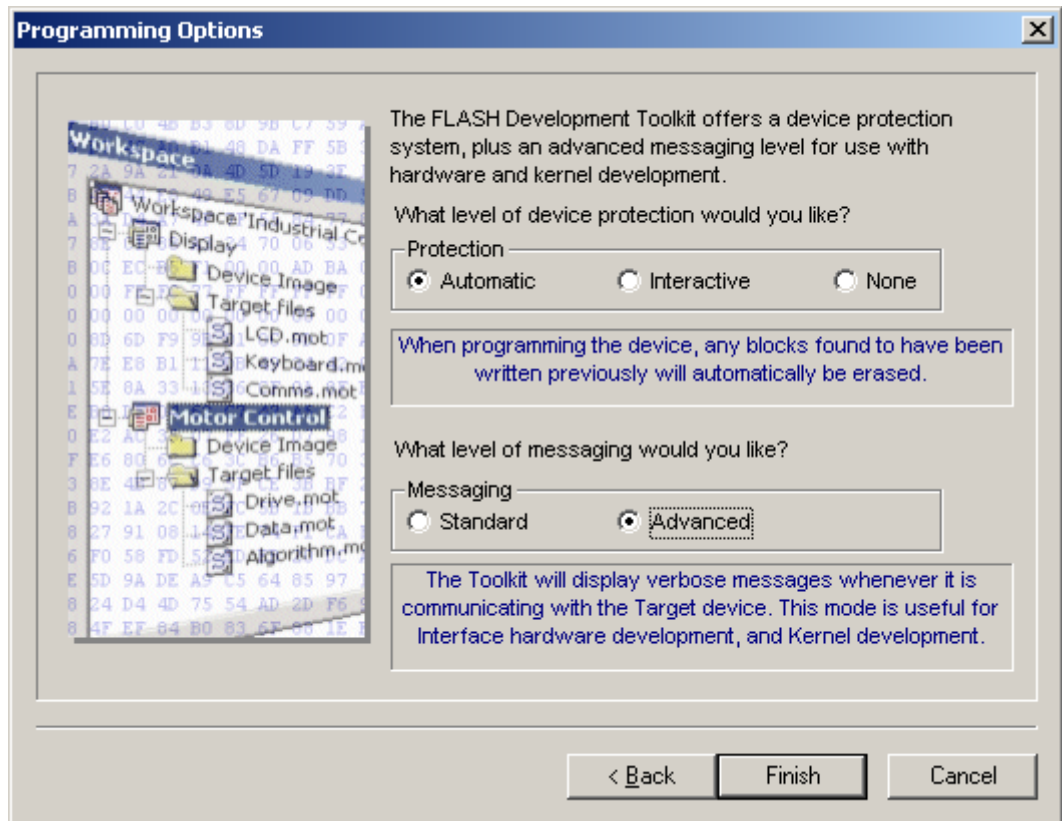

Now the project for the firmware file is finished:

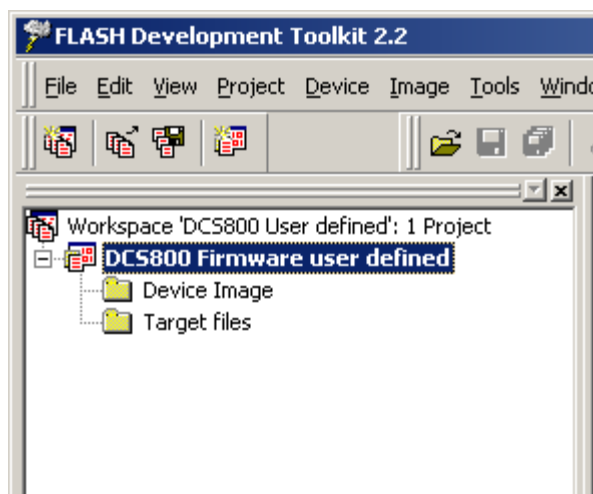

Create the project for the text file:

- Select *Workspace* with a right mouse click and choose *New Project...*

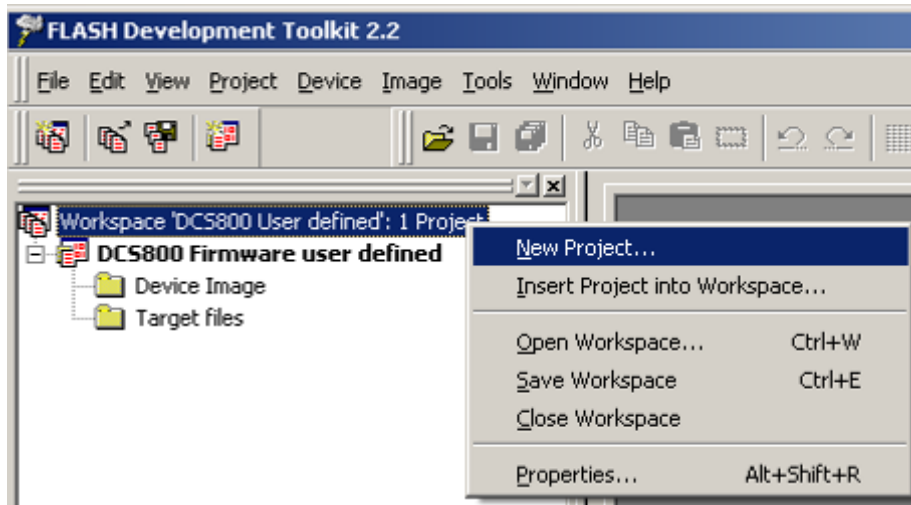

- Name the new project and
- confirm with *Next*

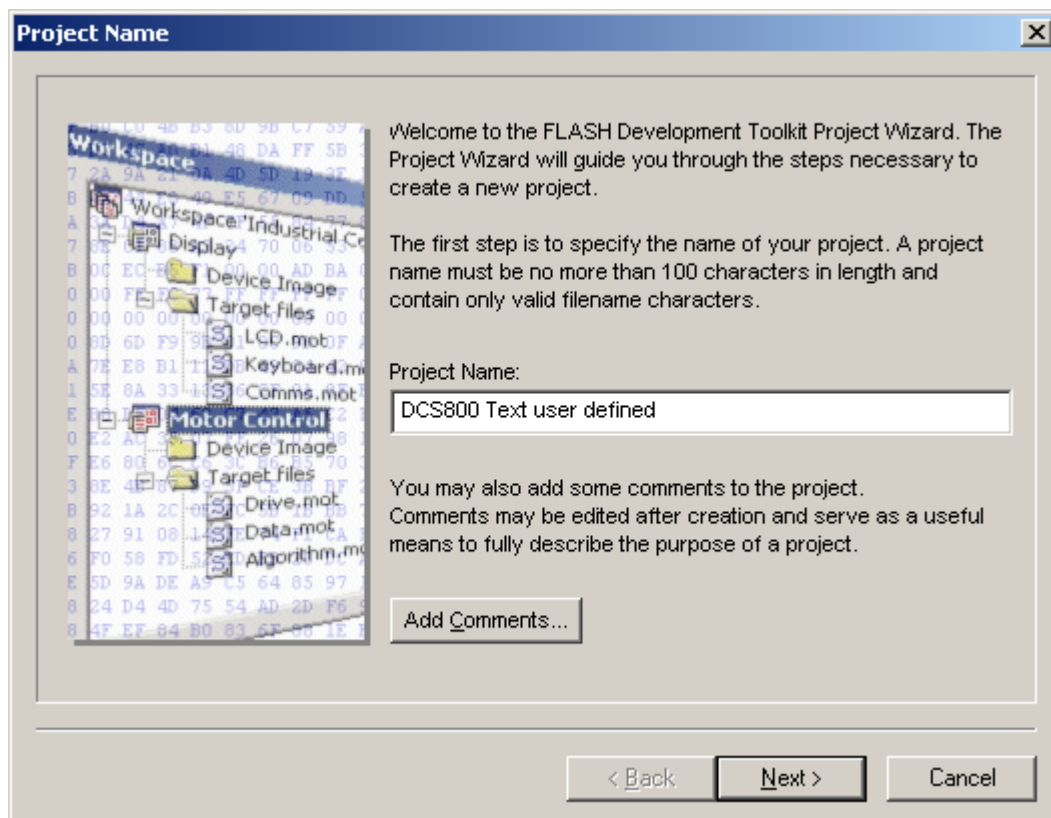

Choose Device And Kernel:

- *Select Device: H8S/2633F and*
- *confirm with Next*

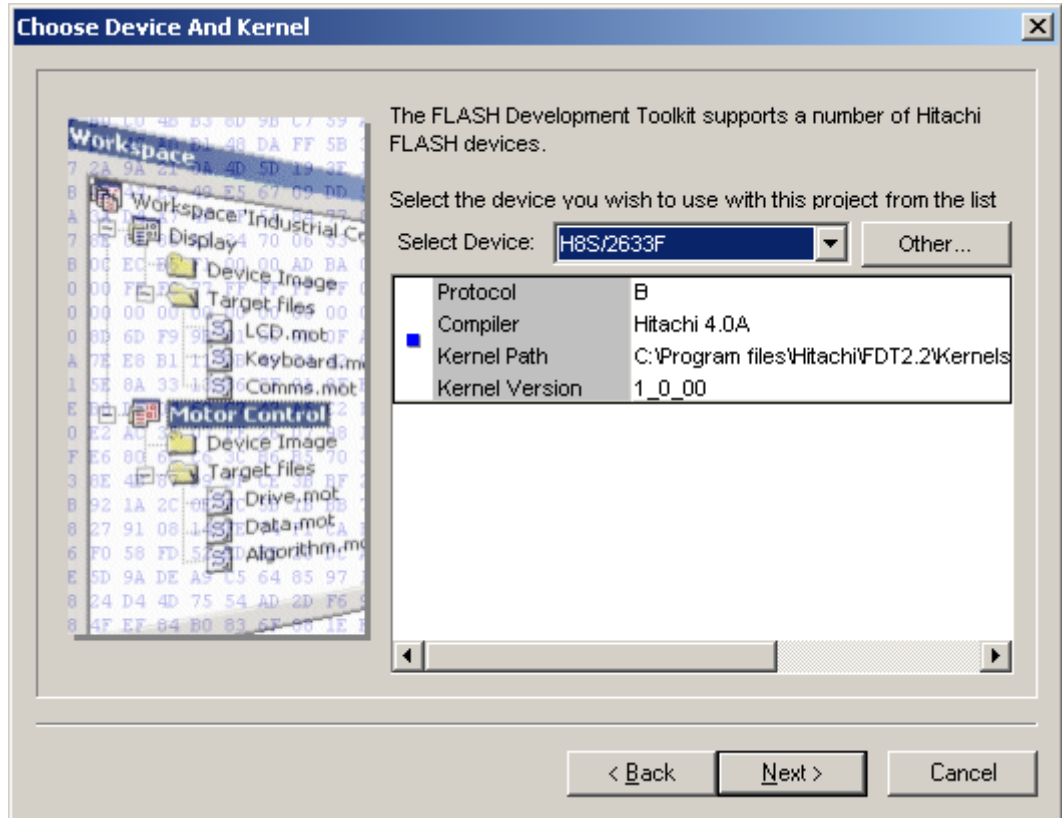

Communication Port:

- Select the proper COM port,
- *Select Baud Rate: 38400,*
- un-tick *Use Default Baud Rate* and
- confirm with *Next*

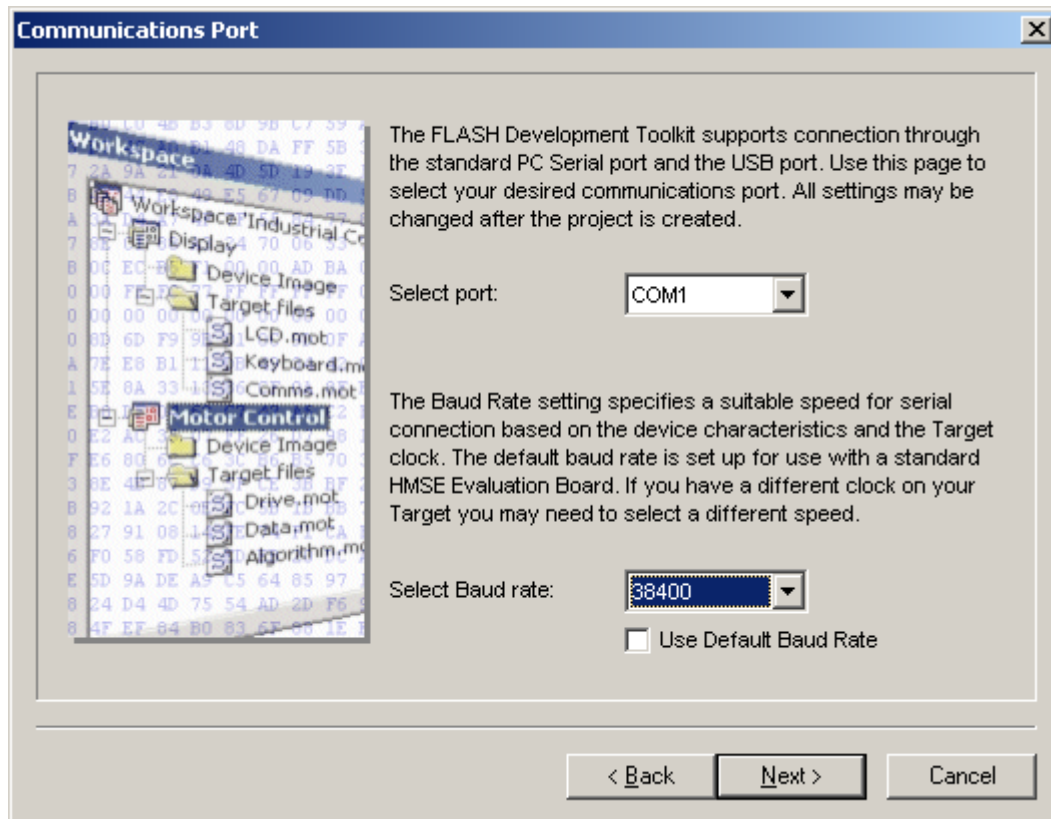

Device Settings:

- Enter the CPU crystal frequency for the selected device: 6.25 MHz,
- Select the multiplier for the main clock frequency (CKM): 4 and
- confirm with *Next*

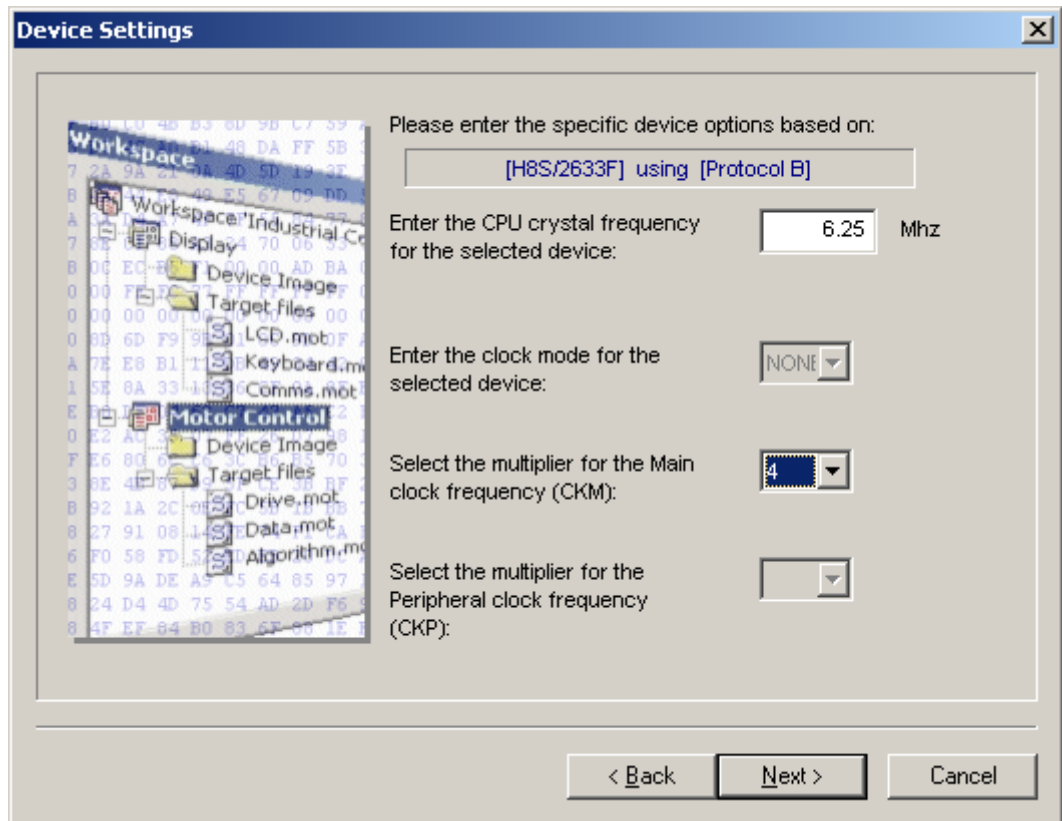

Connection Type:

- *Select connection: BOOT Mode,*
- *Select Interface: Direct Connection,*
- *tick Kernel already resident and*
- *confirm with Next*

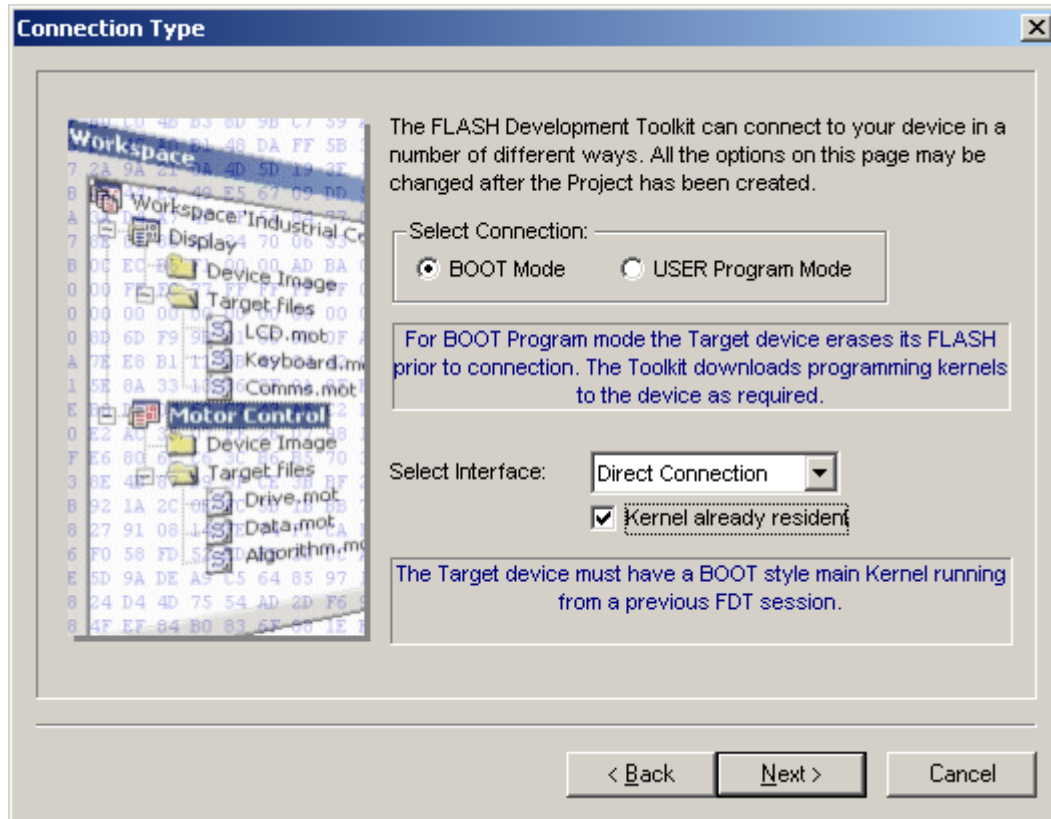

Programming Options:

- *Protection: Automatic* and
- *Messaging: Advanced*,
- confirm with *Finish*

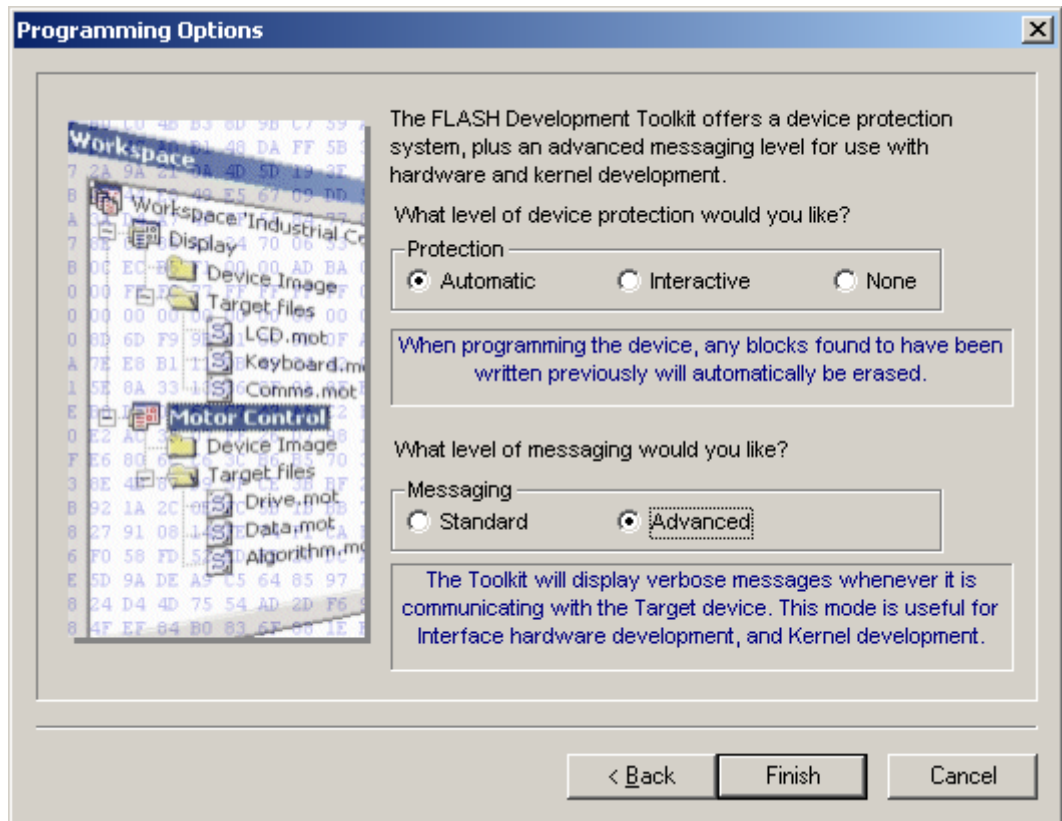

Now the project for the text file is finished:

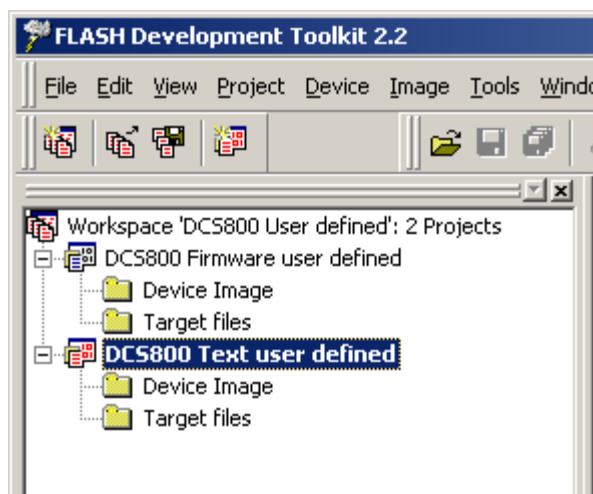

Close download tool:

- When closing the FDT2.2 confirm with Yes

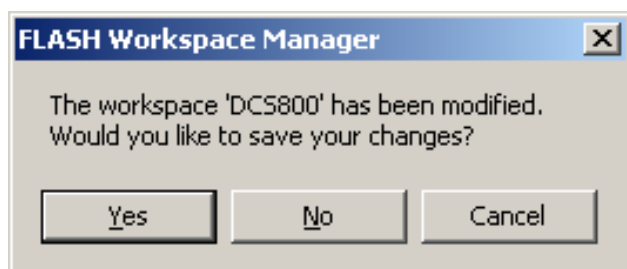

Creating of projects is complete now.

Download SDCS-COM-8 firmware

Requirements:

- In case the PCMCIA adapter NDPA-02 with NDPC-12 is used the NtNisa drivers have to be installed (see NtNisa5x.zip or NtNisa5x.exe) before downloading the firmware.
- In case the USB adapter RUSB-02 is used together with DriveWindow 2.22 (and higher) and firmware package COM-8 88x160.zip (and higher) no additional actions have to be taken.

Firmware download:

- Close **all** applications especially DriveWindow and DriveWindow Light!
- Unzip the SDCS-COM-8 firmware (file COM-8 88xxxx.zip) by right click on the zip file:

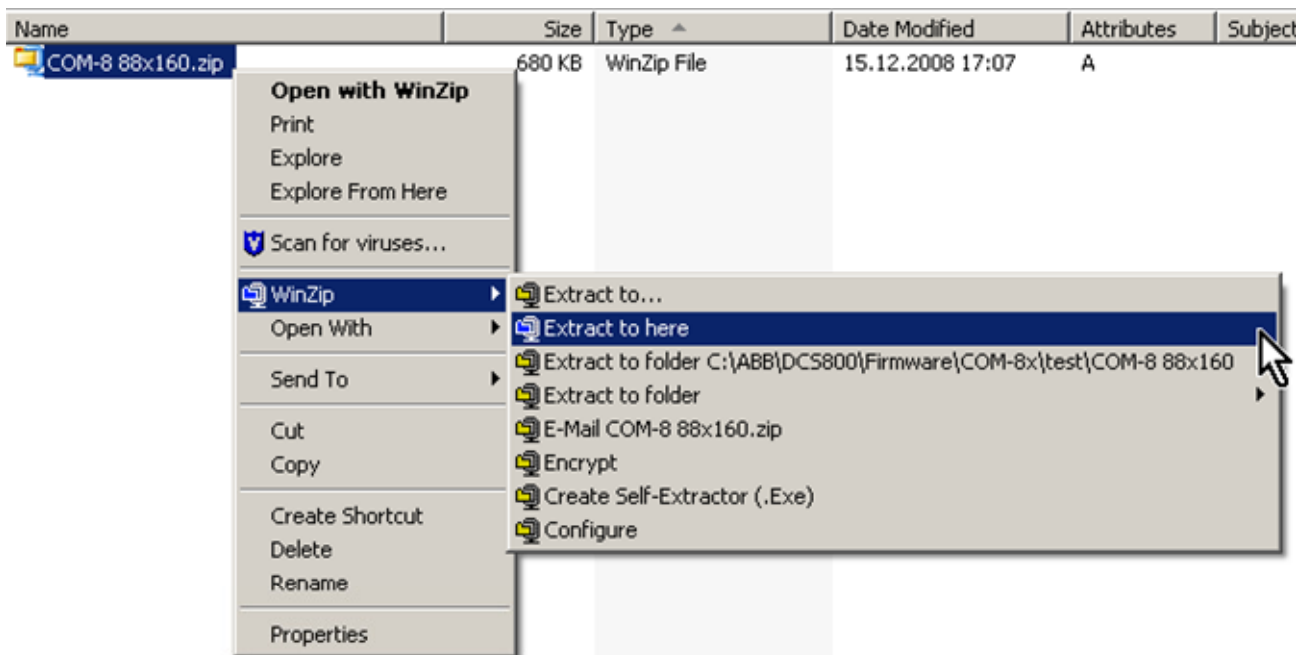

- Following files and folders will be created:

Name	Size	Type	Date Modified
COM-8 88x160.zip	680 KB	WinZip File	15.12.2008 17:07
Files		File Folder	16.12.2008 09:13
Prog		File Folder	16.12.2008 09:13
L_AMC_DC.BAT	5 KB	MS-DOS Batch File	06.10.2008 17:14
Read.me	4 KB	ME File	17.10.2008 16:30

- Connect the DCS800 directly with the PC, fiber optic cable from SDCS-COM-8 channel 3 to:
 1. PCMCIA adapter NDPA-02 with NDPC-12 or
 2. USB adapter RUSB-02
- Switch on the DCS800
- Set *Ch3 HW Config (70.21)* = **Ring**
- Set *Ch3 NodeAddr (70.22)* = 1
- Start firmware download by a double click on file *L_AMC_DC.BAT*:

Name	Size	Type	Date Modified
COM-8 88x160.zip	680 KB	WinZip File	15.12.2008 17:07
Files		File Folder	16.12.2008 09:13
Prog		File Folder	16.12.2008 09:13
L_AMC_DC.BAT	5 KB	MS-DOS Batch File	06.10.2008 17:14
Read.me	4 KB	ME File	17.10.2008 16:30

- A DOS window will appear. Wait until the download is finished (the DOS window will close automatically)

Attention:

Do **not** touch the PC during the download of the firmware!

- Check *Com8SWVersion (4.11)* for proper firmware version
- Set *Ch3 HW Config (70.21)* back to its original setting
- Set *Ch3 NodeAddr (70.22)* back to its original setting
- Re-connect the drive to the DriveWindow network

Set type code

The type code - *TypeCode* (97.01) - is preset in the factory and is write protected. It identifies the drives current-, voltage-, temperature measurement and its quadrant type. The type code can be changed as whole or individually.

To change the type code as whole follow the instructions below:

- un-protect the type code by means of *ServiceMode* (99.06) = **SetTypeCode**
- set *TypeCode* (97.01) = **S01-0020-04** to **S02-5200-05** (details, see table below)

The drive's basic type code: DCS800-AAX-YYYY-ZZB			
Product family:	DCS800		
Type:	AA	= S0	Modules
		= R0	Rebuild system
		= E0	Panel solution
		= A0	Enclosed converter
Bridge type:	X	= 1	single bridge (2-Q)
		= 2	2 anti parallel bridges (4-Q)
Module type:	YYYY	=	converter type current
Rated AC Voltage:	ZZ	= 04	230 VAC - 400 VAC
		= 05	230 VAC - 525 VAC
		= 06	270 VAC - 600 VAC
		= 07	315 VAC - 700 VAC
		= 08	360 VAC - 800 VAC
		= 10	450 VAC - 990 VAC
Power connection:	B	= -	Standard D1 - D6
		= L	Left side D7
		= R	Right side D7
		= a	Second thyristor type D5, D6

Attention:

When using D1, D2, D3 or D4 modules the current and voltage range of the type code setting is limited to max 1000 ADC and max 600 VAC.

- the change of the type code is immediately taken over and *ServiceMode* (99.06) is automatically set back to **NormalMode**
- the new values can be seen in group 4
ConvNomCur (4.05),
ConvNomVolt (4.04),
MaxBridgeTemp (4.17) and
QuadrantType (4.15)

To change the type code individually follow the instructions below:

- un-protect the type code by means of *ServiceMode* (99.06) = **SetTypeCode**
- set the type code individually by means of
 - S ConvScaleCur* (97.02),
 - S ConvScaleVolt* (97.03),
 - S MaxBrdgTemp* (97.04) and
 - S BlockBridge2* (97.07)
- the change of the type code is immediately taken over and *ServiceMode* (99.06) has to be set back to **NormalMode** by the user
- the new values can be seen in group 4
 - ConvNomCur* (4.05),
 - ConvNomVolt* (4.04),
 - MaxBridgeTemp* (4.17) and
 - QuadrantType* (4.15)

Type code table

0	None	50	S01-2050-10	100	S02-0820-04
1	S01-0020-04	51	S01-2600-10	101	S02-0820-05
2	S01-0020-05	52	S01-2600-12	102	S02-1000-04
3	S01-0045-04	53	S01-3000-04	103	S02-1000-05
4	S01-0045-05	54	S01-3000-05	104	S02-0900-06
5	S01-0065-04	55	S01-3000-06	105	S02-0900-07
6	S01-0065-05	56	S01-3000-07	106	S02-1200-04
7	S01-0090-04	57	S01-3000-08	107	S02-1200-05
8	S01-0090-05	58	S01-3300-04	108	S02-1500-04
9	S01-0125-04	59	S01-3300-05	109	S02-1500-05
10	S01-0125-05	60	S01-3300-06	110	S02-1500-06
11	S01-0180-04	61	S01-3300-07	111	S02-1500-07
12	S01-0180-05	62	S01-3300-08	112	S02-1900-08
13	S01-0230-04	63	S01-3300-12	113	S02-2000-04
14	S01-0230-05	64	S01-4000-04	114	S02-2000-05
15	S01-0315-04	65	S01-4000-05	115	S02-2050-05
16	S01-0315-05	66	S01-4000-06	116	S02-2050-06
17	S01-0290-06	67	S01-4000-07	117	S02-2050-07
18	S01-0405-04	68	S01-4000-08	118	S02-2500-04
19	S01-0405-05	69	S01-3300-10	119	S02-2500-05
20	S01-0470-04	70	S01-4000-10	120	S02-2050-10
21	S01-0470-05	71	S01-4800-06	121	S02-2600-10
22	S01-0590-06	72	S01-4800-07	122	S02-2600-12
23	S01-0610-04	73	S01-4800-08	123	S02-3000-04
24	S01-0610-05	74	S01-5200-04	124	S02-3000-05
25	S01-0740-04	75	S01-5200-05	125	S02-2500-06
26	S01-0740-05	76	S02-0025-04	126	S02-2500-07
27	S01-0900-04	77	S02-0025-05	127	S02-3000-06
28	S01-0900-05	78	S02-0050-04	128	S02-3000-07
29	S01-0900-06	79	S02-0050-05	129	S02-2500-08
30	S01-0900-07	80	S02-0075-04	130	S02-3000-08
31	S01-1200-04	81	S02-0075-05	131	S02-3300-04
32	S01-1200-05	82	S02-0100-04	132	S02-3300-05
33	S01-1500-04	83	S02-0100-05	133	S02-3300-06
34	S01-1500-05	84	S02-0140-04	134	S02-3300-07
35	S01-1500-06	85	S02-0140-05	135	S02-3300-08
36	S01-1500-07	86	S02-0200-04	136	S02-3300-12
37	S01-1900-08	87	S02-0200-05	137	S02-4000-04
38	S01-2000-04	88	S02-0260-04	138	S02-4000-05
39	S01-2000-05	89	S02-0260-05	139	S02-4000-06
40	S01-2000-06	90	S02-0350-04	140	S02-4000-07
41	S01-2000-07	91	S02-0350-05	141	S02-4000-08
42	S01-2050-05	92	S02-0320-06	142	S02-3300-10
43	S01-2050-06	93	S02-0450-04	143	S02-4000-10
44	S01-2050-07	94	S02-0450-05	144	S02-4800-06
45	S01-2500-04	95	S02-0520-04	145	S02-4800-07
46	S01-2500-05	96	S02-0520-05	146	S02-4800-08
47	S01-2500-06	97	S02-0650-06	147	S02-5200-04
48	S01-2500-07	98	S02-0680-04	148	S02-5200-05
49	S01-2500-08	99	S02-0680-05	149	S01-4000-12
				150	S02-4000-12

DC-Motor neutral zone adjustment

Types concerned

DC-Motors

Summary

Procedure to adjust the neutral zone of a DC-motor

General

- Loosen the bolts holding the brush bridge.
- Connect a scope or a voltmeter between two adjacent brush-holder assemblies (holders with different polarity).
- Set the scaling on the scope or voltmeter to mV AC.
- Disconnect the excitation cables and connect 110 – 240 VAC between F+ and F- (a normal extension cord is sufficient).
- Start moving the brush bridge slowly in one direction and watch the scope or voltmeter. If the voltage is increasing move the brush bridge in the other direction.
- Try to get the voltage down to less than 50 mV AC. The smaller the better.
- When this is achieved, start tightening the brush bridge bolts and watch the voltage. Sometimes you have to do a little offset to compensate for movements during tightening.
- Finally, mark the correct neutral zone position in case the motor will be taken apart in the future.

Preventive Maintenance

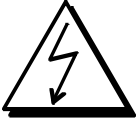

WARNING! Before performing any maintenance the chapter 'Safety Instructions' at the beginning of this manual must be followed. Negligence of these instructions can cause injury or death.



WARNING! The printed circuit boards contain components sensitive to electrostatic discharge. Use an [ESD-field service kit](#) when handling the boards. Do not touch the boards unnecessarily.

Handling the boards:

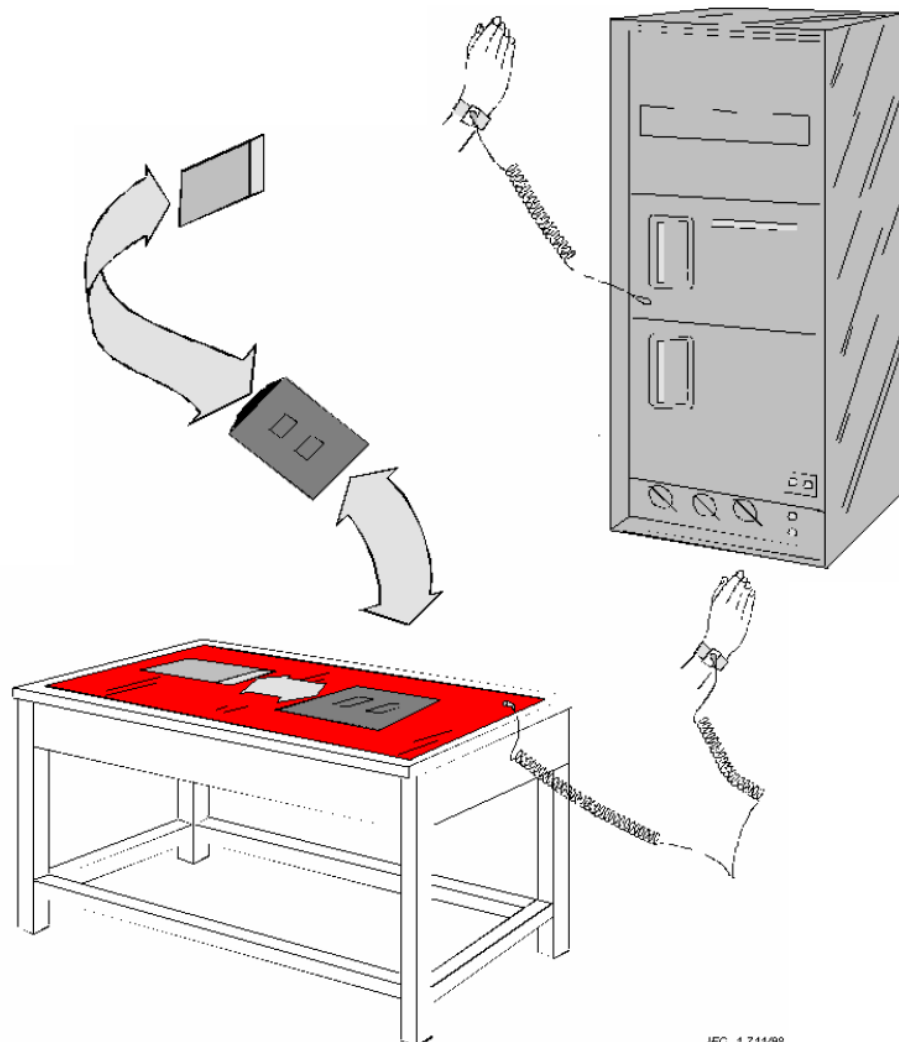

IEC 1711/98

When ESD sensitive boards are removed from the drive and transferred to a temporary work surface, they should be placed in a protective packaging. Handle unprotected ESD sensitive boards only when connected to the system and always place them in a protective package that is sealed. It is easiest to use the spare parts ESD package. Place the protective package on the ESD mat before opening.

Recommended regular maintenance

The DCS requires very little maintenance if installed in an appropriate environment. Regular inspection according to the maintenance schedule is strongly recommended. Preventive maintenance prevents unexpected production stop and production loss. It also increases availability of the drive. The environmental and operating conditions of the drive are also to be considered.

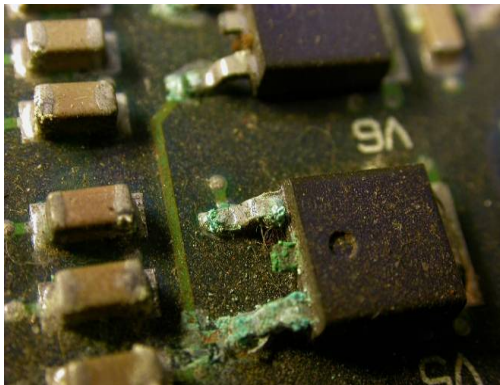

Harsh environment



A harsh environment, such as high ambient temperature, humidity, dust and cyclic heavy load, not only shortens the components lifetime but also the preventive maintenance and replacement intervals.

Maintenance schedule

	Years from start-up																					
	0	1	2	3	4	5	6	7	8	9	10	11	12	13	14	15	16	17	18	19	20	21
Start-up	P																					
Cooling																						
➢ Air Cooled Unit:																						
➢ Cooling fan DCS800 D6, D7		I	I	R	I	I	R	I	I	R	I	I	R	I	I	R	I	I	R	I	I	R
➢ Cooling fan DCS800 D1 (> 45 A)...D5		I	I	I	I	I	R	I	I	I	I	I	R	I	I	I	I	I	R	I	I	I
Aging																						
➢ DCS800 Power interface board SDCS-PIN-4							(R)			R			(R)						R			
➢ DCS800 Power supply board SDCS-POW-4							(R)			R			(R)						R			
Connections & Surroundings																						
➢ Flat cables							(I)			I			(I)						I			
➢ Tightness of terminals				I						I									I			I
➢ Tightness of terminals, heatsink D7		I	I	I	I	I	I	I	I	I	I	I	I	I	I	I	I	I	I	I	I	I
➢ Door filters		I	I	I	I	I	I	I	I	I	I	I	I	I	I	I	I	I	I	I	I	I
➢ Condition of contactors				I			I			I			I			I			I			I
➢ Fiber optic cables (connections)				I			I			I			I			I			I			I
➢ Dustiness, corrosion and temperature		I	I	I	I	I	I	I	I	I	I	I	I	I	I	I	I	I	I	I	I	I
➢ Quality of supply voltage		I	I	I	I	I	I	I	I	I	I	I	I	I	I	I	I	I	I	I	I	I
Improvements																						
➢ Based on product notes		I	I	I	I	I	I	I	I	I	I	I	I	I	I	I	I	I	I	I	I	I
Measurements																						
➢ Basic measurements with supply voltage		P	P	P	P	P	P	P	P	P	P	P	P	P	P	P	P	P	P	P	P	P
Spare Parts																						
➢ Spare Parts		I	I	I	I	I	I	I	I	I	I	I	I	I	I	I	I	I	I	I	I	I

The service intervals and component replacements are based on the operational environment specified by ABB.

Legend:

- R = Replacement of component
- I = Inspection (visual inspection, correction and replacement if needed)
- P = Performance of on-site work (commissioning, tests, measurements, etc.)
- (R) = Replacement if high ambient temperature or cyclic heavy duty

Preventive Maintenance

Annual preventive maintenance

The following actions have to take place:

- Check the cooling fans of units D1 to D7.
The lifetime of the cooling fan is about 30,000 to 45,000 hours depending on the converter type. The actual lifetime depends on the usage of the DCS and the ambient temperature.
Fan failure can be predicted by means of increasing noise from its bearings and a gradual rise of the heatsink temperature. If the DCS operates in a critical part of the process it is recommended to replace the fan once the above mentioned symptoms appear.
- Check the cooling air pressure switch of units D6 and D7.



Cooling air pressure switch

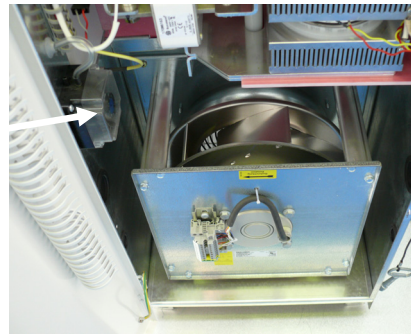

Actions:

- Make sure electrical safety is performed.
- Open the module's door and hold it in position to prevent any movement.
- Repeat it with the cabinet's door.
- Start the drive.
- The air pressure switch is ok when the converter is switched off by **F527 ConvFanAck** - see *ConvFanAck (10.30)*. Crosscheck this result with the module's door closed.

Attention:

Do not reach into the fan. Negligence to this warning can cause injury.

- Check for tightness of heatsink terminals of units D7.
The thyristors together with the heatsinks are stacked. Every single thyristor is connected to the DC+ and DC- busbars via flexible copper busbars. These busbars consist of 10 layers of pre-shaped sheet copper. This construction is able to compensate for small changes in length caused by temperature rise when current is flowing. The screw fixings between heatsink and flexible copper busbar have to withstand different types of mechanical stress. Therefore each fixing needs to be checked for correct torque.

Actions:

- Make sure all supply voltages are switched off, most important the supply for the power part (armature), for the drive electronics (SDCS-POW-4), for the converter fan and for other auxiliaries!
- Open the cabinet's and module's door; if needed secure them.
- Set a latching torque spanner to 25 Nm (18 lb-ft). A 17 mm nut is needed too.

- Check the torque of the screws marked within picture [Power part of a converter module type D7](#) on page 138.
 - Apply the torque spanner to the screw and turn right until the right torque is indicated.
 - Don't loosen the screws by a left hand turn!
- Put on a new marking, if appropriate.

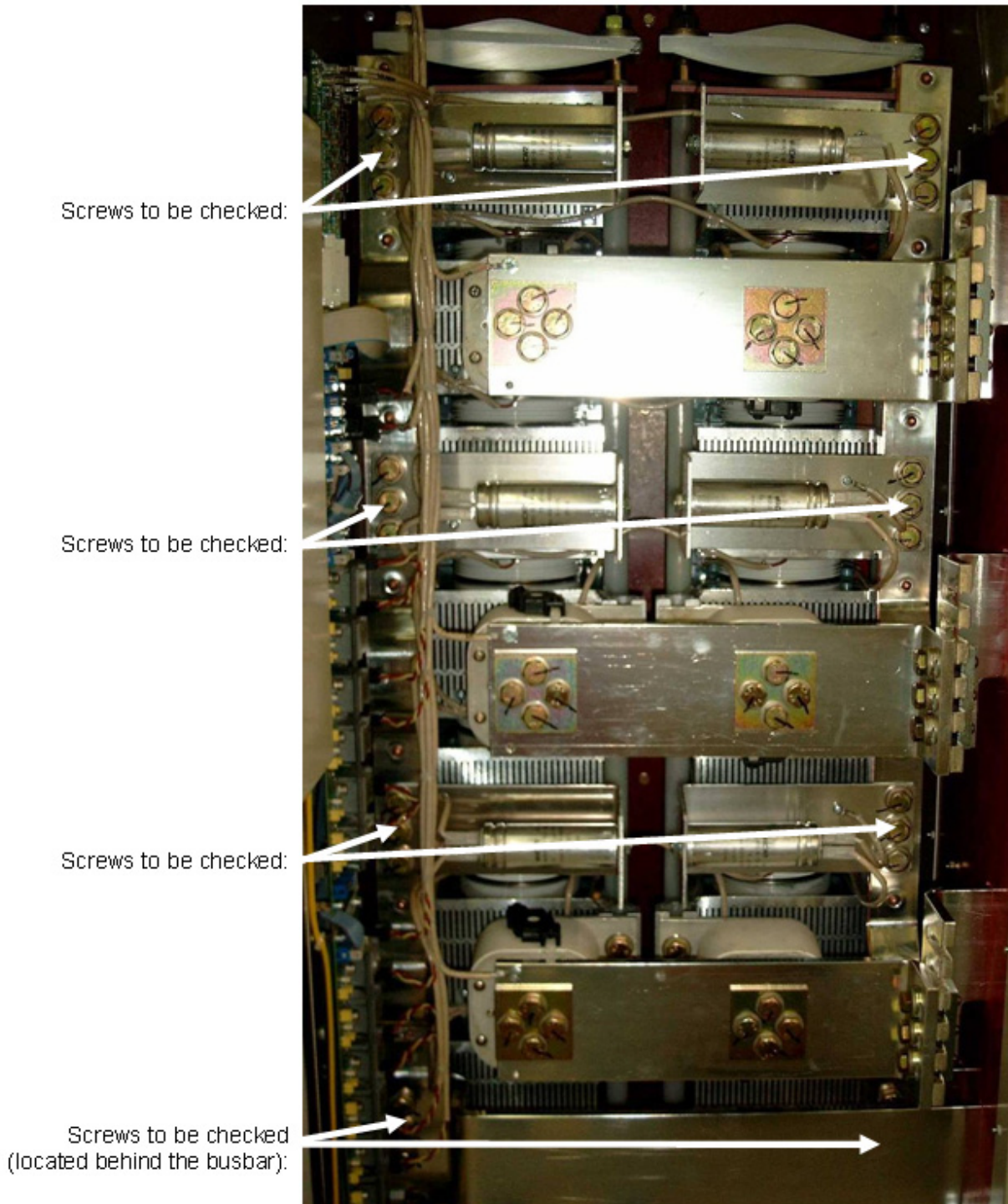

Power part of a converter module type D7

- Check the door air filters.



Door filters

Clocked up filters prevent proper cooling of the drive. Wash dirty filters with water (60°C) and detergent.

- Check for dust, corrosion and temperature inside the module / cabinet. The DCS will run into overtemperature faults if the heatsinks are not clean.

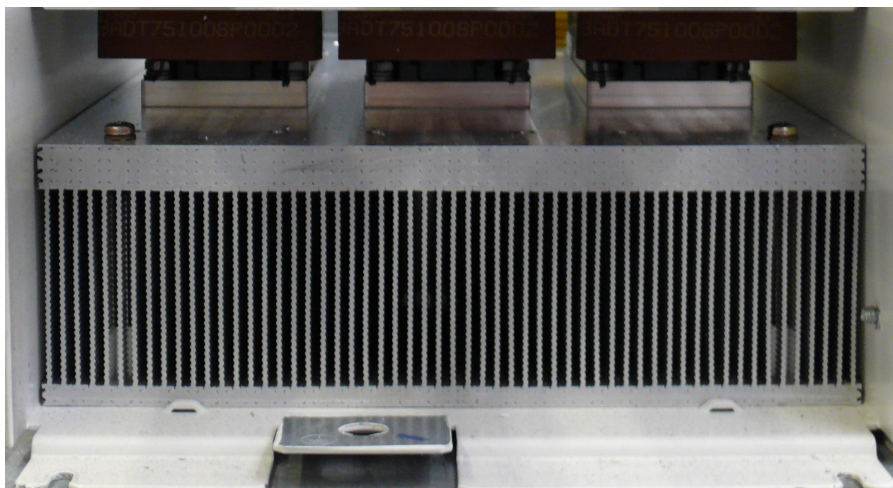

Heatsink

Use compressed air to remove the dust from the heatsinks (the air flow must be from bottom to top). Fan rotation caused by the compressed air must be stopped in order to prevent damage.

Use an [ESD vacuum cleaner](#) to clean the dust from the air inlet, air outlet, the interior of the cabinet and the electronic boards.

Any signs of corrosion, especially at ground components, must be removed.



Ground components

- Check the quality of the supply voltage.

3 years preventive maintenance

Following additional actions have to take place:

- Replace the cooling fans of units D6 and D7.
 - [How to remove the converter fan in a frame D6](#)
 - [How to remove the converter fan in a frame D7](#)

The manufacturers estimation for the operational time of the cooling fan is:

- GR31M: 30,000 hours at 40°C (D6)
- GR35C: 30,000 hours at 40°C (D7)

The mayor problem is the failure of the bearings.

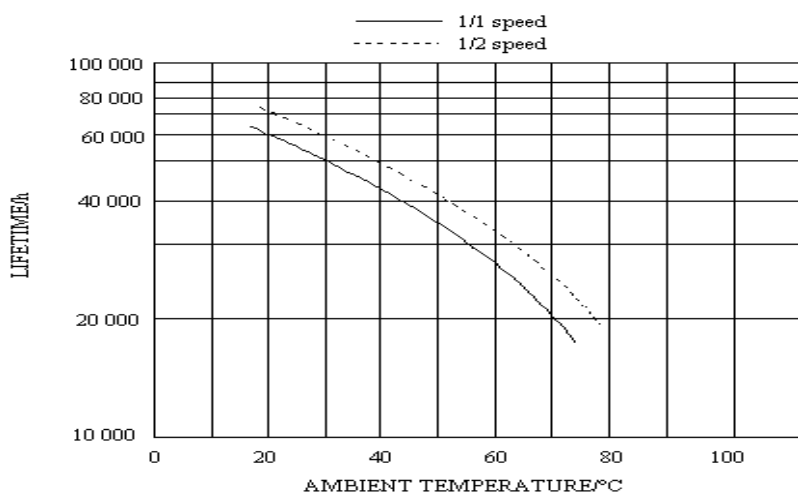

Typical lifetime of the cooling fan versus ambient temperature

Where used:

DCS800-S0x-1900-y4/5/8... DCS800-S0x-3000-y/5/8	D6	GR31M 400 ... 500 V
DCS800-S0x-1900-y6/7 DCS800-S0x-3000-y6/7	D6	GR31M 500 ... 690 V
DCS800-S0x-3300-y1... DCS800-S0x-5200-y1	D7	GR35C 400 V / 690 V

Aging of the components result in:

1. Increased vibration due to the imbalance of the cooling fan (can last for several months)
 2. Increased temperature due to the stopped cooling fan (drive trips with overtemperature)
- Check the tightness of all terminals.
All connections should be inspected and checked for tightness.
 - Check the condition of the contactors and relays.

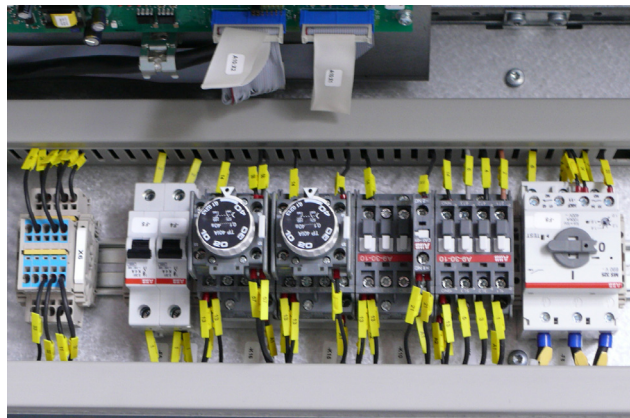

Relays

- Contactors and relays should be checked for proper function.
- Check the fiber optic cables and their connections.

6 years preventive maintenance

Following additional actions have to take place:

- Replace the cooling fans of units D1 to D5.
 - [How to remove the converter fans in frames D1 to D3 \(two fans\)](#)
 - [How to remove the converter fans in a frame D3 \(four fans\)](#)

The manufacturers estimation for the operational time of the cooling fan is:

- CN2B2: 40,000 hours at 60°C
- W2E200: 45,000 hours at 60°C
- W2E250: 40,000 hours
- D2E160: 30,000 hours at 40°C

The mayor problem is the failure of the bearings.

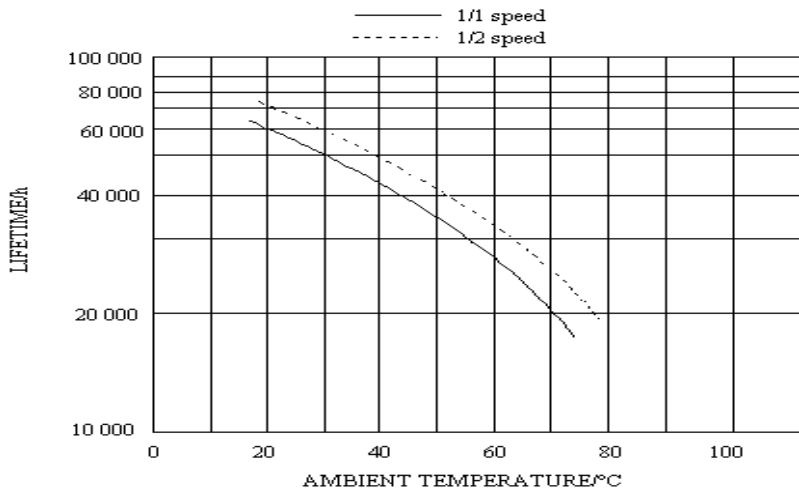

Typical lifetime of the cooling fan versus ambient temperature

Where used:

DCS800-S0x-0045-y1... DCS800-S0x-0140-y1	D1	2x CN2B2
DCS800-S0x-0180-y1... DCS800-S0x-0260-y1	D2	2x CN2B2
DCS800-S0x-0315-y1... DCS800-S0x-0350-y1	D3	2x CN2B2
DCS800-S0x-0405-y1... DCS800-S0x-0520-y1	D3	4x CN2B2
DCS800-S0x-0610-y1... DCS800-S0x-0820-y1	D4	1x W2E200 (230 V)
DCS800-S0x-0610-y1... DCS800-S0x-0820-y1	D4	1x W2E200 (115 V) (plus code E171)
DCS800-S0x-0900-y1... DCS800-S0x-1000-y1	D4	1x W2E250 (230 V)
DCS800-S0x-0900-y1... DCS800-S0x-1000-y1	D4	1x W2E250 (115 V) (plus code E171)
DCS800-S0x-0900-y1... DCS800-S0x-2000-y1	D5	D2E160

Aging of the components result in:

1. Increased vibration due to the imbalance of the cooling fan (can last for several months)
2. Increased temperature due to the stopped cooling fan (drive trips with overtemperature)

9 years preventive maintenance

Following additional actions have to take place:

- Replace the power interface board SDCS-PIN-4 of units D1 to D4.

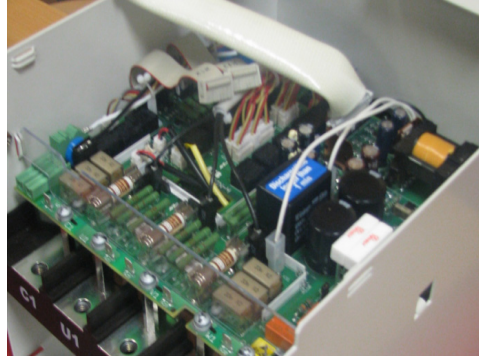

SDCS-PIN-4

The SDCS-PIN-4 is located between the heat sink and the electronic tray. It operates continuously, because it supplies the drive electronics even when the armature current is switched-off. Therefore all its components are exposed to hot conditions.

Additionally the electrolytic capacitors on the SDCS-PIN-4 are aging. The SDCS-PIN-4 also is equipped with several capacitors which are sensitive to high ambient temperature.

Where used:

DCS800-S0x-0020, ..., DCS800-S0x-1000	D1 to D4
---------------------------------------	----------

Aging of the electronic card result in:

1. Damage other devices
 2. Trip the drive and cause break-down time
- Replace the power supply board SDCS-POW-4 of units D5 to D7 and DCS800-R (Rebuild- and Upgrade Kits).

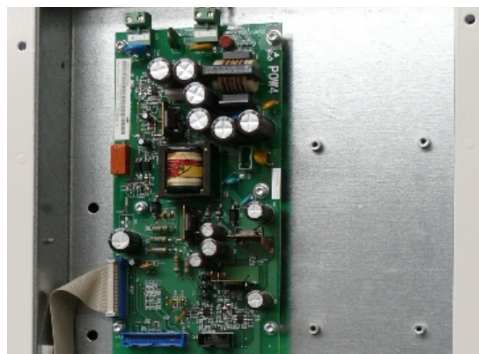

SDCS-POW-4

The SDCS-POW-4 is located between the module door on the electronic tray. It operates continuously, because it supplies the drive electronics even when the armature current is switched-off. Therefore all its components are exposed to hot conditions.

Additionally the electrolytic capacitors on the SDCS-POW-4 are aging. The SDCS-POW-4 also is equipped with several capacitors which are sensitive to high ambient temperature.

Where used:

DCS800-S0x-1000, ..., DCS800-S0x-5200	D5 to D7 and DCS800-R
---------------------------------------	-----------------------

Aging of the electronic card result in:

1. Damage other devices
 2. Trip the drive and cause break-down time
- Check the flat cables and their connections.

Appendix A - Spare Parts List

Item	Content
8.03	Control Panels and plug-in options D1 - D7
8.04 - 8.05	Field exciters FEX-425-Int, DCF803-0035 and DCF503/4B
8.06	Overvoltage protection DCF506-... for fieldexciter DCS800-S0x-0020, ..., 0520, 20 A - 520 A
8.07	Common parts for DCS800-A0 Enclosed Converters
8.08	Parts for DCS800-R0 Rebuild Kit
8.09	Parts for 12-pulse, supply voltage ≥ 800 VAC and hardparallel D7P
10.00 - 29.00	Modules D1 - D4, 20 A - 1000 A, 400 V, 525 V and 600 V
30.00 - 36.00	Modules D5, 900 A - 2000 A, 400 V, 525 V, 600 V and 690 V
40.00 - 49.00	Modules D6, 1900 A - 3000 A, 400 V, 500 V, 600 V, 690 V and 800 V
50.00 - 65.00	Modules D7, 2050 A - 5200 A, 400 V, 500 V, 600 V, 690 V, 800 V, 990 V and 1200 V

Item 8.03

Control Panels and plug-in options D1 - D7

8.03 Control Panels and plug-in options D1 - D7					
DESCRIPTION	QTY		CODE	TYPE/DATA	NOTES
DCS Control Panel	1		3ADT220129R0002	DCS-CP-P	Control Panel for DCS800
CDP312RD Control Panel	1		3ADT220071R0006	CDP312RD Rev.G	Possible via SDCS-COM-8 only
DCSLink board	1		3ADT200005R0001	SDCS-DSL-4	(+S199)
DDCS communication board	1		3ADT220134R0001	SDCS-COM-81	(+L508), 10 Mbd (e.g. AC 800M)
DDCS communication board	1		3ADT220134R0002	SDCS-COM-82	(+L509), 5 Mbd (fieldbus)
PROFIBUS-DP	1		3AFE64606859	RPBA-01	(+K454)
DeviceNet	1		3AFE64606891	RDNA-01	(+K451)
Modbus	1		3AFE64606778	RMBA-01	(+K458)
CANopen	1		3AFE64606905	RCAN-01	(+K457)
ControlNet	1		3AFE64751701	RCNA-01	(+K462)
Ethernet Adapter Module	1		3AFE64751727	RETA-01	(+K466)
EtherCat Adapter Module	1		3AUA0000045102	RECA-01	(+K469)
Analog I/O Extension	2		3AFE64606841	RAIO-01	(+L500)
Digital I/O Extension	2		3AFE64606816	RDIO-01	(+L501)
Pulse Encoder Interface (12 V)	1		3AFE64610805	RTAC-01	(+L502)
Pulse Encoder Interface (TTL)	1		3AFE68654947	RTAC-03	(+L517)
I/O Extension Adapter	1		3AFE68286778	AIMA-01	

Item 8.04 to 8.05

Field exciters FEX-425-Int, DCF803-0035, DCF503/4B

8.04 Field exciters 25 A, 16 A and 35 A, overvoltage protection included					
DESCRIPTION	QTY		CODE	TYPE/DATA	NOTES
FEX-425-Int, 1-Q, 25 A	1		3ADT209022R0001	FEX-425-Int	Internal field exciter for D5
Fuses for FEX-425-Int	3		3ADC770032P0025	KTK 25	25 A / 600 V
DCF803-0016, 1-Q, 16 A	1		3ADT209027R0001	DCF803-0016	Complete unit
DCF803-0035, 1-Q, 35 A	1		3ADT209023R0001	DCF803-0035	Complete unit
Semiconductor fuses field	3		3ADT730004R0001	UR 10A / 660V	For fieldcurrent ≥ 6 ADC
Semiconductor fuses field	3		3ADT730004R0002	UR 16A / 660V	For fieldcurrent ≥ 12 ADC
Semiconductor fuses field	3		3ADT730004R0003	UR 25A / 660V	For fieldcurrent ≥ 16 ADC
Semiconductor fuses field	3		3ADT730004R0004	UR 50A / 660V	For fieldcurrent ≥ 35 ADC
Semiconductor fuses field	3		3ADT730004R0005	UR 63A / 660V	For fieldcurrent ≥ 50 ADC

8.05 Field exciters 50 A and 60 A, overvoltage protection included					
DESCRIPTION	QTY		CODE	TYPE/DATA	NOTES
DCF503B0050, 1-Q, 50 A	1		3ADT209019R0201	DCF503B0050	Complete unit
DCF504B0050, 4-Q, 50 A	1		3ADT209019R0202	DCF504B0050	Complete unit
DCF503B0060, 1-Q, 60 A	1		3ADT209019R0211	DCF503B0060	Complete unit
DCF504B0060, 4-Q, 60 A	1		3ADT209019R0212	DCF504B0060	Complete unit
Fan for DCF50xB0060	2		GHSN700002P0001	AC220V 8556V	Fan M55/M56 for DCF50xB0060

Item 8.06

Overvoltage protection DCF506-... for fieldexciter DCS800-S0x-0020, ..., 0520, 20 A - 520 A

8.06 Overvoltage protection DCF506-... for fieldexciter DCS800-S0x-0020, ..., 0520, 20 A - 520 A					
DESCRIPTION	QTY		CODE	TYPE/DATA	NOTES
Control board DCF505/506	1		3ADT220090R0021	SDCS-FEP-1	(1400 V) for DCF505/506
Overvoltage protection field	1		DCF1127101R0001	DCF506-0140-51	Field exciter 25 A - 100 A
Overvoltage protection field	1		DCF1127119R0001	DCF506-0520-51	Field exciter 200 A - 520 A

Item 8.07

Common parts for DCS800-A Enclosed Converters

8.07 Common parts for DCS800-A Enclosed Converters					
DESCRIPTION	QTY		CODE	TYPE/DATA	NOTES
DI/DO connection board	1		3ADT220090R0014	SDCS-IOB-21	24 VDC - 48 VDC, digital (A9)
DI/DO connection board	1		3ADT220090R0013	SDCS-IOB-22	115 VAC, digital (A9)
DI/DO connection board	1		3ADT220090R0023	SDCS-IOB-23	230 VAC, digital (A9)
AI/AO connection board	1		3ADT220090R0020	SDCS-IOB-3	Analog and encoder (A10)

Item 8.08

Parts for DCS800-R Rebuild Kit

DCR-Kit contains: 2-Q 4-Q

8.08 Parts for DCS800-R Rebuild Kit					
DESCRIPTION	2-Q	4-Q	CODE	TYPE/DATA	NOTES
Pulse interface board	1	1	3ADT220090R0009	SDCS-REB-1	
Pulse amplifier board	1	1	3ADT220090R0034	SDCS-REB-2	
Pulse distribution board	1	1	3ADT309300R0001	SDCS-REB-3	
Power supply for SDCS-REB-2	2	2	3ADT200003P0001	QUINT-240/24/2A	115 - 240 VAC / 24 VDC
Pulstransformer board	1	2	3ADT220090R0043	SDCS-PIN-48	SDCS-PIN-48 replaces SDCS-PIN-41
Power interface board	1	1	3ADT220090R0006	SDCS-PIN-51	For 400 VAC - 1000 VAC
Current transformer 2500 / 1 A	2	2	3ADT751010P0001	LT2032 2500/1A	T51 / T52 for D5 and D6
Current transformer 4000 / 1 A	2	2	3ADT751007P0001	4000/1A	T51 / T52 for D7
FEX-425-Int, 1-Q, 25 A	1	1	3ADT209022R0001	FEX-425-Int	Internal field exciter for Rebuild Kit

Item 8.09

Parts for 12-pulse, supply voltage ≥ 800 VAC, hardparallel D7P and galvanic isolation

8.09 Parts for 12-pulse, supply voltage ≥ 800 VAC, hardparallel D7P and galvanic isolation					
DESCRIPTION	2-Q	4-Q	CODE	TYPE/DATA	NOTES
Current measurement aid	1	1	3ADT220090R0022	SDCS-CMA-2	For D5 - D7 (12-pulse, hardparallel)
Insulation monitor	1	1	DCA0019192P0001	IRDH 265-4	Inside cabinet, 10 - 990 kOhm
Insulation monitor	1	1	3ADV050058P0005	IRDH 365-4	Door mounted, 10 - 990 kOhm
Insulation monitor	1	1	3ADV050058P0001	IRDH 265-3	Inside cabinet EMBR, 2 - 200 kOhm
Voltage adaption for IRDH	1	1	DCA0019711P0001	AGH 204 S	For IRDH ≥ 690 VAC, 6-pulse
Voltage adaption for IRDH	1	1	3ADV050058P0002	AGH 150 W-4	For IRDH ≥ 690 VAC, 12-pulse
DC-DC transducer (Knick) A92	1	1	3ADN260008P0001	P42000D3-0111	For U ≥ 690 VAC, 12-pulse, replaces Knick 8680 A1/A92
High volt. transformer T90	1	1	3ADT745047P0001	T 90, 500 -1200 VAC	For U ≥ 690 VAC, 12-pulse
High volt. fuses for U ≥ 750 VAC	3	3	3ADV050092P0015	CC 1051CP 10A/1000V	3 for T90 and capacitors
High volt. fuses for U ≥ 750 VAC	2	2	3ADV050092P0017	CC 1551CP 10A/1500V	2 for A92
Power Interface U \geq 750 VAC	1	1	3ADT780007R0002	SDCS-PIN-5x-1190 meas.	Special test procedure & modified
Hardparallel board 1	1	1	3ADT220090R0031	SDCS-PAR-1	Hardparallel master
Hardparallel board 2	1	1	3ADT220090R0032	SDCS-PAR-2	Hardparallel slave

Item 10.00 to 29.00

Modules D1 - D4, 20 A - 1000 A, 400 V, 525 V and 600 V

10.00 Common parts for modules D1 - D4, 20 A - 1000 A					
DESCRIPTION	2-Q	4-Q	CODE	TYPE/DATA	NOTES
Control board	1	1	3ADT313900R1501	SDCS-CON-4	Replaces 3ADT313900R1001
Interface board and field supply	1	1	3ADT314100R1001	SDCS-PIN-4	OnBoard field up to 525 VAC
Fuses on SDCS-PIN-4	3	3	3ADC770032P0025	KTK 25	25 A / 600 V
Half controlled bridge block	1	1	3ADC340091R0001	VVZF 70-16xxx	OnBoard field up to 525 VAC
Temperatur sensor (D1 and D2)	1	1	3ADT710005P0001	KTY10-6-M4/250mm	20 A - 260 A, cable 250 mm
Temperatur Sensor (D3 and D4)	1	1	3ADT710005P0002	KTY10-6-M4/400mm	315 A - 1000 A, cable 400 mm

Module contains: 2-Q 4-Q

11.00 DCS800-S01-0020-04/05 & DCS800-S02-0025-04/05 (400 V - 525 V)					
DESCRIPTION	2-Q	4-Q	CODE	TYPE/DATA	NOTES
Thyristor modules	3	6	3ADC340063P0001	SKKT27B/xxx	MCC 26 - 16 xxx
Semiconductor fuses	3	3	3ADT730004R0004	UR 50 A / 660 V	Blade- or knife fuse
Semiconductor fuses (as field)	3	3	3ADV050169P0050	UR 50 A / 600 V	When used as field in D6 or D7 cabinets

Module contains: 2-Q 4-Q

12.00 DCS800-S01-0045-04/05 & DCS800-S02-0050-04/05 (400 V - 525 V)					
DESCRIPTION	2-Q	4-Q	CODE	TYPE/DATA	NOTES
Thyristor modules	3	6	3ADC340063P0001	SKKT27B/xxx	MCC 26 - 16 xxx
Semiconductor fuses	3	3	3ADT730004R0005	UR 63 A / 660 V	Blade- or knife fuse
Cooling fan 115 V, 50/60 Hz	2	2	3ADT754014P0001	CN2B2	4715 MS-12T-B5Axxx
Semiconductor fuses (as field)	3	3	3ADV050169P0080	UR 80 A / 600 V	When used as field in D6 or D7 cabinets

Module contains: 2-Q 4-Q

13.00 DCS800-S01-0065-04/05 & DCS800-S02-0075-04/05 (400 V - 525 V)					
DESCRIPTION	2-Q	4-Q	CODE	TYPE/DATA	NOTES
Thyristor modules	3	6	3ADC340067P0001	SKKT42B/xxx	MCC 44 - 16 xxx
Semiconductor fuses	3	3	3ADT730004R0007	UR 125 A / 660 V	Blade- or knife fuse
Cooling fan 115 V, 50/60 Hz	2	2	3ADT754014P0001	CN2B2	4715 MS-12T-B5Axxx
Semiconductor fuses (as field)	3	3	3ADV050169P0125	UR 125 A / 600 V	When used as field in D6 or D7 cabinets

Module contains: 2-Q 4-Q

14.00 DCS800-S01-0090-04/05 & DCS800-S02-0100-04/05 (400 V - 525 V)					
DESCRIPTION	2-Q	4-Q	CODE	TYPE/DATA	NOTES
Thyristor modules	3	6	3ADC340068P0001	SKKT57B/xxx	MCC 56 -16 xxx
Semiconductor fuses	3	3	3ADT730004R0007	UR 125 A / 660 V	Blade- or knife fuse
Cooling fan 115V, 50/60Hz	2	2	3ADT754014P0001	CN2B2	4715 MS-12T-B5Axxx
Semiconductor fuses (as field)	3	3	3ADV050092P0036	UR 200 A / 660 V	When used as field in D6 or D7 cabinets

Module contains: 2-Q 4-Q

15.00 DCS800-S01-0125-04/05 & DCS800-S02-0140-04/05 (400 V - 525 V)					
DESCRIPTION	2-Q	4-Q	CODE	TYPE/DATA	NOTES
Thyristor modules	3	6	3ADC340064P0001	SKKT106B/xxx	MCC 95 -16 xxx
Semiconductor fuses	3	3	3ADT730004R0008	UR 200 A / 660 V	Blade- or knife fuse
Cooling fan 115 V, 50/60 Hz	2	2	3ADT754014P0001	CN2B2	4715 MS-12T-B5Axxx

Module contains: 2-Q 4-Q

16.00 DCS800-S01-0180-04/05 & DCS800-S02-0200-04/05 (400 V - 525 V)					
DESCRIPTION	2-Q	4-Q	CODE	TYPE/DATA	NOTES
Thyristor modules	3	6	3ADC340064P0001	SKKT106B/xxx	MCC 95 -16 xxx
Semiconductor fuses	3	3	3ADT730004R0009	UR 250 A / 660 V	Blade- or knife fuse
Cooling fan 115 V, 50/60 Hz	2	2	3ADT754014P0001	CN2B2	4715 MS-12T-B5Axxx
Semiconductor fuses (as field)	3	3	3ADV050169P0250	UR 250 A / 660 V	When used as field in D6 or D7 cabinets

Module contains: 2-Q 4-Q

17.00 DCS800-S01-0230-04/05 & DCS800-S02-0260-04/05 (400 V - 525 V)					
DESCRIPTION	2-Q	4-Q	CODE	TYPE/DATA	NOTES
Thyristor modules	3	6	3ADC340094P0001	MCC162-16xxx	TT 162 Nxxx
Semiconductor fuses	3	3	3ADT730004R0010	UR 315 A / 660 V	Blade- or knife fuse
Cooling fan 115 V, 50/60 Hz	2	2	3ADT754014P0001	CN2B2	4715 MS-12T-B5Axxx

Module contains: 2-Q 4-Q

18.00 DCS800-S01-0290-06 & DCS800-S02-0320-06 (600 V)					
DESCRIPTION	2-Q	4-Q	CODE	TYPE/DATA	NOTES
Thyristor modules	3	6	3ADC340096P0001	MCC 224-xxx	
Semiconductor fuses	3	3	3ADT730004R0012	UR 500 A / 660 V	Blade- or knife fuse
Cooling fan 115 V, 50/60 Hz	2	2	3ADT754014P0001	CN2B2	4715 MS-12T-B5Axxx

Module contains: 2-Q 4-Q

19.00 DCS800-S01-0315-04/05 & DCS800-S02-0350-04/05 (400 V - 525 V)					
DESCRIPTION	2-Q	4-Q	CODE	TYPE/DATA	NOTES
Thyristor modules	3	6	GHSN610089P0002	TT250 Nxxx	MCC 255 - xxx
Semiconductor fuses	3	3	3ADT730004R0013	UR 700 A / 660 V	Blade- or knife fuse
Cooling fan 115 V, 50/60 Hz	2	2	3ADT754014P0001	CN2B2	4715 MS-12T-B5Axxx
Semiconductor fuses (as field)	3	3	3ADV050092P0032	UR 450 A / 660 V	When used as field in D6 or D7 cabinets

Module contains: 2-Q 4-Q					
20.00 DCS800-S01-0405-04/05 & DCS800-S02-0450-04/05 (400 V - 525 V)					
DESCRIPTION	2-Q	4-Q	CODE	TYPE/DATA	NOTES
Thyristor modules	3	6	GHSN610089P0002	TT250 Nxxx	MCC 255 - xxx
Semiconductor fuses	3	3	3ADT730004R0013	UR 700 A / 660 V	Blade- or knife fuse
Cooling fan 115 V, 50/60 Hz	4	4	3ADT754014P0001	CN2B2	4715 MS-12T-B5Axxx

Module contains: 2-Q 4-Q					
21.00 DCS800-S01-0470-04/05 & DCS800-S02-0520-04/05 (400 V - 525 V)					
DESCRIPTION	2-Q	4-Q	CODE	TYPE/DATA	NOTES
Thyristor modules	3	6	3ADC340092P0001	TT330 Nxxx	MCC 312 - xxx
Semiconductor fuses	3	3	3ADT730004R0013	UR 700 A / 660 V	Blade- or knife fuse
Cooling fan 115 V, 50/60 Hz	4	4	3ADT754014P0001	CN2B2	4715 MS-12T-B5Axxx

Module contains: 2-Q 4-Q					
22.00 DCS800-S01-0590-06 & DCS800-S02-0650-06 (600 V)					
DESCRIPTION	2-Q	4-Q	CODE	TYPE/DATA	NOTES
Thyristor modules	3	6	3ADC340097P0001	SKKT 430/20xxx	TT430 Nxxx, MT3-430-xx
Semiconductor fuses	3	3	3ADT730004R0014	UR 900 A / 660 V	Blade- or knife fuse
Cooling fan 230 V, 50/60 Hz	1	1	DCA0012171P0001	W2E 200-HH38-06	

Module contains: 2-Q 4-Q					
23.00 DCS800-S01-0590-06 & DCS800-S02-0650-06 +S171 (600 V)					
DESCRIPTION	2-Q	4-Q	CODE	TYPE/DATA	NOTES
Thyristor modules	3	6	3ADC340097P0001	SKKT 430xxx	TT430 Nxxx, MT3-430-xx
Semiconductor fuses	3	3	3ADT730004R0014	UR 900 A / 660 V	Blade- or knife fuse
Cooling fan 115 V, 50/60 Hz	1	1	3ADT754012P0001	W2E 200-HH86-14	(+S171)

Module contains: 2-Q 4-Q					
24.00 DCS800-S01-0610-04/05 & DCS800-S02-0680-04/05 (400 V - 525 V)					
DESCRIPTION	2-Q	4-Q	CODE	TYPE/DATA	NOTES
Thyristor modules	3	6	3ADC340032P0001	TT 425 Nxxx	MCC 501 - xxx
Semiconductor fuses	3	3	3ADT730004R0015	UR 900 A / 660 V	Screw type fuse
Cooling fan 230 V, 50/60 Hz	1	1	DCA0012171P0001	W2E 200-HH38-06	
Fuses as Enclosed Converter	3	3	DCA0012724P0001	170M6813	Fuses as Enclosed Converter with OESA

Module contains: 2-Q 4-Q					
25.00 DCS800-S01-0740-04/05 & DCS800-S02-0820-04/05 (400 V - 525 V)					
DESCRIPTION	2-Q	4-Q	CODE	TYPE/DATA	NOTES
Thyristor modules	3	6	3ADC340066P0001	TT 570 Nxxx	MT3-595-xxx
Semiconductor fuses	3	3	3ADT730004R0015	UR 900 A / 660 V	Screw type fuse
Cooling fan 230 V, 50/60 Hz	1	1	DCA0012171P0001	W2E 200-HH38-06	
Fuses as Enclosed Converter	3	3	DCA0012724P0001	170M6813	Fuses as Enclosed Converter with OESA

Module contains: 2-Q 4-Q

26.00 DCS800-S01-0900-04/05 & DCS800-S02-1000-04/05 (400 V - 525 V)					
DESCRIPTION	2-Q	4-Q	CODE	TYPE/DATA	NOTES
Thyristor modules	3	6	3ADC3400066P0001	TT 570 Nxxx	MT3-595-xxx
Semiconductor fuses	3	3	3ADT730004R0016	UR 1250 A / 660 V	Screw type fuse
Cooling fan 230 V, 50/60 Hz	1	1	3ADT754017P0001	W2E250-HL06-10	
Fuses as Enclosed Converter	3	3	3ADV050092P0020	170M6016	Fuses as Enclosed Converter with OESA

Module contains: 2-Q 4-Q

27.00 DCS800-S01-0610-04/05 & DCS800-S02-0680-04/05 +S171 (400 V - 525 V)					
DESCRIPTION	2-Q	4-Q	CODE	TYPE/DATA	NOTES
Thyristor modules	3	6	3ADC340032P0001	TT 425 Nxxx	MCC 501 - xxx
Semiconductor fuses	3	3	3ADT730004R0015	UR 900 A / 660 V	Screw type fuse
Cooling fan 115 V, 50/60 Hz	1	1	3ADT754012P0001	W2E 200-HH86-14	(+S171)
Fuses as Enclosed Converter	3	3	DCA0012724P0001	170M6813	Fuses as Enclosed Converter with OESA

Module contains: 2-Q 4-Q

28.00 DCS800-S01-0740-04/05 & DCS800-S02-0820-04/05 +S171 (400 V - 525 V)					
DESCRIPTION	2-Q	4-Q	CODE	TYPE/DATA	NOTES
Thyristor modules	3	6	3ADC3400066P0001	TT 570 Nxxx	MT3-595-xxx
Semiconductor fuses	3	3	3ADT730004R0015	UR 900 A / 660 V	Screw type fuse
Cooling fan 115 V, 50/60 Hz	1	1	3ADT754012P0001	W2E 200-HH86-14	(+S171)
Fuses as Enclosed Converter	3	3	DCA0012724P0001	170M6813	Fuses as Enclosed Converter with OESA

Module contains: 2-Q 4-Q

29.00 DCS800-S01-0900-04/05 & DCS800-S02-1000-04/05 +S171 (400 V - 525 V)					
DESCRIPTION	2-Q	4-Q	CODE	TYPE/DATA	NOTES
Thyristor modules	3	6	3ADC3400066P0001	TT 570 Nxxx	MT3-595-xxx
Semiconductor fuses	3	3	3ADT730004R0016	UR 1250 A / 660 V	Screw type fuse
Cooling fan 115 V, 50/60 Hz	1	1	3ADT754015P0001	W2E250-HL08-09	(+S171)
Fuses as Enclosed Converter	3	3	3ADV050092P0020	170M6016	Fuses as Enclosed Converter with OESA

Item 30.00 to 36.00**Modules D5, 900 A - 2000 A, 400 V, 525 V, 600 V and 690 V**

30.00 Common parts for modules D5, 900 A - 2000 A					
DESCRIPTION	2-Q	4-Q	CODE	TYPE/DATA	NOTES
Control board	1	1	3ADT313900R1501	SDCS-CON-4	Replaces 3ADT313900R1001
Power supply board	1	1	3ADT315100R1001	SDCS-POW-4	
Puls transformer board	1	2	3ADT220090R0043	SDCS-PIN-48	SDCS-PIN-48 replaces SDCS-PIN-41
Power interface board	1	1	3ADT220090R0006	SDCS-PIN-51	
Temperatur sensor (R57)	1	1	3ADT710003P0001	KTY 2K-M4-800	
Current transformer 2500 / 1 A	2	2	3ADT751010P0001	LT2032 2500/1A	T51 / T52 for D5 and D6
Cooling fan	1	1	3ADT754018P0001	D2E 160-AH02-15	

Module contains:		2-Q	4-Q			
31.00	DCS800-S01-0900-06/07 & DCS800-S02-0900-06/07 (600 V - 690 V)					
DESCRIPTION	2-Q	4-Q	CODE	TYPE/DATA	NOTES	
Thyristor	6	12	DCA0012007P0001	T459Nxxx	original thyristor type	
Semiconductor fuses	6	6	3ADC770009P0007	UR 630 A / 1250 V	Screw type fuse	

Module contains:		2-Q	4-Q			
31.00a	DCS800-S01-0900-06a/07a & DCS800-S02-0900-06a/07a (600 V - 690 V)					
DESCRIPTION	2-Q	4-Q	CODE	TYPE/DATA	NOTES	
Thyristor	6	12	3ADC340105P0001	T460Nxxx	second thyristor type	
Semiconductor fuses	6	6	3ADC770009P0007	UR 630 A / 1250 V	Screw type fuse	

Module contains:		2-Q	4-Q			
32.00	DCS800-S01-1200-04/05 & DCS800-S02-1200-04/05 (400 V - 500 V)					
DESCRIPTION	2-Q	4-Q	CODE	TYPE/DATA	NOTES	
Thyristor	6	12	DCA0012015P0001	T589Nxxx	original thyristor type	
Semiconductor fuses	6	6	3ADC770010P0005	UR 800 A / 660 V	Screw type fuse	

Module contains:		2-Q	4-Q			
32.00a	DCS800-S01-1200-04a/05a & DCS800-S02-1200-04a/05a (400 V - 500 V)					
DESCRIPTION	2-Q	4-Q	CODE	TYPE/DATA	NOTES	
Thyristor	6	12	3ADC340106P0001	T590Nxxx	second thyristor type	
Semiconductor fuses	6	6	3ADC770010P0005	UR 800 A / 660 V	Screw type fuse	

Module contains:		2-Q	4-Q			
33.00	DCS800-S01-1500-04/05 & DCS800-S02-1500-04/05 (400 V - 500 V)					
DESCRIPTION	2-Q	4-Q	CODE	TYPE/DATA	NOTES	
Thyristor	6	12	3ADC340102P0001	T2 XXX-xx		
Semiconductor fuses	6	6	3ADC770010P0009	UR 1250 A / 660 V	Screw type fuse	

Module contains:		2-Q	4-Q			
34.00	DCS800-S01-1500-06/07 & DCS800-S02-1500-06/07 (600 V - 690 V)					
DESCRIPTION	2-Q	4-Q	CODE	TYPE/DATA	NOTES	
Thyristor	6	12	3ADC340098P0001	T1 XXX-xx		
Semiconductor fuses	6	6	3ADC770009P0012	UR 1100 A / 1250 V	Screw type fuse	

Module contains:		2-Q	4-Q			
35.00	DCS800-S01-2000-04/05 & DCS800-S02-2000-04/05 (400 V - 500 V)					
DESCRIPTION	2-Q	4-Q	CODE	TYPE/DATA	NOTES	
Thyristor	6	12	3ADC340102P0001	T2-XXX-xx		
Semiconductor fuses	6	6	3ADC770010P0012	UR 1600 A / 660 V	Screw type fuse	

Module contains:		2-Q	n.a.			
36.00	DCS800-S01-2000-06/07 (600 V - 690 V)					
DESCRIPTION	2-Q	n.a.	CODE	TYPE/DATA	NOTES	
Thyristor	6	--	3ADC340090P0001	TV 989-2700-xxx		
Semiconductor fuses	6	--	3ADC770009P0013	UR 1400 A / 1100 V	Screw type fuse	

Item 40.00 to 49.00**Modules D6, 1900 A - 3000 A, 400 V, 500 V, 600 V, 690 V and 800 V**

40.00 Common parts for modules D6, 1900 A - 3000 A					
DESCRIPTION	2-Q	4-Q	CODE	TYPE/DATA	NOTES
Control board	1	1	3ADT313900R1501	SDCS-CON-4	Replaces 3ADT313900R1001
Power supply board	1	1	3ADT315100R1001	SDCS-POW-4	
Power interface board	1	1	3ADT220090R0006	SDCS-PIN-51	
Air Flow detector (P1)	1	1	DCF1066659P0001	P 233A-4-AHC	
Temperatur Sensor (R57)	1	1	DCA0012139P0004	KTY 10-6 M4	cable 1200 mm
Current transformer 2500 / 1 A	2	2	3ADT751010P0001	LT2032 2500/1A	T51 / T52 for D5 and D6

Module contains: 2-Q 4-Q

41.00 DCS800-S01-1900-08 & DCS800-S02-1900-08 (800 V)					
DESCRIPTION	2-Q	4-Q	CODE	TYPE/DATA	NOTES
Thyristor	6	12	3ADC340081P0001	T 1329Nxxx	original thyristor type
Puls transformer board	1	2	3ADT220090R0043	SDCS-PIN-48	SDCS-PIN-48 replaces SDCS-PIN-41
Semiconductor fuses	12	12	3ADC770009P0007	UR 630 A / 1250 V	Screw type fuse (double fuses)
Cooling fan	1	1	3ADT754008P0001	GR31M...(500V)	400 V - 500 V / 50/60 Hz

Module contains: 2-Q 4-Q

41.00a DCS800-S01-1900-08a & DCS800-S02-1900-08a (800 V)					
DESCRIPTION	2-Q	4-Q	CODE	TYPE/DATA	NOTES
Thyristor	6	12	3ADC340098P0001	T 1xxx-24	second thyristor type
Puls transformer board	1	2	3ADT220090R0043	SDCS-PIN-48	SDCS-PIN-48
Semiconductor fuses	12	12	3ADC770009P0007	UR 630 A / 1250 V	Screw type fuse (double fuses)
Cooling fan	1	1	3ADT754008P0001	GR31M...(500V)	400 V - 500 V / 50/60 Hz

Module contains: 2-Q 4-Q

42.00 DCS800-S01-2050-05 & DCS800-S02-2050-05 (500 V)					
DESCRIPTION	2-Q	4-Q	CODE	TYPE/DATA	NOTES
Thyristor	6	12	3ADC340081P0001	T 1329Nxxx	original thyristor type
Puls transformer board	1	2	3ADT220090R0043	SDCS-PIN-48	SDCS-PIN-48 replaces SDCS-PIN-41
Semiconductor fuses	6	6	3ADC770010P0011	UR 1500 A / 660 V	Screw type fuse
Cooling fan	1	1	3ADT754008P0001	GR31M...(500V)	400 V - 500 V / 50/60 Hz

Module contains: 2-Q 4-Q

42.00a DCS800-S01-2050-05a & DCS800-S02-2050-05a (500 V)					
DESCRIPTION	2-Q	4-Q	CODE	TYPE/DATA	NOTES
Thyristor	6	12	3ADC340098P0001	T 1xxx-24	second thyristor type
Puls transformer board	1	2	3ADT220090R0043	SDCS-PIN-48	SDCS-PIN-48
Semiconductor fuses	6	6	3ADC770010P0011	UR 1500 A / 660 V	Screw type fuse
Cooling fan	1	1	3ADT754008P0001	GR31M...(500V)	400 V - 500 V / 50/60 Hz

Module contains:		2-Q	4-Q			
43.00	DCS800-S01-2050-06/07 & DCS800-S02-2050-06/07 (600 V - 690 V)					
DESCRIPTION	2-Q	4-Q	CODE	TYPE/DATA	NOTES	
Thyristor	6	12	3ADC340081P0001	T 1329Nxxx	original thyristor type	
Puls transformer board	1	2	3ADT220090R0043	SDCS-PIN-48	SDCS-PIN-48 replaces SDCS-PIN-41	
Semiconductor fuses	12	12	3ADC770009P0008	UR 700 A / 1250 V	Screw type fuse (double fuses)	
Cooling fan	1	1	3ADT754008P0002	GR31M-.(690V)	525 V - 690 V / 50/60 Hz	

Module contains:		2-Q	4-Q			
43.00a	DCS800-S01-2050-06a/07a & DCS800-S02-2050-06a/07a (600 V - 690 V)					
DESCRIPTION	2-Q	4-Q	CODE	TYPE/DATA	NOTES	
Thyristor	6	12	3ADC340098P0001	T 1xxx-24	second thyristor type	
Puls transformer board	1	2	3ADT220090R0043	SDCS-PIN-48	SDCS-PIN-48	
Semiconductor fuses	12	12	3ADC770009P0008	UR 700 A / 1250 V	Screw type fuse (double fuses)	
Cooling fan	1	1	3ADT754008P0002	GR31M-.(690V)	525 V - 690 V / 50/60 Hz	

Module contains:		2-Q	4-Q			
44.00	DCS800-S01-2500-04/05 & DCS800-S02-2500-04/05 (400 V - 500 V)					
DESCRIPTION	2-Q	4-Q	CODE	TYPE/DATA	NOTES	
Thyristor for DCS800-S01, 2-Q	6	-	3ADC340089P0001	T 989-3030xxx		
Thyristor for DCS800-S02, 4-Q	-	6	3ADC340079P0001	5 STB 24-Qxxx	Bidirectional-Controlled-Thyristor (BCT)	
Puls transformer board	1	-	3ADT220090R0043	SDCS-PIN-48	SDCS-PIN-48 replaces SDCS-PIN-41	
Puls transformer board	-	2	3BSE004939R1003	SDCS-PIN-46	only used for BCT's	
Semiconductor fuses	12	12	3ADC770010P0006	UR 900 A / 660 V	Screw type fuse (double fuses)	
Cooling fan	1	1	3ADT754008P0001	GR31M-.(500V)	400 V - 500 V / 50/60 Hz	

Module contains:		2-Q	4-Q			
45.00	DCS800-S01-2500-06/07 & DCS800-S02-2500-06/07 (600 V - 690 V)					
DESCRIPTION	2-Q	4-Q	CODE	TYPE/DATA	NOTES	
Thyristor for DCS800-S01, 2-Q	6	-	3ADC340090P0001	TV 989-2700-2xxx		
Thyristor for DCS800-S02, 4-Q	-	6	3ADC340079P0001	5 STB 24-Qxxx	Bidirectional-Controlled-Thyristor (BCT)	
Puls transformer board	1	-	3ADT220090R0043	SDCS-PIN-48	SDCS-PIN-48 replaces SDCS-PIN-41	
Puls transformer board	-	2	3BSE004939R1003	SDCS-PIN-46	only used for BCT's	
Semiconductor fuses	12	12	3ADC770009P0011	UR 1000 A / 1250 V	Screw type fuse (double fuses)	
Cooling fan	1	1	3ADT754008P0002	GR31M-.(690V)	525 V - 690 V / 50/60 Hz	

Module contains:		2-Q	4-Q			
46.00	DCS800-S01-2500-08 & DCS800-S02-2500-08 (800 V)					
DESCRIPTION	2-Q	4-Q	CODE	TYPE/DATA	NOTES	
Thyristor for DCS800-S01, 2-Q	6	-	3ADC340087P0001	TV 989-2770xxx		
Thyristor for DCS800-S02, 4-Q	-	6	3ADC340079P0001	5 STB 24-Qxxx	Bidirectional-Controlled-Thyristor (BCT)	
Puls transformer board	1	-	3ADT220090R0043	SDCS-PIN-48	SDCS-PIN-48 replaces SDCS-PIN-41	
Puls transformer board	-	2	3BSE004939R1003	SDCS-PIN-46	only used for BCT's	
Semiconductor fuses	12	12	3ADC770009P0011	UR 1000 A / 1250 V	Screw type fuse (double fuses)	
Cooling fan	1	1	3ADT754008P0001	GR31M-.(500V)	400 V - 500 V / 50/60 Hz	

Module contains: 2-Q 4-Q

47.00 DCS800-S01-3000-04/05 & DCS800-S02-3000-04/05 (400 V - 500 V)					
DESCRIPTION	2-Q	4-Q	CODE	TYPE/DATA	NOTES
Thyristor for DCS800-S01, 2-Q	6	-	3ADC340088P0001	T 989-3300xxx	
Thyristor for DCS800-S02, 4-Q	-	6	3ADC340079P0001	5 STB 24-Qxxx	Bidirectional-Controlled-Thyristor (BCT)
Puls transformer board	1	-	3ADT220090R0043	SDCS-PIN-48	SDCS-PIN-48 replaces SDCS-PIN-41
Puls transformer board	-	2	3BSE004939R1003	SDCS-PIN-46	only used for BCT's
Semiconductor fuses	12	12	3ADC770010P0009	UR 1250 A / 660 V	Screw type fuse (double fuses)
Cooling fan	1	1	3ADT754008P0001	GR31M...(500V)	400 V - 500 V / 50/60 Hz

Module contains: 2-Q 4-Q

48.00 DCS800-S01-3000-06/07 & DCS800-S02-3000-06/07 (600 V - 690 V)					
DESCRIPTION	2-Q	4-Q	CODE	TYPE/DATA	NOTES
Thyristor for DCS800-S01, 2-Q	6	-	3ADC340046P0002	5STP 3328Lxxx	
Thyristor for DCS800-S02, 4-Q	-	6	3ADC340079P0001	5 STB 24-Qxxx	Bidirectional-Controlled-Thyristor (BCT)
Puls transformer board	1	-	3ADT220090R0043	SDCS-PIN-48	SDCS-PIN-48 replaces SDCS-PIN-41
Puls transformer board	-	2	3BSE004939R1003	SDCS-PIN-46	only used for BCT's
Semiconductor fuses	12	12	3ADC770009P0012	UR 1100 A / 1250 V	Screw type fuse (double fuses)
Cooling fan	1	1	3ADT754008P0002	GR31M...(690V)	525 V - 690 V / 50/60 Hz

Module contains: 2-Q 4-Q

49.00 DCS800-S01-3000-08 & DCS800-S02-3000-08 (800 V)					
DESCRIPTION	2-Q	4-Q	CODE	TYPE/DATA	NOTES
Thyristor for DCS800-S01, 2-Q	6	-	3ADC340046P0002	5STP 3328Lxxx	
Thyristor for DCS800-S02, 4-Q	-	6	3ADC340079P0001	5 STB 24-Qxxx	Bidirectional-Controlled-Thyristor (BCT)
Puls transformer board	1	-	3ADT220090R0043	SDCS-PIN-48	SDCS-PIN-48 replaces SDCS-PIN-41
Puls transformer board	-	2	3BSE004939R1003	SDCS-PIN-46	only used for BCT's
Semiconductor fuses	12	12	3ADC770009P0012	UR 1100 A / 1250 V	Screw type fuse (double fuses)
Cooling fan	1	1	3ADT754008P0001	GR31M...(500V)	400 V - 500 V / 50/60 Hz

Item 50.00 to 65.00**Modules D7, 2050 A - 5200 A, 400 V, 500 V, 600 V, 690 V, 800 V, 990 V and 1200 V**

50.00 Common parts for modules D7, 2050 A - 5200 A					
DESCRIPTION	2-Q	4-Q	CODE	TYPE/DATA	NOTES
Control Board	1	1	3ADT313900R1001	SDCS-CON-4	
Power supply board	1	1	3ADT315100R1001	SDCS-POW-4	
Puls transformer board	1	2	3ADT220090R0043	SDCS-PIN-48	SDCS-PIN-48 replaces SDCS-PIN-41
Power interface board	1	1	3ADT220090R0006	SDCS-PIN-51	
Air Flow detector (P1)	1	1	DCF 1066659P0001	P233 A-4 AHC	
Temperatur Sensor (R57)	1	1	DCA0012139P0005	KTY 10-6 -M4	cable 1750 mm
Current Transformer 4000 / 1 A	2	2	3ADT751007P0001	4000/1A	T51 / T52 for D7
Cooling fan	1	1	3ADT754020P0001	GR 35C	400 V - 690 V / 50/60 Hz

Module contains: 2-Q 4-Q

51.00 DCS800-S01-2050-10 & DCS800-S02-2050-10 (990 V)					
DESCRIPTION	2-Q	4-Q	CODE	TYPE/DATA	NOTES
Thyristor	6	12	3ADC340086P0001	TV 989-2700-xxx	
Semiconductor fuses	6	6	3ADC770030P0003	UR 1800 A / 1250 V	Flush-end contact fuse

Module contains:		2-Q	4-Q			
52.00	DCS800-S01-2600-10 & DCS800-S02-2600-10 (990 V)					
DESCRIPTION	2-Q	4-Q	CODE	TYPE/DATA	NOTES	
Thyristor	6	12	3ADC340086P0001	TV 989-2700-xxx		
Semiconductor fuses	6	6	3ADC770030P0003	UR 1800 A / 1250 V	Flush-end contact fuse	

Module contains:		2-Q	4-Q			
53.00	DCS800-S01-3300-12 & DCS800-S02-2600-12 (1200 V)					
DESCRIPTION	2-Q	4-Q	CODE	TYPE/DATA	NOTES	
Thyristor	6	12	DCA0012066P0001	5 STP 28Lxxx		
Power Interface U>=750 VAC	1	1	3ADT780007R0002	SDCS-PIN-5x-1190 meas.	Prepared for galvanic isolation (A92)	
Semiconductor fuses	6	6	3ADC770025P0001	UR 1700 A / 1500 V	Flush-end contact fuse	

Module contains:		2-Q	4-Q			
54.00	DCS800-S01-3300-04/05 & DCS800-S02-3300-04/05 (400 V - 500 V)					
DESCRIPTION	2-Q	4-Q	CODE	TYPE/DATA	NOTES	
Thyristor	6	12	3ADC340089P0001	T 989-3030xxx		
Semiconductor fuses	6	6	DCA0012821P0001	UR 2500 A / 660 V	Flush-end contact fuse	

Module contains:		2-Q	4-Q			
55.00	DCS800-S01-3300-06/07 & DCS800-S02-3300-06/07 (600 V - 690 V)					
DESCRIPTION	2-Q	4-Q	CODE	TYPE/DATA	NOTES	
Thyristor	6	12	3ADC340087P0001	TV 989-2770xxx		
Semiconductor fuses	6	6	DCA0012856P0001	UR 2500 A / 1000 V	Flush-end contact fuse	

Module contains:		2-Q	4-Q			
56.00	DCS800-S01-3300-08 & DCS800-S02-3300-08 (800 V)					
DESCRIPTION	2-Q	4-Q	CODE	TYPE/DATA	NOTES	
Thyristor	6	12	3ADC340087P0001	TV 989-2770xxx		
Semiconductor fuses	6	6	DCA0012856P0001	UR 2500 A / 1000 V	Flush-end contact fuse	

Module contains:		2-Q	4-Q			
57.00	DCS800-S01-3300-10 & DCS800-S02-3300-10 (990 V)					
DESCRIPTION	2-Q	4-Q	CODE	TYPE/DATA	NOTES	
Thyristor	6	12	3ADC340084P0001	5 STP 38 Qxxx		
Semiconductor fuses	6	6	3ADC770030P0005	UR 2500 A / 1250 V	Flush-end contact fuse	

Module contains:		2-Q	4-Q			
58.00	DCS800-S01-3300-12 & DCS800-S02-3300-12 (1200 V)					
DESCRIPTION	2-Q	4-Q	CODE	TYPE/DATA	NOTES	
Thyristor	6	12	3ADC340084P0001	5 STP 38 Qxxx		
Power Interface U>=750 VAC	1	1	3ADT780007R0002	SDCS-PIN-5x-1190 meas.	Prepared for galvanic isolation (A92)	
Semiconductor fuses	6	6	3ADC770030P0006	UR 2300 A / 1500 V	Flush-end contact fuse	

Module contains:		2-Q	4-Q			
59.00	DCS800-S01-4000-04/05 & DCS800-S02-4000-04/05 (400 V - 500 V)					
DESCRIPTION	2-Q	4-Q	CODE	TYPE/DATA	NOTES	
Thyristor	6	12	3ADC340088P0001	T 989-3300xxx		
Semiconductor fuses	6	6	DCA0012830P0001	UR 3000 A / 660 V	Flush-end contact fuse	

Module contains: 2-Q 4-Q

60.00 DCS800-S01-4000-06/07 & DCS800-S02-4000-06/07 (600 V - 690 V)					
DESCRIPTION	2-Q	4-Q	CODE	TYPE/DATA	NOTES
Thyristor	6	12	3ADC340046P0002	5 STP 3328 Lxxx	
Semiconductor fuses	6	6	3ADC770030P0002	UR 3000 A / 1000 V	Flush-end contact fuse

Module contains: 2-Q 4-Q

61.00 DCS800-S01-4000-08 & DCS800-S02-4000-08 (800 V)					
DESCRIPTION	2-Q	4-Q	CODE	TYPE/DATA	NOTES
Thyristor	6	12	3ADC340046P0002	5 STP 3328 Lxxx	
Semiconductor fuses	6	6	3ADC770030P0002	UR 3000 A / 1000 V	Flush-end contact fuse

Module contains: 2-Q 4-Q

62.00 DCS800-S01-4000-10 & DCS800-S02-4000-10 (990 V)					
DESCRIPTION	2-Q	4-Q	CODE	TYPE/DATA	NOTES
Thyristor	6	12	3ADC340084P0001	5 STP 38 Qxxx	
Semiconductor fuses	6	6	3ADC770030P0005	UR 2500 A / 1250 V	Flush-end contact fuse

Module contains: 2-Q 4-Q

62.10 DCS800-S01-4000-12 & DCS800-S02-4000-12 (1200 V)					
DESCRIPTION	2-Q	4-Q	CODE	TYPE/DATA	NOTES
Thyristor	6	12	3ADC340084P0001	5 STP 38 Qxxx	
Power Interface U>=750 VAC	1	1	3ADT780007R0002	SDCS-PIN-5x-1190 meas.	Prepared for galvanic isolation (A92)
Semiconductor fuses	6	6	3ADC770030P0006	UR 3300 A / 1500 V	Flush-end contact fuse

Module contains: 2-Q 4-Q

63.00 DCS800-S01-4800-06/07 & DCS800-S02-4800-06/07 (600 V - 690 V)					
DESCRIPTION	2-Q	4-Q	CODE	TYPE/DATA	NOTES
Thyristor	6	12	3ADC340083P0001	5 STP 45 Qxxx	
Semiconductor fuses	6	6	3ADC770030P0002	UR 3000 A / 1000 V	Flush-end contact fuse

Module contains: 2-Q 4-Q

64.00 DCS800-S01-4800-08 & DCS800-S02-4800-08 (800 V)					
DESCRIPTION	2-Q	4-Q	CODE	TYPE/DATA	NOTES
Thyristor	6	12	3ADC340083P0001	5 STP 45 Qxxx	
Semiconductor fuses	6	6	3ADC770030P0002	UR 3000 A / 1000 V	Flush-end contact fuse

Module contains: 2-Q 4-Q

65.00 DCS800-S01-5200-04/05 & DCS800-S02-5200-04/05 (400 V - 500 V)					
DESCRIPTION	2-Q	4-Q	CODE	TYPE/DATA	NOTES
Thyristor	6	12	3ADC340083P0001	5 STP 45 Qxxx	
Semiconductor fuses	6	6	3ADC770030P0001	UR 3500 A / 6900 V	Flush-end contact fuse

DCS800 family



DCS800-S modules

The versatile drive for any application

20 ... 5,200 A_{DC}
0 ... 1,160 V_{DC}
230 ... 1,000 V_{AC}
IP00

- Compact
- Highest power ability
- Simple operation
- Comfortable assistants, e.g. for commissioning or fault tracing
- Scalable to all applications
- Free programmable by means of integrated IEC61131-PLC



DCS800-A enclosed converters

Complete drive solutions

20 ... 20,000 A_{DC}
0 ... 1,500 V_{DC}
230 ... 1,200 V_{AC}
IP21 – IP54

- Individually adaptable to customer requirements
- User-defined accessories like external PLC or automation systems can be included
- High power solutions in 6- and 12-pulse up to 20,000 A, 1,500 V
- In accordance to usual standards
- Individually factory load tested
- Detailed documentation



DCS800-E series

Pre-assembled drive-kits

20 ... 2,000 A_{DC}
0 ... 700 V_{DC}
230 ... 600 V_{AC}
IP00

- DCS800 module with all necessary accessories mounted and fully cabled on a panel
- Very fast installation and commissioning
- Squeezes shut-down-times in revamp projects to a minimum
- Fits into Rittal cabinets
- Compact version up to 450 A and Vario version up to 2,000 A



DCS800-R Rebuild Kit

Digital control-kit for existing powerstacks

20 ... 20,000 A_{DC}
0 ... 1,160 V_{DC}
230 ... 1,200 V_{AC}
IP00

- Proven long life components are re-used, such as power stacks, (main) contactors, cabinets and cabling / busbars, cooling systems
- Use of up-to-date communication facilities
- Increase of production and quality
- Very cost-effective solution
- Open Rebuild Kits for nearly all existing DC drives
- tailor-made solutions for...
 - BBC PxD
 - BBC SZxD
 - ASEA TYRAK
 - other manufacturers



ABB Automation Products GmbH
Wallstadter Straße 59
68526 Ladenburg • GERMANY
Tel: +49 (0) 6203-71 0
Fax: +49 (0) 6203-71 7609
www.abb.com/motors&drives



195R0401A9370000

Ident. No.: 3ADW 000 195 R0501 Rev E
02_2011