

UltraProteus

Operation Manual

© 1994 E-mu Systems, Inc.

All Rights Reserved

FI434 Rev. A

Manual - Riley Smith

E-mu World Headquarters
E-mu Systems, Inc. U.S.A.
P.O. Box 660015
Scotts Valley, CA USA
95067-0015
Telephone: 408-438-1921
Fax: 408-438-8612

Europe, Africa, Middle East
E-mu Systems, Ltd.
Suite 6, Adam Ferguson House
Eskmills Industrial Park
Musselburgh, East Lothian
Scotland, EH21 7PQ
Telephone: 44-31-653-6556
Fax: 44-31-665-0473

Important Notice:

In order to obtain warranty service on your UltraProteus unit, the serial number sticker must be intact and you must have a sales receipt or other proof of purchase. If there is no serial number sticker on UltraProteus, please contact E-mu Systems at once.

This product is covered under one or more of the following U. S. patents: 3,969,682; 3,986,423; 4,404,529; 4,506,579; 4,699,038; 4,987,600; 5,013,105; 5,072,645; 5,111,727 and foreign patents and/or pending patents. UltraProteus is a registered trademark of E-mu Systems, Inc.

IMPORTANT SAFETY INSTRUCTIONS

Use in countries other than the U.S.A. may require the use of a different line cord or attachment plug, or both. To reduce the risk of fire or electric shock, refer servicing to qualified service personnel. To reduce risk of fire or electric shock do not expose this product to rain or moisture.

GROUNDING INSTRUCTIONS

This product must be grounded. If it should malfunction or break down, grounding provides a path of least resistance for electric current, reducing the risk of electric shock. This product is equipped with a cord having an equipment-grounding conductor and a grounding plug. The plug must be plugged into an appropriate outlet properly installed and grounded in accordance with all local codes and ordinances.

DANGER

Improper connection of equipment grounding conductor can result in the risk of electric shock. Check with a qualified electrician or service personnel if you are in doubt as to whether the product is properly grounded. Do not modify the plug provided with this product — if it will not fit the outlet, have a proper outlet installed by a qualified technician.

CAUTION

If the UltraProteus (model number 9053), is rack mounted, a standard 19-inch open frame rack must be used.

USER-MAINTENANCE INSTRUCTIONS

1. UltraProteus should be kept clean and dust free. Periodically wipe the unit with a clean, lint free cloth. Do not use solvents or cleaners.
2. There are no user lubrication or adjustment requirements.
3. Refer all other servicing to qualified service personnel.

INSTRUCTIONS PERTAINING TO A RISK OF FIRE, ELECTRIC SHOCK, OR INJURY TO PERSONS

WARNING; When using electric products, basic precautions should always be followed, including the following:

1. Read all instructions before using UltraProteus.
2. To reduce the risk of injury, close supervision is necessary when UltraProteus is used near children.
3. Do not use UltraProteus near water — for example near a bathtub, washbowl, kitchen sink, in a wet basement, on a wet bar, or near or in a swimming pool.
4. UltraProteus should be situated so that its location or position does not interfere with its proper ventilation.

In this document, whenever the word “UltraProteus” is mentioned, we are referring to the UltraProteus Synthesizer by E-mu Systems, Inc.



This symbol is intended to alert the user to the presence of important operating and maintenance (servicing) instructions in the literature accompanying the appliance.

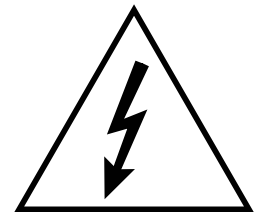

This symbol is intended to alert the user to the presence of uninsulated dangerous voltage within the product's enclosure that may be of sufficient magnitude to constitute a risk of electric shock to persons.

SAVE THESE INSTRUCTIONS

5. UltraProteus should be located away from heat sources such as radiators, heat registers, fireplaces, stoves, or ovens.
6. UltraProteus should only be connected to a power supply of the type described in the operating instructions and as marked on the product.
7. This product, in combination with an amplifier, headphones, and speakers, may be capable of producing sound levels that could cause full or partial hearing loss or damaged equipment. Do not operate for long periods of time at high volume levels or at a level that is uncomfortable. Additionally, care must be taken when programming any of the filters contained herein using extreme operating parameters. This action could also produce signals which result in unacceptable high sound levels as noted previously. If you experience any hearing loss or ringing of the ears consult your physician.
8. UltraProteus may be equipped with a polarized line plug (one blade wider than the other). This is a safety feature. If you are unable to insert this plug into the outlet, do not defeat the safety purpose of the plug. Contact an electrician to replace your obsolete outlet.
9. The power supply cord of UltraProteus should be unplugged from the outlet when left unused for a long period of time.
10. Care should be taken so that objects do not fall and liquids are not spilled into the enclosure of UltraProteus through openings.
11. The product should be serviced by qualified service personnel when:
 - A. The power supply cord has been damaged; or
 - B. Objects have fallen on, or liquid has been spilled into the product; or
 - C. The product has been exposed to rain; or
 - D. The product does not appear to operate normally or exhibits a marked change in performance; or
 - E. The product has been dropped or the enclosure damaged.
12. All servicing should be referred to qualified service personnel.

SAVE THESE INSTRUCTIONS

INTRODUCTION & BASIC SETUP	1
<i>Introduction</i>	3
<i>Getting Started</i>	4
<i>Connection Instructions</i>	5
<i>Background - About Sampling</i>	9
BASIC OPERATION	11
<i>Main Controls</i>	12
<i>Selecting MIDI Channels</i>	14
<i>Selecting Presets/Hyperpresets</i>	14
<i>Adjusting Volume & Pan Position</i>	14
<i>Memory Card</i>	15
<i>Midimap Selection</i>	15
<i>Multi-Timbral Operation</i>	16
<i>Playing the Demo Sequences</i>	16
<i>Master Menu</i>	17
<i>Enabling the Master Menu</i>	19
<i>Master Tune</i>	19
<i>Transpose</i>	19
<i>User Key Tuning</i>	20
<i>Global Bend</i>	20
<i>Global Velocity Curve</i>	20
<i>MIDI Mode</i>	22
<i>MIDI Mode Change</i>	22
<i>MIDI Program Change Map</i>	23
<i>MIDI Controller Assign</i>	24
<i>MIDI Footswitch Control</i>	24
<i>Send MIDI Data</i>	24
<i>Sysex Packet Delay</i>	25
<i>Proteus Sysex</i>	26
<i>Auto Select</i>	26
<i>Compare Mode</i>	26
<i>Viewing Angle</i>	26
<i>Midimap Menu</i>	27
<i>The Midimap</i>	29
<i>Enabling the Midimap Menu</i>	30
<i>Midimap Select</i>	30
<i>Midimap Name</i>	31
<i>Program to Channel Assign</i>	31
<i>Volume, Pan & Output Mix</i>	31

MIDIMAP MENU (cont)

<i>MIDI Enables</i>	33
<i>Bank Select</i>	33
<i>Program Map Select</i>	34
<i>FX A</i>	34
<i>FX B</i>	35
<i>FX Amount</i>	35
<i>FX Output Select</i>	36
<i>Save Midimap</i>	36

EFFECTS SECTION

37

<i>Where are the Effects?</i>	39
<i>Effects Output Routing</i>	40
<i>UltraProteus Effects Bus Architecture</i>	40
<i>Effect Programming Instructions</i>	41
<i>Reverb</i>	42
<i>Stereo Flanger</i>	46
<i>Stereo Phaser</i>	48
<i>Stereo Chorus</i>	49
<i>Stereo Delay</i>	50
<i>Stereo Cross Delay</i>	51
<i>Stereo Echo</i>	52
<i>"B" Effects</i>	53
<i>Stereo Fuzz</i>	54
<i>Ring Modulator</i>	55

HYPERPRESET MENU

57

<i>The Hyperpreset</i>	59
<i>Enabling the Hyperpreset Menu</i>	59
<i>Hyperpreset Name</i>	60
<i>Preset to Zone Assignment</i>	60
<i>Zone Volume and Pan</i>	61
<i>Zone Key Range</i>	61
<i>Zone Velocity Range</i>	62
<i>Zone Velocity Offset</i>	63
<i>Zone Transpose</i>	63
<i>Zone Pitch Tune</i>	63
<i>Hyperpreset Portamento Mode</i>	64
<i>Free-Run Function Generator</i>	64
<i>Save Hyperpreset</i>	66

PRESET PROGRAMMING	67
<i>Starting to Program</i>	69
<i>Modulation</i>	70
<i>Modulation Sources</i>	71
<i>Footswitch Modulation</i>	72
<i>Midipatch</i>	72
<i>Envelope Generators</i>	73
<i>Low Frequency Oscillators</i>	75
<i>Function Generators</i>	76
<i>Filter Modulation</i>	84
<i>Parametric Filters</i>	87
<i>The UltraProteus Filter</i>	88
<i>The Z-Plane Filter</i>	89
<i>Another View</i>	92
<i>UltraProteus Signal Flow</i>	93
<i>Note-On Modulation Control</i>	94
<i>Realtime Modulation Control</i>	95
<i>Key Number</i>	96
<i>Velocity Curves</i>	96
<i>MIDI Realtime Controls</i>	97
PRESET MENU	99
<i>Enabling the Preset Menu</i>	101
<i>Preset Name</i>	102
<i>Primary Instrument</i>	102
<i>Secondary Instrument</i>	102
<i>Volume</i>	103
<i>Pan</i>	103
<i>Key Range</i>	103
<i>Primary Key Range</i>	104
<i>Secondary Key Range</i>	104
<i>Transpose</i>	105
<i>Coarse Pitch Tuning</i>	105
<i>Fine Pitch Tuning</i>	105
<i>Alternate Envelope On/Off</i>	105
<i>Primary Alternate Envelope Parameters</i>	106
<i>Secondary Alternate Envelope Parameters</i>	106
<i>Double + Detune</i>	106
<i>Sound Delay</i>	107
<i>Sound Start</i>	107

PRESET MENU (cont)

<i>Sound Reverse</i>	107
<i>Nontranspose</i>	108
<i>Loop Enable</i>	108
<i>Loop Offset</i>	108
<i>Solo Mode</i>	109
<i>Solo Mode Priority</i>	110
<i>Portamento Rate</i>	110
<i>Portamento Shape</i>	110
<i>Portamento Mode</i>	111
<i>Crossfade Mode</i>	111
<i>Crossfade Direction</i>	112
<i>Crossfade Balance and Amount</i>	112
<i>Cross-switch Point</i>	113
<i>Primary Filter Type</i>	113
<i>Secondary Filter Type</i>	113
<i>Filter Level</i>	113
<i>Morph Offset</i>	114
<i>Filter Frequency Tracking</i>	114
<i>Filter Transform 2</i>	115
<i>Filter Reverse</i>	116
<i>Auxiliary Envelope</i>	116
<i>LFO 1 & 2 - Shape & Amount</i>	117
<i>LFO 1 & 2 - Rate, Delay & Variation</i>	117
<i>Function Generator 1 and 2</i>	118
<i>Note-On Modulation Control</i>	122
<i>Realtime Modulation Control</i>	123
<i>Footswitch Control</i>	124
<i>Pitch Bend Range</i>	124
<i>Pressure Amount</i>	124
<i>MIDI Controller Amount</i>	124
<i>Velocity Curve</i>	125
<i>Keyboard Center</i>	126
<i>Keyboard Tuning</i>	126
<i>Mix Select</i>	127
<i>Save Preset</i>	127

COPY MENU	129
<i>Enabling the Copy Menu</i>	131
<i>Copy Preset</i>	131
<i>Copy Layer</i>	132
<i>Copy Filter</i>	132
<i>Copy LFO</i>	132
<i>Copy Function Generator</i>	133
<i>Copy Auxiliary Envelope</i>	133
<i>Copy Note-On Control</i>	133
<i>Copy Realtime Control</i>	133
<i>Copy Hyperpreset</i>	134
<i>Copy Zone</i>	134
<i>Copy Free-Run Function Generator</i>	134
<i>Copy Midimap</i>	134
<i>Copy Channel</i>	135
<i>Copy Effects</i>	135
<i>Copy Program Change Map</i>	135
<i>Copy Bank</i>	136
STEP-BY-STEP	137
<i>Forward</i>	139
<i>Editing Presets</i>	139
<i>Starting From Scratch</i>	140
<i>The Instrument</i>	140
<i>Volume</i>	141
<i>Pan</i>	141
<i>Transpose</i>	141
<i>Coarse Tuning</i>	142
<i>Fine Tuning</i>	142
<i>Alternate Volume Envelope</i>	143
<i>Anatomy of an Envelope</i>	144
<i>Sound Delay</i>	145
<i>Sound Start</i>	145
<i>Application: Sound Splicing</i>	146
<i>Time to Save?</i>	147
<i>LFO Modulation</i>	147
<i>Modulating Modulators</i>	150
<i>The UltraProteus Filter</i>	151
<i>Just Do It</i>	152
<i>Filter Philosophy</i>	154

STEP-BY-STEP (cont)	
<i>Morphology</i>	<i>157</i>
<i>Using UltraProteus with a Sequencer</i>	<i>158</i>
<i>More Advanced Sequencing</i>	<i>159</i>
REFERENCE SECTION	161
<i>Factory RAM Presets - Bank 0</i>	<i>162</i>
<i>Factory ROM Presets - Bank 1</i>	<i>163</i>
<i>Instrument Listing</i>	<i>164</i>
<i>B3 Wave Diagrams</i>	<i>171</i>
<i>Instrument Locations</i>	<i>172</i>
<i>Percussion Instrument Locations</i>	<i>173</i>
<i>Z-Plane Filter Descriptions</i>	<i>178</i>
<i>Loop Offset Sample Locations</i>	<i>235</i>
<i>Function Generator Curves</i>	<i>239</i>
<i>Function Generator, LFO & Envelope Specifications</i>	<i>247</i>
<i>Technical Specifications</i>	<i>248</i>
<i>MIDI Implementation Chart</i>	<i>249</i>
<i>MIDI Specifications</i>	<i>250</i>
<i>SysEx Tutorial</i>	<i>277</i>
INDEX	281
WARRANTY	285

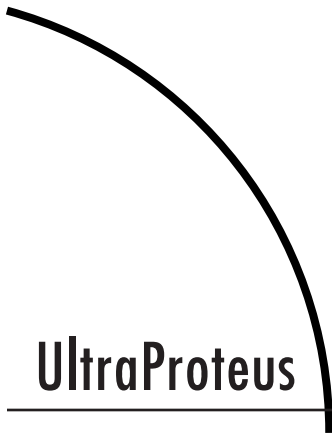
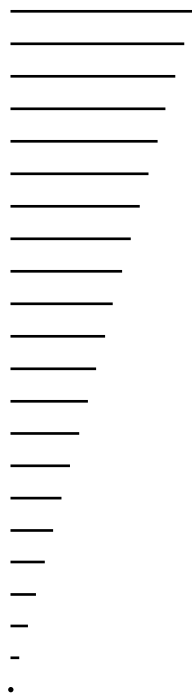

UltraProteus **INTRO/BASIC SETUP**



UltraProteus

UltraProteus is a new type of music synthesizer which upholds the legendary Proteus tradition of crystal-clear sounds while significantly furthering the evolution of electronic sound synthesis.

Many electronic instruments today involve the technology of sampling, where sounds are digitally recorded and played back at different pitches. Sampling has the advantage of highly accurate and realistic sound. One disadvantage of sampling is that once the sounds are recorded, it is difficult to change them in any significant way.

UltraProteus incorporates the E-mu Z-Plane filter, which has the ability to smoothly change its function over time. This ultra-powerful device can accurately simulate the resonance of musical instruments, the human voice or create entirely new timbres. The Z-Plane filter is composed of up to eight complex filters for unprecedented control over subtle aspects of the sound.

UltraProteus contains sixteen megabytes of Pop, Rock, Orchestral and World samples from the Proteus family of instruments. In addition, it includes hot new drum sounds, new waveforms, and the Proformance™ stereo grand piano. This amazing array of sounds can be combined or spliced, modulated and then shaped through one of 288 Z-Plane filters. Sampled sounds can be re-shaped and expressively controlled, allowing you to articulate the subtle nuances of complex instruments.

The 16 bit sound samples are arranged into 256 preset locations, 128 of which are user-programmable. 128 user-programmable *Hyperpresets* allow ultra-flexible keyboard mapping of presets. The optional memory card lets you create an expandable library of your favorite presets and hyperpresets.

UltraProteus features two studio-quality effects processors with 28 different effects to choose from. Hyperpresets allow you to have up to 32 different sounds on the keyboard at one time in any desired arrangement. Sounds can be placed side by side or layered with velocity control. The ability to respond multi-timbrally to all 16 MIDI channels makes UltraProteus ideally suited for multi-track sequencing and composing using a MIDI sequencer.

Other features include 3 stereo outputs for individually processing sounds (also configurable as 6 polyphonic submixes with fully programmable panning), integral sends and returns to allow the addition of external effects units without the need for a separate mixer, user definable alternate tuning, and of course, an extensive MIDI implementation.

THIS SYMBOL APPEARS THROUGHOUT THE MANUAL TO HIGHLIGHT ADDITIONAL INFORMATION RELATING TO THE OPERATION OF ULTRAPROTEUS.

THIS SYMBOL APPEARS THROUGHOUT THE MANUAL TO WARN YOU OF POTENTIALLY CONFUSING OPERATING PROCEDURES.

In its most basic form, UltraProteus is organized as shown in the diagram below. Complete acoustic instrument samples and electronically created sounds are used as raw material to form Presets.

The Preset is a complete set of all program functions and combinations for a complete UltraProteus sound. Each preset consists of one or two Instruments. An **Instrument** is a complete set of samples or a digital waveform which covers the entire keyboard range. An instrument can be assigned to each of the Primary and Secondary layers of the preset.

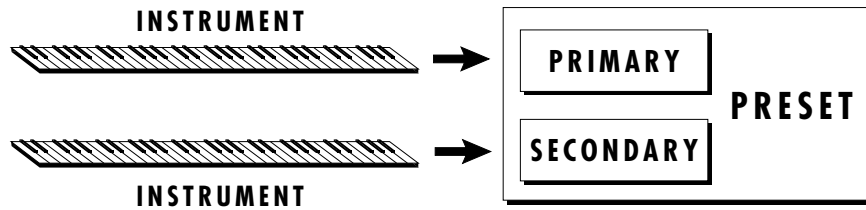

The primary and secondary layers of the preset are essentially two instruments with complete modulation controls. The memory is organized into banks of 128 programmable RAM presets, unalterable ROM presets and Hyperpresets.

- RAM PRESETS CAN BE MOVED, ERASED OR MODIFIED AS DESIRED.

- ROM PRESETS CANNOT BE MOVED OR ALTERED UNLESS THEY ARE FIRST COPIED TO A RAM LOCATION.

- HYPERPRESETS ARE GROUPS OF PRESETS ARRANGED ON THE KEYBOARD TO FORM SPLITS OR LAYERS.

- MEMORY CARD - ALLOWS YOU TO EASILY LOAD AND SAVE ADDITIONAL PRESETS AND HYPERPRESETS.

Bank	Contents
0	- RAM Presets
1	- ROM Presets
2	- RAM Hyperpresets
3	- Card Presets
4	- Card Hyperpresets

A **Hyperpreset** is a combination of up to sixteen presets arranged either side by side on the keyboard (to create a keyboard split) or on top of each other (to create a denser sound). Each preset in a hyperpreset is assigned to a keyboard Zone, with an associated key range, volume, pan, tuning and transpose setting. In addition, each zone can be assigned to a velocity range so that different presets can play depending on the key velocity. There are 128 Hyperpreset locations available to store your own custom keyboard setups.

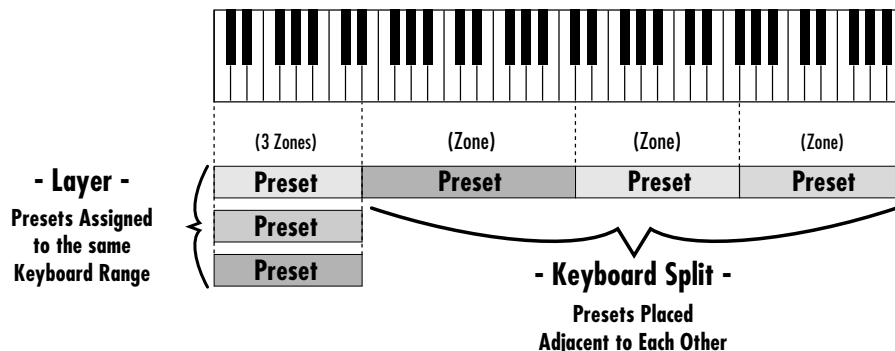

SETUP #1 BASIC SETUP

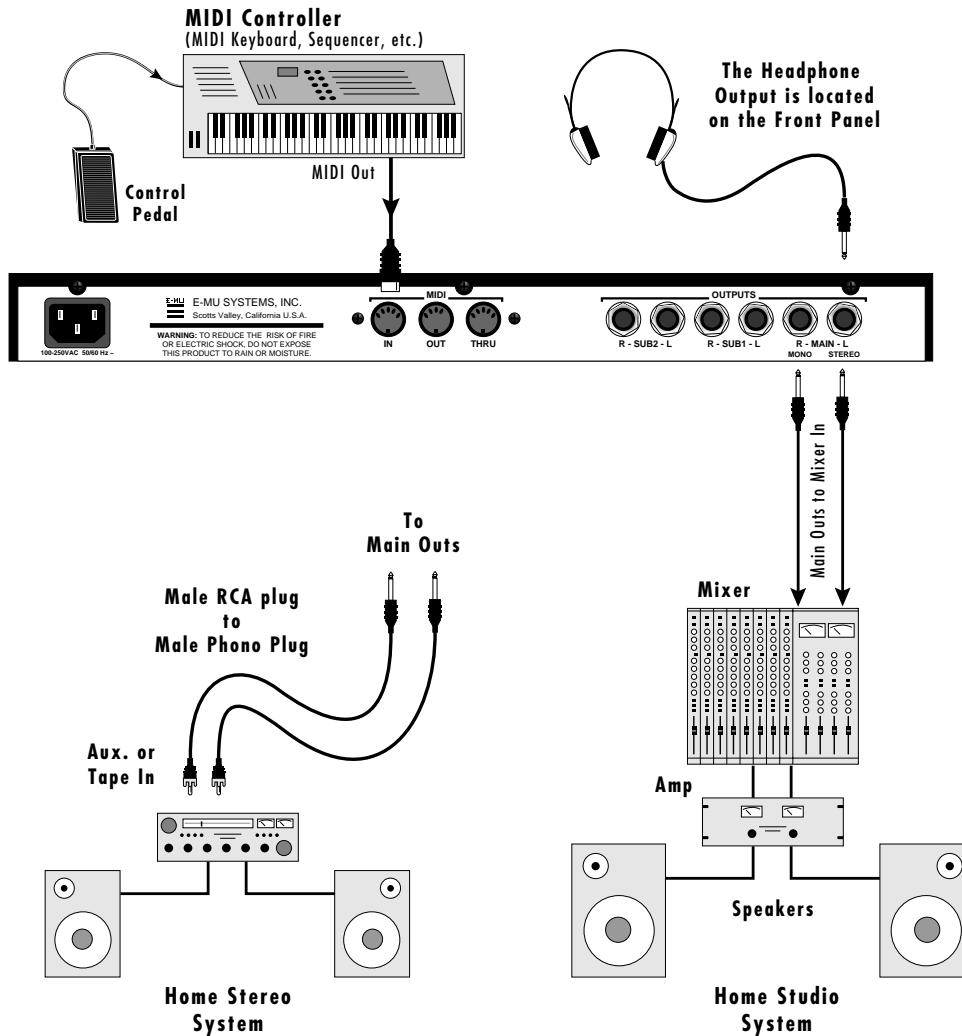

THE HEADPHONE OUTPUT MONITORS THE MAIN OUTPUTS ONLY. THE SUBMIX OUTPUTS DO NOT FEED INTO THE HEADPHONE OUTPUT.

IF ULTRAPROTEUS DOES NOT SEEM TO BE RESPONDING CORRECTLY, MAKE SURE THAT BOTH ULTRAPROTEUS AND YOUR MIDI CONTROLLER ARE SET TO THE SAME MIDI CHANNEL.

MIDI In

UltraProteus is controlled by MIDI messages received at the MIDI In connector. Connect the MIDI In of the UltraProteus to the MIDI Out connector of a MIDI controller such as a MIDI keyboard, MIDI wind controller or MIDI guitar controller.

Audio Outputs

UltraProteus is a high quality, stereo audio device. In order to reproduce its wide dynamic range and frequency response, use a high quality amplification and speaker system such as a keyboard amplifier or home stereo system. A stereo setup is highly desirable because of the added realism of stereophonic sound. Headphones can be used if an amplifier and speaker system is not available. Plug stereo headphones into the headphone jack located on the left side of the front panel. The Right Main output jack serves as a mono output when the Left Main plug is not plugged in. The Left Main output jack serves as a stereo output when the Right Main plug is not plugged in.

MOST ULTRAPROTEUS FACTORY PRESETS ARE PROGRAMMED TO RESPOND TO PEDAL CONTROL.

SET YOUR KEYBOARD TO TRANSMIT PEDAL ON CONTROLLER #4, OR SEE "MIDI REALTIME CONTROLLERS" IN THIS MANUAL FOR ADDITIONAL INFORMATION.

SETUP #2 STUDIO SETUP

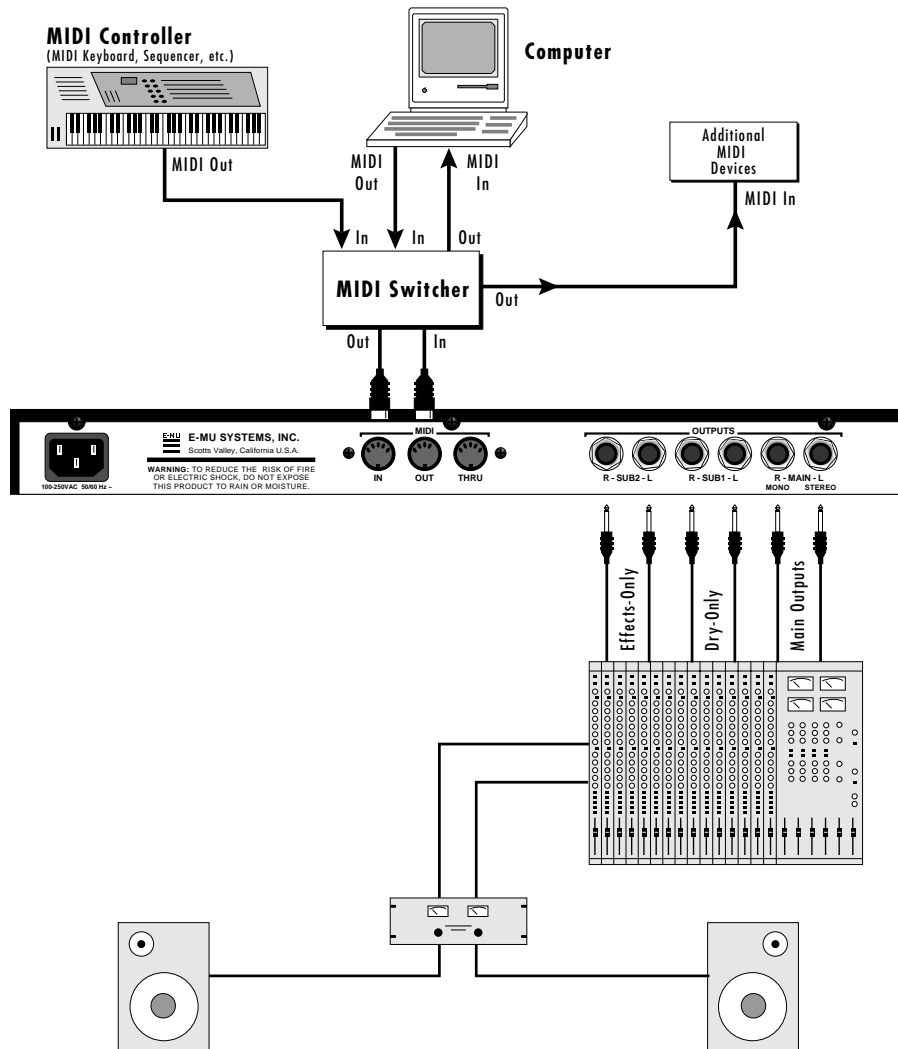

MANY OF THE ULTRAPROTEUS FACTORY PRESETS HAVE BEEN PROGRAMMED TO USE A FOOT PEDAL CONTROLLER. TO USE THIS EXCITING FEATURE, SET YOUR MIDI CONTROLLER TO TRANSMIT THE FOOTPEDAL ON CONTINUOUS CONTROLLER NUMBER 4. (This is the default value, which can be changed to any controller number.)

MIDI In

In this setup, UltraProteus is controlled by MIDI messages received at the MIDI In connector which have been routed by a MIDI switcher. The MIDI switcher allows any MIDI controller such as a MIDI keyboard, MIDI wind controller or a computer to be easily connected.

MIDI Out

The MIDI Out jack is normally used to transmit MIDI System Exclusive data to a computer or other device.

Audio Outputs

UltraProteus has three sets of programmable stereo outputs; Main, Sub 1, and Sub 2. Sub 1 is a non-effects output, Sub 2 is an effects-only output. Specific UltraProteus presets (or MIDI channels) can be routed to one of these stereo pairs in order to be further processed or mixed separately.

SETUP #3 PERFORMANCE SETUP

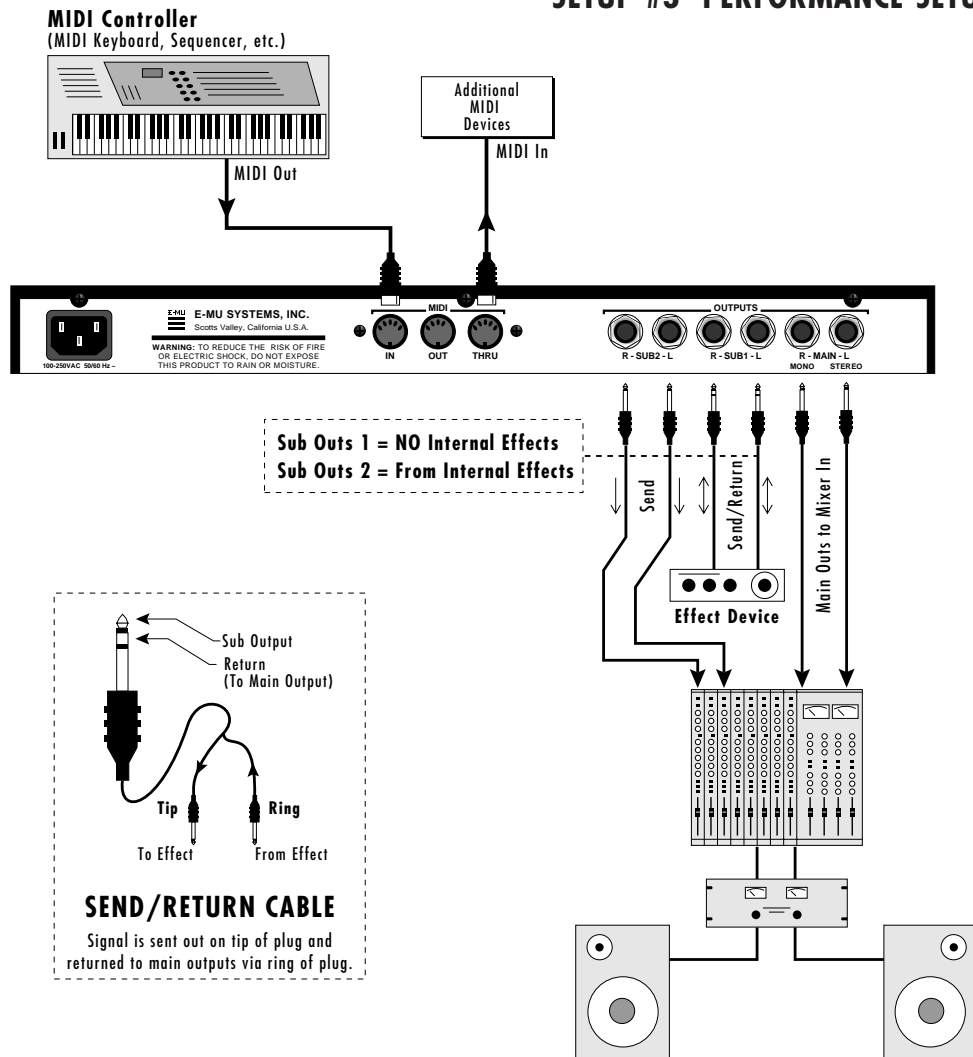

MIDI In

UltraProteus is controlled by MIDI messages received at the MIDI In connector. Connect the MIDI In of UltraProteus to the MIDI Out connector of a MIDI controller such as a MIDI keyboard, MIDI wind controller or MIDI guitar controller.

MIDI Thru

The MIDI Thru jack is used to connect additional MIDI devices onto the MIDI chain. MIDI Thru transmits an exact copy of the messages received at the MIDI In jack.

Audio Outputs

Each of the Sub 1 and Sub 2 output jacks on the UltraProteus are stereo jacks. The tip of each jack (accessed when a standard phone plug is inserted) is the left or right output of that group. If a stereo plug is inserted, the Ring of the stereo plug serves as a signal Return which sums into the Main outputs. The Sub 1 outputs bypass the internal effects. Sub 2 are the outputs of the internal effects.

Therefore, the Sub 1 and Sub 2 jacks can serve as effect sends and returns in order to further process selected instruments and then return them to the main mix.

The diagram shows the Sub 1 and Sub 2 jacks being used as send/returns in order to further process selected UltraProteus presets without using the effects bus on the mixing board. In a pinch, the effect returns could also be used to sum additional instruments into the main outputs.

UltraProteus Output Section

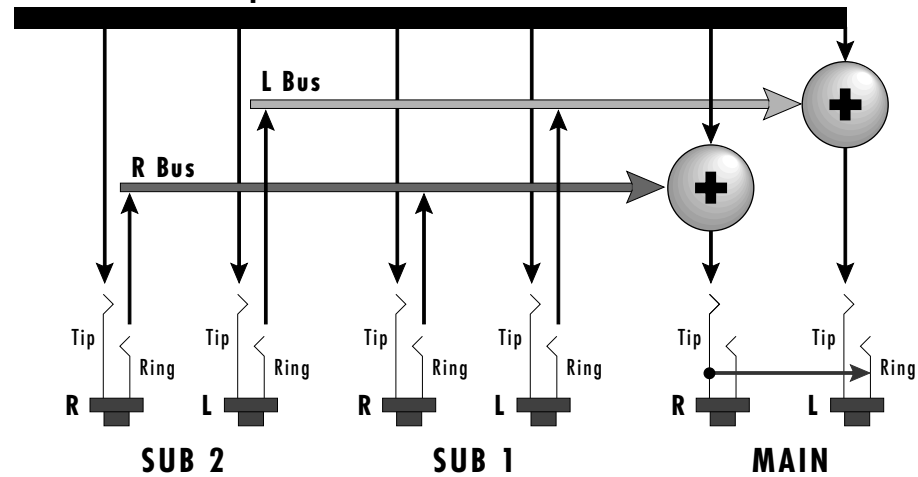

The Sub 1 and Sub 2 jacks can be used as effect returns to the Main Outputs.

POWER UP!

The power switch is located on the right side of the front panel. UltraProteus and its MIDI controller may be turned on in any order. When power is applied, the liquid crystal display will light, indicating that UltraProteus is operating. You may have noticed that there is no 110/220 Volt power selector switch on UltraProteus.

UltraProteus automatically switches itself for 110 or 220 Volt operation.

ABOUT SAMPLING

UltraProteus utilizes digital recording of acoustic sounds for the basis of each Instrument. This is similar to a tape recorder except that inside the UltraProteus, the sounds are permanently recorded on digital memory chips.

Sound and instrument waveforms are first sampled into the Emulator III, our top of the line, 16 bit stereo digital sampler. After the sounds and waveforms have been truncated, looped and processed, they are permanently encoded into the UltraProteus ROM (Read Only Memory) chips.

Conceptually, the sampling process is very simple, as shown in the Basic Sampling System diagram. As a sound wave strikes the diaphragm of a microphone, a corresponding voltage is generated. To sample the sound, the voltage level is repeatedly measured over time and the corresponding data values are stored in memory. To play the sound back, the numbers are read back out of memory, modified by the Z-plane filter, converted back into voltages, then amplified and fed to a speaker which converts the voltage back into sound waves. Of course, playing back 32 channels at different pitches tends to complicate matters, but this is basically how it works.

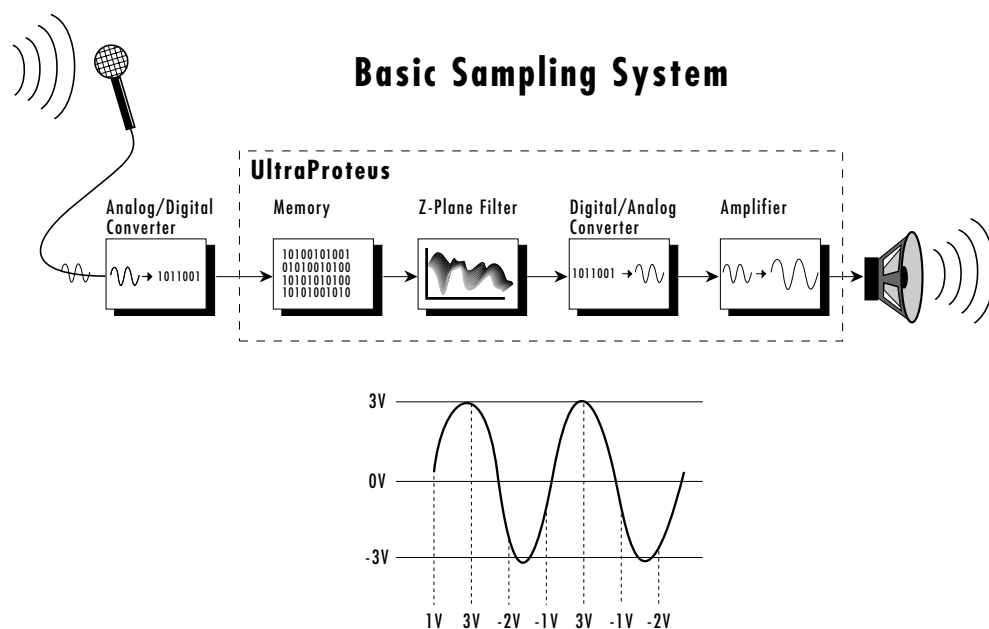

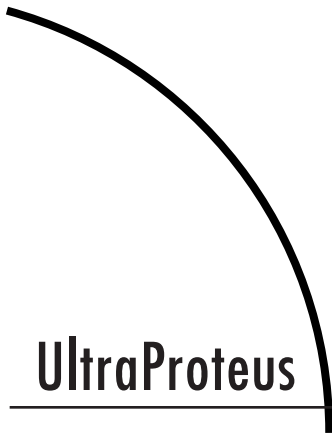
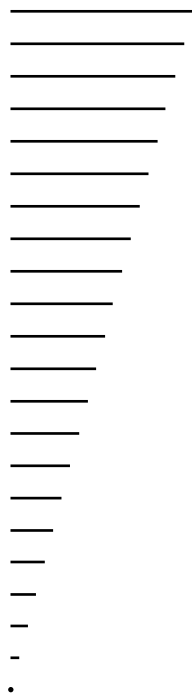

UltraProteus BASIC OPERATION



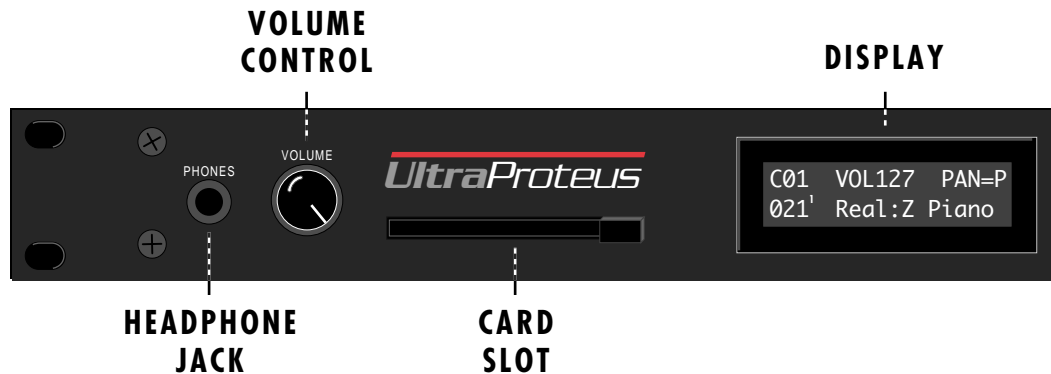

Volume Control

This is the master volume control for all audio outputs. Note: For maximum dynamic range, set this control at full level.

Card Slot

The card slot accepts RAM and ROM cards containing additional presets, hyperpresets and midimaps.

Master Menu Select Button

The Master menu contains global parameters which affect the entire machine. The LED to the left of the button indicates that you are in the Master menu.

Midimap Menu Select Button

A Midimap is a set of parameters used to configure UltraProteus to other MIDI gear such as a sequencer or keyboard setup. The 16 Midimaps contain digital effects setting as well as assignments of presets/hyperpresets to MIDI channels. An LED to the left of the button indicates that you are working in the Midimap menu.

Preset Menu Select Button

The Preset menu is used when you want to create or modify a preset. The LED to the left of the button indicates that you are working in the Preset menu. To **Compare** an edited preset with the unedited version, simply exit Preset Edit mode. The stored preset will be heard whenever the main screen is selected. Changing the preset will erase the edited version.

Hyperpreset Menu Select Button

The Hyperpreset menu is used to place presets at certain locations on the keyboard to create custom keyboard layouts. The LED to the left of the button indicates that you are working in the Hyperpreset menu.

THE COMPARE FEATURE MUST
BE TURNED ON IN THE
MASTER MENU.

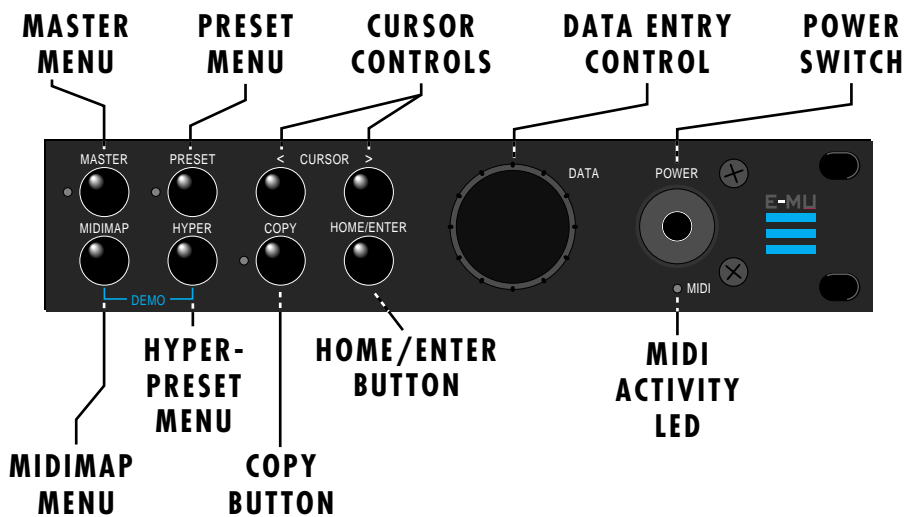

Demo Sequence Select

UltraProteus contains two play-only sequences to demonstrate the range of sounds. Press and hold the Midimap and the Hyperpreset buttons simultaneously to select the Demo Sequence selection screen.

Cursor Control

These buttons move the cursor to the next parameter on the display in a clockwise or counter-clockwise direction. (The cursor is the little flashing line underneath one of the parameters in the display.) Press either cursor control button repeatedly until the cursor is underneath the desired parameter.

Copy Button

The copy menu allows you to copy selected groups of parameters between Presets, Hyperpresets, and Midimaps.

Home/Enter Button

The Home/Enter button is used to confirm a particular operation or to return the cursor the “Home” position in the upper left corner (*main screen-lower left*). The LED flashes to indicate that UltraProteus is waiting for your response.

Data Entry Control

The data entry control is a stepped, variable control which is used to change parameter values. The control increments or decrements the current value one unit with each click. This control incorporates acceleration (values advance faster if the control is turned quickly).

Power Switch

Switches AC power to UltraProteus On and Off.

MIDI Activity LED

Indicates that MIDI data is being received.

YOU MUST HOLD THE MIDIMAP AND HYPERPRESET BUTTONS FOR APPROXIMATELY TWO SECONDS TO START THE DEMO SEQUENCES.

THE CURSOR CAN ALSO BE MOVED BIDIRECTIONALLY USING THE DATA ENTRY CONTROL WHILE THE RIGHT CURSOR BUTTON IS HELD DOWN. (I.E. PRESS AND HOLD THE CURSOR BUTTON AND TURN THE DATA ENTRY KNOB.)

IF ULTRAPROTEUS IS NOT RESPONDING PROPERLY OR PLAYS THE WRONG PRESET, MAKE SURE THAT BOTH ULTRAPROTEUS AND YOUR MIDI CONTROLLER ARE SET TO THE SAME MIDI CHANNEL AND THAT THE MIDI VOLUME IS TURNED UP.

FOR MORE INFORMATION ABOUT MIDI, SEE MIDI REALTIME CONTROLS ON PAGE 97.

Bank	Contents
0	- RAM Presets
1	- ROM Presets
2	- RAM Hyperpresets
3	- Card Presets
4	- Card Hyperpresets

CHANNEL PAN SHOULD NORMALLY BE SET TO "P" UNLESS REALTIME CONTROL OF PANNING IS DESIRED. IF PAN IS SET TO "0", STEREO EFFECTS CREATED IN THE PRESET WILL BE LOST.

MIDI CHANNEL SELECTION

Press the cursor key repeatedly until the cursor is underneath the channel number. (The cursor is the little flashing line underneath one of the parameters in the display.) Rotate the data entry control to select MIDI channel 01-16. As the channel is changed, the display will change to show the preset/hyperpreset, volume and pan associated with the displayed channel.

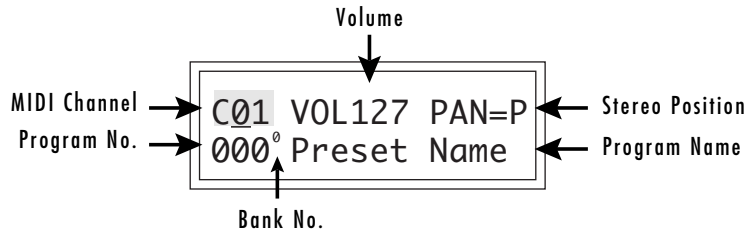

PRESET/HYPERPRESET (PROGRAM) SELECTION

Press the cursor key repeatedly (or press Home/Enter) until the cursor is underneath the program number. A Program is a Preset or a Hyperpreset. As the data entry control is rotated, the program number and name will change. The displayed program will be assigned to the displayed MIDI channel. Programs are arranged into banks of 128, as shown in the diagram at left. Banks can be selected independently of the program number by pressing the Home/Enter button while turning the data entry knob.

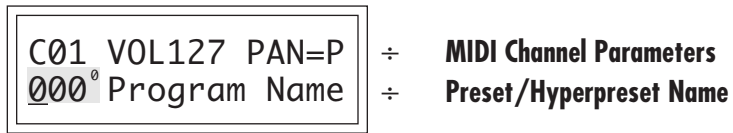

CHANNEL VOLUME

Press the cursor key repeatedly until the cursor is underneath the volume value. Rotate the data entry control to select volume 000-127. (This is the same parameter as MIDI volume control #7, and changes made over MIDI will be shown in the display.)

CHANNEL PAN

Press the cursor key repeatedly until the cursor is underneath the pan value. Rotate the data entry control to select pan values -7 to +7 or "P". When "P" is selected, the pan value specified in the preset is selected. Any other value will override the pan parameter in the preset. (This is the same parameter as MIDI pan control #10, and changes made over MIDI will be shown in the display.)

MEMORY CARD

The memory card is a convenient method of saving and transferring presets and hyperpresets. Insert the card firmly into the slot on the front panel with the label facing up. Press the eject button to release the card. A RAM card stores 128 presets, 128 hyperpresets and 16 midimaps. RAM cards may be *Write-Protected* by moving the little switch on the end of the card. If a memory card is NOT inserted, the display reads “ --noCard-- ” for banks 3 & 4 and the list of selectable midimaps shrinks to 16.

MIDIMAP SELECTION

A Midimap is a set of parameters which can be used as a pre-sequence setup, storing the program and other parameters for each MIDI channel or it could be used as an “Effects Preset”, since each Midimap stores a complete effects setup. There are 16 Midimaps in UltraProteus and an additional 16 Midimaps can be stored on a memory card.

To Select a Midimap

Press the Midimap key, lighting the LED. The current screen will be the one most recently selected since powering up UltraProteus. The first screen in the menu is Midimap Select. Move the cursor to the lower line and use the data entry control to select one of the 16 Midimaps. The Home/Enter LED will be flashing. Press the Home/Enter key to load the new Midimap.

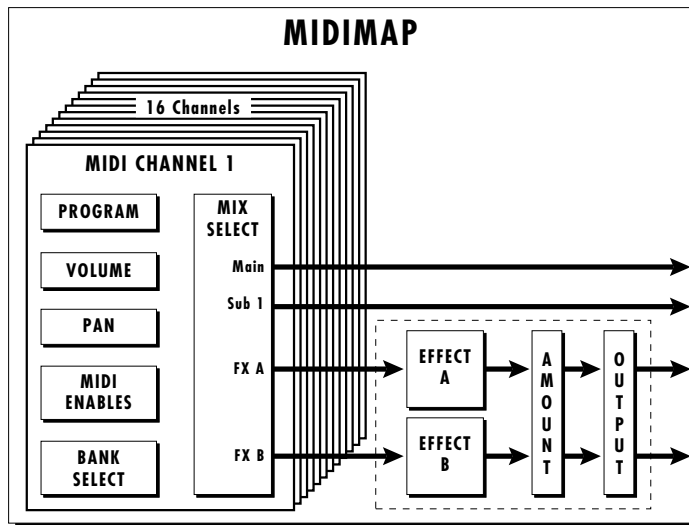
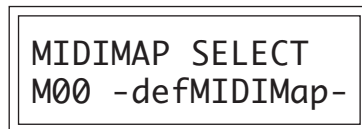

Simply scrolling through the list DOES NOT change the Midimap. You must move the cursor down to line two and press Enter. Try out the different Midimaps and notice that the effects change with each one.

RAM CARDS CAN BE USED TO STORE YOUR OWN PRESETS, HYPERPRESETS AND MIDIMAPS.

ROM CARDS CONTAIN PRE-RECORDED PRESETS, HYPERPRESETS AND MIDIMAPS. YOU CANNOT SAVE DATA TO A ROM CARD.

RAM CARDS NEED TO BE INITIALIZED BEFORE THEY ARE FIRST USED. THEY DISPLAY WILL PROMPT YOU TO INITIALIZE A BLANK CARD.

THE “CURRENT MIDIMAP” IS REMEMBERED ON POWER-DOWN, EVEN THOUGH YOU MAY NOT HAVE SAVED IT. THIS EFFECTIVELY GIVES YOU A TOTAL OF 17 INTERNAL MIDIMAPS.

MULTI-TIMBRAL OPERATION

Multi-timbral operation means that the UltraProteus can play more than one sound at the same time. To access multiple presets on different MIDI channels simultaneously, follow these instructions:

1. Set the MIDI mode to MULTI-Mode, using the MIDI mode function in the Master menu (page 22).
2. Decide which MIDI channels you wish the UltraProteus to receive, and turn “All Messages” Off for the MIDI channels that you DO NOT want UltraProteus to receive using the MIDI Enables in the Midimap menu (page 33). Turning “All Messages Off” turns that channel Off.

If you do not turn any channels Off, UltraProteus will receive all 16 MIDI channels simultaneously!

3. Select the desired preset or hyperpreset for each of the MIDI channels you wish the UltraProteus to receive using the Preset/Hyperpreset -> MIDI Channel selection screen in the Midimap menu (page 31).
4. Save the Midimap using the last screen in the Midimap menu.
5. UltraProteus will now respond multi-timbrally on the MIDI channels you have specified.
6. The effects can be programmed and each MIDI channel assigned to an effects bus if so desired. The volume and pan position can be adjusted for each MIDI channel in the Midimap Volume and Pan screen. Remember to SAVE the Midimap or all of your work will be LOST when you select another Midimap.

PLAYING THE DEMO SEQUENCES

UltraProteus contains a play-only sequencer with 2 different sequences to give you an idea of what is possible using this amazing instrument. Press and hold both the Midimap and Hyper buttons. The sequence will start momentarily. Press the Enter button to stop the sequence. Press the right cursor button to advance to the next sequence. Sequences will cycle automatically.

DEMO 1 2
ENTER=Stop >=Nxt

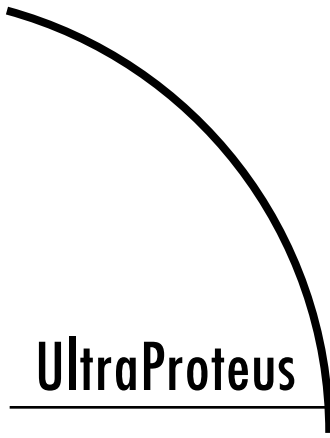
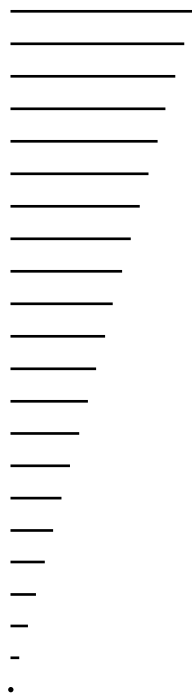

UltraProteus MASTER MENU



The Master menu contains functions that affect the overall operation of UltraProteus. For example, changing the Master Tune will change the tuning of all the presets, not just the one currently displayed.

To enable the Master menu

Press the Master button, lighting the LED. The current screen will be the one most recently selected since powering up UltraProteus. The Cursor will appear underneath the first character of the screen heading on line one.

To select a new screen

Press the Home/Enter button or press the Cursor key repeatedly until the cursor is underneath the screen title heading. Rotate the data entry control to select another screen.

To modify a parameter

Press the Cursor button repeatedly (or hold the right cursor key while turning the data entry control) until the cursor is underneath the parameter value. Rotate the data entry control to change the value.

To return to the main screen

Press the Master button, turning off the LED.

MASTER MENU FUNCTIONS

Master Tune

Master Tune adjusts the overall tuning of all presets so that UltraProteus can be tuned to other instruments. The master tuning range is ± 1 semitone in 1/64th semitone increments. A master tune setting of “+00” would indicate that the UltraProteus is perfectly tuned to concert pitch (A=440 Hz).

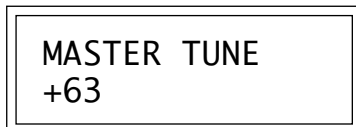

Transpose

This function transposes the key of UltraProteus in half-step intervals. The transpose range is ± 12 semitones or one octave.

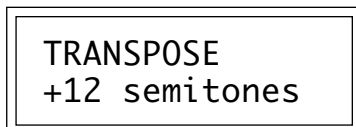

APPLICATION: THE USER KEY TUNING CAN BE USED TO TUNE INDIVIDUAL PERCUSSION INSTRUMENTS.

IT IS POSSIBLE TO TUNE THE PITCH UP SO HIGH THAT THE RANGE OF ULTRAPROTEUS' PITCH SHIFTER IS EXCEEDED. IF THE PITCH WILL NOT GO ANY HIGHER, TRY USING THE TRANSPOSE CONTROL INSTEAD OF COARSE TUNING.

IN ORDER FOR THE PITCH WHEEL TO CONTROL PITCH, IT MUST BE ROUTED TO THIS DESTINATION IN THE REALTIME MODULATION CONTROL SCREEN.

ALSO: THE AMOUNT PARAMETER IN THE MODULATION SCREEN WILL HAVE NO EFFECT WHEN THE PITCH WHEEL IS USED TO CONTROL PITCH.

User Key Tuning

In addition to standard twelve tone equal temperament, UltraProteus contains four additional preset tuning tables (Just C, Vallotti, 19 tone, and Gamelan) and one user definable tuning. User Key Tuning allows you to alter the parameters of the user definable tuning stored in memory. The initial frequency of every key can be individually tuned, facilitating the creation of microtonal scales. Using the cursor key and the data entry control, select the key name, the MIDI key number and the fine tuning. The key name is variable from C-2 to G8. Coarse Tuning (*which also happens to be the MIDI key number*) is variable from 0 to 127. The fine tuning is variable from 00 to 63 in increments of 1/64 of a semitone (approx. 1.56 cents). For each preset, the specific tuning table is selected in the Preset menu.

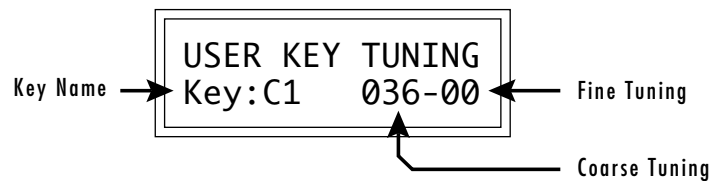

Global Bend

This function sets the range of the pitch wheel controller only when Pitch Wheel is routed to control pitch. The maximum pitch bend range is ± 12 semitones. This function only affects presets which have their individual pitch bend range set to global.



Global Velocity Curve

Incoming velocity data can be modified by a velocity curve in order to provide different types of dynamics in response to your playing or to better adapt to a MIDI controller. This function allows you to select one of eight global velocity curves or leave the velocity data unaltered (off). Global velocity curve only affects presets which have their individual velocity curve set to global.



GLOBAL VELOCITY CURVES

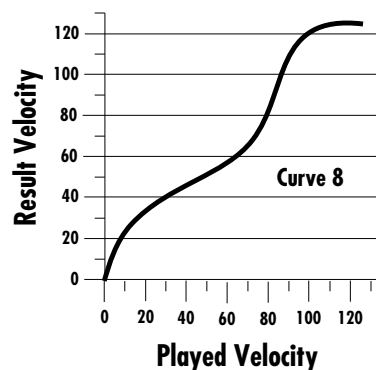
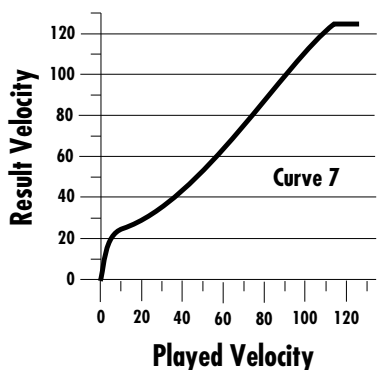
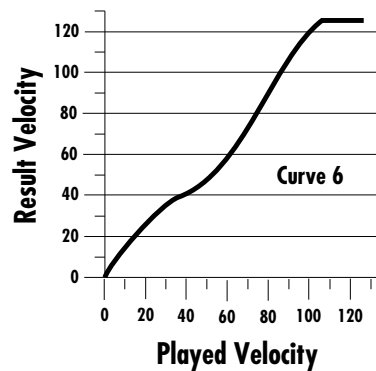
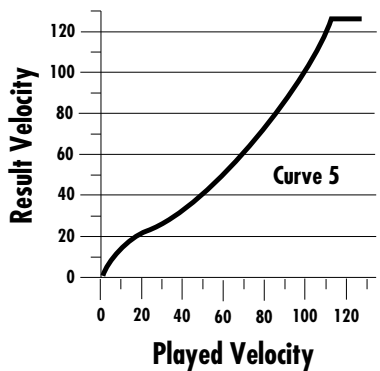
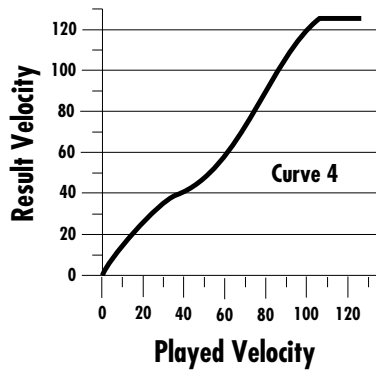
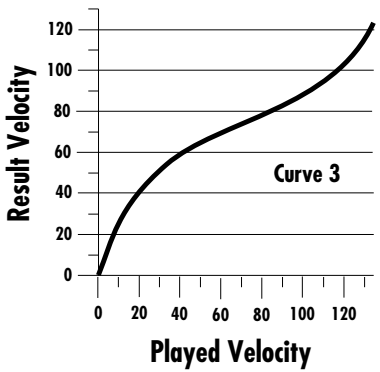
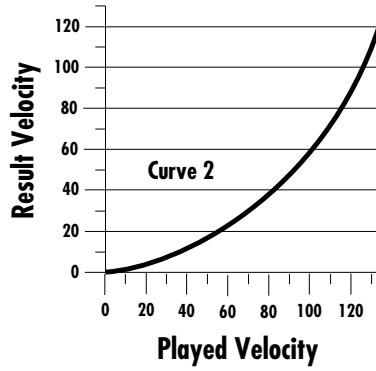
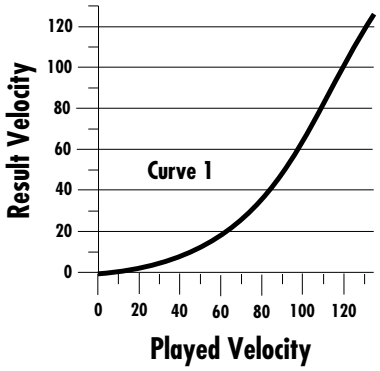

MONO MODE FUNCTIONS THE SAME WAY AS SOLO "WIND" MODE.

WARNING: MIDI SYSEX DATA WILL NOT BE TRANSFERRED BETWEEN TWO ULTRAPROTEUS UNITS UNLESS THE ID NUMBERS OF BOTH UNITS MATCH.

MIDI Mode

This function selects one of the four MIDI receive modes and the MIDI system exclusive ID number.

Omni mode

UltraProteus responds to note information on all MIDI channels and plays the preset currently displayed in the main screen.

Poly mode

UltraProteus only responds to note information received on the currently selected MIDI channel (the "basic channel", displayed on the main screen) and plays that channel's associated preset.

Multi mode

UltraProteus responds to data on any combination of MIDI channels and plays the specific preset associated with each of the MIDI channels.

Mono mode

UltraProteus responds to data on any combination of MIDI channels but plays each channel monophonically. If a new note on a channel is played before the last note is released, the envelopes will not be retriggered. Mono mode is particularly useful with alternate controllers such as MIDI guitars, etc.

Device ID

This function allows an external programming unit to distinguish between multiple UltraProteus units. In the case of multiple UltraProteus units, each unit should have a different device ID number.

MIDI MODE	ID
Omni	00

MIDI Mode Change

This function selects whether or not MIDI mode change commands are accepted or ignored when received over MIDI (see MIDI Mode).

MIDI MODE CHANGE Disabled

MIDI Program Change Map

Incoming MIDI program changes can be remapped to a different numbered preset. This is a handy feature when you want a specific MIDI program number sent from the master synth to be linked with a specific preset or hyperpreset on UltraProteus. For example, the Program Change Map could be set to call up preset 12 whenever UltraProteus receives program change number 26. Any preset or hyperpreset in UltraProteus can be mapped to any incoming MIDI program change number. There are four separate Program Change Maps available. This feature also allows you to call up presets in any bank, which are not accessible through a standard MIDI program change. Note: The Program Map only operates if it is selected in the Midimap and if the Bank Select function in the Midimap is set to bank 0.

PROG CHG MAP #1
026 > 012⁰

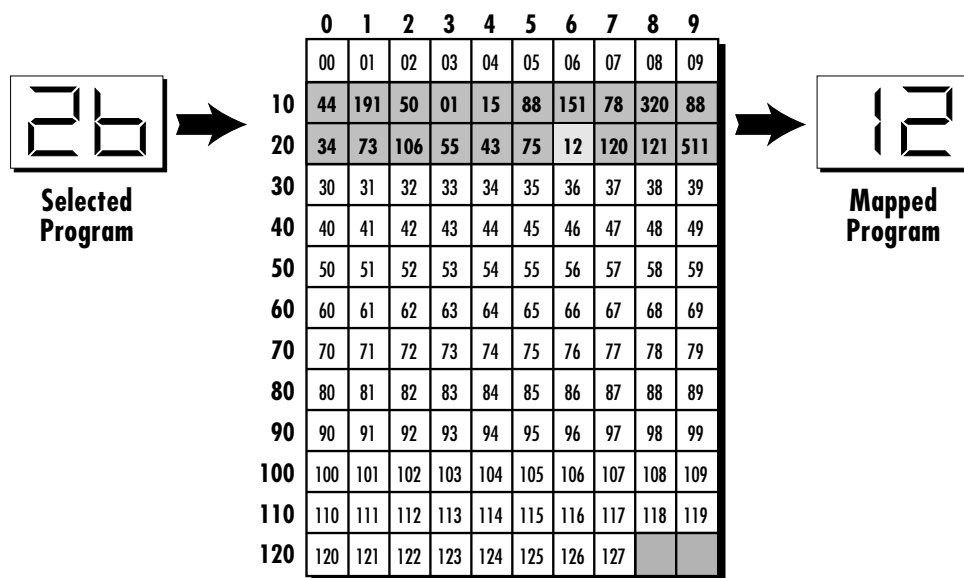

This chart shows how MIDI preset changes can be re-mapped. In this example, program changes 10-29 have been re-mapped. All other programs will be selected normally.

THE BANK SELECT FUNCTION IS LOCATED IN THE MIDIMAP MENU.

A FEW OF THE STANDARDIZED MIDI CONTROLLER NUMBERS ARE LISTED BELOW.

- 1 - MODULATION WHEEL OR LEVER
- 2 - BREATH CONTROLLER
- 3 - AFTERTOUCH: REV 1 DX7
- 4 - FOOT PEDAL
- 5 - PORTAMENTO TIME
- 6 - DATA ENTRY
- 7 - VOLUME
- 8 - BALANCE
- 9 - UNDEFINED
- 10 - PAN
- 11 - EXPRESSION

A FEW OF THE STANDARDIZED MIDI SWITCH NUMBERS ARE LISTED BELOW.

- 64 - SUSTAIN SWITCH (ON/OFF)
- 65 - PORTAMENTO (ON/OFF)
- 66 - SOSTENUTO (ON/OFF)
- 67 - SOFT PEDAL (ON/OFF)
- 69 - HOLD PEDAL 2 (ON/OFF)

WARNING: WHEN TRANSFERRING SYSEX DATA FROM ONE ULTRAPROTEUS TO ANOTHER, THE ID NUMBERS OF BOTH UNITS MUST MATCH.

MIDI Controller Assign

UltraProteus allows you to assign up to four realtime control sources from your MIDI controller. These control sources could be modulation wheels, data sliders or whatever. In this screen, you set up which controllers will be received by the UltraProteus. What effect the controller will have is programmed separately for each preset. The UltraProteus MIDI controllers are each assigned a letter, A-D. Each controller letter can be assigned to a MIDI realtime controller from 00-31. Note: If controller numbers 7 or 10 are selected, they will override the standard MIDI volume and pan control routings. For more information, see MIDI Realtime Controls in the Programming Basics section.

CONTROLLER#	A	B	C	D
01	02	03	04	

MIDI Footswitch Control

Like the MIDI Controllers, 3 MIDI footswitches can be assigned to MIDI footswitch numbers. Footswitches can be assigned numbers from 64-79. Destinations for the footswitch controllers are programmed in the Preset menu.

FOOTSW CTL#	1	2	3
64	65	66	

Send MIDI Data

This function will send MIDI System Exclusive data to the MIDI Out port of UltraProteus. The MIDI data can either be sent to a computer/sequencer or to another UltraProteus. Using the cursor key and the data entry control, select the type of MIDI data you wish to transmit.

SEND MIDI DATA
RAM Presets

The Enter LED will be flashing. Press the Enter button to confirm the operation. To receive MIDI data, simply send the MIDI data into UltraProteus from another UltraProteus or your sequencer. The choices are listed on the following page:

- RAM Presets** Transmits all the user RAM presets.
- ROM Presets** Transmits all the factory ROM presets.
- Card Presets** Transmits all the memory card presets.
- RAM Hypers** Transmits all the user RAM hyperpresets.
- Card Hypers** Transmits all the memory card hyperpresets.
- RAM MIDI Maps** Transmits all the user MIDI maps.
- Card MIDI Maps** Transmits all the memory card MIDI maps.
- Program Change Maps** Transmits all the program change maps.
- Master Settings** Transmits all parameters in the Master menu except tuning table, program change map & viewing angle. The “scratch” Midimap is also transmitted.
- Tuning Table** Transmits only the user tuning table.
- All RAM Data** Transmits all the user RAM data in the machine.
- Individual Program** Transmits only the specified preset or hyperpreset.
- Individual Midimap** Transmits only the specified midimap.
- Individual Program Change Map** Transmits the specified program map.

When Individual Programs, Midimaps or Program Change Maps are received via SysEx, they are placed in their proper locations.

Sysex Packet Delay

Errors can sometimes occur when transferring Sysex data from UltraProteus to a computer because the computer cannot process and store the incoming data fast enough. This function allows you to change the amount of delay between MIDI Sysex data packets so that the input buffer of your computer does not overflow. The default speed is 300 delay units. A setting of “000” allows full speed MIDI Sysex. If you are having data transmission errors, increase the delay until the problem disappears.

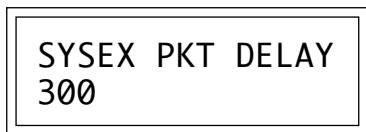

TO RECORD MIDI DATA INTO A SEQUENCER:
 1. SETUP SEQUENCER TO RECEIVE SYSTEM EXCLUSIVE DATA.
 2. PLACE SEQUENCER INTO RECORD MODE, THEN SEND MIDI DATA.

TO RECEIVE MIDI DATA FROM A SEQUENCER:
 1. SIMPLY PLAY BACK THE SEQUENCE INTO ULTRAPROTEUS.

WARNING: SEND DATA FROM YOUR SEQUENCER AS YOU WOULD A REGULAR SEQUENCE. SENDING DATA IN ONE HUGE CHUNK MAY CLOG THE ULTRAPROTEUS INPUT BUFFER.

A MIDIMAP RECEIVED BY ULTRAPROTEUS DOES NOT CHANGE THE “SCRATCH” MIDIMAP UNLESS IT IS CURRENTLY SELECTED. YOU MUST SELECT THE MIDIMAP FOR IT TO BE ACTIVE. SEE PAGE 159.

THE INDIVIDUAL MIDIMAPS AND PROGRAM CHANGE MAPS ARE LOCATED AFTER THE INDIVIDUAL PROGRAMS (KEEP SCROLLING).

TURN “KEYBOARD THRU” MODE OFF ON YOUR SEQUENCER WHEN TRANSFERRING SYSEX DATA OR A MIDI FEEDBACK LOOP MAY RESULT.

Proteus Sysex

When this function is turned On, Proteus presets can be transferred over MIDI into UltraProteus. It also allows the use of Proteus patch editing programs. Instrument numbers will be translated into UltraProteus equivalents. Parameters which are unique to UltraProteus will, of course, NOT be transferred. This function defaults to Off to avoid unplanned conflicts with Proteus Sysex transfers.

PROTEUS SYSEX
Off

Auto Select

When editing a parameter which involves the keyboard, such as a zone range, the parameter can be automatically selected simply by playing the keyboard. This is a handy feature for “power programmers”, but can sometimes be confusing. Therefore, Auto-Select can be turned On or Off. Auto-Select affects the following parameters: User Key Tuning, Zone Select, Key Range, Midimap, Preset & Hyperpreset Naming, Cross-switch Point, Keyboard Center.

AUTO-SELECT
Off

Compare

This function turns the Compare feature (accessed by pressing the Preset button when editing) On or Off. If Compare is turned On, changes made via MIDI SysEx will not be heard except when the Preset menu is enabled.

COMPARE
On

Viewing Angle

This function allows you to change the viewing angle of the display so that it may be easily read from either above or below. The angle is adjustable from +7 to -8. Positive values will make the display easier to read when viewed from above. Negative values make the display easier to read from below.

VIEWING ANGLE
+7

IF ULTRAPROTEUS DOES NOT
RESPOND TO EXTERNAL
PRESET EDITORS, TURN THE
COMPARE FUNCTION OFF.

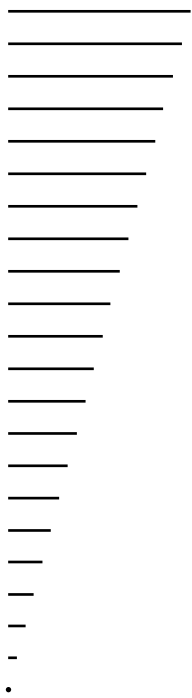

UltraProteus MIDIMAP MENU



THE MIDIMAP

A Midimap is a group of parameters which you might associate with a specific sequence or song. You can also use the Midimaps as “Effects Presets” for your favorite effects setups. The Midimap contains all the pre-sequence setup information, such as the program (preset or hyperpreset) for each MIDI channel, effects settings, etc. There are 16 Midimaps in UltraProteus and an additional 16 can be stored on a memory card.

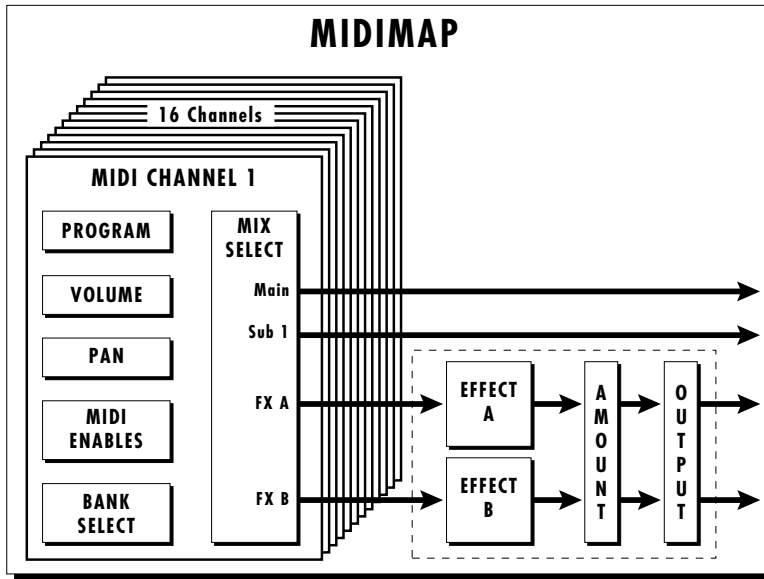

MIDIMAPS CAN ALSO BE CHANGED USING A SYSEX PARAMETER CHANGE COMMAND. SEE PAGE 159.

Midimaps are often used with UltraProteus connected to an external sequencer in MULTI mode. Multi mode allows UltraProteus to receive MIDI data on all 16 channels simultaneously. UltraProteus can store 16 different Midimaps. The two digital effects processors are also part of the Midimap.

MIDI Map	
MIDI Map Name	12 Characters
Program _____	for 16 MIDI Channels
Volume _____	for 16 MIDI Channels
Pan _____	for 16 MIDI Channels
Mix Select _____	for 16 MIDI Channels
MIDI Enables _____	for 16 MIDI Channels
Bank Select _____	for 16 MIDI Channels
Program Change Map	Off, 1-4
Effect A	Effect Select & Parameters
Effect B	Effect Select & Parameters
Effect Amount	Wet/Dry Mix, A->B Amount
Effect Output Select	Main, Sub 1, Sub 2

SELECTING A NEW MIDIMAP
WILL OVERWRITE THE
"CURRENT" OR "SCRATCH"
MIDIMAP.

To enable the Midimap menu

Press the Midimap button, lighting the LED. The current screen will be the one most recently selected since powering up UltraProteus. The cursor will appear underneath the first character of the screen heading on line one.

To select a Midimap

Press the Home/Enter button or press the cursor key repeatedly until the cursor is underneath the screen title heading. The first screen in the list is "Midimap Select". Move the cursor to the lower line of the display and use the data entry control to select the desired Midimap. The Home/Enter LED will be flashing. Press Home/Enter to load the Midimap.

To select a new screen

Press the Home/Enter button or press the cursor key repeatedly until the cursor is underneath the screen title heading. Rotate the data entry control to select another screen.

To modify a parameter

Press the cursor button repeatedly (or hold the cursor key while turning the data entry control) until the cursor is underneath the parameter value. Rotate the data entry control to change the value.

To return to Program Select mode

Press the Midimap button, turning off the LED.

MIDIMAP MENU FUNCTIONS

Midimap Select

This is where you select one of the 16 Midimaps. You can use the Midimaps to setup a particular sequence or song. Position the cursor under the Midimap number and use the data entry control to select the Midimap. The Home/Enter LED will be flashing. You MUST press Enter to load the Midimap.

MIDIMAP SELECT
M00 Cool FX

Midimap Name

This function allows you to name each of the 16 Midimaps with a name of up to 12 characters. Position the cursor underneath the character location and use the data entry control to change the character. The keyboard can also be used to select characters.

This screen displays the current Midimap. The Midimap Select screen is the last screen in the menu.

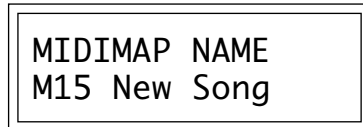

Preset/Hyper to MIDI Channel Assign

This function allows you to assign a preset or hyperpreset (program) to each MIDI channel for the currently selected Midimap.

Position the cursor under the channel number and use the data entry control to change the MIDI channel. Position the cursor under the program number and use the data entry control to change the program assigned to each MIDI channel.



Volume, Pan & Output Mix

This function sets the Volume, Pan Position and Output Mix for each MIDI channel in the selected Midimap. Volume allows you to adjust the relative volume between programs. Pan allows you to position each program in the stereo field. The Volume control acts as an attenuator on the program volume. It cannot increase the volume past the setting programmed in the program.

▼ The Pan control Overrides the pan value programmed in the program.

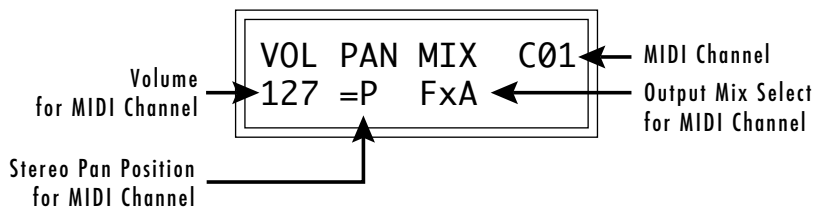

THE AUTO-SELECT FEATURE IN THE MASTER MENU MUST BE TURNED ON IN ORDER TO USE THE KEYBOARD FOR NAMING MIDIMAPS.

THE MIDI CHANNEL SHOWN IN THE RIGHT SIDE OF THE SCREEN IS NOT THE MIDI BASIC CHANNEL, ONLY THE ONE BEING EDITED IN THE MIDIMAP.

CHANNEL PAN SHOULD NORMALLY BE SET TO "P" UNLESS REALTIME CONTROL OF PANNING IS DESIRED. IF PAN IS SET TO "0", STEREO EFFECTS CREATED IN THE PRESET WILL BE LOST.

The Output Mix allows you to selectively route the program through one of the effects processors or direct it to a pair of output jacks (for each of the 16 MIDI channels). An additional selection called Preset or “P”, allows the selection to be made in the preset (Mix Output). Thus effects and outputs can be selected according to MIDI channel or by preset.

Position the cursor under the channel number and use the data entry control to change the MIDI channel. Position the cursor under the volume, pan or mix and use the data entry control to change the value. The volume and pan values are the same ones shown in the main screen.

The diagram below shows the function of Output Mix Select.

PLEASE NOTE THAT THE SUB 2 OUTPUT IS AN “EFFECTS ONLY” OUTPUT.

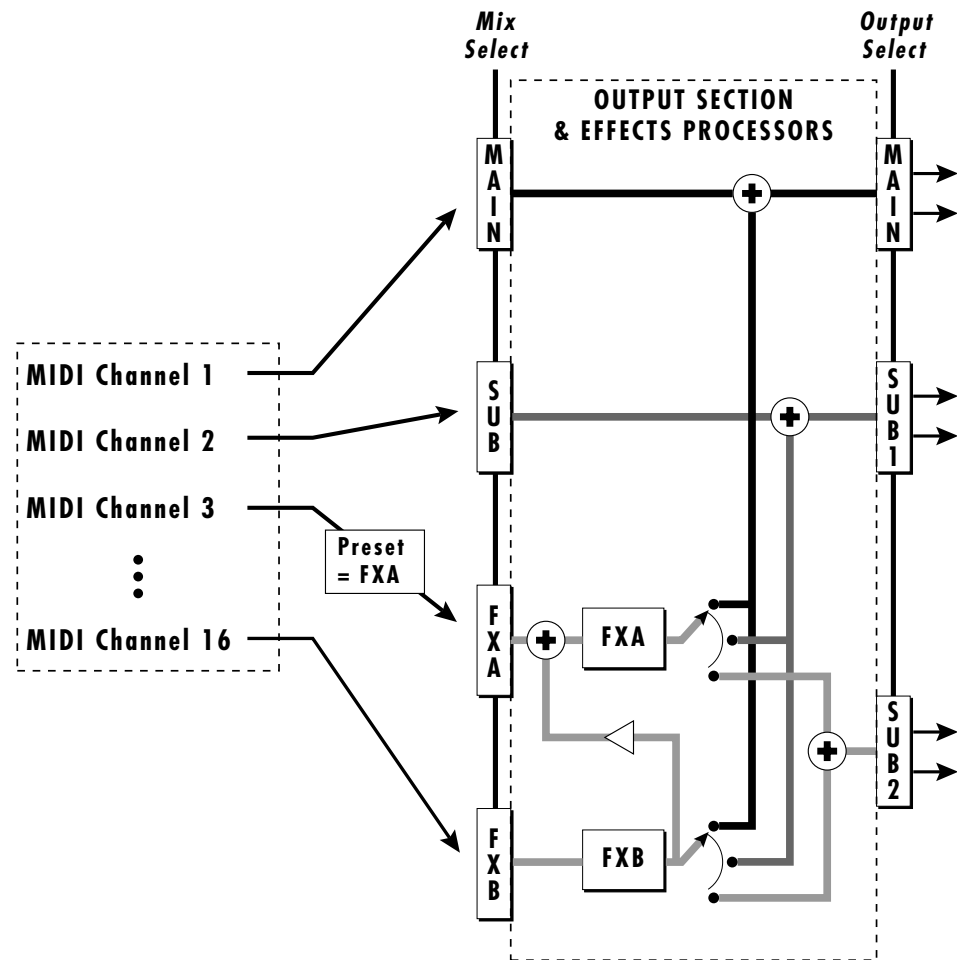

The Output Mix Select (for each MIDI channel) selects which bus in the Output Section will be used.

MIDI Enables

The MIDI enables allow you to enable or filter out specific MIDI messages on a per-channel basis. MIDI messages that can be filtered include:

All Messages (<i>turns channel off</i>)	Pitch Wheel
Program Change	Mono Pressure
Bank Select	Key Pressure
Volume Control (<i>controller #7</i>)	Controllers A-D
Pan Control (<i>controller #10</i>)	Footswitches 1-3

THE CHANNEL PAN CONTROL CAN BE DISABLED TO PREVENT INCOMING MIDI MESSAGES FROM ALTERING STEREO EFFECTS PROGRAMMED IN THE PRESETS.

The “All Messages” filter is useful when you have other MIDI devices connected and do not want UltraProteus to respond to the MIDI channels reserved for other devices. Messages will be passed when On and filtered out when turned Off.

```
MIDI ENABLES C01
AllMessages On
```

Bank Select

The MIDI specification only allows for 128 presets per MIDI channel. This function selects which bank of 128 presets will be used for incoming MIDI program change commands. Banks can be set for each MIDI channel. This function allows you to access all presets and hyperpresets in UltraProteus without using a MIDI Bank Select command.

```
BANK SELECT C01
0
```

MIDI Chan.	Bank#	Type
Channel 1	Bank 0	RAM Presets
Channel 2	Bank 2	RAM Hyperpresets
Channel 3	Bank 1	ROM Presets
⋮	⋮	⋮
Channel 16	Bank 0	RAM Presets

THE PROGRAM CHANGE MAPS ARE LOCATED IN THE MASTER MENU.

Program Map Select

There are four Program Maps in UltraProteus. Program Maps allow incoming MIDI program changes to be translated into another number. For example, a program map could be set up so that program number 12 is selected whenever program change number 26 is received at the MIDI in port. The Program Map Select function allows you to select one of the four Program Maps to be used in the currently selected Midimap or turn the Program Map function Off. Note: The Program Map only operates if it is turned On and the Bank Select function is set to bank 0.

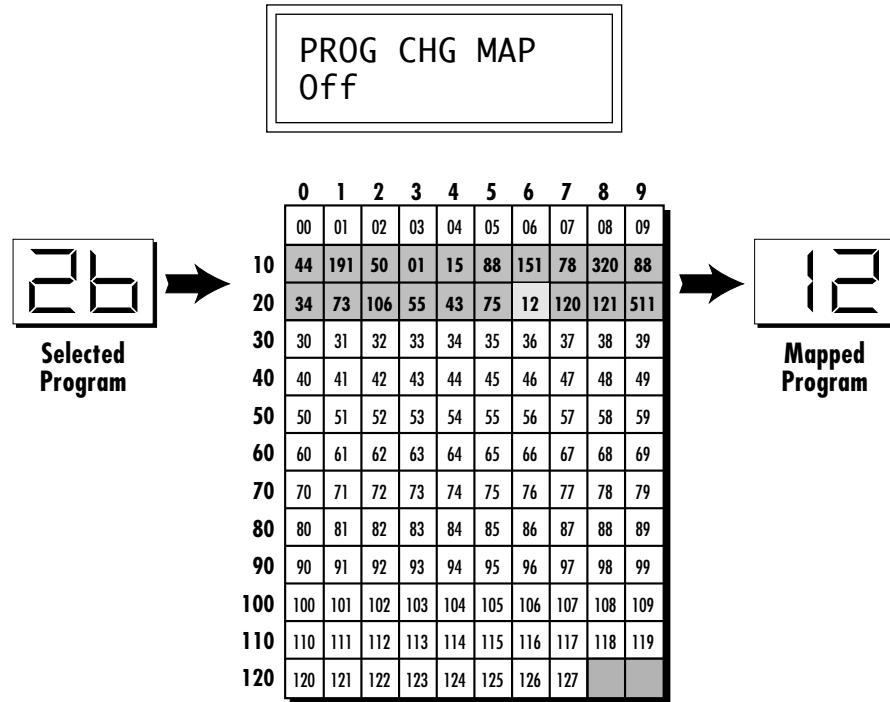

This chart shows how MIDI preset changes can be re-mapped. In this example program changes 10-29 (darkened area) have been re-mapped. All other programs will be selected normally.

FX A

This function allows you to select which effect is active on Effect Processor A. Processor A effects include several types of reverb as well as other effects such as delays, chorus, flanger, and phase shifter. Each effect has one or more adjustable parameters which are accessed by moving the cursor to the lower line. See the Effects section for detailed information on these functions.



FX B

This function allows you to select which effect is active on Effect Processor B. Processor B effects include echo, delay, chorus, phase shifter, distortion and ring modulator. Each effect has one or more adjustable parameters which are accessed by moving the cursor to the lower line. See the Effects section for detailed information on these functions.



FX Amount

This function allows you to adjust the ratio of dry (unprocessed) to wet (processed) signal coming out of the effect processor. A setting of 100% indicates that all of the signal is being processed by the effect. The B->A parameter allows you to adjust the amount of effect B which will be fed through the A effect. If B->A is set to one value above 100%, the word “Only” is displayed and the B amount changes to Off. This disconnects effect B from the main outputs and routes ALL of effect B through effect A.

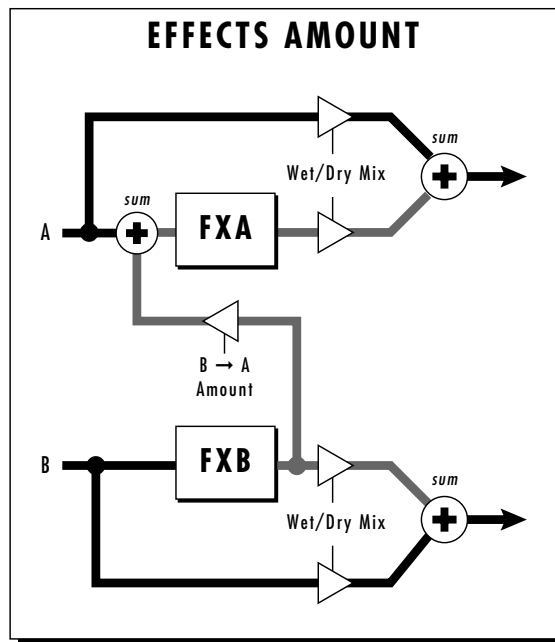
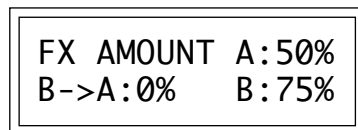

IF THE B->A AMOUNT IS SET TO "ONLY", NO SOUND WILL RESULT IF "NO EFFECT" IS SELECTED FOR EFFECT A

FX Output Select

This function selects which pair of output jacks each effect processor will be routed. This is shown in the diagram on page 32 by the 3-way switches after each effect processor.

```
FX OUTPUT SELECT
A:Main  B:Sub 1
```

Save Midimap

Changes made to a Midimap are not made permanent until the Midimap is Saved. To save a Midimap, move the cursor to the bottom line and select one of the 16 locations with the data entry control. The Enter LED will be flashing. Pressing the Home/Enter switch will confirm the operation. Writing to a Midimap location erases the existing Midimap in that location. Make sure that the location does not contain information you want to keep.

```
Save MIDIMAP to
M00 -defMIDIMap-
```

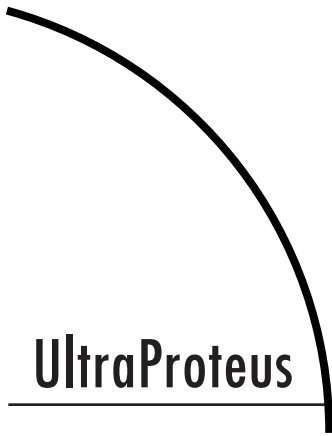
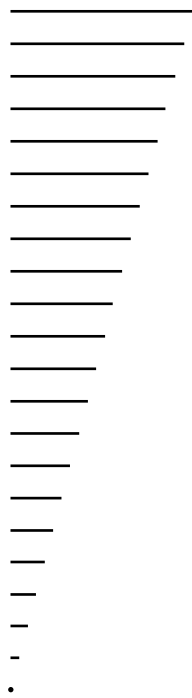

UltraProteus EFFECTS SECTION

Where are the Effects?

The effects in UltraProteus are separate from the preset. This is similar to an external effects unit except that the signal path is kept in the digital domain to maintain excellent sound quality.

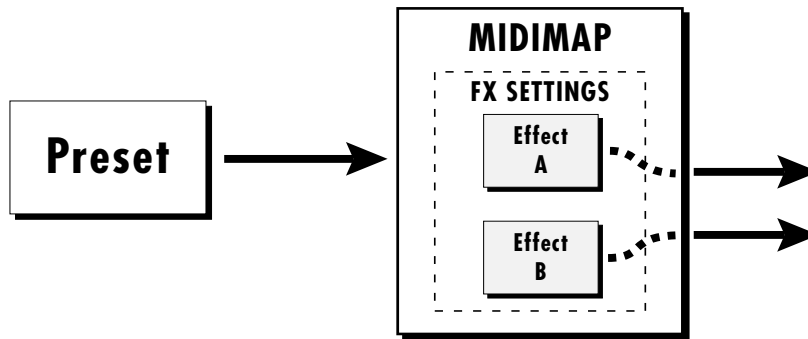

The Effects section in UltraProteus is located external to the preset in the Midimap menu.

The effects section is located within the Midimap. There are 16 Midimaps (and 16 more on a memory card) which store different effects setups. You could think of a Midimap as an Effects Preset (although they store other parameters as well).

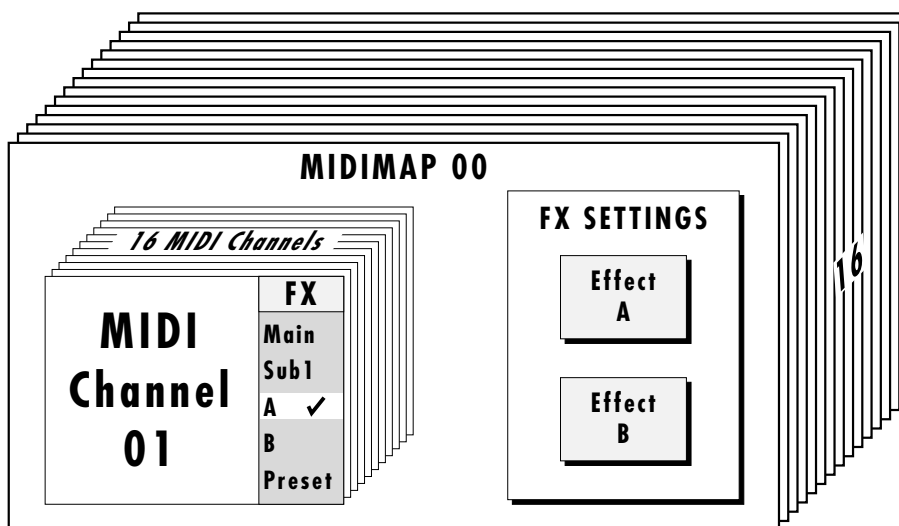

For each of the 16 MIDI channels, you may select: Effect A, Effect B, the Main Outputs (with no effect), the Sub 1 Output (with no effect), or you may choose to use the Mix Select programmed as part of the preset. Therefore you can select effects routings by MIDI channel or by preset. The choice is up to you.

EFFECTS OUTPUT ROUTING

The diagram below shows how the effects section is integrated into the output jack routing scheme. The mix bus can be selected either by the preset or by MIDI channel. When “Preset” is selected, the MIX SELECT programmed in the preset is used.

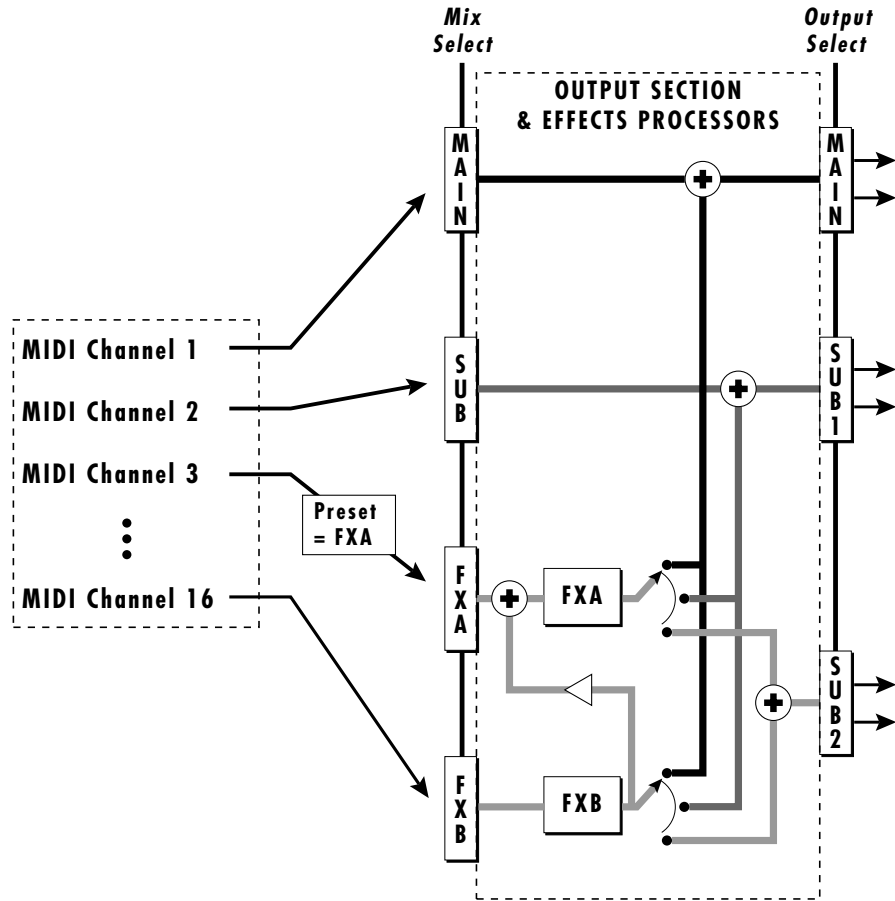

ULTRAPROTEUS EFFECT BUS ARCHITECTURE

The two stereo effect processors on UltraProteus are designated as A and B effects. “A” effects contain Reverb and other effects. The “B” effects do not include Reverbs, but include a host of other great effects which are listed on page 53.

Each effect has its own set of control parameters which are appropriate to that particular effect. For both the A and B effects there is an amount parameter which determines the relative mix of the processed and unprocessed signals (wet/dry mix). The output of the B effect can also be routed back through processor A. In addition, the stereo submix outputs (Sub 1) can be used to externally process selected presets.

TO PROGRAM AN EFFECT:

- 1) Press the **MIDIMAP** button lighting the LED.
- 2) Slowly turn the data entry knob clockwise until you find the screen shown below. Select one of the effect processors in the Mix Selection. This selects the input to the effect processors.

```
VOL PAN MIX C01
127 =P FXA
```

- 3) Set the FX Amount for the A or B effect. This adjusts the ratio of effected to un-effected signal. B->A allows you to route the output of effect B through effect A (set the MIX to effect B).

```
FX AMOUNT A:50%
B->A:0% B:50%
```

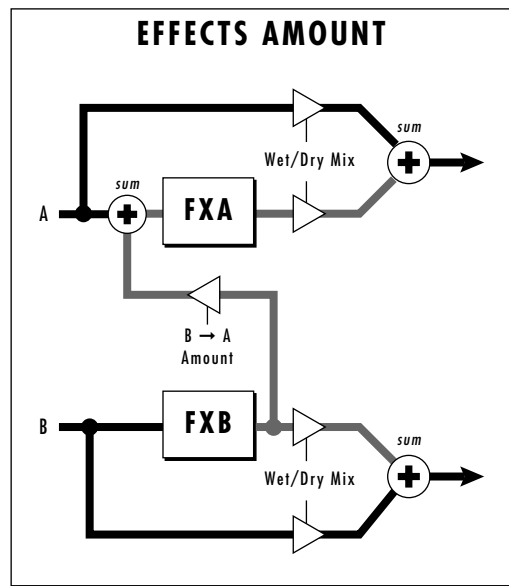

- 4) Select the desired **Effect** and program the appropriate parameters.

```
FXA:Echo
L Delay Time 255
```

- 5) Set the **FX Output** if you want to use the Sub 1 or Sub 2 outputs.

THE DIAGRAM ON THE PREVIOUS PAGE ILLUSTRATES THE FUNCTION OF MIX SELECT.

SETTING THE B->A PERCENTAGE TO MAXIMUM SELECTS "ONLY" WHICH DISCONNECTS EFFECT B FROM THE MAIN OUTPUTS AND ROUTES ALL OF THE SIGNAL THROUGH EFFECT A.

IF THE B->A AMOUNT IS SET TO "ONLY", NO SOUND WILL RESULT IF "NO EFFECT" IS SELECTED FOR EFFECT A

A EFFECTS

- Room
- Warm Room
- Small Rooms 1 & 2
- Halls 1, 2 & 3
- Chambers 1 & 2
- Plates 1 & 2
- Early Reflections 1-4
- Reverse Early Refl.
- Rain & Shimmer
- Stereo Flange
- Phaser
- Stereo Chorus
- Delay
- Cross Delay
- Echo

B EFFECTS

- Fuzz
- Fuzz Lite
- Stereo Flange
- Phaser
- Stereo Chorus
- Delay
- Cross Delay
- Ring Modulator

REVERB

Reverberation is a simulation of a natural space such as a room or hall. The reverb effects in UltraProteus simulate various halls, chambers, rooms and reverberation plates. In addition, there are several other reverb effects such as Early Reflections and Rain. There is only one adjustable parameter on the reverbs - Decay Time. Decay time is the length of time that it takes for the reflected sound from the walls of the room to die away. In general, the larger the room, the longer the decay time.

The diagram below breaks down the reverberated sound into its component parts. After an initial pre-delay period, the echoes from the closest walls or ceiling are heard. These first echoes or the *early reflection cluster*, vary greatly depending on the type of room. Roughly 20 milliseconds after the reflection cluster, the actual reverberation begins and decays according to the time set by the decay time parameter.

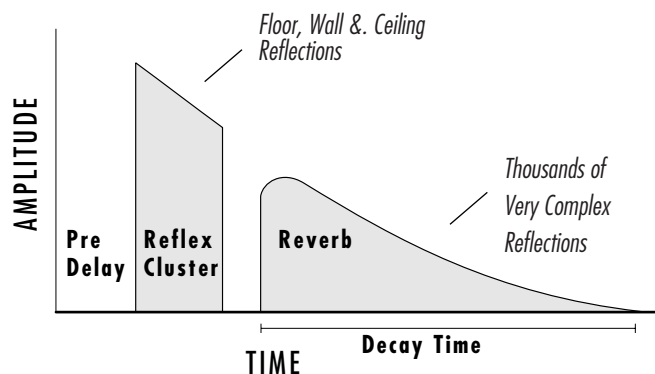

Room programs simulate small rooms with high frequency absorption caused by drapes and furniture.

Plates simulate plate type reverbs with their tight, dense early reflections and sharp reverb build-up.

Chambers simulate medium sized rooms with hard reflective surfaces.

Hall programs recreate the open, spacious ambience of large concert halls.

Early Reflection programs consist of the reflection cluster only without the reverb decay. These effects are similar to a multiple tap delay line and have a single adjustable parameter - Ambience.

The special reverbs **Rain & Shimmer** are variations of the early reflection programs and consist of a dense group of short echoes followed by longer echoes.

FXA:Hall 1 Decay Time: 165

Place the cursor underneath the reverb name and use the data entry control to change the type of reverb. Moving the cursor to the lower line allows you to change the decay time of the reverb. The decay times of the reverb programs range from 10-255. The ambience control of the Early Reflection programs range from 0-100.

Room

A bright, medium sized room. The apparent source position is fairly close to the listener. Suitable for use with 100% wet mix setting for adding ambience.

Warm Room

This reverb is similar to “Room” with more high frequency absorption, slightly larger size and a more distant source position.

Small Room 1

This reverb is also to “Room” with shorter initial reflections, shorter decay times and higher reflection density, due to the reduced room size. The apparent source position is closer to the listener.

Small Room 2

This reverb is a variation of “Small Room 1” with greater high frequency damping and a more distant source position.

Hall 1

Hall 1 is a large, highly reverberant space with auditorium-like acoustics. Like all the Hall programs, “Hall 1” exhibits a warm, distant ambience with slow reflection density buildup. With the decay parameter set to maximum, “infinite” reverberation effects can be obtained. Adjustment of wet-dry mix can be used to position the listener from the “front row” ($\approx 25\%$) to “back of the balcony” ($\approx 100\%$).

Hall 2

This reverb is similar to “Hall 1”, but harder and brighter, with more pronounced slap echoes that come from parallel reflecting surfaces in the room. Hall 2 also exhibits a pronounced reverb “bloom” or late-reflection buildup. A 50% wet mix creates the optimum “close” distance adjustment.

Hall 3

Hall 3 is similar to “Hall 2”, but with larger scale stadium-like acoustics. Hall 3 is warmer than Hall 2 (more high frequency damping) and does not display the obvious early reflections and slap echoes. It also exhibits a distinct pre-delay of approximately 100 milliseconds and a pronounced late reflection buildup both of which contribute to the impression of a large space. Wet mix values of 10% to 50% are most appropriate, although a setting of 100% produces an effective cave simulation.

Chamber 1

A simulation of a bright, medium-sized chamber reverb or recital hall with hard walls. Early reflections are very prominent, with high reflection density. Moderately long decays are possible at the maximum decay setting.

Chamber 2

Similar to “Chamber 1” but with a much warmer sound. The wet mix adjustment provides an effective control over the apparent source location from close (10%) to very distant (100%).

Plate 1

Simulates a plate reverb unit. Gives a tight, bright, slightly metallic sound. Reflection buildup is very rapid, with high density. Early reflections are minimized.

Plate 2

An effect similar to Plate 1, but slightly warmer with less density.

EARLY REFLECTION GROUP

All Early Reflection programs have a single *Ambience* parameter which adds diffusion to the individual reflections. Lower ambience settings cause reflections to become more discrete, simulating harder reflecting surfaces. The early reflection programs are simulations of increasingly large acoustic spaces, from a small studio (Early Refl 1) to a large room like a sound stage (Early Refl 4). The wet mix control acts effectively as source distance control. In general, lower mix amounts are more effective as the room size increases.

Early Reflection 1

Early Reflection 2

Early Reflection 3

Early Reflection 4

Reverse Early Reflection

More of a special effect than an acoustic simulation, Reverse ER contains a set of exponentially increasing delay taps, creating a kind of “zip” sound at low Ambience settings. At maximum ambience and lower wet mix values, the sound is more authentically acoustic, with a long, delayed reflection “bloom”. The effect is similar to a large but well damped parking garage.

SPECIAL REVERBS

These special reverbs all have a single Decay Time parameter.

Rain

Similar to a repeating delay, but with complex spatial and filtering effects occurring across the stereo panorama. The effect on percussive sounds might be likened to a bucket of marbles raining down on a galvanized steel roof.

Shimmer

Distantly related to the Rain effect, Shimmer causes input signals to be progressively diffused in time and space across the stereo panorama. The spatial diffusion is accompanied by a flanging effect. The program is highly responsive to left or right-panned inputs. A stunning special effect with percussive sounds, and especially through headphones.

Stereo Flanger

A flanger consists of a short audio delay line whose output is mixed together with the original signal. Mixing the delayed and original signals together results in multiple frequency cancellations creating a comb filter effect as shown in the diagram below. Since the flanger is a type of filter, it works best with harmonically rich sounds such as strings.

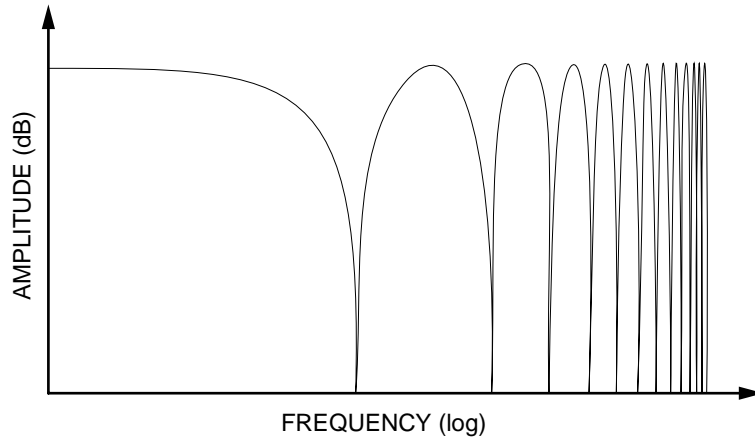

The flanging effect was originally created using two tape recorders playing identical recordings. By exactly synchronizing the two decks and then slowing the speed of one by grasping the tape reel flanges, the flanging effect was born.

The flanger in the UltraProteus is a stereo device consisting of two separate delay lines controlled by a single set of controls. The block diagram of the flanger is shown below.

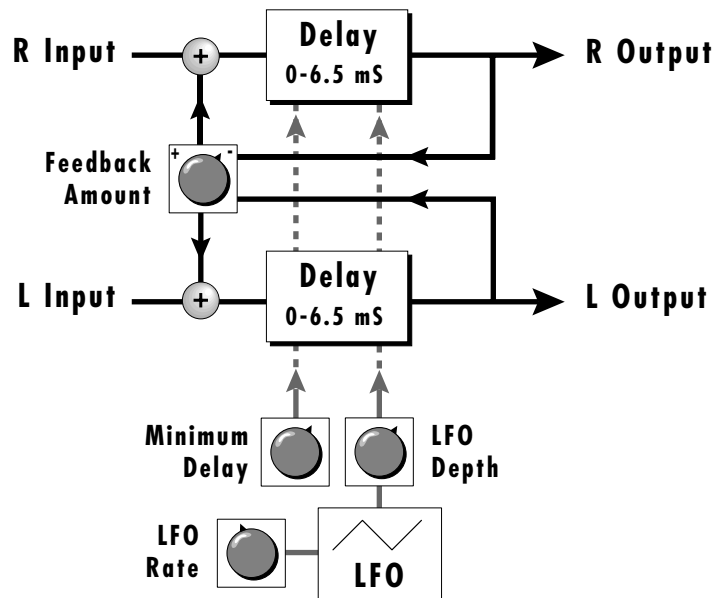

A **Minimum Delay** control serves to tune the flanger. In other words, it adjusts the placement of the comb filter notches. The initial delay is variable from 26 microseconds to 6.5 milliseconds.

```
FXA:StereoFlange  
Min Delay    100
```

A **Low Frequency Oscillator (LFO)** varies this initial delay setting, changing the frequency of the notches and adding animation to the sound. The **LFO Rate** controls the rate of change and the **LFO Depth** controls how much the delay is changed by the LFO. The LFO adds to the initial delay time so that with LFO Depth set to 255 the maximum delay time is 13 milliseconds.

```
FXA:StereoFlange  
LFO Rate     038
```

```
FXA:StereoFlange  
LFO Depth    150
```

The **Feedback** control sends some of the delayed signal through the delay line again. When positive feedback is used (values +1 to +127), the comb filter notches are deepened; when negative feedback is used (values -1 to -127) resonant peaks are formed between the notches which increase with the amount of negative feedback.

```
FXA:StereoFlange  
Feedback     -127
```

Stereo Phaser

The stereo phaser is an effect similar to the flanger although much more subtle. The phaser creates a swirly animation when used with harmonically rich sounds such as strings and voices. It can also be used like a chorus to thicken-up a thin sound.

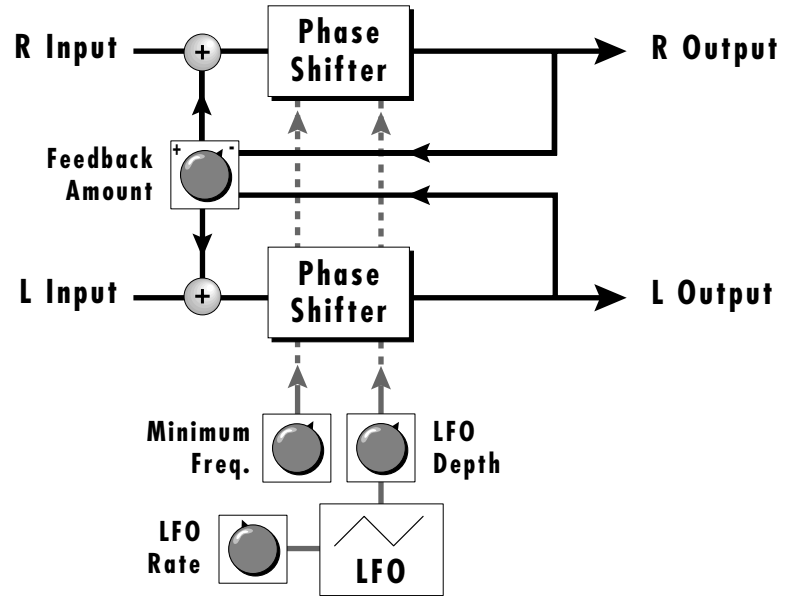

FXA:Phaser
LFO Rate 060

FXA:Phaser
LFO Depth 100

FXA:Phaser
Min Freq 015

FXA:Phaser
Feedback 064

Stereo Chorus

The function of a chorus device is to thicken the sound or to make one voice sound like many. The way the effect is achieved is by mixing one or more delayed versions of the signal in with the original. The delay times used are too short to be perceived as an echo, but long enough so that comb filtering does not occur. In addition, the delay time is varied to simulate the random differences which occur when multiple instruments are playing together. A slight amount of feedback improves the effect by creating multiple images of the sound as it recirculates again and again. The delay times are slightly different for each channel and the LFO phase is inverted on the right channel to help contribute to the overall chorus effect. The LFO Rate and Depth settings are critical to achieving a realistic effect with faster LFO Rates generally requiring less LFO Amount and vice-versa.

The stereo chorus in the UltraProteus is very similar to the stereo flanger except that the delay time is longer. The delay times for the stereo chorus range from 13 milliseconds to 52 milliseconds, compared with the 26 microsecond to 6.5 millisecond range of the flanger.

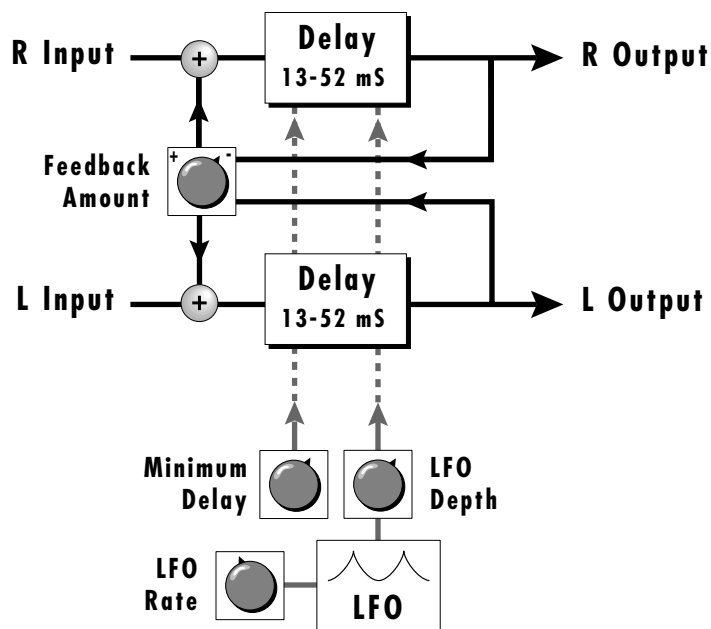

Chorus simulates the effect of multiple instruments playing by creating multiple copies of the sound using a varying delay time and feedback.

FXA:StereoChorus
LFO Rate 050

FXA:StereoChorus
Min Delay 036

FXA:StereoChorus
LFO Depth 050

FXA:StereoChorus
Feedback +100

Delay

The delay line is a stereo effect which can be used for doubling, echoes or fixed formant comb filtering with completely independent delay time and tap levels for the left and right sides. The delay is shown in the diagram below.

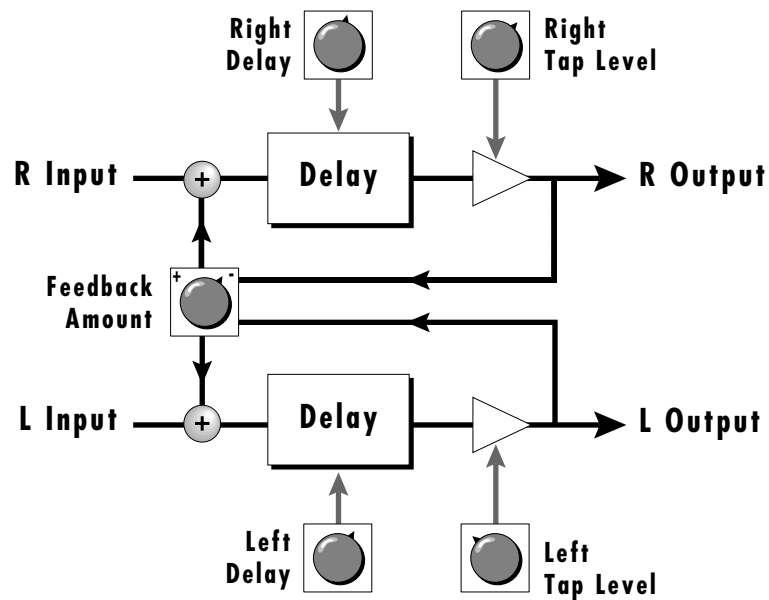

The **Delay Time** parameter is independently variable from 0 to 209 milliseconds for both the left and right channels. The **Tap Level** parameters control the amount of signal from the left and right delays as well as how much signal from each is supplied to the feedback control. **Feedback** controls how many echoes are produced. A setting of 0 produces only one echo. The delay line is incredibly

stable even with large amounts of feedback. This quality allows the delay line to be used as a resonator, where it acts as a kind of oscillator when excited by an input signal. Infinite delay effects are also possible without the risk of runaway. The stereo delay can function as two independent delay lines by panning the primary and secondary instruments to the extreme left and right.

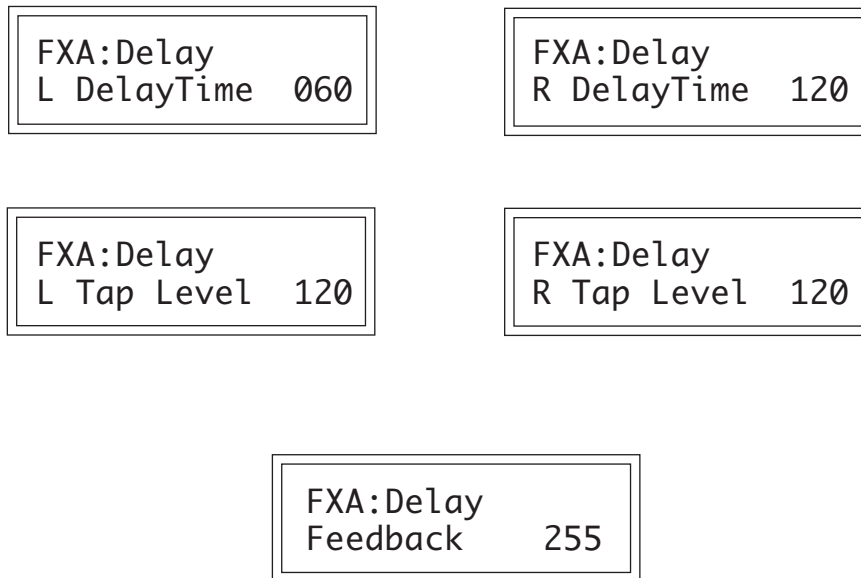

Cross Delay

Cross Delay is identical to the normal delay line except that the output paths and the feedback paths cross over to the opposite channel in order to produce a ping-pong type of effect when reproduced in stereo. Delay time is adjustable from 0 to 209 milliseconds. The Cross Delay is shown in the diagram below.

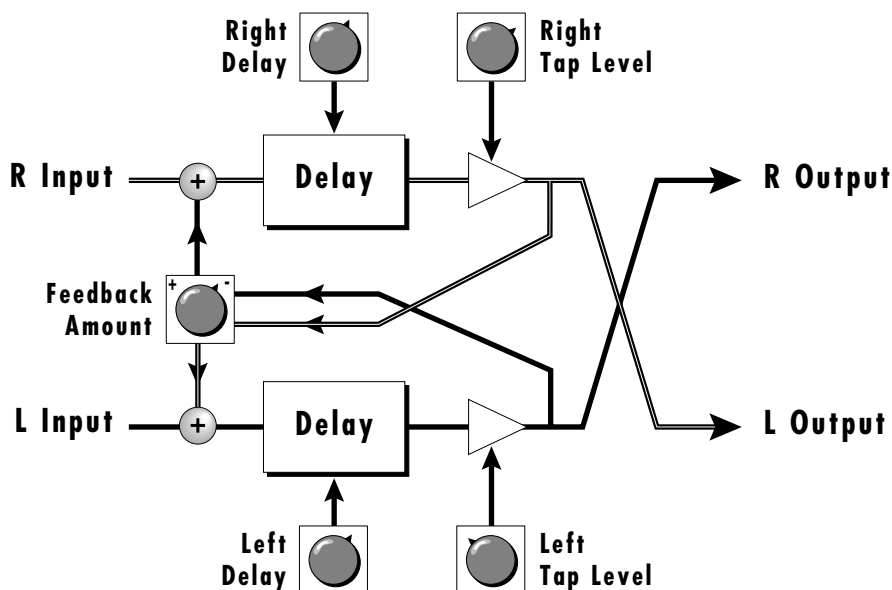

Echo

The Echo produces echoes up to 400 milliseconds in length (twice that of the Delay and Cross Delay effects). The feedback path is independent of the output level and contains a low pass filter which simulates an analog tape echo. The left and right signals are kept completely independent throughout the effect and have separate controls except the feedback amount control which affects both channels.

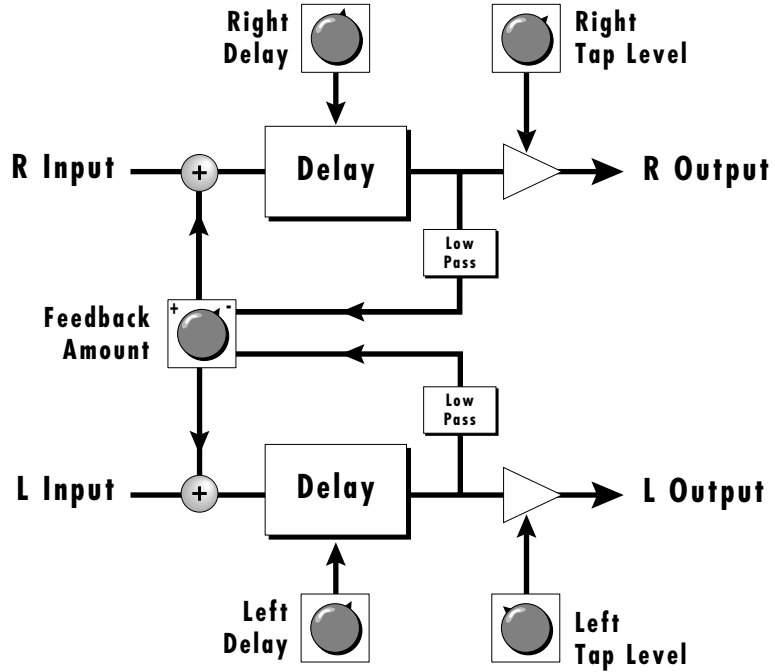

FXA:Echo
L DelayTime 120

FXA:Echo
R DelayTime 100

FXA:Echo
L Tap Level 127

FXA:Echo
R Tap Level 127

FXA:Echo
Feedback 100

B EFFECTS

The B effects include Stereo Flanger, Stereo Chorus, Phaser, Fuzz, Ring Modulator, Delay, Cross Delay and Fuzz Lite. Some of the B effects such as the Fuzz and the Ring Modulator are a bit bizarre (you won't want to use them on every sound), but can be used to create some truly amazing effects. The B effects can additionally be routed through the A effect as shown in the diagram below. Simple effects such as Fuzz can take on a completely new character when routed through the Reverb.

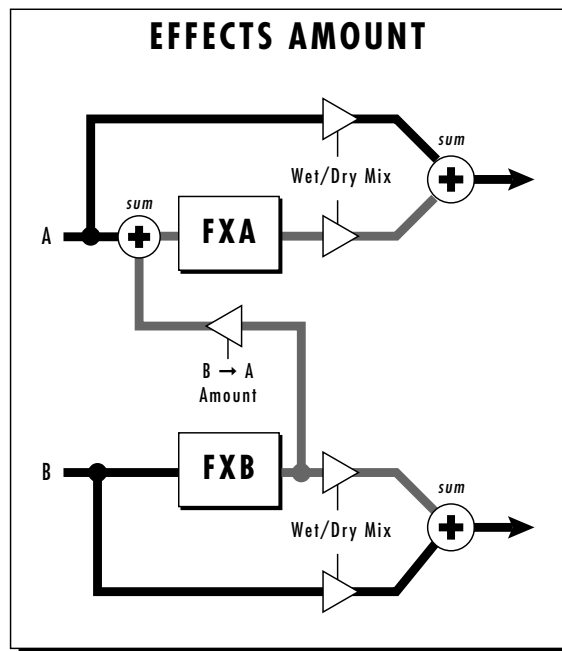

Stereo Delay B

The B Delay is identical to the delay line in the A effect group except that the maximum delay time is 104 milliseconds (instead of 209 milliseconds). This delay is useful for short echoes, slapback and doubling effects, as well as for fixed formant comb filtering. Like Stereo Delay A, the feedback parameter is extremely stable even with high amounts, making it useful as a resonator for “infinite” delays.

Stereo Cross Delay B

The B Cross Delay is identical to the cross delay line in the A effect group except that the maximum delay time is 104 milliseconds (instead of 209 ms). This delay is useful for short ping-pong echoes, stereo slapback and doubling effects.

STEREO FUZZ

The Stereo Fuzz introduces a controlled distortion to any signal passing through it. Distortion creates harmonics by clipping the top of the wave when it exceeds a certain level. Sine waves are transformed into square waves and complex waves take on noise-like qualities. There are two types of fuzz in UltraProteus: Fuzz and Fuzz Lite.

Fuzz

This Fuzz is probably the grungiest fuzz you have ever heard. Two filters, one at the input and one at the output of the fuzz, allow you to control the amount and type of harmonics added to the sound. The **Input Filter** controls the amount of harmonics produced by the fuzz and the **Output Filter** removes harmonics at the output, smoothing the sound. Higher values allow more harmonics to pass. The level of the input sound greatly affects the amount of fuzz, so that UltraProteus' envelopes can now control harmonic content as well as the volume. **Output Volume** sets the output level of the fuzz. There are two complete fuzz effects, controlled by the same set of controls as shown in the diagram below.

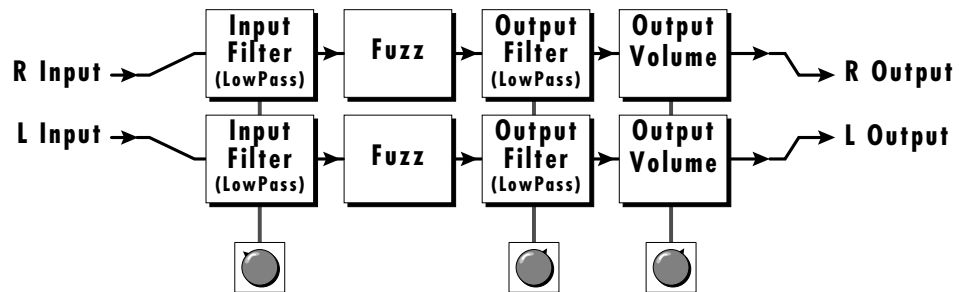

Two independent sounds can be processed by panning primary and secondary to opposite sides, or a single sound can be routed through both sides. If a single sound is panned slightly off center, the fuzz will act slightly differently on each side because of the difference in level.

Fuzz Lite

This is a more restrained type of fuzz utilizing “soft-clipping”. As the level increases, the waveform through Fuzz Lite becomes somewhat squared. As signal level is increased further, it transforms into a square wave. There is no Output Volume control on Fuzz Lite.



Experiment with the way the input and output filters work on the sound. Fuzz is a specialized effect, not for every situation, but another powerful tool in your arsenal.

Ring Modulator

A Ring Modulator is a device which takes two signals and multiplies them together into one resultant signal **containing only the sum and difference frequencies** of the two input waves. The original frequencies are **not** output! However, every harmonic of each signal multiplies every other, according to its amplitude. As a result, ring modulators tend to generate a lot of non-harmonic frequencies which can sound very bell-like or out of tune.

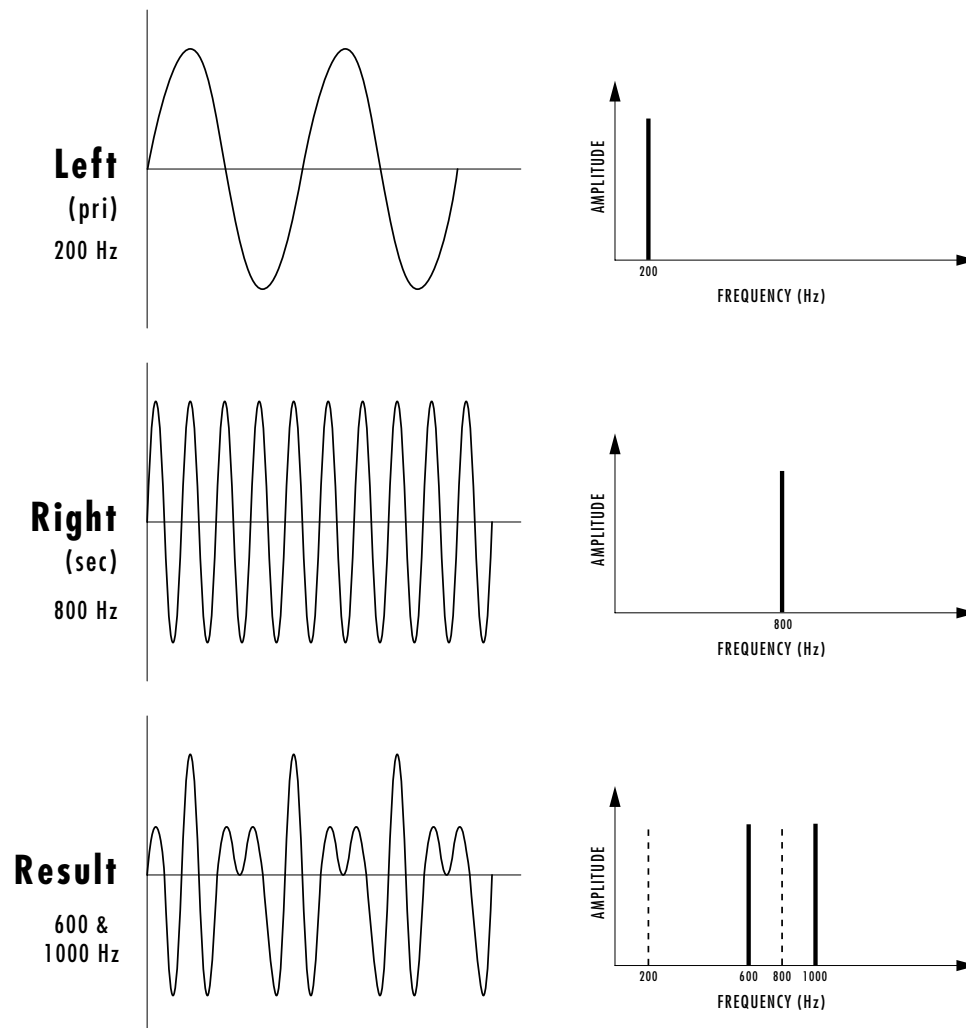

This diagram shows the result of Ring Modulating two sine waves with frequencies of 200 Hz and 800 Hz. Only the Sum and Difference frequencies of 1000 Hz and 600 Hz will result.

There are no controls on the ring modulator as shown by the block diagram below. The left and right outputs are simply multiplied together to form a monophonic output.

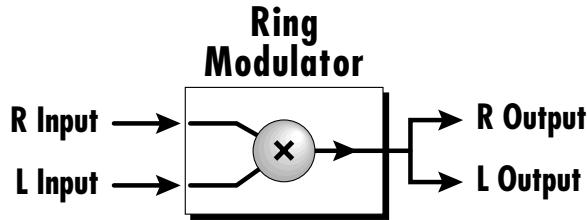

By routing the preset (or MIDI channel) to effect B and panning to opposite sides (shown below), two different waves can be ring modulated. Ring modulation works well with simple waves such as sine waves and the harmonic waveforms. Also, try complex waves modulated with sine waves. (Play chords!) Complex waveforms tend to sound rather noise-like.

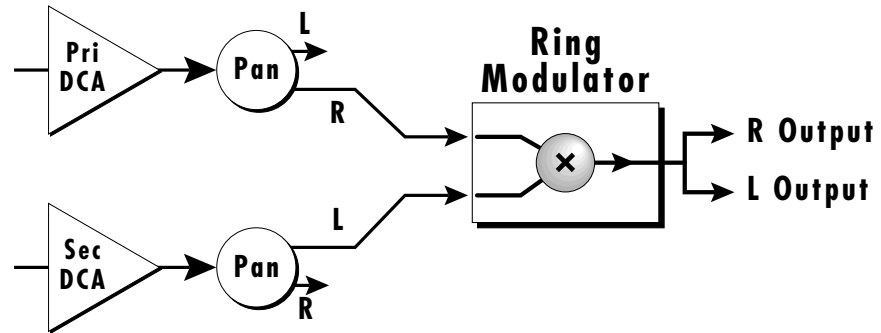

Pan the primary and secondary instruments to left and right in the pan screen, then move to the Effect B screen and select Ring Modulator. There are no parameters to adjust in this effect so the lower line of the display reads: None.

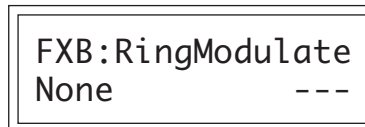

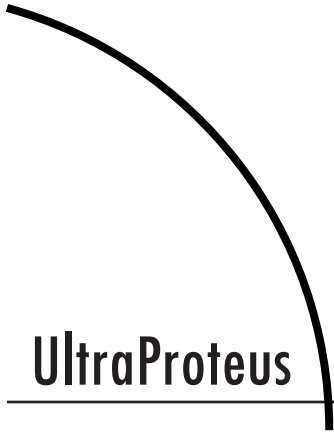

UltraProteus

HYPERPRESET MENU



THE HYPERPRESET

A *Hyperpreset* is a group of one to sixteen presets which have been assigned to areas of the keyboard in order to have more than one sound available at once. Presets are assigned to ranges of the keyboard called *Zones* and may include 1key or all 128 keys. Zones may be placed adjacent to each other (to create a split keyboard) or may overlap (to create fat, layered sounds). Each zone has its own volume, pan, transpose, tuning and velocity range.

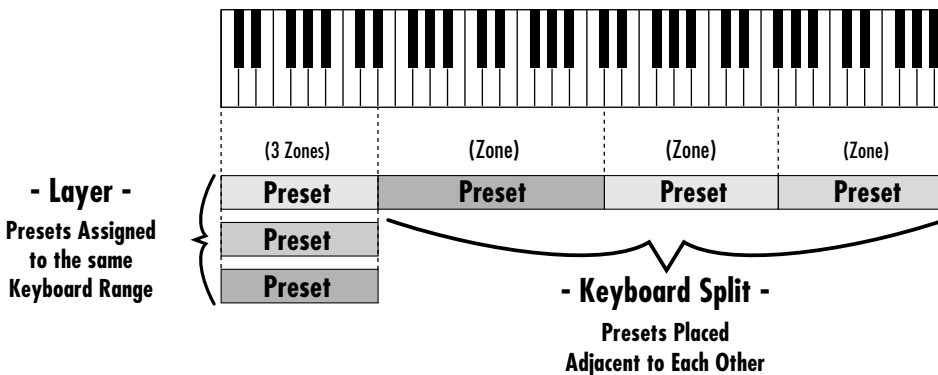

Up to sixteen presets can be assigned to the keyboard in any desired arrangement

To enable the Hyperpreset menu

Press the Hyper button, lighting the LED. The current screen will be the one most recently selected since powering up UltraProteus.

The Hyperpreset to be edited will be the LAST one selected or edited. The cursor will appear underneath the first character of the screen heading on line one.

To select a new screen

Press the Home/Enter button or press a cursor button repeatedly until the cursor is underneath the screen title heading. Rotate the data entry control to select another screen.

To modify a parameter

Press the Cursor button repeatedly (or hold the right cursor button while turning the data entry control) until the cursor is underneath the parameter value. Rotate the data entry control to change the value.

To compare an edited Hyperpreset with the unedited original

Press the Hyper button, turning off the LED. The unedited Hyper is now active. Changing the Hyperpreset number will erase the edit. To hear the edited hyperpreset again, press the Hyper button, lighting the LED.

To return to the main screen

Press the Hyper button, turning off the LED.

AN ADDITIONAL 128 HYPERPRESETS CAN BE STORED ON A MEMORY CARD.

IN ORDER TO HEAR THE HYPERPRESET AS YOU EDIT IT, YOU MUST HAVE IT ASSIGNED TO A MIDI CHANNEL IN THE MAIN SCREEN.

COMPARE MODE MUST BE TURNED ON IN THE MASTER MENU FOR THE COMPARE FEATURE TO WORK.

HYPERPRESET MENU FUNCTIONS

Hyperpreset Name

Hyperpreset Name allows you to name each of the 128 hyperpresets with a name of up to 12 characters. Position the cursor under the character location and use the data entry control to change the character. The keyboard can also be used to select characters. The chart below shows the keyboard character assignments.

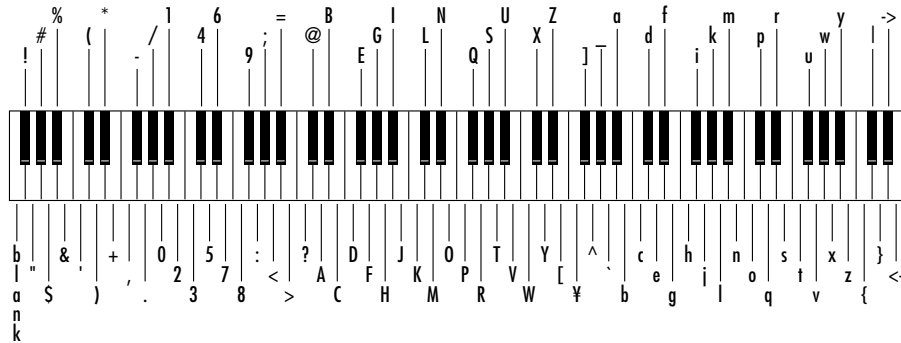

Preset to Zone Assignment

This function allows you to select the preset which will be assigned to each of the sixteen keyboard zones. Position the cursor under the zone number and use the data entry control to change the zone number. Position the cursor under the preset number and use the data entry control to change the preset associated with each zone. Any preset can be assigned to a zone. Set the preset number of unused zones to Off (located below preset 000).

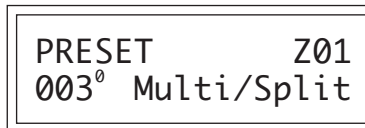

IF THE AUTO-SELECT FUNCTION (IN THE MASTER MENU) IS TURNED ON, ZONES WILL BE SELECTED AS THE KEYBOARD IS PLAYED. IN THE CASE OF OVERLAPPING ZONES, THE LOWEST ZONE NUMBER WILL BE SELECTED. VELOCITY WILL SELECT THE ZONE IF VELOCITY SWITCHING HAS BEEN PROGRAMMED.

Zone Volume and Pan

This function sets the Volume and Pan position for each zone. Volume allows you to adjust the relative volume between presets and pan allows you to change the position of each zone in the stereo field. The Volume control acts as an attenuator on the preset volume. It cannot increase the volume past the setting programmed in the preset. The Pan control adds algebraically to the pan value programmed in the preset. Therefore if the preset pan setting is -7, (full left) a hyperpreset pan setting of +14 would move the sound to (+7) the extreme right side of the stereo field.

Position the cursor under the zone number and use the data entry control to change the zone number. Position the cursor under the volume or pan number and use the data entry control to change the value for each zone.

VOLUME	PAN	Z01
127	+00	

Zone Key Range

Key range sets the keyboard range associated with each of the sixteen possible zones. The key range of each zone can be set anywhere from key C-2 to G8.

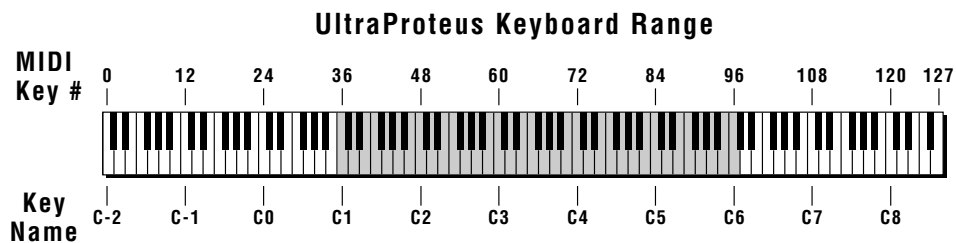

= Standard 5 Octave Keyboard Range

By placing the key ranges next to each other on the keyboard, multiple instruments can be accessed simultaneously. This is called “splitting” the keyboard because the keyboard is literally split up into different sections each containing a different sound.

If multiple presets are placed on the same range of the keyboard, they will all be played simultaneously. This is called “layering” since multiple presets are layered on top of one another. This results in a very dense, “fat” sound.

KEY RANGE	Z01
C-2 -> G8	

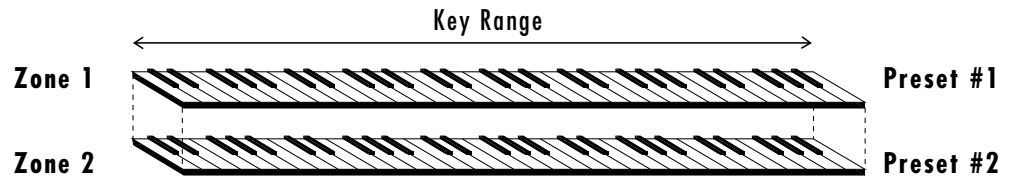

LAYERING TWO PRESETS

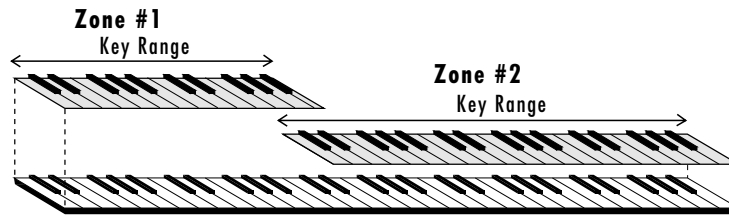

CREATING A SPLIT KEYBOARD

Zone Velocity Range

Each zone can be given its own velocity range so that different presets will be selected according to the keyboard velocity. Imagine two presets assigned to the same keyboard range. If one preset were assigned the velocity range 000 to 64, and the other to velocity range 65 to 127, key velocities below 65 would select the first preset and key velocities 65 and above would select the second preset. Because there are sixteen possible zones, presets can be layered 16 deep!

```

VEL RANGE    Z01
low:000     hi:127
    
```

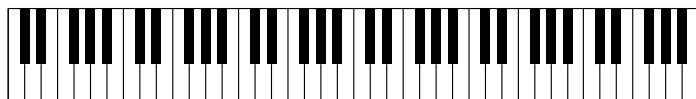

High Velocities
Play this Preset

Preset (Velocity Range 065-127)

Low Velocities
Play this Preset

Preset (Velocity Range 001-064)

Zone Velocity Range allows you to select different preset layers according to key velocity.

Zone Velocity Offset

This function works in conjunction with the Zone Velocity Range feature and adds a programmable offset value to the velocity value applied to the preset. The velocity offset is variable for each zone from -126 to +126.

Suppose that a preset is assigned a velocity range of 000-026 (see previous screen). If the preset was programmed with velocity to volume or tone, the low velocity range will make the preset soft and muted. By offsetting the velocity value to the preset by +100, the preset will receive velocity values of 100-126 instead of 000-026 and the preset will sound normal again.

VEL OFFSET	Z01
+000	

Zone Transpose

The key of each zone can be transposed in half-step intervals. The range of the transpose function is ± 36 semitones (three octaves up or down). Transpose shifts the relative position of the keyboard in relation to middle C rather than actually changing the tuning of the zone.

TRANPOSE	Z01
+36	

Zone Pitch Tune

The tuning of each zone can be adjusted in coarse and fine increments. The coarse tuning adjustment tunes the zone in semitone increments. This is different from the transpose function in that the sounds are actually retuned, rather than having the relative key position changed. This control can produce radical timbre shifts in the sampled sounds. The range of the coarse tuning control is ± 36 semitones (± 3 octaves). The fine tuning control changes the pitch in 1/64 semitone increments (approx. 1.56 cents). The fine tuning range is ± 1 semitone.

PITCH TUNE	Z01
crse+36	fine+64

IF THE AUTO-SELECT FUNCTION (IN THE MASTER MENU) IS TURNED ON, ZONES WILL BE SELECTED AS THE KEYBOARD IS PLAYED.

Hyperpreset Portamento Mode

This function sets the number of notes that will be affected by portamento for all presets in a hyperpreset which have portamento turned On. It works exactly the same as preset portamento mode, but controls the mode for the hyperpreset.

If the Portamento Mode is set to two keys and a three-note chord is played, only two of the notes will glide. Notes will glide from the previous note or notes played. By setting the number of keys to match the number of notes in your chords, smooth glides between those chords can be accomplished without having notes glide in from random starting points. The number of keys can be set from mono to five-note polyphonic.



Free-Run Function Generator

The function generator is another kind of modulation source which is much more programmable than an envelope generator or an LFO (although it can function as either). The function generator can be used when you want the type of complex control that a normal AHDSR envelope cannot provide. See the Function Generator description in the Preset Programming section for complete details.

THE FUNCTION GENERATOR SHAPES ARE DIAGRAMMED ON PAGE 239 OF THIS MANUAL.

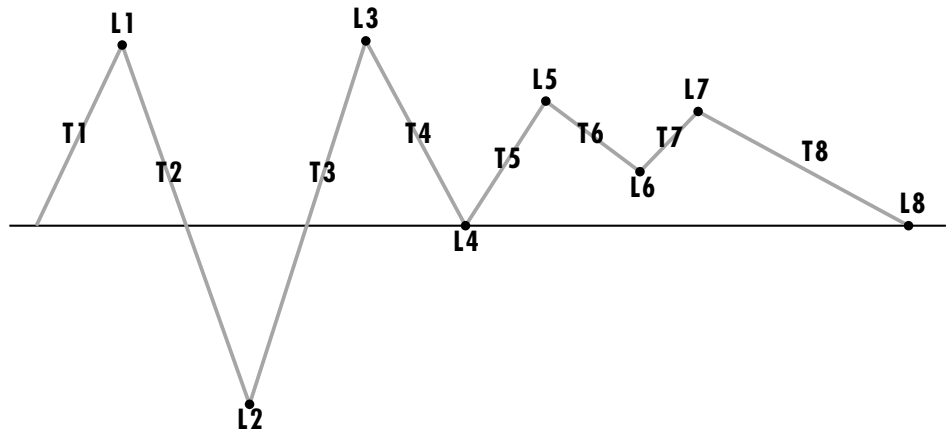
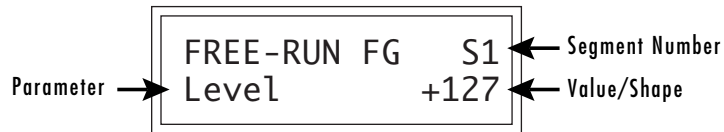
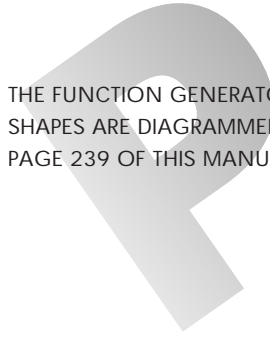

Function Generators contain up to eight segments, each with a level, time, shape, and conditional jump parameter. The Free-Run FG is a kind of “Master” controller which can control all presets contained in a hyperpreset.

Hyperpresets contain a slightly different version of the function generator called a Free-Running Function Generator or Free-Run FG. There is one Free-Run FG per hyperpreset (effectively one per MIDI channel). What the Free-Run FG actually controls is programmed in the preset itself.

The Free-Run FG differs from the other FGs in two fundamental ways. There is one Free-Run FG per Hyperpreset which can modulate any presets in the hyper which have the Free-Run FG assigned. This differs from the 2 function generators in the preset which are completely independent from note to note. Because the Free-Run FG is like a global modulation source, it can be used when you want to modulate multiple sounds in the same way. **The Free-Run FG is only active when playing a Hyperpreset.**

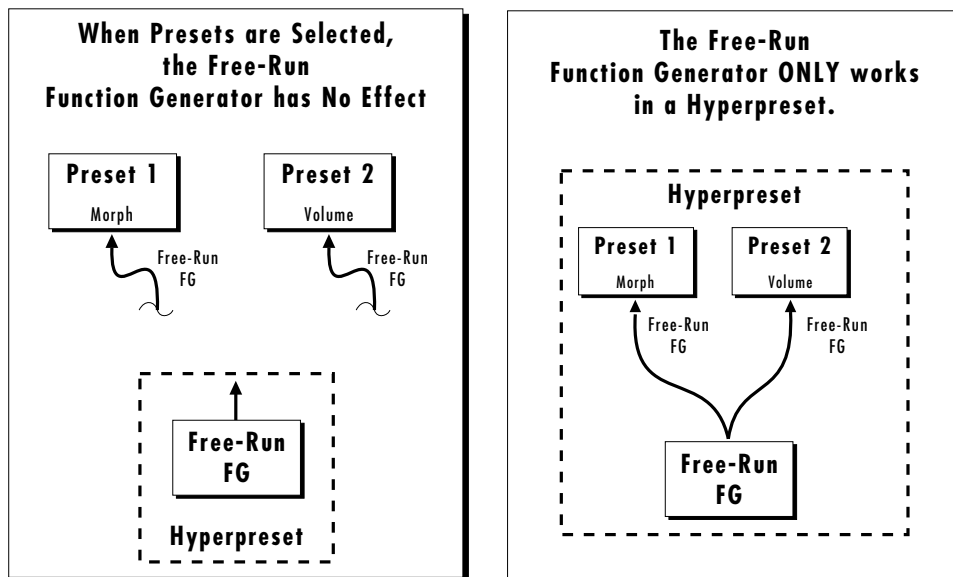

The Free-Run Function Generator only works in a Hyperpreset, even though the modulation routing is made in the preset.

For example, you could program the Free-Run FG to be an LFO and modulate the pitch. All the voices in all presets in that hyperpreset with Free-Run FG assigned would modulate up and down in unison. The Free-Run FG begins the instant the hyperpreset is selected and continues to run until stopped by its programming or when another hyperpreset is selected. **If the Free-Run FG is not programmed to loop, it simply runs to the last segment and stops!** Because it continually runs (if so programmed) and is not started at the beginning of a note like the preset function generators, it is called “free-running”.

••• SEE THE PROGRAMMING BASICS SECTION OF THIS MANUAL FOR ADDITIONAL INFORMATION ON THE FUNCTION GENERATORS.

The functions of the Free-Run FG are almost identical to the preset FG's except that the conditional jumps are more limited. The conditional jumps are listed below.

- Never** Never jumps. Always goes on to next segment.
- Always End** Always jumps at the end of the current segment.
- Note On End** Jumps at the end of the segment if the note is still on.
- Note On Imm.** Jumps immediately if the note is still on.
- Note Off End** Jumps at the end of the segment if the note is off.
- Note Off Imm.** Jumps immediately if the note is off.
- Footsw. 1-3 End** Jumps at the end of the segment if the selected Footswitch is pressed.
- Footsw. 1-3 Imm.** Jumps immediately if the selected Footswitch is pressed.

Save Hyperpreset

Changes made to a hyperpreset are NOT made permanent until the hyperpreset is *Saved*. To save a hyperpreset, move the cursor to the bottom line and select the location for the new hyperpreset with the data entry control. The Enter LED will be flashing. Pressing the Enter switch will confirm the operation. Any of the hyperpreset locations may be selected. Saving to a hyper erases the existing hyper in that location. Make sure that the destination does not contain information you want to keep.

SAVE HYPER to...
000² SynBass/Lead

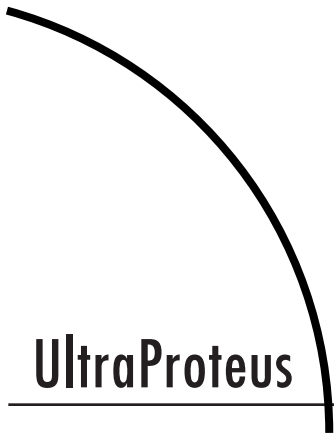
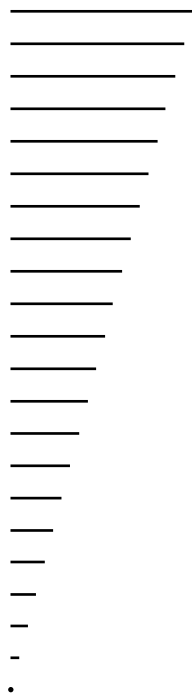

UltraProteus PRESET PROGRAMMING

This chapter explains how preset sounds are constructed in UltraProteus. It also contains important background information on the various programming aspects of the instrument.

If you are new to synthesizers and electronic music, you may need more background information than this manual provides. There are many books dedicated to synthesizer basics and MIDI available through your local music dealer. Magazines such as *Keyboard* and *Electronic Musician*, which are available at most newstands, contain current information on the subject, as well as valuable programming tips.

Your initial involvement with UltraProteus will most likely consist of using the existing presets and selecting MIDI channels. While the factory presets are very good, there are probably some things you would like to change, perhaps the LFO speed, the filter brightness, or the attack time. You may also want to make your own custom presets using complex modulation routings. There are 128 user locations (000°-127°) available to store your own creations or edited factory presets.

Editing Presets

It's easy to create new presets by using the Preset Edit menu to modify existing presets. This is really the best way of getting acquainted with UltraProteus. If you don't like the results, simply change the preset momentarily and you'll be back to the original sound. Changes are not made permanent until you SAVE a preset. Therefore, you can experiment all you want with Presets, Hyperpresets or Midimaps without worrying about losing a sound.

The Copy menu is another way to edit presets. Elements of a preset can be quickly copied to another to create a new hybrid preset.

We encourage you to actually try out the different functions as you read about them. Hearing what a control actually does will remove a lot of the mystery associated with it. The chapter entitled "Step-By-Step" walks you through many of the basic programming functions. Read this chapter first, however, since it contains important information that you need to know.

UltraProteus has an extensive modulation implementation using two multi-wave LFO's (Low Frequency Oscillators), three envelope generators, two multi-segment function generators and the ability to respond to multiple MIDI controllers. You can simultaneously route any combination of these control sources to multiple destinations.

MODULATION

Modulation means to *dynamically change* a parameter, whether it be the volume (amplitude modulation), the pitch (frequency modulation), or whatever. Turning the volume control on your home stereo rapidly back and forth would be an example of amplitude modulation. To modulate something we need a modulation *source* and a modulation *destination*. The source is your hand turning the knob, and the destination is the volume control. If we had a device that would automatically turn the volume control, we would also call that device a modulation source.

UltraProteus is designed so that for each of the variable parameters, such as the volume, there is an initial setting which can be changed by a modulation source. Therefore in the case of volume, we have an initial volume and we can change or modulate that volume with a modulation source. Positive modulation *Adds* to the initial amount. Negative modulation *Subtracts* from the initial amount.

The main modulation sources on UltraProteus are *Envelope Generators*, *Function Generators* and *Low Frequency Oscillators*. In the example above, an envelope generator could be routed to automatically turn the volume control as programmed by the envelope. Or, a low frequency oscillator could be routed to automatically turn the volume control up and down in a repeating fashion.

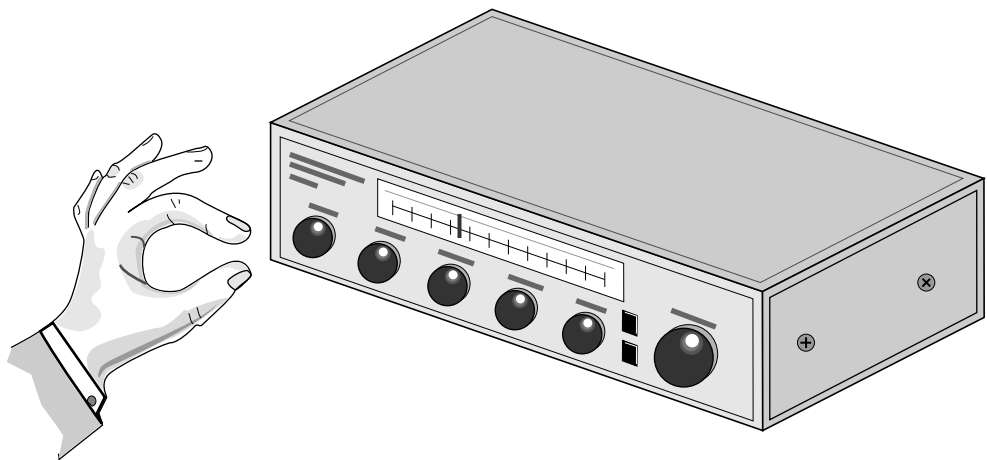

Turning the volume control back and forth on your home stereo is an example of Amplitude Modulation.

MODULATION SOURCES

UltraProteus uses three kinds of modulation sources.

NOTE-ON MODULATION CONTROL

Values which are generated at the start of a note and do not change during the note.

Keyboard Key

Which key is pressed.

Key Velocity

How fast the key is pressed.

Pitch Wheel, Control A-B-C-D, Mono Pressure, Free-Run Func. Generator

These are variable controls which are measured only once at Note-On time.

REALTIME MODULATION CONTROL

Values which can be continuously changed during the entire duration of the sound.

Pitch Wheel

A synthesizer pitch bend wheel.

Miscellaneous Controllers (A-B-C-D)

Any type of MIDI continuous controller data.

Keyboard Pressure (mono aftertouch)

Key Pressure applied after the key is initially pressed.

Polyphonic Key Pressure

Key Pressure from a controller capable of generating polyphonic pressure data.

Low Frequency Oscillators (2 per preset)

Generate repeating waves.

Envelope Generators (3 per preset)

Generate a programmable “contour” which changes over time when a key is pressed.

Function Generators (2 per preset)

Generate complex programmable shapes which begin when a key is pressed.

Free-Running Function Generators (1 per hyperpreset)

Generate complex programmable shapes which begin whenever a hyperpreset is selected.

SEE THE END OF THIS CHAPTER FOR MORE INFORMATION ON MIDI CONTROLLERS A-B-C-D.



FOOTSWITCH MODULATION

Changes a parameter when one of the three footswitches is pressed. The footswitches can be programmed to switch: Sustain (pri/sec/both), Alternate Volume Envelope (pri/sec/both), Alternate Volume Release (pri/sec/both), Cross-Switch between the primary and secondary instruments, or Portamento On or Off (pri/sec/both).

In addition, the footswitches can be used to execute conditional jumps in any of the function generators.

MIDIPATCH

Connecting a modulation Source to a Destination is called a *Patch*. UltraProteus lets you connect the modulation sources in almost any possible way to the modulation destinations. You can even modulate other modulators. Each patch also has an amount parameter which determines “how much” modulation is applied to the destination. The modulation amount can be positive or negative and will either add or subtract from the initial value.

In order to create a modulation patch, you must connect a modulation Source to a modulation Destination using either the Note-On, Realtime or Footswitch Control screens. Think of it like connecting a cord. You must connect both ends of the cord for the cord to work. There are 10 Note-On connections and 10 Realtime connections per preset.

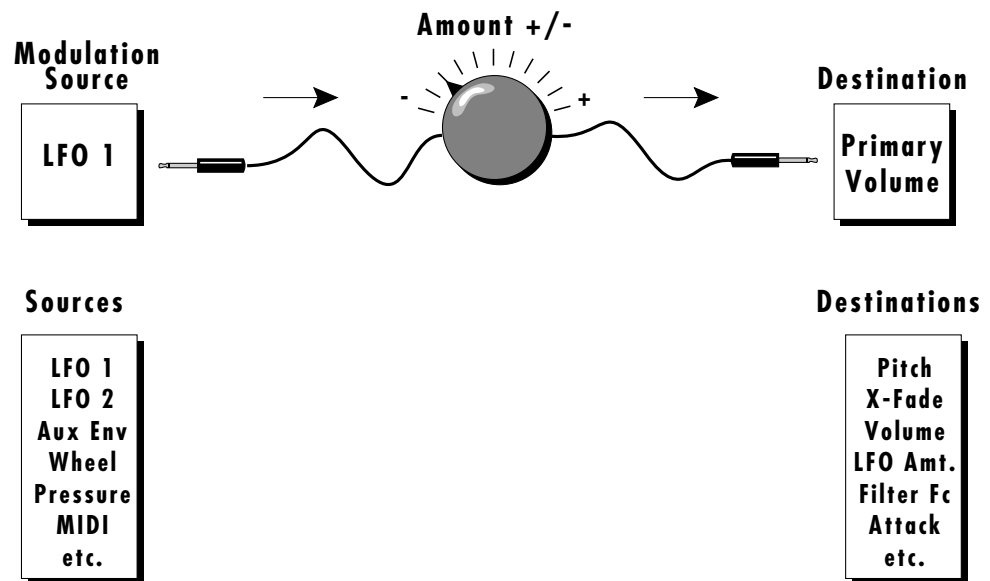

ENVELOPE GENERATORS

An envelope can be described as a “contour” which can be used to shape the sound in some way over time. There are two different envelope generators on UltraProteus. The Alternate Volume Envelope generator controls the volume of the primary or secondary instrument over time and has 5 stages: Attack, Hold, Decay, Sustain, and Release. There is also an Auxiliary Envelope generator which is a general purpose envelope and can be routed to any realtime control destination. The Auxiliary Envelope has an additional delay stage before the attack. The time of each stage can be adjusted to create myriad envelope shapes, which in turn shape the sound over time.

- The way the volume of a sound changes over time determines how we perceive that sound. For example, a bell struck with a hammer is instantly at full volume, then slowly dies away. A bowed violin sound fades in more slowly and dies away slowly. Using the Alternate Volume Envelope, you can simulate different types of instrument volume envelopes by programming them appropriately. By routing the Auxiliary Envelope to control the pitch (realtime control screen) you can easily hear the shape of the envelopes you are creating.

The envelope generator parameters can be described as follows. Refer to the diagrams on the following page.

Delay

The time between when a key is played and when the attack phase begins.

Attack

The rate at which the envelope will go from zero to the peak (full) level.

Hold

The time the envelope will stay at the peak level before starting the decay phase.

Decay

The rate at which the envelope will go from the peak level to the sustain level.

Sustain

The level at which the envelope remains as long as a key is held down.

Release

The rate at which the envelope will fall to the zero level after the key is released.

SHORTENING THE RELEASE TIMES OF THE ALTERNATE ENVELOPE CAN ALLEVIATE CHANNEL “RIPOFF” PROBLEMS. ULTRAPROTEUS EXAMINES THE ALTERNATE ENVELOPE TO DETERMINE IF A CHANNEL CAN BE REUSED.



Piano

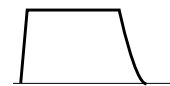

Organ



Strings



Percussion

THE GENERALIZED ENVELOPE SHAPES OF A FEW TYPES OF SOUNDS ARE SHOWN ABOVE.

AUXILIARY ENVELOPE GENERATOR

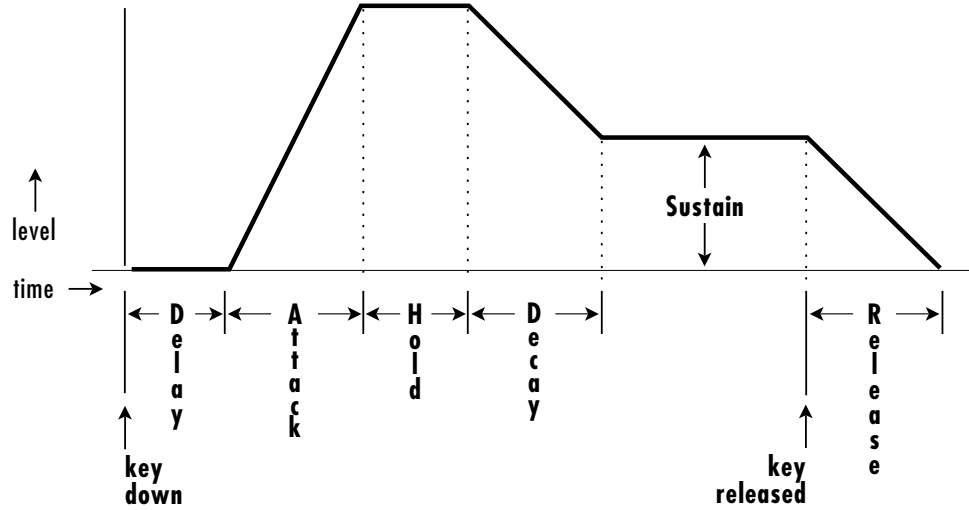

- 1) When a key is pressed, the envelope generator waits for the specified Delay time, then begins to increase at the Attack rate.
- 2) At full level, it waits for the specified Hold time before gliding down at the Decay rate, coming to rest at the Sustain level.
- 3) The envelope remains at the Sustain level until the key is released, then it glides back down to zero at the programmed Release rate.

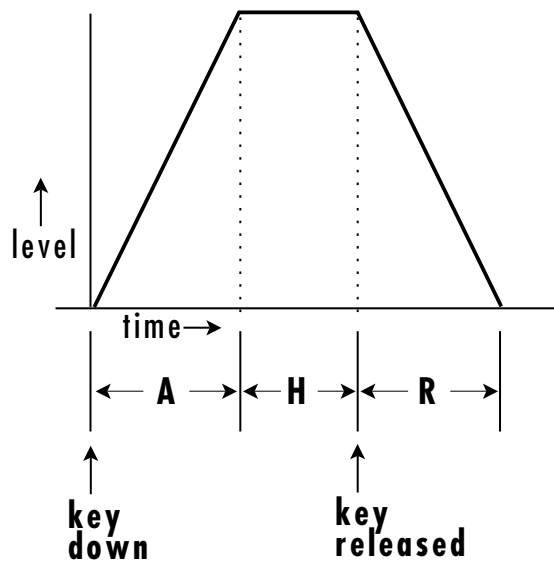

When the key is released, the Release phase immediately begins.

LOW FREQUENCY OSCILLATORS (LFOs)

A *Low Frequency Oscillator* or LFO is simply a wave which repeats at a slow rate. The UltraProteus has two multi-wave LFOs for each of its 32 channels. The LFO waveforms are: Triangle, Sine, Square, Sawtooth, and Random, which is a random “sample and hold” type of wave.

By examining the diagram of the LFO waveforms, you can see how the LFO will affect a modulation destination. Suppose we are modulating the pitch of an instrument. The sine wave looks smooth, and will smoothly change the pitch. The square wave changes abruptly, and will abruptly change the pitch from one pitch to another. The sawtooth wave smoothly decreases, then abruptly changes back up. The sound’s pitch will follow the same course. Controlling the pitch of an instrument is an easy way to hear the effects of the LFO waves.

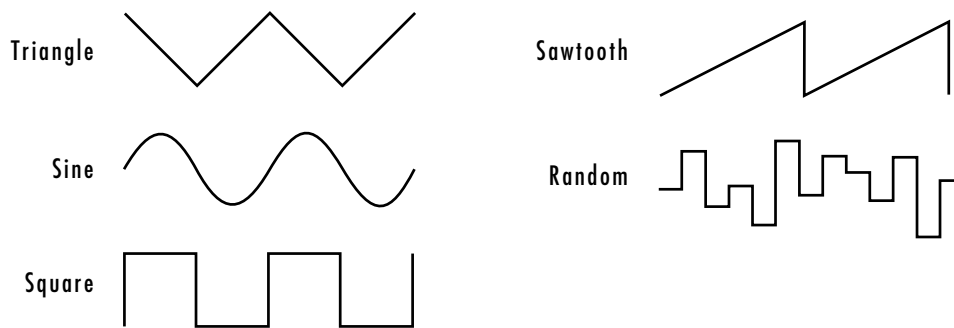

Like the Auxiliary Envelope, the LFOs can be routed to control any realtime functions such as Pitch, Filter, Panning, or Volume. A common use for the LFO is to control the pitch of the sound (LFO ⇒ Pitch). This effect is called vibrato and is an important performance parameter. Many presets use this routing with the modulation wheel controlling “how much” LFO modulation is applied. Another common effect, Tremolo, is created by controlling the volume of a sound (LFO ⇒ Volume) with the LFO.

Another use for the LFOs might be to add a slight bit of animation to the sound by routing the LFO to control the filter. In this example, the LFO amount would be set low, for a subtle effect.

When the amount of an LFO is a negative value, the LFO shape will be inverted. For example, inverting the sawtooth wave produces a wave that smoothly increases, then instantly resets down.

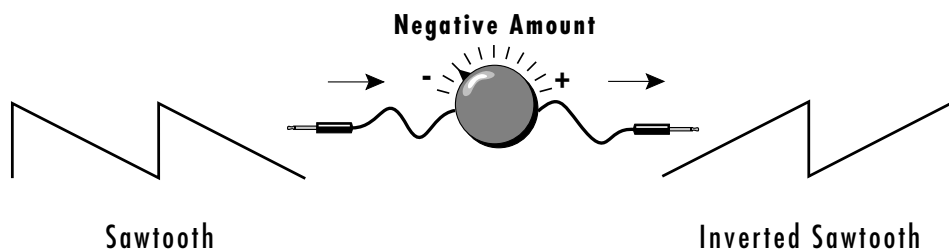

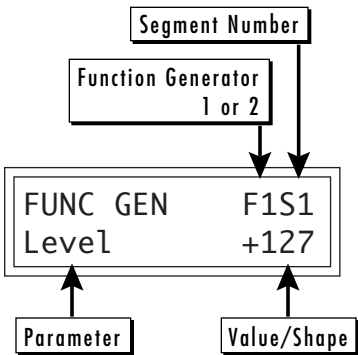

FUNCTION GENERATOR

The Function Generator is another kind of modulation source which is much more programmable than an envelope generator or an LFO although it can function as either. The function generator can be used when you want the type of complex control that a normal AHDSR envelope cannot handle. Refer to the diagram below.

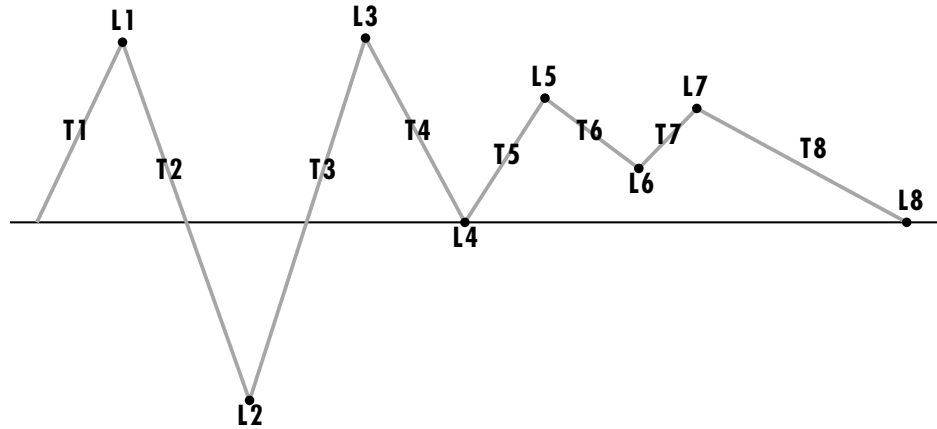

The function generator can have up to eight segments, each with a *Level* and a *Time* parameter. The level parameter can be either positive or negative. Each segment of the function generator can also have a different *Shape*. There are 63 different shapes to choose from, many of which have unusual shapes or are random in nature.

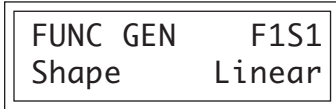
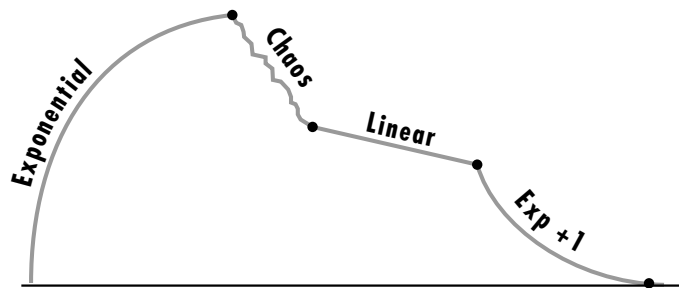

THE FUNCTION GENERATOR SHAPES ARE DIAGRAMMED IN THE REFERENCE SECTION OF THIS MANUAL.

The function generator also has the ability to jump from one segment to another based on certain programmable conditions. For example, the function generator could be programmed to jump back to segment 5 if the key is held, but jump to segment 8 whenever the key is released.

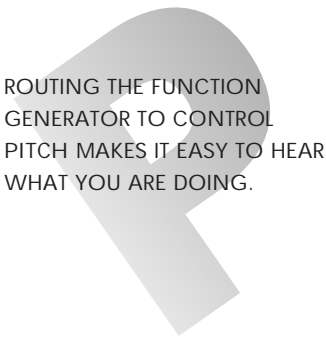
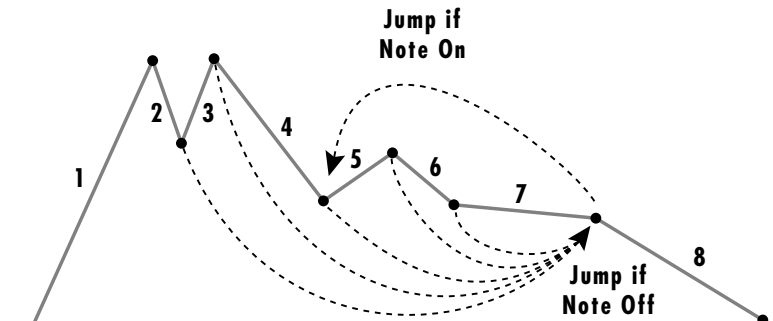

The jumps are called *Conditional Jumps* because they only jump if a certain condition is met. For example, the function generator can be programmed to jump to another segment only if the key is still being held. Otherwise it will continue on to the next segment. Each of the eight segments can have a conditional jump to any segment (including itself).

Conditional Jumps can be programmed to jump to the destination segment immediately or they can wait until the end of the current segment before jumping. The possible conditional jumps are as follows:

- Never** Never jumps. Always goes on to next segment.
- Always End** Always jumps at the end of the current segment.
- Note On End** Jumps at the end of the segment if the note is still on.
- Note On Immed.** Jumps immediately if the note is still on.
- Note Off End** Jumps at the end of the segment if the note is off.
- Note Off Immed.** Jumps immediately if the note is off.
- LFO 1 or 2 End** Jumps at the end of the segment if the value of the selected LFO is equal or greater than the conditional value.
- Footsw. 1-3 End** Jumps at the end of the segment if the selected Footswitch is pressed.
- Footsw. 1-3 Immed.** ... Jumps immediately if the selected Footswitch is pressed.
- Velocity End** Jumps at the end of the segment if the velocity value is greater than a positive conditional value or less than a negative conditional value. See below.
- Key End** Jumps at the end of the segment if the note value is greater than a positive conditional value or less than a negative conditional value. See below.

FUNC GEN F1S1 CondValue +064

When the value is **Positive**, a jump occurs if the velocity or key number is **Greater** than value shown.

FUNC GEN F1S1 CondValue -064

When the value is **Negative**, a jump occurs if the velocity or key number is **Less** than value shown (ignoring the sign).



A CONDITIONAL JUMP ALWAYS GOES TO THE BEGINNING OF THE DESTINATION SEGMENT.

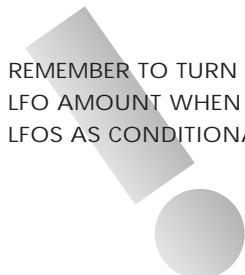

REMEMBER TO TURN UP THE LFO AMOUNT WHEN USING LFOs AS CONDITIONALS.

DRAWING YOUR FUNCTION GENERATOR IDEAS ON PAPER FIRST WILL SIMPLIFY THE PROGRAMMING PROCESS.

WHEN ONE SEGMENT JUMPS TO ANOTHER AT A DIFFERENT LEVEL, A SMOOTH TRANSITION IS MADE BETWEEN THE TWO. THE TIME TO THE END OF THE DESTINATION SEGMENT REMAINS AS SPECIFIED.

In the example below, a standard ADSR envelope generator has been programmed. Segments 5-8 have been set to zero since they are not used. In addition, all conditional jumps for segments 5-8 have been set to “Never”.

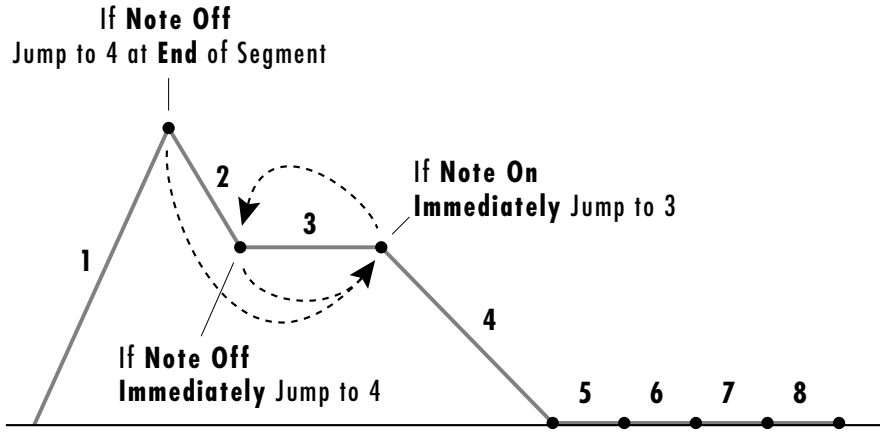

The “Note Off End” conditional at segment 1 will cause a jump to the beginning of segment 4 if the note has been released. Because of the “End”, it will always finish its cycle first. Segment 2 is set for “Note Off Immediate” and will immediately jump to the beginning of segment 4 if the note is released. Segment 3 is set for a “Note On Immediate” jump which causes it to constantly jump back to the beginning of its cycle unless the note is released.

Programming the function generators can get a little complicated. For this reason it is suggested that you draw out your ideas on paper beforehand. Remember that you always jump to the beginning of a segment.

A conditional jump could be programmed to skip a group of segments based on the key velocity. In the example below, segments 2 and 3 would only be played if the velocity value were 84 or above. Velocity values below 84 would cause the function generator to jump to segment 4.

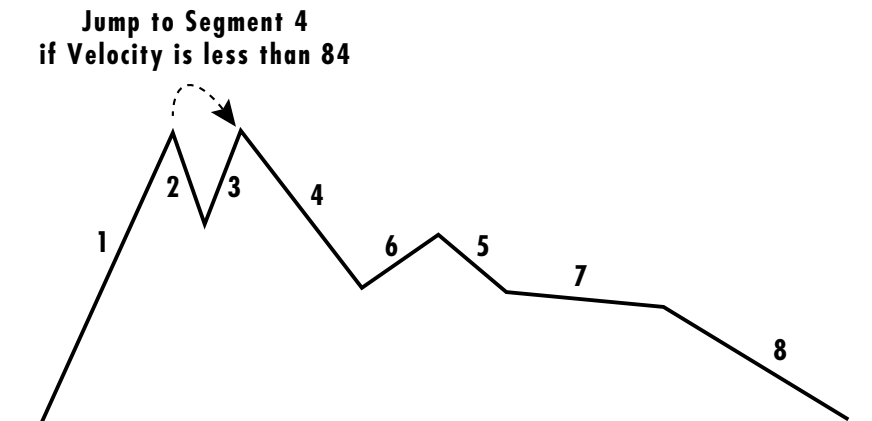

In the example below the function generator becomes a complex LFO through the use of an “Always End” jump which *always* forces a jump back to segment 1 from the end of segment 5. Thus the function generator constantly repeats forming a low frequency oscillator.

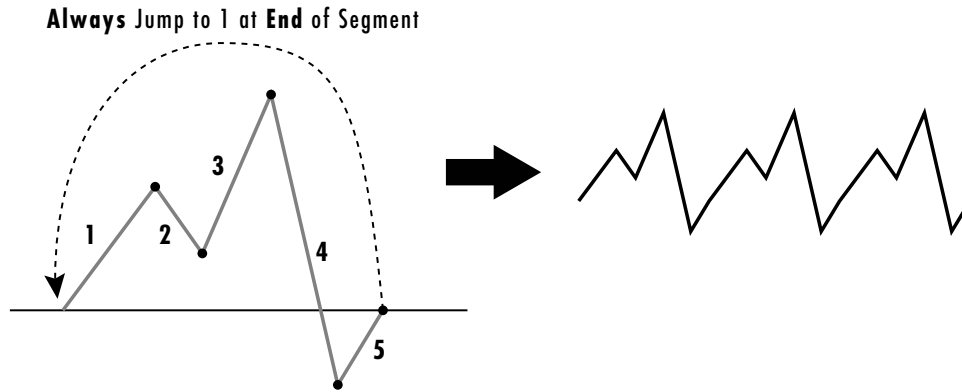

FUNCTION GENERATOR DELTA & RANDOM LEVEL

There are 3 additional options in the function generator level screen, Delta Level (level change), Random, and Random Delta (random change). To access the Delta Level parameter, turn the level value of a function generator one unit past +127. The delta (Δ) symbol appears in the value field.

FUNC GEN	F1S1
Level	Δ -127

Delta Level causes the level to *change* by the specified amount instead of going to an absolute level value. If Level 1 was set to +127 and Level 2 was Δ -027, then the resulting level 2 value would be +100 ($127-27=100$).

The Δ Level parameter can be quite useful when looping segments. In the example below, segment 3 has a level of Δ -016 and loops back to itself as long as the key is held. Because the level is a change rather than an absolute amount, the level decreases by -16 each time the segment loops.

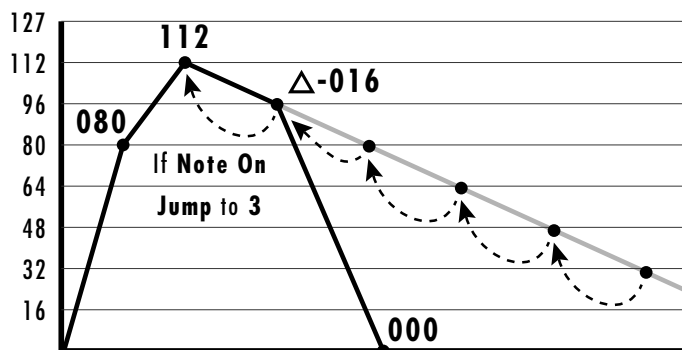

To access the **Random Delta** parameter, turn the level value of a function generator one unit past $r + 127$. The random delta ($r \Delta$) symbol appears in the value field.

FUNC GEN	F1S1
Level	$r\Delta - 127$

A Random Delta level allows the function generator to change by a random amount which does not exceed the random change specified. If a random delta of +16 were programmed, the level could change by any value between 0 and +16. If a value of -16 were programmed, the level could change by any value between 0 and -16.

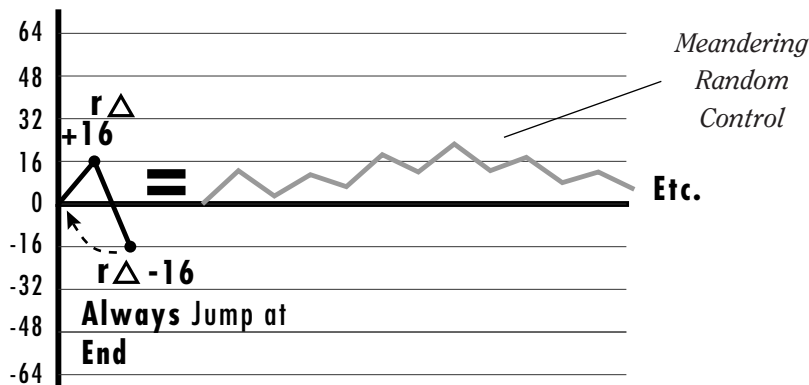

In the example above, the random delta values are set to +16 and -16 and segment 2 always loops back to segment 1. Note that the level may exceed the values of ± 16 as long as the *amount of change* in one segment does not exceed these values. The example above shows a smooth random generator whose rate of change is limited to ± 16 .

FREE-RUNNING FUNCTION GENERATOR

Hyperpresets contain a slightly different version of the function generator called a Free-Running Function Generator or Free-Run FG. The Free-Run FG is only active when a Hyperpreset is in use, even though its destination is programmed in the preset itself. The Free-Run FG differs from the other FGs in two fundamental ways.

There is one Free-Run FG per Hyperpreset which can modulate any presets in the Hyperpreset which have the Free-Run FG assigned. This differs from the 2 function generators in the preset which are completely independent from note to note. Because the Free-Run FG is like a global modulation source, it can be used when you want to modulate multiple sounds in the same way.

If the Free-Run FG were to be programmed as an LFO and to modulate the pitch, all the voices in all presets in that hyperpreset with the Free-Run FG assigned to pitch would modulate up and down in unison.

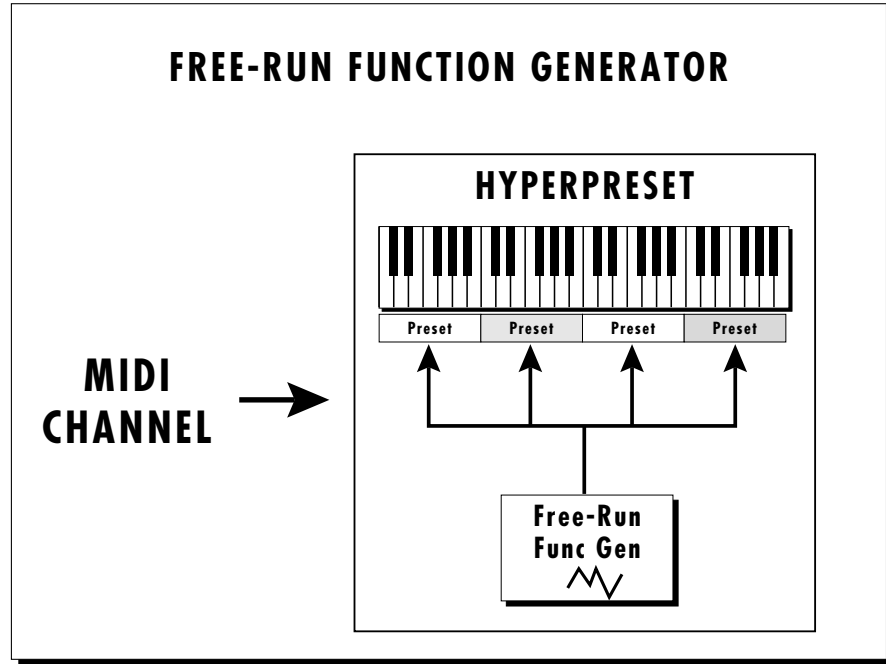

There is one Free-Run Function Generator per MIDI channel which can affect any or all presets in a Hyperpreset. The Free-Run Function Generator begins running the instant the Hyperpreset is selected.

VERSUS

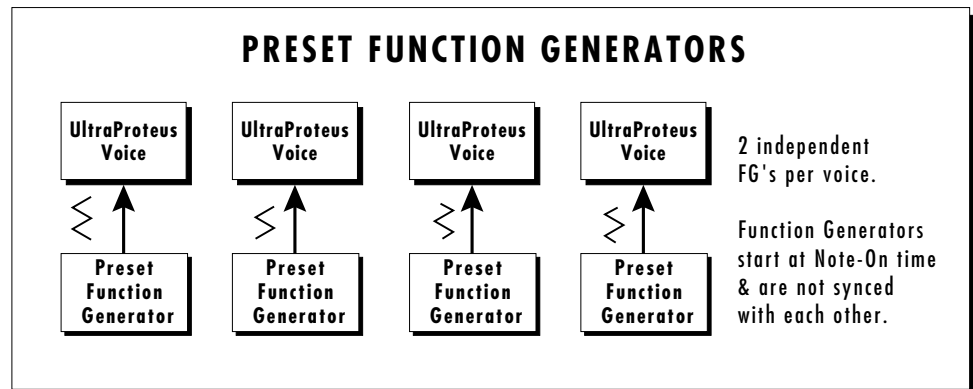

There are two Function Generators per Preset which start at the time a note is pressed.

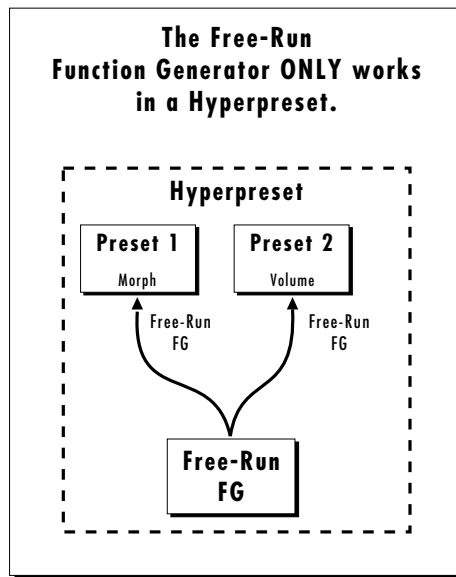
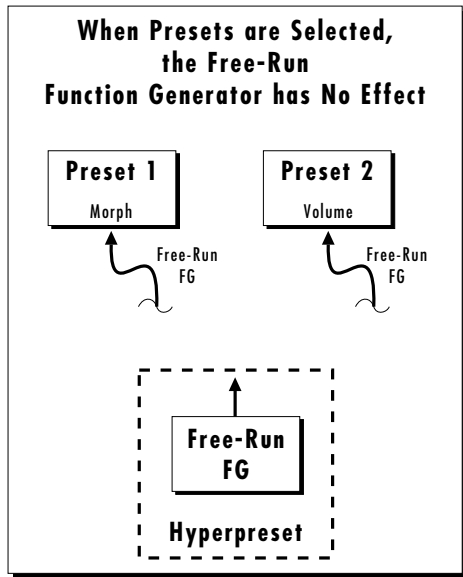

The Free-Run Function Generator only works in a Hyperpreset, even though the modulation routing is made in the preset.

The Free-Run FG begins the instant the Hyperpreset is selected and continues to run until stopped by its programming or when another Hyperpreset is selected. **If the Free-Run FG is not programmed to loop, it simply runs to the last segment and stops!** Because it continually runs (if so programmed) and is not started at the beginning of a note like the preset function generators, it is called “free-running”.

The functions of the Free-Run FG are almost identical to the preset FG's except that the conditional jumps are more limited. The conditional jumps are listed below.

- Never** Never jumps. Always goes on to next segment.
- Always End** Always jump at the end of the current segment.
- Note On End** Jumps at the end of the segment if the note is still on.
- Note On Imm.** Jumps immediately if the note is still on.
- Note Off End** Jumps at the end of the segment if the note is off.
- Note Off Imm.** Jumps immediately if the note is off.
- Footsw. 1-3 End** Jumps at the end of the segment if the selected Footswitch is pressed.
- Footsw. 1-3 Imm.** Jumps immediately if the selected Footswitch is pressed.

FILTER MODULATION

The block diagram of a single channel is shown below.

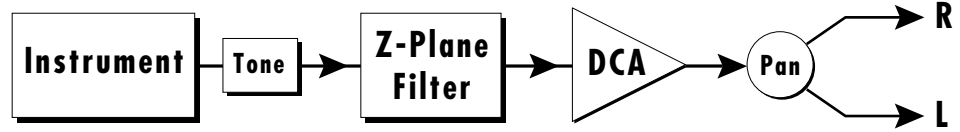

The **Tone** filter is a simple low-pass tone control which can be used to darken the tone of an instrument. The **Z-Plane** filter is an ultra-powerful synthesizer filter which can dramatically alter the sound of an instrument.

To understand how a filter works we need to understand what makes up a sound wave. A sine wave is the simplest form of sound wave. Any waveform except a sine wave can be analyzed as a mix of sine waves at specific frequencies and amplitudes.

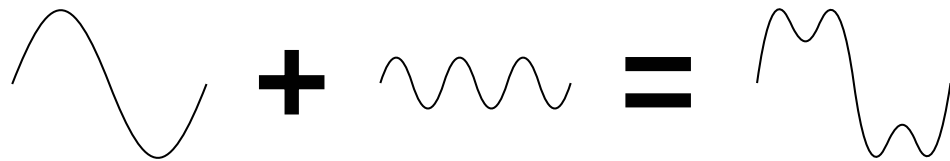

Any waveform can be analyzed as a mixture of sine waves.

One way to represent complex waveforms is to use a chart with frequency on one axis and amplitude on the other. Each vertical line of the chart represents one sine wave at a specific amplitude and frequency.

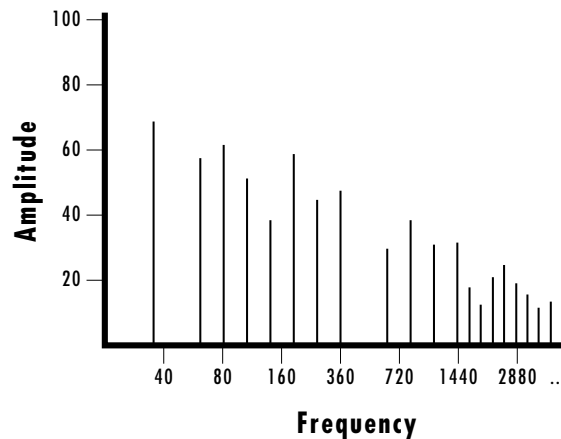

WHAT IS A FILTER?

Most of the instruments in UltraProteus are complex waves containing many sine waves of various amplitudes and frequencies. A **filter is a device which allows us to remove certain components of a sound depending on its frequency.** For example, a *Low Pass Filter* lets the *low frequencies pass* and removes only the high frequencies.

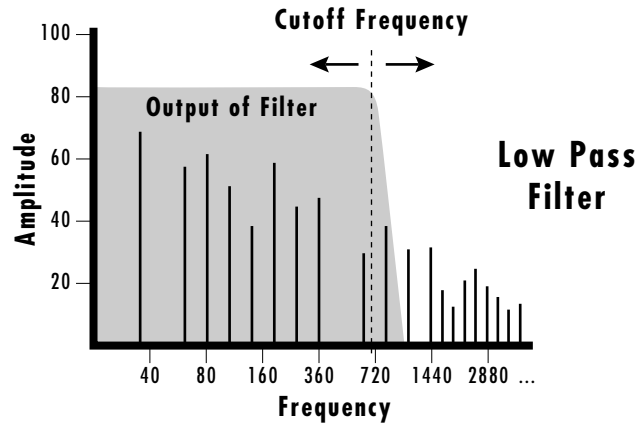

A filter that lets only the high frequencies pass is called a *High Pass Filter*.

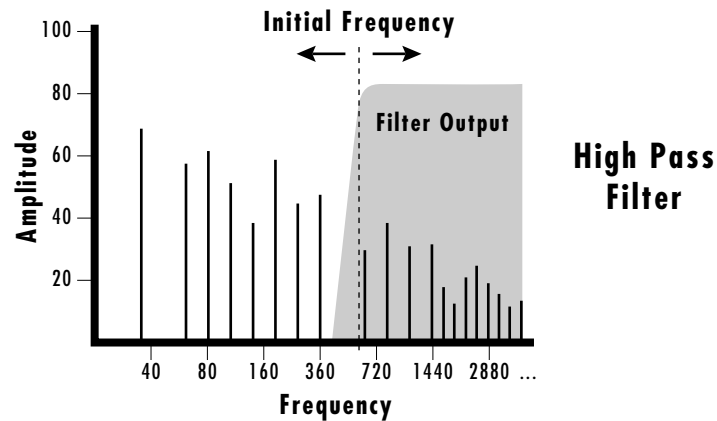

A filter which only lets a certain band of frequencies pass is called a *Bandpass Filter*.

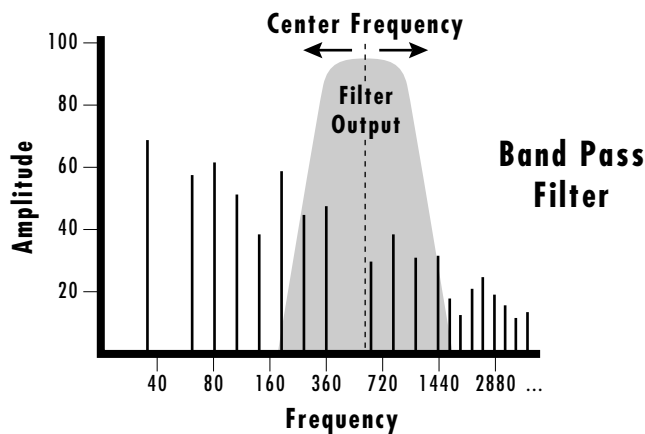

A *Notch Filter* is just the opposite of a bandpass filter and is used to eliminate a narrow band of frequencies.

Another control found on traditional filters is called Q or resonance. A lowpass filter with a high Q would emphasize the frequencies around the cutoff frequency. The chart below shows how different amounts of Q affect the low pass filter response. In terms of sound, frequencies around the cutoff will tend to “ring” with high Q settings. If the filter is slowly swept back and forth, with a high Q, various overtones will be “picked out” of the sound and amplified as the resonant peak sweeps over them. Bells and gongs are real world examples of sounds which have a high Q.

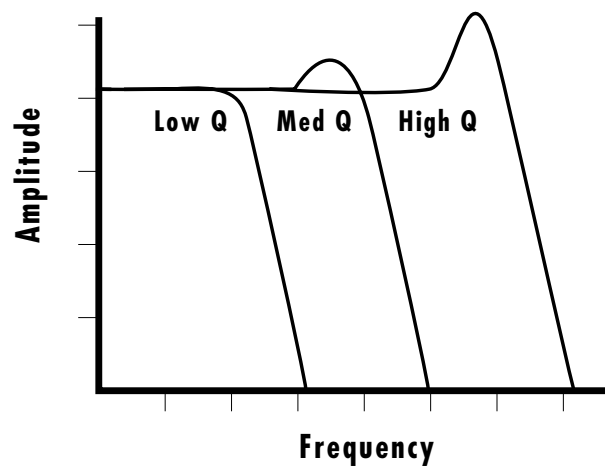

Another characteristic of a filter is the number of poles it contains. Traditional synthesizer filters were usually either 2-pole or 4-pole filters. The number of poles in a filter describes the steepness of its slope. The more poles, the steeper the filter's slope and the stronger the filtering action. The tone controls on your home stereo are probably one-pole or two-pole filters. Parametric equalizers are usually either two-pole or three-pole filters. In terms of vintage synthesizers, Moog and ARP synthesizer filters used 4-pole filters, Oberheim synthesizers were famous for their 2-pole filter sound.

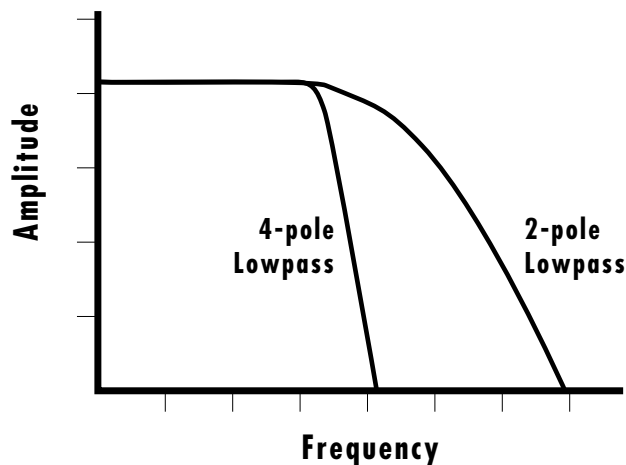

Using a filter, we now have a way to control the harmonic content of a sampled sound. As it turns out, even a simple low pass filter can simulate the response of many natural sounds.

For example, when a piano string is struck by its hammer, there are initially a lot of high frequencies present. If the same note is played softer, there will be fewer of the high frequencies generated by the string. We can simulate this effect by routing the velocity of the keyboard to control the amount of high frequencies that the low pass filter lets through. The result is expressive, natural control over the sound.

If an envelope generator is used to control the cutoff frequency of a low pass filter, the frequency content can be varied dynamically over the course of the note. This can add animation to the sound as well as simulate the response of many natural instruments.

PARAMETRIC FILTERS

A more complex type of filter is called a parametric filter. A parametric filter gives you control over three basic *parameters* of the filter. The three parameters are: *Frequency*, *Bandwidth*, and *Boost/Cut*. The Frequency parameter allows you to select a range of frequencies to be boosted or cut, the Bandwidth parameter allows you to select the width of the range, and the Boost/Cut parameter either boosts or cuts the frequencies within the selected band by a specified amount. Frequencies not included in the selected band are left unaltered. This is different from a band pass filter which attenuates (reduces) frequencies outside the selected band.

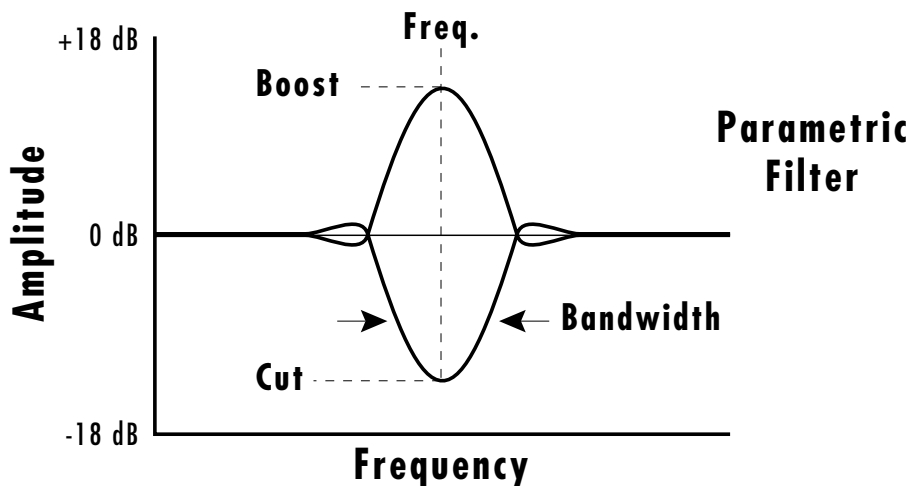

The parametric filter is quite flexible. Any range of frequencies can be either amplified or attenuated. Often times, several parametric sections are cascaded (placed one after another) in order to create complex filter response curves.

If four parametric filter sections were cascaded, it would be possible to create the following complex filter response.

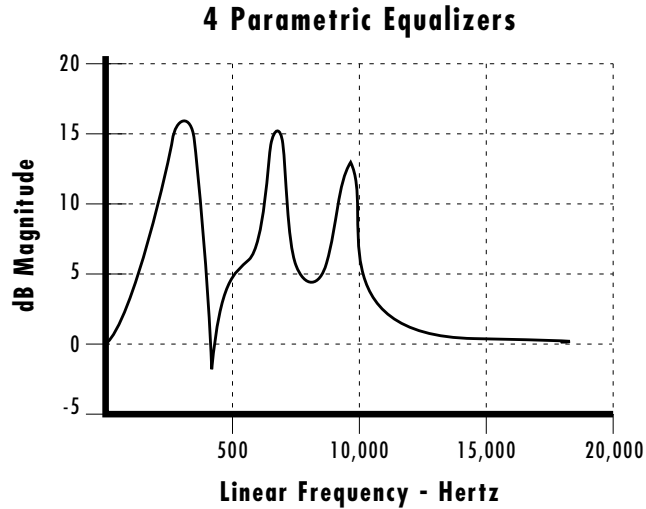

Many natural instruments have complex resonances which are based on their soundboard or tube size. The resonance shown above would be impossible to create using a normal synthesizer filter.

THE ULTRAPROTEUS FILTER

The UltraProteus filter is actually much more complex than the four parametric sections described above. As an example of its power, the diagram below shows one of the possible ways that the UltraProteus filter can be configured. This amount of filtering is unprecedented in all of electronic music history.

(Especially when you consider that we are only talking about one of the 32 channels.)

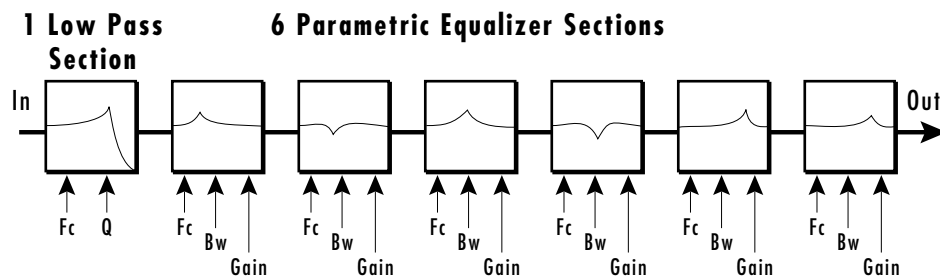

Right away you can see that we now have 20 different parameters to control. Ah, there's the catch. How can all these parameters be effectively controlled? 20 envelope generators? We don't think so.

Consider, as an example, the human vocal tract, which is a type of complex filter or resonator. There are dozens of different muscles controlling the shape of the vocal tract. When speaking, however, we don't think of the muscles, we just remember how it feels to form the vowels. A vowel is really a configuration of many muscles, but we consider it a single object. In changing from one vowel to another, we don't need to consider the frequencies of the resonant peaks! You remember the shape of your mouth for each sound and **interpolate** between them.

THE Z-PLANE FILTER

In a simple UltraProteus filter, we would start with two complex filters and interpolate between them using a single parameter. Refer to the diagram below.

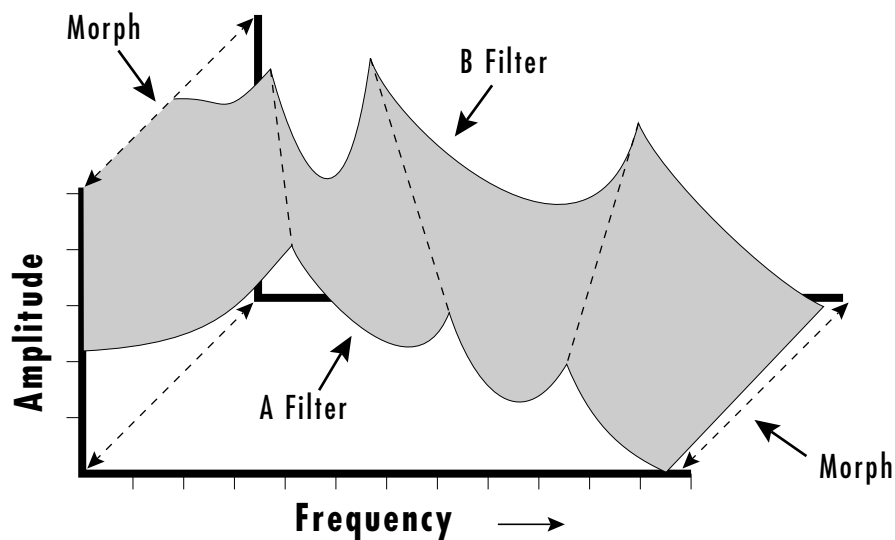

The UltraProteus Z-plane filter has the unique ability to change its function over time.

Filters A and B represent two different complex filters. By changing a single parameter, the **Morph**, many complex filter parameters can now be changed simultaneously. Following along the Morph axis you can see that the filter response smoothly interpolates between the two filters. This is the essence of the Z-plane filter. Through the use of interpolation, many complex parameters are condensed down into one manageable entity.

This Z-Plane filter sweep can be controlled by an envelope or function generator, an LFO, modulation wheels or pedals, keyboard velocity, key pressure, etc. In fact, any of the modulation sources can control the Z-Plane filter.

Because creating the complex filtering is difficult and very time consuming, we have created hundreds of filters and installed them permanently in ROM for your use. You simply select and use the filters in a manner similar to choosing an instrument. Because there are so many types of filters to choose from, the number of possible permutations is staggering. For example, you could play a guitar sound through a vocal tract filter and create a talking guitar sound. Or you could have an acoustic guitar whose body shape changes as you play.

In the current example, two complex filters were created and the Morph parameter was used to interpolate between them. This is the simplest way to visualize a UltraProteus filter



The next logical extension of this two filter model would be to add yet another filter pair. The diagram below shows an example using four filters. Now we have *two* parameters that can be controlled.

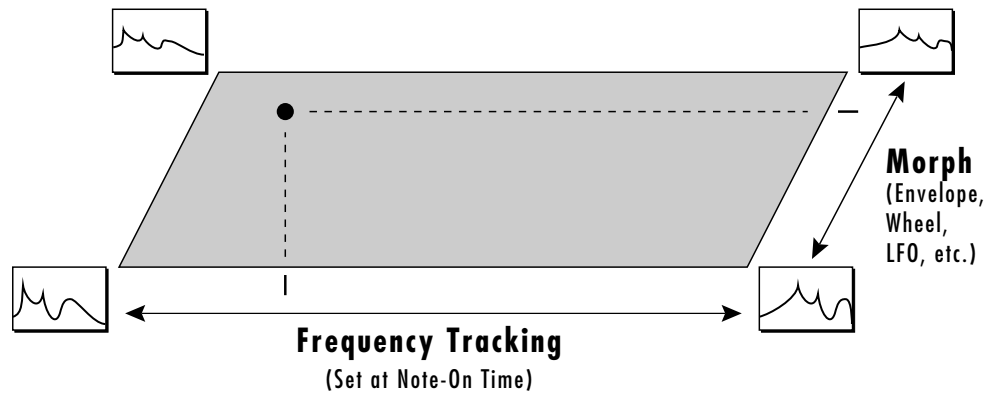

The diagram above, adds a **Frequency Tracking** parameter which varies the frequency of the filter. If we had set the frequency tracking and morph parameters as shown in the diagram above, the dot would represent the resulting filter position: a mixture of all four, but closest in nature to the left rear filter.

In the UltraProteus filter there is only one parameter that can be continuously varied in realtime and that is the Morph parameter. Other filter parameters, such as Frequency Tracking, can only be changed at note-on time.

SEE THE STEP-BY-STEP CHAPTER FOR MORE INFORMATION ON THE Z-PLANE FILTERS.

Suppose we added yet another dimension to the filter model. We could have the realtime Morph parameter, the Frequency Tracking parameter (set at note-on time) and one more parameter, perhaps controlling the amount of the filter peaks with key velocity. One way to visualize a three-dimensional filter model is shown by the diagram below.

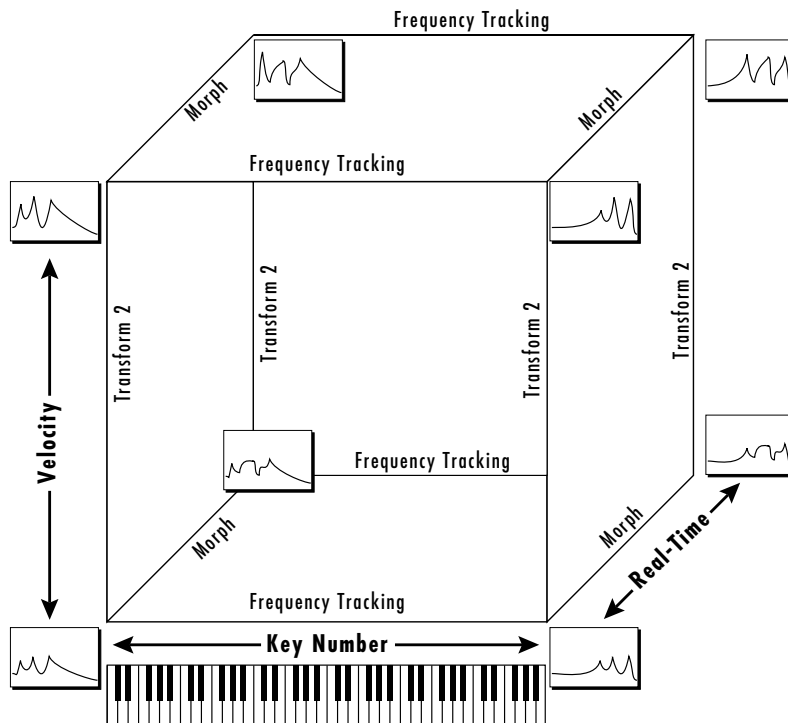

IF THE FREQUENCY GRAPHS AT THE CORNERS OF THE CUBE ARE CONFUSING YOU, THINK OF THEM AS THE SETTINGS ON A GRAPHIC EQUALIZER.

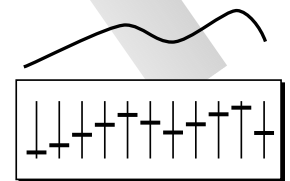

The **Cube** filters are actually constructed of eight different complex filters.

Each axis of the three-dimensional cube changes the filter in a different way. In the example above, key number is being applied to the Frequency Tracking parameter in order to make the filter frequency track or follow the notes played on the keyboard. Assigning the keyboard to frequency is called **Key Tracking** and is used to keep the timbre of the sound constant as you play up and down the keyboard. Without key tracking the sound would get duller as you move up the keyboard and could sound completely different at opposite ends of the keyboard. Because Frequency Tracking is so important it has been assigned its own parameter which is used in many of the filters (there are exceptions).

In the filter model above, there is another note-on (defined at the time the note is pressed) parameter, **Transform 2**. Unlike the Frequency Tracking parameter, the effect of Transform 2 may vary from filter to filter. In the example above, Transform 2 is being used to vary the size of the peaks and notches in the filter. The frequency plots in the upper plane of the cube have sharper peaks. Key velocity could be used to control Transform 2 and the sharpness of the filter peaks.

NOTE: THE FREQUENCY TRACKING PARAMETER IS TRANSFORM 1.

Another View

Another way to look at the Z-Plane filter is simply as a “black box”. You don't really need to think about all the possible filter permutations in order to use it. You just need to know what the controls do and listen to the sound. Each Z-Plane filter is described in the Reference Section of this manual.

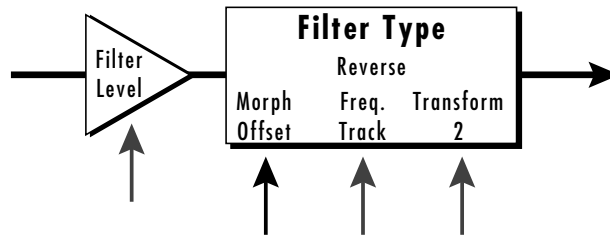

The Z-Plane filter can change its function in time.

Imagine a Lowpass filter transforming into a Bandpass filter. The Morph parameter (Morph Offset) typically handles this type of function.

Lowpass Filter Morphing into a Bandpass Filter

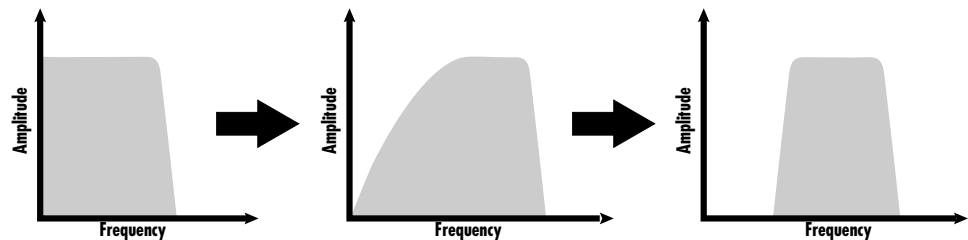

The Morph and Transform 2 parameters vary in function from filter to filter. **About half of the Z-Plane filters are NOT cubes and therefore DO NOT use Transform 2.** The Frequency Tracking parameter usually controls the frequency of the filters, moving peaks, shelves or notches up and down in frequency. Refer to the Reference Section of this manual for specific information on each filter.

Many of the filter types in UltraProteus are models of traditional acoustic instruments such as electric piano or guitar. When an electric piano sample is played through an electric piano filter, the harmonics of the sample can now be controlled using the filter parameters.

Of course, you can put any instrument through the filter and the filter will shape the basic character of the instrument. This “building-block” approach to synthesis is only a part of what makes UltraProteus such a unique and powerful synthesizer.

ON SOME FILTERS, THE FREQUENCY TRACKING PARAMETER DOES NOT CONTROL THE FILTER FREQUENCY. SEE THE FILTER DESCRIPTIONS IN THE REFERENCE SECTION FOR DETAILS.

ULTRAPROTEUS SIGNAL FLOW

Going back to the block diagram for a single channel we can re-examine the complete signal path.

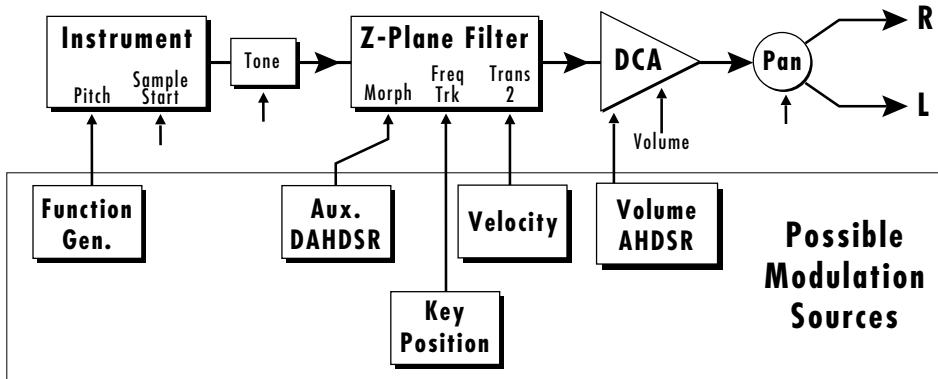

The vertical arrows represent possible modulation routings to the basic signal path.

Instrument

This is the sampled sound wave. The pitch of the instrument can be modulated by any modulation source. The sample start point can only be modulated by a velocity or key source (see the next page).

Tone

Tone is a simple low-pass tone control which can be used to darken the sound. Tone can only be set at note-on time (see the next page). Key velocity is commonly used to modulate the tone (*in a negative way*) so that the harder you play, the brighter the sound becomes.

Z-Plane Filter

The Z-Plane Filter controls the harmonic content of an instrument in a highly controlled manner. Any modulation source can be used to control the various aspects of this complex filter.

DCA

Digitally Controlled Amplifier. Together with the Alternate Volume AHDSR, the DCA is used to shape the volume contour of a sound. The DCA can be controlled by any modulation source. Key Velocity is often used as a modulation source for the DCA so that the harder you play, the louder the sound becomes.

Pan

Adjusts the balance of sound between the left and right channels.

PRESET PROGRAMMING

NOTE-ON

MODULATION SOURCES

KEY NUMBER, KEY VELOCITY
 INITIAL PITCH WHEEL AMOUNT
 INITIAL CONTROLLER A AMOUNT
 INITIAL CONTROLLER B AMOUNT
 INITIAL CONTROLLER C AMOUNT
 INITIAL CONTROLLER D AMOUNT
 INITIAL MONO PRESSURE AMOUNT
 INITIAL FR FUNC. GEN. AMOUNT

DESTINATIONS

OFF
 PITCH, PRIMARY PITCH
 SECONDARY PITCH
 VOLUME, PRIMARY VOLUME
 SECONDARY VOLUME
 ATTACK, PRIMARY ATTACK
 SECONDARY ATTACK
 DECAY, PRIMARY DECAY
 SECONDARY DECAY
 RELEASE, PRIMARY RELEASE
 SECONDARY RELEASE
 CROSSFADE
 LFO 1 AMOUNT, LFO 1 RATE
 LFO 2 AMOUNT, LFO 2 RATE
 AUXILIARY ENVELOPE AMOUNT
 AUXILIARY ENVELOPE ATTACK
 AUXILIARY ENVELOPE DECAY
 AUXILIARY ENVELOPE RELEASE
 FUNCTION GEN 1 AMOUNT
 FUNCTION GEN 2 AMOUNT
 PORTAMENTO RATE
 PRIMARY PORTAMENTO RATE
 SECONDARY PORTAMENTO RATE
 FILTER MORPH
 PRIMARY FILTER MORPH
 SECONDARY FILTER MORPH
 PAN, PRIMARY PAN
 SECONDARY PAN
 SAMPLE START
 PRIMARY SAMPLE START
 SECONDARY SAMPLE START
 TONE, PRIMARY TONE
 SECONDARY TONE
 FILTER LEVEL, PRIMARY FILTER LEVEL
 SECONDARY FILTER LEVEL
 FILTER FREQUENCY TRACK
 PRIMARY FILTER FREQUENCY TRACK
 SECONDARY FILTER FREQ. TRACK
 FILTER TRANSFORM 2
 PRIMARY FILTER TRANSFORM 2
 SECONDARY FILTER TRANSFORM 2

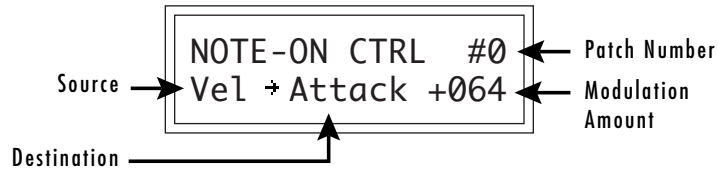
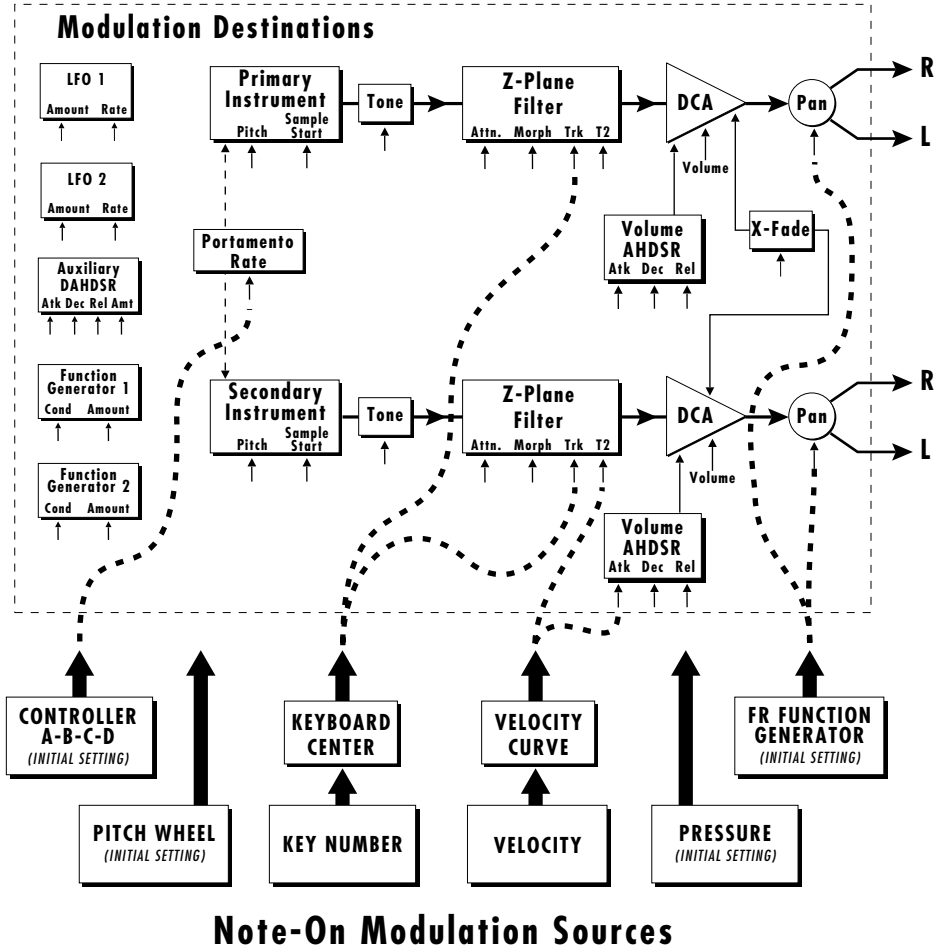

NOTE-ON MODULATION CONTROL

Modulation sources must be connected to a destination in order to have any effect. The diagram and the LCD screen above show how modulation sources are connected to destinations. The modulation sources can control any of the destinations indicated by the small arrows.

- Note-On modulation sources are only measured once at Note-On time, hence the name. Even a controller like the Pitch Wheel is only measured once (at note-on time) when routed as a Note-On control. The Realtime Modulation screen (on the next page), allows continuous variation.

The possible modulation routings are completely flexible as shown in the diagram above. Multiple sources can control the same destination, or a single source can control multiple destinations.

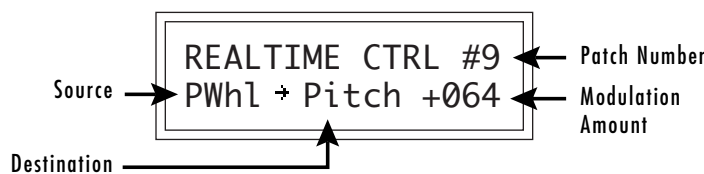
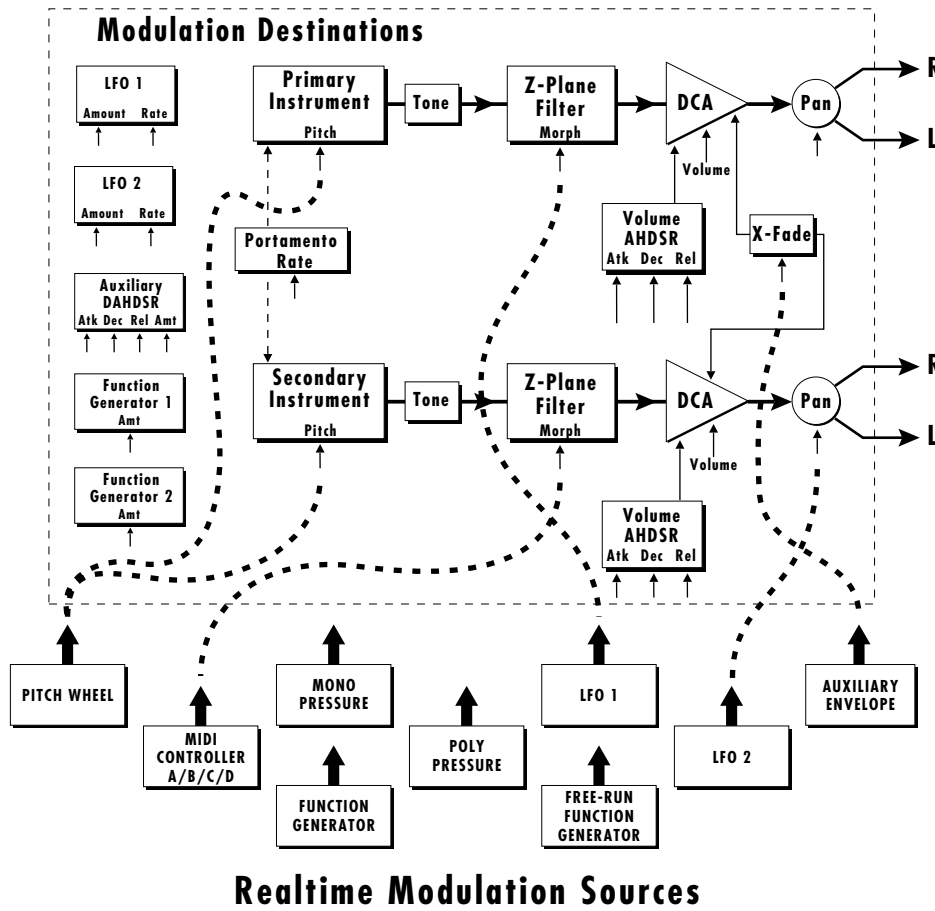

REALTIME MODULATION CONTROL

Realtime modulation sources are parameters which can be continuously varied over time. The velocity and keyboard modulations, in comparison, are set at the key depression. Modulation sources must be connected to a destination in order to have any effect.

The diagram and the LCD screen above show how modulation sources are connected to destinations. The modulation sources can control any of the destinations indicated by the small arrows. The possible modulation routings are completely flexible as shown in the diagram above. Multiple sources can control the same destination, or a single source can control multiple destinations.

REALTIME MODULATION SOURCES

- PITCH WHEEL
- MIDI CONTROL A
- MIDI CONTROL B
- MIDI CONTROL C
- MIDI CONTROL D
- MONO PRESSURE
- POLYPHONIC PRESSURE
- LFO 1, LFO 2
- AUXILIARY ENVELOPE
- FUNCTION GENERATOR 1
- FUNCTION GENERATOR 2
- FREE-RUN FUNCTION GENERATOR

DESTINATIONS

- OFF
- PITCH, PRIMARY PITCH
- SECONDARY PITCH
- VOLUME, PRIMARY VOLUME
- SECONDARY VOLUME
- ATTACK, PRIMARY ATTACK
- SECONDARY ATTACK
- DECAY, PRIMARY DECAY
- SECONDARY DECAY
- RELEASE, PRIMARY RELEASE
- SECONDARY RELEASE
- CROSSFADE
- LFO 1 AMOUNT, LFO 1 RATE
- LFO 2 AMOUNT, LFO 2 RATE
- AUXILIARY ENVELOPE AMOUNT
- AUXILIARY ENVELOPE ATTACK
- AUXILIARY ENVELOPE DECAY
- AUXILIARY ENVELOPE RELEASE
- FUNCTION GEN 1 AMOUNT
- FUNCTION GEN 2 AMOUNT
- PORTAMENTO RATE
- PRIMARY PORTAMENTO RATE
- SECONDARY PORTAMENTO RATE
- FILTER MORPH
- PRIMARY FILTER MORPH
- SECONDARY FILTER MORPH
- PAN, PRIMARY PAN
- SECONDARY PAN

WHEN MODULATING ENVELOPE ATTACK, DECAY OR RELEASE TIMES:
 POSITIVE AMOUNTS OF MODULATION **INCREASE** THE TIME.
 NEGATIVE AMOUNTS OF MODULATION **DECREASE** THE TIME.

KEY NUMBER

The Key Number is affected by the Keyboard Center parameter which can be set to any key from C-2 to G8. The keyboard center establishes a reference point for keyboard modulation; keys above this point will have a positive value, while keys below it will be negative. For example, if we wished to change the volume of an instrument using key number and the key center were set to key A1, the instrument would get progressively louder above A1 and progressively softer below A1.

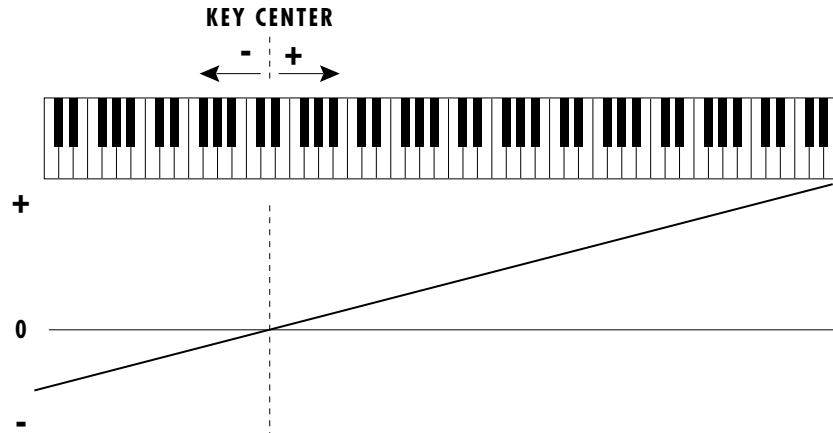

VELOCITY CURVES

Incoming velocity values can be scaled by one of the four velocity curves or by one of the eight Global velocity curves in order to match your playing style or better adapt to the MIDI controller. Experiment with the curves to find the one that works best for your style and MIDI controller.

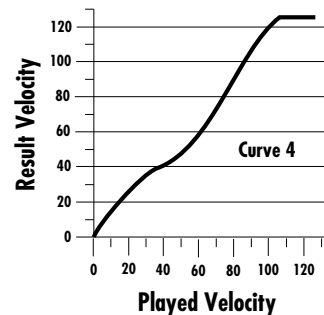
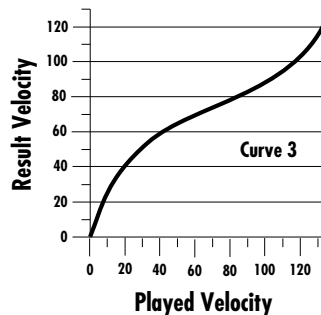
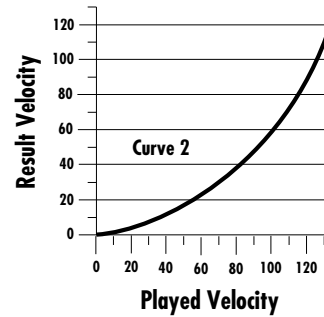
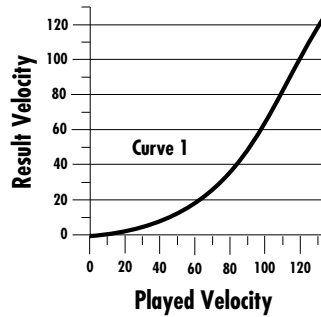

MIDI REALTIME CONTROLS

The MIDI realtime controllers may seem confusing at first, but they are really very simple to understand. You probably already know that there are 16 MIDI channels that can be used. Each of the 16 MIDI channels uses basically 3 types of messages; *note on/off*, *program changes*, and *continuous controller* messages. Your MIDI keyboard, in addition to telling UltraProteus which note was played, may also send *realtime control* information, which simply means occurring in real time or live. (You may be using a MIDI device other than a keyboard, but for simplicity's sake we'll presume that you're using a keyboard.) Realtime control sources include such things as pitch wheels or levers, modulation wheels or levers, control pedals, aftertouch, etc. and are used to add more expression or control. Your MIDI keyboard sends out realtime controller information as *continuous controllers*. There is a set of 32 continuous controllers for each of the 16 MIDI channels. Some of the controllers, such as pitch wheel, volume, and pan have standardized numbers. For example, volume is usually sent on continuous controller #7.

Common realtime controllers such as the pitch wheel, volume, pan and pressure are pre-programmed to their proper destinations. Your keyboard may have

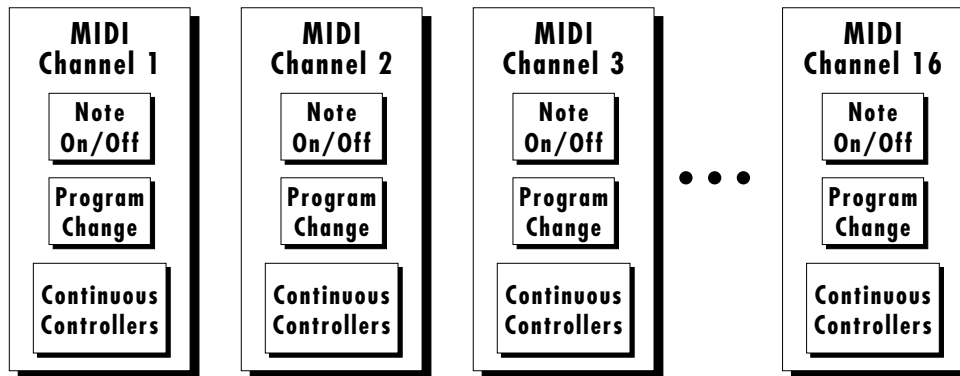

other realtime controls such as a control pedal or data slider which can also be programmed to control most of the parameters on UltraProteus.

UltraProteus is equipped with the sophisticated *MidiPatch™ system*, which allows you to route any continuous controller to any realtime modulation destination. The MidiPatch system is also very easy to use. First, you must know which controller numbers your keyboard can transmit.

Let's say for example, that you are using a Yamaha DX7 as your master keyboard. The DX has pitch and mod. wheels, a breath controller, a data slider and a foot pedal, all of which transmit their values over MIDI. The standard MIDI controller numbers for the controls are listed below (the pitch wheel has a dedicated controller, PWH).

MIDI WIND CONTROLLERS MAY WORK BETTER IF YOU ASSIGN ONE OF THE MIDI A, B, C, D CONTROLLERS TO CONTROL VOLUME. THIS WILL ALLOW THE MIDI VOLUME TO BE ADDED TO THE CURRENT VOLUME.

First, we would go to the Master menu, MIDI Controller Assign and define the 4 MIDI controllers that we wish to use. Assign each controller number to one of the letters A-B-C-D.

- 01 - Modulation Wheel A**
- 02 - Breath Controller B**
- 04 - Foot Pedal C**
- 06 - Data Entry D**

To complete the connections for a particular preset, go to the Edit menu, Realtime Modulation Control, and route the MIDI A, B, C, D to the desired destinations. These could be patched to any four destinations or even to the same destination. The MIDI Controller Amount menu, (in the Preset menu) allows you to scale the amounts of each of the controllers by a positive or negative value. The signal flow is shown in the diagram below.

- STANDARD MIDI CONTROLLER NUMBERS
- 1 MODULATION WHEEL
 - 2 BREATH CONTROLLER
 - 3 PRESSURE REV 1 DX7
 - 4 FOOT PEDAL
 - 5 PORTAMENTO TIME
 - 6 DATA ENTRY
 - 7 VOLUME
 - 8 BALANCE
 - 9 UNDEFINED
 - 10 PAN

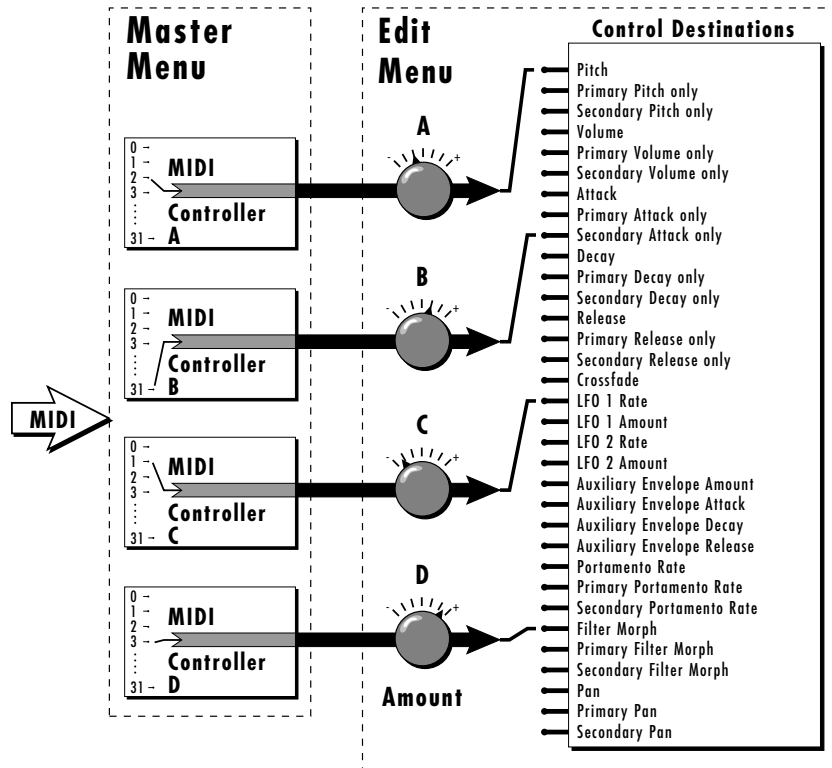

The MIDI controllers A-B-C-D must have both a source (0-31), and a control destination assigned.

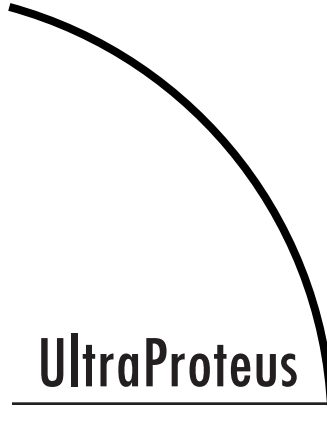
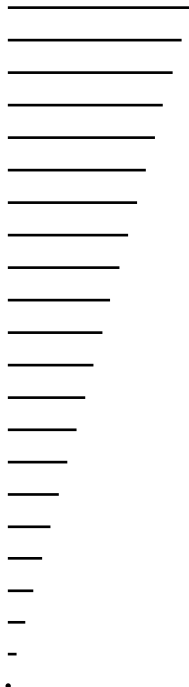

UltraProteus PRESET MENU



The Preset menu contains functions that can be modified by the user and then saved as preset information in one of the user RAM presets. For example, the LFO speed or other parameter can be edited, then the preset can be saved to a user RAM location (0-127, bank 0).

WARNING

Changes made in the Preset menu will be forever lost unless the preset is “saved” using the Save Preset function (page 127) before changing the preset.

To enable the Preset menu

Press the Preset button, lighting the LED. The current screen will be the one most recently selected since powering up the machine. The cursor will appear underneath the first character of the screen heading on line one.

To select a new screen

Press the Home/Enter button or press a cursor button repeatedly until the cursor is underneath the screen title heading. Rotate the data entry control to select another screen.

To modify a parameter

Press the cursor button repeatedly (or hold the right cursor button while turning the data entry control) until the cursor is underneath the parameter value. Rotate the data entry control to change the value.

To compare an edited preset with the original preset

Press the preset button, turning off the LED. The unedited preset is now active. *Changing the preset number will erase the edit.* To hear the edited preset again, press the Preset button, lighting the LED. The stored version of the preset will be heard whenever you are in the main screen.

To return to the main screen

Press the Preset button, turning off the LED.

WHILE THE PRESET MENU IS ACTIVATED, INCOMING MIDI PRESET CHANGES ARE IGNORED. THIS IS A QUICK AND EASY WAY TO TEMPORARILY TURN MIDI PROGRAM CHANGE OFF.

COMPARE MODE MUST BE TURNED ON IN THE MASTER MENU FOR THE COMPARE FEATURE TO WORK.

PRESET MENU FUNCTIONS

Preset Name

Preset Name allows you to name each of the user presets with a name of up to 12 characters. Position the cursor under the character location and use the data entry control to change the character. The keyboard can also be used to select characters. The chart below shows the keyboard character assignment.

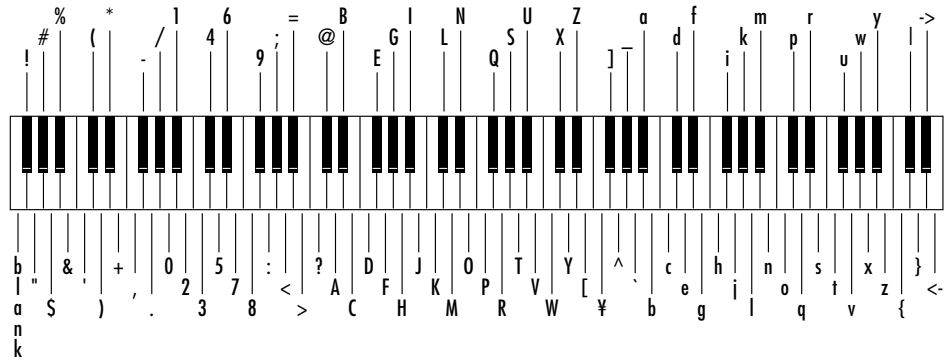
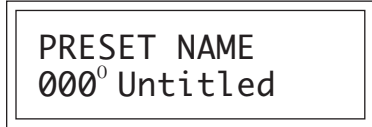

Primary Instrument

This function allows you to select which of the available instrument sounds (or none) will be placed on the primary layer of the current user preset.



Secondary Instrument

This function allows you to select which of the available instrument sounds (or none) will be placed on the secondary layer of the current user preset.



CHANGING THE INSTRUMENT IS A SIMPLE WAY TO CREATE A NEW SOUND WHILE RETAINING ALL OTHER PARAMETERS OF THE PRESET.

Volume

Volume sets the amplitude of the primary and secondary instruments. This function also allows you to compensate for the relative volume differences between instruments.

```
VOLUME
pri:127  sec:64
```

Pan

Pan allows you to independently set the initial pan position of the primary and secondary instruments. A value of -7 pans the instrument hard left and a value of +7 pans the instrument hard right. This pan setting is only valid if “P”, for preset pan, is selected in the main display (or the Midimap).

```
PAN
pri:-7  sec:+7
```

Key Range

Key range sets the keyboard range of both primary and secondary instruments. This sets the keyboard range for the entire preset and will further limit the primary and secondary keyboard ranges. The key range can be set anywhere from C-2 to G8.

```
KEY RANGE
C-2 -> G8
```

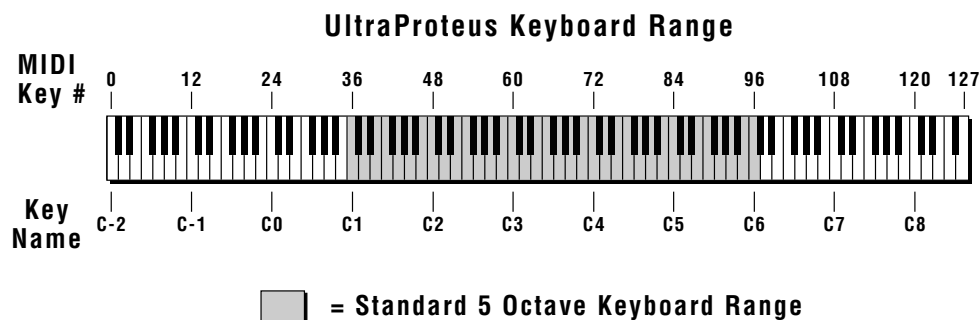

Primary Key Range

Key range sets the keyboard range of the primary instrument. This is useful for creating positional crossfades and keyboard splits between the primary and secondary layers. The key range can be set anywhere from C-2 to G8.

```
KEY RANGE pri
C-2 -> G8
```

Secondary Key Range

Key range sets the keyboard range of the secondary instrument. The key range can be set anywhere from C-2 to G8.

```
KEY RANGE sec
G#4 -> G8
```

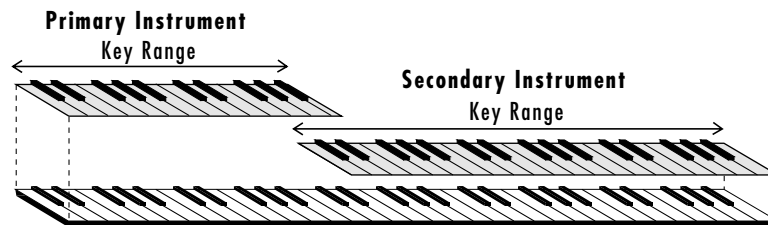

SPLIT KEYBOARD

This diagram shows how a “split” keyboard can be programmed using the primary and secondary instruments.



LAYERING TWO INSTRUMENTS

This diagram shows how instruments can be layered or “stacked” using the primary and secondary instruments.

ENTIRE PRESETS CAN ALSO BE COMBINED TO FORM SPLIT OR LAYERED KEYBOARDS. SEE THE CHAPTER ON HYPERPRESETS IN THIS MANUAL.

Transpose

This function allows you to transpose the key of the primary and secondary instruments in semitone intervals by shifting the keyboard position relative to middle C. The transpose range is -36 to +36 semitones.

```
TRANSPOSE
pri:+00  sec:+00
```

Coarse Pitch Tuning

This function allows you to change the tuning of the primary and secondary instruments in semitone intervals. The coarse tuning range is -36 to +36 semitones.

```
PITCH TUNE crse
pri:+00  sec:+00
```

Fine Pitch Tuning

This function allows you to change the tuning of the primary and secondary instruments in 1/64 semitone intervals (approx. 1.56 cents). The fine tuning range is ± 1 semitone.

```
PITCH TUNE fine
pri:+00  sec:+00
```

Alternate Volume Envelope On/Off

Each instrument has its own factory preset AHDSR volume envelope which is used if this parameter is set to Off. Turn Alternate Volume Envelope On to use the user-programmable alternate envelope.

```
ALT VOL ENVELOPE
pri:Off  sec:0n
```

USE TRANSPOSE WHEN YOU WANT THE INSTRUMENT'S TIMBRE TO REMAIN CONSTANT. USE COARSE TUNING WHEN YOU WANT TO CHANGE THE TIMBRE OF THE INSTRUMENT.

USE THE COARSE TUNING CONTROL TO CHANGE THE TUNING OF MULTIPLE DRUM INSTRUMENTS.

SEE PAGES 73-74 FOR AN EXPLANATION OF THE ENVELOPE PARAMETERS.

SHORTENING THE RELEASE TIMES OF THE ALTERNATE ENVELOPE CAN ALLEVIATE CHANNEL "RIPOFF" PROBLEMS. ULTRAPROTEUS EXAMINES THE ALTERNATE ENVELOPE TO DETERMINE IF A CHANNEL CAN BE REUSED.

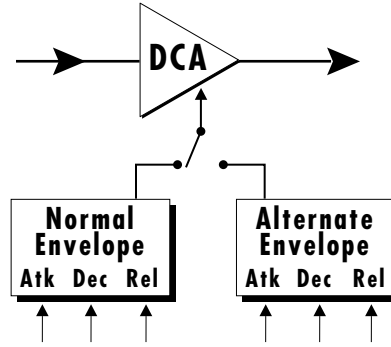

Primary Alternate Envelope Parameters

This function allows you to adjust the alternate volume envelope parameters for the primary instrument. The parameters are Attack time, Hold time, Decay time, Sustain level, Release time and are adjustable from 00 to 99.

P:	A	H	D	S	R
	00	00	00	99	16

Secondary Alternate Envelope Parameters

This function allows you to adjust the alternate volume envelope parameters for the secondary instrument. The parameters are Attack time, Hold time, Decay time, Sustain level, Release time and are adjustable from 00 to 99.

S:	A	H	D	S	R
	00	00	00	99	16

Double + Detune

Double + Detune “thickens” the sound by doubling the sound and then detuning it. The amount is variable over a range of 1 to 15. When Double + Detune is on, a particular instrument will use twice as many channels. If Double + Detune is used for both the primary and secondary instruments, the preset will use four channels per key.

DOUBLE + DETUNE	
pri:Off	sec:07

Sound Delay

Sound Delay varies the time between the arrival of a MIDI Note-On message and the onset of a note. The delay time is adjustable from 0 to 14 seconds (000-127).

```
SOUND DELAY
pri:000  sec:000
```

Sound Start

This function allows you to set where a sample begins playing when you hit a key. A setting of 000 plays a sound from the beginning, higher values move the sample start point toward the end of the sound.

```
SOUND START
pri:000  sec:000
```

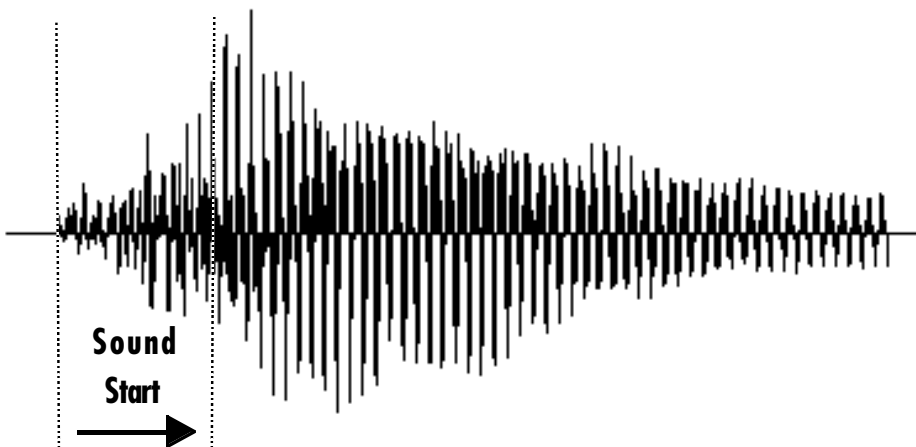

The Sound Start parameter allows you to cut off the beginning of the sound. Higher values move the start point toward the end of the sound.

Sound Reverse

When sound reverse is turned On, the instrument will be played backwards. Since instruments tend to sound very different when reversed, this function extends the number of possible sounds in UltraProteus.

```
SOUND REVERSE
pri:Off  sec:0n
```

SEE THE STEP-BY-STEP SECTION OF THIS MANUAL FOR AN APPLICATION USING SOUND START.

THE SOUND START PARAMETER CAN BE USEFUL TO REMOVE THE GRADUAL ATTACK OF A REVERSED SOUND. THE LOOP OFFSET PARAMETERS CAN ALSO BE PUT TO GOOD USE WITH REVERSED SOUNDS.

IN SOME CASES, SUCH AS THE INDIVIDUAL PERCUSSION SOUNDS, LOOPING MAY NOT BE DESIRABLE. IF THIS IS THE CASE, TURN LOOP ENABLE OFF.

Nontranspose

This function turns keyboard transposition On or Off for the primary and secondary instruments. With Nontranspose On, the keyboard will not control the pitch of the instrument. This is a useful function for drones or “chiffs”, which you may not want to track the keyboard.

```
NONTRANPOSE
pri:0ff  sec:0n
```

Loop Enable

This function allows you to turn the loop in a sound On or Off. Looping is a way that sounds can be sustained indefinitely. If you want an instrument to play once, then stop, turn Off the Loop Enable function.

```
LOOP ENABLE
pri:0ff  sec:0n
```

Loop Offset

All the UltraProteus instruments have been factory looped for your convenience. The Loop Offset function allows you to modify the Loop Start Point and the Loop Size so you can create your own loops.

By looping the sound on the attack portion of an instrument, you can create new waveforms. The Loop Start and Loop Size parameters can cross sample boundaries so that more than one instrument will play. Sample boundary crossing may be useful to create a special effect or background ambience. A Start and Size Offset of 000,000 returns you to the factory loop setting.

LOOP OFFSET IDEAS

LOOP OFFSET CAN BE USED TO CREATE INTERESTING NEW TIMBRES BY LOOPING ON THE ATTACK TRANSIENT OF AN INSTRUMENT.

BY TRAVERSING SEVERAL INSTRUMENTS YOU MAY FIND INTERESTING POLYRHYTHMS.

EXTREMELY LONG LOOP SIZES CAN CREATE INCREDIBLE BACKGROUND AMBIENCE. USE PITCH-SHIFTING AND MULTIPLE KEYS.

Primary

```
LOOP OFFSET
StartP +000,000
```

```
LOOP OFFSET
SizeP +000,000
```

Secondary

```
LOOP OFFSET
StartS +000,000
```

```
LOOP OFFSET
SizeS +000,000
```

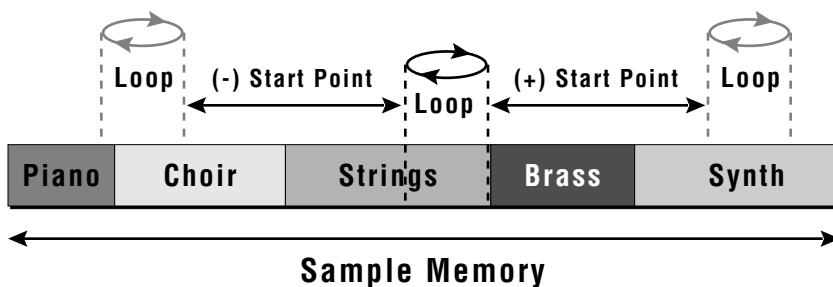

Changing the Loop Offset Start point moves the loop forward or backward (+ or -) through the sample memory, keeping the loop size constant. Large changes will move the loop completely out of the original sample.

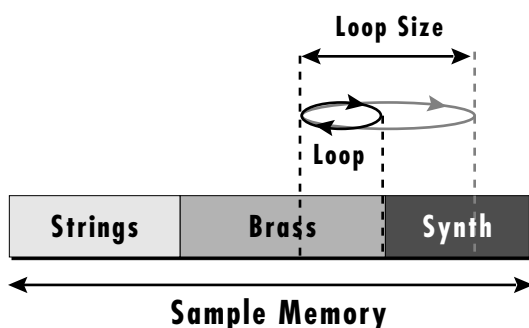

Changing the Loop Offset Size, alters the size of the loop, leaving the loop start point stationary. Large positive offsets will enlarge the loop to encompass multiple samples.

Solo Mode

Solo mode provides the playing action of a monophonic instrument. It can make wind and string instruments sound more realistic by preventing more than one note from sounding at once. Two types of solo mode are provided: *Wind Controller* mode and *Synth* mode. In either solo mode, if a new note is played while another is being held, the envelope generators do not retrigger and the sample remains in the loop. This allows a legato playing technique to be used.

Wind mode

The envelope generator attack always begins at the start of the attack phase when playing staccato. When playing legato, the envelope generator stays in the sustain phase.

Synth mode

The envelope generator attack begins at whatever point in the release phase the envelope is in when a new key is pressed. When playing legato, the envelope generator stays in the sustain phase.

```
SOLO MODE
p:Off    s:Wind
```

SOUNDS ARE LOOPED SO THAT THEY WILL CONTINUE TO SOUND AS LONG AS THE KEY IS PRESSED.

WHEN USING A NEGATIVE LOOP START POINT, THE SOUND MAY JUMP BACK TO A POINT BEFORE THE START OF THE SAMPLE DURING THE LOOP CYCLE.

SOLO MODE ALLOWS YOU TO SIMULATE CERTAIN PLAYING TECHNIQUES SUCH AS "TONGUING" ON A SAXOPHONE, WHERE THE ATTACK IS ONLY HEARD ON CERTAIN NOTES.

THERE IS A FOUR NOTE LIMIT FOR REMEMBERING NOTES IN THE FIRST AND LAST NOTE PRIORITY MODES.



Solo Mode Priority

When multiple notes are played and held in solo mode, the last note played is always heard. As notes are released, the solo mode priority determines which note will take over from the the last note played.

High Note Priority - If multiple notes are being held in solo mode, the highest key being held will play when the last-played key is released.

Low Note Priority - If multiple notes are being held in solo mode, the lowest key being held will play when the last-played key is released.

First Note Priority - If multiple notes are being held in solo mode, and the last note is released, the note will jump back to the first note.

Last Note Priority - If multiple notes are being held in solo mode, only the note last pressed will play. If the note is released it jumps back to the last note before that.

Drum - If multiple notes are being held in solo mode, only the note last pressed will play. If the note is released, no jumping occurs.

```
SOLO PRIORITY
p:Low    s:Hi
```

Portamento Rate

Portamento is a smooth gliding between notes instead of the normal instantaneous change in pitch when a new key is pressed. The portamento rate is the time it takes to glide to the new pitch. The larger the value, the slower the glide rate. The rate is adjustable from 1-127 or it can be turned Off. Portamento glides at a linear or exponential rate between notes and can be set separately for the primary and secondary layers. Portamento works both in and out of Solo Mode.

```
PORTAMENTO RATE
pri:127  sec:Off
```

Portamento Shape

The portamento is variable from convex exponential (8) to linear, for both the primary and secondary instruments. Using the exponential shapes, the portamento rate will slow as the note nears its destination.

```
PORTAMENTO SHAPE
pri:Ex4  sec:Lin
```

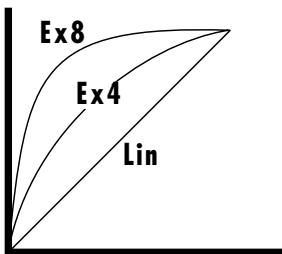

THE PORTAMENTO SHAPE CAN BE VARIED FROM LINEAR TO CONVEX EXPONENTIAL.

Portamento Mode

This function sets the number of notes that will be affected by portamento. For example, if the Portamento Mode is set to two keys and a three-note chord is played, only two of the notes will glide. Notes will glide from the previous note or notes played. By setting the number of keys to match the number of notes in your chords, smooth glides between those chords can be accomplished without having notes glide in from random starting points. The number of keys can be set from mono to 5 note polyphonic.



Crossfade Mode

This function determines which of the following crossfade modes will be selected: Off, Crossfade, or Cross-Switch.

Off

When “Off” is selected, crossfade is disabled.

Crossfade

When “X-Fade” is selected, a control input is used to fade between the primary and secondary instruments. Any modulation source may be used as an input (velocity, wheel, etc.).

Cross-Switch

When “X-Switch” is selected, the secondary layer is selected if the input crosses a certain threshold or if a footswitch controlling cross-switch is activated. The switch occurs only at the start of the note; no further switching takes place while the key is held down. If key position or velocity is routed to cross-switch, the threshold is the *switch point*. Realtime controllers do not have any effect when routed to cross-switch.

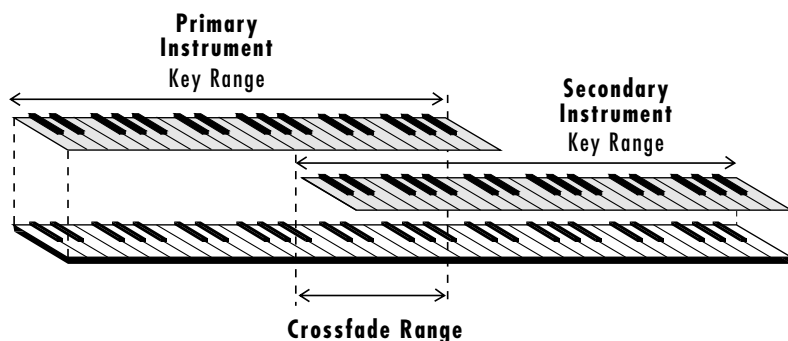

By overlapping the primary and secondary instruments, you can crossfade or cross-switch between the layers.

IN ORDER TO CONTROL THE CROSSFADE OR CROSS-SWITCH FUNCTIONS, YOU MUST ASSIGN CROSSFADE TO A MODULATION SOURCE IN THE REALTIME OR NOTE-ON MODULATION SCREEN.

SEE ALSO, CROSS-SWITCH POINT ON PAGE 113.

TO USE THE KEYBOARD FOR CROSSFADE, SET THE CROSSFADE BALANCE TO 64 AND THE KEY CENTER TO THE SPLIT POINT.

Crossfade Direction

This function determines the polarity of the crossfade or cross-switch. The direction is either primary -> secondary, or secondary -> primary.

```

XFADE DIRECTION
Pri -> Sec
    
```

Crossfade Balance and Amount

The crossfade balance parameter determines the initial balance between the primary and secondary layers. Higher values shift the balance to the secondary instrument. When the Crossfade Direction is Pri->Sec, Modulation subtracts from the primary volume and adds to the secondary volume. When crossfade modulation and balance equal 64, the two instruments are at equal volume.

The crossfade amount parameter determines the range over which crossfading will occur. Crossfade amount is variable from 000 to 255. The larger the value, the more modulation will be required to effect a complete crossfade.

```

XFADE BAL  AMT
   064    128
    
```

A CROSSFADE BALANCE SETTING OF 000 WOULD BE APPROPRIATE WITH A SOURCE SUCH AS A MODULATION WHEEL OR FOOTPEDAL, EITHER OF WHICH CAN ONLY CHANGE THE VALUE IN A POSITIVE DIRECTION.

CROSSFADE SHOULD BE TURNED OFF UNLESS A NOTE-ON OR REALTIME CONTROLLER IS ASSIGNED.

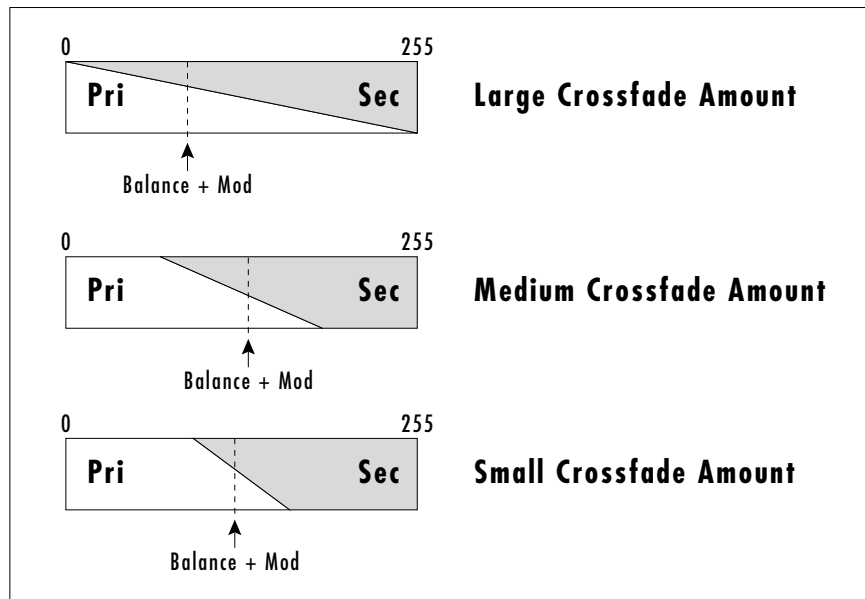

Modulation and Crossfade balance are added together to determine the mixture of primary and secondary instruments. Higher values increase the secondary volume.

Cross-Switch Point

The Cross-Switch point determines the point at which cross-switching will occur when key position or velocity is controlling Cross-Switch.



Primary Filter Type

This screen allows you to select one of 288 Z-Plane filter types available in ROM. These filters include: traditional low-pass filters, flanger simulators, vowel formants, distortion filters, acoustic instrument models and many, many more. See the reference section for a complete listing and descriptions of the filters.

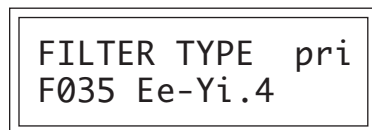

Secondary Filter Type

This screen allows you to set the filter type for the secondary layer. See Primary Filter Type.

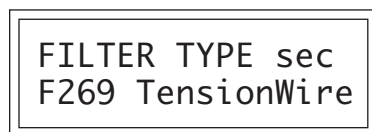

Filter Level

This function sets the amount of signal into the filter. This control can be used to balance the levels between instruments or to control the distortion characteristics of the filter. Depending on the type of instrument and the filter, this control can have a dramatic effect on the sound. This control differs from the Volume parameter which adjusts the volume *after* the filter. The default setting is 255 (full level).



IN ORDER TO CONTROL THE CROSS-SWITCH FUNCTION, YOU MUST ASSIGN CROSSFADE TO A MODULATION SOURCE IN THE NOTE-ON OR REALTIME CONTROL SCREENS.

UNDER CERTAIN UNUSUAL CIRCUMSTANCES THE FILTERS MAY OVERLOAD, PRODUCING A LOUD OBJECTIONABLE NOISE. TURN DOWN THE FILTER LEVEL VALUE TO ALLEVIATE THE PROBLEM.

Morph Offset

This function allows you to set the initial point in the filter morph with no modulation applied. Subsequent modulation will be added or subtracted to this value.

MORPH OFFSET
pri:096 sec:000

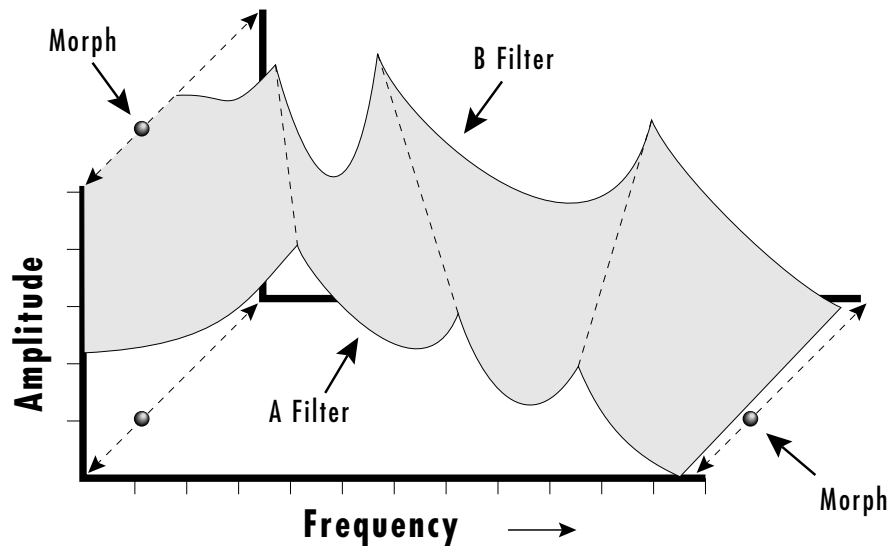

The Morph Offset sets the point along the morph axis where the filter starts with no modulation applied.

Filter Frequency Tracking

If the filter frequency remains constant as the pitch of a sound is varied, the timbre of the sound will change with pitch. A way to correct this is to have the filter's frequency track the pitch of the note. **This function sets the initial frequency of the filter's pitch tracking.** In general, you can think of frequency tracking as a tone control. In order to have keyboard tracking, you must also patch the "Keyboard to Filter Frequency Tracking" in the Note-On modulation screen.

FILT FREQ TRACK
pri:000 sec:000

IN MANY OF THE FILTERS, THE FILTER FREQUENCY TRACKING WORKS LIKE A TONE CONTROL WHICH BRIGHTENS OR DARKENS THE SOUND.

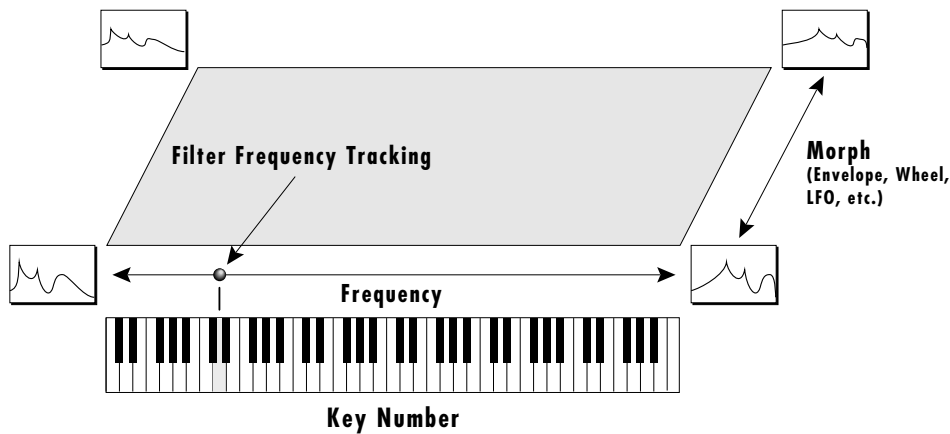

Filter Frequency Tracking allows the timbre of the sound to remain constant up and down the keyboard (if Key Number is routed to this parameter).

Filter Transform 2

Suppose we added yet another dimension to the filter model. We have the realtime *Morph* parameter, the Frequency Tracking parameter (set at note-on time) and one more parameter, perhaps controlling the amount of the filter peaks with key velocity. A way to visualize a three-dimensional filter model is shown in the diagram below.

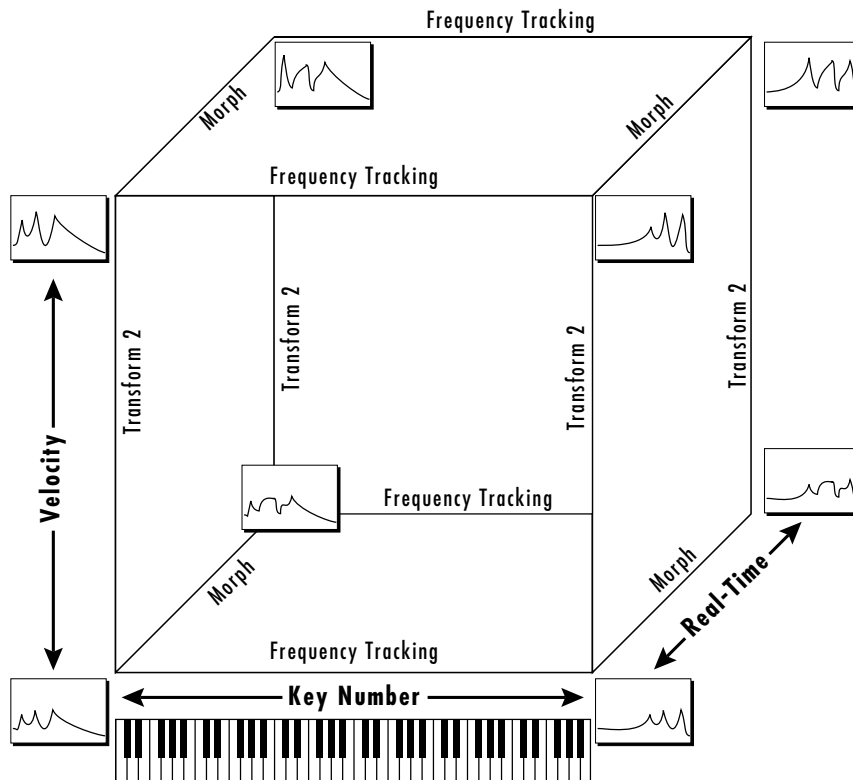

Each UltraProteus filter is actually constructed of up to eight different complex filters.

MANY OF THE FILTERS IN
ULTRAPROTEUS DO NOT USE
TRANSFORM 2.

Each axis of the three-dimensional cube changes the filter in a different way. In the example above, key number is being applied to the Frequency Tracking parameter in order to make the filter frequency track or follow the notes played on the keyboard.

In the 3-D filter model, there is another note-on (defined at the time the note is pressed) parameter, Transform 2. Unlike the frequency tracking parameter, the effect of Transform 2 varies from filter to filter. In the example above, Transform 2 is being used to vary the size of the peaks and notches in the filter. The frequency plots in the upper plane of the cube have sharper peaks. In the example above, key velocity is being used to control Transform 2 and the sharpness of the filter peaks.

Filter Transform 2 sets the **Initial Point** along the Transform 2 axis. Subsequent modulation (from note-on modulation) adds to this initial setting for the primary and secondary filters.

```
FILT TRANSFORM 2
pri:000  sec:127
```

Filter Reverse

This function allows you to reverse the direction of all of the filter controls. Key Tracking, Transform 2 and the Morph parameters will all operate in reverse. The Offset points are reversed, as well as the direction of filter modulation.

```
FILTER REVERSE
pri:0ff  sec:0ff
```

Auxiliary Envelope

This is a supplementary, utility envelope that can be routed to any realtime control destination including the Morph filter. The auxiliary envelope parameters are: Envelope Amount, Delay, Attack Time, Hold Time, Decay Time, Sustain Level, and Release Time. The delay time is variable from 0 to 13 seconds (000-127). The envelope amount is variable from -128 to +127. Negative values will produce inverted envelopes.

```
AUX ENV  AMT DLY
          +127 000
```

```
A:  A  H  D  S  R
    00 00 00 99 20
```

FOR MORE INFORMATION ON
THE ENVELOPES, SEE THE PRESET
PROGRAMMING SECTION OF
THIS MANUAL.

LFO 1 - Shape & Amount

This screen controls the waveshape and amount of Low Frequency Oscillator 1. The LFO can be used to produce vibrato (when routed to pitch), or tremolo (when routed to volume). The LFO can be routed to control any of the Realtime Modulation destinations (page 123). The five LFO waveshapes are: Triangle, Sine, Square, Sawtooth, and Random. The amount can be varied from -128 to +127. Negative values will produce inverted waveshapes.

```

LFO1  SHAPE  AMT
      Rand  +127
    
```

LFO 1 - Rate, Delay & Variation

This screen controls the rate, delay and variation of LFO 1.

LFO Rate

Varies the LFO speed from 0.052 Hz to 25 Hz (000-127).

LFO Delay

Sets the amount of time between hitting a key and the onset of modulation. This can be used to simulate an effect often used by acoustic instrument players, where the vibrato is brought in only after the initial note pitch has been established. The delay range is variable from 0 to 13 seconds (000-127).

LFO Variation

Sets the amount of random variation of an LFO each time a key is pressed. This function is useful for ensemble effects, where each note played has a slightly different modulation rate. The higher the number, the greater the note to note variation in LFO rate. LFO variation is variable from 000-127.

```

LFO1  RT   DLY  VAR
      000  000  000
    
```

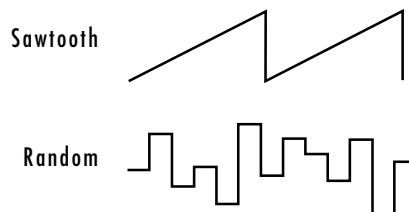
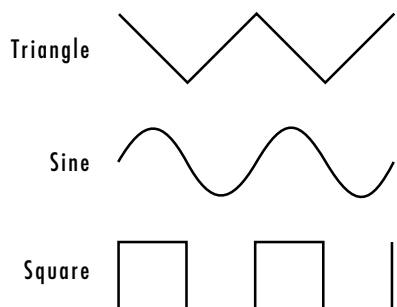

FOR MORE INFORMATION ON THE LFOS, SEE THE PRESET PROGRAMMING SECTION OF THIS MANUAL.

LFO 2 - Shape & Amount

LFO 2 is functionally identical to LFO 1.

LFO 2 - Rate, Delay & Variation

LFO 2 is functionally identical to LFO 1.

Function Generators 1 and 2

The Function Generators are eight segment modulation sources with conditional jumping capabilities and selectable segment shapes. Level and Time parameters are provided for each stage. In addition, the shape of each stage can be individually selected from a palette of 63 shapes. The function generator can be used when you want complex and precise control over a parameter. Through the creative use of its conditional jumps and curves, the function generator can serve as a complex LFO, a complex envelope generator, a mini-sequencer, a random source or all at once if you desire.

FOR MORE INFORMATION ON FUNCTION GENERATORS, SEE THE PRESET PROGRAMMING SECTION OF THIS MANUAL.

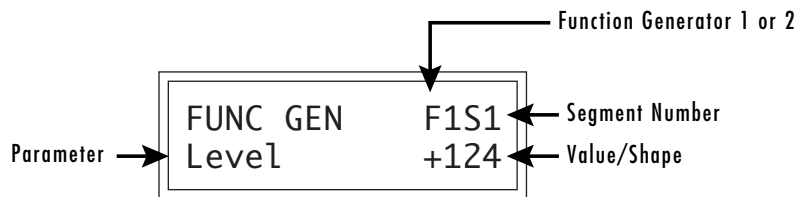

Function Generator Parameters

Level	+127
Time	0750ms
Shape	Linear
CondJump	Never
CondValue	+000
CondDestSeg	2

ROUTING THE FUNCTION GENERATOR TO CONTROL PITCH MAKES IT EASY TO HEAR WHAT YOU ARE DOING.

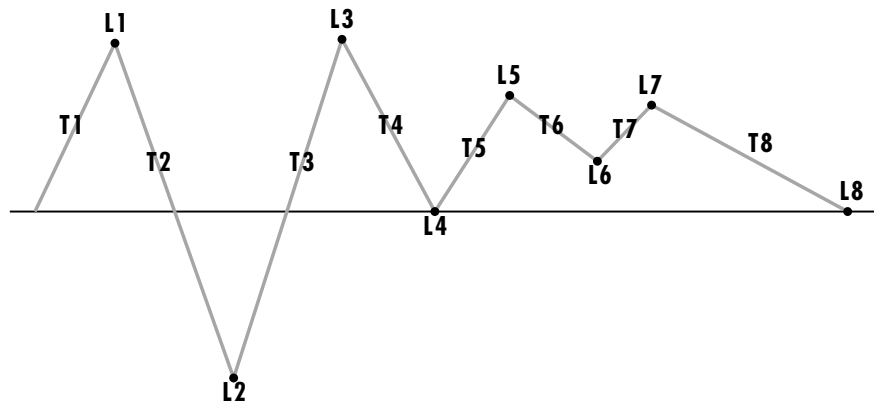

The Function Generator contains eight segments, each with a level and time parameter.

The function generator can have up to eight segments, each with a Level and a Time parameter. The level parameter can be either positive or negative. Each segment of the function generator can have a different Shape. There are 63 different shapes consisting of various curves, straight and crooked line segments, random, chaos and delays.

FUNC GEN	F1S1
Level	+124

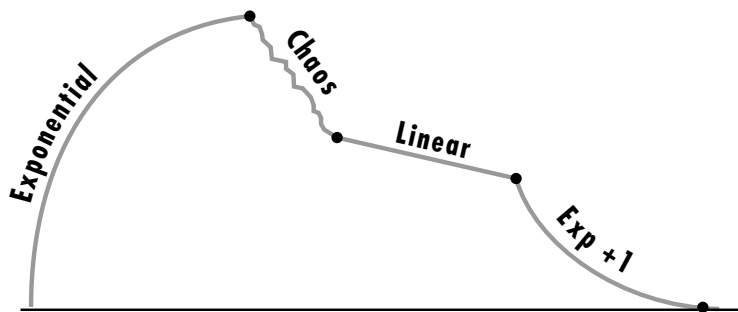

Four of the 63 curves are shown below. By combining the various curve shapes, extremely complex functions can be created. See the Reference Section of this manual for the complete set of function generator curve diagrams.

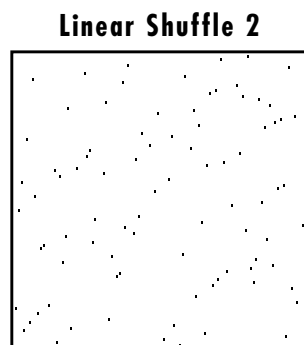
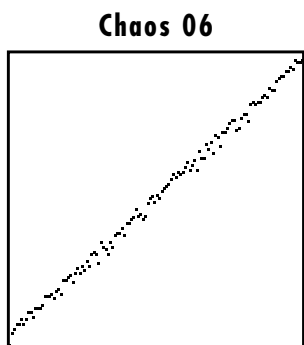
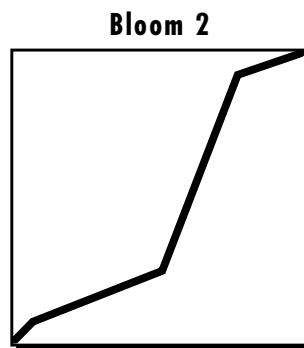
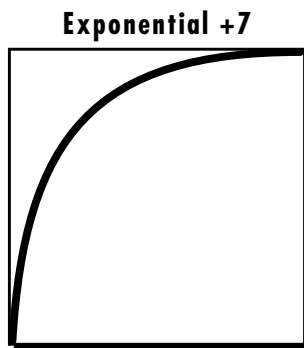

FUNCTION GENERATOR CURVES

- LINEAR
- EXPONENTIAL +1
- EXPONENTIAL +2
- EXPONENTIAL +3
- EXPONENTIAL +4
- EXPONENTIAL +5
- EXPONENTIAL +6
- EXPONENTIAL +7
- CIRCLE 1.4
- CIRCLE 1.6
- CIRCLE 1.8
- CIRCLE 1.16
- SQUEEZE
- FAST LINE 1
- FAST LINE 2
- FAST LINE 3
- MEDIUM LINE 1
- MEDIUM LINE 2
- SLOW RAMP 1
- SLOW RAMP 2
- BLOOM
- BLOOM 2
- CIRCLE 1.16 REVERSE
- CIRCLE 1.8 REVERSE
- CIRCLE 1.6 REVERSE
- CIRCLE 1.4 REVERSE
- SLOW CURVE 1
- SLOW CURVE 2
- DELAY DC
- DC DELAY
- CURVE 2X
- CURVE 2X B
- CURVE 2X C
- ZIZ ZAG 1
- ZIZ ZAG 2
- ZIZ ZAG 3
- CHAOS 03, 06, 12, 16, 25, 33, 37, 50, 66, 75, 95, 99
- LINEAR SHUFFLE 1
- LINEAR SHUFFLE 2
- RANDOM A-L
- RANDOM Z

A CONDITIONAL JUMP ALWAYS GOES TO THE BEGINNING OF THE DESTINATION SEGMENT.

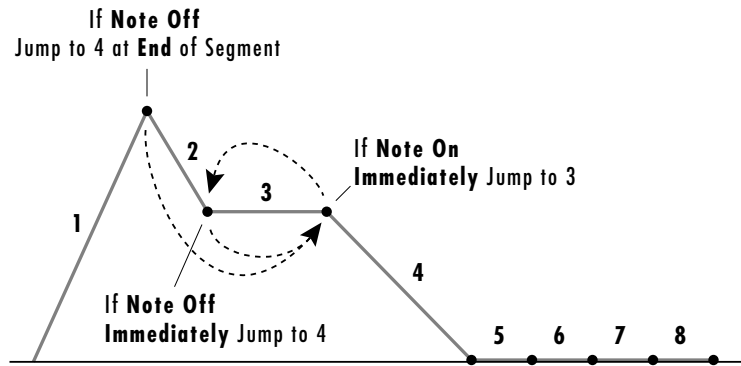

The function generator can be programmed to jump between segments based on certain conditions. Because the decision to jump is based on conditions, these jumps are called Conditional Jumps. For example, the function generator could be programmed to loop only if the key is still being held. In the diagram below, the function generator has been programmed to jump back to segment 3 if the key is held but jump to segment 4 whenever the key is released.

Conditional jumps can be programmed to jump to the destination segment immediately or they can wait until the end of the segment before jumping. The conditional jumps are:

- Never** Never jumps. Always goes on to next segment.
- Always End** Always jumps at the end of the current segment.
- Note On End** Jumps at the end of the segment if the note is still on.
- Note On Immed.** Jumps immediately if the note is still on.
- Note Off End** Jumps at the end of the segment if the note is off.
- Note Off Immed.** Jumps immediately if the note is off.
- LFO 1 or 2 End** Jumps at the end of the segment if the value of the selected LFO is equal or greater than the conditional value.
- Footsw. 1-3 End** Jumps at the end of the segment if the selected footswitch is pressed.
- Footsw. 1-3 Immed....** Jumps immediately if the selected footswitch is pressed.
- Velocity End** Jumps at the end of the segment if the velocity value is greater than a positive conditional value or less than a negative conditional value. See the following page.
- Key End** Jumps at the end of the segment if the note value is greater than a positive conditional value or less than a negative conditional value. See the following page.

REMEMBER TO TURN UP THE LFO AMOUNT WHEN USING LFOS AS CONDITIONALS.

For Velocity End & Key End

```

FUNC GEN   F1S1
CondValue  +064
    
```

When the value is **Positive**, a jump occurs if the velocity or key number is Greater than value shown.

```

FUNC GEN   F1S1
CondValue  -064
    
```

When the value is **Negative**, a jump occurs if the velocity or key number is Less than value shown (ignoring the sign).

- When one segment jumps to another at a different level, a smooth transition is made between the two. The time to the end of the destination segment remains as specified.

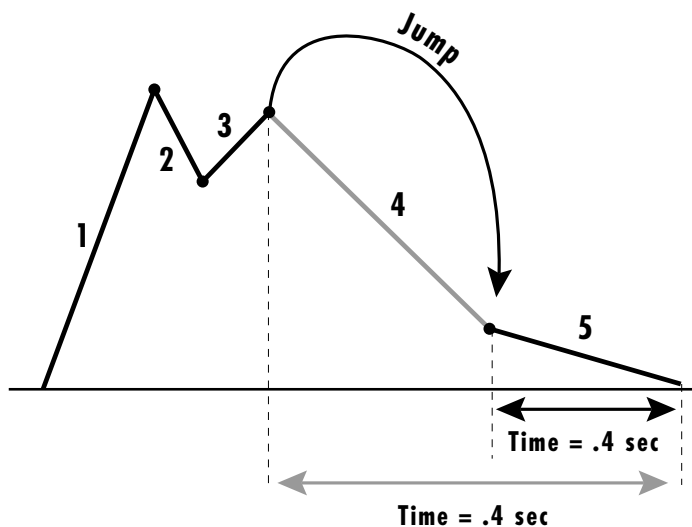

In the example above, segment 4 has been skipped, but the time to the end of segment 5 will remain the same (400 milliseconds). This will alter the slope of segment 5.

Function Generator Amount

This control scales the output of the function generator before it is applied to a modulation destination (in the Realtime Control screen). The amount is like a water faucet. It controls “how much” of the function generator is output. If a negative value is selected, the function generator output will be inverted. Function generator 1 or 2 is selected on the top line of the display (F1 or F2).

```

FUNC GEN AMT  F1
+064
    
```

DRAWING YOUR FUNCTION GENERATOR IDEAS ON PAPER FIRST WILL SIMPLIFY THE PROGRAMMING PROCESS.

REMEMBER THAT YOU MUST ASSIGN THE FUNCTION GENERATOR TO A DESTINATION IN THE REALTIME CONTROL SCREEN.

THE FUNCTION GENERATOR AMOUNT CAN ALSO BE MODULATED BY A REALTIME CONTROL SOURCE.

PRESET MENU

NOTE-ON

MODULATION SOURCES
 KEY NUMBER, KEY VELOCITY
 INITIAL PITCH WHEEL AMOUNT
 INITIAL CONTROLLER A AMOUNT
 INITIAL CONTROLLER B AMOUNT
 INITIAL CONTROLLER C AMOUNT
 INITIAL CONTROLLER D AMOUNT
 INITIAL MONO PRESSURE AMOUNT
 INITIAL FR FUNCTION GEN.
 AMOUNT

DESTINATIONS

OFF
 PITCH, PRIMARY PITCH
 SECONDARY PITCH
 VOLUME, PRIMARY VOLUME
 SECONDARY VOLUME
 ATTACK, PRIMARY ATTACK
 SECONDARY ATTACK
 DECAY, PRIMARY DECAY
 SECONDARY DECAY
 RELEASE, PRIMARY RELEASE
 SECONDARY RELEASE
 CROSSFADE
 LFO 1 AMOUNT, LFO 1 RATE
 LFO 2 AMOUNT, LFO 2 RATE
 AUXILIARY ENVELOPE AMOUNT
 AUXILIARY ENVELOPE ATTACK
 AUXILIARY ENVELOPE DECAY
 AUXILIARY ENVELOPE RELEASE
 FUNCTION GEN 1 AMOUNT
 FUNCTION GEN 2 AMOUNT
 PORTAMENTO RATE
 PRIMARY PORTAMENTO RATE
 SECONDARY PORTAMENTO RATE
 FILTER MORPH
 PRIMARY FILTER MORPH
 SECONDARY FILTER MORPH
 PAN, PRIMARY PAN
 SECONDARY PAN
 SAMPLE START
 PRIMARY SAMPLE START
 SECONDARY SAMPLE START
 TONE, PRIMARY TONE
 SECONDARY TONE
 FILTER LEVEL, PRIMARY FILTER LEVEL
 SECONDARY FILTER LEVEL,
 FILTER FREQ. TRACKING,
 PRIMARY FILTER FREQ. TRACKING
 SECONDARY FILTER FREQ.
 TRACKING
 FILTER TRANSFORM 2
 PRIMARY FILTER TRANSFORM 2
 SECONDARY FILTER TRANSFORM 2

Note-On Modulation Control

These functions allow you to route Note-On information (information received at note-on time such as velocity or key number) to any of the modulation destinations. Up to 10 simultaneous paths or “patches” may be programmed. For each modulation patch, there is a source, a destination and a corresponding amount parameter which is variable from -128 to +127. **Place the cursor under the appropriate parameter and change the patch number, modulation source, modulation destination, or the amount, using the data entry control.** If a parameter is not labeled either primary or secondary, it affects both.

NOTE-ON CTRL #0
 V ÷ Volume +000

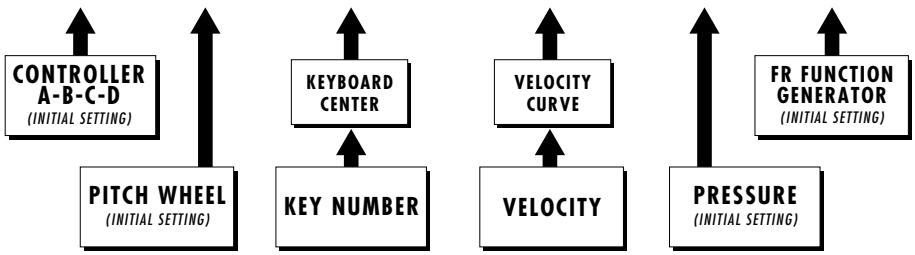
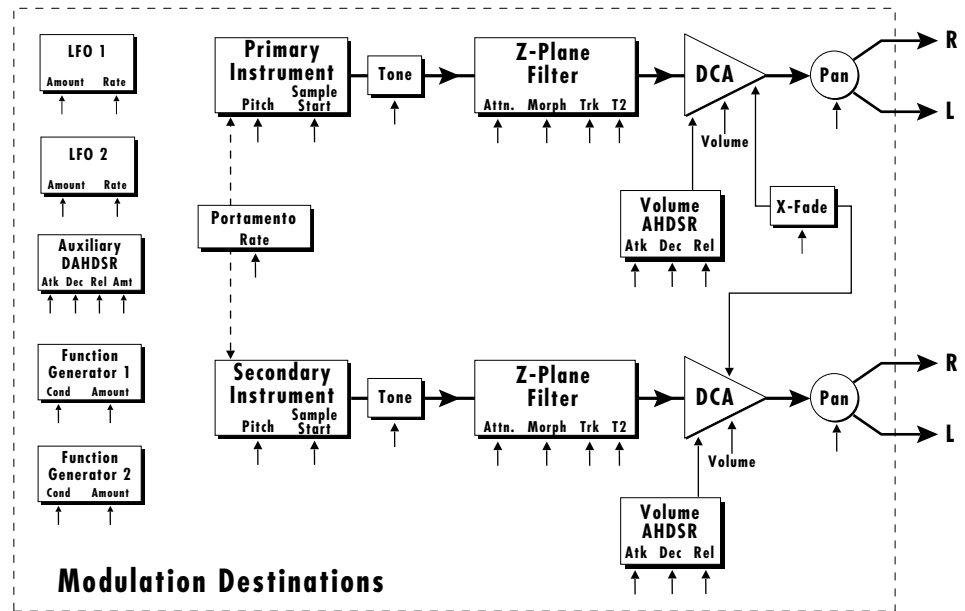

Note-On Modulation Sources

Realtime Modulation Control

These functions allow you to route realtime controllers to any of the modulation destinations except Tone, Sample Start, Filter Frequency Tracking and Filter Transform 2. Up to 10 simultaneous patches may be programmed. For each modulation patch, there is a source and a destination parameter. **Place the cursor under the appropriate parameter and change the patch number, modulation source, modulation destination, or the amount using the data entry control.** If a parameter is not labeled either primary or secondary, it affects both.

REALTIME CTL #0
PWhl → Off +127

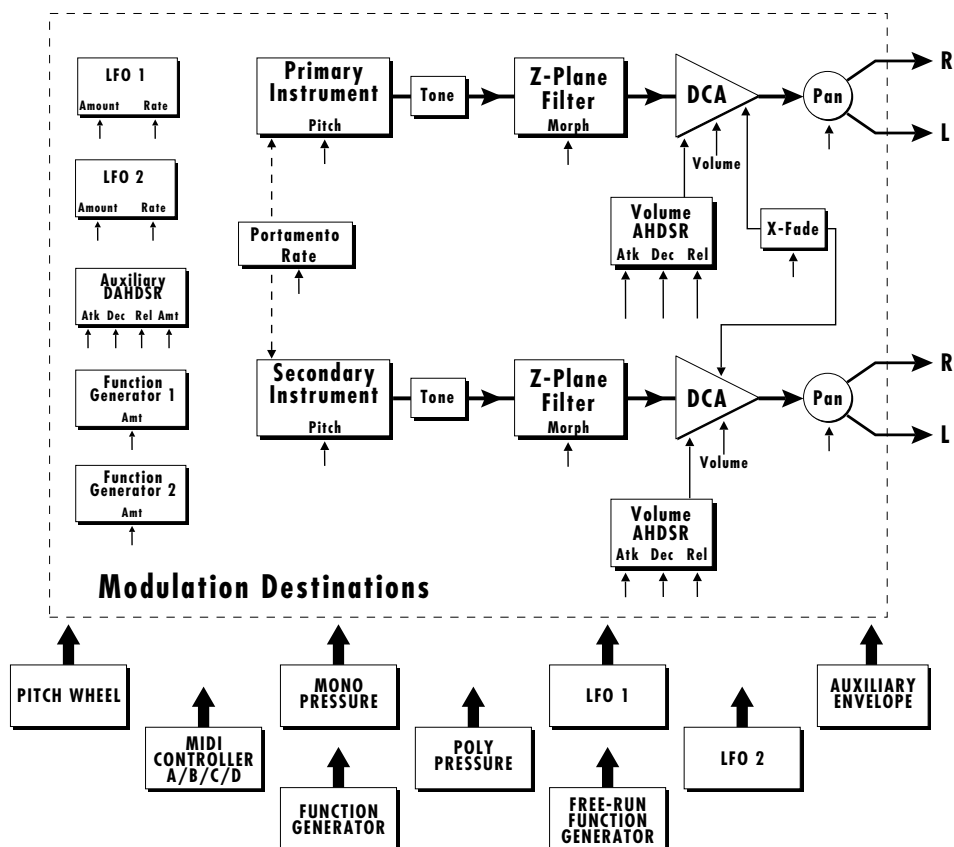

Realtime Modulation Sources

- REALTIME MODULATION SOURCES
- PITCH WHEEL
 - MIDI CONTROL A
 - MIDI CONTROL B
 - MIDI CONTROL C
 - MIDI CONTROL D
 - MONO PRESSURE
 - POLYPHONIC PRESSURE
 - LFO 1, LFO 2
 - AUXILIARY ENVELOPE
 - FUNCTION GENERATOR 1
 - FUNCTION GENERATOR 2
 - FREE-RUN FUNCTION GENERATOR

- DESTINATIONS
- OFF
 - PITCH, PRIMARY PITCH
 - SECONDARY PITCH
 - VOLUME, PRIMARY VOLUME
 - SECONDARY VOLUME
 - ATTACK, PRIMARY ATTACK
 - SECONDARY ATTACK
 - DECAY, PRIMARY DECAY
 - SECONDARY DECAY
 - RELEASE, PRIMARY RELEASE
 - SECONDARY RELEASE
 - CROSSFADE
 - LFO 1 AMOUNT, LFO 1 RATE
 - LFO 2 AMOUNT, LFO 2 RATE
 - AUXILIARY ENVELOPE AMOUNT
 - AUXILIARY ENVELOPE ATTACK
 - AUXILIARY ENVELOPE DECAY
 - AUXILIARY ENVELOPE RELEASE
 - FUNCTION GEN 1 AMOUNT
 - FUNCTION GEN 2 AMOUNT
 - PORTAMENTO RATE
 - PRIMARY PORTAMENTO RATE
 - SECONDARY PORTAMENTO RATE
 - FILTER MORPH
 - PRIMARY FILTER MORPH,
 - SECONDARY FILTER MORPH
 - PAN, PRIMARY PAN
 - SECONDARY PAN

WHEN MODULATING ENVELOPE ATTACK, DECAY OR RELEASE TIMES: POSITIVE AMOUNTS OF MODULATION INCREASE THE TIME. NEGATIVE AMOUNTS OF MODULATION DECREASE THE TIME.

Footswitch Control

This function allows you to route the 3 footswitch controllers (1, 2 or 3) to any of the footswitch destinations. The footswitches can be routed to switch: Sustain (pri/sec/both), alternate volume envelope (pri/sec/both), alternate volume release (pri/sec/both), cross-switch between the primary and secondary instruments or switch portamento Off or On (pri/sec/both).

FOOTSWITCH CTRL
1 -> Sustain

Pitch Bend Range

This function allows you to specify the pitch wheel range for the current preset. The range is variable from ± 0 to ± 12 semitones, or it can be set to "Global", in which case the global pitch bend range (set in the Master menu) is used. Pitch bend range is only used when the pitch wheel is used to control pitch.

PITCH BEND RANGE
+- 12 semitones

Pressure Amount

This function allows you to specify an overall amount parameter for mono or poly keyboard pressure data (pre-patch cord). The pressure amount is variable from -128 to +127.

PRESSURE AMOUNT
+127

MIDI Controller Amount

This function allows you to specify an overall amount parameter (pre-patch cord) which is variable from -128 to +127 for each of the MIDI controllers.

CONTROLLER AMT
A:+127 B:+127

CONTROLLER AMT
C:+127 D:+127

PRESSURE AMOUNT AND CONTROLLER A-B-C-D AMOUNT ARE MASTER CONTROLS WHICH AFFECT THE AMOUNT OF MODULATION WHICH CAN BE PROGRAMMED IN THE REALTIME MODULATION SECTION.

IN ORDER FOR THE REALTIME MODULATION CONTROL AMOUNTS FOR THESE FUNCTIONS TO HAVE A FULL RANGE OF CONTROL, THE PRESSURE AND CONTROLLER A-D AMOUNTS MUST BE SET TO +127.

Velocity Curve

Incoming velocity data can be modified by a velocity curve in order to provide different types of dynamics in response to your playing or better adapt to the MIDI controller. This function allows you to select one of the four velocity curves available in the Preset menu or leave the velocity data unaltered (Off). In addition, the velocity curve can be set to “Global”, which selects the global velocity curve programmed in the Master menu.

VELOCITY CURVE
Global

THE MASTER MENU CONTAINS EIGHT GLOBAL VELOCITY CURVES.

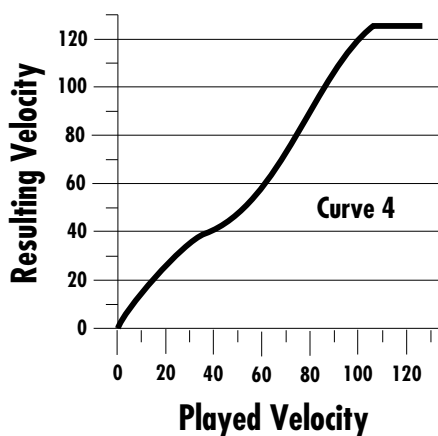
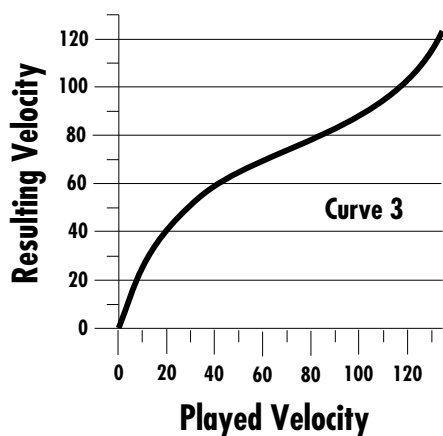
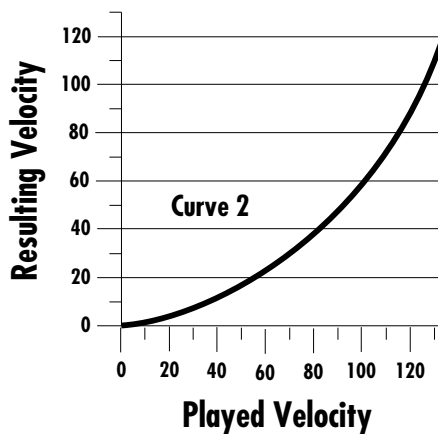
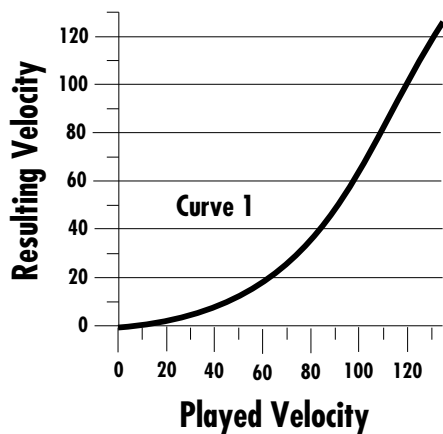

Keyboard Center

The Keyboard Center parameter establishes a reference point for keyboard modulation. Keys above this point will have a positive value and keys below it will be negative. The keyboard center can be set to any key within the range C-2 to G8.

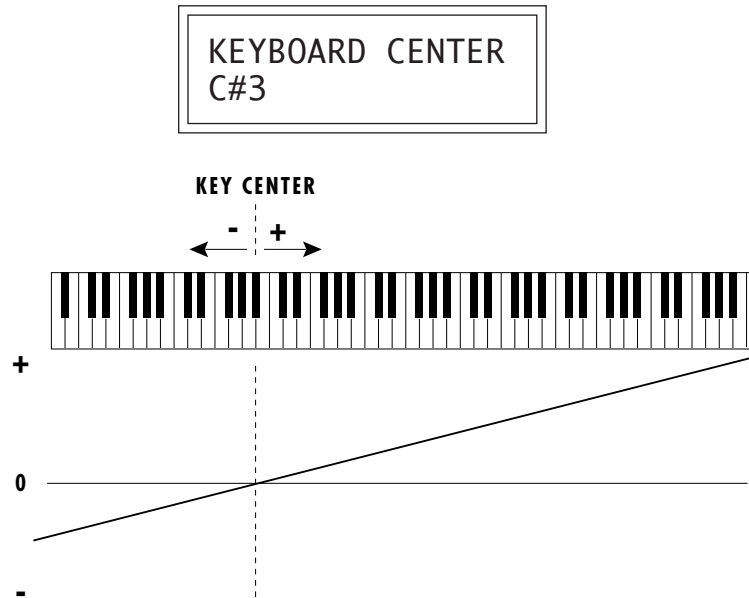

Keyboard Tuning

In addition to the standard equally divided octave tuning, UltraProteus contains four other types of scale tuning and one user-definable tuning. This function selects which tuning will be used in the current preset.

The choices of keyboard tunings are:

Equal tuning (12 tone equal temperament)

Standard Western tuning.

Just C tuning (just intonation)

Based on small interval ratios. Sweet and pure, non-beating intervals.

Vallotti tuning (Vallotti & Young non-equal temperament)

Similar to 12 tone equal temperament. For a given scale, each key has a different character

19 Tone tuning (19 tone equal temperament)

19 notes per octave. Difficult to play, but works well with a sequencer.

Gamelan (Javanese) tuning (5 tone Slendro and 7 tone Pelog)

Pelag-white keys, Slendro-black keys. Exotic tunings of Gamelan flavor.

User tuning

Defined in the Master menu.

Mix Select

This function allows you to direct a particular preset to one of the four destinations (Main, Sub 1, FXA, FXB). This routing is utilized if Mix Select for a particular MIDI channel is set to “Preset” in the current Midimap. Otherwise this setting is ignored. This function allows you to choose the effect bus in the preset rather than by MIDI channel.

MIX OUTPUT
Main

Save Preset

Changes made to a preset in the Preset Edit menu are not made permanent until the preset is *Saved*. To save a preset, move the cursor to the bottom line and select the location for the new preset with the data entry control. The Enter LED will then flash. Pressing the Enter button will confirm the operation.

Any RAM preset (000-127, bank 0) or RAM card location (000-127, bank 3) may be selected using the data entry control. Writing to a RAM preset erases the existing preset in that location. Make sure that the destination preset does not contain information that you want to keep.

SAVE PRESET to
064⁰ Preset Name

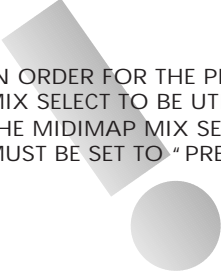

IN ORDER FOR THE PRESET MIX SELECT TO BE UTILIZED, THE MIDIMAP MIX SELECT MUST BE SET TO “PRESET”.

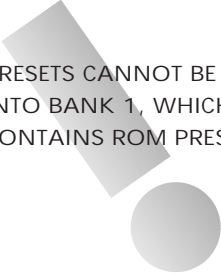

PRESETS CANNOT BE SAVED INTO BANK 1, WHICH CONTAINS ROM PRESETS.



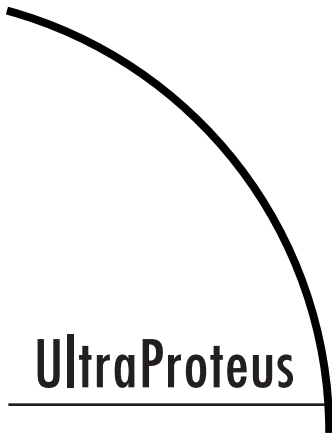

UltraProteus COPY MENU

The Copy menu functions allow you to copy data between Presets, Hyperpresets or Midimaps. Selected groups of parameters, such as Function Generator or Effects settings, can be simply copied, making it easy to build new Presets, Hyperpresets or Midimaps.

- When using the Copy functions, you always copy ***INTO the Current “Scratch” Preset***, Hyperpreset or Midimap. The copy menus allow you to copy data from anywhere in the machine.

To enable the Copy menu

Press the Copy key, lighting the LED. The current screen will be the one most recently selected since powering up the machine. The cursor will appear underneath the first character of the screen heading on line one.

To select a new screen

Press the Home/Enter key or press the cursor keys repeatedly until the cursor is underneath the screen title heading. Rotate the data entry control to select another screen.

To modify a parameter

Press the cursor key repeatedly (or hold the right cursor key while turning the data entry control) until the cursor is underneath the parameter value. Rotate the data entry control to change the value.

To return to the module

Press the Copy key, turning off the LED. You will be returned to the main screen.

COPY MENU FUNCTIONS

Copy Preset

This function allows you to copy a preset from any location in UltraProteus into the current preset location. The current preset is the preset showing in the main screen.

COPY PRESET
000⁰ Preset Name

REMEMBER TO SAVE YOUR EDITED PRESET, HYPERPRESET OR MIDIMAP IF YOU WANT TO KEEP IT. A COPIED PRESET IS NOT AUTOMATICALLY SAVED!

DATA COPIED FROM THE SAME PRESET WILL COME FROM THE SAVED VERSION OF THE PRESET, NOT THE EDITED VERSION. THIS COULD BE USED AS A "REVERT" FEATURE IF YOU MAKE A MISTAKE WHILE EDITING.

Copy Layer

This function allows you to copy everything in the primary or secondary layer (or both) from another preset into the current preset. A primary layer may be copied into the secondary layer and vice-versa. Only parameters which are designated "primary" or "secondary" will be copied. Parameters such as the LFOs or modulation routings will NOT be copied.

There are five options available: Pri to Pri, Pri to Sec, Sec to Sec, Sec to Pri, Pri & Sec (Both).

```
COPY LAYER   P→P
000° Preset Name
```

Copy Filter

This function allows you to copy the filter settings for the primary or secondary layer (or both) from another preset into the current preset.

Copy Filter copies the following parameters only: Filter Type, Filter Level, Morph Offset, Filter Frequency Track (initial setting), Filter Transform 2 (initial setting) and Filter Reverse.

There are five options available: Pri to Pri, Pri to Sec, Sec to Sec, Sec to Pri, Pri & Sec (Both).

```
COPY FILTER   P→P
000° PresetName
```

Copy LFO

This function allows you to copy the LFO settings for LFO1, LFO2 or both from another preset into the current preset.

There are five options available: 1 to 1, 1 to 2, 2 to 2, 2 to 1, 1 & 2 (Both).

```
COPY LFO      1→1
000° PresetName
```

Copy Function Generator

This function allows you to copy the function generator parameters for either FG1, FG2 or both from another preset into the current preset.

There are five options available: 1 to 1, 1 to 2, 2 to 2, 2 to 1, 1 & 2 (Both).

```
COPY FUNCGEN 1→1
000° Preset Name
```

Copy Auxiliary Envelope

This function allows you to copy just the auxiliary envelope parameters from another preset into the current preset. There is only a single option.

```
COPY AUX ENV
000° Preset Name
```

Copy Note-On Control

This function allows you to copy the Note-On modulation routings from another preset into the current preset. There is only a single option.

```
COPY NOTE-ON CTL
000° Preset Name
```

Copy Realtime Control

This function allows you to copy the Realtime modulation routings from another preset into the current preset. There is only a single option.

```
COPY RLTIME CTL
000° Preset Name
```



THE CURRENT HYPERPRESET IS THE LAST ONE SELECTED OR MODIFIED.

Copy Hyperpreset

This function allows you to copy a hyperpreset from any hyperpreset into the current hyperpreset location.

```
COPY HYPERPRESET  
0002 HyperName
```

Copy Zone

This function allows you to copy a single hyperpreset zone from any hyperpreset into the current hyperpreset location. Zones may be placed into any other zone number in the current hyperpreset.

```
COPY ZONE 01÷03  
0002 HyperName
```

Copy Free-Run Function Generator

This function allows you to copy all the Free-Run Function Generator parameters from any hyperpreset into the current hyperpreset location.

```
COPY FREE-RUN FG  
0002 HyperName
```

Copy Midimap

This function allows you to copy an entire midimap into the current midimap location.

```
COPY MIDIMAP  
M00 MidiName
```

Copy Channel

This function allows you to copy all the information from a single MIDI channel from any midimap into the current midimap location. Channels may be placed into any other channel number in the current midimap. The parameters that will be copied are: Preset/Hyper, Volume, Pan, Mix, MIDI Enables, and Bank Select.

```
COPY CHAN  01↔03  
M00 MidiName
```

Copy Effects

This function allows you to copy effects from any midimap into the current midimap location. There are three options available: A to A, B to B, A & B (Both). *(Because of the differences between the A and B effects, it is not possible to copy between A and B.)*

Copying a single A or B effect includes all effects parameters and the A or B amount (but not the A->B amount). When both effects are copied, the A->B amount is included.

```
COPY EFFECT  A↔A  
M00 MidiName
```

Copy Program Change Map

This function allows you to copy a single Program Change Map into any other Program Change Map number. Program Change Maps are located in the Master menu.

```
COPY PRG CHG MAP  
#1 ↔ #3
```

Copy Bank

This function allows you to copy an entire bank of 128 programs or a set of 16 Midimaps between ROM, RAM and Card locations. "All" allows you to copy all RAM presets, Hyperpresets and Midimaps to the card or vice-versa.

WARNING

Be careful when using the Copy Bank function. It is very easy to accidentally overwrite an entire bank of data!

There are ten options available:

Presets - RAM to Card, Card to RAM, ROM to RAM, ROM to Card,

Hypers - RAM to Card, Card to RAM,

MIDImap - RAM to Card, Card to RAM,

All - Card to RAM, RAM to Card

COPY BANK
Presets RAM→Card

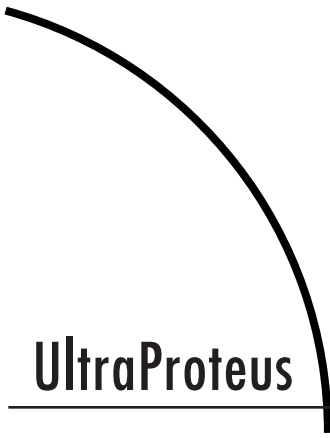
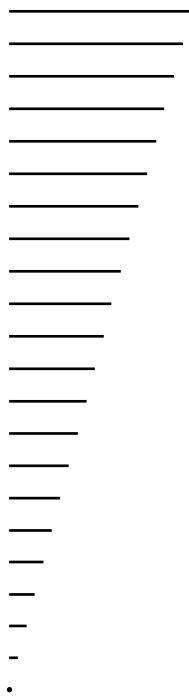

UltraProteus **STEP-BY-STEP**



This chapter walks you through UltraProteus in a step-by-step manner. Although it is not possible to cover every detail of programming a synthesizer of this complexity, these first steps will hopefully get you started in the right direction. Before starting this chapter, please read the Programming Basics chapter of this manual. It contains important background information, which will help you get the most of this chapter.

- If you are new to synthesizers and electronic music, you may need more background information than this manual provides. There are many books dedicated to synthesizer basics and MIDI available through your local music dealer. Magazines such as Keyboard and Electronic Musician, which are available at most newsstands, contain current information on the subject, as well as valuable programming tips.

UltraProteus (or any synthesizer for that matter) is not really one instrument but a collection of modules which can be connected together to create many different instruments. In programming a synthesizer, you become an instrument builder. The more knowledge you have about music, acoustics, and electronics, the more success you will have in constructing the sounds of your dreams.

Learning about sound synthesis will be much easier if you learn to really LISTEN to the sounds all around you, then try to recreate them. Listen to how the pitch rises on that bird's chirp, or how the volume changes on that organ. Soon you'll be hearing sounds in a whole new way. Of course, imitating natural sounds is only a part of sound synthesis. The real fun happens when you create a wonderful new sound that no one has ever heard before. Experimentation + Knowledge = MAGIC!

When playing and programming UltraProteus, you're exploring new territory. You have to explore to find what's out there! This powerful new technology is just waiting to be tapped.

EDITING PRESETS

A good way to get acquainted with UltraProteus is by examining and editing existing presets. If you hear an effect or a control you like, take the time to discover how it was achieved.

Start with a preset you like and try changing it around. If you don't like the result, simply change the preset momentarily and you'll be back to the original sound. Changes are not made permanent until you SAVE a preset. Therefore you can experiment all you want without worrying about losing a sound.



STARTING FROM SCRATCH

When starting from scratch, first select the Default Preset (-defPreset-) which is located in the factory location 127 (bank 1). A default is basically a blank preset which is ready to program. After selecting the default preset, press the Preset button.

The Instrument

The instrument is the basis of your sound. The instruments in UltraProteus are digital recordings of various sounds from the simple (sine wave) to the complex (Grand Piano). The second screen in the Preset menu selects the primary instrument.

INSTRUMENT pri
 I173 Airy Voices

Move the cursor down to the bottom line and change the primary instrument using the data entry control. You should be hearing the instrument change as you scroll through the instruments. A patch diagram (shown below) is useful to visualize the connection you have just made. Press Enter when you find an instrument you like.

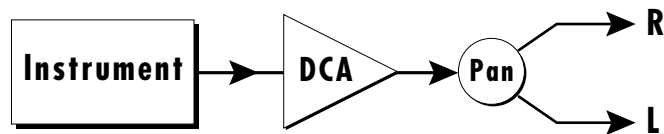

Turn the data knob one click to the right to the secondary instrument select screen. The secondary instruments are identical to the primary instruments. Change the secondary instrument and listen to the various combinations of the two. What you are doing is actually a simple form of additive synthesis. You are adding two sounds together to form a new sound.

✓ Blending two instruments together can create an ensemble effect if the instruments are different, or a thicker sound if both instruments are the same. Two instruments can “fuse” into one new sound if their harmonic content is similar or if harmonic changes such as vibrato (pitch variation) occur in both instruments simultaneously.

For the next experiment, set the primary instrument to “017 P1 AcGuitar” and the secondary instrument to “004 Mono Grand”. Press Enter.

Volume

Turn the data knob one click to the right to the Volume screen. This screen adjusts the volumes of the two instruments. Refer to the block diagram on the previous page as you adjust the volume of the DCA.

```
VOLUME
pri:110  sec:100
```

As you adjust the volume of the two instruments relative to each other, notice how the quality of the sound changes. Whichever instrument is loudest is perceived as the sound of both. But there is a range where the two instruments seem to “fuse” into one unique entity, somewhat like a harpsichord. Careful mixing can result in many beautiful timbres.

Pan

The next screen, Pan adjusts the balance between the left and right outputs. Panning one instrument hard right (+7) and the other hard left (-7) is a good way to keep the identities of the instruments separate. Try it and notice how the guitar and piano instruments are distinct and separate. When you are finished, return the pan settings to “0” and press Enter.

```
PAN
pri:+0  sec:+0
```

Transpose

Move the data knob ahead four clicks until you find the transpose screen. This function transposes the key of the primary or secondary instrument. Each number represents a semitone interval up or down (+ or -). To transpose an instrument up an octave, move the cursor to the bottom line and set the number to +12. A setting of +7 would result in a perfect fifth. Try transposing the piano and guitar sounds. When you are finished, return the settings to “0” and press Enter.

```
TRANSPOSE
pri:+12  sec:+00
```

✓ Transposing an instrument out of its normal range will completely change the character of the sound. Sine waves transposed down can add a killer bottom end to an otherwise harmless bass sound.



TO HEAR HOW TRANSPOSE AND COARSE TUNING DIFFER, TRY THEM ON THE MULTI-PERCUSSION INSTRUMENTS.

USE COARSE TUNING TO TUNE MULTI-INSTRUMENT PERCUSSION INSTRUMENTS.

Coarse Tuning

This function is related to transpose and in fact, the two work well together in the creation of new timbres. A little background: Transpose works by shifting the keyboard assignment of the samples (as if you were sliding the keyboard up and down). Coarse Tuning keeps the keyboard sample placement constant and actually tunes the samples up. With multisampled instruments such as a piano, the timbre can change dramatically using coarse tuning. *(A multisampled sound is one that contains multiple samples placed at various points on the keyboard.)*

To hear this effect, first **Coarse Tune** the guitar up one octave (+12), then **Transpose** it *down* one octave (-12). The pitch remains the same, but what a difference in the tone! (You may want to turn the Piano instrument Off to make it easier to hear the guitar.)

```
PITCH TUNE crse
pri:+12  sec:+00
```

Fine Tuning

The Fine Tune control is related to the coarse tuning, but has a range of one semitone. When both primary and secondary instruments are the same, detuning one of the instruments slightly will create a “fat” sound useful for strings or ensemble effects.

```
PITCH TUNE fine
pri:+00  sec:+00
```

In preparation for the next experiment, let's clean the slate. Since we haven't SAVED the preset yet, any changes you made will be lost as soon as you change the preset. Do that now. Simply press the Preset Edit button extinguishing the LED, dial momentarily to another preset and then go back to the '-defPreset-'. Now everything is erased. Set the primary instrument to I337 Synth Pad, press Home/Enter, then slowly turn the data entry knob until you find the screen shown below.

```
ALT VOL ENVELOPE
pri:Off  sec:Off
```

Alternate Volume Envelope

Turn the Alternate Volume Envelope On for the primary instrument. This enables the next screen, the primary volume envelope.

P:	A	H	D	S	R
	00	00	50	99	15

Going back to the block diagram model, the preset now looks like this:

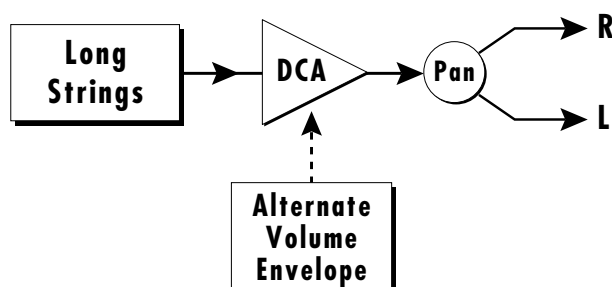

Every sound you hear, be it a piano note, a drum, a bell or whatever, has a characteristic volume curve or *Envelope* which grows louder and softer in various ways during the course of the sound. The volume envelope of a sound is one of the clues that our brain uses to determine what type of sound is being produced.

Every instrument in UltraProteus has its own volume envelope which is used when the Alternate Envelope parameter is turned Off. By turning the Alternate Volume Envelope On, we can re-shape the instrument's natural volume envelope any way we want. By re-shaping the volume envelope, you can dramatically change the way the sound is perceived. For example, by adjusting the envelope parameters you can make “bowed” pianos or backwards gongs. The diagrams at right show the volume envelopes of a few common sounds.

Set all the numbers to 00 and listen to the sound. You should only hear a little blip. Now move the cursor under the Attack Time (A) and slowly increase the value while playing the keyboard. The attack controls the amount of time it takes for the sound to reach full volume when a key is pressed and held.

Set the attack to “00” and slowly increase the Decay (D) instead. Notice how percussion-like the sound becomes. You have just created the percussion envelope shown at the right.



Piano



Organ



Strings



Percussion

THE GENERALIZED VOLUME ENVELOPE SHAPES OF A FEW TYPES OF SOUNDS ARE SHOWN ABOVE.

FOR MORE INFORMATION ABOUT ENVELOPES, SEE THE PROGRAMMING BASICS CHAPTER IN THIS MANUAL.

THE DELAY PARAMETER IS ONLY AVAILABLE IN THE AUXILIARY ENVELOPE.

Set the Sustain (S) to 99 and slowly increase the Release time. Note the effect as you release the note. The release time controls the time it takes for the sound to die away when a note is released.

Practice making different volume envelopes. As you hear everyday sounds, try to imagine what the volume envelope of these sounds might look like.

Anatomy of an Envelope

When a key is pressed, the envelope generator level starts to increase at the **Attack** rate. When it reaches full level, it Holds at that level for the specified **Hold** time. After the hold time has elapsed, the envelope begins to Decay back down at the **Decay** rate until it reaches the **Sustain** Level. (Note that all the other parameters are *Rates*, but the Sustain is a *Level*.) The envelope will stay at the Sustain level for as long as the key is held. When the key is Released, the envelope falls back down to zero at the **Release** rate.

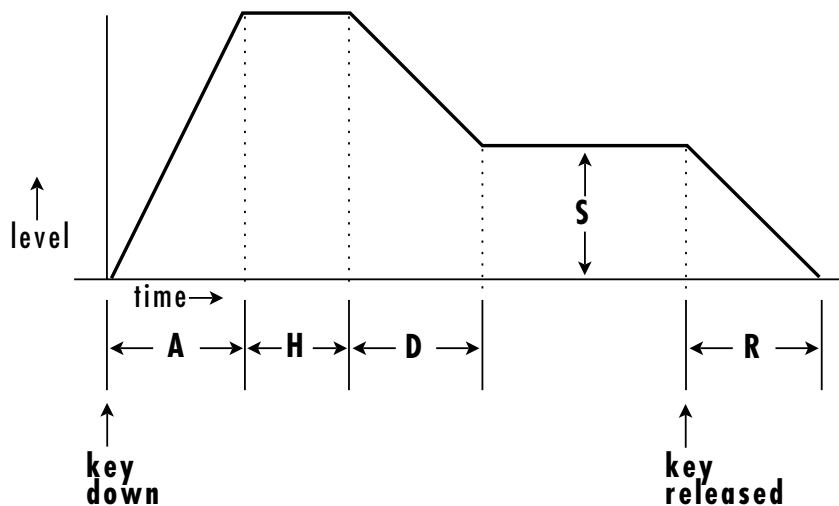

The secondary alternate volume envelope parameters perform the same functions on the secondary layer.

Double + Detune

The next screen, Double + Detune, doubles the instrument and detunes it slightly by an adjustable amount. This acts like a chorus effect and serves to “fatten” the sound. Try it and notice how much fuller the sound becomes. Because this function works by using two instruments per layer, it halves the number of available notes that can be played. Therefore you should only use this feature when necessary to achieve the desired effect.

```
DOUBLE + DETUNE
pri:06  sec:0ff
```

Sound Delay

This function delays the onset of the note after a key is pressed and is mainly used when a secondary instrument is also present. Go ahead and select a secondary instrument now, then come back to this screen to experiment with the delay. A very small amount of delay can serve to give each layer its own sonic “identity”.

```
SOUND DELAY
pri:000  sec:000
```

Applications include:

Echo Effect - Bring in a slightly softer version of the same instrument or even a different instrument. Who says you have to have normal echoes?

Delayed Chorus - Set primary and secondary to the same instrument. Use Double + Delay, Fine Tuning and Sound Delay on the secondary layer.

Sound Splicing - Splice the attack of one sound with the body of another using Sound Delay and Sound Start (the next subject of our investigations). Read on.

Sound Start

Sound Start removes the beginning (attack) of the sound as the value is increased. It's probably time to clean the slate again. Change the preset momentarily then return to the default preset (-defPreset-). Set the primary instrument to: I008 Tine Strike, which is an electric piano sample. Now flip back to the Sound Start screen.

```
SOUND START
pri:000  sec:000
```

As you slowly increase the Sound Start, notice how the percussive attack of the piano disappears. The sound becomes muted.

Application - Sound Splicing

Sound Splicing is an operation that uses most of the features we've gone over. As mentioned above, Sound Splicing merges the attack of one sound with the body of another to form a new sound. The process is illustrated below.

The alternate volume envelopes are used to fade one instrument out while another fades in. UltraProteus also contains many digitally generated waveforms that may be combined with sampled instruments to change the character of the sound, perhaps to add a digital “edge” or add bass. The Sound Delay, Sound Start, Volume and the Transpose parameters allow you to refine the splice point between the primary and secondary instruments.

As an example, let's splice a Sax attack to a Bass Clarinet to create a sort of “Clariphone”. Because these instruments are somewhat related in character, they are perfect candidates for splicing. Start with the default preset again, and change only the parameters listed below. The Tenor Sax instrument is shaped by the Alternate Volume Envelope so that only the honking attack is heard (a short delay and decay with the sustain set to zero).

Primary	Secondary																				
Instrument: 098 Tenor Sax	Instrument: 128 Bass Clarinet																				
Volume: 122	Volume: 125																				
Transpose: +00	Transpose: +12																				
Alt Envelope: 0n	Alt Envelope: 0n																				
<table border="0"> <tr> <td>A</td><td>H</td><td>D</td><td>S</td><td>R</td> </tr> <tr> <td>00</td><td>04</td><td>24</td><td>00</td><td>04</td> </tr> </table>	A	H	D	S	R	00	04	24	00	04	<table border="0"> <tr> <td>A</td><td>H</td><td>D</td><td>S</td><td>R</td> </tr> <tr> <td>08</td><td>01</td><td>52</td><td>48</td><td>24</td> </tr> </table>	A	H	D	S	R	08	01	52	48	24
A	H	D	S	R																	
00	04	24	00	04																	
A	H	D	S	R																	
08	01	52	48	24																	
Sound Delay: 000	Sound Delay: 003																				
Sound Start: 000	Sound Start: 006																				

TRY SUBSTITUTING DIFFERENT INSTRUMENTS USING THE EXAMPLE AT LEFT.

The Bass Clarinet instrument serves as the body of the sound. The Sound Delay parameter is used to delay the onset of the Bass Clarinet until the Sax attack has finished, The Bass Clarinet attack is removed using the Sound Start parameter. The Attack parameter of the Secondary Alternate Envelope is set to 08 so the Bass Clarinet will smoothly fade in as the Sax fades out. The Bass Clarinet has also been transposed up an octave so that the pitches of the two instruments match. Finally, the volumes of the two instruments are balanced with the volume control.

Splicing is only of the many things you can do with UltraProteus. Think of UltraProteus as an audio construction set, which allows you to mold the sound as you would a piece of clay. The instruments are like your raw material and the other parameters are the sculpting tools.

Time to Save?

If you wanted to keep this sound, you would have to *SAVE* it using the Save Preset function (the very last screen in the Preset menu). To save a preset, simply move the cursor to the bottom line of the display, select the preset location where you want to store it, then press Enter. That's it!

Warning: Saving a preset erases whatever preset was already stored in that location. The default preset (-defPreset-, 127, bank 0) is a good place to experiment, since it is only a blank preset.

If you want to re-name your preset, do so using the first screen (Preset Name), then save the preset again to the same location.

LFO Modulation

Let's investigate how modulation routings can affect the sound. For these experiments, you use the default preset. If you just wrote over it, there is another one stored in permanent ROM (127, bank 1). Select any primary instrument, but leave the secondary instrument turned Off.

The LFOs (Low Frequency Oscillators) generate repeating waves which are commonly used to animate the sound or create vibrato (a cyclic pitch change). To create vibrato we can use an LFO to modulate the pitch. As you learned in the Programming Basics section, Modulation requires a modulation *Source* and a *Destination*. The LFO is the source and Pitch is the destination. The block diagram below illustrates this connection.

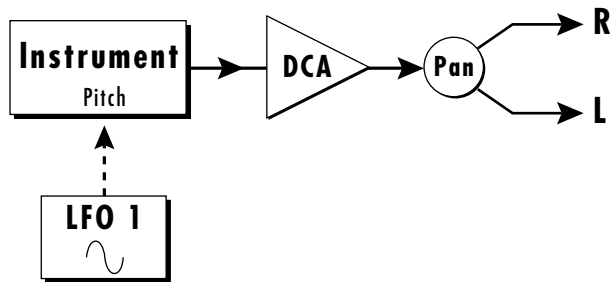

To make the connection between the LFO and the Instrument Pitch, move through the Preset parameters until you find the screen shown below.

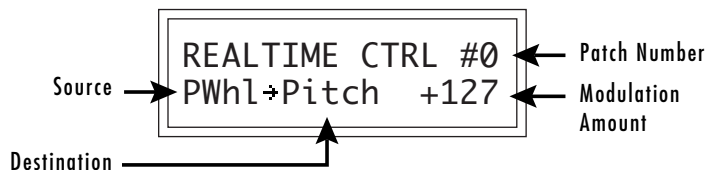

The setting shown indicates that the Pitch Wheel is connected to the Pitch, with an amount of +127 (full). Press the right cursor button (>) twice to place the

APPLYING THE SAME TYPE OF MODULATION TO BOTH PRIMARY AND SECONDARY INSTRUMENTS WILL TEND TO "FUZE" THEM INTO A NEW SOUND. APPLYING DIFFERENT MODULATION WILL TEND TO SEPARATE THEM.

YOU CAN THINK OF EACH MODULATION PATCH AS A "CORD". YOU MUST CONNECT BOTH ENDS OF A CORD FOR IT TO WORK.

cursor under the modulation source. As you slowly turn the data knob, each possible modulation source is displayed. Select LFO 1 as the Source and press Home/Enter.

Turn the data entry knob counter-clockwise until you find the LFO 1 parameter screens shown below.

```
LFO1  SHAPE  AMT
      Tri   +000
```

```
LFO1  RT DLY VAR
      060 000 000
```

Place the cursor under the Amount (AMT) parameter and set the value to +127 (you have to re-key, to hear any changes). You should be hearing lots of vibrato. Adjust the other parameters such as Rate and Shape. Controlling pitch is an easy way to hear the different LFO waveshapes. Delay (DLY) sets a time before the LFO starts. Variation (VAR) makes the rate of each LFO a little different for ensemble effects.

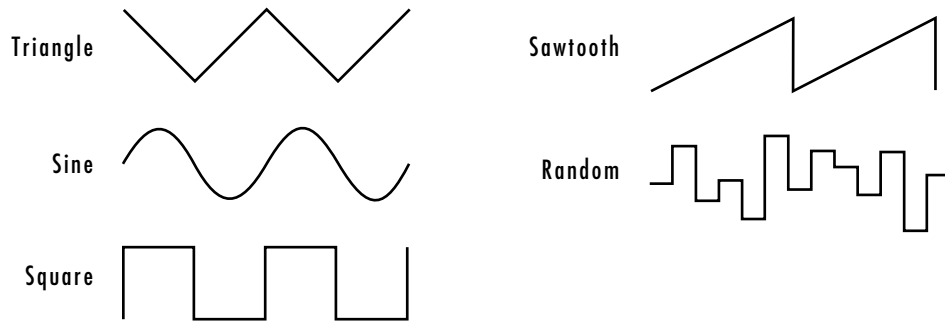

LFO 2 IS IDENTICAL TO LFO 1.

Now set the LFO Rate to about 20 and set the shape to “Saw”. Listen how the sawtooth wave smoothly ramps up then comes abruptly down. Change the amount to -128 and notice that it now ramps down and comes abruptly back up. Anytime you use a negative amount (*in any part of UltraProteus*), you *Invert* the modulation.

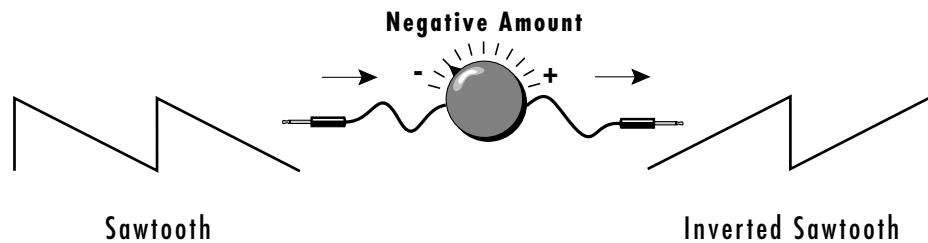

In preparation for the next experiment, set the LFO waveform to “Sine” and the rate to about “050”. Leave the amount set to “-128”. Press Enter.

Go back to the Realtime Modulation screen and set it as shown below.



Notice how the LFO now moves the sound from side to side. The diagram below illustrates the connection you just made.

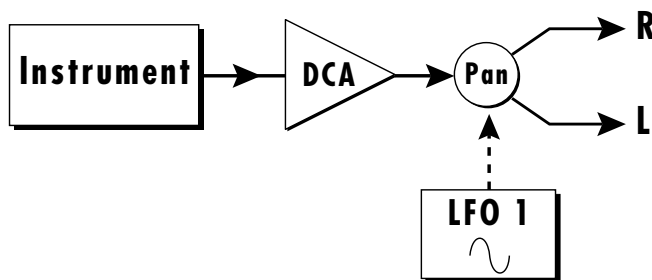

The Realtime Control screen connects ANY realtime modulation source to ANY realtime control destination! The amount parameter controls “how much” modulation is applied. Change the destination to *Volume* and listen. The block diagram for this connection is shown below.

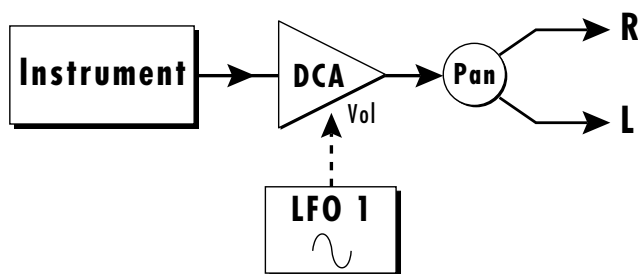

Place the cursor under the “#0” on the top line of the display. Turn the data entry knob and notice that the lower line changes with the patch number. There are TEN (count 'em) realtime modulation patches available per preset! This is what sound synthesis is all about. By simultaneously controlling many parameters, the sound is shaped in complex ways into the desired form.

✓ Now that you understand how to connect modulation sources to destinations, try using the Auxiliary Envelope Generator to control pitch. You've already used the Alternate Volume Envelope generators. The Auxiliary Envelope works exactly the same, except that it has an initial Delay stage and it can be routed to any realtime control destination.

AN LFO MODULATING VOLUME IS CALLED “TREMOLO”. TREMOLO IS USEFUL FOR ORGAN, VOICE, SURF GUITARS, ETC.

YOU CAN THINK OF EACH MODULATION PATCH AS A “CORD”. YOU MUST CONNECT BOTH ENDS OF A CORD FOR IT TO WORK.

Modulating Modulators

Go back again to the LFO 1 screen and turn the amount to “+000”. Next turn to the Note-On Control screen and set up the screen to look like the one below.

```
NOTE-ON CTRL #0
Vel → Lfo1Amt +080
```

The connection you just made is shown below.

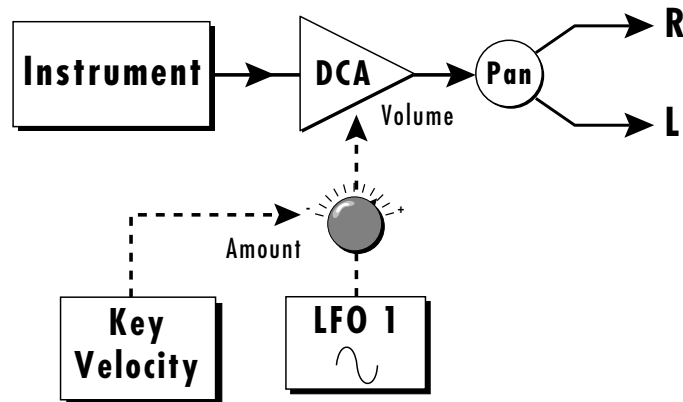

Play the keyboard hard and then softly. The key velocity is controlling the amount of LFO applied to the volume. The harder you play, the more LFO modulation is applied. The modulation wheel (Realtime Control screen) can also be routed to control the LFO 1 amount, or the LFO rate or the Pan position, or all of the above. There can be ten Note-On modulations and ten Realtime modulations in each preset.

You can probably see why patch diagrams are important (even if they only exist in your mind). They allow you to visualize how the connections are being made inside UltraProteus.

The UltraProteus Filter

This is what a lot of you have been waiting for. This incredible filter is what puts the Ultra in UltraProteus. *If you have not read the section on the Z-Plane Filter in the Preset Programming section, please do so before proceeding, since it contains important background information.* Now we can add the Z-Plane filter to our block diagram.

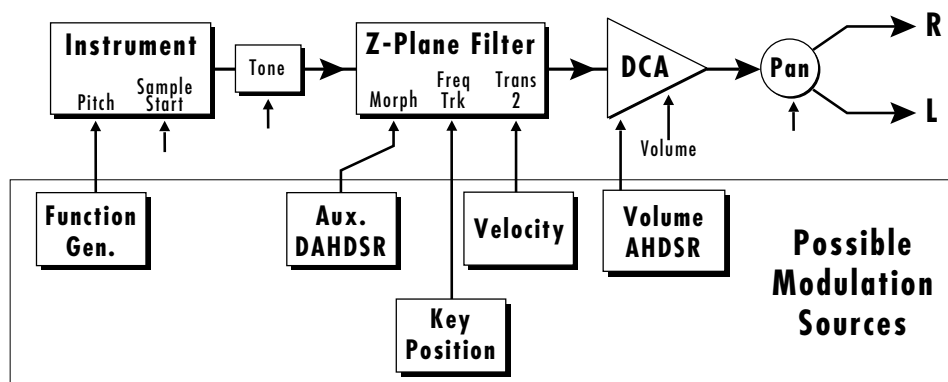

Let's examine the filter controls more closely. The vertical arrows in the diagram below, indicate controls that can be modulated. The Morph Offset is the only filter control that can be modulated continuously by a Realtime Control source.

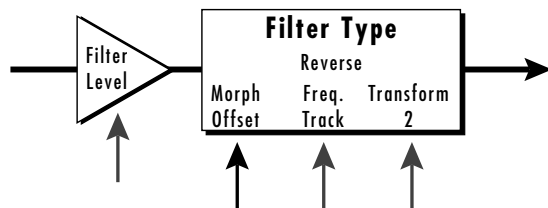

The filter has an input level control called the *Filter Level* which controls how much signal is presented to the filter. This control (like most of the controls in UltraProteus) has an initial amount and can also be controlled from a note-on modulation source. Certain UltraProteus filters are designed to distort the signal as a musical effect. The Filter Level allows you to control the amount of distortion produced by these special filter types.

The action of the *Morph Offset* varies from filter to filter. Because it can be continuously varied, it can be thought of as the main filter control. See the section on UltraProteus Filters in the Reference Section of this manual for specific information on each filter.

The *Frequency Tracking* control changes the frequency of the filter on many of the filter types. This would correspond to Fc or the cutoff frequency of a traditional lowpass filter, You can connect the keyboard to this control (in the note-on Control screen) with an amount setting of "64" if you want the filter frequency to track the keyboard.

FREQUENCY TRACKING DOES NOT ALWAYS CONTROL FREQUENCY AS THE NAME WOULD IMPLY. SEE THE Z-PLANE FILTER DESCRIPTIONS IN THE REFERENCE SECTION FOR DETAILS ON EACH FILTER TYPE.

NOTE: FILTER FREQUENCY TRACKING IS TRANSFORM 1.

MANY OF THE Z-PLANE FILTERS DO NOT USE TRANSFORM 2.

INFORMATION ON CONNECTING MIDI CONTROLLERS CAN BE FOUND AT THE END OF THE PROGRAMMING BASICS SECTION.

Key tracking is used to keep the timbre of the sound constant as you play up and down the keyboard. Of course, you can route any Note-On controller to control Frequency Tracking.

Like the Morph control, the effect of Transform 2 varies from filter to filter and in many cases it is not used at all. On a simple lowpass filter, Transform 2 might be used as a Q (or resonance) control. On a flanger, it might control the depth of the notches. The Z-plane filter descriptions in the Reference Section give specific information on the function of Transform 2 in each filter.

Just Do It!

OK. Let's start experimenting with the filters. First, we should connect the modulation wheel to control Morph so that it will be easy to hear the effect of this important parameter. Start with a clean slate by selecting the default preset again. Enter the Preset menu and select an instrument rich in harmonics such as "I049 P2 Strings 1".

The mod wheel is usually transmitted on MIDI controller 01. UltraProteus Controller A is set to controller 01 by default. So if you have not changed this parameter in the Master menu, Controller A is the mod wheel. We want to route Controller A (the mod wheel) to Morph. Go to the Realtime Modulation Control screen and set it as shown below.

```
REALTIME CTRL #1  
CtlA ↗ Morph +127
```

Note: A good way to verify that the mod wheel is connected is to set the destination (in the screen above) to "Pitch" instead of "Morph". Move the wheel to verify that the pitch varies with the wheel. If so, change the destination back to "Morph".

Move to the "Primary Filter Type" screen and scroll through the various filters as you play the keyboard. Move the modulation wheel and verify that the wheel is controlling the morph parameter. For this experiment, set the filter type to "F029 Vocal Cube". This is an interesting filter and since it is a "cube", it has three parameters to adjust.

```
FILTER TYPE pri  
F029 Vocal Cube
```

Move to the “Filter Frequency Tracking” screen and adjust the primary offset while playing the keyboard. (You must re-key the keyboard to hear the results of changing this value.) As specified, this parameter changes the frequency of the filter, making it brighter as the value is increased. Feel free to adjust the morph parameter as you adjust frequency tracking.

```
FILT_FREQ_TRACK
pri:127 sec:000
```

Next we'll adjust “Filter Transform 2”. On this filter, Transform 2 increases the size of the peaks in the vocal formant. The effect of increasing the peaks is a pronounced “nasal” quality which is quite dramatic.

```
FILT_TRANSFORM_2
pri:127 sec:000
```

Now that you've explored the three main filter parameters, let's go back and connect the keyboard to “Filter Frequency Tracking”. The keyboard is a Note-On control. A setting of “064” is the proper setting for accurate key tracking where the timbre will remain more or less constant up and down the keyboard.

```
NOTE-ON_CTRL #0
Key → FrqTrk +064
```

As long as we're programming Note-On Controls, go ahead and connect Velocity to Transform 2. The screen is shown below.

```
NOTE-ON_CTRL #1
Vel → Trans2 +127
```

The timbre of the sound should now change as the keyboard is played hard and soft. Transform 2, Frequency Tracking, and the Morph are all highly interactive, so a fair amount of adjustment may be required to get the sound just right.

FEEL FREE TO CHANGE THE INSTRUMENT AT ANY TIME DURING THESE EXPERIMENTS. THEY ARE JUST THAT, EXPERIMENTS!

Filter Philosophy

The Instrument and the Filter work together to determine the harmonic content of the final sound. You can think of the instrument like clay which is being squeezed through a die, the filter. The filter tries to impress its structure on the harmonics of the instrument.

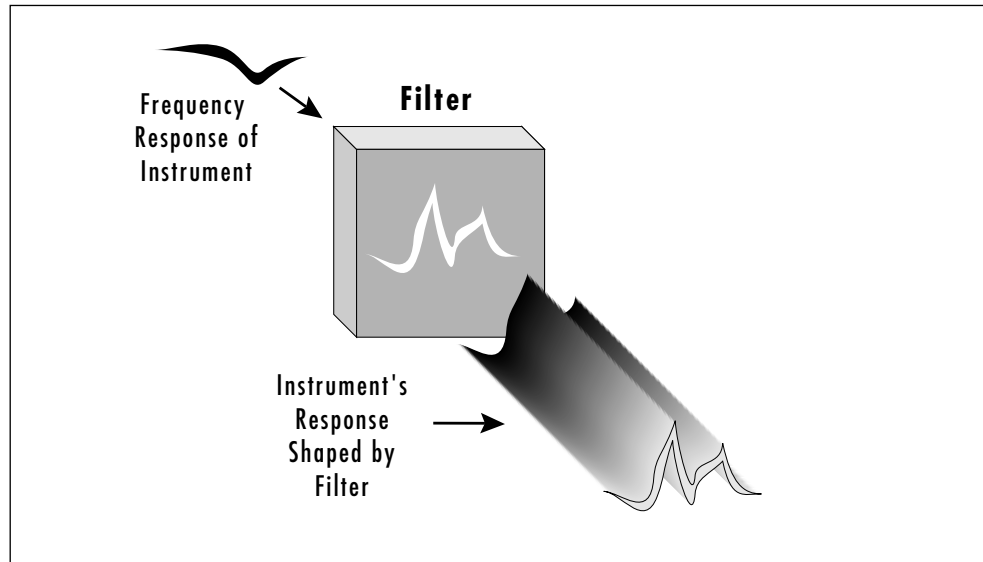

Of course, the filter cannot amplify or attenuate frequencies which do not exist in the original instrument. The Filter Frequency Tracking control can be used to “tune in” the filter to match the instrument.

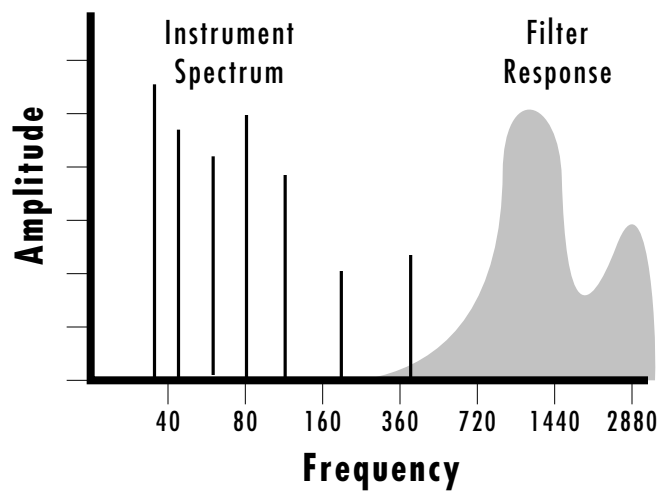

The Filter can only act on frequencies that are present in the Instrument. Use the Filter Frequency Tracking control to “fine tune” the filter to the instrument. No sound would be output from the example above because the filter's frequency response and the harmonic spectrum of the instrument do not coincide.

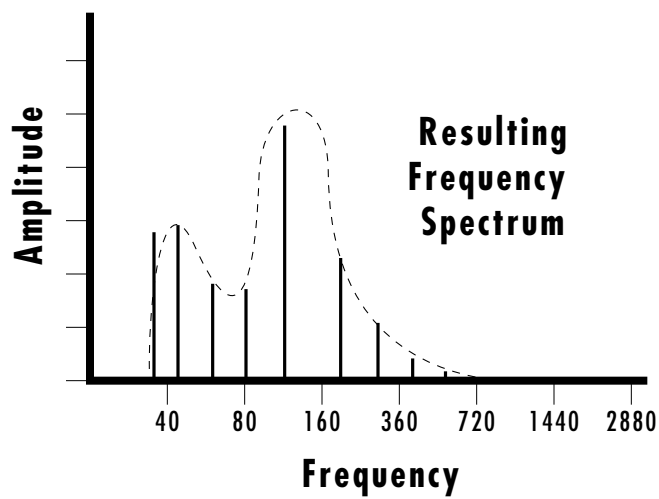
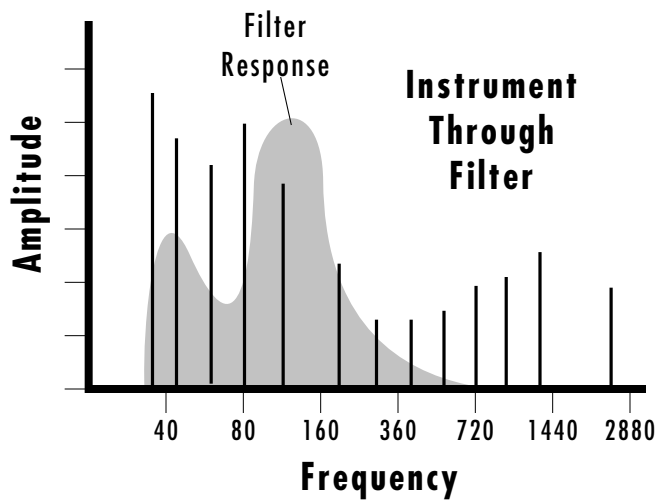
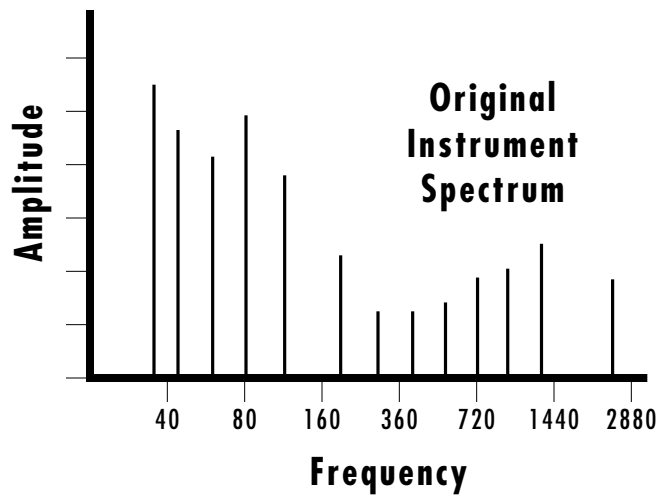

The Filter imposes its response on the harmonic spectrum of the Instrument.

To illustrate the point, let's create a complete sound from scratch as an example of how the various parameters combined with the Z-plane filter can radically alter an instrument. In this case we'll try running a saxophone through a clarinet and oboe filter using only the primary layer. As in previous experiments, start with the default preset and change only the parameters listed.

Saxobo (pri only)	
Instrument: 105 Tenor Sax	Note-On Ctrl
Alt Envelope: On	0 Key -> Freq. Trk +064
A H D S R 00 00 00 99 03	1 Vel -> Trans2 +080
Filter Type: 083 Clr>Oboe	2 Vel -> VolumeP +049
Morph Offset: 000	3 CtrlA -> Attack +007
Filter Freq. Track: 103	4 CtrlA -> Freq Trk -020
Transform 2: 210	Realtime Ctrl
	1 Ctl A -> Morph +050

The Tenor Saxophone is an instrument rich in harmonics, making it ideal for filtering. The Alternate Volume Envelope has been adjusted for a fast attack and release. The filter type is 083 Clarinet->Oboe, which models the resonance characteristics of a clarinet and morphs into the resonance of an oboe. On this particular filter, Transform 2 controls a lowpass filter and increases the volume slightly (more T2 equals brighter and louder). The Morph Offset is turned down to 000 so that it can be turned back up using Controller A (which defaults to the Mod Wheel of your keyboard.). Control A has been routed to control the filter Morph in the Realtime Modulation Control.

Now to the Note-On modulation. The Key Number has been routed to Key Tracking with the standard setting of +064. This keeps the tone constant as you play up and down the keyboard. Velocity has been routed to Transform 2, which will make the sound brighter and louder as you play harder. Velocity increases the Volume as you play harder.

As you increase Control A, three things happen:

- 1) The filter Morphs to the Oboe filter.
- 2) The Attack of the sound becomes just slightly longer (Ctrl A ->Attack).
- 3) The Frequency Tracking amount decreases slightly (Ctrl A ->Freq Trk -050). This was done to balance the tone of the sounds.

This is just a simple example to get you started. To learn more about how great presets are constructed, examine the factory presets in detail and discover their secrets. Interesting and expressive sounds have many different controls occurring simultaneously. Genius is in the details. Take the time to fine tune and polish your creation!

Morphology

The best and ultimately the only way to choose filters is to try them out. UltraProteus is no mere mortal synthesizer with a single filter. UltraProteus has 288 filter types to choose from. Think of the filters as you do instruments: entities which have a particular sound. As you learn what the instrument and the filters sound like, you can mix and match them to suit your needs.

A flanger filter (which is a parametric EQ with closely-spaced notches) sounds like a traditional flanger when swept. If the frequency of the flanger is controlled by key velocity and not swept, the flanger can simulate different plucks on a string or strikes on a surface such as a cymbal.

The need for Keyboard Tracking is reduced when using a parametric EQ since the high frequencies are preserved (unlike a lowpass filter).

Time-variant filter sweeps are good for traditional synthesizer effects such as resonant sweeps, flanges, phasing, stereo panning, vowels, etc. Time-invariant filters are useful for distortion, simulating instrument resonances, plucked strings, cymbals strikes, etc.

Correlate the DCA envelope to emphasize or minimize parallel filter attack and release characteristics.

Try using vibrato (LFO to pitch) with vocal filters for more realistic vocal simulations.

Velocity and Key Number generally alter the timbre in expressive presets. Also, Harder (faster) usually equals Brighter.

Natural sounds tend to use low Q filters.

Fixed Formant Filters:

Can reduce the unwanted effect of pitch shifting the samples (munchkinization).

Simulate instrument body resonances

Simulate cymbal strikes, with variation in the stick position

Simulate woodwind instrument resonance

Simulate guitar and string plucks with variation in pick position

Swept Filters:

Simulate flangers

Can be used for traditional synthesizer lowpass filter effects

Can pick individual harmonics out of complex sounds

USING ULTRAPROTEUS WITH A SEQUENCER

We thought you'd never ask. UltraProteus was designed from its conception with multi-timbral sequencing in mind. Just take a look at the main screen.

```
C01 VOL127 PAN=P
000 Program Name
```

The preset for each MIDI channel is selected from the main screen or from the Midimap menu which stores sixteen (32 with a RAM card installed) complete 16-channel MIDI setups. The Main Screen settings are the same settings in the currently selected Midimap and any changes you make will be reflected in either screen. Press the cursor button to move the cursor up so that it is underneath the channel number.

```
C01 VOL127 PAN=P
000 Program Name
```

Turn the data entry control and you will see that every MIDI channel has a preset assigned to it. Just select a preset or hyperpreset for each of the MIDI channels. It's simple! If you want to store the sixteen channel MIDI setup, press the Midimap button and turn the data entry control to the last screen, "Save Midimap to". Then select a location and press Enter.

In order to respond to multiple MIDI channels, UltraProteus must be in Multi-Mode. Multi-Mode is selected in the Master menu. Press the Master menu button and use the data entry control to scroll through the screens until you find MIDI MODE.

```
MIDI MODE    ID
Multi        00
```

Move the cursor down to the second line and change the mode to **Multi** as shown. UltraProteus will now respond to multiple MIDI channels.

MORE ADVANCED SEQUENCING

Pre-Sequence Setup

Suppose that you want to have your sequencer set up everything for you before the start of the song. Good idea. This will make the UltraProteus setup procedure automatic and prevent the wrong presets from playing.

The basic idea of a pre-sequence setup is to send out a Midimap Select command just before the start of the song. Your pre-programmed Midimap will select all the proper presets, adjust the mix and effects settings as well as the pan positions of each preset.

Most computer-based MIDI sequencers have the ability to send MIDI SysEx data. The **ONLY** way to select a Midimap remotely is to use a SysEx message. Consult your sequencer operation manual for information on sending SysEx messages.

Note: UltraProteus setup information should be transmitted from the sequencer *before* the song actually starts, perhaps during a lead-in measure or countdown. **DO NOT** send setup information just before the first beat of the song or MIDI timing errors could result.

Initial Setup

- 1) Program a Midimap exactly the way you want it, with Channels to Preset/Hyper, MIDI Enables and Effect Settings. Be sure to name your Midimap so you can recognize it later.
- 2) SAVE the Midimap in one of the sixteen internal locations or one of the sixteen RAM card locations.
- 3) Make sure the Device ID (MIDI Mode in the Master menu) is set to 00. Otherwise UltraProteus will simply ignore the SysEx messages.

Before the Sequence Starts

Send the following MIDI SysEx messages exactly as listed.

- 1) Turn On Multi-Mode - Send: F0 18 0C 00 03 08 02 02 00 F7
- 2) Select the Midimap - Send: F0 18 0C 00 03 40 02 **02** 00 F7

Use the chart at right to find the proper “Hex” number (in **Bold**) to insert into the MIDI string. For example, to select Midimap 10, you would insert the hexadecimal number “0A” in the position shown above.

Now your song will play perfectly every time according to the parameters in the Midimap. In addition, programs, volumes and pan positions (or anything else for that matter) can be adjusted in realtime during the song using standard MIDI controllers. **Note:** If the wrong programs are being selected, check the MIDI Program Change Map.

TO CHANGE PROGRAM BANKS VIA MIDI SYSEX, SEND:

Bn 00 00 20 11 Cn pp

n = MIDI chan. number (0-F)

11 = Bank number (00-04)

pp = Preset in the new bank (00-7F)

NOTE: DEVICE ID 00 IS ONLY NECESSARY FOR THE EXAMPLE SHOWN BELOW. DEVICE ID'S ARE USED TO DIFFERENTIATE MULTIPLE ULTRAPROTEUS UNITS ON THE MIDI CABLE.

Midimap Number

Map Hx	10 = 0A	21 = 15
00 = 00	11 = 0B	22 = 16
01 = 01	12 = 0C	23 = 17
02 = 02	13 = 0D	24 = 18
03 = 03	14 = 0E	25 = 19
04 = 04	15 = 0F	26 = 1A
05 = 05	16 = 10	27 = 1B
06 = 06	17 = 11	28 = 1C
07 = 07	18 = 12	29 = 1D
08 = 08	19 = 13	30 = 1E
09 = 09	20 = 14	31 = 1F

TO CONSERVE AUDIO CHANNELS, USE THE EFFECTS SECTION TO "FATTEN" THE SOUND INSTEAD OF "DOUBLE+DETUNE" IN THE PRESET MENU.

USE LONG NOTE DURATIONS WHEN SEQUENCING DRUM TRACKS. THIS TECHNIQUE FREES UP THE CHANNELS FASTER AND CAN HELP PREVENT "CHANNEL RIPOFF".

Using the 32 Channels

As stated earlier, UltraProteus has 32 independent audio channels which are utilized dynamically. With 32 channels and hundreds of sounds, you have a universe of sonic textures at your disposal. You may have noticed that many of the very "big" sounding hyperpresets in UltraProteus are constructed using layered presets or they may use Double+Detune. While this is fine when the hyper is played solo, you may begin to run out of channels when UltraProteus is played multi-timbrally. Layered hyperpresets and the Double+Detune function cause extra output channels to be used. Learn to "budget" your output channels for maximum efficiency.

Channel Ripoff

When UltraProteus uses up all its 32 channels and needs more, it steals a channel from the key that has been held the longest. This is commonly known as "channel rip-off". You will most commonly encounter this "rip-off" when using UltraProteus in multi-timbral mode or when using massive hyperpresets. Long Alternate Envelope attack and release rates can also cause this problem. Since UltraProteus dynamically allocates channels as needed, you must either, play fewer notes, shorten the release rates, use simpler sounds, or turn off Double+Detune to eliminate channel rip-off.

Using External Processing

Don't be afraid to use external processing on specific sounds if you feel the urge. The submix sends and returns on UltraProteus are there for a reason. In certain instances, a little external signal processing will be just the thing an instrument needs to give it a distinct identity. Incidentally, a real guitar or bass amp can work wonders on the guitar and bass sounds. If you think about it, playing these sounds through an instrument amp is much closer to the way they are normally processed. Because the submix outputs are programmable, only selected presets or MIDI channels will be routed to the guitar amp.

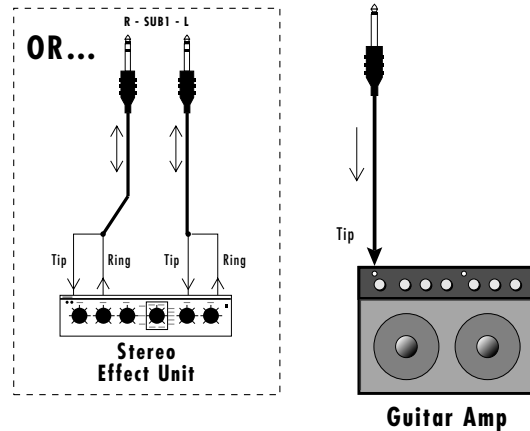
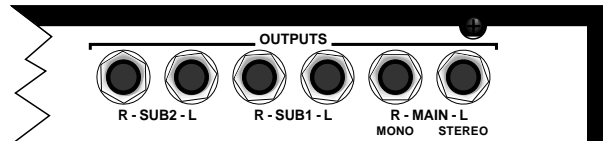

Using the programmable outputs and returns, specific presets can be routed through outboard processors without using up precious mixer channels.

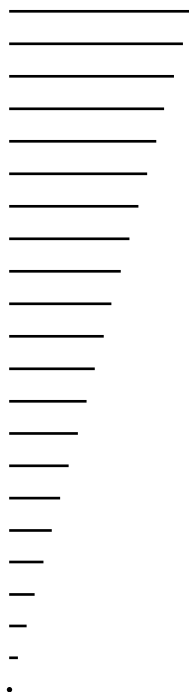

UltraProteus REFERENCE SECTION

<i>Preset Listing</i>	162
<i>Instrument Listing</i>	164
<i>Drawbar Diagrams</i>	171
<i>Instrument Locations</i>	172
<i>Percussion Instrument Locations</i>	173
<i>Z-Plane Filter Descriptions</i>	178
<i>Loop Offset Sample Locations</i>	235
<i>Function Generator Curves</i>	239
<i>Func. Gen., LFO & Envelope Specs</i>	247
<i>Technical Specifications</i>	248
<i>MIDI Specifications</i>	249

PIANO

- 0. Stereo Piano
- 16. Saloon Piano
- 32. Warm Grand
- 48. Wood Piano

STRINGS

- 1. Bowed Viola
- 17. MelloStrings
- 26. Epic Strings
- 33. Synth String
- 49. String River
- 64. Cello(s)
- 65. Viola(s)
- 66. Violin(s)
- 67. Arco Tremolo
- 68. P2 Strings
- 69. Combo String
- 70. Orch Strings
- 71. Dark Strings
- 75. Pan String

CHOIR/VOCAL

- 2. Voices
- 18. BreathyVoice
- 34. Soft Choir
- 72. Man & Woman

BRASS

- 3. BrassSection
- 19. ImperialHrns
- 35. Brass Stabz
- 51. Soft Horns
- 80. Solo Trumpet
- 81. Trumpets
- 82. Solo Trmbone
- 83. Trombones
- 84. TrumpetBone
- 85. FanfareHorns
- 86. Fr. Horn Section

WOODWINDS

- 4. Saxophone
- 20. Flute & Oboe
- 36. Sax Duet
- 52. Oral Sax
- 87. Woodwinds
- 88. EngHrn/Oboe
- 89. Wind & Flute
- 90. WindEnsemble
- 92. Bassoon&Oboe
- 116. Kinky Sax

GUITAR

- 5. ChorusGuitar
- 6. GuitarGrunge
- 21. XprsvEL.Gtr
- 22. GuiTar Pad
- 37. Nylon Guitar
- 53. 12 StrGuitar
- 54. Power Drive

BASS/SYNTH BASS

- 7. Funk Bass
- 8. Warm Bass
- 23. Roto Bass
- 28. KotoWhereRU
- 40. Comp Bass
- 55. Rock Bass
- 56. Synth Bass
- 117. Bass Board
- 118. Bass Change

CHROMATIC PERC.

- 13. Vibra Chimes
- 29. BriteMarimba
- 95. Tube Attack
- 97. Long Sarong
- 99. Plexi Mute
- 106. Xylophone

KEYBOARDS/SYNTH

- 9. Wurli Grand
- 10. Sunset Synth
- 11. Poly Synth
- 12. Etherium
- 25. Electric Pno
- 27. SpectreSweep
- 41. Digi Clav
- 42. Flute Trails
- 43. Sweepstakes
- 44. ChambrMaidns
- 50. Miz Marthas
- 57. Rock Organ
- 58. SikuSymphony
- 59. Trek String
- 61. Techno Clav
- 73. Stringphaze
- 74. Heavens Rise
- 94. Harpsichord
- 109. Big Country
- 111. Glass Church
- 112. Peaya Naow
- 113. Power Org
- 114. Youza
- 115. Pop Sync
- 119. Mod Ular
- 120. Nose Slot
- 121. Rock Bottom

DRUMS/PERCUSSION

- 14. Pop Drums
- 30. Drum Dance
- 45. Deff Drum
- 46. Dance Beat
- 47. ReverseDrums
- 62. Human Drums
- 96. Latin Drums
- 108. Surdo

SOUND EFFECTS

- 15. Sample&Hold
- 31. Ghost Breeze
- 60. Arpeggiate
- 63. Alien Hit
- 102. Kaleidoscpe
- 122. Q-Whips
- 123. Tune Me In
- 124. THX Five
- 125. Off Limits
- 126. Shimmer Top

ENSEMBLE

- 24. Bass & Lead
- 38. Guitar Synth
- 39. Upright&Vibe
- 76. Guitar&Strgs
- 77. Flt&Symphony
- 78. Cello&Shofar
- 79. Pitz & Grand
- 91. Trumpet&Oboe
- 93. Horn&String
- 98. Victory

WORLD

- 100. Banjo
- 101. Likembe
- 103. Jaw Harp
- 104. Sitar
- 105. Shakuhachi
- 107. Bottle Blow
- 110. Rubber World
- 127. -defPreset-

PIANO

- 0. Stereo Grand
- 16. Heaven
- 32. Pianova
- 48. Piano Warp

STRINGS

- 1. HallStrings
- 17. UltraStrings
- 33. Lush Strings
- 49. Vowel Mument
- 64. Solo Cello
- 65. Solo Viola
- 66. Solo Violin
- 67. Quartet
- 68. Chamber
- 69. Arco Basses
- 70. Arco Celli
- 71. Arco Violas
- 72. Arco Violins
- 73. Marcato 1
- 74. Marcato 2
- 75. Legato Str
- 76. Concerto
- 77. Pizz. Basses
- 78. Pizz Celli
- 79. Pizz Violas
- 80. Pizz Violins
- 81. Pizzicato 1
- 82. Pizzicato 2
- 83. Trem Strings
- 84. Tremulus

CHOIR/VOCAL

- 2. Mixed Choir
- 18. Full Choir
- 34. Vocator
- 50. Rolls Voyce

BRASS

- 3. Pop Brass
- 19. Brass Falls
- 35. L.A. Brass
- 51. Funk Brass
- 100. FrenchHorn 1
- 101. FrenchHorn 2
- 102. Ensemble
- 103. Trumpet 1
- 104. Trumpet 2
- 105. Trumpet Duo
- 106. Harmon Mute
- 107. Trombone 1
- 108. Trombone 2
- 109. Tuba
- 110. Brass Band

WOODWINDS

- 4. Tenor Sax
- 20. Flute
- 36. Alto Sax
- 52. Mute. Duet
- 89. Piccolo
- 90. Oboe
- 91. English Horn
- 92. Clarinet
- 93. BassClarinet
- 94. Bassoon
- 95. Cntrabssoon
- 96. Chamber Wind
- 97. SectionWinds

GUITAR

- 5. Acoustic Gtr
- 6. Electric Gtr
- 21. Stereo Mutes
- 22. Purple Tube
- 37. U-Guitar
- 38. Distortion
- 53. Harmonix
- 54. TremGuitar

BASS/SYNTH BASS

- 7. Funk Pops
- 8. Plexi Bass
- 23. Jazz String
- 24. Street Moog
- 39. No Frets
- 40. Saw Bass
- 55. Bottom Bass
- 56. Home Bass

KEYBOARDS/SYNTH

- 9. Dirty Organ
- 10. Phantazia II
- 11. Saturn Pad
- 25. Electratyne
- 26. Power Sweep
- 27. Raw Solo
- 42. Sound Scape
- 43. Analog. Pad
- 41. FM Piano
- 57. Synergy
- 58. El Swirlo
- 59. Hachusaki

CHROMATIC PERC.

- 12. Vibraphone
- 13. Steel Drum
- 28. Tabla Tone
- 29. Tunable Ride
- 44. Glock Bell
- 45. Marimba
- 60. Xylonia
- 61. Tambora
- 111. Pedal Kettle

DRUMS/PERCUSSION

- 14. Standard Kit
- 30. Dance Drums
- 46. Latin Percs
- 62. Conga Rub
- 98. Orch Perc

SOUND EFFECTS

- 15. Vertigo
- 31. AstralChimes
- 47. Blaster
- 63. Trans4mation

ENSEMBLE

- 85. Clarinova
- 86. Voyestra
- 87. Strgs/Flute
- 88. Viola/FHorn
- 99. Wood N Brass

WORLD

- 112. East Indian
- 113. Accordion
- 114. Harp
- 115. Siku Pad
- 116. SpiritCatchr
- 117. Sitar
- 118. Koto
- 119. Shaku Chant
- 120. NuWorldPerc
- 121. Waterphone
- 122. PhlooNey
- 123. Shofars
- 124. Bata Drum
- 125. Bagpipe
- 126. Didgeridoo
- 127. -defPreset-

THE STEREO GRAND PIANO IS A TRUE STEREO GRAND PIANO SAMPLES TAKEN FROM THE E-MU PERFORMANCE™ PIANO MODULE.

◆ SEE THE INSTRUMENT LOCATION DIAGRAMS ON THE FOLLOWING PAGES.

SAMPLED INSTRUMENTS

- | | | |
|-----------------|--------------------|------------------|
| 1. Stereo Grand | 34. E. Guit C | 67. Trem Violin |
| 2. Stereo Slack | 35. E. Guit D | 68. Troubador |
| 3. Stereo Tight | 36. E. Guit E | 69. Troubador A |
| 4. Mono Grand | 37. Solo Cello | 70. Troubador B |
| 5. Mono Slack | 38. Solo Viola | 71. Troubador C |
| 6. Mono Tight | 39. Solo Violin | 72. Troubador D |
| 7. Piano Pad | 40. Pizz Basses | 73. Irish Harp |
| 8. Perc. Organ | 41. Pizz Celli | 74. Irish Harp A |
| 9. Tine Strike | 42. Pizz Violas | 75. Irish Harp B |
| 10. P1 AcGuitar | 43. Pizz Violns | 76. Irish Harp C |
| 11. P3 AcGuitar | 44. Pizz Combos | 77. Dulcimer |
| 12. Rock Bass 1 | 45. Single Pizz | 78. Dulc A |
| 13. Rock Bass 2 | 46. P1 Strings | 79. Dulc B |
| 14. Rock Bass 3 | 47. Long Strings | 80. Dulc C |
| 15. Alt Bass 1 | 48. Slow Strings | 81. Koto |
| 16. Alt Bass 2 | 49. P2 Strings 1 ◆ | 82. Koto A |
| 17. Alt Bass 3 | 50. P2 Strings 2 | 83. Koto B |
| 18. Alt Bass 4 | 51. P2 Strings 3 | 84. Koto C |
| 19. Alt Bass 5 | 52. Quartet 1 | 85. Banjo |
| 20. Alt Bass 6 | 53. Quartet 2 ◆ | 86. Banjo A |
| 21. Alt Bass 7 | 54. Quartet 3 | 87. Banjo B |
| 22. Bass Syn 1 | 55. Quartet 4 | 88. Banjo C |
| 23. Bass Syn 2 | 56. Gambambo | 89. Hi Tar |
| 24. Funk Slap | 57. Arco Basses | 90. Sitar |
| 25. Funk Pop | 58. Arco Celli | 91. Tambura |
| 26. Harmonics | 59. Arco Violas | 92. Tamb/Sitar |
| 27. Bass/Harms1 | 60. ArcoViolins | 93. Renaissance |
| 28. Bass/Harms2 | 61. Dark Basses | 94. Psaltry |
| 29. Bass/Organ | 62. Dark Celli | 95. Waterphone 1 |
| 30. Guitar Mute | 63. Dark Violas | 96. Waterphone 2 |
| 31. El. Guitar | 64. Dark Violins | 97. Bari Sax |
| 32. E. Guit A | 65. Tremolande | 98. Tenor Sax |
| 33. E. Guit B | 66. Trem Bass | 99. Alto Sax |

100. Dark Sax	134. Oboe	168. Jews Harp A
101. Tuba	135. Long Oboe	169. Jews Harp B
102. Trumpet 1 mf	136. Alt. Oboe	170. Jews Harp C
103. Trumpet 1 ff	137. WoodWinds	171. Jews Harp D
104. Trumpet 2 mf	138. Accordion	172. Down Under ♦
105. Trumpet 2 ff	139. Harmonica	173. Airy Voices
106. Trumpet 3	140. Vb Harmonica	174. Dark Voices
107. MuteTrumpet	141. Folk America	175. Voice A
108. Horn Falls	142. Bagpipe Drone	176. Voice B
109. Dark Trumpet mf	143. Chanter A	177. Voice C
110. Dark Trumpet ff	144. Chanter B	178. Voice D
111. Trombone 1	145. Dron/Chant A	179. Voice E
112. Hi Trombone	146. Dron/Chant B	180. Voice F
113. Lo Trombone	147. Mizmars	181. Voice G
114. Dark T-bone	148. Shenai	182. Voice H
115. French Horn mf	149. PenWhistle	
116. French Horn ff	150. Ocarina	
117. Bone/Tpt	151. Siku	
118. Bone/Sax	152. Siku A	
119. Brass mf	153. Siku B	
120. Brass ff	154. Siku C	
121. Flute Attack	155. Shakuhachi	
122. Soft Flute	156. Ney Flute	
123. Flute Vib	157. Shofars	
124. Flute NoVib	158. Shofar A	
125. P2 AltFlute	159. Shofar B	
126. Piccolo	160. Roar/Catch	
127. DarkPiccolo	161. Bull Roarer	
128. B. Clarinet	162. Spirit Catcher	
129. Clarinet	163. Didgeridoo	
130. B.Clar/Clar	164. Didgeridoo A	
131. Cntrabssoon	165. Didgeridoo B	
132. Bassoon	166. Didgeridoo C	
133. EnglishHorn	167. Jews Harp	

♦ SEE THE INSTRUMENT
LOCATION DIAGRAMS ON THE
FOLLOWING PAGES.

PERCUSSION INSTRUMENTS

- | | | |
|---------------------|--------------------|---------------------|
| 183. Rock Perc 1 ♦ | 217. Click 808 | 251. Surdo Drum |
| 184. Rock Perc 2 | 218. Claps 808 | 252. Wood Drum |
| 185. Standard 1 ♦ | 219. Cymbals 808 | 253. Log Drum |
| 186. Standard 2 | 220. Orch Perc 1 | 254. Plexitones |
| 187. Standard 3 | 221. Orch Perc 2 | 255. Steel Drum |
| 188. All 808 ♦ | 222. Low Perc 2 | 256. Gamelan |
| 189. Use Fists | 223. High Perc 2 | 257. Seribu Pulau |
| 190. Rock Perc FX 1 | 224. Orch Perc 3 | 258. World Perc 1 ♦ |
| 191. Rock Perc FX 2 | 225. AllPercWKey | 259. World Perc 2 ♦ |
| 192. Metal Perc | 226. Special FX 1 | 260. World Perc LR |
| 193. G. MIDI 1 ♦ | 227. Special FX 2 | 261. M.EastCombi ♦ |
| 194. G. MIDI 2 ♦ | 228. Special FX 3 | 262. East Indian ♦ |
| 195. Kicks | 229. Timpani | 263. Agogo |
| 196. Kick A | 230. Bass Drum | 264. P1 Wood Block |
| 197. Kick B | 231. Snare | 265. P3 Wood Block |
| 198. Kick C | 232. Piatti | 266. Conga |
| 199. Snares | 233. Tamborine | 267. Hi Tumba Tone |
| 200. Stereo Snare | 234. Temple Block | 268. HTmbaOpSlap |
| 201. Snare B | 235. Tam Tam | 269. Open Hand Tone |
| 202. Snare C | 236. Castanet | 270. Timbale |
| 203. Snare D | 237. Marimba | 271. Timbale Rim |
| 204. Click Snare | 238. Vibraphone | 272. Fingers |
| 205. Toms | 239. Xylophone | 273. Cabasa |
| 206. Tom A | 240. Celesta | 274. Guiro Down |
| 207. Tom B | 241. Triangle | 275. Guiro Up |
| 208. Cymbals | 242. Glockenspiel | 276. Maraca A |
| 209. Hat A | 243. TubularBell | 277. Maraca B |
| 210. Hat B | 244. Tmp/Tubular | 278. Maraca C |
| 211. Hat C | 245. Latin Drums ♦ | 279. Maraca D |
| 212. Ride Cymbal | 246. Latin Perc ♦ | 280. Bata Ipu Tone |
| 213. Crash Cymbal | 247. Maracas | 281. Bata Ipu Slap |
| 214. BD/Tom 808 | 248. The Tabla ♦ | 282. Bata Enu Tone |
| 215. Snare 808 | 249. Bata Drums | 283. Bata Hi Tone |
| 216. Cowbell 808 | 250. Udu Drum ♦ | 284. Bata Hi Mute |

♦ SEE THE PERCUSSION INSTRUMENT LOCATION DIAGRAMS ON THE FOLLOWING PAGES.

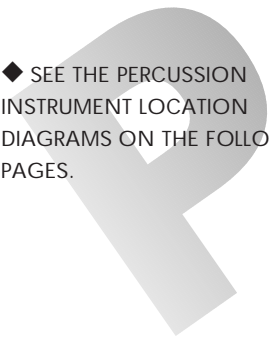

- 285. Bata HiSlap
- 286. Tabla Tone
- 287. Tabla Mute A
- 288. Tabla Mute B
- 289. Tabla Mute C
- 290. Tabla Open
- 291. Udu Tone
- 292. Udu Release
- 293. Udu Finger
- 294. Udu Slap
- 295. Surdo Open
- 296. Surdo Mute
- 297. Deff Slap
- 298. Deff Mute
- 299. Crickets
- 300. Bayan Tone
- 301. Bayan Slap
- 302. Bayan Hit
- 303. Clapper Stick
- 304. Rosewood Bass
- 305. Rosewood Tick
- 306. Rosewood Harm
- 307. Rosewood Finger
- 308. Tanz Shaker
- 309. Hula Stick
- 310. Buzz Likembe
- 311. Likembe
- 312. Likembe Buzz
- 313. Bendir
- 314. Req Open
- 315. Req Slap
- 316. Plexi-Tone
- 317. Plexi-Slap A
- 318. Plexi-Slap B
- 319. Plexi-Slap C
- 320. Bonang
- 321. Kenong
- 322. Saron
- 323. Rubbed Bonang
- 324. Rubbed Kenong
- 325. Rubbed Saron
- 326. Bonang Kenong
- 327. Kenong Bonang
- 328. China Gong
- 329. Rubbed Gong
- 330. Nepal Cymbal
- 331. Tibetan Bowl
- 332. Rubbed Bowl
- 333. Crotales
- 334. Rubbed Crotales
- 335. Suwuk Gong
- 336. Rubbed Suwuk

Miscellaneous

- 337. Synth Pad
- 338. Med. Pad
- 339. Long Pad
- 340. Dark Pad
- 341. Kaleidoscope
- 342. Multi-Form
- 343. Prophet Tone
- 344. Noise Non-X

HARMONIC WAVEFORMS

- 345. Oct 1 Sine
- 346. Oct 2 All
- 347. Oct 3 All
- 348. Oct 4 All
- 349. Oct 5 All
- 350. Oct 6 All
- 351. Oct 7 All
- 352. Oct 2 Odd
- 353. Oct 3 Odd
- 354. Oct 4 Odd
- 355. Oct 5 Odd
- 356. Oct 6 Odd
- 357. Oct 7 Odd
- 358. Oct 2 Even
- 359. Oct 3 Even
- 360. Oct 4 Even
- 361. Oct 5 Even
- 362. Oct 6 Even
- 363. Oct 7 Even
- 364. Low Odds
- 365. Low Evens
- 366. FourOctaves

Starting from the first octave (fundamental), the harmonic waveforms contain the harmonics (odd, even, or all) present in each octave. In each successive octave, the number of harmonics doubles.

By combining (pri/sec or link) the harmonic waveforms in various amounts (volume), and transposing them (course/fine tuning), a wide range of timbres may be produced.

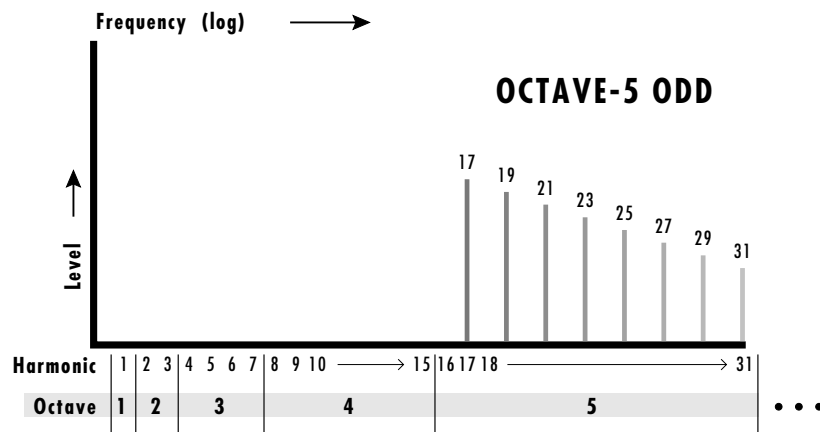

As an example, this chart shows the harmonics present in the **Octave 5 Odd** waveform.

STANDARD SYNTHESIZER WAVEFORMS

- 367. Square
- 368. SquareChrs1
- 369. SquareChrs2
- 370. Sawtooth
- 371. Filter Saw
- 372. Sawstack
- 373. Dark Stack
- 374. Triangle
- 375. Ramp

SYNTHESIZER & ORGAN WAVEFORMS

Single cycle waveforms are sampled waves from various synthesizers and organs. Waveforms highlighted in **Bold** lettering are multicycle samples. The others are single cycle waveforms. B3 waves are various harmonic drawbar settings designed to be used alone or layered.

- 376. Evens Only
- 377. Odds Gone
- 378. Fund Gone 1
- 379. Fund Gone 2
- 380. Moog Saw 1
- 381. Moog Saw 2
- 382. Moog Saw 3
- 383. Moog Saw 4
- 384. Moog Sqr 1
- 385. Moog Sqr 2
- 386. Moog Sqr 3
- 387. Moog Sqr 4
- 388. Moog Sqr 5
- 389. Moog Sqr 6
- 390. Moog Rect 1
- 391. Moog Rect 2
- 392. Moog Rect 3
- 393. Moog Rect 4
- 394. Moog Rect 5

INSTRUMENTS IN BOLD ARE
MULTICYCLE WAVEFORMS.

- | | | |
|-----------------------|-------------------------|-------------------------|
| 395. Moog Pulse1 | 429. Duck Cyc 2 | 463. Fuzzy Clav |
| 396. Moog Pulse2 | 430. Duck Cyc 3 | 464. Electrhode |
| 397. Moog Pulse3 | 431. Wind Cyc 1 | 465. Whine |
| 398. Moog Pulse4 | 432. Wind Cyc 2 | 466. Glass Chrs1 |
| 399. Moog Pulse5 | 433. Wind Cyc 3 | 467. Glass Chrs2 |
| 400. Ob Wave 1 | 434. Wind Cyc 4 | 468. Bell Chorus |
| 401. Ob Wave 2 | 435. Organ Cyc 1 | 469. FM ToneChrs |
| 402. Ob Wave 3 | 436. Organ Cyc 2 | 470. Oooohgan |
| 403. Ob Wave 4 | 437. Vio Essence | |
| 404. Ob Wave 5 | 438. Buzzoon | |
| 405. ARP 2600 1 | 439. Brassy Wave | |
| 406. ARP 2600 2 | 440. Reedy Buzz | |
| 407. ARP 2600 3 | 441. Growl Wave | |
| 408. B3 Wave 1 | 442. HarpsiWave | |
| 409. B3 Chrs 1 | 443. Fuzzy Gruzz | |
| 410. B3 Wave 2 | 444. Power 5ths | |
| 411. B3 Chrs 2 | 445. Ice Bell | |
| 412. B3 Wave 3 | 446. IceBellChrs | |
| 413. B3 Wave 4 | 447. Bronze Age | |
| 414. B3 Wave 5 | 448. Iron Plate | |
| 415. B3 Wave 6 | 449. Aluminum | |
| 416. ARPClarinet | 450. Lead Beam | |
| 417. ARP Bassoon | 451. SteelXtract | |
| 418. Synth Cyc 1 | 452. WinterGlass | |
| 419. Synth Cyc 2 | 453. Town Bell | |
| 420. Synth Cyc 3 | 454. Orch Bells | |
| 421. Synth Cyc 4 | 455. Tubular SE | |
| 422. Bite Cyc | 456. Soft Bell | |
| 423. Buzzy Cyc | 457. Swirly | |
| 424. Metlphone 1 | 458. Tack Attack | |
| 425. Metlphone 2 | 459. ShimmerWave | |
| 426. Metlphone 3 | 460. Mild Tone | |
| 427. Metlphone 4 | 461. Ah Wave | |
| 428. Duck Cyc 1 | 462. Vocal Wave | |

DRAWBAR DIAGRAMS

Each drawbar controls the volume of the associated harmonic or overtone. The 8' drawbar is the fundamental pitch of the sound. You can add animation to the B3 waves (or any other waves) by modulating their pitch or volume with the LFO.

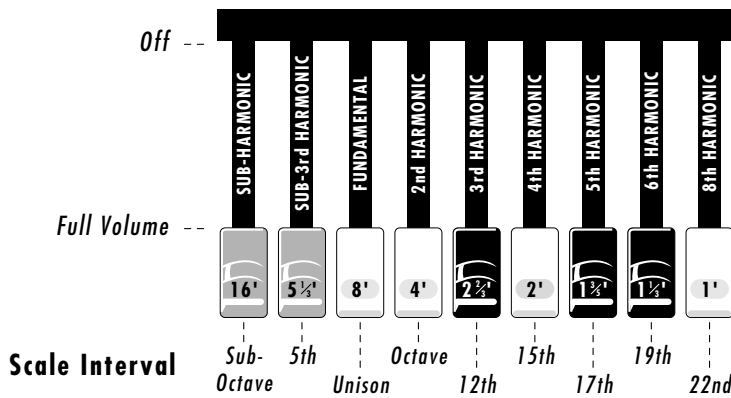

B3 Wave 1

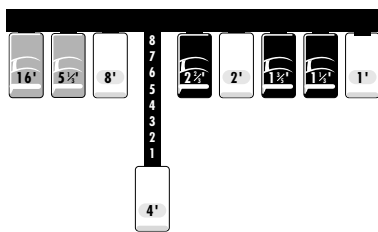

B3 Wave 2

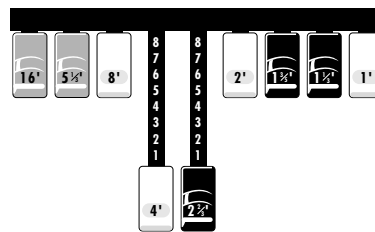

B3 Wave 3

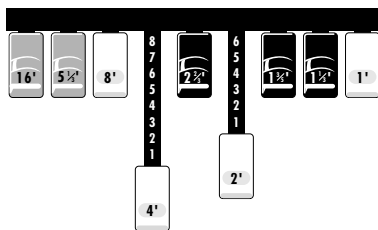

B3 Wave 4

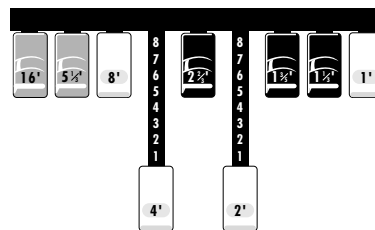

B3 Wave 5

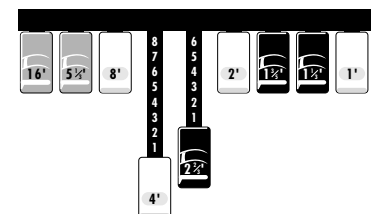

B3 Wave 6

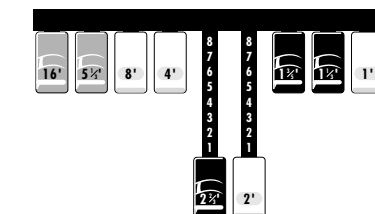

INSTRUMENT LOCATIONS

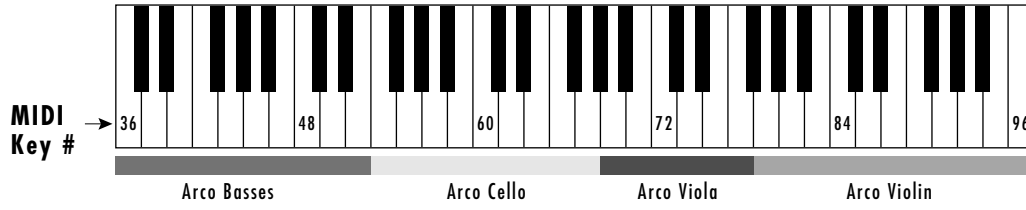

P2 Strings 1
Instrument 049

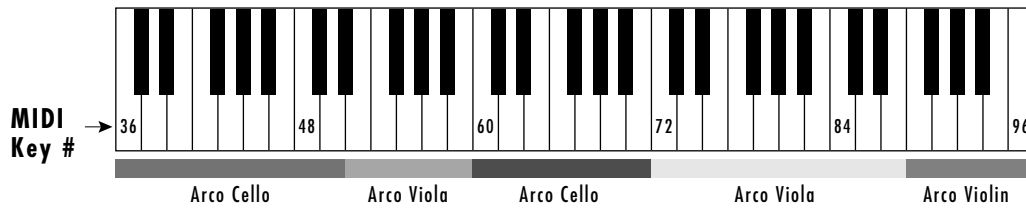

Quartet 2
Instrument 053

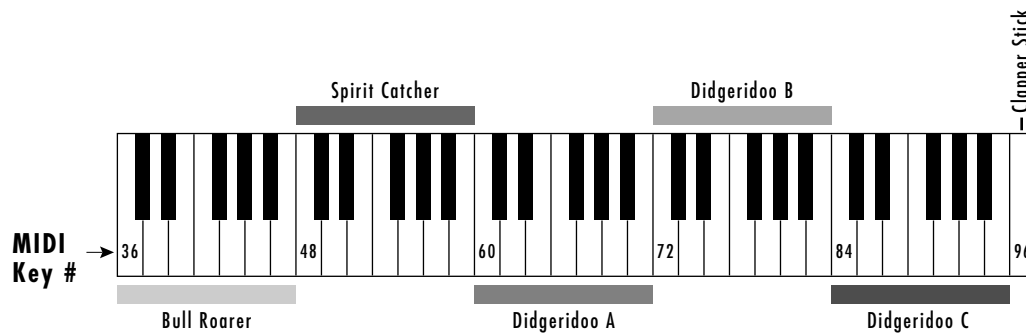

Down Under
Instrument 172

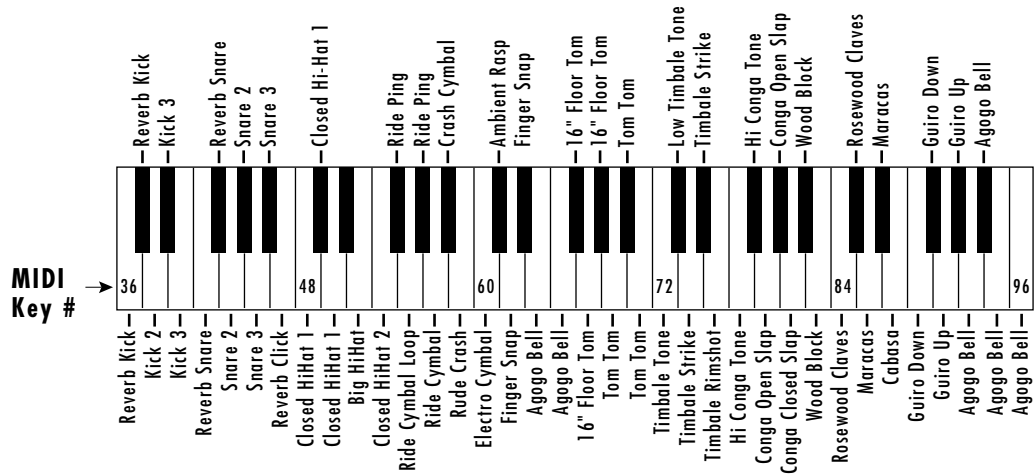

Rock Percussion 1
Instrument 183

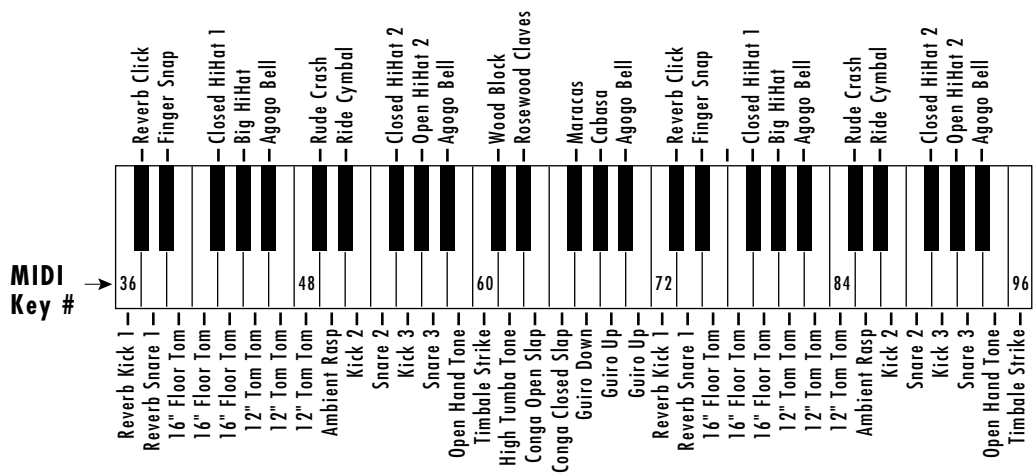

Standard 1
Instrument 185

PERCUSSION INSTRUMENT LOCATIONS

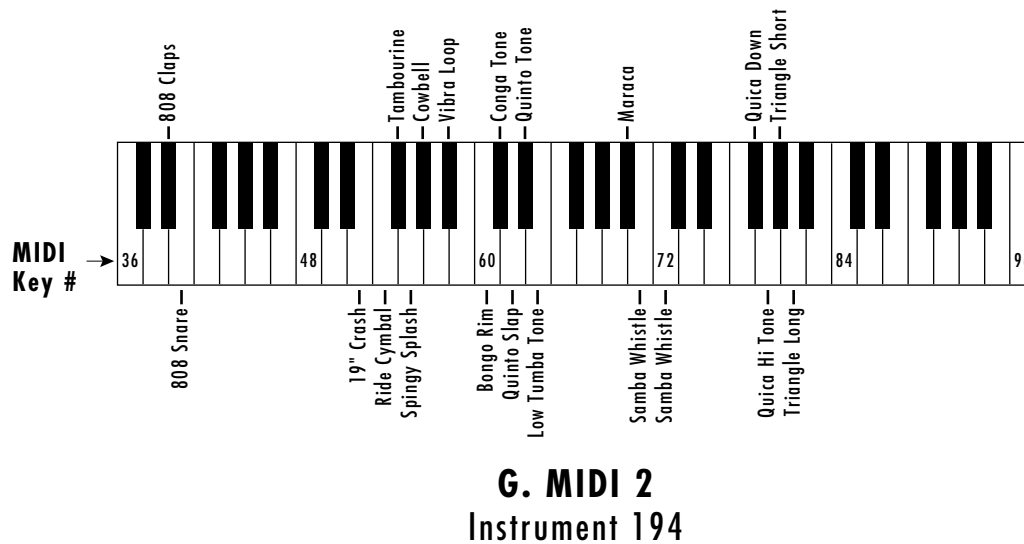
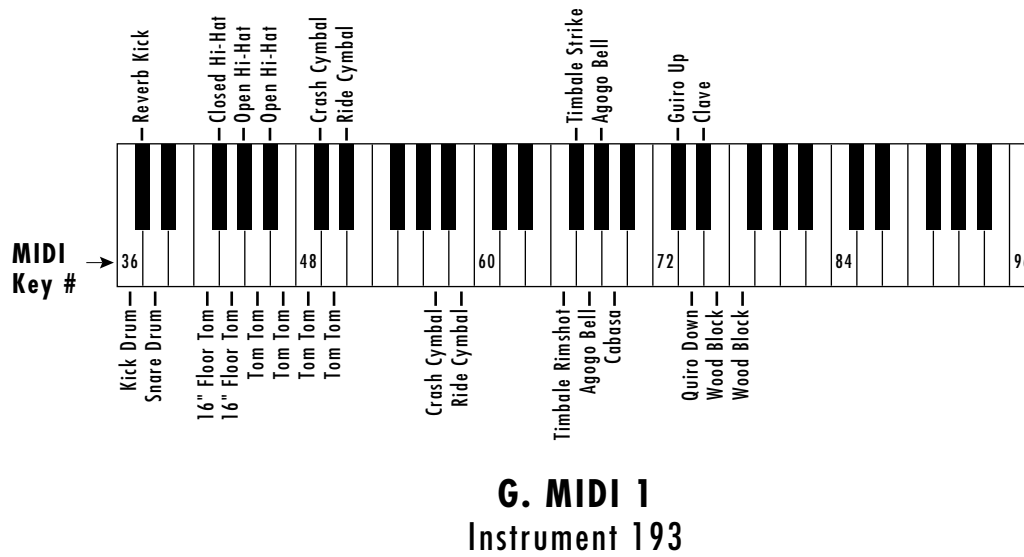
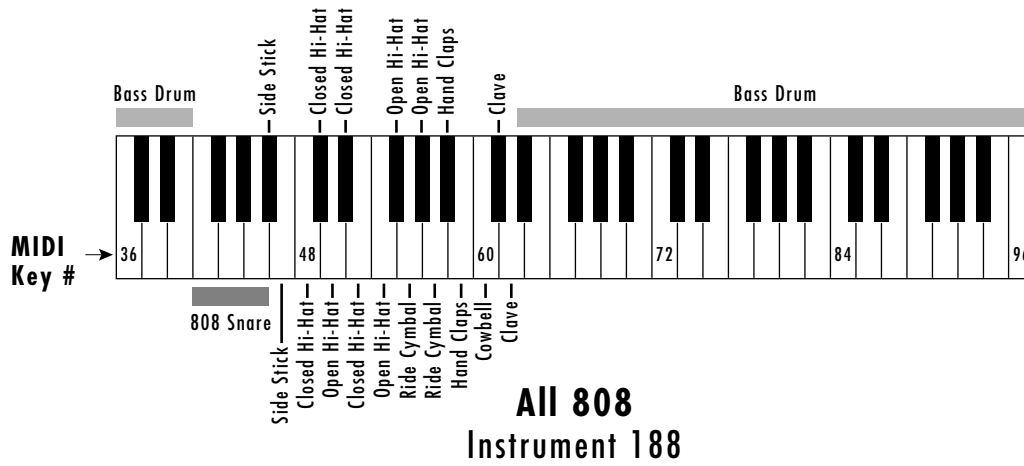

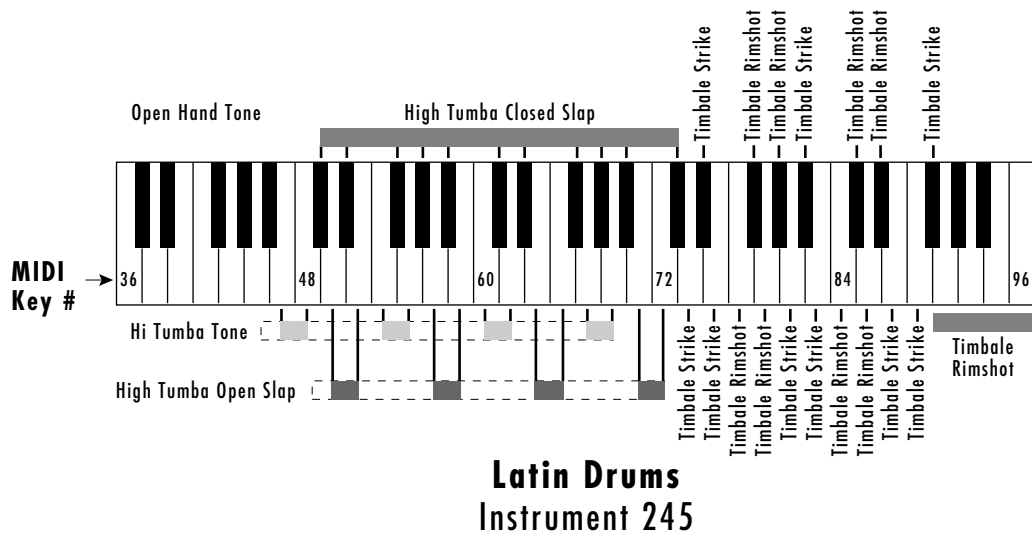

Latin Drums
Instrument 245

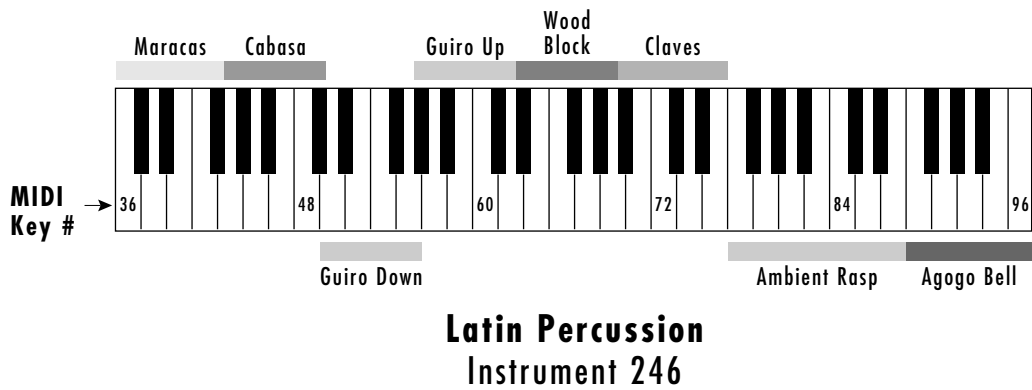

Latin Percussion
Instrument 246

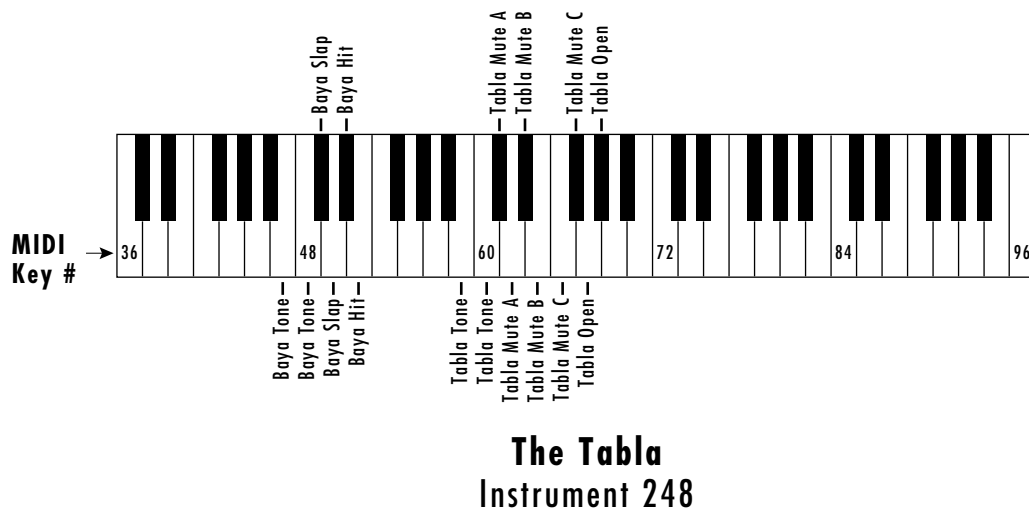

The Tabla
Instrument 248

PERCUSSION INSTRUMENT LOCATIONS

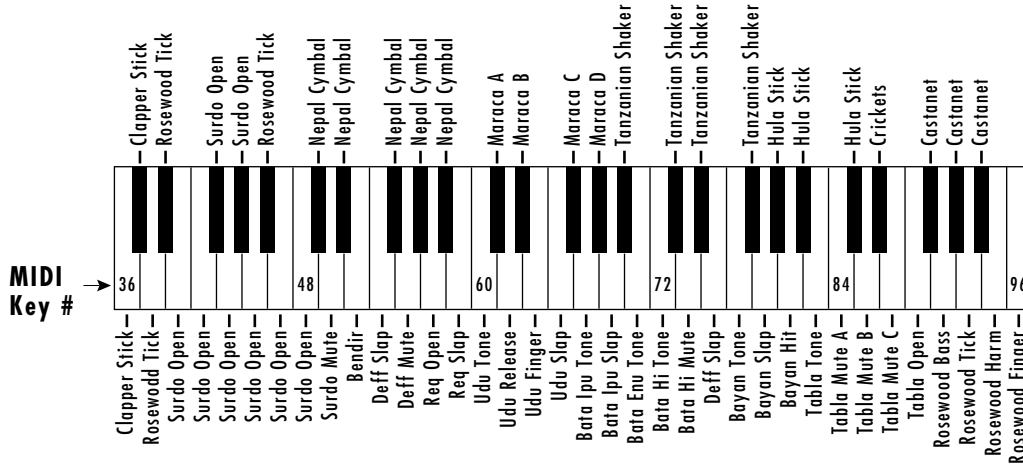

World Percussion 1
Instrument 258

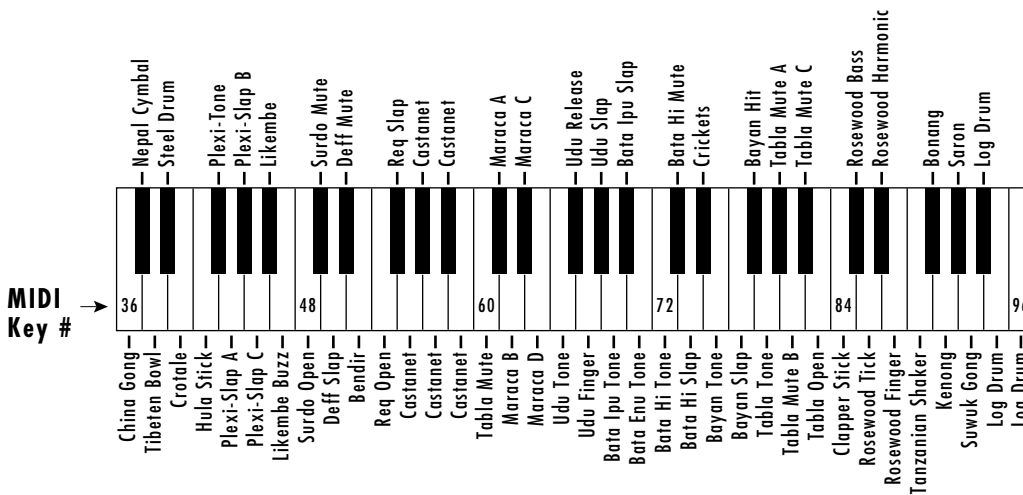

World Percussion 2
Instrument 259

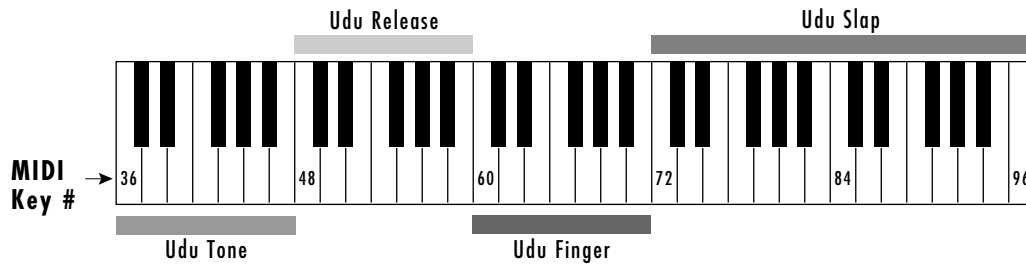

Udu Drum
Instrument 250

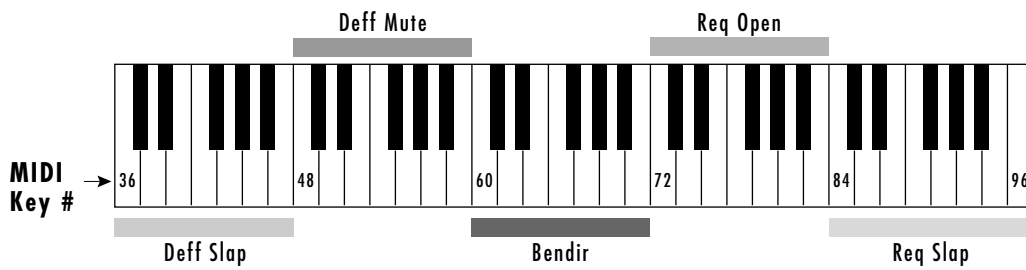

Middle Eastern Combi
Instrument 261

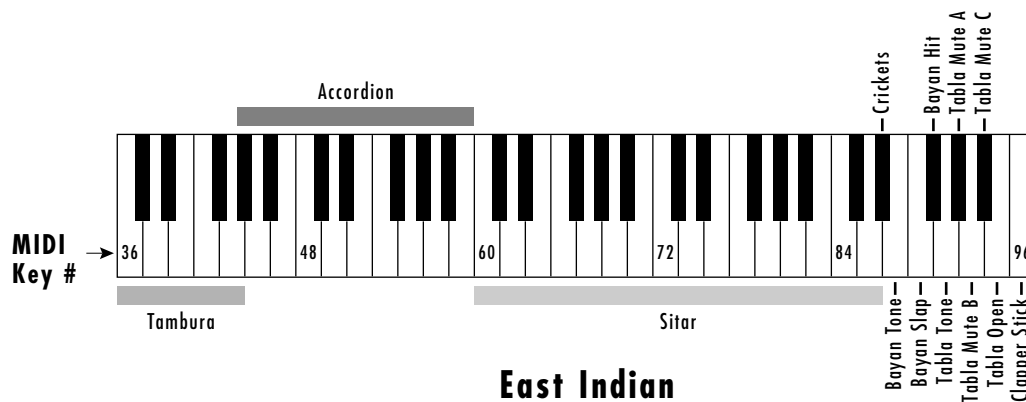

East Indian
Instrument 262

The Z-Plane filters are categorized into groups of: Flangers, Vowel Filters, Traditional Filters, Parametric Filters, Instrument Models, etc. A suffix of '4' or '.4' indicates filter is square, not cube and does not contain a Transform 2 axis.

FLANGERS

Members of this filter family contain a series of notches with various depths, widths and frequencies. The traditional flange effect is created by sweeping different frequency notches with a real time controller. Another application for flangers is enhanced dynamic expression at note-on by using velocity to modulate the frequencies of the notches and overall cut-off. These filters can simulate different pick positions on guitar strings and various locations of drum, mallet and cymbal strikes, etc.

F000 Null Filter

F001 Low Pass Flange .4

Morph: Starts with high end roll-off and deep, narrow notches at 500Hz, 100Hz, 200Hz, 400Hz and 800Hz and transforms into less deep, wider notches at 11799Hz, 13813Hz, 16169Hz, 17495Hz and 18928Hz with no roll-off.

Freq. Tracking: Moves the notches in the first frame of the Morph axis up two octaves. The second frame is completely flat. Tracks filter to keyboard frequencies with Note-on key assignment. Frequency Tracking controls brightness.

Transform 2: Not used.

F002 Low Pass Flange Bk .4

A series of deep notches spaced at octave intervals morphing to less severe, more closely clustered high frequency notches. An additional lowpass filter is at the start of the Morph, opening as the maximum offset is reached.

Morph: Modulate this to create multi-flanging effects.

Freq. Tracking: Tracks flangers across the keyboard. Velocity controls brightness.

Transform 2: Not used.

F003 Flange 2 .4

This flanger has a series of 6 notches placed at octaves, not linearly. Frame 1 starts with notches at 50, 100, 200, 400, 800, and 1600Hz.

Morph: Moves all of the notches up in frequency to above 10kHz, with decreasing depth. This means that the deepest flanging effect is obtained in the first 1/3 to 1/2 of the Morph parameter range. Note that deep notches can cut out the fundamental of a sound which might decrease the volume of the note.

Freq. Tracking: Moves the notches to 400, 800, 1600, 3200, 6400, 12800Hz, which allows key tracking to keep the "sweet spot" of the flanger centered over the harmonics of the note.

Transform 2: Not used.

F004 CubeFlanger

A flanging filter featuring deep notches tuned in octaves and a steep roll-off of high frequencies when all axes have no offset. High settings for Transform 2 can produce some rather metallic-sounding overtones. Apart from flanging effects, this filter can be used in much the same way as a standard resonant synth filter.

Morph: Tunes the filter notches.

Freq. Tracking: Controls lowpass filter cutoff point.

Transform 2: Increases resonance and introduces some peaks.

F005 Flange3.4

Notches are spaced at a ratio of 1.61 between notch frequencies, starting at 40Hz. This spacing means that notches will not fall on top of all of the harmonics of a sound at once. Instead, they should hit harmonics one at a time as they are swept in frequency. Traditional flangers have notches spaced linearly, not log spaced.

Morph: Moves all of the notches up above 10kHz, with the relative frequency spacing decreasing. The deepest flange effect will happen in the lower 1/3 to 1/5 of the morph parameter range.

Freq. Tracking: Sets the initial tuning of the notches, moving all of the notches up from 40Hz to 325Hz as the base frequency.

Transform 2: Not used.

F006 Flange 4.4

A highly resonant flanger /filter type. Sweeping the Morph axis produces dramatic effects. The Filter Frequency Track parameter can be used to tune the flanger; higher values produce more open sounds.

Morph: Increase to raise the cutoff frequency and vary the gain of the various peaks and notches.

Freq. Tracking: Tunes the filter.

Transform 2: Not used.

F007 Flange 5

A complex flange possessing some vocal-sounding characteristics. Sweeping along the Morph or Freq. Track axes produce flanger-like effects.

Morph: Tunes the notches.

Freq. Tracking: Spreads the notches.

Transform 2: Increase this to move the filter toward a more flat curve.

F008 Flange 6.4

Introduces both peaks and notches which start widely spaced and become more tightly distributed as Morph Offset reaches maximum. The center frequencies for the various filter bands move towards higher ranges as the Morph or Filter Freq. Track parameters are swept upward; the effect is not unlike a sweeping of multiple resonant band-pass filters.

F009 Flange 6R.4

This is a variation of filter 008, Flange 6.4. It is a bit more resonant-sounding, due in part to higher 'Q' settings. Sweeping the Morph axis can produce the syllable 'yi'.

Morph: Sweep filter frequency bands up and together when modulated in a positive direction.

Freq. Tracking: Sweep filter frequency bands up and together when modulated in a positive direction.

Transform 2: Not used.

F010 Flanger 7.4

A series of harmonically related notches is moved from the lower-midrange to the upper-midrange as this filter is moved along the Frequency Tracking axis. Morphing brings in the flanging effect

Morph: Use this to sweep the notches.

Freq. Tracking: Use this to tune the notches.

Transform 2: Not used.

F011 BriteFlng.4

A series of notches, tuned in octaves, are swept upward and finally converge at 19.5kHz as this filter is pushed up along the Morph axis. A small bump at about 15kHz is introduced to maintain brightness when Morph is at completely offset.

Morph: Increasing this value sweeps the filter notches upward and together.

Freq. Tracking: Increasing this raises the lowpass filter cutoff point.

Transform 2: Not used.

F012 Flng>Flng1

Morph: Sweeps from flange 1 to flange 2

Freq. Tracking: Provides key tracking to maintain spectrum.

Transform 2: Provides volume and brightness control with velocity and/or key position

Comments: Key tracking enhances the depth of the flange. Try adding velocity to Frequency Tracking for more "Fun".

F013 0>Flng2

Morph: Reveals flat to flange filter

Freq. Tracking: Provides key tracking to maintain spectrum

Transform 2: Adds volume, different flange

Comments: Nice for introducing a subtle flange to a pure sound. Velocity has a natural effect increasing flange depth, volume and brightness.

- F014 Flng>Flng3b**
Morph: Sweeps from flange 1 to 2
Freq. Tracking: Provides key tracking to enhance flanging
Transform 2: Increases depth of flange
Comments: A gentle sweeper.
- F015 Flng>Flng4**
Morph: Sweeps flange
Freq. Tracking: Provides key tracking to enhance flanging.
Transform 2: Reduces depth of flange effect with Morph offset, otherwise, increases flange depth.
- F016 Flng>Flng5**
Morph: Sweeps from flange 1 to 2
Freq. Tracking: Provides key tracking to enhance flanging.
Transform 2: Increases depth of flange, more bell-like.
Comments: Morphing sweeps gently, but Transform 2 adds more depth and introduces a bell-like quality to the flange.
- F017 Flng>Flng6**
Morph: Sweeps from flange 1 to 2.
Freq. Tracking: Provides key tracking to fix partials.
Transform 2: Provides more brightness and flange.
- F018 Flng>FlngT**
Morph: Sweeps between flat and flange.
Freq. Tracking: Provides key tracking to fix partials.
Transform 2: Provides more brightness and flange.
Comments: A gentle-touch flanger. Low Transform 2 gives a soft chorus on morphing. Higher Transform 2 gives exaggerated depth.
- F019 Flng>FlngC**
Morph: Sweeps from open to closed response with all other axes at 0.
Freq. Tracking: Controls brightness.
Transform 2: Adds extra flange.
- F020 CO>FlngT**
Morph: Sweeps from a reveal (almost flat) point to low pass peaks
Freq. Tracking: Raises frequency of peaks.
Transform 2: Increases depth of flange.

DIPTHONGS

Implemented with parametric equalizer subsections, the resonances do not have the traditional overall lowpass effect that a true vocal resonance would have. Instead, they are placed at the same frequency as the resonances would be found in a true vowel, but the response at high frequencies is essentially flat to allow high frequencies of the samples to get through the filter.

The Morph axis controls movement between vowels. Key tracking is controlled by Frequency Tracking. Brightness and depth of effect is controlled by Transform 2. In certain filters, brightness is controlled by assigning velocity to Frequency Tracking. Each paravowel 'A' contains peaks at 800, 1150, 2800, 3500 and 4950Hz. Each paravowel 'E' contains peaks at 400, 1600, 2700, 3300 and 4900Hz. Each 'O' has peaks at 450, 800, 2830, 3500 and 4950Hz. Each 'U' has peaks at 325, 700, 2530, 3500 and 4950Hz.

F021 AEPArLPVow

This paravowel has a low pass filter to provide additional roll off, when desired. Otherwise, it behaves as the other paravowels.

Morph: Controls movement between vowels. Try setting Transform 2 to 255 for additional brightness.

Freq. Tracking: Shifts all of the resonances up in frequency.

Transform 2: Controls volume, depth of effect.

F022 AEPaVowel

Morph: Controls movement between vowels. Try setting Transform 2 to 255.

Freq. Tracking: Shifts all of the resonances up in frequency.

Transform 2: Controls the amplitude of all of the resonances, with 000 providing the lowest resonance amplitude, and 256 providing the highest resonance amplitude.

F023 AOLpParaVow

This paravowel has a low pass filter to provide additional roll off, when desired. Otherwise, it behaves as the other paravowels.

Morph: Controls movement between vowels. Try setting Transform 2 to 255.

Freq. Tracking: Shifts all of the resonances up in frequency.

Transform 2: Controls the amplitude of all of the resonances.

F024 AOPaVowel

Morph: Controls movement between vowels.

Freq. Tracking: Shifts all of the resonances up in frequency.

Transform 2: Controls the amplitude of all of the resonances.

- F025 AUParaVow.4**
Morph: Controls movement between vowels.
Freq. Tracking: Shifts all of the resonances up in frequency.
Transform 2: Controls the amplitude of all of the resonances.
- F026 UOParaVow.4**
Morph: Controls movement between vowels.
Freq. Tracking: Shifts all of the resonances up in frequency.
Transform 2: Controls the amplitude of all of the resonances.
- F027 SftEOVowel4**
Morph: Controls movement between vowels.
Freq. Tracking: Shifts all of the resonances up in frequency.
Transform 2: Controls the amplitude of all of the resonances.
- F028 SoftEOAE**
Morph: Controls movement between vowels.
Freq. Tracking: Shifts all of the resonances up in frequency.
Transform 2: Controls the amplitude of all of the resonances.
- F029 Vocal Cube**
Morph: Sweeps frequencies.
Freq. Tracking: Assign to velocity for brightness control.
Transform 2: Tunes filter.
- F030 C1-6 Harms4**
Morph: Sweeps between a notch at 190Hz to a series of closely spaced peaks from 120Hz to 640Hz
Freq. Tracking: Tracks filter with keyboard. Try assigning velocity to Frequency Tracking for brightness control.
Transform 2: Not used.
- F031 Voce.4**
Morph: Controls movement between ‘oo’ and ‘ee’.
Freq. Tracking: Designed for velocity control of brightness. (Transforms to frequencies two octaves higher.)
Transform 2: Not used.
- F032 ChoralComb4**
Morph: Sweeps between different frequency notches tuned for vocal formants.
Freq. Tracking: Tracks filter with keyboard range.
Transform 2: Not used.

- F033 Bassutoi.4**
Morph: Controls movement between ‘yu’ and ‘ee’.
Freq. Tracking: Tracks filter with keyboard range and controls brightness with velocity assigned.
Transform 2: Not used.
- F034 Be Ye.4**
Designed to say ‘Be Ye’.
Morph: Sweeps vocal formants.
Freq. Tracking: Tracks filter with keyboard range and controls brightness with velocity assigned.
Transform 2: Not used.
- F035 Ee-Yi.4**
Morph: Controls movement between vowels ‘e’ and ‘i’.
Freq. Tracking: Tracks filter with keyboard range and controls brightness with velocity assigned.
Transform 2: Not used.
- F036 li-Yi.4**
Morph: Controls movement between vowels.
Freq. Tracking: Tracks filter with keyboard range and controls brightness with velocity assigned.
Transform 2: Not used.
- F037 Uhrrrah.4**
Morph: Roars like a lion.
Freq. Tracking: Tracks filter with keyboard range and controls brightness with velocity assigned.
Transform 2: Not used.
- F038 YeahYeah.4**
See “What Yeah” preset.
Morph: Moves between ‘ee’ and ‘ya’ sounds.
Freq. Tracking: Tracks filter with keyboard range and controls brightness when assigned to velocity.
Transform 2: Not used.
- F039 Vow>Vow1**
Morph: Sweeps between ‘ah’ and ‘oh’.
Freq. Tracking: Provides key tracking to balance keyboard brightness.
Transform 2: Provides volume and brightness control with velocity and/or key position.
Comments: Transform 2 increases volume and depth of vowel effect.

F040 Vow>Vow2

Morph: Sweeps between ‘ee’ and ‘oh’.

Freq. Tracking: Provides key tracking to fix partials.

Transform 2: Provides volume and brightness control with velocity and/or key position.

Comments: Morphing sweeps between vowels- slight ‘E’ effect.

F041 YahYahs.4

Morph: Sweeps between ‘eeya’ and ‘aa’.

Freq. Tracking: Introduces frequencies two octaves higher for key tracking and brightness control.

Transform 2: Not used.

F042 YoYo.4

Morph: Sweeps between ‘ee’ and ‘oh’ sounds.

Freq. Tracking: Introduces frequencies two octaves higher for key tracking and brightness control.

Transform 2: Not used.

F043 VowelSpace

Dr. William Martens developed this filter cube, which allows any vowel to be approximated with only two parameters.

Morph: Sweeps the first formant of the vowel from 150Hz up to 850Hz.

Freq. Tracking: Sweeps the second formant from 500Hz up to 2500Hz.

Transform 2: Changes the vowel “stress.” Low stress means that all of the vowel frequencies collapse to a relaxed “schwa” sound. Maximum Transform produces the maximum excursion (stress) for all of the vowel frequencies.

STANDARD

These filters are variations on traditional 2 and 4-pole filter models

F044 BrickWaLP.4

This filter features an extreme rolloff at the cutoff point, which moves from 100Hz to 3000Hz. Use this filter to produce low-resonance filter sweeps, or to selectively filter out high frequencies in the source sound.

Morph: Controls filter cutoff.

Freq. Tracking: Controls filter depth and provides gentler roll-off beginning \approx 3000Hz.

Transform 2: Not used.

A “BRICKWALL” FILTER IS ONE WITH AN EXTREMELY STEEP SLOPE.

F045 BrickWaLP2

Morph: Controls filter 'Q'.

Freq. Tracking: Controls filter cutoff.

Transform 2: Use to control filter depth.

F046 MdQ 2PoleLP

A single pole of this filter is swept from low to high as the filter is Morphed. This filter produces nice, not-too-resonant sweep effects.

Morph: Controls filter cutoff.

Freq. Tracking: Controls filter cutoff.

Transform 2: Controls resonance.

F047 HiQ 2PoleLP

A more resonant version of filter 050, with a single frequency band being swept about according to Morph.

Morph: Controls filter cutoff.

Freq. Tracking: Controls filter cutoff.

Transform 2: Controls resonance.

F048 MdQ 4PoleLP

Similar to filters 050 and 051, in this filter two of the poles (tuned to the same frequency) are swept to create a steeper rolloff at the cutoff point, re-creating the classic 4-pole lowpass filter effect. This filter features medium resonance which can be accentuated via the Transform 2 offset.

Morph: Controls filter cutoff.

Freq. Tracking: Controls filter cutoff.

Transform 2: Controls resonance.

F049 HiQ 4PoleLP

Again, (as with filters 050-052), two poles tuned to the same frequency are swept to create a steep rolloff at the filter cutoff point. This filter features high 'Q', which can be controlled via Transform 2.

Morph: Controls filter cutoff.

Freq. Tracking: Controls filter cutoff.

Transform 2: Controls resonance.

F050 2poleLoQLP4

This is basically a 2-pole lowpass filter which can be swept from 60Hz to 19.5kHz. Modulating the Frequency Tracking parameter upward will increase filter resonance. A good choice for emulating certain kinds of analog filter effects.

Morph: Controls filter cutoff.

Freq. Tracking: Controls resonance.

Transform 2: Not used.

F051 4 PoleLoQ.4

A resonant low-pass filter emulation. Morphing creates the familiar filter sweep effect.

Morph: Controls filter cutoff.

Freq. Tracking: Controls filter resonance.

Transform 2: Not used.

F052 4PoleMidQ.4

A 4-filter version of the classic 4-pole resonant filter found in most analog synthesizers.

Morph: Controls filter cutoff.

Freq. Tracking: Controls resonance ('Q').

Transform 2: Not used.

F053 2p>4p 0

Morph: Opens up the filter making it brighter.

Freq. Tracking: This adds a small amount of resonance (Q) to the filter.

Transform 2: Changes from a 4-pole filter (-24dB/oct.) to a 2-pole filter (-12dB/oct.).

Comments: This All Pole filter is modeled on traditional lowpass filter. It has a soft resonance boost.

F054 LowPassPlus

Morph: Sweeps from octave peaks starting at 220Hz to inharmonic, higher frequency peaks.

Freq. Tracking: Keyboard tracking.

Transform 2: Brightens the response.

F055 Low Past.4

Poles with fairly high 'Q' settings are grouped into the lower- to upper-midrange. Sweeping along the Morph or Frequency Tracking axes can produce some rather vocal-sounding effects.

Morph: Use to sweep the frequencies of the pole.

Freq. Tracking: Use to tune the filter.

Transform 2: Not used.

F056 APass.4

Simple lowpass filter with gentle rolloff above 200Hz; morphs to flat.

Morph: Gentle lowpass to flat response.

Freq. Tracking: Also moves the filter towards a flat response, allowing you to control the depth of filtering

Transform 2: Not used.

Comments: A good choice when more subtle filtering is desired.

F057 HPSweep.4

A highly resonant high-pass filter which generally rolls off frequencies steeply below $\approx 2.5\text{kHz}$. Frame 3 provides a relatively flat response (with a gentle cut to the lower frequencies), so the most subtle filtering is achieved with Morph Offset set to 000, and Frequency Tracking set to 255.

Morph: Positive values move the filter higher in frequency.

Freq. Tracking: Positive values move the filter toward a flatter curve.

Transform 2: Not used.

F058 HiSwept1.4

A highly resonant filter with 'Q' increasing as the Morph or Frequency Tracking parameters are swept upward. Frames 1 and 3 are identical, with frame four providing a more resonant, and somewhat brighter, version of frame 3. Increase the value for Frequency Tracking to accentuate this brightness and resonance.

Morph & Freq. Tracking: Control filter cutoff and resonance.

Transform 2: Not used.

F059 HghsSwpt2.4

A more open-sounding version of filter 062. Raises both the filter cutoff point and filter 'Q'.

Morph & Freq. Tracking: Raises both the filter cutoff point and filter 'Q'.

Transform 2: Not used.

F060 HighAccent.4

The center frequencies remain constant throughout all permutations of this filter along the Morph and Frequency Tracking axes; what changes are the 'Q' settings for the various poles and zeros. This allows you to accentuate various resonances, (generally in the upper frequency ranges), of the source sound by manipulating the Morph Offset point and the Frequency Tracking parameter.

Morph: Controls 'Q' of the various poles.

Freq. Tracking: Higher values produce brighter, thinner sounds.

Transform 2: Not used.

F061 HiPassSweep.4

A high-pass filter with the cutoff point moving from about 160Hz to upwards of 2.5kHz (with a sizable gain in resonance) as the filter is morphed upward.

Morph: Higher settings increase cutoff frequency and 'Q'.

Freq. Tracking: Controls filter depth.

Transform 2: Not used.

F062 Deep Combs

This filter can provide a tremendous variety of comb-filtering and filter sweep effects. Higher frequencies are sharply attenuated with Frequency Tracking and Transform 2 set to low values, so be sure at least one of these is either set in the mid- to high-range, or that a modulator is used to offset.

Morph: Positive modulation moves frequency notches towards lower values.

Freq. Tracking: Positive modulation moves frequency notches towards lower values.

Transform 2: Positive modulation moves frequency notches towards lower values.

F063 One Peak

Morph: Try setting Transform 2 to 255 for increased brightness over morph range. Sweeps from a slight peak at 220Hz and roll-off after 650Hz to a series of even peaks at 220,440, 880Hz, and a smaller odd series at 330, 555 and 770Hz.

Freq. Tracking: Tracks filter to keyboard.

Transform 2: Increases the effect of Morph and provides velocity sensing.

F064 More Peaks

Morph: Try setting Transform 2 to 255. Moves from a low cut-off flat frame to a series of peaks at 220, 440, 880, 330, 1000 and 2000Hz.

Freq. Tracking: Tracks keyboard.

Transform 2: Intensifies effect and controls volume.

F065 Rev Peaks

Morph: Try setting Transform 2 to 255. Moves from flat with a low-frequency cut-off to a series of peaks at 220, 440, 660, 880, 1100 and 1320.

Freq. Tracking: Tracks keyboard with notches three octaves higher.

Transform 2: Contains higher gain peaks at same frequencies as Morph axis for volume control and deeper effect.

F066 Notcher 2.4

Frames 1 and 3 contain multiple, unevenly spaced notches and peaks, while frames 2 and 4 are essentially flat. Modulating upward along the Morph axis, then, pushes the filter towards flat. Modulating Frequency Tracking upwards tends to give the source material a bit rounder, more 'open' sound.

Morph: Sweeping over a narrow range with a quick LFO produces some nice rotating speaker effects.

Freq. Tracking: Can be used to tune the filter.

Transform 2: Not used.

F067 Ntches2Oct4

This filter is composed of a series of notches, tuned in octaves.

Morph & Freq. Tracking: Moves notches lower in frequency.

Transform 2: Not used.

Comments: Maximum shift is two octaves along either axis, for a combined total of four octaves if both axes are modulated.

F068 Odd>+

Morph: Changes from odd to even harmonics.

Freq. Tracking: Provides key tracking to maintain spectrum.

Transform 2: Provides volume and brightness control.

Comments: Hints at odd harmonics which are then changed into a different shape depending on the position of Transform 2. (Transform 2 mostly respects natural changes in brightness, however.)

F069 VarSlope.4

A low-pass filter in which the rolloff above the cutoff point (400Hz) becomes steeper as the value for Morph Offset is increased.

Morph: Changes the slope of the rolloff.

Freq. Tracking: Moves the filter toward flat response.

Transform 2: Not used.

Comments: A good choice when more subtle filtering is desired.

EQUALIZATION FILTERS

Most of these filters are variations of traditional parametric EQ filters.

F070 BassEQ 1.4

Morph: Contains deep notch at 196Hz, morphing to a slight bump at 132Hz and a dip at 2600Hz.

Freq. Tracking: Frequency Tracking opens filter completely at maximum offset.

Transform 2: Not used.

F071 B BOOST.4

Morph: Boosts frequencies around 60Hz, sweeping to open response.

Freq. Tracking: Provides gentle rise at 320Hz and 5kHz.

Transform 2: Not used.

F072 BssBOOST2.4

Morph: Boosts frequencies around 60Hz, sweeping to open response.

Freq. Tracking: Introduces a dip at 320Hz and a peak at 2059Hz. With axes offset, a bump at 60Hz and 1200Hz is introduced.

Transform 2: Not used.

F073 BassDrumEQ

Morph: Adds low end boost.

Freq. Tracking: Tends to smooth out the filter.

Transform 2: This adds high end at the expense of low end.

Comments: This is an EQ filter designed for bass drums, based on a low pass EQ filter. The transforms tailor to different types of bass drums.

F074 Snare LPEQ2

Morph: Controls brightness.

Freq. Tracking: This moves the mid range bump down a bit.

Transform 2: This will smooth the boost (widens the 'Q').

Comments: This is an EQ filter designed for snares, based on a low pass EQ filter. There is a strong boost in the 320Hz to 640Hz range and some boost on the low end to give it some punch. The transforms tailor to different types of snares.

F075 HiHatLPEQ

Morph: Controls brightness.

Freq. Tracking: Tends to make the EQ more complex.

Transform 2: Tends to modify the low end.

Comments: This is an EQ filter designed for hi hats, based on a low pass EQ filter. There is a strong boost in the 5kHz to 18kHz range and some cut on the low end. The transforms tailor to different types of hi-hats.

COMPLEX FILTERS

Many of these filters have never existed for musical applications before!

F076 HP LP PZ

Morph: Sets how open or closed the filter is.

Freq. Tracking: Sets the transition from high pass to low pass.

Transform 2: This sets the sharpness of the cut off.

Comments: This Pole/ Zero filter models both low pass and high pass filters.

F077 PZ Notch

Morph: Sets the notches center frequency.

Freq. Tracking: This deepens the notch (more cut).

Transform 2: This makes the notch wider (widens the 'Q').

Comments: This Pole/ Zero filter is a notch that ranges from 80Hz to 10kHz.

F078 Band-aid

Morph: Sets the amount of cut on the high and low frequencies.

Freq. Tracking: This widens the band.

Transform 2: This softens the amount of cut on the high end.

Comments: This Pole/ Zero filter is a band pass that cuts both the high and low end of the sample.

F079 LowQHiQ

Morph: Controls brightness.

Freq. Tracking: Changes from a 4-pole filter (-24dB/oct.) to a 2-pole filter (-12dB/oct.)

Transform 2: This adds resonance ('Q') to the filter.

Comments: This All Pole filter is modeled on traditional low pass filter types. It can emulate most familiar analog sounds.

F080 Wah4Vib.4

Morph: Sweeps from slight rise above 1200Hz to a peak at 590Hz with roll-off after. Sounds more mellow and rounded as offset is increased.

Freq. Tracking: Tracks keyboard.

Transform 2: Not used.

F081 WaWa

Multiple resonant peaks flatten, then invert to become notches as the value for Morph Offset or Frequency Tracking is increased. Increasing the value for Transform 2 can have the effect of sweeping the peaks lower in frequency, inverting the peaks, or both, depending on the settings for Morph Offset and Frequency Tracking.

Morph & Freq. Tracking: Controls polarity of filter gain.

Transform 2: Tunes filter and controls polarity of gain.

F082 BrassRez.4

Compelling trumpet mute effect.

Morph: Try assigning Control A or Velocity to Morph as a note-on controller. Increasing Morph Offset reveals less muted, more open response. Reverse filter for opposite response.

Freq. Tracking: Modulates between a similarly shaped second set of resonances for additional Note-on control.

Transform 2: Not used.

F083 Clr>Oboe

Morph: Sweeps from Clarinet to Oboe

Freq. Tracking: Provides key tracking to fix partials.

Transform 2: Provides volume and brightness control with velocity and/or key position.

Comments: Strong morphing effect with this filter. Transform 2 takes care of velocity expressivity.

F084 O>Muter

Morph: Introduces 'Mute'.

Freq. Tracking: Provides key tracking to fix partials.

Transform 2: Selects 'Mute' variety.

F085 PZ Syn Horn

Morph: Controls brightness.

Freq. Tracking: This moves the harmonic modifiers higher in frequency.

Transform 2: This makes a modest change in brightness (fine tuning).

Comments: This filter models the harmonic content of a synth horn, thus will lend a synth horn sound to other samples.

F086 HP Brass

Generally, each frame in this filter cube provides either a steep rolloff of low frequencies or a sharp boost of high frequencies, with one axis arriving at flat response. Note that with Transform 2 set to 255, the polarity of the sweep along the Morph axis is reversed. This filter can be a good choice when you need a sharp accentuation of high-frequency material.

Morph: Sweeps the highpass filter, with direction dependent on setting of Transform 2.

Freq. Tracking: Higher values produce thinner, brighter sounds.

Transform 2: Sweeps the highpass filter, with direction dependent on setting of Morph Offset.

F087 BrassyBlast

This filter provides several responses similar to that of a lowpass filter, but with the addition of a gentle bump in the midrange to upper-midrange.

Morph: Use to sweep the filter.

Freq. Tracking: Adds a resonant bump at about 200Hz, which flattens out as the value is moved upward.

Transform 2: Works similarly to Frequency Tracking, but adds a gentle bump at about 8kHz as the offset is increased.

Comments: A very smooth-sounding filter, great for brass-type filter sweep effects.

F088 BrassSwell

Similar to a lowpass filter, but multiple resonant peaks give this one a bit of a vocal, phase-shifter-like quality.

Morph: Use to sweep the filter.

Freq. Tracking: Tunes the filter.

Transform 2: Higher values add midrange “beef” and resonance.

F089 BrsSwell2.4

An emulation of a lowpass filter with low resonance designed for brass-type filter sweeps.

Morph: Moves the cutoff frequency higher, and adds a gentle bump in the upper-midrange.

Freq. Tracking: Adds a bit of resonance at the cutoff point, which becomes flatter as the filter is morphed upward.

Transform 2: Not used.

F090 LoVelTrum

A series of tightly spaced peaks is swept upward by each of the filter transforms, with the brightest sounds obtained at maximum settings for Morph Offset, Frequency Tracking, and Transform 2. In addition, Transform 2 increases the resonance.

Morph and Freq. Tracking: Sweeps the peaks.

Transform 2: Tunes the peaks and increases resonance.

F091 Chiffin.4

Morph: Sweeps between low frequency notches.

Freq. Tracking: Allows the notches to track the keyboard.

Transform 2: Not used.

Comments: Use with noise to create a chiff sound on wind instruments.

F092 ShakuFilter

Morph: Sweeps between peaks at 400Hz, 1600Hz, 2700Hz and 3150Hz with roll-off after 30kHz to a mostly flat response with a slight bump at 1900Hz.

Freq. Tracking: Keyboard tracking.

Transform 2: Controls tone and depth.

F093 Cym

Morph: Sweeps from peaks at 100Hz, 300Hz, 400Hz, 600Hz, 900Hz and 1500Hz to peaks at 200Hz, 600Hz, 800Hz, etc.

Freq. Tracking: Keyboard tracking.

Transform 2: Deepens the effect.

Comments: Designed to make interesting cymbal sounds. Both Morph and Frequency Tracking manipulate frequency sweeps.

- F094 VelMarim**
Morph: Sweeps frequencies of small, closely-spaced peaks.
Freq. Tracking: Keyboard tracking.
Transform 2: Deepens the effect.
Comments: Designed to make dynamic marimba sounds using mallet and plate sounds.
- F095 EZ Vibez.4**
Like 098-“Easy Rhodez4”, this is essentially a 2-pole low-pass filter, sweeping from a gentle roll-off at 65Hz to reveal a wide open response.
Morph: Sweeps from lowpass to wide open response.
Freq. Tracking: Keyboard tracking.
Transform 2: Not used.
- F096 Piano 01**
Designed to make possible a set of Piano presets that sound like they were recorded with the sustain pedal down.
- F097 PianoFltr4**
This filter functions much like a lowpass filter with a low ‘Q’ setting. Cutoff frequency is controlled along the Morph axis. Increasing the value for Frequency Tracking increases overall brightness. Although this filter is designed to work well for adding expressiveness to piano-type sounds, it can also be useful in many instances when a filter with a gentle slope is required.
Morph: Controls cutoff frequency.
Freq. Tracking: Controls cutoff frequency and brightness.
Transform 2: Not used.
- F098 EZ Rhodez4**
A lowpass filter, with cutoff frequency ranging from about 200Hz to about 5kHz along the Morph axis.
Morph: Sets cutoff frequency.
Freq. Tracking: Controls filter depth.
Transform 2: Not used.
- F099 MoogVocodr4**
Designed to simulate the classic vocoder filter response. Morph sweeps the frequencies. Frequency Tracking produces a more nasal and enclosed effect.
Morph: Sweeps frequency.
Freq. Tracking: Increases resonance.
Transform 2: Not used.

F100 **MoogVocSwp**

Similar to “MoogVocodr4”, but brighter. Can create variety of interesting responses by altering offsets of each axis, such as sweeping Morph with Frequency Tracking at maximum.

Morph: Sweeps frequency.

Freq. Tracking: Increases resonance.

Transform 2: Changes the effect of the Morph parameter.

F101 **StrngThing4**

A series of widely spaced notches produces this filter, which can sound somewhat like a phase shifter when Morphed - especially if the value for Frequency Tracking is set fairly high. With Morph Offset and Frequency Tracking set high, the curve is essentially flat, with a gentle bump approaching 20kHz, so this filter might be a good choice for adding a subtle sparkle to some sounds.

Morph: Controls cutoff frequency and depth of notches.

Freq. Tracking: Tunes the filter.

Transform 2: Not used.

F102 **StrSweep.4**

Set Frequency Tracking between the ranges of 200 and 255, and gently modulate the Morph Offset parameter in its upper ranges for an effect that will accentuate bowing sounds in string programs.

Morph: Positive modulation increases filter center frequencies and resonance.

Freq. Tracking: Positive modulation decreases resonance, increases brightness slightly.

Transform 2: Not used.

F103 **BassXpress**

This filter provides increased bass, and a sharp notch.

Morph: Controls the depth of the notch.

Freq. Tracking: Tunes the notch.

Transform 2: Controls the lowpass filter cutoff frequency.

F104 **Qbase.4**

Morph: Sweeps from a bright nasal response to accentuated low-frequency boost.

Freq. Tracking: Tracks filter with keyboard.

Transform 2: Not used.

F105 AcGtrRs.4

This filter is designed to emulate some of the resonant characteristics of an acoustic guitar body. With Morph Offset and Frequency Tracking set to 000, the body is extremely resonant, as if a large acoustic guitar were close-miked near the sound hole. Vary the value for Morph Offset to vary the ‘mic position’. Route velocity to Freq. Tracking for controlling brightness and ‘pick position’.

Morph: Controls filter formant notch depth and position.

Freq. Tracking: Frequency Tracking.

Transform 2: Not used.

F106 Tube Sust.4

Use this filter with broad-band waves to produce sounds characteristic of distorted guitars. The fullest sounds are achieved with Morph Offset set to 255, and Frequency Tracking set to 000

Morph: Increasing this increases bass and midrange.

Freq. Tracking: Controls the lower-midrange.

Transform 2: Not used.

F107 GtrSkwk

Morph: Plays the squeak.

Freq. Tracking: Provides key tracking to balance keyboard brightness.

Transform 2: Makes brighter, adds more volume and squeak.

Comments: Higher Transform 2 allows morphing to “string squeak”. Best used with Aux. Env or FG to control this. Routing Velocity to Transform 2 will reduce squeak on low velocities.

F108 GuitXpress

Increasing the Morph Offset value places a notch in the frequency spectrum, the tuning of which can be controlled via the Frequency Tracking and Transform 2 parameters. In addition, increasing the value for Frequency Tracking and/or Transform 2 raises the cutoff point of the lowpass filter. This filter can be used to add a measure of expressiveness, particularly to acoustic instrument simulations. Try using velocity to control Transform 2 and key position to Frequency Tracking. For an additional measure of control, assign Control A (the mod wheel) to control Morph in the Note-on Control section.

Morph: Increases the depth of the filter notch.

Freq. Tracking: Tunes the notch and controls filter cutoff point.

Transform 2: Tunes the notch and controls filter cutoff point.

F109 FG MajTrans4

This filter features a series of peaks tuned to the intervals found in a major triad. Modulating the Morph Offset from 000 to 255 moves the 'chord' from first to second inversion; the Frequency Tracking parameter can be used to tune the chord over a range of several octaves. The effect is perhaps easiest to hear applied to one of the noise waves. It also works well with the RecrdScrch waves.

Morph: Moves the 'chord' of resonant peaks from 1st to 2nd inversion.

Freq. Tracking: Tunes the chord.

Transform 2: Not used.

F110 Tam

Morph: Sweeps frequencies from low to high. Try routing velocity or mod wheel to Morph with offset at 255.

Freq. Tracking: Designed for velocity control of volume & brightness.

Transform 2: Controls brightness and depth.

Comments: Designed to make interesting, dynamic tambourine sounds.

F111 HOTwell.4

Morph: Sweeps frequency range.

Freq. Tracking: Determines degree of frequencies accentuated.

Transform 2: Not used.

Comments: Works well with bell-like sounds.

F112 Bell.Waha

Morph: Sweeps between flat and bell.

Freq. Tracking: Provides key tracking to fix partials.

Transform 2: More dissonance and effect.

Comments: Morphing can pull bell-like sounds out of any sample. Transform 2 adds more dissonance. This is best used with BellWahb which has a similar action but uses different dissonant partials.

F113 Belwahb

Morph: Sweeps between flat and bell.

Freq. Tracking: Provides key tracking to fix partials.

Transform 2: Controls dissonance and depth of effect.

Comments: See BellWaha

F114 0>Bell-

Morph: Sweeps from flat to dissonance.

Freq. Tracking: Provides key tracking to fix dissonant partials.

Transform 2: Increases bell-like effect, makes brighter, louder.

Comments: To be used in conjunction with 0>Bell+. Morphing sweeps partials downwards just away from harmonic values causing bell-like effects.

- F115 0>Bell+**
Morph: Sweeps from flat to dissonance.
Freq. Tracking: Provides key tracking to fix dissonant partials.
Transform 2: Increases bell-like effect, makes the sound brighter and louder.
Comments: To be used in conjunction with 0>Bell-. Morphing sweeps partials to a different dissonance than with 0>Bell-.
- F116 Bel>Crs>Bel**
Morph: Sweeps from flat to dissonance.
Freq. Tracking: Provides key tracking to fix dissonant partials.
Transform 2: Increases bell-like effect. Makes the sound brighter and louder.
Comments: Low velocities on Transform 2 reveals a hint of bells when Morphing. Higher Transform 2 values create a more bell-like and dissonant sound.
- F117 Chrs>Flng1**
Morph: Sweeps to a flange effect.
Freq. Tracking: Provides key tracking to enhance flange effect.
Transform 2: Makes brighter, increases volume.
Comments: Degree of flanging effect depends on velocity.
- F118 Chrs>Flng2**
Morph: Sweeps to a flange effect.
Freq. Tracking: Provides key tracking to enhance flange effect.
Transform 2: Makes brighter, adds volume.
Comments: Velocity controls degree of flange effect.
- F119 Ev/OdNtch.4**
Morph: Sweeps from even notches at 200, 400, 800Hz, etc with an overall low frequency cut-off to notches at 300, 600, 1200, 2400Hz, etc. effecting a warm to bright transition.
Freq. Tracking: Provides key tracking.
Transform 2: Not used.
- F120 Odd/EvnNtch**
Morph: Provides subtle modulation between odd octave intervals starting at 75Hz and even octave intervals starting at 50Hz.
Freq. Tracking: Controls brightness.
Transform 2: Deepens the effect and adds volume.

- F121 NotchPkSwp4**
Morph: Sweeps from nasal to bright; vowel shifts from 'oh' to 'ee'.
Freq. Tracking: Controls brightness and tracks keyboard.
Transform 2: Not used.
- F122 1.5/3KNBPR4**
Morph: Morphs from thin and high to richer and deeper to a yet a different timbre resonance; adds energy.
Freq. Tracking: Frequency Tracking thickens the spectral plot.
Transform 2: Not used.
- F123 Swingshift**
Morph: Try setting Transform 2 to 255 for brighter morph. Modulates from low-frequency cut-off to series of peaks at 349Hz, 494Hz, 698Hz, 988Hz etc.
Freq. Tracking: Tracks filter with keyboard.
Transform 2: Adds depth, volume.
- F124 500up.4**
Poles and zeros alternate, spaced at 500Hz intervals. Increasing Morph Offset boosts the peaks slightly, and greatly deepens the notches, producing an effect similar to band-pass filtering. This effect is further accentuated by increasing the Frequency Tracking value, as well as tuning the entire filter higher.
Morph: Increases depth of notches.
Freq. Tracking: Tunes the filter.
Transform 2: Not used.
- F125 C1Harmonic5oct.8R**
Morph: Try setting Transform 2 to maximum. Controls resonance.
Freq. Tracking: Controls resonance.
Transform 2: Tunes the filter.
- F126 Odd>Even**
Morph: Changes from odds to even harmonics.
Freq. Tracking: Provides key tracking to maintain spectrum.
Transform 2: Controls brightness and volume.
Comments: Odd harmonics are replaced by evens. Can give an impression a raising one octave.

- F127 0>Shp1**
Morph: Changes from flat to shape.
Freq. Tracking: Provides key tracking to maintain spectrum.
Transform 2: Controls brightness and volume.
Comments: Imposes a vowel like shape on a pure sound. (Can be useful for morphing in and out using two samples.)
- F128 0>Shp2**
Morph: Changes from flat to shape.
Freq. Tracking: Provides key tracking to maintain spectrum.
Transform 2: Controls brightness and volume.
Comments: More vowel like changes than 0>Shape1.
- F129 0>Shp3**
Morph: Sweeps to shape.
Freq. Tracking: Provides key tracking to balance keyboard brightness.
Transform 2: Controls brightness and volume.
Comments: Morphing imposes a shape on the sound. Low velocity for mellow, high for bright.
- F130 Shp>Shp1**
 Starts with peaks every half octave from 66Hz and morphs to peaks every octave beginning at 66Hz Effect is 'ee' to 'u' with Frequency Tracking fully offset. Transform 2 reveals a completely flat response with all axes offset.
- F131 Lpeq Vel**
Morph: Moves between different "softs" & "brights".
Freq. Tracking: Provides key tracking to maintain spectrum.
Transform 2: Controls brightness and volume.
Comments: Position of the Morph determines the nature of the softness and brightness.
- F132 CleanSweep4**
 A number of lowpass, highpass and bandpass type effects can be produced using this filter. It works particularly well on solo brass waves to produce a variety of mute effects.
Morph: Effects range from lowpass with low 'Q' to highpass with high 'Q'.
Freq. Tracking: Increase for thinner, brighter and more resonant sounds.
Transform 2: Not used.

F133 PowerSweeps

Alternating resonant peaks and notches, spaced at approximately half-octave intervals can be used to produce a number of flanging and vocal effects. The direction of Morph depends on the Freq. Tracking setting.

Morph: Modulating this sweeps the peaks/notches up and/or down.

Freq. Tracking: Tunes the filter; determines polarity of Morph.

Transform 2: Can also be used to tune the filter.

F134 TSweep.4

A grouping of inharmonically related peaks gives this filter something of a metallic quality, although it can also produce voice-like sounds. Increasing Morph Offset increases overall filter resonance and raises the cutoff point of the lowpass filter. Frequency Tracking can be used to tune the filter.

Morph: Controls 'Q'; controls lowpass cutoff.

Freq. Tracking: Tunes the filter.

Transform 2: Not used.

F135 SweepHiQ1.4

Morph: Sweeps from peaks at 150Hz, 430Hz, 870Hz , 1500Hz, 3000Hz and 7000Hz to peaks an octave higher.

Freq. Tracking: Introduces high Q peaks at 1.2kHz and 3.4kHz to narrowly spaced peaks at 1500Hz to 15kHz.

Transform 2: Not used.

F136 V>FcQuad.4

Designed for velocity to control filter cut-off. Each frame has an octave higher cut-off than the one before it.

Morph: Moves from a bump at 320Hz then a brickwall cut-off up an octave.

Freq. Tracking: Tracks keyboard.

Transform 2: Not used.

F137 Nexus.4

Morph: Moves from a brickwall low pass to higher frequency, relaxed slope response.

Freq. Tracking: Frequency Tracking at maximum inverts effect of morph.

Transform 2: Not used.

Comments: Designed for Frequency Tracking to control brightness with velocity.

A "BRICKWALL" FILTER IS ONE WITH AN EXTREMELY STEEP SLOPE.



F138 Krators.4

Morph: Provides resonant peaks at low-frequencies, morphing from lower to higher frequency.

Freq. Tracking: Controls brightness.

Transform 2: Not used.

Comments: Designed to control brightness by assigning Velocity to Frequency Tracking.

F139 Harmonix.4

Morph: Morphs between complex responses sweeping mid frequency resonances while leaving edges untouched.

Freq. Tracking: Controls brightness and tracks keyboard.

Transform 2: Not used.

F140 GreenWorld4

Morph: A mellow low-frequency sweeper designed for piano applications.

Freq. Tracking: Controls brightness and tracks keyboard.

Transform 2: Not used.

F141 Comb/Swap.4

Morph: Controls a series of notches moving from 160Hz to 10kHz.

Freq. Tracking: Controls brightness and tracks keyboard.

Transform 2: Not used.

F142 Comb/HP.4

Morph: Sweeps between a series of low frequency notches to a high pass response.

Freq. Tracking: Keyboard Tracking and brightness control.

Transform 2: Not used.

Comments: Control the brightness by assigning Velocity to Frequency Tracking.

F143 Swirly

Morph: Moves from series of notches to fewer notches.

Freq. Tracking: Tracks keyboard.

Transform 2: Alters timbre of effect and adds dynamics.

Comments: Try a Transform 2 setting of 255 for a brighter Morph.

F144 Cavatate.4

Emphasizes frequencies from 160Hz to 2kHz.

Morph: Morphs to a modified high pass response.

Freq. Tracking: Brightness control.

Transform 2: Not used.

F145 GentleRZ4

A series of unevenly spaced resonant peaks converge to a single peak as Morph Offset is increased. The Frequency Tracking offset provides a somewhat muted sound (with several gentle bumps in the mid-frequency range), moving toward a flat response. Sweeping this filter produces some very smooth wa-wa effects. Using this filter with the trumpet waves can produce sounds suggestive of French Horns.

Morph: Modulating this sweeps filter peaks.

Freq. Tracking: Use this to control filter depth and cutoff.

Transform 2: Not used.

F146 Bendup/Swap

This complex filter features several series of tuned resonant peaks and notches which can seem to bend up or down in pitch depending on the settings for the various Morph, Frequency Tracking, and Transform 2 parameters.

Morph: Use to tune the filter.

Freq. Tracking: Low values make upward filter sweeps appear to bend pitch up. High values make pitch bend appear to go down.

Transform 2: Higher values make the filter sound more open.

F147 Bendup

This is similar to filter number 160, except that the bend is always in an upward direction (if the Morph axis is swept in a positive direction). Frequency Tracking can be used to tune the filter over a nearly 2-octave range. Transform 2 is used to set the cutoff point of the lowpass filter; higher values raise the cutoff point.

Morph: Sweeps harmonic peaks.

Freq. Tracking: Tunes the filter.

Transform 2: Increase for a brighter effect.

F148 SKWEEZIT

This filter features a complex series of peaks and notches. Varying the Morph parameter varies the 'Q' settings for most of the peaks and notches, while sweeping the frequency and Q of the first pole.

Morph: Sweeps one of the resonant peaks and varies 'Q'.

Freq. Tracking: Tunes the filter.

Transform 2: Controls resonance.

F149 Lo/High4

A scattering of poles and zeros with fairly high Q settings produces this very resonant filter. Sweeping the Morph axis produces quite pronounced wa-wa effects in which multiple resonances are clearly audible. Morph Offset and Frequency Tracking can be used to tune the filter, although with Morph Offset set to 255, the filter is essentially flat.

Morph: Positive values increase pole/zero frequencies and decrease ‘Q’, opening the filter entirely.

Freq. Tracking: Similar to the Morph axis, but a bit higher in pitch.

Transform 2: Not used.

F150 SbtileMvmnt4

Morphing this filter to reverse the polarity of a series of more-or-less evenly spaced peaks and notches produces an effect more subdued than some types of filter sweeps. Using velocity or a mod wheel (assigned through the Note-on Control section) to control the Morph parameter can be useful when developing responsive plucked-string instrument sounds, such as guitar.

Morph: Controls polarity of poles.

Freq. Tracking: Tunes the filter.

Transform 2: Not used.

F151 Buzzy Pad.4

This filter produces a bump at 65Hz and a rolloff above 250Hz at low Morph values. Increasing the Morph value pushes the bump up to about 2kHz, and the cutoff of the lowpass filter up to 20kHz. Increasing the value of Frequency Tracking sends the bump higher yet — up to about 8400Hz at maximum offset. The effect of sweeping the Morph axis is similar to that of a classic 2-pole lowpass filter with medium resonance.

Morph: Tunes the filter.

Freq. Tracking: Tunes the filter.

Transform 2: Not used.

F152 Bw5kHz+6.4

Lowpass cutoff is set to 400Hz with ‘0’ Morph Offset. In addition, there is a 6 dB bump at 5kHz. The bandwidth of this “bump” is controlled by the Morph parameter. Sweeping the Morph Offset upwards moves the bandwidth setting from very narrow to very wide. Frequency Tracking moves the cutoff frequency of the lowpass filter up to a maximum of 20kHz. The range of effects available is from fairly dramatic to quite subtle.

Morph: Controls filter bandwidth.

Freq. Tracking: Controls filter cutoff.

Transform 2: Not used.

F153 Bw65Hz/2k.4

This filter is similar to filter 167, but in addition to sweeping the bandwidth of a single peak along the Morph and Frequency Tracking axes, the peak itself is swept. The range of the frequency sweep is one octave along either axis, although much greater ranges of change are achieved when both the Morph and Frequency Tracking axes are combined. Effects range from gentle, analog-style filter sweeps (with the Frequency Tracking parameter set low), to more 'digital' sounding effects in which high-pitched, whistling harmonics are produced.

Morph: Controls bandwidth and frequency.

Freq. Tracking: Tunes the filter.

Transform 2: Not used.

F154 Bb80Hzbw1.4

With a Morph Offset value of '0', the lowpass filter cutoff set at 400Hz, and a wide-band bump at 80Hz. Morphing the filter increases the gain of this bump from 6 dB to 24 dB. Frequency Tracking increases the cutoff to 19.5kHz, and decreases the bandwidth of the 80Hz bump.

Morph: Controls bandwidth.

Freq. Tracking: Tunes the filter.

Transform 2: Not used.

F155 HighsTwist4

The frequencies of the poles and zeros in this filter remain constant as Morph or Freq. Tracking are modulated, but the 'Q' values are modulated in a variety of ways. The filter is closest to flat (with some emphasis in the high frequency range and a small bump at about 200Hz) when Morph Offset and Frequency Tracking are both set to 000. Modulating either or both of these parameters upward emphasizes more of the highs, with increased values for Frequency Tracking, rolling off the lows as well.

Morph: Controls filter 'Q'.

Freq. Tracking: Modulate upward for thinner, brighter sounds.

Transform 2: Not used.

F156 Cubix

Morphing this filter produces a lowpass filter sweep effect, while pushing the Frequency Tracking parameter in a positive direction moves the filter towards a more flat response, with a bit of subtle emphasis in the higher frequencies.

Morph: Produces low-pass filter effects.

Freq. Tracking: Use to control key tracking or to set overall filter depth.

Transform 2: Controls brightness.

F157 Intervallc4

This filter is similar to the ‘Bendup/Swap’ filter, but here the effect is even more pronounced. With Frequency Tracking set to 000, pushing the Morph Offset higher produces and downward sweep of a series of very resonant harmonics. Set Frequency Tracking to 255, however, and the sweep reverses. Other effects can be achieved by experimenting with the interaction between these two parameters. Because of its metallic overtones, this filter can make a good choice for simulating certain percussion instruments, such as steel drums and kalimbas.

Morph: Causes a downward sweep of harmonic intervals.

Freq. Tracking: Reverses Morph sweep.

Transform 2: Not used.

F158 EvenCuts4

This filter produces a series of notches in the frequency spectrum (based on the even harmonic series), which turn into small bumps when morphed.

Morph: Controls the depth of the notches/height of the bumps.

Freq. Tracking: Tunes the notches/bumps.

Transform 2: Not used.

F159 OddCuts.4

This filter produces a series of notches in the frequency spectrum (based on the odd harmonic series), which turn into small bumps when morphed.

Morph: Controls the depth of the notches/height of the bumps.

Freq. Tracking: Tunes the notches/bumps.

Transform 2: Not used.

F160 PWMtrans.4

This filter produces a series of harmonically related notches, which become peaks as the filter is morphed upward — the effect can be similar to pulse width modulation, depending on the source material. As Frequency Tracking is moved upward, the peaks/notches move toward the high end of the frequency range, and ‘Q’ is increased, producing more resonant sounds.

Morph: Controls depth of the peaks/notches.

Freq. Tracking: Tunes the filter and controls ‘Q’ amount.

Transform 2: Not used.

F161 HiEndQ.4

This filter behaves much like a resonant low-pass filter.

Morph: Sweep this for low-pass filter effects.

Freq. Tracking: Sets the initial cutoff point of the filter.

Transform 2: Not used.

F162 BroadRes.4

Sweeping filter for resonant effects. Can be used for a “waterdrop” effect on percussion.

Morph: Sweeps to a series of peaks and notches. Notches: 80Hz, 160Hz, 320Hz. Peaks: 2kHz, 6kHz, 10kHz.

Freq. Tracking: Turns peaks into notches.

Transform 2: Not used.

F163 RubberHose4

This filter introduces a series of peaks spaced at octave intervals, in the range of 95Hz to 1.5kHz, and a single notch at 47Hz. Increasing the Morph Offset further raises the peaks and lowers the notch.

Morph: Use to control the depth of the peaks/notch.

Freq. Tracking: Higher values attenuate the effect of the filter.

Transform 2: Not used.

F164 HeeghCube

This filter produces a very subtle series of peaks above 4kHz. Morphing increases the gain and bandwidth of the peaks, slightly, and Frequency Tracking can be used to subtly raise the frequency of the peaks. Increasing the value for Transform 2 increases the gain of the peaks without affecting bandwidth.

Morph: Controls gain and bandwidth of peaks.

Freq. Tracking: Tunes the filter.

Transform 2: Controls gain of peaks.

F165 NoizCube

This filter introduces some subtle peaks into the high frequency range, along with a single peak which can be swept.

Morph: Sweeps a single frequency.

Freq. Tracking: Determines range of sweep.

Transform 2: Tunes the sweep, bandwidth, and ‘Q’.

F166 VelctyTilt

This filter can function as a sweepable, subtle low-pass filter.

Morph & Freq. Tracking: Control filter cutoff.

Transform 2: Controls filter resonance.

F167 SynthWow4

An emulation of a resonant low-pass filter. Both Morph Offset and Frequency Tracking control cutoff frequency; the brightest sounds are obtained with both these parameters set to 255.

Morph & Freq. Tracking: Control filter cutoff.

Transform 2: Not used.

F168 CntrySweep4

Multiple peaks are swept in a variety of directions, imparting a phase-shifter-like, almost vocal quality when this filter is morphed.

Morph: Set this higher to move widely spaced peaks closer together.

Freq. Tracking: Set this higher to move low-frequency peaks towards the higher ranges.

Transform 2: Not used.

F169 Diffuser4

Morphing this filter upward sweeps a resonant peak up in frequency and increases low frequency content. The Frequency Tracking parameter can be used to tune the peak.

Morph: Use to tune the resonant peak and control low-frequency content.

Freq. Tracking: Use to ‘tune’ the resonant peak and control low-frequency content.

Transform 2: Not used.

F170 MdlySweep4

Morphing this filter upward sweeps several resonant peaks up in frequency. The Frequency Tracking parameter can be used to tune the peaks.

Morph & Freq. Tracking: Tune the resonant peaks.

Transform 2: Not used.

F171 StrongShimr

This filter produces several deep notches in the frequency spectrum, which can be tuned or swept according to the settings and modulators for the Morph Offset, Frequency Tracking, and Transform 2 parameters.

Morph: Raising this value lowers the frequency of the notches, producing thinner sounds.

Freq. Tracking: Raising this value lowers the frequency of the notches, producing thinner sounds.

Transform 2: Raising this value raises the frequency of the notches, producing fatter sounds.

F172 Acc.Vel-1

Morph: Fixes soft “Start-point”.

Freq. Tracking: Provides key tracking to balance keyboard brightness.

Transform 2: Controls brightness and volume.

Comments: Velocity cube. Use Morph to establish soft start point.

F173 Acc.Vel-2

Variation of “Acc.Vel-1”, except somewhat brighter on bottom and mel-lower on top.

F174 Vel2-Wind

Morph: Fixes soft “Start-point”.

Freq. Tracking: Provides key tracking to balance keyboard brightness.

Transform 2: Controls brightness and volume.

Comments: Velocity cube. Use morph to establish soft start point. Good for wind instruments as more morph gives a “hollower” soft sound.

F175 Harmo

Morph: Changes from “peaky” lowpass response to smooth lowpass.

Freq. Tracking: Provides key tracking to balance keyboard brightness.

Transform 2: Controls volume, brightness and dissonance.

Comments: Cube construction - Use the Aux. Envelope to provide attack transient which then fades off to rear frames.

F176 Start>EndA

Morph: Complex peak at 80Hz to a very gentle lowpass response.

Freq. Tracking: Provides key tracking to balance keyboard brightness.

Transform 2: Brighter, more volume, more harmonics.

Comments: **Cube construction** - Use the Aux. Envelope to provide attack transient which then fades off to rear frames. Softer version than “HarmoEP”. Volume changes for sensitivity are maintained in the cube.

F177 Start>EndB

Morph: Flat response to gentle lowpass.

Freq. Tracking: Key tracking to balance keyboard brightness.

Transform 2: Controls volume, brightness and harmonic content.

Comments: Same model as Start>EndA but more bright and dissonant.

F178 MovingPick1

Morph: Tight<>Hollow

Freq. Tracking: Provides key tracking to balance keyboard brightness.

Transform 2: Controls brightness and volume.

Comments: Uses Morph to simulate acoustic versus electric type response to velocity: plucking closer or further from the bridge of a guitar for example.

F179 MovingPick2

A variation on “MovingPick1” to simulate different pick positions, for example. Morph moves closer to neck, further from bridge.

F180 Mph+Trns1

Morph: Makes vowel like changes.

Freq. Tracking: Provides key tracking to enhance vowel.

Transform 2: Controls vowels, brightness, volume.

Comments: Uses Morph to sweep from one vowel to another. Transform 2 takes care of velocity expression.

F181 O>Odds

Morph: Sweeps from flat to odds only.

Freq. Tracking: Provides key tracking to fix partials.

Transform 2: Controls brightness and volume.

Comments: Strong odds only spectrum with morphing. Transform 2 takes care of brightness.

F182 Comb Voices

Center frequencies of the poles and zeros in this filter can move in opposite directions as the filter is modulated along any of its axes, producing an amazing variety of possible curves. Sweeping the Morph axis produces some lovely phase-shifter/flanger-type effects, especially with the value for Transform 2 set fairly high.

Morph: Use this to animate the comb-filtering effect.

Freq. Tracking: Generally, this can be used to tune the filter.

Transform 2: Moves the filter toward more open sounds.

F183 Odd-Ev Hrm

A series of peaks and notches based on the odd and even harmonic series. Sweeping the Morph axis produces some lovely comb filtering effects, which can be either subtle or dramatic depending on other settings (especially that of Transform 2).

Morph: Use this to sweep the peaks/notches.

Freq. Tracking: Tunes the filter.

Transform 2: Tunes the filter and controls resonance.

F184 OddHrm+rez

This filter cube, based on the odd harmonic series, provides a number of comb-filtering effects. Use the Morph Offset to control filter 'Q', and Frequency Tracking and Transform 2 to tune the filter.

Morph: Increasing this parameter pushes the filter towards a flat curve.

Freq. Tracking: Tunes the filter.

Transform 2: Tunes the filter. Higher values add a high-frequency bump.

F185 EvnHrm+rez

This filter cube is nearly identical to the 'OddHrm+rez' filter, but it's based on the even harmonic series. The overall effect is quite similar, though somewhat less 'hollow' sound at certain settings.

Morph: Increasing this parameter pushes the filter towards a flat curve and reduced 'Q'.

Freq. Tracking: Tunes the filter.

Transform 2: Tunes the filter. Higher values add a high-frequency bump.

F186 MellowPeaks

This filter provides two or three mildly resonant poles which can be swept through the frequency spectrum in a number of ways, depending on the settings for the various parameters. With lower settings for Frequency Tracking, the filter takes on a distinctly vocal quality on most source material.

Morph: Positive values generally move the poles upward in frequency.

Freq. Tracking: Positive values generally move the poles upward in frequency.

Transform 2: Positive values generally move the poles upward in frequency.

F187 AHmBnd.4

The Morph Offset can be swept to sweep a cluster of resonant peaks, producing a pitch-bend effect. The effect is generally most pronounced with Frequency Tracking set to a fairly low value.

Morph: Sweeping produces 'pitch-bend' effect.

Freq. Tracking: Tunes the filter.

Transform 2: Not used.

F188 Vintage

Features an accentuated low end, and a series of notches which can be swept via morphing. The most dramatic resonant sweeps are produced with Frequency Tracking set to minimum and Transform 2 set to maximum, producing the classic analog filter sweep sound.

Morph: Use to sweep the filter.

Freq. Tracking: Tunes the filter.

Transform 2: Controls filter resonance.

F189 MildQPole

Morph: Sweeps between a shallow roll-off low-pass to almost flat response.

Freq. Tracking: Tracks keyboard.

Transform 2: At maximum, inverts morph effect.

F190 Bonk>CO

A series of highly resonant peaks alternating with notches are spaced at intervals of about an octave. The Morph Offset parameter is used to control 'Q' — modulating the Morph Offset upward causes the curve to flatten out. Frequency Tracking can be used to tune the peaks/notches; higher values move the peaks/notches into higher frequency ranges. Transform 2 also tunes the filter, but higher values cause the notches to move down in frequency, slightly. The overall effect of the filter can be very vocal, depending on the source material.

Morph: Controls resonance.

Freq. Tracking: Tunes the filter.

Transform 2: Subtly tunes the filter.

F191 Speaker

Groups of unevenly spaced bumps and dips in the frequency spectrum are used to simulate a number of speaker cabinet responses. Use Morph Offset, Frequency Tracking, and Transform 2 to vary the tuning and depth of the bumps and dips to simulate different speaker cabinet types.

All Axes: Vary center frequency and amount of boost/cut for the various filter bands.

F192 Expander

Frequency Tracking and Transform 2 provide a range of fairly broad-band boosts and cuts at various frequencies, with higher values generally providing thinner, brighter sounds. These can be used to add a measure of expressiveness to the source material — route 'Key' to control Frequency Tracking, for example, and 'Vel' to control Transform 2. Increasing the value for Morph Offset has the effect of flattening the curve, providing you with a filter depth control.

Morph: Use to control filter depth.

Freq. Tracking: Higher values produce thinner, brighter sounds.

Transform 2: Higher values produce thinner, brighter sounds.

F193 Separator

This filter features three inharmonically related resonant peaks, which can be swept via the Morph parameter, producing a metallic set of overtones. Applied to the noise waves, this can sound like whistling wind; applied to pitch sounds, it can produce anything from a hollow, metallic resonances to accentuated high-frequency attack transients.

Morph: Use to sweep the resonant peaks.

Freq. Tracking: Tunes the filter.

Transform 2: Controls filter resonance.

F194 MildPolSwap

Basically, a variable cut-off low pass filter.

Morph: Tunes the filter.

Freq. Tracking: Tunes the filter.

Transform 2: Adds extra brightness to high morph.

DISTORTIONS

Jump Back! The Filter Level is useful to control the distortion filters.

F195 PoleCross.4

Crossing poles produces certain “hot” or “sweet” spots where frequencies correlate.

Morph: Crosses filter “poles” to create hot (distortion) or sweet spots.

Freq. Tracking: Adds extra bite to Morph.

Transform 2: Not used.

F196 ApDistB6.4

Reducing the Filter Level parameter in the preset will not only reduce the volume level, it will also reduce the amount of distortion effect. Therefore, routing velocity, mod wheel, pressure, pedal, etc to Filter Level controls the distortion’s depth as well as volume.

F197 TubeJam.4

All rules are broken here. Peaks are intentionally clipped, yet output volume is within tolerance....barely! Only the morph axis is active.

Freq. Tracking: Not used.

Transform 2: Not used.

VARI-POLE FILTERS

This group of lowpass filters all have a variable slope. Variable slope filters are very rare in synthesizers, but the effect of the variable slope occurs in natural sounds. The number of poles relates to the maximum steepness of the filter.

F198 Poles 1-7

Morph: Controls filter cut-off (Fc); range is from approx 20Hz-20kHz.

Freq. Tracking: Low values produce 1 pole filter; high values produce 7 pole version.

Transform 2: Higher values increase Q. For best keyboard tracking, route key tracking to Morph +088, and set Keyboard Center to C1.

F199 2 Poles

Morph: Controls Fc; range is from approx 20Hz-20kHz.

Freq. Tracking: Higher values increase Q for a single pole.

Transform 2: Higher values increase Q for both poles. For best keyboard tracking, route key tracking to Morph +088, and set Keyboard Center to C1. Note that Freq. Track has no effect with Transform 2 set to 255 and that distortion can be produced.

F200 4 Poles A

A useful filter for bass sounds. Set Morph and Freq. Track to 255 and Transform 2 to 000 for flat response.

Morph: Controls Fc; range is from approx 20Hz - 320Hz.

Freq. Tracking: Controls Fc; range is from approx 320Hz-20kHz.

Transform 2: Higher values increase Q.

F201 4 Poles B

Morph: Controls Fc; range is from approx 20Hz-20kHz.

Freq. Tracking: Higher values flatten response.

Transform 2: Higher values increase Q. For best keyboard tracking, route key tracking to Morph +088, and set Keyboard Center to C1.

F202 4 Poles C

Morph: Controls Fc; range is from approx 20Hz-20kHz.

Freq. Tracking: Higher values decrease filter range.

Transform 2: Higher values increase Q.

F203 6 Poles

Morph: Controls Fc; range is from approx 20Hz-20kHz.

Freq. Tracking: Higher values produce flatter curve.

Transform 2: Higher values increase Q. For best keyboard tracking, route key tracking to Morph +088, and set Keyboard Center to C1.

F_c STANDS FOR THE CENTER
FREQUENCY OF A FILTER.

F204 Multipole

Morph: Controls F_c in lower ranges.

Freq. Tracking: Controls F_c in higher ranges.

Transform 2: Higher values increase Q and re-order some poles. Peaks tuned to octaves are swept along the Morph axis.

TRACKING FILTERS

These filters range from lowpass to resonant peaking filters. The Frequency Tracking parameter allows the filter to “track” specific harmonics as you play up and down the keyboard.

F205 Tracker

Simple lowpass filter. For best keyboard tracking, route key tracking to Morph +088, and set Keyboard Center to C1. Set both Filt. Freq. Track and Transform 2 to 255 for ‘Ultra Q’ lowpass.

Morph: Controls F_c; range is from approx 20Hz-20kHz.

Freq. Tracking: Higher values increase Q.

Transform 2: Higher values increase multi-band Q.

F206 Tracker 2

Morph: Tunes the peak.

Freq. Tracking: Tunes the peak.

Transform 2: Higher values increase the gain of the peak. A single resonant peak can be added and moved around via Morphing and Freq. Tracking. Best tracking is achieved with Key to Freq. Track +117.

F207 Tracker 3

Morph: Tunes the “chord”.

Freq. Tracking: Controls LP F_c.

Transform 2: Higher values produce flatter filter. Filter bands tuned to a suspended chord can be pushed along the Morph axis. For most accurate key tracking, set Key to Morph +127.

F208 Tracker5ths

Morph: Increases filter peak gains.

Freq. Tracking: Tunes the filter.

Transform 2: Use as LP filter (lower values = darker). Harmonic peaks tuned to fifths. For most accurate key tracking, set Key to Freq. Track +127.

F209 InFifths.4

The filter thins and mellows out almost any sound. Morphing has the effect of adding low end warmth. Nice with cellos, hip with trombones. All filters are scaled for Keyboard Center C1.

Morph: Starts with the fundamental, and the 5th and their multiples from 65Hz through 16.64kHz attenuated by 18dB. Results in the fundamental, 5th and their multiples from 65Hz through 16.64kHz boosted by 18dB.

Freq. Tracking: Tunes the filter.

Transform 2: Not Used.

F210 HarmTracker

Lots of harmonically related peaks in this one. Best tracking is obtained with Key Center C1, and Key to Filt. Freq. Track +127.

Morph: Increases gain of peaks.

Freq. Tracking: Tunes the filter.

Transform 2: Shifts balance from lower filter bands to upper.

PARAMETRIC TRACKING FILTERS

These filters are set up with various interesting combinations of peaks and notches. The Frequency Tracking parameter controls various functions such as bandwidth, amount and Fc.

F211 1BndPrmtrcA

Morph: Controls Fc; range is from approx 20Hz-20kHz.

Freq. Tracking: Higher values increase bandwidth.

Transform 2: Values below 127 produce notches; above produce peaks. Set Transform 2 to 127 for closest to flat response.

F212 1BndPrmtrcB

For best keyboard tracking, route Key to Morph +092, and set Keyboard Center to C1. Set Transform 2 to 127 for closest to flat response.

Morph: Controls Fc; range is from approx 80Hz-18kHz.

Freq. Tracking: Values below 127 produce notches; above produce peaks.

Transform 2: Higher values increase bandwidth.

F213 1BndPrmtrcC

Identical to F212 1BndPrmtrcB, except that Morph can be used to control amount of boost or cut, rather than Fc.

Morph: Values below 127 produce notches; above produce peaks.

Freq. Tracking: Controls Fc; range is from approx 80Hz-18kHz.

Transform 2: Higher values increase bandwidth.

F214 1BndPrmtrcD

Very similar to F212 1BndPrmtrcB, but with bigger boosts and cuts.

Morph: Controls Fc; range is from approx 80Hz-18kHz.

Freq. Tracking: Values below 127 produce notches; above produce peaks.

Transform 2: Higher values increase bandwidth.

F215 MultiMetricA

A series of adjustable peaks and notches tuned to octaves. For best keyboard tracking, route Key to Morph +127, and set Keyboard Center to C1.

Morph: Controls Fc; range is from approx 40Hz-20kHz.

Freq. Tracking: Values below 127 produce notches, above produce peaks.

Transform 2: Higher values increase bandwidth.

F216 MultiMetricB

A series of adjustable peaks and notches tuned to even harmonics. For best keyboard tracking, route Key to Morph +127, and set Keyboard Center to C1.

Morph: Controls Fc; range is from approx 80Hz-18kHz.

Freq. Tracking: Values below 127 produce notches, above produce peaks.

Transform 2: Higher values increase bandwidth.

F217 MultiMetricC

A series of adjustable peaks and notches tuned to odd harmonics. For best keyboard tracking, route Key to Morph +127, and set Keyboard Center to C1. Set Transform 2 to 127 for closest to flat response.

Morph: Controls Fc; range is from approx 80Hz-18kHz.

Freq. Tracking: Values below 127 produce notches, above produce peaks.

Transform 2: Higher values increase bandwidth.

F218 Omni Metric

Use Filt. Freq. Track to control whether filter produces peaks or notches (higher values produce peaks), and use Morph to tune them (higher values move them lower in frequency). Increasing Transform 2 flattens response.

Morph: Tunes the filter.

Freq. Tracking: Controls polarity.

Transform 2: Controls overall filter depth.

HARMONIC SHIFTERS

These filters are designed to alter the normal harmonic relationships of instruments by radically shifting the resonant frequency bands using the Morph parameter. The Frequency Tracking parameter allows the filter to “track” specific harmonics as you play up and down the keyboard.

F219 HrmncPeaks

Filter bands can be tuned using Freq. Track; Morph simply controls which bands produce peaks. Note that if Transform 2 and Freq. Track are both set to 000, probably no sound will be heard.

Morph: At 000, even numbered filter bands produce peaks. At 255, peaks are all odd frequencies.

Freq. Tracking: Tunes the filters.

Transform 2: Lowpass effect; higher values open the filter.

F220 HrmncPeaks2

Filter bands can be tuned using Freq. Track; Morph simply controls which bands produce peaks.

Morph: At 000, peaks are even harmonics. At 255, peaks are odd harmonics.

Freq. Tracking: Tunes the filters.

Transform 2: Higher values raise Fc of lowpass filter.

F221 InHarMetric

The peaks and notches in this filter are spaced evenly, though not necessarily harmonically, through approximately a four-octave range.

Morph: Controls bandwidth.

Freq. Tracking: Tunes the filter.

Transform 2: Controls polarity; low values produce peaks, high values produce notches.

F222 HarmShifter

Morph: Shifts emphasis from lower filters to higher.

Freq. Tracking: Tunes the filter.

Transform 2: Higher values increase filter bandwidth.

F223 HarmShiftr2

Morph: Shifts emphasis from lower filters to higher.

Freq. Tracking: Tunes the filter.

Transform 2: 000=peaks, 255=notches, 127=flat.

F224 HarmShiftr3

Harmonically related filter bands can be moved around by adjusting Filt. Freq. Track. Higher values for Transform 2 increase overall filter effect.

Morph: Higher values decrease bandwidth.

Freq. Tracking: Tunes the filters.

Transform 2: Increases depth of peaks and notches.

F225 Phaser

Morph: Spreads all the filters from a single frequency to multiple frequencies.

Freq. Tracking: Controls polarity of the filters; below 127 yields notches, above, peaks.

Transform 2: Controls filter bandwidth; higher values are wider bands.

F226 HrmncPhaser

The effect of Morph and Freq. Track used together is cumulative; the highest-band effects are found with both set to 255.

Morph: Higher values tune the filters higher.

Freq. Tracking: Higher values tune the filters higher.

Transform 2: Notches if set below 127, peaks if above.

F227 HrmncPhsr2

Peaks and notches cross one another to produce a variety of phase shifter-like sweeps.

Morph: Increasing values move peaks lower, notches higher.

Freq. Tracking: Higher values increase depth of peaks and notches (at 000, filter is flat).

Transform 2: Higher values increase filter bandwidth.

F228 Wide Bands

With Transform 2 set low, Morphing produces a series of widely spaced notches over several octaves. Higher Transform 2 values result in widely spaced peaks.

Morph: Increases depth of notches and peaks.

Freq. Tracking: Tunes the filter.

Transform 2: Controls polarity.

F229 New Boost

An attempt to make a more versatile version of the popular F71 B Boost.4 filter.

VOCAL FORMANTS

These filters are designed to simulate human vocal resonances. In these filters, all axes control the movement between vowels. Each filter allows a slightly different type of vowel shifting control.

F230 Vowel Space2

Imparts a different vowel color to the source at each corner of the cube. No simple shifting of formant frequencies is accomplished by any of the three filter controls. When Filt. Freq. Track and Transform 2 are at their minima, Morph moves from 'oo' to 'oh', while when at their maxima, Morph moves from 'ee' to 'ae.' Try all the combinations.

Morph: Sweeps from 'oo', 'er', 'ee', and 'uh' to 'oh', 'ah', 'ae', and 'eh', respectively

Freq. Tracking: Shifts from 'oo' 'er', 'ah', and 'oh' to 'uh', 'ee', 'ae', and 'eh', respectively.

Transform 2: Shifts from 'oo', 'oh', 'eh', and 'uh' to 'er', 'ah', 'ae', and 'ee.'

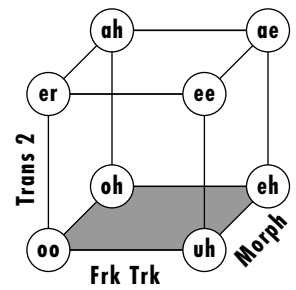

Vowel Space 2

F231 Vowel Space3

Imparts one of four vowel colors to the source when Transform 2 is at its maximum. Morph moves from 'oo' to 'ee' when Filt. Freq. Track is at its maximum, and moves from 'ah' to 'ae' when Filt. Freq. Track is at its minimum. As the level of Transform 2 is reduced, all the vowel colors regress towards the neutral "schwa" sound. Controlling Transform 2 with velocity gives a natural vocal expression corresponding to increasing "stress."

Morph: Sweeps from 'oo' and 'ee', to 'ah', and 'ae', respectively.

Freq. Tracking: Shifts from 'oo' and 'ah', to 'ee', and 'ae' respectively.

Transform 2: Shifts from the neutral schwa to the above distinct vowel colors.

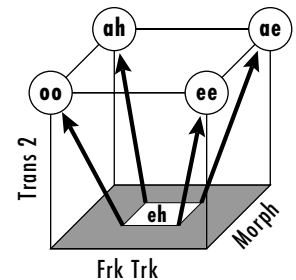

Vowel Space 3
(Perceptual)

F232 Oh Shaper

Based on the formants for the vowel 'O'. Best tracking is achieved with Key to Freq. Track +127. Use the notch setting (Transform 2 between 000-127) to track the keyboard and attenuate unwanted upper and lower formants in pitch-shifted vocal samples. Use the peak setting (Transform 2 between 127-255) with no tracking to add formants. Sweep the Morph for some interesting vocalizations.

Morph: Higher values increase bandwidth.

Freq. Tracking: Tunes the filter.

Transform 2: Low values produce notches, high values produce peaks.

F233 Ah Shaper

Based on the formants for the vowel 'Ah'. Best tracking is achieved with Key to Freq. Track +127. Use the notch setting (Transform 2 between 000-127) to track the keyboard and attenuate unwanted upper and lower formants in pitch-shifted vocal samples. Use the peak setting (Transform 2 between 127-255) with no tracking to add formants.

Morph: Higher values increase bandwidth of filters.

Freq. Tracking: Tunes the filters.

Transform 2: Low values produce notches, high values produce peaks.

F234 Oo Shaper

Based on the formants for the vowel 'Oo'. Best tracking is achieved with Key to Freq. Track +127. Use the notch setting (Transform 2 between 000-127) to track the keyboard and attenuate unwanted upper and lower formants in pitch-shifted vocal samples. Use the peak setting (Transform 2 between 127-255) with no tracking to add formants.

Morph: Higher values increase bandwidth of filters.

Freq. Tracking: Tunes the filters.

Transform 2: Low values produce notches, high values produce peaks.

INSTRUMENT FORMANT FILTERS

These filters are to simulate the resonant characteristics of various types of instruments. The Frequency Tracking parameter sometimes allows the filter to track specific harmonics, although this may not normally occur on real acoustic instruments. The subcategories of instrument formant filters are in the following order: **Keyboards, Strings, Plucked, Wind, Brass, Percussion.**

F235 FrmntShaper

Filter bands are based on formants.

Morph: Controls bandwidth.

Freq. Tracking: Controls gain and tuning.

Transform 2: Controls overall brightness.

F236 Piano LP.4

Designed to work a little better than a simple low pass for enhancing sampled piano velocity response.

Morph: Controls the height and width of the subtle peaks at resonant frequencies.

Freq. Tracking: Tracks filter frequency response with keyboard. This filter works best with Velocity assigned to Morph $\approx +150$ (use two patch cords) and no key to Filt. Freq. Track assigned.

Transform 2: Not Used.

F237 PianoSndBrd

Designed for use with the Stereo Grand Piano, the filters in this cube create a variety of resonances designed to imitate the resonances of both the piano soundboard, the surrounding wood, and various mic placements. All filters in this cube are scaled for Keyboard Center, Minimum Morph, Minimum Transform 2. Provides fat, bass-heavy resonances, somewhat like miking a piano from the bottom. Contains lots of wood knock.

Max. Morph, Min. Transform 2: Pronounced mid-range resonances, as though the soundboard was close-miked near its center without any direct string sound being picked up.

Min. Morph, Max. Transform 2: Lots of mid and high frequency energy, as though the soundboard was being miked by a contact pickup. Exhibits a pronounced electronic sound.

Max. Morph, Max. Transform 2: Almost pure piano sound, with only a bit of high boost starting at about 8kHz. This is the closest to the sound of the raw sample.

F238 Strike Cube

Designed for use with Aux Envelope or Func. Gen. patched to Morph to give struck or plucked tones. Front of Cube gives max brightness, back of cube gives sine wave if Frequency Tracking is used. Transform 2 controls the amount of this effect and can therefore be used for velocity information.

Set-Up Instructions: Set Envelope Generator to Morph in Realtime Controllers. Set velocity to Transform 2 in Note-On Controllers for good velocity response. Set Key Center to C1 and Filt. Freq. Track +64 in order to maintain appropriate pitch tracking. Can also be used for upper register brightness.

Morph: Controls brightness and volume.

Freq. Tracking: Provides slight increase in upper register brightness, maintains some harmonic filter tracking.

Transform 2: Controls brightness and volume.

F239 Clav Curves

Morph: At no offset, starts 24dB down at 20Hz and increases gain to 0 at \approx 800Hz then decreases again until reaching -70dB at 20kHz. At full offset, resolves into a series of closely spaced peaks between 67 and 284Hz.

Freq. Tracking: Tracks filter over keyboard range.

Transform 2: Keeps the same frequencies but inverts the lowest frequency peak to a notch; higher values produce brighter sounds.

F240 **Symphony**

A controlled flanging filter which still allows a simple mellow to bright effect with velocity.

Set-Up Instructions: Set Ctrl A and Pedal to Morph in Realtime Controllers. Set Velocity to Transform 2 in Note-On Controllers for timbre choice. Filt. Freq. Track can be used for upper register brightness or flanging response depending on Morph amount.

Morph: Moves between straight velocity to a flanging effect.

Freq. Tracking: Provides choice of flanging region or response.

Transform 2: Provides straightforward mellow/bright and volume velocity control.

F241 **String Cube**

For a good overbright response through velocity on Transform 2, but with the added possibility of emphasising the 2nd harmonic (first overtone) by morphing, à la strings.

Set-Up Instructions: Set Wheel to Morph in Realtime Controllers. Set Velocity to Transform 2 in Note-On Controllers for good velocity response. Set Key Center to C1 and Key to Filt. Freq. Track +64 in order to maintain appropriate pitch tracking.

Morph: Controls timbre change; picks out first overtone.

Freq. Tracking: Maintains harmonic filter tracking.

Transform 2: Determines brightness and volume.

F242 **Swell Cube**

An easy cube for making swell-like pads controlled by wheel (Ctrl A) or pedal (Ctrl D). Ideal for strings or choirs brought in by pedal. Morph controls a balanced increase in brightness and volume and Transform 2 offers a choice of timbres (vaguely aah to ooh).

Set-Up Instructions: Set Ctrl A and Pedal (Ctrl D) to Morph in Realtime Controllers. Set another controller to Transform 2 in Note-On Controllers for timbre choice. Set Key Center to C1 and Key to Filt. Freq. Track +64 in order to maintain appropriate pitch tracking.

Morph: Controls swell in effect. A mixture of brightness and volume.

Freq. Tracking: Maintains harmonic filter tracking.

Transform 2: Controls timbre choice. (aah <> oohish on choir-like instruments.)

F243 **Quartet.4**

Morph: Widens bump around 1.6kHz while reducing steepness of low-pass slope.

Freq. Tracking: Tracks filter over 5 octaves.

Transform 2: Not Used.

F244 Mellotron.4

Designed for use with strings, voices, flutes, and synth pads, this filter attenuates certain lows and low mids while boosting upper midrange frequencies to give that unnatural, tweaked Mellotron sound. All filters are scaled for Keyboard Center C1.

Morph: Opens filter to allow the natural sample to come through unprocessed.

Freq. Tracking: Tunes the filter.

Transform 2: Not Used.

F245 Cello

Designed for certain types of bowed string sounds. Try using Velocity to drive Morph and/or Transform 2 axes.

Morph: Increasing values turn notches into peaks.

Freq. Tracking: Tunes the filter.

Transform 2: Increase for additional brightness.

F246 Key Squeak

Morph: At low values, contains a fairly mild low pass slope with slight peaks at 400, 1200, 4000, 5200, 8800Hz opening to a flat response with slight peaks at 360, 1280, 4400, 5120 and 8620Hz.

Freq. Tracking: Tracks filter over five octaves of keyboard.

Transform 2: Higher values reduce filtering effect until response is flat at 255.

F247 Pluck.4

Morph: Low Pass with steep slope and two bumps at $\approx 120\text{Hz}$ and $\approx 600\text{Hz}$ which opens to a flat response at higher values.

Freq. Tracking: Tracks filter with keyboard.

Transform 2: Not Used.

F248 Pick It

Designed for acoustic guitar. Assign the wheel to Morph (in the Note-On Controllers) to control pick placement. Assign velocity to Transform 2 for dynamics, and key number to Freq. Track for balance across the guitar's range.

Morph: Controls filter Q.

Freq. Tracking: Tunes the filter.

Transform 2: Gentle lowpass - higher values open the filter.

F249 El Pick It

Designed for electric guitar. Assign Ctrl A to Morph (in the Note-On Controllers) to control pick placement. Assign velocity to Transform 2 for dynamics, and key number to Freq. Track for balance across the guitar's range.

Morph: Controls filter Q.

Freq. Tracking: Tunes the filter.

Transform 2: Gentle lowpass; higher values open the filter.

F250 ElGuit Cube

Designed like the Breath Control cubes to give a complete cutoff of sound in the base position. Transform 2 gives an overbright response for loud playing. Ideal for constructing brass envelopes with the Function Generator or Aux. Envelopes.

Set-Up Instructions: Set Ctrl A/Pedal to Morph in Realtime Controllers. Set Velocity or Controller to Transform 2 in Note-On Controllers for overbrightness. Filter Freq. Track must be used for best effect.

Morph: Moves between no-sound to bright.

Freq. Tracking: Maintains cutoff frequency just above fundamental.

Transform 2: Adds overbrightness.

F251 ElGuit Pick

Designed for use with electric guitar, this filter mimics the effect of pick position on timbre. All 8 filters in this cube are scaled for Keyboard Center C1. Filter Freq. Track is used to track the filter.

Minimum Morph, Min Transform 2: Represent the pick position very close to the bridge with the bridge position pickup used. Timbre is sharp and trebly, with very little body in the tone.

Maximum Morph, Min. Transform 2: Represent the pick position far up the neck (over the fretboard). Timbre is both bassy and trebly, but there is very little body in the overall tone; sounds as though neck position pickup is being used.

Minimum Morph, Max. Transform 2: Represent the pick position midway between the bridge and the neck. Tone is more even and has more body; sounds as though bridge position pickup is being used.

Maximum Morph, Max. Transform 2: Represent the pick position nearer the base of the neck. Tone has body, but also has some high-end "singing." Determines neck position pickup used.

F252 Breather 1

An easy to adjust filter suitable for using breath control for the simulation of wind and brass instruments etc. Also for keyboard use with breath controllers connected. Full effort blow gives more brightness and volume, soft playing gives mellower, quieter sound with optional timbre change with velocity.

Set-Up Instructions: Set Breath Control (Ctrl B) to Morph in Realtime Controllers. Set Velocity to Transform 2 in Note-On Controllers. Set Key Center to C1 and Key to Filt. Freq. Track +64 in order to maintain the softplay timbre difference with velocity.

Morph: Controls brightness and volume representing effort of “blow”.

Freq. Tracking: Controls slight increase in upper register brightness and maintains some harmonic filter tracking.

Transform 2: Changes the timbre colour with soft playing.

F253 Breather 2

Like F252 Breather 1 with more exaggerated volume change, less timbre change with velocity. Full effort blow gives more brightness and volume, soft playing gives mellower, quieter sound.

Set-Up Instructions: Set breath control to Morph in Realtime Controllers. Set velocity to Transform 2 in Note-On Controllers. Set Key Center to C1 and Filt. Freq. Track +64 in order to maintain the softplay timbre difference with velocity.

Morph: Determines brightness and volume representing effort of “blow”.

Freq. Tracking: Provides slight increase in upper register brightness, maintains some harmonic filter tracking.

Transform 2: Determines change in timbre density on mid-power blowing.

F254 WindNoise 1

Allows simple tuning and tracking of white noise suitable for mixing/ layering with wind instruments. Designed for use with Instrument 344 Noise Non-X.

Set-Up Instructions: Set Key Center to C1 & Key to Filt. Tracking +64.

Morph: Controls brightness and volume of noise.

Freq. Tracking: Maintains tuning over pitch.

Transform 2: Provides tuning adjustment.

F255 WindNoise 2

Like F254 WindNoise 1 but with a broader less harmonic effect. Designed for use with Instrument 344 Noise Non-X.

Set-Up Instructions: Set Key Center to C1 & Key to Filter Tracking +64.

Morph: Determines brightness and volume of noise.

Freq. Tracking: Maintains a hint of tuning over pitch.

Transform 2: Controls high end brightness.

F256 Blow Cube

Designed for use without Aux Envelop or Func Gen patched to Morph. Transform 2 controls the volume and brightness and Morph controls the timbral character at all velocity levels.

Set-Up Instructions: Set Wheel to Morph in Realtime Controllers. Set Velocity to Transform 2 in Note-On Controllers for good velocity response. Key Center must be set to C1 and Key to Filt. Freq. Track +64 in order to maintain appropriate pitch tracking.

Morph: Controls timbre change.

Freq. Tracking: Maintains harmonic filter tracking.

Transform 2: Controls brightness and volume.

F257 Overblow

Designed to simulate overblown woodwind effects.

Morph: Higher values accentuate upper harmonics, attenuate lower ones.

Freq. Tracking: Tunes the filter.

Transform 2: Higher values produce subtler effects.

F258 Wind Filter

Morph: At no offset, has a lowpass response with select notches at $\approx 3, 5, 6, 9$ and 12kHz and a peak at 1kHz . At 255, has a flatter response with notches at $\approx 200, 300, 550, 800$ and 870Hz and peak at 1kHz .

Freq. Tracking: Tracks keyboard.

Transform 2: Larger values reduce filter effect and flatten response.

F259 FluiBreth.4

Morph: Peaks at $\approx 100\text{Hz}$ and $\approx 1200\text{Hz}$ with a notch at $\approx 700\text{Hz}$ transform into flat response with higher values.

Freq. Tracking: Tracks keyboard.

Transform 2: Not Used.

F260 VClarinet.4

Designed to turn any sound into a clarinet, or at least simulate its velocity response.

Morph: Controls heights and widths of resonances.

Freq. Tracking: Controls the frequencies of the resonances. Assign Velocity to Morph and Key to Filt. Freq. Track.

Transform 2: Not Used.

F261 New Mute.4

Morph: Higher values flatten filter response.

Freq. Tracking: Tunes the filter. Works well for brass muting.

Transform 2: Not Used.

F262 Trempeto.4

Morph: At 0 offset, response is a lowpass with bump at ≈ 50 Hz and cut-off before 1000Hz. At 255, filter is flat.

Freq. Tracking: Tracks keyboard.

Transform 2: Not Used.

F263 SiBrzando.4

Morph: Starts with a 12dB overall boost except for a dip at ≈ 140 Hz. At higher values, dip is reduced and boost increased after dip until flattening at 5kHz.

Freq. Tracking:

Transform 2: Not Used.

F264 UduFilter.4

Designed to enhance the velocity response of percussion sounds, especially the Udu.

Morph: Contains a single peak at 240Hz with mild roll-off of higher frequencies at low Morph offsets, becoming flatter with higher Morph offsets.

Freq. Tracking: Tracks five octaves.

Transform 2: Not Used.

F265 Hip Kick

Morph: Adjusts slope of low-pass response.

Freq. Tracking: Tunes filters.

Transform 2: Reduces overall lowpass effect.

F266 Cymbal Cube

Useful for simulating the response of a cymbal to changes in drumstick location.

Morph: Positions drumstick on cymbal.

Freq. Tracking: Tunes the filter.

Transform 2: Larger values reduce filter effect.

F267 ChimeFlange

Morph and Freq. Tracking: Provide two different sets of peaks and notches (Filt. Freq. Track uses higher frequencies overall) which both raise in frequency as values are increased. Cool with Gamelan and various bells.

Transform 2: Reduces filter effect.



MISCELLANEOUS FILTERS

A potpourri of unique filters that don't fit in any other category.

F268 CableRing.4

All 4 formants are scaled for Keyboard Center C1. When used with the Stereo Grand Piano, the Morph parameter results in a resonant sweep that ultimately goes high enough above the piano's main frequency range that the body of the piano tone comes back though; the filter simply adds a glass-like shimmer to the overall sound; a very resonant, ringing filter. Try putting the Morph Offset at maximum and assigning negative velocity (about -60) to Morph.

Morph: Sweeps resonant peaks.

Freq. Tracking: Tunes the filter.

Transform 2: Not Used.

F269 TensionWire

Morph: Accentuates lower frequencies as values increase.

Freq. Tracking: Eliminates low frequencies as values increased.

Transform 2: Reduces overall filter effect and flattens response.

F270 Auto Clang

Morphing this one puts a couple of very pronounced (and harmonically unrelated) peaks and a notch (or vice-versa, depending on setting for Transform 2) into the mix. Good for adding extra overtones to bell patches, but works with a variety of sounds.

Morph: Controls gain.

Freq. Tracking: Tunes the filter.

Transform 2: Controls polarity.

F271 Dragon Claw

Useful for making adjustable horn mutes. Also works well with electric basses.

Morph: Tracks one set of unevenly-spaced notches from medium to medium high frequencies.

Freq. Tracking: Tracks another, lower frequency set of unevenly-spaced notches to higher frequency notches.

Transform 2: Reduces overall effect of filter as amount is increased.

F272 Spectra

This filter can produce some fairly metallic sounds when Morph is set high and can result in distortion. Use velocity to control Morph for clangorous effects. Some interesting digital chiffs can be produced as well. Best tracking is obtained with Key Center C1, and Key to Filt. Freq. Track +127.

Morph: Relatively wide notches become narrow peaks as amount is increased.

Freq. Tracking: Tunes the filter.

Transform 2: Higher values increase bandwidth.

F273 RippleSheet

Morph: Opens low pass response.

Freq. Tracking: Accentuates higher frequencies as values increase.

Transform 2: Reduces overall filter effect. Provides good velocity response with the acoustic guitar.

F274 Clear Water

Provides a high frequency sheen to any sound. Transforms perform very subtly. Transform 2 reduces shimmer effect.

Morph: Modulates high frequency accents.

Freq. Tracking: Tracks Keyboard

Transform 2: Reduces filter effect.

F275 Invisible

Morph: As Morph offset increases, boosts at 70 and 269Hz and cuts at 167, 560, and 810Hz reverse polarity; peaks become notches, and vice versa.

Freq. Tracking: Raises frequencies two octaves.

Transform 2: Reduces effect of filter.

F276 Wine Glass

Morph: At 0 offset, provides gentle roll-off to 1kHz with peaks at 2.5kHz and 18kHz. At 255 offset, provides a cut at 82Hz and a boost at 398Hz with a gradual boost from 5 to 18kHz.

Freq. Tracking: Tracks filter to keyboard.

Transform 2: Reduces overall morph effect.

F277 SnakeCros.4

Morph: At 0 offset, provides gentle lowpass cutting frequencies at 431 and 810Hz and boosting 640Hz. At full offset, response is flat with cuts at 2.6kHz and 4kHz and a slight boost at 6.7kHz.

Freq. Tracking: Flattens response.

Transform 2: Not Used

F278 Analog.4

Morph: At 0 offset, provides a lowpass rolling off at 2.5kHz with a single peak at 44Hz. At full offset, provides a flat response with an 11.5kHz boost.

Freq. Tracking: Same as Morph.

Transform 2: Not Used

F279 Skrtch Cube

Like F241 String Cube, a good overbright response through velocity on Transform 2, In this filter, Morph offers a choice of “soft play” effects. In zero position, soft play is very mellow as normally expected. In full Morph position, soft play is scratchy and bright, like fingernails on a guitar string or drum.

Set-Up Instructions: Set Wheel to Morphing in Realtime Controllers. Set Velocity to Transform 2 in Note-On Controllers for good response. Set Key Center to C1 and Key to Filt. Freq. Track +64 in order to maintain appropriate pitch tracking. Should be used to get correct filter effect but can be used for upper register brightness.

Morph: Controls timbre change, from mellow to scratchy.

Freq. Tracking: Maintains harmonic filter tracking.

Transform 2: Determines brightness and volume.

F280 KitchenSink

Morph: Starts as a mild all-pass boost and results in a large peak at $\approx 130\text{Hz}$.

Freq. Tracking: Tunes the filter.

Transform 2: Controls polarity and intensity of filter effect. Well-suited for sweep effects.

F281 Head Pan 1

Should be used on the primary instrument in conjunction with Head Pan 2 on the secondary instrument. Together, these two filter cubes mimic the directionally-dependent filtering of the head and pinna (external ear). In contrast to a conventional pan, the headphone image starts above the head (when the Morph control is at its maximum) and moves lower as it moves to either side. When the Morph control is at its minimum, however, the Filt. Freq. Track control pans between left and right at ear level.

Set-up Instructions: Try assigning velocity to Transform 2 +127, and Ctrl D (pedal) to Filt. Freq. Track +127 in Note-On Controllers. Assign Ctrl A to Morph +127 in Real Time Controllers. Initial Pan settings: Primary -7, Secondary +7. Re-trigger notes as controllers are modulated. (Use headphones for maximum effect.)

Morph: Sweeps transform peak and notches from high to very high frequency.

Freq. Tracking: Reverses left and right filters, regardless of morphing level.

Transform 2: Gradually increases brightness and volume.

TRY THE HEAD PAN FILTERS WITH
PERCUSSION INSTRUMENTS.
THEY REALLY WORK.



F282 Head Pan 2

The same as F281 Head Pan 1 with the Frequency Tracking filters reversed for the opposite ear.

Morph: Sweeps apparent elevation angle from low to high.

Freq. Tracking: Shifts apparent azimuth from left to right.

Transform 2: Shifts apparent distance from far to near.

F283 Arpeggio

Several peaks are tuned to a series of notes. Increasing the Morph offset decreases the gain of lower frequencies, while increasing the gain of higher frequencies. Best tracking is obtained with Key Center set to C1, and Key to Filt. Freq. Track +127.

Morph: Controls gain of the various peaks.

Freq. Tracking: Tunes the filter.

Transform 2: Higher values increase overall gain of the various peaks.

F284 HeavyFilt.4

Morph: Starts (at 0 offset) as a high shelving filter with a boost at 2.5kHz and resolves (at 255) to a flat response with dips at 6 and 14kHz.

Freq. Tracking: Starts flat until a dip at 4kHz and tracks it up in frequency as offset is increased.

Transform 2: Not Used.

F285 Noiz Cube 2

A series of non-harmonically related filter bands. Can impart a woody quality to some sounds; nice for organs.

Morph: Controls bandwidth and gain.

Freq. Tracking: Tunes the filter.

Transform 2: Controls polarity.

DISTORTION FILTERS

New and improved distortion filters which allow better control over harmonic content. Grunge, beautiful grunge!

F286 Feedback

Morph: Increases gain of the overtone; higher values distort.

Freq. Tracking: Tunes the filter.

Transform 2: Adjusts low pass Fc. Use this to add feedback, or a pronounced harmonic to an instrument. Best tracking is achieved with Key to Filt. Freq. Track +127.

F287 AllPoleDist

Maximum shred is obtained with both Morph and Transform 2 set to 255. Use Morph to control character of the distortion, and Transform 2 to adjust amount. Best tracking is obtained with Key Center set to C1, and Key to Filt. Freq. Track +127.

Morph: Higher values increase Q.

Freq. Tracking: Tunes the filter.

Transform 2: Sweeps a single pole.

F288 AllPoleDst2

Warning: This filter can easily overload.

Morph: Sweeps the frequency of a single zero.

Freq. Tracking: Lower settings rolloff highs, higher settings rolloff lows.

Transform 2: Higher values increase overall Q.

This listing represents the actual order of the ROM samples in memory. This information may be useful when adjusting the Loop Offset parameters in the preset menu. When the loop size reaches the end of memory, it jumps back to the start.

Start...	arcovio c3	strings a3	fastfalls f3
piano e0	arcovio cx3	strings d4	fastfalls a3
piano a0	arcovio e3	string g4	fastfalls d4
piano d1	arcovio e3	vox f2	mute e1
piano f1	arcovio g3	vox a2	mute a1
piano c2	arcovio g3	vox c3	mute d2
piano c3	arcovio c4	vox d3	mute g2
piano g3	arcovio e4	vox f3	mute b2
piano c4	arcovio g4	vox a3	mute e3
piano f4	arcovio c5	vox c4	kmguitar e1
piano c5	arcovio e5	vox d4	kmguitar a1
piano f5	arcovio g5	sax c2	kmguitar d2
piano g5	pizzbass a1	sax d3	kmguitar g2
piano c6	pizzbass d2	sax e2	kmguitar b2
piano f6	pizzbass f2	sax g2	kmguitar e3
arcoviola e1	pizzbass d3	sax a2	kmguitar a3
arcoviola g1	pizzbass f3	sax f3	acgtr e1
arcoviola c2	pizzbass a3	sax c4	acgtr a1
arcoviola e2	pizzcelli f1	sax d4	acgtr d2
arcoviola g2	pizzcelli f2	sfttrump a1	acgtr g2
arcoviola c3	pizzcelli a2	sfttrump d2	acgtr b3
arcoviola e3	pizzcelli f3	sfttrump g2	acgtr e3
arcoviola g3	pizzcelli a3	sfttrump c3	acgtr a3
arcoviola c4	pizzviolas g1	sfttrump f3	rockbass e1
arcocello d1	pizzviolas c2	sfttrump a3	rockbass a2
arcocello dx1	pizzviolas g2	hrdtrump a1	rockbass d3
arcocello f1	pizzviolas c3	hrdtrump d2	rockbass g4
arcocello fx1	pizzviolas g3	hrdtrump g2	rockbass c4
arcocello a1	pizzvio g1	hrdtrump c3	rockbass f4
arcocello ax1	pizzvio c2	hrdtrump f3	gsbass e1
arcocello d2	pizzvio e2	hrdtrump a3	gsbass a1
arcocello dx2	pizzvio g2	hrdtrump d4	gsbass d2
arcocello f2	pizzviol c3	trom c2	gsbass g2
arcocello fx2	pizzvio e3	trom b2	slapbass e1
arcocello a2	pizzvio g3	trom e3	slapbass a2
arcocello ax2	pizzvio c4	trom a3	slapbass d3
arcocello d3	string b0	trom d4	popbass d3
arcocello f3	string e1	trom g4	popbass g4
arcocello a3	string a1	trom c5	popbass c4
arcovio g1	strings d2	fastfall a1	popbass f4
arcovio c2	strings g2	fastfalls d2	bassharm e1
arcovio e2	strings c3	fastfalls g2	bassharm a2
arcovio g2	strings f3	fastfalls c3	bassharm d3

LOOP OFFSET SAMPLE LOCATIONS

bassharm g4	fmtone d3	mrt1 g3	ob4 c5
moogbass c2	fmtine a2	mrt1 g5	ob5 g1
czbass c2	sawtootha 3	mrt1 c6	ob5 c3
synthpad g3	sawtooth a4	mrt2 g3	ob5 c4
synthpad g4	sawtooth a5	mrt2 g5	ob5 g4
organ b2	sawtooth a6	mrt2 c6	ob5 c5
organ a3	msaw1 g3	mrt3 g3	arp1 a1
organ c5	msaw1 c5	mrt3 g5	arp1 d0
marimba c2	msaw1 g5	mrt3 c6	arp1 g0
marimba c3	msaw1 c6	mrt4 g3	arp1 c1
vibes e2	msaw2 g3	mrt4 g5	arp1 f1
vibes e3	msaw2 c5	mrt4 c6	arp1 f3
fingers	msaw2 g5	mrt5 g3	arp2 c1
opnhndtone	msaw2 c6	mrt5 g5	arp2 f1
hitumbatone	msaw3 g3	mrt5 c6	arp2 a1
htmbaclsslapp	msaw3 c5	mpw1 g3	arp2 a3
htmbaopnslap	msaw3 g5	mpw1 c5	arp3 c1
timbalsstrike	msaw3 c6	mpw1 g5	arp3 f1
timbalermsht	msaw4 g3	mpw1 c6	arp3 a1
woodblock	msaw4 c5	mpw2 g3	arp3 d2
rosewdclave	msaw4 g5	mpw2 c5	arp3 g2
maracas	msaw4 c6	mpw2 g5	arp3 c3
cabasa	filtsaw fx5	mpw2 c6	arp3 c4
guirodown	sawoddgone a2	mpw3 g3	b3wave 1
guiroup	sawoddgone a3	mpw3 c6	b3wave 2
agogobell	sawoddgone a4	mpw4 g3	b3wave 3
kick 2	sawoddgone a5	mpw4 g5	b3wv 4
revrbkick 1	square a3	mpw4 c6	b3wv 5
kick 3	square a4	mpw5 c5	b3wv 6
cwsnare 1	triangle d4	mpw5 g5	clarinet a2
revrbsnare 1	triangle d6	mpw5 c6	buzzoon a2
snare 3	msq1 g3	ob1 g0	nonpitch c2
snare 2	msq1 g5	ob1 g	fullpnknoise
clsdhh 1	msq1 c6	ob1 g3	sinewave e4
bighat	msq2 g3	ob1 g4	oct2all e4
clsdhh 2	msq2 g5	ob1 g1	oct3all e4
rideping	msq3 c6	ob1 c3	oct4all e4
zilda16medcr	msq3 g3	ob3 c0	oct5all e4
ambientrasp	msq3 g5	mpw4 c5	oct6all e3
ludwig16floo	msq3 c6	mpw5 g3	oct7all e2
ludwig12tom	msq4 g3	ob3 g2	oct3odd e4
verbclick	msq4 g5	ob3 g3	oct4odd e4
sawstack a3	msq4 c6	ob3 c4	oct5odd e4
squarechr c4	msq5 g3	ob3 g4	oct6odd e3
b3chorus a2	msq5 g5	ob3 c5	oct7odd e2
b3chrs2 a4	msq5 c6	ob4 g1	lowodds e4
icebellchr a3	msq6 g3	ob4 c3	lowevens e4
eguit chrs	msq6 g5	ob4 c4	four octave e4
metlbell f4	msq6 c6	ob4 g4	synthcyl d4

synthcyc2 d4	icebell e5	arcbasses f1	piccolo d3
synthcyc3 d4	icebell e6	arcbasses a1	bclarinet c1
synthcyc4 d4	bronzeage e3	arcobasses d2	bclarinet e1
fundgone1 d4	bronzeage e6	arcbasses f2	bclarinet g1
fundgone2 d4	ironplate d4	arcbasses a2	bclarinet c2
bitecyc d4	ironplate d6	arcobasses d3	clarinet d2
buzzycyc d4	aluminum d4	arcobassesg 3	clarinet b2
metlphone1 d4	leadbeam b3	arcocelli d1	clarinet d3
metlphone2 d4	stelxtrct a4	arcocelli f1	clarinet b3
metlphone3 d4	stelxtrct a5	arcocelli a1	clarinet c3
metlphone4 d4	wntglass a3	arcocelli d2	contrabssn g0
duckcyc1 d4	wntglass e4	arcocelli f2	contrabssn c1
duckcyc2 d4	wntglass a4	arcocelli a2	bassoon g1
duckcyc3 d4	wntglass a6	arcocelli d3	bassoon c2
windcyc1 d4	townbell c2	arcocelli f3	bassoon e2
windcyc2 d4	townbell c4	arcoviola d1	bassoon g2
windcyc3 d4	orchbells c2	arcoviola f1	bassoon c3
windcyc4 d4	orchbells c4	arcoviola a1	bassoon e3
organcyc1 d4	tubularse c4	arcoviola d2	bassoon c4
organcyc2 d4	tubularse c6	arcoviola f2	enghorn f2
vioessenc b2	softbell e3	arcoviola a2	enghorn b2
vioessenc a3	softbell e4	arcoviola d3	enghorn d3
vioessenc c4	softbell e	arcovio g2	enghorn g3
vioessenc c5	swirly a4	arcovio c3	oboe c3
buzzoon a3	swirly a6	arcovio f3	oboe f3
buzzoon a6	tackatik a4	arcovio a3	oboe a3
brassywave a3	tackatik a6	arcovio d4	oboe e4
brassywave a4	shimmer d4	arcovio g4	oboe a4
brassywave a5	shimmer d5	arcovio c5	oboe c5
reedybuzz d4	shimmer d6	tremovio e3	tromff d1
reedybuzz d5	mildtone c3	tremovio g3	tromff g1
reedybuzz d6	mildtone c4	tremovio c4	tromff c2
growl a2	mildtone c6	trembass c2	tromff f2
growl a4	ahwave dx2	trembass e2	tromff a2
growl a6	ahwave dx5	trembass g2	tromff d3
harpsiwave a2	vocalwave gx2	trembass c3	tromff g3
harpsiwave a4	vocalwave gx4	flute d3	mfrumpet f2
fuzzygruzz a2	fuzzyclav d4	flute g3	mfrumpet a2
fuzzygruzz a4	fuzzyclav d6	flute g3	mfrumpet d3
power5th a2	electrode c4	flute c4	mfrumpet g3
power5th a4	electrode c6	flute c4	mfrumpet c4
power5th a5	whine1 c3	flute f4	mfrumpet f4
ramp a3	whine1 c5	flute a4	mfrumpet b4
ramp a4	b3wave7 f3	flute d5	ffrumpet g2
ramp a5	deadair	flute g5	ffrumpet c3
ramp a6	flute a2	piccolo a1	ffrumpet f3
rampeven a3	flute d3	piccolo d2	ffrumpet a3
rampeven a5	flute g3	piccolo f2	ffrumpet d4
icebell e4	arcobasses d1	piccolo a2	ffrumpet g4
			ffrumpet c5

LOOP OFFSET SAMPLE LOCATIONS

harmmute g2	dlcmr c3	chanter a1	banyatone
harmonmute c3	dlcmr b3	chanter g1	banyaslap
harmonmute e3	koto g2	bullroarer	banyahit
harmmute g3	koto c3	sprtcatchr	tablatone
harmmute c4	koto g3	digeridoo	tablamutea
harmmute e4	banjo g2	digeritone	tablamuteb
harmmute a4	banjo d3	digeriscrm	tablamutec
frhornmf d2	banjo g3	jewsharp a	tablaopen
frhornmf g2	banjo d4	jewsharp b	clapprstik
frhornmf c3	tar d2	jewsharp c	rosewdbass
frhornmf f3	guitar g1	jewsharp d	rosewdtick
frhornmf a3	guitar c2	plexislap c	rosewdharm
frhornmf d4	guitar f2	bronzesaron	rosewdfngr
frenchhorn d2	guitar b2	suwukgong	tanzshaker
frenchhorn f2	guitar e3	chinagong	bonang
frenchhorn c3	sitar d4	nepalcymb1	kenong
frenchhorn f3	tamboura c2	tibetbowl	lowtumbatone
frenchhrn a3	bwdsaltry e3	steeldrum	quintclsdsp
frenchhrn d4	waterphone 1	crotales d5	quintotone
tuba f0	waterphone 2	hulastick	quicadwnstrk
tuba d1	accord f2	plexitone	quicahitone
tuba f1	accord a2	plexislapa	cowbell
tuba a1	accord f3	plexislapb	bongo rim
xylo e4	harmonica d2	surdoopen	bongo tone
xylo g4	harmonica a2	likembe f3	vibraloop
xylo e5	harmonica vb d2	likembebuz d3	springysplash
celeste e5	harmonica vb a2	log drum	ridebellkm
triangle ax3	harmonica vb c3	surdomute	zildjian19ch
bassdrum g1	harmonica vb f3	deffslap	sambawhistle
snare	harmonica vb a3	deffmute	clave808
snareroll	harmonica vb c3	bendiropen	snare808
rimshot	harmonica vb d3	reqopen	bd808
rimclick	harmonica vb a4	reqslap	sidestick808
timpani a1	harmonica vb c5	castanet	cowbell808
piatti f3	mizmars a3	maraca a	clsdhat808
brasstamb	shenai g4	maraca b	openhat808
tamtam c4	penwhistl g1	maraca c	claps808
tempblock e4	ocarina f2	maraca d	ridecym808
glock g4	shofarloop	udutone	deadairdeadair
tubbell d4	shofarrlse	udurelease	deadair
templeblk b4	siku e2	udufinger	multfrm1c
troubharp e2	siku b2	uduslap	kaleidoscope
troubharp c3	siku f3	iputone	...End
troubharp f3	charmerloop	ipuslap	
troubhrp a3	neyflute b2	enutone	
irishharp c3	neyflute f3	batatone	
irishharp f3	neyflute b3	batamute	
irishharp a3	neyflute a4	bataslap	
dlcmr c2	bagpipedr n	crickets	

Linear

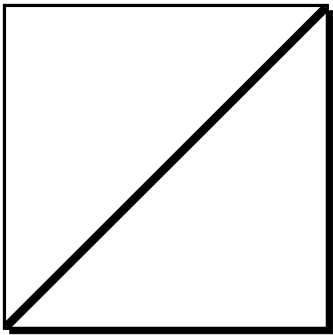

Exponential +1

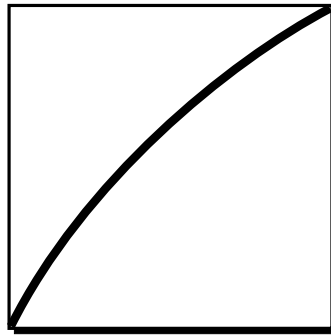

Exponential +2

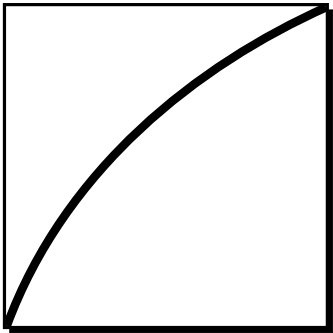

Exponential +3

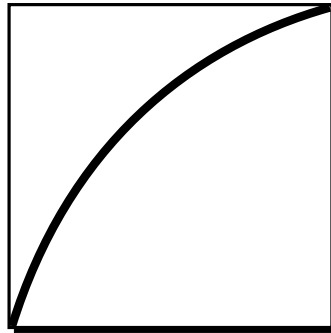

Exponential +4

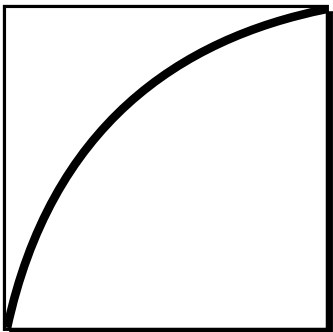

Exponential +5

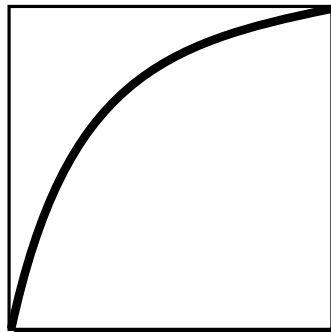

Exponential +6

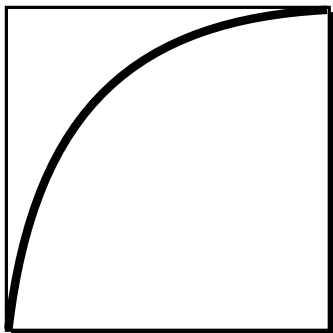

Exponential +7

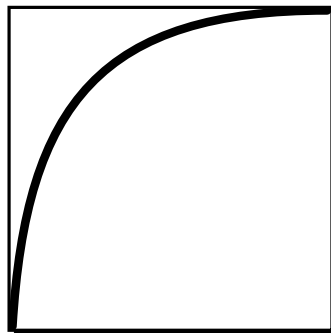

Circle 1.4

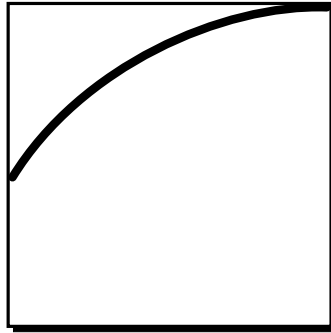

Circle 1.6

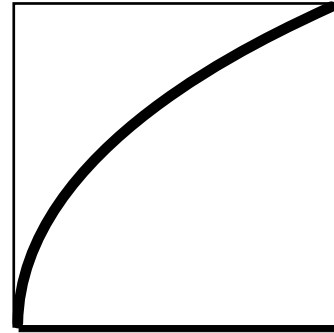

Circle 1.8

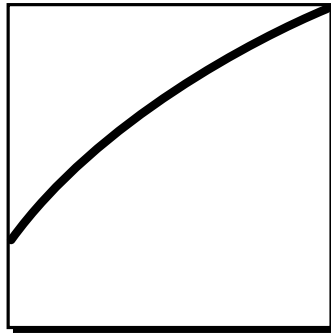

Circle 1.16

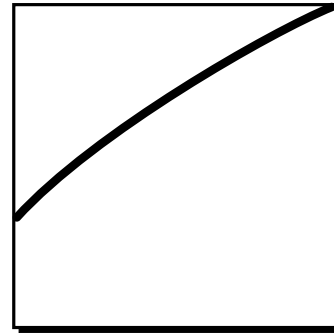

Squeeze

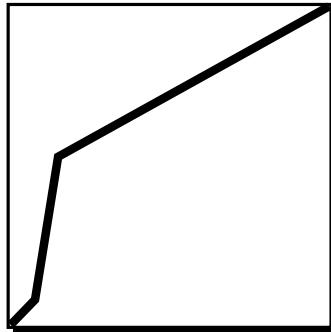

Fast Line 1

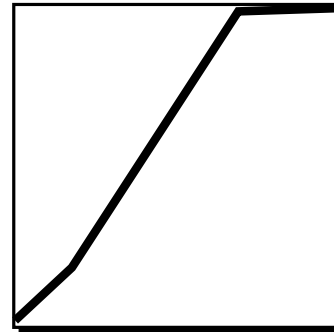

Fast Line 2

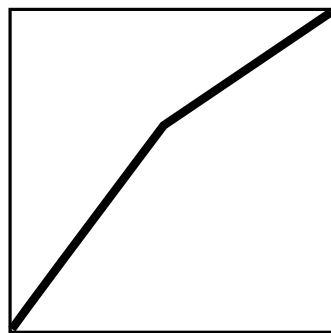

Fast Line 3

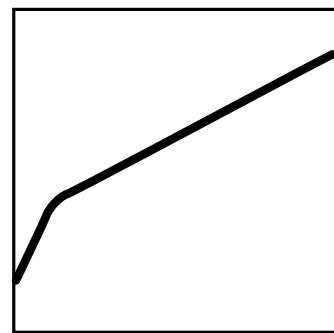

Medium Line 1

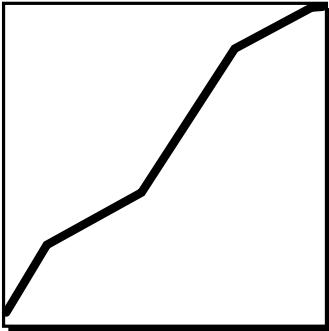

Medium Line 2

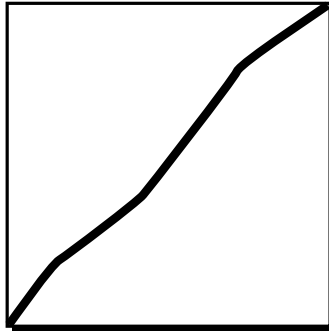

Slow Ramp 1

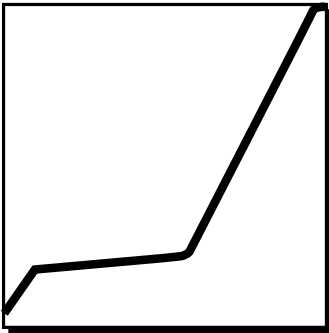

Slow Ramp 2

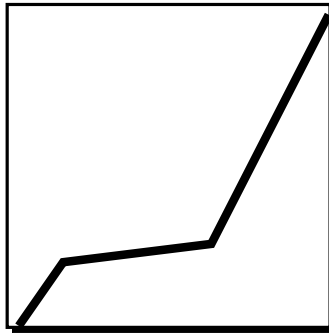

Bloom

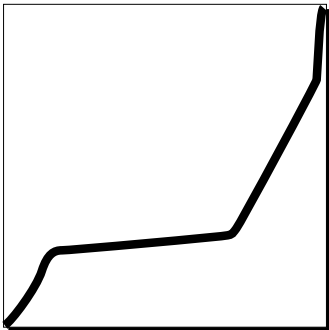

Bloom 2

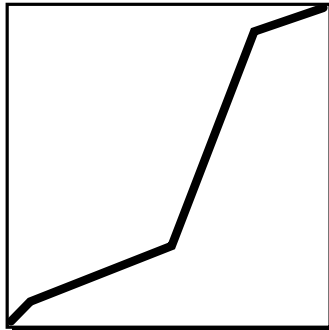

Circle 1.16 R

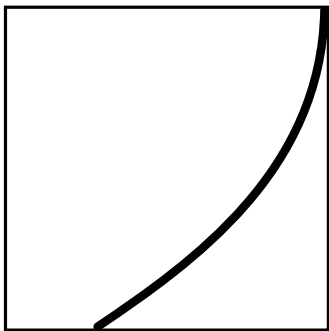

Circle 1.8 R

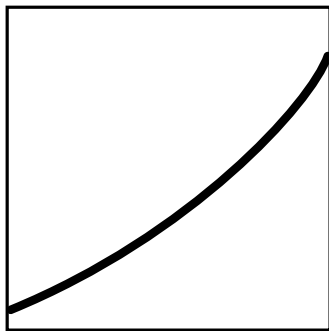

Circle 1.16 R

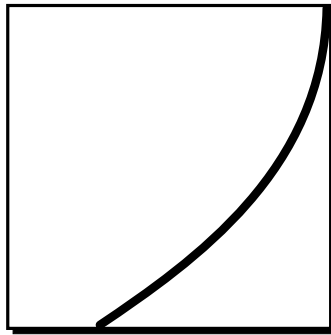

Circle 1.4 R

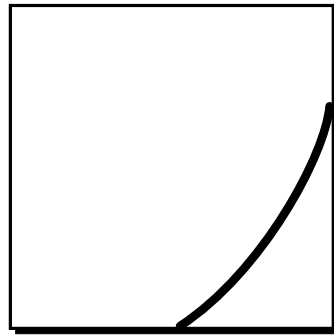

Slow Curve 1

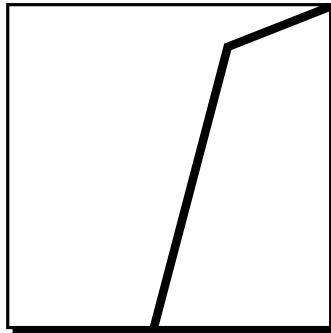

Slow Curve 2

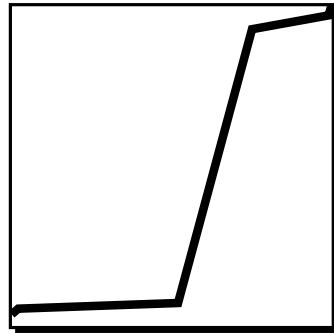

Delay DC

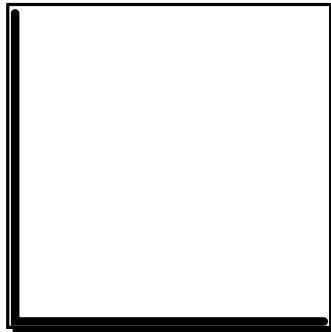

DC Delay

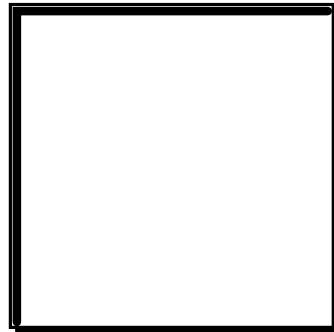

DELAY DC WAITS FOR THE SPECIFIED TIME, THEN OUTPUTS THE LEVEL.

DC DELAY OUTPUTS THE LEVEL, THEN WAITS FOR THE SPECIFIED TIME BEFORE MOVING ON TO THE NEXT SEGMENT.

THESE TWO SHAPES ARE USEFUL FOR CREATING STEPPED MINI-SEQUENCES.

Curve 2x

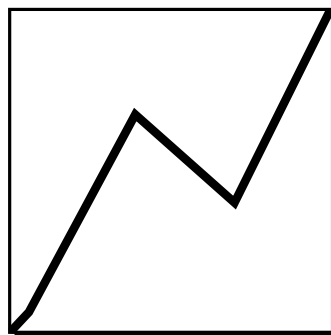

Curve 2x B

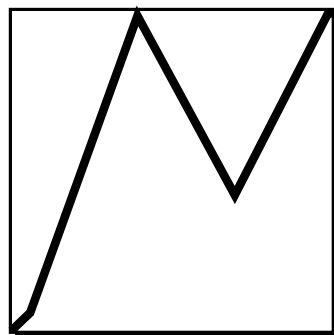

Curve 2x C

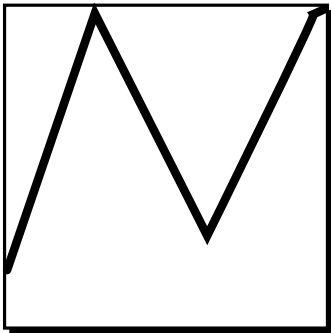

Ziz-Zag 1

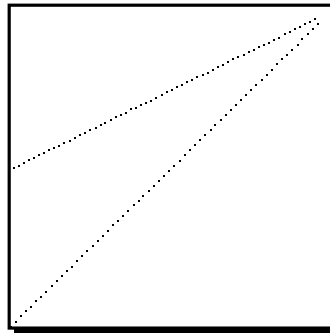

Ziz-Zag 2

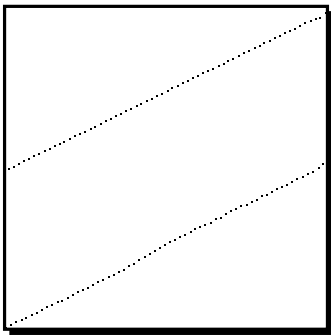

Ziz-Zag 3

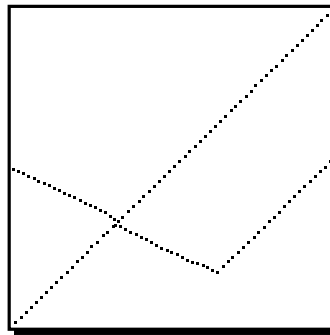

Chaos 03

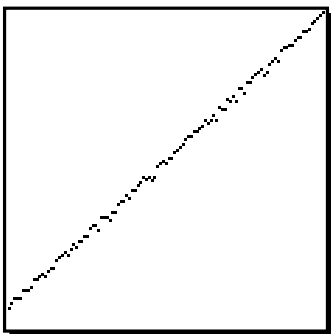

Chaos 06

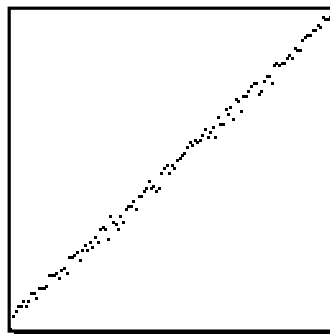

Chaos 12

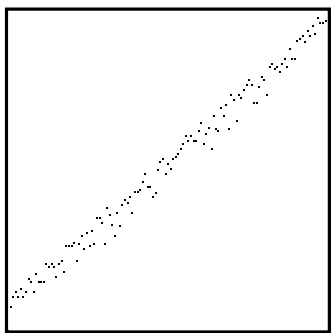

Chaos 16

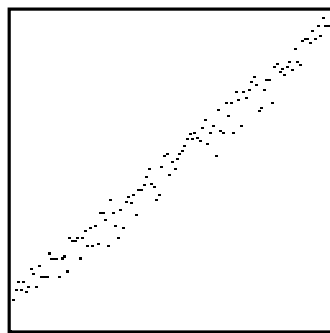

Chaos 25

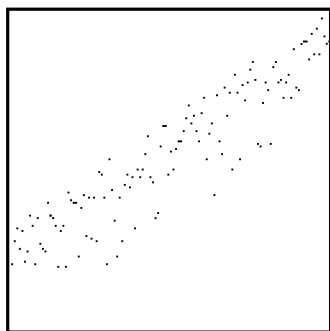

Chaos 33

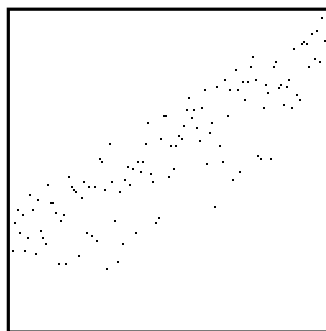

Chaos 37

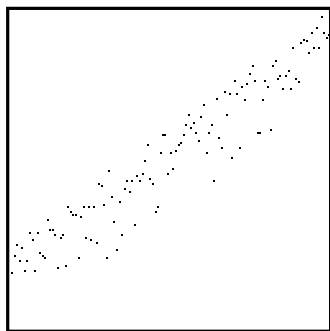

Chaos 50

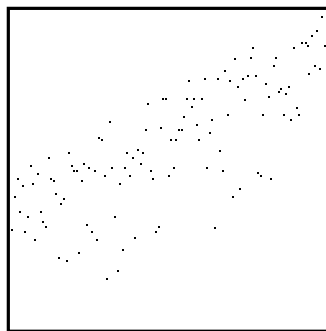

Chaos 66

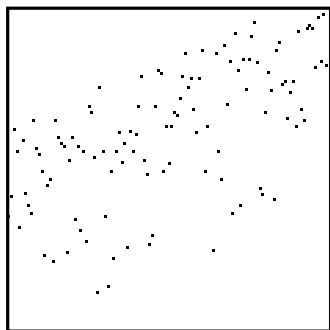

Chaos 75

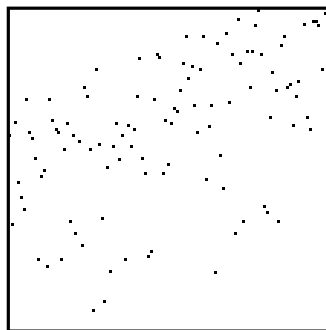

Chaos 95

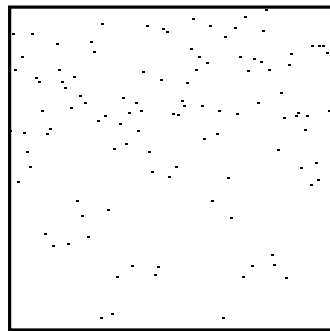

Chaos 99

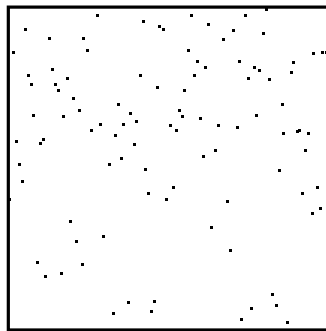

Linear Shuffle

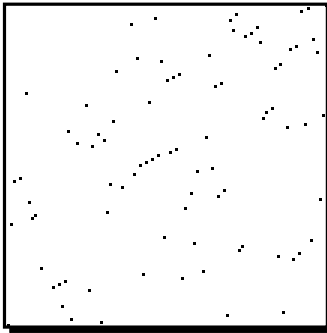

Linear Shuffle 2

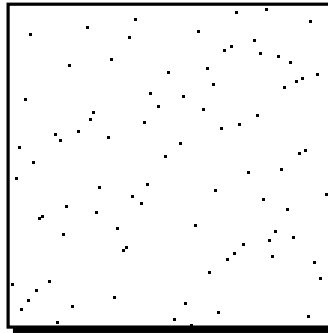

Random A

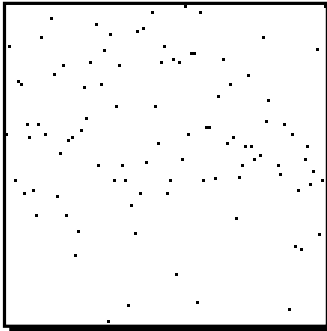

Random B

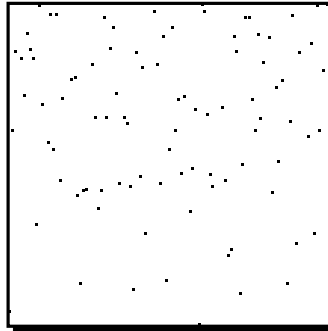

Random C

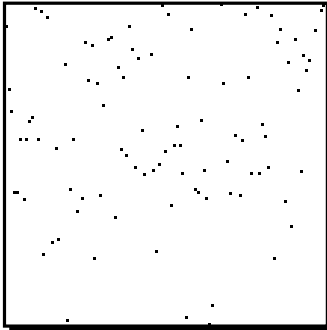

Random D

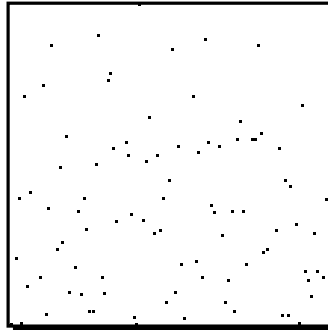

Random E

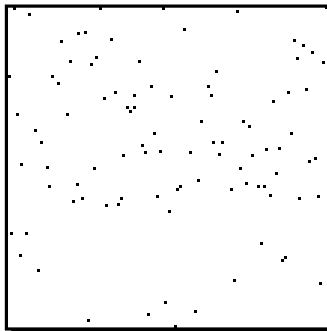

Random F

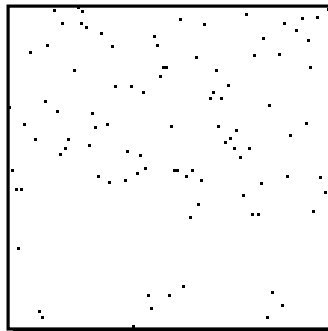

Random G

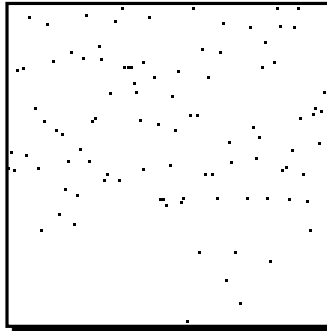

Random H

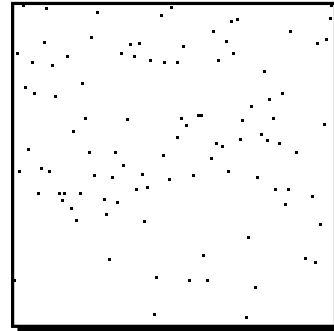

Random I

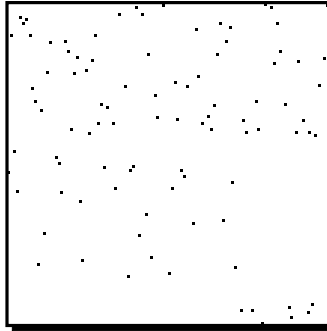

Random J

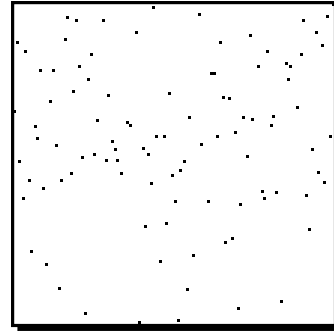

Random K

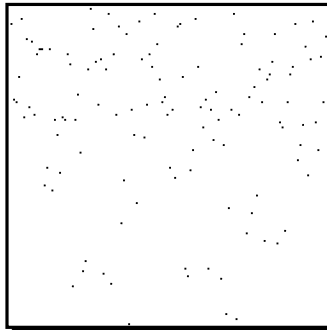

Random L

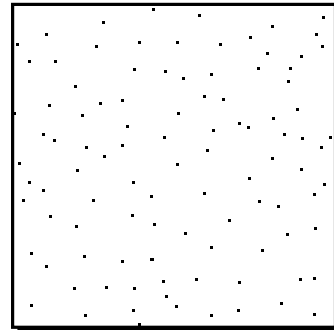

Random Z

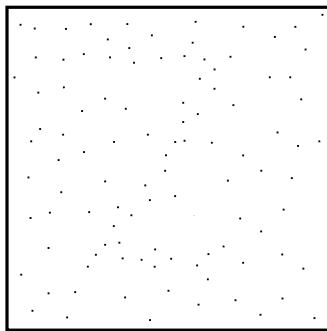

DELAY TIMES	
Display	Time (secs)
1	.02
4	.10
8	.18
16	.38
32	.89
36	1.05
48	1.61
56	2.06
88	5.02
100	6.77
116	9.94
127	12.85

LFO RATES	
Display	Rate (Hz)
000	.052
5	.1
10	.6
15	.8
20	1.33
25	1.8
30	2.2
40	3.3
50	7
60	10
80	16
127	25

ENVELOPE RATES	
Display	Rate (secs)
4	.066
8	.090
16	.174
24	.246
32	.408
48	1.04
60	2.06
76	5.05
88	9.87
96	15.56
100	19.64
127	163.6

FUNCTION GEN. PITCH INTERVALS	
Display	Semitone
+16	1
+32	2
+49	3
+65	4
+81	5
+97	6
+113	7
+127	<8

LFO PITCH INTERVALS	
Display	Semitone
32	1
65	2
98	3
127	4
127+36	5
127+69	6
127+101	<7

THE PITCH INTERVALS CAN BE USED WHEN MODULATING PITCH. ALL OTHER ATTENUATORS SHOULD BE SET TO +127. MULTIPLE "PATCH CORDS" CAN BE ADDED FOR GREATER PITCH INTERVALS.

Audio Channels:	32
Audio Outputs:	6 (2 main, 2 effects, 2 submix)
Submix Inputs:	4
Max. Output Level:	+4 dB into 600Ω
Output Impedance:	1kΩ
MIDI:	In, Out, Thru
Data Encoding:	16 bit Linear
Sample Playback Rate:	39 kHz
Max. Signal to Quiescent Noise:	>90 dB
Dynamic Range:	>90 dB
Frequency Response:	20 Hz-15 kHz
THD +N:	<.05%
IMD:	<.05%
Stereo Phase:	Phase Coherent ±1° at 1 kHz
Filter:	(32) 14-pole Z-Plane Filters (32) LP Tone Filters
Power Requirements:	25 watts
Dimensions:	H: 1.75" W: 19" L: 8.5"
Weight:	6 lb, 14 oz (3.1 Kg)

Function...	Transmitted	Recognized	Remarks
Basic Channel Default Changed	No No	1 1-16	Memorized
Mode Default Messages	No	Mode 1, 3, 4 MONO, POLY OMNI, ON/OFF	Memorized
Note Number True Voice	No No	0-127 0-127	
Velocity Note ON Note OFF	No No	Yes v=1-127 No	
After Touch Keys Channels	No No	Yes Yes	
Pitch Bender	No	Yes	
Control Change	No	Yes	0-31 64-79
Bank Select	No	Yes	
Program Change True Number	No No	Yes 0-127 Yes 0-127	
All Sound Off	No	Yes	
All Notes Off	No	Yes	
Reset All Controllers	No	Yes	
System Exclusive	Yes	Yes	
System Common :Song Pos :Song Sel :Tune	No No No	No No No	
System Real Time :Clock :Commands	No No	No No	
Aux Messages :Local On/Off :Active Sense :Reset	No No No	No No No	
Notes: Pan 0=hard left 127=hard right Mode 1: OMNI ON, POLY Mode 2: OMNI ON, MONO Mode 3: OMNI OFF, POLY Mode 4: OMNI OFF, MONO			

GENERAL INFORMATION FOR ULTRAPROTEUS SYSEX

- Product ID for UltraProteus is 0C.
- Device ID is [00-0F] (0-15 decimal).
- Parameter Number and Parameter Value are 2 bytes each.
- Since MIDI data bytes cannot be greater than [7F] (127 decimal), the data values are “nibble-ized” to a 14-bit signed 2's complement format.
- There is one edit buffer for the current preset (the preset shown in the display), one for the hyperpreset, and one for the midimap (the current midimap). Only one preset, hyper or midimap can be edited at a time via SysEx commands and changing the current preset, hyper or midimap erases the associated edit buffer.

RECEIVED CHANNEL COMMANDS

Channels number (n) = 0-15. Message bytes are represented in hex. All other numbers are decimal. Running Status is supported.

Command	Message	Comments
Note Off	8n kk vv	release velocity is ignored
Note On	9n kk vv	velocity 0 = note off
Key Aftertouch	An kk vv	kk = 0-127 vv = 0-127
Program Change	Cn vv	0-127
Channel Aftertouch	Dn vv	0-127
Pitch Bend	En ll mm	l = lsb, m = msb
Realtime Controller	Bn cc vv	cc = 00-31
Footswitch	Bn cc vv	cc = 64-79, vv ≥ 64 = on
Volume	Bn 07 vv	0-127
Pan	Bn 0A vv	0 = hard left, 127 = hard right
All Sound Off	Bn 78 00	turns all sound off
Reset All Controllers	Bn 79 00	ignored in omni mode
All Notes Off	Bn 7B 00	ignored in omni mode
Omni Mode Off*	Bn 7C 00	forces all notes & controls off
Omni Mode On*	Bn 7D 00	forces all notes & controls off
Mono Mode On (<i>Poly Off</i>)*	Bn 7E 00	forces all notes & controls off
Poly Mode On (<i>Mono Off</i>)*	Bn 7F 00	forces all notes & controls off
Bank Select	Bn 00 00 20 bb Cn pp	bb = bank # pp = program in bank

* Special Notes:

From Omni Mode Omni Off turns Poly On.
 From Poly Mode..... Omni On turns Omni On; Mono On turns Mono On.
 From Mono Mode Mono Off turns Poly On; Omni On turns Omni On.
 From Multi Mode Omni On turns Omni On; Omni Off or Mono Off turns
 Poly On; Mono On turns Mono On.

All other changes have no effect.

MIDI SYSEX COMMANDS

For system exclusive commands, the following format is used:

F0	System Exclusive Status Byte
18	E-mu ID Byte
0C	Product ID Byte (<i>will also respond to ID 04 - Proteus</i>)
dd	Device ID Byte
cc	Command Byte
...	Data Bytes
F7	EOX

SysEx Editing

Preset and setup parameters may be edited individually using system exclusive commands. The preset being edited is the active preset (the preset on the basic or global channel and the one which is shown in the LCD). The value of a given parameter may be changed by sending a *parameter value* command. The value of a parameter may be read by sending a *parameter value request*, to which the machine will respond by sending back the parameter value. Please note that there is only one edit buffer

All SysEx bytes are displayed in Hex, unless specified otherwise. All comment numbers are displayed in decimal, unless specified otherwise.

Two MIDI bytes (lsb, msb) are required for each 14 bit data word. Bits 0-6 are sent first, followed by bits 7-13 in the next MIDI byte. All data words are signed 2's complement values with sign-extension out to the most significant bit (bit 13). This convention applies to all data words, regardless of the parameter's value range.

Preset data may also be transmitted or received in a single block (one complete preset) using system exclusive commands. A *preset data request* may be issued by a host computer, to which the machine will respond sending the data block for the requested preset. Conversely, the computer may send new preset data which will replace the specified preset currently in the machine. Additionally, a front panel command will transmit one or all user presets for backup onto an external sequencer. These presets may be restored by simply playing back the sequence into the machine.

Warning: When transferring preset banks and tuning table data back and forth from UltraProteus to a computer, the data should be recorded as you would a regular sequence. Sending the data in one huge chunk will clog the input buffer on UltraProteus unless a time period of approximately 100 mS is inserted between each preset. The SysEx Packet Delay feature in the Master menu can be used to slow down the data rate when the computer's input buffer is being clogged.

ULTRAPROTEUS WILL RECEIVE PROTEUS 1/2/3 PRESETS (IF ENABLED IN THE MASTER MENU). IT WILL FILL IN THE EXTRA PARAMETERS WITH DEFAULT VALUES AND MATCH INSTRUMENT NUMBERS TO EITHER THE EXACT INSTRUMENT OR TO THE ULTRAPROTEUS EQUIVALENT. PRESET LINKS WILL NOT BE TRANSFERRED.

THERE IS ONLY ONE EDIT BUFFER EACH FOR THE CURRENT PRESET, THE CURRENT HYPERPRESET, AND THE CURRENT MIDIMAP.

ONLY ONE PRESET, HYPERPRESET OR MIDIMAP CAN BE EDITED AT A TIME VIA SYSEX COMMANDS AND CHANGING THE CURRENT PRESET, HYPER OR MIDIMAP ERASES THE ASSOCIATED EDIT BUFFER.

COMMAND SUMMARY

The following SysEx Command IDs are recognized by UltraProteus.

Command Number	Function
00	Preset Request
01	Preset Data
02	Parameter Request
03	Parameter Data
04	Tune Table Request
05	Tune Table Data
06	Prog Map Request
07	Prog Map Data
08	Master Data Request
..	Unused
0A	Version Request
0B	Version Data
0C	Configuration Request
0D	Configuration Data
0E	Instrument List Request
0F	Instrument List Data
..	Unused
12	Preset List Request
13	Preset List Data
..	Unused
44	Hyperpreset Request
45	Hyperpreset Data
46	Midimap Request
47	Midimap Data
..	Unused
50	Hyperpreset List Req
51	Hyperpreset List Data
52	Midimap List Req
53	Midimap List Data
54	Effect List Req
55	Effect List Data
56	Filter List Req
57	Filter List Data

COMMAND DETAILS

All parameters are sent as 14-bit signed values, LSB-MSB. (See page 277)
 Numbers in the far left column are decimal offsets into the dumps. These numbers are added to the parm base offsets in order to do individual parameter editing. (See *PARAMETER editing cmds*) Data sent to a ROM card or a card that is protected is ignored. Requests for card data while card is not inserted will be ignored. Removing the card while a dump involving card data is in progress can cause unexpected results. (Generally, default data will be sent. No data corruption in the box should occur.)

PRESET REQUEST

Request preset. Uses preset index values (not the same as program numbers). Request for card presets will be ignored if card is not present. Preset numbers are: 0-127 RAM, 128-255 ROM, 256-319 CARD. Values 0x0400+ bank number represent request for banks. (Banks are blocks of 128 presets.)

F0	SysEx Status Byte
18	E-mu Mfg. ID
0C	UltraProteus Product ID
dd	Device ID 0-15
00	Command ID
ll	lsb Preset Number
mm	msb Preset Number
F7	End of SysEx Status

PRESET DATA

Version 0x01 format is as follows:

F0	SysEx Status Byte
18	E-mu Mfg. ID
0C	UltraProteus Product ID
dd	Device ID 0-15
01	Command ID - Preset Data
vv	Preset Data Version
ll	ls byte Preset Number
mm	ms byte Preset Number

THE PARAMETER NUMBERS SHOWN AT RIGHT MUST BE ADDED TO THE PRESET PARAMETER BASE VALUE (8192 FOR PRESET PARMS) IN ORDER TO ACCESS INDIVIDUAL PARAMETERS.

Offset	Name	Range
0	Preset Name	12 chars, ASCII 32-127
12	Preset Low Key	0-127 MIDI key number
13	Preset Hi Key	0-127 MIDI key number
14	Bend Range	0-13, ± 0-12 semitones, 13 = Global
15	Velocity Curve	0-5, 0 = Off, 5 = Global
16	Keyboard Center	0-127 MIDI key number
17	Tune Table	0-5, Equal, Just C, Vallotti, 19-Tone, Gamelan, User
18	Mix Bus	0-3, Main, Sub1, FXA, FXB
19	Port Mode	0-5, Mono, Poly 1-5 keys
20	X-Fade Mode	0-2, Off, XFade, XSwitch
21	X-Fade Direction	0-1, Pri->Sec, Sec->Pri
22	X-Fade Balance	0-127
23	X-Fade Amount	0-255
24	X-Switch Pointt	0-127, MIDI key number or velocity
25	Note-on Source	<i>See PATCHCORDS SRC</i>
26	Note-on Dest.	<i>See PATCHCORDS SRC</i>
27	Note-on Amount	-128 to +127
	...	10 note-on cords (3 parms each)
55	Realtime Source	<i>See PATCHCORDS DEST</i>
56	Realtime Dest.	<i>See PATCHCORDS DEST</i>
57	Realtime Amount	-128 to +127
	...	10 realtime cords (3 parms each)
85	Foot Dest.	<i>See PATCHCORDS DEST</i>
	...	3 footswitch cords (1 parm each)
88	Ctrl. A Amount	-128 to +127
89	Ctrl B Amount	-128 to +127
90	Ctrl C Amount	-128 to +127
91	Ctrl D Amount	-128 to +127
92	Pressure Amount	-128 to +127
93	LFO Shape	0-4, Rand, Tri, Sine, Saw, Square
94	LFO Rate	0-127
95	LFO Delay	0-127
96	LFO Variation	0-127
97	LFO Amount	-128 to +127
	...	2 LFOs (5 parms each)
103	FG Amount	-128 to +127
104	FG Seg Level	<i>See FUNCGEN LEVELS</i>

Offset	Name	Range
105	FG Seg Time	0-4095 msecs
106	FG Seg Shape	See <i>FUNCGEN SHAPES</i> chart
107	FG Seg CondJump	See <i>FUNCGEN CONDITIONS</i> chart
108	FG Seg CondVal	± 127
109	FG Seg DestSeg	0-7 segment number
	...	8 funcgen segments (6 parms each)
	...	2 function generators (49 parms each)
201	Aux Env Delay	0-127
202	Aux Env Attack	0-99 rate
203	Aux Env Hold	0-99 time
204	Aux Env Decay	0-99 rate
205	Aux Env Sustain	0-99 level
206	Aux Env Release	0-99 rate
207	Aux Env Amount	-128 to +127
208	(L) Instrument	See <i>INSTRUMENT NUMBERS</i>
209	(L) Low Key	0-127 MIDI key number
210	(L) Hi Key	0-127 MIDI key number
211	(L) Volume	0-127
212	(L) Pan	-7 to +7
213	(L) Course Tune	± 36 semitones
214	(L) Key Xpose	± 36 semitones
215	(L) Fine Tune	± 64 semitone/64
216	(L) AltEnv Enable	0-1, Off, On
217	(L) AltEnv Attack	0-99 rate
218	(L) AltEnv Hold	0-99 time
219	(L) AltEnv Decay	0-99 rate
220	(L) AltEnv Sustain	0-99 level
221	(L) AltEnv Release	0-99 rate
222	(L) Loop Enable	0-1, Off, On
223	(L) LoopStart MS	± 999 thousand samples
224	(L) LoopStart LS	± 999 samples
225	(L) LpSizeOff MS	± 999 thousand samples
226	(L) LpSizeOff LS	± 999 samples
227	(L) Sound Start	0-127
228	(L) Sound Delay	0-127
229	(L) Solo Mode	0-2, Off, Wind, Synth
230	(L) Solo Priority	0-4, Hi, Low, First, Last, Drum
231	(L) Portamento Rate	0-127, 0 = Off

THE PARAMETERS LABELED WITH (L) ARE THE PRIMARY LAYER. THE SECONDARY LAYER PARAMETERS BEGIN AT NUMBER 243.

THE PARAMETERS LABELED WITH (L) ARE THE PRIMARY LAYER. THE SECONDARY LAYER PARAMETERS BEGIN AT NUMBER 243.

Offset	Name	Range
232	(L) Pmento Shape	0-8, 0 = Linear, Expo1 - Expo8
233	(L) Double+Detune	0-15, 0 = Off
234	(L) Sound Reverse	0-1, Off, On
235	(L) Nontranspose	0-1, Off, On
236	(L) Filt Type	See <i>FILTER TYPES</i>
237	(L) Filt Reverse	0-1, Off, On
238	(L) Filt Level	0-255
239	(L) Filt Morph	0-255
240	(L) Filt FrqTrk	0-255
241	(L) Filt Trans2	0-255
242	(L) Unused	0
(L) = Layer	...	2 layers (35 parms each)
	cs	Checksum
F7		End of SysEx Status

Hyperpreset Request

Request Hyper uses index values (not the same as program numbers). Request for RAM Card presets will be ignored if card is not present. Hyperpreset numbers are: 0-127 RAM, 128-255 CARD. Values 0x0400 + bank number represent request for banks. (Banks are blocks of 128 Hyperpresets.)

F0	SysEx Status Byte
18	E-mu Mfg ID
0C	UltraProteus Product ID
dd	Device ID 0-15
44	Command ID
ll	Hyperpreset Number ls byte
mm	Hyperpreset Number ms byte
F7	End of SysEx Status

Hyperpreset Data

Version 0x01 format is as follows:

F0	SysEx Status Byte
18	E-mu Mfg. ID
0C	UltraProteus Product ID
dd	Device ID 0-15
45	Command ID
vv	Data Version
ll	ls Byte Hyperpreset Number
mm	ms Byte Hyperpreset Number

Offset	Name	Range
0	Hyperpreset Name	12 chars, ASCII 32-127
12	Port Mode	0-5, Mono, Poly 1-5 keys
13	FG Seg Level	See <i>FUNCGEN LEVELS</i>
14	FG Seg Time	0-4095 msec
15	FG Seg Shape	See <i>FUNCGEN SHAPES</i>
16	FG Seg CondJump	See <i>FUNCGEN CONDITIONS</i>
17	FG Seg CondVal	± 127
18	FG Seg DestSeg	0-7 segment number
	...	8 funcgen segments (6 parms each)
61	Z Preset	-1 = None, 0-MAX PRESET
62	Z Volume	0-127
63	Z Pan	± 14
64	Z Low Key	0-127 MIDI key number
65	Z High Key	0-127 MIDI key number
66	Z Low Vel	0-127
67	Z High Vel	0-127
68	Z Vel Offset	± 126
69	Z Xpose	± 36 keys
70	Z Coarse Tune	± 36 semitones
71	Z Fine Tune	± 64 semitones/64
Z = zone	...	16 zones (11 parms each)
	cs	Checksum
	F7	End of SysEx Status

THE PARAMETERS LABELED WITH (Z) EQUATE TO ZONE 1. ZONES 2-16 BEGIN AT PARAMETER NUMBER 72.

Midimap Request

Request midimap. Request for card midimaps will be ignored if card is not present. Midimap numbers: 0-15 RAM, 16-31 CARD the scratch map is accessed by requesting MASTER settings or individual parameter requests. Values 0x0400 + bank number represent request for banks. (Banks are blocks of 16 Midimaps.)

F0	SysEx Status Byte
18	E-mu Mfg. ID
0C	UltraProteus Product ID
dd	Device ID 0-15
46	Command ID
ml	ls byte Midimap Number
mb	ms byte Midimap Number
F7	End of SysEx Status

Midimap Data

Version 01 of the midimap follows. If map is sent to current selected location, the scratch map will be loaded from the newly stored map. Midimap numbers: 0-15 RAM, 16-31 CARD

F0	SysEx Status Byte
18	E-mu Mfg. ID
0C	UltraProteus Product ID
dd	Device ID 0-15
47	Command ID
vv	Data Version
ll	Midimap Number ls byte
mm	Midimap Number ms byte

Offset	Name	Range
0	Midimap Name	12 chars, ASCII 32-127
12	Ch. Program	See <i>PROGRAM NUMBERS</i>
13	Ch. Bank	0-4, See <i>PROG. NUMBERS</i> for bank #s
14	Ch. Volume	0-127
15	Ch. Pan	± 7, -8 = Preset
16	Ch. Mix Bus	-1 = preset, 0-3 Main, Sub1, FxA, FxB
17	Ch. Enable	0-1, Off, On
18	Ch. ProgChg Enbl	0-1, Off, On
19	Ch. BankChg Enbl	0-1, Off, On
20	Ch. VolCtl Enbl	0-1, Off, On
21	Ch. PanCtl Enbl	0-1, Off, On
22	Ch. PWhl Enbl	0-1, Off, On
23	Ch. MPress Enbl	0-1, Off, On
24	Ch. PPress Enbl	0-1, Off, On
25	Ch. Ctl. A Enbl	0-1, Off, On
26	Ch. Ctl. B Enbl	0-1, Off, On
27	Ch. Ctl. C Enbl	0-1, Off, On
28	Ch. Ctl. D Enbl	0-1, Off, On
29	Ch. Ftsw. 1 Enbl	0-1, Off, On
30	Ch. Ftsw. 2 Enbl	0-1, Off, On
31	Ch. Ftsw. 3 Enbl	0-1, Off, On
...		for 16 channels (20 parms each)
332	Prog Map	-1 for None, 0-3
333	FX A Type	See <i>EFFECTS TYPES</i>
334	FX A Parm Vals	See <i>EFFECTS TYPES</i>

Offset	Name	Range
...		10 parm values
344	FX B Type	See <i>EFFECTS TYPES</i> chart
345	FX B Parm Vals	See <i>EFFECTS TYPES</i> chart
...		10 parm values
355	FX A Amt	0-100%
356	FX B Amt	0-100%
357	B->A Amt	0-100%, 101 = B->A Only
358	FX A Bus	0-2, Main, Sub1, Sub2
359	FX B Bus	0-2, Main, Sub1, Sub2
	cs	Checksum
F7	End of SysEx Status	

Parameter Request

Request a parameter value. An unknown parameter number will respond with a value of zero. Individual parameter editing uses a unique parm number for each editable parm. See *PARAMETER NUMBERS* chart for a listing of the parameters.

F0	SysEx Status Byte
18	E-mu Mfg. ID
0C	UltraProteus Product ID
dd	Device ID 0-15
02	Command ID
pl	Parm Number ls byte
pm	Parm Number ms byte
F7	End of SysEx Status

Parameter Data

The format of a parameter value request response is as follows. This is the format used to edit an individual parameter.

F0	SysEx Status Byte
18	E-mu Mfg. ID
0C	UltraProteus Product ID
dd	Device ID 0-15
03	Command ID
pl	Parm Number ls byte
pm	Parm Number ms byte
vl	Parm Value ls byte
vm	Parm Value ms byte
F7	End of SysEx Status

Tuning Table Request

F0	SysEx Status Byte
18	E-mu Mfg. ID
0C	UltraProteus Product ID
dd	Device ID 0-15
04	Command ID
bb	Table Number, 0 - MAX TUNETABLE
F7	End of SysEx Status

Tuning Table Data

F0	SysEx Status Byte
18	E-mu Mfg. ID
0C	UltraProteus Product ID
dd	Device ID 0-15
05	Command ID
bb	Table Number (only 1 table in UltraProteus)
ll	ls byte of Tune Value
mm	ms byte of Tune Value
...	128 total entries
F7	End of SysEx Status

Program Map Request

F0	SysEx Status Byte
18	E-mu Mfg. ID
0C	UltraProteus Product ID
dd	Device ID 0-15
06	Command ID
bb	Map Number, 0-3
F7	End of SysEx Status

Program Map Data

F0	SysEx Status Byte
18	E-mu Mfg. ID
0C	UltraProteus Product ID
dd	Device ID 0-15
07	Command ID
bb	Map Number, 0-3
ll	ls byte of Program Number
mm	ms byte of Program Number
...	128 total entries
F7	End of SysEx Status

Master Settings Request

F0	SysEx Status Byte
18	E-mu Mfg. ID
0C	UltraProteus Product ID
dd	Device ID 0-15
08	Command ID
F7	End of SysEx Status

Master Settings Data

A master settings request responds with streams of parmnumber/parmvalue pairs in running status mode. Two separate dumps are sent: first global parms, then scratch midimap parms.

F0	SysEx Status Byte
18	E-mu Mfg. ID
0C	UltraProteus Product ID
dd	Device ID 0-15
03	Command ID
pl	lsb Parm Number
pm	msb Parm Number
vl	lsb Parm Value
vm	msb Parm Value
...	Global Parms
F7	End of SysEx Status

then...	
F0	SysEx Status Byte
18	E-mu Mfg. ID
0C	UltraProteus Product ID
dd	Device ID 0-15
03	Command ID
pl	lsb Parm Number
pm	msb Parm Number
vl	lsb Parm Value
vm	msb Parm Value
...	Scratch Midimap Params
F7	End of SysEx Status

Version Request

Use this command to determine the model (version code) and the software revision. Different models and revisions may have more or less features, so use the command to verify what machine is being controlled.

F0	SysEx Status Byte
18	E-mu Mfg. ID
0C	UltraProteus Product ID
dd	Device ID 0-15
0A	Command ID
F7	End of SysEx Status

Version Data

F0	SysEx Status Byte
18	E-mu Mfg. ID
0C	UltraProteus Product ID
dd	Device ID 0-15
0B	Command ID
02	Version Code for UltraProteus
r1	Revision x.xx (i.e. 1.00)
r2	
r2	
F7	End of SysEx Status

Configuration Request

Use this command to get configuration information. Note that much of the information is dynamic (e.g. if RAM card is installed or not) and therefore the information is only valid for some window of time. This command can be used to determine if a card is presently installed.

F0	SysEx Status Byte
18	E-mu Mfg. ID
0C	UltraProteus Product ID
dd	Device ID 0-15
0C	Command ID
F7	End of SysEx Status

Configuration Data

See the Request Command Description for information regarding the validity of this information.

F0	SysEx Status Byte
18	E-mu Mfg. ID
0C	UltraProteus Product ID
dd	Device ID 0-15
0D	Command ID
pl	lsb Number of Presets
pm	msb Number of Presets
s1	Sound Set Rank A
sl	lsb Number of Insts Rank A
sm	msb Number of Insts Rank A
s2	Sound Set Rank B
sl	lsb Number of Insts Rank B
sm	msb Number of Insts Rank B
hl	lsb Number of Hyperpresets
hm	msb Number of Hyperpresets
hl	lsb Number of Filters
hm	msb Number of Filters
ml	lsb Number of Midimaps
mm	msb Number of Midimaps
el	lsb Number of A Effects
em	msb Number of A Effects
el	lsb Number of B Effects
em	msb Number of B Effects
F7	End of SysEx Status

Instrument List Request

Request list of available instruments. *See data message for format of response.*

F0	SysEx Status Byte
18	E-mu Mfg. ID
0C	UltraProteus Product ID
dd	Device ID 0-15
0E	Command ID
F7	End of SysEx Status

Instrument List Data

List of currently available instruments and their ids in the order they appear in the box. *See INSTRUMENT NUMBERS for a description of the instrument number.*

F0	SysEx Status Byte
18	E-mu Mfg. ID
0C	UltraProteus Product ID
dd	Device ID 0-15
0F	Command ID
nl	lsb Number of Instruments
nm	msb Number of Instruments
il	lsb Instrument Number
im	msb Instrument Number
nn	Instrument Name
...	11 ASCII Chars per Instrument
00	String Null Terminator
...	for number of instruments
F7	End of SysEx Status

Filter List Request

Request list of available filters. *See data message for format of response.*

F0	SysEx Status Byte
18	E-mu Mfg. ID
0C	UltraProteus Product ID
dd	Device ID 0-15
56	Command ID
F7	End of SysEx Status

Filter List Data

List of currently available filters and their ids in the order they appear in the box. See *FILTER TYPES* for information regarding interpretation of this data.

F0	SysEx StatusByte
18	E-mu Mfg. ID
0C	UltraProteus Product ID
dd	Device ID 0-15
57	Command ID
nl	lsb Number of Filters
nm	msb Number of Filters
il	lsb Filter Number
im	msb Filter Number
nn	Filter Name
...	11 ASCII chars per instrument
00	String Null Terminator
tl	lsb of Transform Number
tm	msb of Transform Number
...	for number of filters
F7	End of SysEx Status

Preset List Request

Request list of available presets. See *data message for format*.

F0	SysEx Status Byte
18	E-mu Mfg. ID
0C	UltraProteus Product ID
dd	Device ID 0-15
12	Command ID
F7	End of SysEx Status

Preset List Data

List of currently available presets in the order they appear in UltraProteus.

F0	SysEx Status Byte
18	E-mu Mfg. ID
0C	UltraProteus Product ID
dd	Device ID 0-15
0F	Command ID
nl	lsb Number of Presets
nm	msb Number of Presets
nn	Preset Name
...	12 ASCII chars per instrument
00	String Null Terminator
...	for number of presets
F7	End of SysEx Status

Hyperpreset List Request

Request list of available Hypers. *See data message for format of response.*

F0	SysEx Status Byte
18	E-mu Mfg. ID
0C	UltraProteus Product ID
dd	Device ID 0-15
50	Command ID
F7	End of SysEx Status

Hyperpreset List Data

Currently available Hypers in the order they appear in UltraProteus.

F0	SysEx Status Byte
18	E-mu Mfg. ID
0C	UltraProteus Product ID
dd	Device ID 0-15
51	Command ID
nl	lsb Number of Hyperpresets
nm	msb Number of Hyperpresets
nn	Hyperpreset Name
...	12 ASCII Chars per Hyperpreset
00	String Null Terminator
...	for number of Hyperpresets
F7	End of SysEx Status

Midimap List Request

Request list of available midimaps. *See the data message for the format of the response.*

F0	SysEx Status Byte
18	E-mu Mfg. ID
0C	UltraProteus Product ID
dd	Device ID 0-15
52	Command ID
F7	End of SysEx Status

Midimap List Data

List of currently available midimaps in the order as they appear in UltraProteus.

F0	SysEx Status Byte
18	E-mu Mfg. ID
0C	UltraProteus Product ID
dd	Device ID 0-15
53	Command ID
nl	lsb Number of Midimaps
nm	msb Number of Midimaps
nn	Midimap Name
...	12 ASCII Chars per Midimap
00	String Null Terminator
...	for number of Midimap
F7	End of SysEx Status

Effect List Request

Request list of available effects. *See the data message for the format of the response.*

F0	SysEx Status Byte
18	E-mu Mfg. ID
0C	UltraProteus Product ID
dd	Device ID 0-15
54	Command ID
F7	End of SysEx Status

Effect List Data

List of currently available effects and their IDs in the order they appear in the box. See *EFFECT TYPES* for information regarding the interpretation of this data.

F0	SysEx Status Byte
18	E-mu Mfg. ID
0C	UltraProteus Product ID
dd	Device ID 0-15
55	Command ID
nl	lsb Number of A Effects
nm	msb Number of A Effects
il	lsb Effect ID
im	msb Effect ID
nn	Effect Name
...	12 ASCII Chars per Effect
00	String Null Terminator
pl	lsb Effect Number of Params
pm	msb Effect Number of Params
nn	Effect Parm Name
...	11 ASCII Chars per Effect Parm
00	String Null Terminator
vl	lsb Parm Min Value
vm	msb Parm Min Value
vl	lsb Parm Max Value
vm	msb Parm Max Value
vl	lsb Parm Default Value
vm	msb Parm Default Value
...	for number of params for each effect
nl	lsb Number of B Effects
nm	msb Number of B Effects
...	same format as for A Effect List
F7	End of SysEx Status

Write Buffer Command

Use this command to save the edit buffer into a specified location. It is equivalent to the SAVE TO screen in each of the edit menus. Note that there are a lot of factors that determine what the “scratch” preset or stack is, especially if you are editing from the front panel also. You can use a PARAMETER request to determine what the current edit buffer number is for each of the types.

F0	SysEx Status byte
18	E-mu Mfg. ID
0C	UltraProteus Product ID
dd	Device ID (0-15)
22	Command ID
dd	Buffer type 0 = Preset, 1 = Stack, 2 = Midimap
Dest number	0 - MAX for each type
F7	End of SysEx Status

Parameter Numbers

Additional parameter numbers:

320	current midimap	0-MAXMAP
321	scratch preset	0-MAXPRESET
322	scratch stack	0-MAXSTACK

MISCELLANEOUS DOCUMENTATION**Patchcord Sources**

The MIDI patchcord sources are unique across all Proteus type products. The Note-On patchcords, valid for UltraProteus, are as follows:

MIDI Value	Description
0	Key
1	Velocity
2	Pitchwheel
3	Control A
4	Control B
5	Control C
6	Control D
7	Mono Pressure
8	Free-run Function Generator

The realtime patchcord sources, valid for UltraProteus, are as follows:

MIDI Value	Description
0	Pitchwheel
1	Control A
2	Control B
3	Control C
4	Control D
5	Mono Pressure
6	Poly Pressure
7	LFO 1
8	LFO 2
9	Auxiliary Envelope
10	Function Generator 1
11	Function Generator 2
12	Free-run Function Generator

Patchcord Destinations

The MIDI patchcord destination numbers are unique across all Proteus type products. Note-on and realtime numbers are shared. The chart shows whether a cord is available to note-on (NO) realtime (RT) or both. The patchcord destinations available to UltraProteus are as follows:

MIDI Value	Description	NO/RT Availability
0	Off	RT/NO
1	Pitch	RT/NO
2	PitchP	RT/NO
3	PitchS	RT/NO
4	Volume	RT/NO
5	VolumeP	RT/NO
6	VolumeS	RT/NO
7	Attack	RT/NO
8	AttackP	RT/NO
9	AttackS	RT/NO
10	Decay	RT/NO
11	DecayP	RT/NO
12	DecayS	RT/NO
13	Release	RT/NO
14	RelP	RT/NO
15	RelS	RT/NO
16	XFade	RT/NO
17	Lfo1Amt	RT/NO
18	Lfo1Rt	RT/NO
19	Lfo2Amt	RT/NO
20	Lfo2Rt	RT/NO
21	AuxAmt	RT/NO
22	AuxAtt	RT/NO
23	AuxDec	RT/NO
24	AuxRel	RT/NO
25	Start	NO
26	StartP	NO
27	StartS	NO
28	Pan	RT/NO
29	PanP	RT/NO
30	PanS	RT/NO
31	Tone	NO

MIDI Value	Description	NO/RT Availability
32	ToneP	NO
33	ToneS	NO
34	Morph	RT/NO
35	MorphP	RT/NO
36	MorphS	RT/NO
37	Trans2	NO
38	Trans2P	NO
39	Trans2S	NO
40	PortRt	RT/NO
41	PortRtP	RT/NO
42	PortRtS	RT/NO
43	FG1Amt	RT/NO
44	FG2Amt	RT/NO
45	FltLev	NO
46	FltLevP	NO
47	FltLevS	NO
48	FreqTrk	NO
49	FreqTrkP	NO
50	FreqTrkS	NO

Function Generator Shapes

The function generator shapes are as follows:

MIDI Value	Shape Name	MIDI Value	Shape Name
0	Linear	12	Squeeze
1	Expo+1	13	FastLn1
2	Expo+2	14	FastLn2
3	Expo+3	15	FastLn3
4	Expo+4	16	MedLn1
5	Expo+5	17	MedLn2
6	Expo+6	18	SlwRmp1
7	Expo+7	19	SlwRmp2
8	Circ1.4	20	Bloom
9	Circ1.6	21	Bloom2
10	Circ1.8	22	Cr1.16R
11	Cir1.16	23	Cir1.8R

MIDI Value	Shape Name	MIDI Value	Shape Name
24	Cir1.6R	43	Chaos50
25	Cir1.4R	44	Chaos66
26	SlwCrv1	45	Chaos75
27	SlwCrv2	46	Chaos95
28	DelayDC	47	Chaos99
29	DCdelay	48	LnShfl
30	Curve2X	49	LnShfl2
31	Curv2XB	50	RandomA
32	Curv2XC	51	RandomB
33	ZizZag1	52	RandomC
34	ZizZag2	53	RandomD
35	ZizZag3	54	RandomE
36	Chaos03	55	RandomF
37	Chaos06	56	RandomG
38	Chaos12	57	RandomH
39	Chaos16	58	RandomI
40	Chaos25	59	RandomJ
41	Chaos33	60	RandomK
42	Chaos37	61	RandomL
		62	RandomZ

Function Generator Conditions

The function generator condition values are shared between preset funcgens and hyper funcgens, though some values are excluded in the hyper func gen. The chart shows the numbers and the availability.

MIDI Value	Description	Availability
0	Never	Preset, Hyperpreset
1	AlwaysEnd	Preset, Hyperpreset
2	NoteOnEnd	Preset, Hyperpreset
3	NoteOnImm	Preset, Hyperpreset
4	NoteOffEnd	Preset, Hyperpreset
5	NoteOffImm	Preset, Hyperpreset
6	LFO1End	Preset
7	LFO2End	Preset
8	Footswitch1End	Preset, Hyperpreset
9	Footswitch1Imm	Preset, Hyperpreset

MIDI Value	Description	Availability
10	Footswitch2End	Preset, Hyperpreset
11	Footswitch2Imm	Preset, Hyperpreset
12	Footswitch3End	Preset, Hyperpreset
13	Footswitch3Imm	Preset, Hyperpreset
14	VelocityEnd	Preset
15	KeyEnd	Preset

Function Generator Levels

The funcgen level parm value is comprised of two bitfields.

$$\text{Funcgen Level} = (\text{levelType} \ll 8) + \text{levelValue}$$

bits 8-13 = level type, 0-3

bits 0-7 = level value, +-127

The level types are defined as follows:

MIDI Value	Description
0	absolute level
1	delta level
2	random absolute level
3	random delta level

Filter Types

Use the FILTER LIST command to get a list of the currently available filter names, ids and transform number. the filter type number sent via sysex are unique ids. (they are not the index into the screens) The transform number is used to determine the active parms for that filter. The number of parms active for any filter is determined by the number of frames in the filter.

Number of Frames	Active Parm
2	Morph
4	Morph, Frequency Track
6	Morph, Frequency Track, Transform 2
8	Morph, Frequency Track, Transform 2

Transform	Filter Type
0	2 frame filter
1	4 frame “square” filter
2	6 frame “phantom cube” filter
3	8 frame “cube” filter
4	unused
5	4 frame “square” filter, gain reduced

Effect Types

Use the EFFECT LIST command to get a list of the currently available EFFECTS and their IDs. The effect type number sent via SysEx are unique IDs. (they are not the index into the screens). Note that the A and B effect IDs do not overlap. e.g. the A effect StereoFlange does not have the same ID as the B effect StereoFlange.

Parameter Numbers

The following parameter numbers are in decimal.

Parm Number	Parm Description	Range
0-128	Proteus Preset Parm	
256	Basic Channel	0-15
257	Channel Volume	0-127
258	Channel Pan	± 7 , -8 = P
259	Current Program	0-MAXPROGRAM
260	Master Tune	± 64 Semitones
261	Master X-pose	± 12 Midi Keys (semitones)
262	Global Bend	0-12 \pm Semitones
263	Global Velcurve	0-8, 0 = Off
264	Midi Mode	0-3, Omni, Poly, Multi, Mono
265	Unused	
266	Control A	0-31
267	Control B	0-31
268	Control C	0-31
269	Control D	0-31
270	Footswitch 1	64-79
271	Footswitch 2	64-79
272	Footswitch 3	64-79
273	Midi Modechange Enable	0-1, Disabled, Enabled

Parm Number	Parm Description	Range
274	SysEx Device ID	0-15
...	Unused	
320	Current Midimap	0-MAXMAP
...	Unused	
323	Auto Select	0-1, Off, On
324	Packet Delay	0-999 (approx. 600 μSecs/unit)
325	Proteus SysEx	0-1, Off, On
326	Compare Mode	0-1, Off, On
..	Unused	
2048-2407	Midimap Vers. 1 Parm	<i>See MIDIMAP DATA</i>
8192-8469	Preset Vers. 1 Parm	<i>See PRESET DATA</i>
8704-8940	Hyper Vers. 1 Parm	<i>See HYPERPRESET DATA</i>

Instrument Numbers

Use the INSTRUMENT LIST commands to get a list of the IDs and names as they appear in the box. Instrument numbers are comprised of two bitfields. (romset<<8) + index.

bits 8-13 = romset number.

bits 0-7 is an index into the romset.

The UltraProteus contains romsets number 9 & 10. Instrument numbers start at **2304** for romset 9 and **2560** for romset 10.

Program Numbers

The mapping of program numbers for preset changes and midimap program number editing is as follows:

MIDI Bank	Program Numbers	Program Type
0	0-127	RAM Presets
1	128-255	ROM Presets
2	256-383	RAM Hypers
3	383-511	Card Presets
4	512-639	Card Hypers

14-BIT SIGNED 2'S COMPLEMENT NUMBERS

If the data value is negative, you must first take the 2's complement of the number: In the case of a 14-bit number this is equivalent to adding 16384 to the original negative value.

To fit the 7-bit MIDI protocol, numbers must be “nibble-ized”.

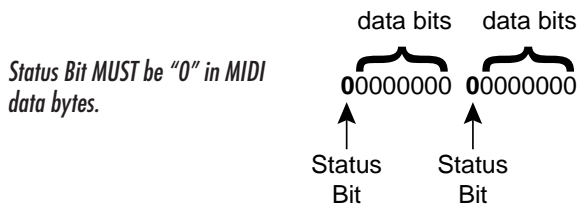

To get the 14-bit nibble-ized value (of a positive value or a 2's complemented negative value):

$$\begin{aligned} \text{msb} &= \text{value DIV } 128 \text{ (divide and ignore the remainder)} \\ \text{lsb} &= \text{value MOD } 128 \text{ (divide and use only the remainder)} \end{aligned}$$

To go the other way (convert 14 bit signed 2's complement to a signed real number)

$$\begin{aligned} \text{raw Value} &= (\text{msb} * 128) + \text{lsb} \quad \text{(gives you the unsigned raw value) if} \\ \text{raw Value} &\geq 8192 \quad (8192 = 2^{13}) \\ \text{then signed Value} &= \text{raw value} - 16384 \quad (16384 = 2^{14}) \end{aligned}$$

Example: To find the “nibble-ized” Hex value of -127:

- 1) $-127 + 16384 = \mathbf{16257}$
- 2) $16257 \div 128 = \mathbf{127 \text{ r}1}$
- 3) 127 in Hex = **7F** = msb
- 4) 1 in Hex = **01** = lsb
- 5) Parameter value would be transmitted as **01 7F**

Example: To find the “nibble-ized” Hex value of parameter number 257:

- 1) $257 \div 128 = \mathbf{2 \text{ r}1}$
- 2) 2 in Hex = **02** = msb
- 3) 1 in Hex = **01** = lsb
- 4) Parameter number would be transmitted as **01 02**

SEE MIDI MODE IN THE MASTER MENU FOR ADDITIONAL INFORMATION ON DEVICE ID.

IN ALL OF THESE EXAMPLES, THE PROCESS OF HEXADECIMAL CONVERSION HAS BEEN OMITTED. USE A TABLE OR A HEX CALCULATOR TO CONVERT DECIMAL NUMBERS TO HEXADECIMAL.

HOW TO EDIT AN INDIVIDUAL PRESET PARAMETER

Parameter data editing is accomplished using the format described on page 259.

F0	System Exclusive Status Byte
18	E-mu Mfg. ID
0C	Ultra Product ID Byte
dd	Device ID 0-15 (<i>usually 00</i>)
03	Command ID - Parameter Data (<i>from Command Summary</i>)
pl	Parameter Number ls byte
pm	Parameter Number ms byte
vl	Parameter Value ls byte
vm	Parameter Value ms byte
F7	EOX

Example: Change the waveshape of LFO 1 to Random.

- 1) Find the command ID for the operation you wish to perform from the Command Summary on page 252 (03 = Parameter Data).
- 2) Next, we need to find the preset parameter number for LFO 1 waveshape in Hexadecimal. This will be the Parameter Number portion of the message.
The preset parameter numbers shown on pages 254-256 must be added to the base offsets in order to get the actual parameter number.
- 3) The preset parameter list shows LFO 1 waveshape as 93 (*page 254*). The base offset number for preset parameters is 8192 (*page 276*). Add these numbers to get the actual parameter number. $8192 + 93 = 8285$.
- 4) Now the parameter number must be converted into 14-bit 2's complement in order to fit into the MIDI format. The instructions are given on the previous page, but we will go through the process again.
 - a) $8285 \div 128 = \mathbf{64\ r93}$
 - b) 64 in Hex = **40** = msb
 - c) 93 in Hex = **5D** = lsb
- 5) The least significant byte is always sent first. The MIDI SysEx string now looks like this: **F0 18 0C 00 03 5D 40 XX XX F7**. We're still missing the value data to select the desired waveform.
- 6) From the table on page 254 you can find out that "0" corresponds to the random wave. Zero is the easiest number to convert. 0 in 14-bit 2's complement is still 0, or more strictly speaking 00 00.
- 7) The completed message is: **F0 18 0C 00 03 5D 40 00 00 F7**.
- 8) If we wanted to change the waveform to Square, the message would be: **F0 18 0C 00 03 5D 40 04 00 F7**. Substitute **04 00** for 00 00 in the data bytes (*lsb first*).

HOW TO EDIT A GLOBAL PARAMETER

Parameter data editing is accomplished using the format described on page 259.

F0	System Exclusive Status Byte
18	E-mu Mfg. ID
0C	Ultra Product ID Byte
dd	Device ID 0-15 (<i>usually 00</i>)
03	Command ID - Parameter Data (<i>from Command Summary</i>)
pl	Parameter Number ls byte
pm	Parameter Number ms byte
vl	Parameter Value ls byte
vm	Parameter Value ms byte
F7	EOX

Example: Change the Pan value of the Basic channel to “P”.

- 1) We need to find the preset parameter number for Channel Pan in Hexadecimal. This will be the Parameter Number portion of the message.

The Channel Pan parameter is found on page 275. This is the actual number and not an offset, so we only need to convert it to 14-bit 2's complement. The parameter number for Channel Pan = 258.

- a) $258 \div 128 = 2 \text{ r}2$
 - b) 2 in Hex = **02** = msb
 - c) 2 in Hex = **02** = lsb
- 2) The least significant byte is always sent first. The MIDI SysEx string now looks like this: **F0 18 0C 00 03 02 02 XX XX F7**. We're still missing the value data to select the pan position.
 - 3) From the table on page 275 you can find out that “-8” corresponds to Preset Pan. For negative numbers, add 16384 to the original negative value.
16384 - 8 = 16376 (*page 277*).
 - 4) Next we convert this number into “nibblized” Hex form.
 - a) $16376 \div 128 = 127 \text{ r}120$
 - b) 127 in Hex = **7F** = msb
 - c) 120 in Hex = **78** = lsb
 - 5) The completed message is: **F0 18 0C 00 03 02 02 78 7F F7**.

One More

If we wanted to change the Basic Channel to 5, the message would be:

F0 18 0C 00 03 00 02 04 00 F7. Basic Channel is two parameters before Pan in the list, Subtract 2 from the Parameter Number ($02\ 02 - 2 = 00\ 02$). MIDI channels begin at 00; therefore channel 5 would be 4. Convert 4 into Hex = **04**. (LSB first = 04 00.)

SEE MIDI MODE IN THE MASTER MENU FOR ADDITIONAL INFORMATION ON DEVICE ID.

NOTE: CHANGING BASIC CHANNEL PAN IS THE SAME AS CHANGING MIDIMAP PAN.

IN ALL OF THESE EXAMPLES, THE PROCESS OF HEXADECIMAL CONVERSION HAS BEEN OMITTED. USE A TABLE OR A HEX CALCULATOR TO CONVERT DECIMAL NUMBERS TO HEXADECIMAL.

HOW TO EDIT A MIDIMAP PARAMETER

We'll offer one more example by popular request. Editing a Midimap is just another type of parameter data editing. The number given for the parameters is an OFFSET which will be added to the base number for MidiMap given on page 276. The format for parameter editing is the same as always.

F0	System Exclusive Status Byte
18	E-mu Mfg. ID
0C	Ultra Product ID Byte
dd	Device ID 0-15 (<i>usually 00</i>)
03	Command ID - Parameter Data (<i>from Command Summary</i>)
pl	Parameter Number ls byte
pm	Parameter Number ms byte
vl	Parameter Value ls byte
vm	Parameter Value ms byte
F7	EOX

Example: Change the Amount of FX A to 50%.

- 1) Find the command ID for the operation you wish to perform from the Command Summary on page 252 (03 = Parameter Data).
- 2) Next, we need to find the Midimap parameter number for FXA Amount in Hexadecimal. This will be the Parameter Number portion of the message.
The Midimap offset numbers shown on pages 258-259 must be added to the base offset in order to get the actual parameter number.
- 3) The Midimap parameter list shows FXA Amount as 355 (*page 259*). The base offset number for Midimap parameters is 2048 (*page 276*). Add these numbers to get the actual parameter number. $2048 + 355 = 2403$.
- 4) Now the parameter number must be converted into 14-bit 2's complement in order to fit into the MIDI format. The instructions are given on the previous page, but we will go through the process again.
 - a) $2403 \div 128 = \mathbf{18\ r99}$
 - b) 18 in Hex = **12** = msb
 - c) 99 in Hex = **63** = lsb
- 5) The least significant byte is always sent first. The MIDI SysEx string now looks like this: **F0 18 0C 00 03 63 12 XX XX F7**. We're still missing the value data to set the Amount.
- 6) From the table on page 259 we see that the FXA Amount range is 0-100%. Simply send the desired amount in Hexadecimal. **50** in Hex = **32**, or **00 32**.
- 7) The completed message is (*lsb first*): **F0 18 0C 00 03 63 12 32 00 F7**.

A

"A" effects list 42
 A-B-C-D controllers 24, 97-98, 122-124
 About sampling 9
 Aftertouch 71
 Alternate volume envelope 73, 105, 143
 Attack 73, 144
 Audio outputs 5, 6
 Auto select 26
 Auxiliary envelope 73, 116

B

"B" effects list 53
 B3 waves 167
 Bandpass filter 85
 Bank select 33
 Basic channel 22
 Basic operation 11
 Basic setup 5

C

Card slot 12
 Chamber reverb 43, 44
 Channel -> Preset/Hyper 31
 Channel pan 14
 Channel volume 14
 Chorus 49
 Compare 26, 59, 101
 Conditional jump 120
 Connections 5-8
 Continuous controller 97
 Contour See Envelope Generator
 Controller ABCD 24, 71
 Copy 131
 Copy button 13
 Cross delay 53
 Cross-switch 111
 Cross-switch point 113
 Crossfade 111
 Crossfade amount 112
 Crossfade balance 112
 Crossfade direction 112
 Crossfade mode 111
 Cursor 13

D

Data entry control 13
 DCA 93
 Decay 73, 144
 Delay 50, 53 73
 Demo sequence select 13
 Demo sequences 16
 Dimensions: 248
 Diphthong filters 182
 Distortion effect 54
 Distortion filters 214, 233
 Double + Detune 106, 144
 Drawbar diagrams 169
 Drum priority 110

E

Early reflection 43
 Editing presets 69, 139
 Effects 37
 Effect bus architecture 40
 Effect processor A 34
 Effect processor B 35
 Effect returns 8
 Effects location 39
 Effect output routing 40
 Effect programming 41
 Envelope 143, 144
 Envelope generator 71, 73
 Envelope time chart 247
 Equal tuning 126

F

Factory presets 162-163
 RAM presets 162
 ROM presets 163
 Feedback 47
 Filter 84-92, 113, 154, 157
 Descriptions 178-234
 Frequency tracking 114
 Level 113, 151
 Modulation 84
 Reverse 116
 Transform 2 115
 Type 152
 Fine pitch tuning 105
 First note priority 110
 Flanger 46
 Flange filters 178



F (cont)

- Footswitch 72
- Footswitch control 124
- Formant filters 222
- Free-run function generator 64, 65, 81
- Frequency tracking 114, 151
- Function generator 71, 76, 118
 - Conditional jumps 66, 77
 - Delta level 79
 - Random delta 81
 - Random level 79
 - Time chart 247
 - Amount 121
 - Curves 239-246
- Fuzz 54
- Fuzz lite 54
- FX A 34
- FX amount 35
- FX B 35
- FX output select 36

G

- Gamelan tuning 126
- Glide See Portamento
- Global velocity curve 20

H

- Hall 43, 44
- Harmonic shift filters 219
- Harmonic waveforms 168
- Headphones 5
- High note priority 110
- High pass filter 85
- Hold 73, 144
- Home/Enter 13
- Hyperpreset 4, 59
 - Portamento mode 64
 - Preset to zone assignment 60
 - Zone key range 61
 - Zone pan 61
 - Zone pitch tune 63
 - Zone transpose 63
 - Zone velocity offset 63
 - Zone velocity range 62
 - Zone volume 61
- Hyperpreset menu select button 12
- Hyperpreset name 60

I

- ID number 22
- Instruments 4, 93, 140, 164-170

J

- Just C tuning 126

K

- Key number 96
- Key range 61, 103
- Key velocity 71
- Keyboard center 126
- Keyboard key 71
- Keyboard pressure 71
- Keyboard tuning 126

L

- Last note priority 110
- Layered keyboard 104
- LFO 47, 75, 117, 147
 - Variation 117
 - Waves 75
- Loop enable 108
- Loop offset 108
- Loop size 108
- Loop start 108
- Loop offset sample locations 235-238
- Low frequency oscillator 71, 75
- Low note priority 110
- Low pass filters 185
- Low pass filter, descr. 85

M

- Main controls 12, 13
- Master 19, 20
- Master menu select button 12
- Master tune 19
- Master menu 17, 57, 129
- Memory card 15
- MIDI
 - MIDI basic channel 22
 - MIDI activity LED 13
 - MIDI basic channel 22
 - MIDI channel selection 14
 - MIDI controller amount 124
 - MIDI controller assign 24
 - MIDI enables 32
 - MIDI footswitch control 24

M (cont)

- MIDI implementation chart* 249
- MIDI in* 5, 6, 7
- MIDI mode* 22
- MIDI mode change* 22
- MIDI modes* 22
- MIDI out* 6
- MIDI program change map* 23
- MIDI realtime controls* 97
- MIDI specifications* 249-280
- MIDI sysex tutorial* 277-280
- MIDI sysex packet delay* 25
- Midimap* 29
 - Midimap pan* 31
 - Midimap volume* 31
- Menu select button* 12
- Name* 31
 - Select* 15, 30
- Midipatch* 72, 97
- Mix select* 127
- Modulation* 70
- Modulation sources* 71, 95, 123
- Mono mode* 22
- Morph* 89-92, 114, 151
- Morph offset* 114, 151
- Multi mode* 22
- Multi-timbral operation* 16

N

- Nontranspose* 108
- Notch filters* 185
- Notch filter, descr.* 86
- Note-on modulation control* 71, 94, 122

O

- Organ waveforms* 171
- Omni mode* 22
- Only, effect mode* 35
- Output impedance:* 248
- Output level:* 214
- Output mix* 31

P

- Pan* 61, 93
- Parametric filters* 87, 217
- Percussion instrument locations* 173-177
- Percussion instruments* 166-167
- Performance setup* 7

- Phaser* 48
- Pitch tune* 63
- Pitch wheel* 124
- Pitch bend range* 124
- Pitch wheel* 71
- Plates, reverb* 43
- Poles* 86
- Poly mode* 22
- Polyphonic key pressure* 71
- Portamento* 110
- Portamento mode* 64, 111
- Portamento rate* 110
- Portamento shape* 110
- Power* 8
- Power requirements:* 248
- Power switch* 13
- Preset* 4
- Preset menu* 101
- Preset menu select button* 12
- Preset name* 102
- Presets* 160
- Pressure amount* 124
- Primary alternate envelope* 106
- Primary key range* 104
- Primary filter type* 113
- Primary instrument* 102
- Program map select* 34
- Program selection* 14
- Programming basics* 67
- Proteus sysex* 26

Q

- Q* 86

R

- Rain effect* 43
- Random LFO wave* 75
- Realtime control* 97
- Realtime modulation* 71, 95, 123, 149
- Reference section* 161
- Release* 73, 144
- Reverb* 42, 43
- Reverse sound* 107
- Ring modulator* 55

S

Sample rate 248
Sampled sounds listing 164
Sampling 9
Save 147
 Save hyperpreset 66
 Save midimap 36
 Save preset 127
Sawtooth, LFO wave 75
Secondary alternate envelope 106
Secondary filter type 113
Secondary key range 104
Secondary instrument 102
Send, MIDI data 24
Setup, UltraProteus 5
Sequencer, using UltraProteus 158-159
Shimmer effect 43
Sine, LFO wave 75
Solo mode 109
Solo mode priority 110
Sound delay 107, 145
Sound reverse 107
Sound splicing 146
Sound start 107, 145
Split keyboard 104
Square, LFO wave 75
Studio setup 6
Sub 1 & 2 8
Sustain 73, 144
Synth mode 109
Synthesizer waves 169
Sysex 24, 251-280

T

Tap level 50
Technical specifications 248
Tone 84, 93
Tone filter 84, 93
Tracking, filter freq. 90, 114
Tracking filters 216
Transform 2 152
Transpose 19, 63, 105
Tremolo 75
Triangle, LFO wave 75
Tuning
 Coarse & fine tuning 63, 105
 Tuning to other instruments 19
 User key tuning 20, 126

U

User key tuning 20

V

Vallotti tuning 126
Variable slope filters 190, 215
Variation, LFO 117
Velocity curve 96, 125
Velocity offset 63
Velocity range 62
Vibrato 75
Viewing angle 26
Vocal filters 221
Volume 61, 103, 141
Volume Control 12

W

Weight: 248
Wind mode 109

Z

Z-plane filter 84, 89, 93, 151
Z-plane filter descriptions 178-234
Zone 4, 59

110/220 8

19-tone tuning 126

Please read this warranty, as it gives you specific legal rights.

Length of Warranty

This warranty covers all defects in materials and workmanship for a period of one year from the date of purchase by the original owner, provided that the Warranty Registration Card is filled out and returned to E-mu Systems within 14 days from the date of purchase. Cases may arise where E-mu's Service Department or one of E-mu's authorized service centers will ask for a copy of your sales receipt to facilitate warranty service. Please keep your purchase receipt in a safe place.

E-mu Systems does not cover:

- Damages due to improper or inadequate maintenance, accident, abuse, misuse, alteration, unauthorized repairs, tampering, or failure to follow normal operating procedures as outlined in the owner's manual.
- Deterioration or damage of the cabinet.
- Damages occurring during any shipment of the product for any reason.
- An E-mu product that has in any way been modified by anyone other than E-mu Systems, Inc.

Limitation of Implied Warranties

No warranty is expressed or implied. E-mu Systems specifically disclaims the implied warranties of merchantability and fitness for a particular purpose.

Exclusion of Certain Damages

E-mu Systems' liability for a product found defective is limited to repair or replacement of the unit, at E-mu's option. In no event shall E-mu Systems be liable for damages based on inconvenience, whether incidental or consequential, loss of use of the unit, loss of time, interrupted operation or commercial loss, or any other consequential damages.

Some states do not allow limitation of the duration of implied warranties or the exclusion or limitation of incidental or consequential damages, so the above limitations and exclusions may not apply to you.

How To Obtain Warranty Service

All E-mu products are manufactured with the highest standards of quality. If you find that your instrument does require service, it may be done by an authorized E-mu service center. If you are unable to locate a service center in your area, please contact E-mu Systems Service Department at (408) 438-1921. They will either refer you to an authorized service center or ask that you return your instrument to the factory. When returning an instrument to the factory, you will be issued a Return Authorization number (RA). Please label all cartons, shipping documents and correspondence with this number. E-mu suggests you carefully and securely pack your instrument for return to the factory. Mark the outside of the shipping carton clearly with your RA number. Send to E-mu Systems, Inc. 1600 Green Hills Road, Scotts Valley, California, 95066. You must pre-pay shipping charges to the service location. E-mu Systems will pay return shipping fees. You will be responsible for any damage or loss sustained during shipment in any direction.

11/92

