

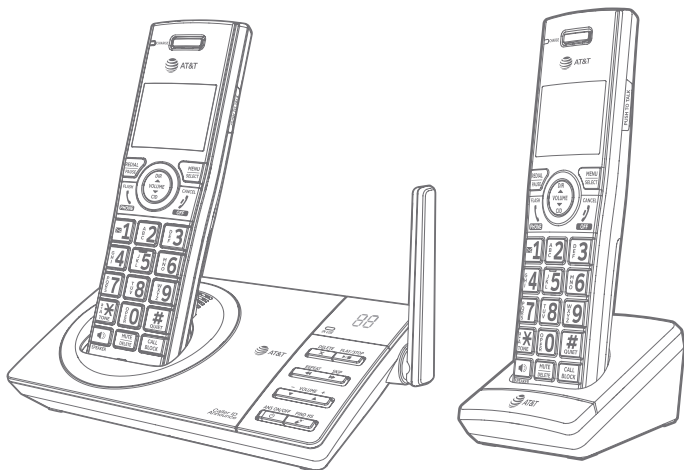

Complete user's manual

CL82107/CL82207/CL82257/CL82267/
CL82307/CL82357/CL82367/CL82407/
CL82467/CL82507/CL82547/CL82557

DECT 6.0 cordless telephone/
answering system with caller ID/
call waiting



Congratulations

on your purchase of this AT&T product. Before using this AT&T product, please read the **Important safety information** section on pages 149-151 of this manual. Please thoroughly read this user's manual for all the feature operations and troubleshooting information necessary to install and operate your new AT&T product. You can also visit our website at

<https://telephones.att.com> or call **1 (800) 222-3111**.

In Canada, dial **1 (866) 288-4268**.

This telephone meets the California Energy Commission regulations for energy consumption. Your telephone is set up to comply with the energy-conserving standards right out of the box. No further action is necessary.

This telephone system is compatible with certain AT&T DECT 6.0 cordless headsets and speakerphones. Visit

<https://telephones.att.com/accessories> for a list of compatible cordless headsets and speakerphones.

Model number: CL82107 (one handset)
CL82207/CL82257/CL82267 (two handsets)
CL82307/CL82357/CL82367 (three handsets)
CL82407/CL82467 (four handsets)
CL82507/CL82547/CL82557 (five handsets)

Type: DECT 6.0 cordless telephone/answering system with caller ID/call waiting

Serial number: _____

Purchase date: _____

Place of purchase: _____

Both the model and serial numbers of your AT&T product can be found on the bottom of the telephone base.

Save your sales receipt and original packaging in case it is necessary to return your telephone for warranty service.



Telephones identified with this logo have reduced noise and interference when used with most T-coil equipped hearing aids and cochlear implants. The TIA-1083 Compliant Logo is a trademark of the Telecommunications Industry Association. Used under license.



The ENERGY STAR® program (www.energystar.gov) recognizes and encourages the use of products that save energy and help protect our environment. We are proud to mark this product with the ENERGY STAR® label indicating it meets the latest energy efficiency guidelines.

© 2017-2020 Advanced American Telephones. All Rights Reserved. AT&T and the AT&T logo are trademarks of AT&T Intellectual Property licensed to Advanced American Telephones, San Antonio, TX 78219. Printed in China.

Parts checklist

Your telephone package contains the following items. Save your sales receipt and original packaging in the event warranty service is necessary.

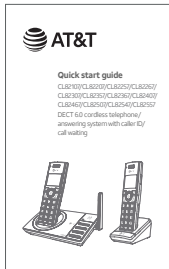

Quick start guide



Smart call blocker leaflet

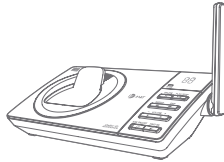

Telephone base

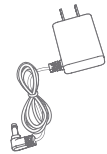

Power adapter for telephone base



Cordless handset



Battery for cordless handset



Battery compartment cover

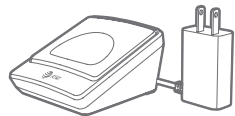

Charger for cordless handset with power adapter installed

(1 for CL82107)
(2 for CL82207/CL82257/CL82267)
(3 for CL82307/CL82357/CL82367)
(4 for CL82407/CL82467)
(5 for CL82507/CL82547/CL82557)

(1 for CL82207/CL82257/CL82267)
(2 for CL82307/CL82357/CL82367)
(3 for CL82407/CL82467)
(4 for CL82507/CL82547/CL82557)

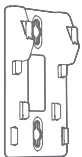

Wall-mount bracket



Telephone line cord

Complete user's manual

CL82107/CL82207/CL82257/CL82267/
CL82307/CL82357/CL82367/CL82407/
CL82467/CL82507/CL82547/CL82557
DECT 6.0 cordless telephone/
answering system with caller ID/call
waiting



Table of contents

Getting started

Installation	1
Quick reference guide - handset	2
Quick reference guide - telephone base	6
Telephone base and charger installation	7
Telephone base installation	7
Charger installation	8
Battery installation and charging	9
Initial setups	12
Installation options	14
Tabletop to wall-mount installation	14
Wall-mount to tabletop installation	15

Telephone settings

Handset settings	16
Ringer volume	17
Ringer tone	18
Set date/time	19
LCD language	20
Caller ID announce	21

Set speed dial voicemail number	23
Voicemail (visual message waiting) indicator	23
Clear voicemail indication	24
Rename handset	25
Use caller ID to automatically set date and time	26
Key tone	26
Home area code	27
Dial mode	28
Web address	28
QUIET mode	29

Telephone operation

Telephone operation	30
Making a call	30
On hook dialing (predialing)	30
Answering a call	30
Ending a call	30
Auto off	30
Temporary ringer silencing	31
Handset speakerphone ...	31

Last number redial	31
Equalizer	32
Options while on calls	33
Volume control.....	33
Call waiting	33
Mute	34
Chain dialing	35
Temporary tone dialing ...	36
Blind transfer	37

Multiple handset use

Multiple handset use.....	38
Handset locator	38
Join a call in progress	38
Intercom	39
Answer an incoming call during an intercom call	40
Call transfer using intercom	41
Push-to-talk (PTT).....	42
Turn PTT on or off	42
PTT call to a single device	43
PTT call to multiple devices.....	44
Answer a PTT call	45
Change a one-to-one PTT call to an intercom call	45
Answer an incoming call during a PTT call.....	46
Make an outgoing call during PTT call.....	46
End or leave a PTT call.....	47

Directory

About the directory	48
Shared directory.....	48
Capacity	48
Create directory entries.....	49
Create a new directory entry.....	49

Add a predialed telephone number to the directory.....	50
Review the directory.....	51
Review directory entries.....	51
Search the directory	52
Search by name	52
Dial, delete or edit directory entries	53
Display dial.....	53
Delete a directory entry...53	
Edit a directory entry	54
Speed dial	55
Assign a speed dial number.....	55
Assign your voicemail speed dial number.....	56
Reassign a speed dial number.....	56
Delete a speed dial number.....	57
Make a call using speed dial.....	58
Check your voicemail using speed dial.....	58

Caller ID

About caller ID.....	59
Information about caller ID with call waiting	59
Caller ID log	60
How the caller ID log works.....	60
Missed (new) call indicator	60
Caller ID operation.....	61
Memory match	61
Review the caller ID log... 62	
View dialing options	63
Dial a caller ID log entry... 64	

Delete caller ID log entries.....	64
Save a caller ID log entry to the directory	65
Save a caller ID log entry to the allow list	66
Save a caller ID log entry to the block list.....	66
Save a caller ID log entry to the star name list.....	67
Reasons for missing caller ID information	68

Smart call blocker

About Smart call blocker*	69
Call categories	70
Call controls	71
Call block settings.....	73
Set Smart call blocker on/off	73
Control calls without numbers	73
Control uncategorized calls	74
Block list	76
Allow list	81
Star name list.....	86
Screening announcements.....	89
Allowed calls	92
Allow calls without numbers	92
Allow uncategorized calls	93
Blocked calls	94
Block calls without numbers	94
Block uncategorized calls	95
Screen calls without numbers	96

Answer call once.....	97
Send call to answering system	98
End call	98
Screen uncategorized calls	99
Allow call once.....	101
Always allow	101
Block call	102
Send call to answering system	102
Option while on a call	103

Answering system

Answering system settings	104
Announcement.....	104
Answer on/off	106
Voice guide	107
Call screening.....	108
Number of rings.....	109
Remote access code.....	110
Message alert tone.....	111
Message recording time	112
Answering system and voicemail indicators	113
Using the answering machine and voicemail together	114
Message capacity	115
Voice prompts.....	115
Call screening.....	116
Call intercept.....	117
Base ringer.....	117
Temporarily turning off the message alert tone	117
Message playback.....	118
Options during playback	119

Delete all old messages.....	120
Recording and playing memos	121
Record a memo	121
Play back a memo	121
Base message counter displays.....	122
Message counter displays	122
Remote access.....	123
Appendix	
Adding and registering handsets/headsets/speakerphones	125
Register a handset to the telephone base.....	125
Deregistering handsets	127
Deregister all handsets from the telephone base.....	127
Alert tones and lights.....	129
Handset screen icons.....	129
Handset alert tones	130
Telephone base alert tones.....	130
Lights.....	131
Screen display messages....	132
Screen messages	132
Troubleshooting.....	136
Maintenance	148
Important safety information	149
Safety information.....	149
Especially about cordless telephones.....	150
Precautions for users of implanted cardiac pacemakers	151
Pacemaker patients.....	151

ECO mode	151
Especially about telephone answering systems.....	151
FCC Part 68 and ACTA.....	152
FCC Part 15	154
California Energy Commission battery charging testing instructions	155
Limited warranty	156
Technical specifications.....	159
DECT 6.0 digital technology.....	159
Telephone operating range.....	159
Redefining long range coverage and clarity.....	159
HD audio.....	159
Simulated full-duplex handset speakerphone	159

Index

Index.....	160
------------	-----

You must install and charge the battery before using the telephone.



STOP!

See pages 9-11 for easy instructions.

Install the telephone base close to a telephone jack and a power outlet not controlled by a wall switch. The telephone base can be placed on a flat surface or vertically mounted on the wall (see page 14). For optimum range and better reception, place the telephone base in a central and open location.

If you subscribe to high-speed Internet service (DSL - digital subscriber line) through your telephone line, you must install a DSL filter between the telephone line cord and the telephone wall jack (see page 7). The filter prevents noise and caller ID problems caused by DSL interference. Please contact your DSL service provider for more information about DSL filters.

Your product may be shipped with protective stickers covering the handset and telephone base displays - remove them before use.

For customer service or product information, visit our website at <https://telephones.att.com> or call **1 (800) 222-3111**. In Canada, dial **1 (866) 288-4268**.

Avoid placing the telephone base and charger too close to:

- ▶ Communication devices such as television sets, VCRs, or other cordless telephones.
- ▶ Excessive heat sources.
- ▶ Noise sources such as a window with traffic outside, motors, microwave ovens, refrigerators, or fluorescent lighting.
- ▶ Excessive dust sources such as a workshop or garage.
- ▶ Excessive moisture.
- ▶ Extremely low temperature.
- ▶ Mechanical vibration or shock such as on top of a washing machine or workbench.

Quick reference guide - handset

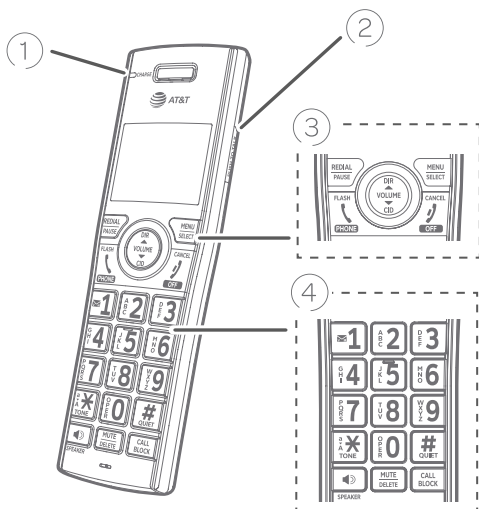

① CHARGE light

- ▶ On when the handset is charging in the telephone base or charger.

② PUSH TO TALK

- ▶ Press to initiate a one-to-one or one-to-group broadcast.
- ▶ Press and hold to broadcast to a group of system devices.

③ REDIAL/PAUSE

- ▶ Press repeatedly to view the last ten numbers dialed (page 31).
- ▶ While entering numbers, press and hold to insert a dialing pause (page 49).

MENU/SELECT

- ▶ When the handset is not in use, press to show the menu.
- ▶ While in the menu, press to select an item or save an entry or setting.

PHONE/FLASH

- ▶ Press to make or answer a call (page 30).
- ▶ During a call, press to answer an incoming call when you receive a call waiting alert (page 104).
- ▶ During message playback, press to call back the caller if the caller's number is available (page 119).

▲ DIR/VOLUME

- ▶ Press ▲ **DIR** to show directory entries when the handset is not in use (page 51).
- ▶ Press to scroll up while in menus.
- ▶ While entering names or numbers, press to move the cursor to the right.
- ▶ Press to increase the listening volume when on a call (page 33), or to increase the message playback volume (page 119).

Quick reference guide - handset

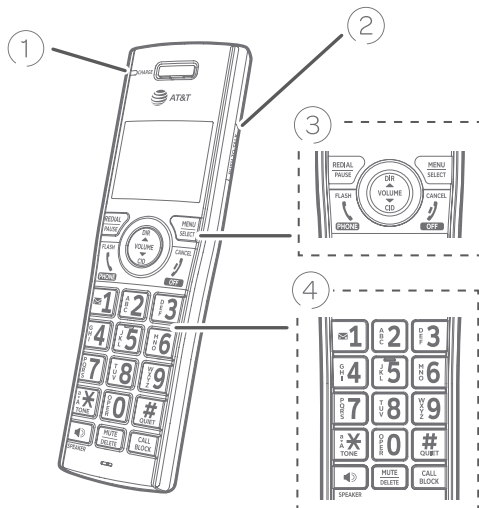

3 ▼CID/VOLUME

- ▶ Press ▼CID to show caller ID log when the handset is not in use (page 62).
- ▶ Press to scroll down while in menus.
- ▶ While entering names or numbers, press to move the cursor to the left.
- ▶ Press to decrease the listening volume when on a call (page 33), or to decrease the message playback volume (page 119).

⏏OFF/CANCEL

- ▶ During a call, press to hang up (page 30).
- ▶ While in a menu, press to cancel an operation, back up to the previous menu, or exit the menu display; or press and hold this button to exit to idle mode.
- ▶ When the handset is ringing, press to mute the ringer temporarily (page 31).

- ▶ Press and hold while the telephone is not in use to erase the missed call indicator (page 60).

4 1

- ▶ While reviewing a caller ID log entry, press repeatedly to add or remove 1 in front of the telephone number before dialing or saving it in the directory (page 63).
- ▶ Press and hold to set (page 23) or to dial your voicemail number (page 58).

TONE /a>A

- ▶ Press to switch to tone dialing temporarily during a call if you have pulse service (page 36).
- ▶ While entering names, press to change the next letter to upper or lower case (page 49).

Quick reference guide - handset

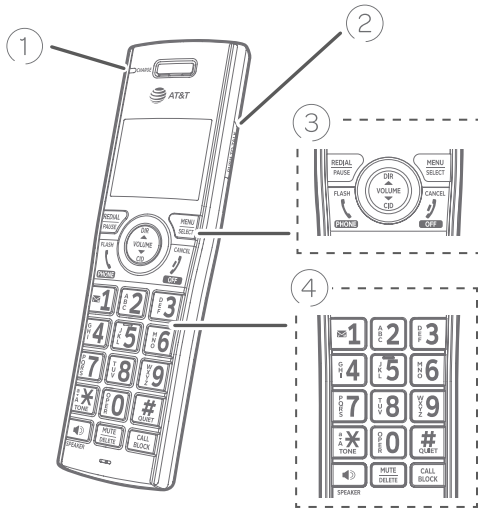

4 QUIET# (pound key)

- ▶ Press repeatedly to display other dialing options when reviewing a caller ID log entry (page 63).
- ▶ Press and hold to enter the **QUIET** mode setting screen, or to deactivate **QUIET** mode (page 29).

🔊/SPEAKER

- ▶ Press to make or answer a call using the speakerphone (page 30).
- ▶ Press to switch between the speakerphone and the handset (page 31).

MUTE/DELETE

- ▶ During a call, press to mute the microphone (page 34).
- ▶ When the handset is ringing, press to mute the ringer temporarily (page 31).
- ▶ While reviewing the caller ID log, directory, redial memory, block list, allow list, or star name list, press to delete an individual entry.
- ▶ While predialing, press to delete digits.
- ▶ During message or announcement playback, press to delete the playing message or the recorded announcement.

CALL BLOCK

- ▶ Press to block the incoming call when the telephone is ringing (page 69) or during the call (page 103).
- ▶ When the handset is not in use, press to show the Smart call blocker menu (page 73).

Quick reference guide - handset

Main menu



Main menu

- › Play messages (page 118)
- › Answering sys (page 104)
- › Smart call blk (page 69)
- › Directory (page 48)
- › Caller ID log (page 59)
- › Intercom (page 39)
- › Ringers (page 17)
- › Set date/time (page 19)
- › Settings (page 20)
- › Web address (page 28)

The > symbol highlights a menu item.



Using menus:

- › Press **MENU/SELECT** to show the menu.
- › Press **▼CID** or **▲DIR** to scroll through menu items.
- › Press **MENU/SELECT** to confirm or save changes to a highlighted menu item.
- › Press **!OFF/CANCEL** to cancel an operation, back up to the previous menu, or exit the menu display.

Quick reference guide - telephone base

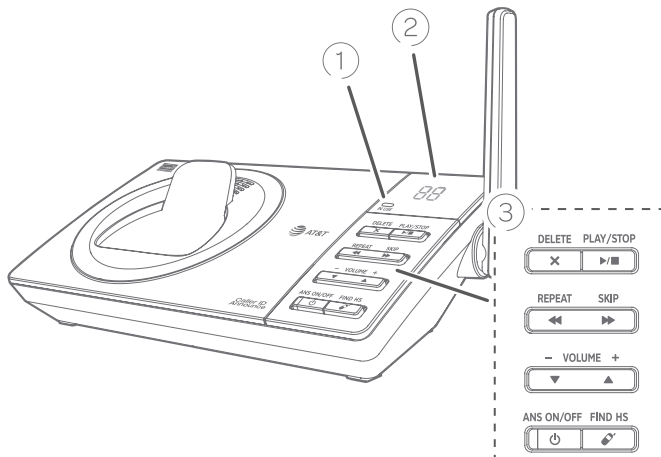

① IN USE indicator

- ▶ On when the handset is in use, or when the answering system is answering an incoming call.
- ▶ Flashes when another telephone is in use on the same line.
- ▶ Flashes when there is an incoming call.

② Message counter

- ▶ Shows the number of messages or other answering system information.

③ X/DELETE

- ▶ Press to delete the message currently playing (page 119).
- ▶ Press twice to delete all old messages when the phone is not in use (page 120).

▶/■/PLAY/STOP

- ▶ Press to start or stop message playback (page 118).

◀/REPEAT

- ▶ Press to repeat a message.
- ▶ Press twice to play the previous message (page 119).

▶/SKIP

- ▶ Press to skip a message (page 119).

▼ / -VOLUME+ / ▲

- ▶ During message playback, press to adjust the listening volume (page 119).
- ▶ While in idle mode, press to adjust the base ringer volume.

⏻/ANS ON/OFF

- ▶ Press to turn the built-in answering system on or off (page 106).

📞/FIND HS

- ▶ While the phone is idle, press to page all handsets (page 38).

Telephone base and charger installation

Install the telephone base and charger, as shown below.

The telephone base is ready for tabletop use. If you want to change to wall-mounting, see **Installation options** on page 14 for details.

Telephone base installation

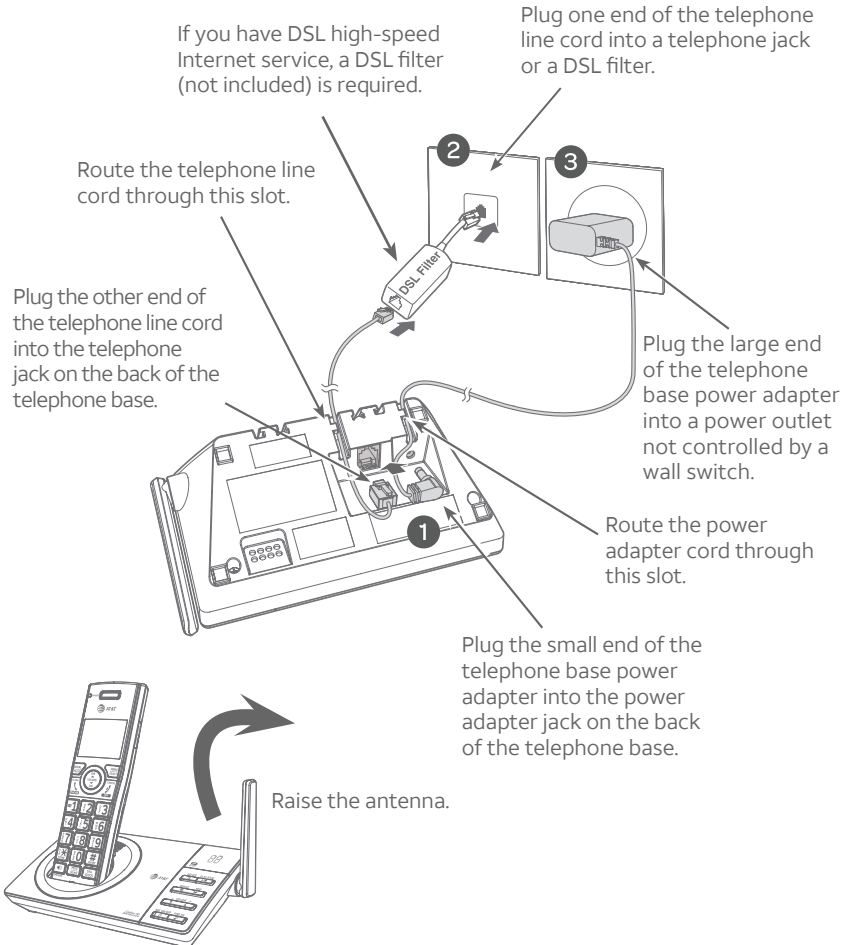

Telephone base and charger installation

Charger installation

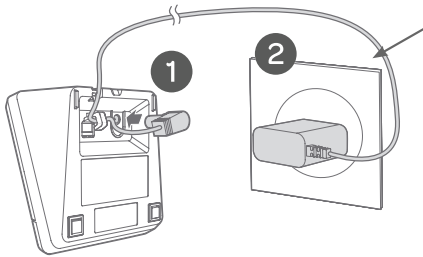

Plug the power adapter into a power outlet not controlled by a wall switch.



IMPORTANT INFORMATION

- ▶ Use only the power adapter(s) supplied with this product. To order a replacement power adapter, visit our website at <https://telephones.att.com> or call **1 (800) 222-3111**. In Canada, dial **1 (866) 288-4268**.
- ▶ The power adapters are intended to be correctly oriented in a vertical or floor mount position. The prongs are not designed to hold the plug in place if it is plugged into a ceiling, under-the-table or cabinet outlet.

Battery installation and charging

Install the battery, as shown below. Once you have installed the battery, the screen indicates the battery status (see the following table). If necessary, place the handset in the telephone base or charger to charge the battery. For best performance, keep the handset in the telephone base or charger when not in use. The battery is fully charged after ten hours of continuous charging. See the table on page 159 for battery operating times.

If the screen shows **Place in charger** and  flashes, you need to charge the handset without interruption for at least 30 minutes to give the handset enough charge to use the telephone for a short time. The following table summarizes the battery charge indicators and actions to take.

Battery indicators	Battery status	Action
The screen is blank, or shows Place in charger and  (flashing).	Battery has no or very little charge. The handset cannot be used.	Charge without interruption (at least 30 minutes).
The screen shows Low battery and  (flashing).	Battery has enough charge to be used for a short time.	Charge without interruption (at least 30 minutes).
The screen shows HANDESET X .	Battery is charged.	To keep the battery charged, place it in the telephone base or charger when not in use.



Note: If you are on a phone call in low battery mode, you hear four short beeps every minute.

Battery installation and charging

Step 1

Plug the battery connector securely into the socket inside the handset battery compartment. Insert the supplied battery with the label **THIS SIDE UP** facing up, as indicated.

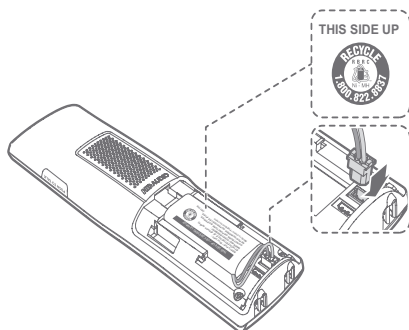

Step 2

Align the cover flat against the battery compartment, then slide it upwards until it clicks into place.

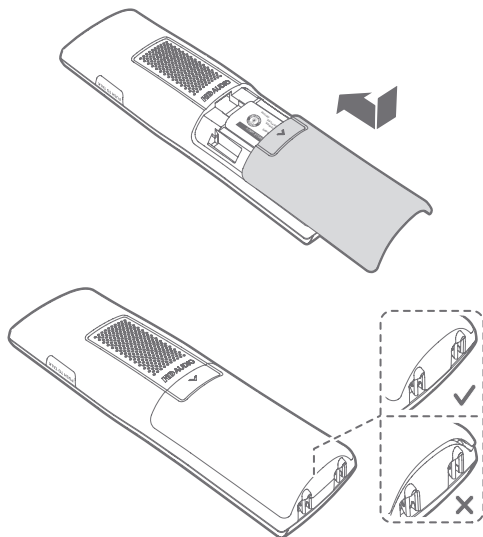

Battery installation and charging

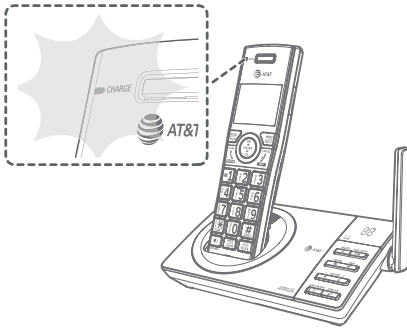

Step 3

Charge the handset by placing it face forward in the telephone base or charger. The **CHARGE** light on the handset is on during charging.

IMPORTANT INFORMATION

- ▶ Use only the supplied rechargeable battery or replacement battery (model BT183342/BT283342). To order, visit our website at <https://telephones.att.com> or call **1 (800) 222-3111**. In Canada, dial **1 (866) 288-4268**.
- ▶ If you do not use the handset for a long time, disconnect and remove the battery to prevent possible leakage.

Initial setups

After you install your telephone or power returns following a power outage, the handset will prompt you to set the date and time. For instructions, see **Set date/time** on page 19. To skip setting the date and time, press **⏏/OFF/CANCEL** on the handset.



After the date and time setting is done or skipped, the handset then prompts if you want to set Smart call blocker. Press **MENU/SELECT** on the handset to start the Smart call blocker setup via voice guide. To skip the setup, press **⏏/OFF/CANCEL** on the handset.

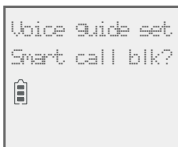

Voice guide to set Smart call blocker:

If you choose to set Smart call blocker via voice guide, you hear a voice prompt, *"Hello! This voice guide will assist you with the basic setup of Smart call blocker..."*. Listen to the instructions and then choose one of the following options.



On the handset:

- ▶ Press **1** if you want to screen calls with telephone numbers that are not saved in your directory, allow list or star name list;
- ▶ Press **2** if you only want to screen calls that do not display a phone number; or
- ▶ Press **3** if you do not want to screen calls, and want to allow all incoming calls to get through.

Initial setups

If you select option 1 to screen all incoming calls, we recommend that you add the phone numbers of your family members and friends, and desired businesses to your **Directory** (see page 49) or **Allow list** (see page 81), or add their names to the **Star name list** (see page 86). This will avoid Smart call blocker to screen their calls.

For more details on **Smart call blocker**, see page 69.



Note: You can restart the voice guide to set Smart call blocker by resetting your handset power.

After the Smart call blocker setting is done or skipped, the handset will prompt if you want to set up the answering system. Press **MENU/SELECT** to start the answering system setup via voice guide. For more details, see **Voice guide** on page 107. To skip the setup, press **OFF/CANCEL** on the handset.

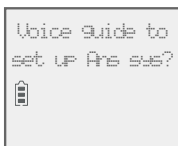

Installation options

Your telephone base is ready for tabletop use. If you want to mount your telephone on a wall, follow the steps to connect the telephone base with a standard dual-stud telephone wall-mounting plate. You may need a professional to install the mounting plate.

Tabletop to wall-mount installation

1. Plug the telephone line into the telephone base. If you are using a DSL filter, plug the other end of the telephone line into the filter. Route the telephone line cord (or DSL filter) through the wall-mount bracket hole.
2. Align the holes on the wall-mount bracket with the standard wall plate and slide the wall-mount bracket down until it locks securely.
3. Position the telephone base, as shown below. Insert the extended tabs (marked B) of the wall-mount bracket into the slots on the back of the telephone base. Push the telephone base down until it is securely in place.
4. Plug the power adapter into a power outlet not controlled by a wall switch. Plug the other end of the power adapter into the telephone base. Bundle the telephone line cord and power adapter cord neatly with twist ties.

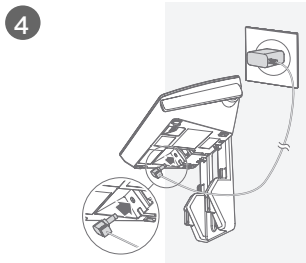
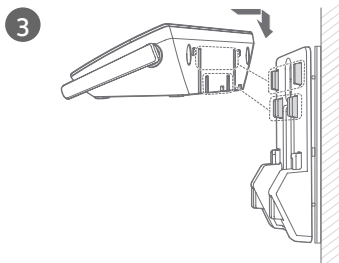
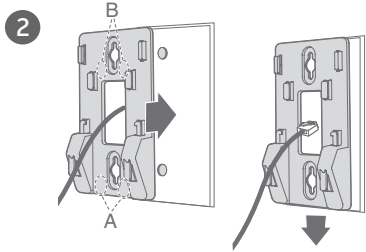
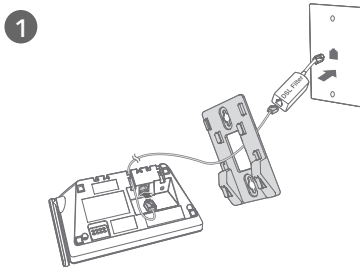

Installation options

Wall-mount to tabletop installation

1. Unplug the large end of the power adapter from the electrical outlet.
2. If the telephone line cord and power adapter cord are bundled, untie them first. Slide the wall-mount bracket up and remove it from the wall-mounting plate.

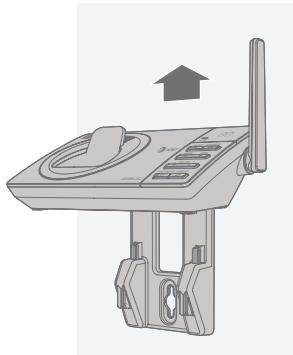

3. Unplug the telephone line cord or the DSL filter from the telephone wall jack. Push the telephone base up and away from the wall-mount bracket to detach it from the wall-mount bracket.

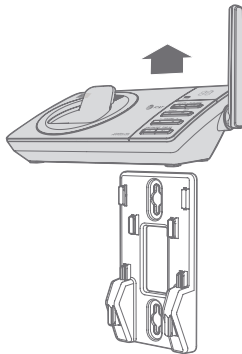

4. See **Telephone base and charger installation** on page 7.

Handset settings

Use the menu to change the telephone settings.

1. Press **MENU/SELECT** on the handset when it is not in use to enter the main menu.
2. Press **▼CID** or **▲DIR** to scroll to the feature to be changed. When scrolling through the menu, the **>** symbol indicates the selected menu item.
3. Press **MENU/SELECT** to select the highlighted item.

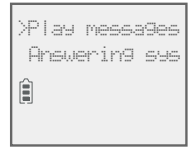

Note: Press **↵OFF/CANCEL** to cancel an operation, back up to the previous menu or exit the menu display. Press and hold **↵OFF/CANCEL** to return to idle mode.

Handset settings

Ringer volume

You can set the ringer volume level to one of six levels or turn the ringer off. When the ringer is off,  appears on the screen.

1. Press **MENU/SELECT** in idle mode to enter the main menu.
2. Use **▼CID** or **▲DIR** to scroll to **Ringers**, then press **MENU/SELECT**.
3. Press **MENU/SELECT** again to select **Ringer volume**.
4. Press **▼CID** or **▲DIR** to sample each volume level.
5. Press **MENU/SELECT** to save your preference. There is a confirmation tone and the screen returns to the previous menu.



Notes:

- ▶ The handset ringer volume also determines the ringer volume for intercom calls.
- ▶ If the ringer volume is set to off, that handset is silenced for all incoming calls except paging tone.
- ▶ If the ringer volume is set to off, the caller ID will not be announced and the screen will briefly display **Caller ID won't be announced**.

Handset settings

Ringer tone

You can choose one of ten ringer tones.

1. Press **MENU/SELECT** in idle mode to enter the main menu.
2. Use **▼CID** or **▲DIR** to scroll to **Ringers**, then press **MENU/SELECT**.
3. Press **▼CID** or **▲DIR** to scroll to **Ringer tone**, then press **MENU/SELECT**.
4. Press **▼CID** or **▲DIR** to sample each ringer tone.
5. Press **MENU/SELECT** to save your preference.



There is a confirmation tone and the screen returns to the previous menu.



Note: If you turn off the ringer volume, you will not hear ringer tone samples.

Handset settings

Set date/time

The answering system announces the day and time of each message prior to playing it. Before using the answering system, set the date and time as follows. If you subscribe to caller ID service, the day, month and time are set automatically with each incoming call. The year must be set so that the day of the week can be calculated from the caller ID information. You can turn off the date and time settings of the caller ID service and set the date and time manually (see **Use caller ID to automatically set date and time** on page 26).

After a power failure or handset registration, the system prompts you to set the date and time.

To set the date and time manually:

1. When the handset is in idle mode, press **MENU/SELECT** to enter the main menu.
2. Press **▼CID** or **▲DIR** to scroll to **Set date/time** and then press **MENU/SELECT**.
3. Press **▼CID** or **▲DIR** to select the month, then press **MENU/SELECT**, or enter the number using the dialing keys.
4. Press **▼CID** or **▲DIR** to select the day, then press **MENU/SELECT**, or enter the number using the dialing keys.
5. Press **▼CID** or **▲DIR** to select the year, or enter the number using the dialing keys, then press **MENU/SELECT** to move on to set the time.
6. Press **▼CID** or **▲DIR** to select the hour, then press **MENU/SELECT**, or enter the number using the dialing keys.
7. Press **▼CID** or **▲DIR** to select the minute, then press **MENU/SELECT**, or enter the number using the dialing keys.



Handset settings

- Press **▼CID** or **▲DIR** to highlight **AM** or **PM**, or press **2** for **AM** or **7** for **PM**. Press **MENU/SELECT** to confirm. There is a confirmation tone and the screen returns to the previous menu.



Note: If the clock is not set when a message is recorded, the system announces, "Time and day not set," before it plays the message.

LCD language

You can select the language used for all screen displays.

- Press **MENU/SELECT** in idle mode to enter the main menu.
- Use **▼CID** or **▲DIR** to scroll to **Settings**, then press **MENU/SELECT**.
- Press **MENU/SELECT** to choose **LCD language**.
- Press **▼CID** or **▲DIR** to highlight **English**, **Français** or **Español**, then press **MENU/SELECT**. The screen prompts **Set English/Français/Español as LCD language?**
- Press **MENU/SELECT** to save your preference. There is a confirmation tone and the screen returns to the previous menu.



Note: If you accidentally change the LCD language to French or Spanish, you can reset it back to English without going through the French or Spanish menus. Press **MENU/SELECT** on the handset in idle mode, then enter **364#**. There is a confirmation tone.

Handset settings

Caller ID announce

The caller ID announce feature lets you know who's calling without having to look at the display. When you have an incoming call, the handset and/or base speaks "Call from..." and the name of the caller based on the directory or caller ID information. If the caller's name is private or unknown, the phone number up to the last 11 digits will be announced. If the caller's phone number is also private or unknown, no information will be announced. The default setting is **On**.

To turn on or off the caller ID announce feature:

1. Press **MENU/SELECT** in idle mode to enter the main menu.
2. Use **▼CID** or **▲DIR** to scroll to **Settings**, then press **MENU/SELECT**.
3. Use **▼CID** or **▲DIR** to scroll to **Caller ID annc**, then press **MENU/SELECT**.
4. Use **▼CID** or **▲DIR** to highlight the desired option, then press **MENU/SELECT**.
 - ▶ **Set all On/Off** - Change the setting for the base and all handsets.
 - ▶ **Local handset** - Change the setting for that handset only.
 - ▶ **Base** - Change the setting for the telephone base only.
5. Use **▼CID** or **▲DIR** to highlight **On** or **Off**, then press **MENU/SELECT**. There is a confirmation tone and the screen returns to the previous menu. If you change the setting to **Set all On/Off**, the screen shows **CID Annc ON/OFF on all HS & BS**. The caller ID announce feature has been turned on or off on all handsets and on the telephone base.



Handset settings



Notes:

- ▶ To use the caller ID announce feature, you must subscribe to caller ID service from your telephone service provider.
- ▶ When there are up to five handsets registered, the telephone system supports caller ID announce for all handsets. If six or more devices are registered, the system supports caller ID announce for the first four registered handsets only.
- ▶ This feature does not announce information for call waiting calls.
- ▶ It takes at least two rings for the phone to receive caller ID information and announce it. If the phone is answered before the end of the second ring, the phone won't have time to announce the caller's information.
- ▶ Pronunciation of names may vary with this feature. Not all names may be pronounced correctly.
- ▶ Caller ID announce is available in English only.
- ▶ If you have paired an AT&T **TL80133** DECT 6.0 cordless speakerphone to the telephone base, the caller ID announce setting for all devices also applies to the cordless speakerphone. When the setting is **On**, the cordless speakerphone speaks "Call from..." and the name of the caller based on the directory or caller ID information during an incoming call. If the caller's name is unavailable, the phone number up to the last 11 digits will be announced.

Handset settings

Set speed dial voicemail number

This feature lets you save your voicemail number for easy access when you press and hold the  **1** key.

To save your voicemail number:

1. Press **MENU/SELECT** in idle mode to enter the main menu.
2. Use **▼CID** or **▲DIR** to scroll to **Settings**, then press **MENU/SELECT**.
3. Use **▼CID** or **▲DIR** to scroll to **Voicemail #**, then press **MENU/SELECT**.
4. Use the dialing keys to enter the voicemail access number provided by your telephone service provider (up to 30 digits) when prompted.
 - ▶ Press **▼CID** or **▲DIR** to move the cursor to the left or right.
 - ▶ Press **MUTE/DELETE** on the handset to erase a digit.
 - ▶ Press and hold **MUTE/DELETE** on the handset to erase all digits.
 - ▶ Press **REDIAL/PAUSE** to enter a three-second dialing pause (a **p** appears).
5. Press **MENU/SELECT** to save. There is a confirmation tone and the screen displays **Voicemail # saved**, then returns to the previous menu.

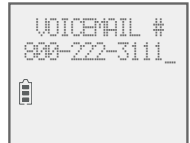

Voicemail (visual message waiting) indicator

If you subscribe to a voicemail service offered by your telephone service provider, this feature provides a visual indication when you have new voicemail messages.

New voicemail and the  icon appear on the handset screen.

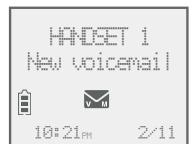

Handset settings



Notes:

- ▶ This feature does not indicate new messages recorded on your phone's built-in answering system.
- ▶ For more information about the difference between your answering system and voicemail, see page 113.

Clear voicemail indication

Use this feature when the telephone indicates that you have new voicemail but there is none. For example, when you have accessed your voicemail while away from home. This feature only turns off the displayed **New voicemail** and the  icon; it does not delete your voicemail messages. As long as you have new voicemail messages, your telephone service provider continues to send the signal to turn on the indicators.

To manually turn off the new voicemail indicators:

1. Press **MENU/SELECT** when in idle mode to enter the main menu.
2. Use **▼CID** or **▲DIR** to scroll to **Settings**, then press **MENU/SELECT**.
3. Use **▼CID** or **▲DIR** to scroll to **Clr voicemail**, then press **MENU/SELECT**. The screen shows **Reset Voicemail Indicator?**.
4. Press **MENU/SELECT** again to turn the voicemail indication off. There is a confirmation tone and the screen returns to the previous menu.

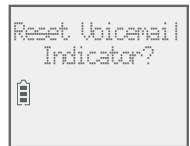
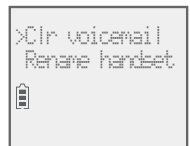

Notes:

- ▶ Your telephone service provider voicemail may alert you to new messages with a stutter (broken) dial tone. Contact your telephone service provider for more details.
- ▶ For information about using your voicemail service, contact your telephone service provider.

Handset settings

Rename handset

You can edit the handset name for each system handset.

1. When the handset is idle, press **MENU/SELECT**.
2. Use **▼CID** or **▲DIR** to scroll to **Settings**, then press **MENU/SELECT**.
3. Use **▼CID** or **▲DIR** to scroll to **Rename handset**, then press **MENU/SELECT**.
4. Change the handset name when prompted.
 - ▶ Press **▼CID** or **▲DIR** to move the cursor to the left or right.
 - ▶ Use the dialing keys to enter a name (up to 11 characters). Each time you press a key, a character on that key appears. Additional key presses produce other characters on that key. See the chart on page 50.
 - ▶ Press **MUTE/DELETE** to backspace and delete a character.
 - ▶ Press and hold **MUTE/DELETE** to delete all characters.
5. Press **MENU/SELECT** to save the setting and return to the previous menu. There is a confirmation tone.



Handset settings

Key tone

The handset is set to beep with each key press. You can adjust the key tone volume or turn it off. If you turn off the key tone, there are no beeps when you press keys.

1. Press **MENU/SELECT** in idle mode to enter the main menu.
2. Use **▼CID** or **▲DIR** to scroll to **Settings**, then press **MENU/SELECT**.
3. Use **▼CID** or **▲DIR** to scroll to **Key tone**, then press **MENU/SELECT**.
4. Use **▼CID** or **▲DIR** to select the desired volume or **Off**.
5. Press **MENU/SELECT** to save your preference. There is a confirmation tone and the screen returns to the previous menu.



Use caller ID to automatically set date and time

If you subscribe to caller ID service, the day, month and time are set automatically with each incoming call. Follow the steps to turn the **CID time sync** feature on or off. The default setting is **On**.

1. When the handset is in idle mode, press **MENU/SELECT** to enter the main menu.
2. Press **▼CID** or **▲DIR** to scroll to **Settings**, then press **MENU/SELECT**.
3. Press **▼CID** or **▲DIR** to scroll to **CID time sync**, then press **MENU/SELECT**.
4. Press **▼CID** or **▲DIR** to highlight **On** or **Off**, then press **MENU/SELECT** to save. There is a confirmation tone and the screen returns to the previous menu.

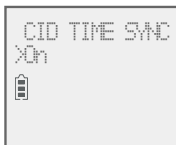

Handset settings

Home area code

If you dial seven digits to make a local call (no area code required), enter your area code into the telephone as the home area code. When you receive a call from within your home area code, the caller ID log only displays the seven digits of the telephone number.

This feature makes it easy for you to place a call from the caller ID log. If you dial ten digits to make a local phone call, do not use this home area code feature. If you do, you cannot place local calls from your caller ID log, as they will have only seven digits.

To set the home area code:

1. Press **MENU/SELECT** in idle mode to enter the main menu.
2. Use **▼CID** or **▲DIR** to scroll to **Settings**, then press **MENU/SELECT**.
3. Use **▼CID** or **▲DIR** to scroll to **Home area code**, then press **MENU/SELECT**. The screen briefly shows **Only for 7digit dial from CID**.
4. Use the dialing keys to enter a three-digit home area code.
 - Press **MUTE/DELETE** to delete a digit.
 - Press and hold **MUTE/DELETE** to delete all digits.
5. Press **MENU/SELECT** to save. There is a confirmation tone and the screen shows **Area code will not show in CID** briefly before returning to the previous menu.



Note: If in the future, your telephone service provider requires you to dial ten digits to make a local call (area code plus telephone number), you need to delete your home area code and dial out locally from the call ID log. With the home area code displayed, press and hold **MUTE/DELETE** until the digits are deleted, and then press **MENU/SELECT**. The home area code is now restored to its default setting of ___ (empty).

Handset settings

Dial mode

The dial mode is preset to tone dialing. If you have pulse (rotary) service, you must change the dial mode to pulse dialing before using the telephone.

To set the dial mode:

1. Press **MENU/SELECT** in idle mode to enter the main menu.
2. Use **▼CID** or **▲DIR** to scroll to **Settings**, then press **MENU/SELECT**.
3. Use **▼CID** or **▲DIR** to scroll to **Dial mode**, then press **MENU/SELECT**.
4. Use **▼CID** or **▲DIR** to highlight **Touch-tone** or **Pulse**, then press **MENU/SELECT**. There is a confirmation tone and the screen returns to the previous menu.



Web address

Use this feature to view the AT&T website address.

1. Press **MENU/SELECT** in idle mode to enter the main menu.
2. Use **▼CID** or **▲DIR** to scroll to **Web address**, then press **MENU/SELECT**.



Handset settings

QUIET mode

When **QUIET** mode is turned on, the telephone silences all sounds during the set period of time (1-12 hours). However, the handset locator paging tone and any sound-generating operations initiated by users, such as making calls using the speakerphone or setting ringer volume, will sound as normal. After you turn on **QUIET** mode, this feature activates immediately and the answering system turns on automatically. When **QUIET** mode is on, the answering system takes calls and records messages without broadcasting them.

To turn QUIET mode on:

1. Press and hold **QUIET #** in idle mode to enter the **QUIET** mode setting screen. The screen shows **Quiet: __ hours (1-12 hours)**.
2. Use the dialing keys to enter the desired number of hours (1-12) you would like to turn on **QUIET** mode, then press **MENU/SELECT**. Your screen briefly shows **Answering sys is ON** and then **Quiet mode on**.

To turn QUIET mode off:

- ▶ While **QUIET** mode is on, press and hold **QUIET #**. The screen then shows **Quiet mode is off** and you hear a confirmation tone.



Notes:

- ▶ If you change the base ringer, handset ringer, ringer volume, key tone, or caller ID announce features when QUIET mode is on, the sample plays but the feature is still muted after saving the setting.
- ▶ After QUIET mode is turned off or the set period of time has expired, all muted features will be activated again.
- ▶ The PTT function is not available when QUIET mode is on.
- ▶ Intercom is available during QUIET mode, but the handset will not ring.
- ▶ When QUIET mode is on, and Smart call blocker is on and in screening mode, all screened calls will be sent to the answering system after screening. For more information on Smart call blocker, see page 69.

Telephone operation

Making a call

- Press **\ PHONE/FLASH** or **📞/SPEAKER**, then enter the telephone number.

The screen displays the elapsed time as you talk (in hours, minutes and seconds).



Note: Pressing **\ PHONE/FLASH** or **📞/SPEAKER** to access services from your telephone service provider does not affect the elapsed time.

Elapsed time



On hook dialing (predialing)

- Enter the telephone number. Press **MUTE/DELETE** to make corrections when entering the phone number.
- Press **\ PHONE/FLASH** or **📞/SPEAKER** to dial.

Answering a call

- Press **\ PHONE/FLASH** or **📞/SPEAKER**.
-OR-
- Press any dialing key (**0-9, TONE X** or **#**).

Ending a call

- Press **📞 OFF/CANCEL** or return the handset to the telephone base or charger.

Auto off

A call ends automatically when you put the handset in the telephone base or charger.

Telephone operation

Temporary ringer silencing

Press **⏸/OFF/CANCEL** or **MUTE/DELETE** while the telephone is ringing to silence the ringer temporarily on that handset only. This turns off the ringer without disconnecting the call. The next incoming call rings normally at the preset volume.

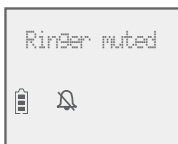

Handset speakerphone

During a call, press **📞/SPEAKER** to switch between handsfree speakerphone and normal handset use. Press **⏸/OFF/CANCEL** or return the handset to the telephone base or charger to hang up.



Notes:

- ▶ When you use the speakerphone, the key pad and the **📞/SPEAKER** button on the handset are lit.
- ▶ The speakerphone uses more power than the normal handset. If the handset battery becomes very low while you are using the speakerphone, the call remains in speakerphone mode until you hang up or the battery becomes depleted.
- ▶ After installing a battery into the handset, the screen may show **Low battery**. If you use the speakerphone at this time, the battery may become depleted. Follow the instructions in the **Battery installation and charging** section on pages 9-11.

Last number redial

Each handset stores the last ten telephone numbers dialed (up to 30 digits).

To view the ten most recently dialed numbers:

- ▶ To display the most recently called number, press **REDIAL/PAUSE**.
- ▶ To view up to ten recently called numbers, press **REDIAL/PAUSE**, then **▼CID**, **▲DIR** or **REDIAL/PAUSE** repeatedly.

The handset beeps twice at the end of the list. Press **⏸/OFF/CANCEL** to exit.

Telephone operation

To redial a number:

- ▶ To dial the displayed number, press **\ PHONE/FLASH** or **📞/SPEAKER**.
-OR-
- ▶ Press **\ PHONE/FLASH** or **📞/SPEAKER**, then press **REDIAL/PAUSE** repeatedly to view the redial memory. Press **MENU/SELECT** to dial the displayed number.



To delete a redial entry:

- ▶ While the screen displays the desired number, press **MUTE/DELETE** to delete the number from the redial memory.

Equalizer

The handset equalizer enables you to change the quality of the audio to best suit your hearing.

While on a call or intercom call, press **MENU/SELECT** to select the equalizer setting **Treble 1**, **Treble 2**, **Bass** or **Natural** (the default setting). The current setting is shown on the handset screen for two seconds.



Notes:

- ▶ If you switch the call between the handset and the speakerphone by pressing **📞/SPEAKER**, the audio setting remains unchanged.
- ▶ The current equalizer setting remains unchanged until a new setting is selected.

Options while on calls

Volume control

You can set the listening volume to one of six levels. While on a call, press **▼CID/VOLUME** to decrease or press **▲DIR/VOLUME** to increase the listening volume.

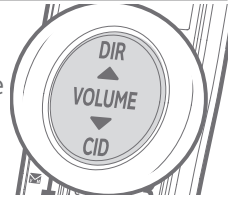

Notes:

- ▶ Handset and speakerphone volume settings are independent.
- ▶ When the volume reaches the minimum or maximum setting, you hear two beeps.

Call waiting

If you subscribe to call waiting service from your telephone service provider, and someone calls while you are already on a call, you hear two beeps.

- ▶ Press **\ PHONE/FLASH** on the handset to put your current call on hold and take the new call.
- ▶ Press **\ PHONE/FLASH** on your handset at any time to switch back and forth between calls.



Note:

- ▶ If the Smart call blocker feature is on and in screening mode, and you receive a call waiting call:
 - If you have already picked up a screened call, the telephone checks whether the call waiting call's number can be found in the directory, block list or allow list. It also checks whether the caller name is in the star name list. After that, the telephone displays the caller ID information or **Blocked call** accordingly. You can press **\ PHONE/FLASH** or **🔊/SPEAKER** to take the new call, or press **CALL BLOCK** on the handset to block it.
 - If the telephone is screening a call, the call waiting call will be ignored and logged as missed call in the caller ID log.

Options while on calls

Mute

Use the mute function to turn off the microphone. You can hear the caller, but the caller cannot hear you.

To mute a call:

- While on a call, press **MUTE/DELETE**. When mute is on, the handset shows **Muted** for a few seconds and **MUTE** icon displays until you turn off mute.

To end mute a call:

- Press **MUTE/DELETE** again. When mute is off, **Microphone ON** appears temporarily on the handset.

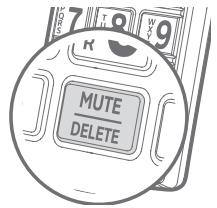

Options while on calls

Chain dialing

Use this feature to initiate a dialing sequence from the numbers in the directory, caller ID log or redial memory while you are on a call.

Chain dialing is useful when you wish to access other numbers (such as bank account numbers or access codes) from the directory, caller ID log or redial list.

To access the directory while on a call:

1. Press **MENU/SELECT**.
2. Press **▼CID** or **▲DIR** to scroll to **Directory** and then press **MENU/SELECT**.
3. Press **▼CID** or **▲DIR** to scroll to the desired number.
4. Press **MENU/SELECT** to dial the number shown.

**To access the caller ID log while on a call:**

1. Press **MENU/SELECT**.
2. Press **▼CID** or **▲DIR** to scroll to **Caller ID log**, then press **MENU/SELECT**.
3. Press **▼CID** or **▲DIR** to scroll to the desired number.
4. Press **MENU/SELECT** to dial the number shown.

**To access the redial list while on a call:**

1. Press **REDIAL/PAUSE** to show the most recently dialed number.
2. Press **▼CID** or **▲DIR** to scroll to the desired number, or press **REDIAL/PAUSE** repeatedly to find the desired number. Press **MENU/SELECT** to dial the number shown.

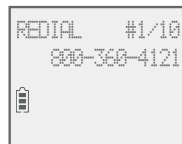

Notes:

- ▶ You cannot edit a directory entry while on a call. For more details about the directory, see pages 48-58.
- ▶ You cannot copy a caller ID entry into the directory while on a call. For more details about the caller ID log, see pages 59-68.
- ▶ If you press **REDIAL/PAUSE** while on a call, you can only view the ten most recently dialed numbers but you cannot erase the entries. For more details about the redial memory, see page 31.
- ▶ Press **↵OFF/CANCEL** on the handset to exit redial, directory or caller ID log when on a call.

Options while on calls

Temporary tone dialing

If you have pulse (rotary) service only, you can switch from pulse to touch-tone dialing temporarily during a call. This is useful if you need to send touch-tone signals to access your telephone banking or long distance services.

1. During a call, press **TONEX**.
2. Use the dialing keys to enter the desired number. The telephone sends touch-tone signals.
3. The telephone automatically returns to pulse dialing after you end the call.

Options while on calls

Blind transfer

While on an outside call, you can transfer the call to a specific device or any device without notifying them.

To transfer an outside call directly without notifying the desired device:

1. During the call, press **MENU/SELECT**.
2. Press **▼CID** or **▲DIR** to scroll to **Transfer** and then press **MENU/SELECT**.
 - ▶ If you have a two-handset system and no other registered devices, the outside call is put on hold and your handset shows **Transferring call...** The other handset rings and shows **Transfer from other handset**.
 - ▶ If you have other registered device(s) or more than two handsets, your screen shows **TRANSFER TO:**. Use the dialing keys to enter a specific device number (**1-9** for handsets 1-9, **TONE X** followed by **0-2** for handsets 10-12, or **TONE X** followed by **#** for all devices), or press **▼CID** or **▲DIR** to scroll to the desired device and press **MENU/SELECT**. The outside call is put on hold and your handset screen shows **Transferring call...** or **Transferring call to all...** The other device rings and shows **Transfer from HANDSET X (HANDSET** represents the handset name, **X** represents the handset number).
3. To answer the call on the destination handset, press **\ PHONE/FLASH**, **📞/SPEAKER**, or any dialing key (**0-9**, **TONE X** or **#**). The initiating handset shows **Call transferred** and goes to idle mode.



Notes:

- ▶ To cancel the transfer and return to the external call before the blind transfer call is answered, press **OFF/CANCEL \ PHONE/FLASH** or **📞/SPEAKER** on your handset.
- ▶ If the other device does not answer the transfer within 30 seconds, the transfer ends and the initiating device rings while showing **No response to transfer**. If it does not pick up within 30 seconds, the device returns to idle mode and the outside call ends.

Multiple handset use

Handset locator

The handset locator feature is useful if you misplace any handsets.

To start the paging tone:

- Press **FIND HS** on the telephone base to start the paging tone on all handsets for 60 seconds.

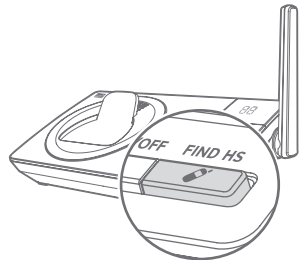

Note: If you press **OFF/CANCEL** or **MUTE/DELETE** on a handset, the ringer of that handset stops, but the paging to the rest of the handsets continues.

To stop the paging tone:

- Press **PHONE/FLASH**, **SPEAKER**, or any dialing key (**0-9**, **TONE** or **#**) on the handset(s).

-OR-

- Press **FIND HS** on the telephone base.

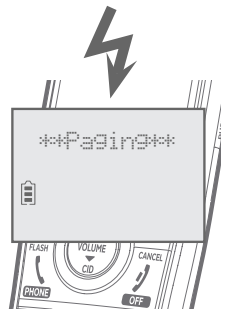

Join a call in progress

When a handset is already on a call and you would like to join the call, press **PHONE/FLASH** or **SPEAKER** on your handset.

To end the call using a handset, press **OFF/CANCEL** or place the handset in the telephone base or charger. The call does not end until all handsets hang up.



Notes:

- If you have registered a cordless headset or cordless speakerphone to the telephone base, you can also join a call in progress using the registered device. Refer to the user's manuals of your cordless headset or speakerphone for more information.
- You can use up to four system handsets at the same time on an outside call.

Intercom

Use the intercom feature for conversations between two handsets, or a handset and a cordless headset/speakerphone (sold separately). You can purchase expansion handsets (AT&T model CL80067, CL80107 or CL80117), cordless headsets, and speakerphones (AT&T model TL80133) for this telephone base to expand your telephone system (up to 12 handsets, cordless headsets or speakerphones). CL80067 (wood color) is for use with CL82267/CL82367/CL82467. CL80107 (black) is for use with CL82107/CL82207/CL82307/CL82407/CL82507. CL80117 (white) is for use with CL82257/CL82357/CL82547/CL82557.

Using a handset to initiate intercom calls:

1. Press **MENU/SELECT** in idle mode to enter the main menu. Press **▼CID** or **▲DIR** to scroll to **Intercom**, then press **MENU/SELECT**.



- ▶ If you have a two-handset system and no other registered devices, the handset shows **Calling other handset**.
- ▶ If you have more than two handsets and/or cordless headset(s)/speakerphone(s), the handset shows **INTERCOM TO:**. Use the dialing keys to enter a specific device number (**1-9** for handsets 1-9, **TONEX** followed by **0-2** for handsets 10-12, **#** for a single headset/speakerphone, **#** followed by **1** or **2** for headset/speakerphone 1 or 2, or **TONEX** followed by **#** for all devices), or press **▼CID** or **▲DIR** to scroll to the desired handset and press **MENU/SELECT**. Your handset screen shows **Calling HANDSET X** or **Calling all handsets**.

The destination handset(s) rings and shows **Other handset is calling**, **HANDSET X is calling** or **HANDSET X is calling all** (**HANDSET** represents the handset name, **X** represents the handset number).

2. To answer the intercom call, press **\PHONE/FLASH**, **📞/SPEAKER** or any dialing key (**0-9**, **TONEX**, or **#**) on the called device. Both devices now show **Intercom**.

Intercom

3. To end the intercom call, one party presses **∩ OFF/CANCEL**, or place the handset back in the telephone base or charger. The other party hears four beeps. Both devices display **Intercom ended**.



Notes:

- ▶ Before the intercom call is answered, you can cancel it by pressing **∩ OFF/CANCEL**.
- ▶ If the called party does not answer within 100 seconds or if the handset is in use, on a call or out of range, the initiating device shows **No answer. Try again**.
- ▶ To temporarily silence the intercom ringer, press **∩ OFF/CANCEL** or **MUTE/DELETE**.
- ▶ You can only use one pair of handsets at a time to make intercom calls.
- ▶ For cordless headsets and speakerphones, refer to the corresponding user's manual on how to answer and end an intercom call.
- ▶ If a total of two cordless headset(s) and/or speakerphone(s) are registered to the telephone base, they appear as **HEADSET 1** and **HEADSET 2**, respectively.

Answer an incoming call during an intercom call

If you receive an outside call during an intercom call, there is a two-beep call waiting tone.

- ▶ To answer the call, press **\ PHONE/FLASH**. The intercom call ends automatically. The party on the intercom call hears four beeps. Other system devices can also answer the incoming call by pressing **\ PHONE/FLASH**.
- ▶ To end the intercom call without answering the incoming call, press **∩ OFF/CANCEL** on the handset.

Call transfer using intercom

Use the intercom feature to transfer an outside call to another system device. You can also share an outside call with another system device.

To transfer or share an outside call using intercom:

1. During the call, press **MENU/SELECT**.
2. Press **▼CID** or **▲DIR** to scroll to **Intercom** and press **MENU/SELECT**.
3. If you have a two-handset system and no other registered devices, your handset screen shows **Calling other handset**.

-OR-

If you have more than two handsets and/or cordless headset(s)/ speakerphone(s), your screen shows **INTERCOM TO:**. Use the dialing keys to enter a specific device number (**1-9** for handsets 1-9, **TONE ✕** followed by **0-2** for handsets 10-12, or **TONE ✕** followed by **#** for all devices), or press **▼CID** or **▲DIR** to scroll to the desired handset and press **MENU/SELECT**. Your handset screen shows **Calling HANDSET X**, or **Calling all handsets**.

4. When the destination handset picks up, your handset shows **Intercom** and the outside call is put on hold. You have the following options:
 - You can transfer the call. Press **MENU/SELECT**, then press **▼CID** or **▲DIR** to scroll to **Transfer**. Press **MENU/SELECT** again. The handset shows **Call transferred**. The other handset automatically connects to the outside call.
 - You can let the other handset join you on the outside call in a three-way conversation. Press **MENU/SELECT**. Press **▼CID** or **▲DIR** to highlight **Share call**, then press **MENU/SELECT**.
 - You can end the intercom call and continue the outside call with your handset. Press **☎PHONE/FLASH** on your handset (the ended intercom call party hears four beeps).

Push-to-talk (PTT)

You can directly broadcast messages to the speakerphone of any device. Press and hold **PUSH TO TALK** on a handset to begin two-way communication.

- Only one device can talk at a time. To do so, press and hold **PUSH TO TALK**.
- You must release **PUSH TO TALK**, so the other person can respond.
- Only one PTT session can be active at a time.
- While PTT is in use between two devices, other devices cannot use the intercom feature but can access the answering system.
- When you attempt to place a PTT call to another device which is accessing the answering system or on an intercom call or outside call, your device screen shows **Not available at this time**.

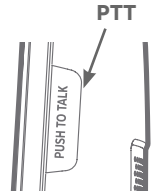

Note: The PTT function is not available when QUIET mode is on or if you have only one handset.

Turn PTT on or off

1. Press **PUSH TO TALK** when the handset is not in use. The **PUSH TO TALK** menu displays.
2. Press **▼CID** or **▲DIR** to highlight **PTT On/Off**, then press **MENU/SELECT**.
3. Press **▼CID** or **▲DIR** to choose **On** or **Off**, then press **MENU/SELECT**.



Note: The handset screen displays **No Incoming PTT** when PTT is turned off.

Push-to-talk (PTT)

PTT call to a single device

- There are a few ways to begin a PTT call to a single device. When the handset is not in use:
 - If you have a two-handset system, press and hold **PUSH TO TALK**.
 - If you have more than two handsets:
 - Press **PUSH TO TALK** on the handset, then use the dialing keys to enter the destination device number.

-OR-

 - Press **PUSH TO TALK** on the handset. Press **▼CID** or **▲DIR** to highlight the destination device number, then press **MENU/SELECT** or **PUSH TO TALK**.



The handset shows **Connecting to HANDSET X...** (**HANDSET** represents the handset name, **X** represents the destination handset number). When the connection is made, both your and the destination device screens display **Press and hold [PTT] to talk**.

- Press and hold **PUSH TO TALK**. A chirp indicates your microphone is on. Speak towards the device. Your voice is broadcast to the destination device. While you are speaking, your handset shows **PTT To handset: X**.



- Release **PUSH TO TALK** after speaking. Both devices beep once again and the screens show **Press and hold [PTT] to talk**, then you can press and hold **PUSH TO TALK** to continue speaking or the destination device can respond (see **Answer a PTT call** on page 45).
- To end the PTT call, press **↵OFF/CANCEL** or place the handset in the telephone base or charger. The handset shows **Push to talk Ended**.

Push-to-talk (PTT)

PTT call to multiple devices

When there are multiple handsets registered to the phone system, PTT supports one-to-group calls. PTT supports a maximum of one-to-four calls when one to five handsets are registered, and a maximum of one-to-three calls when six or more handsets are registered. The first four registered handsets will be able to use this feature. Other handsets can only use PTT for one-to-one calls.

To call multiple devices:

1. You have three ways to call multiple devices. When the handset is not in use:
 - Press and hold **PUSH TO TALK** until the handset shows **Connecting to group...**
 - Press **PUSH TO TALK**. Press **▼CID** or **▲DIR** to choose **Group**. Press **MENU/SELECT** or press **PUSH TO TALK** and your handset shows **Connecting to group....**
 - Press **PUSH TO TALK**. Press **TONEX** followed by **#** (pound key). The handset shows **Connecting to group...**

When the connection is made, both the caller and the destination parties hear a beep. The speakerphones on all other devices automatically activate.

2. You need to press and hold **PUSH TO TALK** when you want to speak. Speak towards the handset. Your voice is broadcast to all devices.
3. Release **PUSH TO TALK** after speaking.
4. Any extension can reply (see **Answer a PTT call** on page 45).



Note: After **PUSH TO TALK** on the handset is released, the PTT call remains open for a short time. If no one presses **PUSH TO TALK** on the handset within ten seconds, the PTT call ends automatically.

Push-to-talk (PTT)

Answer a PTT call

You can respond to a PTT call, as described below.

1. When your device receives a PTT call, it beeps and shows **Press and hold [PTT] to talk**.
2. When the other party is speaking, your speakerphone light is on, and your device shows **PTT From HS X To HS X** (the first **X** represents the initiating handset number, and the second **X** represents your handset number; a maximum of four handset numbers appear).
3. When your speakerphone light is off (the screen shows **Press and hold [PTT] to talk**), press and hold **PUSH TO TALK** on your handset. You will hear a chirp. Speak towards the device.
 - While you are speaking, your device shows **PTT To handset: X** (**X** represents the handset numbers of one or more destination handsets; a maximum of four handset numbers appear).
 - Your voice is broadcast to all destination devices.

After speaking, release **PUSH TO TALK**. Your device will beep. After the beep, if your speakerphone light is off, you can press and hold **PUSH TO TALK** to continue speaking.

Change a one-to-one PTT call to an intercom call

You can convert a one-to-one PTT session to an intercom call.

1. When your device shows **Press and hold [PTT] to talk**, press **MENU/SELECT**. The screen shows **Intercom**.
2. Press **MENU/SELECT**. Your device displays **Calling other handset** or **Calling HANDSET X**. The destination device briefly shows **Push to talk Ended** and then **Other handset is calling** or **HANDSET X is calling**. The destination device rings.
3. Press **\ PHONE/FLASH** or any dialing keys (**0-9, #** or **TONEx**) on the destination device to answer the intercom call. Both devices now show **Intercom**.
4. To end the intercom call, press **/ OFF/CANCEL** on your handset or place the handset in the telephone base or charger. Both screens show **Intercom ended**.

Push-to-talk (PTT)

Answer an incoming call during a PTT call

When you receive an outside call during PTT, there is an alert tone.

- ▶ During a one-to-one PTT, press **\ PHONE/FLASH** on the initiating or destination handset. The PTT call ends automatically and the outside call is answered.
- ▶ During a one-to-group PTT call, press **\ PHONE/FLASH** on the initiating handset. The PTT call ends automatically and the outside call is answered.
- ▶ During a one-to-group PTT call, press **\ PHONE/FLASH** on any one of the destination handsets. That device answers the outside call. The PTT call continues for the rest of the PTT participants.
- ▶ To leave the PTT call without answering the incoming call, press **/ OFF/CANCEL**. The telephone continues to ring.

Make an outgoing call during PTT call

- ▶ During a one-to-one PTT call, press **\ PHONE/FLASH** to get a dial tone. The PTT call ends automatically.
- ▶ During a one-to-group PTT call, press **\ PHONE/FLASH** on the initiating handset. The PTT call ends automatically and you get a dial tone.
- ▶ During a one-to-group PTT call, press **\ PHONE/FLASH** on any one of the destination handsets. That device gets a dial tone. The PTT call continues for the rest of the PTT participants.

Push-to-talk (PTT)

End or leave a PTT call

For one-to-one PTT calls, both initiating and destination devices can end the PTT call. For PTT calls to multiple devices, the initiating device can end the PTT call. If any one of the destination devices leaves the PTT call, the call continues until all participants or the initiator hangs up.

Press **∕ OFF / CANCEL** on the handset. The screen shows **Push to talk Ended.**

-OR-

Place the handset in the telephone base or charger, then the handset returns to idle mode.



Note: After **PUSH TO TALK** is released, the PTT call remains open for a short time. If no one presses **PUSH TO TALK** within ten seconds, the PTT call ends automatically.

About the directory

Shared directory

The directory is shared by all handsets. Changes made to the directory from any device apply to all.



Note:

- ▶ Only one handset can review the directory at a time. If another device tries to enter the directory, the screen shows **Not available at this time**.
- ▶ Directory entries can also be saved to the allow list or block list. See **Allow list** on page 81 and **Block list** on page 76.
- ▶ When Smart call blocker is on, calls with numbers saved in the directory will get through and ring on your telephone. If a number saved in the directory is also saved in the block list, calls from this number will be blocked.



Capacity

The directory can store up to 50 entries, with a maximum of 15 alphanumeric characters (including spaces) for names and 30 digits for telephone numbers. A convenient search feature can help you find and dial numbers quickly (page 52).

If you try to save an entry when there are already 50 entries, the screen shows **Directory full**. You cannot store a new number until you delete one.

Create directory entries

Create a new directory entry

1. Press **MENU/SELECT** in idle mode to enter the main menu.
2. Press **▼CID** or **▲DIR** to scroll to **Directory**, then press **MENU/SELECT**.
3. Press **▼CID** or **▲DIR** to highlight **Add contact**.
4. Press **MENU/SELECT**.
5. Use the dialing keys to enter a telephone number (up to 30 digits) when prompted.
 - ▶ Press **▼CID** or **▲DIR** to move the cursor to the left or right.
 - ▶ Press **MUTE/DELETE** to erase a digit.
 - ▶ Press and hold **MUTE/DELETE** to erase all digits.
 - ▶ Press and hold **REDIAL/PAUSE** to enter a three-second dialing pause (a **p** appears).



-OR-

Copy a number from the redial list by pressing **REDIAL/PAUSE**, then **▼CID** or **▲DIR**, or pressing **REDIAL/PAUSE** repeatedly to locate the number. Press **MENU/SELECT** to copy the number.

6. Press **MENU/SELECT** to move on to the name.
 - ▶ The screen shows **Number already saved** if the number is already in the directory. You cannot save the same number twice.
7. Use the dialing keys to enter a name (up to 15 characters) when prompted. Each time you press a key, the character on that key appears. Additional key presses produce other characters on that key. See the chart on next page.
 - ▶ Press **▼CID** or **▲DIR** to move the cursor to the left or right.
 - ▶ Press **0** to add a space.
 - ▶ Press **MUTE/DELETE** to erase a character.
 - ▶ Press and hold **MUTE/DELETE** to erase all characters.
 - ▶ Press **TONE X** to change the next letter to upper or lower case.



Create directory entries



Note: The first letter of every word is a capital letter. The remaining letters in a word start as lower case letters, as shown in the chart below.

Dialing keys	Characters by number of key presses										
	1	2	3	4	5	6	7	8	9	10	11
1	1	.	-	'	()	*	#	&	/	,
2	A	B	C	a	b	c	2				
3	D	E	F	d	e	f	3				
4	G	H	I	g	h	i	4				
5	J	K	L	j	k	l	5				
6	M	N	O	m	n	o	6				
7	P	Q	R	S	p	q	r	s	7		
8	T	U	V	t	u	v	8				
9	W	X	Y	Z	w	x	y	z	9		
0	space	0									
*											
#											

8. Press **MENU/SELECT** to store your new directory entry. There is a confirmation tone and the screen shows **Saved to directory**. To change the entry later, see page 54.

Add a predialed telephone number to the directory

You can save a predialed telephone number to the directory.

1. Enter the telephone number when in idle mode.
2. Follow the steps in **Edit a directory entry** on page 54.

Review the directory

Review directory entries

1. Press **▲DIR** when in idle mode. The summary screen shows briefly and then the first entry in the directory shows.

-OR-

Press **MENU/SELECT** when in idle mode, then press **▼CID** or **▲DIR** to scroll to **Directory**. Press **MENU/SELECT** twice.

2. Press **▼CID** or **▲DIR** to browse through the directory. Entries appear alphabetically by the first letter in the name.



Notes:

- ▶ If the telephone number in the directory exceeds 15 digits, **☞** appears in front of the telephone number. Press **TONE ✕** to move towards the end of the telephone number or press **#** (pound key) to move towards the beginning of the telephone number.
- ▶ If there are no directory entries when you press **▲DIR** in idle mode, **Directory empty** appears briefly on the screen, followed by **Add contact?**. If you would like to add a new contact, press **MENU/SELECT** and refer to page 49 for instructions on creating a new directory entry. Otherwise, press **↵ OFF/CANCEL** to cancel.

Search the directory

Search by name

1. Press **▲DIR** in idle mode to show the first listing in the directory.
2. When an entry appears, press the dialing keys (**0-9**) to start a name search. The directory shows the first name beginning with the first letter associated with the dialing key, if there is an entry in the directory beginning with that letter. Press **▼CID** or **▲DIR** to scroll through the directory.
3. To see other names starting with the letters on the same dialing key, keep pressing the key. The names appear in alphabetical order.

For example, if you have the names **Jennifer**, **Jessie**, **Kevin** and **Linda** in your directory:

- ▶ If you press **5 (JKL)** once, you see **Jennifer**. Press **▼CID** and you see **Jessie**.
- ▶ If you press **5 (JKL)** twice, you see **Kevin**.
- ▶ If you press **5 (JKL)** three times, you see **Linda**.
- ▶ If you press **5 (JKL)** four times, you see **5** and then the directory entry beginning with 5 or the next closest entry after 5.
- ▶ If you press **5 (JKL)** five times, you see **Jennifer** again.



Notes

- ▶ If there is no name matching the first letter of the key you press, the directory shows a name matching the following letters of the key.
- ▶ If you press a key (**0-9**) and no name starts with any of the letters on that key, the directory shows the entry matching the next letter in the directory.

Dial, delete or edit directory entries

To dial, delete or edit a directory entry (name and number), the entry must be displayed on the screen. Use **Review the directory** (page 51) or **Search by name** (page 52) to show an entry.

Display dial

To dial a displayed number from the directory, press **\ PHONE/FLASH** or **🔊/SPEAKER**.

Delete a directory entry

To delete the displayed directory entry, press **MUTE/DELETE**. Press **MENU/SELECT** to confirm. There is a confirmation tone and the screen shows **Contact deleted**. You cannot retrieve a deleted entry.

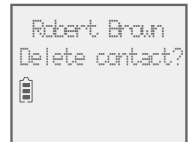



Dial, delete or edit directory entries

Edit a directory entry

1. When a directory entry displays, press **MENU/SELECT**. The screen shows **EDIT NUMBER** along with the phone number to be edited. If you only want to edit the name, skip to Step 3.

Linda Miller
 888-722-7792

2. To edit the number:
 - ▶ Press the dialing keys to add digits.
 - ▶ Press **▼CID** or **▲DIR** to move the cursor to the left or right.
 - ▶ Press **MUTE/DELETE** to erase a digit.
 - ▶ Press and hold **MUTE/DELETE** to erase all digits.
 - ▶ Press and hold **REDIAL/PAUSE** to add a three-second dialing pause (a **p** appears).

EDIT NUMBER
 888-883-2445_



EDIT NAME
 Robert Brown_

3. Press **MENU/SELECT** to move on to the name. The screen shows **EDIT NAME** along with the name to be edited.

Robert Brown
 888-883-2445

4. To edit the name:
 - ▶ Press the dialing keys to add characters (page 50).
 - ▶ Press **▼CID** or **▲DIR** to move the cursor to the left or right.
 - ▶ Press **0** to add a space.
 - ▶ Press **MUTE/DELETE** to erase a character.
 - ▶ Press and hold **MUTE/DELETE** to erase all characters.
 - ▶ Press **-tone** to change the next letter to upper or lower case.
5. Press **MENU/SELECT** to save the entry. There is a confirmation tone and the screen shows **Saved to directory**.



Note: If the telephone number has more than 11 digits, **EDIT NUMBER** will not be displayed on the screen.

Directory Speed dial

The telephone system has nine speed dial locations (2-9, 0) and a voicemail access location  **1** where you can store the telephone numbers you wish to dial more quickly. You can store up to 30 digits in each location. Speed dial assignments can only be selected from the existing directory entries. The voicemail access number must be manually entered. In the directory, speed dial locations are indicated by their number on the bottom of the screen.



Speed dial location

Assign a speed dial number

1. When the telephone is idle, press **MENU/SELECT**.
2. Press **▼CID** or **▲DIR** to scroll to **Directory**. Press **MENU/SELECT**.
3. Press **▼CID** or **▲DIR** to scroll to **Speed dial**. Press **MENU/SELECT**.
4. Press **▼CID** or **▲DIR** to choose your desired speed dial location (**0** or **2-9**), then press **MENU/SELECT**. The screen briefly shows **Copy from Directory...** and then displays the directory list.
5. Press **▼CID** or **▲DIR** to scroll to the phone number you wish to assign to the selected speed dial location.
6. Press **MENU/SELECT** to save the setting and return to the previous menu. There is a confirmation tone and the screen returns to the speed dial list.



-OR-

1. When the telephone is idle, press and hold any dialing keys (**0** or **2-9**).
2. Press **▼CID** or **▲DIR** to choose your desired speed dial location (**0** or **2-9**), then press **MENU/SELECT**. The screen briefly shows **Copy from Directory...** and then displays the directory list.

Directory Speed dial

3. Press **▼CID** or **▲DIR** to scroll to the phone number you wish to assign to the selected speed dial location.
4. Press **MENU/SELECT** to save the setting and return to the previous menu. There is a confirmation tone and the screen returns to the speed dial list.

Assign your voicemail speed dial number

To assign your voicemail speed dial number to location  **1**, see page 23.

Reassign a speed dial number

1. When the telephone is idle, press **MENU/SELECT**.
2. Press **▼CID** or **▲DIR** to scroll to **Directory**. Press **MENU/SELECT**.
3. Press **▼CID** or **▲DIR** to scroll to **Speed dial**. Press **MENU/SELECT**.
4. Press **▼CID** or **▲DIR** to choose the location you wish to reassign, then press **MENU/SELECT** to show the directory entry.
5. Press **MENU/SELECT** again.
6. Scroll to **Change SD** and then press **MENU/SELECT**. The screen briefly shows **Copy from Directory...** and then displays the directory list.
7. Press **▼CID** or **▲DIR** to scroll to the phone number you wish to reassign to the selected speed dial location.
8. Press **MENU/SELECT** to save the setting and return to the speed dial list. There is a confirmation tone.



Delete a speed dial number

1. When the telephone is idle, press **MENU/SELECT**.
2. Press ▼**CID** or ▲**DIR** to scroll to **Directory**. Press **MENU/SELECT**.
3. Press ▼**CID** or ▲**DIR** to scroll to **Speed dial**. Press **MENU/SELECT**.
4. Press ▼**CID** or ▲**DIR** to scroll to the location you wish to delete the speed dial number from, then:
 - ▶ Press **MUTE/DELETE** to delete the displayed speed dial number. There is a confirmation tone and the screen shows **Speed dial empty** before returning to the speed dial list.



-OR-

- i. Press **MENU/SELECT** to show the directory entry.
- ii. Press **MENU/SELECT** again.
- iii. Scroll to **Clear SD** and then press **MENU/SELECT** to delete the displayed speed dial number. There is a confirmation tone and the screen shows **Speed dial empty** before returning to the speed dial list.

Directory Speed dial

Make a call using speed dial

When in idle mode, press and hold the dialing key (**0** or **2-9**) corresponding to the assigned location you wish to call.

-OR-

1. Press **MENU/SELECT** when in idle mode.
2. Press **▼CID** or **▲DIR** to scroll to **Directory**, then press **MENU/SELECT**.
3. Press **▼CID** or **▲DIR** to scroll to **Speed dial**, then press **MENU/SELECT**.
4. Press **▼CID** or **▲DIR** to scroll to the desired location (**0** or **2-9**) and then press **\PHONE/FLASH** or **📞/SPEAKER**.

Check your voicemail using speed dial

When in idle mode, press and hold **📧 1** to dial the voicemail number you have set. See page 23 to set your voicemail speed dial number.

About caller ID

This product supports caller ID services offered by most telephone service providers. Caller ID allows you to see the name, number, date and time of calls. The available caller ID information will appear after the first or second ring.

Information about caller ID with call waiting

Caller ID with call waiting lets you see the name and telephone number of the caller before answering the call, even while on another call.

It may be necessary to change your telephone service to use this feature. Contact your telephone service provider if:

- ▶ You have both caller ID and call waiting, but as separate services (you may need to combine these services).
- ▶ You have only caller ID service, or only call waiting service.
- ▶ You don't subscribe to caller ID or call waiting services.

There are fees for caller ID services. In addition, services may not be available in all areas.

This product can provide information only if both you and the caller are in areas offering caller ID service and if both telephone service providers use compatible equipment. The time and date, along with the call information, are from the telephone service provider.

Caller ID information may not be available for every incoming call. Callers may intentionally block their names and/or telephone numbers. You can only view a maximum of 15 digits of every caller ID log entry. To view caller ID log entries with numbers between 16 and 24 digits, you must save the entry to the directory (see page 65).

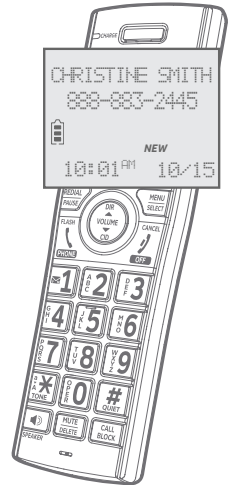

Note: You can use this product with regular caller ID service, or you can use this product's other features without subscribing to caller ID or combined caller ID with call waiting service.

Caller ID log

How the caller ID log works

The telephone stores caller ID information about the last 50 incoming calls. Entries are stored in reverse chronological order. The phone deletes the oldest entry when the log is full to make room for new calls. This information is common to all handsets, so changes made using any handset are reflected in all other devices. If you answer a call before the information appears on the screen, it does not show in the caller ID log.



Note: Each entry may have up to 24 digits for the phone number and 15 characters for the name.

Missed (new) call indicator

When a handset is in idle mode and has new or missed calls, its screen shows **XX Missed calls**.

All new and missed entries are counted as missed calls. Each time you review a new caller ID log entry (indicated by **NEW** on the screen), the number of missed calls decreases by one.

If you do not want to review the missed calls one by one, but still want to keep them in the caller ID log, you can press and hold **OFF/CANCEL** for four seconds when the handset is idle. You will hear a confirmation tone. All the entries in the caller ID log become old (reviewed already), and the missed calls message goes away.

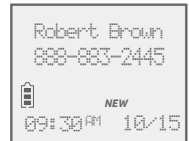

Caller ID operation

Memory match

If the incoming telephone number matches the last 7 digits of a telephone number in your directory, the name that appears on the screen matches the corresponding name in your directory.

For example, if Christine Smith calls, her name appears as **Chris** if this is how you entered it into your directory.



Note: The number shown in the caller ID log will be in the format sent by the telephone service provider. The telephone service provider usually delivers ten-digit phone numbers (area code plus telephone number). If the telephone number of the caller does not match a number in your directory, the name will appear as it is delivered by the telephone service provider.

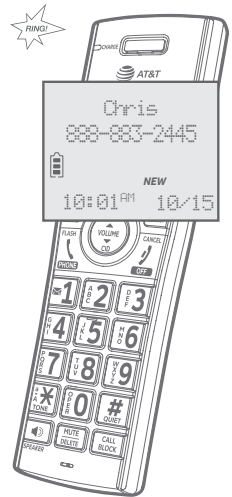

Caller ID operation

Review the caller ID log

Review the caller ID log to find out who called, to return the call, or to copy the caller's name and number into your directory. **Caller ID log empty** appears if there are no records in the caller ID log.

1. When the handset is in idle mode, press **▼CID** to review the caller ID log in reverse chronological order starting with the most recent call.

-OR-

Review the caller ID log by pressing **MENU/SELECT**. Press **▼CID** or **▲DIR** to scroll to **Caller ID log**, then press **MENU/SELECT** twice to select **Review**.

2. Press **▼CID** or **▲DIR** to scroll through the list.
3. Press **↵OFF/CANCEL** to exit the caller ID log.

You hear a double beep when the list reaches the beginning or end of the caller ID log.

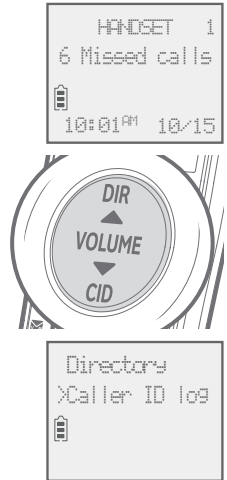

Note: Only one handset can review the caller ID log at a time. If another device tries to enter the directory or caller ID log, it shows **Not available at this time**.

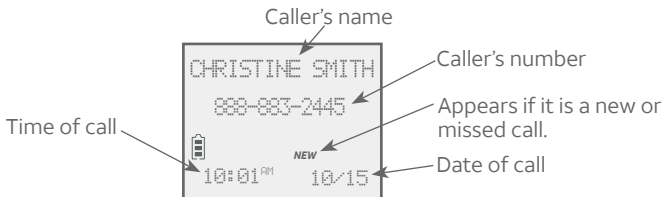

Caller ID operation

View dialing options

Although the incoming caller ID log entries have ten digits (the area code plus the seven-digit number), in some areas, you may need to dial only the 7 digits, 1 plus the seven digits, or 1 plus the area code plus the seven digits. You can change and store the number of digits that you dial in the caller ID log.

While reviewing the caller ID log, press **#** (pound key) repeatedly to show different dialing options for local and long distance numbers before dialing or saving the telephone number in the directory.

Press **1** repeatedly if you need to add or remove 1 in front of the telephone number before dialing or saving it in the directory.

When the number is in the correct format for dialing, press **PHONE/FLASH** or **SPEAKER** to call the number.

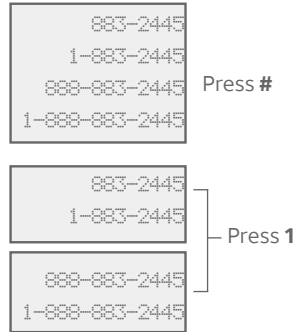

Note: This feature is only available to telephone numbers with 7 or 10 digits.

To save the number to the directory, allow list, block list or star name list, see page 65, page 83, page 78 and page 87.

Caller ID operation

Dial a caller ID log entry

1. When in the caller ID log, press ▼**CID** or ▲**DIR** to browse.
2. Press \ **PHONE/FLASH** or 📞/**SPEAKER** to dial the displayed entry.

Delete caller ID log entries

To delete an entry:

- ▶ Press **MUTE/DELETE** to delete the shown entry.

To delete all entries:

1. Press **MENU/SELECT** when in idle mode.
2. Press ▼**CID** or ▲**DIR** to scroll to **Caller ID log**, then press **MENU/SELECT**.
3. Press ▼**CID** or ▲**DIR** to scroll to **Del all calls**, then press **MENU/SELECT**.
4. When the screen shows **Delete all calls?**, press **MENU/SELECT** to confirm. There is a confirmation tone and the screen returns to the previous menu.



Caller ID operation

Save a caller ID log entry to the directory

1. When in the caller ID log, press **▼CID** or **▲DIR** to browse.
2. When the desired entry displays, press **MENU/SELECT**.
3. Press **MENU/SELECT** to choose **Directory**.
4. When the screen displays **EDIT NUMBER**, use the dialing keys to edit the number.
 - ▶ Press **▼CID** or **▲DIR** to move the cursor to the left or right.
 - ▶ Press **MUTE/DELETE** to backspace and erase a digit.
 - ▶ Press and hold **MUTE/DELETE** to erase the entire entry.
 - ▶ Press and hold **REDIAL/PAUSE** to insert a three-second dialing pause (a **p** appears).
5. Press **MENU/SELECT** to move to the name.
6. When the screen displays **EDIT NAME**, use the dialing keys (page 50) to edit the name.
 - ▶ Press **▼CID** or **▲DIR** to move the cursor to the left or right.
 - ▶ Press **0** to add a space.
 - ▶ Press **MUTE/DELETE** to erase a character.
 - ▶ Press and hold **MUTE/DELETE** to erase all characters.
 - ▶ Press **#** (pound key) to move the last word to the front. For example, **Johnson Charlie** becomes **Charlie Johnson** when you press **#** (pound key).
 - ▶ Press **TONEX** to change the next letter to upper or lower case.
7. Press **MENU/SELECT** when done. The screen shows **Saved to directory**.



Notes:

- ▶ You may need to change how a caller ID number is dialed if the entry does not appear in the correct format. Caller ID numbers may appear with an area code that is not necessary for local calls, or without a 1 that is necessary for long distance calls (see **View dialing options** on page 63).
- ▶ If the caller's name you received from the telephone service provider is all in capital letters, the first letter of every word remains a capital letter, while other letters become lower case. However, the next letter after the prefix "Mac", "Mc", "D", "C" or "O", is kept as a capital letter. For example, the "D" in "MacDonald" is kept as a capital letter. Another exception is that "VAN DER" will be changed to "Van der".
- ▶ If the telephone number from the caller ID information has already been saved in the directory under a different name, the new name will overwrite the old one.
- ▶ If you save a blocked number in the caller ID log to the directory, the original name from the caller ID information will be saved.

Caller ID operation

Save a caller ID log entry to the allow list

1. When in the caller ID log, press **▼CID** or **▲DIR** to browse.
2. When the desired entry displays, press **MENU/SELECT**.
3. Press **▼CID** or **▲DIR** to choose **Allow list**, then press **MENU/SELECT**.
4. When the screen displays **EDIT NUMBER**, use the dialing keys to edit the number.
 - ▶ Press **▼CID** or **▲DIR** to move the cursor to the left or right.
 - ▶ Press **MUTE/DELETE** to backspace and erase a digit.
 - ▶ Press and hold **MUTE/DELETE** to erase the entire entry.
 - ▶ Press and hold **REDIAL/PAUSE** to insert a three-second dialing pause (a **p** appears).
5. Press **MENU/SELECT** to move to the name.
6. When the screen displays **EDIT NAME**, use the dialing keys (page 50) to edit the name.
 - ▶ Press **▼CID** or **▲DIR** to move the cursor to the left or right.
 - ▶ Press **0** to add a space.
 - ▶ Press **MUTE/DELETE** to erase a character.
 - ▶ Press and hold **MUTE/DELETE** to erase all characters.
 - ▶ Press **#** (pound key) to move the last word to the front. For example, **Johnson Charlie** becomes **Charlie Johnson** when you press **#** (pound key).
 - ▶ Press **TONEX** to change the next letter to upper or lower case.
7. Press **MENU/SELECT** when done. The screen shows **Saved to allow list**.

Save a caller ID log entry to the block list

1. When in the caller ID log, press **▼CID** or **▲DIR** to browse.
2. When the desired entry displays, press **MENU/SELECT**.
3. Press **▼CID** or **▲DIR** to choose **Block list**, then press **MENU/SELECT**.
4. When the screen displays **EDIT NUMBER**, use the dialing keys to edit the number.

Caller ID operation

- ▶ Press **▼CID** or **▲DIR** to move the cursor to the left or right.
 - ▶ Press **MUTE/DELETE** to backspace and erase a digit.
 - ▶ Press and hold **MUTE/DELETE** to erase the entire entry.
 - ▶ Press and hold **REDIAL/PAUSE** to insert a three-second dialing pause (a **p** appears).
5. Press **MENU/SELECT** to move to the name.
 6. When the screen displays **EDIT NAME**, use the dialing keys (page 50) to edit the name.
 - ▶ Press **▼CID** or **▲DIR** to move the cursor to the left or right.
 - ▶ Press **0** to add a space.
 - ▶ Press **MUTE/DELETE** to erase a character.
 - ▶ Press and hold **MUTE/DELETE** to erase all characters.
 - ▶ Press **#** (pound key) to move the last word to the front. For example, **Johnson Charlie** becomes **Charlie Johnson** when you press **#** (pound key).
 - ▶ Press **TONE~~X~~** to change the next letter to upper or lower case.
 7. Press **MENU/SELECT** when done. The screen shows **Saved to block list**.

Save a caller ID log entry to the star name list

1. When in the caller ID log, press **▼CID** or **▲DIR** to browse.
2. When the desired entry displays, press **MENU/SELECT**.
3. Press **▼CID** or **▲DIR** to choose **Star name list**, then press **MENU/SELECT**.
4. When the screen displays **Star this name?** and the caller's name, press **MENU/SELECT** to confirm. The screen shows **Saved to star name list**.

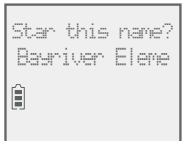

Reasons for missing caller ID information

There are occasions when other information or no information shows for various reasons:

On-screen message	Reason
PRIVATE NUMBER	The caller prefers not to show the phone number.
PRIVATE NAME	The caller prefers not to show the name.
PRIVATE CALLER	The caller prefers not to show the phone number and name.
UNKNOWN NUMBER	Your telephone service provider cannot determine the caller's number.
UNKNOWN NAME	Your telephone service provider cannot determine the caller's name.
UNKNOWN CALLER	Your telephone service provider cannot determine the caller's name and telephone number. Calls from other countries may also generate this message.

About Smart call blocker*

If you have subscribed to caller ID service, then you can use Smart call blocker to filter robocalls, telemarketing calls and unwanted calls, while allowing welcome calls to get through.

You can set up your lists of welcome callers and unwelcome callers. Smart call blocker allows calls from your welcome callers to get through, and it blocks calls from your unwelcome callers.

For other unknown calls, you can allow these calls, block these calls, or forward these calls to the answering system.

With some easy configurations, you can set to only filter robocalls by asking the callers to press the pound key (#) before the calls are put through to you.

You can also set Smart call blocker to screen incoming calls by asking the callers to record their names and press the pound key (#). After your caller completes the request, your telephone rings and announces the caller's name. You can then choose to block or answer the call, or you can forward the call to the answering system. If the caller does not respond or record his/her name, the call is blocked from ringing through. When you add your welcome callers to your allow list, they will bypass all screening and ring directly to your handsets.



Notes:

- ▶ Smart call blocker is on, once you install your telephone. It allows all incoming calls to get through and ring by default. You can change the Smart call blocker settings to screen incoming calls. For more details, see **Control calls without numbers** on page 73 and **Control uncategorized calls** on page 74.
- ▶ With call screening active, Smart call blocker screens and filters all incoming calls from numbers or names that are not yet saved in your directory, allow list, block list, or star name list. You can easily add incoming phone numbers to your allow list and block list. This allows you to build up your lists of allowed and blocked numbers, and Smart call blocker will know how to deal with these calls when they come in again.
- ▶ To turn off Smart call blocker, see **Set Smart call blocker on/off** on page 73.

* Includes licenced Qalte™ technology.

Qalte™ is a trademark of Truecall Group Limited.

About Smart call blocker

Call categories

Calls are classified into four categories:

Welcome calls

Welcome calls are calls with telephone numbers saved in your allow list or directory, and not in your block list. Welcome calls also include calls with caller names saved in your star name list.



Note: There are many organizations like schools, medical offices, and pharmacies that use robocalls to communicate important information to you. Robocall uses an autodialer to deliver pre-recorded messages. By entering the name of the organizations into the star name list, it ensures these calls will ring through when you only know the caller names but not their numbers.

Unwelcome calls

Unwelcome calls are calls with telephone numbers saved in your block list, and you want to block their calls.

Calls without numbers

Calls without numbers are calls that are “out of area“ or with numbers set to “Private“.

Uncategorized calls

Uncategorized calls include calls with absent caller ID number, calls with numbers that are not in your directory, allow list, or block list, or calls with caller ID names that are not in your star name list.



Note: The allow list stores up to 200 entries, the block list stores up to 1,000 entries, and the star name list stores up to 10 names.

About Smart call blocker

Call controls

- ▶ Smart call blocker is set to on, and to allow all incoming calls by default. When Smart call blocker is on, the first ring of all incoming calls will be muted.
- ▶ If your directory, allow list, star name list and block list are empty when Smart call blocker is on, and you have set to screen calls, the telephone will screen all incoming calls and asks callers to announce their names or press the pound key (#).
- ▶ If Smart call blocker is off, all incoming calls ring, including numbers saved in the block list.
- ▶ If QUIET mode is on, and Smart call blocker is on and in screening mode, all screened calls will be sent to the answering system after screening.

Smart call blocker handles calls in the following ways:

Call category	Call control
Welcome calls	Allow The telephone rings when there is an incoming call with number saved in your allow list or directory, but not in your block list. Robocalls with caller names saved in your star name list will also ring.
Unwelcome calls	Block The telephone does not ring when there is an incoming call with number saved in your block list, and the call will be rejected.

About Smart call blocker

Call category	Call control
<p>Calls without numbers</p> <ul style="list-style-type: none"> You can set to screen, allow, or block all calls of this call category, or to send these calls to the answering system. Allow is the default setting. To change the setting, see Control calls without numbers on page 73. 	<p>Screening with caller name</p> <p>If you have selected this option, the telephone plays the screening announcement, and then ask the caller to say his/her name before the call rings on your telephone. You can then answer the call, and hear the caller's name announced. You can decide whether to accept or reject the call, or to forward the call to the answering system.</p> <p>Screening without caller name</p> <p>If you have selected this option, the telephone plays the screening announcement, and then ask the caller to press the pound key (#) before the call rings on your telephone. You can then answer the call.</p>
<p>Uncategorized calls</p> <ul style="list-style-type: none"> You can set to screen, allow, or block all calls of this call category, or to send these calls to the answering system. Allow is the default setting. To change the setting, see Control uncategorized calls on page 74. 	<p>Allow (default settings)</p> <p>The telephone allows the calls to get through and ring. The caller's number will not be saved to the allow list.</p> <p>Answering system</p> <p>If you have selected this option, the telephone forwards the calls to the answering system without ringing.</p> <p>Block</p> <p>If you have selected this option, the telephone rejects the calls with block announcement without ringing. The caller's number will not be saved to the block list.</p>

Call block settings

Set Smart call blocker on/off

The Smart call blocker feature is set to on by default.

1. Press **CALL BLOCK** on the handset when it is not in use, and then press **MENU/SELECT** to select **SCB On/Off**.

-OR-

Press **MENU/SELECT** to enter the main menu when the handset is not in use. Press **▼CID** or **▲DIR** to scroll to **Smart call blk**, then press **MENU/SELECT** twice.

2. Press **▼CID** or **▲DIR** to highlight **On** or **Off**, then press **MENU/SELECT** to save the setting. You hear a confirmation tone.

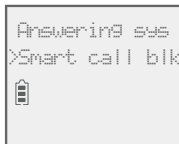
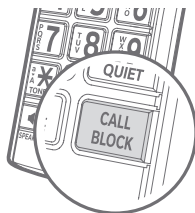

Control calls without numbers

Use this setting to control “out of area” or “Private” calls. You can choose to allow or reject these calls directly. You can also choose to screen them with or without learning the callers’ names before you decide whether to answer or reject these calls. Moreover, you can forward these calls to the answering system.

To change the setting:

1. Press **CALL BLOCK** on the handset when it is not in use.

-OR-

Press **MENU/SELECT** to enter the main menu when the handset is not in use. Press **▼CID** or **▲DIR** to scroll to **Smart call blk**, then press **MENU/SELECT**.

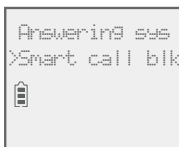

Call block settings

2. Press **▼CID** or **▲DIR** to scroll to **Calls w/o num**, then press **MENU/SELECT**.
3. Press **▼CID** or **▲DIR** to choose one of the following options, then press **MENU/SELECT**.
 - **Screening** - ask the caller to press the pound key (#) or to say his/her name before the call rings on your telephone.
 - **Allow** - allow the calls to get through and ring.
 - **Answering sys** - forward the calls to the answering system without ringing.
 - **Block** - reject the calls with block announcement.
4. If you select **Screening**, press **▼CID** or **▲DIR** to choose one of the following options, then press **MENU/SELECT**.
 - **w/ Caller name** - ask the caller to say his/her name before the call rings on your telephone. You can then answer the call, and hear the caller's name announced. You can decide whether to answer or reject the call, or to forward the call to the answering system.
 - **w/o Caller name** - ask the caller to press the pound key (#) before the call rings on your telephone. You can then answer the call.

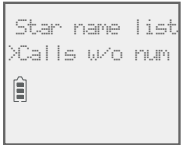

Control uncategorized calls

Use this setting to control calls with numbers that are not on your directory, allow list or block list, or have no caller ID number display. You can choose to allow or reject these calls directly. You can also choose to screen them with or without learning the callers' names before you decide whether to answer or reject these calls. Moreover, you can forward these calls to the answering system.

To change the setting:

1. Press **CALL BLOCK** on the handset when it is not in use.

Call block settings

-OR-

Press **MENU/SELECT** to enter the main menu when the handset is not in use. Press **▼CID** or **▲DIR** to scroll to **Smart call blk**, then press **MENU/SELECT**.

2. Press **▼CID** or **▲DIR** to scroll to **Uncategorized**, then press **MENU/SELECT**.
3. Press **▼CID** or **▲DIR** to choose one of the following options, then press **MENU/SELECT**.
 - **Screening** - ask the caller to press the pound key (#) or to say his/her name before the call rings on your telephone.
 - **Allow** - allow the calls to get through and ring.
 - **Answering sys** - send the calls to the answering system without ringing.
 - **Block** - reject the calls with block announcement.
4. If you select **Screening**, press **▼CID** or **▲DIR** to choose one of the following options, then press **MENU/SELECT**.
 - **w/ Caller name** - ask the caller to say his/her name before the call rings on your telephone. You can then answer the call, and hear the caller's name announced. You can decide whether to answer or reject the call, or to forward the call to the answering system.
 - **w/o Caller name** - ask the caller to press the pound key (#) before the call rings on your telephone. You can then answer the call.

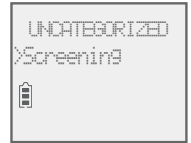
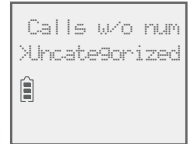
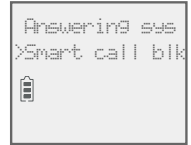

Note: Robocalls will be classified as uncategorized calls. If you select **Screening**, the telephone screens and filters these calls. It asks the caller to press the pound key (#) or announces his/her name before putting the call through to you. There may be robocalls that you do not want to miss. For example, robocalls with announcements or notices from schools or pharmacies. You can set up your star name list with these caller names to allow their calls to get through to you. See **Star name list** on page 86.

Call block settings

Block list

Add numbers that you want to prevent their calls from ringing through. The block list stores up to 1,000 entries.

Add a block entry:

1. Press **CALL BLOCK** on the handset when it is not in use.
-OR-
 Press **MENU/SELECT** to enter the main menu when the handset is not in use. Press **▼CID** or **▲DIR** to scroll to **Smart call blk**, then press **MENU/SELECT**.
2. Press **▼CID** or **▲DIR** to scroll to **Block list**, and then press **MENU/SELECT**.
3. Press **▼CID** or **▲DIR** to scroll to **Add new entry**, then press **MENU/SELECT**.
4. When the screen displays **ENTER NUMBER**, use the dialing keys to enter a number (up to 30 digits).
 - ▶ Press **▼CID** or **▲DIR** to move the cursor to the left or right.
 - ▶ Press **MUTE/DELETE** to erase a digit.
 - ▶ Press and hold **MUTE/DELETE** to erase all digits.
 - ▶ Press and hold **REDIAL/PAUSE** to enter a three-second dialing pause (a **p** appears).



-OR-

Copy a number from the redial list by pressing **REDIAL/PAUSE**. Then, press **▼CID**, **▲DIR** or **REDIAL/PAUSE** repeatedly to find the desired number. Press **MENU/SELECT** to copy the number.

5. Press **MENU/SELECT** to move on to the name.
 - ▶ The screen shows **Number already saved** if the number is already in the block list. You cannot save the same number twice.

Call block settings

- When the screen displays **ENTER NAME**, use the dialing keys to enter a name (up to 15 characters). Press a key repeatedly until the desired character appears. The first character of every word is capitalized.
 - Press **▼CID** or **▲DIR** to move the cursor to the left or right.
 - Press **0** to add a space.
 - Press **MUTE/DELETE** to erase a character.
 - Press and hold **MUTE/DELETE** to erase all characters.
 - Press **-tone ✕** to change the next letter to upper or lower case.
- Press **MENU/SELECT** to store your block entry.



Notes:

- Numbers saved in your directory can also be saved to the block list.
- If you save a block entry that has already been saved to the allow list, the entry in the allow list will be removed.

Review block list:

- Press **CALL BLOCK** on the handset when it is not in use.

-OR-

Press **MENU/SELECT** to enter the main menu when the handset is not in use. Press **▼CID** or **▲DIR** to scroll to **Smart call blk**, then press **MENU/SELECT**.

- Press **▼CID** or **▲DIR** to scroll to **Block list**, and then press **MENU/SELECT**.
- Press **MENU/SELECT** to choose **Review**.
- Press **▼CID** or **▲DIR** to browse through the block entries.



Note: **Block list is empty** appears if there are no block entries.



Call block settings

Save a caller ID log entry to block list:

1. Search for the desired caller ID log entry (see **Review the caller ID log** on page 62).
2. When the desired entry displays, press **MENU/SELECT**.
3. Press **▼CID** or **▲DIR** to scroll to **Block list**, then press **MENU/SELECT**.
4. The handset displays **EDIT NUMBER**. Use the dialing keys to edit the number, when necessary.
 - Press **▼CID** or **▲DIR** to move the cursor to the left or right.
 - Press **MUTE/DELETE** on the handset to backspace and erase a digit.
 - Press and hold **MUTE/DELETE** to erase the entire entry.
 - Press and hold **REDIAL/PAUSE** to insert a three-second dialing pause (a **p** appears).
5. Press **MENU/SELECT** to move to the name. The screen displays **EDIT NAME**.
6. Use the dialing keys to add or edit the name.
 - Press **▼CID** or **▲DIR** to move the cursor to the left or right.
 - Press **0** to add a space.
 - Press **MUTE/DELETE** to erase a character.
 - Press and hold **MUTE/DELETE** to erase all characters.
 - Press **#** (pound key) to move the last word to the front. For example, **Johnson Charlie** becomes **Charlie Johnson** when you press **#** (pound key).
 - Press **TONE~~X~~** to change the next letter to upper or lower case.
7. Press **MENU/SELECT** when done and the screen shows **Saved to block list**.

Call block settings

Edit a block entry:

1. Search for the desired entry in the block list (see **Review block list** on page 77).
2. When the desired entry displays, press **MENU/SELECT**. The screen displays **EDIT NUMBER** along with the phone number to be edited. If you only want to edit the name, skip to Step 4.
3. To edit the number:
 - ▶ Use the dialing keys to enter digits.
 - ▶ Press **▼CID** or **▲DIR** to move the cursor to the left or right.
 - ▶ Press **MUTE/DELETE** on the handset to erase a digit.
 - ▶ Press and hold **MUTE/DELETE** to erase all digits.
 - ▶ Press and hold **REDIAL/PAUSE** to enter a three-second dialing pause (a **p** appears).
4. Press **MENU/SELECT** to move on to the name. The screen displays **EDIT NAME** along with the name to be edited.
5. To edit the name:
 - ▶ Use the dialing keys to enter characters.
 - ▶ Press **▼CID** or **▲DIR** to move the cursor to the left or right.
 - ▶ Press **0** to add a space.
 - ▶ Press **MUTE/DELETE** to erase a character.
 - ▶ Press and hold **MUTE/DELETE** to erase all characters.
6. Press **MENU/SELECT** to save the entry. The screen displays **Saved to block list**.

Call block settings

Delete a block entry:

1. Search for the desired entry in the block list (see **Review block list** on page 77).
2. When the desired entry displays, press **MUTE/DELETE** on the handset. The screen shows **Delete entry?**.
3. Press **MENU/SELECT** to confirm. The screen show **Entry deleted**, and the next entry displays. You cannot retrieve a deleted entry.

Delete all block entries:

1. Press **CALL BLOCK** on the handset when it is not in use.
-OR-
Press **MENU/SELECT** to enter the main menu when the handset is not in use. Press **▼CID** or **▲DIR** to scroll to **Smart call blk**, then press **MENU/SELECT**.
2. Press **▼CID** or **▲DIR** to scroll to **Block list**, and then press **MENU/SELECT**.
3. Press **▼CID** or **▲DIR** to highlight **Delete all**, then press **MENU/SELECT**. The screen shows **Delete all in block list?**.
4. Press **MENU/SELECT** again to confirm. The screen displays **Deleted**. There is a confirmation tone.

Call block settings

Allow list

Add numbers that you want to allow their calls to get through to you. The allow list stores up to 200 entries.

Add an allow entry:

1. Press **CALL BLOCK** on the handset when it is not in use.
-OR-
Press **MENU/SELECT** to enter the main menu when the handset is not in use. Press **▼CID** or **▲DIR** to scroll to **Smart call blk**, then press **MENU/SELECT**.
2. Press **▼CID** or **▲DIR** to scroll to **Allow list**, and then press **MENU/SELECT**.
3. Press **▼CID** or **▲DIR** to scroll to **Add new entry**, then press **MENU/SELECT**.
4. When the screen displays **ENTER NUMBER**, use the dialing keys to enter a number (up to 30 digits).
 - Press **▼CID** or **▲DIR** to move the cursor to the left or right.
 - Press **MUTE/DELETE** to erase a digit.
 - Press and hold **MUTE/DELETE** to erase all digits.
 - Press and hold **REDIAL/PAUSE** to enter a three-second dialing pause (a **p** appears).**-OR-**
Copy a number from the redial list by pressing **REDIAL/PAUSE**. Then, press **▼CID**, **▲DIR** or **REDIAL/PAUSE** repeatedly to find the desired number. Press **MENU/SELECT** to copy the number.
5. Press **MENU/SELECT** to move on to the name.
 - The display shows **Number already saved** if the number is already in the allow list. You cannot save the same number twice.

Call block settings

6. When the screen displays **ENTER NAME**, use the dialing keys to enter a name (up to 15 characters). Press a key repeatedly until the desired character appears. The first character of every word is capitalized.



- ▶ Press **▼CID** or **▲DIR** to move the cursor to the left or right.
 - ▶ Press **0** to add a space.
 - ▶ Press **MUTE/DELETE** to erase a character.
 - ▶ Press and hold **MUTE/DELETE** to erase all characters.
 - ▶ Press **TONE X** to change the next letter to upper or lower case.
7. Press **MENU/SELECT** to store your allow entry.



Notes:

- ▶ Numbers saved in your directory can also be saved to the allow list.
- ▶ If you save an allow entry that has already been saved to the block list, the entry in the block list will be removed.

Review allow list:

1. Press **CALL BLOCK** on the handset when it is not in use.

-OR-

Press **MENU/SELECT** to enter the main menu when the handset is not in use. Press **▼CID** or **▲DIR** to scroll to **Smart call blk**, then press **MENU/SELECT**.

2. Press **▼CID** or **▲DIR** to scroll to **Allow list**, and then press **MENU/SELECT**.
3. Press **MENU/SELECT** to choose **Review**.
4. Press **▼CID** or **▲DIR** to browse through the allow entries.



Note: **Allow list is empty** appears if there are no allow entries.

Call block settings

Save a caller ID log entry to allow list:

1. Search for the desired caller ID log entry (see **Review the caller ID log** on page 62).
2. When the desired entry displays, press **MENU/SELECT**.
3. Press **▼CID** or **▲DIR** to scroll to **Allow list**, then press **MENU/SELECT**.
4. The handset displays **EDIT NUMBER**. Use the dialing keys to edit the number, when necessary.
 - ▶ Press **▼CID** or **▲DIR** to move the cursor to the left or right.
 - ▶ Press **MUTE/DELETE** on the handset to backspace and erase a digit.
 - ▶ Press and hold **MUTE/DELETE** to erase the entire entry.
 - ▶ Press and hold **REDIAL/PAUSE** to insert a three-second dialing pause (a **p** appears).
5. Press **MENU/SELECT** to move to the name. The screen displays **EDIT NAME**.
6. Use the dialing keys to add or edit the name.
 - ▶ Press **▼CID** or **▲DIR** to move the cursor to the left or right.
 - ▶ Press **0** to add a space.
 - ▶ Press **MUTE/DELETE** to erase a character.
 - ▶ Press and hold **MUTE/DELETE** to erase all characters.
 - ▶ Press **#** (pound key) to move the last word to the front. For example, **Johnson Charlie** becomes **Charlie Johnson** when you press **#** (pound key).
 - ▶ Press **TONE~~X~~** to change the next letter to upper or lower case.
7. Press **MENU/SELECT** when done and the screen shows **Saved to allow list**.

Call block settings

Edit an allow entry:

1. Search for the desired entry in the allow list (see **Review allow list** on page 82).
2. When the desired entry displays, press **MENU/SELECT**. The screen displays **EDIT NUMBER** along with the phone number to be edited. If you only want to edit the name, skip to Step 4.
3. To edit the number:
 - ▶ Use the dialing keys to enter digits.
 - ▶ Press **▼CID** or **▲DIR** to move the cursor to the left or right.
 - ▶ Press **MUTE/DELETE** on the handset to erase a digit.
 - ▶ Press and hold **MUTE/DELETE** to erase all digits.
 - ▶ Press and hold **REDIAL/PAUSE** to enter a three-second dialing pause (a **p** appears).
4. Press **MENU/SELECT** to move on to the name. The screen displays **EDIT NAME** along with the name to be edited.
5. To edit the name:
 - ▶ Use the dialing keys to enter characters.
 - ▶ Press **▼CID** or **▲DIR** to move the cursor to the left or right.
 - ▶ Press **0** to add a space.
 - ▶ Press **MUTE/DELETE** to erase a character.
 - ▶ Press and hold **MUTE/DELETE** to erase all characters.
6. Press **MENU/SELECT** to save the entry. The screen displays **Saved to allow list**.



Call block settings

Delete an allow entry:

1. Search for the desired entry in the allow list (see **Review allow list** on page 82).
2. When the desired entry displays, press **MUTE/DELETE** on the handset. The screen shows **Delete entry?**.
3. Press **MENU/SELECT** to confirm. The screen show **Entry deleted**, and the next entry displays. You cannot retrieve a deleted entry.

Delete all allow entries:

1. Press **CALL BLOCK** on the handset when it is not in use.
-OR-
Press **MENU/SELECT** to enter the main menu when the handset is not in use. Press **▼CID** or **▲DIR** to scroll to **Smart call blk**, then press **MENU/SELECT**.
2. Press **▼CID** or **▲DIR** to scroll to **Allow list**, and then press **MENU/SELECT**.
3. Press **▼CID** or **▲DIR** to highlight **Delete all**, then press **MENU/SELECT**. The screen shows **Delete all in allow list?**.
4. Press **MENU/SELECT** again to confirm. The screen displays **Deleted**. There is a confirmation tone.

Call block settings

Star name list

There are many organizations like schools, medical offices, and pharmacies that use robocalls to communicate important information to you. Robocall uses an autodialer to deliver pre-recorded messages. By entering the name of the organizations into the star name list, it ensures these calls will ring through when you only know the caller names but not their numbers.

If the first 15 characters of the incoming caller ID's name match a name saved in your star name list, the call will get through and ring. The star name list stores up to 10 names.

Add a star name entry:

1. Press **CALL BLOCK** on the handset when it is not in use.
-OR-
 Press **MENU/SELECT** to enter the main menu when the handset is not in use. Press **▼CID** or **▲DIR** to scroll to **Smart call blk**, then press **MENU/SELECT**.
2. Press **▼CID** or **▲DIR** to scroll to **Star name list**, and then press **MENU/SELECT**.
3. Press **▼CID** or **▲DIR** to scroll to **Add new entry**, then press **MENU/SELECT**.
4. When the screen displays **ENTER NAME**, use the dialing keys to enter a name (up to 15 characters). Press a key repeatedly until the desired character appears. The first character of every word is capitalized.

 - ▶ Press **▼CID** or **▲DIR** to move the cursor to the left or right.
 - ▶ Press **0** to add a space.
 - ▶ Press **MUTE/DELETE** to erase a character.
 - ▶ Press and hold **MUTE/DELETE** to erase all characters.
 - ▶ Press **TONE ✕** to change the next letter to upper or lower case.
5. Press **MENU/SELECT** to store your star name entry. The display shows **Name already saved** if the name is already in the star name list. You cannot save the same name twice.

Call block settings

Review star name list:

1. Press **CALL BLOCK** on the handset when it is not in use.
-OR-
Press **MENU/SELECT** to enter the main menu when the handset is not in use. Press **▼CID** or **▲DIR** to scroll to **Smart call blk**, then press **MENU/SELECT**.
2. Press **▼CID** or **▲DIR** to scroll to **Star name list**, and then press **MENU/SELECT**.
3. Press **MENU/SELECT** to choose **Review**.
4. Press **▼CID** or **▲DIR** to browse through the star name entries.



Note: **Star name list is empty** appears if there are no star name entries.

Save a caller ID log entry to star name list:

1. Search for the desired caller ID log entry (see **Review the caller ID log** on page 62).
2. When the desired entry displays, press **MENU/SELECT**.
3. Press **▼CID** or **▲DIR** to scroll to **Star name list**, then press **MENU/SELECT**.
4. The handset displays **Star this name?**, and the caller ID name of the caller.
5. Press **MENU/SELECT**, and the screen shows **Saved to star name list**.



Call block settings

Edit a star name entry:

1. Search for the desired entry in the star name list (see **Review star name list** on page 87).
2. When the desired entry displays, press **MENU/SELECT**. The screen displays **EDIT NAME** along with the name to be edited.
3. To edit the name:
 - Use the dialing keys to enter characters.
 - Press **▼CID** or **▲DIR** to move the cursor to the left or right.
 - Press **0** to add a space.
 - Press **MUTE/DELETE** to erase a character.
 - Press and hold **MUTE/DELETE** to erase all characters.
4. Press **MENU/SELECT** to save the entry. The screen displays **Saved to star name list**.

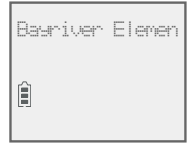

Delete a star name entry:

1. Search for the desired entry in the star name list (see **Review star name list** on page 87).
2. When the desired entry displays, press **MUTE/DELETE** on the handset. The screen shows **Delete entry?**.
3. Press **MENU/SELECT** to confirm. The screen show **Entry deleted**, and the next entry displays. You cannot retrieve a deleted entry.

Call block settings

Delete all star name entries:

1. Press **CALL BLOCK** on the handset when it is not in use.
-OR-
Press **MENU/SELECT** to enter the main menu when the handset is not in use. Press ▼**CID** or ▲**DIR** to scroll to **Smart call blk**, then press **MENU/SELECT**.
2. Press ▼**CID** or ▲**DIR** to scroll to **Star name list**, and then press **MENU/SELECT**.
3. Press ▼**CID** or ▲**DIR** to highlight **Delete all**, then press **MENU/SELECT**. The screen shows **Delete all in star name list?**.
4. Press **MENU/SELECT** again to confirm. The screen displays **Deleted**. There is a confirmation tone.

Screening announcements

If you have set to screen calls without numbers and/or screen uncategorized calls, the callers of one or all of the following incoming call categories will hear a screening announcement.

- ▶ Calls that are “out of area“ or with numbers set to “Private“.
- ▶ Calls with numbers that are not on your directory, allow list, or block list, or with absent caller ID number.
- ▶ Calls with caller ID names that are not on your star name list.

The telephone has two screening options, and each option has its default screening announcements.

Screening with caller name - *“Hello. Calls to this number are being screened by Smart call blocker. Please say your name after the tone, then press pound.”*

-OR-

Screening without caller name - *“Hello. Calls to this number are being screened by Smart call blocker. If you’re a family member, friend or invited caller, please press pound to be connected. If you’re a solicitor, please hang up now.”* You can use these announcements, or record your own name to replace *“this number”* in both announcements.

Please refer to **Record your name for all screening announcements** on page 91.

Call block settings

Play your current announcement of screening with caller name:

1. Press **CALL BLOCK** on the handset when it is not in use.
-OR-
Press **MENU/SELECT** to enter the main menu when the handset is not in use. Press **▼CID** or **▲DIR** to scroll to **Smart call blk**, then press **MENU/SELECT**.
2. Press **▼CID** or **▲DIR** to scroll to **Screening annc**, then press **MENU/SELECT**.
3. Press **▼CID** or **▲DIR** to scroll to **Play annc**, then press **MENU/SELECT**.
4. Press **MENU/SELECT** again to select **w/ Caller name**.



Play your current announcement of screening without caller name:

1. Press **CALL BLOCK** on the handset when it is not in use.
-OR-
Press **MENU/SELECT** to enter the main menu when the handset is not in use. Press **▼CID** or **▲DIR** to scroll to **Smart call blk**, then press **MENU/SELECT**.
2. Press **▼CID** or **▲DIR** to scroll to **Screening annc**, then press **MENU/SELECT**.
3. Press **▼CID** or **▲DIR** to scroll to **Play annc**, then press **MENU/SELECT**.
4. Press **▼CID** or **▲DIR** to scroll to **w/o Caller name**, then press **MENU/SELECT**.

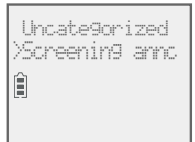

Call block settings

Record your name for all screening announcements:

1. Press **CALL BLOCK** on the handset when it is not in use.
-OR-
Press **MENU/SELECT** to enter the main menu when the handset is not in use. Press **▼CID** or **▲DIR** to scroll to **Smart call blk**, then press **MENU/SELECT**.
2. Press **▼CID** or **▲DIR** to scroll to **Screening annc**, then press **MENU/SELECT**.
3. Press **MENU/SELECT** to select **Rec your name**. The system announces, *"Record after the tone. Press 5 when you are done."*
4. Speak towards the handset to record your name. Press 5 to end recording.

To listen to the announcement with your recorded name again, scroll to **Play annc** and press **MENU/SELECT**.

Reset all your screening announcements:

1. Press **CALL BLOCK** on the handset when it is not in use.
-OR-
Press **MENU/SELECT** to enter the main menu when the handset is not in use. Press **▼CID** or **▲DIR** to scroll to **Smart call blk**, then press **MENU/SELECT**.
2. Press **▼CID** or **▲DIR** to scroll to **Screening annc**, then press **MENU/SELECT**.
3. Press **▼CID** or **▲DIR** to scroll to **Reset annc**, then press **MENU/SELECT**. The screen shows **Reset to default annc?**. Press **MENU/SELECT** again to confirm. The screen shows **Ann. reset to default** before returning to the previous menu.
-OR-
While an announcement is playing, press **MUTE/DELETE**. The screen shows **Ann. Deleted** before returning to the previous menu.



Your name will be deleted from all the screening announcements, and the telephone will use the default screening announcements described on page 89.

Allowed calls

If Smart call blocker is on, the following types of incoming calls can get through to you and ring on your telephone system:

- ▶ Calls with numbers saved in your allow list.
- ▶ Calls with numbers saved in your directory, but not on your block list.
- ▶ Calls with caller ID names saved in your star name list.



Note: When Smart call blocker is off, all incoming calls will ring on your telephone system, including calls with numbers saved in the block list.

Allow calls without numbers

If Smart call blocker is on, and you have set to allow calls without numbers, the following type of incoming calls will ring on your telephone system.

- ▶ Calls that are “out of area“ or with numbers set to “Private“.

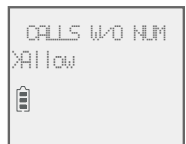

Allowed calls

Allow uncategorized calls

If Smart call blocker is on, and you have set to allow uncategorized calls, the following type of incoming calls will ring on your telephone system.

- ▶ Calls with numbers that are not on your directory, allow list or block list, or with absent caller ID number.
- ▶ Calls with caller ID names that are not on your star name list.



Note: If you have set to allow all uncategorized calls, the caller's numbers will not be saved to the allow list. If you want to save the caller's number to your allow list or block list, you can retrieve the number from caller ID log and save it to the allow list or block list. See **Save a caller ID log entry to the block list** on page 78 and **Save a caller ID log entry to the allow list** on page 83. If you want to retrieve the name from caller ID log and save it to the star name list, see **Save a caller ID log entry to the star name list** on page 87.

```
>SCB On/Off  
Block list  
☎
```

```
Calls w/o num  
>Uncategorized  
☎
```

```
UNCATEGORIZED  
>Allow  
☎
```

Smart call blocker

Blocked calls

If Smart call blocker is on, incoming calls with numbers saved in your block list will not ring. The telephone plays the block announcement *“Calls to this number are being screened by Smart call blocker. The number you are calling is not accepting your call. Please hang up.”* to the caller, and the call will be terminated.

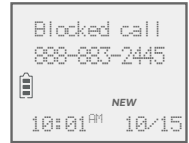

Note: If Smart call blocker is off, incoming calls with numbers saved in your block list will ring on your telephone system.

Block calls without numbers

If Smart call blocker is on, and you have set to block calls without numbers, the following type of incoming calls will not ring, and the calls will be terminated.

- ▶ Calls that are “out of area” or with numbers set to “Private”.

The telephone plays the block announcement *“Calls to this number are being screened by Smart call blocker. The number you are calling is not accepting your call. Please hang up.”* to the caller.

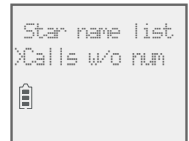

Note: The telephone can respond to remote access code while it is playing the block announcement. This allows you to access your answering system from an unknown number remotely. See **Remote access** on page 123.

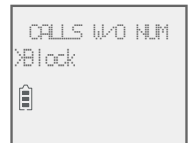

Blocked calls

Block uncategorized calls

If Smart call blocker is on, and you have set to block uncategorized calls, the following type of incoming calls will not ring, and the calls will be terminated.

- ▶ Calls with numbers that are not on your directory, allow list or block list, or with absent caller ID number.
- ▶ Calls with caller ID names that are not on your star name list.

The telephone plays the block announcement “*Calls to this number are being screened by Smart call blocker. The number you are calling is not accepting your call. Please hang up.*” to the caller.

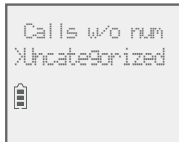

Notes:

- ▶ If you have set to block all uncategorized calls, the caller's numbers will not be saved to the block list. If you want to save the caller's number to your allow list or block list, you can retrieve the number from caller ID log and save it to the allow list or block list. See **Save a caller ID log entry to the block list** on page 78 and **Save a caller ID log entry to the allow list** on page 83. You can also retrieve the name from caller ID log and save it to the star name list. See **Save a caller ID log entry to the star name list** on page 87.
- ▶ The telephone can respond to remote access code while it is playing the block announcement. This allows you to access your answering system from an unknown number remotely. See **Remote access** on page 123.

Screen calls without numbers

If Smart call blocker is on, and your telephone is set to screen calls without number, the telephone will not ring when receiving incoming calls that are “out of area” or with numbers set to “Private”. It plays a screening announcement to the caller and asks the caller to respond before putting the call through to you.

The telephone has two screening options. You can set your Smart call blocker to screen these calls by asking the callers to record their names and then press the pound key (#). Alternatively, you can screen these calls by only asking the callers to press the pound key (#).

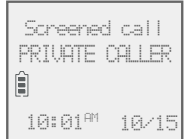
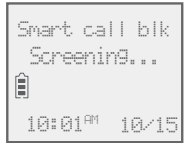

Screen calls without numbers and ask for caller names

When screening a call, the telephone announces to the caller, *“Hello. Calls to this number are being screened by Smart call blocker. Please say your name after the tone, then press pound.”* After the caller completes the request, the telephone announces to the caller *“Please wait a moment while your call is connected.”* The telephone starts ringing and announces the caller’s name. The telephone screen displays **Screened call** and you can pick up the call. The telephone will then ask whether you want to answer or reject the call, or to forward the call to the answering system.

Screen calls without numbers and do not ask for caller names

When screening a call, the telephone announces to the caller, *“Hello. Calls to this number are being screened by Smart call blocker. If you’re a family member, friend or invited caller, please press pound to be connected. If you’re a solicitor, please hang up now.”* After the caller presses the pound key (#), the telephone announces to the caller *“Please wait a moment while your call is connected.”* The telephone starts ringing, and you can answer the call. This option is suitable for you to filter calls that uses autodialers to deliver pre-recorded messages, for example, robocalls and telemarketing calls.

Screen calls without numbers



Notes:

- ▶ The telephone announces to the caller with *“Hello. Calls to this number are being screened by Smart call blocker...”* If you have recorded your name in the screening announcements, your recorded name will replace *“this number”* in the announcements. See **Screening announcement** on page 89.
- ▶ If the caller hangs up before the call is screened, or without leaving his/her name while the call is being screened, the call will be logged as missed call in the caller ID log.
- ▶ While a call is being screened, you can press **\ PHONE/FLASH** or **📞/SPEAKER** to stop screening and answer the call.
- ▶ After the telephone screened a call, and is ringing and announcing the caller’s name, you can press **🔇/OFF/CANCEL** to mute the ringer, or press **CALL BLOCK** to reject the call directly.
- ▶ After you picked up a screened call and the telephone is announcing the screening options, you can press **🔇/OFF/CANCEL** to hang up the call.
- ▶ If you receive a call waiting call without number while on a call, Smart call blocker will not screen the new call. You can press **\ PHONE/FLASH** or **📞/SPEAKER** to take the new call.
- ▶ Robocalls are unable to respond to the screening announcement, and therefore, will not get through and ring. If you want to allow some robocalls to get through, save their names in the star name list. See page 86.
- ▶ The telephone can respond to remote access code while it is playing the screening announcement. This allows you to access your answering system from an unknown number remotely. See **Remote access** on page 123.

Answer call once

1. When the telephone starts ringing, and the screen displays **Screened call**, press **\ PHONE/FLASH** or **📞/SPEAKER** to pick up the call. If you have turned on the caller ID announce feature, the telephone announces *“You have a call from...”* and the caller’s name. After you picked up the call, the telephone announces *“To answer the call, press 1. To send this call to the answering system, press 4. To repeat these options, press *”*.
2. Press **1** to answer the call. The telephone number will not be added to your allow list.

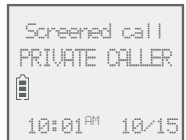

Notes:

- ▶ To turn on or off caller ID announce, see page 21.
- ▶ When the telephone is ringing, you can press **🔇/OFF/CANCEL** to mute the ringer temporarily.

Screen calls without numbers

Send call to answering system

1. When the telephone starts ringing, and the screen displays **Screened call**, press **\ PHONE/FLASH** or **📞/SPEAKER** to pick up the call. If you have turned on the caller ID announce feature, the telephone announces “*You have a call from...*” and the caller’s name. After you picked up the call, the telephone announces “*To answer the call, press 1. To send this call to the answering system, press 4. To repeat these options, press **”.
2. Press **4** to send the caller to the answering system.

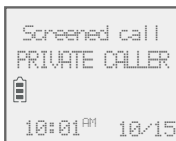

Notes:

- ▶ The caller is sent to the answering system and can leave a message even if the answering system is off.
- ▶ To turn on or off caller ID announce, see page 21.
- ▶ When the telephone is ringing, you can press **📞/OFF/CANCEL** to mute the ringer temporarily.

End call

1. When the telephone starts ringing, and the screen displays **Screened call**, press **\ PHONE/FLASH** or **📞/SPEAKER** to pick up the call. If you have turned on the caller ID feature, the telephone announces “*You have a call from...*” and the caller’s name. After you picked up the call, the telephone announces “*To answer the call, press 1. To send this call to the answering system, press 4. To repeat these options, press **”.
2. If you do not want to take the call, press **📞/OFF/CANCEL** to end the call.

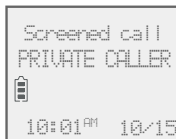

Screen uncategorized calls

If Smart call blocker is on, and your telephone is set to screen uncategorized calls, the telephone will not ring when receiving the following incoming calls:

- ▶ Incoming calls with absent caller ID numbers;
- ▶ Incoming calls with numbers that are not in your directory, allow list, nor block list; or
- ▶ Incoming calls with names that are not in your star name list.

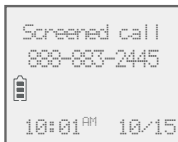

The telephone plays a screening announcement to the caller and asks the caller to respond before putting the call through to you. There are two screening options. You can set your Smart call blocker to screen these calls by asking the callers to record their names and then press the pound key (#). Alternatively, you can screen these calls by only asking the callers to press the pound key (#).

Screen uncategorized calls and ask for caller names

When screening a call, the telephone announces to the caller, *"Hello. Calls to this number are being screened by Smart call blocker. Please say your name after the tone, then press pound."* After the caller completes the request, the telephone announces to the caller *"Please wait a moment while your call is connected."* The telephone starts ringing and announces the caller's name. The telephone screen displays **Screened call** and you can pick up the call. The telephone will then ask whether you want to answer or reject the call, or to forward the call to the answering system.

Screen uncategorized calls without asking for caller names

When screening a call, the telephone announces to the caller, *"Hello. Calls to this number are being screened by Smart call blocker. If you're a family member, friend or invited caller, please press pound to be connected. If you're a solicitor, please hang up now."* After the caller presses the pound key (#), the telephone announces to the caller *"Please wait a moment while your call is connected."* The telephone starts ringing, and you can pick up the call. This option is suitable for you to filter calls that uses autodialers to deliver pre-recorded messages, for example, robocalls and telemarketing calls.

Screen uncategorized calls



Notes:

- ▶ You can set Smart call blocker to screen and filter all uncategorized calls from numbers or names that are not saved in your directory, allow list, block list, or star name list. You can easily add incoming phone numbers to your allow list and block list. This allows you to build up your lists of allowed and blocked numbers, and Smart call blocker will know how to deal with these calls when they come in again.
- ▶ The telephone announces to the caller with “*Hello. Calls to this number are being screened by Smart call blocker...*” If you have recorded your name in the screening announcements, your recorded name will replace “*this number*” in the announcements. See **Screening announcements** on page 89.
- ▶ If the caller hangs up before the call is screened, or without leaving his/her name while the call is being screened, the call will be logged as missed call in the caller ID log.
- ▶ While a call is being screened, you can press **\ PHONE/FLASH** or **🔊/SPEAKER** to stop screening and answer the call.
- ▶ After the telephone screened a call, and is ringing and announcing the caller’s name, you can press **🔇/OFF/CANCEL** to mute the ringer, or press **CALL BLOCK** to reject the call directly. The caller’s number will be added to the block list.
- ▶ After you picked up a screened call and the telephone is announcing the screening options, you can press **🔇/OFF/CANCEL** to hang up the call. The caller’s number will not be saved to the block list.
- ▶ If the Smart call blocker feature is on and in screening mode, and you receive a call waiting call:
 - If you have already picked up a screened call, the telephone checks whether the call waiting call’s number can be found in the directory, block list or allow list. It also checks whether the caller name is in the star name list. After that, the telephone displays the caller ID information or **Blocked call** accordingly. You can press **\ PHONE/FLASH** or **🔊/SPEAKER** to take the new call.
 - If the telephone is screening a call, the call waiting call will be ignored and logged as missed call in the caller ID log.
- ▶ Robocalls are unable to respond to the screening announcement, and therefore, will not get through and ring. If you want to allow some robocalls to get through, save their names in the star name list. See page 86.
- ▶ The telephone can respond to remote access code while it is playing the screening announcement. This allows you to access your answering system from an unknown number remotely. See **Remote access** on page 123.

Screen uncategorized calls

Allow call once

1. When the telephone starts ringing, and the screen displays **Screened call**, press **\ PHONE/FLASH** or **🔊/SPEAKER** to pick up the call. If you have turned on the caller ID announce feature, the telephone announces “*You have a call from...*” and the caller’s name. After you picked up the call, the telephone announces “*To answer the call, press 1. To answer and always allow this number, press 2. To block this number, press 3. To send this call to the answering system, press 4. To repeat these options, press **”.
2. Press **1** to answer the call. The telephone number will not be added to your allow list.

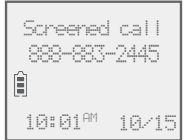

Notes:

- ▶ To turn on or off caller ID announce, see page 21.
- ▶ When the telephone is ringing, you can press **🔊/OFF/CANCEL** to mute the ringer temporarily.

Always allow

1. When the telephone starts ringing, and the screen displays **Screened call**, press **\ PHONE/FLASH** or **🔊/SPEAKER** to pick up the call. If you have turned on the caller ID announce feature, the telephone announces “*You have a call from...*” and the caller’s name. After you picked up the call, the telephone announces “*To answer the call, press 1. To answer and always allow this number, press 2. To block this number, press 3. To send this call to the answering system, press 4. To repeat these options, press **”.
2. Press **2** to answer the call. The telephone number will be added to your allow list.

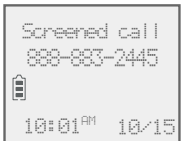

Notes:

- ▶ To turn on or off caller ID announce, see page 21.
- ▶ When the telephone is ringing, you can press **🔊/OFF/CANCEL** to mute the ringer temporarily.

Screen uncategorized calls

Block call

1. When the telephone starts ringing, and the screen displays **Screened call**, press **\ PHONE/FLASH** or **🔊/SPEAKER** to pick up the call. If you have turned on the caller ID announce feature, the telephone announces “*You have a call from...*” and the caller’s name. After you picked up the call, the telephone announces “*To answer the call, press 1. To answer and always allow this number, press 2. To block this number, press 3. To send this call to the answering system, press 4. To repeat these options, press **”.
2. Press **3** or **CALL BLOCK** to block the call. The telephone plays the block announcement “*The number you are calling is not accepting your call. Please hang up.*” to the caller. The telephone number will be added to your block list.



Send call to answering system

1. When the telephone starts ringing, and the screen displays **Screened call**, press **\ PHONE/FLASH** or **🔊/SPEAKER** to pick up the call. If you have turned on the caller ID announce feature, the telephone announces “*You have a call from...*” and the caller’s name. After you picked up the call, the telephone announces “*To answer the call, press 1. To answer and always allow this number, press 2. To block this number, press 3. To send this call to the answering system, press 4. To repeat these options, press **”.
2. Press **4** to forward the call to the answering system.



Note: The call is forwarded to the answering system and the caller can leave a message even if the answering system is off.

Option while on a call

When you are on a call and speaking to the caller, and you do not want to continue the call, you can press the **CALL BLOCK** button on the handset to end the call. The telephone plays the block announcement “*The number you are calling is not accepting your call. Please hang up.*” to the caller, and the call will be terminated. The caller’s number will be added to your block list.

- ▶ Press **CALL BLOCK** on the handset. The screen displays **Block and end?** and the caller’s number, if available. Press **MENU/SELECT** to end the call.



Notes:

- ▶ The caller’s number, if available, will be saved to the block list. The screen displays **Added to block list** after pressing **CALL BLOCK** on the handset. If caller’s number is not available, the screen displays **No number to block.**
- ▶ You can press **CALL BLOCK** on the handset to end the call even if Smart call blocker is turned off.

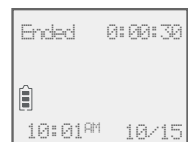
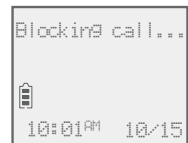
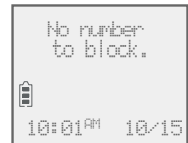
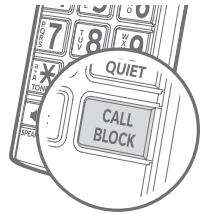

Answering system settings

Use the answering system menu of a system handset to set up the announcement message, turn on or off the answering system or message alert tone, activate call screening, or change the number of rings, remote access code or message recording time. If you turn off the answering system and you change any setting in the answering system setup menu, the answering system automatically turns on again.



1. When the device is in idle mode, press **MENU/SELECT** to enter the main menu.
2. Press **▼CID** or **▲DIR** to scroll to **Answering sys**, then press **MENU/SELECT**.

Announcement

Your outgoing announcement plays when calls are answered by the answering system.

The telephone has a default outgoing announcement, *"Hello. Please leave a message after the tone."* You can use this announcement, or record your own.

You can record an announcement up to 90 seconds. The system does not record any announcement shorter than two seconds.

To play your current outgoing announcement:

1. When the handset is in idle mode, press **MENU/SELECT** to enter the main menu.
2. Press **▼CID** or **▲DIR** to scroll to **Answering sys**, then press **MENU/SELECT**.
3. Press **MENU/SELECT** again to select **Announcement**.
4. Press **▼CID** or **▲DIR** to scroll to **Play annc**, then press **MENU/SELECT**.



Answering system settings

To record a new outgoing announcement:

1. When the handset is in idle mode, press **MENU/SELECT** to enter the main menu.
2. Press **▼CID** or **▲DIR** to scroll to **Answering sys**, then press **MENU/SELECT**.
3. Press **MENU/SELECT** again to select **Announcement**.
4. Press **MENU/SELECT** to select **Record annc**. The system announces, *"Record after the tone. Press 5 when you are done."*
5. Speak towards the handset to record your announcement. Press **5** to end recording. Your recorded announcement plays.



To listen to the recorded announcement again, scroll to **Play annc** and press **MENU/SELECT**.

To reset your outgoing announcement:

1. When the handset is in idle mode, press **MENU/SELECT** to enter the main menu.
2. Press **▼CID** or **▲DIR** to scroll to **Answering sys**, then press **MENU/SELECT**.
3. Press **MENU/SELECT** again to select **Announcement**.
4. Press **▼CID** or **▲DIR** to scroll to **Reset annc**, then press **MENU/SELECT**. The screen shows **Reset to default annc?**. Press **MENU/SELECT** again to confirm. The screen shows **Ann. reset to default** before returning to the previous menu.

-OR-

Press **▼CID** or **▲DIR** to scroll to **Play annc**, then press **MENU/SELECT**. While the announcement is playing, press **MUTE/DELETE** to delete the announcement. The screen shows **Ann. Deleted** before returning to the previous menu.

When your announcement is deleted, the system answers calls with the default announcement described on page 104. You cannot delete the default announcement.

Answering system settings

Answer on/off

By default, the answering system is on and ready to record messages. You can turn the answering system off, but if you do so, the answering system does not answer calls and record incoming messages.

To turn the answering system on or off:

Using a cordless handset:

1. When the handset is in idle mode, press **MENU/SELECT** to enter the main menu.
2. Press **▼CID** or **▲DIR** to scroll to **Answering sys**, then press **MENU/SELECT**.
3. Press **▼CID** or **▲DIR** to scroll to **Answer ON/OFF**, then press **MENU/SELECT**.
4. Press **▼CID** or **▲DIR** to highlight **On** or **Off**, then press **MENU/SELECT** to save the setting. You hear a confirmation tone.

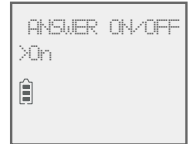

When the answering system is on, the handset shows **ANS ON**.

Using the telephone base:

- ▶ Press **⓪/ANS ON/OFF** to turn the answering system on or off. If the answering system is turned on, it announces, "Calls will be answered." If the answering system is turned off, it announces, "Calls will not be answered."

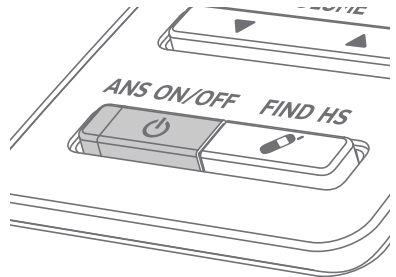

When the answering system is on, the light next to **⓪/ANS ON/OFF** will be on.



Note: If the answering system is off and there is an incoming call, the system answers after ten rings and announces, "Please enter your remote access code." For more information about remote access, see page 123.

Answering system settings

Voice guide

This feature is an alternative way for you to do the basic setup of the answering system. You can follow the voice guide to record your own announcement, set the number of rings, and set the message alert tone.

This feature is only available on the cordless handset.

1. Press **MENU/SELECT** on the handset when it is not in use.
2. Press **▼CID** or **▲** to scroll to **Answering sys**, then press **MENU/SELECT**.
3. Press **▼CID** or **▲DIR** to scroll to **Voice guide**, then press **MENU/SELECT**. You hear a voice prompt, *“This voice guide will assist you with the basic setup of your answering system.”*
4. Setup your answering system by inputting designated numbers, as instructed in the voice guide.

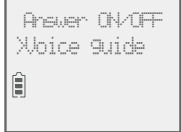

Notes:

- ▶ You can press **OFF/CANCEL** to quit the voice guide at any time.
- ▶ If the system does not receive any input, it will announce *“Sorry, I still have not received any input. If you want to restart the voice guide, please enter the menu and select Voice guide under Answering system. Good bye.”*
- ▶ After a power outage, the handset prompts you to set the date and time, and Smart call blocker. After these settings are done or skipped, the handset prompts if you want to set up the answering system via **voice guide**. Press **MENU/SELECT** to start the setup.
- ▶ If the answering system is off and there is an incoming call, the system answers after ten rings and announces, *“Please enter your remote access code.”* For more information about remote access, see page 123.

Answering system settings

Call screening

Use this feature to choose whether incoming messages can be heard over the speaker when they are being recorded. If you turn call screening on, you hear the incoming message. While monitoring an incoming message, you can answer the call by pressing **\ PHONE/FLASH** on the handset.

To change the setting:

1. When the handset is in idle mode, press **MENU/SELECT** to enter the main menu.
2. Press **▼CID** or **▲DIR** to scroll to **Answering sys**, then press **MENU/SELECT**.
3. Press **▼CID** or **▲DIR** to scroll to **Ans sys setup**, then press **MENU/SELECT**.
4. Press **MENU/SELECT** to select **Call screening**.
5. Press **▼CID** or **▲DIR** to choose **On** or **Off**.
6. Press **MENU/SELECT** to save the setting. You hear a confirmation tone.



Note: For more information on call screening, see page 108.

```
Voice guide
>Ans sys setup
```



```
>Call screening
# of rings
```



```
CALL SCREENING
>On
```



Answering system settings

Number of rings

You can set the answering system to answer an incoming call after two, three, four, five or six rings. You can also select toll saver. If toll saver is selected, the answering system answers a call after two rings when you have new messages, and after four rings when there are no new messages. This feature allows you to check for new messages and avoid paying long distance charges when calling from out of your local area. By default, the answering system answers an incoming call after four rings.

To set the number of rings:

1. When the handset is in idle mode, press **MENU/SELECT** to enter the main menu.
2. Press **▼CID** or **▲DIR** to scroll to **Answering sys**, then press **MENU/SELECT**.
3. Press **▼CID** or **▲DIR** to scroll to **Ans sys setup**, then press **MENU/SELECT**.
4. Press **▼CID** or **▲DIR** to scroll to **# of rings**, then press **MENU/SELECT**.
5. Press **▼CID** or **▲DIR** to choose among **2, 3, 4, 5, 6** or **Toll saver**.
6. Press **MENU/SELECT** to save the setting. You hear a confirmation tone.



Notes:

- ▶ If you subscribe to voicemail service through your telephone service provider, see **Answering system and voicemail indicators** on page 113.
- ▶ If you set the number of rings for the answering system as two or three rings, the caller ID announce feature may not have enough time to announce the caller's full information.
- ▶ If Smart call blocker is on, the first ring of all incoming calls will be muted.

Answering system settings

Remote access code

To access your answering system remotely from any touch-tone phone, you need to enter a two-digit number (00-99). By default, the remote access code is **19**.

To change the remote access code:

1. When the handset is in idle mode, press **MENU/SELECT** to enter the main menu.
2. Press **▼CID** or **▲DIR** to scroll to **Answering sys**, then press **MENU/SELECT**.
3. Press **▼CID** or **▲DIR** to scroll to **Ans sys setup**, then press **MENU/SELECT**.
4. Press **▼CID** or **▲DIR** to scroll to **Remote code**, then press **MENU/SELECT**.
5. Use the dialing keys to enter a two-digit number. Press **MUTE/DELETE** to backspace and delete a digit.
6. Press **MENU/SELECT** to save the setting. You hear a confirmation tone.

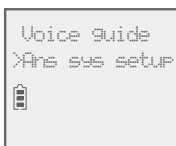

Answering system settings

Message alert tone

When the message alert tone is set to **On**, and there is at least one new message, the telephone base beeps every ten seconds. By default, the message alert tone is set to off.

There is no audible alert at the handset.

To change the setting:

1. When the handset is in idle mode, press **MENU/SELECT** to enter the main menu.
2. Press ▼ **CID** or ▲ **DIR** to scroll to **Answering sys**, then press **MENU/SELECT**.
3. Press ▼ **CID** or ▲ **DIR** to scroll to **Ans sys setup**, then press **MENU/SELECT**.
4. Press ▼ **CID** or ▲ **DIR** to scroll to **Msg alert tone**, then press **MENU/SELECT**.
5. Press ▼ **CID** or ▲ **DIR** to choose **On** or **Off**.
6. Press **MENU/SELECT** to save the setting. You hear a confirmation tone.



Notes:

- ▶ The message alert tone beeps only if all the following conditions are met:
 - Answering system is on.
 - Message alert tone setting is on.
 - There are new messages.
- ▶ To temporarily turn off the message alert tone, see page 117.

Answering system settings

Message recording time

You can set the recording time allowed for incoming messages. The message length is three minutes by default.

To change the setting:

1. When the handset is in idle mode, press **MENU/SELECT** to enter the main menu.
2. Press **▼CID** or **▲DIR** to scroll to **Answering sys**, then press **MENU/SELECT**.
3. Press **▼CID** or **▲DIR** to scroll to **Ans sys setup**, then press **MENU/SELECT**.
4. Press **▼CID** or **▲DIR** to scroll to **Recording time**, then press **MENU/SELECT**.
5. Press **▼CID** or **▲DIR** to choose **3 minutes**, **2 minutes** or **1 minute**, then press **MENU/SELECT** to save the setting. You hear a confirmation tone.

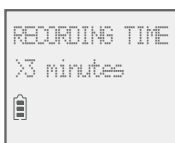

About the answering system

Answering system and voicemail indicators

Your telephone has separate indicators for two different types of voice messages: those left on its built-in digital answering system and those left at your telephone service provider's voicemail (fees may apply). Your telephone's built-in digital answering system messages and voicemail messages are separate. Each alerts you to new messages differently.

- ▶ If **OO** and **XX New messages** show on the handset and the message window, there are new messages in the built-in answering system. To listen to messages recorded on your digital answering system, press **▶/■/PLAY/STOP** on the telephone base (page 118).
- ▶ If **✉** and **New voicemail** display on the handset, your telephone service provider is indicating that it has new voicemail for you. To listen to your voicemail, dial an access number provided by your telephone service provider, followed by a security code or PIN.

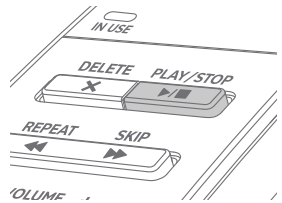

Some telephone service providers bundle or combine multiple services like voicemail and call waiting, so you may not be aware that you have voicemail. To check what services you have and how to access them, contact your telephone service provider.

To use your voicemail service rather than the answering system, turn off the answering system. To use the answering system rather than your voicemail service, contact your telephone service provider to deactivate your voicemail service.



Note: After reviewing all new messages, the number of old messages appears on the message counter.

About the answering system

Using the answering machine and voicemail together

You can also use your telephone answering system and voicemail together by setting your built-in answering system to answer before voicemail answers, as described below. To learn how to program your voicemail settings, contact your telephone service provider. If you are on a call, or the answering system is busy recording a message and you receive another call, the second caller can leave a voicemail message.

Set your answering system to answer calls at least two rings earlier than your voicemail is set to answer. For example, if your voicemail answers after six rings, set your answering system to answer after four rings. Some voicemail providers may program the delay before answering calls in seconds instead of rings. In this case, allow six seconds per ring when determining the appropriate setting.

About the answering system

Message capacity

The answering system can record up to 99 messages, depending on the length of each message. Individual messages can be up to three minutes, and the maximum recording time is approximately 22 minutes. The actual recording time depends on individual message characteristics. Messages remain available for replay until you delete them.

When there are new messages (including memos) on the answering system, the number of messages stored shows in the message counter.

If the answering system has less than three minutes of recording time left, it announces, *“Less than three minutes to record,”* before message playback at the handset or the telephone base. **Rec mem low** displays on the device screen in idle mode. When you turn on the answering system at the telephone base, it announces, *“Calls will be answered. Less than three minutes to record.”*

If the memory is full, the answering system announces, *“Memory is full,”* before message playback. The device screen displays **Rec mem full** in idle mode. Once the memory is full, you cannot turn the answering system back on if it has been turned off, nor can you record new messages until old ones have been deleted. **Memory full** displays if you want to turn on the answering system on the handset but there is no memory.

Voice prompts

The system provides voice prompts to guide you through the setup procedures on your handsets, message playback, remote access and recording outgoing announcements. The system also provides basic answering system setup via voice guide to record your own announcement, set the number of rings, and set the message alert tone.

About the answering system

Call screening

To screen a call at the telephone base:

If the answering system and call screening are on (see **Call screening** on page 108), the announcement and the incoming message broadcast at the telephone base when a call is answered by the answering system.

Options while a message is being recorded:

- ▶ Press **▲VOLUME+** or **▼VOLUME-** on the telephone base to adjust the call screening volume.
- ▶ Press **▶/■/PLAY/STOP** to temporarily silence the call screening.
- ▶ Press **▶/■/PLAY/STOP** to temporarily turn on the call screening if call screening is set to off.

To screen a call at the handset:

While a message is being recorded, the handset shows

To screen call, press [SELECT]. Press **MENU/SELECT** to screen the call.

Options while a message is being recorded:

- ▶ Press **▼CID/VOLUME** or **▲DIR/VOLUME** on the handset to adjust the call screening volume.
- ▶ Press **⏸/OFF/CANCEL** to temporarily silence the call screening.
- ▶ Press **MENU/SELECT** to temporarily turn on the call screening if call screening is set to off.
- ▶ Press **🔊/SPEAKER** to broadcast the announcement and the incoming message through the speakerphone. Press again to turn off the speakerphone.

About the answering system

Call intercept

While screening a call, you can stop recording and speak to the caller by pressing **\ PHONE/FLASH**.

Base ringer

Press **▲ VOLUME+** or **▼ VOLUME-** on the telephone base to adjust the ringer volume when the telephone is not in use.

You hear a sample of the ringer while adjusting the volume. The telephone base announces, “*Base ringer is off*,” when you set the volume to **0**.

Temporarily turning off the message alert tone

If the message alert tone is turned on, the telephone base beeps every ten seconds when there are new messages. Pressing any telephone base key (except **🔍 FIND HS**) temporarily silences the message alert tone.

However, if you press a key at the telephone base to silence the message alert tone, the telephone base will also perform the corresponding key function. For example, if you press **X/DELETE** when in idle mode to temporarily turn off the message alert tone, there is a voice prompt directing you to press **X/DELETE** again to delete all old messages. The message alert tone is temporarily off. Only press **X/DELETE** a second time if you wish to erase all old messages in your answering system.

The message alert tone resumes when you receive another message.

Message playback

If you have new messages, you hear only the new messages in chronological order. If there are no new messages, the system plays back all old messages (in chronological order). If there are both new and old messages, you have the option of playing the new or old messages on the cordless handset. The message counter flashes indicating the number of new messages saved.

When playback begins, the total number of messages is announced. Before each message, you hear the day and time of the recording. If the date and time are not set, you hear, *"Time and date not set,"* before playback. After the last message, you hear, *"End of messages."* If the recording time is less than three minutes, you hear, *"Less than three minutes to record"* before playback (see **Message capacity** on page 115).

To listen to messages at the telephone base:

Press ►/■/**PLAY/STOP** on the telephone base to listen to the messages. The system announces the number of messages, then begins playback. Press ►/■/**PLAY/STOP** again to end the message playback.

To listen to messages on a cordless handset:

1. When the handset is in idle mode, press **MENU/SELECT** to enter the main menu.
2. Press **MENU/SELECT** again to select **Play messages**.
 - ▶ If there are new and old messages, press ▼**CID** or ▲**DIR** to select **Play new msgs** or **Play old msgs**, then press **MENU/SELECT**.
 - ▶ If there are only new or only old messages, they will play automatically.

The system announces the number of messages, then begins playback. The message sequence is shown on the handset. If there are no recorded messages, the handset shows **No messages** and you hear, *"You have no message."*

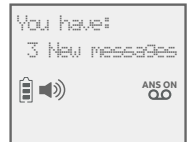

Message playback

Options during playback

When a message is playing, you can adjust the playback volume, skip, repeat, pause or delete the message.

When messages are playing on the telephone base:

- ▶ Press **▲VOLUME+** or **▼VOLUME-** to adjust the message playback volume.
- ▶ Press **▶/SKIP** to skip to the next message.
- ▶ Press **◀/REPEAT** to repeat the message. Press twice to hear the previous message.
- ▶ Press **X/DELETE** to delete the message.
- ▶ Press **▶/■/PLAY/STOP** to stop the playback.

When messages are playing on the handset:

- ▶ Press **▼CID/VOLUME** or **▲DIR/VOLUME** to adjust the message playback volume.
- ▶ Press **6** to skip to the next message.
- ▶ Press **4** to repeat the message. Press twice to hear the previous message.
- ▶ Press **MUTE/DELETE** to delete the message.
- ▶ Press **5** or **⏸/OFF/CANCEL** to stop the playback.
- ▶ Press **📞/SPEAKER** to switch between speakerphone mode and handset mode.
- ▶ Press **\ PHONE/FLASH** to stop playback. The screen shows **Call back?**, then press **MENU/SELECT** or **\ PHONE/FLASH** to call back the caller if the caller's number is available. If the dialing format used is not correct, then use the following option to choose the correct dialing format before calling back the caller.
- ▶ Press **MENU/SELECT** to pause playback and show the caller ID information if available. From here, you can press **⏸/OFF/CANCEL** to resume playback, or press **#** (pound key) repeatedly to show the desired dialing option (page 63), then press **MENU/SELECT** or **\ PHONE/FLASH** to call back the caller. If you do not call back within ten seconds, message playback resumes automatically.

Message playback



Note: The current equalizer settings remains unchanged until a new setting is selected.

Delete all old messages

You can only delete old (reviewed) messages. You cannot delete new messages until you review them. You cannot retrieve deleted messages.

To delete all old messages on the telephone base:

1. When the telephone is idle, press **X/DELETE**. The system announces, *“To delete all old messages, press **DELETE** again.”*
2. Press **X/DELETE** again. The system announces, *“All old messages deleted.”*



To delete all old messages on the handset:

1. Press **MENU/SELECT** when in idle mode to enter the main menu.
2. Press **▼CID** or **▲DIR** to scroll to **Answering sys.** Press **MENU/SELECT**.
3. Press **▼CID** or **▲DIR** to highlight **Delete all old**, then press **MENU/SELECT**. The screen shows **Delete all old messages?**
4. Press **MENU/SELECT** again to confirm. The screen displays **Deleting...** and then **All old msgs deleted!**. There is a confirmation tone.



Recording and playing memos

Memos are your own recorded messages used as reminders for yourself or others using the same answering system. Play and delete them in the same way as incoming messages.

Record a memo

1. When the handset is in idle mode, press **MENU/SELECT** to enter the main menu.
2. Press **▼CID** or **▲DIR** to scroll to **Answering sys.** Press **MENU/SELECT**.
3. Press **▼CID** or **▲DIR** to highlight **Record memo**, then press **MENU/SELECT**. The system announces, *"Record after the tone. Press 5 when you are done."* You can record a memo for up to four minutes.
4. Speak towards the handset to record a memo.
5. Press **5** to stop recording. The system announces, *"Recorded."* The system does not save memos shorter than two seconds.



Play back a memo

Play memos the same way as messages. See **Message playback** on page 118.

Base message counter displays

The base message counter shows the total number of answering system messages. See the following table for other message counter displays.

Message counter displays

0	No messages.
0 (flashing)	You need to set the date and time (page 19).
1-99	Total number of old messages and memos, or message number currently playing during old message playback.
1-99 (flashing)	Total number of messages and memos. The number flashes when there are new or missed messages. After a power failure, the number in the message counter flashes to indicate that you need to set the clock.
1-99 & F (alternating)	Memory is full. You must delete some messages before recording new messages.
... ..	The system is answering a call, recording a message or memo, or is being reached remotely. The telephone line is in use.
0-6	Shows for two seconds while adjusting the telephone base ringer volume.
1-8	Shows for two seconds while adjusting the telephone base speaker volume.

Remote access

You can reach your answering system remotely by dialing your home telephone number from any touch-tone telephone.

To remotely reach your answering system:

1. Dial your telephone number from any touch-tone telephone.
2. When the system answers, enter the two-digit remote access code (**19** is the default code. See page 110 to change it).
 - The system automatically announces the number of new or old messages (if any), and then begins to play them.
3. You can also enter the following remote commands:

Remote commands	Actions
1	Press to listen to all messages.
2	Press to listen to new messages only.
3	Press to delete the current message (during playback).
33	Press twice to delete all old messages.
4	Press to repeat the current message (during playback).
5	Press to stop any operation (including recording).
*5	Press to listen to a list of remote commands.
6	Press to skip to the next message (during playback).
*7	Press to record a new announcement.
8	Press to end remote access (the call will be terminated).
0	Press to turn the answering system on or off.

4. Hang up or press **8** to end the calls.

Remote access

Cut out and carry the remote access wallet card at the back of this user's manual for quick reference.



Notes:

- ▶ If you do not enter a valid remote access code, the system answers the call automatically.
- ▶ If you pause for more than four seconds during remote access, you hear a help menu listing all features and commands. If there is no command for another 20 seconds, the call ends automatically.
- ▶ If the memory is full, the answering system answers after ten rings and announces, *"Memory is full. Enter the remote access code."* Enter your remote access code to access the messages and announcements.
- ▶ The telephone can respond to remote access code while it is playing the screening announcement or block announcement. This allows you to access your answering system from an unknown number remotely. See **Screen calls without numbers** on page 96 and **Screen uncategorized calls** on page 99.

Adding and registering handsets/headsets/speakerphones

Your telephone can support up to 12 DECT 6.0 cordless handsets, headsets or speakerphones. You can purchase additional handsets (AT&T model CL80067, CL80107 or CL80117, sold separately) or up to ten cordless handsets and two cordless headsets or speakerphones (sold separately). CL80067 (wood color) is for use with CL82267/CL82367/CL82467. CL80107 (black) is for use with CL82107/CL82207/CL82307/CL82407/CL82507. CL80117 (white) is for use with CL82257/CL82357/CL82547/CL82557.

Visit <https://telephones.att.com/accessories> for a list of compatible DECT 6.0 cordless headsets or speakerphones. Each new handset, headset or speakerphone must be registered to the telephone base before use. You must register each handset, headset or speakerphone separately.

To register a cordless headset or speakerphone to this telephone system, please refer to the corresponding user's manual for details. To register a cordless handset, see below.

The handsets provided within your product box are already registered as **HANDSET 1**, and so forth. Additional handsets are assigned numbers in the sequential order they are registered (up to **HANDSET 12**).

Adding and registering handsets/headsets/speakerphones

Register a handset to the telephone base

1. Before you begin registration, make sure the handset is out of the telephone base or charger and shows **To register HS, see manual.**
2. Put the handset you wish to register on the telephone base cradle.
3. The handset shows **Registering... Please wait** and the **IN USE** light on the telephone base turns on. **HANDSET X Registered** appears on the handset screen (**HANDSET** represents the handset name, **X** represents the handset number). The handset beeps and the **IN USE** light turns off. The handset is now registered with the telephone base.

To register HS,
see manual.



Registering...
Please wait



HANDSET X
Registered

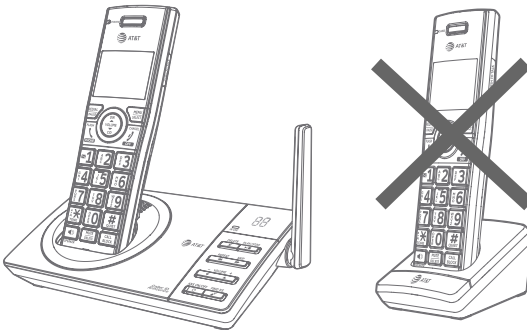

If registration fails, the system will automatically try to register again. If registration fails after the third try, **Registration failed** appears on the screen for a few seconds, and then **To register HS, see manual.** This may take up to five minutes to occur. Please start again from Step 1.



Note: You cannot register a handset if any other system handset is in use.

Deregistering handsets

You may need to deregister your handsets if:

- ▶ You have 12 registered handsets and need to replace a handset.

-OR-

- ▶ You wish to change the designated handset number of your registered handsets.

You must first deregister ALL handsets, and then register each handset you wish to use again, one at a time.

Please read carefully through all the instructions on this page before beginning the deregistration process.

Deregister all handsets from the telephone base

In addition to the cordless handsets, this operation will also deregister all cordless headsets or speakerphones registered to your telephone base.

1. Make sure that all handsets are out of the telephone base and chargers before you begin deregistration.
2. Press and hold **FIND HS** on the telephone base for about ten seconds (until the **IN USE** light starts to flash). Release **FIND HS**.
3. Immediately press **FIND HS** while the **IN USE** light is still flashing. (If the light stops flashing, start again with Step 1.)
4. It takes up to ten seconds to complete the deregistration process. Before registering the handset again, wait for the cordless handset screen to display **To register HS, see manual**.
5. To register the handset(s) to the telephone base again, follow the registration instructions on pages 125-126.

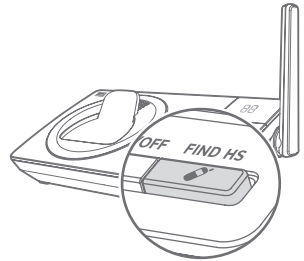

Deregistering handsets









Notes:

- ▶ If the deregistration process fails, you may need to reset the system and try again. To reset, unplug the power from the telephone base and plug it back in.
- ▶ You cannot deregister the handsets if any other system handset is in use.
- ▶ Even if the battery is depleted, you can still deregister the handsets by following the steps mentioned above. After the handset is charged for at least ten minutes, the screen shows **To register HS, see manual.**

Alert tones and lights

Handset screen icons

	Battery status - battery is charging (animated display).
	Battery status - low battery (flashing); place the handset in telephone base or charger to recharge.
	Speakerphone - the speakerphone is in use.
	Ringer off - the handset ringer is off.
	New voicemail - you have new voicemail from your telephone service provider.
ANS ON	Answering system on - the answering system is turned on to answer calls.
	Message - new message in the built-in answering system.
NEW	New caller ID log - new and missed calls.
MUTE	MUTE - the handset microphone is off.
	Message counter - number of message playing/total number of messages.



Alert tones and lights

Handset alert tones

One short beep	Tone of each key press, if key tone is turned on.
One long beep	Indication to begin recording a message, memo or announcement.
Two short beeps	You are pressing ▼CID or ▲DIR on a cordless handset when the volume is already at its highest or lowest setting. -OR- Call waiting tone. -OR- Error tone.
Confirmation tone (three rising tones)	The system has completed the command successfully.
Four beeps	The other party has ended your intercom call. -OR- The handset has gone out of range from the base during a call.
Four short beeps	Low battery warning.

Telephone base alert tones

One long beep	Indicates the start of message recording during call screening or the end of a message playback session.
Four short beeps	Registration failure tone.
Beeps every ten seconds	Message alert.
Fast ringer tone	You are setting the ringer volume by pressing the ▲VOLUME+ or ▼VOLUME- key on the telephone base.

Alert tones and lights

Lights

IN USE

- ▶ On when the handset is in use, or when the answering system is answering an incoming call.
- ▶ On when a handset is being registered.
- ▶ Flashes quickly when there is an incoming call or when handsets are being deregistered.
- ▶ Flashes when another telephone is in use on the same line.

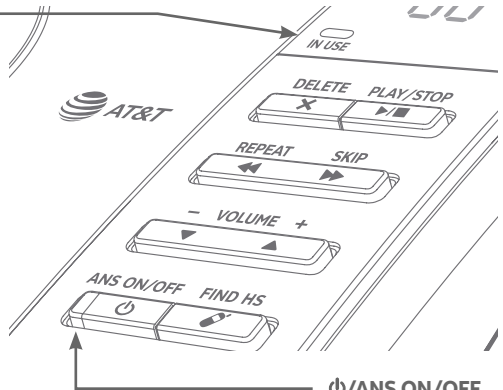

⏻/ANS ON/OFF

On when the answering system is on.

CHARGE light

On when the handset is charging in the telephone base or charger.

Extra large display

Big lighted buttons

🔊/SPEAKER

On when the speakerphone is on.

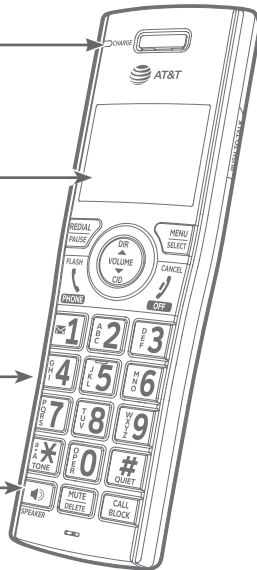

Screen display messages

Screen messages

Added to allow list	An entry has been added to the allow list.
Added to block list	An entry has been added to the block list.
Added to star name list	An entry has been added to the star name list.
Blocked call	An incoming call is blocked.
Block list is empty	There are no block list entries.
Call transferred	You have transferred an outside call to another device.
Caller ID log empty	There are no entries in the caller ID log.
Calling HANDSET X (for systems with 3 or more handsets)	The handset is calling another handset (for intercom calls). The handset is transferring an outside call to another handset.
Calling other handset (for systems with 2 handsets)	The handset is calling the other handset (for intercom calls).
CID Annc ON/OFF on all HS and BS	The caller ID announce features has been turned on or off on all handsets and on the telephone base.
Contact deleted	A directory entry is deleted.
Directory empty	There are no directory entries.
Directory full	The directory is full. You cannot save any new entries unless you delete some current entries.
Ended	You have just ended a call.
HANDSET X is calling (for systems with 3 or more handsets)	Another system handset is calling.

Screen display messages

Screen messages

Incoming call	There is a call coming in
Intercom	The device is on an intercom call.
Intercom ended	The intercom call has just ended.
INTERCOM TO: (for systems with 3 or more handsets)	You have started the intercom process, and need to enter the number of the device you wish to call.
Line in use	An extension phone, or one of the devices is in use.
Low battery	The battery is low. You should charge the battery.
Microphone ON	Mute is off so the other party can hear your voice.
Muted	The microphone is off. The other party cannot hear you.
New voicemail	There are new voicemail messages from your telephone service provider.
No answer. Try again	The device(s) you are trying to transfer a call to is out of range, off hook, or has no power.
No battery	The handset in the charger has no battery installed.
No caller info	The caller information is unavailable.
No Incoming PTT	The incoming PTT function is turned off. The handset will not receive PTT calls.
No line	There is no telephone line connection.
Not available at this time	Someone else is already using the directory or caller ID log.
Number already saved	The telephone number you have entered is already in the directory or call block list.
Out of range OR No Pwr at base	The telephone base has lost power, or the handset is out of range.
** Paging **	The cordless handset is paged by the telephone base.
Phone	The handset is on a call.

Screen display messages

Screen messages

Place in charger	The battery is very low. The handset should be charged.
Quiet mode on	QUIET mode is on.
Quiet mode is off	QUIET mode is turned off.
Rec mem full	The system recording time is full.
Rec mem low	The system recording time is low.
Registering... Please wait	The handset is registering to the telephone base.
Registration failed	The handset registration is not successful.
Ringer off	The ringer is turned off.
Ringer muted	The ringer is off temporarily while the device is ringing.
Saved to directory	An entry has been successfully saved to the directory.
Screened call	The Smart call blocker feature of the telephone has screened a call and is putting the call through to you.
Setting up Ans sys...	The handset is playing voice guide to set up the answering system.
Smart call blk screening	The telephone is screening an incoming call.
Speaker	The handset speakerphone is in use.
Voice guide set Smart call blk?	After you install your telephone or power returns following a power outage, the handset will prompt you to set the date and time. After the date and time setting is done or skipped, the handset will then prompt if you want to set up the Smart call blocker feature via voice guide.
TRANSFER TO: (for systems with 3 or more handsets)	You have started transferring a call, and need to enter the desired device number or choose all devices.
Transferring call...	The handset is transferring an outside call to the other handset.

Screen display messages

Screen messages

To register HS, see manual.	Screen display before handset registration.
To screen call, press [SELECT]	Press MENU/SELECT to activate call screening.
Unable to call. Try again	You try to join a call when there are already four handsets on that call. You try to make an outside call when another device is transferring a call with the intercom feature.
XX Missed calls	There are new calls in the caller ID log.
XX New messages	There are new messages in the answering system.

Troubleshooting

If you have difficulty with your phone, please try the following suggestions. For Customer Service, visit our website at <https://telephones.att.com> or call **1 (800) 222-3111**. In Canada, dial **1 (866) 288-4268**.

My telephone doesn't work at all.

- ▶ Make sure the power cord is securely plugged in.
- ▶ Make sure you plug the battery connector securely into the cordless handset.
- ▶ Make sure you plug the telephone line cord securely and firmly into the telephone base and the telephone wall jack.
- ▶ Charge the battery in the cordless handset for at least ten hours. For optimum daily performance, return the cordless handset to the telephone base or charger when not in use.
- ▶ If the battery is depleted, it may take approximately 30 minutes to charge the handset before it shows **Low battery**. See page 9 for details.
- ▶ Reset the telephone base. Unplug the electrical power. Wait for approximately 15 seconds, then plug it back in. Allow up to one minute for the cordless handset and telephone base to reset.
- ▶ You may need to purchase a new battery. Please refer to **Battery installation and charging** in this user's manual on pages 9-11.

The display shows No line. I cannot get a dial tone.

- ▶ Try all the suggestions, as mentioned above.
- ▶ If the previous suggestions do not work, disconnect the telephone line cord from your telephone and connect the telephone line cord to another telephone.
 - ▶ If there is no dial tone on that other telephone either, your telephone line cord may be defective. Install a new telephone line cord.
 - ▶ If changing the telephone line cord does not help, the wall jack (or the wiring to this wall jack) may be defective. Try using a different wall jack in your home to connect your CL82107/CL82207/CL82257/CL82267/CL82307/CL82357/CL82367/CL82407/CL82467/CL82507/CL82547/CL82557 telephone, or contact your telephone service provider (charges may apply).

Troubleshooting

I cannot dial out.

- ▶ Try all the suggestions, as mentioned above.
- ▶ Make sure you have a dial tone before dialing. The cordless handset may take a second or two to find the telephone base and produce a dial tone. This is normal. Wait an extra second before dialing.
- ▶ Eliminate any background noise. Noise from a television, radio or other appliances may cause the phone to not dial out properly. If you cannot eliminate the background noise, first try muting the cordless handset before dialing, or dialing from another room with less background noise.
- ▶ If other phones in your home are having the same problem, contact your telephone service provider (charges may apply).

My cordless handset isn't performing normally.

- ▶ Make sure you plug the power cord securely into the telephone base. Plug the power adapter into a different working electrical outlet without a wall switch.
- ▶ Move the cordless handset closer to the telephone base. You may have moved out of range.
- ▶ Reset the telephone base. Unplug the electrical power. Wait for 15 seconds, then plug it back in. Allow up to one minute for the cordless handset and telephone base to reset.
- ▶ Other electronic products such as HAM radios and other DECT phones, can cause interference with your cordless phone. Try installing your phone as far away as possible from these types of electronic devices.

Out of range OR No pwr at base appears on my cordless handset.

- ▶ Ensure you plug the telephone base in properly and the power is on.
- ▶ Place the cordless handset in the telephone base for one minute to allow the cordless handset and base to synchronize.
- ▶ Move the cordless handset closer to the telephone base. You may have moved out of range.

Troubleshooting

- ▶ Reset the telephone base. Unplug the electrical power. Wait for 15 seconds, then plug it back in. Allow up to one minute for the cordless handset and telephone base to reset.
- ▶ Other electronic products such as HAM radios and other DECT phones, can cause interference with your cordless phone. Try installing your phone as far away as possible from these types of electronic devices.

The batteries do not hold a charge.

- ▶ If the cordless handset is in the telephone base or charger and the charge light is not on, refer to **The charge light is off** (page 141).
- ▶ Charge the battery in the cordless handset for at least ten hours. For optimum daily performance, return the cordless handset to the telephone base or charger when not in use.
- ▶ If the battery is depleted, it may take approximately 30 minutes to charge the handset before it shows **Low battery**. Refer to the table on page 9 for details.
- ▶ You may need to purchase a new battery. Please refer to **Battery installation and charging** in this user's manual on pages 9-11.

Troubleshooting

I get noise, static, or weak signals even when I'm near the telephone base.

- ▶ If you subscribe to high-speed Internet service (DSL - digital subscriber line) through your telephone line, you must install a DSL filter between the telephone line cord and the telephone wall jack (page 7). The filter prevents noise and caller ID problems as a result of DSL interference. Please contact your DSL service provider for more information about DSL filters.
- ▶ You may be able to improve the performance of your cordless phone by installing your new telephone base as far as possible from any other existing cordless telephone system that may already be installed.
- ▶ Other electronic products such as HAM radios and other DECT phones, can cause interference with your cordless phone. Try installing your phone as far away as possible from these types of electronic devices.
- ▶ Do not install this phone near a microwave oven or on the same electrical outlet. You may experience decreased performance while the microwave oven is operating.
- ▶ If you plug your phone in with a modem or a surge protector, plug the phone (or modem/surge protector) into a different location. If this does not solve the problem, relocate your phone or modem farther apart from one another, or use a different surge protector.
- ▶ Move your phone to a higher location. The phone may have better reception in a high area.
- ▶ If other phones in your home are having the same problem, contact your telephone service provider (charges may apply).

Troubleshooting

I experience poor sound quality when using the handset speakerphone.

- ▶ For increased sound quality while using the handset speakerphone, place the handset on a flat surface with the dial pad facing up.

I hear other calls while using my phone.

- ▶ Disconnect the telephone base from the telephone jack, and plug in a different telephone. If you still hear other calls, call your telephone service provider.

My cordless handset does not ring when I receive a call.

- ▶ Make sure that the ringer is not off. Refer to **Ringer volume** on page 17 in this user's manual.
- ▶ Make sure you plug in the telephone line cord securely into the telephone base and the telephone jack. Make sure you plug in the power cord securely.
- ▶ The cordless handset may be too far from the telephone base.
- ▶ Charge the battery in the cordless handset for at least ten hours. For optimum daily performance, return the cordless handset to the telephone base or charger when not in use.
- ▶ You may have too many extension phones on your telephone line to allow all of them to ring simultaneously. Try unplugging some of the other phones.
- ▶ The layout of your home or office may be limiting the operating range. Try moving the telephone base to another location, preferably to a higher location.
- ▶ If other phones in your home are having the same problem, contact your telephone service provider (charges may apply).
- ▶ Test a working phone at the phone jack. If another phone has the same problem, contact your telephone service provider (charges may apply).
- ▶ Other electronic products can cause interference with your cordless phone. Try installing your phone as far away as possible from electronic devices such as television sets, VCRs, or other cordless telephones.

Troubleshooting

- Remove the battery. Install the battery again and place the cordless handset into the telephone base. Wait for the cordless handset to reestablish its connection with the telephone base. Allow up to one minute for this to take place.
- Your line cord may be defective. Try installing a new line cord.

My calls cut in and out while I'm using my cordless handset.

- Other electronic products such as HAM radios and other DECT phones, can cause interference with your cordless phone. Try installing your phone as far away as possible from these types of electronic devices.
- Do not install this phone near a microwave oven or on the same electrical outlet. You may experience decreased performance while the microwave oven is operating.
- If you plug your phone in with a modem or surge protector, plug the phone (or modem/surge protector) into a different location. If this does not solve the problem, relocate your phone or modem farther apart from one another, or use a different surge protector.
- Move your telephone base to a higher location. The phone may have better reception when installed in a high area.
- If other phones in your home are having the same problem, contact your telephone service provider (charges may apply).

The charge light is off.

- Make sure you plug the power and line cords in correctly and securely.
- Unplug the electrical power. Wait for 15 seconds, then plug it back in. Allow up to one minute for the cordless handset and telephone base to reset.
- Clean the cordless handset, charger and telephone base charging contacts each month with a pencil eraser or cloth.
- The battery may not be connected to the handset or is missing completely. Ensure that the battery is installed properly.

Troubleshooting

My caller ID isn't working.

- ▶ Caller ID is a subscription service. You must subscribe to this service from your telephone service provider for this feature to work on your phone.
- ▶ The caller may not be calling from an area that supports caller ID.
- ▶ Both your and your caller's telephone service providers must use caller ID compatible equipment.
- ▶ If you subscribe to high-speed Internet service (DSL - digital subscriber line) through your telephone line, you must install a DSL filter between the telephone line cord and the telephone wall jack (page 7). The filter prevents noise and caller ID problems resulting from DSL interference. Please contact your DSL service provider for more information about DSL filters.

System does not receive caller ID when on a call.

- ▶ Make sure you subscribe to caller ID with call waiting features from your telephone service provider. Caller ID features works only if both you and the caller are in areas offering caller ID service, and if both telephone service providers use compatible equipment.

System screens all my incoming calls.

- ▶ You may have set Smart call blocker to screen calls without numbers and uncategorized calls. The telephone asks callers to announce their names or press the pound key (#). We recommend that you add the phone numbers of your family members and friends, and desired businesses to your **Directory** (see page 48) or **Allow list** (see page 81), or add their names to the **Star name list** (see page 86). This will avoid Smart call blocker to screen their calls.
- ▶ To turn Smart call blocker off, see **Set Smart call blocker on/off** on page 73.

Troubleshooting

While screening a call, the telephone suddenly stops screening and connects to the call.

- ▶ Another handset may have picked up the screening call.
- ▶ If you have other telephone system sharing the same telephone line, and someone picks up the call on the other telephone system while the screening is in progress, the screening process will be terminated and connect you to the caller.

My telephone blocks calls from someone I know.

- ▶ You may have saved the caller's number in your block list. To remove the number from the block list, see **Delete a block entry** on page 80.

Blocking calls with numbers saved in my block list only.

- ▶ If you want to block calls with numbers saved in your block list only, and allow all other calls to get through to you, change the settings to accept calls without numbers and uncategorized calls. See **Control calls without numbers** on page 73 and **Control uncategorized calls** on page 74.

Blocking all unknown calls.

- ▶ If you want to block all unknown calls with numbers or names that are not in your directory, allow list or star name list, change the settings to block calls without numbers and uncategorized calls. See **Control calls without numbers** on page 73 and **Control uncategorized calls** on page 74.

Forwarding all unknown calls to the answering system.

- ▶ If you want to forward all unknown calls with numbers or names that are not in your directory, allow list or star name list to the answering system, see **Control calls without numbers** on page 73 and **Control uncategorized calls** on page 74 to change the settings.

Troubleshooting

Incomplete messages.

- ▶ If a caller leaves a very long message, part of it may be lost when the system disconnects the call after the maximum recording time you have set.
If the caller pauses for longer than seven seconds, the system stops recording and disconnects the call.
- ▶ If the system's memory becomes full during a message, the system stops recording and disconnects the call.
- ▶ If the caller's voice is very soft, the system may stop recording and disconnect the call.

Difficulty hearing messages.

- ▶ Press **▲VOLUME+** to increase the telephone base speaker volume.
- ▶ Press **▲DIR/VOLUME** to adjust the message playback volume on a handset.

System does not answer after the correct number of rings.

- Make sure that the answering system is on. **ANS ON** should show on the handset and the **📞/ANS ON/OFF** light on the telephone base should be on.
- If toll saver is activated, the number of rings changes to two when you have new messages stored (page 109).
- If the memory is full or the system is off, the system will answer after ten rings.
- ▶ In some cases, the answering system is affected by the ringing system used by your telephone service provider.
- ▶ If you subscribe to voicemail service, change the number of rings so that your answering system answers before your voicemail (page 109). To determine how many rings activate your voicemail, contact your telephone service provider.
- ▶ If there is a fax machine connected to the same telephone line, try disconnecting the fax machine. If that solves the problem, consult your fax machine documentation for information on compatibility with answering systems.

Troubleshooting

System does not respond to remote commands.

- ▶ Make sure to enter your remote access code correctly (page 110).
- ▶ Make sure you are calling from a touch-tone phone. When you dial a number, you should hear tones. If you hear clicks, the phone is not a touch-tone telephone and cannot activate the answering system.
- ▶ The answering system may not detect the remote access code while your announcement or message is playing. Try waiting until the announcement or message is over, or press command code **5** to stop the operation before entering other codes.
- ▶ There may be interference on the phone line you are using. Press dialing keys firmly.

System does not record messages.

- ▶ Make sure the answering system is on. **ANS ON** should show on the handset and the **📞/ANS ON/OFF** light on the telephone base should be on.
- ▶ Make sure the memory of the answering system is not full.
- ▶ If you subscribe to voicemail service, change the number of rings so that your answering system answers before your voicemail (page 109). To determine how many rings activate your voicemail, contact your telephone service provider.
- ▶ If there is a fax machine connected to the same telephone line, try disconnecting the fax machine. If that solves the problem, consult your fax machine documentation for information on compatibility with answering systems.

System announces, “Time and day not set.”

- ▶ You need to reset the system clock (page 19).

Troubleshooting

Outgoing announcement is not clear.

- ▶ When you record your announcement, make sure you speak in a normal tone of voice, about nine inches from the handset.
- ▶ Make sure there is no background noise (TV, music, etc.) while recording.

New voicemail and show on the screens, and I don't know why.

- ▶ Your telephone has both a built-in answering system and voicemail indication. If **New voicemail** and  appear on the screens, then your telephone has received a signal from your telephone service provider that you have a voicemail message waiting for you to retrieve from them. Contact your telephone service provider for more information on how to access your voicemail.

I cannot retrieve voicemail messages.

- ▶ Your telephone has both a built-in answering system and voicemail indication. They are independent features and each alerts you to new messages differently (page 113). If you subscribe to voicemail service from your telephone service provider, contact your telephone service provider for more information on how to access your voicemail.

I've set my LCD language to Spanish or French and I don't know how to change it back to English.

- ▶ Press **MENU/SELECT** on your handset in idle mode, then enter **364#**. You hear a confirmation tone.

I subscribe to a nontraditional telephone service that uses my computer to establish connections, and my telephone doesn't work.

- ▶ Make sure your computer is powered on.
- ▶ Make sure your Internet connection is working properly.

Troubleshooting

- ▶ Make sure that the software is installed and running for your nontraditional telephone service.
- ▶ Make sure to plug your USB telephone adapter into a dedicated USB port on your computer. Do not plug it into a multiple port USB hub (USB splitter) that is not powered.
- ▶ In a few rare instances, the USB port on your computer may not have enough power. Try using a USB hub with its own external power supply.
- ▶ If you are using a firewall, it may prevent access to your nontraditional telephone service provider. Contact your service provider for more information.

Common cure for electronic equipment.

If the telephone does not seem to be responding normally, try putting the cordless handset in the telephone base or charger. If it does not fix the problem, do the following (in the order listed):

1. Disconnect the power to the telephone base.
2. Disconnect the cordless handset battery.
3. Wait a few minutes.
4. Connect power to the telephone base.
5. Remove the battery. Replace the battery and place the cordless handset into the telephone base or charger.
6. Wait for the cordless handset to reestablish its connection with the telephone base. Allow up to one minute for this to take place.

Maintenance

Taking care of your telephone

- ▶ Your cordless telephone contains sophisticated electronic parts, so you must treat it with care.
- ▶ Avoid rough treatment.
- ▶ Place the handset down gently.
- ▶ Save the original packing materials to protect your telephone if you ever need to ship it.

Avoid water

- ▶ You can damage your telephone if it gets wet. Do not use the handset in the rain, or handle it with wet hands. Do not install the telephone base near a sink, bathtub or shower.

Electrical storms

- ▶ Electrical storms can sometimes cause power surges harmful to electronic equipment. For your own safety, take caution when using electric appliances during storms.

Cleaning your telephone

- ▶ Your telephone has a durable plastic casing that should retain its luster for many years. Clean it only with a soft cloth slightly dampened with water or mild soap.
- ▶ Do not use excess water or cleaning solvents of any kind.

Remember that electrical appliances can cause serious injury if used when you are wet or standing in water. If the telephone base should fall into water, DO NOT RETRIEVE IT UNTIL YOU UNPLUG THE POWER CORD AND TELEPHONE LINE CORDS FROM THE WALL. Pull the unit out by the unplugged cords.

Important safety information



This symbol is to alert you to important operating or servicing instructions that may appear in this user's manual. Always follow basic safety precautions when using this product to reduce the risk of injury, fire, or electric shock.

Safety information

- ▶ Read and understand all instructions in the user's manual. Observe all markings on the product.
- ▶ Avoid using a telephone during a thunderstorm. There may be a slight chance of electric shock from lightning.
- ▶ Do not use a telephone in the vicinity of a gas leak. Under certain circumstances, a spark may be created when the adapter is plugged into the power outlet, or when the handset is replaced in its cradle. This is a common event associated with the closing of any electrical circuit. In an inadequately ventilated environment, the user should not plug the phone into a power outlet, nor put a charged handset into the cradle where there are concentrations of flammable or flame-supporting gases. A spark in such an environment could create a fire or explosion. Such environments may include: medical use of oxygen without adequate ventilation; industrial gases (cleaning solvents; gasoline vapors; etc.); a leak of natural gas; etc.
- ▶ Do not use this product near water or when you are wet. For example, do not use it in a wet basement or shower, nor next to a swimming pool, bathtub, kitchen sink, and laundry tub. Do not use liquids or aerosol sprays for cleaning. If the product comes in contact with any liquid, unplug any line or power cord immediately. Do not plug the product back in until it has dried thoroughly.
- ▶ Install this product in a protected location where no one can trip over any line or power cords. Protect cords from damage or abrasion.
- ▶ If this product does not operate normally, see the **Troubleshooting** section on pages 136-147 of this user's manual. If you cannot solve the problem, or if the product is damaged, refer to the **Limited warranty** section on pages 156-158. Do not open this product except as directed in your user's manual. Opening the product or reassembling it incorrectly may expose you to hazardous voltages or other risks.
- ▶ Replace batteries only as described in your user's manual (pages 9-11). Do not burn or puncture batteries — they contain caustic chemicals.
- ▶ The power adapters are intended to be correctly oriented in a vertical or floor mount position. The prongs are not designed to hold the plug in place if it is plugged into a ceiling, under-the-table or cabinet outlet.

Important safety information



Cautions:

- ▶ Use only the power adapters provided with this product. To obtain a replacement, visit our website at **<https://telephones.att.com>** or call **1 (800) 222-3111**. In Canada, dial **1 (866) 288-4268**.
- ▶ Use only the supplied rechargeable battery or replacement battery (model BT183342/BT283342). To order, visit our website at **<https://telephones.att.com>** or call **1 (800) 222-3111**. In Canada, dial **1 (866) 288-4268**.
- ▶ To prevent risk of fire or battery explosion, replace with the correct battery type. Dispose of used batteries according to the instructions.

Especially about cordless telephones

- ▶ **Privacy:** The same features that make a cordless telephone convenient create some limitations. Telephone calls are transmitted between the telephone base and the handset by radio waves, so there is a possibility that your cordless telephone conversations could be intercepted by radio receiving equipment within range of the cordless handset. For this reason, you should not think of cordless telephone conversations as being as private as those on corded telephones.
- ▶ **Electrical power:** The telephone base of this cordless telephone must be connected to a working electrical outlet which is not controlled by a wall switch. Calls cannot be made from the handset if the telephone base is unplugged, switched off or if the electrical power is interrupted.
- ▶ **Potential TV interference:** Some cordless telephones operate at frequencies that may cause interference to TVs and VCRs. To minimize or prevent such interference, do not place the telephone base of the cordless telephone near or on top of a TV or VCR. If interference is experienced, moving the cordless telephone farther away from the TV or VCR will often reduce or eliminate the interference.
- ▶ **Rechargeable batteries:** This product contains nickel-metal hydride rechargeable batteries. Exercise care in handling batteries in order not to create a short circuit with conductive material such as rings, bracelets and keys. The battery or conductor may overheat and cause harm. Observe proper polarity between the battery and the battery charger.
- ▶ **Nickel-metal hydride rechargeable batteries:** Dispose of these batteries in a safe manner. Do not burn or puncture. Like other batteries of this type, if burned or punctured, they could release caustic material which could cause injury.

Important safety information



The RBRC Seal means that the manufacturer is voluntarily participating in an industry program to collect and recycle nickel-metal hydride rechargeable batteries when taken out of service within the United States. These batteries may be taken to a participating local retailer of replacement batteries or recycling center. Or you may call 1-800-8-BATTERY® for locations accepting spent Ni-MH batteries.

The RBRC Seal and 1-800-8-BATTERY® are registered trademarks of Call2recycle, Inc.

Precautions for users of implanted cardiac pacemakers

Cardiac pacemakers (applies only to digital cordless telephones):

Wireless Technology Research, LLC (WTR), an independent research entity, led a multidisciplinary evaluation of the interference between portable wireless telephones and implanted cardiac pacemakers. Supported by the U.S. Food and Drug Administration, WTR recommends to physicians that:

Pacemaker patients

Should keep wireless telephones at least six inches from the pacemaker.

Should NOT place wireless telephones directly over the pacemaker, such as in a breast pocket, when it is turned ON.

Should use the wireless telephone at the ear opposite the pacemaker.

WTR's evaluation did not identify any risk to bystanders with pacemakers from other persons using wireless telephones.

ECO mode

This power conserving technology reduces power consumption for optimal battery performance. The ECO mode activates automatically whenever the handset is synchronized with the telephone base.

Especially about telephone answering systems

Two-way recording: This unit does not sound warning beeps to inform the other party that the call is being recorded. To ensure that you are in compliance with any federal or state regulations regarding recording a telephone call, you should start the recording process and then inform the other party that you are recording the conversation.

SAVE THESE INSTRUCTIONS

FCC Part 68 and ACTA

This equipment complies with Part 68 of the FCC rules and with technical requirements adopted by the Administrative Council for Terminal Attachments (ACTA). The label on the back or bottom of this equipment contains, among other things, a product identifier in the format US:AAAEQ##TXXXX. This identifier must be provided to your telephone service provider upon request.

The plug and jack used to connect this equipment to premises wiring and the telephone network must comply with the applicable Part 68 rules and technical requirements adopted by ACTA. A compliant telephone cord and modular plug is provided with this product. It is designed to be connected to a compatible modular jack that is also compliant. An RJ11 jack should normally be used for connecting to a single line and an RJ14 jack for two lines. See the installation instructions in the user's manual.

The Ringer Equivalence Number (REN) is used to determine how many devices you may connect to your telephone line and still have them ring when you are called. The REN for this product is encoded as the 6th and 7th characters following the US: in the product identifier (e.g., if ## is 03, the REN is 0.3). In most, but not all areas, the sum of all RENs should be five (5.0) or less. For more information, please contact your telephone service provider.

This equipment must not be used with Party Lines. If you have specially wired alarm dialing equipment connected to your telephone line, ensure the connection of this equipment does not disable your alarm equipment. If you have questions about what will disable the alarm equipment, consult your telephone service provider or a qualified installer.

If this equipment is malfunctioning, it must be unplugged from the modular jack until the problem has been corrected. Repairs to this telephone equipment can only be made by the manufacturer or its authorized agents. For repair procedures, follow the instructions outlined under the Limited warranty.

If this equipment is causing harm to the telephone network, the telephone service provider may temporarily discontinue your telephone service. The telephone service provider is required to notify you before interrupting service. If advance notice is not practical, you will be notified as soon as possible. You will be given the opportunity to correct the problem and the telephone service provider is required to inform you of your right to file a complaint with the FCC. Your telephone service provider may make changes in its facilities, equipment, operation, or procedures that could affect the proper functioning of this product. The telephone service provider is required to notify you if such changes are planned.

If this product is equipped with a corded or cordless handset, it is hearing aid compatible.

If this product has memory dialing locations, you may choose to store emergency telephone numbers (e.g., police, fire, medical) in these locations. If you do store or test emergency numbers, please:

Remain on the line and briefly explain the reason for the call before hanging up.

Perform such activities in off-peak hours, such as early morning or late evening.

FCC Part 68 and ACTA

Industry Canada

This device complies with Industry Canada licence-exempt RSS standard(s).

Operation is subject to the following two conditions: (1) this device may not cause harmful interference, and (2) this device must accept any interference received, including interference that may cause undesired operation.

Privacy of communications may not be ensured when using this telephone.

The term "IC:" before the certification/registration number only signifies that the Industry Canada technical specifications were met.

The Ringer Equivalence Number (REN) for this terminal equipment is 1.0. The REN indicates the maximum number of the maximum number of devices allowed to be connected to a telephone interface. The termination of an interface may consist of any combination of devices subject only to the requirement that the sum of the RENs of all the devices not exceed five.

This product meets the applicable Innovation, Science and Economic Development Canada technical specifications.

FCC Part 15

NOTE: This equipment has been tested and found to comply with the requirements for a Class B digital device under Part 15 of the Federal Communications Commission (FCC) rules. These requirements are intended to provide reasonable protection against harmful interference in a residential installation. This equipment generates, uses and can radiate radio frequency energy and, if not installed and used in accordance with the instructions, may cause harmful interference to radio communications. However, there is no guarantee that interference will not occur in a particular installation. If this equipment does cause harmful interference to radio or television reception, which can be determined by turning the equipment off and on, the user is encouraged to try to correct the interference by one or more of the following measures:

- ▶ Reorient or relocate the receiving antenna.
- ▶ Increase the separation between the equipment and receiver.
- ▶ Connect the equipment into an outlet on a circuit different from that to which the receiver is connected.
- ▶ Consult the dealer or an experienced radio/TV technician for help.

WARNING: Changes or modifications to this equipment not expressly approved by the party responsible for compliance could void the user's authority to operate the equipment.

This device complies with Part 15 of the FCC Rules. Operation is subject to the following two conditions: (1) this device may not cause harmful interference, and (2) this device must accept any interference received, including interference that may cause undesired operation. Privacy of communications may not be ensured when using this telephone.



To ensure safety of users, the FCC has established criteria for the amount of radio frequency energy that can be safely absorbed by a user or bystander according to the intended usage of the product. This product has been tested and found to comply with the FCC criteria. The handset may be safely held against the ear of the user. The telephone base shall be installed and used such that parts of the user's body other than the hands are maintained at a distance of approximately 20 cm (8 inches) or more.

This Class B digital apparatus complies with Canadian requirement:
CAN ICES-3 (B)/NMB-3(B)

California Energy Commission battery charging testing instructions

This telephone is set up to comply with the energy-conserving standards right out of the box. These instructions are intended for California Energy Commission (CEC) compliance testing only. When the CEC battery charging testing mode is activated, all telephone functions, except battery charging, will be disabled.

To activate the CEC battery charging testing mode:

1. Unplug the telephone base power adapter from the power outlet. Make sure all handsets are inserted with charged batteries before proceeding.
2. While you press and hold  **FIND HS**, plug the telephone base power adapter back to the power outlet.
3. After about 20 seconds, when the **IN USE** light starts flashing, release  **FIND HS** and then press it again within two seconds.



The process takes up to one minute to complete. When the phone successfully enters the CEC battery charging testing mode, the **IN USE** light turns off and all handsets display **To register HS, see manual**. You hear a confirmation tone.

When the phone fails to enter this mode, repeat the steps mentioned above.

Note: The telephone base will be powered up as normal if you fail to press  **FIND HS** within two seconds in Step 3.

To deactivate the CEC battery charging testing mode:

1. Unplug the telephone base power adapter from the power outlet, then plug it back in. The telephone base is powered up as normal.
2. Register your handsets back to the telephone base. See pages 125-126 for handset registration instructions.

Limited warranty

The AT&T brand is used under license - any repair, replacement or warranty service, and all questions about this product should be directed to our website at

<https://telephones.att.com> or call **1 (800) 222-3111**. In

Canada, dial **1 (866) 288-4268**.

1. What does this limited warranty cover?

The manufacturer of this AT&T branded product warrants to the holder of a valid proof of purchase (“CONSUMER” or “you”) that the product and all accessories provided in the sales package (“PRODUCT”) are free from defects in material and workmanship, pursuant to the following terms and conditions, when installed and used normally and in accordance with the PRODUCT operating instructions. This limited warranty extends only to the CONSUMER for products purchased and used in the United States of America and Canada.

2. What will be done if the PRODUCT is not free from defects in materials and workmanship during the limited warranty period (“materially defective PRODUCT”)?

During the limited warranty period, the manufacturer’s authorized service representative will repair or replace at the manufacturer’s option, without charge, a materially defective PRODUCT. If the manufacturer repairs the PRODUCT, they may use new or refurbished replacement parts. If the manufacturer chooses to replace the PRODUCT, they may replace it with a new or refurbished PRODUCT of the same or similar design. The manufacturer will retain defective parts, modules, or equipment. Repair or replacement of the PRODUCT, at the manufacturer’s option, is your exclusive remedy. The manufacturer will return repaired or replacement products to you in working condition. You should expect the repair or replacement to take approximately 30 days.

3. How long is the limited warranty period?

The limited warranty period for the PRODUCT extends for ONE (1) YEAR from the date of purchase. If the manufacturer repairs or replaces a materially defective PRODUCT under the terms of this limited warranty, this limited warranty also applies to repaired or replacement PRODUCT for a period of either (a) 90 days from the date the repaired or replacement PRODUCT is shipped to you or (b) the time remaining on the original one-year limited warranty; whichever is longer.

4. What is not covered by this limited warranty?

This limited warranty does not cover:

- ▶ PRODUCT that has been subjected to misuse, accident, shipping or other physical damage, improper installation, abnormal operation or handling, neglect, inundation, fire, water, or other liquid intrusion; or
- ▶ PRODUCT that has been damaged due to repair, alteration, or modification by anyone other than an authorized service representative of the manufacturer; or

Limited warranty

- ▶ PRODUCT to the extent that the problem experienced is caused by signal conditions, network reliability or cable or antenna systems; or
- ▶ PRODUCT to the extent that the problem is caused by use with non-AT&T accessories; or
- ▶ PRODUCT whose warranty/quality stickers, PRODUCT serial number plates or electronic serial numbers have been removed, altered or rendered illegible; or
- ▶ PRODUCT purchased, used, serviced, or shipped for repair from outside the United States of America or Canada, or used for commercial or institutional purposes (including but not limited to products used for rental purposes); or
- ▶ PRODUCT returned without valid proof of purchase (see item 6); or
- ▶ Charges for installation or setup, adjustment of customer controls, and installation or repair of systems outside the unit.

5. How do you get warranty service?

To obtain warranty service, visit our website at

<https://telephones.att.com> or call **1 (800) 222-3111**. In

Canada, dial **1 (866) 288-4268**.

NOTE: Before calling for service, please review the user's manual; a check of the PRODUCT's controls and features may save you a service call.

Except as provided by applicable law, you assume the risk of loss or damage during transit and transportation and are responsible for delivery or handling charges incurred in the transport of the PRODUCT(s) to the service location. The manufacturer will return repaired or replaced PRODUCT under this limited warranty to you. Transportation, delivery or handling charges are prepaid. The manufacturer assumes no risk for damage or loss of the PRODUCT in transit. If the PRODUCT failure is not covered by this limited warranty, or proof of purchase does not meet the terms of this limited warranty, the manufacturer will notify you and will request that you authorize the cost of repair prior to any further repair activity. You must pay for the cost of repair and return shipping costs for the repair of products that are not covered by this limited warranty.

6. What must you return with the PRODUCT to get warranty service?

You must:

- ▶ Return the entire original package and contents including the PRODUCT to the service location along with a description of the malfunction or difficulty; and
- ▶ Include a "valid proof of purchase" (sales receipt) identifying the PRODUCT purchased (PRODUCT model) and the date of purchase or receipt; and
- ▶ Provide your name, complete and correct mailing address, and telephone number.

Limited warranty

7. Other limitations

This warranty is the complete and exclusive agreement between you and the manufacturer of this AT&T branded PRODUCT. It supersedes all other written or oral communications related to this PRODUCT. The manufacturer provides no other warranties for this PRODUCT. The warranty exclusively describes all of the manufacturer's responsibilities regarding the PRODUCT. There are no other express warranties. No one is authorized to make modifications to this limited warranty and you should not rely on any such modification.

State/Provincial Law rights: This warranty gives you specific legal rights, and you may also have other rights which vary from state to state or province to province.

Limitations: Implied warranties, including those of fitness for a particular purpose and merchantability (an unwritten warranty that the PRODUCT is fit for ordinary use) are limited to one year from date of purchase. Some states/provinces do not allow limitations on how long an implied warranty lasts, so the above limitation may not apply to you. In no event shall the manufacturer be liable for any indirect, special, incidental, consequential, or similar damages (including, but not limited to lost profits or revenue, inability to use the PRODUCT or other associated equipment, the cost of substitute equipment, and claims by third parties) resulting from the use of this PRODUCT. Some states/provinces do not allow the exclusion or limitation of incidental or consequential damages, so the above limitation or exclusion may not apply to you.

Please retain your original sales receipt as proof of purchase.

Technical specifications

RF frequency band	1921.536MHz - 1928.448MHz
Channels	5
Telephone base voltage (AC voltage, 60Hz)	96Vrms - 130Vrms
Telephone base voltage (AC adapter output)	6VDC @ 400mA
Handset battery	2.4V 400mAh, 2xAAA Ni-MH
Charger voltage (AC adapter output)	6VDC @ 100mA

Operation	Operating time*
Talk time (cordless handset)	Up to 7 hours
Standby	Up to 5 days

* Operating times vary depending on your actual use and the age of the battery.

DECT 6.0 digital technology

The AT&T DECT 6.0 products offer unsurpassed range performance and sound clarity. This is achieved through a unique antenna design and advances in noise-filtering technology. An independent laboratory has confirmed that AT&T DECT 6.0 products perform up to 45% better in range competitions against similarly equipped phones of the leading competition. Now, calls can be taken in the basement, backyard and garage with exceptional sound quality.

Telephone operating range

This cordless telephone operates within the maximum power allowed by the Federal Communications Commission (FCC). Even so, this handset and telephone base can communicate over a certain distance — which can vary with the locations of the telephone base and handset, the weather, and the construction of your home or office.

Redefining long range coverage and clarity

This telephone base comes with an antenna which gives much better clarity and covers a longer range than before.

HD audio

HD audio improves sound quality by expanding and rebuilding frequencies that are lost with traditional phone calls. There is no additional telephone service requirement to use HD audio. It is designed to work with standard telephone service. Your system will automatically enhance all received sound with HD audio.

Simulated full-duplex handset speakerphone

The simulated full-duplex speakerphone on your handset allows both ends of a call to speak and be heard at the same time. Optimal performance is subject to external factors and individual usage.

Index

A

- Alert tones
 - handset 130
 - telephone base 130
- Allow list 81
- Announcement 104
- Answer an incoming call
 - during an intercom call 40
 - during PTT 46, 47
- Answering calls 30
- Answering system 104–124
- Assign a speed dial number 55
- Auto off 30

B

- Battery charging 9
- Battery installation 9, 10
- Blind transfer 37
- Block list 76

C

- Caller ID announce 21
- Caller ID (CID)
 - add entries to phone
 - directory 65, 66
 - delete entries 64
 - dial entries 64
 - review entries 62
- Call transfer 41
- Chain dialing 35
- Charger installation 7, 8
- Clear voicemail indication 24
- Clock 19

D

- Day and time 19
- Delete
 - a caller ID log entry 64
 - a directory entry 53
 - a speed dial number 57, 58
- Dialing
 - from a record in the caller ID history 64
 - from the directory 53
- Directory
 - dial a number 53
 - edit entries 54
 - name search 52
 - new entries 49
- Display dial 53
- DSL 7, 14

E

- Ending a call 30

H

- Handset
 - handset locator 38
 - quick reference guide 2–4
 - ringer tone 18
 - ringer volume 17
 - screen icons 129
 - speakerphone 31
 - temporary ringer silencing 31
 - voicemail indicator 23
- HD audio 159

Index

I

- Important safety information 149–151
- Installation 1
- Intercom 39–41

L

- Last number redial 31
- LCD language
 - reset LCD language 20
- Lights 131
- Limited warranty 156–158

M

- Maintenance 148
- Make an outgoing call
 - during PTT 46
- Making calls 30
- Memory match 61
- Message
 - alert tone 111
 - counter display 122
 - playback 118–120
- Mute 34

N

- Names
 - enter into directory 49
 - search 52
- Number of rings 109

O

- On-hook dialing (predialing) 30
- Outgoing announcement 104

P

- Paging tone 38
- Power adapter 8
- Predialing 30
- Push-to-talk 42–47

Q

- Quick reference guide 2–5
- Quiet mode 29

R

- Reassign a speed dial number 56
- Receiving calls 30
- Recharging 11
- Redial 31
- Remote access 123–124
- Ringer silencing 31
- Ring tone options 18

S

- Safety information 149–151
- Screen display
 - messages 132–134
- Smart call blocker 69–103
 - allow calls 71
 - block calls 71
 - calls without numbers 72
 - screen calls without numbers 96
 - screen uncategorized calls 99
 - set Smart call blocker
 - on/off 73
 - uncategorized calls 72

Index

Speakerphone 31

Speed dial

delete a number 57, 58

edit a number 56

enter a number 55

Star name list 86

T

Technical specifications 159

Telephone base

quick reference guide 6

Temporary ringer silencing 31

Time 19

Troubleshooting 136–147

U

Unwelcome calls 70

V

Visual message waiting

indicator 23

Voice guide 13, 107

Voicemail 23, 113

quick access 56, 58

Voice prompts 115

Volume control

handset 17, 33, 34, 118

telephone base 118

W

Wall-mount installation 14

Warranty 156–158

Welcome calls 70

Remote access wallet card

Use the following wallet card to help you remember commands to control your answering system from any touch-tone telephone.

Cut along dotted line.



Call your phone number, then enter your two-digit access code (preset to **19**).

Action	Remote command
--------	----------------

Play all messages.....	1
Play new messages.....	2
Delete the message	3
Delete all old messages	33
Repeat or go back.....	4
Stop	5
Help menu.....	*5

Fold here.

Skip the message.....	6
Record announcement.....	*7
End remote access call	8 (or hang up)
Turn system off or on	0

Models: CL82107/CL82207/CL82257/CL82267/CL82307/CL82357/CL82367/
CL82407/CL82467/CL82507/CL82547/CL82557

Type: DECT 6.0 cordless telephone/answering system with caller ID call waiting

© 2017- 2020 Advanced American Telephones. All Rights Reserved.
AT&T and the AT&T logo are trademarks of AT&T Intellectual Property
licensed to Advanced American Telephones, San Antonio, TX 78219.
Printed in China.



<https://telephones.att.com>

© 2017-2020 Advanced American Telephones. All Rights Reserved.
AT&T and the AT&T logo are trademarks of AT&T Intellectual Property licensed to
Advanced American Telephones, San Antonio, TX 78219.

QalTel™ is a trademark of Truecall Group Limited.

The RBRC Seal and 1-800-8-BATTERY® are registered trademarks of
Call2recycle, Inc.

Printed in China. Issue 5.0 AT&T 12/20.