

STEERING PARTS

- Teile der Lenkung
- Partes de la dirección

- Componenti Volante
- Peças da direcção

- Pièces direction
- Stuurinrichtingsonderdelen
- Styretøjsdele

FIAT - FIAT AGRI - FIAT Trattori tractors

GOLD VALUE

NEW HOLLAND
AGRICULTURE

POWER STEERING CYLINDER REPAIR KIT

- Kit de réparation de cylindre de direction assistée • Reparatursatz Kraftlenkzylinder • Equipo de reparación del cilindro de dirección asistida
- Kit di riparazione cilindro servosterzo • Kit de reparacão do cilindro da direção assistida • Reparatiekit stuurbekrachtigingscilinder
- Reparationssæt til servostyreylinder

640DT, 45-66, 45-76, 50-66, 50-86, 55-46, 55-56, 55-66, 55-76, 55-86, 55-88, 55-90, 56-66, 60-46, 60-56, 60-66, 60-76, 60-86, 60-88, 60-90, 60-93, 60-94, 65-46, 65-56, 65-66, 65-88, 65-90, 65-93, 65-94, 70-56, 70-66, 70-76, 70-88, 70-90, 72-86, 72-93, 72-94, 80-66, 80-76, 80-88, 80-90, 82-86, 82-93, 82-94, 85-90, 88-93, 88-94, 90-90, 100-90, 110-90, F100DT, F110DT

87569183

9961670



SERVO STEERING CYLINDER REPAIR KIT

- Kit de réparation de cylindre de direction • Reparatursatz Servolenkzylinder
- Equipo de reparación del cilindro de servodirección • Kit di riparazione cilindro servosterzo • Kit de reparacão do cilindro de servo-direção
- Reparatiekit cilinder servo-stuurinrichting • Reparationssæt til servostyreylinder

65-46, 70-46, 70-56, 70-66, 70-90, 80-66, 80-90, 90-90, 100-90, 110-90

87569184

9961823

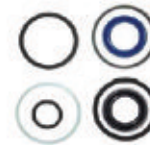

SHORT SHAFT - THRUST WASHER

- Arbre court - anneau de butée • Kurze Welle - Druckscheibe
- Eje corto - arandela de empuje • Albero corto - rondella di spinta
- Veio pequeno - anilha de impulso • Korte as - drukring
- Kort aksel - trykskive

450, 480, 640, 55-46, 60-46, 65-46

87569185

597377



CUP

- Cuvette • Topfmanschette • Tapón • Cappuccio • Copo • Loopring • Skål

450, 480, 640, 55-46, 60-46, 65-46

87569187

597378



INNER TIE ROD TUBE

- Tube intérieur de biellette • Innenrohr Spurstange • Tubo de biela interna
- Tubo del tirante interno • Tubo interior do tirante
- Binnenste spoorstangbuis • Rør til indvendig forbindelsesstang

400, 450, 500

87569158

4961886



TIE ROD

- Biellette • Spurstange • Biela • Tirante • Tirante
- Spoorstang • Forbindelsesstang

45-76, 50-86, 55-46, 55-56, 55-76, 55-86, 55-88, 55-90, 60-46, 60-66, 60-76, 60-86, 60-88, 60-90, 60-93, 60-94, 65-46, 65-56, 65-66, 65-88, 65-90, 65-93, 65-94, 70-56, 70-66, 70-76, 70-88, 70-90, 72-86, 72-93, 72-94, 80-66, 80-76, 80-88, 80-90, 82-86, 82-93, 82-94, 85-90, 88-93, 88-94, 90-90, 100-90, 110-90

87569188

9960076

STEERING PARTS

- Teile der Lenkung
- Partes de la direcció

- Componenti Volante
- Peças da direcção

- Pièces direction
- Stuurinrichtingsonderdelen
- Styretøjsdele

FIAT - FIAT AGRI - FIAT Trattori tractors

GOLD VALUE



TIE ROD END

- Extrémité de biellette • Spurstangenkopf • Extremo de la biela
- Estremità del tirante • Extremidade do tirante • Uiteinde spoorstang
- Forbindelsesstangens ende

Som 415, 400, 450, 480, 500, 540, 550, 600, 640, 250DT, 300DT, 312R, 315, 315R

87569195 588309

550, 600

87569525 4956562

55-46, 55-56, 60-56, 70-46, 70-56, 70-66DT, 80-66DT, 90-90DT, 100-90DT, 110-90DT (2nd serie), 115-90, 115-90DT, 130-90, 130-90DT, 140-90, 140-90DT, 160-90, 160-90DT, 180-90, 180-90DT, 1180, 1180DT, 1280, 1280DT, 1380, 1380DT, 1580, 1580DT, 1880, F120DT, F130DT, F140DT

87569194 5117314

L60, L65, L75, L85, L95

87569511 5178390

Som40, Som45, Som50, Som55, 511, 615, 650DT, 715, 750DT, 800, 850, 850Special, 850DT, 880DT(2nd series), 900, 1000, 1000DT, 1180, 1280, 1300DT(Heavy Duty), 1380, 1580, 1880

87713008 62750017
5115341

Som40, Som45, Som50, Som55, 511, 570, 580, 615, 650, 650Special, 670, 680, 715, 750Special, 780, 800, 850, 880, 980

87713009 44078446



TIE ROD END LEFT HAND

- Extrémité de biellette gauche • Spurstangenkopf links
- Extremo izquierdo de la biela • Estremità del tirante lato sinistro
- Extremidade do tirante, lado esquerdo • Uiteinde spoorstang links
- Forbindelsesstangens ende, venstre

45-66, 50-66, 55-46, 55-56, 55-66, 60-46, 60-66, 65-46, 65-56, 65-66, 70-56, 70-66

87569213 5119377

TIE ROD END RIGHT HAND

- Extrémité de biellette droite • Spurstangenkopf rechts
- Extremo derecho de la biela • Estremità del tirante lato destro
- Extremidade do tirante, lado direito • Uiteinde spoorstang rechts
- Forbindelsesstangens ende, højre

350DT, 466, 500DT, 566, 570, 580, 650, 650DT, 666, 670, 680, 750DT, 766, 780, 880, 980, 45-66, 50-66, 55-46, 55-56, 55-66, 55-76, 55-86, 55-88, 55-90, 60-46, 60-66, 60-76, 60-86, 60-88, 60-90, 60-93, 60-94, 65-46, 65-56, 65-88, 65-90, 65-93, 65-94, 70-56, 70-66, 70-76, 70-88, 70-90, 72-93, 72-94, 80-66, 80-88, 80-90, 82-86, 82-93, 82-94, 85-90, 90-90, 100-90, 110-90, F100, F110, F115, F120, F130, F140

87569214 4987961
5109526

DRAG LINK ASSEMBLY

- Tirant de direction assemblé • Lenkstangenbaugruppe • Conjunto de articulaciones de arrastre • Complessivo tirante longitudinale sterzo
- Conjunto da barra de direcção • Stuurstangeenheid • Styrestang

90-90, 100-90, 110-90

87569189 5127193

70-66, 70-90, 80-66, 80-90

87569190 5126942

70-66, 80-66, 90-90, 100-90, 110-90, F100, F110, F115

87569191 5142245

780, 55-46, 55-56, 55-66, 55-88, 55-90, 60-46, 60-66, 60-88, 60-90, 60-93, 60-94, 65-46, 65-56, 65-66, 65-88, 65-90, 65-93, 65-94, 70-56, 70-66, 70-76, 70-88, 70-90, 72-86, 72-94, 80-66, 80-88, 80-90, 82-86, 82-93, 82-94, 85-90, 88-93, 88-94, 90-90, 100-90, 110-90, F100, F115, F120, F130, F140

87569192 5101179

70-66, 70-88, 80-66, 80-88

87569193 5142233

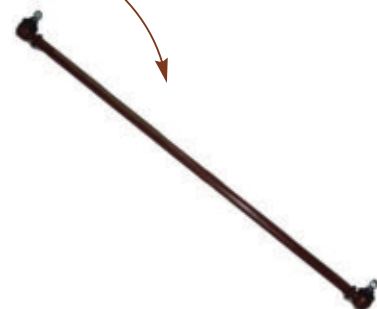

STEERING PARTS

- Teile der Lenkung
- Componenti Volante
- Partes de la dirección
- Peças da direção

- Pièces direction
- Stuurinrichtingsonderdelen
- Styretøjsdele

FIAT - FIAT AGRI - FIAT Trattori tractors

GOLD VALUE

NEW HOLLAND
AGRICULTURE



ROD TUBE

- Tube • Stangenrohr • Tubo de biela • Tubo del tirante • Tubo do tirante
- Stangbuis • Rør til stang

570, 580, 650, 670, 680, 780, 880, 980,
55-46, 55-56, 60-56, 70-46, 70-56

87569196

5085084
5101177



OUTER TIE ROD

- Tube extérieur de biellette • Äußere Spurstange • Tubo externo de biela
- Tirante esterno • Tirante exterior • Buitenste spoorstang
- Udvendig forbindelsesstang

UNIVERSAL / 450R

87569197

4988565



CLAMP

- Collier de serrage • Rohrschelle • Abrazadera • Fascetta
- Braçadeira • Klem • Klemme

415, 450, 480, 480S, 540, 640,
45-66, 50-66, 55-46

87569198

4961706



LEVER

- Levier • Hebel • Palanca • Leva • Alavanca • Hendel • Greb

415, 450, 480, 540, 640

87569212

4956307
4973658



RIGHT HAND STEERING ARM

- Bras de direction droit • Rechter Spurhebel • Brazo de dirección derecho
- Braccio di comando lato destro • Braço de direção, lado direito
- Fusee-arm rechts • Højre styrearm

415, 450, 480, 640

87569210

588299

LEFT HAND STEERING ARM

- Bras de direction gauche • Linker Spurhebel • Brazo de dirección izquierdo
- Braccio di comando lato sinistro • Braço de direção, lado esquerdo
- Fusee-arm links • Venstre styrearm

415, 450, 480, 640

87569211

588768



STEERING KNUCKLE RH

- Porte-fusée de direction droit • Achsschenkel rechts
- Pivote de la dirección derecho • Articolazione di sterzo DX
- Mancal do eixo, lado direito • Stuurgewricht rechts • Styrespindel, højre

70-66, 70-90, 80-66, 80-90

87569355

5126939

STEERING KNUCKLE LH

- Porte-fusée de direction gauche • Achsschenkel links • Pivote de la dirección izquierdo
- Articolazione di sterzo SX • Mancal do eixo, lado esquerdo
- Stuurgewricht links • Styrespindel, venstre

70-66, 70-90, 80-66, 80-90

87569356

5126938



PIPE

- Tuyau • Rohr • Tubo • Tubo • Tubo • Leiding • Rør

55-46, 55-56, 55-66, 60-46, 60-66, 65-46, 65-56,
65-66, 70-56, 70-66, 70-76, 72-86, 80-66, 82-86

87569215

5120997



STEERING PARTS

- Teile der Lenkung
- Partì dello sterzo
- Partes de la dirección
- Peças da direcção

- Pièces direction
- Stuurinrichtingsonderdelen
- Styretøjsdele

FIAT - FIAT AGRI - FIAT Trattori tractors

GOLD VALUE

NEW HOLLAND
AGRICULTURE



STEERING SEAL

- Joint de direction • Lenkdichtung • Junta de dirección
- Guarnizione sterzo • Vedante de direcção • Afdichting stuurinrichting
- Tætning til styretøj

480, 640

87569490

9955110

415, 450, 480, 640

87569564

4509873



STEERING SHAFT BEARING

- Roulement de l'arbre de direction • Lenkwellenlager
- Cojinete del eje de dirección • Cuscinetto albero dello sterzo
- Chumaceira do veio de direcção • Stuuraslager • Leje til styreaksel

415, 450, 480, 540, 550, 580, 600, 640

87569474

998933
4654656

415, 450, 480, 540, 640

87569475

4654657
4654658



HYDRAULIC STEERING CYL BUSHING

- Bague du vérin de direction hydraulique • Hydrauliklenkung Zylinderbuchse • Casquillo del cilindro de dirección hidráulica
- Boccia cil. sterzo idraulico • Casquilho do cilindro hidráulico da direcção • Lager cylinder hydraulische stuurinrichting
- Cylinderbøsning til hydraulisk styretøj

35-66, 45-66, 45-76, 50-66, 50-86, 55-46, 55-56, 55-66, 55-76, 55-86, 55-88, 55-90, 56-66, 60-46, 60-66, 60-86, 60-88, 60-90, 60-93, 60-94, 65-46, 65-56, 65-66, 65-88, 65-90, 65-93, 65-94, 70-56, 70-66, 70-76, 70-86, 70-88, 70-90, 72-86, 72-93, 72-94, 80-66, 80-88, 80-90, 82-86, 82-93, 82-94, 85-90, 88-93, 88-94, 90-90, 100-90, 110-90, F100, F110, F115, F120, F130, F140

87569217

5102972



HYDRAULIC STEERING CYL PIN

- Axe du vérin de direction hydraulique • Hydrauliklenkung Zylinderstift
- Pasador del cilindro de dirección hidráulica • Perno cil. sterzo idraulico
- Pino do cilindro hidráulico da direcção • Pen cylinder hydraulische stuurinrichting • Cylinderstift til hydraulisk styretøj

45-66, 45-76, 50-66, 50-86, 55-46, 55-56, 55-66, 55-76, 55-86, 55-88, 55-90, 56-66, 60-46, 60-66, 60-86, 60-88, 60-90, 60-93, 60-94, 65-46, 65-56, 65-66, 65-88, 65-90, 65-93, 65-94, 70-56, 70-66, 70-76, 70-86, 70-88, 70-90, 72-86, 72-93, 72-94, 80-66, 80-88, 80-90, 82-86, 82-93, 82-94, 85-90, 88-93, 88-94, 90-90, 100-90, 110-90, F100, F110, F120, F140

87569534

4997697

STEERING PARTS

- Teile der Lenkung
- Partes de la dirección

- Parti dello sterzo
- Peças da direcção

- Pièces direction
- Stuurinrichtingsonderdelen
- Styretøjsdele

FIAT - FIAT AGRI - FIAT Trattori tractors

GOLD VALUE



STEERING CYLINDER PIN

- Axe du vérin de direction • Lenkzylinderstift • Pasador del cilindro de dirección • Perno del cilindro sterzo • Pino do cilindro da direcção • Stuurcilinderpen • Cylinderstift til styretøj



45-66, 50-66, 55-46, 55-56, 55-66, 55-88, 55-90, 56-66, 60-46, 60-56, 60-66, 60-88, 60-90, 60-93, 60-94, 65-46, 65-56, 65-66, 65-88, 65-90, 65-93, 65-94, 70-56, 70-66, 70-76, 70-90, 72-86, 72-93, 72-94, 80-66, 80-90, 82-86, 82-93, 82-94, 85-90, 88-93, 88-94, 90-90, 100-90, 110-90, F100, F110, F115

87569218

4987671

70-66, 70-88, 70-90, 80-66, 80-88, 80-90, 90-90, 100-90, 110-90, 115-90, 130-90, 140-90, 160-90, 180-90, F120DT, F130DT, F140DT

87569219

5111572

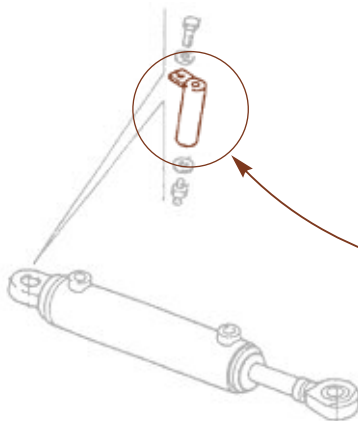

STEERING CYLINDER PIVOT PIN

- Broche-Vérin de servodirection • Stift - Servolenkungszyylinder • Pasador-Cilindro de servodirección • Perno-Cilindro servosterzo • Cilindro de direcção pino-servo • Pen-servostuurcilinder • Stift til servostyringscylinder

70-66, 70-90, 80-66, 80-90, 90-90, 100-90, 115-90, 130-90, 140-90, 160-90, 180-90

87694771

5111574

STEERING CYLINDER PIPE

- Tuyau-Servodirection • Rohr - Servolenkung • Tubo-Servodirección • Tubo-Servosterzo • Direcção tubo-servo • Leiding-servosturing • Rør til servostyring



55-46, 55-56, 55-66, 55-66S, 60-46, 60-66, 60-66S, 65-46, 65-56, 65-66, 65-66S, 70-46, 70-56, 70-66, 70-66S, 70-76, 72-86, 80-66, 80-66S, 82-86

87694772

5120999

FRONT AXLE PARTS

- Teile der vorderachse
- Partes de eje delantero

- Ricambi assale anteriore
- Peças do eixo dianteiro

- Pièces essieu avant
- Voorasonderdelen
- Dele til foraksel

FIAT - FIAT AGRI - FIAT Trattori tractors

GOLD VALUE

NEW HOLLAND
AGRICULTURE

FRONT SPINDLE RH

- Fusée avant droite • Vorderachse rechts • Husillo delantero derecho
- Fuso anteriore Dx • Veio dianteiro, lado direito • Voorwiels rechts
- Forreste akseltap, højre

55-56, 55-66, 60-66, 65-66, 65-93, 70-66, 70-76, 72-86, 72-93, 72-94, 82-86, 82-93, 82-94, 88-93

87569553

5125406
5145932

55-88, 60-56, 60-66, 60-88, 60-93, 60-94, 65-56, 65-88, 65-93, 70-56, 70-66, 70-88, 72-93, 72-94, 80-66, 82-93, 82-94, 88-93

87569557

5086701
5145817

FRONT SPINDLE LH

- Fusée avant gauche • Vorderachse links • Husillo delantero izquierdo
- Fuso anteriore Sx • Veio dianteiro, lado esquerdo • Voorwiels links
- Forreste akseltap, venstre

55-56, 55-66, 60-66, 65-66, 65-93, 70-66, 70-76, 72-86, 72-93, 72-94, 82-86, 82-93, 82-94, 88-93

87569558

5125408
5145934

55-88, 60-56, 60-66, 60-88, 60-93, 60-94, 65-56, 65-88, 65-93, 70-56, 70-66, 70-88, 72-93, 72-94, 80-66, 82-93, 82-94, 88-93

87569559

5086703
5145819

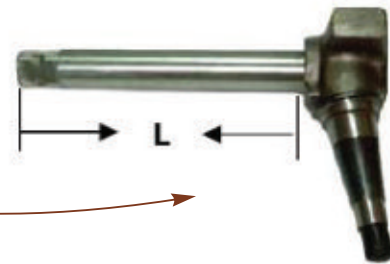

FRONT SPINDLE COVER SEAL

- Joint du couvercle de fusée avant • Dichtung Vorderachsenabdeckung
- Junta de la cubierta de husillo delantero • Guarnizione coperchio fuso anteriore • Vedante da cobertura do veio dianteiro • Afdichting kap voorwiels • Tætning til forreste akseltaps dæksel

315, 400, 411, 411R, 415, 450, 500, 550

87569177

561956

480, 500S, 540, 600, 640

87569178

4971457

570, 580, 670, 680, 780, 466, 566, 666, 766, 880, 980, 55-46, 55-56, 55-66, 55-90, 60-46, 60-56, 60-66, 60-90, 60-93, 60-94, 65-46, 65-56, 65-66, 65-90, 65-94, 70-56, 70-66, 70-90, 72-93, 72-94, 80-66, 80-90, 82-93, 82-94

87569179

4951077



FRONT HUB

- Moyeu avant • Vordere Radnabe • Cubo delantero • Mozzo anteriore
- Cubo dianteiro • Voornaaf • Forreste nav

55-46, 55-56, 55-66, 55-88, 55-90, 60-46, 60-66, 60-76, 60-88, 60-90, 60-93, 60-94, 62-86, 65-46, 65-56, 65-66, 65-88, 65-90, 65-93, 70-56, 70-66, 70-76, 70-88, 70-90, 72-86, 72-93, 72-94, 80-66, 80-76, 80-88, 80-90, 82-86, 82-93, 82-94, 85-90, 88-93, 88-94

87569180

5115659

415, 450, 480, 540, 640

87569181

4971444
5087141

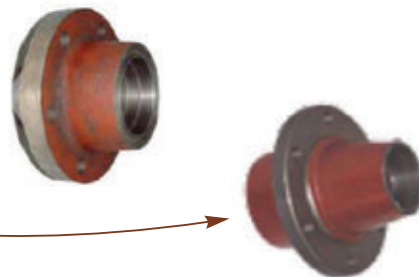

FRONT HUB CAP

- Enjoliveur avant • Deckel vordere Radnabe • Tapa de cubo delantero
- Coprimozzo anteriore • Cobertura do cubo dianteiro Kap voornaaf
- Hætte til forreste nav

415, 450, 480, 540, 640, 55-46, 55-56, 55-66, 55-88, 55-90, 60-46, 60-66, 60-76, 60-88, 60-90, 60-93, 60-94, 62-86, 65-46, 65-56, 65-66, 65-88, 65-90, 65-93, 70-56, 70-66, 70-76, 70-88, 70-90, 72-86, 72-93, 72-94, 80-66, 80-76, 80-88, 82-86, 82-93, 82-94, 85-90, 88-93, 88-94, L60, L65, L75, L85, L95

87569182

561939
4957312



FRONT AXLE PARTS

- Teile der vorderachse
- Partes de eje delantero

- Ricambi assale anteriore
- Peças do eixo dianteiro

- Pièces essieu avant
- Voorasonderdelen
- Dele til foraksel

FIAT - FIAT AGRI - FIAT Trattori tractors

GOLD VALUE

NEW HOLLAND
AGRICULTURE

REAR AXLE HOUSING

- Carter d'essieu arrière • Hinterachsgehäuse
- Alojamiento del eje trasero • Alloggiamento assale posteriore
- Alojamento do eixo traseiro • Achterashuis • Bagakslens hus

70-88, 70-90, 72-93, 72-94, 80-88, 80-90,
82-93, 82-94, 85-90, 88-93, 88-94

87694795

4991470

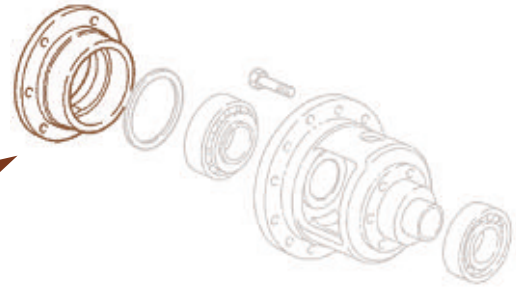

NUT-FRONT SPINDLE

- Ecrou - Fusée avant • Mutter Vorderachse • Tuerca - husillo delantero
- Dado - Fuso anteriore • Porca do veio dianteiro • Moer-vooras
- Motrik - forreste akseltap

415, 450, 480, 540, 640, 55-46, 55-66, 55-88,
55-90, 60-46, 60-56, 60-66, 60-76, 60-88, 60-90,
60-93, 60-94, 62-86, 65-46, 65-56, 65-66, 65-88,
65-90, 65-93, 70-56, 70-66, 70-76, 70-88, 70-90,
72-86, 72-93, 72-94, 80-66, 80-76, 80-88, 80-90,
82-86, 82-93, 82-94, 85-90, 88-93, L60, L65,
L75, L85, L95

87569199

10727420
14044271



FRONT SPINDLE BUSH BRASS

- Coussinet laiton de la fusée avant • Vorderachsenbuchse Messing
- Casquillo del husillo delantero de latón
- Boccia fuso anteriore in ottone • Casquilho de latão do veio dianteiro
- Messing bus voor vooras • Bøsning til forreste akseltap, messing

450, 480, 540, 640

87569204

4964379



KING PIN

- Pivot de fusée • Achsschenkelbolzen • Pivote de la mangueta
- Perno del fuso a snodo • Perno mestre • Fuseepen • Styrebolt

400, 415, 450, 480, 540, 550, 600, 640

87569265

588301
596188



FRONT AXLE PARTS

- Teile der vorderachse
- Partes de eje delantero

- Ricambi assale anteriore
- Peças do eixo dianteiro

- Pièces essieu avant
- Voorasonderdelen
- Dele til foraksel

FIAT - FIAT AGRI - FIAT Trattori tractors

GOLD VALUE

NEW HOLLAND
AGRICULTURE

CENTRAL PIN

- Axe central • Zentralbolzen • Pasador central • Perno centrale
- Perno central • Centrale pen • Midterbolt

55-46, 55-56, 60-46, 60-56, 60-66, 60-93, 60-94, 65-46, 65-56, 65-66, 65-93, 65-94, 70-56, 70-66, 72-93, 72-94, 80-66, 82-93, 82-94, 88-93, 88-94, L60, L65, L75, L85, L95	87569263	5110400
55-88, 55-90, 60-66, 60-88, 60-90, 65-88, 65-90, 70-88, 70-90, 80-88, 80-90, 85-90, 90-90, 100-90	87569264	5109536 5135906



FRONT AXLE PIVOT BUSHING

- Bague d'essieu avant • Vorderachsebusche
- Casquillo de eje delantero • Boccia Assale Anteriore
- Casquilho do eixo dianteiro • Bus Vooras • Foraksel bøsning

35-66DT, 45-66, 50-66, 55-46, 55-56, 55-66, 55-76, 55-86, 55-88, 55-90, 56-66, 60-46, 60-56, 60-66, 60-76, 60-86, 60-88, 60-90, 60-93, 60-94, 62-86, 65-46, 65-56, 65-66, 65-88, 65-90, 65-93, 65-94, 70-56, 70-66, 70-76, 70-86, 70-88, 70-90, 72-86, 72-93, 72-94, 80-66, 80-76, 80-88, 80-90, 82-86, 82-93, 82-94, 85-90, 88-93, 88-94, 90-90, 100-90, 110-90, 115-90, 130-90, 140-90, 160-90, 180-90, F100DT, F115DT, L60, L65, L75, L85, L95	87569269	5129385
---	-----------------	---------



FRONT AXLE SPIDER (FOR U JOINT)

- Croisillon de l'essieu avant (pour joint torique)
- Vorderachsenkreuzstück (für U-Verbindung) • Cruceta del eje delantero (para unión en U) • Portasatelliti assale anteriore (per giunto a U)
- Armação do eixo dianteiro (para junta em U) • Kruisstuk vooras (voor kruiskoppeling) • Kardankryds til foraksel (til kardanaksler)

45-76, 50-86, 55-76, 55-86, 60-86, 70-66, 70-88, 70-90, 72-93, 72-94, 80-66, 80-88, 80-90, 82-93, 82-94, 85-90, 88-93, 88-94, 90-90, 100-90, 110-90, F100, F110, F115	87569266	9961774 9962244
115-90, 130-90, 140-90, 160-90, 180-90, F120, F130, F140	87569267	9959701 45482194
55-66, 55-76, 55-86, 55-88, 60-66, 60-76, 60-86, 60-88, 60-93, 60-94, 62-86, 65-46, 65-66, 65-88, 65-93, 65-94, 70-86, 45-66, 50-66, 55-46, 55-56, 55-66, 55-90, 56-66, 60-46, 60-56, 60-66, 60-90, 65-56, 65-66, 65-90, 70-56, 70-66, 70-76, 72-86, 80-66, 80-76, 82-86	87569268	7533624 9959898
27 x 75 / side greaser / graisseur latéral	87685856	9926504 9956514
39,7 x 116 / side greaser / graisseur latéral	87685843	9957590 62710281
30 x 92 / side greaser / graisseur latéral	87685853	9959701 45482194
30 x 92 / center greaser / graisseur central	87685855	9959701 45482194
35 x 97 / central greaser / graisseur central	87685854	9927092
27 x 82 / sealed long life / graissage à vie	87685818	9961774 9962244



FRONT AXLE PARTS

- Teile der vorderachse
- Partes de eje delantero

- Ricambi assale anteriore
- Peças do eixo dianteiro

- Pièces essieu avant
- Voorasonderdelen
- Dele til foraksel

FIAT - FIAT AGRI - FIAT Trattori tractors

GOLD VALUE



SHAFT

- Arbtre • Welle • Eje • Albero • Veio • Aandrijfjas • Aksel

640, 65-46, 65-66, 70-56

87694798

4995341



WASHER

- Rondelle • Unterlegscheibe • Arandela • Rondella
- Anilha • Keerring • Spændeskive

35-66, 45-66S, 50-66S, 60-66S, 65-66S, 70-66, 70-66S, 70-88, 70-90, 72-93, 72-94, 80-66, 80-66S, 80-88, 80-90, 82-93, 82-94, 85-90, 88-93, 88-94, 90-90, F100, F110, F115, 100-90, 110-90, 46 & 56 series

87694774

5140456



FRONT WHEEL RIM (600x16)

- Jante-Avant (600x16) • Radfelge - vorn (600x16) • Llanta de rueda - Delantera (600x16) • Cerchione ruota - Anteriore (600x16)
- Jante da roda - Dianteira (600x16) • Wielvelg - v (600x16)
- Hjulfælæg - forrest (600x16)

415, 450, UNIVERSAL,
all models with tyres 600x16

87694775

5087127
562317

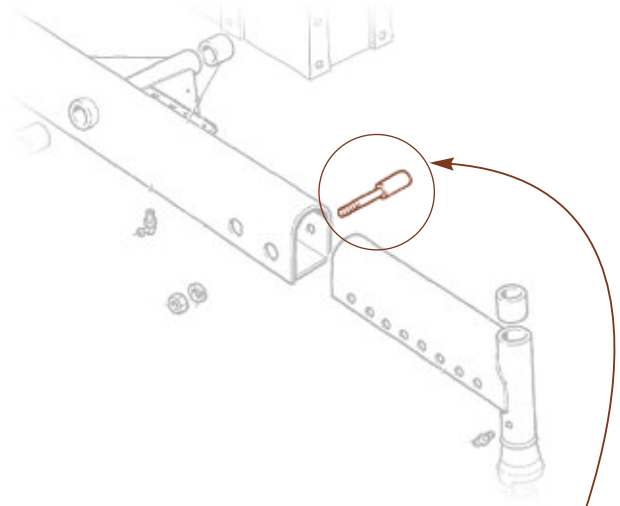

STUD

- Goujon • Bolzen • Espárrago • Prigioniero • Pino • Tapeinde • Tap

55-46, 55-56, 55-66, 55-66S, 55-88, 55-90, 60-46, 60-56, 60-66, 60-66S, 60-76, 60-88, 60-90, 60-93, 60-94, 62-86, 65-46, 65-56, 65-66, 65-66S, 65-88, 65-90, 65-93, 65-94, 70-56, 70-66, 70-66S, 70-76, 70-88, 70-90, 72-86, 72-93, 72-94, 80-66, 80-66S, 80-76, 80-88, 80-90, 82-86, 82-93, 82-94, 85-90, 88-93, 88-94

87694773

5127012



FRONT WHEEL STUD

- Goujon de roue avant • Vorderradbolzen
- Espárrago de rueda delantera • Prigioniero ruota anteriore
- Perno da roda dianteira • Tapeind voorwiel • Tapbolt til forhjul

466, 566, 580, 666, 680, 780, 45-66, 55-66, 55-90, 56-66, 60-66, 60-90, 65-46DT, 70-56DT, 70-66, 70-90, 80-66DT, 80-90

87569571

15983821

FRONT WHEEL STUD M18x1,5x35

- Goujon-Roue avant M18 x 1.5 x 35 • Bolzen - Vorderrad M18x1,5x35
- Espárrago - Rueda delantera M18x1.5x35 • Prigioniero - Ruota anteriore M18x1,5x35 • Perno - Roda dianteira M18x1,5x35
- Tapeind - voorwiel M18x1,5x35 • Tap - forhjul M18x1,5x35

65-46DT, 70-56DT, 80-66DT

87694776

15983821

BOLT AND NUT-FRONT WEIGHT

- Vis et écrou-Poids avant • Bolzen und Mutter - Vordergewicht
- Perno y tuerca -Peso delantero • Dado e bullone-Zavorra anteriore
- Peso dianteiro do parafuso e da porca • Bout en moer-frontgewicht
- Bolt og møtrik til frontvægt

415, 450, 480, 540, 640, 35-66, 55-46, 55-56, 60-46, 60-56, 65-46, 65-56, 70-56

87694777

561460

LIFT & LINKAGE PARTS

- Hub- und gestangeteile
- Partes de articulaci3n y elevaci3n
- Parti del sollevatore e dell'attacco

- Pices de relevage et d'attelage
- Peas do elevador e de ligao
- Onderdelen van hefinrichting en stangenstelsel
- Dele til lift og forbindelsesled

FIAT - FIAT AGRI - FIAT Trattori tractors

GOLD
VALUE

NEW HOLLAND
AGRICULTURE

LOWER LINK ARM

- Bielle infrieure • Unterer Gelenkarm • Brazo de articulaci3n inferior
- Barre d'attacco inferiori • Brao da ligao inferior
- Onderste hefarm • Arm til nederste forbindelse

450, 480 and all tractors

87569220

4982413

680, 780, 880

87569574

5109973



MOUNTING PIN

- Goupille de montage • Befestigungsstift • Pasador de montaje
- Perno di montaggio • Pino de montagem • Montagepen
- Monteringsstift

450, 480, 550, 600

87569467

4954462

480, 540, 640, 55-46, 55-56, 60-46,
60-56, 65-46, 65-56, 70-56

87569221

4954461



HOUSING - HYDRAULIC CROSS SHAFT

- Carter - Arbre transversal hydraulique
- Gehause - Hydrauliklenkstockwelle • Carcasa - eje cruzado hidrulico
- Alloggiamento - Albero trasversale idraulico
- Alojamento - veio hidrulico transversal
- Huis - Hydraulische dwarsas • Hus - hydraulisk breaxsel

980, 90-90, 100-90, 110-90

87569222

5109977

566, 666, 766, 45-66, 45-76, 50-66, 50-86,
55-66, 55-76, 55-86, 55-88, 55-90, 56-66, 60-66,
60-76, 60-86, 60-88, 60-90, 60-93, 60-94, 65-66,
65-88, 65-90, 65-93, 65-94, 70-66, 70-76, 70-86,
70-88, 70-90, 72-86, 72-93, 72-94, 80-66, 80-88,
80-90, 82-86, 82-93, 82-94, 85-90, 88-93, 88-94,
L60, L75, L85, L95

87569225

5116244



LIFT ROD ASSEMBLY

- Ensemble tige de relevage • Hubstangenbaugruppe
- Conjunto de varillas de elevaci3n • Complessivo tiranti di sollevamento
- Conjunto do tirante do elevador • hefstang • L3ftestang

450, 460, 470, 480, 580, 600, 55-46, 60-46

87569226

5104706
5148398

640, 55-46, 60-46, 65-46

87569227

4982245
4999170



TURNBUCKLE

- Tige de tension • Spannschloss • Tensor • Tenditore
- Tensor • Spanner • Spndem3trik

312, 315, 350, 450, 480, 500, 540, 550, 570,
580, 600, 640, 55-46, 55-56, 60-46, 60-56,
65-46, 65-56, 70-56

87569229

584731
5087630



LIFT & LINKAGE PARTS

- Hub- und gestangeteile
- Partes de articulaci3n y elevaci3n
- Parti del sollevatore e dell'attacco

- Pices de relevage et d'attelage
- Peas do elevador e de ligao
- Onderdelen van hefinrichting en stangenstelsel
- Dele til lift og forbindelsesled

FIAT - FIAT AGRI - FIAT Trattori tractors

GOLD VALUE

NEW HOLLAND
AGRICULTURE

LEVELLING BOX LOWER PIN SHORT

- Botier de mise  niveau - Goupille infrieure courte
- Kurzer, unterer Stift Planierkasten • Pasador corto inferior de caja de nivelaci3n • Perno inferiore corto scatola di livellamento
- Caixa niveladora, pino inferior pequeno
- Onderste pen nivelleerkast kort • Nederste stift til nivelleringsboks, kort

450, 480, 640, 35-66, 55-46, 55-56, 60-46,
60-56, 65-46, 65-56

87569230

568721

LEVELLING BOX LOWER PIN LONG

- Botier de mise  niveau - Goupille infrieure longue
- Langer, unterer Stift Planierkasten • Pasador largo inferior de caja de nivelaci3n • Perno lungo scatola di livellamento • Caixa niveladora, pino inferior longo • Nederste stift til nivelleringsboks, lang
- Onderste pen nivelleerkast lang

450, 480, 640, 35-66, 55-46, 55-56, 60-46,
60-56, 65-46, 65-56

87569231

568720
4989141

LEVELLING BOX LOWER PIN TICK

- Botier de mise  niveau - Protection de goupille infrieure
- Haken unterer Stift Planierkasten • Pasador grueso inferior de caja de nivelaci3n • Perno inferiore spesso scatola di livellamento
- Caixa niveladora, pino inferior espesso
- Onderste pen nivelleerkast dik • Nederste stift til nivelleringsboks, tyk

640, 55-56, 60-56, 65-46, 65-56, 70-56, 70-76

87569232

574882
8308275

SEAL-HYDRAULIC PISTON

- Joint - Piston hydraulique • Dichtung Hydraulikkolben • Junta - pist3n hidrulico • Guarnizione - Pistone idraulico • Vedante: pisto hidrulico
- Keerring-hydraulische zuiger • Ttning - hydraulikstempel

55-46, 55-66, 60-46, 60-66, 60-76, 65-46, 65-66,
65-90, 70-66, 70-76, 70-88, 70-90, 72-86, 72-93,
72-94, 80-66, 80-76, 80-88, 80-90, 82-86, 82-93,
82-94, 85-55, 85-90, 88-93, 88-94, 90-90, 95-66,
L65, L75, L85, L95, 100-90, 115-90, 130-90,
140-90, 160-90, 180-90 / Laverda combine :
3650, 3650R, 3750, 3750R, 3850, 3850R

87569233

14465981

HYDRAULIC PISTON

- Piston Hydraulique • Hydraulikkolben • Pist3n hidrulico • Pistone idraulico • Pisto hidrulico • Hydraulische zuiger • Hydraulikstempel

640, 55-46, 60-46, 65-46

87569234

4981457

480

87569491

4982383
4982393

HYDRAULIC CYLINDER

- Vrin hydraulique • Hydraulikzylinder • Cilindro hidrulico
- Cilindro idraulico • Cilindro hidrulico • Hydraulische cilinder
- Hydraulikcylinder

450, 480, 640, 45-66, 45-76, 50-66, 50-86, 55-56,
55-66, 55-76, 55-86, 56-66, 60-56, 60-86, 65-56,
70-56, 70-86

87569235

5125639

640, 55-46, 60-46, 65-46

87569236

4981455
5105648



LIFT & LINKAGE PARTS

- Hub- und gestängeteile
- Partes de articulación y elevación
- Parti del sollevatore e dell'attacco

- Pièces de relevage et d'attelage
- Peças do elevador e de ligação
- Onderdelen van hefinrichting en stangenstelsel
- Dele til lift og forbindelsesled

FIAT - FIAT AGRI - FIAT Trattori tractors

GOLD
VALUE

NEW HOLLAND
AGRICULTURE

HYDRAULIC LIFT CONTROL LEVER - QUADRANT SPRING

- Levier de commande de relevage hydraulique - Ressort de grille des vitesses
- Hydraulikhub-Steuerhebel - Wählhebelfeder • Palanca de control de elevación hidráulica - muelle cuadrante • Leva di comando sollevatore idraulico - Molla settore
- Alavanca de controlo do elevador hidráulico - mola quadrante
- Bedieningshendel hydraulische hefinrichting - kwadrant-veer
- Betjeningsgreb til hydraulisk lift - kvadrantfjeder



480, 640, 55-46, 60-46, 65-46

87569237

567861



HYDRAULIC LIFT CONTROL VALVE SPRING

- Ressort du distributeur de relevage hydraulique • Hydraulikhub-Steuventilfeder
- Muelle de la válvula de control de elevación hidráulica • Molla distributore sollevatore idraulico • Mola da válvula de controlo do elevador hidráulico • Regelklepveer hydraulische hefinrichting • Fjeder til den hydrauliske lifts betjeningsgreb

480, 640, 55-46, 60-46, 65-46

87569252

559948

HYDRAULIC LIFT - ROCKER ARM PIVOT PIN

- Relevage hydraulique - Axe d'articulation du bras de culbuteur • Hydraulikhub - Schwinghebel-Gelenkbolzen • Elevación hidráulica - eje oscilante del brazo de balancín • Sollevatore idraulico - Perno del bilanciore • Elevador hidráulico - Perno do braço oscilante • Hydraulische hefinrichting - Draaipen kleptuimelaar • Hydraulisk lift - drejetap til vippear

55-56, 60-56, 65-56, 70-56

87569238

5144280

450, 480, 640, 55-46, 60-46, 65-46, 70-56

87569239

566604

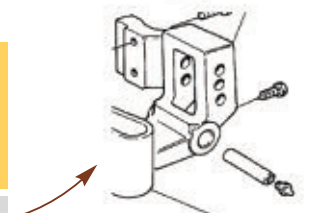

HYDRAULIC LIFT - PUSH ROD

- Relevage hydraulique - Tige de culbuteur • Hydraulikhub - Stößelstange
- Elevación hidráulica - biela de empuje • Sollevatore idraulico - Asta di comando
- Elevador hidráulico - Haste de comando do balancim
- hydraulische hefinrichting - Stoterstang • Hydraulisk lift - stødstang

480, 640, 55-46, 60-46, 65-46

87569240

4981484

45-66, 45-76, 50-66, 50-86, 55-56, 55-66, 55-76, 55-86,
56-66, 60-56, 60-86, 65-56, 70-56, 70-86

87569241

5086095
5125647

LIFT & LINKAGE PARTS

- Hub- und gestangeteile
- Partes de articulaci3n y elevaci3n
- Parti del sollevatore e dell'attacco

- Pices de relevage et d'attelage
- Peas do elevador e de ligao
- Onderdelen van hefinrichting en stangenstelsel
- Dele til lift og forbindelsesled

FIAT - FIAT AGRI - FIAT Trattori tractors

GOLD VALUE

NEW HOLLAND
AGRICULTURE

PUSH ROD PIN

- Goupille de la tige de culbuteur • St3sselstangenbolzen • Pasador de la biela de empuje • Perno asta di comando • Pino da haste de comando do balancim
- Pen stoterstang • Stift til st3dstang

480, 640, 55-46, 60-46, 65-46

87569242

594787

45-66, 45-76, 50-66, 50-86, 55-56, 55-66, 55-76, 55-86, 56-66, 60-56DT, 60-86, 65-56, 70-56, 70-86

87569243

5125648

55-65, 55-66, 55-75, 55-85, 55-88, 55-90, 60-65, 60-66, 60-75, 60-76, 60-85, 60-88, 60-90, 60-93, 60-94, 62-85, 62-86, 65-66, 65-88, 65-90, 65-93, 65-94, 70-65, 70-66, 70-75, 70-76, 70-88, 70-90, 72-85, 72-86, 72-93, 72-94, 80-65, 80-66, 80-75, 80-76, 80-88, 80-90, 82-85, 82-86, 82-93, 82-94, 85-90, 88-85, 88-93, 88-94, 90-90, 100-90, 110-90, L60, L65, L75, L85, L95

87569526

5122356



SEAL - SPACER

- Joint-Entretoise • Dichtung - Distanzstck • Junta - Separador
- Canna idraulica - Distanziale • Vedante do espaador
- Afdichting - afstandsstuk • Pakning - afstandsstykke

480, 640, 55-46, 60-46, 65-46

87694801

14471180



ADJUSTING HYDRAULIC CROSS SHAFT

- Rglage-Arbre transversal du moteur hydraulique • Einstellung - Hydraulische Querwelle • Ajuste - Eje cruzado hidrulico • Regolazione - Albero trasversale impianto idraulico • Ajuste do veio transversal hidrulico • Afstelling - dwarsas van hydraulisch systeem • Justering - hydraulik Breaksel

55-66, 55-66S, 60-66, 60-66S, 60-76, 62-86, 65-66, 65-66S, 70-66, 70-66S, 70-76, 70-86, 80-66, 80-66S, 80-76, 82-86

87694802

5116248



HYDRAULIC CROSS SHAFT

- Arbre transversal hydraulique • Hydrauliklenkstockwelle • Eje cruzado hidrulico
- Albero trasversale idraulico • Veio transversal hidrulico • Hydraulische dwarsas
- Hydraulisk breaksel

45-66, 45-76, 50-66, 50-86, 55-56, 55-66, 55-76, 55-86, 56-66, 60-56, 60-86, 65-56, 70-56

87569249

5125283

480, 640, 55-46, 60-46, 65-46

87569250

4981538
4998814



LIFT & LINKAGE PARTS

- Hub- und gestängeteile
- Partes de articulación y elevación
- Parti del sollevatore e dell'attacco

- Pièces de relevage et d'attelage
- Peças do elevador e de ligação
- Onderdelen van hefinrichting en stangenstelsel
- Dele til lift og forbindelsesled

FIAT - FIAT AGRI - FIAT Trattori tractors

GOLD
VALUE

NEW HOLLAND
AGRICULTURE



HYDRAULIC LIFT - CROSS SHAFT - RH SPACER

- Relevage hydraulique - Arbre transversal - Entretoise droite
- Hydraulikhub - Lenkstockwelle - rechtes Abstandstück
- Elevación hidráulica - eje cruzado - placa distanciadora derecha
- Sollevatore idraulico - Albero trasversale - Distanziatore DX
- Elevador hidráulico - Veio transversal - Espaçador do lado direito
- Hydraulische hefinrichting - Dwarsas - Rechteraafstandsstuk
- Hydraulisk lift - bæreaksel - højre afstandsstykke

480, 640, 55-46, 60-46, 65-46

87569244

4981488



BUSH - HYDRAULIC CROSS SHAFT RH

- Douille - Arbre transversal hydraulique droit • Buchse - Hydrauliklenkstockwelle rechts • Casquillo - eje cruzado derecho hidráulico • Boccola - Albero trasversale idraulico DX • Casquilho - veio transversal hidráulico, lado direito • Bus - hydraulische dwarsas rechts • Bøsning - hydraulisk bæreaksel, højre

450, 480, 640, 55-46, 60-46, 65-46

87569247

4955420

BUSH - HYDRAULIC CROSS SHAFT LH

- Douille - Arbre transversal hydraulique gauche • Buchse - Hydrauliklenkstockwelle links • Casquillo - eje cruzado izquierdo hidráulico • Boccola - Albero trasversale idraulico SX • Casquilho - veio transversal hidráulico, lado esquerdo • Bus - hydraulische dwarsas links • Bøsning - hydraulisk bæreaksel, venstre

450, 480, 640, 55-46, 60-46, 65-46

87569465

4955421

87569248
(metal)

4955421



TOP LINK SENSING SPRING

- Ressort de détection du bras supérieur • Fühlerfeder oberes Glied
- Muelle de detección de articulación superior • Molla di rilevamento puntone superiore • Mola sensora de ligação superior
- Veer sensor topstang • Trykfølsom fjeder til øverste forbindelse

570, 580, 640, 55-56, 60-56, 65-46, 65-56, 70-56

87569254

598648

450, 480, 500, 540, 550, 55-46, 60-46

87569255

596421



HYDRAULIC VALVE PLUG

- Fixation soupape hydraulique • Hydraulikventilstopfen
- Tapón de válvula hidráulica • Maschio della valvola idraulica
- Tampão da válvula hidráulica • Plug hydraulische klep
- Hydraulisk ventilprop

480, 640, 55-46, 60-46, 65-46

87569253

559952

LIFT & LINKAGE PARTS

- Hub- und gestänge-teile
- Partes de articulación y elevación
- Parti del sollevatore e dell'attacco

- Pièces de relevage et d'attelage
- Peças do elevador e de ligação
- Onderdelen van hefinrichting en stangenstelsel
- Dele til lift og forbindelsesled

FIAT - FIAT AGRI - FIAT Trattori tractors

GOLD VALUE

NEW HOLLAND
AGRICULTURE



HYDRAULIC LIFT REMOTE CONTROL CABLE

- Câble du distributeur de relevage hydraulique • Fernsteuerungskabel Hydraulikhub • Cable de control remoto de elevación hidráulica • Cavo di controllo remoto sollevatore idraulico • Cabo de control remoto do elevador hidráulico • Afstandsbedieningskabel hydraulische hefinrichting • Fjernstyringskabel til hydraulisk lift

580, 680, 780, 880, 980, 1180

87569256

4999388



HYDRAULIC CONNECTOR FOR DOUBLE ACTING

- Connecteur hydraulique pour double effet • Hydraulikanschluss für Zug- und Druckstufe • Conector hidráulico de doble acción • Connettore idraulico per doppia azione • Conector hidráulico para acción dupla • Hydraulische connector voor dubbelwerkend(e) • Hydraulisk konnektor for dobbeltfunktion

411, 415, 450, 500, 550, 600, 640, 650,
670, 750, 55-46, 60-46, 65-46

87569262

576233



PIN FOR STABILIZER CHAIN

- Goupille pour la chaîne du stabilisateur • Stift für Stabilisatorkette • Pasador de cadena estabilizadora • Perno per catena stabilizzatore • Pino para corrente do estabilizador • Pen voor stabilisatieketting • Stift til stabiliseringskæde

450, 480, 640, 35-66, 55-46, 55-56, 55-66,
55-76, 55-86, 60-46, 60-56, 60-66, 60-86,
65-46, 65-56, 70-56, 70-66, 70-76, 70-86

87569468

568910



HYDRAULIC OIL INLET TUBE

- Tube d'admission d'huile hydraulique • Hydrauliköl-Einlassschlauch • Tubo de admisión de aceite hidráulico • Tubo di ingresso olio idraulico • Tubo de entrada de óleo hidráulico • Toevoerbuiss hydraulische olie • Indløbsrør til hydraulikolie

55-46, 55-56

87569258

5134447

65-46, 65-56, 70-56

87569259

5134477

640

87569260

4981458
4982766

450, 480

87569261

4982391
4982961



TOW HOOK MOUNTING PIN

- Goupille de montage du crochet de remorquage • Befestigungsbolzen Zughaken • Pasador de montaje de enganche de remolque • Perno di montaggio gancio di traino • Pino de montagem de gancho de engate • Montagepen trekhaak • Monteringsstift til bugseringskrog

55-66, 55-88, 55-90, 60-66, 60-88, 60-90, 60-93,
60-94, 65-66, 65-88, 65-90, 65-93, 65-94, 70-66,
70-76, 70-88, 70-90, 72-86, 72-93, 72-94, 80-66,
72-94, 80-66, 80-88, 80-90, 82-86, 82-93, 82-94,
85-90, 88-93, 88-94, L60, L65, L75, L85, L95

87569363

5117437

HYDRAULIC TOP LIFT LH ARM

- Bras de relevage supérieur hydraulique gauche • Oberer Hydraulikhubarm links • Brazo superior izquierdo de elevación hidráulica • Braccio SX sollevatore superiore idraulico • Braço superior de elevação hidráulica, lado esquerdo • Hydraulische hefarm linksboven • Øverste hydrauliske forbindelse, venstre arm

480, 600, 640

87569471

596294

HYDRAULIC TOP LIFT RH ARM

- Bras de relevage supérieur hydraulique droit • Oberer Hydraulikhubarm rechts • Brazo superior derecho de elevación hidráulica • Braccio DX sollevatore superiore idraulico • Braço superior de elevação hidráulica, lado direito • Hydraulische hefarm rechtsboven

480, 600, 640

87569472

596293

LIFT & LINKAGE PARTS

- Hub- und gestangeteile
- Partes de articulaci3n y elevaci3n
- Parti del sollevatore e dell'attacco

- Pices de relevage et d'attelage
- Peas do elevador e de ligao
- Onderdelen van hefinrichting en stangenstelsel
- Dele til lift og forbindelsesled

FIAT - FIAT AGRI - FIAT Trattori tractors

GOLD
VALUE

NEW HOLLAND
AGRICULTURE

SPRING FOR LINKAGE

- Ressort d'attelage • Feder fur Getriebekette • Muelle de articulaci3n
- Molla per tiranteria • Mola para ligao • Veer voor stangenstelsel
- Fjeder til forbindelsesled

45-66, 45-76, 50-66, 50-86, 55-46, 55-56, 55-66,
55-76, 55-86, 55-88, 55-90, 56-66, 60-46, 60-56,
60-66, 60-76, 60-86, 60-88, 60-90, 60-93, 60-94,
62-86, 65-46, 65-56, 65-66, 65-88, 65-90, 65-93,
65-94, 70-56, 70-66, 70-76, 70-86, 70-90, 72-86,
80-66, 80-76, 80-90, 82-86, 82-90, L60, L65,
L75, L85, L95

87569493

4950756

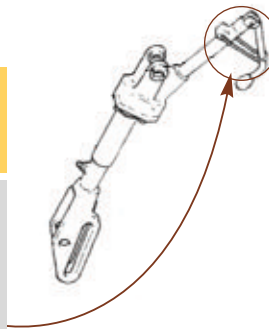

LATCH

- Verrou • Verriegelung • Cierre • Dispositivo di chiusura • Engate
- Vergrendeling • Pal

640, 55-65, 55-75, 60-65, 60-75, 65-46,
70-65, 80-65

87569494

597358



SHIM 6 MM-FULCRUM PIN

- Cale 6 mm - Pivot • Unterlegplatte 6 mm fur Achsschenkelbolzen
- Cuna 6 mm - eje de articulaci3n • Spessore da 6 Mm - Fulcro
- Anilha de 6 mm - Pino rotativo • Vulring 6 mm - Draaipen
- 6 mm afstandsskive - omdrejningstap

415, 450, 480, 540, 640

87569496

588324



BRACKET

- Support • Halter • Soporte • Staffa • Suporte • Steun • Beslag

640, 55-56, 55-65, 55-75, 55-85, 60-56, 60-65,
60-75, 60-85, 62-85, 65-46, 65-56, 70-56,
70-65, 70-75, 72-75, 72-85, 80-65, 80-75,
82-85, 88-85

87569501

598493



LEVER- QUADRANT

- Levier- Grille des vitesses • Wahlhebel • Palanca - cuadrante
- Leva - Settore • Alavanca - Quadrante • Hefboom - kwadrant
- Greb- kvadrant

480, 640, 55-46, 65-46

87569502

566583
4987044



SPRING- QUADRANT

- Ressort - Grille des vitesses • Feder - Wahlhebel • Muelle - cuadrante
- Molla - Settore • Mola - Quadrante • Veer-kwadrant • Fjeder- kvadrant

480, 640, 55-46, 60-46, 65-46

87569514

559970

LIFT & LINKAGE PARTS

- Hub- und gestangeteile
- Partes de articulaci3n y elevaci3n
- Parti del sollevatore e dell'attacco

- Pices de relevage et d'attelage
- Peas do elevador e de ligao
- Onderdelen van hefinrichting en stangenstelsel
- Dele til lift og forbindelsesled

FIAT - FIAT AGRI - FIAT Trattori tractors

GOLD
VALUE

NEW HOLLAND
AGRICULTURE

GEAR-LEVELLING LINKAGE

- Pignon d'attelage • Getriebenivelliergestange • Engranaje - articulaci3n de nivelaci3n • Ingranaggio - Tiranteria di livellamento
- Ligao de nivelamento da engrenagem • Tandwiel - Nivelleringsstangenstelsel • Tandhjul - forbindelsesled til nivellering

640, 55-46, 60-46, 65-46

87569529

4964349
4982276

55-56, 60-56, 65-56, 70-56

87569524

5146784

55-66, 60-66, 60-76, 62-86, 65-66, 65-90, 70-66,
70-76, 70-90, 72-86, 80-66, 80-76, 82-86, L60

87569527

5122576



STABILIZER PIN

- Goupille de stabilisateur • Stabilisatorstift • Pasador del estabilizador
- Perno stabilizzatore • Perno estabilizador • Stabilisatorpen
- Stabiliseringsstift

580, 670, 680, 766, 780, 880, 980, 70-66, 70-88,
70-90, 72-93, 72-94, 80-66, 80-88, 80-90, 88-93,
88-94, 90-90, 100-90, 110-90, L60, L65, L75,
L85, L95

87569576

5103862



TOP LINK ASSEMBLY

- Ensemble bras suprieur • Obere Gelenkbaugruppe
- Conjunto de articulaci3n superior • Complessivo puntone superiore
- Conjunto de ligao superior • Topstang • verste ledforbindelse

70-66, 80-66

87569528

5143959
97000366



TOP LINK BRACKET, ROCKER ARM

- Support de bras suprieur, bras du culbuteur • Oberer Gelenkhalter, Schwinghebel • Soporte de articulaci3n superior, brazo del balancin • Staffa puntone superiore, bilanciere • Suporte de ligao superior, brao oscilante • Steun topstang , kleptuimelaar
- Beslag til verste forbindelse, vippearm

640, 55-56, 60-56, 65-46, 65-56, 70-56

87569473

598492
9967165



GEARS & TRANSMISSION PARTS

- Pièces vitesses et transmission
- Zahnräder und getriebeteile
- Partes de la transmisión y marchas
- Ingranaggi e parti della trasmissione

- Peças da engrenagem e da transmissão
- Tandwielen en transmissie-onderdelen
- Dele til gear og transmission

FIAT - FIAT AGRI - FIAT Trattori tractors

GOLD VALUE

NEW HOLLAND
AGRICULTURE



LOCK WASHER

- Rondelle frein • Sicherungsscheibe • Arandela de bloqueo
- Rondella di sicurezza • Anilha de pressão • Borgring • Låseskive

450, 480, 540, 640, 55-46, 55-56, 55-65, 55-66,
55-75, 55-85, 60-46, 60-56, 60-65, 60-66,
60-75, 60-85, 65-46, 65-56, 65-66, 70-56

87569186

563681



HAND ACCELERATOR KNOB

- Pommeau de vitesses • Handgasknauf • Mando del acelerador manual
- Manopola acceleratore a mano • Comutador de aceleração manual
- Handgasknop • Gashåndtag

350, 400, 415, 450, 480, 500, 540, 600, 640,
55-46, 65-46, 70-56, 80-66

87569461

5085043
44014604



TRANSMISSION LEVER SEAL-BOOT

- Bague d'étanchéité du soufflet levier de transmission
- Getriebehebel-Dichtungsmanschette • Funda de junta de la palanca de transmisión • Guarnizione della leva trasmissione - parapolvere
- Base de vedação da alavanca de transmissão • Afdichthoes keerring transmissiehendel • Tætning til gearstang - manchet

540, 640, 55-46, 55-56, 55-88, 55-90, 60-46,
60-56, 60-88, 60-90, 60-93, 60-94, 65-46, 65-56,
65-88, 65-90, 65-93, 65-94, 70-56, 70-88, 70-90,
72-93, 72-94, 80-88, 80-90, 82-93, 82-94, 85-90,
88-93, 88-94, 90-90, 100-90, 110-90, 160-55,
L60, L65, L75, L85, L95

87569283

4984223

SEAL-COUNTER SHAFT 45x65x10

- Joint-Arbre intermédiaire 45x65x10 • Dichtung - Gegenwelle 45x65x10
- Junta - Eje secundario 45x65x10 • Guarnizione - Albero secondario 45x65x10
- Vedante do veio intermediário 45x65x10
- Keerring - contra-as 45x65x10 • Pakning - mellemaksel 45x65x10

540, 640, 55-46, 65-46, 70-56

87694779

5105944
40000371

SEAL-INPUT SHAFT

- Joint-Arbre d'entrée • Dichtung - Eingangswelle • Junta-Eje de entrada
- Guarnizione-Albero di entrata • Vedantes do veio de entrada
- Afdichting-ingaande as • Pakning til indgangsaksel

580,780, 85-55, 95-55, 100-55
Laverda combine : MX240R, MX300, MX300R

87694780

40000270



GEAR SHIFT LEVER

- Levier de vitesses • Schalthebel • Palanca de cambio de marcha
- Leva del cambio marce • Alavanca de mudança de velocidade
- Versnellingshendel • Gearstang

55-46, 55-56, 60-46, 60-56, 65-46, 65-56, 70-56

87569281

5123867



TRANSMISSION LEVER PIN

- Goupille du levier de transmission • Getriebehebelstift • Pasador de la palanca de transmisión • Perno della leva trasmissione • Perno da alavanca de transmissão • Pen transmissiehendel • Stift til gearstang

540, 640, 55-46, 55-56, 60-46, 60-56, 65-46,
65-56, 70-56, 160-55

87569295

593662



PLATE - TRANSMISSION TOP

- Plaque - Partie supérieure de la transmission • Platte - Getriebeoberseite • Placa - parte superior de la transmisión
- Piastra - Parte superiore trasmissione • Placa - Topo da transmissão
- Plaat - Bovenkant transmissie • Plade - Transmissionens øverste del

540, 640, 55-46, 55-56, 60-46, 60-56, 65-46,
65-56, 70-56

87569282

593728

GEARS & TRANSMISSION PARTS

- Pièces vitesses et transmission
- Zahnräder und getriebeteile
- Partes de la transmisión y marchas
- Ingranaggi e parti della trasmissione

- Peças da engrenagem e da transmissão
- Tandwielen en transmissie-onderdelen
- Dele til gear og transmission

FIAT - FIAT AGRI - FIAT Trattori tractors

GOLD VALUE

NEW HOLLAND
AGRICULTURE

REDUCTION GEAR LEVER BOOT

- Soufflet levier du réducteur de vitesse
- Manschette Untersetzungsgetriebehebel
- Funda de palanca de marchas reductoras • Parapolvere della leva riduttore • Base da alavanca de redução de engrenagem
- Afdichthoes hendel reductiekast • Reduktionsgearstang - manchet

570, 580, 670, 680, 780, 880, 980, serie 66

87569284

4999009



HIGH AND LOW GEAR FORK

- Fourchette de pignon haute et basse • Schalthebel hohe und niedrige Gänge • Horquilla de marcha alta y baja • Forcella marce alte e basse
- Forquilha de engrenagem alta e baixa • Vork hoge en lage versnelling
- Gaffel til højt og lavt gearområde

415, 450, 480, 540, 640, 780

87569286

567871

540, 640, 55-46, 55-56, 60-46, 60-56, 65-46, 65-56, 70-56

87569287

593668

415, 450, 480, 460, 470

87569288

593351
9967045



SYNCHRO GEAR FORK

- Fourchette du pignon de synchroniseur • Synchroschalthebel
- Horquilla de marcha sincronizada • Forcella marce sincronizzatore
- Forquilha de sincronização de engrenagem
- Vork gesynchroneerde versnelling • Gaffel til synkrongear

415, 450, 480, 460, 470

87569289

588710
588711

540, 640, 55-46, 55-56, 60-46, 60-56, 65-46, 65-56, 70-56

87569290

593670
593671



FORK

- Fourchette • Hebel • Horquilla • Forcella • Forquilha • Vork • Gaffel

780, 55-46, 55-56, 55-66, 55-88, 55-90, 60-46, 60-56, 60-66, 60-76, 60-88, 60-90, 60-93, 60-94, 62-86, 65-46, 65-56, 65-66, 65-88, 65-90, 65-93, 65-94, 70-56, 70-66, 70-76, 70-88, 70-90, 72-86, 72-93, 72-94, 80-66, 80-76, 80-88, 80-90, 82-86, 82-93, 82-94, 85-90, 88-93, 88-94, 90-90, 100-90, 110-90

87569569

4993814



GEARS & TRANSMISSION PARTS

- Pièces vitesses et transmission
- Zahnräder und getriebeteile
- Partes de la transmisión y marchas
- Ingranaggi e parti della trasmissione

- Peças da engrenagem e da transmissão
- Tandwielen en transmissie-onderdelen
- Dele til gear og transmission

FIAT - FIAT AGRI - FIAT Trattori tractors

GOLD VALUE

NEW HOLLAND
AGRICULTURE

LEVER 1ST AND 2ND GEARS

- Levier 1^{er} et 2^e vitesses • Hebel 1. und 2. Gang • Palanca de marchas 1^a y 2^a • Leva marce 1a e 2a • 1^a e 2^a velocidade da alavanca
- Hendel 1e en 2e versnelling • Greb, 1. og 2. gear

780

87569550

4996931

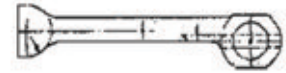

1ST & 2ND GEAR FORK

- Fourchette 1^{re} et 2^e vitesses • Schalthebel 1. und 2. Gang
- Horquilla de marchas 1^a y 2^a • Forcella marce 1a e 2a
- Forquilha de engrenagem, 1^a e 2^a velocidades
- Vork 1e en 2e versnelling • Gaffel til 1. og 2. gear

540, 640, 55-46, 55-56, 60-46, 60-56,
65-46, 65-56, 70-56

87569292

598293
9967151



3RD & 4TH GEAR FORK

- Fourchette 3e et 4e vitesses • Schalthebel 3. und 4. Gang • Horquilla de marchas 3^a y 4^a • Forcella marce 3a e 4a • Forquilha de engrenagem, 3^a e 4^a velocidades
- vork 3e en 4e versnelling • Gaffel til 3. og 4. gear

540, 640, 55-46, 55-56, 60-46, 60-56,
65-46, 65-56, 70-56

87569293

598294
9967152



RANGE FORK SHAFT

- Arbre de fourchette • Bereichsschalthebelwelle • Eje de horquilla de intervalo • Albero forcella gamme • Veio da forquilha de gama
- Vorkas schakelgroep • Aksel til områdegaffel

540, 640, 55-46, 55-56, 60-46, 60-56,
65-46, 65-56, 70-56

87569298

593767



CARRIER GEAR HOUSING

- Carter de porte-pignon • Trägergetriebegehäuse • Carcasa del soporte del engranaje • Alloggiamento porta-ingranaggi • Alojamento do suporte da engrenagem • Huis tandwieldrager • Planethjulshus

55-46, 55-56, 60-46, 60-56, 65-46, 65-56, 70-56

87569297

586279

GEARS & TRANSMISSION PARTS

- Pièces vitesses et transmission
- Zahnräder und getriebeteile
- Partes de la transmisión y marchas
- Ingranaggi e parti della trasmissione

- Peças da engrenagem e da transmissão
- Tandwielen en transmissie-onderdelen
- Dele til gear og transmission

FIAT - FIAT AGRI - FIAT Trattori tractors

GOLD VALUE

NEW HOLLAND
AGRICULTURE

CENTRAL REDUCTION GEARS

- Réducteur central de vitesse • Zentraluntersetzungsgetriebe
- Archas reductoras centrales • Riduttori centrali • Engrenagens de redução central • Centrale reductiekasten • Centrale reduktionsgear



COUPLING GEAR

- Pignon d'accouplement • Kupplungszahnäder
- Engranaje de acoplamiento • Dispositivo di accoppiamento
- Acoplamento de engrenagem • Koppelingstandwiel
- Koblingsgear

55-46, 55-46DT, 55-56, 55-56DT,
60-46, 60-46DT, 60-56, 65-46,
65-46DT, 65-56, 70-56, 70-56DT

87694793

5109000



CENTRAL REDUCTION GEARS - RING

- Rondelle • Ring • Marchas reductoras centrales • Anello
- Anel • Ring • Ring

450, 480, 640, 55-46, 60-46, 65-46

87569301

597376

87569302

597375

CENTRAL REDUCTION GEAR : DRIVEN GEAR

- Pignon d'entraînement • Angetriebenes Zahnrad
- Marcha motriz • Ingranaggio condotto • Engrenagem de accionamento • Aangedreven tandwiel • Drevet hjul

415, 450, 480, 540, 640, 55-46, 55-56,
60-46, 60-56, 65-46, 65-56, 70-56

87569314

579295



CENTRAL REDUCTION GEARS - HOUSING LH

- Carter gauche • Gehäuse links • Carcasa izquierda
- Alloggiamento SX • Alojamento do lado esquerdo
- Huis links • Hus i venstre side

55-46, 55-56, 60-46, 60-56,
65-46, 65-56

87569299

5144039

CENTRAL REDUCTION GEARS - HOUSING RH

- Carter droit • Gehäuse rechts • Carcasa derecha
- Alloggiamento DX • Alojamento do lado direito
- Huis rechts • Hus i højre side

55-46, 55-56, 60-46, 60-56,
65-46, 65-56

87569300

5144040



CENTRAL REDUCTION GEAR : GEAR CARRIER ASSEMBLY

- Ensemble porte-pignon • Getriebeträgerbaugruppe
- Conjunto del soporte del engranaje • Complessivo porta-ingranaggi • Conjunto do suporte da engrenagem
- Tandwieldrager • Planethjulsholder

415, 450, 480, 540, 640, 55-46, 55-56,
60-46, 60-56, 65-46, 65-56, 70-56

87569313

4986426
5012184

GEARS & TRANSMISSION PARTS

- Pièces vitesses et transmission
- Zahnräder und getriebeteile
- Partes de la transmisión y marchas
- Ingranaggi e parti della trasmissione

- Peças da engrenagem e da transmissão
- Tandwielen en transmissie-onderdelen
- Dele til gear og transmission

FIAT - FIAT AGRI - FIAT Trattori tractors

GOLD VALUE

NEW HOLLAND
AGRICULTURE



2ND SPEED GEAR

- Pignon 2^e vitesse • Getriebe 2. Gang • Marcha 2^a velocidad
- 2a marcia • 2^a engrenagem de velocidade • 2^e versnelling • 2. gear

540, 640, 55-46, 55-56, 60-46,
60-56, 65-46, 70-56

87569303

598180
5102790

4TH SPEED GEAR

- Pignon 4^e vitesse • Getriebe 4. Gang • Marcha 4^a velocidad
- 4a marcia • 4^a engrenagem de velocidade • 4^e versnelling • 4. gear

540, 640, 55-46, 55-56, 60-46, 60-56,
65-46, 70-56

87569304

598184
5109837



TRANSMISSION - REVERSE GEAR

- Pignon marche arrière • Getriebe - Rückwärtsgang • Transmisión - marcha atrás • Trasmissione - retromarcia • Transmissão - marcha-atrás
- Achteruitversnelling • Transmission - bakgear

55-66, 55-88, 55-90, 60-66, 60-76, 60-88, 60-90,
65-66, 65-88, 65-90, 70-66, 70-76, 70-88, 70-90,
80-66, 80-76, 80-88, 80-90

87569324

5121042



REVERSE GEAR DRIVEN

- Pignon d'entraînement marche arrière • Rückwärtsgang, angetrieben
- Marcha atrás motriz • Ingranaggio condotto retromarcia • Marcha-atrás de accionamento • Achteruitversnelling aangedreven • Drevet bakgear

55-66S, 60-66S, 65-66S, 70-66, 80-66, L60,
L65, L75, L85, L95,

87569325

5164583



CARRIER GEAR

- Porte-pignon • Trägergetriebe • Soporte del engranaje • Porta-ingranaggi • Suporte da engrenagem • Tandwielendrager • Planethjul

780, 980, 980DT

87569563

5102287



REVERSE GEAR Z=29

- Pignon Marche arrière Z=29 • Rückwärtsgang Z=29
- Marcha atrás Z=29 • Retromarcia Z=29 • Marcha-atrás, Z=29
- Achteruitversnelling Z=29 • Bakgear Z=29

415, 450, 480, 460, 470

87569500

563444



PINION SHAFT

- Arbre de pignons • Ritzelwelle • Eje del piñón • Albero del pignone
- Veio do pinhão • Pignonas • Drevaksel

415, 450

87569567

4964932



SATELLITE PINION SHAFT

- Arbre pour pignon satellite • Satellitenritzelwelle • Eje del piñón satélite
- Albero del pignone satellite • Veio do pinhão satélite
- Pignonas satelliet • Planethjulsaksel

580, 680, 780, 1180, 70-66, 70-90, 72-93, 72-94,
80-66, 80-90, 82-93, 82-94, 85-90, 88-93, 88-94,
140-90, 160-90, 180-90, L75, L85, L95

87569306

4991652
5168624

GEARS & TRANSMISSION PARTS

- Pièces vitesses et transmission
- Zahnräder und getriebeteile
- Partes de la transmisión y marchas
- Ingranaggi e parti della trasmissione

- Peças da engrenagem e da transmissão
- Tandwielen en transmissie-onderdelen
- Dele til gear og transmission

FIAT - FIAT AGRI - FIAT Trattori tractors

GOLD VALUE



DIFFERENTIAL PIN

- Goupille de différentiel • Differenzialstift • Pasador del diferencial
- Perno differenziale • Pino diferencial • Pen differentieel
- Differentialestift

580, 680, 780, 1180, 70-66, 70-88, 70-90, 72-93, 72-94, 80-66, 80-88, 80-90, 82-93, 82-94, 85-90, 88-93, 88-94, 115-90, 140-90, 160-90, 180-90, F120, F130, F140, L75, L85, L95

87569307

4991719



INPUT SHAFT

- Arbre d'entrée • Antriebswelle • Eje de entrada • Albero di ingresso
- Veio de entrada • Ingaande as • Indgangsaksel

540, 640, 55-46, 55-56, 60-46, 60-56, 65-46, 65-56, 70-56

87569308

598173
4985299



COUNTER SHAFT

- Arbre intermédiaire • Vorgelegewelle • Eje secundario
- Albero secundario • Veio intermediário • Tussenas • Mellemaksel

415, 450, 480

87569517

4985294
5105602

ADDITIONAL REDUCTION - WASHER

- Réduction supplémentaire - rondelle • Zusätzliche Reduktion - Unterlegscheibe • Reducción adicional - arandela
- Riduttore aggiuntivo - rondella • Redução adicional - anilha
- Extra reductie - onderlegging • Ekstra reduktion - spændeskive

415, 450, 480, 540, 640, 55-46, 55-56, 60-46, 60-56, 65-46, 65-56, 70-56

87569309

4986427

DISC WASHER

- Rondelle • Tellerscheibe • Arandela de disco • Rondella disco
- Anilha de disco • Onderlegging schijf • Spændeskive

415, 450, 480, 540, 640, 55-46, 55-56, 60-46, 60-56, 65-46, 65-56, 70-56

87569315

567882

ADDITIONAL REDUCTION - THRUST WASHER

- Réduction supplémentaire - anneau de butée • Zusätzliche Reduktion - Druckscheibe • Reducción adicional - arandela de empuje • Riduttore aggiuntivo - rondella reggispinta • Redução adicional - anilha de impulso
- Extra reductie - drukkring • Ekstra reduktion - trykskive

415, 450, 480, 540, 640, 55-46, 55-56, 60-46, 60-56, 65-46, 65-56, 70-56

87569311

567883

55-46, 55-56, 60-46, 60-56, 65-46, 65-56, 70-56

87569310

586285

THRUST WASHER

- Anneau de butée • Druckscheibe • Arandela de empuje
- Rondella reggispinta • Anilha de impulso • Drukkring • Trykskive

55-46, 55-56, 60-46, 60-56, 65-46, 65-56, 70-56

87569312

586286



GEARS & TRANSMISSION PARTS

- Pièces vitesses et transmission
- Zahnräder und getriebeteile
- Partes de la transmisión y marchas
- Ingranaggi e parti della trasmissione

- Peças da engrenagem e da transmissão
- Tandwielen en transmissie-onderdelen
- Dele til gear og transmission

FIAT - FIAT AGRI - FIAT Trattori tractors

GOLD VALUE

NEW HOLLAND
AGRICULTURE



GEAR BOX SAFETY START SWITCH

- Commutateur démarrage de sécurité de la boîte de vitesses
- Getriebegehäuse Sicherheitsanlassschalter
- Interruptor de arranque de seguridad de la caja de cambios
- Interruttore di sicurezza dell'avviamento cambio
- Interruptor de arranque de segurança da caixa de velocidades
- Veiligheidsstartknop tandwielkast • Sikkerhedsstartkontakt til gearkasse

400, 446, 450, 480, 500, 540, 550, 600, 640,
55-46, 55-56, 60-46, 60-56, 65-46, 65-56, 70-56

87569317

4073976
5109221



REAR AXLE HALF SHAFT LH (C/W OIL BRAKE)

- Arbre gauche pont arrière • Hinterachse links (komplett mit Ölbremse)
- Eje trasero izquierdo (A/C freno de aceite) • Assale posteriore SX (con olio freni) • Eixo traseiro, lado esquerdo (com óleo dos travões)
- Achteras links (met oliërem) • Venstre bagaksel (med oliebremse)

70-66, 80-66

87569320

5141651

55-46, 55-56, 60-46, 60-56, 65-46, 65-56

87569322

5144053

REAR AXLE HALF SHAFT RH (C/W OIL BRAKE)

- Arbre droit pont arrière • Hinterachse rechts (komplett mit Ölbremse)
- Eje trasero derecho (A/C freno de aceite) • Assale posteriore DX (con olio freni) • Eixo traseiro, lado direito (com óleo dos travões)
- Achteras rechts (met oliërem) • Højre bagaksel (med oliebremse)

70-66, 80-66

87569321

5141650

55-46, 55-56, 60-46, 60-56, 65-46, 65-56

87569323

5144052



PTO GEAR - DRIVEN

- Pignon d'entraînement PDF • Zapfwellenzahnrad - angetrieben
- Marcha de TDF - motriz • Ingranaggio PDF - condotto
- Engrenagem da TDF - accionada • Tandwiel aftakas - aangedreven
- Kraftudtagsgear - drevet

450, 480, 640, 55-46, 55-56, 60-46,
60-56, 65-46, 70-56

87569328

563511



SYNCHRONIZER RING

- Couronne dentée de synchroniseur • Synchronisiering
- Anillo sincronizador • Anello sincronizzatore • Anel sincronizador
- Synchronisatiering • Synkroniseringsring

411, 450, 480, 540, 640, 55-46, 55-66, 55-90,
60-46, 60-66, 60-90, 65-46, 70-56, 70-66,
70-90, 80-66, 80-90

87569318

5118187

140-90, 160-90, 180-90, 55-66S, 55-88,
60-66S, 60-76F, 60-88, 60-93, 60-94, 62-86,
65-66S, 65-88, 65-93, 65-94, 70-66S, 70-76,
70-88, 72-86, 72-93, 72-94, 80-66S, 80-76,
80-88, 82-86, 82-93, 82-94, 85-90, 88-93,
88-94, L60, L65, L75, L85, L95

87569319

5138207
5138210



PTO SHAFT LONG

- Arbre long de PDF • Zapfwelle lang • Eje de TDF largo • Albero PDF lungo • Veio longo da TDF • Aftakas lang • Kraftudtagsaksel, lang

55-46, 55-56, 60-46, 60-56, 65-46, 70-56

87569326

4950663

450, 480, 640

87569327

496736
4974988



PTO GEAR

- Pignon PDF • Zapfwellenzahnrad • Marcha de TDF • Ingranaggio PDF
- Engrenagem da TDF • Tandwiel aftakas • Kraftudtagsgear

55-46, 65-46, 70-56

87569329

4956269

GEARS & TRANSMISSION PARTS

- Pièces vitesses et transmission
- Zahnräder und getriebeteile
- Partes de la transmisión y marchas
- Ingranaggi e parti della trasmissione
- Peças da engrenagem e da transmissão
- Tandwielen en transmissie-onderdelen
- Dele til gear og transmission

FIAT - FIAT AGRI - FIAT Trattori tractors

GOLD VALUE



PTO DRIVE SHAFT

- Arbre d'entraînement de PDF • Zapfwellen-Antriebswelle
- Eje de accionamiento de la TDF • Albero di trasmissione PDF
- Veio de transmissão da TDF • As aftakasaandrijving
- Kraftudtagsdrivaksel

480, 640, 55-46, 55-56, 60-56, 65-46, 65-56, 70-56

87569330

4950933



PTO SHAFT SHORT

- Arbre court de PDF • Zapfwelle kurz • Eje de TDF corto • Albero PDF corto • Veio curto da TDF • Aftakas kort • Kraftudtagsaksel, kort

311, 411, 415, 450, 480, 500, 540, 550, 600, 640, 55-46, 55-56, 60-46, 60-56, 65-46, 65-56, 70-56

87569423

4958986
4959916



666, 766, 55-66, 55-88, 55-90, 60-66, 60-76, 60-88, 60-90, 60-93, 60-94, 65-66, 65-88, 65-90, 65-93, 65-94, 70-66, 70-88, 70-90, 72-86, 72-93, 72-94, 80-66, 80-76, 80-88, 80-90, 82-93, 82-94, 85-90, 88-93, 88-94, L60, L65, L75, L85

87569331

5109726



BUSH-TIMING GEAR

- Douille - Pignon de commande de distribution
- Buchse - Steuergestänge • Casquillo - engranaje de distribución
- Boccola - Distribuzione • Casquilho - carretos de distribuição
- Bus distributietandwiel • Bøsning - takthjul

45-66, 45-76, 50-66, 50-86, 55-46, 55-56, 55-65, 55-66, 55-75, 55-76, 55-85, 55-86, 55-88, 55-90, 56-66, 60-46, 60-56, 60-65, 60-66, 60-75, 60-76, 60-85, 60-86, 60-88, 60-90, 60-93, 60-94, 62-85, 62-86, 65-46, 65-56, 65-66, 65-88, 65-90, 65-93, 65-94, 70-56, 70-65, 70-66, 70-75, 70-76, 70-86, 70-88, 70-90, 72-85, 72-86, 72-93, 72-94, 80-65, 80-66, 80-75, 80-76, 80-88, 80-90, 82-86, 82-93, 82-94, 85-55, 85-90, 88-85, 88-93, 88-94, 90-90, 95-55, 100-90, 110-90, 115-90, 130-90, 140-90, L60, L65, L75, L85, L95 / Laverda combine : 3300, 3300AL, 3300R, 3400, 3400R, 3500, 3500R, 3550, 3550R, 3650, 3650R, 3750, 3750R / BRAUD : 1214, 1620, 1620S

87569352

4769418

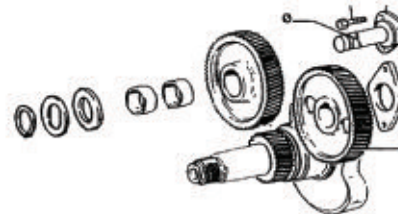

TIMING GEAR

- Pignon • Steuergestänge • Engranaje de distribución • Distribuzione
- Carretos de distribuição • Distributietandwiel • Takthjul

640, 780

87569369

4607772

640

87569370

4607773

480

87569512

4662614
4677580

640 / Laverda combine 3300AL

87569549

4662597

640 / Laverda combine 3300AL

87569532

4678405
153630744

87569538

4607651

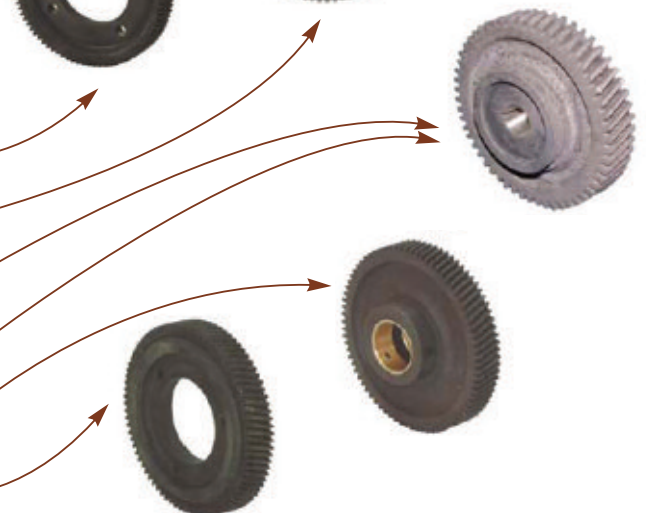

GEARS & TRANSMISSION PARTS

- Pièces vitesses et transmission
- Zahnräder und getriebeteile
- Partes de la transmisión y marchas
- Ingranaggi e parti della trasmissione

- Peças da engrenagem e da transmissão
- Tandwielen en transmissie-onderdelen
- Dele til gear og transmission

FIAT - FIAT AGRI - FIAT Trattori tractors

GOLD VALUE

NEW HOLLAND
AGRICULTURE

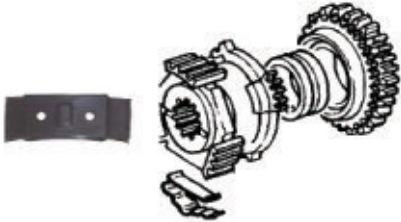

BIG CLIP SYNCHRONIZER

- Circlip large de synchroniseur • Big Clip-Synchronisierereinrichtung
- Clip grande sincronizador • Fermo grande sincronizzatore
- Sincronizador: braçadeira grande • Synchronisatie-inrichting grote klem • Stor klemme, synkroniseringsanordning

415, 450, 480, 540, 640, 60-66, 70-66, 70-76,
70-90, 80-66, 80-90, 85-90, 90-90, 100-90,
110-90

87569414

5150557
5153938



SYNCHRONIZER SLEEVE GEAR

- Pignon • Schaltmuffenzahnrad
- Engranaje del manguito sincronizador • Manicotto sincronizzatore
- Engrenagem de manga do sincronizador • Schakelmof synchronisator
- Tandhjul til synkroniseringsmuffe

540, 640, 55-46, 55-56, 60-46, 60-56,
65-46, 65-56, 70-56

87569408

593634

SYNCHRONIZER SPRING SMALL

- Petit ressort du synchroniseur • Synchronisierfeder klein
- Sincronizador de resorte pequeño • Molla sincronizzatore piccola
- Mola do sincronizador • Synchronisatie klein
- Lille fjeder til synchromesh

415, 450, 480, 540, 640

87694782

4568626



NUT COUNTER SHAFT

- Ecrou d'arbre intermédiaire • Mutter Gegenwelle
- Eje secundario de tuerca • Dado albero secundario
- Porca do veio intermediário • Moer tussenas • Motrik, mellemaksel

540, 640, 55-46, 55-56, 60-46, 60-56,
65-46, 65-56, 70-56

87569418

5123112



SYNCHRO OUTER CONE

- Cône extérieur du synchroniseur • Äußerer Synchronkegel
- Cono exterior de sincronizador • Anello esterno sincronizzatore
- Cone exterior do sincronizador • Synchro buitenste conus
- Udvendig konus til synkrongear

415, 450, 480, 540, 640, 55-46, 65-46, 70-56

87569417

4572858
5102853

SYNCHRONIZER OUTER CONE H=26

- Cône extérieur de synchronisation H=26
- Synchronisierer Außenkonus H=26 • Cono exterior de sincronizador H=26 • Cono esterno sincronizzatore H=26
- Cone exterior do sincronizador, altura=26 • Buitenste kegel synchronisatie-inrichting H=26 • Synkromesh, udvendig konus H=26

415, 450, 480, 540, 640, 55-46, 55-56,
60-46, 60-56, 65-46, 65-56, 70-56

87694781

5102147

TRANSMISSION GEAR DRIVE

- Pignon d'entraînement de transmission • Getriebezahnradantrieb
- Marcha de transmisión • Comando ingranaggio trasmissione
- Engrenagem de transmissão • Aandrijving versnelling
- Transmissionens tandhjulsdrev

780

87569560

4997651



SPRING-TRANSMISSION LEVER

- Ressort-Levier de transmission • Feder - Getriebehebel/Muelle - Palanca de transmisión • Molla - Leva trasmissione • Mola - Alavanca de transmissão • Veer - transmissiehendel • Fjeder - gearstang

415, 450, 480, 540, 640, 780

87694794

592758



PINION NUT

- Ecrou-Pignon • Mutter - Ritzelzahnrad • Tuerca - Engranaje del piñón
- Dado - Ingranaggio pignone • Porca da engrenagem do pinhão
- Moer - pignontandwiel • Motrik - differentialehjul

480, 640, 55-46, 55-56, 60-46, 60-56,
65-46, 65-56, 70-56

87694796

5123113

GEARS & TRANSMISSION PARTS

- Pièces vitesses et transmission
- Zahnräder und getriebeteile
- Partes de la transmisión y marchas
- Ingranaggi e parti della trasmissione
- Peças da engrenagem e da transmissão
- Tandwielen en transmissie-onderdelen
- Dele til gear og transmission

FIAT - FIAT AGRI - FIAT Trattori tractors

GOLD VALUE

NEW HOLLAND
AGRICULTURE

DIFFERENTIAL WASHER

- Rondelle de différentiel • Ausgleichsscheibe • Arandela del diferencial
- Rondella differenziale • Anilha de diferencial • Sluitring differentieel
- Spændeskive til differentiale

415, 450

87569488

562068



WASHER 1,5 mm - DIFFERENTIAL GEAR

- Rondelle 1,5 mm - Engrenage différentiel • Unterlegscheibe 1,5 mm - Differenzialgetriebe • Arandela 1,5 mm - Engranaje del diferencial
- Rondella 1,5 mm - Ingranaggio differenziale • Anilha 1,5 mm - Engrenagem diferencial • Onderlegring 1,5 mm l/ >Differentialtandwiel
- Spændeskive 1,5 mm - Differentialgear

580, 680, 780, 1180, 70.66, 70-90, 80.66,
80-66S, 80-88, 80-90, 82-93, 82-94, 85-90,
88-93, 88-94, F120, F130, F140

87694797

4997235



TRANSMISSION WASHER

- Rondelle de transmission • Getriebeunterlegscheibe • Arandela de la transmisión • Rondella trasmissione • Anilha de transmissão
- Pakking transmissie • Spændeskive til transmission

415, 450, 480

87569503

570849



IDLER GEAR

- Pignon intermédiaire • Angetriebenes Zahnrad • Piñón del tensor
- Ingranaggio intermedio • Carreto livre • Tussentandwiel • Mellemhjul

415, 450, 480

87569552

583546



FLY WHEEL RING GEAR Z-104

- Couronne de volant moteur Z=104 • Schwungradring Zahnrad Z-104
- Corona del volante Z-104 • Corona dentata volano Z-104
- Engrenagem, anel do volante do motor Z-104
- Ringwiel vliegwiél Z-104 • Kronhjúl til svinghjúl Z-104

411, 415

87569566

893322



HYDRAULICS

- Hydraulik
- Sistema hidráulico

- Impianto idraulico
- Sistema hidráulico

- Circuit hydraulique
- Hydraulisch systeem
- Hydraulik

FIAT - FIAT AGRI - FIAT Trattori tractors

GOLD VALUE



HYDRAULIC PUMP FIXING BOLT

- Vis de fixation de pompe hydraulique • Hydraulikpumpe, Befestigungsschraube • Perno fijador de la bomba hidráulica
- Bullone di fissaggio pompa idraulica • Parafuso de fixação da bomba hidráulica • Bevestigingsbout hydraulische pomp
- Fastgørelsesbolt til hydraulikpumpe

450, 480, 540, 640, 55-46, 55-56, 65-46, 70-56, 80-66

87569492 569325

87569521 568292



HYDRAULIC PUMP GEAR WITHOUT SHAFT

- Pignon de pompe hydraulique sans arbre • Hydraulikpumpengetriebe ohne Welle • Engranaje de la bomba hidráulica sin eje
- Ingranaggio pompa idraulica senza albero • Engrenagem da bomba hidráulica sem veio • Tandwiel hydraulische pomp, zonder as
- Hydraulisk pumpegear uden aksel

45-66, 45-76, 50-66, 50-86, 55-46, 55-56, 55-65, 55-66, 55-75, 55-76, 55-85, 55-86, 55-88, 55-90, 56-66, 60-46, 60-56, 60-65, 60-66, 60-75, 60-76, 60-85, 60-86, 60-90, 60-93, 60-94, 62-85, 62-86, 65-46, 65-56, 65-88, 65-90, 65-93, 65-94, 70-56, 70-65, 70-66, 70-75, 70-76, 70-86, 70-88, 70-90, 72-85, 72-86, 72-93, 72-94, 80-65, 80-66, 80-75, 80-76, 80-88, 80-90, 82-85, 82-86, 82-93, 82-94, 85-55, 85-90, 88-85, 88-93, 88-94, L60, L65, L75, L85, L95

87569554 4769590
98465572



STEERING HYDRAULIC PUMP C-18

- Pompe hydraulique de direction C-18 • Lenkhydraulikpumpe C-18
- Bomba hidráulica de dirección C-18 • Pompa idraulica sterzo C-18
- Bomba de direção hidráulica C-18 • Stuur-/hydraulische pomp C-18
- Hydraulisk pumpe til styretøj C-18

50-86, 55-56, 55-86, 60-56, 60-66, 60-86, 62-86, 65-56, 65-66, 70-56, 70-66, 70-86, 72-86, 80-66, 82-86, 45-76, 50-86, 55-46, 55-56, 55-66, 55-76, 55-86, 60-46, 60-56, 60-66, 60-76, 60-86, 60-93, 62-86, 65-46, 65-56, 65-66, 65-93, 70-56, 70-66, 70-76, 70-86, 72-86, 72-93, 80-66, 80-76, 82-86, 82-93, 88-93

87569205 5179722
8273385



HYDRAULIC HOSE

- Tuyau hydraulique • Hydraulikschlauch • Tubo flexible hidráulico
- Flessibile idraulico • Mangueira hidráulica • Hydraulische slang
- Hydraulikslange

45-66, 45-76, 50-66, 55-56, 55-66, 55-76, 55-88, 55-90, 56-66, 60-56, 60-66, 60-90, 60-93, 60-94, 65-56, 65-66, 65-88, 65-90, 65-93, 65-94, 70-56, 70-66, 70-76, 70-88, 70-90, 72-93, 72-94, 80-66, 80-76, 80-88, 80-90, 82-93, 82-94, 85-90, 88-93, 88-94

87569531 5118862



HYDRAULIC PUMP GEAR WITH SHAFT

- Pignon de pompe hydraulique avec arbre • Hydraulikpumpengetriebe mit Welle
- Engranaje de la bomba hidráulica con eje
- Ingranaggio pompa idraulica con albero
- Engrenagem da bomba hidráulica com veio
- Tandwiel hydraulische pomp, met as
- Hydraulisk pumpegear med aksel

480, 640, 55-46, 65-46, 70-56 /
Laverda combine : 3300AL

87569348 4621357
4673811



GASKET-HYDRAULIC PUMP

- Joint-Pompe hydraulique • Hydraulikdichtung Pumpe
- Junta - Bomba hidráulica • Guarnizione - Pomp idraulica
- Junta da bomba hidráulica • Pakking - hydraulische pomp
- Pakning - hydraulik Pumpe

450, 480, 540, 640, 55-46, 55-56, 65-46, 70-56,
80-66 / Laverda combine : 3300, 3300R

87694799 4607590

HYDRAULICS

- Hydraulik
- Sistema hidráulico
- Impianto idraulico
- Sistema hidráulico

- Circuit hydraulique
- Hydraulisch systeem
- Hydraulik

FIAT - FIAT AGRI - FIAT Trattori tractors

GOLD VALUE



WATER PUMP ASSEMBLY

- Pompe à eau • Wasserpumpenbaugruppe
- Conjunto de la bomba de agua • Complessivo pompa dell'acqua
- Conjunto da bomba de água • Complete waterpomp • Vandpumpe

01/93 => 12/95 : 45-66, 50-66, 55-46, 55-65, 55-66, 55-90, 60-46, 60-65, 60-66, 60-90, 65-46, 65-66, 65-90, 70-65, 70-66, 70-90, 80-65, 80-66, 80-90, 85-55, 90-90, 95-55, 100-90, 115-90, 130-90, 140-90, "76", "86", "93", "94", F100, F110, F115, F120, F130, F140

87569332

98465322
98497117

Someca 655, 670, 650, 800, 750, 805, 850, 940

87569333

8822883
8829787

250, 300, 350, 355, 400, 420, 440, 446, 450, 455, 460, 465, 466, 470, 474, 480, 500, 505, 540, 550, 555, 565, 566, 570, 600, 640, 666, 670, 765, 766, 880-5, 980, 1000, 1180, 1280, 1380

87569334

4679242
93191101

580, 680, 780, 855, 1180

87569335

1930925
4696707

=> 12/92 : 45-66, 50-66, 55-46, 55-65, 55-66, 55-90, 60-46, 60-65, 60-66, 60-90, 65-46, 65-66, 65-90, 70-65, 70-66, 70-90, 80-65, 80-66, 80-90, 85-55, 90-90, 95-55, 100-90, 115-90, 130-90, 140-90, F100, F110, F115, F120, F130, F140

87569336

98403016
98497117

400, 411, 415, 421, 431, FL4 (first fitting)

87569339

566997



WATER PUMP SEAL

- Joint de pompe à eau • Wasserpumpendichtung • Junta de la bomba de agua • Guarnizione pompa dell'acqua • Vedante da bomba de água
- Afdichting waterpomp • Tætning til vandpumpe

450, 480, 540, 640, 780 / Laverda combine 3300AL, MX300, MX300R / Hesston 7720, 7725

87569535

4603870



OIL PUMP

- Pompe à huile • Ölpumpe • Bomba de aceite
- Pompa olio • Bomba de óleo • Oliepomp • Oliepumpe

All models with "Fiat" engine 3 and 4cyl : 8035.01, 8035.02, 8035.04, 8035.05, 8035.06, 8045.01, 8045.02, 8045.04, 8045.05, 8045.06, 8045.25

87569389

4705827
4705833



DRAIN TAP

- Robinet de vidange • Ablasshahn • Llave de drenaje • Rubinetto di spurgo • Torneira de drenagem • Aftapkraan • Aftapningsventil

All "Fiat" tractors

87569342

8802992
45024835



HYDRAULICS

- Hydraulik
- Sistema hidráulico
- Impianto idraulico
- Sistema hidráulico

- Circuit hydraulique
- Hydraulisch systeem
- Hydraulik

FIAT - FIAT AGRI - FIAT Trattori tractors

GOLD VALUE

NEW HOLLAND
AGRICULTURE



VALVE STEM SEAL

- Joint de tige de soupape • Schieberspindeldichtung • Junta del vástago de válvula • Guarnizione stelo valvola • Vedante da haste da válvula • Klepsteelpakking • Pakning til ventilspindel

411, 415, 45-66, 45-76, 50-66, 50-86, 55-46, 55-56, 55-65, 55-66, 55-75, 55-76, 55-85, 55-86, 55-90, 56-66, 60-46, 60-56, 60-56, 60-65, 60-66, 60-75, 60-76, 60-85, 60-86, 60-88, 60-90, 60-93, 60-94, 62-85, 62-86, 65-46, 65-56, 65-66, 65-88, 65-90, 65-93, 65-94, 70-56, 70-65, 70-66, 70-76, 70-86, 70-88, 70-90, 72-85, 72-86, 72-93, 72-94, 80-65, 80-66, 80-75, 80-76, 80-88, 80-90, 82-85, 82-86, 82-93, 82-94, 85-55, 85-90, 88-85, 88-94, 90-90, 95-55, 100-55, 100-90, 110-90, 115-90, 130-90, 140-90, F100, F110, F115, F120, F130, F140, L60, L75, L85, L95 / Laverda combine: 3300, 3300AL, 3300R, 3400, 3400R, 3500, 3500R, 3550, 3550AL, 3550R, 3560AL, 3650, 3650R, 3750, 3750R, L517, L518, L520 / BRAUD : 1214, 1620, 1620S

87569347

561293



FUEL TAP

- Robinet de carburant • Kraftstoffhahn • Tapón de combustible • Tappo carburante • Torneira de combustível • Brandstofkraan • Brændstofventil

312, 315, 350, 400, 411, 450, 460, 480, 500, 540, 550, 600, 640, 650, 750, 1300

87569374

5086583
5109270



OIL FILLER CAP

- Bouchon de filtre à huile • Ölfilterkappe • Tapón del filtro de aceite • Tappo del filtro olio • Tampão do filtro de óleo • Olievuldop • Oliefilterdæksel

All tractor models

87694763

4232606
5088084



SHAFT-FUEL INJECTION PUMP GEAR

- Arb-Engrenage de pompe à injection de carburant • Welle der Kraftstoffeinspr. Pumpenzahnrad • Eje - Engranaje de bomba de inyección de combustible • Albero - Ingranaggio pompa iniez. carburante • Veio da engrenagem da bomba de injeção de combustível • Aandrijfas - tandwiel brandstofinspuitpomp • Aksel - brændstofindsprøjtning Pumpegear

480, 640

87694767

4607652



WATER PUMP TUBE SEAL

- Joint de tuyau de pompe à eau • Rohrdichtung Wasserpumpe • Junta del tubo de la bomba de agua • Guarnizione tubo pompa dell'acqua • Vedante do tubo da bomba de água • Afdichting leiding waterpomp • Tætning til vandpumperør

450, 480, 540, 640, 55-46, 55-66, 55-90, 60-46, 60-66, 60-90, 65-46, 70-66, 70-90, 80-66, 80-90, 90-90, 65-46, 65-56, 65-66, 65-88, 65-90, 65-93, 65-94, 70-56, 70-65, 70-66, 70-76, 70-86, 70-88, 70-90, 72-85, 72-86, 72-93, 72-94, 80-65, 80-66, 80-75, 80-76, 80-88, 80-90, 82-85, 82-86, 82-93, 82-94, 85-55, 85-90, 88-85, 88-93, 88-94, 100-90, 110-90, 115-90, 130-90, 140-90, 160-90, 180-90 / BRAUD : 2720 / Laverda combine : 3300AL

87569394

14462881
14462882



FUEL TANK CAP

- Bouchon de réservoir de carburant • Kraftstofftankverschluss • Tapón del depósito de combustible • Tappo serbatoio carburante • Tampão do depósito de combustível • Tankdop • Dæksel til brændstofftank

300, 350, 400, 450, 460, 480, 500, 540, 550, 600, 640, 650, 750, 900

87569373

4117122
5118532



FUEL LIFT PUMP STRAINER

- Crépine de pompe aspiratrice de carburant • Filter Kraftstoffförderpumpe • Filtro de la bomba de admisión de combustible • Filtro pompa di alimentazione carburante • Filtro da bomba de combustível • Filter brandstofopvoerpomp • Filter til brændstoffødepumpe

411, 415, 160-55, 160-90 / Laverda combine : 3300AL, 3400, 3400R, 3500, 3500R, 3550, 3550AL, 3650, 3750, 3750R, MX240, MX240R

87569380

705603
772160



HOUSING-FUEL INJECTION PUMP GEAR

- Carter - Pignon de pompe à injection de carburant • Gehäuse - Kraftstoffeinspritzpumpenge triebe • Carcasa - engranaje de la bomba de inyección de combustible • Alloggiamento - Ingranaggio pompa di iniezione carburante • Alojamento da engrenagem da bomba de injeção de combustível • Behuizing - tandwiel brandstofinspuitpomp • Hus - tandhjul til brændstofindsprøjtningpumpe

480, 640

87569485

4607654

HYDRAULICS

- Hydraulik
- Sistema hidráulico

- Impianto idraulico
- Sistema hidráulico

- Circuit hydraulique
- Hydraulisch systeem
- Hydraulik

FIAT - FIAT AGRI - FIAT Trattori tractors

GOLD VALUE

NEW HOLLAND
AGRICULTURE



SUPPORT - FUEL FEED PUMP

- Support-Pompe d'alimentation en carburant • Halterung - Kraftstoff Förderpumpe • oporte de la bomba de alimentación de combustible
- Supporto - Pompa alimentazione carburante • Suporte da bomba de alimentação de combustível • Steun - brandstof-opvoerpomp
- Beslag - brændstof Fødepumpe

45-66S, 45-76, 50-66S, 50-86, 50-86S, 55-46, 55-56, 55-66, 55-66S, 55-76, 55-85, 55-86, 55-86S, 55-88, 55-66S, 60-56, 60-66, 60-66S, 60-76, 60-85, 60-86, 60-86S, 60-88, 60-93, 60-94, 62-85, 62-86, 65-46, 65-56, 65-66, 65-66S, 65-88, 65-90, 65-93, 65-94, 70-56, 70-66, 70-66S, 70-76, 70-86, 70-86S, 70-88, 70-90, 72-85, 72-86, 72-93, 72-94, 80-66, 80-66S, 80-76, 80-88, 80-90, 82-85, 82-86, 82-93, 82-94, 85-90, 88-85, 88-93, 88-94
Laverda combine : 3300, 3300AL, 3300R, 3400, 3400R, 3500, 3500R, 3550, 3550R, 3650R, 3750, 3750R / BRAUD : 1620, 1620S

87694768

4784968
4784968



SERVICE VALVE

- Valve hydraulique • Haupthahn-Absperrehebel • Palanca de la válvula de servicio • Leva valvola di servizio • Alavanca de válvula de serviço
- Hendel voor serviceklep • Greb til tappeventil

450, 480, 640, 55-46, 60-46, 65-46

87569464

588771
4998886



BOLT FOR FUEL PUMP

- Vis pour pompe à carburant • Schraube für Kraftstoffpumpe
- Perno de la bomba de combustible • Bullone per pompa carburante
- Parafuso para a bomba de combustível • Bout voor brandstofpomp
- Bolt til brændstofpumpe

450, 480, 640, 45-66, 45-66S, 45-76, 50-66, 50-86, 55-56, 55-75, 55-76, 55-85, 55-86, 55-88, 56-66, 60-56, 60-66, 60-75, 60-76, 60-85, 60-86, 60-88, 60-93, 60-94, 62-85, 62-86, 65-56, 65-88, 65-90, 65-93, 65-94, 70-56, 70-75, 70-76, 70-86, 70-88, 70-90, 72-85, 72-86, 72-93, 72-94, 80-66, 80-75, 80-76, 80-88, 80-90, 82-85, 82-86, 82-93, 82-94, 85-90, 88-93, 88-94, 100-55, 100-90, 110-90, 115-90, 130-90, 140-90, 160-90, 180-90, F100, F110, F115, F120, F130, F140, L60, L65, L75, L85, L95 / BRAUD : 1620S / LAVERDA : 3550AL, 3560AL, 3650, 3650R, 3750R, 3790, 3790R, 3790, 3790R, L517, L518, L520, L521, L523, L524, L525, L625, L626, L627

87569510

10181711
10181717



SERVICE VALVE LEVER

- Levier de valve hydraulique • Haupthahn-Absperrehebel
- Palanca de la válvula de servicio • Leva valvola di servizio • Alavanca de válvula de serviço • Hendel voor serviceklep • Greb til tappeventil

450, 480, 640, 55-46, 65-46, 70-56

87569463

594631

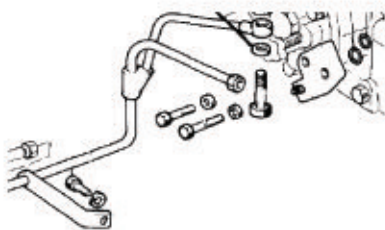

BANJO BOLT

- Vis banjo • Hohlschraube • Perno banjo • Bullone maschio
- Parafuso de ligação • Banjobout • Banjobolt

480, 640, 45-66, 45-76, 50-66, 50-86, 55-46, 55-56, 55-65, 55-66, 55-75, 55-76, 55-86, 55-88, 55-90, 56-66, 60-46, 60-56, 60-65, 60-66, 60-75, 60-86, 60-88, 60-90, 60-93, 60-94, 62-86, 65-46, 65-56, 65-66, 65-88, 65-90, 65-93, 65-94, 70-56, 70-65, 70-66, 70-86, 70-88, 70-90, 72-86, 72-93, 72-94, 80-65, 80-66, 80-88, 80-90, 82-86, 82-93, 82-94, 85-90, 88-93, 88-94, 90-90, 100-90, 110-90, 160-55, F100, F110, F115, F120, F130, F140, L60, L65, L75, L85, L95, M100, M115, M135, M160 / Laverda combine MX240, MX240R, MX300

87569539

10184417



CONNECTOR

- Connecteur • Anschluss • Conector • Connettore • Conector
- Connector • Konnektor

35-66, 45-76, 50-86, 55-56, 55-66, 55-76, 55-86, 60-56, 60-66, 60-76, 60-86, 62-86, 65-56, 65-66, 70-56, 70-66, 70-76, 70-86, 72-86, 80-66, 80-76, 82-86

87569556

5124083

55-46, 55-46DT, 55-56, 55-56DT, 55-66, 55-66S, 55-66DT, 60-46, 60-46DT, 60-56DT, 60-66, 60-66S, 60-66DT, 65-46, 65-56, 65-56DT, 65-66, 65-66S, 65-66DT, 70-56, 70-56DT, 70-66, 70-66S, 70-66DT, 70-66S DT, 80-66, 80-66S, 80-66DT, 80-66S DT

87569573

5131514

COOLING

- Kühlung
- Refrigeración

- Impianto di raffreddamento
- Refrigeração

- Refroidissement
- Koelsysteem
- Køling

FIAT - FIAT AGRI - FIAT Trattori tractors

GOLD VALUE

NEW HOLLAND
AGRICULTURE

GASKET - THERMOSTAT HOUSING

- Joint - Carter de thermostat • Dichtung - Thermostatgehäuse
- Junta - carcasa del termostato
- Guarnizione - Alloggiamento termostato
- Junta - Alojamento do termostato
- Pakking - thermostaathuis • Pakning - termostathus

3, 4, 5 and 6 cylinders with "Fiat" engine

87569340

4599809



THERMOSTAT 74° WITH BY PASS

- Thermostat 74° avec dérivation • Thermostat 74° mit Umgehung
- Termostato 74° con derivación • Termostato da 74° con bypass
- Termostato 74° com by-pass • Thermostaat 74° met omloop
- Thermostat 74° med bypass-funktion

3, 4, 5 and 6 cylinders with "Fiat" engine

87569341

4823226
5088099



THERMOSTAT 60° WITH BY PASS

- Thermostat 60° avec dérivation • Thermostat 60° mit Umgehung
- Termostato 60° con derivación • Termostato da 60° con bypass
- Termostato 60° com by-pass • Thermostaat 60° met omloop
- Thermostat 60° med bypass-funktion

3, 4, 5 and 6 cylinders with "Fiat" engine

87569391

5088099
98463637



THERMOSTAT FLANGE

- Bride de thermostat • Thermostatflansch • Brida del termostato
- Flangia del termostato • Flange do termostato • Thermostaatflens
- Thermostatflange

3, 4, 5 and 6 cylinders with "Fiat" engine

87569392

4599810
4661543



RADIATOR BOTTOM HOSE

- Tuyau inférieur du radiateur • Unterer Kühlerschlauch • Manguito inferior del radiador • Flessibile inferiore radiatore • Mangueira inferior do radiador • Onderste radiateurslang • Kølerens nederste slange

3, 4, 5 and 6 cylinders with "Fiat" engine

87569402

596153
77902285

411, 415

87569537

10134980



RADIATOR TOP HOSE

- Tuyau supérieur du radiateur • Oberer Kühlerschlauch
- Manguito superior del radiador • Flessibile superiore radiatore
- Mangueira superior do radiador • Radiateurslang bovenkant
- Kølerens øverste slange

450, 480, 500, 540, 550, 580, 600, 640

87569403

4950088
4950089

580, 680, 780, 880-5, 980, 55-90, 60-90, 65-90,
65-94, 70-90, 72-94, 80-90, 82-94, 85-90,
88-94, 90-90, 95-90, 100-90, 110-90

87569343

4997263



COOLING

- Kühlung
- Refrigeración

- Impianto di raffreddamento
- Refrigeração

- Refroidissement
- Koelsysteem
- Køling

FIAT - FIAT AGRI - FIAT Trattori tractors

GOLD VALUE

NEW HOLLAND
AGRICULTURE

RADIATOR COOLER 4 CORE

- Refroidisseur du radiateur • 4-Block-Wärmetauscher
- Refrigerador del radiador 4 núcleos • Radiatore 4 masse radianti
- Refrigeração do radiador, 4 núcleos • Radiateurkoeler, 4 blokken
- Køleenhed til køler, 4 kerner

450, 480

87569397

4952983
4973345



RADIATOR CAP

- Bouchon de radiateur • Kühlerverschluss • Tapón del radiador • Tappo radiatore
- Tampão do refrigerador • Radiateurdop • Kølerdæksel

All tractors except : 115-90, 130-90,
140-90, 160-90, 180-90, F140

87569398

4075101
4999682



FAN BELT

- Courroie de ventilateur • Ventilatorriemen • Correa del ventilador
- Cinghia della ventola • Correia da ventoinha • V-riem • Ventilatorrem

300, 350, 420, 450, 446, 466, 480, 500, 540,
550, 566, 570, 600, 640, 665, 666, 670, 766,
900, 1000, 45-66, 55-46, 55-66, 60-46, 60-66,
60-94, 65-46, 65-93, 70-56, 70-66, 72-93

87569399

98473706
920016251

300, 350, 420, 450, 446, 466, 480, 500, 540,
550, 566, 570, 600, 640, 665, 666, 670, 766,
900, 1000, 45-66, 55-46, 55-66, 60-46, 60-66,
60-94, 65-46, 65-93, 70-56, 70-66, 72-93

87569400

98473706
920016251

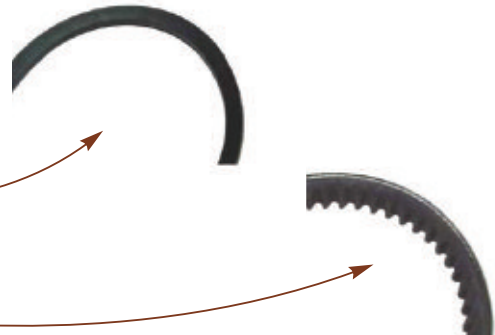

FAN BLADE

- Ventilateur • Gebläseflügel • Pala del ventilador • Pala della ventola
- Ventilatorblad • Lâmina da ventoinha • Ventilatorvinge

450, 480, 540, 640, 55-46, 55-56, 55-66, 55-88,
60-46, 60-56, 60-65, 60-66, 60-75, 60-88, 60-93,
60-94, 62-85, 65-46, 65-56, 65-88, 65-93, 70-56,
70-65, 70-66, 70-75, 70-88, 72-85, 72-93, 80-65,
80-66, 80-75, 80-88, 82-85, 82-93, 88-85, 88-93

87569401

4593320
153634274



BRAKES

- Bremsen
- Frenos

- Freni
- Travões

- Freins
- Remmen
- Bremser

FIAT - FIAT AGRI - FIAT Trattori tractors

GOLD VALUE

NEW HOLLAND
AGRICULTURE

SHAFT - BRAKE PEDAL

- Arbre de pédalier de frein • Bremspedalachse • Eje - pedal de freno
- Albero - Pedale del freno • Veio do pedal do travão
- As - rempedaal • Aksel - bremsepedal

55-66, 60-66, 65-66, 70-66, 80-66, 80-76

87569270

5118944



HAND BRAKE TOOTHED SECTOR

- Secteur denté du frein à main • Zahnsektor Handbremse
- Sector dentado del freno de mano • Settore dentato del freno a mano
- Sector dentado do travão de mão • Getand gedeelte handrem
- Håndbremse, tandsegment

415, 450, 480, 540, 640, 55-46, 55-56, 55-65,
55-75, 60-46, 60-56, 60-65, 60-75, 62-85,
65-46, 65-56, 70-56, 70-65, 70-75, 72-85,
80-65, 80-75, 82-85, 88-85

87569272

559640



LINK CONROD

- Bielle d'articulation • Nebenpleuelstange • Biela de conexión
- Biella articolazione • Biela de ligação • Linker drijfstang
- Plejstang til forbindelse

55-46, 55-56, 60-46, 60-56, 65-46,
65-56, 70-56

87569273

5145471



SPRING FOR BRAKE ACTUATOR

- Ressort de mécanisme de frein • Feder für Bremsenstellglied
- Muelle del actuador del freno • Molla per attuatore freni
- Mola para o actuador do travão • Veer voor remactuatoer
- Fjeder til bremseaktuatoer

45-66, 45-76, 50-66, 55-46, 55-56, 55-66,
55-76, 60-46, 60-56, 60-66, 60-76, 62-85,
62-86, 65-46, 65-56, 65-66, 70-56, 70-66,
70-76, 72-85, 72-86, 80-66, 80-76, 82-85,
82-86, 88-85

87569274

5086612
9960588

NUT - BRACKET FIXING FOR BRAKE ACTUATOR

- Ecrou - Fixation du support pour mécanisme de frein
- Halterbefestigungsmutter für Bremsenstellglied • Tuerca - soporte de fijación para el actuador del freno • Dado - Fissaggio staffa attuatore freni • Fixação de porca-braçadeira para o actuador do travão • Moer - bevestiging steun voor remactuatoer • Møtrik - beslag til bremseaktuatoer

45-66, 50-66, 55-46, 60-46, 60-56, 60-66,
60-76, 65-46, 65-56, 70-56, 70-66, 70-76,
80-66, 80-76

87569497

5086611
9959986



BUSH

- Douille • Buchse • Casquillo • Boccola • Casquilho • Bus • Bøsning

55-46, 55-56, 60-46, 60-56, 65-46,
65-56, 70-56

87569275

5145474



BRAKES

- Bremsen
- Frenos

- Freni
- Travões

- Freins
- Remmen
- Bremser

FIAT - FIAT AGRI - FIAT Trattori tractors

GOLD VALUE

NEW HOLLAND
AGRICULTURE

BRAKE BUSHING

- Bague de frein • Bremsenbuchse • Casquillo de freno • Boccola freni
- Casquilho do travão • Rembus • Bremsebøsning

400, 415, 446, 450, 480, 500, 540, 550,
600, 640, 55-46, 60-46, 65-46, 70-56

87569276

4980835
5112681

87569277

5109317
5112682



BRAKE DRUM

- Tambour de frein • Bremstrommel • Tambor de freno • Tamburo del freno
- Tambor do travão • Remtrommel • Bremsetromle

450, 480

87569278

596206

400, 415, 446, 450, 480, 500, 540, 550,
600, 640, 55-46, 60-46, 65-46

87569279

4980824



BRAKE BAND

- Bande de frein • Bremsband • Banda de freno • Nastro del freno
- Cinta de travão • Remband • Bremsebånd

450, 480

87569427

5112676
5160713

440, 450, 500, 540, 640, 55-46, 60-46,
65-46, 70-56

87569428

5112685
5160714



LEVER

- Levier • Hebel • Palanca • Leva • Alavanca • Hendel • Greb

450, 480, 640, 55-46, 65-46, 70-56

87569429

4981805
5085662

87569430

4981806
5085664



PIN - BRAKE BAND

- Goupille - Bande de frein • Bremsbandstift
- Pasador - banda de freno • Perno - Nastro del freno
- Pino da cinta de travão • Pen - remband • Stift - bremsebånd

450, 480, 640, 55-46, 60-46, 65-46, 70-56

87569542

567309
4981807



AIR CLEANERS & FILTERS

- Reiniger und filter
- Limpiadores & filtros

- Filtri
- Filtros

- Éléments de nettoyage et filtres
- Reinigers en filters
- Filtre

FIAT - FIAT AGRI - FIAT Trattori tractors

GOLD VALUE

NEW HOLLAND
AGRICULTURE

TANK - HYDRAULIC OIL W/O FILTER

- Réservoir d'huile hydraulique • Hydraulikölbehälter ohne Filter
- Depósito - aceite hidráulico sin filtro • Serbatoio - Olio idraulico senza filtro • Depósito - Óleo hidráulico SEM filtro • Tank - hydraulische olie, zonder filter • Hydraulikoliebeholder - uden filter

35-66, 45-66, 45-76, 50-66, 60-86, 55-46,
55-56, 55-66, 55-76, 55-85, 55-86, 55-88,
55-90, 56-66, 60-46, 60-56, 60-66, 60-76,
60-85, 60-86, 60-88, 60-90, 60-93, 60-94,
62-85, 62-86, 65-46, 65-56, 65-66, 65-88,
65-90, 65-93, 65-94, 70-56, 70-66, 70-76,
70-86, 70-88, 70-90, 72-85, 72-86, 72-93,
72-94, 80-66, 80-76, 80-88, 80-90, 82-85,
82-86, 82-93, 82-94, 85-90, 88-85, 88-93,
88-94, L60, L65, L75, L85

87569206

5087811
5111529



OIL BATH AIR CLEANER ELEMENT

- Élément du filtre à air à bain d'huile • Ölbadfilterelement
- Elemento limpiador de aire de baño de aceite • Elemento del filtro aria in bagno d'olio • Elemento de filtro de ar, banho de óleo
- Element voor oliebadluchtfiler • Filterelement til oliebad

450, 480, 640, 45-66, 50-66, 55-46, 55-56,
55-65, 55-66, 55-75, 55-88, 55-90, 60-46,
60-56, 60-65, 60-66, 60-75, 60-88, 60-90,
60-93, 65-46, 65-56, 65-88, 65-90, 65-93,
70-56, 70-65, 70-66, 70-88, 70-90, 72-93,
80-65, 80-66, 80-90, 82-93, 85-55, L60, L65,
L75

87569376

8322103
9959755



FUEL FILTER GLASS BOWL

- Bol témoin du filtre à carburant • Kraftstofffilter-Glasbehälter • Cubeta de cristal del filtro de combustible • Bicchierino di vetro filtro carburante
- Recipiente de vidro do filtro de combustível • Glazen kolf brandstofffilter • Glasskål til brændstoffilter

450, 480, 540, 640, 780, 55-46, 55-65, 55-66,
55-90, 60-65, 60-66, 60-90, 65-46, 65-56,
65-66, 65-88, 65-90, 65-93, 65-94, 70-56,
70-65, 70-66, 70-75, 70-76, 70-88, 70-90,
72-85, 72-93, 72-94, 80-65, 60-66, 80-75,
80-76, 80-88, 80-90, 82-85, 82-93, 82-94,
85-55, 85-90, 88-85, 88-93, 88-94, 115-90,
130-90, 140-90, L60, L65, L75 / Laverda
combine : 3300, 3300AL, 3300R, 3400,
3400R, 3500, 3500R, 3550, 3550AL, 3550R,
3650, 3650R, 3750, 3750R, L517

87569378

9918123



FUEL FILTER SEAL

- Joint du filtre à carburant • Kraftstofffilterdichtung
- Junta del filtro de combustible • Guarnizione del filtro carburante
- Vedante do filtro de combustível • Afdichting brandstofffilter
- Tætning til brændstoffilter

450, 480, 540, 640, 780, 55-46, 55-65, 55-66,
55-90, 60-65, 60-66, 60-90, 65-46, 65-56,
65-66, 65-88, 65-90, 65-93, 65-94, 70-56,
70-66, 70-75, 70-76, 70-88, 70-90, 72-85,
72-93, 72-94, 80-65, 80-66, 80-75, 80-76,
80-88, 80-90, 82-85, 82-93, 82-94, 85-55,
85-90, 88-85, 88-93, 88-94, 115-90, 130-90,
140-90 / Laverda combine : 3300AL, 3300R,
3400, 3400R, 3500, 3500R, 3550, 3550AL,
3550AL, 3650, 3650R, 3750, 3750R, L517

87569379

9918124



AIR CLEANERS & FILTERS

- Reiniger und filter
- Limpiadores & filtros

- Filtri
- Filtros

- Éléments de nettoyage et filtres
- Reinigers en filters
- Filtre

FIAT - FIAT AGRI - FIAT Trattori tractors

GOLD VALUE

NEW HOLLAND
AGRICULTURE

FUEL FILTER HEAD SINGLE INLET AND OUTLET

- Tête de filtre à carburant • Kraftstofffilterkopf, Einzelein- und -auslass • Entrada y salida simple de cabeza del filtro de combustible • Entrada e uscita singola testa del filtro carburante
- Cabeça do filtro de combustível: entrada e saída única • Bovenkant brandstofffilter, inlaat en uitlaat • Brændstofffilterhoved, enkelt ind sugning og udstødning

450, 480, 540, 55-46, 55-65, 55-66, 55-90, 60-66, 60-90

87569489

9927916



HYDRAULIC FILTER

- Filtre hydraulique • Hydraulikfilter • Filtro hidráulico • Filtro idraulico • Filtro hidráulico
- Hydraulisch filter • Hydraulikfilter

250 Nastro d'Oro, 255, 300, 300DT, 311C/CR, 312C, 315C, 315 Diamante, 331RS, 332C, 332RS, 342, 350, 350S, 350F, 351C, 352C, 355C, 355CM, 400, 415/R/C Diamante, 420, 420DT, 421, 431C, 440, 440DT, 441, 441C, 446, 450, 450DT/DAL/UTB, 450R, 451C, 455C, 455C Super, 455DAL, 460, 460DT, 460V, 466, 466DT, 480, 480DT S, 480-8, 480-8DT, 500, 500S DT/S, 505C, 540S, 540DT, 550, 555, 570DT Frutteto, 570DT Vigneto, 600, 640, 650, 670, 670DT, 670 Frutteto, 750, 35-66, 180-55 Turbo Hydrodrive / Supercharged engine: 160-90, 160-90DT Turbo, 180-90, 180-90DT Turbo

87569466

1909134
4975589



AIR FILTER INNER

- Partie intérieure du filtre à air • Luftfilter, innen • Filtro de aire interno • Filtro dell'aria interno
- Filtro de ar interno • Luchtfilter, binnen • Luftfilter, indvendigt

55-46, 55-56, 55-66, 55-88, 60-46, 60-56, 60-66, 60-88, 60-93, 60-94, 65-46, 65-56, 65-66, 65-88, 65-93, 65-94, 70-56, 70-66, 70-88, 72-93, 72-94, 80-65, 80-66, 80-88, 82-93, 82-94, L60, L65, L75

87569499

1930537

55-65F, 55-65V, 55-65M, 60-65M, 60-65V, 55-66, 55-66DT, 55-66LP, 55-66LPDT, 60-66, 60-66DT, 60-66LP, 60-66F, 60-66FDT, 60-66LPDT, 60-76F, 60-76FDT, 60-93, 60-94, 62-86F, 62-86DT, 65-46, 65-46DT, 65-56, 65-56DT, 65-66, 65-66DT, 65-88, 65-88DT, 65-93, 65-94, 70-56, 70-56DT, 70-65 Montagna, 70-66, 70-66DT, 70-66F, 70-66LP, 70-66LPF, 70-66LPDT, 70-75C, 70-75CM, 70-76, 70-76V, 70-76LP, 70-76LPDT, 70-88, 70-88DT, 70-90, 70-90DT, 72-86LP, 72-86DT, 72-93, 72-93DT, 72-94, 72-94DT, 80-65, 80-66, 80-66DT, 80-75C, 80-76F, 80-76FDT, 80-88, 80-88DT, 80-90, 80-90DT, 82-86LP, 82-86F, 82-86DT, 82-93, 82-93DT, 82-94, L60, L65, L75, L85, L95

87569522

1930588

88-94, 110-90, F100DT, F110DT, F115, F120DT, L85, L95

87569533

1930590

580, 680, 680DT-H, 780, 780DT, 855C, 880, 880DT, 880/5DT, 905C, 980, 980DT, 995C, 65-90, 65-90DT, 70-90, 70-90DT, 80-90, 80-90DT, 72-93, 72-93DT, 72-94, 72-94DT, 73-93DT, 85-55, 85-90, 85-90DT, 90-55, 90-90, 90-90DT, 95-55, 100-90, 100-90DT, 110-90, 110-90DT, F100DT, F110DT, F115, F120DT

87569504

5102240
9933226



FILTER HYDRAULIC OIL TANK

- Filtre + Réservoir d'huile hydraulique • Filter + Hydraulik öltank • Filtro + depósito de aceite hidráulico • Filtro + Serbatoio dell'olio idraulico • Filtro + Depósito de óleo hidráulico
- Filter + hydraulische-olietank • Filter + hydraulik Olietank

466, 466DT, 470, 470DT, 470S, 474 vigneto, 474DT, 474DTE, 570, 570DT, 580, 580DT, 665C, 665 Montagna, 666, 666DT, 670, 670DT, 670 Frutteto, 765C, 766, 766DT, 775C, 780, 780DT, 850, 850 Special, 850DF, 880, 880DT, 980, 980DT, 1000, 1000S, 1000DT, 1000N, 1180, 1180DT, 1280, 1280DT, 1380, 1380DT, 1580, 1580DT, 1880, 1880DT, 70-90, 70-90DT, 80-90, 80-90DT, 90-90, 90-90DT, 100-90, 100-90DT, 110-90DT, 115-90, 115-90DT, 130-90, 130-90DT, 140-90, 140-90DT turbo moteur 8065.25, L85, L95, TL70, TL80, TL90, TL100

87694778

1909143
1909144



AIR CLEANERS & FILTERS

- Reiniger und filter
- Limpiadores & filtros

- Filtri
- Filtros

- Éléments de nettoyage et filtres
- Reinigers en filters
- Filtre

FIAT - FIAT AGRI - FIAT Trattori tractors

GOLD VALUE

NEW HOLLAND
AGRICULTURE



AIR FILTER OUTER

- Partie extérieure du filtre à air • Luftfilter, außen • Filtro de aire externo
- Filtro dell'aria esterno • Filtro de ar externo • Luchtfiler, buiten
- Luftfilter, udvendigt

680, 680DT-H, 780, 780DT, 855C, 880, 880DT, 880/5DT, 905C, 980, 980DT, 995C, 65-90, 65-90DT, 70-90, 70-90DT, 80-90, 80-90DT, 85-55, 85-90, 90-90, 95-55, 100-90, 100-90DT, 110-90, 110-90DT

87569577 1909116

680, 680DT-H, 780, 780DT, 855C, 880, 880DT, 880/5DT, 905C, 980, 980DT, 995C, 55-90, 55-90DT, 60-90, 60-90DT, 70-90, 70-90DT, 80-90, 80-90DT, 85-55, 85-90, 85-90DT, 90-90, 90-90DT, 95-55, 100-55, 100-90, 100-90DT, 110-90, 110-90DT / BRAUD: 2420

87569545 1930138

55-46, 55-56, 55-66, 55-88, 60-46, 60-56, 60-66, 60-88, 60-93, 60-94, 65-46, 65-56, 65-66, 65-88, 65-93, 65-94, 70-56, 70-66, 70-88, 72-93, 72-94, 80-65, 80-66, 80-88, 82-93, 82-94, L60, L65, L75

87569578 1930536

M135, M160

87569540 82008606



AIR FILTER HOSE

- Tube extérieur du filtre à air • Luftfilterschlauch
- Manguito del filtro de aire • Flessibile filtro dell'aria
- Mangueira do filtro de ar • Luchtfilterslang • Luftfilter, slange

55-46, 55-56, 55-66, 55-88, 60-46, 60-56, 60-65, 60-66, 60-88, 60-93, 65-46, 65-56, 65-66, 65-88, 65-93, 70-56, 70-65, 70-66, 70-88, 72-93, 80-65, 80-66, 80-88, 82-93

87569546 5111544



INLET TUBE FOR AIR CLEANER

- Tube d'admission pour le filtre à air • Einlassschlauch für Luftfilter
- Tubo de admisión para el limpiador de aire
- Tubo di entrata filtro dell'aria • Tubo de entrada para o filtro de ar
- Inlaatleiding voor luchtfiler • Indsugningsrør til luftfilter

55-46, 55-56, 55-66, 55-88, 60-46, 60-56, 60-65, 60-66, 60-75, 60-88, 62-85, 65-46, 65-56, 65-66, 65-88, 70-56, 70-65, 70-66, 70-75, 70-88, 72-85, 80-65, 80-66, 80-75, 80-88, 80-88, 82-85

87569561 5134488
5163496



BOWL FOR UNDER HOOD PRE CLEANER

- Bol pour le préfiltre sous capot • Behälter für Motorraumvorfilter
- Cubeta para el prelimpiador bajo el capó • Bicchierino per prefiltra
- Recipiente para pré-filtro debaixo do capot • Behuizing voor voorfilter onder motorkap • Skål til forfilter under motorhjel

450, 480, 550, 580, 600, 640, 780, 55-46, 65-46, 70-56

87569568 4997665



OIL BATH AIR CLEANER

- Filtre à air à bain d'huile • Ölbadluftfilter
- Limpiador de aire de baño de aceite • Filtro aria in bagno d'olio
- Filtro de ar, banho de óleo • Oliebadluchtfiler • Filter til oliebad

45-66, 45-76, 50-66, 55-56, 55-66, 55-88, 60-56, 60-66, 60-88, 60-93, 65-56, 65-66, 65-88, 65-93, 70-56, 70-66, 70-88, 72-93, 80-66, 80-88, 82-93

87569505 5136558
8323083



SEAL FOR OIL BATH AIR CLEANER

- Joint pour filtre à air à bain d'huile • Dichtung für Ölbad-Luftreinigung
- Junta para depurador de aire de baño de aceite
- Paraolio per filtro aria in bagno d'olio
- Vedante para filtro de ar de banho de óleo
- Afdichting voor oliebadluchtfiler • Pakning til oliebadets luftrenser

55-65, 55-75, 60-65, 60-75

87694769 553659



RUBBER SUPPORT - PRE FILTER TO HOOD

- Support en caoutchouc du préfiltre au niveau du capot
- Gummihalter für Vorfilter zur Haube • Soporte de caucho - prefiltra para el capó
- Supporto in gomma - Prefiltro sul cofano
- Suporte de borracha - Pré-filtro para capot • Rubberen steun - voorfilter op motorkap • Gummibeslag - forfilter til motorhjel

450, 480, 640, L60, L65, L75

87569516 4957544
9959751

CLUTCHES

- Kupplungen
- Embragues

- Frizioni
- Embraiagens

- Embrayages
- Koppelingen
- Koblinger

FIAT - FIAT AGRI - FIAT Trattori tractors

GOLD VALUE

NEW HOLLAND
AGRICULTURE

MAIN DRIVE SET LUK 11"

- Kit de réparation embrayage avancement LUK 11"
- Hauptantriebssatz LUK 11" • Conjunto de marchas principal LUK 11"
- Gruppo comando principale LUK 11"
- Conjunto de transmissão principal LUK 11"
- Hoofdaandrijvingsset LUK 11" • Hoveddrev indstillet LUK 11"

55-46, 55-56, 55-66, 55-90, 56-66, 60-46,
60-56, 60-66, 60-76, 60-86, 60-90, 60-93,
60-94, 62-86, 65-46, 65-56, 65-66, 65-90,
65-93, 65-94, 70-56, 70-66, 70-76, 70-86,
70-88, 70-90, 72-86, 72-93, 72-94, 80-66,
80-76, 80-88, 80-90, 82-86, 82-93, 82-94,
85-90, 88-93, 88-94

87569029

9956463
9962518

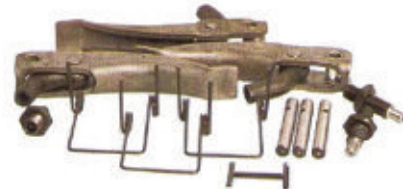

PTO SET LUK 11"

- Kit de réparation embrayage PDF LUK 11" • Zapfwellensatz LUK 11"
- Conjunto de TDF LUK 11" • Gruppo PDF LUK 11" • Conjunto de TDF LUK 11" • Aftakasset LUK 11" • Kraftudtag indstillet LUK 11"

55-46, 55-56, 55-66, 55-90, 56-66, 60-46,
60-56, 60-66, 60-76, 60-86, 60-90, 60-93,
60-94, 62-86, 65-46, 65-56, 65-66, 65-90,
65-93, 65-94, 70-56, 70-66, 70-76, 70-86,
70-88, 70-90, 72-86, 72-93, 72-94, 80-66,
80-76, 80-88, 80-90, 82-86, 82-93, 82-94,
85-90, 88-93, 88-94

87569031

9956482
9959899

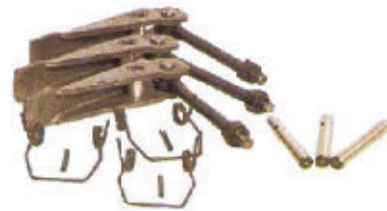

MAIN DRIVE SET OMG 11"

- Kit de réparation embrayage avancement OMG 11"
- Hauptantriebssatz OMG 11" • Conjunto de marchas principal OMG 11"
- Gruppo comando principale OMG 11"
- Conjunto de transmissão principal OMG 11"
- Hoofdaandrijvingsset OMG 11" • Hoveddrev indstillet OMG 11"

55-46, 55-56, 55-66, 55-90, 60-46, 60-56,
60-66, 60-90, 65-46, 65-56, 65-66, 65-90,
70-56, 70-66, 70-88, 70-90, 80-66, 80-88,
80-90, 85-90

87569030

9960722



PTO SET OMG 11"

- Kit de réparation embrayage PDF OMG 11" • Zapfwellensatz OMG 11"
- Conjunto de TDF OMG 11" • Gruppo PDF OMG 11" • Conjunto de TDF OMG 11" • Aftakasset OMG 11" • Kraftudtag indstillet OMG 11"

55-46, 55-56, 55-66, 55-90, 60-46, 60-56,
60-66, 60-90, 65-46, 65-56, 65-66, 65-90,
70-56, 70-66, 70-88, 70-90, 80-66, 80-88,
80-90, 85-90

87569032

9956581
9966227



CLUTCHES

- Kupplungen
- Embragues

- Frizioni
- Embraiagens

- Embrayages
- Koppelingen
- Koblinger

FIAT - FIAT AGRI - FIAT Trattori tractors

GOLD VALUE

NEW HOLLAND
AGRICULTURE

MAIN DISC, TRANSMISSION SIDE, MOUNTED

• Friction d'avancement, côté transmission, monté • Hauptscheibe, Getriebeseite, montiert • Disco principal montado en el lado de la transmisión • Disco principale, lato trasmissione, montato • Disco principal, lado da transmissão, montado • Hoofdplaat, transmissiezijde, vast • Hovedskive, transmissionside, monteret

840, 850 / => 1978 : 880

446, R450S, 466, 480-8 /DT /V, 500, 540, 550, 566, 570, 580, 600, 640, 666, 670, 680, 740, 766, 780 /DT, 55-46, 55-66 /DT, 55-90 /DT, 60-66 F LP S /DT, 60-76, 60-90 /DT, 62-86 /DT, 65-46 /DT, 65-66 /DT, 65-90 /DT, 65-93 /DT, 65-94 /DT, 70-66 F LP V /DT, 70-76 LP F V /DT, 70-88, 70-90 /DT, 72-86, 72-93 /DT, 72-94 /DT, 80-66 /DT, 80-76 F /DT, 80-88 /DT, 80-90 /DT, 82-86 LP F /DT, 85-90 /DT

82-93, 82-94, 88-93, 88-94

87569035 5102262
328007410

87569036 5145718
328018510

87569037 5156213
328018511

87569038 5171053
328018516

87569039 5162901
328026110

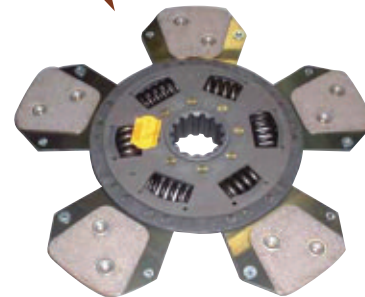
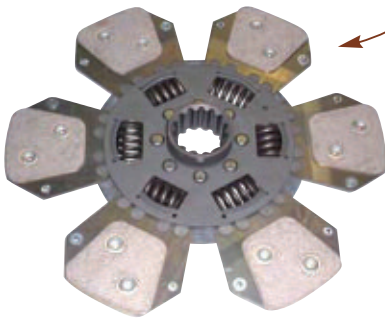
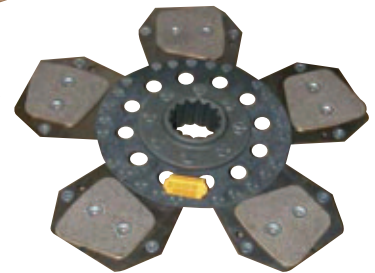
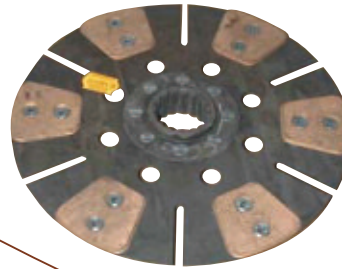

PTO DISC, ENGINE SIDE, LOOSE

• Friction PDF, côté moteur, libre • Zapfwellenscheibe, Motorseite, lose • Disco de TDF suelto en el lado del motor • Disco PDF, lato motore, parte sfusa • Disco da TDF, lado do motor, solto • Aftakasplaat, motorzijde, los • Kraftudtagsskive, motorside, løs

840, 850 / => 1978 : 880

446, R450S, 466, 480-8 /DT /V, 500, 540, 550, 566, 570, 580, 600, 640, 666, 670, 680, 740, 766, 780 /DT, 55-46 /DT, 65-46 /DT, 55-66 /DT, 55-90 /DT, 60-66 F LP S /DT, 60-76, 60-90 /DT, 62-86 /DT, 65-66 /DT, 65-90 /DT, 65-93 /DT, 65-94 /DT, 70-66 F LP V /DT, 70-76 LP F V /DT, 70-88, 70-90 /DT, 72-86, 72-93 /DT, 72-94 /DT, 80-66 /DT, 80-76 F /DT, 80-88 /DT, 80-90 /DT, 82-86 LP F /DT, 82-93, 82-94, 85-90 /DT, 88-93, 88-94

50-86, 60-86 F D /DT, 70-86 V /DT

87569040 5160410
328009216

87569041 5154703
328018616

87569042 44909044
328025310



CLUTCHES

- Kupplungen
- Embragues

- Frizioni
- Embraiaçens

- Embrayages
- Koppelingen
- Koblinger

FIAT - FIAT AGRI - FIAT Trattori tractors

GOLD VALUE

NEW HOLLAND
AGRICULTURE

CLUTCH PRESSURE PLATE

- Plateau de pression • Kupplungsdruckplatte • Placa de presión de embrague • Spingidisco frizione • Prato de pressão da embraiaçem
- Drukplaat koppeling • Koblingstrykplade

450, 455, 460, 470, 480

87569513

596247



TRACTION CLUTCH CONTROL CABLE

- Câble d'embrayage • Zugkupplungsseil • Cable de control de embrague de tracción • Cavo di comando frizione trazione
- Cabo de controlo de tracção da embraiaçem
- Regelkabel tractiekoppeling • Styrekabel til trækkobling

880, 980, 55-88, 55-90, 60-88, 60-90, 60-93, 60-94, 65-88, 65-90, 65-93, 65-94, 70-88, 70-90, 72-93, 72-94, 80-88, 80-90, 82-93, 82-94, 85-90, 88-94, 90-90, 100-90, 110-90

87569043

5115689
5120399

580, 680, 780

87569044

5115686

570, 580, 670, 680, 780

87569046

5101223
5101694



CLUTCH OIL HOSE

- Tube d'huile embrayage • Kupplungsölschlauch
- Manguito del aceite de embrague
- Flessibile olio frizione • Mangueira de óleo da embraiaçem
- Slang koppelingolie • Koblingsolieslange

540, 640, 55-46, 65-46, 70-56

87569435

744462



CUP PTO CLUTCH

- Coupelle de l'embrayage de PDF • Zapfwellenkupplungsschale
- Tapón del embrague de TDF • Cappuccio frizione PDF
- Copo da embraiaçem da TDF • Schotel aftakoppeling
- Skål, kraftudtagskobling

540, 640, 55-46, 65-46, 70-56

87569508

597149



COUPLING SEAL

- Joint du coupleur • Kupplungsdichtung • Junta de acoplamiento
- Guarnizione giunto • Vedante de acoplamento • Afdichting koppeling
- Forbindelsestætning

450, 455, 460, 470, 480

87569530

4957107
5085653

INSTRUMENTS & CONTROLS

- Tableau de bord et commandes
- Instrumente und bedienelemente
- Instrumentos & controles
- Strumenti e comandi
- Instrumentos e controles
- instrumenten en bedieningsmechanismen
- instrumenter og betjeningsanordninger

FIAT - FIAT AGRI - FIAT Trattori tractors

GOLD VALUE



FUEL & THERMOMETER GAUGE

- Jauge de carburant et de température • Kraftstoff- und Temperaturanzeige • Combustible y termómetro • Indicatore carburante e termometro • Manómetro de combustível e termómetro • Brandstof- en thermometermeter • Brændstof- og temperaturmåler

SOM 615, 715, 670 / 450, 480, 500, 540, 550,
600, 640, 650, 750, 800, 850, 900, 1000

87569349

4249631
4334917



STOP CABLE

- Câble d'arrêt • Bremskabel • Cable de parada • Cavo di arresto • Cabo de paragem • stopkabel • Stopkabel

446, 466, 566, 570, 670, 980, 1180, 1580,
70-66, 80-66, 160-90

87569354

5113254
5116829



LEVEL ROD

- Tige de levier • Nivellierstange • Varilla de nivel • Asta graduada • Tirante de nivelamento • Vlotterstang • Niveaustang

450, 480, 640, 55-46, 55-56, 60-56,
65-46, 65-56, 70-56

87569519

596428
5085354



DIPSTICK

- Jauge • Ölmesstab • Varilla de medición de nivel • Astina di livello • Vareta • Peilstok • Målepind

445, 450, 460, 470, 480, 550

87569572

4608223



HOUSING-OIL IND. SENDER

- Carter - sonde de niveau d'huile • Ölstandsanzeigergehäuse Sender • Carcasa - indicador de aceite Transmisor • Alloggiamento-Ind. olio Trasmettitore • Alojamento- óleo ind. Sensor • Behuizing - inductieve sensor olie • Hus - olieindikator Sendeenhed

55-46, 55-56, 55-66, 55-85, 60-46, 60-56,
60-66, 60-75, 60-85, 62-85, 65-46, 65-56,
65-66, 70-56, 70-66, 70-75, 72-85, 80-66,
80-75, 82-85, 85-55, 88-85, 95-55, 100-55,
130-90, 140-90, L60, L75, L85, L95

87569562

598310



TACHOMETER GEAR

- Pignon de tachomètre • Drehzahlmesser Getriebe • Engranaje del tacómetro • Ingranaggio tachimetro • Engrenagem do tacómetro • Tandwiel toerenteller • Tandhjul til omdrejningstæller

480, 640

87569565

4177683



EXHAUST

- Auspuff
- Escape

- Sistema di scarico
- Saída

- Echappement
- Uitlaat
- Udstødning

FIAT - FIAT AGRI - FIAT Trattori tractors

GOLD VALUE

NEW HOLLAND
AGRICULTURE

EXHAUST MANIFOLD

- Collecteur d'échappement • Auspuffkrümmer
- Colector de escape • Collettore di scarico • Colector de escape
- Uitlaatspruitstuk • Udstødningsmanifold

780, 65-90, 70-90, 80-90

87569350

4694202
7150225



INLET MANIFOLD

- Collecteur d'admission • Einlasskrümmer • Colector de admisión
- Collettore di aspirazione • Colector de admissão
- Inlaatspruitstuk • Indsugningsmanifold

450, 480, 45-66, 45-76, 50-66, 50-86, 55-46,
55-56, 55-65, 55-66, 55-75, 55-76, 55-85,
55-86, 55-88, 55-90, 58-66, 60-46, 60-56,
60-65, 60-66, 60-75, 60-85, 60-86, 60-88,
60-90, 60-93, 60-94, 62-85, 62-86

87569351

4602345



EXHAUST MANIFOLD GASKET

- Joint de collecteur d'échappement • Einlasskrümmerdichtung
- Junta de colector de escape • Guarnizione collettore di scarico
- Junta do colector de admissão • Pakning uitlaatspruitstuk
- Pakning til udstødningsmanifold

All models with "Fiat" engine
except 8365.05 and 8365.25

87569384

98428397
98489690



UNDERCARRIAGE

- Bodengruppe
- Bastidor

- Carrello
- Subestructura

- Train de chenilles
- Onderstel
- Understel

FIAT - FIAT AGRI - FIAT Trattori tractors

GOLD VALUE



ROLLER

- Galet • Rolle • Rodillo • Rulli • Rolamento • Rol • Rulle

FIAT CRAWLER TRACTOR : 100-55 LAVERDA COMBINE : 3400R, 3500R, 3550R, 3650, 3650R, 3750, 3750R, 3790R	73314860	5181118
FIAT CRAWLER TRACTOR : 100-55	73314861	5181119
FIAT CRAWLER TRACTOR : 70-65, 70-65M, 70-75, 70-75M, 72-85, 72-85M, 80-65, 80-75, 82-85M, 88-85M, A70 CS-CLS, A80 CS, C8066, C8066M, C8076, C8070 SPECIAL N-L, C70 AGRIFULL, 505C SUPER, 605C SUPER, 665C, 665CM, 765C, TKA SERIES, TK65V, TK75F, TK75M, TK76, TK76M, TK85, TK85M, TK95M	87661069	5111356
FIAT CRAWLER TRACTOR : 60-65, 60-65M, 60-65V, 60-75, 60-75M, 62-85, 62-85M, 70-65, 70-65M, 70-75, 70-75M, 72-85, 72-85M, 80-65, 80-75, 82-85M, 88-85M, A60CS-CLS, A70CS-CLS, A80CS, C8066, C8066M, C8076, C8070 SPECIAL N-L, C70 AGRIFULL, 505C SUPER, 605C SUPER, 665C, 665CM, 765C, TKA SERIES, TK65V, TK75F, TK75M, TK76, TK76M, TK85, TK85M, TK95M	87661070	5111357
COMBINES : LAVERDA L411, L413, L416, L516, L624, L625, L626 / NEW HOLLAND TC52, TC54, TC56, TF76, TF78, TX62, TX63, TX64, TX65, TX66, TX67, TX68 / FIAT CRAWLER TRACTOR : 160-55C, Hydro 180-55	87661073	76029464
COMBINES : LAVERDA L411, L413, L416, L516, L624, L625, L626 / NEW HOLLAND TC52, TC54, TC56, TF76, TF78, TX62, TX63, TX64, TX65, TX66, TX67, TX68 / FIAT CRAWLER TRACTOR : 160-55C, Hydro 180-55	87661074	76029465
FIAT CRAWLER TRACTOR : C8050 N-L-C, 355, 355M, 455C/DAL, 455C SUPER, 465, 465M, 465 FRUTTO-VIGNETO, 55-65, 55-65M, 55-75V, 55-75F, 55-75M, 55-85, 60-65, 60-65M, 60-75V, 60-75M, 60-85, A55 C F II, A60 C II, A55 CVS-CFS, A60 CS-CLS, TKA SERIES, TK65F, TK65V, TK70FA, TK70VA, TK75V, TK75VA	87661075	4968573 5193323

BOLT

- Boulon • Bolzen • Perno • Bullone • Parafuso • Bout • Bolt

FIAT CRAWLER TRACTOR : 60-65 / 60-65M / 60-65V / 60-75 / 60-75M / 62-85 / 62-85M / 70-65 / 70-65M / 70-75 / 70-75M / 72-85 / 72-85M / 80-56 / 80-65 / 80-66 / 80-75 / 80-76 / 82-85M / 88-85 / TKA SERIES / TK76 / TK76M / 505 SUPER / 605 SUPER / 565 / 665 / 765 / C8070 SPECIAL N-L	87661078	5117440
FIAT CRAWLER TRACTOR : 160-55, Hydro 180-55, 1355	87661086	79004489
FIAT CRAWLER TRACTOR : 160-55, Hydro 180-55, 1355	87661087	79039443

NUT

- Ecrou • Schrauben-mutter • Tuerca • Dado
- Porca • Moer • Møtrik

FIAT CRAWLER TRACTOR : 60-65 / 60-65M / 60-65V / 60-75 / 60-75M / 62-85 / 62-85M / 70-65 / 70-65M / 70-75 / 70-75M / 72-85 / 72-85M / 80-56 / 80-65 / 80-66 / 80-75 / 80-76 / 82-85M / 88-85 / TKA SERIES / TK76 / TK76M / 505 SUPER / 605 SUPER / 565 / 665 / 765 / C8070 SPECIAL N-L	87661079	5117441 79031163
--	-----------------	---------------------

SPROCKET

- Couronne dentée • Kettenrad • Rueda dentada • Ingranaggio
- Roda dentada • Kettingwiel • Kædehjul

FIAT CRAWLER TRACTOR : 505C SUPER, 605C SUPER, C8070 SPECIAL N-L	87661066	566417 4957406
---	-----------------	-------------------

TRACK SHOE

- Tuile • Kettenplatte • Zapata de oruga • Pattino cingolo
- Sapata • Rupsbandschakel • Bæltesko

FIAT CRAWLER TRACTOR : 100-55	73314874	5169390
-------------------------------	-----------------	---------

CHAIN

- Chaîne • Kette • Cadena • Catena • Corrente • Ketting • Kæde

FIAT CRAWLER TRACTOR : 455C SUPER, C8050- N.L.C., 455C/DAL, C350CN-L-SS, 355C-355CM	73314819	4960993
FIAT CRAWLER TRACTOR : 55-65F, 55-65M, 55-65V, 55-75F, 55-75M, 55-75V, 55-85F, 55-85M, 55-85V, 60-65, 60-65M, 60-65V, 60-75M, 60-75V, 60-85F, 60-85V	73314836	5114442
FIAT CRAWLER TRACTOR : 95-55, 100-55	73314838	5115554
FIAT CRAWLER TRACTOR : 505C SUPER	87661064	580372
FIAT CRAWLER TRACTOR : 605C SUPER, C8070 SPECIAL N-L	87661065	580373
FIAT CRAWLER TRACTOR : 665C, 665CM, C8066, C8066M, 70-65, 70-65M, 70-75, 70-75M, 72-85, 72-85M, A70C II, A70 CS-CLS, TKA SERIES	87661067	5112816
FIAT CRAWLER TRACTOR : 80-65, 80-75, A80CS, 765C, C8076	87661068	5112817
FIAT CRAWLER TRACTOR : 1355C, 120C	87661071	4979232 76000483
FIAT CRAWLER TRACTOR : 120C	87661072	79002871



VARIOUS

- Verschiedenes
- Varios

- Varie
- Diversos

- Divers
- Diversen
- Diverse

FIAT - FIAT AGRI - FIAT Trattori tractors

GOLD VALUE

NEW HOLLAND
AGRICULTURE



AIR DISPATCHING TAP

- Robinet de répartition de l'air • Luftverteilerhahn
- Tapa de distribución de aire • Tappo distribuzione aria
- Tampão de saída de ar • Ontluchttingskraan • Luftfordelingsventil

415, 450, 480, 540, 640, 35-66, 55-66, 55-56, 55-66, 55-90, 60-46, 60-56, 60-66, 60-76, 60-90, 62-85, 62-86, 65-46, 65-56, 70-56, 70-65, 70-66, 70-76, 70-90, 72-85, 72-86, 80-65, 80-66, 80-90, 82-85, 82-86, 88-85, 90-90, 95-55, 100-55, 100-90, 110-90, 115-90, 130-90, 140-90, 160-55, 160-90, 180-90, F100, F110, F115, F120, F130, F140

87569366

4950044
13413290



R PIN 6 MM

- Goupille 6 Mm • R Bolzen 6 Mm • R Perno 6 Mm • R Perno 6 Mm
- R Pino 6 Mm • R Pen 6 Mm • R Bolt 6 Mm

450, 480, 640, 45-66, 45-76, 50-66, 50-86, 55-46, 55-56, 55-66, 55-76, 55-86, 55-88, 55-90, 60-46, 60-56, 60-66, 60-76, 60-86, 60-88, 60-90, 60-93, 60-94, 62-86, 65-46, 65-56, 65-66, 65-66S, 65-88, 65-90, 65-93, 65-94, 70-56, 70-66, 70-66S, 70-76, 70-86, 70-86S, 70-88, 70-90, 72-86, 72-93, 72-94, 80-66, 80-66S, 80-76, 80-88, 80-90, 82-86, 82-93, 82-94, 85-90, 88-93, 88-94, 90-90, 100-90, 110-90, 115-90, 130-90, 140-90, 160-90, 180-90, F100, F110, F115, F120, F130, F140, L60, L65, L75, L85, L95

87569384

98428397
98489690



PIN-FRONT WEIGHT

- Axe - Masse avant • Bolzen - Frontgewichte
- Perno - Delante Contrapesos • Perno - Anteriore zavorre
- Pino - Dianteiro Contrapesos • Pen - Frontgewichten • Bolt - Frontvægt

55-46, 55-56, 55-66, 55-88, 55-90, 60-46, 60-56, 60-66, 60-88, 60-90, 60-93, 60-94, 65-46, 65-56, 65-66, 65-88, 65-90, 65-93, 65-94, 70-56, 70-66, 70-88, 70-90, 72-93, 72-94, 80-66, 80-88, 80-90, 82-93, 82-94, 85-90, 88-93, 88-94, 90-90, 100-90, 110-90, 115-90, 130-90, 140-90, 160-90, 180-90, F100, F110, F115, F120, F130, F140, L60, L65, L75, L85, L95

87569520

5118742



R PIN 3,5 MM

- Goupille 3,5 Mm • R Bolzen 3,5 Mm • R Perno 3,5 Mm
- R Perno 3,5 Mm • R Pino 3,5 Mm • R Pen 3,5 Mm
- R Bolt 3,5 Mm

450, 480, 640, 35-66, 45-66, 45-76, 50-66, 50-86, 55-46, 55-56, 55-65, 55-66, 55-75, 55-76, 55-85, 55-86, 55-88, 55-90, 56-66, 60-46, 60-56, 60-65, 60-66, 60-75, 60-76, 60-85, 60-86, 60-88, 60-90, 60-93, 60-94, 62-85, 62-86, 65-46, 65-56, 65-66, 65-88, 65-90, 65-93, 65-94, 70-56, 70-65, 70-66, 70-75, 70-76, 70-86, 70-88, 70-90, 72-85, 72-86, 72-93, 72-94, 80-65, 80-66, 80-75, 80-76, 80-88, 80-90, 82-85, 82-86, 82-93, 82-94, 85-55, 85-90, 88-85, 88-93, 88-94, 90-90, 95-55, 100-55, 100-90, 110-90, 115-90, 130-90, 140-90, 160-55, 160-90, 180-90, F100, F110, F115, F120, F130, F140, L60, L65, L75, L85, L95 / BRAUD : 1214, 1620, 1620S / LAVERDA : 3300, 3300AL, 3300R, 3400, 3400R, 3500, 3500R, 3550, 3550AL, 3550R, 3560AL, 3650, 3650R, 3750, 3750R, L517, L518, L520

87569486

567406
5112606



SCREW-FRONT WEIGHT

- Vis - Masse avant • Schraube - Frontgewichte
- Torillo - Delante Contrapesos • Vite - Anteriore zavorre
- Parafuso - Dianteiro contrapesos • Schroef - Frontgewichten
- Skrue - Frontvægt

35-66, 50-86, 55-46, 55-56, 55-66, 55-76, 55-86, 55-88, 55-90, 60-46, 60-56, 60-66, 60-76, 60-86, 60-88, 60-90, 60-93, 60-94, 62-86, 65-46, 65-56, 65-66, 65-88, 65-90, 65-93, 65-94, 70-56, 70-66, 70-76, 70-86, 70-88, 70-90, 72-86, 72-93, 72-94, 80-66, 80-76, 80-88, 80-90, 82-86, 82-93, 82-94, 85-90, 88-93, 88-94, 90-90, 100-90, 110-90, 115-90, 130-90, 140-90, 160-90, 180-90, L60, L65, L75, L85, L95, F100, F110, F115, F120, F130, F140

87569507

5124778

FIAT - FIAT AGRI - FIAT Trattori tractors



A series of horizontal dotted lines spanning the width of the page, intended for writing notes.