

ARJOHUNTLEIGH

GETINGE GROUP

Carendo

INSTRUCTIONS FOR USE



CE

WARNING

To avoid injury, always read this Instructions for Use and accompanied documents before using the product.



Mandatory to read the Instructions for Use

Design Policy and Copyright

® and ™ are trademarks belonging to the ArjoHuntleigh group of companies.

© ArjoHuntleigh AB 2014.

As our policy is one of continuous improvement, we reserve the right to modify designs without prior notice. The content of this publication may not be copied either whole or in part without the consent of ArjoHuntleigh AB.

Contents

Foreword	4
Intended Use	5
Safety Instructions	6
Preparations	7
Parts Designation	8
Product Description / Functions	10
Reclined Function	10
Lifting Function – High/Low	10
Care Raiser	10
Leg Support	10
Driving Handles	11
Manoeuvre Handles	11
Castors	11
Safety Belt	11
Hand Control	12
Back Pillow (Accessory)	12
Battery Charger	13
Battery	13
Seat Cushion	13
Emergency Lowering	14
Emergency Stop	14
Storage Net	14
Bedpan and Bedpan Holder	15
Independent Patients	16
Dependent Patients	17
Transfer to the Shower	20
Transfer to the Toilet	22
Home Care Use	24
Cleaning and Disinfection Instructions	26
Battery Instructions	28
Care and Preventive Maintenance	30
Troubleshooting	34
Technical Specifications	36
Labels	38
Approvals and List of Standards	40
Electromagnetic Compatibility	40
Parts and Accessories	42
ArjoHuntleigh Addresses	Last page

Foreword

Thank You for Purchasing ArjoHuntleigh Equipment.

Your *Carendo* shower and toilet chair is part of a series of quality products designed especially for hospitals, nursing homes and other health care use.

Please contact us if you have any questions about the operation or maintenance of your ArjoHuntleigh equipment.

Please Read these Instructions for Use Thoroughly!

Please read this *Instructions for Use (IFU)* in its entirety before using your *Carendo* shower and toilet chair. Information in this *IFU* is crucial to the proper operation and maintenance of the equipment. It will help protect your product and make sure that the equipment performs to your satisfaction. The information in this *IFU* is important for your safety and must be read and understood to help prevent possible injury.

Unauthorized modifications on any ArjoHuntleigh equipment may affect its safety. ArjoHuntleigh will not be held responsible for any accidents, incidents or lack of performance that occur as a result of any unauthorized modification to its products.

Report Unexpected Operations or Events

Contact your local ArjoHuntleigh representative if any unexpected operations or events occur. The contact information appear on the last page of this *IFU*.

Service and Support

A service routine must be performed on your *Carendo* shower and toilet chair every year by qualified personnel to make sure the safety and operating procedures of your product. See section *Care and Preventive Maintenance* on page 30.

If you require further information, please contact ArjoHuntleigh for comprehensive support and service programs to maximize the long-term safety, reliability and value of the product.

Contact your local ArjoHuntleigh representative for replacement parts. The contact information appear on the last page of this *IFU*.

Complementary Information

If a DVD accompanies this *IFU*, please note that the DVD does not replace the information in this *IFU*. The *IFU* contains additional important safety instructions.

Definitions in this *IFU*

WARNING

Means: Safety warning. Failure to understand and obey this warning may result in injury to you or to others.

CAUTION

Means: Failure to follow these instructions may cause damage to all or parts of the system or equipment.

NOTE

Means: This is important information for the correct use of this system or equipment.



Means: The name and address of the manufacturer.

Intended Use

This equipment must be used in accordance with these safety instructions. Anyone using the equipment must also have read and understood the instructions in this *Instructions for Use (IFU)*.

If there is anything you are not sure about, contact your ArjoHuntleigh representative.

This equipment is intended for assisted hygiene care, showering and toileting of adult residents in care environments similar to senior/assisted living, group home, special care, nursing homes, hospitals and home care. The equipment is intended for indoor use.

The Carendo must be used by appropriately trained caregivers with the adequate knowledge of the care environment, it's common practices and procedures, and in accordance with the guidelines in the *Instructions for Use (IFU)*.

Resident Assessment

We recommend that facilities establish regular assessment routines. Caregivers should assess each resident according to the following criteria prior to use:

- The residents weight should not exceed 136 kg/ 300 lbs.
- The resident should understand and respond to instructions to stay seated in an upright position.

If a resident does not meet these criteria an alternative lift shall be used.

Lifetime of the Equipment

The equipment must only be used for the purposes stated above.

The lifetime of this equipment is ten (10) years and the service life of the safety belt is two (2) years. Depending on the storage of the battery, the use frequency and the charging intervals, the service life of the battery is 2-5 years.

The lifetime and service life are stated providing that the preventive maintenance are being carried out in accordance with the instructions for care and maintenance in this *IFU*.

Depending on level of wear some equipment parts such as castors and hand control may need to be replaced during the equipment lifetime according to information in this *IFU*.

Safety Instructions

WARNING

To avoid explosion or fire, never use the equipment in oxygen rich environment, in presence of heat source or flammable anaesthetic gases.

WARNING

To avoid entrapment, make sure to keep the patient's hair, arms and feet close to the body and use designated grab supports during any movement.

WARNING

To avoid the device from tipping and the patient from falling, do not use the equipment on floor with recessed drains, holes or slopes exceeding a ratio of 1:50 (1.15°).

WARNING

To avoid falling, make sure that the patient is positioned in accordance with this IFU.

WARNING

To avoid falling during transfer, always make sure that the brakes are applied on all equipment being used.

WARNING

To avoid falling during patient transfer, always make sure that the brakes on the equipment receiving the patient are applied.

WARNING

To avoid entrapment of the patients or caregivers legs or feet, make sure that they are kept clear of all obstacles.

WARNING

To avoid the device in use from tipping, do not raise or lower other equipment close to it and be aware of stationary object when lowering.

NOTE

All materials used in this product complies with established biocompatibility standards and have been tested accordingly (ISO 10993).

NOTE

Do not lift the *Carendo* shower and toilet chair using the armrests; use the chassis. Only one function movement (e.g reclined function) can be done at a time. Pushing on more than one button at a time will stop all movements.

Preparations

Actions Before the First Use

(9 steps)

- 1 Visually check the package for damage. If the product looks damaged make a complaint to the transport agency.
- 2 The packaging should be recycled according to local regulations.
- 3 Check that all parts of the product are supplied. Compare with the product description in this *IFU*. If any part is missing or damaged - do NOT use the product.
- 4 Unpack the battery charger. Select and attach the adapter correctly suited to your power outlet. See *Battery charger IFU*.
- 5 Charge each battery for a minimum of 14 hours (Japan 3.5 hours).
- 6 Disinfect the product according to section *Cleaning and Disinfection Instructions on page 26*.
- 7 Prepare an area that is dry, with good ventilation and out of direct sunlight for storage of the *Carendo* shower and toilet chair.
- 8 Choose a designated area, where the Instructions for Use should be kept and is accessible at all times for the users.
- 9 Make sure to have a rescue plan in case of a patient emergency.

NOTE

If you have any questions, please contact your local ArjoHuntleigh representative for support and service. See contact information according to *ArjoHuntleigh Addresses on page 43*.

Action Before Every Use

(4 steps)

- 1 Check that all parts of the *Carendo* shower and toilet chair are in place. Compare to section *Parts Designation on page 8*.
- 2 Check accessories and parts for damage. If any part is missing or damaged - do NOT use the product.
- 3 **WARNING**
To prevent cross-contamination, always follow the disinfection instructions in this *Instructions for Use*.
- 4 Assess the patient whether the safety belt is needed.

Carendo Directions

The directions right or left and intended driving direction in this IFU are shown below.

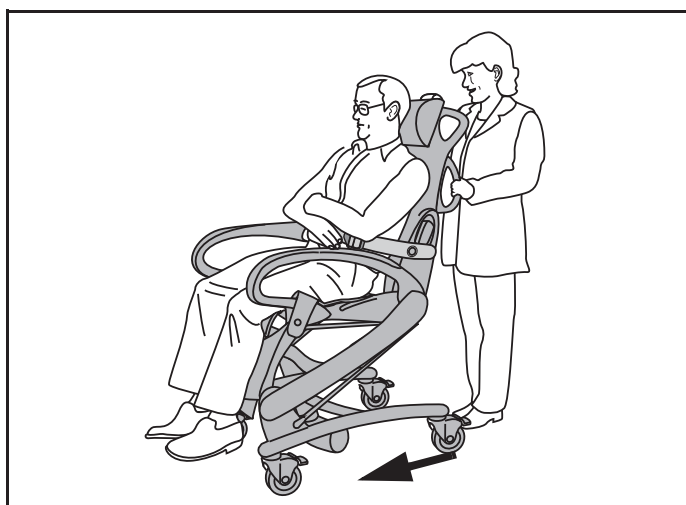
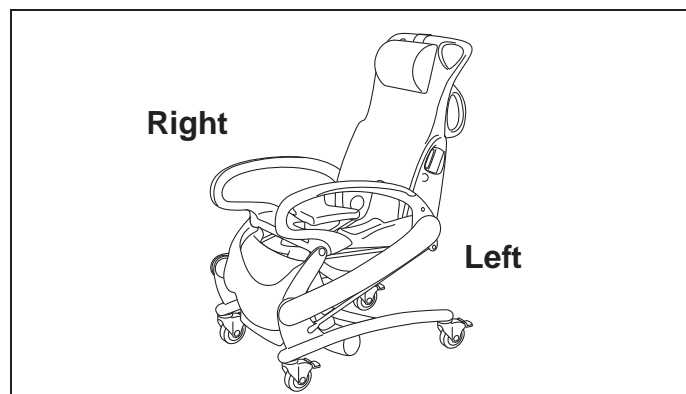

Parts Designation

- 1 Chassis
- 2 Care Raiser
- 3 Castors
- 4 Lifting frame
- 5 Backrest
- 6 Neck pillow
- 7 Transfer handles
- 8 Manoeuvring handles
- 9 Storage net
- 10 Safety belt
- 11 Seat
- 12 Leg support
- 13 Armrests
- 14 Hand control
- 15 Battery
- 16 Battery charger
- 17 Battery holder
- 18 Seat cushion
- 19 Bed pan holder (optional)
- 20 Bed pan (optional)
- 21 Back pillow (optional)
- 22 Emergency stop button
- 23 Emergency lowering button
- 24 Hand control connector



Applied part: Type B (Entire product)
protection against electric shock in
accordance with IEC 60601-1.

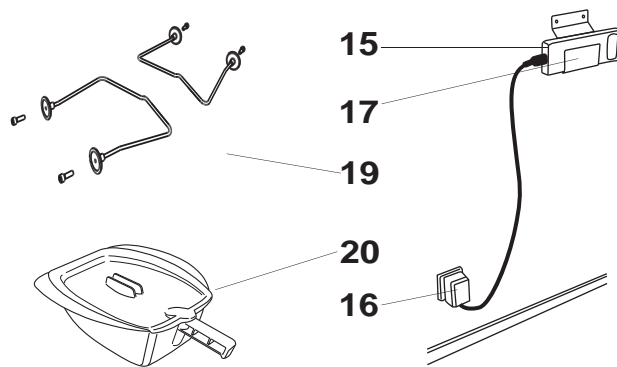
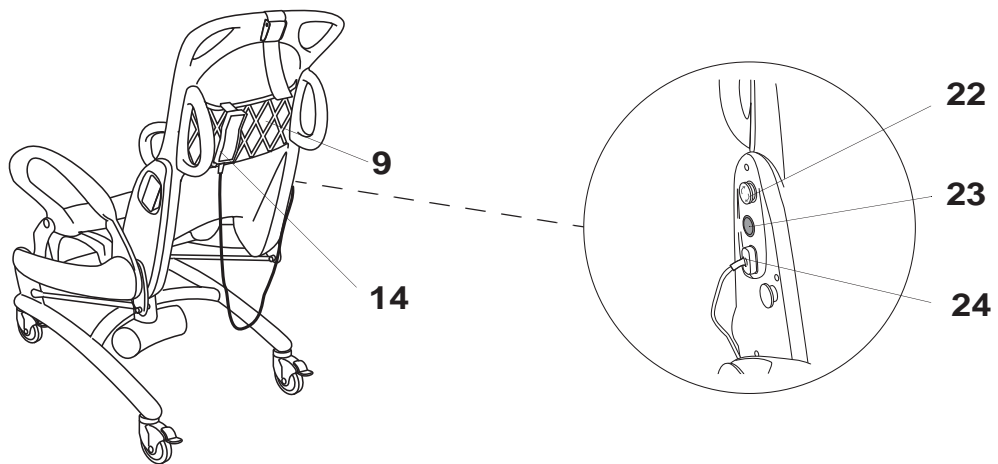
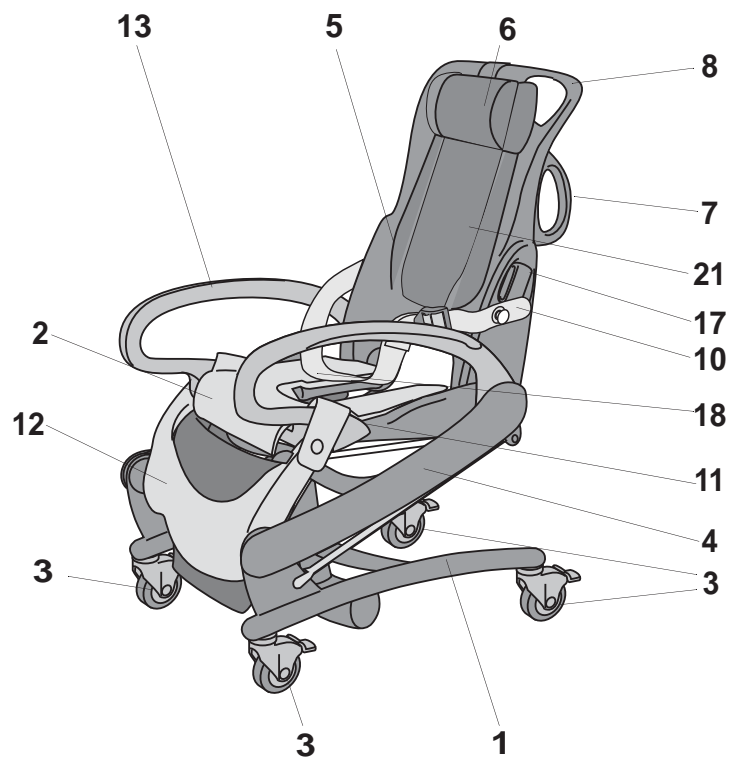

Product Description / Functions

Fig. 1

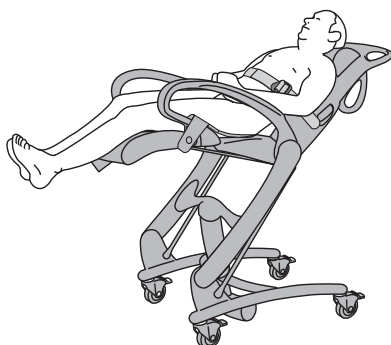

Reclined Function

A function which makes hygienic care of the patient easier.

From a sitting position, a reclined position can be achieved by means of turning gears which makes the backrest move in backwards and upright directions.

Corresponding to this movement the leg rest is moving up and down. (See Fig. 1)

Fig. 2



Lifting Function – High/Low

The patient can, in a sitting position, be transferred and the chair can be adjusted to a suitable height over the toilet.

The lifting/lowering movement is performed by a linear actuator driven by an electric motor. (See Fig. 2)

Fig. 3



Care Raiser

A function which makes undressing and changing of incontinence pads of the patient easier. (See Fig. 3)

From a sitting position, a raising of the posterior parts of the patient and at the same time a backwards movement of the backrest is activated. (See Fig. 4)

These movements are synchronized to each other.

WARNING

To avoid entrapment or pinching of genitals and skin, always use the seat cushion.

Fig. 4

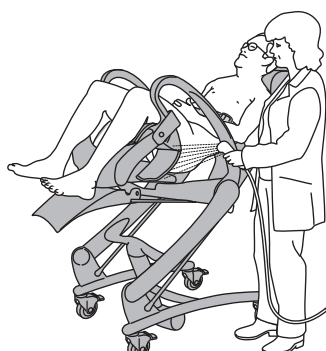

Leg Support

Supports the patient's legs, and also prevents the legs from getting jammed under the seat.

Moves forward when the chair is adjusted to the reclined position.

Fig. 1



Driving Handles

Driving handles on the backrest give correct driving position for the caregiver. (See Fig. 1)

Fig. 2

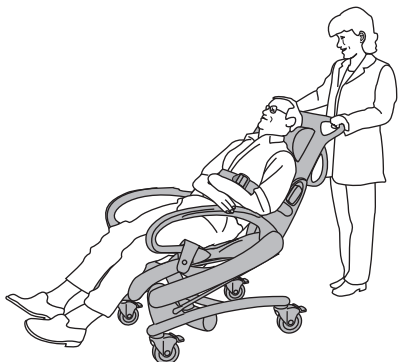

Manoeuvre Handles

The manoeuvring handles on the backrest help the caregiver to get the chair in the correct position over the toilet and in the shower. (See Fig. 2)

Fig. 3

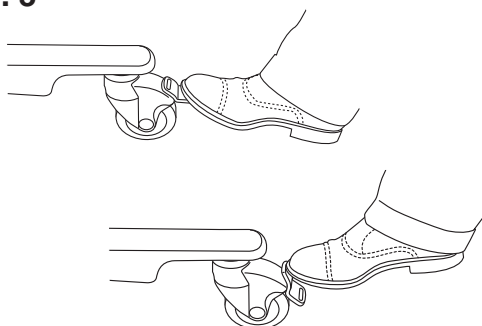

Castors

The *Carendo* shower and toilet chair is equipped with lockable castors.

The castors will brake by pressing the castor lock tab down with your foot (A). (See Fig. 3)

The castors are released by pressing up the centre tab (B). (See Fig. 3)

Fig. 4

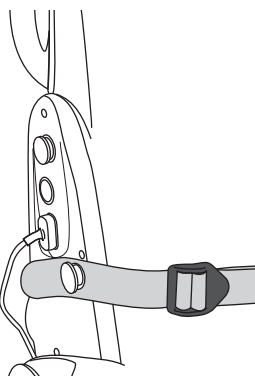

Safety Belt

WARNING

To prevent the patient from falling, make sure the safety belts are undamaged. If damaged, do NOT use the safety belts, replace with new ones before use.

Secure the patient with the safety belt if needed. The safety belt will secure the patient in the chair. Fasten at the knobs on either side of the backrest. Adjust the length by pulling the safety belt end by the buckle. Make sure the safety belt is close to the patients body.

When the safety belt is not in use don't let the safety belt hang over the floor. (See Fig. 4)

Fig. 1

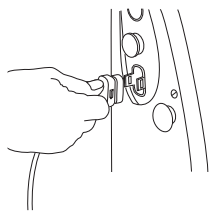

Hand Control

Connect the connector of the hand control on the right side of the backrest. (See Fig. 1)

Fig. 2

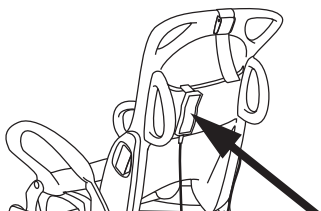

The hand control has a hook on the back, making it easy to attach it to various parts of the chair. (See Fig. 2)

Fig. 3

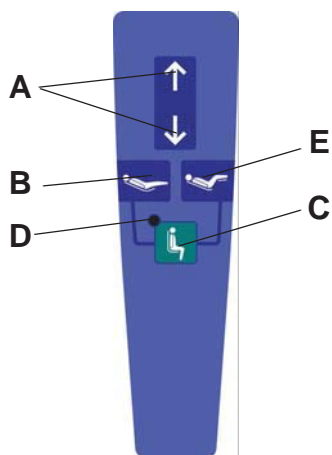

Hand control

(See Fig.3)

- Arrow pointing upwards/downwards for raising or lowering (A).
- Reclined (B) and sitting position (C).
- Green LED, flashing when the Care Raiser is possible to activate (D).
- Care Raiser (E) and sitting position (C).

NOTE

A buzzing tone will be heard and the green LED is flashing when sitting position is reached.

Fig. 4

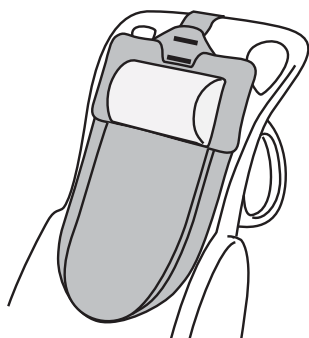

NOTE

Care raising can only be activated when the green LED is flashing.

Fig. 5

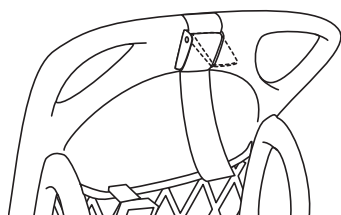

Back Pillow (Accessory)

An additional pillow to support the back.

An integrated easy glide function when the chair is adjusted to reclined position. Easy to adjust according to the length of the patient. (See Fig. 4-5)

See separate instructions *accompanying the product*.

Fig. 1

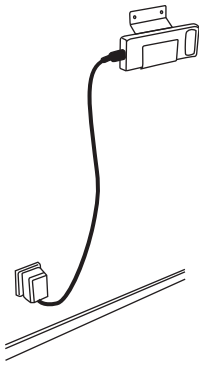

Battery Charger

The battery holder should be attached to a suitable wall and the charger connected to a properly grounded wall socket. (See Fig. 1)

NOTE

The battery charger is designed for use in a dry location and should not be installed in bathrooms, etc.

See *NEA 8000 Battery Charger IFU*.

Fig. 2

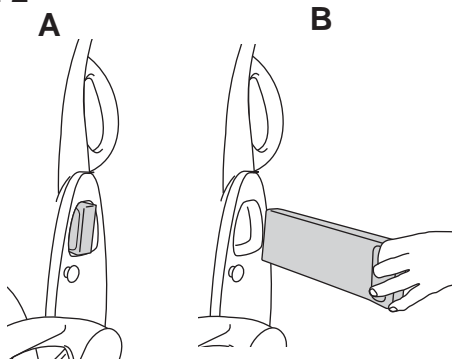

Battery

The battery is placed at the left side of the chair. (See Fig. 2 A-B)

NOTE

See to that the rounded ridge of the battery is turned upwards.

Fig. 3

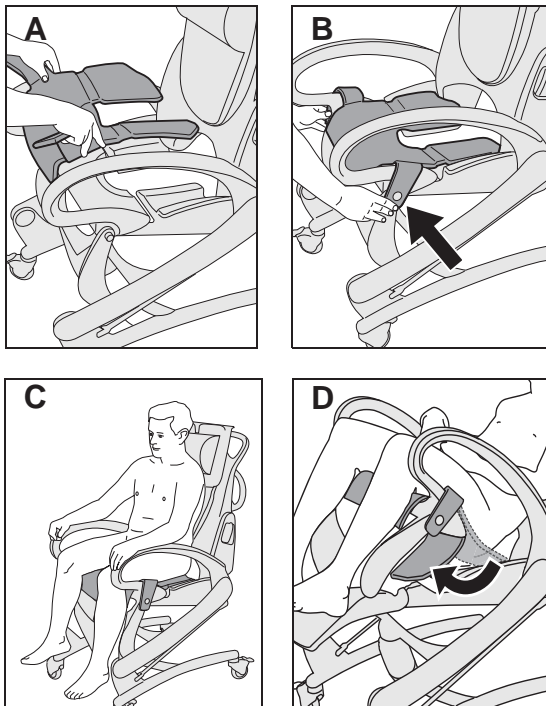

Seat Cushion

A seat cushion that provides comfort and protection against pinching. (See Fig. 3 A-D)

Fig. 1

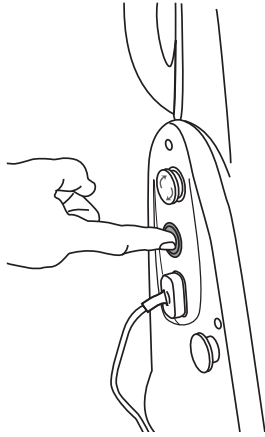

Emergency Lowering

In case of electrical malfunction, the chair can be lowered by pushing the green button. (See Fig. 1)

NOTE

This function should only be used in emergency.

Fig. 2

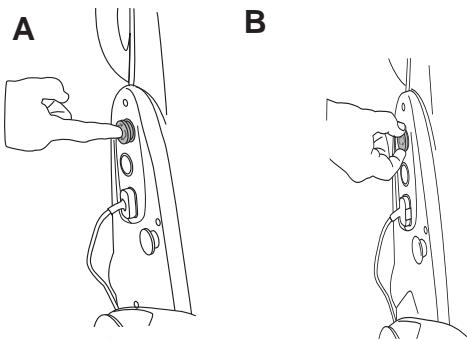

Emergency Stop

In any case of emergency, all functions can be stopped by pushing the red button (A).

To reset this function, turn the red button clockwise (B). (See Fig. 2)

Fig. 3

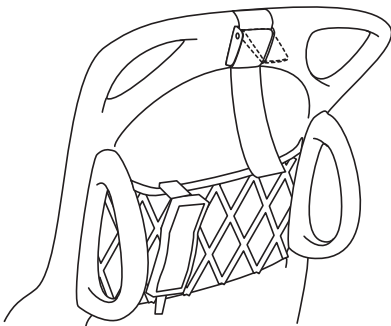

Storage Net

A net on the backside of the backrest where shampoo, soap, incontinence pads etc. can be kept. (See Fig. 3)

Fig. 1

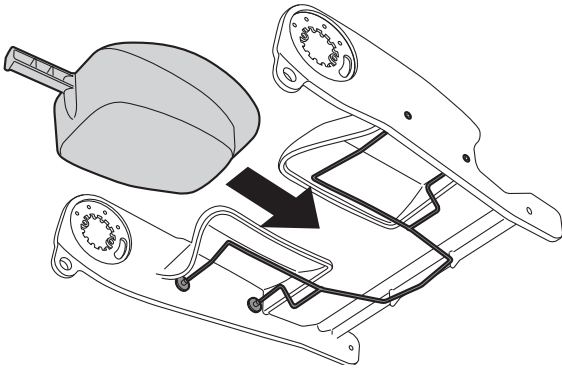

Bedpan and Bedpan Holder

WARNING

To avoid entrapment or pinching of genitals, make sure there is enough clearance during movement over the tub edge, toilet, bedpan or other furniture.

A bedpan holder can be mounted under the seat. (See Fig. 1-2)
See separate instruction *Bedpan Holder*.

Fig. 2

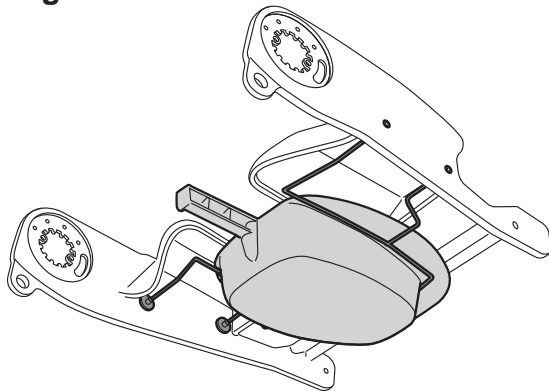

Independent Patients

WARNING

To avoid entrapment or pinching of genitals and skin, always use the seat cushion.

From a standing position or using a walking frame (5 steps)

- 1 Place the *Carendo* shower and toilet chair and adjust the height so that the edge of the seat touches the back of the patient's knees.
- 2 Activate the brake.
- 3 Let the patient hold on the armrest so that he/she can lean on it. (See Fig. 1)
- 4 Help the patient to sit down.
- 5 Raise the *Carendo* shower and toilet chair to a height which is convenient for moving the patient.

From a wheelchair (3 steps)

For the patient to be able to move from a wheelchair without lifting aids, the individual must be strong enough to move himself/herself sideways and/or be able to stand up.

- 1 Apply the castor brakes on the wheelchair.
- 2 Lower the *Carendo* shower and toilet chair so that its seat is at the same level as the wheelchair seat, or as close as possible.
- 3 Apply the brakes on the *Carendo* shower and toilet chair.

The patient can now move himself/herself from the wheelchair to the *Carendo* shower and toilet chair by placing his/her hands on the hand rest of the *Carendo* shower and toilet chair. (See Fig. 2)

From a sitting to a standing position (3 steps)

- 1 Lower the *Carendo* shower and toilet chair until the patient's feet are in contact with the floor.
- 2 Activate the brake.
- 3 Help the patient to stand up. (See Fig. 3)

Fig. 1



Fig. 2



Fig. 3



Dependent Patients

WARNING

To avoid entrapment or pinching of genitals and skin, always use the seat cushion.

Fig. 1



From the wheelchair/chair to the Carendo shower and toilet chair with a passive lift

(5 steps)

Follow the separate operating instructions regarding the passive lift.

- 1 Apply the brakes on the *Carendo* shower and toilet chair.
- 2 Place the passive lift with the patient as close as possible to the *Carendo* shower and toilet chair. Position the patient in the sling directly over the seat of the *Carendo* shower and toilet chair. (See Fig. 1)
- 3 Raise the *Carendo* shower and toilet chair until the seat reaches the patient and there is slack in the sling straps. Unhook and remove the sling. (See Fig. 2)
- 4 Secure the patient with the safety belt if needed.
- 5 Transfer the patient to shower or toilet.

Fig. 2



Fig. 1

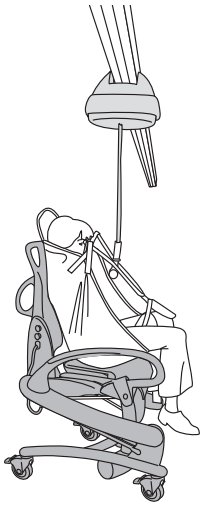

From the bed to the Carendo shower and toilet chair with a ceiling lift

(5 steps)

Follow the separate operating instructions regarding the ceiling lift.

- 1 Place the *Carendo* shower and toilet chair under the ceiling lift with the patient in the sling. (See Fig. 1)
- 2 Apply the brakes on the *Carendo* shower and toilet chair.
- 3 Lower the sling with the patient until he/she reaches the seat of the *Carendo* shower and toilet chair. Unhook and remove the sling.
- 4 Secure the patient with the safety belt if needed.
- 5 Transfer the patient to shower or toilet.

Fig. 2



From the wheelchair/chair to the Carendo shower and toilet chair with an active lift

(6 steps)

Follow the separate operating instructions regarding the active lift.

- 1 Apply the brakes on the *Carendo* shower and toilet chair.
- 2 Place the active lift with the patient as close as possible to the *Carendo* shower and toilet chair. Position the patient directly over the seat of the *Carendo* shower and toilet chair. (See Fig. 2)
- 3 Apply the brakes on the active lift.
- 4 Lower the patient till he/she reaches the seat of the *Carendo* shower and toilet chair. Unhook sling and remove, if present. (See Fig. 3)
- 5 Secure the patient with the safety belt if needed.
- 6 Transfer the patient to shower or toilet.

Fig. 3



Intentionally left blank

Transfer to the Shower

Fig. 1



Fig. 2



Fig. 3

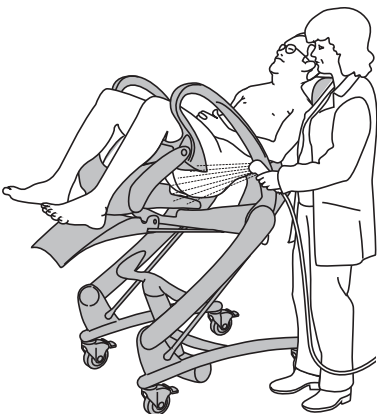

(18 steps)

- 1 Place the *Carendo* shower and toilet chair with the patient in the shower room.
- 2 Apply the castor brakes.
- 3 Raise the chair in a sitting position to a comfortable height for the caregiver.
- 4 Activate the Care Raiser on the hand control.
- 5 Pull down the trousers to the knees. (See Fig. 1)
If the patient uses incontinence pads, remove them by pulling from behind. (See Fig. 2)
- 6 Raise the *Carendo* shower and toilet chair to a sitting position with the hand control.

WARNING

To avoid entrapment, make sure to keep the patient's hair, arms and feet close to the body and use designated grab supports during any movement.

- 7 Undress the patient.
- 8 Activate the reclined position on the hand control.

WARNING

To avoid entrapment or pinching of genitals, make sure there is enough clearance during movement over the tub edge, toilet, bedpan or other furniture.

- 9 Wash and shower the patient in this position. (See Fig. 3)

Continue with the steps on the next page.

Fig. 4

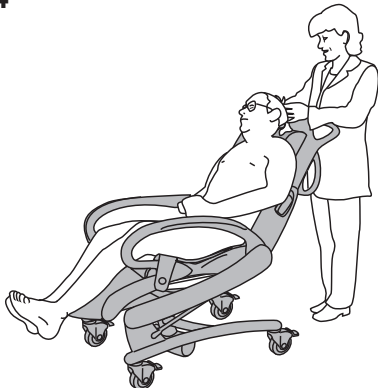

- 10 Adjust the height of the chair for a correct working posture during hair wash and pedicure. (See Fig. 4-5)
- 11 Dry the patient with a towel.
- 12 Adjust the *Carendo* shower and toilet chair to a sitting position.
- 13 Dry the back of the patient.

Fig. 5

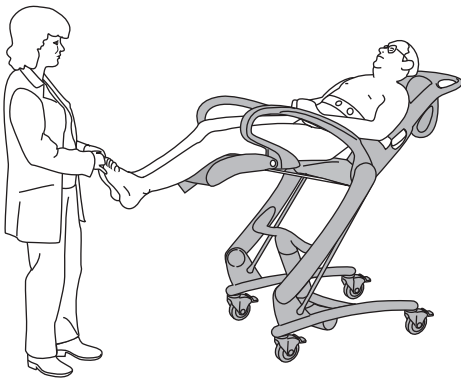
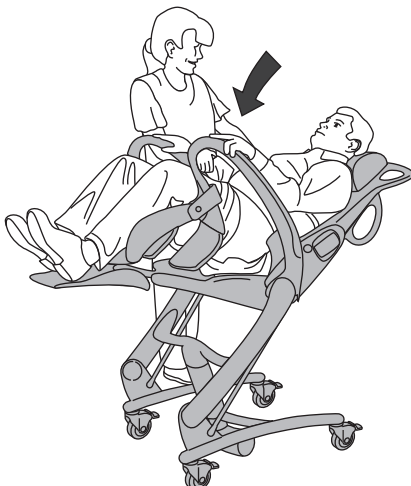

Fig. 6



- 14 Dress the upper part of the body and pull up the trousers to the knees. (See Fig. 6)
- 15 Activate the Care Raiser on the hand control.

Fig. 7



- 16 Put on the incontinence pads, if used, and pull up the trousers completely. (See Fig. 7)
- 17 Adjust the *Carendo* shower and toilet chair back to a sitting position and lower the chair. Secure the patient with the safety belt, if needed.

WARNING

To avoid entrapment, make sure to keep the patient's hair, arms and feet close to the body and use designated grab supports during any movement.

- 18 Release the brakes and start the transfer.

Transfer to the Toilet

(13 steps)

The *Carendo* shower and toilet chair can be used regardless of whether the toilet is attached to the wall or to the floor.

See the measurements below on matching toilet chairs:

Fig. 1



Fig. 2



Fig. 3

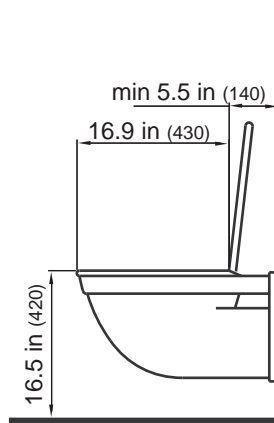

max width : 15.3 in (390mm)

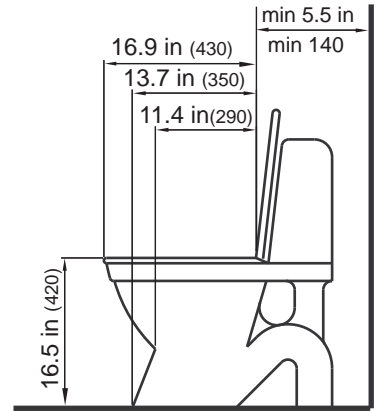

max width : 15.3 in (390mm)

- 1 Place the *Carendo* shower and toilet chair with the patient close to the toilet.
- 2 Raise the chair in a sitting position to a comfortable height for the caregiver.
- 3 Activate the Care Raiser on the hand control.
- 4 Pull down the trousers to the knees. (See Fig. 1)
If the patient uses incontinence pads, remove them by pulling from behind. (See Fig. 2)
- 5 Raise to a sitting position on the hand control.

WARNING

To avoid entrapment or pinching of genitals, make sure there is enough clearance during movement over the tub edge, toilet, bedpan or other furniture.

- 6 Position the *Carendo* shower and toilet chair directly over the toilet bowl. Lower the chair and apply the castor brakes. (See Fig. 3)

Continue with the steps on the next page.

Fig. 4

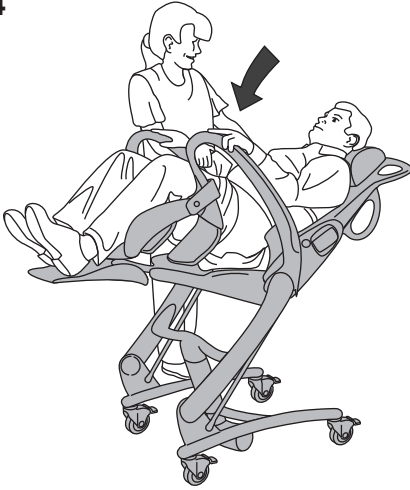

- 7 When the patient is ready, release the brakes and remove the chair from the toilet.
- 8 Raise the *Carendo* shower and toilet chair and clean the patient.
- 9 Apply the castor brakes again.
- 10 Activate the Care Raiser on the hand control. (See Fig. 4)

Fig. 5



- 11 Put on the incontinence pads, if used, and pull up the trousers completely. (See Fig. 5)
- 12 Adjust the *Carendo* shower and toilet chair back to a sitting position and lower the chair.

WARNING

To avoid entrapment, make sure to keep the patient's hair, arms and feet close to the body and use designated grab supports during any movement.

- 13 Release the brakes and start the transfer.

Home Care Use

For Distributors and Renters

When transporting the *Carendo* shower and toilet chair to the customer with a van:

- Make sure the lift is properly secured during transport.
- Avoid manoeuvring the *Carendo* shower and toilet chair in dirty ground when transporting it to and from the van.
- No person is allowed to sit in the product during transport of the product in vehicles.

When delivering the *Carendo* shower and toilet chair make sure that:

- You read this *IFU* together with the receiver (including relatives and caregivers).
- Show the features and intended usage described in the *IFU* with help of the real product.
- The user has understood the cleaning and disinfection instructions.
- Read all the warnings to the receiver.
- The environment fulfils all the requirements described in this *IFU*.

Cleaning and disinfection:

- Make sure that the cleaning and disinfection procedure described in this *IFU* always is carried out before the product reaches a new user.
- Make sure that the cleaning and disinfection procedure described in this *IFU* always is carried out before and after any type of service procedure.

Using the *Carendo*

Before using the *Carendo* shower and toilet chair in home environment make sure that:
(See Fig. 1-3)

WARNING

To avoid the device from tipping and the patient from falling, do not use the equipment on floor with recessed drains, holes or slopes exceeding a ratio of 1:50 (1.15°).

- All caregivers, including relatives, have read and understood the instructions in this *IFU*.
- All carpets and rugs in the environment are removed.
- All thresholds in the environment are removed.
- All stairs and edges have a fence and safety gate to prevent the *Carendo* shower and toilet chair from rolling down.
- There is room enough in the environment for use of the *Carendo* shower and toilet chair.

During Storage of the *Carendo* shower and toilet chair make sure that:

WARNING

To avoid strangulation, make sure to never leave children unattended near the equipment.

- No children can access the hygiene chair /shower and toilet chair.
- No pets can come in contact with the *Carendo* shower and toilet chair.
- The storage environment fulfils the requirements specified according to section *Technical Specifications* on page 36.

Fig. 1

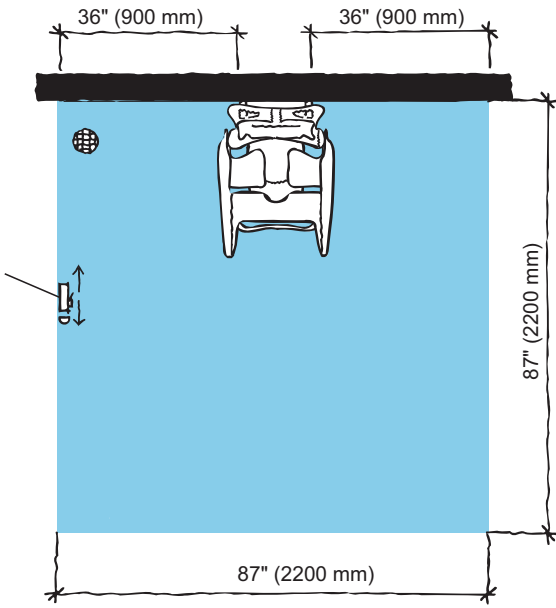

Fig. 2

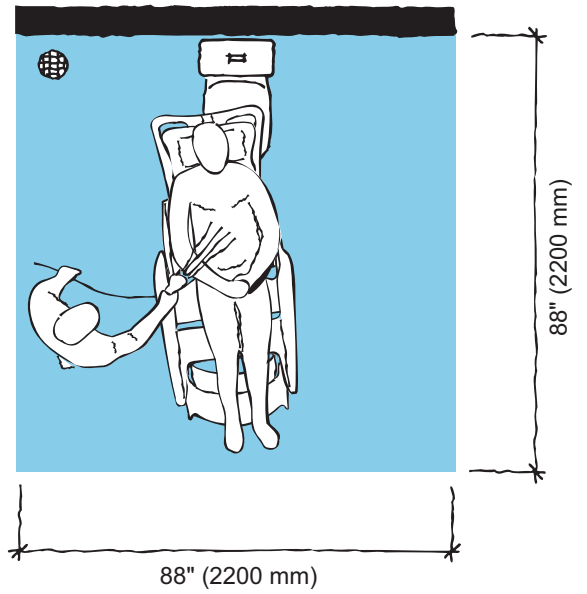
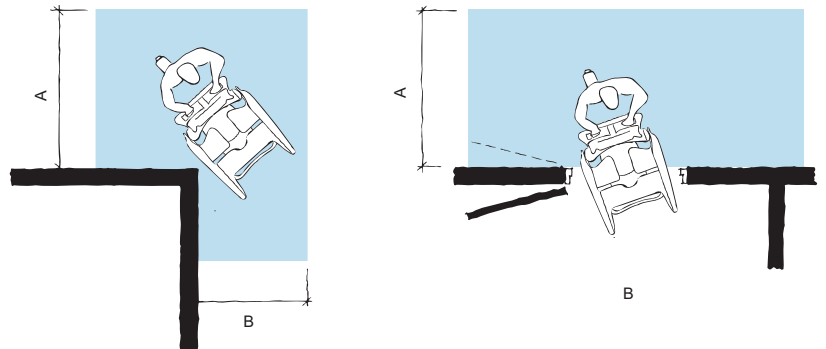
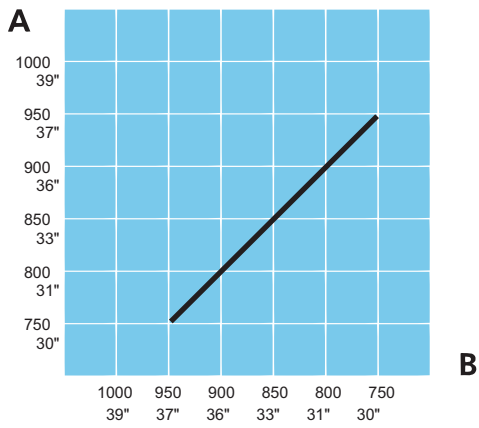

Fig. 3



Cleaning and Disinfection Instructions

Only use ArjoHuntleigh branded disinfectant cleansers (e.g. Arjo Clean™).

If you have any questions regarding disinfecting the *Carendo* shower and toilet chair, or wish to order disinfectant, contact ArjoHuntleigh Customer Service. See section *Parts and Accessories on page 42*.

Make sure to have the Material Safety Data Sheets (MSDS) available for the disinfectant being used.

WARNING

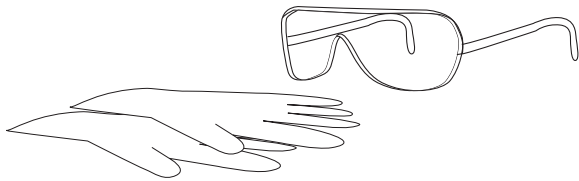

To avoid eye and skin damage, always use protective glasses and gloves. If contact occurs rinse with plenty of water. If eyes or skin becomes irritated, contact a physician. Always read the IFU and the Material Safety Data Sheet (MSDS) of the disinfectant.

WARNING

To prevent cross-contamination, always follow the disinfection instructions in this *Instructions for Use*.

WARNING

To avoid eye or skin irritation, never disinfect in the presence of a patient.

CAUTION

To avoid damage on the equipment only use ArjoHuntleigh branded disinfectants.

Allowed Disinfectants

- Arjo Clean
- Arjo General Purpose Disinfectant
- Arjo Disinfectant Cleanser IV
- Arjo All Purpose Disinfectant
- Arjo CenKleen IV

Accessories for Disinfecting the Carendo

- Protective gloves
- Protective glasses
- Spray bottle with disinfectant or disinfection spray handle with disinfectant
- Spray bottle with water or shower handle with water
- Cloths - wet and dry
- Disposable towels
- Soft bristle brush
- Long handled soft bristled brush

Always Follow these 13 Steps for Cleaning and Disinfection

If an ArjoHuntleigh shower panel will be used, see respective *IFU*.

Removing visual residue (step 1-2 of 13)

- 1 Detach pillow, cushions and safety belt.
- 2 Clean
 - the *Carendo* shower and toilet chair (start from the top and move downwards)
 - all removed partsfrom visible residue using a cloth soaked in water or if more suitable by spraying/showering water using a brush and/or wipe with a clean cloth.

Cleaning (step 3-7 of 13)

- 3 Put on protective gloves and eye wear.
- 4 Spray disinfectant on
 - the *Carendo* shower and toilet chair.
 - all removed partsUse a brush soaked in disinfectant and scrub thoroughly, especially on handles and hand control.
- 5 Rinse thoroughly with water (approx. 25 °C (77 °F)) until all the disinfectant has been removed.
- 6 Soak a cloth in disinfectant and wipe all other areas such as chassis.
- 7 Wet a new cloth with water and remove all traces of disinfectant on other areas. The cloth must occasionally be rinsed in running water when removing disinfectant.

Disinfection (step 8-13 of 13)

- 8 Spray disinfectant on:
 - the *Carendo* shower and toilet chair.
 - all removed parts
- 9 Soak a cloth in disinfectant and wipe all other areas such as chassis.
- 10 Allow a disinfection time according to the instructions on the disinfectant bottle label.
- 11 Spray or shower water (approx. 25 °C (77 °F)) and wipe with a clean cloth to remove all traces of the disinfectant. The cloth should occasionally be rinsed in running water during removal of disinfectant.
- 12 If disinfectant cannot be removed, spray water on the affected part and wipe off with disposable towels. Repeat until all of the disinfectant has been removed.
- 13 Let all parts dry.

NOTE
The cushion and the foam inside of it is water repellent.

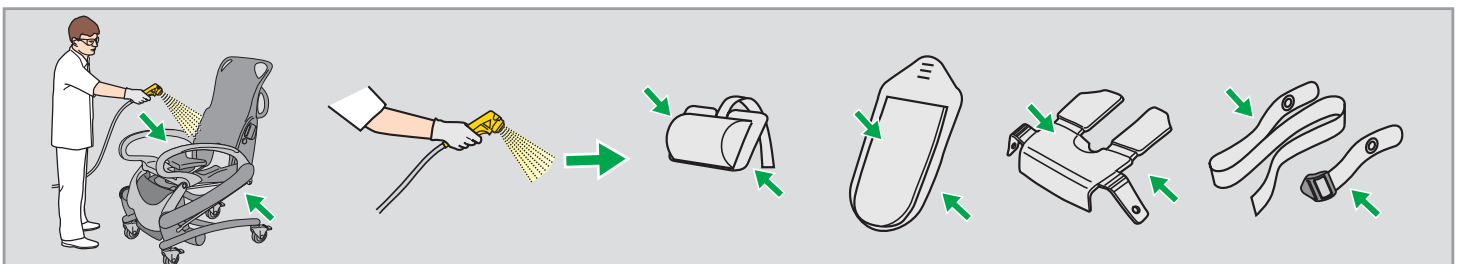

Battery Instructions

WARNING

To avoid bodily injury, do NOT crush, puncture, open, dismantle or otherwise mechanically interfere with the battery.

- Should the battery casing crack and cause contents to come in contact with skin or clothing, rinse immediately with plenty of water.
- If contents come in contact with the eyes, rinse immediately with plenty of water and seek medical attention.

Inhalation of the contents can cause respiratory irritation. Provide fresh air and medical attention.

CAUTION

To avoid the battery from overheating and exploding, do NOT expose the battery to flames or excessive heat.

- Be careful not to drop the battery.
- Contact the appropriate local authority for advice when disposing of batteries.
- Check label on the battery.

Storage of Batteries

- The battery is delivered charged but we recommend you recharge the battery when received due to a slow self discharge.
- This battery will slowly self discharge when not used.
- A battery not in use should be stored in a temperature range of -0 °C (32 °F) to + 30 °C (86 °F).
- For maximum battery performance do not store the battery above 50 °C (122 °F).

Charging Intervals

- To prolong the life of the battery, charge it at regular intervals, i.e. every night.
- If the *Carendo* shower and toilet chair is used frequently, it is recommended to use two batteries, one in operation and one as a stand-by in the charger.
- It is recommended that a battery not in use is left in the charger. There is no risk of overcharging the battery.

Battery Service Life

Make sure to always have two well functional batteries, one to use and one in storage.

If using a freshly charged battery and the battery indicator starts to flash and sound after only a few activities are carried out, it is time to order a new battery.

Low Charge Warning

A buzzer sound will go off when the battery reaches a low charge. The battery should then be recharged as soon as possible.

Installation of Charger

See *NEA 8000 Battery Charger IFU*.

How to Change the Battery

See *NEA 8000 Battery Charger IFU*.

Intentionally left blank

Care and Preventive Maintenance

Caregiver Obligations

The *Carendo* shower and toilet chair is subject to wear and tear, and the following actions must be performed when specified to make sure that the product remains within its original manufacturing specification.

WARNING

To avoid malfunction resulting in injury, make sure to conduct regular inspections and follow the recommended maintenance schedule. In some cases due to heavy use of the product and exposure to aggressive environment more frequent inspections should be carried out. Local regulations and standards may be more stringent than the recommended maintenance schedule.

PREVENTIVE MAINTENANCE SCHEDULE Carendo shower and toilet chair

CAREGIVER OBLIGATIONS Action/ Check	Every USE	Every WEEK	Every 6 MONTHS	Every 2:nd YEAR
Clean/Disinfect	X			
Visually check safety belt		X		
Visually check all exposed parts		X		
Visually check mechanical attachments		X		
Check hand control and cable		X		
Check/clean castors		X		
Check cushions/pillows		X		
Visually check battery charger and battery		X		
Lubricate locking pins			X	
Replace the safety belt				X

WARNING

To avoid injury to both patient and caregiver, never modify the equipment or use incompatible parts.

Caregiver Obligations

Caregiver obligations shall be carried out by personnel with sufficient *Carendo* knowledge following the instructions in this *IFU*.

Every day

- **Disinfect.** The *Carendo* shower and toilet chair has to be disinfected immediately after every use. ArjoHuntleigh disinfectants and shampoos should be used in **recommended concentrations**. See section *Cleaning and Disinfection Instructions* on page 26.

Every week

- **Visually check the safety belt.** Check the complete length for fraying, cuts, crack, tears, that no inner fabric is showing and that no other damage is visible. If the safety belt is found damaged, replace it. (See Fig. 1)
- **Visually check all exposed parts,** especially where personal contact is made by either the patient or caregiver. Make sure no cracks or sharp edges have developed that could cause the patient or user injury or that has become unhygienic. Replace damaged parts.
- **Visually check mechanical attachments:** Visually check that all screws and nuts are tightened and that there are no gaps - contact your local ArjoHuntleigh representative if defects are found. (See Fig.2)
- **Check hand control and cable:** Visually check the condition of the hand control and its cable if it is cut or damaged. Also check the emergency stop, see product functions. Contact your local ArjoHuntleigh representative if defects are found. (See Fig. 3)

Fig. 1

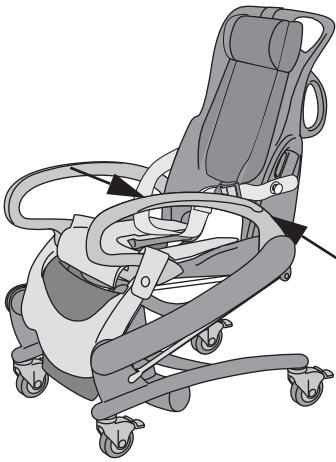

Fig. 2

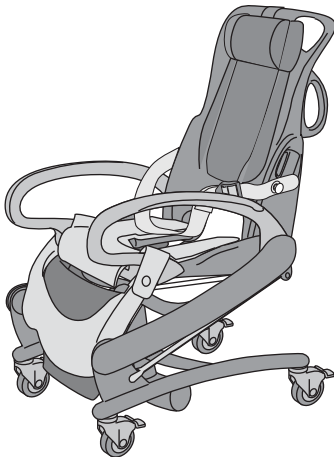

Fig. 3

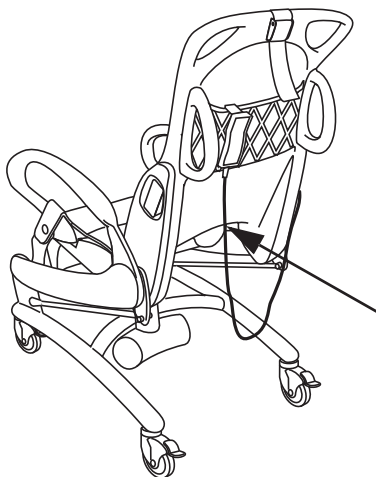
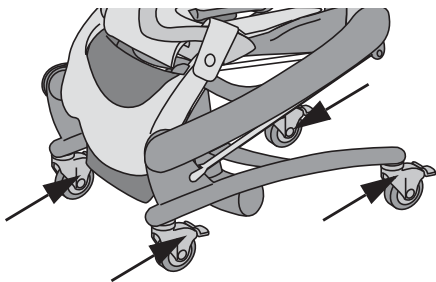
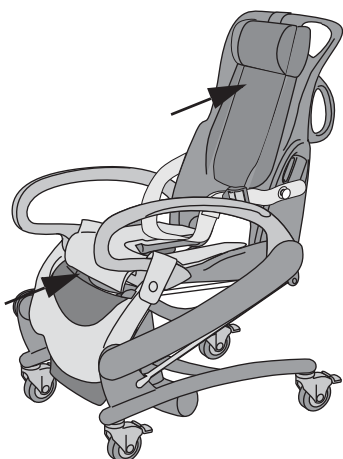

Fig. 4



- **Check that the castors are properly fixed and are rolling and swivelling freely**, (the function can be affected by soap, hair, dust and chemicals from floor cleaning). If not, contact your local ArjoHuntleigh representative. **(See Fig. 4)**

Fig. 5



- **Check the cushions/pillows** to make sure there are no cracks or tears that would allow water to get into the filling. If there is such damage, replace the cushions/pillows. **(See Fig. 5)**

Fig. 6

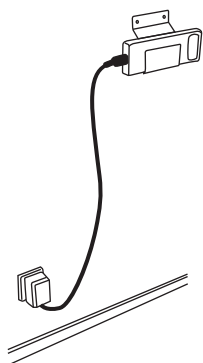

- **Visually check the condition of the battery charger, its cable and the battery**. Withdraw immediately and replace if damaged. **(See Fig. 6)**

Fig. 7



Every sixth months

Lubricate the locking pins. Use grease Wekem WS267 (can be purchased from ArjoHuntleigh). **(See Fig. 7)**

Yearly

The *Carendo* shower and toilet chair has to be serviced according to the table *QUALIFIED PERSONNEL Action/Check* on page 33.

WARNING

To avoid injury and/or unsafe product, the maintenance activities must be carried out at the correct frequency by qualified personnel using correct tools, parts and knowledge of procedure. Qualified personnel must have documented training in maintenance of this device.

QUALIFIED PERSONNEL Action/Check	Every YEAR
Lubricate bearings	X
Check function of emergency lowering	X
Check the safety stop function	X
Perform a safe working load test, (local requirements)	X
Check all vital parts for corrosion/damage	X
Perform full feature functionality test	X
Check mechanical attachments	X
Check that the latest updates have been implemented	X
Check battery	X
Inspect castors	X

NOTE

All checkpoints in the table *CAREGIVER OBLIGATIONS Action/Check on page 30* are to be checked when performing the checkpoints in the table *QUALIFIED PERSONNEL Action/Check on page 33*.

Troubleshooting

NOTE

If the product does not work as intended, immediately contact your local ArjoHuntleigh representative for support.

PROBLEM	ACTION
It is only possible to lower the lift.	The lifting device of this equipment is equipped with a safety nut. If the safety nut will be activated it will only be possible to lower the equipment into a safe position. In case of this scenario stop using the equipment and contact qualified personnel for repair of the equipment.
ALARMS	ACTION
A beeping sound is heard as the hygiene chair is begin raised.	<p>The battery needs charging. Complete the patient transferring progress and change to a fully charged battery.</p> <div data-bbox="742 875 1501 1003" style="border: 1px solid black; padding: 5px;"> <p>WARNING To avoid injury, make sure that the patient is not left unattended at any time.</p> </div>
Only a few activities are carried out before the battery indicator will flash and sound.	<p>Replace the battery with a fully charged one.</p> <p>If using a freshly charged battery and the battery indicator starts to flash and sound after only a few activities are carried out, it is time to order a new battery.</p>

Intentionally left blank

Technical Specifications

Carendo, Lift and Shower Chair Model BIB2000-01	
Safe Working Load (SWL) (Maximum total load)	136 kg (300 lbs)
Weight	65 kg (143 lbs)
Maximum total weight (lift + patient)	200 kg (441 lbs)
Chassis, maximum width	640 mm (25 1/4")
Width between legs	508 mm (20")
Clearance under chassis	35 mm (1 3/8")
Chassis, maximum length	865 mm (34")
Turning area	Ø960 mm (37 3/4")
Lifting stroke range (seat)	530 mm (20 7/8")
Supply voltage	24 V DC
Maximum power	150 VA
Battery	NiMH; ArjoHuntleigh NEA 0100
Battery charger	NEA 8000
Colors	blue/grey
Operating forces of control	2.23 N
Operating forces of brakes	115 N
Degree of protection	IPX4 IP: Ingress Protection X: The protection against contact and ingress of objects is not specified for this product. 4: Water splashing against the product from any direction does not effect safety or essential performance
Degree of protection - Hand control	IP X7 IP: Ingress Protection X: The protection against contact and ingress of objects is not specified for this product. 7: Immersion up to 1 m of the product does not effect safety or essential performance
Medical equipment	type B 
Sound level	<58 dB
Mode of operation	ED maximum 10%; Maximum 2 minutes ON; Minimum 18 minutes OFF
Pollution Degree	2

Carendo, Positions	Maximum length, mm (inches)	Width, mm (inches)	Maximum height, mm (inches)	Seat height, mm (inches)
Sitting, lowest position	875 (34 1/2")	640 (25 1/4")	1220 (48")	510 (20")
Sitting, highest position	880 (34 5/8")	640 (25 1/4")	1550 (61")	1040 (41")
Reclined, lowest position	1395 (54 7/8")	640 (25 1/4")	1020 (40 1/8")	510 (20")
Reclined, highest position	1510 (59 1/2")	640 (25 1/4")	1225 (48 1/4")	1050 (41 3/8")
Care Raise, lowest position	1390 (54 3/4")	640 (25 1/4")	1020 (40 1/8")	765 (30 1/4")
Care Raise, highest position	1510 (59 1/2")	640 (25 1/4")	1490 (58 5/8")	1260 (49 5/8")

Allowed Combination	
The <i>Carendo</i> integrate with the following ArjoHuntleigh products	Sara Lite, Sara Plus, Sara 3000 Maxi Twin, Maxi Move, Maxi Sky
No other combinations are allowed	

Recycling (The device should be recycled according to national regulations.)	
Battery	NiMH. Recyclable. Not for disposal. Environment danger
Package	Wood and corrugated cardboard, recyclable
The Lift and Charger	Electric, steel and plastic parts shall be separated and recycled according to (WEEE).

Operating, Transport and Storage	
Ambient temperature range	+10 °C - +40 °C (+50 °F - +104 °F) Operation -20 °C to +70 °C (-4 °F to +158 °F) Transport -20 °C to +70 °C (-4 °F to +158 °F) Storage
Relative humidity range	30% - 75% Operation 10% to 80% including condensation Transport and Storage
Atmospheric pressure range	800 - 1060 hPa Operation 500 - 1100 hPa Transport 500 - 1100 hPa Storage

Disposal of the Carendo	
Lift	The device is marked with the WEEE symbol to indicate that it is electronic equipment covered by the Directive 2002/96/EC on waste electrical and electronic equipment. In European countries the crossed out wheeled-bin WEEE symbol reminds you that all the electrical and electronic products, batteries and accumulators must be taken to separate collection at end of their working life. This requirement applies in the European Union. Do not dispose these products as unsorted municipal waste. You can return your device and accessories to ArjoHuntleigh or you can contact your local authorities for advice on disposal.



Labels



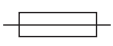

Label explanation

Attention Label	Important user information for correct use.
Approval Label	States approvals for the current product.
Battery Label	States safety and environmental information for the battery.
Data Label	States technical performance and requirements, e.g. Input Power, Input Voltage and maximum Patient Weight etc.
Emergency Lowering Label	States emergency information, see section <i>Emergency Lowering on page 14</i> .
Identification Label	States the product identification, serial number and year and month of manufacturing. For example, 1402XXXXX where “14” states manufacturing year, “02” states manufacturing month and “XXXXX” states serial number.

Symbol explanation

SWL	Safe Working Load
	Lifting stroke 550 mm (21 5/8")
24V DC	Supply voltage
MAX: 150VA	Maximum power, high-low 150 VA Maximum power, reclining 150 VA
	Fuse F1 - T8AL 250 V Fuse F2 - T6.3AL 250 V Fuse F3 - T8AL 250 V
IP X4	Protection class - Protection against splashing water.
ED max 10%	Mode of operation for Hi/Lo function: ED maximum 10%; Maximum 2 minutes ON; Minimum 18 minutes OFF

NEA0100-083 24 Vdc 2.5 Ah	Product no. of the battery
	Mandatory to read the Instructions for Use
	A battery is the power source of this equipment.
	Separate electrical and electronic components for recycling in accordance with the European Directive 2002/96/EC (WEEE)

	Recognized by Underwriters Laboratories Inc. with respect to electric shock, fire, mechanical hazards and other specified hazards only in accordance with UL 60601-1 and CAN/CSA - C 22.2 No 601.1-M90.
	CE marking in accordance with the Medical Devices Directive 93/42/EEC.
	TÜV marking. The lift has been safety tested according to: EN/ISO 10535
	Environmental danger. Not for disposal.
	Recyclable

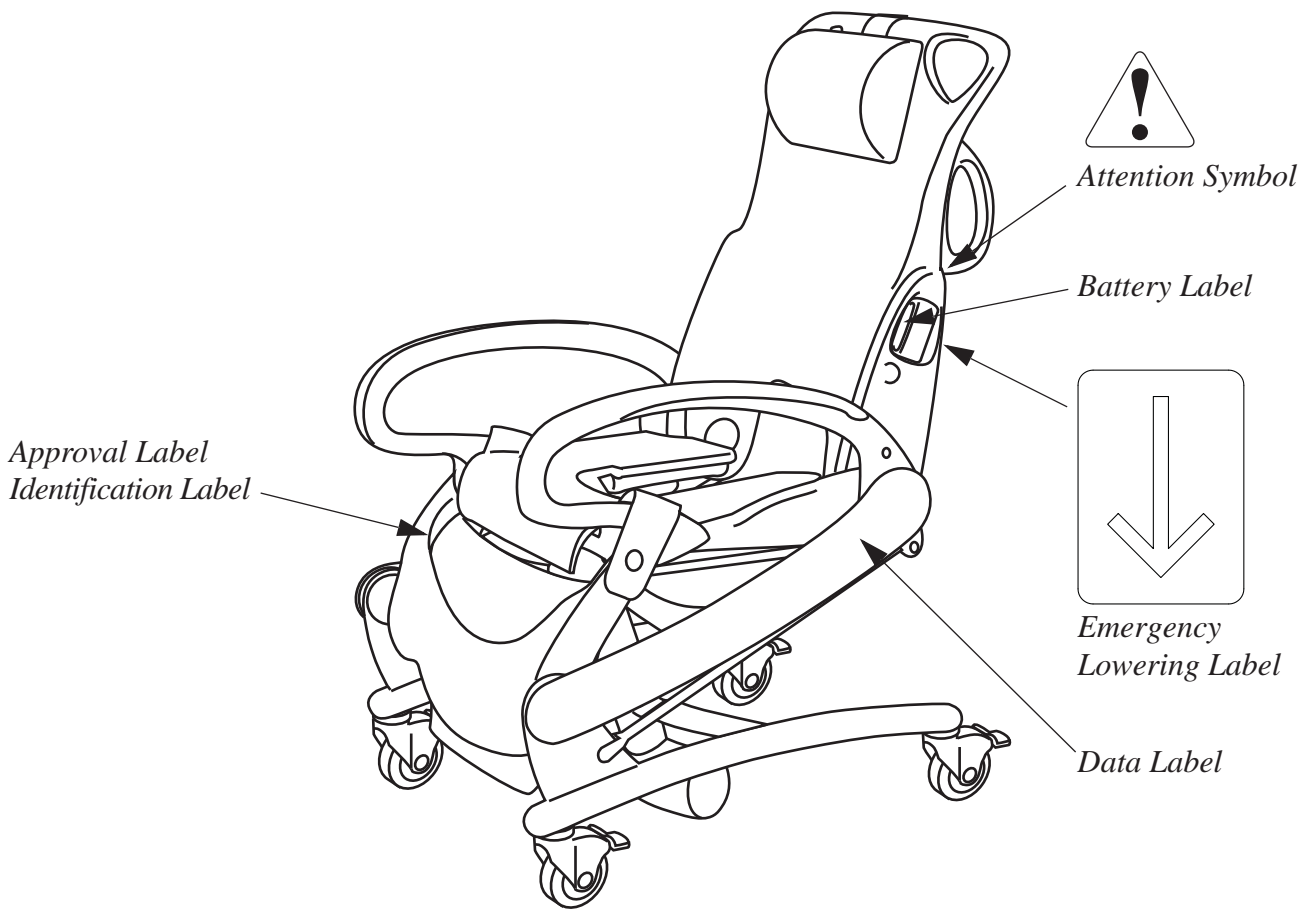

Approvals and List of Standards

CERTIFICATE	STANDARDS
EN/ISO/IEC/UL 60601-1	Medical electrical equipment Part 1: General requirements for basic safety and essential performance.
EN 60601-1-2	Electromagnetic Compatibility - Requirements and Tests
EN 60601-1-11	Requirements for medical electrical equipment and medical electrical systems used in the home healthcare environment.
CAN/CSA-C22.2 No. 601.1	Medical equipment Certified for Canada

Electromagnetic Compatibility

Medical electrical equipment needs special precautions regarding EMC (Electromagnetic compatibility) and needs to be used according to the EMC information below.

The *Carendo* shower and toilet chair is intended for use in the electromagnetic environment specified below. The customer or the user of the *Carendo* shower and toilet chair should assure that it is used in such an environment.

WARNING

Stacking or placing other electrical equipment next to this device is not recommended, it can interfere with the equipment's operation and safety. Portable and mobile radio-frequency (RF) communications equipment can interfere with this equipment operation and safety.

WARNING

The equipment may cause radio interference or may disrupt the operation of nearby equipment. It may be necessary to take action, such as reorienting, relocating the equipment or shielding the location.

Guidance and manufacturer's declaration - electromagnetic emissions		
Emissions test	Compliance	Electromagnetic environment - guidance
RF emissions CISPR 11	Group 1	The <i>Carendo</i> shower and toilet chair uses RF energy only for its internal function. Therefore, its RF emissions are very low and are not likely to cause any interference in nearby electronic equipment.
RF emissions CISPR 11	Class B	The <i>Carendo</i> shower and toilet chair is suitable for use in all establishments, those directly connected to the public low-voltage power supply network that supplies buildings used for domestic purposes.

Guidance and manufacturer's declaration - electromagnetic immunity			
Immunity test	IEC 60601 test level	Compliance level	Electromagnetic environment - guidance
Electrostatic discharge (ESD) IEC 61000-4-2	6 kV contact 8 kV air	6 kV contact 8 kV air	Floors should be wood, concrete or ceramic tile. If floors are covered with synthetic material, the relative humidity should be at least 30%.
Radiated RF IEC 61000-4-3	3 Vrms 80 MHz to 2.5 GHz	10 Vrms 80 MHz to 2.5 GHz	<p>Portable and mobile RF communications equipment should be used no closer to any part of the <i>Carendo</i> shower and toilet chair, including cables, than 1 meter if the transmitters output power rating exceeds 1 W.</p> <p>Field strengths from fixed RF transmitters, as determined by an electromagnetic site survey, ^a should be less than the compliance level in each frequency range. ^b</p> <p>Interference may occur in the vicinity of equipment marked with the following symbol: </p>
<p>^a Field strengths from fixed transmitters, such as base stations for radio (cellular/cordless) telephones and land mobile radios, amateur radio, AM and FM radio broadcast and TV broadcast cannot be predicted theoretically with accuracy. To assess the electromagnetic environment due to fixed RF transmitters, an electromagnetic site survey should be considered. If the measured field strength in the location in which the <i>Carendo</i> shower and toilet chair is used exceeds the applicable RF compliance level above, the <i>Carendo</i> shower and toilet chair should be observed to verify normal operation. If abnormal performance is observed, additional measures may be necessary.</p> <p>^b Over the frequency range 150 kHz to 80 MHz, field strengths should be less than 1 V/m.</p>			

Recommended separation distances between portable and mobile RF communications equipment and the *Carendo* shower and toilet chair.

The *Carendo* shower and toilet chair is intended for use in an electromagnetic environment in which radiated RF disturbances are controlled. The customer or the user of the *Carendo* shower and toilet chair can help prevent electromagnetic interference by maintaining a minimum distance between portable and mobile RF communications equipment (transmitters) and the *Carendo* shower and toilet chair by maintaining a distance of not less than 1 meter to any part of the *Carendo* shower and toilet chair, including cables, if the transmitters output power rating exceeds 1 W.

Parts and Accessories

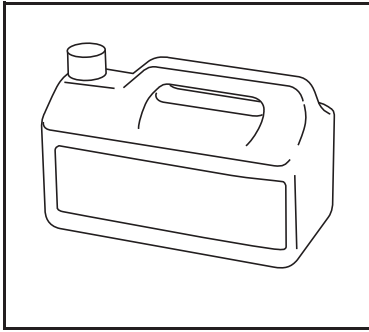

For disinfectant contact
the ArjoHuntleigh local
representative

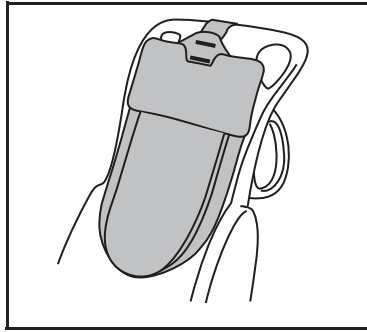

Back Pillow

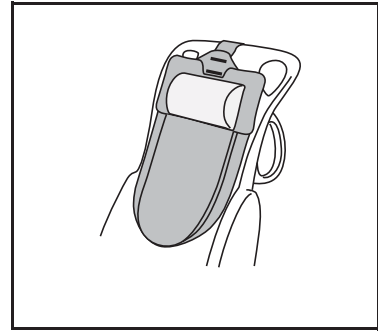

Neck Pillow

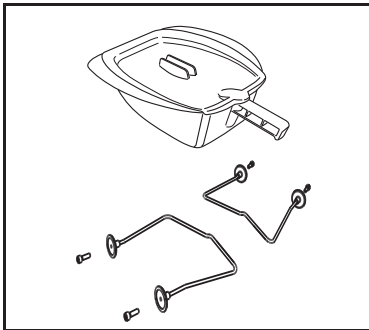

Bed pan & Holder

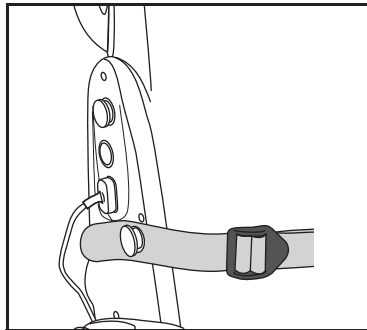

Safety belt

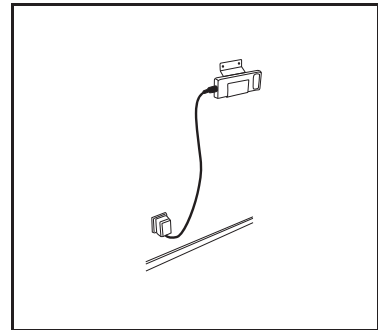

Battery and Charger